

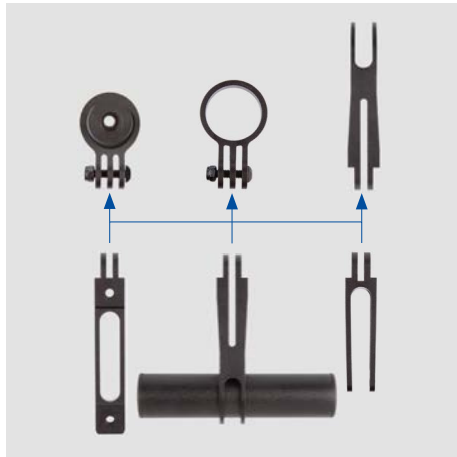







02/2019  
**PRODUCT  
NEWS**

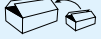

***messingschlager*** 1924

THE BIKE EXPERIENCE

<p>ART.-NR.</p> 	<p>BESCHREIBUNG</p>	<p>DESCRIPTION</p>	<p>UVP verfügbar ab/ available in</p>
<p>081082 1</p>	<p><b>HELMAUSSTELLUNGSSTÄNDER ›TOP ASSIST‹</b></p> <ul style="list-style-type: none"> <li>• für bis zu <b>20 Helme</b></li> <li>• mit versetzbarem <b>Spiegel</b></li> <li>• <b>mobil</b> durch <b>4 Rollen</b></li> <li>• ca. 229 (H) x 60 (B) x 60 cm (T)</li> <li>• individueller Logo-Aufkleber auf Wunsch möglich</li> </ul>	<p><b>HELMET DISPLAY ›TOP ASSIST‹</b></p> <ul style="list-style-type: none"> <li>• for up to <b>20 helmets</b></li> <li>• with moveable <b>mirror</b></li> <li>• <b>mobile</b> by <b>4 rolls</b></li> <li>• approx. 229 (H) x 60 (W) x 60 cm (D)</li> <li>• individual logo sticker on request</li> </ul>	 <p>279,00 €</p> <p>35/19</p>
<p>120939 <b>NEW</b></p> <p>120940 U</p> <p>120941 100 <b>NEW</b></p>	<p><b>DREIECKSWESTE ›SASH ILLU‹</b></p> <ul style="list-style-type: none"> <li>• <b>super leicht</b>, atmungsaktiv und mit <b>maximaler Bewegungsfreiheit</b></li> <li>• neongelbe Weste mit <b>Reflexstreifen</b> vorne, hinten und seitlich</li> <li>• <b>Weite sehr flexibel</b> einstellbar durch Klettverschluss und elastischen Gummiband</li> <li>• für alle Outdoor-Aktivitäten, z. B. Radfahren, Joggen, Walking, ...</li> <li>• im Polybeutel mit Euroloch</li> </ul> <p>XS / S</p> <p>M / L</p> <p>XL / XXL</p>	<p><b>TRIANGLE VEST ›SASH ILLU‹</b></p> <ul style="list-style-type: none"> <li>• <b>super light</b>, breathable and offers <b>maximum mobility</b></li> <li>• neon yellow vest with <b>reflective tape</b> at the front, rear and sides</li> <li>• <b>very flexible width</b> adjustment using hook and loop fasteners and elastic rubber strip</li> <li>• for all outdoor activities, e.g. cycling, jogging, walking, ...</li> <li>• in PE bag with eurohole</li> </ul> <p>XS / S</p> <p>M / L</p> <p>XL / XXL</p>	 <p>5,90 €</p> <p>35/19</p> <p>5,90 €</p> <p>35/19</p> <p>5,90 €</p> <p>35/19</p> 
<p>122900 100 Paar</p>	<p><b>PEDALTASCHE ›ROTTERDAM PEDAL P‹</b></p> <ul style="list-style-type: none"> <li>• <b>2 Taschen für 1 Paar Pedale</b></li> <li>• aus Neopren</li> <li>• als <b>Transporttaschen</b> oder zum <b>Schutz am Rad</b> verwendbar</li> <li>• ca. 135 x 145 mm</li> <li>• 1 Paar auf M-Wave Eurolochkarte</li> </ul>	<p><b>PEDAL BAG ›ROTTERDAM PEDAL P‹</b></p> <ul style="list-style-type: none"> <li>• <b>2 bags for 1 pair of pedals</b></li> <li>• made of neoprene</li> <li>• suitable as <b>transport bags</b> or as <b>protection on the bike</b></li> <li>• approx. 135 x 145 mm</li> <li>• 1 pair on M-Wave eurohole card</li> </ul>	 <p>9,90 €</p>  <p>46/19</p>





## M-WAVE BIKEPACKING-SERIE











- hoch reißfestes Ripstop-Gewebe
- 100 % wasserdicht
- jede Menge Stauraum
- extrem belastbar
- viele clevere Features

## M-WAVE BIKEPACKING-SERIES



- high tensile strength ripstop fabric
- 100 % waterproof
- lots of storage space
- extremely resilient
- many clever features









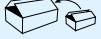

ART.-NR. 	BESCHREIBUNG	DESCRIPTION	UVP verfügbar ab/ available in
<b>122636</b> 20	<b>SATTELTASCHE</b> ›ROUGH RIDE SADDLE L‹ <ul style="list-style-type: none"> <li>• zum Transport <b>großer Gepäckmengen ohne Gepäckträger</b></li> <li>• <b>100 % wasserdicht</b></li> <li>• <b>besonders gute Sichtbarkeit durch neongelbe Farbe und Reflexaufdruck</b></li> <li>• <b>Rollverschluss</b> für universelle Größeneinstellung</li> <li>• hohe Reißfestigkeit durch verstärktes Ripstop-Gewebe</li> <li>• sichere Befestigung mit zwei breiten Klettverschlüssen</li> <li>• aufgesetzte Gepäckgurte und Schlaufen zur zusätzlichen Gepäckbefestigung, zur Anbringung einer Beleuchtung, ...</li> <li>• Volumen bis ca. 11 Liter</li> <li>• ca. 53 x 13 x 15 cm</li> </ul>	<b>SADDLE BAG</b> ›ROUGH RIDE SADDLE L‹ <ul style="list-style-type: none"> <li>• to transport <b>many luggage without carrier</b></li> <li>• <b>100 % waterproof</b></li> <li>• <b>very good visibility due to neon yellow colour and reflective print</b></li> <li>• <b>roll cover</b> for individual size adjustment</li> <li>• high tear resistance through reinforced ripstop textile</li> <li>• secure mounting with two wide hook and loop fasteners</li> <li>• attached luggage belts and loops for the additional luggage connection, for attachment of lights, ...</li> <li>• volume approx. 11 litres</li> <li>• approx. 53 x 13 x 15 cm</li> </ul>	  35/19
<b>122637</b> 25	<b>LENKERTASCHE</b> ›ROUGH RIDE FRONT‹ <ul style="list-style-type: none"> <li>• einzeln verwendbarer, <b>100 % wasserdichter Packsack mit Rollverschluss</b></li> <li>• <b>besonders gute Sichtbarkeit durch neongelbe Farbe und Reflexaufdruck</b></li> <li>• hohe Reißfestigkeit durch verstärktes Ripstop-Gewebe</li> <li>• <b>abnehmbares, transparentes Kartenfach</b> (Art. 122639)</li> <li>• sichere Befestigung mit drei universell versetzbaren Klettverschlüssen</li> <li>• Volumen bis ca. 10 Liter</li> <li>• ca. 59 x 23 cm</li> </ul>	<b>HANDLEBAR BAG</b> ›ROUGH RIDE FRONT‹ <ul style="list-style-type: none"> <li>• solo useable, <b>100 % waterproof duffel with roll cover</b></li> <li>• <b>very good visibility due to neon yellow colour and reflective print</b></li> <li>• high tear resistance through reinforced ripstop textile</li> <li>• <b>removable, transparent card container</b> (art. 122639)</li> <li>• secure mounting with three universally displaceable hook and loop fasteners</li> <li>• volume approx. 10 litres</li> <li>• approx. 59 x 23 cm</li> </ul>	  35/19

ART.-NR. 	BESCHREIBUNG	DESCRIPTION		UVP verfügbar ab/ available in
<b>122638</b> 25	<b>RAHMEN-DREIECKSTASCHE</b> ›ROUGH RIDE TRIANGLE‹ <ul style="list-style-type: none"> <li>• <b>wasserdichter Reißverschluss und 100 % wasserdichte Innenauskleidung</b></li> <li>• <b>besonders gute Sichtbarkeit durch neongelbe Farbe und Reflex-aufdruck</b></li> <li>• <b>Volumen vergrößerbar</b> auf bis zu 4,2 Liter</li> <li>• variable Unterteilungsmöglichkeit des Hauptfachs</li> <li>• hohe Reißfestigkeit durch verstärktes Ripstop-Gewebe</li> <li>• sichere und universelle Befestigung mit fünf universell versetzbaren Klettverschlüssen</li> <li>• vier aufgesetzte Netztaschen für schnellen Zugriff auf wichtige Klein-utensilien</li> <li>• ca. 42 x 14 - 25 cm</li> </ul>	<b>FRAME TRIANGLE BAG</b> ›ROUGH RIDE TRIANGLE‹ <ul style="list-style-type: none"> <li>• <b>waterproof zipper and 100 % waterproof inner lining</b></li> <li>• <b>very good visibility due to neon yellow colour and reflective print</b></li> <li>• <b>volume flexible</b> up to 4.2 litres</li> <li>• variable dividing possibilities of the main compartment</li> <li>• high tear resistance through reinforced ripstop textile</li> <li>• secure and universal mounting with five universally displaceable hook and loop fasteners</li> <li>• four attached net pockets for quick access to important small utensils</li> <li>• approx. 42 x 14 - 25 cm</li> </ul>	 	<b>44,90 €</b>           35/19
<b>122640</b> 80	<b>OBERROHRTASCHE</b> ›ROUGH RIDE TOP‹ <ul style="list-style-type: none"> <li>• <b>wasserdichter Reißverschluss und wasserdichte Innenauskleidung</b></li> <li>• <b>besonders gute Sichtbarkeit durch neongelbe Farbe und Reflex-aufdruck</b></li> <li>• sichere Befestigung mit drei universellen Klettverschlüssen</li> <li>• erschütterungsabsorbierende, weiche Polstereinlage</li> <li>• verstärkter Boden</li> <li>• ca. 7 x 8,5 x 29 cm</li> </ul>	<b>TOP TUBE BAG</b> ›ROUGH RIDE TOP‹ <ul style="list-style-type: none"> <li>• <b>waterproof zipper and waterproof inner lining</b></li> <li>• <b>very good visibility due to neon yellow colour and reflective print</b></li> <li>• secure mounting with three universal hook and loop fasteners</li> <li>• shock absorbing, soft padding</li> <li>• reinforced bottom</li> <li>• approx. 7 x 8.5 x 29 cm</li> </ul>	 	<b>21,90 €</b>           35/19
<b>122635</b> 20	<b>BIKER SPEZIAL-RUCKSACK</b> ›ROUGH RIDE BACK‹ <ul style="list-style-type: none"> <li>• <b>gepolsterte, atmungsaktive Schultertragegurte und Beckengurt</b></li> <li>• <b>besonders gute Sichtbarkeit durch neongelbes Material und Reflex-aufdruck</b></li> <li>• zusätzlicher, verstellbarer Brustgurt</li> <li>• Tragegestell und anpassbares Rückennetzteil für <b>optimal belüfteten Tragekomfort</b></li> <li>• <b>integrierter Regenüberzug</b></li> <li>• <b>inkl. abnehmbarem Helmaufbewahrungsnetz</b></li> <li>• 1 Hauptfach und 4 kleinere Fächer mit Reißverschluss</li> <li>• integriertes <b>isoliertes</b> Fach für <b>Trinkblase</b></li> <li>• zusätzlich 2 äußere Fächer und 1 großes Innenfach</li> <li>• mit Rücklichthalter</li> <li>• Volumen ca. 15 Liter</li> <li>• ca. 46 x 28 x 12 cm</li> </ul>	<b>BIKER SPECIAL BACKPACK</b> ›ROUGH RIDE BACK‹ <ul style="list-style-type: none"> <li>• <b>padded, breathable shoulder straps and waist belt</b></li> <li>• <b>very good visibility due to neon yellow material and reflective print</b></li> <li>• additional, adjustable chest belt</li> <li>• carrying structure and adaptable back net for <b>optimally ventilated wearing comfort</b></li> <li>• <b>integrated rain cover</b></li> <li>• <b>incl. detachable helmet storage net</b></li> <li>• 1 main compartment and 4 smaller pockets with zipper</li> <li>• integrated <b>insulated</b> compartment for <b>water bag</b></li> <li>• additionally 2 outer compartments and 1 big inner compartment</li> <li>• with rear light strap</li> <li>• volume approx. 15 litres</li> <li>• approx. 46 x 28 x 12 cm</li> </ul>	    	<b>39,90 €</b>           35/19



ART.-NR.	BESCHREIBUNG	DESCRIPTION		UVP verfügbar ab/ available in
<p><b>122621</b></p> <p><b>122620</b></p> <p>10</p>	<p><b>BIKER RUCKSACK</b> ›ROUGH RIDE BACK‹ INKL. WASSERBLASE ›SOURCE‹</p> <p><b>Hochwertige Wasserblase</b> ›SOURCE‹ (Art. 122515)</p> <ul style="list-style-type: none"> <li>• 2-Liter-Wasserblase mit <b>anti-bakterieller Innenbeschichtung</b></li> <li>• 2.000 % <b>glattere Oberfläche</b> als herkömmliche TPU-Folien beugt Schimmelbildung vor</li> <li>• <b>große Öffnung</b> für schnelles und leichtes Befüllen und Reinigen</li> <li>• <b>geschmacksneutral</b> und <b>frei von BPA und Phthalaten</b></li> <li>• Trinkschlauch mit <b>antibakterieller Innenbeschichtung</b> und <b>auswechselbarem Silikon-Mundstück</b> (Art. 122516)</li> </ul> <p><b>Biker Rucksack</b> ›ROUGH RIDE BACK‹</p>	<p><b>BIKER BACKPACK</b> ›ROUGH RIDE BACK‹ INCL. WATER BAG ›SOURCE‹</p> <p><b>high-quality water bag</b> ›SOURCE‹ (art. 122515)</p> <ul style="list-style-type: none"> <li>• 2-litres-water bag with <b>antimicrobial protection inside</b></li> <li>• 2,000 % <b>smoother surface</b> than conventional TPU foils prevents mould formation</li> <li>• <b>big opening</b> for fast and easy filling and cleaning</li> <li>• <b>tasteless</b> and <b>free from BPA and phthalates</b></li> <li>• drinking tube with <b>antimicrobial protection inside</b> and <b>exchangeable silicone bite valve</b> (art. 122516)</li> </ul> <p><b>biker backpack</b> ›ROUGH RIDE BACK‹</p>	<p><b>SOURCE</b></p> <p>Art. 122516</p>  <p>M-WAVE</p>	<p><b>59,90 €</b></p> <p>35/19</p> <p><b>59,90 €</b></p> <p>35/19</p>
<p><b>122625</b></p> <p>25</p> <p><b>122630</b></p> <p>U 20</p>	<p><b>SATTELTASCHE</b> ›ROUGH RIDE SADDLE‹</p> <ul style="list-style-type: none"> <li>• zum Transport von <b>Gepäck ohne Gepäckträger</b></li> <li>• <b>100 % wasserdicht</b></li> <li>• <b>flexibler Rollverschluss</b></li> <li>• hohe Reißfestigkeit durch verstärktes Ripstop-Gewebe</li> <li>• sichere Befestigung mit zwei breiten Klettverschlüssen</li> <li>• aufgesetzte Gepäckgurte und Schlaufen zur zusätzlichen Gepäckbefestigung, zur Anbringung einer Beleuchtung, ...</li> </ul> <p>Volumen bis ca. 5 Liter ca. 46 x 9 x 11 cm</p> <p>Volumen bis ca. 11 Liter ca. 53 x 13 x 15 cm</p>	<p><b>SADDLE BAG</b> ›ROUGH RIDE SADDLE‹</p> <ul style="list-style-type: none"> <li>• to transport <b>luggage without carrier</b></li> <li>• <b>100 % waterproof</b></li> <li>• <b>adjustable roll cover</b></li> <li>• high tear resistance through reinforced ripstop textile</li> <li>• secure mounting with two wide hook and loop fasteners</li> <li>• attached luggage belts and loops for the additional luggage connection, for attachment of lights, ...</li> </ul> <p>volume approx. 5 litres approx. 46 x 9 x 11 cm</p> <p>volume approx. 11 litres approx. 53 x 13 x 15 cm</p>	<p>M</p> <p>L</p>  <p>M-WAVE</p>	<p><b>29,90 €</b></p> <p>35/19</p> <p><b>39,90 €</b></p> <p>35/19</p>
<p><b>122881</b></p> <p>15</p>	<p><b>GEPÄCKTRÄGERTASCHE</b> ›SUBURBAN CARRY‹</p> <ul style="list-style-type: none"> <li>• <b>100 % wasserdicht</b> und staubdicht</li> <li>• mit <b>verschweißten Nähten</b></li> <li>• sehr stabil und strapazierfähig trotz geringem Gewicht</li> <li>• <b>Rollverschluss</b> für universelle Größeneinstellung</li> <li>• mit entnehmbarer <b>Innentasche</b></li> <li>• integrierte Seitentasche mit <b>verschweißtem</b> Reißverschluss</li> <li>• mit flexiblem Gummiband-Helmhalter</li> <li>• stabiler, verstellbarer <b>Clip-on</b>-Halter zur sekundenschnellen (De-)Montage an Gepäckträgerrohren von 10 - 16 mm</li> <li>• zusätzliche <b>3. Fixierungsmöglichkeit</b> an der Gepäckträgerstrebe</li> <li>• mit <b>Reflexaufdruck</b></li> <li>• Volumen ca. 25 Liter</li> <li>• Größe ca. 33 x 14,5 x 61 cm (L x B x H)</li> </ul>	<p><b>CARRIER SINGLE BAG</b> ›SUBURBAN CARRY‹</p> <ul style="list-style-type: none"> <li>• <b>100 % waterproof</b> and dustproof</li> <li>• with <b>heat-sealed joints</b></li> <li>• very stable and durable despite low weight</li> <li>• <b>roll cover</b> for individual size adjustment</li> <li>• with detachable <b>inner bag</b></li> <li>• integrated side pocket with <b>heat-sealed zipper</b></li> <li>• with flexible rubber strap helmet holder</li> <li>• firm, adjustable <b>clip-on</b> bracket for (de-)mounting within seconds on carrier tubes of 10- 16 mm</li> <li>• additional <b>3. mounting option</b> at the luggage stay</li> <li>• with <b>reflective print</b></li> <li>• volume approx. 25 litres</li> <li>• size approx. 33 x 14.5 x 61 cm (L x W x H)</li> </ul>	 <p>M-WAVE</p>	<p><b>49,90 €</b></p> <p>35/19</p>

















ART.-NR. 	BESCHREIBUNG	DESCRIPTION	 	UVP verfügbar ab/ available in
<b>122882</b> 20	<b>LENKERTASCHE</b> ›SUBURBAN FRONT‹ <ul style="list-style-type: none"> <li>• <b>100 % wasserdicht</b> und staubdicht</li> <li>• mit <b>verschweißten Nähten</b></li> <li>• sehr stabil und strapazierfähig trotz geringem Gewicht</li> <li>• <b>Rollverschluss</b> für universelle Größeneinstellung</li> <li>• <b>wasserdichtes, transparentes Sichtfenster</b> zur Bedienung eines <b>Touch-displays</b></li> <li>• integrierte Seitentaschen mit <b>verschweißtem Reißverschluss</b></li> <li>• stabiler 2-Punkt <b>Clip-on</b>-Halter mit einfacher (De-)Montage, passend für Lenker-Ø <b>22,2 - 31,8 mm</b> (Art. 122709)</li> <li>• absolut <b>verdrehsicher</b></li> <li>• innen mit zusätzlicher Versteifung</li> <li>• mit Schultergurt</li> <li>• mit <b>Reflexaufdruck</b></li> <li>• Größe ca. 13 x 28 x 21 cm (L x B x H)</li> <li>• Volumen ca. 7 Liter</li> </ul>	<b>HANDLEBAR BAG</b> ›SUBURBAN FRONT‹ <ul style="list-style-type: none"> <li>• <b>100 % waterproof</b> and dustproof</li> <li>• with <b>heat-sealed joints</b></li> <li>• very stable and durable despite low weight</li> <li>• <b>roll cover</b> for individual size adjustment</li> <li>• <b>waterproof, transparent window</b> for operating a <b>touch display</b></li> <li>• integrated side pockets with <b>heat-sealed zipper</b></li> <li>• stable 2-point <b>clip-on</b> bracket with easy (de-)mounting, suitable for handlebar Ø <b>22.2 - 31.8 mm</b> (art. 122709)</li> <li>• absolutely <b>anti-twist</b></li> <li>• additional internal stiffness</li> <li>• with shoulder strap</li> <li>• with <b>reflective print</b></li> <li>• size approx. 13 x 28 x 21 cm (L x W x H)</li> <li>• volume approx. 7 litres</li> </ul>	 <p>Ø 22,2-31,8 mm</p>	<b>39,90 €</b>  35/19
<b>122736</b> 50	Ersatz-/Zweit-Halter, passend für <b>E-Bike-Mitteldisplays</b> , für Art. 431515, 121920, 122882, auf M-Wave Eurolochkarte	replacement / second bracket, suitable for <b>e-bike center displays</b> , for art. 431515, 121920, 122882, on M-Wave eurohole card		<b>19,90 €</b> 35/19
<b>122883</b> 40	<b>OBERROHRTASCHE</b> ›SUBURBAN TOP‹ <ul style="list-style-type: none"> <li>• <b>100 % wasserdicht</b> und staubdicht</li> <li>• mit <b>verschweißten Nähten und Reißverschluss</b></li> <li>• sehr stabil und strapazierfähig trotz geringem Gewicht</li> <li>• <b>wasserdichtes, transparentes Sichtfenster</b> zur Bedienung eines <b>Touch-displays</b></li> <li>• für große Smartphones, wie iPhone X</li> <li>• sichere Befestigung mit 3 Klettverschlüssen</li> <li>• verstärkter Boden</li> <li>• mit <b>Reflexaufdruck</b></li> <li>• Größe ca. <b>18,5 x 9,5 x 8,5 cm</b> (L x B x H)</li> </ul>	<b>TOP TUBE BAG</b> ›SUBURBAN TOP‹ <ul style="list-style-type: none"> <li>• <b>100 % waterproof</b> and dustproof</li> <li>• with <b>heat-sealed joints and zipper</b></li> <li>• very stable and durable despite low weight</li> <li>• <b>waterproof, transparent window</b> for operating a <b>touch display</b></li> <li>• for big smartphones like iPhone X</li> <li>• secure mounting with 3 hook and loop fasteners</li> <li>• reinforced bottom</li> <li>• with <b>reflective print</b></li> <li>• size approx. <b>18.5 x 9.5 x 8.5 cm</b> (L x W x H)</li> </ul>	 <p>XL</p> <p>185 mm</p> <p>95 mm</p>	<b>17,90 €</b>  35/19
<b>122884</b> 50	<b>SATTELTASCHE</b> ›SUBURBAN SADDLE‹ <ul style="list-style-type: none"> <li>• <b>100 % wasserdicht</b> und staubdicht</li> <li>• mit <b>verschweißten Nähten</b></li> <li>• sehr stabil und strapazierfähig trotz geringem Gewicht</li> <li>• sichere Befestigung mit 3 Klettverschlüssen</li> <li>• <b>Rollverschluss</b> für universelle Größeneinstellung</li> <li>• mit <b>Reflexaufdruck</b></li> <li>• Größe ca. 20 x 9 x 9 cm (L x B x H)</li> <li>• Volumen max. 2,5 Liter</li> </ul>	<b>SADDLE BAG</b> ›SUBURBAN SADDLE‹ <ul style="list-style-type: none"> <li>• <b>100 % waterproof</b> and dustproof</li> <li>• with <b>heat-sealed joints</b></li> <li>• very stable and durable despite low weight</li> <li>• secure mounting with 3 hook and loop fasteners</li> <li>• <b>roll cover</b> for individual size adjustment</li> <li>• with <b>reflective print</b></li> <li>• size approx. 20 x 9 x 9 cm (L x W x H)</li> <li>• volume max. 2.5 litres</li> </ul>		<b>17,90 €</b>  35/19
<b>122411</b> 100	<b>HALTER FÜR MOBILE ENDGERÄTE</b> ›EINDHOVEN GRIP EDGE‹ <ul style="list-style-type: none"> <li>• aus stabilem ABS-Kunststoff</li> <li>• <b>universelle</b> Größenanpassung (55 x 116 x 12 mm bis 90 x 180 x 12 mm)</li> <li>• passend für viele mobile Endgeräte</li> <li>• <b>360° drehbar</b>, mit Fixierfunktion</li> <li>• mit Moosgummi-Einlage zur individuellen Anpassung und Stoßabsorption</li> <li>• für Lenkerdurchmesser 22,2 - 31,8 mm</li> <li>• <b>werkzeuglos</b> montierbar</li> <li>• in M-Wave Eurolochbox</li> </ul>	<b>BRACKET FOR MOBILE DEVICES</b> ›EINDHOVEN GRIP EDGE‹ <ul style="list-style-type: none"> <li>• made of stable ABS plastic</li> <li>• <b>universal</b> size adjustment (55 x 116 x 12 mm to 90 x 180 x 12 mm)</li> <li>• suitable for many mobile devices</li> <li>• <b>360° turnable</b>, with fixing function</li> <li>• with foam rubber inlay for individual size adaptation and shock absorption</li> <li>• for handlebar diameter 22.2 - 31.8 mm</li> <li>• <b>toolless</b> mounting</li> <li>• in M-Wave eurohole box</li> </ul>	 <p>116 - 180 mm</p> <p>55 - 90 mm</p> <p>360°</p>	<b>9,90 €</b>  35/19















<b>ART.-NR.</b> 	<b>BESCHREIBUNG</b>	<b>DESCRIPTION</b>		<b>UVP</b> verfügbar ab/ available in
<b>122819</b> 12	<b>LENKERTASCHE</b> <b>›UTRECHT TRAVEL ECO‹</b> <ul style="list-style-type: none"> <li>• Befestigung mit zwei <b>universell versetzbaren</b> Klettverschlüssen an Fahrrädern, Rollern, ...</li> <li>• innen mit zusätzlicher Versteifung</li> <li>• mit <b>Reflexaufdruck</b></li> <li>• Größe ca. 22 x 10 x 16 cm (L x B x H)</li> <li>• mit M-Wave Anhänger</li> </ul>	<b>HANDLEBAR BAG</b> <b>›UTRECHT TRAVEL ECO‹</b> <ul style="list-style-type: none"> <li>• mounting with two <b>universally displaceable</b> hook and loop fasteners to bicycles, scooters, ...</li> <li>• additional internal stiffness</li> <li>• with <b>reflective print</b></li> <li>• size approx. 22 x 10 x 16 cm (L x W x H)</li> <li>• with M-Wave tag</li> </ul>		<b>9,90 €</b>          46/19
<b>122831</b> 12	<b>SATTELTASCHE</b> <b>›AMSTERDAM BOTTLE‹</b> <ul style="list-style-type: none"> <li>• <b>geräumiges</b> Hauptfach mit großer Öffnung</li> <li>• mit <b>Trinkflaschenhalterfach</b></li> <li>• sichere Befestigung mit vier <b>universell anpassbaren</b> Klettverschlüssen</li> <li>• mit <b>Rücklichthalterschleife</b></li> <li>• mit <b>Reflexaufdruck</b></li> <li>• Größe ca. 9,5 x 10 x 27 cm (L x B x H)</li> <li>• mit M-Wave Anhänger</li> </ul>	<b>SADDLE BAG</b> <b>›AMSTERDAM BOTTLE‹</b> <ul style="list-style-type: none"> <li>• <b>spacious</b> main compartment with large opening</li> <li>• with <b>bottle holder pocket</b></li> <li>• secure mounting with four <b>universally adjustable</b> hook and loop fasteners</li> <li>• with <b>rear light bracket strap</b></li> <li>• with <b>reflective print</b></li> <li>• size approx. 9.5 x 10 x 27 cm (L x W x H)</li> <li>• with M-Wave tag</li> </ul>		<b>13,90 €</b>          49/19
<b>122290</b> ~ 100	<b>REPARATUR-SET</b> bestehend aus:  <b>Satteltasche</b> (Art. 122353) <ul style="list-style-type: none"> <li>• Befestigung mit Klettverschluss an Sattel, Rahmenrohr, ...</li> <li>• ca. 140 x 85 x 50 mm</li> <li>• mit Reflexlogo</li> </ul> <b>Mini-Faltwerkzeug</b> (Art. 880940) <ul style="list-style-type: none"> <li>• 11 Funktionen</li> <li>• 2/2,5/3/4/5/6/8 mm Stahl-Innensechskant</li> <li>• 1 Schlitzschraubendreher</li> <li>• 1 Kreuzschraubendreher</li> <li>• 1 Kettennietdrücker</li> <li>• T 25 Vielzahn Schlüssel</li> <li>• mit Nylontasche</li> </ul> <b>Flickzeugset</b> (Art. 880162) <ul style="list-style-type: none"> <li>• 1 Tube Vulkanisierlösung (10 ml / 6,5 g)</li> <li>• 2 Flicker Ø 26 mm</li> <li>• 4 Flicker 25 x 34 mm</li> <li>• 1 Flicker 34 x 51 mm</li> <li>• 1 Sandpapier</li> <li>• 1 Ventilschlauch</li> <li>• Arbeitsanleitung</li> <li>• in Kunststoffbox</li> </ul> <b>Reifenheber</b> (Art. 880018) <ul style="list-style-type: none"> <li>• Kunststoff</li> <li>• 3 Stück im Set</li> </ul> auf Eurolochkarte	<b>REPAIR KIT</b> consisting of:  <b>saddle bag</b> (art. 122353) <ul style="list-style-type: none"> <li>• fixing with hook and loop fastener at saddle, frame tubes, ...</li> <li>• approx. 140 x 85 x 50 mm</li> <li>• with reflex logo</li> </ul> <b>Mini Folding Tool</b> (art. 880940) <ul style="list-style-type: none"> <li>• 11 functions</li> <li>• 2/2.5/3/4/5/6/8 mm steel allen key</li> <li>• 1 flat screwdriver</li> <li>• 1 Phillips screwdriver</li> <li>• 1 chain riveting tool</li> <li>• T 25 star screwdriver</li> <li>• with nylon bag</li> </ul> <b>Repair Kit</b> (art. 880162) <ul style="list-style-type: none"> <li>• 1 tube solution (10 ml / 6.5 g)</li> <li>• 2 patches Ø 26 mm</li> <li>• 4 patches 25 x 34 mm</li> <li>• 1 patch 34 x 51 mm</li> <li>• 1 sand paper</li> <li>• 1 valve tube</li> <li>• instruction</li> <li>• in box</li> </ul> <b>Tire Levers</b> (art. 880018) <ul style="list-style-type: none"> <li>• plastic</li> <li>• 3 pieces in a set</li> </ul> on eurohole card		<b>14,90 €</b>          35/19



ART.-NR. 	BESCHREIBUNG	DESCRIPTION		UVP verfügbar ab/ available in
<p><b>122529</b> 10</p>	<p><b>LAUFRADTASCHE</b> ›ROTTERDAM WSB DOUBLE‹</p> <ul style="list-style-type: none"> <li>• für <b>2 Laufräder</b> bis <b>29"</b></li> <li>• Tasche durch Reißverschluss <b>in zwei Einzeltaschen unterteilbar</b> (auch einzeln verwendbar)</li> <li>• Durchmesser <b>76 cm</b></li> <li>• <b>gepolstert</b></li> <li>• inkl. <b>Schutzscheiben</b> für die Naben</li> <li>• <b>Innentasche</b> für Schnellspanner</li> <li>• mit Tragegriff und <b>Schultergurt</b></li> <li>• mit beschriftbarem <b>Namensanhänger</b></li> <li>• mit M-Wave Anhänger</li> </ul>	<p><b>WHEEL BAG</b> ›ROTTERDAM WSB DOUBLE‹</p> <ul style="list-style-type: none"> <li>• for <b>2 wheels</b> up to <b>29"</b></li> <li>• zippered bag <b>dividable into two single bags</b> (can also be used separately)</li> <li>• diameter <b>76 cm</b></li> <li>• <b>padded</b></li> <li>• incl. <b>protection discs</b> for the hubs</li> <li>• <b>inner pocket</b> for the QRs</li> <li>• with handle and <b>shoulder strap</b></li> <li>• with inscribable <b>name tag</b></li> <li>• with M-Wave tag</li> </ul>	<p>✓ <b>2x 29"</b> ✓ <b>4x 700 C</b></p>  	<p><b>44,90 €</b></p> <p>35/19</p>
<p><b>220743</b> 100/20</p>	<p><b>AKKULAMPE</b> ›METEOR‹</p> <ul style="list-style-type: none"> <li>• <b>weiße CREE XP-G Hochleistungs-LED</b></li> <li>• spritzwassergeschütztes <b>Gehäuse</b></li> <li>• maximale Lichtleistung: <b>400 Lumen</b></li> <li>• 36 Lux in 10 m Entfernung</li> <li>• nur 66 g</li> <li>• 8 Funktionen: 4 Dauer-, 4 Blinklichtfunktionen</li> <li>• mit <b>Funktionsmemory</b></li> <li>• <b>Präzisionslinse</b> für volle Ausleuchtung</li> <li>• bis zu 80 Stunden Laufzeit</li> <li>• inkl. Lithium Polymer-Akku (1.200 mAh)</li> <li>• aufladbar über <b>USB-Kabel</b> (inklusive)</li> <li>• Batterie- und Ladezustandsanzeige</li> <li>• mit schwenkbarer Gummihalterung für Lenker (Art. 223550)</li> <li>• werkzeuglose Montage</li> <li>• in Moon Eurolochbox</li> </ul> <p>Ohne deutsches Prüfzeichen - Verkauf und Nutzung im Geltungsbereich der StVZO (Deutschland) unzulässig (Abgabe nur an außerdeutsche Kunden).</p>	<p><b>RECHARGEABLE LAMP</b> ›METEOR‹</p> <ul style="list-style-type: none"> <li>• <b>white CREE XP-G high power LED</b></li> <li>• water resistant <b>housing</b></li> <li>• max. light output: <b>400 Lumen</b></li> <li>• 36 Lux in 10 m distance</li> <li>• only 66 g</li> <li>• 8 functions: 4 steady light, 4 flashing light functions</li> <li>• with <b>memory</b> function</li> <li>• <b>precision lens</b> for full illumination</li> <li>• up to 80 hours run time</li> <li>• incl. Lithium Polymer rechargeable battery (1,200 mAh)</li> <li>• chargeable by <b>USB cable</b> (included)</li> <li>• battery level and charge control indicator</li> <li>• with adjustable rubber bracket for handlebars (art. 223550)</li> <li>• toolless mounting</li> <li>• in Moon eurohole box</li> </ul>	   <p><b>400 LUMEN</b></p>    <p><b>66 g</b></p>   	<p><b>49,90 €</b></p> <p>35/19</p>
<p><b>220461</b> 100/20</p>	<p><b>AKKUBLINKLICHT</b> ›SHIELD-X AUTO‹</p> <ul style="list-style-type: none"> <li>• 1 rote <b>CREE XPE 2 LED</b> und <b>1 COB LED</b> mit bis zu <b>300 Lumen</b></li> <li>• 9 Funktionen (inkl. Tageslichtblinkfunktion)</li> <li>• <b>Auto-Save-Funktion:</b> mindestens 1 h verlängerte Leuchtdauer durch automatisches Umschalten in Energiespar-Modus</li> <li>• mit <b>Helligkeitssensor</b></li> <li>• mit <b>Funktionsmemory</b></li> <li>• CNC-gefrästes <b>Aluminiumgehäuse</b></li> <li>• nur <b>50 g</b></li> <li>• <b>Lithium-Polymer-Akku</b> (3,7V - 700 mAh)</li> <li>• bis zu <b>42 Stunden Laufzeit</b></li> <li>• Ladezeit 2 Stunden</li> <li>• mit Gummiband-Universalhalter für Ø 20 - 52 mm, Sattelgestellhalter und Clip-on-Halter (Art. 223548) für Trikottasche, Gürtel, ..., werkzeuglose Montage</li> <li>• 90° drehbar</li> <li>• aufladbar über <b>USB-Kabel</b> (inkl.)</li> <li>• in Moon Eurolochbox</li> </ul> <p>Ohne deutsches Prüfzeichen - Verkauf und Nutzung im Geltungsbereich der StVZO (Deutschland) unzulässig (Abgabe nur an außerdeutsche Kunden).</p>	<p><b>RECHARGEABLE FLASHING LIGHT</b> ›SHIELD-X AUTO‹</p> <ul style="list-style-type: none"> <li>• 1 red <b>CREE XPE 2 LED</b> and <b>1 COB LED</b> up to <b>300 Lumen</b></li> <li>• 9 functions (incl. daylight flashing function)</li> <li>• <b>auto-save function:</b> at least 1h extended bright life through switching automatically into power safe mode</li> <li>• with <b>light sensor</b></li> <li>• with <b>memory</b> function</li> <li>• CNC machined <b>aluminium</b> housing</li> <li>• only <b>50 g</b></li> <li>• <b>Lithium Polymer rechargeable battery</b> (3.7V - 700 mAh)</li> <li>• up to <b>42 hours run time</b></li> <li>• charging time 2 hours</li> <li>• with rubber strap universal bracket for Ø 20 - 52 mm, saddle rail bracket and clip-on bracket (art. 223548) for jersey pocket, belt, ..., toolless mounting</li> <li>• 90° turnable</li> <li>• chargeable by <b>USB cable</b> (incl.)</li> <li>• in Moon eurohole box</li> </ul>	   <p><b>300 LUMEN</b></p>    <p><b>50 g</b></p>      	<p><b>44,90 €</b></p> <p>35/19</p>



















ART.-NR. 	BESCHREIBUNG	DESCRIPTION	   	UVP verfügbar ab/ available in
<p><b>220465</b> 60</p>	<p><b>AKKULAMPE ›TOURING 25‹</b></p> <ul style="list-style-type: none"> <li>• 3  <b>Hochleistungs-LED</b></li> <li>• 25 Lux</li> <li>• mit <b>Tagfahrlicht</b></li> <li>• 4 Funktionen: 3 Dauerlicht-Helligkeitsstufen, 1 Blinklichtfunktion</li> <li>• Lithium-Polymer-Akku mit 1.000 mAh</li> <li>• Leuchtdauer: 2 - 30 Stunden</li> <li>• <b>wasserabweisend</b></li> <li>• aufladbar über <b>USB-Kabel</b> (inkl.)</li> <li>• mit Batterie- und Ladezustandsanzeige</li> <li>• mit QR-Clip-on-Halter bis Ø 31,8 mm</li> <li>• auf Smart Eurolochkarte</li> </ul> <p><small>Ohne deutsches Prüfzeichen - Verkauf und Nutzung im Geltungsbereich der StVZO (Deutschland) unzulässig (Abgabe nur an außerdeutsche Kunden).</small></p>	<p><b>RECHARGEABLE LAMP ›TOURING 25‹</b></p> <ul style="list-style-type: none"> <li>• 3  <b>high power LED</b></li> <li>• 25 Lux</li> <li>• with <b>daytime running light</b></li> <li>• 4 functions: 3 steady light brightness levels, 1 flashing light function</li> <li>• Lithium polymer battery with 1,000 mAh</li> <li>• run time: 2 - 30 hours</li> <li>• <b>water resistant</b></li> <li>• chargeable by <b>USB cable</b> (incl.)</li> <li>• with battery power meter and charge control indicator</li> <li>• with QR clip-on bracket up to Ø 31.8 mm</li> <li>• on Smart eurohole card</li> </ul>	 <p>25 LUX</p> 	<p><b>35,90 €</b></p> <p>45/19</p>
<p><b>220841</b> 60</p>	<p><b>BATTERIELAMPE ›RAYS 150‹</b></p> <ul style="list-style-type: none"> <li>• 1  <b>LED</b></li> <li>• <b>150 Lumen</b></li> <li>• 27 Lux</li> <li>• mit <b>deutschem Prüfzeichen</b></li> <li>• Leuchtdauer: ca. 2 Stunden</li> <li>• aufladbar über <b>USB-Kabel</b> (inkl.)</li> <li>• mit Batterie- und Ladezustandsanzeige</li> <li>• <b>klein aber fein, nur 31 g</b></li> <li>• mit QR-Clip-on-Halter bis Ø 31,8 mm</li> <li>• auf Smart Eurolochkarte</li> </ul>	<p><b>BATTERY LAMP ›RAYS 150‹</b></p> <ul style="list-style-type: none"> <li>• 1  <b>LED</b></li> <li>• <b>150 Lumen</b></li> <li>• 27 Lux</li> <li>• with <b>German approval number</b></li> <li>• run time: approx. 2 hours</li> <li>• chargeable by <b>USB cable</b> (incl.)</li> <li>• with battery level and charge control indicator</li> <li>• <b>small but fine, only 31 g</b></li> <li>• with QR clip-on bracket up to Ø 31.8 mm</li> <li>• on Smart eurohole card</li> </ul>	 <p>27 LUX</p> 	<p><b>27,90 €</b></p> <p>45/19</p>
<p><b>221519</b> 100/50</p>	<p><b>BATTERIERÜCKLICHT ›TRAIL 80‹</b></p> <ul style="list-style-type: none"> <li>• 1 <b>rote Hochleistungs-LED</b></li> <li>• mit <b>deutschem Prüfzeichen</b></li> <li>• <b>220 Grad</b> Abstrahlwinkel</li> <li>• Laufzeit: bis zu <b>80 Stunden</b></li> <li>• mit Halter bis Ø 31,8 mm</li> <li>• mit integriertem Clip-on-Halter für Trikottasche, Gürtel, ...</li> <li>• Batteriezustandsanzeige</li> <li>• inkl. <b>Batterien</b> (2 x AAA)</li> <li>• auf Smart Eurolochkarte</li> </ul>	<p><b>BATTERY REAR LIGHT ›TRAIL 80‹</b></p> <ul style="list-style-type: none"> <li>• 1 <b>red super bright LED</b></li> <li>• with <b>German approval number</b></li> <li>• <b>220 degrees</b> illumination angle</li> <li>• running time: up to <b>80 hours</b></li> <li>• with bracket up to Ø 31.8 mm</li> <li>• with integrated clip-on bracket for jersey pocket, belt, ...</li> <li>• battery level indicator</li> <li>• incl. <b>batteries</b> (2 x AAA)</li> <li>• on Smart eurohole card</li> </ul>	 	<p><b>14,90 €</b></p> <p>35/19</p>
<p><b>220404</b> 100/20</p>	<p><b>AKKULAMPE ›APOLLON K 30 USB‹</b></p> <ul style="list-style-type: none"> <li>• 1 weiße <b>LED</b></li> <li>• 2 Funktionen: maximale Beleuchtung, Energiesparmodus</li> <li>• Helligkeit <b>30 / 15 Lux</b></li> <li>• mit <b>deutschem Prüfzeichen</b></li> <li>• 360° drehbarer Halter für Ø 19 - 35 mm</li> <li>• schnelle werkzeuglose Montage</li> <li>• mit Batterie- und Ladezustandsanzeige</li> <li>• nur ca. 51 g</li> <li>• <b>Lithium-Akku</b> (3,7 V / 1.200 mAh)</li> <li>• aufladbar über <b>USB-Kabel</b> (inkl.)</li> <li>• in M-Wave Blisterverpackung</li> </ul>	<p><b>RECHARGEABLE LAMP ›APOLLON K 30 USB‹</b></p> <ul style="list-style-type: none"> <li>• 1 white <b>LED</b></li> <li>• 2 functions: maximum illumination, power saving mode</li> <li>• brightness <b>30 / 15 Lux</b></li> <li>• with <b>German approval number</b></li> <li>• 360° turnable bracket for Ø 19 - 35 mm</li> <li>• quick toolless mounting</li> <li>• with battery level and charge control indicator</li> <li>• only approx. 51 g</li> <li>• <b>Lithium rechargeable battery</b> (3.7 V / 1,200 mAh)</li> <li>• chargeable by <b>USB cable</b> (incl.)</li> <li>• in M-Wave blister packaging</li> </ul>	 <p>30 / 15 LUX</p> 	<p><b>19,90 €</b></p> <p>40/19</p>











ART.-NR. 	BESCHREIBUNG	DESCRIPTION	     	UVP verfügbar ab/ available in
<b>220559</b> 100/20	<b>AKKURÜCKLICHT ›HELIOS K 1.1 USB‹</b> <ul style="list-style-type: none"> <li>• 1 rote <b>LED</b></li> <li>• mit <b>deutschem Prüfzeichen</b></li> <li>• Halter für Ø 19 - 35 mm</li> <li>• Winkel des Halters einstellbar</li> <li>• <b>240 Grad</b> Abstrahlwinkel</li> <li>• <b>klein aber fein</b>, nur <b>11 g</b> (ohne Halter)</li> <li>• schnelle werkzeuglose Montage</li> <li>• mit Batterie- und Ladezustandsanzeige</li> <li>• aufladbar über <b>USB-Kabel</b> (inkl.)</li> <li>• <b>Lithium-Polymer Akku</b></li> <li>• in M-Wave Blisterverpackung</li> </ul>	<b>RECHARGEABLE REAR LIGHT ›HELIOS K 1.1 USB‹</b> <ul style="list-style-type: none"> <li>• 1 red <b>LED</b></li> <li>• with <b>German approval number</b></li> <li>• bracket for Ø 19 - 35 mm</li> <li>• adjustable angle of the bracket</li> <li>• <b>240 degrees</b> illumination angle</li> <li>• <b>small but fine</b>, only <b>11 g</b> (without bracket)</li> <li>• quick toolless mounting</li> <li>• with battery level and charge control indicator</li> <li>• chargeable by <b>USB cable</b> (incl.)</li> <li>• <b>Lithium Polymer rechargeable battery</b></li> <li>• in M-Wave blister packaging</li> </ul>	  	<b>13,90 €</b>  35/19
<b>221091</b> 50/10 Set	<b>LED-AKKULAMPENSET ›ATLAS K 11 USB‹</b> <ul style="list-style-type: none"> <li>• mit <b>deutschem Prüfzeichen</b></li> <li>• schnelle werkzeuglose Montage</li> <li>• mit Batterie- und Ladezustandsanzeige</li> <li>• aufladbar über <b>USB-Kabel</b> (inkl.)</li> <li>• in M-Wave Blisterverpackung</li> </ul> <p><b>Frontlicht</b> Art. 220404:</p> <ul style="list-style-type: none"> <li>• 1 weiße <b>LED</b></li> <li>• 2 Funktionen: maximale Beleuchtung, Energiesparmodus</li> <li>• Helligkeit <b>30 / 15 Lux</b></li> <li>• 360° drehbarer Halter für Ø 19 - 35 mm</li> <li>• nur ca. 51 g</li> <li>• <b>Lithium-Akku</b> (3,7 V / 1.200 mAh)</li> </ul> <p><b>Rücklicht</b> Art. 220559:</p> <ul style="list-style-type: none"> <li>• 1 rote <b>LED</b></li> <li>• Halter für Ø 19 - 35 mm</li> <li>• <b>240 Grad</b> Abstrahlwinkel</li> <li>• <b>Lithium-Polymer Akku</b></li> </ul>	<b>LED RECHARGEABLE LAMP SET ›ATLAS K 15 USB‹</b> <ul style="list-style-type: none"> <li>• with <b>German approval number</b></li> <li>• quick toolless mounting</li> <li>• with battery level and charge control indicator</li> <li>• chargeable by <b>USB cable</b> (incl.)</li> <li>• in M-Wave blister packaging</li> </ul> <p><b>front light</b> art. 220404:</p> <ul style="list-style-type: none"> <li>• 1 white <b>LED</b></li> <li>• 2 functions: maximum illumination, power saving mode</li> <li>• brightness <b>30 / 15 Lux</b></li> <li>• 360° turnable bracket for Ø 19 - 35 mm</li> <li>• only approx. 51 g</li> <li>• <b>Lithium rechargeable battery</b> (3.7 V / 1,200 mAh)</li> </ul> <p><b>rear light</b> art. 220559:</p> <ul style="list-style-type: none"> <li>• 1 red <b>LED</b></li> <li>• bracket for Ø 19 - 35 mm</li> <li>• <b>240 degrees</b> illumination angle</li> <li>• <b>Lithium Polymer rechargeable battery</b></li> </ul>	   	<b>29,90 €</b>  40/19
<b>231451</b> 10	<b>RAHMENSCHLOSS MIT KETTE ›RINGCHAIN XL‹</b> <ul style="list-style-type: none"> <li>• <b>70 mm</b> Durchlaufbreite für <b>besonders breite Reifen</b></li> <li>• für Montage an der Pletscherplatte oder den Sitzrohrstreben</li> <li>• mit <b>quadratischer Kette</b>, 5,5 x 5,5 x <b>1.000 mm</b> (Art. 231452) zur <b>Verlängerung des Absperrradius</b>, mit schwarzem Textilüberzug</li> <li>• mit Befestigungsmaterial</li> <li>• auf M-Wave Eurolochkarte</li> </ul>	<b>FRAME LOCK WITH CHAIN ›RINGCHAIN XL‹</b> <ul style="list-style-type: none"> <li>• <b>70 mm</b> inner width for <b>very wide tires</b></li> <li>• for mounting on the Pletscher plate or seat stays</li> <li>• with <b>square chain</b>, 5.5 x 5.5 x <b>1,000 mm</b> (art. 231452) for <b>prolonging the locking range</b>, with black textile cover</li> <li>• with mounting material</li> <li>• on M-Wave eurohole card</li> </ul>	 	<b>21,90 €</b>  35/19
<b>231452</b> 20/10  <b>231453</b>	<b>SCHLOSSKETTE</b> <ul style="list-style-type: none"> <li>• <b>Ersatz-/Verlängerungskette</b> für Rahmenschloss Art. 231451 und <b>andere Rahmenschlösser</b></li> <li>• zur Verlängerung des Absperrradius</li> <li>• mit schwarzem Textilüberzug</li> <li>• Montageverpackung</li> </ul> <p>›C 5,5.10‹ 5,5 x 5,5 x <b>1.000 mm</b></p> <p>›C 5,5.14‹ 5,5 x 5,5 x <b>1.400 mm</b></p>	<b>LOCK CHAIN</b> <ul style="list-style-type: none"> <li>• <b>replacement and extension chain</b> for frame lock art. 231451 and <b>other frame locks</b></li> <li>• for prolonging the locking range</li> <li>• with black textile cover</li> <li>• OEM</li> </ul> <p>›C 5,5.10‹ 5.5 x 5.5 x <b>1,000 mm</b></p> <p>›C 5,5.14‹ 5.5 x 5.5 x <b>1,400 mm</b></p>		<b>11,90 €</b> 35/19  <b>13,90 €</b> 35/19

ART.-NR. 	BESCHREIBUNG	DESCRIPTION		UVP verfügbar ab/ available in
REFLEX	REFLEX	REFLEX	REFLEX	REFLEX
<b>230961</b> 40/10	<b>SPIRAKABELSCHLOSS</b> <b>›S 10.18 ILLU‹</b> <ul style="list-style-type: none"> <li>• Ø 10 x 1.800 mm</li> <li>• mit <b>Reflexstreifen</b></li> <li>• Clip-on-Halter (Art. 233849) für Sattelstütze und Rahmenrohr, beidseitig einführbar</li> <li>• mit <b>Staubschutzkappe</b></li> <li>• <b>automatische Verriegelung</b></li> <li>• auf M-Wave Eurolochkarte</li> </ul>	<b>SPIRAL CABLE LOCK</b> <b>›S 10.18 ILLU‹</b> <ul style="list-style-type: none"> <li>• Ø 10 x 1,800 mm</li> <li>• with <b>reflective stripe</b></li> <li>• clip-on bracket (art. 233849) for seat post and frame tube, clip-on possibility from both sides</li> <li>• with <b>dust cap</b></li> <li>• <b>automatic locking</b></li> <li>• on M-Wave eurohole card</li> </ul>	<div style="border: 1px solid black; padding: 2px; display: inline-block;">10 x 1.800</div> 	<b>8,90 €</b>  45/19
<b>230962</b> 40/10	<b>SPIRAKABELSCHLOSS</b> <b>›DS 10.18 ILLU‹</b> <ul style="list-style-type: none"> <li>• Ø 10 x 1.800 mm</li> <li>• mit <b>Reflexstreifen</b></li> <li>• <b>verstellbarer</b>, persönlicher Sicherheitscode</li> <li>• Clip-on-Halter (Art. 233849) für Sattelstütze oder Rahmenrohr, beidseitig einführbar</li> <li>• auf M-Wave Eurolochkarte</li> </ul>	<b>SPIRAL CABLE LOCK</b> <b>›DS 10.18 ILLU‹</b> <ul style="list-style-type: none"> <li>• Ø 10 x 1,800 mm</li> <li>• with <b>reflective stripe</b></li> <li>• <b>changeable</b>, individual security code</li> <li>• clip-on bracket (art. 233849) for seat post or frame tube, clip-on possibility from both sides</li> <li>• on M-Wave eurohole card</li> </ul>	<div style="border: 1px solid black; padding: 2px; display: inline-block;">10 x 1.800</div> 	<b>8,90 €</b>  45/19
<b>230960</b> 60/10	<b>KABELSCHLOSS</b> ›C 15.8 ILLU‹ <ul style="list-style-type: none"> <li>• Ø 15 x 800 mm</li> <li>• mit <b>Reflexstreifen</b></li> <li>• <b>automatische Verriegelung</b></li> <li>• auf M-Wave Eurolochkarte</li> </ul>	<b>CABLE LOCK</b> ›C 15.8 ILLU‹ <ul style="list-style-type: none"> <li>• Ø 15 x 800 mm</li> <li>• with <b>reflective stripe</b></li> <li>• <b>automatic locking</b></li> <li>• on M-Wave eurohole card</li> </ul>	<div style="border: 1px solid black; padding: 2px; display: inline-block;">15 x 800</div> 	<b>7,90 €</b>  45/19
<b>230963</b> 12/6	<b>KETTENSCHLOSS</b> ›C 6.8,5 ILLU‹ <ul style="list-style-type: none"> <li>• 6 x 850 mm</li> <li>• Textilüberzug mit <b>Reflexstreifen</b></li> <li>• <b>automatische Verriegelung</b></li> <li>• mit Staubschutzkappe</li> <li>• <b>computerdesignte</b> Schlüssel</li> <li>• mit M-Wave Banderole</li> </ul>	<b>CHAIN LOCK</b> ›C 6.8,5 ILLU‹ <ul style="list-style-type: none"> <li>• 6 x 850 mm</li> <li>• textile cover with <b>reflective stripe</b></li> <li>• <b>automatic locking</b></li> <li>• with dust cap</li> <li>• <b>computer-designed</b> keys</li> <li>• with M-Wave banderole</li> </ul>	<div style="border: 1px solid black; padding: 2px; display: inline-block;">6 x 850</div> 	<b>14,90 €</b>  45/19
<b>230964</b> 12/6	<b>ZAHLEN-KETTENSCHLOSS</b> <b>›D 6.8,5 ILLU‹</b> <ul style="list-style-type: none"> <li>• 6 x 850 mm</li> <li>• Textilüberzug mit <b>Reflexstreifen</b></li> <li>• mit <b>5 Zahlenscheiben</b></li> <li>• mit <b>verstellbarem</b>, persönlichem Sicherheitscode</li> <li>• mit M-Wave Banderole</li> </ul>	<b>COMBINATION CHAIN LOCK</b> <b>›D 6.8,5 ILLU‹</b> <ul style="list-style-type: none"> <li>• 6 x 850 mm</li> <li>• textile cover with <b>reflective stripe</b></li> <li>• with <b>5 digits</b></li> <li>• with <b>changeable</b>, individual security codes</li> <li>• with M-Wave banderole</li> </ul>	<div style="border: 1px solid black; padding: 2px; display: inline-block;">6 x 850</div>  <div style="border: 1px solid black; padding: 2px; display: inline-block; margin-top: 10px;">5x</div>	<b>14,90 €</b>  45/19







































ART.-NR. 	BESCHREIBUNG	DESCRIPTION	 	UVP verfügbar ab/ available in
<p><b>244361</b> 100/20</p> 	<p><b>FAHRRADCOMPUTER</b> ›XIV W‹</p> <p><b>14 Funktionen mit 3-fach Anzeige</b></p> <ul style="list-style-type: none"> <li>• drahtlose Funkübertragung</li> <li>• Geschwindigkeit</li> <li>• Durchschnittsgeschwindigkeit</li> <li>• maximale Geschwindigkeit</li> <li>• Geschwindigkeitsvergleich</li> <li>• Gesamtkilometer</li> <li>• Tageskilometer</li> <li>• Fahrzeit</li> <li>• Uhrzeit</li> <li>• Kalorienverbrauchsanzeige</li> <li>• Umdrehungsfrequenz pro Min.</li> <li>• autom. Anzeigenwechsel</li> <li>• Kilometer- / Meilenauswahl</li> <li>• Raddurchmesser einstellbar</li> <li>• Auto Stopp</li> <li>• inkl. Batterie (CR 2026)</li> <li>• wassergeschützt</li> <li>• mit 90° drehbarem Universalhalter</li> <li>• Bedienungsanleitung in DE, EN, FR, ES, IT, NL, CS, PL, HU</li> <li>• in Eurolochbox</li> </ul>	<p><b>BICYCLE COMPUTER</b> ›XIV W‹</p> <p><b>14 functions with three line display</b></p> <ul style="list-style-type: none"> <li>• wireless transmission</li> <li>• current speed</li> <li>• average speed</li> <li>• maximum speed</li> <li>• speed comparator</li> <li>• total trip distance</li> <li>• trip distance</li> <li>• auto trip timer</li> <li>• clock</li> <li>• calorie consumption</li> <li>• round frequency per min.</li> <li>• auto scan</li> <li>• kilometres / miles selection</li> <li>• wheel diameter adjustable</li> <li>• auto stop</li> <li>• incl. battery (CR 2026)</li> <li>• water-protected</li> <li>• with 90° turnable universal bracket</li> <li>• manual in DE, EN, FR, ES, IT, NL, CS, PL, HU</li> <li>• in eurohole box</li> </ul>	 <p>3-fach 3-line Display</p> 	<p><b>19,90 €</b></p> <p>41/19</p>
<p><b>244527</b> 120/24</p>	<p><b>FAHRRADCOMPUTER</b> ›XI‹</p> <p><b>11 Funktionen mit 3-fach Anzeige:</b></p> <ul style="list-style-type: none"> <li>• Geschwindigkeit</li> <li>• maximale Geschwindigkeit</li> <li>• Durchschnittsgeschwindigkeit</li> <li>• Gesamtkilometer</li> <li>• Tageskilometer</li> <li>• autom. Anzeigenwechsel</li> <li>• Uhrzeit</li> <li>• Auto Start / Stopp</li> <li>• Fahrzeit</li> <li>• Kilometer- / Meilenauswahl</li> <li>• Raddurchmesser einstellbar</li> <li>• inkl. Batterie (CR 2032, Art. 640814/6)</li> <li>• wassergeschützt</li> <li>• mit 90° drehbarem Universalhalter</li> <li>• Bedienungsanleitung in DE, EN, FR, ES, IT, NL, CS, PL, HU</li> <li>• in Eurolochbox</li> </ul>	<p><b>BICYCLE COMPUTER</b> ›XI‹</p> <p><b>11 functions with three line display:</b></p> <ul style="list-style-type: none"> <li>• current speed</li> <li>• maximum speed</li> <li>• average speed</li> <li>• total trip distance</li> <li>• trip distance</li> <li>• auto scan</li> <li>• clock</li> <li>• auto start / stop</li> <li>• riding time</li> <li>• kilometres / miles selection</li> <li>• wheel diameter adjustable</li> <li>• incl. battery (CR 2032, art. 640814/6)</li> <li>• water-protected</li> <li>• with 90° turnable universal bracket</li> <li>• manual in DE, EN, FR, ES, IT, NL, CS, PL, HU</li> <li>• in eurohole box</li> </ul>	 <p>3-fach 3-line Display</p> 	<p><b>14,90 €</b></p> <p>41/19</p>
<p><b>244691</b> 100</p>	<p><b>AHEADKAPPEN-HALTERUNG</b> ›DAVENPORT AHEAD‹</p> <ul style="list-style-type: none"> <li>• zur Gabelschaft- / Ahead-Montage (1 1/8")</li> <li>• universell passend für Garmin, ... (kein original Garmin, ... Ersatzteil)</li> <li>• auf M-Wave Eurolochkarte</li> </ul>	<p><b>AHEAD CAP BRACKET</b> ›DAVENPORT AHEAD‹</p> <ul style="list-style-type: none"> <li>• for steerer / ahead-cap mount (1 1/8")</li> <li>• universally suitable for Garmin, ... (no original Garmin, ... spare part)</li> <li>• on M-Wave eurohole card</li> </ul> 	  	<p><b>9,90 €</b></p> <p>41/19</p>
<p><b>244690</b> 100</p>	<p><b>UNIVERSELLE ADAPTERPLATTE</b> ›DAVENPORT PLUG‹</p> <ul style="list-style-type: none"> <li>• zur Befestigung von Mobiltelefonen, Navigationsgeräten, ... auf Garmin-Halterungen (kein original Garmin Ersatzteil)</li> <li>• mit 3M Klebepad und Sicherheits-schrauben</li> <li>• auf M-Wave Eurolochkarte</li> </ul>	<p><b>UNIVERSAL ADAPTER PLATE</b> ›DAVENPORT PLUG‹</p> <ul style="list-style-type: none"> <li>• for mounting of mobile phones, navigation devices, ... to Garmin mounts (no original Garmin spare part)</li> <li>• with 3M glue pad and safety screws</li> <li>• on M-Wave eurohole card</li> </ul> 	  	<p><b>7,90 €</b></p> <p>41/19</p>

















ART.-NR.	BESCHREIBUNG	DESCRIPTION		UVP verfügbar ab/ available in
<p><b>250225</b> 20</p>	<p><b>RENNSATTEL</b> <b>›SPEEDFLEX VACU FC‹</b></p> <ul style="list-style-type: none"> <li>• sportlich und haltbar dank <b>Vakuump-Technologie</b>: verschweißte, <b>wasserdichte und nahtlose</b> Oberfläche</li> <li>• Gestell mit <b>Skala</b></li> <li>• "Arc-Tech" <b>gefederter</b> Stützpunkt</li> <li>• komfortable, aber leichte <b>Gel</b>-Einlage</li> <li>• <b>"O-Zone Full Cut"</b></li> <li>• nur 346 g</li> <li>• L = 269 x B = 143 mm</li> <li>• auf Velo Eurolochkarte</li> </ul> 	<p><b>RACING SADDLE</b> <b>›SPEEDFLEX VACU FC‹</b></p> <ul style="list-style-type: none"> <li>• sportive and durable thanks to <b>Vacuum Technology</b>: welded, <b>waterproof and seamless</b> surface</li> <li>• rails with <b>scale</b></li> <li>• "Arc-Tech" <b>suspension</b></li> <li>• comfortable, but light <b>gel</b>-inlay</li> <li>• <b>"O-Zone Full Cut"</b></li> <li>• only 346 g</li> <li>• L = 269 x W = 143 mm</li> <li>• on Velo eurohole card</li> </ul>	<p><b>GEL</b></p>  	<p><b>29,90 €</b></p> <p>35/19</p>
<p><b>252176</b></p> <p><b>252197</b> <b>NEW</b></p> <p><b>252177</b></p> <p><b>Montageverpackung</b></p> <p><b>252180</b></p> <p><b>252182</b> <b>NEW</b></p> <p><b>252181</b> 20</p>	<p><b>GEFEDERTE PARALLELOGRAMMSATTELSTÜTZE</b> <b>›FOURSPRING‹</b></p> <ul style="list-style-type: none"> <li>• <b>einteiliges Aluminiumrohr</b> mit <b>Design-Schutzabdeckung</b></li> <li>• <b>hervorragendes Ansprechverhalten</b> durch Parallelogrammverschiebung (kein Verkanten)</li> <li>• Vorspannung einstellbar</li> <li>• 2-Punkt Befestigung des Sattelgestells, mit <b>Winkelskala</b></li> <li>• Federweg: <b>36 mm</b> im Kreisbogen</li> <li>• Länge 350 mm</li> <li>• mit Skala (Höheneinstellung)</li> <li>• max. Fahrergewicht 85 kg</li> </ul> <p><b>auf M-Wave Eurolochkarte</b></p>	<p><b>PARALLELOGRAM SUSPENSION SEAT POST</b> <b>›FOURSPRING‹</b></p> <ul style="list-style-type: none"> <li>• <b>one-piece aluminium</b> tube with <b>design protective</b> cover</li> <li>• <b>very sensitive response characteristic</b> through parallelogram movement (no tilting)</li> <li>• preload adjustable</li> <li>• 2-point fixation of the saddle rails, with <b>angular scale</b></li> <li>• travel: <b>36 mm</b> in a circular arc</li> <li>• length 350 mm</li> <li>• with scale (height adjustment)</li> <li>• max. weight of rider 85 kg</li> </ul> <p><b>on M-Wave eurohole card</b></p>	<p><b>Trekkingbike TIPP</b></p>    <p><b>0 - 120 kg!</b></p>	<p><b>99,90 €</b></p> <p>35/19</p> <p><b>99,90 €</b></p> <p>35/19</p> <p><b>99,90 €</b></p> <p>35/19</p> <p><b>99,90 €</b></p> <p>35/19</p> <p><b>99,90 €</b></p> <p>35/19</p> <p><b>99,90 €</b></p> <p>35/19</p>
<p><b>252178</b></p> <p><b>252165</b></p> <p><b>252179</b> 100</p>	<p><b>ERSATZ-/TUNING-FEDER</b></p> <ul style="list-style-type: none"> <li>• zum Umbau der Sattelstützen Art. 252180-2 für ein anderes Fahrergewicht</li> <li>• im Polybeutel mit Aufkleber</li> </ul>	<p><b>REPLACEMENT-/TUNING-SPRING</b></p> <ul style="list-style-type: none"> <li>• for converting seat post art. 252180-2 to another rider's weight</li> <li>• in PE bag with sticker</li> </ul>		<p><b>8,90 €</b></p> <p>35/19</p> <p><b>8,90 €</b></p> <p>35/19</p> <p><b>8,90 €</b></p> <p>35/19</p>

ART.-NR. 	BESCHREIBUNG	DESCRIPTION		UVP verfügbar ab/ available in
<p><b>252071</b></p> <p><b>252061</b></p> <p><b>NEW</b></p> <p><b>252072</b></p> <p>25</p>	<p><b>SATTELSTÜTZE</b></p> <ul style="list-style-type: none"> <li>• <b>Carbon</b></li> <li>• mit Skala (Höheneinteilung)</li> <li>• einfache Sattelneigeinstellung durch 1-Schrauben-Einstellsystem</li> <li>• <b>Länge 350 mm</b></li> <li>• nur <b>209 g</b> (Ø 27,2 x 350 mm)</li> <li>• in Promax Eurolochbox</li> </ul> <p>Ø 27,2 mm, UD Carbon</p> <p>Ø 30,9 mm, UD Carbon</p> <p>Ø 31,6 mm, 3K Carbon</p>	<p><b>SEAT POST</b></p> <ul style="list-style-type: none"> <li>• <b>Carbon</b></li> <li>• with scale (height adjustment)</li> <li>• easy saddle angle adjustable with 1 bolt</li> <li>• <b>length 350 mm</b></li> <li>• only <b>209 g</b> (Ø 27.2 x 350 mm)</li> <li>• in Promax eurohole box</li> </ul> <p>Ø 27.2 mm, UD Carbon</p> <p>Ø 30.9 mm, UD Carbon</p> <p>Ø 31.6 mm, 3K Carbon</p> <p><small>Tested by the manufacturer according to ISO 4210</small></p>	<p><b>CARBON</b></p> <p><b>PROMAX</b></p>   	<p><b>54,90 €</b></p> <p>35/19</p> <p><b>54,90 €</b></p> <p>~ Nov./19</p> <p><b>54,90 €</b></p> <p>35/19</p>
<p><b>259960</b></p> <p>200/10</p>	<p><b>SATTELSTÜTZADAPTER</b></p> <ul style="list-style-type: none"> <li>• <b>Aluminium</b></li> <li>• <b>schwarz</b></li> <li>• Länge <b>80 mm</b></li> <li>• I-Ø 31,6 mm, A-Ø 34,9 mm</li> <li>• 10 Stück im Polybeutel</li> </ul>	<p><b>SEAT POST ADAPTER</b></p> <ul style="list-style-type: none"> <li>• <b>aluminium</b></li> <li>• <b>black</b></li> <li>• length <b>80 mm</b></li> <li>• I-Ø 31,6 mm, O-Ø 34,9 mm</li> <li>• 10 pieces in PE bag</li> </ul>		<p><b>3,90 €</b></p> <p>35/19</p>
<p><b>270015</b></p> <p><b>270016</b></p> <p><b>NEW</b></p> <p>50</p>	<p><b>FAHRRADSPIEGEL ›SPY SPACE‹</b></p> <ul style="list-style-type: none"> <li>• <b>3-dimensional verstellbar</b></li> <li>• <b>gestochen scharfes, entspiegeltes, schlagfestes und blendfreies Echtglas</b></li> <li>• sehr beständiges Gehäuse aus <b>Nylonfasern</b></li> <li>• Aluminiumschelle Ø 22,2 mm</li> <li>• in M-Wave Eurolochbox</li> </ul> <p>zur Montage an der linken Seite</p> <p>zur Montage an der <b>rechten</b> Seite</p>	<p><b>BICYCLE MIRROR ›SPY SPACE‹</b></p> <ul style="list-style-type: none"> <li>• <b>3-dimensionally adjustable</b></li> <li>• <b>high definition, antireflective, blast resistant and glare-free genuine glass</b></li> <li>• high impact <b>nylon fiber</b> frame</li> <li>• aluminium clamp Ø 22.2 mm</li> <li>• in M-Wave eurohole box</li> </ul> <p>for mounting at the left side</p> <p>for mounting at the <b>right</b> side</p>	<p><b>E</b></p> <p><b>M-WAVE</b></p>  	<p><b>21,90 €</b></p> <p>35/19</p> <p><b>21,90 €</b></p> <p>35/19</p>
<p><b>270070</b></p> <p>50</p>	<p><b>FAHRRADSPIEGEL ›SPY SPACE 45‹</b></p> <ul style="list-style-type: none"> <li>• <b>ECE geprüft:</b> für alle Fahrzeuge der Klasse L, die keine den Fahrer umschließende Karosserie aufweisen, z.B. <b>geeignet für E-Bikes, S-Pedelecs</b> bis 45 km/h Maximalgeschwindigkeit, <b>Mofas, Motorräder, Quads, ...</b></li> <li>• <b>3-dimensional verstellbar</b></li> <li>• <b>blendfreies Echtglas</b></li> <li>• zur Montage am Lenkerende mit Innen-Ø 14,5 - 16,5 mm und Ø 18 - 19,5 mm</li> <li>• in M-Wave Eurolochbox</li> </ul>	<p><b>BICYCLE MIRROR ›SPY SPACE 45‹</b></p> <ul style="list-style-type: none"> <li>• <b>ECE approved:</b> for all class L vehicles which do not have a bodywork surrounding the driver, e.g. <b>suitable for E-Bikes, S-Pedelecs</b> up to 45 km/h maximum speed, <b>mopeds, motorcycles, quads, ...</b></li> <li>• <b>3-dimensionally adjustable</b></li> <li>• <b>glare-free genuine glass</b></li> <li>• for mounting on handlebar ends with inner-Ø 14.5 - 16.5 mm and Ø 18 - 19.5 mm</li> <li>• in M-Wave eurohole box</li> </ul>	<p><b>ECE APPROVED</b></p> <p><b>E</b></p> <p><b>M-WAVE</b></p>  	<p><b>19,90 €</b></p> <p>35/19</p>
<p><b>270080</b></p> <p>~100</p>	<p><b>FAHRRADSPIEGEL ›SPY BASE‹</b></p> <ul style="list-style-type: none"> <li>• <b>3-dimensional verstellbar</b></li> <li>• variable Einstellmöglichkeiten</li> <li>• <b>konvexe und blendfreie</b> Spiegelfläche (ca. 105 x 70 mm)</li> <li>• Klemmschelle Ø 22,2 mm</li> <li>• ohne Demontage von Griff, ... montierbar</li> <li>• Länge: ca. 300 mm</li> <li>• in M-Wave Verpackung</li> </ul>	<p><b>BICYCLE MIRROR ›SPY BASE‹</b></p> <ul style="list-style-type: none"> <li>• <b>3-dimensionally adjustable</b></li> <li>• variable adjustment</li> <li>• <b>convex and glarefree</b> mirror surface (approx. 105 x 70 mm)</li> <li>• clamp Ø 22.2 mm</li> <li>• mountable without demounting of grip, ...</li> <li>• length: approx. 300 mm</li> <li>• in M-Wave packaging</li> </ul>	<p><b>M-WAVE</b></p>  	<p><b>9,90 €</b></p> <p>~ Nov./19</p>















ART.-NR. 	BESCHREIBUNG	DESCRIPTION		UVP verfügbar ab/ available in
<p><b>303504</b></p> <p><b>303505</b> 20</p>	<p><b>KETTE ›DLC12‹</b></p> <ul style="list-style-type: none"> <li>• 12-fach</li> <li>• 126 Glieder</li> <li>• „<b>Diamond Like Coating</b>“ verlängert die Lebensdauer zusätzlich</li> <li>• kompatibel mit <b>Shimano / Sram MTB / Campagnolo</b></li> <li>• hochpräzise Fertigung garantiert <b>exzellentes Schaltverhalten</b></li> <li>• nur <b>220 g</b> (110 Gl.)</li> <li>• mit MissingLink Verschlussglied</li> <li>• in KMC Einzelverpackung</li> </ul> <p>schwarz - orange</p> <p>schwarz - gelb</p>	<p><b>CHAIN ›DLC12‹</b></p> <ul style="list-style-type: none"> <li>• 12 speed</li> <li>• 126 links</li> <li>• „<b>Diamond Like Coating</b>“ additionally extends the durability</li> <li>• compatible to <b>Shimano / Sram MTB / Campagnolo</b></li> <li>• high-precision production guarantees <b>excellent shifting behavior</b></li> <li>• only <b>220 g</b> (110 li.)</li> <li>• with MissingLink</li> <li>• in KMC box</li> </ul> <p>black - orange</p> <p>black - yellow</p>	      	<p><b>119,95 €</b></p> <p>46/19</p> <p><b>119,95 €</b></p> <p>46/19</p>
<p><b>303514</b></p> <p><b>303515</b> 30</p>	<p><b>KETTE ›X12‹</b></p> <ul style="list-style-type: none"> <li>• 12-fach</li> <li>• 126 Glieder</li> <li>• kompatibel mit <b>Shimano / Sram MTB / Campagnolo</b></li> <li>• hochpräzise Fertigung garantiert <b>exzellentes Schaltverhalten</b></li> <li>• nur <b>234 g</b> (110 Gl.)</li> <li>• mit MissingLink Verschlussglied</li> <li>• in KMC Einzelverpackung</li> </ul> <p>›X12 Blacktech‹</p> <p>›X12 Silver/Black‹</p>	<p><b>CHAIN ›X12‹</b></p> <ul style="list-style-type: none"> <li>• 12 speed</li> <li>• 126 links</li> <li>• compatible to <b>Shimano / Sram MTB / Campagnolo</b></li> <li>• high-precision production guarantees <b>excellent shifting behavior</b></li> <li>• only <b>234 g</b> (110 li.)</li> <li>• with MissingLink</li> <li>• in KMC box</li> </ul> <p>›X12 Blacktech‹</p> <p>›X12 Silver/Black‹</p>	   	<p><b>49,95 €</b></p> <p><b>34,90 €</b></p> <p>35/19</p>
<p><b>303544</b> 50 m</p>	<p><b>KETTE ›X11‹</b></p> <ul style="list-style-type: none"> <li>• 11-fach</li> <li>• kompatibel mit <b>Shimano / Sram / Campagnolo</b></li> <li>• grau</li> <li>• mit MissingLink Verschlussgliedern</li> <li>• auf <b>Rolle zu je 50 Meter</b></li> </ul>	<p><b>CHAIN ›X11‹</b></p> <ul style="list-style-type: none"> <li>• 11 speed</li> <li>• compatible to <b>Shimano / Sram / Campagnolo</b></li> <li>• grey</li> <li>• with MissingLinks</li> <li>• on <b>reels with 50 meter</b></li> </ul>	  <div data-bbox="1029 1433 1380 1534" style="border: 1px solid black; padding: 5px;"> <p><b>Workshop</b></p> <p><b>50 running meter</b></p>  </div> 	<p><b>15,90 €</b></p> <p>35/19</p>
<p><b>306102</b> 30</p>	<p><b>SPEZIALKETTE FÜR E-BIKES MIT KETTENSCHALTUNG ›e12EPT‹</b></p> <ul style="list-style-type: none"> <li>• <b>maximale Haltbarkeit</b> durch <b>verstärkte Vernietung, erhöhte Torsionsfestigkeit</b> und <b>minimalisierte Toleranzen</b></li> <li>• mit „<b>ECO ProTeQ</b>“ für eine <b>extrem rostresistente, glatte</b> und <b>umweltfreundliche</b> Oberfläche</li> <li>• 12-fach</li> <li>• <b>130 Glieder, XL</b>, extra lang für <b>Elektrofahrräder</b></li> <li>• kompatibel mit <b>Shimano / Sram MTB / Campagnolo</b></li> <li>• mit MissingLink Verschlussglied</li> <li>• in KMC Einzelverpackung</li> </ul>	<p><b>SPECIAL CHAIN FOR E-BIKES WITH DERAILLEUR ›e12EPT‹</b></p> <ul style="list-style-type: none"> <li>• <b>maximum durability</b> due to <b>reinforced riveting, higher torsion stability</b> and <b>minimalized tolerances</b></li> <li>• with „<b>ECO ProTeQ</b>“ for an <b>extremely rust resistant, smooth</b> and <b>environmentally friendly</b> cover</li> <li>• 12 speed</li> <li>• <b>130 links, XL</b>, extra long for <b>E-bikes</b></li> <li>• compatible to <b>Shimano / Sram MTB / Campagnolo</b></li> <li>• with MissingLink</li> <li>• in KMC box</li> </ul>	    <div data-bbox="1165 1780 1380 1859" style="border: 1px solid black; padding: 5px;"> <p><b>E-BIKE APPROVED</b></p> <p><b>XL 130 LINKS</b></p> </div>  	<p><b>69,90 €</b></p> <p>46/19</p>

ART.-NR. 	BESCHREIBUNG	DESCRIPTION		UVP verfügbar ab/ available in
<b>301911</b> 60	<b>FAHRRADKETTEN</b> <ul style="list-style-type: none"> <li>mit <b>Antirost-Beschichtung</b></li> <li>mit Verschlussglied</li> <li>im M-Wave Einzelkarton</li> </ul> <ul style="list-style-type: none"> <li>für <b>11-fach</b> Schaltungssysteme</li> <li>1/2" x 11/128"</li> <li>116 Glieder</li> <li>kompatibel mit <b>Shimano / Sram / Campagnolo</b></li> </ul>	<b>BICYCLE CHAINS</b> <ul style="list-style-type: none"> <li>with <b>anti rust coating</b></li> <li>with connecting link</li> <li>in M-Wave single box</li> </ul> <ul style="list-style-type: none"> <li>for <b>11 speed</b></li> <li>1/2" x 11/128"</li> <li>116 links</li> <li>compatible to <b>Shimano / Sram / Campagnolo</b></li> </ul>	  	<b>34,90 €</b> 41/19
<b>301910</b> 60	<ul style="list-style-type: none"> <li>für <b>10-fach</b> Schaltungssysteme</li> <li>1/2" x 11/128"</li> <li>116 Glieder</li> <li>kompatibel mit <b>Shimano / Sram / Campagnolo</b></li> </ul>	<ul style="list-style-type: none"> <li>for <b>10 speed</b></li> <li>1/2" x 11/128"</li> <li>116 links</li> <li>compatible to <b>Shimano / Sram / Campagnolo</b></li> </ul>		<b>32,90 €</b> 41/19
<b>301909</b> 60	<ul style="list-style-type: none"> <li>für <b>9-fach</b> Schaltungssysteme</li> <li>1/2" x 11/128"</li> <li>116 Glieder</li> <li>kompatibel mit <b>Shimano / Sram / Campagnolo</b></li> </ul>	<ul style="list-style-type: none"> <li>for <b>9 speed</b></li> <li>1/2" x 11/128"</li> <li>116 links</li> <li>compatible to <b>Shimano / Sram / Campagnolo</b></li> </ul>		<b>27,90 €</b> 41/19
<b>301908</b> 60	<ul style="list-style-type: none"> <li>für <b>8, 7, 6-fach</b> Schaltungssysteme</li> <li>auch für <b>Nabenschaltungen</b> geeignet</li> <li>1/2" x 3/32"</li> <li>116 Glieder</li> </ul>	<ul style="list-style-type: none"> <li>for <b>8, 7, 6 speed</b></li> <li>also suitable for <b>internal gear hubs</b></li> <li>1/2" x 3/32"</li> <li>116 links</li> </ul>		<b>16,90 €</b> 41/19
<b>301915</b> 60	<ul style="list-style-type: none"> <li>für <b>1-fach</b></li> <li>auch für <b>Nabenschaltungen</b> geeignet</li> <li>1/2" x 1/8"</li> <li>112 Glieder</li> </ul>	<ul style="list-style-type: none"> <li>for <b>single speed</b></li> <li>also suitable for <b>internal gear hubs</b></li> <li>1/2" x 1/8"</li> <li>112 links</li> </ul>	 	<b>9,90 €</b> 41/19
<b>301941</b> 30	<b>FAHRRADKETTEN</b> <ul style="list-style-type: none"> <li>besonders geeignet für <b>E-Bikes</b></li> <li><b>längere Haltbarkeit</b> durch Verstärkungen</li> <li>mit Verschlussglied</li> <li>für <b>Brose, Bosch, Shimano, Bafang, ...</b> Antriebe</li> <li>im M-Wave Einzelkarton</li> </ul> <ul style="list-style-type: none"> <li>für <b>11-fach</b> Schaltungssysteme</li> <li>1/2" x 11/128"</li> <li>116 Glieder</li> </ul>	<b>BICYCLE CHAINS</b> <ul style="list-style-type: none"> <li>particularly suitable for <b>e-bikes</b></li> <li><b>longer durability</b> due to reinforcements</li> <li>with connecting link</li> <li>for <b>Brose, Bosch, Shimano, Bafang, ...</b> drives</li> <li>in M-Wave single box</li> </ul> <ul style="list-style-type: none"> <li>for <b>11 speed</b></li> <li>1/2" x 11/128"</li> <li>116 links</li> </ul>	  	<b>39,90 €</b> 41/19
<b>301940</b> 30	<ul style="list-style-type: none"> <li>für <b>10-fach</b> Schaltungssysteme</li> <li>1/2" x 11/128"</li> <li>116 Glieder</li> </ul>	<ul style="list-style-type: none"> <li>for <b>10 speed</b></li> <li>1/2" x 11/128"</li> <li>116 links</li> </ul>		<b>34,90 €</b> 41/19
<b>301945</b> 30	<ul style="list-style-type: none"> <li>für <b>1-fach</b></li> <li>auch für <b>Nabenschaltungen</b> geeignet</li> <li>1/2" x 3/32"</li> <li>112 Glieder</li> </ul>	<ul style="list-style-type: none"> <li>for <b>1 speed</b></li> <li>also suitable for <b>internal gear hubs</b></li> <li>1/2" x 3/32"</li> <li>112 links</li> </ul>	 	<b>16,90 €</b> 41/19





<b>ART.-NR.</b> 	<b>BESCHREIBUNG</b>	<b>DESCRIPTION</b>	  	<b>UVP</b> verfügbar ab/ available in
<b>311869</b> 10 Paar	<b>CARTRIDGE PEDALACHSE</b> <ul style="list-style-type: none"> <li>gedichtete, CNC-gefräste Titan-Achse</li> <li>mit 2 japanischen Kugellagern</li> <li>Ersatz-Achse für Exustar-Pedal Art. 311855</li> <li>Tuning-Achse für Art. 311853</li> <li>nur 42 g</li> <li>sehr einfach austauschbar</li> <li>1 Paar im Polybeutel mit Exustar Eurolochheader</li> </ul>	<b>CARTRIDGE PEDAL AXLE</b> <ul style="list-style-type: none"> <li>sealed, CNC machined titanium axle</li> <li>with 2 Japanese sealed bearings</li> <li>replacement axle for Exustar pedal art. 311855</li> <li>tuning axle for art. 311853</li> <li>only 42 g</li> <li>very easy to replace</li> <li>1 pair in PE bag with Exustar eurohole header</li> </ul>	 <p>TITANIUM</p> 	<b>139,90 €</b>          35/19
<b>312062</b> 30 Paar	<b>KLICKPEDAL ›DRAG-R2‹</b> <ul style="list-style-type: none"> <li>Aluminiumkörper</li> <li>CrMo-Achse</li> <li>mit Industriekugellager</li> <li>Montage auch mit Innensechskant-Schlüssel möglich</li> <li>Käfig schützt Klickmechanismus</li> <li>mit Schuhplattenset (auch passend für Shimano Pedale)</li> <li>Pedal passt auch für Shimano Schuhplatten (kein original Shimano Ersatzteil)</li> <li>auf M-Wave Eurolochkarte</li> </ul>	<b>CLIPLESS PEDAL ›DRAG-R2‹</b> <ul style="list-style-type: none"> <li>aluminium body</li> <li>CrMo axle</li> <li>with sealed bearing</li> <li>mounting also possible with allen key</li> <li>cage protects click mechanism</li> <li>with cleat set (also suitable for Shimano pedals)</li> <li>pedal also suitable for Shimano cleats (no original Shimano spare part)</li> <li>on M-Wave eurohole card</li> </ul> <p><small>Tested by the manufacturer according to ISO 4210</small></p>	   	<b>44,90 €</b>          36/19
<b>313451</b> 50 Paar	<b>KLICKPEDAL ›DRAG-R1‹</b> <ul style="list-style-type: none"> <li>Aluminiumkörper</li> <li>CrMo-Achse</li> <li>große Auflagefläche für hohen Komfort und optimale Kraftübertragung</li> <li>Look Keo kompatibel</li> <li>mit Schuhplattenset, 9° drehbar</li> <li>nur 327 g/Paar</li> <li>auf M-Wave Eurolochkarte</li> </ul>	<b>CLIPLESS PEDAL ›DRAG-R1‹</b> <ul style="list-style-type: none"> <li>aluminium body</li> <li>CrMo axle</li> <li>large pedalling area for high comfort and great pedalling efficiency</li> <li>Look Keo compatible</li> <li>with cleat set, 9° turnable</li> <li>only 327 g/pair</li> <li>on M-Wave eurohole card</li> </ul>	   	<b>34,90 €</b>          35/19
<b>311921</b> 50 Paar	<b>PEDAL</b> <ul style="list-style-type: none"> <li>Aluminiumkörper und -käfig</li> <li>9/16"-Achse mit hochwertigem Polymer-Gleitlager</li> <li>mit deutschem Prüfzeichen</li> <li>mit Reflektoren</li> <li>beide Trittflächen verwendbar</li> <li>Montage mit Innensechskant</li> <li>Trittfläche: 63 x 87 mm (L x B)</li> <li>Montageverpackung</li> </ul>	<b>PEDAL</b> <ul style="list-style-type: none"> <li>aluminium body and cage</li> <li>9/16" axle with high-quality polymer plain bearing</li> <li>with German approval number</li> <li>with reflectors</li> <li>both treads usable</li> <li>mounting with allen key</li> <li>tread surface: 63 x 87 mm (L x W)</li> <li>OEM</li> </ul> <p><small>Tested by the manufacturer according to ISO 4210</small></p>	 	<b>12,90 €</b>          ~ Jan./20





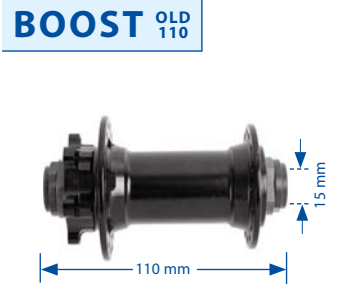
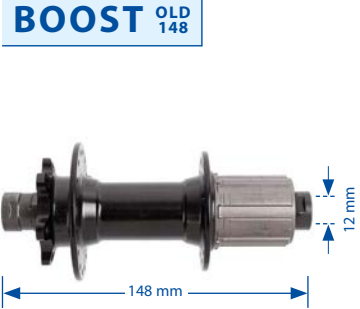

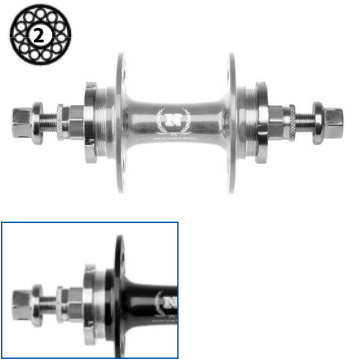















ART.-NR. 	BESCHREIBUNG	DESCRIPTION		UVP verfügbar ab/ available in
<p><b>313176</b></p> <p>50 Paar</p>	<p><b>ANTI-RUTSCHPEDAL</b></p> <ul style="list-style-type: none"> <li>• schwarzer Kunststoffkörper mit <b>sandartiger Anti-Rutschauflage</b></li> <li>• <b>CrMo</b>-Achse</li> <li>• mit <b>Industriekugellager</b></li> <li>• <b>anatomisch</b> geformte, konkave Auflagefläche</li> <li>• mit Reflektoren</li> <li>• mit <b>deutschem Prüfzeichen</b></li> <li>• Trittfläche: 88 x 100 mm (L x B)</li> <li>• auf VP Eurolochkarte</li> </ul>	<p><b>NON-SLIP PEDAL</b></p> <ul style="list-style-type: none"> <li>• black plastic body with <b>sandlike non-slip layer</b></li> <li>• <b>CrMo</b> axle</li> <li>• with <b>sealed bearing</b></li> <li>• <b>anatomically</b> shaped concave supporting surface</li> <li>• with reflectors</li> <li>• with <b>German approval number</b></li> <li>• tread surface: 88 x 100 mm (L x W)</li> <li>• on VP eurohole card</li> </ul> <p style="text-align: right;"><small>Tested by the manufacturer according to ISO 4210</small></p>	   <p><b>ANATOMIC</b></p>  	<p><b>29,90 €</b></p> <p>35/19</p>
<p><b>311511</b></p> <p><b>311510</b></p> <p>50 Paar</p>	<p><b>ANTI-RUTSCHPEDAL ›STEADY SAND‹</b></p> <ul style="list-style-type: none"> <li>• schwarzer Aluminiumkörper mit <b>sandartiger Anti-Rutschauflage</b></li> <li>• <b>Boron</b>-Achse</li> <li>• mit <b>Polymergleitlager</b> und <b>Industriekugellager</b></li> <li>• <b>anatomisch</b> geformte, konkave Auflagefläche</li> <li>• mit Reflektoren</li> <li>• Trittfläche: 87 x 98 mm (L x B)</li> </ul> <p>auf M-Wave Eurolochkarte</p> <p>Montageverpackung</p>	<p><b>NON-SLIP PEDAL ›STEADY SAND‹</b></p> <ul style="list-style-type: none"> <li>• black aluminium body with <b>sandlike non-slip layer</b></li> <li>• <b>boron</b> axle</li> <li>• with <b>polymer plain bearing</b> and <b>sealed bearing</b></li> <li>• <b>anatomically</b> shaped concave supporting surface</li> <li>• with reflectors</li> <li>• tread surface: 87 x 98 mm (L x W)</li> </ul> <p>on M-Wave eurohole card</p> <p>OEM</p> <p style="text-align: right;"><small>Tested by the manufacturer according to ISO 4210</small></p>	   <p><b>ANATOMIC</b></p>  	<p><b>21,90 €</b></p> <p>47/19</p> <p><b>21,90 €</b></p> <p>47/19</p>
<p><b>313340</b></p> <p><b>313341</b></p> <p>40 Paar</p>	<p><b>PLATTFORM-PEDAL ›FREEDOM SL‹</b></p> <ul style="list-style-type: none"> <li>• <b>CNC gefräster Aluminiumkörper</b></li> <li>• <b>CNC gefräste CrMo</b>-Achse</li> <li>• mit <b>Industriekugellager</b></li> <li>• Montage auch mit Innensechskant möglich</li> <li>• mit austauschbaren Pins</li> <li>• gemäß <b>ISO 4210</b>: erhöhte Anforderungen bis <b>140 kg</b></li> <li>• nur <b>297 g</b>/Paar</li> <li>• Trittfläche: 96 x 91 mm (L x B)</li> <li>• auf M-Wave Eurolochkarte</li> </ul> <p>schwarz</p> <p>titangrau</p>	<p><b>FLAT PEDAL ›FREEDOM SL‹</b></p> <ul style="list-style-type: none"> <li>• <b>CNC machined aluminium body</b></li> <li>• <b>CNC machined CrMo</b> axle</li> <li>• with <b>sealed bearing</b></li> <li>• mounting also possible with allen key</li> <li>• with interchangeable pins</li> <li>• according to <b>ISO 4210</b>: increased requirements up to <b>140 kg</b></li> <li>• only <b>297 g</b>/pair</li> <li>• tread surface: 96 x 91 mm (L x W)</li> <li>• on M-Wave eurohole card</li> </ul> <p>black</p> <p>titan grey</p> <p style="text-align: right;"><small>Tested by the manufacturer according to ISO 4210</small></p>	    <p>16 mm</p>  	<p><b>39,90 €</b></p> <p>35/19</p> <p><b>39,90 €</b></p> <p>35/19</p>
<p><b>313181</b></p> <p><b>313180</b></p> <p>50 Paar</p>	<p><b>PLATTFORM-PEDAL</b></p> <ul style="list-style-type: none"> <li>• Kunststoffkörper</li> <li>• mit <b>2 Kugellagern</b></li> <li>• mit <b>deutschem Prüfzeichen</b></li> <li>• mit <b>Reflektoren</b></li> <li>• Montage auch mit <b>Innensechskant</b> möglich</li> <li>• <b>anatomisch</b> geformte, konkave Auflagefläche</li> <li>• Trittfläche: 106 x 101 mm (L x B)</li> </ul> <p>auf M-Wave Eurolochkarte</p> <p>Montageverpackung</p>	<p><b>FLAT PEDAL</b></p> <ul style="list-style-type: none"> <li>• plastic body</li> <li>• with <b>2 ball bearings</b></li> <li>• with <b>German approval number</b></li> <li>• with <b>reflectors</b></li> <li>• mounting also possible with <b>allen key</b></li> <li>• <b>anatomically</b> shaped concave supporting surface</li> <li>• tread surface: 106 x 101 mm (L x W)</li> </ul> <p>on M-Wave eurohole card</p> <p>OEM</p> <p style="text-align: right;"><small>Tested by the manufacturer according to ISO 4210</small></p>	   <p><b>ANATOMIC</b></p>  	<p><b>4,90 €</b></p> <p>~ Jan./20</p> <p><b>4,90 €</b></p> <p>~ Jan./20</p>

ART.-NR.	BESCHREIBUNG	DESCRIPTION		UVP verfügbar ab/ available in
<b>326416</b> 20	<b>VORDERRADSCHIBENBREMS-NABE ›D791SB/A‹</b> <ul style="list-style-type: none"> <li>• <b>24 Loch</b></li> <li>• <b>4 in 1:</b> vorbereitet für <b>12 mm Steckachse</b>, optional umrüstbar durch Ausgleichshülsen für 5 mm (Art. 320117) oder 9 mm (Art. 320118) Schnellspanner und 15 mm (Art. 320120) Steckachse</li> <li>• <b>2 japanische Industriekugellager</b></li> <li>• Aluminium-Achse</li> <li>• nur <b>141 g</b></li> <li>• Einbaumaß: 100 mm</li> <li>• PCD: 58/45 mm, FTF: 62 mm A: 26,2 mm, B: 11,8 mm</li> <li>• im Novatec Einzelkarton</li> </ul>	<b>FRONT DISC BRAKE HUB ›D791SB/A‹</b> <ul style="list-style-type: none"> <li>• <b>24 hole</b></li> <li>• <b>4 in 1:</b> prepared for <b>12 mm thru axle</b>, optionally convertible through spacers to 5 mm (art. 320117) or 9 mm (art. 320118) QR and 15 mm thru axle (art. 320120)</li> <li>• <b>2 Japanese sealed bearings</b></li> <li>• aluminium axle</li> <li>• only <b>141 g</b></li> <li>• OLD: 100 mm</li> <li>• PCD: 58/45 mm, FTF: 62 mm A: 26.2 mm, B: 11.8 mm</li> <li>• in Novatec box</li> </ul>	<div style="display: flex; align-items: center;"> <div style="margin-right: 10px;"> <p><b>4 IN 1</b></p> <p><b>24 HOLE</b></p>  <p>Japan</p> </div> <div style="margin-right: 10px;">  </div> <div>  <p>141 g</p> </div> </div> 	<b>64,90 €</b>
<b>326473</b> 20	<b>HINTERRADSCHIBENBREMS-NABE ›D792SB/A-AA-11S‹</b> <ul style="list-style-type: none"> <li>• <b>24 Loch</b></li> <li>• <b>4 in 1:</b> ausgestattet mit <b>12 mm Steckachse</b>, optional umrüstbar durch Umrüstsets für 5 mm Schnellspanner (Art. 320112), 10 mm (Art. 320079) und 12x135 mm Steckachse (Art. 320080)</li> <li>• <b>4 japanische Industriekugellager</b></li> <li>• Aluminium-Achse</li> <li>• kompatibel mit Shimano 8-11-fach (MTB+Road)</li> <li>• umrüstbar auf Sram XX1 und X01 durch Kassettenkörper Art. 326293 und für 12-fach Sram-Kassetten durch Kassettenkörper Art. 326272</li> <li>• nur <b>268 g</b></li> <li>• Einbaumaß: 142 mm</li> <li>• PCD: 58/49 mm, FTF: 56,4 mm A: 31,5 mm, B: 47,1 mm</li> <li>• im Novatec Einzelkarton</li> </ul>	<b>REAR DISC BRAKE HUB ›D792SB/A-AA-11S‹</b> <ul style="list-style-type: none"> <li>• <b>24 hole</b></li> <li>• <b>4 in 1:</b> equipped with <b>12 mm thru axle</b>, optionally convertible through spacers to 5 mm QR (art. 320112), 10 mm thru axle (art. 320079) and 12x135 mm thru axle (art. 320080)</li> <li>• <b>4 Japanese sealed bearings</b></li> <li>• aluminium axle</li> <li>• compatible with Shimano 8-11 speed (MTB+Road)</li> <li>• convertible to Sram XX1 and X01 by cassette body art. 326293 and for 12 speed Sram cassettes by cassette body art. 326272</li> <li>• only <b>268 g</b></li> <li>• OLD: 142 mm</li> <li>• PCD: 58/49 mm, FTF: 56.4 mm A: 31.5 mm, B: 47.1 mm</li> <li>• in Novatec box</li> </ul>	<div style="display: flex; align-items: center;"> <div style="margin-right: 10px;">  <p>Japan</p> </div> <div style="margin-right: 10px;">  </div> <div>  <p>268 g</p> </div> </div>  	<b>119,90 €</b>
<b>326572</b> 20	<b>HINTERRADSCHIBENBREMS-NABE ›D932SB-B12-S66S-11S‹</b> <ul style="list-style-type: none"> <li>• <b>verstärkte Nabe</b> um den erhöhten Anforderungen von <b>E-Bikes</b> zu entsprechen</li> <li>• für <b>12 mm Steckachse</b></li> <li>• 32 Loch</li> <li>• mit <b>4 Industriekugellagern</b></li> <li>• kompatibel mit Shimano 8-11fach (MTB + Road)</li> <li>• Kassettenkörper mit <b>2 x 6 Sperrklinken</b> und Ratchet Ring mit <b>48 Zähnen</b> für schnelle Kraftübertragung <b>fast ohne Verzögerung</b></li> <li>• Ersatzkassettenkörper Sram XD Drive, E-Typ, Art. 326282</li> <li>• Einbaumaß: <b>148 mm</b></li> <li>• PCD: 62 mm, FTF: 61,6 mm A: 35,6 mm, B: 50,8 mm</li> <li>• im Novatec Einzelkarton</li> </ul>	<b>REAR DISC BRAKE HUB ›D932SB-B12-S66S-11S‹</b> <ul style="list-style-type: none"> <li>• <b>reinforced hub</b> to conform to the increased demands of <b>e-bikes</b></li> <li>• for <b>12 mm thru axle</b></li> <li>• 32 hole</li> <li>• with <b>4 sealed bearings</b></li> <li>• compatible with Shimano 8-11 speed (MTB+Road)</li> <li>• cassette body with <b>2 x 6 pawls</b> and ratchet ring with <b>48 teeth</b> for fast power transmission nearly <b>without delay</b></li> <li>• replacement cassette body Sram XD Drive, E-Type, art. 326282</li> <li>• OLD: <b>148 mm</b></li> <li>• PCD: 62 mm, FTF: 61.6 mm A: 35.6 mm, B: 50.8 mm</li> <li>• in Novatec box</li> </ul>	<div style="display: flex; align-items: center;"> <div style="margin-right: 10px;">  </div> <div style="margin-right: 10px;"> <p><b>BOOST</b></p> </div> <div style="margin-right: 10px;">  </div> </div> 	<b>199,00 €</b>





Tested by the manufacturer according to E-Bike Norm DIN EN 15194

ART.-NR. 	BESCHREIBUNG	DESCRIPTION		UVP verfügbar ab/ available in
<b>326427</b> 30	<b>VORDERRADSCHEIBEN-BREMSNABE</b> <ul style="list-style-type: none"> <li>• <b>Boost</b></li> <li>• Aluminium</li> <li>• 32 Loch</li> <li>• für <b>15 mm Steckachse</b></li> <li>• nur 298 g</li> <li>• Einbaumaß: <b>110 mm</b></li> <li>• PCD: 58/49 mm, FTF: 63,8 mm</li> <li>• A: 26 mm, B: 20,2 mm</li> <li>• neutral, ohne Logo</li> <li>• Montageverpackung</li> </ul>	<b>FRONT DISC BRAKE HUB</b> <ul style="list-style-type: none"> <li>• <b>boost</b></li> <li>• aluminium</li> <li>• 32 hole</li> <li>• for <b>15 mm thru axle</b></li> <li>• only 298 g</li> <li>• OLD: <b>110 mm</b></li> <li>• PCD: 58/49 mm, FTF: 63.8 mm</li> <li>• A: 26 mm, B: 20.2 mm</li> <li>• neutral, without Logo</li> <li>• OEM</li> </ul>		<b>34,90 €</b>  35/19
<b>326428</b> 30	<b>HINTERRADSCHEIBEN-BREMSNABE</b> <ul style="list-style-type: none"> <li>• <b>Boost</b></li> <li>• Aluminium</li> <li>• 32 Loch</li> <li>• für <b>12 mm Steckachse</b></li> <li>• für 8-11 (MTB)-fach Shimano</li> <li>• nur 394 g</li> <li>• Einbaumaß: <b>148 mm</b></li> <li>• PCD: 58/49 mm, FTF: 64 mm</li> <li>• A: 35 mm, B: 49 mm</li> <li>• neutral, ohne Logo</li> <li>• Montageverpackung</li> </ul>	<b>REAR DISC BRAKE HUB</b> <ul style="list-style-type: none"> <li>• <b>boost</b></li> <li>• aluminium</li> <li>• 32 hole</li> <li>• for <b>12 mm thru axle</b></li> <li>• for 8-11 (MTB) speed Shimano</li> <li>• only 394 g</li> <li>• OLD: <b>148 mm</b></li> <li>• PCD: 58/49 mm, FTF: 64 mm</li> <li>• A: 35 mm, B: 49 mm</li> <li>• neutral, without Logo</li> <li>• OEM</li> </ul>		<b>54,90 €</b>  35/19
<b>326700</b>  <b>326701</b> 25	<b>VORDERRADNABE ›A565 SBT‹</b> <ul style="list-style-type: none"> <li>• für Vorderrad Hochflansch</li> <li>• mit <b>2 Industriekugellagern</b></li> <li>• <b>CrMo</b>-Achse M9 x 140 mm</li> <li>• Einbaumaß: 100 mm</li> <li>• PCD: 62 mm, FTF: 70 mm</li> <li>• A: 15 mm, B: 15 mm</li> <li>• Montageverpackung</li> </ul> <p><b>36 Loch</b>, silber</p> <p><b>32 Loch</b>, schwarz eloxiert</p>	<b>FRONT HUB ›A565 SBT‹</b> <ul style="list-style-type: none"> <li>• front high flange</li> <li>• with <b>2 sealed bearings</b></li> <li>• <b>CrMo</b> axle M9 x 140 mm</li> <li>• OLD: 100 mm</li> <li>• PCD: 62 mm, FTF: 70 mm</li> <li>• A: 15 mm, B: 15 mm</li> <li>• OEM</li> </ul> <p><b>36 hole</b>, silver</p> <p><b>32 hole</b>, black anodised</p>		<b>34,90 €</b> 35/19 <b>34,90 €</b> 35/19
<b>326702</b>  <b>326703</b> 25	<b>HINTERRADNABE ›A566 SBT‹</b> <ul style="list-style-type: none"> <li>• für Hinterrad Hochflansch</li> <li>• mit <b>2 Industriekugellagern</b></li> <li>• <b>CrMo</b>-Achse M10 x 165 mm</li> <li>• Einbaumaß: 120 mm</li> <li>• PCD: 62 mm, FTF: 59 mm</li> <li>• A: 30,5 mm, B: 30,5 mm</li> <li>• Montageverpackung</li> </ul> <p>Gewinde 1,37" und 1,29" <b>beidseitig</b></p> <p><b>36 Loch</b>, silber</p> <p><b>32 Loch</b>, schwarz eloxiert</p>	<b>REAR HUB ›A566 SBT‹</b> <ul style="list-style-type: none"> <li>• rear high flange</li> <li>• with <b>2 sealed bearings</b></li> <li>• <b>CrMo</b> axle M10 x 165 mm</li> <li>• OLD: 120 mm</li> <li>• PCD: 62 mm, FTF: 59 mm</li> <li>• A: 30.5 mm, B: 30.5 mm</li> <li>• OEM</li> </ul> <p>thread 1.37" and 1.29" on <b>both sides</b></p> <p><b>36 hole</b>, silver</p> <p><b>32 hole</b>, black anodised</p>		<b>49,90 €</b> 35/19 <b>49,90 €</b> 35/19
<b>326704</b> 50	<ul style="list-style-type: none"> <li>• <b>free/ fixed</b></li> <li>• Gewinde 1,37" und 1,37/1,29"</li> <li>• <b>32 Loch</b>, schwarz eloxiert</li> </ul>	<ul style="list-style-type: none"> <li>• <b>free/ fixed</b></li> <li>• thread 1.37" and 1.37/1.29"</li> <li>• <b>32 hole</b>, black anodised</li> </ul>		<b>49,90 €</b>  ~ Nov./19









ART.-NR. 	BESCHREIBUNG	DESCRIPTION		UVP verfügbar ab/ available in
<p><b>326282</b> 50</p>	<p><b>KASSETTENKÖRPER</b></p> <p>Typ ›E‹</p> <ul style="list-style-type: none"> <li>für E-Bike Nabe Art. 326572</li> <li>XD Drive für <b>Sram XX1</b> Kassette</li> <li><b>12 Sperrklinken</b></li> <li>im Novatec Einzelkarton</li> </ul>	<p><b>CASSETTE BODY</b></p> <p>›E‹ type</p> <ul style="list-style-type: none"> <li>for e-bike hub art. 326572</li> <li>XD Drive for <b>Sram XX1</b> cassette</li> <li><b>12 pawls</b></li> <li>in Novatec Box</li> </ul>	   	<p><b>89,90 €</b></p> <p>35/19</p> <p><b>69,00 €</b></p> <p>35/19</p>
<p><b>321195</b> 200</p>	<p><b>STECKACHSE MIT HEBEL</b> ›SCRAX B-12 148 QR‹</p> <ul style="list-style-type: none"> <li><b>versenkbarer</b> Schnellspann-Hebel</li> <li><b>Einbaumaß 148 mm</b></li> <li><b>Aluminium</b>, nur <b>55 g</b></li> <li>M12 x Länge 178 mm</li> <li>Gewindesteigung 1,5 mm</li> <li>Gewindelänge 15 mm</li> <li>z.B. für MTB- oder E-Bike-Rahmen Art. 613620 ff.</li> <li>Montageverpackung</li> </ul>	<p><b>THRU AXLE WITH LEVER</b> ›SCRAX B-12 148 QR‹</p> <ul style="list-style-type: none"> <li><b>hidden</b> QR lever</li> <li><b>OLD 148 mm</b></li> <li><b>aluminium</b>, only <b>55 g</b></li> <li>M12 x length 178 mm</li> <li>thread pitch: 1.5 mm</li> <li>thread length: 15 mm</li> <li>e.g. for MTB or e-bike frames art. 613620 et seq.</li> <li>OEM</li> </ul>	   	<p><b>36,90 €</b></p> <p>35/19</p>
<p><b>340051</b></p> <p><b>340053</b> 100</p>	<p><b>FLASCHENHALTER</b></p> <ul style="list-style-type: none"> <li>besonders geeignet für <b>E-Bike Rahmengemetrien</b> mit eingeschränktem Platz</li> <li>nach außen gebogene Ränder <b>erleichtern</b> das Einführen der Flasche</li> <li>mit Befestigungsschrauben</li> <li>auf M-Wave Eurolochkarte</li> </ul> <p>›BC 29 Side‹</p> <ul style="list-style-type: none"> <li>Flasche kann <b>auch von der Seite</b> leicht eingeführt und entnommen werden</li> <li>nur 29 g</li> </ul> <p>›BC 26 Side‹</p> <ul style="list-style-type: none"> <li>Flasche kann auch <b>schräg von der Seite</b> leicht eingeführt und entnommen werden</li> <li>nur 26 g</li> </ul>	<p><b>BOTTLE CAGE</b></p> <ul style="list-style-type: none"> <li>especially suitable for <b>e-bike frame geometries</b> with limited space</li> <li>outward chamfered edge <b>makes it easier</b> to put the bottle in</li> <li>with mounting screws</li> <li>on M-Wave eurohole card</li> </ul> <p>›BC 29 Side‹</p> <ul style="list-style-type: none"> <li>bottle can be easily put in and taken away, also <b>from the side</b></li> <li>only 29 g</li> </ul> <p>›BC 26 Side‹</p> <ul style="list-style-type: none"> <li>bottle can be easily put in and taken away, also <b>diagonal from the side</b></li> <li>only 26 g</li> </ul>	        	<p><b>4,90 €</b></p> <p>01/20</p> <p><b>4,90 €</b></p> <p>01/20</p>
<p><b>340018</b> 100</p>	<p><b>FLASCHENHALTER</b> ›BC 45‹</p> <ul style="list-style-type: none"> <li><b>Aluminium</b> und hochwertiger Kunststoff</li> <li>nur 45 g</li> <li>guter Halt der Flasche durch <b>flexibles Rückenteil</b></li> <li>mit Befestigungsschrauben</li> <li>auf M-Wave Eurolochkarte</li> </ul>	<p><b>BOTTLE CAGE</b> ›BC 45‹</p> <ul style="list-style-type: none"> <li><b>aluminium</b> and high quality plastic</li> <li>only 45 g</li> <li>good hold of the bottle due to <b>flexible back part</b></li> <li>with mounting screws</li> <li>on M-Wave eurohole card</li> </ul>	  	<p><b>4,90 €</b></p> <p>43/19</p>



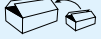

ART.-NR. 	BESCHREIBUNG	DESCRIPTION		UVP verfügbar ab/ available in
<b>340152</b> 250	<b>FLASCHENHALTER</b> <ul style="list-style-type: none"> <li>• <b>universell</b> passend für handelsübliche <b>Trinkflaschen, Kaffeebecher, ...</b></li> <li>• aus hochwertigem Kunststoff</li> <li>• nur 24 g</li> <li>• für Lenker, ...</li> <li>• Befestigungsklemme Ø 22,2 - 25,4 mm</li> <li>• auf Eurolochkarte</li> </ul>	<b>BOTTLE CAGE</b> <ul style="list-style-type: none"> <li>• <b>universally</b> suitable for customary <b>bottles, coffee mugs, ...</b></li> <li>• made of high quality plastic</li> <li>• only 24 g</li> <li>• for handlebar, ...</li> <li>• mounting clamp Ø 22.2 - 25.4 mm</li> <li>• on eurohole card</li> </ul>		<b>3,90 €</b>  35/19
<b>340013</b> 100	<b>FLASCHENHALTER-ADAPTER ›ADA SLIDE‹</b> <ul style="list-style-type: none"> <li>• zur optimalen Montage eines Flaschenhalters bei <b>verschiedensten Rahmengeometrien</b> oder bei eingeschränktem Platz an E-Bikes</li> <li>• <b>90 mm (+/- 45 mm) Verstellbereich</b> in der Höhe</li> <li>• aus Aluminium</li> <li>• inkl. Befestigungsmaterial</li> <li>• in M-Wave Eurolochbox</li> </ul>	<b>BOTTLE CAGE ADAPTER ›ADA SLIDE‹</b> <ul style="list-style-type: none"> <li>• for optimal mounting of a bottle cage at <b>most different frame geometries</b> or for e-bikes with little space for bottle cage mounting</li> <li>• <b>90 mm (+/- 45 mm) height adjustment range</b></li> <li>• made of aluminium</li> <li>• incl. fixing material</li> <li>• in M-Wave eurohole box</li> </ul>		<b>9,90 €</b>  35/19
<b>340041</b> 20 Set	<b>FLASCHENHALTER-ADAPTER ›ADA BC FLEX 2‹</b> <ul style="list-style-type: none"> <li>• zur universellen Montage eines Flaschenhalters an unterschiedlichen Stellen, bei <b>verschiedensten Rahmen-geometrien</b> oder bei eingeschränktem Platz an E-Bikes</li> <li>• schnelle und flexible <b>Montage-möglichkeiten durch</b> non-slip Klettbänder (Art. 340042)</li> <li>• 1 Set = 2 Paar</li> <li>• auf M-Wave Eurolochkarte</li> </ul>	<b>BOTTLE CAGE ADAPTER ›ADA BC FLEX 2‹</b> <ul style="list-style-type: none"> <li>• for universal mounting of a bottle cage at different places, at <b>most different frame geometries</b> or for e-bikes with little space for bottle cage mounting</li> <li>• fast and flexible <b>mounting possibilities</b> by non-slip hook and loop fasteners (art. 340042)</li> <li>• 1 set = 2 pairs</li> <li>• on M-Wave eurohole card</li> </ul>		<b>9,90 €</b>  46/19
<b>340042</b> 3.000	<b>UNIVERSALBEFESTIGUNGS-BAND</b> <ul style="list-style-type: none"> <li>• Klettband</li> <li>• mit Silikon-Antirutsch-Streifen</li> <li>• Länge: 25 cm, Breite: 2 cm</li> <li>• Montageverpackung</li> </ul>	<b>UNIVERSAL MOUNTING TAPE</b> <ul style="list-style-type: none"> <li>• hook and loop fastener</li> <li>• with silicone non-slip stripes</li> <li>• length: 25 cm, width: 2 cm</li> <li>• OEM</li> </ul>		<b>0,99 €</b>  46/19
<b>340212</b> <b>340213</b> <b>340214</b> 100/10 Set	<b>KINDERTRINKFLASCHE MIT HALTER</b> <ul style="list-style-type: none"> <li>• 300 ml Volumen</li> <li>• mit Motivaufklebern und Staubschutzkappe</li> <li>• <b>inkl. Halter</b> und gleichfarbigem Kabelbinder für <b>universelle Befestigungsmöglichkeiten</b> am Rahmen, Lenker, ...</li> <li>• Montageverpackung</li> </ul>	<b>CHILDREN WATER BOTTLE WITH CAGE</b> <ul style="list-style-type: none"> <li>• 300 ml volume</li> <li>• with design stickers and protection cap</li> <li>• <b>incl. cage</b> and cable tie in the same colour for <b>universal mounting possibilities</b> at the frame, handlebar, ...</li> <li>• OEM</li> </ul>		<b>3,90 €</b> 35/19 <b>3,90 €</b> 35/19 <b>3,90 €</b> 35/19

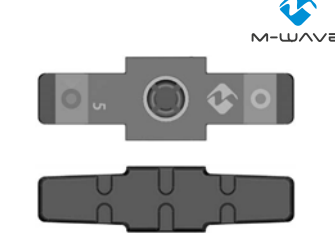



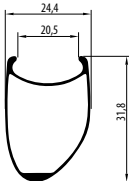

ART.-NR. 	BESCHREIBUNG	DESCRIPTION		UVP verfügbar ab/ available in
	<p><b>E-BIKE KETTENBLÄTTER</b></p> <ul style="list-style-type: none"> <li>für 1/2 x 3/32" und 1/2 x 11/128" Ketten</li> <li>für <b>Bosch</b> E-Bikemotoren Generation 1 und 3 und <b>Brose</b> E-Bikemotoren (kein original Bosch/Brose Ersatzteil)</li> <li>gerade, nicht gekröpft</li> <li>Lochkreis 104 mm</li> </ul> <p><b>Montageverpackung</b></p> <ul style="list-style-type: none"> <li><b>356200</b> 32 Zähne</li> <li><b>356201</b> 36 Zähne</li> <li><b>352685</b> 38 Zähne</li> <li><b>356220</b> 40 Zähne</li> <li><b>352686</b> 42 Zähne</li> <li><b>352687</b> 44 Zähne</li> <li><b>356228</b> 46 Zähne</li> </ul> <p><b>auf M-Wave Eurolochkarte</b></p> <ul style="list-style-type: none"> <li><b>356204</b> 36 Zähne</li> <li><b>NEW</b> <b>352682</b> 38 Zähne</li> <li><b>356205</b> 40 Zähne</li> <li><b>NEW</b> <b>352683</b> 42 Zähne</li> <li><b>352684</b> 44 Zähne</li> <li><b>356206</b> 46 Zähne</li> <li><b>NEW</b> 50</li> </ul>	<p><b>E-BIKE CHAINRINGS</b></p> <ul style="list-style-type: none"> <li>for 1/2 x 3/32" and 1/2 x 11/128" chains</li> <li>for <b>Bosch</b> e-bike engines generation 1 and 3 and <b>Brose</b> e-bike engines (no original Bosch/Brose spare part)</li> <li>0 Offset</li> <li>bolt circle 104 mm</li> </ul> <p><b>OEM</b></p> <ul style="list-style-type: none"> <li>32 teeth</li> <li>36 teeth</li> <li>38 teeth</li> <li>40 teeth</li> <li>42 teeth</li> <li>44 teeth</li> <li>46 teeth</li> </ul> <p><b>on M-Wave eurohole card</b></p> <ul style="list-style-type: none"> <li>36 teeth</li> <li>38 teeth</li> <li>40 teeth</li> <li>42 teeth</li> <li>44 teeth</li> <li>46 teeth</li> </ul>	<p><b>BOSCH ✓</b> GENERATION 1 + 3</p> <p><b>M-WAVE</b></p> <p><b>BROSE ✓</b></p> <p><b>E</b></p> <p>32 - 40 teeth</p> <p>42 - 46 teeth</p> 	<p>9,90 €</p> <p>9,90 €</p> <p>9,90 €</p> <p>9,90 €</p> <p>9,90 €</p> <p>9,90 €</p> <p>9,90 €</p> <p>9,90 €</p> <p>9,90 €</p> <p>9,90 €</p> <p>9,90 €</p> <p>9,90 €</p> <p>9,90 €</p> <p>35/19</p>
	<p><b>KETTENSCHUTZ</b></p> <ul style="list-style-type: none"> <li>für <b>Brose Motor Drive S + C + T + TF</b></li> <li>aus <b>Aluminium</b></li> <li>schwarz</li> <li>Montageverpackung</li> </ul> <ul style="list-style-type: none"> <li><b>356285</b> 42 - 44 Zähne</li> <li><b>356286</b> 46 - 48 Zähne</li> </ul> <p>100/10</p>	<p><b>CHAIN GUARD</b></p> <ul style="list-style-type: none"> <li>for <b>Brose Motor Drive S + C + T + TF</b></li> <li>made of <b>aluminium</b></li> <li>black</li> <li>OEM</li> </ul> <ul style="list-style-type: none"> <li>42 - 44 teeth</li> <li>46 - 48 teeth</li> </ul>	<p><b>E</b></p> <p><b>BROSE ✓</b></p> 	<p>11,90 €</p> <p>38/19</p> <p>11,90 €</p> <p>38/19</p>
	<p><b>HALTER FÜR KETTENSCHUTZ</b></p> <ul style="list-style-type: none"> <li>für <b>Brose Motor Drive S + C + T + TF</b></li> <li>mit 2 <b>Halte winkeln</b></li> <li>schwarz</li> <li>inkl. Befestigungsschrauben</li> <li>Montageverpackung</li> </ul> <ul style="list-style-type: none"> <li><b>356287</b> passend zu Art. 356285 (42 - 44 Zähne)</li> <li><b>356297</b> passend zu Art. 356286 (46 - 48 Zähne)</li> </ul> <p>200/10</p>	<p><b>BRACKET FOR CHAIN GUARD</b></p> <ul style="list-style-type: none"> <li>for <b>Brose Motor Drive S + C + T + TF</b></li> <li>with 2 <b>angle brackets</b></li> <li>black</li> <li>incl. mounting screws</li> <li>OEM</li> </ul> <ul style="list-style-type: none"> <li>suitable for art. 356285 (42 - 44 teeth)</li> <li>suitable for art. 356286 (46 - 48 teeth)</li> </ul>		<p>5,90 €</p> <p>38/19</p> <p>5,90 €</p> <p>38/19</p>
	<p><b>HALTEWINKEL</b></p> <ul style="list-style-type: none"> <li>zur Befestigung des Kettenschutzes an der Sitzrohrstrebe oder am Ausfallende</li> <li>aus <b>Aluminium</b></li> <li>passend zu Art. 356285/6</li> <li>schwarz</li> <li>inkl. Befestigungsmaterial</li> <li>Montageverpackung</li> </ul> <p>4.000</p>	<p><b>ANGLE BRACKET</b></p> <ul style="list-style-type: none"> <li>for fixing the chain guard at the seat stay or at the drop out</li> <li>made of <b>aluminium</b></li> <li>suitable for art. 356285/6</li> <li>black</li> <li>incl. mounting material</li> <li>OEM</li> </ul>		<p>0,99 €</p> <p>38/19</p>

ART.-NR. 	BESCHREIBUNG	DESCRIPTION		UVP verfügbar ab/ available in
<b>361770</b> 100/10 Paar	<b>CARTRIDGE RENNRAD-BREMSSCHUHE ›BPR-RR-BASE-ALU‹</b> <ul style="list-style-type: none"> <li>• <b>Aluminium</b>-Bremsschuhe mit <b>austauschbaren</b> Bremsgummis</li> <li>• Länge: 55 mm</li> <li>• auch für Rennradbremsen von Shimano (Dura Ace, Ultegra, ...; kein original Shimano-Ersatzteil)</li> <li>• für trockene und nasse Verhältnisse</li> <li>• für alle Stahl- und Aluminiumfelgen</li> <li>• paarweise auf M-Wave Eurolochkarte</li> </ul>	<b>CARTRIDGE ROAD RACING BRAKE SHOES ›BPR-RR-BASE-ALU‹</b> <ul style="list-style-type: none"> <li>• <b>aluminium</b> brake shoes with <b>replaceable</b> brake rubbers</li> <li>• length: 55 mm</li> <li>• also for racing brakes of Shimano (Dura Ace, Ultegra, ...; no original Shimano spare part)</li> <li>• for dry and wet conditions</li> <li>• for all steel- and aluminium rims</li> <li>• 1 pair on M-Wave eurohole card</li> </ul> <p style="text-align: right; font-size: small;">Tested by the manufacturer according to ISO 4210</p>		<b>8,90 €</b>          35/19
<b>361772</b> 100/10 Paar	<b>BREMSSCHUH-ERSATZBELAG ›BPR-INSERT-RR‹</b> <ul style="list-style-type: none"> <li>• passend für Art. 361770 und Shimano Bremsen (Dura Ace, Ultegra, ...; kein original Shimano Ersatzteil)</li> <li>• paarweise auf M-Wave Eurolochkarte</li> </ul>	<b>BRAKE SHOE REPLACEMENT RUBBER ›BPR-INSERT-RR‹</b> <ul style="list-style-type: none"> <li>• suitable for art. 361770 and Shimano brakes (Dura Ace, Ultegra, ...; no original Shimano spare part)</li> <li>• 1 pair on M-Wave eurohole card</li> </ul>		<b>2,90 €</b>          35/19
<b>361742</b> 100/10 Paar	<b>CARTRIDGE V-BREMSSCHUHE ›BPR-VC-BASE-ALU‹</b> <ul style="list-style-type: none"> <li>• <b>Aluminium</b>-Bremsschuhe mit <b>austauschbaren</b> Bremsgummis</li> <li>• Länge: 72 mm</li> <li>• für V-Bremsen</li> <li>• für trockene und nasse Verhältnisse</li> <li>• für alle Stahl- und Aluminiumfelgen</li> <li>• paarweise auf M-Wave Eurolochkarte</li> </ul>	<b>CARTRIDGE V-BRAKE SHOES ›BPR-VC-BASE-ALU‹</b> <ul style="list-style-type: none"> <li>• <b>aluminium</b> brake shoes with <b>replaceable</b> brake rubbers</li> <li>• length: 72 mm</li> <li>• for V-brakes</li> <li>• for dry and wet conditions</li> <li>• for all steel- and aluminium rims</li> <li>• 1 pair on M-Wave eurohole card</li> </ul> <p style="text-align: right; font-size: small;">Tested by the manufacturer according to ISO 4210</p>		<b>8,90 €</b>          35/19
<b>361771</b> 100/10 Paar	<b>BREMSSCHUH-ERSATZBELAG ›BPR-INSERT-VC‹</b> <ul style="list-style-type: none"> <li>• passend für Art. 361742, ...</li> <li>• mit <b>Nirosta</b>-Stift</li> <li>• paarweise auf M-Wave Eurolochkarte</li> </ul>	<b>BRAKE SHOE REPLACEMENT RUBBER ›BPR-INSERT-VC‹</b> <ul style="list-style-type: none"> <li>• suitable for art. 361742, ...</li> <li>• with <b>stainless</b> pin</li> <li>• 1 pair on M-Wave eurohole card</li> </ul>		<b>2,90 €</b>          35/19
<b>361021</b> 100/10 Paar	<b>V-BREMSSCHUHE ›BPR-VC-DUAL‹</b> <ul style="list-style-type: none"> <li>• mit <b>2-farbigen</b> Bremsgummis: <b>2 Farben = 2 Funktionen durch 2 Profile:</b> <b>schwarz</b> = starke Bremswirkung <b>rot</b> = Wasserverdrängung</li> <li>• Länge: 72 mm</li> <li>• für V-Bremsen</li> <li>• für trockene und nasse Verhältnisse</li> <li>• für alle Stahl- und Aluminiumfelgen</li> <li>• Bolzen mit Gewinde und Befestigungsmaterial</li> <li>• paarweise auf M-Wave Eurolochkarte</li> </ul>	<b>V-BRAKE SHOES ›BPR-VC-DUAL‹</b> <ul style="list-style-type: none"> <li>• with <b>2 coloured</b> brake shoes <b>2 colours = 2 functions through 2 profiles:</b> <b>black</b> = extra grip <b>red</b> = water displacement</li> <li>• length: 72 mm</li> <li>• for V-brakes</li> <li>• for dry and wet conditions</li> <li>• for all steel- and aluminium rims</li> <li>• bolt with thread and mounting material</li> <li>• 1 pair on M-Wave eurohole card</li> </ul> <p style="text-align: right; font-size: small;">Tested by the manufacturer according to ISO 4210</p>		<b>4,90 €</b>          35/19





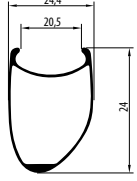





ART.-NR. 	BESCHREIBUNG	DESCRIPTION		UVP verfügbar ab/ available in
<b>361020</b> 100/10 Paar	<b>V-BREMSSCHUHE</b> <b>›BPR-VC-BASE‹</b> <ul style="list-style-type: none"> <li>• Länge: 72 mm</li> <li>• für V-Bremsen</li> <li>• für trockene und nasse Verhältnisse</li> <li>• für alle Stahl- und Aluminiumfelgen</li> <li>• Bolzen mit Gewinde und Befestigungsmaterial</li> <li>• paarweise auf M-Wave Eurolochkarte</li> </ul>	<b>V-BRAKE SHOES</b> <b>›BPR-VC-BASE‹</b> <ul style="list-style-type: none"> <li>• length: 72 mm</li> <li>• for V-brakes</li> <li>• for dry and wet conditions</li> <li>• for all steel- and aluminium rims</li> <li>• bolt with thread and mounting material</li> <li>• 1 pair on M-Wave eurohole card</li> </ul> <p style="text-align: right; font-size: small;"><a href="#">Tested by the manufacturer according to ISO 4210</a></p>		<b>2,90 €</b>  35/19
<b>361023</b> 300  <b>361022</b> 100/10 Paar	<b>V-BREMSSCHUHE</b> <b>›BPR-VC-NT‹</b> <ul style="list-style-type: none"> <li>• Länge: 72 mm</li> <li>• für trockene und nasse Verhältnisse</li> <li>• für alle Stahl- und Aluminiumfelgen</li> <li>• Bolzen ohne Gewinde</li> </ul> <p>• paarweise im Polybeutel</p> <p>• paarweise auf M-Wave Eurolochkarte</p>	<b>V BRAKE SHOES</b> <b>›BPR-VC-NT‹</b> <ul style="list-style-type: none"> <li>• length: 72 mm</li> <li>• for dry and wet conditions</li> <li>• for all steel- and aluminium rims</li> <li>• bolt without thread</li> </ul> <p>• 1 pair in PE bag</p> <p>• 1 pair on M-Wave eurohole card</p> <p style="text-align: right; font-size: small;"><a href="#">Tested by the manufacturer according to ISO 4210</a></p>		<b>2,90 €</b> 36/19  <b>2,90 €</b> 35/19
<b>361030</b> 100/10 Paar	<b>BREMSSCHUHE</b> <b>›BPR-T‹</b> <ul style="list-style-type: none"> <li>• Länge: 55 mm</li> <li>• für trockene und nasse Verhältnisse</li> <li>• für alle Stahl- und Aluminiumfelgen</li> <li>• Bolzen mit Gewinde und Befestigungsmaterial</li> <li>• paarweise auf M-Wave Eurolochkarte</li> </ul>	<b>BRAKE SHOES</b> <b>›BPR-T‹</b> <ul style="list-style-type: none"> <li>• length: 55 mm</li> <li>• for dry and wet conditions</li> <li>• for all steel- and aluminium rims</li> <li>• bolt with thread and mounting material</li> <li>• 1 pair on M-Wave eurohole card</li> </ul> <p style="text-align: right; font-size: small;"><a href="#">Tested by the manufacturer according to ISO 4210</a></p>		<b>2,90 €</b>  35/19
<b>361792</b> 500/100 Paar	<b>BREMSSCHUHE FÜR HYDRAULISCHE FELGENBREMSEN</b> <b>›BPR-HY‹</b> <ul style="list-style-type: none"> <li>• für <b>Aluminium-</b> und <b>Stahlfelgen</b></li> <li>• z. B. für <b>Magura HS11, HS22, HS33R, HS33R Trial, HS33 R FIRMtech</b> (kein original Magura Ersatzteil)</li> <li>• <b>50 mm</b></li> <li>• paarweise im <b>Polybeutel</b></li> </ul>	<b>BRAKE SHOES FOR HYDRAULIC RIM BRAKES</b> <b>›BPR-HY‹</b> <ul style="list-style-type: none"> <li>• for <b>aluminium</b> and <b>steel</b> rims</li> <li>• e. g. <b>Magura HS11, HS22, HS33R, HS33R Trial, HS33 R FIRMtech</b> (no original Magura spare part)</li> <li>• <b>50 mm</b></li> <li>• 1 pair in <b>PE bag</b></li> </ul> <p style="text-align: right; font-size: small;"><a href="#">Tested by the manufacturer according to ISO 4210</a></p>		<b>5,90 €</b>  36/19
<b>• 381011</b> 10	<b>FELGE ›VENTURA DOUBLE‹</b> <ul style="list-style-type: none"> <li>• 26"</li> <li>• <b>Aluminium</b></li> <li>• mit Verschleißanzeige</li> <li>• <b>CNC aufgeraute Bremsflanken (GBS)</b></li> <li>• <b>32 Loch</b></li> <li>• für AV/DV/FV</li> <li>• schwarz</li> <li>• Wandstärke 1,8 mm</li> <li>• ERD: 537 mm</li> </ul>	<b>RIM ›VENTURA DOUBLE‹</b> <ul style="list-style-type: none"> <li>• 26"</li> <li>• <b>aluminium</b></li> <li>• with wearout indicator</li> <li>• <b>CNC grooved braking sides (GBS)</b></li> <li>• <b>32 hole</b></li> <li>• für AV/DV/FV</li> <li>• black</li> <li>• wall thickness 1.8 mm</li> <li>• ERD: 537 mm</li> </ul> <p style="text-align: right; font-size: small;"><a href="#">Tested by the manufacturer according to ISO 14764</a></p>		<b>16,90 €</b>  35/19



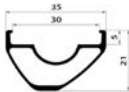

ART.-NR. 	BESCHREIBUNG	DESCRIPTION		UVP verfügbar ab/ available in
<b>384179</b> 1	<b>LAUFRADSATZ 28"</b> <b>›JETFLY DISC U4.0‹</b>  <b>Naben:</b> <ul style="list-style-type: none"> <li>inkl. Schnellspanner</li> <li><b>Aluminium</b>-Dichtungsscheiben</li> <li><b>Bremsscheibenaufnahme vorne:</b></li> <li><b>4 in 1:</b> vorbereitet für <b>12 mm Steckachse</b>, optional umrüstbar durch Ausgleichshülsen für 5 mm (Art. 320117) oder 9 mm (Art. 320118) Schnellspanner und 15 mm (Art. 320120) Steckachse</li> <li><b>2 austauschbare, japanische Industriekugellager</b></li> <li>Einbaumaß: 12 x 100 mm</li> </ul> <b>hinten:</b> <ul style="list-style-type: none"> <li><b>4 in 1:</b> vorbereitet für <b>12 mm Steckachse</b>, optional umrüstbar durch Umrüstsets für 5 mm Schnellspanner (Art. 320112), 10 mm (Art. 320079) und 12x135 mm Steckachse (Art. 320080)</li> <li><b>4 austauschbare, japanische Industriekugellager</b></li> <li>Einbaumaß: 12 x 142 mm</li> <li>für 8/9/10/11-fach Kassette für Shimano oder Sram (MTB+Road)</li> <li><b>rot eloxierter, austauschbarer</b> Aluminium Kassettenkörper (Art. 326297 = Shimano/ Sram, Art. 326293 = Sram XD, Art. 326298 = Campagnolo), mit <b>Anti Bite Guard</b></li> </ul> <b>Felgen:</b> <ul style="list-style-type: none"> <li><b>asymmetrisches Felgen-Design</b></li> <li>Aluminium-Hohlkammerfelge</li> <li><b>Tubeless ready</b></li> <li>700C</li> <li>Höhe <b>31,8 mm</b></li> <li>vorne 24 Loch / hinten 28 Loch</li> <li>für Drahtreifen</li> </ul> <b>Speichen:</b> <ul style="list-style-type: none"> <li><b>Nirosta doppelkonifiziert</b></li> <li><b>Aluminium</b> Nippel</li> </ul> <b>Extras:</b> inkl. Ersatzspeichen, -nippel und Tubelessventil max. Fahrergewicht <b>110 kg</b>	<b>WHEEL SET 28"</b> <b>›JETFLY DISC U4.0‹</b>  <b>Hubs:</b> <ul style="list-style-type: none"> <li>inkl. QRs</li> <li><b>aluminium</b> side caps</li> <li><b>disc brake mount front:</b></li> <li><b>4 in 1:</b> prepared with <b>12 mm thru axle</b>, optionally convertible through spacers to 5 mm (art. 320117) or 9 mm (art. 320118) QR and 15 mm thru axle (art. 320120)</li> <li><b>2 exchangeable, Japanese sealed bearings</b></li> <li>OLD: 12 x 100 mm</li> </ul> <b>rear:</b> <ul style="list-style-type: none"> <li><b>4 in 1:</b> prepared for <b>12 mm thru axle</b>, optionally convertible through spacers to 5 mm QR (art. 320112), 10 mm thru axle (art. 320079) and 12x135 mm thru axle (art. 320080)</li> <li><b>4 exchangeable, Japanese sealed bearings</b></li> <li>OLD: 12 x 142 mm</li> <li>for 8/9/10/11-speed Shimano or Sram cassette (MTB+Road)</li> <li><b>red anodized, replaceable</b> aluminium cassette body (art. 326297 = Shimano/ Sram, art. 326293 = Sram XD, art. 326298 = Campagnolo), with <b>Anti Bite Guard</b></li> </ul> <b>Rims:</b> <ul style="list-style-type: none"> <li><b>asymmetric rim design</b></li> <li>aluminium double wall</li> <li><b>tubeless ready</b></li> <li>700C</li> <li>height <b>31.8 mm</b></li> <li>front 24 hole / rear 28 hole</li> <li>for clinchers</li> </ul> <b>Spokes:</b> <ul style="list-style-type: none"> <li><b>double butted stainless steel</b></li> <li><b>aluminium</b> nipples</li> </ul> <b>Extras:</b> incl. replacement spokes, nipples and tubeless valve max. Fahrergewicht <b>110 kg</b>	<div data-bbox="1034 259 1225 293">Tested by the manufacturer according to ISO 4210</div> <div data-bbox="1034 309 1225 331"><b>TUBELESS READY</b></div> <div data-bbox="1251 259 1382 313">  </div> <div data-bbox="1426 259 1530 293"><b>599,00 €</b></div> <div data-bbox="1034 362 1102 450">   1.745g         </div> <div data-bbox="1034 483 1382 819">   800 g         </div> <div data-bbox="1034 887 1331 1290">   945 g         </div> <div data-bbox="1257 1346 1385 1525">  </div>	<div data-bbox="217 1507 419 1529">Cyclo Cross</div> <div data-bbox="419 1507 616 1529">Sprint</div> <div data-bbox="616 1507 818 1529">Endurance</div> <div data-bbox="818 1507 1015 1529">Aero / Time Trial</div>

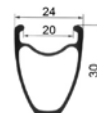







ART.-NR. 	BESCHREIBUNG	DESCRIPTION		UVP verfügbar ab/ available in
<b>384181</b> 1	<p><b>LAUFRADSATZ 28"</b> ›CXD U4.0‹</p> <p><b>Naben:</b></p> <ul style="list-style-type: none"> <li>• Aluminium-Dichtungsscheiben</li> <li>• <b>Bremsscheibenaufnahme vorne:</b></li> <li>• <b>4 in 1:</b> vorbereitet für <b>12 mm Steckachse</b>, optional umrüstbar durch Ausgleichshülsen für 5 mm (Art. 320117) oder 9 mm (Art. 320118) Schnellspanner und 15 mm (Art. 320120) Steckachse</li> <li>• <b>2 austauschbare, japanische Industriekugellager</b></li> <li>• Einbaumaß: 12 x 100 mm</li> </ul> <p><b>hinten:</b></p> <ul style="list-style-type: none"> <li>• <b>4 in 1:</b> vorbereitet für <b>12 mm Steckachse</b>, optional umrüstbar durch Umrüstsets für 5 mm Schnellspanner (Art. 320112), 10 mm (Art. 320079) und 12x135 mm Steckachse (Art. 320080)</li> <li>• <b>4 austauschbare, japanische Industriekugellager</b></li> <li>• Einbaumaß: 12 x 142 mm</li> <li>• für <b>8/9/10/11-fach</b> Shimano oder Sram Kasette (MTB+Road)</li> <li>• <b>rot eloxierter, austauschbarer</b> Aluminium Kassettenkörper (Art. 326297 = Shimano/Sram, Art. 326293 = Sram XD, Art. 326298 = Campagnolo), mit <b>Anti Bite Guard</b></li> </ul> <p><b>Felgen:</b></p> <ul style="list-style-type: none"> <li>• <b>asymmetrisches Felgen-Design</b></li> <li>• Aluminium-Hohlkammerfelge</li> <li>• <b>Tubeless ready</b></li> <li>• 700C</li> <li>• Höhe 24 mm</li> <li>• vorne 20 Loch / hinten 24 Loch</li> <li>• für Drahtreifen</li> </ul> <p><b>Speichen:</b></p> <ul style="list-style-type: none"> <li>• <b>Nirosta doppelkonifiziert</b></li> <li>• mit <b>schwarzen Aluminium</b> Nippeln</li> </ul> <p><b>Extras:</b> inkl. Ersatzspeichen, -nippel und Tubelessventil</p> <p>max. Fahrergewicht <b>110 kg</b></p>	<p><b>WHEEL SET 28"</b> ›CXD U4.0‹</p> <p><b>Hubs:</b></p> <ul style="list-style-type: none"> <li>• <b>aluminium</b> side caps</li> <li>• <b>disc brake mount front:</b></li> <li>• <b>4 in 1:</b> prepared for <b>12 mm thru axle</b>, optionally convertible through spacers to 5 mm (art. 320117) or 9 mm (art. 320118) QR and 15 mm thru axle (art. 320120)</li> <li>• <b>2 exchangeable, Japanese sealed bearings</b></li> <li>• OLD: 12 x 100 mm</li> </ul> <p><b>rear:</b></p> <ul style="list-style-type: none"> <li>• <b>4 in 1:</b> prepared for <b>12 mm thru axle</b>, optionally convertible through spacers to 5 mm QR (art. 320112), 10 mm thru axle (art. 320079) and 12x135 mm thru axle (art. 320080)</li> <li>• <b>4 exchangeable, Japanese sealed bearings</b></li> <li>• OLD: 12 x 142 mm</li> <li>• for <b>8/9/10/11-speed</b> Shimano or Sram cassette (MTB+Road)</li> <li>• <b>red anodized, replaceable</b> aluminium cassette body (art. 326297 = Shimano/Sram, art. 326293 = Sram XD, art. 326298 = Campagnolo), with <b>Anti Bite Guard</b></li> </ul> <p><b>Rims:</b></p> <ul style="list-style-type: none"> <li>• <b>asymmetric rim design</b></li> <li>• aluminium double wall</li> <li>• <b>tubeless ready</b></li> <li>• 700C</li> <li>• height 24 mm</li> <li>• front 20 hole / rear 24 hole</li> <li>• for clinchers</li> </ul> <p><b>Spokes:</b></p> <ul style="list-style-type: none"> <li>• <b>double butted stainless steel</b></li> <li>• with <b>black aluminium</b> nipples</li> </ul> <p><b>Extras:</b> incl. replacement spokes, nipples and tubeless valve</p> <p>max. riders weight <b>110 kg</b></p>	<p>Tested by the manufacturer according to ISO 4210</p> <p><b>TUBELESS READY</b></p> <p><b>CYCLO CROSS</b>   <b>DISC</b></p> <p> <b>1.615g</b></p> <p> <b>734 g</b></p> <p> <b>881 g</b></p> <p></p>	<p></p> <p><b>549,00 €</b></p>
	Cyclo Cross	Sprint	Endurance	Aero / Time Trial

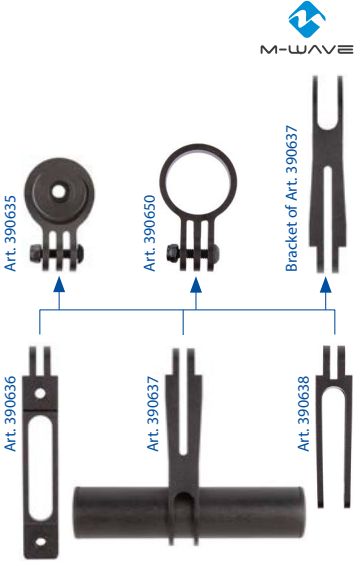

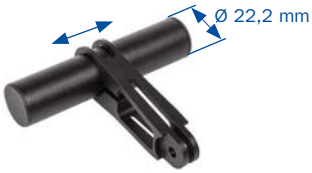







ART.-NR. 	BESCHREIBUNG	DESCRIPTION	UVP verfügbar ab/ available in	
384240 1	<b>LAUFRADSATZ 29" ›DIABLO XL BOOST U2.1‹</b>  <b>Naben:</b> <ul style="list-style-type: none"> <li>• <b>Bremsscheibenaufnahme</b></li> <li>• <b>Aluminium-Dichtungsscheiben</b></li> </ul> <b>vorne:</b> <ul style="list-style-type: none"> <li>• Nabe serienmäßig mit Einbaumaß <b>15 x 110 mm Boost Standard</b></li> <li>• <b>2 austauschbare, japanische Industriekugellager</b></li> </ul> <b>hinten:</b> <ul style="list-style-type: none"> <li>• Nabe serienmäßig mit Einbaumaß <b>12 x 148 mm Boost Standard</b></li> <li>• <b>4 austauschbare, japanische Industriekugellager</b></li> <li>• für 8-11-fach Shimano Kassette (MTB)</li> <li>• <b>schwarz eloxierter Aluminium-Kassettenkörper mit Anti Bite Guard</b> (Art. 326296)</li> <li>• mit Kassettenkörper Art. 326286 umrüstbar für Sram XX1-Kassette</li> </ul> <b>Felgen:</b> <ul style="list-style-type: none"> <li>• 29"</li> <li>• <b>asymmetrisches Felgen-Design</b>, damit Speichen auf Zahnkranzseite nicht so steil sind</li> <li>• extra breite Felgen: 30/35 mm</li> <li>• <b>Aluminium-Hohlkammerfelge mit Ösen</b></li> <li>• <b>Tubeless ready</b></li> <li>• 32 Loch</li> </ul> <b>Speichen:</b> <ul style="list-style-type: none"> <li>• <b>Nirosta doppelkonifiziert</b></li> </ul> <b>Extras:</b> <ul style="list-style-type: none"> <li>• inkl. 2 tubeless Felgenbändern und 2 tubeless Ventilen</li> <li>• inkl. Ersatzspeichen und Ersatznippel</li> </ul> max. Fahrergewicht <b>110 kg</b>	<b>WHEEL SET 29" ›DIABLO XL BOOST U2.1‹</b>  <b>Hubs:</b> <ul style="list-style-type: none"> <li>• <b>disc brake mount</b></li> <li>• <b>aluminium</b> side caps</li> </ul> <b>front:</b> <ul style="list-style-type: none"> <li>• hub standard with OLD <b>15 x 110 mm boost standard</b></li> <li>• <b>2 exchangeable, Japanese sealed bearings</b></li> </ul> <b>rear:</b> <ul style="list-style-type: none"> <li>• hub standard with OLD <b>12 x 148 mm boost standard</b></li> <li>• <b>4 exchangeable, Japanese sealed bearings</b></li> <li>• for 8-11 speed Shimano cassette (MTB)</li> <li>• <b>black anodized</b> aluminium cassette body with <b>Anti Bite Guard</b> (art. 326296)</li> <li>• with cassette body art. 326286 convertible to Sram XX1 cassette</li> </ul> <b>Rims:</b> <ul style="list-style-type: none"> <li>• 29"</li> <li>• <b>asymmetric rim design</b>, so the spokes are not too steep</li> <li>• extra wide rims: 30/35 mm</li> <li>• <b>aluminium</b> hollow section rim with eyelets</li> <li>• <b>tubeless ready</b></li> <li>• 32 hole</li> </ul> <b>Spokes:</b> <ul style="list-style-type: none"> <li>• <b>double butted stainless steel</b></li> </ul> <b>Extras:</b> <ul style="list-style-type: none"> <li>• inkl. 2 tubeless rim tapes and 2 tubeless valves</li> <li>• incl. replacement spokes and nipples</li> </ul> max. riders weight <b>110 kg</b>	Tested by the manufacturer according to ISO 4210 Boost  2.135g  1.020 g  1.115 g 	
Crosscountry   Trail / Tour   All Mountain		Enduro   Freeride   Downhill		<b>699,00 €</b>  35/19
384184 1	<b>LAUFRADSATZ 28" ›30 DISC‹</b>  <b>Naben:</b> <ul style="list-style-type: none"> <li>• <b>Bremsscheibenaufnahme</b></li> </ul> <b>vorne:</b> <ul style="list-style-type: none"> <li>• <b>4 in 1:</b> vorbereitet für <b>12 mm Steckachse</b>, optional umrüstbar durch Ausgleichshülsen für 5 mm (Art. 320117) oder 9 mm (Art. 320118) Schnellspanner und 15 mm (Art. 320120) Steckachse</li> <li>• <b>2 austauschbare Industriekugellager</b></li> <li>• Einbaumaß: 12 x 100 mm</li> </ul> <b>hinten:</b> <ul style="list-style-type: none"> <li>• <b>2 austauschbare Industriekugellager</b></li> <li>• für <b>8/9/10/11-fach</b> Shimano oder Sram Kassette (MTB+Road)</li> <li>• Einbaumaß: 12 x 142 mm</li> </ul> <b>Felgen:</b> <ul style="list-style-type: none"> <li>• <b>Aluminium-Hohlkammerfelge</b></li> <li>• <b>Tubeless ready</b></li> <li>• 700C</li> <li>• Höhe 30 mm</li> <li>• vorne 24 Loch / hinten 28 Loch</li> <li>• für Drahtreifen</li> </ul> <b>Speichen:</b> <ul style="list-style-type: none"> <li>• schwarz</li> <li>• mit <b>Aluminium Nippeln</b></li> </ul> max. Fahrergewicht <b>110 kg</b>	<b>WHEEL SET 28" ›30 DISC‹</b>  <b>Hubs:</b> <ul style="list-style-type: none"> <li>• <b>disc brake mount</b></li> </ul> <b>front:</b> <ul style="list-style-type: none"> <li>• <b>4 in 1: prepared for 12 mm thru axle</b>, optionally convertible through spacers to 5 mm (art. 320117) or 9 mm (art. 320118) QR and 15 mm thru axle (art. 320120)</li> <li>• <b>2 exchangeable sealed bearings</b></li> <li>• OLD: 12 x 100 mm</li> </ul> <b>rear:</b> <ul style="list-style-type: none"> <li>• <b>2 exchangeable sealed bearings</b></li> <li>• for <b>8/9/10/11-speed</b> Shimano or Sram cassette (MTB+Road)</li> <li>• OLD: 12 x 142 mm</li> </ul> <b>Rims:</b> <ul style="list-style-type: none"> <li>• <b>aluminium</b> double wall</li> <li>• <b>tubeless ready</b></li> <li>• 700C</li> <li>• height 30 mm</li> <li>• front 24 hole / rear 28 hole</li> <li>• for clinchers</li> </ul> <b>Spokes:</b> <ul style="list-style-type: none"> <li>• black</li> <li>• with <b>aluminium</b> nipples</li> </ul> max. riders weight <b>110 kg</b>	Tested by the manufacturer according to ISO 4210 Disc  1.965g  845 g  1120 g 	<b>329,00 €</b>  35/19
Cyclo Cross   Sprint		Endurance   Aero / Time Trial		









ART.-NR.	BESCHREIBUNG	DESCRIPTION		UVP verfügbar ab/ available in
<b>388595</b>  <b>388596</b> 2	<b>LAUFRÄDER ›BOOST‹ 28"/29"</b> <ul style="list-style-type: none"> <li>Felgen: ›<b>Double Disc 24 Plus</b>‹ Art. 381150, 28"/29", 32 Loch, schwarz, für <b>Scheibenbremsen</b></li> <li>Nippel: <b>CnSpoke</b>, Messing, silber</li> <li>inkl. Felgenband Art. 519342</li> </ul> <b>Vorderrad</b> <ul style="list-style-type: none"> <li><b>Nabe: Novatec 15 x 110 mm Boost Standard</b> (Art. 326427)</li> <li>Speichen: <b>CnSpoke</b>, Nirosta, schwarz</li> </ul> <b>Hinterrad</b> <ul style="list-style-type: none"> <li><b>Nabe: Novatec 12 x 148 mm Boost Standard</b> (Art. 326428), für 8-11-fach Shimano Kasette (MTB)</li> <li>Speichen: <b>CnSpoke</b>, Nirosta, schwarz</li> </ul>	<b>WHEEL SET ›BOOST‹ 28"/29"</b> <ul style="list-style-type: none"> <li>rims: ›<b>Double Disc 24 Plus</b>‹, art. 381150, 28"/29", 32 hole, black, for <b>disc brakes</b></li> <li>nipples: <b>CnSpoke</b>, brass, silver</li> <li>incl. rim tape art. 519342</li> </ul> <b>front wheel</b> <ul style="list-style-type: none"> <li><b>Hub: Novatec 15 x 110 mm boost standard</b> (art. 326427)</li> <li>spokes: <b>CnSpoke</b>, stainless, black</li> </ul> <b>rear wheel</b> <ul style="list-style-type: none"> <li><b>Hub: Novatec 12 x 148 mm boost standard</b> (art. 326428), for 8-11 speed Shimano cassette (MTB)</li> <li>spokes: <b>CnSpoke</b>, stainless, black</li> </ul>		<b>99,90 €</b>  35/19 <b>119,00 €</b>  35/19
<b>388427</b>  <b>388428</b> 2	<b>LAUFRÄDER ›BOOST‹ 27,5"</b> <ul style="list-style-type: none"> <li>Felgen: ›<b>Double Disc 24 Plus</b>‹ Art. 381151, 27,5", 32 Loch, schwarz, für <b>Scheibenbremsen</b></li> <li>Nippel: <b>CnSpoke</b>, Messing, silber</li> <li>inkl. Felgenband Art. 519371</li> </ul> <b>Vorderrad</b> <ul style="list-style-type: none"> <li><b>Nabe: Novatec 15 x 110 mm Boost Standard</b> (Art. 326427)</li> <li>Speichen: <b>CnSpoke</b>, Nirosta, schwarz</li> </ul> <b>Hinterrad</b> <ul style="list-style-type: none"> <li><b>Nabe: Novatec 12 x 148 mm Boost Standard</b> (Art. 326428), für 8-11-fach Shimano Kasette (MTB)</li> <li>Speichen: <b>CnSpoke</b>, Nirosta, schwarz</li> </ul>	<b>WHEEL SET ›BOOST‹ 27.5"</b> <ul style="list-style-type: none"> <li>rims: ›<b>Double Disc 24 Plus</b>‹, art. 381151, 27.5", 32 hole, black, for <b>disc brakes</b></li> <li>nipples: <b>CnSpoke</b>, brass, silver</li> <li>incl. rim tape art. 519371</li> </ul> <b>front wheel</b> <ul style="list-style-type: none"> <li><b>Hub: Novatec 15 x 110 mm boost standard</b> (art. 326427)</li> <li>spokes: <b>CnSpoke</b>, stainless, black</li> </ul> <b>rear wheel</b> <ul style="list-style-type: none"> <li><b>Hub: Novatec 12 x 148 mm boost standard</b> (art. 326428), for 8-11 speed Shimano cassette (MTB)</li> <li>spokes: <b>CnSpoke</b>, stainless, black</li> </ul>		<b>99,90 €</b>  35/19 <b>119,00 €</b>  35/19
<b>386011</b> 50	<b>DIRT BOARD ›MUD MAX DT‹</b> <ul style="list-style-type: none"> <li>universelle Befestigung am Unterrohr</li> <li>asymmetrisches Design für <b>optimalen Schutz bei unterschiedlichen Fahrpositionen</b> (180° drehbar)</li> <li><b>werkzeuglose</b> Montage mit 2 Gummibändern</li> <li>aus schlagfestem Kunststoff</li> <li>mit Non-Slip-Einlagen</li> <li>ca. 32 x 9/13 cm</li> <li>auf M-Wave Eurolochkarte</li> </ul>	<b>DIRT BOARD ›MUD MAX DT‹</b> <ul style="list-style-type: none"> <li>universal mounting on the down tube</li> <li>asymmetric design <b>to protect optimally in various drive positions</b> (180° turnable)</li> <li><b>toolless</b> mounting by two rubber strips</li> <li>impact resistant plastic</li> <li>with non-slip inlays</li> <li>approx. 32 x 9/13 cm</li> <li>on M-Wave eurohole card</li> </ul>		<b>6,90 €</b>  35/19
<b>386033</b>  <b>386032</b> 60 Set  <b>NEW</b>	<b>SCHUTZBLECH-SET ›MUD MAX KIDS F+R‹</b> <ul style="list-style-type: none"> <li>für Vorder- und Hinterrad</li> <li>aus <b>hochwertigem, flexiblem Kunststoff: ohne Beschädigung knick- und drehbar</b></li> <li><b>seitliche Versteifungen</b></li> <li>passend für V- und Cantilever-Bremsen</li> <li>variable <b>Steckbefestigung</b></li> <li>langer <b>Spritzschutz aus Gummi hinten</b></li> <li>auf M-Wave Eurolochkarte</li> </ul> für 16"-20" Kinderräder  für 12"-18" Kinderräder	<b>MUDGUARD SET ›MUD MAX KIDS F+R‹</b> <ul style="list-style-type: none"> <li>for front and rear</li> <li><b>high quality flexible plastic: turnable and bendable without damage</b></li> <li><b>reinforced sides</b></li> <li>suitable for V- and cantilever brakes</li> <li>variable <b>clip-on-system</b></li> <li>long <b>rubber end at the rear</b></li> <li>on M-Wave eurohole card</li> </ul> for 16"-20" children bikes  for 12"-18" children bikes  From a minimum of 500 pieces, these mudguards are also available in blue, red, yellow, black, grey or white without upcharge! Rubber end in 12 different colours.		<b>11,90 €</b>  35/19 <b>11,90 €</b>  35/19

ART.-NR. 	BESCHREIBUNG	DESCRIPTION		UVP verfügbar ab/ available in
	<p><b>MODULARES HALTER-SYSTEM ›QRIR‹</b></p> <ul style="list-style-type: none"> <li>• <b>vielseitige Kombinationsmöglichkeiten</b> von Haltern und Adaptern für Lampen, Trinkflaschen, Fahrrad-computer, Action-Kameras, ...</li> <li>• optimale Anpassung an die <b>individuellen Bedürfnisse</b> jedes Rad-fahrers</li> <li>• <b>CNC-gefrästes Aluminium</b></li> <li>• Verbindungs-Konstruktion auch für GoPro geeignet (keine original GoPro Ersatzteile)</li> <li>• auf M-Wave Eurolochkarte</li> </ul> <p><b>ADAPTER</b></p> <ul style="list-style-type: none"> <li>• für Ahead Steuersatz</li> <li>• 1 1/8" und verjüngt</li> <li>• für Flaschenhalter-Adapter (Art. 390636), Lenkercockpit (Art. 390637) oder Lampenhalter (Art. 390638)</li> </ul>	<p><b>MODULAR BRACKET SYSTEM ›QRIR‹</b></p> <ul style="list-style-type: none"> <li>• <b>versatile combinations</b> of brackets and adapters for lamps, water bottles, cycle computers, action cams, ...</li> <li>• optimal adaptation to the <b>individual needs</b> of every cyclist</li> <li>• <b>CNC machined aluminium</b></li> <li>• connection construction also suitable for GoPro (no original GoPro spare parts)</li> <li>• on M-Wave eurohole card</li> </ul> <p><b>ADAPTER</b></p> <ul style="list-style-type: none"> <li>• for ahead head set</li> <li>• 1 1/8" and tapered</li> <li>• for bottle cage adapter (art. 390636), handlebar cockpit (art. 390637) or lamp bracket (art. 390638)</li> </ul>		
390650	<p><b>Distanzring ›QRIR Spacer‹</b> Höhe: 10 mm</p>	<p><b>Spacer ›QRIR Spacer‹</b> height: 10 mm</p>		<p><b>7,90 €</b> 42/19</p>
390635 500	<p><b>Ahead-Kappe ›QRIR Top‹</b></p>	<p><b>Ahead cap ›QRIR Top‹</b></p>		<p><b>8,90 €</b> 42/19</p>
390637 120	<p><b>HALTER</b> für Distanzring (Art. 390650) und Ahead-Kappe (Art. 390635)</p> <p><b>Lenkercockpit ›QRIR Cockpit‹</b></p> <ul style="list-style-type: none"> <li>• universelle Montage von Lampen, Fahrradcomputern, E-Bike Displays, ...</li> <li>• Klemmdurchmesser: 22,2 mm</li> <li>• Rohr: 90 x 22,2 mm</li> <li>• <b>Zusatzfunktion:</b> Bei Entnahme des "Cockpit-Rohres" ist eine umgekehrte Montage am Lenker möglich. So können die Halter Art. 390636/8, Scheinwerfer, ... problemlos im <b>Ø 22,2 mm-Klemmbereich des Lenkers</b> montiert werden.</li> </ul>	<p><b>BRACKET</b> for spacer (art. 390650) and ahead cap (art. 390635)</p> <p><b>Handlebar cockpit ›QRIR Cockpit‹</b></p> <ul style="list-style-type: none"> <li>• universal mounting of lamps, bicycle computers, e-bike displays ...</li> <li>• clamp diameter: 22.2 mm</li> <li>• tube: 90 x 22.2 mm</li> <li>• <b>additional function:</b> When removing the "cockpit tube" a reverse mounting on the handlebar is possible. Thus, the brackets art. 390636/8, head lights, ... can be easily mounted at the <b>Ø 22.2 mm clamp area of the handlebar.</b></li> </ul>	 <div style="display: flex; justify-content: space-around;"> <div data-bbox="1027 1339 1214 1518"> <p><b>FUNCTION 1</b></p>  </div> <div data-bbox="1225 1339 1378 1518"> <p><b>FUNCTION 2</b></p>  </div> </div>	<p><b>12,90 €</b> 42/19</p>
390636 500	<p><b>Flaschenhalter ›QRIR Bottle‹</b></p> <ul style="list-style-type: none"> <li>• zur Montage eines Flaschenhalters</li> <li>• Winkel stufenlos einstellbar</li> <li>• Länge: ca. 93 mm</li> </ul>	<p><b>Bottle cage ›QRIR Bottle‹</b></p> <ul style="list-style-type: none"> <li>• for mounting of a bottle cage</li> <li>• steplessly adjustable angle</li> <li>• length: approx. 93 mm</li> </ul>		<p><b>7,90 €</b> 42/19</p>
390638 500	<p><b>Lampenhalter ›QRIR Extender‹</b></p> <ul style="list-style-type: none"> <li>• zur Montage eines Scheinwerfers</li> <li>• auch in Kombination mit der Klemme des Lenkercockpits (Art. 390637) im <b>Ø 22,2 mm-Klemmbereich des Lenkers</b> montierbar</li> </ul>	<p><b>Lamp bracket ›QRIR Extender‹</b></p> <ul style="list-style-type: none"> <li>• for mounting of a head light</li> <li>• can also be used in combination with the clamp of the handlebar cockpit (art. 390637) for mounting at the <b>Ø 22.2 mm clamp area of the handlebar</b></li> </ul>		<p><b>7,90 €</b> 42/19</p>
			 <p>Art. 390637 + 390638</p> 	

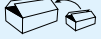
ART.-NR. 	BESCHREIBUNG	DESCRIPTION	UVP verfügbar ab/ available in
<p><b>395215</b> 8</p>	<p><b>FEDERGABEL ›187 AMS‹ 28"</b> Besonders geeignet für <b>E-Bikes</b></p> <p>Federweg: 65 mm Federsystem: Federn und MCU-Elastomere <b>einstellbar</b>, mit <b>Lock-Out</b> Funktion</p> <p>Tauchrohr: <b>Aluminium</b>, einteilig, 28" Standrohr: konifiziertes Hi-Ten Brücke: geschmiedetes <b>Aluminium</b>, mit "Suntour Lichthalter" (kein original Suntour Halter)</p> <p>für Bremse: V- und Scheibenbremse (PM) Schaft: 1½", 320 mm, ohne Gewinde Farbe: mattschwarz Verpackung: Montageverpackung</p>	<p><b>SUSPENSION FORK ›187 AMS‹ 28"</b> Especially suitable for <b>e-bikes</b></p> <p>travel: 65 mm suspension system: <b>adjustable</b> springs and MCU elastomers, with <b>Lock-Out</b> function</p> <p>lower: butted Hi-Ten stanchion: forged <b>aluminium</b> with "Suntour light bracket" (no original Suntour bracket)</p> <p>for brake: V- and disc brake (PM) steerer: 1½" 320 mm, without thread colour: matt black packaging: OEM</p> <p><small>Tested by the manufacturer according to EN 15194</small></p>	<p><b>28"</b>  </p> <p><b>LOCKOUT</b> </p> <p>43/19</p>
<p><b>400326</b> 20</p>	<p><b>LENKERVORBAU</b></p> <ul style="list-style-type: none"> <li>• <b>Schnellverstellung</b> von Winkel und Lenkerklemmung <b>ohne Werkzeug</b></li> <li>• <b>Aluminium</b></li> <li>• von <b>0° bis 70° verstellbar</b></li> <li>• mit verstärktem Nylon Schnellspanner</li> <li>• Lenkerklemmung: <b>Ø 31,8 mm</b></li> <li>• Länge: 110 mm</li> <li>• Schaft: Ø 25,4 mm, <b>180 mm</b></li> <li>• in Promax Eurolochbox</li> </ul>	<p><b>HANDLE STEM</b></p> <ul style="list-style-type: none"> <li>• <b>quick adjusting</b> of angle and handlebar clamp <b>without tools</b></li> <li>• <b>aluminium</b></li> <li>• <b>adjustable</b> from <b>0° to 70°</b></li> <li>• with reinforced nylon QR</li> <li>• handlebar clamp: <b>Ø 31,8 mm</b></li> <li>• length: 110 mm</li> <li>• shaft: Ø 25.4 mm, <b>180 mm</b></li> <li>• in Promax eurohole box</li> </ul> <p><small>Tested by the manufacturer according to ISO 4210</small></p>	<p> </p> <p><b>open-close</b> </p> <p><b>Ø 31,8 mm</b> </p> <p></p> <p>~ Jan./20</p>
<p><b>400316</b> 30</p>	<p><b>AHEAD LENKERVORBAU</b></p> <ul style="list-style-type: none"> <li>• <b>Schnellverstellung</b> von Winkel und Lenkerklemmung <b>ohne Werkzeug</b></li> <li>• <b>Aluminium</b></li> <li>• von <b>-10° bis 90° verstellbar</b></li> <li>• mit Schnellspanner</li> <li>• Lenkerklemmung: <b>Ø 31,8 mm</b></li> <li>• Länge 110 mm</li> <li>• 1½" (28,6 mm)</li> <li>• auf Promax Eurolochkarte</li> </ul>	<p><b>AHEAD HANDLE STEM</b></p> <ul style="list-style-type: none"> <li>• <b>quick adjusting</b> of angle and handlebar clamp <b>without tools</b></li> <li>• <b>aluminium</b></li> <li>• <b>adjustable</b> from <b>-10° to 90°</b></li> <li>• with QR</li> <li>• handlebar clamp: <b>Ø 31.8 mm</b></li> <li>• length 110 mm</li> <li>• 1½" (28.6 mm)</li> <li>• on Promax eurohole card</li> </ul> <p><small>Tested by the manufacturer according to ISO 4210</small></p>	<p> </p> <p><b>Ø 31,8 mm</b> </p> <p><b>90°</b> </p> <p><b>-10°</b></p> <p></p> <p>~ Jan./20</p>

ART.-NR. 	BESCHREIBUNG	DESCRIPTION		UVP verfügbar ab/ available in
<p><b>400312</b></p> <p><b>400313</b></p> <p>50</p>	<p><b>AHEAD LENKERVORBAU</b></p> <ul style="list-style-type: none"> <li>• getestet gemäß <b>ISO 4210</b>: erhöhte Anforderungen bis <b>140 kg</b></li> <li>• <b>Aluminium</b></li> <li>• von <b>0° bis 90° verstellbar</b></li> <li>• Lenkerklemmung für Ø 31.8 mm</li> <li>• 1 1/8" (28,6 mm)</li> <li>• mattschwarz</li> <li>• Montageverpackung</li> </ul> <p>Länge 90 mm</p> <p>Länge 110 mm</p>	<p><b>AHEAD HANDLE STEM</b></p> <ul style="list-style-type: none"> <li>• tested according to <b>ISO 4210</b>: increased requirements up to <b>140 kg</b></li> <li>• <b>aluminium</b></li> <li>• <b>adjustable</b> from <b>0° to 90°</b></li> <li>• clamp Ø 31.8 mm</li> <li>• 1 1/8" (28.6 mm)</li> <li>• matt black</li> <li>• OEM</li> </ul> <p>length 90 mm</p> <p>length 110 mm</p> <p><small>Tested by the manufacturer according to ISO 4210</small></p>		<p><b>19,90 €</b></p> <p>35/19</p> <p><b>19,90 €</b></p> <p>35/19</p>
<p><b>400120</b></p> <p>300/50 Set</p>	<p><b>REDUZIERHÜLSEN-SET</b></p> <ul style="list-style-type: none"> <li>• reduziert die Lenkerklemmung von Vorbauten von <b>31,8 mm auf 25,4 mm</b></li> <li>• Länge: <b>50 mm, für großflächige und schonende Klemmung</b></li> <li>• Aluminium</li> <li>• 1 Paar im Polybeutel mit Barcode-aufkleber</li> </ul>	<p><b>SHIM SET</b></p> <ul style="list-style-type: none"> <li>• reduces the handlebar clamp of stems from <b>31.8 mm to 25.4 mm</b></li> <li>• length: <b>50 mm, for extensive and careful clamping</b></li> <li>• aluminium</li> <li>• 1 pair in PE bag with barcode sticker</li> </ul>		<p><b>2,90 €</b></p> <p>35/19</p>
<p><b>408060</b></p> <p>100 Paar</p>	<p><b>LENKERZUSATZGRIFF ›BE ANATOM IN‹</b></p> <ul style="list-style-type: none"> <li>• zur <b>Befestigung innen am Lenker</b> für <b>aerodynamische Fahrposition</b></li> <li>• <b>anatomische</b> Form</li> <li>• einteilig</li> <li>• <b>Magnesium</b></li> <li>• schwarz</li> <li>• mit Klemmung für Ø 22,2 mm</li> <li>• auf M-Wave Eurolochkarte</li> </ul>	<p><b>BAR END ›BE ANATOM IN‹</b></p> <ul style="list-style-type: none"> <li>• for <b>fixing at the inside of the handlebar</b> for <b>aerodynamic driving position</b></li> <li>• <b>anatomic</b> shape</li> <li>• one-piece</li> <li>• <b>magnesium</b></li> <li>• black</li> <li>• with clamp for Ø 22.2 mm</li> <li>• on M-Wave eurohole card</li> </ul>	 	<p><b>14,90 €</b></p> <p>35/19</p>
<p><b>410160</b></p> <p>50 Paar</p>	<p><b>SCHAUMSTOFF-SCHRAUBGRIFF ›ERGO EVA D3‹</b></p> <ul style="list-style-type: none"> <li>• <b>Dreikomponenten-Schraubgriff</b>: harter Kunststoff innen, weiche Gummimischung in der Mitte für <b>Komfort</b> und <b>Stoßabsorbierung</b> und <b>weiche EVA soft-grip Oberfläche</b> außen</li> <li>• Kunststoffbasis mit <b>Aluminium Schraubbefestigung</b> für <b>leichte (De-) Montage</b> und festen Halt am Lenker</li> <li>• Komfortgriff mit <b>ergonomischer Form</b>, die dem Abknicken der Handgelenke vorbeugt</li> <li>• nur 85 g/Pair</li> <li>• mit Lenkerendstopfen</li> <li>• 131 mm</li> <li>• auf Velo Eurolochkarte</li> </ul>	<p><b>FOAM SCREW-ON GRIP ›ERGO EVA D3‹</b></p> <ul style="list-style-type: none"> <li>• <b>3-Component screw-on grip</b>: hard inner mixture, soft rubber mixture in the middle for <b>comfort</b> and <b>shock absorbing</b> and <b>light EVA soft-grip surface</b> at the outside</li> <li>• plastic base with <b>aluminium screw attachment</b> for <b>easy (dis-) assembly</b> and perfect grip at the handlebar</li> <li>• comfort grip with <b>ergonomic shape</b>, which prevents the wrists from deviating</li> <li>• only 85 g/pair</li> <li>• with handlebar plugs</li> <li>• 131 mm</li> <li>• on Velo eurohole card</li> </ul>		<p><b>21,90 €</b></p> <p>36/19</p>



ART.-NR. 	BESCHREIBUNG	DESCRIPTION		UVP verfügbar ab/ available in
<b>410102</b> 50 Paar	<b>SCHRAUBGRIFF ›MUSHROOM D2‹</b> <ul style="list-style-type: none"> <li>• <b>Mushroom-Design</b></li> <li>• die nach außen <b>leicht konisch verlaufende Form</b> und die <b>spezielle Oberflächenstruktur wirken dem Abrutschen entgegen</b></li> <li>• nach innen <b>fließender Übergang zur Klemme</b></li> <li>• <b>Zweikomponenten-Schraubgriff:</b> harter Kunststoff innen und weiche Mischung außen für <b>Komfort</b> und <b>Stoßabsorbierung</b></li> <li>• Kunststoffbasis mit <b>Schraubbefestigung</b> für leichte <b>(De-)Montage</b> und <b>festen Halt</b> am Lenker</li> <li>• mit geschlossenem Ende</li> <li>• 135 mm</li> <li>• auf Velo Eurolochkarte</li> </ul>	<b>SCREW-ON GRIP ›MUSHROOM D2‹</b> <ul style="list-style-type: none"> <li>• <b>Mushroom-Design</b></li> <li>• <b>slightly conical shape</b> to the outside and the <b>special surface structure counteract slipping</b></li> <li>• <b>smooth transition to the clamp</b> on the inside</li> <li>• <b>2-Component screw-on grip:</b> hard inner mixture and soft outer mixture for <b>comfort</b> and <b>shock absorbing</b></li> <li>• plastic base with <b>screw attachment</b> for easy <b>(dis-)assembly</b> and <b>perfect grip</b> at the handlebar</li> <li>• with closed end</li> <li>• 135 mm</li> <li>• on Velo eurohole card</li> </ul>	 	<b>11,90 €</b>  48/19
<b>410278</b> 100 Set	<b>LENKERBAND ›KNOB GRIP‹</b> <ul style="list-style-type: none"> <li>• <b>besonders griffig</b> und <b>stoßabsorbierend</b> durch <b>ausgeprägte und rutschfeste Noppen-Oberflächenstruktur</b></li> <li>• <b>extrem reißfest</b></li> <li>• 1 <b>Set</b> = 2 Bänder (2 x <b>200 x 3 cm</b>)</li> <li>• besonders lange und breite Bänder auch für Gravel Bikes, ...</li> <li>• mit Lenkerendstopfen</li> <li>• im Velo Einzelkarton</li> </ul>	<b>HANDLEBAR TAPE ›KNOB GRIP‹</b> <ul style="list-style-type: none"> <li>• <b>particularly non-slip</b> and <b>shock absorbing</b> through <b>textured non-slip knob</b> surface structure</li> <li>• <b>extrem tearproof</b></li> <li>• 1 <b>set</b> = 2 tapes (2 x <b>200 x 3 cm</b>)</li> <li>• extra long and wide tapes also for gravel bikes, ...</li> <li>• with handlebar plugs</li> <li>• in Velo box</li> </ul>		<b>16,90 €</b>  48/19
<b>410897</b> 250 Set  <b>410898</b> 1.000/100	<b>LENKERENDSTOPFEN ›FIT-PLUGS‹</b> <ul style="list-style-type: none"> <li>• aus <b>elastischem TPR Kunststoff</b></li> <li>• durch <b>Flexibilität</b> passend für viele verschiedene Innendurchmesser</li> <li>• wiederverwendbar</li> </ul>	<b>HANDLEBAR PLUGS ›FIT-PLUGS‹</b> <ul style="list-style-type: none"> <li>• made of <b>elastic TPR plastic</b></li> <li>• due to <b>flexibility</b> suitable for many different inner diameters</li> <li>• reusable</li> </ul>		<b>1,90 €</b> 37/19 <b>0,48 €</b> 37/19
<b>410628</b>   <b>410603</b>  <b>410629</b>  <b>410604</b> 100 Paar	<b>SCHRAUBGRIFF ›CLOUD BUFF FIX‹</b> <ul style="list-style-type: none"> <li>• <b>Anatomisch geformter Echtlederoptikgriff</b></li> <li>• leichte <b>(De-)Montage</b> und <b>fester Halt</b> am Lenker durch <b>doppelte Aluminium-Schraubbefestigung</b></li> <li>• mit elastischen Lenkerendstopfen</li> </ul>	<b>SCREW-ON GRIP ›CLOUD BUFF FIX‹</b> <ul style="list-style-type: none"> <li>• <b>anatomic shaped genuine leather design grip</b></li> <li>• easy <b>(dis-)assembly</b> and <b>perfect grip</b> at the handlebar through <b>double aluminium screw attachment</b></li> <li>• with elastic handlebar plugs</li> </ul>		<b>14,90 €</b> 35/19 <b>14,90 €</b> 35/19 <b>14,90 €</b> 35/19 <b>14,90 €</b> 35/19

ART.-NR.	BESCHREIBUNG	DESCRIPTION		UVP verfügbar ab/ available in
<p><b>410124</b></p> <p><b>410125</b> 50 Paar</p>	<p><b>SCHRAUBGRIF</b> <b>›CLOUD ERGO MAX FIX BE‹</b></p> <ul style="list-style-type: none"> <li>• Komfortgriff mit extra großer <b>ergonomischer</b> Auflagefläche, die dem Abknicken der Handgelenke vorbeugt</li> <li>• <b>Zweikomponentengriff</b>: harte Mischung innen und weiche Mischung außen für Komfort und Stoßabsorbierung</li> <li>• <b>Microtech Noppen</b> für noch besseren Halt</li> <li>• <b>Aluminium-Klemme</b> und <b>integrierte 2-fache Schraubbefestigung</b> für leichte (De-)Montage und besonders festem Halt am Lenker</li> <li>• mit Lenkerendstopfen</li> <li>• 140 mm</li> </ul> <p>auf M-Wave Eurolochkarte</p> <p>paarweise im Polybeutel</p>	<p><b>SCREW-ON GRIP</b> <b>›CLOUD ERGO MAX FIX BE‹</b></p> <ul style="list-style-type: none"> <li>• comfort grip with especially wide <b>ergonomic contact area</b>, which prevents the wrists from deviating</li> <li>• <b>2-Component grip</b>: hard inner mixture and soft outer mixture for comfort and shock absorbing</li> <li>• <b>Microtech knobs</b> for still better grip</li> <li>• <b>aluminium clamp</b> and <b>integrated double screw attachment</b> for easy (dis-)assembly and perfect grip at the handlebar</li> <li>• with handlebar plugs</li> <li>• 140 mm</li> </ul> <p>on M-Wave eurohole card</p> <p>one pair in PE bag</p>	 <p>Double D2 Density</p> <p>M-WAVE</p> <p>140 mm</p> <p>110 mm</p> <p>bottom view:</p> <p>FIX</p> <p>FIX</p> <p>MICROTECH KNOBS</p>	<p><b>24,90 €</b></p> <p>48/19</p> <p><b>24,90 €</b></p> <p>48/19</p>
<p><b>410053</b></p> <p><b>410052</b> 50 Paar</p>	<p><b>SCHRAUBGRIF</b> <b>›CLOUD ERGOMAX FIX‹</b></p> <ul style="list-style-type: none"> <li>• <b>fest integrierte Schraubbefestigung</b> für leichte (De-)Montage und festem Halt am Lenker</li> <li>• Komfortgriff mit <b>ergonomischer Form</b>, die dem Abknicken der Handgelenke vorbeugt</li> <li>• <b>Zweikomponentengriff</b>: harte Mischung innen und weiche Mischung außen für Komfort und Stoßabsorbierung</li> <li>• <b>Microtech Noppen</b> für noch besseren Halt</li> <li>• geschlossenes Ende</li> <li>• 138 mm</li> </ul> <p>auf M-Wave Eurolochkarte</p> <p>paarweise im Polybeutel</p>	<p><b>SCREW-ON GRIP</b> <b>›CLOUD ERGOMAX FIX‹</b></p> <ul style="list-style-type: none"> <li>• <b>firmly integrated screw attachment</b> for easy (dis-)assembly and perfect grip at the handlebar</li> <li>• comfort grip with <b>ergonomic shape</b>, which prevents the wrists from deviating</li> <li>• <b>2-Component grip</b>: hard inner mixture and soft outer mixture for comfort and shock absorbing</li> <li>• <b>Microtech knobs</b> for still better grip</li> <li>• closed end</li> <li>• 138 mm</li> </ul> <p>on M-Wave eurohole card</p> <p>one pair in PE bag</p>	 <p>Double D2 Density</p> <p>M-WAVE</p> <p>FIX</p> <p>bottom view:</p> <p>MICROTECH KNOBS</p>	<p><b>12,90 €</b></p> <p>35/19</p> <p><b>12,90 €</b></p> <p>35/19</p>











ELUMATIK USB

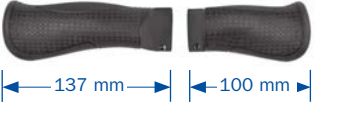

M-WAVE AKKU-MINIPUMPE

- Universeller Doppelpumpenkopf
- Leistungstarker Lithium-Ionen Akku
- Pumpst selbstständig bis zum voreingestellten Druck
- Max. Luftdruck 100 psi / 7 bar
- Mit Ballnadel und Luftmatratzenadapter
- Für alle drei Ventilarten (AV, DV, FV)







ART.-NR. 	BESCHREIBUNG	DESCRIPTION		UVP verfügbar ab/ available in
<p><b>410054</b> U 50 Paar</p> <p><b>410055</b> 100 Paar</p> <p><b>410056</b></p> <p><b>410057</b> 100 Paar</p>	<p><b>SCHRAUBGRIFF</b> ›CLOUD ERGO FIX‹</p> <ul style="list-style-type: none"> <li>• <b>fest integrierte Schraubbefestigung</b> für leichte (De-)Montage und festem Halt am Lenker</li> <li>• Komfortgriff mit <b>ergonomischer Form</b>, die dem Abknicken der Handgelenke vorbeugt</li> <li>• <b>Zweikomponentengriff D2</b>: harte Mischung innen und weiche Mischung außen für Komfort und Stoßabsorbierung</li> <li>• <b>Microtech Noppen</b> für noch besseren Halt</li> <li>• geschlossenes Ende</li> </ul> <p><b>132 / 132 mm</b></p> <p>auf M-Wave Eurolochkarte</p> <p>paarweise im Polybeutel</p> <p><b>132 / 92 mm</b> 92 mm mit <b>Innenklemmung</b></p> <p>auf M-Wave Eurolochkarte</p> <p>paarweise im Polybeutel</p>	<p><b>SCREW-ON GRIP</b> ›CLOUD ERGO FIX‹</p> <ul style="list-style-type: none"> <li>• <b>firmly integrated screw attachment</b> for easy (dis-)assembly and perfect grip at the handlebar</li> <li>• comfort grip with <b>ergonomic shape</b>, which prevents the wrists from deviating</li> <li>• <b>2-component grip D2</b>: hard inner mixture and soft outer mixture for comfort and shock absorbing</li> <li>• <b>Microtech knobs</b> for still better grip</li> <li>• closed end</li> </ul> <p><b>132 / 132 mm</b> on M-Wave eurohole card</p> <p>one pair in PE bag</p> <p><b>132 / 92 mm</b> 92 mm with <b>inner clamp</b> on M-Wave eurohole card</p> <p>one pair in PE bag</p>	<p><b>Double D2 Density</b></p> <p><b>M-WAVE</b></p>  <p><b>9,90 €</b> 35/19</p> <p><b>9,90 €</b> 35/19</p> <p><b>11,90 €</b> 48/19</p> <p><b>11,90 €</b> 48/19</p>	
<p><b>410617</b></p> <p>• <b>410618</b> 100 Paar</p>	<p><b>SCHRAUBGRIFF</b> ›CLOUD SLICK FIX 6‹</p> <ul style="list-style-type: none"> <li>• leichte (De-)Montage und <b>fester Halt</b> am Lenker durch <b>Aluminium-Schraubbefestigung</b></li> <li>• <b>Zweikomponentengriff</b>: harte Mischung innen für guten Halt auf dem Lenker und weiche Mischung außen für Komfort und Stoßabsorbierung</li> <li>• mit Lenkerendstopfen</li> <li>• 130 mm</li> </ul> <p>auf M-Wave Eurolochkarte</p> <p>paarweise im Polybeutel</p>	<p><b>SCREW-ON GRIP</b> ›CLOUD SLICK FIX 6‹</p> <ul style="list-style-type: none"> <li>• easy (dis-)assembly und <b>perfect grip</b> at the handlebar with <b>aluminium screw attachment</b></li> <li>• <b>2-component grip</b>: hard inner mixture for good connection with handlebar and soft outer mixture for comfort and shock absorbing</li> <li>• with handlebar plugs</li> <li>• 130 mm</li> </ul> <p>on M-Wave eurohole card</p> <p>one pair in PE bag</p>	<p><b>M-WAVE</b></p>  <p><b>6,90 €</b> 37/19</p> <p><b>6,90 €</b> 37/19</p>	
<p><b>410316</b> 50 Paar</p> <p><b>410317</b> 100 Paar</p>	<p><b>SCHRAUBGRIFF</b> ›CLOUD SLICK SHORT‹</p> <ul style="list-style-type: none"> <li>• <b>extra kurzer Griff: 115 mm</b></li> <li>• für kleine Hände</li> <li>• <b>fest integrierte Kunststoff-Schraubbefestigung</b> für leichte (De-)Montage und festem Halt am Lenker</li> <li>• <b>Zweikomponentengriff</b>: harte Mischung innen für guten Halt auf dem Lenker und weiche Mischung außen für Komfort und Stoßabsorbierung</li> <li>• geschlossenes Ende</li> </ul> <p>auf M-Wave Eurolochkarte</p> <p>paarweise im Polybeutel</p>	<p><b>SCREW-ON GRIP</b> ›CLOUD SLICK SHORT‹</p> <ul style="list-style-type: none"> <li>• <b>extra short grip: 115 mm</b></li> <li>• for small hands</li> <li>• <b>firmly integrated plastic screw attachment</b> for easy (dis-)assembly and perfect grip at the handlebar</li> <li>• <b>2-component grip</b>: hard inner mixture for good connection with handlebar and soft outer mixture for comfort and shock absorbing</li> <li>• closed end</li> </ul> <p>on M-Wave eurohole card</p> <p>one pair in PE bag</p>	<p><b>Double D2 Density</b></p> <p><b>115 mm</b></p> <p><b>M-WAVE</b></p>  <p><b>8,90 €</b> 35/19</p> <p><b>8,90 €</b> 35/19</p>	









ART.-NR. 	BESCHREIBUNG	DESCRIPTION		UVP verfügbar ab/ available in
<p><b>410121</b></p> <p>• <b>410126</b></p> <p><b>410122</b></p> <p>• <b>410127</b></p>	<p><b>SCHRAUBGRIFF ›CLOUD BASE 2 FIX‹</b></p> <ul style="list-style-type: none"> <li>• <b>integrierte Schraubbefestigung</b> für leichte (De-)Montage und festem Halt am Lenker</li> <li>• Komfortgriff mit <b>ergonomischer Form</b>, die dem <b>Abknicken der Handgelenke</b> vorbeugt</li> <li>• <b>Zweikomponentengriff</b>: harte Mischung innen für guten Halt auf dem Lenker und weiche Mischung außen für Komfort und Stoßabsorbierung</li> <li>• geschlossenes Ende</li> </ul> <p><b>137 / 137 mm</b></p> <p>auf M-Wave Eurolochkarte</p> <p>paarweise im Polybeutel</p> <p><b>137 / 100 mm</b></p> <p>auf M-Wave Eurolochkarte</p> <p>paarweise im Polybeutel</p> <p>50 Paar</p>	<p><b>SCREW-ON GRIP ›CLOUD BASE 2 FIX‹</b></p> <ul style="list-style-type: none"> <li>• <b>integrated screw attachment</b> for easy (dis-)assembly and perfect grip at the handlebar</li> <li>• comfort grip with <b>ergonomic shape</b>, which prevents the <b>wrists from deviating</b></li> <li>• <b>2-Component grip</b>: hard inner mixture for good connection with handlebar and soft outer mixture for comfort and shock absorbing</li> <li>• closed end</li> </ul> <p><b>137 / 137 mm</b></p> <p>on M-Wave eurohole card</p> <p>one pair in PE bag</p> <p><b>137 / 100 mm</b></p> <p>on M-Wave eurohole card</p> <p>one pair in PE bag</p>	<p></p> <p></p> <p></p> <p></p> <p></p>	<p><b>6,90 €</b></p> <p>~ Jan./20</p> <p><b>6,90 €</b></p> <p>~ Jan./20</p> <p><b>6,90 €</b></p> <p>~ Jan./20</p> <p><b>6,90 €</b></p> <p>~ Jan./20</p>
<p><b>410539</b></p> <p>• <b>410540</b></p>	<p><b>GRIFF ›CLOUD BASE 2 S‹</b></p> <ul style="list-style-type: none"> <li>• Komfortgriff mit <b>ergonomischer Form</b>, die dem <b>Abknicken der Handgelenke</b> vorbeugt</li> <li>• geschlossenes Ende</li> <li>• 130 / 95 mm</li> </ul> <p>auf M-Wave Eurolochkarte</p> <p>paarweise im Polybeutel</p> <p>100 Paar</p>	<p><b>GRIP ›CLOUD BASE 2 S‹</b></p> <ul style="list-style-type: none"> <li>• comfort grip with <b>ergonomic shape</b>, which prevents the <b>wrists from deviating</b></li> <li>• closed end</li> <li>• 130 / 95 mm</li> </ul> <p>on M-Wave eurohole card</p> <p>one pair in PE bag</p>	<p></p> <p></p>	<p><b>4,90 €</b></p> <p>35/19</p> <p><b>4,90 €</b></p> <p>35/19</p>
<p><b>410241</b></p> <p>• <b>410242</b></p>	<p><b>GRIFF ›CLOUD TIRE 2‹</b></p> <ul style="list-style-type: none"> <li>• griffige Struktur gibt <b>guten Halt</b></li> <li>• geschlossenes Ende</li> <li>• 120 mm</li> </ul> <p>auf M-Wave Eurolochkarte</p> <p>paarweise im Polybeutel</p> <p>200 Paar</p>	<p><b>GRIP ›CLOUD TIRE 2‹</b></p> <ul style="list-style-type: none"> <li>• non-slip <b>structure</b> gives <b>good grip</b></li> <li>• closed end</li> <li>• 120 mm</li> </ul> <p>on M-Wave eurohole card</p> <p>one pair in PE bag</p>	<p></p> <p></p> <p></p>	<p><b>2,90 €</b></p> <p>37/19</p> <p><b>2,90 €</b></p> <p>37/19</p>

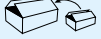

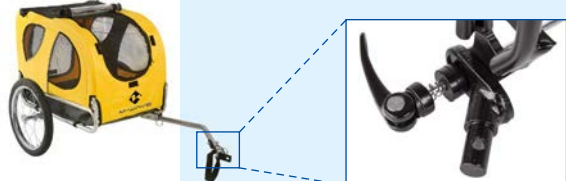





<b>ART.-NR.</b> 	<b>BESCHREIBUNG</b>	<b>DESCRIPTION</b>		<b>UVP</b> verfügbar ab/ available in
<b>420190</b> 240/12	<b>KINDERGLOCKENSORTIMENT</b> ›BELLA TRILL-MIX‹ <ul style="list-style-type: none"> <li>• Stahl</li> <li>• farbig sortiert</li> <li>• mit verschiedenen Kindermotiven</li> <li>• 12 Stück im M-Wave Thekendisplay</li> </ul>	<b>CHILDREN BELLS ASSORTMENT</b> ›BELLA TRILL-MIX‹ <ul style="list-style-type: none"> <li>• steel</li> <li>• assorted colours</li> <li>• with different designs</li> <li>• 12 pcs in M-Wave sales display</li> </ul>		<b>2,90 €</b>          35/19
<b>420030</b> U 300/20	<b>MINIGLOCKENSORTIMENT</b> ›BELLA MINI-MIX‹ <ul style="list-style-type: none"> <li>• bedruckt</li> <li>• mit verschiedenen Motiven</li> <li>• 20 Stück im M-Wave Thekendisplay</li> </ul>	<b>MINI BELLS ASSORTMENT</b> ›BELLA MINI-MIX‹ <ul style="list-style-type: none"> <li>• with imprints</li> <li>• in different designs</li> <li>• 20 pieces in M-Wave sales display</li> </ul>		<b>2,90 €</b>          35/19
<b>420026</b> 300/20	<b>MINIGLOCKE</b> ›BELLA MINI-BLACK‹ <ul style="list-style-type: none"> <li>• mit <b>metrischer Schraube</b></li> <li>• Stahl</li> <li>• 20 Stück im M-Wave Thekendisplay</li> </ul>	<b>MINI BELL</b> ›BELLA MINI-BLACK‹ <ul style="list-style-type: none"> <li>• with <b>metric screw</b></li> <li>• steel</li> <li>• 20 pieces in M-Wave sales display</li> </ul>		<b>1,90 €</b>          35/19
<b>420590</b> 100	<b>WINDRAD</b> ›COLORWHEEL‹ <ul style="list-style-type: none"> <li>• aus Kunststoff</li> <li>• <b>universelle Befestigung</b> am Lenker, Steuersatzrohr, ... durch Lenkerhalter Ø 22,2 - 26 mm</li> <li>• Montageverpackung</li> </ul>	<b>WINDMILL</b> ›COLORWHEEL‹ <ul style="list-style-type: none"> <li>• made of plastic</li> <li>• <b>universal mounting</b> on handlebar, headtube, ... by handlebar bracket Ø 22.2 - 26 mm</li> <li>• OEM</li> </ul>	 	<b>3,90 €</b>          35/19













ART.-NR. 	BESCHREIBUNG	DESCRIPTION		UVP verfügbar ab/ available in
<p>• <b>430925</b> 40</p>	<p><b>FAHRRADSTÄNDER</b></p> <ul style="list-style-type: none"> <li>• <b>stabile</b> Ausführung für <b>E-Bikes</b>, ...</li> <li>• zur Montage an der <b>Kettenstrebe</b>, universell passend für Lochabstand <b>40 und 18 mm</b></li> <li>• mit 2 x M6 <b>Nirosta</b> Beilagscheiben und Muttern</li> <li>• <b>Aluminium</b></li> <li>• <b>werkzeuglos verstellbar</b></li> <li>• für <b>24" - 29"</b></li> <li>• mit <b>Sicherheitsfuß</b></li> <li>• inkl. Montagematerial</li> <li>• Montageverpackung</li> </ul>	<p><b>SIDE STAND</b></p> <ul style="list-style-type: none"> <li>• <b>robust</b> design for <b>E-bikes</b>, ...</li> <li>• for mounting at the <b>chain stay</b>, universally suitable for hole distance <b>40 and 18 mm</b></li> <li>• with 2 x M6 <b>stainless steel</b> washers and nuts</li> <li>• <b>aluminium</b></li> <li>• <b>adjustable without tools</b></li> <li>• for <b>24" - 29"</b></li> <li>• with <b>safety foot</b></li> <li>• incl. mounting material</li> <li>• OEM</li> </ul>		<p><b>14,90 €</b></p> <p>47/19</p>
<p><b>430295</b> 10</p>	<p><b>FAHRRADHALTER</b> ›EASYSTAND PREMIUM‹</p> <ul style="list-style-type: none"> <li>• <b>hochwertige Ausführung</b> aus <b>Edelstahl</b></li> <li>• für <b>Fahrräder aller Größen 12" - 29"</b></li> <li>• Reifenbreite bis <b>2,50"</b></li> <li>• kein Anheben des Rades notwendig, <b>einfach hinein-/herausrollen</b></li> <li>• mit <b>Breitenadapter/Schaumstoffschutz</b></li> <li>• aus stabilem Rundrohr</li> <li>• <b>Non-Slip</b> Füße</li> <li>• in M-Wave Verpackung</li> </ul>	<p><b>BICYCLE STAND</b> ›EASYSTAND PREMIUM‹</p> <ul style="list-style-type: none"> <li>• <b>high-quality</b> made of <b>stainless steel</b></li> <li>• for <b>bicycles of all sizes 12" - 29"</b></li> <li>• max. tire width up to <b>2.50"</b></li> <li>• no lifting of the bike necessary, <b>just roll in and out</b></li> <li>• with <b>width adapter/foam cover</b></li> <li>• solid round tubes</li> <li>• <b>non-slip</b> feet</li> <li>• in M-Wave packaging</li> </ul>		<p><b>44,90 €</b></p> <p>~ Jan./20</p>
<p><b>430298</b></p>	<p><b>VERBINDUNGSTEIL</b></p> <p>Machen Sie den Einzelständer zum <b>variablen Mehrfachsystem!</b></p> <ul style="list-style-type: none"> <li>• <b>hochwertige Ausführung</b> aus <b>Edelstahl</b></li> </ul>	<p><b>CONNECTOR</b></p> <p>Make your basic stand to a <b>variable multiple system!</b></p> <ul style="list-style-type: none"> <li>• <b>high-quality</b> made of <b>stainless steel</b></li> </ul>		<p>~ Jan./20</p>
<p><b>430241</b> 10</p>	<p><b>FAHRRADHALTER</b> ›SUPERSTAND EXTREME‹</p> <ul style="list-style-type: none"> <li>• ideal für Reifenbreite von <b>2,50"</b> bis <b>3,25"</b></li> <li>• für <b>Fahrräder aller Größen 12" - 29"</b></li> <li>• kein Anheben des Rades notwendig, <b>einfach hinein-/herausrollen</b></li> <li>• aus stabilem Rundrohr</li> <li>• <b>Non-Slip</b> Füße</li> <li>• silber</li> <li>• H = 78,5 cm x B = 39 cm x L = 41 cm</li> <li>• im Superstand Einzelkarton</li> </ul>	<p><b>BICYCLE STAND</b> ›SUPERSTAND EXTREME‹</p> <ul style="list-style-type: none"> <li>• ideal for tire width from <b>2.50"</b> up to <b>3.25"</b></li> <li>• for <b>bicycles of all sizes 12" - 29"</b></li> <li>• no lifting of the bike necessary, <b>just roll in and out</b></li> <li>• made of solid round tubes</li> <li>• <b>non-slip</b> feet</li> <li>• silver</li> <li>• H = 78,5 cm x W = 39 cm x L = 41 cm</li> <li>• in Superstand box</li> </ul>		<p><b>37,90 €</b></p> <p>35/19</p>
<p><b>439903</b> 10</p>	<p><b>FAHRRADSTÄNDER</b> ›CHOPSTAND APART‹</p> <ul style="list-style-type: none"> <li>• <b>werkzeug- und stufenlos höhenverstellbar um 150 mm</b></li> <li>• <b>platzsparend zerlegbar</b></li> <li>• mit <b>Kratzschutz</b></li> <li>• für <b>12" - 29"</b> geeignet</li> <li>• für Verwendung an der Vorder- oder Hinterradachse</li> <li>• für fast alle Räder mit <b>Scheibenbremsen geeignet</b></li> <li>• in M-Wave Eurolochbox</li> </ul>	<p><b>BIKE STAND</b> ›CHOPSTAND APART‹</p> <ul style="list-style-type: none"> <li>• <b>150 mm stepless height adjustment without tools</b></li> <li>• <b>space savingly demountable</b></li> <li>• with <b>scratch protection</b></li> <li>• suitable for <b>12" - 29"</b></li> <li>• for using at the front or rear axle</li> <li>• suitable for almost every bike with <b>disc brakes</b></li> <li>• in M-Wave eurohole box</li> </ul>		<p><b>19,90 €</b></p> <p>35/19</p>

ART.-NR. 	BESCHREIBUNG	DESCRIPTION		UVP verfügbar ab/ available in
<b>430244</b> 25	<b>AUSSTELLUNGSSTÄNDER</b> <ul style="list-style-type: none"> <li>• platzsparend <b>zusammenklappbar</b></li> <li>• für <b>12" - 29"</b> geeignet</li> <li>• universelle Montage an der <b>Kettenstrebe</b> oder der <b>Hinterradachse</b></li> <li>• mit Sicherheits-/Befestigungsgummi</li> <li>• Montageverpackung</li> </ul>	<b>DISPLAY STAND</b> <ul style="list-style-type: none"> <li>• space saving <b>foldable</b></li> <li>• suitable for <b>12" - 29"</b></li> <li>• universal mounting position at the <b>chain stay</b> or at the <b>rear hub axle</b></li> <li>• with securing/fixing rubber</li> <li>• OEM</li> </ul>		<b>14,90 €</b>  37/19
<b>440490</b> 100 Set	<b>SCHNELLSPANNER SET</b> <ul style="list-style-type: none"> <li>• zur Montage von <b>Gepäckträgern</b> an Räder:</li> <li>- ohne Befestigungsösen (z.B. Rennräder)</li> <li>- mit <b>hinderlichen Sitzrohr- oder Kettenstreben, Ausfallenden, ...</b></li> <li>• passend auch für <b>Fahrradhanhänger</b> Art. 640050, ...</li> <li>• mit 8 je 5 mm breiten <b>Adapter-scheiben</b></li> <li>• <b>Aluminium</b>hebel</li> <li>• Länge 210 mm</li> <li>• für Nabeneinbaumaß: <b>≥ 130 mm</b></li> <li>• <b>Einklembreite: 137 mm - 177 mm</b> (in 5 mm Schritten)</li> <li>• auf M-Wave Eurolochkarte</li> </ul> 	<b>QUICK RELEASE SET</b> <ul style="list-style-type: none"> <li>• for mounting of carriers to bicycles:</li> <li>- <b>without mounting eyelets</b> (e.g. road bikes)</li> <li>- with <b>obstructive seat stays, chain stays, derailleur hangers, ...</b></li> <li>• also suitable for <b>bicycle trailer</b> art. 640050, ...</li> <li>with 8 <b>adapters</b>, each 5 mm wide</li> <li>• <b>aluminium</b> lever</li> <li>• length 210 mm</li> <li>• OLD: <b>≥ 130 mm</b></li> <li>• <b>clamp width: 137 - 177 mm</b> (in 5 mm steps)</li> <li>• on M-Wave eurohole card</li> </ul> 		<b>9,90 €</b>  35/19
<b>449901</b> 8	<b>ALUMINIUM-GEPÄCKTRÄGER</b> <ul style="list-style-type: none"> <li>• <b>verstellbar</b> für 24" - 29"</li> <li>• spezielle Passform für Räder mit <b>Scheibenbremsen</b>, dicken Strebenenden, ...</li> <li>• bei Kürzung der Abstandhalter auch für <b>Boost-Standard</b> geeignet</li> <li>• für <b>Gepäckträgertaschen</b></li> <li>• mit Reflektor-/Rücklichthalter und Federklappe</li> <li>• Auflagefläche: 38 x 13,5 cm (L x B)</li> <li>• Montageverpackung</li> </ul>	<b>ALUMINIUM CARRIER</b> <ul style="list-style-type: none"> <li>• <b>adjustable</b> for 24" - 29"</li> <li>• special construction for bicycles with <b>disc brakes</b>, massive chainstay ends, ...</li> <li>• when shortening the spacers also suitable for <b>boost standard</b></li> <li>• for <b>carrier bags</b></li> <li>• with reflector/rear light bracket and spring flap</li> <li>• loading surface: 38 x 13,5 cm (L x W)</li> <li>• OEM</li> </ul> <p><small>Tested by the manufacturer according to EN 14872</small></p>		<b>29,90 €</b>  44/19
<b>449902</b> 30	<b>GEPÄCKTRÄGERPLATTE</b> »RACKY BASEPLATE« <ul style="list-style-type: none"> <li>• Trägerplatte zur <b>Vergrößerung der Auflagefläche des Gepäckträgers</b></li> <li>• inkl. <b>3 Universal</b>befestigungsstreben</li> <li>• für alle gängigen Gepäckträger</li> <li>• <b>Aluminium</b></li> <li>• 400 x 400 mm</li> <li>• mit M-Wave Banderole</li> </ul>	<b>CARRIER PLATE</b> »RACKY BASEPLATE« <ul style="list-style-type: none"> <li>• carrier plate for <b>enlarging the contact area of the carrier</b></li> <li>• incl. <b>3 universal</b> mounting struts</li> <li>• for all common carriers</li> <li>• <b>aluminium</b></li> <li>• 400 x 400 mm</li> <li>• with M-Wave banderole</li> </ul> 		<b>17,90 €</b>  43/19

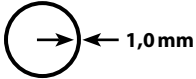

ART.-NR. 	BESCHREIBUNG	DESCRIPTION	UVP verfügbar ab/ available in
<b>461651</b> 50	<b>E-BIKE-SCHEINWERFER ›D&amp;E‹</b> <ul style="list-style-type: none"> <li>• für <b>E-Bikes</b> (DC 6 - 48 V)</li> <li>• mit <b>Reflektor</b></li> <li>• 1 weiße <b>LED</b></li> <li>• <b>30 Lux</b></li> <li>• mit <b>deutschem Prüfzeichen</b></li> <li>• auf Smart Eurolochkarte</li> </ul>	<b>E-BIKE HEAD LAMP ›D&amp;E‹</b> <ul style="list-style-type: none"> <li>• for <b>e-bikes</b> (DC 6 - 48 V)</li> <li>• with <b>reflector</b></li> <li>• 1 white <b>LED</b></li> <li>• <b>30 Lux</b></li> <li>• with <b>German approval number</b></li> <li>• on Smart eurohole card</li> </ul>	 <p><b>16,90 €</b></p> <p>47/19</p>
<b>466458</b> <b>NEW</b>	<b>E-BIKE GEPÄCKTRÄGER-RÜCKLICHT ›VULCAN MINI‹</b> <ul style="list-style-type: none"> <li>• für <b>E-Bikes</b> (DC 6 - 15 V)</li> <li>• mit <b>3 roten LEDs</b></li> <li>• Abstrahlwinkel 220°</li> <li>• für 50 mm Lochabstandsmontage</li> <li>• nur ca. <b>63 x 20 mm</b></li> <li>• Kabellänge: 100 cm</li> <li>• inkl. Befestigungsteilen</li> <li>• auf Smart Eurolochkarte</li> </ul>	<b>E-BIKE CARRIER REAR LIGHT ›VULCAN MINI‹</b> <ul style="list-style-type: none"> <li>• for <b>e-bikes</b> (DC 6 - 15 V)</li> <li>• with <b>3 red LEDs</b></li> <li>• radiation angle 220°</li> <li>• for 50 mm hole distance mounting</li> <li>• only approx. <b>63 x 20 mm</b></li> <li>• cable length: 100 cm</li> <li>• incl. mounting parts</li> <li>• on Smart eurohole card</li> </ul>	 <p><b>11,90 €</b></p> <p>45/19</p>
<b>466457</b> 80	ohne deutsches Prüfzeichen Verkauf und Nutzung im Geltungsbereich der StVZO (Deutschland) unzulässig (Abgabe nur an außerdeutsche Kunden).	without German approval number	 <p><b>11,90 €</b></p> <p>35/19</p>
<b>466100</b> <b>466101</b> <b>466095</b> 1.000/5	<b>REFLEKTORHALTER</b> <ul style="list-style-type: none"> <li>• für Montage an der Sattelstütze, Sitzrohr, Vorbau, ...</li> <li>• Montageverpackung</li> </ul>	<b>REFLECTOR BRACKET</b> <ul style="list-style-type: none"> <li>• for mounting at seat post, seat tube, stem, ...</li> <li>• OEM</li> </ul>	 <p><b>0,50 €</b></p> <p>35/19</p> <p><b>0,50 €</b></p> <p>35/19</p> <p><b>0,50 €</b></p> <p>35/19</p>
<b>470157</b> 32	<b>MINI-PUMPE</b> <ul style="list-style-type: none"> <li>• <b>Aluminium</b></li> <li>• <b>titanfarben</b> eloxiert</li> <li>• <b>Universal-Doppelpumpenkopf</b> für FV, AV and DV</li> <li>• mit <b>T-Klappgriff</b></li> <li>• mit <b>Schnellverschlusshebel</b></li> <li>• mit Staubschutzkappe</li> <li>• mit Halter</li> <li>• auf Ventura Eurolochkarte</li> </ul>	<b>MINI-PUMP</b> <ul style="list-style-type: none"> <li>• <b>aluminium</b></li> <li>• <b>titanium</b> anodized colour</li> <li>• <b>universal double pump head</b> for FV, AV and DV</li> <li>• with <b>foldable T-handle</b></li> <li>• with <b>quick fastening lever</b></li> <li>• with dust protection cap</li> <li>• with bracket</li> <li>• on Ventura eurohole card</li> </ul>	 <p><b>5,90 €</b></p> <p>~ Nov./19</p>
<b>470183</b> 500/20	<b>CO2-PATRONE</b> <ul style="list-style-type: none"> <li>• <b>25 g</b></li> <li>• mit Gewinde</li> <li>• im 20er Einzelkarton</li> </ul>	<b>CO2 CARTRIDGE</b> <ul style="list-style-type: none"> <li>• <b>25 g</b></li> <li>• with thread</li> <li>• 20 pieces in box</li> </ul>	 <p><b>4,90 €</b></p> <p>36/19</p>

ART.-NR. 	BESCHREIBUNG	DESCRIPTION		UVP verfügbar ab/ available in
<b>470376</b> 10	<b>HOCHDRUCK-STANDPUMPE</b> <ul style="list-style-type: none"> <li>• Stahl</li> <li>• mit <b>Universal-Doppelpumpenkopf</b> für FV, AV und DV</li> <li>• bis <b>11 bar / 160 psi</b></li> <li>• mit Manometer</li> <li>• mit Beto Anhänger</li> </ul>	<b>HIGH PRESSURE FLOOR PUMP</b> <ul style="list-style-type: none"> <li>• steel</li> <li>• with <b>universal double pump head</b> for FV, AV and DV</li> <li>• up to <b>11 bar / 160 psi</b></li> <li>• with manometer</li> <li>• with Beto tag</li> </ul>		<b>19,90 €</b>  35/19
<b>470378</b> 10	<b>STANDPUMPE</b> <ul style="list-style-type: none"> <li>• Stahl</li> <li>• <b>Ballnadel</b> und Luftmatratzenadapter</li> <li>• mit <b>Manometer</b></li> <li>• mit Universal-Doppelpumpenkopf für FV, AV und DV</li> <li>• mit Schnellverschlusshebel</li> <li>• mit Ventura Anhänger</li> </ul>	<b>FLOOR PUMP</b> <ul style="list-style-type: none"> <li>• steel</li> <li>• <b>ball needle</b> and adapter for air mattress</li> <li>• with <b>manometer</b></li> <li>• with universal double pump head for FV, AV and DV</li> <li>• with quick fastening lever</li> <li>• with Ventura tag</li> </ul>		<b>16,90 €</b>  ~ Nov./19
<b>470377</b> 20	<b>STANDPUMPE</b> <ul style="list-style-type: none"> <li>• Stahl</li> <li>• <b>Ballnadel</b> und Luftmatratzenadapter</li> <li>• mit <b>höherliegendem Manometer</b> für bessere Ablesbarkeit</li> <li>• mit Universal-Doppelpumpenkopf für FV, AV und DV</li> <li>• mit Schnellverschlusshebel</li> <li>• mit Ventura Anhänger</li> </ul>	<b>FLOOR PUMP</b> <ul style="list-style-type: none"> <li>• steel</li> <li>• <b>ball needle</b> and adapter for air mattress</li> <li>• with <b>higher arranged manometer</b> for better readability</li> <li>• with universal double pump head for FV, AV and DV</li> <li>• with quick fastening lever</li> <li>• with Ventura tag</li> </ul>		<b>11,90 €</b>  ~ Nov./19
<b>519400</b>          <b>519401</b> 500/10 Paar	<b>SELBSTKLEBENDES HOCHDRUCK-GEWEBE-FELGENBAND</b> <ul style="list-style-type: none"> <li>• aus <b>sehr hochwertigem, 0,5 mm starkem, blauem Nylongewebe</b></li> <li>• eine spezielle Klebeschicht <b>verhindert Verrutschen</b> auch bei starker Belastung und hohen Temperaturen</li> <li>• sehr <b>leicht</b> (nur 15 g bei 16-622)</li> <li>• passend für <b>12" - 29"</b></li> <li>• mit Ventilloch</li> <li>• <b>1 Paar</b> = 2 x 2 m im Polybeutel mit M-Wave Eurolochheader</li> </ul>	<b>SELF-ADHESIVE HIGH PRESSURE TEXTILE RIM TAPE</b> <ul style="list-style-type: none"> <li>• <b>high-grade, 0.5 mm thick, blue nylon fabric</b></li> <li>• the special glue layer <b>prevents</b> the tape from <b>slipping</b>, even at intense strain or high temperatures</li> <li>• very <b>light</b> (only 15 g in size 16-622)</li> <li>• suitable for <b>12" - 29"</b></li> <li>• with valve hole</li> <li>• <b>1 pair</b> = 2 x 2 m in PE bag with M-Wave eurohole header</li> </ul>		<b>4,90 €</b> 35/19  <b>4,90 €</b> 35/19

ART.-NR. 	BESCHREIBUNG	DESCRIPTION	 	UVP verfügbar ab/ available in
	<p><b>UNIVERSALSCHLAUCH</b></p> <ul style="list-style-type: none"> <li>hochelastische Spezial-Butyl-Mischung</li> <li>doppelte Kontrolle auf Luftdichtheit</li> <li>in Kenda Eurolochbox</li> </ul> <p>• <b>700 x 23/26 C</b> ETRTO 23/26-622</p> <p>• <b>FV</b></p>	<p><b>UNIVERSAL TUBE</b></p> <ul style="list-style-type: none"> <li>highly elastic special Butyl mixture</li> <li>double check of air-tightness</li> <li>in Kenda eurohole box</li> </ul> <p>• <b>700 x 23/26 C</b> ETRTO 23/26-622</p> <p>• <b>FV</b></p>	 <p>5,90 €</p>	<p><b>5,90 €</b></p> <p>35/19</p>
<p><b>516491</b></p>	<p>Ventil: 60 mm, <b>mit herauschraubbarem Ventileinsatz</b></p>	<p>valve: 60 mm, <b>with removable valve insert</b></p>		<p><b>5,90 €</b></p> <p>35/19</p>
<p><b>516280</b> 50</p>	<p>Ventil: 80 mm, <b>mit herauschraubbarem Ventileinsatz</b></p>	<p>valve: 80 mm, <b>with removable valve insert</b></p>		<p><b>9,90 €</b></p> <p>35/19</p>
<p><b>516215</b></p>	<p>Ventil: 32 mm</p>	<p>valve: 32 mm</p>		<p><b>5,90 €</b></p> <p>35/19</p>
<p><b>516292</b> 50</p>	<p>Ventil: 48 mm</p>	<p>valve: 48 mm</p>		<p><b>5,90 €</b></p> <p>35/19</p>
<p><b>516299</b></p>	<ul style="list-style-type: none"> <li><b>29/28 x 1.90 - 2.35</b> ETRTO 50/58-622</li> <li><b>FV, 48 mm</b></li> </ul>	<ul style="list-style-type: none"> <li><b>29/28 x 1.90 - 2.35</b> ETRTO 50/58-622</li> <li><b>FV, 48 mm</b></li> </ul>	 <p>→ ← 1,0 mm</p>	<p><b>7,90 €</b></p> <p>35/19</p>
<p><b>516316</b></p>	<ul style="list-style-type: none"> <li><b>24 x 1.3/8</b> ETRTO 32/40-540/541</li> <li><b>AV</b></li> </ul>	<ul style="list-style-type: none"> <li><b>24 x 1.3/8</b> ETRTO 32/40-540/541</li> <li><b>AV</b></li> </ul>		<p><b>5,90 €</b></p> <p>35/19</p>
<p><b>517320</b> 50</p>	<ul style="list-style-type: none"> <li><b>20 x 1.25 - 1.50</b> ETRTO 32/40-406</li> <li><b>AV</b></li> </ul>	<ul style="list-style-type: none"> <li><b>20 x 1.25 - 1.50</b> ETRTO 32/40-406</li> <li><b>AV</b></li> </ul>		<p><b>5,90 €</b></p> <p>35/19</p>
<p><b>519990</b></p>	<p><b>VENTILEINSATZ</b> 100 Stück im Polybeutel</p> <p>für AV</p>	<p><b>VALVE INSERT</b> 100 pieces in PE-bag</p> <p>for AV</p>		<p><b>0,59 €</b></p> <p>35/19</p>
<p><b>519991</b> 2.000/100</p>	<p>für FV</p>	<p>for FV</p>		<p><b>0,59 €</b></p> <p>35/19</p>
<p><b>519988</b></p>	<p><b>FELGENMUTTER</b> 100 Stück im Polybeutel</p> <p>für AV</p>	<p><b>RIM NUT</b> 100 pieces in PE-bag</p> <p>for AV</p>		<p><b>0,20 €</b></p> <p>35/19</p>
<p><b>519989</b> 2.000/100</p>	<p>für FV</p>	<p>for FV</p>		<p><b>0,20 €</b></p> <p>35/19</p>
<p><b>519960</b> 2.000/100</p>	<p><b>VENTILKAPPE</b></p> <ul style="list-style-type: none"> <li>für FV</li> <li>aus transparentem Kunststoff</li> <li>100 Stück im Polybeutel</li> </ul>	<p><b>VALVE CAP</b></p> <ul style="list-style-type: none"> <li>for FV</li> <li>made of transparent plastic</li> <li>100 pieces in PE-bag</li> </ul>		<p><b>0,20 €</b></p> <p>35/19</p>

- +** RUNDUM PANNENSCHUTZ
- +** HÖHERER GRIP UND GERINGERER ROLLWIDERSTAND
- +** EINFACHE MONTAGE OHNE WERKZEUGE
- +** WIEDERVERWENDBAR
- +** SEHR LEICHT

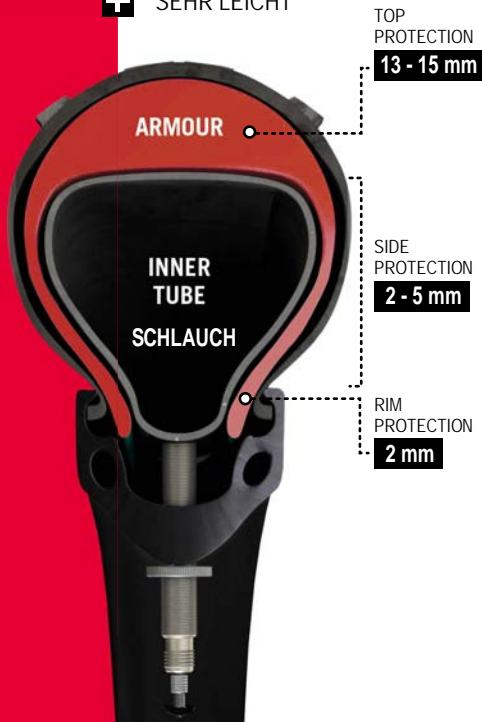

**Der Rundum-Schutz gegen Durchstiche, Schnitte und Quetschungen. Der Tannus Armour ist deutlich effektiver als andere Pannenschutzsysteme.**

- 15 mm an der dicksten Stelle, 2 mm an den Seiten und im Felgenbereich
- freie Reifen- und Profiwahl
- sehr leicht
- wiederverwendbar
- Unterstützung des gesamten Reifens: auch bei niedrigerem Luftdruck wirkt der Armour gegen Verformung durch seitliche Kräfte, wodurch höherer Grip und bessere Traktion ermöglicht wird
- vermindert die Gefahr von Snake Bites (z.B. durch einen starken Aufprall)
- patentierte Aither 1.1-Technologie: sehr leichter High Tech Polymerschäum mit Millionen von Bläschen sorgt für Stoß- und Vibrationsdämpfung
- niedriger Rollwiderstand
- Noteinlage: mit defektem Schlauch kann man mit reduzierter Geschwindigkeit weiterfahren
- einfache Montage ohne Werkzeuge
- Einklemmschutz bei Schlauchmontage
- Universalgrößen für mehrere Breiten
- recycelbar
- ideal auch für Bike Sharing Flotten



ART.-NR. 	ARMOUR GRÖSSE ARMOUR SIZE	PASSENDER REIFEN MATCHING TIRE	PASSENDER SCHLAUCH MATCHING TUBE	FELGENINNEN- BREITE RIM INNER WIDTH	GEWICHT WEIGHT	UVP verfügbar ab/ available in	SET ART.-NR. mit passendem Schlauch/ with fitting tube FV 48 mm
519125 17	29 x 1.95 - 2.50 50/63 - 622	~ 29 x 1.95 - 2.50 ~ 50/63 - 622	~ 700 x 44 - 54 C ~ 44/54 - 622	~ 19 - 33 mm	320 g	29,90 € 35/19	519155 34,90 € 47/19
519128 27	700 x 28 - 34 C 28/34 - 622	~ 700 x 28 - 34 C ~ 28/34 - 622	~ 700 x 20 - 25 C ~ 20/25 - 622	~ 16 - 25 mm	200 g	29,90 € 35/19	519158 34,90 € 47/19
519123 27	700 x 35 - 40 C 35/40 - 622	~ 700 x 35 - 40 C ~ 35/40 - 622	~ 700 x 20 - 28 C ~ 20/28 - 622	~ 19 - 25 mm	260 g	29,90 € 35/19	519153 34,90 € 47/19
519124 22	700 x 42 - 47 C 42/47 - 622	~ 700 x 42 - 47 C ~ 42/47 - 622	~ 700 x 28 - 40 C ~ 28/40 - 622	~ 19 - 25 mm	290 g	29,90 € 35/19	519154 34,90 € 47/19
519122 17	27.5 x 1.95 - 2.50 50/63 - 584	~ 27.5 x 1.95 - 2.50 ~ 50/63 - 584	~ 27.5 x 1.65 - 2.125 ~ 44/54 - 584	~ 19 - 33 mm	310 g	29,90 € 35/19	519152 34,90 € 47/19
519120 22	26 x 1.60 - 1.90 42/47 - 559	~ 26 x 1.60 - 1.90 ~ 42/47 - 559	~ 26 x 1.10 - 1.50 ~ 28/40 - 559	~ 19 - 25 mm	260 g	29,90 € 35/19	519150 34,90 € 47/19
519129 17	26 x 1.95 - 2.10 50/54 - 559	~ 26 x 1.95 - 2.10 ~ 50/54 - 559	~ 26 x 1.65 - 1.90 ~ 44/50 - 559	~ 19 - 33 mm	250 g	29,90 € 35/19	519159 34,90 € 47/19
519121 17	26 x 1.95 - 2.50 50/63 - 559	~ 26 x 1.95 - 2.50 ~ 50/63 - 559	~ 26 x 1.65 - 1.90 ~ 44/54 - 559	~ 19 - 33 mm	300 g	29,90 € 35/19	519151 34,90 € 47/19
519127 17	24 x 1.95 - 2.50 50/63 - 507	~ 24 x 1.95 - 2.50 ~ 50/63 - 507	~ 24 x 1.65 - 2.125 ~ 44/54 - 507	~ 19 - 33 mm	270 g	29,90 € 35/19	519157 34,90 € 47/19
519126 17	20 x 1.95 - 2.50 50/63 - 406	~ 20 x 1.95 - 2.50 ~ 50/63 - 406	~ 20 x 1.65 - 2.125 ~ 44/54 - 406	~ 19 - 33 mm	220 g	29,90 € 35/19	519156 34,90 € 47/19
519130 17	20 x 1.75 - 1.95 47/50 - 406	~ 20 x 1.75 - 1.95 ~ 47/50 - 406				29,90 € ~ Jan./20	519160 34,90 € ~ Jan./20



- + PUNCTURE PROTECTION ALL-ROUND
- + HIGHER GRIP AND LOWER ROLLING RESISTANCE
- + EASY MOUNTING WITHOUT TOOLS
- + REUSABLE
- + VERY LIGHT

TANNUS  
**ARMOUR**  
**NEVER STOP RIDING**



**The all-round protection against punctures, cuts and pinching. The Tannus Armour is significantly more effective than other puncture protection systems!**

- 15 mm at the tread, 2 mm at the sides and in the rim area
- free tire and tread selection
- very light
- reusable
- support for the entire tire: even at lower air pressure, the Armour works against deformation by lateral forces, allowing greater grip and better traction
- reduces the risk of snake bites (e.g. by a strong impact)
- patented Aither 1.1 technology: very lightweight high-tech polymer foam with millions of bubbles provides shock and vibration damping
- low rolling resistance
- in case of emergency: with flattened tube you can continue riding at reduced speed
- easy mounting without tools
- anti-pinch protection for hose mounting
- universal sizes for several widths
- recyclable
- ideal also for bike sharing fleets



Art. 084163



ART.-NR.

GRÖSSE  
SIZE

ETRTO NR.  
ETRTO NO.

SPEZIFIKATIONEN  
SPECIFICATIONS

VERPACKUNG  
PACKAGING

UVP  
verfügbar ab/  
available in

- Speed ■ ■ ■ ■
- Grip ■ ■ ■ ■
- Protection ■ ■ ■ ■
- Durability ■ ■ ■ ■



›FLINTRIDGE‹  
K-1152

**KENDA**

›FLINTRIDGE PRO‹

›FLINTRIDGE PRO‹

521743  
20

700 x 35 C

35-622

- 120 TPI
- Kevlar faltbar / folded
- GCT (Gravel Casing Technology)
- DTC
- Tubeless Ready
- Reflective Hot Patch (RHP) für bessere Sichtbarkeit / for better visibility
- nur / only 481 g
- TCC: 2.218 mm



Eurolochkarte  
eurohole card



54,90 €

35/19

›FLINTRIDGE ELITE‹

›FLINTRIDGE ELITE‹

523337  
20

700 x 40 C

40-622

- 60 TPI
- Kevlar faltbar / folded
- L3R Pro
- Reflective Hot Patch (RHP) für bessere Sichtbarkeit / for better visibility
- nur / only 468 g
- TCC: 2.231 mm



Eurolochkarte  
eurohole card



29,90 €

35/19

ART.-NR. 	GRÖSSE SIZE	ETRTO NR. ETRTO NO.	SPEZIFIKATIONEN SPECIFICATIONS	VERPACKUNG PACKAGING	UVP verfügbar ab/ available in
---	----------------	------------------------	-----------------------------------	-------------------------	--------------------------------------

**KENDA**

Speed   
 Grip   
 Protection   
 Durability 



## REGOLITH PRO<sup>κ</sup> K-1214

**BEST ALLROUNDER**

<b>521956</b> 10 ★★★★	<b>29 x 2.20</b>	56-622	<ul style="list-style-type: none"> <li>• 120 TPI</li> <li>• Kevlar faltbar / folded</li> <li>• Tubeless Race</li> <li>• Dual Tread</li> <li>• nur / only 683 g</li> <li>• TCC: 2.347 mm</li> </ul>	<b>DUAL TREAD</b> 	Eurolochkarte eurohole card 	<b>59,90 €</b>  46/19
<b>521949</b> 10 ★★★★			<ul style="list-style-type: none"> <li>• 120 TPI</li> <li>• Kevlar faltbar / folded</li> <li>• SCT</li> <li>• Dual Tread</li> <li>• nur / only 755 g</li> <li>• TCC: 2.347 mm</li> </ul>	<b>DUAL TREAD</b> 	Eurolochkarte eurohole card 	<b>57,90 €</b>  41/19
<b>521974</b> 10 ★★★★	<b>29 x 2.40</b>	61-622	<ul style="list-style-type: none"> <li>• 120 TPI</li> <li>• Kevlar faltbar / folded</li> <li>• SCT</li> <li>• Dual Tread</li> <li>• nur / only 827 g</li> <li>• TCC: 2.372 mm</li> </ul>	<b>DUAL TREAD</b> 	Eurolochkarte eurohole card 	<b>64,90 €</b>  35/19
<b>521975</b> 10 ★★★★	<b>650 B x 2.40</b> <b>27.5 x 2.40</b>	61-584	<ul style="list-style-type: none"> <li>• 120 TPI</li> <li>• Kevlar faltbar / folded</li> <li>• SCT</li> <li>• Dual Tread</li> <li>• nur / only 785 g</li> <li>• TCC: 2.243 mm</li> </ul>	<b>DUAL TREAD</b> 	Eurolochkarte eurohole card 	<b>64,90 €</b>  41/19

**KENDA**

Speed   
 Grip   
 Protection   
 Durability 





## BOOSTER PRO<sup>κ</sup> K-1227

**BEST CONTROL IN CX**

*Bester Kompromiss hinsichtlich Traktion, Geschwindigkeit, Beschleunigung, Grip und Belastbarkeit!*

*Best compromise regarding traction, speed, acceleration, grip and endurance!*

M-WAVE PRO TEAM 

<b>521970</b> 10 ★★★★	<b>29 x 2.20</b>	56-622	<ul style="list-style-type: none"> <li>• 120 TPI</li> <li>• Kevlar faltbar / Kevlar folded</li> <li>• Tubeless Race</li> <li>• Single Tread Compound</li> <li>• nur / only 589 g</li> <li>• TCC: 2.337 mm</li> </ul>	<b>SINGLE TREAD</b> 	Eurolochkarte eurohole card 	<b>59,90 €</b>  35/19
<b>521971</b> 10 ★★★★			<ul style="list-style-type: none"> <li>• 120 TPI</li> <li>• Kevlar faltbar / Kevlar folded</li> <li>• SCT</li> <li>• Single Tread Compound</li> <li>• nur / only 670 g</li> <li>• TCC: 2.337 mm</li> </ul>	<b>SINGLE TREAD</b> 	Eurolochkarte eurohole card 	<b>59,90 €</b>  35/19

ART.-NR. 	GRÖSSE SIZE	ETRTO NR. ETRTO NO.	SPEZIFIKATIONEN SPECIFICATIONS	VERPACKUNG PACKAGING	UVP verfügbar ab/ available in
---	----------------	------------------------	-----------------------------------	-------------------------	--------------------------------------





**KENDA**

- Speed ■ ■ ■ ■ ■
- Grip ■ ■ ■ ■ ■
- Protection ■ ■ ■ ■ ■
- Durability ■ ■ ■ ■ ■



## HELLDIVER PRO K-1202

**FASTEST GRAVITY REARWHEEL TIRE**

<b>521972</b> 10 ★ ★ ★	<b>29 x 2.40</b>	60-622	<ul style="list-style-type: none"> <li>• 120 TPI</li> <li>• Kevlar faltbar / folded</li> <li>• ATC (Advanced Trail Casing)</li> <li>• Tubeless Ready</li> <li>• Dual Tread</li> <li>• nur / only 942 g</li> <li>• TCC: 2.334 mm</li> </ul>	<b>DUAL TREAD</b> 	Eurolochkarte eurohole card 	<b>64,90 €</b>  35/19
<b>521968</b> 10 ★ ★ ★	<b>650 B x 2.40</b> <b>27.5 x 2.40</b>	60-584	<ul style="list-style-type: none"> <li>• 120 TPI</li> <li>• Kevlar faltbar / folded</li> <li>• ATC (Advanced Trail Casing)</li> <li>• Tubeless Ready</li> <li>• Dual Tread</li> <li>• nur / only 737 g</li> <li>• TCC: 2.224 mm</li> </ul>	<b>DUAL TREAD</b> 	Eurolochkarte eurohole card 	<b>64,90 €</b>  35/19

### MARATHON/CC TEST

**Regolith Pro** **Booster Pro**  
(Art. 521956) (Art. 521971)



### TRAIL TEST

**Hellkat Pro** **Nevegal<sup>2</sup> Pro**  
(Art. 521965) (Art. 521960)



**KENDA**

#### Perfekte Kombination für Marathon und Trail

Die renommierte MTB-Zeitschrift „BIKE“ testete in der Ausgabe 8/2019 Reifenpaare für Marathon / CC und Trail. Das Ergebnis: Kenda hat die aktuellen Trends erkannt und bietet zwei echte Traumpaare. Im Marathonbereich sorgten der Regolith Pro vorne und der Booster Pro hinten für hervorragenden Grip unter allen Bedingungen, ohne dabei Rollwiderstand und Pannenschutz außer Acht zu lassen. Dies überzeugte die Redaktion und das Testurteil fiel mit „sehr gut“ und „super“ sehr erfreulich aus.

#### Perfect match for marathon and trail

The well-known MTB magazine "BIKE" tested tire pairs for Marathon / CC and Trail in issue 8/2019. The result: Kenda has recognized the current trends and offers two real dream teams. For marathon use, Regolith Pro at the front and Booster Pro at the rear provided excellent grip in all conditions, without neglecting rolling resistance and puncture protection. This convinced the editors and the test verdict was very pleasing with "very good" and "super".

Noch besser der Trailreifen – Test: die Kombi aus Hellkat Pro vorne und Nevegal<sup>2</sup> Pro hinten erhielt den BIKE-Tipp für Pannenschutz! Neben den sehr guten Fahreigenschaften hinterließ insbesondere der Pannenschutz bleibenden Eindruck mit Bestwerten im Testfeld. Insgesamt ein überragender Auftritt der aktuellsten Kenda Modelle!

The trail tire – test was even better: the combination of Hellkat Pro front and Nevegal<sup>2</sup> Pro on the rear received the BIKE tip for puncture protection! In addition to the very good handling characteristics, in particular the puncture protection left lasting impression with best values in the test field. Overall, an outstanding performance of the latest Kenda models!





ART.-NR. 	GRÖSSE SIZE	ETRTO NR. ETRTO NO.	SPEZIFIKATIONEN SPECIFICATIONS	VERPACKUNG PACKAGING	UVP verfügbar ab/ available in
---	----------------	------------------------	-----------------------------------	-------------------------	--------------------------------------

















**KENDA**

Speed   
 Grip   
 Protection   
 Durability 



## HELLKAT PRO K-1201

BEST CONTROL IN GRAVITY

<p><b>521962</b> 10 </p>	<p><b>29 x 2.40</b></p>	<p>60-622</p>	<ul style="list-style-type: none"> <li>• 120 TPI</li> <li>• Kevlar faltbar / Kevlar folded</li> <li>• ATC (Advanced Trail Casing)</li> <li>• Dual Tread</li> <li>• Tubeless Ready</li> <li>• nur / only 874 g</li> <li>• TCC: 2.350 mm</li> </ul> <p><b>DUAL TREAD</b> </p>	<p>Eurolochkarte eurohole card</p> 	<p><b>59,90 €</b></p> <p>50/19</p>
<p><b>521973</b> 10 </p>			<ul style="list-style-type: none"> <li>• 60 TPI</li> <li>• Kevlar faltbar / Kevlar folded</li> <li>• AEC (Advanced Enduro Casing)</li> <li>• RSR Dual Layer</li> <li>• Tubeless Ready</li> <li>• nur / only 1096 g</li> <li>• TCC: 2.350 mm</li> </ul> <p> </p>	<p>Eurolochkarte eurohole card</p> 	<p><b>64,90 €</b></p> <p>41/19</p>
<p><b>521963</b> 10 </p>	<p><b>29 x 2.60</b></p>	<p>66-622</p>	<ul style="list-style-type: none"> <li>• 120 TPI</li> <li>• Kevlar faltbar / Kevlar folded</li> <li>• ATC (Advanced Trail Casing)</li> <li>• Dual Tread</li> <li>• Tubeless Ready</li> <li>• nur / only 1.039 g</li> <li>• TCC: 2.384 mm</li> </ul> <p><b>DUAL TREAD</b> </p>	<p>Eurolochkarte eurohole card</p> 	<p><b>59,90 €</b></p> <p>35/19</p>
<p><b>521969</b> 10 </p>	<p><b>650 Bx2.40 27.5 x 2.40</b></p>	<p>60-584</p>	<ul style="list-style-type: none"> <li>• 60 TPI</li> <li>• Kevlar faltbar / Kevlar folded</li> <li>• AEC (Advanced Enduro Casing)</li> <li>• RSR Dual Layer</li> <li>• Tubeless Ready</li> <li>• nur / only 1010 g</li> <li>• TCC: 2.224 mm</li> </ul> <p> </p>	<p>Eurolochkarte eurohole card</p> 	<p><b>64,90 €</b></p> <p>41/19</p>
<p><b>521961</b> 10 </p>	<p><b>650 Bx2.60 27.5 x 2.60</b></p>	<p>66-584</p>	<ul style="list-style-type: none"> <li>• 120 TPI</li> <li>• Kevlar faltbar / Kevlar folded</li> <li>• ATC (Advanced Trail Casing)</li> <li>• Tubeless Ready</li> <li>• Dual Tread</li> <li>• nur / only 958 g</li> <li>• TCC: 2.271 mm</li> </ul> <p><b>DUAL TREAD</b> </p>	<p>Eurolochkarte eurohole card</p> 	<p><b>59,90 €</b></p> <p>50/19</p>



ART.-NR. 	GRÖSSE SIZE	ETRTO NR. ETRTO NO.	SPEZIFIKATIONEN SPECIFICATIONS	VERPACKUNG PACKAGING	UVP verfügbar ab/ available in
---	----------------	------------------------	-----------------------------------	-------------------------	--------------------------------------

**KENDA**

- Speed ■ ■ ■ ■
- Grip ■ ■ ■ ■ ■ ■
- Protection ■ ■ ■ ■ ■ ■ ■ ■
- Durability ■ ■ ■ ■



## NEVEGAL<sup>2</sup> PRO<sub>K</sub> K-1211

BEST ENDURO FOLDING IN LIGHTWEIGHT CLASS



<b>521958</b> 10 ★ ★ ★	<b>29 x 2.40</b>	60-622	<ul style="list-style-type: none"> <li>• 120 TPI</li> <li>• Kevlar faltbar / Kevlar folded</li> <li>• ATC (Advanced Trail Casing)</li> <li>• Dual Tread</li> <li>• Tubeless Ready</li> <li>• nur / only 865 g</li> <li>• TCC: 2.340 mm</li> </ul> <p><b>DUAL TREAD</b> </p>	Eurolochkarte eurohole card 	<b>59,90 €</b>  35/19
<b>521957</b> 10 ★ ★ ★	<b>29 x 2.60</b>	66-622	<ul style="list-style-type: none"> <li>• 120 TPI</li> <li>• Kevlar faltbar / Kevlar folded</li> <li>• ATC (Advanced Trail Casing)</li> <li>• Dual Tread</li> <li>• Tubeless Ready</li> <li>• nur / only 959 g</li> <li>• TCC: 2.278 mm</li> </ul> <p><b>DUAL TREAD</b> </p>	Eurolochkarte eurohole card 	<b>59,90 €</b>  35/19
<b>521959</b> 10 ★ ★ ★	<b>650 B x 2.60 27.5 x 2.60</b>	66-584	<ul style="list-style-type: none"> <li>• 120 TPI</li> <li>• Kevlar faltbar / Kevlar folded</li> <li>• ATC (Advanced Trail Casing)</li> <li>• Dual Tread</li> <li>• Tubeless Ready</li> <li>• nur / only 911 g</li> <li>• TCC: 2.265 mm</li> </ul> <p><b>DUAL TREAD</b> </p>	Eurolochkarte eurohole card 	<b>59,90 €</b>  35/19

**KENDA**



## EL CAPO<sub>K</sub> K-1221 PLUS

<b>522780</b> 25 <b>NICE PRICE</b>	<b>650 B x 2.60 27.5 x 2.60</b>	66-584	<ul style="list-style-type: none"> <li>• 30 TPI</li> <li>• nur / only 969 g</li> <li>• TCC: 2.265 mm</li> </ul>	Montageverpackung OEM	<b>21,90 €</b>  35/19
--	-------------------------------------	--------	---	--------------------------	-----------------------------

ART.-NR. 	GRÖSSE SIZE	ETRTO NR. ETRTO NO.	SPEZIFIKATIONEN SPECIFICATIONS	VERPACKUNG PACKAGING	UVP verfügbar ab/ available in
---	----------------	------------------------	-----------------------------------	-------------------------	--------------------------------------



**KENDA**

## ›KLONDIKE‹ K-1014

<b>528113</b> 10 ★	<b>700 x 40 C</b>	42-622	<ul style="list-style-type: none"> <li>• 30 TPI</li> <li>• mit 100 Spikes with 100 studs</li> <li>• nur / only 802 g</li> <li>• TCC: 2.231 mm</li> </ul>	Banderole tag 	<b>49,90 €</b>
--------------------------	-------------------	--------	--	--	----------------



42/19

**KENDA**



Speed   
Grip   
Protection   
Durability 















## ›JUGGERNAUT‹ K-1151

›JUGGERNAUT PRO‹			›JUGGERNAUT PRO‹		
<b>528221</b> 6 ★★★★	<b>26 x 4.00</b>	98-559	<ul style="list-style-type: none"> <li>• 120 TPI</li> <li>• Kevlar faltbar / Kevlar folded</li> <li>• R3C</li> <li>• Tubeless Race</li> <li>• nur / only 808 g</li> <li>• TCC: 2.366 mm</li> </ul>	 Einzelkarton box 	<b>89,90 €</b>

35/19



























›JUGGERNAUT SPORT‹			›JUGGERNAUT SPORT‹		
<b>528220</b> 10 ★	<b>26 x 4.00</b>	98-559	<ul style="list-style-type: none"> <li>• 60 TPI</li> <li>• Fast Rolling Compound</li> <li>• nur / only 1.147 g</li> <li>• TCC: 2.366 mm</li> </ul>	Banderole tag 	<b>59,90 €</b>
<b>528222</b> 10 ★	<b>26 x 4.50</b>	116-559	<ul style="list-style-type: none"> <li>• 60 TPI</li> <li>• Fast Rolling Compound</li> <li>• nur / only 1.609 g</li> <li>• TCC: 2.428 mm</li> </ul>	Banderole tag 	<b>89,90 €</b>

35/19









ART.-NR. 	GRÖSSE SIZE	ETRTO NR. ETRTO NO.	SPEZIFIKATIONEN SPECIFICATIONS	VERPACKUNG PACKAGING	UVP verfügbar ab/ available in	
<b>KENDA</b>						
						
<b>›KHAN II‹ K-1172</b>						
<b>529259</b> 10 ★	<b>700 x 35 C</b>	35-622	<ul style="list-style-type: none"> <li>• 60 TPI</li> <li>• K-Shield Plus</li> <li>• E-Bike geeignet / E-Bike approved</li> <li>• Reflex</li> <li>• TCC: 2.190 mm</li> </ul>	 	Banderole tag 	<b>24,90 €</b>  46/19
<b>529258</b> 10 ★	<b>700 x 40 C</b>	42-622	<ul style="list-style-type: none"> <li>• 60 TPI</li> <li>• K-Shield Plus</li> <li>• E-Bike geeignet / E-Bike approved</li> <li>• Reflex</li> <li>• TCC: 2.218 mm</li> </ul>	 	Banderole tag 	<b>27,90 €</b>  46/19
<b>529009</b> 25			<ul style="list-style-type: none"> <li>• Reflex</li> <li>• TCC: 2.218 mm</li> </ul>		Montageverpackung OEM	<b>13,90 €</b>  35/19
<b>529010</b> 25			<ul style="list-style-type: none"> <li>• creme</li> <li>• 30 TPI</li> <li>• Reflex</li> <li>• TCC: 2.218 mm</li> </ul>		Montageverpackung OEM	<b>15,90 €</b>  35/19
<b>529257</b> 10 ★	<b>700 x 45 C 28 x 1.75</b>	45-622	<ul style="list-style-type: none"> <li>• 60 TPI</li> <li>• K-Shield Plus</li> <li>• E-Bike geeignet / E-Bike approved</li> <li>• Reflex</li> <li>• TCC: 2.253 mm</li> </ul>	 	Banderole tag 	<b>27,90 €</b>  46/19
<b>529008</b> 25			TCC: 2.271 mm		Montageverpackung OEM	<b>10,90 €</b>  35/19

**KENDA****›KOURIER‹  
K-192**

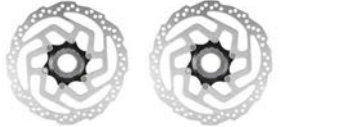



<b>529055</b> 25	<b>26 x 1 3/8</b>	37-590	<ul style="list-style-type: none"> <li>• nur / only 586 g</li> <li>• TCC: 2.083 mm</li> </ul>		Montageverpackung OEM	<b>8,90 €</b>  35/19
<b>529053</b> 25	<b>24 x 1 3/8</b>	37-540	<ul style="list-style-type: none"> <li>• nur / only 539 g</li> <li>• TCC: 1.932 mm</li> </ul>		Montageverpackung OEM	<b>8,90 €</b>  35/19







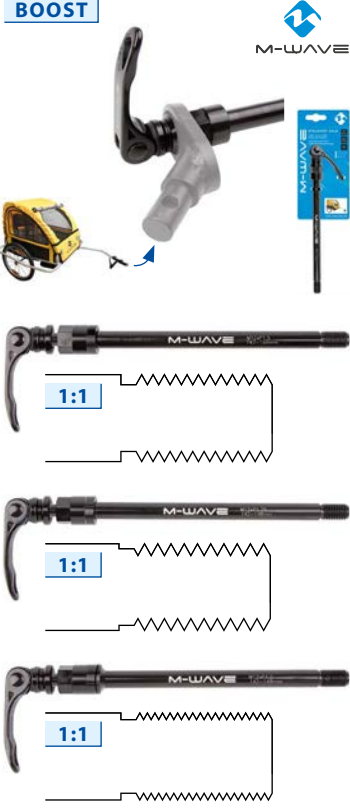



ART.-NR. 	BESCHREIBUNG	DESCRIPTION		UVP verfügbar ab/ available in
<b>587830</b> 25	<b>SHIMANO DEORE XT 12-Gang</b> <b>Schaltwerk</b> RD-M8100 SGS • Top-Normal • in Shimano Eurolochbox	<b>SHIMANO DEORE XT 12 speed</b> <b>Rear derailleur</b> RD-M8100 SGS • top normal • in Shimano eurohole box	 	<b>169,00 €</b> 39/19
<b>587829</b> 12	<b>Kassetten-Zahnkranz</b> CS-M8100 • 10-51 Zähne • in Shimano Eurolochbox	<b>Cassette sprocket</b> CS-M8100 • 10-51 teeth • in Shimano eurohole box	 	<b>249,00 €</b> 35/19
<b>587828</b> 20	<b>Schalthebel</b> SL-M8100-R • rechts • in Shimano Eurolochbox	<b>Shift lever</b> SL-M8100-R • right • in Shimano eurohole box	  	<b>99,90 €</b> 35/19
<b>580483</b> 15	<b>SHIMANO SLX 12-Gang</b> <b>Schaltwerk</b> RD-M7100 SGS • Top-Normal • in Shimano Eurolochbox	<b>SHIMANO SLX 12 speed</b> <b>Rear derailleur</b> RD-M7100 SGS • top normal • in Shimano eurohole box	 	<b>119,00 €</b> 39/19
<b>580482</b> 12	<b>Kassetten-Zahnkranz</b> CS-M7100 • 10-51 Zähne • in Shimano Eurolochbox	<b>Cassette sprocket</b> CS-M7100 • 10-51 teeth • in Shimano eurohole box	 	<b>149,90 €</b> 50/19
<b>580484</b> 10	<b>Schalthebel</b> SL-M7100-R • rechts • in Shimano Eurolochbox	<b>Shift lever</b> SL-M7100-R • right • in Shimano eurohole box	  	<b>59,90 €</b> 44/19
<b>588550</b>	<b>SHIMANO DEORE 10-Gang</b> <b>Schaltwerk, Top-Normal</b> RD-M6000	<b>SHIMANO DEORE 10 speed</b> <b>Rear derailleur, top normal</b> RD-M6000	 	<b>89,90 €</b> 48/19
<b>588545</b> U 50	RD-M610-SGS  <b>Umwerfer</b> • mit Klemme Ø 34,9 mm, Sattelrohr und Adapter für Ø 31,8 mm • Top Swing • im Einzelkarton	RD-M610-SGS  <b>Front derailleur</b> • with clamp Ø 34,9 mm, seat tube and adapter for Ø 31,8 mm • top swing • in box		<b>69,90 €</b> 35/19
<b>587666</b> U 50	FD-M610 • für <b>dreifach</b> (für dual pull) • passend für max. 42 Zähne • Kapazität 20 Zähne	FD-M610 • for <b>triple</b> (for dual pull) • suitable for max. 42 teeth • capacity 20 teeth		<b>39,90 €</b> 35/19
<b>587771</b> 25	FD-M618-L • für <b>zweifach</b> (für down pull) • Kapazität 14 Zähne	FD-M618-L • for <b>double</b> (for down pull) • capacity 14 teeth	 	<b>39,90 €</b> 35/19
<b>587668</b>	<b>Kassetten-Zahnkranz</b> CS-HG500-10, 11-34 Zähne	<b>Cassette sprocket</b> CS-HG500-10, 11-34 teeth		<b>49,90 €</b> 35/19
<b>586279</b> U	CS-HG500-10, 11-36 Zähne	CS-HG500-10, 11-36 teeth		<b>54,90 €</b>
<b>587792</b> 25	CS-HG500-10, <b>11-42</b> Zähne	CS-HG500-10, <b>11-42</b> teeth	 	<b>59,90 €</b> 35/19
<b>586229</b> 20	<b>Schalthebel</b> SL-M6000 links	<b>Shift lever</b> SL-M6000 left		<b>39,90 €</b> 35/19
<b>586247</b> 40	rechts	right		<b>39,90 €</b> 48/19

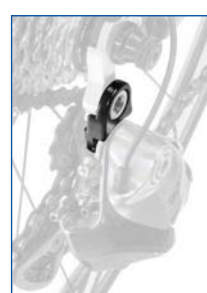



ART.-NR. 	BESCHREIBUNG	DESCRIPTION		UVP verfügbar ab/ available in
<b>587824</b> <b>587825</b> 25	<b>SHIMANO DEORE 10-Gang</b> <b>Scheibenbremse</b> BR-MT200 und Bremshebel BL-MT200, mit <b>Hydraulikleitung</b> (ohne IS-Adapter) vorne, Leitung 1.000 mm hinten, Leitung 1.700 mm	<b>SHIMANO DEORE 10 speed</b> <b>Disc brake</b> BR-MT200 and brake lever BL-MT200, with <b>hydraulic tube</b> (w/o IS-adapter) front, cable 1,000 mm rear, cable 1,700 mm		<b>44,90 €</b> <b>44,90 €</b> 48/19
<b>587826</b> <b>587827</b> 50	<b>Bremsscheibe SM-RT64</b> <ul style="list-style-type: none"> <li>Center Lock</li> <li>für Sinter- und organische Bremsbeläge, aufgeraut</li> <li>in Shimano Eurolochbox</li> </ul> 160 mm 180 mm	<b>Brake disc SM-RT64</b> <ul style="list-style-type: none"> <li>Center Lock</li> <li>for sintered and organic brake pads, roughened</li> <li>in Shimano eurohole box</li> </ul> 160 mm 180 mm		<b>32,90 €</b> <b>39,90 €</b> 46/19
<b>587745</b> <b>587746</b> 50	<b>Bremsscheibe SM-RT10, Center Lock</b> 160 mm 180 mm	<b>Brake disc SM-RT10, center lock</b> 160 mm 180 mm		<b>10,90 €</b> <b>14,90 €</b> 35/19
<b>586433</b> 10 Set	<b>Kettenradgarnitur FC-MT500-3</b> <ul style="list-style-type: none"> <li>22/30/40 Zähne</li> <li>175 mm Aluminium-Kurbel</li> </ul>	<b>Chainwheel Set FC-MT500-3</b> <ul style="list-style-type: none"> <li>22/30/40 teeth</li> <li>175 mm aluminium crank</li> </ul>		<b>139,00 €</b> 35/19
<b>586434</b> 10 Set	<b>Kettenradgarnitur FC-MT500-2</b> <ul style="list-style-type: none"> <li>26-36 Zähne</li> <li>175 mm Aluminium-Kurbel</li> </ul>	<b>Chainwheel Set FC-MT500-2</b> <ul style="list-style-type: none"> <li>26-36 teeth</li> <li>175 mm aluminium crank</li> </ul>		<b>139,00 €</b> ~ Dez./19
<b>587677</b> 50	<b>Innenlager SM-BB52B</b> <ul style="list-style-type: none"> <li>Hollowtech 2</li> <li>in Shimano Eurolochbox</li> </ul>	<b>B.B. axle SM-BB52B</b> <ul style="list-style-type: none"> <li>Hollowtech 2</li> <li>in Shimano eurohole box</li> </ul>		<b>21,90 €</b> 40/19
<b>586257</b> 50 <b>586230</b> 20	<b>SHIMANO ALIVIO 9-Gang</b> <b>Schalt-/Bremshebel</b> links, ST-EF500-L rechts, ST-EF510-9R	<b>SHIMANO ALIVIO 9 speed</b> <b>Shift/brake lever</b> left, ST-EF500-L right, ST-EF510-9R		<b>18,90 €</b> 48/19 <b>29,90 €</b> ~ Dez./19
<b>586250</b> <b>586251</b> 100	<b>SHIMANO SL-M315 8-Gang</b> <b>Schalthebel</b> links, SL-M315-L rechts, SL-M315-8R	<b>SHIMANO SL-M315 8 speed</b> <b>Shift lever</b> left, SL-M315-L right, SL-M315-8R		<b>18,90 €</b> 48/19 <b>19,90 €</b> 48/19
<b>586257</b> <b>586259</b> 50	<b>SHIMANO ST-EF500 7-Gang</b> <b>Schalt-/Bremshebel</b> links, ST-EF500-L rechts, ST-EF500-7R	<b>SHIMANO ST-EF500 7 speed</b> <b>Shift/brake lever</b> left, ST-EF500-L right, ST-EF500-7R		<b>18,90 €</b> 48/19 <b>19,90 €</b> 48/19

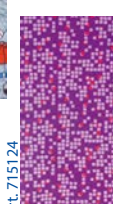











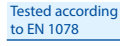

ART.-NR. 	BESCHREIBUNG	DESCRIPTION		UVP verfügbar ab/ available in
<b>610053</b> 1	<b>E-BIKE AKKU</b> <ul style="list-style-type: none"> <li>mit <b>Batteriemanagementsystem</b></li> <li>375 Wh / 36 Volt</li> <li>abschließbar</li> <li>mit Ladegerät</li> <li><b>am Fahrrad und separat aufladbar</b></li> <li>mit Ladezustandsanzeige</li> <li>zur Befestigung an Flaschenhalterösen</li> <li>Gefahrgutklasse UN 38.3</li> </ul>	<b>E-BIKE BATTERY</b> <ul style="list-style-type: none"> <li>with <b>accumulator management system</b></li> <li>375 Wh / 36 Volt</li> <li>lockable</li> <li>with charger</li> <li><b>rechargeable mounted on bike and separately</b></li> <li>with charge control indicator</li> <li>for mounting at eyelets for bottle cages</li> <li>dangerous goods class UN 38.3</li> </ul>		<b>549,00 €</b>  35/19
<b>613015</b> 120	<b>E-BIKE MOTOR ›DRIVE C‹</b> <ul style="list-style-type: none"> <li>25 km/h</li> <li>36 V / 250 W</li> <li>bis 50 Nm</li> </ul>	<b>E-BIKE MOTOR ›DRIVE C‹</b> <ul style="list-style-type: none"> <li>25 km/h</li> <li>36 V / 250 W</li> <li>up to 50 Nm</li> </ul>		<b>829,00 €</b>  35/19
<b>613017</b> 120	<b>E-BIKE MOTOR ›DRIVE S MAG‹</b> <ul style="list-style-type: none"> <li>für vertikalen Einbau</li> <li>25 km/h</li> <li>36 V / 250 W</li> <li>bis 90 Nm</li> </ul>	<b>E-BIKE MOTOR ›DRIVE S MAG‹</b> <ul style="list-style-type: none"> <li>for vertical mounting</li> <li>25 km/h</li> <li>36 V / 250 W</li> <li>up to 90 Nm</li> </ul>		<b>1.199,00 €</b>  ~ Nov./19
<b>613056</b>	<b>DISPLAY UND ZUBEHÖR</b> <b>LCD Display ›Allround‹</b>	<b>DISPLAY AND ACCESSORIES</b> <b>LCD Display ›Allround‹</b>		<b>199,90 €</b>  31/19
<b>613058</b>	<b>Bedieneinheit ›Remote‹</b>	<b>operating unit ›Remote‹</b>		<b>159,90 €</b>  41/19
<b>613057</b> 12	<b>LCD Display ›Centrak</b> optionale Ergänzung zu Bedieneinheit ›Remote‹ (Art. 613058)	<b>LCD Display ›Centrak</b> optional supplement to control unit ›Remote‹ (art. 613058)		<b>199,90 €</b>  50/19
<b>613661</b> <b>613662</b> <b>613663</b> 4	<b>E-BIKE RAHMEN ›CITY WAVE‹</b> <ul style="list-style-type: none"> <li>700 C, 28"</li> <li>Aluminium roh</li> <li>für Linkage-Akku (Art. 613200)</li> <li>Einbaumaß 135 mm</li> <li>ohne Ausfallende</li> <li>mit außenliegendem Ladeanschluss</li> <li>für semiintegrierten Steuersatz, 1 1/8" → 1,5"</li> <li>für Sattelstütze mit Ø 31,6 mm</li> <li>auch für Riemenantrieb geeignet</li> </ul>	<b>E-BIKE FRAMES ›CITY WAVE‹</b> <ul style="list-style-type: none"> <li>700 C, 28"</li> <li>aluminium raw finish</li> <li>for Linkage battery (art. 613200)</li> <li>OLD 135 mm</li> <li>without drop outs</li> <li>external charging connection</li> <li>for semi-integrated head set, 1 1/8" → 1.5"</li> <li>for seat stays with Ø 31.6 mm</li> <li>also suitable for gates</li> </ul>		<b>599,00 €</b>  35/19 <b>599,00 €</b>  35/19 <b>599,00 €</b>  35/19
<b>613609</b> 300	<b>AUSFALLENDEN</b> für City Wave-Rahmen (Art. 613661-3) für Schaltwerk, für Antriebsseite	<b>DROP OUTS</b> for City and frames (art. 613661-3) for rear derailleur, for drive side		<b>24,90 €</b>  35/19
<b>613610</b> 250	für Nabenschaltung, für Antriebsseite	for internal gear hub, for drive side		<b>24,90 €</b>  35/19
<b>613614</b> 200	für Nicht-Antriebsseite, mit Befestigung für Postmount Bremse 160 mm	for non-drive side, with brake mount PM 160 mm		<b>39,90 €</b>  35/19







ART.-NR. 	BESCHREIBUNG	DESCRIPTION		<b>UVP</b> verfügbar ab/ available in
<b>612021</b> 20	<b>E-BIKE AKKU-SCHUTZHÜLLE</b> <b>›E-PROTECT WRAP‹</b> <ul style="list-style-type: none"> <li>• <b>Universalgröße</b> für in den Rahmen integrierte E-Bikes Akkus</li> <li>• <b>verlängerte Akkulaufzeit</b> durch Isolierung</li> <li>• <b>Schutz</b> vor Kälte und Witterung, Kratzern, Steinschlag und Stoßschäden</li> <li>• aus Neopren</li> <li>• im M-Wave Einzelkarton</li> </ul>	<b>E-BIKE BATTERY PROTECTION COVER</b> <b>›E-PROTECT WRAP‹</b> <ul style="list-style-type: none"> <li>• <b>universal size</b> for in the frame integrated e-bike batteries</li> <li>• isolation provides <b>extended battery capacity</b></li> <li>• <b>protection</b> from coldness and weather conditions, scratches, stone chipping and impact damages</li> <li>• made of neoprene</li> <li>• in M-Wave box</li> </ul>		<b>14,90 €</b>  37/19
<b>612022</b> 250	<b>E-BIKE AKKU KONTAKTSCHUTZ</b> <b>›E-PROTECT CONNECT‹</b> <ul style="list-style-type: none"> <li>• <b>Universalgröße</b> zur <b>Abdeckung der Anschlusskontakte</b> am Rahmen bei entnommenen E-Bike Akkus</li> <li>• Schutz vor Schmutz, Wasser und Beschädigung</li> <li>• aus Neopren</li> <li>• auf M-Wave Eurolochkarte</li> </ul>	<b>E-BIKE BATTERY CONNECTOR COVER</b> <b>›E-PROTECT CONNECT‹</b> <ul style="list-style-type: none"> <li>• <b>universal size to cover the connection contacts</b> of the frame with removed e-bike batteries</li> <li>• protection from dirt, water and damages</li> <li>• made of neoprene</li> <li>• on M-Wave eurohole card</li> </ul>		<b>9,90 €</b>  37/19
<b>640140</b>  <b>640141</b>  <b>640142</b> 100	<b>STECKACHSE FÜR ANHÄNGER-KUPPLUNG</b> <b>›STALWART AXLE‹</b> <ul style="list-style-type: none"> <li>• zur <b>Montage von standard Fahrrad-Anhänger-Kupplungen</b> an <b>12 mm Steckachs-naben</b></li> <li>• durch 6 mm Distanzscheibe passend für 12 mm Steckachsnaben mit <b>142 mm</b> Einbaumaß und für <b>Boost-Naben</b> mit <b>148 mm</b> Einbaumaß</li> <li>• Aluminium</li> <li>• mit Schnellspanner</li> <li>• mit zusätzlichen Unterlegscheiben zur Einstellung der Schnellspannhebel-Position</li> <li>• auf M-Wave Eurolochkarte</li> </ul> <ul style="list-style-type: none"> <li>• <b>Shimano Type</b> (kein original Shimano Ersatzteil)</li> <li>• Gewindesteigung: P1.5 x T20</li> </ul> <ul style="list-style-type: none"> <li>• <b>Maxle Type</b> (kein original Maxle Ersatzteil)</li> <li>• Gewindesteigung: P1.75 x T20</li> </ul> <ul style="list-style-type: none"> <li>• <b>Syntace Type</b> (kein original Syntace Ersatzteil)</li> <li>• Gewindesteigung: P1.0 x T20</li> <li>• mit konischer Verbindungsscheibe</li> </ul>	<b>THRU AXLE FOR TRAILER MOUNT</b> <b>›STALWART AXLE‹</b> <ul style="list-style-type: none"> <li>• for <b>mounting of standard bicycle trailer adapters</b> at <b>12 mm thru axle hubs</b></li> <li>• by 6 mm spacer suitable for 12 mm thru axle hubs with <b>OLD 142 mm</b> and for <b>boost hubs</b> with <b>OLD 148 mm</b></li> <li>• aluminium</li> <li>• with QR</li> <li>• with additional spacers for adjusting the QR lever position</li> <li>• on M-Wave eurohole card</li> </ul> <ul style="list-style-type: none"> <li>• <b>Shimano Type</b> (no original Shimano spare part)</li> <li>• thread pitch: P1.5 x T20</li> </ul> <ul style="list-style-type: none"> <li>• <b>Maxle Type</b> (no original Maxle spare part)</li> <li>• thread pitch: P1.75 x T20</li> </ul> <ul style="list-style-type: none"> <li>• <b>Syntace Type</b> (no original Syntace spare part)</li> <li>• thread pitch: P1.0 x T20</li> <li>• with conical spacer</li> </ul>		<b>44,90 €</b> 43/19  <b>44,90 €</b> 43/19  <b>44,90 €</b> 43/19
<b>640824</b> 100 Set	<b>ALKALINE-BATTERIE</b> <b>LR 23A</b> <ul style="list-style-type: none"> <li>• 23A / 12V</li> <li>• z.B. für Art. 420270, ...</li> <li>• 2 Stück in Blisterverpackung</li> </ul>	<b>ALKALINE BATTERY</b> <b>LR 23A</b> <ul style="list-style-type: none"> <li>• 23A / 12V</li> <li>• e.g. for art. 420270, ...</li> <li>• 2 pieces in blister packaging</li> </ul>		<b>2,90 €</b>  36/19
<b>640828</b> 360/20 Set	<b>MAXELL, L1154F / LR44 / AG13</b> <ul style="list-style-type: none"> <li>• 1,5V / 110 mAh</li> <li>• z.B. für Fahrradcomputer, Blinklichter, ...</li> <li>• 10 Stück in perforierter Blisterverpackung</li> </ul>	<b>MAXELL, L1154F / LR44 / AG13</b> <ul style="list-style-type: none"> <li>• 1.5V / 110 mAh</li> <li>• e.g. for bicycle computers, flashing lights, ...</li> <li>• 10 pieces in perforated blister packaging</li> </ul>		<b>14,90 €</b>  35/19





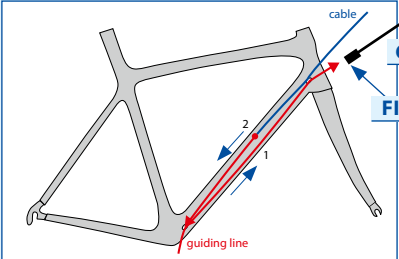





ART.-NR. 	BESCHREIBUNG	DESCRIPTION		UVP verfügbar ab/ available in
	<p><b>ZUBEHÖRSET FÜR KINDER</b></p> <p><b>Korb</b></p> <ul style="list-style-type: none"> <li>• aus Kunststoff</li> <li>• ca. 20 x 14 x 13 cm</li> <li>• universelle Befestigung mit Kunststoffbändern am Lenker, Gepäckträger, ...</li> </ul> <p><b>Glocke</b></p> <ul style="list-style-type: none"> <li>• Stahl</li> <li>• mit 3D-Motiv</li> <li>• Kunststoffunterteil mit 2 Schrauben</li> </ul> <p><b>Trinkflasche</b></p> <ul style="list-style-type: none"> <li>• 300 ml</li> <li>• mit Staubschutzkappe</li> <li>• <b>inkl. Flaschenhalter</b></li> </ul> <p>auf Ventura Kids Eurolochkarte</p>	<p><b>ACCESSORY KIT FOR CHILDREN</b></p> <p><b>Basket</b></p> <ul style="list-style-type: none"> <li>• made of plastic</li> <li>• approx. 20 x 14 x 13 cm</li> <li>• universal mounting with plastic straps on handlebar, carrier, ...</li> </ul> <p><b>Bell</b></p> <ul style="list-style-type: none"> <li>• steel</li> <li>• with 3D picture</li> <li>• plastic base with 2 screws</li> </ul> <p><b>Water bottle</b></p> <ul style="list-style-type: none"> <li>• 300 ml</li> <li>• with protection cap</li> <li>• <b>incl. bottle cage</b></li> </ul> <p>auf Ventura Kids Eurolochkarte</p>	<p><b>VENTURA® kids</b></p> 	<p><b>9,90 €</b> 35/19</p> <p><b>9,90 €</b> 35/19</p> <p><b>9,90 €</b> 35/19</p>
<p><b>650040</b></p> <p>›Horse‹</p> <p>bestehend aus Korb (Art. 431556), Glocke (Art. 420197) und Trinkflasche (Art. 340212)</p>		<p>›Horse‹</p> <p>consisting of basket (art. 431556), bell (art. 420197) and water bottle (art. 340212)</p>		<p><b>9,90 €</b> 35/19</p>
<p><b>650041</b></p> <p>›Soccer‹</p> <p>bestehend aus Korb (Art. 431549), Glocke (Art. 420198) und Trinkflasche (Art. 340213)</p>		<p>›Soccer‹</p> <p>consisting of basket (art. 431549), bell (art. 420198) and water bottle (art. 340213)</p>		<p><b>9,90 €</b> 35/19</p>
<p><b>650042</b></p> <p>›Smile‹</p> <p>bestehend aus Korb (Art. 431551), Glocke (Art. 420199) und Trinkflasche (Art. 340214)</p> <p>30 Set</p>		<p>›Smile‹</p> <p>consisting of basket (art. 431551), bell (art. 420199) and water bottle (art. 340214)</p>		<p><b>9,90 €</b> 35/19</p>
<p><b>680280</b></p> <p>400</p> <p><b>SCHALTWERK-ADAPTER</b></p> <p>›ADA RANGE‹</p> <ul style="list-style-type: none"> <li>• Aluminium</li> <li>• <b>ermöglicht die Verwendung von wide-range Kassetten</b> mit großen Ritzeln, ohne dass ein Kettenwechsel mit längerem Käfig nötig ist</li> <li>• besonders geeignet zum Umbau auf 1-fach Kettenradgarnitur</li> <li>• auf M-Wave Eurolochkarte</li> </ul>	<p><b>REAR DERAILLEUR ADAPTER</b></p> <p>›ADA RANGE‹</p> <ul style="list-style-type: none"> <li>• aluminium</li> <li>• <b>allows the installation of wide-range cassettes</b> with large sprockets, without the need for a chain change with a longer cage</li> <li>• especially suitable for conversion to 1 speed chainwheel set</li> <li>• on M-Wave eurohole card</li> </ul>	<p><b>M-WAVE</b></p>   	<p><b>9,90 €</b></p> <p>41/19</p>	
<p><b>715122</b></p> <p>›Stripes B/W‹</p> 	<p><b>HALS-/KOPFTUCH</b></p> <ul style="list-style-type: none"> <li>• 100 % Polyester <b>Funktions-Microfaser</b></li> <li>• <b>nahtlos, elastisch</b> und <b>atmungsaktiv</b></li> <li>• Größe: ca. 24 x 48 cm</li> <li>• auf M-Wave Eurolochkarte</li> </ul>	<p><b>TUBULAR HEADWEAR</b></p> <ul style="list-style-type: none"> <li>• 100 % Polyester <b>function microfibre</b></li> <li>• <b>seamless, elastic</b> and <b>breathable</b></li> <li>• size: approx. 24 x 48 cm</li> <li>• on M-Wave eurohole card</li> </ul>	<p><b>M-WAVE</b></p>  <p>57 g</p>   	<p><b>5,90 €</b> 35/19</p> <p><b>5,90 €</b> 35/19</p> <p><b>5,90 €</b> 35/19</p>
	<p><b>715123</b></p> <p>›Balls‹</p> 			
<p><b>715124</b></p> <p>›Purple Squared‹</p> <p>150</p> 		<p>›Purple Squared‹</p>		







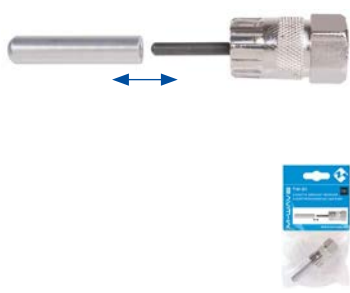
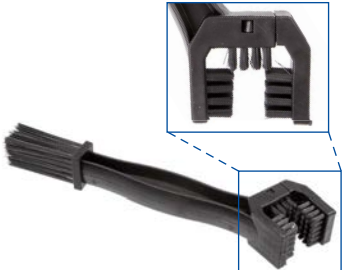

ART.-NR. 	BESCHREIBUNG	DESCRIPTION		UVP verfügbar ab/ available in
<p><b>719994</b> Größe XS</p> <p><b>719995</b> Größe S 250 Paar</p>	<p><b>FAHRRADHANDSCHUHE</b></p> <ul style="list-style-type: none"> <li>• für Kinder/Jugendliche</li> <li>• außen <b>elastisches Lycra</b></li> <li>• innen <b>Non-Slip Noppen</b></li> <li>• auf Eurolochkarte</li> </ul>	<p><b>BICYCLE GLOVES</b></p> <ul style="list-style-type: none"> <li>• for children/youths</li> <li>• outside made of <b>elastic lycra</b></li> <li>• inside <b>non-slip knobs</b></li> <li>• on eurohole card</li> </ul> <p>size XS</p> <p>size S</p>	<p><b>VENTURA</b> BIKE-OUTDOOR</p> 	<p><b>4,90 €</b> 37/19</p> <p><b>4,90 €</b> 37/19</p>
	<p><b>FAHRRAD-/SPORTBRILLEN</b> ›RAYON‹</p> <ul style="list-style-type: none"> <li>• <b>UV400-Schutz</b></li> <li>• <b>CE</b>-geprüft</li> <li>• gemäß ISO 12312-1</li> <li>• mit <b>Mikrofaser-Schutzhülle</b></li> <li>• mit fast <b>unzerbrechlichen</b> Polycarbonat <b>Sicherheitsgläsern</b></li> <li>• <b>Antikratzbeschichtung</b></li> <li>• in Kunststoffbox</li> </ul>	<p><b>BIKE/SPORTS EYEWEAR</b> ›RAYON‹</p> <ul style="list-style-type: none"> <li>• <b>UV400 Protection</b></li> <li>• <b>CE</b> approved</li> <li>• according to ISO 12312-1</li> <li>• with <b>microfibre bag</b></li> <li>• with almost <b>unbreakable</b> polycarbonate <b>security lenses</b></li> <li>• <b>scratch proof treatment</b></li> <li>• in plastic box</li> </ul>	<p><b>ISO 12312-1</b></p> <p><b>CE</b></p> <p><b>MIGHTY</b></p> 	
<p><b>710916</b> 100/10</p>	<p><b>FAHRRAD-/SPORTBRILLE</b> ›RAYON G4 PRO‹</p> <ul style="list-style-type: none"> <li>• Rahmen aus <b>Polycarbonat</b></li> <li>• mit <b>auswechselbaren, rot Iridium beschichteten</b> Gläsern</li> <li>• mit zusätzlichen dunkel <b>entspiegelten, orangen</b> und <b>klaren</b> Ersatzgläsern</li> <li>• mit <b>weichen, verstellbaren</b> Nasenbügeln</li> <li>• Rahmen mattschwarz</li> </ul>	<p><b>BIKE/SPORTS EYEWEAR</b> ›RAYON G4 PRO‹</p> <ul style="list-style-type: none"> <li>• <b>polycarbonate</b> frame</li> <li>• with <b>exchangeable, red Iridium coated</b> lenses</li> <li>• with additional <b>anti-glare, orange</b> and <b>clear</b> spare lenses</li> <li>• with <b>soft, adjustable</b> nose pads</li> <li>• frame matt black</li> </ul>	 <p><b>IRIDIUM COATED</b></p> 	<p><b>44,90 €</b></p> <p>46/19</p>
<p><b>710138</b> 100/10</p>	<p><b>FAHRRAD-/SPORTBRILLE</b> ›RAYON FLEXI 4‹</p> <ul style="list-style-type: none"> <li>• mit <b>auswechselbaren, dunklen</b> Gläsern</li> <li>• mit zusätzlichen <b>klaren, orangen</b> und <b>braunen Ersatzgläsern</b></li> <li>• mit <b>weichen</b> Nasenbügeln</li> <li>• mit <b>weichen</b> Bügelendeinlagen</li> <li>• Rahmen in mattschwarz</li> </ul>	<p><b>BIKE/SPORTS EYEWEAR</b> ›RAYON FLEXI 4‹</p> <ul style="list-style-type: none"> <li>• with <b>exchangeable</b> dark lenses</li> <li>• with additional <b>clear, orange</b> and <b>brown spare lenses</b></li> <li>• with <b>soft</b> nose pads</li> <li>• with <b>soft</b> temple tips</li> <li>• frame matt black</li> </ul>		<p><b>24,90 €</b></p> <p>51/19</p>
<p><b>710917</b> 100/10</p>	<p><b>FAHRRAD-/SPORTBRILLE</b> ›RAYON F1‹</p> <ul style="list-style-type: none"> <li>• mit dunklen, <b>polarisierenden</b> Gläsern</li> <li>• mit <b>weichen</b> Bügelendeinlagen</li> <li>• Rahmen in dunkelgrau</li> </ul>	<p><b>BIKE/SPORTS EYEWEAR</b> ›RAYON F1‹</p> <ul style="list-style-type: none"> <li>• with dark, <b>polarized</b> lenses</li> <li>• with <b>soft</b> temple tips</li> <li>• frame dark grey</li> </ul>	<p><b>POLARIZED LENSES</b></p> 	<p><b>24,90 €</b></p> <p>51/19</p>





















ART.-NR. 	BESCHREIBUNG	DESCRIPTION		UVP verfügbar ab/ available in
	<p><b>FAHRRADHELM ›MOVE‹ INKL. HELMLICHT ›LIGHT TRI‹</b>  <b>Fahrradhelm ›Move‹</b> (Art. 731844-7)</p> <p>Unser <b>Multisport-</b> und <b>Commuter-</b>Helm der neuesten Generation. Die zurückhaltende Form mit nach hinten heruntergezogener Schale begeistert sowohl Pendler, BMX-Fahrer als auch Inline-Skater. Durch seine vielen Belüftungsöffnungen hilft er, einen kühlen Kopf zu bewahren.</p> <p>Belüftung: <b>20 Öffnungen</b>            Gewicht: 276 g (M, ohne Visier)            Einstellsystem: Ringsystem            Komfort: herausnehmbare, waschbare Comfort Pads, mit <b>Netzschutz</b>, mit zusätzlichen <b>Ersatzpads</b></p> <p>Technologie: <b>In-Mould</b> Microshell            Visier: Ansteckvisier            Helmlicht: <b>›Light Tri‹</b> (Art. 731898)            - <b>6 rote LEDs</b>            - 3 Funktionen (Dauerlicht, 2 x Blinklicht)            - inkl. Batterie (CR 2032)</p> <p>Design: <b>mattschwarz</b></p> <p><b>731874</b> Größe M, 52 - 58 cm (Jugend)</p> <p><b>731875</b> Größe L, 58 - 63 cm (Erwachsene)</p> <p>Design: <b>mattweiß</b></p> <p><b>731876</b> Größe M, 52 - 58 cm (Jugend)</p> <p><b>731877</b> Größe L, 58 - 63 cm (Erwachsene)</p> <p>10</p>	<p><b>BICYCLE HELMET ›MOVE‹ INCL. HELMET LIGHT ›LIGHT TRI‹</b>  <b>Bicycle helmet ›Move‹</b> (Art. 731844-7)</p> <p>Our latest generation of <b>multi sport</b> and <b>commuter</b> helmet. Commuters, BMX riders as well as inline skaters will love this reserved shape with tucked in shell on the back. It helps to keep cool through its numerous ventilation holes.</p> <p>ventilation: <b>20 holes</b>            weight: 276 g (M, w/o visor)            adjustment system: ring system            comfort: removable, washable comfort pads, with <b>fly net</b>, with additional <b>replacement pad set</b></p> <p>technology: <b>In-Mould</b> Microshell            visor: clip-on visor            helmet light: <b>›Light Tri‹</b> (art. 731898)            - <b>6 red LEDs</b>            - 3 functions (steady light, 2 x flashing light)            - incl. battery (CR 2032)</p> <p>design: <b>matt black</b></p> <p>size M, 52 - 58 cm (youth)</p> <p>size L, 58 - 63 cm (adult)</p> <p>design: <b>matt white</b></p> <p>size M, 52 - 58 cm (youth)</p> <p>size L, 58 - 63 cm (adult)</p>	<p> <b>276 g</b></p> <p> Tested according to EN 1078</p> <p> <b>MIGHTY</b></p> <p></p> <p></p> <p></p> <p></p> <p></p> <p></p>	<p><b>69,90 €</b> 35/19</p> <p><b>69,90 €</b> 35/19</p> <p><b>69,90 €</b> 35/19</p> <p><b>69,90 €</b> 35/19</p>
<p><b>880436</b> 120/25</p>	<p><b>KETTENNIETDRÜCKER ›TB-CC 65‹</b></p> <ul style="list-style-type: none"> <li>• für <b>1-12-fach</b> Ketten</li> <li>• <b>hohe Präzision</b> beim Drücken der Bolzen</li> <li>• automatische Fixierung der Kette</li> <li>• <b>CR-V-Stahl mit Holzgriff</b></li> <li>• auf Super B Eurolochkarte</li> </ul>	<p><b>CHAIN RIVETING TOOL ›TB-CC 65‹</b></p> <ul style="list-style-type: none"> <li>• for <b>1-12 speed</b> chains</li> <li>• <b>high precision</b> when pushing the bolts</li> <li>• automatic chain lock</li> <li>• <b>CR-V steel with wooden handle</b></li> <li>• on Super B eurohole card</li> </ul>	<p></p> <p></p> <p></p> <p></p>	<p><b>32,90 €</b></p> <p>37/19</p>

ART.-NR. 	BESCHREIBUNG	DESCRIPTION		UVP verfügbar ab/ available in
<b>880355</b>  100	<b>NIPPELDREHER ›TB-7816‹</b>  <ul style="list-style-type: none"> <li>ermöglicht ein <b>einfaches</b> und <b>schnelles Einspeichen</b></li> <li>mit Ersatzfeder</li> <li>auf Super B Eurolochkarte</li> </ul>	<b>NIPPLE DRIVER ›TB-7816‹</b>  <ul style="list-style-type: none"> <li>provides an <b>easy</b> and <b>fast wheel set manufacturing</b></li> <li>with replacement spring</li> <li>on Super B eurohole card</li> </ul>		<b>11,90 €</b>  35/19
<b>880312</b>  100/25	<b>EINZIEHHILFE FÜR INTERNE KABELFÜHRUNG ›TB-IR20‹</b>  <ul style="list-style-type: none"> <li>zum <b>einfachen Einziehen von Zügen und Hüllen</b> durch <b>magnetische Führung</b> von außen</li> <li>für <b>Zughüllen, Bremsleitungen, Shimano Di2-Kabel, ...</b></li> <li>1,3 m Führungsseil</li> <li>3 Buchsen für Hüllen und Di2-Kabel</li> <li>1 Magnetadapter</li> <li>auf Super B Eurolochkarte</li> </ul>	<b>INTERNAL CABLE ROUTING TOOL ›TB-IR20‹</b>  <ul style="list-style-type: none"> <li>for <b>easy insertion of cables and housings</b> by <b>magnetic routing</b> from the outside</li> <li>for <b>internal cables, hydraulic hoses, Shimano Di2 E-tube cables, ...</b></li> <li>1.3 m guiding line</li> <li>3 sockets for hoses and Di2 cables</li> <li>1 magnetic adapter</li> <li>on Super B eurohole card</li> </ul> 		<b>29,90 €</b>  ~ Nov./19
<b>880919</b>  100/25 Set	<b>MINIWERKZEUG ›TB-FD55‹</b> <b>16 in 1 faltwerkzeug</b>  <ul style="list-style-type: none"> <li>3/4/5/6/8 mm Innensechskantschlüssel</li> <li>T25 Vielzahnschlüssel</li> <li>1 Kreuzschraubenzieher</li> <li><b>15 mm Pedalschlüssel</b></li> <li><b>10 mm Maulschlüssel</b></li> <li>Bremsbelagspreizer</li> <li><b>1 Kettennietdrücker</b></li> <li>Speichenschlüssel 3,2/3,5 mm und Mavic 5.65 mm</li> <li>2 Reifenheber</li> <li>Flaschenöffner</li> <li>mit Neoprenhülle</li> <li>nur 70 x 43 x 19 mm</li> <li>auf Super B Eurolochkarte</li> </ul>	<b>MINI TOOL ›TB-FD55‹</b> <b>16 in 1 folding tool</b>  <ul style="list-style-type: none"> <li>3/4/5/6/8 mm allen keys</li> <li>T25 star screwdriver</li> <li>1 Phillips screw driver</li> <li><b>15 mm pedal wrench</b></li> <li><b>10 mm spanner</b></li> <li>brake piston press</li> <li><b>1 chain riveting tool</b></li> <li>spoke wrenches 3.2/3.5 mm and Mavic 5.65 mm</li> <li>2 tire levers</li> <li>bottle opener</li> <li>with neopren sleeve</li> <li>only 70 x 43 x 19 mm</li> <li>on Super B eurohole card</li> </ul>		<b>35,90 €</b>  45/19
<b>880918</b>  100/25 Set	<b>MINIWERKZEUG ›TB-FD 40‹</b> <b>17 in 1 faltwerkzeug</b>  <ul style="list-style-type: none"> <li>2/2,5/3/4/5/6/8 mm Innensechskantschlüssel</li> <li>T25 Vielzahnschlüssel</li> <li>1 Kreuzschraubenzieher</li> <li>1 Schlitzschraubenzieher</li> <li><b>1 Kettennietdrücker</b></li> <li>Speichenschlüssel 3,2/3,3/3,5 mm</li> <li>2 Reifenheber</li> <li>mit Neoprenhülle</li> <li>nur 73 x 45 x 24 mm</li> <li>auf Super B Eurolochkarte</li> </ul>	<b>MINI TOOL ›TB-FD 40‹</b> <b>17 in 1 folding tool</b>  <ul style="list-style-type: none"> <li>2/2.5/3/4/5/6/8 mm allen keys</li> <li>T25 star screwdriver</li> <li>1 Phillips screw driver</li> <li>1 flat screw driver</li> <li><b>1 chain riveting tool</b></li> <li>spoke wrenches 3.2/3.3/3.5 mm</li> <li>2 tire levers</li> <li>with neopren sleeve</li> <li>only 73 x 45 x 24 mm</li> <li>on Super B eurohole card</li> </ul>		<b>24,90 €</b>  41/19

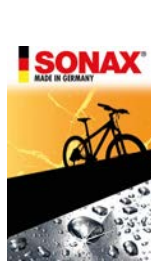
ART.-NR. 	BESCHREIBUNG	DESCRIPTION		UVP verfügbar ab/ available in
<b>880190</b> 1.000/100	<b>CARBON MONTAGEPASTE</b> ›TB-3256‹ <ul style="list-style-type: none"> <li>für Carbonteile</li> <li>verhindert Verrutschen</li> <li><b>niedrigere Klemmkräfte</b> (Drehmoment) reichen für gute Verbindung</li> <li><b>leichteres Lösen</b> der Verbindung möglich</li> <li>in 5 ml Beutel</li> <li>100 Beutel im Super B <b>Thekendisplay</b></li> </ul>	<b>ANTI SLIP COMPOUND</b> ›TB-3256‹ <ul style="list-style-type: none"> <li>for carbon parts</li> <li>prevents slipping</li> <li><b>low clamping force</b> (torque) is enough for good connection</li> <li>connection <b>easily resolvable</b></li> <li>in 5 ml bag</li> <li>100 bags in Super B <b>counter display</b></li> </ul>	   	<b>2,49 €</b>          37/19
<b>881009</b> 50	<b>INNENLAGER WERKZEUG</b> ›BB SCREW 1‹ <ul style="list-style-type: none"> <li>für <b>außenliegende Kugellagerschalen</b></li> <li>passend für 12-kerbige außenliegende Lagerschalen (z.B. Sram Dub BSA / Rotor BSA30 / RaceFace Cinch / Zipp Vuma, Hawk Racing BB3086, ...)</li> <li>im Polybeutel mit Barcode-Aufkleber</li> </ul>	<b>BOTTOM BRACKET TOOL</b> ›BB SCREW 1‹ <ul style="list-style-type: none"> <li>for <b>outer bearing cups</b></li> <li>suitable for 12 notches external BB (e.g. Sram Dub BSA / Rotor BSA30 / RaceFace Cinch / Zipp Vuma, Hawk Racing BB3086, ...)</li> <li>in PE bag with barcode sticker</li> </ul>	 	<b>14,90 €</b>          35/19
<b>880456</b> 50	<b>E-MOTOR VERSCHLUSSRING WERKZEUG</b> ›BB SCREW 2‹ <ul style="list-style-type: none"> <li>für <b>Montage und Demontage des Verschlussrings</b> des Spiders/Kettenblatts</li> <li>aus stabilem, wärmebehandeltem Stahl</li> <li>für Bosch Classic Line (1. Generation) und Active Line (2. Generation), Performance Line, Performance Line CX</li> <li>mit M-Wave Karte</li> </ul>	<b>E-MOTOR LOCKRING TOOL</b> ›BB SCREW 2‹ <ul style="list-style-type: none"> <li><b>to mount and demount the lockring</b> of the spider/chainring</li> <li>made of stable, heat-treated steel</li> <li>for Bosch Classic Line (1. Generation) and Active Line (2. Generation), Performance Line, Performance Line CX</li> <li>with M-Wave tag</li> </ul>	<div style="border: 1px solid blue; padding: 2px; display: inline-block;">2 in 1</div>  	<b>21,90 €</b>          35/19
<b>880458</b> 100	<b>KASSETTENZAHNKRANZ-ABZIEHER</b> ›TW-D1‹ <ul style="list-style-type: none"> <li>mit <b>5 mm Führungstift</b> für Schnellspannachsen</li> <li>abnehmbarer Adapter für Naben mit <b>12 mm Steckachse</b></li> <li>für Shimano Hyperglide-Kassette</li> <li>für Sram XD Drive</li> <li>zur (De-)Montage von Shimano Centerlock Bremsscheiben (QR9) (kein Original Shimano/Sram Ersatzteil)</li> <li>für 1/2" Steckverbindung oder 24 mm Schlüssel</li> <li>im Polybeutel mit M-Wave Euroloch-header</li> </ul>	<b>CASSETTE SPROCKET REMOVER</b> ›TW-D1‹ <ul style="list-style-type: none"> <li>with <b>5 mm guide pin</b> for quick release axles</li> <li>removable adapter for hubs with <b>12 mm thru axle</b></li> <li>for Shimano hyperglide cassette</li> <li>für Sram XD Drive</li> <li>for (dis-)mounting of Shimano centerlock discs (QR9) (no original Shimano/Sram spare part)</li> <li>for 1/2" drive or 24 mm wrench</li> <li>in PE bag with M-Wave eurohole header</li> </ul>	<div style="border: 1px solid blue; padding: 2px; display: inline-block;">3 in 1</div>  	<b>6,90 €</b>          ~ Nov./19
<b>880407</b> 200	<b>REINIGUNGSBÜRSTE</b> <ul style="list-style-type: none"> <li>speziell zum <b>Reinigen von Ketten</b></li> <li>auch für andere Teile (z. B. Kassette, Umwerfer, ...)</li> <li>stabiler Kunststoffgriff</li> <li>im Polybeutel mit Barcode-Aufkleber</li> </ul>	<b>CLEANING BRUSH</b> <ul style="list-style-type: none"> <li>especially for <b>cleaning chains</b></li> <li>also for other parts (e.g. cassette, front derailleur, ...)</li> <li>stable plastic handle</li> <li>in PE bag with barcode sticker</li> </ul>		<b>4,99 €</b>          35/19

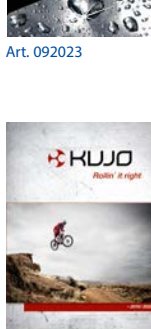

ART.-NR. 	BESCHREIBUNG	DESCRIPTION		UVP verfügbar ab/ available in
<b>880449</b> 30	<b>KETTENNIETDRÜCKER</b> <ul style="list-style-type: none"> <li>• <b>hochwertige Ausführung</b></li> <li>• für 1-12-fach Ketten</li> <li>• kunststoffummantelter <b>Non-Slip</b> Griff</li> <li>• <b>Ersatzstift</b> durch <b>drehbaren</b> Nietstift</li> <li>• mit <b>zusätzlichem Ersatzstift</b></li> <li>• Montageverpackung</li> </ul>	<b>CHAIN RIVETING TOOL</b> <ul style="list-style-type: none"> <li>• <b>high quality</b></li> <li>• for 1-12 speed chains</li> <li>• plastic coated <b>non-slip</b> handle</li> <li>• <b>replacement bolt</b> by turnable riveting bolt</li> <li>• with <b>additional replacement bolt</b></li> <li>• OEM</li> </ul>		<b>24,90 €</b>  35/19
<b>880435</b> 25	<b>KETTENNIETDRÜCKER ›MINI CHAIN TOOL KMC‹</b> <ul style="list-style-type: none"> <li>• <b>hochwertige Ausführung</b> für unterwegs</li> <li>• für 9-12-fach Ketten</li> <li>• Aluminium</li> <li>• nur <b>46 g</b>, nur 68 x 29 mm</li> <li>• mit Neopren-Aufbewahrungshülle</li> <li>• in KMC Blisterverpackung</li> </ul>	<b>CHAIN RIVETING TOOL ›MINI CHAIN TOOL KMC‹</b> <ul style="list-style-type: none"> <li>• <b>high quality</b> on the way</li> <li>• for 9-12 speed chains</li> <li>• aluminium</li> <li>• only <b>46 g</b>, only 68 x 29 mm</li> <li>• with neoprene storage case</li> <li>• in KMC blister packaging</li> </ul>		<b>22,90 €</b>  31/19
<b>880970</b> 60/10 Set	<b>INNENVIELZAHN-SCHLÜSSEL-SATZ</b> <ul style="list-style-type: none"> <li>• <b>T10, T15, T20, T25, T27, T30, T40, T45, T50</b> an <b>beiden Enden</b></li> <li>• aus <b>Chrom-Vanadium-Stahl</b></li> <li>• durch Vertiefung in der Mitte <b>für Sicherheitsschrauben geeignet</b></li> <li>• auf Ventura Eurolochkarte</li> </ul>	<b>STAR SCREWDRIVER SET</b> <ul style="list-style-type: none"> <li>• <b>T10, T15, T20, T25, T27, T30, T40, T45, T50</b> at <b>both ends</b></li> <li>• made of <b>chrome vanadium steel</b></li> <li>• <b>suitable for security screws</b> by deepening in the middle</li> <li>• on Ventura eurohole card</li> </ul>		<b>9,80 €</b>  37/19
<b>880932</b> 200/50 Set	<b>INNENVIELZAHN-SCHLÜSSEL-SATZ</b> <ul style="list-style-type: none"> <li>• <b>T10, T15, T20, T25, T30</b> an <b>beiden Enden</b></li> <li>• durch Vertiefung in der Mitte <b>für Sicherheitsschrauben geeignet</b></li> <li>• verzinkt</li> <li>• auf Ventura Eurolochkarte</li> </ul>	<b>STAR SCREWDRIVER SET</b> <ul style="list-style-type: none"> <li>• <b>T10, T15, T20, T25, T30</b> at <b>both ends</b></li> <li>• <b>suitable for security screws</b> by deepening in the middle</li> <li>• zinc plated</li> <li>• on Ventura eurohole card</li> </ul>		<b>2,90 €</b>  35/19
<b>880909</b> 200/50 Set	<b>WERKZEUG-SET</b> bestehend aus <ul style="list-style-type: none"> <li>• Innensechskantschlüsseln 4, 5, 6 mm</li> <li>• Vielzahnschlüssel T25</li> <li>• Pedalschlüssel 15 mm</li> <li>• verzinkt</li> <li>• im Polybeutel mit Aufkleber</li> </ul>	<b>TOOL SET</b> consisting of <ul style="list-style-type: none"> <li>• allen keys 4, 5, 6 mm</li> <li>• star screwdriver T25</li> <li>• pedal wrench 15 mm</li> <li>• zinc plated</li> <li>• in PE bag with sticker</li> </ul>		<b>2,90 €</b>  37/19
<b>881048</b> 1	<b>WAND-/WERKBANK-MONTAGE-/REPARATURSTÄNDER ›TOP ASSIST W&amp;T‹</b> <ul style="list-style-type: none"> <li>• <b>für Wand- und Tischmontage</b></li> <li>• <b>Schnellverschluss-Klemme</b> und Arm <b>360° drehbar</b></li> <li>• Ersatz-Klemm-Verkratzschutz (Art. 881049)</li> <li>• mit Befestigungsmaterial</li> <li>• im M-Wave Einzelkarton</li> </ul>	<b>WALL/WORKBENCH UNIVERSAL WORKSTATION ›TOP ASSIST W&amp;T‹</b> <ul style="list-style-type: none"> <li>• <b>for wall and table mounting</b></li> <li>• <b>QR clamp</b> and arm <b>360° turnable</b></li> <li>• replacement clamping scratch protection (art. 881049)</li> <li>• with mounting material</li> <li>• in M-Wave box</li> </ul>		<b>59,90 €</b>  47/19

ART.-NR. 	BESCHREIBUNG	DESCRIPTION		UVP verfügbar ab/ available in		
	<p><b>PROSPEKTE</b></p> <p>Wir unterstützen mit vielen individuellen, zweisprachigen (deutsch, englisch) Prospekten gezielt den Verkauf unserer Marken. Bei Bedarf kontaktieren Sie bitte unsere Verkaufsabteilung.</p>	<p><b>BROCHURES</b></p> <p>We support the sale of our brands specifically with many individual bilingual (German, English) brochures. If required please contact our sales department.</p>				
092018	Mighty					0,99 €
092016	M-Wave	Art. 092018	Art. 092016	Art. 092020	Art. 092011	1,99 €
092020	Smart					0,99 €
092011	Echowell					0,99 €
092021	Velo					0,99 €
092027	cnSpoke	Art. 092021	Art. 092027	Art. 092014	Art. 092019	0,99 €
092014	Exustar					0,99 €
092019	Novatec					0,99 €
092022	Neco					0,99 €
092026	Anlun					0,99 €
092028	Trailgator	Art. 092022	Art. 092026	Art. 092028	Art. 092015	0,99 €
092015	Kenda					0,99 €
092017	Microshift					0,99 €
092023	Sonax					0,99 €
092024	Super B	Art. 092017	Art. 092023	Art. 092024	Art. 092029	0,99 €
092029	Beto					0,99 €
092030	Moon					0,99 €
092037	Kujo	Art. 092030	Art. 092037	Art. 092038/9	Art. 092002	0,99 €
092038	E-Mobility Solutions Deutsch/German					1,00 €
092039	E-Mobility Solutions Englisch/English					1,00 €
092002	Tannus Armour					0,99 €
	<p>Unter <a href="http://www.messingschlagler.com">www.messingschlagler.com</a> finden Sie unsere Markenprospekte auch zum Download.</p>	<p>Under <a href="http://www.messingschlagler.com">www.messingschlagler.com</a> you will find our brand brochures for download.</p>				



**SAMOX**

**E7**

**CARBON CRANK ARMS  
DIRECT DRIVE ONE - PIECE CHAINRINGS  
FOR BOSCH, SHIMANO, BROSE, FAZUA, ...**

### E-BIKE ANTRIEBSTEILE AUS EINER HAND

Sie haben bestimmt schon einmal ein Teil von Samox in der Hand gehalten, aber es vielleicht gar nicht gemerkt. Kein Wunder, denn Samox produziert für viele renommierte Anbieter Kettenradgarnituren, Kurbeln, Kettenblätter, Spyder, Kettenschutzringe, ... für den E-Bike Bereich – und das schon seit über 10 Jahren und je nach Vorgabe in verschiedenen Preislagen und Qualitäten. Auch die Fertigung individuell spezifizierter Teile wird gerne in Angriff genommen. Wir freuen uns, Ihnen Produkte dieses erfahrenen Anbieters in einem stark wachsenden Teilessegment zur Verfügung stellen zu können! Falls Sie einen gewünschten Artikel in unserem Angebot nicht finden sollten, dann fragen Sie uns gerne danach.

- größtes, umfassendes Teilesortiment für E-Bikes
- Wunschanfertigungen auf Anfrage
- verschiedene Materialien und Oberflächenbehandlungen möglich
- alle Artikel getestet nach ISO 4210, Test nach EFBE möglich
- mehr als 10 Jahre Kompetenz in der Produktion von E-Bike Teilen
- schnelle Verfügbarkeit dank unseres Zentrallagers in Baunach
- für Aftermarket und Fabriken

### E-BIKE DRIVE PARTS FROM ONE HAND

You may have already held a part of Samox in your hand, but perhaps you did not realize it. No wonder, because -Samox produces for many renowned suppliers cranksets, cranks, chainrings, Spyder, chain rings, ... for the e-bike sector - for more than 10 years and depending on the specification in different price ranges and qualities. Also the production of individually specified parts is gladly tackled. We are pleased to be able to provide you with products of this experienced supplier in a fast growing segment! If you can not find a desired item in our brochure, then feel free to ask for it.

- largest, comprehensive range of parts for e-bikes
- Custom-made products on request
- various materials and surface treatments possible
- all articles tested according to ISO 4210, test according to EFBE possible
- more than 10 years of competence in the production of e-bike parts
- fast availability thanks to our central warehouse in Baunach
- for aftermarket and factories

***messingschlager***

Haßbergstr. 45  
96148 Baunach - Germany  
Tel.: +49 (0) 95 44 94 44 - 0  
[www.messingschlager.com](http://www.messingschlager.com)



Vertrieb / distribution: