

InterPuls®

Advanced Product Guide

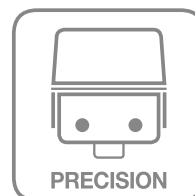

Company Profile

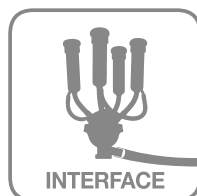

40+
YEARS



Profile
Established in: 1974
Presence: 70 countries
 across the 5 continents
30 patents in the last 5 years
10% of the annual turnover
 invested in R&D

Employees: 85
Average age: 37
University graduates: 20%



 Designed &
 Manufactured
 in Italy



InterPuls S.p.A.
 sales@interpuls.com
 www.interpuls.com





Milkrite Goals

Our customers benefit from enhanced value through improved milking efficiency, better teat health and superior on farm performance.

Our goal is to permanently improve on farm milking conditions, through our products, support and advice



Focus

We believe in thinking differently and challenging the status quo. We focus on the milk extraction process and overall animal health, with the aim of more efficient milking for both the animal and the milker.



Milkrite Europe

Hampton Park West
Semington Road / Melksham
Wiltshire / SN12 6NB / UK

Tel: +44 (0) 1225 89 64 26
Fax: +44 (0) 1225 89 63 07

sales@milkrice.com
www.milkrice.com



InterPuls member of Avon Dairy Solutions since August 2015.

Milkrite | InterPuls is the leading producer of milking point technology, providing complete teat to pipeline solutions for the Dairy sector. Milkrite | InterPuls has a long history in the heart of milking, manufacturing liners and tubing with the latest technology as well as high tech pulsation, measurement and milking control equipment, distributing in 80 countries worldwide.

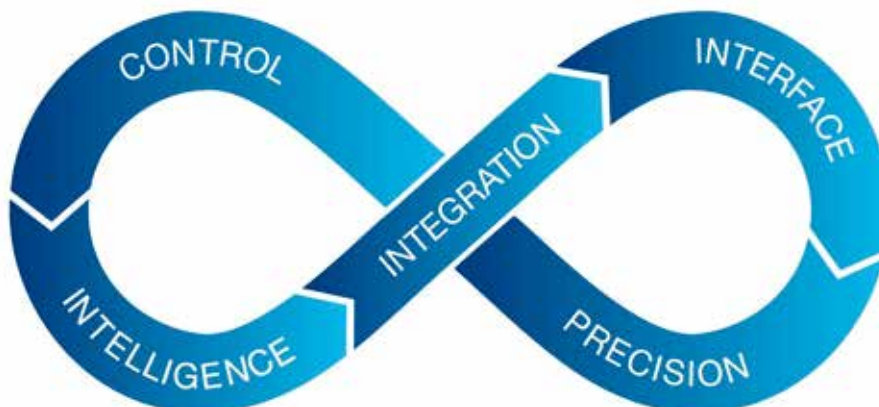

! The languages used in this catalogue are the following:



InterPuls

First in Pulsation!

It was the 70's when the Pulsator "Universal" had been launched on the market. Today the InterPuls Pulsation range makes us a world leader in this sector.

The advanced technology together with the same Passion, allow us to supply O.E.M., distributors and technical dealers with Pulsation with the capital "P"!

InterPuls Passion pulses here!

1 Q. What's Pulsation?

A. Pulsation is the alternating opening and closing of a liner, generated by a Pulsator, and it is composed by two parameters: Milking rate and ratio.

Der Pulsator Universal kam in den 70-er Jahren auf den Markt. InterPuls hat heute ein Sortiment im Bereich Pulsation, das uns zu einem Weltmarktführer in diesem Sektor macht.

Durch innovative Technologie und die Leidenschaft für das, was wir tun, können wir Erstausrüstern, Händlern und Anlagenkonstruktoren „Pulsation mit großem P“ liefern.

InterPuls Passion pulses here!

1 F. Was ist Pulsation?

A. Die Pulsation ist das zyklische Öffnen und Schließen eines Zitzengummis, das von einem Pulsator erzeugt wird und aus zwei Parametern besteht: Melkfrequenz und Melkverhältnis.



> Universal
1970



> L3
1974



> L80
1978



> LL90
1994



> LE20
1998



INTERPULS



INTERPULS®



2 Q. What is the Milking rate?

A. The Milking rate is the number of times a liner opens and closes in the time interval, thus regulating the rate of the Pulsation cycle which is composed by 4 phases, called A, B, C and D.
If ever the Pulsation Frequency increases, only the phase B (Milking) and D (massage) will change. Phases A and C, so called transitory, depend on the length and section of the Pulsation tubes.

3 Q. What is Milking ratio?

A. The Milking ratio is the percentage of time necessary to open (and keep open) the liner (phase A+B), thus allowing the milk to be drawn through the teat, thanks to the vacuum action and compared to the time required to close (and keep closed) the liner (phases C+D) in order to massage.

2 F. Was ist die Melkfrequenz?

A. Die Melkfrequenz ist die Anzahl der Male, die sich der Zitzengummi im Zeitintervall öffnet und schließt. Sie steuert damit die Geschwindigkeit des Pulsationszyklus, der aus den vier Phasen A,B,C und D besteht.
Bei erhöhter Pulsationsfrequenz verändern sich nur die Phase B (Melken) und die Phase D (Massage). Die Übergangphasen A und C hängen von der Länge und dem Querschnitt der Pulsationsschläuche ab.

3 F. Was ist das Melkverhältnis?

A. Das Melkverhältnis ist der Anteil der Zeit, die für das Öffnen und Offenhalten des Zitzengummis (Phasen A+B) nötig ist, damit die Milch durch das Vakuum aus der Zitze ausfließen kann, in Bezug auf die für das Schließen und Geschlossenhalten des Zitzengummis (Phasen C+D) für die Massagephase nötige Zeit.

4 Q. So, is the vacuum important as well?

A. The vacuum level is fundamental, because it allows the milk outflow, overcoming the effect of orifice's muscle of the teat. It's really important yet that the vacuum level doesn't exceed certain limits; researches show that at 40-42kPa the cows' teat is completely open. A high vacuum level causes stress for the animal and congestion at the teat's ends. A low vacuum level extends the milking time, it squeezes the liners with a consequent risk for cluster falling and it makes the massage not effective.

4 F. Also ist auch das Vakuum wichtig?

A. Die Stärke des Vakuums ist entscheidend, weil das Vakuum die Wirkung des Schließmuskels der Zitze überwindet und die Milch abfließen kann. Allerdings ist es sehr wichtig, dass die Stärke des Vakuums bestimmte Grenzen nicht überschreitet. Die Forschung zeigt, dass bei 40-42kPa die Zitzen der Kühe bereits vollständig geöffnet sind. Eine höhere Stärke des Vakuums verursacht Stress beim Tier und führt zu Stauungen an der Spitze der Zitzen. Ein zu schwaches Vakuum verlängert die Melkzeit und die Zitzengummis rutschen ab, sodass die Gefahr besteht, dass das gesamte Melkzeug herunterfällt. Auch die Massage wird dadurch unwirksam.

Pulsation Timeline



Animal breed	Vacuum level [kPa]		Rate [ppm]	Ratio [%]
	High line & bucket	Low line		
Cow	48 - 50	42 - 44	60	60:40
Goat	42 - 44	38 - 40	90	60:40
Sheep	40 - 42	36 - 38	120	50:50
Buffalo	50 - 52	44 - 46	60	60:40
Horse & Donkey	40 - 42	36 - 38	90	60:40
Camel	40 - 42	36 - 38	80	60:40

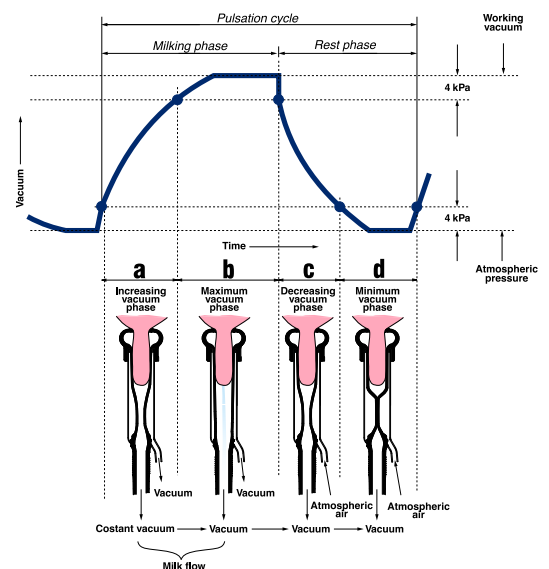



















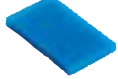

















ISO International Standards (ED. 2007)
 ISO 3918 Milking machine installations - Vocabulary
 ISO 5707 Milking machine installations - Construction and Performance
 ISO 6690 Milking machine installations - Mechanical tests

ISO-Normen (Ausg. 2007)
 ISO 3918 Melkanlagen - Begriffe
 ISO 5707 Melkanlagen - Konstruktion und Leistung
 ISO 6690 Melkanlagen - Mechanische Prüfungen

Top 30

Saving Opportunity - Sparangebot

Q.ty		TOP 30 Set Ref.	Note
25 x		1000221	- Lateral cover screw - Befestigungsschraube für Seitenwand
50 x		1000225	- O-ring - Dichtungsring
25 x		1000286	- Maintenance kit Alt. 60/40 - Wartungssatz Wechselt. 60/40
3 x		1010156	- LL90 Filter
25 x		1010191	- Filter LL90
50 x		1010192	- Main diaphragm - Hauptmembran
25 x		1010246	- Maintenance kit Alt. 60/40 - Wartungssatz Wechselt. 60/40
10 x		1060235	- Upper Gasket LE/LP/CV30 - Obere Dichtung LE/LP/CV30
10 x		1060236	- Lower Gasket LE/LP/CV30 - Untere Dichtung LE/LP/CV30
5 x		1030318	- 24V/DC solenoid - 24V/DC-Spule
5 x		1030319	- 12V/DC solenoid - 12V/DC-Spule
25 x		1030298	- Retrofit filter - Nachrüstfilter
25 x		1030299	- Piston - Kolben
10 x		1030499	- LE/LP20 Service kit - LE/LP20 Service-Satz
50 x		1050115	- Small diaphragm - Kleine Membran
20 x		1900063	- Pulsation tubes extension nipple - Verlängerungsnippel für Pulsationsschlauch
25 x		1050124	- Maintenance kit Alt. 60/40 - Wartungssatz Wechselt. 60/40
25 x		1050125	- Maintenance kit. Alt. 70/30 - Wartungssatz Wechselt. 70/30

Q.ty		TOP 30 Set Ref.	Note
25 x		1530291	- Locking valve plug - Ventilverschluss
25 x		1580141	- Locking valve plug - Ventilverschluss
50 x		1530292	- Small gasket - Kleine Dichtung
25 x		1530428	- Shut-off valve - Absperrventil
25 x		1570047	- Lunik Shut-off valve - Lunik Absperrventil
100 x		1570024	- Lunik200 bowl protection plug pin - Lunik200 Schutzstecker
25 x		1530315	- Gasket - Dichtung
25 x		1580140	- Gasket - Dichtung
25 x		1900036	- Inflation plug 22-24 mm - Zitzenbecher-Stopfen 22-24 mm
50 x		1900061	- Retaining ring D. 35 - Haltering DM 35
50 x		1900062	- Retaining ring D. 32 - Haltering DM 32
50 x		1900052	- Retaining Flat Band D.32 - Flacher Haltering DM 32
50 x		1900051	- Retaining Flat Band D.35 - Flacher Haltering DM 35
20 x		1900039	- Jetter D. 22 - Spülstopfen DM 22
20 x		1900040	- Jetter D. 24 - Spülstopfen DM 24
10 x		2079016	- ITP 207 automatic system - Automatiksystem ITP 207
10 x		2059016	- ITP 205 automatic system - Automatiksystem ITP 205
10 x		2050018	- ITP 205 deflector - Deflektor ITP 205
30 x		2060078	- Plastic bend vented - Kunststoff-Rohrknie mit Entlüftungsöffnung
30 x		2060079	- Plastic bend not vented - Kunststoff-Rohrknie ohne Entlüftungsöffnung
25 x		2809114	- Adapter - Adapter
10 x		3100054	- Gasket for lid - Deckeldichtung
25 x		3420015	- Drain Valve 1/2" - Ablassventil 1/2"
25 x		5200122	- DVC Snap hook - DVC Karabinerhaken



LE30/LP30

Servo-Direct Pulsators



✓ Patented



Servo-Direct LE30-LP30 Pulsators represent today's benchmark for precision, robustness and reliability.

Servo-Direct-Pulsatoren LE30-LP30 setzen heute den Maßstab in Bezug auf Präzision, Robustheit und Zuverlässigkeit.

Les Pulsateurs Servo-Direct LE30-LP30 sont les meilleurs outils actuellement disponibles sur le marché, au niveau de la précision, de la solidité et de la fiabilité à long terme.

Servo-Direct LE30-LP30 Los pulsadores representan el referente actual de precisión, robustez y fiabilidad

Benefits

- ✓ The patented "Servo-Direct" Pulsation system enables precise signal control
- ✓ Designed to minimise vacuum consumption and ensure excellent vacuum stability
- ✓ Low electrical consumption to reduce the risk of oxidation of electrical contacts and save energy
- ✓ If milk escapes into the Pulsator, as a result of a split liner for example, clean water may simply be flushed through via the pulsation tubes, without having to dismantle the unit
- ✓ Quick and easy to service: complete maintenance takes less than 1 minute

Vorteile

- ✓ Das patentierte „Servo-Direct“-Pulsationssystem ermöglicht präzise Signalsteuerung
- ✓ Entwickelt für geringeren Vakuumverbrauch und hervorragende Vakuumstabilität
- ✓ Geringer Energieverbrauch, um Energie zu sparen und das Risiko von oxidierten Kontakten zu senken
- ✓ Falls Milch in den Pulsator gelangt, z.B. bei einem geteilten Zitzengummi, kann über die Pulsationsschläuche einfach mit sauberem Wasser gespült werden, ohne dass die Einheit auseinandergenommen werden muss
- ✓ Schnell und einfach instand zu halten: die vollständige Wartung dauert weniger als eine Minute

Avantages

- ✓ Le principe de Pulsation breveté « Servo-Direct » permet de contrôler le signal avec précision
- ✓ Conçu pour réduire les consommations de vide afin de garantir une excellente stabilité du vide
- ✓ Faible consommation électrique pour éviter l'oxydation des contacts et faire des économies d'énergie
- ✓ Si le lait est aspiré dans le Pulsateur en raison, par exemple, d'une fissure dans le manchon, il est possible d'aspirer de l'eau claire par les tuyaux d'aspiration, sans devoir tout démonter
- ✓ Facile et rapide à réviser : la maintenance complète peut être faite en moins de 1 minute

Beneficios

- ✓ El sistema patentado de pulsación "Servo-Direct" permite un control con precisión de la señal
- ✓ Diseñado para minimizar el consumo de vacío y garantizar una excelente estabilidad de vacío.
- ✓ Bajo consumo eléctrico para reducir el riesgo de oxidación de contactos eléctricos y para ahorrar energía.
- ✓ Si la leche se escapa hacia el pulsador, como resultado de una rotura de la pezonera, por ejemplo, puede sencillamente aclararse con un chorro de agua limpia a través de los tubos de pulsación, sin necesidad de desmontar la unidad.
- ✓ Fácil y rápido de mantener: el mantenimiento completo dura menos de 1 minuto.

LE30 & LP30

Pos.	Ref.	Note
001	1060023	
002	1060024	LE30
003	1030046	LE PCB
004	1030151	
005	1060011	
006	1060005	
Top 30 007	1060235	
008	1060102	
009	1060034	
010	1060109	2 Exits
011	1060090	
Top 30 012	1060236	
013	1060133	
015	1030108	
Top 30 016	1030298	
017	1030109	
018	1030111	
020	1030274	LE
021	1030272	LE 1,5 mt
024	1030476	LP PCB
058	1060110	4 Exits
068	1060031	LP30
Top 30 302	1030299	
314	2800122	
Top 30 323	1030318	24 V
Top 30 324	1030319	12 V
332	1030275	LP
333	1030273	LP 1,5 mt

Top 30 pag. 6-7

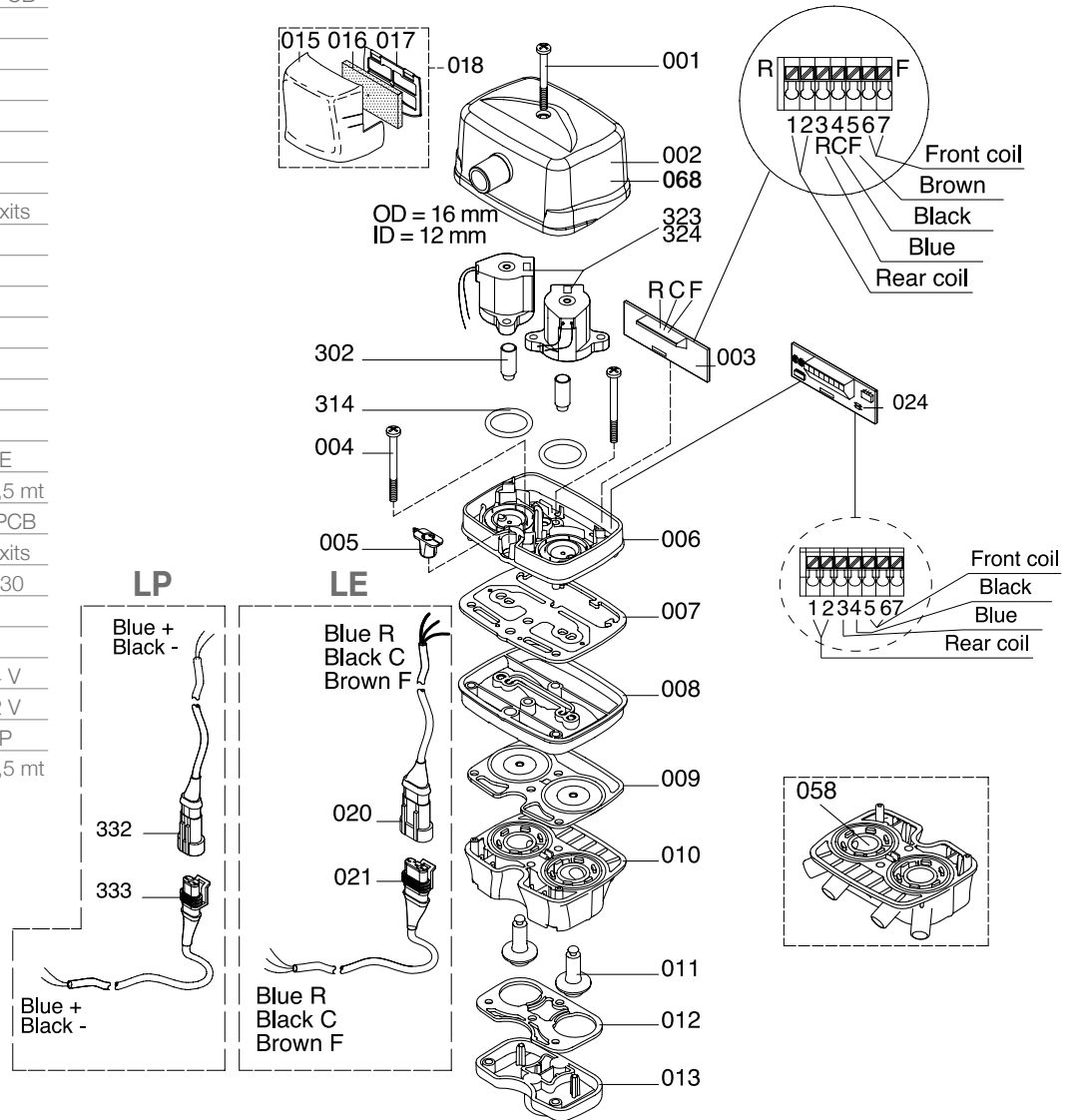

LE/LP/CV30 service kit	Ref.	A frequenza-rate			B rapporto-ratio						
		Rate	1	2	3	Front	Rear	4	5	6	
	1060115	55	OFF	OFF	OFF	50/50	60/40	OFF	OFF	OFF	
		60	ON	OFF	OFF		55/45	60/40	ON	OFF	OFF
		90	OFF	ON	OFF		50/50	50/50	OFF	ON	OFF
		120	ON	ON	OFF		60/40	60/40	ON	ON	OFF
		150	OFF	ON	ON		65/35	65/35	OFF	OFF	ON
		180	OFF	OFF	ON		70/30	70/30	ON	OFF	ON

Technische Daten

Typ: Wechseltakt oder Gleichtakt
 Betriebsspannung: 12*/24 V DC
 Leistungsaufnahme: 260 mA (130 mA pro 24V-Spule);
 260 mA (130 mA pro 12V-Spule);
 Vakuumschluss: 1/2" BSP-Innengewinde
 Betriebssystem: Servo-Direct
 Gehäusematerial: Thermoplastischer Kunststoff
 Abmessungen: 85x90x105 mm
 Gewicht: 0,40 kg

*12V Sonderausführung auf Anfrage

Technical Data

Type: Alternate or Simultaneous
 Operating Voltage: 12*/24VDC
 Power Consumption: 260 mA (130 mA per bobina 24V);
 540 mA (270 mA per bobina 12V)
 Vacuum Connection: 1/2" Bsp female
 Operating System: Servo-Direct
 Body Material: Thermoplastic resin
 Dimensions: 85x90x105 mm
 Weight: 0,40 Kg

*12V Special item available on demand



- ✓ Totally sealed to provide total protection against moisture and humidity.
- ✓ Zum Schutz vor Feuchtigkeit vollständig abgedichtet.
- ✓ Protection totale contre l'humidité et les projections d'eau.
- ✓ Totalmente sellado para proporcionar protección total contra la humedad y el moho.

LE30 Electronic Pulsators

	24 VDC	12 VDC
	1069001 1069159 iMilk 400 vers.	1069005
	1069002	1069006
	1069003	1069007
	1069004	1069008

IUC - Control Boxes

	Model	24 VDC output	12 VDC output
	IUC24	-	1049130 100 - 260 VAC @ 50/60 Hz 200 VA
	IUC32	1049133 100 - 260 VAC @ 50/60 Hz 200 VA	-

LP30 Individual Electronic Pulsators

	24 VDC	12 VDC
	1069009 1069162 CombiFast vers.	1069013
	1069010	1069014
	1069011	1069015
	1069012	1069016

IT - Power Units 24 VDC

	Model	230 VAC - 50/60 Hz
	IT01	1049122 5 VA - 0.2 A
	IT04	1049124 25 VA - 1 A
	IT08	1049125 45 VA - 1.8 A

IUP - Universal Power Supply

		24 VDC output
	IUP	1049131 100 - 260 VAC @ 50/60 Hz 320 W - 13 A up to 50 LP - Pulsators

Accessories

Ref.









Description

	1060016	Restrictor for C phase adjusting Begrenzer für Einstellung der Phase C
	1060095	Restrictor D.4 for A & C phase Begrenzer DM 4 für Phasen A u. C

CV30 / CV20

Control Valves



CV20 Vac/Vac	24 VDC	12 VDC	⚡ Energized Coils ⚡
	1039092 1 x 3 cable	1039108 1 x 3 cable	 VAC Detacher Cylinder VAC Shut off normally closed (HFS/HFSO)
CV20 service kit	Ref.		
	1030339		
CV30 Vac/Atm	24 VDC	12 VDC	⚡ Energized Coils ⚡
	1069020 1 x 3 cable	1069021 1 x 3 cable	 VAC Detacher Cylinder ATM Shut off normally open (NO HFS/HFSO)
CV30 Atm/Atm	24 VDC	12 VDC	
	1069235 2 x 2 cables	1069236 2 x 2 cables	 ATM Shut off normally open (NO HFS/HFSO) ATM Shut off normally open (NO HFS/HFSO)
LE/LP/CV30 service kit	Ref.		
	1060115		

Technische Daten

Betriebsspannung: 12/24VDC
 Leistungsaufnahme: 540mA (270mA für Solenoidspule12V);
 260mA (130mA für Solenoidspule24V);
 Vakuumanschluss: 1/2" BSP-Innengewinde
 Betriebssystem: Servo-Direct
 Gehäusematerial: Thermoplastischer Kunststoff
 Abmessungen: 85x90x105 mm
 Gewicht: 0,40 kg

Technical Data

Operating Voltage: 12/24VDC
 Power Consumption: 540mA (270mA for solenoid 12V);
 260mA (130mA for solenoid 24V)
 Vacuum Connection: 1/2" Bsp female
 Operating System: Servo-direct
 Body Material: Thermoplastic resin
 Dimensions: 85x90x105 mm
 Weight: 0,40 Kg

CV20

Vac/Vac control valve

Pos.	Ref.	Note
001	1030152	
003	1030046	12/24 V
004	1030151	
005	1030016	
006	1030103	
008	2800067	
010	1030405	
012	1030134	
013	1030334	
015	1030108	
Top 30 016	1030298	
017	1030109	
018	1030111	
019	1030322	
020	1030274	
021	1030272	1,5 mt
036	1030130	
037	1030416	
038	1030004	
039	1030452	2 Exits
040	1030267	4x1 cable
041	1030265	4x1 cable
042	1030509	2x2 cable
Top 30 302	1030299	
Top 30 323	1030318	24 V
Top 30 324	1030319	12 V
Top 30 325	1000225	
331	1030052	
334	1030104	

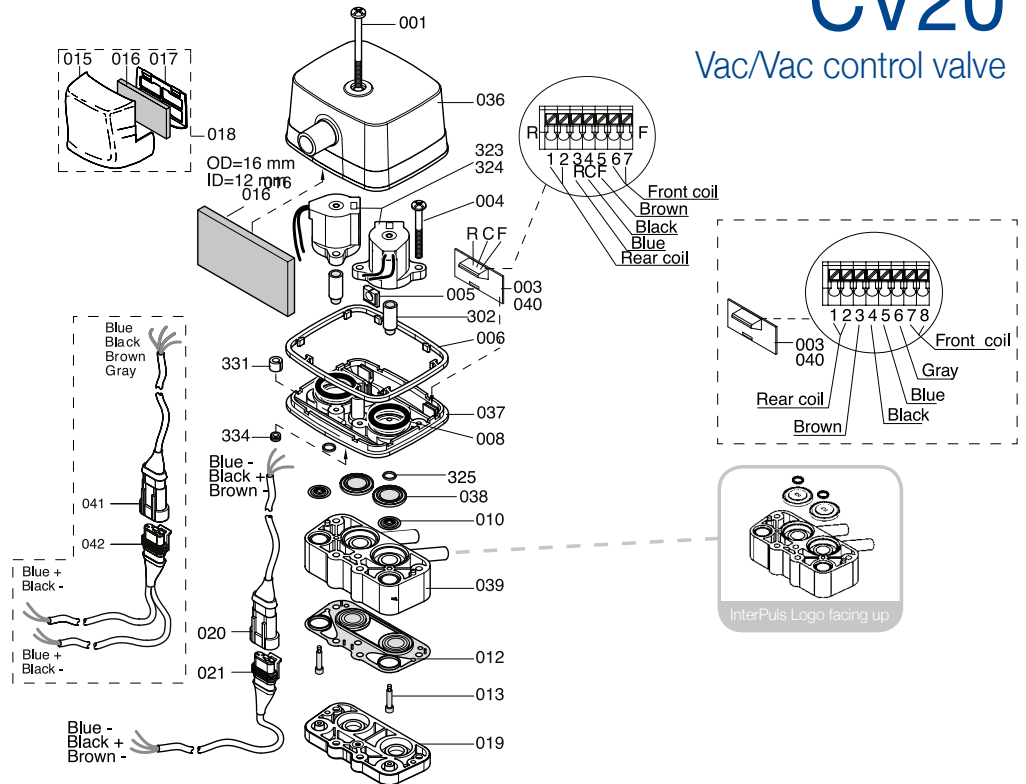

Top 30 pag. 6-7

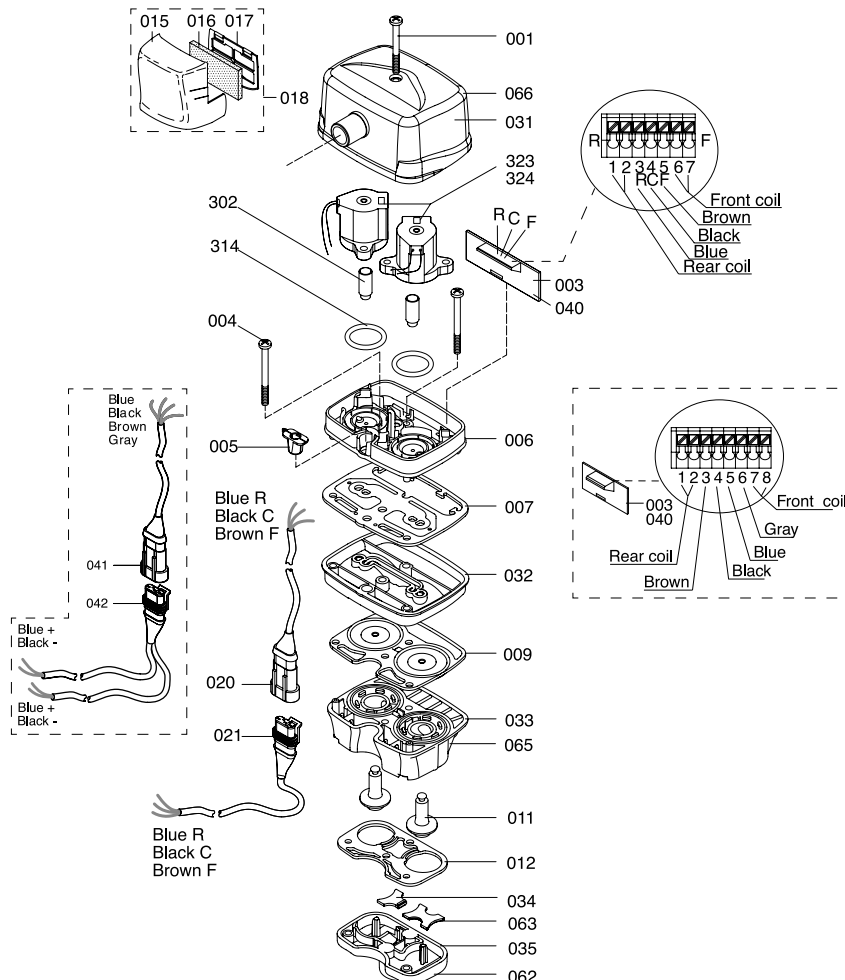

CV30

Vac/Atm & Atm/Atm control valves

Pos.	Ref.	Note
001	1060023	
003	1030046	12/24 V
004	1030151	
005	1060011	
Top 30 006	1060005	
Top 30 007	1060235	
009	1060034	
Top 30 011	1060090	
Top 30 012	1060236	
015	1030108	
Top 30 016	1030298	
017	1030109	
018	1030111	
020	1030274	
021	1030272	1,5 mt
031	1060033	
032	1060103	
033	1060014	
033	1060111	2 Exits
034	1060015	
035	1060013	
040	1030267	4x1 cable
041	1030265	4x1 cable
042	1030509	2x2 cable
062	1060168	Atm/Atm
063	1060169	Atm/Atm
065	1060170	Atm/Atm
066	1060180	Atm/Atm
Top 30 302	1030299	
314	2800122	
Top 30 323	1030318	24 V
Top 30 324	1030319	12 V
Top 30 325	1000225	

Top 30 pag. 6-7

IUC24 - IUC32

Control Box



Easy to program



Protection class **IP54**

To extend the IC - Control Box range, InterPuls has developed the innovative IUC.

Mit dem innovativen IUC erweitert InterPuls sein Sortiment im Bereich IC-Steuergeräte.

InterPuls a mis au point et réalisé l'extraordinaire IUC pour compléter la gamme Control Box.

Para ampliar la gama de Cajas de Control IC, InterPuls ha desarrollado el innovador IUC

Technische Daten

Eingangsspannung: 100-260 V AC bei 50/60 Hz
 Versorgungsspannung: 200 VA
 Stromaufnahme: 3,5 A bei 115 V AC - 1,7 A bei 230 V AC
 Ausgangsspannung: 24 V DC / 12 V DC
 Abmessungen: 150x270x370 mm
 Gewicht: 2,7 kg

Technical Data

Input Voltage: 100-260 VAC @50/60 Hz
 Power Supplied: 200 VA
 Absorption: 3,5 A @115 VAC - 1,7 A @230 VAC
 Output Voltage: 24 VDC / 12 VDC
 Dimensions: 150x270x370 mm
 Weight: 2,7 Kg

IUC - Control Boxes

	Model	24 VDC output	12 VDC output
	IUC24	-	1049130 * 100 - 260 VAC @ 50/60 Hz 200 VA
	IUC32	1049133 100 - 260 VAC @ 50/60 Hz 200 VA	-



* Special item available on demand.



IUP

Universal Power Supply



Protection class **IP54**

Competitive solution for 24VDC input devices. Up to 20 ACR complete milking points or up to 50 LP20/LP30 individual Pulsators. IUP is protected against: short-circuits, over-load, over-voltage, over-heat

Konkurrenzfähige Lösung für Geräte mit 24 V DC Stromversorgung. Für bis zu 20 vollständige ACR-Melkplätze oder bis zu 50 unabhängige LP20/LP30-Pulsatoren. IUP is protected against: short-circuits, over-load, over-voltage, over-heat

Idéal pour tous services qui ont besoin d'alimentation à 24VDC. Jusqu'à 20 systèmes complets, du boîtier de commande ACR au 50 Pulsateurs individuels LP20/LP30. IUP est protégé contre court-circuits, surcharges, surtensions, surchauffe

Solución competitiva para dispositivos con entrada de 24VCC. Hasta 20 puntos de ordeño completo ACR o hasta 50 pulsadores individuales LP20/LP30. IUP está protegido contra cortocircuitos, sobrecarga, sobretensión, recalentamiento.

Technische Daten

Eingangsspannung: 100-260 V AC bei 50/60 Hz
 Max. Leistung: 320W
 Max. Stromstärke: 13 Amp
 Ausgangsspannung: 24 V DC stabilisiert
 Abmessungen: 150x270x370 mm
 Gewicht: 2,7 kg

Technical Data

Input Voltage: 100-260VAC @50/60Hz
 Max Power: 320W
 Max Current: 13Amp
 Output Voltage: 24VDC stabilized
 Dimensions: 150x270x370mm
 Weight: 2,7 Kg

IUP - Universal Power Supply

	Ref.	Note
	1049131	up to 50 LP - Pulsators bis zu 50 LP-Pulsatoren

Electronic Regulator

	Ref.	Note
	9001022	500 W 3A 160 ÷ 250 VAC @50/60Hz 500 W 3A 160 ÷ 250 VAC @50/60Hz



REVOLUTIONAir.



✓ Patented

L02 has been super-charged! The well-known milking performances have been improved thanks to the 50% more AirBoost!

L02 hat den Turbo eingelegt! Die bekannten Melkleistungen wurden dank 50 % mehr Air-Boost noch weiter verbessert.

L02 a été suralimenté! Les performances de traite déjà reconnues ont été améliorées grâce au 50% d'AirBoost en plus!

¡L02 ha sido súper cargado! ¡Los conocidos rendimientos del ordeño han sido mejorados gracias al 50% más de Air-Boost!

Benefits

- ✓ Oversized filtering surface
- ✓ Gentle and uniform milking
- ✓ Excellent massage phase
- ✓ Reliable SUREMATCH® coupling system
- ✓ Easy-to-clean filter
- ✓ Performant, long-life pneumatic reversal mechanism

Vorteile

- ✓ Überdimensionierte Filterfläche
- ✓ Schonendes, gleichmäßiges Melken
- ✓ Hervorragende Massagephase
- ✓ Zuverlässiges SUREMATCH®-Anschlusssystem
- ✓ Leicht zu reinigender Filter
- ✓ Leistungsstarker, langlebiger pneumatischer Umkehrmechanismus

Avantages

- ✓ Surface filtrante augmentée
- ✓ Traite délicate et uniforme
- ✓ Phase de massage optimale
- ✓ Système d'accouplement SUREMATCH® fiable
- ✓ Nettoyage du filtre simplifié
- ✓ Inversion pneumatique performante et à long terme

Beneficios

- ✓ Mayor superficie filtrante
- ✓ Ordeño suave y uniforme
- ✓ Fase de masaje excelente
- ✓ Sistema de acoplamiento fiable SUREMATCH®
- ✓ Filtro fácil de limpiar
- ✓ Mecanismo de inversión neumática de larga duración y altas prestaciones

Technische Daten

Modell: L02Air
 Pulsationstyp: Wechseltakt
 Frequenz: 50 - 180 ppm
 Melkverhältnis: 50/50, 60/40, 65/35, 70/30
 Betriebssystem: Vakuum
 Arbeitsweise: Membranen
 Abmessungen: 102x87x64 mm
 Gewicht: 0,30 kg

Technical Data

Model: L02Air
 Pulsation Type: Alternate
 Rate: 50 ÷ 180 ppm
 Milking Ratio: 50/50, 60/40, 65/35, 70/30
 Operating System: Vacuum
 Working Principle: Diaphragms
 Dimensions: 102x87x64 mm
 Weight: 0,30 Kg

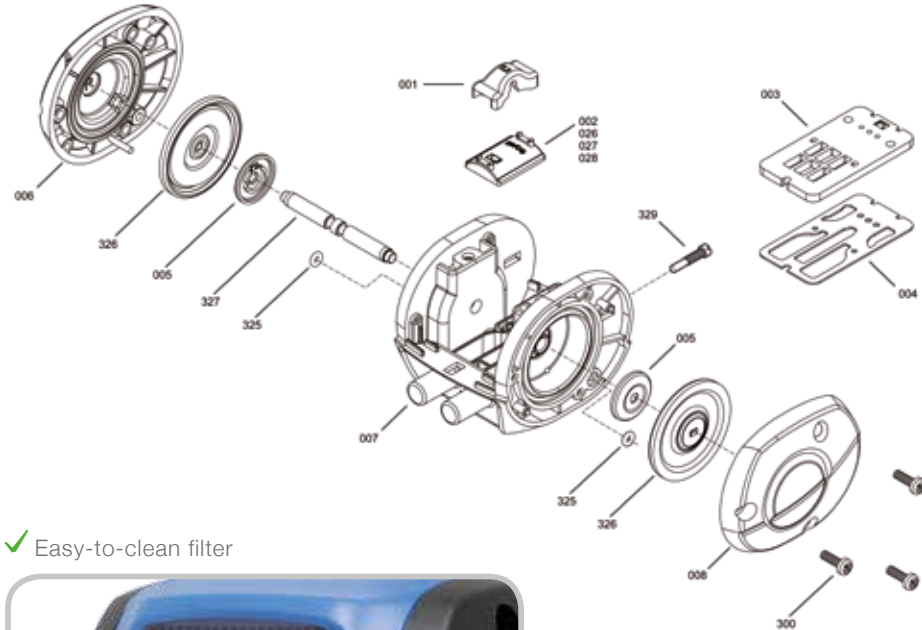
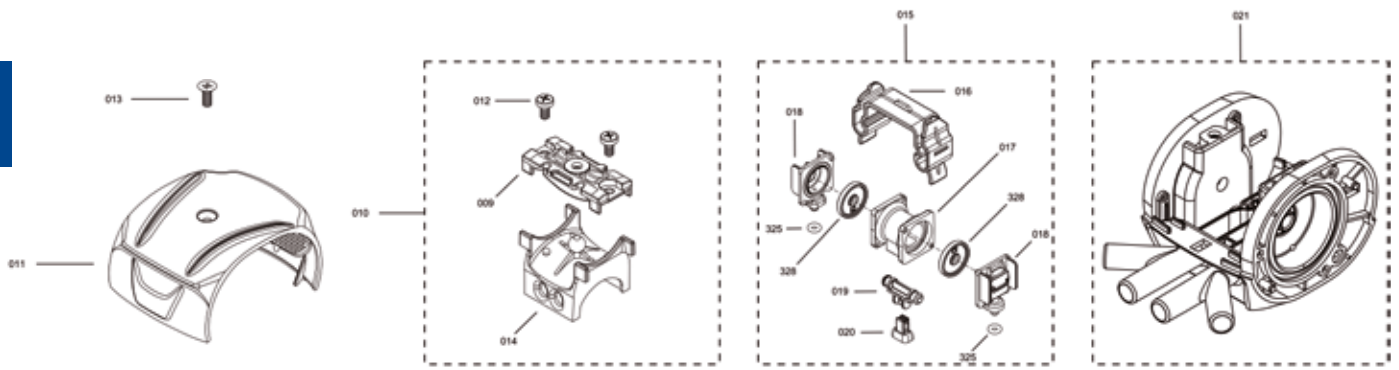



✓ Easy-to-clean filter



Pos.	Ref.	Note
001	1050011	
002	1050012	60/40
003	1050007	
004	1050008	
005	1050009	
006	1090002	Right Cover
007	1090001	2 Exits
008	1090003	Left Cover
009	1090005	
010	1090004	
011	1090007	
012	1050054	
013	1090006	
014	1050016	
015	1050116	
016	1050026	
017	1050024	
018	1050025	
019	1050023	
020	1050022	
021	1090020	4 Exits
026	1050015	50/50
027	1050014	65/35
028	1050013	70/30
Top 30	300	1000221
Top 30	325	1000225
Top 30	326	1010192
	327	1050047
Top 30	328	1050115
	329	1050004

Top 30 pag. 6-7

Accessories	Ref.	Note
	Top 30 1050124 1050118 1050119 Top 30 1050125	Alt. 60/40 Alt. 50/50 Alt. 65/35 Alt. 70/30
	Top 30 pag. 6-7	

L02 Air	Ratio			
	60/40	50/50	65/35	70/30
	1099001	1099002	1099003	1099004
	1099013	1099014	1099015	-

L80 Air

Vacuum Pulsator



legendAir

L80Air is the evolution of the legendary L80 Pulsator. The innovative design of its cover, with an oversized air filter, grants a gentle and uniform milking. Ideal for bucket milking, L80Air is perfect solution for the those looking for a LegendAir product!

L80Air ist die Weiterentwicklung des legendären L80-Pulsators. Die innovative Konstruktion der Abdeckung mit überdimensioniertem Luftfilter sorgt für schonendes, gleichmäßiges Melken. L80Air eignet sich ideal für das Eimermelken und die perfekte Lösung für jeden, der ein LegendAires Produkt sucht!

Le L80Air est la nouvelle génération du légendaire pulsateur L80. Le nouveau design du capot avec un filtre à air grande capacité garantit une traite douce et stable. Idéal pour la traite en pot trayeur, le L80Air est la solution parfaite pour ceux qui cherchent un produit légendAir!

L80Air es la evolución del legendario Pulsador L80. El innovador diseño de su cubierta, con un filtro de aire de gran tamaño, permite un ordeño suave y uniforme. Ideal para cubo de ordeño, ¡L80Air es la solución perfecta para quienes buscan un producto LegendAir!

Benefits

- ✓ Improved milking performances
- ✓ Easy-to-clean filter
- ✓ Reinforced internal partition walls: additional protection from impurities
- ✓ Maintenance free
- ✓ Sturdy and reliable

Vorteile

- ✓ Verbesserte Melkleistungen
- ✓ Leicht zu reinigender Filter
- ✓ Verstärkte Trennwände innen: zusätzlicher Schutz vor Verunreinigungen
- ✓ Wartungsfrei
- ✓ Robust und zuverlässig

Avantages

- ✓ Performances de traite améliorées
- ✓ Nettoyage du filtre simplifié
- ✓ Parois de séparation internes renforcées: protection supplémentaire contre les impuretés
- ✓ Aucune maintenance
- ✓ Robuste et fiable

Beneficios

- ✓ Mayores prestaciones de ordeño
- ✓ Filtro fácil de limpiar
- ✓ Reforzado con paredes divisorias internas: protección adicional contra las impurezas
- ✓ No necesita mantenimiento
- ✓ Resistente y fiable

Technische Daten

Modell: L80Air
Pulsationstyp: Wechseltakt
Frequenz: 50 - 180 ppm
Melkverhältnis: 50/50, 60/40, 65/35, 70/30
Betriebssystem: Vakuum
Arbeitsweise: Membranen
Abmessungen: 102x87x64 mm
Gewicht: 0,30 kg

Technical Data

Model: L80Air
Pulsation Type: Alternate
Rate: 50 ÷ 180 ppm
Milking Ratio: 50/50, 60/40, 65/35, 70/30
Operating System: Vacuum
Working Principle: Diaphragms
Dimensions: 102x87x64 mm
Weight: 0,30 Kg

L80 Air Vacuum Pulsator

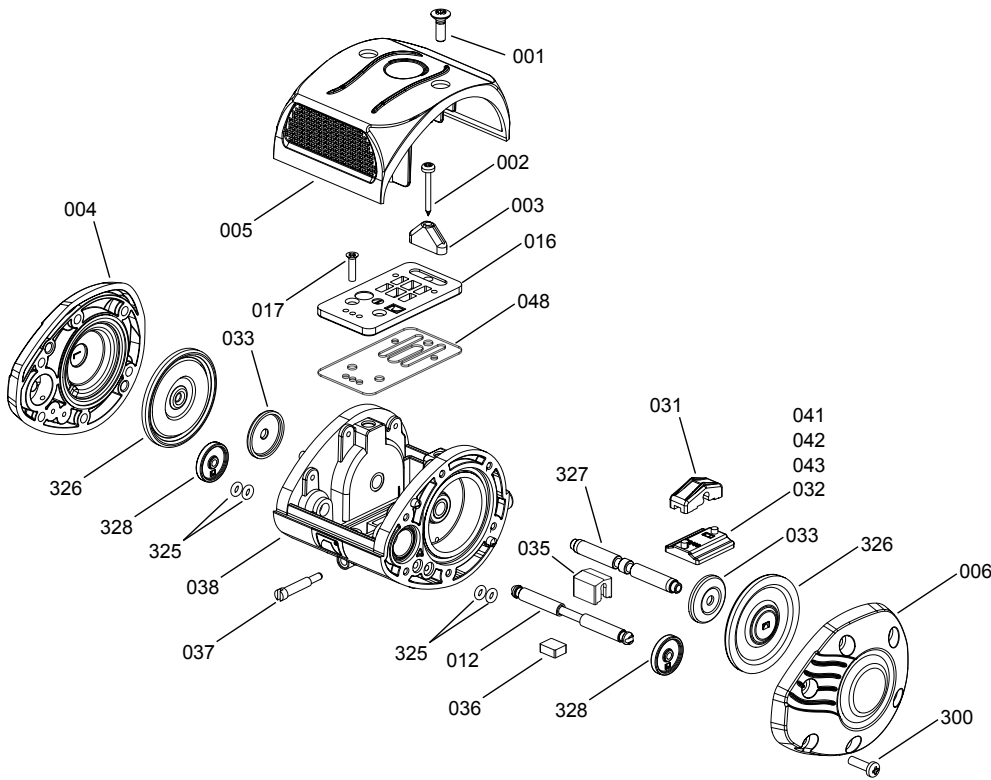



Pos.	Ref.	Note
001	1000031	
002	1010093	
003	1010092	
004	1020032	
005	1020033	
006	1020031	
012	1000162	
016	1010085	
017	1000037	
031	1000377	
032	1000324	60/40
033	1000312	
035	1000379	
036	1000378	
037	1000321	
038	1000366	
041	1000326	50/50
042	1000328	70/30
043	1000330	65/35
048	1000365	
Top 30	300	1000221
Top 30	325	1000225
Top 30	326	1010192
	327	1050047
Top 30	328	1050115

✓ Don't lubricate

Top 30 pag. 6-7

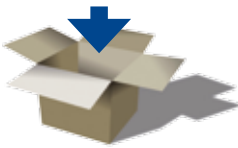
L80 Air	Ref.			
Alt.	60/40	50/50	65/35	70/30
	1029009	1029010	1029011	1029012
Alt.				

	Ref.	Note	Spare Parts	Ref.	Note
	1029002	30x L80Air - master 60/40		1020037	Alt. 60/40
	1029004	30x L80Air - master 50/50		1020038	Alt. 50/50
	1029006	30x L80Air - master 65/35		1020039	Alt. 65/35
	1029008	30x L80Air - master 70/30		1020040	Alt. 70/30
			L80 Air service kit		

CombiFast

Pipeline
Milking
System



Vacuum Pulsator version



Easy to inspect

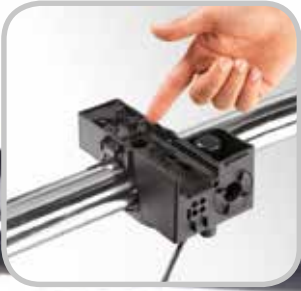

✓ Patented

a CombiFast, is a patented connecting system designed by InterPuls for simultaneously connecting milk, vacuum, electric power and data transfer lines.

CombiFast ist ein von InterPuls entwickeltes patentiertes Verbindungssystem zur gleichzeitigen Verbindung von Milch-, Vakuum-, Strom- und Datenübertragungsleitungen.

CombiFast d'InterPuls est un système de raccordement breveté. Il est idéal pour raccorder à la fois le lactoduc, la canalisation à vide, l'alimentation électrique et transférer les données.

CombiFast es un sistema de conexión patentado, diseñado por InterPuls para conectar simultáneamente las líneas de ordeño, vacío, alimentación eléctrica y transferencia de datos.



Benefits

- ✓ Ergonomic, practical handle, with built-in Pulsator option
- ✓ Easy to carry
- ✓ Maintenance free
- ✓ Self-cleaning milk inlet
- ✓ Secure, single action, airtight connection
- ✓ Data transfer version also available

Vorteile

- ✓ Ergonomischer, praktischer Griff mit eingebautem Pulsator
- ✓ Leicht zu tragen
- ✓ Wartungsfrei
- ✓ Selbstreinigender Milcheinlauf
- ✓ Sicherer, luftdichter Anschluss, der mit einem einzigen Arbeitsschritt erzeugt wird.
- ✓ Version mit Datenübertragung ebenfalls verfügbar

Avantages

- ✓ Poignée ergonomique et pratique, y compris avec Pulsateur intégré
- ✓ Facile à transporter
- ✓ Pas de maintenance nécessaire
- ✓ Entrée du lait avec profil autonettoyant
- ✓ Raccordement précis en un seul geste, sans aucune admission d'air accidentelle
- ✓ Version pour le transfert des données disponible

Beneficios

- ✓ Mango ergonómico y práctico, con opción de pulsador incorporado
- ✓ Fácil de transportar
- ✓ No necesita mantenimiento
- ✓ Tubo de entrada de leche autolimpiante
- ✓ Conexión segura, de acción única y hermética
- ✓ También disponible la versión con transferencia de datos

Lead Angle

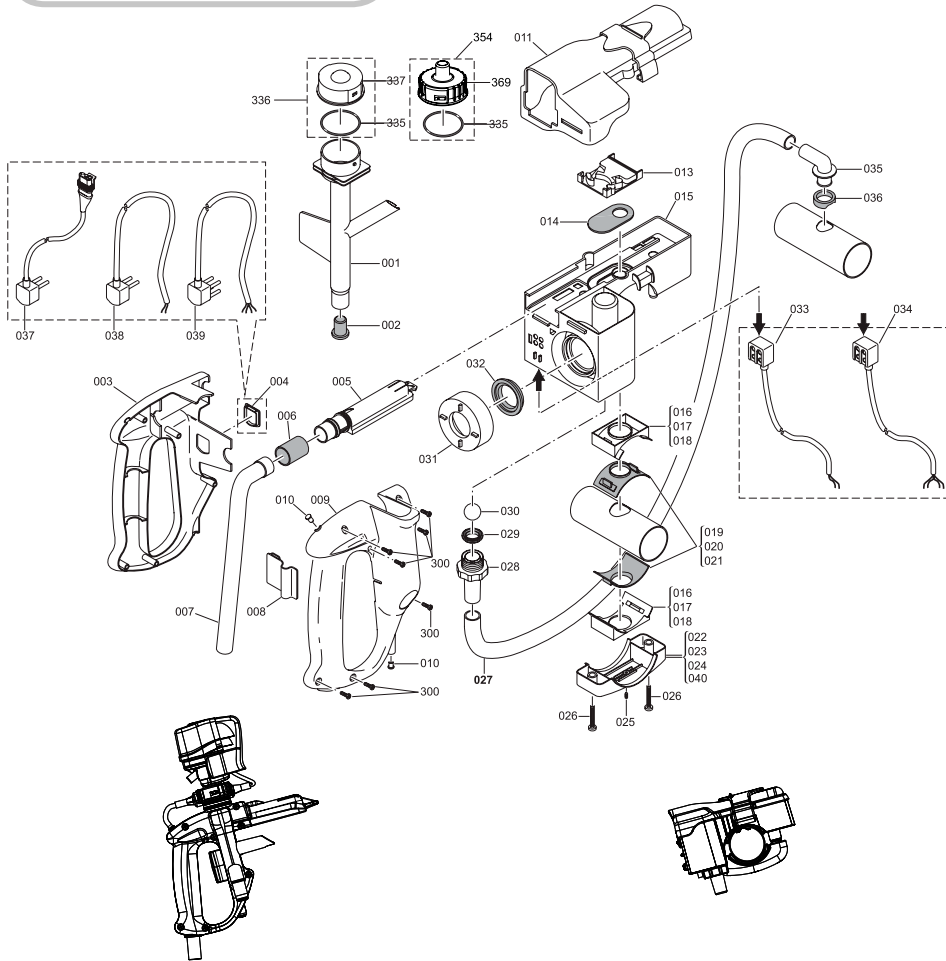
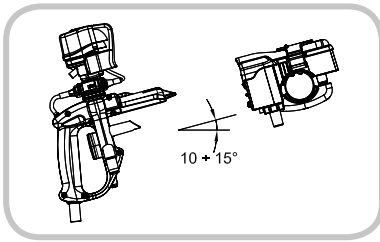

Pos.	Ref.	Note
001	1420148	
002	1420153	
003	1420126	
004	1420040	
005	1420158	
006	1420155	
007	1420159	
008	1420034	
009	1420127	
010	1420041	
011	1420061	
013	1420099	
014	1420121	
015	1420128	
016	1420019	D. 40
017	1420020	D. 52
018	1420021	D. 63
019	1420134	D. 40
020	1420135	D. 52
021	1420136	D. 63
022	1420016	D. 40
023	1420067	D. 52
024	1420068	D. 63
025	1420017	
026	1420018	
027	1420083	0,5 mt
028	1420149	
029	1420146	
030	1420009	
031	1420006	
032	1420005	
033	1420110	2 pins female
034	1420112	4 pins female
035	1420025	
036	1420137	
037	1420113	2 pins male w/conn
038	1420116	2 pins 2 mt cable
039	1420115	4 pins 2 mt cable
040	1420140	D. 50,8
300	1000221	
335	2800123	
336	2800155	
337	2800131	
354	2800234	
369	2800130	

Technische Daten - Gleiteinheit

Milchleitung: ODxID 18x16 mm
 Vakuumleitung: ODxID 19x14 mm
 Abmessungen: 240x240x89 mm
 Gewicht: 0,416 kg

Technische Daten - Stationseinheit

Milchleitung: OD 40 - 50,8 - 52 - 63 mm
 Durchmesser der Einlassöffnung der Milchleitung: 22 mm
 Durchmesser der Einlassöffnung der Vakuumleitung: 22 mm
 Vakuumanschluss: ODxID 19x14 mm
 Abmessungen: 173x148x102 mm
 Gewicht: 0,506 kg

Top 30

pag. 6-7

Technical Data - Glide Unit

Milk Line: ODxID 18x16 mm
 Vacuum Line: ODxID 19x14 mm
 Dimensions: 240x240x89 mm
 Weight: 0,416 Kg

Technical Data - Station Unit

Milk Line: OD 40 - 50,8 - 52 - 63 mm
 Milk Line inlet hole diameter: 22 mm
 Vacuum Line inlet hole diameter: 22 mm
 Vacuum connection: ODxID 19x14 mm
 Dimensions: 173x148x102 mm
 Weight: 0,506 Kg











CombiFast Glide Unit

Ref.	Note
1429010	Glide Unit for vacuum Pulsator
1429011	Glide Unit 2 pins with cable for LP electronic Pulsator
1429013	Glide Unit 4 pins data transfer for LP electronic Pulsator
1429026	Glide Unit 2 pins for IMILK400 only - 2 m cable

CombiFast Glide Unit - vacuum Pulsator

Ref.	Note
1429046	Glide Unit with L02Air 60/40 
1429015	Glide Unit with L02 60/40 S/S cover 
1429016	Glide Unit with LL90 60/40 

CombiFast Glide Unit - electronic Pulsator

Ref.	Note
1429017	Glide Unit with LP20 
1429020	Glide Unit with LP20 Stim 
1429019	Glide Unit with LP30 

CombiFast Station - vacuum Pulsator

Ref.	Note
1429001	Standard Station - Milk line D. 40
1429028	Standard Station - Milk line D. 50,8 - 2"
1429004	Standard Station - Milk line D. 52
1429007	Standard Station - Milk line D. 63

CombiFast Station - electronic Pulsator

Ref.	Note
1429002	Electric Station 2 pins - Milk line D. 40
1429029	Electric Station 2 pins - Milk line D. 50,8
1429005	Electric Station 2 pins - Milk line D. 52
1429008	Electric Station 2 pins - Milk line D. 63
1429003	Electric-Data Station 4 pins - Milk line D. 40
1429030	Electric-Data Station 4 pins - Milk line D. 50,8 - 2"
1429006	Electric-Data Station 4 pins - Milk line D. 52
1429009	Electric-Data Station 4 pins - Milk line D. 63

CombiFast Cluster Hook

Ref.	Note
1420100	



Portable iMilk401

Tie Stall Milk Yield Indicator

Portable iMilk401 "Lite"



iMilk401 is the answer to the growing demand of milk yield indicator for tie-stall barn. The panel permits to choose among 5 milking program, ensuring a tailor made setting depending of the need.

iMilk401 ist die Antwort auf die wachsende Nachfrage nach Milchleistungsindikatoren für Anbindeställe. Das Bedienungsfeld ermöglicht eine Auswahl zwischen 5 Melkprogrammen und gewährleistet eine den jeweiligen Bedürfnissen entsprechende individuelle Einstellung.

iMilk401 est la réponse au besoin croissant d'avoir une indication de la production du lait dans les installation à stabulation fixe. Le panneau permet de choisir entre 5 programmes de traite, en assurant le réglage idéal pour toutes exigences.

iMilk401 es la respuesta a la creciente demanda del indicador de producción láctea para los establos. El panel permite elegir entre 5 programas de ordeño, ofreciendo una configuración a la medida en función de sus necesidades.

Features

- ✓ Advanced Yield indication
- ✓ Conductivity and SCC information
- ✓ Advanced Pulsation control
- ✓ Advanced stimulation control
- ✓ Reliable ACR control
- ✓ DHM Dairy Management available
- ✓ Manual ID

Eigenschaften

- ✓ Erweiterte Leistungsanzeige
- ✓ Leitfähigkeit und SCC-Informationen
- ✓ Erweiterte Pulsationskontrolle
- ✓ Erweiterte Stimulationskontrolle
- ✓ Zuverlässiges ACR-Control
- ✓ Verfügbares DHM-Melkmanagement
- ✓ Manuelle ID

Caractéristiques

- ✓ Indication avancée de la production
- ✓ Détection de la conductivité des cellules somatiques
- ✓ Contrôle avancé de la pulsation
- ✓ Contrôle avancé de la stimulation
- ✓ Contrôle avancé des fonctions de l'ACR
- ✓ Disponible avec Dairy Management DHM
- ✓ Identification manuelle

Características

- ✓ Indicación de producción avanzada
- ✓ Información sobre conductividad y recuento de células somáticas
- ✓ Control de pulsación avanzado
- ✓ Control de estimulación avanzado
- ✓ Control ACR fiable
- ✓ Gestión de lácteos DHM disponible
- ✓ Identificación manual

Benefits

- ✓ Ergonomic milking
- ✓ Up to 45 milking record per panel
- ✓ Complete and user-friendly Dairy Management
- ✓ Large multifunction display
- ✓ Advanced washing control

Vorteile

- ✓ Ergonomisches Melken
- ✓ Bis zu 45 Melkaufzeichnungen pro Bedienungsfeld
- ✓ Komplettes und anwendungsfreundliches Melkmanagement
Großes Multifunktionsdisplay
- ✓ Erweiterte Reinigungskontrolle

Avantages

- ✓ Traite ergonomique
- ✓ Jusqu'à 45 traits mémorisables pour chaque panneau
- ✓ Software pour la gestion du troupeau complet et facile à utiliser
- ✓ Display de grande taille et multifonctions
- ✓ Contrôle avancé des fonctions de lavage

Beneficios

- ✓ Ordeño ergonómico
- ✓ Registro de hasta 45 ordeños por panel
- ✓ Gestión de lácteos completa y de fácil acceso.
- ✓ Amplia pantalla multifunción
- ✓ Control avanzado de lavado



Portable iMilk401 set-up includes:

- Electronic Pulsator and CV ✓
- DVC1000 cylinder ✓
- iMilk401 + sensor ✓
- SOvalve evo ✓
- Prewired cables ✓

Technische Daten

Genauigkeit der Milchleistung +/- 10%
Eingangsspannung: 24 V DC
Gewicht tragbares iMilk401: 4,5 kg
Gewicht tragbares iMilk401 + Melkzeug: 9,5 kg

Technical Data

Milk yield accuracy: +/- 10%
Input Voltage: 24 VDC
Weight Portable iMilk401: 4,5 Kg
Weight Portable iMilk401 + Cluster: 9,5 Kg



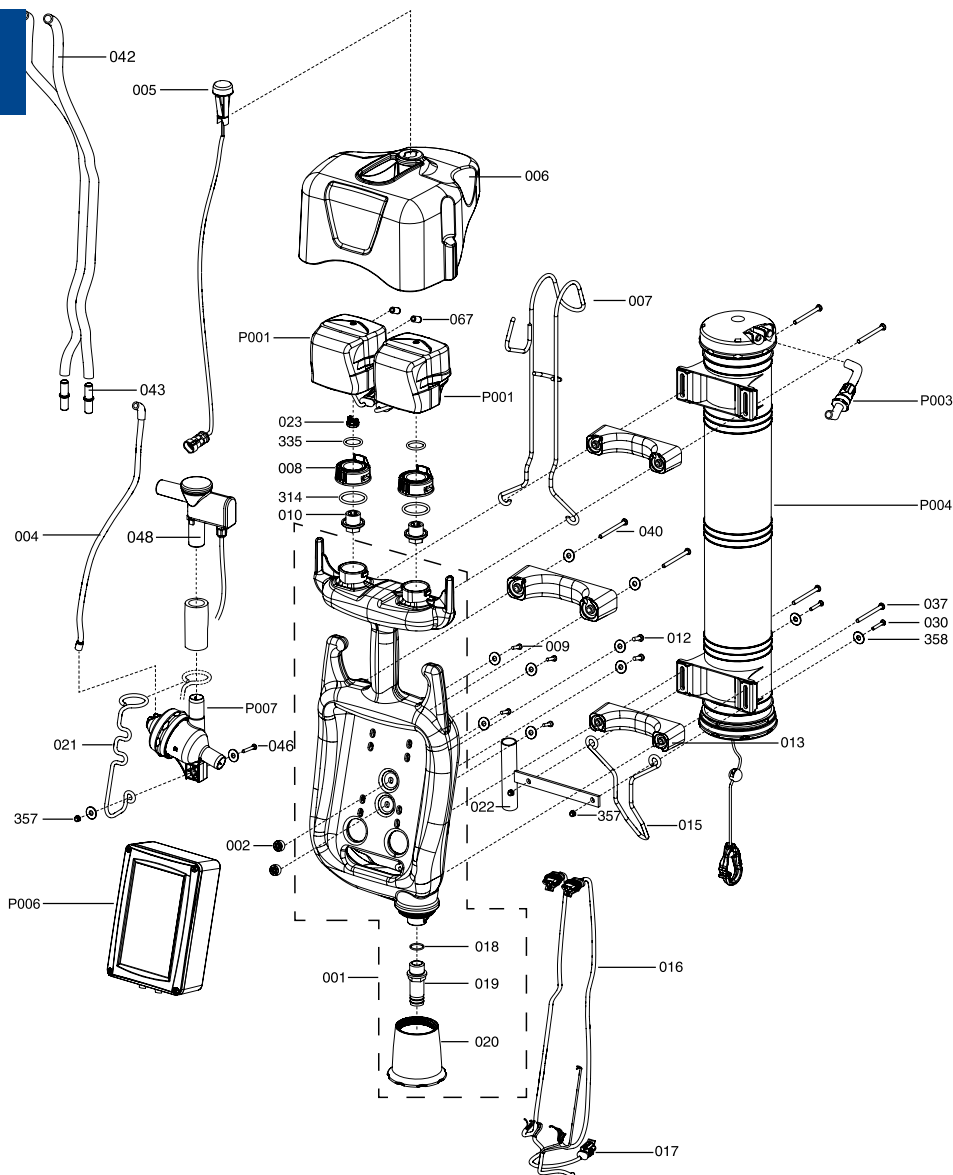

Pos.	Ref.	Note
P001	1069001	LE30
P003	5200104	
P004	5209043	DVC1000
P006	5640031	iMilk401
P007	5529018	SOValve evo
001	5610025	Chassis
002	5610024	
004	5610028	
005	5640035	
006	5610030	
007	5610004	
008	5610043	
009	5610017	
010	5610060	
012	5610016	
013	5610011	
015	5610006	
016	5610056	
017	5610026	
018	5610022	
019	5610014	
020	5610010	
021	5640037	
022	5640019	
023	1030426	
030	5510035	
037	5610015	
040	5610048	
042	5610051	
Top 30 043	1900063	
046	5610049	
048	5640008	iMilk401 sensor
067	1060095	
314	2800122	
335	2800123	
357	5510036	
358	5200037	

Top 30 pag. 6-7

Portable iMilk401	Ref.	Note
	5649005 5649007	Portable iMilk401 Complete Portable iMilk401 "Lite"
	1429012 1429013	Glide Unit 2 pins Glide Unit 4 pins - DHM
	1429002	Electric Station 2 pins - Milk line D. 40
	1429029	Electric Station 2 pins - Milk line D. 50,8
	1429005	Electric Station 2 pins - Milk line D. 52
	1429008	Electric Station 2 pins - Milk line D. 63
	1429003* 1429030* 1429006* 1429009*	Data Station 4 pins - Milk line D. 40 Data Station 4 pins - Milk line D. 50,8 - 2" Data Station 4 pins - Milk line D. 52 Data Station 4 pins - Milk line D. 63
		* Milk-room Station for DHM Data Download
	1049131	IUP - up to 20 Portable iMilk401



DHM Dairy Management

Portable iMilk401

Milking



Performance

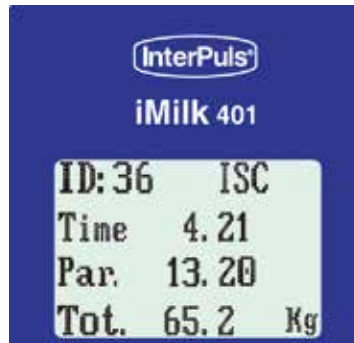

Washing



Genauigkeit der Milchleistung +/- 10%
 Eingangsspannung: 24 V DC
 Gewicht tragbares iMilk401: 4,5 kg
 Gewicht tragbares iMilk401 + Melkzeug: 9,5 kg

Die Software Dairy Herd Management ermöglicht die Erfassung und Analyse der Produktionsdaten der Herde, die von iMilk401 gesammelt wurden. Während des Reinigungsverfahrens werden die Melkinformationen auf den PC heruntergeladen.

Le software Dairy Herd Management permet l'acquisition et l'analyse des données de production du troupeau que iMilk401 va recueillir. Pendant le lavage les données de la traite sont logées dans l'ordinateur à disposition de l'éleveur, grâce à un interface facile à utiliser.

El software Dairy Herd Management permite adquirir y analizar los datos de producción del rebaño recopilados por los paneles de iMilk401. Durante el lavado la información es descargada en el ordenador.



Data import interface
 Displays data on user-friendly chart

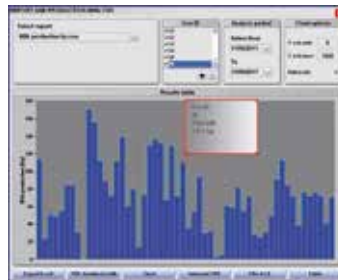

Herd performance
 Permits to summarize the herd's performance through an intuitive graph

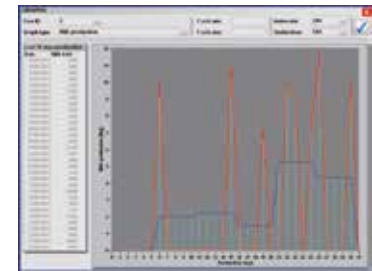

Cow milk Yield
 The cow performance at a glance! The milk graph permits to plan an appropriate strategy.



Cows Manager
 Cow data: ID number, name, birth date, ISO tag
 Cow agenda: lactation, insemination, treatment...
 Cow status: dry, milking...

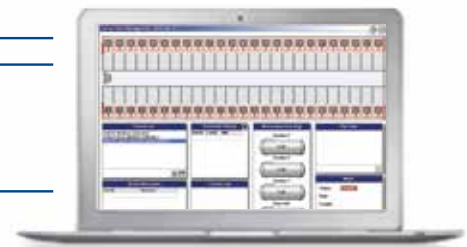

DHM Dairy Management	Ref.	Note
	5640010	DHM 401 Pro
	5640020	CAN BUS Cable 100 m roll



Portable ACR

Tie Stall Milking Point



- ✓ Ergonomic.
- ✓ Easy to handle.

Automation and milking comfort are growing demands in tie stall plants too. That's the reason why we've conceived and developed Portable ACR: an innovative solution that grants a milking point with an automatic detaching system for a quick and physiologically ideal milking.

Auch für Anbindeställe steigt die Nachfrage nach Automation und Melkcomfort. Aus diesem Grund haben wir das tragbare ACR entworfen und entwickelt: eine innovative Lösung, die einen Melkplatz mit einem automatischen Abziehsystem für ein schnelles und physiologisch optimales Melken gewährleistet.

L'automation et le confort pendant la traite sont des exigences qui vont augmenter dans les salles de traite à stabulation fixe. Pour cette raison on a conçu et développé Portable ACR, une solution innovante qui permet d'avoir un poste de traite avec décrochage automatique pour obtenir une traite rapide et physiologiquement optimale des bovins laitiers.

Asimismo, la automatización y la comodidad en las operaciones de ordeño son demandas crecientes en los establos. Es por eso que hemos ideado y desarrollado el Portable ACR: una solución innovadora que asegura un punto de ordeño con un sistema automático de desenganche para lograr una labor rápida e ideal desde el punto de vista fisiológico.



Benefits

- ✓ Easy to handle and ergonomic
- ✓ Integrated 2L vacuum reserve
- ✓ Zero fluctuation and zero waste
- ✓ "Plug & Play" solution
- ✓ Made by 100% recyclable polymer
- ✓ Service free

Vorteile

- ✓ Handlich und ergonomisch
- ✓ Eingebaute 2-Liter-Vakuumreserve
- ✓ Keine Schwankungen und keine Verschwendung
- ✓ Plug-&-Play-System
- ✓ Aus 100 % recyclingfähigem Polymer
- ✓ Wartungsfrei

Avantages

- ✓ Maniable et ergonomique
- ✓ 2L réserve de vide intégrée
- ✓ Aucune oscillation et aucune perte
- ✓ Solution "Plug & Play"
- ✓ Composé par un polymère 100% recyclable
- ✓ Sans entretien

Beneficios

- ✓ Fácil de manejar y ergonómico
- ✓ Reserva de vacío 2l incorporado
- ✓ Fluctuación y derroches nulos
- ✓ Solución «Plug-and-play»
- ✓ Hecho de polímero reciclable 100%
- ✓ No necesita mantenimiento

CombiFast hook



Portable ACR set-up includes:

- Electronic Pulsator and CV ✓
- DVC1000 cylinder ✓
- ACRsmart panels ✓
- HFSevo ✓
- Prewired cables ✓

Technische Daten

Eingangsspannung: 24 V DC
 Gewicht tragbares ACR: 4,5 kg
 Gewicht tragbares ACR + Melkzeug: 9,5 kg

Technical Data

Input Voltage: 24 VDC
 Weight Portable ACR: 4,5 Kg
 Weight Portable ACR + Cluster: 9,5 Kg



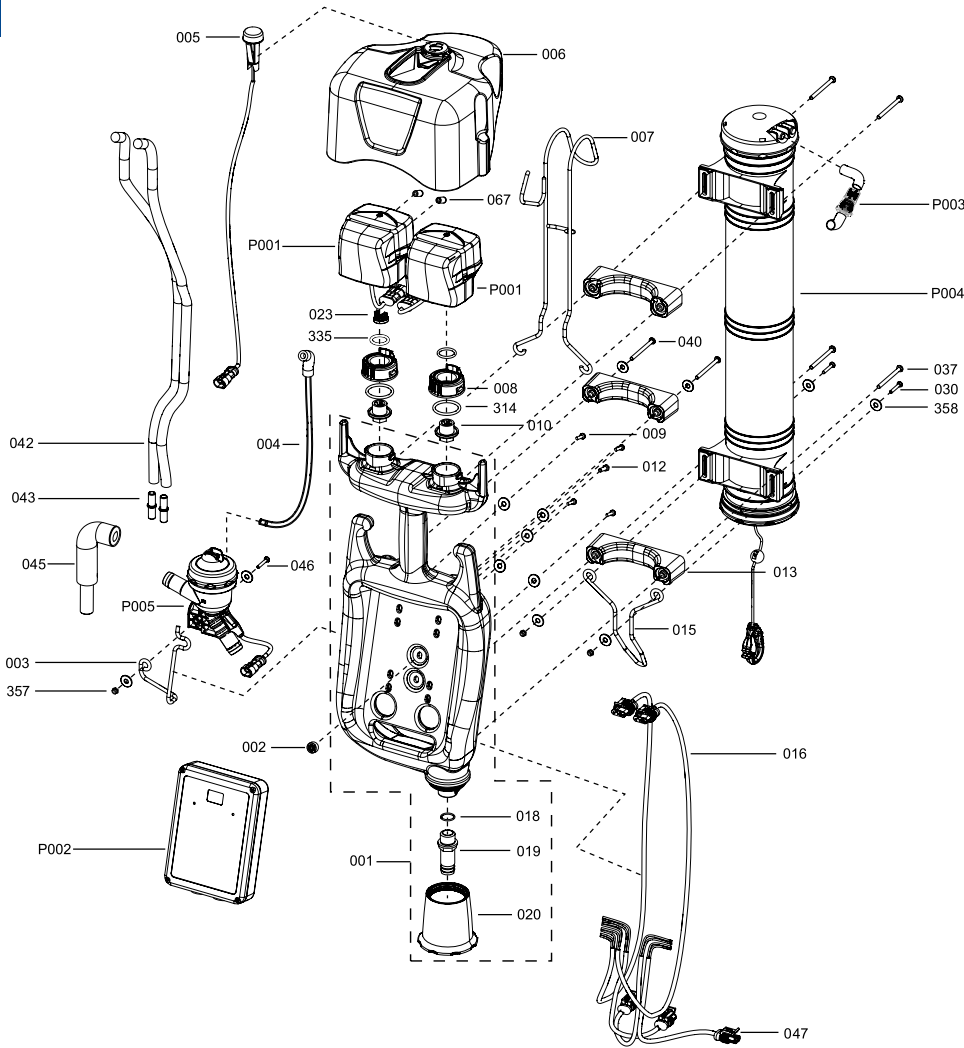

Pos.	Ref.	Note
P001	1069001	LE30
P002	5639001	ACRsmart
P003	5200104	
P004	5209043	DVC1000
P005	5519040	HFSevo
001	5610025	Chassis
002	5610024	
003	5610007	
004	5610028	
005	5640035	
006	5610030	
007	5610004	
008	5610043	
009	5610017	
010	5610060	
012	5610016	
013	5610011	
015	5610006	
016	5610056	
018	5610022	
019	5610014	
020	5610010	
023	1030426	
030	5510035	
037	5610015	
040	5610048	
042	5610051	
Top 30 043	1900063	
045	5610055	
046	5610049	
047	5610057	
067	1060095	
314	2800122	
335	2800123	
357	5510036	
358	5200037	

Top 30 pag. 6-7

Portable ACR	Ref.	Note
	5619006	Portable ACR
	1429026	Glide Unit 2 pins - 2 m cable
	1429002 1429029 1429005 1429008	Electric Station 2 pins - Milk line D. 40 Electric Station 2 pins - Milk line D. 50,8 Electric Station 2 pins - Milk line D. 52 Electric Station 2 pins - Milk line D. 63
	1049131	IUP - up to 20 Portable ACR

Quick Mounting Fastening Family



Vacuum line 52÷110 mm



✓ Patented

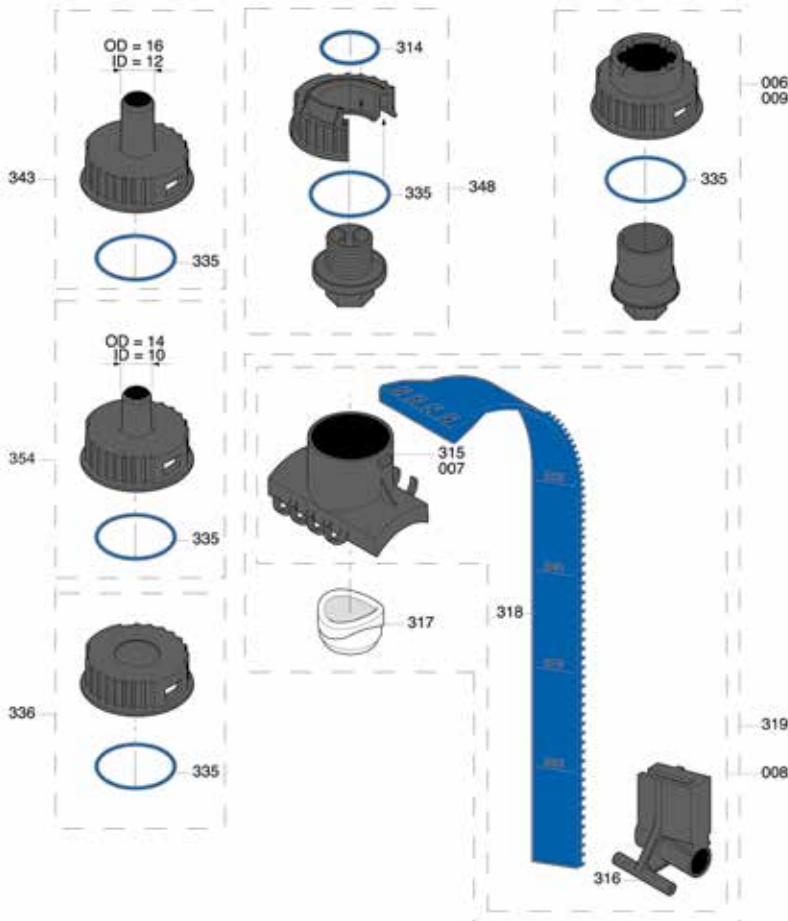

Pos.	Ref.	Note
006	2800186	Blank
007	2800185	Blank
008	2800188	Blank
009	2800187	ID 21,5
314	2800122	
315	2800124	
316	2800128	
317	2800135	
318	2800136	
319	2800137	
335	2800123	ID 32,9
336	2800155	
343	2800153	
348	2800132	
354	2800234	

Quick fit mounting (52 ÷ 114 mm)	Note	Ref.	Adapter	Ref.
		2800137 2800188 Blank		
	Electronic Pulsator & CV	2809078		2800132
	Clear airline	2809079 D. 16		2800153
  2809116	Vacuum Pulsator	2809133 D. 14		2800234
	Sanivac	2809088 Blank		2800186 Blank
	Servo pilot valve	2809089		2800187
	Blanking cap			2800155

3 Step Mounting

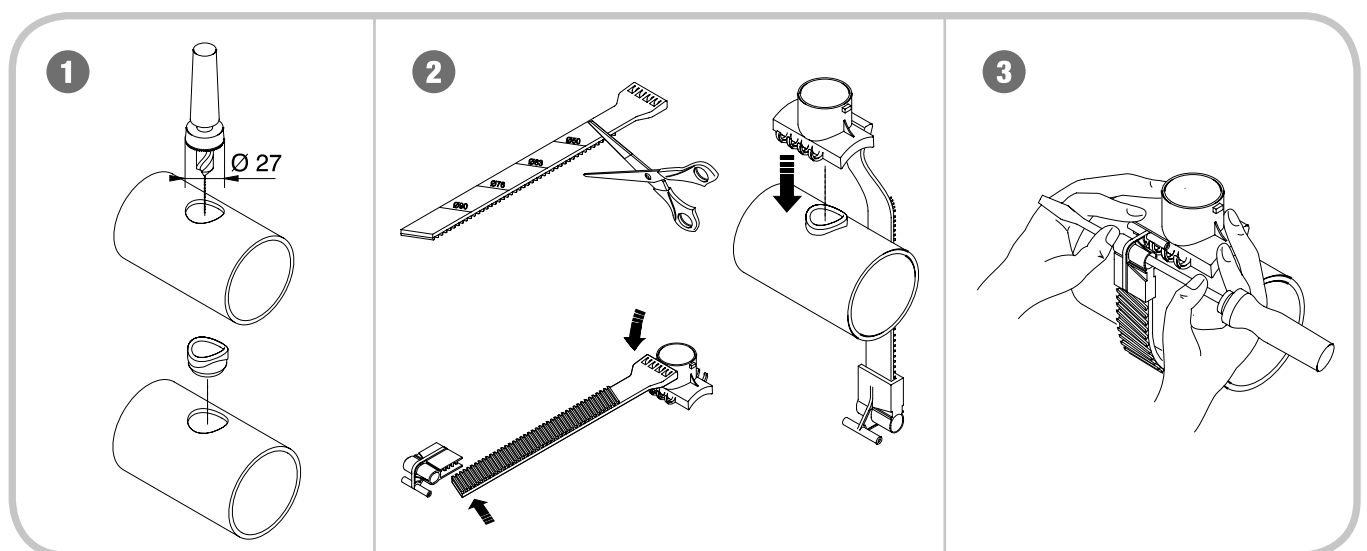

Adapters



Ref.	Note
Top 30 2809114	High - STD (26 mm)

Top 30 pag. 6-7

- Standard adapter.
- Standardmäßiger Adapter.
- Attache standard.
- Adaptador estándar.

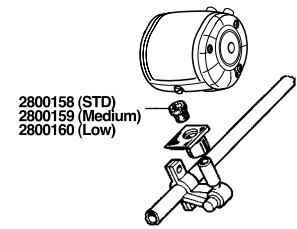

Ref.	Note
2809093	1/2" - M

- Standard adapter complete with fitting.
- Standardadapter einschließlich Anschlussstücke.
- Attache std pour prise de vide en salle de traite.
- Adaptador estándar con racor.

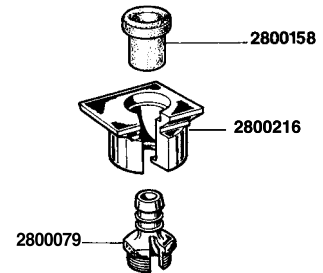

Ref.	Note
2809094	1/2" - F

- Standard adapter complete with fitting.
- Standardadapter einschließlich Anschlussstücke.
- Attache std pour prise de vide en salle de traite.
- Adaptador estándar con racor.

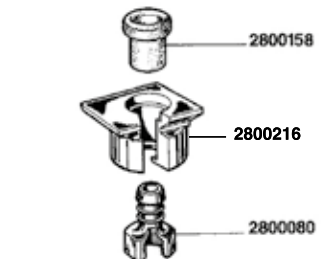

Ref.	Note
2809120	

- Adapter complete with fixing handwheel and valve for use on stainless steel bucket lid.
- Adapter mit Fixierhandrad und Ventil für Edelstahlimerdeckel.
- Attache avec écrou et clapet pour l'application sur couvercle en acier inox.
- Adaptador con volante de fijación y válvula para su uso en la tapa del cubo de acero inoxidable.

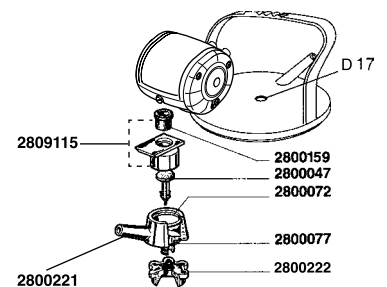

Ref.	Note
2809121	

- Adapter complete with fixing handwheel for use on mobile milking machines and pipeline installations.
- Adapter mit Fixierhandrad für mobile Melkmaschinen und Leitungen.
- Attache avec écrou sans clapet pour l'application sur chariot trayeur et bras de traite.
- Adaptador con volante de fijación para su uso en máquinas ordeñadoras y brazos de ordeño.

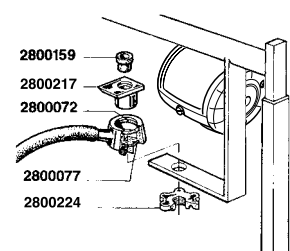

* Special Item available on demand.



Ref.	Note
2809025	

- Adapter complete with fixing handwheel for use on mobile milking machines.
- Adapter mit Fixierhandrad für mobile Melkmaschinen.
- Attache avec écrou sans clapet pour l'application sur chariot trayeur.
- Adaptador con volante de fijación para su uso en máquinas ordeñadoras móviles.

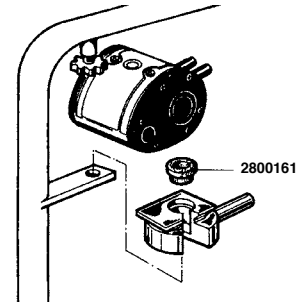

Ref.	Note
2809122	

- Adapter complete with valve for use on DeLaval and Manus stainless steel bucket lid.
- Adapter mit Ventil zur Verwendung an DeLaval and Manus Edelstahlimerdeckel.
- Attache avec clapet pour l'application sur le couvercle en acier inox DeLaval et Manus.
- Adaptador con válvula para su uso en tapa del cubo DeLaval y Manus de acero inoxidable.

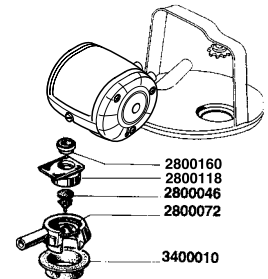

Ref.	Note
2809013	

- Low adapter for use on DeLaval plastic or aluminium bucket lid.
- Low-Adapter zur Verwendung an DeLaval-Eimerdeckeln aus Kunststoff oder Aluminium.
- Attache basse pour l'application sur le couvercle en plastique ou aluminium DeLaval.
- Adaptador bajo para su uso en tapa del cubo de plástico o de aluminio DeLaval.

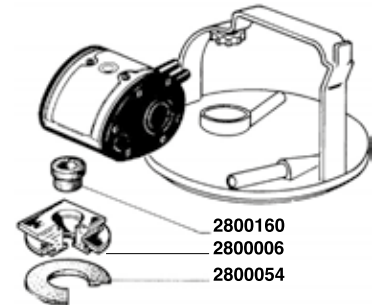

Ref.	Note
2809113	

- Bayonet adapter for use on pipeline installations, milking parlours and DeLaval - Manus mobile milking machines.
- Bajonett-Adapter für Leitungen, Melkstände und mobile Melkmaschinen von DeLaval - Manus.
- Attache à baionnette pour l'application sur les transferts à lait, salles de traite et trayeuses à chariots DeLaval - Manus.
- Adaptador de bayoneta para su uso en brazos de ordeño, salas de ordeño y máquinas ordeñadoras DeLaval - Manus.

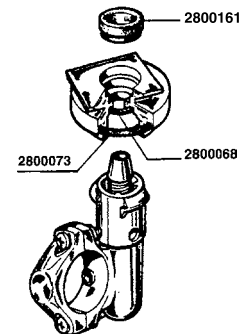

Ref.	Note
2809139	

- Adapter for use on Miele-export lid.
- Adapter für Deckel Miele-export.
- Attache pour l'application sur couvercle Miele-export.
- Adaptador para su uso en tapa Miele-export.

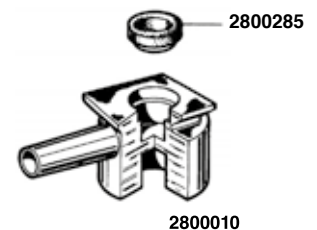

Ref.	Note
2809032	

- Adapter for use on WestfaliaSurge lid, new type.
- Adapter für Deckel WestfaliaSurge, neuer Typ.
- Attache pour l'application sur le couvercle WestfaliaSurge, nouveau type.
- Adaptador para su uso en tapa WestfaliaSurge, tipo nuevo.

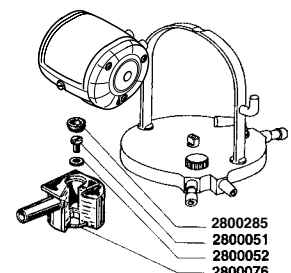



Ref.	Note
2809140	Spina - Pin D. 5 mm
2809141	Spina - Pin D. 4 mm

- Bayonet adapter for use on WestfaliaSurge installations.
- Bajonett-Adapter für WestfaliaSurge-Installationen.
- Attache à baïonnette pour l'application sur les installations WestfaliaSurge.
- Adaptador de bayoneta para su uso en instalaciones WestfaliaSurge..

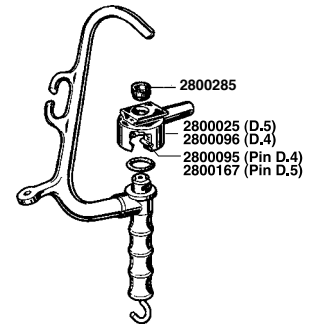

Ref.	Note
2809040	

- Adapter for use on Fullwood lid.
- Adapter für Deckel Fullwood.
- Attache pour l'application sur le couvercle Fullwood.
- Adaptador para su uso en tapa Fullwood.

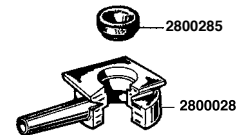

Ref.	Note
2809137	

- Adapter for use on Fullwood pipeline installations and milking parlours.
- Adapter für Leitungen und Melkstände Fullwood.
- Attache pour l'application sur les transferts à lait et salles de traite Fullwood.
- Adaptador para su uso en brazos y salas de ordeño Fullwood.

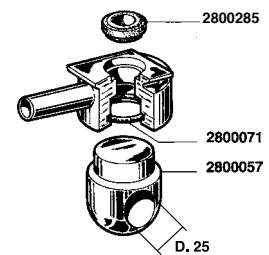

Ref.	Note
2809136	

- Adapter for use on Fullwood installations, without plug.
- Adapter für Fullwood-Installationen, ohne Stecker.
- Attache pour l'application sur installations Fullwood, sans bouchon.
- Adaptador para su uso en instalaciones Fullwood sin tapón.

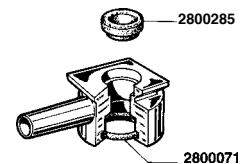

Ref.	Note
2809043	

- Adapter for use on Effectiv (SAC) stainless steel lid
- Adapter für Edelstahldeckel Effectiv (SAC).
- Attache pour l'application sur le couvercle inox Effectiv (SAC).
- Adaptador para su uso en tapa de acero inoxidable Effectiv (SAC).

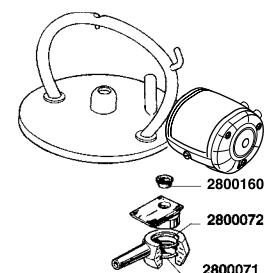

Ref.	Note
2809046	

- Adapter for use on Melotte pipeline installations
- Adapter für Leitungen Melotte.
- Attache pour l'application sur les poignées Melotte, nouveau modèle.
- Adaptador para su uso en brazos de ordeño Melotte.

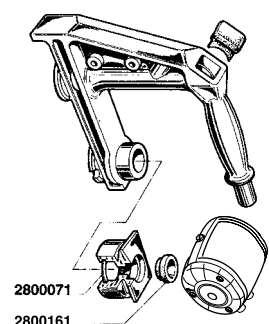



Ref.	Note
2809138	

- Adapter for use on Gascoigne lid.
- Adapter für Deckel Gascoigne
- Attache pour l'application sur le couvercle Gascoigne.
- Adaptador para su uso en tapa Gascoigne.

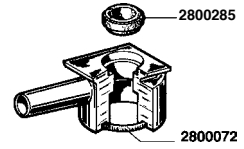

Ref.	Note
2809050	

- Bayonet adapter suitable for A.H.I.
- Bajonett-Adapter für A.H.I.
- Attache à bayonnette avec joint adaptable A.H.I.
- Adaptador de bayoneta ideal para A.H.I.

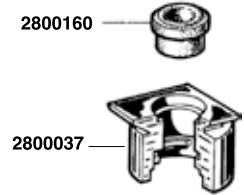

Ref.	Note
2809056	

- Adapter for use on Melotte stainless steel lid.
- Adapter für Edelstahldeckel Melotte.
- Attache pour l'application sur le couvercle inox Melotte.
- Adaptador para su uso en tapa de acero inoxidable Melotte

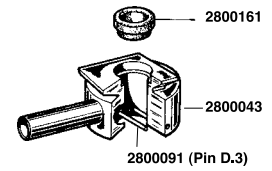

Ref.	Note
2809034	

- Adapter for use on WestfaliaSurge lid, old type.
- Adapter für Deckel WestfaliaSurge, alter Typ.
- Attache pour l'application sur le couvercle WestfaliaSurge, ancien type.
- Adaptador para su uso en tapa WestfaliaSurge, tipo antiguo.

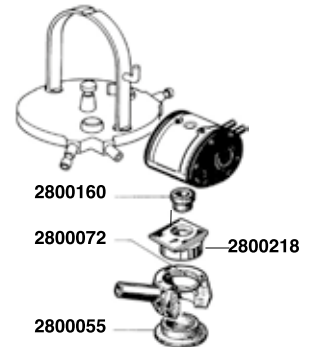

Ref.	Note
2809061	

- Adapter for use on Surge lid, suspended bucket.
- Adapter für Deckel Surge, hängender Eimer.
- Attache pour l'application sur le couvercle Surge, pot suspendu.
- Adaptador para su uso en tapa Surge, cubo suspendido.

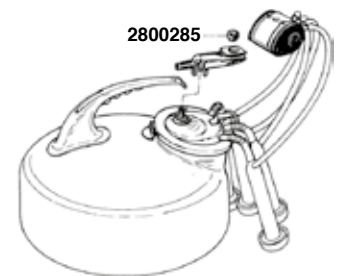

Ref.	Note
2809117	

- Adapter for use on Boumatic milking parlours.
- Adapter für Melkstände Boumatic.
- Attache pour l'application sur le salles de traite Boumatic.
- Adaptador para su uso en salas de ordeño Boumatic.

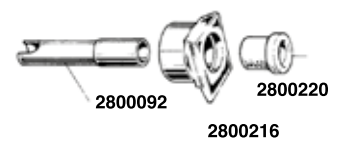



Ref.	Note
2809118	

- Adapter for use on DeLaval milking parlours.
- Adapter für Melkstände DeLaval.
- Attache pour l'application sur le salles de traite DeLaval.
- Adaptador para su uso en salas de ordeño DeLaval.

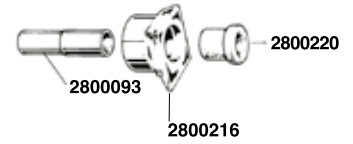

Ref.	Note
2809119	

- Adapter for UNIVERSAL installations.
- Adapter für UNIVERSAL-Installationen.
- Attache pour l' application UNIVERSAL.
- Adaptador para instalaciones UNIVERSAL.

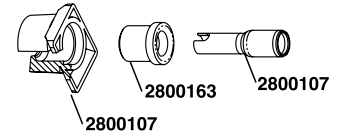

Ref.	Note
2809106	

- Adapter for use on Russian lid.
- Adapter für russischen Deckel.
- Attache pour l' application sur le couvercle russe.
- Adaptador para su uso en tapa rusa.

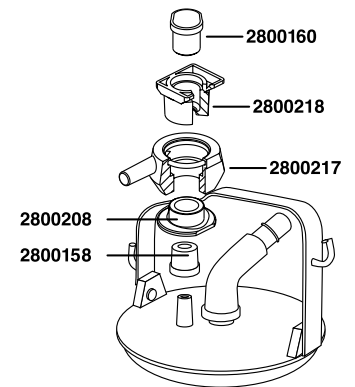



Stabilvac

Spring Vacuum Regulator



✓ Patented

Benefits

- ✓ Easy to install
- ✓ Stable, reliable vacuum regulation
- ✓ Designed for small systems
- ✓ Silent

Vorteile



- ✓ Einfach zu installieren
- ✓ Stabile, zuverlässige Regelung des Vakuums
- ✓ Konzipiert für kleine Systeme
- ✓ Leise

Avantages

- ✓ Facile à installer
- ✓ Réglage du niveau de vide stable et fiable
- ✓ Indiqué pour les petites installations de traite
- ✓ Silencieux

Beneficios

- ✓ Fácil de instalar
- ✓ Regulación de vacío estable y fiable
- ✓ Diseñado para pequeños sistemas
- ✓ Silencioso

	Ref.	Note
	5069001	Spring vacuum Regulator 1" Vacuum pump capacity: 250 l/min
	5049001	Spring vacuum Regulator 1" Vacuum pump capacity: 500 l/min

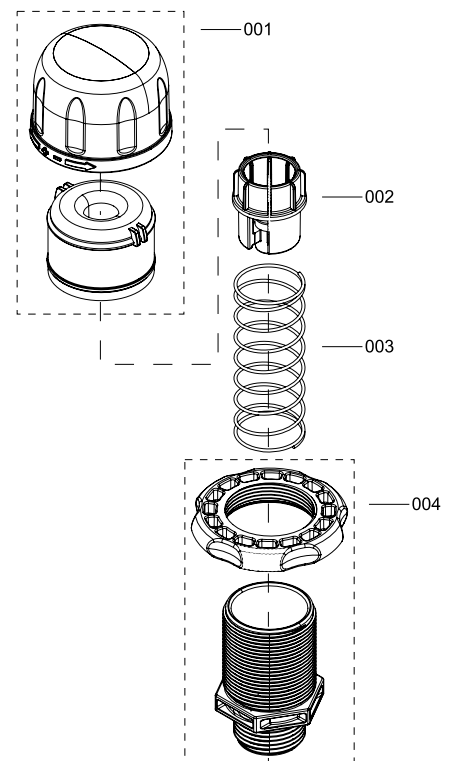

Pos.	Ref.	Note
001	5060008	
002	5060004	
003	5060003	
004	5060007	

Stabilvac 1500-3600

Servo Vacuum Regulators



✓ Patented

The Stabilvac vacuum regulators grant a stable and reliable vacuum in any condition, protect animal's health.

Die Stabilvac-Vakuumregler sorgen jederzeit für ein stabiles, zuverlässiges Vakuum und schützen so die Gesundheit des Tieres.

Les régulateurs du vide Stabilvac assurent un vide constant et fiable en toutes conditions de travail, en protégeant la santé des animaux.

Los reguladores de vacío c permiten un vacío estable y fiable en cualquier condición y protegen la salud del animal.

Benefits

- ✓ High accuracy of the signal and great sensitivity of the valve allow a quick reaction when regulating the vacuum system
- ✓ Designed expressly to minimise the vacuum consumption avoiding to reduce unnecessarily the vacuum reserve of the milking system
- ✓ Quick and easy to install

Vorteile

- ✓ Die hohe Signalgenauigkeit und Empfindlichkeit des Ventils ermöglicht eine schnelle Antwort bei der Einstellung des Vakuumsystems
- ✓ Speziell dafür entwickelt, den Vakuumverbrauch zu senken, damit die Vakuumreserven des Melksystems nicht unnötig verbraucht werden
- ✓ Schnell und einfach zu installieren

Avantages

- ✓ La haute précision du signal et la grande sensibilité de la valve permettent d'intervenir instantanément dans la régulation du vide
- ✓ La conception vise spécifiquement à réduire au minimum la consommation de vide et à éviter d'entamer la réserve utile de la machine
- ✓ Installation simple et rapide

Beneficios

- ✓ La señal de alta precisión y gran sensibilidad de la válvula permite una rápida reacción regulando el sistema de vacío
- ✓ Diseñado expresamente para minimizar el consumo de vacío evitando reducir innecesariamente la reserva de vacío del sistema de ordeño
- ✓ Fácil y rápido de instalar

Technische Daten

Anschlussgewinde: 1" BSP-Außengewinde
Abmessungen: 131x131x181 mm
Gewicht: 0,415 Kg

Technical Data

Connection thread: 1" Bsp Male
Dimensions: 131x131x181 mm
Weight: 0,415 Kg

Pos.	Ref.	Note
001	5010039	
002	5010023	
003	5010006	1500
004	5000047	with OR
005	5010062	
006	5000030	
007	5000019	
008	5000029	
009	5000033	
010	5000046	
011	5000015	
012	5010007	
013	5010001	1500
014	5000027	

Pos.	Ref.	Note
015	5000054	0,5 mm
016	5000044	
017	5010003	1500
018	5000016	
019	5000005	
020	5010051	1500
021	5010058	3600
022	5010034	3600
023	5010060	3600
024	5010053	3600
047	5010063	
321	5000032	
330	5020004	

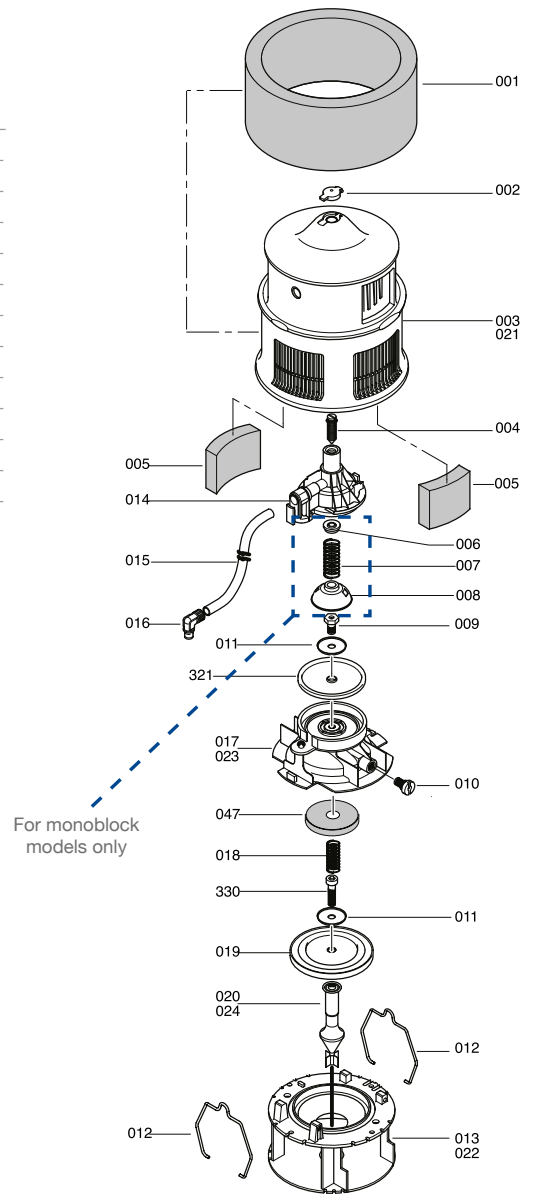

	50 kPa (15" Hg)		Monoblock	
	l/min	cfm	1500	3600
Vacuum pump maximum capacity	350	12		
	500	18		
	750	27	OPTIMUM	
	1000	35		
	1250	44		
	1500	53		
	1750	62		OPTIMUM
	2000	71		

Stabilvac

1500 monoblock	3600 monoblock	3600 separate
		
5019007	5019008	5019011



Stabilvac 4000-6000

Servo Vacuum Regulators



✓ Patented

The Stabilvac vacuum regulators grant a stable and reliable vacuum in any condition, protect animal's health.

Die Stabilvac-Vakuumregler sorgen jederzeit für ein stabiles, zuverlässiges Vakuum und schützen so die Gesundheit des Tieres.

Les régulateurs du vide Stabilvac assurent un vide constant et fiable en toutes conditions de travail, en protégeant la santé des animaux.

Los reguladores de vacío Stabilvac permiten un vacío estable y fiable en cualquier condición y protegen la salud del animal.

Benefits

- ✓ High accuracy of the signal and great sensitivity of the valve allow a quick reaction when regulating the vacuum system
- ✓ Excellent quietness
- ✓ Quick and easy to install

Vorteile

- ✓ Die hohe Signalgenauigkeit und Empfindlichkeit des Ventils ermöglicht eine schnelle Antwort bei der Einstellung des Vakuumsystems
- ✓ Hervorragende Laufruhe
- ✓ Schnell und einfach zu installieren

Avantages

- ✓ La haute précision du signal et la grande sensibilité de la valve permettent d'intervenir instantanément dans la régulation du vide
- ✓ Très silencieuse
- ✓ Installation simple et rapide

Beneficios

- ✓ La señal de alta precisión y gran sensibilidad de la válvula permite una rápida reacción regulando el sistema de vacío
- ✓ Extremadamente silencioso
- ✓ Fácil y rápido de instalar

Technische Daten SPV

Anschlussgewinde: 1/2" BSP-Außengewinde
Abmessungen: 108x108x114 mm
Gewicht: 0,210 kg

Technische Daten MCV

Anschlussgewinde: 1/2" BSP-Außengewinde
Abmessungen: 140x140x237 mm
Gewicht: 1,150 kg

SPV Technical Data

Connection thread: 1/2" Bsp Male
Dimensions: 108x108x114 mm
Weight: 0,210 Kg

MCV Technical Data

Connection thread: 1 - 1/2" Bsp Male
Dimensions: 140x140x237 mm
Weight: 1,150 Kg

SPV Servo Pilot Valve

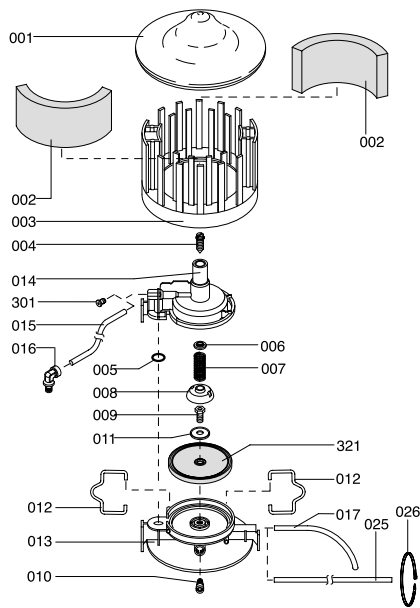



Pos.	Ref.	Note	Pos.	Ref.	Note
001	5000031		011	5000015	
002	5000095		012	5000010	
003	5000072		013	5000115	
004	5000047	with OR	014	5000027	
005	5000041		015	5000054	0,5 mt Mon.
006	5000030		016	5000044	Mon.
007	5000019		017	5000055	0,12 mt Mon.
008	5000029		025	5000056	10 mt Sep.
009	5000033		301	1000274	Sep.
010	5000046		321	5000032	

MCV Main Control Valve

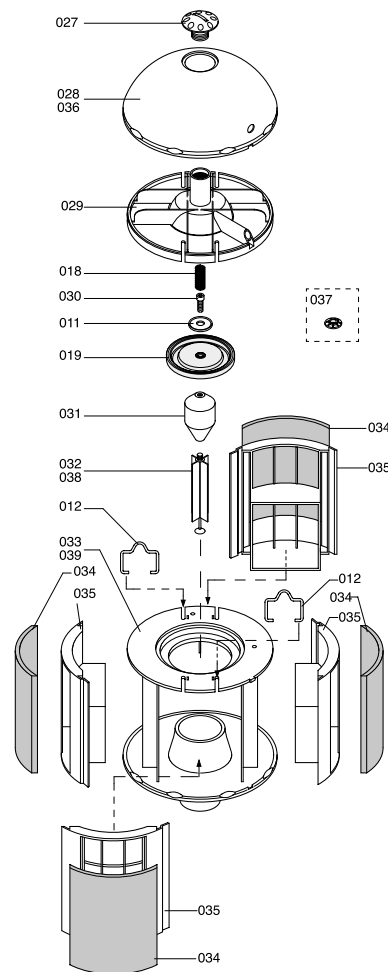
Pos.	Ref.	Note
011	5000015	4000
012	5000010	
018	5000016	
019	5000005	
027	5000013	Sep.
028	5000066	4000
029	5000001	
030	5000018	
031	5000026	
032	5000012	4000
034	5000042	
035	5000039	
036	5000067	6000
037	5000017	6000
038	5000011	6000
045	5000002	4000/6000



Stabilvac	Ref.	
Servo Vacuum Regulators	4000	6000
Monoblock 	5009008	5009009
Separate 	5009025 With Q.M. kit (SPV)	5009026 With Q.M. kit (SPV)

	50 kPa (15" Hg)		Monoblock		Separate		Separate	
	l/min	cfm	4000	6000	4000	6000	2 x 4000	2 x 6000
Vacuum pump maximum capacity	2100	74						
	2500	88	OPTIMUM		OPTIMUM			
	3000	106						
	3300	115						
	2 x 1500	2 x 53		OPTIMUM		OPTIMUM		
	3 x 1500	3 x 53					OPTIMUM	
	2 x 3000	2 x 106						OPTIMUM
	2 x 3300	2 x 115						

Vacuum Regulators	Ref.	
 SPV	5009024 With Q.M. kit	
 MCV	5009001 MCV 4000	5009002 MCV 6000



Accessories	Ref.	Description
	5020006	
	5000056	Supplementary connection tube 10 m Zusätzlicher Verbindungsschlauch 10 m
SPV 	3400056 3400058 3400060 3400101	63 x 1/2" F 76 x 1/2" F 90 x 1/2" F 110 x 1/2" F
MCV / Safety Valve 	3400057 3400059 3400061 3400108	63 x 1"-1/2 F 76 x 1"-1/2 F 90 x 1"-1/2 F 110 x 1"-1/2 F
	Top 30 3420015 3420014 Top 30 pag. 6-7	Drain Valve - 1/2" - Thread part Ablassventil - 1/2" - Gewindestück Drain Valve - 3/4" - Thread part Ablassventil - 3/4" - Gewindestück

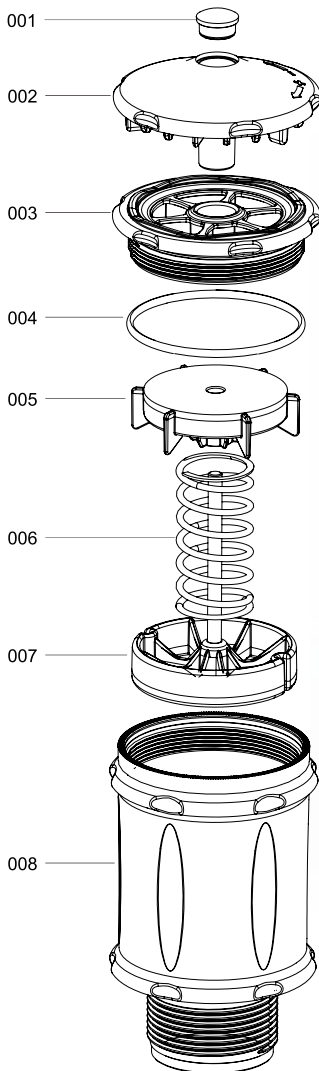

Pop-Off Safety Valve



Pop Off Safety Valve is the compact, easy to install, "stand-alone" solution designed to safeguard the integrity of the milking system and the health of herd.



Pos.	Ref.	Vacuum Regulators	Ref.	Note
001	5020027		5029008	Pop Off 6000 - 1" 1/2 Gas
002	5020023			
003	5020022			
004	5020029			
005	5020024			
006	5020028			
007	5020025			
008	5020030			

iDrive100

Frequency Regulator



✓ Ideal with DVG500



✓ Multidisplay



The new InterPuls iDrive100 makes it possible to modulate the speed of the vacuum pump, thus reducing consumption, noise and maintenance costs and ensuring maximum stability of vacuum levels during milking.

Der neue InterPuls iDrive100 ermöglicht eine Geschwindigkeitsregulierung der Vakuumpumpe, wodurch der Verbrauch, der Geräuschpegel und die Wartungskosten reduziert und die maximale Stabilität des Vakuums während des Melkverfahrens gewährleistet werden.

Le nouveau iDrive100 InterPuls permet de moduler la vitesse de la pompe à vide en réduisant les consommations, les bruits et les coûts d'entretien et en garantissant la stabilité maximale du niveau de vide durant la traite.

El nuevo iDrive100 de InterPuls hace posible modular la velocidad de la bomba del vacío, reduciendo de este modo el consumo, el ruido y los costes de mantenimiento y garantizando una mayor estabilidad de los niveles de vacío durante las operaciones de ordeño.

Features

- ✓ iDrive100 can govern one or more parallel or cascade pumps
- ✓ The new **"Milk+"** software, in synergy with the reliable sensor, guaranteed a swifter response, as well as improved vacuum stability.

Eigenschaften

- ✓ iDrive100 kann eine Pumpe oder mehrere parallel oder stufenförmig angeordnete Pumpen steuern.
- ✓ Die neue **"Milk+"**-Software garantiert in Kombination mit dem zuverlässigen Sensor eine schnellere Antwort und eine verbesserte Stabilität des Vakuums.

Caractéristiques

- ✓ iDrive100 peut commander une ou plusieurs pompes, en parallèle ou en cascade
- ✓ Le nouveau logiciel **"Milk+"**, en harmonie avec le capteur, caractérisé par sa fiabilité, garantit une plus grande vitesse de réponse unie à une plus grande stabilité du vide.

Características

- ✓ iDrive100 puede gestionar una o varias bombas paralelas o de cascada.
- ✓ El nuevo software **"Milk+"** en sinergia con el sensor de alta fiabilidad, garantiza una velocidad de respuesta mayor, así como una estabilidad optimizada del vacío.

✓ iDrive100 can rapidly be programmed "on site" using the convenient mini-keyboard, or by connecting it to a PC.

✓ iDrive100 kann anhand einer handlichen Mini-Tastatur oder mittels Anschluss an einen PC schnell „vor Ort“ programmiert werden.

✓ iDrive100 peut être programmé rapidement «sur le terrain» à travers un clavier pratique, en le branchant à l'ordinateur.

✓ iDrive100 se puede programar rápidamente «in situ» utilizando el cómodo mini-teclado o conectándolo a un ordenador.

✓ During the washing process, it is possible to set a higher vacuum level than during milking.

✓ Während des Reinigungsverfahrens kann ein höherer Vakuumpgrad im Vergleich zum Melkvorgang eingestellt werden.

✓ Durant le lavage, il est possible de configurer un niveau de vide plus important par rapport à celui de la traite.

✓ Durante el proceso de lavado, es posible configurar un nivel de vacío más alto respecto al del ordeño.

✓ New "ribs" design for improved heat dispersion.

✓ Neues „Rippen“-Design für eine verbesserte Wärmeausbreitung.

✓ Nouveau design «à ailettes» pour une meilleure dispersion de la chaleur.

✓ Nuevo diseño de «aletas» para una mejor dispersión térmica.

✓ "Start&Stop" system for optimising the functioning of the cooling fan.

✓ "Start&Stop"-System zur Optimierung der Funktion des Kühlventilators.

✓ Système d'optimisation du fonctionnement de la vanne de refroidissement «Start&Stop».

✓ Sistema «Start&Stop» para optimizar el funcionamiento del ventilador de enfriamiento.

Benefits

- ✓ Lower consumption
- ✓ Noise free
- ✓ Vacuum pumps less subject to wear
- ✓ Quick return of the investment
- ✓ Monitoring of the temperature of the motor
- ✓ Fits to vane pumps, lobe pumps or liquid ring pumps

Vorteile

- ✓ Geringerer Verbrauch:
- ✓ Geräuschlos
- ✓ Die Vakuumpumpen sind weniger dem Verschleiß ausgesetzt
- ✓ Schnelle Rendite aus der Investition
- ✓ Überwachung der Temperatur des Motors
- ✓ Geeignet für Flügelzellenpumpen, Kreiskolbenpumpen oder Wasserringpumpen.

Avantages

- ✓ Consommations réduites
- ✓ Silence
- ✓ Usure réduite des pompes à vide
- ✓ Retour rapide de l'investissement
- ✓ Possibilité de montage de la température du moteur
- ✓ Adaptable pour les pompes à palettes, à lobes ou à anneau liquide

Beneficios

- ✓ Menor consumo
- ✓ Completamente silencioso
- ✓ Bombas de vacío menos sujetas a desgaste
- ✓ Rápido retorno de inversión
- ✓ Supervisión de la temperatura del motor
- ✓ Adaptable a las bombas de paletas, bombas de lóbulos o bombas de anillo líquido

■ Frequency
■ Vacuum

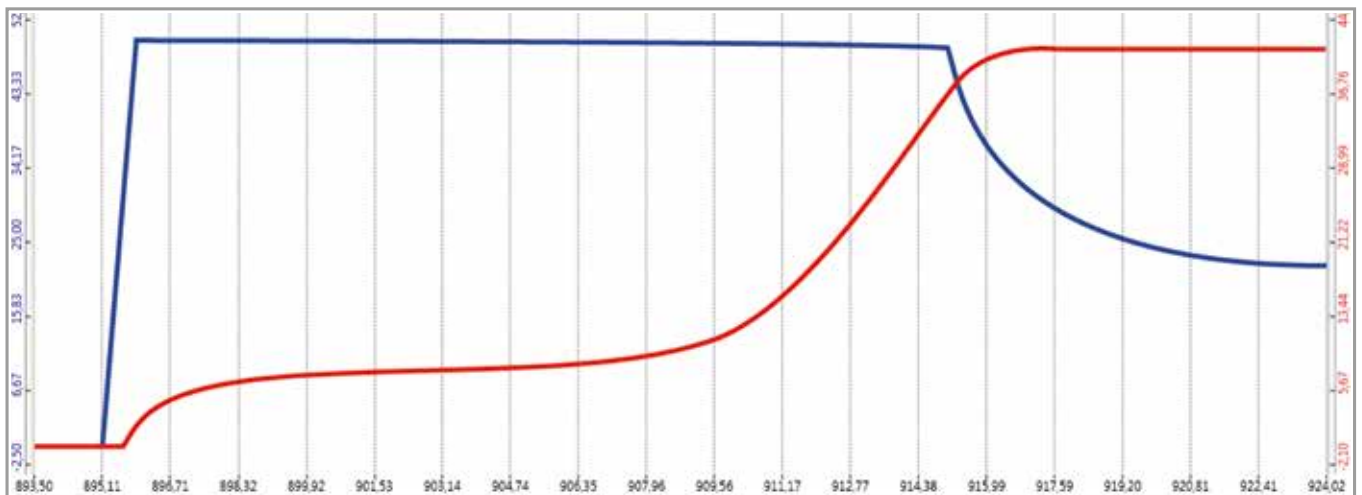

	Ref.	Description
	5109020	DVG-500 20-4 mA - 24 VDC
	7010001	iDrive display board
	7019001 7019002 7019003 7019004 7019005 7019006 7019007 7019008 7019009	iDrive100 S 380-500V 3.4A 1.5HP iDrive100 S 380-500V 4.8A 2.0HP iDrive100 S 380-500V 5.6A 3.0HP iDrive100 S 380-500V 8.0A 5.0HP iDrive100 S 380-500V 9.6A 5.0HP iDrive100 S 380-500V 12.0A 7.5HP iDrive100 M 380-500V 16.0A 10.0HP iDrive100 M 380-500V 23.0A 15.0HP iDrive100 M 380-500V 31.0A 20.0HP
	7019010 7019011 7019012	iDrive100 L 380-500V 38.0A 25.0HP iDrive100 L 380-500V 46.0A 30.0HP iDrive100 L 380-500V 61.0A 40.0HP
	7010015 7010014 7010021	Integrated Switch iDrive100 S Integrated Switch iDrive100 M Integrated Switch iDrive100 L
	7010016	USB-RJ45 RS485 Cable
	7010017	Shielded Cable 4x2.5 - 5mt
	7010018	Shielded Cable 4x2.5 - 50mt

* Special Item available on demand.



DVG-P / DVG-T

Portable Digital Vacuum Gauge



Benefits

- ✓ Compact and ergonomic
- ✓ Ideal for vacuum inspection
- ✓ Cordless device
- ✓ Microprocessor technology
- ✓ Environmental temperature detection

Vorteile

- ✓ Kompakt und ergonomisch
- ✓ Ideal zur Vakuumprüfung geeignet
- ✓ Schnurloses Gerät
- ✓ Mikroprozessortechnologie
- ✓ Erfassung der Umgebungstemperatur

Avantages

- ✓ Compact et ergonomique
- ✓ Idéal pour mesurer les variations dans le vide à différents endroits de l'installation
- ✓ Fonctionnement sans fil à batterie
- ✓ Technologie fiable avec microprocesseur
- ✓ Détection de la température de l'environnement

Beneficios

- ✓ Compacto y ergonómico
- ✓ Ideal para medir el vacío
- ✓ Dispositivo inalámbrico
- ✓ Tecnología de microprocesadores
- ✓ Detección de la temperatura ambiente

Technische Daten

Druckmessbereich: -100 kPa ÷ +100kPa
 Temperaturmessbereich: -20°C ÷ +50 °C
 Druckmesspräzision: ± 0,6 kPa
 Druckmesstemperatur: +/- 0,5 °C
 Druckauflösung: 0,1 kPa +/- eine Stelle
 Temperatureauflösung: 0,1°C +/- eine Stelle
 Abmessungen: 145x80x35 mm
 9V-Blockbatterie-Betrieb
 Gewicht: 0,2 kg

Technical Data

Pressure measurement range: -100 kPa ÷ +100kPa
 Temperature measurement range: -20°C ÷ +50 °C
 Pressure measurement accuracy: ± 0,6 kPa
 Temperature measurement accuracy: +/- 0,5 °C
 Pressure resolution: 0,1 kPa +/- digit
 Temperature resolution: 0,1°C +/- digit
 Dimensions: 145x80x35 mm
 9V transistor battery powered
 Weight: 0,2 kg

DVG-P

Ref.



5109014

DVG-T

Ref.



5109018



Protection class IP65

- ACR control
- + Pulsation
- + Stimulation
- + Swingover feature
- + Competitive design



Benefits

- ✓ Advanced Pulsation control
- ✓ Advanced control of cluster remover functions
- ✓ "On-demand" and flow based Stimulation
- ✓ New "Last", "Milking" e "Washing" features
- ✓ Reliable HFS sensors by InterPuls
- ✓ Led indicator for remover/flow/stimulation/alarm

Vorteile

- ✓ Erweiterte Pulsationskontrolle
- ✓ Erweiterte Kontrolle der Melkzeugabnahmefunktionen
- ✓ Stimulation "on-demand" und flussbasierte Stimulation
- ✓ Neue Funktionen „Last“, „Milking“ und „Washing“
- ✓ Zuverlässiger HFS-Sensors von InterPuls
- ✓ LED-Anzeige für Entferner/Fluss/Stimulation/Alarm

Avantages

- ✓ Contrôle avancé de la pulsation
- ✓ Contrôle avancé des fonctions de décrochage
- ✓ Stimulation "on demand" et selon flux
- ✓ Nouvelles fonctions "Last", "Milking" et "Washing"
- ✓ Fiables HFS InterPuls capteurs
- ✓ Led pour signaler le détachement / flux/ stimulation /alarme

Beneficios

- ✓ Control de pulsación avanzado
- ✓ Control avanzado de las funciones del retirador del grupo de ordeño
- ✓ Estimulación «a pedido» o basada en el flujo
- ✓ Nuevas funciones «Last», «Milking» y «Washing»
- ✓ Sensores HFS fiables de InterPuls
- ✓ Indicador de led para retirador/flujo/estimulación/alarma

Information

- ✓ Led presence of milk
- ✓ Led Continual flow
- ✓ Led Automatic Milking
- ✓ Led Manual Milking
- ✓ Led Stimulation
- ✓ Led Washing
- ✓ Led Error
- ✓ Milking Time

Information





- ✓ LED vorhandene Milch
- ✓ LED kontinuierlicher Fluss
- ✓ LED automatisches Melken
- ✓ LED manuelles Melken
- ✓ LED Stimulation
- ✓ LED Reinigung
- ✓ LED Fehler
- ✓ Melkzeit

Informations

- ✓ LED présence de lait
- ✓ LED Flux continu
- ✓ LED Traite Automatique
- ✓ LED Traite Manuelle
- ✓ LED Stimulation
- ✓ LED Lavage
- ✓ LED Erreur
- ✓ Temps de Traite

Information

- ✓ Led de presencia de leche
- ✓ Led de flujo continuo
- ✓ Led de ordeño automático
- ✓ Led de ordeño manual
- ✓ Led de estimulación
- ✓ Led de lavado
- ✓ Led de error
- ✓ Tiempo de ordeño

ACR Panels	Ref.	Note
 	<p>5639001</p>	<p>ACRsmart Panel ACRsmart Bedienungsfeld</p>
Spare Parts	Ref.	Note
 	<p>5630001 5630005 5630009</p>	<p>PCB Only ACRsmart Keyboard only ACRsmart Keyboard + Front cover</p> <p>Nur PCB Nur ACRsmart-Tastatur Nur ACRsmart-Tastatur + Vorderdeckel</p>



ACRsmart MMV

Milk Meter



Ideal for

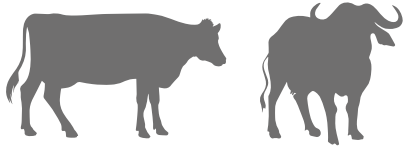

Protection class IP67

The **MMV** version of **ACRsmart** represents a reliable and competitive solution for automatic cluster remover and milk metering "stand-alone". Perfect for the Farmer that needs a milk yield control per cow without complication for the layout of the milking parlour.

ACRsmart MMV is the ideal solution even for existing farms. The system is modular and can be easily updated with iMilk600 milk meter.

Die **MMV**-Version von **ACRsmart** ist eine autonome, zuverlässige und wettbewerbsfähige Lösung zur automatischen Melkzeugabnahme und Milchmessung. Sie eignet sich perfekt für alle Milchbauern, die eine Milchleistungskontrolle pro Kuh ohne Komplikationen für den Aufbau des Melkstandes benötigen.

ACRsmart MMV ist auch für bereits bestehende Milchbetriebe die ideale Lösung. Das System ist modular und kann leicht mit dem iMilk600 Milchmessgerät aktualisiert werden.



La version **MMV** de **ACRsmart** représente une solution fiable et compétitive pour le décrochage et le mesurage "stand-alone". **ACRsmart MMV** est idéal pour l'éleveur qui veut avoir un contrôle de la production de lait par bovine, sans aucune complication dans la configuration de l'installation de traite.

ACRsmart MMV est également la solution idéale pour les installations déjà existantes. Le système est modulaire et peut être mis à jour, à tout moment, avec le mesureur iMilk600.

La versión de **MMV** de **ACRsmart** representa una solución fiable y competitiva para la retirada automática del grupo de ordeño y la medición independiente de leche. Ideal para el ganadero que necesita contar con un control de la producción láctea por vaca, sin tener complicaciones relacionadas con la disposición de la sala de ordeño.

ACRsmart MMV es la solución ideal incluso para las granjas ya existentes. El sistema modular se puede actualizar con el medidor de leche iMilk600.

Benefits

- ✓ Reliable milk meter (< 2% error)
- ✓ Gentle cluster remover – no overmilking
- ✓ Washing temperature monitoring
- ✓ Easy to install, to use and to program

Vorteile

- ✓ Zuverlässiges elektronisches Milchmessgerät (< 2% Fehler)
- ✓ Behutsame Melkzeugabnahme - kein Blindmelken
- ✓ Überwachung der Reinigungstemperatur
- ✓ Leicht installierbar, anwendbar und programmierbar

Avantages

- ✓ Mesurage fiable (< 2% d'erreur)
- ✓ Décrochage délicat - aucun risque de surtraite
- ✓ Contrôle température de lavage
- ✓ Facile à installer, utiliser et programmer

Beneficios

- ✓ Medidor de leche fiable (< 2% de error)
- ✓ Retirador delicado del grupo de ordeño - ausencia de sobreordeño
- ✓ Control de la temperatura de lavado
- ✓ Fácil de instalar, utilizar y programar

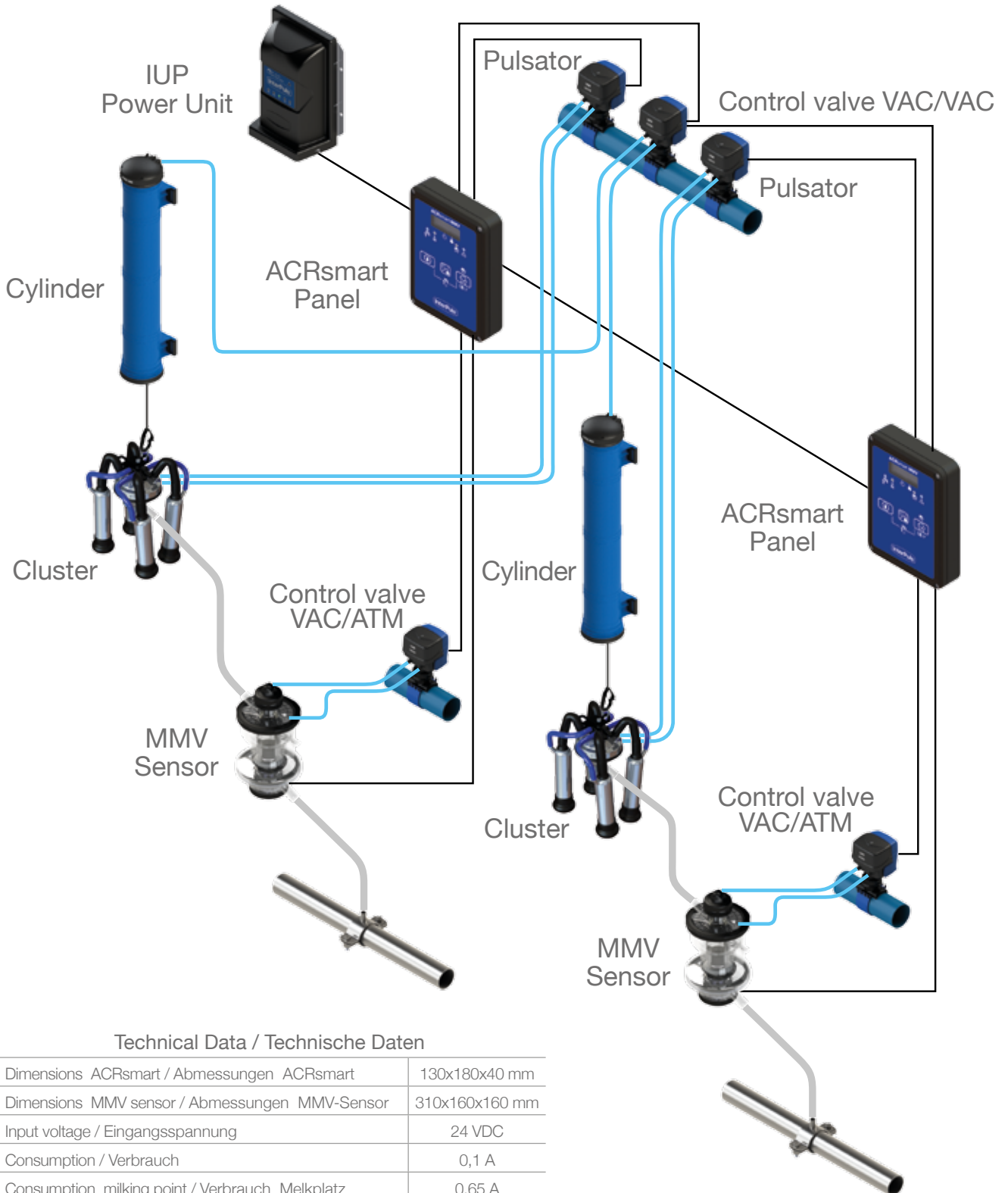

Technical Data / Technische Daten

Dimensions ACRsmart / Abmessungen ACRsmart	130x180x40 mm
Dimensions MMV sensor / Abmessungen MMV-Sensor	310x160x160 mm
Input voltage / Eingangsspannung	24 VDC
Consumption / Verbrauch	0,1 A
Consumption milking point / Verbrauch Melkplatz	0,65 A
Milk indicator accuracy / Genauigkeit Milchanzeiger	+/- 2%

ACRsmart MMV

Milk Meter









Display
Milk yield / milking time /
washing temperature

**Manual & Automatic
milking / Stimulation**

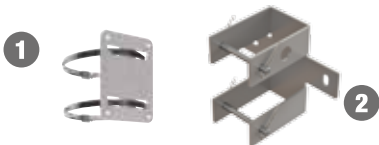
Milk yield / milking time

Stop

	Ref.	Note
	5769007	ACRsmart MMV
	5769001	ACRsmart MMV Panel
	5629001	Volumetric milk meter

	Ref.	Note
	<p>5500076</p> <p>5620063</p>	<p>ACRsmart Panel Bracket 1</p> <p>MMV Bracket 2</p>
	<p>5620019</p>	<p>Sensor cable - 100 mt roll</p>
	<p>5629003</p>	<p>Milk Sampler</p>
	<p>1049131</p>	<p>IUP - up to 20 Portable iMilk401</p>
	<p>5519025</p>	<p>HFSevo 2,5 mt cable</p>
	<p>5519042</p>	<p>HFSevo 10 mt cable</p>



iMilk600

Milk Meter



Ideal for

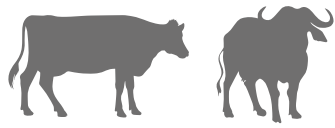

Protection class IP67

iMilk600 is the state-of-the-art in electronic milk metering. Advanced electronics and reliable sensors make this new milk meter a unique product; perfect for the Farmer that aims to maximize the dairy herd profit.

The “fill-and-dump” Sensor, with on-board shut off, is the most compact on the market. Thanks to the double chamber, the milk is precisely measured and the internal design grants stable vacuum and foam free environment. Easy to clean, thanks to the smooth internal design, the **iMilk600** sensor can be easily serviced by hands. No tools required.

iMilk600 ist Spitzentechnologie im Bereich der elektronischen Milchmessung. Fortschrittliche Elektronik und zuverlässige Sensoren machen dieses neue Milchmessgerät zu einem einzigartigen Produkt; es eignet sich perfekt für Milchbauern, die die Ertragskraft der Milchkuhherde maximieren möchten.

Der “Fill-and-dump-Sensor” mit eingebautem Abschalt-system ist der kompakteste auf dem Markt. Dank des Zwei-Kammer-Systems kann die Milch präzise gemessen werden, und das interne Design gewährleistet ein stabiles Vakuum und eine schaumfreie Umgebung. Der **iMilk600**-Sensor kann dank seines geschmeidigen internen Designs leicht von Hand gewartet werden. Werkzeuglose Wartung.

iMilk600 est ce qu'il y a de plus évolué sur le marché. Une électronique avancée et un système de capteurs fiables font de ce compteur électronique un produit unique et idéal pour l'éleveur qui veut maximiser les profits de son troupeau laitier.

Le capteur volumétrique, avec clapet de fermeture incorporée, est le plus compacte du marché. Grâce à la double chambre le lait est mesuré avec précision et le design à l'intérieur assure un niveau de vide stable, sans mousse. Facile à nettoyer, grâce aux surfaces internes, le capteur **iMilk600** peut être inspecté et démonté sans l'aide des outils spécifiques.

iMilk600 representa el estado actual de la técnica en cuanto a medición de leche. La electrónica de vanguardia y los sensores fiables hacen de este medidor de leche un producto único; perfecto para el ganadero, cuyo objetivo consiste en incrementar la rentabilidad del rebaño lechero.

El sensor de «llenado y vaciado», con válvula de cierre, es el más compacto en el mercado. Gracias a la cámara doble, la leche es medida con precisión, mientras que el diseño interno garantiza un nivel de vacío estable, sin espuma. Fácil de limpiar gracias a su diseño interno, el mantenimiento del sensor **iMilk600** se puede llevar a cabo manualmente, sin tener que utilizar herramientas.

Benefits

- ✓ Reliable milk metering (less 2% error)
- ✓ Gentle take off – no over-milking
- ✓ Conductivity alert
- ✓ Data networking feature
- ✓ Multi-display option
- ✓ Easy to install and to program

Vorteile

- ✓ Zuverlässige Milchmessung (weniger als 2% Fehler)
- ✓ Behutsame Abnahme - kein Blindmelken
- ✓ Warnmeldung Leitfähigkeit
- ✓ Datenvernetzungsfunktion
- ✓ Multidisplayoption
- ✓ Leicht installierbar und programmierbar

Avantages

- ✓ Mesurage fiable (erreur inférieure à 2%)
- ✓ Détachement délicat – aucune surtraite
- ✓ Alerte conductivité
- ✓ Fonction data networking
- ✓ Option multi display
- ✓ Facile à installer et à programmer

Beneficios

- ✓ Medición de leche fiable (error menor a 2%)
- ✓ Desenganche suave - ausencia de sobreordeño
- ✓ Alerta de conductividad
- ✓ Función red de datos
- ✓ Opción multipantalla
- ✓ Fácil de instalar y programar

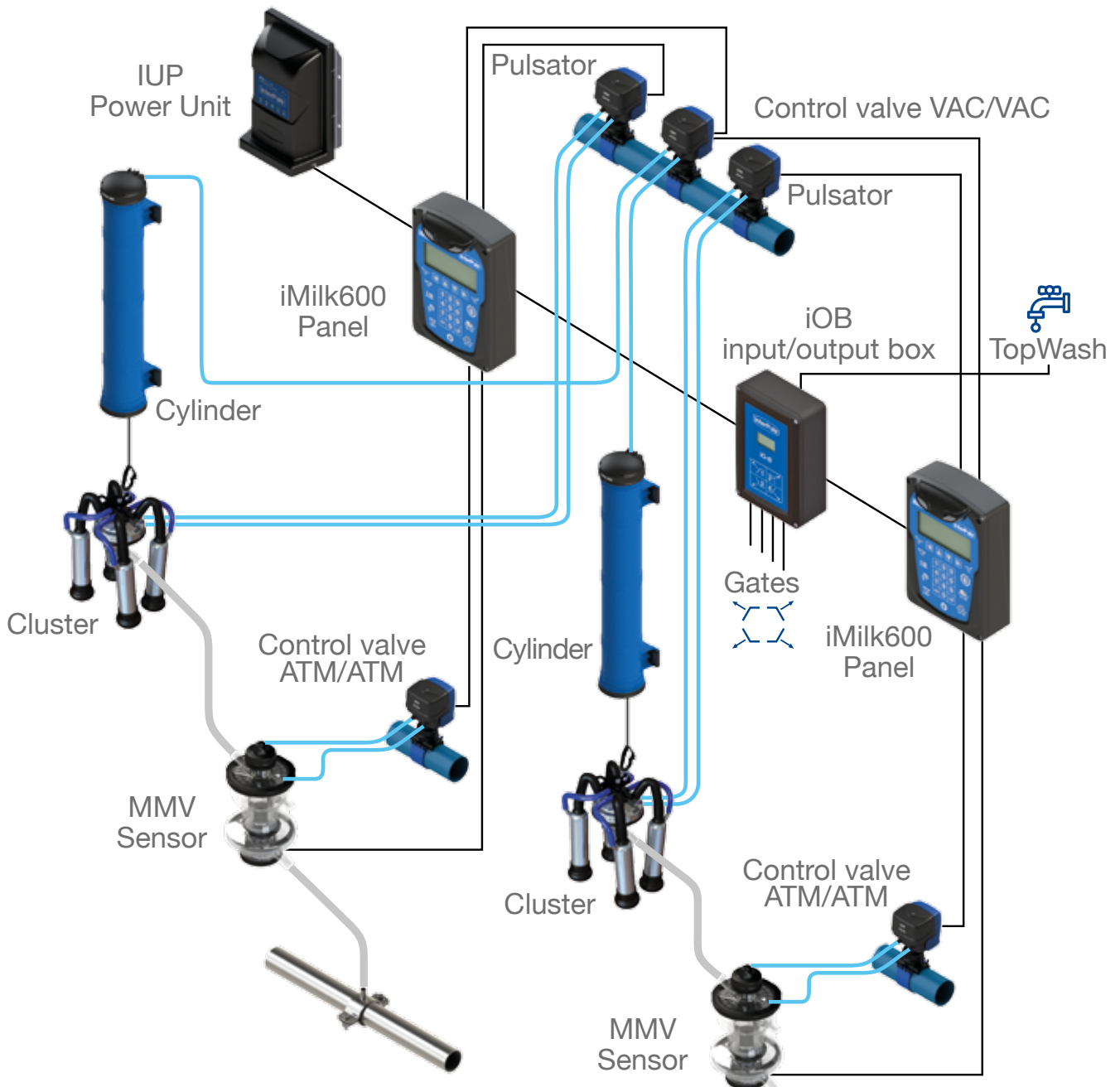

Technical Data / Technische Daten

Dimensions iMilk600 panel / Abmessungen iMilk600-Bedienungsfeld	225x150x70 mm
Dimensions MMV sensor / Abmessungen MMV-Sensor	310x160x160 mm
Input voltage / Eingangsspannung	24 VDC
Consumption / Verbrauch	0,35 A (Panel only), 0,7-1,2 A (Milking Point)
Milk indicator accuracy / Genauigkeit Milchanzeiger	+/- 2%

iMilk600

Milk Meter



MULTI-LANGUAGE MENU

12 IT/FR/DE/
GB/ES/PT/
RU/CN/KOR/
JP/TR/AR
LANGUAGES

EMBEDDED DAIRY MANAGEMENT

1 LACTATION DATA STORAGE

Milking Status Alarm Led

Buzzer

Display Options



Basic

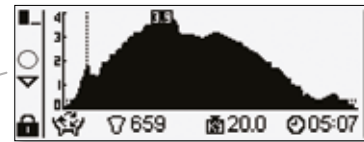

Graphic

	38.3	3.4	5.6
	38.3	6.9	6.3
	659	20.0	05:07

Full-data



Milking info

Stim/Preparation

Cleaning/
Washing report

Aut/Man
in-parlour feeding

Shift

Gate Control (4 gates)

Stop

Manual take-off

Automatic take-off

Volumetric Meter

Benefits

- ✓ Reliable fill and dump technology
- ✓ Resistant food-grade polymer
- ✓ On-board shut-off.
- ✓ Easy to service, tools-free

Vorteile

- ✓ Zuverlässige Fill- und Dump-Technologie
- ✓ Widerstandsfähiges lebensmitteltaugliches Polymer
- ✓ Eingebautes Abschaltssystem.
- ✓ Einfache, werkzeuglose Wartung















HIGH ACCURACY
2%
LESS THAN
ERROR

Avantages

- ✓ Technologie volumétrique fiable
- ✓ Polymère alimentaire à haute résistance
- ✓ Clapet de fermeture Shut-off incorporé
- ✓ Entretien facile, sans outils

Beneficios

- ✓ Tecnología de «llenado y vaciado» fiable
- ✓ Polímero alimentario de alta resistencia
- ✓ Válvula de cierre incorporada
- ✓ De mantenimiento sencillo, sin herramientas

	Ref.	Note
	<p>5659005</p> <p>5659003</p> <p>5629001</p>	<p>iMilk600 Panel + sensor</p> <p>iMilk600 Panel 1</p> <p>Volumetric milk meter 2</p>
	<p>5620063</p>	<p>MMV Bracket</p>
	<p>5620019</p> <p>5550173</p>	<p>Sensor cable - 100 mt roll 1</p> <p>4 wire shielded cable 2 x 2 x 0,8 mm² Power and Data transmission - 100 mt roll 2</p>
	<p>5659006</p>	<p>iOB input/output box (washing - gates control)</p>
	<p>5629003</p>	<p>Milk Sampler</p>
	<p>1049131</p>	<p>IUP 13 A, 320 W up to 16 iMilk600 milking points Stand alone</p> <p>IUP 13 A, 320 W up to 10 iMilk600 milking points + in-parlour feeding + lock gate</p>
	<p>5620064</p>	<p>MMV Service Kit (lower shutter + Shut Off Valve)</p>
	<p>5620065</p>	<p>MMV Service Kit (Diaphragm + Gasket)</p>
	<p>5620066</p>	<p>MMV Service Kit (Probe + Floater)</p>
	<p>5620067</p>	<p>MMV 6 Floaters set</p>
	<p>5620068</p>	<p>MMV 6 Springs set</p>
	<p>5620070</p>	<p>MMV Service Kit (6 CPL Connectors)</p>

	Ref.	Note	
	5500076	ACR Bracket	
	1030227	Silencer	
	5209031 5209032 5209035	DVC1000 2,7 mt rope DVC1000 2,7 mt rope + Safety Clip DVC1000 5 mt rope	
	5229014 5229016 5229017 5229025	DVC1000 AS 2,7 mt rope - 1,5 mt cable DVC1000 AS 2,7 mt rope - 1,5 mt cable + Safety Clip DVC1000 AS 2,7 mt rope - 10 mt cable DVC1000 AS 5,0 mt rope - 1,5 mt cable	
	5219001 5219003	DVC800 2,7 mt rope DVC800 2,7 mt rope + Safety Clip	
	5249001 5249003	DVC800 AS 2,7 mt rope - 1,5 mt cable DVC800 AS 2,7 mt rope - 1,5 mt cable + Safety Clip	
	5239001	Quick Vent Valve	
	5200104	One Way Valve (already included with DVC AutoStart)	
	5200040 5200047	D. 38 D. 51	
 	Ref.	Panel + CV20	Panel + CV20 + Pulsator
	IUP - 1049131 100 - 260 VAC @ 50/60 Hz 320 W - 13 A	35	20

DVC800 AS

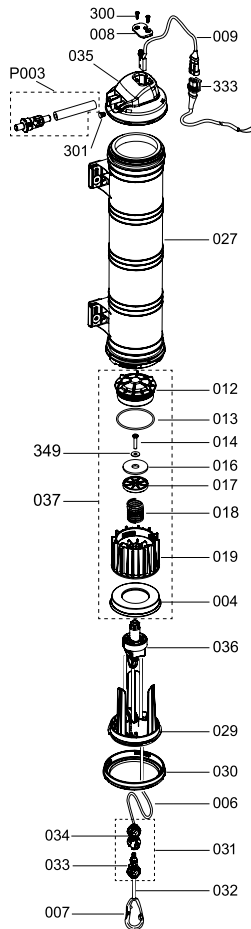

Pos.	Ref.
P003	5200104
004	5200005
006	5240010
Top 30 007	5200122
008	5220038
009	5220063
012	5220041
013	5220046
014	5220045
016	5220043
017	5220048
018	5220047
019	5220040
027	5210023
029	5210010
030	5210003
031	5200100
032	5240012
033	5200098
034	5200099
035	5240001
036	5240004
037	5240003
Top 30 300	1000221
301	1000274
333	1030273
349	5500075

Top 30 pag. 6-7

DVC800

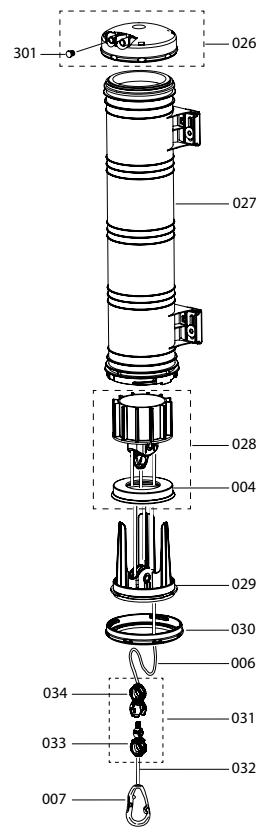

Pos.	Ref.
004	5200005
006	5240010
Top 30 007	5200122
026	5210011
027	5210023
028	5210008
029	5210010
030	5210003
031	5200100
032	5240012
033	5200098
034	5200099
301	1000274

Top 30 pag. 6-7

DVC1000

Pos.	Ref.
001	5200077
002	5200115
003	5200008
004	5200005
006	5240010
Top 30 007	5200122
030	5210003
031	5200100
032	5240012
033	5200098
034	5200099
037	5210002
301	1000274

Top 30 pag. 6-7

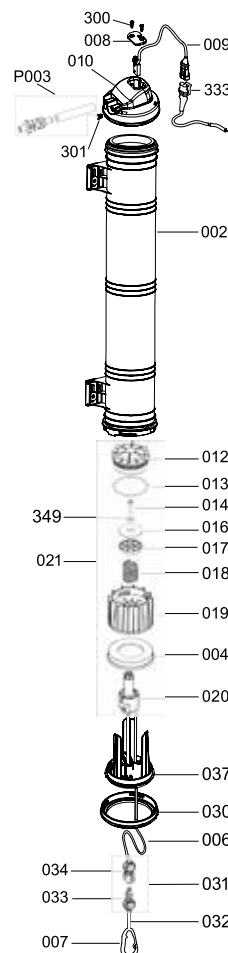
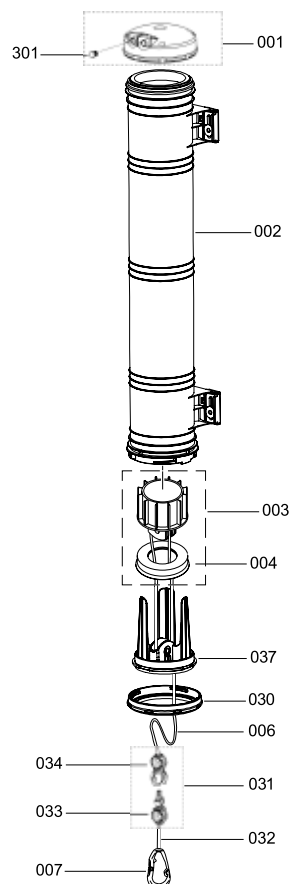

Pos.	Ref.
P003	5200104
002	5200115
004	5200005
006	5240010
Top 30 007	5200122
008	5220038
009	5220063
010	5220054
012	5220041
013	5220046
014	5220045
016	5220043
017	5220048
018	5220047
019	5220040
020	5220056
021	5220049
030	5210003
031	5200100
032	5240012
033	5200098
034	5200099
037	5210002
Top 30 300	1000221
301	1000274
333	1030273
349	5500075

Top 30 pag. 6-7

HFS & Shut-Off Valves Range





	Ref.	Note
	5519013	- HFS 2,5 mt cable - HFS 2,5m Kabel
	5519015	- HFS 10 mt cable - HFS 10m Kabel
	5529007	- HFSDO - High Flow Shut-Off - HFSDO - High Flow Shut-Off
	5519025	- HFSevo 2,5 mt cable - HFSevo 2,5m Kabel
	5519042	- HFSevo 10 mt cable - HFSevo 2,5m Kabel
	5529017	- Shut-Off 90° - Shut-Off 90°
	5529018	- Shut-Off EVO 90° - Shut-Off EVO 90°
	5519018	- HFS for ITP206 2,5 mt cable - HFS für ITP206 2,5m Kabel

Technical Data

Weight: 320 g
Dimensions: 120x70x140 mm
Milk Inlet hose: 21x16 mm
Milk Outlet hose: 21x16 mm

Technische Daten

Gewicht: 320 g
Abmessungen: 120x70x140 mm
Milcheinlaufschlauch: 21x16 mm
Milchablaufschlauch: 21x16 mm

	Ref.	Note
	5510062	- HFS / Shut-Off Bracket - HFS / Absperrhalter
	5510135	- PVC Tube 5x1,5 - 200 m roll - PVC-Rohr 5x1,5 - 200 m Rolle

HFS

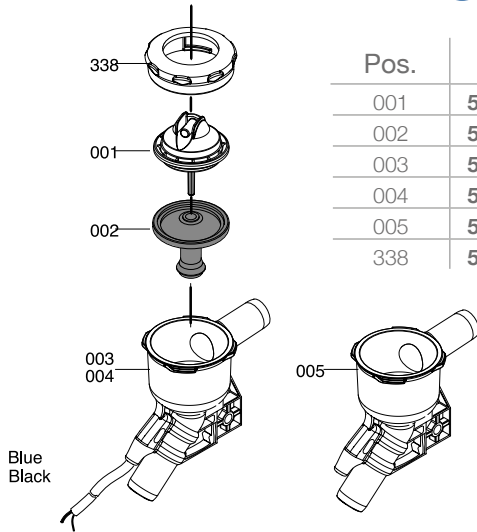

Pos.	Ref.	Note
001	5510056	
002	5510053	
003	5510121	2,5 mt cable
004	5510131	10 mt cable
005	5520004	HFSO
338	5510044	

HFS evo

Pos.	Ref.	Note
003	5510121	2,5 mt cable
004	5510131	10 mt cable
019	5510090	
020	5510088	
021	5510089	
022	5510091	
023	5510093	
024	5510092	
025	5510108	
026	5510107	
028	5510116	
029	5510119	

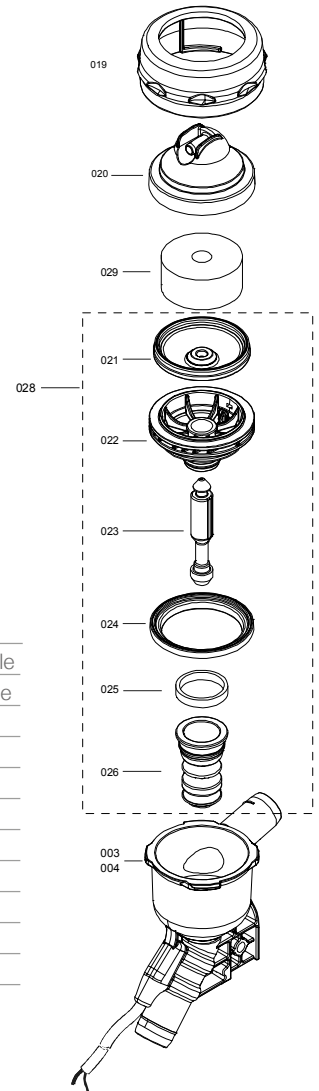

SO Valve evo

Pos.	Ref.
019	5510090
020	5510088
021	5510089
022	5510091
023	5510093
024	5510092
025	5510108
026	5510107
027	5520005
028	5510116
029	5510119

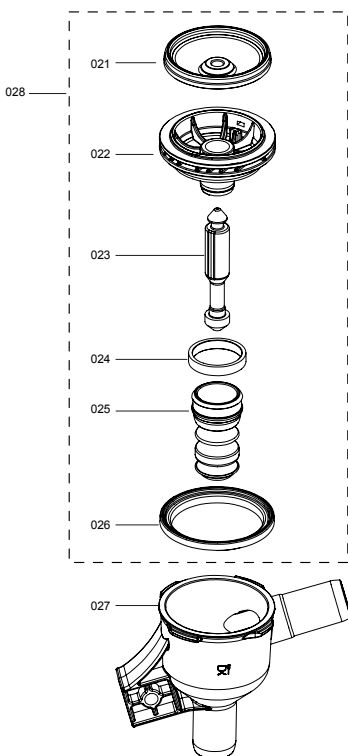

SO Valve

Pos.	Ref.
001	5510056
002	5510053
027	5520005
338	5510044

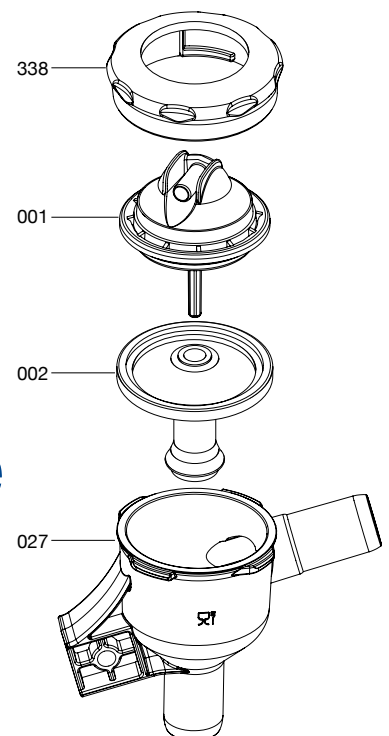



Milk Meter



MK5 - Parlour	Ref.	Capacity
	9000989	30 Kg
	9002405	42 Kg

Technical data
 L = 115 mm
 W = 180 mm
 H = 545 mm
 Milk Inlet tubes: 21x16 mm
 Milk Outlet tubes: 19x14 mm

MK5 - RTS	Ref.	Capacity
	9000990	30 Kg
	9002445	42 Kg











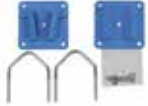



Technical data
 L = 115 mm
 W = 180 mm
 H = 720 mm (with Hanger)
 Milk Inlet tubes: 21x16 mm
 Milk Outlet tubes: 19x14 mm

MK5 - Sheep & Goat	Ref.	Capacity
	9001171	4,5 Lts.

Technical data
 L = 115 mm
 W = 180 mm
 H = 545 mm
 Milk Inlet tubes: 21x16 mm
 Milk Outlet tubes: 19x14 mm



Milk Sampler	
REF	Note
9001323	Milk Sampler Complete

Spare parts	Ref.	Note
	9000992	MK5 Service Kit
	9001184	MK5 Mounting set
	9000991	MK5 hanger Bracket RTS
	9001173	MK5 Base
	9001174	MK5 Open bung 30 Kg flask
	9001175	MK5 Cover clip
	9001176	MK5 Connector
	9001177	MK5 Cover
	9001179	MK5 Flask 30 Kg
	9001180	MK5 valve housing gasket
	9001181	MK5 housing tap
	9001183	MK5 metering head 30 Kg cpl.
	9001187	MK5 Oring 29 mm
	9001190	MK5 3 way tap with strap
	9000993	MK5 wedge block kit with bolts
	9000994	MK5 wedge mounting bracket

Milk Yield Evolution

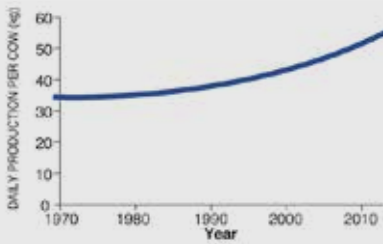

Lunik 350

High performance milking claw

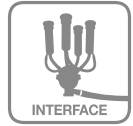

✓ Patented

Lunik 350 is the new claw designed by InterPuls for milking high genetic cows.

Bei Lunik 350 handelt es sich um ein neues Melkzeug, das von InterPuls für das Melken von Hochleistungskühen entwickelt wurde.

Lunik 350 est la nouvelle griffe, conçue par InterPuls, pour la traite des vaches à lait de grande race.

Lunik 350 es la garra nueva diseñada por InterPuls para ordeñar vacas lecheras de raza grande.

Benefits

- ✓ High evacuation capacity
- ✓ Differentiated nipples for a perfect adaptation to modern morphologies
- ✓ Anti- cross contamination separation cross
- ✓ Easy and quick maintenance
- ✓ Shock-resistant

Vorteile

- ✓ Hohe Melkleistung
- ✓ Verschiedene Anschlussstücke zur perfekten Anpassung an moderne Morphologien
- ✓ Trennkreuz gegen Kreuzkontamination
- ✓ Einfache und schnelle Wartung
- ✓ Stoßfest

Avantages

- ✓ Grande capacité d'écoulement
- ✓ Trayons différenciés, pour parfaite adaptation aux morphologies modernes
- ✓ Croix de séparation anti "cross contamination"
- ✓ Entretien facile et rapide
- ✓ Résistance aux chocs

Beneficios

- ✓ Alta capacidad de evacuación
- ✓ Pezoneras diferenciadas para una adaptación perfecta a las morfologías modernas
- ✓ Cruz de separación anti contaminación cruzada
- ✓ Mantenimiento fácil y rápido
- ✓ A prueba de golpes

Technical Data

Model: Lunik 350
Capacity: 350 cc
Weight: 550 g
Milk inlet tube: 13x10 or 15x13 mm
Milk outlet tube: 21x16 mm
Air inlet tube: 10x8 mm
Air outlet tube: 10x8 mm
Dimensions: 155x145x115 mm

Technische Daten



Modell: Lunik 350
Kapazität: 350 cm³
Gewicht: 550 g
Milcheinlaufschlauch: 13x10 oder 15x13 mm
Milchablaufschlauch: 21x16 mm
Lufteinlassschlauch: 10x8 mm
Luftablassschlauch: 10x8 mm
Abmessungen: 155x145x115 mm

Pos.	Ref.	Note
001	1580061	
002	1580143	Left / Right
003	1580018	
004	1580003	
Top 30 005	1580140	
006	1580132	
008	1580007	
009	1580006	
010	1580023	w/o valve
011	1580144	Front / Rear
012	1580019	13 x 10
013	1580020	15 x 13
Top 30 014	1570047	
015	1580136	
016	1570040	
Top 30 017	1580141	
018	1580137	with valve
019	1580096	
020	1580015	
021	1580107	
352	5500074	
353	1530137	

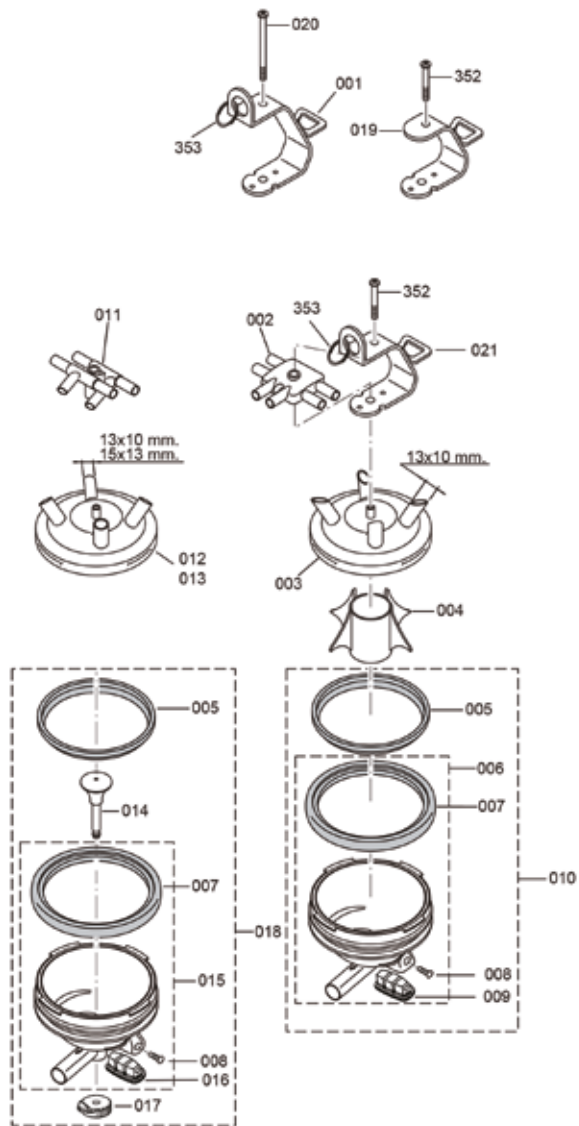
Top 30 pag. 6-7



Lunik 350	Model	Milk outlet	SO valve	Angled cut nipples	Front/Rear	Bracket ACR	Note
	1589061	21x16	●	13x10 - 45°			
	1589064	21x16	●	13x10 - 45°	●		
	1589001	21x16		13x10 - 45°		●	
	1589004	21x16		13x10 - 45°	●	●	
	1589085	21x16	●	13x10 - 45°		●	
	1589081	21x16	●	13x10 - 45°	●	●	

Lunik 350	Model	 Milk outlet	 SO valve	 Straight cut nipples	 Front/Rear	 Bracket ACR	Note
	1589062	21x16	●	13x10 - 30°			
	1589065	21x16	●	13x10 - 30°	●		
	1589063	21x16	●	15x13 - 30°			
	1589066	21x16	●	15x13 - 30°	●		
	1589002	21x16		13x10 - 30°		●	
	1589003	21x16		15x13 - 30°		●	
	1589005	21x16		13x10 - 30°	●	●	
	1589006	21x16		15x13 - 30°	●	●	
	1589086	21x16	●	13x10 - 30°		●	
	1589087	21x16	●	15x13 - 30°		●	
	1589088	21x16	●	13x10 - 30°	●	●	
	1589082	21x16	●	15x13 - 30°	●	●	
	1589093	21x16		15x13 - 30°		●	Parallel version
	1589094	21x16		15x13 - 30°	●	●	Parallel version
	1589097	21x16	●	15x13 - 30°	●	●	Parallel version
	1589098	21x16	●	15x13 - 30°		●	Parallel version

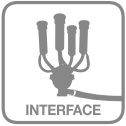

Orbiter 250-350

Heavy Duty Restyling



✓ Patented

InterPuls presents the restyling of the Orbiter 250 and 350 family. Designed for Heavy Duty milking systems it integrates a new locking system among the parts and a brand new bowl composed by sturdy polymer resistant to high temperatures and acids action.

InterPuls präsentiert die Neugestaltung der Produktfamilien Orbiter 250 und 350. Das Gerät ist für Heavy-Duty-Melksysteme konzipiert und umfasst ein neues System für die Verbindung der Teile miteinander sowie einen brandneuen Milchbehälter aus robustem Polymer, der gegenüber hohen Temperaturen und Säuren resistent ist.

InterPuls est fier de vous présenter le redesign de la gamme Orbiter 250 et 350. Conçue exprès pour les installations "Heavy Duty" elle se compose d'un nouveau système d'accrochage des parties, idéal pour les applications les plus exigeantes, ainsi que d'une boule en polymère résistant aux températures élevées, aux acides et aux chocs.

InterPuls presenta el nuevo estilo de la familia Orbiter 250 y 350. Diseñado para sistemas de ordeño intensivo, incorpora un nuevo sistema de fijación entre sus piezas y un bol completamente nuevo compuesto por un robusto polímero, que es resistente a las altas temperaturas y a la acción de los ácidos.

Technische Daten Orbiter 250 Heavy Duty

Kapazität: 250 cm³
Gewicht: 470 g
Milcheinlaufschlauch: 13x10 oder 15x13 mm
Milchablaufschlauch: 21x16 mm
Lufteinlassschlauch: 10x8 mm
Luftablassschlauch: 10x7,5 mm
Abmessungen: 155x112x109 mm

Technische Daten Orbiter 350 Heavy Duty

Kapazität: 350 cm³
Gewicht: 600 g
Milcheinlaufschlauch: 13x10 oder 15x13 mm
Milchablaufschlauch: 21x16 mm
Lufteinlassschlauch: 10x8 mm
Luftablassschlauch: 10x7,5 mm
Abmessungen: 155x112x123 mm

Orbiter 250 Heavy Duty Technical Data

Capacity: 250 cc
Weight: 470 g
Milk inlet tube: 13x10 or 15x13 mm
Milk outlet tube: 21x16 mm
Air inlet tube: 10x8 mm
Air outlet tube: 10x7,5 mm
Dimensions: 155x112x109 mm

Orbiter 350 Heavy Duty Technical Data

Capacity: 350 cc
Weight: 600 g
Milk inlet tube: 13x10 or 15x13 mm
Milk outlet tube: 21x16 mm
Air inlet tube: 10x8 mm
Air outlet tube: 10x7,5 mm
Dimensions: 155x112x123 mm



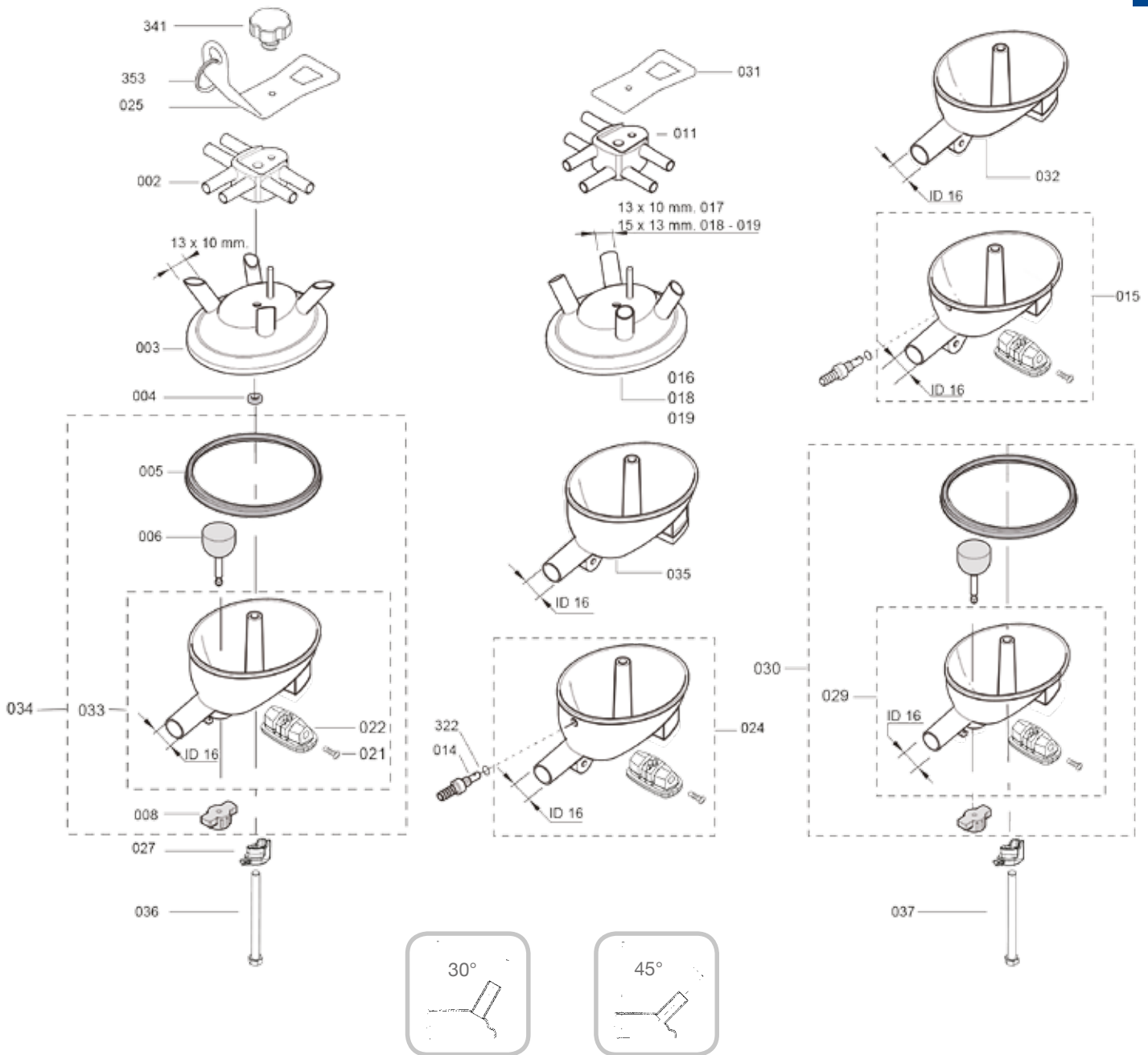





Orbiter 250 - 350 Heavy Duty

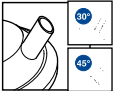
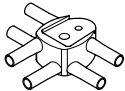
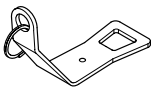

Pos.	Ref.	Note
002	1530189	Left/Right
003	1530052	45° - 13 x 10
Top 30	004	1530292
Top 30	005	1530315
Top 30	006	1530428
Top 30	008	1530291
011	1530193	Front/Rear
014	1530143	
015	1530339	250 - B/F ID16
016	1530313	30° - 13 x 10
018	1530044	30° - 15 x 13
019	1530053	45° - 15 x 13
022	1530153	
024	1530346	350 - B/F ID16
025	1530433	





Pos.	Ref.	Note
027	1530430	
029	1540066	250 - ID16 with valve
030	1540071	250 - ID16 with valve CPL
031	1530434	
032	1540054	250 - ID16 w/o valve
033	1530233	350 - ID16 with valve
034	1530235	350 - ID16 with valve CPL
035	1530318	350 - ID16 w/o valve
036	1530431	
037	1540070	
322	5000040	
340	2030023	
341	2200035	
353	1530137	











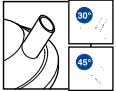
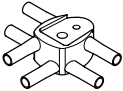
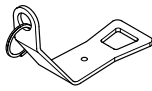

Orbiter 250 HD	Model	 Milk outlet	 SO valve	 Angled cut nipples	 Front/Rear	 Bracket ACR	Note
	1549071	21x16		13x10 - 45°		•	
	1549072	21x16		13x10 - 45°	•	•	
	1549073	21x16	•	13x10 - 45°		•	
	1549074	21x16	•	13x10 - 45°	•	•	
	1549075	21x16		13x10 - 45°			Back Flush

Orbiter 250 HD	Model	 Milk outlet	 SO valve	 Straight cut nipples	 Front/Rear	 Bracket ACR	Note
	1549076	21x16		15x13 - 30°		•	
	1549077	21x16		15x13 - 30°	•	•	
	1549078	21x16	•	15x13 - 30°		•	
	1549079	21x16	•	15x13 - 30°	•	•	
	1549080	21x16		15x13 - 30°			Back Flush
	1549081	21x16		15x13 - 45°			Back Flush

Accessories	Ref.	Accessories	Ref.
	1530113		1530112 - D. 38
	1530196*		1530134 - D. 51
	1530208*		1530187* - D. 38

* Special item available on demand

Orbiter 350 HD	Model	 Milk outlet	 SO valve	 Angled cut nipples	 Front/Rear	 Bracket ACR	Note
	1539251	21x16		13x10 - 45°		•	
	1539252	21x16		13x10 - 45°	•	•	
	1539249	21x16	•	13x10 - 45°		•	
	1539253	21x16	•	13x10 - 45°	•	•	
	1539254	21x16		13x10 - 45°			Back Flush

Orbiter 350 HD	Model	 Milk outlet	 SO valve	 Straight cut nipples	 Front/Rear	 Bracket ACR	Note
	1539255	21x16		13x10 - 30°		•	
	1539256	21x16		13x10 - 30°	•	•	
	1539257	21x16	•	13x10 - 30°		•	
	1539258	21x16	•	13x10 - 30°	•	•	
	1539259	21x16		15x13 - 30°		•	
	1539260	21x16		15x13 - 30°	•	•	
	1539261	21x16	•	15x13 - 30°		•	
	1539262	21x16	•	15x13 - 30°	•	•	
	1539263	21x16		15x13 - 30°			Back Flush
	1539264	21x16		15x13 - 45°			Back Flush





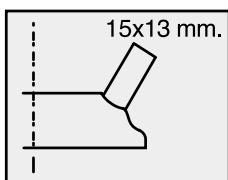

IPL 11 Liner

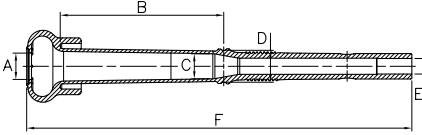

IPL11 Liner

-  Gentle massaging action
- Common on the Market**
-  Two-way massaging action
-  Three-way massaging action

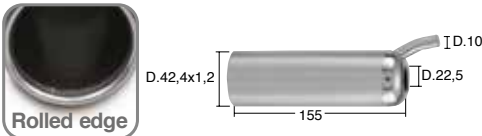
✓ Patented

Liner Set (4x IPL11)	Ref.	Note																					
	<p>1809011 - D. 22 1809005 - D. 20</p>	 <table border="1" data-bbox="1077 1355 1476 1556"> <thead> <tr> <th></th> <th>A</th> <th>B</th> <th>C</th> <th>D</th> <th>E</th> <th>F</th> </tr> </thead> <tbody> <tr> <td>IPL11 D. 22</td> <td>22</td> <td>136</td> <td>21</td> <td>26,5</td> <td>13</td> <td>321</td> </tr> <tr> <td>IPL11 D. 20</td> <td>20</td> <td>136</td> <td>21</td> <td>26,5</td> <td>13</td> <td>321</td> </tr> </tbody> </table>		A	B	C	D	E	F	IPL11 D. 22	22	136	21	26,5	13	321	IPL11 D. 20	20	136	21	26,5	13	321
	A	B	C	D	E	F																	
IPL11 D. 22	22	136	21	26,5	13	321																	
IPL11 D. 20	20	136	21	26,5	13	321																	
Jetter Cup	Ref.	Note																					
	<p>9001461 9000152</p>	<p>Jetter Cup for IPL11 - Low Line Jetter Cup for IPL11 - High Line</p>																					
TCS	Ref.	Note																					
	<p>4208191</p>	<p>gr 200</p>																					
Liner Reinforcement	Ref.	Note																					
	<p>9002270</p>	<p>Indicative dimensions in mm. for IPL11</p>																					



IPL 01 - IPL 02

Liner

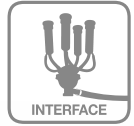

IPL 01

IPL 02



✓ Patented

IPL 01 Liner

Set 4x IPL 01

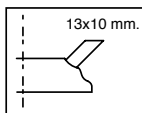

1809001

Light TCS

Heavy TCS

Plastic TCS

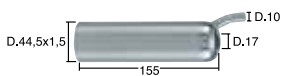

4208125
gr 250



4208006
gr 420



4308002
gr 365

IPL 02 Liner

Set 4x IPL 02

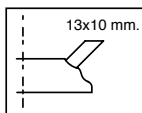

1809002

Light TCS

Heavy TCS

Plastic TCS

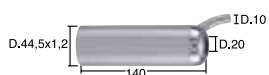

4208043
gr 175



4208010
gr 380



4308001
gr 330

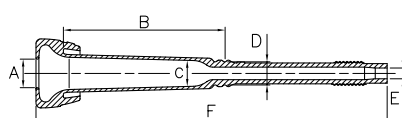

	A	B	C	D	E	F
IPL 01	24	136	22	19,5	9	295
IPL 02	24	122	22,5	22	9,5	290

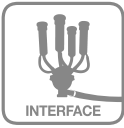

IPL 01

Bubalus



The first liner specifically designed for dairy buffaloes!



Spiral reinforcing

IPL 01 Bubalus

Set 4x IPL 01 Bubalus

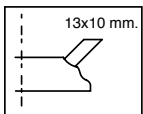

1809006

Light TCS

Heavy TCS

Plastic TCS



4208125
gr 250



4208006
gr 420



4308002
gr 365

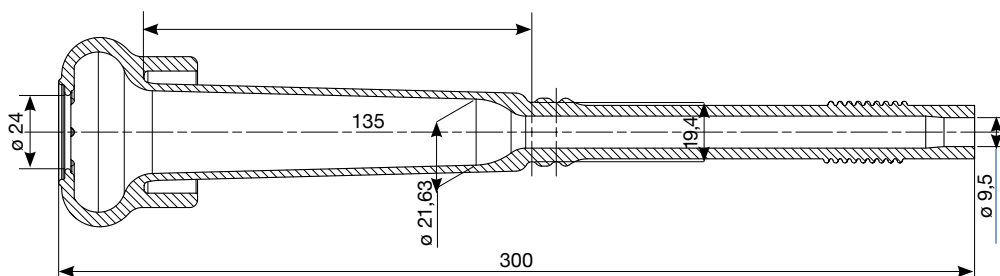



Accessories

Milking Clusters

Short Pulsation Tube 8 x 14,5 x 230 mm	Ref. set x 4 pcs	Ref. set x 50 pcs
	1900055	1900056
Short Pulsation Tube 8 x 14,5 x 205 mm	Ref. set x 4 pcs	Ref. set x 50 pcs
	1900057	1900058
Liner Plug	Ref.	Note
	1900013	Liner hole 18-20 mm
	Top 30 1900036	Liner hole 22-24 mm



Top 30 pag. 6-7

- ✓ Patented
- ✓ Compound FDA approved

Retaining Flat Band	Ref.	Dimensions
	Top 30 1900052	D. 32
	Top 30 1900051	D. 35
Retaining Ring	Ref.	Dimensions
	Top 30 1900062	D. 32
	Top 30 1900061	D. 35

Top 30 pag. 6-7

Spinjet

Spinjet	Ref.	Spinjet	Ref.
	Top 30 1900039 D. 22 - for Cows and Goats		1900014 D. 18 - for Sheep
	Top 30 1900040 D. 24 - for Cows		

Top 30 pag. 6-7

Pos.	Ref.	Note
A		SpinJet
B	1900041	Adapter for SpinJet
C	3400053	Clamp for washing tube D.30
	3400054	Clamp for washing tube D.40
	3400055	Clamp for washing tube D.50



Pos.	Ref.	Note
A		SpinJet
B	9000044	Rubber tube for jetter C.I.P.
C	9000074	Distributor with air vent
	9000283	Distributor w/o air vent



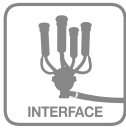

Optiflow III

Washing Unit



Optiflow III is an innovative new InterPuls washing unit. The innovative spinjet guarantees perfect cleaning of the inner structure of the teatcup liner thanks to the effective rotational flow.

Optiflow III ist eine innovative neue Wascheinheit von InterPuls. Der innovative Spinjet garantiert die perfekte Reinigung der Innenstruktur des Zitzenbechers dank der wirksamen Rotationsbewegung.

Optiflow III est la nouvelle unité de lavage InterPuls. Le tout nouveau dispositif spinjet garantit un lavage parfait des parois internes des manchons trayeurs grâce à la rotation qui entraîne une phase de lavage plus efficace.

Optiflow III es una nueva unidad de lavado de InterPuls. El spinjet innovador garantiza la limpieza perfecta de la estructura interna de la pezonera gracias al eficaz flujo rotatorio.

Benefits

- ✓ Improved cleaning action thanks to the rotating flow
- ✓ Excellent support for the milking unit
- ✓ Adjustable clamps
- ✓ Flow adjustment screw
- ✓ Folds up for greater compactness
- ✓ Automatic drain valve

Vorteile

- ✓ Verbesserte Reinigung dank der Rotationsbewegung.
- ✓ Hervorragende Unterstützung der Melkeinheit
- ✓ Verstellbare Klemmen
- ✓ Flussregulierungsschraube
- ✓ Zusammenklappbar für eine größere Kompaktheit
- ✓ Automatisches Ablassventil

Avantages

- ✓ Qualité de lavage améliorée grâce à l'action du flux rotationnel
- ✓ Soutien optimal du faisceau
- ✓ Fixations orientables
- ✓ Vis de réglage du flux
- ✓ Fermeture basculante - dimensions réduites
- ✓ Clapet de drainage automatique

Beneficios

- ✓ Acción de limpieza optimizada gracias al flujo rotatorio
- ✓ Soporte excelente de la unidad de ordeño
- ✓ Abrazaderas ajustables
- ✓ Tornillo de ajuste del flujo
- ✓ Plegable para ofrecer dimensiones reducidas
- ✓ Válvula de drenaje automático

Technische Daten

Optiflow III

Gewicht: 1,27 Kg
Abmessungen im geöffneten Zustand: 320x175x155 mm
Abmessungen im geschlossenen Zustand: 190x175x155 mm
Wassereinflüsse ODxID: 16x12,5 mm
DM Klemmen: 44,5 mm oder 42 mm

Optiflow III Highline

Gewicht: 0,75 Kg
Abmessungen: 175x175x155 mm
Wassereinflüsse ODxID: 16x12,5 mm
DM Klemmen: 44,5 mm oder 42 mm

Technical Data





Optiflow III

Weight: 1,27 Kg
Dimensions open: 320x175x155 mm
Dimensions closed: 190x175x155 mm
Water inlets ODxID: 16x12,5 mm
D. Clamps: 44,5 mm or 42 mm

Optiflow III High Line

Weight: 0,75 Kg
Dimensions: 175x175x155 mm
Water inlets ODxID: 16x12,5 mm
D. Clamps: 44,5 mm or 42 mm



Foldable Version	Ref.	Note
	<p>5329001 5329002</p>	<p>Optiflow III foldable with clamp D. 42 Optiflow III foldable with clamp D. 44,5</p>
	<p>5320031</p>	<p>Extension kit</p>
High Line Version	Ref.	Note
	<p>5329005* 5329006*</p>	<p>Optiflow III Highline clamp D. 42 Optiflow III Highline clamp D. 44,5</p>
	<p>5320029</p>	<p>Fixing kit for Optiflow III Highline</p>
<p>*Bracket 5320029 not included</p>		
On Pipe Version with Cover	Ref.	Note
	<p>5329003 5329004</p>	<p>Optiflow III with cover - D. 40 tube Optiflow III with cover - D. 50,8-52 tube</p>

Optiflow III foldable and highline

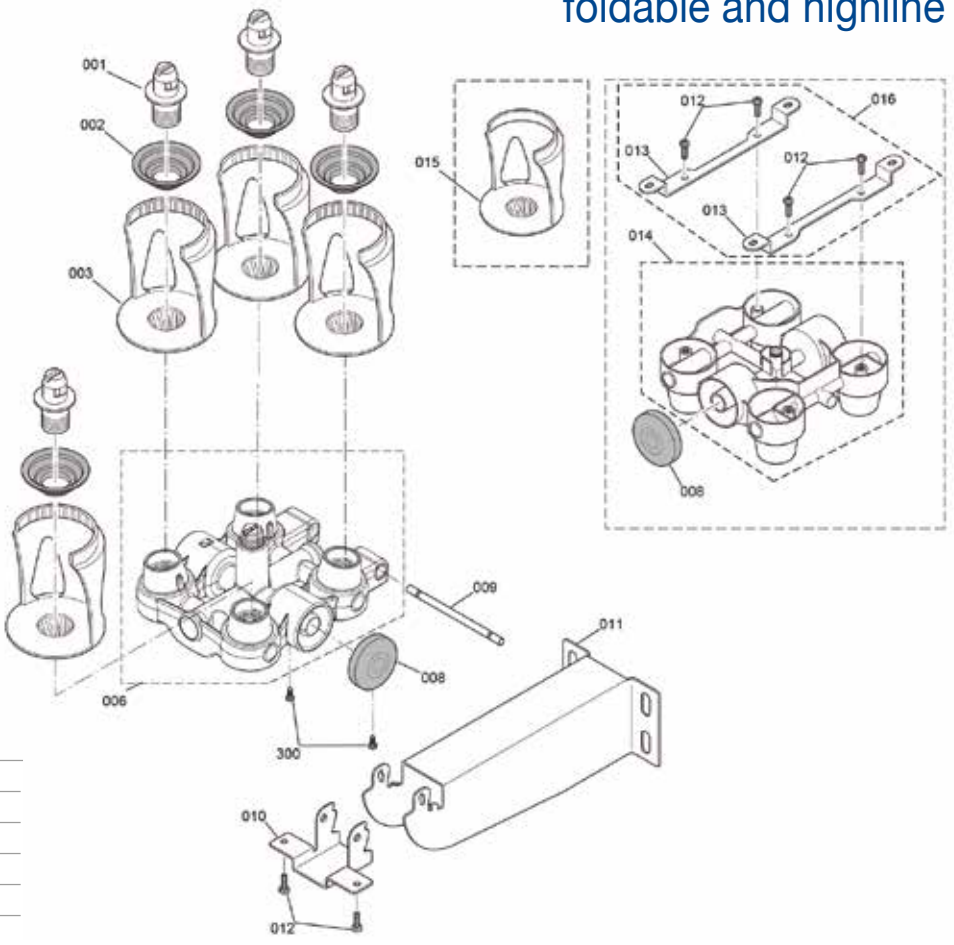
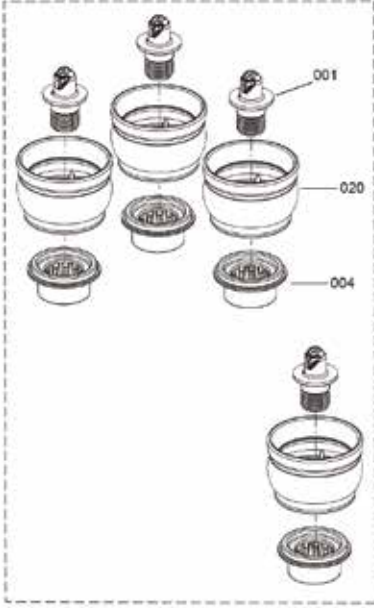

Pos.	Ref.	Note
001	5310005	
002	5310012	
003	5320008	D. 42
004	5310004	
006	5320038	
008	5320014	
009	5320006	
010	5320005	
011	5320004	
012	5320017	
013	5320016	
014	5320039	
015	5320009	D. 44,5
016	5320029	
020	5320048	
300	1000221	

Top 30
Top 30 pag. 6-7

Optiflow III with cover on-pipe fixing

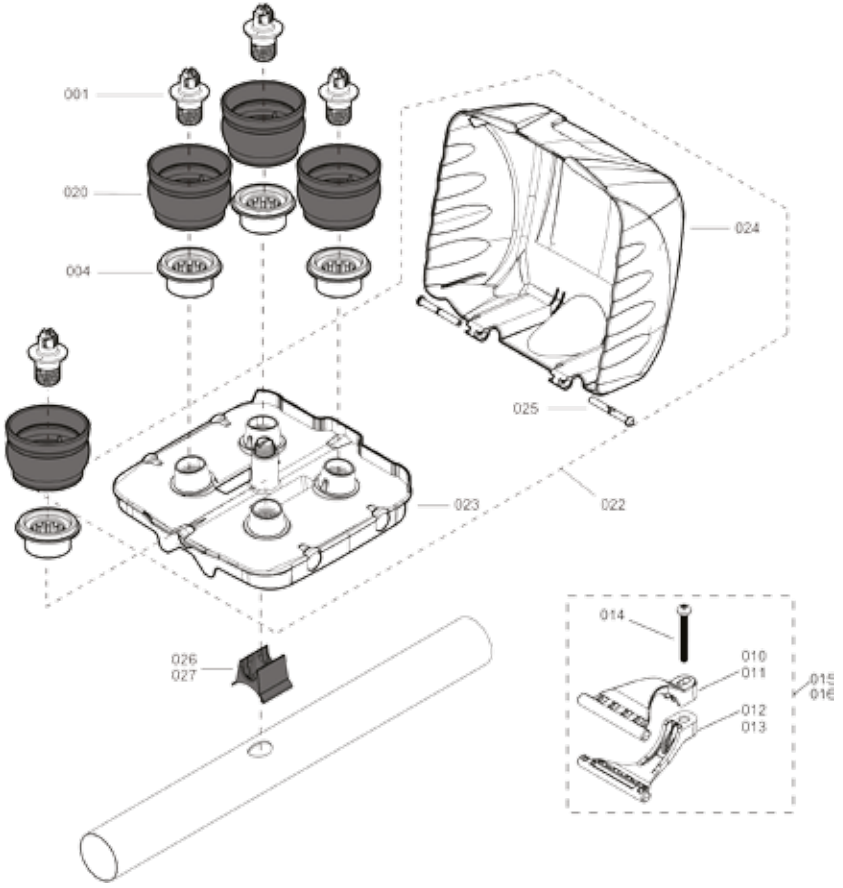

Pos.	Ref.	Note
001	5310005	
004	5310004	
010	5310022	D. 40
011	5310025	D. 52/50,8
012	5310023	D. 40
013	5310026	D. 52/50,8
014	5310032	
015	5310030	Kit D. 40
016	5310031	Kit D. 52/50,8
020	5320048	
022	5320043	
023	5320045	
024	5320046	
025	5320047	
026	5320049	D. 40
027	5320050	D. 52/50,8

Top Wash Lite II

Washing Programmer



Protection class IP65

We introduce the latest release of the Top Wash Lite range. The washing programmer TWLite II incorporates the smart, user friendly design of the Top Wash Lite and the performance of the over-sized water solenoids.

Wir führen die neueste Version des Sortiments Top Wash Lite ein. Das Reinigungsprogramm TWLite II kombiniert das elegante und anwendungsfreundliche Design von Top Wash Lite mit der Leistung der übergroßen Wasser-Solenoidspulen.

Nous vous présentons la dernière version de la gamme Top Wash Lite. Le programmeur de lavage TWLite II combine le design élégant et simple à utiliser de Top Wash Lite et la performance des solénoïdes pour le chargement de l'eau surdimensionnées.

Presentamos la última versión de la gama Top Wash Lite. El programador de lavado TWLite II incorpora el diseño inteligente e intuitivo de Top Wash Lite y las prestaciones de los solenoides sobredimensionados para cargar el agua.

Benefits

- ✓ Plug & Play, competitive solution
- ✓ Top hygiene and equipment sanitization
- ✓ Easy to program
- ✓ Sturdy electronic and IP65 protection class

Vorteile

- ✓ Plug & Play, konkurrenzfähige Lösung
- ✓ Hervorragende Hygiene und Sanitisierung der Anlagekomponenten
- ✓ Leicht zu programmieren
- ✓ Robuste Elektronik und Schutzart IP65

Avantages

- ✓ Plug & Play, solution compétitive
- ✓ Hygiène maximale et désinfection des installations de traite
- ✓ Facile à programmer
- ✓ Electronique programmable et classe de protection IP65

Beneficios





- ✓ «Plug & play», solución competidora
- ✓ Higiene máximo e higienización del equipo de ordeño
- ✓ Fácil de programar
- ✓ Electrónica resistente y clase de protección IP65

Technische Daten





Abmessungen: 130x180x38 mm programmer;
100x230x100 mm Edelstahlbehälter
Gewicht: 6 Kg
Stromversorgung: 24 VAC
Maximale Stromaufnahme 2300 mA

Technical Data

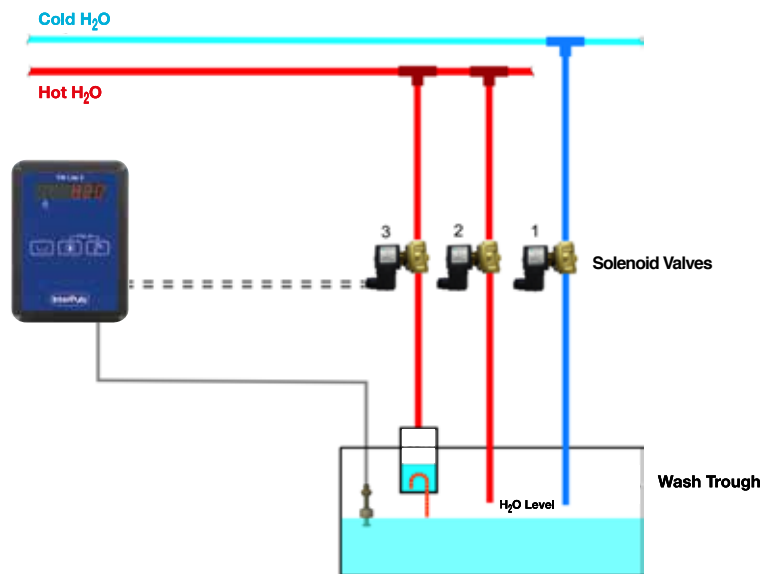
Dimensions: 130x180x38 mm programmer;
100x230x100 mm S/S container
Weight: 6 Kg
Power supply: 24 VAC
Maximum power consumption: 2300 mA

Top Wash Lite II	Ref.	Description
	5409034	TW Lite 1 S/S detergent container 1,5 Lts
Accessories	Ref.	Description
	1049132	IUT - 24 VAC 220 VAC @50/60 Hz 220 VA - 8 A
	5409017	Transformer 230 V - 24 VAC (75 VA)
	9001252	Safety Switch



Spare parts	Ref.	Note
	5409035	TW Lite electronic box
	5400201	TW Lite panel bracket
	5400304	Solenoid valve 1/2" - 24 VAC (max capacity 45 l/min)
	5400037	Drain Valve 24 VAC
	4600250 4600592	S/S container - 1,5 L S/S container - 2 L

Top Wash III - New Software 3.3

Washing Programmer



The new software 3.3 makes it more versatile, performing and adaptable to every milking installation.

Die neue Software 3.3 macht Top Wash vielseitiger, leistungsstärker und anpassungsfähiger an sämtliche Melkanlagen.

Le nouveau software 3.3 rend Top Wash plus versatile, performante et adaptable à toutes les installations de traite.

El nuevo software 3.3 hace que Top Wash sea más versátil, ofrezca mayores prestaciones y se adapte a cada instalación de ordeño.

Features

- ✓ Easy to install and to program
- ✓ Up to 4 washing programs
- ✓ Up to 10 washing cycles per each program

Eigenschaften

- ✓ Leicht installierbar und programmierbar
- ✓ Bis zu 4 Reinigungsprogramme
- ✓ Bis zu 10 Reinigungszyklen pro Programm

Caractéristiques

- ✓ Facile à installer et programmer
- ✓ Mémorise jusqu'à 4 programmes de lavage
- ✓ Jusqu'à 10 cycles de lavage pour chaque programme

Características

- ✓ Fácil de instalar y programar
- ✓ Hasta 4 programas de lavado
- ✓ Hasta 10 ciclos de lavado por cada programa

New Functions

- ✓ **Extra Water** – adds water in the container if necessary
- ✓ **Pre-Drain** – releases dirty water so avoiding to send it recirculating
- ✓ **Sanivac / Air Injector** – separate functions with delay possibility
- ✓ **Water Stop** – water suction blocking in the installation
- ✓ **Temperature 3** – water heating if necessary + minimum level control
- ✓ **Safety Switch** – milking/washing safety

Neu Funktionen

- ✓ **Extra Water** – fügt dem Behälter ggf. Wasser hinzu
- ✓ **Pre-Drain** – lässt Schmutzwasser ab und verhindert somit, dass dieses wieder in Umlauf gelangt
- ✓ **Sanivac / Air Injector** – separate Funktionen mit Verzögerungsoption
- ✓ **Water Stop** – Sperre der Wasseransaugung in der Installation
- ✓ **Temperature 3** – ggf. Warmwasserbereitung + Leerlaufschutz
- ✓ **Safety Switch** – Melk- / Reinigungssicherheit

Nouvelles Fonctions

- ✓ **Extra Water** – ajoute de l'eau dans le cuve si nécessaire
- ✓ **Pre-Drain** – décharge l'eau sale en évitant de l'envoyer à recirculation
- ✓ **Sanivac / Air Injector** – fonctions séparées avec possibilité de délai
- ✓ **Water Stop** – bloque l'aspiration de l'eau dans l'installation
- ✓ **Temperature 3** – chauffage de l'eau si nécessaire + contrôle du niveau minimum
- ✓ **Safety Switch** – sûreté traite / lavage

Nuevas funciones

- ✓ **Extra Water** - añade agua en el recipiente si fuera necesario
- ✓ **Pre-Drain** - descarga el agua sucia evitando la recirculación
- ✓ **Sanivac / Inyector de aire** - funciones separadas con posibilidad de retraso
- ✓ **Water Stop** - bloqueo de la aspiración de agua en la instalación
- ✓ **Temperature 3** - calentamiento de agua si fuera necesario + control de nivel mínimo
- ✓ **Safety Switch** - seguridad en ordeño/lavado

Alarms

- ✓ Vacuum – slow water suction
- ✓ Water – slow container upload
- ✓ Heating – slow water heating
- ✓ Temperature – water not sufficiently heated

Alarm

- ✓ Vakuum – langsame Wasserransaugung
- ✓ Wasser - langsame Füllung des Behälters
- ✓ Erwärmung – langsame Warmwasserbereitung
- ✓ Temperatur - Wasser nicht ausreichend erhitzt

Alarmes

- ✓ Vide – aspiration lente de l'eau
- ✓ Eau – lent chargement de l'eau
- ✓ Chauffage – lent chauffage de l'eau
- ✓ Température – eau pas assez chaude

Alarmas

- ✓ Vacío - aspiración lenta de agua
- ✓ Agua - carga lenta en recipiente
- ✓ Calentamiento - calentamiento lento del agua
- ✓ Temperatura – agua no suficientemente caliente

Technische Daten

Maximaler Druck des Wasserzulaufs: 10 atm
 Stromversorgung: 24 VAC (2300 mA)
 Gewicht: 8 Kg
 Abmessungen: 300x175x240 mm

Technical Data

Maximum pressure of inlet water: 10 atm
 Power supply: 24 VAC (2300 mA)
 Weight: 8 Kg
 Dimensions: 300x175x240 mm

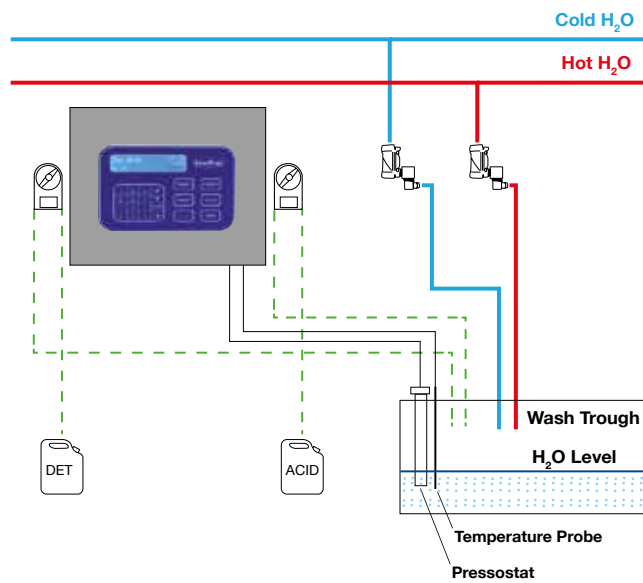

Top Wash III HD	Ref.	Note
	5409029	- 2 Peristaltic pumps - 2 Schlauchpumpen
	5409033	- 3 Peristaltic pumps - 3 Schlauchpumpen
	5400264	- Set 2 x Solenoid valve 1" - 24 VAC (max capacity 190 l/min) - Satz 2 x Magnetventile 1" - 24 VAC (Höchstleistung 190 l/min)
	1049132	IUT - 24 VAC 220 VAC @50/60 Hz 220 VA - 8 A
	1049134	IUT - 24 VAC 115 VAC @50/60 Hz 220 VA - 8 A
	5409017	- Transformer 230 V - 24 VAC (75 VA) - Transformator 230 V - 24 VAC (75 VA)
	9001252	- TW Lite Safety Switch - TW Lite Safety Switch

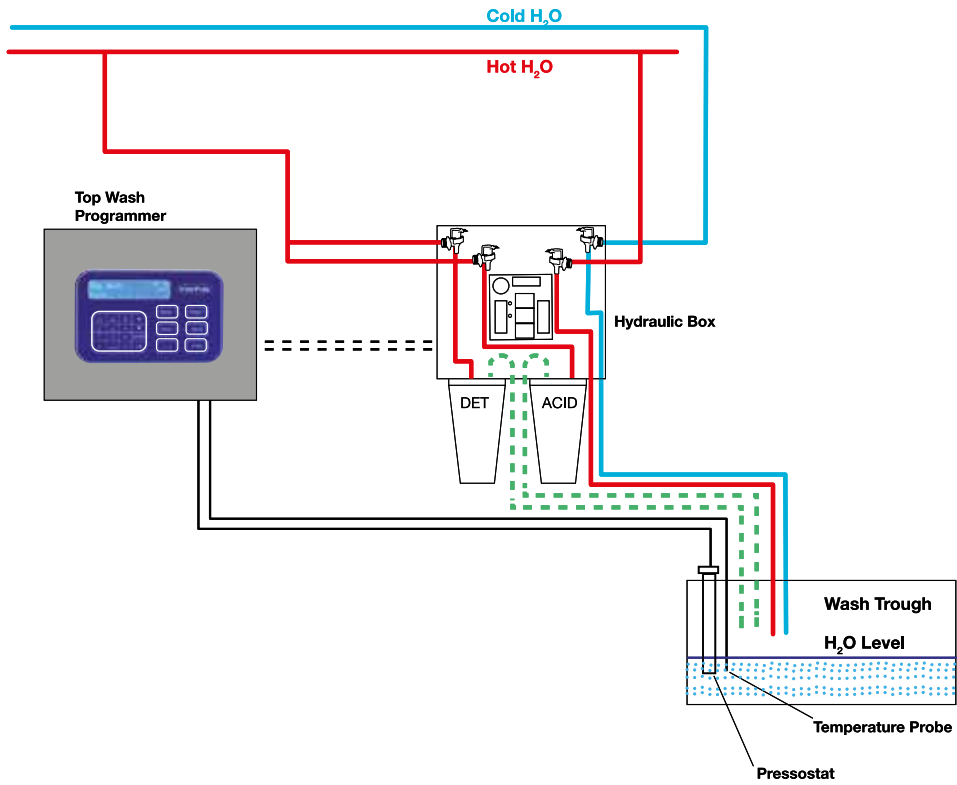

Top Wash	Ref.	Description
	5409012	Top Wash III - 2 containers
	5409015	Top Wash III - S/S detergent container 1.4 Lts.
	5409013	Top Wash III - 2 Peristaltic pumps
	5409014	Top Wash III - 3 Peristaltic pumps
	1049132	IUT - 24 VAC 220 VAC @50/60 Hz 220 VA - 8 A
	5409017	Transformer 230 V - 24 VAC (75 VA)
	9001252	TW Lite Safety Switch
Remote Control Switches box	Ref.	Description
	9001563	Box up to 4 remote control switches

TWIII with 2 peristaltic pumps

Hydraulic Set-up

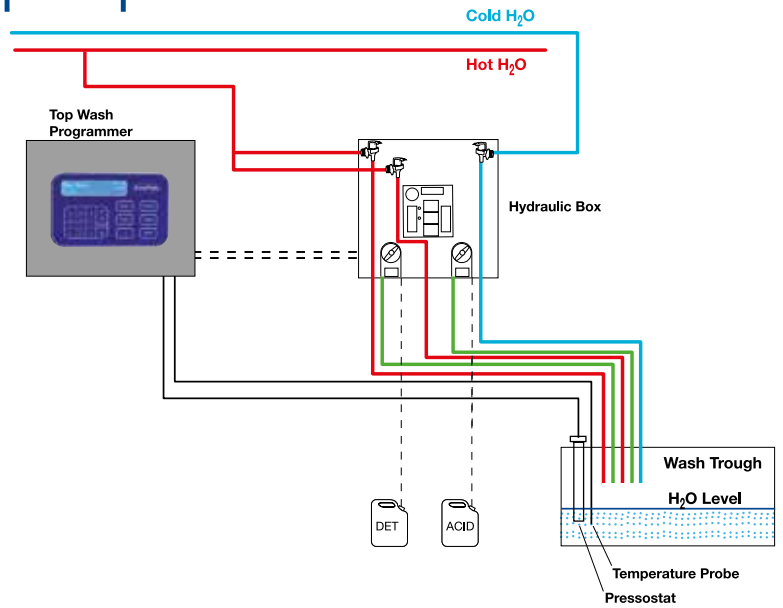

TWIII with 3 peristaltic pumps

Hydraulic Set-up

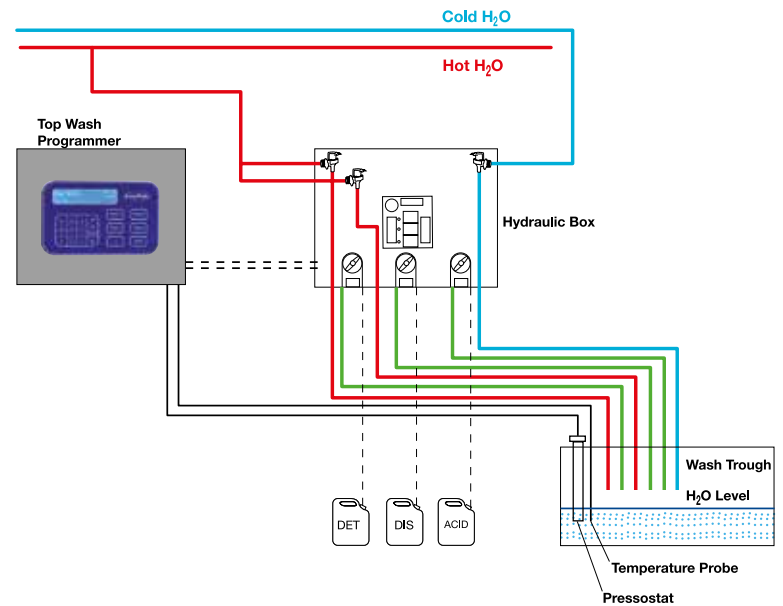

TWIII with 1 S/S container

Hydraulic Set-up

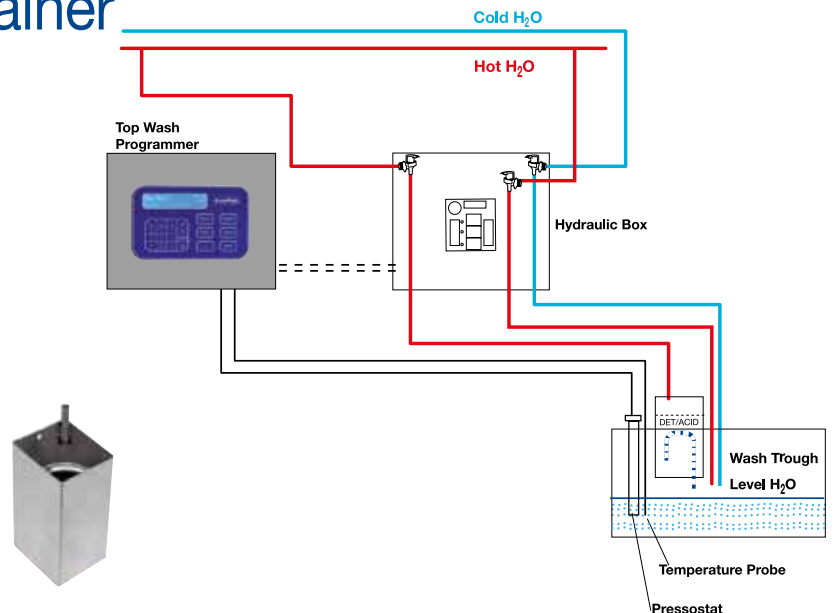

Top Wash III

Spare Parts

Spare parts	Ref.	Note
	5400220	TWIII PCB
	5400079	TWIII keyboard
	5400264*	Set 2 x Solenoid valve 1"-24 VAC (max capacity 190 l/min)
	5400110	3/4" STD solenoid valve 24 VAC (max capacity 20 l/min)
	5400080	Temperature probe
	5400111	Peristaltic pump 24 VDC (max capacity 0,8 l/min)
	5400212	Tube for peristaltic pump
	5400113	Det/acid plastic container
	5400114	Mounting base for det/acid container
	5400115	Gasket for det/acid container
	5400218	TWIII S/S electronic box
	5400162	TWIII S/S hydraulic box with containers
	5400163	TWIII S/S peristaltic box - 2 pumps
	5400182	TWIII S/S peristaltic box - 3 pumps
	5400185	TWIII Box for S/S container (S/S container not included)
	5400037	Drain Valve 24 VAC
	4600250 4600592	S/S container - 1,5 L. S/S container - 2 L.

*Special item available on demand.



Turbo Wash 4000 & 4000 P

Air Injector

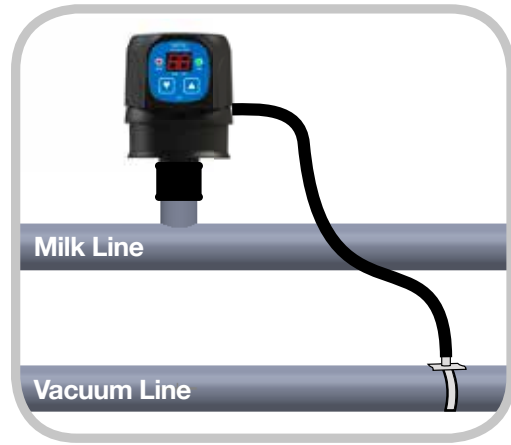

Benefits

- ✓ Effective cleaning and sanitization of the system
- ✓ High performance, up to 4000 l/min of air capacity
- ✓ Low energy consumption
- ✓ Reliable electronic and easy to program
- ✓ Easy to install, service-free

Vorteile

- ✓ Wirksame Reinigung und Desinfizierung des Systems
- ✓ Leistungsstark, Druckluftdurchsatz bis zu 4000 l/min
- ✓ Geringer Energieverbrauch
- ✓ Zuverlässige Elektronik und leicht zu programmieren
- ✓ Einfache Installation, wartungsfrei

Avantages

- ✓ Lavage et nettoyage efficace de l'installation
- ✓ Hautes performances, jusqu'à 4000 l/min. capacité
- ✓ Faible consommation d'énergie
- ✓ Électronique fiable et programmation intuitive
- ✓ Facile à installer et sans entretien

Beneficios

- ✓ Limpieza e higienización eficaces del sistema
- ✓ Alto rendimiento, hasta 4000 l/min de capacidad de aire
- ✓ Bajo consumo de energía
- ✓ Electrónica fiable y fácil de programar
- ✓ Fácil de instalar, sin mantenimiento

Technische Daten

Stromversorgung: 24 V DC/AC
 Durchmesser des Befestigungsrohrs: 40 mm
 Abmessungen: 130x150x130 mm
 Gewicht: 670 g
 Leistungsaufnahme: 130 mA

Technical Data

Power supply: 24 V DC/AC
 Diameter of fixing pipe: 40 mm
 Dimensions: 130x150x130 mm
 Weight: 670 g
 Consumption: 130 mA

Turbo Wash	Ref.	Description
	5079001	TurboWash 4000 P - 24V AC/DC programmable version (with PCB) TurboWash 4000 P - 24V AC/DC Programmierbare Ausführung (mit PCB)
	1049122	IT01 Power Unit 230 VAC @50/60 Hz IT01 Netzteil 230 VAC bei 50/60 Hz
	5079002	TurboWash 4000 - 24V AC/DC Top Wash version (without PCB) TurboWash 4000 - 24V AC/DC Top Wash Ausführung (ohne PCB)
	3410026	Rubber adapter D.38 mm Gummiadapter DM 38 mm

Sanivac

Washing Vacuum Regulator

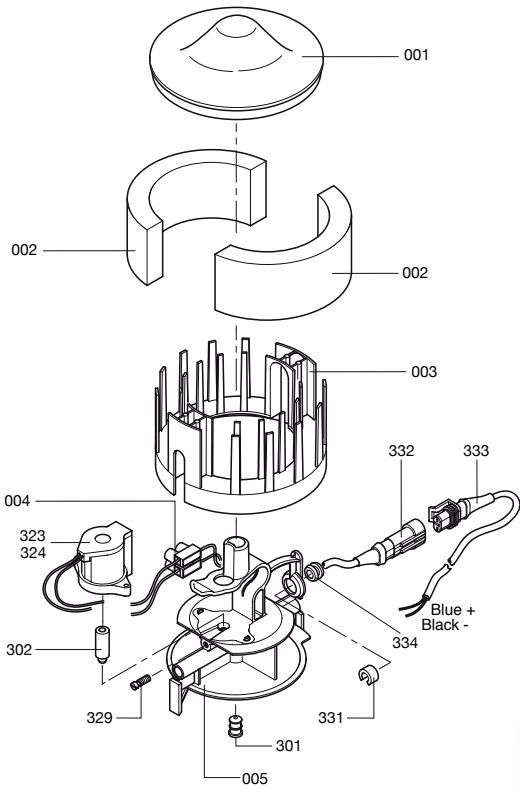

Sanivac is an unique device conceived to encrease the washing effectiveness thanks to the vacuum.

Sanivac ist ein einzigartiges Gerät, das zur Erhöhung der Reinigungseffizienz anhand des Vakuums entwickelt wurde.

Vacuum Regulators	Ref.	Note
 Sanivac	5039009	Q.M. kit 24 VDC
	5039010	Q.M. kit 12 VDC

Pos.	Ref.	Note	Pos.	Ref.	Note
001	5030028		Top 30 323	1030318	24 V
002	5000095		Top 30 324	1030319	12 V
003	5030003		329	1050004	
004	5030002		331	1030052	
005	5030001		332	1030275	
301	1000274		333	1030273	
Top 30 302	1030299		334	1030104	

Top 30 pag. 6-7



ITP 203-205-207

Sheep & Goats, Claws & System



✓ Patented

After many years of research and development in close cooperation with animal breeders, InterPuls is pleased to present its new range of high performance components for the efficient milking of small ruminants.

Nach vielen Jahren Forschung und Entwicklung in enger Zusammenarbeit mit Tierzüchtern freut sich InterPuls, sein neues Sortiment an Hochleistungskomponenten zum effizienten Melken kleiner Wiederkäuer vorstellen zu können.

Après des années de recherche et d'expérience aux côtés des éleveurs, InterPuls présente une nouvelle série de composants, plus performants, pour traire correctement les ruminants de petite taille.

Después de muchos años de investigación y desarrollo en estrecha colaboración con los ganaderos, InterPuls tiene el placer de presentar su nueva gama de componentes de alto rendimiento para el ordeño eficiente de pequeños rumiantes.



ITP 203 Alternate

ITP 203 Simultaneous

Technische Daten ITP203

Kapazität: 120 cm³
 Gewicht: 170 g
 Milcheinlaufschlauch: 14x10 mm
 Milchablaufschlauch: 18x14 mm
 Pulsationsschlauch (lang): 10x7,5 mm
 Pulsationsschlauch (kurz): 10x7,5 mm
 Abmessungen: 122x66x163 mm

ITP203 Technical Data

Capacity: 120 cc
 Weight: 170 g
 Milk inlet tube: 14x10 mm
 Milk outlet tube: 18x14 mm
 Puls. tube (long): 10x7,5 mm
 Puls. tube (short): 10x7,5 mm
 Dimensions: 122x66x163 mm

Technische Daten ITP205/207

Kapazität: 20 cm³
 Gewicht: 30 g
 Milcheinlaufschlauch: 14x10 mm
 Milchablaufschlauch: 14x10 mm
 Abmessungen: 97x40x79 mm

ITP205/207 Technical Data

Capacity: 20 cc
 Weight: 30 g
 Milk inlet tube: 14x10 mm
 Milk outlet tube: 14x10 mm
 Dimensions: 97x40x79 mm



ITP 205

ITP 207

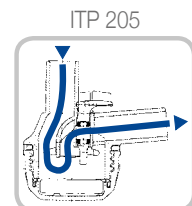

ITP 205

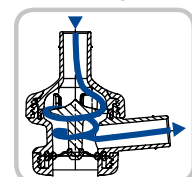

ITP 207

Classic

Pos.	Ref.	Note
003	2040011	
008	2020021	
013	2000081	Goats D.20
014	2000076	Goats
015	2000069	Sheep D.18,5
016	2000077	Sheep
017	2050019	
018	2050021	ITP205
019	2050018	
020	2040005	
021	2000003	ITP205
022	2040004	
023	2040002	
028	2000075	Sheep D.17
029	2000007	
030	2000038	
031	2020009	
032	2040010	
033	2000037	
034	2060068	

Top 30 pag. 6-7

Pos.	Ref.	Note
035	2070005	ITP207
036	2070013	ITP207
038	2070004	
039	2070007	ITP207
040	2070001	ITP207
041	2070019	ITP207
042	2070009	
043	2070003	
044	2000082	Goats D.18

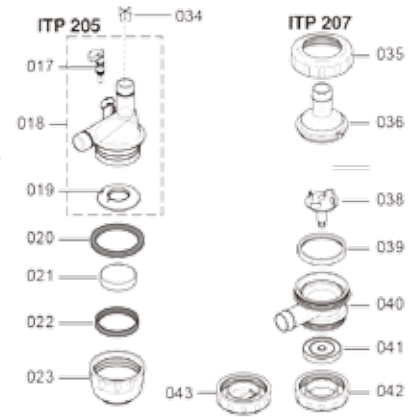
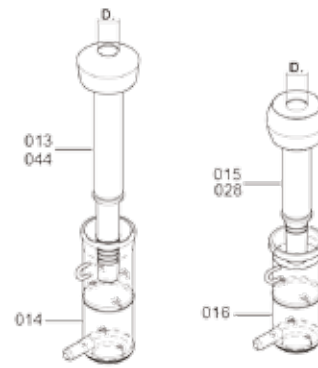
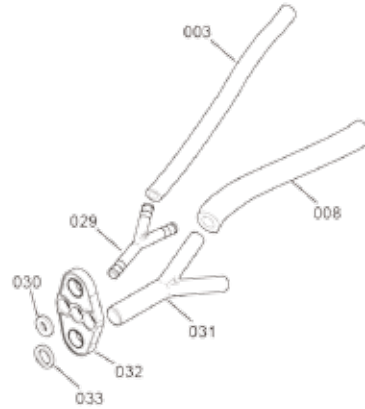

Vanguard





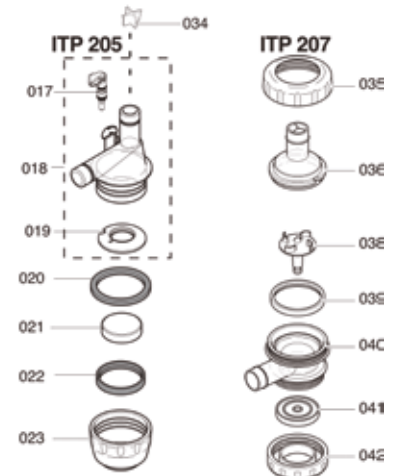
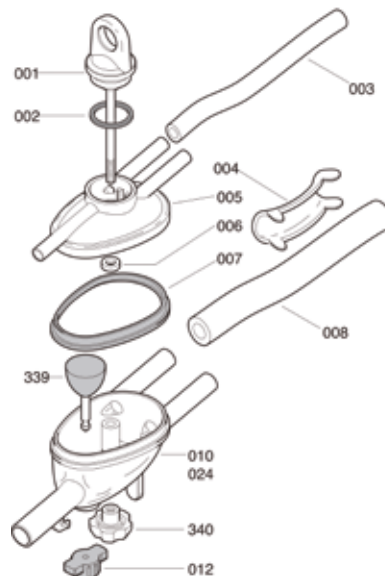
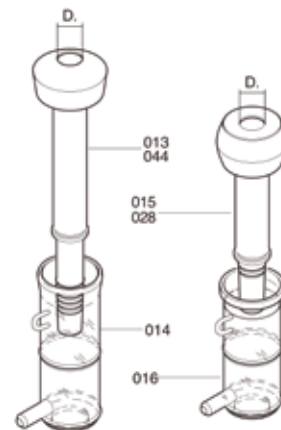
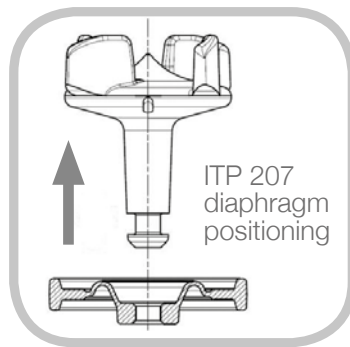

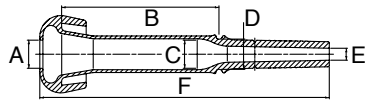

Pos.	Ref.	Note
001	2030003	
002	2030036	
003	2040011	
004	2030018	
005	2030029	Not vented
006	2030027	
007	2030005	
008	2020021	
010	2030030	Valve
012	2030006	
013	2000081	Goats D.20
014	2000076	Goats
015	2000069	Sheep D.18,5
016	2000077	Sheep
017	2050019	
018	2050021	
019	2050018	
020	2040005	
021	2000003	
022	2040004	
023	2040002	
024	2030031	w/o valve
025	2030034	Not vented
026	2030035	Vented
027	2030032	Vented
028	2000075	Sheep D.17
034	2060068	
035	2070005	ITP207
036	2070013	ITP207
038	2070004	
039	2070007	ITP207
040	2070001	ITP207
041	2070019	ITP207
042	2070009	
044	2000082	
339	2030038	
340	2030023	

Top 30 pag. 6-7

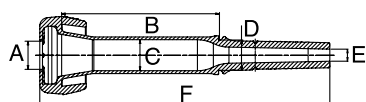

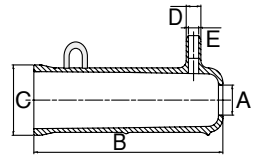
<p>ITP 203</p>  <p>Sim.</p>	<p>Ref.</p> <p>With vent 2039006 - With Shut-off 2039051* - With Shut-off - PSU</p> <p>Without vent 2039005 - With Shut-off 2039049 - With Shut-off - PSU</p>	<p>ITP 203</p>  <p>Alt.</p>	<p>Ref.</p> <p>With vent 2039018 - With Shut-off 2039057* - With Shut-off - PSU</p> <p>Without vent 2039017 - With Shut-off 2039059* - With Shut-off - PSU</p>
<p>ITP 203</p>  <p>Sim.</p>	<p>With vent 2039008* - Without Shut-off 2039053* - Without Shut-off - PSU</p> <p>Without vent 2039012* - Without Shut-off 2039055* - Without Shut-off - PSU</p>	<p>ITP 203</p>  <p>Alt.</p>	<p>Without vent 2039029 - With Shut-off</p>
<p>ITP 207</p> 	<p>Ref.</p> <p>Top 30 2079016 Automatic without spring Normally closed</p> <p>Top 30 pag. 6-7</p>	<p>ITP 205</p> 	<p>Ref.</p> <p>Top 30 2059016 Semi-Automatic Normally open</p> <p>Top 30 pag. 6-7</p>
<p>Classic for Goats</p> 	<p>Ref.</p> <p>2059012 ITP205</p>	<p>Classic for Sheep</p> 	<p>Ref.</p> <p>2059013 ITP205</p>
<p>Vanguard for Goats</p>  <p>Sim.</p>	<p>Ref.</p> <p>2039032 ITP205</p>	<p>Vanguard for Sheep</p>  <p>Sim.</p>	<p>Ref.</p> <p>2039033 ITP205</p>
<p>Vanguard for Goats</p>  <p>Sim.</p>	<p>2039034 ITP205 Without Shut-off valve</p>	<p>Vanguard for Sheep</p>  <p>Sim.</p>	<p>2039033 ITP205</p>
<p>Vanguard for Goats</p>  <p>Alt.</p>	<p>2039035 ITP205</p>	<p>Vanguard for Sheep</p>  <p>Alt.</p>	<p>2039036 ITP205</p>
<p>Vanguard for Goats</p>  <p>Alt.</p>	<p>2039037 ITP205 Without Shut-off valve</p>	<p>Vanguard for Sheep</p>  <p>Alt.</p>	<p>2039036 ITP205</p>

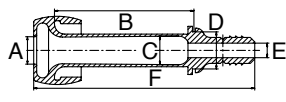
*Special item available on demand.

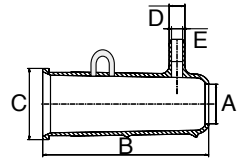
Classic for Goats	Ref. 2079003 ITP207	Classic for Sheep	Ref. 2079004 ITP207 2079011 with sheep liner D. 17 Ref. liner 2000075																					
Vanguard for Goats	Ref. 2039038 ITP207	Vanguard for Sheep	Ref. 2039039 ITP207																					
Sim.																								
Sim.	2039040 ITP207 Without Shut-off valve	Sim.																						
Alt.	2039041 ITP207																							
Alt.	2039043 ITP207 Without Shut-off valve	Alt.	2039042 ITP207																					
Goats Liner & TCS	Ref.	Note																						
	2000082* - D. 18 2000081 - D. 20		<table border="1"> <thead> <tr> <th></th> <th>A</th> <th>B</th> <th>C</th> <th>D</th> <th>E</th> <th>F</th> </tr> </thead> <tbody> <tr> <td>Goats</td> <td>18</td> <td>112</td> <td>20</td> <td>21,5</td> <td>8,5</td> <td>206</td> </tr> <tr> <td>Goats</td> <td>20</td> <td>112</td> <td>20</td> <td>21,5</td> <td>8,5</td> <td>206</td> </tr> </tbody> </table>		A	B	C	D	E	F	Goats	18	112	20	21,5	8,5	206	Goats	20	112	20	21,5	8,5	206
	A	B	C	D	E	F																		
Goats	18	112	20	21,5	8,5	206																		
Goats	20	112	20	21,5	8,5	206																		
Rounded head																								
	2000083		<table border="1"> <thead> <tr> <th></th> <th>A</th> <th>B</th> <th>C</th> <th>D</th> <th>E</th> <th>F</th> </tr> </thead> <tbody> <tr> <td>Goats</td> <td>20</td> <td>112</td> <td>22</td> <td>20</td> <td>8,5</td> <td>206</td> </tr> </tbody> </table>		A	B	C	D	E	F	Goats	20	112	22	20	8,5	206							
	A	B	C	D	E	F																		
Goats	20	112	22	20	8,5	206																		
Flat head																								
	2000076		<table border="1"> <thead> <tr> <th></th> <th>A</th> <th>B</th> <th>C</th> <th>D</th> <th>E</th> </tr> </thead> <tbody> <tr> <td>Goats</td> <td>20,5</td> <td>129</td> <td>48</td> <td>10</td> <td>7</td> </tr> </tbody> </table>		A	B	C	D	E	Goats	20,5	129	48	10	7									
	A	B	C	D	E																			
Goats	20,5	129	48	10	7																			
Sheep Liner & TCS	Ref.	Note																						
	2000075* - D. 17 2000069 - D. 18,5		<table border="1"> <thead> <tr> <th></th> <th>A</th> <th>B</th> <th>C</th> <th>D</th> <th>E</th> <th>F</th> </tr> </thead> <tbody> <tr> <td>Sheep</td> <td>17</td> <td>94</td> <td>19,3</td> <td>25</td> <td>9,8</td> <td>149</td> </tr> <tr> <td>Sheep</td> <td>18,5</td> <td>94</td> <td>19,3</td> <td>25</td> <td>9,8</td> <td>149</td> </tr> </tbody> </table>		A	B	C	D	E	F	Sheep	17	94	19,3	25	9,8	149	Sheep	18,5	94	19,3	25	9,8	149
	A	B	C	D	E	F																		
Sheep	17	94	19,3	25	9,8	149																		
Sheep	18,5	94	19,3	25	9,8	149																		
	2000077		<table border="1"> <thead> <tr> <th></th> <th>A</th> <th>B</th> <th>C</th> <th>D</th> <th>E</th> </tr> </thead> <tbody> <tr> <td>Sheep</td> <td>25</td> <td>105</td> <td>45</td> <td>10</td> <td>7</td> </tr> </tbody> </table>		A	B	C	D	E	Sheep	25	105	45	10	7									
	A	B	C	D	E																			
Sheep	25	105	45	10	7																			

*Special item available on demand.

Indicative dimensions in mm.

Accessories	Ref.	Note
Cluster studied to prevent the teat blocking.  	2030018	Teat cup positioner Dilatator Positionneur du faisceau Posicionador de pezoneras
	1900001	Cluster positioner Haltevorrichtung für das Melkzeug Positionneur du faisceau Posicionador de grupo de ordeño
	9000278	Up & down hanger Verstellbarer Aufhänger Tourniquet réglage Suspensión arriba y abajo
 <p>D. 14x10</p> <p>D. 14x10</p>	<p>Top 30 2060078 With vent for ITP206</p> <p>Top 30 2060079 Without vent</p> <p>Top 30 pag. 6-7</p>	
<p>A  D. 17x8</p> <p>B  D. 17x8</p>	<p>A 9000065 Sheep</p> <p>B 9000152 Goats</p>	Jetter Spülstopfen Jetter cup Spülbecher
 <p>D. 9x7</p> <p>D. 17x13</p>	9000074	Distributor with vent Verteiler mit Entlüftung Distributeur d'eau avec entrée d'air Distribuidor con sistema de ventilación
	9000283	Distributor 4-Wege-Verteiler Distributeur d'eau Desviación en 4 vías
 <p>D. 8x6</p>	2000007	Air distributor Luftverteiler Distributeur d'air Distribuidor de aire
 <p>D. 14x10</p> <p>D. 18x14</p>	2020023	With vent Mit Entlüftung Avec entrée d'air Con ventilación
 <p>D. 14x10</p> <p>D. 18x14</p>	2020009	W/o vent Ohne Entlüftung Sans entrée d'air Sin ventilación

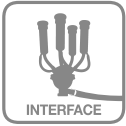

ITP 206

Sheep & Goats ACR claw

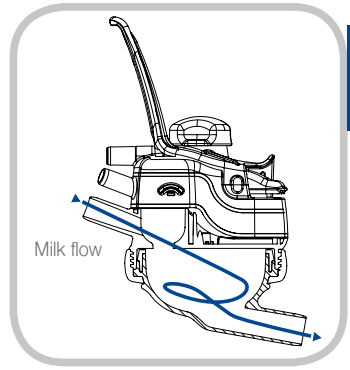

✓ Milk Bend

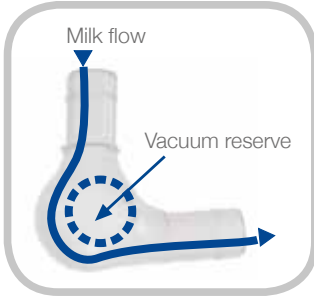

✓ HFS for ITP 206



✓ Patented

There is a constantly growing need for automation: this also applies to the milking process of small ruminants. For this reason InterPuls has devised the new collector for Goats and Sheep ITP206.

Der Bedarf an Automation nimmt ständig zu, so auch beim Melken kleiner Wiederkäuer. Aus diesem Grund hat InterPuls den neuen Milchkollektor ITP206 für Schafe und Ziegen entwickelt.

L'automatisme est une nécessité de plus en plus présente, y compris pour la traite des petits ruminants. À cet effet, InterPuls propose son nouveau collecteur Chèvres et Brebis ITP206.

Existe una necesidad constante y creciente de automatización, lo cual también se aplica al proceso de ordeño de los pequeños rumiantes. Por esta razón InterPuls ha ideado el nuevo colector para cabras y ovejas ITP206.



Benefits

- ✓ High vacuum stability
- ✓ High evacuation capacity of the milk flow
- ✓ Valves which are «normally closed» - zero leakages from the start of the milking process
- ✓ Operating principle based on separate valves
- ✓ Lightweight, ergonomic design
- ✓ Easy to clean and inspect

Vorteile

- ✓ Hohe Vakuumstabilität
- ✓ Hohe Melkleistung
- ✓ NC-Ventile - von Anfang des Melkvorgangs an keine Verluste
- ✓ Auf getrennten Ventilen basierendes Funktionsprinzip
- ✓ Leicht, ergonomisches Design
- ✓ Leicht zu reinigen und inspizieren

Avantages

- ✓ Grande stabilité du vide
- ✓ Grande efficacité d'évacuation du lait
- ✓ Vannes «normalement fermées» - chute de vide inexistante au départ
- ✓ Principe de fonctionnement à vannes indépendantes
- ✓ Légèreté et ergonomie
- ✓ Facilité de nettoyage et de contrôle

Beneficios

- ✓ Alta estabilidad de vacío
- ✓ Alta capacidad de evacuación del flujo de leche
- ✓ Las válvulas que están «normalmente cerradas» - no producen ninguna fuga desde el comienzo del proceso de ordeño.
- ✓ Principio de funcionamiento basado en válvulas separadas
- ✓ Peso ligero, diseño ergonómico
- ✓ Fácil de limpiar e inspeccionar

Technische Daten

Kapazität: 120 cm³
 Gewicht: 240 g
 Milcheinlaufschläuche: 14x10 mm
 Milchablaufschläuche: 18x14 mm
 Pulsationsschläuche: 10x7,5 mm
 Abmessungen Highline-Ausführung: 111x100x173 mm
 Abmessungen Lowline-Ausführung: 111x100x196 mm

Technical Data

Capacity: 120 cc
 Weight: 240 g
 Milk inlet tubes: 14x10 mm
 Milk outlet tubes: 18x14 mm
 Pulsation tubes: 10x7,5 mm
 Dimensions high-line version: 111x100x173 mm
 Dimensions low-line version: 111x100x196 mm

Pos.	Ref.	Note
001	2060025	Low Line
002	2060111	
003	2060021	
004	2060020	
005	2060019	
006	2060022	
007	2060036	Low Line
008	2060048	
009	2060018	
010	2060015	
011	2060014	
012	2060097	
013	2000081	Goat D.20
014	2000076	Goat
015	2000069	Sheep D.19
016	2000077	Sheep
017	2060008	

Pos.	Ref.	Note
018	2060055	
019	2060058	
020	2060109	
021	2060007	
Top 30 022	2060078	
023	2060054	
024	2060089	Low Line
025	2060004	
027	2060096	
028	2060049	
029	2060038	
030	2060024	High Line
031	2060016	High Line
032	2060088	High Line
033	2060001	High Line
034	2060068	
035	2060080	Low Line 10°

Top 30 pag. 6-7

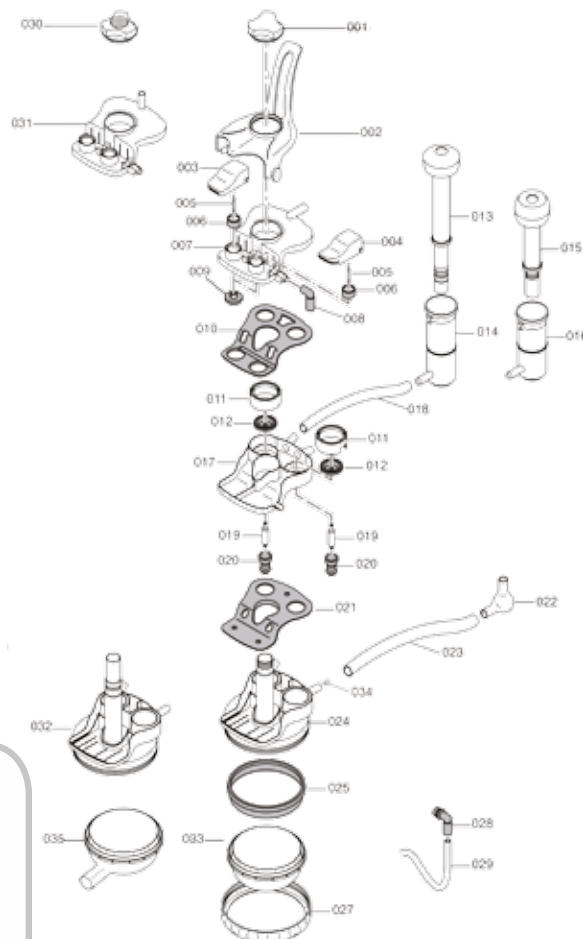

ITP 206 High Line	Ref.	ITP 206 Low Line 10°	Ref.
	2069042 Sim. not vented		2069028 Sim. not vented
Plastic Bend	Ref.	Plastic Bend	Ref.
	Top 30 2060078 Vented for ITP206 Top 30 pag. 6-7		Top 30 2060079 not Vented Top 30 pag. 6-7
ITP 206 Cluster for Goats	Ref.	ITP 206 Cluster for Sheep	Ref.
	2069056 High Line Sim.		2069057 High Line Sim.
	2069036 Low Line 10° Sim.		2069037 Low Line 10° Sim.

*Special item available on demand.

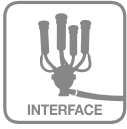

Optiflow III Sheep & Goats

Washing System



✓ Patented

InterPuls presents the new washing unit Optiflow III Sheep & Goats, the result of many years' experience earned in the small ruminants sector.

InterPuls präsentiert die neue Wascheinheit Optiflow III Schafe und Ziegen - das Ergebnis langjähriger Erfahrungen in der Branche der kleinen Wiederkäuer.

Fruit de sa grande expérience obtenue dans le secteur des petits ruminants, InterPuls présente son nouveau système de lavage Optiflow III Sheep & Goats.

InterPuls presenta su nueva unidad de lavado Optiflow III para ovejas y cabras, resultado de muchos años de experiencia obtenidos en el sector de los pequeños rumiantes.

Benefits

- ✓ Improved washing action thanks to the rotational flow
- ✓ Directly fixed to the pipe - more compact
- ✓ Available in two versions, with jetter cups or clamp
- ✓ Available for 40, 50.8 and 52 mm wash lines

Vorteile

- ✓ Verbesserte Reinigung dank der Rotationsbewegung.
Direkt am Rohr befestigt - kompakter
- ✓ In zwei Versionen mit Spülbechern oder Klemmen erhältlich
- ✓ Für 40, 50.8 und 52 mm Wäschanlagen erhältlich

Avantages

- ✓ Action de lavage améliorée grâce au flux de rotation
- ✓ Fixation directe sur la canalisation - réduction de l'encombrement
- ✓ Disponible dans la version avec coupelles ou avec serrures
- ✓ Disponible pour les lignes de lavage 40, 50.8 et 52 mm

Beneficios

- ✓ Acción de lavado optimizada gracias al flujo rotatorio
- ✓ Fijado directamente en el tubo - más compacto
- ✓ Disponible en dos versiones, con tazones limpiadores o abrazadera
- ✓ Disponible para líneas de lavado de 40, 50,8 y 52 mm

Technische Daten

Optiflow III S&Z mit Klemme

Gewicht: 250 g
Abmessungen: 200x180x80 mm
Wassereinlassschläuche ODxD: 15,5x12 mm
DM Klemmen: 44,5 mm

Optiflow III S&Z mit Spülbechern

Gewicht: 220 g
Abmessungen: 190x130x60 mm
Wassereinlassschläuche ODxD: 15,5x12 mm
DM Becher für Schafe ODxD: 60x49 mm
DM Becher für Ziegen ODxD: 66,5x56 mm

Technical Data

Optiflow III S&G with clamp

Weight: 250 g
Dimensions: 200x180x80 mm
Water inlet tubes ODxD: 15,5x12 mm
D. clamps: 44,5 mm

Optiflow III S&G with jetter cups

Weight: 220 g
Dimensions: 190x130x60 mm
Water inlet tubes ODxD: 15,5x12 mm
D. sheep cups ODxD: 60x49 mm
D. goat cups ODxD: 66,5x56 mm

Pos.	Ref.	Note
001	5310005	
002	5310012	
003	5310007	ID 56 Goats
004	5310004	
005	5310038	
008	5310002	
009	5310010	
010	5310022	D. 40
011	5310025	D. 52/50,8
012	5310023	D. 40
013	5310026	D. 52/50,8
014	5310032	
015	5310030	Kit D. 40
016	5310031	Kit D. 52/50,8
017	5310011	D. 44,5
018	5310006	ID 49 Sheep

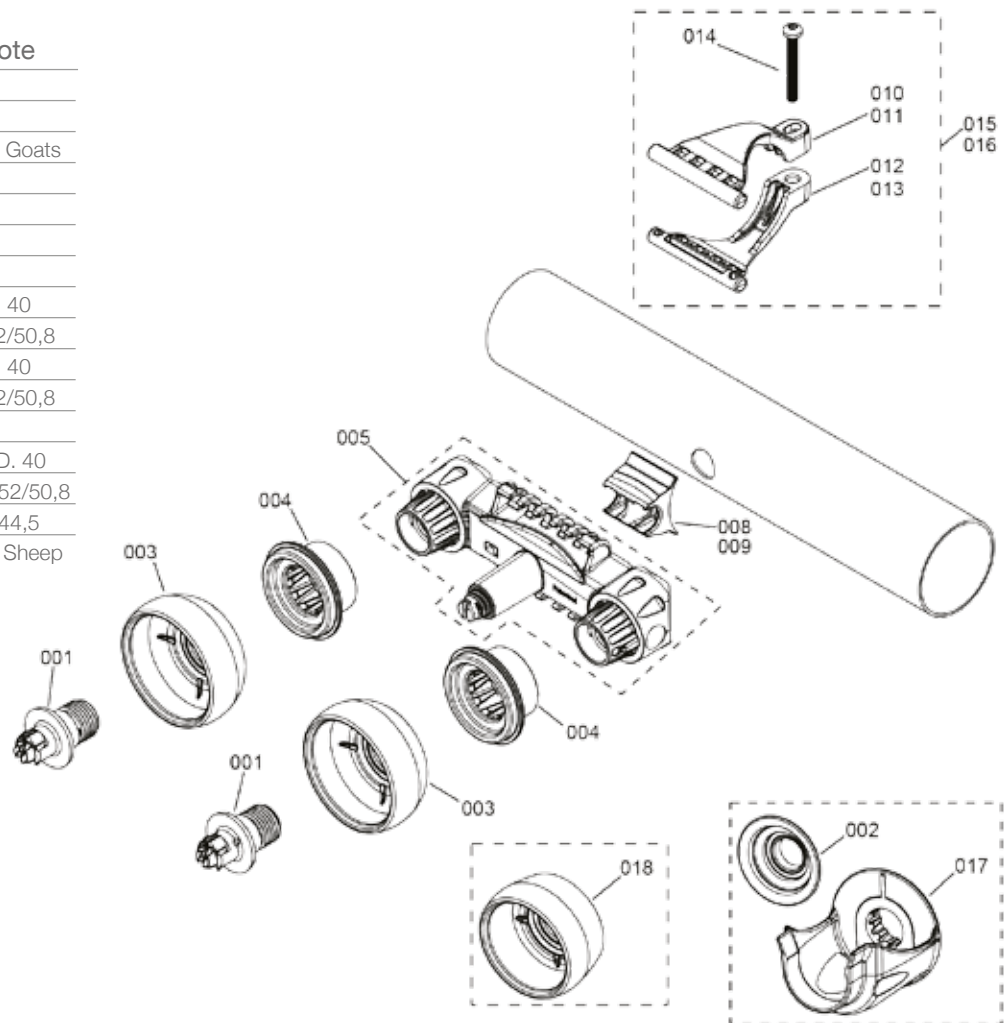

	Ref.	Note
	5319005 5319006	Optiflow III Sheep & Goats Clamp - Pipe D. 40 Optiflow III Sheep & Goats Clamp - Pipe D. 52/50,8
	5319001 5319002 5319003 5319004	Optiflow III Goats Jetter Cup - Pipe D. 40 Optiflow III Goats Jetter Cup - Pipe D. 52/50,8 Optiflow III Sheep Jetter Cup - Pipe D. 40 Optiflow III Sheep Jetter Cup - Pipe D. 52/50,8

3 Step Mounting

1 Drill the hole



2 Place the Optiflow

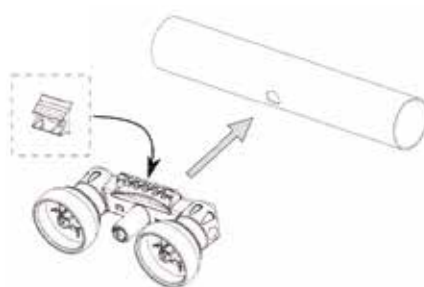

3 Fix the screw

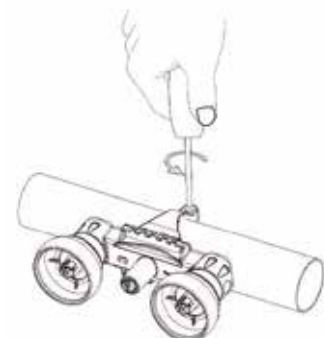

Sheep & Goat Yoke and Feeding Trough



- 1. Vacuum pump
- 2. Vacuum regulator
- 3. Vacuum gauge
- 4. Vacuum cock
- 5. Bucket assembly
- 6. Push up
- 7. Yoke & feeding trough

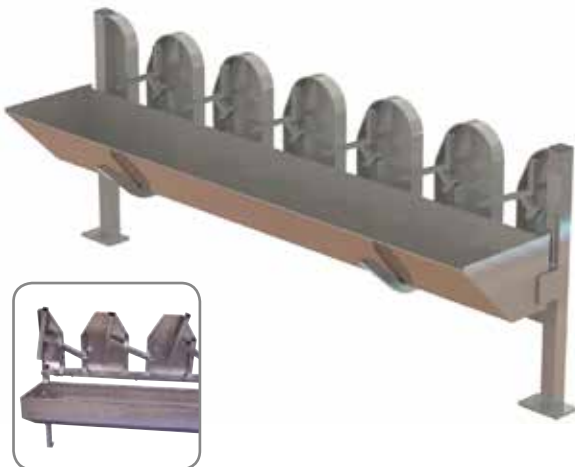
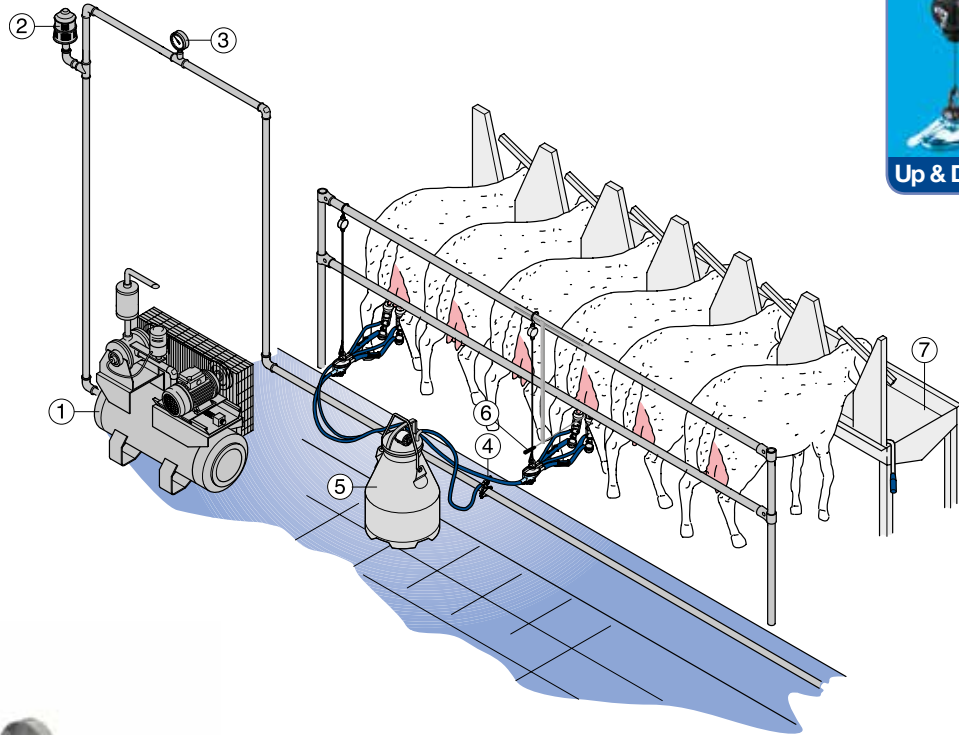

Sheep & goat yoke & feeding trough			
REF	Module distance [mm.]	Dimensions [mm.]	Weight [Kg]
9002894	320 (6 station 1.920)	Length 2.000 Width 380 Height 800	42













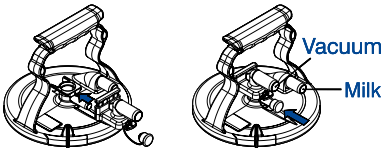

Libero 14 & 16

Clear Lid



Libero 14-16	Ref.	Note
 Adaptable to 142 mm bucket's handle	3100001	LIBERO 14
	3100002	LIBERO 16
		 OD19 - ID14  OD21- ID16
Libero 16 By Pass	Ref.	Note
 Adaptable to 142 mm bucket's handle	3100014	
Accessories	Ref.	Note
	Top 30 pag. 6-7	3100054 Gasket D. 205 mm
	3100006	Hook
	3100062	By-Pass TB 16
	2800285	Rubber Adaptor Seat
	2800046	Shut-Off Plug

Clear Lids



✓ Check valve housing



✓ Check valve



✓ Check valve assembly

ITP 30	Ref.	Note	Gasket	Ref.
	3100056 3100055 3100066	2 TB 19x14 2 TB 21x16 1 TB 21x16 + 1 TB 19x14	 D. 169,2 D. 205	Top 30 3100054
	3100058 3100059	3 TB 19x14 3 TB 21x16		Top 30 pag. 6-7
	3000018 3000019 3000020	2 TB 17x12 2 TB 21x16 1 TB 17x12 + 1 TB 21x16	 D. 172 D. 205	3000017
ITP 40	Ref.	Note	Gasket	Ref.
	3000010 3000025	3 TB 17x12 3 TB 21x16		
	3000011 3000024	2 TB 17x12 2 TB 21x16	 D. 182 D. 240	3000015



Ecobucket

23 & 30 L

100%
Recyclable Polymer



Benefits

- ✓ Built with advanced technology and composed by 100% recyclable polymers
- ✓ Semi-transparent translucent material
- ✓ Milk level is easily seen on the permanent graduated scale in kg & lb
- ✓ Easy to clean, thanks to the internal smooth surface
- ✓ Moulded in 1 piece, seamless between the bottom rim and the bucket body

Vorteile

- ✓ Hergestellt mit innovativer Technologie, aus 100 % recyclingfähigen Polymeren
- ✓ Halbtransparentes lichtdurchlässiges Material
- ✓ Milchfüllstand kann auf der Skala mit kg und lb leicht abgelesen werden
- ✓ Dank der glatten Innenfläche leicht zu reinigen
- ✓ In einem Stück gegossen, daher keine Schweißnähte zwischen Boden und Körper des Eimers

Avantages

- ✓ Construit avec technologie avancée et composé par 100% recyclables polymères
- ✓ Matériau translucide semi-transparent
- ✓ L'échelle graduée permanente en kg et en lb facilite la lecture du niveau du lait
- ✓ Facilité de nettoyage excellente grâce à la face intérieure lisse
- ✓ Moulé en une seule pièce, sans aucune soudure entre le bord inférieur et le corps du pot trayeur

Beneficios

- ✓ Construido con tecnología a la vanguardia y compuesto por polímeros reciclables 100%
- ✓ Material semitransparente translúcido
- ✓ El nivel de la leche se ve fácilmente en la escala permanente graduada en kg y lb
- ✓ Fácil de limpiar gracias a su superficie interna lisa
- ✓ De 1 pieza, sin empalmes entre el borde inferior y el cuerpo del cubo

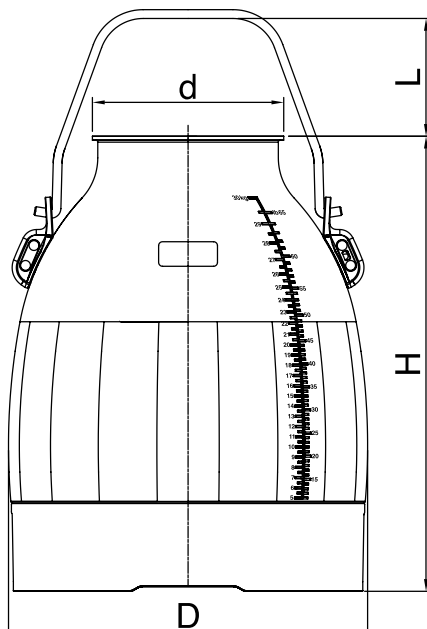

Capacity	H	d	D	L (STD)	Weight
30 L	464	195	366	145	3 kg
23 L	390	195	366	145	2,8 kg

Ecobucket 30 L	Ref.	Set Ecobucket 30 L	Ref.
	2619001 145 mm STD Handle		2619013 Set 12 x Ecobucket 30 L Standard Handle
Ecobucket 23 L	Ref.	Set Ecobucket 23 L	Ref.
	2619006 145 mm STD Handle		2619017 Set 12 x Ecobucket 23 L Standard Handle
Accessories	Ref.	Libero by-pass kit	Ref.
	2610031 Side Ear Kit		3100064*
	2610073 Bottom Part Only		

* Ecobucket not included.

Quarter Milker kits	Ref.	Note
	3100075*	Quarter Milker kit - L02 Air + ITP205
	3100077*	Quarter Milker kit - L80 + ITP205

* Ecobucket not included.

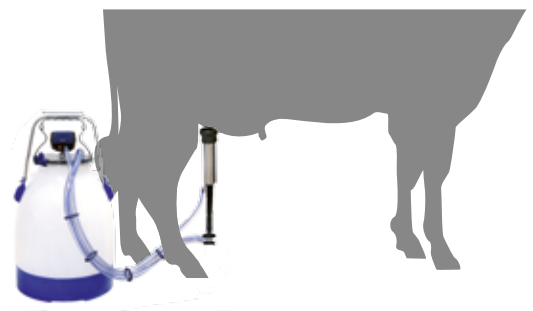

Stainless Steel Buckets

23, 25 & 30 L



Rounded Rim	Ref.	Capacity
		
	2609051	23 L
	2609061	25 L
	2609071	30 L



Sanitary Traps

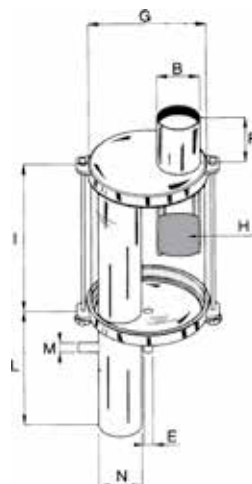

Ref.	Capacity [L]	B	E	F	G [D]	H	I	L	M	N
2209073	9	76	16	80	198	80	300	200	17	76
2209074	9	63	16	80	198	80	300	200	17	63
2209086	9	76	16	80	198	80	300	200	17	63

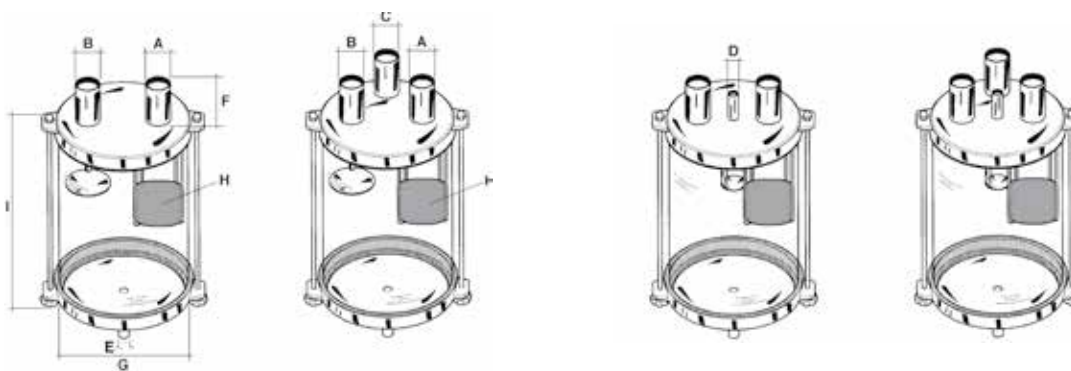

Ref.	Capacity [L]	A	B	C	D	E	F	G [D]	H	I
2209063	9	51	38			16	110	198	80	300
2209064	9	51	51			16	110	198	80	300
2209065	9	63	51			16	110	198	80	300
2209066	9	76	63			16	110	198	80	300
2209068	9	51	38		16	16	110	198	80	300
2209069	9	51	51		16	16	110	198	80	300
2209070	9	63	51		16	16	110	198	80	300
2209071	9	76	63		16	16	110	198	80	300
2209072	9	63	51	51	16	16	110	198	80	300

Indicative dimensions in mm.



S/S Filter



3400106

✓ FDA approved

Ref.	Calza Sock 57	A	B
2409109	620	32	32
2409110	620	40	40

Ref.	Calza Sock 76	A	B
2409113	620	32	32
2409114	620	40	40

Double filter

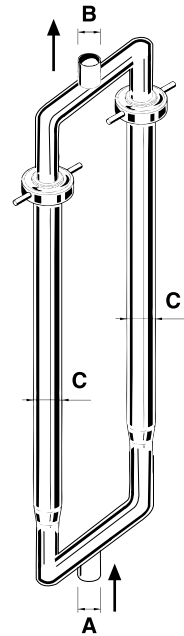

Ref. Sock 57	Calza Sock	A	B	C
2409096*	620	32	32	51
2409106*	620	40	40	51

Ref. Sock 57	Ref. Sock 76	Calza Sock	A	B	C
2409040	-	320	32	32	51
2409062	2409035*	455	32	32	51
2409063	2409036*	620	32	32	51
2409076	-	455	34	34	51
2409077	2409080*	620	34	34	51
2409047	-	320	40	40	51
2409064	2409038*	455	40	40	51
2409061	2409039*	620	40	40	51

Indicative dimensions in mm.

*Special item available on demand

Side entry

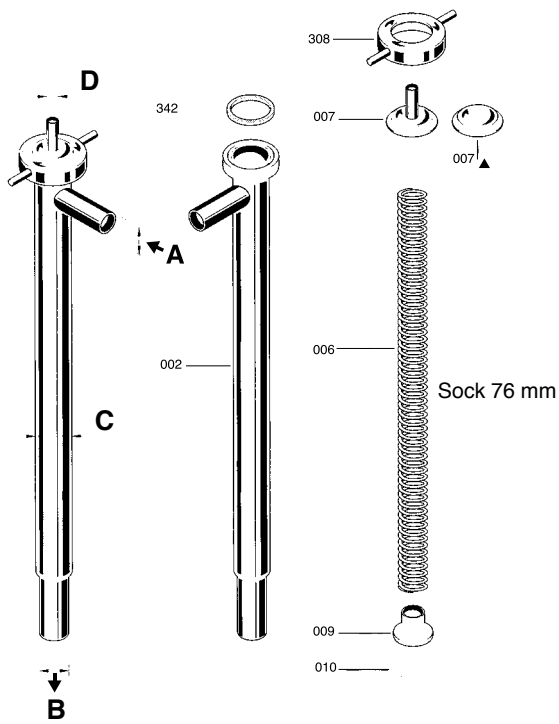

Ref. Sock 76	Calza Sock	A	B	C	D
2409010*	455	32	32	51	16
2409011*	620	32	32	51	16
2409013*	320	40	40	51	16
2409015*	620	40	40	51	16
2409018*	455	32	32	51	-
2409019*	620	32	32	51	-
2409023*	620	40	40	51	-

*Special item available on demand

✓ Polished inside and outside.





Swing Over Family

Telescopic & Compact Arm



Benefits

- ✓ Adjustable height
- ✓ Maintenance-free, self-lubricating bush
- ✓ Sturdy frame in square-section stainless steel
- ✓ Ergonomic height for the panel

Vorteile

- ✓ Verstellbare Höhe
- ✓ Wartungsfrei, selbstschmierende Hülse
- ✓ Robuste Struktur aus Vierkantedelstahl
- ✓ Ergonomische Höhe des Bedienungsfelds

Avantages

- ✓ Réglable en hauteur
- ✓ Bague autolubrifiante, exempte d'entretien
- ✓ Structure robuste en acier inox à section carrée
- ✓ Hauteur ergonomique de fixation du panneau

Beneficios

- ✓ Altura ajustable
- ✓ No necesita de mantenimiento, escobilla de lubricación automática
- ✓ Bastidor resistente de acero inoxidable de sección cuadrada
- ✓ Altura ergonómica del panel

Technische Daten

Interne Rohrführung für 16x28 mm Milchrohr
7.6x14.5 mm paarig
Maße "Telescopic": 1250x670x70 mm
Gewicht: 10 kg
Maße "Compact": 620x650x70 mm
Gewicht "Compact": 6 kg

Technical Data

Internal conduit for 16x28 mm milk pipe;
7.6x14.5 mm twin
Measurements "Telescopic": 1250x670x70 mm
Weight: 10 kg
Measurements "Compact": 620x650x70 mm
Weight "Compact": 6 kg

Swing Over	Ref.	Note
	4600571	Swing Over arm telescopic D. 52-63
	4600544	Swing Over arm compact D. 52-63
Accessories	Ref.	Note
	4600288	Autostart sensor kit



Stainless Steel Lids

Ref.	Note
4008001	D. 17 mm
4008080*	D. 19 mm



- Stainless steel lid suitable for the bucket of some Italian milking machines.
- Edelstahldeckel, der für den Eimer einiger italienischer Melkanlagen geeignet ist.
- Couvercle en acier inox adaptable sur pot de certaines trayeuses italiennes.
- Tapa de acero inoxidable apta para cubos de algunas máquinas ordeñadoras italianas.

Ref.	Note
4008003	D. 17 mm



- Stainless steel lid for different solutions (especially suitable for goat and sheep milking).
- Edelstahldeckel für verschiedene Lösungen (besonders gut zum Melken von Ziegen und Schafen geeignet).
- Couvercle en acier inox pour solutions diverses (particulièrement indiqué pour chevres et brebis).
- Tapa de acero inoxidable para distintas soluciones (especialmente apta para ordeñar ovejas y cabras).

Ref.	Note
4008009	D. 17 mm
4008082	D. 19 mm

Handwheel 3400028 not included



- Stainless steel lid suitable for different kinds of bucket.
- Edelstahldeckel, der für verschiedene Arten von Eimern geeignet ist.
- Couvercle en acier inox adaptable sur pot de plusieurs marques.
- Tapa de acero inoxidable apta para diferentes tipos de cubo.

Ref.	Note
4008010	D. 17 mm
4008084*	D. 19 mm

Handwheel 3400028 not included



- Stainless steel lid suitable for different kinds of bucket.
- Edelstahldeckel, der für verschiedene Arten von Eimern geeignet ist.
- Couvercle en acier inox adaptable sur pot de plusieurs marques.
- Tapa de acero inoxidable apta para diferentes tipos de cubo.

* Special item available on demand.



Ref.	Note
4008043	

Handwheel 3400030 included

- Stainless steel lid for different solutions (especially suitable for goat and sheep milking).
- Edelstahldeckel für verschiedene Lösungen (besonders gut zum Melken von Ziegen und Schafen geeignet).
- Couvercle en acier inox pour solutions diverses (particulièrement indiqué pour chèvres et brebis).
- Tapa de acero inoxidable para distintas soluciones (especialmente apta para ordeñar ovejas y cabras)



Ref.	Note
4008011	

Handwheel 3400028 not included

- Stainless steel lid for different solutions (especially suitable for goat and sheep milking).
- Edelstahldeckel für verschiedene Lösungen (besonders gut zum Melken von Ziegen und Schafen geeignet).
- Couvercle en acier inox pour solutions diverses (particulièrement indiqué pour chèvres et brebis).
- Tapa de acero inoxidable para distintas soluciones (especialmente apta para ordeñar ovejas y cabras)



Ref.	Note
4008019	D. 17 - H. 142 mm
4008075*	D. 19 - H. 142 mm
4008020*	D. 17 - H. 183 mm

- Stainless steel lid suitable for WestfaliaSurge bucket.
- Für WestfaliaSurge-Eimer geeigneter Edelstahldeckel.
- Couvercle en acier inox adaptable sur pot WestfaliaSurge.
- Tapa de acero inoxidable apta para cubo WestfaliaSurge



Ref.	Note
4008044	D. 17 mm
4008045*	D. 19 mm

Handwheel 3400030 included

- Stainless steel lid suitable for DeLaval bucket.
- Für WestfaliaSurge-Eimer geeigneter Edelstahldeckel.
- Couvercle en acier inox adaptable sur pot trayeur DeLaval.
- Tapa de acero inoxidable apta para cubo DeLaval.



Ref.	Note
4008026	D. 17 mm

- Stainless steel lid suitable for Melotte bucket.
- Für Melotte-Eimer geeigneter Edelstahldeckel.
- Couvercle en acier inox adaptable sur pot Melotte.
- Tapa de acero inoxidable apta para cubo Melotte.

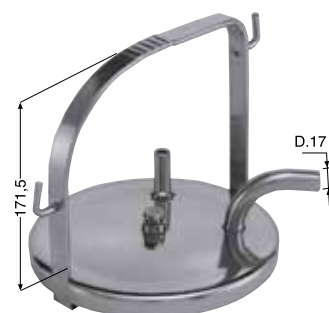

Ref.	Note
4008021*	

- Stainless steel lid suitable for Miele bucket.
- Für Miele-Eimer geeigneter Edelstahldeckel.
- Couvercle en acier inox adaptable sur pot trayeur Miele.
- Tapa de acero inoxidable apta para cubo Miele.



Ref.	Note
4008029	D. 17 mm
4008115	D. 19 mm
4008117*	D. 22 mm

- Stainless steel lid for different solutions.
- Edelstahldeckel für verschiedene Lösungen.
- Couvercle en acier inox pour solutions diverses.
- Tapa de acero inoxidable para distintas soluciones.



Ref.	Note
3400098	

Top 30 pag. 6-7

- Plastic handwheel for s/s std lid.
- Kunststoffhandrad für Standarddeckel aus Edelstahl.
- Écrou en plastique pour couvercle inox.
- Volante de plástico para tapa estándar de acero inoxidable.



Ref.	Note
3400030	

- Plastic handwheel for s/s std lid.
- Kunststoffhandrad für Standarddeckel aus Edelstahl.
- Écrou en plastique pour couvercle inox.
- Volante de plástico para tapa estándar de acero inoxidable.

* Special item available on demand.



Ref.	Note
3100054	D. 205 mm

Top 30 pag. 6-7

- Gasket for lid.
- Deckeldichtung.
- Joint pour couvercle.
- Junta para tapa.

✓ The height of the lid handle is quoted without considering the gasket. The inside diameter of the lid plate is of 198 mm.

S/S Teat Cup Shell

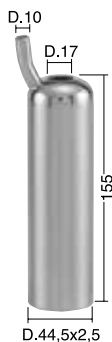
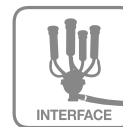

Ref.	Note
4208006	gr 420

- Stainless steel teatcup shell suitable for DeLaval.
- Für DeLaval geeigneter Zitzenbecher aus Edelstahl.
- Gobelet en acier inox adaptable DeLaval.
- Colector de pezoneras de acero inoxidable ideal para DeLaval.

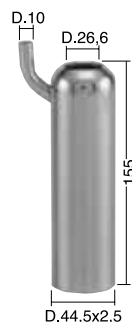

Ref.	Note
4208132	gr 400

- Stainless steel teatcup shell standard
- Standardmäßiger Zitzenbecher aus Edelstahl.
- Gobelet en acier inox mod. standard.
- Colector estándar de pezoneras

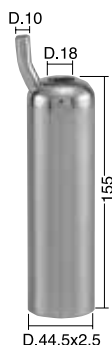

Ref.	Note
4208007	gr 420

- Stainless steel teatcup shell suitable for DeLaval.
- Für DeLaval geeigneter Zitzenbecher aus Edelstahl.
- Gobelet en acier inox adaptable DeLaval.
- Colector de pezoneras de acero inoxidable ideal para DeLaval.



Ref.	Note
4208125	gr 250

- Stainless steel teatcup shell suitable for Alfa-Laval.
- Für Alfa-Laval geeigneter Zitzenbecher aus Edelstahl.
- Gobelet en acier inox adaptable Alfa-Laval.
- Colector de pezoneras de acero inoxidable ideal para Alfa-Laval

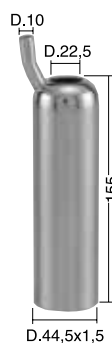

Ref.	Note
4208147	H 155 - gr 250
4208215*	H 155 - gr 420
4208175*	H 140 - gr 230

- Stainless steel teatcup shell suitable for DeLaval.
- Für DeLaval geeigneter Zitzenbecher aus Edelstahl.
- Gobelet en acier inox adaptable DeLaval.
- Colector de pezoneras de acero inoxidable ideal para DeLaval.



Ref.	Note
4208146*	gr 200

- Stainless steel teatcup shell suitable for Alfa-Laval.
- Für Alfa-Laval geeigneter Zitzenbecher aus Edelstahl.
- Gobelet en acier inox adaptable Alfa-Laval.
- Colector de pezoneras de acero inoxidable ideal para Alfa-Laval



Ref.	Note
4208210	gr 240

- Stainless steel teatcup shell suitable for DeLaval.
- Für DeLaval geeigneter Zitzenbecher aus Edelstahl.
- Gobelet en acier inox adaptable DeLaval.
- Colector de pezoneras de acero inoxidable ideal para DeLaval.



Ref.	Note
4208191	gr 200

- Stainless steel teatcup shell suitable for Alfa-Laval.
- Für Alfa-Laval geeigneter Zitzenbecher aus Edelstahl.
- Gobelet en acier inox adaptable Alfa-Laval.
- Colector de pezoneras de acero inoxidable ideal para Alfa-Laval



Ref.	Note
4208043	gr 175

- Stainless steel teatcup shell suitable for DeLaval.
- Für DeLaval geeigneter Zitzenbecher aus Edelstahl.
- Gobelet en acier inox adaptable DeLaval.
- Colector de pezoneras de acero inoxidable ideal para DeLaval

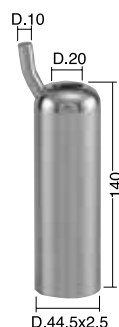

Ref.	Note
4208010	gr 380

- Stainless steel teatcup shell suitable for DeLaval.
- Für DeLaval geeigneter Zitzenbecher aus Edelstahl.
- Gobelet en acier inox adaptable DeLaval.
- Colector de pezoneras de acero inoxidable ideal para DeLaval

* Special item available on demand.



Ref.	Note
4208082*	gr 430

- Stainless steel teacup shell suitable for DeLaval.
- Für DeLaval geeigneter Zitzenbecher aus Edelstahl.
- Gobelet en acier inox adaptable DeLaval.
- Colector de pezoneras de acero inoxidable ideal para DeLaval.



Ref.	Note
4208012	gr 420

- Stainless steel teacup shell suitable for Manus.
- Für Manus geeigneter Zitzenbecher aus Edelstahl.
- Gobelet en acier inox adaptable Manus.
- Colector de pezoneras de acero inoxidable ideal para Manus.

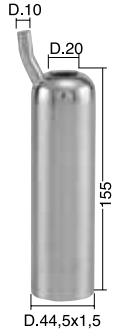

Ref.	Note
4208051	gr 260

- Stainless steel teacup shell suitable for Manus-Gascoigne.
- Für Manus-Gascoigne geeigneter Zitzenbecher aus Edelstahl.
- Gobelet en acier inox adaptable Manus-Gascoigne.
- Colector de pezoneras de acero inoxidable ideal para Manus-Cascoigne.



Ref.	Note
4208004	D. 17,5 - gr 260

- Stainless steel teacup shell suitable for Gascoigne.
- Für Gascoigne geeigneter Zitzenbecher aus Edelstahl.
- Gobelet en acier inox adaptable Gascoigne.
- Colector de pezoneras de acero inoxidable ideal para Cascoigne.

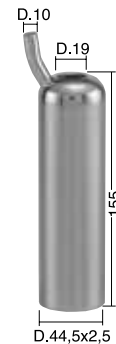

Ref.	Note
4208003	gr 420 - D. 44,5x2,5
4208062	gr 260 - D. 44,5x1,5

- Stainless steel teacup shell suitable for Gascoigne.
- Für Gascoigne geeigneter Zitzenbecher aus Edelstahl.
- Gobelet en acier inox adaptable Gascoigne.
- Colector de pezoneras de acero inoxidable ideal para Cascoigne.

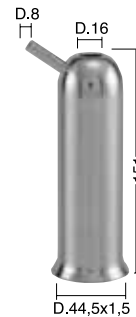

Ref.	Note
4208015*	gr 265

- Stainless steel teacup shell suitable for Melotte.
- Für Melotte geeigneter Zitzenbecher aus Edelstahl.
- Gobelet en acier inox adaptable Melotte.
- Colector de pezoneras de acero inoxidable ideal para Melotte.

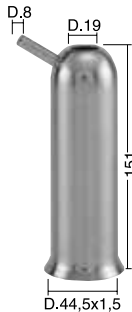

Ref.	Note
4208017*	gr 265

- Stainless steel teacup shell suitable for Melotte.
- Für Melotte geeigneter Zitzenbecher aus Edelstahl.
- Gobelet en acier inox adaptable Melotte.
- Colector de pezoneras de acero inoxidable ideal para Melotte.

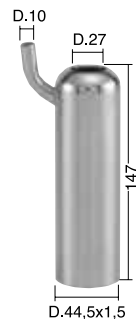

Ref.	Note
4208136	D. 27 - gr 230

- Stainless steel teacup shell suitable for Westfalia.
- Für Westfalia geeigneter Zitzenbecher aus Edelstahl.
- Gobelet en acier inox adaptable Westfalia.
- Colector de pezoneras de acero inoxidable ideal para Westfalia.

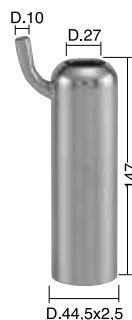

Ref.	Note
4208133	D. 27 - gr 390
4208139*	D. 27,5 - gr 390

- Stainless steel teacup shell suitable for Westfalia.
- Für Westfalia geeigneter Zitzenbecher aus Edelstahl.
- Gobelet en acier inox adaptable Westfalia.
- Colector de pezoneras de acero inoxidable ideal para Westfalia.

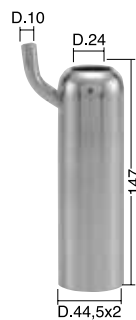

Ref.	Note
4208134*	gr 320

- Stainless steel teacup shell suitable for Miele.
- Für Miele geeigneter Zitzenbecher aus Edelstahl.
- Gobelet en acier inox adaptable Miele.
- Revestimiento de la pezonera de acero inoxidable ideal para Miele.

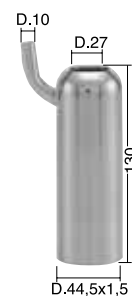

Ref.	Note
4208138*	gr 205

- Stainless steel teacup shell suitable for Westfalia.
- Für Westfalia geeigneter Zitzenbecher aus Edelstahl.
- Gobelet en acier inox adaptable Westfalia.
- Colector de pezoneras de acero inoxidable ideal para Westfalia.

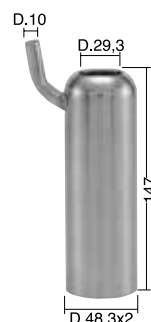

Ref.	Note
4208089	gr 320

- Stainless steel teacup shell suitable for Fullwood.
- Für Fullwood geeigneter Zitzenbecher aus Edelstahl.
- Gobelet en acier inox adaptable Fullwood.
- Colector de pezoneras de acero inoxidable ideal para Fullwood.

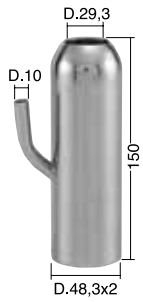

Ref.	Note
4208018	gr 340
<ul style="list-style-type: none"> - Stainless steel teacup shell suitable for Fullwood. - Für Fullwood geeigneter Zitzenbecher aus Edelstahl. - Gobelet en acier inox adaptable Fullwood. - Colector de pezoneras de acero inoxidable ideal para Fullwood. 	



Ref.	Note
4208149*	SP 1,5 mm - gr 240
4208194*	SP 1,2 mm - gr 200
<ul style="list-style-type: none"> - Stainless steel teacup shell suitable for Fullwood. - Für Fullwood geeigneter Zitzenbecher aus Edelstahl. - Gobelet en acier inox adaptable Fullwood. - Colector de pezoneras de acero inoxidable ideal para Fullwood. 	

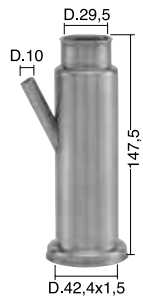

Ref.	Note
4208114*	gr 230
<ul style="list-style-type: none"> - Stainless steel teacup shell suitable for DeLaval. - Für DeLaval geeigneter Zitzenbecher aus Edelstahl. - Gobelet en acier inox adaptable DeLaval. - Colector de pezoneras de acero inoxidable ideal para DeLaval. 	



Ref.	Note
4208123*	gr 190
<ul style="list-style-type: none"> - Stainless steel teacup shell suitable for DeLaval. - Für DeLaval geeigneter Zitzenbecher aus Edelstahl. - Gobelet en acier inox adaptable DeLaval. - Colector de pezoneras de acero inoxidable ideal para DeLaval. 	



Ref.	Note
4208140	gr 180
<ul style="list-style-type: none"> - Stainless steel teacup shell suitable for Boumatic. - Für Boumatic geeigneter Zitzenbecher aus Edelstahl. - Gobelet en acier inox adaptable Boumatic. - Colector de pezoneras de acero inoxidable ideal para Boumatic. 	

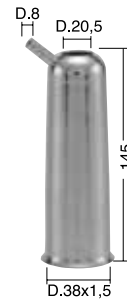

Ref.	Note
4208141*	H 145 mm - gr 200
4208198*	JF H 140 mm - gr 200
<ul style="list-style-type: none"> - Stainless steel teacup shell suitable for Surge. - Für Surge geeigneter Zitzenbecher aus Edelstahl. - Gobelet en acier inox adaptable Surge. - Colector de pezoneras de acero inoxidable ideal para Surge. 	

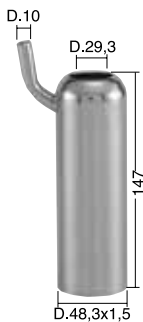

Ref.	Note
4208163*	gr 240
<ul style="list-style-type: none"> - Stainless steel teacup shell suitable for Fullwood. - Für Fullwood geeigneter Zitzenbecher aus Edelstahl. - Gobelet en acier inox adaptable Fullwood. - Colector de pezoneras de acero inoxidable ideal para Fullwood. 	



Ref.	Note
4308002	gr 365 - D. 17 (for IPL01)
4308005	gr 363 - D. 20
<ul style="list-style-type: none"> - Stainless steel teacup shell. - Zitzenbecher aus Edelstahl. - Gobelet en acier inox. - Colector de pezoneras de acero inoxidable 	



Ref.	Note
4308001	gr 330
<ul style="list-style-type: none"> - Stainless steel teacup shell for IPL 02 liners. - Zitzenbecher aus Edelstahl für IPL 02 Zitzengummis. - Gobelet en acier inox pour IPL 02 manchons trayeurs. - Colector de pezoneras de acero inoxidable para pezoneras IPL 02 	

* Special item available on demand.



Vacuum Taps & Accessories



Ref.	Note
3200004	1/2"
3200006	3/8"

- Vacuum tap straight, threaded male, nickeled.
- Gerader Vakuumhahn, Gewindegewinde mit Außengewinde, vernickelt



Ref.	Note
3200007	3/8"
3200005	1/2"

- Vacuum tap straight, threaded male, nickeled.
- Gerader Vakuumhahn, Gewindegewinde mit Außengewinde, vernickelt



Ref.	Note
3200011	3/4"-1" (26,9-33,7 mm)

- Straight vacuum tap clamped, nickeled.
- Gerade befestigter Vakuumhahn vernickelt

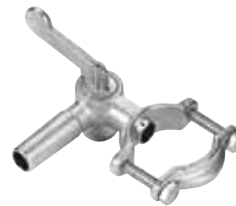

Ref.	Note
3200002	3/4"-1" (26,9-33,7 mm)
3200003	1-1/4"-1-1/2" (42,4-48,3 mm)

- Angle vacuum tap clamped, nickeled.
- Winklig befestigter Vakuumhahn, vernickelt.



Ref.	Note
3200040	2" (60,3 mm)

- Ball vacuum tap clamped, nickeled.
- Kugelförmig befestigter Vakuumhahn, vernickelt.



Ref.	Note
3200001	

- Complete s/s nipple for ball vacuum tap.
- Komplettes Anschlussstück aus Edelstahl für kugelförmig Vakuumhahn.



Ref.	Note
3200049	1/2"

- Ball vacuum tap threaded male, nickeled.
- Kugelförmiger Vakuumhahn, Gewindegewinde mit Außengewinde, vernickelt



Ref.	Note
3200015	

- Stainless steel spring.
- Edelstahlfeder.



Ref.	Note
3200041	

- Gasket for ball vacuum tap.
- Dichtung für kugelförmigen Vakuumhahn.



Ref.	Note
3200019	

- Stainless steel nipple.
- Edelstahlanchlussstück.



Ref.	Note
3200020	

- Gasket for vacuum tap clamped.
- Dichtung für befestigten Vakuumhahn.



Ref.	Note
4600247	



Rubber sleeves

Ref.	Size [mm.]	Note
9000340	29 x 29	
9000341	38 x 29	
9000342	36 x 36	
9000343	38 x 38	
9000160	49 x 38	
9000092	49 x 49	
9000344	61 x 49	
9000345	61 x 61	
9000346	73 x 61	
9000347	73 x 73	



Elbows

Ref.	Size [mm.]	Note
9000348	28 x 13	
9000349	29 x 29	
9000350	38 x 29	
9000351	36 x 36	
9000352	38 x 38	
9000353	49 x 38	
9000093	50 x 50	
9000354	61 x 49	
9000355	61 x 61	
9000356	73 x 61	
9000357	73 x 73	



Blank Cap



Milk entry for terminal units

Ref.	Size [mm.]	Note
9000358	38 x 43	
9000359	40 x 59	
9000360	50 x 59	
9000361	63 x 76	
9001570	76 x 76	

Blank Cap for terminal units

Ref.	Size [mm.]	Note
9001164	D.59	Blank Cap
9001165	D.76	Blank Cap

Milk line stopper



Blank



With S/S tube

D.16

Ref.	Size [mm.]	Note
9000363	D.38	Closed
9000364	D.50	Closed
9000422	D.60	Closed
9000806	D.73	Closed
9000275	D.38	With s/s exit
9000305	D.50	With s/s exit
9000782	D.60	With s/s exit
9000807	D.73	With s/s exit

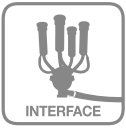

Fittings & Accessories

InterPuls comprehensive range of fixture and fittings facilitate correct installation of piping systems for new plants and upgrade of existing ones.



Stainless Steel straight milk entry

REF	Nipple [mm]	Saddle clamp	Note
9001090	16 x 1	38,1 ÷ 40	
9001091	16 x 1	50,8 ÷ 52	
9001092	18 x 1	38,1 ÷ 40	
9001093	18 x 1	50,8 ÷ 52	
9001094	18 x 1	63,5	
9001096	18 x 1	76,2	
9001097	22 x 1	38,1 ÷ 40	
9001098	22 x 1	50,8 ÷ 52	
9001099	22 x 1	63,5	
9001101	22 x 1	76,2	



Stainless Steel bended milk entry

REF	Nipple [mm]	Saddle clamp	Note
9001102	18 x 1	50,8 ÷ 52	
9001103	18 x 1	63,5	
9001105	22 x 1	70	



REF	Nipple [mm]	Saddle clamp	Note
9001106	18 x 1	50,8 ÷ 52	
9001107	18 x 1	63,5	
9001109	22 x 1	70	



Gasket for milk entry

REF	Nipple [mm]	Saddle clamp	Note
9001110	16 x 1	38,1 ÷ 52	
9001111	18 x 1	38,1 ÷ 52	
9001112	22 x 1	38,1 ÷ 52	
9001113	16 x 1	63,5 ÷ 76,2	
9001114	18 x 1	63,5 ÷ 76,2	
9001115	22 x 1	63,5 ÷ 76,2	



Stainless Steel straight milk entry

REF	Nipple [mm]	Saddle clamp	Note
9001116	16 x 1	38,1 ÷ 52	
9001117	16 x 1	63,5 ÷ 76,2	
9001118	18 x 1	38,1 ÷ 52	
9001119	18 x 1	63,5 ÷ 76,2	
9001120	22 x 1	38,1 ÷ 52	
9001121	22 x 1	63,5 ÷ 76,2	



Stainless Steel bended milk entry

REF	Nipple [mm]	Saddle clamp	Note
9001122	16 x 1	31,8 ÷ 52	180°
9001123	18 x 1	31,8 ÷ 52	180°
9001124	16 x 1	63,5 ÷ 76,2	180°
9001125	18 x 1	63,5 ÷ 76,2	180°



Milk Valve

REF	Nipple [mm]	Saddle clamp	Note
9001126	16 x 1	31,8 ÷ 52	Gaskets included
9001127	18 x 1	31,8 ÷ 52	Gaskets included
9001128	16 x 1	63,5 ÷ 76,2	Gaskets included
9001129	18 x 1	63,5 ÷ 76,2	Gaskets included



REF	Nipple [mm]	Note
9001130	16 x 1	Sliding nipple 90°
9001131	18 x 1	Sliding nipple 90°



Gasket top under slide

REF	Note
9001133	Gasket ID. 14 mm. top under slide
9001135	Gasket ID. 16 mm. top under slide

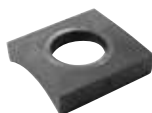

Gasket bottom - milk

REF	Note
9001132	Gasket ID. 14 mm. bottom - milk
9001134	Gasket ID. 16 mm. bottom - milk
9001136	Gasket ID. 20 mm. bottom - milk



Expanding Union

REF	Note
9002193	DIN11851 D.20
9002194	DIN11851 D.25
9002195	DIN11851 D.32
9002196	DIN11851 D.40
9002197	DIN11851 D.51
9002198	SMS D.25
9002199	SMS D.32
9002200	SMS D.40
9002201	SMS D.51



Coupling

REF	H [mm]	Clamp [mm]	Note
9001139	60	31,8 ÷ 34	
9001140	60	38,1 ÷ 40	
9001141	60	50,8 ÷ 52	
9001142	80	63,5	
9001143	80	76,2	
9001144	100	63,5	
9001145	100	76,2	

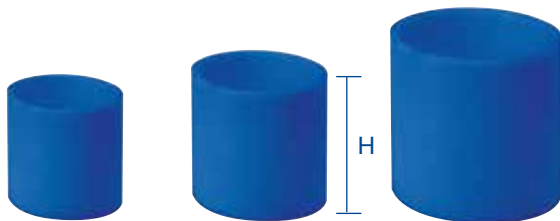

Coupling Socket

REF	H [mm]	Clamp [mm]	Note
9001146	60	31,8 ÷ 34	
9001147	60	38,1 ÷ 40	
9001148	60	50,8 ÷ 52	
9001149	80	63,5	
9001150	80	76,2	
9001151	100	63,5	
9001152	100	76,2	



Coupling

REF	H [mm]	Clamp [mm]	Note
9001265	60	31,8 ÷ 34	
9001023	60	38,1 ÷ 40	
9001024	60	50,8 ÷ 52	
9001026	80	63,5	
9001027	80	76,2	
9001028	100	63,5	
9001267	100	76,2	



Coupling Socket

REF	H [mm]	Clamp [mm]	Note
9001268	60	31,8 ÷ 34	
9001058	60	38,1 ÷ 40	
9001059	60	50,8 ÷ 52	
9001061	80	63,5	
9001062	80	76,2	
9001269	100	63,5	
9001270	100	76,2	



Snaplock		
REF	Size [mm]	Note
9001137	13 x 24	
9001138	16 x 28	



Butterfly Valve		
REF	Size [mm]	Note
9001153	40	
9001154	50,8	
9001155	52	
9001156	63,5	
9001157	76,2	



Manual Gate Valve		
REF	Size [mm]	Note
9002202	51	
9002203	63	
9002204	76	



3 Way Plug Valve		
REF	Size [mm]	Note
9001158	40	
9001159	52	
9001160	63,5	



U - Bends		
REF	Size [mm]	Note
9002174	40 x 110	
9002175	51 x 110	
9002176	51 x 120	
9002177	63 x 110	
9002178	63 x 120	
9002179	76 x 110	
9002180	76 x 120	
9002181	76 x 155	
9002182	76 x 180	
9002183	89 x 225	
9002184	101 x 180	



Stainless steel Straight Tube

REF	Size [mm]	Note
9001161	101,6 x 16	
9001162	101,6 x 18	
9001163	101,6 x 22	

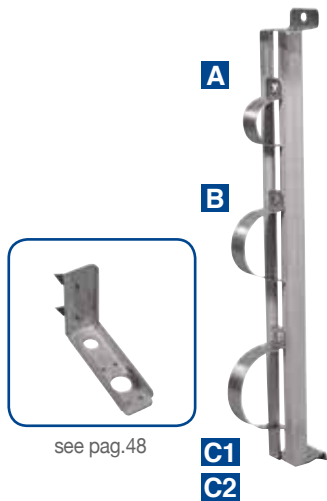

Stainless steel channel rail

REF	Size [mm]	Note
9001421	250	Raily only
9001441	350	Raily only
9000489	500	Raily only

Stainless steel channel rail clamp

REF	Size [mm]	Note
9000490	40	A
9000491	52	B
9000492	63	C1
9000493	76	C2



Tubing clamp

REF	Size [mm]	Note
9000499	32	
9000500	40	
9000501	50	
9000502	63	
9000503	76	
9000504	90	

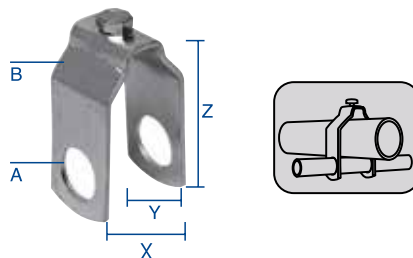

Hot galvanized tube wall bracket

REF	Diameters				Bolt and nut n°1	Overall Dimensions		
	A	B	A	B		X	Y	Z
9000261 *	1/2" x 1"		21 x 33		8 x 20	44	30	75
9000262 *	1/2" x 1" 1/4		21 x 42		8 x 20	50	35	83
9001254 *	1/2" x 1" 1/2		21 x 48		8 x 20	56	35	93
9000650 *	1/2" x 2"		21 x 60		8 x 20	74	35	100

* Master of 50 PCS

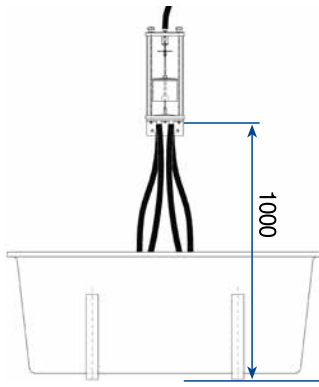

Bucket cluster wash unit

REF	Note
5339001	Boiling water version

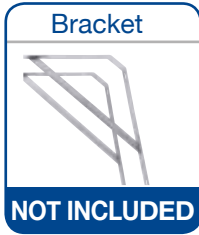

S/S Wash Trough Bottom Rounded

REF	Note	Size [mm]
9001229	50 L	460 x 525 x 320
9001230	70 L	625 x 525 x 320
9001231	Set of S/S wall brackets for 50 & 70 L	



S/S Wash Trough Rectangular

REF	Note	Size [mm]
9001232	100 L	555 x 490 x 490
9001646	150 L	805 x 490 x 490
9002205	200 L	1055 x 490 x 490
9002206	250 L	1305 x 490 x 490
9002207	300 L	1555 x 490 x 490
9002208	350 L	1820 x 490 x 490



S/S Lid for Wash Trough

REF	Note	Size [mm]
9001240	S/S Lid for 100 L	
9001842	S/S Lid for 150 L	
9002862	S/S Lid for 200 L	
9002863	S/S Lid for 250 L	
9002864	S/S Lid for 300 L	
9002865	S/S Lid for 350 L	

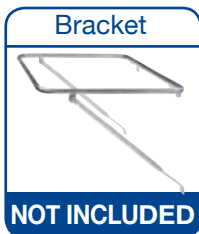

Plastic Wash Trough

REF	Note	Size [mm]
9001261	Plastic Wash Trough 60 L	720 x 590 x 300
9001262	Bracket for plastic W.T. 60 L	
9001263	Plastic Wash Trough 100 L	1000 x 490 x 490
9001264	Bracket for plastic W.T. 100 L	



S/S Plate

REF	Note	Size [mm]
9002209	InterPuls plate	290 x 180 x 1,5



Strip Cup	
REF	Note
9001418	Strip Cup



Standard Dipper	
REF	Note
9001403	



Non Return Dipper Cup	
REF	Note
9001402	



Non Return Unidipper	
REF	Note
9001404	Sheep & Goats



Multifoamer	
REF	Note
9001419	Multifoamer Dip Cup



Dipmizer



Cassette

Dipmizer	
REF	Note
9001531	
9002532	Cassette

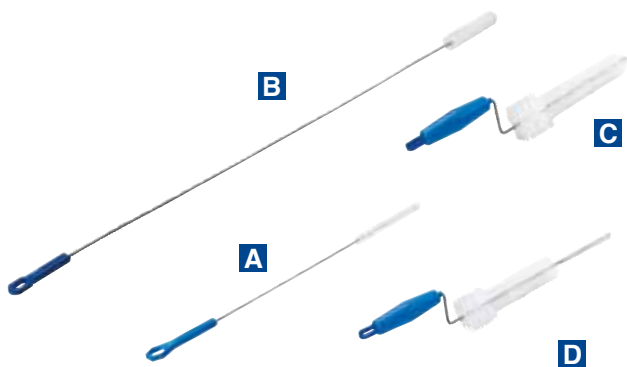

Brush		
REF	Size [mm]	Note
9000024	D.11 L.400	A - Short brush
9000025	D.22 L.1000	B - Long brush
9000256	D.80 L.2000	B - Long brush
9001591	D.19/38	C - Turning brush sheep
9000573	D.22/40	C - Turning brush goats
9000026	D.35/55	C - Turning brush
9000052	D.11/35/55	D - Turning brush

Milk Pumps



Milk Pump FP4100

Ref.	Description	MAX FLOW m ³ /h		Motor				
		Capacity @100kPa	Capacity @50kPa	Motor kW	Absorb. (A) @50Hz	Hz	Voltage	RPM
9000636	FP4100 MON 0.55 kW	12	8	0,55	4,1	50	220-240	2700
9000637	FP4100 TRI 0.55 kW	12	8	0,55	2,36/1,36	50	230-400	2800

- Capacity: 12 m³/h (200 l/min) @100kPa / 8 m³/h (133 l/min) @50kPa
- Inlet diameter: 32 mm • Outlet diameter: 22 mm + threaded part • Double bladed impeller



Milk Pump FP4600

9000638	FP4600 MON 0.75 kW	16	13	0,75	5,5	50	220-400	2700
9000639	FP4600 TRI 0.75 kW	16	13	0,75	3,05/1,75	50	230-400	2855
9000640	FP4600 TRI 1.1 kW	16	13	1,1	4,2/2,4	50	460-603	2845
9000643	Milk Pump Kit FP4600	16	13					

- Capacity: 16 m³/h (266 l/min) @100kPa / 13 m³/h (216 l/min) @50kPa
- Inlet diameter: 50 mm • Outlet diameter: 25 mm + threaded part • Double bladed impeller



Transfer Pump

9000987	FP4600 S/N TRI 0.75 kW	16	13	0,75	3,05/1,75	50	230-400	2855
9001017	FP66 TRI 1.5 kW	18	15	1,5	6,2/3,6	50	230-400	2800
9001645	FP66 TRI 1.1 kW (D.40)	18	15	1,1	4,25/2,49	50	220-380	2800
9001717	FP66 TRI 0.55 kW	18	15	0,55	2,36/1,36	50	230-400	2800
9000988	Milk Pump Kit FP66	18	15					

- Capacity: 18 m³/h (300 l/min) @100kPa
- Inlet diameter: 40 & 50 mm • Outlet Diameter: 25 mm + Threaded part

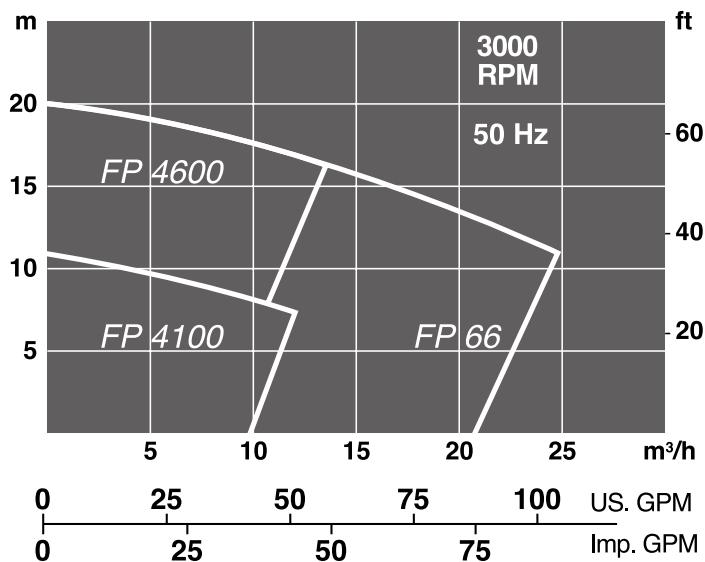



UTV Spare Parts



UTV control box

REF	Note
9001249	for mono phase milk pump
9000608	for three phase milk pump



A6D component

REF	Note
9001458	



UTV control box remote switch

REF	Note
9001414	for three phase control box
9001420	for mono phase control box



Accessories

REF	Note
9000607	FP 4100
9000651	FP 4600



Accessories

REF	Note
9000645	32 mm
9000646	32 / 40 mm

3400106
FDA Approved



Accessories

REF	Note
9000647	32 mm
9000648	32 / 40 mm



2 ways Distributor

REF	Size
9000725	11 x 16 mm



Elbow Double Drain

REF	Note
9002189	D.32 for FP4100, FP4600 and FP66 1.1 kW pumps
9002190	D.38
9002191	D.40
9002192	D.40 only for FP66 1.5 kW pumps

UTV Heavy Duty



Transparent Lid

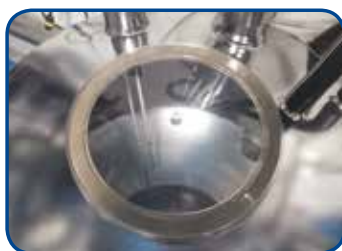

UTV Heavy Duty @50Hz

Ref.	Capacity	Milk Line	Milk Pump
9002841	54 L	40	4100 Mono.
9002842	54 L	52	4100 Tri.
9002843	84 L	63	4100 Tri.
9002844	84 L	70	4100 Tri.
9002845	104 L	63	4600 Tri.
9002846	104 L	70	4600 Tri.



UTV Heavy Duty

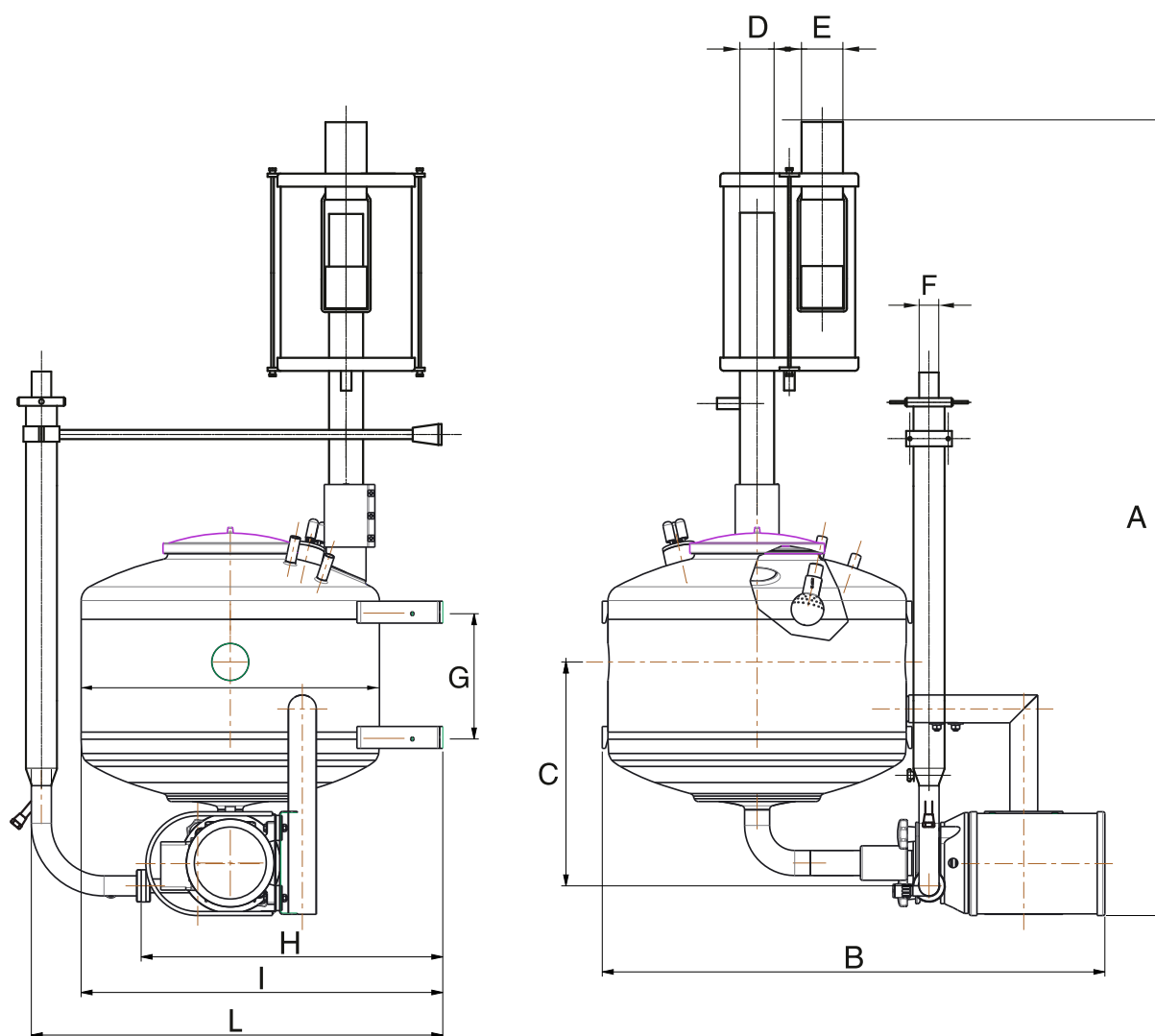

	UTV HD 54L	UTV HD 84L	UTV HD 104L
A	1.330	1.470	1.650
B	800	800	840
C	360	500	680
D	63	63	76
E	63	63	76
F	32	32	40
G	200	320	460
H	480	480	510
I	570	570	570
L	660	660	700
Sanitary trap	2209074	2209074	2209073
Milk filter	2409117	2409117	2409118
Milk pump @50Hz	9002853 - FP4100 0.55 kW Mono. 9002854 - FP4100 0.55 kW Three.	9002854 - FP4100 0.55 kW Three.	9002855 - FP4600 1.1 kW Three.
Control box	9001249 Monophase 9000608 Triphase	9000608 Triphase	9000608 Triphase
Milk Entry	9000359 40x59 9000360 50x59	9000361 63x76 9000362 70x76	9000361 63x76 9000362 70x76

Indicative dimensions in mm.

Vacuum Pumps



For high reliability and high efficiency. Our vacuum pumps deliver outstanding dependability from rugged cast-iron pump housing; powerful, proven motors; long life, low rpm operation; and innovative designs that minimize moving parts. Replacing vanes is simple and inexpensive.

Für hohe Zuverlässigkeit und hohe Effizienz. Unsere Vakuumpumpen bieten hervorragende Zuverlässigkeit durch ein robustes, gusseisernes Pumpengehäuse; leistungsstarke, bewährte Motoren; lange Lebensdauer und Betrieb bei niedriger Drehzahl; ein innovatives Design mit möglichst wenigen beweglichen Teilen. Der Austausch von Pumpenflügeln ist einfach und kostengünstig.

EPV



* US Plug

Monophase Rotary vane vacuum pumps

REF	Model	RPM	HP	KW	V	HZ	Capacity@50kPa [l. / min]	Note
6159003	EPV170	1.400	1	0,75	220	50	170	Dry

EPV



* US Plug

Monophase Rotary vane vacuum pumps

REF	Model	RPM	HP	KW	V	HZ	Capacity@50kPa [l. / min]	Note
6159004	EPV220	1.400	1	0,75	220	50	220	Dry

GEPV



Monophase Rotary vane vacuum pumps

REF	Model	RPM	HP	KW	V	HZ	Capacity@50kPa [l. / min]	Note	Vacuum tank capacity
6159007	GEPV170	1.400	1	0,75	220	50	170	Dry	17 L
6159008	GEPV220	1.400	1	0,75	220	50	220	Dry	17 L



Ref.	Note
5120001	G 1/4" (D. 63 mm) ITP Version
5120002	G 3/8" (D. 100 mm) ITP Version

- Standard vacuum meter.
- Standardmäßiges Vakuummeter.



Ref.	Note
9001382	A 1/2" M - 3/8" F
9001383	B 1/2" M - 1/4" F
3400053	C D. 32 - 1/2" F
3400054	C D. 40 - 1/2" F
3400055	C D. 50 - 1/2" F
3400056	C D. 63 - 1/2" F
3400058	C D. 76 - 1/2" F
3400060	C D. 90 - 1/2" F

- Adattatori fissaggio vacuometri analogici.
- Adapters for vacuum analogic gauge.

OD -1" - 1/4



GPV



PV



PV & GPV 350: Thriphase-50Hz - Rotary vane vacuum pumps

REF	Model	RPM	HP	KW	Amp.	Capacity@50kPa [l. / min]	Electric Motor Pulley size	Vacuum Pump Pulley size	Vacuum tank capacity
9000163*	PV350	-	-	-	-	350	-	130 1A	-
9000187	GPV350	1.400	1,5	1,1	5,8	350	130 1A	130 1A	45 L

*complete with oiler, belt, pulley and silencer



PV



GPV

OD -2"



PV



PV & GPV 500: Thriphase-50Hz - Rotary vane vacuum pumps

REF	Model	RPM	HP	KW	Amp.	Capacity@50kPa [l. / min]	Electric Motor Pulley size	Vacuum Pump Pulley size	Vacuum tank capacity
9000871*	PV500	-	-	-	-	500	-	-	-
9000665**	PV500	-	-	-	-	500	-	150 1A	-
9000125	GPV500	1.250	2,0	1,5	8,5	500	130 1A	150 1A	65 L

*vacuum pump only

**complete with oiler, belt, pulley and silencer



PV



GPV

OD -2"



PV



PV & GPV 750: Thriphase-50Hz - Rotary vane vacuum pumps

REF	Model	RPM	HP	KW	Amp.	Capacity@50kPa [l. / min]	Electric Motor Pulley size	Vacuum Pump Pulley size	Vacuum tank capacity
9000872*	PV750	-	-	-	-	750	-	-	-
9000668**	PV750	-	-	-	-	750	-	150 1A	-
9000156	GPV750	1.250	3,0	2,3	11,0	750	130 1A	150 1A	65 L

*vacuum pump only

**complete with oiler, belt, pulley and silencer

Suggested lubricating oil: ISO 46



PV



GPV

OD - 2" for 65 L
OD - 3" for 85 L



PV



PV & GPV 1000 - 1500: Thriphase-50Hz - Rotary vane vacuum pumps

REF	Model	RPM	HP	KW	Amp.	Capacity@50kPa [l. / min]	Electric Motor Pulley size	Vacuum Pump Pulley size	Tank	Servo
9000873*	PV1000	-	-	-	-	1000	-	-	-	
9000247**	PV1000	-	-	-	-	1000	-	150 1B	-	
9000157	GPV1000	1.200	4,0	3,0	5,2	1000	130 1B	150 1B	65 L	
9002252	GPV1000	1.200	4,0	3,0	5,2	1000	130 1B	150 1B	65 L	●
9001330*	PV1500	-	-	-	-	1500	-	-	-	
9000385**	PV1500	-	-	-	-	1500	-	150 1B	-	
9000470	GPV1500	1.300	5,5	4,0	7,4	1500	140 1B	150 1B	85 L	
9002253	GPV1500	1.300	5,5	4,0	7,4	1500	140 1B	150 1B	85 L	●

*vacuum pump only

**complete with oiler, belt, pulley and silencer



GPV without Vacuum Tank



GPV 2200 - 3300: Thriphase-50Hz - Rotary vane vacuum pumps

REF	Model	RPM	HP	KW	Amp.	Capacity@50kPa [l. / min]	Electric Motor Pulley size	Vacuum Pump Pulley size
9000471	GPV2200	1.350	7,5	5,5	10,9	2200	140 2B	150 2B
9000854	GPV3300	1.350	10,0	7,5	12,7	3300	130 2B	180 2B



PV



GPV

OD - 3" for 85 L
OD - 4" for 110 L



PV



PV & GPV 2200 - 3300: Thriphase-50Hz - Rotary vane vacuum pumps

REF	Model	RPM	HP	KW	Amp.	Capacity@50kPa [l. / min]	Electric Motor Pulley size	Vacuum Pump Pulley size	Tank	Servo
9000875*	PV2200	-	-	-	-	2200	-	-	-	
9000718**	PV2200	-	-	-	-	2200	-	150 2B	-	
9000472	GPV2200	1.350	7,5	5,5	10,9	2200	140 2B	150 2B	85 L	
9002254	GPV2200	1.350	7,5	5,5	10,9	2200	140 2B	150 2B	85 L	●
9000876*	PV3300	-	-	-	-	3300	-	-	-	
9001255**	PV3300	-	-	-	-	3300	-	180 2B	-	
9001260	GPV3300	1.350	10,0	7,5	12,7	3300	130 2B	180 2B	110 L	
9002255	GPV3300	1.350	10,0	7,5	12,7	3300	130 2B	180 2B	110 L	●

*vacuum pump only

**complete with oiler, belt, pulley and silencer

Suggested lubricating oil: ISO 46



Vacuum Accessories



Oilers		
REF	Pump model	Note
9000996	250 - 350	
9000997	500 - 750 - 1000	
9000998	1500	
9000720	2200 - 3300	
Accessories	Note	
9000623	Oiler plast. cont. only	



Oil separator		
REF	Pump model	Note
9000291	500 - 750	
9000290	1000 - 1500	



Drip Oiler	
REF	Note
9001832	5 L

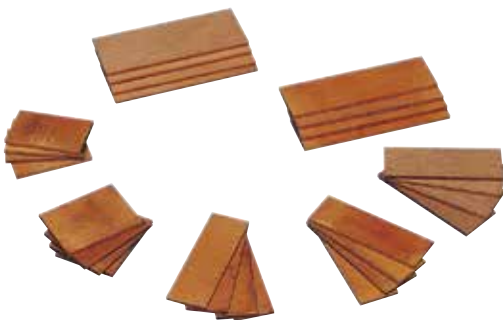

Vanes x4 set			
REF	Size [mm.]	Pump model	Note
6100021	70 x 42,5 x 5	EPV 170	Graphite
6100022	82 x 42,5 x 5	EPV 220	Graphite
9002351	120 x 45 x 5	PV 350	Kevlar
9002364	85 x 55 x 6	PV 450	Kevlar
9002353	85 x 65 x 6	PV 500	Kevlar
9002354	82 x 65 x 6	PV 750	Kevlar
9002352	164 x 50 x 6	PV 1000	Kevlar
9002358	164 x 65 x 6	PV 1500	Kevlar
9002359	245 x 65 x 6	PV 2200	Kevlar
9002360	289 x 87 x 6	PV 3300	Kevlar

Stall Ventilation Systems



Axial Fan



Axial Fan Benefits:

- Improves stall ventilation during the warm season
- Reduced moisture in the air
- Less heat stress for animals
- Reduced presence of insects and pests
- Significant increase in milk production
- Patented anti-fall blade system
- Quiet thanks to its low rotational speed

Vorteile des Axiallüfters:

- Verbessert die Stallventilation während der warmen Jahreszeit
- Reduziert die Luftfeuchtigkeit
- Weniger Hitzestress für die Tiere
- Geringerer Insekten- und Ungezieferbefall
- Erhebliche Steigerung der Milchproduktion
- Patentiertes absturzsicheres Schaufelsystem
- Geräuscharm dank der niedrigen Rotationsgeschwindigkeit

Axial Fan Blades Set

REF	Model	D [mm]	N° Blade	Air Flow m ³ /hour @ 50 Hz	Ventilation area [m ²]	Weight [Kg]
9001816	Axial Fan 4000	4000	6	150.000	200	24,5
9001817	Axial Fan 5000	5000	6	180.000	300	28,8
9001818	Axial Fan 6000	6000	6	200.000	600	33,6
9001819	Axial Fan 7000	7000	6	230.000	1000	37,4

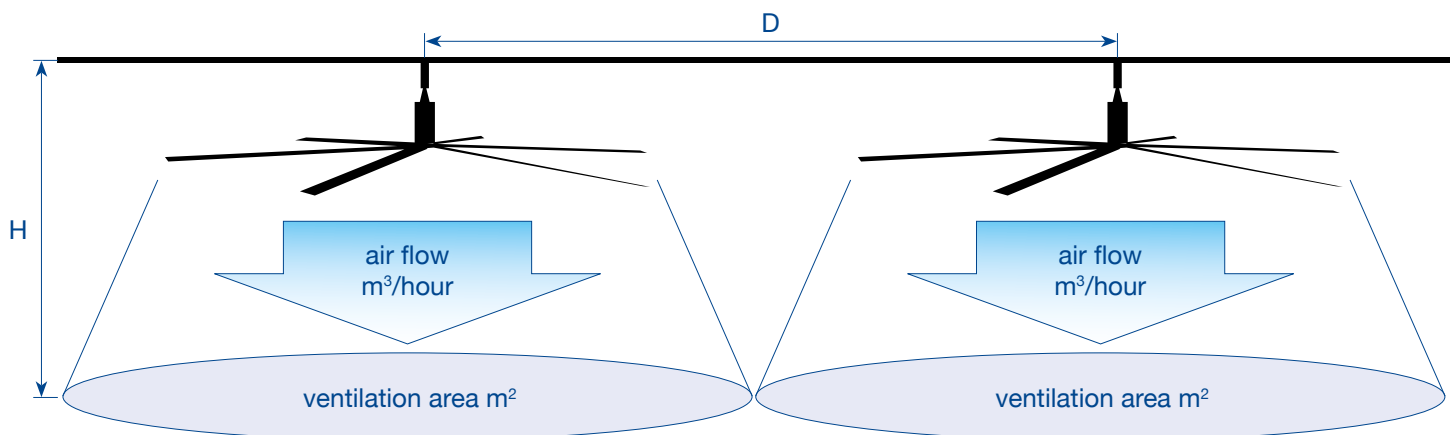

D → Axial Fan 4000 = 16 m, Axial Fan 5000 = 20 m, Axial Fan 6000 = 28 m, Axial Fan 7000 = 38 m

H = 2 m + D/2 Ex.: Axial Fan 7000 → 2 m + (7000/2) = 5,5 m



Wind Kit



Hub for Axial Fan Blades

REF	Note
9001840	Hub for Axial Fan 4000 Knotenpunkt für Axiallüfters 4000
9002148	Hub for Axial Fan 5000 + Wind Kit Knotenpunkt für Axiallüfters 5000 + Windkit
9002150	Hub for Axial Fan 6000-7000 + Wind Kit Knotenpunkt für Axiallüfters 6000-7000 + Windkit

Beam Bracket

REF	Note
9001820	Beam Bracket for Axial Fan Trägerklammer für Axiallüfter

Motor - Reductor for Axial Fan

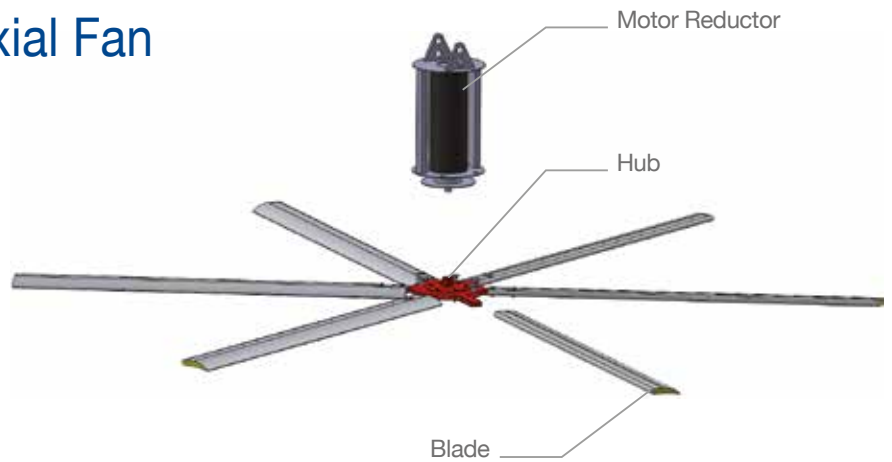

REF	Model	Motor	V	kW	Hz	A	Weight [Kg]
9001833	Motor-Reductor Axial Fan 4000-5000 Motorreduktor Axiallüfter 4000-5000	three-phase	380V	1,1	50	2,5	32,5
9001834	Motor-Reductor Axial Fan 6000-7000 Motorreduktor Axiallüfter 6000-7000	three-phase	380V	1,5	50	3,0	39,5



Horizontal Fan

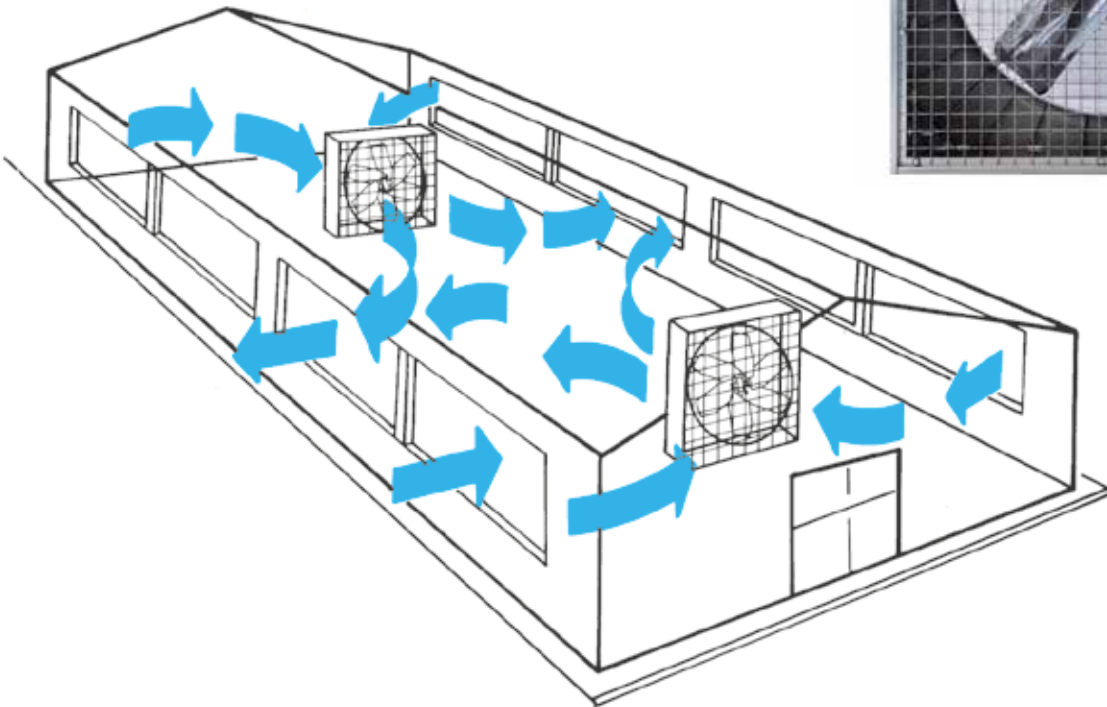

Horizontal Fan Benefits:

- Improved animal height ventilation
- Less heat stress
- Reduced moisture in the air
- Reduced presence of insects and pests
- Significant increase in milk production

Vorteile des Horizontallüfters:

- Verbesserte Ventilation auf Tierhöhe
- Geringerer Hitzestress
- Reduziert die Luftfeuchtigkeit
- Geringerer Insekten- und Ungezieferbefall
- Erhebliche Steigerung der Milchproduktion

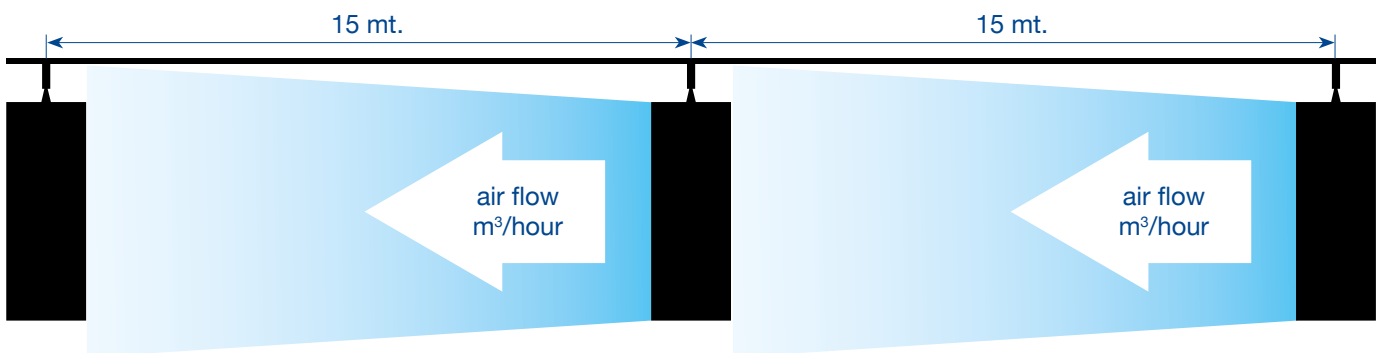

Horizontal Fan

REF	Model	Motor	V	kW	Hz	A	Air Flow [m³ hour]	Dimensions [mm]	Weight [Kg]
9001835*	Fan 660	three-phase	380V	0,37	50	1,4	15600	800 x 800 x 330	28
9001836*	Fan 780	three-phase	380V	0,37	50	1,4	17000	960 x 960 x 330	32
9001837*	Fan 990	three-phase	380V	0,37	50	2,3	25000	1150 x 1150 x 330	40
9001838*	Fan 1270	three-phase	380V	0,37	50	2,3	38000	1380 x 1380 x 330	50
9001839*	Fan 1750	three-phase	380V	0,37	50	3,8	72000	1930 x 1930 x 330	75

*Product subject to minimum order quantity. Please check with our sales office before placing any inquiry.



Fan Control Box

Suitable for Axial & Horizontal Fans

Fan Controller Benefits:

- Electric cost saving thanks to the inverter technology
- Easy to install
- Easy to program through the practical keyboard
- IP65 Protection class
- Automatic/Manual managing switch
- Manages up to 4 cooling speeds
- Automatic temperature-controlled speed modulation
- Temperature-controlled autostart

TECHNICAL DATA

- Input voltage: 380 V - 50/60 Hz
- Power: 1,5 - 5,5 kW

Vorteile der Lüftersteuerung

- Stromkosteneinsparungen dank der Wechselrichtertechnologie
- Einfach zu installieren
- Leicht über eine praktische Tastatur programmierbar
- Schutzart IP65
- Automatische / manuelle Umschalttaste
- Steuert bis zu 4 Kühlgeschwindigkeiten
- Automatische, temperaturgesteuerte Geschwindigkeitsregulierung
- Temperaturgesteuerter Autostart

TECHNISCHE DATEN

- Eingangsspannung: 380 V - 50/60 Hz
- Leistung: 1,5 - 5,5 kW

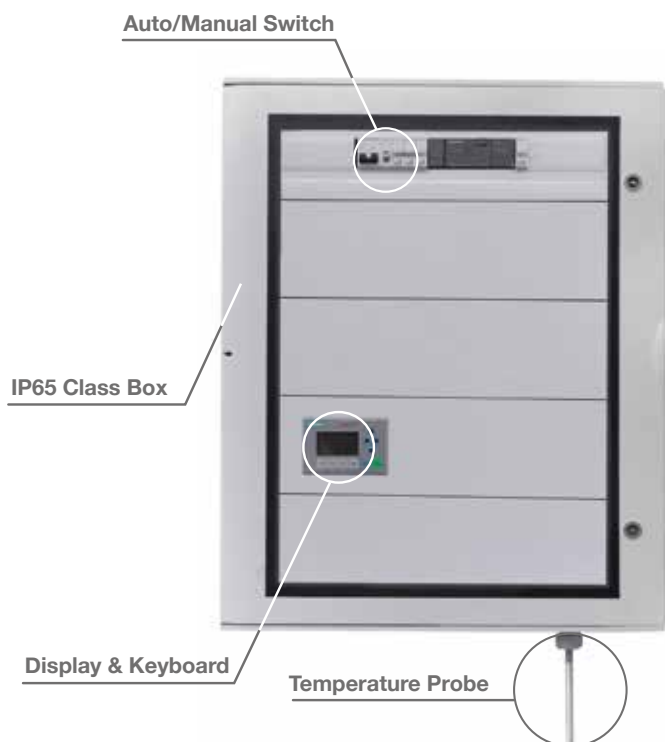

Inverter Technology

Fan Controller				
REF	V	kW	Hz	Dimensions [cm]
7009001	380	1,5	50/60	50 x 43 x 21
7009002	380	5,5	50/60	81 x 62 x 32

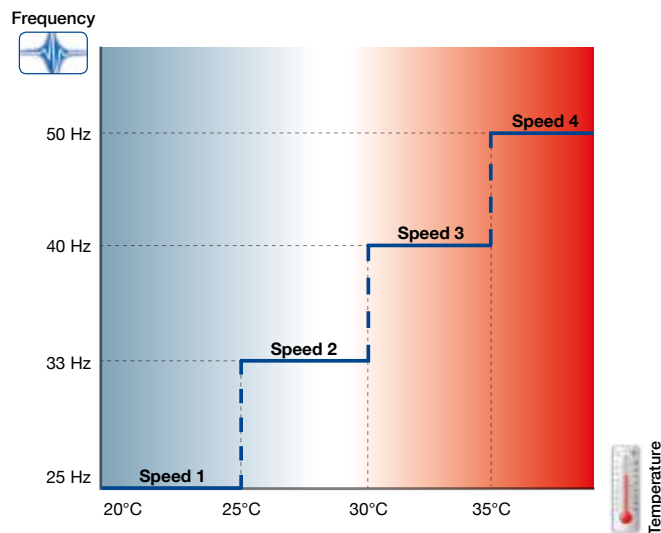

Thermal Switch

REF	Note
7000004	Thermal Switch 1,6 - 2,5 A / Thermoschalter 1,6 - 2,5 A
7000005	Thermal Switch 2,5 - 4 A / Thermoschalter 2,5 - 4 A
7000006	Thermal Switch 4 - 6,3 A / Thermoschalter 4 - 6,3 A



Thermal Switch Box

REF	Note
7000003	up to 4 Thermal Switches / bis zu 4 Thermoschalter



Portable Milking Machine

Ideal for low cows and buffaloes



PMM 170

Ref.	Description	Model	V	Hz
6019036	PMM 1 Bucket	1 Cow	220	50

Portable Milking Machine set up:

Pulsator	1 x L02 S/S cover 60/40
Cluster	1 x Lunik200 + IPL01 Liners
Bucket	1 x Ecobucket 30L
Vacuum Pump	1 x EPV170 dry



Ideal for sheep and goats



PMM 220 - Classic Cluster

Ref.	Description	Model	V	Hz
6019053	PMM 1 Bucket	2 Sheep Classic	220	50
6019055	PMM 1 Bucket	2 Goats Classic	220	50

Portable Milking Machine set up:

Pulsator (Sheep)	1 x L02 S/S cover 50/50 - 120ppm
Pulsator (Goats)	1 x L02 S/S cover 60/40 - 90ppm
Clusters	2 x Classic Sheep or Goats with ITP205 sim.
Bucket	1 x Ecobucket 30L
Vacuum Pump	1 x GEPV220 dry with 17L tank





ITALIA

Portable Milking Machine



InterPuls launches a new concept of "entry level". The sinuous shape, the ergonomic design, the innovative and recyclable materials together with an advanced production technology make the ITALIA portable system a new landmark that only the "Milking component specialist" could mark. 170ITALIA & 220ITALIA grant sturdiness and reliability in every condition, ergonomics in order to answer to the farmer's need and a sophisticated design to distinguish themselves!

Interpuls stellt ein neues „Einsteigermodell“ vor. Die geschwungene Form, das ergonomische Design, die innovativen, recycelbaren Materialien sowie fortschrittliche Produktionstechnologien machen das tragbare System ITALIA zu einem neuen Meilenstein, den nur der „Spezialist für Melkzubehör“ setzen konnte. 170ITALIA und 220ITALIA garantieren Robustheit und Zuverlässigkeit unter allen Einsatzbedingungen, Ergonomie, um die Anforderungen des Milchbauern zu erfüllen, sowie ein anspruchsvolles Design, mit denen sich die Geräte von anderen abheben.



Benefits



Ref.	Note
6009010	170ITALIA 220V @50 Hz - 1 cow

Ref.	Note
3100079	Bucket check valve

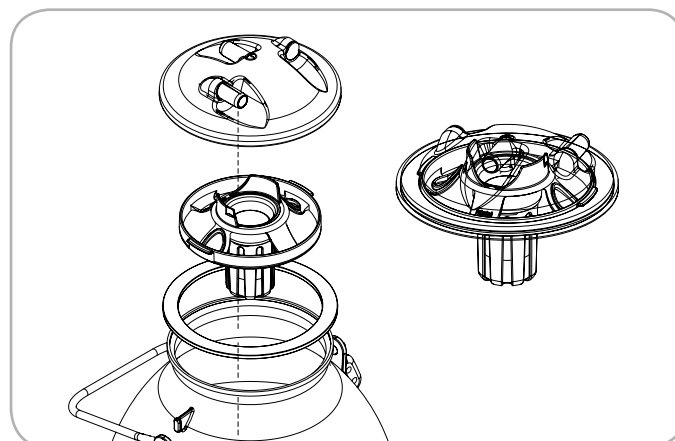



Tagliafieno LH22

Tagliafieno LH22 is the ideal solution for cutting hay bales and silage. Robust and easy-to-handle permits noise-free work, without dust and vibrations. The blades are designed to ensure precise cut, thanks to the optimal penetration, even in case of hard forage. It's advisable to oscillate the blades during the use, in order to benefit of the whole cutting width.

Der Tagliafieno LH22 ist die ideale Lösung zum Schneiden von Heuballen und Silage. Das Gerät ist robust und leicht zu handhaben und ermöglicht leises Arbeiten ohne Staub und Vibrationen. Die Messer sind so konstruiert, dass sie auf optimale Weise eindringen und somit präzise Schnitte auch bei hartem Futter gewährleisten. Es ist ratsam, die Messer während der Anwendung schwingen zu lassen, um die gesamte Schnittbreite zu nutzen.



Tagliafieno LH22	
Ref.	Note
6209001	Tagliafieno 230V @50/60Hz

Technical Data

Voltage: 230V @50Hz, 2000 rpm, 1.0kW, 4,5Amp;
 115V @60Hz, 2000 rpm, 0.9kW, 8,6Amp
 Weight: 15Kg
 Cutting width: 50cm
 Cutting depth: 60cm

Technische Daten

Spannung: 230V bei 50Hz, 2000 rpm, 1.0kW, 4,5Amp;
 115V @60Hz, 2000 rpm, 0.9kW, 8,6Amp
 Gewicht: 15 kg
 Schnittbreite: 50cm
 Schnitttiefe: 60cm



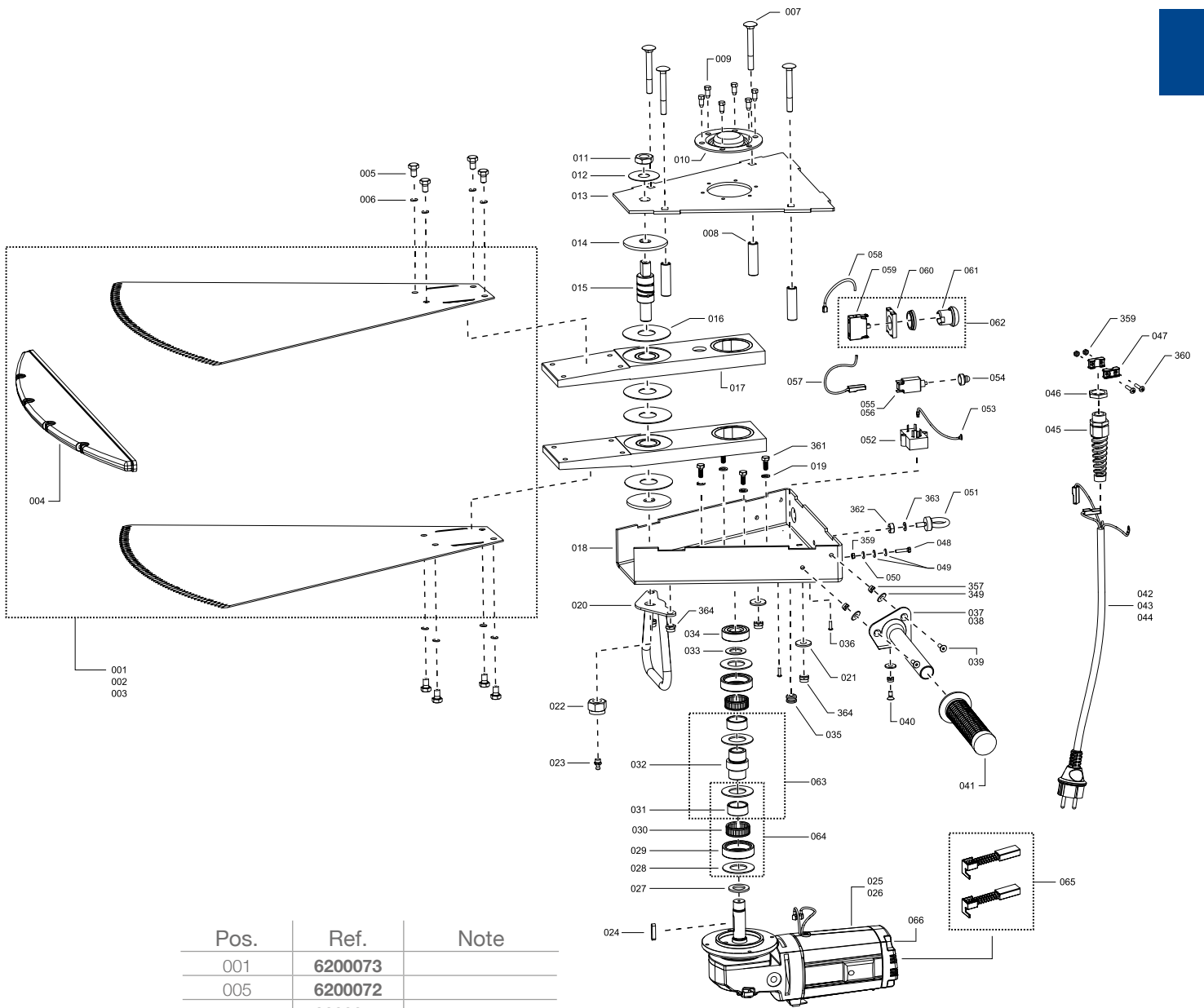

Pos.	Ref.	Note
040	6200064	
041	6200066	
042	6200049	EU Plug
044	6200051	US/CAN/JP Plug
045	6200044	
046	6200043	
047	6200039	
048	6200048	
049	6200047	
050	6200046	
051	6200045	
052	6200060	
053	6200054	
055	6200055	4 A
056	6200056	6 A
057	6200053	
058	6200052	
062	6200096	
063	6200078	
064	6200092	
065	6200093	
066	6200006	



Butter Churn



Butter Churn	
Ref.	Note
6219001	220V @50Hz

* Ecobucket not included

The vertical butter churn has been conceived and produced to obtain butter from cream, exploiting the effect of centrifugation. The butter churn use is suggested with 23L Ecobucket.

Die vertikale Buttermaschine wurde dafür entwickelt, durch Schleudern aus Sahne Butter zu machen. Es wird empfohlen, die Buttermaschine zusammen mit einem 23-l-Ecobucket zu benutzen.

La baratte de type verticale avec capacité a été pensée et réalisée pour obtenir le beurre directement de la crème, en exploitant l'effet de la centrifugation. C'est idéal si utilisé avec l'Ecobucket à 23L.

La mantequera vertical ha sido ideada y producida para obtener mantequilla a partir de la nata, aprovechando el efecto de la centrifugación. Se sugiere el uso de la mantequera con el Ecobucket de 23L.

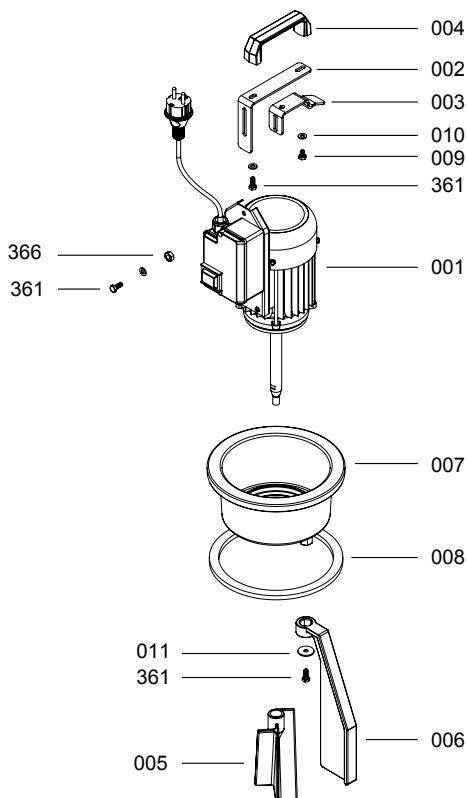

Pos.	Ref.	Note
007	6200011	
008	6200014	



Testing Equipment



Flow meter fluss 6000 with 6 ring

REF	Note
9000455	

- Small flows ring nut: with a continuous increment 0 ÷ 300 nl/min
- Large flows ring nut: 0 ÷ 2700 nl/min with an increment of 300 nl/min
- Macro flows ring nut: fixed leakage to 3000 nl/min
- Dimensions: (DxL) 70x160 mm
- Weight: 0,4 Kg



Flow Meter



Pulsator tester PT V

REF	Note
9001352	PT V with Flow Meter 7000 l/min

- Measuring range: +10 to -90 kPa
- Display: 320x240 dots Reflective Display
- Sensor accuracy: +/- 1 kPa
- Resolution: 0.1 kPa
- Power supply: 7,2 Battery cells Ni-MH
- Dimensions: (LxWxH) 250x183x52 mm
- Weight: 1,4 Kg



PT V Digital Flow Meter

REF	Note
9001082	Flow Meter 7000 l/min for PT V only
9000658	Flow Meter 3000 l/min for PT V only



Flow Meter Sleeve set

REF	Size [mm]	Note
9001259	38 x 29 49 x 38 49 x 49 61 x 49 73 x 61	Sleeve set for flow meter



PT V Printer DPU 414

REF	Note
9001353	For Pulsator tester PT V



iMilk700

ICAR approved Milk Meter



iMilk700 is the Milk Meter supplied by InterPuls to dairies requiring measurements certified by the International Committee of Animal Recording (ICAR).

iMilk700 ist das Milchmessgerät, das InterPuls an Molkereien liefert, die vom Internationalen Komitee für Leistungsprüfungen in der Tierproduktion (ICAR) zertifizierte Messungen benötigen.

iMilk700 est le Compteur de Lait proposé par InterPuls pour ceux qui ont besoin d'un mesurage certifié par l'International Committee of Animal Recording (ICAR).

iMilk700 es el medidor de leche proporcionado por InterPuls para las centrales lecheras que necesitan mediciones certificadas por el Comité Internacional del Registro de Animales (ICAR).

Technical Data / Technische Daten

Dimensions iMilk700 panel / Abmessungen iMilk700 Bedienungsfeld panel	240x90x180 mm
Dimensions Sensor / Abmessungen Sensor	350x150x150 mm
Input voltage / Eingangsspannung	24 VDC
Consumption / Verbrauch	0,75 A
Milk indicator accuracy / Genauigkeit Milchanzeiger	+/- 2% (ICAR)

Benefits

iMilk700 is a modular system. The simple base unit is equipped with advanced cluster removal functions, as well as ICAR-certified measurements, but it is also possible to integrate a number of additional modules, including:

- ✓ AUTOSTART device for the automatic start of milking simply by lifting the collector
- ✓ Automatic animal identification through a pedometer (attached to the foot or round the neck), or an electronic collar or electronic ear tag (half-duplex or full-duplex ISO)
- ✓ "iMilk700" Dairy Management system, complete with instruments to analyse the performance of the herd, group, milking unit, etc..
- ✓ Automatic separation system for animals which require specific attention
- ✓ Early heat detection system
- ✓ Automatic feed control according to the lactation period and the effective milk production of each cow
- ✓ Weight monitoring system
- ✓ Hi-tech control of milk conductivity for the early identification of possible illness
- ✓ Device for the sampling of milk that is "representative" of the entire milking process

Vorteile

iMilk700 ist ein Modularesystem. Die einfache Basiseinheit verfügt über erweiterte Melkzeugabnahmefunktionen sowie über ICAR-zertifizierte Messungen, es können aber auch einige Zusatzmodule integriert werden, einschließlich:

- ✓ AUTOSTART-Einheit für den automatischen Start des Melkverfahrens durch einfaches Anheben des Melkkollektors
- ✓ Automatische Tieridentifikation mittels Schrittmesser (an den Klauen oder am Hals befestigt) oder mit Hilfe eines elektronischen Halsbands oder einer elektronischen Ohrmarke (halbduplex oder vollduplex ISO).
- ✓ "iMilk700" Melkmanagementsystem einschließlich Instrumente zur Ergebnisanalyse der Herde, Gruppe, Melkeinheit, usw..
- ✓ Automatisches Trennsystem für Tiere, die eine Sonderbehandlung benötigen
- ✓ System zur frühzeitigen Brunsterkennung
- ✓ Automatische Futterkontrolle entsprechend der Laktationsperiode und der effektiven Milchproduktion einer jeden Kuh
- ✓ Gewichtsüberwachungssystem
- ✓ High-Tech-Kontrolle der Milchleitfähigkeit für eine frühzeitige Krankheitserkennung.
- ✓ Gerät zur Entnahme von Milchproben, die für das gesamte Melkverfahren „repräsentativ“ sind.

Avantages

iMilk700 est un système modulaire. Le simple produit de base prévoit déjà des fonctions avancées de l'enlèvement du groupe de traite, outre le mesurage certifié ICAR, et il est également possible d'intégrer une série de modules supplémentaires tels que par exemple:

- ✓ Dispositif AUTOSTART pour le commencement automatique de la traite à partir d'une simple élévation du collecteur
- ✓ Identification automatique des animaux par podomètre (à la patte ou au cou) ou par collier électronique ou par marque auriculaire électronique (half-duplex ou full-duplex ISO)
- ✓ Appareil de gestion de traite "iMilk700" doté d'instruments d'analyse des performances du troupeau, des groupes, des trayeurs, etc..
- ✓ Séparation automatique des animaux qui requièrent des attentions spécifiques
- ✓ Identification précoce des chaleurs
- ✓ Contrôle automatique de l'alimentation suivant la période de lactation et la production effective de lait de chaque animal
- ✓ Système de contrôle du poids
- ✓ Contrôle avancé de la conductivité du lait pour l'identification précoce d'éventuels malaises
- ✓ Dispositif pour le prélèvement d'un échantillon de lait "représentatif" de l'ensemble de la traite

Beneficios

iMilk700 es un sistema modular. La sencilla unidad base está equipada con funciones avanzadas de retirada del grupo de ordeño, cuenta además con mediciones certificadas por ICAR, y es posible incorporar muchos módulos adicionales, incluidos:







- ✓ Dispositivo AUTOSTART para la puesta en marcha del proceso de ordeño elevando simplemente el colector
- ✓ Identificación automática del animal a través de un podómetro (fijado en la pata o alrededor del cuello) o un collar electrónico o marca auricular (ISO semidúplex o dúplex completo)
- ✓ Sistema de gestión de lácteos «iMilk700», con instrumentos para analizar el rendimiento del rebaño, grupo, unidad de ordeño, etc.
- ✓ Sistema de separación automático de animales que requieren atención especial
- ✓ Detección de celo prematuro
- ✓ Control de alimentación automático según el periodo de lactancia y la producción real de leche de cada vaca
- ✓ Sistema de monitorización del peso
- ✓ Control de alta tecnología sobre la conductividad de la leche para la detección temprana de posibles enfermedades
- ✓ Dispositivo para el muestreo de leche «representativa» de todo el proceso de ordeño





iMilk700















iMilk700 Panels + Sensors

	Ref.	Note
	5550001	iMilk700 panel std
	5550004 5550090	iMilk700 sensor with s/off valve iMilk700 sensor sticker
	5550252	iMilk700 panel std support
	5550006 5550008	iMilk700 panel softw. standalone iMilk700 panel softw. net-plus
	5550172	wash valve for iMilk700 system
	9001713	vacuum nipple x iMilk700 sensor









Milk Sampler

	Ref.	Note
	5550005	iMilk700 sampler icar
	9001323	milk sampler ambic

iMilk700 Spare Parts

	Ref.	Note
	5550212	iMilk700 basic pcb
	5550134	iMilk700 display pcb
	5550133	iMilk700 pcb basic + display
	5550114	iMilk700 Shut Off Valve complete with diaphragm
	5550096	iMilk700 diaphragm for the Shut Off Valve
	5550178	iMilk700 upper chamber w nipple x SOff Valve
	5550116	maintenance kit for iMilk700 electrovalve
	5550176	coil for iMilk700 electrovalve
	5550174	white cone for iMilk700 sensor
	5550292	white ring support for cone iMilk700 sensor
	5550115	red floater for iMilk700 sensor
	5550140	measuring chamber with conductivity probe
	5550095	service kit for iMilk700 sensor measuring stem
	5550180	support ring iMilk700 sensor
	5550175	underframe measuring stem for iMilk700 sensor

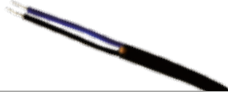
iMilk700 Power & Communication

	Ref.	Note
	1049131	iup 320w 24vdc smps 1x16 iMilk700 panels
	5550040	connection bridge 1x16 panels
	5550041	interface bridge - data com. x32 panels
	5550327	nicnest box 1
	5550326	nicnest box 2
	5550173	4 wire shielded cable 0.8 mm ² - green
	9001723	2 wire cable 0,5mm ² x sens valve
	5550012	10 wire cable 0,34mm ² x extension
	9001722	heat shrink tubing protection

Precision Farming



Improving the pregnancy rate is fundamental in order to ensure the profitability of the dairy herd, but it's not the only aspect.

In order to increase it, it's important to be able to monitor the health and well-being of each cow. InterPuls makes this possible through the "Precision Farming Kit": a plug & play box that comes pre-wired and pre-assembled and only requires a minimum router/internet configuration in order to get started. The range is then completed with "3D Leg Tag" and "3D Neck Tag", which grant a punctual and careful check both of cows activity and of eating time: two important aspects that influence milk production and farm profitability.

Die Verbesserung der Trächtigkeitsrate ist ein wesentlicher Bestandteil zur Gewährleistung der Ertragskraft der Milchkuhherde, aber nicht der einzige Aspekt.

Zugunsten der Erhöhung der Trächtigkeitsrate muss die Überwachung der Gesundheit und des Wohlbefindens einer jeden Kuh gewährleistet werden. InterPuls macht das mit dem „Präzisionslandwirtschaftssatz“ möglich: eine Plug&Play-Box wird vorverkabelt und vormontiert geliefert und bedarf zur Inbetriebnahme nur einer minimale Router- / Internetkonfiguration. Das Sortiment wird durch „3D-Erkennungsmarken für die Klauen“ und „3D-Erkennungsmarken für den Hals“ abgerundet, die eine präzise und sorgfältige Überprüfung der Aktivität der Kühe sowie der Fresszeiten gewährleisten: zwei wichtige Aspekte, die die Milchproduktion und die Rentabilität der Landwirtschaftsbetriebe beeinflussen.



“3D” LegTag



Standing & Lying



Heat Detection



Health Monitoring



Calendar events



New feature: Standing & Lying

A cow shows the same pattern of behaviour and movements every day. Standing and Lying Monitoring tracks different aspects of this pattern: walking, standing and lying time, the number of times the animal stands up and the number of steps she takes per day. The system accurately tracks the cow 24/7 and issues alerts if there are any changes from the average of the past few days.

Eine Kuh hat jeden Tag dasselbe Verhaltens- und Bewegungsmuster. Die Überwachung des Stehens und Liegens umfasst verschiedene Aspekte dieses Musters: das Laufen, die im Liegen und im Stehen verbrachte Zeit, wie häufig das Tier aufsteht sowie die Anzahl der Schritte pro Tag. Das System überwacht die Kuh sorgfältig rund um die Uhr, sieben Tage die Woche und gibt Warnmeldungen aus, treten Abweichungen von dem Durchschnitt der Vortage auf.



24/7

HEAT, ACTIVITY, STANDING & LYING DETECTION



“3D” NeckTag



Heat Detection



Eating Behaviour



Calendar events



Precision Farming Set

	Ref.	Note
	5559030	Precision Farming kit

Antenna UHF

	Ref.	Note
	5550239	Antenna UHF
	5550278	Antenna UHF long range
	5550256	Antenna Support



Access Point / Wi-Fi Extender

	Ref.	Note
	5780024	Access Point N300 (2,4GHZ)
	5550361 5550400 5780025 5550402	LAN cable 1 mt LAN cable 5 mt LAN cable 20 mt LAN cable 50 mt
	5780027	LAN switch

Smart Leg Tags

	Ref.	Note
	5550242	set 10 x smart leg tags UHF
	5550246	set 10 x smart leg tags UHF + ISO
	5550058	set 10 x leg-strap

Smart Neck Tags

	Ref.	Note
	5550289	set 10 x smart neck tag UHF
	5550290	set 10 x smart neck tag UHF + ISO
	5550294	set 10 x neck collars

Slide Numbers

	Ref.	Note
	5550059	Set 10 x Slidenumbers Nr. "0"
	5550060	Set 10 x Slidenumbers Nr. "1"
	5550061	Set 10 x Slidenumbers Nr. "2"
	5550062	Set 10 x Slidenumbers Nr. "3"
	5550063	Set 10 x Slidenumbers Nr. "4"
	5550064	Set 10 x Slidenumbers Nr. "5"
	5550065	Set 10 x Slidenumbers Nr. "6"
	5550066	Set 10 x Slidenumbers Nr. "7"
	5550067	Set 10 x Slidenumbers Nr. "8"
5550068	Set 10 x Slidenumbers Nr. "9"	







Extra UHF Antenna Control Unit

	Ref.	Note
	5550328	NicNest Box 1
	5550071	vp2002 transformer
	5550364	extra control unit UHF
	5550240	extra UHF antenna cable
	5550239	antenna UHF
	5550278	antenna UHF long range
	5550256	antenna support
	5780024	Access Point N300 (2,4GHZ)
	5550361	LAN cable 1 mt
	5550400	LAN cable 5 mt
	5550082	additional CAN-BUS cable





Velos is the Nedap platform that we use for iMilk700, iMilk600, Heat Detection, Feeding (in parlour and out of parlour), animal identification in the milking parlour, sorting gates and separation gates.

Velos ist die Nedap-Plattform, die wir für iMilk700, iMilk600, zur Brunsterkennung, zur Fütterung (innerhalb und außerhalb des Melkstandes), zur Tieridentifikation im Melkstand sowie für Sortier- und Trenntore verwenden.

Velos Process Controller

	Ref.	Note
	1049131	IUP 320w 24VDC smps
	5550327	NicNest box 1
	5550321	VP8001 + sw velos base 5000 cows
	5550075	basic license + 5000 cows
	5550082	can communication cable
	5550400 5780025 5550402	LAN cable 5 mt LAN cable 20 mt LAN cable 50 mt

Velos Extra Control Unit (Slave)

	Ref.	Note
	1049131	IUP 320w 24VDC smps
	5550327	NicNest box 1
	5550070	vp8001 "vpu" process ctrl
	5550083	ethernet cable set 100mt
	5780027	LAN switch

Leg Tags, Neck Tags, Ear Tags





Animals can be identified with SMART leg tags, SMART neck tags, simple neck tags and simple ear tags.

Eine Identifizierung der Tiere ist mittels SMART-Erkennungs-
marken für die Klauen, SMART-Erkennungs-
marken für den Hals, einfachen Erkennungs-
marken für den Hals und einfa-
chen Ohrmarken möglich.

Leg Tags

	Ref.	Note
	5550057	set 10 x leg pedometers ISO Satz 10 x Schrittmesser für Klauen ISO
	5550242	set 10 x smart leg tags UHF Satz 10 x SMART-Erkennungs- marken für die Klauen UHF
	5550246	set 10 x smart leg tags UHF + ISO Satz 10 x SMART-Erkennungs- marken für die Klauen UHF+ISO
	5550058	set 10 x leg-strap Satz 10 x Beinschlaufe ISO

Neck Tags

	Ref.	Note
	5550289	set 10 x smart neck tag UHF Satz 10 x SMART-Erkennungs- marken für den Hals UHF
	5550290	set 10 x smart neck tag UHF + ISO Satz 10 x SMART-Erkennungs- marken für den Hals UHF+ISO
	5550055	set 10 x neck power-ID blue Satz 10 x Hals Power-ID blau
	5550294	set 10 x neck collars Satz 10 x Halsbänder



Slide Numbers

	Ref.	Note
	5550059	Set 10 x Slidenumbers Nr. "0"
	5550060	Set 10 x Slidenumbers Nr. "1"
	5550061	Set 10 x Slidenumbers Nr. "2"
	5550062	Set 10 x Slidenumbers Nr. "3"
	5550063	Set 10 x Slidenumbers Nr. "4"
	5550064	Set 10 x Slidenumbers Nr. "5"
	5550065	Set 10 x Slidenumbers Nr. "6"
	5550066	Set 10 x Slidenumbers Nr. "7"
	5550067	Set 10 x Slidenumbers Nr. "8"
5550068	Set 10 x Slidenumbers Nr. "9"	

	Ref.	Note
	9002887	ear-tag fdx m+f
	9001520	applicator x ear-tag fdx











Velos Milking

Velos Milking

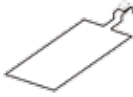









	Ref.	Note
	5550327	NicNest box 1
	5550150	vp3104 milking parl.interf (max 100)
	5550200 5550314 5550344	license milking 2x50 4id parlour license per place ID license milking rotary ID



Velos Antenna Set Milking Parlour

	Ref.	Note
	5550327	NicNest box 1
	5550073 5550208	vp1001 fdx vp1001 fdx+hdx
	5550326	NicNest box 2
	5550342	vp1910 iso dsp reader
	5559005	walkover antenna set
	5559006	walkthrough antenna set
	5550205	side antenna vp6150 autotune
	9001252	gate switch
	4600266	cable gland
	9001726	rele monostabile
	5550146	v-trace scanner

Velos Antenna Set Rotary

	Ref.	Note
	5550327	NicNest box 1
	5550266	vp1007 twin fdx+hdx
	5550344	license milking rotary id
	5559005	walkover antenna set
	5559006	walkthrough antenna set
	5550205	side antenna vp6150 autotune
	5550080	vp6011 v-sense antenna feedst.
	5550027	bail power-id
	5550125	cover x bail power-id
	9001252	gate switch
	4600266	cable gland







Velos Place ID

	Ref.	Note
	5550327	NicNest box 1
	5550275 5550073	vp1004 iso reader multiplexer vp1001 fdx
	5550080	vp6011 neck antenna x place id
	5550314	license per place id
	5559006	walkthrough antenna set
	9001252	gate switch
	4600266	cable gland
	9001726	rele monostabile



Velos Heat Detection

Velos UHF Heat Detection





	Ref.	Note
	5550327	NicNest box 1
	5550364	vp4102 - uhf reader
	5550240	1.5m cable for uhf antenna
	5550239	antenna uhf 433 mhz
	5550278	long range antenna uhf 433 mhz
	5550279	15m extension cable for uhf antenna
	5550256	antenna support

Velos ISO Heat Detection





	Ref.	Note
	5550327	NicNest box 1
	5550073	vp1001 fdx
	5559005	walkover antenna set

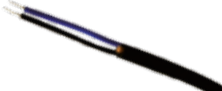











Velos Feeding

Velos In Parlour Feeding

	Ref.	Note
	1049131	iup 320w 24vdc smps
	5550327	NicNest box 1
	5550209	vp3001 control unit
	5550206	in-parlour feeding 2x50 4id incl.rot
	5680015	pipe feeder 24vdc (1652) 1440mm
	9001723	2 wire cable 0,5mm2 x sens valve

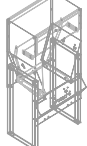
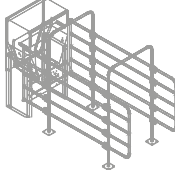

Velos Out Parlour Feeding

	Ref.	Note
	5550327	NicNest box 1
	5550073 5550208 5550209	vp1001 fdx vp1001 fdx+hd vp3001 control unit
	5550199	out-p feeding 16st. 6types backgate
	5559020	floor antenna set cow feedst
	5550080	vp6011 ear/neck antenna feedstat.

	Ref.	Note
	5550119	feed hopper black
	5550193	cover x feed hopper black
	5550123	feed motor
	5550124	auger flight m8 100gr s/s
	5550339	auger flight m8 50gr s/s
	5550338	auger cup s/s
	5550120	2 x lid 75mm x hole auger
	5550077	partition plate velos 1 feed sort
	5550078	partition plate velos 2 feed sorts
	5750001	feedstation front galv.
	5750003	feedstation front s/s
	5750004	feedstation complete galv.
	5750005	feedstation complete s/s
	5750006	backgate texas
	5680011	backgate vertical
	5680025	pipefeeder 1140 mm

Velos Sorting and Routing

Velos Separation Unit

	Ref.	Note
	5550327	NicNest box 1
	5550073 5550208	vp1001 fdx vp1001 fdx+hdx
	5550326	NicNest box 2
	5550342	vp1910 iso dsp reader
	5550201	velos sorting/routing 16units 2/3w
	5559005	walkover antenna set
	5559006	walkthrough antenna set
	5550205	side antenna vp6150 autotune
	5550106	photosensor
	5550265	manual separ. ctrl. unit - velos
	5550204	cable for sep.manual ctrl.unit
	9002327	3 wires cable blue-brown-yel/gr
	9001937 9001940	kit separation unit 2 way kit separation unit 3 way
	9001942	connection bar x separation unit

Velos Software Licenses

Velos Software License

	Ref.	Note
	5550194	lic. heat d. 500 cows 4id @ mob
	5550200	lic. milking 2x50 4id parlour
	5550199	out-p feeding 16st. 6types backgate
	5550206	in-parlour feeding 2x50 4id incl.rot
	5550201	velos sorting/routing 16units 2/3w
	5550163	velos module taurus cows
	5550314	license per place ID
5550344	license milking rotary ID	

Nedap V-BOXes and Transformers

Nedap V-BOX and Transformers

	Ref.	Note
	5550195	v-box 1 with 2 lights
	5550069	v-box 2 with 2 lights
	5550072	v-box 1 with 1 light
	5550079	transf. vp2001 - 25vdc - 8.0 a
	5550071	transf. vp2002 - 25vdc - 2.5 a

Velos Dairy Management



✓ MILKING INFORMATION (current lactation)

- Milk production per herd
- Milk production per single cow and detailed graph
- Conductivity graph and early alarm in case of deviation from the average
- Milk separation based on calendar events
- Centralized milk separation through the panel or through the PC
- Milking parlour monitoring for herringbone/parallel and rotary

✓ MELKINFORMATIONEN (aktuelle Laktation)

- Milchproduktion pro Herde
- Milchproduktion pro Kuh und detaillierte Grafik
- Grafik der Leitfähigkeit und Frühwarnsystem im Falle von Abweichungen vom Durchschnitt
- Milchtrennung auf der Grundlage der Kalenderereignisse
- Zentralisierte Milchtrennung mittels Bedienungs-feld oder PC
- Überwachung des Melkstands mit Fischgrätenmuster / paralleler und drehbarer Struktur

✓ INFORMATIONS SUR LA TRAITE (lactation en cours)

- Production du lait du troupeau
- Production pour chaque vache avec graphique détaillé
- Graphique de la conductivité avec alerte précoce en cas des écarts à la moyenne
- Séparation du lait selon le calendrier des événements
- Séparation centralisée du lait de panneau où de l'ordinateur
- Contrôle de la traite pour salles herringbones, parallèles ou tournantes

✓ INFORMACIÓN DE ORDEÑO (lactancia actual)

- Producción de leche por rebaño
- Producción de leche por vaca y gráfico detallado
- Gráfico de conductividad y alarma temprana en caso de desviación respecto al promedio
- Separación de leche basada en eventos del calendario
- Separación centralizada de leche a través del panel o del ordenador
- Supervisión del ordeño en salas en espina de pez/paralelas y rotativas



✓ **ADVANCED HEAT DETECTION**

- 24/7 activity control
- High accuracy in heat detection, less labour
- Optimum Insemination moment prediction
- Early detection in case of decreased activity

✓ 5 cows are in heat

✓ **FORTSCHRITTLICHE BRUNSTERKENNUNG**

- Aktivitätskontrolle rund um die Uhr, sieben Tage die Woche
- Hohe Präzision der Brunsterkennung, weniger Aufwand
- Vorhersage des optimalen Besamungszeitpunktes
- Früherkennung einer verminderten Aktivität.

✓ 5 Kühe sind brünstig

✓ **DÉTECTION DES CHALEURS AVANCÉE**

- Contrôle de l'activité 24/7
- Détection des chaleurs précise et fiable, moins d'efforts
- Prévision du moment idéal pour l'insémination
- Détection précoce de la diminution de l'activité

✓ 5 vaches montrent signes de chaleurs

✓ **DETECCIÓN AVANZADA DE CELO**

- Control de la actividad 24 h a la semana
- Detección del celo precisa y fiable, menos esfuerzos
- Previsión óptima del momento de inseminación
- Detección prematura en caso de menor actividad

✓ 5 vacas se hallan en celo



✓ Cow 671 started to be in heat yesterday night and she is still in the Optimum Insemination Time

✓ Kuh 671 wurde gestern Nacht brünstig und ist noch in der optimalen Besamungszeit

✓ La vache no. 671 est en chaleur dès la nuit dernière et elle est encore dans le moment idéal pour être inséminée

✓ La vaca 671 entró en celo ayer por la noche y aún está en óptimo período de inseminación

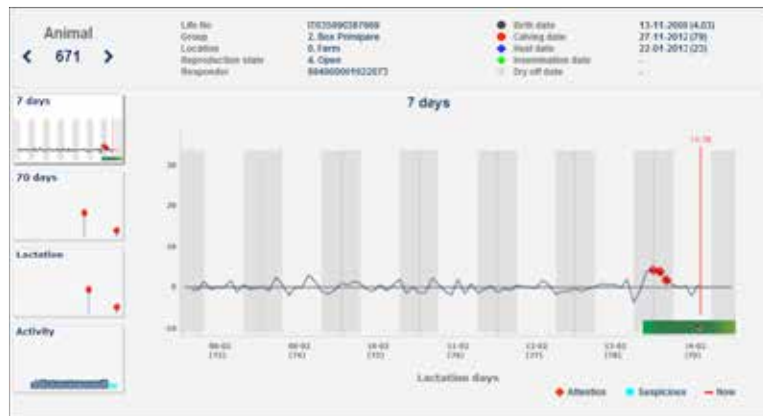

✓ Cow 671 is at the 79th lactation day and the previous heat was detected 22 days ago

✓ Kuh 671 hat den 79. Laktationstag und die letzte Brunst wurde vor 22 Tagen festgestellt

✓ La vache no. 671 est dans le 79^e jour de lactation et la chaleur antérieure a été relevée il y a 22 jours

✓ La vaca 671 se halla en el día 79 de lactancia y el celo anterior fue detectado hace 22 días atrás

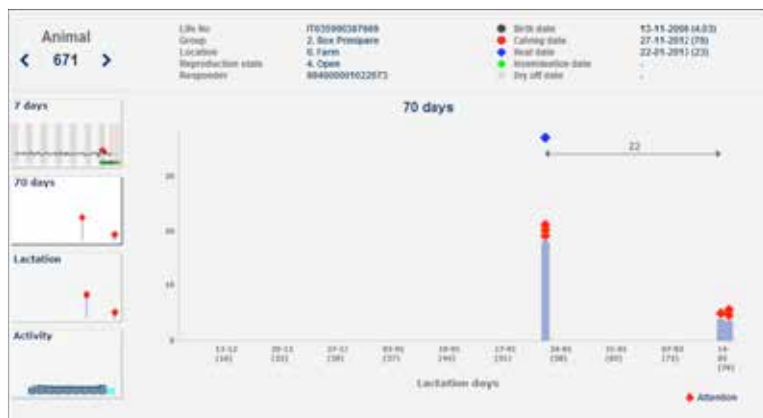

✓ The average activity of Cow 625 has decreased in the latest days

✓ Die durchschnittliche Aktivität von Kuh 625 hat in den letzten Tagen abgenommen

✓ L'activité moyenne de l'animal 625 diminuée dans les derniers jours

✓ La actividad promedio de la vaca 625 ha disminuido en los últimos días

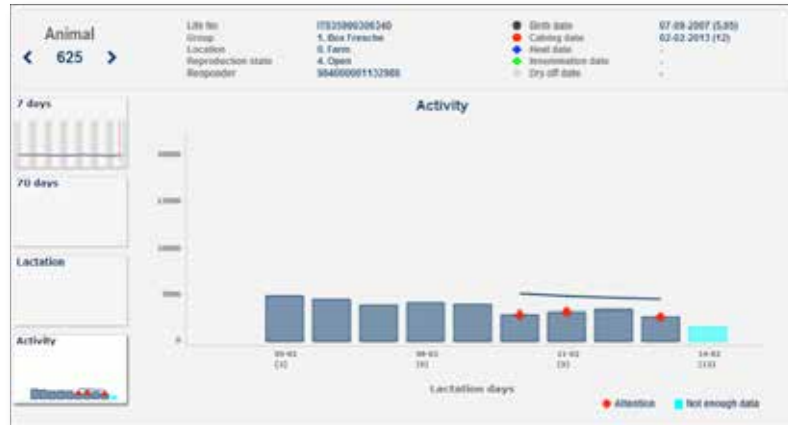

✓ **NECKTAG EATING MONITORING**

- Accurate eating behavior monitoring
- Ideal for pasture and free-stall
- Less diseases due to low feed intake

✓ **ERKENNUNGSMARKE FÜR DEN HALS ZUR ÜBERWACHUNG DES FRESSVERHALTENS**

- Präzise Überwachung des Fressverhaltens
- Ideal für die Weide und für Laufställe
- Weniger Erkrankungen aufgrund einer geringen Futtermittelaufnahme

✓ **NECKTAG CONTRÔLE DE L'INGESTION DE LA RATION**

- Contrôle précis de l'ingestion de la ration
- Ideal même pour animaux au pâturage que en stabulation
- Réduction des pathologies liées à une pauvre ingestion de la ration

✓ **NECKTAG MONITORIZACIÓN DE LA ALIMENTACIÓN**

- Monitorización precisa de la conducta alimentaria
- Ideal para animales en pastizales y estabulación
- Menor número de enfermedades relacionadas con baja ingesta alimentaria

✓ **FEEDING**

- Feed strategies based on lactation time or on calendar events
- Up to 6 different feed-types per feed station
- In-parlour feeding module available

✓ **FÜTTERUNG**

- Fütterungsstrategien entsprechend der Laktationszeit oder der Kalenderereignisse
- Bis zu 6 verschiedene Fütterungsarten pro Fütterungsstation
- Fütterungsmodul für den Melkstand verfügbar

✓ **FEEDING**

- Régimes alimentaires conçus selon la période de lactation ou selon des événements sur le calendrier
- Jusqu'à 6 types de fourrage pour chaque station d'alimentation
- Module complémentaire en station d'alimentation

✓ **ALIMENTACIÓN**

- Regímenes alimentarios basados en tiempo de lactancia o en eventos del calendario
- Hasta 6 tipos de alimentos por cada estación de alimentación
- Módulo de alimentación en sala de ordeño disponible

Advised feed strategies:

Number	Name
1	Lactation feed table
2	Insemination feed table
3	Dry off feed table
99	Unknown responders
100	Animals out of group housing area (no feed station in e.g calving area)

Example feed table with feed 1 graph for lactation, insemination and dry off feed table.

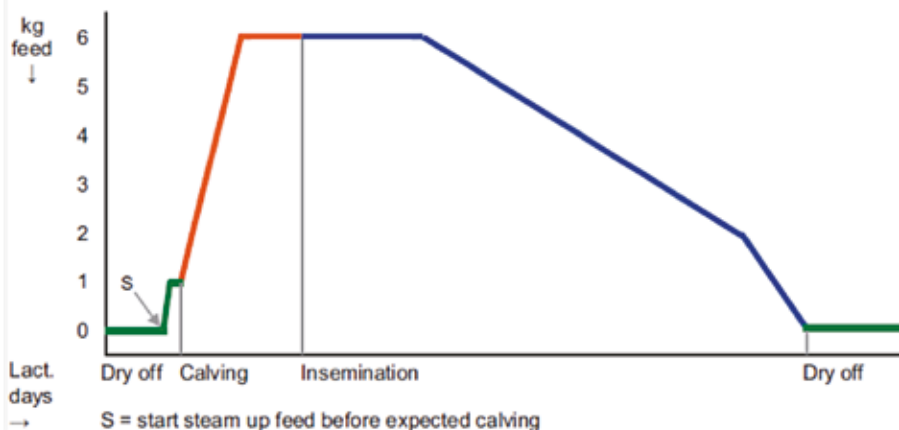

Example of 2 cycles, 4 periods and 3 feed spreading (release) periods per day.

24 hour		24 hour total							
Cycle	Cycle 1				Cycle 2				
NrPeriod	1	2	3	4	1	2	3	4	
Rel. Per.	1	2	3		1	2	3		
Time (h)	0	3	6	9	12	15	18	21	24
Clocktime	14.00	17.00	20.00	23.00	02.00	05.00	08.00	11.00	14.00
	D	P	P	P	C	P	P	P	D

D = Daily feed start e.g. 14.00 h = calculation new feed balance next 24 hour.

C = Cycle start e.g. 02.00 h (12 hour cycle = 2 cycles per day).

P = Period start (e.g. 4 periods in a 12 h cycle = 3 hour period)

✓ COW TRAFFIC

- Automatic cow separation based on events or on attentions
- Manual cows separation

✓ KUHVERKEHR

- Automatische Trennung der Kühe entsprechen der Ereignisse oder der Aufmerksamkeiten
- Manuelle Trennung der Kühe

✓ CIRCULATION DES VACHES

- Séparation automatique basée sur évènements ou alarmes
- Séparation manuelle des animaux

✓ TRÁFICO DE VACAS

- Separación automática de vacas basada en eventos o alarmas
- Separación manual de las vacas

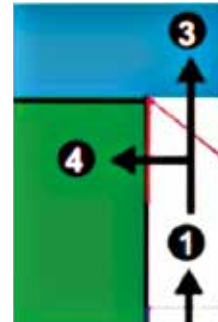
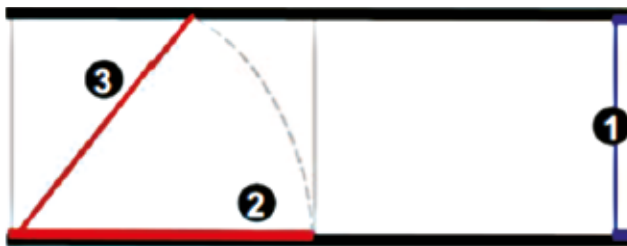

✓ COW INFORMATION

- Cow NR
- Up to 3 ID Responder Numbers
- Life Number
- Birthdate

✓ INFORMATIONEN ZUR KUH

- Nummer der Kuh
- Bis zu 3 Tier- und Respondernummern
- Lebensnummer
- Geburtsdatum

✓ INFORMATIONS SUR LA VACHE

- Numéro de la vache
- Jusqu'à 3 dispositifs ID pour chaque vache
- Enregistrement ministériel
- Date de naissance

✓ INFORMACIÓN SOBRE VACAS

- Nº de la vaca
- Hasta 3 números de respondedores ID
- Número permanente
- Fecha de nacimiento

✓ CALENDAR

- Reproduction State
- Calving date
- Heat Detection date
- Insemination date
- Pregnancy Check date
- Dry-Off date
- Next Calving Time
- Custom Attentions

✓ KALENDER

- Reproduktionszustand
- Datum der Abkalbung
- Datum der Brunsterkennung
- Datum der Besamung
- Datum der Trächtigkeitskontrolle
- Datum des Beginns der Trockenstehphase
- Nächste Abkalbung
- Spezifische Betreuung

✓ CALENDRIER

- Etat de la reproduction
- Vêlage
- Détection des chaleurs
- Vérification de la gestation
- Date du tarissement
- Prochain vêlage
- Alarmes personnalisables

✓ CALENDARIO

- Estado de reproducción
- Fecha del parto
- Fecha de detección del celo
- Fecha de inseminación
- Fecha del control de preñez
- Fecha de secado
- Próximo periodo de parto
- Cuidados personalizados

Calendar dates							
Number	Group	Birth date	Calving date	Reproduction state	Heat date	Insemination date	Dry off date
385	1	27-02-2000 (12.11)	22-01-2013 (23)	Open			
395	1	24-04-2000 (12.09)	17-01-2013 (28)	Open			
402	1	29-05-2000 (12.08)	20-09-2012 (147)	Pregnant	19-10 (118)	17-12 (50)	
443	1	05-07-2001 (11.07)	05-08-2012 (193)	Pregnant	12-09 (155)	28-10 (109)	
454	1	17-11-2001 (11.03)	21-08-2012 (177)	Open	12-10 (125)		
459	1	03-02-2002 (11.00)	04-09-2011 (1.05)	Pregnant	05-05 (285)	04-07 (225)	
460	1	09-02-2002 (11.00)	09-12-2012 (67)	Inseminated	15-01 (30)	15-01 (30)	
465	1	20-02-2002 (10.12)	27-12-2012 (49)	Open			
474	1	12-05-2002 (10.09)	24-08-2012 (174)	Open	07-01 (38)		
479	1	19-07-2002 (10.07)	04-03-2012 (347)	Pregnant	04-05 (286)	04-05 (286)	14-12 (62)
489	1	05-10-2002 (10.04)	25-04-2012 (294)	Pregnant	05-05 (253)	06-06 (253)	13-01 (32)
490	1	11-10-2002 (10.04)	17-01-2013 (28)	Open	07-02 (7)		
495	1	24-10-2002 (10.03)	05-09-2011 (1.05)	Pregnant	05-03 (346)	04-06 (256)	13-01 (32)
504	1	19-04-2003 (9.10)	07-12-2012 (59)	Open			
515	1	17-03-2003 (9.11)	29-08-2012 (159)	Pregnant	05-10 (132)	25-10 (111)	
517	1	25-05-2003 (9.08)	29-07-2012 (200)	Open	05-02 (9)		
524	1	09-08-2003 (9.05)	27-05-2012 (263)	Pregnant	28-06 (231)	15-08 (182)	
526	1	22-10-2003 (9.03)	08-08-2012 (190)	Pregnant	23-10 (114)	08-12 (68)	
529	1	29-10-2003 (9.03)	02-09-2012 (165)	Open	10-02 (4)		
530	1	15-11-2003 (9.03)	09-01-2013 (38)	Open			
531	1	13-03-2004 (8.11)	29-11-2012 (77)	Inseminated	04-02 (10)	04-02 (10)	

✓ AUTOMATIC E-MAIL ALERTS

Different operators can receive real-time e-mail alerts in case of:

- Activity Attention
- Decreased Activity (possible disease or possible lameness)
- Calendar Alerts (Dry-Off, Calving, Pregnancy Check)
- Personalized Calendar Alerts
- Attention Alerts (No Heat, No Insemination, High Conductivity...)
- System Attention

✓ AUTOMATISCHE E-MAIL-WARNMELDUNGEN

Verschiedene Betreiber können in folgenden Fällen in Echtzeit E-Mail-Warnungen erhalten:

- Aktivitätswarnung
- Verringerte Aktivität (eventuelle Erkrankung oder Lähmung)
- Kalenderwarnungen (Trockenstehphase, Abkalbung, Trächtigkeitskontrolle)
- individuell abgestimmte Kalenderwarnungen
- Warnmeldungen (keine Brunst, keine Besamung, hohe Leitfähigkeit ...)
- Systemwarnung

✓ ALERTE AUTOMATIQUE DE MAIL

Opérateurs différents peuvent recevoir real-time e-mail alerts si:

- Il y a un alarme de l'activité
- Il y a un suspect d'activité
- L'activité a été réduite (possibilité de maladie ou boiterie)
- Alertes du calendrier (tarissement – vêlage – gestation)
- Alarmes du calendrier personnalisées
- Alertes d'attention (pas de chaleur pas d'insémination, conductivité élevée, etc ...)
- Alarme du système

✓ ALERTAS AUTOMÁTICAS POR E-MAIL

Operadores diferentes pueden recibir e-mails en tiempo real en caso de:

- Alarma de la actividad
- Menor actividad (posibles enfermedades o cojeras)
- Eventos del calendario (secado, parto, control de preñez)
- Alertas personalizadas del calendario
- Atención de alertas (sin celo, sin inseminación, alta conductividad, etc.)
- Alarma de sistema

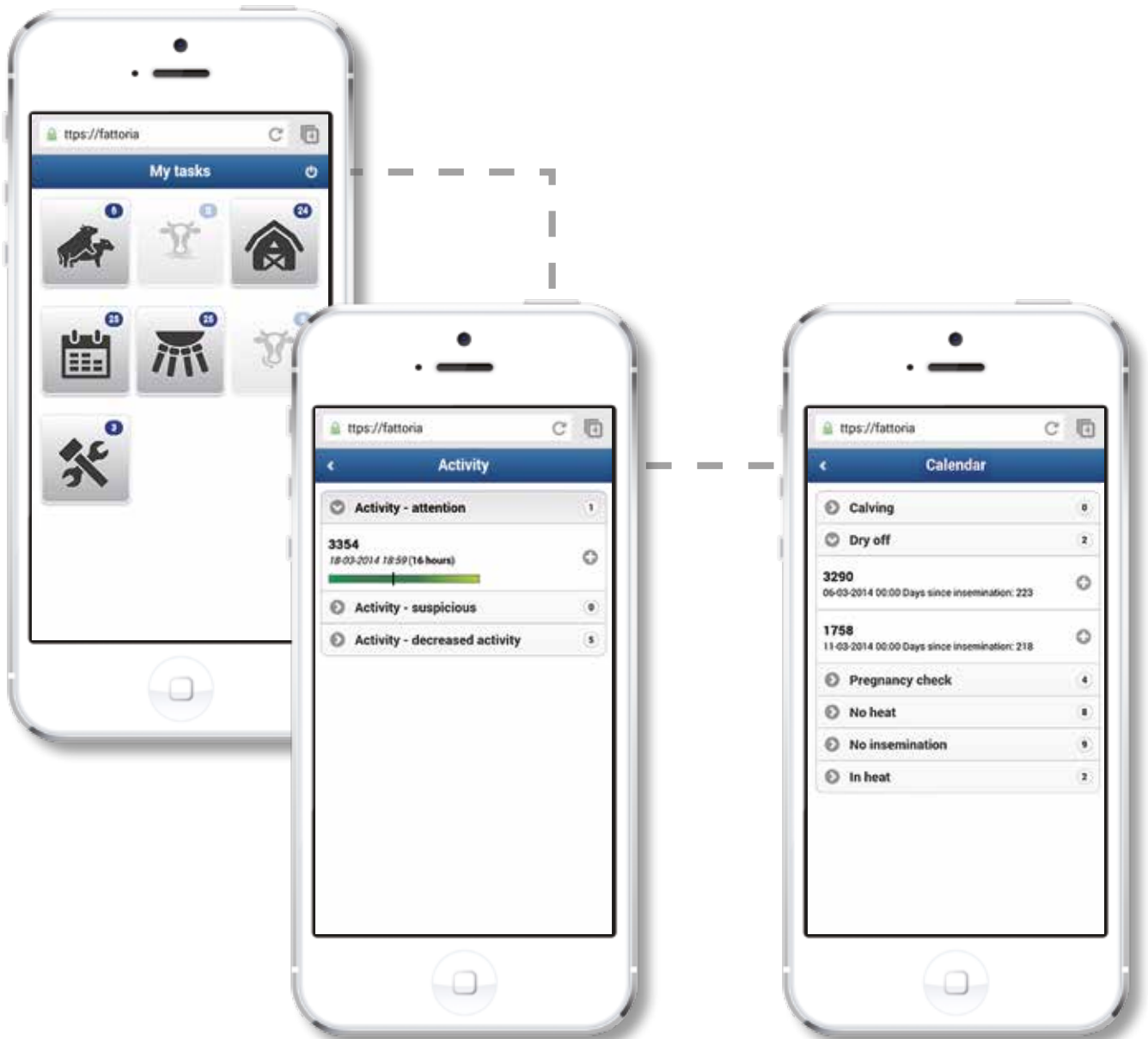

✓ **STANDING AND LYING MONITORING**

A cow shows the same pattern of behaviour and movements every day. Standing and Lying Monitoring tracks different aspects of this pattern: walking, standing and lying time, the number of times the animal stands up and the number of steps she takes per day. The system accurately tracks the cow 24/7 and issues alerts if there are any changes from the average of the past few days.

✓ **ÜBERWACHUNG DES STEHENS UND LIEGENS**

Eine Kuh hat jeden Tag dasselbe Verhaltens- und Bewegungsmuster. Die Überwachung des Stehens und Liegens umfasst verschiedene Aspekte dieses Musters: das Laufen, die im Liegen und im Stehen verbrachte Zeit, wie häufig das Tier aufsteht sowie die Anzahl der Schritte pro Tag. Das System überwacht die Kuh sorgfältig rund um die Uhr, sieben Tage die Woche und gibt Warnmeldungen aus, treten Abweichungen von dem Durchschnitt der Vortage auf.

✓ **STANDING AND LYING MONITORING**

La bovine a une activité presque identique tous les jours. Le contrôle du “debout et couché” permet de suivre tous les aspects liés à cette activité: combien de temps elle marche, combien de temps elle est debout ou est couchée, la fréquence avec laquelle elle s’élève et le numéro des pas. Le système mémorise ces données pour chaque animal, 24h/24 et il avertit l’opérateur s’il y a des changements importants dans l’activité en la comparant aux jours précédents.

✓ **SUPERVISIÓN DE POSTURA DE PIE O RECOSTADA**

Una vaca muestra el mismo patrón de conducta y los mismos movimientos cada día. La monitorización de las posturas de pie y recostada sigue la pista de los distintos aspectos de este patrón: tiempo de marcha, de pie y recostada, número de veces que el animal se pone de pie y el número de pasos que ejecuta diariamente. El sistema tiene bajo control de forma precisa a la vaca durante las 24 horas de la semana y emite alertas en caso de variaciones respecto al promedio de los últimos días.



✓ EATING BEHAVIOUR

The NeckTag Eating Monitoring function is the next step in automatic tracking of signals that highlight potential health problems in the individual animal. How many hours per day the cow dedicates to eat is a strategic data that permits early and precise actions on every single bovine that shows changes in feed behavior. Preserving the cow's health and saving veterinary and managing costs turn in higher profit for the dairy farm. Thanks to the long range antenna Eating Monitoring fits to free-stall and grazing farms.

✓ FRESSVERHALTEN

Die Erkennungsmarke für den Hals zur Überwachung des Fressverhaltens ist der nächste Schritt im Rahmen der automatischen Erkennung von Signalen, die potentielle Gesundheitsprobleme der einzelnen Tiere aufzeigen. Informationen über die Anzahl der Stunden pro Tag, während deren die Kuh frisst, zählen zu den strategischen Daten, die eine frühzeitige und präzise Behandlung eines jeden einzelnen Rinds ermöglichen, das Änderungen des Fressverhaltens zeigt. Eine Aufrechterhaltung der Rindergesundheit und die Einsparung von Tierarzt- und Verwaltungskosten führt zu einem höheren Profit des Milchbetriebs. Dank der Antenne mit hoher Reichweite eignet sich die Erkennungsmarke für den Hals zur Überwachung des Fressverhaltens für Laufställe und Weidebetriebe.

✓ EATING BEHAVIOUR

La fonction de surveillance d'alimentation par collier est la prochaine étape dans le suivi automatique des signaux qui mettent en évidence les problèmes de santé potentiels de chaque animal. Combien d'heures par jour la vache consacre à manger, est une donnée stratégique qui permet des actions précoces et précises sur chaque bovin et qui montre les changements dans le comportement d'alimentation. Préserver la santé de la vache, économiser les produits vétérinaires et gérer les coûts, rendent des bénéfices plus élevés pour la ferme laitière. Grâce à l'antenne longue portée de la surveillance d'alimentation, compatible avec les fermes de pâturages et fermes à stabulation libre.

✓ CONDUCTA ALIMENTARIA

La función NeckTag de monitorización de la alimentación es el paso siguiente en el seguimiento automático de señales que ponen de relieve potenciales problemas sanitarios en un animal específico. La cantidad de horas diarias que una vaca pasa comiendo es un dato estratégico que permite tomar acciones prontas y precisas en cada bovino que muestra cambios en su conducta alimentaria. Proteger la salud de las vacas y ahorrar en costes de tipo veterinario y de gestión da como resultado ganancias para la granja lechera. Gracias a la antena larga, la monitorización de la alimentación se adapta a las granjas de estabulación y de pastoreo.



Professional Dairy Management

✓ Thanks to the partnership with an international specialist we present our solution for professional dairy management software.

✓ Dank der Partnerschaft mit einem internationalen Spezialisten können wir unsere Lösung für eine professionelle Melkmanagement-Software präsentieren.

✓ A travers la coopération avec un spécialiste international, nous souhaitons vous présenter notre solution pour un software professionnel à gérer le troupeau laitier.

✓ Gracias a la colaboración con un especialista internacional presentamos nuestro software para la gestión profesional del ganado lechero.

Professional Milking Analysis



Economy Module



Lactations Database

Multi Farm / Multi Herd Module

Item	Value	Item	Value	Item	Value
84	114	261	10	35	45
549	727	0	214		

Feeding Monitoring

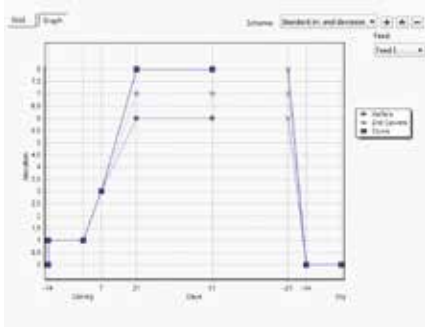

Groups



Report Editor



Android & iOS Mobile App

Uniform Agri Software

Uniform Agri Professional Software

	Ref.	Note
	5670001 5670005	ua sw prof global-250 cows ua sw exp process pc link

Uniform Agri Additional Modules

	Ref.	Note
	5670010 5670002 5670003 5670004 5670006 5670007 5670008 5670009 5670011	ua sw exp economy ua sw exp country link ua sw exp pda mobile ua sw exp touch ua sw exp stickreader link ua sw exp multiherd ua sw exp extra database ua sw exp tmr ua sw exp network

Uniform Agri Number of Cows

	Ref.	Note
	5670025 5670026 5670027 5670028 5670029 5670030 5670031 5670032 5670033 5670012 5670064	ua sw exp 250/ 499 cows ua sw exp 500/ 749 cows ua sw exp 750/ 999 cows ua sw exp 1000/1499 cows ua sw exp 1500/1999 cows ua sw exp 2000/2499 cows ua sw exp 2500/2999 cows ua sw exp 3000/3999 cows ua sw exp 4000/5000 cows ua sw exp over 5000 cows +1000 ua sw web-training hour

Uniform Agri Annual

	Ref.	Note
	5670013 5670017 5670022 5670014 5670015 5670016 5670018 5670019 5670020 5670021 5670023 5670034 5670035 5670036 5670037 5670038 5670039 5670040 5670041 5670042 5670024	ua annual prof global-250 cows ua annual exp process link ua annual exp economy ua annual exp country link ua annual exp pda mobile ua annual exp touch ua annual exp stickr. link ua annual exp multiherd ua annual exp extra database ua annual exp tmr ua annual exp network ua annual exp 250/ 499 cows ua annual exp 500/ 749 cows ua annual exp 750/ 999 cows ua annual exp 1000/1499 cows ua annual exp 1500/1999 cows ua annual exp 2000/2499 cows ua annual exp 2500/2999 cows ua annual exp 3000/3999 cows ua annual exp 4000/5000 cows ua annual exp over 5000 cows +1000

Recommended Service Program

Warranty Policy: www.interpuls.com

Family	Product	Recommended service program	Empfohlene Wartung
ELECTRONIC PULSATORS ELEKTROPULSATOREN	Pulsator LE20 - LE30 Pulsator LP20 - LP30 Control Valve CV30 - CV20 LC30	<ul style="list-style-type: none"> › clean the filter every 6 months (every 3 months under very damp and dusty conditions), rinse with clean water and mild detergent. Do not lubricate the filter › check rate & ratio at least every 12 months › clean immediately whenever milk has been sucked into the pulsator › a general overhaul is needed after 5.000 working hours 	<ul style="list-style-type: none"> › Reinigung des Filters alle 3-6 Monate mit Wasser und Seife › Prüfung von Melkverhältnis und -frequenz alle 12 Monate › Sofortige Reinigung bei hineingelaufener Milch bei defektem Zitzengummi › Generalüberholung nach 5000 Betriebsstunden
VACUUM PULSATORS PNEUMATISCHE PULSATOREN	Pulsator L02 Pulsator L80 Pulsator LL90	<ul style="list-style-type: none"> › do not lubricate the moving parts › clean the filter at least once per month (use water mild detergent and soft not-metallic brush for L02 & L80; blow compressed air for LL90 filter) › check rate & ratio at least every 12 months › every 2 months clean the working parts and the pulsator body with water mild detergent and soft not-metallic brush. rinse all parts in clean water and dry › clean immediately whenever milk has been sucked into the pulsator › a general overhaul is needed after 1.500 working hours 	<ul style="list-style-type: none"> › Bewegliche Teile nicht schmieren › Reinigung des Filters einmal im Monat (Wasser und Bürste für I02 und I80, Druckluft für I190) › Prüfung von Melkverhältnis und -frequenz alle 12 Monate › Alle 2 Monate allgemeine Reinigung der verschiedenen Teile und des Gerätekörpers: lauwarmes Wasser und milde Seife sowie eine nichtmetallische Bürste verwenden, mit sauberem Wasser spülen und abtrocknen › Sofortige Reinigung bei hineingelaufener Milch bei defektem Zitzengummi › Generalüberholung nach 1500 Betriebsstunden
VACUUM REGULATORS VAKUUMREGLER	Stabilvac 1500 Stabilvac 3600 Stabilvac 4000 MON. Stabilvac 4000 SEP. Stabilvac 6000 MON. Stabilvac 6000 SEP.	<ul style="list-style-type: none"> › check system vacuum level daily › check & clean "Servo Pilot Valve" every 12 months: use damp cloth, unscrew and blow compressed air into the 2 calibrated orifices › inspect and clean cone valve every 12 months with damp cloth › inspect air filters every month. Clean with warm water and mild detergent. Replace if damaged › replace diaphragms after 2.500 working hours or 1 year › inspect sensor tubes every month and replace if damaged 	<ul style="list-style-type: none"> › Prüfung der Stärke des Vakuums in der Anlage bei jedem Melkvorgang › Reinigung der Servoregelung alle 12 Monate: ein feuchtes Tuch verwenden, die beiden Schrauben mit kalibrierter Öffnung abschrauben und mit Druckluft ausblasen › Reinigung des Hauptventilverschlusses alle 12 Monate › Reinigung der Filter einmal pro Monat (warmes Wasser und mildes Reinigungsmittel); ersetzen, falls beschädigt › Austausch der Membranen nach 2500 Betriebsstunden oder 1 Jahr nach der Installation › Prüfung der Signalleitungen einmal pro Monat
	Spring regulators	<ul style="list-style-type: none"> › check system vacuum level daily › dismount and clean every 12 months 	<ul style="list-style-type: none"> › Prüfung der Stärke des Vakuums in der Anlage bei jedem Melkvorgang › Allgemeine Reinigung alle 12 Monate
	Sanivac	<ul style="list-style-type: none"> › inspect system vacuum level at every washing time › inspect air filters monthly. Clean with warm water and neutral detergent or replace if damaged › inspect sensor tubes monthly Replace if damaged 	<ul style="list-style-type: none"> › Prüfung der Stärke des Vakuums in der Anlage bei jeder Wäsche › Prüfung der Luftfilter einmal pro Monat. Reinigung mit warmem Wasser und mildem Reinigungsmittel. Ersetzen, falls beschädigt › Prüfung der Signalleitungen einmal pro Monat Ersetzen, falls beschädigt
MILK METER ELEKTRONISCHES MESSGERÄT	iMilk600	<ul style="list-style-type: none"> › clean after every milking session with appropriate products › three times a week wash with a solution of water + phosphoric or phosphonitic acid, in concentrations NOT exceeding 3% › For correct operation of the sensor, we recommend replacing the soft parts, especially the MMV moving parts, once every 2 years or every 5000 h of operation (the hours include milking and washing hours) 	<ul style="list-style-type: none"> › Wäsche mit speziellen Reinigungsmitteln nach jedem Melkvorgang › Dreimal in der Woche mit einer Lösung aus Wasser und Phosphorsäure oder Schwefelsäure, in einer Konzentration von NICHT mehr als 3% waschen. › Es wird darauf hingewiesen, die Auswechslung der weichen Teile, vor allem der Bewegungsteile des MMV, ein Mal alle 2 Jahre oder alle 5000 Betriebsstunden durchzuführen (Stunden einschließlich Melk- und Waschstunden)
ACR SYSTEM ABNAHMESYSTEM	HFS HFSO SO Valve	<ul style="list-style-type: none"> › clean after every milking session with appropriate products › check diaphragm every 12 months. Replace if needed 	<ul style="list-style-type: none"> › Wäsche mit speziellen Reinigungsmitteln nach jedem Melkvorgang › Prüfung des Zustands der Membran alle 12 Monate. Bei Bedarf austauschen

Family	Product	Recommended service program	Empfohlene Wartung
ACR SYSTEM ABNAHMESYSTEM	DVC800 & DVC1000	<ul style="list-style-type: none"> ➤lubricate with silicon spray only ➤check piston diaphragm every 6 months. replace if needed 	<ul style="list-style-type: none"> ➤Nur mit Silikonspray schmieren ➤Prüfung der Kolbendichtung alle 6 Monate; bei Bedarf austauschen
MILKING CLUSTERS FOR COWS MELKZEUGE FÜR KÜHE	Lunik 200 Orbiter 250 Orbiter 350 Lunik 350	<ul style="list-style-type: none"> ➤clean after every milking session with appropriate products ➤check the vent daily. Clean when necessary ➤replace gaskets & shut-off valve every 12 months 	<ul style="list-style-type: none"> ➤Wäsche mit speziellen Reinigungsmitteln nach jedem Melkvorgang ➤Ständige Überprüfung der Sauberkeit der Lufteinlassöffnung ➤Austausch der Dichtungen und des Absperrventils alle 12 Monate
	Liner IPL01 Liner IPL02 Liner IPL11 Liner IP01 Bubalus	<ul style="list-style-type: none"> ➤clean after every milking session with appropriate products ➤replace after 2.500 milking cows or after 6 months $2.500 : \left(\frac{n. \text{ of cows} \times n. \text{ of milkings}}{n. \text{ of clusters}} \right)$ 	<ul style="list-style-type: none"> ➤Wäsche mit speziellen Reinigungsmitteln nach jedem Melkvorgang ➤Austausch nach 2.500 Melkvorgängen oder 6 Monaten $2500 : \left(\frac{\text{Anz. Kühe} \times \text{Anz. Melkvorgänge}}{\text{Anz. Melkzeuge}} \right)$
	Short pulse tube	<ul style="list-style-type: none"> ➤check every 12 months. Replace if needed 	<ul style="list-style-type: none"> ➤Prüfung des allgemeinen Zustands alle 12 Monate; bei Bedarf austauschen
	Rubber parts	<ul style="list-style-type: none"> ➤replace all rubber parts every 12 months 	<ul style="list-style-type: none"> ➤Alle Gummitteile auf jeden Fall alle 12 Monate austauschen
MILKING CLUSTERS FOR SHEEP & GOATS MELKZEUGE FÜR SCHAFEN UND ZIEGEN	ITP203 claw ITP205 valve ITP206 valve ITP207 valve Classic cluster Vanguard cluster	<ul style="list-style-type: none"> ➤clean after every milking session with appropriate products ➤check the vent daily. Clean when necessary ➤replace gaskets & shut-off valve every 12 months 	<ul style="list-style-type: none"> ➤Wäsche mit speziellen Reinigungsmitteln nach jedem Melkvorgang ➤Ständige Überprüfung der Sauberkeit der Lufteinlassöffnung ➤Austausch der Dichtungen und des Absperrventils alle 12 Monate
	Liners for sheep Liners for goats	<ul style="list-style-type: none"> ➤clean after every milking session with appropriate products ➤replace after every lactation 	<ul style="list-style-type: none"> ➤Wäsche mit speziellen Reinigungsmitteln nach jedem Melkvorgang ➤Austausch nach jedem Melkvorgang
	Rubber parts	<ul style="list-style-type: none"> ➤replace all rubber parts every 12 months 	<ul style="list-style-type: none"> ➤Alle Gummitteile auf jeden Fall alle 12 Monate austauschen
WASHING PROGRAMMER WASCHPROGRAMMIERER	Top Wash III Top Wash Lite II	<ul style="list-style-type: none"> ➤inspect sensor tubes monthly. Replace if damaged ➤a general overhaul is recommended every 12 months ➤inspect peristaltic pump internal tube every 6 months 	<ul style="list-style-type: none"> ➤Die Wassereinflussfilter einmal pro Monat reinigen (alle 14 Tage, wenn das Wasser sehr viel Kalk oder andere Substanzen enthält) ➤Allgemeine technische Prüfung alle 12 Monate ➤Die Rohre in den peristaltischen Pumpen alle 6 Monate auf Defekte prüfen.
	Lids Gaskets	<ul style="list-style-type: none"> ➤clean after every milking session with appropriate products ➤check and clean gaskets every 12 months. Replace if needed 	<ul style="list-style-type: none"> ➤Wäsche mit speziellen Reinigungsmitteln nach jedem Melkvorgang ➤Prüfung des Zustands der Dichtungen alle 12 Monate; bei Bedarf austauschen
	Gaskets	<ul style="list-style-type: none"> ➤clean after every milking session with appropriate products ➤check and clean gaskets every 12 months. Replace if needed 	<ul style="list-style-type: none"> ➤Wäsche mit speziellen Reinigungsmitteln nach jedem Melkvorgang ➤Prüfung des Zustands der Dichtungen alle 12 Monate; bei Bedarf austauschen
MILK FILTER MILCHFILTER	Filter Gaskets	<ul style="list-style-type: none"> ➤replace filter after every milking session ➤clean after every milking session with appropriate products ➤check and clean gaskets every 12 months. Replace if needed 	<ul style="list-style-type: none"> ➤Austausch des Filters nach jedem Melkvorgang ➤Wäsche mit speziellen Reinigungsmitteln nach jedem Melkvorgang ➤Prüfung des Zustands der Dichtungen alle 12 Monate; bei Bedarf austauschen

New Milking Parlour

Check List

Chart • Chart

New milking parlour designing requires a lot of planning in order to reach the target of a practical and cost effective complete system. The checklist below is an useful step by step guide for the correct estimate of each singular device.

Milking parlour specifications

System type

- Bucket milking
- Pipeline
- Swingover
- Side by side
- Rotary

Description	Value
Milking system size	
Vacuum pump	
Vacuum regulator	
Pulsation	
Cluster	
Therminal unit	
Milk pump	
Vacuum line size	
Milk line size	
Automatic washing programmer	
Washing unit	
Automatic cluster remover	
Manual milk meter	
Electronic milk meter	
Wash trough size	
Dairy management	
Manual ID	
Electronic ID	
Heat detection	
Automatic feeding	

Der Entwurf eines neuen Melkstands erfordert eine gründliche Planung, damit das Ziel eines praktischen, kostengünstigen und kompletten Systems erreicht wird. Die nachstehende Prüfliste ist eine hilfreiche schrittweise Anleitung für die korrekte Schätzung einer jeden einzelnen Vorrichtung.

Leistungsverzeichnis des Melkstandes

Systemart

- Eimermelken
- Rohrleitung
- Swingover
- Nebeneinander
- Drehbar

Beschreibung	Wert
Größe des Melksystems	
Vakuumpumpe	
Vakuumregler	
Pulsation	
Melkzeug	
Endeinheit	
Milchpumpe	
Größe der Vakuumleitung	
Größe der Milchleitung	
Automatisches Reinigungsprogramm	
Wascheinheit	
Automatische Melkzeugabnahmen	
Manuelles Milchmessgerät	
Elektronisches Milchmessgerät	
Größe des Waschtrogs	
Melkmanagement	
Manuelle ID	
Elektronische ID	
Brunsterkennung	
Automatische Fütterung	

#Pulsation

LE30/LP30 (pag. 8)
IUC24/IUC32 (pag. 13)
IUP (pag. 14)
L02 Air (pag. 15)
L80 Air (pag. 17)
Quick Mounting (pag. 29)
Adapters (pag. 31)

#Pipeline & Buckets

Combifast (pag. 19)
Portable iMilk401 + Software DHM (pag. 22)
Portable ACR (pag. 26)
Libero Lid (pag. 96)
Clear Lids (pag. 97)
Ecobucket (pag. 98)

#Vacuum Care

Stabilvac 600/1400 (pag. 36)
Stabilvac 1500/3600 (pag. 37)
Stabilvac 4000/6000 (pag. 39)
Pop-Off (pag. 42)
iDrive100 (pag. 43)
DVG-P/DVG-T (pag. 46)

#Automation

CV30/CV20 (pag. 11)
ACRsmart (pag. 47)
ACRsmart MMV (pag. 49)
iMilk600 (pag. 53)
DVC Family & Accessories (pag. 57)
HFS Family (pag. 59)
Milk Meter MK5 (pag. 61)

#Milking Clusters

Lunik350 (pag. 63)
Orbiter Heavy Duty (pag. 66)
IPL11/IPL01/IPL02 (pag. 70-71)
IPL01 Bubalus (pag. 72)
Accessories (pag. 73)

#Cleaning Solutions

Spinjet (pag. 73)
Optiflow III (pag. 74)
Top Wash Lite II (pag. 77)
Top Wash III Software 3.3 (pag. 79)
Turbo Wash 4000 (pag. 84)
Sanivac (pag. 85)

#Sheep & Goats

ITP203/205/207 (pag. 86)
Classic/Vanguard Milking Cluster (pag. 87-88)
Accessories (pag. 90)
ITP206 (pag. 91)
Optiflow III S&G (pag. 93)
Sheep & Goat Yoke and Feeding Trough (pag. 95)

#Stainless Steel & Milk Line

Buckets (pag. 100)
Sanitary Traps (pag. 101)
Milk Filters (pag. 102)
Swing Over (pag. 104)
Lids (pag. 105)
Teat Cup Shell (pag. 107)
Vacuum Taps (pag. 110)
Fittings & Accessories (pag. 111-112)
Milk Pumps (pag. 119)
UTV (pag. 120)
Vacuum Pumps (pag. 123)
Accessories (pag. 126)

#Stall Ventilation System

Axial Fan (pag. 127)
Horizontal Fan (pag. 129)
Fan Box Control (pag. 130)

#PMM

PMM (pag. 131)
PMM Italia (pag. 132)

#Smart Solutions

Tagliafieno LH22 (pag. 134)
Butter Churn (pag. 136)

#Testing Equipment

PTV Flow Meter & Accessories (pag. 137)

#Top30

Saving Opportunity (pag. 6-7)

#Intelligence

iMilk700 (pag. 138)
Precision Farming kit (pag. 143)
Velos Dairy Management (pag. 158)
Professional Dairy Management (pag. 165)

- ✓ É vietato riprodurre anche solo parzialmente i testi, le foto e i disegni senza nostra autorizzazione scritta.
- ✓ InterPuls  è un marchio registrato di proprietà di InterPuls SpA.
- ✓ Le informazioni incluse in questo catalogo non sono impegnative e sono soggette a modifica senza preavviso. I riferimenti a marchi registrati di costruttori riportati in questo catalogo, hanno unicamente una funzione identificativa. Alcuni nomi di prodotti ed aziende utilizzati nel catalogo sono marchi registrati di proprietà dei loro rispettivi depositari.

- ✓ Il est interdit de reproduire, même en partie seulement, les textes, les photographies et les dessins, sans avoir obtenu au préalable notre autorisation écrite.
- ✓ InterPuls  est une marque déposée qui appartient à InterPuls SpA.
- ✓ Les données contenues dans ce catalogue ne représentent pas un engagement. Elles peuvent être modifiées à tout moment et sans préavis. Les références aux marques du producteur, qui figurent sur ce catalogue, ne sont données qu'à titre indicatif. Certains noms de produits et de sociétés, dont le catalogue fait mention, sont des marques appartenant à leurs propriétaires respectifs.

- ✓ Eine vollständige oder teilweise Vervielfältigung des Textes oder der darin enthaltenen Fotografien und Zeichnungen ist ohne unsere ausdrückliche schriftliche Genehmigung streng verboten.
- ✓ InterPuls  ist ein eingetragenes Warenzeichen der InterPuls SpA.
- ✓ Die in diesem Katalog enthaltenen Informationen sind unverbindlich und können ohne vorherige Ankündigung geändert werden. Bezugnahmen auf Warenzeichen der Hersteller in diesem Katalog dienen einzig und allein der Identifizierung. Bestimmte in diesem Katalog verwendete Unternehmens- und Produktnamen sind Warenzeichen ihrer jeweiligen Eigentümer.

- ✓ Está prohibido reproducir, parcial o totalmente, textos, fotografías y dibujos sin contar con la autorización escrita de nuestra empresa.
- ✓ InterPuls  es marca registrada de InterPuls.
- ✓ La información contenida en este catálogo no es vinculante y está sujeta a modificaciones sin aviso previo. Las referencias presentes en este catálogo relativas a fabricantes son solo a título de identificación. Algunos nombres de empresas y productos utilizados en este catálogo son marcas registradas de sus respectivos propietarios.

FOLLOW US!



REF: 9505770 - 05/16