



2023

LEAVE YOUR IMPRINT.



Full-line Catalog
[MillerWelds.com](https://www.MillerWelds.com)



MILLER PRODUCTS BUILT BY PEOPLE LIKE YOU, FOR PEOPLE LIKE YOU.

Careful planning. Attention to detail. Pride in a job well done. That's how people like you weld. That's how people at Miller work.

Miller has been headquartered in Appleton, Wisconsin for more than 90 years. Our employees put expertise, ingenuity and work ethic into everything we build. And because we listen to the people who use our equipment, we're always creating new solutions to meet your needs.

Whether you weld to build a project, a business or a dream, you can depend on Miller products to get the job done right. Because we work the way you work.

**MILLER
DISTRIBUTORS**
KNOWLEDGE+ADVICE+SUPPORT.

When you work with a Miller distributor, you're working with a valued partner. You can depend on their in-depth knowledge and assistance to select a perfect Miller solution — and their support throughout your product's long lifetime of service. Visit MillerWelds.com to find a Miller distributor near you.

MillerWelds.com



1-800-4-A-Miller (1-800-426-4553)



NEW FROM BLUE

13

**Intellx™ Elite
Wire Feeders**



20

**ArcReach® 16
Wire Feeders**



34

**Hercules™
High-Deposition
Automated
Welding System**



35

**Copilot™
Collaborative
Welding Cell**



45/61

**Dynasty® 300
Multiprocess
and Dynasty®
210/300 Series
TIG Power Sources**



50

**XMT® 650
and XMT® 650
ArcReach®
Multiprocess
Power Sources**



77

**Fusion 185
Welder/Generator**



107

**FILTAIR® 215
Fume Extractor**



112

**Hard Hat PAPR
Powered
Air Purifying
Respirator**



114/115

**T94i™ XL
Welding Helmet
and New Welding
Helmet Graphics**



AccuLock™ consumables are now available on select feeders and industrial packages. Look for the AccuLock™ logo in MIG and Wire Feeders sections or check out the packages in the Multiprocess section. See page 27 for more information on AccuLock™ consumables.

BENEFITS OF BLUE TECHNOLOGIES AND INNOVATIONS.

Miller is committed to bringing forward-thinking technologies and solutions to the welding industry. We listen to your challenges and constantly seek to improve our products and services to better address them.

Ease of use

ArcConnect™

Next generation communication that utilizes high-speed signals to improve weld performance and allow point-of-use controls to be located at the feeder. Found on the Deltaweld® Systems (pg 12).

AUTO-LINE™ TECHNOLOGY Allows for any input voltage hookup with no manual linking. Provides convenience in any job setting and is ideal for dirty or unreliable power. Found on the following products:

MIG

Millermatic® 255 (pg 9)
AlumaPower™ 350 (pg 11)
Continuum™ (pg 14)
Auto-Continuum™ (pg 15)

Multiprocess

Multimatic® 255 (pg 44)
Maxstar® 280 Multiprocess (pg 45)
Dynasty® 300 Multiprocess (pg 45)
XMT® 350 (pg 46–49)

Stick

Maxstar® (pg 53–54)
CST™ 282 (pg 55)

TIG

Maxstar® (pg 57/60/62)
Syncrowave® 210 (pg 58)
Dynasty® (pg 61–62)

Plasma cutters

Spectrum® (except 875) (pg 96)

AutoSense™

Reduces issues related to setting helmet sensitivity by allowing welder to push and hold the AutoSense button to automatically set the helmet sensitivity for their environment. Found on Digital Infinity™, Digital Elite™ and Digital Performance™ welding helmets (pg 115).

Auto-Set™

Provides speed, convenience and confidence of preset controls and eliminates guesswork when setting weld parameters. Variations of this technology include **Advanced Auto-Set** and **Auto-Set Elite**. Found on the following products:

MIG

Millermatic® (except 252)
(pg 7/9/10)

Multiprocess

Multimatic® (pg 41–44)

TIG

Syncrowave® 210 (pg 58)

MVP™ plugs and adapters

Allows connection to common 120- or 240-volt receptacles without the use of tools — just choose the plug/adaptor that fits the receptacle. Found on the following products:



MIG

Millermatic® 211 (pg 7)

Multiprocess

Multimatic® 200/215 (pg 41)
Multimatic® 220 AC/DC (pg 42)

Stick

Thunderbolt® 160 (pg 53)

TIG

Diversion™ 180 (pg 57)
Syncrowave® 210 (pg 58)

Engine drives

Fusion 185 (pg 77)

Plasma cutters

Spectrum® 375/625 (pg 96)



Provides single-phase stick weld capability with the engine shut off by plugging into 120- or 240-volt wall power. Ideal for indoor or noise-sensitive environments. Found on the Fusion 185 engine drive (pg 77).

Pro-Set™

Provides speed, convenience and confidence of preset controls and eliminates guesswork when setting TIG or stick weld parameters. Found on the following products:

Multiprocess

Multimatic® 220 AC/DC (pg 42)
Multimatic® 235 (pg 43)
Maxstar® 280 Multiprocess (pg 45)
Dynasty® 300 Multiprocess (pg 45)

TIG

Syncrowave® (pg 58–59)
Maxstar® (except 161) (pg 60/62)
Dynasty® (pg 61–62)

QuickTech™

Provides easy setup and process changing on the Multimatic® 220 AC/DC multiprocess welder (pg 42).

- *Automatically* determines polarity. Work is always connected to the bottom right receptacle. MIG gun and TIG torch can stay connected at the same time.
- *Automatically* switches to the right process. Just hit trigger or foot control and the machine automatically changes, eliminating the need to manually change processes.
- *Automatically* recalls settings from the last process used.

Remote start/stop

Allows you to easily turn your Bobcat™ welder/generator on and off remotely so it only runs when you need it. Get more out of each tank, extend time between maintenance and work without the hassle of walking back to your machine. Found on the Bobcat™ 225 and 260 (non-LP) engine drives (pg 80).



X-Mode™

Electromagnetically senses the weld to reduce sunlight interference and continuously detects the arc even if sensors are blocked. Found on the T94™, Digital Infinity™, Digital Elite™ and Classic VSi™ welding helmets (pg 114–115).



Advanced welding processes

Versa-Pulse™ is a fast, low-heat, low-spatter process designed for materials up to 1/4 inch and is great for gap filling.

Accu-Pulse® is better for out-of-position welds, provides higher deposition rates and has the most adaptive arc on 16 gauge and thicker materials.

RMD® (Regulated Metal Deposition) is a modified-short-circuit process with the lowest heat and limited travel speed.

Designed to fill gaps in thin-material applications, it provides a higher quality root pass, calm and stable arc, and less spatter.

Advanced welding processes are found on the following products:

MIG

Deltaweld® 350/500 with Intelli™ Pro or Elite feeder (Accu-Pulse only) (pg 12)
Continuum™ Systems (pg 14)
Auto-Continuum™ Systems (pg 15)

Multiprocess (RMD only)
XMT® 350 FieldPro models (pg 48) with ArcReach Smart Feeder

Multiprocess (RMD only) (cont.)
PipeWorx 400 System (pg 52)

Engine drives (RMD only)
Trailblazer® 325 ArcReach models (pg 82) w/ArcReach Smart Feeder
Big Blue® ArcReach models (pg 84–87) with ArcReach Smart Feeder

Augmented reality welding

Training solution that builds a larger, more skilled welding workforce and quickly helps correct errors, reinforces proper welding practices and accelerates skill advancement. Found on the MobileArc™ and AugmentedArc™ augmented reality welding systems (pg 120).

ClearLight™ 2.0 Lens Technology

Provides advanced high-definition optics for the most realistic view. Found on T94™, Digital Infinity™, Digital Elite™ and Digital Performance™ welding helmets. Classic Series uses **ClearLight** lens (pg 114–115).

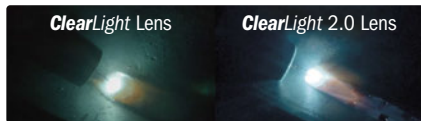

DYNAMIC DIG™ Automatically adjusts the amount of current required to clear a short. Delivers a smoother, more consistent arc that can be tailored to match the application, material, fit-up and welder technique. Found on Trailblazer® 325 (pg 82) and Big Blue® (pg 84–87) engine drives.

Insight Welding Intelligence™

Insight Core™ is an easy-to-use welding information solution that gives visibility into your operation so you can improve productivity.

Insight Centerpoint™ is a real-time welder feedback solution that provides guidance and control within the weld cell to ensure consistent weld quality.

For more information, see pages 73–75. Insight Welding Intelligence is found on the following products:

MIG (Insight Core standard)
Deltaweld® 350/500 (pg 12)
Continuum™ (pg 14)
Auto-Continuum™ (pg 15)
MIG (Insight Centerpoint optional)
Continuum™ (pg 14)
Auto-Continuum™ (pg 15)

*Note: **Insight Core** is compatible with many 14-pin compliant Miller® power sources (see chart at MillerWelds.com/insight) using an Insight Core 14-pin module. **Insight Centerpoint** is compatible with ALL power sources using an ArcAgent Manual or ArcAgent Auto.*

ArcReach® Allows operators to adjust welding parameters right at the weld joint without a control cord, using the wire feeder (pg 18–20, 51) or remote (pg 51) — maximizing arc-on time and impacting the bottom line. Found on the following products:

Multiprocess	Engine drives
XMT® 350 FieldPro™ models (pg 48)	Trailblazer® 325 ArcReach models (pg 82)
XMT® 450 CC/CV ArcReach (pg 49)	Big Blue® ArcReach models (pg 84–87)
XMT® 650 ArcReach models (pg 50)	

Auto-Speed™

Automatically adjusts engine speed to meet demands so the engine never works harder than necessary. Reduces fuel consumption and noise levels on the Bobcat™ 200 Air Pak™ (pg 79) and Trailblazer® 325 (pg 82) engine drives.

Excel™ power

Provides 2,400 watts (20 A) of 120-volt power at all engine speeds, including idle. Reduces fuel consumption and noise levels on select models of the Trailblazer® 325 engine drive (pg 82).

Fan-On-Demand™

Fan only operates when needed to reduce noise, energy use and amount of contaminants pulled through the machine. Found on various MIG, multiprocess, stick, TIG and plasma cutter products.

InfoTrack™ 2.0

Data monitoring technology tracks arc time and arc count. Found on the T94™, Digital Infinity™ and Digital Elite™ welding helmets (pg 114–115).

WIRELESS INTERFACE CONTROL

Get full control of your welder/generator in the palm of your hand. Change welding processes, adjust parameters, select and save preset programs, turn the machine on/off, get service reminders and more from wherever you are on the jobsite. Extend time between fill ups and maintenance intervals while eliminating the need to go back to your machine to make adjustments. Found on select models of the Trailblazer® 325 (pg 82) and Big Blue® (pg 84–87) engine drives.

ZoneFlow™ technology

Extended-capture weld fume extraction technology extends the capture zone up to five feet deep and four feet wide (versus up to 18 inches from conventional source capture extractors). The increased capture zone reduces arm interactions so operators can keep welding, increasing arc-on time and productivity. Found on the FILTAIR® Capture 5, and select FILTAIR® SWX and 4000–12000 models (pg 108–110).





Product Guide

	Page	Class	MIG	Pulsed MIG	Flux-cored*	CAC-A	Portability	Weldable Metals	Welding Output Range	Special Features	Typical Applications
1-Phase	Millermatic® 141	7	●	●	●		Handles, optional running gear	Steel, stainless, aluminum	30-140 A	All-in-one, 120 V input, Auto-Set™, Smooth-Start™	Up to 3/16 in. using self-shielded wire maintenance/repair, auto body, hobby
	Millermatic® 211	7	●	●	●				30-230 A	All-in-one, 120 or 240 V input, Auto-Set™, Smooth-Start™	Up to 3/8 in. maintenance/repair, auto body, hobby
	Millermatic® 252	8	●	●	●		Installed running gear	Steel, stainless, aluminum	30-300 A	All-in-one, standard timers menu, Fan-On-Demand™, connects to standard MIG gun, push-pull gun or spool gun	Up to 1/2 in. industrial production/fabrication, farm
	Millermatic® 255	9	●	●	●		Handles, optional running gear	Steel, stainless, aluminum	20-350 A	All-in-one, Auto-Set™ stores up to four programs, connects to standard MIG gun, push-pull gun or spool gun	Up to 1/2 in. industrial production/fabrication, pulsed MIG ideal for thin gauge aluminum
1- & 3-Ph	Millermatic® 355	10	●	●	●		Handles, optional running gear	Steel, stainless, aluminum	20-400 A 12-34 V	All-in-one, Auto-Set™ stores up to four programs, connects to standard MIG gun, push-pull gun or spool gun	Up to 1/2 in. industrial production/fabrication, pulsed MIG ideal for thin gauge aluminum
	AlumaFeed® 350 Aluminum System	11	●	●	●		Handles, optional cart, MIGRunner™	Aluminum	5-425 A 10-38 V	Profile Pulse™ lightweight feeder can be up to 100 feet from power source	Heavy industrial aluminum production/fabrication, truck trailer, shipbuilding
3-Phase	AlumaFeed® 450 Aluminum System	11	●	●	●		Handles, optional cart, MIGRunner™	Aluminum	15-600 A 10-38 V	Profile Pulse™ lightweight feeder can be up to 100 feet from power source	Heavy industrial aluminum production/fabrication, truck trailer, shipbuilding
	Deltaweld® 350 Systems	12	●	●	●		Lift eye, optional running gear, MIGRunner™	Steel, stainless	20-400 A 10-38 V	Special arc control feature when paired with Intelx™ feeders, Accu-Pulse® MIG welding with Intelx Pro and NEW! Intelx Elite wire feeders; optional Insight Core™	Medium-to-large manufacturing and fabrication
	Deltaweld® 500 Systems	12	●	●	●	3/8"			30-650 A 10-44 V	Special arc control feature when paired with Intelx™ feeders, Accu-Pulse® MIG welding with Intelx Pro and NEW! Intelx Elite wire feeders; optional Insight Core™	Medium-to-large manufacturing and fabrication
	Continuum™ 350	14	●	●	●	1/4"	Lift eye, optional running gear, MIGRunner™	Most metals	20-400 A 10-44 V	Advanced arc performance, Insight Core™; optional Insight Centerpoint™	Mid- to high-volume manufacturing
	Continuum™ 500	14	●	●	●	3/8"			20-600 A 10-44 V	Advanced arc performance, Insight Core™; optional Insight Centerpoint™	Mid- to high-volume manufacturing
	Auto-Continuum™ 350	15	●	●	●		Lift eye	Most metals	20-400 A 10-44 V	Available for EtherNet/IP™ DeviceNet and analog protocol, Insight Core™; optional Insight Centerpoint™	Fixed and flexible automation
	Auto-Continuum™ 500	15	●	●	●				20-600 A 10-44 V	Available for EtherNet/IP™ DeviceNet and analog protocol, Insight Core™; optional Insight Centerpoint™	Fixed and flexible automation

Product Key

Class: ● Light industrial ● Industrial ● Heavy industrial Capability: ● Designed for this process ● Capable of this process
NEW! or IMPROVED! products appear in blue type. *If using self-shielded wire on a CC/CV machine, use CV weld output.

Millermatic® 141 and 211

See literature DC/12.42 (141) and DC/12.58 (211)

Light industrial **CV DC 1** Phase



Millermatic 211



Multi-voltage plug (MVP™) allows connection to common 120- and 240-volt power receptacles without the use of any tools – simply choose the plug that fits the receptacle and connect to the power cord.

Millermatic 141



Mild Steel Welding Capability

		3/8 in. (9.5 mm)
Max.	3/16 in. (4.8 mm)	
Model	141	211
Min.	24 ga. (0.6 mm)	24 ga. (0.6 mm)

Aluminum Welding Capability

		3/8 in. (9.5 mm)
Max.	14 ga. (1.9 mm)	
Model	141	211
Min.	18 ga. (1.2 mm)	18 ga. (1.2 mm)

Aluminum welding with the Millermatic 141 uses optional Spoolmate 100 spool gun and 4043 series aluminum wire. Aluminum welding with the Millermatic 211 uses optional Spoolmate 100 spool gun with 4043 aluminum series wire **OR** optional Spoolmate 150 spool gun with 4000 or 5000 series aluminum wire.

Recommended aluminum solution

Spoolmate 100 (page 29) with both Millermatic models **OR** Spoolmate 150 (page 29) with Millermatic 211.



Auto-Set™ automatically provides the right settings to weld mild steel while **infinite voltage control** allows the flexibility to manually set your own parameters.



Millermatic 211 model provides additional capabilities.

- Set the wire diameter (141: .024/.030 in.) (211: .024/.030/.035 in.), a blue light shows Auto-Set is activated
- Dial in the thickness of material you are welding
- Start welding with the exact parameters you need!

Angled cast-aluminum drive system with calibrated tension knob creates consistent feeding and easy setup.

Quick Select™ drive roll makes setup quicker by offering three grooves – two for different size solid wire and a third for flux-cored wire.

Auto Spool Gun Detect™ automatically detects when a MIG gun or spool gun is connected, eliminating the need for a switch.

Smooth-Start™ provides a smooth, spatter-free start.

Thermal overload protection shuts down unit and activates the **over temperature light** if airflow is blocked or duty cycle is exceeded. Automatically resets when unit cools.

Uses 4- or 8-inch (102 or 203 mm) spools.

Millermatic 211 model additional features

Advanced Auto-Set™ includes five different wire/gas combinations and .024-, .030- and .035-inch wire capabilities.

Inverter technology combines best-in-class arc characteristics with the portability of a 38-pound machine. The arc is extremely forgiving to variations in arc length and travel speeds.

Fan-On-Demand™ cooling system only operates when needed, reducing power consumption and keeping internal components cleaner.

Processes

- MIG (GMAW) ▪ Flux-cored (FCAW)

Comes complete with

- 10 ft. (3 m) 100-amp MDX™-100 MIG gun with AccuLock™ MDX™ consumables
- 10 ft. (3 m) work cable with clamp
- 6.5 ft. (2 m) power cord with plug (Millermatic 141) **OR** 6.5 ft. (2 m) power cord with MVP plugs for 120 V and 240 V (Millermatic 211)
- Quick Select™ drive roll for .024 in. (0.6 mm) or .030/.035 in. (0.8/0.9 mm) solid wire, and .030/.035 in. (0.8/0.9 mm) flux-cored wire



- Flow gauge regulator and gas hose for argon or AR/CO₂ mix, two .030 in. contact tips, Hobart® spool of .030 in. solid wire, hook-and-loop cord wraps and material thickness gauge (229895)

Most popular accessories

- Spoolmate™ 100 300371 (pg 29)
- Spoolmate™ 150 301272 (pg 29) (for Millermatic 211 only)



- **Running Gear/Cylinder Rack** 301239 (pg 122)
- Protective Cover 301262 (pg 125)
- V-Knurled Drive Roll 202926

Visit MillerWelds.com or your distributor for other Miller® options and accessories.

Model/Stock Number	Input Power	Amperage Range	Rated Output	Amps Input at Rated Output, 50/60 Hz				Wire Feed Speed	Wire Type and Diameter Capacity	Power Source Dimensions	Power Source Net Weight
				120 V	240 V	KVA	KW				
Millermatic 141 907612 951601 With running gear/ cylinder rack	120 V	30-140	90 A at 18.5 VDC, 20% duty cycle	20	–	3.0	2.45	15-360 ipm (0.4-9.1 m/min.)	Solid steel .023-.030 in. (0.6-0.8 mm) Stainless .023-.030 in. (0.6-0.8 mm) Flux-cored .030-.035 in. (0.8-0.9 mm)	H: 12.5 in. (318 mm) W: 11.25 in. (286 mm) D: 20.5 in. (521 mm)	51 lb. (23.1 kg)
Millermatic 211 907614 951603 With running gear/ cylinder rack	120 V	30-130	115 A at 19.8 VDC, 20% duty cycle	24.3	–	2.9	2.9	60-600 ipm (1.5-15.2 m/min.)	Solid steel .023-.035 in. (0.6-0.9 mm) Stainless .023-.035 in. (0.6-0.9 mm) Flux-cored .030-.045 in. (0.8-1.2 mm)		38 lb. (17.2 kg)
	240 V	30-230	150 A at 21.5 VDC, 40% duty cycle	–	16.6	4.0	4.0				

Millermatic® 252

See literature DC/12.49



Recommended aluminum solution
Spoolmatic 15A **OR** 30A
(page 30).

Welding Capability

Max. 1/2 in. (13 mm)		Max. 3/8 in. (9.5 mm)
Mild Steel		Aluminum
Min. 22 ga. (0.8 mm)		Min. 14 ga. (1.9 mm)

Aluminum welding uses optional Spoolmatic 15A **OR** 30A spool gun.

Infinite voltage control with self-calibrating digital meters that permit presetting of voltage and wire feed speed. Ensures precise parameters and accuracy.

EXCLUSIVE! Auto-Gun Detect™ automatically adjusts voltage, wire speed and timers for faster switching between MIG, push-pull and spool guns.

Integrated digital timers come complete with presettable preflow/postflow, bumback, spot and delay (stitch) timers. Independent timers for MIG and spool gun.

Superior aluminum MIG welding with direct connection of optional Spoolmate™ 200 and Spoolmatic® spool guns or XR™ push-pull guns. No extra module to buy or install.

Heavy-duty aluminum two-drive-roll system.

Uses 4-, 8- or 12-inch (102, 203 or 305 mm) spools.

Fan-On-Demand™ cooling system only operates when needed, reducing power consumption and keeping internal components cleaner.

Industrial ● **CV DC 1**
Phase

Processes

- MIG (GMAW) ▪ Flux-cored (FCAW)

Comes complete with

- 15 ft. (4.5 m), 250-amp MDX™-250 MIG gun with AccuLock™ MDX™ consumables
- 10 ft. (3 m) work cable with clamp
- 10 ft. (3 m) industrial power cord (and plug on 208/240 V model)
- Factory-installed gas solenoid
- Flow gauge regulator and gas hose for argon or AR/CO₂ mix
- Factory-installed lowered running gear/cylinder rack with chain to secure gas cylinder
- .030/.035 in. reversible dual-groove drive rolls
- Extra contact tips

Most popular accessories

- Spoolmate™ 200 Spool Gun (pg 29)
- Spoolmatic® Spool Gun (pg 30) (non-Pro gun only)
- Dual EZ-Change™ Low Cylinder Rack 300337 (pg 122)
- Elevated Gun and Cable Rack 300335 (pg 122)
- Protective Cover 195142 (pg 125)
- 230-Volt Extension Cord 770644

Visit MillerWelds.com or your distributor for other Miller® options and accessories.

*With Spoolmatic 30A, additional regulator and dual EZ-Change low cylinder rack with elevated gun and cable rack.
**While idling.

Stock Number	Amperage Range	Rated Output	Amps Input at Rated Output, 60 Hz					Wire Feed Speed	Wire Type and Diameter Capacity	Dimensions	Net Weight		
			208 V	230 V	240 V	460 V	575 V					KVA	KW
907321 208/240 V 951960* 208/240 V	30-300	200 A at 24 VDC, 60% duty cycle	57.0	-	50.8	-	-	11.4	7.1	50-700 ipm (1.3-17.8 m/min.)	Solid steel .023-.045 in. (0.6-1.2 mm) Stainless .023-.045 in. (0.6-1.2 mm) Flux-cored .030-.045 in. (0.8-1.2 mm)	H: 30 in. (762 mm) W: 19 in. (483 mm) D: 40 in. (1,016 mm)	205 lb. (93 kg)
		250 A at 26.5 VDC, 40% duty cycle	64.2	-	56.4	-	-	12.6	9.4				
907322 230/460/575 V 951961* 230/460/575 V		200 A at 24 VDC, 60% duty cycle	-	46	-	23	18	9.8	7.5				
		250 A at 26.5 VDC, 40% duty cycle	-	2**	-	1**	0.8**	0.46**	0.13**				

NEW
FABCO®
TRIPLE 7

EXPANDED

PROPERTIES. EXPANDED POSSIBILITIES.

FabCO® Triple 7 (FCAW-G)

- Upgraded & relaunched product
- Premium weldability in all positions
- Gas & application versatility
- D1.8 approved for seismic applications
- Ideal for all skill levels

FabCOR® EDGE™

X-CEPTIONAL PERFORMANCE AND PRODUCTIVITY.

FabCOR® Edge™ XP

- Next generation of FabCOR® Edge™ metal-cored wire
- Boosts productivity
- Balanced arc characteristics
- Best-in-class silicon gathering
- Exceptional wetting action over mill scale



Visit HobartBrothers.com
for more information.

Millermatic® 255 See literature DC/12.8



Millermatic 255 with EZ-Latch single cylinder running gear shown.

Welding Capability

Max. 1/2 in. (13 mm)	Max. 1/2 in. (13 mm)
Mild Steel	Aluminum
Min. 24 ga. (0.6 mm)	Min. 18 ga. (1.2 mm)

Aluminum welding uses optional XR-Aluma-Pro push-pull gun.

Recommended aluminum solution

XR-Aluma-Pro™ push-pull gun (page 31).



Easy-to-understand interface with 7-inch color LCD display ensures proper machine setup and parameter selection, reducing setup time and increasing weld time.

- Quick-access Auto-Set and pulse mode backlit buttons across the top illuminate when active
- Soft-key buttons below the display change function depending on which screen is displayed – makes setup or change quick, easy and intuitive
- Large text for easier readability
- Intuitive connection setup images
- Full troubleshooting descriptions versus help errors and look up codes

AUTO-LINE™ TECHNOLOGY Allows for any input voltage hookup (208–240 V, single-phase) with no manual linking, providing convenience in any job setting. Ideal solution for dirty or unreliable power.

Built-in pulsed MIG programs. All programmed information is restored after each power up – steel/stainless steel/aluminum/silicon bronze.

Auto-Set™ Elite offers predefined weld settings to increase ease of use and ensure that the job is done right for operators of all skill levels.

- Available for MIG and pulsed MIG processes with the ability to fine-tune your settings
- Set weld parameters by selecting wire and gas type, wire diameter and material thickness

Program mode allows easy save and recall of favorite weld settings. Delivers greater productivity and consistent quality while minimizing supervisor intervention.

EXCLUSIVE! Auto-Gun Detect™ automatically adjusts voltage, wire speed and timers for faster switching between MIG, push-pull and spool guns.

Heavy-duty aluminum two-drive-roll system.

Uses 4-, 8- or 12-inch (102, 203 or 305 mm) spools.

Fan-On-Demand™ cooling system only operates when needed, reducing power consumption and keeping internal components cleaner.

Industrial ● **CV DC 1** Phase

Processes

- MIG (GMAW) ▪ Flux-cored (FCAW)
- Pulsed MIG (GMAW-P)

Comes complete with

- 15 ft. (4.5 m) 250-amp MDX™-250 MIG gun with AccuLock™ S consumables
- 10 ft. (3 m) work cable with clamp
- 10 ft. (3 m) industrial power cord
- Factory-installed gas solenoid
- Flow gauge regulator and gas hose for argon or AR/CO₂ mix
- .035/.045 in. reversible V-groove drive rolls
- Extra contact tips and material thickness gauge (229895)

Most popular accessories

- Spoolmatic® Spool Gun (pg 30) (non-Pro gun only)
 - XR-Aluma-Pro™ Air-Cooled Push-Pull Guns (pg 31)
 - XR™-Pistol-Pro Air-Cooled Push-Pull Guns (pg 31)
 - EZ-Latch™ Single Cylinder Running Gear 301449 (pg 122)
 - EZ-Latch™ Dual Cylinder Rack with Elevated Gun and Cable Rack 301481 (pg 122)
- Converts an EZ-Latch™ Single Cylinder Running Gear into a Dual Cylinder Rack Running Gear as seen below



- **EZ-Latch™ Dual Cylinder Rack Running Gear** 951769 (pg 122)
- Protective Cover 301521 (pg 125)

Visit MillerWelds.com or your distributor for other Miller® options and accessories.

Stock Number 907734 951766 With EZ-Latch single cylinder running gear	Amperage Range	Rated Output	Amps Input at Rated Output, 50/60 Hz				Wire Feed Speed (1.3–20 m/min.)	Wire Type and Diameter Capacity			Power Source Dimensions H: 19.25 in. (489 mm) W: 13.75 in. (349 mm) D: 24.25 in. (616 mm)	Power Source Net Weight 84 lb. (38 kg)
	20–350	230 A at 25.5 VDC, 60% duty cycle	208 V	240 V	KVA	KW		Solid steel	Stainless	Aluminum		
			44.0	39.5	9.5	7.2		.023–.045 in. (0.6–1.2 mm)	.023–.045 in. (0.6–1.2 mm)	.035–.047 in. (0.9–1.2 mm)		
								Flux-cored	.030–.045 in. (0.8–1.2 mm)			
								Silicon bronze	.030–.035 in. (0.8–0.9 mm)			

Millermatic® 355

See literature DC/12.95



Millermatic 355 with BTB MIG gun and EZ-Latch single cylinder running gear shown.



Easy-to-understand interface with 7-inch color LCD display ensures proper machine setup and parameter selection, reducing setup time and increasing weld time.

- Quick-access Auto-Set and pulse mode backlit buttons across the top illuminate when active
- Soft-key buttons below the display change function depending on which screen is displayed – makes setup or change quick, easy and intuitive
- Large text for easier readability
- Intuitive connection setup images
- Full troubleshooting descriptions versus help errors and look up codes

Single- or three-phase input power provides versatility to utilize any North American power (208, 240, 460, 575 V).

Input voltage selection switch located in the wire drive compartment provides the ability to manually switch input voltage.

*See literature DC/12.95 for dimensions and weight with running gear.

Welding Capability

Max. 1/2 in. (13 mm)	Max. 1/2 in. (13 mm)
Mild Steel	Aluminum
Min. 22 ga. (0.8 mm)	Min. 18 ga. (1.2 mm)

Aluminum welding uses optional XR-Aluma-Pro push-pull gun.

Recommended aluminum solution

XR-Aluma-Pro™ push-pull gun (page 31).



Built-in pulsed MIG programs. All programmed information is restored after each power up – steel/stainless steel/aluminum/metal core/silicon bronze.

Auto-Set™ Elite offers predefined weld settings to increase ease of use and ensure that the job is done right for operators of all skill levels.

- Available for MIG and pulsed MIG processes with the ability to fine-tune your settings
- Set weld parameters by selecting wire and gas type, wire diameter and material thickness

Program mode allows easy save and recall of favorite weld settings. Delivers greater productivity and consistent quality while minimizing supervisor intervention.

Trigger program select increases productivity by eliminating the need to go back to machine to change weld settings. Simply tap MIG, spool or push-pull gun trigger to select the program.

EXCLUSIVE! Auto-Gun Detect™ automatically adjusts voltage, wire speed and timers for faster switching between MIG, push-pull and spool guns.

Heavy-duty aluminum four-drive-roll system.

Uses 4-, 8- or 12-inch (102, 203 or 305 mm) spools.

Fan-On-Demand™ cooling system only operates when needed, reducing power consumption and keeping internal components cleaner.

Optional demo cable kit (sold separately) powers the display through USB to train users in a quiet conference room or showroom versus connecting to shop power in a noisy work environment.

Industrial ● **CV DC 3 1**
Phase Phase

Processes

- MIG (GMAW) ▪ Flux-cored (FCAW)
- Pulsed MIG (GMAW-P)

Comes complete with

- 15 ft. (4.5 m) 300-amp Bernard® BTB MIG gun with AccuLock™ S consumables and .035/.045 in. reversible V-groove drive rolls
- **OR** 25 ft. (7.6 m) XR-Aluma-Pro™ air-cooled push-pull MIG gun with Miller® FasTip™ consumables and .035/.047 in. reversible U-groove drive rolls for aluminum wire
- 10 ft. (3 m) work cable with clamp
- 9 ft. (2.7 m) industrial power cord
- Factory-installed gas solenoid
- Flow gauge regulator and gas hose for argon or AR/CO₂ mix
- Extra contact tips and material thickness gauge (229895)

Most popular accessories

- Bernard® MIG Guns (pg 27–28)
 - Spoolmate™ 200 Spool Gun (pg 29)
 - Spoolmatic® Spool Gun (pg 30) (non-Pro gun only)
 - XR-Aluma-Pro™ Air-Cooled Push-Pull Guns (pg 31)
 - XR™-Pistol-Pro Air-Cooled Push-Pull Guns (pg 31)
 - EZ-Latch™ Single Cylinder Running Gear 301449 (pg 122)
 - EZ-Latch™ Dual Cylinder Rack with Elevated Gun and Cable Rack 301481 (pg 122)
- Converts an EZ-Latch™ Single Cylinder Running Gear into a Dual Cylinder Rack Running Gear as seen below



- **EZ-Latch™ Dual Cylinder Rack Running Gear** 951769 (pg 122)



- **Demo Cable Kit** 289696

Visit MillerWelds.com or your distributor for other Miller® options and accessories.

Stock Number	Input Power	Amp/Volt Ranges	Rated Output	Amps Input at Rated Output, 50/60 Hz	Max. Open-Circuit Voltage	Wire Feed Speed	Wire Type and Diameter Capacity	Power Source Dimensions*	Power Source Net Weight*
907808 w/BTB MIG gun	3-phase	20–400 A 12–34 V	310 A at 29.5 VDC, 60% duty cycle	32.3 28.8 18.2 15.4 15.3 11.5	90 VDC	50–800 ipm (1.3–20 m/min.)	Solid steel .035–.045 in. (0.9–1.2 mm)	H: 19.25 in. (489 mm)	99 lb. (45 kg)
951926 w/BTB MIG gun and EZ-Latch single cylinder running gear				– – 35.6 32.3 15.0 11.1			Stainless .023–.045 in. (0.6–1.2 mm)		
951927 w/XR-Aluma-Pro gun and EZ-Latch single cylinder running gear	1-phase, 460 or 575 V	20–400 A 12–34 V	60% duty cycle	69.6 62.5 – – 15.0 11.1	90 VDC	50–800 ipm (1.3–20 m/min.)	Aluminum .035–.047 in. (0.9–1.2 mm)	W: 13.75 in. (349 mm)	D: 26.25 in. (667 mm)
	1-phase, 208 or 240 V	20–350 A 12–32 V		– – 35.6 32.3 15.0 11.1			Flux-cored .035–.045 in. (0.9–1.2 mm)		
							Metal-core .045–.052 in. (1.2–1.3 mm)		
							Silicon bronze .030–.035 in. (0.8–0.9 mm)		

AlumaFeed® Synergic Aluminum Welding Systems

See literature DC/34.0

Dedicated aluminum system for the most advanced MIG and synergic pulsed MIG performance.



AlumaPower™ 350 MPa and XR-AlumaFeed® SuitCase® with XR-Aluma-Pro gun air-cooled package shown.

AUTO-LINE TECHNOLOGY AlumaPower™ 350 model allows for any input voltage hookup (208-575 V, single- or three-phase) with no manual linking, providing convenience in any job setting. Ideal solution for dirty or unreliable power. 450 model is 230/460 V manual link or 575 V, three-phase only.

Impact-resistant and flame-retardant suitcase-style feeder.

Synchronized, true push-pull wire feed system for precise wire feeding and arc performance.

Profile Pulse™ provides TIG appearance with MIG simplicity and productivity. Achieve “stacked dimes” without gun manipulation. Profile Pulse frequency can be changed to increase or decrease the spacing between the ripple pattern to achieve the desired weld appearance.

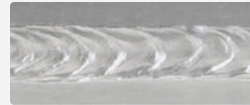

Synergic pulsed MIG. As wire speed increases/decreases, pulse parameters also increase/decrease to match the right amount of power needed, reducing the need to make additional adjustments.

Built-in MIG and pulsed MIG programs automatically set the optimal parameters for a wide variety of wires making it easy to set up and use.

Parameter and system locks enhance quality assurance and protect weld consistency.

Trigger schedule select allows operator to change between two sets of weld parameters.

Heavy industrial
CV DC 3 1 AlumaPower 450
 Phase Phase is 3-phase only.

Processes

- Aluminum MIG (GMAW)
- Aluminum pulsed MIG (GMAW-P)

Most popular accessories

- XR™ Push-Pull Guns (pg 31)
- MIGRunner™ Cart 195445 (pg 123)
- Coolmate™ 3 043007 (pg 123)
- Coolant 043810 (pg 123)
- Industrial MIG 4/0 Kits (pg 125)
 - 300405 With Dinse connectors (350 MPa only)
 - 300390 With lug connectors (450 MPa only)
- Consists of flowmeter regulator with 10 ft. (3 m) gas hose, 10 ft. (3 m) 4/0 feeder weld cable, and 15 ft. (4.6 m) work cable with 600-amp C-clamp
- Extension Cables (pg 130)
 - 247831025 25 ft. (7.6 m)
 - 247831050 50 ft. (15 m)
 - 247831080 80 ft. (24.4 m)
- 1/16-Inch (1.6 mm) Liner and Wire Kit for Gun 230708
- 1/16-Inch (1.6 mm) Drive Roll Kit for Control Box 195591
- For gun and feeder remote options, see literature DC/34.0 or visit MillerWelds.com

Visit MillerWelds.com or your distributor for other Miller® options and accessories.



Models/Packages

*Additional packages are available – visit MillerWelds.com or your distributor.



Power Source Only Stock Number	Package Stock Number*	XR-AlumaFeed SuitCase Feeder	XR-Aluma-Pro™ Push-Pull MIG Gun	XR™-Pistol-Pro Push-Pull MIG Gun	Industrial MIG 4/0 Kit	Coolmate™ with Coolant	Cart
AlumaPower 350 MPa 907420 208-575 V 907420001 208-575 V w/auxiliary power	951834 w/350 model (907420)	301567	25 ft. air-cooled	–	–	–	–
	951836 w/350 model (907420)	301567	–	25 ft. air-cooled	–	–	–
	951833 w/350 model (907420)	301567	25 ft. air-cooled	–	With Dinse connectors	–	MIGRunner cart
AlumaPower 450 MPa 907483 230/460 V w/auxiliary power 907484 575 V w/auxiliary power	951840 w/450 model (907483)	301567	25 ft. air-cooled	–	With lug connectors	–	MIGRunner cart
	951839 w/450 model (907483)	301567	25 ft. water-cooled	–	With lug connectors	Coolmate 3	MIGRunner cart

Note: All packages listed include gun drive rolls, feeder drive rolls and consumables for .035- and 3/64-inch (0.9 and 1.2 mm) wire. All systems come set up out of the box to run 3/64-inch wire. 1/16-inch consumables not included – order separately above.

Model	Input Power	Amp/Volt Ranges	Rated Output	Amps Input at Rated Load Output, 60 Hz					KVA	KW	Max. Open-Circuit Voltage	Dimensions	Net Weight
				208 V	230 V	400 V	460 V	575 V					
AlumaPower 350 MPa	3-phase	5-425 A 10-38 V	350 A at 34 VDC, 60% duty cycle	40.4	36.1	20.6	17.8	14.1	14.2	13.6	75 VDC	H: 17 in. (432 mm) W: 12.5 in. (318 mm) D: 24 in. (610 mm)	80 lb. (36.3 kg)
	1-phase	5-425 A 10-38 V	300 A at 32 VDC, 60% duty cycle	60.8	54.6	29.7	24.5	19.9	11.7	11.2			
AlumaPower 450 MPa	3-phase	15-600 A 10-38 V	450 A at 36.5 VDC, 100% duty cycle	–	49.4	–	27.2	23.6	21.6 (23.5 on 575 V)	18.3	90 VDC	H: 17.25 in. (438 mm) W: 14.5 in. (368 mm) D: 27.125 in. (689 mm)	122 lb. (55.3 kg)
XR-AlumaFeed SuitCase Feeder	Input Power	Input Welding Circuit Rating	Wire Feed Speed	Wire Diameter Capacity					Maximum Spool Size Capacity	Dimensions	Net Weight		
	24 VAC, 5 A, 50/60 Hz	400 A at 100% duty cycle System duty cycle is limited to gun rating	50-900 ipm (1.3-23 m/min.)	.035-1/16 in. (0.9-1.6 mm) Requires gun wire kit (230708) and control box drive roll kit (268850) to run 1/16 in. (1.6 mm) wire					12 in. (305 mm)	H: 15.5 in. (394 mm) W: 9 in. (229 mm) D: 21 in. (533 mm)	31 lb. (14.1 kg)		

Deltaweld® Systems

See literature DC/16.5 (Deltaweld 350) and DC/16.7 (Deltaweld 500)

The new standard in manufacturing provides the solution for welders of all skill levels, plus pulsed MIG capabilities with Intelx™ Pro and Intelx™ Elite integrated packages.

Reduce the time and hassle of setting up welding systems. Make your move to a weld-ready Deltaweld MIGRunner™.

Ships as a complete package.

Just hook up your primary power, add gas, wire and welding gun, and you're ready to weld.

Versatile MIGRunner cart keeps you organized with dual cylinder rack, MIG gun holders and storage compartment beneath power source, and portable with lockable front casters and oversized rear wheels.

Old Deltaweld® System



Time spent assembling old Deltaweld package

New Deltaweld® System



Time spent assembling new Deltaweld package



Deltaweld 500 MIGRunner with single-wire Intelx Pro feeder and factory-installed Insight Core shown.



Quality-engineered cable management protects your connections to keep you productive.



Single-wire feeder swivels for convenience and function, reducing wear on gun and liner assembly. It moves with the MIG gun, allowing operator to see the front of the feeder and which parameters are selected.

NEW! MIGRunner packages (see chart at right) now include a Bernard® BTB Gun 400 A (two with dual-wire feeders) with AccuLock™ consumables.

Note: Additional packages are available, including packages with a push-pull gun for aluminum welding – visit MillerWelds.com or your distributor.

Model Most Popular MIGRunner ◀	MIGRunner with Intelx Feeder		MIGRunner with Intelx Pro Feeder		MIGRunner with Intelx Elite Feeder	
	Single-Wire	Dual-Wire	Single-Wire	Dual-Wire	Single-Wire	Dual-Wire
Deltaweld 350 208/230/460 V	951792001	951817001	951777001 ◀	951818001	951946001	951948001
Deltaweld 350 w/Insight Core 208/230/460 V	–	–	951825001	–	951947001	–
Deltaweld 500 208/230/460 V	951814001	951819001	951808001 ◀	951820001	951949001	951955001
Deltaweld 500 w/Insight Core 208/230/460 V	–	–	951826001	–	951950001	–
Deltaweld 500 575 V	–	–	951824001 ◀	–	951956001	951959001
Deltaweld 500 w/Insight Core 575 V	–	–	951827001	–	951957001	–

Deltaweld Power Sources



Deltaweld 350 with factory-installed Insight Core shown.

Deltaweld 500 with factory-installed Insight Core shown.

Two power source choices

- **Deltaweld 350** has auxiliary power standard and optional 14-pin receptacle and meters for use with legacy feeders.
- **Deltaweld 500** has auxiliary power and meters standard and an optional 14-pin receptacle. It adds more power (500 amps at 100 percent duty cycle) and a dedicated gouge mode for up to 3/8-inch carbons.

ArcConnect™ is a next generation communication that utilizes high-speed signals to improve weld performance and allow point-of-use controls to be located at the feeder.

Wind Tunnel Technology™ Internal air flow that protects components, greatly improving reliability.

Fan-On-Demand™ cooling system only operates when needed, reducing power consumption and keeping internal components cleaner.

Welding Intelligence™ Get more done, produce higher-quality welds and control costs with Insight Core (factory-installed option on select models). Gives owners/managers visibility of welder productivity, so they can make informed decisions to drive improvements (see page 74).

Intelx™ Wire Feeders



Intelx feeders include .035/.045 in. V-groove drive rolls and a Bernard® BTB Gun 400 A (two with dual-wire feeders) with AccuLock™ consumables.

AccuLock™ **NEW!** Intelx wire feeders now include a Bernard® BTB Gun 400 A (two with dual-wire feeders) with AccuLock™ consumables.

Three dedicated wire feeder options

- **Intelx™** with arc control feature means welders can produce better welds with minimal parameter adjustments.
- **Intelx™ Pro** adds EZ-Set, Accu-Pulse®, memory buttons and weld programs. EZ-Set simplifies parameter setup based on material thickness, while Accu-Pulse® provides a 28 percent wider operating window and a more forgiving arc.
- **Intelx™ Elite** adds additional weld programs, intuitive display with on-demand graphics and more control (see chart at right).

Dual-wire models allow two different wire types to be available on one feeder, avoiding downtime from changing spools and drive rolls.

User-friendly interface makes the system easy to set up and adjust with minimal training.

Rotatable drive assembly eliminates severe bends in the wire feed path. This extends gun-liner life and aids in feeding difficult wires.

Balanced-pressure drive-roll design and tensioners feed wire in its truest and straightest form for consistent feedability and better welding performance.

Intelx Feeder Features

Feature	Intelx	Pro	Elite
Digital meters color	●	●	Full color LCD
Remote voltage	●	●	●
Wire feed speed	●	●	●
Arc control	●	●	●
Trigger hold	●	●	●
Wire jog and purge	●	●	●
Wire feed speed feedback	●	●	●
Four drive rolls	●	●	●
Rotatable drive	●	●	●
Up to 60 lb. spool	●	●	●
Dual-wire models	●	●	●
MIG process	●	●	●
EZ-Set MIG and Accu-Pulse®		●	●
Trigger select		●	●
Preflow and Postflow		●	●
Memory slots		2	8
Out-of-box programs (steel/stainless)		●	●
Out-of-box programs (aluminum/nickel/copper nickel/bronze/titanium)			●
Profile Pulse			●
Weld sequence control			●
Trigger dual schedule			●
Dual schedule switch support			●
Parameter limits			●
Memory lockouts and system lock			●
Auto thread and auto purge			●

Intelx™ Swingarc™

Order each separately

Required pipe post

Required Deltaweld 350 or 500 power source

Optional

Swingpak base



Model	Swingarc with Intelx Pro Feeder		Swingarc with Intelx Elite Feeder	
	Single-Wire	Dual-Wire	Single-Wire	Dual-Wire
12 ft. (3.7 m)	951804001	951932001	951943001	951945001
16 ft. (4.9 m)	951806001	—	951944001	—

Intelx Swingarc models now include .035/.045 in. V-groove drive rolls and a Bernard® BTB Gun 400 A (two with dual-wire models) with AccuLock™ consumables.

*Additional models are available – visit MillerWelds.com or your distributor.

**Refer to Deltaweld 500 owner's manual for gouge mode ratings and KVA/ KW for 575 V models.

Heavy industrial ● CV DC 3 Phase

Processes

- MIG (GMAW) ▪ Flux-cored (FCAW)
- Accu-Pulse® MIG (GMAW-P) with Intelx Pro and Elite feeders
- Air carbon arc gouging (CAC-A) with Deltaweld 500

MIGRunner™ packages include

- Deltaweld power source
350: 907747 or 907747002
500: 907785 or 907785002
500 (575 V): 907786 or 907786002
- Intelx **OR** Intelx Pro **OR** Intelx Elite wire feeder with .035/.045 in. reversible V-groove drive rolls
- Bernard® BTB Gun 400 A (two with dual-wire feeders) with AccuLock™ consumables
- Factory-installed Deltaweld running gear with cable holder, gun holders, and chains for gas cylinders
- Cart accessory kit consisting of flowmeter regulator(s) with 5 ft. (1.5 m) gas hose(s), 10 ft. (3 m) 4/0 feeder weld cable with lugs, 15 ft. (4.6 m) work cable with 600-amp C-clamp, and 9 ft. (2.7 m) ArcConnect cable
- Quick-setup guide and video

Most popular accessories

- Bernard® MIG Guns (pg 27-28)
- Deltaweld 350/500 Running Gear 301523 (pg 123)
- Industrial MIG 4/0 Kits with lugs (stationary packages only) (pg 125)
- ArcConnect Control/Motor Cables
280471009 9 ft. (2.7 m)
280471015 15 ft. (4.6 m)
280471025 25 ft. (7.6 m)
280471050 50 ft. (15.2 m)
280471075 75 ft. (22.9 m)
280471100 100 ft. (30.5 m)
280471150 150 ft. (45.7 m)
- Feeder Swivel Kit 301533
Mounts single- or dual-wire feeder to Deltaweld – only single feeder swivels
- Stationary Handle Kit 301529
- Hanging Bail 058435
- Pipe Post with 18 in. Base
149838 4 ft.
149839 6 ft.
- SwingPak™ Base 183997
- Single/Dual Spool Carrier for 6 ft. Pipe Post 300352

Visit MillerWelds.com or your distributor for other Miller® options and accessories.

Power Source Only/Stock Number Most Popular Models	Amp/Volt Ranges	Rated Output**	Amps Input at Rated Load Output, 60 Hz**						Power Source Dimensions (Includes lift eye)	Power Source Net Weight
			208 V	230 V	460 V	575 V	KVA	KW		
350 A Deltaweld 350* 907747 ◀ 208/230/460 V 907747001 208/230/460 V with 14-pin and meters 907747002 208/230/460 V with Insight Core™	20–400 A 10–38 V	300 A at 29 VDC, 100% duty cycle	29.3	26.5	14.6	—	11.6	10.0	H: 22.36 in. (568 mm) W: 15.35 in. (390 mm) D: 29.15 in. (740 mm)	115 lb. (52.2 kg)
		350 A at 31.5 VDC, 60% duty cycle	36.7	33.4	18.1	—	14.5	12.5		
		425 A at 35.25 VDC, 30% duty cycle	50.0	45.1	23.1	—	18.5	16.9		
500 A Deltaweld 500* 907785 ◀ 208/230/460 V with meters 907785001 208/230/460 V with 14-pin and meters 907785002 208/230/460 V with meters and Insight Core™ 907786 575 V with meters 907786001 575 V with 14-pin and meters 907786002 575 V with meters and Insight Core™	30–650 A 10–44 V	500 A at 39 VDC, 100% duty cycle	64.2	58.1	30.4	24.8	24.2	21.7	H: 22.36 in. (568 mm) W: 15.35 in. (390 mm) D: 31.65 in. (804 mm)	145 lb. (65.8 kg)
		575 A at 42.75 VDC, 60% duty cycle	80.2	73.5	38.0	30.4	30.3	27.2		
		650 A at 44 VDC, 25% duty cycle	94.2	84.9	43.9	34.9	35.0	31.6		

Feeder Only	Stock Number	Input Power	Input Welding Circuit Rating	Wire Feed Speed	Wire Diameter Capacity	Maximum Spool Size Capacity	Dimensions	Net Weight
Intelx	951783001 Single-wire 951815001 Dual-wire	50 VDC	600 A at 113 VDC, 60% duty cycle	50–780 ipm (1.3–19.8 m/min.)	.023–5/64 in. (0.6–2.0 mm)	18 in. (457 mm), 60 lb. (27 kg)	Single: H: 16.25 in. (413 mm) W: 12.38 in. (314 mm) D: 27.88 in. (708 mm) Dual: H: 14 in. (356 mm) W: 18 in. (457 mm) D: 34.5 in. (876 mm)	Single: 44.8 lb. (20.3 kg) Dual: 77 lb. (34.9 kg)
Intelx Pro	951784001 ◀ Single-wire 951816001 Dual-wire							
Intelx Elite	951941001 Single-wire 951942001 Dual-wire							

Continuum™ Systems

See literature DC/36.0

Next generation of advanced industrial welding solutions improves productivity through weld quality, ease of use and system flexibility.



Continuum 350 push-only MIGRunner package shown (motor cable not pictured).

More power – better reliability

Up to 26 percent more welding output (than competitive models) for demanding industrial applications.

AUTO-LINE TECHNOLOGY Allows for any input voltage hookup (230–575 V, three-phase) with no manual linking, providing convenience in any job setting. Ideal solution for dirty or unreliable power.

Power source design

Smart and powerful digital design has the fast response needed to deliver the most stable welding performance for better welding results.

Flexible to meet current and future needs with integrated expansion capabilities.

Welding Intelligence™ Get more done, produce higher-quality welds and control costs.

- **Insight Core™ (standard)** gives owners/managers visibility of welder productivity, to make informed decisions to drive improvements (see page 74).
- **Insight Centerpoint™ (optional)** gives real-time guidance to welders, so less training is required and weld quality is improved (see page 75).

Feeder design

AccuLock™ NEW! Continuum wire feeders now include a Bernard® BTB Gun 400 A (two with dual-wire feeders) with AccuLock™ consumables.

Tru-Feed™ technology provides precise feeding operation for stable arc performance.

- **Low-inertia motor** provides faster response for the best arc starts with the least amount of spatter.
- **Balanced-pressure drive-roll design and tensioners** feed wire in its truest and straightest form for consistent feedability, resulting in better welding performance.

User-friendly interface makes the system easy to set up and adjust with minimal training.

Continuum Processes

Best For	Standard Spray	High-Deposition MIG	Accu-Pulse	Versa-Pulse	Short Circuit	RMD
Deposition	A	A	A	B	D	D
Gap Filling	D	D	B	B	A	A
Low Heat Input	D	C	B	A	A	A
Out-of-Position Welds			A	B	B	B
Low Spatter	A	A	A	B	C	B
Thick Metals	A	A	A	C	D	D
Thin Metals			B	A	A	A
Increased Travel Speed	A	A	A	A	B	C

HOT COLD

*While idling.

Ratings A, B, C, and D are relative values. An "A" rating indicates a best fit between your performance needs and process.

A "blank" rating indicates that the process is not recommended for that application.

Accu-Pulse is the most popular process for majority of industrial welding applications.

Versa-Pulse is a fast, low-heat, low-spatter process designed for thin-material applications.

RMD is a low-heat, modified short-circuit process designed to fill gaps with thin-material applications.

High-deposition MIG provides increased deposition rates over standard spray on thicker materials.

Heavy Industrial CC CV DC 3 Phase

Processes

- Accu-Pulse® MIG (GMAW-P)
- Versa-Pulse™ ▪ RMD® ▪ MIG (GMAW)
- High-deposition MIG (GMAW)
- Flux-cored (FCAW)
- Air carbon arc gouging (CAC-A)

MIGRunner™ packages include

- Continuum power source
- **Push-only pkg:** Continuum single-wire feeder with .035/.045 in. V-groove drive rolls and Bernard® BTB Gun 400 A with AccuLock™ consumables
- **Push-pull pkg:** Continuum dual-wire feeder with .035/.047 in. U-groove and .035/.045 in. V-groove drive rolls, XR-Aluma-Pro Plus gun, and Bernard® BTB Gun 400 A with AccuLock™ consumables
- Continuum running gear/cylinder rack and handles/cable hangers
- 3 ft. (0.9 m) control/motor cable
- Industrial MIG 4/0 kit consisting of flowmeter regulator(s) with 10 ft. (3 m) gas hose(s), 10 ft. (3 m) 4/0 feeder weld cable with lugs, and 15 ft. (4.6 m) work cable with 600-amp C-clamp

Wire feeding options

- Continuum Feeders* (see chart below)
- Continuum Swingarc™ Feeders*
 - 951635001 12 ft. (3.7 m) single-wire
 - 951636001 16 ft. (4.9 m) single-wire
 - 951725001 12 ft. (3.7 m) dual-wire

*Feeders include .035/.045 in. V-groove drive rolls and a Bernard BTB Gun 400 A (two with dual-wire models) with AccuLock consumables.

- See literature DC/36.0 for additional booms and options

Most popular accessories

- Bernard® MIG Guns (pg 27–28)
- Insight Centerpoint™ Software (pg 75)
- Continuum Running Gear/Cylinder Rack 301264 (pg 123)
- Industrial MIG 4/0 Kits (with lug connectors) (pg 125)
- Continuum Integrated Cooler 301214 Mounts to bottom of power source – does not require external power
- Motor/Control Cables
 - 263368003 3 ft. (0.9 m)
 - 263368015 15 ft. (4.6 m)
 - 263368025 25 ft. (7.6 m)
 - 263368050 50 ft. (15 m)
 - 263368080 80 ft. (24.4 m)
 - 263368100 100 ft. (30.5 m)

Visit MillerWelds.com or your distributor for other Miller® options and accessories.

Model	Stock Number	Amp/Volt Ranges	Rated Output	Amps Input at Rated Output, 50/60 Hz, 3-Phase						Max. Open-Circuit Voltage	Power Source Dimensions (Includes lift eye)	Power Source Net Weight	
				230 V	380 V	400 V	460 V	575 V	KVA	KW			
Continuum 350	951852001	20–400 A	350 A at 31.5 VDC, 100% duty cycle	36.7	21.8	20.8	18.8	14.6	14.4	13.8	71 VDC	H: 27.187 in. (691 mm) W: 17.5 in. (444 mm) D: 28.125 in. (714 mm)	127 lb. (57.6 kg)
	951865001	10–44 V		0-1*	0-1*	0-1*	0-1*	0-1*	0.8*	0.17*			
	907636												
	907636001												
Continuum 500	951853001	20–600 A	500 A at 39 VDC, 100% duty cycle	57.6	34.7	33.2	28.9	23.3	23.1	21.9	71 VDC		148 lb. (67.1 kg)
	951866001	10–44 V		0-1*	0-1*	0-1*	0-1*	0-1*	0.8*	0.17*			
	907640												
	907640001												
Model/Stock Number		Input Power	Input Welding Circuit Rating	Wire Feed Speed	Wire Diameter Capacity		Maximum Spool Size Capacity		Dimensions		Net Weight		
Continuum Feeder 951631001 Single-wire model 951673001 Dual-wire model		50 VDC	500 A at 100% duty cycle	Standard: 50–1,000 ipm (1.3–25.4 m/min.)	.035–5/64 in. (0.9–2.0 mm)		18 in. (457 mm), 60 lb. (27 kg)		H: 13.812 in. (351 mm) Single W: 16.312 in. (414 mm) Dual W: 17 in. (432 mm) D: 29.687 in. (754 mm)		Single: 43 lb. (19.5 kg) Dual: 61.5 lb. (27.9 kg)		

Auto-Continuum™ Systems See literature AU/10.0

Next generation automation welding solution delivers advanced arc performance to improve throughput and weld quality.



Auto-Continuum 500 shown with robot arm (not included) and Auto-Continuum wire drive motor assembly.



Close-up of Auto-Continuum wire drive motor assembly (left-hand drive).

More power – better reliability. Up to 26 percent more welding output (than competitive models) for demanding industrial applications.

AUTO-LINE TECHNOLOGY Allows for any input voltage hookup (230–575 V, three-phase) with no manual linking, providing convenience in any job setting. Ideal solution for dirty or unreliable power.

Improve work environment and reduce spatter. Versa-Pulse and Accu-Pulse processes reduce fume generation, and by precisely controlling the welding arc they also reduce spatter size and quantity. Fume generation can be reduced up to 50 percent over traditional CV MIG.

- **Versa-Pulse** is a fast, low-heat, low-spatter process for high-speed automation on thin materials and is great for gap filling.
- **Accu-Pulse** is better for out-of-position welds, provides higher deposition rates and is designed for thicker materials than Versa-Pulse.

Easy communication from robot to power source.

Designed for easy integration with fixed and flexible automation.

Fleet standardization. Auto-Continuum can be used for both automation and hand-held applications.

Welding Intelligence™ Get more done, produce higher-quality welds and control costs.

- **Insight Core™ (standard)** gives owners/managers visibility of welder productivity, so they can make informed decisions to drive improvements (see page 74).
- **Insight Centerpoint™ (optional)** gives real-time guidance to welders, so less training is required and weld quality is improved (see page 75).

Heavy industrial ● CV DC 3 Phase

Processes

- Accu-Pulse® MIG (GMAW-P)
- Versa-Pulse™ ▪ RMD® ▪ MIG (GMAW)
- High-deposition MIG (GMAW)
- Flux-cored (FCAW)

Most popular accessories

- Insight Centerpoint™ Software (pg 75)
- Auto-Continuum Robotic MIG Kit 301455
Consists of 25 ft. (7.6 m) motor control cable, 15 ft. (4.6 m) 90-degree motor control extension cable, 15 ft. (4.6 m) weld cable, flowmeter regulator, 30 ft. (9.1 m) gas hose, 9.8 ft. (3 m) Ethernet cable, .035/.045-inch V-groove drive roll kit with guides, 30 ft. (9.1 m) weld wire conduit assembly, and 10 ft. (3 m) conduit and clamps (for mounting motor control cable, weld cable and gas hose)
- Wire Drive Motor Mounting Brackets 300013 FANUC®/KUKA®/Motoman® 300483 FANUC® 100 and 120 IC
- Continuum Integrated Cooler 301214 Mounts to bottom of power source – does not require external power
- Motor/Control Cables
263368025 25 ft. (7.6 m)
263368050 50 ft. (15 m)
263368080 80 ft. (24.4 m)
263368100 100 ft. (30.5 m)
- 90-degree Motor Control Extension Cables
281554015 15 ft. (4.6 m)
281554025 25 ft. (7.6 m)
- EtherNet/IP™ Communication Cables
300734 9.8 ft. (3 m)
300736 32.8 ft. (10 m)
- DeviceNet Communication Cable 300021 20 ft. (6.1 m)
- DeviceNet to Analog Adapter 301547

Visit MillerWelds.com or your distributor for other Miller® options and accessories.

*While idling.

Model/Stock Number	Amp/Volt Ranges	Rated Output	Amps Input at Rated Output, 50/60 Hz, 3-Phase						Max. Open-Circuit Voltage	Dimensions (Includes lift eye)	Net Weight	
			230 V	380 V	400 V	460 V	575 V	KVA				KW
Auto-Continuum 350 907656 907658 With auxiliary power	20–400 A 10–44 V	350 A at 31.5 VDC, 100% duty cycle	36.7 0–1*	21.8 0–1*	20.8 0–1*	18.8 0–1*	14.6 0–1*	14.4 0.8*	13.8 0.17*	72 VDC	H: 27.187 in. (691 mm) W: 17.5 in. (444 mm) D: 28.22 in. (717 mm)	130 lb. (59.4 kg)
Auto-Continuum 500 907657 907659 With auxiliary power	20–600 A 10–44 V	500 A at 39 VDC, 100% duty cycle	57.6 0–1*	34.7 0–1*	33.2 0–1*	28.9 0–1*	23.3 0–1*	23.1 0.8*	21.9 0.17*	72 VDC		150 lb. (69 kg)
Model/Stock Number	Input Power	Input Welding Circuit Rating	Wire Feed Speed		Wire Diameter Capacity		Dimensions	Net Weight				
Auto-Continuum Wire Drive Motor Assembly 301207 Left-hand drive	50 VDC	500 A at 100% duty cycle	Standard: 50–1,000 ipm (1.3–25.4 m/min.)		.035–5/64 in. (0.9–2.0 mm)		H: 8.75 in. (222 mm) W: 10 in. (254 mm) D: 10 in. (254 mm)	16.5 lb. (7.5 kg)				

Less tip
changes

Less
troubleshooting

More beads
worth
bragging
about

Transform your business with

AccuLock™ CONSUMABLES

Enjoy more efficiency, less downtime and better weld quality in all of your semi-automatic and robotic welding operations with AccuLock™ S and AccuLock™ R Consumables.

AccuLock™ S consumables work to maximize productivity by reducing issues that lead to costly rework and downtime and increasing life.

To learn more about AccuLock S see page 27 or contact your local welding distributor or Bernard directly.



AccuLock™ R consumables help ensure that your equipment continues to operate at its highest efficiency by reducing both planned and unplanned downtime in your operations.

To learn more about AccuLock R see pages 38-39 or contact your local welding distributor or Tregaskiss directly.



[Tregaskiss.com/AccuLock](https://www.tregaskiss.com/AccuLock)

| 1-855-MIGWELD (644-9353)



For more detailed information, visit

MillerWelds.com/wirefeeders

Wire Feeders

Also see MIG, MIG Guns and Multiprocess sections for wire feeding options.



Product Guide

Product	Page	Class	MIG	Pulsed MIG ¹	RMD ²	Flux-cored ²	Gouge	Power Source Required	Wire Types				Wire Diameter Capacity	Special Features	Typical Applications
									Solid	Gas-shld	Flux-cored Self-shld	Alum.			
ArcReach® SuitCase® (8 and 12)	18	●	●	●	●	●		CC/CV	●	●	● CV ²	●	.023-5/64 in. (0.6-2.0 mm)	8 in. (SuitCase 8) or 12 in. (SuitCase 12) diameter spool capacity, powered by arc voltage, remote voltage control without a control cord with ArcReach power sources. ArcReach Suitcase 12 Heavy Duty model available for use with large diameter 3/32 in. cored wire	Construction, site fabrication, field maintenance
ArcReach® Smart Feeder	18	●	●	●	●	●		ArcReach equipped	●	●			.035-.045 in. (0.9-1.1 mm)	12 in. diameter spool capacity, remote voltage control without a control cord, requires an XMT 350 FieldPro connected to three-phase power or an ArcReach-equipped engine drive	Process piping, refinery, petrochemical, power plants, HVAC, water pipe
SuitCase® 12RC	18	●	●	●	●	●		CV	●	●	●	●	.023-5/64 in. (0.6-2.0 mm)	12 in. diameter spool capacity, standard remote voltage control, powered by 14-pin control cord	Field maintenance, site fabrication
ArcReach® 16	20	●	●			●	● ³	CC/CV	●	●	●		.035-3/32 in. (0.9-2.4 mm)	60 lb. spool capacity, powered by arc voltage, remote voltage and process control without a control cord with XMT® 650 ArcReach power sources, large diameter 3/32 in. wire, isolated gouge stud, available with shop cart or IP23-rated field roller	Structural steel, fabrication, erection
20 Series (Basic and Digital)	22	●	●	●	●	●		CV	●	●	●	●	.023-5/64 in. (0.6-2.0 mm)	Four quick-change drive rolls, digital meter, remote voltage control (meter and remote voltage control are a field kit option on basic model)	Manufacturing, fabrication
74 MPa Plus (Single- and Dual-Wire)	22	●	●	●	●	●		CV	●	●	●	●	.023-5/64 in. (0.6-2.0 mm)	Sequence control, locks and limits, four weld program memories, synergic pulsed MIG with MPa power sources, dedicated XR-Aluma-Pro™ Plus or XR™-Pistol Plus guns for feeding soft wires	Manufacturing requiring multiple wire types
74 MPa Plus Remote Configurations (Single- and Dual-Wire)	24	●	●	●	●	●		CV	●	●	●	●	.023-5/64 in. (0.6-2.0 mm)	Control box, cables and wire drive motor assemblies for generic booms or fixed automation	Heavy and light manufacturing, fabrication

Portable

Bench

Product Key

Class: ● Light industrial ● Industrial ● Heavy industrial Capability: ● Designed for this process ● Capable of this process

¹ Smart Feeder requires an XMT® 350 FieldPro™ connected to three-phase power or an ArcReach-equipped engine drive. All other feeders require an MPa inverter power source.

² Certain self-shielded wires require CV output. Miller recommends a CV power source whenever possible.

³ ArcReach 16 requires an XMT® 650 power source to gouge.

NEW! products appear in blue type.

SuitCase® Series Portable Feeders

Portable SuitCase feeders that set the standard for performance and provide extreme reliability to stand up to the demands of construction and fabrication.

SuitCase Series Features

Feature	ArcReach				12RC
	8	12	12 HD	Smart	
Available with Bernard gun: BTB Gun 300 A S-Gun	●	●			●
Dura-Flux gun PipeWorx 300-15 gun	●	●		●	
Remote voltage control (control cord required)					●
Remote voltage control (without a cord)	●	●	●	●	
Digital meters	●	●	●	●	●
Impact-resistant case	●	●	●	●	●
Gas purge	●	●	●	●	●
Wire jog	●	●	●	●	●
Feeds 3/32 in. wire			●		



Note: ArcReach SuitCase feeders are compatible with standard power sources and engine-driven welders, but function as standard equipment without remote control capabilities. Full functionality of ArcReach is only available with ArcReach power sources.



Bernard BTB Gun 300 A shown.

Feeders include a male Tweco® connector installed on the weld cable and are available with drive rolls and a Bernard® gun (see chart on page 19), except ArcReach SuitCase 12 Heavy Duty which is sold as a feeder only (drive rolls and gun should be ordered separately). Feeders with BTB Gun 300 A and S-Gun™ come with reversible dual size (.045 and 1/16 in. V-knur) drive rolls. Feeders with Dura-Flux™ flux-cored gun come with reversible dual size (.068/.072 and 5/64 in. V-knur) drive rolls. Feeders with PipeWorx 300-15 gun come with reversible dual size (.045 and 1/16 in. V-knur) drive rolls.

Setting the standard for performance

AccuLock™ NEW! ArcReach Suitcase and SuitCase 12RC wire feeders with a Bernard BTB Gun now include AccuLock™ consumables (see chart on page 19).

Heavy-duty drive motor with tachometer control provides wire feed speed that is accurate and consistent from the start of the weld to the finish and from one weld to the next. Consistent wire feed speed is very important with large-diameter cored wire, because small changes in wire feed speed make large changes in deposition rates.

Wide voltage range for small and large wires with no contactor chatter or arc outages.

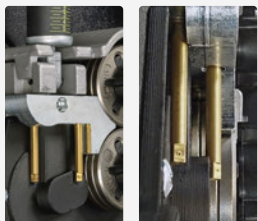

Ultra-low-drag inlet guide pins make loading the wire easy and do not deform the wire on the way into the drive rolls, improving wire feeding performance.



Scaled wire pressure knob provides easy adjustment and consistent pressure on the drive rolls and wire.



Digital meters with SunVision™ technology can display voltage, wire feed speed, and also amperage if desired. Meters can be seen clearly even in direct sunlight.

Unique and durable case

Impact-resistant, flame-retardant case provides strength and durability, while protecting components and welding wire from moisture, dust and other contaminants.

Built-in slide rails for positioning and durability.

Innovative feeder door design allows you to change wire while feeder is standing upright or laying down.

ArcReach SuitCase models are available in two sizes. SuitCase 8 model is sized for an 8-inch spool of wire, can be carried to remote welding sites, and fits through a 14-inch manhole/manway. SuitCase 12 model is sized for an 8- or 12-inch spool of wire. 12-inch spools are the most common in structural steel and fabrication.

Extreme reliability

Potted-and-trayed main printed circuit board for the harshest environments adds exceptional reliability. Board has full-trigger isolation so a shorted gun trigger will not affect feeder operation.



Gun locking tab works with guns having corresponding locking grooves to prevent gun from being pulled out if the feeder is dragged by the gun.



Gas inlet recessed into back of case is protected from incidental contact by the weld cable, ensuring consistent and contaminant-free shielding gas delivery to the gun. **Double-filtered gas valve** helps keep dirt from clogging and affecting gas flow.

ArcReach® SuitCase® 8 and 12 and ArcReach Smart Feeder

See literature M/6.55

ArcReach Remote control of the power source without a cord.

With an ArcReach SuitCase feeder and ArcReach power source you can change output voltage at the feeder, and save a trip to the power supply. No extra control cord to purchase, maintain, string or unstring – saving time and money. See pages 48–50 and 82–87 for ArcReach power sources and engine drives.

Easy process changeover. Simply connect the ArcReach feeder to your leads and you are ready to go. All controls automatically shift to the ArcReach feeder.

Voltage-sensing feeders designed to run off of arc voltage. The ArcReach SuitCase 8 and 12 operate on the arc voltage of almost any power source. The ArcReach Smart Feeder requires an XMT® 350 FieldPro™ (page 48) connected to three-phase power or an ArcReach-equipped engine drive (pages 82–87).

Weld with large diameter wire. The ArcReach SuitCase 12 Heavy Duty model is specifically designed for applications using 3/32-inch cored wire.

Additional features of ArcReach Smart Feeder

Delivers excellent synergic RMD® and pulsed MIG welding up to 200 feet away from the power source with no control cords – twice the distance previously possible. RMD and pulsed MIG welding permits procedures with one wire and one gas to eliminate process switch-over time. RMD and pulsed MIG processes also help reduce weld failures and eliminate backing gas on some stainless and chrome-moly applications.

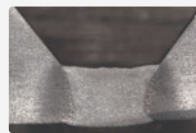

RMD carbon steel

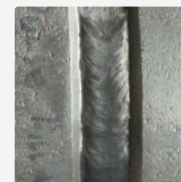

Pulsed MIG stainless

SuitCase® 12RC See literature M/6.5

Standard remote voltage control with a control cord. For applications where the feeder is within 100 feet of the power source and control cords are acceptable.

*Additional packages are available – visit MillerWelds.com or your distributor.

Heavy industrial

Use with CC/CV (CV only with 12RC), DC power sources. See spec chart below for Smart Feeder requirements.

Processes

- MIG (GMAW) ▪ Flux-cored (FCAW)
- RMD and pulsed MIG (GMAW-P) with ArcReach Smart Feeder

Suggested power sources

Note: ArcReach SuitCase feeders are compatible with standard power sources and engine-driven welders, but function as standard equipment without remote control capabilities. Full functionality of ArcReach is only available with ArcReach power sources.

For ArcReach SuitCase 8 and 12

- Maxstar® 280 Multiprocess (pg 45)
- Dynasty® 300 Multiprocess (pg 45)
- XMT® Series (pg 46–50)
- Bobcat™ 200 Air Pak™ (pg 79)
- Bobcat™ Series (pg 80)
- Trailblazer® Series (pg 82–84)
- Big Blue® Series (pg 84–87)

For ArcReach Smart Feeder

- XMT® 350 FieldPro™ (pg 48) (requires three-phase power)
- Trailblazer® Series (ArcReach models only) (pg 82)
- Big Blue® Series (ArcReach models only) (pg 84–87)

For SuitCase 12RC (requires power source with 14-pin connector)

- XMT® Series (pg 46, 50)
- Trailblazer® Series (pg 82–84)
- Big Blue® Series (pg 84–87)

Suggested guns

- Bernard® Guns (pg 27–28)

Most popular accessories

- Extension Cables (pg 130) (for SuitCase 12RC only, 1 required)
- Flowmeter Kit 300343
- Shielding Gas Filter 195189

Visit MillerWelds.com or your distributor for other Miller® options and accessories.

	Model	Stock Number*	Input Power	Input Welding Circuit Rating	Wire Feed Speed	Wire Type and Diameter Capacity	Maximum Spool Size Capacity	Dimensions	Net Weight
ArcReach	ArcReach SuitCase 8	951726001 w/Bernard BTB Gun 300 A 951727 w/Bernard S-Gun 951728 w/Bernard Dura-Flux gun 301457 Feeder only	Operates on open-circuit voltage and arc voltage: 14–48 VDC / 110 max. OCV	330 A at 60% duty cycle	50–780 ipm (1.3–19.8 m/min.) dependent on arc voltage	Solid wire .023–.052 in. (0.6–1.4 mm) Flux-cored .030–5/64 in. (0.8–2.0 mm)	8 in. (203 mm), 14 lb. (6.4 kg)	H: 12.75 in. (324 mm) W: 7.25 in. (184 mm) D: 18 in. (457 mm)	28 lb. (13 kg)
	ArcReach SuitCase 12	951729001 w/Bernard BTB Gun 300 A 951730 w/Bernard S-Gun 951731 w/Bernard Dura-Flux gun 951732 w/Bernard PipeWorx 300-15 gun 301456 Feeder only		425 A at 60% duty cycle					
	ArcReach SuitCase 12 Heavy Duty	301604 Feeder only	450 A at 60% duty cycle	30–400 ipm (0.8–10.2 m/min.) dependent on arc voltage	Flux-cored .030–3/32 in. (0.8–2.4 mm)	12 in. (305 mm), 45 lb. (20 kg)	H: 15.5 in. (394 mm) W: 9 in. (229 mm) D: 21 in. (533 mm)	35 lb. (15.9 kg)	
	ArcReach Smart Feeder	951733 w/Bernard PipeWorx gun 300935 Feeder only	XMT 350 FieldPro connected to three-phase power or an ArcReach-equipped engine drive	275 A at 60% duty cycle	50–500 ipm (1.3–12.7 m/min.) dependent on arc voltage	.035–.045 in. (0.9–1.1 mm)	12 in. (305 mm), 33 lb. (15 kg)	H: 18 in. (457 mm) W: 13 in. (330 mm) D: 21.5 in. (546 mm)	50 lb. (23 kg)
	SuitCase 12RC	951580001 w/Bernard BTB Gun 300 A 301121 Feeder only	24 VAC, 10 A, 50/60 Hz	425 A at 60% duty cycle	50–700 ipm (1.3–17.8 m/min.)	Solid wire .023–.052 in. (0.6–1.4 mm) Flux-cored .030–5/64 in. (0.8–2.0 mm)	12 in. (305 mm), 45 lb. (20 kg)	H: 15.5 in. (394 mm) W: 9 in. (229 mm) D: 21 in. (533 mm)	31 lb. (14.1 kg)

ArcReach® 16 Portable Feeder

See literature DC/18.98

Portable feeder that takes productivity, cost savings, and power to the next level for structural steel fabrication and erection.

ArcReach 16 Features

Feature	
Available with Bernard Gun: BTB Gun 400 A	●
IronPro 450-15 gun	●
Remote voltage control (without a cord)	●
Gouge	●
Digital meters	●
Gas purge	●
Wire jog	●
Feeds 3/32 in. wire	●
Available with shop cart or field roller	●



NEW!

AccuLock™ ArcReach 16 wire feeders with a Bernard BTB Gun or IronPro include AccuLock™ consumables (see chart below).

ArcReach® Remote control of the power source without a cord. With an ArcReach 16 feeder and XMT 650 ArcReach power source (page 50) you can change output voltage at the feeder, and save a trip to the power supply. No extra control cord to purchase, maintain, string or unstring – saving time and money.

Easy process changeover. Simply connect the ArcReach 16 wire feeder to your weld lead and you are ready to go. Switch between welding and gouging with a push of a button with no need to swap leads or disconnect the wire feeder with isolated outputs.

Integrated gouging stud on wire feeder. Isolated gouging stud allows easy connection for gouging at point of use, eliminating the need to disconnect the wire feeder and to swap leads.

Voltage-sensing feeder designed to run off of arc voltage. The ArcReach 16 operates on the arc voltage of almost any power source, but is best paired with an XMT 650 model (page 50).

Weld with up to 60-pound spools and large diameter (3/32 in.) wire to minimize downtime and maximize productivity.

Easy mobility in the shop and on-site (optional shop cart and field roller). The ArcReach 16 wire feeder preassembled options include a shop cart and a field roller.

- **Shop cart** provides easy shop mobility with low clearance. Handle doubles as a cable holder.
- **Field roller** provides easy field mobility over pan decking and other surfaces. Designed for the environment with spool cover and IP23 rating. Includes spool cover, hanging bail and cable holder.

Heavy industrial Use with CC/CV, DC power sources.

Processes

- MIG (GMAW) = Flux-cored (FCAW)
- Air carbon arc cutting and gouging (CAC-A) (rated 3/8 in. carbons) with XMT 650 power source

Suggested power sources

Note: ArcReach 16 feeder is compatible with standard power sources and engine-driven welders, but functions as standard equipment without remote control capabilities. Full functionality of ArcReach is only available with XMT 650 ArcReach power source.

- XMT® 650 Series (pg 50)

Suggested guns

- Bernard® BTB Gun 400 A (pg 27)

NEW!



- **Bernard® IronPro™ 450-15 293039** Self-shielded gun designed for ironworkers and structural steel erectors to excel in the outdoors with large diameter self-shielded flux cored wire up to 3/32 inch – sealed trigger remains slag and spatter free for extended life and ergonomic design provides excellent access and maneuverability for hard-to-reach weld joints

Most popular accessories

- Inline Filter 211989
- Wire Reel Assembly 108008

Visit MillerWelds.com or your distributor for other Miller® options and accessories.

Stock Number	Input Power	Input Welding Circuit Rating	Wire Feed Speed	Wire Type and Diameter Capacity	Max. Spool Size Capacity	Dimensions (H x W x D)	Net Weight
301619 Base feeder only	Operates on open-circuit voltage and arc voltage: 12-110 VDC	450 A at 100% duty cycle	50-780 ipm (1.3-19.8 m/min.) dependent on arc voltage	Solid wire .035-5/64 in. (0.9-1.9 mm) Flux-cored .045-3/32 in. (1.1-2.4 mm)	18 in. (457 mm) 60 lb. (27.2 kg)	Base feeder 15.3 x 16.7 x 32.8 in. (388 x 424 x 833 mm) Shop cart 20 x 24.9 x 36.3 in. (508 x 632 x 922 mm) Field roller 28.2 x 19.9 x 42.7 in. (716 x 505 x 1,084 mm)	Base feeder 101 lb. (45.8 kg) Shop cart 120 lb. (54.4 kg) Field roller 123 lb. (55.7 kg)
301664 With shop cart		500 A at 60% duty cycle					
951000065 With shop cart and Bernard BTB Gun 400 A		CAC-A 600 A at 40% duty cycle					
301663 With field roller							
951000066 With field roller and Bernard IronPro 450-15 gun							

NEWSLETTERS DELIVERED RIGHT TO YOUR INBOX

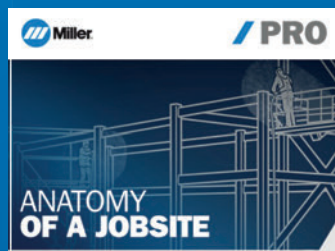

DIY – Project ideas, how-to videos, tips and more for welding do-it-yourselfers.

PRO – Industry news, technical information and application videos for welding professionals.

THE BEVEL – Success stories, resources and events for pipe, construction and fabrication professionals.

INSTRUCTOR – Classroom resources, safety tips and school spotlights for welding instructors.

SAFETY – Regulatory updates, industry news and solutions for occupational health and safety professionals.

alumaNATION – Tips, projects and technical information for anyone who welds aluminum.

WORK TRUCK TODAY – Resources, best practices and industry trends for work truck fleet operators and managers.

Sign up now at
MillerWelds.com/newsletters

Follow us @MillerWelds

NEW!



Find videos to help you improve your skills and inspire your next project.



20 Series Industrial Bench Feeders

74 MPa Plus Heavy-Industrial Bench Feeders

Designed for manufacturing, our popular bench feeders are available in two series with multiple models to fit your needs.



20 Series and 74 MPa Plus Features

Feature	20 Series		74 MPa Plus
	Basic	Digital	
Available w/Bernard gun: BTB Gun 400 A	●	●	●
Trigger hold	●	●	●
Digital meter(s)	●	●	●
Remote voltage control	●	●	●
Adjustable run-in control	●	●	●
Automatic run-in control			●
Dual-wire models			●
Rotatable drive assembly			●
Accu-Mate™			●
Preflow/postflow			●
Spot control			●
Dual schedule control			●
Trigger program select			●
Trigger dual schedule			●
Sequence control			●
Locks and limits			●
Weld programs			4
Trigger schedule select			●
Push-pull capability			●
Synergic pulsed MIG			●
Profile Pulse™			●

● Standard ● Field option

Feeders include a 10 ft. interconnecting cord and are available with reversible dual size (.035/.045 in. V-groove) drive rolls and a Bernard® BTB Gun 400 A (two with dual-wire models, see chart on page 23).



AccuLock™ NEW! 20 Series and 74 MPa Plus wire feeders with a Bernard BTB Gun now include AccuLock™ consumables (see chart on page 23).

Trigger hold allows the operator to make long welds without having to hold the trigger continuously. Reduces operator fatigue.

Miller® standard quick-change drive rolls save time.

Quick-release drive-roll pressure arm allows drive roll change without losing spring preload setting.

Easy loading and threading of welding wire without having to release the drive roll pressure arm.

Four gear-driven drive rolls provide more consistent feeding on larger wire diameters.

20 Series (Basic and Digital) See literature M/11.0

Simple and cost-effective feeders for industrial manufacturing and fabricating.

Ideal for most high-duty-cycle applications requiring day-in/day-out trouble-free operation.

On-board burnback and motor ramp control for excellent starting and stopping performance.

Digital meter (standard on digital model, field option on basic model) ensures accuracy when presetting and reading actual voltage, amperage and wire feed speed.

Remote voltage control (standard on digital model, field option on basic model) at feeder for easier adjustments in the weld cell.

Adjustable run-in control (standard on digital model, field option on basic model) for better arc-starting performance on a variety of wires.

74 MPa Plus See literature M/3.0

Feeders for heavy-duty industrial applications with features for weld control and programs, plus push-pull aluminum capabilities. Optimized with AlumaPower™ MPa or XMT® MPa power sources.

Available in dual-wire models which allow two different wire types to be available on one feeder, avoiding downtime from changing spools and drive rolls.

Toolless rotatable drive assembly allows operator to rotate the drive housing, allowing a straight path for wire flow.

Accu-Mate™ properly seats the MIG gun power pin for best feeding performance.

High-torque permanent-magnet motor, sealed ball bearing gear drive and solid-state speed and brake control are maintenance free for long life.

Digital meters ensure accuracy when presetting and reading actual voltage, amperage and wire feed speed.

Remote voltage control allows you to set both voltage and wire feed speed at the feeder, saving time and increasing weld quality.

Adjustable run-in control for improved arc starts.

Dual schedule control allows the operator to switch between two preconfigured welding parameters without readjusting the machine, saving time and enhancing quality.

Trigger schedule select saves time when switching between two weld settings by simply tapping gun trigger.

Trigger program select provides the ability to access any of the four active programs.

Sequence control gives the operator the ability to adjust all of the welding parameters: preflow, run-in, weld time, crater, burnback and postflow.

Locks and limits for restricting or limiting operator adjustments, such as voltage and wire feed speed parameters.

Four weld program memories allow operators to recall up to four previously used processes and their weld settings.

Push-pull capability provides consistent, versatile and dependable aluminum wire feeding over greater distances.

Recommended aluminum solution.

Dedicated XR Plus guns (gooseneck and pistol grip) work with MPa Plus feeders to coordinate wire feed speed of the gun and the feeder. This provides optimized aluminum feeding and welding performance. See chart below for gun models and stock numbers.



Additional features when used with AlumaPower MPa or XMT MPa power sources

Synergic pulsed MIG. As wire speed increases/decreases, pulse parameters also increase/decrease to match the right amount of power needed, reducing the need to make additional adjustments.

Profile Pulse™ provides TIG appearance with MIG simplicity and productivity. Achieve “stacked dimes” without gun manipulation. Profile Pulse frequency can be changed to increase or decrease the spacing between the ripple pattern to achieve the desired weld appearance.

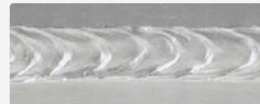

Industrial ● 20 Series
Heavy industrial ● 74 MPa Plus

CVDC Use with CV, DC power sources.

Processes

- MIG (GMAW) ▪ Flux-cored (FCAW)
- Pulsed MIG (GMAW-P) with MPa Plus feeder and MPa power source

Suggested power sources

- AlumaPower™ MPa (pg 11)
- XMT® Series (pg 46-50)

Suggested guns

- Bernard® Guns (pg 27-28)
- XR-Aluma-Pro™ Plus and XR™-Pistol Plus (see chart below)

Most popular accessories

- Feeder Cart 142382 (pg 122)
 - Extension Cables (pg 130)
 - Spool Adapter 047141 (pg 130)
 - Turntable Assembly 146236 (pg 130)
 - Wire Straightener (pg 130)
 - Field Kits for 20 Series Basic 301513 Digital meter and remote voltage control 301515 Run-in control
 - Hanging Bail 058435
 - Spool Covers 057607 For 20 Series and 74 MPa Plus single-wire models and left side of dual-wire models 090389 For right side of 74 MPa Plus dual-wire models
 - Wire Reel Assembly 108008
 - Remote configurations are available – see page 24 and literature M/3.0
- Visit MillerWelds.com or your distributor for other Miller® options and accessories.

*Additional packages are available – visit MillerWelds.com or your distributor. **Requires gun wire kit (230708) to run 1/16 in. (1.6 mm) wire.

Model	Stock Number*	Input Power	Wire Feed Speed	Wire Type and Diameter Capacity	Maximum Spool Size Capacity	Dimensions	Net Weight	
20 Series	301499 Basic feeder only	24 VAC, 3.5 A, 50/60 Hz	75-750 ipm (1.9-19 m/min.)	.023-5/64 in. (0.6-2.0 mm)	60 lb. (27 kg) coil with optional wire reel assembly (108008)	H: 16 in. (406 mm) W: 12.375 in. (314 mm) D: 27.875 in. (708 mm)	46 lb. (21 kg)	
	951779001 Basic feeder w/Bernard BTB Gun 400 A							
	301499001 Digital feeder only 951780001 Digital feeder w/Bernard BTB Gun 400 A							
74 MPa Plus	951291001 S-74 MPa Plus single-wire feeder w/Bernard BTB Gun 400 A	24 VAC, 10 A, 50/60 Hz	50-780 ipm (1.3-19.8 m/min.)	Solid wire .023-5/64 in. (0.6-2.0 mm) Aluminum** .035-1/16 in. (0.9-1.6 mm)	60 lb. (27 kg) coil with optional wire reel assembly (108008)	H: 14 in. (356 mm) W: 12.5 in. (318 mm) D: 28 in. (711 mm)	48 lb. (21.2 kg)	
	951292001 D-74 MPa Plus dual-wire feeder w/two Bernard BTB Gun 400 A						87 lb. (39.5 kg)	
Optional Push-Pull Gun (For MPa Plus feeders only)		Cable Length		Welding Current Rating	Wire Feed Speed	Wire Type and Diameter Capacity	Dimensions	Gun Only Net Weight
		15 ft. (4.6 m)	25 ft. (7.6 m)					
	XR-Aluma-Pro Plus (Air-cooled)	301575	301574	300 A at 100% duty cycle	70-780 ipm (1.8-19.8 m/min.)	Aluminum** .030-1/16 in. (0.8-1.6 mm)	H: 5 in. (127 mm) W: 2.5 in. (64 mm) L: 17 in. (432 mm)	2.5 lb. (1.1 kg)
	XR-Aluma-Pro Plus (Water-cooled)	301576	301577	400 A at 100% duty cycle	70-780 ipm (1.8-19.8 m/min.)	Aluminum** .030-1/16 in. (0.8-1.6 mm)	H: 7.375 in. (187 mm) W: 1.875 in. (48 mm) L: 10.625 in. (270 mm)	2.9 lb. (1.3 kg)
	XR-Pistol Plus (Air-cooled)	300753	300754	200 A at 100% duty cycle				2.2 lb. (1 kg)
	XR-Pistol Plus (Water-cooled)	–	300757	400 A at 100% duty cycle				2.4 lb. (1.1 kg)

74 MPa Plus Remote Configurations See literature M/3.0

Remote wire feeder control box and wire drive assembly for non-Miller boom applications.

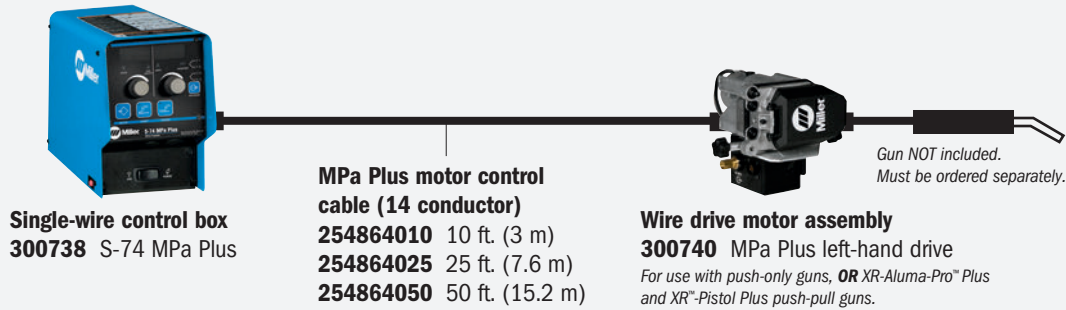

Single-wire control box
300738 S-74 MPa Plus

MPa Plus motor control cable (14 conductor)
254864010 10 ft. (3 m)
254864025 25 ft. (7.6 m)
254864050 50 ft. (15.2 m)

Wire drive motor assembly
300740 MPa Plus left-hand drive
For use with push-only guns, OR XR-Aluma-Pro™ Plus and XR™-Pistol Plus push-pull guns.

Gun NOT included. Must be ordered separately.

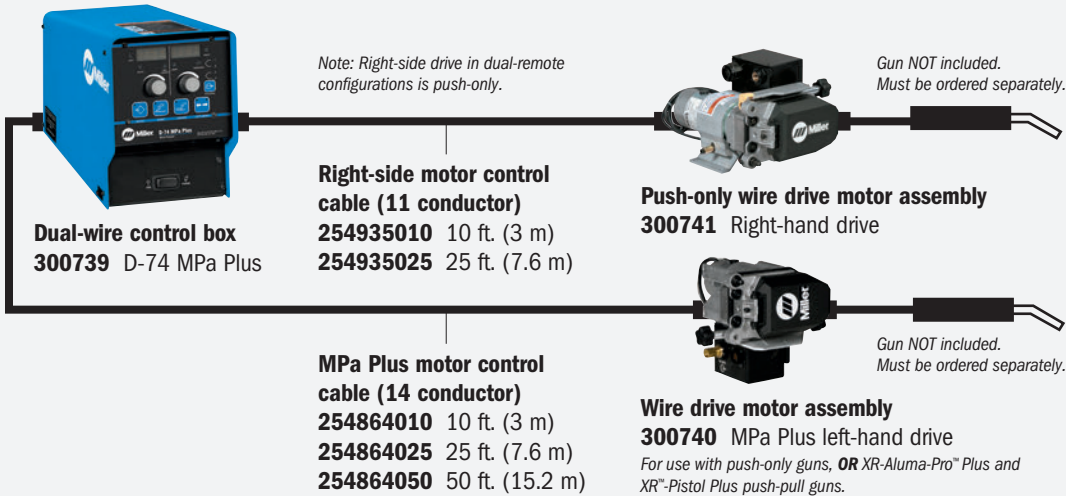

Dual-wire control box
300739 D-74 MPa Plus

Note: Right-side drive in dual-remote configurations is push-only.

Right-side motor control cable (11 conductor)
254935010 10 ft. (3 m)
254935025 25 ft. (7.6 m)

Push-only wire drive motor assembly
300741 Right-hand drive

MPa Plus motor control cable (14 conductor)
254864010 10 ft. (3 m)
254864025 25 ft. (7.6 m)
254864050 50 ft. (15.2 m)

Wire drive motor assembly
300740 MPa Plus left-hand drive
For use with push-only guns, OR XR-Aluma-Pro™ Plus and XR™-Pistol Plus push-pull guns.

Gun NOT included. Must be ordered separately.

Heavy industrial **CV DC**

Use with CV, DC power sources.

Processes

- MIG (GMAW) = Flux-cored (FCAW)
- Pulsed MIG (GMAW-P) with MPa Plus configurations and MPa power source

Suggested power sources/guns

- Same as 74 MPa Plus bench feeder

Most popular accessories



- **Feeder Base** 195369

For use with spooled wire

Visit MillerWelds.com or your distributor for other Miller® options and accessories.

For All Your Industrial MIG Gun and Consumable Needs

Our Bernard® and Tregaskiss® catalog and website provide one source for all your semi-automatic, robotic, and fixed automatic MIG welding gun and consumable needs.

Visit us online today at Tregaskiss.com to access product information, use our online product configurators and learn how to get more out of your welding applications. While you're there you can **request a hard copy of the latest Bernard and Tregaskiss MIG Welding Guns and Consumables catalog** or **sign up for Amperage**, our electronic newsletter.

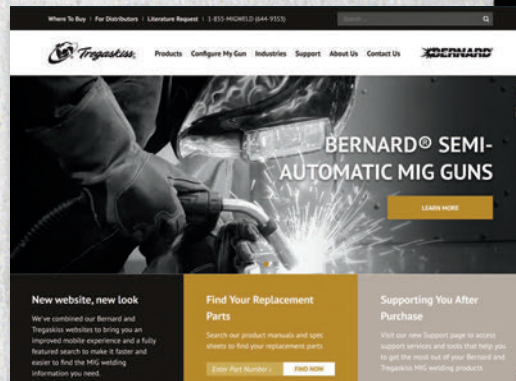

Tregaskiss.com





For more detailed information, visit

MillerWelds.com/guns-torches

Product Guide

	Page	Class	MIG	Pulsed MIG	Flux-cored*	Solid	Wire Types			Wire Diameter Capacity	Available Cable Lengths	Typical Applications	
							Flux-cored		Alum.				
							Gas-shld	Self-shld					
MIGmatic™ M-100 MIG Gun	25	●	●	●	●	●	●	●	● CV*	.023-.045 in. (0.6-1.2 mm)	10 ft.	Light industrial steel fabrication	Steel
MIGmatic™ M-150 MIG Guns	25	●	●	●	●	●	●	●	● CV*	.023-.045 in. (0.6-1.2 mm)	15 ft.	Light industrial steel fabrication	
MDX™-100 MIG Gun	26	●	●	●	●	●	●	●	● CV*	.023-.045 in. (0.6-1.2 mm)	10 ft.	Light industrial steel fabrication	
MDX™-250 MIG Guns	26	●	●	●	●	●	●	●	● CV*	.023-.045 in. (0.6-1.2 mm)	10, 12 or 15 ft.	Industrial steel fabrication	
Bernard® BTB MIG Guns	27	●	●	●	●	●	●	●	● CV*	.023-1/8 in. (0.6-3.2 mm)	10, 15, 20, or 25 ft.	Heavy industrial steel fabrication	
Bernard® Clean Air™ Fume Extraction Guns with Straight Handle	28	●	●	●	●	●	●	●	● CV*	.023-1/8 in. (0.6-3.2 mm)	8, 10, 12, 15, 20, or 25 ft.	Heavy industrial steel fabrication	
Bernard® Clean Air™ Fume Extraction Guns with Curved Handle	28	●	●	●	●	●	●	●	● CV*	.023-5/64 in. (0.6-2.0 mm)	8, 10, 12, 15, 20, or 25 ft.	Heavy industrial steel fabrication	
Bernard® Dura-Flux™ Guns with Fixed Liner	28	●	●	●	●	●	●	●	● CV*	1/16-3/32 in. (1.6-2.4 mm)	8, 10, 12, 15, 20, or 25 ft.	Heavy industrial steel fabrication	
Bernard® Dura-Flux™ Guns with Replaceable Liner	28	●	●	●	●	●	●	●	● CV*	.045-5/64 in. (1.2-2.0 mm)	8, 10, 12, 15, 20, or 25 ft.	Heavy industrial steel fabrication	
Spoolmate™ Spool Guns	29	●	●	●	●	●	●	●	●	100/200/3035 models: .023-.035 in. (0.6-0.9 mm) 150 model: .030-.035 in. (0.8-0.9 mm)	100 model: 12 ft. 150/200/3035 models: 20 ft.	Light industrial aluminum fabrication	Aluminum
Spoolmatic® Spool Guns	30	●	●	●	●	●	●	●	● CV*	.030-1/16 in. (0.8-1.6 mm)	15 or 30 ft.	Industrial aluminum fabrication	
XR-Aluma-Pro™ Lite Push-Pull Gun	31	●	●	●	●	●	●	●	●	.030-.047 in. (0.8-1.2 mm)	25 ft.	Industrial aluminum fabrication	
XR-Aluma-Pro™ Push-Pull Guns	31	●	●	●	●	●	●	●	●	.030-1/16 in. (0.8-1.6 mm)	15, 25 or 35 ft.	Heavy industrial aluminum fabrication	
XR™ Pistol Push-Pull Guns	31	●	●	●	●	●	●	●	●	.030-1/16 in. (0.8-1.6 mm)	XR-Pistol: 15 or 30 ft. XR-Pistol-Pro: 15, 25 or 35 ft.	Heavy industrial aluminum fabrication	

Product Key

Class: ● Light industrial ● Industrial ● Heavy industrial Capability: ● Designed for this process ● Capable of this process
*Certain self-shielded wires require CV output. Miller recommends a CV power source whenever possible.

MIGmatic™ M-Series MIG Guns See literature AY/15.0

Upgrade your M-100 and M-150 MIG guns to AccuLock™ MDX™ consumables with a conversion diffuser.



AccuLock™ MDX™ Conversion Kit 1880269

Kit features a conversion diffuser to consolidate MIG nozzles and contact tips to AccuLock MDX. Includes diffuser (1070115), 1/2-inch flush nozzle (NS-M1200C), five .030-inch contact tips (T-M030), five .035-inch contact tips (T-M035) and a consumables storage box.

Light Industrial ●

Processes

- MIG (GMAW) ■ Flux-cored (FCAW)

Suggested power sources

- Millermatic® 141/211 (M-100/M-150) (pg 7)
- Multimatic® 200 (M-150) (pg 41)
- Multimatic® 215 (M-100/M-150) (pg 41)
- Multimatic® 220 (M-100/M-150) (pg 42)

Most popular accessories

- MIGmatic M-Series Consumable Kits (pg 125)
234607 .023 in. (0.6 mm)
234608 .030 in. (0.8 mm)
234609 .035 in. (0.9 mm)
- AccuLock™ MDX™ Conversion Kit 1880269

Allows MIGmatic M-100 and M-150 MIG guns to upgrade to AccuLock™ MDX™ nozzles and tips (see pg 26)

Visit MillerWelds.com or your distributor for other Miller® options and accessories.

Model	Stock Number	Cable Length	Rated Output	Rated Duty Cycle	Wire Diameter Capacity	Gun Only Net Weight
M-100	248282	10 ft. (3 m)	100 A	100% with CO ₂ gas, 60% with mixed gas	.023-.045 in. (0.6-1.2 mm)	3.2 lb. (1.5 kg)
M-150	249041	15 ft. (4.6 m)	150 A	100% with CO ₂ gas, 60% with mixed gas	.023-.045 in. (0.6-1.2 mm)	6.0 lb. (2.7 kg)

MDX™ Series MIG Guns

See literature AY/15.5

An ideal match for Miller® all-in-one MIG machines or other Miller® wire feeders.



Durable, ergonomic handle features rubber overmolding for improved grip and rear swivel to reduce welder fatigue.

AccuLock™ consumables provide long life and superior wire feeding. See below for more information.

Pulse welding capable (MDX-250 only) due to increased copper in the gun cable which ensures reliable performance with CV and pulse waveforms.

Model	Stock Number	Cable Length	Rated Output	Rated Duty Cycle	Standard Wire Size	Standard Consumables
MDX-100	1770028	10 ft. (3 m)	100 A	100% with CO ₂ gas, 60% with mixed gas	.030-.035 in. (0.8-0.9 mm)	AccuLock MDX
MDX-250	1770035	10 ft. (3 m)	250 A	100% with CO ₂ gas, 60% with mixed gas	.030-.035 in. (0.8-0.9 mm)	AccuLock MDX
	1770036	12 ft. (3.7 m)	250 A	100% with CO ₂ gas, 60% with mixed gas	.030-.035 in. (0.8-0.9 mm)	AccuLock MDX
	1770037	15 ft. (4.6 m)	250 A	100% with CO ₂ gas, 60% with mixed gas	.030-.035 in. (0.8-0.9 mm)	AccuLock MDX
	1770038	15 ft. (4.6 m)	250 A	100% with CO ₂ gas, 60% with mixed gas	.035-.045 in. (0.9-1.2 mm)	AccuLock MDX
	1770041	10 ft. (3 m)	250 A	100% with CO ₂ gas, 60% with mixed gas	.035-.045 in. (0.9-1.2 mm)	AccuLock S
	1770042	12 ft. (3.7 m)	250 A	100% with CO ₂ gas, 60% with mixed gas	.035-.045 in. (0.9-1.2 mm)	AccuLock S
	1770043	15 ft. (4.6 m)	250 A	100% with CO ₂ gas, 60% with mixed gas	.035-.045 in. (0.9-1.2 mm)	AccuLock S

AccuLock™ MDX™ Consumables

See literature AY/15.5

Flawless wire feeding path. Front-loading liner is locked and concentrically aligned with both the contact tip and power pin.

Error-proof liner trimming ensures accurate replacement every time – no measuring required!

Maximize electrical conductivity and tip life. Tapered mating surface between the contact tip and gas diffuser locks tips in place for optimal performance.

AccuLock MDX power pin caps are available in three wire range sizes. They work together with AccuLock gas diffusers to lock and concentrically align the liner to both the contact tip and power pin to ensure smooth, uninterrupted delivery of the wire to the weld puddle.



Upgrade to AccuLock S consumables for increased durability and longer life when guns are used in pulsed welding or more industrial applications. See page 27 for more information.



AccuLock MDX



AccuLock S

MDX Series MIG Guns Consumable Kits



For MDX-100 with AccuLock MDX

1880272 .023 in. (0.6 mm)

1880273 .030 in. (0.8 mm)

1880274 .035 in. (0.9 mm)

For MDX-250 with AccuLock MDX

1880275 .030 in. (0.8 mm)

1880276 .035 in. (0.9 mm)

1880277 .045 in. (1.2 mm)

For MDX-250 with AccuLock S

1880278 .035 in. (0.9 mm)

1880279 .045 in. (1.2 mm)

Kits include ten contact tips, one nozzle, one diffuser, and a consumable storage box. Both kits for MDX-250 gun also include one neck insulator.

Light industrial ● MDX-100
Industrial ● MDX-250

Processes

- MIG (GMAW) = Flux-cored (FCAW)
- Pulsed MIG (GMAW-P) with MDX-250

Suggested power sources

For MDX-100

- Millermatic® 141/211 (pg 7)
- Multimatic® 215 (pg 41)
- Multimatic® 220 AC/DC (pg 42)

For MDX-250

- Millermatic® 252 (pg 8)
- Millermatic® 255 (pg 9)
- Multimatic® 200 (pg 41)
- Multimatic® 235 (pg 43)
- Multimatic® 255 (pg 44)

Most popular consumables

AccuLock Consumables

Power Pin Caps (inches)

2200360 .023-.030

2200361 .030-.035

2200362 .035-.045

Liners (inches)

LM1A-10 .023-.025, 10 ft. length

LM2A-10 .030-.035, 10 ft. length

LM3A-10 .035-.045, 10 ft. length

LM1A-12 .023-.025, 12 ft. length

LM2A-12 .030-.035, 12 ft. length

LM3A-12 .035-.045, 12 ft. length

LM1A-15 .023-.025, 15 ft. length

LM2A-15 .030-.035, 15 ft. length

LM3A-15 .035-.045, 15 ft. length

Diffusers

D-M100 MDX-100

D-M250 MDX-250

D-MA250M MDX-250 AccuLock S conversion

MDX-100 Nozzles (inches)

NS-M1200B 1/2 ID, flush, brass

NS-M1200C 1/2 ID, flush, copper

NS-MFLX Gasless nozzle

MDX-250 Nozzles (inches)

AccuLock MDX

N-M1200C 1/2 ID, flush, copper

N-M1218C 1/2 ID, 1/8 rec., copper

N-M5800C 5/8 ID, flush, copper

N-M5818C 5/8 ID, 1/8 rec., copper

N-M58XTC 5/8 ID, 1/8 ext., copper

AccuLock S

N-A5800CM 5/8 ID, flush, copper

N-A5818CM 5/8 ID, 1/8 rec., copper

N-A5814CM 5/8 ID, 1/4 rec., copper

Contact Tips (inches)

AccuLock MDX

T-M023 .023

T-M030 .030

T-M035 .035

T-M045 .045

T-M047 3/64

AccuLock S

T-A023CHM .023

T-A030CHM .030

T-A035CHM .035

T-A039CHM .039

T-A045CHM .045

Visit MillerWelds.com or your distributor for other Miller® options and accessories.

Bernard® Semi-Automatic Guns

Miller offers rugged and reliable Bernard welding guns that have been customized to match the performance of many of its industrial wire feeders and power sources.

BTB Air-Cooled MIG Guns See Bernard literature SP-BTB

Fully configurable BTB MIG guns help keep your skilled welders comfortable while also increasing their productivity.



Choose from a variety of necks, handles and trigger styles to optimize welder ergonomics and weld access, then standardize with a single line of consumables to simplify maintenance and contain costs. **See chart below for a pre-configured BTB MIG gun. Configure your BTB MIG gun by visiting Tregaskiss.com/ConfigureMyGun**

¹ Comes with a Miller® power pin and conventional liner.

² Comes with a Miller® power pin and QUICK LOAD® liner.

Stock Number	Amperage	Cable Length	Nozzle Recess	Handle	Trigger	Neck	Consumables	Wire Size
Q3015AE9HMC ¹	300	15 ft. (4.6 m) Hytrel® polymer	1/8 in. recess	B Series small curved	Standard	Rotatable med. 45°	AccuLock™ S	.035-1/16 in. (0.9-1.6 mm)
Q3015AE9EMC ¹	300	15 ft. (4.6 m) Hytrel® polymer	1/8 in. recess	B Series small curved	Standard	Rotatable med. 45°	AccuLock™ S	.035-1/16 in. (0.9-1.6 mm)
Q4015AE9EMC ¹	400	15 ft. (4.6 m) Hytrel® polymer	1/8 in. recess	B Series curved	Standard	Rotatable med. 45°	AccuLock™ S	.035-1/16 in. (0.9-1.6 mm)
Q4015AE9EMC ¹	400	15 ft. (4.6 m) Hytrel® polymer	1/8 in. recess	B Series curved	Standard	Rotatable med. 45°	AccuLock™ S	.035-1/16 in. (0.9-1.6 mm)
Q4015VS9EMQ ²	400	15 ft. (4.6 m) Hytrel® polymer	1/8 in. recess	C Series straight	Standard	Fixed med. 60°	AccuLock™ S	.035-1/16 in. (0.9-1.6 mm)

AccuLock™ S Consumables See Bernard literature SP-ALS

Increase tip life, reduce replacement frequency

- Contact tips are 60% buried within the diffuser for less exposure to the heat of the weld
- Mating tapers on both tip-to-diffuser and diffuser-to-neck connection provide good electrical conductivity
- Shielding gas cools contact tip tail



Now available with select Miller packages. Scan the QR code or visit Tregaskiss.com/acculocks-systems to find out more.



AccuLock™

Heavy industrial ●

Processes

- MIG (GMAW) ▪ Flux-cored (FCAW)
- Pulsed MIG (GMAW-P)

Duty cycle ratings

- 100% with CO₂
- 60% with mixed gases

Suggested feeders

- Intellx™ Feeders (pg 13)
- Continuum™ Feeder (pg 14)
- SuitCase® Series (pg 18)
- ArcReach® 16 (pg 20)
- 20 Series and 74 MPa Plus (pg 22-24)

Suggested power source

- Millermatic® 355 (pg 10)

Most popular consumables

AccuLock™ S Consumables

Diffusers*

- DS-A1-C** Conventional liner, small, thread-on
- DS-A2-C** Conventional liner, small, slip-on
- D-A1-C** Conventional liner, large, thread-on
- D-A2-C** Conventional liner, large, slip-on

Brass Nozzles* (inches)

- NS-A1218B** 1/2 ID, 1/8 rec., small

Copper Nozzles* (inches)

- NS-A5818C** 5/8 ID, 1/8 rec., small
- N-A5818C** 5/8 ID, 1/8 rec., large
- N-A5814C** 5/8 ID, 1/4 rec., large
- N-A3414C** 3/4 ID, 1/4 rec., large

Contact Tips* (inches)

- T-A035CH** .035
- T-A045CH** .045
- T-A052CH** .052
- T-A062CH** 1/16

*Small diffusers are compatible with small nozzles; large diffusers are compatible with large nozzles. The contact tips listed above are compatible with both small and large diffusers.

Visit Tregaskiss.com or your distributor for additional Bernard consumable options.



For more detailed information, visit Tregaskiss.com



Bernard® Semi-Automatic Guns

Industrial-duty fume extraction and flux-cored welding solutions built for the way you weld.



Straight handle
(shown with optional
short nozzle shroud)

Curved handle

Clean Air™ Fume Extraction MIG Guns

See Bernard literature SP-CLA

Maintaining a clean working environment is important and Bernard understands the need for a reliable fume extraction solution. Extract fumes at the weld bead using either of our two models and a FILTAIR® 130 or 215 fume extractor.

Clean Air straight handle gun

- Available in 300-, 400-, 500- and 600-amp models
- Compatible with Centerfire, Quik Tip and TOUGH LOCK consumables
- Ergonomic, lightweight handle with rear swivel improves operator comfort

Clean Air curved handle gun

- Available in 300- and 400-amp models
- Compatible with Centerfire, Quik Tip and TOUGH LOCK consumables
- Small lightweight handle maximizes maneuverability and comfort

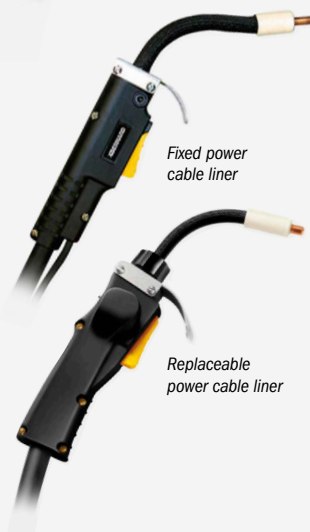

Fixed power
cable liner

Replaceable
power cable liner

Dura-Flux™ Self-Shielded Flux-Cored Guns

See Bernard literature SP-DF

For structural steel applications, bridge construction and heavy equipment repair, Bernard offers two types of 350-amp self-shielded flux-cored guns.

Dura-Flux gun with fixed power cable liner

- Ultra-heavy-duty steel monocoil power cable is highly resistant to kinking
- Centerfire consumables are easy to use and high performing, providing better arc starts, less spatter and more consistent welds

Dura-Flux gun with replaceable power cable liner

- Replaceable power cable liner allows quick and easy power cable maintenance
- Quik Tip consumables provide excellent heat transfer and electrical conductivity

Bernard® Welding Consumables (cutaways shown)



Centerfire™ consumables

See Bernard literature SP-CFC

- Drop-in contact tip (no tools required to replace tip or nozzle) means quick changeover and reduced downtime
- Spatter shield within nozzle holds tip in place, protects diffuser and directs gas evenly with reduced turbulence
- Diffuser mates securely with contact tip for better conductivity



Quik Tip™ consumables

See Bernard literature SP-QTC

- A quick twist is all it takes to install contact tips
- Threaded taper lock increases tip life and allows excellent heat transfer and electrical conductivity
- Fixed contact tip position for repeatability and consistent quality welds



TOUGH LOCK® consumables

See Bernard literature SP-TLC

- Dual taper technology keeps consumables locked from tip to neck for improved weld consistency, positive electrical conductivity and maximized heat dissipation
- Consumables run cooler, improving performance and extending life

Heavy industrial ●

Processes

- MIG (GMAW) = Flux-cored (FCAW)
- Pulsed MIG (GMAW-P)

Duty cycle ratings

- 100% with CO₂
- 60% with mixed gases

Suggested feeders

- Intelli™ Feeders (pg 13)
- Continuum™ Feeder (pg 14)
- SuitCase® Series (pg 18)
- ArcReach® 16 (pg 20)
- 20 Series and 74 MPa Plus (pg 22-24)

Suggested power source

- Millermatic® 355 (pg 10)

Suggested fume extractors

- FILTAIR® 130 (pg 106)
- FILTAIR® 215 (pg 107)

Most popular consumables

Centerfire™ Consumables

Diffusers (amps)

- DS-1** 300, small
- D-1** 400, 500, 600, large

Copper Nozzles (inches)

- NS-5818C** 5/8 ID, 1/8 rec., small
- N-5818C** 5/8 ID, 1/8 rec., large
- N-5814C** 5/8 ID, 1/4 rec., large
- N-3414C** 3/4 ID, 1/4 rec., large

Contact Tips (inches)

- T-035** .035
- T-045** .045
- T-052** .052
- T-062** 1/16

Contact Tip Insulator

- 7010024** For Dura-Flux gun with fixed power cable liner only

Contact Tip Holder

- 7010026** For Dura-Flux gun with fixed power cable liner only

Quik Tip™ Consumables

Diffusers (amps)

- D118Q** 300, 400
- D114Q** 500, 600

Plated Copper Nozzles (inches)

- N1C58Q** 5/8 ID
- N1C34Q** 3/4 ID

Contact Tips (inches)

- T1035** .035
- T1045** .045
- T1116** 1/16

Contact Tip Insulator

- 7010062** For Dura-Flux gun with replaceable power cable liner only

TOUGH LOCK® Consumables

Diffusers (amps)

- 404-44-25** 300, 400, 500, 600 HD

Copper Nozzles (inches)

- 401-6-62** 5/8 ID, 1/8 rec., HD
- 401-5-75** 3/4 ID, 1/4 rec., HD

Contact Tips (inches)

- 403-20-35-25** .035 HD
- 403-20-45-25** .045 HD
- 403-20-52-25** .052 HD
- 403-20-116-25** 1/16 HD

Visit Tregaskiss.com or your distributor for additional Bernard consumable options.



For more detailed information, visit Tregaskiss.com



Spoolmate™ Spool Guns

Reliable and economical spool guns designed for home hobbyists and light fabricators.



Spoolmate 100

Spoolmate 100 includes carrying case that holds gun and cable, extra contact tips, nozzle and wire (wire sold separately).

Spoolmate 100 See literature M/1.45

Light industrial gun for 4043 series aluminum wire rated at 135 amps at 30 percent duty cycle.

12-foot direct-connect cable with heavy-duty strain relief provides extended reach and accessibility to your work.

Dual V-knurl drive rolls with adjustable tension control for consistent feeding of different types of wire.

Clear spool canister protects the wire and allows easy view of spool.

Includes carrying case, extra contact tips and nozzle.



Spoolmate 150

Spoolmate 150 See literature M/1.46

Light industrial gun for 4000 or 5000 series aluminum wire rated at 150 amps at 60 percent duty cycle.

20-foot direct-connect cable with heavy-duty strain relief provides extended reach and accessibility to your work.

Heavy-duty head tube.

Dual V-knurl drive rolls with adjustable tension control for consistent feeding of different types of wire.

Clear spool canister protects the wire and allows easy view of spool.

PORTABLE!



Spoolmate 200

Spoolmate 200 See literature M/1.47

Light industrial gun for 4000 or 5000 series aluminum wire rated at 160 amps at 60 percent duty cycle.

20-foot weld/control cables with strain relief and sheath provide extended reach and accessibility to your work.

Wire feed speed adjustment on the gun – not machine – for easy setup.

Easy access to drive assembly and drive rolls.

Two-stage trigger with built-in gas valve allows for gas preflow/postflow.

Toolless head tube removal allows easy replacement. Comes standard with heavy-duty head tube. Three optional head tubes available.



Spoolmate 3035

Spoolmate 3035 See literature M/1.5

Light industrial gun for 4000 or 5000 series aluminum wire rated at 150 amps at 60 percent duty cycle.

20-foot weld/control cables with strain relief and sheath provide extended reach and accessibility to your work.

Light weight and well balanced for operator comfort.

Clear spool canister protects the wire and allows easy view of spool.

Easy-to-remove head tube assembly.

Light industrial **CV DC**

Use with CV, DC power sources.

Processes

- MIG (GMAW) with aluminum and other soft alloy wires
- MIG (GMAW) with solid wires

Suggested power sources

For Spoolmate 100

- Millermatic® 141/211 (pg 7)
- Multimatic® 200/215 (pg 41)
- Multimatic® 220 AC/DC (pg 42)
- Multimatic® 235 (pg 43)
- Syncrowave® 210 (pg 58) (requires MIG accessory kit 301254)

For Spoolmate 150

- Millermatic® 211 (pg 7)
- Multimatic® 200 (pg 41) (effective with serial number MF364047N)
- Multimatic® 215 (pg 41)
- Multimatic® 220 AC/DC (pg 42)
- Multimatic® 235 (pg 43)
- Syncrowave® 210 (pg 58) (requires MIG accessory kit 301254)

For Spoolmate 200

- Millermatic® 252 (pg 8)
- Millermatic® 255 (pg 9)
- Millermatic® 355 (pg 10)
- Multimatic® 235 (pg 43)
- Multimatic® 255 (pg 44)
- Bobcat™ 200 Air Pak™ (pg 79)

For Spoolmate 3035

- Direct connect to vintage Millermatic 210/212 tapped-voltage models

Most popular accessories

For Spoolmate 200

- 45-Degree Head Tube 300591
- 9-Inch Extension Head Tube 300592
- 5-Inch Head Tube 243385
- Spoolmatic Adapter Cable 195287 Allows connection to older Millermatic 210 and 212 (non-Auto-Set)

For Spoolmatic 3035

- Heavy-Duty Head Tube 195375

Visit MillerWelds.com or your distributor for other Miller® options and accessories.

Model/ Stock Number	Welding Current Rating	Wire Feed Speed	Wire Type and Diameter Capacity	Maximum Spool Size Capacity	Dimensions	Net Weight with Cable Assembly
Spoolmate 100 300371	135 A at 30% duty cycle	5-625 ipm (1.7-15.9 m/min.) Wire speed dependent on power source used	Aluminum .030-.035 in. (0.8-0.9 mm) Solid steel .023-.035 in. (0.6-0.9 mm) Stainless .023-.035 in. (0.6-0.9 mm)	4 in. (102 mm)	H: 11.5 in. (291 mm) W: 3 in. (76 mm) L: 13 in. (330 mm)	6 lb. (2.7 kg) 9 lb. (4.1 kg) with case
Spoolmate 150 301272	150 A at 60% duty cycle	115-715 ipm (2.9-18.1 m/min.) Wire speed dependent on power source used	Aluminum .030-.035 in. (0.8-0.9 mm) Solid steel .030-.035 in. (0.8-0.9 mm) Stainless .030-.035 in. (0.8-0.9 mm)	4 in. (102 mm)	H: 11.5 in. (291 mm) W: 3 in. (76 mm) L: 12.5 in. (318 mm)	7.3 lb. (3.2 kg)
Spoolmate 200 300497	160 A at 60% duty cycle,	70-875 ipm (1.8-22.2 m/min.)	Aluminum .030-.035 in. (0.8-0.9 mm) Solid steel .023-.035 in. (0.6-0.9 mm) Stainless .023-.035 in. (0.6-0.9 mm)	4 in. (102 mm)	H: 9 in. (229 mm) W: 2.5 in. (64 mm) L: 14.5 in. (368 mm)	11 lb. (5 kg)
Spoolmate 3035 195016	150 A at 60% duty cycle, 200 A at 60% duty cycle with optional heavy-duty head tube	115-715 ipm (2.9-18.1 m/min.)	Aluminum .030-.035 in. (0.8-0.9 mm) Solid steel .023-.035 in. (0.6-0.9 mm) Stainless .023-.035 in. (0.6-0.9 mm)	4 in. (102 mm)	H: 11.5 in. (291 mm) W: 2.25 in. (57 mm) L: 8 in. (203 mm)	9.1 lb. (4.1 kg)

Spoolmatic® Spool Guns

Portable, aluminum wire feeder for industrial applications.



Spoolmatic

PORTABLE!

Spoolmatic See literature M/1.73

Integrated spool canister rotates 180 degrees for operator flexibility and comfort.

Available in 15- or 30-foot cable lengths, providing flexibility to be used in the shop and in the field.

Two-stage trigger with built-in gas valve allows for gas preflow and eliminates the need to purge long gas lines.

Wire feed speed adjustment on the gun handle and reversible drive rolls save time and money.

Quick-change, single-turn contact tip provides excellent performance and is easy to replace.



Spoolmatic Pro

Spoolmatic Pro (additional features) See literature M/1.76

Wire tension settings. 4000- or 5000-specific tension settings ensure the very best wire feeding performance and arc consistency.

More durable motor and drive design improves feedability and arc consistency while helping reduce downtime and maintenance costs.

Easy access to drive assembly and removable toolless head tube reduce service time by allowing a means of changing drive rolls and head tube, or performing routine maintenance, without disassembly of gun.

Easy-to-rotate, self-seating head tube allows for better access into tight spots, preventing leaks and providing excellent current transfer. Head tubes are common with the XR-Aluma-Pro™ and XR™-Pistol-Pro guns.

Head tube options in several different lengths and bend configurations are available for when a standard head tube doesn't fit the application.

Industrial ● **CC CV DC**

Use with CC/CV, DC power sources.

Processes

- MIG (GMAW) with aluminum and other soft alloy wires
- MIG (GMAW) with solid wires
- Pulsed MIG (GMAW-P) with pulsing power source

Suggested power sources

For Spoolmatic (non-Pro model only)

- Millermatic® 252 (pg 8)
- Millermatic® 255 (pg 9)
- Millermatic® 355 (pg 10)
- Multimatic® 235 (pg 43)
- Multimatic® 255 (pg 44)

For both Spoolmatic models

- Bobcat™ 200 Air Pak™ (pg 79)
- Bobcat™ Series (pg 80) (requires WC-115A w/contactor 137546011)

These power sources require

WC-24 control (137549)

- AlumaPower™ MPa (pg 11)
- XMT® Series (pg 46-50)
- Trailblazer® Series (pg 82-84)
- Big Blue® Series (except Big Blue 450 Duo CST) (pg 84-87)

Most popular accessories

- WC-115A 137546 (pg 130)
- WC-115A with contactor 137546011 (pg 130)
- WC-24 137549 (pg 130)

Visit MillerWelds.com or your distributor for other Miller® options and accessories.

*Spoolmatic Pro requires gun wire kit (230708) to run 1/16 in. (1.6 mm) wire.

Model/Stock Number	Welding Current Rating	Wire Feed Speed	Wire Type and Diameter Capacity	Maximum Spool Size Capacity	Dimensions	Gun Only Net Weight
Spoolmatic 195156 15 ft. (4.6 m) cable 130831 30 ft. (9 m) cable	200 A at 100% duty cycle	70-875 ipm (1.8-22.2 m/min.) Wire speed dependent on control box or power source used	Aluminum* .030-1/16 in. (0.8-1.6 mm) Solid wire .030-.045 in. (0.8-1.1 mm)	4 in. (102 mm)	H: 10.25 in. (260 mm) W: 2.5 in. (64 mm) L: 15.125 in. (384 mm)	2.9 lb. (1.3 kg)
Spoolmatic Pro 301147 15 ft. (4.6 m) cable 301148 30 ft. (9 m) cable	200 A at 100% duty cycle	70-900 ipm (1.8-23 m/min.) Wire speed dependent on control box or power source used			H: 10.75 in. (273 mm) W: 2.5 in. (64 mm) L: 15.375 in. (390 mm)	3.0 lb. (1.4 kg)

Miller recommends



Hobart® aluminum filler metals — wire and cut lengths — have been designed to provide the best performance for the best welds. These products are backed by the deep industry knowledge of Hobart welding specialists who can help customers find the right aluminum filler metal solution. Every time. No matter how challenging the application.

Visit HobartBrothers.com or your local distributor to learn more.

Questions? Hobart is here to help.

XR™ Push-Pull Guns

XR-Aluma-Pro and XR-Pistol guns work in conjunction with an XR-AlumaFeed SuitCase or select Millermatic/Multimatic machines to provide the best solution for push-pull applications.



XR-Aluma-Pro Lite

XR-Aluma-Pro

PORTABLE!



XR-Pistol

XR-Pistol-Pro

Threaded quick-change 360-degree rotatable head tubes are available in different bends and lengths for even those hard-to-reach welds. Over 30 different styles to fit your application and welder's preference.

Wire tension settings (except XR-Pistol). 4000- or 5000-specific tension settings ensure the very best wire feeding performance and arc consistency.

Heavy-duty construction. All internal components are designed to provide long lasting performance and feeding precision.

XR-Aluma-Pro™ Lite See literature M/1.75

Lightest weight gooseneck-style gun features rear trigger that allows access to hard-to-reach welds.

XR-Aluma-Pro™ See literature M/1.71

Robust professional-grade gun has the highest duty cycle rating in its class.

Easy access to drive assembly and removable toolless head tube reduce service time by allowing a means of changing drive rolls and head tube, or performing routine maintenance, without disassembly of gun.

XR™-Pistol See literature M/1.73

Reliable, cost-effective gun for light- to medium-industrial applications.



XR™-Pistol-Pro See literature M/1.74

Exceptional aluminum welding results for heavy-industrial applications.

Most durable motor and drive design improves feedability and arc consistency while helping reduce downtime and maintenance costs.

Easy access to drive assembly and removable toolless head tube reduce service time by allowing a means of changing drive rolls and head tube, or performing routine maintenance, without disassembly of gun.

Industrial ● XR-Aluma-Pro Lite
Heavy Industrial ● XR-Aluma-Pro and all Pistol models

  Use with CC/CV, DC power sources.

Processes

- MIG (GMAW) with aluminum wire (capable of other wires with optional solid wire kits)
- Pulsed MIG (GMAW-P) with pulsing power source

Suggested feeders/controls

- XR-AlumaFeed® SuitCase® (pg 11)

Suggested power sources

- Millermatic® 255 (pg 9) (XR-Aluma-Pro Lite, XR-Aluma-Pro and XR-Pistol-Pro guns only)
- Millermatic® 355 (pg 10) (XR-Aluma-Pro Lite, XR-Aluma-Pro and XR-Pistol-Pro guns only)
- Multimatic® 255 (pg 44) (XR-Aluma-Pro Lite, XR-Aluma-Pro and XR-Pistol-Pro guns only)

These power sources require an XR-AlumaFeed SuitCase

- AlumaPower™ MPa (pg 11)
- Deltaweld® 350/500 (pg 12) (14-pin receptacle models only)
- XMT® Series (pg 46-50)
- Trailblazer® Series (pg 82-84)

Most popular accessories

- Solid Wire Liner Kit 198377
- Visit MillerWelds.com or your distributor for other Miller® options and accessories.

*Dependent on control box or Millermatic/Multimatic used. **XR-Aluma-Pro and XR-Pistol-Pro require gun wire kit (230708) to run 1/16 in. (1.6 mm) wire.

Model	Cable Length				Welding Current Rating	Wire Feed Speed*	Wire Type and Diameter Capacity	Dimensions	Gun Only Net Weight
	15 ft. (4.6 m)	25 ft. (7.6 m)	30 ft. (9 m)	35 ft. (10.6 m)					
XR-Aluma-Pro Lite (Air-cooled)	—	300948	—	—	175 A at 60% duty cycle	70-900 ipm (1.8-23 m/min.)	Aluminum .030-.047 in. (0.8-1.2 mm)	H: 4 in. (102 mm) W: 1.9 in. (48 mm) L: 15 in. (381 mm)	2.0 lb. (0.9 kg)
XR-Aluma-Pro (Air-cooled)	301568	301569	—	301570	300 A at 100% duty cycle	70-900 ipm (1.8-23 m/min.)	Aluminum** .030-1/16 in. (0.8-1.6 mm)	H: 5 in. (127 mm) W: 2.5 in. (64 mm) L: 17 in. (432 mm)	2.5 lb. (1.1 kg)
XR-Aluma-Pro (Water-cooled)	301571	301572	—	301573	400 A at 100% duty cycle	70-900 ipm (1.8-23 m/min.)	Aluminum** .030-1/16 in. (0.8-1.6 mm)	H: 5 in. (127 mm) W: 2.5 in. (64 mm) L: 17 in. (432 mm)	2.9 lb. (1.3 kg)
XR-Pistol (Air-cooled)	198127	—	198128	—	200 A at 100% duty cycle	70-875 ipm (1.8-22.2 m/min.)	Aluminum .030-1/16 in. (0.8-1.6 mm)	H: 7.375 in. (187 mm) W: 1.875 in. (48 mm) L: 10.625 in. (270 mm)	2.2 lb. (1 kg)
XR-Pistol (Water-cooled)	198129	—	198130	—	400 A at 100% duty cycle	70-875 ipm (1.8-22.2 m/min.)	Aluminum .030-1/16 in. (0.8-1.6 mm)	H: 7.375 in. (187 mm) W: 1.875 in. (48 mm) L: 10.625 in. (270 mm)	2.4 lb. (1.1 kg)
XR-Pistol-Pro (Air-cooled)	300782	300783	—	300784	200 A at 100% duty cycle	70-900 ipm (1.8-23 m/min.)	Aluminum** .030-1/16 in. (0.8-1.6 mm)	H: 7.375 in. (187 mm) W: 1.875 in. (48 mm) L: 10.625 in. (270 mm)	2.2 lb. (1 kg)
XR-Pistol-Pro (Water-cooled)	300786	300787	—	300788	400 A at 100% duty cycle	70-900 ipm (1.8-23 m/min.)	Aluminum** .030-1/16 in. (0.8-1.6 mm)	H: 7.375 in. (187 mm) W: 1.875 in. (48 mm) L: 10.625 in. (270 mm)	2.4 lb. (1.1 kg)



To order automation solutions: Contact local Miller district manager or email MWA.Sales@MillerWelds.com

For automation service/parts: Call **1-630-653-6819** or email MWAService@MillerWelds.com

PERFORMARC™ ROBOTIC WELDING SYSTEM



A family of pre-engineered automation cells to increase productivity and improve weld quality.

Fast installation. Pre-wired and pre-assembled make setup fast and easy. Most systems are up and running in under two hours from delivery (connect power/wire/gas/floor mounting/install tooling).

Integrated controls. Control station and full-color teach pendant keep the operator informed, maximizing production uptime.

Flexibility. Fully welded frame allows easy relocation and reconnection as production plans or layouts change.

Increased productivity. Operator can load and inspect parts while robot is welding.

A/B 180° Indexing Table Single-station load/unload systems

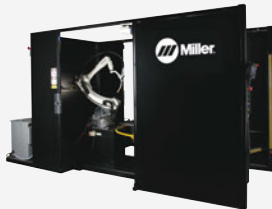

- PA250M** 250 lb./side, 60 in. manually indexing table
- PA350S** 350 lb./side, 66 in. servo indexing table
- PA750S** 750 lb./side, 92 in. servo indexing table
- PA1500SW** 1,500 lb./side, 92 or 108 in. servo indexing table

Side-by-Side Two-station load/unload systems

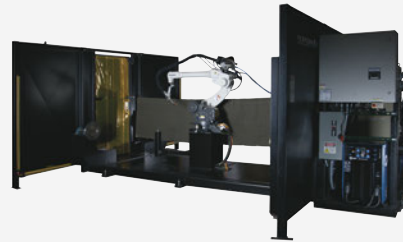

Robot between dual head and tailstock/ single- or dual-robot configuration.

- PA1100SS** 1,100 lb./side, 120 in. long x 44 in. turning diameter
- PA2200SS** 2,200 lb./side, 120 in. long x 66 in. turning diameter

A/B 180° Indexing H-Frame Single-station load/unload systems



Dual head and tailstock/ single- or dual-robot configuration.

- PA1100HW** 1,100 lb./side, 60 in. long x 40 in. turning diameter on 108 in. servo indexer

A/B 180° Indexing Ferris Wheel Single-station load/unload systems



Dual head and tailstock/ single-, dual- or triple-robot configuration.

- PA1100FW** 1,100 lb./side, 118 in. long x 43 in. turning diameter

Laser Welding Systems



- PL1100HW** 1,100 lb./side, 60 in. long x 34 in. turning diameter on 108 in. servo indexer

Integrated laser solution with fiber cable management.

- Autogenous systems
- Class 1 laser-safe enclosure
- Available with fiber or diode laser configurations

To order automation solutions: Contact local Miller district manager or email MWA.Sales@MillerWelds.com

For automation service/parts: Call 1-630-653-6819 or email MWAService@MillerWelds.com

Active Wire Process (AWP)

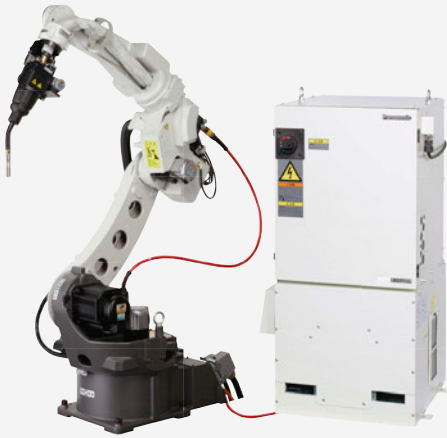

Active wire is an advanced short arc welding process combining the robot motion path, welder waveform and servo wire feed control simultaneously reversing the wire at the short circuit to control the weld deposition precisely.

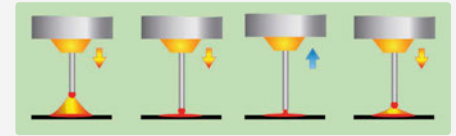

Spatter control. Spatter is virtually eliminated in all phases of the weld using mixed argon 90/10 or 100 percent CO₂ gas.

Fast and clean arc striking. At the moment the wire touches the base the wire is reversed, reducing arc strike spatter by up to 90 percent.

Flexibility. Large variations in torch angle are possible, allowing push-pull in and out of corners without increasing spatter.

Appearance. The precise nature of the process allows many customers an alternative to TIG welding.

Wide range of materials. Mild steels, stainless steels and aluminum from thin to medium gauge benefit from AWP.

Thick Plate Welding

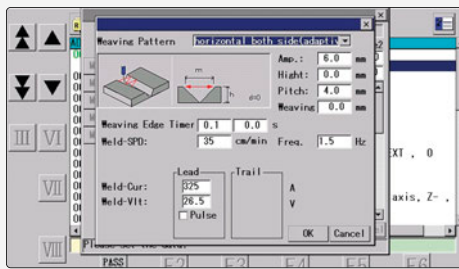

Fast and easy programming even on the most complex multi-pass weldments. All required commands and sensor setup in a single menu screen. Welding procedures can be developed quickly and transported easily from part to part.

Graphical, menu-driven interface. Pop-up graphical windows allow for fast programming of any welding joint in a single location.

Multi-layer path control. Easy-to-use interface to sequence the location of starts/stops and create multi-layer weld paths with appropriate offsets.

Advanced sensors. High-voltage touch sensing with menu-driven touch macros, a specialized high-amperage arc sensor system, and adaptive fill capability allow the weld process to adapt to incoming/varying production parts.

DeskTop Programming and Simulation (DTPS)

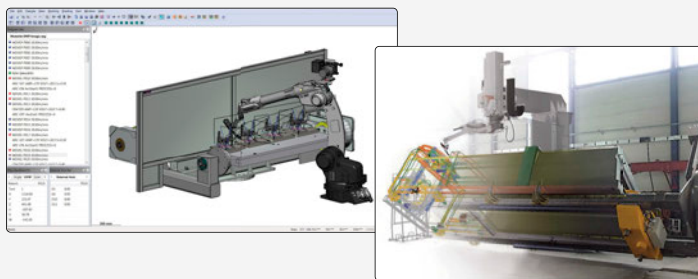

Software allows the development of programs offline, minimizing robot downtime and maximizing throughput and productivity.

Specialized software generates programs and simulates the actual taught paths from your desktop.

Native language programming. Same language and functions that the technician will see on the teaching pendant, making program generation off-line easier than competitive code-based systems.

Simplified file transfer. Transfer robot programs between robot types, sizes and controller generations.

Automation Components



Auto-Continuum™ power sources (pg 15)



Insight Core™, Centerpoint™ and ArcAgent™ Welding Intelligence™ (pg 73-75)



Tregaskiss® robotic MIG guns and reamers (pg 38-39)



FILTAIR® weld fume extraction system with low profile hood (pg 110-111)



Miller recommends Hobart® filler metals (visit HobartBrothers.com)

To order automation solutions: Contact local Miller district manager
or email Hercules@MillerWelds.com

For automation service/parts: Call 1-630-653-6819
or email MWAService@MillerWelds.com

NEW! Hercules™ High-Deposition Automated Welding System

Developed by Miller, Hobart and Tregaskiss, the revolutionary Hercules MIG welding system combines Miller® power source and wire feed technology, a specialized Hobart® metal-cored wire and a unique Tregaskiss® torch. Together, they boldly go beyond the welding productivity rates you thought were possible.



Miller power sources and Hercules drive.

An Auto-Continuum™ and XMT® 450 power source work with the Hercules drive. Together, they deliver the big amperage and fast, precise wire feeding the Hercules MIG welding system requires.

Hobart FabCOR® Hercules metal-cored wire.

Formulated exclusively for the Hercules system, FabCOR Hercules is the only metal-cored wire that can accommodate faster travel speeds to deliver the Hercules system's higher deposition rates and extraordinary productivity.

Tregaskiss Hercules torch. The Tregaskiss Hercules torch has dual contacts that allow two sources of power input, which are crucial for the high-deposition process. Created specifically for the Hercules MIG welding system, this torch's water-cooled design maximizes electrical conductivity and optimizes filler metal delivery.

Coordination of all the components along with the unique formulation of the filler metal wire is what makes the Hercules process work. Hercules customers have enjoyed up to 30 percent and often higher deposition rate improvement over welding processes they previously considered best in class, raising the bar for state-of-the-art, high-deposition-rate welding productivity.

Auto-Continuum power source (see page 15)

- Stacks atop Continuum Cooler
- Welding processes include Accu-Pulse® and Versa-Pulse™ with profile-pulse modification
- Coordinates with XMT to enable Hercules process

Continuum™ Cooler (see page 15)

- Space-saving design operates on integrated power – turns on and off with the system
- Flow and temperature detection – protection from overheating
- Run-On-Demand – pump shuts off after delay when welding stops
- Options to use Coolmate™ or other coolers

XMT CC/CV power source (see pages 46/47)

- Controlled by Auto-Continuum
- Provides secondary power input to enable Hercules process

Hercules drive

- Controlled by Auto-Continuum
- Provides the speed and precision for Hercules wire

Hobart FabCOR Hercules cored filler metal

- Unique formulation for Hercules
- Available in drums

Tregaskiss Hercules water-cooled torch

- Water-cooled
- Tregaskiss consumables
- High duty cycle enables Hercules process

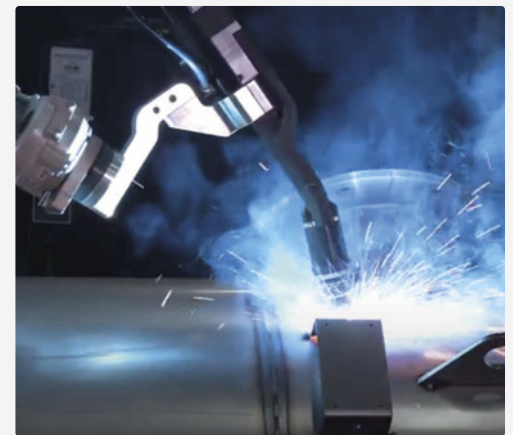

To order automation solutions: Contact local Miller district manager or email MWA.Sales@MillerWelds.com

For automation service/parts: Call 1-630-653-6819 or email MWAService@MillerWelds.com

NEW! Copilot™ Collaborative Welding Cell

Copilot is our smallest, most affordable welding cell that delivers the productivity and repeatability of robotic welding and utilizes the capabilities of collaborative robotics.



Entry-level collaborative welding cell. Operators can load and unload from a single station that can be shared with the robot envelope. Great for new-to-automation welding challenges and for experienced robotic welders who need the ability to address high-mix, low-volume operating scenarios in a small footprint.

Full complement of capabilities with Auto-Continuum™ 350 (see page 15). GMAW power source with advanced arc modes (Accu-Pulse®, Versa-Pulse™, RMD®) grows with your needs.

Tregaskiss® TOUGH GUN® CA3 robotic MIG gun (see page 38) is engineered for accurate, reliable and repeatable performance that maximizes production uptime and throughput.

Teach pendant carriage allows for convenient hands-free viewing.

Weld-ready tool surface is 48 x 48 inches and outfitted with 5/8-inch tooling holes that are spaced 2 x 2 inches in a 42 x 30 inch pattern on center. Compatible with Bluco® and StrongHand Tools®, among others.

Note: Bluco® is a registered trademark of Bluco® Corporation. StrongHand Tools® is a registered trademark of StrongHand Tools®.

Easy to relocate. Relocate your cobot workstation in four easy steps: unplug equipment and raise leveling feet, push by hand, re-level feet, and plug in equipment.

Ships partially assembled with a video setup guide and instructions. Copilot is mounted on castor wheels for easy positioning and adjustment.

Stock Number 907857 Includes Auto-Continuum 350, Auto-Continuum wire drive, welding robot, TOUGH GUN® CA3 robotic MIG gun, integrated welding table, and all required interconnecting cables	Input Power	Standard Arc Welding Configuration	Payload Capacity	Approximate Dimensions		Approximate Shipping Weight
	Standard: 3-phase, 480 V, 30 A Optional: 240-575 V Copilot: 110 V	Arc welder: Miller® Auto-Continuum™ 350 Wire drive: Miller® Auto-Continuum™ Robotic air-cooled MIG gun: Tregaskiss® TOUGH GUN® CA3	1,500 lb. (680 kg) with feet 750 lb. (340 kg) with casters	Height: 84 in. (2,134 mm) Width: 48 in. (1,219 mm) Depth: 52 in. (1,321 mm)	Max. tool height: Contact Miller Load height: 37 in. (940 mm)	1,700 lb. (771 kg)



Jetline offers a partnership to ensure you find the right solution to improve your weld quality and productivity – from design to installation, our engineers will help you get the results you need to stay competitive. Learn more at MillerWelds.com/jetline

Longitudinal Seam Welding Systems



Jetline longitudinal seam welders deliver speed and precision. Features include linear welding, high-volume cylinder production, joining thin-gauge or coiled sheets and more.

- High-precision travel and positioning result in weld accuracy
- Complete solution, single source
- All seam welders come standard with a 9700T series control, as an option a 9900 control is available
- Aluminum hold-down fingers with copper tips absorb and dissipate heat
- Toe-touch tapeswitch control activates finger clamping
- Seam welder models include:
 - External: flat sheets, cylinders and more
 - Internal: flat sheets and internal welds on cylinders
 - Combination: internal and external welds on cylinders and flat sheets
 - Elevating: seam welder raises and lowers to accommodate a wide range of part diameters, up to 96-inch OD
 - Bench style: small seam welder for welding shorter, smaller parts

Circumferential Welding Systems

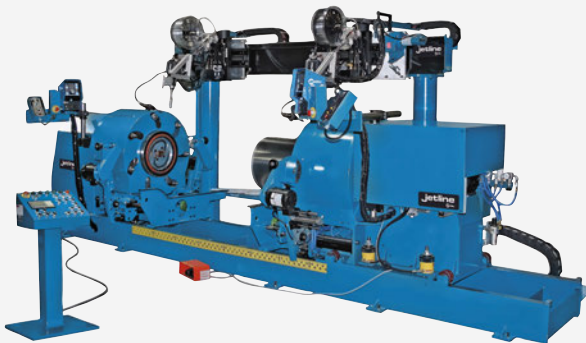

Jetline precision lathes and light-, medium- and heavy-duty circumferential welders handle a wide variety of part sizes and dimensions – from less than one pound up to 10,000 pounds, and from one inch up to 60 inches in diameter. Whatever the challenge, Jetline can work with you to find the perfect solution.

- Powered variable speed headstock
- Adjustable tailstock can be moved along the bed to accommodate differing part lengths
- Air-operated tailstocks apply a constant clamping pressure to the part throughout the welding cycle
- Circumferential welder models include:
 - Precision: 500-pound maximum part
 - Light duty: 500-pound maximum part
 - Medium duty: 2,000-pound maximum part
 - Heavy duty: 10,000-pound maximum part

Weld Head Locators



Jetline precision weld head locators provide a universal solution to position weld heads for circumferential and linear welding applications. With a variety of control systems, bolt-on accessories and base options, we can design the solution to meet your needs.

- Jetline weld head locators allow for simplified torch positioning
- Linear rails provide high-precision movement of the boom for linear welding
- 360 degrees of column rotation allows the weld head to be positioned over multiple fixtures
- Remote pushbutton pendant for weld head locator operation
- Weld head locator models include:
 - 6 x 6 foot
 - 9 x 9 foot
 - 12 x 12 foot

To order Jetline automation solutions: Call **1-630-653-6819** or email JetlineSales@MillerWelds.com

9900 Controller



The 9900 controller is a touch screen industrial computer with an intuitive graphical user interface.

- Large 15-inch touch screen panel with industrial PC
- User-friendly graphical interface and easy programming using industry-standard terms
- Graphical representation of the weld parameters during the weld and programming

- Standard configuration controls up to 15 channels
- Ethernet and fiber optic communication for flexibility and speed
- Software options

9700T Controller



The 9700T controller is the standard Jetline control and sequencer used on our motor-driven equipment.

- Microprocessor-based control technology
- User-friendly front panel layout with large-screen graphic backlit display
- Closed-loop control for higher accuracy and stability
- Modbus® provides enhanced control of compatible Dynasty® and Maxstar® power sources for a single point of programming
- Processes include GTAW, GMAW, SAW and PAW
- Integrates with other optional Jetline components including arc length control, cold wire and hot wire feeders, and oscillators

Arc Length Control



Jetline arc length control maintains a constant arc length by controlling arc voltage in gas tungsten arc welding (GTAW) or plasma arc welding (PAW) applications.

- Regulation of welding voltage for precise, repeatable welds
- Provides consistent performance and results
- Simplified setup and operation requires minimal operator intervention

- Touch retract allows starting gap to be automatically preset in TIG (GTAW) applications
- Standard package includes 9790 arc length control and 6-inch arc length control actuator

Cold Wire Feeder



Jetline cold wire feeder is used for automated gas tungsten arc welding (GTAW) or plasma arc welding (PAW) applications to add “fill” to a weld joint.

- Cold wire feeder system includes 9700W microprocessor control, four-roll feed assembly and wire guide positioner
- 9700W microprocessor controller offers a simple menu for setup and operation
- Four-roll feed assembly optimizes feeding of both hard and soft wires
- Wire guide positioner provides fine adjustment to position where the wire enters the weld puddle
- Optional clear spool cover protects the wire from the dust and dirt from the manufacturing environment

Seam Tracking Systems



Jetline tactile seam tracking systems simplify welding operation, ensuring the weld head is consistently positioned for optimal arc performance.

- Auto and manual modes allow system to be used as a seam tracker or motorized slide system
- Heavy-duty motorized slides provide 330-pound payload capacity at 15.7 inches

Mechanical Oscillators



Jetline mechanical oscillators are used to weave (or oscillate) the welding arc to meet various welding requirements or to achieve a desired effect.

- Oscillating the arc helps with sidewall fusion and reduces undercuts
- For applications where precision and repeatability are critical
- Improves productivity and quality in overlay, hard-facing, cladding and banding operations
- Micro-stepper drive provides precision arc oscillation
- Integrates with existing Jetline control packages

Tregaskiss® Robotic Guns

Available with all PerformArc® robotic welding systems, fully configurable Tregaskiss TOUGH GUN® TA3 and CA3 robotic MIG guns are engineered for accurate, reliable and repeatable performance that maximizes production uptime and throughput. Upgrading to AccuLock™ R consumables has no impact on Tool Center Point (TCP).



TOUGH GUN
TA3 MIG gun

TOUGH GUN
CA3 MIG gun

Air-Cooled MIG Guns

See Tregaskiss literature SP-TA3 and SP-CA3

TOUGH GUN® TA3 robotic MIG gun (internal to the robot arm)

- Available in 350-amp models at 100 percent duty cycle (mixed gases)
- Available as a complete package from the power pin to the contact tip
- Durable neck clamp provides consistent clamping force for repeatability and TCP accuracy
- Available with AccuLock™ R or TOUGH LOCK® consumables
- **NEW!** LSR+ unicable with SmoothTurn™ Technology maximizes production uptime – see Tregaskiss literature SP-TA3 for more details

TOUGH GUN® CA3 robotic MIG gun (external to the robot arm)

- Available in 385-amp models at 100 percent duty cycle (mixed gases)
- Replaceable unicable reduces downtime through faster repair and extended service life
- Cable guide minimizes stress on cable connection as robot articulates
- Durable neck clamp provides consistent clamping force for repeatability and TCP accuracy
- Available with AccuLock™ R or TOUGH LOCK® consumables

Tregaskiss® Fixed Automatic Guns

Tregaskiss fixed automatic MIG guns are engineered for hard tooling automation applications requiring a simple, durable and repeatable MIG gun. These automatic guns can be configured with the same AccuLock family of consumables as your Bernard® semi-automatic or Tregaskiss robotic MIG guns to simplify your inventory.



MA1 MIG gun

MW1 MIG gun

AW2 MIG gun

Air-Cooled MIG Guns

See Tregaskiss literature SP-MA1

MA1 automatic MIG gun

- Available in 350-amp and 385-amp models
- Spring-guard strain relief prevents kinking and abrasion
- Air-cooled neck is made from aircraft-grade aluminum

Water-Cooled MIG Guns

See Tregaskiss literature SP-MW1 and SP-AW2

MW1 automatic MIG gun

- Available in 500-amp (MW15) and 600-amp (MW16) models
- Spring-guard strain relief prevents kinking and abrasion
- Stainless steel water-cooled neck is silver brazed and leak tested
- 600-amp water-cooled model has a thread-on heavy-duty nozzle

AW2 automatic MIG gun

- Available in both cable and cableless 600-amp models
- Power cable equipped guns are available in lengths of 3 feet to 25 feet in 1/2-foot increments
- Internal threaded connections stay tight inside the anti-vibration compression fit body for good electrical connectivity and longer life
- Not compatible with QUICK LOAD® liners

Industrial ●

Process ▪ MIG (GMAW)

Compatible robots for robotic air-cooled guns

- Panasonic® ▪ ABB® ▪ COMAU® ▪ FANUC®
- KUKA® ▪ Yaskawa® Motoman®
- OTC Daihen®

Packages

- PerformArc Systems (pg 32)

Most popular accessories

- TOUGH GUN® I.C.E.® Technology – Adds water-cooling to air-cooled guns for a boost in duty cycle
- Neck Checking Fixture
- TOUGH GUN® TT4 Reamers (pg 39)

Most popular consumables

AccuLock™ R Consumables

TA3, CA3 and MA1 Diffusers

- D-ATSH Slip-On
- D-ATTH Thread-On

MW1 Diffusers

- D-ATSH Slip-On (500 amps)
- D-ATTH-MW1 Thread-On (600 amps)

AW2 Diffuser

- D-ATSH-AW2 Slip-On

TA3, CA3 and MA1 Nozzles (inches)

Slip-On

- 401-6-62 5/8 ID, 1/8 recessed
- 401-30-62 5/8 ID, 1/8 stickout
- 401-87-62 5/8 ID, 1/8 stickout, tapered

Thread-On

- 401-14-62 5/8 ID, 1/8 recessed
- 401-20-62 5/8 ID, 1/8 stickout, tapered
- 401-30-62T 5/8 ID, 1/8 stickout

MW1 Nozzles (inches)

Slip-On (500 amps)

- 401-6-62 5/8 ID, 1/8 recessed
- 401-5-62 5/8 ID, 1/4 recessed

Thread-On (600 amps)

- 601-6-62 5/8 ID, 1/8 recessed
- 601-5-75 3/4 ID, 1/4 recessed

AW2 Slip-On Nozzle

- 5627 3/4 ID, 1/8 recessed

Contact Tips (inches)

- T-A039CH .039 copper
- T-A045CH .045 copper
- T-A039WH .039 HDP
- T-A045WH .045 HDP
- T-A052WH .052 HDP

6 ft. QUICK LOAD® Liners

TA3, CA3, MA1 and MW16 Liners (inches)

- 415-35-6Q .035-.045
- 415-116-6Q .045-1/16

TA3 and CA3 Liners (inches)

- 415-35-062Q .035-.045, galvanized
- 415-116-062Q .045-1/16, galvanized

See literature SP-QLL for complete offering.

Visit Tregaskiss.com or your distributor for additional Tregaskiss consumable options.



For more information or to configure your gun online, visit

Tregaskiss.com/ConfigureMyGun



Tregaskiss® TOUGH GUN® TT4 Reamers

See Tregaskiss literature SP-TT4

TOUGH GUN TT4 reamer robotic nozzle cleaning stations power through the toughest spatter for increased uptime and weld quality. Automating spatter removal helps to extend the life of your robotic MIG guns and consumables. You'll spend less time maintaining and troubleshooting your robotic welding equipment and more time getting product out the door.



Two models available

- TOUGH GUN TT4A (analog) reamer
- TOUGH GUN TT4E (Ethernet) reamer

Standard features

- Anti-spatter reservoir with tethered cap and increased fluid volume capacity
- Fluid level indicator sends a signal to robot operator and the PLC/robot when anti-spatter is running low
- Dedicated motor lubricator maximizes performance and protects your investment by extending the life of the motor
- Spray containment unit helps prevent air contamination, improving the air quality of the working environment and maintaining the cleanliness of the weld cell

TT4E Ethernet model is designed for durability, serviceability and repeatability. Provides greater control optimization, remote monitoring capability and faster troubleshooting to facilitate increased productivity.

Two-year warranty on TOUGH GUN TT4 reamers, or **extend your warranty to three years** with exclusive use of TOUGH GARD® anti-spatter liquid.

Industrial ●

Most popular accessories

- Wire Cutter
- Nozzle Detect
- TOUGH GUN® Reamer Stand – Custom height, quick installation, easy on the budget



- **TOUGH GARD® Anti-Spatter Liquid** – Ready-to-use, water-soluble and non-toxic, creates a sacrificial surface that reduces spatter adhesion – prolongs the life of consumables and minimizes downtime for nozzle cleaning
- **TOUGH GARD® Multi-Feed System** – Eliminates the need to frequently refill sprayer reservoirs – feed up to 10 TOUGH GUN® reamer units from a single 5-gallon or 55-gallon drum of TOUGH GARD® anti-spatter liquid

Visit Tregaskiss.com or your distributor for other Tregaskiss nozzle cleaning options and accessories.



For more information visit

Tregaskiss.com/TT4Reamer



Tregaskiss® Welding Consumables

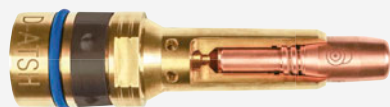

Cutaway of AccuLock R slip-on diffuser and contact tip shown

AccuLock™

AccuLock™ R consumables

See Tregaskiss literature SP-ALR

AccuLock contact tips are 60% buried within the diffuser for less exposure to the heat of the weld, providing longer tip life and reducing frequency of tip replacement. Upgrading from copper tips to **AccuLock HDP contact tips** can increase life by an additional 6 to 10 times or more depending on the application.

- AccuLock contact tips concentrically align with the diffuser to eliminate cross-threading
- Mating tapers on both tip-to-diffuser and diffuser-to-neck connections provide good electrical conductivity – the contact tip and diffuser can be replaced with no impact to Tool Center Point (TCP)
- Use AccuLock R consumables on Tregaskiss robotic and fixed automatic guns (see page 38) to simplify inventory and reduce replacement errors



QUICK LOAD® liners

See Tregaskiss literature SP-QLL

For ease of maintenance, QUICK LOAD liners install from the front of the MIG gun in less than half the time required to install conventional liners.

- Two-piece system with retainer installed inside the power pin on first use
- No need to cut and waste wire!
- Avoid climbing over robotic tooling or transfer systems to remove the torch from the wire feeder
- Change the liner from a safe zone in the robotic work cell
- Compatible with most Tregaskiss robotic and fixed automatic guns (see page 38)



Multiprocess

For more detailed information, visit



MillerWelds.com/multiprocess



Power Source Welding Performance		Light Industrial			Industrial				Heavy Industrial		
		Multimatic® 200 (page 41)	Multimatic® 215 (page 41)	Multimatic® 220 AC/DC (page 42)	Multimatic® 235 (page 43)	Multimatic® 255 (page 44)	Maxstar® 280 Multiprocess (page 45)	Dynasty® 300 Multiprocess (page 45)	XMT® 350 Models (pages 46-49)	XMT® 450 Models (pages 46-49)	XMT® 650 Models (page 50)
Material	Mild Steel	●	●	●	●	●	●	●	●	●	●
	Stainless Steel	●	●	●	●	●	●	●	●	●	●
	Aluminum	●	●	●	●	●	●	●	● ¹	● ¹	●
Material Thickness	Gauge (.020-.125 in.)	●	●	●	●	●	●	●	●	●	●
	Sheet (.125-.375 in.)	●	●	●	●	●	●	●	●	●	●
	Plate (.375-1 in.)									●	●
	Plate (1+ in.)									●	●
Wire Size	.023 in.	●	●	●	●	●	●	●	●	●	●
	.030 in.	●	●	●	●	●	●	●	●	●	●
	.035 in.	●	●	●	●	●	●	●	●	●	●
	.045 in.	●	●	●	●	●	●	●	●	●	●
	.052 in.										
	1/16 in.										
	5/64 in.										
3/32 in.											
Process	Short Circuit	★★★★	★★★★	★★★★	★★★★	★★★★	★★★★	★★★★	★★★★	★★★★	★★★★
	Pulsed Spray					★★★★			★★★★ ²	★★★★ ²	
	Stick	★★	★★	★★	★★★	★★★	★★★★	★★★★	★★★★	★★★★	★★★★
	AC TIG			★★★★				★★★★			
	DC TIG	★★★	★★★	★★★★	★★★	★★★	★★★★	★★★★	★★★	★★★	★★★
	CAC-A						3/16 in.	3/16 in.	1/4 in.	5/16 in.	3/8 in.

Icon Key

Capability: ● Designed for ● Capable of
 NEW! products appear in blue type.

Process Quality: ★ Good ★★ Better ★★★ Best ★★★★ Optimized

¹ CC/CV and FieldPro™ models are capable of aluminum welding. MPa models are designed for aluminum welding. XR-AlumaFeed® system is recommended for best results.

² MPa models only.

Multimatic® 200 and 215

See literature DC/12.57 (200) and DC/12.59 (215)

Light industrial ● **DC** **1** Phase



Multi-voltage plug (MVP™) allows connection to common 120- and 240-volt power receptacles without the use of any tools – simply choose the plug that fits the receptacle and connect to the power cord.

Welding Capability

Max. 3/8 in. (9.5 mm)	Max. 3/8 in. (9.5 mm)
MIG Mild Steel	MIG Aluminum
Min. 24 ga. (0.6 mm)	Min. 18 ga. (1.2 mm)
Max. 3/16 in. (4.8 mm)	Max. 3/8 in. (9.5 mm)
TIG Mild Steel	Stick Mild Steel
Min. 24 ga. (0.6 mm)	Min. 16 ga. (1.5 mm)

Aluminum welding uses optional Spoolmate 100 and 4000 series aluminum wire **OR** Spoolmate 150 (effective with Multimatic 200 serial number MF364047N) and either 4000 or 5000 series aluminum wire. TIG welding uses optional TIG contractor kit.

Weighing only 29 pounds (Multimatic 200) or 38 pounds (Multimatic 215), these lightweight MIG, stick and TIG welders provide portability on the job.

Impact-resistant, flame-retardant case (Multimatic 200) provides strength and durability, while protecting components and welding wire from moisture, dust and other contaminants.

Auto-Set™ Elite can be used on multiple materials and multiple processes with the ability to fine-tune your settings. Easy to set up and use!

Excellent arc characteristics! Positive arc starts and an extremely stable arc with minimal spatter.

Auto Spool Gun Detect™ automatically detects when a MIG gun or spool gun is connected, eliminating the need for a switch.

Uses 4- or 8-inch (102 or 203 mm) spools.

Multimatic 215 model additional features

Intuitive color LCD interface makes it quick and easy to adjust parameters.

Angled cast-aluminum drive system provides smooth feeding and the ability to use 10-, 12- or 15-foot guns.



Processes

- MIG (GMAW) ▪ Flux-cored (FCAW)
- DC stick (SMAW) ▪ DC TIG (DC GTAW)

Comes complete with

- 10 ft. (3 m) 250-amp MDX™-250 MIG gun with AccuLock™ MDX™ consumables (Multimatic 200) **OR** 10 ft. (3 m) 100-amp MDX™-100 MIG gun with AccuLock™ MDX™ consumables (Multimatic 215)
- 13 ft. (4 m) cable with electrode holder and 25 mm Dinse-style connector
- 10 ft. (3 m) work cable with clamp and 25 mm Dinse-style connector
- Power cord with MVP plugs for 120 V and 240 V
- Quick Select™ drive roll for .024 in. (0.6 mm) or .030/.035 in. (0.8/0.9 mm) solid wire, and .030/.035 in. (0.8/0.9 mm) flux-cored wire



- Flow gauge regulator and gas hose for argon or AR/CO₂ mix, extra MDX contact tips, information/settings chart and material thickness gauge (229895) – Hobart® spool of .030 in. solid wire and hook-and-loop cord wraps as seen in photo above are included with Multimatic 215 model only

Most popular accessories

- Spoolmate™ Spool Guns (pg 29)
 - 300371 Spoolmate 100
 - 301272 Spoolmate 150
- Running Gear/Cylinder Rack 301239 (pg 122)
- Protective Cover 301262 (pg 125) (for Multimatic 215 only)
- TIG Contractor Kits (pg 128)
 - 301287 For Multimatic 200
 - 301337 For Multimatic 215

Visit MillerWelds.com or your distributor for other Miller® options and accessories.

Model/Stock Number	Welding Mode/Process	Input Power	Amperage Range	Rated Output	Amps Input at Rated Output, 50/60 Hz				Wire Feed Speed	Max. Open-Circuit Voltage	Dimensions	Net Weight
					120 V	230 V/240 V	KVA	KW				
Multimatic 200 907518 951649 With TIG contractor kit – see page 128 for kit contents	CV: MIG/flux-cored	120 V	30–140	90 A at 18.5 V, 60% duty cycle	18.0	–	2.2	2.0	70–425 ipm (1.8–10.8 m/min.)	90 VDC	H: 14.5 in. (368 mm) W: 9.75 in. (248 mm) D: 17 in. (432 mm)	29 lb. (13.2 kg)
				110 A at 19.5 V, 20% duty cycle	22.4	–	2.7	2.6				
	230 V	30–200	150 A at 21.5 V, 20% duty cycle	–	17.5	4.0	3.8					
			150 A at 16 V, 30% duty cycle	27.0	–	3.3	3.2					
	CC: TIG	120 V	5–150	150 A at 16 V, 30% duty cycle	–	13.8	3.2	3.0				
				230 V	5–150	150 A at 16 V, 30% duty cycle	–	20.8				
CC: Stick	120 V	20–100	100 A at 24 V, 35% duty cycle	24.0	–	2.9	2.8					
			230 V	20–150	150 A at 26 V, 30% duty cycle	–	20.8	4.8	4.5			
Multimatic 215 907693 951674 With TIG contractor kit – see page 128 for kit contents	CV: MIG/flux-cored	120 V	30–125	110 A at 19.5 V, 60% duty cycle	23.0	–	2.8	2.8	60–600 ipm (1.5–15.2 m/min.)	58 VDC	H: 12.5 in. (318 mm) W: 11.25 in. (286 mm) D: 20.5 in. (521 mm)	38 lb. (17.2 kg)
				200 A at 24 V, 20% duty cycle	–	25.8	6.2	6.2				
		240 V	30–230	150 A at 21.5 V, 40% duty cycle	–	16.7	4.0	4.0				
	CC: TIG	120 V	20–150	140 A at 15.6 V, 40% duty cycle	24.6	–	3.0	3.0				
				240 V	20–210	190 A at 17.6 V, 20% duty cycle	–	18.0	6.7	6.7		
	CC: Stick	120 V	30–100	90 A at 23.6 V, 40% duty cycle	22.7	–	2.7	2.7				
240 V				30–200	190 A at 27.6 V, 20% duty cycle	–	27.0	6.5	6.5			



Multimatic® 220 AC/DC

See literature AD/9.0

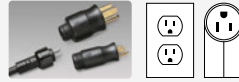

Multi-voltage plug (MVP™) allows connection to common 120- and 240-volt power receptacles without the use of any tools – simply choose the plug that fits the receptacle and connect to the power cord.



See page 129

Welding Capability

Max. 3/8 in. (9.5 mm)	Max. 3/8 in. (9.5 mm)
MIG Mild Steel	MIG Aluminum
Min. 24 ga. (0.6 mm)	Min. 18 ga. (1.2 mm)
Max. 1/4 in. (6.4 mm)	Max. 1/4 in. (6.4 mm)
TIG Mild Steel	TIG Aluminum
Min. 24 ga. (0.6 mm)	Min. 24 ga. (0.6 mm)
Max. 3/8 in. (9.5 mm)	
Stick Mild Steel	
Min. 16 ga. (1.5 mm)	

MIG aluminum welding uses optional Spoolmate 100 and 4000 series aluminum wire OR Spoolmate 150 and either 4000 or 5000 series aluminum wire.

All in one. Comes equipped with all accessories to MIG, stick, AC and DC TIG weld with one machine – unlike other machines where you need to purchase additional accessories.

Intuitive color LCD interface makes it quick and easy to adjust parameters.



Weighing only 56 pounds, this lightweight MIG, stick and AC/DC TIG welder provides portability on the job.

Innovative QuickTech™ makes setup and changing processes easy.

- Automatically determines the polarity. Work is always connected to the bottom right receptacle. MIG gun and TIG torch can stay connected at the same time.
- Automatically switches to the right process. Just hit the trigger or the foot control and the machine automatically changes, eliminating the need to manually change processes.
- Automatically recalls the settings from the last process used.

Auto-Set™ Elite can be used on multiple materials and multiple processes with the ability to fine-tune your settings. Easy to set up and use!

Pro-Set™ (TIG/stick) eliminates the guesswork when setting weld parameters. Use Pro-Set when you want the speed, convenience and confidence of preset controls.

Two shielding gas connections (one for MIG gas and one for TIG gas) so both gases can be left connected to the machine – no switching needed.

Manual mode offers additional TIG adjustments for increased control including AC balance, AC frequency and DC pulsing.

TIG high-frequency (HF) arc starting for non-contact arc initiation, reducing tungsten and material contamination.

Uses 4- or 8-inch (102 or 203 mm) spools.

Light Industrial ● CC CV AC DC 1 Phase

Processes

- MIG (GMAW) = Flux-cored (FCAW)
- DC stick (SMAW) = AC/DC TIG (GTAW)
- Pulsed TIG (GTAW-P)

Comes complete with

- 10 ft. (3 m) 100-amp MDX™-100 MIG gun with AccuLock™ MDX™ consumables
- 13 ft. (4 m) cable with electrode holder and 25 mm Dinse-style connector
- 12.5 ft. (3.8 m) Weldcraft™ A-150 (WP-17) TIG torch with 25 mm Dinse-style connector
- 10 ft. (3 m) work cable with clamp and 25 mm Dinse-style connector
- 6.5 ft. (2 m) power cord with MVP plugs for 120 V and 240 V
- RFCS-14 HD foot control with 20 ft. (6 m) cord
- Quick Select™ drive roll for .024 in. (0.6 mm) or .030/.035 in. (0.8/0.9 mm) solid wire, and .030/.035 in. (0.8/0.9 mm) flux-cored wire
- Two flow gauge regulators and gas hoses for argon or AR/CO₂ mix, extra contact tips, Hobart® spool of .030 in. solid wire, AK2C TIG torch accessory kit, hook-and-loop cord wraps and material thickness gauge (229895)

Most popular accessories

- Spoolmate™ Spool Guns (pg 29)
 - 300371 Spoolmate 100
 - 301272 Spoolmate 150



- Dual Cylinder Rack Cart 951770 (pg 122)
- Protective Cover 301524 (pg 125)
- Wireless Remote Foot Control 301580 (pg 129)

Visit MillerWelds.com or your distributor for other Miller® options and accessories.

Stock Number	Welding Mode/Process	Input Power	Amperage Range	Rated Output	Amps Input at Rated Output, 50/60 Hz	Wire Feed Speed	Max. Open-Circuit Voltage	Dimensions	Net Weight						
907757	CV: MIG/flux-cored	120 V	30-125	105 A at 19.2 V, 60% duty cycle	23.3	–	2.8	H: 17.5 in. (445 mm) W: 11.25 in. (286 mm) D: 21.5 in. (546 mm)	56 lb. (25.3 kg)						
				200 A at 24 V, 20% duty cycle	–	27.2	4.8			4.8					
				170 A at 21.5 V, 40% duty cycle	–	21.5	3.8			3.8					
	CC: TIG	120 V	20-140	130 A at 15.2 V, 40% duty cycle	24.0	–	2.9			46 VDC					
				210 A at 18.4 V, 20% duty cycle	–	22.4	5.4					5.4			
	CC: Stick	120 V	30-90	90 A at 23.6 V, 40% duty cycle	24.5	–	2.9								
				240 V	30-200	200 A at 28.4 V, 15% duty cycle	–						31.3	7.5	7.5

Multimatic® 235

See literature DC/14.0



Multimatic 235 with EZ-Latch single cylinder running gear shown.



See page 129

Welding Capability

Max. 3/8 in. (9.5 mm)	Max. 3/8 in. (9.5 mm)
Mild Steel	Aluminum
Min. 24 ga. (0.6 mm)	Min. 18 ga. (1.2 mm)
Max. 3/8 in. (9.5 mm)	Max. 3/8 in. (9.5 mm)
TIG Mild Steel	Stick Mild Steel
Min. 24 ga. (0.6 mm)	Min. 16 ga. (1.5 mm)

Aluminum welding uses optional spool guns.
TIG welding uses optional Multimatic 235/255 TIG kit.



Easy-to-understand interface with 4.3-inch color LCD display and intuitive connection setup images.

Weighing only 63 pounds (machine only), this lightweight MIG, stick and DC TIG welder provides portability on the job.

Compatible with Spoolmate™ 100, 150 and 200, and Spoolmatic 15A and 30A spool guns to offer a variety of aluminum welding solutions.

EXCLUSIVE! Auto-Gun Detect™ automatically adjusts voltage, wire speed and timers for faster switching between MIG and spool guns.

Heavy-duty aluminum two-drive-roll system.

Uses 4-, 8- or 12-inch (102, 203 or 305 mm) spools.

Auto-Set™ Elite offers predefined weld settings to increase ease of use and ensure that the job is done right for operators of all skill levels.

- Available for MIG, stick and DC TIG processes with the ability to fine-tune your settings
- Set weld parameters by:
 - MIG – selecting wire and gas type, wire diameter and material thickness
 - Stick – selecting electrode type, electrode diameter and material thickness
 - DC Lift-Arc™ TIG – selecting remote on/off, tungsten diameter and material thickness

Pro-Set™ (TIG/stick) eliminates the guesswork when setting weld parameters. Use Pro-Set when you want the speed, convenience and confidence of preset controls.

Two shielding gas connections (one for MIG gas and one for TIG gas) so both gases can be left connected to the machine – no switching needed.

Manual mode offers additional stick and TIG adjustments for increased control including adjustable DIG control for stick and 0.1-150 pulses per second for DC pulsed TIG.

Fan-On-Demand™ cooling system only operates when needed, reducing power consumption and keeping internal components cleaner.

Industrial ● CC CV DC 1 Phase

Processes

- MIG (GMAW) ▪ Flux-cored (FCAW)
- DC stick (SMAW)
- DC Lift-Arc™ TIG (GTAW)
- Pulsed TIG (GTAW-P)

Comes complete with

- 15 ft. (4.5 m) 250-amp MDX™-250 MIG gun with AccuLock™ MDX™ consumables
- 10 ft. (3 m) cable with electrode holder
- 10 ft. (3 m) work cable with clamp
- 7 ft. (2.1 m) industrial power cord
- Two factory-installed gas solenoids
- Flow gauge regulator and gas hose for argon or AR/CO₂ mix
- .030/.035 in. reversible V-groove drive rolls
- Extra contact tips and material thickness gauge (229895)

Most popular accessories

- Spoolmate™ Spool Guns (pg 29)
 - 300371 Spoolmate 100
 - 301272 Spoolmate 150
 - 300497 Spoolmate 200
 - Spoolmatic® Spool Gun (pg 30) (non-Pro gun only)
 - EZ-Latch™ Single Cylinder Running Gear 301449 (pg 122)
 - EZ-Latch™ Dual Cylinder Rack with Elevated Gun and Cable Rack 301481 (pg 122)
- Converts an EZ-Latch™ Single Cylinder Running Gear into a Dual Cylinder Rack Running Gear as seen below



- EZ-Latch™ Dual Cylinder Running Gear 951769 (pg 122)
- Protective Cover 301521 (pg 125)
- Multimatic 235/255 TIG Kit 301518 (pg 128)
- 10-Pin to 14-Pin Adapter Cord 301545 (pg 128)
- Wireless Remote Foot Control 301580 (pg 129)

Visit MillerWelds.com or your distributor for other Miller® options and accessories.

*Input voltage range for the Multimatic 235 is 204–276 V.

Stock Number 907780	Welding Mode/Process	Amperage Range	Rated Output	Amps Input at Rated Output, 50/60 Hz			Wire Feed Speed	Max. Open-Circuit Voltage	Power Source Dimensions	Power Source Net Weight
				240 V*	KVA	KW				
951846 With EZ-Latch single cylinder running gear	CV: MIG/flux-cored	30–235	170 A at 22.5 V, 60% duty cycle	20.0	5.0	4.9	60–600 ipm (1.5–15.2 m/min.)	54 VDC	H: 19.25 in. (489 mm) W: 13.75 in. (349 mm) D: 24.25 in. (616 mm)	63 lb. (29 kg)
951847 With EZ-Latch dual cylinder rack running gear and TIG kit	CC: Stick	30–200	150 A at 26 V, 60% duty cycle	20.2	5.0	4.8	–			
	CC: DC TIG	20–210	180 A at 17.2 V, 60% duty cycle	17.0	4.2	4.1				

Multimatic® 255 See literature DC/12.9



Multimatic 255 with EZ-Latch single cylinder running gear shown.



See page 129

Welding Capability

Max. 1/2 in. (13 mm)	Max. 1/2 in. (13 mm)
Mild Steel	Aluminum
Min. 22 ga. (0.8 mm)	Min. 18 ga. (1.2 mm)
Max. 3/8 in. (9.5 mm)	Max. 5/16 in. (7.9 mm)
TIG Mild Steel	Stick Mild Steel
Min. 24 ga. (0.6 mm)	Min. 16 ga. (1.5 mm)

Aluminum welding uses optional XR-Aluma-Pro push-pull gun. TIG welding uses optional Multimatic 235/255 TIG kit.



Easy-to-understand interface with 7-inch color LCD display ensures proper machine setup and parameter selection, reducing setup time and increasing weld time.

- Quick-access process and weld mode backlit buttons across the top illuminate when active
- Soft-key buttons below the display change function depending on which screen is displayed – makes setup or change quick, easy and intuitive
- Large text for easier readability
- Intuitive connection setup images
- Full troubleshooting descriptions versus help errors and look up codes

AUTO-LINE TECHNOLOGY Allows for any input voltage hookup (208–575 V, single-phase) with no manual linking, providing convenience in any job setting. Ideal solution for dirty or unreliable power.

Fan-On-Demand™ cooling system only operates when needed, reducing power consumption and keeping internal components cleaner.

Built-in pulsed MIG programs. All programmed information is restored after each power up – steel/stainless steel/aluminum/silicon bronze.

Auto-Set™ Elite offers predefined weld settings to increase ease of use and ensure that the job is done right for operators of all skill levels.

- Available for MIG, pulsed MIG, stick and DC TIG processes with the ability to fine-tune your settings
- Set weld parameters by:
 - MIG – selecting wire and gas type, wire diameter and material thickness
 - Stick – selecting electrode type, electrode diameter and material thickness
 - DC Lift-Arc™ TIG – selecting remote on/off, tungsten diameter and material thickness

Program mode allows easy save and recall of favorite weld settings. Save up to four programs for each process. Delivers greater productivity and consistent quality while minimizing supervisor intervention.

EXCLUSIVE! Auto-Gun Detect™ automatically adjusts voltage, wire speed and timers for faster switching between MIG, push-pull and spool guns.

Heavy-duty aluminum two-drive-roll system.

Uses 4-, 8- or 12-inch (102, 203 or 305 mm) spools.

Compatible with 6010 stick electrodes.

Industrial ● CC CV DC 1 Phase

Processes

- MIG (GMAW) ▪ Flux-cored (FCAW)
- Pulsed MIG (GMAW-P)
- DC stick (SMAW)
- DC Lift-Arc™ TIG (GTAW)
- Pulsed TIG (GTAW-P)

Comes complete with

- 15 ft. (4.5 m) 250-amp MDX™-250 MIG gun with Bernard® AccuLock™ S consumables
- 10 ft. (3 m) cable with electrode holder
- 10 ft. (3 m) work cable with clamp
- 10 ft. (3 m) industrial power cord
- Two factory-installed gas solenoids
- Flow gauge regulator and gas hose for argon or AR/CO₂ mix
- .035/.045 in. reversible V-groove drive rolls
- Extra contact tips and material thickness gauge (229895)

Most popular accessories

- Spoolmatic® Spool Gun (pg 30) (non-Pro gun only)
 - XR-Aluma-Pro™ Air-Cooled Push-Pull Guns (pg 31)
 - XR™-Pistol-Pro Air-Cooled Push-Pull Guns (pg 31)
 - EZ-Latch™ Single Cylinder Running Gear 301449 (pg 122)
 - EZ-Latch™ Dual Cylinder Rack with Elevated Gun and Cable Rack 301481 (pg 122)
- Converts an EZ-Latch™ Single Cylinder Running Gear into a Dual Cylinder Rack Running Gear as seen below



- **EZ-Latch™ Dual Cylinder Rack Running Gear** 951769 (pg 122)
- Protective Cover 301521 (pg 125)
- Multimatic 235/255 TIG Kit 301518 (pg 128)
- 10-Pin to 14-Pin Adapter Cord 301545 (pg 128)
- Wireless Remote Foot Control 301580 (pg 129)

Visit MillerWelds.com or your distributor for other Miller® options and accessories.

Stock Number	Welding Mode/Process	Amperage Range	Rated Output	Amps Input at Rated Output, 50/60 Hz	Wire Feed Speed	Max. Open-Circuit Voltage	Power Source Dimensions	Power Source Net Weight
907728				208 V 240 V 460 V 575 V KVA KW				
951767 With EZ-Latch single cylinder running gear	CV: MIG/flux-cored	20–350	230 A at 25.5 V, 60% duty cycle	34.7 29.7 17.1 14.3 8.2 8.2	50–800 ipm (1.3–20 m/min.)	81 VDC	H: 19.25 in. (489 mm) W: 13.75 in. (349 mm) D: 24.25 in. (616 mm)	84 lb. (38 kg)
951768 With EZ-Latch dual cylinder rack running gear and TIG kit	CC: Stick	30–275	200 A at 28 V, 60% duty cycle	33.5 29 16.4 13.6 7.8 7.8	–			
	CC: DC TIG	5–275	275 A at 21 V, 60% duty cycle	34.1 29.9 17 14.1 8.1 8.1				

Maxstar® 280 Multiprocess

NEW! Dynasty® 300 Multiprocess

See literature DC/35.5 (Maxstar) and AD/4.97 (Dynasty)

Multiprocess performance in a portable package. Designed for industrial applications that require a versatile solution with superior arc performance.



**WIRELESS
REMOTE
COMPATIBLE**

See page 129

ArcReach® SuitCase® feeder paired with the CV output of the Maxstar or Dynasty power source gives this unit MIG process capabilities.

Note: Maxstar and Dynasty are not capable of ArcReach control.

Maxstar 280 Multiprocess (far left) and NEW! Dynasty 300 Multiprocess shown with ArcReach SuitCase 12 (packages available for Dynasty with ArcReach SuitCase, see below).

AUTO-LINE TECHNOLOGY Allows for any input voltage hook-up (Maxstar: 208–575 V, Dynasty: 208–600 V) with no manual linking, providing convenience in any job setting. Ideal solution for dirty or unreliable power.

Blue Lightning™ high-frequency (HF) arc starter for non-contact arc initiation. Provides more consistent arc starts and greater reliability compared to traditional HF arc starters.

Pulsed TIG can be used to increase puddle agitation, arc stability and travel speeds while reducing heat input and distortion.

Quiet Pulse™. Activate Quiet Pulse by selecting sine or triangular waveshape to reduce audible noise.

Fan-On-Demand™ cooling system only operates when needed, reducing power consumption and keeping internal components cleaner.

Cooler-On-Demand™ feature operates the auxiliary cooling system only when needed. Reduces noise, energy use, and airborne contaminants pulled through the cooler.



Dynasty 300 Multiprocess Complete package shown.

Industrial  **3 1** Maxstar is DC only
DC CV AC DC Phase Phase

Processes

- AC¹/DC TIG (GTAW) ■ Pulsed TIG (GTAW-P)
- MIG (GMAW)² ■ Flux-cored (FCAW)²
- Stick (SMAW) ■ Air carbon arc (CAC-A)

¹ Dynasty model only.

² With ArcReach SuitCase wire feeder.

Comes with

- 8 ft. (2.4 m) power cord (no plug)
- Two 50 mm Dinse-style connectors
- Two Dinse/Tweco® adapters
- 8 ft. (2.4 m) weld cable with Tweco®-style connectors to power feeder

TIGRunner® includes above plus

- Small Runner™ Cart
- Coolmate™ 1.3

Contractor package includes above (except TIGRunner) plus

- Contractor kit with A-200 TIG torch and RFCS-14 HD foot control (301549)
- ArcReach® SuitCase® 12 with two .035/.045 in. reversible V-groove drive rolls
- Bernard® BTB Gun 300 A with AccuLock™ consumables

Complete package includes TIGRunner above plus

- ArcReach® SuitCase® 12 with two .035/.045 in. reversible V-groove drive rolls
- Bernard® BTB Gun 300 A with AccuLock™ consumables
- Coolant (4 one-gallon bottles)
- Wireless foot control
- Weldcraft™ W-280 water-cooled torch kit

Most popular accessories

- ArcReach® SuitCase® Feeders (pg 18)
- Small Runner™ Cart 301615 (pg 123)
- Coolmate™ 1.3 301616 (pg 123)
- Contractor Kits (pg 128)
 - 301311 w/RCCS-14 finger control
 - 301309 w/RFCS-14 HD foot control
- Weldcraft™ Water-Cooled Torch Kits (pg 128)
 - 300185 W-250 (WP-20)
 - 300990 W-280 (WP-280)
 - 301268 W-375
- Remote Controls (pg 128–129)

Visit MillerWelds.com or your distributor for other Miller® options and accessories.

*Refer to owner's manual for complete ratings.

**Sense voltage for low OCV stick and Lift-Arc™ TIG.

	Model/Stock Number	Welding Process	Input Power	Welding Amp Range	Rated Output at 60% Duty Cycle	Amps Input at Rated Load Output, 50/60 Hz										Max. Open-Circuit Voltage	Power Source Dimensions	Power Source Net Weight
						208 V	230 V	240 V	400 V	460 V	575 V	600 V	KVA	KW				
DC Maxstar	Maxstar 280 Multiprocess 907552001 Power source only See page 60 in the TIG section for Maxstar 280 Series	TIG	3-phase	1-280	250 A at 20 V	21	19	–	11	9	7	–	7.6	7.3	60 VDC (11 VDC**)	H: 13.6 in. (346 mm) W: 8.6 in. (219 mm) D: 22.5 in. (569 mm)	47 lb. (21.3 kg)	
			1-phase	1-280	250 A at 20 V	35	32	–	18	16	13	–	7.3	7.1				
		Stick	3-phase	5-280	250 A at 30 V	*	*	–	14	13	10	–	9.9	9.6				
			1-phase	5-280	180 A at 27.2 V	32	29	–	*	*	*	–	6.7	6.5				
		MIG/ flux-cored	3-phase	5-280	250 A at 26.5 V	*	*	–	13	11	9	–	9.2	8.9				
			1-phase	5-280	200 A at 24 V	31	29	–	*	*	*	–	6.5	6.3				
AC/DC Dynasty	Dynasty 300 Multiprocess 9078119 Power source only 907819001 TIGRunner 951939 Contractor w/foot and SuitCase 12 951940 Complete w/wireless foot and SuitCase 12 See page 61 in the TIG section for Dynasty 300 Series	TIG	3-phase	2-300 (AC) 1-300 (DC)	250 A at 20 V	19	–	16	10	8	–	7	7.5	6.6	60 VDC (11 VDC**)	H: 13.88 in. (352 mm) W: 8.5 in. (216 mm) D: 21.88 in. (555 mm)	55 lb. (25 kg)	
			1-phase	2-300 (AC) 1-300 (DC)	250 A at 20 V	33	–	29	17	15	–	11	6.7	6.7				
		Stick	3-phase	5-300	250 A at 30 V	*	–	*	14	12	–	9	9.8	9.1				
			1-phase	5-300	200 A at 27.2 V	35	–	31	*	*	–	*	9.3	9.2				
		MIG/ flux-cored	3-phase	5-300	250 A at 26.5 V	*	–	*	12	11	–	9	8.9	8.1				
			1-phase	5-300	200 A at 24 V	31	–	27	*	*	–	*	6.2	6.1				



XMT® Series

Portability and excellent multiprocess arc performance make the XMT family the most popular in the industry. With many models to choose from, the XMT family has the right solution for your business.



Input power choices

AUTO-LINE TECHNOLOGY XMT 350 models allow for any input voltage hookup (208–575 V, single- or three-phase) with no manual linking, providing convenience in any job setting. Ideal solution for dirty or unreliable input power.

Standard hookup on XMT 450 models. 230/460 V manual link or 575 V, three-phase only.

Advanced features for the professional welder

Adaptive Hot Start™ makes starting stick electrodes easy without creating an inclusion.

Infinite arc control available in the stick and wire modes for easier fine tuning of tough-to-weld materials and out-of-position applications.

Lift-Arc™ provides arc starting that minimizes contamination of the electrode and without the use of high frequency.

Insight Core™ Welding Intelligence™ system. XMT 14-pin models are Insight Core capable to monitor weld voltage, amperage, and arc-time and percentage.

Reliability

Wind Tunnel Technology™ Internal air flow that protects components, greatly improving reliability.

Fan-On-Demand™ cooling system only operates when needed, reducing power consumption and keeping internal components cleaner.

Welder-friendly control panel

Process selector switch reduces the number of control setup combinations without reducing any features.

Ultra-tough, polycarbonate-blended cover protects front controls from damage.

Large, dual digital meters are easy to view and presettable to ease setting weld output.

Output connector choices

Dinse- or Tweco®-style weld receptacles (XMT 350) provide high-quality weld cable connections.

Note: Two Dinse connectors are supplied with Dinse machines. Tweco connectors must be ordered separately.

Weld studs (XMT 450).

14-pin receptacle provides a quick, direct connection to Miller® wire feeders. Capable of remote voltage control.

Choose the Right XMT

	350 Amp		450 Amp	
	XMT 350 CC/CV	XMT 350 MPa	XMT 450 CC/CV	XMT 450 MPa
Input Power	3- or 1-phase power		3-phase	
Primary Operating Range	Auto-Line (208–575 V)		Manual link (230/460 V) or 575 V	
Weld Output	350 A at 34 VDC (3-phase input power at 60% duty cycle)		450 A at 38 VDC (3-phase input power at 100% duty cycle)	
Carbon Arc Gouging	Rated: 1/4 in. (6.4 mm)		Rated: 5/16 in. (7.9 mm)	
Net Weight	80 lb. (36.3 kg)		122 lb. (55.3 kg)	
Output Connector	Dinse-style	Dinse- or Tweco-style	1/2 in. stud	
Pulsed MIG	–	Yes	–	Yes
14-pin Compliant	Yes		Yes	
Insight Core Capable (requires Insight Core 14-pin module)	Yes (page 74)		Yes (page 74)	
ArcReach™	Factory option (page 48)	–	Factory option (page 49)	–

XMT® 350 CC/CV and 450 CC/CV

See literature DC/18.93 (350) and DC/18.94 (450)

Flexibility and simplicity make this the most popular model. It has the core multiprocess capabilities along with the flexibility of a 14-pin for spool guns, feeders and remote controls.



Heavy industrial  XMT 450
Phase Phase is 3-phase only.

Processes

- MIG (GMAW) ▪ Pulsed MIG (GMAW-P)*
- Stick (SMAW) ▪ TIG (GTAW)
- Flux-cored (FCAW)
- Air carbon arc cutting and gouging (CAC-A) (carbons – 350: 1/4 in., 450: 5/16 in.)

*XMT MPa models only.

MIGRunner™ package includes

- XMT 350 CC/CV power source
- 20 Series Basic wire feeder with .035/.045 in. reversible V-groove drive rolls
- Bernard® BTB Gun 400 A with AccuLock™ consumables
- MIGRunner™ cart
- 10 ft. (3 m) 2/0 work cable with clamp, 6 ft. (1.8 m) 2/0 wire feeder to power source weld cable, and flowmeter regulator with 3 ft. (0.9 m) gas hose

Most popular accessories

- XR-AlumaFeed® SuitCase® 301567 (pg 11)
- SuitCase® Feeders (pg 18)
- 20 Series and 74 MPa Plus Feeders (pg 22)
- Spoolmatic®/ WC-24 (pg 30/130)
- MIGRunner™ Cart 195445 (pg 123)
- Running Gear Cylinder Rack 300408 (pg 123)
- Coolmate™ Coolant System (pg 123)
- Industrial MIG 4/0 Kits (pg 125) 300405 For XMT 350 300390 For XMT 450
- Gas Valve Kit See literature DC/18.93 (350) and DC/18.94 (450)

Visit MillerWelds.com or your distributor for other Miller® options and accessories.

XMT® 350 MPa and 450 MPa

See literature DC/18.93 (350) and DC/18.94 (450)

Built-in pulse programs for manufacturing and fabrication applications that have benefits for standard steels, high-strength steels and aluminum.

Pulse programs provide a reduced heat-affected zone and good gap filling ability, and are great for thick to thin metal. They allow welding in all positions, as well as faster travel speeds and deposition.

SharpArc® controls the arc in pulsed MIG mode and gives total control over the arc cone shape, puddle fluidity and bead profile.

Additional features when using a 74 MPa Plus feeder or XR-AlumaFeed® SuitCase® feeder.

Synergic pulsed MIG.

As wire speed increases/decreases, pulse parameters also increase/decrease to match the right amount of power needed, reducing the need to make additional adjustments.

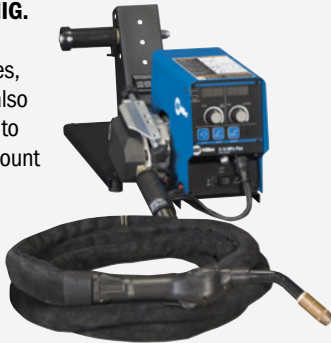

Profile Pulse™ provides TIG appearance with MIG simplicity and productivity. Achieve “stacked dimes” without gun manipulation. Profile Pulse frequency can be changed to increase or decrease the spacing between the ripple pattern to achieve the desired weld appearance.

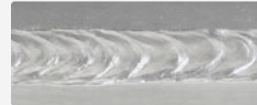

Added capabilities with Insight Core.™ When using an MPa Plus feeder, wire deposition is added to the Insight Core capabilities.

*Optional 115-volt auxiliary power provides 10 amps of circuit-breaker protected power for coolant systems, etc.

**Duty cycle rating below achieved with 6-gauge input power cord (8-gauge cord supplied with unit).

	Model/Stock Number Most Popular Models ◀	Input Power	Amperage/ Voltage Ranges	Rated Output	Amps Input at Rated Load Output, 60 Hz	Max. Open-Circuit Voltage	Power Source Dimensions	Power Source Net Weight
350 A	XMT 350 CC/CV (Dinse) 907161 ◀ 208-575 V power source only 907161011 208-575 V with auxiliary power* 951786001 208-575 V MIGRunner	3-phase	5-425 A 10-38 V	350 A at 34 VDC, 60% duty cycle	40.4 36.1 20.6 17.8 14.1 14.2 13.6	75 VDC	H: 17 in. (432 mm) W: 12.5 in. (318 mm) D: 24 in. (610 mm)	80 lb. (36.3 kg)
	XMT 350 MPa (Dinse except where noted) 907366 ◀ 208-575 V power source only 907366011 208-575 V with auxiliary power* 907366014 208-575 V with Tweco®	1-phase	5-425 A 10-38 V	300 A at 32 VDC, 60% duty cycle**	60.8 54.6 29.7 24.5 19.9 11.7 11.2			
450 A	XMT 450 CC/CV (1/2 in. stud) 907481 ◀ 230/460 V power source only 907482 575 V with ArcReach	3-phase	15-600 A 10-38 V	450 A at 38 VDC, 100% duty cycle	– 51 – 27.6 24.4 22 18.9	90 VDC	H: 17.25 in. (438 mm) W: 14.5 in. (368 mm) D: 27.125 in. (689 mm)	122 lb. (55.3 kg)
	XMT 450 MPa (1/2 in. stud) 907479 ◀ 230/460 V power source only 907479001 230/460 V with auxiliary power* 907480 575 V power source only				– 51 – 27.6 23.6 21.6 18.3 (KVA is 23.5 on 575 V)			

XMT[®] 350 FieldPro[™] Systems See literature DC/18.96



Top row left to right: ArcReach SuitCase 12 feeder, XMT 350 FieldPro power source, XMT 350 FieldPro with Polarity Reversing power source, and ArcReach Smart Feeder. Bottom row left to right: ArcReach Stick/TIG Remote and ArcReach Stick/TIG Remote with Polarity Reversing. Feeders include drive rolls and gun (see page 49 for details).

ArcReach[®]

Every year, outdated welding equipment wastes hundreds of productive work hours – and thousands of dollars in profit – by forcing operators to make numerous walks from the weld joint to the welder. Welding systems with ArcReach technology let operators adjust welding parameters right at the weld joint without a control cord using the wire feeder or remote – maximizing arc-on time, improving safety and impacting the bottom line. See pages 18/51 for ArcReach feeders and page 51 for the Stick/TIG Remotes.

Don't walk. Weld! Learn more at MillerWelds.com/arcreach

More jobsite productivity and efficiency

Cable Length Compensation (CLC[™]) ensures that the voltage a weld operator sets is the voltage they get by automatically adjusting voltage based on weld cable length, even hundreds of feet away from the power source.

Polarity reversing models of power source and remote are ideal for pipe and module assembly where changing polarity happens frequently.

AUTO-LINE[™] TECHNOLOGY For portability and reliability, Auto-Line allows for any input voltage hookup (208–575 V, single- or three-phase) with no manual linking, providing convenience in any job setting. Ideal solution for dirty or unreliable power.

Auto-Bind[™] automatically establishes exclusive communication between the power source and the wire feeder, using the existing weld cables upon system power up.

Exceptional arc performance

Common weld failures can be minimized with stick stops that are specifically programmed to eliminate arc strikes outside of the heat-affected zone.

Regulated Metal Deposition (RMD[®]) and pulsed MIG are fully supported, enabling operators to use these advanced processes in the field for faster, more-efficient welds.

Increased uptime

Delivers the performance you need. XMT 350 FieldPro welders and ArcReach feeders and remotes have been extensively proven in the field.

Wind Tunnel Technology[™] Internal air flow that protects electrical components and PC boards from dirt, dust, debris... greatly improving reliability.

Eliminate expenses related to maintaining or replacing easily damaged control cords because the weld cables are used to communicate weld parameters between the wire feeder and power source.

Improved jobsite safety

ArcReach[®] technology decreases the chances of slip, trip or fall injuries by allowing weld operators to make parameter changes at the wire feeder or remote instead of having to travel through multistory and cluttered jobsites back to the power source.

Maximum fleet compatibility

Maximize fleet compatibility and get the benefits of ArcReach when you pair XMT 350 FieldPro welders and ArcReach feeders with other ArcReach compatible products.

More operator control

Adjust While Welding (AWW[™]) allows weld operators to change weld parameters while the arc is on.

Inadvertent parameter changes by other jobsite workers can be easily avoided because connecting an ArcReach accessory from the power source automatically locks out the power source's panel controls.

Return to a previous weld process faster because the power source is restored to its previous settings once the ArcReach accessory is removed.

Auto-Process Select[™] decreases the chance of an incorrect weld process being used because it automatically sets the power source to the correct weld process based on the polarity applied to the weld accessory.

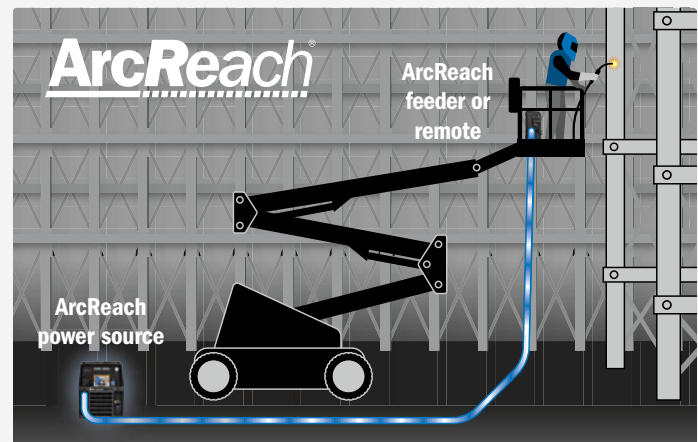

XMT® 450 CC/CV ArcReach® See literature DC/18.94



Note: XMT 450 CC/CV ArcReach does not support the Cable Length Compensation (CLC™) and Adjust While Welding (AWW™) features or the ArcReach Smart Feeder.

Auto-Process Select.™ System automatically changes to MIG/FCAW (with gas) if electrode positive polarity is detected or FCAW (no gas) if electrode negative polarity is detected, when ArcReach communication is established between the feeder and the XMT – reducing the need to access the power supply.

Automatic return to panel settings. System automatically returns to XMT setting when ArcReach communication is terminated. For example, if the XMT is set to gouging at 550 amps and an ArcReach feeder is connected, the XMT will go to a MIG/FCAW process. If the feeder is disconnected, the XMT will go back to its previous setting (gouging at 550 amps).

Auto-Bind™ automatically establishes exclusive communication between the power source and the wire feeder, using the existing weld cables upon system power up.

Operator can precisely set arc voltage at the feeder and monitor the actual arc voltage and current delivered to the weld using the digital meters on the feeder. This removes guesswork when it comes to adhering to weld procedures.

Remote override of XMT. When an ArcReach feeder is connected to an XMT 450 ArcReach the feeder has full control and the XMT controls are disabled, preventing accidental changes by personnel other than the welding operator.

XMT® Racks See literature DC/18.81

All the benefits of an individual XMT in an easy-to-transport package for multiple arcs in the field.



XMT 350 FieldPro Rack shown.

Flexible solution. The flexibility of the XMT makes it ideal for multiple system racks. Every system in a rack can be used for different tasks on-site, increasing fleet utilization and making the best use of equipment budgets.

Easy installation. The power distribution system on the rack allows the entire rack to be wired into a single power drop, isolating high-voltage power in the field.

Model	Stock Number	Input Power to Rack
XMT 350 FieldPro	907739 4-Pack Rack	230-575 V, three-phase
	907740 6-Pack Rack	(fused for 460/575 V)
XMT 350 FieldPro with Polarity Reversing	907742 4-Pack Rack	230-575 V, three-phase
	907741 6-Pack Rack	(fused for 460/575 V)
XMT 450 CC/CV ArcReach	907700 4-Pack Rack	230/460 V, three-phase (fused for 460 V)

*Optional 115-volt auxiliary power provides 10 amps of circuit-breaker protected power for coolant systems, etc.
**Duty cycle rating below achieved with 6-gauge input power cord (8-gauge cord supplied with unit).

Heavy industrial  XMT 450
Phase Phase is 3-phase only.

Processes

- MIG (GMAW) ■ Stick (SMAW)
- TIG (GTAW) ■ Flux-cored (FCAW)
- RMD* ■ Pulsed MIG (GMAW-P)*
- Air carbon arc cutting and gouging (CAC-A) (carbons – 304: 1/4 in., 350: 1/4 in., 450: 5/16 in.)

*XMT 350 FieldPro only with ArcReach Smart Feeder.

Stick/TIG system includes

- XMT 350 FieldPro power source
- ArcReach Stick/TIG Remote

MIG/flux-cored system includes

- XMT 350 FieldPro power source
- ArcReach SuitCase 12 feeder with .045 and 1/16 in. reversible V-knurl drive rolls
- Bernard® BTB Gun 300 A with AccuLock™ consumables

RMD/pulse system includes

- XMT 350 FieldPro power source
- ArcReach Smart Feeder with .045 in. and 1/16 in. reversible V-knurl drive rolls
- Bernard® PipeWorx 300-15 MIG gun

Most popular accessories

- XR-AlumaFeed® SuitCase® 301567 (pg 11)
- ArcReach® SuitCase® Feeders (pg 18/51)
- ArcReach® Smart Feeder (pg 18/51) (for XMT 350 FieldPro power sources only)
- ArcReach® Heater (pg 51/94) (for XMT 350 FieldPro power sources only)
- 20 Series and 74 MPa Plus Feeders (pg 22)
- Spoolmatic®/ WC-24 (pg 30/130)
- ArcReach® Stick/TIG Remote 301325 (pg 51)
- ArcReach® Stick/TIG Remote with Polarity Reversing 300934 (pg 51) (for XMT 350 FieldPro with Polarity Reversing power source only)



Visit MillerWelds.com or your distributor for other Miller® options and accessories.

	Model/Stock Number Most Popular Models ◀	Input Power	Amperage/ Voltage Ranges	Rated Output	Amps Input at Rated Load Output, 60 Hz						Max. Open-Circuit Voltage	Power Source Dimensions	Power Source Net Weight	
					208 V	230 V	400 V	460 V	575 V	KVA	KW			
350 A	XMT 350 FieldPro System (Tweco®) 951736 Stick/TIG 951734001 ◀ MIG/flux-cored 951738 RMD/pulse	3-phase	5-425 A 10-38 V	350 A at 34 VDC, 60% duty cycle	40.4	36.1	20.6	17.8	14.1	14.2	13.6	75 VDC	H: 17 in. (432 mm) W: 12.5 in. (318 mm) D: 24 in. (610 mm)	93 lb. (42.2 kg)
		1-phase	5-425 A 10-38 V	300 A at 32 VDC, 60% duty cycle**	60.8	54.6	29.7	24.5	19.9	11.7	11.2			
	XMT 350 FieldPro w/Polarity Reversing System (Tweco®) 951737 Stick/TIG 951735001 MIG/flux-cored 951739 ◀ RMD/pulse	3-phase	5-425 A 10-38 V	350 A at 34 VDC, 60% duty cycle	40.4	36.1	20.6	17.8	14.1	14.2	13.6	75 VDC	H: 17 in. (432 mm) W: 12.5 in. (318 mm) D: 24 in. (610 mm)	93 lb. (42.2 kg)
		1-phase	5-425 A 10-38 V	300 A at 32 VDC, 60% duty cycle**	60.8	54.6	29.7	24.5	19.9	11.7	11.2			
450 A	XMT 450 CC/CV ArcReach (1/2 in. stud) 907481003 ◀ 230/460 V 907481004 230/460 V w/auxiliary power* 907482 575 V	3-phase	15-600 A 10-38 V	450 A at 38 VDC, 100% duty cycle	–	51	–	27.6	24.4	22	18.9	90 VDC	H: 17.25 in. (438 mm) W: 14.5 in. (368 mm) D: 27.125 in. (689 mm)	122 lb. (55.3 kg)



XMT® 650 and XMT® 650 ArcReach® See literature DC/18.98

Developed for harsh environmental conditions and output requirements that range from power-intensive to precise.



XMT 650 ArcReach power source (top center) shown with **NEW!** ArcReach 16 feeder (top left, field roller option shown), ArcReach SuitCase 12 Heavy Duty feeder (top right), and ArcReach Stick/TIG Remote (left). All sold separately. Stationary and MIGRunner packages are available for XMT 650 (non-ArcReach model, see chart below).

ArcReach®

Every year, outdated welding equipment wastes hundreds of productive work hours – and thousands of dollars in profit – by forcing operators to make numerous walks from the weld joint to the welder. Welding systems with ArcReach technology let operators adjust welding parameters right at the weld joint without a control cord using the wire feeder or remote – maximizing arc-on time, improving safety and impacting the bottom line. See pages 18/20/51 for ArcReach feeders and page 51 for the Stick/TIG Remote.

Don't walk. Weld! Learn more at MillerWelds.com/arcreach

Note: ArcReach Smart Feeder is not supported.

Three models available: with or without ArcReach, and ArcReach with polarity reversing. ArcReach models allow control of ArcReach accessories hundreds of feet away without a control cable. Polarity reversing model adds switching between FCAW EN and gouging without swapping cables.



LED process indicator (ArcReach model without polarity reversing shown). Process selections are illuminated with an LED that identifies process. Enables weld process to be seen from a distance.

Cable Length Compensation (CLC™) ensures that the voltage a weld operator sets is the voltage they get by automatically adjusting voltage based on weld cable length, even hundreds of feet away from the power source.

Adjust While Welding (AWW™) allows weld operators to change weld parameters while the arc is on.

All aluminum construction helps the machine resist corrosion for long life.

Exclusive protection input inductor protects machine's performance and reliability from "dirty" input power.

Wind Tunnel Technology™ Internal air flow that protects components, greatly improving reliability.

Fan-On-Demand™ cooling system only operates when needed, reducing power consumption and keeping internal components cleaner.

High-quality performance in all welding processes, from thick to thin metals.

Arc control available in the Stick and Wire modes for easier fine tuning of tough-to-weld materials and out-of-position applications.

Reduced size and weight results in an easier-to-handle package that exceeds the welding performance of larger, heavier machines.

High electrical efficiency and excellent power factor mean getting more welding done while using less power.

Return to a previous weld process faster because the power source is restored to its previous settings once the ArcReach accessory is removed.

Polarity reversing model allows welding operator to change process and polarity with an ArcReach® 16 wire feeder. Stay at the weld joint and switch between welding and gouging with the push of a button.

Heavy industrial

Processes

- MIG (GMAW) ■ Flux-cored (FCAW)
- Stick (SMAW) ■ TIG (GTAW)*
- Submerged arc (SAW)*
- Air carbon arc cutting and gouging (CAC-A) (rated 3/8 in. carbons)

*XMT 650 models without polarity reversing.

XMT 650 Stationary package includes

- XMT 650 power source
- S-74 MPa Plus feeder with .035/.045 in. reversible V-groove drive rolls
- Bernard® BTB Gun 400 A with AccuLock™ consumables
- Industrial MIG 4/0 kit consisting of flowmeter regulator with 10 ft. (3 m) gas hose, 10 ft. (3 m) 4/0 feeder weld cable with lugs, and 15 ft. (4.6 m) work cable with 600-amp C-clamp

XMT 650 MIGRunner™ package includes above plus

- Running gear cylinder rack

Most popular accessories



- **XMT 650 ArcReach® Racks**
907860 Without polarity reversing
907852 With polarity reversing
Comes assembled with four XMT 650 ArcReach power sources fused for 460 volts
- ArcReach® SuitCase® Feeders (pg 18/51)
- ArcReach® 16 Feeder (pg 20/51)
- ArcReach® Stick/TIG Remote 301325 (pg 51)
(for ArcReach models only)
- ArcReach® Heater (pg 51/94)
(for ArcReach models only)
- Running Gear Cylinder Rack 300408 (pg 123)
- Industrial MIG 4/0 Kit (with lug connectors) 300390 (pg 125)
- Extension Cables (pg 130)
242208025 25 ft. (7.6 m)
242208050 50 ft. (15 m)
242208080 80 ft. (24.4 m)

Visit MillerWelds.com or your distributor for other Miller® options and accessories.

*XMT 650 ArcReach with 575-volt input is 60 Hz only. **XMT 650/650 ArcReach without polarity reversing models only.

Model/Stock Number	Amperage/ Voltage Ranges	Rated Output	Amps Input at Rated Output, 50/60 Hz 380 V 460 V 575 V* KVA KW	Max. Open- Circuit Voltage	Power Source Dimensions (Includes lift eye)	Power Source Net Weight
XMT 650 907843 380/460 V power source only 951000067 380/460 V stationary package 951000068 380/460 V MIGRunner package	CC mode: 10-815 A CV mode: 10-44 V SAW mode: 10-65 V**	650 A at 44 VDC, 100% duty cycle	53.0 42.6 34.1 33.9 31.9 (subject to change without notice)	82 VDC	H: 28.187 in. (716 mm) W: 16.687 in. (424 mm) D: 31.625 in. (803 mm)	187 lb. (84.8 kg)
XMT 650 ArcReach 907823 380/460 V power source only 907845 575 V* power source only		750 A at 44 VDC, 60% duty cycle	59.5 49.1 40.6 39.1 37.2 (subject to change without notice)			
XMT 650 ArcReach w/ Polarity Reversing 907822 380/460 V power source only		825 A at 44 VDC, 25% duty cycle	64.0 53.6 45.1 42.7 40.5 (subject to change without notice)			

DONT WALK WELD™

ArcReach WELDING SYSTEMS **The more they walk the more it costs.**



ARCREACH PLUG-IN POWER SOURCES

XMT® 350 FieldPro™ Systems (page 48)

Exceptional arc performance maximizes weld quality, minimizes defects.

XMT® 350 FieldPro™ Systems with Polarity Reversing (page 48)

Provides outstanding stick and TIG performance for pipe welding, including automatic polarity selection.

XMT® 450 CC/CV ArcReach®* (page 49)

Portability and excellent arc performance with flexibility and simplicity.

XMT® 650 ArcReach®** (page 50)

For harsh environments and a wide range of output requirements.

XMT® 650 ArcReach® with Polarity Reversing** (page 50)

Allows operator to change process and polarity from feeder with push of a button.



ARCREACH ENGINE-DRIVEN POWER SOURCES

Trailblazer® 325 ArcReach® Models*** (page 82)

Unbeatable arc performance with superior runtimes and increased fuel efficiency.

Big Blue® ArcReach® Models*** (page 84–87)

Tackle tough jobs that require high output for welding, gouging and aux power.



ARCREACH WIRE FEEDERS

ArcReach® SuitCase® Feeders (page 18)

For all ArcReach power sources. For MIG and flux-cored welding. Features remote voltage control and Auto-Process Select™.

ArcReach® Smart Feeder (page 18)

For both XMT 350 FieldPro models and all ArcReach engine drives. For RMD® and pulsed MIG welding up to 200 feet from the power source.

ArcReach® 16 Feeder (page 20)

For both XMT 650 ArcReach models. Features remote process select, gouging stud connection, and mobile integrated field cart or field roller option.



ARCREACH STICK/TIG REMOTES

ArcReach® Stick/TIG Remote 301325

For all ArcReach power sources except XMT 350 FieldPro with Polarity Reversing. Features remote amperage control, arc control for stick and Auto-Process Select™.

ArcReach® Stick/TIG Remote with Polarity Reversing 300934

For XMT 350 FieldPro with Polarity Reversing power source only. Provides remote control functionality of the XMT 350 FieldPro with Polarity Reversing hundreds of feet from the power source, including process changeover and amperage adjustment — with no special cables.

ArcReach HEATING SYSTEMS **Allows economical, insourced weld preheating.**



ARCREACH HEATER AIR-COOLED INDUCTION SYSTEM

ArcReach® Heater and Tools (page 94)

For both XMT 350 FieldPro models and all ArcReach engine drives. Designed for preheating and bakeout applications up to 600 degrees Fahrenheit. Induction heating tools (air-cooled cables or air-cooled quick wraps) connect to the heater which is powered by an ArcReach power source.

*Does not support the Cable Length Compensation (CLC) and Adjust While Welding (AWW) features or the ArcReach Smart Feeder.

**Does not support the ArcReach Smart Feeder.

***Does not support the Cable Length Compensation (CLC) and Adjust While Welding (AWW) features.



PipeWorx 400 Welding System See literature PWS/2.0

Optimized for pipe fabrication shops.

PipeWorx 400 welding system shown with PipeWorx accessory kit for dual-wire feeder (sold separately). Filler metal and shielding gas also sold separately.



Simple process setup

- The front panel was designed by welders for welders
- Requires just a few basic steps to set up a new weld process, resulting in less training time and minimizing errors from incorrect setups
- Memory feature stores four programs for each selection: stick, DC TIG, and MIG (left and right side of feeder) – eliminates the need to remember parameters

True multiprocess machine

- Weld processes are optimized to deliver superior arc performance and stability, specifically for root, fill and cap passes on pipe
- RMD® and pulsed MIG increase quality and productivity

Quick process changeover

- Simply push a process selection button to choose a welding process
- Reduces setup time and the risk of weld reworks due to incorrect cable connections
- PipeWorx “Quick Select” technology automatically selects the welding process, the correct polarity, cable outputs, gas solenoid, and user-programmed welding parameters

Single-system design

- One machine designed to perform all of your pipe welding needs
- Simplified and optimized specifically for pipe welding

Heavy industrial

Processes

- Stick (SMAW) ▪ DC TIG (GTAW)
- MIG (GMAW) ▪ Flux-cored (FCAW)
- RMD ▪ Pulsed MIG (GMAW-P)
- Air carbon arc cutting and gouging (CAC-A)

PipeWorx welding system comes complete with

- PipeWorx 400 power source with cable hangers (907382 **OR** 907384)
- Dual-wire feeder with drive rolls (300366)
- Two Bernard® PipeWorx 300-15 MIG guns (195400)
- Running gear with gas cylinder rack and handles (300368)
- Cable kit with 25 ft. (7.6 m) work sense lead (300367)

Most popular accessories

- Bernard® PipeWorx 300-15 Gun 195400 15 ft. (4.6 m)
- PipeWorx Accessories Kit for Dual-wire Feeder 300568 Includes 25 ft. (7.6 m) work cable with EG500 clamp, two flowmeter regulators and two 5 ft. (1.5 m) gas hoses
- Composite Cable Kit 300454 25 ft. (7.6 m) 300456 50 ft. (15.2 m)
- PipeWorx Cooler 300370
- Foot Control Bracket 300676
- RFCS-14 HD 194744 (pg 128)
- RPBS-14 300666 (pg 128)

Visit MillerWelds.com or your distributor for other Miller® options and accessories.

Advanced Technologies of PipeWorx System

Regulated Metal Deposition (RMD®)

- Higher quality root pass
- Calm and stable arc
- Less spatter
- More tolerant of hi-lo conditions
- Reduced training requirements
- Less chance of cold lap or lack of fusion; reduces rework
- Can eliminate the need for a hot pass
- Can eliminate backing/purge gas in some stainless applications

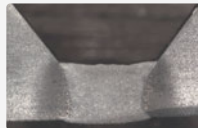

RMD carbon steel

Pulsed MIG

- Less heat input than traditional spray pulse transfer
- Shorter arc length
- Narrower arc cone
- Improved fusion and fill at the toes of the weld resulting in:
 - Faster travel speeds
 - Higher deposition rates
- Less training time required because pulsed MIG:
 - Virtually eliminates arc wander
 - Is easier to control the puddle
 - Compensates for tip-to-work variations automatically
- When used with RMD, it is possible to use one wire and one gas for all passes

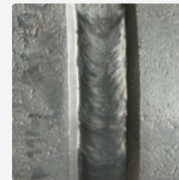

Pulsed MIG stainless

*Dimensions and weight are for power source only.

Model/Stock Number Most Popular System	Welding Mode/ Process	Amperage/ Voltage Ranges	Rated Output at 100% Duty Cycle	Amps Input at Rated Output, 60 Hz, 3-Phase			KVA			KW			Max. Open- Circuit Voltage	Dimensions*	Net Weight*
				230 V	460 V	575 V	230 V	460 V	575 V	230 V	460 V	575 V			
PipeWorx 400 Welding System 951381 230/460 V 951382 575 V	CC: Stick	40-400 A	400 A at 36 VDC	43.9	26.6	22.4	17.5	21.2	22.3	16.1	16.3	16.4	90 VDC	H: 28.5 in. (724 mm) W: 19.5 in. (495 mm) D: 31.75 in. (806 mm)	225 lb. (102 kg)
PipeWorx 400 Power Source only 907382 230/460 V 907384 575 V	CC/DC: TIG	10-350 A	350 A at 24 VDC	29.3	18.2	13.5	11.8	14.5	13.4	10.7	10.6	10			
	CV: MIG/flux-cored	10-44 V	400 A at 34 VDC	42.9	24	20.5	17.3	19.2	20.5	16	15.8	16.2			
Model/Stock Number	Input Power	Input Welding Circuit Rating	Wire Feed Speed	Wire Diameter Capacity			Maximum Spool Size Capacity			Dimensions			Net Weight		
PipeWorx Dual-wire Feeder only 300366	24 VAC, 11 A	100 V, 750 A at 100% duty cycle	50-780 ipm (1.3-19.8 m/min.)	.035-.062 in. (0.9-1.6 mm)			60 lb. (27 kg)			H: 14 in. (356 mm) W: 19 in. (483 mm) D: 29 in. (737 mm)			90 lb. (41 kg)		



For more detailed information, visit

MillerWelds.com/stick

SMAW Stick



Also see Multiprocess and TIG sections for machines that can stick weld.

Product Guide

	Page	Class	Stick	DC TIG	Portability	Weldable Metals	Welding Amperage Range	Special Features	Typical Applications	
Thunderbolt® 160	53	●	●		Handle, shoulder strap	Steel, stainless	20-160 DC	Infinite amperage control, dual-voltage MVP™ plugs	Garage/job shops, maintenance/repair, farm	1-Phase
Thunderbolt® 210	53	●	●				25-210 DC	Infinite amperage control	Garage/job shops, maintenance/repair, farm	
Maxstar® 161 S	53	●	●		Handle/shoulder strap, optional case		20-160 DC	Auto-Line™ (120-240 V), digital meter	MRO, ship installation/repair, farm/ranch	
Maxstar® 210 STR	54	●	●	●	Handles, shoulder strap, optional carts	Steel, stainless	10-210 DC	Auto-Line™ (120-480 V), digital meters	Construction, fabrication, pipe, steel erection, shipbuilding	1- & 3-Ph
CST™ 282	55	●	●	●	Handle, optional cart		5-280 DC	Portable at 34.6 lb., Auto-Line™ (208-575 V), digital meter, also available in multioperator rack	Construction, fabrication, pipe, steel erection, shipbuilding	
CST™ 282 Rack	55	●	●	●	Lift eye, casters	Steel, stainless	5-280 DC	Up to 4 or 8 operators, light weight	Construction, maintenance/repair, shipbuilding	3-Ph

Product Key

Class: ● Light industrial ● Industrial ● Heavy industrial Capability: ● Designed for this process ● Capable of this process

Thunderbolt® 160 and 210

See literature DC/37.0

Dependable, portable, powerful stick welder.



Thunderbolt 160 shown.

Nearly 100 pounds lighter so you can work smarter not harder by bringing the welder to the work.

More powerful. Up to 85 more amps compared to leading competitive machine means you can weld thicker materials.

Hot Start™ technology provides easy, quick and reliable arc starts.



Thunderbolt 160 includes multi-voltage plug (MVP™)

which allows for connection to 120- or 240-volt receptacles without tools. Choose the plug that fits the receptacle and connect it to the power cord.

Light industrial ● **CC DC 1** Phase

Process - Stick (SMAW)

Comes complete with

- 10 ft. (3 m) No. 4 electrode cable with heavy-duty electrode holder
- 10 ft. (3 m) work cable with clamp
- 6.5 ft. (2 m) power cord with MVP™ plugs for 120 V and 240 V (Thunderbolt 160) **OR** standard 240 V plug (Thunderbolt 210)
- Cable pouch

Visit MillerWelds.com or your distributor for Miller® options and accessories.

Model	Stock Number	Input Power	Welding Amperage Range	Rated Output	Amps Input at Rated Output	Max. Open-Circuit Voltage	Dimensions	Net Weight
Thunderbolt 160	907721	120 V	20-80	65 A at 20% duty cycle	20.7	91 VDC	H: 10.5 in. (267 mm)	15 lb. (6.8 kg)
		240 V	20-160	160 A at 30% duty cycle	27.8	91 VDC	W: 7.125 in. (181 mm)	15.5 lb. (7.0 kg)
Thunderbolt 210	907722	240 V	25-210	210 A at 20% duty cycle	43.4	85 VDC	D: 13.375 in. (340 mm)	

Maxstar® 161 S

See literature DC/27.3

Industrial class – provides maximum portability and performance in the most compact stick package in the industry.



Maxstar 161 S with X-CASE shown.



Allows for any input voltage hookup (120-240 V) with no manual linking, providing convenience in any job setting. Ideal solution for dirty or unreliable power.

Portable with adjustable handle/shoulder strap. Easy to transport at only 13 pounds.

Fan-On-Demand™ power source cooling system operates only when needed, reducing noise, energy use and the amount of contaminants pulled through the machine.

Digital meter for more precise control when presetting or monitoring welding amperage.

Adaptive Hot Start™ for stick arc starts.

Stick-Stuck detects if the electrode is stuck to the part and turns the welding output off to safely and easily remove the electrode. Menu selectable.

Superior stick arc performance even on the difficult-to-run electrodes like E6010.

Industrial ● **CC DC 1** Phase

Process - Stick (SMAW)

Comes complete with

- 6.5 ft. (2 m) power cords for 120 V and 240 V
- 13 ft. (4 m) electrode cable with holder and 25 mm Dinse-style connector
- 10 ft. (3 m) work cable with clamp and 25 mm Dinse-style connector
- Quick-reference guide

907709001 includes above plus

- Protective X-CASE™

Most popular accessories

- Protective X-CASE™ 301429 (pg 128)

Visit MillerWelds.com or your distributor for other Miller® options and accessories.

*Sense voltage for stick.

Stock Number	Input Power	Welding Amperage Range	Rated Output	Amps Input at Rated Output, 50/60 Hz	KVA at Duty Cycle	KW	Max. Open-Circuit Voltage	Dimensions	Net Weight
907709001 With X-CASE See page 57 in the TIG section for Maxstar 161 STL and STH	120 V	20-90	90 A at 23.6 V, 30% duty cycle	23.2	2.8	2.8	48 VDC (12-16 VDC*)	H: 10.3 in. (262 mm)	13 lb. (5.9 kg)
	240 V	20-160	160 A at 26.4 V, 20% duty cycle	22.6	5.4	5.3		W: 5.6 in. (142 mm)	
								D: 13.5 in. (343 mm)	

Maxstar® 210 STR See literature DC/32.1

Maximum flexibility with automatic connection to any input power while maintaining the best DC stick/TIG welding performance in its product class.



AUTO-LINE TECHNOLOGY Allows for any input voltage hookup (120–480 V) with no manual linking, providing convenience in any job setting. Ideal solution for dirty or unreliable power.

Lift-Arc™ provides TIG arc initiation without the use of high frequency.

Dual schedule allows operators to switch between welding parameters for specific electrodes without readjusting the machine.

Hot Start™ adaptive control provides positive arc starts without sticking.

Stick-Stuck detects if the electrode is stuck to the part and turns the welding output off to safely and easily remove the electrode. Menu selectable.

Fan-On-Demand™ power source cooling system operates only when needed, reducing noise, energy use and the amount of contaminants pulled through the machine.

Remote amperage control.

Digital meters for more precise control when presetting or monitoring welding amperage.

Portable with adjustable shoulder strap.

**Sense voltage for stick and Lift-Arc TIG.*

Industrial ● **CC DC 3 1**
Phase Phase

Processes

- Stick (SMAW) ▪ TIG (GTAW)

Comes complete with

- 8 ft. (2.4 m) power cord (no plug)
- Two 50 mm Dinse-style connectors

Most popular accessories

- 12.5 ft. (3.8 m) Weldcraft™ A-150 Valve TIG torch WP-17V-25-2 (pg 66)
- Remote Controls (pg 128)
- Air-Cooled TIG Torch Connector (pg 129)

Visit MillerWelds.com or your distributor for other Miller® options and accessories.

Stock Number 907682 <small>See page 60 in the TIG section for Maxstar 210 Series</small>	Welding Process	Input Power	Welding Amperage Range	Rated Output at 60% Duty Cycle	Amps Input at Rated Load Output, 50/60 Hz						Max. Open-Circuit Voltage (11 VDC*)	Dimensions H: 13.6 in. (346 mm) W: 8.6 in. (219 mm) D: 19.5 in. (495 mm)	Net Weight (16.3 kg)
					120 V	208 V	240 V	400 V	480 V	KVA			
Stick	3-phase		10-210	160 A at 26.4 V	–	15	13	8	6	5.5	5.2		
	1-phase		10-210	160 A at 26.4 V	–	26	22	13	11	5.3	5.3		
	1-phase (120 V)		10-100	90 A at 23.6 V	23	–	–	–	–	2.8	2.8		
TIG	3-phase		10-210	210 A at 18.4 V	–	14	12	7	6	5.2	4.9		
	1-phase		10-210	210 A at 18.4 V	–	24	20	12	10	4.9	4.9		
	1-phase (120 V)		10-150	125 A at 15 V	22	–	–	–	–	2.6	2.6		

WELDING EDUCATORS:

Experience Hobart's Premium Weldability

High Quality Products at an Exceptional Discount

Industry Leading Support and Technical Resources¹

Highest Rated Customer Satisfaction in the Filler Metal Industry¹

Ask your local welding & gas supplier about educational discount pricing and save up to

40%*

Request FREE literature at HobartBrothers.com/support



*Discount valid on any quantity. Product can be purchased directly from distributor's inventory. Standard shipping policy applies to all orders outside of distributor inventory. Contact Matt.Barr@HobartBrothers.com for additional details.

¹Based on research conducted by The Martec Group, an independent third party.



CST™ 282 See literature DC/29.6

Durable power source designed for the construction industry. Ideal for stick electrodes up to 3/16-inch and TIG welding of pipe and plate.



**WIRELESS
REMOTE
COMPATIBLE**
See page 129

CST 282 with Tweco®-style receptacles shown.

Superior stick arc performance even on the difficult-to-run electrodes like E6010.

AUTO-LINE™ TECHNOLOGY For portability and reliability, Auto-Line allows for any input voltage hookup (208–575 V, single- or three-phase) with no manual linking, providing convenience in any job setting. Ideal solution for dirty or unreliable power.

Digital meter for more precise control when presetting or monitoring welding amperage.

Portable in the shop or at the jobsite – at 34.6 pounds (15.7 kg) the CST 282 is easily moved from location to location.

Lift-Arc™ provides TIG arc initiation without the use of high frequency.

Universal connector system allows the machine to be quickly configured to Tweco®, Dinse- or Cam-Lok™-style receptacles. Extra receptacles and wrench are sold separately as Universal Connector Kits.



Industrial ● **CC DC 3 1**
Phase Phase

Processes

- Stick (SMAW) ▪ TIG (GTAW)

Comes with

- 6 ft. (1.8 m) power cord

Most popular accessories

- CST 282 Rack (see below)
- Remote Controls (pg 128–129)
- Universal Connector Kits
 - 301611 Tweco-style receptacles
 - 301595 Dinse-style receptacles
 - 301637 Cam-Lok-style receptacles
- For TIG torches see literature DC/29.6

Visit MillerWelds.com or your distributor for other Miller® options and accessories.

Stock Number	Welding Process	Input Power	Welding Amperage Range	Rated Output	Amps Input at Rated Load Output, 50/60 Hz					KVA	KW	Max. Open-Circuit Voltage	Dimensions	Net Weight
					208 V	230 V	400 V	460 V	575 V					
907770 Tweco®	Stick	3-phase	30-280	280 A at 31.2 V, 35% duty cycle	29.63	26.65	15.71	13.92	12.08	12	10.2	103 VDC	H: 13.5 in. (343 mm) W: 8 in. (203 mm) D: 18.5 in. (470 mm)	34.6 lb. (15.7 kg)
907810 Dinse				200 A at 28 V, 100% duty cycle	18.86	17.09	10.6	9.37	8.02	8	6.4			
				1-phase	30-280	200 A at 28 V, 50% duty cycle	33.7	30.65	17.61	16.18	14.51			
	TIG	3-phase	5-280	280 A at 21.2 V, 35% duty cycle	20.77	18.85	11.54	10.22	8.95	8.9	7.1	9.5 VDC		
				200 A at 18 V, 100% duty cycle	12.89	11.74	7.42	6.55	5.49	5.4	4.3			
				1-phase	5-280	200 A at 18 V, 50% duty cycle	22.12	19.71	12.89	11.06	10.61			
				150 A at 16 V, 100% duty cycle	14.84	13.38	8.73	8.63	7.72	5.1	2.9			

CST™ 282 Racks See literature DC/29.6

Rugged enclosure provides simple means for protecting and transporting multiple welding power sources for construction, power plant turn-arounds and shipbuilding applications.



4-pack rack

8-pack rack

Note: For additional rack systems see XMT® Racks on pages 49 and 50.

**WIRELESS
REMOTE
COMPATIBLE**
See page 129

One easy connection allows up to eight inverters to be connected with one primary power drop.

All controls including power switch are located on front of machine for easy access.

Top cover protects machines from falling debris.

Lift eye(s) simplify crane or overhead lifting device transport.

Lift truck fork pockets.

Common output ground connection (for same polarity use only).

Racks include casters that can be bolted to the rack base. Two swivel casters and two non-swivel casters. Large 5-inch diameter wheels enable the rack to be moved over grating and driveway gravel.

Heavy industrial ● **CC DC 3**
Phase

Processes

- Stick (SMAW) ▪ TIG (GTAW)

Comes with

- Cables to connect power sources to common work connection
- 5-inch casters

Most popular accessories

- Remote Controls (pg 128–129)
- For TIG torches see literature DC/29.6

Visit MillerWelds.com or your distributor for other Miller® options and accessories.

Model	Stock Number	Rack Capacity	Input Power to Rack	Amps Input at Rated Load Output, 50/60 Hz			KVA	KW	Dimensions (H x W x D) (Includes lift eye)	Net Weight
				230 V	460 V	575 V				
4-Pack Rack	951883 Tweco®	4 units	208-575 V, 3-phase, 50/60 Hz	106.5	56	48.5	48	40.8	50.75 x 25.5 x 26.5 in. (1,289 x 648 x 673 mm)	330 lb. (150 kg)
8-Pack Rack	907812 Tweco®	8 units	(fused for 460 V)	213	112	97	96	81.6	59.38 x 43 x 34.38 in. (1,508 x 1,092 x 873 mm)	550 lb. (250 kg)
Empty Rack	951934	4 units	–	–	–	–	–	–	Same as 4-pack rack above	166 lb. (75 kg)
	301610	8 units	–	–	–	–	–	–	Same as 8-pack rack above	280 lb. (127 kg)



TIG GTAW

Also see Multiprocess section for machines that can TIG weld.

For more detailed information, visit



MillerWelds.com/tig



	Product Guide		Page	Class	TIG	Pulsed TIG	Stick	CAC-A	MIG/Flux-cored	Max. Electrode Diameter				CAC-A	Material Thickness Range (TIG)	Welding Amperage Range	Pulse Capability	Net Weight	Generator Power Requirement
	E6010/11	E6013								E7018	E7024								
DC (Steel)	Maxstar® 161	57	●	●	●	●				5/32 in.	1/8 in.	1/8 in.	3/32 in.	—	.020-3/16 in.	5-160 A	0-150 pps (STH model)	13 lb. (5.9 kg)	5.3 kW
	Maxstar® 210	60	●	●	●	●				3/16 in.	3/16 in.	5/32 in.	5/32 in.	—	.002-1/4 in.	1-210 A	0.1-250 pps (base model) 0.1-500 pps (DX model)	38 lb. (17.2 kg)	9 kW
	Maxstar® 280	60	●	●	●	●	●			7/32 in.	3/16 in.	3/16 in.	3/16 in.	3/16 in.	.004-3/8 in.	1-280 A	0.1-250 pps (base model) 0.1-500 pps (DX model)	47 lb. (21.3 kg)	11 kW
	Maxstar® 400	62	●	●	●	●	●			5/16 in.	5/16 in.	1/4 in.	1/4 in.	1/4 in.	.012-5/8 in.	3-400 A	0.1-5,000 pps	134 lb. (61 kg)	20 kW
	Maxstar® 800	62	●	●	●	●	●			5/16 in.	5/16 in.	5/16 in.	5/16 in.	3/8 in.	.020-1 in.	5-800 A	0.1-5,000 pps	198 lb. (90 kg)	45 kW
AC/DC (Aluminum/Steel)	Diversion™ 180	57	●	●						—	—	—	—	—	.030-3/16 in. (alum.) .025-3/16 in. (steel)	10-180 A	—	50 lb. (23 kg)	5.5 kW
	Syncrowave® 210	58	●	●	●	●	●	●		5/32 in.	1/8 in.	1/8 in.	3/32 in.	—	.020-1/4 in. (aluminum/steel)	5-210 A	0.1-150 pps	133.5 lb. (61 kg)	6 kW
	Syncrowave® 300	59	●	●	●	●				5/32 in.	5/32 in.	1/8 in.	1/8 in.	—	.015-3/8 in. (alum.) .012-1/2 in. (steel)	5-300 A	0.1-150 pps	101 lb. (45.8 kg)	9 kW
	Syncrowave® 400	59	●	●	●	●				3/16 in.	3/16 in.	3/16 in.	3/16 in.	—	.015-3/8 in. (alum.) .012-5/8 in. (steel)	5-400 A	0.1-150 pps	131 lb. (59.4 kg)	14 kW
	Dynasty® 210	61	●	●	●	●				3/16 in.	3/16 in.	5/32 in.	5/32 in.	—	.012-1/4 in. (alum.) .002-1/4 in. (steel)	2-210 A (AC) 1-210 A (DC)	0.1-500 pps	47 lb. (21.3 kg)	9 kW
	Dynasty® 300	61	●	●	●	●	●			7/32 in.	3/16 in.	3/16 in.	3/16 in.	3/16 in.	.012-3/8 in. (alum.) .004-3/8 in. (steel)	2-300 A (AC) 1-300 A (DC)	0.1-500 pps	55 lb. (25 kg)	12.5 kW
	Dynasty® 400	62	●	●	●	●	●			5/16 in.	5/16 in.	1/4 in.	1/4 in.	1/4 in.	.015-5/8 in. (alum.) .012-5/8 in. (steel)	3-400 A	0.1-500 pps (AC) 0.1-5,000 pps (DC)	134 lb. (61 kg)	20 kW
	Dynasty® 800	62	●	●	●	●	●			5/16 in.	5/16 in.	5/16 in.	5/16 in.	3/8 in.	.020-1 in. (aluminum/steel)	5-800 A	0.1-500 pps (AC) 0.1-5,000 pps (DC)	198 lb. (90 kg)	50 kW

Product Key

Class: ● Light industrial ● Industrial ● Heavy industrial Capability: ● All models ● Some models
NEW! products appear in blue type.

Diversion™ 180 AC/DC TIG

See literature AD/1.5

Professional-grade arc in a package designed specifically for personal users. Contains all of the features you need – simplicity combined with superior performance and value.



TIG Welding Capability

Max. 3/16 in. (4.8 mm)	Max. 3/16 in. (4.8 mm)
Steel	Aluminum
Min. 0.025 in. (0.6 mm)	Min. 0.030 in. (0.75 mm)



Multi-voltage plug (MVP™) allows for connection to 120- or 240-volt receptacles without tools. Choose the plug that fits the receptacle and connect it to the power cord.

Fan-On-Demand™ power source cooling system operates only when needed, reducing noise, energy use and the amount of contaminants pulled through the machine.

Auto-postflow adjusts the length of postflow time based on the amperage setting, shielding your tungsten and eliminating the need to set the postflow time.

Advanced squarewave AC provides a fast freezing weld puddle and deeper penetration.

Weldcraft™ A-150 torch with Diamond Grip™ provides more comfortable grip and reduces operator fatigue.

Easy-to-understand operator interface. Power up, select material type, set material thickness range and start welding!

Inverter-based AC/DC power source provides a more consistent welding arc while using less power.

HF arc starting for non-contact arc initiation that reduces tungsten and material contamination.

Portable. Easy to transport at 50 pounds.

*While idling.

Light industrial **CC** AC **1** DC Phase

Process - TIG (GTAW)

Comes with

- Power cord with MVP plugs for 120 V and 240 V
- 12.5 ft. (3.8 m) Weldcraft™ A-150 TIG torch
- 12 ft. (3.7 m) work cable with clamp
- RFCS-RJ45 remote foot control
- Flow gauge regulator with hose

Most popular accessories

- TIG Torch Accessory Kit AK2C (pg 72)
- Running Gear/Cylinder Rack 301239 (pg 122)
- Protective Cover 300579 (pg 128)
- RCCS-RJ45 Remote Fingertip Control 301146 (pg 128)
- RJ45 to 14-Pin Adapter Cord 300688
- Weldcraft™ Flexible Torch Body Kits (requires handle 105Z55R) A-125F (WP-9F) A-150F (WP-17F)

Visit MillerWelds.com or your distributor for other Miller® options and accessories.

AC/DC	Stock Number	Input Power	Welding Amp Range	Rated Output	Amps Input at Rated Output	KVA	KW	Max. Open-Circuit Voltage	Dimensions	Net Weight
	907627	115 V	10-125	125 A at 15 V, 35% duty cycle	26.5 (.88*)	3.1 (.1*)	3.0 (.03*)	80 VDC	H: 17 in. (433 mm) W: 9.875 in. (251 mm) D: 23.875 in. (608 mm)	50 lb. (23 kg)
		230 V	10-180	150 A at 16 V, 20% duty cycle	16 (.44*)	3.7 (.1*)	3.6 (.03*)			
			180 A at 17.2 V, 10% duty cycle	20.5 (.44*)	4.7 (.1*)	4.6 (.03*)				

Maxstar® 161 STL and STH DC TIG and Stick

See literature DC/27.5

Maximum portability and performance provided in one compact TIG/stick package.



TIG Welding Capability

Max. 3/16 in. (4.8 mm)
Steel
Min. 0.020 in. (0.5 mm)

Two models available.

STL: DC TIG/stick with Lift-Arc™ starting without high frequency
STH: DC TIG/stick with high frequency and Lift-Arc™ starting, plus built-in pulsing from 0-150 pulses per second

AUTO-LINE TECHNOLOGY Allows for any input voltage hookup (120-240 V) with no manual linking, providing convenience in any job setting.

Portable with adjustable handle/shoulder strap. Easy to transport at only 13 pounds.

Built-in gas solenoid eliminates need for a bulky torch with a gas valve.

Digital meter for more precise control.

Fan-On-Demand™ power source cooling system.

Superior stick arc performance even on the difficult-to-run electrodes like E6010.

Maxstar 161 STH TIG/stick package with remote fingertip control shown – includes X-CASE.

*Sense voltage for stick and Lift-Arc™ TIG.

Industrial **CC** DC **1** Phase

Processes

- TIG (GTAW) ■ Stick (SMAW)
- Pulsed TIG (GTAW-P) with STH model

Comes with

- 6.5 ft. (2 m) power cords for 120 V and 240 V
- 13 ft. (4 m) electrode cable with holder and 25 mm Dinse-style connector
- 10 ft. (3 m) work cable with clamp and 25 mm Dinse-style connector
- Air-cooled TIG torch connector
- Quick-reference guide

TIG/stick packages include above plus

- 12.5 ft. (3.8 m) Weldcraft™ A-150 TIG torch (WP1712RD125)
- Protective X-CASE™ (301429)
- Flow gauge regulator with hose
- AK2C TIG torch accessory kit
- RCCS-6M remote fingertip control (packages 907710002 and 907711001 only)

Visit MillerWelds.com or your distributor for Miller® options and accessories.

DC	Model/Stock Number	Welding Process	Input Power	Welding Amp Range	Rated Output	Amps Input at Rated Output, 50/60 Hz	KVA at Duty Cycle	KW	Max. Open-Circuit Voltage	Dimensions	Net Weight	
	Maxstar 161 STL 907710 Power source only 907710001 TIG/stick package 907710002 TIG/stick package with remote fingertip control	Maxstar 161 STH 907711 Power source only 907711001 TIG/stick package with remote fingertip control	TIG	120 V	5-130	130 A at 15.2 V, 30% duty cycle	22.6	2.73	2.70	48 VDC (12-16 VDC*)	H: 10.3 in. (262 mm) W: 5.6 in. (142 mm) D: 13.5 in. (343 mm)	13 lb. (5.9 kg)
				240 V	5-160	160 A at 16.4 V, 20% duty cycle	15.05	3.62	3.49			
		Stick	120 V	20-90	90 A at 23.6 V, 30% duty cycle	23.16	2.78	2.76				
			240 V	20-160	160 A at 26.4 V, 20% duty cycle	22.55	5.41	5.25				

See page 53 in the Stick section for Maxstar 161 S

Syncrowave® 210

AC/DC TIG, Stick and MIG (with Spool Gun)

See literature AD/4.6

Continuing the tradition of innovation through advanced inverter technology for light-industrial and personal users.

Syncrowave 210 TIG/stick only package shown.



See page 129



Easy to use.

- 1) Turn power on.
- 2) Select the process.
- 3) Set amperage or voltage based on material thickness.

Then weld! It's easy as 1,2,3.

TIG Welding Capability

Max. 1/4 in. (6.4 mm)

Steel

Aluminum

Min. 0.020 in. (0.5 mm)

AUTO-LINE TECHNOLOGY Allows for any input voltage hookup (120–240 V) with no manual linking, providing convenience in any job setting. Ideal solution for dirty or unreliable power.



Multi-voltage plug (MVP™) allows for connection to 120- or 240-volt receptacles without tools. Choose the plug that fits the receptacle and connect it to the power cord.

Low power draw. Inverter-based power source provides full welding output from 240 volts while drawing less than 30 amps.

High-frequency (HF) arc starting for non-contact arc initiation, reducing tungsten and material contamination.

Pro-Set™ (TIG/stick) eliminates the guesswork when setting weld parameters. Use Pro-Set when you want the speed, convenience and confidence of preset controls.

AC frequency (TIG) controls the width of the arc cone and can improve directional control of the arc.

AC balance (TIG) control provides adjustable oxide removal which is essential for creating the highest quality aluminum welds.

Pulse (TIG). Pulsing can increase puddle agitation, arc stability and travel speeds while reducing heat input and distortion.

DIG (stick) control allows the arc characteristics to be changed for specific applications and electrodes. Lower the DIG setting for smooth running electrodes like E7018 and increase the DIG setting for stiffer, more penetrating electrodes like E6010.

Auto-Set™ (MIG) automatically sets your welder to the proper parameters. Simply set the wire size, material thickness, and shielding gas and you're ready to weld with the Spoolmate™ spool gun.

Light industrial ● CC AC 1 DC Phase

Processes

- AC/DC TIG (GTAW) ■ DC stick (SMAW)
- Pulsed TIG (GTAW-P) ■ MIG (GMAW)*
- Flux-cored (FCAW)*

*With Spoolmate 150.

Comes with

- 10 ft. power cord with MVP plugs for 120 V and 240 V
- 12.5 ft. (3.8 m) Weldcraft™ A-150 TIG torch (WP1712MFDI50)
- 12 ft. (3.7 m) work cable with clamp and Dinse-style connector
- Electrode holder with Dinse-style connector
- RFCS-14 HD heavy-duty remote foot control
- Flow gauge regulator with hose
- Factory-installed running gear with EZ-Change™ low cylinder rack
- Quick-reference guide

TIG/MIG Complete package includes above plus

- Spoolmate™ 150 spool gun (301272)
- 4-14 pin connector
- Flow-thru Dinse-style connector

Most popular accessories

- 25 ft. (7.6 m) Weldcraft™ A-150 TIG Torch WP-17-25-R (pg 66)



- **TIG Torch Accessory Kit AK2C** (pg 72)

Includes one short back cap, one of each size (#4, #5, #6) alumina nozzle, and one of each size (.040, 1/16, 3/32 in.) of the following: collet, collet body, and 7-inch 2% ceriated tungsten electrode

- TIG Torch Accessory Kit AK-150MFC (pg 72)

Allows A-150 torch customization. Converts into 28 different torch styles while using existing cable. Includes collets, collet bodies, nozzles, torch heads, handle and more

- Protective Cover 195142 (pg 128)
- RCC-14 Remote Control 151086 (pg 128)
- Wireless Remote Foot Control 301580 (pg 129)

Visit MillerWelds.com or your distributor for other Miller® options and accessories.

AC/DC	Stock Number 907596 TIG/stick only package 951684 TIG/MIG Complete package – includes Spoolmate 150	Input Power	Welding Process	Welding Amperage Range	Rated Output (R.M.S.) at 60% Duty Cycle	Amps Input at Rated Output	Max. Open-Circuit Voltage	Dimensions	Net Weight
		115 V	DC TIG	5–125	95 A at 13.8 V	17.4 (.58 while idling)	47 VDC	H: 31.5 in. (800 mm) W: 18.5 in. (470 mm) D: 43 in. (1092 mm)	TIG/stick only: 133.5 lb. (61 kg) TIG/MIG Complete: 139.5 lb. (63 kg)
230 V	AC TIG	5–125	90 A at 13.6 V	12.4 (.58 while idling)	47 VDC				
		DC stick	20–90	70 A at 22.8 V				20.5 (.58 while idling)	
		DC TIG	5–210	125 A at 15 V				11.9 (.35 while idling)	
AC TIG	5–210	114 A at 14.6 V	8.62 (.35 while idling)	47 VDC					
	DC stick	20–150	90 A at 23.6 V				11.9 (.35 while idling)		

Syncrowave® 300 and 400 AC/DC TIG and Stick

See literature AD/4.25 (300) and AD/4.28 (400)



TIG Welding Capability

400 Max. 5/8 in. (15.9 mm)	400 Max. 1/2 in. (12.7 mm)
300 Max. 1/2 in. (12.7 mm)	300 Max. 3/8 in. (9.5 mm)
Steel	Aluminum
Min. 0.012 in. (0.3 mm)	Min. 0.015 in. (0.4 mm)



See page 129

Industrial **CC** AC/DC **3** 1 Phase Phase

Processes

- TIG (GTAW) ▪ Stick (SMAW)
- DC pulsed TIG (GTAW-P)

Comes with

- 10 ft. (3 m) power cord (no plug)
- Two 50 mm Dinse-style connectors

TIGRunner® includes above plus

- Syncrowave 300/400 4-Wheel Cart
- Coolmate™ 3S

Complete packages include above plus

- Coolant (four 1-gallon bottles)
- Remote control (foot or wireless foot)
- Weldcraft™ water-cooled torch kit
Syncrowave 300: W-280
Syncrowave 400: W-375

Most popular accessories



- Syncrowave 300/400 4-Wheel Cart 301601 (pg 123)
- Coolant 043810 (pg 123)



- Weldcraft™ Water-Cooled Torch Kits (pg 128)
300990 W-280 (WP-280)
301268 W-375
- Remote Controls (pg 128-129)
043688 RCCS-14 fingertip control
194744 RFCS-14 HD foot control
301580 Wireless foot control

Visit MillerWelds.com or your distributor for other Miller® options and accessories.

Auto-Link® circuit automatically links the power source to primary voltage being applied (208/240/480 V, single- or three-phase).

AC frequency controls the width of the arc cone and can improve directional control of the arc.

AC balance control features adjustable cleaning action while increasing arc stability on various aluminum alloys, and helps eliminate tungsten spitting and arc rectification.

Blue Lightning™ high-frequency (HF) arc starter for non-contact arc initiation. Provides more consistent arc starts and greater reliability compared to traditional HF arc starters.

Lift-Arc™ provides AC or DC arc initiation without the use of high frequency.

Auto-postflow adjusts the length of postflow time based on the amperage setting, shielding your tungsten and eliminating the need to set the postflow time.

Pro-Set™ eliminates the guesswork when setting weld parameters. Use Pro-Set when you want the speed, convenience and confidence of preset controls.

Arc timer/cycle counter records actual welding time and number of arc starts. Great for estimating job costs.

Line voltage compensation keeps power source constant regardless of fluctuations in input power (± 10 percent).

Coolmate™ 3S cooler (shown in Complete package).

Three-gallon cooling system features a flow indicator to visually indicate system is working and an external filter to stop objects from entering the water-cooled torch cable.

¹For Syncrowave 400 refer to owner's manual for 208 V output rating and duty cycle.

²Sense voltage for low OCV stick and Lift-Arc™ TIG.

³See literature AD/4.25 and AD/4.28 for Complete package dimensions and weight.

AC/DC	Model/Stock Number	Welding Process	Input Power	Welding Amp Range	Rated Output at 60% Duty Cycle ¹	Amps Input at Rated Output, 50/60 Hz					Max. Open-Circuit Voltage	Power Source Dimensions ³	Power Source Net Weight ³
					208 V	240 V	480 V	KVA	KW				
AC/DC	Syncrowave 300	TIG (includes cooler power draw)	3-phase	5-300	210 A at 18.4 V	16	14	7	5.9	5.5	60 VDC (13 VDC ²)	H: 29.4 in. (746 mm) W: 15 in. (381 mm) D: 24.6 in. (625 mm)	101 lb. (45.8 kg)
	907782 Power source only			5-300	210 A at 18.4 V	27	24	12	5.7	5.5			
	907782001 TIGRunner®			Stick	3-phase	160 A at 26.4 V	16	11	5	5.7			
	951829 Complete w/foot	1-phase	5-230		160 A at 26.4 V	27	23	11	5.7	5.5			
	951872 Complete w/wireless foot	3-phase	5-400		300 A at 22 V	25	23	11	9.1	8.8			
	Syncrowave 400	TIG (includes cooler power draw)	3-phase	5-400	300 A at 22 V	43	42	20	9.7	8.9			
907783 Power source only	5-400			300 A at 22 V	47	43	21	10.4	9.5				
907783001 TIGRunner®	Stick	3-phase	5-300	250 A at 30 V	27	24	12	9.8	9.4				
951831 Complete w/foot		1-phase	5-300	250 A at 30 V	47	43	21	10.4	9.5				
951873 Complete w/wireless foot		3-phase	5-300	250 A at 30 V	47	43	21	10.4	9.5				

Maxstar® 210/280 Series DC TIG and Stick

See literature DC/32.1 (210) and DC/35.0 (280)



Maxstar 210

Maxstar 280 DX



See page 129

TIG Welding Capability

210 Max. 1/4 in. (6.4 mm)
Steel
210 Min. 0.002 in. (0.05 mm)
280 Max. 3/8 in. (9.5 mm)
Steel
280 Min. 0.004 in. (0.1 mm)

Base and DX models available. Base model provides essential TIG and stick functions. DX models have extended ranges for sequencer, full trigger options, and full preflow and pulser functions.

AUTO-LINE TECHNOLOGY Allows for any input voltage hookup (210 models: 120–480 V, 280 models: 208–575 V) with no manual linking, providing convenience in any job setting. Ideal solution for dirty or unreliable power.

Blue Lightning™ high-frequency (HF) arc starter for non-contact arc initiation. Provides more consistent arc starts and greater reliability compared to traditional HF arc starters.

Lift-Arc™ provides DC arc initiation without the use of high frequency.

Hot Start™ adaptive control provides positive arc starts without sticking.

Auto-postflow adjusts the length of postflow time based on the amperage setting, shielding your tungsten and eliminating the need to set the postflow time.

Pro-Set™ eliminates the guesswork when setting weld parameters. Use Pro-Set when you want the speed, convenience and confidence of preset controls. Simply select the feature and adjust until Pro-Set appears on the display.

Sleep timer conserves electricity. This programmable feature will power down the machine if it sits idle for a specified time.

Update and expand. Front panel memory card data port provides the ability to easily update software and expand product features.

Quiet Pulse™ (DX models only). Activate Quiet Pulse by selecting sine or triangular waveshape to reduce audible noise.

Optional cooler power supply (CPS) (available on Maxstar 280 only) is an integrated 120-volt dedicated-use receptacle for the Coolmate™ 1.3.

Cooler-On-Demand™ (CPS models only) feature operates the auxiliary cooling system only when needed. Reduces noise, energy use, and airborne contaminants pulled through the cooler.

Industrial ● **CC DC 3 1**
Phase Phase

Processes

- TIG (GTAW) ▪ Stick (SMAW)
- Pulsed TIG (GTAW-P)
- Air carbon arc (CAC-A) with 280 model

Comes with

- 8 ft. (2.4 m) power cord (no plug)
- Two 50 mm Dinse-style connectors

TIGRunner® includes above plus

- Small Runner™ Cart
- Coolmate™ 1.3

Most popular accessories

- 2-Wheel Trolley Cart 300971 (pg 123)
- Small Runner™ Cart 301615 (pg 123)
- Coolmate™ 1.3 301616 (pg 123)
- Coolant 043810 (pg 123)



- **Contractor Kits** (pg 128)
 - 301309 A-150 w/RFCs-14 HD
 - 301311 A-150 w/RCCS-14
 - 301549 A-200 w/RFCs-14 HD
 - 301550 A-200 w/RCCS-14



- **Weldcraft™ Water-Cooled Torch Kits** (pg 128)
 - 300185 W-250 (WP-20)
 - 300990 W-280 (WP-280)
 - 301268 W-375
- **Remote Controls** (pg 128–129)
 - 043688 RCCS-14 fingertip control
 - 194744 RFCs-14 HD foot control
 - 301580 Wireless foot control

Visit MillerWelds.com or your distributor for other Miller® options and accessories.

*Refer to owner's manual for complete ratings.
**Sense voltage for low OCV stick and Lift-Arc™ TIG.

Model/ Stock Number	Welding Process	Input Power	Welding Amp Range	Rated Output at 60% Duty Cycle	Amps Input at Rated Load Output, 50/60 Hz										Max. Open- Circuit Voltage	Dimensions	Net Weight
					120 V	208 V	230 V	240 V	400 V	460 V	480 V	575 V	KVA	KW			
Maxstar 210 907683 Power source only Maxstar 210 DX 907684 Power source only See page 54 in the Stick section for Maxstar 210 STR	TIG	3-phase	1-210	210 A at 18.4 V	–	14	–	12	7	–	6	–	5.2	4.9	80 VDC (11 VDC**)	H: 13.6 in. (346 mm) W: 8.6 in. (219 mm) D: 19.5 in. (495 mm)	38 lb. (17.2 kg)
			1-210	210 A at 18.4 V	–	24	–	20	12	–	10	–	4.9	4.9			
		1-phase (120 V)	1-150	125 A at 15 V	22	–	–	–	–	–	–	–	2.6	2.6			
	Stick	3-phase	5-210	160 A at 26.4 V	–	15	–	13	8	–	6	–	5.5	5.2			
			1-phase	5-210	160 A at 26.4 V	–	26	–	22	13	–	11	–	5.3			
		1-phase (120 V)	5-100	90 A at 23.6 V	23	–	–	–	–	–	–	–	2.8	2.8			
Maxstar 280 907552 Power source only 907538 Power source w/CPS 907538002 TIGRunner w/CPS Maxstar 280 DX 907553 Power source only 907539 Power source w/CPS 907539001 TIGRunner w/CPS See page 45 in the Multiprocess section for Maxstar 280 Multiprocess	TIG	3-phase	1-280	250 A at 20 V	–	21	19	–	11	9	–	7	7.6	7.3	60 VDC (11 VDC**)	H: 13.6 in. (346 mm) W: 8.6 in. (219 mm) D: 22.5 in. (569 mm)	47 lb. (21.3 kg) 50 lb. (22.7 kg) with CPS
			1-phase	1-280	250 A at 20 V	–	35	32	–	18	16	–	13	7.3			
		Stick	3-phase	5-280	250 A at 30 V	–	*	*	–	14	13	–	10	9.9			
	1-phase			5-280	180 A at 27.2 V	–	32	29	–	*	*	–	*	6.7			

Dynasty® 210/300 Series AC/DC TIG and Stick

See literature AD/4.81 (210) and AD/4.96 (300)



Dynasty 210

Dynasty 300

TIG Welding Capability

210 Max. 1/4 in. (6.4 mm)		210 Max. 1/4 in. (6.4 mm)	
Steel	Aluminum	Steel	Aluminum
210 Min. 0.002 in. (0.05 mm)	210 Min. 0.012 in. (0.3 mm)	210 Min. 0.002 in. (0.05 mm)	210 Min. 0.012 in. (0.3 mm)
300 Max. 3/8 in. (9.5 mm)		300 Max. 3/8 in. (9.5 mm)	
Steel	Aluminum	Steel	Aluminum
300 Min. 0.004 in. (0.1 mm)	300 Min. 0.012 in. (0.3 mm)	300 Min. 0.004 in. (0.1 mm)	300 Min. 0.012 in. (0.3 mm)



See page 129

Intuitive LCD display. Ensures proper machine setup and parameter selection. Informative on-screen explanations and dynamic images enhance the parameter selection process.

Program memory allows easy naming, saving and recalling of favorite weld settings.

Locks and limits provide control of weld parameter ranges, minimizing deviation from the welding procedure specification (WPS).

USB. Front panel port provides the ability to easily update software, back-up settings and transfer saved weld programs from one unit to the next.

AUTO-LINE TECHNOLOGY Allows for any input voltage hookup (210 models: 120-480 V, 300 models: 208-600 V) with no manual linking, providing convenience in any job setting. Ideal solution for dirty or unreliable power.

Blue Lightning™ high-frequency (HF) arc starter for non-contact arc initiation. Provides more consistent arc starts and greater reliability compared to traditional HF arc starters.

Lift-Arc™ provides AC or DC arc initiation without the use of high frequency.

Auto-postflow adjusts the length of postflow time based on the amperage setting, shielding your tungsten and eliminating the need to set the postflow time.

Quiet Pulse™. Activate Quiet Pulse by selecting sine or triangular waveshape to reduce audible noise.

Pro-Set™ eliminates the guesswork when setting weld parameters. Use Pro-Set when you want the speed, convenience and confidence of preset controls. Simply select the feature and adjust until Pro-Set appears on the display.

AC waveforms (TIG) for advanced squarewave, soft squarewave, sine wave and triangular wave.

AC balance (TIG) control provides adjustable oxide removal which is essential for creating the highest quality aluminum welds.

AC frequency (TIG) controls the width of the arc cone and can improve directional control of the arc.

Optional cooler power supply (CPS) is an integrated 120-volt dedicated-use receptacle for the Coolmate™ 1.3.

Cooler-On-Demand™ (CPS models only) feature operates the auxiliary cooling system only when needed. Reduces noise, energy use, and airborne contaminants pulled through the cooler.

Dynasty 300 Complete package with wireless foot control and CPS shown.



Industrial ● CC AC 3 1 DC Phase Phase

Processes

- TIG (GTAW) ▪ Stick (SMAW)
- Pulsed TIG (GTAW-P)
- Air carbon arc (CAC-A) with 300 model

Comes with

- 8 ft. (2.4 m) power cord (no plug)
- Two 50 mm Dinse-style connectors

TIGRunner® includes above plus

- Small Runner™ Cart
- Coolmate™ 1.3

Complete packages include above plus

- Coolant (four 1-gallon bottles)
- Wireless foot remote control
- Weldcraft™ water-cooled torch kit
Dynasty 210: W-250
Dynasty 300: W-280

Most popular accessories

- 2-Wheel Trolley Cart 300971 (pg 123)
- Small Runner™ Cart 301615 (pg 123)
- Coolmate™ 1.3 301616 (pg 123)
- Coolant 043810 (pg 123)



Contractor Kits (pg 128)

- 301309 A-150 w/RFCs-14 HD
- 301311 A-150 w/RCCS-14
- 301549 A-200 w/RFCs-14 HD
- 301550 A-200 w/RCCS-14



Weldcraft™ Water-Cooled Torch Kits (pg 128)

- 300185 W-250 (WP-20)
- 300990 W-280 (WP-280)
- 301268 W-375
- Remote Controls (pg 128-129)
043688 RCCS-14 fingertip control
194744 RFCs-14 HD foot control
301580 Wireless foot control

Visit MillerWelds.com or your distributor for other Miller® options and accessories.

*Additional packages are available – visit MillerWelds.com or your distributor.

Refer to owner's manual for complete ratings. *Sense voltage for low OCV stick and Lift-Arc™ TIG.

AC/DC	Model/Stock Number*	Welding Process	Input Power	Welding Amp Range	Rated Output at 60% Duty Cycle	Amps Input at Rated Load Output, 50/60 Hz							Max. Open-Circuit Voltage	Dimensions	Net Weight			
						120 V	208 V	240 V	400 V	460 V	480 V	600 V	KVA	KW				
AC/DC	Dynasty 210 907816 Power source only 907816001 Power source w/CPS 907816002 TIGRunner w/CPS 951936 Complete with wireless foot and CPS	TIG	3-phase	1-210	210 A at 18.4 V	–	16	14	8	–	7	–	5.7	5.2	80 VDC (11 VDC***)	H: 13.88 in. (352 mm) W: 8.5 in. (216 mm) D: 21.88 in. (555 mm)	47 lb. (21.3 kg) 50 lb. (22.7 kg) with CPS	
				1-210	210 A at 18.4 V	–	28	23	14	–	12	–	5.8	5.6				
				1-phase (120 V)	1-150	125 A at 15 V	26	–	–	–	–	–	–	2.8				2.7
		Stick	3-phase	5-210	160 A at 26.4 V	–	16	14	9	–	8	–	6.0	5.8				
				1-phase	5-210	160 A at 26.4 V	–	28	24	14	–	12	–	6.4				5.5
				1-phase (120 V)	5-100	90 A at 23.6 V	27	–	–	–	–	–	–	2.9				2.8
AC/DC	Dynasty 300 907818 Power source w/CPS 907818002 TIGRunner w/CPS 951937 Complete with wireless foot and CPS See page 45 in the Multiprocess section for Dynasty 300 Multiprocess	TIG	3-phase	2-300 (AC)	250 A at 20 V	–	19	16	10	8	–	7	7.5	6.6	60 VDC (11 VDC***)	H: 13.88 in. (352 mm) W: 8.5 in. (216 mm) D: 21.88 in. (555 mm)	55 lb. (25 kg) with CPS	
				1-300 (DC)	250 A at 20 V	–	33	29	17	15	–	11	6.7	6.7				
		Stick	3-phase	5-300	250 A at 30 V	–	**	**	14	12	–	9	9.8	9.1				
				1-phase	5-300	200 A at 27.2 V	–	35	31	**	**	–	**	9.3				9.2

Maxstar® and Dynasty® 400 and 800 DC (Maxstar) and AC/DC (Dynasty) TIG and Stick

See literature DC/24.5 (Maxstar) and AD/5.5 (Dynasty)



Dynasty 400

Dynasty 800



See page 129

TIG Welding Capability

800 Max. 1 in. (25.4 mm)		800 Max. 1 in. (25.4 mm)	
400 Max. 5/8 in. (15.9 mm)		400 Max. 5/8 in. (15.9 mm)	
Steel		Aluminum (Dynasty only)	
400 Min. 0.012 in. (0.3 mm)	400 Min. 0.015 in. (0.4 mm)	400 Min. 0.015 in. (0.4 mm)	400 Min. 0.015 in. (0.4 mm)
800 Min. 0.020 in. (0.5 mm)	800 Min. 0.020 in. (0.5 mm)	800 Min. 0.020 in. (0.5 mm)	800 Min. 0.020 in. (0.5 mm)

AUTO-LINE TECHNOLOGY Allows for any input voltage hookup (208-575 V) with no manual linking, providing convenience in any job setting. Ideal solution for dirty or unreliable power.

Blue Lightning™ high-frequency (HF) arc starter for non-contact arc initiation. Provides more consistent arc starts and greater reliability compared to traditional HF arc starters.

Lift-Arc™ provides AC or DC arc initiation without the use of high frequency.

Hot Start™ adaptive control provides positive arc starts without sticking.

Auto-postflow adjusts the length of postflow time based on the amperage setting, shielding your tungsten and eliminating the need to set the postflow time.

Quiet Pulse™. Activate Quiet Pulse by selecting sine or triangular waveshape to reduce audible noise.

Cooler power supply (CPS) is an integrated 120-volt dedicated-use receptacle for the Coolmate™ 3.5.

Program memory features nine independent program memories that maintain/save your parameters.

High-speed DC TIG pulse controls capable of 5,000 pulses per second.

*Sense voltage for low OCV stick and Lift-Arc™ TIG.

**See literature DC/24.5 and AD/5.5 for Complete package dimensions and weight.

Dynasty welders add AC TIG capabilities and the following AC features

Waveforms for advanced squarewave, soft squarewave, sine wave and triangular wave.

Balance control provides adjustable oxide removal which is essential for creating the highest quality aluminum welds.

Frequency controls the width of the arc cone and can improve directional control of the arc.

AC amplitude/amperage allows EP and EN amperages to be set independently to precisely control heat input to the work and electrode.

Dynasty 400 Complete package with wireless foot control shown.



Heavy industrial
CC AC 3 1 DC Phase Phase Maxstar is DC only

Processes

- TIG (GTAW) ▪ Stick (SMAW)
- Pulsed TIG (GTAW-P)
- Air carbon arc (CAC-A)

400 models come with

- 8 ft. (2.4 m) power cord (no plug)
- Two 50 mm Dinse-style connectors
- Quick-reference guide (Dynasty only)

800 models come with

- Thread-lock torch connector
- Two thread-lock weld cable connectors
- Quick-reference guide (Dynasty only)

Note: Power cord is NOT included with 800 models.

TIGRunner® includes above plus

- Runner™ cart
- Coolmate™ 3.5

Complete packages include above plus

- Coolant (four 1-gallon bottles)
- Remote control (foot or wireless foot)
- Weldcraft™ water-cooled torch kit
Maxstar/Dynasty 400: W-375
Dynasty 800: W-400

Most popular accessories

- Runner™ Cart 300244 (pg 123)
- Coolmate™ 3.5 300245 (pg 123)
- Coolant 043810 (pg 123)



Weldcraft™ Water-Cooled Torch Kits (pg 128)

- 300185 W-250 (WP-20)
- 300990 W-280 (WP-280)
- 301268 W-375
- 300186 W-400 (WP-18SC)
- Remote Controls (pg 128-129)
043688 RCCS-14 fingertip control
194744 RFCS-14 HD foot control
301580 Wireless foot control

Visit MillerWelds.com or your distributor for other Miller® options and accessories.

	Model/Stock Number	Welding Process	Input Power	Welding Amp Range	Rated Output at 60% Duty Cycle	Amps Input at Rated Load Output, 50/60 Hz					Max. Open-Circuit Voltage	Power Source Dimensions**	Power Source Net Weight**		
						208 V	230 V	400 V	460 V	575 V	KVA	KW			
DC Maxstar	Maxstar 400	TIG/stick	3-phase	3-400	300 A at 32 V	33	30	17	15	12	12.0	11.6	75 VDC (10-15 VDC*)	H: 24.75 in. (629 mm) W: 13.75 in. (349 mm) D: 22 in. (559 mm)	134 lb. (61 kg)
	907716 Power source only														
	907716001 TIGRunner		1-phase	3-400	250 A at 30 V	48	43	24	20	16	10	9.2			
	951692 Complete w/foot														
951874 Complete w/wireless foot															
DC Maxstar	Maxstar 800	TIG/stick	3-phase	5-800	600 A at 44 V	90	80	45	39	31	32	31	75 VDC (10-15 VDC*)	H: 34.5 in. (876 mm) W: 13.75 in. (349 mm) D: 22 in. (559 mm)	198 lb. (90 kg)
	907718 Power source only														
	1-phase		5-800	500 A at 40 V	126	112	61	53	41	26	24				
AC/DC Dynasty	Dynasty 400	TIG/stick	3-phase	3-400	300 A at 32 V	36	33	19	16	13	13.1	12.5	75 VDC (10-15 VDC*)	H: 24.75 in. (629 mm) W: 13.75 in. (349 mm) D: 22 in. (559 mm)	134 lb. (61 kg)
	907717 Power source only														
	907717001 TIGRunner		1-phase	3-400	250 A at 29 V	52	47	26	22	17	10.9	9.9			
	951694 Complete w/foot														
951876 Complete w/wireless foot															
AC/DC Dynasty	Dynasty 800	TIG/stick	3-phase	5-800	600 A at 44 V	96	86	48	42	33	35	33	75 VDC (10-15 VDC*)	H: 34.5 in. (876 mm) W: 13.75 in. (349 mm) D: 22 in. (559 mm)	198 lb. (90 kg)
	907719 Power source only														
	907719001 TIGRunner		1-phase	5-800	500 A at 40 V	136	122	66	56	44	28	26			
	951696 Complete w/foot														
951875 Complete w/wireless foot															

LEAVE YOUR IMPRINT.

YOU STRIKE AN ARC. YOU LAY A BEAD. YOU LEAVE YOUR IMPRINT. WELDERS LIKE YOU LEAVE A PIECE OF THEMSELVES IN EVERY COMPLETED PROJECT. SEE HOW WELDING HAS CHANGED THE LIVES OF PEOPLE LIKE YOU — AND HEAR MOTIVATIONAL STORIES FROM THOSE WHO LEAVE THEIR IMPRINT ON THE WORLD.

PA'TRICE FRAZIER

IS DETERMINED TO SHARE HER LOVE OF WELDING WITH THE WORLD. SEE WHY.

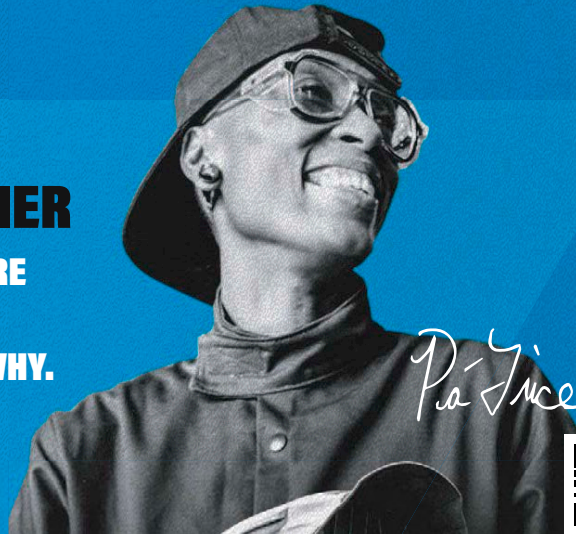

Pa'Trice Frazier



SHANE BARBER

EXPLAINS HOW WELDING A SHIPPING-CONTAINER HOME HEALED HIS FAMILY. WATCH NOW.



Shane Barber



PRESTON LEWIS

TEACHES KIDS ABOUT RESILIENCE WITH WELDING AND OFF-ROAD RACING. SEE WHY.



Preston Lewis



Weldcraft™ Series TIG Torches

Synonymous with versatility and performance, Weldcraft TIG torches can handle the most intricate to the most demanding TIG welding challenges. From the 125-amp hand-held MicroTIG® torch to the 500-amp machine-held water-cooled models, there's a Weldcraft torch for nearly every TIG application.

For more detailed information, visit MillerWelds.com/tigtorches



Setting the standard for performance

Super Cool™ technology provides additional surface area to increase cooling efficiency and capacity.

Comfort and control are increased with the lightweight, well-balanced body and handle designs, helping to reduce fatigue.

Robust performance through heavy copper construction that delivers maximum welding capacity for rugged fieldwork.

Simplify torch package installation with ColorSmart™ hose and cable sets that differentiate input water, water/power cable, and gas hoses.

Improve gas coverage and cooling capacity through the use of a gas lens.

Extreme reliability

Reduce downtime due to overheating through consistent water-cooled performance.

Extend parts life using the durable copper components, maximizing current capacity.

Reduce leakage of gas and water through secure mechanical fittings.

Works in cold weather with the Tri-Flex™ hose and cable assembly that remains flexible to ease handling and extends cable life.

Part Number	Description	Quantity
WC332X7	2% Ceriated Tungsten (3/32" dia.)	1
54N63	Large Diameter GL Insulator	1
53N88XXL	#10 Large Dia. GL Alumina Nozzle XXLong	1
10N24	Collet for 3/32" dia. Tungsten	1
45V64	Large Gas Lens for 3/32" dia. Tungsten	1
300M	Medium Back Cap	1

TIG TORCH CONFIGURATOR

MAKE SURE YOU ARE USING THE RIGHT TORCH AND CONSUMABLES FOR YOUR APPLICATION.

Answer a few simple questions about your specific application and get a recommendation for the appropriate torch, tungsten, collet, collet body and more. Email or print the recommendation for reference when purchasing your next Weldcraft torch.

Visit now at MillerWelds.com/torchconfig

Weldcraft™ Air-Cooled Torches

Recommended for welding amperages under 250 amps. Air-cooled torches are great for portable applications as they do not require a water-circulator. For power sources without a built-in gas solenoid the air-cooled two-piece torch is the solution of choice.

Weldcraft™ Water-Cooled Torches

Recommended for welding amperages above 200 amps. Offering a small torch design, water-cooled torches allow for precise control due to the efficient around-the-head cooling. This same cooling allows for extended torch life and higher amperage capacities.

Weldcraft™ Specialty Torches

Specialty torches are designed to fit best in unique applications. The Modular Series torches allow for a quick change to many different torch styles for any joint configuration. For those hard-to-reach areas the W-125 MicroTIG® torch provides access and superior maneuverability.

Weldcraft™ Automation Torches

Ideal for mechanized applications, the Weldcraft Automation Series offers air-cooled and water-cooled torches designed for low- and high-amperage mechanized applications.

Process

- TIG (GTAW)

Suggested power sources

- Multimatic® 200 / 215 (pg 41) (A-150)
- Multimatic® 220 AC/DC (pg 42) (A-150)
- Multimatic® 235 (pg 43) (A-150)
- Multimatic® 255 (pg 44) (A-150)
- Maxstar® 280 Multiprocess (pg 45) (A-200, A-250, W-280)
- Dynasty® 300 Multiprocess (pg 45) (A-200, A-250, W-280)
- XMT Series (pg 46-49) (A-200, A-250)
- CST™ 282 (pg 55) (A-250)
- Maxstar® 161 STL/STH (pg 57) (A-150)
- Syncrowave® 210 (pg 58) (A-150)
- Syncrowave® 300 (pg 59) (W-280)
- Syncrowave® 400 (pg 59) (W-375)
- Maxstar® 210 (pg 60) (A-150, W-250)
- Maxstar® 280 (pg 60) (A-200, A-250, W-280)
- Dynasty® 210 (pg 61) (A-150, W-250)
- Dynasty® 300 (pg 61) (A-200, A-250, W-280)
- Maxstar® / Dynasty® 400 (pg 62) (W-375)
- Maxstar® / Dynasty® 800 (pg 62) (W-400)

Weldcraft™ A-80 Series

See literature AY/21.0

Formerly known as WP-24 Series



Innovative air-cooled torches designed for intricate welding applications, especially in limited-access areas and on thin-gauge materials.

Featherweight torch body is well balanced to improve operator comfort and control.

Minimize discontinuities. Insulating gasket on torch body minimizes gas leakage and minimizes weld discontinuities.

Combined flexible neck and gas valve (A-80 Flex Valve) is ideal for optimal positioning and gas flow control.

Applications

- Shipbuilding
- Motorsports
- Aerospace
- Restricted areas

Most popular consumables

- Collets
 - 53N16 .040 in. (1.0 mm)
 - 53N14 1/16 in. (1.6 mm)
 - 24C332 3/32 in. (2.4 mm)
- Collet Bodies
 - 53N18 .040 in. (1.0 mm)
 - 53N19 1/16 in. (1.6 mm)
 - 24CB332 3/32 in. (2.4 mm)
- Alumina Nozzles
 - A53N24 #4, 1/4 in.
 - A53N25 #5, 5/16 in.
 - A53N27 #6, 3/8 in.

Most popular accessories

- Collet Body Wrench 53N20
- Visit MillerWelds.com or your distributor for other Miller® options and accessories.

Model	Rubber		Type	Rated Output	Electrode Range
	12.5 ft. (3.8 m)	25 ft. (7.6 m)			
A-80 Flex	WP-24F-12-R	WP-24F-25-R	Air-cooled	DC: 80 A at 60% duty cycle AC: 50 A at 60% duty cycle	.020-3/32 in. (0.5-2.4 mm)
A-80 Flex Valve	WP-24FV-12-R	WP-24FV-25-R			

Weldcraft™ A-125 Series

Formerly known as WP-9 Series

See literature AY/22.0



Air-cooled torches designed for optimal control while welding thin-gauge materials, especially in hard-to-reach places.

Lightweight body reduces fatigue and downtime, while increasing operator comfort.

Pencil-style model (A-125 Pencil) without a back cap allows for superior access to confined areas.

Combined flexible neck and gas valve (A-125 Flex Valve) for welding limited-access joints using power sources without gas solenoids.

Applications

- Maintenance and repair
- Home/hobby ▪ Motorsports
- Metal art ▪ Fabrication

Most popular consumables

- Collets
 - 13N22 1/16 in. (1.6 mm)
 - 13N23 3/32 in. (2.4 mm)
 - 13N24 1/8 in. (3.2 mm)
- Collet Bodies
 - 13N27 1/16 in. (1.6 mm)
 - 13N28 3/32 in. (2.4 mm)
 - 13N29 1/8 in. (3.2 mm)
- Alumina Nozzles
 - 13N10 #6, 3/8 in.
 - 13N11 #7, 7/16 in.
 - 13N12 #8, 1/2 in.

Most popular accessories

- Accessory Kit AK1C (pg 72)

Visit MillerWelds.com or your distributor for other Miller® options and accessories.

Model	Rubber 12.5 ft. (3.8 m) 25 ft. (7.6 m)		2-Piece Rubber 12.5 ft. (3.8 m) 25 ft. (7.6 m)		Type	Rated Output	Electrode Range
	WP-9-12-R	WP-9-25-R	—	—			
A-125	WP-9-12-R	WP-9-25-R	—	—	Air-cooled	DC: 125 A at 60% duty cycle AC: 100 A at 60% duty cycle	.020-1/8 in. (0.5-3.2 mm)
A-125 Valve	WP-9V-12-R	WP-9V-25-R	—	WP-9V-25-2			
A-125 Flex	WP-9F-12-R	WP-9F-25-R	WP-9F-12-2	WP-9F-25-2			
A-125 Flex Valve	WP-9FV-12-R	WP-9FV-25-R	—	WP-9FV-25-2			
A-125 Pencil	WP-9P-12-R	WP-9P-25-R	—	—			

Weldcraft™ A-150 Series

Formerly known as WP-17 Series

See literature AY/23.0

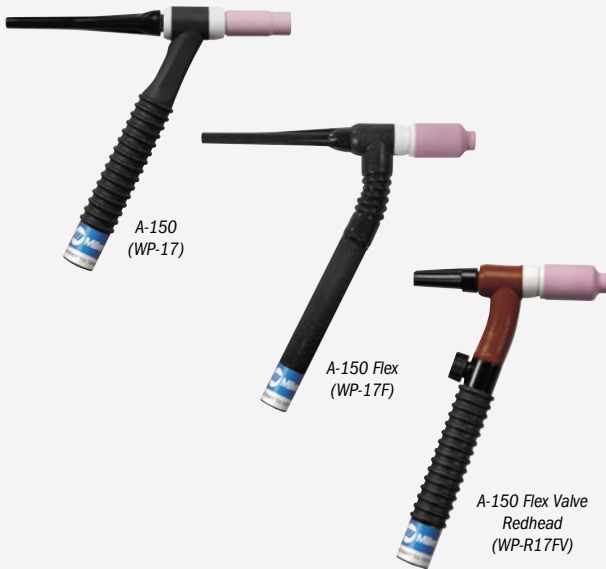

Versatile and innovative air-cooled torches designed for maximum comfort in a variety of applications.

Diamond Grip™ head design (A-150 and A-150 Valve) has ergonomic contact points for thumb and fingers. Provides a more comfortable grip and reduces operator fatigue.

Improve control and comfort (A-150 Flex) with a flexible neck that allows access into hard-to-reach areas.

Maximum versatility. Utilize the Redhead™ Series torches in a variety of welding applications without adding expenses.

Applications

- Fabrication ▪ Maintenance and repair
- Aerospace ▪ Food/beverage industry
- Metal art ▪ Petro/chemical
- Shipbuilding

Most popular consumables

- Collets
 - 10N23 1/16 in. (1.6 mm)
 - 10N24 3/32 in. (2.4 mm)
 - 10N25 1/8 in. (3.2 mm)
- Collet Bodies
 - 10N31 1/16 in. (1.6 mm)
 - 10N32 3/32 in. (2.4 mm)
 - 10N28 1/8 in. (3.2 mm)
- Alumina Nozzles
 - 10N48 #6, 3/8 in.
 - 10N47 #7, 7/16 in.
 - 10N46 #8, 1/2 in.

Most popular accessories

- Accessory Kit AK-150MFC (pg 72)
Converts A-150 into 28 different torch styles while using existing cable — includes collets, collet bodies, nozzles, torch heads, handle and more

Visit MillerWelds.com or your distributor for other Miller® options and accessories.

Model	Rubber 12.5 ft. (3.8 m) 25 ft. (7.6 m)		Mono-Flex™ 12.5 ft. (3.8 m) 25 ft. (7.6 m)		2-Piece Rubber 12.5 ft. (3.8 m) 25 ft. (7.6 m)		Type	Rated Output	Electrode Range
	WP-17-12-R	WP-17-25-R	WP-17-12-MF	WP-17-25-MF	WP-17-12-2	WP-17-25-2			
A-150	WP-17-12-R	WP-17-25-R	WP-17-12-MF	WP-17-25-MF	WP-17-12-2	WP-17-25-2	Air-cooled	DC: 150 A at 60% duty cycle AC: 115 A at 60% duty cycle	.020-1/8 in. (0.5-3.2 mm)
A-150 Valve	WP-17V-12-R	WP-17V-25-R	WP-17V-12-MF	WP-17V-25-MF	WP-17V-12-2	WP-17V-25-2			
A-150 Flex	WP-17F-12-R	WP-17F-25-R	—	—	—	WP-17F-25-2			
A-150 Flex Valve	WP-17FV-12-R	WP-17FV-25-R	—	—	WP-17FV-12-2	WP-17FV-25-2			
A-150 Flex Valve Redhead	WP-R17FV-12-R	WP-R17FV-25-R	—	—	—	—			

Weldcraft™ A-200 Series

Formerly known as WP-26 Series

See literature AY/24.0



Dependable, top-performing air-cooled torches designed for heavy-duty welding applications.

Eliminate the expense of a water-cooled system. The air-cooled capability of the A-200 Series pairs reliability with cost-effectiveness for all field applications.

Combined flexible neck and gas valve (A-200 Flex Valve) advances capabilities with greater comfort and control.

Maximum versatility. Utilize the Redhead Series torches in a variety of welding applications without adding expenses.

Applications

- Fabrication
- Maintenance and repair
- Manufacturing
- Shipbuilding
- Vocational

Most popular consumables

- Collets
 - 10N23 1/16 in. (1.6 mm)
 - 10N24 3/32 in. (2.4 mm)
 - 10N25 1/8 in. (3.2 mm)
- Collet Bodies
 - 10N31 1/16 in. (1.6 mm)
 - 10N32 3/32 in. (2.4 mm)
 - 10N28 1/8 in. (3.2 mm)
- Alumina Nozzles
 - 10N47 #7, 7/16 in.
 - 10N46 #8, 1/2 in.
 - 10N45 #10, 5/8 in.

Most popular accessories



- **Gas Lens Kit AK3GL** (pg 72)
Includes one short back cap, one of each size (#6, #7, #8) alumina nozzle, and one of each size (1/16, 3/32, 1/8 inch) of the following: gas lens, collet, and 7-inch 2% ceriated tungsten electrode



- **Accessory Kit AK3C** (pg 72)
Includes one short back cap, one of each size (#5, #6, #8) alumina nozzle, and one of each size (1/16, 3/32, 1/8 inch) of the following: collet, collet body, and 7-inch 2% ceriated tungsten electrode
Visit MillerWelds.com or your distributor for other Miller® options and accessories.

Model	Rubber 12.5 ft. (3.8 m)		2-Piece Rubber 12.5 ft. (3.8 m)		Type	Rated Output	Electrode Range
	25 ft. (7.6 m)	25 ft. (7.6 m)	12.5 ft. (3.8 m)	25 ft. (7.6 m)			
A-200	WP-26-12-R	WP-26-25-R	WP-26-12-2	WP-26-25-2	Air-cooled	DC: 200 A at 60% duty cycle AC: 150 A at 60% duty cycle	.020-5/32 in. (0.5-4.0 mm)
A-200 Valve	WP-26V-12-R	WP-26V-25-R	WP-26V-12-2	WP-26V-25-2			
A-200 Flex	WP-26F-12-R	WP-26F-25-R	—	WP-26F-25-2			
A-200 Flex Valve	WP-26FV-12-R	WP-26FV-25-R	WP-26FV-12-2	WP-26FV-25-2			
A-200 Flex Redhead	WP-R26F-12-R	—	—	—			
A-200 Flex Valve Redhead	—	WP-R26FV-25-R	—	—			

Weldcraft™ A-250 Series

See literature AY/24.5



Dependable, top-performing air-cooled torches designed for heavy-duty welding applications.

Eliminate the expense of a water-cooled system. The air-cooled capability of the A-250 Series pairs reliability with cost-effectiveness for all field applications.

Robust performance. The heavy copper construction delivers optimal welding capacity for rugged fieldwork.

Effortless adjustments (A-250 Valve). Gas control valve ensures quick and easy adjustment of shielding gas flow.

Model	2-Piece Rubber, 25 ft. (7.6 m)	Type	Rated Output	Electrode Range
A-250	301525025	Air-cooled	DC: 250 A at 60% duty cycle AC: 188 A at 60% duty cycle	.020-5/32 in. (0.5-4.0 mm)
A-250 Valve	301526025			



THE GARAGE PROJECT SHOW THAT KEEPS IT REAL.

New year, same Andy. Real Garage with Andy is back, and the transformation of the 1969 Trans Am is taking shape! Don't miss a project, tip or weld — catch all the episodes on the Real Garage YouTube channel.



WATCH AND SUBSCRIBE

Weldcraft™ W-180

Formerly known as WP-24W

See literature AY/26.0



One of the smallest water-cooled TIG torches on the market and designed for welding in confined areas that require high amperage.

Use high amperage in confined areas for efficient welding.

Superior maneuverability in limited-access locations with the compact torch body.

Excellent weld capacity without increasing torch size, due to the efficient cooling system.

Applications

- Aerospace ▪ Manufacturing
- Food/beverage industry ▪ Shipbuilding
- Maintenance and repair
- Petro/chemical ▪ Precision fabrication

Most popular consumables

- Collets
 - 53N16 .040 in. (1.0 mm)
 - 53N14 1/16 in. (1.6 mm)
 - 24C332 3/32 in. (2.4 mm)
- Collet Bodies
 - 53N18 .040 in. (1.0 mm)
 - 53N19 1/16 in. (1.6 mm)
 - 24CB332 3/32 in. (2.4 mm)
- Alumina Nozzles
 - A53N24 #4, 1/4 in.
 - A53N25 #5, 5/16 in.
 - A53N27 #6, 3/8 in.

Model	Braided Rubber, 25 ft. (7.6 m)	Vinyl, 25 ft. (7.6 m)	Type	Rated Output	Electrode Range
W-180	WP-24W-25-R	WP-24W-25	Water-cooled	DC: 180 A at 100% duty cycle, AC: 115 A at 100% duty cycle	.020-3/32 in. (0.5-2.4 mm)

Weldcraft™ W-200 Pencil Flex

Formerly known as WP-25

See literature AY/27.0



Versatile water-cooled torch optimized for use in limited-access welding situations.

Pencil-style with flexible neck designed for both high-amperage applications and confined-area access.

Decreased downtime and longer trouble-free service due to overheating with the innovative cooling design.

Comfort and control are increased with the lightweight, well-balanced body design.

Applications

- Aerospace ▪ Aluminum fabrication
- Automotive ▪ Manufacturing
- Exotic material fabrication
- Precision metal fabrication
- Pressure vessel fabrication
- Shipbuilding ▪ Tool and die
- Tube and pipe ▪ Vocational

Most popular consumables

- Insulator (non-gas lens and gas lens) (required) 598882
- Collets (non-gas lens and gas lens)
 - 13N21 .040 in. (1.0 mm)
 - 13N22 1/16 in. (1.6 mm)
 - 13N23 3/32 in. (2.4 mm)
 - 13N24 1/8 in. (3.2 mm)
- Collet Bodies
 - 13N26 .040 in. (1.0 mm)
 - 13N27 1/16 in. (1.6 mm)
 - 13N28 3/32 in. (2.4 mm)
 - 13N29 1/8 in. (3.2 mm)
- Gas Lens
 - 45V42 .040 in. (1.0 mm)
 - 45V43 1/16 in. (1.6 mm)
 - 45V44 3/32 in. (2.4 mm)
 - 45V45 1/8 in. (3.2 mm)

Model	Braided Rubber		Vinyl		Type	Rated Output	Electrode Range
	12.5 ft. (3.8 m)	25 ft. (7.6 m)	12.5 ft. (3.8 m)	25 ft. (7.6 m)			
W-200 Pencil Flex	WP-25-12-R	WP-25-25-R	WP-25-12	WP-25-25	Water-cooled	DC: 200 A at 100% duty cycle AC: 140 A at 100% duty cycle	.020-1/8 in. (0.5-3.2 mm)

Weldcraft™ W-250 Series

Formerly known as WP-20 Series

See literature AY/29.0



W-250 (WP-20)

W-250 Valve (WP-20V)

Water-cooled torches that provide consistent performance and long-term trouble-free service with around-the-head water cooling.

Extend torch life and minimize downtime due to overheating with the efficient around-the-head cooling design.

Reduce leakage of gas and water through secure mechanical fittings and connections.

Easy hose replacement (W-250 Valve) with the innovative mechanical fittings design.

- Alumina Nozzles
 - 13N08 #4, 1/4 in.
 - 13N09 #5, 5/16 in.
 - 13N10 #6, 3/8 in.
 - 13N11 #7, 7/16 in.
 - 13N12 #8, 1/2 in.
 - 13N13 #10, 5/8 in.
 - 53N58 #4, 1/4 in. (gas lens)
 - 53N59 #5, 5/16 in. (gas lens)
 - 53N60 #6, 3/8 in. (gas lens)
 - 53N61 #7, 7/16 in. (gas lens)
 - 53N61S #8, 1/2 in. (gas lens)

Most popular accessories



- Cable Covers
 - WC-3-10 10 ft. (3 m)
 - WC-3-22 22 ft. (6.7 m)

Visit MillerWelds.com or your distributor for other Miller® options and accessories.

Model	Braided Rubber		Vinyl		Type	Rated Output	Electrode Range
	12.5 ft. (3.8 m)	25 ft. (7.6 m)	12.5 ft. (3.8 m)	25 ft. (7.6 m)			
W-250	WP-20-12-R	WP-20-25-R	WP-20-12	WP-20-25	Water-cooled	DC: 250 A at 100% duty cycle AC: 180 A at 100% duty cycle	.020-1/8 in. (0.5-3.2 mm)
W-250 Valve	—	—	—	WP-20V-25			

Weldcraft™ W-280 Super Cool™

Formerly known as WP-280

See literature AY/30.0



Reliable water-cooled torch designed for demanding, high-amperage applications.

Super Cool technology provides additional surface area to increase cooling efficiency and capacity.

Reduce downtime due to overheating through consistent water-cooled performance.

Reduce leakage of gas and water through secure mechanical fittings and connections.

Model	Braided Rubber 12.5 ft. (3.8 m) 25 ft. (7.6 m)		Braided Rubber with 50 mm Dinse 25 ft. (7.6 m)	Type	Rated Output	Electrode Range
	301251012	301251025	301251001			
W-280 Super Cool	301251012	301251025	301251001	Water-cooled	DC: 280 A at 100% duty cycle AC: 195 A at 100% duty cycle	.020–1/8 in. (0.5–3.2 mm)

Applications

- Aerospace ▪ Aluminum fabrication
- Automotive ▪ Manufacturing
- Exotic material fabrication
- Precision metal fabrication
- Pressure vessel fabrication
- Shipbuilding ▪ Tool and die
- Tube and pipe ▪ Vocational

Most popular consumables

- Insulator (non-gas lens and gas lens) (required) 598882
- Collets (non-gas lens and gas lens)
 - 13N21 .040 in. (1.0 mm)
 - 13N22 1/16 in. (1.6 mm)
 - 13N23 3/32 in. (2.4 mm)
 - 13N24 1/8 in. (3.2 mm)
- Collet Bodies
 - 13N26 .040 in. (1.0 mm)
 - 13N27 1/16 in. (1.6 mm)
 - 13N28 3/32 in. (2.4 mm)
 - 13N29 1/8 in. (3.2 mm)
- Gas Lens
 - 45V42 .040 in. (1.0 mm)
 - 45V43 1/16 in. (1.6 mm)
 - 45V44 3/32 in. (2.4 mm)
 - 45V45 1/8 in. (3.2 mm)
- Alumina Nozzles
 - 13N08 #4, 1/4 in.
 - 13N09 #5, 5/16 in.
 - 13N10 #6, 3/8 in.
 - 13N11 #7, 7/16 in.
 - 13N12 #8, 1/2 in.
 - 13N13 #10, 5/8 in.
 - 53N58 #4, 1/4 in. (gas lens)
 - 53N59 #5, 5/16 in. (gas lens)
 - 53N60 #6, 3/8 in. (gas lens)
 - 53N61 #7, 7/16 in. (gas lens)
 - 53N61S #8, 1/2 in. (gas lens)
- Back Caps
 - 41V33 Short
 - 41V35 Medium
 - 41V24 Long

Weldcraft™ W-375 Super Cool™

See literature AY/32.5



Reliable water-cooled torch designed for demanding, high-amperage applications.

Super Cool technology provides additional surface area to increase cooling efficiency and capacity.

Reduce downtime due to overheating through consistent water-cooled performance.

Reduce leakage of gas and water through secure mechanical fittings and connections.

Model	Braided Rubber 12.5 ft. (3.8 m) 25 ft. (7.6 m)		Braided Rubber with 50 mm Dinse 25 ft. (7.6 m)	Type	Rated Output	Electrode Range
	301253012	301253025	301253001			
W-375 Super Cool	301253012	301253025	301253001	Water-cooled	DC: 375 A at 100% duty cycle AC: 265 A at 100% duty cycle	.020–1/8 in. (0.5–3.2 mm)

Most popular accessories

- Cable Covers
 - WC0183 11.75 ft. (3.6 m)
 - WC0182 24.25 ft. (7.4 m)
- Visit MillerWelds.com or your distributor for other Miller® options and accessories.

Weldcraft™ W-350 Series

Formerly known as WP-18 Series

See literature AY/32.0



Rugged water-cooled torches engineered for high-amperage and continuous hand-held welding.

Reduce downtime and costs by minimizing overheating with the unique cooling design engineered for operator comfort.

Reduce discomfort and fatigue using the comfortable handle design.

Superior gas flow control (W-350 Valve) offered through the built-in fingertip gas control.

Model	Rubber 12.5 ft. (3.8 m) 25 ft. (7.6 m)		Vinyl 12.5 ft. (3.8 m) 25 ft. (7.6 m)		Type	Rated Output	Electrode Range
	WP-18-12-R	WP-18-25-R	WP-18-12	WP-18-25			
W-350	WP-18-12-R	WP-18-25-R	WP-18-12	WP-18-25	Water-cooled	DC: 350 A at 100% duty cycle AC: 250 A at 100% duty cycle	.020–5/32 in. (0.5–4.0 mm)
W-350 Valve	–	WP-18V-25-R	–	WP-18V-25			

Applications

- Fabrication ▪ Manufacturing
- Maintenance and repair
- Shipbuilding ▪ Tube and pipe

Most popular consumables

- Collets
 - 10N24 3/32 in. (2.4 mm)
 - 10N25 1/8 in. (3.2 mm)
 - 54N20 5/32 in. (4.0 mm)
- Collet Bodies
 - 10N32 3/32 in. (2.4 mm)
 - 10N28 1/8 in. (3.2 mm)
 - 406488 5/32 in. (4.0 mm)
- Alumina Nozzles
 - 10N48 #6, 3/8 in.
 - 10N47 #7, 7/16 in.
 - 10N46 #8, 1/2 in.
 - 10N45 #10, 5/8 in.
 - 10N44 #12, 3/4 in.

Weldcraft™ W-400 Super Cool™

See literature AY/33.0

Formerly known as WP-18SC



Water-cooled torch designed to endure some of the most demanding applications while minimizing overheating.

Extend torch and consumable life with the full-flow water chamber that provides around-the-head cooling.

Improve gas coverage and cooling capacity with gas lens usage with heavy-duty stubby collet body.

Extend parts life using the durable copper components, maximizing current capacity.

Applications

- Heavy fabrication ▪ Tool and die
- Pipe and tube fabrication
- Pressure vessel fabrication

Most popular consumables

- Heavy-Duty Collets
10N25HD 1/8 in. (3.2 mm)
54N20HD 5/32 in. (4.0 mm)
18C36 3/16 in. (4.8 mm)
- Heavy-Duty Nose Collet Body (all sizes) NCB-36
- Alumina Nozzles
54N16 #6, 3/8 in.
54N15 #7, 7/16 in.
54N14 #8, 1/2 in.
- Back Caps
57Y04 Short
300M Medium

Model	Rubber, 25 ft. (7.6 m)	Vinyl, 25 ft. (7.6 m)	Type	Rated Output	Electrode Range
W-400 Super Cool	WP-18SC-25-R	WP-18SC-25	Water-cooled	DC: 400 A at 100% duty cycle, AC: 280 A at 100% duty cycle	.020-3/16 in. (0.5-4.8 mm)

Weldcraft™ Modular Series

See literature AY/36.0



Air-cooled and water-cooled torches engineered to weld multiple joint configurations for various applications and angles.

Built-in, efficient cooling system reduces overheating to extend parts and consumable life.

Modular design minimizes costs and downtime for torch changeover and parts inventory.

Easy configurable head options provide greater flexibility and joint access, minimizing downtime for torch changeover.

Gas valve (A-150 Modular Valve) provides greater shielding gas flow control.

Applications

- Maintenance and repair ▪ Aerospace
- Metal art ▪ Food/beverage industry
- Petro/chemical ▪ Shipbuilding
- Manufacturing ▪ Vocational
- Precision fabrication ▪ Tube and pipe

Most popular accessories



- **Accessory Kit** (pg 72)
AK-150MFC For A-150 torch
AK-225MFC For W-225 torch

Model	Rubber 12.5 ft. (3.8 m)	25 ft. (7.6 m)	Type	Rated Output (Torch head dependent)	Electrode Range (Torch head dependent)	
A-150 Modular	WP-150-12-R	WP-150-25-R	Air-cooled	DC: 150 A at 60% duty cycle AC: 105 A at 60% duty cycle	.020-1/8 in. (0.5-3.2 mm)	
A-150 Modular Valve	WP-150V-12-R	WP-150V-25-R				
Model	Braided Rubber 12.5 ft. (3.8 m)	25 ft. (7.6 m)	Vinyl 25 ft. (7.6 m)	Type	Rated Output (Torch head dependent)	Electrode Range (Torch head dependent)
W-225 Modular	WP-225-12-R	WP-225-25-R	WP-225-25	Water-cooled	DC: 225 A at 100% duty cycle AC: 160 A at 100% duty cycle	.020-5/32 in. (0.5-4.0 mm)

Weldcraft™ W-125 Long Micro

See literature AY/25.0

Formerly known as WP-125L



Water-cooled MicroTIG® torch designed for limited-access joints.

Small 5-inch torch body designed for limited-access joints.

Low-profile nozzle fits into holes as small as 5/8-inch diameter.

45-degree, 90-degree, and 180-degree options improve access in tight areas.

Lower maintenance costs incurred with the replaceable silicone rubber insulator and head components.

Applications

- Aerospace ▪ Food/beverage industry
- HVAC ▪ Automotive ▪ Petro/chemical
- Precision fabrication

Most popular consumables

- 90° Chucks
125C40-90 .040 in. (1.0 mm)
125C116-90 1/16 in. (1.6 mm)
125C332-90 3/32 in. (2.4 mm)
- 90° Quartz Nozzle (all sizes)
125N90Q (other nozzles are available)



Model	Braided Rubber, 25 ft. (7.6 m)	Type	Rated Output	Electrode Range
W-125 Long Micro	WP-125L-25-R	Water-cooled	DC: 125 A at 100% duty cycle AC: 80 A at 100% duty cycle	.040-3/32 in. (1.0-2.4 mm)

Weldcraft™ Automation Series

See literature AY/37.0



Air-cooled and water-cooled torches designed for low- and high-amperage mechanized applications.

Minimize downtime associated with tungsten changeover by using the front or back tungsten loading areas.

Built-in gas lens (W-500A Automation and W-500B Automation) improves gas coverage to minimize shielding gas turbulence and improve weld quality.

Handle the most demanding high-amperage applications (W-500A Automation and W-500B Automation).

Applications

- Aerospace
- Food/beverage industry
- Pressure vessel fabrication
- Petro/chemical

Most popular accessories

- Cable Covers
 - WC-3-10 10 ft. (3 m)
 - WC-3-22 22 ft. (6.7 m)
 - WC-4-10 10 ft. (3 m)
 - WC-4-22 22 ft. (6.7 m)



- **Air-Cooled Torch 1-Piece Power Cable Connector** (pg 129)
 - 195378 50 mm Dinse-style



- **Water-Cooled Torch 1-Piece Power Cable Connectors** (pg 129)
 - 195377 50 mm Dinse-style
 - 225028 50 mm thread-lock

Visit MillerWelds.com or your distributor for other Miller® options and accessories.

Model	Rubber, 12.5 ft. (3.8 m)		2-Piece Rubber, 12.5 ft. (3.8 m)			Type	Rated Output	Electrode Range
A-150 Automation	WP-23A-12-R		WP-23A-12-2			Air-cooled	DC: 150 A at 60% duty cycle AC: 120 A at 60% duty cycle	.040-3/32 in. (1.0-2.4 mm)
Model	Rubber 3 ft. (0.9 m) 12.5 ft. (3.8 m)		Vinyl 3 ft. (0.9 m) 12.5 ft. (3.8 m) 25 ft. (7.6 m)			Type	Rated Output	Electrode Range
W-250 Automation	—	—	WP-22A-3	WP-22A-12	WP-22A-25	Water-cooled	DC: 250 A at 100% duty cycle AC: 180 A at 100% duty cycle	.040-1/8 in. (1.0-3.2 mm)
W-500A Automation	WP-27A-3	WP-27A-12	—	—	—	Water-cooled	DC: 500 A at 100% duty cycle AC: 350 A at 100% duty cycle	.040-1/4 in. (1.0-6.4 mm)
W-500B Automation	WP-27B-3	WP-27B-12	—	—	—	Water-cooled	DC: 500 A at 100% duty cycle AC: 350 A at 100% duty cycle	.040-1/4 in. (1.0-6.4 mm)

Weldcraft™ Tungsten

Tungsten for the most demanding TIG welding applications!

Available in four types and industry-standard diameters, our line of Weldcraft tungsten electrodes has undergone rigorous testing to ensure the highest quality and durability. Color-coded packages include ten 7-inch (175 mm) tungsten electrodes.

Type	Stock Number	Diameter in. (mm)	Type	Stock Number	Diameter in. (mm)
2% Ceriated (EWCe-2)			Pure (EWP)		
Performs well in DC welding and arc starting at low-current settings. Offers excellent performance in AC processes.	WC040X7	0.040 (1.0)	Forms a clean, balled end when heated. Provides good arc stability for AC welding with a balanced or unbalanced squarewave or sine wave.	—	0.040 (1.0)
	WC116X7	1/16 (1.6)		WP116X7	1/16 (1.6)
	WC332X7	3/32 (2.4)		WP332X7	3/32 (2.4)
	WC018X7	1/8 (3.2)		WP018X7	1/8 (3.2)
WC532X7	5/32 (4.0)	—	5/32 (4.0)		
2% Lanthanated (EWLa-2)			Rare Earth (EWG)		
Provides excellent arc starting, arc stability and re-ignition, and less tip erosion in AC or DC welding. Can substitute for 2% Thoriated.	WL2040X7	0.040 (1.0)	Combines the best of all alloying elements, and provides excellent arc stability in AC or DC welding.	—	0.040 (1.0)
	WL2116X7	1/16 (1.6)		WG116X7	1/16 (1.6)
	WL2332X7	3/32 (2.4)		WG332X7	3/32 (2.4)
	WL2018X7	1/8 (3.2)		WG018X7	1/8 (3.2)
	WL2532X7	5/32 (4.0)		—	5/32 (4.0)



Note: Refer to manufacturer SDS sheets for proper preparation and safety. Use proper ventilation/capture during preparation. Refer to manufacturer warning regarding ventilation.

Weldcraft™ TIG Torch Accessories

GL Kits (Gas Lens Kits)

Gas lenses improve the gas coverage of the tungsten during the TIG welding process. They can save you time and money by increasing your weld quality while using less gas. GL kits provide three different-sized gas lenses and consumables in each kit to work with a variety of different applications.



alumina nozzle, and one of each size (1/16, 3/32, 1/8 inch) of the following: gas lens, collet, and 7-inch 2% ceriated tungsten electrode.



back cap, one of each size (#6, #7, #8) alumina nozzle, and one of each size (1/16, 3/32, 1/8 inch) of the following: gas lens, collet, and 7-inch 2% ceriated tungsten electrode.

AK Kits (Accessory Kits)

AK kits provide a set of different consumables for Weldcraft torches to tackle a variety of different applications. Kits include nozzles, collets, collet bodies, tungsten and back caps.



one of each size (.040, 1/16 inch) of the following: collet, collet body, and 7-inch 2% ceriated tungsten electrode.



size (.040, 1/16, 3/32 inch) of the following: collet, collet body, and 7-inch 2% ceriated tungsten electrode.



and 7-inch 2% ceriated tungsten electrode.



one of each size (#5, #6, #7) alumina nozzle, and one of each size (1/16, 3/32, 1/8 inch) of the following: collet, collet body, and 7-inch 2% ceriated tungsten electrode.



collet, one of each size (.020-1/8 inch, 1/8-3/16 inch) collet body, and one of each size (3/32, 1/8, 5/32 inch) 7-inch 2% ceriated tungsten electrode.



nozzle, and one of each size (.040, 1/16 inch) of the following: 180-degree chuck, 45-degree chuck, 90-degree chuck, and 7-inch 2% ceriated tungsten electrode.



application. Kit converts into 28 different torch styles while using the A-125 and A-150 existing cable. Features collets, collet bodies, nozzles, torch heads, handle and more.



handle and more.



Also includes the following ten collets: (1) .040, (3) 1/16, (3) 3/32, (2) 1/8, (1) 5/32; and eight collet bodies: (1) .040, (2) 1/16, (2) 3/32, (2) 1/8, (1) 5/32.

AK4C

For W-250 Series, W-280 Super Cool and W-375 Super Cool. Includes

AK18C

For W-400 Super Cool. Includes one short back cap, one of each size (#6, #7, #8) alumina nozzle, one

AK125C

For W-125 Long Micro. Includes one of each size (180°, 45°, 90°, 90° short) glass

AK150MFC

For A-125 Series, A-150 Series and A-150 Modular Series. Allows welding operators to customize their standard A-125 (WP-9) or A-150 (WP-17) TIG torch for their specific

AK225MFC

For W-225 Modular. Includes five additional torch heads, collets, collet bodies, nozzles, handle and more.

MAK2S

For W-350 Series. Includes one short and one long back cap, four back cap o-rings, two cup gaskets, one gas lens insulator, and one of each size (.040, 1/16, 3/32, 1/8 inch) gas lens.

Quick Connects



QRG

Allows for quick connection and removal of torch shielding gas hoses.



QRW

Allows for quick connection and removal of torch coolant hoses.

Cable Covers



WC-3-10 10 ft. (3 m)

WC-3-22 22 ft. (6.7 m)

WC-3-48 48 ft. (14.6 m)

Cable covers protect the welding cables from the day-to-day wear and tear of common welding

environments. Available in 10-foot, 22-foot, and 48-foot lengths, these covers can help prevent the frequent replacement of expensive welding cables.

Remote Controls

See pages 128-129 in Accessories section for stock numbers and more information.



East/west rotary-motion fingertip current/contactor controls.



North/south rotary-motion fingertip current/contactor controls.



Foot pedal current/contactor controls.



Miniature hand current/contactor controls.



Momentary- and maintained-contact rocker switch for contactor control.



Momentary-contact switch for contactor controls.



Remote on/off control.



For more detailed information, visit

MillerWelds.com/insight

Welding Intelligence™



Insight Welding Intelligence™: The Total Welding Data Solution

With an Insight weld monitoring system you can get more done, produce higher-quality welds and control costs.



Complete coverage for any application.



Manufacturing



Automation



Submerged arc

Choose the Right Welding Intelligence System

		<i>Insight</i> Core™	<i>Insight</i> Centerpoint™	<i>Insight</i> ArcAgent™
For Use With	Factory-Installed	<ul style="list-style-type: none"> Continuum™/Auto-Continuum™ (standard) Deltaweld® (optional) 	<ul style="list-style-type: none"> Continuum™/Auto-Continuum™ (optional) 	<ul style="list-style-type: none"> ANY welding power source (old or new) ANY brand ANY welding process
	Field-Installed/Activated	<ul style="list-style-type: none"> 14-pin compliant power source (see MillerWelds.com/insight) 	<ul style="list-style-type: none"> Continuum™/Auto-Continuum™ 	
Requirements		<ul style="list-style-type: none"> Internet connection (wired/wireless) 	<ul style="list-style-type: none"> PC and Ethernet connection 	<ul style="list-style-type: none"> See <i>Insight</i> ArcAgent literature WI/1.0
What Capability Do You Need?		<ul style="list-style-type: none"> Productivity monitoring Weld parameter verification Goal setting Analytic tools 	<ul style="list-style-type: none"> Ensure quality welds Reduce missed welds Minimize overwelding/underwelding Electronic work instructions 	<ul style="list-style-type: none"> Universal solution for use with <i>Insight</i> Centerpoint
Data Storage		<ul style="list-style-type: none"> Cloud based 	<ul style="list-style-type: none"> Local server or PC 	<ul style="list-style-type: none"> See <i>Insight</i> ArcAgent literature WI/1.0

Insight Core™

Reports welding productivity from a web-based application to measure and improve your operation.

Helps you answer

- Who is your most productive operator?
- What is your most productive welder, station, cell?
- Are your quality risks increasing or decreasing?
- What are your true welding costs?



Software features

Measures productivity.

See each welder's arc-on time to set baselines, plan improvements and measure goals.

Reports. Easy-to-understand dashboards show trends and develop reports. Compare welders, cells and plants.

Easily install and use.

Just connect it to the internet. View secure data on any web-connected device anywhere.

Analytics tools. Business analytic tools allowing for weld data analysis based on individual/cell performance as well as overall financial terms.

Notifications. Email/text notifications based on your desired frequency and subject.

Multiple languages available.

English, German, Spanish, French, Italian, Dutch, Portuguese and Chinese.

How it works

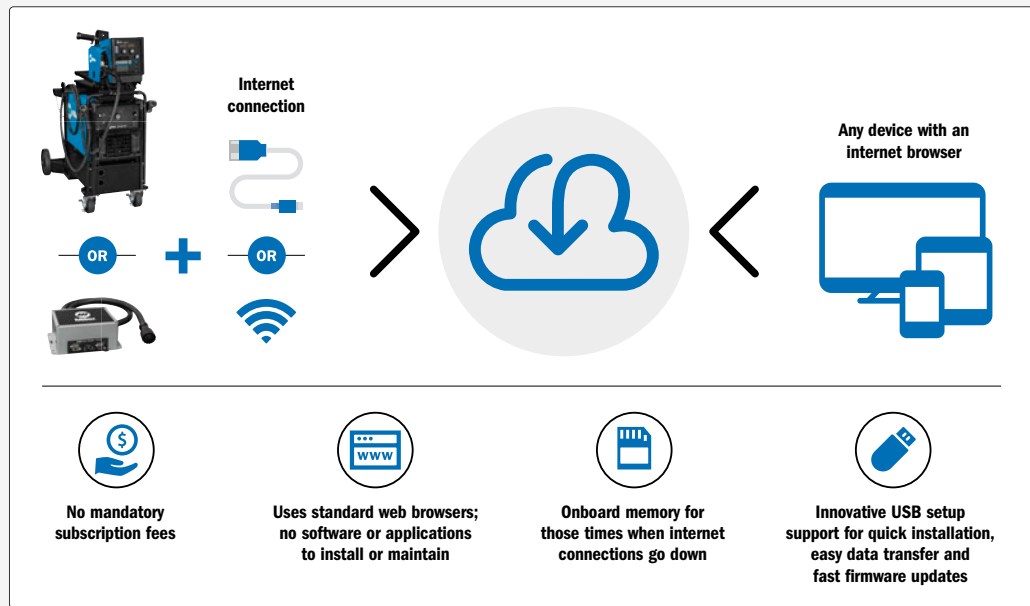

For more information: Email insight@MillerWelds.com

¹ Additional stock numbers are available – visit MillerWelds.com/insight.

² SubArc Digital Series also requires Insight Core to SubArc Digital Series Adapter Kit (301295).

Type	Power Sources ¹			Miller 14-Pin Compliant Power Sources
Factory-Installed Insight Core	Deltaweld® 350 907747002 208/230/460 V Deltaweld® 500 907785002 208/230/460 V Deltaweld® 500 907786002 575 V	Continuum™ 350 907636 230–575 V Continuum™ 500 907640 230–575 V	Auto-Continuum™ 350 907656 230–575 V Auto-Continuum™ 500 907657 230–575 V	–
Field-Installed Insight Core	–			Requires Insight Core 14-pin module 301072² See MillerWelds.com/insight for a list of 14-pin compatible power sources

Insight Centerpoint™

Real-time welder feedback that provides guidance and control within the weld cell, ensuring consistent quality.

Helps you

- Present welders with step-by-step work instructions
- Identify the impact of non-welding activities
- Eliminate missing or poor welds
- Identify the true cost of a welded component

Version 10

- Designed for ease of use
- Faster start up time
- Drastically shortened learning curve



Software features

Reduce training time.

Part Tracking™ guides welders through the weld sequence in real time, using visualizations of the part.

Ensure quality welds. Contain weld defects early and control your weld operation by monitoring every parameter of every weld.

Reduce costs. Alert welders if a weld is missed or is outside of acceptable parameters, allowing it to be corrected cost-effectively.

WorkFlow™. Gain additional control with documentation through embedded videos, images, audio and other file types.

How it works

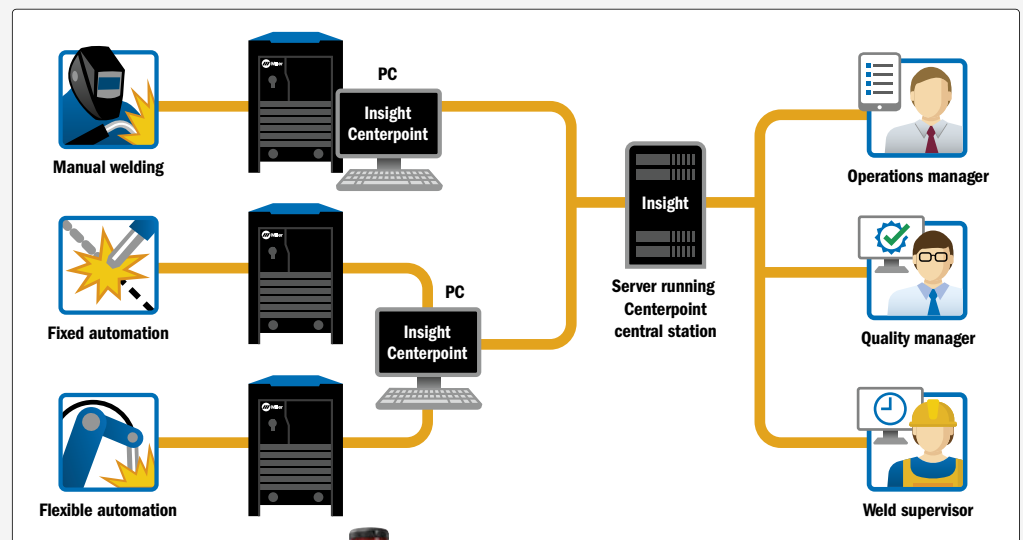

Universal brand capability

With an ArcAgent™ module, customers can have the power of Insight Centerpoint on any machine from any manufacturer.

For more information: Email insight@MillerWelds.com

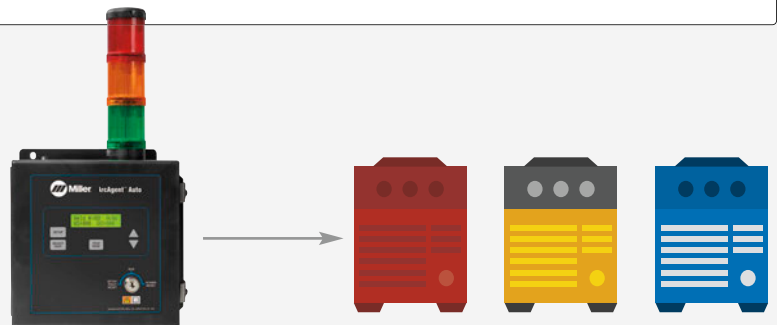

¹ Additional stock numbers are available – visit MillerWelds.com/insight.

Type	Power Sources ¹	Universal Adaptability (works with ALL brands/models of power sources)	Insight Centerpoint Software	Accessories	Field Application Support	
Optional Factory-Installed Insight Centerpoint	Continuum™ 350 907636 230-575 V Continuum™ 500 907640 230-575 V	Auto-Continuum™ 350 907656 230-575 V Auto-Continuum™ 500 907657 230-575 V	–	951809	Insight LTD Gun Q4015JS3EML For Continuum Insight LTD Remote 301383	195480 Miller field support – contact distributor for details
Field-Installed Insight Centerpoint	–	Requires ArcAgent Manual or Auto 301345 Manual with Insight torch capability 301346 Auto	301485	M12/RJ45 Ethernet Cables 300734 9.8 ft. (3 m) 300736 32.8 ft. (10 m)		



Engine-Driven

For more detailed information, visit



MillerWelds.com/enginedriven



Product Guide

	Page	Class	Stick	MIG	Flux-cored*	AC TIG	DC TIG	PAC**	CAC-A	Portability	Weldable Metals	Continuous Generator Pwr. (watts)	Welding Amperage Range	Engine Brand	Special Features	Typical Applications	
Gasoline	Fusion 185	77	●	●				●		Optional lift eye or running gear	Steel	6,200	30-185 DC	Kohler	Portable, PowerShift technology, inverter stick	Maintenance, construction, repair, service trucks,	
	Blue Star® 185	77	●	●				●	●				60-195 DC	Kohler	Compact		
	Bobcat™ 200 Air Pak™	79	●	●	●	●	●	●	●	Lift eye, optional running gear or trailer	Steel, stainless, aluminum	6,500	30-210 DC	Kohler	Air compressor, battery charge/crank assist, Auto-Speed™, inverter CC/CV	Service trucks, repair, maintenance, farm/ranch	
	Bobcat™ 225	80	●	●	●	●	●	●	●			9,500	60-160 AC 40-225 DC	Kohler	Remote start/stop, cost-effective AC/DC stick	Maintenance, farm/ranch, construction	
	Bobcat™ 3 Phase	80	●	●	●	●	●	●	●				3-ph: 10,000 1-ph: 9,500	40-225 AC 40-210 DC	Kohler	3-phase power for pivot irrigation	Farm/ranch
	Trailblazer® 325	82	●	●	●	●	●	●	●	3/16"		Steel, stainless	10,500	10-325 DC	Kohler	ArcReach®, Auto-Speed™; optional wireless interface control, EFI, Excel™ power, battery charge/crank assist	Fab, maintenance, structural, repair, pipe
	Trailblazer® 302 Air Pak™	84	●	●	●	●	●	●	●	3/16"		Steel, stainless, aluminum	11,000	10-225 AC 10-350 DC	Kohler	AC/DC, CC/CV, air compressor, battery charge/crank assist	Service/maintenance, construction
Gas or LP	Bobcat™ 260	80	●	●	●	●	●	●	3/16"	Lift eye, optional running gear or trailer	Steel, stainless, aluminum	9,500	40-260 DC	Kohler	Most popular engine drive, remote start/stop on gas models, AC/DC	Fab, maintenance, farm/ranch, construction	
Diesel	Bobcat™ 200 Air Pak™ Diesel	79	●	●	●	●	●	●		Lift eye, optional running gear or trailer	Steel, stainless, aluminum	6,500	30-210 DC	Kubota	Air compressor, battery charge/crank assist, Auto-Speed™, inverter CC/CV	Service trucks, repair, maintenance, farm/ranch	
	Trailblazer® 325 Diesel	82	●	●	●	●	●	●	3/16"		Steel, stainless	10,500	10-325 DC	Kubota	ArcReach®, Auto-Speed™; optional wireless interface control, Excel™ power	Fab, maintenance, structural, repair, pipe	
	Big Blue® 400 Pro	84	●	●	●	●	●	●	3/16"	Lift eye, optional trailer	Steel, stainless	10,000	20-400 DC	CAT, Kubota, Mitsubishi	Quiet, compact, fuel efficient; optional wireless interface control, ArcReach®	Construction, repair	
	Big Blue® 400 PipePro®	85	●	●	●	●	●	●	1/4"				20-400 DC	CAT, Mitsubishi	Wireless interface control, ArcReach®, Line-X® top cover, lift-off service door; optional stainless steel	Cross country pipeline	
	Big Blue® 450 Duo CST™	85	●	●			●	●	3/16"				5-450 DC	Mitsubishi	Dual operator in a compact package	Construction, fabrication, pipe	
	Big Blue® 500 Pro	86	●	●	●	●	●	●	5/16"	Lift eye, generally mounted on optional trailer	Steel, stainless	3-ph: 20,000 1-ph: 12,000	20-500 DC	Kubota	Quiet, fuel efficient; optional ArcReach®, wireless interface control	Construction, repair	
	Big Blue® 600 Series	86	●	●	●	●	●	●	3/8"				20-600 DC	Kubota (Pro), Deutz (Air Pak)	Quiet, powerful, fuel efficient; optional ArcReach®, wireless interface control – Air Pak™ model has ArcReach® standard and adds air compressor	Construction, repair, maintenance, mining, rail	
	Big Blue® 800 Series	87	●	●	●	●	●	●	1/2"				20-800 DC	Deutz	ArcReach®, dual operator; optional wireless interface control – Air Pak™ model adds air compressor	Construction, repair, maintenance, mining, rail	

Product Key

Class: ● Light industrial ● Industrial ● Heavy industrial Capability: ● Designed for this process ● Capable of this process
 NEW! products appear in blue type. *If using self-shielded wire, use CV weld output. **With appropriate Spectrum plasma cutter.

NEW! Fusion 185 See literature ED/2.9

Delivers a smooth, stable arc from either engine power or 120/240-volt utility power, providing a unique combination of versatility and productivity in a lightweight package.



POWER SHIFT

Work anywhere convenience. PowerShift technology provides weld capabilities using either the Fusion 185 gasoline engine or 120/240-volt utility power. You'll have the confidence of knowing

that you can weld virtually anywhere with just one machine – outdoors with engine or utility power and indoors with utility power. The multi-voltage plug (MVP™) makes it easy to connect the welder to either 120- or 240-volt power.

Easier to transport. At only 242 pounds, the Fusion 185 is up to 45 pounds lighter than similar machines, so moving it is easier and faster. Less time is spent waiting, and more work can get done.

Less rework. Inverter technology delivers a smooth, stable stick arc that's forgiving of variations in arc length and travel speed, so it's easier to produce clean welds that meet specifications – and avoid the time and expense of rework.

Light industrial ● **CC DC** 1 Phase

Process

- Stick (SMAW)

Gasoline engine

Kohler CH440: 13.4 hp at 3,600 rpm
One-cylinder, four-cycle, OHV, air-cooled

Note: Engine is warranted separately by engine manufacturer.

Most popular accessories

- Lifting Eye 195353 (pg 124)
- Running Gear 301246 (pg 124)
- Twist Lock Adapter Cord 301489 (pg 124)
- Protective Cover 301245 (pg 124)

Visit MillerWelds.com or your distributor for other Miller® options and accessories.

Gasoline	Stock Number	Input Power	Welding Mode	Welding Process	Amperage Range	Rated Output at 104°F (40°C)	Amps Input at Rated Output, 50/60 Hz, 1-Phase	Single-Phase Generator Power at 104°F (40°C)	Dimensions	Net Weight									
	907781										Engine power	CC/DC	DC stick	30-185	185 A at 26.4 V, 20% duty cycle 110 A at 24.4 V, 100% duty cycle	–	Peak: 6,500 watts (629 mm) Continuous: 6,200 watts	H: 24.75 in. (629 mm) W: 20.125 in. (511 mm) D: 31.25 in. (794 mm)	242 lb. (110 kg)
											PowerShift 120 V			30-100	90 A at 23.6 V, 40% duty cycle	22.7	–		
											PowerShift 240 V			30-185	185 A at 26.4 V, 20% duty cycle 110 A at 24.4 V, 100% duty cycle	25.0	–		

Blue Star® 185 See literature ED/2.5

Reliable outdoor portable power – great for farm, ranch, maintenance, construction and hobbyists.



Compact and portable. With a small footprint, the Blue Star uses little truck space. Optional running gear also makes it one-man portable.

All engine controls are on front panel.

Stick and TIG capable.

Accu-Rated™ peak generator power is usable for maximum generator loads such as plasma cutting, Millermatic® MIG welders and motor starting.

Includes electric start, 120-volt GFCI and 240-volt receptacles, 6.25-gallon fuel capacity, auto-idle and engine hour meter.

Light industrial ● **CC DC**

Processes

- Stick (SMAW) ▪ TIG (GTAW)

Gasoline engine

Kohler CH440: 13.4 hp at 3,600 rpm
One-cylinder, four-cycle, OHV, air-cooled

Note: Engine is warranted separately by engine manufacturer.

Most popular accessories

- Lifting Eye 195353 (pg 124)
- Running Gear 301246 (pg 124)
- Protective Cover 301245 (pg 124)

Visit MillerWelds.com or your distributor for other Miller® options and accessories.

Gasoline	Stock Number	Welding Mode	Welding Process	Amperage Range	Rated Output at 104°F (40°C)	Single-Phase Generator Power at 104°F (40°C)	Dimensions	Net Weight
	907664							

Bobcat™/Trailblazer® Gas Model Comparison – Which is Right for You?

*Based on typical usage – 150 amps welding 40% of the time; 20 amps generator power 30% of the time; and idling without load 30% of the time.

Bobcat: The most popular welder/generator

- Dependable power and weld output
- Cost-effective multiprocess welder/generator
- Easy to maintain
- Quietest in its class



Trailblazer: The best performer in the industry

- Unbeatable arc performance
- Independent welder and generator power system
- Exclusive technologies – Auto-Speed™ and Excel™ power
- Most fuel efficient and quietest in its class



Sound Levels (at 23 feet)	Bobcat 225 (page 80)	Bobcat 260 (page 80)	Trailblazer 325 (page 82)
At Maximum Load/ At 150 Amps	73.5 dB / 72 dB	72.5 dB / 72 dB	74 dB/65 dB
Sound Quality	Good	Very good	Excellent
Fuel System			
Typical Runtime per 12-Gallon Tank*	13 hours	13 hours	Up to 21 hours with options
Efficiency	Good	Good	Excellent
Type	Gasoline	Gasoline or LP	Gasoline
Delivery	Carburetor	Carburetor	Carburetor or EFI available
Generator			
Peak Watts	11,000 watts	11,000 watts	12,000 watts
Clean Power Quality	Very good/ Excellent	Very good/ Excellent	Excellent
Power While Welding	Fair/ Good – With voltage control set near maximum	Good – Easier to fine-tune with arc voltage control near maximum	Independent weld and generator power with no interaction between tools and welding arc
Excel™ Power Generator (120 V, 60 Hz at all engine speeds)	–	–	Excel power available
Weld Performance			
Stick	Good/ Very good	Very good	Excellent
MIG – Wire (solid/ FCAW), Steel	Fair (.035 in.)	Good (.035–1/16 in.)	Excellent (.023–1/16 in.)
MIG – Wire, Aluminum w/ Spool Gun	Fair/ Good (add WC-115A with contactor)	Very good (add WC-115A with contactor)	Excellent (add WC-24)
DC TIG (steel)	Good	Very good	Excellent
AC Weld	60–160 amps	40–260 amps	Add Dynasty® (page 61)
Carbon Arc Gouging	–	Good Carbons: Rated 3/16 in.	Very good Carbons: Rated 3/16 in., Capable 1/4 in.
Key Features			
Digital Meters	–	–	With Sunvision™
Maintenance Displays	Hours/ Oil change	Hours/ Oil change/ Fuel	Hours/ Oil change/ Fuel/ rpm
Battery Charge/ Crank Assist	–	–	12 and 24 volt available
14-pin Receptacle	–	–	With Auto Remote Sense™
Remote Capabilities	Remote start/stop standard	Remote start/stop standard (on gas model)	ArcReach technology standard (on most models) Wireless interface control available

Bobcat™/Trailblazer®/Big Blue® Air Pak™ Comparison – Which is Right for You?

Cost-effective welder/generator/air compressor/battery charger



Bobcat 200 Air Pak (page 79)

AC/DC multiprocess welder/generator/air compressor/battery charger



Trailblazer 302 Air Pak (page 84)

Quiet and powerful multiprocess welder/generator/air compressor



Big Blue 600 Air Pak (page 86)

Heavy-duty, dual-operator welder/generator/air compressor



Big Blue 800 Duo Air Pak (page 87)

Compressed Air	Bobcat 200 Air Pak (page 79)	Trailblazer 302 Air Pak (page 84)	Big Blue 600 Air Pak (page 86)	Big Blue 800 Duo Air Pak (page 87)
Battery Charge/Crank Assist	12 and 24 volt	12 and 24 volt	–	–
Generator Power	Single-phase	Peak: 8,000 watts Continuous: 6,500 watts	Peak: 13,000 watts Continuous: 11,000 watts	Peak: 15,000 watts Continuous: 12,000 watts
	Three-phase	–	–	Peak: 27,000 watts Continuous: 20,000 watts
Weld Output Range	30–210 amps (CV/DC, CC/DC)	10–300 amps (CV/DC, CC/DC, CC/AC)	20–600 amps (CV/DC, CC/DC)	Single weld mode: 40–800 amps Dual weld mode: 20–400 amps (CV/DC, CC/DC)
Fuel Type	Gas/Diesel	Gas	Diesel	Diesel
Size	29.78 x 20 x 44.61 in. (gas) 29.75 x 20 x 47.25 in. (diesel)	28 x 20 x 59.625 in.	46 x 28.5 x 69.5 in.	46 x 28.5 x 69.5 in.
Weight	514 lb. (gas), 618 lb. (diesel)	771 lb.	2,040 lb.	2,095 lb.
Remote Capabilities	–	–	ArcReach technology standard Wireless interface control available	ArcReach technology standard Wireless interface control available

Bobcat™ 200 Air Pak™ Gas or Diesel See literature ED/4.36

Quiet, fuel-efficient all-in-one that maintains power capabilities in a compact, lightweight footprint and is backed by industry-leading reliability and performance.



Bobcat 200 Air Pak (gas)

Bobcat 200 Air Pak Diesel

Maximize available payload. Reduce weight by up to 600 pounds and increase available payload by up to 24 cubic feet by reducing the equipment on the truck.

Reduce fuel consumption. Minimize fuel costs by reducing truck engine idle time by as much as 75 percent, or if you have a separate engine-driven compressor by only operating one engine.

Minimize operating costs. Potentially save more than \$50,000 over ten years from increased fuel efficiency, decreased maintenance costs and increased asset life.

Advanced Auto-Speed™ technology automatically adjusts engine speed to match weld and battery charge demands – reducing fuel consumption, maintenance costs and noise for more efficient jobsites.

Industrial rotary-screw air compressor. Easily outperforms and outlasts reciprocating compressors. Many air tools can be powered by the compressor including most 3/4-inch impact wrenches. Immediately supplies 30 cfm at 175 psi, 100 percent duty cycle, continuous air output.

210-amp welder. Maximize downtime and delays by making metal repairs in the field to stay on schedule.

6,500-watt generator power to support jobsite tools, lights, and high-demand applications like plasma cutters and TIG welders.

Battery charge/crank assist. Provides up to 100 amps at idle to quickly charge 12- and 24-volt batteries. Jobsite equipment with weak batteries can get up to 300 amps of crank assist.

Industrial 

Process

- Stick (SMAW) • MIG (GMAW)¹
- Flux-cored (FCAW)¹ • DC TIG (GTAW)²

¹ With voltage-sensing feeder.

² Two-piece TIG torch recommended.

Engines

EFI gas: Kohler ECH730

23.5 hp at 3,600 rpm
Twin-cylinder, four-cycle, overhead valve, industrial, air-cooled

EPA Tier 4 Final Diesel: Kubota D722

19 hp at 3,600 rpm
Three-cylinder, industrial, liquid-cooled

Note: Engines are warranted separately by engine manufacturer.

Most popular accessories

- ArcReach® SuitCase® Feeders (pg 18)
- Spoolmate™ 200 300497 (pg 29)
- Spoolmatic® 30A 130831 (pg 30)
- Spectrum® 375 X-TREME™ (pg 96)
- Multi-Terrain Running Gear 301460 (pg 124)
- Full KVA Adapter Cord 300517 (pg 124)
- Protective Cover (pg 124)
 - 301475 Gas without running gear
 - 301476 Gas with running gear
 - 301531 Diesel without running gear
 - 301532 Diesel with running gear
- Remote Output Panel Kit 951850 (pg 124)
- HWY-Mid Frame Trailer 301438 (pg 125)
- 25 ft. Battery Charge/Jump Cables with Plug 300422
- Air Compressor Oil Heater 301448
- Air Dryer Kit 301488
- Spool Gun Extension Hose and Cable Kit 132228

Visit MillerWelds.com or your distributor for other Miller® options and accessories.

	Model/Stock Number	Welding Mode	Welding Process	Amp/Volt Ranges	Rated Weld Output at 104°F (40°C)	Single-Phase Generator Power at 104°F (40°C)	Dimensions	Net Weight	
Gasoline	Bobcat 200 Air Pak 907771 Kohler	CC/DC	DC stick/TIG	30-210 A	120 A at 25 V, 100% duty cycle 140 A at 26 V, 60% duty cycle 210 A at 28 V, 20% duty cycle	Peak: 8,000 watts Continuous: 6,500 watts	H: 24.25 in. (616 mm) H: 29.78 in. (756 mm) to top of exhaust W: 20 in. (508 mm) D: 44.61 in. (1,133 mm)	514 lb. (233 kg)	
		CV/DC	MIG/FCAW	15-26 V	120 A at 20 V, 100% duty cycle 140 A at 21 V, 60% duty cycle 210 A at 25 V, 20% duty cycle				
Diesel	Bobcat 200 Air Pak Diesel 907760 Kubota	CC/DC	DC stick/TIG	30-210 A	120 A at 25 V, 100% duty cycle 140 A at 26 V, 60% duty cycle 210 A at 28 V, 20% duty cycle	Peak: 8,000 watts Continuous: 6,500 watts	H: 28.875 in. (734 mm) H: 29.75 in. (756 mm) to top of exhaust W: 20 in. (508 mm) D: 47.25 in. (1,200 mm)	618 lb. (280 kg)	
		CV/DC	MIG/FCAW	15-26 V	120 A at 20 V, 100% duty cycle 140 A at 21 V, 60% duty cycle 210 A at 25 V, 20% duty cycle				
Rotocomp Air Compressor		Features			Free Air Delivery		Working Pressure	Duty Cycle	Oil Capacity
		Rotary screw with electric clutch for on/off, oil change intervals of 500 hours			30 cfm (0.85 m ³ /min.) at 3,600 rpm		80-175 psig	100%	2 qt. (1.89 L)

Bobcat™ Series Gas or LP



Reliable, powerful and durable –
the legendary Bobcat welder/generator.

Remote start/stop

Take control and eliminate engine noise. Standard on most models (see page 81 chart for exceptions). Easily turn your Bobcat machine on and off remotely so it only runs when you need it. Get more out of each tank, extend time between maintenance and work without the hassle of walking back to your machine.

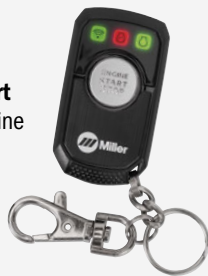

Easier and more reliable engine starts

Carbureted gas Bobcat welder/generators now have eChoke technology, which automatically sets the proper air/fuel mixture and eliminates the need to manually engage the choke, so cold-starting is now hands free.

eChoke is a trademark of Kohler Co.



Versatile AC and DC welding

Provides AC and DC welding output for greater versatility and quality welds on all types of metals. DC is smooth and easy to run while AC stick is used when arc blow occurs.

Compact design

Bobcat welder/generators can easily be moved around and take up less space, leaving more room on your truck for other equipment and tools.

Savings on fuel and maintenance

Remote start/stop allows you to quickly turn off your Bobcat welder/generator when it is not in use. With fewer engine hours, you will spend less money on fuel and less time and money on maintenance.

Less noise

Reduce the number of machines running on a jobsite and increase your awareness of potential warning sounds when you easily turn your Bobcat welder/generator off with remote start/stop.

SAVE UP TO **\$1,500**
ANNUALLY ON FUEL AND MAINTENANCE BY SHUTTING THE MACHINE OFF.

0dB
WHEN YOU DON'T NEED POWER, TURN THE MACHINE OFF REMOTELY.

Bobcat™ 225 (Gas) See literature ED/4.41

Cost-effective, multiprocess welder/generator primarily used for stick welding. Great for farm, ranch and maintenance/repair.

Features three DC stick/TIG controls, one AC stick/TIG control and one wire range for output control. Stick ranges designed for 3/32, 1/8 and 5/32 inch. Very easy to set.



Bobcat™ 3 Phase (Gas) See literature ED/4.33

Designed for farm and ranch owners in need of single- and three-phase power to run 480-volt three-phase pivot irrigation systems or to provide backup power for farm and/or ranch.

Bobcat™ 260 (Gas or LP) See literature ED/4.42

MOST POPULAR! Multiprocess welder/generator capable of carbon arc gouging features a larger stabilizer for less spatter and smoother arc. Ideal welder/generator for maintenance/repair, construction or farm/ranch.

Convenient front panel fuel gauge.

Precise amperage settings with wide range for optimal stick/flux-cored welding.

Features four AC/DC stick/TIG controls and two wire ranges for output control. Stick ranges designed for 3/32, 1/8, 5/32 and 3/16 inch. Very easy to set.



Industrial 

Processes

- AC/DC stick (SMAW)
- MIG (GMAW)¹ = Flux-cored (FCAW)¹
- AC²/DC TIG (GTAW)
- Air carbon arc cutting and gouging (CAC-A)³ (rated 3/16 in. carbons)

¹With voltage-sensing feeder.

²With Dynasty® 210 Series.

³Bobcat 260 models only.

Engines

Gas: Kohler CH730 with eChoke™

23.5 hp at 3,600 rpm

LP: Kohler CH730

Liquid withdrawal LP system

21.5 hp at 3,600 rpm

V-twin-cylinder, four-cycle, overhead valve, industrial, air-cooled

Note: Engines are warranted separately by engine manufacturer.

Most popular accessories

- ArcReach® SuitCase® Feeders (pg 18)
- Dynasty® 210 Series (pg 61)
- Spectrum® 625 X-TREME™ (pg 96)
- Running Gear (pg 124)
- Protective Cage with Cable Holders (pg 124)
- Hose and LP Tank Mounting Assembly (pg 124)
- Remote Oil Drain/Filter Kit (pg 124)
- Full KVA Adapter Cord 300517 (pg 124)
- Protective Cover (pg 124)
- Remote Output Panel Kit 951850 (pg 124)
- HWY-Mid Frame Trailer (pg 125)
- Remote Start/Stop Fob Replacement 286385
- GFCI Panel Mount 120 VAC Duplex Kit 300975
- Electric Fuel Pump Kit 300976 (gas models only, recommended for operation at altitudes above 5,000 ft.)
- Spark Arrestor Kit 300924

Visit MillerWelds.com or your distributor for other Miller® options and accessories.

*Electric fuel pump recommended for operation at altitudes above 5,000 feet.

**For LP model order Hose and LP Tank Mounting Assembly (300917) separately.

	Model	Stock Number	Welding Mode	Welding Process	Amp/Volt Ranges	Rated Output at 104°F (40°C)	Generator Power at 104°F (40°C)	Dimensions	Net Weight
Gasoline	Bobcat 225	907791001 Kohler 907791 Kohler with GFCI	CC/AC	Stick/TIG	60-160 A	150 A at 25 V, 100% duty cycle	Single-phase Peak: 11,000 watts Continuous: 9,500 watts	H: 28 in. (711 mm) H: 32.75 in. (832 mm) to top of exhaust W: 20 in. (508 mm) D: 40.5 in. (1,029 mm)	485 lb. (220 kg)
			CC/DC	Stick/TIG	40-225 A	225 A at 25 V, 100% duty cycle			
			CV/DC	MIG/FCAW	19-28 V	200 A at 20 V, 100% duty cycle			
	Bobcat 3 Phase	Non-remote start/stop model 907505 Kohler with GFCI	CC/AC	Stick/TIG	40-225 A	200 A at 25 V, 100% duty cycle	Single-phase/three-phase Peak: 11,000 watts Continuous: 9,500/10,000 watts		495 lb. (225 kg)
			CC/DC	Stick/TIG	40-210 A	210 A at 25 V, 100% duty cycle			
			CV/DC	MIG/FCAW	19-28 V	200 A at 20 V, 100% duty cycle			
Gas or LP	Bobcat 260	907792001 Kohler 907792 Kohler with GFCI 907792002 Kohler with electric fuel pump* Non-remote start/stop model 907794** LP Kohler with GFCI	CC/AC	Stick/TIG	40-260 A	260 A at 25 V, 60% duty cycle 225 A at 25 V, 100% duty cycle	Single-phase Peak: 11,000 watts Continuous: 9,500 watts	H: 28 in. (711 mm) H: 32.75 in. (832 mm) to top of exhaust W: 20 in. (508 mm) D: 40.5 in. (1,029 mm)	501 lb. (227 kg)
			CC/DC	Stick/TIG	40-260 A	260 A at 25 V, 100% duty cycle			
			CV/DC	MIG/FCAW	17-28 V	275 A at 25 V, 60% duty cycle 260 A at 28 V, 100% duty cycle			

Trailblazer® Series Gas or Diesel

See lit. ED/4.75 (Gas) and ED/4.8 (Diesel)



Trailblazer welder/generators deliver unbeatable arc performance providing the smoothest, most stable arc in the industry. Miller®-exclusive Auto-Speed™ technology delivers superior runtimes, increased fuel efficiency, and improved welder/generator performance.

ArcReach® remote control technology

Parameter control at the wire feeder or stick/TIG remote without needing a control cord. Standard on most

models (see page 83 chart for exceptions). An ArcReach system allows you to change weld settings from your ArcReach feeder or stick/TIG remote, saving a trip to the welding power source. ArcReach technology uses the existing weld cable to communicate welding control information between the feeder or stick/TIG remote and the power source. This technology eliminates the need for control cords, and their associated problems and costs. Learn more at MillerWelds.com/arcreach



Unbeatable arc performance

Dynamic DIG™ technology automatically adjusts the amount of current required to clear a short. Delivers a smoother, more consistent arc that can be tailored to match the application, material, fit-up and welder technique.



Increased performance at high altitude

Electric fuel pumps are standard on all EFI models leading to better performance when operating at altitudes of 5,000 feet or greater.

More productive jobsites

Quieter jobsites are more productive because work crews can communicate easier, and work can start earlier and end later – even in noise-sensitive areas.

Auto-Speed™ technology

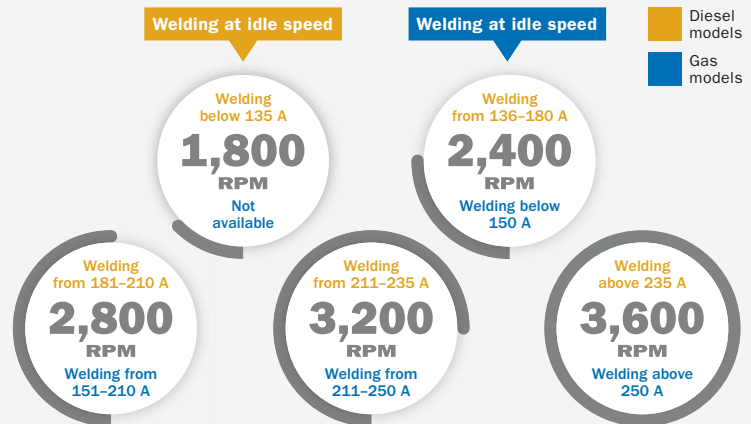

Get the welding power you need – plus reduced fuel consumption and lower noise levels for a more profitable jobsite. Trailblazer-exclusive Auto-Speed technology responds to weld requirements by automatically adjusting engine speed to a corresponding rpm level so the engine never works harder than necessary. Refueling time and operating costs are reduced, which means more productivity and profitability. Auto-Speed technology – available only from Miller.

Options to Maximize Your Trailblazer® 325 Performance

Electronic fuel injection (EFI) (gas models)

Adding EFI to your Trailblazer welder/generator adds multiple benefits. With EFI, you'll get faster, more-reliable starts in any weather – no choke adjustments needed. EFI-equipped Trailblazer machines are also up to 42 percent more fuel efficient than standard carbureted models, improving profitability. Plus, refueling less frequently means you'll spend more of your time welding, improving productivity.

Add Excel power to your Trailblazer with EFI for maximum fuel efficiency.

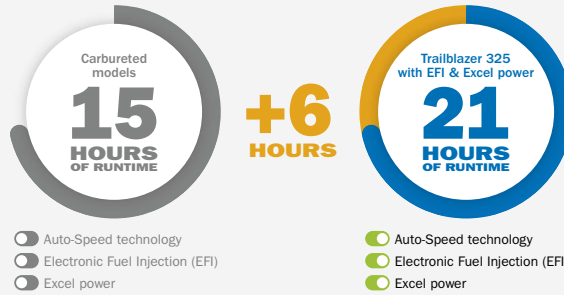

Based on typical usage – 150 amps welding 40% of the time; 20 amps generator power 30% of the time; and idling without load 30% of the time.

Wireless interface control (WIC)

Work hassle-free with full welder/generator control in the palm of your hand.

With wireless interface control, you can change welding processes, adjust parameters, select and save preset programs, turn the machine on/off, get service reminders and more from wherever you are on the jobsite. Extend time between fill ups and maintenance intervals while eliminating the need to go back to your machine to make adjustments.

Wireless interface control is available as a factory-installed option on select models.



WIRELESS
INTERFACE CONTROL

Excel™ power

Excel power delivers a full 2,400 watts (20 A) of 120-volt inverter-based, pure sine wave power at all speeds, including idle. Unlike competitive machines that provide auxiliary power only at 3,600 rpm (max), with Excel power you can operate jobsite tools like grinders at quiet, fuel-saving speeds.

Refueling time and operating costs are reduced with Excel power, which means more productivity and profitability. Plus everyone on the jobsite gets a better working environment because noise levels are lowered. Excel power – available only from Miller.

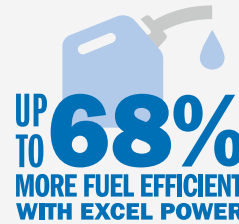

Battery charge/crank assist (gas models)

Reduce downtime with battery charge/crank assist capability. Designed and recommended for mechanics or anyone responsible for a fleet of trucks or equipment. By using your Trailblazer to charge dead batteries or jump a stubborn engine, you'll keep your crew working and the fleet up and running. Provides up to 75 amps of DC current to quickly charge 12- and 24-volt batteries. Jobsite equipment with weak batteries can get up to 350 amps of crank assist.

Note: Battery charge/jump cables (300422) must be ordered separately.

*Electric fuel pump recommended for operation at altitudes above 5,000 feet. This feature is standard on EFI Trailblazers and sold as a kit for other gas models.

Heavy industrial 

Processes

- Stick (SMAW) • MIG (GMAW)¹
- Flux-cored (FCAW)¹ • DC TIG (GTAW)²
- RMD³ • Pulsed MIG (GMAW-P)³
- Air carbon arc cutting and gouging (CAC-A) (rated 3/16 in. carbons)

¹ With wire feeder.

² Two-piece TIG torch recommended.

³ ArcReach models only with ArcReach Smart Feeder.

Engines

Gas: Kohler CH730

23.5 hp at 3,600 rpm

EFI gas: Kohler ECH730

23 hp at 3,600 rpm

EPA Tier 4 Final Diesel: Kubota D902

24.8 hp at 3,600 rpm

Three-cylinder, industrial, liquid-cooled

Note: Engines are warranted separately by engine manufacturer.

Most popular accessories

- SuitCase® Feeders (pg 18/51)
- ArcReach® Smart Feeder (pg 18/51)⁴
- ArcReach® Stick/TIG Remote (pg 51)⁴
- ArcReach® Heater (pg 51/94)⁴
- Spoolmatic® 30A/WC-24 Control 130831/137549 (pg 30/130)
- Running Gear (pg 124)
- Protective Cage with Cable Holders (pg 124)
- Full KVA Adapter Cord (pg 124)
- Protective Cover (pg 124)
- Remote Output Panel Kit 951850 (pg 124)
- HWY-Mid Frame Trailer (pg 125)
- Electric Fuel Pump Kit 300976 (gas models only, recommended for operation at altitudes above 5,000 ft.)
- 25 ft. Battery Charge/Jump Cables with Plug 300422 (Trailblazer 325 EFI 907798004 only)
- Wireless Interface Control Screen Protectors 287594 (5 pack)

⁴ For ArcReach models only.

Visit MillerWelds.com or your distributor for other Miller® options and accessories.

	Model	Stock Number	Welding Mode	Welding Process	Amp/Volt Ranges	Rated Output at 104°F (40°C)	Single-Phase Generator Power at 104°F (40°C)	Dimensions	Net Weight
Gas	Trailblazer 325	907797 Kohler	CC/DC	Stick/TIG	10-325 A	325 A at 28 V, 100% duty cycle	Peak: 12,000 watts Continuous: 10,500 watts Excel power (optional) 2,400 watts 20 A at 120 V, 60 Hz pure generator power at idle speed and while welding.	H: 28 in. (711 mm) H: 32.75 in. (832 mm) to top of exhaust W: 20 in. (508 mm) D: 40.5 in. (1,029 mm)	460 lb. (209 kg)
		907797001 Kohler with GFCI							
		907798 EFI* Kohler	CV/DC	MIG/FCAW	10-35 V				
		907798002 EFI* Kohler with Excel power							
		907798003 EFI* Kohler with GFCI, Excel power and WIC							
		907798004 EFI* Kohler w/Excel power and battery charge/crank assist							
907798005 EFI* Kohler w/Excel power, battery charge/crank assist and WIC									
Diesel	Trailblazer 325 Diesel	907799 Kubota with GFCI	CC/DC	Stick/TIG	10-325 A	325 A at 33 V, 100% duty cycle	Peak: 12,000 watts Continuous: 10,500 watts Excel power (optional) 2,400 watts 20 A at 120 V, 60 Hz pure generator power at idle speed and while welding.	H: 28 in. (711 mm) H: 34.5 in. (876 mm) to top of exhaust W: 20 in. (508 mm) D: 45.5 in. (1,156 mm)	620 lb. (281 kg)
		907799002 Kubota with GFCI and Excel power							
		907799003 Kubota with GFCI, Excel power and WIC							
		907799003 Kubota with GFCI, Excel power and WIC							

Trailblazer® 302 Air Pak™ See literature ED/4.78

Powerful all-in-one tool designed for repair and construction with multiprocess weld quality, generator power, air compressor and battery charge/crank assist.



*Electric fuel pump recommended for operation at altitudes above 5,000 feet.

Superior arc performance. Preset DIG settings optimized for the majority of stick welding applications, best-in-class wire arc performance, and two Lift-Arc™ TIG modes for most DC TIG applications.

Strongest combined generator/compressor power. Delivers an industry-leading 13,000 watts of peak generator power independent of weld settings.

Rotary screw air compressor. Delivers up to 31 cfm and 160 psi with no storage tank and runs many tools at idle speed. Provides 100 percent deliverable air, rated at an industry-high 104 degrees Fahrenheit. Front panel adjustment and automatic overpressure shutdown with indication. 30,000-hour life expectancy and warranted for three years by Miller.

Battery charge/crank assist. Provides selectable 12- or 24-volt battery charging with up to 450 amps of battery crank assist capability. Convenient front panel access.

Note: Battery charge/jump cables (300422) must be ordered separately.

Heavy Industrial

Processes

- AC/DC stick (SMAW)
- MIG (GMAW)¹ ■ Flux-cored (FCAW)¹
- AC²/DC³ TIG (GTAW)
- Air carbon arc cutting and gouging (CAC-A) (rated 3/16 in. carbons, capable 1/4 in. carbons)

¹ With wire feeder.

² With Dynasty® 210 Series.

³ Two-piece TIG torch recommended.

Gasoline engine

Kohler CH750: 27 hp at 3,600 rpm V-twin-cylinder, four-cycle, overhead valve, industrial, air-cooled

Note: Engine is warranted separately by engine manufacturer.

Most popular accessories

- SuitCase® Feeders (pg 18)
- Spoolmatic® 30A/WC-24 Control 130831/137549 (pg 30/130)

Visit MillerWelds.com or your distributor for other Miller® options and accessories.

Gasoline	Stock Number	Welding Mode	Welding Process	Amp/Volt Ranges	Rated Weld Output at 104°F (40°C)	Single-Phase Generator Power at 104°F (40°C)	Dimensions	Net Weight
	907549001 Kohler	CC/DC	Stick/TIG	10-300 A	280 A at 32 V, 100% duty cycle	Peak: 13,000 watts	H: 28 in. (711 mm)	771 lb.
	907549 Kohler with GFCl and electric fuel pump*	CV/DC	MIG/FCAW	13-35 V, 350 A	300 A at 32 V, 100% duty cycle 350 A at 32 V, 60% duty cycle	Continuous: 11,000 watts	H: 34.5 in. (876 mm) to top of exhaust W: 20 in. (508 mm)	(350 kg)
	907549003 Kohler with GFCl, cooler/separators and electric fuel pump*	CC/AC	Stick/TIG	10-225 A	200 A at 25 V, 60% duty cycle		D: 59.625 in. (1,514 mm)	
Air Compressor	Features	Free Air Delivery			Working Pressure Constant	Duty Cycle	Oil Capacity	
	Rotary screw with electric clutch for on/off, oil change intervals of 500 hours	31 cfm (0.88 m ³ /min.) at 3,600 rpm	28 cfm (0.79 m ³ /min.) at 3,000 rpm	22 cfm (0.62 m ³ /min.) at 2,400 rpm (idle)	80-160 psig	100%	1.75 qt. (1.7 L)	

Big Blue® 400 Pro See literature ED/5.7

The professional welder's choice – designed with the professional in mind, the Big Blue 400 Pro is the best for ease of use, reliability and fuel economy.



Wireless interface control (WIC) optional on select models.



Parameter control at the wire feeder or stick/TIG remote without needing a control cord. Factory-installed option on select models. See page 82 for more information.



Work hassle-free with full welder/generator control in the palm of your hand. Factory-installed option on select models.

Dynamic DIG™ technology automatically adjusts the amount of current required to clear a short. Delivers a smoother, more consistent arc that can be tailored to match the application, material, fit-up and welder technique.



Industrial USB port. Upload the latest software and download machine log files to retrieve information such as diagnostics and machine statistics.

Quiet operation. Only 71.6 decibels (96 Lwa) under full load. Improves jobsite communication and safety.

Standard features include digital meters with SunVision™ automatic idle, adjustable Hot Start™ output contactor control and 120-volt block heater.

Heavy Industrial

Processes

- Stick (SMAW) ■ MIG (GMAW)¹
- Flux-cored (FCAW)¹ ■ DC TIG (GTAW)
- RMD®² ■ Pulsed MIG (GMAW-P)²
- Air carbon arc cutting and gouging (CAC-A) (rated 3/16 in. carbons)

¹ With wire feeder.

² ArcReach models only with ArcReach Smart Feeder.

Diesel engines

EPA Tier 4 Final choices

Caterpillar C1.5T: 24.7 hp at 1,800 rpm Turbo-charged, three-cylinder, industrial, liquid-cooled

Kubota V1505: 20.2 hp at 1,800 rpm

Four-cylinder, industrial, liquid-cooled

Mitsubishi S4L2: 24.7 hp at 1,800 rpm

Four-cylinder, industrial, liquid-cooled

Note: Engines are warranted separately by engine manufacturer.

Most popular accessories

- SuitCase® Feeders (pg 18/51)
- ArcReach® Smart Feeder (pg 18/51)³
- ArcReach® Stick/TIG Remote (pg 51)³
- ArcReach® Heater (pg 51/94)³
- Protective Cover 195301 (pg 124)

³ For ArcReach models only.

Visit MillerWelds.com or your distributor for other Miller® options and accessories.

Diesel	Stock Number	Welding Mode	Welding Process	Amp/Volt Ranges	Rated Output at 104°F (40°C)	Single-Phase Generator Power at 104°F (40°C)	Dimensions	Net Weight
	907774 CAT	CC/DC	Stick/TIG	20-400 A	300 A at 32 V, 100% duty cycle 350 A at 27 V, 100% duty cycle 400 A at 24 V, 100% duty cycle	Peak: 12,000 watts Continuous: 10,000 watts	H: 32 in. (813 mm) W: 26.25 in. (667 mm) D: 56 in. (1,422 mm)	CAT: 1,038 lb. (471 kg) Kubota: 950 lb. (431 kg) Mitsubishi: 993 lb. (450 kg)
	907774001 CAT with ArcReach							
	907732 Kubota							
907732001 Kubota with ArcReach								
907732013 Kubota with ArcReach and WIC								
907733 Mitsubishi								
907733001 Mitsubishi with ArcReach								

Big Blue® 400 PipePro® See literature ED/5.8

Designed for the transmission pipeline welder — the Big Blue 400 PipePro, with wireless interface control standard, offers superior downhill stick arc characteristics, as well as MIG/flux-cored capabilities, to meet high-strength steel requirements for the most demanding pipeline jobs.



Wireless interface control (WIC) standard on all models.

WIRELESS
INTERFACE CONTROL

Elevate your performance. Now get full control of your machine in the palm of your hand. Change welding processes, adjust parameters, select and save preset programs, turn the machine on/off, and more. Standard on all models.

ArcReach

Parameter control at the wire feeder or stick/TIG remote without needing a control cord. Standard on all models. See page 82 for more information.

Dynamic DIG™ technology automatically adjusts the amount of current required to clear a short. Delivers a smoother, more consistent arc that can be tailored to match the application, material, fit-up and welder technique.



Industrial USB port. Upload the latest software and download machine log files to retrieve information such as diagnostics and machine statistics.

Compact size and weight optimizes truck space.

LINE-X® cover provides superior impact, corrosion and abrasion protection.

Standard features include wireless interface control, ArcReach, digital meters with SunVision™, automatic idle, adjustable Hot Start™, output contactor control, 120-volt block heater, engine coolant temperature gauge and lift-off service door. Also available with optional stainless steel enclosure.

Heavy industrial 

Processes

- Stick (SMAW) • MIG (GMAW)¹
- Flux-cored (FCAW)¹ • DC TIG (GTAW)
- RMD² • Pulsed MIG (GMAW-P)²
- Air carbon arc cutting and gouging (CAC-A) (rated 1/4 in. carbons)

¹With wire feeder.

²With ArcReach Smart Feeder.

Diesel engines

EPA Tier 4 Final choices

Caterpillar C1.5T: 24.7 hp at 1,800 rpm Turbo-charged, three-cylinder, industrial, liquid-cooled

Mitsubishi S4L2: 24.7 hp at 1,800 rpm Four-cylinder, industrial, liquid-cooled

Note: Engines are warranted separately by engine manufacturer.

Most popular accessories

- SuitCase® Feeders (pg 18/51)
- ArcReach® Smart Feeder (pg 18/51)
- ArcReach® Stick/TIG Remote (pg 51)
- ArcReach® Heater (pg 51/94)
- Dynasty® 210 Series (pg 61)
- Full KVA Adapter Cord 300517 (pg 124)
- Single-Phase Full KVA Plug Kit 119172 (pg 124)
- Protective Cover 195301 (pg 124)
- Remote Output Panel Kit 951850 (pg 124)
- HWY-Mid Frame Trailer (pg 125)
- Wireless Interface Control Screen Protectors 287594 (5 pack)

Visit MillerWelds.com or your distributor for other Miller® options and accessories.

Diesel	Stock Number	Welding Mode	Welding Process	Amp/Volt Ranges	Rated Output at 104°F (40°C)	Single-Phase Generator Power at 104°F (40°C)	Dimensions	Net Weight
	907806001 CAT	CC/DC	Stick/TIG	20-400 A	300 A at 32 V, 100% duty cycle 350 A at 27 V, 100% duty cycle 400 A at 24 V, 100% duty cycle	Peak: 12,000 watts Continuous: 10,000 watts	H: 32 in. (813 mm) W: 26.25 in. (667 mm) D: 56 in. (1,422 mm)	CAT: 1,038 lb. (471 kg) Mitsubishi: 993 lb. (450 kg)
907806 CAT w/stainless steel								
907805001 Mitsubishi	CV/DC	MIG/FCAW	14-40 V					
907805 Mitsubishi w/stainless steel								

Big Blue® 450 Duo CST™ See literature ED/5.5

Durable dual-operator welder/generator delivers proven CST stick/TIG performance with two superior arcs in one compact package, for maximum productivity and efficiency.



Two separate outputs with Tweco®-style receptacles deliver up to 280 amps of output per operator.

Quiet operation. At 72.1 decibels (97 Lwa) under full load, it's quieter than most single-operator models. Improves jobsite communication and safety.

Vandalism lockout kit (not shown). Lockable hinged steel panel protects front control panels and ignition switch.

Simple-to-operate process selector knob automatically sets proper DIG setting on E6010 and E7018 electrodes for superior stick performance.

Lift-Arc™ start for TIG starts without the use of high frequency.

Remote amperage control permits the use of standard and wireless amperage control devices.

Increased efficiency. More arcs and better fuel economy equal increased profits for your business. Estimated savings are up to 34 percent with a dual-operator unit versus two single-operator units.

Heavy industrial 

Processes

- Stick (SMAW) • DC TIG (GTAW)
- Air carbon arc cutting and gouging (CAC-A) (rated 3/16 in. carbons)

Diesel engine

EPA Tier 4 Final

Mitsubishi S4L2: 24.7 hp at 1,800 rpm Four-cylinder, industrial, liquid-cooled

Note: Engine is warranted separately by engine manufacturer.

Most popular accessories

- Full KVA Adapter Cord 300517 (pg 124)
- Single-Phase Full KVA Plug Kit 119172 (pg 124)
- Protective Cover 195301 (pg 124)
- HWY-Mid Frame Trailer 301438 (pg 125)
- Spark Arrestor Kit 195012

Visit MillerWelds.com or your distributor for other Miller® options and accessories.

Diesel	Stock Number	Process	Output Mode	Amperage Range	Rated Output at 122°F (50°C)	Single-Phase Generator Power at 122°F (50°C)	Dimensions	Net Weight
	907477 Mitsubishi	DC stick/TIG	Separate (dual outputs)	5-225 (each side) 5-280 (one side only)	175 A at 27 V, 100% duty cycle	Continuous: 10,000 watts	H: 32 in. (813 mm) W: 26.25 in. (667 mm) D: 56 in. (1,422 mm)	1,064 lb. (483 kg)
		Paralleled (combined)	10-450	350 A at 27 V, 100% duty cycle				

Big Blue® 500 Pro and 600 Series

See literature ED/11.0 (500) and ED/11.5 (600)

Clean, quiet, multiprocess machines designed to give welders the output they need for heavy-duty applications in fabrication and on construction sites.



Big Blue 500 and 600 Pro

Big Blue 600 Air Pak

Wireless interface control (WIC) optional on select models.

ArcReach®

Parameter control at the wire feeder or stick/TIG remote without needing a control cord. Standard on all Deluxe and Air Pak™ models. See page 82 for more information.

WIRELESS INTERFACE CONTROL

Work hassle-free with full welder/generator control in the palm of your hand. Factory-installed option on select models.

Electronic engine display simultaneously displays fuel level, engine hours, coolant temperature, oil pressure, battery volts, and engine rpm. Also tracks oil change intervals and displays engine diagnostics for easier servicing.



Dynamic DIG™ technology automatically adjusts the amount of current required to clear a short. Delivers a smoother, more consistent arc that can be tailored to match the application, material, fit-up and welder technique.



Industrial USB port. Quickly upload the latest software and download machine log files to retrieve in-depth information such as diagnostics and machine statistics.

20,000 watts of pure generator power. Plug in Miller® inverter-based power sources for additional welding arcs.

Standard features include digital meters with SunVision™, adjustable Hot Start™, output contactor control, automatic idle, thermal overload protection and 120-volt block heater.

Deluxe and Air Pak™ models add ArcReach technology, polarity reversing switch and vandalism lockout kit (protects control panel and receptacles).

Ingersoll Rand ultra-reliable industrial rotary screw compressor (Air Pak™ model only). 30,000-hour life expectancy. Independent on/off control for applications not requiring compressed air – allows greater fuel savings and longer compressor service intervals.

Heavy industrial DC

Processes

- Stick (SMAW) ■ MIG (GMAW)¹
- Flux-cored (FCAW)¹ ■ DC TIG (GTAW)
- RMD^{®2} ■ Pulsed MIG (GMAW-P)²
- Submerged arc (SAW)
- Air carbon arc cutting and gouging (CAC-A) (500: rated 5/16 in. carbons; 600: rated 3/8 in. carbons)

¹With wire feeder.

²ArcReach models only with ArcReach Smart Feeder.

Diesel engines

EPA Tier 4 Final choices

500 and 600 Pro: Kubota V2403

48.9 hp at 1,800 rpm
Turbo-charged, four-cylinder, industrial, liquid-cooled

600 Air Pak: Deutz TD2.9 L4

65.7 hp at 1,800 rpm
Turbo-charged, four-cylinder, industrial, liquid-cooled

Note: Engines are warranted separately by engine manufacturer.

Most popular accessories

- SuitCase® Feeders (pg 18/51)
- ArcReach® Smart Feeder (pg 18/51)³
- ArcReach® Stick/TIG Remote (pg 51)³
- ArcReach® Heater (pg 51/94)³
- Dynasty 210® Series (pg 61)
- Full KVA Adapter Cord (pg 124)
- Full KVA Plug Kit (pg 124)
- Protective Cover (pg 124)
 - 301495 Kubota
 - 301113 Deutz
- Remote Output Panel Kit 951850 (pg 124)
- HWY-225 Trailer 301338 (pg 125)
- Desiccant Air Dry System (for Air Pak model only)
 - 195117 Side mount
 - 195117001 Rear mount
 Eliminates moisture in the air stream and prevents air line freeze-ups in cold climates
- Cold Weather Kit 301482
- Spark Arrestor Kit 195012
- Wireless Interface Control Screen Protectors 287594 (5 pack)

³For ArcReach models only.

Visit MillerWelds.com or your distributor for other Miller® options and accessories.

*Big Blue 600 Series has welder truck specific models available – visit MillerWelds.com or your distributor for more information.

Model/Stock Number	Welding Mode/Process	Amp/Volt Ranges	Rated Output at 104°F (40°C)	Generator Power at 104°F (40°C)	Dimensions	Net Weight
Big Blue 500 Pro 907736 Kubota 907736001 Kubota Deluxe model 907736008 Kubota Deluxe model with WIC	CC/DC (Stick/TIG)	20-500 A	400 A at 36 V, 100% duty cycle 450 A at 38 V, 100% duty cycle 500 A at 40 V, 100% duty cycle	Three-phase Peak: 27,000 watts Continuous: 20,000 watts	H: 46 in. (1,168 mm) W: 28.5 in. (724 mm) D: 69.5 in. (1,765 mm)	1,750 lb. (794 kg)
	CV/DC (MIG/FCAW)	15-50 V		Single-phase Peak: 15,000 watts Continuous: 12,000 watts		
Big Blue 600 Pro* 907737 Kubota 907737001 Kubota Deluxe model 907737003 Kubota Deluxe model with WIC	CC/DC (Stick/TIG)	20-600 A	600 Pro: 500 A at 40 V, 100% duty cycle 550 A at 42 V, 60% duty cycle 600 A at 42 V, 40% duty cycle	Three-phase Peak: 27,000 watts Continuous: 20,000 watts	H: 46 in. (1,168 mm) W: 28.5 in. (724 mm) D: 69.5 in. (1,765 mm)	600 Pro: 1,750 lb. (794 kg) 600 Air Pak: 2,040 lb. (925 kg)
	CV/DC (MIG/FCAW)	15-50 V	600 Air Pak: 500 A at 40 V, 100% duty cycle 575 A at 43 V, 100% duty cycle 600 A at 44 V, 60% duty cycle	Single-phase Peak: 15,000 watts Continuous: 12,000 watts		
Big Blue 600 Air Pak* 907750 Deutz 907750003 Deutz with WIC	CV/DC (MIG/FCAW)	15-50 V	600 Air Pak: 500 A at 40 V, 100% duty cycle 575 A at 43 V, 100% duty cycle 600 A at 44 V, 60% duty cycle	Single-phase Peak: 15,000 watts Continuous: 12,000 watts		
Ingersoll Rand CE55 G1 Air Compressor (Air Pak model only)	Features	Free Air Delivery		Working Pressure Constant	Duty Cycle	Oil Capacity
	Rotary screw with electric clutch for on/off, oil change intervals of 500 hours, life expectancy of 30,000 hours	Idle: 40 cfm (1.13 m ³ /min.) Weld: 60 cfm (1.70 m ³ /min.)		100 psig (7 bar)	100%	4 qt. (3.79 L)

Big Blue® 800 Series

See literature ED/14.0

The most powerful lineup of diesel welder/generators in the industry. Robust output for welding and power generation; ideal for dual-operator applications on labor-intensive or limited-space jobsites.



Big Blue 800 Duo Pro

Big Blue 800 Duo Air Pak

Wireless interface control (WIC) optional on select models.

ArcReach®

Parameter control at the wire feeder or stick/TIG remote without needing a control cord. Standard on all models. See page 82 for more information.

WIRELESS INTERFACE CONTROL

Work hassle-free with full welder/generator control in the palm of your hand. Factory-installed option on select models.

Note: WIC-equipped Big Blue 800 Series machines include two remotes so both operators have full control of their processes and parameters.

Multi-arc welding. One dependable engine – two independent arcs with up to 400 amps each. Or plug in additional inverters for a true multioperator work platform! Example: Two additional XMT® machines equals four operators, up to 200 amps each. Premium quality arcs allow operators to work independently with no arc interaction. Multioperator welding has never been easier or more versatile.

Increased efficiency. More arcs and better fuel economy equal increased profits for your business. Estimated savings are up to 34 percent with a dual-operator unit versus two single-operator units.

Simple paralleling switch makes switching from a single operator to dual operators a breeze. Weld up to 400 amps per side when set up in dual-operator mode, or up to 800 amps in single-operator mode.

Electronic engine display simultaneously displays fuel level, engine hours, coolant temperature, oil pressure, battery volts and engine rpm. Also tracks oil change intervals and displays engine diagnostics for easier servicing. Air Pak model adds air pressure and compressor hours displays.



Dynamic DIG™ technology automatically adjusts the amount of current required to clear a short. Delivers a smoother, more consistent arc that can be tailored to match the application, material, fit-up and welder technique.



Industrial USB port. Upload the latest software and download machine log files to retrieve information such as diagnostics and machine statistics.

20,000 watts of pure generator power. Plug in Miller® inverter-based power sources for additional welding arcs.

Standard features include ArcReach, digital meters with SunVision™, automatic idle, 120-volt block heater and vandalism lockout kit (protects control panel and receptacles).

Ingersoll Rand ultra-reliable industrial rotary screw compressor (Air Pak™ model only). 30,000-hour life expectancy. Independent on/off control for applications not requiring compressed air – allows greater fuel savings and longer compressor service intervals.

Heavy industrial 

Processes

- Stick (SMAW) ▪ MIG (GMAW)¹
- Flux-cored (FCAW)¹ ▪ DC TIG (GTAW)
- RMD² ▪ Pulsed MIG (GMAW-P)²
- Submerged arc (SAW)
- Air carbon arc cutting and gouging (CAC-A) (rated 1/2 in. carbons)
- Stud (1/2 in.)

¹With wire feeder.

²With ArcReach Smart Feeder.

Diesel engine

EPA Tier 4 Final

Deutz TD2.9 L4: 65.7 hp at 1,800 rpm Turbo-charged, four-cylinder, industrial, liquid-cooled

Note: Engines are warranted separately by engine manufacturer.

Most popular accessories

- SuitCase® Feeders (pg 18/51)
- ArcReach® Smart Feeder (pg 18/51)
- ArcReach® Stick/TIG Remote (pg 51)
- ArcReach® Heater (pg 51/94)
- Dynasty 210® Series (pg 61)
- Full KVA Adapter Cord 300517 (pg 124)
- Full KVA Plug Kit (pg 124)
 - 119172 Single-phase
 - 254140 Three-phase
- Protective Cover 301113 (pg 124)
- Remote Output Panel Kit 951850 (pg 124)
- HWY-225 Trailer 301338 (pg 125)
- Desiccant Air Dry System (Air Pak model only)
 - 195117 Side mount
 - 195117001 Rear mount
 Eliminates moisture in the air stream and prevents air line freeze-ups in cold climates
- Cold Weather Kit 301482
- Spark Arrestor Kit 195012
- Wireless Interface Control Screen Protectors 287594 (5 pack)

Visit MillerWelds.com or your distributor for other Miller® options and accessories.

*Big Blue 800 Duo Air Pak has welder truck specific models available – visit MillerWelds.com or your distributor for more information.

Diesel	Model/Stock Number*	Welding Mode/Process	Output Mode	Amp/Volt Ranges	Rated Output at 100% Duty Cycle at 104°F (40°C)	Generator Power at 104°F (40°C)	Dimensions	Net Weight
	Big Blue 800 Duo Pro 907751 Deutz 907751001 Deutz with WIC Big Blue 800 Duo Air Pak 907752 Deutz 907752003 Deutz with WIC	CC/DC (Stick/TIG)	Separate (dual outputs)	20–400 A	400 A at 36 V (each side)	Three-phase Peak: 27,000 watts Continuous: 20,000 watts	H: 46 in. (1,168 mm) W: 28.5 in. (724 mm) D: 69.5 in. (1,765 mm)	Duo Pro: 1,869 lb. (848 kg) Duo Air Pak: 2,095 lb. (968 kg)
	CV/DC (MIG/FCAW)	Separate (dual outputs)	15–50 V	400 A at 34 V (each side)	Single-phase Peak: 15,000 watts Continuous: 12,000 watts			
		Paralleled (combined)	40–800 A	700 A at 44 V, 800 A at 38 V				
		Paralleled (combined)	15–50 V	750 A at 40 V, 800 A at 38 V				
Ingersoll Rand CE55 G1 Air Compressor (Air Pak model only)	Features	Free Air Delivery	Working Pressure Constant	Duty Cycle	Oil Capacity			
	Rotary screw with electric clutch for on/off, oil change intervals of 500 hours, life expectancy of 30,000 hours	Idle: 40 cfm (1.13 m ³ /min.) Weld: 60 cfm (1.70 m ³ /min.)	100 psig (7 bar)	100%	4 qt. (3.79 L)			



Submerged Arc

For more detailed information, visit MillerWelds.com/subarc

Miller offers an array of versatile submerged arc components, including power sources, controls, wire drives, torches, tractors and a variety of other accessories.

SubArc Digital Series See literature AD/7.3

The SubArc Digital Series of power sources, interface controls and accessories include digital control and communication electronics designed to improve weld performance and simplify the integration of the equipment in more advanced applications.



Heavy industrial ● SubArc DC Series is DC only.

Processes

- Submerged arc (SAW)
- Electroslag (ESW)
- Air carbon arc cutting and gouging (CAC-A)

Most popular accessories

- 14-pin Insight Core™ Module 301072 (pg 74)
Requires Insight Core to SubArc Digital Series Adapter Kit (301295)
- Insight ArcAgent™ Auto 301346 (pg 75)
- 15 ft. (4.6 m) SubArc Parallel Cable 260775015 (pg 127)
- 15 ft. (4.6 m) SubArc Tandem Cable 260878015 (pg 127)

Visit MillerWelds.com or your distributor for other Miller® options and accessories.

Two DC power source models and one AC/DC power source model. Power sources have sufficient power capacity to cover applications from traditional DC single-arc to multi-wire tandem welding. In the case of electroslag welding or other high-current demand, two or more power sources can easily be paralleled (both DC and AC/DC machines).

Low-voltage accessory operation and improved environmental protection. The Digital Series accessories are powered with 24 VAC control voltage from the power source. All power sources, interface controls and wire drives are IP23 rated providing a high level of protection for harsh environments.

Easy to integrate. Our SubArc power sources are easy to integrate by using a standard Modbus® connection.

All power sources feature thermal overload protection, line voltage compensation and Fan-On-Demand.™

*While idling.

Model/Stock Number	Amperage Range (CC Mode)	Voltage Range (Sub Arc Mode)	Rated Output	Amps Input at Rated Output, 60 Hz					Max Open-Circuit Voltage	Dimensions (Includes lift eye, but not strain relief)	Net Weight
				230 V	460 V	575 V	KVA	KW			
SubArc DC 650 Digital 907622 230/460/575 V	50-815 A	20-44 V	650 A at 44 V, 100% duty cycle	126 3.8*	63 1.9*	50.4 1.4*	50 1.52*	34.8 0.76*	75 Vpk	H: 30 in. (762 mm) W: 23 in. (584 mm) D: 38 in. (965 mm)	593 lb. (269 kg)
SubArc DC 1000 Digital 907624 230/460/575 V	100-1,250 A	20-44 V	1,000 A at 44 V, 100% duty cycle	180 5.8*	90 2.9*	72 2.4*	73 3.2*	53 0.5*	68 Vpk		682 lb. (309 kg)
SubArc AC/DC Digital 907620 460 V	300-1,250 A	20-44 V	1,000 A at 44 V, 100% duty cycle	-	122 3.0*	-	98 2.37*	53 0.95*	93 Vpk	H: 43 in. (1,092 mm) W: 28 in. (711 mm) D: 48 in. (1,219 mm)	1,187 lb. (538 kg)

SubArc Interface Digital Control

See literature no. AD/7.3



Easier setup and operation. The SubArc Interface Digital control recognizes the power source and wire drive connected, and automatically configures the system for proper operation.

Internal terminal strip is able to integrate with positioners, sidebeams, turning rolls and other peripheral equipment.

Most popular accessories

- SubArc Control Cables (pg 127)
 - 260622030 30 ft. (9.1 m)
 - 260622050 50 ft. (15 m)
 - 260622060 60 ft. (18.3 m)
 - 260622080 80 ft. (24.4 m)
 - 260622100 100 ft. (30.5 m)
 - 260622120 120 ft. (36.6 m)
 - 260622200 200 ft. (61.0 m)

Visit MillerWelds.com or your distributor for other Miller® options and accessories.

Stock Number	Input Power from Welding Power Source	Welding Power Source Type	Weld Voltage and Amperage Capacity	Dimensions	Net Weight
300936	24 VAC, 1-phase, 25 A, 50/60 Hz	Constant voltage (CV), AC or DC, with remote contactor and output control capabilities	0-100 V 0-1,500 A	H: 11.5 in. (292 mm) W: 12 in. (305 mm) D: 7 in. (178 mm)	15.8 lb. (7.2 kg)

SubArc Remote Operator Interface

See literature AD/7.3



Motor Control Digital



Remote Pendant Digital

Point-of-use installation. Remote Pendant can be handheld or secured at point of use to improve operation.

Remote installation. Motor Control can be remotely installed, resulting in reduced cables at the operator workstation.

Side handles on Remote Pendant provides option for handheld operation with full functionality of a traditional SubArc Interface.

Most popular accessories

- SubArc Control Cables (see pg 127 for complete list)
 - 260622030 30 ft. (9.1 m)
 - 260622050 50 ft. (15 m)
 - 260622080 80 ft. (24.4 m)
- Continuum™ Control/Motor Cables (see pg 127 for complete list)
 - 263368015 15 ft. (4.6 m)
 - 263368025 25 ft. (7.6 m)
 - 263368050 50 ft. (15 m)

Visit MillerWelds.com or your distributor for other Miller® options and accessories.

Model/Stock Number	Input Power from Welding Power Source	Welding Power Source Type	Weld Voltage and Amperage Capacity	Dimensions	Net Weight
SubArc Motor Control Digital 301425 Requires SubArc Remote Pendant Digital below and Continuum control/motor cable	24 VAC, 1-phase, 25 A, 50/60 Hz	Constant voltage (CV), AC or DC, with remote contactor and output control capabilities	0-100 V 0-1,500 A	H: 11.5 in. (292 mm) W: 12 in. (305 mm) D: 7 in. (178 mm)	15.8 lb. (7.2 kg)
SubArc Remote Pendant Digital 301424 Requires SubArc Motor Control Digital above and Continuum control/motor cable	42 VDC, 1 A			H: 11 in. (279 mm) W: 10.63 in. (270 mm) D: 3.125 in. (80 mm)	3 lb. (1.4 kg)



Miller recommends



Customers count on Hobart® to provide an exceptional level of expertise and commitment in developing unique filler metal and flux solutions with them to meet current and future challenges.

Rely on Hobart for submerged arc applications and all your welding needs.

Visit HobartBrothers.com or your local distributor to learn more.

Questions? Hobart is here to help.



SubArc Wire Drive 400 Digital Low Voltage

See literature AD/7.3



SubArc Wire Drive 400 Digital Low Voltage is a standard-speed, right-angle wire drive assembly.

Most popular accessories

- Motor Extension Cables (pg 127)
 - 254232005 5 ft. (1.5 m)
 - 254232010 10 ft. (3 m)
 - 254232025 25 ft. (7.6 m)
 - 254232065 65 ft. (19.8 m)
- Drive Rolls (pg 127)
- Single-Wire Straightener 199733 (pg 127)
- Twin-Wire Straightener 301160 (for twin-wire torches only) (pg 127)
- Manual Single Slide (pg 127)

Visit MillerWelds.com or your distributor for other Miller® options and accessories.

Stock Number	Input Power	Input Power Cord	Rating	Wire Feed Speed	Wire Diameter Capacity	Net Weight
300938	38 VDC	4 ft. (1.2 m)	1/5 hp, 85 rpm	30-400 ipm (0.8-10.2 m/min.)	3/32-3/16 in. (2.4-4.8 mm)	26 lb. (11.8 kg)

SubArc Torches

See literature AD/7.3



OBT 600 torch has concentric flux flow nozzle. 600 amps at 100 percent duty cycle. For use with 1/16-5/32 inch (1.6-4.0 mm) wire.

OBT 1200 torch has concentric flux flow nozzle. 1,200 amps at 100 percent duty cycle. For use with 1/16-5/32 inch (1.6-4.0 mm) wire. OBT 1200 features a replaceable breakaway adapter end to prevent costly damage should torch run into an obstruction.

1200-Amp Twin-Wire Torch (long). 1,200 amps at 100 percent duty cycle. For use with 3/64-3/32 inch (1.2-2.4 mm) wire.

Most popular accessories

- OBT 600 Torch Body Extensions (pg 127)
 - 043967 1 inch (25.4 mm)
 - 043969 2 inch (50.8 mm)
 - 043973 4 inch (101.6 mm)
 - 043975 6 inch (152.4 mm)
- OBT 1200 Torch Body Extension 043981 (pg 127)
- Contact Tips (pg 127)

Visit MillerWelds.com or your distributor for other Miller® options and accessories.

Model	Stock Number	Rated Output	Wire Diameter Capacity	Single/Twin	Torch Body Length
OBT 600	043923	600 A at 100% duty cycle	1/16-5/32 in. (1.6-4.0 mm)	Single	10.25 in. (260.4 mm)
OBT 1200	043900	1,200 A at 100% duty cycle	1/16-5/32 in. (1.6-4.0 mm)	Single	17.25 in. (438.2 mm)
1200-Amp Twin-Wire Torch (long)	301144	1,200 A at 100% duty cycle	3/64-3/32 in. (1.2-2.4 mm)	Twin	16.97 in. (431 mm)

SubArc Flux Hopper Digital Low Voltage

See literature AD/7.3



Improved flux delivery system. Our SubArc Flux Hopper Digital Low Voltage utilizes a flux valve mechanism that assures continuous delivery of flux to the arc.

Sight glass allows the weld operator to visually monitor the remaining flux in the hopper.

Versatile opening is sized to allow hookup of any flux-hopper-mounted recovery system.

Includes slag screen to capture fused slag particles from entering the flux hopper.

Most popular accessories

- Flux Hopper Extension Cables (pg 127)
 - 260623010 10 ft. (3 m)
 - 260623025 25 ft. (7.6 m)
 - 260623065 65 ft. (19.8 m)

Visit MillerWelds.com or your distributor for other Miller® options and accessories.

Stock Number	Input Power	Input Power Cord	Flux Capacity	Net Weight
300942	12 VDC (PWM signal from SubArc Interface)	11 ft. (3.3 m)	25 lb. (11 kg)	11 lb. (5 kg)

SubArc 3-Wheel Tractor

See literature AD/7.7



Easy-to-use foot- or hand-operated clutch allows for easy engagement of tractor drive and disengagement to move tractor into position.

Flexible mast configuration allows torch to be positioned in multiple weld zones and adapts to your weld application.

SubArc Tractor Interface Digital provides easy-to-operate single control for power source and tractor operation.

Regulated travel speed ensures your actual and set travel speeds are consistent, improving weld quality.

Locking front wheel can be set in place to desired travel path.

Easily accommodates a 60-pound (27 kg) wire reel for fewer time-consuming wire changeovers.

Low-voltage operation and improved environmental protection. The new digital series accessories are powered with 24 VAC control voltage from the power source. All power sources, interface controls and wire drives are IP23 rated providing a high level of protection for harsh environments.

Package includes

- SubArc 3-Wheel Tractor
- SubArc Tractor Interface Digital
- SubArc Wire Drive 400 Digital Low Voltage
- 10 lb. (4.5 kg) capacity flux hopper with manual valve
- 60 lb. (27 kg) wire reel
- OBT 600 torch
- Wire straightener

Required power source

- SubArc Digital Series (pg 88)

Most popular accessories

- SubArc Control Cables (pg 127)
- Contact Tips (pg 127)
- Drive Rolls (pg 127)

Visit MillerWelds.com or your distributor for other Miller® options and accessories.

Stock Number	Input Power from Welding Power Source	Wire Feed Speed	Wire Diameter Capacity	Gun Positioning Slides	Drive Motor	Travel Speed	Dimensions	Net Weight
951755	24 VAC, 1-phase, 50/60 Hz, 25 A	30-400 ipm (0.8-10.2 m/min.)	1/16-5/32 in. (1.6-4.0 mm)	3.5 in. (88.9 mm)	38 VDC	5-70 ipm (0.13-1.75 m/min.)	H: 36 in. (914 mm) W: 43.25 in. (1,149 mm) D: 31.63 in. (803 mm)	120 lb. (54.4 kg) without flux or wire

SubArc Portable Welding System

See literature AD/7.6



Self-contained system for pressure vessel, pipe and general welding applications. Houses a power source, column and boom on a mobile platform.

Built-in fork pockets and caster wheels allow welding system to be brought to the joint.

Easy positioning of the weld head through use of integrated motorized column, manual telescoping boom, slide and 360-degree column rotation.

Motorized column with pendant control and manual telescoping boom provides 44 inches (1,117 mm) of vertical travel and 31 inches (787 mm) of horizontal travel respectively.

Manual slide provides 7.87 inches (200 mm) of fine vertical and horizontal torch adjustment.

SubArc DC 650
Digital portable
system shown.

Systems include

- Portable column and boom
- SubArc Digital power source
- SubArc Interface Digital and control cable
- SubArc Wire Drive 400 Digital Low Voltage
- 25 lb. (11.3 kg) capacity flux hopper with valve
- 60 lb. (27 kg) wire reel and support assembly
- OBT 600 torch (650 system) or OBT 1200 torch (1000 system)
- Wire straightener
- Manual slide

Most popular accessories

- 14-pin Insight Core™ Module 301072 (pg 74)
Requires Insight Core to SubArc Digital Series Adapter Kit (301295)
- Insight ArcAgent™ Auto 301346 (pg 75)
- Contact Tips (pg 127)
- Drive Rolls (pg 127)

Visit MillerWelds.com or your distributor for other Miller® options and accessories.

Stock Number	Supply Voltage	Column Stroke	Column Travel	Boom Stroke	Boom Travel	Base Rotation	Minimum Working Height	Maximum Working Height	Overall Height
951675 w/SubArc DC 650 Digital 951676 w/SubArc DC 1000 Digital See page 88 for power source specs	120 V, 1-phase, 60 Hz See page 88 for power source requirement	44 in. (1,117 mm)	Constant speed	31 in. (787 mm)	Manual	360°	DC 650: 33.5 in. (851 mm) DC 1000: 26.25 in. (667 mm)	DC 650: 77.5 in. (1,969 mm) DC 1000: 70.25 in. (1,784 mm)	102 in. (2,590 mm)



ProHeat™ Induction Heating

Induction heating is a simple and cost-effective heating process that can deliver fast and consistent heat. Applications that would typically require hours to heat can be done in minutes.

- Welding fabrication and construction
- Preheating of welds
- Post-weld heat treatment (PWHT)
- Hydrogen bakeout
- Shrink fit applications

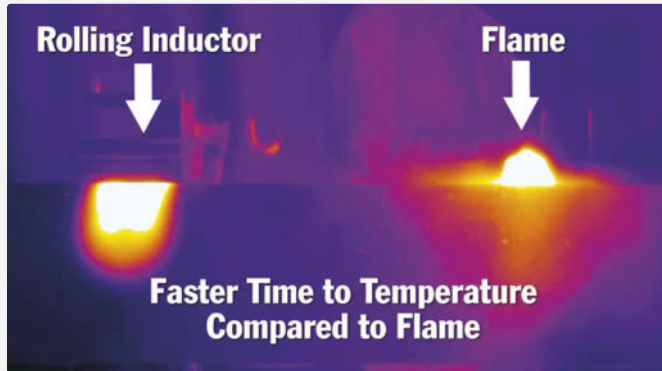

Induction heating solves many key issues in today's environment.

- Does not produce the exposure to burns associated with open flames and electrical resistance wires (only the workpiece becomes hot)
- No significant expense of fuel gases
- Produces less particulate from overheated insulation caused by high-temperature electrical wires and ceramic pads

Induction heating applications:

- Process piping
- Refinery
- Petrochemical
- Power piping
- Pressure vessels
- Structural
- Shipbuilding
- Pipeline



For more information:

Call **1-844-IND-HEAT (1-844-463-4328)**

or email InductionSales@MillerWelds.com

ProHeat 35 Power Source

The ProHeat 35 induction power source is equipped with a built-in temperature controller allowing for manual or temperature-based programming using up to four control thermocouples. At more than 90 percent efficiency, the ProHeat 35 power source transfers more energy to the part, reducing operating costs over different heating methods.

Digital Recorder (optional)

The digital recorder is commonly used in stress relieving and critical preheat applications. The recorder stores temperature data based on time. It is not required to perform successful heating applications.

Heavy-Duty Induction Cooler (optional)

Optimized for induction heating applications, cooler features a 2.5-gallon rustproof polyethylene tank, high-pressure pump, and blower to yield a high cooling capacity.



ProHeat 35 power source shown with optional heavy-duty induction cooler, running gear and digital recorder.

Note: Primary input cable is not included with power source.

One ProHeat™ System – Four Basic Induction Heating Configurations

ProHeat 35 induction heating systems solve preheating, post weld heat treatment (PWHT) and stress relieving problems.

Liquid-Cooled Cables See literature IN/15.0

Preheat applications up to 1,450 degrees Fahrenheit (788°C).

- A highly versatile tool for preheating, stress relieving, hydrogen bakeout, post weld heat treatment and shrink fit in a variety of pipe diameters and flat plate
- Designed with flexibility in mind, the ProHeat liquid-cooled induction heating cables can be wrapped into coils of various shapes and sizes to fit almost any induction heating application



Liquid-Cooled Rolling See literature IN/13.0

Preheat of moving parts up to 600 degrees Fahrenheit (315°C).

- Ideal for preheating rolling pipe and moving parts, with easy and time-saving setup and movement for maintaining and adhering to preheat and interpass temperatures
- Enables the benefits of rolled pipe welding while also addressing some of the concerns associated with other popular heating methods, such as open flame and resistance heating
- *Optional* infrared temperature sensor can read the temperature on the moving part from 212–750 degrees Fahrenheit (100–400°C)
- *Optional* travel detect system can be used for setting different heating rates/ramps based on workpiece speed travel – when no movement is detected the system turns off the output preventing damage to workpiece and rolling inductor



Air-Cooled Blankets See literature IN/14.0

Preheating applications up to 400 degrees Fahrenheit (204°C).

- Air-cooled blankets are available for pipe diameters from 8–60 inches (20–152 cm), or in the case of plate the lengths are 41–205 inches (1–5.2 m)
- The blankets easily conform to circular and flat parts and install in a matter of seconds
- Manufactured from durable high-temperature materials, flexible induction blankets are designed to withstand the tough conditions in both industrial and construction applications



Air-Cooled Cables See literature IN/14.0

Preheating applications up to 392 degrees Fahrenheit (200°C).

- Air-cooled cables are available in lengths of 30 foot (9.1 m), 50 foot (15.2 m) or 80 foot (24.4 m) for flexible configurations
- Designed with flexibility and efficiency in mind, the air-cooled cables can be wrapped into coils of various shapes and sizes to fit almost any induction preheating application, without the need for cooler and coolant
- Air-cooled cables provide the same flexibility as liquid-cooled cables for preheating





ArcReach® Heater Air-Cooled Induction System

See literature IN/16.0

Field preheat and bakeout applications up to 600 degrees Fahrenheit (315°C).



ArcReach Heater



Air-cooled cable

Air-cooled quick wrap

ArcReach Heater systems allow economical insourced weld preheating and bakeout. The induction heating tools (air-cooled cables or air-cooled quick wraps) connect to the ArcReach Heater, which is powered by select on-site welding power sources. With ArcReach Heater systems you can:

- Eliminate the costly overruns common with heating contractors
- Eliminate delays due to transitions between heating and welding crews
- Run your own schedule without depending on third-party contractors
- Use existing on-site welding equipment up to 200 feet away as the heating power source
- Lower preheating and bakeout costs
- Automatically and accurately document joint temperatures
- Eliminate safety concerns caused by traditional resistance and open-flame heating

Easy setup with flexibility to fit a variety of pipe diameters, plates or odd geometries.

Time-to-temperature is faster than conventional processes due to the method of applying heat, reducing cycle time.

Uniform heating is maintained along and through the heat zone by using induction heat within the material. The surface of the part is not marred by localized conducted heat at higher than specified temperatures.

Improved working environment during welding. Welders are not exposed to open flames, explosive gases and hot elements associated with fuel gas heating and resistance heating.

ArcReach Heater is equipped with built-in temperature control allowing for either manual or computer-loaded programming using up to six thermocouples. It can run either one or two heating tools (air-cooled cable or air-cooled quick wrap) at the same time. Requires ArcReach Heater extension cable to operate.

Air-cooled cables are designed with flexibility and efficiency in mind. Cables can be wrapped into coils of various shapes and sizes to fit any induction preheat or bakeout application (flat plate, pipe, odd geometries).

Air-cooled quick wraps provide a fast and easy way to wrap a pipe joint (up to 10-inch diameter) for preheat and bakeout. Simply place around the pipe, connect the ends, and cinch the clip as close to the pipe as possible.

Durable high-temperature materials. Air-cooled cables and quick wraps are designed to withstand the tough conditions in both industrial and construction applications.

Preheat and bakeout programs can be manually entered or loaded via USB drive.

Heating data is automatically recorded and can be used in quality control and documentation needs.

Industrial ●

Process

- Induction heating

Suggested power sources

- XMT® 350 FieldPro™ (pg 48)
- XMT® 650 ArcReach (pg 50)
- Trailblazer® Series (ArcReach models only) (pg 82)
- Big Blue® Series (ArcReach models only) (pg 84-87)

Most popular accessories



ArcReach Heater Extension Cable

- 301451 10 ft. (3 m)
- Air-Cooled Quick Wrap 301452
- Air-Cooled Cable
- 301453030 30 ft. (9.1 m)
- 301453050 50 ft. (15.2 m)
- 301453080 80 ft. (24.4 m)

- Cable Cover
- 204611 30 ft. (9.1 m)
- 204614 50 ft. (15.2 m)
- 204620 80 ft. (24.4 m)



Preheat Insulation

- 204669 1/2 x 6 x 120 in. (1.3 x 15 x 305 cm)
- 195376 1/2 x 6 x 240 in. (1.3 x 15 x 305 cm)
- 211474 1/2 x 12 x 120 in. (1.3 x 31 x 305 cm)



Preheat Insulation w/Cable Harness

- 301334 1/2 x 16 x 120 in. (1.3 x 41 x 305 cm)
- Series Cable Adapter 195437
- High-Temperature Rope 194965
- Temperature Measurement (two options available)
- Contact Thermocouple Sensor (Probe) 301517 **OR** welded on thermocouples which require 500 ft. (152 m)
- Thermocouple Wire 194999,
- Thermocouple Connectors (10 pack) 195098, and Thermocouple Attachment Unit 194959

Visit MillerWelds.com for more information selecting Miller® induction heating options and accessories.

Stock Number	Input Power	Output Current	Output Voltage	Source Current	Output Frequency	Rated Output	Heater Dimensions	Heater Net Weight
301390 Heater only – requires ArcReach Heater extension cable to operate	Operates on open-circuit voltage: 50–70 V provided by an XMT 350 FieldPro, XMT 650 ArcReach or an ArcReach-equipped engine drive	200 A	300 V	33 A	5–30 kHz	7.8 kW at 100% duty cycle	H: 18.6 in (472 mm) W: 11.2 in (285 mm) D: 26.7 in (678 mm)	43 lb. (20 kg)
951848 Heater w/extension cable								
951849 Heater w/extension cable and two air-cooled quick wraps								



For more detailed information, visit

MillerWelds.com/plasmacutters

Plasma Cutters



Product Guide

	Page	Class	Gouging	Piercing	Rated Output/ Duty Cycle	Rated Cutting Thickness*			Max. Sever Thickness Mild Steel	Special Features	Typical Applications	
						Mild Steel	Stainless Steel	Aluminum				
Spectrum® 375 X-TREME™	96	●	●	●	30 A at 40%	3/8 in.	3/8 in.	1/4 in.	5/8 in.	Auto-Line™ (120-240 V), MVP™ plugs, Auto-Refire™, automatic air regulation, only 19 lb., XT30 torch	HVAC, maintenance, light construction, hobbyist, auto restoration, fabrication	1-Phase
Spectrum® 625 X-TREME™	96	●	●	●	40 A at 60%	5/8 in.	1/2 in.	3/8 in.	7/8 in.	Auto-Line™ (120-240 V), MVP™ adapters, Auto-Refire™, automatic air regulation, only 21 lb., XT40 torch	Maintenance, light construction, body shops, prototyping	
Spectrum® 875	96	●	●	●	60 A at 50%	7/8 in.	7/8 in.	5/8 in.	1-1/4 in.	Auto-Refire™, automatic air regulation, only 49 lb., XT60 or XT60M torch	Construction, maintenance/repair, fabrication	
Spectrum® 875 Auto-Line™	96	●	●	●	208: 60 A at 40% 230-380 V: 60 A at 50% 380-575 V: 60 A at 60%	7/8 in.	7/8 in.	5/8 in.	1-1/4 in.	Auto-Line™ (208-575 V), Auto-Refire™, automatic air regulation, only 54 lb., XT60 or XT60M torch	Construction, maintenance/repair, fabrication	1&3-Ph

Engine-Driven Welder/Generator	Continuous Generator Power	Spectrum 375 X-TREME Steel Cut / Output Amp Setting**	Spectrum 625 X-TREME Steel Cut / Output Amp Setting**	Spectrum 875 / 875 Auto-Line Steel Cut / Output Amp Setting**	
Fusion 185 and Blue Star® 185	6,200 watts	3/8 in. / 30 A	Not recommended	Not recommended	Cutting w/Engine Drive
Bobcat™ 200 Air Pak™	6,500 watts	3/8 in. / 30 A	Not recommended	Not recommended	
Bobcat™ 225, 260, 3 Phase	9,500 watts	3/8 in. / 30 A	5/8 in. / 40 A	1/2 in. / 45 A	
Trailblazer® Series	10,500 watts	3/8 in. / 30 A	5/8 in. / 40 A	1/2 in. / 45 A	
Big Blue® 400 Pro, 400 PipePro® and 450 Duo CST™	10,000 watts	3/8 in. / 30 A	5/8 in. / 40 A	1/2 in. / 45 A	
Big Blue® 500 Pro, 600 Series and 800 Series	1-phase: 12,000 watts 3-phase: 20,000 watts	3/8 in. / 30 A	5/8 in. / 40 A	7/8 in. / 50 A	

***Note on cut capacity ratings:** The Spectrum Series rating system is designed to provide a guide to help our customers choose the right machine for their application. Rated cut capacity is based on traveling approximately 15 inches per minute to achieve a steady, precise cut. This is the key rating that should meet or exceed your typical cutting thickness requirements. Sever cut is the maximum cut achieved in ideal conditions. Some factors that dictate actual cut speeds, thickness capacity and duty cycles are: types of thermally conductive material being cut, available input power, output power settings and operator technique. For highly thermal conductive metals such as aluminum, cutting capacities may be reduced up to 30 percent compared to mild steel.

Product Key

Class: ● Light industrial ● Industrial ● Heavy industrial Capability: ● Designed for this process ● Capable of this process

*See note on cut capacity ratings above. **240 V, full KVA plug. Derate cut capacity with less generator power.

For more detailed information, see individual literature sheets.

Spectrum® Series Plasma Cutters

Our Spectrum line of plasma cutters provides big cutting power in portable packages and with features like flexible cables and Auto-Refire technology they are better than ever. Step up to Spectrum 625 X-TREME™ or 875/875 Auto-Line™ models to add Ultra-Quick Connect hand-held torches. Machine torch capabilities are available with Spectrum 875/875 Auto-Line™ models only.



Spectrum 375 X-TREME

Spectrum 625 X-TREME

Spectrum 875

Spectrum 875 Auto-Line

Spectrum Features

Feature	375 X-TREME	625 X-TREME	875	875 Auto-Line
Auto-Line (120-240 V)	●	●		●
Auto-Line (208-575 V)	●	●		●
MVP™ plugs/adapters	●	●		●
Ultra-Quick Connect™ torch with flexible cable			●	●
Quick connect flexible work cable with clamp	●	●	●	●
Built-in gas/air filter and regulator	●	●	●	●
Auto-Refire™	●	●	●	●
Auto postflow	●	●	●	●
Auto air regulation	●	●	●	●
X-CASE™	●	●		
Machine torch capable			●	●

Steel/Stainless/Aluminum Rated Cutting Capacity

	Spectrum 375 X-TREME	Spectrum 625 X-TREME	Spectrum 875/875 Auto-Line
Steel/Stainless	3/8 in. (9.5 mm)	5/8 in. (15.9 mm)*	7/8 in. (22.2 mm)
Aluminum	1/4 in. (6.4 mm)	3/8 in. (9.5 mm)	5/8 in. (15.9 mm)

*Stainless: 1/2 in. (12.7 mm) for Spectrum 625 X-TREME.

Cut capacity ratings are based on traveling speed of approximately 15 inches per minute to achieve a precise cut. This is the key rating that should meet or exceed your typical cutting thickness requirements. Factors that can affect actual cut speeds, thickness capacity and duty cycles are: types of thermally conductive material being cut, available input power, output power settings and operator technique. For highly thermal conductive metals such as aluminum, cutting capacities may be reduced up to 30 percent compared to mild steel.

Power factor correction (PFC). Uses less energy by utilizing input power more efficiently.

LED indicators for easy troubleshooting.

Non-high-frequency arc starting does not interfere with or damage controls or computers.

Postflow cooling circuitry extends life of the consumable and torch by cooling them with postflow air after trigger is released.

Auto-Refire™ provides ultimate convenience by automatically controlling the pilot arc when cutting expanded metal or multiple pieces of metal.

Automatic air regulation compensates for input pressure variation to provide constant recommended torch pressure for optimal cutting performance.

Built-in gas/air filter and regulator. Provides air filtration of airborne particles five microns and larger. Additional filtration and water separation recommended.

LVC™ line voltage compensation provides peak performance power under variable input voltage conditions for clean, steady cuts.

Wind Tunnel Technology™ prevents abrasive dust and particles from damaging internal components.

Fan-On-Demand™ cooling system only operates when needed, reducing power consumption and keeping internal components cleaner.

Quick connect flexible work cable with heavy-duty clamp.

Spectrum 625 X-TREME and 875/875 Auto-Line hand-held torches



Ultra-Quick Connect™ hand-held torches with flexible cables.

XT40 hand-held torch for Spectrum 625 X-TREME and XT60 hand-held torch for both Spectrum 875 models

feature quick torch connection, ergonomic handles to help prevent operator fatigue and flexible cables that make maneuvering easier.

Spectrum 875/875 Auto-Line machine torches

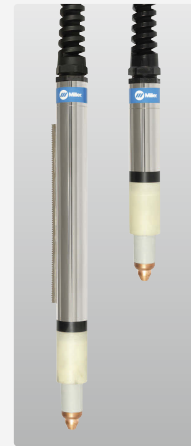

Long and short body machine torches.

XT60M machine torches for both Spectrum 875 models come in long or short body configurations in either 25- or 50-foot cable lengths. Only long body torches are available in packages, but both bodies can be ordered separately (see page 126).

Models/packages

Spectrum 375 X-TREME hand-held torch package shown.

Spectrum 875 Auto-Line long body machine torch package shown.



Model	Hand-Held Torch Packages			Long Body Machine Torch Packages	
	12 ft. (3.7 m)	20 ft. (6.1 m)	50 ft. (15.2 m)	25 ft. (7.6 m)	50 ft. (15.2 m)
Spectrum 375 X-TREME	907529	—	—	—	—
Spectrum 625 X-TREME	907579	907579001	—	—	—
Spectrum 875	—	907583	907583001	907583002	—
Spectrum 875 Auto-Line	—	907584	907584001	907584002	907584004

Spectrum® 375 X-TREME™/625 X-TREME™

See literature PC/9.2 (375 X-TREME) and PC/9.6 (625 X-TREME)

AUTO-LINE TECHNOLOGY Allows for any input voltage hookup (120–240 V, single-phase, 50/60 Hz for 375 X-TREME and 120–240 V, single-phase, 60 Hz for 625 X-TREME) with no manual linking, providing convenience in any job setting.

X-CASE™ provides the ultimate protection during transport and storage. Additional space is ideal for MVP plugs, consumables box, gloves, etc.

Multi-voltage plug (MVP™) (Spectrum 375 X-TREME) and MVP™ adapter (Spectrum 625 X-TREME) allow connection to 120- or 240-volt receptacles without tools.

XT30 hand-held torch (Spectrum 375 X-TREME) and Ultra-Quick Connect™ XT40 hand-held torch (Spectrum 625 X-TREME) feature ergonomic design and flexible cables.



Spectrum 625 X-TREME shown

Automatic gouging consumable detection (Spectrum 625 X-TREME). Detects gouging consumable and adjusts gas pressure to optimize performance, eliminating the need for a manual regulator.

Spectrum® 875/875 Auto-Line™

See literature PC/9.8

AUTO-LINE TECHNOLOGY Spectrum 875 Auto-Line model allows for any input voltage hookup (208–575 V, single- or three-phase) with no manual linking, providing convenience in any job setting. *Standard Spectrum 875 model operates on 208/230 V, single-phase input voltage only.*

Consumables storage compartment provides convenient access to consumables and parts.

Machine torch capable. Both Spectrum 875 models can be ordered with a long body machine torch or can be converted to use a machine torch with optional automation kits. Machine torches are NOT included in automation kits and must be ordered separately (see page 126).



Spectrum 875 shown

Ultra-Quick Connect™ XT60 hand-held torch with ergonomic design and flexible cable or XT60M long body machine torch included.

Light industrial ● 375/625 models
Industrial ● 875 models

DC 3 1 Only 875 Auto-Line has 3-phase capabilities.

Processes

- Air plasma cutting
- Air plasma gouging (625/875 models)

375 X-TREME package comes complete with

- XT30 hand-held torch with 12 ft. (3.7 m) cable
- Heavy-duty work clamp with 12 ft. (3.7 m) flexible cable
- 10 ft. (3 m) power cord with MVP 5-15P (120 V, 15 A) and 6-50P (240 V, 50 A) plugs
- X-CASE for protection and storage
- Shoulder strap
- Consumables box with two electrodes, two tips, deflector and air fitting

625 X-TREME packages come complete with

- XT40 hand-held torch with 12 ft. (3.7 m) or 20 ft. (6.1 m) cable
- Heavy-duty work clamp and flexible cable with quick connect
- 12 ft. (3.7 m) power cord with 240 V, L6-30P twist lock plug
- MVP adapters with 5-15P (120 V, 15 A) and 6-50P (240 V, 50 A) plugs
- X-CASE for protection and storage
- Shoulder strap
- Consumables box with two electrodes, two 40 A tips, one 30 A tip, one 30 A drag shield, deflector and air fitting

875 and 875 Auto-Line packages come complete with

- XT60 hand-held torch with 20 ft. (6 m) or 50 ft. (15.2 m) cable **OR** XT60M long body machine torch with 25 ft. (7.6 m) or 50 ft. (15.2 m) cable
- Heavy-duty work clamp and flexible cable with quick connect
- 10 ft. (3 m) power cord
- Extra consumables
- Machine torch packages include corresponding automation kit

Most popular accessories

- Automation Kits for Spectrum 875 models (pg 126)
- Cables and Cable Covers (pg 126)
- Cutting Guides (pg 126)
- Filters (pg 126)
- Plugs and Cords (pg 126)
- X-CASE (pg 126)
- Torches (pg 126)
- Torch Consumables (pg 126)

Visit MillerWelds.com or your distributor for other Miller® options and accessories.

Model	Input Power	Rated Output at 104°F (40°C)	Amps Input at Rated Output	KVA	KW	Compressor Requirement	Dimensions	Net Weight with Torch
Spectrum 375 X-TREME 120–240 V, 50/60 Hz	1-phase	120 V (15 A): 20 A at 88 VDC, 60% duty cycle	18.3	2.1	2.1	5.0 cfm (142 L/min.) at 90 psi (621 kPa)	H: 9 in. (229 mm) W: 5.5 in. (140 mm) D: 13.25 in. (337 mm)	12 ft. torch: 19 lb. (8.6 kg)
		120 V (20 A): 27 A at 92 VDC, 35% duty cycle	26.1	3.1	3.1			
		240 V: 30 A at 92 VDC, 40% duty cycle	14.7	3.5	3.4			
Spectrum 625 X-TREME 120–240 V, 60 Hz	1-phase	120 V (15 A): 20 A at 88 VDC, 60% duty cycle	17.7	2.1	2.1	6.0 cfm (170 L/min.) at 90 psi (621 kPa)	H: 9 in. (229 mm) W: 5.5 in. (140 mm) D: 13.25 in.(337 mm)	12 ft. torch: 21 lb. (9.5 kg) 20 ft. torch: 23 lb. (10.5 kg)
		120 V (20 A): 27 A at 91 VDC, 35% duty cycle	25.0	3.0	3.0			
		240 V: 40 A at 140 VDC, 60% duty cycle	27.6	6.6	6.5			
Spectrum 875 208/230 V, 50/60 Hz	1-phase	208 V: 60 A at 140 VDC, 40% duty cycle	208 V: 47	9.9	9.8	6.75 cfm (191 L/min.) at 90 psi (621 kPa)	H: 13.5 in. (343 mm) W: 8.75 in. (222 mm) D: 18.5 in. (470 mm)	20 ft. torch: 49 lb. (22.2 kg) 25 ft. torch: 51 lb. (23.1 kg) 50 ft. torch: 58 lb. (26.3 kg)
		230 V: 60 A at 140 VDC, 50% duty cycle	230 V: 42					
Spectrum 875 Auto-Line 208–575 V, 50/60 Hz	3-phase	208 V: 60 A at 140 VDC, 40% duty cycle	208 V: 27.5	9.9	9.4	6.75 cfm (191 L/min.) at 90 psi (621 kPa)	H: 13.5 in. (343 mm) W: 8.75 in. (222 mm) D: 18.5 in. (470 mm)	20 ft. torch: 54 lb. (24.5 kg) 25 ft. torch: 56 lb. (25.4 kg) 50 ft. torch: 63 lb. (28.6 kg)
		230–380 V: 60 A at 140 VDC, 50% duty cycle	230 V: 25					
		380–575 V: 60 A at 140 VDC, 60% duty cycle	380 V: 15					
		380–575 V: 50 A at 140 VDC, 100% duty cycle	460 V: 12.4 575 V: 9.8					
3-phase	208 V: 60 A at 140 VDC, 40% duty cycle	208 V: 47.4	9.9	9.7				
	230 V: 60 A at 140 VDC, 40% duty cycle	230 V: 42.2						
3-phase	208 V: 60 A at 140 VDC, 40% duty cycle	208 V: 47.4	9.9	9.7				
	230 V: 60 A at 140 VDC, 40% duty cycle	230 V: 42.2						
3-phase	208 V: 60 A at 140 VDC, 40% duty cycle	208 V: 47.4	9.9	9.7				
	230 V: 60 A at 140 VDC, 40% duty cycle	230 V: 42.2						



Miller offers an extensive line of quality regulators, cutting torches, tips and a variety of accessories for your oxy-fuel cutting and welding requirements.

Pressure Regulators



Series 40



Series 30

Heavy-duty and medium-duty single-stage pressure regulators

Series 40™ and Series 30™ industrial-grade pressure regulators provide accurate pressure readings for heating, cutting, welding and other applications. Extremely durable construction and simplified design provide consistent gas flow and longer trouble-free operation. Covered by a three-year warranty.

Also available

Series 30 single-stage regulator twin packs	Stock Number	Gas	Regulator	Max. Delivery Pressure or Flow	Inlet Connection
HTP2		Oxygen	30-100-540	100 psig (7 bar)	CGA 540
		LP Acetylene	30-15-510	15 psig (1 bar)	CGA 510
HTP5		Oxygen	30-100-540	100 psig (7 bar)	CGA 540
		Acetylene	30-15-300	15 psig (1 bar)	CGA 300



Medium-duty two-stage pressure regulators

Series 35™ two-stage regulators drop cylinder pressure to working pressure in two stages for consistent and accurate outlet pressure and flow regardless of inlet pressure. Recommended where outlet pressure and flow must be maintained without variation. Covered by a three-year warranty.



Heavy-duty single-stage station regulators

Series 46™ brass line regulators are rugged, accurate and corrosion resistant. Station regulators are used to connect pipeline gas delivery systems to the welding stations. Because the pipeline pressure is regulated upstream, station regulators only require a single delivery pressure gauge. Covered by a three-year warranty.

Note: Body inlet is 1/4-inch NPT.

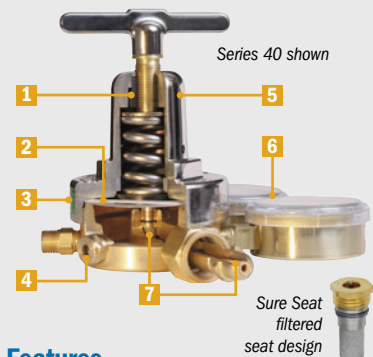

Features

- 1 Resin bonnet insert** allows smooth, easy adjustment even at high-pressure levels. Note: Series 40 and 46 only.
- 2 Stainless steel diaphragm** resists corrosion, leaking and freeze-up if used with liquid (cryogenic) gases for extended service life. Note: Series 30 and 35 have a neoprene diaphragm.
- 3 Color-coded labels** supply performance capabilities, easy gas service identification and technical information.
- 4 External relief valve** protects regulator from damage due to inadvertent high-pressure surge. Relief valve will release excessive pressure and automatically reset.
- 5 Nickel-plated bonnet and brass body** protect against corrosion.
- 6 Easy-to-read 2.5-inch gauges with polycarbonate lenses and polished brass cases** are shatter- and corrosion-resistant. Note: Series 30 and 35 have 2-inch gauges with painted steel cases.
- 7 Dual filters including Sure Seat™** protect high-pressure seat from debris for reliable operation and long service life.

Model	Stock Number	Gas	Max. Delivery Pressure	Max. Inlet Pressure	Outlet Connection	Inlet Connection
Heavy-Duty Series 40 Single-Stage Pressure Regulators	40-175-540	Single-stage Oxygen	175 psig (12 bar)	3,000 psig (207 bar)	9/16"-18 RH "B"	CGA 540
	40-275-540	Single-stage Oxygen	275 psig (19 bar)	3,000 psig (207 bar)	9/16"-18 RH "B"	CGA 540
	40-15-510	Single-stage Acetylene	15 psig (1 bar)	400 psig (28 bar)	9/16"-18 LH "B"	CGA 510
	40-15-300	Single-stage Acetylene	15 psig (1 bar)	400 psig (28 bar)	9/16"-18 LH "B"	CGA 300
	40-50-510	Single-stage LP gas	50 psig (3 bar)	400 psig (28 bar)	9/16"-18 LH "B"	CGA 510
	40-275-580	Single-stage Inert gas	275 psig (19 bar)	3,000 psig (207 bar)	5/8"-18 RH internal	CGA 580
Medium-Duty Series 30 Single-Stage Pressure Regulators	30-100-540	Single-stage Oxygen	100 psig (7 bar)	3,000 psig (207 bar)	9/16"-18 RH "B"	CGA 540
	30-20-540	Single-stage Oxygen	20 psig (1.4 bar)	3,000 psig (207 bar)	9/16"-18 RH "B"	CGA 540
	30-15-510	Single-stage Acetylene	15 psig (1 bar)	400 psig (28 bar)	9/16"-18 LH "B"	CGA 510
	30-15-300	Single-stage Acetylene	15 psig (1 bar)	400 psig (28 bar)	9/16"-18 LH "B"	CGA 300
	30-15-520	Single-stage Acetylene	15 psig (1 bar)	400 psig (28 bar)	9/16"-18 LH "B"	CGA 520
	30-15-200	Single-stage Acetylene	15 psig (1 bar)	400 psig (28 bar)	9/16"-18 LH "B"	CGA 200
	30-50-510	Single-stage LP gas	50 psig (3 bar)	400 psig (28 bar)	9/16"-18 LH "B"	CGA 510
	30-150-580	Single-stage Inert gas	150 psig (10 bar)	3,000 psig (207 bar)	5/8"-18 RH internal	CGA 580
	30-150-320	Single-stage CO ₂	150 psig (10 bar)	3,000 psig (207 bar)	5/8"-18 RH internal	CGA 320
	30-100-350	Single-stage Hydrogen	100 psig (7 bar)	3,000 psig (207 bar)	9/16"-18 LH "B"	CGA 350
Medium-Duty Series 35 Two-Stage Pressure Regulators	35-125-540	Two-stage Oxygen	125 psig (9 bar)	3,000 psig (207 bar)	9/16"-18 RH "B"	CGA 540
	35-15-510	Two-stage Acetylene	15 psig (1 bar)	400 psig (28 bar)	9/16"-18 LH "B"	CGA 510
	35-50-580	Two-stage Inert gas	50 psig (3 bar)	3,000 psig (207 bar)	5/8"-18 RH internal	CGA 580
Heavy-Duty Series 46 Station Regulators	46-175	Single-stage Oxygen	175 psig (12 bar)	200 psig (14 bar)	9/16"-18 RH "B"	CGA 024 7/8"-14 RH "C"
	46-15	Single-stage Acetylene	15 psig (1 bar)	200 psig (14 bar)	9/16"-18 LH "B"	CGA 025 7/8"-14 LH "C"
	46-50	Single-stage LP gas	50 psig (3 bar)	200 psig (14 bar)	9/16"-18 LH "B"	CGA 025 7/8"-14 LH "C"

Flowmeter and Flow Gauge Regulators

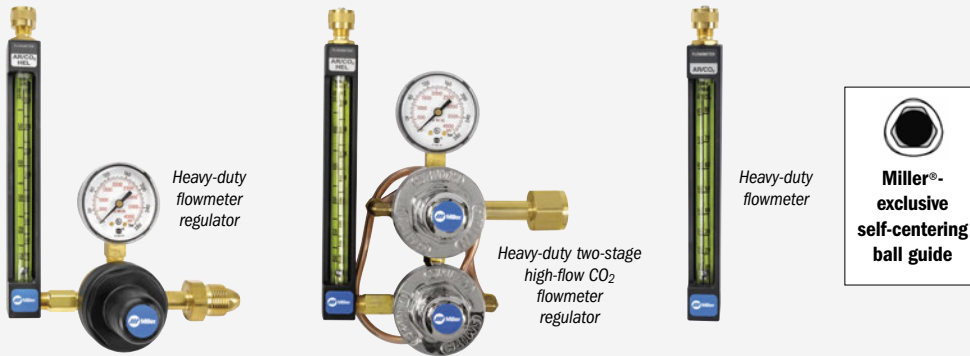

Heavy-duty flowmeter regulators and flowmeters

Heavy-duty flowmeter regulators and flowmeters feature an exclusive self-centering ball guide which provides accurate readings even if tipped. This ensures optimum weld quality and gas savings. Others use a non-self-centering flow tube ball that tends to float off center causing actual gas flow to be up to two times greater than indicated. Covered by a three-year warranty.

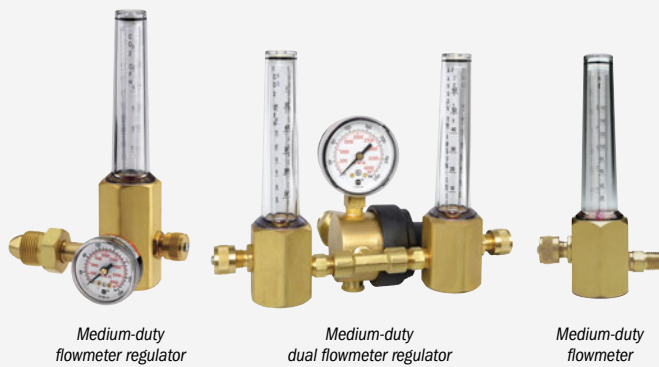

Medium-duty flowmeter regulators and flowmeters

Medium-duty flowmeter regulators and flowmeters combine exceptional value and a compact design with precise shielding gas regulation for MIG and TIG welding applications and more. Covered by a three-year warranty.



Single-stage flow gauge regulators

Series 30" single-stage flow gauge regulators are compact and feature a forged brass body and a self-resetting pressure relief valve. They include a Sure Seat™ protective inlet filter and a durable neoprene-composite diaphragm. Covered by a three-year warranty.



Heavy-duty model features

- Rugged aluminum protective housing** protects flow tubes from damage while offering unobstructed view of flow reading.
- Extra-long flow tube with high-visibility green background** eases readings from a distance and in low-light conditions.
- Expanded multi-scale flow tube** made of shatter-resistant polycarbonate resin. Easy to read and accurate within five percent of full reading for inert gases.
- Auto-reset external pressure-relief valve** protects regulator from damage due to high-pressure surge. Relief valve will release excessive pressure and automatically reset.
- Dual filters including Sure Seat™** protect high-pressure seat from debris for reliable operation and long service life.

Medium-duty model features

- Built-in rupture disc** reduces possibility of flow tube damage due to high-pressure surge. Must be replaced if ruptured – not auto-resetting.
- Shatter-resistant triple-scale flow tube** is made of polycarbonate resin and can be rotated to position desired scale for easy reading. Scaled for CO₂, argon and argon/CO₂ mix, and helium.
- Precision flow-adjustment valve** allows easy adjustment to desired setting.

Model	Stock Number	Gas	Flow Range	Max. Inlet Pressure	Outlet Connection	Inlet Connection
Heavy-Duty Flowmeter Regulators	22-80-580 Single-stage	Argon/CO ₂	10-80 scfh (5-38 lpm)	3,000 psig (207 bar)	5/8"-18 RH internal	CGA 580
	22-80-580-6 Single-stage w/gas hose					
	22-80-320 Single-stage	CO ₂	10-80 scfh (5-38 lpm)	3,000 psig (207 bar)		
	22-80-320-6 Single-stage w/gas hose					
	22-30-580 Single-stage	Argon/CO ₂	10-55 scfh (5-26 lpm)	3,000 psig (207 bar)		
Heavy-Duty Flowmeters	16530 Argon, CO ₂	Argon, CO ₂	10-80 scfh (5-38 lpm)	80 psig (6 bar) recommended	5/8"-18 RH internal	1/4" NPT female
	16531 Argon, CO ₂ , helium	Argon, CO ₂ , helium	Depends on gas	30 psig (2 bar) recommended		
Medium-duty Flowmeter Regulators	H2051B-580 Single-stage	Argon	0-60 scfh (0-28 lpm)	3,000 psig (207 bar)	5/8"-18 RH internal	CGA 580
	H2051B-580H Single-stage w/gas hose	CO ₂	0-50 scfh (0-24 lpm)	3,000 psig (207 bar)		
	23-50-580 Single-stage dual flowmeter regulator	Helium	0-160 scfh (0-78 lpm)	3,000 psig (207 bar)		
Medium-duty Flowmeters	H2230A Multi-scale	Argon, helium, CO ₂	Depends on gas	50 psig (3 bar) recommended	5/8"-18 RH internal	1/4" NPT male
	H2231A Multi-scale					5/8"-18 RH external
Single-Stage Series 30 Flow Gauge Regulators	31-50-580 Single-stage	Argon	0-50 scfh (0-24 lpm)	3,000 psig (207 bar)	5/8"-18 RH internal	CGA 580
	31-50-580-6 Single-stage w/gas hose					
	31-50-320 Single-stage	CO ₂	0-50 scfh (0-24 lpm)	3,000 psig (207 bar)		

Specialty Regulators



HVAC/refrigeration purge/leak test regulator

Single-stage nitrogen regulator is specially designed to meet the specifications of HVAC refrigerant-purging applications. This regulator is used with nitrogen to test HVAC systems to locate leaks and to purge an area for installation and repair. It is economical, accurate and its compact size is useful where space is limited. Covered by a one-year warranty.

- 2-inch (51 mm) gauges with shatter-resistant lenses and solid brass body for durability
- Large durable nylon knob for easy pressure adjustment

Stock Number	Gas	Max. Delivery Pressure	Max. Inlet Pressure	Outlet Connection	Inlet Connection
30-450-580	Nitrogen	450 psig (31 bar)	3,000 psig (207 bar)	7/16"-20 external flair fitting	CGA 580



824-0009

Heavy-duty high-pressure regulator

820 Series regulators are for use on cylinders with a wide variety of non-corrosive inert gases. Typical applications include high-pressure testing, purging/charging, calibration kits, airline charging carts, chemical plants, manufacturing processes, research/development and laboratories. Covered by a two-year warranty.

- Piston-sensor design gives structural reliability in high-pressure use
- Low-torque-control adjusting screw for easy pressure adjustments in closed/dead end systems
- Due to specific configurations, we cannot accept returns of 820 Series regulators

Model Series	Max. Delivery Pressure	Max. Inlet Pressure	Option 1 - Outlet pressure	Model Configuration	Option 3 Inlet connection (additional inlet connections available)/Max. inlet pressure
823	500 psig	6,000 psig	823 0-500 psig	825 - 66 26	00 1/4" FNPT
824	1,000 psig		824 0-1,000 psig	Option 2 Outlet connection	08 CGA 540 (oxygen) 3,000 psig
825	2,000 psig		825 0-2,000 psig		00 1/4" FNPT
826	4,000 psig		826 0-4,000 psig	66 Stainless steel needle valve with 1/4" NPT	26 CGA 347 stainless steel 5,500 psig
827	6,000 psig		827 0-6,000 psig		27 CGA 677 stainless steel 7,500 psig
					28 CGA 680 stainless steel 5,500 psig



254-8209

Rear-entry liquid cylinder regulator

250 Series regulators are ideal for non-corrosive high-purity applications and have a rear-entry connection that provides clearance of the liquid cylinder ring for easier gauge reading. Covered by a two-year warranty.

- Easy-to-read single-scale 2.5-inch (64 mm) gauge with shatter-resistant lens
- Nickel-plated brass body for corrosion resistance
- Large 1.875-inch stainless steel diaphragm for precise control of pressure
- Large durable nylon knob for easy pressure adjustment
- Due to specific configurations, we cannot accept returns of 250 Series regulators

Note: Use Series 40™ heavy-duty regulators constructed with a stainless steel diaphragm for high-volume or liquid (cryogenic) cylinder applications.

Model Series	Max. Delivery Pressure	Max. Inlet Pressure	Option 1 - Outlet pressure	Model Configuration	Option 3 Inlet connection
252	100 psig	3,500 psig	252 0-100 psig	252 - 20 08	00 1/4" FNPT
254	200 psig		254 0-200 psig	Option 2 Outlet connection	02 CGA 320
255	350 psig		255 0-350 psig		00 1/4" FNPT
256	500 psig		256 0-500 psig	82 Chrome needle valve with 1/4" NPT	09 CGA 580
				82 9/16"-18 RH "B"	



16347-3 (with pressure switch)

Three-stage nitrogen low-pressure regulator

Preset regulators are specially designed to deliver a highly accurate and consistent 0.50 psig supply of nitrogen to the head space of oil-filled power transformers. Available with or without electronic pressure switch. Covered by a one-year warranty.

- Built-in self-relieving valve set at 8 psig protects the system from over-pressurization due to temperature variation
- Rapid-fill bypass pressure valve allows rapid filling of the transformer with 6 psig of pressure
- Pressure switch preset at 250 psig, but is adjustable from 70-300 psig using 3/32-inch Allen head screw switch
- Operation voltage amps at 12/24 volts DC or 125 volts AC: 3 amps at 250 volts
- Switch wiring: Normally open or normally closed (DPDT), three 18-inch flying leads

Stock Number	Preset Outlet Pressure		Delivery Pressure 3rd Stage	Bypass Rapid Fill/Purge	Max. Inlet Pressure	Outlet Connection	Inlet Connection	Operating Temperature
	1st Stage	2nd Stage						
16391 Without pressure switch	150 psig (10 bar)	8 psig (0.6 bar)	0.4-0.6 psig (0.03-0.04 bar)	6 psig (0.4 bar)	3,000 psig (207 bar)	1/2" FNPT	CGA 580	-40° to +180°F (-40° to +82°C)
16347-3 With pressure switch	into 2nd stage	into 3rd stage	into outlet					

Most popular accessories

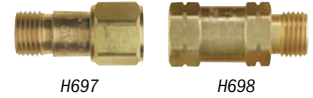

- **Reverse-Flow Check Valve Set (oxy and fuel)**
- H697 Torch mount
- H698 Regulator mount



- **Flashback Arrestor Set (oxy and fuel)**
- H743 Torch mount
- H753 Regulator mount



- **Fixed-Flow Adapters**
- H1400 Series fixed-flow adapters are for welding operations requiring fixed-flow gases. Ideal for directly connecting to pipeline outlet. Visit MillerWelds.com for more information.



- **Surge Protectors**
- 15001 Series surge protectors are for MIG welding applications to help eliminate sudden surges of shielding gas in the wire feeder. Ideal for directly connecting to a welder or wire feeder. Visit MillerWelds.com for more information.



- **GASAVER™**
- WDW100 Propylene/oxygen
- WDW101 Acetylene/oxygen
- WDW103 Propane or natural gas (less than 4 psi)
- WDW104 Propane or natural gas/oxygen (4 psi and above)
- For repetitious brazing and soldering
- Hang torch to shut off
- Pilot light for relighting
- Eliminates flame readjustment

Visit MillerWelds.com or your distributor for other Miller® options and accessories.

Torches



Cutting torches (acetylene, natural gas, LP or propylene-based fuels)

Gas Axe™ extra-heavy-duty cutting torches are ideal for scrap, salvage and demolition cutting.

- Covered by a one-year warranty
- Reversible (top or bottom) mount cutting lever
- Thick-wall forged brass head available in three different head angles
- Uses our long-lasting Graf-Tite™ soft-seat cutting tips with in-tip gas mixing design for operator safety
- Cuts up to 20 inches (508 mm) with LP and up to 12 inches (305 mm) with acetylene or propylene

Heavy-duty cutting torches are ideal for construction, fabrication and shipyard industries.

- Covered by a five-year warranty
- Nickel-plated finish for added corrosion resistance and to reflect residual heat
- Available in two lengths and three different head angles
- Uses our long-lasting Graf-Tite™ soft-seat cutting tips with in-tip gas mixing design for operator safety
- Cuts up to 12 inches (305 mm)

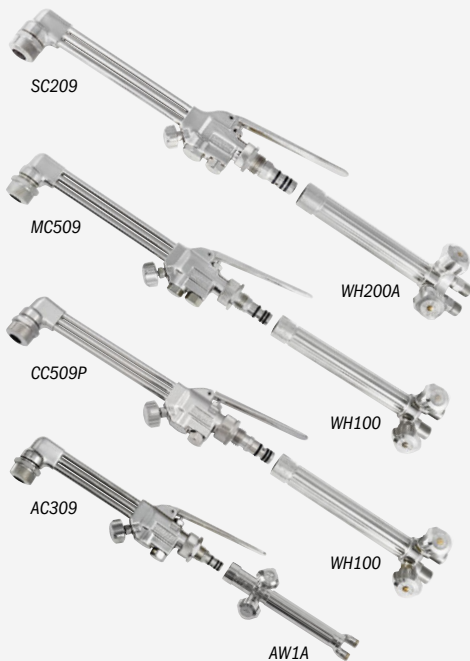

Combination torches (acetylene, natural gas, LP or propylene-based fuels)

Constructed to last a lifetime for safe performance under rugged conditions. For cutting, heating, welding or brazing.

- Covered by a five-year warranty (except Toughcut™ cutting attachment CC509P which has a three-year warranty)
- Exclusive Flo-Trol™* safety feature protects the cutting assembly and operator from flashbacks (heavy-duty and medium-duty cutting attachments only)
- Ease-on cutting oxygen valve to reduce slag blowback when piercing
- Thick-wall brass head forgings resist warping and distortion
- Uses our long-lasting Graf-Tite™ soft-seat cutting tips with in-tip gas mixing design for operator safety
- Heavy-duty torches cut up to 8 inches (203 mm), medium-duty and Toughcut™ up to 6 inches (152 mm), and standard-duty up to 3 inches (76 mm)

*Flo-Trol is a spring-loaded back-pressure check valve that prevents burn out and damage to the cutting assembly by preventing mixed gas from traveling back into the high-pressure seat area.



Machine torches (acetylene, natural gas, LP or propylene-based fuels)

Superior performance with solid construction.

- Covered by a five-year warranty
- Torch barrels are adjustable to four positions at 90-degree increments and barrel diameters are 1-3/8 inches (9.5 mm) to fit most machines
- Rack pitch is 32-8 teeth per inch
- Uses our long-lasting Graf-Tite™ soft-seat cutting tips with in-tip gas mixing design for operator safety
- Cuts up to 12 inches (305 mm)

Torches

Stock Number	Head Angle in Degrees	Length Inches (mm)
--------------	-----------------------	--------------------

Gas Axe Extra Heavy-Duty Cutting Torches

SC925	75	21 (533)
SC929	90	21 (533)
SC935	75	36 (914)
SC939	90	36 (914)
SC930	180	36 (914)
SC945	75	48 (1,219)
SC949	90	48 (1,219)
SC940	180	48 (1,219)
SC965	75	72 (1,829)
SC969	90	72 (1,829)
SC960	180	72 (1,829)

Heavy-Duty Cutting Torches

SC225	75	21 (533)
SC229	90	21 (533)
SC229S*	90	21 (533)
SC220	180	21 (533)
SC365	75	36 (914)
SC369	90	36 (914)
SC360	180	36 (914)

*Torch head made with thicker-wall manganese bronze for more severe service.

Heavy-Duty Combination Torches

SC205	75	12.5 (318)
SC209	90	12.5 (318)
WH200A	Handle	7.5 (191)

Medium-Duty Combination Torches

MC505	75	11.25 (286)
MC509	90	11.25 (286)
WH100	Handle	7 (178)

Toughcut™ Combination Torches

CC509P	90	11.25 (286)
WH100	Handle	7 (178)

Standard-Duty Combination Torches

AC309	90	8.5 (216)
AW1A	Handle	5.75 (146)

Machine Torches

SC772A	—	13.75 (349)
SC770	—	8 (203)

See page 102 for heavy-duty tips to use with cutting torches and combination torches.

See page 103 for medium-duty tips to use with combination torches.

Most popular accessories



▪ Circle Cutter Guide 16229



▪ Flashback Arrestor Set (oxy and fuel)
H743 Torch mount
H753 Regulator mount

Visit MillerWelds.com or your distributor for other Miller® options and accessories.

Heavy-Duty Outfits and Packs



HBA-40510

Combination torch outfits

Outfits include just about everything needed for your cutting, heating, welding or brazing project.

- Heavy-duty combination torch with nickel plating to deflect heat and Flo-Trol™ safety device which prevents reverse flow of mixed gases
- Heavy-duty Series 40™ regulators (HBA-40XXX) **OR** medium-duty Series 30™ regulators (HBA-30XXX)
- Heavy-duty tips with in-tip gas mixing design for operator safety
- Graf-Tite™ soft-seat cutting tips maintain positive seating for longer use even if tip is nicked
- Torch-mount flashback arrestors (acetylene outfits) **OR** regulator-mount check valves (propane outfit) for added safety
- Cuts up to 8 inches (203 mm) with optional tips



16280

Combination torch and tips packs

Packs are an easy and economic way to update or change your oxy-fuel system. Available with cutting, heating and welding tips **OR** multiple cutting tips.

- Heavy-duty combination torch with nickel plating to deflect heat and Flo-Trol™ safety device which prevents reverse flow of mixed gases
- Heavy-duty tips with in-tip gas mixing design for operator safety
- Graf-Tite™ soft-seat cutting tips maintain positive seating for longer use even if tip is nicked
- Torch-mount flashback arrestors for added safety
- Cuts up to 8 inches (203 mm) with optional tips



HBS-30510

(HBS outfits are not shown, see chart for items included)

Cutting torch outfits

Hand cutting torch outfits are built for the toughest jobs.

- Heavy-duty hand cutting torch with nickel plating to deflect heat, reversible (top or bottom) mount cutting lever, and an ease-on oxygen feature that reduces slag blowback when piercing
- Heavy-duty Series 40™ regulators with gauge guards (HBS outfits) **OR** medium-duty Series 30™ regulators (HBAS outfits)
- Graf-Tite™ soft-seat cutting tips maintain positive seating for longer use even if tip is nicked, and in-tip gas mixing for added resistance to flashbacks
- Torch-mount flashback arrestors (HBAS outfits) for added safety
- Cuts up to 12 inches (305 mm) with optional tips

Heavy-duty tips

Stock Number	Max. Metal Thickness Inches (mm)	Cutting Jet Drill Size
Acetylene Cutting		
SC12-00	3/16 (5)	68
SC12-0	3/8 (10)	62
SC12-1	5/8 (16)	56
SC12-2	1-1/4 (32)	54
SC12-3	2 (51)	51
SC12-4	4 (102)	45
SC12-5	8 (203)	41
SC12-6	12 (305)	32
Propane/Natural Gas Cutting		
SC50-0	3/8 (10)	62
SC50-1	5/8 (16)	56
SC50-2	1-1/4 (32)	54
SC50-3	2 (51)	51
SC50-4	4 (102)	45
SC50-5	8 (203)	41
SC50-6	12 (305)	32
SC50-7	14 (354)	28
SC50-8	18 (457)	17
SC50-9	20 (508)	3
Propylene Cutting		
SC60-0	3/8 (10)	62
SC60-1	5/8 (16)	56
SC60-2	1-1/4 (32)	54
SC60-3	2 (51)	51
SC60-4	4 (102)	45
SC60-5	8 (203)	41
SC60-6	12 (305)	32
Acetylene Gouging		
SC13-3	3/8 (10) wide, 1/4 (6) deep	
Propane/Natural Gas Gouging		
SC23-3	3/8 (10) wide, 1/4 (6) deep	
Propylene Gouging		
SC23-3M	3/8 (10) wide, 1/4 (6) deep	
Acetylene Heating		
ST602	40,000 Btu	
ST603	72,000 Btu	
ST605	125,000 Btu	
ST610	195,000 Btu	
Acetylene Welding		
SW201	1/32 in. (0.7 mm)	
SW203	5/64 in. (1.9 mm)	
SW205	1/8 in. (3 mm)	
SW207	3/16 in. (5 mm)	
SW209	3/8 in. (10 mm)	
SW210	1/2 in. (13 mm)	

Visit MillerWelds.com or your distributor for additional tips, options and accessories.

Outfit/Pack	Stock Number	Fuel	Oxygen Regulator	Fuel Gas Regulator	Torch	Cut Tip	Heat Tip	Weld Tip	Accessories	
Combination Torch Outfits	HBA-40510	Acetylene	40-175-540	40-15-510	SC209/WH200A	SC12-1, SC12-2	ST602	SW205	25 ft. (7.6 m), 1/4 in. (6 mm) "R"-grade hose, lighter, shade 5 safety glasses, tip cleaner and flashback arrestors	
	HBA-40300			40-15-300						
	HBA-30510			30-100-540						30-15-510
	HBA-30300									30-15-300
	HBA-30510LP	Propane/natural gas	30-100-540	30-50-510	SC209/WH200A	SC40-1	ST615	–	20 ft. (6.1 m), 1/4 in. (6 mm) "T"-grade hose, lighter, shade 5 safety glasses, tip cleaner and check valves	
Combination Torch and Tips Packs	16206	Acetylene	–	–	SC209/WH200A	SC12-1	ST602	SW203	H743 flashback arrestors	
	16280					SC12-0, SC12-1	–	–		
Cutting Torch Outfits	HBS-H510S	Acetylene	40-175-540S	40-15-510S	SC229	SC12-2	–	–	Hard Hat™ gauge guards (denoted by "S" designation at end of regulator number)	
	HBS-H300S			40-15-300S						
	HBAS-30510		30-100-540	30-15-510						
	HBAS-30300			30-15-300						
									20 ft. (6.1 m), 3/16 in. (5 mm) "R"-grade hose, lighter, shade 5 safety glasses, tip cleaner and flashback arrestors	

Medium-Duty Outfits and Packs



MBA-30510

Combination torch outfits

Outfits include just about everything needed for your cutting, heating, welding or brazing project.

- Medium-duty combination torch with nickel plating to deflect heat and Flo-Trol™ safety device which prevents reverse flow of mixed gases
- Medium-duty Series 30™ regulators with dual filters for reliable operation
- Medium-duty tips with in-tip gas mixing design for operator safety
- Graf-Tite™ soft-seat cutting tips maintain positive seating for longer use even if tip is nicked
- Torch-mount flashback arrestors (acetylene outfits) **OR** regulator-mount check valves (propane outfit) for added safety
- Cuts up to 6 inches (153 mm) with optional tips



16205

Combination torch and tips packs

Packs are an easy and economic way to update or change your oxy-fuel system. Available with cutting, heating and welding tips **OR** multiple cutting tips.

- Medium-duty combination torch with nickel plating to deflect heat and Flo-Trol™ safety device which prevents reverse flow of mixed gases
- Medium-duty tips with in-tip gas mixing design for operator safety
- Graf-Tite™ soft-seat cutting tips maintain positive seating for longer use even if tip is nicked
- Torch-mount flashback arrestors for added safety
- Cuts up to 6 inches (153 mm) with optional tips

Medium-duty tips

Stock Number	Max. Metal Thickness Inches (mm)	Cutting Jet Drill Size
Acetylene Cutting		
MC12-00	3/16 (5)	68
MC12-0	3/8 (10)	62
MC12-1	5/8 (16)	55
MC12-2	1 (25)	54
MC12-3	2 (51)	51
MC12-4	4 (102)	45
MC12-5	6 (152)	41
Propane/Natural Gas Cutting		
MC40-00	3/16 (5)	68
MC40-0	3/8 (10)	62
MC40-1	5/8 (16)	55
MC40-2	1-1/4 (32)	54
MC40-3	2 (51)	51
MC40-4	4 (102)	51

Acetylene Gouging

MC13-3	3/8 (10) wide, 1/4 (6) deep
---------------	-----------------------------

Note: Tips above fit medium- and standard-duty torches.

Acetylene Heating

MT603	40,000 Btu
MT605	73,000 Btu
MT610	129,000 Btu

Propane/Natural Gas Heating

MT805	208,000 Btu
MT615	269,000/182,000 Btu

Acetylene Welding

MW201	1/32 in. (0.7 mm)
MW203	5/64 in. (1.9 mm)
MW205	1/8 in. (3 mm)
MW207	3/16 in. (5 mm)
MW209	3/8 in. (10 mm)

Most popular accessories



- **"R"-Grade Welding Hose** RL935
For acetylene. 20 ft. (6.1 m), 3/16 in. (5 mm) ID, "B" fittings



- **"T"-Grade Welding Hose** TRL1131
For propane/natural gas. 20 ft. (6.1 m), 1/4 in. (6 mm) ID, "B" fittings

Visit MillerWelds.com or your distributor for other Miller® options and accessories.



Outfit/Pack	Stock Number	Fuel	Oxygen Regulator	Fuel Gas Regulator	Torch	Cut Tip	Heat Tip	Weld Tip	Accessories
Combination Torch Outfits	MBA-30510	Acetylene	30-100-540	30-15-510	MC509/WH100	MC12-0, MC12-1	MT603	MW205	20 ft. (6.1 m), 3/16 in. (5 mm) "R"-grade hose, lighter, shade 5 safety glasses, tip cleaner and flashback arrestors
	MBA-30300			30-15-300					
	MBA-30510LP	Propane/natural gas	30-100-540	30-50-510	MC509/WH100	MC40-1	MT805	—	20 ft. (6.1 m), 1/4 in. (6 mm) "T"-grade hose, lighter, safety glasses and check valves
Combination Torch and Tips Packs	16205	Acetylene	—	—	MC509/WH100	MC12-1	MT603	MW203	Flashback arrestors
	16281					MC12-0, MC12-1	—	—	

Toughcut™ Outfits and Packs

Toughcut medium-duty combination torches include many features found in our premium medium-duty torches.



MB55A-300

TL-550 (Tag-A-Long)



287643

287641

Combination torch outfits

Outfits are available in convenient packaging or in a portable carrier for 10–20 cu. ft. cylinders.

- Toughcut medium-duty combination torch
- Medium-duty Series 30™ regulators with dual filters for reliable operation
- Medium-duty tips with in-tip gas mixing design for operator safety
- Graf-Tite™ soft-seat cutting tips maintain positive seating for longer use even if tip is nicked
- Regulator-mount check valves for added safety and torch life
- Cuts up to 6 inches (153 mm) with optional tips

Combination torch packs

Easy and economic way to make changes to an oxy-fuel system without buying a full outfit. Available with multiple tips **OR** with regulators.

- Toughcut medium-duty combination torch
- Torch-mount flashback arrestors for added safety
- Cuts up to 6 inches (153 mm) with optional tips

Torch and tips packs

- Medium-duty tips with in-tip gas mixing design for operator safety
- Graf-Tite™ soft-seat cutting tips maintain positive seating for longer use even if tip is nicked

Torch and regulators packs

- Medium-duty Series 30™ regulators with dual filters for reliable operation

Medium-duty tips

Stock Number	Max. Metal Thickness Inches (mm)	Cutting Jet Drill Size
Acetylene Cutting		
MC12-00	3/16 (5)	68
MC12-0	3/8 (10)	62
MC12-1	5/8 (16)	55
MC12-2	1 (25)	54
MC12-3	2 (51)	51
MC12-4	4 (102)	45
MC12-5	6 (152)	41
Propane/Natural Gas Cutting		
MC40-00	3/16 (5)	68
MC40-0	3/8 (10)	62
MC40-1	5/8 (16)	55
MC40-2	1-1/4 (32)	54
MC40-3	2 (51)	51
MC40-4	4 (102)	51

Acetylene Gouging

MC13-3	3/8 (10) wide, 1/4 (6) deep
--------	-----------------------------

Note: Tips above fit medium- and standard-duty torches.

Acetylene Heating

MT603	40,000 Btu
MT605	73,000 Btu
MT610	129,000 Btu

Propane/Natural Gas Heating

MT805	208,000 Btu
MT615	269,000/182,000 Btu

Acetylene Welding

MW201	1/32 in. (0.7 mm)
MW203	5/64 in. (1.9 mm)
MW205	1/8 in. (3 mm)
MW207	3/16 in. (5 mm)
MW209	3/8 in. (10 mm)

Most popular accessories



- **"R"-Grade Welding Hose** RL921 For Tag-A-Long TL-500 and TL-550 acetylene outfits. 12.5 ft. (3.8 m), 3/16 in. (5 mm) ID, "B" fittings

Visit MillerWelds.com or your distributor for other Miller® options and accessories.

Outfit/Pack	Stock Number	Fuel	Oxygen Regulator	Fuel Gas Regulator	Torch	Cut Tip	Heat Tip	Weld Tip	Accessories
Combination Torch Outfits	MB55A-510	Acetylene	30-100-540	30-15-510	CC509P/WH100	MC12-1	MT603	MW205	20 ft. (6.1 m), 3/16 in. (5 mm) "R"-grade hose, lighter, shade 5 safety glasses and check valves
	MB55A-300			30-15-300					
Tag-A-Long Combination Torch Portable Outfits	TL-500 (no tanks) TL-550	Acetylene	30-100-540	30-15-200	CC509P/WH100	MC12-0	—	MW203	Carrier, 12.5 ft. (3.8 m), 3/16 in. (5 mm) "R"-grade hose, lighter, shade 5 safety glasses, check valves, oxygen cylinder and acetylene cylinder (cylinders NOT included with TL-500)
Combination Torch and Tips Packs	287643	Acetylene	—	—	CC509P/WH100	MC12-1, MC12-2	MT603	—	Lighter, shade 5 safety glasses and flashback arrestors
	287644	Propane/natural gas	—	—		MC40-1, MC40-2			
Combination Torch and Regulators Packs	287641	Acetylene OR LP gas	30-100-540	30-15-510	CC509P/WH100	—	—	—	Lighter, shade 5 safety glasses and flashback arrestors
	287642	Acetylene		30-15-300					

Versa-Torch® Standard-Duty Outfit



Lightweight and compact outfit for easy handling in confined space. Portable carrier houses 10–20 cu. ft. cylinders. A broad selection of cutting, welding and specialty attachments (see at right) makes the Versa-Torch® ideal for air conditioning, refrigeration, plumbing, metal fabrication, jewelry, metal sculpture, maintenance and repair.

- Standard-duty combination torch
- Medium-duty Series 30" regulators with dual filters for reliable operation
- Regulator-mount check valves for added safety and torch life
- Graf-Tite™ soft-seat cutting tips maintain positive seating for longer use even if tip is nicked
- Compatible with MC12-00 to MC12-4 medium-duty cutting tips
- Cuts up to 4 inches (102 mm) with optional tips

Standard-duty tips	
Stock Number	Max. Metal Thickness Inches (mm)
Acetylene Cutting	
MC12-00	3/16 (5)
Acetylene Heating	
AT605	41,550 Btu (multi-flame)
AT600	6,000 Btu (twin-flame), 10 in. length
AT600X6	6,000 Btu (twin-flame), 6 in. length
Acetylene Heating Tip End (use with AT60 mixer tube)	
13716	16,080 Btu
Stock Number	Brazing Capacity Copper Pipe Diameter
Acetylene Brazing	
AW201	1/4-3/8 in. (6-10 mm)
AW203	3/8-5/8 in. (10-16 mm)
AW205	1/2-7/8 in. (12-22 mm)
AW207	5/8-1-3/8 in. (16-35 mm)
AW209	3/4-2-1/8 in. (19-54 mm)
AW210	7/8-2-5/8 in. (22-65 mm)
Acetylene Brazing Tip Ends (use with AT60 mixer tube or AT600/AT600X tips)	
LT103	1/2-3/4 in. (12-19 mm)
LT104	5/8-1 in. (16-25 mm)
LT106	3/4-1-1/2 in. (19-38 mm)

Stock Number	Fuel	Oxygen Regulator	Fuel Gas Regulator	Torch	Cut Tip	Mixer Tube	Heat Tip End	Braze Tip	Accessories
VT-4T	Acetylene	30-100-540	30-15-200	AC309/AW1A	MC12-00	AT60	13716 Rosebud	LT103, LT104, LT106	Carrier, 12.5 ft. (3.8 m), 3/16 in. (5 mm) "R"-grade hose, lighter, shade 5 safety glasses, check valves, oxygen cylinder and acetylene cylinder

Proportional Gas Mixers

Efficient. Economical. Precise. Produce better quality welds with proper shielding gas mixtures for various welding processes.



Argon/CO₂ gas mixer 299-006-1C

Accurate, on-site shield gas mixing. Various welding processes require different gas mixes for the best results. Our proportional gas mixers are accurate and allow custom mixtures for optimal welds.

No stocking or handling of premixed gases saves time and money and also reduces the number of cylinders that need to be stored.

Reduces setup time. No need to change cylinders, regulators, flow control devices or hoses when switching from one range of mixed gas to another.

Ideal for education and training. Operators can quickly see the effect of various gas mixtures on weld appearance, quality and penetration.

Easy operation. Simply set the dials for the desired mix and flow. Mixers are mechanical, no electricity is required.

Serves from one to five welding stations with a single mixer. Delivers accurate mixtures at flows ranging from 10 to 180 scfh.

Covered by a one-year warranty.

Stock Number	Gases	Adjustment % Range	Flow Range	Outlet Pressure	Required Inlet Pressure	Outlet Connection	Inlet Connection
299-006-1C	Argon	0-100%	10-180 scfh	50 psig (3.5 bar)	105-115 psig (7.3-7.9 bar)	5/8"-18 RH internal	5/8"-18 RH internal
	CO ₂	100-0%					
299-006-3C	Argon	0-100%	10-180 scfh	50 psig (3.5 bar)	105-115 psig (7.3-7.9 bar)	5/8"-18 RH internal	5/8"-18 RH internal
	Helium	100-0%					
299-011-1C	Argon	50-100%	10-180 scfh	50 psig (3.5 bar)	105-115 psig (7.3-7.9 bar)	5/8"-18 RH internal	5/8"-18 RH internal
	Hydrogen	50-0%					9/16"-18 LH external
299-014-1C	Argon	80-100%	10-180 scfh	50 psig (3.5 bar)	105-115 psig (7.3-7.9 bar)	5/8"-18 RH internal	5/8"-18 RH internal
	Oxygen	20-0%					



Safety products designed to protect welders and enhance their long-term performance

The Miller focus has always been welding – understanding welders, their needs and the safety products used within their work environments.

We provide multiple solutions for weld fume control that fulfill each level of OSHA’s hierarchy of controls. We will help you get maximum productivity out of each welder while keeping them comfortable and improving compliance. Our complete line of Weld Environment, Head and Face, and Hand and Body protection is designed to perform in demanding welding, cutting and grinding applications.

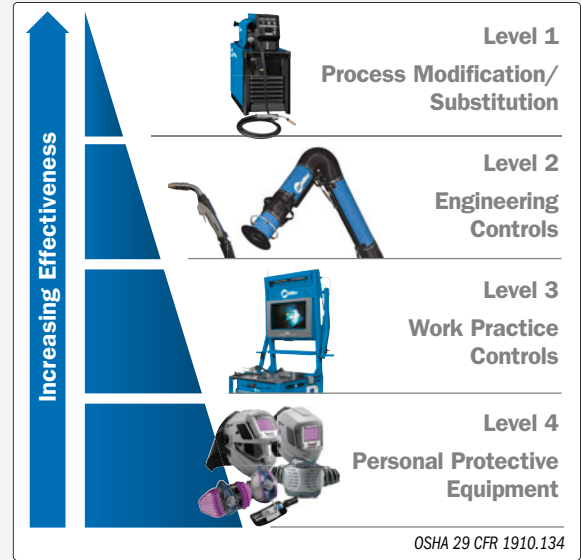

Fume Extractors

Our line of **FILTAIR®** fume extractors are designed specifically for welding – drawing weld fumes away from the user’s breathing zone and helping keep your facility clean. We offer many types of fume extraction equipment to best fit your environment. Visit MillerWelds.com/filtair for more information.

FILTAIR	130 (page 106)	NEW! 215 (page 107)	MWX (page 108)	Capture 5 (page 108)	SWX (page 109)	4000–12000 (page 110)
Weld Fume Extractor Type	Portable, high-vacuum	Mobile, high-vacuum	Mobile, low-vacuum	Mobile, low-vacuum with up to a five-foot capture zone	Stationary, low-vacuum suited for wall or column mounting	Centralized, low-vacuum customizable systems
Ideal For	Contractors, maintenance and repair operations, light fabrication work and light manufacturing	Heavy industrial fabrication and fume guns/long distance extraction	Fabrication shops, manufacturing, and training centers	Manufacturing and fabrication – the best solution for weldments over 18 inches long	Fabrication shops, manufacturing, and training centers where weld areas are near filtration system	Manufacturing, hand-held and automation, fabrication shops, and training facilities
Technology	–	–	–	ZoneFlow (see page 110)	Available w/ZoneFlow (see page 110)	Available w/ZoneFlow (see page 110)
Welding Arcs	1	2	1	1	Up to 2 per unit	Up to 18 per unit
Filter Type	Manual cleaning	Self-cleaning	MWX-D: Disposable MWX-S: Self-cleaning	Self-cleaning (automatic)	SWX-D: Disposable SWX-S: Self-cleaning	Self-cleaning (automatic/programmable)

FILTAIR® 130

See literature AY/3.1



Portable, high-vacuum weld fume extractor designed for use with accessories like nozzles and fume guns to collect weld fume particulate at the source.

Superior filters. The MERV 15 rating of our FilTek XL filters provides superior filtering of up to 95 percent of weld fume particulate.

Excellent filtering performance. Weld fume particulate is captured with a cleanable filter and deposited in the integrated particulate bin.

Accu-Rated™ suction power of 132 cfm at the hood opening.

Note: Accu-Rated is the true, accurate airflow at the inlet of the collection hood.

Less noise. Only 68.5 decibels at five feet.

Portable and compact. At only 46 pounds (21 kg) the vertical-shaped machine is easy to move around.

Processes

- Stick (SMAW) ■ Flux-cored (FCAW)
- MIG (GMAW) ■ TIG (GTAW)

Comes with

- FilTek® XL filter
- 8 ft. (2.4 m) collection hose
- 20 ft. (6 m) power cord

Most popular consumables

- FilTek XL Filter 301267

Most popular accessories

- Bernard® Clean Air™ Fume Extraction MIG Gun (pg 28)
- Collection Hose 300896 17 ft. (5.2 m)
- 300897 34 ft. (10.4 m)

Slotted

- Magnetic Nozzle** 300895
- 12 in. (305 mm) width



- Flexible Funnel Magnetic Nozzle** 300668

Stock Number	Filter Media	Accu-Rated™ Airflow	Sound Level	Motor	Input Power	Dimensions	Net Weight
300595 951860 With flexible funnel magnetic nozzle	31 sq. ft. (2.88 sq. m)	132 cfm (62 L/sec.)	68.5 dBA at 5 ft. (1.5 m)	1.27 kW	115 V, 1-phase, 60 Hz at 11.25 A	H: 23 in. (584 mm) W: 12 in. (305 mm) D: 12 in. (305 mm)	46 lb. (21 kg)



FILTAIR® 215

See literature AY/3.15

NEW!



Industrial, high-vacuum weld fume extractor designed for use with accessories like nozzles and fume guns to collect weld fume particulate at the source.

Adjustable flow control and true two-fume gun performance optimizes weld fume source capture at long distances when combined with collection hoses and accessories.

Superior filters. The MERV 16 rating of our FilTek XL filters provides superior filtering of 95 percent or more of weld fume particulate.

Excellent filtering performance. Weld fume particulate is captured with a self-cleaning filter and deposited in the particulate disposal drawer.

Disposal drawer provides easy and convenient access to empty out collected particulate. Handle releases drawer allowing it to slide out.

Quick and efficient cleaning cycle automatically activates when needed, or manually starts with a push of a button on the control panel to clean the filter from the inside out.

Note: Compressed air required to operate cleaning mechanism.

Filter cleaning gauge indicates when filter needs to be cleaned.

Optional auto start-stop (sold separately). Fume extractor remains off until the sensor detects torch activity, maximizing energy savings and extending filter life.

Capable of holding dual wire feeder and fume guns with convenient hose/gun storage handles.

Processes

- Stick (SMAW) ▪ Flux-cored (FCAW)
- MIG (GMAW) ▪ TIG (GTAW)

Comes with

- FilTek® XL MERV 16 filter
- 8 ft. (2.4 m) collection hose

Most popular consumables

- **FilTek XL Filter** 301675
Self-cleaning MERV 16 filter efficiently captures weld fume particulate and offers superior filter life – includes eight magnetic pegs and plastic bag to aid in removal of used filter



Most popular accessories

- **Bernard® Clean Air™ Fume Extraction MIG Gun** (pg 28)
- **Collection Hose**
300896 17 ft. (5.2 m)
300897 34 ft. (10.4 m)



- **Slotted Magnetic Nozzle** 300895 12 in. (305 mm) width



- **Flexible Funnel Magnetic Nozzle** 300668



- **Auto Start-Stop** 292774

Stock Number	Filter Media	Nominal Airflow (variable)	Sound Level	Motor	Input Power	Dimensions	Net Weight
301674	75 sq. ft. (7 sq. m)	215 cfm (101 L/sec.)	Low: 70 dBA at 5 ft. (1.5 m) High: 80 dBA at 5 ft. (1.5 m)	5.5 hp	460 V, 3-phase, 60 Hz	H: 30 in. (762 mm) W: 22 in. (559 mm) D: 46 in. (1,168 mm)	390 lb. (177 kg)

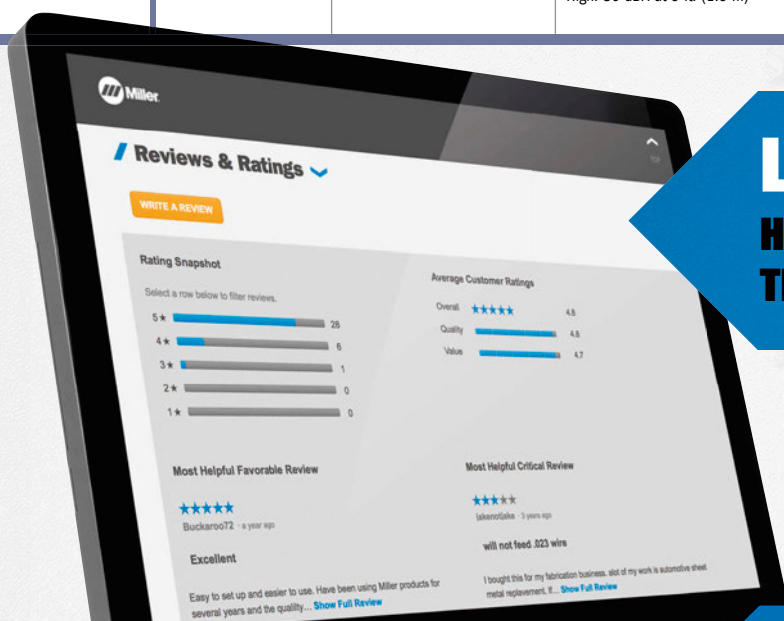

LEAVE A REVIEW

HELP YOUR FELLOW WELDERS SELECT THE RIGHT WELDING EQUIPMENT.

Reviews are written and submitted by people who have purchased and used Miller® equipment. If you'd like to share your experience, consider writing a review. Simply visit the product page and click on "Write a Review".

Visit now at MillerWelds.com



FILTAIR® MWX Series and Capture 5

See literature AY/3.0 (MWX) and AY/3.5 (Capture 5)

Mobile fume extraction systems easily positioned near the weld area and designed specifically for welding. Disposable or self-cleaning filter models for multiple applications.



MWX-S (self-cleaning filter) model shown with 10 ft. extraction arm.

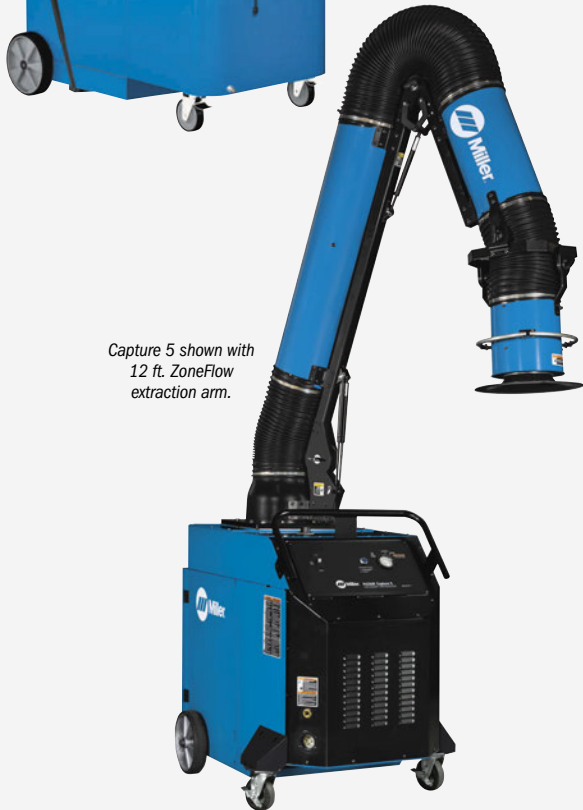

Capture 5 shown with 12 ft. ZoneFlow extraction arm.

Features common to all models

Source capture. Designed to draw weld fume away from the welder's breathing zone and help keep the facility clean.

Superior filters. The MERV 15 rating of our FilTek XL filters provides superior filtering of up to 95 percent of weld fume particulate.

Class-leading suction power of 875 cfm (MWX) or 900 cfm (Capture 5) is Accu-Rated™ at the hood to better capture weld fumes and provide a cleaner environment.

Note: Accu-Rated is the true, accurate airflow at the inlet of the collection hood.

Durable aluminum pre-assembled extraction arm with external adjustments for better airflow and longer life.

Self-cleaning models additional features

Upgrade to self-cleaning models for high arc-on time, extracting from heavy fume processes, or when welding aluminum or galvanized materials.

Excellent filtering performance. Weld fume particulate is captured with a self-cleaning filter and deposited in the integrated particulate bin.

Quick and efficient cleaning cycle operates with a push of a button on the control panel to clean the filter from the inside out.

Note: Compressed air required to operate cleaning mechanism.

Disposal drawer provides easy and convenient access to empty out collected particulate. Handle releases drawer allowing it to slide out.

Capture 5 model additional features

EXCLUSIVE! ZoneFlow™ technology. Extends the capture zone up to five feet versus up to 18 inches with conventional source capture arms. See page 110 for more information.

Minimizes downtime with fewer fume extractor adjustments. With increased capture area, arm interactions are minimized.

Processes

- Stick (SMAW) ▪ Flux-cored (FCAW)
- MIG (GMAW) ▪ TIG (GTAW)

Comes with

- FilTek® XL filter
- Pre-assembled arm

Most popular consumables



FilTek XL Filters

- 300540 For MWX (self-cleaning)
 - 300539 For MWX (disposable)
 - 301106 For Capture 5 (self-cleaning)
- Filters efficiently capture weld fume particulate and offer superior filter life

Most popular accessories



Hood Light with Arc Sensor

- 300689 For MWX Series
- Illuminates the welding zone and enables the fume extractor to start automatically when welding begins

Model/Stock Number	Filter Media	Accu-Rated™ Airflow	Extraction Arm Diameter	Sound Level	Motor	Input Power	Dimensions	Net Weight	
MWX-S (Self-Cleaning) 951510 7 ft. standard arm 951511 10 ft. standard arm 951512 12 ft. standard arm	MWX-D (Disposable Filter) 951507 7 ft. standard arm 951508 10 ft. standard arm 951509 12 ft. standard arm	490 sq. ft. (45.52 sq. m)	875 cfm (413 L/sec.)	8 in. (203 mm)	Approximately 70 dBA at 5 ft. (1.5 m)	1 hp, 3,450 rpm	115 V, 1-phase, 60 Hz at approximately 11.9 A	H: 34.75 in. (883 mm) W: 31.75 in. (806 mm) D: 48 in. (1,219 mm)	MWX-S: 300 lb. (136 kg) MWX-D: 238 lb. (108 kg)
Capture 5 (Self-Cleaning) 951639 208/230 V, 10 ft. ZoneFlow arm 951640 208/230 V, 12 ft. ZoneFlow arm 951574 460 V, 10 ft. ZoneFlow arm 951575 460 V, 12 ft. ZoneFlow arm		452 sq. ft. (42 sq. m)	900 cfm (425 L/sec.)	10 in. (254 mm)	Approximately 77 dBA at 5 ft. (1.5 m)	3 hp, 3,450 rpm	208/230 V, 1-phase, 60 Hz at 13.5 A 460 V, 3-phase, 60 Hz at 13.7 A	H: 43 in. (1,092 mm) W: 36 in. (915 mm) D: 48 in. (1,219 mm)	660 lb. (300 kg) with 12 ft. arm



FILTAIR® SWX Series See literature AY/3.2

Stationary fume extraction systems, wall- or column-mounted next to the weld area and designed specifically for welding. Disposable or self-cleaning filter models for multiple applications.



SWX-D (disposable filter) model shown with telescoping arm.



SWX-S (self-cleaning filter) model shown with 12 ft. ZoneFlow extraction arm.

Features common to both models

Source capture. Designed to draw weld fume away from the welder's breathing zone and help keep the facility clean.

Superior filters. The MERV 15 rating of our FilTek XL filters provides superior filtering of up to 95 percent of weld fume particulate.

Class-leading suction power of 875 cfm is Accu-Rated™ at the hood to better capture weld fumes and provide a cleaner environment.

Note: Accu-Rated is the true, accurate airflow at the inlet of the collection hood.

Durable aluminum pre-assembled extraction arms. Choose from three different arm styles:

- **Telescoping arms** fit small booth spaces and telescope from 3 to 4.5 feet
- **Standard arms** cover larger spaces and are available in 7-, 10-, and 12-foot versions
- **ZoneFlow arms (self-cleaning models only)** extend the capture zone up to 5 feet and are available in 10- and 12-foot versions

Self-cleaning model additional features

Upgrade to self-cleaning models for high arc-on time, extracting from heavy fume processes, or when welding aluminum or galvanized materials.

Excellent filtering performance. Weld fume particulate is captured with a self-cleaning filter and deposited in the integrated particulate bin.

Quick and efficient cleaning cycle operates with a push of a button on the control panel to clean the filter from the inside out.

Note: Compressed air required to operate cleaning mechanism.

Disposal drawer provides easy and convenient access to empty out collected particulate. Handle releases drawer allowing it to slide out.

ZoneFlow™ arm additional features

EXCLUSIVE! ZoneFlow technology. Extends the capture zone up to five feet versus up to 18 inches with conventional source capture arms. See page 110 for more information.

Minimizes downtime with fewer fume extractor adjustments. With increased capture area, arm interactions are minimized.

Processes

- Stick (SMAW) ▪ Flux-cored (FCAW)
- MIG (GMAW) ▪ TIG (GTAW)

Comes with

- FilTek® XL filter
- Pre-assembled arm

Most popular consumables



▪ FilTek XL Filters

- 300540 For self-cleaning models
 - 300539 For disposable filter models
- Filters efficiently capture weld fume particulate and offer superior filter life

Most popular accessories



▪ Hood Light with Arc Sensor

- 300763 For SWX Series (telescoping and standard arms only)
- Illuminates the welding zone and enables the fume extractor to start automatically when welding begins



▪ SWX Dual-Arm Add-On Packages

- 951621 With telescoping arm
 - 951519 With 7 ft. standard arm
 - 951520 With 10 ft. standard arm
 - 951521 With 12 ft. standard arm
 - 951762 With 10 ft. ZoneFlow arm
 - 951822 With 12 ft. ZoneFlow arm
- Includes 8-inch diameter arm, blower, control box, mounting bracket, duct and back draft dampers to turn single-arm weld fume extractor into dual-arm extractor

Model/Stock Number	Filter Media	Accu-Rated™ Airflow	Extraction Arm Diameter	Sound Level	Motor	Input Power	Dimensions	Net Weight without Arm
SWX-S (Self-Cleaning) 951620 Telescoping arm 951516 7 ft. standard arm 951517 10 ft. standard arm 951518 12 ft. standard arm 951760 10 ft. ZoneFlow arm 951761 12 ft. ZoneFlow arm	SWX-D (Disposable Filter) 951619 Telescoping arm 951513 7 ft. standard arm 951514 10 ft. standard arm 951515 12 ft. standard arm	490 sq. ft. (45.52 sq. m)	875 cfm (413 L/sec.)	8 in. (203 mm)	Standard: Approximately 75 dBA at 5 ft. (1.5 m) ZoneFlow: Approximately 80 dBA at 5 ft. (1.5 m)	1 hp, 3,450 rpm Blower motor: 115 V, 1-phase, 60 Hz at approximately 11.9 A ZoneFlow: 115 V, 1-phase, 60 Hz at approximately 12 A	SWX-S H: 33 in. (838 mm) SWX-D H: 29 in. (737 mm) W: 27.25 in. (692 mm) D: 33 in. (838 mm)	Cabinet: SWX-S: 195 lb. (88 kg) SWX-D: 130 lb. (59 kg) Blower/bracket: 95 lb. (43 kg)



FILTAIR® 4000-12000

See literature AY/3.4

The industrial centralized weld fume extractors are custom-engineered solutions designed for multiple capture sources which require ducting and accessories to complete the system.



FILTAIR 4000 model shown. Other models are available (6000, 8000, and 12000).

FILTAIR engineering resources. Design and engineering resources recommend, develop and support custom-engineered solutions.

Improves operating efficiency. Helps create a cleaner shop with less downtime spent cleaning equipment.

Stand-alone space saver. Our fully assembled fume extractor provides up to a 65 percent smaller footprint versus traditional cartridge-style extractors. It provides all the necessary extraction tools, while offering customizable options.

Less noise. High-efficiency motors and integrated silencer housing create a quieter, more productive work area.

Integrated electrical controls. Control panel manages all of the collector functions, including fan, filter differential, and pulse cleaning system.



24 VDC motor start/stop feedback relay allows an external signal to automate the remote start of collector fan from other equipment.

FilTek XL filters

Easy-clean filter with surface-loaded filter technology allows for more effective weld fume pulse cleaning without penetration into the filter. This provides an easier filter cleaning process, while outlasting conventional cartridge filters.

Smaller size and fewer filters.

One FilTek XL filter replaces up to three cartridge-style filters increasing efficiency, reducing extractor size and lowering operational costs.



ZoneFlow™ arm additional features

EXCLUSIVE! ZoneFlow technology. Extends capture zone up to five feet versus up to 18 inches with conventional source capture arms. See below for more information.

Minimizes downtime with fewer fume extractor adjustments.

With increased capture area, arm interactions are minimized.

Call us toll-free at 866-931-9730 or email us at FILTAIR@millerwelds.com for information and requests for quotes on custom-engineered solutions to fit your needs.

*Based on clean filters. **Dimensions for base models without factory options.

Model	Nominal Airflow Range*	Number of Filter Packs	Sound Level	Input Power	Dimensions** (H x W x D)	Ship Weight
FILTAIR 4000	2,000-4,800 cfm (944-2,265 L/sec.)	4	72-75 dBA at 5 ft. (1.5 m)	230, 460 or 575 V, 3-phase, 60 Hz	86.1 x 31.2 x 83.2 in. (2,187 x 792 x 2,113 mm)	1,600 lb. (726 kg)
FILTAIR 6000	2,300-6,600 cfm (1,085-3,115 L/sec.)	6	Peak pulse cleaning is 92.7 dBA at 5 ft. (1.5 m)		117.2 x 31.2 x 83.2 in. (2,977 x 792 x 2,113 mm)	2,250 lb. (1,021 kg)
FILTAIR 8000	2,500-7,000 cfm (1,180-3,304 L/sec.)	8			135 x 37.2 x 83.2 in. (3,429 x 945 x 2,113 mm)	2,900 lb. (1,315 kg)
FILTAIR 12000	4,000-10,500 cfm (1,888-4,955 L/sec.)	12			120.3 x 59.7 x 83.2 in. (3,056 x 1,516 x 2,113 mm)	3,900 lb. (1,769 kg)

Processes

- Stick (SMAW) ■ Flux-cored (FCAW)
- MIG (GMAW) ■ TIG (GTAW)

Custom solutions

- Configured to source fume extraction
- Configured for ambient push-pull collection

Comes with

- FilTek® XL filter
- Top OR front air inlet
- Configured for indoor OR outdoor mounting (outdoor models are wind load and seismic rated and include remote-mounted control box)

Most popular consumable

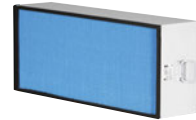

- FilTek XL Filter 300927

Most popular accessories

- Extraction Arms (pg 111)
- Arm Mounting Bracket Kit (pg 111)
- Low Profile Hoods (pg 111)
- Call us toll-free at 866-931-9730 for information on factory options such as HEPA filter kit, weather hood, Spark Cooler® and integration services

ZoneFlow™ Technology

The capture zone redefined. Innovative, extended-capture fume extraction system designed specifically for welding.

ZoneFlow is a patented airflow technology that creates an extraction zone where the air on the inside of the zone has lower pressure than the air on the outside.

The air pressure difference causes weld fume to get funneled to the center of the extraction arm. *ZoneFlow technology has capture zones up to five feet (versus up to 18 inches for conventional technology) without affecting shielding gas or weld performance!*

The increased capture zone reduces arm interactions so operators can keep welding, increasing arc-on time and productivity. Miller®-exclusive ZoneFlow technology is standard on the FILTAIR Capture 5, and optional on the FILTAIR SWX Series and FILTAIR 4000-12000 models (see pages 108, 109 and above).





FILTAIR® 4000-12000 Accessories

See literature AY/3.7 (Extraction Arms) and AY/3.6 (Low Profile Hoods)

Miller offers a full line of accessories for complete system solutions and turnkey installation.



Easy-to-operate, pre-assembled extraction arms and mounting equipment

- **Telescoping arms** are designed to fit small booth spaces used in training centers and educational booths. Telescopes from 3 to 4.5 feet with a wide range of motion to cover all positions
- **Standard arms** are designed to cover larger spaces and are available in 7-, 10- and 12-foot versions. External brackets and adjustments allow air to pass through with less resistance giving you stronger cfm (airflow)
- **ZoneFlow™ arms** are designed to cover larger spaces and are available in 10- and 12-foot versions. ZoneFlow arms extend the capture zone up to five feet versus up to 18 inches with conventional source capture arms. External brackets and adjustments allow air to pass through with less resistance giving you stronger cfm (airflow)
- **Arm mounting bracket and ducting kit** includes a supporting bracket and collar for connecting an extraction arm to ductwork

Model	6-Inch Diameter	8-Inch Diameter
Telescoping Arm	301242 3-4.5 ft. arm	301237 3-4.5 ft. arm
Standard Arm	300953 7 ft. arm	300980 7 ft. arm
	300954 10 ft. arm	300981 10 ft. arm
	300955 12 ft. arm	300982 12 ft. arm
ZoneFlow Arm with Motor Control Box	951810 10 ft. arm	951758 10 ft. arm
	951811 12 ft. arm	951759 12 ft. arm
Arm Mounting Bracket and Ducting Kit	300952	300771

Spark Cooler®

- Cools sparks using the fume extractor's airflow
- Very efficient – maximizes the extractor's power
- Simple design is easy to install



FILTAIR low profile hood

- Available in sizes from 4 x 4 feet up to 16 x 16 feet in one-foot increments
- Exclusive design – capture velocity zone is maximized and distributed over the work area
- Hood airflow design reduces sound for better communication
- Unique airflow offers spark abatement in the extraction rail, as well as the recommended Spark Cooler
- Clear, UV-protected polycarbonate ceiling panels allow maximum light into the cell
- Corner lift hooks are convenient for installing or hanging over a work area – hood can also be placed on an existing cell enclosure or supported with post assemblies

Call us toll-free at 866-931-9730 or email us at FILTAIR@millerwelds.com for information and requests for quotes on custom-engineered solutions to fit your needs.

Cleaner Air with FilTek® XL Filters

The FilTek XL filter's higher MERV rating means unrivaled filtering performance.

MERV Comparison

Applicable Weld Fume MERV Rating Categories ¹	Particle Size Range Efficiency % ²		
	0.3 to 1 µm	1 to 3 µm	3 to 10 µm
10	Not Rated	50-65%	85%
11	Not Rated	65-80%	85%
12	Not Rated	80-90%	85%
13	<75%	90%	90%
14	75-85%	90%	90%
15	Miller® FilTek XL	85-95%	90%
16		≥95%	≥95%
HEPA ³	≥99.97%	≥99.97%	≥99.97%
Weld Fume Composition ⁴	75-95%	≤15%	≤10%

¹American Society of Heating, Refrigeration and Air Conditioning Engineers (ASHRAE) 52.2

²National Air Filtration Association (NAFA) Guide

³HEPA filters are depth loading and have high restrictions to air flow, reducing system performance versus FilTek XL filters.

⁴Jenkins, Pierce, Edgar, Particle Size Distribution of GMAW and FCAW

Filters are rated on a MERV scale, which measures filter efficiency based on particle count. MERV ratings range from 1 to 16, with 16 being the best at filtering small particulate – such as those found in weld fumes.

Filters in common air filtration systems often have MERV ratings from 7 to 11. FilTek XL filters are rated at class-leading MERV 15 or 16 to capture from 85-95 percent or more of weld fume particulate.



Respiratory

PAPR Systems

PAPR (Powered Air Purifying Respirator) systems consist of blower assembly, HEPA filter, prefilters (6), spark guard, breathing tube, breathing tube cover, padded belt, comfortable shoulder straps, lithium-ion batteries (2), battery charger, flowmeter, tool bag, and helmet assembly **OR** helmet assembly with integrated hard hat **OR** face shield assembly with clear shield (see packages at right).

- HEPA filter provides up to 99.97 percent filtration of airborne particulate
- NIOSH 42 CFR 84 certified, assigned protection factor of 25 with standard head seal **OR** 1,000 with optional heavy-duty head seal (Hard Hat and Face Shield only)

Designed for comfort

Well-balanced design reduces torque on neck, increasing all-day wear.

Patent-pending Dualtec™ manifold system optimizes helmet balance and sound, while **six-point air distribution system** maximizes cooling through targeted air placement.

Ergonomic headgear (T94-R and Face Shield) provides secure fit without the need for over-tightening.

MSA Fas-Trac® III ratchet-suspension headgear (Hard Hat) provides exceptional comfort, reducing pressure points while increasing stability.

Lightweight low-profile blower assembly with integrated shoulder straps reduces lower back strain and fatigue.

Superior visibility

ClearLight™ Lens Technology (T94-R) provides high-definition optics for precision arc recognition.

ClearLight™ 2.0 Lens Technology (Hard Hat) provides advanced high-definition optics for the most realistic view that's clearer and brighter – before, during and after every weld.

Shade 5.0 side windows and oversized clear grind shield maximize downward and peripheral visibility, improving sense of surroundings.

Half-shade lens adjustability provides fine shade adjustment for optimized comfort and vision.

Large integrated grind shield (T94i-R and Hard Hat) provides 44 sq. in. of clear viewing area for grinding and other tasks.

High-Definition View (HDV) technology (Hard Hat and Face Shield)

for a sharp detailed view at any angle with minimal distortion.

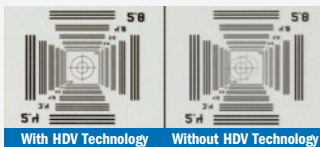

Improved productivity

Enhanced comfort, cooling and visibility maximize all-day wearability – increasing productivity, safety and regulatory compliance.

Low-profile breathing-tube attachment eases on/off process while flexible tube material reduces breathing tube snags in work cell.

Two lightweight lithium-ion batteries included with each package eliminate downtime.



T94-R™ PAPR See literature AY/4.1

With T94-R™ helmet (external grind control)

264573 With auto-darkening lens assembly

With T94i-R™ helmet (integrated clear grind shield)

264575 With auto-darkening lens assembly

T94-R™ helmet upgrade kit (for use with existing PAPR system)

279870 Includes T94-R helmet assembly, breathing tube, breathing tube cover and flowmeter

T94i-R™ helmet upgrade kit (for use with existing PAPR system)

279871 Includes T94i-R helmet assembly, breathing tube, breathing tube cover and flowmeter



Includes MSA V-Gard® hard hat.

Hard Hat PAPR (Gen. 2) See literature AY/4.15

With T94iH-R™ helmet (integrated clear grind shield)

287510 With auto-darkening lens assembly and integrated MSA V-Gard® hard hat

287188 Heavy-duty head seal only

Lift-to-talk head assembly improves communication by allowing operator access to face without removal of the head assembly.



Optional heavy-duty head seal provides additional protection with an APF of 1,000 (sold separately).



Face Shield PAPR (Gen. 2)

See literature AY/4.2

288356 With HDV face shield

288346 Heavy-duty head seal only



Optional heavy-duty head seal provides additional protection with an APF of 1,000 (sold separately).



Respiratory

SAR Systems



SAR (Supplied Air Respirator) systems consist of C50 air regulator, belt assembly, flowmeter, breathing tube, breathing tube cover, tool bag, T94i-R helmet assembly and air hose (see packages at left).

- NIOSH 42 CFR 84 certified, assigned protection factor of 25. To provide a NIOSH-approved respiratory system, the SAR with T94i-R must be used with Miller® helmet, hoses, connectors, filters and other components recommended by Miller

Well-balanced design reduces torque on neck, increasing all-day wear.

Patent-pending Dualtec™ manifold system optimizes helmet balance and sound, while **six-point air distribution system** maximizes cooling through targeted air placement.

Ergonomic headgear provides secure fit without the need for over-tightening.

Lightweight versatile C50 air regulator can be positioned horizontally or vertically to naturally align with body movements.

ClearLight™ Lens Technology provides high-definition optics for precision arc recognition.

Shade 5.0 side windows and oversized clear grind shield maximize downward and peripheral visibility, improving sense of surroundings.

Half-shade lens adjustability provides fine shade adjustment for optimized comfort and vision.

Large integrated grind shield provides 44 sq. in. of clear viewing area for grinding and other tasks.

Enhanced comfort, cooling and visibility maximize all-day wearability – increasing productivity, safety and regulatory compliance.

Low-profile breathing-tube attachment eases on/off process while flexible tube material reduces breathing tube snags in work cell.

C50 air regulator cools Grade-D breathing air by up to 50 degrees Fahrenheit (28°C) under your hood, heightening productivity and relieving heat stress. Performance under different applications may vary. 360-degree swivel air hose connection alleviates hose coiling, reducing potential trip hazards.

T94i-R™ SAR See literature AY/4.3

With T94i-R™ helmet (integrated clear grind shield)

951800 With auto-darkening lens assembly and 25 ft. straight air hose

951801 With auto-darkening lens assembly and 100 ft. straight air hose

951802 With auto-darkening lens assembly and 25 ft. coiled air hose

951803 With auto-darkening lens assembly and 100 ft. coiled air hose

264871 With auto-darkening lens assembly (air hose not included)

T94i-R™ helmet upgrade kit (for use with existing SAR system)

279871 Includes T94i-R helmet assembly, breathing tube, breathing tube cover and flowmeter

Also available



BreatheAir™ portable box

275983 Two person, 10 ppm alarm

275985 Four person, 10 ppm alarm

Supplies Grade-D breathing air while monitoring for CO.

Monitor calibration kit

275988 10 ppm



BreatheAir™ panel

275961 Two person, 10 ppm alarm

275970 Four person, 10 ppm alarm

Supplies Grade-D breathing air while monitoring for CO.

Monitor calibration kit

275988 10 ppm

Half Mask Respirators



**LPR-100™ OV
Half Mask Respirator**

See literature AY/4.5

ML00996 Respirator with P100 organic vapor filters (small/medium)

ML00997 Respirator with P100 organic vapor filters (medium/large)

Filters and accessories

SA00820 P100/OV filters (one pair)

285686 Protective hard carrying case

261086 Quantitative fit-test kit adapter

- Low-profile design fits under T94™ and Digital Elite™ welding helmets and provides maximum field of vision.
- P100/OV filters provide up to 99.97 percent filtration of specific organic vapors and airborne particulates
- NIOSH 42 CFR 84 certified, assigned protection factor of 10



LPR-100™ Half Mask Respirator

See literature AY/4.5

ML00894 Respirator with P100 filters (small/medium)

ML00895 Respirator with P100 filters (medium/large)

ML00994 Respirator with P100 nuisance level OV relief filters (small/medium)

ML00995 Respirator with P100 nuisance level OV relief filters (medium/large)

Filters and accessories

SA00818 P100 filters (one pair)

SA00819 P100 nuisance level OV relief filters (one pair)

283374 Protective hard carrying case

261086 Quantitative fit-test kit adapter

- Low-profile design fits under T94™, Digital Elite™ and Classic welding helmets and provides maximum field of vision.
- P100 filters provide up to 99.97 percent filtration of airborne particulates
- Nuisance level OV relief filters are designed for use with organic vapor concentrations not exceeding OSHA's PELs or other applicable government occupational exposure limits, whichever is lower
- NIOSH 42 CFR 84 certified, assigned protection factor of 10



Welding Helmets

See page 116 for welding helmet accessories.

Helmets with *ClearLight 2.0* have a four-year warranty. Classic Series helmets have a three-year warranty.

	NEW! T94i™ XL	T94i™	T94™	Digital Infinity™	Digital Elite™	Digital Performance™	Classic VSI™	Classic VS	Classic FS#10 Flip-Up
Viewing Area	13 sq. in.	9 sq. in.	9 sq. in.	Largest Viewing Area 13.4 sq. in.	9.2 sq. in.	7.2 sq. in.	5.9 sq. in.	6 sq. in.	5.1 sq. in.
Auto-Darkening	Yes	Yes	Yes	Yes	Yes	Yes	Yes	Yes	Yes
ClearLight™ Lens Technology	—	—	—	—	—	—	Yes	Yes	Yes
ClearLight™ 2.0 Lens Technology	Yes	Yes	Yes	Yes	Yes	Yes	—	—	—
AutoSense™	—	—	—	Yes	Yes	Yes	—	—	—
Modes	Weld/Cut/X-Mode/ Flip grind	Weld/Cut/X-Mode/ Flip grind	Weld/Cut/X-Mode/ External grind	Weld/Cut/X-Mode/ Grind	Weld/Cut/X-Mode/ External grind or Grind	Weld/Cut/ Grind	Weld/X-Mode/ Flip grind	Weld/Cut/ Grind	Weld/ Flip grind
Shades	Weld: 8-14 Cut: 5-8	Weld: 8-14 Cut: 5-8	Weld: 8-14 Cut: 5-8 Grind: 3	Weld: 8-13 Cut: 5-8 Grind: 3	Weld: 8-13 Cut: 5-8 Grind: 2.5 or 3	Weld: 8-13 Cut: 5-8 Grind: 3	Weld: 8-13	Weld: 8-13 Cut: 5-8 Grind: 3	Weld: 10
Integrated Grind Shield	Yes	Yes	—	—	—	—	Yes	—	Yes
Auto-on	Yes	Yes	Yes	Yes	Yes	Yes	Yes	Yes	Yes
Sensors	4	4	4	4	4	3	3	2	2
TIG Rating	3 amps	3 amps	3 amps	5 amps/below	5 amps/below	5 amps	5 amps/below	5 amps/below	20 amps
Switching Speed	1/25,000 second	1/25,000 second	1/25,000 second	1/25,000 second	1/25,000 second	1/25,000 second	1/20,000 second	1/23,000 second	1/3,600 second
Digital Controls	Yes	Yes	Yes	Yes	Yes	Yes	—	Yes	—
Premium Headgear	Yes	Yes	Yes	Yes	Yes	Yes	—	—	—
HDV Technology	Yes	Yes	Yes	—	—	—	—	—	—
InfoTrack™ 2.0	Yes	Yes	Yes	Yes	Yes	—	—	—	—
Weight	28 oz. (794 g)	26 oz. (737 g)	21 oz. (599 g)	23 oz. (652 g)	18 oz. (510 g)	17 oz. (482 g)	23 oz. (652 g)	16 oz. (454 g)	14 oz. (396 g)
Warranty	4 years	4 years	4 years	4 years	4 years	4 years	3 years	3 years	3 years

See chart above for feature availability.

ClearLight™ Lens Technology provides high-definition optics for precision arc recognition.

ClearLight™ 2.0 Lens Technology provides advanced high-definition optics for the most realistic view that's clearer and brighter – before, during and after every weld.

AutoSense™ reduces issues related to setting helmet sensitivity by allowing the welder to push and hold the AutoSense button to automatically set the helmet sensitivity for their environment.

X-Mode™ Electromagnetically senses the weld to reduce sunlight interference and continuously detects the arc even if sensors are blocked.

High Definition View (HDV) technology. The curve of traditional lens designs can often times distort or blur your view. HDV technology provides a sharp detailed view at any angle with minimal distortion.

InfoTrack™ 2.0 data monitoring technology tracks arc time and arc count.

IMPROVED! T94™ Series Maximized comfort, visibility and productivity for the professional welder. See literature AY/41.1

All T94 Series helmets now feature ClearLight™ 2.0 Lens Technology.



Best-in-class comfort for all-day wearability

Lightweight, well-balanced design reduces neck torque, minimizing operator fatigue and strain, leading to an increase in comfort.



4% LIGHTER for reduced fatigue



14% BETTER BALANCE for elevated comfort



17% LESS TORQUE for reduced neck strain

Statistics above compare T94i to previous model.

Matte silver finish reflects ambient heat, keeping the user cooler.

Four operating modes for ultimate versatility: weld, cut, grind and X-Mode™

Half-shade settings for precise lens adjustment.

Simplistic digital lens interface allows for easy adjustment with or without gloves.

Shade 5.0 side windows enhance peripheral vision, amplifying sense of surroundings.

Chiseled shell design provides optimal skin coverage while easily accommodating a Miller® Half Mask Respirator.

Gen IV premium headgear with four-point flexible design provides a secure fit, while avoiding major pressure points within the head, maximizing all-day wear. Customizable fit with seamless tilt, distance and tightness adjustments.

HDV technology provides a sharp detailed view at any angle with minimal distortion on integrated grind shield (T94i XL/T94i) and quick-release one-piece cover lens (all models).

Helmet Lighting Accessory 281361

- Provides additional lighting in low-light environments for T94 welding helmets
- Includes two lights (one for each side) and all required mounting hardware





IMPROVED!

Digital Infinity, Digital Elite and Digital Performance Series helmets now feature ClearLight™ 2.0 Lens Technology.

Digital Infinity™ Series Largest viewing area maximizes visibility. See literature AY/42.5



Black
289714

Black Ops™
289715

Departed™
289720

Stars and Stripes™
288420

Relic™
288722

Imperial™
288725

NEW!
'22 Custom Kindig-it
292933

Digital Elite™ Series Industry-leading helmet provides high-performance versatility. See literature no. AY/43.5 (External Grind) and AY/43.0 (all others)



NEW!

Black w/External Grind
288924

Black
289755

Lucky's Speed Shop™
289756

Stars and Stripes™ III
289759

Inferno™
289762

Vintage Roadster™
289764

Raptor™
289768

Gear Box™
289844

NEW!

Blue Rage™ II
281010

Digital Performance™ Series Lightweight helmet with superior headgear for ultimate comfort. See literature AY/44.0



Black
289842

Blue Rage™
289802

'64 Custom™
289807

Crusher™
289808

NEW!

Unity™
282006

Helmet Lighting Accessory 282013

- Provides additional lighting in low-light environments for most Miller® welding helmets including Infinity, Elite, Performance, Classic and MP-10
- Includes two lights (one for each side) and all required mounting hardware



Classic Series Helmets for the value-minded welder. See literature AY/45.5



VSi™
287794

Black (VS)
287803

Metalworks™ (VS)
287810

Rise™ (VS)
287815

Liberty™ (VS)
287820

Metal Matrix™ (VS)
288519

NEW!

Hex™ (VS)
291189

FS#10 Flip-Up
287798

MP-10™



Black
238497

Best-in-class traditional passive shade 10 lens helmet.



Welding Helmet Accessories



Slotted Hard Hat Adapter 259637

- Compatible with most slotted hard hats. Helmet and hat not included

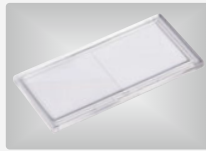

Hard Hat Adapter 265315

For T94™ welding helmets

222003 For Titanium™, Infinity™, Elite™, Performance™, Classic and MP-10™ welding helmets

- Compatible with most Fibre Metal and MSA hats. Other brands may fit depending on size and shape. Helmet and hat not included



2x4 Auto-Darkening Lens with ClearLight™ Lens Technology

287828 Shade 9

287830 Shade 10

287833 Shade 11

- Fits all 2x4-inch windows
- Solar powered
- Two arc sensors
- Two-year warranty



Magnifying Lens

212235 0.75 magnification

212236 1.00 magnification

212237 1.25 magnification

212238 1.50 magnification

212239 1.75 magnification

212240 2.00 magnification

212241 2.25 magnification

212242 2.50 magnification

- 4.25 x 2 x 5/23 inch lens for all Miller® helmets



Helmet Bib 253882

- Flame-resistant WeldX™ material provides additional neck coverage for the Infinity, Elite, Performance, Classic and MP-10 welding helmets



Helmet Bib 279078

- Flame-resistant material provides additional neck coverage for the T94 welding helmets



Helmet Cape 279080

- Flame-resistant material provides additional head and back-of-the-neck coverage for the T94 welding helmets



Helmet Hook 251018

- Holds welding helmets, grinding shields or other helmets with a headgear
- Silicone strap secures the helmet in place



Jobsite Tool Bag 228028

- Over twenty separate pockets
- Opening of 12 x 18.5 inches (305 x 470 mm)



CoolBelt™ Belt-Mounted Cooling System 245230

- Up to **17 degrees Fahrenheit cooler** under the hood
- Provides all-day comfort through maximized airflow power
- Multiple airflow speeds eliminate stagnant air and reduce fogging
- Lightweight design extends wearability
- Compatible with Infinity, Elite, Performance, Classic and MP-10 welding helmets

Weld-Mask™ See literature AY/40.0

Compact auto-darkening lenses allow users to weld in spaces where access with traditional welding helmets is limited. Close-fitting soft eye covering provides total darkness for precision welding. Face shield and flame-retardant head cover provide coverage for UV/IR rays and applications with limited spatter. Two-year warranty.



Weld-Mask

Weld-Mask 2

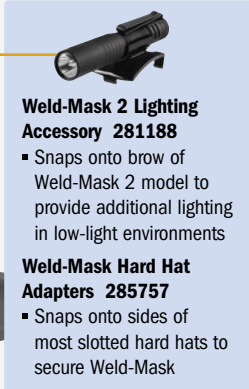

Weld-Mask 2 Lighting Accessory 281188

- Snaps onto brow of Weld-Mask 2 model to provide additional lighting in low-light environments

Weld-Mask Hard Hat Adapters 285757

- Snaps onto sides of most slotted hard hats to secure Weld-Mask

Weld-Mask 267370

- Shades 5, 7, 9, 11 and 13 for use with MIG, TIG, stick, and gas welding and cutting
- Extremely lightweight (8 oz.), virtually eliminates neck strain

Weld-Mask 2 280982

- Ideal for industrial or construction environments — can be worn under a hard hat with a Miller® Half Mask Respirator and select safety glasses
- Shades 5-13 for use with MIG, TIG, stick, and gas welding and cutting
- X-Mode™ electromagnetically senses the weld to reduce sunlight interference and continuously detects the arc even if sensors are blocked
- Wide, singular lens provides unmatched auto-darkening range of visibility

Safety Glasses See literature AY/46.0



- Anti-fog coating and high-quality optics
- Form-fitting orbital eye coverage
- Shatterproof polycarbonate lenses
- Wrap-around designs meet ANSI side shield requirements

- ANSI Z87.1+ compliant
- I/O (indoor/outdoor) lenses feature light shading with a mirrored finish
- Shade 3 and 5 IR lenses are for cutting, brazing or soldering

Safety and Cutting Glasses Chart

Frame Style (Color)	Clear Lenses	I/O Lenses	Shade 3 Lenses	Shade 5 Lenses
Classic (Black)	272187	—	—	—
Spatter™ (Black)	272191	—	—	—
Spark™ (Black/Blue)	272190	—	—	—
Slag™ (Black)	272201	272202	—	272205
Gen I (Black)	—	—	235662	235658



Face Shield Series

See literature AY/46.5



Face Shield

- 288269** Clear
- 288274** Clear + Anti-Fog
- 288270** Shade 3
- 288273** Shade 5

- HDV technology for a sharp detailed view at any angle without distortion
- Impact-resistant shield for increased durability and protection
- Lightweight design for all-day wear and comfort
- Clear + Anti-Fog lens coating prevents fogging for enhanced visibility
- Shade 3 and 5 lenses provide protection for cutting, brazing or soldering applications
- Made of polycarbonate material that provides 99.9 percent UVA/UVB/UVC protection to help prevent eye damage
- ANSI Z87.1 compliant



Halo Hard Hat Adapter
222003

Slotted Hard Hat Adapter Clips
(not shown) 259637

Welding Gloves

See literature AY/47.0

Performance – exceptional comfort and performance combined with dexterity and flexibility.



Heavy-Duty MIG/Stick

- Strategically placed patches on palm and back for extended glove life
- Double-layered insulated palm and back
- Pig grain leather palm provides extreme durability and protection

MIG (Lined)

- Dual-padded palm
- Fleece-insulated palm, foam-insulated back
- Cow grain palm, pig split back and goat grain inner fingers provide exceptional dexterity and comfort

TIG

- Completely unlined for heightened feel and dexterity
- Triple-padded palm for added comfort
- Goat grain leather offers superior flexibility and dexterity

TIG/Multitask

- Dual-padded palm for added comfort
- Wool back provides ultimate insulation
- Goat grain leather offers superior flexibility and dexterity

Metalworker

- Durable top grain leather and spandex back for enhanced durability and dexterity
- Neoprene wrist with hook-and-loop closure increases fit and support
- Padded, reinforced palm and thumb saddle for extended wear

Classic – traditional design for the value-minded welder.



Heavy-Duty MIG/Stick

- Reflective insulation on back reduces heat impact
- Moisture-wicking fleece and foam insulation
- Pig grain palm, pig split back and cuff

MIG (Pigskin)

- Reinforcement patches enhance durability
- Moisture-wicking fleece and foam insulation
- Pig split leather palm, back and cuff

MIG (Cowhide)

- Reinforcement patches enhance durability
- Moisture-wicking fleece and foam insulation
- Cow split palm, pig split back and cuff

TIG

- Thin internal padding for added comfort
- Unlined palm for precise dexterity
- Sheep grain palm, cow split back and cuff

Work

- Dual-padded palm for added durability
- Fleece back provides ultimate insulation
- Cow grain leather offers superior durability and abrasion resistance

Cut-resistant – exceptional comfort, performance and protection.



- ANSI A5 cut rating, level 4 puncture and abrasion rating, and level 3 heat rating
- Designed with pre-curved fingers for ergonomic fit and exceptional comfort
- Ergonomic wrist design for additional comfort
- Goat grain palm, cow split back and cuff, with Kevlar® flame-resistant thread
- 2-millimeter foam lining and mylar back for additional protection (MIG)
- Drag patch for enhanced durability (TIG)

Welding Glove Size Chart *All asterisked stock numbers are sold as one pair. All others are sold as six packs (six pairs).

Performance	Small	Medium	Large	X-Large	2X-Large	Classic	Medium	Large	X-Large	Cut-Resistant	Small	Medium	Large	X-Large	2X-Large
Hy-Duty MIG/Stick	–	–	263339	263340	269615*	Hy-Duty MIG/Stick	–	271877*	271887*	MIG	290412*	290413*	290414*	290415*	290416*
MIG (Lined)	–	263332	263333	263334	269618*	MIG (Pigskin)	–	279875*	279876*	TIG	290401*	290402*	290403*	290404*	290411*
TIG	263346	263347	263348	263349	–	MIG (Cowhide)	–	271890*	271891*						
TIG/Multitask	263352	263353	263354	263355	–	TIG	279897*	279898*	279899*						
Metalworker	–	251066	251067	251068	–	Work	266041*	266042*	266043*						



Welding Apparel

See literature AY/47.5



Grain Leather Jacket (see size chart)

- Top-grain pigskin leather
- Expandable leather strategically placed for optimal mobility
- Flame-resistant inside cuff
- Satin lining
- Tapered, athletic cut
- Sewn entirely with Kevlar® thread, adding structural durability at each seam



Split Leather Jacket (see size chart)

- Premium pig split leather
- Extended rear tail for additional protection
- Expandable leather strategically placed for optimal mobility
- Mesh lining
- Sewn entirely with Kevlar® thread, adding structural durability at each seam



WeldX™ Jacket (see size chart)

- 7-ounce WeldX front and flame-resistant navy cotton back
- Lightweight exclusive material with extreme flame-resistant properties
- Vented back/extended rear tail
- Zipper closure with hook-and-loop fastened flap
- Chromium free for easy disposal



Combo Jacket (see size chart)

- 9-ounce Indura® flame-resistant cotton (flame resistance guaranteed for life of jacket)
- Top-grain leather
- Pre-shrunk fabric



Indura® Cloth Jacket (see size chart)

- 9-ounce Indura® flame-resistant cotton (flame resistance guaranteed for life of jacket)
- Pre-shrunk fabric



Classic Cloth Jacket (see size chart)

- 9-ounce flame-resistant navy cotton
- Pre-shrunk fabric
- Fold-in sleeve snaps
- Finished hems and reinforced stitching

Note: Indura® is a registered trademark of Westex® by Milliken™ used under license by IFR Workwear Inc.



Leather Bib/Apron 231125

- Attaches to combo jacket with snaps across the chest as a bib or along the bottom as an apron



Combo Sleeves 231096

- Indura® flame-resistant cotton/top-grain leather
- 21-inch length



Classic Cloth Sleeves 247148

- 18-inch length
- Fold-in sleeve snaps
- Upper arm elastic band



Classic Cloth Apron 247149

- 35-inch length with accessible front pocket
- Adjustable drawstring ensures a good fit

Welding Apparel Size Chart

Apparel	Small	Medium	Large	X-Large	2X-Large	3X-Large	4X-Large	5X-Large
Grain Leather Jacket	—	—	231090	231091	231092	—	—	—
Split Leather Jacket	273212	273213	273214	273215	273216	273217	273218	273219
WeldX Jacket	247114	247115	247116	247117	247118	247119	247120	247121
Combo Jacket	—	231081	231082	231083	231084	—	—	—
Indura Cloth Jacket	—	258097	258098	258099	258100	—	—	—
Classic Cloth Jacket	244749	244750	244751	244752	244754	244755	244756	244758



For more detailed information, visit

MillerWelds.com/arcstation

Workstations



Count on Miller to design the perfect workbench to make welding projects faster and easier. The ArcStation is the first-ever, all-in-one workstation designed for welding and metalworking. It's versatile, affordable and just the right height to work comfortably. You can organize equipment, tools, and raw materials into one convenient workspace.

ArcStation™ 60SX Fully Loaded

The 60SX Fully Loaded is perfect for the welder who needs a tough workbench for the fab shop or the home garage.



60SX Fully Loaded

30 x 60 inch size tabletop provides double the work surface of the 30FX.

3/8-inch X-pattern steel tabletop allows trouble-free clamping.

Durable 1/8-inch steel frame with cross bar and heavy-duty tabletops provide a sturdy area for welding or metalworking.

Adjustable leveling feet keep workbench rock-steady.

Comes customized with a wide range of handy accessories to make this the *ultimate* workbench (see at right for what is included and replacement accessories).

ArcStation 60SX Fully Loaded comes with

- 1 6-inch X-clamp** 300613
- 2 Dust Tray** 300605
- 3 Tool Chest** with ball-bearing slides 300610
- 4 Side Shelf** 300680
- 5 5-inch Quick-Remove Vise** with mount 300611
- 6 Weld Curtain** 300686
- 7 Casters** 300849



Convenience Kit 300614

Includes the following:

- 8 Gun holder**
- 9 Tool holder**
- 10 Clamp bar**



Visit MillerWelds.com or your distributor for other Miller® options and accessories.

ArcStation™ 30FX

When portability or space-savings is a concern, the ArcStation 30FX is your solution.



30FX shown with two 6-inch X-clamps (sold separately).

Wheels, handle, and fold-up design make unit easy to take to the jobsite or move around the shop.

Compact size makes storing unit a breeze. Unit folds down to 6 x 29 x 48 inches (152 x 737 x 1219 mm).

30 x 30 inch size tabletop provides plenty of work surface.

3/16-inch X-pattern steel tabletop allows trouble-free clamping.

1.5-inch diameter steel tube frame provides strength and durability.

Includes removable gun holder.

Add optional 6-inch X-clamp (300613) to make this the *ultimate* portable workbench.

Model	Stock Number	Steel Top	Load Capacity	Dimensions	Weight
ArcStation 60SX Fully Loaded	951793	(1) 29 x 29 x 3/8 in. solid, (1) 29 x 29 x 3/8 in. X-pattern	1,000 lb. (454 kg)	35 x 58 x 29 in. (889 x 1,473 x 737 mm)	318 lb. (144 kg)
ArcStation 30FX	300837	(1) 29 x 29 x 3/16 in. X-pattern	500 lb. (227 kg)	35 x 29 x 35 in. (889 x 737 x 889 mm)	74 lb. (34 kg)



From our FREE OpenBook™ training software to our student safety packs, MobileArc™ and AugmentedArc® augmented reality welding systems, and LiveArc™ welding performance management system, we provide solutions to meet all of your welding training needs.

MobileArc™ Augmented Reality Welding System See literature TS/3.0

An affordable and easy-to-use MIG welding simulation tool designed to attract, engage and introduce students to welding through a hands-on augmented reality experience.

Only available at approved distributors!



Highly portable, lightweight design allows for easy transport for remote learning and recruiting events.

Easy setup and simple user interface allows for students to work independently, helping to increase instructor efficiency.

Real-time feedback is provided on users' technique to help correct errors, reinforce proper welding practices and accelerate skill advancement, prior to actual live arc welding in a lab.

Minimize material cost by saving wire, gas and workpieces in this simulation environment.

Output can be streamed to an external display for a more collaborative learning environment.

Comes complete with

- Mobile device with case
- Black Classic helmet with mobile device mount
- MIG welding gun with AR nozzle
- Mobile device gun mount
- Workpiece (base and top plates)
- 1.50 and 2.00 magnifying lenses
- Mobile device charger
- Travel bag



Two interactive viewing options: helmet mount (above) or gun mount (below).



Stock Number	Battery Life	Process	Welding Positions	Multi-Pass	Net Weight
907817 Only available at approved distributors	Mobile device (internal rechargeable battery): 3 hours of continuous simulation (will run indefinitely when powered through USB charging port)	Welding gun (9-volt battery): 70 hours of continuous use	GMAW 2F, 1G	T-joint, butt joint, lap joint	System with travel bag: 7 lb. (3.2 kg) Welding helmet with mobile device: 25 oz. (709 g)

AugmentedArc® Augmented Reality Welding System

See literature TS/2.0

Only available at approved distributors!



Lightweight and balanced AR welding helmet with large viewing area provides a realistic augmented reality environment.

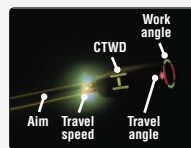
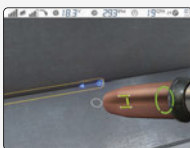

The highly realistic multiprocess welding simulation solution for classroom training.

Optimize instructor efficiency by using the Teacher software to create a virtual classroom with customized curriculum, quizzes and weld exercises.

Real-time feedback is provided on users' technique to help correct errors, reinforce proper welding practices and accelerate skill advancement prior to actual live arc welding in a lab.

Reduce overall training time. Compared to traditional methods, AugmentedArc significantly reduces the amount of time needed to teach students.

Minimize material cost by saving wire, gas and workpieces in this simulation environment, while allowing students to refine their welding skills before live arc welding.

Build a larger, more-skilled welding workforce when computer-savvy individuals are drawn to welding education programs that increase their success.

Comes complete with

- AugmentedArc simulator
- Teacher software
- OpenBook™ theory content, quizzes, assignments and NCCER exercises
- Black Infinity™ AR helmet
- Internal router
- MIG gun with AR nozzle,
- SMAW stinger
- TIG torch with AR nozzle
- Two electrode/filler rods with AR tips
- Work stand for out-of-position apps
- Seven workpieces: t-joint, butt joint, lap joint, pipe-to-plate, butt pipe, V-groove with backing and V-groove without backing

Optional components

- **TIG Foot Pedal Kit** 286033
Includes TIG foot pedal, connection cable and adapter cable
- AugmentedArc Controller 301395
For multiple system connectivity
- Heavy-duty Transportation Cases 951775
Protects complete system during transportation or storage



Stock Number	Input Power	Voltage/Amperage Selection	Welding Positions	Polarity Selection	Shielding Gas Selection	Wire Speed Selection	Base Material Selection	Workpiece Selection	Stick Electrode Selection	Diameter Selection	Simulator Dimensions	Net Weight
951823 Only available at approved distributors	115 V, 15 A, 60 Hz 230 V, 10 A, 50 Hz	GMAW: 10-38 V 50-425 A FCAW: 10-38 V 50-425 A SMAW: 50-425 A GTAW: 50-425 A	1F-4F 1G-6G	DCEP DCEN AC	CO ₂ Argon O ₂ Argon CO ₂ Argon	GMAW/FCAW: 50-1,000 ipm (1.27-25.4 m/min.)	Carbon steel Stainless steel Aluminum	1/8, 1/4, 3/8 in. (3.2, 6.4, 9.5 mm)	E7018 E6010 E6013	Solid wire: .030, .035, .045 in. (0.8, 1.0, 1.2 mm) Stick electrode: 1/8, 3/32, 5/32 in. (2.5, 3.25, 4.0 mm) Filler rod: 3/32 in. (2.4 mm)	H: 21 in. (533 mm) W: 9.38 in. (238 mm) D: 17.25 in. (438 mm)	Simulator: 20.7 lb. (9.4 kg) Helmet: 1.97 lb. (0.9 kg)

LiveArc™ Welding Performance Management System

See literature TS/1.0

Only available at approved distributors!

GMAW/FCAW/SMAW system shown.



The reality-based recruiting, screening, training, and re-qualification solution for industrial, manufacturing and educational markets.

Better and more cost-effective training with faster results. Benefit from both weld simulation and the real-world experience of live arc welding with instant, valuable feedback on welding technique to quickly help build skills.

Motion-tracking technology measures the operator's adherence to preset technique parameters. Cameras track the movement of LEDs embedded in the MIG SmartGun and SMAW SmartStinger during pre-weld simulations and live welds; the system then delivers visual feedback on the operator's performance via the LiveArc system's main display.



SmartGun (left) and SmartStinger (right) shown.

GMAW/FCAW system comes complete with

- Computer with Intel core i7, 128 GB SSD, fanless cooling, and HDMI port for connection to most secondary monitors (not included)
- 21.5 HD LCD touch screen monitor
- SmartGun with 15 ft. (4.6 m) cable
- Calibration tool
- Two table clamps
- Removable arm extension with C-clamp assembly for out-of-position right- and left-hand applications
- Extra Bernard® consumables

GMAW/FCAW/SMAW system includes above plus

- SmartStinger with 12 ft. (3.7 m) cable
- 15 ft. (4.6 m) Dinse-style cable
- Router box
- Software update for SMAW applications

Stock Number	Input Power	Processes	Positions	Multi-Pass	Rated Output	Electrode Diameter	Dimensions	Net Weight
907714 GMAW/FCAW system	120 V, 60 Hz Compatible with Miller® power sources	GMAW, GMAW-S, GMAW-P, FCAW-G	2F-4F, 1G-4G	Groove and fillet up to 1 in. (25 mm) plate	SmartGun: 400 A at 60% duty cycle (mixed gases)	SmartGun: Up to 5/64 in. (2.0 mm)	H: 77.5 in. (1,969 mm) W: 46 in. (1,168 mm) D: 31 in. (787 mm)	GMAW/FCAW system: 480 lb. (218 kg)
907714001 GMAW/FCAW/SMAW system Only available at approved distributors		SMAW	2F-4F, 1G-4G	Limited groove applications	SmartStinger: 250 A at 60% duty cycle	SmartStinger: Up to 1/8 in. (3.2 mm)		GMAW/FCAW/SMAW system: 527 lb. (239 kg)

Educational Resources

Visit MillerWelds.com/education for more information on educational resources.

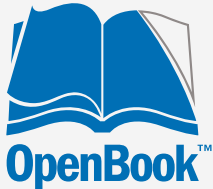

OpenBook provides FREE interactive online training resources, educational materials and tracking tools. Visit OpenBook.MillerWelds.com for details.

Customize your classroom

- Implement materials that fit your curriculum and learning objectives, including:
 - e-Learning modules
 - Weld lab activities
 - Course builder
 - Quiz builder
 - Lab builder
 - Customizable certificates of completion
- Miller® and Hobart® pre-defined courses with certificates of completion
- Track individual student progress
- All material aligns with AWS standards

Motivate and engage students

- Interactive, stimulating learning includes videos and activities
- Quick, digestible segments
- Mobile friendly
 - Easy to access homework from anywhere
 - Students can check grades and status
- Ideal for high school and post-secondary welding programs

Student Safety Packs



All-in-one safety pack ensures students are prepared and outfitted with comfortable and fitted personal protection equipment (PPE).

- 291661 Medium
- 291662 Large
- 291663 X-Large

Note: Orders must be drop shipped to the school. This offer cannot be combined with any other offer.

Safety packs consist of black Classic VS auto-darkening welding helmet, Classic Cloth jacket, MIG (lined) gloves, TIG/multitask gloves, Classic clear safety glasses, Slag™ shade 5 safety glasses, jobsite tool bag, and more.



Automated MIG 122

Cable Connectors and Adapters 122/129

Carts, Cylinder Racks and Running Gear 122-124

Coolmate Coolant Systems 123

Engine Drive Accessories 124-125

- Big Blue Accessories ▪ Blue Star and Fusion Accessories
- Bobcat and Trailblazer Accessories
- Generator Accessories ▪ Protective Covers
- Remote Output Panel Kit ▪ Trailers

Load Banks 125

MIG Accessories 125

- Machine and Gun Accessory Kits ▪ Protective Covers

Plasma Cutter Accessories 126

- Automation Kits ▪ Cables and Cable Covers
- Cutting Guides ▪ Filters ▪ Plugs and Cords
- Protective Case ▪ Torches

Process Selector Control/Polarity Switch 127

Remote Controls and Wireless Remote Controls 127-129

Stick Accessory Kits 127

Submerged Arc Accessories 127

- Cables ▪ Torch Accessories
- Wire Drive Assembly Accessories

TIG Accessories 128-129

- Kits ▪ Protective Case/Covers ▪ Remote Controls
- Torch and Weld Cable Connectors

Wire Feeder Accessories 130

- Extension Cables (14-pin) ▪ Power Supply Adapter
- Spool Adapter ▪ Spool Gun Controls and Kits
- Wire Straightener

Automated MIG

For adapters and drive motors, visit MillerWelds.com.



Coolant Flow Switch 195461

For water-cooled guns. To ensure coolant is flowing in the system. A lack of coolant flow may cause damage to water-cooled guns.

Module allows wiring into the peripheral connector port. 50-foot (15.2 m) cable with connector and separate shell connector for simple modification to desired length in the field. Quarter-turn quick connection.

Cable Connectors and Adapters

Also see Torch and Weld Cable Connectors in TIG Accessories on page 129.

For AlumaPower 350 MPa, XMT 350, CST, Syncrowave, Maxstar and Dynasty. These power sources are equipped with Dinse- or Tweco-style connectors for secondary connections.

Dinse-Style Connector Kits

042418 Accepts #4 to #1/0 AWG cable

042533 Accepts #1/0 to #2/0 AWG cable

Kits include one male Dinse-style plug which attaches to the work and/or weld cables and plugs into the female Dinse-style receptacles on the power source.

Extension Kit for Dinse-Style Cable Connectors

042419 Accepts #4 to #1/0 AWG cable

Used to adapt or extend weld and/or work cables. Kit includes one male Dinse-style plug and one in-line female Dinse-style receptacle.

Extensions for Dinse-Style Cable Connectors

134460 Male Dinse-style plug

136600 Female Dinse-style receptacle

Used to adapt or extend weld and/or work cables. Accepts #1/0 to #2/0 AWG cable.



Tweco-Style Connector 191981

Accepts #1/0 to #2/0 AWG

cable. Kit includes one male Tweco-style plug which attaches to the work and/or weld cables and plugs into the female Tweco-style receptacles on the power source.



Dinse/Tweco Adapter 042465

Dinse/Cam-Lok Adapter 042466

One-piece adapter with male Dinse-style

plug (to power source) on one end and female Tweco- or Cam-Lok-style receptacle (for weld cable connection) on other end.



Tweco/Dinse Adapter 210061

One-piece adapter with male Tweco-style plug (to power source) on one end and female Dinse-style receptacle (for weld cable connection) on other end.

Carts, Cylinder Racks and Running Gear

Also see Engine Drive Accessories on page 124.



Feeder Cart 142382

A low-profile creeper cart which allows the operator to easily move the feeder around the work area.



Universal Cart and Cylinder Rack 042934

For XMT 350, CST, Diversion, Maxstar 210/280 and Dynasty 210/300. Accommodates a single gas cylinder up to 56 inches (1,422 mm) high measuring 6 to 9 inches

(152 to 229 mm) in diameter. Also provides storage for auxiliary items such as electrodes, helmets and gloves.



Running Gear/Cylinder Rack 301239

For Millermatic 141/211, Multimatic 200/215 and Diversion. Heavy-duty construction with 8-inch rubber rear wheels, convenient front handles, cable holders and plastic consumable box. For gas

cylinders no greater than 7 inches (178 mm) in diameter or 65 pounds (29.5 kg) in weight.



Dual Cylinder Rack Cart 951770

For Millermatic 141/211, Multimatic 200/215/220 AC/DC and Diversion.

Similar to Running Gear/Cylinder Rack, but with dual-cylinder rack and a bracket that holds a variety

of tools. **Dual Cylinder Rack Conversion Kit and Tool Holder (301454)** is also available separately for use with Running Gear/Cylinder Rack 301239 above.



Dual EZ-Change™ Low Cylinder Rack with Elevated Gun and Cable Rack 300337

For Millermatic 252 and Syncrowave 210. Allows operators to easily roll cylinders on and off the rack with no lifting and keeps cables off the floor and tangle free. **Elevated Gun and Cable Rack (300335)**

is also available separately for use with factory-installed single-cylinder rack.



EZ-Latch™ Single Cylinder Running Gear 301449

For Millermatic 255/355 and Multimatic 235/255. Running gear with a single-cylinder rack and storage compartment. Machine is secured to cart by latches that rotate to disengage machine for easy portability.



EZ-Latch™ Dual Cylinder Rack Running Gear 951769

For Millermatic 255/355 and Multimatic 235/255. Similar to EZ-Latch Single Cylinder Running Gear, but with a dual-cylinder rack and elevated gun/cable rack to keep cables off the floor and tangle free.



EZ-Latch™ Dual Cylinder Rack with Elevated Gun and Cable Rack 301481

For Millermatic 255/355 and Multimatic 235/255. Converts an EZ-Latch Single Cylinder Running Gear into an EZ-Latch Dual Cylinder Rack Running Gear including the elevated gun/cable rack to keep cables off the floor and tangle free.



MIGRunner™ Cart 195445
For AlumaFeed system and XMT 350/400 models with single-wire feeders. Small footprint and easily maneuverable, with a dual-cylinder rack low enough that you do not have to lift bottles. Durable, heavy-duty ergonomic handles are designed for comfort.



Deltaweld 350/500 Running Gear 301523
For Deltaweld 350/500. Features small footprint, dual-cylinder rack, chains for gas cylinders, ergonomic handle design, lockable front casters, two torch holders, plus a storage area below.



2-Wheel Trolley Cart 300971
For Maxstar 210/280 and Dynasty 210/300 with or without Coolmate 1.3. Easy-to-maneuver two-wheel cart features single-cylinder rack, chain for cylinder, straps (quick and easy to detach and carry machine), cable holders, torch holder, storage area, and filler rod storage area.



Running Gear Cylinder Rack 300408
For XMT with single- or dual-wire feeders. Holds two large gas cylinders and has gun cable hangers and a consumable drawer in front. A convenient handle allows the cart to be pulled easily through doorways. Power source and single- or dual-wire feeders can be mounted to cart and secured.



Continuum Running Gear/Cylinder Rack 301264
For Continuum. Small footprint and easily maneuverable, with cylinder rack low enough that you do not have to lift bottles.



Small Runner™ Cart 301615
For Maxstar 210/280 and Dynasty 210/300 with or without Coolmate 1.3. Cart features single-cylinder rack, foot pedal holder, two cable/torch holders and two TIG filler holders.



Syncrowave 300/400 4-Wheel Cart 301601
For Syncrowave 300/400 (machine only). Cart includes storage space with latching door, handles, cylinder rack with chain, foot control holster, and cooler adapter kit. Allows for the addition of a Coolmate 3 externally powered cooler if desired.



Runner™ Cart 300244
For Maxstar 400/800 and Dynasty 400/800 with or without Coolmate 3.5. Cart features single-cylinder rack, foot pedal holder, three cable/torch holders and two TIG filler holders.

Coolmate™ Coolant Systems See literature AY/7.2 **1 Phase**



Coolmate 1.3 301616 120 V
For Maxstar 210/280 and Dynasty 210/300. Light industrial, 1.3-gallon cooler designed for water-cooled torches on power sources rated up to 300 amps*.

Coolmate 3 043007 120 V 043008 240 V
Economical, 3-gallon cooler designed for water-cooled torches rated up to 500 amps*.

Coolmate 3.5 300245 120 V
For Maxstar 400/800 and Dynasty 400/800. Industrial, 3.5-gallon cooler designed for water-cooled torches rated up to 600 amps*.

Coolmate 4 042288 120 V
Best performer in its class – industrial, 4-gallon cooler designed for water-cooled torches rated up to 600 amps*.

*May vary with torch design and cable length. Miller® coolant systems are backed by the best warranty in the industry – one full year.

Coolant

Must be ordered in quantities of four. One-gallon recyclable plastic bottle. Miller® coolants contain a base of ethylene glycol and deionized water to protect against freezing to -37 degrees Fahrenheit (-38°C) or boiling to 227 degrees Fahrenheit (108°C).



Low-Conductivity Coolant (clear, pre-mixed) 043810

For TIG and MIG applications. NOT for use in push-pull systems or systems where aluminum is in coolant path/circuit.

Aluminum-Protecting Coolant (green, pre-mixed) 043809

Primarily used in push-pull systems where aluminum is in coolant path/circuit and high frequency is NOT used.

Model	Motor Input Voltage	Maximum Current Draw	Maximum Cooling Capacity	IEC Cooling Capacity	Tank Capacity	Dimensions	Net Weight
Coolmate 1.3	115 V, 50/60 Hz	5.9 A (50 Hz), 4.7 A (60 Hz)	3,400 W (11,600 Btu/hr.) 3.8 qt./min. (3.6 L/min.)	1,330 W (4,540 Btu/hr.) 1.1 qt./min. (1 L/min.)	1.3 gal. (4.9 L)	H: 11.38 in. (289 mm) W: 10.38 in. (264 mm) D: 24.25 in. (616 mm)	46 lb. (21 kg)
Coolmate 3	115 V, 50/60 Hz	5.9 A (50 Hz), 4.7 A (60 Hz)	3,820 W (13,000 Btu/hr.) 4.2 qt./min. (4.0 L/min.)	1,420 W (4,840 Btu/hr.) 1.1 qt./min. (1 L/min.)	3 gal. (11.4 L)	H: 13.25 in. (337 mm) W: 12.25 in. (311 mm) D: 23.25 in. (584 mm)	40 lb. (18 kg)
	230 V, 50/60 Hz	2.5 A (50 Hz), 3.0 A (60 Hz)					
Coolmate 3.5	115 V, 50/60 Hz	5.9 A (50 Hz), 4.7 A (60 Hz)	4,140 W (14,000 Btu/hr.) 5.0 qt./min. (4.7 L/min.)	1,660 W (5,660 Btu/hr.) 1.1 qt./min. (1 L/min.)	3.5 gal. (13.2 L)	H: 11.75 in. (298 mm) W: 15.75 in. (400 mm) D: 26 in. (660 mm)	64 lb. (29 kg)
Coolmate 4	115 V, 50/60 Hz	5.9 A (50 Hz), 4.7 A (60 Hz)	5,500 W (18,000 Btu/hr.) 5.9 qt./min. (5.6 L/min.)	1,780 W (6,070 Btu/hr.) 1.1 qt./min. (1 L/min.)	4 gal. (15 L)	H: 16.25 in. (413 mm) W: 15.25 in. (387 mm) D: 18.75 in. (476 mm)	38 lb. (17 kg)

●●● Accessories

Engine Drive Accessories

Also see Trailers on page 125.

Big Blue Accessories



Cable Holder 043946
For Big Blue 500 Pro/600 Series/800 Series.



Vandalism Lockout Kit 399802 Field
For Big Blue 500 Pro/600 Series. Lockable hinged steel panels cover and protect name plate gauges and ignition switch (padlock included). Also includes engine compartment door lock and key.

Blue Star and Fusion Accessories



Lifting Eye 195353
For Fusion and Blue Star.



Running Gear 301246
For Fusion and Blue Star. Compact and balanced, lightweight wheelbarrow-style running gear provides easy on-site mobility.

Bobcat and Trailblazer Accessories (Gas/LP)



Multi-Terrain Running Gear with Never Flat™ Tires 301460
For Bobcat 200 Air Pak.
300914
For gas/LP Bobcat and gas Trailblazer (except Air Pak models).

Includes two heavy-duty 15-inch tires, two 8-inch rubber swivel casters and a heavy-duty handle. Recommended for all surfaces and applications and is easy to move around the jobsite.



Off-Road Running Gear with Never Flat™ Tires 300910
For gas/LP Bobcat and gas Trailblazer (except Air Pak models). Includes four heavy-duty 15-inch tires and a rugged handle to provide maximum maneuverability.



Off-Road Running Gear with Protective Cage and Never Flat™ Tires 300912
For gas/LP Bobcat and gas Trailblazer (except Air Pak models). Running gear and rugged cage with cable holders protects your investment and is easy to move around the jobsite.



Protective Cage with Cable Holders 300921 For gas/LP Bobcat and gas Trailblazer (except Air Pak models).

300473 For Trailblazer 302 Air Pak.

Rugged cage with cable holders protects your investment. Works with Running Gear, Gas Cylinder Mounting Assembly or LP Tank Mounting Assembly.



Gas Cylinder Mounting Assembly 300918
For gas Bobcat and Trailblazer (except Air Pak models). Designed for use with Running Gear, Protective Cage, or by itself. Includes base tray with bottle bracket, vertical support rack and safety chain.

Note: Not for use with LP Tank Mounting Assembly. Not recommended for use with Protective Cover.



Hose and LP Tank Mounting Assembly 300917
For LP Bobcat. Designed for use with Running Gear, Protective Cage, or by itself. Includes bracket and clamp to mount 33- and 43-pound tanks horizontally, and hose with fittings to converter.

Note: Not for use with Gas Cylinder Mounting Assembly. Not recommended for use with Protective Cover.



Remote Oil Drain and Filter Kit 300923 Field
For gas Bobcat and Trailblazer (except Air Pak models). Front mount for Kohler engines makes servicing easy when engine drive is mounted in tight spots.

Trailblazer Accessories (Diesel)



All-Purpose Running Gear with Never Flat™ Tires 300477
For Trailblazer 325 Diesel. Includes two heavy-duty 15-inch tires, two 8-inch rubber swivel casters and a heavy-duty handle. Recommended for all surfaces

and applications and is easy to move around the jobsite.



Protective Cage with Cable Holders 195331
For Trailblazer 325 Diesel. Rugged cage with cable holders protects your investment. Works with Running Gear or with trailer.
Note: Not for use with Protective Cover.

Generator Accessories



Twist Lock Adapter Cord 301489
For Fusion. L14-30R to NEMA 6-50R. Adapts engine drive 120/240-volt twist lock plug to common Millermatic and Spectrum 240-volt plug.



Full KVA Adapter Cord 300517
For Bobcat, Trailblazer and Big Blue models. NEMA 14-50P to NEMA 6-50R. Adapts engine drive 120/240-volt plug to common Millermatic and Spectrum 240-volt plug.



Full KVA Plug Kit 119172 1-phase, 120/240 V, 50 A plug (NEMA 14-50P). For Bobcat, Trailblazer and Big Blue models.
165963 3-phase, 480 V, 30 A plug (NEMA L16-30P). For Bobcat 3 Phase.
254140 3-phase, 240 V, 50 A plug (NEMA 15-50P). For Big Blue 500 Pro/600 Series/800 Series.

Protective Covers



Protective covers (300919) and (195301) shown.

Protective Covers

Heavy-duty, water- and mildew-resistant covers protect and maintain the finish of the welder.

- 301245** For Fusion and Blue Star.
- 301475** For gas Bobcat 200 Air Pak **without** Running Gear.
- 301476** For gas Bobcat 200 Air Pak **with** Running Gear.
- 301531** For diesel Bobcat 200 Air Pak **without** Running Gear.
- 301532** For diesel Bobcat 200 Air Pak **with** Running Gear.
- 300919** For gas Bobcat and Trailblazer (except Air Paks) **without** Protective Cage or Running Gear.
- 300920** For gas Bobcat and Trailblazer (except Air Paks) **with** Protective Cage or Running Gear.
- 301099** For Trailblazer 325 Diesel **without** Protective Cage or Running Gear.
- 300379** For Trailblazer 302 Air Pak.
- 195301** For Big Blue 400 Pro/400 PipePro/450 Duo CST.
- 301495** For Big Blue 500 Pro/600 Pro with Kubota.
- 301113** For Big Blue 600 Air Pak/800 Series with Deutz.

Remote Output Panel Kit



Remote Output Panel Kit 951850
For Bobcat, Trailblazer and Big Blue (except 450 Duo CST) models. Kit allows you to locate your welder/generator's output panels at the point of use, so you don't need to climb onto the truck as often to make connections.

Trailers

See literature AY/20.0



HWY-Mid Frame Trailer 301438

For Bobcat, Trailblazer and Big Blue 400 Pro/400 PipePro/450 Duo CST. A 1,424-pound (646 kg) capacity highway trailer with welded steel tubing frame, heavy-duty axle with roller bearing hubs and leaf-spring suspension. Includes jack stand, fenders, lights, and dual hitch with 2-inch (50 mm) ball hitch and 3-inch (76 mm) lunette eye.

HWY-225 Trailer 301338

For Big Blue models. A 2,700-pound (1,225 kg) capacity highway trailer with welded steel tubing frame, heavy-duty axle with roller bearing hubs and leaf-spring suspension. Includes jack stand, fenders, lights, and dual hitch with 2-inch (50 mm) ball hitch and 3-inch (76 mm) lunette eye.

Note: Trailers are shipped unassembled. *Width at outside of fenders.

Trailer accessories

Fender Kit 301439

For HWY-Mid Frame and HWY-225. Replacement fenders.

Dual Hitch 301441

For HWY-Mid Frame and HWY-225. Combination 2-inch (50 mm) ball hitch and 3-inch (76 mm) lunette eye in one reversible assembly.



Cable Tree 043826

For HWY-Mid Frame and HWY-225. Provides an area to conveniently wrap weld cables and extension cords.



2-In-1 Document/Fire Extinguisher Holder 301236

For HWY-Mid Frame and HWY-225. Stores documents and holds a 5-pound fire extinguisher.

Note: Holder shown mounted on trailer. Fire extinguisher not included.



Model	Gross Axle Weight Rating	Gross Vehicle Weight Rating	Net Payload	Height of Bed	Road Clearance	Track (Center to Center of tires)	Standard Tires (Standard Rating or P-size Rating)	Dimensions	Net Weight
HWY-Mid Frame	1,605 lb. (728 kg)	1,424 lb. (646 kg)	1,424 lb. (646 kg)	19.5 in. (495 mm)	8 in. (203 mm)	46 in. (1,168 mm)	ST175/80D-13 Load Range C	L: 101 in. (2,565 mm) W: 55 in. (1,397 mm)*	181 lb. (82 kg)
HWY-225	3,500 lb. (1,588 kg)	2,999 lb. (1,360 kg)	2,700 lb. (1,225 kg)	19 in. (483 mm)	7.5 in. (191 mm)	50 in. (1,270 mm)	ST175/80R-13 Load Range D	L: 105.5 in. (2,680 mm) W: 56.5 in. (1,435 mm)*	280 lb. (127 kg)

Load Banks



LBP-350 043329

Designed to provide an adjustable load for troubleshooting or calibrating welding power sources or generators. Standard equipment

includes analog meters for both AC and DC output with jacks for external metering connections. It comes with a 13-foot (4 m) 115-volt power cord and has seven 50-amp load switches, providing a maximum capacity of 350 amps.



Welding Power Load Bank 902804

Designed to load test the output of transformer-type, engine- or motor-driven generator welding power sources. This unit can be used to test AC or DC welder outputs, and to demonstrate welding equipment to customers.

MIG Accessories

Machine and Gun Accessory Kits



MIG kit with Dinse-style connectors for single-wire feeders shown.

Industrial MIG 4/0 Kit (with lugs)

300390 For single-wire feeders.

300957 For dual-wire feeders.

Consists of flowmeter regulator with 10-foot (3 m) gas hose, 10-foot (3 m) 4/0 feeder weld cable with lugs, and 15-foot (4.6 m) work cable with 600-amp C-clamp. Dual kit comes with two flowmeter regulators and gas hoses.

Industrial MIG 4/0 Kit (with Dinse-style connectors)

300405 For single-wire feeders.

300956 For dual-wire feeders.

Same as above except weld and work cables have Dinse-style connector on one end instead of lug.

MIGmatic™ M-Series Gun Consumable Kits

234607 .023 in. (0.6 m) wire

234608 .030 in. (0.8 m) wire

234609 .035 in. (0.9 m) wire

For M-100/M-150 guns. Kits include ten contact tips, one tip adapter, one standard nozzle and a consumable storage box.

Protective Covers



301262

For Millermatic 141/211 and Multimatic 215.



301524

For Multimatic 220 AC/DC.



301521

For Millermatic 255 and Multimatic 235/255. Features side pocket.



195142

For Millermatic 252 and Syncrowave 210. Features side pocket.

Plasma Cutter Accessories

Automation Kits



Spectrum 875 Auto-Line automation kit shown.

Automation Kits for Spectrum 875 and 875 Auto-Line 301156 For Spectrum 875.

301157 For Spectrum 875 Auto-Line.

Upgrades hand-held torch packages to add machine torch capabilities. Automation kit for Spectrum 875 Auto-Line (**301157**) includes a remote pendant control for manual on/off. Machine torches are NOT included in kits and must be ordered separately.

Cables and Cable Covers



Flexible Work Cable

234838 20 ft. (6.1 m)

234930 50 ft. (15.2 m)

Work cable with quick connect and heavy-duty clamp.



Cable Covers

239642 20 ft. (6.1 m)

231867 25 ft. (7.6 m)

231868 50 ft. (15.2 m)

Cutting Guides

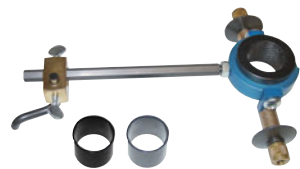

Plasma Circle-Cutting Guides 253055

For XT30/XT40/XT60 torches. Cut straight lines or circles up to 12 inches in diameter.



Suction/Magnetic Pivot Base 195979

Add this to your cutting guide for convenient attachment to all flat surfaces. The extended arm accommodates holes up to 30 inches in diameter.



Plasma Standoff Roller Guide 253054

Helps maintain recommended standoff distance to maximize cutting performance and improve tip life.

Filters



In-Line Air Filter Kit 228926

For Spectrum 375 X-TREME/625 X-TREME/875/875 Auto-Line. Mounts to back of the plasma cutter. Includes male and female 1/4-inch NPT quick-disconnect fittings and hose for easy on/off connection. The replaceable filter element (**228928**) filters for removal of 99.9 percent of water, dirt and oil.



RTI Filter and Bracket 300491

For Spectrum 875/875 Auto-Line. Can be mounted on plasma cutter or on wall. Install as close as possible to point of air consumption. The replaceable filter element (**212771**) filters as small as one micron for removal of 99.9 percent of water, dirt and oil.

Plugs and Cords

MVP™ Plugs



219258

For 6-50P power cable (230/240 V, 50 A).



219261

For 5-15P power cable (115/120 V, 15 A).



219259

For 5-20P power cable (115/120 V, 20 A).

For Spectrum 375 X-TREME, Millermatic 211, Multimatic 200/215/220 AC/DC, Thunderbolt 160, Diversion, Syncrowave 210 and Fusion. Allows connection of machine to 115/120-volt or 230/240-volt receptacles without tools – just choose the plug that fits the receptacle.

MVP™ Adapters



Female Receptacle



254328

For connection to 6-50P receptacle (240 V, 50 A).



254330

For connection to 5-15P receptacle (120 V, 15 A).



254331

For connection to 5-20P receptacle (120 V, 20 A).

For Spectrum 625 X-TREME. Allows connection of machine to 120- or 240-volt receptacles without tools – just choose the adapter cord that fits the receptacle.



Female Receptacle

Full KVA Adapter Cord 300517

NEMA 14-50P to NEMA 6-50R. Adapts engine drive 120/240-volt plug to common Millermatic and Spectrum 240-volt plug.

230-Volt Extension Cord 770644

20-foot (6.1 m) NEMA 6-50P to NEMA 6-50R heavy-duty extension cord. 8-gauge cord has lighted ends that show power is on and a molded integrated strain relief.

Protective Case



X-CASE 300184

For Spectrum 375 X-TREME/625 X-TREME.

Torches

See your Miller distributor for complete information on the following XT plasma torches and their consumables:



Spectrum Plasma Cutter Hand-Held Torches

For Spectrum 375 X-TREME

249949 12 ft. (3.7 m) XT30

For Spectrum 625 X-TREME

260633 12 ft. (3.7 m) XT40

260635 20 ft. (6.1 m) XT40

For Spectrum 875 and 875 Auto-Line

249953 20 ft. (6.1 m) XT60

249954 50 ft. (15.2 m) XT60



Spectrum 875 and 875 Auto-Line Plasma Cutter Machine Torches

249955 25 ft. (7.6 m) long body XT60M

249956 50 ft. (15.2 m) long body XT60M

257464 25 ft. (7.6 m) short body XT60M

263952 50 ft. (15.2 m) short body XT60M



Each consumable kit includes a storage box.

Plasma Torch Consumable Kits

253520 For XT30 torch. Includes five electrodes, five tips, one swirl ring, one retaining cup, one o-ring and silicone grease.

253521 For XT40 torch. Includes five electrodes, five 40-amp tips, three 30-amp tips, one 40-amp drag shield, two 30-amp drag shields, one deflector, one o-ring, one swirl ring, one retaining cup, one 40-amp gouge tip, one gouge shield and silicone grease.

256033 For XT60 torch. Includes three standard electrodes, three standard tips, one drag shield, one deflector, one o-ring, one swirl ring, one retaining cup, one gouge tip, one gouge shield and silicone grease.

127493 Empty consumable storage box.

Process Selector Control/Polarity Switch



Process Selector Control 042872

For CC, CV or CC/CV welding power source. Provides an easy way to change the welding process. Also for

use with dual wire feeders or any application where electrical isolation and/or polarity reversing of weld current is required. Both functions can be used at the same time.

Remote Controls

Also see Remote Controls in TIG Accessories on pages 128 and 129.



PRHC-14 Hand Control 195511

For all solid-state power sources after serial number JK674521. Complete current or voltage control brings 120 volts of GFCI power to work area in a single cord. Housed in a durable and light aluminum case and includes 125-foot (38 m) cord with plugs.

Stick Accessory Kits



No. 2 Stick Cable Sets

195196 15 ft. (4.6 m)

300836 50 ft. (15 m)

Consists of either 15- or 50-foot electrode cable with holder and work cable with clamp. 200 A, 100% duty cycle.



2/0 Stick Cable Sets

173851 50 ft. (15 m), 350 A

043952 100/50 ft. (30/15 m), 300 A

Consists of either 50- or 100-foot electrode cable with holder and 50-foot work cable with clamp. 100% duty cycle.



Weld Cables

195457 2/0 cable with electrode holder, 400 A

195458 2/0 cable with work clamp, 400 A

301387 1/0 cable with electrode holder, 250 A

Consists of a stud/Tweco® adapter and 10-foot (3 m) weld cable with a male Tweco-style plug and either an electrode holder or work clamp.



2/0 Weld Cable Extensions

195456 50 ft. (15 m)

Extends weld cables

(**195457**, **195458** and **301387**).

Submerged Arc Accessories

Cables



SubArc Control Cables

260622030 30 ft. (9.1 m)

260622050 50 ft. (15 m)

260622060 60 ft. (18.3 m)

260622080 80 ft. (24.4 m)

260622100 100 ft. (30.5 m)

260622120 120 ft. (36.6 m)

260622200 200 ft. (61.0 m)

Cable between SubArc Interface or Motor Control and power source.



Flux Hopper Extension Cables

260623010 10 ft. (3 m)

260623025 25 ft. (7.6 m)

260623065 65 ft. (19.8 m)

Cable between SubArc Interface or Motor Control and flux hopper.



Motor Extension Cables

254232005 5 ft. (1.5 m)

254232010 10 ft. (3 m)

254232025 25 ft. (7.6 m)

254232065 65 ft. (19.8 m)

Cable between SubArc Interface or Motor Control and drive motor.



Continuum Motor/Control Cables

263368015 15 ft. (4.6 m)

263368025 25 ft. (7.6 m)

263368050 50 ft. (15 m)

263368080 80 ft. (24.4 m)

263368100 100 ft. (30.5 m)

Cable between SubArc Motor Control and SubArc Remote Pendant.



SubArc Parallel Cable

260775015 15 ft. (4.6 m)



SubArc Tandem Cable

260878015 15 ft. (4.6 m)

Torch Accessories

OBT 600 Torch Body Extensions

043967 1 inch (25.4 mm)

043969 2 inch (50.8 mm)

043973 4 inch (101.6 mm)

043975 6 inch (152.4 mm)

OBT 1200 Torch Body Extension 043981

Overall length with extension is 9 inches (228.6 mm).

Actual length of extension is 8.5 inches (215.9 mm).

OBT Torch Contact Tips

OBT 600	OBT 1200	Wire Size
192700	192141	1/16 in. (1.6 mm)
192701	199026	5/64 in. (2.0 mm)
192702	192142	3/32 in. (2.4 mm)
192703	200771	7/64 in. (2.8 mm)
192704	192143	1/8 in. (3.2 mm)
192705	192144	5/32 in. (4.0 mm)

1200-Amp Twin-Wire Torch Contact Tips

264595 3/64 in. (1.2 mm)

264596 1/16 in. (1.6 mm)

264597 5/64 in. (2.0 mm)

264588 3/32 in. (2.4 mm)

Wire Drive Assembly Accessories

Drive Rolls

132955 1/16 in. (1.6 mm)

132960 5/64 in. (2.0 mm)

132961 3/32 in. (2.4 mm)

132962 7/64 in. (2.8 mm)

132963 1/8 in. (3.2 mm)

193700 5/32 in. (4.0 mm)



Single-Wire Straightener 199733

For OBT 600 and OBT 1200 single-wire torches. For 1/16–5/32 inch (1.6–4.0 mm) wire.



Twin-Wire Straightener 301160

For 1200-amp twin-wire torch only. Single adjustment.



Manual Single Slide 301137

Provides smooth and accurate movement of the welding heads. Allows for 7.87 inch (200 mm) travel adjustment with load capacity of 220 pounds (100 kg) at 1.64 feet (500 mm). **Not recommended for tandem.**



Wire Reel 108008

Supports 60-pound (27 kg) coil of wire. Requires **Spool Support Assembly (119438)**.

TIG Accessories

Kits



A-200 torch with RCCS-14 kit shown.

Contractor Kit

301309 A-150 torch with RFCS-14 HD foot pedal
301311 A-150 torch with RCCS-14 fingertip
301549 A-200 torch with RFCS-14 HD foot pedal
301550 A-200 torch with RCCS-14 fingertip
 For Maxstar 210/280 and Dynasty 210/300. All-in-one TIG/stick welding kit comes with either a Weldcraft™ A-150 OR A-200 TIG torch, RFCS-14 HD foot control OR RCCS-14 fingertip control, 200-amp stick electrode holder and 300-amp work clamp with 15-foot (4.6 m) cables, flow gauge regulator with 12-foot (3.7 m) gas hose, gas hose coupler, AK2C torch accessory kit, and TIG torch connector.

TIG Contractor Kit 301287

For Multimatic 200.

301337

For Multimatic 215.

Kit comes with Weldcraft™ A-150 TIG torch with Dinse-style connector, either an



Multimatic 215 contractor kit shown.

RFCS-6M foot control (Multimatic 200 kit) OR RFCS-RJ45 foot control (Multimatic 215 kit), flow gauge regulator with 12-foot (3.7 m) gas hose, and AK2C torch accessory kit.

Multimatic 235/255 TIG Kit 301518

Kit comes with 25-foot (7.6 m) Weldcraft™ A-150 TIG torch with Dinse-style connector, RFCS-14



HD foot control, 10-pin to 14-pin adapter cord, flow gauge regulator with 5-foot (1.5 m) gas hose, and AK3C torch accessory kit.



W-280 torch kit shown.

Weldcraft™ Water-Cooled Torch Kits

300185 250 A, W-250 (WP-20)
300990 280 A, W-280 (WP-280)
301268 375 A, W-375
300186 400 A, W-400 (WP-18SC)
 For Syncrowave 300/400, Maxstar (except 161 models) and Dynasty. Kit comes with 25-foot (7.6 m) TIG torch with Dinse-style connector (thread-lock on 400-amp kit), torch cable cover, work clamp with 15-foot (4.6 m) cable (12-foot [3.7 m] cable on 400-amp kit), flowmeter regulator with gas hose, and AK4GL gas lens accessory kit (AK18C accessory kit on 400-amp kit).

Protective Case/Covers



X-CASE 301429
For Maxstar 161 models.



Protective covers (300579) and (301382) shown.

300579 For Diversions.

195142 For Syncrowave 210.

301381 For Maxstar 210.

301382 For Maxstar 280 and Dynasty 210/300.

Remote Controls

14-Pin to 6-Pin Adapter Cord 300507

For Multimatic 200 and Maxstar 161 STL/STH. 12-inch (305 mm) cord adapts Miller® 14-pin foot control or fingertip control to a 6-pin plug.



10-Pin to 14-Pin Adapter Cord 301545

For Multimatic 235/255. Allows standard 14-pin



TIG remote controls to be used with the Multimatic 235 and Multimatic 255.



RCC-6M (6-pin plug)
301118 13.25 ft. (4 m) cord with plug
 For Multimatic 200 and Maxstar 161 STL/STH.

RCC-14 (14-pin plug)
151086 26.5 ft. (8 m) cord with plug

East/west rotary-motion fingertip current/contacter control attaches to TIG torch using two hook-and-loop fasteners. Great for production or contractors that need quick ramp-up.



RCCS-6M (6-pin plug)
195184 13.25 ft. (4 m) cord with plug
195503 26.5 ft. (8 m) cord with plug
 For Multimatic 200 and Maxstar 161 STL/STH.

RCCS-RJ45
301146 13.25 ft. (4 m) cord with plug
 For Multimatic 215 and Diversions.

RCCS-14 (14-pin plug)
043688 26.5 ft. (8 m) cord with plug
 North/south rotary-motion fingertip current/contacter control attaches to TIG torch using two hook-and-loop fasteners. Great for applications that require a finer amperage control.



RFCS-RJ45 300432
For Multimatic 215 and Diversions. Foot pedal current/contacter control. Includes 14-foot (4.3 m) cord with plug.



RFCS-6M HD (6-pin plug)
195183 13.25 ft. (4 m) cord with plug
195504 20 ft. (6 m) cord with plug
 For Multimatic 200 and Maxstar 161 STL/STH.

RFCS-14 HD (14-pin plug)
194744 20 ft. (6 m) cord with plug
 Heavy-duty foot pedal current/contacter control provides increased stability and durability from larger base and heavier cord. Reconfigurable cord can exit front, back or either side of the pedal for flexibility.



RHC-14 (14-pin plug)
242211020 20 ft. (6 m) cord with plug
242211100 100 ft. (30.5 m) cord with plug
 Miniature hand current/contacter control. Dimensions: 4 x 4 x 3.25 inches (102 x 102 x 82 mm).



RMLS-14 (14-pin plug) **129337**
 Momentary- and maintained-contact rocker switch for contactor control. Push forward for maintained contact and backward for momentary contact. Includes 26.5-foot (8 m) cord with plug.



RMS-6M (6-pin plug) **195269**
 For Multimatic 200 and Maxstar 161 STL/STH.

RMS-14 (14-pin plug) **187208**
 Momentary-contact switch for contactor control. Rubber-covered pushbutton dome switch ideal for repetitive on-off applications. Includes 26.5-foot (8 m) cord with plug.



RPBS-14 (14-pin plug) **300666**
 Attaches to the TIG torch to remotely start and stop the TIG welding process. Includes 25-foot (7.6 m) cord with plug.

Wireless Remote Foot and Hand Controls

See literature AY/6.5 (Foot) and AY/6.6 (Hand)

Increases productivity, saves money, improves safety and is easy to use.



Wireless 14-pin receiver (included with both systems)

Wireless foot control

Wireless hand control

Bluetooth® communication technology provides consistent and reliable connection, allowing precise control of the amperage.

Improves productivity and maneuverability by eliminating control cord tangles. Reduces clean up time and work area cord clutter.

Improves reliability and safety by eliminating control cord failures and reducing potential trip hazard.

Multiple frequency sharing allows up to 20 systems to operate in a 90-foot (27.4 m) radius with accuracy and precision – and without delay, system interference, or crosstalk.

Easy-to-install receiver plugs directly into the 14-pin receptacle of Miller® machines.

Easily programmable. Control can be quickly and easily paired with any other Miller® 14-pin wireless receiver. Control is preprogrammed when purchased with the receiver.

Foot control

Foot control is designed specifically for TIG welding in manufacturing, fabrication and plant applications, allowing operator to adjust amperage at point of use without the limitations of a remote cord.

Auto on/off feature extends the battery life up to 1,500 hours of welding without turning the pedal on and off.

Easy-Glide Wear Pads™ glide across concrete, making it easy to reposition the pedal for comfort and speed.

Hand control

Hand control is designed for stick, TIG, MIG and flux-cored welding, allowing operator to adjust parameters for different joint configurations, electrodes and wire types/sizes at the point of use instead of walking back to the machine.

Allows parameter adjustments up to 300 feet away from welder without returning to machine.

Improves weld quality. Operators can adjust their machines to optimize the parameters for different joint configurations, electrodes, and wire types and sizes.

Smart Touch™ buttons allow quick and accurate machine parameter adjustments.

Digital meter display allows presetting percentage of machine output before welding, and viewing of amperage and voltage while welding.

Industrial ●

Processes

- TIG (GTAW) ▪ Pulsed TIG (GTAW-P)
- Stick (SMAW)¹ ▪ MIG (GMAW)^{1,2}
- Flux-cored (FCAW)^{1,2}

¹With wireless hand control only.

²Only with voltage-sensing feeder.

Comes complete with

- Wireless foot control (301580) **OR** hand control (301582) transmitter
- Wireless 14-pin receiver (301584)
- Four AA batteries
- Four Easy-Glide Wear Pads™ (foot control only – sold individually, 248274)
- Carabiner clip (hand control only, 285341)

Suggested power sources



Look throughout this catalog for the icon above signifying compatibility with a wireless remote.

**Some applications are not suitable for wireless communication. Keep in mind that the rated range is subjective, and depends on factors such as obstructions, frequency interference, transmission technology, and weather. The figures listed assume ideal conditions are present.*

Model/Stock Number	Component	Power Supply	Battery Life	Rated Range*	Temperature	Radio Frequency	RF Power	Antenna	Dimensions	Weight
Wireless Foot Control System 301580	Foot control (transmitter)	Four AA batteries	1,500 hours	90 ft. (27.4 m)	-13° to +122°F (-25° to +50°C)	2.4 Ghz (ISM band)	<6.31 mW	Internal	H: 6 in. (152 mm)	3 lb.
									W: 5.75 in. (146 mm)	(1.4 kg)
Wireless Hand Control System 301582	Hand control (transmitter)	Four AA batteries	1,500 hours	300 ft. (91 m)					D: 11.5 in. (292 mm)	w/batteries
									H: 4.9 in. (125 mm)	0.8 lb.
									W: 3 in. (76 mm)	(0.39 kg)
									D: 1.7 in. (44 mm)	w/batteries

TIG Accessories (continued)

Torch and Weld Cable Connectors

Air-Cooled TIG (GTAW) Torch Connectors



273483^{1,2}
For Multimatic 200/215/220 and Maxstar 161.
25 mm (small) Dinse-style gas thru for one-piece air-cooled torches.



194723 A-200 (WP26)
194722² All others
For Syncrowave 210.
50 mm Dinse-style gas thru for one-piece air-cooled torches.



195379 A-200 (WP26)
195378² All others
For Multimatic 235/255, CST, Syncrowave 300/400, Maxstar 210/280/400 and Dynasty 210/300/400.
50 mm Dinse-style for one-piece air-cooled torches.

Water-Cooled TIG (GTAW) Torch Connectors



50 mm Dinse-Style Flow Thru 195380
For Syncrowave 210.
Used with all Weldcraft™ water-cooled torches.



50 mm Dinse-Style with Water Return Line 195377
For Syncrowave 300/400, Maxstar 210/280/400 and Dynasty 210/300/400.
Used with all Weldcraft™ water-cooled torches.



50 mm Thread-Lock-Style 225028
For Maxstar/Dynasty 800.
Used with all Weldcraft™ water-cooled torches.



Thread-Lock-Style Weld Cable Connectors 225029
For Maxstar/Dynasty 800.
Contains two male connectors that accept #1/0 to #4/0 AWG size cable.

¹Except A-200 (WP26) torches. ²A-80 (WP24) torches require 24-5 adapter.

●●● Accessories

Wire Feeder Accessories

Extension Cables (14-Pin)

8-Conductor Cables

242208025 25 ft. (7.6 m)

242208050 50 ft. (15 m)

242208080 80 ft. (24.4 m)

For SuitCase 12RC and 20 Series feeders. For 14-pin remote controls and 24 VAC wire feeders. 14-pin plug to a 14-pin socket. Not for 115-volt XR feeders.

11-Conductor Cables

247831025 25 ft. (7.6 m)

247831050 50 ft. (15 m)

247831080 80 ft. (24.4 m)

For XR-AlumaFeed SuitCase and 74 MPa Plus feeders.

Eleven conductors to support contactor control and remote voltage control on all Miller® electronic constant-voltage (CV) 14-pin power sources. Additional functions supported when using the AlumaPower MPa or XMT MPa power sources include synergic pulsed MIG, remote process select and side select capabilities.

14-Conductor Cables

242205025 25 ft. (7.6 m)

242205050 50 ft. (15 m)

For HDC and WC-115 weld controls. Fully-loaded 14-pin extension cables for remote controls, and 24-volt and 115-volt feeders.

Power Supply Adapter



PSA-2 Control 141604

Required when using SuitCase 12RC, 20 Series or 74 MPa Plus feeders with power sources having only 115-volt power available. Control is equipped with a 14-pin receptacle and a 10-foot (3 m) interconnecting cord with Hubbell connections for older-style power sources.

Can also be used with competitive power sources requiring a contact closure for contactor control.

PSA-2 Extension Cord 047813

25-foot (7.6 m) cord extends 10-foot (3 m) cord supplied with PSA-2 control (4-pin to 4-pin connection).

Spool Adapter

047141

For use with 14-pound (6.4 kg) spool of Hobart or Lincoln self-shielding wire.

Spool Gun Controls and Kits

For more information on WC-115A and WC-24 see literature M/1.73 or M/1.76.



WC-115A Weld Control

137546 Without contactor
137546011 With contactor
Operates on 115-volt power and designed primarily for constant-current DC power sources. Can also be used with constant-voltage (CV) power sources or DC engine

drives supplying 115 volts. Used with a constant-current (CC) source the control circuit functions in a voltage-sensing mode, and with a CV source it functions as a constant-speed circuit. Includes wire run-in and drive motor acceleration controls which ensure optimum arc starting performance.

WC-24 Weld Control

137549

For Spoolmate 200, Spoolmatic and Spoolmatic Pro. Easily mounts on power source. Designed for use with Miller® constant-voltage (CV) power sources with 14-pin receptacles and supplying 24 VAC.



Spool Gun Extension Hose and Cable Kits

132228 25 ft. (7.6 m)

132229 50 ft. (15 m)

For Spoolmate 200, Spoolmatic and Spoolmatic Pro.

Extends leads, etc. between spool gun and power source.

Wire Straightener



141580 For .035-.045 inch (0.9-1.1 mm) wire

141581 For 1/16-1/8 inch (1.6-3.2 mm) wire

For 20 Series and 74 MPa Plus.



REGISTER YOUR NEW EQUIPMENT — IT'S QUICK AND EASY.

Registering your new Miller® equipment may help in the event we need to contact you regarding changes or upgrades, or with any future insurance claims. All Miller® equipment should be registered so we can provide you with the highest level of service.

Register now at MillerWelds.com/register



MillerWeldsStore.com

















**BUY MILLER® GEAR ONLINE.
SHIRTS, HATS, MUGS, BANNERS AND MORE!**



Index **New!** or **Improved!** products appear in blue type.

A AlumaFeed Welding Systems 11	D Dynasty 300 Series 61	M MDX Series MIG Guns 26	T 20 Series Bench Feeders 22
ArcReach 16 Feeder 20	Dynasty 400 62	MIGmatic M-Series MIG Guns 25	Thunderbolt 160 53
ArcReach Heater 94	Dynasty 800 62	Millermatic 141 7	Thunderbolt 210 53
ArcReach Smart Feeder 18/51	F FILTAIR 130 106	Millermatic 211 7	Tregaskiss Guns and Peripherals 38
ArcReach Stick/TIG Remotes 51	FILTAIR 215 107	Millermatic 252 8	Fixed Automatic Guns 38
ArcReach SuitCase Feeders 18/51	FILTAIR 4000-12000 110	Millermatic 255 9	Robotic Guns 38
ArcStation 30FX 119	FILTAIR 4000-12000 Accessories 111	Millermatic 355 10	TOUGH GUN TT4 Reamers 39
ArcStation 60SX 119	FILTAIR Capture 5 108	MobileArc System 120	Welding Consumables 39
AugmentedArc System 120	FILTAIR MWX Series 108	Multimatic 200 41	Trailblazer Series 82
Auto-Continuum Systems 15	FILTAIR SWX Series 109	Multimatic 215 41	Trailblazer 302 Air Pak 84
B Bernard MIG Guns 27/28	Fusion 185 77	Multimatic 220 AC/DC 42	Trailers 125
BTB MIG Guns 27	G Gas Equipment 98	Multimatic 235 43	W Weldcraft Series TIG Torches 64
Dura-Flux Guns 28	Outfits & Packs 102/103/104/105 105	Multimatic 255 44	Air-Cooled Torches 65
Fume Extraction Guns 28	Proportional Gas Mixers 105	O OpenBook 121	Automation Torches 71
Welding Consumables 27/28	Regulators 98/99/100	P PerformArc Robotic 121	Specialty Torches 70
Big Blue 400 PipePro 85	Torches 101	Welding Systems 32	Torch Accessories 72
Big Blue 400 Pro 84	H Hercules Automated 34	PipeWorx 400 Welding System 52	Tungsten 71
Big Blue 450 Duo CST 85	Welding System 34	ProHeat Induction Heating 92	Water-Cooled Torches 68
Big Blue 500 Pro 86	I Insight ArcAgent 75	S 74 MPa Plus Bench Feeders 22	Welding Safety and Health 106
Big Blue 600 Series 86	Insight Centerpoint 75	74 MPa Plus 24	Apparel/Jackets 118
Big Blue 800 Series 87	Insight Core 74	Remote Configurations 24	Face Shields 117
Blue Star 185 77	Intelx Feeders and Swingarc 13	Spectrum Series 96	Gloves 117
Bobcat 200 Air Pak 79	J Jetline Fixed Automation 36	Spoolmate Spool Guns 29	Helmets 114/115
Bobcat Series 80	L LiveArc System 121	Spoolmatic Spool Guns 30	Helmet Accessories 114/115/116
C Continuum Systems 14	M Maxstar 161 S 53	Student Safety Packs 121	Respiratory 112/113
Continuum Feeder and Swingarc 14	Maxstar 161 STL/STH 57	SubArc Digital Series 88	Safety Glasses 116
Coolmate Coolant Systems 123	Maxstar 210 Series 60	SubArc Components 89/90	Weld-Mask 116
Copilot Collaborative Welding Cell 35	Maxstar 210 STR 54	SubArc Portable Welding System 91	Wireless Remote Controls 129
CST 282 55	Maxstar 280 Multiprocess 45	SubArc 3-Wheel Tractor 91	X XMT 350 FieldPro Systems 48
CST 282 Racks 55	Maxstar 280 Series 60	SuitCase 12RC Feeder 18	XMT 450 CC/CV ArcReach 49
D Deltaweld Systems 12	Maxstar 400 62	Syncrowave 210 58	XMT 650/650 ArcReach 50
Diversion 180 57	Maxstar 800 62	Syncrowave 300 59	XMT 650 ArcReach Racks 50
Dynasty 210 Series 61		Syncrowave 400 59	XMT Racks 49
Dynasty 300 Multiprocess 45			XMT Series 46
			XR Push-Pull Guns 23/31

CONTENTS

INTRO	New from Blue 3 Benefits of Blue 4
	MIG (GMAW) 6
	Wire Feeders 17
	MIG Guns 25
	Automation 32
	Multiprocess 40
	Stick (SMAW) 53
	TIG (GTAW) 56
	Welding Intelligence™ 73
	Engine-Driven 76
	Submerged Arc 88
	Induction Heating 92
	Plasma Cutters 95
	Gas Equipment 98
	Welding Safety and Health 106
	Workstations 119
	Training Solutions 120
	Accessories 122

Share your passion!



Tag or mention us - [#millerwelders](#)

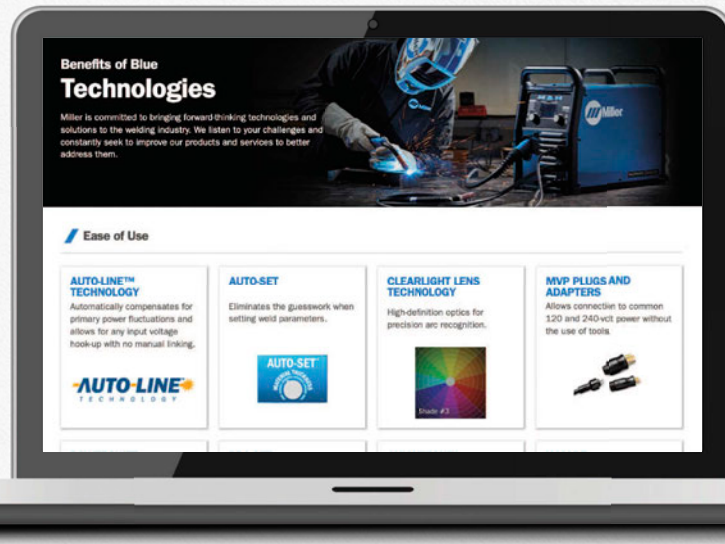

Check us out at
[MillerWelds.com](https://www.millerwelds.com)

Distributed By:



The Power of Blue®

© 2023 Miller Electric Mfg. LLC