



Surveillance Video Encoder  
**SNT-EX/EP Series**

SNT-EX101/EX101E, SNT-EX104/EP104, SNT-EX154/EP154

(simulated images)

Stunning video and audio brought to you by the IPELA series of visual communication products that encompass the three-pronged concept of "Reality," "Intelligence," and "Usability." IPELA is the identity symbolizing the Sony vision for the workplace of the future, connecting people, places, and information with reality that has never before been achieved. IPELA products let you share, understand, and experience as if you are actually there, when in fact, you are miles away. It allows you to quickly grasp a situation to make better business decisions.

### Reality

- High Frame Rate
- Visibility Enhancer
- XDNR

### Intelligence

- Audio Detection
- Voice Alert
- Tamper Alarm
- DEPA Advanced

### Usability

- 3 codecs with Dual Streaming
- 4 IP & MAC Address Support\*

Real audiovisual communication over networks – this is business communication of the future, this is business communication brought to you today, this is "IPELA."

\* Available on SNT-EX104/EP104/EX154/EP154

## With the SNT-EX/EP Series, Your Analog Cameras Will Be Reborn

Sony's SNT-EX/EP Series includes a full lineup of video encoders designed to meet various system requirements. There's a choice of 1-channel and 4-channel standalone models, as well as 1U and 3U Rack Stations that accept 4-channel blades – all of which can dual-stream H.264/JPEG, H.264/MPEG-4, or MPEG-4/JPEG video at full 30/25 fps (NTSC/PAL) in up to D1 resolution.

These video encoders not only convert analog video signals to a digital video stream for IP-based networks, but also improve the picture quality of the original signals with state-of-the-art image-enhancing technology. What's more, the SNT-EX Series also incorporates advanced security features such as DEPA Advanced™ intelligent video and audio analytics.

The SNT-EX/EP Series is the ideal choice when migrating from an existing analog camera system to an IP-based monitoring system with intelligence technology, even in the most demanding application environments, such as education, transportation, factories, healthcare facilities, public venues, and airports.

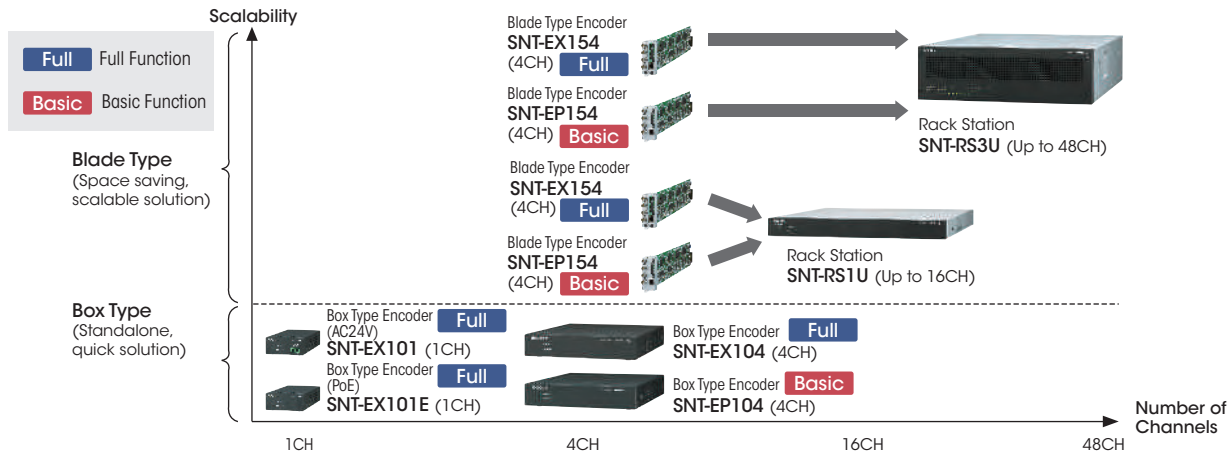

Key Features	Full Function				Basic Function	
	1CH Box		4CH Box	4CH Blade	4CH Box	4CH Blade
	SNT-EX101	SNT-EX101E	SNT-EX104	SNT-EX154	SNT-EP104	SNT-EP154
XDNR	●	●	●	●	●	●
Visibility Enhancer	●	●	●	●	●	●
DFI	●	●	●	●	●	●
Super-Impose	●	●	●	●	●	●
Privacy Masking	●	●	●	●	●	●
DEPA Advanced	●	●	●	●		
Voice Alert	●	●	●	●		
Local Storage	●	●	●			
PTZ Control	●	●	●	●		
RS422	●	●				
RS485	●	●	●	●		
Coaxitron	●	●	●	●		
AC24V power	●					
PoE		●				

# FEATURES

## High-quality Images Based on Advanced Technology

The SNT-EX/EP Series delivers clearer and brighter, high-quality images thanks to state-of-the-art image-enhancing technology.

### Visibility Enhancer

The SNT-EX/EP Series includes Visibility Enhancer technology. This tone-correction technology optimizes the visibility of a scene by increasing brightness in darker areas of the scene and compressing the brighter areas. The result is sharper, clearer images and a higher level of visibility – all of which are critical for security surveillance.



OFF



ON

(Actual images)

### XDNR (eXcellent Dynamic Noise Reduction)

Incorporating newly developed XDNR technology, these video encoders can provide clear images while at the same time minimizing motion blur under low illumination. What's more, when both XDNR and Visibility Enhancer are turned on, the video encoders can achieve four times the sensitivity compared to when they are off.

This technology is ideal for any outdoor surveillance monitoring, such as a car parked at night.

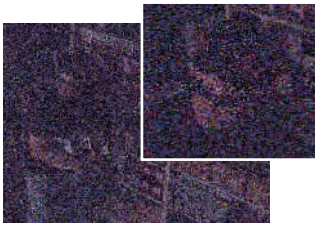

OFF



ON

(Actual images)

### Dynamic Frame Integration (DFI)

Incorporating Dynamic Frame Integration (DFI) technology, the SNT-EX/EP Series can reproduce clear images that contain both still and moving objects. DFI technology detects movement within the image and reproduces those areas with minimal blurring, while – at the same time – areas with little or no movement are displayed naturally with minimal jagged edges. DFI also ensures clear images in low light conditions.



Without DFI



With DFI

(Actual images)

## System Flexibility

### Three Codecs – H.264, MPEG-4, and JPEG Support

Each model supports the H.264, MPEG-4, and JPEG compression formats at full 30/25 fps in D1 resolution. The industry-standard JPEG compression format is the best choice for high-quality still images. MPEG-4 provides clear moving images efficiently over networks when bandwidth and storage are limited. While H.264 provides twice the efficiency of MPEG-4, for when bandwidth and storage is even more limited.

### Dual-encoding Capability

With its dual-encoding capability, the SNT-EX/EP Series can generate any two formats from H.264, MPEG-4, and JPEG simultaneously. This flexibility allows you to maximize your network and storage resources.

1 <sup>st</sup> Stream Codec	2 <sup>nd</sup> Stream Codec	Examples
H.264	H.264	1 <sup>st</sup> stream at high frame rate for live monitoring that requires clear moving.
MPEG-4	MPEG-4	2 <sup>nd</sup> at low frame rate stream for recording that needs to meet storage capability.
MPEG-4	H.264	For the system that has limited decoding capability
JPEG	H.264	For the system that requires JPEG Images
JPEG	MPEG-4	

## Intelligence

### DEPA Advanced – Intelligent Video and Audio Analytics\*1 (SNT-EX Series)

Incorporating DEPA Advanced technology, the SNT-EX Series offers intelligent video and audio analytics. With this feature, the video encoders can trigger an alarm based on user-defined rules. This allows users to further refine the criteria for triggering an alarm, making the overall system more efficient.

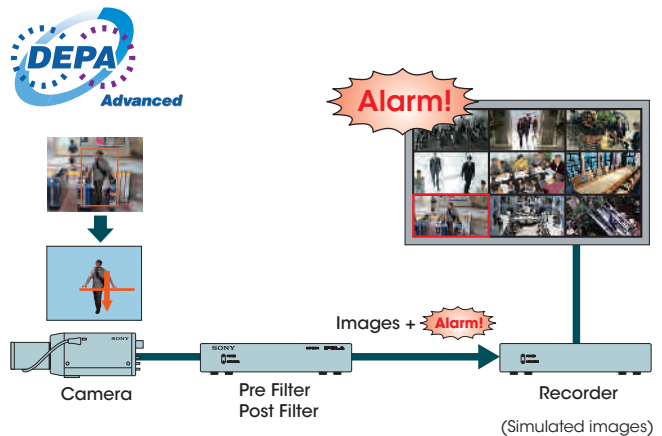

### Intelligent Motion Detection

With this feature, the SNT-EX Series can trigger an alarm based on up to three user-defined rules, such as intrusion across a virtual border utilizing edge VMF or a beam intrusion detector\*7

**• Tamper Alarm**

When an attempt is made to tamper with the camera, such as spray-painting the lens, the SNT-EX Series detects this and triggers an alarm. This event can be used to activate the camera relays, or even to start the Voice Alert function.

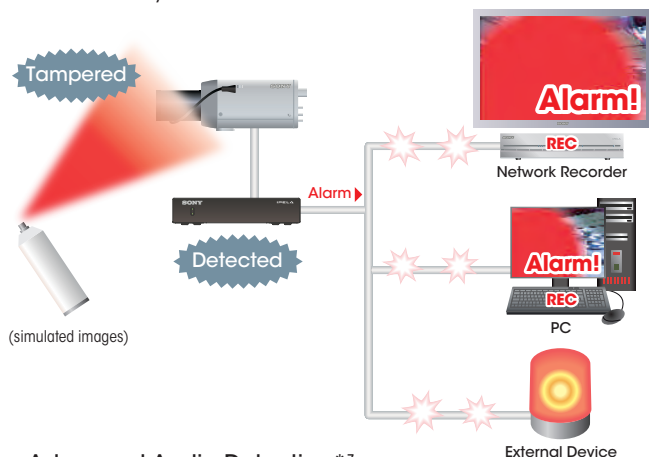

**• Advanced Audio Detection\*7**

Unlike conventional audio detection where an alarm is triggered based on a simple preset audio level, the SNT-EX Series takes into account the ambient sound levels as well as its associated frequencies to establish a threshold where any audio level above this is treated as an alarm.

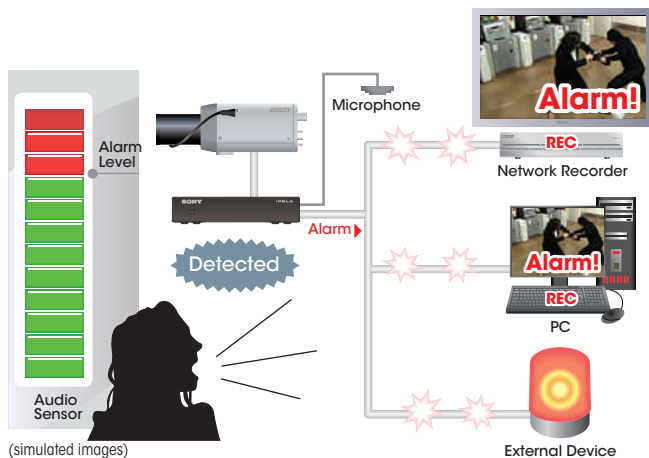

**Audio Functions\*1 (SNT-EX Series)**

**Voice Alert**

The SNT-EX Series can store up to three pre-recorded audio files. Upon initiation, either manually or via an alarm, these video encoders can play out one of the three pre-recorded audio files via a locally connected active speaker.

**Ambient Sound Filter**

The SNT-EX Series is capable of learning ambient sound and suppressing extraneous noise.

**Dynamic Range Compressor\*7**

To prevent audio clipping from occurring due to high audio levels, these video encoders employ the dynamic range compressor, which dynamically controls the gain to maintain incoming audio at a proper level.

**Echo Cancellation**

The SNT-EX Series has an echo-cancellation capability. This feature cancels the echo that would otherwise occur between the operator site and the video encoder site, when speakers and microphones are used in the system.

**Easy Installation**

**Supports Four IP and Four MAC Addresses\*2**

The four-channel models, including the blade encoders, support four IP and four MAC addresses. This enables you to monitor your video cameras via the SNT-EX/EP Series using each camera's unique IP address. Furthermore, defining an IP address for each camera is very simple, so system setup can be achieved quickly.

**Remember Function\*3**

MAC address information is stored on the 1U and 3U rack stations. After installing the blade and assigning the IP address, the IP address is then stored in the rack station. In the event of a failure on a blade encoder, you can simply replace the card with a new one and be up and running very quickly.

**ONVIF Software**

(Open Network Video Interface Forum)



In line with Sony's commitment to open standards, the SNT-EX/EP Series conforms to ONVIF™ software specifications. ONVIF defines a common protocol for the exchange of information between different network video devices regardless of manufacturer, and realizes greater interoperability in multi-vendor network video systems.

**Support for IPv6**

The SNT-EX/EP Series supports Internet Protocol Version 6 (IPv6).

**Versatile Interfaces**

**Third-party PTZ Control via Serial Interface RS-422\*4/485\*5**

The SNT-EX Series has an RS-422/485 serial interface. It also has built-in protocols to support the control of third-party analog Pan/Tilt/Zoom (PTZ) cameras, plus support of some setting adjustments. For further ease of installation, the camera ID of the PTZ camera can be set on the SNT-EX Series, so there is no need to manually change or set the camera address.

**Coaxitron Protocol Support\*1**

The SNT-EX Series supports the Coaxitron® Protocol, which allows both video and command signals to be transmitted with just a single BNC cable. This means the SNT-EX Series can support a wider variety of monitoring environments.

**Local Storage\*6**

**Stream Support\*7**

Video can be stored on optional USB memory and then streamed by using RTP/RTCP/RTSP protocol.

**USB Port for External Data Storage**

Data storage capacity is available with USB flash memory, onto which all the compressed video formats – MPEG-4, JPEG, and H.264 – can be recorded. Periodic recording is possible and pre-/post-alarm images can also be recorded.

\*1 Available on SNT-EX Series \*2 Available on SNT-EX104/EP104/EX154/EP154

\*3 Available on SNT-EX154/EP154 \*4 Available on SNT-EX101/EX101E

\*5 Available on SNT-EX101/EX101E/EX154 \*6 Available on SNT-EX101/EX101E/EX104

\*7 These functions are available with software version 1.1 or later.

# SYSTEM CONFIGURATIONS

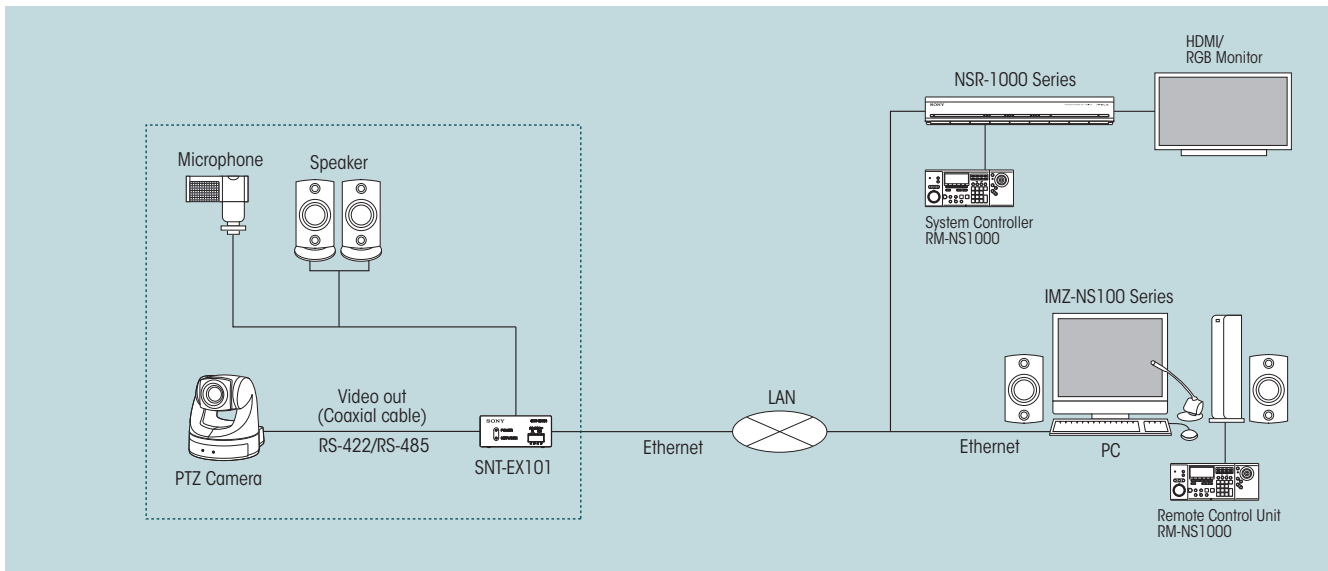
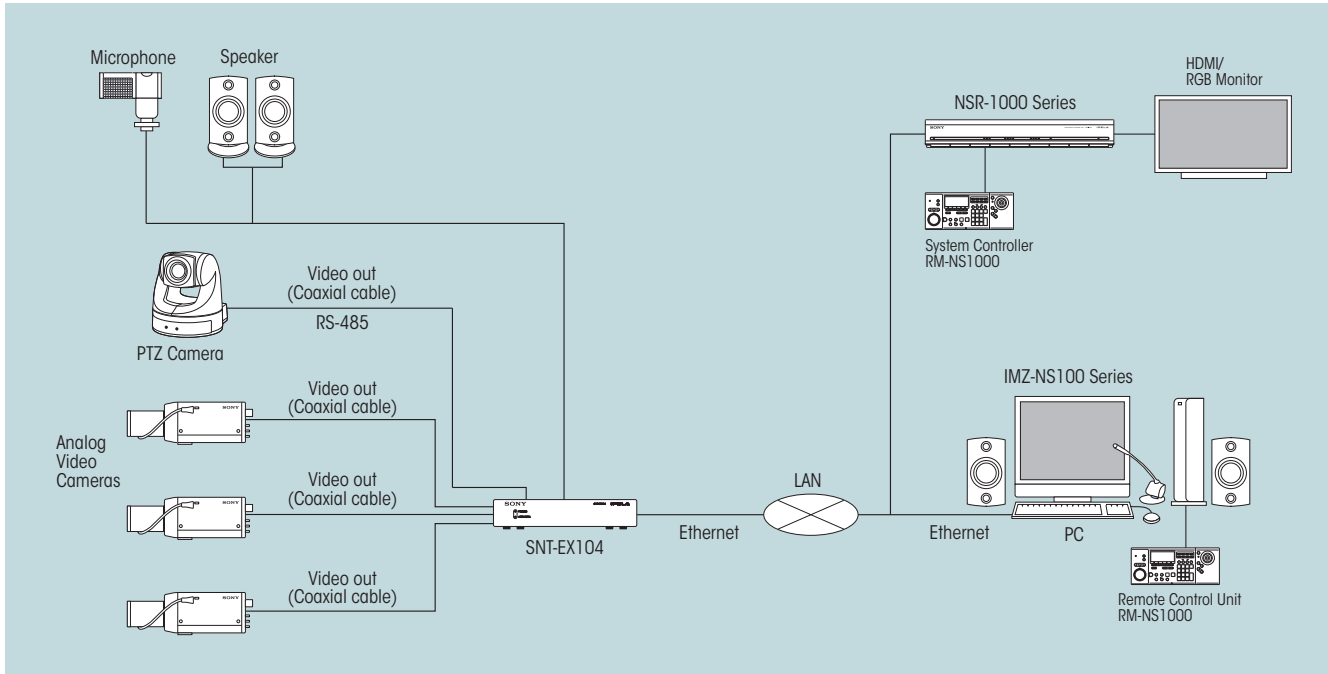

## RACK STATION



### SNT-RS1U

Accepts up to 4 blade encoders (up to 16 ch)  
 Universal power capability  
 AC 100V - AC240V 50/60 Hz



### SNT-RS3U

Accepts up to 12 blade encoders (up to 48 ch)  
 Universal power capability  
 AC 100V - AC240V 50/60 Hz

## OPTIONAL ACCESSORY



### SNTA-RP1

Redundant Power Supply Unit  
 (for SNT-RS3U only)

# REAR PANELS

■ SNT-EX101/EX101E

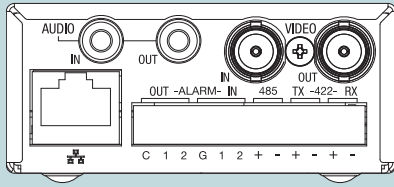

■ SNT-EX154

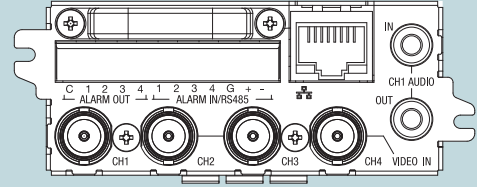

■ SNT-EX104

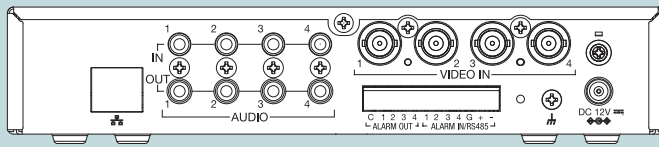

■ SNT-EP154

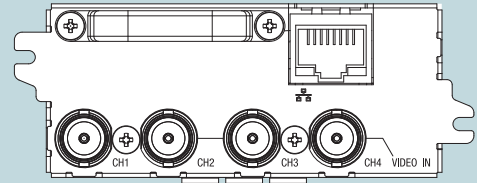

■ SNT-EP104

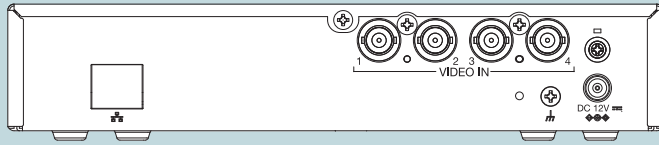

■ SNT-RS1U with SNT-EX154

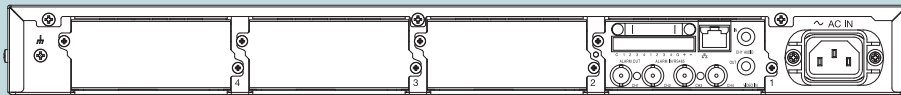

■ SNT-RS3U with SNT-EX154

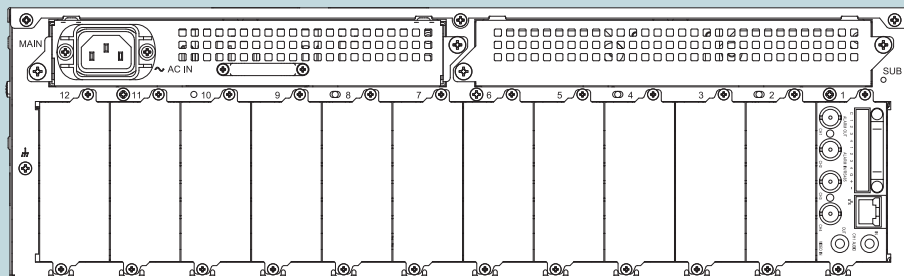

# DIMENSIONS

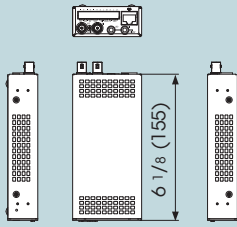

■ SNT-EX101

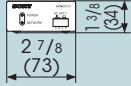

■ SNT-EX101E

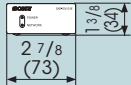

■ SNT-EX104



■ SNT-EP104

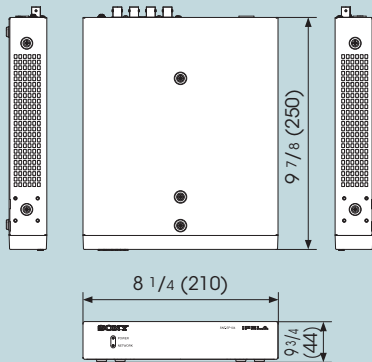

■ SNT-RS3U

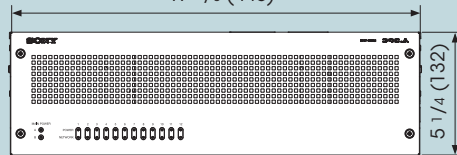
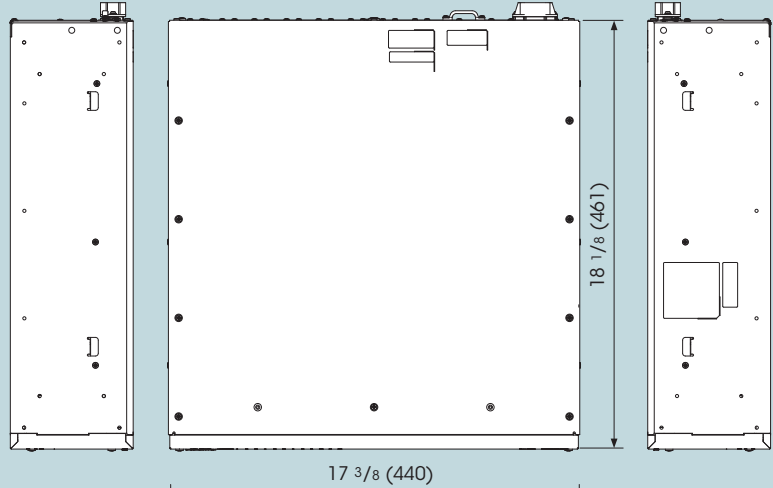
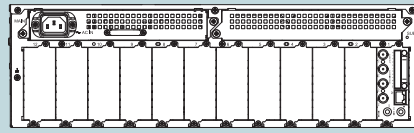

■ SNT-EX104

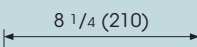

■ SNT-EP104



■ SNT-RS1U

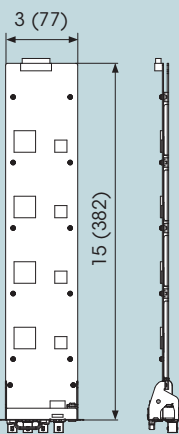
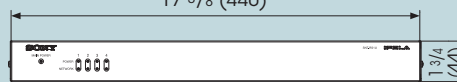
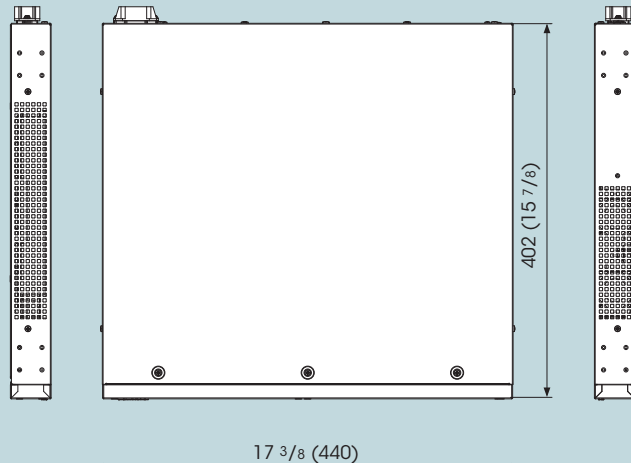

■ SNT-EP154

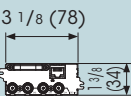

■ SNT-EX154

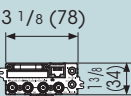

Unit: inches (mm)

# SPECIFICATIONS

	SNT-EX101	SNT-EX101E	SNT-EX104	SNT-EP104	SNT-EX154	SNT-EP154
<b>Encoder Features</b>						
Visibility Enhancer	Yes					
XDNR	Yes					
Coaxitron control	Yes			No	Yes	No
<b>Interface</b>						
Analog video input	x 1		x 4			
Composite buffered through out	x 1		-			
Ethernet	10BASE-T/100BASE-TX (RJ-45)					
Serial Interface	RS-422/RS-485		RS-485	-	RS-485	-
USB Memory slots	x 1		x 4			
Sensor input	x 2		x 4		x 4	
Alarm output	x 2		x 4		x 4	
Audio interface (IN/OUT)	IN x 1, OUT x 1		IN x 4, OUT x 4		IN x 1, OUT x 1	
External microphone input	Mini-jack (Monaural), MIC IN/LINE IN: over 2.2kohm, 2.45VDC plug-in power			-		Mini-jack (Monaural), MIC IN/LINE IN: over 2.2kohm, 2.45VDC plug-in power
Audio line output	Mini-jack (Monaural), Max output level: 1.5Vp-p			-		Mini-jack (Monaural), Max output level: 1.5Vp-p
<b>Image</b>						
Codec image size (HxV)	D1 (NTSC: 720 x 480, PAL: 720 x 576), VGA (640 x 480), CIF (384 x 288), QVGA (320 x 240)					
Video compression format	H.264, MPEG-4, JPEG					
Codec streaming capability	Dual streaming (Any combination with IPEG/MPEG-4/H.264 including multiple streams of the same format)					
Maximum frame rate	H.264/MPEG-4/JPEG: 30fps (NTSC: 720 x 480, PAL: 720 x 576)					
<b>Audio</b>						
Audio compression	G.711/G.726		-		G.711/G.726	
<b>Scene analytics</b>						
Intelligent motion detection	Yes (with built-in Post Filter)			No	Yes (with built-in Post Filter)	No
Motion detection	Yes			Yes	Yes	Yes
Advanced audio detection	Yes			No	Yes	No
<b>Network</b>						
Protocols	IPv4, IPv6, TCP, UDP, ARP, ICMP, IGMP, HTTP, HTTPS, FTP (client/server), SMTP, DHCP, DNS, NTP, RTP/RTCP, RTSP, SNMP (MIB-2)					
Number of clients	10					
Authentication	IEEE802.1x					
Number of IP address/ Mac Address	x 1		x 4			
<b>General</b>						
Weight	Approx. 14 oz (0.4 kg)		Approx. 3 lb 1 oz (1.4 kg)	Approx. 2 lb 14 oz (1.3 kg)	Approx. 14 oz (0.4 kg)	
Dimensions (W x H x D)	2 7/8 x 1 3/8 x 6 1/8 inches (73 x 34 x 155 mm)		8 3/8 x 1 3/4 x 9 7/8 inches (210 x 44 x 250 mm)		3 1/8 x 1 3/8 x 15 1/8 inches (78 x 34 x 382 mm)	
Power requirements	AC 24V in with loop through output Input AC 24 V +/-20%	PoE (IEEE802.3af)	DC12 V		From Rack Station	
Power consumption	9.6W max.		14.4W max.	12W max.		
Operating temperature	32 to 122 °F (0 to 50 °C)		32 to 113 °F (0 to 45 °C)			
Storage temperature	-4 to 140 °F (-20 to +60 °C)					
<b>System Requirements</b>						
Operating system	Microsoft Windows® XP, Windows Vista™					
Processor	Intel Core2 Duo, 1.8GHz or higher					
Memory	1GB or more					
Web browser	Microsoft Internet Explorer Ver.6.0, Ver.7.0					
<b>Supplied accessories</b>						
	CD-ROM (User's Guide and supplied programs) (1), Installation Manual (1), B&P Warranty Booklet (1), I/O port connector (1), 24 V AC connector (1), (SNT-EX101 only) (1), Attachment brackets (4), Attachment screws (8)		CD-ROM (User's Guide and supplied programs) (1), Installation Manual (1), B&P Warranty Booklet (1), AC adaptor (AC-NB12A) (1), Power cord (1), I/O port connector (SNT-EX104 only) (1)		Installation Manual (1), B&P Warranty Booklet (1), I/O port connector (only SNT-EX154) (1), Attachment screws (2)	

(software version 1.1 or later)

These products include software developed by the OpenSSL Project for use in the OpenSSL Toolkit. (<http://www.openssl.org/>)

# SONY

Sony Electronics Inc.  
1 Sony Drive  
Park Ridge, NJ 07656  
click: [sony.com/security](http://sony.com/security)

© 2009 Sony Electronics Inc. All rights reserved.  
Reproduction in whole or in part without written permissions is prohibited.  
Features and specifications are as of software version 1.1 or later,  
and subject to change without notice.

All non-metric weights and measurements are approximate.  
Sony, the Sony logo, ONVIF, IPELA and DEPA Advanced are the trademarks of Sony.  
Windows XP and Windows Vista are trademarks of Microsoft Corporation.  
Coaxitron is a registered trademark of Pelco Inc.