

3 Megapixels

2048 x 1536
8x software zoom

30 Frames/s

VGA (640 x 480)
12 fps Mega

-22°F to +140°F

Weatherproof

-30°C to +60°C, IP65
no heating necessary

IEEE 802.3af

PoE

network power
even in winter

microphone & speaker

Audio

bi-directional via IP
variable frame rates

Video SIP Client

IP Telephony

alarm notify,
camera remote control

Video motion

multiple windows
precision pixel-based

lip-synchronized audio

Recording

event ring buffer
30 cams each 30 fps

Live viewing

30 cams at 30 fps
all on one screen

Backlight

safe using CMOS
without mechanical iris

Wall mount

with cable cover
for RJ45 wall outlet

Robust

no moving parts
fiber glass housing

D12

Camera Manual

Part 1

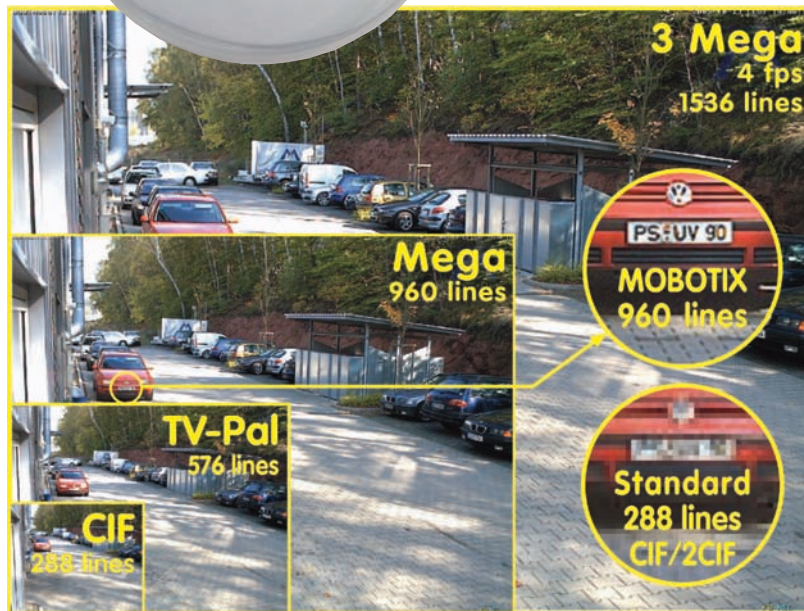

Complete integration for web and security

Current PDF File:
www.mobotix.com > Support > Manuals

MOBOTIX AG • Security-Vision-Systems • Made in Germany

www.mobotix.com • sales@mobotix.com • 08.09.2008



MOBOTIX ... the new face of IP video

D12 Camera Manual Part 1

MOBOTIX Camera Data

Enter the data of your camera here!

Camera Model: _____

Camera Name: _____

Factory IP Address:

 . . .

Current IP Address:

 . . .

DHCP:

activated

deactivated

Admin User Name: _____

Admin Password: _____

ISDN Dial-In Number: _____

ISDN User Name: _____

ISDN Password: _____

Notes:

Note: MOBOTIX offers inexpensive seminars that include a workshop and practical exercises:

Basic Seminar 3 days, **Advanced Seminar** 2 days.

For more information, see www.mobotix.com

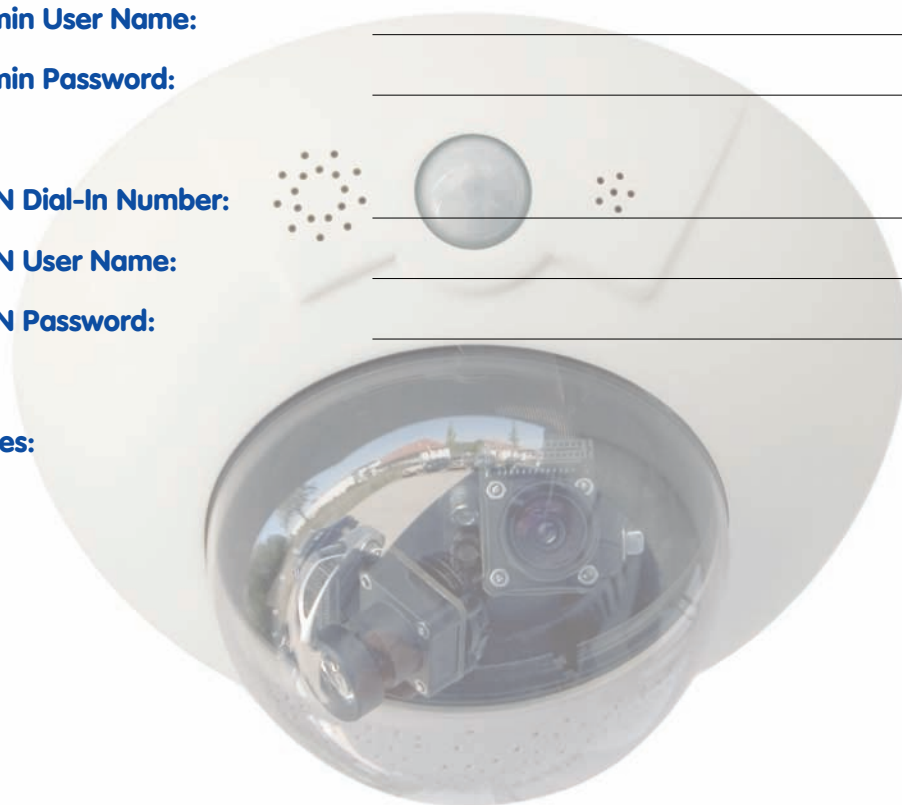

D12 CAMERA MANUAL PART 1

1	INTRODUCTION	10
1.1	MOBOTIX D12 Concept	16
1.2	Lens Options, Hardware and Software Features	22
2	MOUNTING	26
2.1	Overview of the Camera Versions	26
2.2	Directions	27
2.3	Preparatory Steps	28
2.3.1	Mounting to a Ceiling	28
2.3.2	Mounting to a Wall	29
2.3.3	Deciding on the Connections (Network/ISDN/RS232)	30
2.3.4	Selecting the Power Supply	31
2.3.5	Using Uninterruptible Power Supplies (UPS)	32
2.3.6	Providing the Connections (Network/ISDN/RS232)	33
2.3.7	Connecting Additional CAT5 Cables	33
2.3.8	Connecting a Cable to the Serial interface (RS232)	35
2.4	Delivered Parts, Components and Dimensions - D12D Standard	36
2.4.1	Delivered Parts and Components - D12D Standard	36
2.4.2	Camera Housing and Connectors - D12D Standard	37
2.4.3	Dimensions - D12D Standard	38
2.5	Installing the Lens Units - D12D Standard	40
2.5.1	Activating the Camera Configuration in the Quick Installation Wizard	43
2.6	Delivered Parts, Components and Dimensions - D12D-180°	44
2.6.1	Delivered Parts and Components - D12D-180°	44
2.6.2	Camera Housing and Connectors - D12D-180°	45
2.6.3	Dimensions - D12D-180°	46
2.7	Delivered Parts, Components and Dimensions - D12M-CS	48
2.7.1	Delivered Parts and Components - D12M-CS	48
2.7.2	Camera Housing and Connectors - D12M-CS	49
2.7.3	Dimensions - D12M-CS	50
2.8	Indoor/Outdoor Mounting Instructions	52
2.8.1	Mounting Indoor Cameras to a Wall or Ceiling	52
2.8.2	Mounting Outdoor Cameras to a Wall	53
2.8.3	Mounting Outdoor Cameras to a Wall or Pole	53
2.9	Delivered Parts of the Outdoor Wall Mount (Optional Accessory)	54
2.10	Delivered Parts of the Corner and Pole Mount (Optional Accessory)	55
2.11	Mounting the Corner and Pole Mount	56
2.11.1	Overview	56
2.11.2	Mounting to the Corner of a Building	57
2.11.3	Mounting to a Pole	58

2.11.4 Mounting the Outdoor Wall Mount to the Corner and Pole Mount	59
2.12 Mounting the Camera With the Outdoor Wall Mount	60
2.12.1 Setting the Direction of the Passive Infrared Sensor (PIR)	60
2.12.2 Mounting the Outdoor Wall Mount	61
2.12.3 Determining the Position of the Camera on the Bottom Plate	63
2.12.4 Mounting the Camera on the Bottom Plate	64
2.12.5 Connecting the Camera and Mounting the Bottom Plate	65
2.13 Finishing the Installation	66
2.13.1 Establishing a Connection to the Camera	66
2.13.2 Adjusting the Lenses, Visual Check	66
2.13.2 Adjusting the Single Images of a MOBOTIX D12D-180°	67
2.13.3 Mounting the Dome and the Camera's Outer Shell	70
2.14 Dismantling the Camera	71
2.15 Mounting the Camera to Different Surfaces	74
2.15.1 Mounting to a Wooden Wall or Surface	75
2.15.2 Mounting to a Drywall	76
2.15.3 Mounting to a Concrete or Brick Wall	77
2.15.4 After Mounting the Camera	78
2.16 Notes	80
2.16.1 Cleaning Instructions	80
2.16.2 Wiring, Fire Prevention, Lightning and Surge Protection	80
2.17 Camera Accessories	82
3 OPERATING THE CAMERA	84
3.1 General Procedure	84
3.1.1 Establishing the Power Supply to the Camera	84
3.1.2 Connecting the Camera	84
3.3 Connecting the Camera to the Network and to the Power Supply	86
3.2.1 Notes on Cable Lengths and Power Supply	86
3.2.2 Camera Startup Sequence	87
3.2.3 Power Supply (MxPoE) Using a Switch	88
3.2.4 Power Supply (MxPoE) When Connected Directly to a Computer	88
3.2.5 Power Supply Using a Network Power Rack (MxPoE)	89
3.2.6 Power Supply (PoE IEEE 802.3af) Using Power-over-Ethernet Products	89
3.2.7 ISDN: Power Supply Using a Network Power Adapter	90
3.2.8 ISDN: Directly Supplying Power Using the External Power Supply	91
3.2.9 Ethernet and ISDN: Power Supply When Using Both	91
3.3 The First Image from the Camera	92
3.3.1 Preparing the Ethernet and ISDN Connections	92
3.3.2 The First Image in the Browser	95
3.3.3 The First Image in MxControlCenter	98
3.3.4 The First Image in MxEasy	103
3.3.5 Starting the Camera With an Automatic IP Address (DHCP)	106
3.3.6 Starting the Camera Using the Factory IP Address	1071

3.4	Configuring the Camera in the Browser	108
3.4.1	Overview	108
3.4.2	The First Configuration Steps	108
3.4.3	Additional Configuration Options	110
3.5	SD Card Recording	112
3.5.1	Introduction	112
3.5.2	Formatting an SD Card With the MxFFs Format	115
3.5.3	Activating the Recording on an SD Card	116
3.5.4	Accessing the Data on an SD Card	116
3.5.5	Using an SD Card in a Different MOBOTIX Camera	117
3.5.6	Deactivating SD Card Recording and Removing the Card	118
3.5.7	Limitations on Warranty When Using Flash Storage Media	118
3.5.8	Problems Accessing an SD Card	119
3.6	Connecting External Devices and Sensors: MX Interface Connector	120
3.6.1	MX Interface Connector for Direct Connections	120
3.7	Signal Input/Output (RS232 Interface)	122
3.7.1	Signal Input Pins	122
3.7.2	Signal Output Pins	123
3.8	Important Notes	124
3.8.1	Weatherproofness	124
3.8.2	Password for the Administration Menu	124
3.8.3	Irreversibly Deactivating the Microphone	124
3.8.4	Starting the Camera Using the Factory IP Address	125
3.8.5	Resetting the Camera to Factory Defaults	125
3.8.6	Activating Event Control for Security Applications	125
3.8.7	Deactivating Text and Logo Options	125
3.8.8	Deactivating the Automatic Daily Reboot of the Camera	126
3.8.9	ISDN Compatibility Notes	126
3.8.10	Using Internet Browsers	126
3.8.11	Cleaning Instructions	126
3.8.12	Safety Warnings	126
3.8.13	Additional Information	127
3.9	Drilling Templates	128

APPENDIX: IP65 CERTIFICATE, DECLARATION OF CONFORMITY DRILLING TEMPLATES

Note

Chapters 4 and above are part of the **Camera Software Manual** (*Software Manual* in short). The main headings are listed below to give you an overview of the *Software Manual* contents.

Download the newest version of this document as a PDF file from www.mobotix.com, Support > Manuals

SOFTWARE MANUAL PART 2

4 CAMERA USER INTERFACE

- 4.1 The First Image in the Browser
- 4.2 The First Image in MxControlCenter
- 4.3 The Live Screen in the Browser
- 4.4 The Playback Screen in the Browser
- 4.5 The MultiView Screen in the Browser
- 4.6 The Multiwatcher Screen in the Browser
- 4.7 The PDA Screen in the Browser
- 4.8 The Guest Screen in the Browser
- 4.9 Configuring Softbuttons and Managing Functions
- 4.10 Fast Video Streaming
- 4.11 Operating Multiple Cameras

5 GENERAL CAMERA CONFIGURATION

- 5.1 Overview
- 5.2 Quick Installation
- 5.3 Connection Test
- 5.4 Basic Settings
- 5.5 Image Controls
- 5.6 Logos
- 5.7 Exposure Settings
- 5.8 Day & Night Modes
- 5.9 Managing Settings
- 5.10 Enhanced Security Settings

6 SOFTWARE UPDATES

- 6.1 Overview
- 6.2 Preparatory Steps
- 6.3 Updating the Camera Software
- 6.4 Update Checklist

7 EVENTS, ACTIONS AND MESSAGES

- 7.1 Overview**
- 7.2 Functional Overview**
- 7.3 General Procedure**
- 7.4 Screen Display of Event Settings in Live Image**
- 7.5 Arming**
- 7.6 Events**
- 7.7 Actions and Messaging, Action and Messaging Profiles**
- 7.8 Working with Profiles**
- 7.9 Time Tasks**

8 RECORDING

- 8.1 Overview**
- 8.2 Recording Modes**
- 8.3 Recording Types**

9 TELEPHONY FEATURES

- 9.1 Overview**
- 9.2 VoIP Settings**
- 9.3 Camera Telephone**
- 9.4 Phone profiles – Phone Calls from the Camera**
- 9.5 Phone Call-In - From a Telephone to the Camera**
- 9.6 Remotely Controlling the Camera Using a Phone**
- 9.7 Sample Configurations for IP Telephony via Internet**
- 9.8 Sample Configurations for IP Telephony on a LAN**
- 9.9 Video Telephony**

10 MOBOTIX CAMERAS ON THE WEB

- 10.1 Overview**
- 10.2 Indirectly Accessing MOBOTIX Cameras via the Web, FTP Uploads**
- 10.3 Directly Accessing MOBOTIX Cameras via the Web**
- 10.4 Configuring the Router**
- 10.5 DynDNS**

11 SOFTWARE INTERFACES

11.1 Overview

11.2 Accessing the Camera's Live Image and the Event Images

11.3 Accessing the Camera's Live Image Using the Second Image Channel

11.4 Video Streaming

11.5 The HTTP API

11.6 Access Rights

12 TROUBLESHOOTING

**Chapter 12 of this manual is
still under development!**

Note

Download the latest version of this document as a PDF file from www.mobotix.com, **Support > Manuals**.

More information:
www.mobotix.com

Information subject to change without notice!

Copyright © 1999-2008 MOBOTIX AG, Kaiserslautern, Germany.

All rights reserved. MOBOTIX, MxPEG and MxControlCenter are worldwide trademarks of MOBOTIX AG. Microsoft, Windows and Windows Server are registered trademarks of Microsoft Corporation. Apple, the Apple logo, Mac and Mac OS X are trademarks of Apple Inc. Linux is a trademark of Linus Torvalds. All other marks and names mentioned herein may be trademarks or registered trademarks of the respective owners.

MOBOTIX Cost Benefits

- 1 Increased resolution reduces amount of cameras**
1536-line, high-resolution sensors give a better overview and allow monitoring an entire room with just one camera from the corner
- 2 Reduced installation costs at any distance**
Standard Ethernet connection enables the use of common network components such as fiber, copper and wireless (WiFi)
- 3 Intelligent recording technology reduces storage**
Decentralized recording technology in the camera software puts less strain on PCs and reduces the amount of storage PCs (DVRs) by 10 times
- 4 Event-controlled image rate minimizes storage cost**
Event-driven, automatically adjusted recording frame rate based on event or sensor action reduces amount of data and storage costs
- 5 No additional power and no heating required**
Anti-fogging without heating allows usage of standard PoE technology to power the system via network and saves costs of power cabling
- 6 Backup power requirement reduced by 8 times**
Low power consumption, 3 Watt, enables year-round (no heating required) PoE with one centralized UPS from installation room via network
- 7 Robust and practically maintenance free**
Fiberglass-reinforced composite housing with built-in cable protection and no mechanical moving parts (no autoiris) guarantees longevity
- 8 No software and no licence costs**
Control and recording software is integrated in the camera and is free of charge; new functions are available via free software downloads
- 9 Unlimited scalability and high return on investment**
While in use, more cameras and storage can be added at any time; image format, frame rate & recording parameters can be camera specific
- 10 Additional functions and other extras included**
Audio support, lens, wall mount and weatherproof housing (-30° to +60°C, -22° to +140°F) included; microphone & speaker available in certain models

MOBOTIX Technical Advantages

Overview—MOBOTIX
Technical Advantages

- 1 Progressive-scan instead of half-frame blur**
Megapixel sensor and image processing inside the camera with digital white balance generates sharp and true color images at every scale
- 2 Sun and backlight compensation**
CMOS sensor without auto iris, digital contrast enhancement and configurable exposure measurement zones guarantee optimum exposure control
- 3 Dual camera technology: 2-in-1**
Two possible camera views with picture-in-picture technology or 180° panoramic view; one Dual-Fixdome camera with 2.5 megapixel is enough
- 4 Long-term, high-performance Terabyte recording incl.**
Event detection and ring buffer recording by the camera itself allow recording of 40 smooth video streams on a single PC (1200 VGA images/s)
- 5 Simultaneous recording, event search and live viewing**
Live video for multiple users, recording and event search simultaneously possible in seconds from anywhere in the world via network
- 6 Very low network load**
Efficient MxPEG video codec, motion detection based recording and video buffering inside camera guarantee a very low network load
- 7 Bridging of recording during network failures**
Internal camera ring buffer bridges network failures and bandwidth fluctuations of wireless links (WLAN/UMTS) for several minutes
- 8 Day & night maintenance free**
Unique Day/Night camera technology without moving parts guarantees extreme light sensitivity and ensures long-term reliability
- 9 Audio and SIP telephony**
Lip-synchronized audio (live & recording); each camera is a video IP telephone based on SIP standard with automatic alarm call and remote control
- 10 MxControlCenter included**
Dual screen technology with building plans, free camera positioning, event search, image processing, lens distortion correction and PTZ support

High resolution: QXGA
format with 2048x1536!

30 frames per second in
VGA format!

Everything integrated!

MxControlCenter

1 INTRODUCTION

The **D12** cameras are powerful yet compact MOBOTIX network cameras that are capable of creating high-resolution live video streams (**QXGA format: 2048x1536 pixels**) with high image rates.

When showing **VGA video (640x480)**, the camera can deliver up to **30 fps**.

Even **Megapixel video (1280x960)** will still generate up to **10 fps**. The camera transmits realtime sound from the microphone in the browser (using the ActiveX plug-in) or in MxControlCenter.

The MOBOTIX D12 is available as **SECURE** or **IT** model with different features. Apart from the standard version, the MOBOTIX D12 is offered in two additional **versions**: the **D12D-180°** offers a 180° panorama view and the **D12M-CS** is equipped with the **CS-Mount lens** (24 - 54 mm) already used in the **M22M-CSVario**.

Because of the low power consumption of only 3 Watts, the MOBOTIX D12 cameras feature the highest operating temperature range in the market from **-30 to + 60°C (-22 to 140°F)**. Since MOBOTIX cameras neither fog up nor require heating, power can be supplied via the network cabling using standard PoE products. All models can cover wall outlets, thus providing for perfectly protected cabling.

Like all other MOBOTIX cameras, the D12 models have more to offer than only the camera features. The integrated software features include a multitude of functions, such as **video motion detection**, **long-term recording**, **alarm messaging** and **video IP telephony** to name but a few features. Unlike in camera systems from other manufacturers, buying and installing additional software on the computer is thus unnecessary. Instead of using a web browser, you can also download the free **MxControlCenter** from the MOBOTIX website, which allows displaying multiple cameras on one monitor, allows for comfortably searching and evaluating the alarm video clips and provides alerting features (including audio).

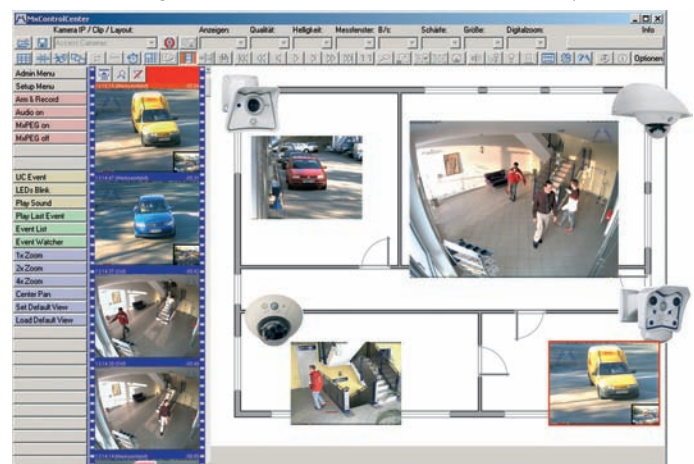
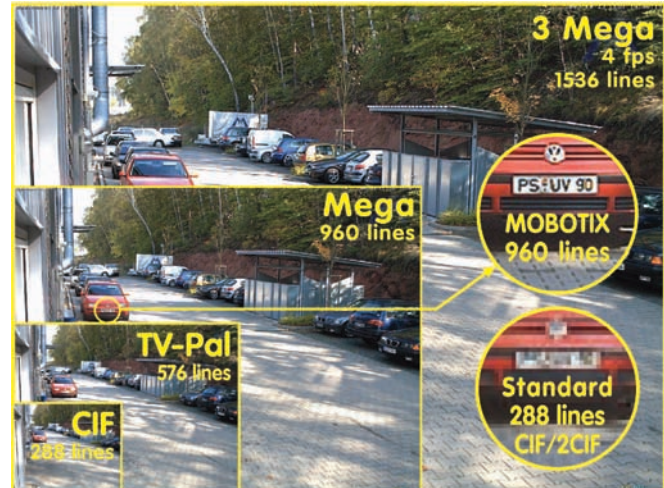

While **MxControlCenter** has been providing **virtual PTZ features** for quite a while, these features are now available **directly in the MOBOTIX camera**. This means that you can continuously zoom into or out of the live image using either the mouse wheel or a joystick. When storing images or video sequences, you can choose to store either the **visible image area** of the live image or the **full sensor image**. The second option would also allow examining the parts of an image or video after the event that had not been in the visible image section of the live image.



Virtual PTZ

Another problem known from photography are the distortions from wide-angle lenses. Straight lines at the image borders are bent inwards towards the corners. The integrated distortion correction features of the camera (and of MxControlCenter) allow **correcting** the bent lines of various lenses **using software algorithms**.



Image section with correction of wide-angle distortion

The current MOBOTIX cameras support direct storage on the **integrated Flash storage media, internal SD cards and external USB media**. The **MOBOTIX Secure R versions** are highlight in this respect as they are delivered with an **integrated Flash storage device** (e.g. **R8** with 8 GB).



a

180° Panorama View with the MOBOTIX D12D-180°

The MOBOTIX **D12D-180°** is equipped with two 90° super-wide-angle lenses mounted on a single lens holder and delivers 180° panorama images. Using **only one camera**, you can cover one side of a building and the adjacent areas (parking lots, lawns, etc.).



D12-180°:
Façade surveillance with only one camera and 2 x 90° L22 Super Wide-Angle lenses



D12M-CS:

Light-sensitive Vario CS-Mount lens with 24 - 54 mm focal length (f-stop 1.6 - 2.3)

The two image sensors can look into the same or into different directions

MOBOTIX D12M-CS for CS-Mount lenses

The MOBOTIX **D12M-CS** is equipped with a **CS-Mount vario lens** (24 - 54 mm), but also allows using other CS-Mount lenses.



The MOBOTIX D12D-Fixdome Outdoor

MOBOTIX D12D-Outdoor Concept

As an innovative camera system, the MOBOTIX D12D-FixDome has captured an impressive piece of market share in the network camera market. Thanks to its two image sensors, this camera system delivers video surveillance of one scene in day/night mode (**Night** models) or it can monitor two different areas using different day or night lenses.

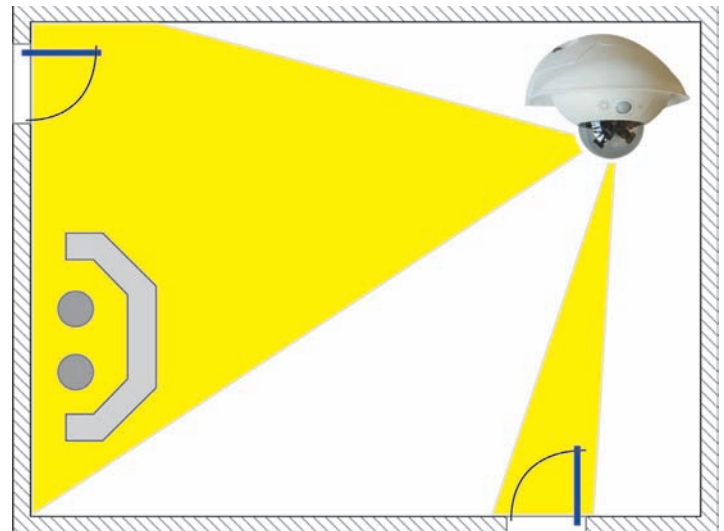

The D12D-Outdoor and the wall mount (optional accessories) now allow mounting this unique camera system outside for enhanced outdoor surveillance. Besides the many advantages inherent to the MOBOTIX concept, the **outdoor wall mount offers these additional benefits:**

Perfect weather protection for an innovative camera system

Together with the Outdoor Wall Mount, the MOBOTIX D12D reaches protection class **IP65** (absolutely dustproof, resistant against water jets). Operating temperatures may vary between -30°C and +60°C (-22°F to 140°F), making it the ideal camera for the most demanding weather situations. From stations in Antarctica to production monitoring at a steel smelting plant—MOBOTIX cameras offer unmatched flexibility and versatility.

Simply mounted outdoors

Since the wall mount and the wall sealing have been designed to fit over RJ45 outdoor wall outlets, providing the network connection can be separated from actually

Elegantly covers RJ45 wall outlets

mounting the camera. After the position of the wall mount has been determined, the installer of the MOBOTIX camera system can connect the camera system to an **installed network outlet**, which has been properly tested and configured by the network installer. The wall mount also brings ample space for additional modules (rechargeable batteries, 3G/UMTS, WiFi, etc.).

Robust design makes for a long life

Like all MOBOTIX cameras, the outdoor wall mount is made from **PBT-30GF** (Polybutyleneterephthalate with 30% fiberglass). This material is used heavily in the automotive industry and is sturdy, resistant against high temperatures, UV rays as well as other environmental influences, chemicals, etc. Combined with the purely software-based design of the MOBOTIX D12D and the free software updates, the whole surveillance system has a long product life and thus provides a high return on investment (ROI).

Extreme environmental conditions (sand storms, high levels of salt in the air, heavy rain, etc.) may lead to higher abrasion than usual; the wall mount should thus be checked on a regular basis. When planning an application under extreme environmental conditions, you should consider the **MOBOTIX M12 camera models** as they are more robust due to their factory-preset and locked lenses, absence of moving parts and the lower weight. This applies especially to locations that are subjected to vibrations (e.g. when mounted to a ski-lift) and other environmental conditions, (e.g. sand storms, near coast lines, etc.).

Easy to clean

Cleaning the D12D-Outdoor is simple enough—wipe the dome using a lint-free cotton cloth and a mild household detergent without abrasive particles.

Open for enhancements

The outdoor wall mount's design provides for easy integration of WiFi or GSM/GPRS modules within the housing without disturbing the overall appearance of the surveillance unit. Likewise, relays for alarm sirens or lights can be installed easily and elegantly within the outdoor wall mount.



D12 with Corner and Pole Mount

More mounting options using the MOBOTIX Corner and Pole Mount

MOBOTIX offers an additional mount that allows securely attaching the outdoor wall mount (optional accessory) to 90-degree corners of buildings and to masts. Thanks to the unmatched flexibility when positioning the MOBOTIX D12D-Outdoor's image sensors, large outdoor areas can be monitored using only very few cameras.

Room for additional modules in the interior of the wall mount

No yellowing of housing even after years thanks to **PBT-30GF**

Outdoor Corner and Pole Mount

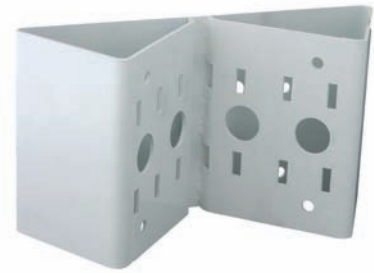

Outdoor wall mount with Corner and Pole mount

Corner and Pole Mount
(rear view)**MOBOTIX D12D-Outdoor Product Advantages**

Besides the many product advantages inherent to the MOBOTIX D12, the MOBOTIX D12D-Outdoor offers these additional benefits:

- **Attractive design** blends in well with building façades.
- **Perfect weather protection** for the MOBOTIX D12D: **IP65**, -30 to +60°C (-22 to 140°F).
- **Easily mounted** and perfect cover for outdoor wall outlets.
- **Weatherproof** and **easy to clean** thanks to housing built from **PBT-30GF**.
- Ample room for **extension modules** (WiFi, GSM/GPRS) stored within the housing of the outdoor wall mount.
- High **return on investment (ROI)** thanks to the software-based MOBOTIX design and **free updates**.
- Mounting to building corners and poles (from 60 to 180 mm/2.5 to 7 in) is easily accomplished using the **Corner and Pole Mount** (stainless steel, white).
- Unique **flexibility** when setting the direction of the image sensors provides for thorough video surveillance while requiring relatively few cameras.
- As **D12D-180°**, allows monitoring the complete side of a building with only **one camera**.
- The MOBOTIX **D12M-CS** is equipped with a **CS-Mount lens** (24 – 54 mm), but also allows using other **CS-Mount lenses**.

D12D



+

Outdoor wall mount



=

D12D-Outdoor



Robust network video system for indoor and outdoor applications

1.1 MOBOTIX D12 Concept

High-resolution live video with up to 30 frames/s

The MOBOTIX cameras deliver smooth live video display in VGA format (640x480 pixels) with synchronous live audio, yet it keeps the network load to a minimum. Live video display now matches the performance of analog video systems. When recording, MOBOTIX systems easily outperform analog systems, since MOBOTIX cameras store the high live image resolution and frame rate without compromising image quality. MOBOTIX technology thus allows **simultaneously** recording the video from **30 cameras in continuous recording mode on one standard PC at 30 frames per second each, including the audio channel** of the cameras.

Low bandwidth requirements

MOBOTIX' patent pending **MxPEG** streaming format allows fast live video with audio at extremely low network loads (1 to 2 Mbps). Since the MOBOTIX camera itself detects movements in the image (and not the computer), video is only transmitted if movements occur, and when the video and audio data are being stored.

Voice over IP and ISDN

Moreover, **MxPEG** provides for lip-synchronized audio and two-way communication between the camera and your computer. Room surveillance with audio is possible using Internet Explorer or MxControlCenter. Alarm notification on your mobile via Internet (SIP) or ISDN telephony is just as easy as event-controlled voice messages directly from the camera (ISDN requires M12 or D12 model).

IP telephony and video SIP

All telephone features can be used via Internet telephony thanks to the integrated SIP client. The SIP client allows remote-controlling the camera using the touchtone keys and also makes the alarm calls of the camera. Video telephony allows establishing SIP audio/video connections to the camera using Windows Messenger or similar applications (e.g. Counter-Path X-Lite/Eyeball).

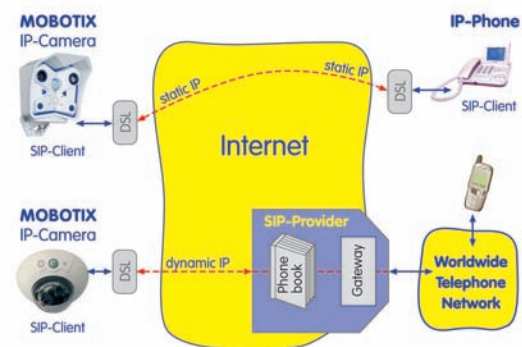

Long-term storage on file servers included

MOBOTIX cameras have an integrated long-term storage system for Linux, Windows and Mac OS X computers. Every camera manages its own ring buffer storage on the shared folder. Thanks to this decentralized approach, 30 live cameras can store images on one computer with **30 frames per second each, including audio** (also depends on the operating system).

M12 and D12 models feature ISDN telephony

IP Telephony!

Recording on Flash, USB and SD storage media

The current MOBOTIX cameras support direct storage on the **integrated Flash storage media, internal SD cards and external USB media.**

	Int. Flash	SD Card	USB Device	Remarks for USB Devices
M12	X*	X**	X	Adapter cable required
D12	X*	X**	X	Adapter cable required
V12	X*			
M22M	X*		X	Device can be connected directly
D22M		X**	X	Adapter cable required
Q22M		X**		

*Integrated Flash storage has to be installed at the factory

**SD cards will be supported from software version 3.4.2

The **MOBOTIX Secure R versions** are a highlight in this respect as they are delivered with an **integrated Flash storage device** (e.g. **R8** with 8 GB). These models have been preconfigured at the factory for Flash device storage. By using Flash, the camera features these additional possibilities:

- **Stand-alone use of the camera** without file server thanks to **recording on the Flash device.**
- **High-security application** with **recording on a file server or NAS/SAN** in which the Flash device serves as storage buffer. It can thus bridge longer failures of the network or the file server without losing any video sequences (supported in a future software version).
- **Event downloads** to USB media or SD cards for **evaluation of the recorded sequences** on a computer.

30 live cameras using MxControlCenter

Instead of using a web browser, you can also download the free **MxControlCenter** client from www.mobotix.com, which allows displaying up to 30 MOBOTIX cameras on one monitor (Linux and Mac OS X versions are currently being developed). In addition, **MxControlCenter** can process incoming alarms from the cameras and allows comfortably searching and evaluating the alarm video clips (including audio). The integrated Layout Editor of MxControlCenter provides for quickly creating floor plans by simply dragging/dropping the cameras onto a background image. Load a floor plan as background image, drag&drop the cameras; done.



Event and time-controlled

Just like event-controlled recording upon detecting movements in the image, the camera can also record when the volume detected by the microphone exceeds a set trigger value. Using scheduled recording, time tasks can start or stop video recording, uploading of images to a web site or sending of e-mails with video/audio clips. Special programs control vacation times and holidays.

Remote alerting

In case of an alarm, MOBOTIX cameras automatically pop up windows or activate other functions at a remote security control center. The cameras can use network/wireless, GSM/GPRS/UMTS (3G) or Internet connections for this purpose.

Day & Night

The Night versions of the MOBOTIX cameras with only one image sensor (Mono) deliver crisp and clear B/W images of moving objects even at night, MOBOTIX Day/Night models (M12D-DNight und D12D-DNight) with two image sensors (1x color, 1x B/W) deliver brilliant color images during the day and crisp B/W images at night. The cameras switch lenses automatically, depending on the level of illumination.

Integrated Power over Ethernet

Power is supplied as **Power-over Ethernet** via the network cabling **using the MOBOTIX power supply** (in combination with the Network Power Adapter), a MOBOTIX **Network Power Rack** (8 to 20 cameras), a **Network Power Box** (4 cameras), or by using a PoE-compatible switch (according to **PoE standard IEEE 802.3af**).



Since the camera's plastic housing insulates well and is anti-fogging, no additional heating or fans are necessary. This is why MOBOTIX, unlike other manufacturer's cameras, have low power requirements (3 Watts) and PoE can be used every day of the year indoors as well as outdoors for supplying power.

Weatherproof

MOBOTIX cameras are certified according to IP65 and are designed for outdoor as well as indoor usage*. As the cameras do not have any moving parts, they are extremely robust and resistant against heat and cold (-30°C to +60°C; -22°F to +140°F).

Logos, animated or freestyle

The logo generator of MOBOTIX cameras allows integrating banners and graphics (including files loaded from any URL) into the current camera images—with optional scheduler control. MOBOTIX cameras are the only network IP cameras supporting animated and transparent graphics.



No heating required—PoE is no problem even in the wintertime!

*D12 models together with Outdoor Wall Mount

Logo generator

Expanded connections - MX Interface Connector D Sub 15 HD

Depending on your requirements, you can connect additional sensors via the **D Sub 15 HD** socket of the MOBOTIX M12, D12 and V12 models, allowing you to expand the



range of sensors already in the camera. Likewise, you can use the signal outputs of the camera to switch or trigger external devices, such as alarm systems. The **D Sub 15 HD** socket also provides a Line In pin, a Line Out pin, power supply for USB devices, USB master data signals and a pin for connecting a backup power supply (can also be used by solar panels).

2048 x 1536 pixels

*Telephony features can be used via VoIP (Internet telephony; all MOBOTIX cameras) or via ISDN (M12 and D12 models)!

Logo generator

More Features

- **Live images** of up to 2048x1536 pixels resolution via network, ISDN, GSM, GPRS, UMTS, wireless with up to 30 fps (at VGA resolution 640x480), also adapted for **PDA**s.
- **Continuous digital zoom** (up to 8x zoom) and integrated panning (clicking with the mouse near the borders of the image will move the visible image area within the full image).
- **True software scaling** using the proven and continuously improved MOBOTIX algorithms, which delivers brilliant images even with smaller image formats (e.g. 320 x 240/CIF).
- **Audio video recording*** with three different recording modes: Event recording with audio, continuous recording with variable frame rate and audio as well as event-controlled snapshot recording of JPEG images.
- **Storage failure detection** can monitor a file server (or a Flash device) and can use one or more of the defined messaging options for error notification.
- **Playback** of recorded images/video sequences with audio in the integrated video management system.
- **Multivatcher screen** can display and monitor several cameras via the Internet, with only one camera requiring access from the outside. This "proxy" camera uses only very little bandwidth, making it an ideal solution for low-bandwidth connections.
- **MultiView** screen for displaying multiple cameras or events in one browser window.
- **Event notification** by e-mail, SMS (using a provider), voice notification (Phone Call-Out), sounds and by visual means (e.g. red frame in live image) using two separate messaging paths.
- **Object tracing** for analyzing the paths of objects that are moving in the image.
- **Logo generator** for displaying logos in the camera images with dialogs for managing image files and defining image and logo profiles for controlling logo display.
- **Logos** can have **transparent areas** and can be displayed partially transparent at the same time (creating a watermark effect), banner rotation and animations are also possible.
- **Time Tables** for handling customized days, e.g. for holidays and vacations. The time tables are used to control the camera's arming, image recording, action, messaging, logo, obscure image and other features.

- **Remote signaling** for **master/slave** cameras, with the master camera controlling the arming status of the slave cameras. This allows arming, for example, of all slave cameras by using a key switch that is connected to the master camera.
- **Transfer profiles** for comfortably controlling transmissions via FTP, e-mail, phone calls and network messages.
- **Speaker phone*** with talk, listen and intercom modes via **Internet telephony (SIP) and ISDN** using the integrated microphone and speaker.
- **Phone Call-In*** to remotely control the camera using a touchtone phone via **Internet telephony (SIP) and ISDN** (retrieve camera information, establish Internet connection, announcement of retrieved IP address, intercom feature, etc.).
- **MxPEG video compression** using **MOBOTIX MxControlCenter**. The ActiveX plug-in for Internet Explorer users brings all advantages of MxPEG to the browser-based user interface (including the audio stream from and to the camera).
- **Routing** allows using other network connections besides the standard route.
- **DynDNS client** for accessing the camera via the Web using a symbolic name (e.g. `mymobotixcam.dyndns.org`) although the provider is assigning a new dynamic IP address every time the camera connects to the Internet.
- Inerasable **backup operating system** that is used to restart the camera in the event that a software update has failed, allowing you to restart the update process.
- **Enhanced startup options** for the camera (obtain IP address via **DHCP**, announcement of IP address and other network data, reset to factory default settings).
- **Notifications upon errors or when rebooting** provide a method for executing one or more notifications if the camera detects errors or when it reboots (e.g. blinking of the camera LEDs, audio message, FTP, e-mail, phone call, network message).
- **Extended security features** protect pages and features of the camera and prohibit unauthorized access (IP-level access control, intrusion detection) and also provide SSL-protected transmission of the video sequences and the data (using SSL encryption and X.509 certificates).

Software Updates

MOBOTIX provides **free** software updates at regular intervals that improve and expand the camera's functionality. Chapter 6, *Software Update*, in the *Software Manual* provides more information on the process.

*Telephony features can be used via VoIP (Internet telephony; all MOBOTIX cameras) or via ISDN (M12 and D12 models)!

Free software updates on www.mobotix.com

1.2 Lens Options, Hardware and Software Features

MOBOTIX currently offers five standard lenses with M14 thread from **Super Wide-Angle L22** with 22 mm focal length up to the **tele lens L135** with 135 mm focal length (equiv. to 35 mm camera). Since MOBOTIX cameras are backlight-proof, they do not require a mechanical auto iris. This makes all MOBOTIX lenses extremely robust and maintenance-free.

- **L22 Super Wide-Angle** 90° image angle (horizontally)
- **L32 Wide angle*** 60° image angle (horizontally)
- **L43 Wide angle** 45° image angle (horizontally)
- **L65 Tele*** 31° image angle (horizontally)
- **L135 Tele** 15° image angle (horizontally)

*L32 and L65 lenses are not available for M12 cameras

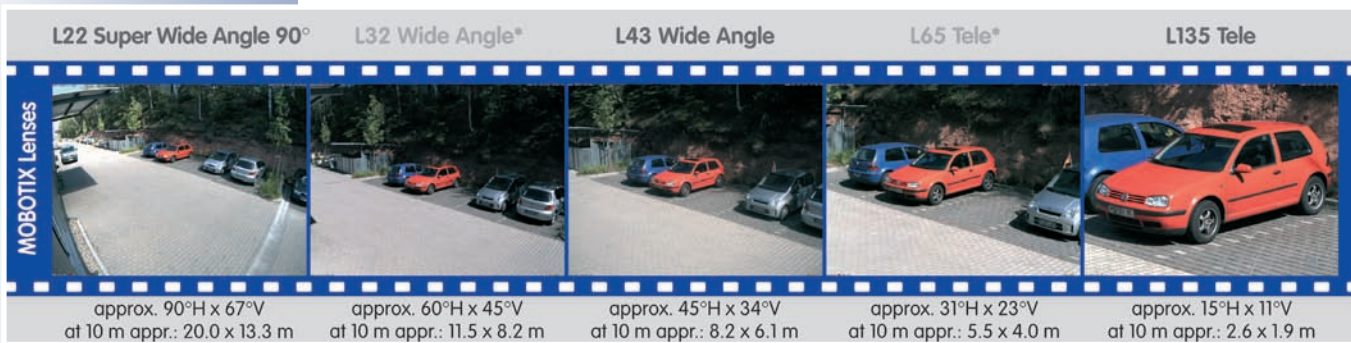

The **L22 Super Wide-Angle 90°** lens has very little distortion and excellent image quality, even when using the maximum digital zoom. If a camera with this lens has been mounted in the corner of a room, the complete room is visible on the image

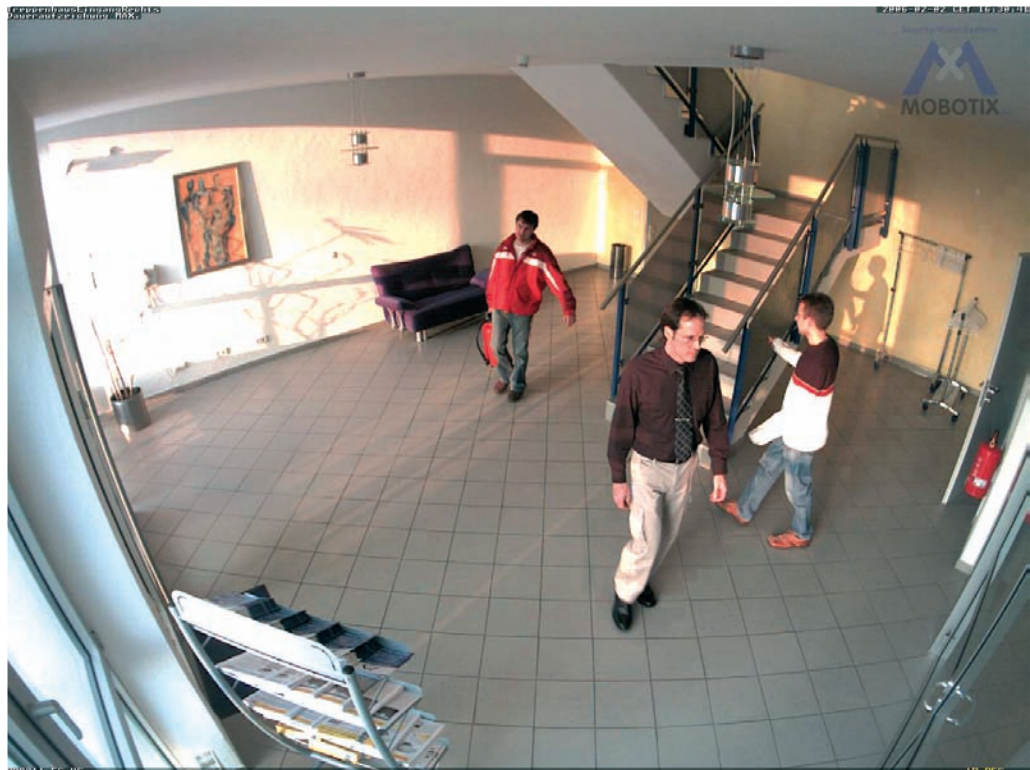

L22 Super Wide-Angle 90°

Lens Table					
Order name	L22	L32*	L43	L65*	L135
Original image					
35 mm equivalent	22 mm	32 mm	43 mm	65 mm	135 mm
Focal length	4 mm	6 mm	8 mm	12 mm	25 mm
F-Number	2.0	2.0	2.0	2.0	2.5
Image angle horizontally	90°	60°	45°	31°	15°
Image angle vertically	67°	45°	34°	23°	11°
Distance 1 m	m	m	m	m	m
• Image width	2.0	1.1	0.8	0.5	0.3
• Image height	1.3	0.8	0.6	0.4	0.2
Distance 5 m	m	m	m	m	m
• Image width	10.0	5.7	4.1	2.7	1.3
• Image height	6.6	4.1	3.0	2.0	1.0
Distance 10 m	m	m	m	m	m
• Image width	20.0	11.5	8.2	5.5	2.6
• Image height	13.3	8.2	6.1	4.0	1.9
Distance 20 m	m	m	m	m	m
• Image width	40.0	23.0	16.4	11.0	5.2
• Image height	26.6	16.4	12.2	8.0	3.8
Distance 50 m	m	m	m	m	m
• Image width	100.0	57.5	41.0	27.5	13.0
• Image height	66.0	41.0	30.5	20.0	9.5

*L32 and L65 lenses are not available for M12 cameras

Note

The focal lengths of MOBOTIX lenses do not reflect the actual focal length of the lenses, but the focal length (Lxx mm) converted to 35 mm camera format. For example, the MOBOTIX Super Wide-Angle lens has an actual focal length of 4 mm. This would be the equivalent of 22 mm on a 35 mm camera. This lens is thus called L22.

Since the image sensors in digital cameras have different sizes, converting to 35 mm camera as a known format provides for better comparing the image formats and the fields of vision of the different lenses. Another benefit is that you can easily set a 35 mm camera (analog or digital) to the same focal length (Lxx) to obtain the same field of vision. This approach greatly facilitates lens selection.

Focal lengths of MOBOTIX lenses are always given as compared to a 35 mm camera

To determine the lens you need, simply use a camera with zoom lens to find a matching MOBOTIX lens

	D12Di-IT MX-D12Di-IT-D22D22	D12Di-IT-DNIGHT MX-D12Di-IT-DNIGHT-D22N22	D12Di-Sec MX-D12Di-Sec-D22D22	D12Di-Sec-DNIGHT MX-D12Di-Sec-DNIGHT-D22N22	D12Di-Sec MX-D12Di-Sec-N22N22	D12Di-Sec-180° MX-D12Di-Sec-180°
---	---------------------------------------	---	---	---	---	--

D12 Hardware Features

Outdoor weatherpr. (IP54/IP65*)	IP54/IP65*	IP54/IP65*	IP54/IP65*	IP54/IP65*	IP54/IP65*	IP54/IP65*
Ethernet, ISDN, USB, RS232	E/I/U [†] /R	E/I/U [†] /R	E/I/U [†] /R	E/I/U [†] /R	E/I/U [†] /R	E/I/U [†] /R
SD card slot	1	1	1	1	1	1
Microphone/Speaker	M/S	M/S	M/S	M/S	M/S	M/S
Mono (M)/Dual (D)	D	D-Night	D	D-Night	D	D
Image Sensor	Color	Color/BW	Color	Color/BW	BW	Color
Lens	L22/L22	L22/L22	L22/L22	L22/L22	L22/L22	L22/L22
Image Size	VGA	VGA	3 Mega	3 Mega**	Mega	3 Mega**
Resolution horizontal x vertical	640x480	640x480	2048x1536	2048x1536	1280x960	2048x1536
Max. frame rate CIF/VGA/Mega	30/30/-	30/30/-	30/30/12	30/30/12	30/30/12	30/30/12
Sensitivity at 1/60 second (Lux)	1	0.1	1	0.1	0.1	1
Sensitivity at 1 second (Lux)	0.05	0.005	0.05	0.005	0.005	0.05
Automatic night lens switch	-	X	-	X	-	-
Storage (MB)	64	64	128	128	128	128
Video ring buffer (MB)	32	32	64	64	64	64
CIF images approx.	2,000	2,000	4,000	4,000	4,000	4,000
VGA images approx.	1,250	1,250	2,500	2,500	2,500	2,500
Mega images approx.	-	-	800	800	800	800
External audio (Line-In/Out)	X	X	X	X	X	X
Signal input pins	1/3	1/3	1/3	1/3	1/3	1/3
Signal output pins	1 (2 ^{††})	1 (2 ^{††})	1 (2 ^{††})	1 (2 ^{††})	1 (2 ^{††})	1 (2 ^{††})
Concealed cabling	X	X	X	X	X	X
In stock	X	X	X	X	X	X
Wall mount (optional accessory)	X	X	X	X	X	X

*Only D12 cameras with Outdoor Wall Mount are IP65-certified

[†]Requires special adapter cable for USB

**3 MEGA resolution with 2048x1536 pixels; the B/W image sensors of the Sec-DNIGHT versions have Mega resolution (1280x960 pixels)

^{††}The second signal output is only available with attached MOBOTIX ExtIO!

*L32 and L65 lenses are not available for M12 cameras

	L22 Super Wide Angle 90°	L32 Wide Angle*	L43 Wide Angle	L65 Tele*	L135 Tele
MOBOTIX Lenses					
	approx. 90°H x 67°V at 10 m appr.: 20.0 x 13.3 m	approx. 60°H x 45°V at 10 m appr.: 11.5 x 8.2 m	approx. 45°H x 34°V at 10 m appr.: 8.2 x 6.1 m	approx. 31°H x 23°V at 10 m appr.: 5.5 x 4.0 m	approx. 15°H x 11°V at 10 m appr.: 2.6 x 1.9 m

	Basic Models	Web Models	IT Models	Secure Models
				
Software Features (All Models)				
Digital zoom (up to 8x, continuous) with panning	-	X	X	X
Motion JPEG/MxPEG video streaming	X/X	X/X	X/X	X/X
Custom exposure windows	X	X	X	X
Video Motion detection	X	X	X	X
Time and event control (FTP, email, logos)	X	X	X	X
Custom time tables/holidays	-	X	X	X
Web functionality (FTP, email)	X	X	X	X
Quad/MultiView in browser	X	X	X	X
Recording/Playback in browser	X	X	X	X
Logo generator, animated	-	X	X	X
Single image recording (pre-/post-alarm images)	3	3	10	50
Terabyte ring buffer (Win/Lin/Mac) via network	-	-	X	X
Continuous video/audio recording, 0.2 to 30 fps	-	-	X	X
Video/audio recording (event-triggered)	-	-	X	X
Event-controlled frame rate with continuous audio	-	-	X	X
Flexible event logic	-	-	-	X
Master/Slave arming by one camera	-	-	-	X
Scheduled privacy zones, several areas	-	-	-	X
Bidirectional audio (IP) from/to browser	-	-	X*	X*
Customized voice messages	-	-	X	X
VoIP telephony (Audio/Video, SIP)	-	-	X*	X*
Alarm calls to softphones (SIP) e.g. X-Lite	-	-	X	X
Remote alarm notification (via TCP/IP, IP Notify)	-	-	X	X
RS232 Data Logger/Terminal	-	-	X**	X**
Programming interface/HTTP API	-	-	X	X
Security features (HTTPS/SSL, IP-level access control, network authentication IEEE 802.1X)	X	X	X	X
Model Feature List				
Image size	VGA	3 Mega**	VGA	3 Mega**
Image Sensor	Color	Color	Color/BW	Color/BW
Standard lens for software version	L22*	L22*	L22*	L22*
Audio support (Microphone/Speaker)	-/S*	-/S*	M/S*	M/S*

The Web version is available only as M12 model

The Basic version is available only as D22M and Q22M model

The IT version is not available as Q22M model

*D22M IT and Secure models allow connecting an external speaker and microphone. D22M cameras do not have a microphone or speaker.



**3 MEGA resolution with 2048x1536 pixels; the B/W image sensors of the Sec-DNight versions have Mega resolution (1280x960 pixels)

**M22M models require the CamIO; not available for D22M models

*M12 models are delivered with the lenses specified by the customer

2 MOUNTING

2.1 Overview of the Camera Versions

The **MOBOTIX D12** is offered in three versions:

- D12D:** The **standard version** of the D12 can be used with all MOBOTIX lenses with M14 thread and is available with different combinations of image sensors for daylight (**color**) and night images (**black & white**; see section 2.5, *Installing the Lens Units - D12D Standard*).
Summary: Standard version for all MOBOTIX M14 lenses; almost no limitations when positioning the two image sensors.



D12 standard has freely positionable lens mounts

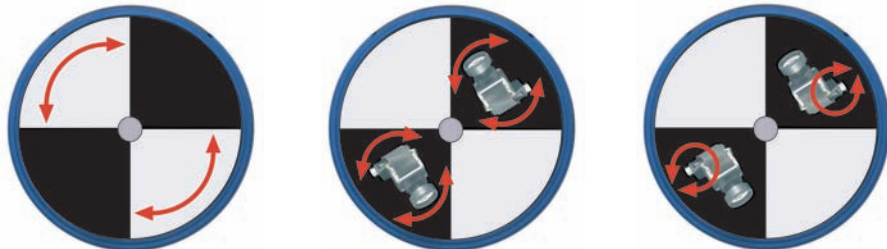

- D12D-180°:** The **panorama version** of the D12 has a horizontal field of view of 180° (2 x 90° L22 Super Wide-Angle lenses) and delivers dual Mega images (max. 2560x960 pixels resolution, 960 lines). This camera is available as a daylight camera (**D12D-180°**, 2 x color image sensor) or a night camera (**D12D-Night-180°**, 2 x black & white image sensors).



Summary: The panorama version with 2 x 90° L22, joined dual image and 180° horizontal field of view is the ideal camera for monitoring the façade of a building.

Façade surveillance with 2 x 90° L22 Super Wide-Angle

Beachten Sie die Hinweise zur optimalen Einstellung der Objektive in Abschnitt 2.13.3!



- D12M-CS:** The **Mono-CS** version can be fitted with any **CS-Mount** lens (1" thread). This camera is available with a **CS-Mount lens** (24 - 54 mm) as a daylight camera (**D12M-CS**) or a night camera (**D12M-Night-CS**). Using C-Mount lenses is not possible in this camera.





Summary: Version for CS-Mount lenses.



Light-sensitive Vario CS-Mount lens with 24 - 54 mm focal length and f-stop 1.6 - 2.3

2.2 Directions

In order to facilitate mounting of the camera, please follow the corresponding steps below:

Directions	
Preparatory Tasks	Sections
All camera versions	2.3: Preparatory Steps
Camera Version	Sections
D12D Standard 	2.4: Parts, Components and Dimensions - D12D Standard 2.5: Installing the Lens Units - D12D Standard
D12D-180° 	2.6: Parts, Components and Dimensions - D12D-180°
D12M-CS 	2.7: Parts, Components and Dimensions - D12M-CS
Installation Type	Sections
Indoor installation	2.8.1: Mounting Indoor Cameras to a Wall or Ceiling 2.13: Finishing the Installation
Outdoor installation with wall mount 	2.8.2: Mounting Outdoor Cameras to a Wall 2.9: Delivered Parts of the Outdoor Wall Mount 2.12: Mounting the Camera With Outdoor Wall Mount 2.13: Finishing the Installation
Installation on building corners or poles 	2.8.2: Mounting Outdoor Cameras to a Wall 2.8.3: Mounting Outdoor Cameras to a Wall or Pole 2.9: Delivered Parts of the Outdoor Wall Mount 2.10: Delivered Parts of the Corner and Pole Mount 2.11: Mounting the Corner and Pole Mount 2.12: Mounting the Camera With Outdoor Wall Mount 2.13: Finishing the Installation

Please also observe the general hints in section 2.15 on mounting the camera to different surfaces!

2.3 Preparatory Steps

Before mounting the MOBOTIX D12 and (if required) the Outdoor Wall Mount (see sections 2.9 and 2.12), the following questions should be solved:

- **Which connections** should the camera use (network/ISDN/RS232)?
- Where should the camera be mounted and which area should the **PIR sensor** cover?
- How will you provide the camera **power supply** (PoE switch, inline using Network Power Adapter/Rack, external power supply)?
- How will the connections be provided **from within the building** (network, ISDN, RS232, power supply)?
- Which other **mounting options** (e.g. corner/pole mount) are available?

Note

In order to solve these and other questions, you should consult shop.mobotix.com for more information on the **MOBOTIX D12D**, the **D12D-Outdoor**, **D12D-180°** and the **D12M-CS** as well as the available accessories.

2.3.1 Mounting to a Ceiling

When mounting the camera to a ceiling, make sure that the PIR sensor points into the direction where it is most useful. The PIR sensor reaches about 10 meters (33 ft) and has a field of view of $\pm 15^\circ$. **The cable outlet should be positioned so that it is directly behind the center of the camera housing.**

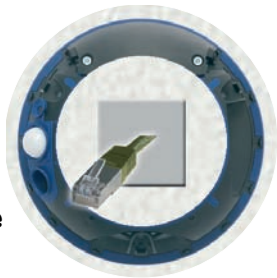

Use the supplied drilling template (*fold-out at the back of the manual*) to properly position the holes for the camera fixtures.

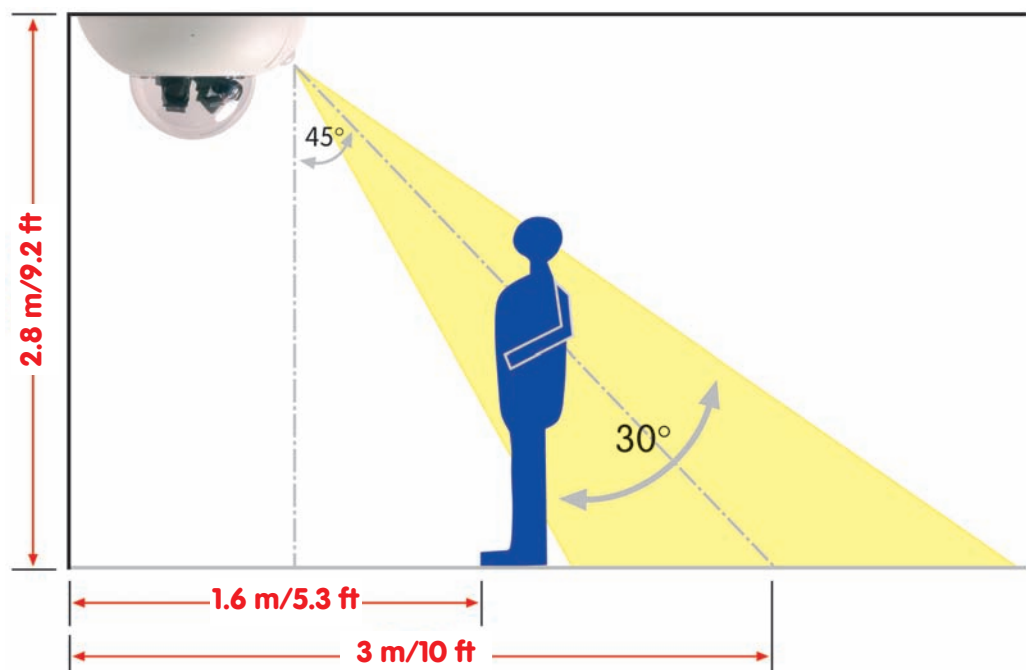

2.3.2 Mounting to a Wall

When mounting the camera to a wall, make sure that the PIR sensor points into the direction where it is most useful; usually, it should point downwards. **The wall outlet should be positioned so that it is directly behind the center of the camera housing.**

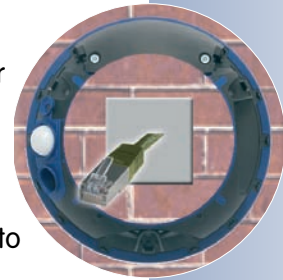

Use the supplied drilling template (*fold-out at the back of the manual*) to properly position the holes for the camera fixtures.

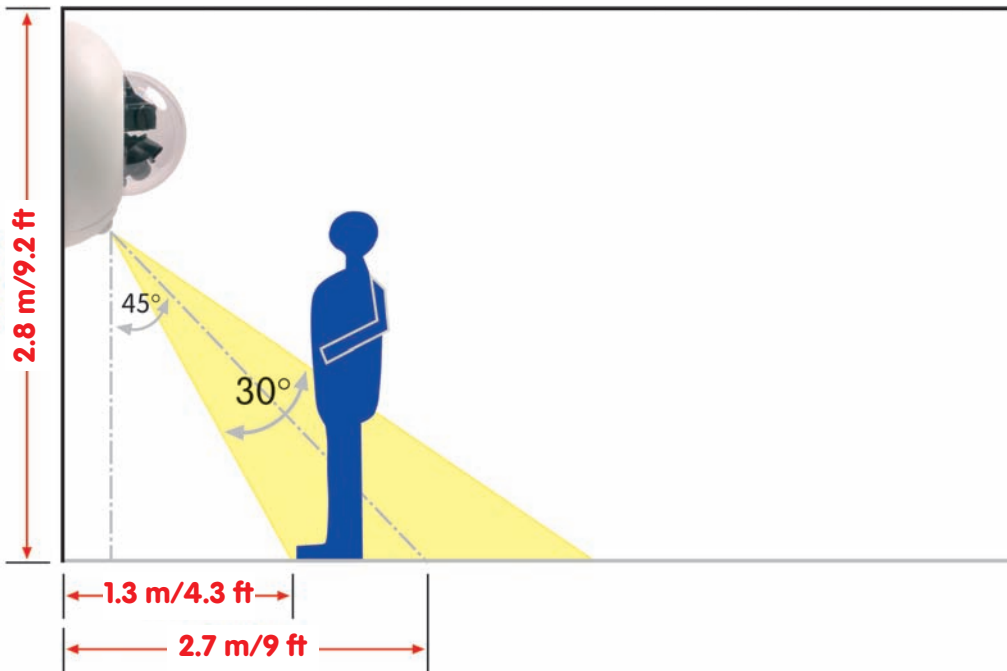

Note

The following is recommended for all D12 models used outdoors or indoors with high variations in temperature: cut the outer sealing with a sharp knife (as shown in the figure) to prevent condensation from accumulating.

The notch should be 3 mm wide (as wide as the Allen wrench) and should point downwards when the camera is mounted.



Caution: Apply notch to prevent damage from condensation

2.3.3 Deciding on the Connections (Network/ISDN/RS232)

First, decide which camera connections you would like to use.

Network is key

In general, you should always provide a **network connection**, if technically possible (a WiFi connection using a **bridge** or similar would also be acceptable), since a network connection brings a number of advantages:

- The highest **frame rate** is only reached if the bandwidth is high enough; ISDN and GSM/GPRS will *not* suffice to deliver smooth video images.
- The camera's **external ring buffer** (storing the video/audio data on a file server) can only be used via a network connection.
- Compared to the **costs** of dial-up connections (ISDN, GSM/GPRS), the costs for file transfers and other accesses by and to the camera are reduced considerably when using a network that is already up and running.
- **Software updates** are best accomplished using a network connection. Note that you will not need to dismount the camera for this.

SIP telephony reduces costs

ISDN connection of MOBOTIX cameras is not required if the network permits SIP connections for Internet phone connections. Thanks to the **SIP capabilities of the MOBOTIX D12** (see chapter 9, *Telephony Features*, in the *Software Manual*), the camera can place voice calls (e.g. for alarm notification) via the network and can also accept incoming voice calls via Internet telephony. You can call the camera from a phone to obtain the time and date of the last event, for example.

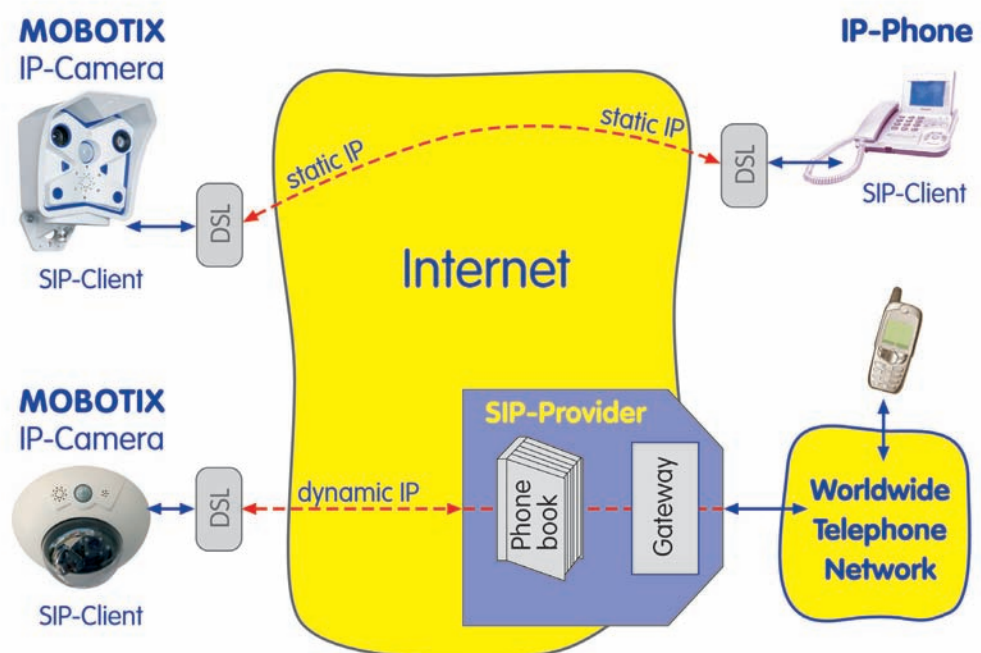

Always use the network, if possible

Free software updates

Internet telephony

ISDN-only operation

When operating the camera using ISDN only, you need to install an additional ISDN cable (see section 2.3.7, *Connecting Additional CAT5 Cables*), then attach the power supply using the **MOBOTIX ISDN split cable** and the **NET** connector of the camera.

ISDN operation:
 - Euro ISDN
 - Japan
 (USA not supported)

2.3.4 Selecting the Power Supply

Caution

It is not possible to use an ISDN NT and the S0 bus to supply power to the MOBOTIX D12. Using the ISDN split cable and MOBOTIX PoE products (see section 2.17, Camera Accessories), the power can be injected into the ISDN data cable (8-wire cable required).

In order to reduce the amount of cabling, you should always use the Ethernet cable (**NET**) to inject power into the camera cabling (**Power over Ethernet**).

For smaller installations, the MOBOTIX **Network Power Adapter** *MX-NPA-3-RJ* and the universal **power supply** *MX-SNT-E/U/GB/J/AUS01-30-RJ* is sufficient. Larger installations would benefit from one or more MOBOTIX **Network Power Boxes/Racks** that are available for supplying power to 4, 8 or 20 cameras (*MX-NPR-4*, *-8* or *-20*). See section 2.17, *Camera Accessories*, for more information on these and other items or open shop.mobotix.com (**Products > Accessories** section).

The D12 supports the MOBOTIX PoE products for power injection into the network cabling and the Power-over-Ethernet standard IEEE 802.3af



Network Power Adapter
MX-NPA-3-RJ



Network Power Rack
MX-NPR-4



Network Power Rack
MX-NPR-20

MX-NPA-3-RJ: Easy installation for smaller systems

MX-NPR-4: For mounting in wiring cupboards; includes DIN rail clip

MX-NPR-8/20: 19" rack mount (2 rack units)

Advantages of MOBOTIX PoE Products

- Zero maintenance and durable without fans.
- Higher reliability of the system as a whole, since standard switches without PoE can be used (lower risk of failure).
- Easy installation on DIN rails using supplied adapter (*MX-NPR-4*) or in 19" racks (*MX-NPR-8/20*).

Since the MOBOTIX D12 supports **Power over Ethernet (IEEE 802.3af)**, you can also use PoE switches or routers for supplying power. Section 3.2, *Connecting the Camera to the Network and to the Power Supply*, contains more information on the possible combinations of connections and power supply options.

Note

If you are using **Power over Ethernet (IEEE 802.3af) network components** for supplying power to the MOBOTIX D12, make sure that these components do not have a fan. Since the power consumption of MOBOTIX cameras is very low compared to other products, the reliability of the entire system is increased and the life cycle of these components is expanded.

PoE components without fans increase overall reliability of the entire system

UPS not only protect the camera against power failures, they also protect all other connected network devices against damage from voltage peaks and lows

2.3.5 Using Uninterruptible Power Supplies (UPS)

In order to maintain a continuous power supply even when utility power fails, you should install an uninterruptible power supply (UPS). These devices also provide full protection against electrical surges and voltage fluctuations and thus enhance the reliability of the system as a whole.

When using more powerful 19" rack-mounted USPs, you can also protect all other network components (e.g. switches, routers, PoE switches, etc.).

Since MOBOTIX cameras do not require any heating even in the wintertime, the power consumption of 3 W is quite low. This in turn means that you can centralize the USP-protected power supply by injecting power into the network cables (max. 100 m/300 ft). This kind of protected power supply can be used either with MOBOTIX PoE products (MX-NPA-3-RJ + external power supply or MX-NPR-4/8/20) or with PoE-compliant switches according to IEEE 802.3af.

Typical setup of a 19" system with UPS

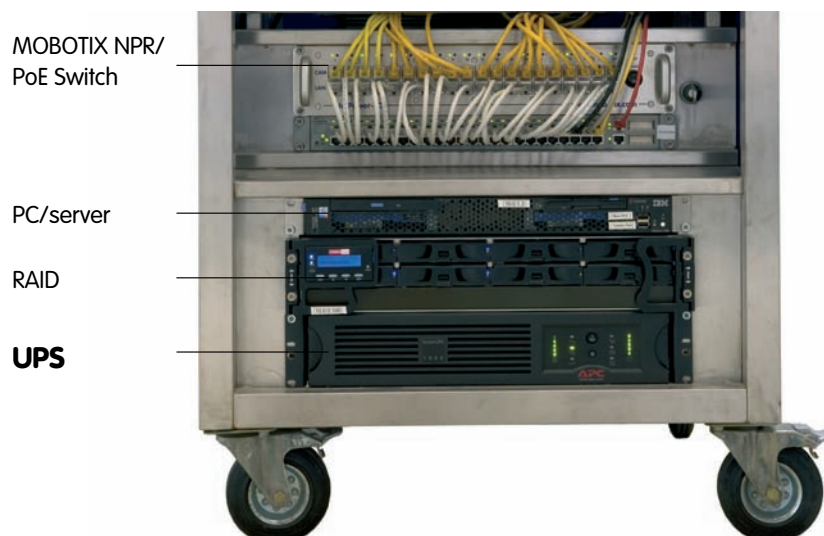

2.3.6 Providing the Connections (Network/ISDN/RS232)

Once the camera position, the position of the cable outlets, and the method of power supply have been decided upon, the cabling should be installed.

Before mounting the MOBOTIX D12, you should make sure that the network and ISDN connections have been properly tested, so that the proper functioning of the camera is guaranteed.

2.3.7 Connecting Additional CAT5 Cables

If the MOBOTIX D12 should use a **network (Ethernet)** and an **ISDN connection**, make sure to install a second CAT5 cable (**min. 50 cm/28 in for D12 only, 70 cm/28 in for D12 with outdoor wall mount**) and to guide it into the camera housing. In order to prevent confusing this cable with the pre-installed network cable, the second cable should have a different color (e.g. **green** as in the figure) and it should be clearly marked as ISDN cable.

- Remove the M4x25 Allen screws of the **cable cover (item 1.7)** using the supplied 3 mm Allen wrench and lift the cover out of its seat.

Note: If the cable cover cannot be removed by hand, take a screwdriver to lift it out of its seat. Insert the screwdriver into the grooves shown below and gently lift the cable cover.



- Lead the CAT5 cable from the bottom of the camera housing through the right-hand opening and guide it around the camera housing in counter-clockwise direction (as seen from above). Make sure that this cable is running properly as shown in the figures below.



3mm Allen wrench is included in the delivery

Lead the cables through the cable guides at the outer rim of the housing

If you are only using one cable, close the unused cable guide with one of the supplied **rubber plugs**

Example:

Yellow: Networking
Green: ISDN

Always mount the cable cover (IP65)!

- Remove the **rubber plug from the blue cable guide beneath the left side of the cable cover** and store the plug in a safe place.

If you are only using one cable later on, close the unused cable guide again using this plug. This will ensure that the camera remains weatherproof (IP65), even if it has only one cable.

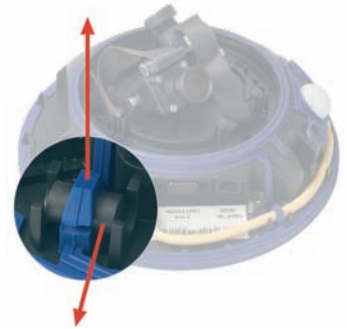

- Insert the cable into the cable guide.



- If you are using both connectors, the two cables should cross one another in front of the connectors.



- Push the **cable cover (item 1.7)** back into its seat and fasten the two Allen screws M4x25. When mounting the cable cover, take care to properly align the cover with the seal of the camera housing and the two cable guides. This will ensure that the camera remains weatherproof (IP65).



- Properly lead the cable through the **cable guides** at the outer rim of the housing and make sure that the outer shell can be properly mounted later on.



2.3.8 Connecting a Cable to the Serial interface (RS232)

If the **RS232 interface** of the MOBOTIX D12 is to be used for switching external **re-lays** (lights, alarm sirens, gates, etc.), evaluating **external sensors** (light barriers, etc.) or for **data connections** (weather station, GSM/GPRS modem, etc.), you need to install an additional **serial cable** (similar to the steps in section 2.3.7, *Connecting Additional CAT5 Cables*) before installing the camera.

Due to the design of the camera, a suitably **short connector** should be used to ensure that the cable cover still fits perfectly without jeopardizing the weatherproofness of the camera.

Please also make sure that the serial cable is thick enough to fill the cable guide beneath the cable cover so that no water can enter the area beneath.

Section 3.7, *Signal Input/Output (RS232 Interface)*, contains more information on the RS232 interface (pin-out, etc.).

Switching external relays
using the RS232 interface



D12D Standard

Make sure to check the delivered parts!

2.4 Delivered Parts, Components and Dimensions - D12D Standard

2.4.1 Delivered Parts and Components - D12D Standard



Item	Count	Part Name
1.1	1	Camera housing
1.2	2	Lens
1.3	2	Lens mount
1.4	2	Lock ring
1.5	2	Ribbon cable
1.6	8	Cable clamp
1.7	1	Cable cover
1.8	2	Dome; 1x tinted, 1x transparent
1.9	1	Outer shell
1.10	1	Ethernet cable
1.11	1	Allen wrench 3 mm
1.12	1	Custom tool with magnet

Mounting Supply

Item	Count	Part Name
M.1	3	Dowels 10 mm
M.2	3	Stainless steel washers Ø 9 mm
M.3	3	Stainless steel wood screws with hex head 8x70 mm

2.4.2 Camera Housing and Connectors - D12D Standard

The MOBOTIX **D12D** consists of three main components (**camera housing (item 1.1)**, **outer shell (item 1.9)** and **dome (item 1.8)**). Like the MOBOTIX M12 models, the MOBOTIX **D12D** is also delivered with PIR sensor, microphone and speaker.

External Sensors

- PIR sensor
- Microphone

Connections

- NET (Ethernet network) / power supply
- In/Out / RS232 / MX Interface Connector D Sub 15 HD
- ISDN
- Slot for SD card

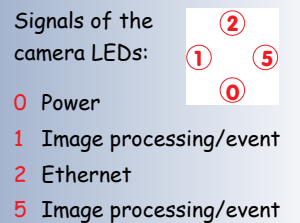
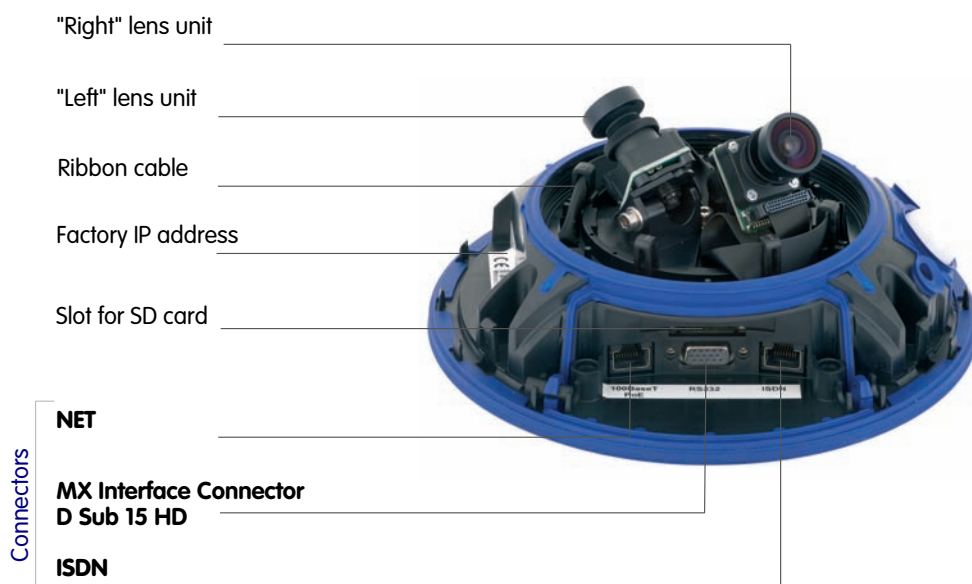
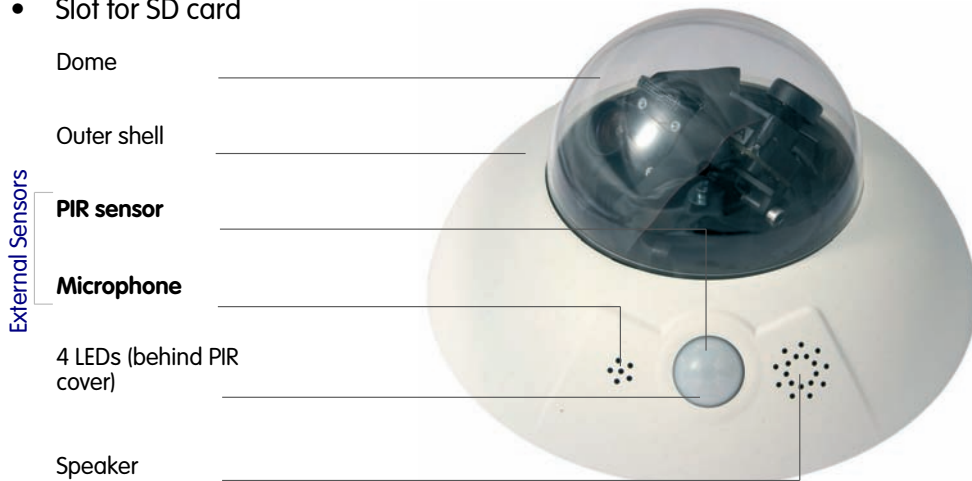

MOBOTIX **D12D**

2.4.3 Dimensions - D12D Standard





Notes:









2.5 Installing the Lens Units - D12D Standard

The standard models of the MOBOTIX D12 are delivered with a pre-mounted dome. **Lens units (lens mount, image sensor and lens) are delivered separately** and need to be installed as described in the following:

The ribbon cables for connecting the image sensors are marked by the letters **L** (left) and **R** (right). Depending on the type of sensor used, the sensors (mounted on the lens units) are marked either by the  icon (BW, black & white) or the  icon (RGB, color).

The **following combinations of ribbon cables (L, R) and sensors (color, black & white)** are possible:

Image Sensor Combination	Ribbon Cable <i>L</i>	Ribbon Cable <i>R</i>
Color/Color		
Color/Black & White		
Black & White/Black & White		

Notes

Make sure that you only use the combinations of sensors and ribbon cables listed in the table!

When setting up the camera, the installed combination of image sensors has to be set in the camera's user interface. This is done either automatically in the **Quick Installation** wizard or manually by opening the **Admin Menu > Image Sensor Configuration** dialog.

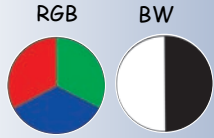

Designation of the lens units

Possible image sensor combinations for the MOBOTIX D12D Standard

(1) Remove the dome

Take a cotton cloth and remove the transparent dome by turning it in **counter-clockwise direction**.



Dismount the dome by turning it **counter-clockwise**



(2) Insert the lens units and mount the central lens screw

Remove the center lock screw and the washer. Insert the lens units into the seatings. Insert the lock screw with a washer into the center of the camera and gently tighten it to hold the lens units in place.

Caution: Avoid over-tightening the screw as this might damage the camera housing.

**(3) Connect the ribbon cables to the lens units**

Connect the ribbon cables marked **L** and **R** according to the *Image Sensor Combination* table (opposite page) to the installed lens units.

Example: A **D12D-Night** always takes the **L** ribbon cable on the  (BW) lens mount, the **R** ribbon cable is **always** connected to the  (color) lens mount (see *Image Sensor Combination* table on the opposite page).



While doing so, make sure that the **lens unit's ribbon cable connectors are always pointing upwards into the dome**. This will ensure that the lenses can be positioned freely later on, without putting any strain on the ribbon cables. Make sure that the ribbon cables are running properly along the inside of the dome's rim. The ribbon cables must not obstruct the line of vision of the lenses!

Press clamp together cautiously, then insert into the seats; make sure the pin fits snug into the hole!

Align the **mark** of the dome with the PIR sensor

Tighten the dome by turning **clockwise**

(4) Secure the ribbon cables using the cable clamps

To do so, gently squeeze the clamps between your fingers and insert the clamps into their seats along the inside of the dome's rim. Make sure that the pin of each clamp is properly positioned in the corresponding hole of the camera housing.

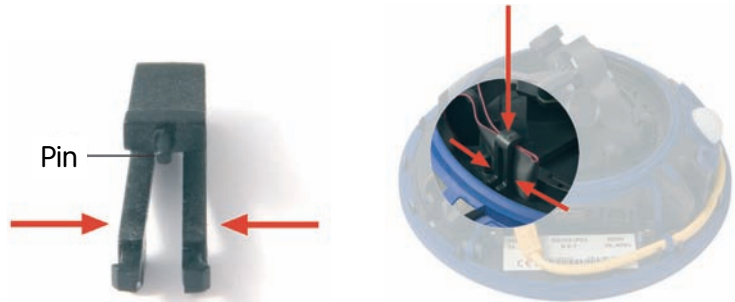

5) Mount the dome

Take a cotton cloth, **insert the dome into the housing with the mark pointing towards the camera's PIR sensor** and tighten the dome in **clockwise direction**. This will prevent accidental repositioning of the lenses through the rest of the mounting process.

Important: Always insert the dome into the housing with the mark of the dome pointing towards the camera's PIR sensor, in order to preserve the camera's weatherproofness!

Note: The camera is delivered with an additional tinted dome with reduced transparency!



(6) Adjust the lenses and install the outer shell

For additional information on this topic, see section 2.13, *Finishing the Installation*.

2.5.1 Activating the Camera Configuration in the Quick Installation Wizard

Since the D12D can be ordered with different sensor configurations (**color/color**, **color/black & white**, **black & white/black & white**), you need to set the installed sensor combination in the camera user interface. This is done either in the **Quick Installation** wizard or in the **Admin Menu > Image Sensor Configuration** dialog.

Configuring the image sensors: **Admin Menu > Quick Installation** or **Admin Menu > Image Sensor Configuration**

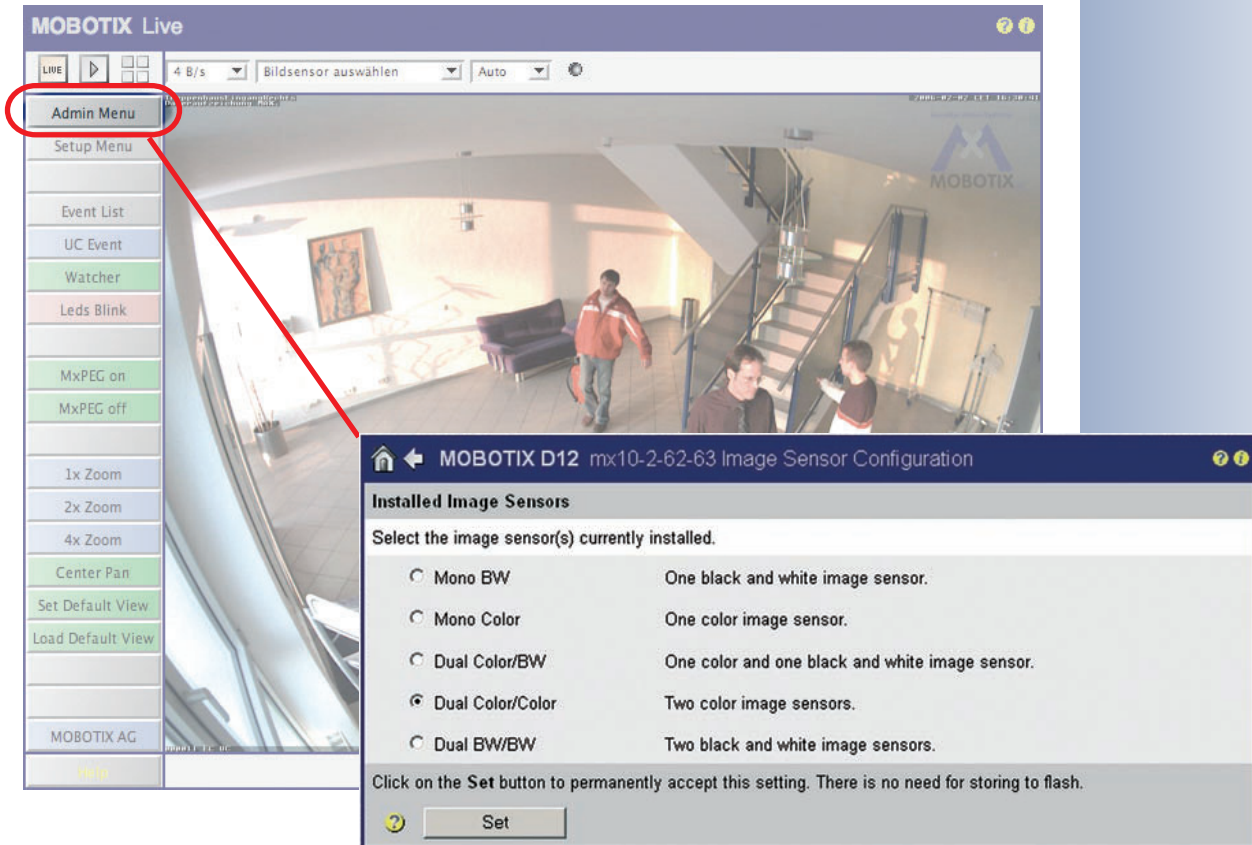



D12D-180°

Make sure to check the delivered parts!

2.6 Delivered Parts, Components and Dimensions - D12D-180°

2.6.1 Delivered Parts and Components - D12D-180°

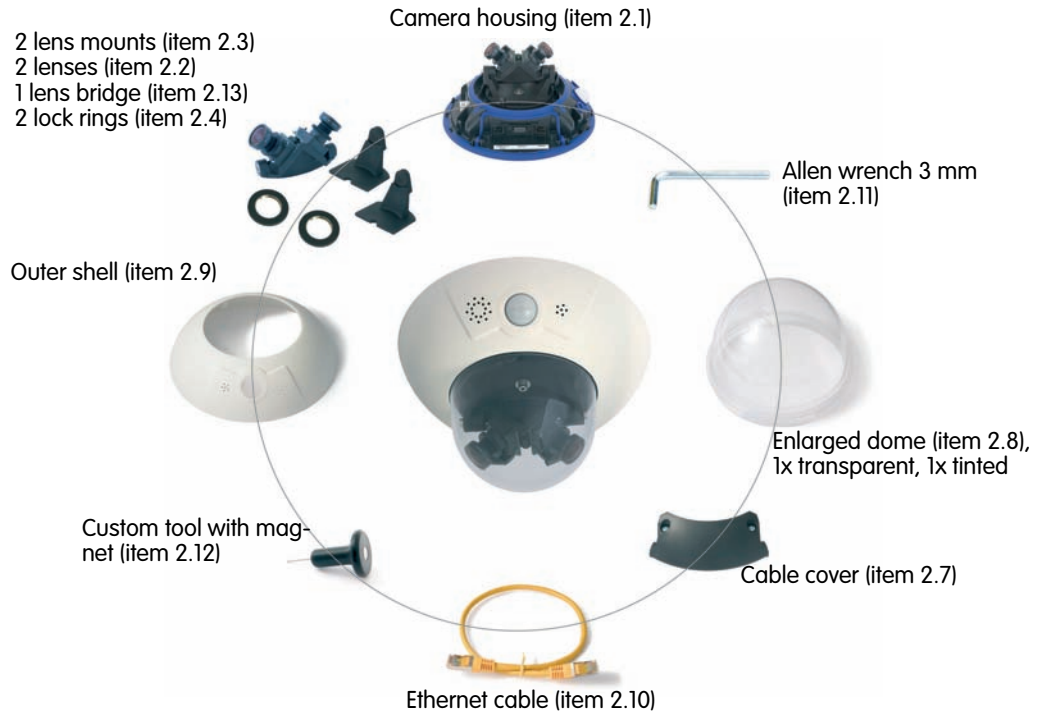

Item	Count	Part Name
2.1	1	Camera housing
2.2	2	Lens
2.3	2	Lens mount
2.4	2	Lock ring
2.5	2	Ribbon cable
2.6	8	Cable clamp
2.7	1	Cable cover
2.8	2	Dome; 1x tinted, 1x transparent
2.9	1	Outer shell
2.10	1	Ethernet cable
2.11	1	Allen wrench 3 mm
2.12	1	Custom tool with magnet
2.13	1	Lens bridge

Mounting Supply

Item	Count	Part Name
M.1	3	Dowels 10 mm
M.2	3	Stainless steel washers Ø 9 mm
M.3	3	Stainless steel wood screws with hex head 8x70 mm

2.6.2 Camera Housing and Connectors - D12D-180°

The MOBOTIX **D12D-180°** consists of three main components (**camera housing (item 2.1)**, **outer shell (item 2.9)** and **dome (item 2.8)**). Like the MOBOTIX M12 models, the MOBOTIX **D12D-180°** is also delivered with PIR sensor, microphone and speaker.

External Sensors

- PIR sensor
- Microphone

Connections

- NET (Ethernet network) / power supply
- In/Out / RS232 / MX Interface Connector D Sub 15 HD
- ISDN
- Slot for SD card

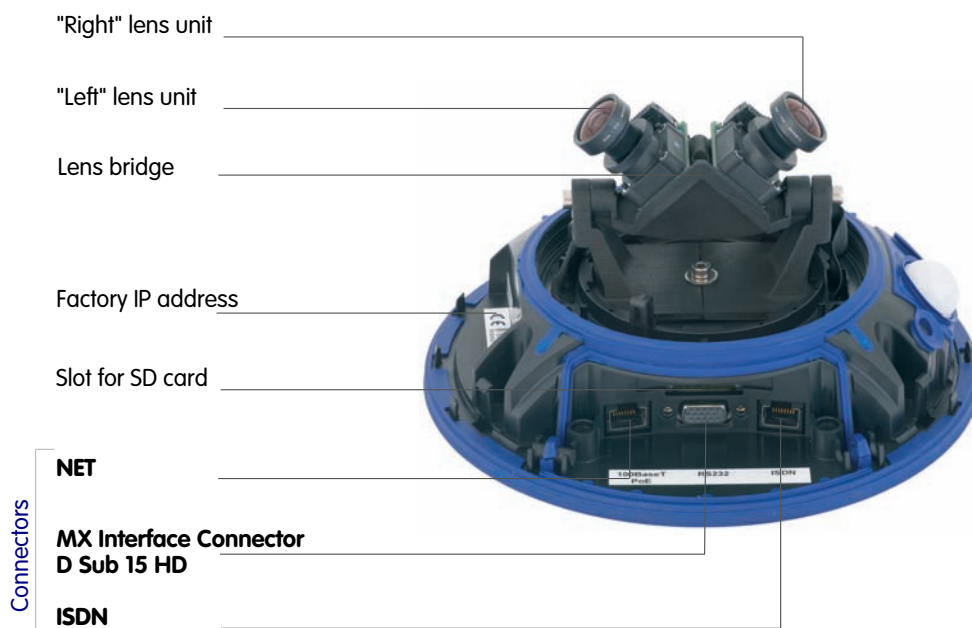
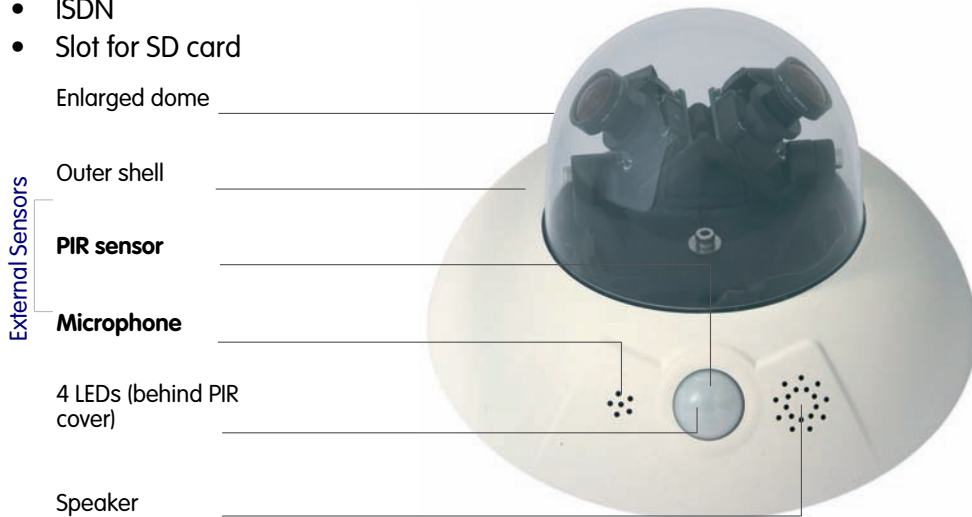

Signals of the camera LEDs:

- 0 Power
- 1 Image processing/event
- 2 Ethernet
- 5 Image processing/event

MOBOTIX **D12D-180°**

2.6.3 Dimensions - D12D-180°



Notes:





D12M-CS

Make sure to check the delivered parts!

2.7 Delivered Parts, Components and Dimensions - D12M-CS

2.7.1 Delivered Parts and Components - D12M-CS



Item	Count	Part Name
3.1	1	Camera housing
3.2	1	Lens
3.3	2	Lens mount
3.4	2	Lock ring
3.5	2	Ribbon cable
3.6	8	Cable clamp
3.7	1	Cable cover
3.8	2	Dome; 1x tinted, 1x transparent
3.9	1	Outer shell
3.10	1	Ethernet cable
3.11	1	Allen wrench 3 mm
3.12	1	Custom tool with magnet
3.13	1	Lens bridge

Mounting Supply

Item	Count	Part Name
M.1	3	Dowels 10 mm
M.2	3	Stainless steel washers Ø 9 mm
M.3	3	Stainless steel wood screws with hex head 8x70 mm

2.7.2 Camera Housing and Connectors - D12M-CS

The MOBOTIX **D12M-CS** consists of three main components (**camera housing (item 3.1)**, **outer shell (item 3.9)** and **dome (item 3.8)**). Like the MOBOTIX M12 models, the MOBOTIX **D12M-CS** is also delivered with PIR sensor, microphone and speaker.

External Sensors

- PIR sensor
- Microphone

Connections

- NET (Ethernet network) / power supply
- In/Out / RS232 / MX Interface Connector D Sub 15 HD
- ISDN
- Slot for SD card

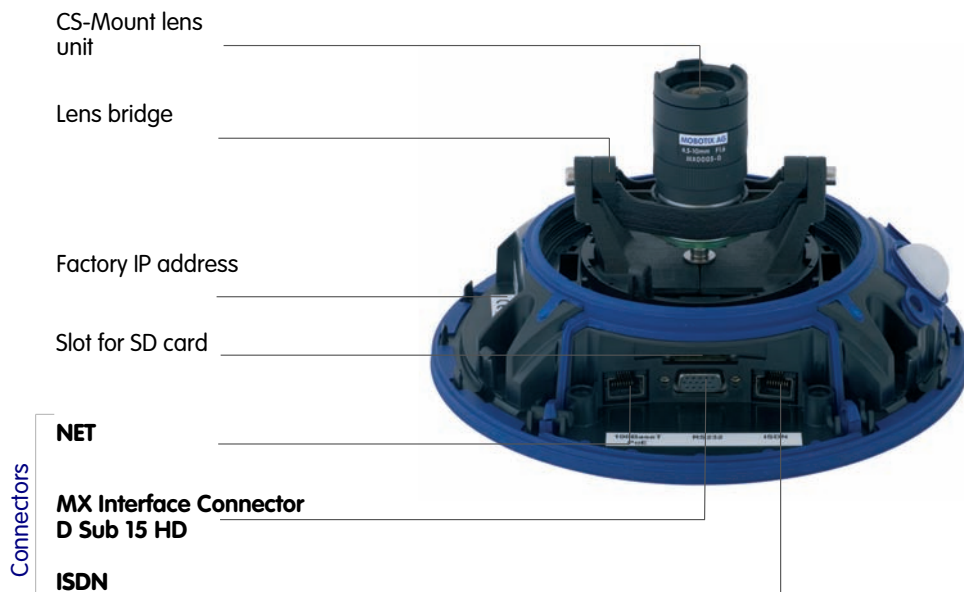
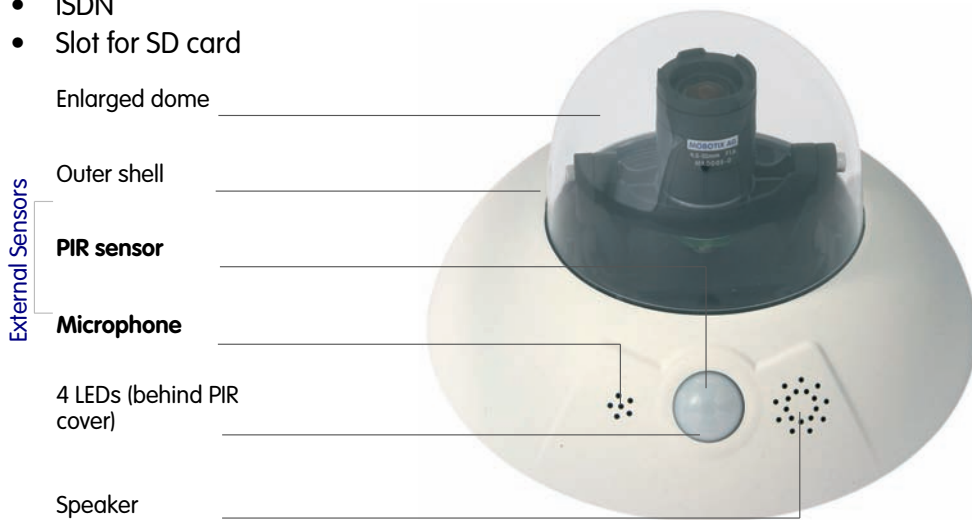

Signals of the camera LEDs:

- 0 Power
- 1 Image processing/event
- 2 Ethernet
- 5 Image processing/event

MOBOTIX **D12M-CS**

2.7.3 Dimensions - D12M-CS



Notes:



Please also observe the general hints in section 2.15 on mounting the camera to different surfaces!

Find the folded drilling templates at the end of the manual!

Make sure that the drilling template is not scaled down when printing!

Max. torque for all screws: 4 Nm (2.95 lbf ft)

2.8 Indoor/Outdoor Mounting Instructions

2.8.1 Mounting Indoor Cameras to a Wall or Ceiling

In order to mount the MOBOTIX D12 to a ceiling or wall, you need to drill the holes for the fixtures. Use the supplied *drilling template* to mark the position of the holes for the fixtures and the holes through which the cables will be led later on (fold-out). **Remember to position the drilling template according to the direction of the camera's PIR sensor.**

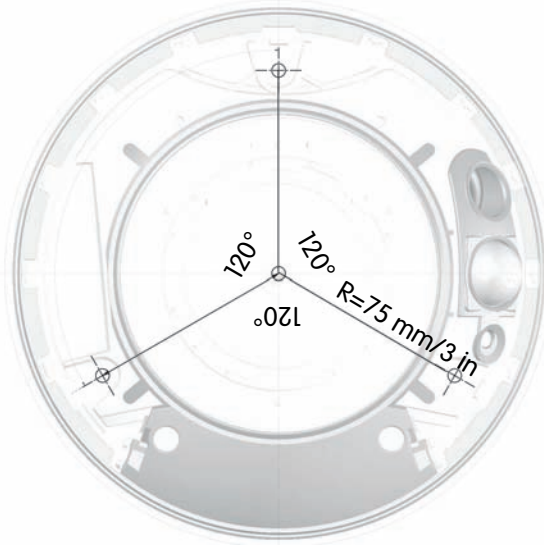

Planning and Connecting the CAT 5 Cable

- (1) Position the camera housing over the cable exit.
- (2) Lead the cables through the appropriate holes in the housing.
- (3) Properly lead the cable(s) through the cable guides at the outer rim of the housing.
- (4) Use the proper screws to mount the camera housing to the wall or ceiling.

Note

Make sure that the **cable length** is appropriate. Check the following figure to see how the cables are running properly. Cable length should be **50 cm (20 in)** when mounting the D12 and **70 cm (28 in)** when mounting the D12 with Outdoor wall mount, always measured from the wall. There are two ways to accommodate cable that is too long (see figures):

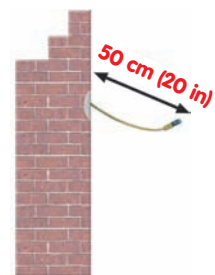

- (1) Loop near the RJ45 connectors
- (2) Loop beneath the camera

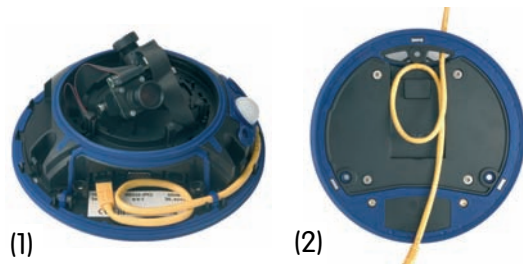

2.8.2 Mounting Outdoor Cameras to a Wall

In conjunction with the **Outdoor Wall Mount**, the D12 can be mounted outside for enhanced outdoor surveillance. Together with the Outdoor Wall Mount, the MOBOTIX D12 reaches protection class **IP65** (absolutely dustproof, resistant against water jets). Operating temperatures may vary between -30°C and +60°C (-22°F to 140°F), making it the ideal camera for the most demanding weather situations. In order to mount the MOBOTIX D12 with the Outdoor Wall Mount, you need to prepare the holes for the fixtures. Use the supplied *drilling template* to mark the position of the holes for the fixtures and the holes through which the cables will be led later on (fold-out).

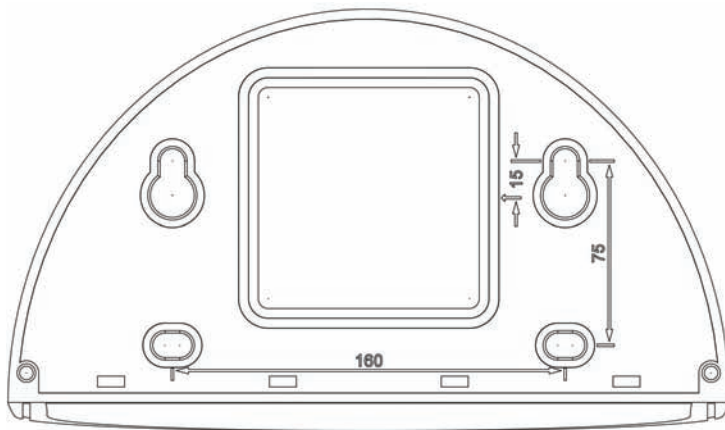

2.8.3 Mounting Outdoor Cameras to a Wall or Pole

If you would like to mount the MOBOTIX D12 to the corner of a building or a pole, you should consider using the **MOBOTIX Corner and Pole Mount**. The Corner and Pole Mount can be used only together with the Outdoor Wall Mount. The supplied stainless steel straps allow fixing the mount to poles with diameters between **60 and 180 mm (2.4 to 7.1 in)**.

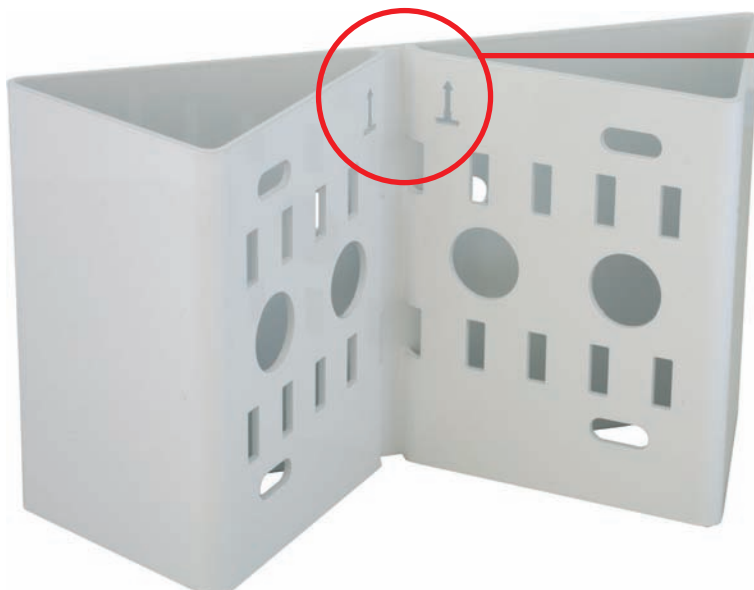

Please also observe the general hints in section 2.15 on mounting the camera to different surfaces!

Find the folded drilling templates at the end of the manual!

Make sure that the drilling template is not scaled down when printing!

Make sure that the arrows are pointing upwards when mounting!

2.9 Delivered Parts of the Outdoor Wall Mount (Optional Accessory)

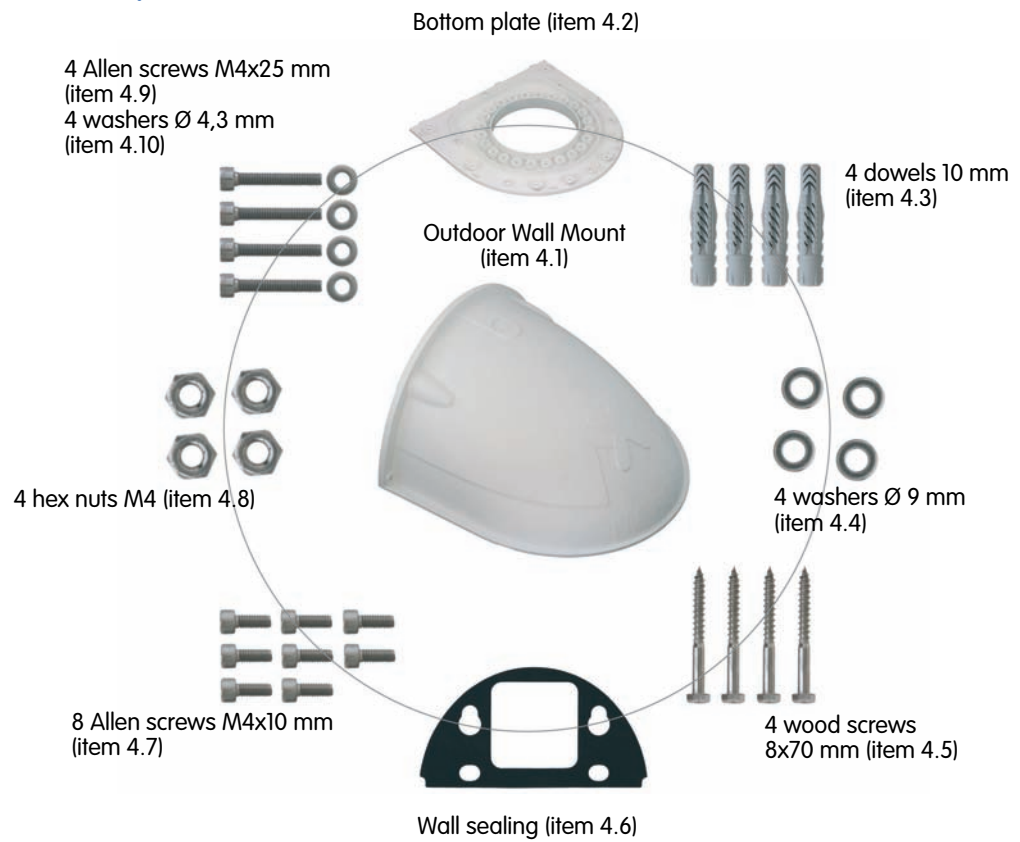

Make sure to check the delivered parts!

Item	Count	Part Name
4.1	1	Outdoor wall mount
4.2	1	Bottom plate
4.3	4	Dowels 10 mm
4.4	4	Stainless steel washers Ø 9 mm
4.5	4	Stainless steel wood screws with hex head 8x70 mm
4.6	1	Wall sealing
4.7	8	Stainless steel Allen screws M4x10 mm
4.8	4	Stainless steel hex nuts M4
4.9	4	Stainless steel Allen screws M4x25 mm
4.10	4	Stainless steel washers Ø 4.3 mm

The rectangular hole in the center of the rear covers the wall outlet

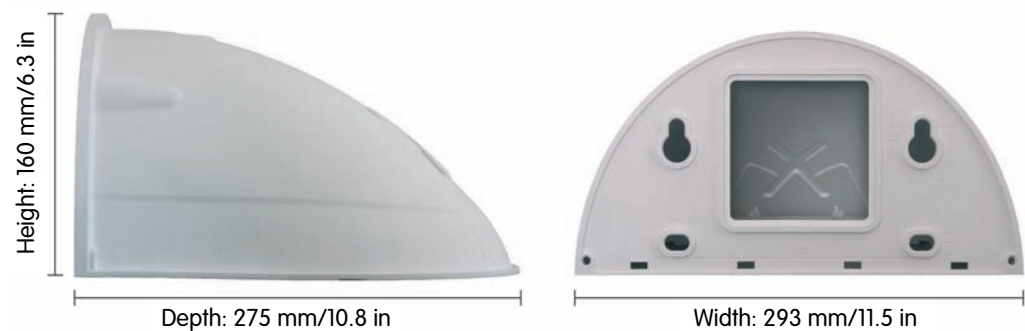

2.10 Delivered Parts of the Corner and Pole Mount (Optional Accessory)

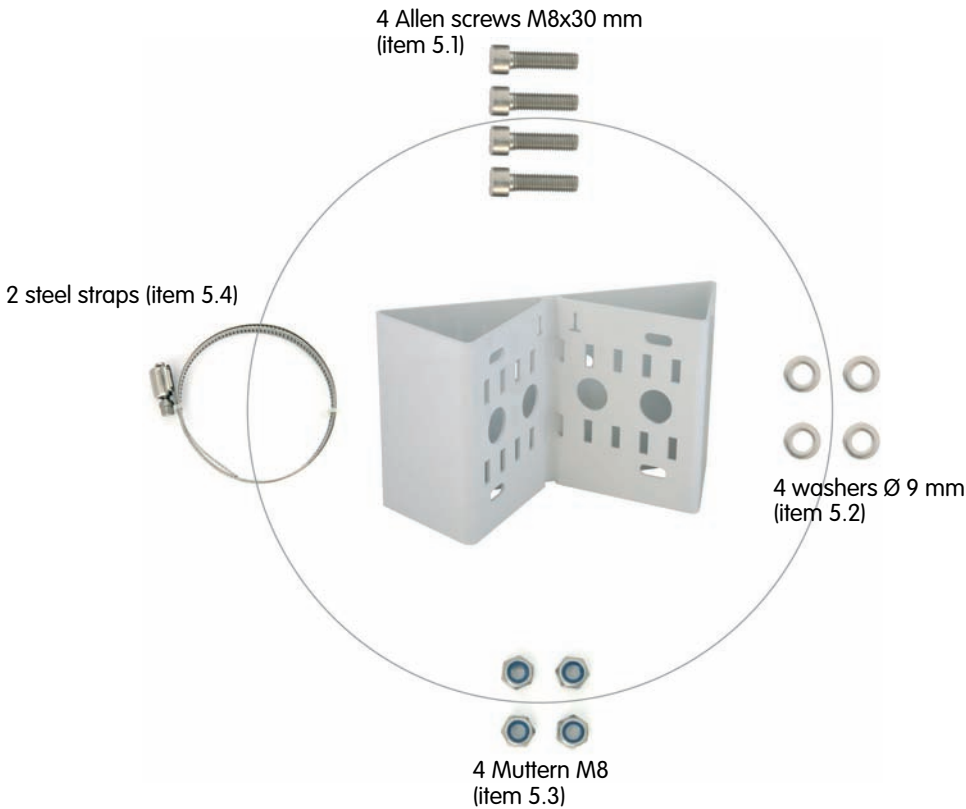

Robust and maintenance-free: Corner and Pole Mount made of 3 mm stainless steel

D12 accessory for easily mounting to corners or poles

Item	Count	Part Name
5.1	4	Stainless steel Allen screws M8x30 mm
5.2	4	Stainless steel washers Ø 9 mm
5.3	4	Stainless steel lock nuts M8
5.4	2	Stainless steel straps

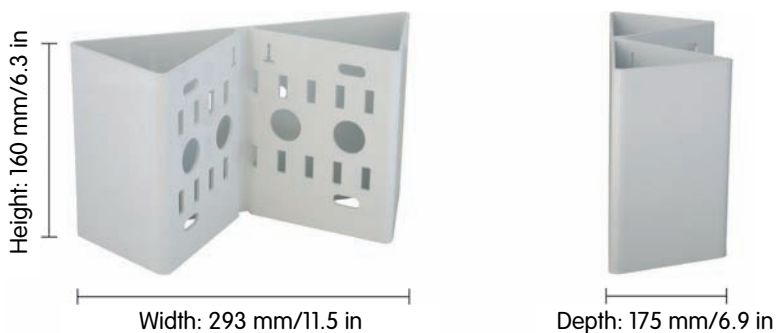

2.11 Mounting the Corner and Pole Mount

2.11.1 Overview

If you would like to mount the MOBOTIX D12 to the corner of a building or a pole, you should consider using the **MOBOTIX Corner and Pole Mount**. This mount is made of **3 mm powder-coated stainless steel (white)** and has been designed specifically for the **Outdoor Wall Mount**. The supplied stainless steel straps allow fixing the mount to poles with diameters between **60 and 180 mm (2.4 to 7.1 in)**.

By design, the Corner and Pole Mount does *not* allow using a wall outlet for the camera cabling.



Mounted to a corner

Like the Outdoor Wall Mount, the Corner and Pole Mount is made from weather-proof material and is just as robust and maintenance-free.



Mounted to a pole

2.11.2 Mounting to the Corner of a Building

Use the **dowels, screws and washers supplied with the Outdoor Wall Mount** (see section 2.9, *Delivered Parts of the Outdoor Wall Mount*) to mount the Outdoor Wall Mount to the corner of a building.

- Mark the **four holes for dowels** at the corner (make sure that the arrows in the mount point to the top) and drill the holes using a 10 mm (3/8 in) drill bit for walls.

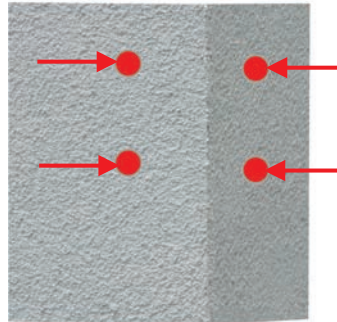

- Guide the **camera cables** through one of the large round holes at the back of the Corner and Pole Mount, then through one of the holes with 16 mm (5/8 in) diameter. In order to properly **protect the cabling**, you should let the cabling run from the inside of the building through the Corner and Pole Mount directly into the camera.



Note: The cable to the camera should be running at least 80 cm (32 in) from the corner!

- Insert the **supplied 10 mm dowels (item 4.3)** into the dowel holes, then mount the Corner and Pole Mount to the corner of the building using the **8x70 mm screws (item 4.5)** and **9 mm dia. washers (item 4.4)**.

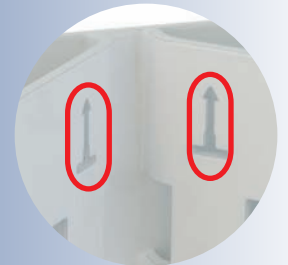

Make sure that the arrows are pointing upwards when mounting!

Make sure not to squeeze and damage the cables when mounting!

Next, mount the **Outdoor Wall Mount** to the **Corner and Pole Mount**, as described in section 2.11.4, *Mounting the Outdoor Wall Mount to the Corner and Pole Mount*.

2.11.3 Mounting to a Pole

Use the **stainless steel straps** supplied with the **Corner and Pole Mount** for affixing the pole mount to a pole.

- Guide the **stainless steel straps (item 5.4)** through the holes in the pole mount (see figure). Make sure that you are using the slots of the mount which are fitting best for the thickness of the pole. The stainless steel straps allow attaching the mount to **poles with diameters between 60 and 180 mm (2.4 to 7.1 in)**.

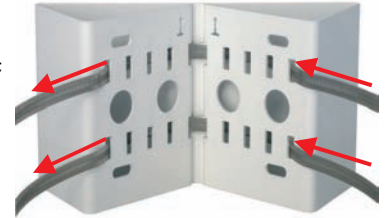

Pole diameters:
60 to 180 mm (2.4 to
7.1 in)

- Guide the **camera cables** from behind through one of the large round holes of the Corner and Pole Mount. In order to properly **protect the cabling**, you should let the cabling run from the inside of the pole through the Corner and Pole Mount directly into the camera.



Note: The cable to the camera should be running at least 80 cm (32 in) from the pole!

- **Firmly tighten the screws of the stainless steel straps.** If required, clip the ends of the stainless steel straps.



Next, mount the **Outdoor Wall Mount** to the **Corner and Pole Mount**, as described in section 2.11.4, *Mounting the Outdoor Wall Mount to the Corner and Pole Mount*.

2.11.4 Mounting the Outdoor Wall Mount to the Corner and Pole Mount

Use the **stainless steel screws, washers and hex nuts supplied with the Corner and Pole Mount** for affixing the Outdoor Wall Mount to the Corner and Pole Mount already in place.

- Lead the cables through the appropriate hole at the back of the Outdoor Wall Mount.



- Use the **Allen crews M8x35 mm (item 5.1), washers dia. 9 mm (item 5.2) and nuts M8 (item 5.3) supplied with the Corner and Pole Mount** to attach the Outdoor Wall Mount to the Corner and Pole Mount.



Next, mount the **camera to the Outdoor Wall Mount**, as described in section 2.12.3, *Determining the Position of the Camera on the Bottom Plate*.





D12 with Outdoor Wall Mount

PIR specs: range approx. 10 m (30 ft), field of view approx. +/-15°

2.12 Mounting the Camera With the Outdoor Wall Mount

2.12.1 Setting the Direction of the Passive Infrared Sensor (PIR)

When mounting the camera, make sure that the PIR sensor points into the direction where it is most useful. The PIR sensor reaches about **10 meters (33 ft)** and has a **field of view of $\pm 15^\circ$** .

The positions that are available depend on how high the MOBOTIX D12D-Outdoor has been mounted and the position of the camera on the **bottom plate (item 4.2)**, which can be adjusted in steps of 15 degrees (see also section 2.12.3, *Determining the Position of the Camera on the Bottom Plate*).

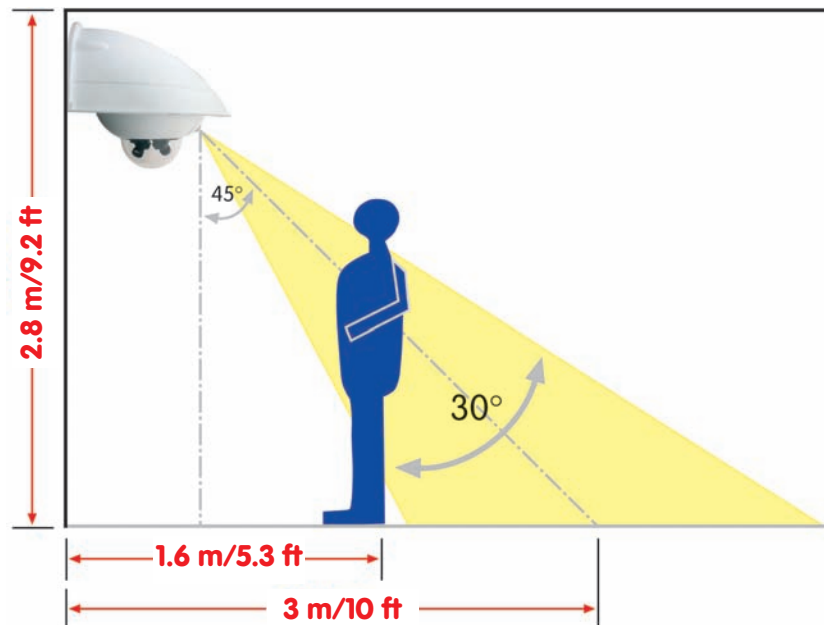

Hint: It may be useful to mark the ideal position of the PIR sensor on the bottom plate with a pencil.

2.12.2 Mounting the Outdoor Wall Mount

Ideally, the Outdoor Wall Mount is mounted over the tested wall outlet, which provides the connections (network, ISDN, Power over Ethernet) to the camera.

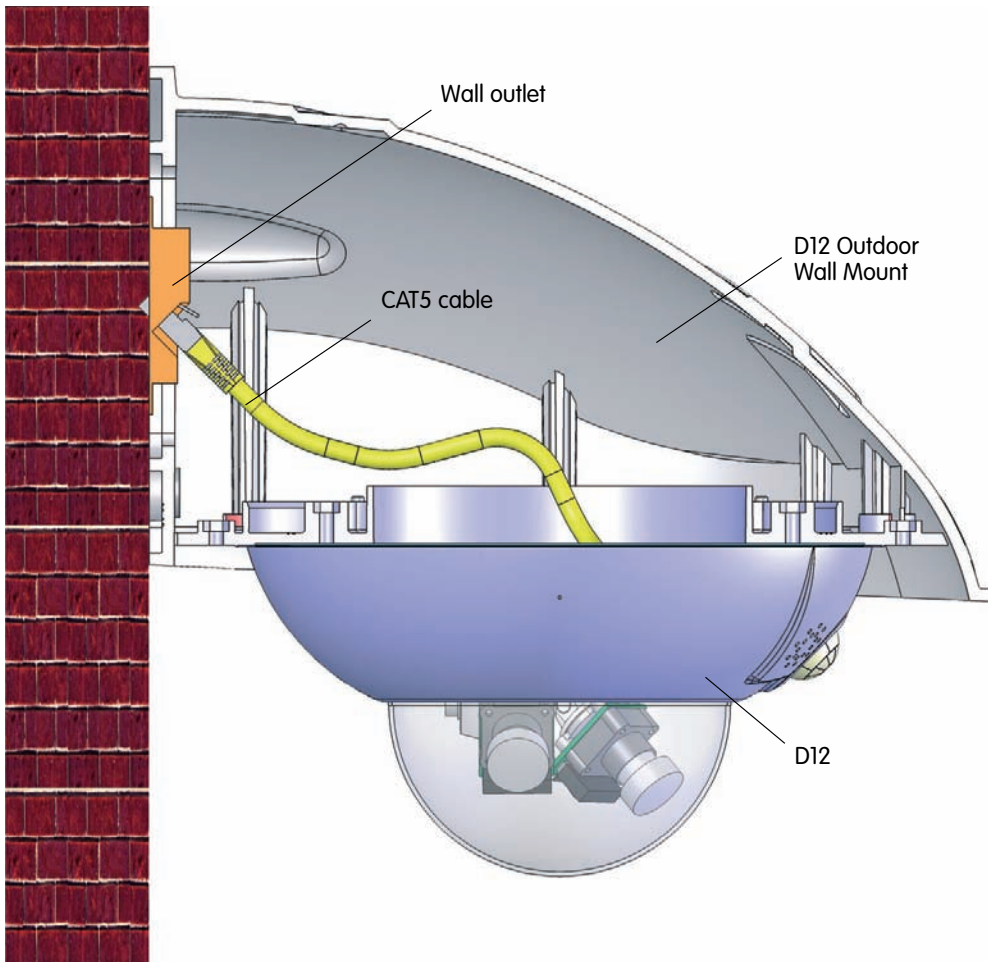

Mounting the Outdoor Wall Mount and the camera

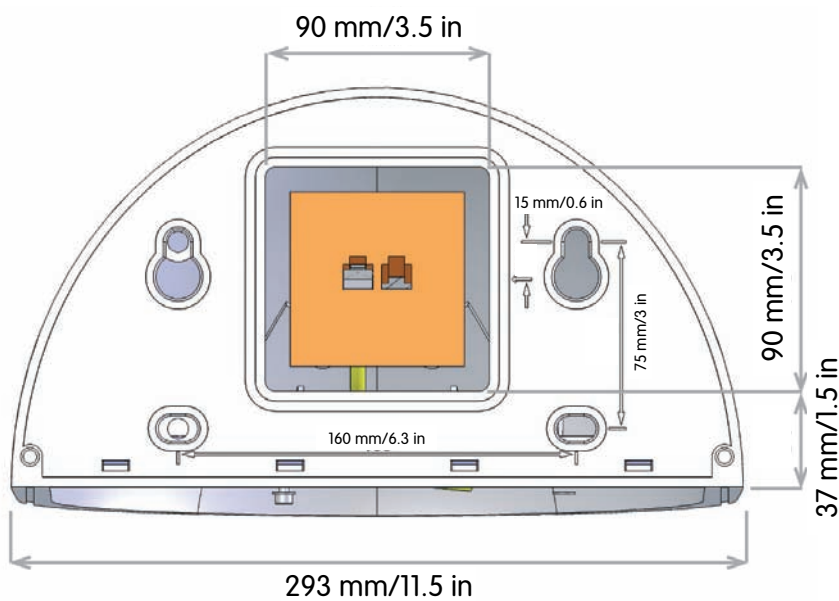

Find the folded drilling templates at the end of the manual!

Make sure that the drilling template is not scaled down when printing!

Silicone sealant is optional!

Cable length from wall: minimum **70 cm (28 in)**

Cable length from wall: min. **80 cm (32 in)** when using the Corner and Pole Mount

Use the **supplied drilling template** (fold-out at the end of this manual) to mark the position for drilling the dowel holes and the holes through which the cables will be led later on. When printing or copying the drilling template, make sure that it is not scaled down!

- Use the supplied **10 mm dowels (item 4.3), 8x70 mm screws (item 4.5) and 9 mm dia. washers (item 4.4)** for mounting the Outdoor Wall Mount to the wall!

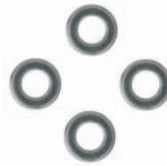

- Before mounting the wall mount, attach the supplied **wall sealing (item 4.6)** to its rear (wall) side using some silicone sealant. If the outdoor wall mount is mounted to a very rough surface, the top of the wall mount should also be sealed against the wall using good-quality **silicone sealant**.



- The rectangular opening at the wall mount's rear side is supposed to cover the wall outlet.



- If you *do not* use the pre-installed Ethernet cable, make sure that the **cable runs at least 70 cm (28 in)** from the wall or wall outlet (**80 cm (32 in)** when using the Corner and Pole Mount, see section 2.11).

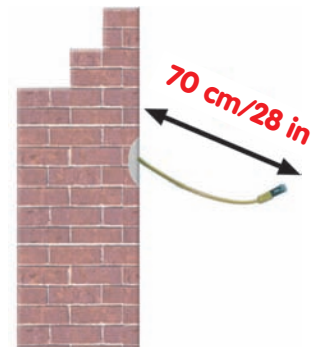

2.12.3 Determining the Position of the Camera on the Bottom Plate

Once the outdoor wall mount has been mounted to the wall or pole, the camera can be mounted to the underside of the **bottom plate (item 4.2)**. The **bottom plate** closes off the outdoor wall mount from below and also holds the camera.

The upper side of the bottom plate has 24 holes for the **M4 stainless steel hex nuts (item 4.8)**; it is thus possible to mount the camera in increments of 15 degrees. In order to facilitate the mounting process, all holes have numbers from 1 to 8.



The bottom plate closes off the outdoor wall mount from below and also holds the camera

Three **standard positions** are identified as described below:

- PIR sensor of the camera looks straight **ahead**: Use the holes marked by the number **1** for the **M4 hex nuts (item 4.8)**.
- PIR sensor of the camera looks to the **right**: Use the holes marked by the number **3** for the **M4 hex nuts (item 4.8)**.
- PIR sensor of the camera looks to the **left**: Use the holes marked by the number **7** for the **M4 hex nuts (item 4.8)**.



PIR looking straight ahead: 1



PIR looking to the right: 3



PIR looking to the left: 7

2.12.4 Mounting the Camera on the Bottom Plate

In order to mount the camera to the bottom plate, use three of the supplied **Allen screws M4x25 mm (item 4.9)**, three **washers Ø 4.3 mm (item 4.10)** and the corresponding hex nuts.

Caution

When fastening the Allen screws using the 3 mm Allen wrench, make sure that you do not scratch the camera dome!

- Guide the **connector cables of the camera** from below (smooth side) through the round opening of the bottom plate (item 4.2).



- Position the camera on the underside of the bottom plate so that the PIR sensor points in the desired direction and the hole in the housing to the right of the PIR sensor is situated above a hole in the bottom plate.
- Insert the **first M4 hex nut (item 4.8)** into the corresponding hole of the bottom plate, then use one **Allen screw M4x25 mm (item 4.9)** and a **washer Ø 4.3 mm (item 4.10)** and *lightly* fasten the screw.
- Turn the bottom plate around and determine the number next to the hex nut you just inserted (example: PIR points straight ahead → hole should have the number **1**). Insert the remaining **M4 hex nuts (item 4.8)** into the other holes with the same number (**1** in this case) and use the two **Allen screws M4x25 mm (item 4.9)** with the corresponding washers to mount the camera to the bottom plate.

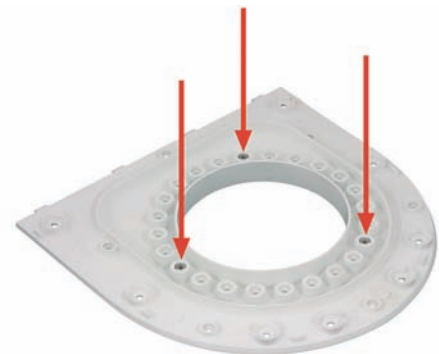

Mount the camera housing to the bottom plate *before* mounting the bottom plate itself

PIR sensor of the camera looks straight ahead: **Position 1**

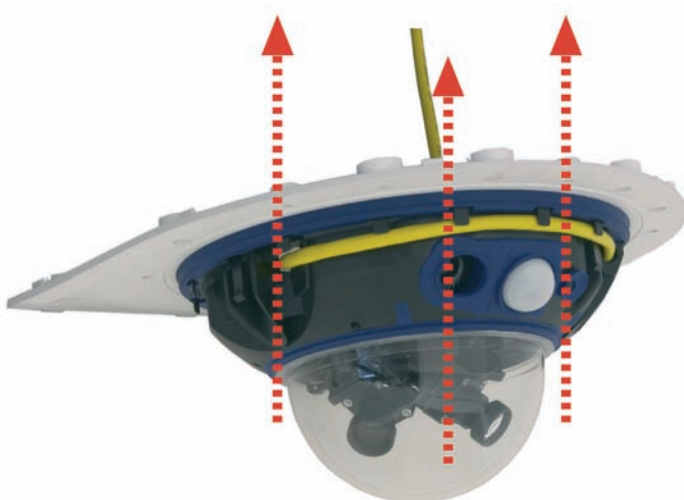

Mounting the camera on the bottom plate

- **Make sure** that you have properly fastened the three **Allen screws M4x25 mm (item 4.9)**.

2.12.5 Connecting the Camera and Mounting the Bottom Plate

- Plug the **camera connector cables** into the appropriate wall outlets or adapters.
- Insert the **(straight) wall side of the bottom plate** into the back of the wall mount as shown in the figure.



Pushing the bottom plate into the Outdoor Wall Mount

- Push the front of the bottom plate upwards.
- **Mount** the bottom plate to the wall mount (**eight Allen screws M4x10 mm; item 4.7**) and make sure the screws are all properly fastened.

Max. torque for all screws: 4 Nm (2.95 lbf ft)

2.13 Finishing the Installation

2.13.1 Establishing a Connection to the Camera

Establish a connection to the camera as described in section 3.1.2, *Connecting the Camera*.

2.13.2 Adjusting the Lenses, Visual Check

Make sure that you see the live image of the camera on the monitor of your computer or laptop. Now adjust the lenses one by one until you see the desired image area on your monitor:

- Remove the camera **dome** using a lint-free cotton cloth.
- Release the lens' **lock ring**, adjust the **image focus** and tighten the lock ring again. **Never turn the lens to far into the lens mount and never apply excessive force when doing so as this would damage the lens mount otherwise.**



Lock ring secures lenses against vibrations

Note

Use the **focusing aid** of the MOBOTIX camera to properly adjust the lens' focus (see Section 4.3.3, *Image and Audio Settings, Quick Controls* in the *Software Manual*).

- Make sure that the lenses' ribbon cables are properly secured.
- Make sure that the **cable clamps** are properly seated. This will prevent the cable clamps from falling into the dome and obscuring parts of the image once the camera has been mounted.

Caution (Only 135 mm Tele Lenses)

Image Focus: Due to the lens effect of the dome, the focus of the 135 mm tele lens is shifting slightly once the dome has been mounted. Before mounting the dome, the tele lens should be turned about **90° in counter-clockwise direction** (as seen from the lens' front). Make sure that you check the focus of the live image in your browser with the dome installed and re-adjust the lens, if required.

- **Mount the dome** again using the cotton cloth and finally check the focus of both lenses on the monitor.

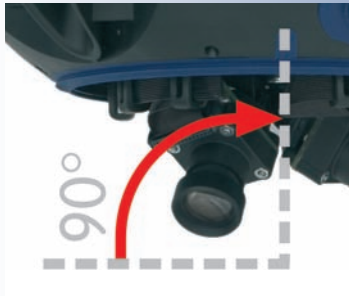

2.13.3 Adjusting the Single Images of a MOBOTIX D12D-180°

The **MOBOTIX D12D-180°** has two 90° wide-angle lenses that are mounted on a lens bridge in such a way that they produce a 180° dual image. Due to tiny manufacturing tolerances, the images of the two lenses do not always fit perfectly.

When installing a **D12D-180°**, you need to follow these extra steps to create a good combined image from the two single images (left and right image sensor).

Step 1: Activating the 180° View

When accessing the images of the D12D-180° for the first time, the camera only shows the image of the right image sensor. Click on the **Camera Selection** Quick Control above the live image and set the value in the field alongside to **180° View**. If the image does not fit on your monitor, because the camera currently shows a larger format than VGA (i.e. Mega), use a different Quick Control to set the image format to VGA: **Resolution** Quick Control > **VGA (640x480)**.

When examining the live image, the following issues are apparent:

- Parts of the image information (especially at the upper and lower image border) are duplicated.
- Both images are slightly tilted in the same direction.
- The camera shows the controls for adjusting the 180° view in the left bottom corner of the live image (these will be hidden again later).

Make sure to use a monitor with a high resolution and a wide screen for this work!

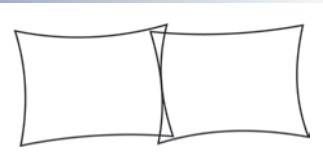

Controls for configuring the 180° View



Step 2: Zooming the single images

This step consists of increasing the zoom of the two single images so that the gray area at the center of the image and the duplicate image information is not visible any more.

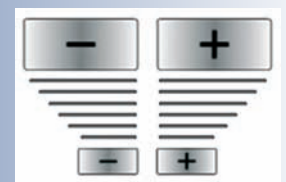
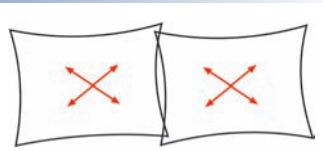

Zooming the single images

To achieve this, simply click on the corresponding control to increase or decrease the zoom level. Note that clicking on the small icon close to the bottom image border results in small changes while clicks farther away from the border on the larger icon result in larger changes.

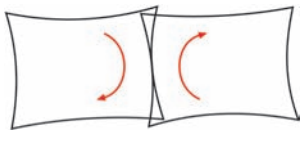

Tilting the single images

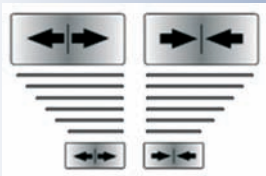
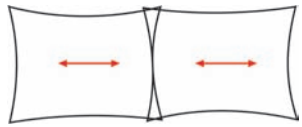

Merging the single images



Step 3: Tilting the single images

If the single images are tilted in the same direction, you can change this by clicking on the corresponding control.

- Clicking on the left symbol turns both images in clockwise direction, clicking on the right symbol turns both images in counter-clockwise direction.
- The distance of clicking from the bottom border controls the angle of rotation: the farther away from the border you are clicking, the larger the angle of rotation will be.

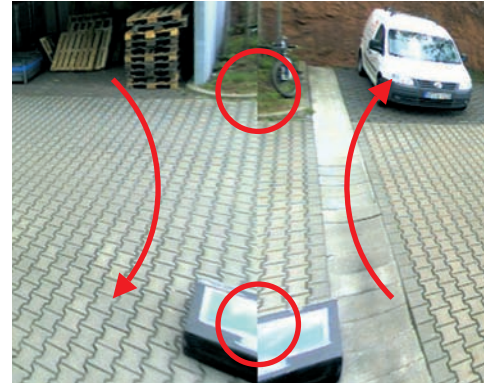

Step 4: Merging the single images

Click on the corresponding control to merge the single images so that they are congruent at the seam line.

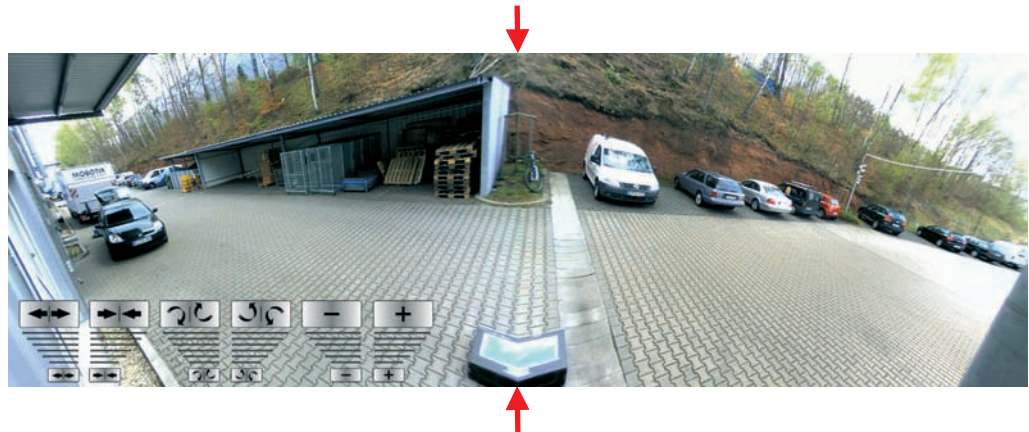

Step 5: Deactivating the 180° configuration

This last step stops the configuration mode of the **D12D-180°**. Click on the **180° View Configuration Quick Control** and set the value in the field alongside to *Disable*. In order to use the new configuration after the next reboot, the camera will



ask you to store the full configuration. **It is strongly recommended to store the configuration; if you do not save your changes now, they will be lost after the next reboot.**

Caution

The **zoom features** of the **D12D-180°** are **deactivated** if the **180° View** has been activated!

If you would like to manually store the complete configuration, you can do so using the **Manage Settings > Store Complete Configuration** Quick Control above the image on the Live screen. Note that you need administration rights on the camera to store the configuration.

Finding the Lens Tilt Angle for the Best Image

In order to properly align the two single images, you need to make sure that the camera is not tilted too far downwards; if this is the case, the single images do not fit very well to one another. The image area that is most interesting for the viewer should be in the center of the image so that the camera creates an image that is as close to reality as possible.



D12D-180° tilted too far down: Level area seems to buckle

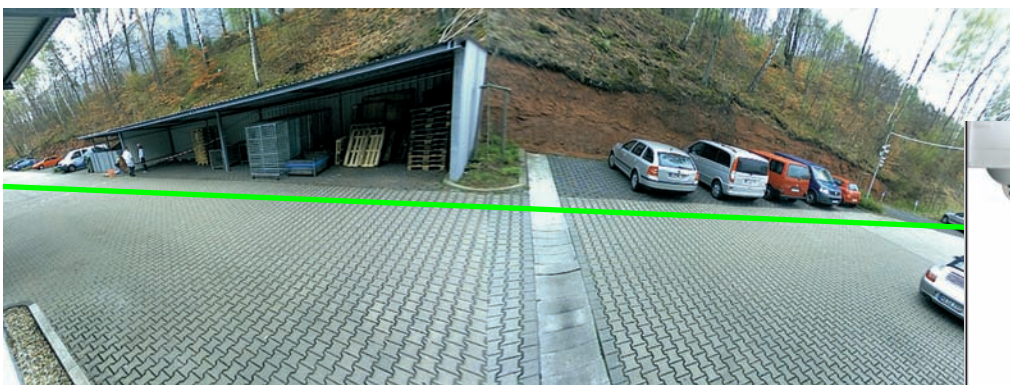

Optimum adjustment of D12D-180°: Level area is displayed correctly

2.13.4 Mounting the Dome and the Camera's Outer Shell

Once the wall mount and the camera have been mounted, it's time to mount the **dome**:

- Take a cotton cloth and mount the dome onto the camera by turning it in **clockwise direction**. This will prevent accidental repositioning of the lenses through the rest of the mounting process.

Important: Position the mark of the dome pointing towards the camera's PIR sensor and gently seat the dome into the threads. This will prevent misaligning the threads of the dome!

Note: The camera is delivered with an additional tinted dome with reduced transparency!



Next, install the camera's **outer shell**:

- Only mount the outer shell if you have finished setting the lenses' focus and mounted the camera dome.
- Hold the outer shell so that the round hole of the shell is positioned over the PIR sensor of the camera. Gently press the shell into the shell's seats in the camera housing.



Tighten the dome by turning **clockwise**

Align the **mark** of the dome with the PIR sensor

The outer shell snaps into its seats at the camera housing by pressing gently down on the ring

Dismount the outer shell using the supplied custom tool (see section 2.14, *Dismantling the Camera*).

Caution

The MOBOTIX D12D-Outdoor is only **weatherproof** if the camera housing has been mounted tightly to the bottom plate and both the camera dome and the outer shell are properly seated.

2.14 Dismantling the Camera

Start dismantling the camera by removing the outer shell of the D12. For removing the outer shell of the D12, you need the supplied custom tool; for dismantling the dome, a lint-free cotton cloth is required (see section 2.16.1, *Cleaning Instructions*).

(1) Remove the outer shell

For security reasons, the outer shell can only be removed using the supplied custom tool. Proceed as shown in the figure below:

- Remove the outer shell using the supplied custom tool. Insert the tip of the custom tool into the three small holes of the shell, one by one. Gently lift the shell near each hole to loosen the shell.
- Remove the outer shell from the camera.

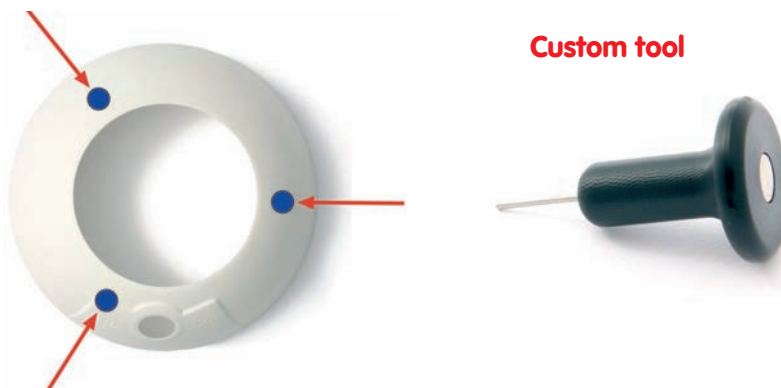

For **security reasons**, the outer shell can only be removed using the supplied custom tool

Allen wrench is included in delivery

(2) Remove the cable cover

Remove the 4 mm Allen screws of the cable cover and remove the cover.

Note: If the cable cover cannot be removed by hand, take a screwdriver to lift it out of its seat. Insert the screwdriver into the grooves shown below and gently lift the cable cover.

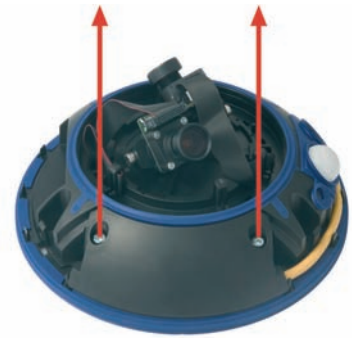

(3) Remove the Ethernet and ISDN cables

Remove the cables one by one by gently pressing down the lock and pulling each cable out of its socket. Now take the cables out of the cable guides at the bottom of the housing and remove them through the appropriate holes in the housing. **Take care to avoid any damage to the cable guides at the bottom of the camera housing** (see figure).



(4) Remove the dome

Take a cotton cloth and remove the transparent dome by turning it in **counter-clockwise direction**.



Dismount the dome by turning it **counter-clockwise**

(5) Remove the cable clamps in the dome's interior

Gently press the sides of the cable clamps and lift the clamps from their seats.

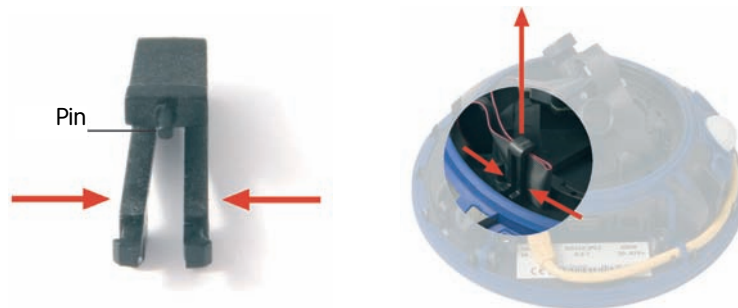
**(6) Remove the lens connectors**

Press the clamps on the side of each ribbon cable connector, then gently pull the connectors from the lens' pin header.

**(7) Remove the central lens screw and the lens units**

Remove the central lens screw using the supplied 3 mm Allen wrench. Lift the lens units out of their seats.



2.15 Mounting the Camera to Different Surfaces

Notes

Mounting the camera outdoors:

When using a **wall outlet for an outdoor installation**, you should use silicone sealant to prevent water from entering the wall outlet and the cabling by sealing off the mount's base against the wall.

Wall thickness:

Make sure that the wall is at least five centimeters (2 in) thick if you intend to use the supplied dowels and screws.

Caution: The screws should be at least 15 mm (5/8 in) longer than the dowels

Max. torque for all screws: 4 Nm (2.95 lbf ft)

Find the folded **drilling template** at the end of the manual!

Mounting Supply

Item	Count	Part Name
M.1	3	Dowels 10 mm
M.2	3	Stainless steel washers Ø 9 mm
M.3	3	Stainless steel wood screws with hex head 8x70 mm

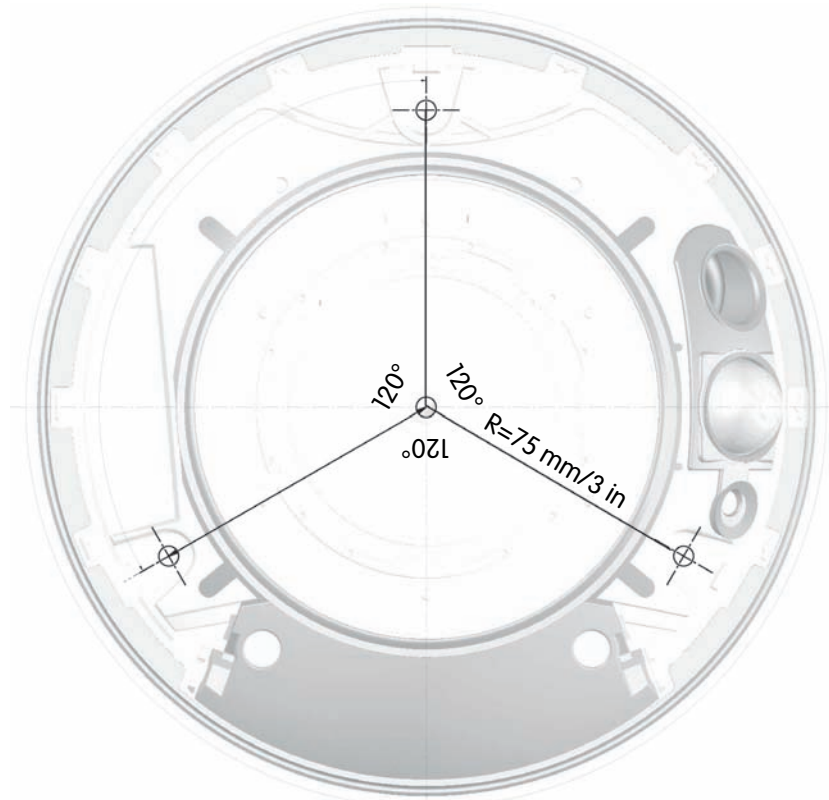

Caution

Never use screws with countersunk heads to fasten the mount, as these screws will destroy the mount.



2.15.1 Mounting to a Wooden Wall or Surface

Use the supplied materials and suitable tools for mounting the camera to a wooden wall or surface. Follow the *Mounting Instructions* below to complete the installation.

Use the supplied wood screws without dowels, if you are mounting the camera to a thick wooden wall or structure. If the wooden wall or surface is too thin or if concrete or brick is behind the wood, you should also use the supplied dowels for mounting. Make sure that you know how thick the wooden wall or surface is, before you start drilling the holes. Please also follow the instructions in the following sections.

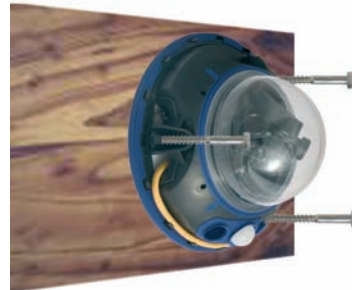

Required Materials:

- 3 hex head screws (item M.3)
- 3 washers (item M.2)

Required Tools:

- Wrench or ratchet for M6 hex heads
- Allen wrench 5 mm (item 1.11)
- Possibly power drill and drill bit for pre-drilling

Mounting Instructions:

- Slide a washer (item M.2) over every hex head screw (item M.3).
- Press the camera against the wooden wall or surface.
- Insert the screws (with washers) into the openings in the foot of the camera.
- Tighten the screws using the wrench or ratchet (max. torque is 4 Nm/ 2.95 lbf ft).

Max. torque for all screws: 4 Nm (2.95 lbf ft)

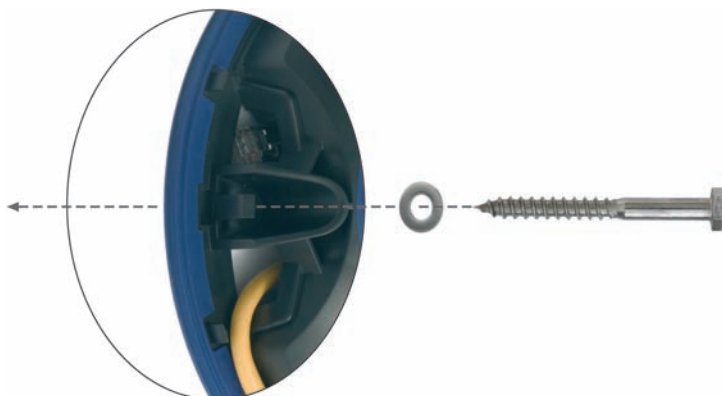

Caution: The screws should be at least 15 mm (5/8 in) longer than the dowels

Find the drilling template at the end of the manual

Max. torque for all screws: 4 Nm (2.95 lbf ft)



2.15.2 Mounting to a Drywall

Use the supplied materials and suitable tools for mounting the camera to a drywall. Follow the *Mounting Instructions* below to complete the installation.

Required Materials:

- 3 hex head screws (item M.3)
- 3 washers (item M.2)
- 3 dowels (item M.1)

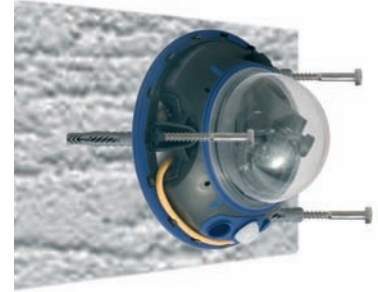

Required Tools:

- Power drill
- Suitable drill bit
- Hammer (optional)
- Wrench or ratchet for M6 hex heads
- Allen wrench 5 mm (item 1.11)

Mounting Instructions:

- Hold the drilling template at the position where you would like to mount the camera.
- Mark the holes for drilling with a pencil or a sharp object, then remove the drilling template.
- Drill the holes with the power drill where you just marked.
- Insert a dowel (item M.1) into each of the holes you just drilled. If required, use the hammer to press the dowels into the holes.
- Slide a washer (item M.2) over every hex head screw (item M.3).
- Hold the camera against the wall. Make sure that the openings in the mount's foot line up with the dowels.
- Insert the screws (with washers) into the openings in the foot of the camera and into the dowels.
- Tighten the screws using the wrench or ratchet (max. torque is 4 Nm/ 2.95 lbf ft).

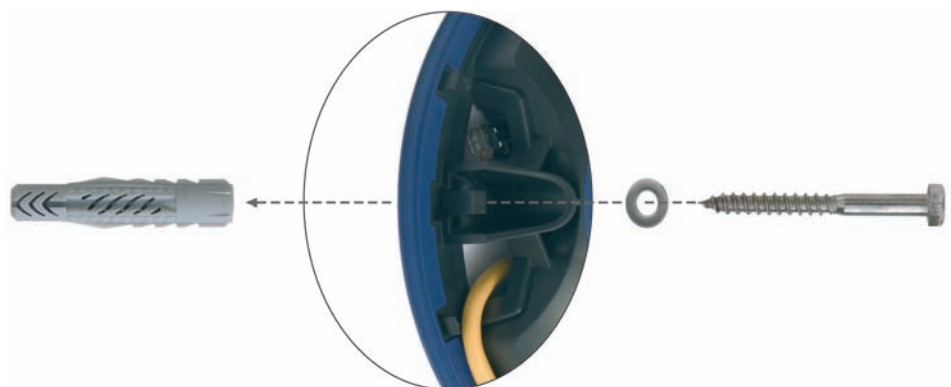

2.15.3 Mounting to a Concrete or Brick Wall

Use the supplied materials and suitable tools for mounting the camera to a concrete or brick wall. Follow the *Mounting Instructions* below to complete the installation.

Required Materials:

- 3 hex head screws (item M.3)
- 3 washers (item M.2)
- 3 dowels (item M.1)

Required Tools:

- Power drill
- Suitable drill bit
- Wrench or ratchet for M6 hex heads
- Hammer (optional)
- Allen wrench 5 mm (item 1.11)



Caution: The screws should be at least 15 mm (5/8 in) longer than the dowels

Mounting Instructions:

- Hold the drilling template at the position where you would like to mount the camera.
- Mark the holes for drilling with a pencil or a sharp object, then remove the drilling template.
- Drill the holes with the power drill where you just marked.
- Insert a dowel (item M.1) into each of the holes you just drilled. If required, use the hammer to press the dowels into the holes.
- Slide a washer (item M.2) over every hex head screw (item M.3).
- Hold the camera against the wall. Make sure that the openings in the mount's foot line up with the dowels.
- Insert the four screws (with washers) into the openings in the foot of the camera and into the dowels.
- Tighten the screws using the wrench or ratchet (max. torque is 4 Nm/ 2.95 lbf ft).

Find the drilling template at the end of the manual

Max. torque for all screws: 4 Nm (2.95 lbf ft)

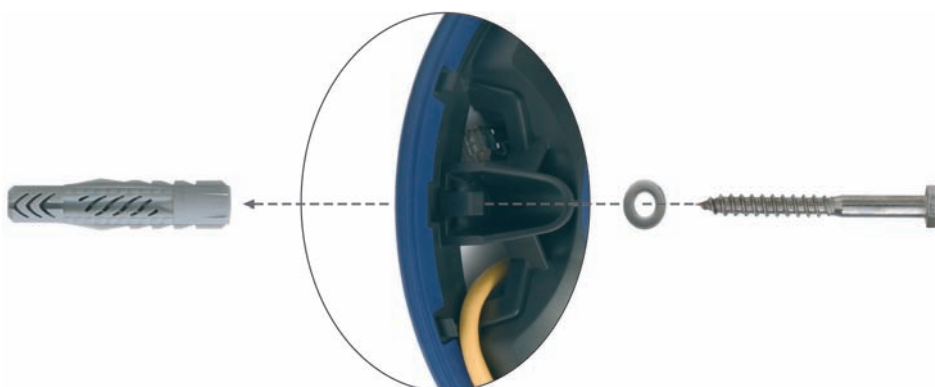

2.15.4 After Mounting the Camera

Controlling the image position and the focus

- Remove the dome using a lint-free cotton cloth or the supplied plastic protection.
- Loosen the screw in the center of the camera using the supplied Allen wrench (item 1.11) so that you can easily turn and tilt the sensor units.
- Display the camera images on a computer monitor, then turn and tilt the sensor units until you have found the best position.
- If required, clean the lens' surfaces using a clean, lint-free cotton cloth.
- Check the image focus (tele lens L135 only) and the camera position on the computer monitor. Please also see section 2.13.2, *Adjusting the Lenses, Visual Check*.
- Mount the dome again using a lint-free cotton cloth or the supplied plastic protection. Make sure that you insert the dome into the housing with the mark of the dome pointing towards the camera's PIR sensor, in order to preserve the camera's weatherproofness!

WWW.VTVENDAMI.RATONA.COM

2006-06-12 WED 11:29:05



2.16 Notes

2.16.1 Cleaning Instructions

Cleaning the Dome

- In order to protect the dome from being scratched and from getting dirty, only handle the dome using a soft cotton cloth or the protective plastic of the camera's shipping box.
- You should clean the dome at regular intervals. Always use a lint-free cotton cloth for this purpose.
- If the dirt is more persistent, add a mild alcohol-free detergent without abrasive particles.
- Make sure you instruct cleaning personnel on how to clean the camera.

Cleaning the Lens

If the lens is dirty from the installation process, clean the lens using a lint-free cotton cloth. Make sure that the lens is still in focus after cleaning and adjust the lens' focus if required.

2.16.2 Wiring, Fire Prevention, Lightning and Surge Protection

When installing the wiring inside or outside of buildings, make sure you always adhere to the relevant regulations on wiring, fire prevention and protection against lightning.

MOBOTIX recommends having MOBOTIX cameras installed only by certified specialists accustomed to installing network devices and having proper respect for the applicable regulations regarding lightning protection and **fire prevention** as well as the current technology for preventing damages from electrical surges.

More information is available at an institution such as the **International Electrotechnical Commission** (IEC, www.iec.ch) or at a manufacturer of protection devices against lightning and electrical surges, such as Dehn (www.dehn.de).

Wiring

When installing the wiring, make sure to follow these guidelines:

- **Data cable:** Make sure you only use double-shielded CAT 5/7 cable (**S/STP**) for Ethernet connections.
- **Outdoors:** Installing the camera outdoors requires special precautions and measures regarding the cables as well as lightning and surge protection (see further below in this section).
- **Wire lengths:** The cable segments must not exceed the maximum allowed cable lengths in order to ensure proper data transfer (see section 3.2, *Connecting the Camera to the Network and to the Power Supply*).



Use double-shielded CAT 5/7 cables for wiring

- **Avoiding induction:** When running data cables parallel to existing regular power lines or high-voltage wires, make sure you observe the minimum distances to the power cables.

Make sure that you follow these important instructions!

Fire Prevention

When installing the power lines to the camera, make sure you always adhere to the relevant regulations on wiring and fire prevention at the site of the installation.

Lightning and Surge Protection

To prevent damage from lightning and power surges, make sure you follow these guidelines:

- **Lightning conductors:** In areas exposed to lightning (e.g. on roofs), a distance holder (1 m (3 ft) above and away from the camera) and proper lightning conductors need to be installed in order to prevent lightning strikes into the camera and to ensure that the energy of a lightning strike is properly led to the ground.
- **Surge protection:** Make sure you have installed proper protection against electrical surges in order to prevent damage to the camera, the building and the network infrastructure. This includes surge protectors for 19" racks, adding an uninterruptible power supply (UPS) to the MOBOTIX camera, and installing surge arresters or similar for routers, switches, servers, etc.



Not required if network components are used that support the PoE (Power over Ethernet) standard IEEE 802.3af!

Power supply for smaller systems

Intelligent and robust power supply thanks to DIN rail installation

Zero maintenance and durable as these devices do not require fans

2.17 Camera Accessories

Power supply (MX-SNT-E/U/GB/J/AUS01-30-RJ)

The MOBOTIX power supply is required if you do not use a **Network Power Rack** or **Network Power Box**, or a PoE-compatible switch or router.



Network Power Adapter (MX-NPA-3-RJ)

The Network Power Adapter allows injecting the power supply for the MOBOTIX camera into the network cable. It thus allows using the network cable for connecting to the camera and for remotely supplying power (up to 100 m (300 ft)). The Network Power Adapter is required, if you are using the universal power supply, and if power is not supplied using a PoE switch/router or a MOBOTIX Netpower Box/Rack.



Netpower Box for up to 4 Cameras (MX-NPR-4)

The MX-NPR-4 allows supplying power to up to four MOBOTIX cameras via the network cable. The NPR-4 thus replaces four separate power supplies and four Network Power Adapters. The Netpower Box delivery includes a (detachable) clip at the back, which simply clicks onto DIN rails.



Netpower Rack for 8/20 Cameras (MX-NPR-8/20)

The MX-NPR-8/MX-NPR-20 allow supplying power to up to 8/20 MOBOTIX cameras, respectively, via the network cable. These NPRs thus replace 8/20 separate power supplies and the same number of Network Power Adapters; they are easily mounted in 19" racks (2 rack units).



Advantages of MOBOTIX PoE Products

- Zero maintenance and durable without fans.
- Higher reliability of the system as a whole, since standard switches without PoE can be used (lower risk of failure).
- Easy installation on DIN rails using supplied adapter (MX-NPR-4) or in 19" racks (MX-NPR-8/20).

Outdoor Wall Mount (MX-WH-Dome)

When mounted to the **Outdoor Wall Mount**, the D12 can be used outside for enhanced outdoor surveillance. Together with the Outdoor Wall Mount, the MOBOTIX D12 reaches protection class **IP65** (absolutely dustproof, resistant against water jets). Operating temperatures may vary between -30°C and $+60^{\circ}\text{C}$ (-22°F to 140°F), making it the ideal camera for the most demanding weather situations.



Outdoor Wall Mount from sturdy PBT 30GF

Corner and Pole Mount (MX-MH-Dome-ESWS)

If you are intending to mount the camera to the corner of a building or a pole, you should consider using the Corner and Pole Mount together with the Outdoor Wall Mount. This Corner and Pole Mount is made of **3 mm powder-coated stainless steel (white)** and has been designed specifically for outdoor use. The supplied stainless steel straps allow attaching the mount to poles with diameters between **60 and 180 mm (2.4 to 7.1 in)**; see section 2.11, *Mounting the Corner and Pole Mount*.

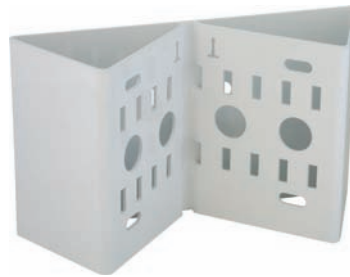

Corner and Pole Mount: Outdoor quality made of 3 mm stainless steel

Split Cable for ISDN-Only Power Supply (MX-OPT-ISDN-SPLIT)

If only ISDN is available for the camera and only one cable should be used for connecting the camera, you will need to inject power into the 8-wire cable using either a **power supply** and the **Network Power Adapter** or an **MX-NPR-4/8/20**.

Power injection into one cable when using only ISDN

3 OPERATING THE CAMERA

3.1 General Procedure

The MOBOTIX camera **does not require any software installation**; all you need is your preferred browser with JavaScript support to operate the camera. Thus, the MOBOTIX camera is supported by all common operating systems (such as **Windows, Linux, Macintosh, ...**).

3.1.1 Establishing the Power Supply to the Camera

You can choose between the following options:

- **External power supply and Network Power Adapter (MX-NPA-3-RJ):** Power supply of one camera injected into the network cabling (max. length 100 m/110 yd), from the NPA to the **10BaseT/NET** connector of the camera (see section 2.17, *Camera Accessories*).
- **Network Power Box/Rack (MX-NPR-4 or MX-NPR-8/20):** Power supply of 4/8/20 cameras injected into the network cabling (max. length 100 m/110 yd), from the NPR to the **10BaseT/NET** connector of the camera (see section 3.2.5).
- **Power over Ethernet:** Power supply using network components according to the PoE standard **IEEE 802.3af** (section 3.2.6).

3.1.2 Connecting the Camera

The camera has been set at the factory to support the following connection methods:

- **Ethernet interface of the camera** (10/100 Mbps Ethernet): Connect directly from a computer (using a crossover cable) or by using a Network Power Adapter or a switch and a regular patch cable. Launch a browser and enter the IP address printed on the camera label (e.g. **10.1.0.99**).

If the computer does not have an IP address in the **10.x.x.x** network range, you should install **MxControlCenter** (see section 3.3.3). The remaining process of connecting to the camera is based on Zeroconf/Bonjour. If this is not possible, you will need to briefly set the computer to the IP address range of the camera (see section 3.3.1).

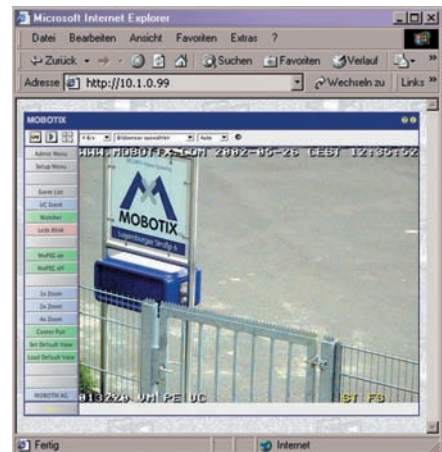

- **ISDN interface of the camera:** From a computer with ISDN card using a RAS connection (**linux/tux**). Launch a browser and enter the IP address printed on the camera label (e.g. **10.1.0.99**).

MOBOTIX PoE products do not require any fans and are robust and durable!

PoE components (IEEE 802.af) should not have fans as this would decrease the overall reliability of the entire system

Automatic camera search using **MxControlCenter** and **Zeroconf/Bonjour**

In the RAS box (computer):

- Camera phone number
- User: **linux**
- Password: **tux**

Once a connection has been established, click on the **Admin Menu** button to start configuring the camera. The **Admin Menu** controls all network settings (IP address, netmask, DHCP, etc.), ISDN behavior and all other options.

Note

After first booting a new MOBOTIX camera or after resetting to factory defaults, accessing the Administration menu (**Admin Menu** button) will automatically start the **Quick Installation** wizard. This is where you configure the most important camera parameters in a step-by-step manner. If you have completed the Quick Installation wizard at least once, the standard Administration menu will open when you click on the **Admin Menu** button.

Always use **Quick Installation** for initial configuration!

The configuration follows these steps:

- 1) Establish the first connection (Ethernet or ISDN).
- 2) Set the parameters for the desired connection type (Ethernet/ISDN) using the **Quick Installation** wizard.
- 3) Set the event control (events, actions and messages); see chapter 7, *Events, Actions and Messages*, in the *Software Manual*.
- 4) Set the storage target (internal storage, FTP, file server or Flash device).
- 5) Store the configuration in the camera's permanent storage (flash).



Live image: <http://preparkcam.mobotixserver.de>

3.2 Connecting the Camera to the Network and to the Power Supply

3.2.1 Notes on Cable Lengths and Power Supply

- The **power supply of the camera** can only be established using the 10BaseT/NET connector of the camera with the (pre-installed) network cable. In order to supply power via the network cabling we recommend the MOBOTIX PoE products (MxPoE, see also section 2.17, *Camera Accessories*):
 - for one camera using the **Network Power Adapter** (MX-NPA-3-RJ)
 - for up to four cameras using the **Network Power Box** (MX-NPR-4)
 - for up to 8 or 20 cameras using the **Network Power Rack** (MX-NPR-8/20)
- The **maximum length** of the network cable for remotely supplying power is **100 m (300 ft)**.
- Make sure that you only use switches or routers that support the **10/100 Mbps Ethernet interface** of the camera. Check the LED activity of the corresponding port at the switch or router. When operating many cameras, please also see section 4.11, *Operating Many Cameras*, in the *Software Manual*, for additional hints.
- It is highly recommended to use **uninterruptible power supplies (UPS)**, which also protect the cameras and the network components against electrical surges.
- **Advantages of MOBOTIX PoE Products:**
 - Zero maintenance and durable without fans.
 - Higher reliability of the system as a whole, since standard routers/switches without PoE can be used (lower risk of failure).
 - Easy installation on DIN rails (MX-NPR-4) or in 19" racks (MX-NPR-8/20).
- If you are using **IEEE 802.3af Power-over-Ethernet network components** for supplying power to MOBOTIX cameras, make sure that these components do not have a fan. Since the power consumption of MOBOTIX cameras is very low compared to other products, the reliability of the entire system is increased, thus extending the life of these components.

Uninterruptible power supply (UPS) should be installed

MOBOTIX PoE products have zero maintenance and are durable as the systems do not require fans

Use the MOBOTIX MX-NPR-4 for smaller installations

Use the 19" MOBOTIX Netpower rack-mount units to supply power to 8 or 20 cameras (MX-NPR-8 or 20)

Make sure not to exceed the maximum cable lengths

Maximum Cable Lengths (ISDN)

Connection to **ISDN outlet**: max. **5-10 m (16 to 33ft)**

Connection to **NT (without term. resistors)**: max. **5-10 m (16 to 33 ft)**

Connection to **NT (with termination resistors)**: **120 m (130 yd)**

Caution

Missing termination resistors and wrong cable lengths are the most common installation errors!
Always observe the instructions regarding maximum cable lengths and proper ISDN termination!

3.2.2 Camera Startup Sequence

As soon as the camera's power supply has been established, the 4 LEDs (behind the PIR cover of the camera) will show the progress of the starting sequence:

- **Hardware test:** After the power has been connected, the **LEDs 1 and 5** will light up for about two seconds. The camera's computer (boot loader) checks the camera hardware.
- **Backup system test:** The camera checks the operating system. **In case of an error**, the camera will start using the backup operating system, allowing you to re-install the system software.
- **Unpacking the OS:** The boot loader unpacks the operating system from the Flash EPROM and copies it to the camera's memory (the **LEDs 1 and 5** light up for about 10 seconds).

Starting the OS: The Linux operating system unpacks its data to the ramdisk and initializes the system. All operating system components are verified against their checksums in order to detect changes.

- **Boot mode (factory IP address/DHCP):** If the magnetic side of the supplied custom tool is pressed to the spot marked **L**, the camera starts either using its factory default IP address (**all LEDs light up**, see section 3.3.6, *Starting the Camera Using the Factory IP Address*) or with DHCP support (**LEDs 0 and 5 light up**, see section 3.3.5, *Starting the Camera With an Automatic IP Address (DHCP)*).
- **Starting the applications:** Once the application software is running, the **LEDs 1 and 5** start blinking and **LED 0** burns continuously (provided the LEDs have not been switched off for this configuration). You can now access the camera using a web browser.

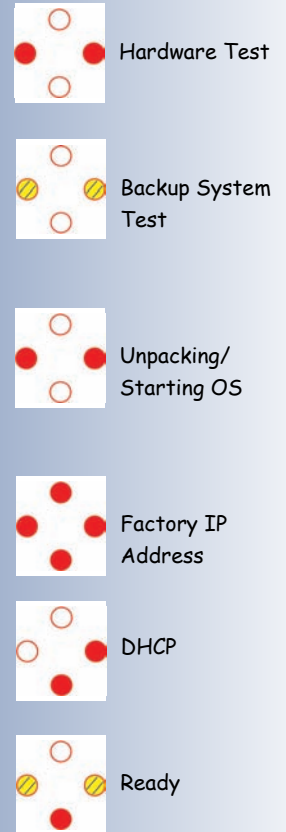

Note

During the startup sequence, the LEDs will always light up, even if they have been deactivated in **Admin Menu > LED Setup**.



Default signals of the camera LEDs:

- 0 Power
- 1 Image processing/event
- 2 Ethernet
- 5 Image processing/event

MOBOTIX power supply and Network Power Adapter required

3.2.3 Power Supply (MxPoE) Using a Switch

- (1) Connect the **10BaseT/NET** connector of the camera to the **Camera** connector of the Network Power Adapter.
- (2) Connect the **LAN/Power** connector of the NPA to an Ethernet connector of the switch/router or the Ethernet wall outlet.
- (3) Plug the RJ45 connector of the external power unit into the **PC/Power** connector of the Network Power Adapter.

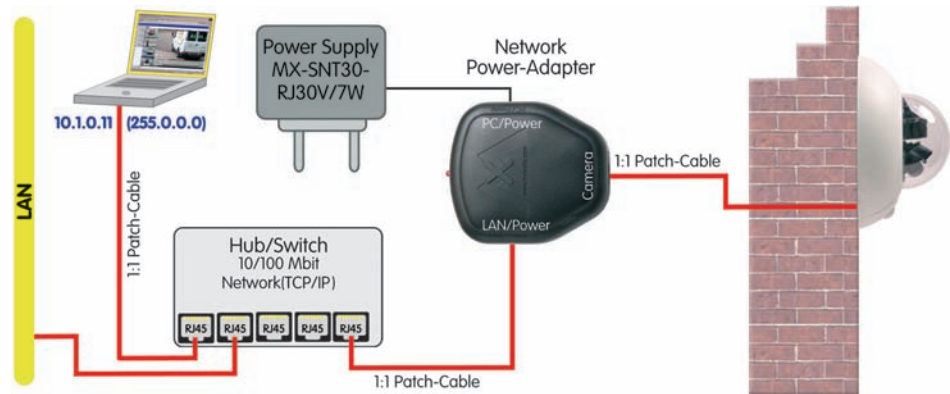

3.2.4 Power Supply (MxPoE) When Connected Directly to a Computer

- (1) Connect the **10BaseT/NET** connector of the camera to the **Camera** connector of the Network Power Adapter.
- (2) Connect the **PC/Power** connector of the Network Power Adapter to the Ethernet port of the computer.
- (3) Plug the RJ45 connector of the external power unit into the **LAN/Power** connector of the Network Power Adapter.

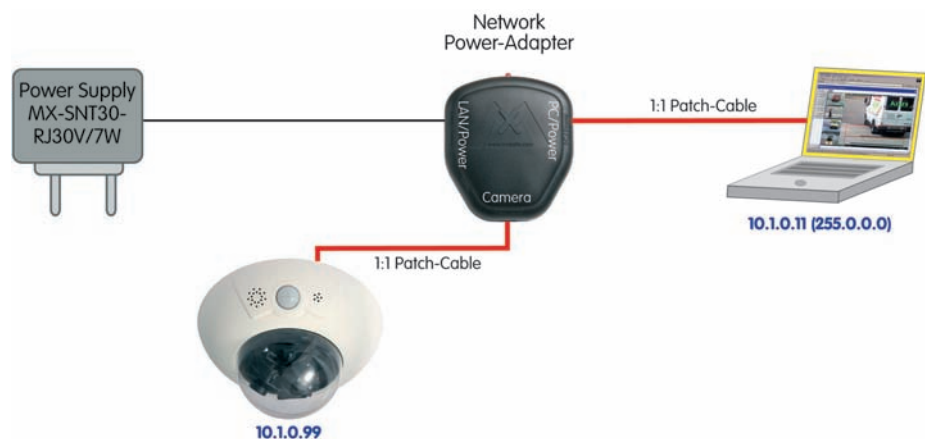

MOBOTIX power supply and Network Power Adapter required

The Network Power Adapter replaces the crossover cable when directly connecting to a computer

3.2.5 Power Supply Using a Network Power Rack (MxPoE)

- (1) Connect the **10BaseT/NET** connector of the camera to the **CAM** connector of the **Network Power Rack (MX-NPR-8/20)** or the **Network Power Box (MX-NPR-4)**.
- (2) Connect the **LAN** connector of the Network Power Rack to an Ethernet connector of the switch/router.

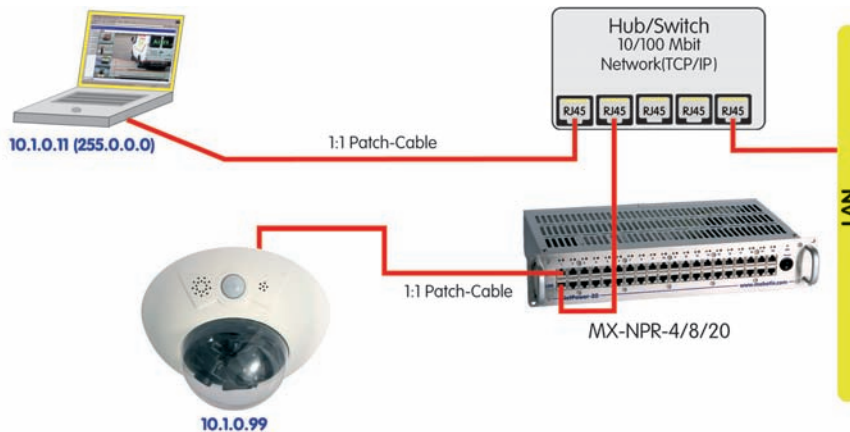

A **Network Power Box (MX-NPR-4)** is connected in the same way.

3.2.6 Power Supply (PoE IEEE 802.3af) Using Power-over-Ethernet Products

Connect the factory pre-installed cable of the camera to the Ethernet connector of the PoE switch/router. The switch/router needs to support the **PoE standard IEEE 802.3af**.

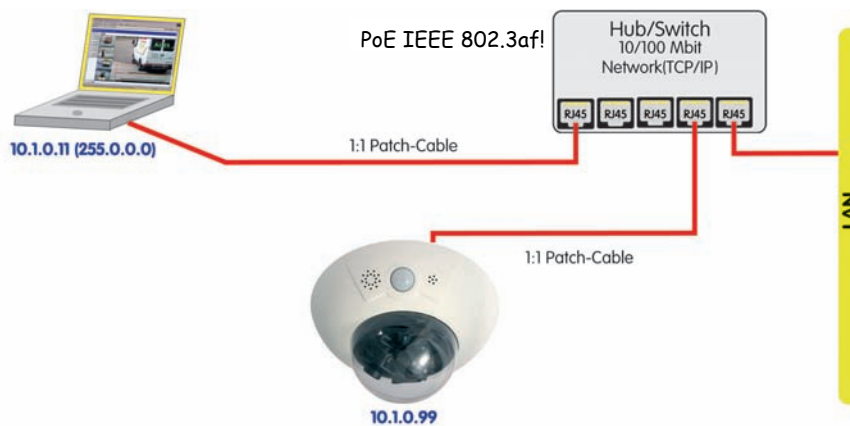

MOBOTIX Network Power Rack or Network Power Box required

Use the 19" MOBOTIX Netpower rack-mount units to supply power to 8/20 cameras

Use the MOBOTIX Network Power Box for smaller installations

Uninterruptible power supply (UPS) should be installed

PoE switch/router according to IEEE 802.3af required

3.2.7 ISDN: Power Supply Using a Network Power Adapter

- (1) Push the designated connector of the ISDN split cable (*MX-OPT-ISDN-SPLIT*; optional accessory) into the **IOBaseT/NET** connector and the remaining cable into the **ISDN** connector of the camera.
- (2) Use an 8-wire (patch) cable to connect the **Camera** connector of the Network Power Adapter to the socket of the ISDN split cable.
- (3) Connect the **LAN/Power** connector of the Network Power Adapter to the ISDN S0 bus/NT.
- (4) Plug the RJ45 connector of the external power unit into the **PC/Power** connector of the Network Power Adapter.

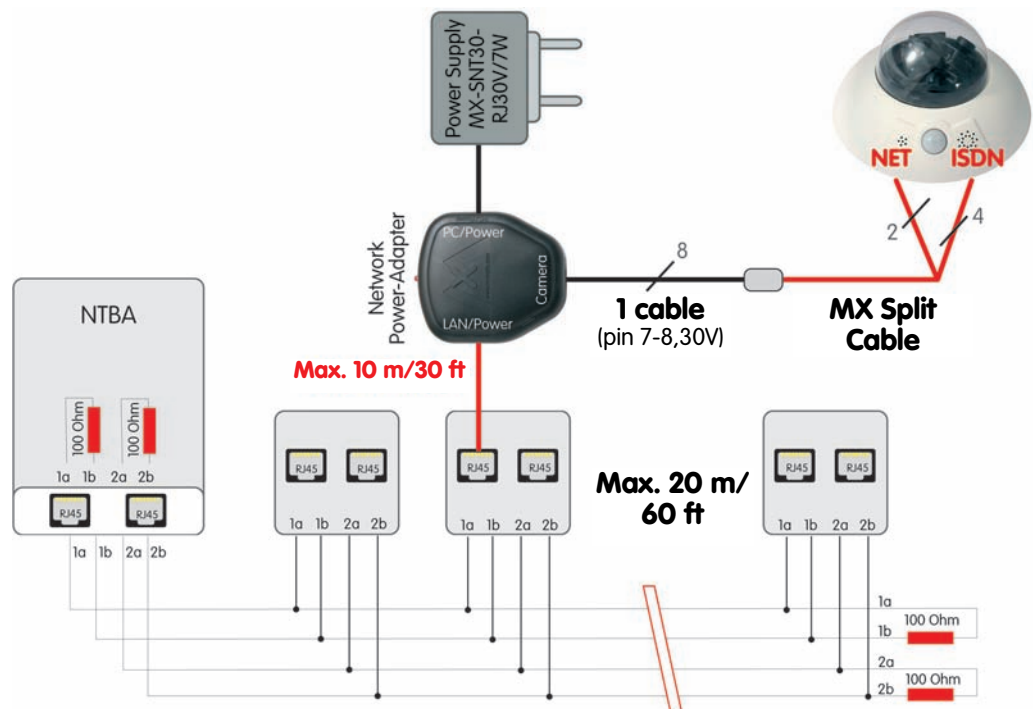

3.2.8 ISDN: Directly Supplying Power Using the External Power Supply

- 1) Connect the **ISDN** connector of the camera to the S0 bus/NT.
- 2) Plug the RJ45 connector of the external power supply into an RJ45 extension cable and plug the extension into the **10BaseT/NET** connector of the camera.

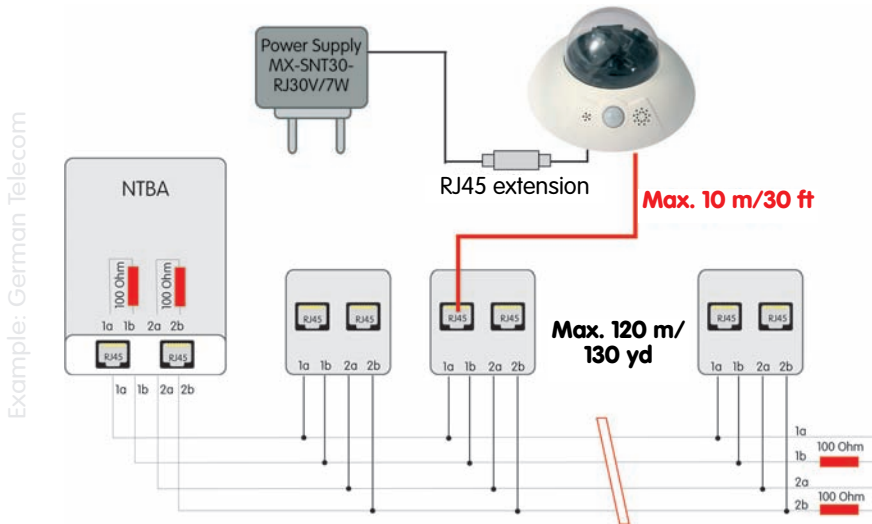

Up to 12 wall outlets, with up to 8 devices attached

ISDN is a bus system, which requires termination (100 Ohms) at both ends

3.2.9 Ethernet and ISDN: Power Supply When Using Both

In order to use Ethernet and ISDN **simultaneously**, plug the Ethernet and ISDN cables into the corresponding connectors of the camera. **Power is supplied only via the Ethernet cable and the 10BaseT/NET connector of the camera** (using **MOBOTIX PoE products** or Power over Ethernet according to IEEE 802.af).



3.3 The First Image from the Camera

3.3.1 Preparing the Ethernet and ISDN Connections

In order to establish the first connection to the MOBOTIX camera, choose one of the following options:

- **Ethernet** (10/100 Mbps network):
 - **Automatic camera search and configuration** using **MxControlCenter** (free software for MOBOTIX cameras; section 3.3.3, *The First Image in MxControlCenter*)
 - **Manual configuration** (section *Preparing the Ethernet Connection*)
- **ISDN** (section *Preparing the ISDN Connection*)

Besides using **MxControlCenter**, you can also use a **browser** to access the camera (section 3.3.2, *The First Image in the Browser*).

In order to finish the camera configuration, you can use either **MxControlCenter** or the browser-based user interface of the camera (see section 4.3, *The Live Screen in the Browser*, in the *Software Manual*).

Preparing the Ethernet Connection

For this example, we will use a camera with the factory IP address **10.1.0.99**. **Replace this IP address with the IP address of your camera.** You will find this address on a **small sticker on the camera**. Accessing the camera is always the same and is independent of the connection type: simply enter the camera's IP address in the address field of the browser (see section 3.3.2, *The First Image in the Browser*).

Note

Pressing the **"L" key** with the magnetic side of the custom tool will prompt the camera to **announce its current IP address on the camera speaker**.

Your computer has to have a network or a wireless interface, and it should be in the same subnet as the camera. If your network also uses IP addresses of a class A network (e.g. **10.x.x.x**, network mask **255.0.0.0**), you should be able to access the camera directly (provided no other network device uses the same IP address).

Determine the IP address of your computer:

- Open a command shell (Windows) or a terminal (Linux/UNIX/OS X) and enter the following command:

Windows 2000/XP: `ipconfig`
Linux/UNIX und OS X: `ifconfig`

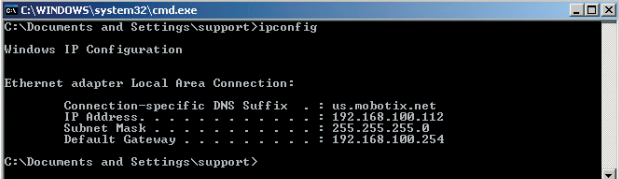

```

C:\WINDOWS\system32\cmd.exe
C:\Documents and Settings\support>ipconfig

Windows IP Configuration

Ethernet adapter Local Area Connection:

    Connection-specific DNS Suffix  . : us.mobotix.net
    IP Address . . . . . : 192.168.100.112
    Subnet Mask . . . . . : 255.255.255.0
    Default Gateway . . . . . : 192.168.100.254

C:\Documents and Settings\support>
  
```

Automatic camera search using **MxControlCenter** and **Zeroconf/Bonjour**

Caution: Netmask 255.0.0.0

Open a Command Prompt (Windows):
Start > Run, enter "cmd", then press [Return]

You will find the IP address of your Windows computer behind **IP address**; for Linux/UNIX and OS X computers, search for the **inet address** parameter of the **eth0** or **en0** device (the first network interface). If your computer does not use an IP address in the **10.x.x.x** range, you should change the network configuration of your computer or add a new IP address (see below).

Make sure that no other network device uses the camera's IP address:

- Open a command shell (Windows) or a terminal (Linux/UNIX/OS X) and enter the following command:
ping <factory IP address>

If you receive an answer from another network device although the camera is not connected, you will have to remove that device until you have reset the MOBOTIX camera to a free IP address. We recommend using the Quick Installation wizard for assigning a new IP address to the camera.

If your computer does not use an IP address in the 10.0.0.0 network (e.g. a 192.168.x.x or 172.x.x.x network), you should temporarily set a new IP address in the 10.x.x.x range:

Windows 2000/XP

- (1) Open the **Network Connections** and open the **Properties of LAN Connection**.
- (2) Double-click **Internet Protocol (TCP/IP)**.
- (3) On the **General** tab, activate the **Use the following address** option.
- (4) Enter an IP address (e.g. **10.1.0.11**) in the class A network (**10.x.x.x**) that is unique in your network and that is not the same as the camera's IP address.
- (5) Close all dialogs by clicking on **OK**.

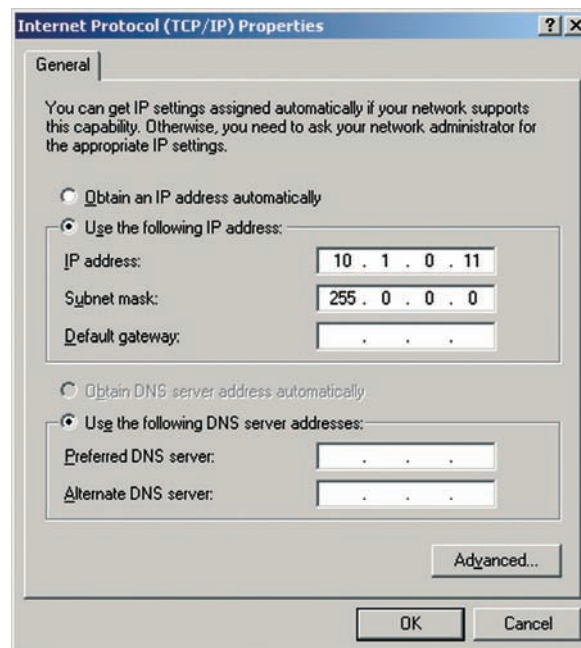

Linux/UNIX/OS X

- (1) Open a terminal as **root** user and enter the following command (**eth0** or **en0** is usually the first network interface):
Linux/UNIX: ifconfig eth0:1 10.1.0.11
OS X: ifconfig en0:1 10.1.0.11

The computer now has the additional IP address **10.1.0.11**, allowing it to access the camera with its factory IP address in the 10.x.x.x network (**10.1.0.99** in this example).

The factory IP address is printed on the sticker on the camera housing

Example: 10.1.0.99

Make sure that you use the IP address of your camera instead of 10.1.0.99!

Setting up a second IP address on Windows computers

Setting up a second IP address on Linux/UNIX and OS X computers

Requires an ISDN interface card in the PC

Assign different MSNs (phone numbers) to different cameras if they are on the same SO bus

Routing allows reaching different network addresses using different connection types/routes

Preparing the ISDN Connection

Your computer must have a properly configured ISDN card to establish a connection. If your network has an ISDN router, contact your network administrator for more information.

- (1) Create a new Point-to-Point connection (PPP) on your computer.
- (2) Enter **linux** as user name and **tux** as password.
- (3) Enter the phone number (a free MSN) of the ISDN port to which you connected the camera. If your computer is connected to an internal telephone system, make sure that you enter the prefix that is required to obtain an outside line.

The MOBOTIX camera can **automatically determine the MSN** (see section 5.2.2, *Quick Installation Pages in Detail*, in the *Software Manual*).

- (4) Establish the connection.

By factory default, the camera will react to every MSN of an ISDN port (you may change this in **Admin Menu > ISDN Connections**).

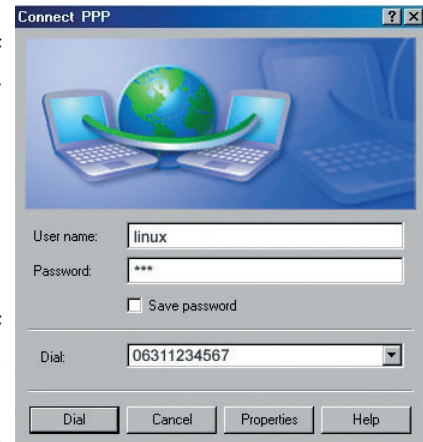

Note

Default ISDN access credentials for RAS connections

User Name: **linux**
Password: **tux**

Simultaneously Using ISDN and Ethernet Connections

In most cases, MOBOTIX cameras will be used either on an Ethernet LAN **or** on ISDN, not both. The gateway (for accessing computers outside of the local network) needs to be set manually for Ethernet; it is usually obtained automatically for ISDN.

In order for the camera to open an ISDN dial-out connection while both Ethernet and ISDN are used, the **default route** has to be set to the preferred ISDN dial-out connection (**Admin Menu > ISDN Data Connections > Dial-Out Connections**). See also section 5.2, *Quick Installation*, in the *Software Manual*.

If you would like to use connections to different networks for other tasks (e.g. backup to an FTP server), you can set more network routes in **Admin Menu > Routing**. See the **Routing** topic in the camera help for more information.

3.3.2 The First Image in the Browser

Now that you have successfully started the camera for the first time, you can access the camera using your preferred browser to see the live video stream and the user interface. Internet Explorer, Mozilla, Firefox, Safari or any other graphical browser with activated JavaScript is suitable. The operating system is of no importance, even PDAs can be used without any problems.

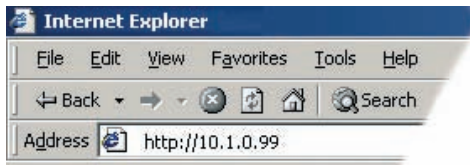

Camera access:
http://10.1.0.99
(example IP)

The factory IP address is printed on the sticker on the camera



Administration menu:
User name: **admin**
Password: **meinsm**

Softbuttons are **freely configurable**

After entering the camera's IP address in the browser address bar (e.g. **http://10.1.0.99**), you will see the Live screen of the MOBOTIX camera with its user interface controls, such as **softbuttons**, **buttons** for the different camera screens, pull-down menus (*Quick Controls*), icons for accessing the online help and the camera status, as well as status information elements above and below the live image.

Make sure that you use the IP address of your camera instead of 10.1.0.99!

Note

Credentials for accessing the Administration Menu

User name: **admin**
Password: **meinsm**

Browser Screens

Live: Live screen of the camera



Player: Playback of recorded image/video sequences



MultiView: Display of several cameras (Live or Player), management features

Camera Screens in the Browser

Per factory default, the MOBOTIX camera automatically shows the **Live** screen. You can set a different start page (e.g. the **Guest** screen) in **Admin Menu > Language and Start Page** as this screen only shows the current live image without any further controls.

The other available standard screens include the **Player** screen (playback of recorded images/video sequences) and the **MultiView** screen (shows several camera with live or recorded images). The **Multiwatcher** provides a view of several cameras via a "proxy" camera (especially interesting if you would like to access your cameras from outside of the network and have limited bandwidth) and the **PDA** mode offers a special screen for mobile devices.

For more information on camera screens, see section 4.1.1, *Camera Screens in the Browser*, in the *Software Manual* or in the **online help** of the camera's browser interface. Click on the yellow  icon in the top right corner of the **Live screen** to open the corresponding page of the online help.

Notizen:

A series of horizontal dashed lines for taking notes.

3.3.3 The First Image in MxControlCenter

Installing MxControlCenter

If you have an **MxControlCenter installation CD**, insert it into your computer drive.



If this is not the case or if you would like to update to a newer version, you can download the latest **MSI** or **ZIP** file from the MOBOTIX website. The latest version is available at **www.mobotix.com > Support > Software Downloads** in the **MxControlCenter** section.

If you are using the installation CD, the installation process starts automatically and leads you through the necessary steps. In case you have downloaded the Installer, simply double-click the **MSI** file to start the installation process.

Download MxControlCenter free of charge from www.mobotix.com

Automatic installation of MxControlCenter with Windows Installer (MSI)



The installer automatically creates shortcuts for the most important programs on your desktop.

Using MxControlCenter for the First Time

Double-click on the shortcut created by the installer (see the previous section *Installing MxControlCenter*) or on the program file itself to start MxControlCenter.

Automated Search for MOBOTIX Cameras

If you start MxControlCenter for the first time or if you have not yet stored a start layout with the desired video sources (i.e. MOBOTIX cameras), the **Open Video Sources** dialog will open and automatically starts scanning the network.

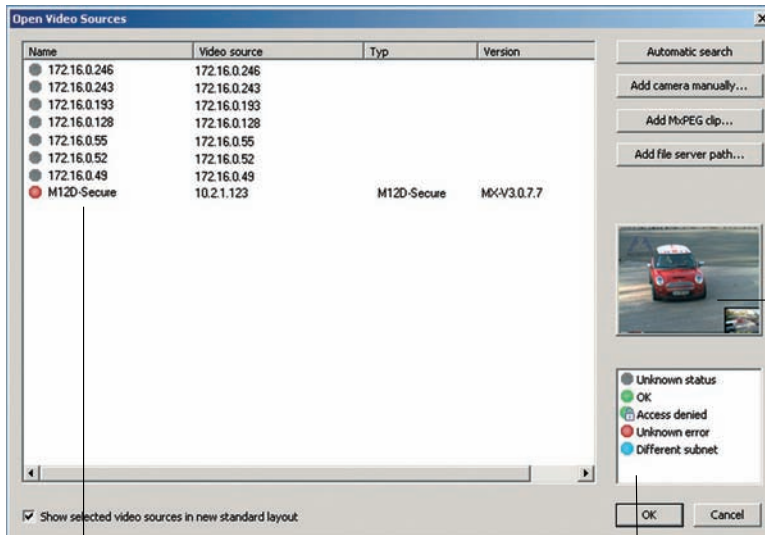

Automatic search for MOBOTIX cameras!

Video sources list

Legend

Camera preview

After all MOBOTIX cameras have been identified, MxControlCenter performs an operational test on the cameras to determine their status and then lists them according to the legend.

Next, MxControlCenter automatically selects all cameras.

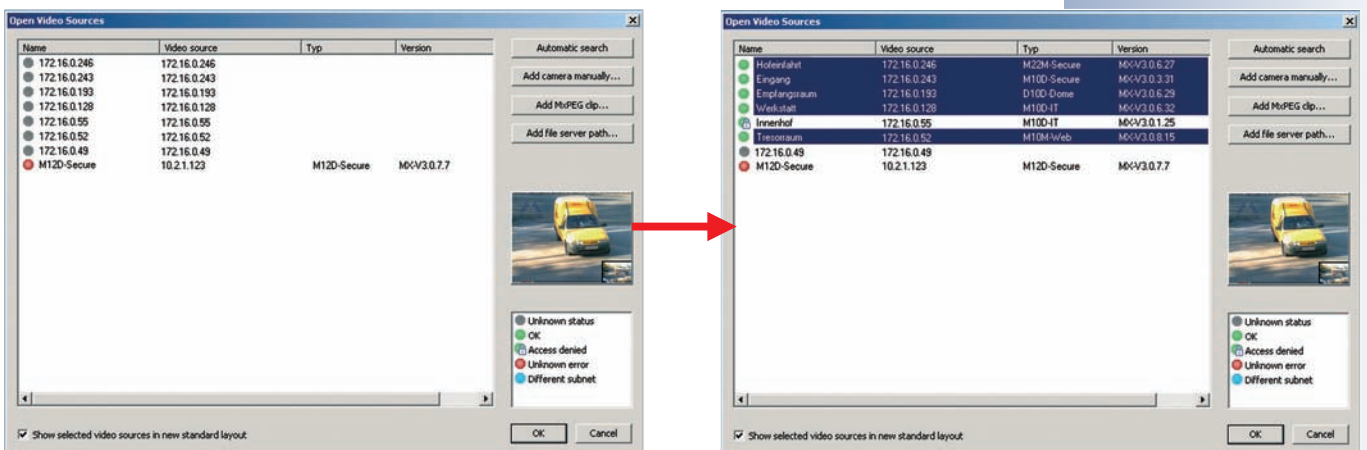

Click on **OK** to add the selected cameras to the **Open Video Sources** dialog.

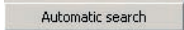
Anytime you connect a new camera to the local network, you can initiate the search in the **Open Video Sources** dialog again by pushing the  button.

If the desired MOBOTIX cameras are highlighted as *OK* in the video source list (status , *OK*), proceed to the *Selecting Video Sources* section further below.

Configuring MOBOTIX Cameras for a Different Network

Using Bonjour, MxControlCenter finds not only cameras on the same subnet (network range) but also **MOBOTIX cameras located in other subnets** (status , *Different subnet*). In such a case, you would not be able to establish any connection to cameras in a different network or subnet (without going into much further detail about the complicated details of TCP/IP network configurations). This is possible, for example, when a camera with a factory IP address is connected to a network in which a DHCP server automatically assigns the IP addresses.

Right-click on a camera, then click on *Configure network* in the context menu and **MxControlCenter can automatically reconfigure this camera** so that it is "integrated" into your existing subnet. However, MxControlCenter first needs some information about the subnet into which the camera will be integrated. You can enter this information in the **Configure Cameras** dialog.

If your computer gets its IP address automatically from a DHCP server, then this is certainly the best choice for that specific camera and most likely for all other cameras which have been found in a different subnet (**Apply to all selected cameras** checkbox).

If you have assigned a fixed IP address to your computer, you will most likely prefer to assign fixed IP addresses (issued by your system administrator) to every camera. In most cases, you should enter a similar configuration as the one found for your computer's **Network Connections** in the **Properties of Internet protocol (TCP/IP)** dialog.

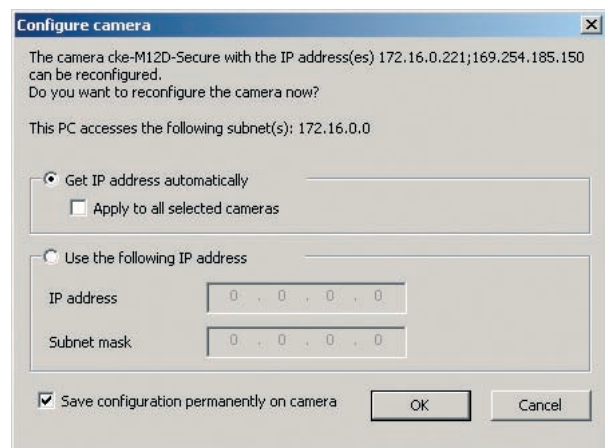

MxControlCenter changes the network configuration of the current camera and, after a short time, the camera also appears in the list with a new IP address and in the same subnet as your computer.

Make sure that the **Save configuration permanently on camera** checkbox is activated so that the new network settings will be used from now on and not just until the camera's next reboot.

MxControlCenter automatically configures cameras

Note

If you have set a different user name and password for administration than the factory-preset ones (**admin**, **meinsm**), you will need to have these user credentials available and enter them in the appropriate dialog. To open the dialog, click on the **Enter password** context menu entry.

Defining Additional Video Sources

Besides automatically detecting MOBOTIX cameras, you can also **manually add other video sources** to the list of available video sources in MxControlCenter.

- **Automatic search:** Scans the (physical) network. This scan will find all MOBOTIX cameras, regardless of whether they are in the same subnet as the computer or in a different one.
- **Add camera manually:** Enter a known IP address or the DNS name of a MOBOTIX camera if this camera had not been detected during the automatic search in the first place.
- **Add MxPEG clip:** Adds an MxPEG video clip previously recorded by a MOBOTIX camera as a video source.
- **Add file server path:** Adds the alarm images previously stored by a MOBOTIX camera on an external file server as a video source.

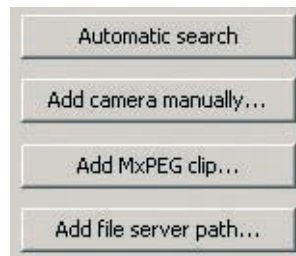
**Selecting Video Sources**

Highlight the desired video sources you would like to manage and display in MxControlCenter.

Camera Preview

If you select a camera with a status of *OK*, MxControlCenter **automatically displays the live image of that camera in the preview window**. If you are using [Ctrl]-click to select more than one camera, the image from the camera selected last is shown in the preview window. This feature facilitates identifying the cameras you would like to use.

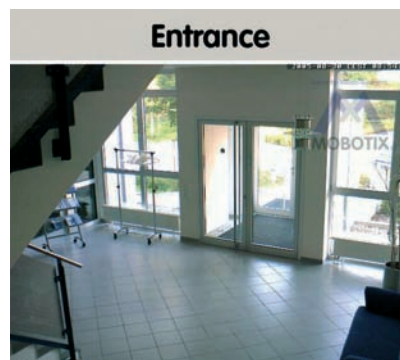

Editing the Video Source List

This list provides a context menu (right mouse button), allowing you to select/deselect all video sources at once. Similarly, you can highlight some or all of the listed video sources and remove them from the list if they are not to be displayed or managed in MxControlCenter.

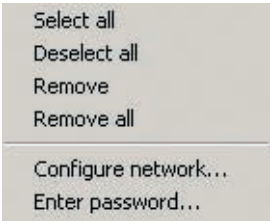

If you interrupt the discovery process (section *Configuring MOBOTIX Cameras for a Different Subnet*) or require a password that is different from the factory-preset password, you can always relaunch the configuration process from the context menu at a later time and enter the appropriate user name and password.

Using the Selected Video Sources

Clicking on **OK** instructs MxControlCenter to use the highlighted cameras. Activate the **Show selected video sources in new standard layout** checkbox and MxControlCenter automatically generates a layout with the live images of all highlighted cameras.

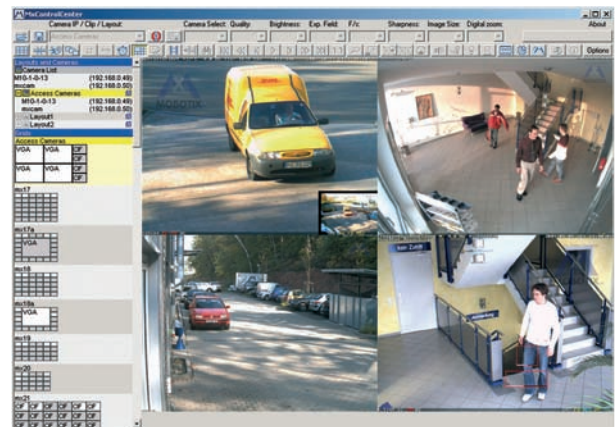
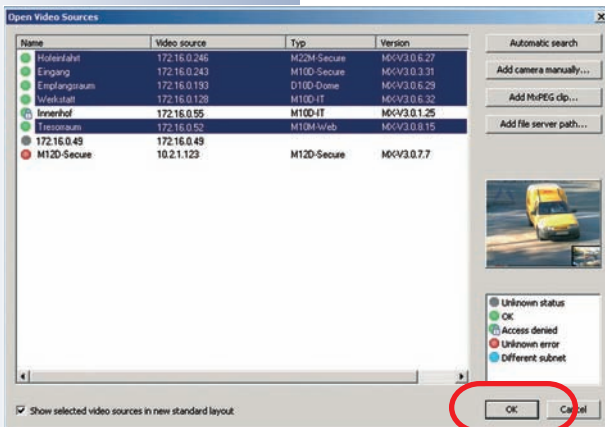

3.3.4 The First Image in MxEasy

Installing MxEasy

If you have an **MxEasy installation CD**, insert it into your computer drive. The wizard will guide you through the installation process. If this is not the case or if you would like to update to a newer version, you can download the latest MxEasy version for your operating system from the MOBOTIX website. MxEasy will be available from Q4/2008 at www.mobotix.com > **Support** > **Software Downloads** in the **MxEasy** section.



MxEasy is currently under development

Using MxEasy for the First Time



Double-click on the shortcut created by the installer (see the previous section *Installing MxEasy*) or on the program file itself to start MxEasy.

Automated Search for MOBOTIX Cameras

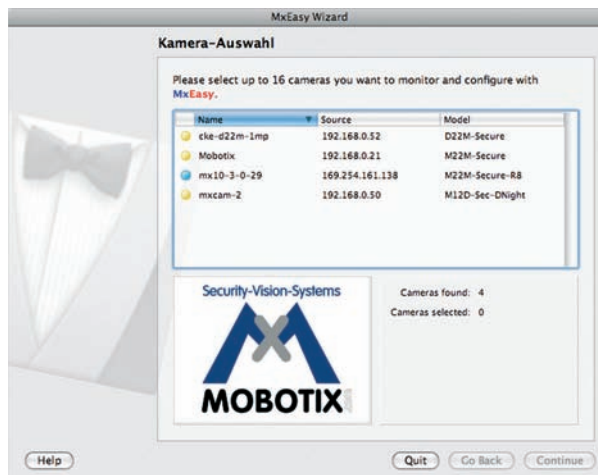
If you start MxEasy for the first time on a computer, the **Camera Selection** dialog will appear, showing all detected MOBOTIX cameras. The camera list will be updated automatically if new cameras are connected to or removed from the network.



MxEasy also automatically monitors and displays the operating status of all cameras. Cameras that are not on the same subnet as the computer will get a differently colored icon than the cameras that are on the same subnet. Likewise, the cameras that have an unknown password or for which no user name/password combination has been specified in MxEasy will get a differently colored icon.

If the desired MOBOTIX cameras are highlighted as  OK in the video source list, proceed to the *Selecting Cameras* section further below. Cameras that have an  *Different subnet* icon can be reconfigured for the "proper" subnet as described in the following section.

Configuring MOBOTIX Cameras for a Different Network

Using Bonjour, MxEasy finds not only cameras on the same subnet (network range), but also **MOBOTIX cameras located in other subnets** (status  *Different subnet*). In such a case, you would not be able to establish any connection to cameras in a different network or subnet (without going into much further detail about the specific details of TCP/IP network configurations). This is possible, for example,

Automatic search for cameras

when a camera with a factory IP address is connected to a network in which a DHCP server automatically assigns the IP addresses. **MxEasy can automatically configure such a camera** so that it is "integrated" into your existing network. To do so, simply highlight the desired camera in the list.

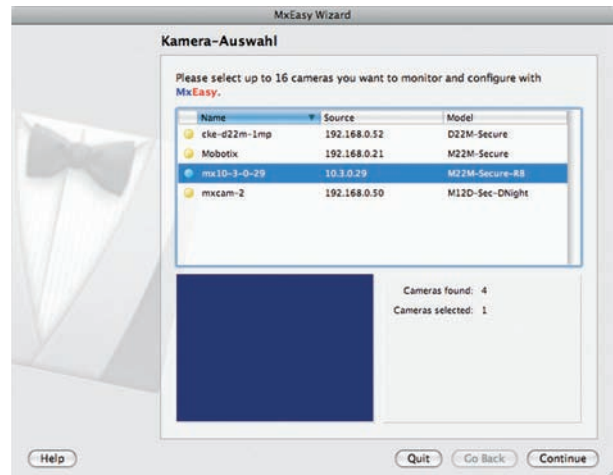

Click on **Next** to display a security prompt; if you click on **OK**, the dialog for reconfiguring the selected camera will appear.

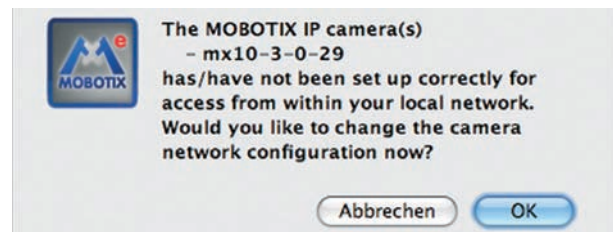

Configuration of IP addresses

If your computer gets its IP address automatically from a DHCP server, then this is certainly the best choice for the that specific camera (**Automatically obtain an IP address**) and most likely for all other cameras which have been found in a different subnet (**Apply to all selected cameras** checkbox).



If you have assigned a fixed IP address to your computer, you will most likely prefer to assign fixed IP addresses (issued by your system administrator) to every camera (**Use the following IP address**). Here, for the most part, you should enter a similar configuration as in the network settings of your computer.

Once you click on **OK**, the selected cameras will be reconfigured automatically. All reconfigured cameras are now running in the same subnet as the computer and are displayed with an  OK status in the camera list.

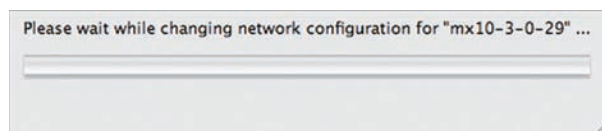

Selecting Cameras

Highlight the desired cameras you would like to manage and display in MxEasy. If you select one camera with an  OK status, MxEasy **automatically displays the live image of that camera in the preview window**. If you are using [Ctrl]-click to select more than one camera, the image from the camera selected last is shown in the preview window.

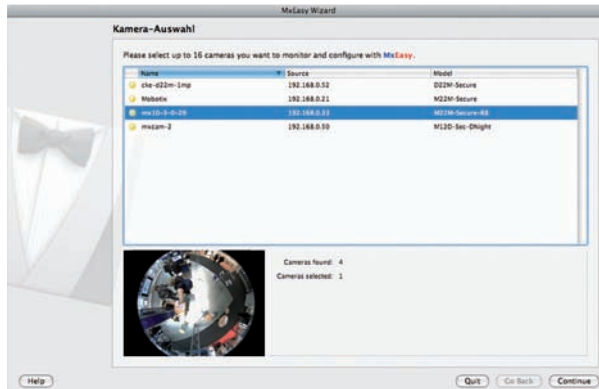

Select cameras for display

Editing the Camera List

Use the context menu commands (right-click) to add MOBOTIX cameras to or remove them from the list. In addition, you can display further information of a camera and change the user name/password of a camera. For additional information on this topic, see the *MxEasy User Manual*.

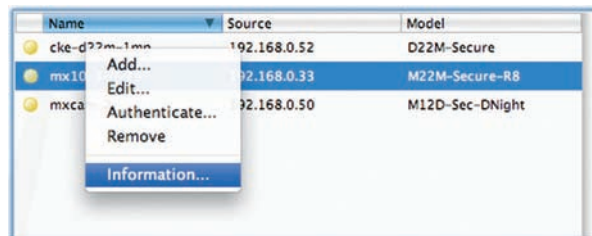

Using the Selected Cameras

Clicking on **Next** will prompt MxEasy to use the selected cameras and to generate a screen with the live images of the four cameras you selected first.

The panel at the bottom right corner will always show the last event image of the camera that is displayed in the large panel. Double-click on a small camera panel to move this camera's live image to the large panel.



Display of the cameras in MxEasy

If you would like to add MOBOTIX cameras to MxEasy, simply click the **Add cameras** button (max. 16 cameras in total).



3.3.5 Starting the Camera With an Automatic IP Address (DHCP)

If your network has a DHCP server, you can start the camera with DHCP support. In this case, the DHCP server automatically assigns an IP address.

As soon as startup has been completed, the camera automatically announces its IP address, its network mask and its MAC address. Please note that this feature needs to be activated for this to work. Note that this announcement function can be deactivated (**Admin Menu > Loudspeaker and Microphone**).

Proceed as follows to start the camera using DHCP:

- Remove the outer shell using the supplied custom tool (see section 2.14, *Dismantling the Camera*).
- If the camera is powered on, disconnect the power supply of the camera by unplugging the corresponding cable.
- Reconnect power to the camera and observe the LEDs.
- Wait until the **LEDs 0 (bottom) and 5 (right) are lighting up simultaneously**.
- Now hold the **magnetic side of the custom tool** onto the spot above the microphone labeled **L** in the figure (the switch is inside the camera housing).
- Only remove the custom tool when the camera plays a double sound ("Boing, Boing").
- After about another 10 seconds, the camera will announce the network parameters.



Activate the camera speaker!

Announcement of network data: Press "**L**" key

In case of an error, the camera uses its last IP address



You can now access the camera using the IP address it just announced.

Note

If you would like to have a running camera repeat its network settings, simply activate the "**L**" key once using the magnetic side of the custom tool.

Caution

When starting the camera with DHCP support, make sure that the network has a properly functioning DHCP server. If this is not the case, the camera cannot obtain a valid IP address and will fall back to its last known IP address.

3.3.6 Starting the Camera Using the Factory IP Address

Under certain circumstances, you may have to reset the camera to its factory IP address. This could be the case if the IP address of the camera has been lost or the camera does not react to the last known IP address.

Passwords and camera settings will not be changed!

Proceed as follows to start the camera using its factory IP address:

- Remove the outer shell using the supplied custom tool (see section 2.14, *Dismantling the Camera*).
- If the camera is powered on, disconnect the power supply of the camera by unplugging the corresponding cable.
- Reconnect the power supply of the camera.
- Wait until **all LEDs are lighting up simultaneously**.
- Now hold the **magnetic side of the custom tool** onto the spot above the microphone labeled **L** in the figure (the switch is inside the camera housing).
- Only release the custom tool when the camera plays a single sound ("Boing").



The camera is now accessible again using its factory IP address (see label on the camera housing).

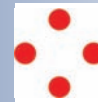

Note

If you use the camera's "**L**" key to load the factory network configuration, this configuration is not automatically saved to flash memory. Upon restarting the camera the next time **without** using the camera's "**L**" key, the *last stored network configuration* will be used. To permanently store the new network configuration in the camera's flash memory, open **Admin Menu > Store ...**

Make sure you store the factory network configuration to the permanent flash memory!

Caution

As opposed to resetting the camera using *Admin Menu > Reset configuration to factory defaults*, the user information will not be reset if the camera is booted using the factory IP address.

Users and passwords will **not** be changed!

3.4 Configuring the Camera in the Browser

3.4.1 Overview

You can set up and operate the MOBOTIX camera using a **JavaScript-enabled browser** on all common operating systems (such as **Windows, Linux, Macintosh**, etc.). The camera provides an HTML-based user interface for this purpose. The camera executes the changes you make to the camera configuration via HTTP commands using programs and scripts of the embedded software. The settings are stored in the camera's flash memory.

This section contains an overview over the first steps for properly configuring the MOBOTIX camera as well as information on further configuration options. For information on configuration steps specific to the D12D-180°, see section 2.13.3, *Adjusting the Single Images of a MOBOTIX D12D-180°*. Please see the *Software Manual Part 2* for more detailed information on the software features.

3.4.2 The First Configuration Steps

- **Run the Quick Installation:** After booting the MOBOTIX camera for the first time, accessing the administration menu (**Admin Menu** button) will automatically start the Quick Installation wizard. The Quick Installation wizard helps you in setting the most important parameters of the camera. For security reasons, you should set your own administration password and disable the public access to the camera (see below).
=> ([Software Manual, section 5.2](#))
- **Disable public access:** Guest users are only allowed to access the Guest screen of the camera without entering a password. If this is not desired, you should deactivate public access (**Quick Installation** or **Admin Menu > Users and Passwords**).
=> ([Software Manual, section 5.4.1](#))
- **Add users and assign access rights:** Similar to a computer operating system you can add users and user groups and assign the desired rights (**Admin Menu > Users and Passwords** and **Admin Menu > Group Access Control Lists**). This approach allows assigning individual access rights to camera-specific features based on the user groups.
=> ([Software Manual, section 5.4.1](#))
- **Deactivate the automatic reboot:** In its factory state, every MOBOTIX camera will automatically reboot every morning at 3:36 am. If the camera does not use an external file server, the internal Flash storage or SD cards, but the internal volatile memory, all recorded images and video sequences will be deleted when the camera reboots. Make sure that you deactivate the automatic reboot if this is not desired (**Admin Menu > Time Tasks**).
=> ([Software Manual, section 7.9.2](#))

Software Manual Part 2:
www.mobotix.com

Always use **Quick Installation** for initial configuration!

Admin Menu
User: **admin**
Password: **meinsm**

- **Optimize the image settings:** The factory image settings of MOBOTIX cameras deliver excellent images for most application scenarios and should not be changed. If you do wish to make changes, your changes should be minor and gradual. You should, however, set an image program according to the application scenario of the camera. Image programs provide a quick and simple method for adjusting the camera to the application scenario as they perform several configuration steps at once (**Image Programs Quick Control**).
=> ([Software Manual, section 5.5.2](#))
- **Set the resolution of the live image:** By factory default, all MOBOTIX cameras are delivered with an image resolution of 640x480 pixels. You can select the desired resolution using the **Resolution Quick Control**.
=> ([Software Manual, section 4.3.3](#))
- **Adjust the exposure:** The automatic exposure control of the MOBOTIX camera uses individually configurable windows to determine the best image exposure. Open the **Exposure Windows Quick Control** and select a predefined set of exposure windows. If required, you can also define custom exposure windows (**Setup Menu > Exposure Settings**).
=> ([Software Manual, section 5.7](#))
- **Activate event control and recording:** By factory default, the MOBOTIX camera's event control is disabled. Click on the **Arm & Record** button to activate event control. This will activate video motion detection and recording. Cameras with integrated Flash memory (MOBOTIX R models and models with SD card) will use the Flash memory by default to store the image and video data (recording target). If desired, you can set additional events and adjust the settings of the recording and storage parameters (**Setup Menu > Event Settings, Setup Menu > Recording and Admin Menu > Recording to External File Server / Flash Device**).
=> ([Software Manual, chapters 7 and 8](#))
- **Set up actions/messaging:** Upon detecting an event, the MOBOTIX camera can trigger alarms. These alarms can be adjusted to your needs and you can assign them to one or more events: playing back a sound alarm on the camera speaker, showing the visual alarm in the camera live image, sending an e-mail or network message with the alarm image, placing a phone call, uploading an alarm image to an FTP server, switching a signal output line of the camera (e.g. for switching on the lights/opening a door). To change the corresponding settings, please refer to these dialogs: **Setup Menu > Actions, Setup Menu > Messaging and Messaging 2, Setup Menu > Enhanced Signal Out Options**.
=> ([Software Manual, chapter 7](#))

Recommendation: Select an image program to quickly adapt the camera to the current application scenario

Admin Menu
 User: **admin**
 Password: **meinsm**

Make sure to permanently
 store changed parameters!

Automatic time synchronization
 using a time server

More: Display advanced
 features

Less: Hide advanced
 features

3.4.3 Additional Configuration Options

- **Administering the camera:** You can modify the camera configuration in the Administration menu (**Admin Menu** button) or the Setup menu (**Setup Menu** button).
 - **Admin Menu:** This menu contains the basic configuration dialogs of the camera (e.g. passwords, interfaces, software update).
 - **Setup Menu:** This menu contains the dialogs for configuring the image, event and recording parameters. Some of these settings can be changed using the corresponding **Quick Controls** in the Live screen.
- **Resetting changes:** If you would like to reset changes in one dialog without resetting the complete configuration, you can use the **Factory** button at the bottom of the dialog to reset only this dialog's settings to the factory defaults. If you would like to reset all image settings, you can do so using the **Manage Settings > Restore Image Settings** Quick Control above the image on the Live screen.
- **Storing the configuration permanently:** Once you have finished configuring the camera, you should always **store the settings in the camera's permanent memory**. You can do so in each dialog (clicking on **Set** at the bottom of each dialog will temporarily set the changes; clicking on **Close** will ask you to store the complete configuration in the camera's permanent memory) or in the **Configuration** section of the administration menu (**Admin Menu > Store current configuration into flash memory**). The **Configuration** section of the administration menu provides more functions for storing, copying and managing camera settings. For additional information on this topic, see chapter 5, *Basic Camera Configuration*, in the *Software Manual*.
- **Time tasks and time synchronization:** Apart from a multitude of possibilities for controlling the camera using time (time tables, holiday and vacation, scheduled tasks, etc.), the camera can also **synchronize its internal clock**. This allows you to keep the camera in synch manually with a computer or fully automatic using a time server or another MOBOTIX camera. The camera can use either NTP time servers or Time Protocol servers. For additional information on this topic, see section 5.4.2, *Date and Time / Time Zones and Time Servers*, in the *Software Manual*.
- **The "More" and "Less" buttons:** When opening some of the camera dialogs, the camera only shows the most important parameters. These dialogs have a **More** button in the bottom right corner; click on it to display additional options. If all options are displayed, click on the **Less** button to hide the additional options.

3.5 SD Card Recording

3.5.1 Introduction

Flash-based storage devices (SD cards, CF cards, USB sticks and solid-state disks) do not contain any moving parts as compared to the commonly used hard disks. Flash-based devices are compact, largely resistant to humidity and shock, use very little energy, do not lose data on power failures and get less expensive all the time. They are thus ideally suited for the MOBOTIX cameras.

Maximum Data Transfer Rate

Using high-quality Flash devices such as the MOBOTIX R models will allow recording the video sequences of a MOBOTIX camera with the highest possible frame rate (e.g. continuous recording including audio). When using SD cards, however, it is imperative to use a high-quality card with a high maximum data transfer rate (writing speed is most important). For information on recommended SD cards, please see the MOBOTIX website www.mobotix.com.

Number of Write/Delete Cycles per Flash Storage Cell

The number of write/delete cycles of every storage cell of a Flash device is limited (e.g. 10,000, 100,000 or more, depending on the quality). The controller of the Flash device automatically detects Flash cells that do not work properly any more. The contents of the faulty cell will then be rebuilt using a checksum and will be moved to a properly working spare cell. The faulty storage cell will be marked as "bad" and will not be used any more. Note that no data is lost in this process.

In addition, MOBOTIX cameras constantly monitor the wear of activated Flash storage devices. MOBOTIX has developed a technology to test the wear of the Flash device by logging the number of write/delete cycles (patent pending). Open **Admin Menu > Camera Status** to see the **Flash Cell Wear** parameter. The camera can also display this information in the status bar at the bottom of the live image.

Conservative Memory Usage Thanks to MOBOTIX MxFFS File System

MxFFS formatting of the SD card means that the MOBOTIX camera software will use the Flash device as evenly as possible, thus allowing for the maximum possible number of write/delete cycles. This also means that all storage cells of the Flash device will be written and deleted with the same frequency, if possible. The MOBOTIX technology increases the life of the Flash device considerably and also improves the security and the reliability of the storage process.

Storage Requirements and Life Expectancy of SD Cards

The life expectancy of an SD card increases proportionally to the storage capacity, since the camera software will execute fewer write/delete cycles on each storage cell. The first delete operation will start once the SD card has been filled to capacity (first full cycle).

The following tables contain estimated values for the expected storage requirements in connection with image resolution, frame rate and video codec used (M-JPEG or MxPEG) as well as the expected life of two SD cards with different capacities (16 GB and 1 GB).

16 GB SD Card: Storage Requirements and Life Expectancy					
	6 fps CIF	6 fps VGA		1 fps MEGA	1 fps QXGA
	M-JPEG	M-JPEG	MxPEG	M-JPEG	M-JPEG
File size single image	15 kB	45 kB	-	120 kB	240 kB
Storage req. per second	90 kB	270 kB	75 kB	120 kB	240 kB
Storage req. per 24 hrs	7.8 GB	23.5 GB	6.5 GB	10.4 GB	20.8 GB
Time for one full cycle	2 days	16 hours	2.4 days	1.5 days	18 hours
Est. theor. life expectancy	30 years	10 years	36.5 years	23 years	11.5 years

All values are rounded estimates

1 GB SD Card: Storage Requirements and Life Expectancy					
	6 fps CIF	6 fps VGA		1 fps MEGA	1 fps QXGA
	M-JPEG	M-JPEG	MxPEG	M-JPEG	M-JPEG
File size single image	15 kB	45 kB	-	120 kB	240 kB
Storage req. per second	150 kB	270 kB	75 kB	120 kB	240 kB
Storage req. per 24 hrs	7.8 GB	23.5 GB	6.5 GB	10.4 GB	20.8 GB
Time for one full cycle	3 hours	1 hour	3.6 hours	2.3 hours	1.1 hours
Est. theor. life expectancy	1.9 years	7.5 months	2.2 years	1.4 years	8.5 months

All values are rounded estimates

Caution

It is recommended to use only high-grade SD cards that are new. For information on recommended SD cards, please see www.mobotix.com.

For security applications, it is highly recommended to exchange the SD card against a new one after one year of operation.

When storing to an SD card, you should limit event recording to the *minimum* required frame rate instead of the default *Max fps* setting (Setup Menu > Recording).

Monitoring the Cell Wear of Flash Storage Devices (Patent Pending)

MOBOTIX uses its own technology for this purpose and has a pending patent. Open **Admin Menu > Camera Status** to see the **Flash Cell Wear** parameter. The camera can also display this information in the status bar at the bottom of the live image. In addition, the camera can send a warning message (e.g. via e-mail) if the Flash cell wear reaches a critical value (**Admin Menu > Storage on External File Server / Flash Device**). This leaves enough time to exchange the SD card before the chance of losing data gets too high.

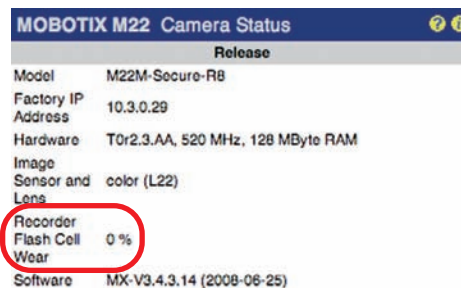

MOBOTIX M22 Camera Status	
Release	
Model	M22M-Secure-R8
Factory IP Address	10.3.0.29
Hardware	T0r2.3.AA, 520 MHz, 128 MByte RAM
Image Sensor and Lens	color (L22)
Recorder Flash Cell Wear	0 %
Software	MX-V3.4.3.14 (2008-06-25)

MOBOTIX R Models vs. Storage on SD Cards

The Flash memory in MOBOTIX R models (CF card) has been carefully selected by MOBOTIX and is tested in every camera. This ensures that the requirements for fast storage of video and image sequences are fulfilled or even exceeded in any case. The maximum data rate (write speed) of the memory used in MOBOTIX R models is by far higher than the maximum data output of the MOBOTIX camera even in extreme situations. This means that there are always ample reserves.

In contrast to the CF memory of R models, the maximum data rate of SD cards that the user has inserted into the camera is unknown. It is likewise unknown if the SD card has been used before and how worn out the Flash cells are. **MOBOTIX can thus guarantee the quality of the Flash memory in R models, but not the quality of SD cards.**

Advantages of R Models

- Guaranteed quality of the Flash memory
- Guaranteed minimum data throughput rate
- Enhanced security thanks to integration into the camera housing
- High data security thanks to encryption (optional)

Advantages of SD Card Recording

- Easily accessible
- Easily exchangeable
- Scalable
- Can be read on computers running MxControlCenter (with SD card reader)
- High data security thanks to encryption (optional)

3.5.2 Formatting an SD Card With the MxFFS Format

Before a MOBOTIX camera can store image and video sequences on an SD card, it needs to be formatted as **MxFFS** (SD cards delivered with MOBOTIX cameras are already **MxFFS**-formatted).

Follow these steps to format a storage device (**Admin Menu > Storage on External File Server / Flash Device** dialog):

- 1) Make sure that an SD card is in the SD card slot of the MOBOTIX camera.
- 2) Click on the **Options** button behind **SD Flash Card**.
- 3) Select the *Quick Format* option in the next dialog and click **OK**.



The *Safe Format* option will make sure that the data on the SD card is overwritten completely so that the data cannot be recovered in any way. Please note, however, that the formatting process with this option takes much longer (several hours) than when using the *Quick Format* option (a few minutes).

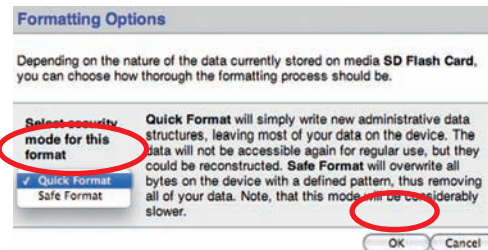

- 4) Enter the user name and password of a user of the *admins* group in the dialog that opens and click on **OK**.

The MOBOTIX camera starts formatting the SD card. It usually takes between 5 to 12 minutes to format an 8 GB SD card using the *Quick Format* option and 3 to 14 hours using the *Safe Format* option.

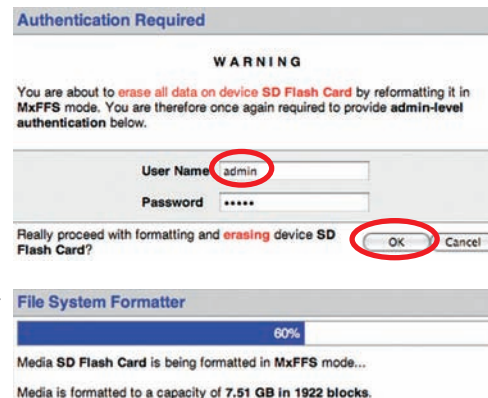

Once the formatting has been completed, you can activate the SD card for recording (see next section).

Follow these steps to format an SD card in **Admin Menu > Storage on External File Server / Flash Device**

The **Safe Formatting** option takes several hours. You can also use suitable applications on Windows, Linux and Mac OS X computers to safely format the SD card.

Caution

Make sure that you always wait until the formatting process has been completed before accessing the camera again. This usually takes only several minutes, but it may take several hours when using the *Safe Formatting* option! You can only access the SD card once MxFFS formatting has completed!

3.5.3 Activating the Recording on an SD Card

Follow these steps to activate the recording to an SD card that has already been MxFFS-formatted (**Admin Menu > Storage on External File Server / Flash Device**):

- 1) Make sure that an SD card is in the SD card slot of the MOBOTIX camera.
- 2) Make sure that the SD card has been MxFFS-formatted (see section 3.5.2, *Formatting an SD Card With the MxFFS Format*).
- 3) Activate the **SD Flash Card** option.
- 4) Click on **Set**, then on **Close** and store the configuration to the camera's permanent memory.
- 5) Reboot the camera (**Admin Menu > Reboot Camera**).
- 6) Once the camera has rebooted, make sure that the camera shows the **FR REC** symbols in the live image. If this is the case, the camera uses the SD card as recording target. If not, you can activate the recording (see below).

Activating the Recording

If the **FR REC** symbols are not visible in the camera's live image after rebooting, you need to activate the recording using one of the following methods.

- In the web browser: Click on the **Arm & Record** button, then on **OK** to automatically activate recording.
- In the web browser: Set the **Recording** Quick Control to *Recording on* to manually activate recording.
- In the web browser: Open the **Setup Menu > Recording** dialog to manually activate recording.
- MxEasy: You can use the calendar features of MxEasy to activate recording based on time and date information (see also section 3.3.4, *The First Image in MxEasy*).

Activating Encryption and Authentication

If security is an issue, you can opt to store only encrypted video data on the SD card. If you would like to use encryption, make sure that you activate this option when formatting the card. Note that you also need to enter an **Authentication** password. Switching from encrypted to unencrypted storage (and back) is not possible without reformatting the SD card.

3.5.4 Accessing the Data on an SD Card

To access the stored image and video sequences on the SD card, you can use the camera's Playback screen. The following options are available:

Follow these steps to activate the recording on an SD card in **Admin Menu > Storage on External File Server / Flash Device**

MxEasy is currently under development

MxEasy is currently under development

- **In the web browser:** Play back the recorded video sequences directly from the SD card using the Playback screen of the camera. To do so, insert the SD card into any SD card-enabled MOBOTIX camera.
- **In MxEasy:** Play back the recorded video sequences from the SD card via the MOBOTIX camera.
- **In MxControlCenter:**
 - Play back the recorded video sequences from the SD card via the MOBOTIX camera.
 - Play back the recorded video sequences directly from the SD card in a card reader connected to the computer. Access the card by setting the SD card's drive/volume as a "directory" in MxControlCenter.

If the SD card's contents are encrypted, you need to enter the corresponding password before you can access the recorded video data. In MxControlCenter or MxEasy, a dialog will automatically prompt you for this purpose.

Caution

When using the SD card from one MOBOTIX camera in another MOBOTIX camera, you need to make sure that the time on the original camera is in sync with the new camera. It is recommended to use automatic time synchronization via a time server.

3.5.5 Using an SD Card in a Different MOBOTIX Camera

An SD card containing recorded video data from a MOBOTIX camera can be inserted into any SD card-enabled MOBOTIX camera. Once SD card recording has been activated (requires a reboot), the "new" MOBOTIX camera automatically synchronizes with the SD card and resumes recording. Note that no data is lost in this process. Make sure that you deactivate **SD card recording** and reboot the MOBOTIX camera before removing the card!

Caution

An SD card may only be removed from the camera after you have deactivated *Recording to SD Card* and rebooted the camera. Failing to do so may lead to loss of data!

Removing connected storage media from the camera without properly deactivating them will destroy certain areas of the storage device. When using MxFFS-formatted media, this is limited to 4 MB lost data per incident; a FAT storage device may even be destroyed completely when removing the device without properly deactivating it first!



If the SD card's contents are encrypted, you need to enter the corresponding password in the "new" camera in the **Admin Menu > Storage on External File Server / Flash Device** dialog. Otherwise, the camera cannot access the SD card.

3.5.6 Deactivating SD Card Recording and Removing the Card

Follow these steps to deactivate the recording to an SD card (**Admin Menu > Storage on External File Server / Flash Device**):

- 1) Activate the **None** option.
- 2) Click on the **Set** button at the bottom of the dialog, then on **Close**.
- 3) Reboot the camera (**Admin Menu > Reboot Camera**).
- 4) Once the camera has rebooted, make sure that the camera does not show the **FR** symbol in the bottom right corner of the live image.
- 5) You can now safely remove the SD card from the camera.

Caution

An SD card may only be removed from the camera after you have deactivated *Recording to SD Card* and rebooted the camera. Failing to do so may lead to loss of data!

Removing connected storage media from the camera without properly deactivating them will destroy certain areas of the storage device. When using MxFFS-formatted media, this is limited to 4 MB lost data per incident; a FAT storage device may even be destroyed completely when removing the device without properly deactivating it first!



3.5.7 Limitations on Warranty When Using Flash Storage Media

Caution

MOBOTIX will not assume any responsibility for Flash storage devices (e.g. SD cards or connected USB storage devices) delivered with or integrated in MOBOTIX cameras. The same applies to damages to Flash storage media not acquired through MOBOTIX or by the use of such media.

3.5.8 Problems Accessing an SD Card

Caution

Some SD cards cannot be set back reliably by the MOBOTIX camera when rebooting. In rare occasions, the camera cannot access such an SD card after the camera has executed a soft reboot. If this should be the case, you need to execute a camera hard reboot (disconnect the camera from the power supply, then reconnect it, e.g. by disconnecting, then reconnecting the network cable at a PoE switch). The SD card should be once again accessible in the usual way.

If you experience this behavior, you should also deactivate the automatic reboot of the camera in the *Admin Menu > Time Tasks* dialog.

Notes:

.....

.....

.....

.....

.....

.....

.....

.....

.....

.....

.....

.....

.....

.....

.....

.....

.....

.....

.....

.....

.....

.....

.....

3.6 Connecting External Devices and Sensors: MX Interface Connector

3.6.1 MX Interface Connector for Direct Connections



MOBOTIX M12, D12 and V12 cameras have an MX Interface Connector (D Sub 15 HD), which features **one signal input** and **one signal output for switching loads**. In addition, the interface also provides **two signal inputs and two signal outputs**. You can use these signal input/output pins to detect an opening door (using e.g. a Reed switch) or to switch an external device (e.g. a lamp) via a relay. The interface connector also has Line In/Out pins for external audio devices. You can use the Line In pin to have the camera transmit and record external audio signals (e.g. from an external microphone with pre-amplifier). On the other hand, the camera can use the Line Out pin to transmit sound to external devices (e.g. an audio amplifier). This in turn opens new possibilities as the camera can feed external loudspeakers (such as announcement systems on a train station) or it can use external and more sensitive microphones that can be placed farther away from the camera (e.g. when using a MOBOTIX camera as a video conferencing system and in access control scenarios).

Pin-Out of MX Interface Connector D Sub 15 HD					
	Pin	Signal	Alternative	Description	Remarks
	5	GND		Ground for RS232, USB, Backup V-In	
Audio	4	Line-In +		Audio input , Line signal level $U_{RMS}=1V$	Galvanically isolated by transformer (DC decoupled)
	6	Line-In -			
	10	Line-Out +		Audio output , Line signal level $U_{RMS}=1V$	Galvanically isolated by transformer (DC decoupled)
	14	Line-Out -			
In/Out	9	In 1		Signal input , active <0.5V, inactive >+3V, max. voltage 24V	
	1	Out 1		Signal output , OpenCollector, active vs. GND, max. 24V/50mA, inactive 10kOhms vs. 3.3V	
USB	13	USB +5V		Power supply for USB devices 5V/100mA vs. GND	With backup power (12V) or PoE, 500mA also possible
	11	USB D+		USB master data signals , 0V to 3.3V	
	12	USB D-			
Serial interface	2	RxD	RxD RS232	active = -3V to -12V, inactive +3V to +12V	
			RxD I/O	Signal input , inactive: open or voltage >3V, active : GND or voltage <0V, max. $\pm 12V$	
	3	TxD	TxD RS232	active = -3V to -12V, inactive +3V to +12V	
			TxD I/O	Signal output , inactive: <3V max. 3mA, active : >+3V max. 3mA, max. voltage $\pm 12V$	While the system boots, the signal state is undefined
	7	RTS	RTS RS232	active = +3V to +12V, inactive -3V to -12V	
			RTS I/O	Signal output , inactive: <3V max. 3mA, active : >+3V max. 3mA, max. voltage $\pm 12V$	While the system boots, the signal state is undefined
8	CTS	CTS RS232	active = +3V to +12V, inactive -3V to -12V		
		CTS I/O	Signal input , inactive: open or voltage >3V, active : GND or voltage <0V, max. $\pm 12V$		
	15	Backup V-In		Backup power 6V to 12V vs. GND, max. 1A	



The signal lines of the serial interface can also be programmed as additional signal inputs. **Setup Menu > Event Settings > Second/Third/Fourth Signal Input > Signal Input 1/2/3**. This means that you can use three additional signal input lines

Polarity can be switched

Bridge < 2 kOhms

Integrated low-pass filter: 10 kOhms, 10 nF

3.7 Signal Input/Output, RS232 Interface

The MOBOTIX M12, D12 and V12 models provide one **signal input** and one **signal output** as well as **two additional signal input pins** and **two signal output pins** on its RS232 interface (only available in IT and Secure models). You can use the camera's signal input/output to detect an opening door (using a Reed switch) or to switch an external device (e.g. a lamp using a relay). The signal input/output pins of the RS232 interface can be used for attaching additional sensors and devices.

3.7.1 Signal Input Pins

Pin 9 of the D Sub 15 HD connector is used for detecting the signal input. To trigger the signal input, simply connect pin 5 (ground) to pin 9 (no current required). You can also connect other devices (e.g. SPS machines) that close a contact (0 V) to trigger the signal input.

Click on **Setup Menu > Event Settings** to specify, which state of the signal input should create an event - an open loop or a closed loop. For example, if you would like to secure all windows and doors of a building, connect all closed switches in a serial loop and connect the wires to signal input (pin 9) and ground (pin 5). The loop should have a resistance of less than 2 kOhms. This pin of the camera is already equipped with a low pass filter (10 kOhms/10 nF).

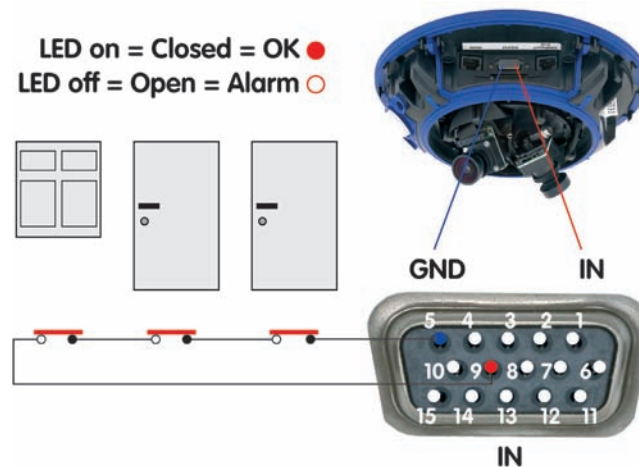

Open **Setup Menu > Event Settings** to activate the additional signal input pins of the RS232 interface (*Closed/Low* or *Open/High* option; CTS: pins 8-5, RxD: pins 2-5). Open **Admin Menu > Setup of serial interface and modem** and configure the serial interface accordingly (**Serial: Data, Mode: I/O Mode**).

Click on **Admin Menu > LED Setup** and set one or more LEDs to *Signal input* to display the state of the input signal for testing (*Signal input* option: loop closed = LED on).

"0": Voltage higher than +3 V ==> inactive ==> LED off

"1": Voltage lower than 0.5 V ==> active ==> LED on

3.7.2 Signal Output Pins

When an event is detected, the MOBOTIX camera can switch the signal output (pin 1). Use the corresponding options in **Setup Menu > Actions** to specify how long the camera should close the signal output.

- **Off**: Signal output is open (10 kOhms on 3.3 V).
- **1s, 2s, 5s, 10s, 30s, 1min, 5min**: Closes the contact between pin 1 of the D Sub 15 connector and ground (pin 5). The signal output is protected against power surges and unwanted feedback (± 48 V) and switches up to 50 mA. It can thus switch a 12 V relay with 0.6 W and a 24 V relay with 1,2 W.

Open **Setup Menu > Enhanced Signal Out Options** to set custom switching times for any combination of events (not Web models). This dialog also allows using a time table and setting a dead time.

Click on **Admin Menu > LED Setup** and set one or more LEDs to *Signal input* to display the state of the input signal for testing (*Signal input* option: loop closed = LED on).

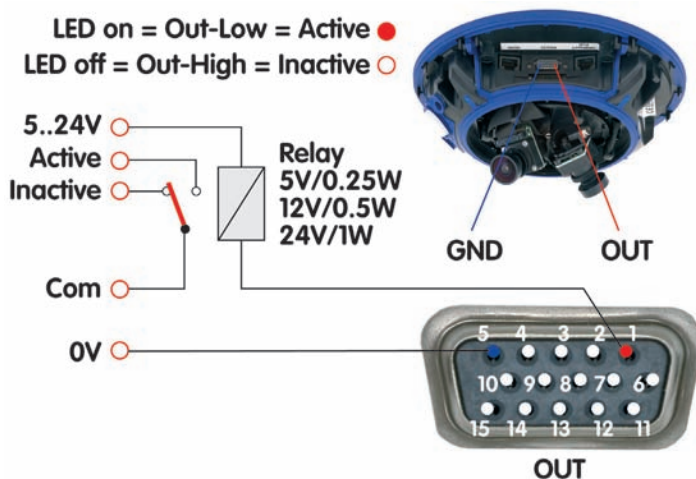

Activate the signal output in **Admin Menu > LED Setup** or for specific events in **Setup Menu > Event Settings**

The event settings allow activating the signal output for a certain time only (e.g. to generate an impulse)

Example setup

Select the trigger condition:

- Open (high)
- Closed (low)
- Rising (low to high)
- Falling (high to low)
- Change: (rising or falling)

Besides detecting the current state (open or closed), you may also trigger upon rising, falling or changing signal flanks.

Notes

In contrast to the **signal output pins** of the RS232 interface (pins **3** and **7**), the **signal output pin 1** assumes an inactive state and will stay inactive while the camera is booting.

The *Pin-Out of MX Interface Connector D Sub 15 HD* table in section 3.7.1, *MX Interface Connector for Direct Connections*, contains a detailed explanation of the individual pins.

3.8 Important Notes

3.8.1 Weatherproofness

The MOBOTIX D12 has been certified **weatherproof according to IP 65 when installed with the wall mount** (absolutely dustproof, resistant against water jets). Without the wall mount, the D12 reaches IP54.

3.8.2 Passwords for the Administration Menu and ISDN Dial-In

Accessing the administration area of the camera (**Admin Menu** button) is only possible after entering a user name and password.

- Factory default user: **admin**
- Factory default password: **meinsm**

The **Quick Installation** wizard will appear automatically when accessing the Administration Menu for the first time. It provides an easy method to adjust the basic camera settings to the current application scenario. **For security reasons, it is highly recommended to change the default administrator password after the camera has been configured properly.**

Dialing into the camera via ISDN is protected by a separate password. When setting up a dial-in connection from a computer, you need to provide this information.

- Factory default user: **linux**
- Factory default password: **tux**

Enter the user name and password exactly as shown above. Note that all entries are case-sensitive.

Caution

Make sure that you store information on user names and passwords in a secure place. If you lose the administrator password and cannot access the Administration menu, the password can only be reset at the factory. This service is subject to a service charge!

3.8.3 Irreversibly Deactivating the Microphone

Deactivating a camera's microphone may become necessary in order to protect the privacy of persons at a workplace or for other reasons. You can permanently and **irreversibly** deactivate the microphone in the **Admin Menu > Loudspeaker and Microphone** dialog.

Caution

This deactivation is permanent and cannot be reversed even by MOBOTIX engineers. Deactivating the microphone will also deactivate all features that use the camera's microphone.

The microphone can be irreversibly deactivated!

3.8.4 Starting the Camera Using the Factory IP Address

If the camera's IP address is not known, you can start the camera with its factory IP address. Section 3.3.6, *Starting the Camera Using the Factory IP Address*, describes this procedure in more detail.

3.8.5 Resetting the Camera to Factory Defaults

All settings of the MOBOTIX camera can be reset permanently to the factory default settings. This makes sense if you have, for example, obtained a camera without any information or you would like to reset all settings after testing the camera. In order to perform this procedure, you need to have access to the administration area of the camera (**admins** group). Open **Admin Menu > Reset ...** to reset the camera to factory defaults.

Note: All defined users will be deleted and the admin password will be reset to the factory default when you reset the camera using **Admin Menu > Reset ...** Proceed according to section 3.3.6, *Starting the Camera Using the Factory IP Address*, if you would like to maintain existing users.

3.8.6 Activating Event Control for Security Applications

In its default configuration, the camera's **event control and video motion detection features** are **not enabled**. In order to activate event-controlled recording, open **Setup Menu > General Event Settings** and activate the **Arming** switch. Another method to achieve this is to click on the **Arm & Record** softbutton of the browser user interface. The camera displays the video motion detection window in the live image (dotted frame in the center) and the camera automatically stores images as soon as the video motion window detects movements.

3.8.7 Deactivating Text and Logo Options

As the camera arming is deactivated in its default configuration (see preceding section), the MOBOTIX camera only displays the Text **WWW.MOBOTIX.COM**, the time stamp and the MOBOTIX logo at the top of the image. Once the camera arming has been activated, the text at the bottom of the live image (event, action, messaging and recording symbols) will also appear.

You can deactivate the status text at the bottom and the text at the top left corner of the live image by setting **Text Display** in the **Setup Menu > Text & Display Settings** dialog to *Off*. Setting **Text Display** to *Date & Time* will only display the time stamp in the live image.

In order to hide the logo in the live image, open **Admin Menu > Logo Profiles** and set **Logo Display** to *Disable*.

The configuration can also be reset partially

If the dotted rectangle in the live image is visible, the camera is armed

Text and logos can be also deactivated or customized to your liking

Deactivating the camera
reboot

3.8.8 Deactivating the Automatic Daily Reboot of the Camera

Per factory default, the MOBOTIX camera automatically reboots every morning at 3:36 am. The reason for this is that external influences (e.g. radiation in high locations) can lead to camera malfunctions. The automatic reboot will refresh the camera's memory and will ensure proper operation without requiring any interaction on the part of the user. If desired, you can deactivate the automatic reboot of the camera in the **Admin Menu > Time Tasks** dialog.

3.8.9 ISDN Compatibility Notes

MOBOTIX Q22M, M22M and D22M models do not possess ISDN functionality. MOBOTIX M12, D12 and V12 cameras are compatible with **Euro ISDN standard TBR3/TBR3 A1**. MOBOTIX offers special models for the Japanese market that support the Japanese ISDN standard. For additional information on this topic, see the Japanese section at www.mobotix.com.

3.8.10 Using Internet Browsers

Current Internet browsers (Internet Explorer, Netscape, Mozilla Firefox, Safari, Konqueror, Opera, ...) with enabled **JavaScript** can show the camera's live images with their standard settings. Text-based browsers (e.g. **lynx**) cannot display the user interface and are *not* suitable for operating the camera.

Section 4.1.3, *Browser Settings*, in the *Software Manual* contains more information on browser compatibility. For additional information on troubleshooting the camera, see chapter 12, *Troubleshooting*.

3.8.11 Cleaning Instructions

If a lens is dirty (e.g. from the installation process), you can clean the lens using a lint-free cotton cloth.

3.8.12 Safety Warnings

Electrical surges can be induced by other electrical appliances, improper wiring, but also from the outside (e.g. lightning strikes to phone or power lines).



MOBOTIX cameras are protected against the effects of small electrical surges by numerous measures. These measures, however, cannot prevent the camera from being damaged when stronger electrical surges occur. Special care should be taken when installing the camera outside of buildings to ensure proper protection against lightning, since this also protects the building and the whole network infrastructure.

MOBOTIX recommends having MOBOTIX cameras installed only by specialists accustomed to installing network devices and having proper respect for the pertinent regulations regarding lightning protection and fire prevention as well as the current technology for preventing damages from electrical surges.

For more information on wiring and potential dangers, see the section *Wiring, Fire Prevention, Lightning and Surge Protection* at the end of chapter 2.

3.8.13 Additional Information

For more information on this topic, see the **News** and **Functional Overview** pages in the **online help** of the camera's browser interface. Click on the yellow [Objekt] icon in the top right corner to open the camera's online help.

-  Camera Help
-  Camera Status

To get complete information on the camera status and its current configuration, open the **Camera Status** dialog. Click on the yellow [Objekt] icon in the top right corner to open the corresponding camera dialog.

Another source of information on all dialogs and parameters of the MOBOTIX camera is the **Reference Manual** (PDF), which consists of the camera's online help. You can download the PDF file from the MOBOTIX website in the **Support > Manuals** section. This section also contains the latest version of the *Software Manual Part 2*.

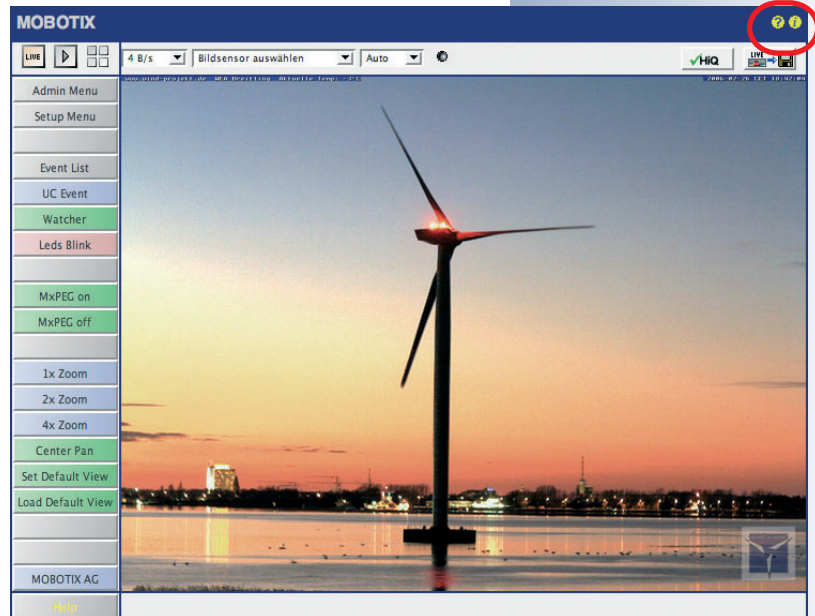

Enlarged Dome for D12D-180° and D12M-CS

For the **D12D-180°** and the **D12M-CS**, an enlarged dome provides a better field of vision when looking horizontally with a camera that is mounted to a ceiling. Make sure that you always include the full model name of the camera when ordering the dome as a replacement part!

3.9 Drilling Templates

Find the drilling templates (scale 1:1) at the end of the manual as a fold-out

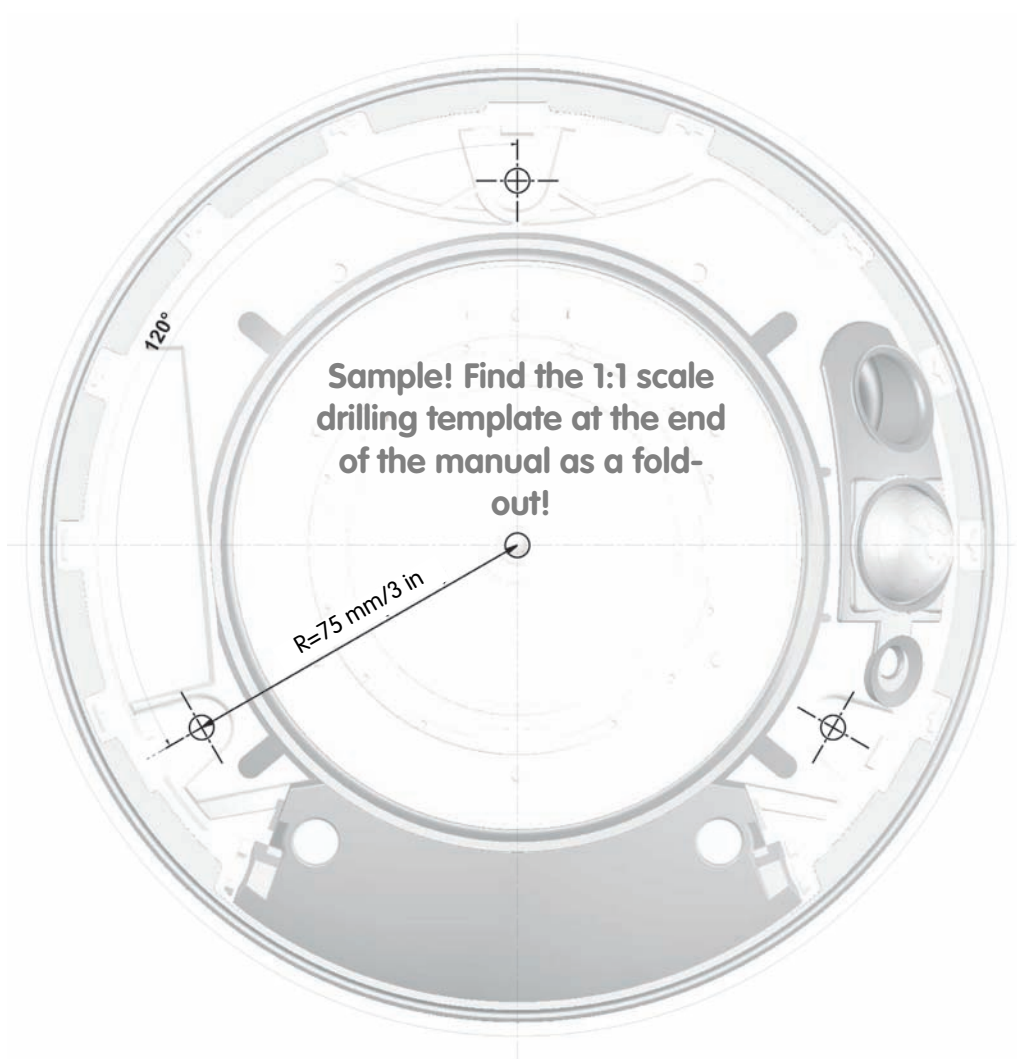

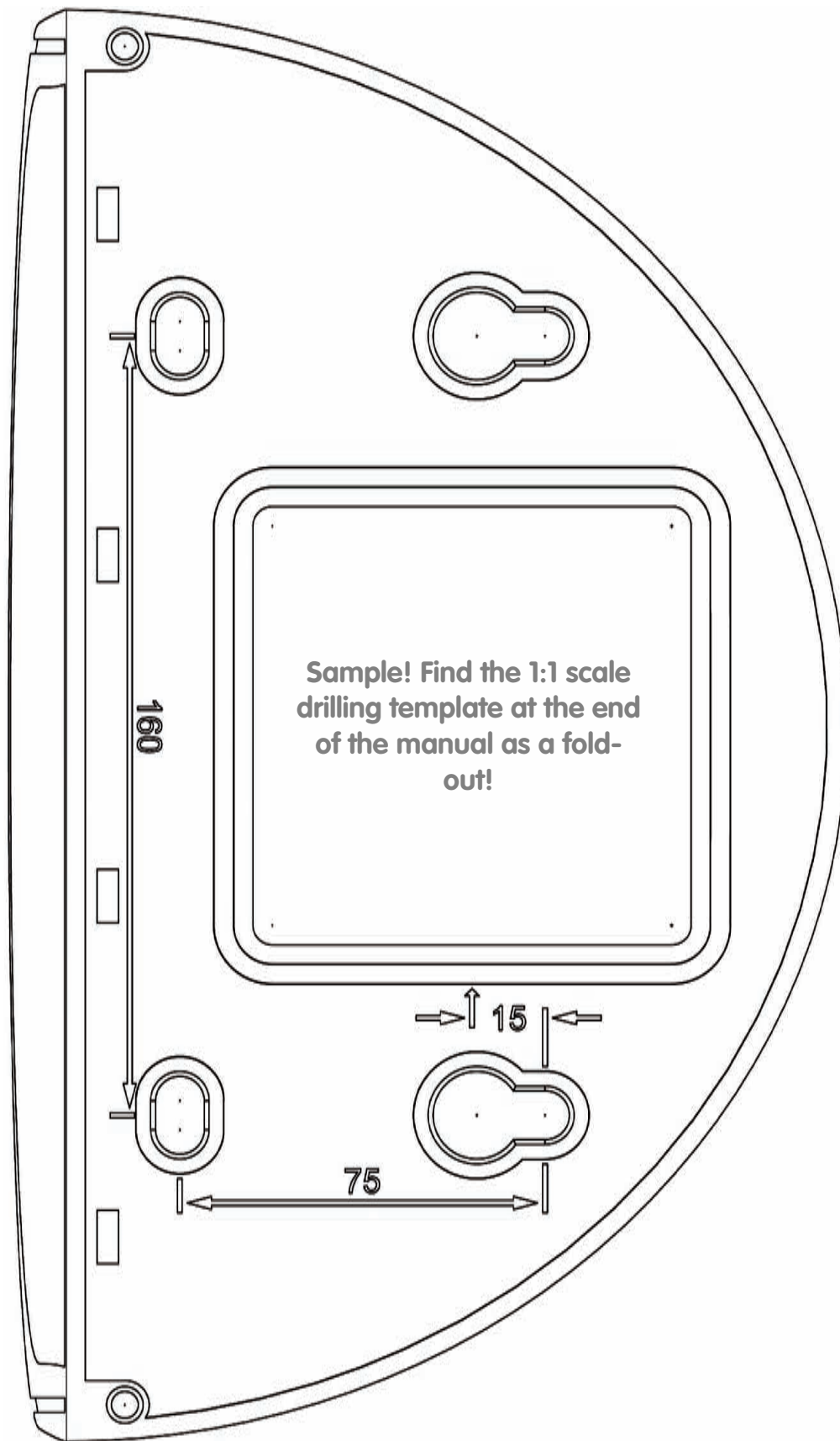

D12 wall mount and weather protection

IP65 Certificate

VDE Prüf- und Zertifizierungsinstitut

VDE VERBAND DER ELEKTROTECHNIK
ELEKTRONIK INFORMATIONSTECHNIK e.V.

KONFORMITÄTSBESTÄTIGUNG STATEMENT OF COMPLIANCE

Für das (die) überprüfte(n) Produkt(e)
for the approved product(s)

Erzeugnis <i>Product</i>	FixDome outdoor Secure-Kamera mit Dual-Optik <i>FixDome outdoor secure-camera with Dual-Optik</i>
Typenbezeichnung <i>Model/Type ref.</i>	D10
Weitere Information(en) <i>Further information</i>	IP65
Warenzeichen <i>Trade mark</i>	 MOBOTIX
Auftraggeber / Hersteller <i>Client / Manufacturer</i>	MOBOTIX AG Luxemburger Strasse 6 67657 Kaiserslautern
Angewandte Normen <i>Applied standards</i>	Abschnitte / Clauses: 12; 13; 14 DIN EN 60529/VDE 0470 Teil 1:2000-09 EN 60529:1991 + A1:2000
Prüfbericht-Nr. <i>Test report reference no</i>	2514700-9010-0001/65621 FG33/bhl 2005-11-25

Die Konformitätsbestätigung erfolgt auf Basis einer einmaligen Untersuchung von Produkten, die in einer zwischen Auftraggeber und VDE vereinbarten Menge aus der laufenden Produktion oder dem bereitgestellten Versandlos entnommen wurden. Sie bezieht sich ausschließlich auf die entnommenen Muster. Bei der im Prüfbericht dokumentierten Untersuchung wurden keine Abweichungen festgestellt. Detaillierte Ergebnisse sind dem Prüfbericht zu entnehmen.

Diese Überprüfung berechtigt nicht zum Führen eines VDE-Zeichens.

The statement of compliance is based on a single inspection carried out on the basis of the samples selected from running production or from a provided delivery lot of a quantity agreed between applicant and VDE. It only refers to the selected samples. No deviations were detected during the inspection documented in the test report. Detailed results can be taken from the test report.

This inspection is no authorization to use VDE marks.

Ausstellungsort / Datum
Place of issue / date

Offenbach, 2005-12-05

VDE Prüf- und Zertifizierungsinstitut
VDE Testing and Certification Institute

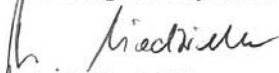

Leiter Fachbereich F3
Head of Department F3



VDE Prüf- und Zertifizierungsinstitut *VDE Testing and Certification Institute* Merianstraße 28 63069 Offenbach Germany www.vde.com

Declaration of Conformity

Konformitätserklärung gemäß dem Gesetz über Funkanlagen und Telekommunikationsendeinrichtungen (FTEG) und der Richtlinie 1999/5/EG (R&TTE)

Declaration of Conformity in accordance with the Radio and Telecommunications Terminal Equipment Act (FTEG) and Directive 1999/5/EC (R&TTE Directive)

Déclaration de conformité selon la loi sur les équipements hertziens et les équipements terminaux de télécommunication (FTEG) et la directive 1995/5/EC (R&TTE)

Hersteller/verantwortliche Person: MOBOTIX AG
 Manufacturer/responsible person:
 Fabricant/personne responsable :

erklärt, dass das Produkt: Netzwerk-Kamera
 declares that the product: Network camera
 déclare que le produit : Caméra de réseau

Typ: D12
 Type:
 Type :

Telekommunikations(Tk-)endeinrichtung: Netzwerk-Kamera zum Anschluss an das EURO-ISDN
 Telecommunications terminal equipment: Network camera for connection to the EURO ISDN
 Equipement de terminal de télécommunication: Caméra de réseau pour connecter au RNIS EURO

Verwendungszweck: Übertragung von Bildern und Toninformationen
 Intended purpose: Transmission of images and audio information
 Le but suivi : Transmission d'images et du son

bei bestimmungsgemäßer Verwendung den grundlegenden Anforderungen des § 3 und den übrigen einschlägigen Bestimmungen des FTEG (Artikel 3 der R&TTE) entspricht.
 complies with the essential requirements of §3 and the other relevant provisions of the FTEG (article 3 of the R&TTE Directive), when used for its intended purpose.
 est conforme aux exigences fondamentales du paragraphe 3 du FTEG (article 3 du R&TTE) et des autres clauses s'y rapportant.

Gesundheit und Sicherheit gemäß § 3 (1) 1. (Artikel 3 (1) a))
 Health and safety requirements pursuant to § 3 (1) 1. (article 3 (1) a))
 Santé et sécurité conformes au paragraphe 3 (1) 1. (article 3 (1) a))

angewendete harmonisierte Normen: EN 60950:2000 (NSR 73/23/EWG & 93/68/EWG)
 harmonised standards applied: (LVD 73/23/EWG & 93/68/EC)
 normes harmonisées : (Directive Basse Tension 73/23/EWG & 93/68/EC)

Schutzanforderungen in Bezug auf die elektromagn. Verträglichkeit § 3 (1) 2, Artikel 3 (1) b))
 Protection requirements concerning electromagnetic compatibility § 3 (1) 2, (article 3 (1) b))
 Exigences de protection concernant la compa tibilité électromagnétique, paragraphe 3 (1) 2; (article 3 (1) b))

angewendete harmonisierte Normen: EN 61000-4-2 EN 55022, Class B (EMV-RL 1995/5/EG
 harmonised standards applied: EN 61000-4-3 EN 55024 (R&TTE))
 normes harmonisées : EN 61000-4-4 EN 61000-6-2 (EMCD 1995/5/EG
 EN 61000-4-5 EN 61000-6-3 (R&TTE))
 EN 61000-4-6 (Directive EMC 1995/5/EG
 EN 61000-4-11 (R&TTE))

Anschrift: MOBOTIX AG
 Address: Luxemburger Str. 6
 Adresse : 67657 Kaiserslautern
 Germany

+ TK-Nr. / Phone number / N° de communication:

Fon: +49 (631) 3033-100
 Fax: +49 (631) 3033-190
 E-Mail: info@mobotix.com

Kaiserslautern, 01.09.2006

Ort, Datum
 Place & date of issue
 Lieu et date

Dr. Ralf Hinkel
 Vorstand/CEO, MOBOTIX AG

Name und Unterschrift
 Name and signature
 Nom et signature

MOBOTIX - the HighRes Video Company



**All images in this manual are genuine MOBOTIX camera images.
Enjoy the image quality!**

Manufacturer:

MOBOTIX AG
Luxemburger Str. 6
67657 Kaiserslautern
Germany

Phone: +49 (631) 3033-103
Fax: +49 (631) 3033-190

<http://www.mobotix.com>
sales@mobotix.com

CEO:

Dr. Ralf Hinkel

Court of Registration:
Amtsgericht Kaiserslautern
Registration Number: HRB 3724

Tax Code: 19/650/0812/1
Tax Office: Kaiserslautern

VAT ID: DE 202203501

Download the newest version of this document from:
www.mobotix.com, **Support** section.



Technical information subject to change without notice!

3 Megapixels

2048 x 1536
8x software zoom

30 Frames/s

VGA (640 x 480)
12 fps Mega

-22°F to +140°F

Weatherproof

-30°C to +60°C, IP65
no heating necessary

IEEE 802.3af

PoE

network power
even in winter

microphone & speaker

Audio

bi-directional via IP
variable frame rates

Video SIP Client

IP Telephony

alarm notify,
camera remote control

Video motion

multiple windows
precision pixel-based

lip-synchronized audio

Recording

event ring buffer
30 cams each 30 fps

Live viewing

30 cams at 30 fps
all on one screen

Backlight

safe using CMOS
without mechanical iris

Wall mount

with cable cover
for RJ45 wall outlet

Robust

no moving parts
fiber glass housing

D12

Camera Manual

Part 1

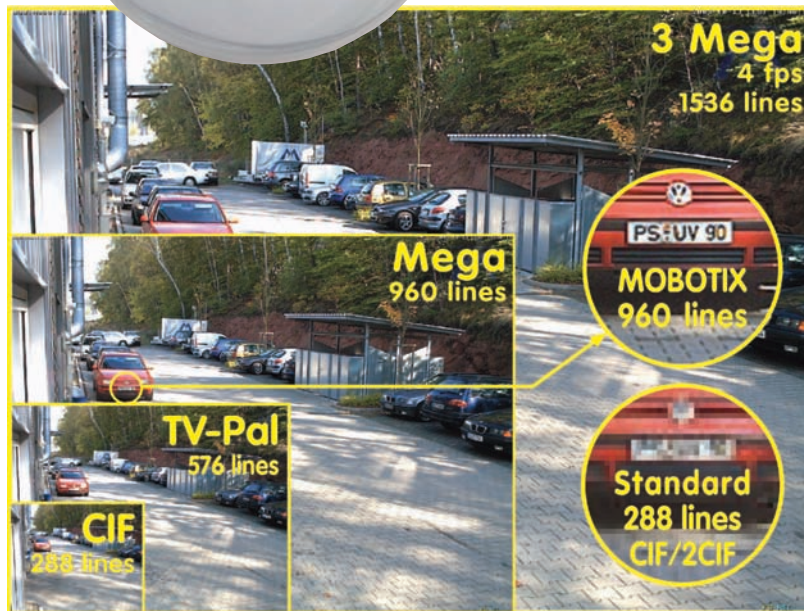

Complete integration for web and security

Current PDF File:
www.mobotix.com > Support > Manuals

MOBOTIX AG • Security-Vision-Systems • Made in Germany

www.mobotix.com • sales@mobotix.com • 08.09.2008



MOBOTIX ... the new face of IP video