

Megapixel

1280 x 960
software zoom

30 Frames/s

VGA (640 x 480)
10 fps Mega

-22°F to +140°F

Weatherproof

-30°C to +60°C, IP65
no heating necessary

IEEE 802.3af

PoE

network power
even in winter

microphone & speaker

Audio

bi-directional via IP
variable framerates

Video SIP Client

IP Telephony

alarm notify,
cam remote control

Video motion

multiple windows
precision pixel-based

lip-synchronized audio

Recording

event-ringbuffer
30 cams each 30 fps

Live viewing

30 cams at 30 fps
all on one screen

Backlight

safe using CMOS
without mechanical iris

Vandalism-protected

Wall bracket

with cable cover
for RJ45 wall outlet

Robust

no moving parts
fiber glass housing

CamIO

User Manual

Security-Vision-Systems

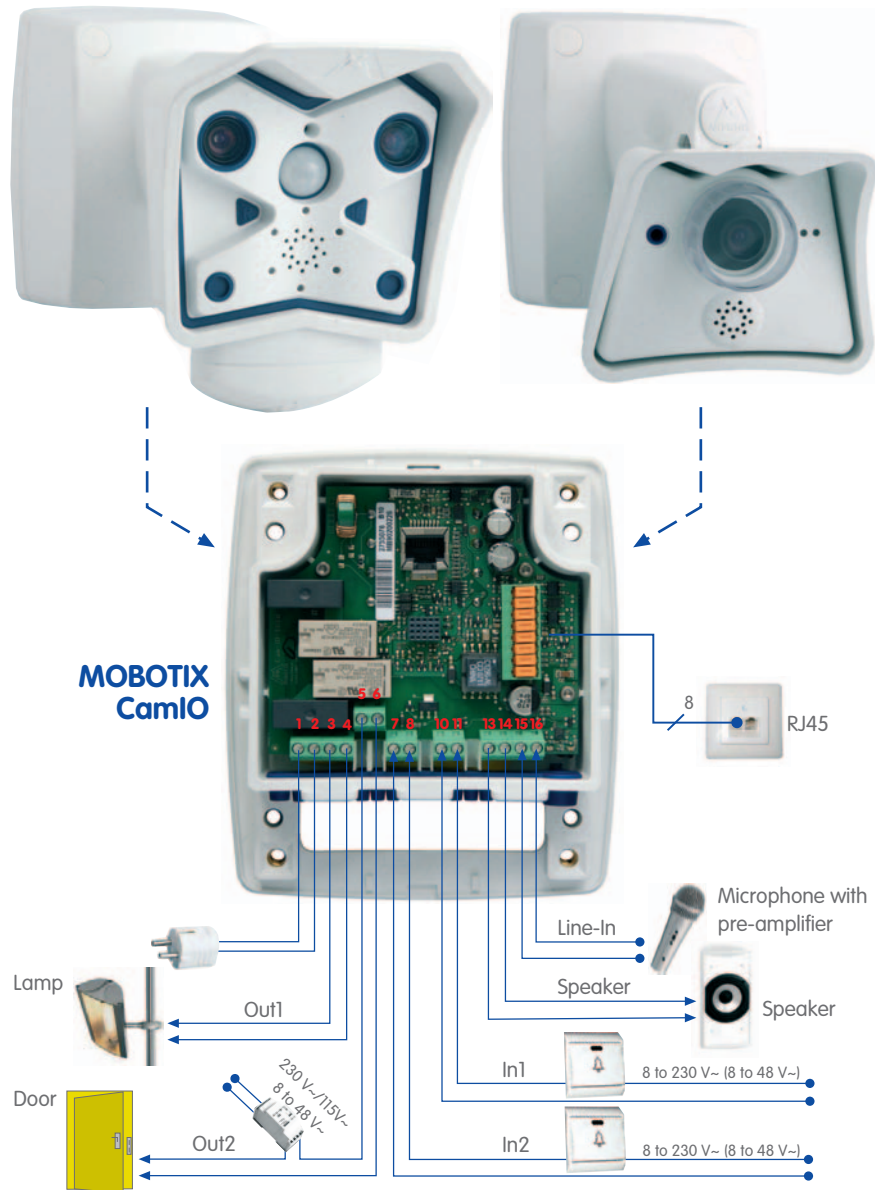

Complete integration for web and security

Current PDF File:
www.mobotix.com > Support > Manuals

MOBOTIX AG • Security-Vision-Systems • Made in Germany

www.mobotix.com • sales@mobotix.com • 9.11.2007

MOBOTIX ... the new face of IP video

Caution

Only qualified personnel may install and open the CamIO and connect it to the mains power; make sure that the relevant regulations of your country are respected!

It is imperative that all electrical wires have been disconnected from the mains power when working on or servicing the CamIO! Please also make sure to adhere to the applicable regulations for this kind of work!

MOBOTIX will not assume any responsibility for damages from faulty installations or inappropriate use!

Notes

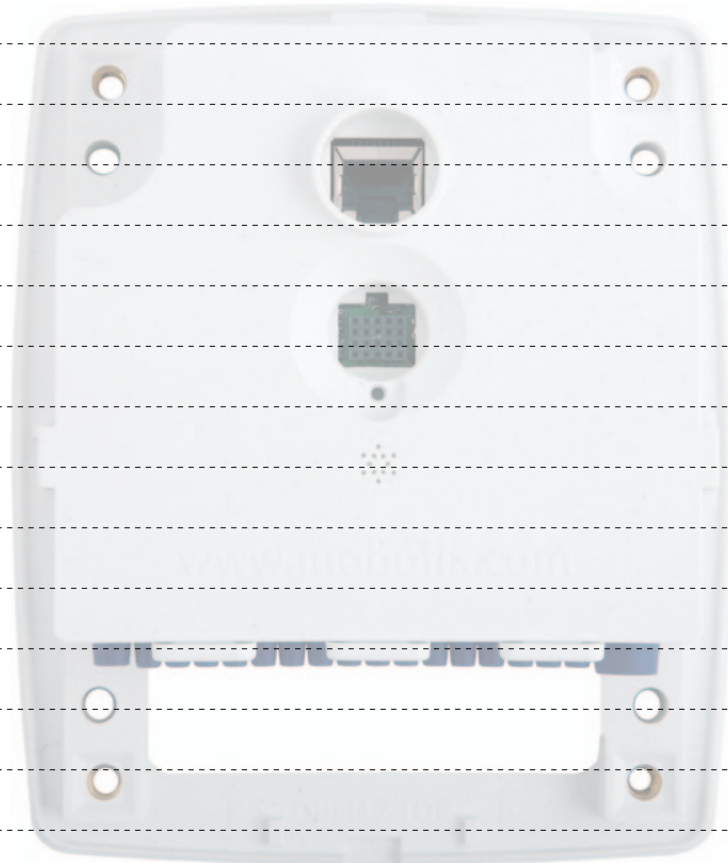

Note: MOBOTIX offers inexpensive seminars that include a workshop and practical exercises: **Basic Seminar** three days, **Advanced Seminar** two days.

For more information, see www.mobotix.com

CamIO User Manual

1	INTRODUCTION	4
1.1	MOBOTIX CamIO Concept	6
1.2	The MOBOTIX CamIO and MOBOTIX Cameras	8
1.2.1	Functional Overview of the CamIO Models	8
1.2.2	Connection Cables between CamIO and MOBOTIX Cameras	9
1.3	Important Notes	10
1.3.1	Safety Regulations	10
1.3.2	Cables for the MOBOTIX CamIO	10
1.3.3	Minimum Load at the Signal Outputs	11
1.3.4	Safety Notes for Operating the MOBOTIX CamIO	11
1.3.5	Maximum Cable Lengths	12
1.3.6	Charging the Rechargeable Battery (CamIO-ACplus)	12
1.3.7	Weatherproofness, Temperature Range	12
1.3.8	Cleaning Instructions	12
1.3.9	Additional Information	12
2	MOUNTING	14
2.1	Delivered Parts, Components, Dimensions and Connectors	14
2.1.1	Delivered Parts and Components	14
2.1.2	Wall Mount Foot and Housing	15
2.1.3	Dimensions and Drilling Template	16
2.1.4	Connectors and Wiring	20
2.2	Information on Connecting the MOBOTIX CamIO	22
2.3	Mounting the CamIO Wall Mount and the Control Cable	24
2.3.1	Mounting with an M12 Camera	24
2.3.2	Mounting with an M22 Camera	26
2.4	Mounting the CamIO Housing and Installing the Cables	28
2.4.1	Mounting the CamIO Housing on the Wall	28
2.4.2	Power Supply of the CamIO	29
2.4.3	Ethernet Connection of the CamIO	32
2.5	Connecting External Components to the CamIO	33
2.5.1	Connecting External Devices, Sensors and Audio Devices	33
2.6	Mounting the Camera on the CamIO	36
2.6.1	Connecting the Additional Speaker in the Wall Mount Foot	36
2.6.2	Connecting the Ethernet and the CamIO Control Cables	37
2.7	Wiring, Fire Prevention, Lightning and Surge Protection	38
2.7.1	Wiring	38
2.7.2	Fire Prevention	38
2.7.3	Lightning and Surge Protection	38
2.8	Accessories, Replacement Parts	40

3	OPERATION OF THE CAMIO	42
3.1	Activating the CamIO	42
3.2	Configuration Sample	43
3.2.1	Functional Overview	43
3.2.2	Terminal Connections of the CamIO	44
3.2.3	Overview of the Configuration Steps	44
3.2.4	Configuring the MOBOTIX Camera	45
3.2.5	Configuring a Softphone	51
4	TECHNICAL SPECIFICATIONS	52
APPENDIX: DECLARATION OF CONFORMITY DRILLING TEMPLATE (SCALE 1:1)		

Download the latest version of this document as a PDF file from www.mobotix.com:
Support > Manuals

Note

Download the latest version of this document as a PDF file from www.mobotix.com, **Support > Manuals**.

Information subject to change without notice!

Copyright © 1999-2007 MOBOTIX AG, Kaiserslautern, Germany.

All rights reserved. MOBOTIX, MxPEG and MxControlCenter are worldwide trademarks of MOBOTIX AG. Microsoft, Windows and Windows Server are registered trademarks of Microsoft Corporation. Apple, the Apple logo, Mac and Mac OS X are trademarks of Apple Inc. Linux is a trademark of Linus Torvalds. All other marks and names mentioned herein may be trademarks or registered trademarks of the respective owners.

1 INTRODUCTION

All CamIO models can be used with the MOBOTIX M12 and M22 cameras (IT and Secure models).

The CamIO can switch Ohm resistive loads with max. 5 A, (max. 500 W lamps at 230 V or 300 W lamps at 115 V).

The **MOBOTIX CamIO** is the expansion box for connecting the MOBOTIX cameras **M12** and **M22M** (IT and Secure models). In the security and home automation fields, the CamIO is the ideal supplement to the MOBOTIX cameras, if you want to switch lamps, doors, control wires, pushbuttons or other external devices, evaluate other sensors than those in the camera or use external audio devices (M12 models only).

An **external device** (e.g. a lamp) connected to the **CamIO-AC/ACplus** can be powered directly by the CamIO and is switched on or off using the first signal output of the MOBOTIX camera. The second signal output can be used for potential-free switching of another external device (e.g. door opener; max. 230V~ or 48V~/68V=, depending on the CamIO model). This signal output can also be used to connect the MOBOTIX camera to the input of an alarm system, for example.

You can also attach **external sensors** to the MOBOTIX camera via the CamIO, e.g. to evaluate remote sensors, such as light barriers, reed switches, external PIR sensors or the output of an alarm system.

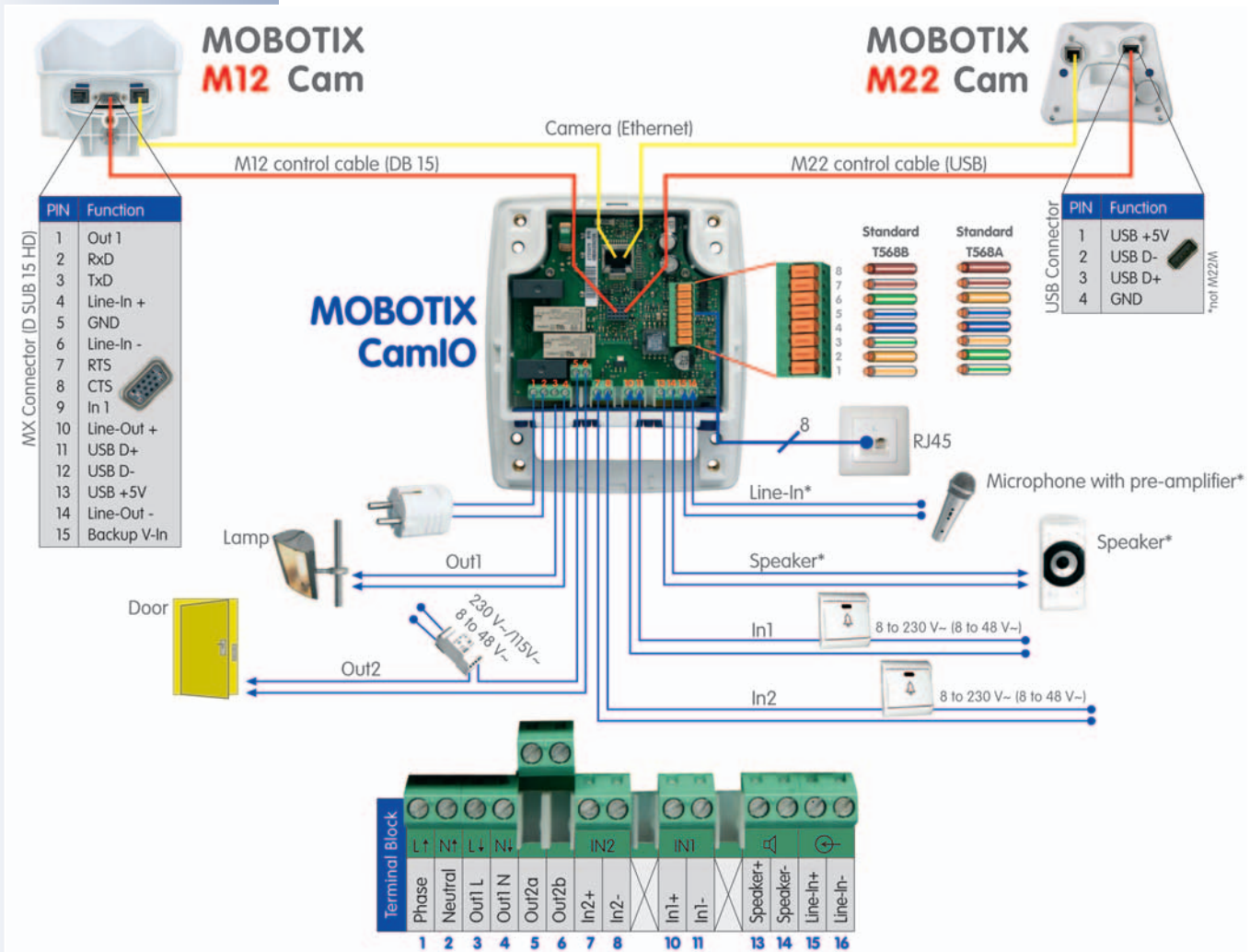

When mounting the MOBOTIX CamIO, the foot of the CamIO wall mount replaces the original foot of an M12 or M22 camera mount. The foot of the CamIO wall mount covers the CamIO and reliably protects it against **atmospheric exposure (IP65)**. In addition, the foot of the CamIO wall mount also contains an **additional speaker**, which is more powerful than the camera's internal speaker.

CamIO models

- CamIO-PoE:** This model is supplied using **PoE** (IEEE 802.3af), which powers the camera and the CamIO itself. The **signal output Out1** can switch one external device (max. 5 A), if max. 48 V~ or 68 V= have been connected to terminals 1 and 2; the **signal output Out2** can be used for potential-free switching of another external device (max. 5 A) with max. 48 V~ or 68 V=.

The **CamIO-PoE** also features **two signal inputs, one audio input (Line-In) and one audio output** for directly connecting the **supplied additional speaker** (max. 2.5 W/8 Ω).



MX-CAMIO-POE

- CamIO-AC:** This model has the same features as the **CamIO-PoE**, but it can be connected directly to utility power (230 V~/115 V~) and can power **one external device with up to 230 V~ current** (Ohm resistive load, max. 5 A, max. 500 W lamp on 230 V~, max. 300 W on 115 V~). It can also be used for potential-free switching of a second external device (max. 5 A) with **up to 230 V~/115 V~ at signal output Out2**.



**MX-CAMIO-AC-230
MX-CAMIO-AC-115**

- CamIO-ACplus:** In addition to the features of the CamIO-AC, the **CamIO-ACPlus** has a **rechargeable battery**, which provides a **backup power supply for the M12 models** even during power failures (approx. 45 minutes at 20°C/68°F, 20 minutes at -20°C/-4°F).

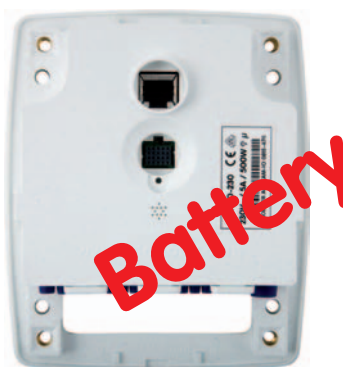

**MX-CAMIO-ACPLUS-230
MX-CAMIO-ACPLUS-115**

Currently, the audio features of the CamIO can only be used with M12 cameras. A future version of the CamIO will support external speakers and microphones also on M22 cameras.

The CamIO AC and ACplus versions are VDE-certified

Using the backup power feature of the CamIO-ACplus requires a MOBOTIX M12. M22 cameras do not support this feature yet.

1.1 MOBOTIX CamIO Concept

Simple Installation

When designing the MOBOTIX CamIO, special focus was placed on easy installation of the expansion box. The supplied drilling template facilitates mounting the CamIO and connecting the cabling for devices and data connections is easy, secure and weatherproof.

Directly supplying power to and switching of external devices

The **CamIO-AC** and **CamIO-ACplus** models can directly power one device at **signal output Out1** (230 V~/115 V~ at terminals 1 and 2 required), allowing you to switch this device from the MOBOTIX camera (max. 5 A, max. 500 W lamp on 230 V, max. 300 W on 115 V). You can use the second **signal output Out2** for potential-free switching of another external device.

The **CamIO-PoE** model has similar possibilities for switching devices, but can only switch loads of up to 48 V~/68 V=.

To supply power to an external device (terminals 3 and 4), make sure that the CamIO itself is connected to the power supply (terminals 1 and 2).

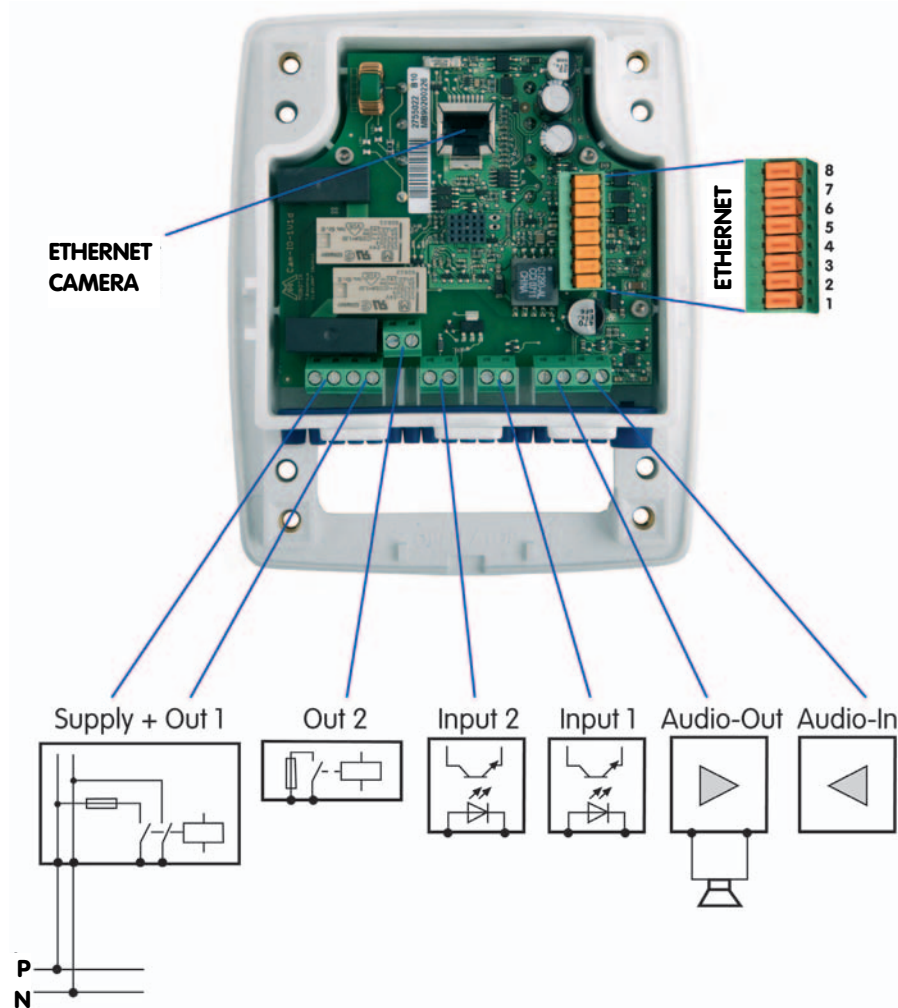

Backup power using the CamIO-ACplus

The integrated rechargeable battery of the **CamIO-ACplus** model can bridge smaller power failures and thus protects the integrity of the video and audio data. At room temperature (20°C/68°F), the CamIO can power a MOBOTIX M12D for about 45 minutes; at -20°C (-4°F), the CamIO still provides 20 minutes of backup power. Providing backup power for an M22M using a CamIO-ACplus is currently not possible.

Using external sensors

Using the two **signal inputs** of the CamIO, the MOBOTIX camera can monitor external sensors and apply the different mechanisms available to the camera for storing audio/video and for sending notification messages.

Connecting audio devices to M12 Cameras

Using the audio terminal of the MOBOTIX CamIO (Audio-Out), you can attach **the supplied external speaker in the wall mount foot** to the MOBOTIX camera (2.5 W/8 Ω; M12 models only). If you connect an **external microphone** via an external pre-amplifier to the Line-In terminals of the CamIO, the MOBOTIX camera will also use this input device. It is likewise possible to connect the Line-In terminals of the CamIO to the Line-Out connector of a computer.

Weatherproof

The weatherproofness of the MOBOTIX CamIO has been tested extensively and has reached IP65 (absolutely dustproof and resistant against water jets). Special attention has been paid to the waterproofness of the power cables, for which special cable seals have been developed.

Robust and durable

Like all other MOBOTIX products, the CamIO has been designed for a long product life. The housing from **PBT-30GF** is robust and reliably protects the interior of the CamIO.

The CamIO-ACplus can provide backup power for a MOBOTIX M12D for about 45 minutes.

Using the backup power feature of the CamIO-ACplus requires a MOBOTIX M12. M22 cameras do not support this feature yet.

Currently, the audio features of the CamIO can only be used with M12 cameras. A future version of the CamIO will support external speakers and microphones also on M22 cameras.

1.2 The MOBOTIX CamIO and MOBOTIX Cameras

1.2.1 Functional Overview of the CamIO Models

All CamIO models can be used with MOBOTIX M12 and M22 cameras (IT/Secure models).

Using the backup power feature of the CamIO-ACplus requires a MOBOTIX M12. M22 cameras do not support this feature yet.

Currently, the audio features of the CamIO can only be used with M12 cameras. A future version of the CamIO will support external speakers and microphones also on M22 cameras.

	CamIO-PoE Mx-CAMIO-POE		CamIO-AC Mx-CAMIO-AC-230 Mx-CAMIO-AC-115		CamIO-ACplus Mx-CAMIO-ACPLUS-230 Mx-CAMIO-ACPLUS-115	
Hardware Features						
Outdoor - weatherproof	IP65		IP65		IP65	
Power Supply	PoE		230 V~ / PoE 115 V~ / PoE		230 V~ / PoE 115 V~ / PoE	
Integrated rechargeable battery	-		-		X	
Concealed cabling	X		X		X	
Features	M12	M22M	M12	M22M	M12	
Audio Out (speaker/microphone)	X	-	X	-	X	
Line In (microphone with pre-amp.)	X	-	X	-	X	
Signal outputs	2	2	2	2	2	
Signal inputs	2	2	2	2	2	
Input voltage (terminals 1 and 2)	8 to 48 V~		230 V~ 115 V~		230 V~ 115 V~	
	11 to 68 V=					

Note

In order to use all features of the CamIO, make sure that you are activating it in the camera software (Admin Menu > Manage Hardware Expansions). Please note that you will need a software version 3.3.1.x or higher on the MOBOTIX M22M and a software version 3.1.0.x or higher on the MOBOTIX M12.

1.2.2 Connection Cables between CamIO and MOBOTIX Cameras

Two cables are required to connect the MOBOTIX camera to the CamIO:

- **Ethernet cable:** Establishes the data connection and the power supply to the camera.
- **Control cable:** Connects the serial interface (M12) or the USB interface (M22) of the camera in order to provide the signal outputs and inputs of the camera at the CamIO. The different cameras require different control cables, which need to be ordered separately.

The control cable required for connecting the CamIO is not part of the standard delivery. Always order a corresponding control cable for your M12 or M22.

Control cable for the MOBOTIX M12



MX-CAMIO-OPT-M12

Control cable for the MOBOTIX M22M



MX-CAMIO-OPT-M22

1.3 Important Notes

1.3.1 Safety Regulations

Caution

Only qualified personnel may install and open the CamIO and connect it to the mains power; make sure that the relevant regulations of your country are respected!

It is imperative that all electrical wires have been disconnected from the mains power when working on or servicing the CamIO! Please also make sure to adhere to the applicable regulations for this kind of work!

MOBOTIX will not assume any responsibility for damages from faulty installations or inappropriate use!

1.3.2 Cables for the MOBOTIX CamIO

Only use cables, which have been approved for the pertinent type of installation. Always observe the allowed wire cross-sectional sizes (see table below) and the maximum cable lengths.

- Connecting the power supply:** To provide the power supply to the CamIO, a two-wire cable is required. A ground conductor is not needed. If a power cable with ground conductor is used, this wire must not be connected in the junction box. Instead, connect the ground conductor of any attached device in the junction box.

Make sure that the fuse for this cable is not stronger than 16 A.

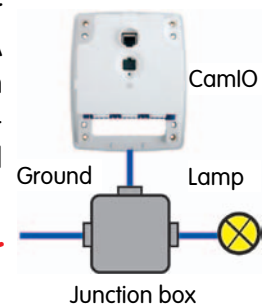

- Connecting an electrical device:** In order to provide power to an external device (Ohm resistive load, max. 5 A, 500 W lamp on 230 V, max. 300 W lamp on 115 V), the CamIO switches two wires (phase conductor and neutral).

A ground conductor for grounding the external device needs to come from the junction box.

- Connecting signal wires and external sensors:** Use suitable installation cable for connecting another relay or a signal line (e.g. to an alarm system) or an external sensor.

- Connecting the Ethernet cable:** Make sure that you are using a suitable eight-wire Ethernet installation cable CAT5 (or higher) for connecting the CamIO to the patch panel of a structured wiring system in a building.



Make sure that you are completely removing the shielding of the Ethernet cable and that no part of the shielding touches the circuit board.



For information on allowed cable diameters and lengths, see chapter 4, *Technical Specifications*.

Allowed Cable Dimensions	Solid	AWG
Bottom terminal (terminals 1 to 16)	0.14 to 2.5 mm ²	26 to 14
Ethernet terminal (cutting clamps)	0.13 to 0.31 mm ²	26 to 22

Cable diameters should be tailored to the electrical load and must follow the applicable regulations.

AWG:
American Wire Gauge (for measuring cable diameters)

Note

The **length of the cables for signal wires and external sensors is not restricted**. You need to make sure, however, that the minimum voltage at the corresponding terminal is reached (see chapter 4, *Technical Specifications*). A possible loss of voltage due to the resistance of the wires needs to be considered.

1.3.3 Minimum Load at the Signal Outputs

In order to avoid oxidation of the relay points, you should use minimum loads of 5 V=/100 mA.

1.3.4 Safety Notes for Operating the MOBOTIX CamIO

When installing the wiring inside or outside of buildings, make sure you always adhere to the relevant regulations on wiring, fire prevention and protection against lightning.

MOBOTIX recommends having MOBOTIX devices installed only by certified specialists accustomed to installing network devices and having proper respect for the applicable regulations regarding **lightning protection** and **fire prevention** as well as the current technology for preventing damages from electrical surges.

More information is available at an institution such as the **International Electrotechnical Commission** (IEC, www.iec.ch) or at a manufacturer of protection devices against lightning and electrical surges, such as Dehn (www.dehn.de).

Wiring

When installing the wiring, make sure to follow these guidelines:

- **Outdoors:** Installing the camera outdoors requires special precautions and measures regarding the cables as well as lightning and surge protection (see further below in this section).
- **Wire lengths:** The cable segments must not exceed the maximum allowed cable lengths in order to ensure proper data transfer (see also section 3.3, *Connecting the Camera to the Network and to the Power Supply*, in the corresponding camera manual).
- **Avoid induction:** When running data cables parallel to existing regular power lines or high-voltage wires, make sure you observe the minimum distances to the power cables.

Fire Prevention

When installing the power lines to the camera, make sure you always adhere to the relevant regulations on wiring and fire prevention at the site of the installation.

Lightning and Surge Protection

To prevent damage from lightning and power surges, make sure you follow these guidelines:

- **Lightning conductors:** In areas exposed to lightning (e.g. on roofs), a distance holder (1 m (3 ft) above and away from the camera) and proper lightning conductors need to be installed in order to prevent lightning strikes into the camera and to ensure that the energy of a lightning strike is properly led to the ground.
- **Surge protection:** Make sure you have installed proper protection against electrical surges in order to prevent damage to the camera, the building and the network infrastructure. This includes surge protectors for 19" racks, adding an uninterruptible power supply (UPS) to the MOBOTIX camera, and installing surge arresters or similar for routers, switches, servers, etc.

1.3.5 Maximum Cable Lengths

According to **UL regulations**, the length of the cable to a MOBOTIX camera must be limited to **140 feet** or less running outside of buildings. The installation must comply with articles **725** and **800** of the **National Electric Code**.

1.3.6 Charging the Rechargeable Battery (CamIO-ACplus)

The **CamIO-ACPlus** model features a **rechargeable battery**, which provides **backup power supply** even during power failures (approx. 45 minutes at 20°C/ 68°F, 20 minutes at -20°C/-4°F). Please note that the full capacity of the rechargeable battery is only available after the CamIO has been attached to mains power for at least 48 hours.

1.3.7 Weatherproofness, Temperature Range

The housing of the MOBOTIX CamIO is weatherproof (**IP65**, absolutely dustproof, resistant against water jets) and can be used at temperatures from **-30 to +60°C (-22 to +140°F)**.

1.3.8 Cleaning Instructions

The housing of the MOBOTIX CamIO and the wall mount foot are made of fiber-reinforced **PBT-30GF**. This material is robust, maintenance-free and can be cleaned using a mild household detergent without solvents or abrasive particles.

1.3.9 Additional Information

For additional information on the **MOBOTIX CamIO**, see www.mobotix.com.

Notes

A series of horizontal dashed lines for taking notes.

2 MOUNTING

2.1 Delivered Parts, Components, Dimensions and Connectors

2.1.1 Delivered Parts and Components

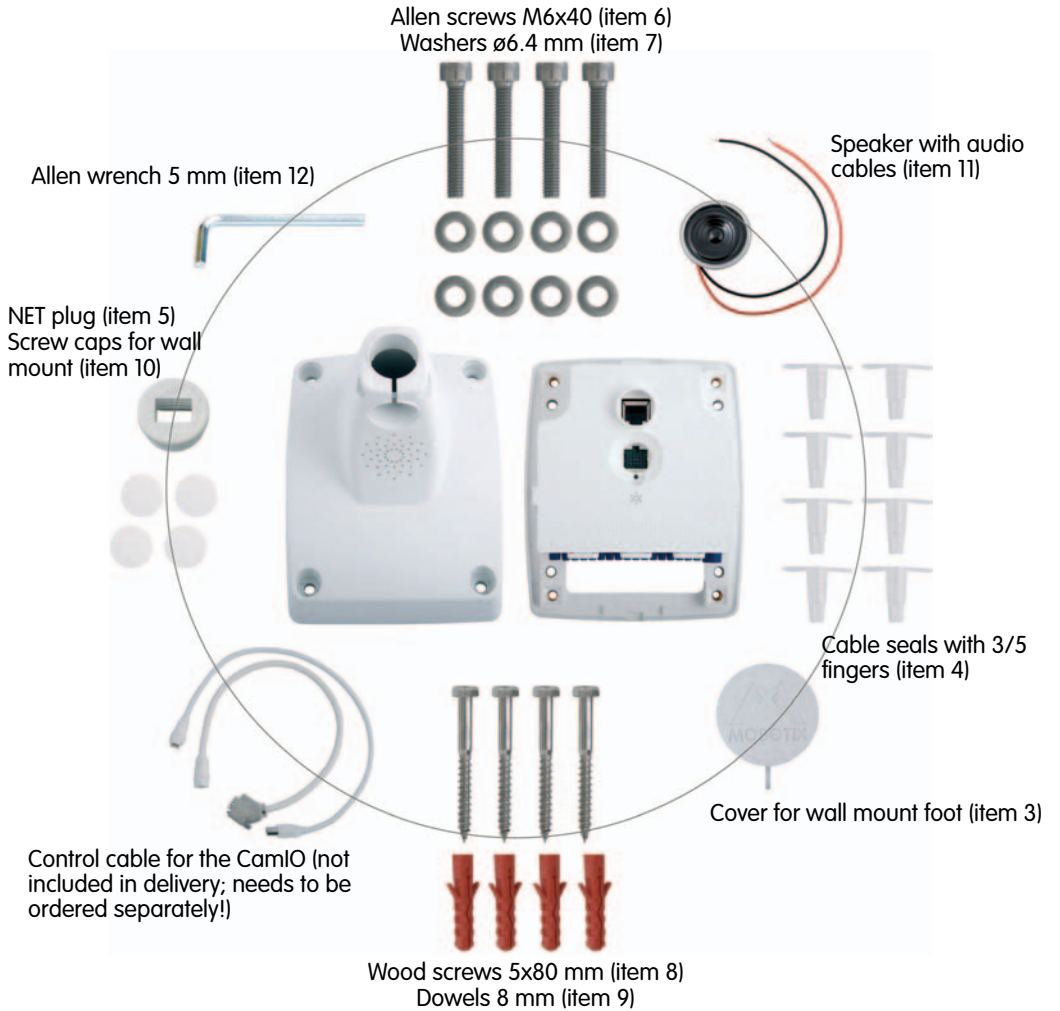

The control cable required for connecting the camera to the CamIO is not part of the standard delivery. Always order the corresponding control cable for your M12 or M22.

Item	Count	Part Name
1	1	CamIO Wall Mount Foot
2	1	CamIO Housing
3	1	Cover for wall mount
4	8	Cable seals (4x with 3, 4x with 5 fingers)
5	1	NET plug
6	4	Allen screws M6x40
7	8	Washers ø6.4 mm
8	4	Wood screws 5x80 mm
9	4	Dowels 8 mm
10	4	Screw caps for wall mount
11	2	Speaker with audio cables (mounted in wall mount foot)
12	1	Allen wrench 5 mm
13	1	Wood screw 3x10 mm
14	1	Washer ø3.4 mm

2.1.2 Wall Mount Foot and Housing

The MOBOTIX CamIO housing (item 1) and the housing of the CamIO itself (item 2) are made of white, fiber-reinforced **plastic (PBT-30GF, Polybutyleneterephthalate with 30% fiberglass)**. This material is used heavily in the automotive industry and is sturdy, resistant against high temperatures, environmental influences, chemicals, etc.

CamIO Wall Mount Foot



The additional speaker can currently only be used with M12 cameras. A future version of the CamIO will support external speakers and microphones also on M22 cameras.

CamIO Housing

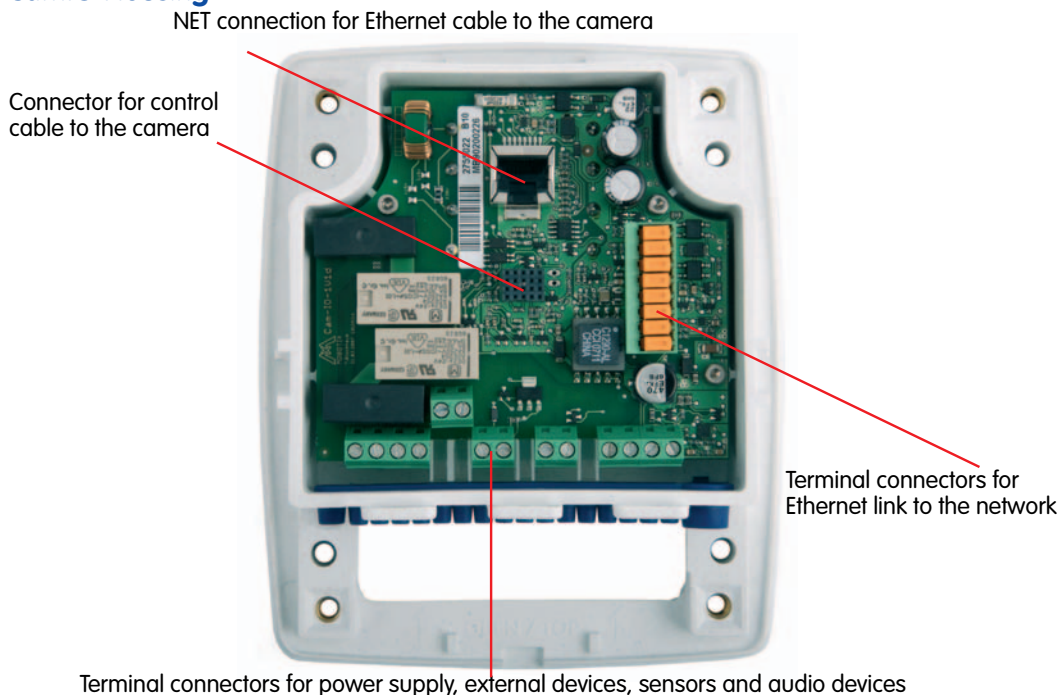

2.1.3 Dimensions and Drilling Template

Dimensions of the MOBOTIX CamIO Housing

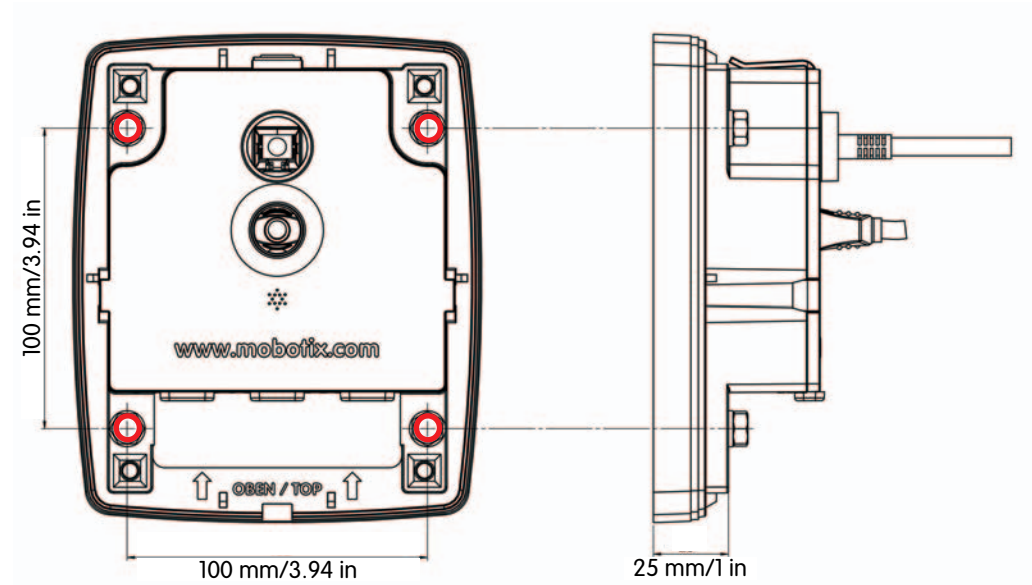

The appendix of this manual contains a 1:1 drilling template for drilling the **dowel holes** for the CamIO.

Dimensions of the MOBOTIX CamIO Housing with Wall Mount Foot

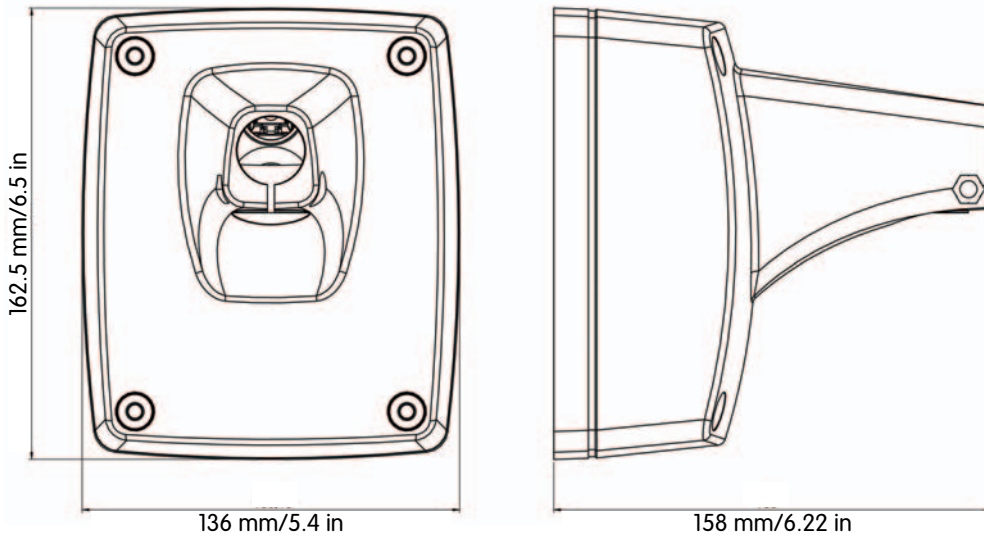



MOBOTIX M12 Cam

MX Connector (D SUB 15 HD)

PIN	Function
1	Out 1
2	RxD
3	TxD
4	Line-In +
5	GND
6	Line-In -
7	RTS
8	CTS
9	In 1
10	Line-Out +
11	USB D+
12	USB D-
13	USB +5V
14	Line-Out -
15	Backup V-In

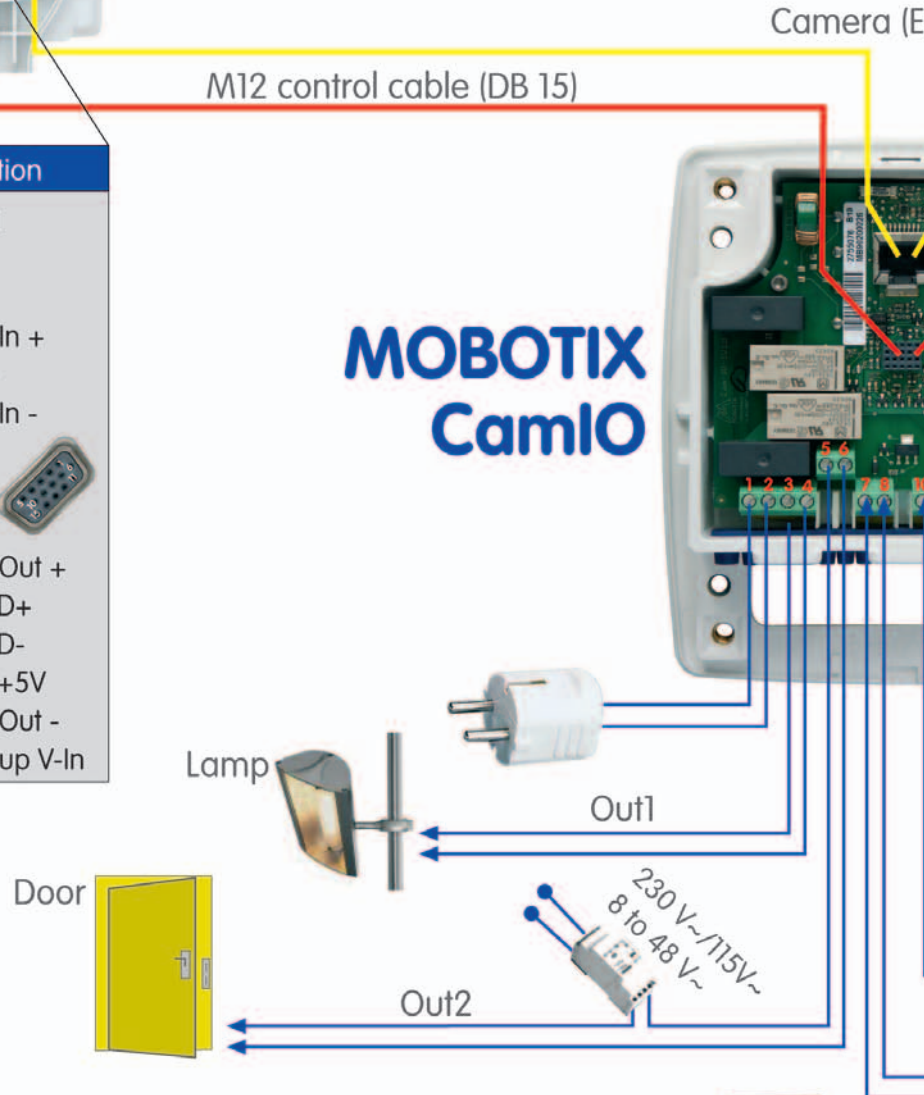

Terminal Block	L ↑	N ↑	L ↓	N ↓	IN2			
	Phase	Neutral	Out1 L	Out1 N	Out2a	Out2b	In2+	In2-
	1	2	3	4	5	6	7	8

MOBOTIX M22 Cam

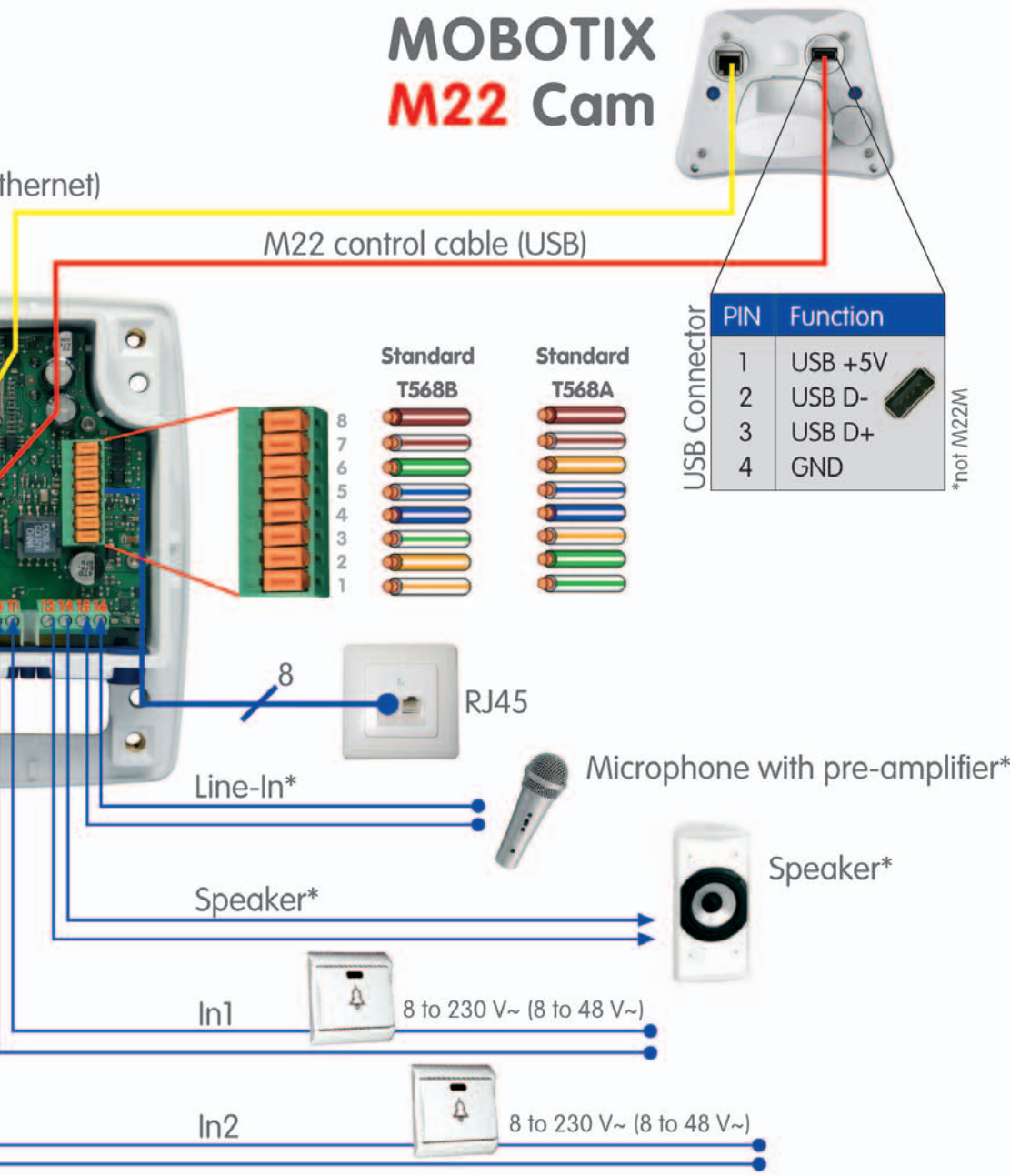

USB Connector	PIN	Function
	1	USB +5V
	2	USB D-
	3	USB D+
	4	GND

*not M22M

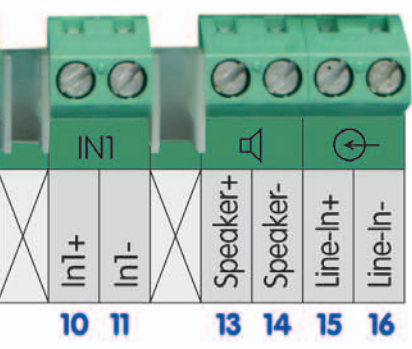

2.1.4 Connectors and Wiring

Terminal Connector for Power Supply, External Devices, Sensors and Audio Devices

Make sure that you are adhering to the applicable regulations in your country regarding the allowed cables when connecting the wires to the terminal connector. Always observe the allowed wire cross-sectional sizes (see table below).

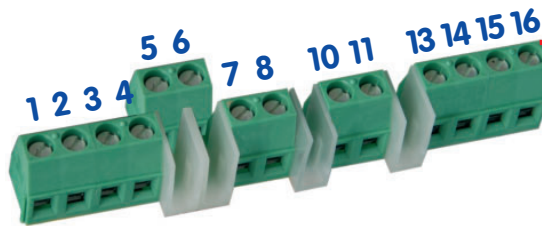

Allowed Cable Dimensions	Solid	AWG
Bottom terminal (terminals 1 to 16)	0.14 to 2.5 mm ²	26 to 14
Cable diameters should be tailored to the electrical load and must follow the applicable regulations.		

AWG:
American Wire Gauge (for measuring cable diameters)

If a power cable with ground conductor is used (three-wire cable), this wire must not be connected at the junction box! Instead, connect the ground conductor in the junction box and not within the CamIO.

Terminal	Part Name	Remark
1	Phase conductor L	Direct power supply for CamIO and Out1
2	Neutral conductor N	
3	Out1 L (signal output 1)	Ext. devices without individual power supply, max. 5 A, max. 500 W lamps
4	Out1 N (signal output 1)	
5	Out2a (signal output 2)	Ext. devices with individual power supply 5 to 230 V~, max. 5 A (min. 5 V=, 100 mA)
6	Out2b (signal output 2)	
7	In2 + (signal input 2)	Ext. sensor 2, 8 to 230 V~ (48 V~) (min. 2 mA)
8	In2 - (signal input 2)	
10	In1 + (signal input 1)	Ext. sensor 1, 8 to 230 V~ (48 V~) (min. 2 mA)
11	In1 - (signal input 1)	
13	Speaker +	Ext. speaker can be connected directly, max. 2.5 W/8 Ω
14	Speaker -	
15	Line-In +	Ext. microphone with ext. pre-amplifier
16	Line-In -	

Terminal Connector and Wiring of the Ethernet Connector

Make sure that you are using a standard CAT5 Ethernet cable for connecting the Ethernet cable to the Ethernet terminal connector (see section 2.4.3, *Ethernet Connection of the CamIO*). Always observe the allowed wire cross-sectional sizes and the applied connection standard. The color codes of the individual wires are usually easy to spot at a CAT5 plug.

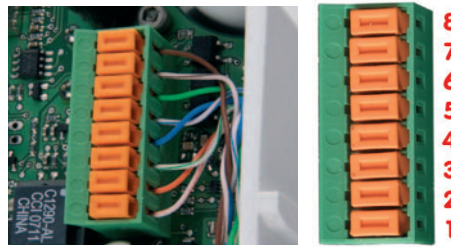

Allowed Cable Dimensions	Solid	AWG
Ethernet terminal (cutting clamps)	0.13 to 0.31 mm ²	26 to 22
Cable diameters should be tailored to the electrical load and must follow the applicable regulations.		

AWG:
American Wire Gauge (for measuring cable diameters)

Ethernet cabling today follows an EIA/TIA standard (*EIA: Electronic Industries Alliance, TIA: Telecommunications Industry Association*), commonly **T568B (AT&T 258A)** is being used; older Ethernet cabling may have been connected according to **T568A**:

Connection Standard T568B

Terminal	TIA-568B Pair No.	TIA-568 Color	
8	4	Brown cable/white line	
7	4	White cable/brown line	
6 (Rx-)	3	Green cable/white line	
5	1	White cable/blue line	
4	1	Blue cable/white line	
3 (Rx+)	3	White cable/green line	
2 (Tx-)	2	Orange cable/white line	
1 (Tx+)	2	White cable/orange line	

Variant B - T568B

Connection Standard T568A

Terminal	TIA-568A Pair No.	TIA-568 Color	
8	4	Brown cable/white line	
7	4	White cable/brown line	
6 (Rx-)	2	Orange cable/white line	
5	1	White cable/blue line	
4	1	Blue cable/white line	
3 (Rx+)	2	White cable/orange line	
2 (Tx-)	3	Green cable/white line	
1 (Tx+)	3	White cable/green line	

Variant A - T568A

2.2 Information on Connecting the MOBOTIX CamIO

The CamIO can be used with a MOBOTIX M12 or an M22. Simply replace the original foot of the corresponding SecureFlex mount of the camera by the supplied foot of the CamIO wall mount.

MOBOTIX M12 with CamIO



MOBOTIX M22M with CamIO



Mounting the CamIO in four steps

Mounting the CamIO is done in four steps (or three, if no external devices are connected; skip step 3 in this case):

1) Preparing the camera: Mounting the CamIO Wall Mount and the Control Cable

Replace the foot of the original SecureFlex wall mount against the foot of the CamIO wall mount. This step includes connecting the M12/M22 control cable to the camera and guiding it and the network cable into the CamIO wall mount (*section 2.3*).

2) Preparing the CamIO: Mounting the CamIO Housing and Installing the Cables

First, mount the housing of the CamIO to a wall. This step involves connecting the network cable and the power cable coming from the building infrastructure to the CamIO (*section 2.4*).

3) Connecting External Components to the CamIO

This (optional) step involves connecting external devices, sensors and audio devices to the CamIO (terminals 3 to 16 of the terminal connectors; *section 2.5*).

4) Mounting the Camera on the CamIO

Install the MOBOTIX camera (mounted to the CamIO wall mount foot) on the CamIO housing. This step involves connecting the cables to the camera (audio cables, Ethernet cables, CamIO control cable; *section 2.6*).

2.3 Mounting the CamIO Wall Mount and the Control Cable

2.3.1 Mounting with an M12 Camera

- Unscrew the **upper Allen screw** in the original foot of the mount, which holds the turn/tilt unit in place (5 mm Allen wrench, item 12). Remove the Allen screw, the washer and the hex nut from the mount.

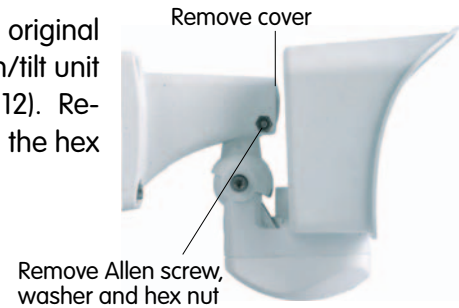

- Remove the **cover**.

- Gently pull the **turn/tilt unit** and all cables out of the vertical opening of the original wall mount foot.

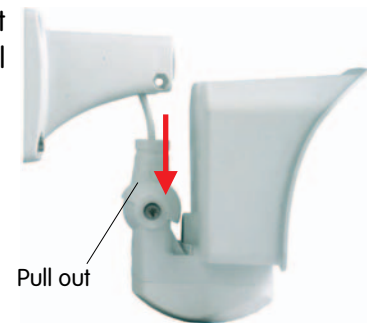

- Remove the **Allen screw** of the **bottom cover** and take off the cover.



- MOBOTIX M12 cameras feature a pre-installed **insect protection**, which effectively prevents small animals from entering the camera. Make sure that the **condensation escape vents** remain open. **Never push any objects into the drain holes as this may damage the plugs!**

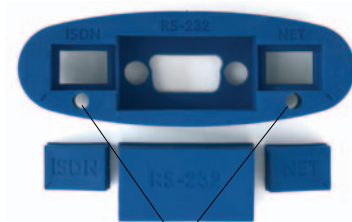

Condensation escape vents
(do not block or damage)

- Insert the M12 control cable for the CamIO from below into the turn/tilt unit of the camera. Remove the blue plug labeled **RS-232** from the insect protection. Connect the HD 15 connector to the M12.



- Make sure that the camera's insect protection remains firmly in place. Reinstall the **bottom cover** of the mount.



- Insert the Ethernet cable and the M12 control cable from below into the turn/tilt unit of the CamIO wall mount foot.
- Insert the supplied **cover** into the free opening of the CamIO wall mount foot.

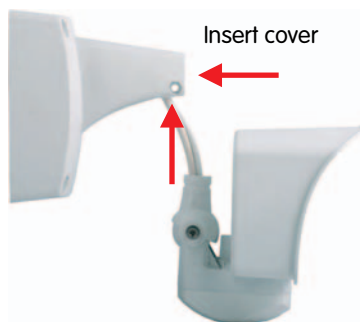

Insert the cover!

- Insert the turn/tilt unit of the camera into the vertical opening of the mount (all the way to the stop).



- Place the hex nut into the corresponding hole, insert the **Allen screw** with washer and lightly fasten the screw so that you can still easily turn the camera.

Maximum torque for all screws is 1 to 1.2 Nm (0.74 lbf ft)

2.3.2 Mounting with an M22 Camera

- Unscrew the **upper Allen screw** in the original foot of the mount, which holds the turn/tilt unit in place (5 mm Allen wrench, item 12). Remove the Allen screw, the washer and the hex nut from the mount.
- Remove the **cover**.

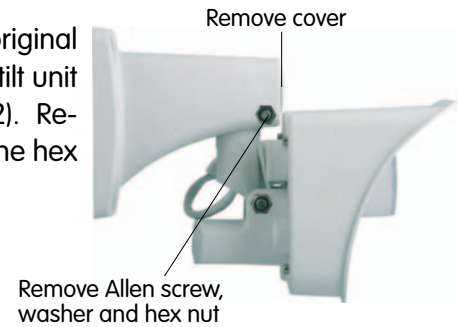

- Gently pull the **turn/tilt unit** and all cables out of the vertical opening of the original wall mount foot.

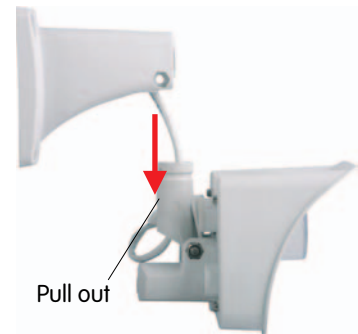

- Insert the M22 control cable for the CamIO (USB connector first) from above into the turn/tilt unit of the camera.
- Now guide the M22 control cable through the bent opening of the USB plug.



- Attach the USB connector of the M22 control cable to the USB socket of the camera.
- Push the USB plug over the USB connector and the corresponding ring of the camera's housing. It is very important that the rubber plug reliably protects the housing and the USB connector against moisture. This will guarantee the weatherproofness (IP65) of the camera.

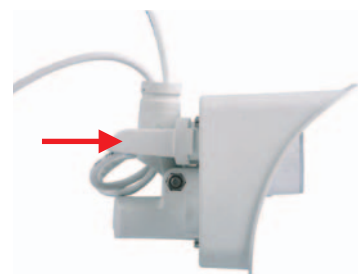

- Insert the Ethernet cable and the M22 control cable from below into the turn/tilt unit of the CamIO wall mount foot.
- Insert the supplied **cover** into the free opening of the CamIO wall mount foot.

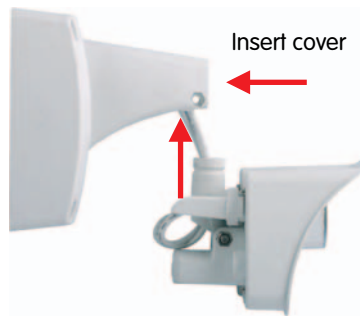

- Insert the turn/tilt unit of the camera into the vertical opening of the mount (all the way to the stop).



- Place the hex nut into the corresponding hole, insert the **Allen screw** with washer and lightly fasten the screw so that you can still easily turn the camera.



Insert the cover!

Maximum torque for all screws is 1 to 1.2 Nm (0.74 lbf ft)

Caution

Make sure that you are always using the proper plugs (NET for the Ethernet cable, USB for the USB cable)!

Also make sure that the plugs are not bent or the cable is under tension as this could lead to water entering the camera!



2.4 Mounting the CamIO Housing and Installing the Cables

2.4.1 Mounting the CamIO Housing on the Wall

The appendix of this manual contains a 1:1 drilling template for mounting the CamIO. Use this template for drilling the holes for the dowels.

- Mount the CamIO using the supplied screws, washers and dowels.

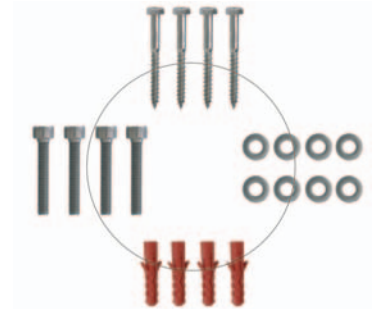

- Make sure that the installation cables are guided through the opening at the bottom of the CamIO and that the arrows next to the **OBEN / TOP** label of the CamIO are pointing upwards.

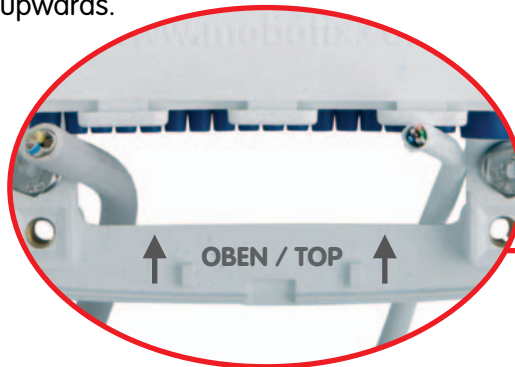

- Remove the lid of the CamIO to continue with the installation. To do so, gently lift the latch at the top with a screwdriver (1), tilt the lid slightly towards you (2) and remove the lid by pulling it upward (3).



2.4.2 Power Supply of the CamIO

You can supply power to the MOBOTIX CamIO using one of these two methods:

- **Direct power supply:** Mains power (230 V~/115 V~) is connected to terminals 1 and 2 of the CamIO's terminal connector at the bottom. The CamIO will power a MOBOTIX camera and an external device attached to terminals 3 and 4. The external device will get the same voltage that has been connected to terminals 1 and 2 of the CamIO.
- **Indirect power supply:** The CamIO is powered by a PoE switch, which provides power according to the **Power-over-Ethernet standard IEEE 802.3af**. The attached MOBOTIX camera is powered by the same switch.

You can supply power to the CamIO-AC and CamIO-ACplus models either directly or indirectly.

Power to the CamIO-PoE can only be supplied indirectly via the network cabling (PoE).

Note

The **CamIO-PoE** model supports indirect power supply via PoE. Providing direct power with 230/115 VAC is not possible when using the PoE model. For additional information on the features of the individual CamIO models, see chapter 1.

Caution

When supplying power to an external device from the CamIO (terminals 3 and 4), the CamIO itself needs to be connected to the power supply (terminals 1 and 2). This is possible on **CamIO-AC** and **CamIO-ACplus** models by directly connecting **230/115 V~** to terminals 1 and 2 of the CamIO. For the CamIO-PoE, the maximum allowed voltage at terminals 1 and 2 is **48 V~** or 68 V=. This voltage is then available at terminals 3 and 4 of the CamIO.

Make sure that an external load never exceeds 5 A.

Caution

Only qualified personnel may install and open the CamIO and connect it to the mains power; make sure that the relevant regulations of your country are respected!

It is imperative that all electrical wires have been disconnected from the mains power when working on or servicing the CamIO! Please also make sure to adhere to the applicable regulations for this kind of work!

MOBOTIX will not assume any responsibility for damages from faulty installations or inappropriate use!

Installing the power supply:

Use a two-wire cable (or any other suitable cable) to provide the power supply. Make sure that you are respecting the minimum cable diameters.

Caution

The power supply cable to the CamIO needs to have a basic insulation level (BIL) of at least 230 V/115 V (depending on the mains voltage). Never lay bell wires (BIL 50 V) next to 230 V or 115 V cables! Make sure that the fuse for this cable is not stronger than 16 A.

If a power cable with ground conductor is used (three-wire cable), this wire must not be connected in the junction box! Instead, connect the ground conductor of any attached device in the junction box.

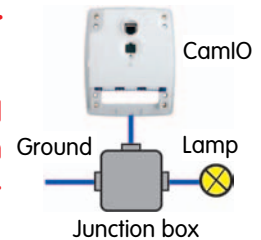
**Install the cable seals:**

- Remove about 5 cm (2 in) of the outer insulation (sheath) of the power cable.
- Next, remove about 5 mm (0.2 in) of the wire insulation.
- Guide each wire into a separate finger of the cable seal. Make sure that each finger only contains a single wire (the clear plastic facilitates this check, see figure).
- Puncture the tips of the cable seal fingers with the wires.

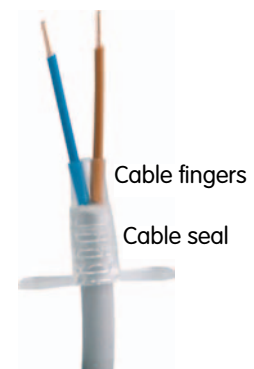
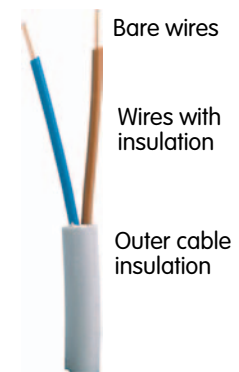

According to common regulation, no moisture should enter between the wires and the cable insulation, since this may lead to corrosion of the cables. The silicone compound and the cable seals will reliably protect the cables against moisture.

Note

The supplied **cable seals** contain a small amount of silicone compound, which facilitates pushing the wires through the cable fingers. Make sure that you clean the wires and the cable after mounting to remove any remaining silicone.



Connect the power supply to the CamIO:

- Puncture the blue seal with the end of the black/brown wire (phase conductor L) and guide it into terminal 1. Tighten the screw to lock the wire in place.
- Puncture the blue seal with the end of the blue wire (neutral N) and guide it into terminal 2. Tighten the screw to lock the wire in place.

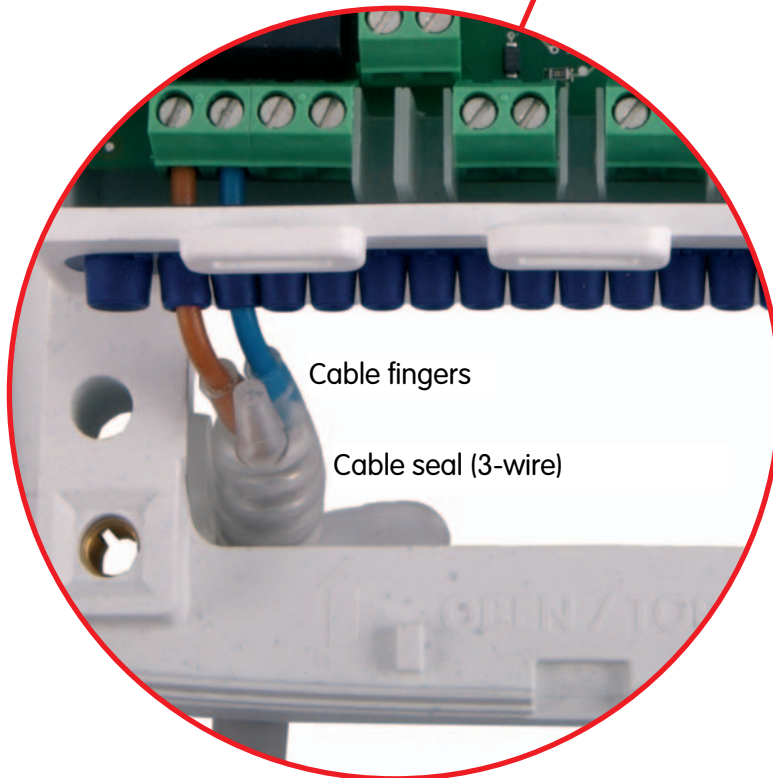

If the blue seal has been punctured at the wrong place, you need to replace the entire housing to maintain the IP65 protection class!

If a power cable with ground conductor is used (three-wire cable), this wire must not be connected in the junction box! Instead, connect the ground conductor of any attached device in the junction box.

Note

Make sure that you are installing the supplied **cable seals** when installing the cables for power supply, external devices, sensors and audio devices. The seals will protect the cables against water entering along the wires.



2.4.3 Ethernet Connection of the CamIO

- Remove the outer insulation (sheath) of the Ethernet cable and guide it through the proper opening at the bottom of the CamIO housing on the right-hand side (see figure).

Make sure that you are respecting the cable assignment and the minimum cable diameters. For additional information on this topic, see chapter 4, *Technical Specifications*.



- Lift all clamps of the Ethernet terminal.

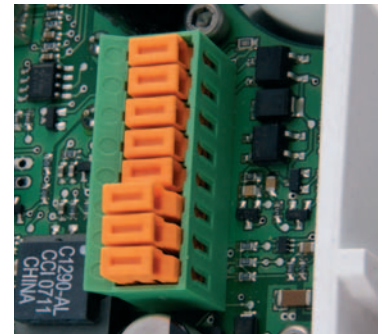

Make sure that you follow the proper wiring of the Ethernet cabling!

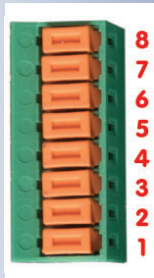

- Push the wires of the Ethernet cable all the way into the terminals and observe the correct sequence while doing so. Do not remove the insulation from any of the Ethernet wires. Make sure that you are using the proper connection standard for the Ethernet connection as outlined in section 2.1.4, *Connectors and Wiring*.



- Secure the wires by firmly pushing down the clamp until it locks in place. Gently pull on each wire to make sure that it has been properly clamped down.

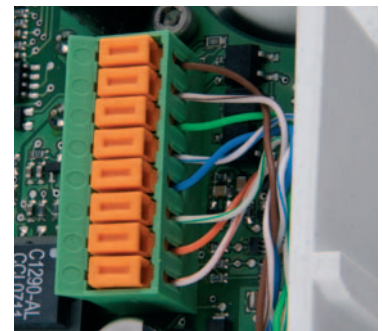

2.5 Connecting External Components to the CamIO

2.5.1 Connecting External Devices, Sensors and Audio Devices

The MOBOTIX CamIO supplies connectors for the following functions:

- Switch and supply power to external devices without individual power supply with loads of up to 5 A.
- Potential-free switching of external devices with individual power supply and with loads between 100 mA and 5 A.
- Connect external sensors to the signal inputs of the camera (e.g. light barriers or external PIR sensors).
- Connect external audio devices to the camera (speakers and microphones with an external pre-amplifier).

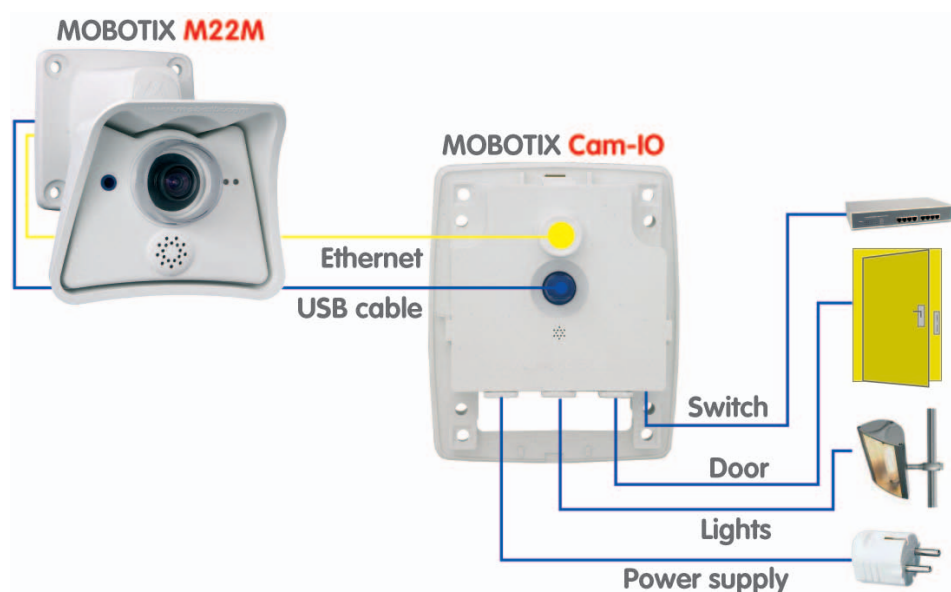
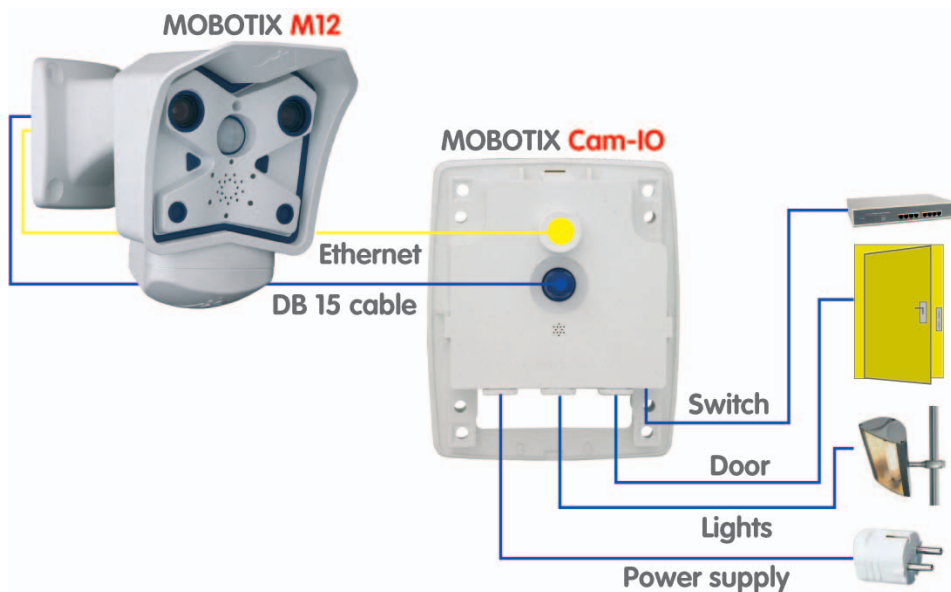

Make sure that you follow the terminal assignment of the CamIO's bottom terminal connector. Connecting and sealing the cables follows the same instructions as for power cables (see section 2.4.2, *Power Supply of the CamIO*). Make sure that you are adhering to the applicable regulations in your country regarding the allowed cables when connecting the wires to the terminal connector.

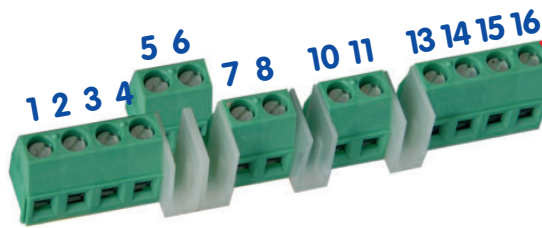

Terminal	Part Name	Remark
3	Out1 L (signal output 1)	Ext. devices without individual power supply, max. 5 A, max. 500 W lamps
4	Out1 N (signal output 1)	
5	Out2a (signal output 2)	Ext. devices with individual power supply 5 to 230 V~, max. 5 A (min. 5 V=, 100 mA)
6	Out2b (signal output 2)	
7	In2 + (signal input 2)	Ext. sensor 2, 8 to 230 V~ (48 V~) (min. 2 mA)
8	In2 - (signal input 2)	
10	In1 + (signal input 1)	Ext. sensor 1, 8 to 230 V~ (48 V~) (min. 2 mA)
11	In1 - (signal input 1)	
13	Speaker +	Ext. speaker can be connected directly, max. 2.5 W/8 Ω
14	Speaker -	
15	Line-In +	Ext. microphone with ext. pre-amplifier
16	Line-In -	

Note

Make sure that you are installing the supplied **cable seals** when installing the cables for power supply, external devices, sensors and audio devices. The seals will protect the cables against water entering along the wires.



Make sure that you are respecting the minimum cable diameters!

Caution

The cables for power supply, external devices, sensors and audio devices need to have a basic insulation level (BIL) of at least 230 V/115 V (depending on the mains voltage). Never lay bell wires (BIL 50 V) next to 230 V or 115 V cables!

MOBOTIX CamIO Connection Example

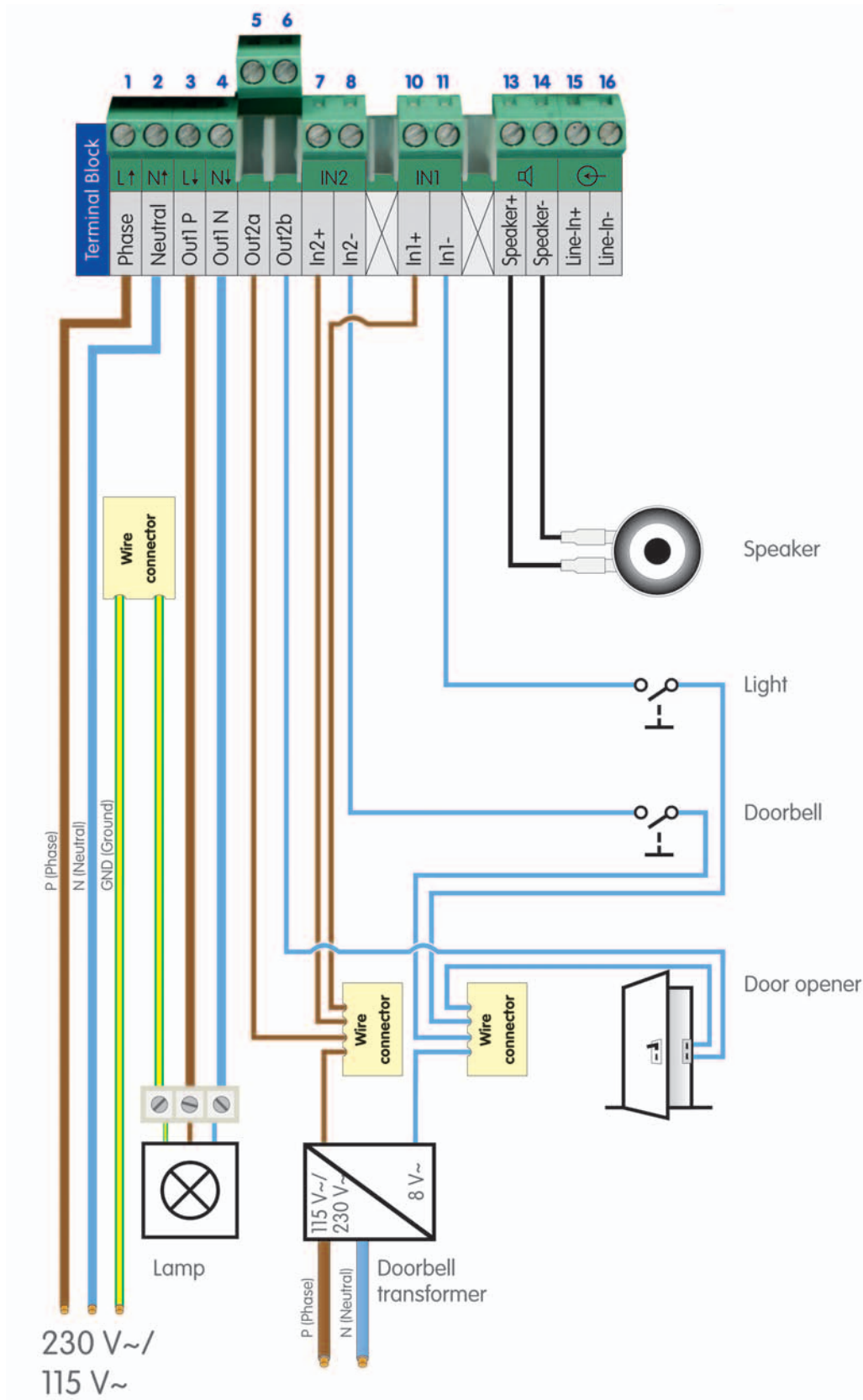

2.6 Mounting the Camera on the CamIO

Once the camera has been mounted to the foot of the CamIO wall mount, the Ethernet and control cables have been connected and optional external devices have been attached, you can mount the CamIO/camera assembly to the CamIO housing.



2.6.1 Connecting the Additional Speaker in the Wall Mount Foot

The foot of the wall mount has a built-in speaker, which can be used for audio output in connection with MOBOTIX M12 cameras. This speaker has a higher output power than the camera speaker and is an excellent enhancement to the camera's audio capabilities.

- Connect the two supplied audio cables to the terminals 13 and 14 (Speaker) of the CamIO.



- If required, the additional speaker (IP65) can be pulled from its position in the wall mount foot (1). To insert the speaker again, push it back into the foot (2).

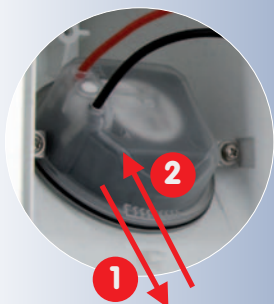

2.6.2 Connecting the Ethernet and the CamIO Control Cables

In order to connect the camera to the CamIO, you need to attach the Ethernet and control cables of the camera to the CamIO.

- Insert the cover into the guides at the bottom of the CamIO housing (1) and press at the top of the cover until it clicks in place (2).



- Push the supplied rubber plug (NET, item 5) over the Ethernet cable coming from the camera, insert the cable into the Ethernet socket of the CamIO and press the plug firmly into the socket to seal off the cable against moisture.



- Connect the control cable from the camera to the remaining socket of the CamIO. Install the cable and lock it in place using the supplied screw (item 13) and the washer (item 14).



- Press the wall mount foot with the camera onto the CamIO housing and secure the foot on the CamIO using the four Allen screws (item 6) and the washers (item 7). Take care not to squeeze and damage the cables when mounting the foot onto the CamIO.
- Push the screw caps (item 10) into the four openings of the Allen screws in the foot of the CamIO wall mount.

Maximum torque for all screws is 1 to 1.2 Nm (0.74 lbf ft)

2.7 Wiring, Fire Prevention, Lightning and Surge Protection



When installing the wiring inside or outside of buildings, make sure you always adhere to the relevant regulations on wiring, fire prevention and protection against lightning.

MOBOTIX recommends having MOBOTIX devices installed only by specialists accustomed to installing network devices and having proper respect for the pertinent regulations regarding **lightning protection** and **fire prevention** as well as the current technology for preventing damages from electrical surges.

More information is available at an institution such as the **International Electrotechnical Commission** (IEC, www.iec.ch) or at a manufacturer of protection devices against lightning and electrical surges, such as Dehn (www.dehn.de).

2.7.1 Wiring

When installing the wiring, make sure you follow these guidelines:

- **Data cable:** Make sure to use only double-shielded CAT 5/7 cable (**S/STP**) for Ethernet connections (see section 3.3, *Connecting the Camera* in the *Camera Manual*). 
- **Outdoors:** Installing the camera outdoors requires special precautions and measures regarding the cables as well as lightning and surge protection (see section 2.7.3, *Lightning and Surge Protection*). 
- **Wire lengths:** The cable segments must not exceed the maximum allowed cable lengths in order to ensure proper data transfer (see section 3.3, *Connecting the Camera* in the *Camera Manual*).
- **Avoid induction:** When running data cables parallel to existing regular power lines or high-voltage wires, make sure you observe the minimum distances to the power cables.

2.7.2 Fire Prevention

When installing the power lines to the camera, make sure you always adhere to the relevant regulations on wiring and fire prevention at the site of the installation.

2.7.3 Lightning and Surge Protection

To prevent damage from lightning and power surges, make sure you follow these guidelines:

- **Lightning conductors:** In areas exposed to lightning (e.g. on roofs), a distance holder (1 m (3 ft) above and away from the camera) and proper lightning conductors need to be installed in order to prevent lightning strikes into the camera and to ensure that the energy of a lightning strike is properly led to the ground.

- **Surge protection:** Make sure you have installed proper protection against electrical surges in order to prevent damage to the camera, the building and the network infrastructure. This includes surge protectors for 19" racks, adding an uninterruptible power supply (UPS) to the MOBOTIX camera, and installing surge arresters or similar for routers, switches, servers, etc.

2.8 Accessories, Replacement Parts

CamIO Wall Mount Foot

The wall mount foot is used for mounting the camera to the MOBOTIX CamIO.



CamIO Housing

Replacement housing for all CamIO models.



M12 Control Cable (MX-CAMIO-OPT-M12)

Control cable for connecting the CamIO and an M12 camera.



M22 Control Cable (MX-CAMIO-OPT-M22)

Control cable for connecting the CamIO and an M22M camera.



Cable Seals

The seals will protect the cables against water that could be entering along the wires.



M22 NET Plug

Plug for sealing off the Ethernet cable on M22M camera models.



M22 USB Plug

Plug for sealing off the USB cable on M22M camera models.



Additional CamIO Speaker

Replacement speaker with audio cables for the CamIO wall mount foot.



3 OPERATION OF THE CamIO

3.1 Activating the CamIO

Once the CamIO and the MOBOTIX camera have been properly installed (see chapter 2), you can set up the camera for proper operation. To begin with, it is necessary to establish the power supply of the CamIO (either 230 V/115 V directly or indirectly via the network cabling using a PoE switch).

Once the power supply to the CamIO has been established, the connected MOBOTIX camera should also have power and you should be able to access the camera from any browser via the network (chapter 3, *Operating the Camera*, of the corresponding *Camera Manual* contains more information on this topic).

After you have established the connection to the camera (Live screen in the browser window), you need to activate the CamIO in the camera software (**Admin Menu > Manage Hardware Expansions**). Activating the CamIO is a mandatory step for using all features of the CamIO.

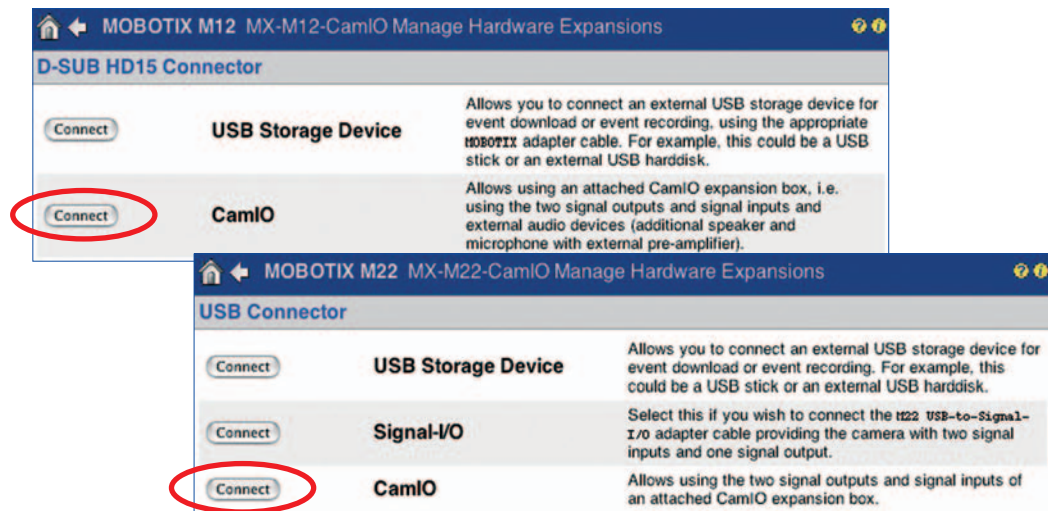

MOBOTIX M12 Cameras

MOBOTIX
M22M Cameras

Hint

To test the CamIO for proper operation with a MOBOTIX M12, simply check if the additional speaker in the foot of the wall mount works (**Admin Menu > Loudspeaker and Microphone > Audio Output**). When clicking on the **Test** button, you should hear the alarm from the camera speaker and the additional speaker of the CamIO.

Note

In order to use all features of the CamIO, make sure that you are activating it in the camera software (Admin Menu > Manage Hardware Expansions). Please note that you will need a software version 3.3.1.x or higher on the MOBOTIX M22M and a software version 3.1.0.x or higher on the MOBOTIX M12.

3.2 Configuration Sample

The following example of a door intercom system demonstrates one possible application and shows the steps for properly configuring a MOBOTIX M12 with a CamIO-AC/ACplus. Make sure that you have installed and setup the CamIO and the MOBOTIX camera as described in chapter 2.

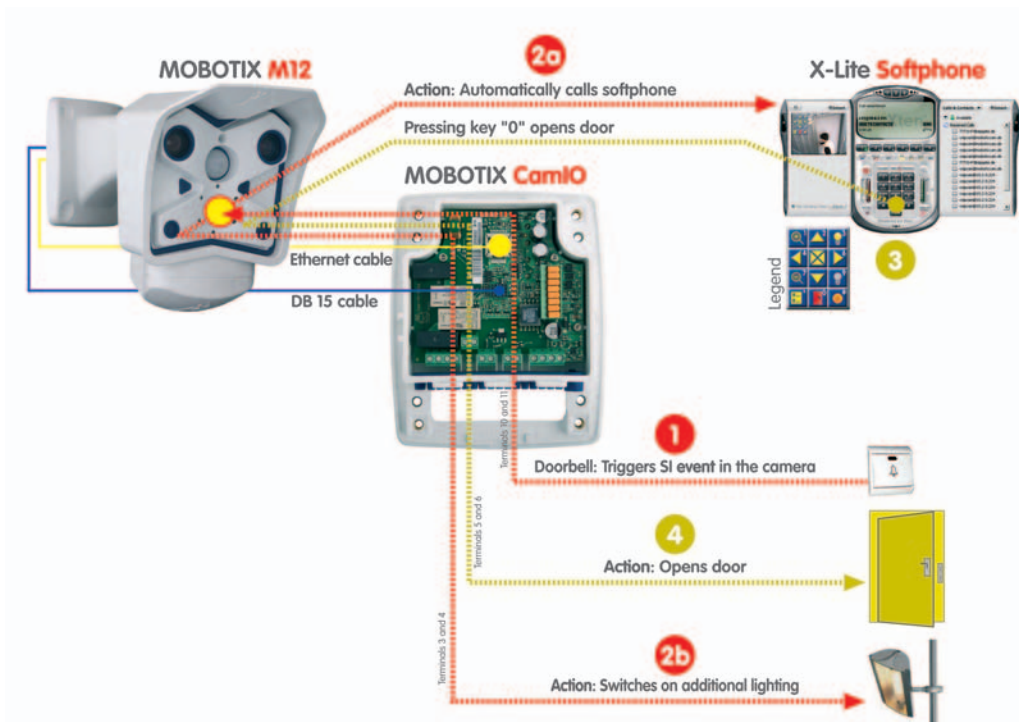

Sample: Door intercom system with Video SIP and additional lighting

3.2.1 Functional Overview

A MOBOTIX camera and a CamIO are used at the entrance of a building for access control purposes and should open the door when prompted to do so.

If a visitor rings the doorbell (signal input 1), the MOBOTIX camera automatically activates an additional source of light near the entrance (signal output 1), plays back a voice message ("Welcome to xyz company ...") and establishes a video SIP connection to the receptionist's computer (or the guard on duty).

The softphone on the receptionist's computer signals an inbound video phone call from the corresponding camera at the entrance. The receptionist accepts the call and can talk to the guest at the entrance (using the additional speaker of the CamIO and the microphone of the door intercom system, which is also connected to the CamIO).

The image displayed on the softphone, i.e. the live video stream from the MOBOTIX camera allows for visually checking the visitor. The softphone's keys provide functions for selecting certain image areas and for zooming the image (keys 1, 7: zoom control, keys 2, 4, 6, 8: image section movement, key 5: center the image).

If the receptionist would like to open the door for the visitor, he/she activates the door opener (signal output 2) using the softphone key 0, allowing the visitor to en-

ter the building. If required, the receptionist can manually switch the additional lighting using the softphone keys: key 3 to switch the lights on and key 9 to switch them off again.

In the meantime, the camera is automatically recording the video and audio stream on a file server. Furthermore, the CamIO's rechargeable battery (CamIO-ACplus models only) protects the MOBOTIX camera against short-time power failures. As an alternative, you can also use the doorbell system's UPS for this purpose.

3.2.2 Terminal Connections of the CamIO

- Terminals 1 and 2: Power supply of the CamIO and the additional lighting (230 V~/115 V~).
- Terminals 3 and 4 (Out1): Additional lighting
- Terminals 5 and 6 (Out2): Door opener of the door intercom system
- Terminals 10 and 11 (In1): Doorbell of the door intercom system
- Terminals 13 and 14 (Speaker): Additional speaker in the foot of the CamIO wall mount
- Terminals 15 and 16 (Line-In): Microphone of the door intercom system (with external pre-amplifier)

3.2.3 Overview of the Configuration Steps

Configuring the MOBOTIX Camera (section 3.2.4)

- 1) Activate arming of the camera
- 2) Configure recording
- 3) Configure SI event and switching of additional lighting (SO action)
- 4) Configure SI event and voice message (SD action)
- 5) Configure SI event and VoIP phone call (CL message)

Configuring the Softphone (section 3.2.5)

- 6) Start and configure the softphone

3.2.4 Configuring the MOBOTIX Camera

1) Activate arming of the camera

- Activate arming (**Setup Menu > General Event Settings**).

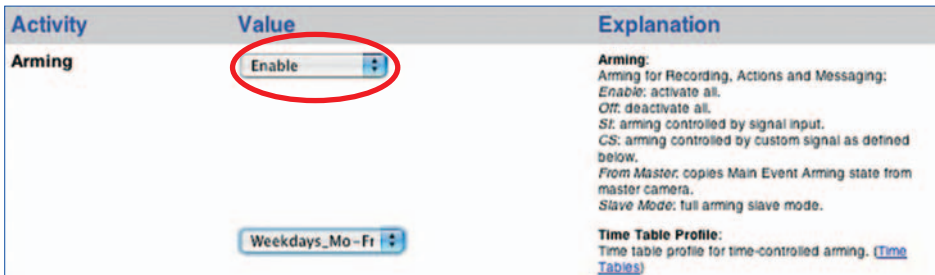

2) Configure recording

- Set up event storage on an external file server (**Admin Menu > Event Storage**).

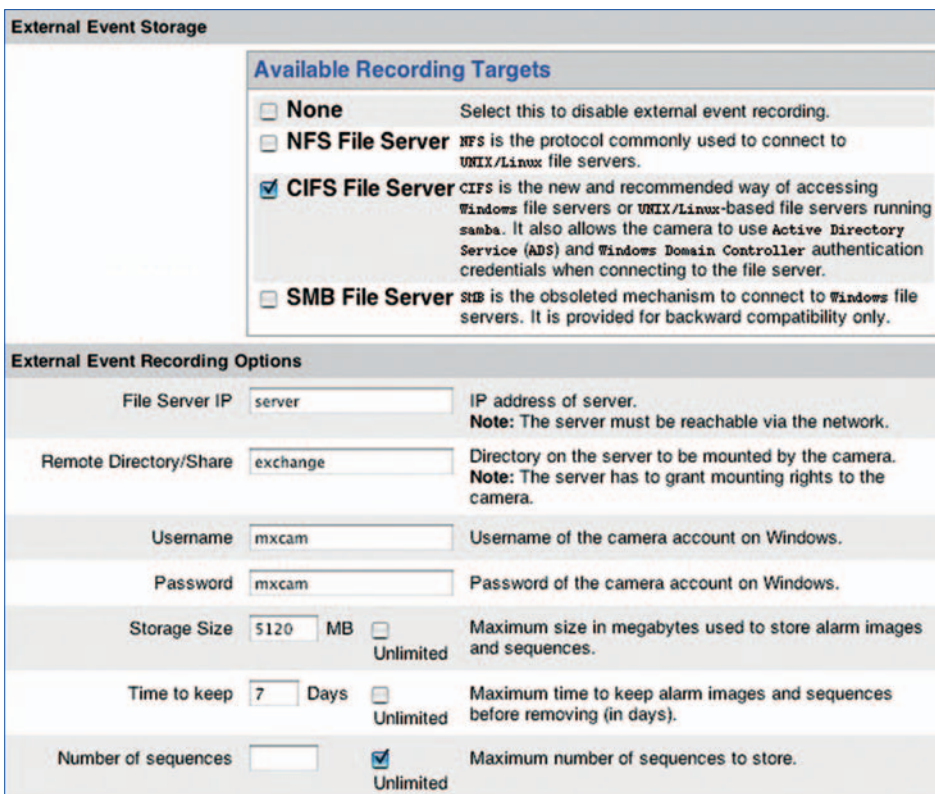

- Activate recording for VM event (**Setup Menu > Recording**).

General Settings	Value	Explanation
Arming	Enable	Arm Recording: Controls camera recording. <i>Enable:</i> activate Recording. <i>Off:</i> deactivate Recording. <i>St:</i> Recording armed by signal input. <i>CS:</i> Recording armed by custom signal as defined in General Event Settings <i>From Master:</i> copies Recording arming state from master camera.
	(no time table)	Time Table Profile: Time table profile for time-controlled recording. (Time Tables)
Storage Settings	Value	Explanation
Recording (REC)	Event Recording	Recording Mode: Type of event and story recording. <i>Snap Shot Recording:</i> stores single JPEG pictures. <i>Event Recording:</i> stores stream files for every event using MxPEG codec. <i>Continuous Recording:</i> continuously streams videodata to stream files using MxPEG codec.
	Include audio	Record Audio Data: Store audio data in stream file if available. Enable and configure microphone .
Start Recording	VM - Video Motion	Start Recording: Select the events which will start recording. Use [Ctrl]-Click to select more than one event. Events in brackets need to be activated first. EC or EL for filtered events.
	Max fps	Event Frame Rate: Recording speed if an event is detected, in frames per second.

- Activate VM event and set up video motion window (**Setup Menu > Event Settings**).

Video Motion Window (VM)	<input checked="" type="checkbox"/>	Video Motion Enable: Motion detection using digital image analysis.
0, 540, 380, 200, 200, 25		Video Motion Definitions (VM): Lens, x, y, width, height, area[0..99%], max. area[0..99%] Origin: Lower left corner Lens: 0=right, 1=left Add Rectangle
<input type="checkbox"/> Copy Video Motion Definitions		Copy Video Motion Definitions: Uses the same video motion definitions for both lenses.
<input type="checkbox"/> Dual Lens Video Motion		Dual Lens Video Motion: Detects Video Motion events on both lenses, even if only one of them is displayed. May reduce the frame rate.
<input checked="" type="checkbox"/> Show Video Motion Window ID		Show Video Motion Window ID: Display the line number from the definition list above in the upper left corner of each window.
On and highlight on event		Video Motion Style for Group 1: Appearance of motion window border.
Off	Off	Low-Light Suppression: Disables motion detection if illumination drops below selected value. Can be set independently for each camera lens.

3) Configure SI event and switching of additional lighting (SO action)

- Configure SO action and activate action profile (**Setup Menu > Actions**).

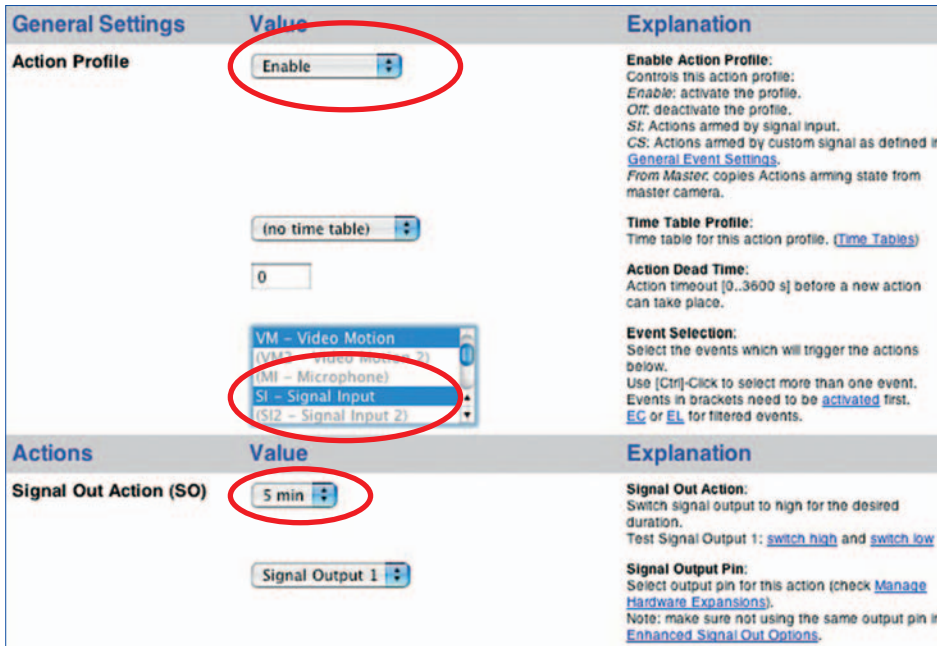

4) Configure SI event and voice message (SD action)

- Activate and configure the speaker and the microphone (volume, microphone sensitivity in **Admin Menu > Loudspeaker and Microphone**); set **Audio Input** temporarily to *Microphone* (only required when recording the voice message via the camera microphone).

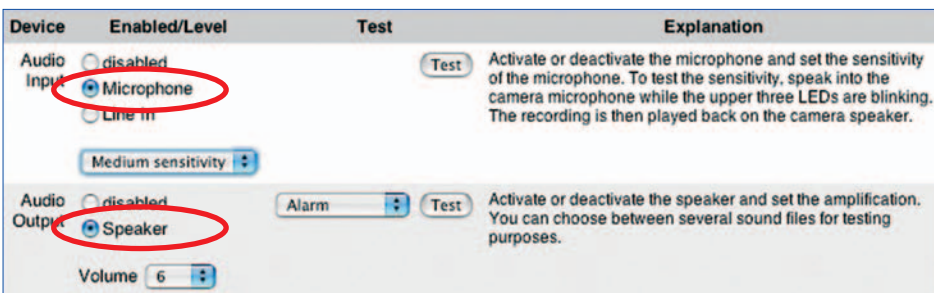

- Record the voice message (**Admin Menu > Manage Voice Messages**); optional: upload sound file to the camera.

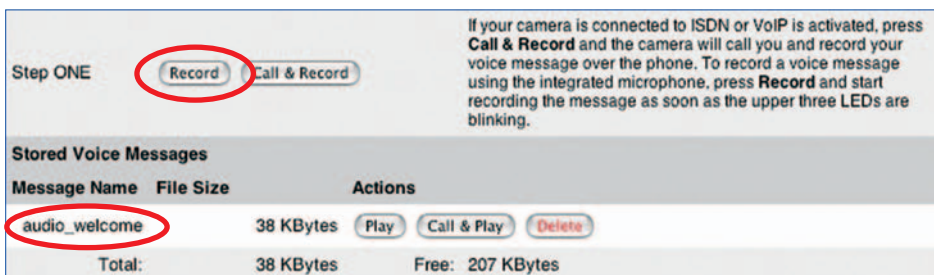

- Set **Audio Input** to *Line In* (**Admin Menu > Loudspeaker and Microphone**; audio comes from the door intercom system's microphone).

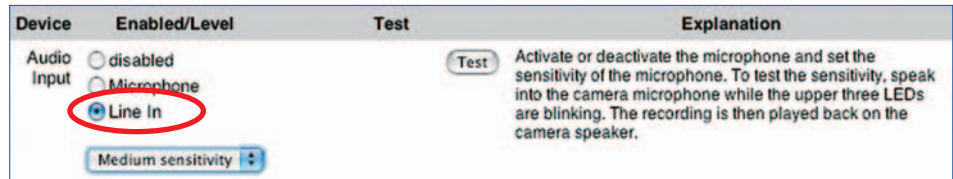

- Set up and activate SI event (**Setup Menu > Event Settings**).

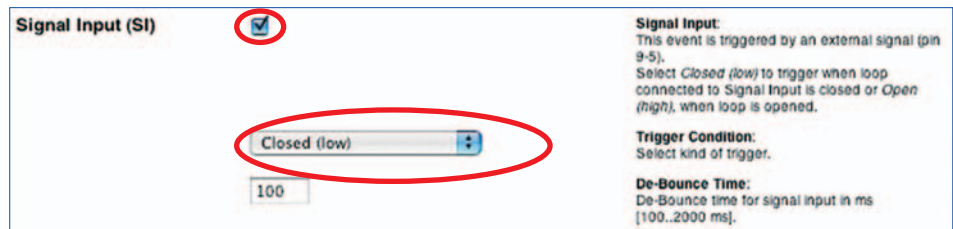

- Set up and activate SD message (**Setup Menu > Messaging 2**), select *SI* event and recorded voice message.

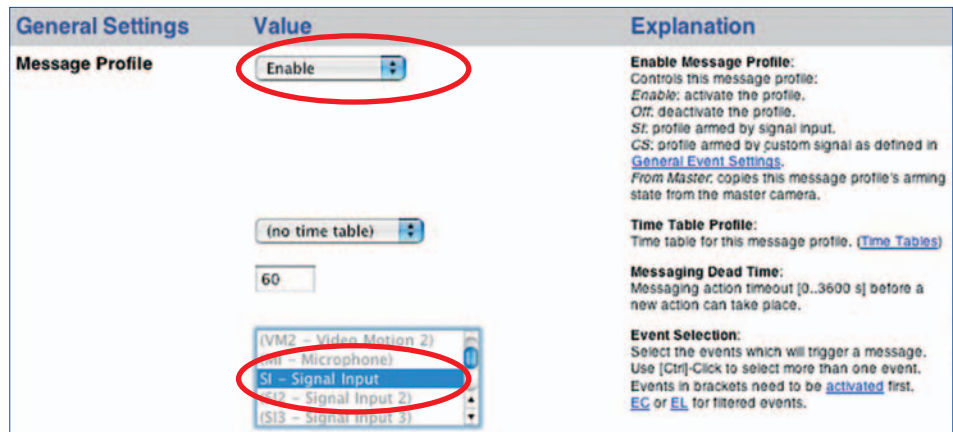

5) Configure SI event and VoIP phone call (CL message)

For more information on setting up the SIP telephony features of MOBOTIX cameras, read chapter 9, *Telephony Features* in the *Software Manual*.

- Configure the VoIP settings and activate VoIP (**Admin Menu > VoIP Settings**).

General Phone Settings

VoIP: **Enabled** (dropdown menu)

Hangup on Outgoing Calls: **Disabled** (dropdown menu)

SIP Settings

User Name: **mxcam_accesscontrol** (text input)

SIP Domain: **172.16.0.134** (text input)

Audio Codec Settings

Use PCMA Codec:

Use GSM Codec:

Use PCMU Codec:

Video Settings

Video: **Enabled** (dropdown menu)

Video Size: **CIF** (dropdown menu)

Video Quality: **50%** (dropdown menu)

- Set up a phone profile (**Admin Menu > Phone Profiles**).

Profile Configuration

mxcamentrance (Profile Name)

Phone Number or SIP Address: **softphone@172.16.0.134**

Dial Attempts: **1**

Dial Timeout: **10**

Connection type: **SIP Video**

Message name: **Standard**

Confirm call with PIN code: [Empty]

After the message has been sent: **Intercom**

Camera Remote Control: **On**

Hangup after: **Never**

- Add CL message to messaging profile and select phone profile (**Setup Menu > Messaging 2**; SD message has already been configured).

Actions	Value	Explanation
Second File Transfer (FT2)	Off	FTP Profile: Transfer image to remote host using file transfer protocol. (FTP Profiles)
Sound on Event (SD2)	Enable CuckooClock Default Phoning Standard audio_welcome Randomize	Sound Enable: Play one or more sounds on the loudspeaker if an event is detected. (Manage Voice Messages) Play List: Use [Ctrl]-Click to select more than one audio message. Playback Sequence: Playback sequence of play list.
Second E-Mail (EM2)	Off	E-Mail Profile: Send image by e-mail. (E-Mail Profiles)
Second Phone Call-Out (CL2)	mxcamentrance	Phone Profile: Notify by telephone call. (Phone Profiles)

3.2.5 Configuring a Softphone

- Configure the softphone and make sure that it is running on the computer.

For more information on setting up a softphone for use with MOBOTIX cameras, read chapter 9, *Telephony Features* in the *Software Manual*.



4 TECHNICAL SPECIFICATIONS

Using the backup power feature of the CamIO-ACplus requires a MOBOTIX M12. M22 cameras do not support this feature yet.

Currently, the audio features of the CamIO can only be used with M12 cameras. A future version of the CamIO will support external speakers and microphones also on M22 cameras.

	CamIO-PoE Mx-CAMIO-POE	CamIO-AC Mx-CAMIO-AC-230 Mx-CAMIO-AC-115	CamIO-ACplus Mx-CAMIO-ACPLUS-230 Mx-CAMIO-ACPLUS-115		
Hardware Features					
Outdoor - weatherproof	IP65	IP65	IP65		
Power Supply	PoE	230 V~ / PoE 115 V~ / PoE	230 V~ / PoE 115 V~ / PoE		
Integrated recharg. battery	-	-	X		
Concealed cabling	X	X	X		
Features	M12	M22M	M12	M22M	M12
Audio Out (speaker/microphone)	X	-	X	-	X
Line In (microphone with pre-amp)	X	-	X	-	X
Signal outputs	2	2	2	2	2
Signal inputs	2	2	2	2	2
Input voltage (terminals 1 and 2)	8 to 48 V~		230 V~ 115 V~		230 V~ 115 V~
	11 to 68 V=				

Technical Specifications		AC Models	PoE Model
Output Out1	Max. voltage	230 V~	48 V~/68 V=
	Max. amperage	5 A	5 A
	Max. lamp load	500 W at 230 V~ 300 W at 115 V~ 240 W at 230 V= 120 W at 115 V=	240 W
Output Out2	Max. voltage	230 V~	48 V~/68 V=
	Max. amperage	5 A	5 A
	Max. lamp load	500 W at 230 V~ 300 W at 115 V~ 240 W at 230 V= 120 W at 115 V=	240 W
	Min. voltage	5 V=	5 V=
	Min. amperage	100 mA	100 mA
Inputs (In1, In2)	Max. voltage	230 V~/325 V=	48 V~/68 V=
	Min. voltage	8 V~/11 V=	8 V~/11 V=
	Min. amperage	2 mA	2 mA
Speaker (Audio Out)	Output rating	2.5 W / 8 Ω	
CamIO main board	Max. power input	3.5 W (without camera)	
Recharg. battery (ACplus only)	Endurance	approx. 45 minutes (20°C/68°F) approx. 20 minutes (-20°C/-4°F)	

Allowed Cable Diameters and Cable Lengths

Allowed Outer Diameters	3-wire cable	5-wire cable
Sheathed cables	8.2 to 11.0 mm (5/16 to 7/16 in)	9.5 to 12.5 mm (3/8 to 1/2 in)

Note

Make sure that the **length of the Ethernet cable** does not exceed **100 m (300 ft)**. The **length of the cables for signal wires and external sensors is not restricted**. You need to make sure, however, that the minimum voltage at the corresponding terminal is reached.

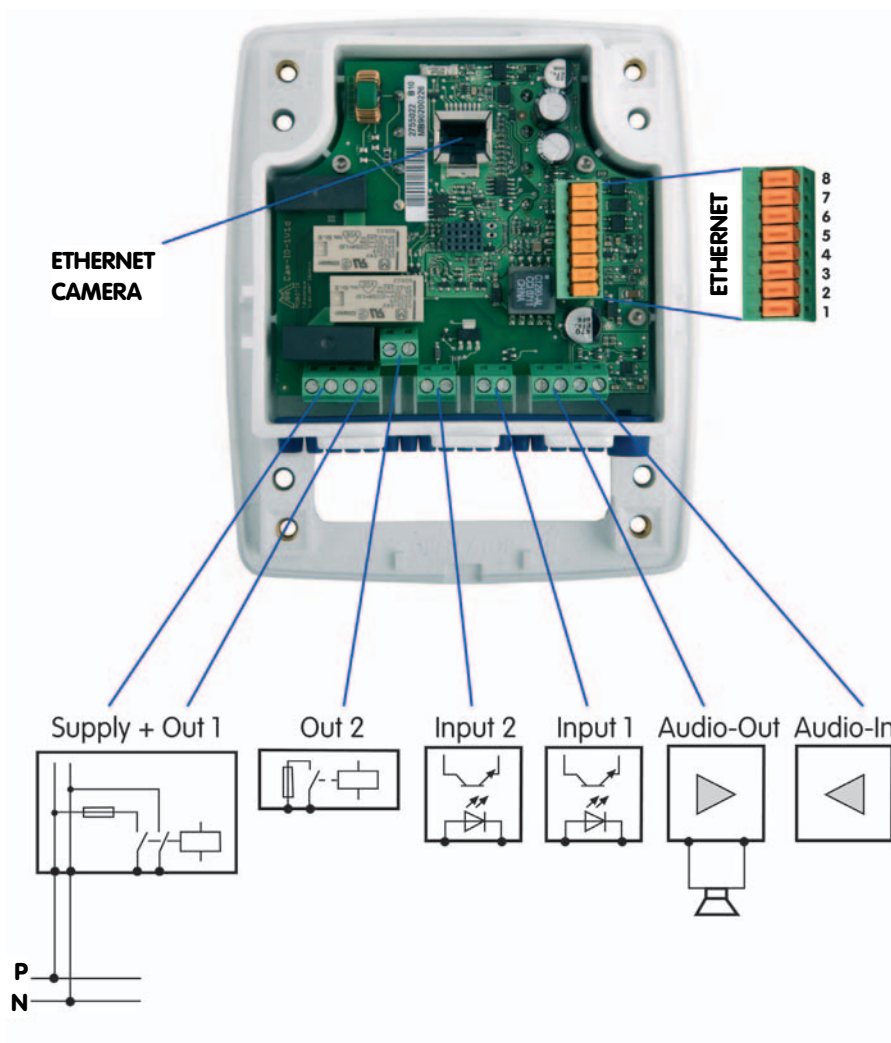

Terminal Connector for Power Supply, External Devices, Sensors and Audio Devices

AWG:
American Wire Gauge (for measuring cable diameters)

Allowed Cable Dimensions	Solid	AWG
Bottom terminal (terminals 1 to 16)	0.14 to 2.5 mm ²	26 to 14

Cable diameters should be tailored to the electrical load and must follow the applicable regulations.

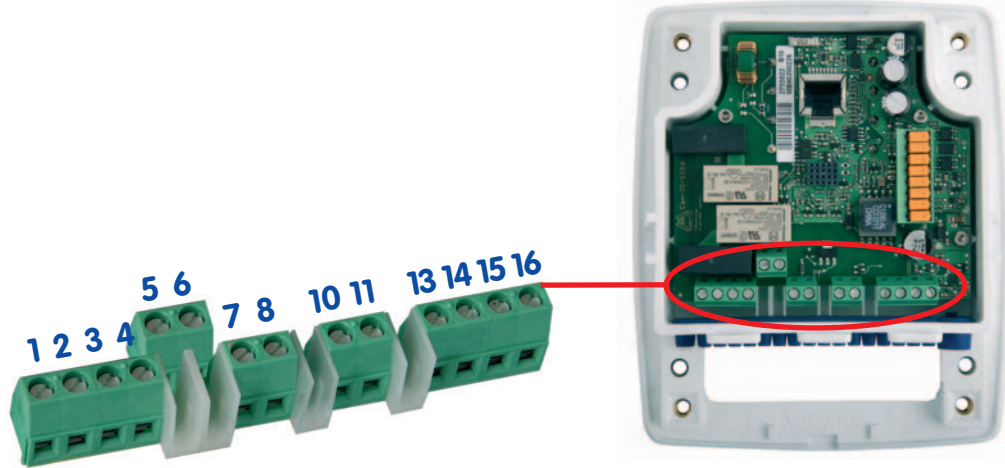

Terminal	Part Name	Remark
1	Phase conductor L	Direct power supply for CamIO and Out1
2	Neutral conductor N	
3	Out1 L (signal output 1)	Ext. devices without individual power supply, max. 5 A, max. 500 W lamps
4	Out1 N (signal output 1)	
5	Out2a (signal output 2)	Ext. devices with individual power supply 5 to 230 V~, max. 5 A (min. 5 V=, 100 mA)
6	Out2b (signal output 2)	
7	In2 + (signal input 2)	Ext. sensor 2, 8 to 230 V~ (48 V~) (min. 2 mA)
8	In2 - (signal input 2)	
10	In1 + (signal input 1)	Ext. sensor 1, 8 to 230 V~ (48 V~) (min. 2 mA)
11	In1 - (signal input 1)	
13	Speaker +	Ext. speaker can be connected directly, max. 2.5 W/8 Ω
14	Speaker -	
15	Line-In +	Ext. microphone with ext. pre-amplifier
16	Line-In -	

Caution

The power supply cable to the CamIO needs to have a basic insulation level (BIL) of at least 230 V/115 V (depending on the mains voltage). Never lay bell wires (BIL 50 V) next to 230 V or 115 V cables! Make sure that the fuse for this cable is not stronger than 16 A.

If a power cable with ground conductor is used (three-wire cable), this wire must not be connected in the junction box! Instead, connect the ground conductor of any attached device in the junction box.

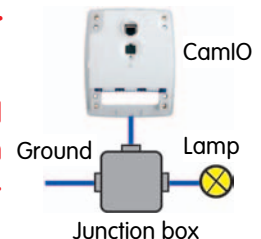

Terminal Connector and Wiring of the Ethernet Connector

Allowed Cable Dimensions	Solid	AWG
Ethernet terminal (cutting clamps)	0.13 to 0.31 mm ²	26 to 22

Cable diameters should be tailored to the electrical load and must follow the applicable regulations.

AWG:
American Wire Gauge (for measuring cable diameters)

Ethernet cabling today commonly follows the **T568B standard**; older Ethernet cabling may have been connected according to the **T568A standard**:

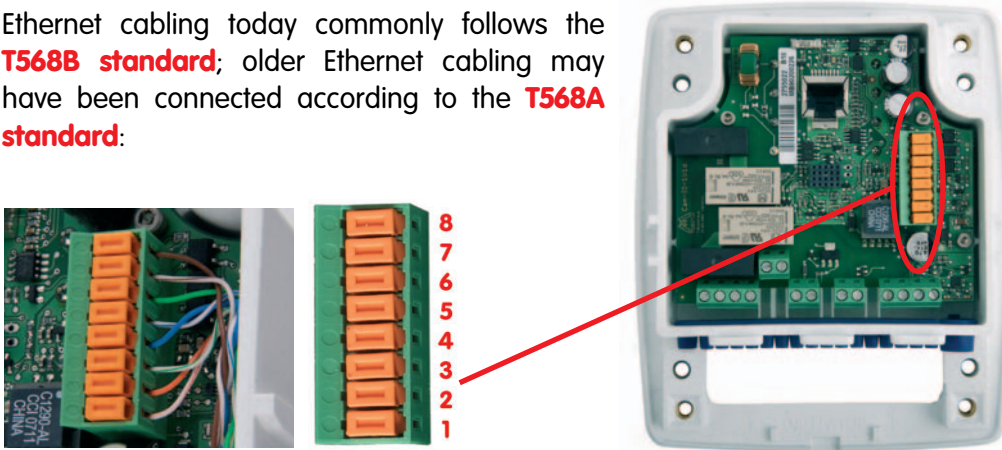

Connection Standard **T568B**

Terminal	TIA-568B Pair No.	TIA-568 Color	
8	4	Brown cable/white line	
7	4	White cable/brown line	
6 (Rx-)	3	Green cable/white line	
5	1	White cable/blue line	
4	1	Blue cable/white line	
3 (Rx+)	3	White cable/green line	
2 (Tx-)	2	Orange cable/white line	
1 (Tx+)	2	White cable/orange line	

Variant **B** - T568B

Connection Standard **T568A**

Terminal	TIA-568A Pair No.	TIA-568 Color	
8	4	Brown cable/white line	
7	4	White cable/brown line	
6 (Rx-)	2	Orange cable/white line	
5	1	White cable/blue line	
4	1	Blue cable/white line	
3 (Rx+)	2	White cable/orange line	
2 (Tx-)	3	Green cable/white line	
1 (Tx+)	3	White cable/green line	

Variant **A** - T568A

Declaration of Conformity

EC Declaration of Conformity

Issuer's name and address:

MOBOTIX AG
Luxemburger Strasse 6
67657 Kaiserslautern

Product:

Electronic switch for installation

Type designation:

CAM-IO

The designated product is in conformity with the European Directive:

2006/95/EC

"Council Directive on the harmonization of the laws of the Member States relating to electrical equipment designed for use within certain voltage limits".

Full compliance with the standards listed below proves the conformity of the designated product with the provisions of the above-mentioned EC Directive:

DIN EN 60669-1 (VDE 0632 Teil 1):2003-09; EN 60669-1:1999 + A1:2002
DIN EN 60669-2-1 (VDE 0632-2-1):2005-08; EN 60669-2-1:2004
DIN EN 50428 (VDE 0632-400):2006-01; EN 50428:2005

The VDE Testing and Certification Institute (EU Identification No. 0366), Merianstr. 28, D-63069 Offenbach, has tested and certified the product granting the VDE Approval for the mark(s) as displayed.



*Certificate No.
File Reference*

40022533
2514700-1690-0001 / 90365 FG31 / DU

Kaiserslautern, 05.11.07
(Place, Date)

(legally binding signature of the issuer)

MOBOTIX – The HiRes Video Company

Security-Vision-Systems



To demonstrate our confidence in the quality of our products,
MOBOTIX cameras were used to capture all the images that
appear in this manual.

Manufacturer

MOBOTIX AG

Kaiserstrasse

D-67722 Langmeil

Germany

Tel : +49 6302 9816-103

Fax: +49 6302 9816-190

<http://www.mobotix.com>

sales@mobotix.com

Executive Board

Dr. Ralf Hinkel

Registration Office: Kaiserslautern Local Court

Registration Number: HRB 3724

Tax Code: 44/676/0700/4

Tax Office: Worms-Kirchheimbolanden, Germany

VAT ID:

DE202203501

You can find the latest version of this document
at www.mobotix.com under **Support**.



Technical specifications subject to change without notice!

Megapixel

1280 x 960
software zoom

30 Frames/s

VGA (640 x 480)
10 fps Mega

-22°F to +140°F

Weatherproof

-30°C to +60°C, IP65
no heating necessary

IEEE 802.3af

PoE

network power
even in winter

microphone & speaker

Audio

bi-directional via IP
variable framerates

Video SIP Client

IP Telephony

alarm notify,
cam remote control

Video motion

multiple windows
precision pixel-based

lip-synchronized audio

Recording

event-ringbuffer
30 cams each 30 fps

Live viewing

30 cams at 30 fps
all on one screen

Backlight

safe using CMOS
without mechanical iris

Vandalism-protected

Wall bracket

with cable cover
for RJ45 wall outlet

Robust

no moving parts
fiber glass housing

CamIO

User Manual

Security-Vision-Systems

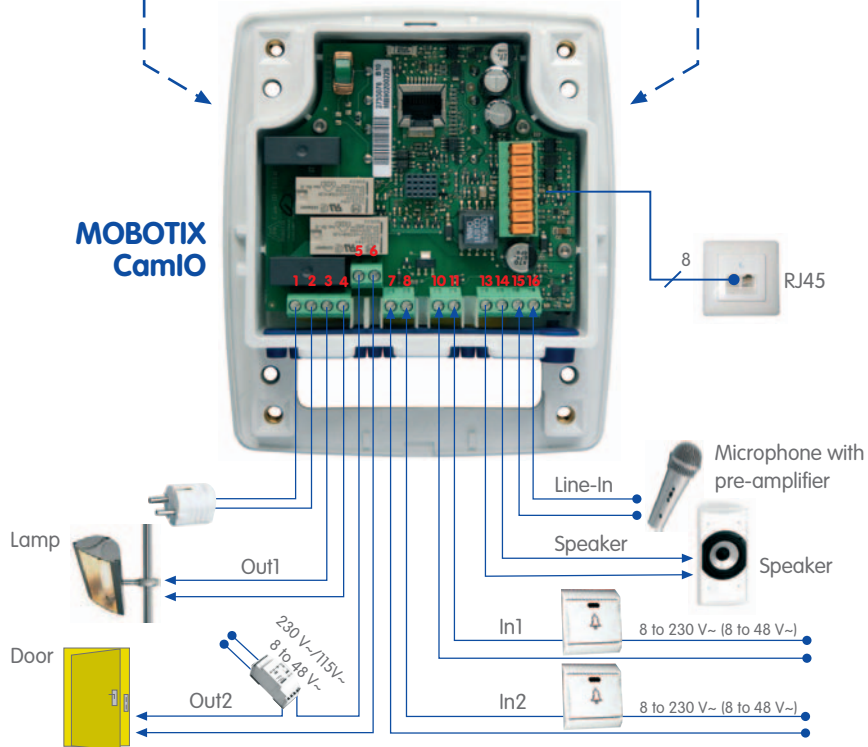

Complete integration for web and security

Current PDF File:
www.mobotix.com > Support > Manuals

MOBOTIX AG • Security-Vision-Systems • Made in Germany

www.mobotix.com • sales@mobotix.com • 9.11.2007

MOBOTIX ... the new face of IP video