

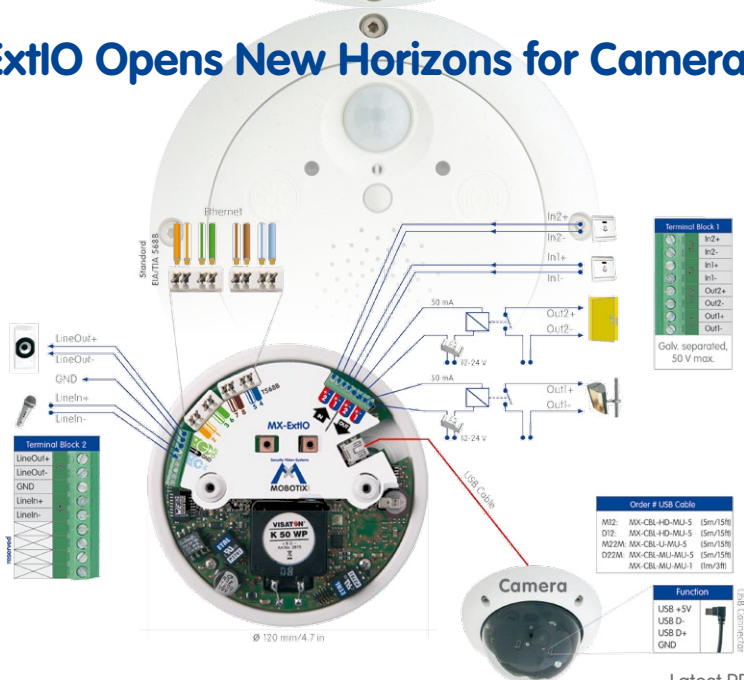

ExtIO Opens New Horizons for Cameras



Latest PDF file:
www.mobotix.com > Support > Manuals

HiRes

6 Megapixel4096 x 1536
Software zoom

Skyline

Format freeEach image format
freely definable**30 Frames/s**VGA (640 x 480)
30 F/s Mega**Virtual PTZ**Digital pan, tilt,
zoom**Backlight**Safe using CMOS
without mechanical iris**Internal DVR**Internal via Flash,
external via Network

Win/Lin/Mac

Recordingvia Network on PC
up to 1 Terabyte

Microphone & speaker

Audiobi-directional via IP,
variable framerates

SIP-Client with video

IP TelephonyAlarm notify,
cam remote control**VideoMotion**Multiple windows
precision pixel-based

-22 to +140 °F

Weatherproof-30 to +60 °C, IP65,
no heating necessary

IEEE 802.3af

PoENetwork power
even in winter**Robust**No moving parts
finger glass housing

Mac/Win/Easy

Licence freeVideo-Management-
Software**HiRes Video Innovations**

The German company MOBOTIX AG is known as the leading pioneer in network camera technology and its decentralized concept has made high-resolution video systems cost efficient.

MOBOTIX AG • D-67722 Langmeil • Tel: +49-6302-9816-103 • Fax: +49-6302-9816-190 • sales@mobotix.com

Notes

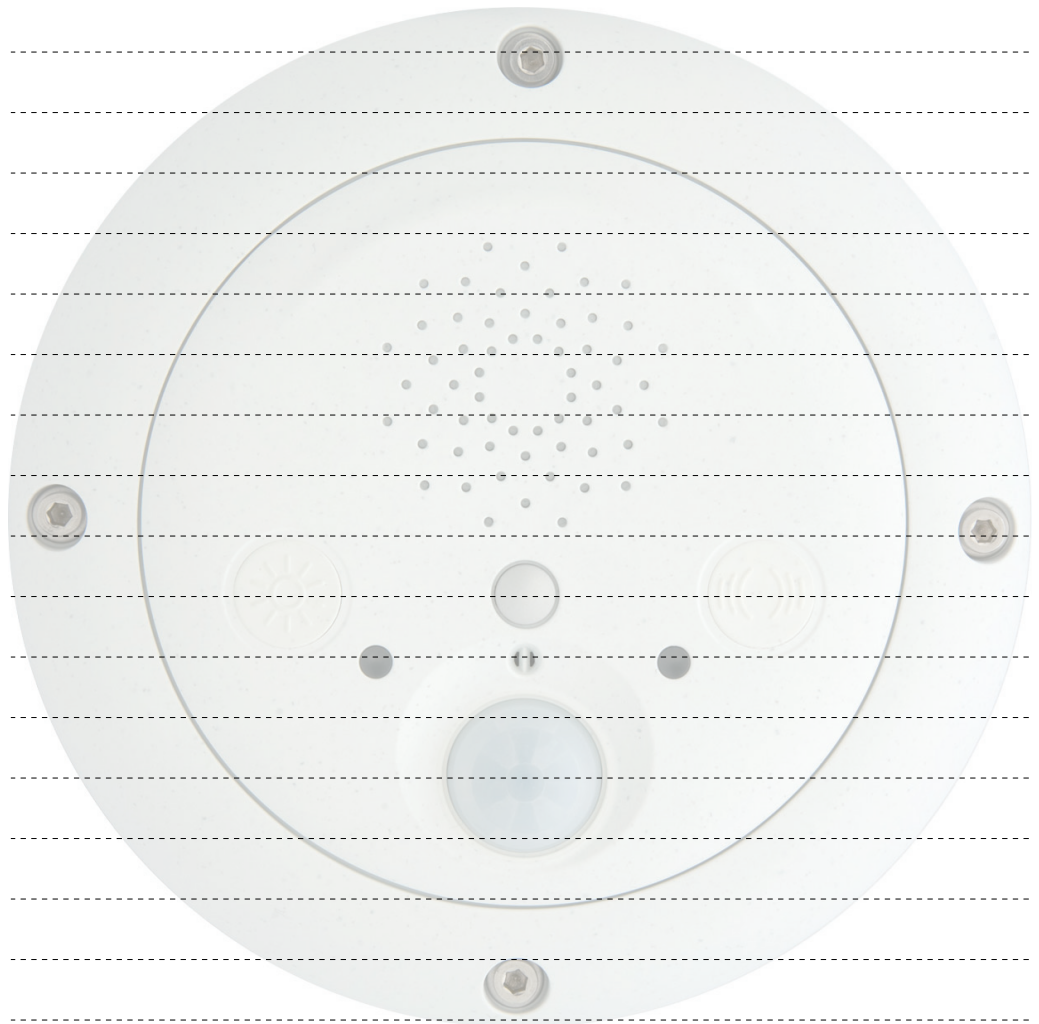

Note: MOBOTIX offers inexpensive seminars that include a workshop and practical exercises: **Basic Seminar** three days, **Advanced Seminar** two days.

For more information, please visit www.mobotix.com.

EXTIO USER MANUAL

1	INTRODUCTION	4
1.1	MOBOTIX ExtIO Concept	6
1.2	The MOBOTIX ExtIO and MOBOTIX Cameras	8
1.2.1	Functional Overview of the ExtIO	8
1.2.2	Comparison ExtIO/CamIO	9
1.3	Accessories	10
2	MOUNTING THE EXTIO	12
2.1	Preparing the Installation	12
2.1.1	Mounting to a Wall or Ceiling	13
2.1.2	Connecting via Network or USB	13
2.1.3	Mounting Options	14
2.1.4	Providing the Camera Connections, Wall Outlets	14
2.1.5	Directions for Mounting	15
2.2	ExtIO: Delivered Parts, Components and Dimensions	16
2.2.1	Delivered Parts and Components	16
2.2.2	Housing	17
2.2.3	ExtIO Dimensions	18
2.2.4	Drilling Template Mounting Ring	18
2.3	ExtIO Accessories: Delivered Parts, Components and Dimensions	20
2.3.1	On-Wall Set	20
2.3.2	In-Ceiling Set	22
2.3.3	Wall Mount	24
2.3.4	Pole Mount	26
2.4	Connecting the Terminal Connectors, Wiring	30
2.4.1	Overview: ExtIO Board and Connectors	30
2.4.2	ExtIO Terminal Connector for the Ethernet Cabling	31
2.4.3	ExtIO Terminal Connector 1 (Signal Inputs/Outputs)	32
2.4.4	ExtIO Terminal Connector 2 (Line-In/Line-Out)	33
2.5	Connecting a MOBOTIX USB Cable to the Camera	34
2.5.1	Overview	34
2.5.2	Establishing the USB Connection to a D22M Camera	35
2.5.3	Establishing the USB Connection to a M22M Camera	36
2.5.4	Establishing the USB Connection to a M12 Camera	38
2.5.5	Establishing the USB Connection to a D12 Camera	40
2.6	Connecting the Cable to the ExtIO	42
2.6.1	Connecting the Ethernet Cable to the ExtIO	42
2.6.2	Connecting the USB Cable to the ExtIO	44
2.6.3	Connecting Additional Cables to the ExtIO	46
2.7	Mounting the ExtIO	48
2.7.1	Mounting the ExtIO Without Additional Mounting Options	48

2.8	Important Notes	50
2.8.1	Safety Regulations	50
2.8.2	Suitable Cables for the MOBOTIX ExtIO	50
2.8.3	Safety Notes for Operating the MOBOTIX ExtIO	51
2.8.4	Weatherproofness, Temperature Range	52
2.8.5	Cleaning Instructions	52
2.8.6	Additional Information	52
3	OPERATION OF THE EXTIO	54
3.1	Activating the ExtIO	54
3.1.1	Activating the USB Operating Mode	55
3.1.2	Activating the Ethernet Mode (NET)	56
3.1.3	Setting up the Network Parameters of the ExtIO for Ethernet Operation	57
3.1.4	LED-Patterns of the ExtIO	59
3.1.5	Starting the ExtIO Using the Factory Default Settings	60
3.1.6	Starting the ExtIO With an Automatic IP Address (DHCP)	61
3.2	Sensors and Input/Output Interfaces of the ExtIO	62
3.2.1	Status LEDs	62
3.2.2	Speaker and Microfon	62
3.2.3	Buttons	63
3.2.4	PIR Motion Sensor	63
3.2.5	Signal Inputs/Outputs	63
3.2.6	Temperature Sensor	64
3.3	Software Updates	65
3.4	Configuration Sample	66
3.4.1	Functional Overview	66
3.4.2	Overview of the Configuration Steps	67
3.4.3	Configuring the MOBOTIX Camera	67
3.4.4	Configuring a Softphone	73

APPENDIX: DECLARATION OF CONFORMITY DRILLING TEMPLATES (SCALE 1:1)

Information subject to change without notice!

Copyright © 1999-2008 MOBOTIX AG, Kaiserslautern, Germany.

All rights reserved. MOBOTIX, MxPEG and MxControlCenter are worldwide trademarks of MOBOTIX AG. Microsoft, Windows and Windows Server are registered trademarks of Microsoft Corporation. Apple, the Apple logo, Macintosh, OS X and Bonjour are trademarks of Apple Inc. Linux is a trademark of Linus Torvalds. All other marks and names mentioned herein may be trademarks or registered trademarks of the respective owners.

*You can use the ExtIO with all MOBOTIX IT and Secure models. MOBOTIX Q22M models can only be connected to the ExtIO using Ethernet.

1 INTRODUCTION

The **MOBOTIX ExtIO** is the weatherproof, compact expansion and connection box for connecting all MOBOTIX cameras (IT and Secure models). This box expands the cameras by a powerful audio unit with microphone and speaker, a passive-Infrared detector, an external temperature sensor, an illumination sensor as well as two signal inputs and two signal outputs. The two large buttons on the unit allow easily implementing door and gate communication solutions.



In the security and house technology area, the MOBOTIX ExtIO represents the ideal addition to the MOBOTIX cameras, especially if you would like to control e.g. **lamps, doors, controls wires or other external devices using pushbuttons**. The signal output can also be used to connect the MOBOTIX camera via the ExtIO to the input of an alarm system, for example.

You can also attach **external sensors** to the MOBOTIX camera via the ExtIO, e.g. to evaluate remote sensors, such as light barriers, reed switches, external PIR sensors or the output of an alarm system.

You can easily mount the MOBOTIX ExtIO remotely (i.e. not directly near) a MOBOTIX camera inside of a building or outside, to a wall or ceiling. Its weatherproof housing (**IP65**) **reliably protects the ExtIO against any kind of weather**. The connection to the MOBOTIX camera can be established using either the LAN (Ethernet cabling) or a special MOBOTIX USB cable (specific for each camera model; max. 5 m/16 ft long). In both cases, the camera's power supply uses the cable (LAN/PoE or USB). As power is supplied via the cabling, the ExtIO does not require its own power supply.



Ethernet & USB

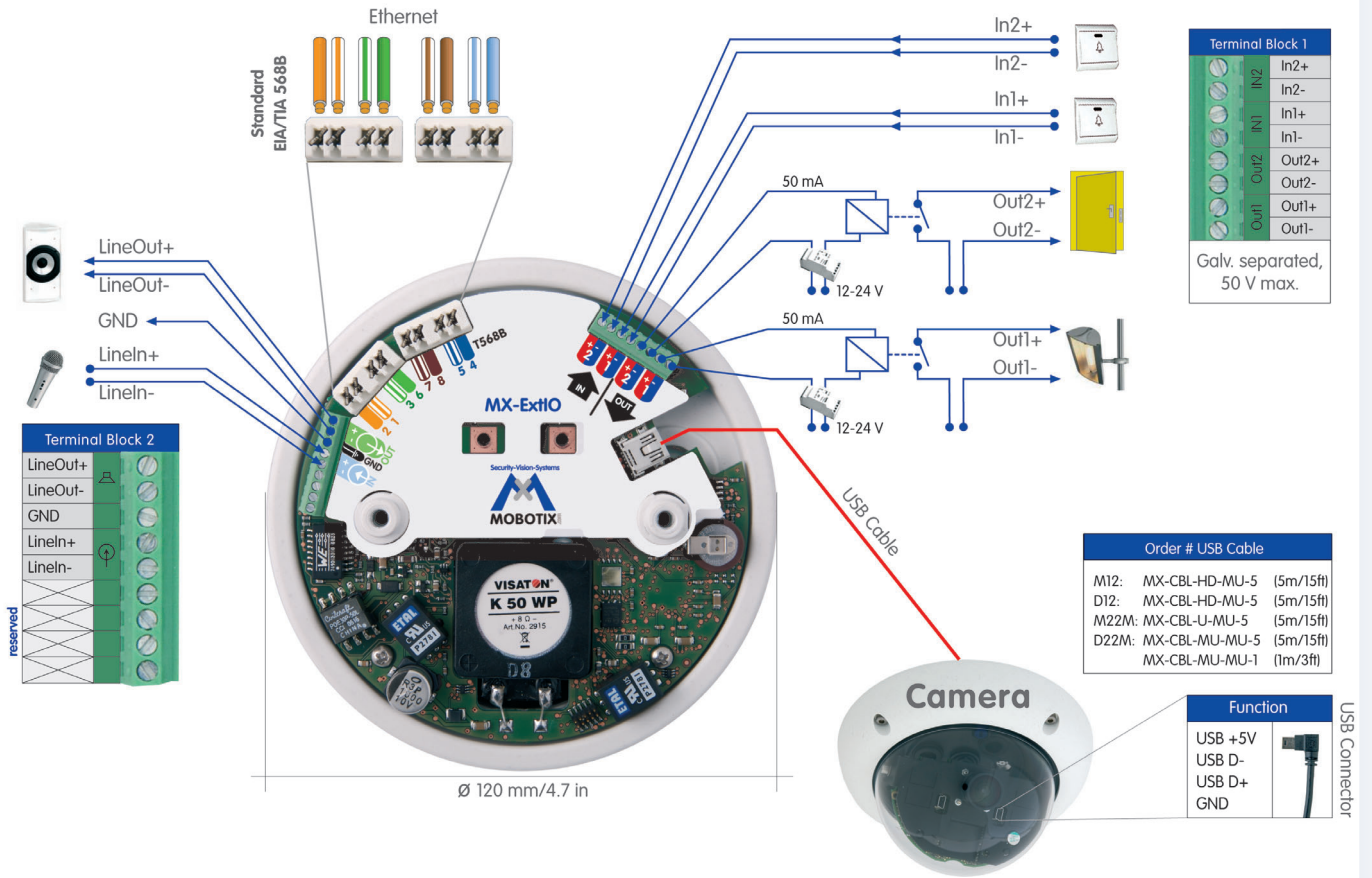

1.1 MOBOTIX ExtIO Concept

Simple Installation

When designing the MOBOTIX ExtIO, special focus was placed on easy installation of the expansion box. The supplied drilling template facilitates mounting the ExtIO and makes connecting the cabling for data and audio connections easy, secure and weatherproof.

Buttons

The two **buttons** of the ExtIO can be used to control its two signal outputs, for example. In addition, a MOBOTIX camera connected to the ExtIO can react to the pressed button and can execute the messaging options and actions defined in the MOBOTIX camera.

Switching external Devices

Using the two galvanically separated **signal outputs**, the ExtIO can switch devices with up to 50 V AC or DC and max. 100 mA (5 W).

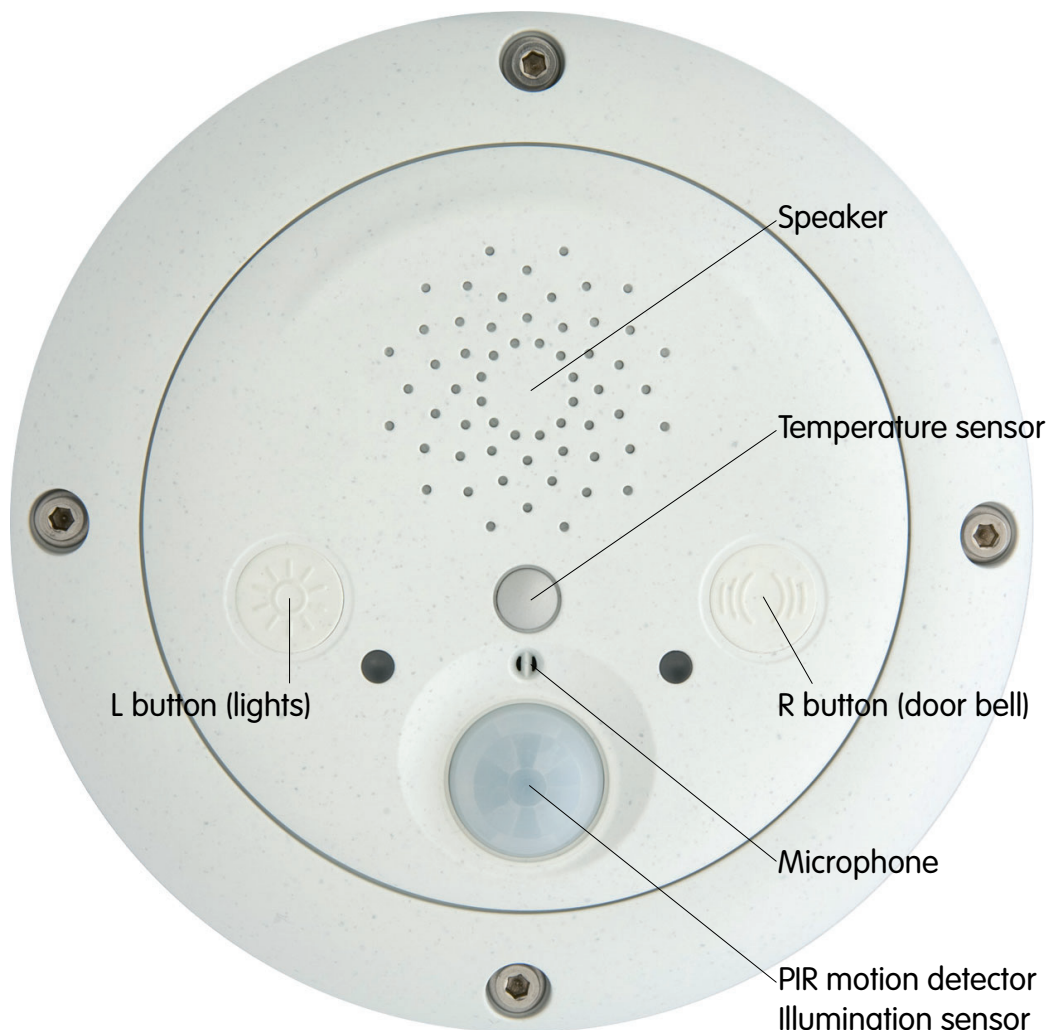

Using External Sensors

Using the two galvanically separated **signal inputs** of the ExtIO, the MOBOTIX camera can monitor external sensors and apply the different mechanisms available to the camera for storing audio/video and for sending notification messages.

Weatherproofness

The weatherproofness of the MOBOTIX ExtIO has been tested extensively; the ExtIO reaches **protection class IP65** (absolutely dustproof and resistant against water jets).

Robust and durable

Like all other MOBOTIX products, the ExtIO has been designed for a long product life. The housing from **PBT-GF30** is robust and reliably protects the interior of the ExtIO.

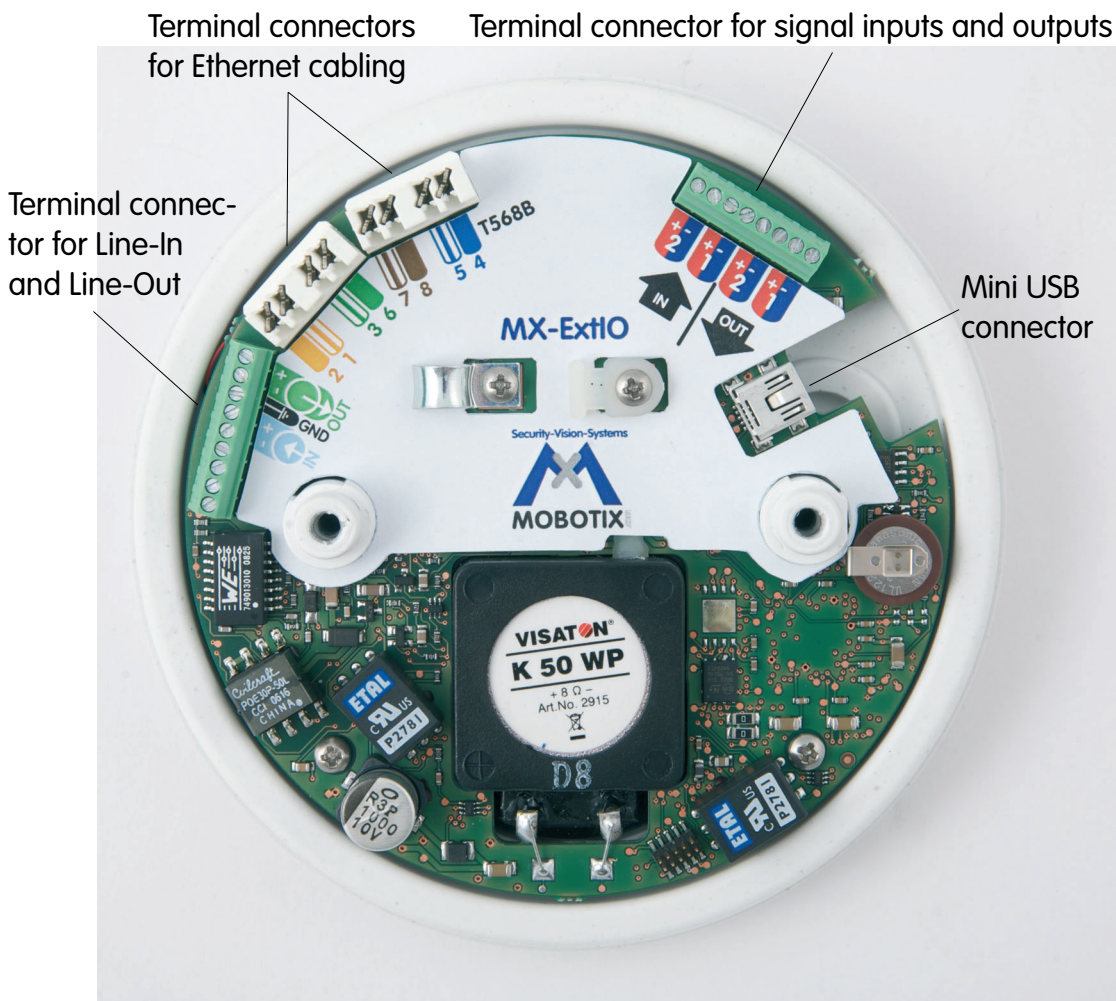

1.2 The MOBOTIX ExtIO and MOBOTIX Cameras

1.2.1 Functional Overview of the ExtIO

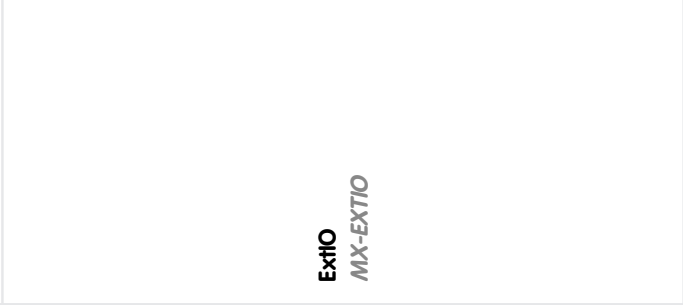
	
Hardware Features	
Outdoor - weatherproof	IP65
Power Supply	Using PoE (Class 2)* or USB cable
Sensors	Speaker, microphone, 2 status LEDs, PIR motion detector, 2 buttons, external temperature sensor, illumination sensor
Concealed cabling	Yes
Dimensions/Weight	160 x 42 mm/6.3 x 1.7 in (dia. x height), approx. 430 g/15.2 ounces
Audio	
Speaker	0.5 W / 8 Ohm
Microphone	X
Line-Out / Line-In	X / X
Outputs	
Count	2 (galvanically separated)
Max. switching voltage	50 V~ / 50 V=
Min. switching voltage	5 V~ / 5 V=
Max. amperage	100 mA
Min. amperage	-
Max. inductive load	6 VA
Max. Ohm resistive load	5 W
Open Collector	-
Galvanically separated	X
Inputs	
Count	2 (galvanically separated)
Max. voltage	50 V~ / 50 V=
Min. voltage	self-powered
Min. amperage	-
Switching level	High active

*IEEE 802.3af required

You can use the ExtIO with all MOBOTIX IT and Secure models. MOBOTIX Q22M models can only be connected to the ExtIO using Ethernet.

Note that the cable required for connecting the ExtIO (MOBOTIX USB cable or Ethernet installation cable) is not included in the delivered parts.

If you would like to use a USB cable to connect the ExtIO to a camera, please order the corresponding MOBOTIX USB cable for your camera model:

M12/D12:
SUB HD to Mini USB
MX-CBL-HD-MU-5
(5 m/16 ft)

M22M:
USB to Mini USB
MX-CBL-U-MU-5
(5 m/16 ft)

D22M:
Mini-USB to Mini-USB
MX-CBL-MU-MU-1
(1 m/3 ft)
MX-CBL-MU-MU-5
(5 m/16 ft)

1.2.2 Comparison ExtIO/CamIO



Hardware Features	ExtIO	CamIO
Supported MOBOTIX models	all models*	M12, M22**
Outdoor - weatherproof	IP65	IP65
Power Supply	PoE (Class 2)*** / USB	230 V AC / PoE
Power input	typ. 1 W	typ. 3.5 W
Integrated recharg. battery	-	(only ACplus model for M12)
Sensors	Speaker, microphone 2 status LEDs, 2 buttons PIR motion detector, temperature, illumination	Speaker****
Concealed cabling	Yes	Yes
Dimensions	160 x 42 mm/6.3 x 1.7 in (dia. x height)	136 x 163 x 158 mm/5.4 x 6.4 x 6.2 in (width x depth x height)
Audio		
Integrated Speaker	0.5 W	2.5 W****
Integrated Microphone	X	-
Line-Out / Line-In	X / X	X / X
Outputs		
Count	2 (galvanically separated)	2 (galvanically separated)
Max. switching voltage	50 V~ / 50 V=	230 V~ / 48 V~/68 V=
Min. switching voltage	5 V~ / 5 V=	5 V~ / 5 V=
Max. amperage	100 mA	5 A
Min. amperage	-	100 mA
Max. inductive load	6 VA	600 VA / 400 VA
Max. Ohm resistive load	5 W	500 W / 300 W
Inputs		
Count	2 (galvanically separated)	2 (galvanically separated)
Max. voltage	50 V~ / 50 V=	230 V~/325 V= / 48 V~/68 V=
Min. voltage	self-powered	8 V~ / 11 V=
Min. amperage	-	2 mA
Switching level	High active	High active

*You can use the ExtIO with all MOBOTIX IT and Secure models. MOBOTIX Q22M models can only be connected to the ExtIO using Ethernet.

**You can use the CamIO with all M12 and M22M IT and Secure models

***IEEE 802.3af required

****The integrated speaker of the CamIO can only be used with M12 models

The ExtIO is not included in the delivered parts

On-Wall set (IP65, suitable for outdoor applications)

On-Wall set 10° (IP65, suitable for outdoor applications)

In-Ceiling set (ExtIO not included)

Wall Mount made from sturdy PBT-GF30 (IP65)

Pole Mount: Outdoor quality made of 3 mm stainless steel (in conjunction with Outdoor Wall Mount)

1.3 Accessories

On-Wall Set (MX-D22-OPT-AP)

The On-Wall set can reliably protect external cables to the ExtIO if the cables cannot be guided from below the housing but have to be led above the wall.



On-Wall Set 10° (MX-OPT-AP-10DEG)

This On-Wall set is identical to the regular On-Wall set, except that the mounted device is inclined by 10 degrees.



In-Ceiling Set (MX-D22-OPT-IC)

The In-Ceiling set allows mounting the ExtIO cameras in fake ceilings, for example, thus providing a secure, yet elegant and unobtrusive installation option.



Wall Mount (MX-D22-OPT-WH)

This mount is the ideal solution for mounting the ExtIO to walls in indoor and outdoor applications. The wall mount also covers RJ45 wall outlets and has ample space for additional modules.



Pole Mount (MX-D22-OPT-MH)

If you would like to mount the MOBOTIX ExtIO to a pole, you should consider using the MOBOTIX Pole Mount. This mount can only be used in conjunction with the wall mount. The supplied stainless steel straps allow attaching the mount to poles with diameters between 60 and 180 mm (2.4 to 7.1 in).



2 MOUNTING THE EXTIO

2.1 Preparing the Installation

Before mounting the MOBOTIX ExtIO, the following questions should be answered:

- 1) **Where will the ExtIO be mounted?**
Mounting to a ceiling or wall; *section 2.1.1.*
- 2) **How should I connect the ExtIO to the camera?**
Via LAN/network or via USB; *section 2.1.2.*
- 3) **Which additional mounting options are available?**
On-wall mounting, in-ceiling mounting, wall mounting with Wall Mount or Pole Mount, *section 2.1.3*
- 4) **How are the connections furnished from the building?**
Wall outlets, *section 2.1.4*
- 5) **Which sections of the Mounting Instructions should I read?**
In order to mount the ExtIO with its optional accessories as quickly and efficiently as possible, you should consult the **Directions for Mounting**, *section 2.1.5.*

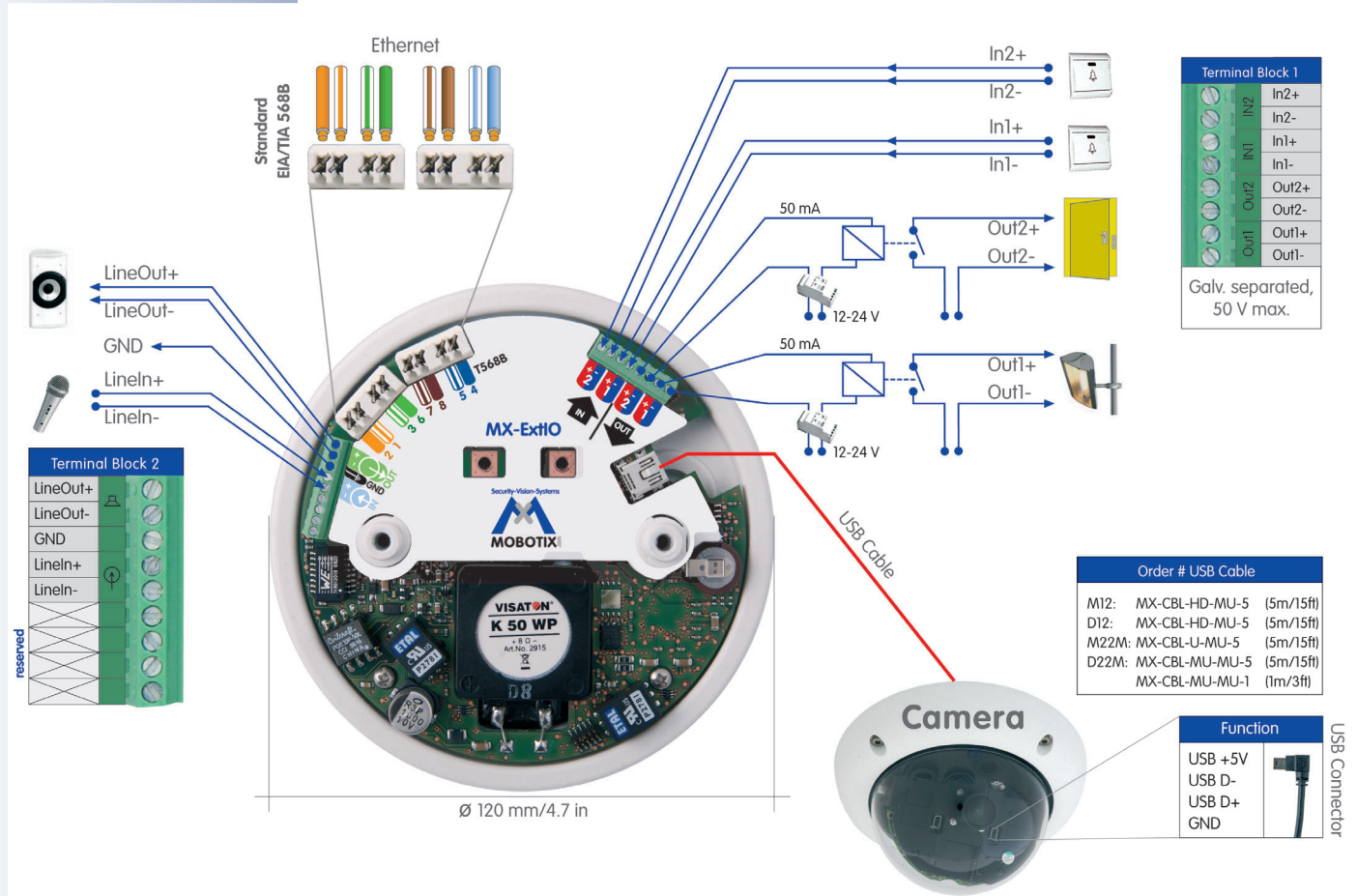

The following sections contain a brief overview for all of these questions as well as references to the relevant sections in this manual, which contain more detailed information. For more information on the MOBOTIX ExtIO and the available accessories, please also refer to www.mobotix.com in the **Products** section.

2.1.1 Mounting to a Wall or Ceiling

The ExtIO has been designed for mounting directly to a wall or ceiling. In order to simplify the installation, you can use the following mounting options (On-Wall set, In-Ceiling set, Wall Mount, Pole Mount).

Follow these general steps to install and operate the ExtIO:

- 1) Prepare the installation (drill the holes and install the cabling, select a mounting option – directly to a wall, with On-Wall set, with In-Ceiling set, ...)
- 2) Connect the model-specific USB cable to the MOBOTIX camera (not required when connecting the ExtIO via Ethernet)
- 3) Connect the cables to the ExtIO
 - a) Connect the Ethernet cable or the model-specific USB cable
 - b) Connect the cables for external components (optional)
- 4) Mount the ExtIO to the wall, ceiling or to the mounting option (On-Wall set, In-Ceiling set, ...)
- 5) Activate the ExtIO in the camera software

The back of the ExtIO's housing has three openings for cables. For more detailed information on the installation process, see *sections 2.2 and higher*; the drilling templates are at the end of the manual.

2.1.2 Connecting via Network or USB

You can either use the LAN (Ethernet cabling) or the model-specific MOBOTIX USB cables to connect the ExtIO to a MOBOTIX camera. Note that the maximum length for USB cables is 5 m/16 ft (100 m/110 yd for Ethernet cabling).

Advantage of using Ethernet – you do not need to modify the camera. When using USB, you need to install an additional model-specific cable to connect the camera to the ExtIO. This usually means that you need to take down the camera, guide the USB cable through the mount and mount the camera again.

Advantage of using USB separate network connection to the ExtIO is not required. You simply use the attached MOBOTIX camera for activating and configuring the ExtIO with only a few clicks.

Never mount the ExtIO to metal surfaces (condensation may damage the ExtIO!)

MOBOTIX USB cables:

M12/D12:
SUB HD to Mini USB
MX-CBL-HD-MU-5
 (5 m/16 ft)

M22M:
USB to Mini USB
MX-CBL-U-MU-5
 (5 m/16 ft)

D22M:
Mini USB to Mini USB
MX-CBL-MU-MU-1
 (1 m/3 ft)
MX-CBL-MU-MU-5
 (5 m/16 ft)

On-Wall set (IP65, suitable for outdoor applications)

On-Wall set 10° (IP65, suitable for outdoor applications)

In-Ceiling set (ExtIO not included)

Wall Mount made from sturdy PBT-GF30 (IP65)

Pole Mount: Outdoor quality made of 3 mm stainless steel (in conjunction with Outdoor Wall Mount)

2.1.3 Mounting Options

On-Wall Set (MX-D22-OPT-AP)

The On-Wall set can reliably protect external cables to the ExtIO if the cables cannot be guided from below the housing but have to be led above the wall. Note that the On-Wall set is also available with 10 degrees inclination.



In-Ceiling Set (MX-D22-OPT-IC)

The In-Ceiling set allows mounting the ExtIO in fake ceilings, for example, thus providing a secure, yet elegant and unobtrusive installation option.



Wall Mount (MX-D22-OPT-WH)

This mount is the ideal solution for mounting the ExtIO to walls in indoor and outdoor applications. The wall mount also covers RJ45 wall outlets and has ample space for additional modules.

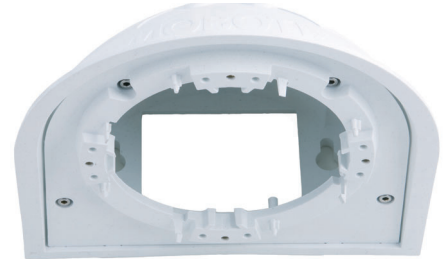

Pole Mount (MX-D22-OPT-MH)

If you would like to mount the MOBOTIX ExtIO to a pole, you should consider using the MOBOTIX Pole Mount. This mount can only be used in conjunction with the wall mount. The supplied stainless steel straps allow attaching the mount to poles with diameters between 60 and 180 mm (2.4 to 7.1 in).

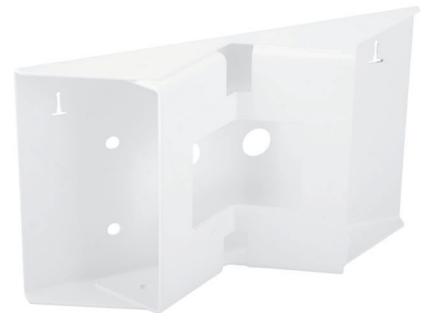





2.1.4 Providing the Camera Connections, Wall Outlets

Once the mounting position, the mounting options and the type of connection have been decided upon, the cabling can be installed. If you are planning to use the network to connect the camera and the ExtIO, you should make sure that the network connections have been properly tested before mounting the ExtIO, so that the proper functioning is guaranteed.

Please also observe section 2.8, *Important Notes*.

2.1.5 Directions for Mounting

Once the type of installation, the camera connections and the mounting options have been decided upon, you should follow the directions listed below. This ensures that you only have to read the relevant sections of this chapter, which will speed up installing the ExtIO and connecting it to the MOBOTIX camera.

Directions for Mounting	
Preparatory Tasks	Sections
ExtIO 	2.1 <i>Preparing the Installation</i> 2.2 <i>ExtIO Accessories: Delivered Parts, Components and Dimensions</i> 2.4 <i>Connecting the Terminal Connectors, Wiring</i>
Connection Type	Sections
ExtIO NET Operation	2.4.2 <i>Terminal Connectors for the Ethernet Cabling</i> 2.6.1 <i>Connecting the Ethernet Cable to the ExtIO</i>
ExtIO USB Operation*	2.5 <i>Connecting the USB Cable to the Camera</i> 2.6.2 <i>Connecting the USB Cable to the ExtIO</i>
Type of Installations	Sections
All Mounting Types	2.7 <i>Mounting the ExtIO to a Wall or Ceiling</i>
Mounting to Walls or Ceilings with On-Wall Set 	2.2 <i>ExtIO Accessories: Delivered Parts, Components and Dimensions</i> 2.3.1 <i>Delivered Parts, Components, Dimensions On-Wall Set</i>
Mounting to Walls or Ceilings with In-Ceiling Set 	2.2 <i>ExtIO Accessories: Delivered Parts, Components and Dimensions</i> 2.3.2 <i>Delivered Parts, Components, Dim. In-Ceiling Set</i>
Mounting to a Wall Using the Wall Mount 	2.2 <i>ExtIO Accessories: Delivered Parts, Components and Dimensions</i> 2.3.3 <i>Delivered Parts, Components, Dim. Wall Mount</i>
Mounting to a Pole 	2.2 <i>ExtIO Accessories: Delivered Parts, Components and Dimensions</i> 2.3.3 <i>Delivered Parts, Components, Dim. Wall Mount</i> 2.3.4 <i>Delivered Parts, Components, Dim. Pole Mount</i>

Note that the cable required for connecting the ExtIO (MOBOTIX USB cable or Ethernet installation cable) is not included in the delivered parts.

*If you would like to use a USB cable to connect the ExtIO to a camera, please order the corresponding MOBOTIX USB cable for your camera model:

M12/D12:
SUB HD to Mini USB
MX-CBL-HD-MU-5
(5 m/16 ft)

M22M:
USB to Mini USB
MX-CBL-U-MU-5
(5 m/16 ft)

D22M:
Mini USB to Mini USB
MX-CBL-MU-MU-1
(1 m/3 ft)
MX-CBL-MU-MU-5
(5 m/16 ft)

2.2 ExtIO: Delivered Parts, Components and Dimensions

2.2.1 Delivered Parts and Components

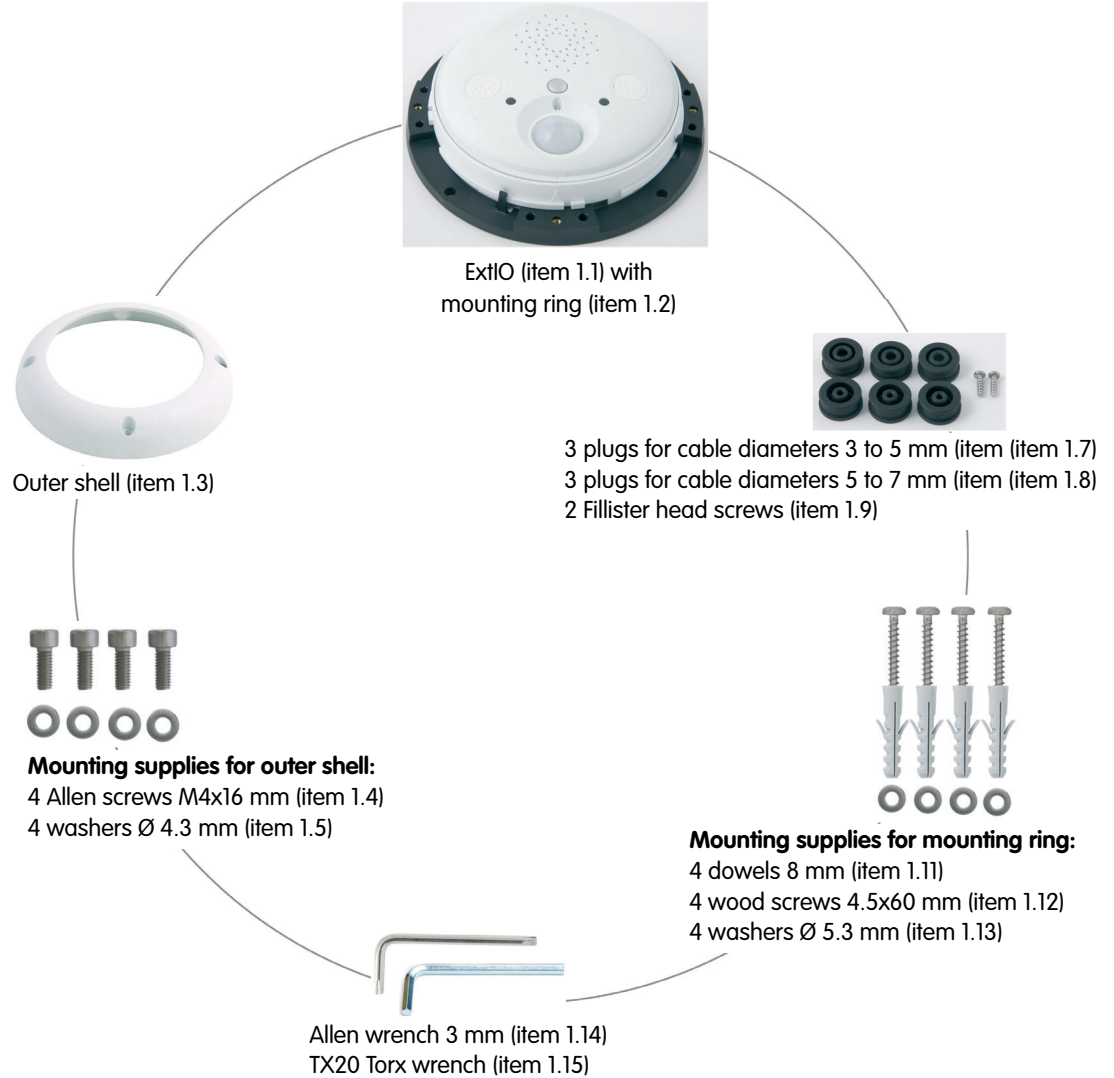

Item	Count	Part Name
1.1	1	ExtIO housing (with back and main board)
1.2	1	Mounting ring
1.3	1	Outer shell
1.4	4	Allen screws M4x16 mm (for outer shell)
1.5	4	Washers Ø 4.3 mm (for outer shell)
1.6	3	Plug for 8 wires (preinstalled)
1.7	3	Plug for cable diameters 3 to 5 mm
1.8	3	Plug for cable diameters 5 to 7 mm
1.9	2	Fillister head screws (for cable clamps, replacement)
1.10	2	Cable ties (for cable clamps)
1.11	4	Dowels 8 mm
1.12	4	Wood screws with Torx head 4.5x60 mm
1.13	4	Washers Ø 5.3 mm
1.14	1	Allen wrench 3 mm (for outer shell)
1.15	1	Torx wrench TX20 (for wood screws)

2.2.2 Housing

The housing of the MOBOTIX ExtIO is made of white fiber-reinforced **plastic (PBT-GF30, Polybutyleneterephthalate with 30% fiberglass)**. This material is used heavily in the automotive industry and is sturdy, resistant against high temperatures, environmental influences, chemicals, etc.

The MOBOTIX ExtIO's main components are the ExtIO housing (includes the main board), the outer shell and the mounting ring.

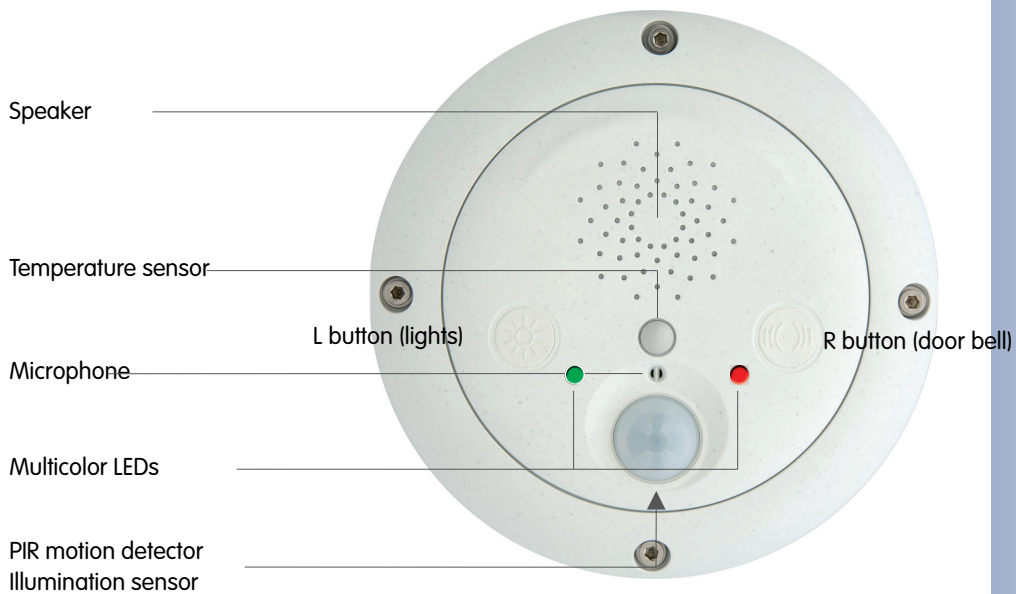

2.2.3 ExtIO: Dimensions Without Mounting Options

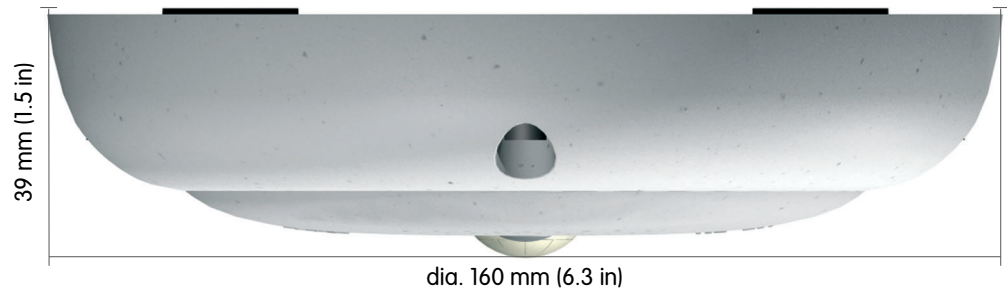

2.2.4 Drilling Template Mounting Ring

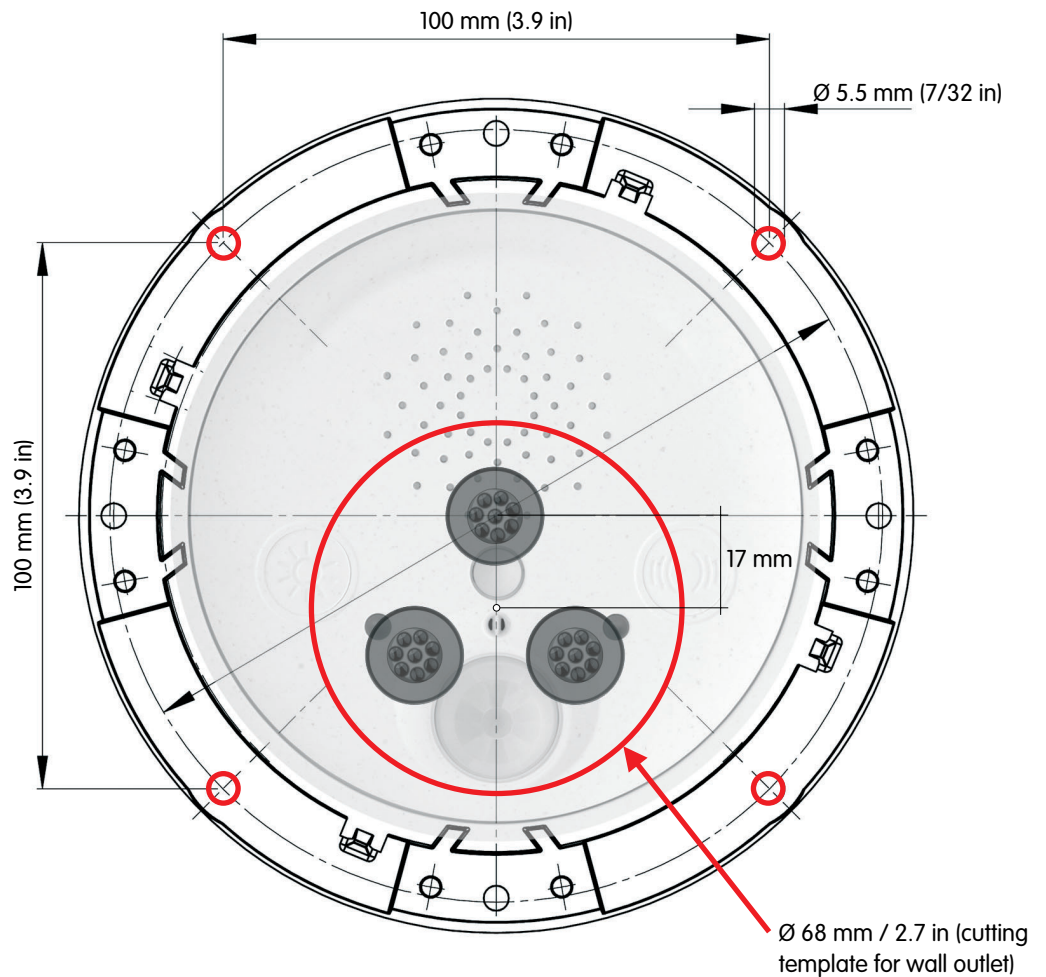

Find the drilling templates (scale 1:1) at the end of the manual as a fold-out

Note

Find the folded drilling template at the end of the manual.

Make sure that the drilling template is not scaled or adjusted to the paper size when printing the PDF file.

2.3 ExtIO Accessories: Delivered Parts, Components, Dimensions

2.3.1 On-Wall Set

The ExtIO is not included in the delivery of the On-Wall set!

Housing (item 2.1)

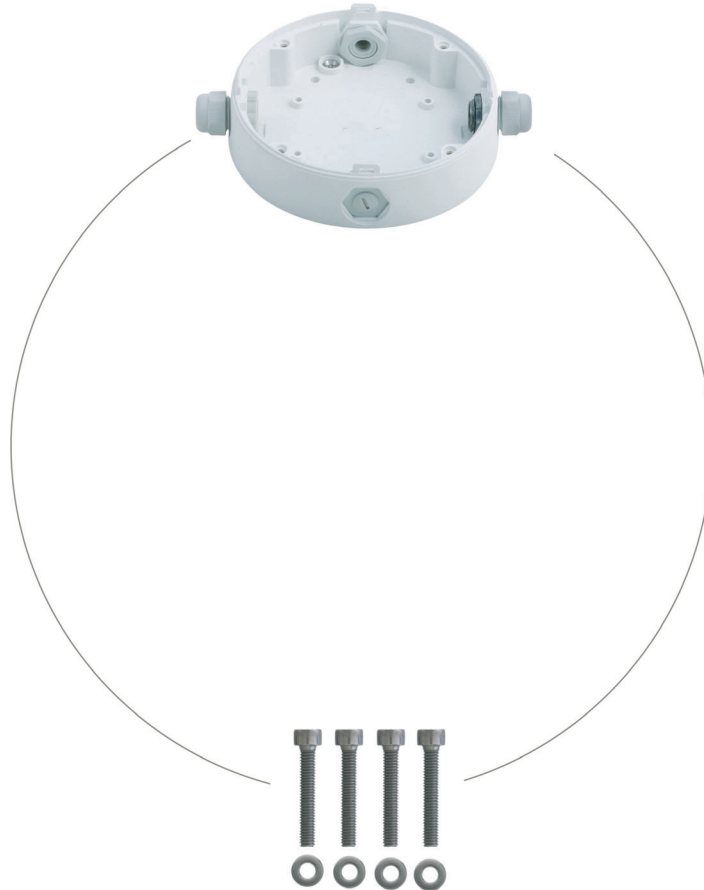

4 Allen screws M4x35 mm (item 2.2)
4 washers dia. 4.3 mm (item 2.3)

The On-Wall set can be used for the ExtIO and all Q22M and D22M models

Item	Count	Part Name
2.1	1	On-Wall set housing
2.2	4	Stainless steel Allen screws M4x35 mm
2.3	4	Stainless steel washers Ø 4.3 mm

Drilling Template On-Wall Set

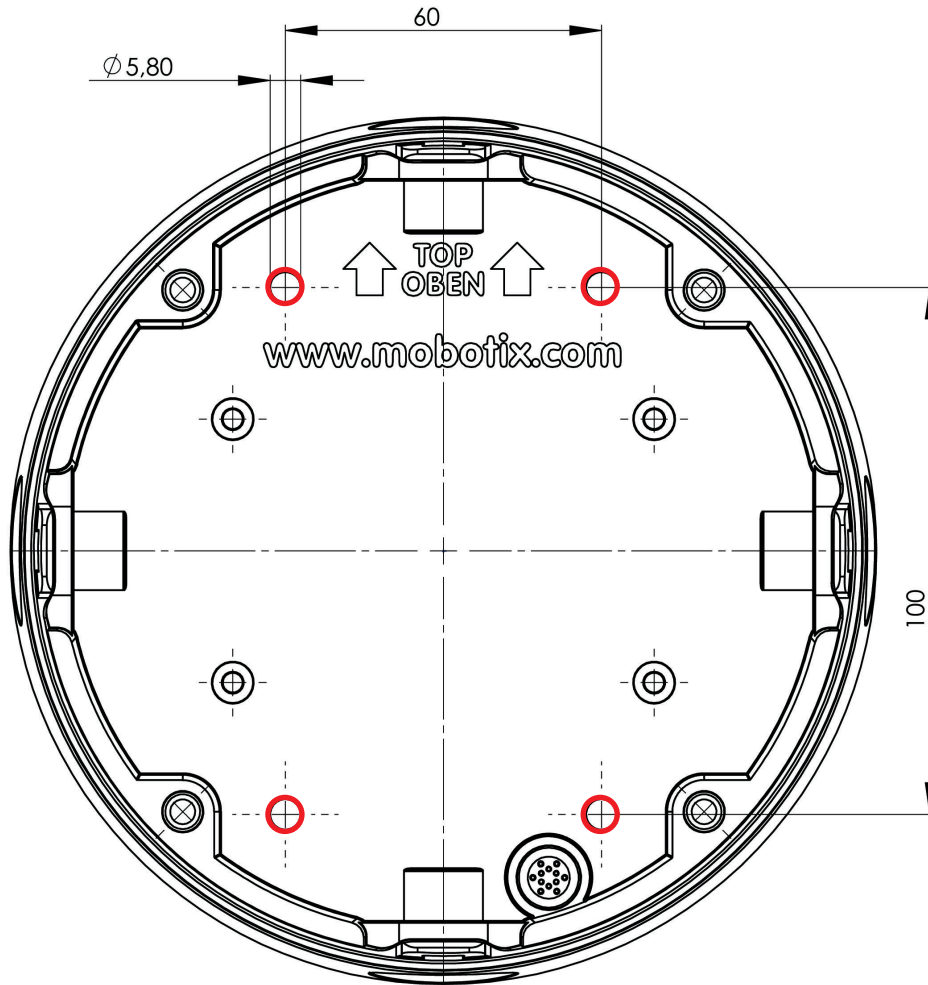

Find the drilling templates (scale 1:1) at the end of the manual as a fold-out

Note

Find the folded drilling template at the end of the manual.
 Make sure that the drilling template is not scaled or adjusted to the paper size when printing the PDF file.

2.3.2 In-Ceiling Set

The ExtIO is not included in the delivery of the In-Ceiling set!

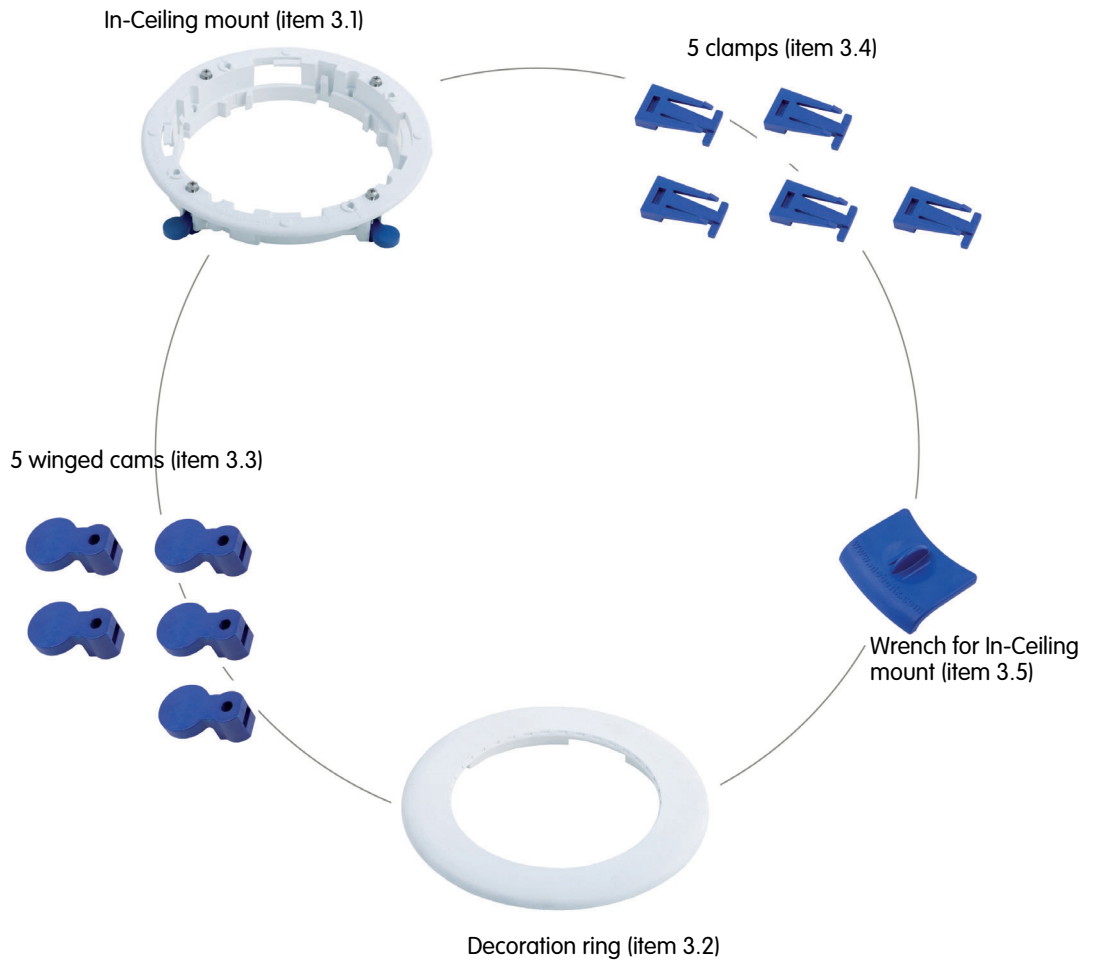

The In-Ceiling set can be used for the ExtIO and all Q22M and D22M models

Item	Count	Part Name
3.1	1	In-Ceiling set
3.2	1	Decoration ring
3.3	5	Winged cam
3.4	5	Clamps
3.5	2	Wrench for In-Ceiling mount

Cutting Template for In-Ceiling Set

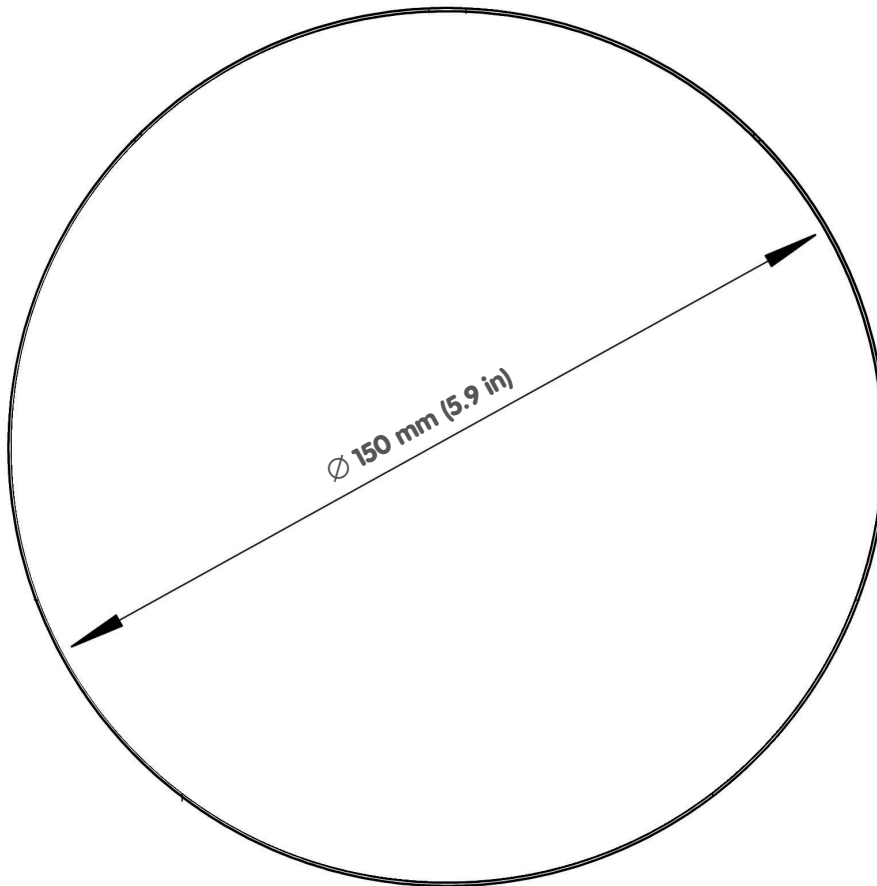

Find the cutting template (scale 1:1) at the end of the manual as a fold-out

Note

Find the folded drilling template at the end of the manual.

Make sure that the drilling template is not scaled or adjusted to the paper size when printing the PDF file.

2.3.3 Wall Mount

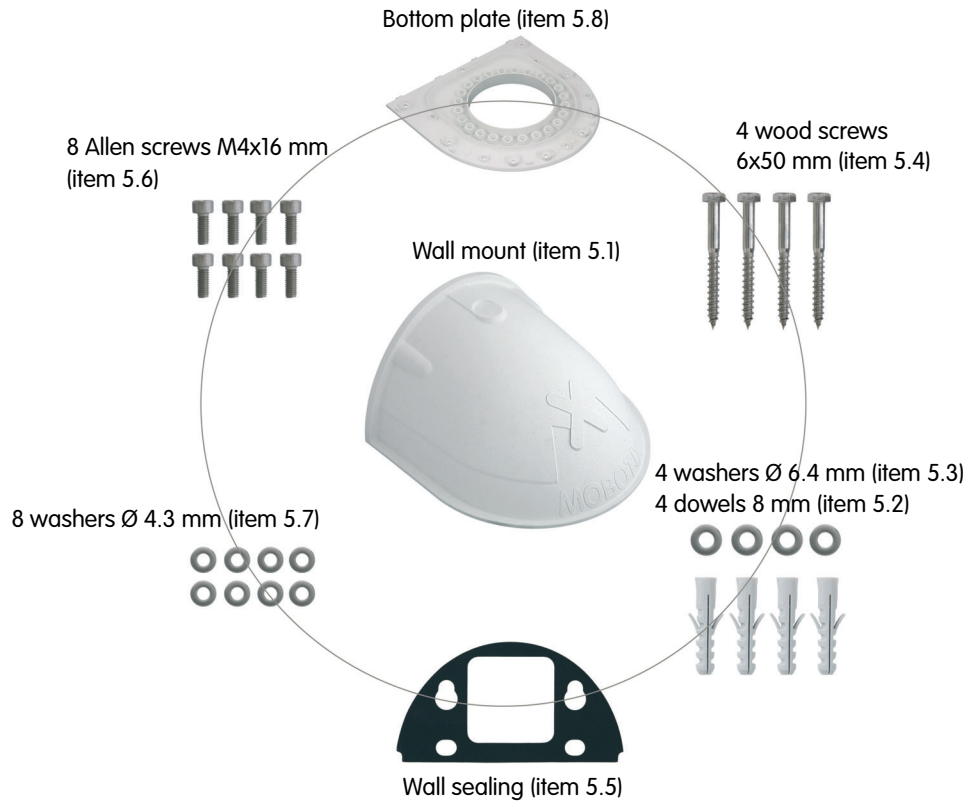

The Wall Mount can be used for the ExtIO and all Q22M and D22M models

Item	Count	Part Name
5.1	1	Wall Mount
5.2	4	Dowels 8 mm
5.3	4	Stainless steel washers Ø 6.4 mm
5.4	4	Stainless steel wood screws with hex head 6x50 mm
5.5	1	Wall sealing
5.6	8	Stainless steel Allen screws M4x16 mm
5.7	8	Stainless steel washers Ø 4.3 mm
5.8	1	Bottom plate

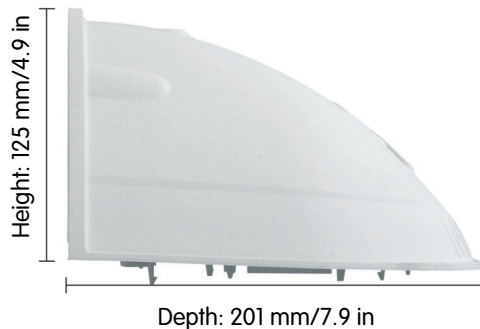

Drilling Template Wall Mount

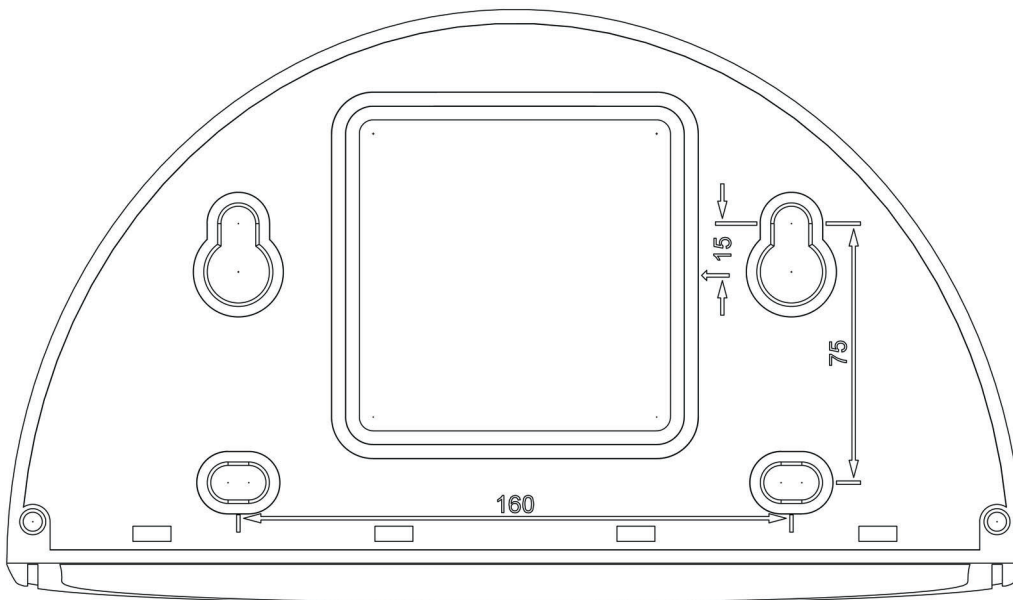

Find the drilling templates (scale 1:1) at the end of the manual as a fold-out

Note

Find the folded drilling template at the end of the manual.

Make sure that the drilling template is not scaled or adjusted to the paper size when printing the PDF file.

2.3.4 Pole Mount

The Pole Mount can only be used in conjunction with the Wall Mount

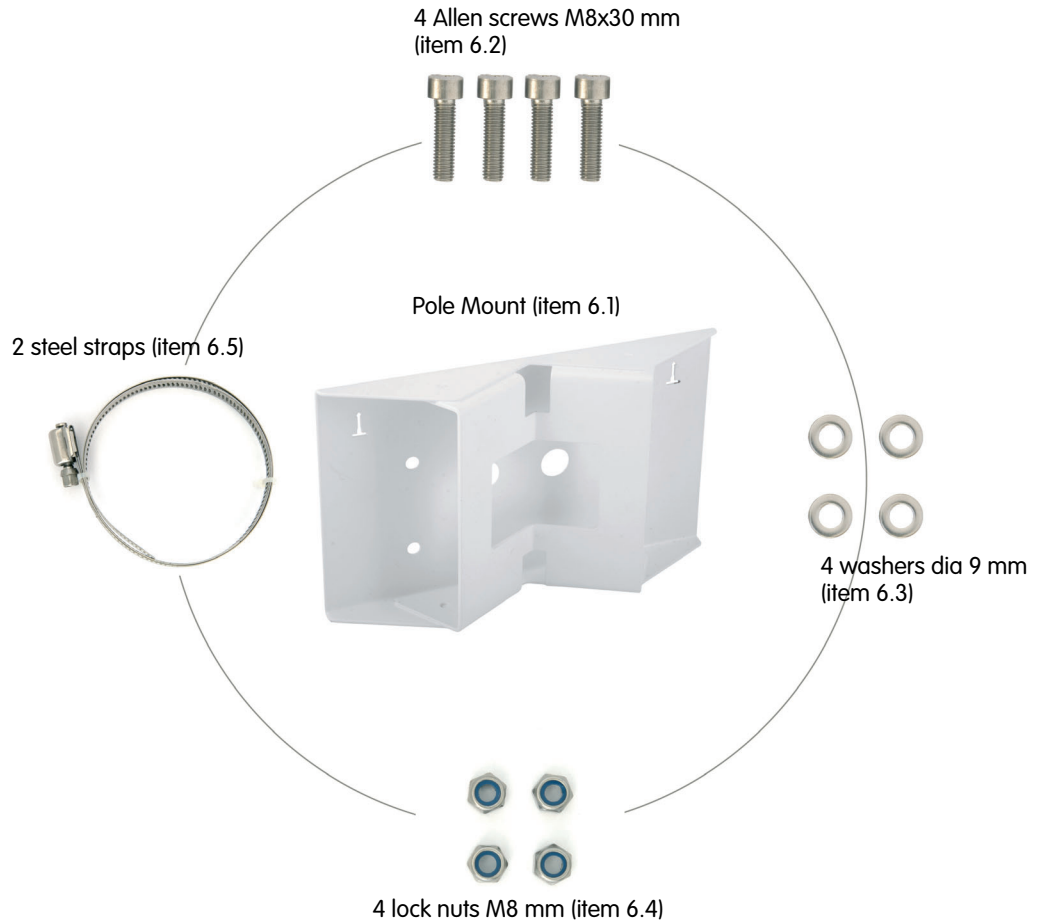

The Pole Mount can be used for the ExtIO and all Q22M and D22M models

Item	Count	Part Name
6.1	1	Pole mount, stainless steel 3 mm, white powder-coated
6.2	4	Stainless steel Allen screws M8x30 mm
6.3	4	Stainless steel washers Ø 9 mm
6.4	4	Stainless steel lock nuts M8
6.5	2	Stainless steel straps

Height: 125 mm (4.9 in)

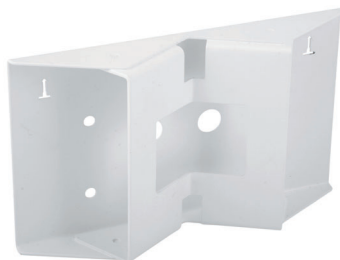

Width: 201 mm (7.9 in)



Depth: 55 mm (2.2 in)

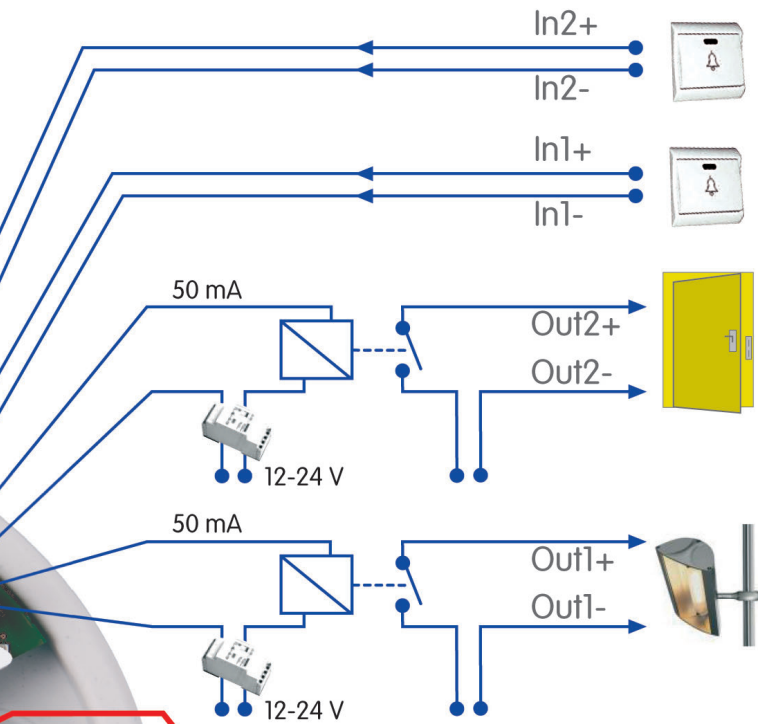

Terminal Block 1		
IN2		In2+
		In2-
IN1		In1+
		In1-
Out2		Out2+
		Out2-
Out1		Out1+
		Out1-

Galv. separated,
50 V max.

Order # USB Cable		
M12:	MX-CBL-HD-MU-5	(5m/15ft)
D12:	MX-CBL-HD-MU-5	(5m/15ft)
M22M:	MX-CBL-U-MU-5	(5m/15ft)
D22M:	MX-CBL-MU-MU-5	(5m/15ft)
	MX-CBL-MU-MU-1	(1m/3ft)

USB Cable



Function	
USB +5V	
USB D-	
USB D+	
GND	

USB Connector

2.4 Connecting the Terminal Connectors, Wiring

2.4.1 Overview: ExtIO Board and Connectors

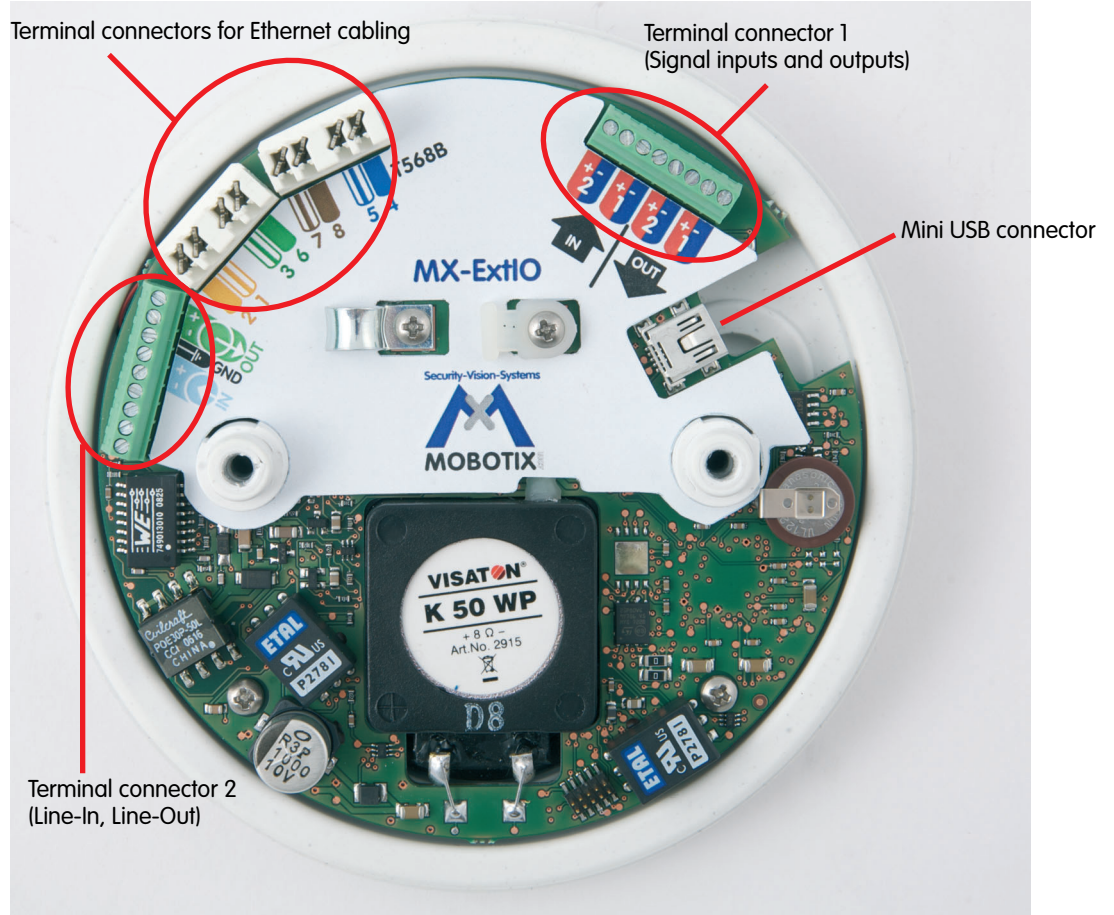

Terminal connectors - overview



ExtIO connection template

2.4.2 ExtIO Terminal Connectors for the Ethernet Cabling

Use Ethernet installation cable for connecting the cable to the Ethernet terminal connector. Make sure that you adhere to the allowed wire dimensions and to the applied Ethernet connection standard (usually EIA/TIA-568B).

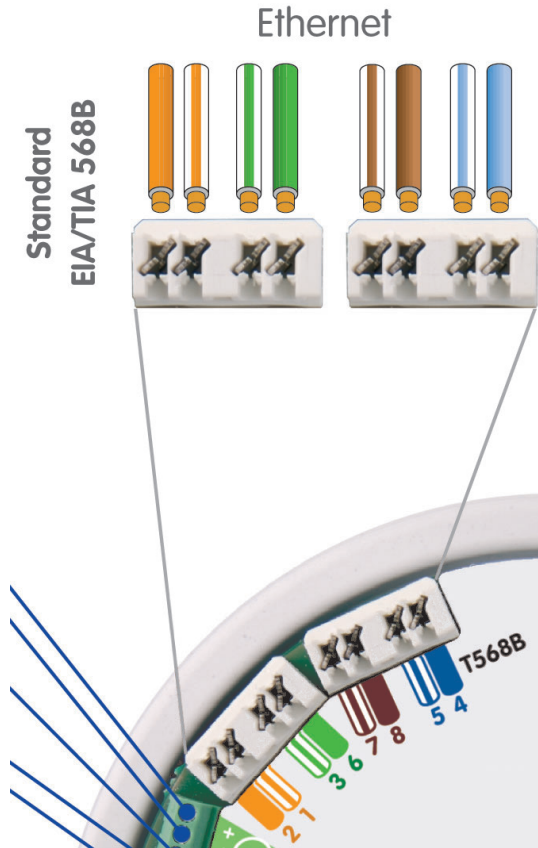

Cable color		Ethernet pair number
Orange		2 - Eth #2 (Tx-)
White / orange Line		2 - Eth #1 (Tx+)
White / green Line		3 - Eth #3 (Rx+)
Green		3 - Eth #6 (Rx-)
White / brown Line		4 - Eth #7
Brown		4 - Eth #8
White / blue Line		1 - Eth #5
Blue		1 - Eth #4

Allowed Wire Dimensions	Solid	AWG
Ethernet terminal (cutting clamps)	0.13 – 0.31 mm ²	26 to 22

Cable diameters should be tailored to the electrical load and must follow the applicable regulations.

Caution

The Ethernet cabling usually follows the EIA/TIA-568B (AT&T 258A) standard. If the Ethernet cabling follows the EIA/TIA-568A standard, you need to swap the orange and green cables of the Ethernet cable!

Ethernet connection standard **EIA/TIA-568B (AT&T 258A)**

AWG: American Wire Gauge (for measuring cable diameters)

EIA: Electronic Industries Alliance
TIA: Telecommunications Industry Association

2.4.3 ExtIO Terminal Connector 1 (Signal Inputs/Outputs)

Make sure that you are adhering to the applicable regulations in your country regarding the allowed cables when connecting the wires to the terminal connector. Always observe the allowed wire dimensions (see table below).

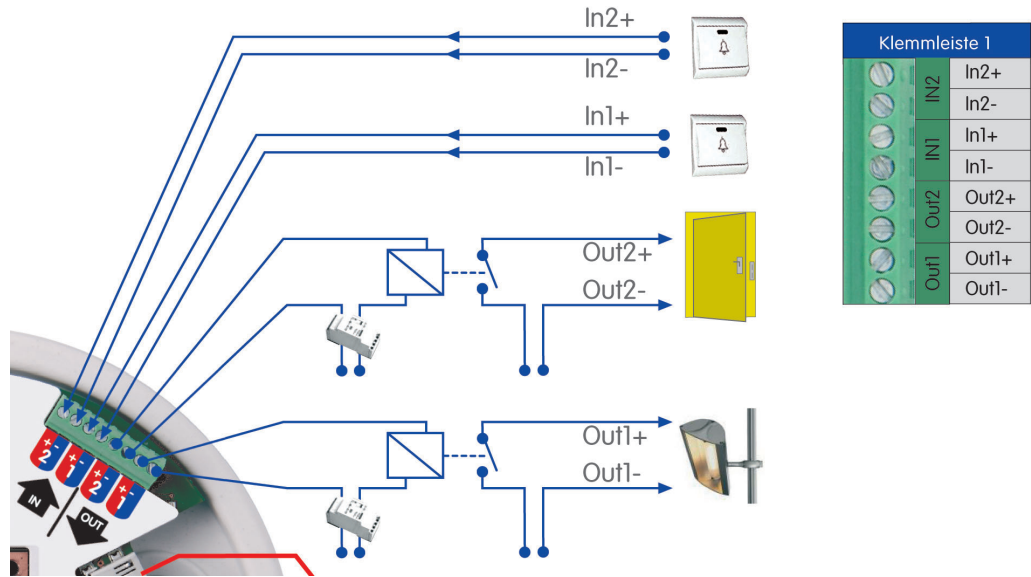

Terminal	Part Name	Remark
In2+	Signal input 2	Ext. sensor 2, max. 50 V~/50 V=
In2-		
In1+	Signal input 1	Ext. sensor 1, max. 50 V~/50 V=
In1-		
Out2+	Signal output 2	Ext. device 2, 5 V~ to 50 V~ / 5 V= to 50 V=, max. 100 mA, max. 5 W
Out2-		
Out1+	Signal output 1	Ext. device 1, 5 V~ to 50 V~ / 5 V= to 50 V=, max. 100 mA, max. 5 W
Out1-		

Allowed Wire Dimensions	Solid	AWG
Terminal connector 1	0.14 – 0.5 mm ²	26 to 20

Cable diameters should be tailored to the electrical load and must follow the applicable regulations.

AWG: American Wire Gauge (for measuring cable diameters)

2.4.4 ExtIO Terminal Connector 2 (Line-In/Line-Out)

Make sure that you are adhering to the applicable regulations in your country regarding the allowed cables when connecting the wires to the terminal connector. Always observe the allowed wire dimensions (see table below).

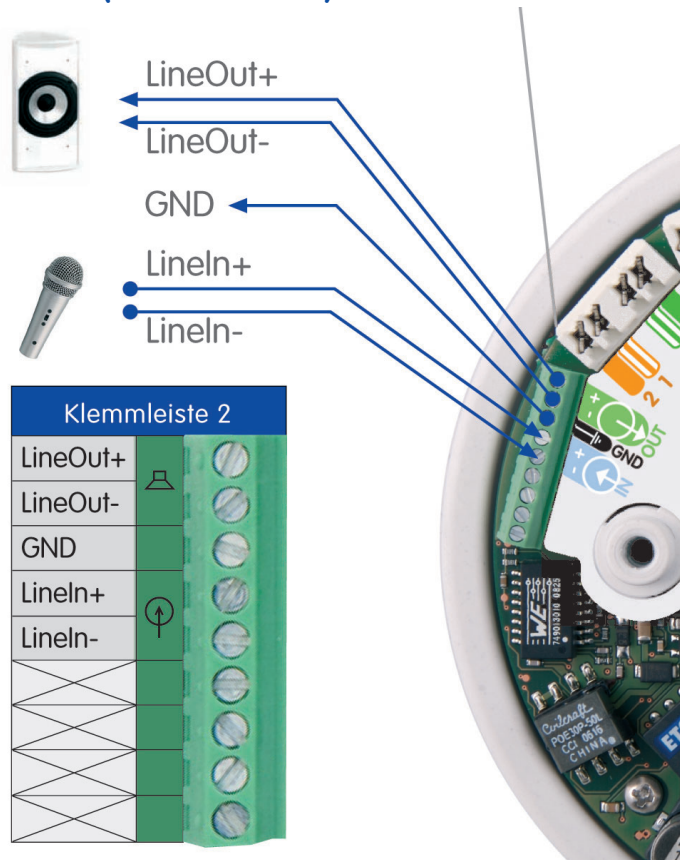

Terminal	Remark
Line-Out+	For connecting to the Line-In port of a computer or when using an external speaker with an amplifier, for example.
Line-Out-	
GND	Ground
Line-In+	For connecting to the Line-Out port of a computer or when using an external Microphone with a pre-amplifier, for example.
Line-In-	

Allowed Wire Dimensions	Solid	AWG
Terminal connector 2	0.14 – 0.5 mm ²	26 to 20
Cable diameters should be tailored to the electrical load and must follow the applicable regulations.		

AWG: American Wire Gauge (for measuring cable diameters)

When using the ExtIO via USB, you also need to order a model-specific MOBOTIX USB cable

D22M USB cables:
MX-EXTIO-D22-1
 (1 m/3 ft)
MX-EXTIO-D22-5
 (5 m/16 ft)

M22M USB cable:
MX-CBL-U-MU-5
 (5 m/16 ft)

M12-/D12 USB cable:
MX-CBL-HD-MU-5
 (5 m/16 ft)

M12-/D12 USB cable:
MX-CBL-HD-MU-5
 (5 m/16 ft)

2.5 Connecting a MOBOTIX USB Cable to the Camera

2.5.1 Overview

When using USB, you need to install the model-specific USB cable in the camera and then guide it through the camera, the SecureFlex mount or the mounting option. Follow the steps that are required for your camera model:

D22M

- 1) Disassemble the D22M camera housing.
- 2) Remove the rubber plug.
- 3) Guide the USB cable into the interior of the D22M.
- 4) Connect the cable's Mini USB connector to the D22M.
- 5) Close off the opening for the USB cable at the back of the housing with the rubber plug.
- 6) Reassemble the camera housing.

For additional information on this topic, see section 2.5.2.

M22M

- 1) Disassemble the SecureFlex mount.
- 2) Guide the USB cable for the M22M through the SecureFlex mount.
- 3) Remove the rubber plug of the USB connector.
- 4) Connect the USB connector of the cable to the M22M.
- 5) Properly attach the USB rubber plug to the USB connector.
- 6) Reassemble the SecureFlex mount.

For additional information on this topic, see section 2.5.3.

M12

- 1) Disassemble the SecureFlex mount.
- 2) Guide the USB cable for M12/D12 into the interior of the camera/wall mount.
- 3) Plug the D Sub 15 HD connector of the USB cable into the camera.
- 4) Reassemble the SecureFlex mount.

For additional information on this topic, see section 2.5.4.

D12

- 1) Disassemble the D12 camera housing.
- 2) Guide the USB cable for the M12/D12 into the interior of the camera mount.
- 3) Plug the D Sub 15 HD connector of the USB cable into the camera.
- 4) Reassemble the camera housing.

For additional information on this topic, see section 2.5.5.

2.5.2 USB Connection to a D22M Camera

- 1) Remove one of the rubber plugs in the back of the D22M camera housing. This plug will not be used any more in the course of the installation process.

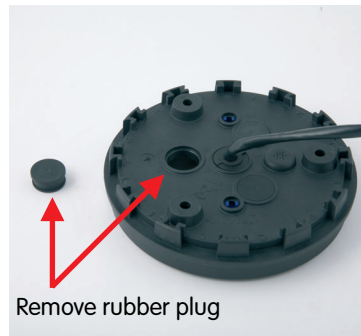

- 2) Guide the MOBOTIX D22M USB cable with the angled Mini USB plug first from the opening in the back and under the lens mount.



- 3) Insert the Mini USB plug into the Mini USB/ MOBOTIX Bus connector at the front of the lens mount. Make sure that you do not insert the plug into the audio connector by accident.



- 4) Close off the opening in the back of the D22M camera housing by properly inserting the rubber plug that is attached to the MOBOTIX D22M USB cable into its seating. Make sure that about 12 cm/5 in of free cable remain in the camera.

It is very important that the rubber plug reliably protects the housing against moisture. This will guarantee the weatherproofness (IP65) of the camera. Please only use the pre-installed rubber plug of the cable.

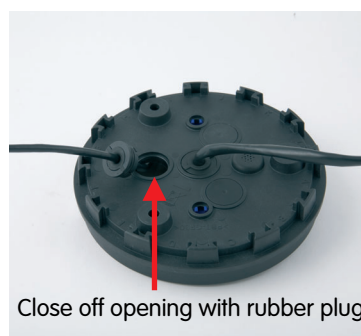

USB cables for MOBOTIX D22M models:

- MX-CBL-MU-MU-1**
(1 m/3 ft)
- MX-CBL-MU-MU-5**
(5 m/16 ft)

Caution

Please only use the rubber plug that is attached to the MOBOTIX D22M USB cable! This will guarantee the weatherproofness (IP65) of the camera.

USB cable (5 m/16 ft) for MOBOTIX M22M models:

MX-CBL-U-MU-5

5 mm Allen wrench is included in the delivery of the M22M cameras

2.5.3 USB Connection to a M22M Camera

- 1) Unscrew the **upper Allen screw** in the foot of the mount, which holds the turn/tilt unit in place (5 mm Allen wrench). Remove the Allen screw, the washer and the hex nut from the mount.

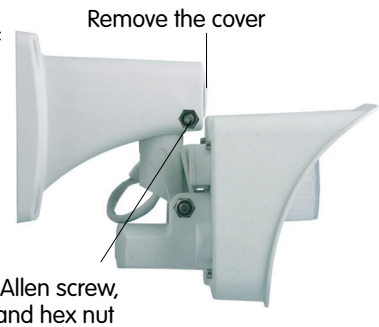

- 2) Remove the **cover**.

- 3) Gently pull the **turn/tilt unit** and the installed network cable out of the opening of the mount.

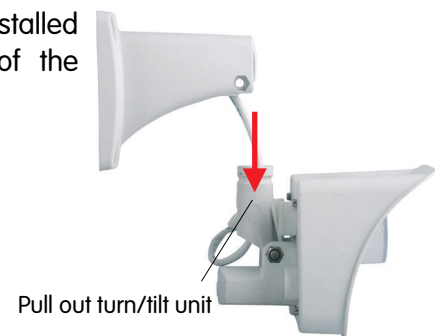

- 4) Guide the MOBOTIX M22M USB cable with the angled Mini USB plug first from below through the turn/tilt unit of the camera.

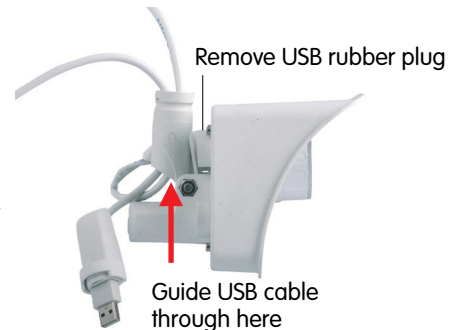

- 5) Remove the camera's USB rubber plug at the back of the camera housing. This plug will not be used any more in the course of the installation process.

- 6) Insert the USB plug of the MOBOTIX M22M USB cable into the USB connector at the back of the camera housing.

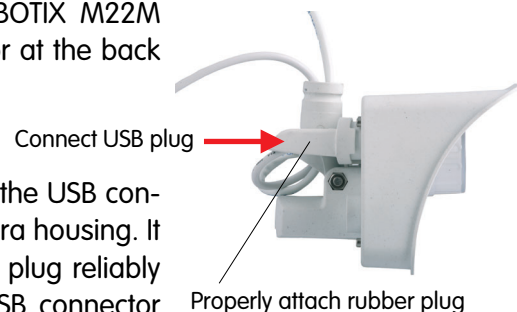

- 7) Push the white rubber plug over the USB connector and the collar at the camera housing. It is very important that the rubber plug reliably protects the housing and the USB connector against moisture. This will guarantee the weatherproofness (IP65) of the camera. Please only use the rubber plug that is delivered with the USB cable.



- 8) Guide the MOBOTIX M22M USB cable with the angled Mini USB plug first from below through the wall mount.
- 9) Insert the **cover** into the free opening of the wall mount's foot.

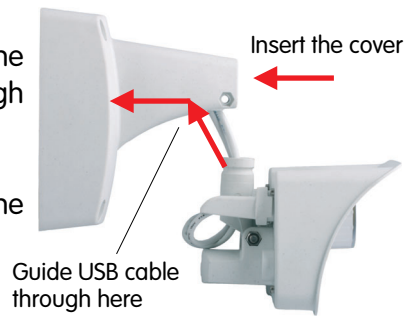

- 10) Insert the turn/tilt unit of the camera into the horizontal opening of the mount (all the way to the stop).
- 11) Insert the hex nut into the corresponding hole and fasten the **Allen screw** with washer.

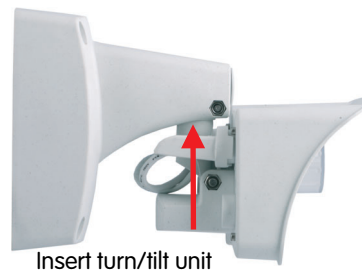

Insert the cover

Maximum torque for all screws is 1 to 1.2 Nm (0.74 lbf ft)

Caution

Please only use the rubber plug that is supplied with the MOBOTIX M22M USB cable! This will guarantee the weatherproofness (IP65) of the camera.

Also make sure that the connectors are not bent or the cable is under tension as this could lead to water entering the camera!

USB cable (5 m/16 ft) for MOBOTIX M12 and D12 models:

MX-CBL-HD-MU-5

5 mm Allen wrench is included in the delivery of the M12 cameras

2.5.4 USB Connection to a M12 Camera

- 1) Unscrew the **upper Allen screw** in the foot of the mount, which holds the turn/tilt unit in place (5 mm Allen wrench). Remove the Allen screw, the washer and the hex nut from the mount.

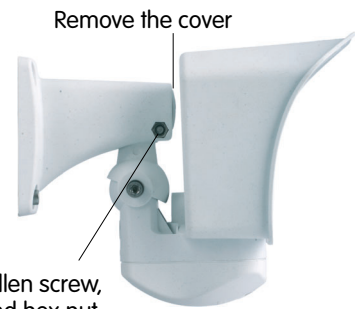

- 2) Remove the **cover**.

- 3) Gently pull the **turn/tilt unit** and the installed network cable out of the opening of the mount.



- 4) Remove the **Allen screw** of the **bottom cover** and take off the cover.



- 5) Remove the blue plug labeled **RS-232** from the insect protection.

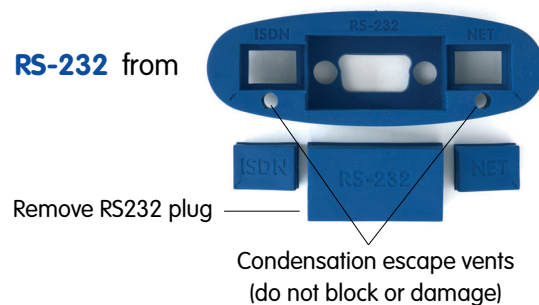

Caution: MOBOTIX M12 cameras feature a pre-installed **insect protection**, which effectively prevents small animals from entering the camera. Make sure that the **condensation escape vents** remain open. **Never push any objects into the drain holes as this may damage the plugs!**

6) Guide the MOBOTIX M12 USB cable with the angled Mini USB plug first from below through the turn/tilt unit of the camera.

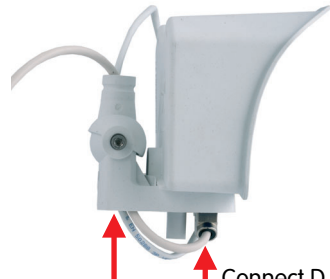

Guide USB cable through here

7) Insert the D Sub 15 HD plug of the MOBOTIX M12 USB cable into the D Sub 15 HD connector of the MOBOTIX camera.

Connect D Sub 15 HD plug



8) Reinstall the **bottom cover** of the mount. In the process, make sure that the camera's insect protection remains firmly in place.



Attach bottom cover



9) Guide the MOBOTIX M12 USB cable with the angled Mini USB plug first from below through the wall mount.

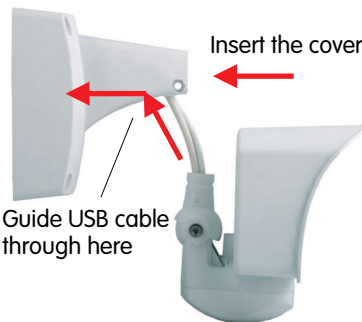

Insert the cover

Guide USB cable through here

10) Insert the **cover** into the free opening of the wall mount's foot.



Insert the cover

11) Insert the turn/tilt unit of the camera into the vertical opening of the mount (all the way to the stop).



Insert turn/tilt unit

12) Insert the hex nut into the corresponding hole and fasten the **Allen screw** with washer.

Maximum torque for all screws is 1 to 1.2 Nm (0.74 lbf ft)

USB cable (5 m/16 ft) for MOBOTIX D12 and M12 models:

MX-CBL-HD-MU-5

3 mm Allen wrench is included in the delivery of the D12 cameras

Lead the cables through the cable guides at the outer rim of the housing

If you are only using one cable, close the unused cable guide with one of the supplied plugs

2.5.5 USB Connection to a D12 Camera

- 1) Remove the two Allen screws of the **cable cover** (3 mm Allen wrench) and lift off the cable cover.

Note: If the cable cover cannot be removed by hand, take a screwdriver to lift it out of its seat. Insert the screwdriver into the grooves shown below and gently lift the cable cover.



Remove cable cover

- 2) Lead the MOBOTIX D12 USB cable with the Mini USB plug first from the bottom of the camera housing through the right-hand opening and guide it around the camera housing in counter-clockwise direction (as seen from above). Make sure that this cable is running properly as shown in the figures below.



Ethernet cable

USB cable

- 3) Insert the D Sub 15 HD plug of the MOBOTIX D12 USB cable into the D Sub 15 HD connector of the MOBOTIX camera and properly lead the cable through the guides at the outer rim of the housing. Make sure that the cable is running properly as shown in the figures below. The cables should cross one another just before the connectors.

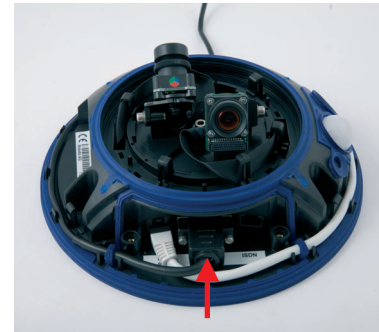

Connect D Sub 15 HD plug

- 4) Remove the rubber plug from the cable guide before leading the USB cable through the guide.

If you need to remove the USB cable again sometime, you will need to reinsert the rubber plug into the cable guide. This will ensure that the camera remains weatherproof (IP65).

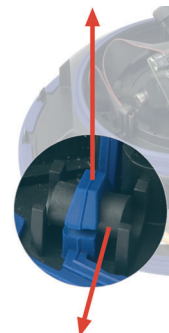

Remove rubber plug

- 5) Push the **cable cover** back into its seat and fasten the two Allen screws. When mounting the cable cover, take care to properly align the cover with the seal of the camera housing and the two cable guides. This will ensure that the camera remains weatherproof (IP65).



Always mount the cable cover (IP65)!

Maximum torque for all screws is 1 to 1.2 Nm (0.74 lbf ft)

- 6) Properly lead the cable through the cable guides at the outer rim of the housing. This will ensure that you can properly install the outer shell again later on.

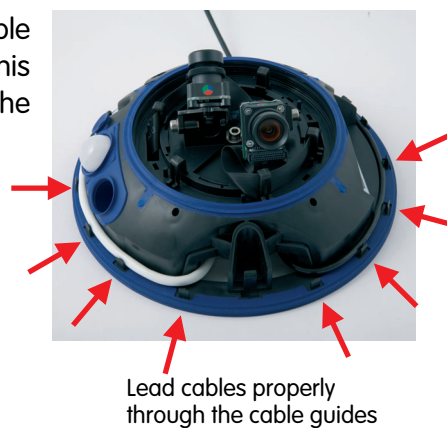

Caution

Make sure that you close off any unused cable openings with the supplied rubber plugs. This will ensure that the camera remains weatherproof (IP65).

2.6 Connecting the Cables to the ExtIO

2.6.1 Connecting the Ethernet Cable to the ExtIO

- 1) **Remove the outer shell from the ExtIO:** Remove the outer shell (item 1.3) from the ExtIO. Use the supplied Allen wrench (item 1.14) for this purpose.



Remove outer shell

- 2) **Remove the mounting ring from the ExtIO:** Remove the mounting ring from the ExtIO. Carefully bend the four black clamps of the mounting ring back, one after the other using a suitable tool.



Remove mounting ring

- 3) **Remove the back of the ExtIO housing:** Remove the back of the ExtIO. Use a suitable Phillips screwdriver to remove the two Phillips head screws in the bottom. Gently press on the screw heads with the screwdriver before fully removing them; this will press the top shell of the housing out of its seat. **Never insert tools into the sealed openings as this may damage parts on the ExtIO's main board!**



Remove the back of the housing

- 4) **Prepare the Ethernet cable:** Remove about 6 to 8 cm (2.4 to 3.2 in) of insulation from the Ethernet cable. Shorten the sheath to about 1 cm (3/8 in) and carefully fold it backwards around the insulation. Apply the suitable rubber plug around the Ethernet cable.

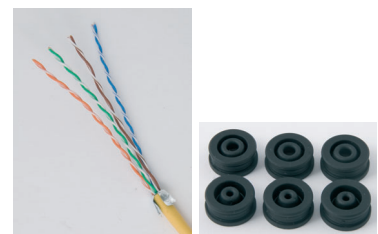

Prepare the Ethernet cable: remove insulation, shorten sheath and fold back over insulation, push rubber seal over cable

The delivered parts of the ExtIO include rubber plugs for cables with outside diameters from 3 to 5 mm (1/8 to 3/16 in) and 5 to 7 mm (3/16 to 9/32 in). Cables with larger outside diameters must not be used.

5) **Guide the Ethernet cable through the ExtIO's back and close the opening with a plug:** Remove the rubber plug at the center of the ExtIO's back. This plug will not be used any more in the course of the installation process. Guide the Ethernet cable through the opening into the interior. Make sure that about 17 cm/6.7 in of free cable remain in the camera. Carefully close off the opening in the ExtIO's back using the integrated plug of the Ethernet cable.



Insert cable into ExtIO's back and close off with rubber plug

6) **Lock Ethernet cable in place with clamp:** Lock the Ethernet cable in place using the left clamp. When tightening the clamp with a suitable Phillips screwdriver, make sure that the clamp holds down the folded-back sheath of the Ethernet cable.



Lock cable in place with cable clamp

7) **Insert the cable wires using the LSA PLUS tool:** Insert the cable wires using the LSA PLUS wire insertion tool: Make absolutely sure that you insert the wires according to their colors as shown. Please also observe the notes in section 2.4.2, *ExtIO Terminal Connectors for the Ethernet Cabling*.

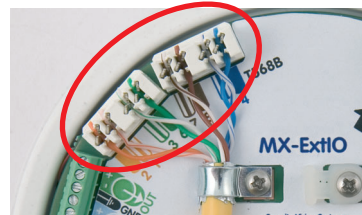

Insert the wires

8) **Reseat ExtIO housing into the back and tighten the screws:** Close the ExtIO housing again by reseating the ExtIO's top into the back. To do so, properly align the two arrows at the rims of the top and the back. Before closing the ExtIO housing, make sure that all cables are running properly inside of the housing.



Assemble ExtIO housing
Align arrows

The back of the ExtIO also has a mark for the speaker. This mark shows the proper position of the two housing parts towards one another.



Mark for speaker inside the back

Make absolutely sure that top of housing is properly seated in the back all around the housing (firmly press the top into the back). This will guarantee the weatherproofness (IP65) of the ExtIO. Fasten the ExtIO's back using the two Fillister head screws in the corresponding holes. Use a suitable Phillips screwdriver for this task. Finally make sure that all rubber plugs in the ExtIO's back are firmly in place and that they seal off the housing properly.

Maximum torque for all screws is 1 to 1.2 Nm (0.74 lbf ft)

2.6.2 Connecting the USB Cable to the ExtIO

- 1) **Remove the outer shell from the ExtIO:** Remove the outer shell (item 1.3) from the ExtIO. Use the supplied Allen wrench (item 1.14) for this purpose.



Remove outer shell

- 2) **Remove the mounting ring from the ExtIO:** Remove the mounting ring from the ExtIO. Carefully bend the four black clamps of the mounting ring back using a suitable tool, one after the other. While doing so, press against the housing from below to push the housing out of the clamps.



Remove mounting ring

- 3) **Remove the back of the ExtIO housing:** Remove the back of the ExtIO. Use a suitable Phillips screwdriver to remove the two Fillister head screws in the bottom. Gently press on the screw heads with the screwdriver before fully removing them; this will press the top shell of the housing out of its seat. **Never insert tools into the sealed openings as this may damage parts on the ExtIO's main board!**



Remove the back of the housing

- 4) **Guide the USB cable through the ExtIO's back:** Remove the rubber plug at the center of the ExtIO's back. This plug will not be used any more in the course of the installation process. Guide the model-specific USB cable with the angled Mini USB plug through the opening into the interior.



Remove center plug and guide USB cable through

MOBOTIX USB cables:

M12/D12:
SUB HD to Mini USB
MX-CBL-HD-MU-5
(5 m/16 ft)

M22M:
USB to Mini USB
MX-CBL-U-MU-5
(5 m/16 ft)

D22M:
Mini-USB to Mini-USB
MX-CBL-MU-MU-1
(1 m/3 ft)
MX-CBL-MU-MU-5
(5 m/16 ft)

- 5) **Close off ExtIO's back with USB plug:** Carefully close off the opening in the ExtIO's back using the integrated plug of the Ethernet cable. Make sure that about 17 cm/6.7 in of free cable remain in the camera. All MOBOTIX USB cables have been prepared in such a way.



Close off opening with rubber plug

- 6) **Connect USB cable to Mini USB connector of the ExtIO and guide the cable in the housing:** Insert the plug of the Mini USB connector of the MOBOTIX USB cable into the proper connector of the ExtIO.

Before closing the ExtIO housing, make sure that the USB cable runs properly beneath the speaker (see figure).



Insert USB plug
Properly guide the cable

- 7) **Reseat ExtIO housing into the back and tighten the screws:** Close the ExtIO housing again by reseating the ExtIO's top into the back. To do so, properly align the two arrows at the rims of the top and the back.

The back of the ExtIO also has a mark for the speaker. This mark shows the proper position of the two housing parts towards one another.



Assemble ExtIO housing
Align arrows



Mark for speaker inside the back

Make absolutely sure that top of housing is properly seated in the back all around the housing (firmly press the top into the back). This will guarantee the weatherproofness (IP65) of the ExtIO. Fasten the ExtIO's back using the two Fillister head screws in the corresponding holes. Use a suitable Phillips screwdriver for this task. Finally make sure that all rubber plugs in the ExtIO's back are firmly in place and that they seal off the housing properly.

Maximum torque for all screws is 1 to 1.2 Nm (0.74 lbf ft)

2.6.3 Connecting Additional Components to the ExtIO

- 1) **Remove the outer shell from the ExtIO:** Remove the outer shell (item 1.3) from the ExtIO. Use the supplied Allen wrench (item 1.14) for this purpose.



Remove outer shell

- 2) **Remove the mounting ring from the ExtIO:** Remove the mounting ring from the ExtIO. Carefully bend the four black clamps of the mounting ring back using a suitable tool, one after the other. While doing so, press against the housing from below to push the housing out of the clamps.



Remove mounting ring

- 3) **Remove the back of the ExtIO housing:** Remove the back of the ExtIO. Use a suitable Phillips screwdriver to remove the two Fillister head screws in the bottom. Gently press on the screw heads with the screwdriver before fully removing them; this will press the top shell of the housing out of its seat. **Never insert tools into the sealed openings as this may damage parts on the ExtIO's main board!**



Remove the back of the housing

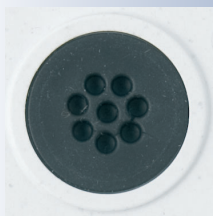

Use 8-wire rubber plug

- 4) **Prepare the wires and the ExtIO's back:** Push each of the wires through one of the openings of the 8-wire rubber plug in the ExtIO's back (item 1.6). Use one of the two rubber plugs at the top for this purpose (see figure). The rubber plug at the center should remain closed for the Ethernet or the USB cable.

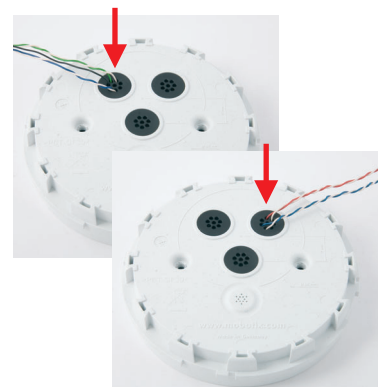

Push each wire through one of the openings of the 8-wire plug

Make sure that the openings in the ExtIO's back are properly sealed off later on with the 8-wire rubber plugs.

- 5) **Prepare the cable ties:** Push one of the cable ties supplied with the ExtIO from the top downwards into the plastic clamp prepared for this purpose.

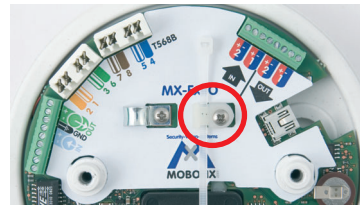

Prepare the cable ties

- 6) **Lock the cable in place with cable tie:** Lock all wires of the cable in place using the cable tie and clip the superfluous end of the cable tie.

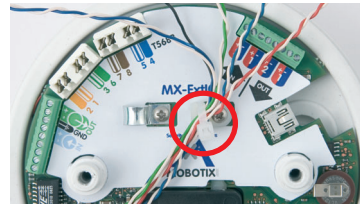

Lock the cable in place with cable tie and clip cable tie

- 7) **Lock the wires in the terminal connector:** Shorten the individual wires to the required length. Remove about 5 mm (3/16 in) from the wire's insulation, guide it into the appropriate cable connector and tighten the screw.

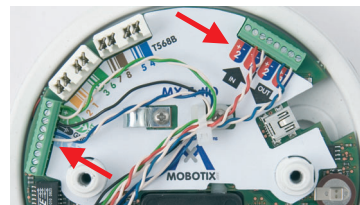

Lock the wires in the terminal connectors

Please also read the notes in sections 2.4.3, *ExtIO Terminal Connector 1 (Signal Inputs/Outputs)* and 2.4.4, *ExtIO Terminal Connector 2 (Line-In/Line-Out)*.

- 8) **Reseat ExtIO housing into the back and tighten the screws:** Close the ExtIO housing again by reseating the ExtIO's top into the back. To do so, properly align the two arrows at the rims of the top and the back.



Assemble ExtIO housing
Align arrows

The back of the ExtIO also has a mark for the speaker. This mark shows the proper position of the two housing parts towards one another.



Mark for speaker inside the back

Make absolutely sure that top of housing is properly seated in the back all around the housing (firmly press the top into the back). This will guarantee the weatherproofness (IP65) of the ExtIO. Fasten the ExtIO's back using the two Fillister head screws in the corresponding holes. Use a suitable Phillips screwdriver for this task. Finally make sure that all rubber plugs in the ExtIO's back are firmly in place and that they seal off the housing properly.

Maximum torque for all screws is 1 to 1.2 Nm (0.74 lbf ft)

2.7 Mounting the ExtIO

2.7.1 Mounting the ExtIO Without Additional Mounting Options

- 1) **Prepare the network or USB connection:** The network cabling or USB cable need to enter the ExtIO from the back in the center of the housing. The cabling is perfectly protected by the mount and cannot be seen or damaged.

Note

Use a flush-mounted (empty) wall outlet for the cabling. The ExtIO itself cannot be mounted directly on top of protruding wall outlets.

Find the folded drilling template for the mounting ring of the ExtIO at the end of the manual!

The red circle marks up the hole to cut for the wall outlet

Maximum torque for all screws is 1 to 1.2 Nm (0.74 lbf ft)

- 2) **Prepare the holes and the wall outlet:** Drill the holes for the supplied dowels (item 1.11). We also recommend using a flush-mounted wall outlet.

Use the supplied drilling template for the mounting ring (fold-out at the end of this manual) to mark the position for drilling the dowel holes and the hole for the wall outlet.

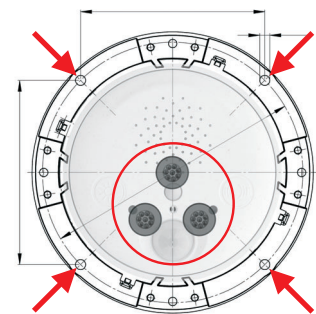

Drill the holes

- 3) **Attach the mounting ring to the wall or ceiling:** Attach the mounting ring of the ExtIO to the designated position at the wall or ceiling using the delivered screws (item 1.12), the washers (item 1.13) and the Torx wrench (item 1.15).

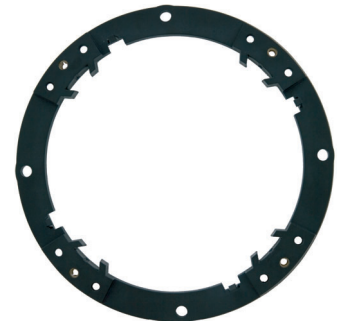

Attach the mounting ring to the wall

- 4) **Prepare ExtIO with cables:** Connect the Ethernet or USB cable and all other required cables to the ExtIO and reassemble the ExtIO again. Make sure that the housing is properly closed and that it is sealed off using the appropriate rubber plugs. For more information on this topic, see section 2.6, *Connecting the Cables to the ExtIO*.



Prepare ExtIO with cables

- 5) **Attach the ExtIO to the mounting ring:** Now press the ExtIO into the guides of the mounting ring. The tapered guides at the back of the ExtIO housing fit exactly into the openings of the mounting ring. Make sure that the ExtIO is properly oriented. The cover of the PIR sensor is supposed to be at the bottom, the speaker should be on top (see figures).



Attach the ExtIO to mounting ring

- 6) **Attach the outer shell:** Attach the outer shell (item 1.3) to the ExtIO. Use the supplied Allen screws (item 1.4), the washers (item 1.5) and the Allen wrench (item 1.14) for this purpose.



Mount outer shell

Maximum torque for all screws is 1 to 1.2 Nm (0.74 lbf ft)

- 7) **Establish a connection to the ExtIO:** Establish a connection between the ExtIO and the camera and make sure that the ExtIO has been properly activated. For additional information on this topic, see chapter 3, *Operation of the ExtIO*.

MOBOTIX D22 Manage Hardware Expansions		
USB Connector		
<input type="button" value="Connect"/>	USB Stick / Flash-based Solid State Drive	Allows connecting a USB stick or a flash-based solid state drive for event download or event recording. Do not select this option if you wish to connect a harddisk.
<input type="button" value="Connect"/>	External USB Harddisk	Allows connecting an external USB harddisk for event download or event recording. Do not select this option if you wish to connect a flash-based USB stick or solid state drive.
<input type="button" value="Connect"/>	Signal-I/O	Select this option if you wish to connect the D22 USB-to-Signal-I/O adapter cable providing the camera with two signal inputs and one signal output.
<input checked="" type="button" value="Connect"/>	ExtIO (USB Connection)	Connect to the external I/O via USB interface.
Network Interface		
<input checked="" type="button" value="Connect"/>	ExtIO (Ethernet Connection)	Connect to the external I/O via ethernet. Please enter IP here .

2.8 Important Notes

2.8.1 Safety Regulations

Caution

It is imperative that all electrical wires have been disconnected from the mains power when working on or servicing the device! Also make sure to adhere to the applicable regulations for this kind of work!

MOBOTIX will not assume any responsibility from faulty installation or inappropriate use!

2.8.2 Suitable Cables

Only use cables, which have been approved for the pertinent type of installation. Always observe the allowed wire diameters and the maximum cable lengths.

- **Ethernet:** Make sure that you are using a suitable eight-wire Ethernet installation cable for connecting the device to the patch panel of a structured wiring system in a building. **The maximum length for Ethernet cables is 100 m/110 yd.**
- **USB:** Make sure that you are only using the MOBOTIX connection cables together with the preinstalled rubber plug (M22M, D22M). **The maximum length for USB cables is 5 m/16 ft.**
- **Signal wires and external sensors:** Use suitable installation cable for connecting more relays or signal lines (e.g. to an alarm system) or an external sensor and make sure that you adhere to the allowed wire dimensions.

The length of the cables for signal wires and external sensors is not restricted. You need to make sure, however, that the minimum voltage at the corresponding terminal is reached. A possible loss of voltage due to the resistance of the wires needs to be considered. **When using a cable with a wire with 0.3 mm² dimension (AWG 23), the cable can be up to 500 m (547 yd) long.**

Suitable Installation Cable:

- JY(ST)Y twisted wire pairs, shielded
- A2Y(ST)2Y underground cables
- YR low-current cables

Allowed Wire Dimensions:

- Ethernet terminal (cutting clamps) inflexible 0.14 to 0.5 mm² AWG 26 to 20
- Terminals 1 and 2 inflexible 0.13 to 0.31 mm² AWG 26 to 22

AWG: American Wire Gauge (for measuring cable diameters)

2.8.3 Safety Notes for Operating the MOBOTIX ExtIO

When installing the wiring inside or outside of buildings, make sure you always adhere to the relevant regulations on wiring, fire prevention and protection against lightning.

MOBOTIX recommends having MOBOTIX cameras and accessories installed only by certified specialists accustomed to installing network devices and having proper respect for the applicable regulations regarding lightning protection and **fire prevention** as well as the current technology for preventing damages from electrical surges.

Find more information at an institution such as the **International Electrotechnical Commission** (IEC, www.iec.ch) or at a manufacturer of protection devices against lightning and electrical surges, such as Dehn (www.dehn.de).

Wiring

When installing the wiring, make sure to follow these guidelines:

- **Outdoors:** Installing the camera outdoors requires special precautions and measures regarding the cables as well as lightning and surge protection (see further below in this section).
- **Wire lengths:** The cable segments must not exceed the maximum allowed cable lengths in order to ensure proper data transfer.
- **Avoiding induction:** When running data cables parallel to existing regular power lines or high-voltage wires, make sure you observe the minimum distances to the power cables.

Fire Prevention

When installing the power lines to the camera, make sure you always adhere to the relevant regulations on wiring and fire prevention at the site of the installation.

Lightning and Surge Protection

To prevent damage from lightning and power surges, make sure you follow these guidelines:

- **Lightning conductors:** In areas exposed to lightning (e.g. on roofs), a distance holder (1 m/3 ft above and away from the camera or the ExtIO) and proper lightning conductors need to be installed in order to prevent lightning strikes into the camera/ExtIO and to ensure that the energy of a lightning strike is properly led to the ground.
- **Surge protection:** Make sure you have installed proper protection against electrical surges in order to prevent damage to the camera, the ExtIO, the building and the network infrastructure. This includes surge protectors for 19" racks, adding an uninterruptible power supply (UPS) to the MOBOTIX camera, and installing surge arresters or similar for routers, switches, servers, etc.

2.8.4 Weatherproofness, Temperature Range

The housing of the MOBOTIX ExtIO is weatherproof (**IP65**, absolutely dustproof, resistant against water jets) and can be used at temperatures from **-30 to +60°C (-22 to +140°F)**.

2.8.5 Cleaning Instructions

The housing of the MOBOTIX ExtIO is made of fiber-reinforced **PBT-30GF**. This material is robust, maintenance-free and can be cleaned using a mild household detergent without solvents or abrasive particles.

2.8.6 Additional Information

For additional information on the **MOBOTIX ExtIO**, see www.mobotix.com.

3 OPERATION OF THE EXTIO

3.1 Activating the ExtIO

Once the ExtIO and the MOBOTIX camera have been properly installed, you can set up the camera for proper operation. When using USB, the camera directly supplies power via the model-specific USB cable. When using Ethernet, power is supplied via the Ethernet cable (PoE according to **IEEE 802.3af**). Once the connection between the ExtIO and the MOBOTIX camera has been established, you can set the operation mode (USB or Ethernet) via the camera software.

Note

In order to use the ExtIO, make sure that you are activating it in the camera software (Admin Menu > Manage Hardware Expansions). Please ensure that you are using a camera software version that properly supports the ExtIO (3.4.2.16 or higher for USB only, 3.4.4.15 or higher for Ethernet and USB).

Note that an ExtIO with a software lower than 1.1.0.3 only supports USB connections. After applying a free-of-charge software update, you can use the Ethernet mode without limitations (see section 3.3, Software Updates).

You can find the current software version of the ExtIO in the web interface of the ExtIO or the camera software: . Note that the ExtIO needs to be connected with the camera for this to work.

MOBOTIX D22 Camera Status	
System	
Model	D22M-Secure
Factory IP Address	10.0.3.33
Hardware	T2r1.0.AA, 520 MHz, 128 MByte RAM
ExtIO	0x000003 (a, V1.1.0.5, I): 10.0.0.123

The ExtIO only needs a couple of seconds for booting.

LED permanently green:
ExtIO ready and connected



3.1.1 Activating the USB Operating Mode

To activate the USB operating mode, open the **Admin Menu > Manage Hardware Expansions** dialog in the camera's browser interface. The ExtIO connected to the camera starts after you click the **Connect** button in front of the **ExtIO (USB)** entry. Once the green LED is on permanently, the ExtIO has successfully connected to the camera. The remaining configuration can now be performed in the camera software.

Note that you can activate the USB operating mode in the camera even though you have not connected the ExtIO yet, e.g. to prepare the MOBOTIX camera for using an ExtIO later on. Once you attach any ExtIO to the camera, the camera software will automatically establish the connection. There is no further configuration required.

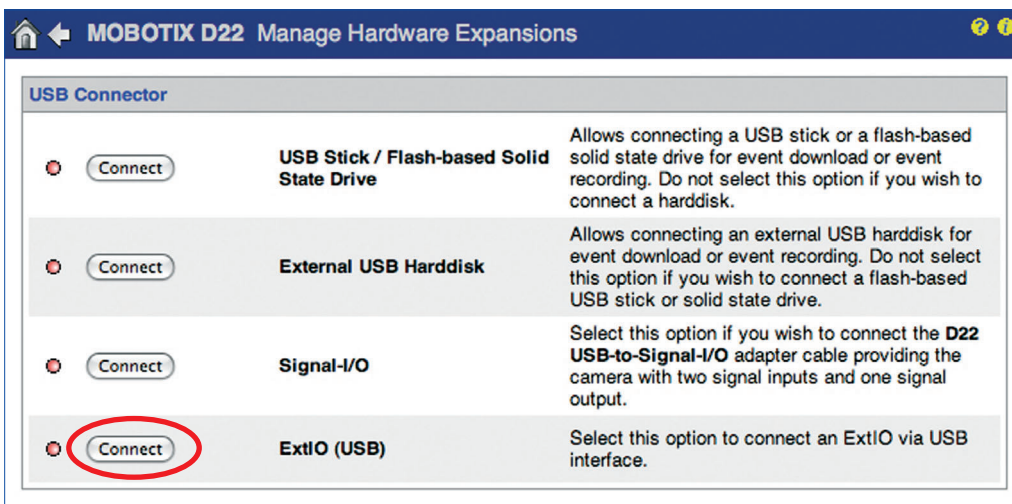

Activating the USB operating mode of the ExtIO

Note

Note that you can activate the USB operating mode even though you have not connected the ExtIO yet. In this case, the ExtIO will start automatically once the USB cable has been attached. This approach allows preconfiguring the camera for an ExtIO connection before mounting it.

Note that you can use an ExtIO configured for USB operation with an Ethernet connection without any problems later on. All settings in the camera software remain unchanged even if you change the operating mode at a later point in time.

3.1.2 Activating the Ethernet Operating Mode (NET)

To activate the Ethernet operating mode, open the **Admin Menu > Manage Hardware Expansions** dialog in the camera's browser interface. Note that you need to enter the IP address of the ExtIO to establish a connection.

Click on the **Connect** button in front of **ExtIO (Ethernet Connection)** to establish a connection between the camera and the ExtIO. Once the green LED is on permanently, the ExtIO has successfully connected to the camera. The remaining configuration can now be performed in the camera software.

Note that the ExtIO has to be reachable on the network. For information on setting up the ExtIO with a suitable network configuration (IP address, network mask, gateway and DHCP), please see section 3.1.3.

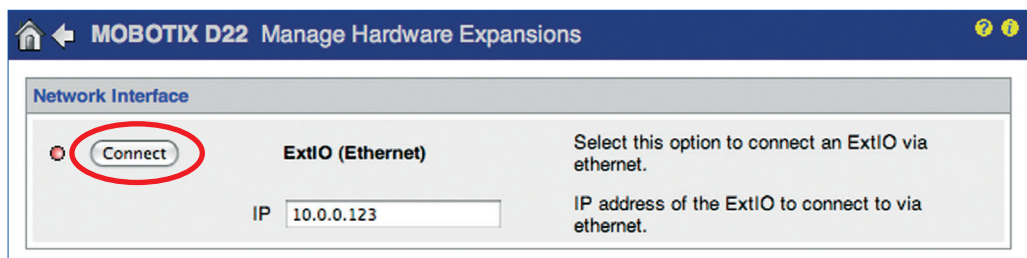

Activating the Ethernet operating mode of the ExtIO

Note that you can activate the Ethernet operating mode even though you have not connected the ExtIO yet. As soon as the camera can reach the ExtIO on the network via its IP address, the camera will automatically establish the connection. There is no further configuration required.

Note

Note that you can activate the Ethernet operating mode even though you have not connected the ExtIO yet. In this case, the camera software will automatically connect to the ExtIO once it can be reached on the network. This approach allows preconfiguring the camera for an ExtIO connection before mounting it.

Note that you can use an ExtIO configured for Ethernet operation with a USB connection without any problems later on. All settings in the camera software remain unchanged even if you change the operating mode at a later point in time.

3.1.3 Setting up the Network Parameters of the ExtIO for Ethernet Operation

In order to integrate the ExtIO into the target network, you need to specify proper network parameters in the ExtIO (IP address, network mask, gateway). Please follow these steps to perform this task:

- 1) Connect the ExtIO and your computer via a PoE switch.

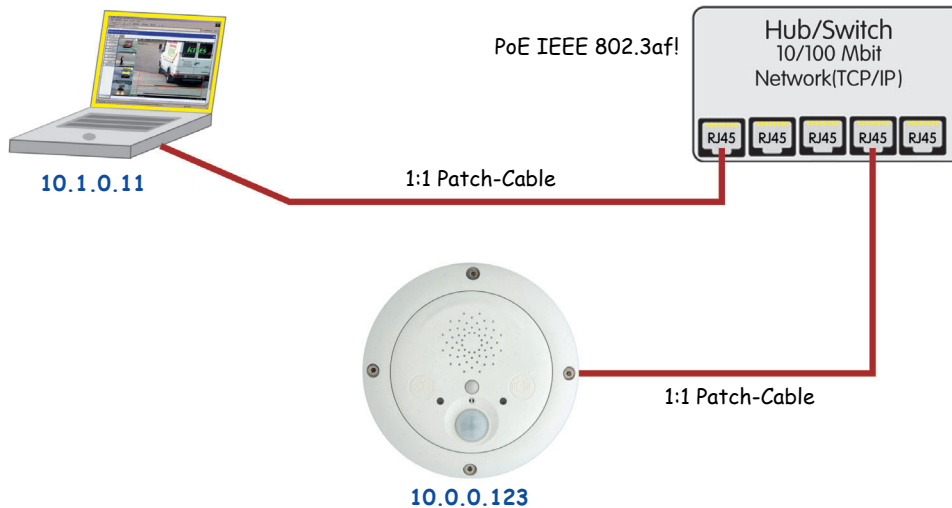

PoE switch/router according to IEEE 802.3af required

- 2) Reset the ExtIO to factory defaults before you proceed (see section 3.1.4).
- 3) Set up your computer to run in a 10.x.x.x network, for example:

IP Address: 10.1.0.11, netmask: 255.0.0.0

Please see section 3.4.1, *Preparing the Ethernet Connection*, in the corresponding *Camera Manual* for more detailed information on setting up a computer to run on a 10.x.x.x network.

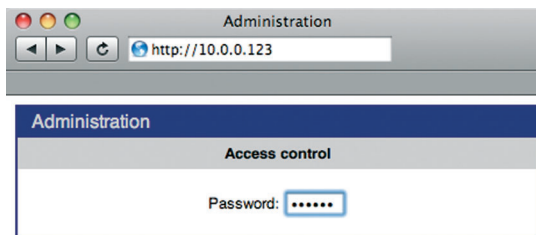

- 4) Open the user interface of the ExtIO by entering the ExtIO's IP address in the address field of a browser (the factory default password is **meinsm**).
- 5) Enter the future network parameters of the ExtIO (**Network Setup > Ethernet Interface** section) or select **BOOTP/DHCP > On** to activate the automatic IP address assignment from a DHCP server on the network.

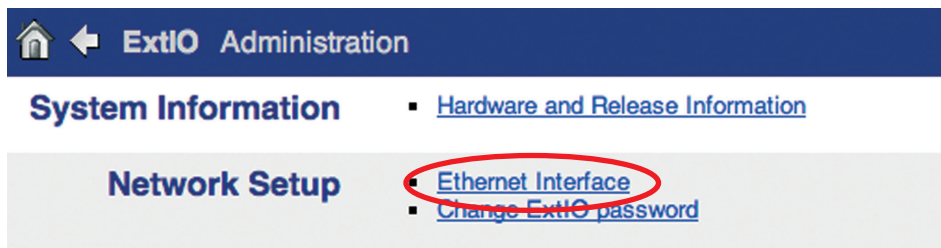

Note that these parameters are examples only. Make sure that you are using the correct parameters for your network.

The screenshot shows the 'ExtIO Administration' web interface. Under the 'Ethernet Parameters' section, there are three main fields: 'BOOTP/DHCP', 'IP Address', 'Network Mask', and 'Gateway'. The 'BOOTP/DHCP' section has two radio buttons: 'On. Use BOOTP/DHCP to set network configuration automatically.' (unselected) and 'Off. Set network configuration manually.' (selected). The 'IP Address' field contains '192.168.0.123'. The 'Network Mask' field contains '255.255.255.0'. The 'Gateway' field contains '192.168.0.254'. At the bottom of the form, there are four buttons: 'Set', 'Factory', 'Restore', and 'Close'.

- 6) Click on **Set**, then on **Close** to store the configuration permanently in the ExtIO's Flash memory.
- 7) Change the network parameters of your computer back to its original settings.

You can now connect the ExtIO to the target network and use the camera software to activate it (see above). Once the connection between the camera and the ExtIO has been established successfully, the left LED is permanently green. The remaining configuration can now be performed in the camera software

Note











When using the ExtIO with DHCP, make sure that the assigned IP address does not change. Please contact your network administrator in order to assign a fixed network address from the pool of reserved IP addresses to this ExtIO.

In a home network (e.g. a DSL router with DHCP server and switch), an IP address assigned by DHCP will usually not change if there are only few network devices.

While the ExtIO has not been connected to the camera using the camera software, you can prompt the ExtIO to announce its IP address by pressing the right button ("Bell").

3.1.4 LED-Patterns of the ExtIO

The MOBOTIX ExtIO uses its two multi-color LEDs to display status information. They can light up permanently or blink in red, green and orange. The following table contains the most important LED patterns of the ExtIO.

Status	Left LED	Right LED
Ready	 left on	
Error	 blinking	
No connection to camera	 blinking	
Microphone activated, speaker deactivated	 both on	
Speaker activated, microphone deactivated	 both on	



3.1.5 Starting the ExtIO Using the Factory Default Settings

Under certain circumstances, you may have to reset the ExtIO to its factory default settings (e.g. if the IP address is unknown).

Proceed as follows to start the device using its factory default settings:

- 1) If the ExtIO is powered on, disconnect the power supply by unplugging the USB and Ethernet cables.
- 2) Reconnect the power supply of the ExtIO by reconnecting the corresponding cable(s).
- 3) Wait until the **left LED lights up orange**.
- 4) Press the **"Lights" button** until the **left LED starts blinking green**.

Press **"Lights" button**...
... as soon as LED lights up orange



- 5) After several seconds, the device plays a sound twice (**"Boing, Boing"**) and the ExtIO announces its factory default IP address via the speaker. **The ExtIO is now accessible using its factory IP address (see label on the ExtIO housing).**

Note

The factory default configuration is automatically stored in the ExtIO's permanent Flash memory. All settings will be reset to factory defaults, including the password. This can be helpful if you are trying to access an ExtIO that cannot be reached otherwise.

3.1.6 Starting the ExtIO With an Automatic IP Address (DHCP)

If required, the ExtIO can *temporarily* obtain an IP address from a DHCP server on your local network.

Proceed as follows to start the ExtIO using DHCP:

- 1) If the ExtIO is powered on, disconnect the power supply by unplugging the USB and Ethernet cables.
- 2) Reconnect the power supply of the ExtIO by reconnecting the corresponding cable(s).
- 3) Wait until the **left LED lights up orange**.
- 4) Press the **“Bell” button** until the **right LED starts blinking green**.

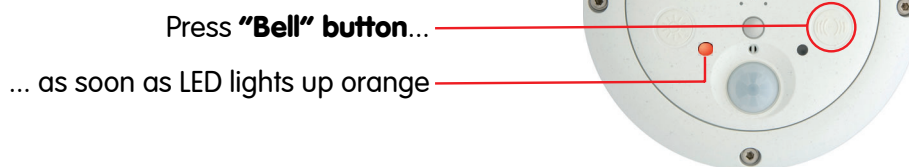

- 5) After several seconds, the device plays a sound (**“Boing”**). Once it has obtained an IP address from the DHCP server, the ExtIO announces this address via the speaker (after about 30 seconds). **You can now access the ExtIO using the IP address it just announced.**

If the ExtIO cannot obtain an IP address from the DHCP server within about one minute, the ExtIO again plays the sound (**“Boing”**).

Note

Note that the ExtIO will use the network parameters stored in the Flash memory when booting the next time.

While the ExtIO has not been connected to the camera using the camera software, you can prompt the ExtIO to announce the IP address assigned by the DHCP server by pressing the “Bell” button.

3.2 Sensors and Input/Output Interfaces of the ExtIO

The ExtIO has the following sensors and input/output interfaces:

- Status LEDs
- Speaker and Microphone
- Buttons (L – “Lights”, R – “Bell”)
- PIR Motion Sensor
- Signal Inputs/Outputs
- Temperature sensor

The following sections contain an overview over the additional configuration options if an ExtIO has been attached and connected.

3.2.1 Status LEDs

In addition to the camera LEDs, you can now also configure the ExtIO's LEDs (**Admin Menu > LED Setup**).

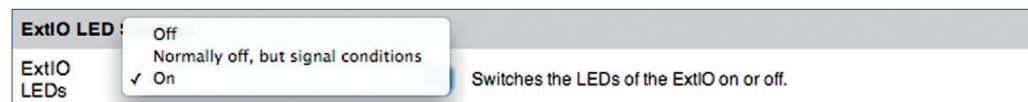

3.2.2 Speaker and Microphone

Once the ExtIO has been attached and is connected, it will automatically activate its microphone and speaker and deactivate the microphone and speaker of the MOBOTIX camera.

All events, actions or messages that are involving the speaker or the microphone will not use the camera's speaker and microphone, but the speaker and microphone of the ExtIO.

To configure the speaker and microphone, open **Admin Menu > Loudspeaker and Microphone**. This dialog also contains options for activating an external microphone connected to Line In (via a pre-amplifier) and an external speaker connected to Line Out (via an amplifier).

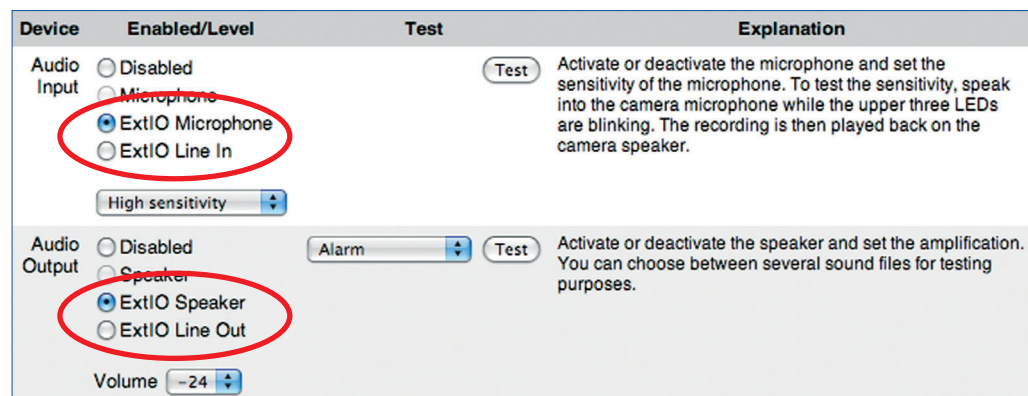

3.2.3 Buttons

Once the ExtIO has been attached and is connected, it will automatically activate its buttons and deactivate the buttons of the MOBOTIX camera.

All events, actions or messages that are involving the buttons will not use the camera's buttons, but the buttons of the ExtIO.

Open **Setup Menu > Event Settings** to set up the button events.

Buttons (BT)	<input checked="" type="checkbox"/>	<div style="border: 1px solid black; padding: 2px; width: fit-content;"> <input type="checkbox"/> Right <input type="checkbox"/> Left <input type="checkbox"/> Right OR left <input checked="" type="checkbox"/> Right AND left </div>	Buttons Enable: Trigger an event by pressing button(s) on the camera body. Announce network data (during runtime) will be disabled by activating this event. Button Combination: Select button(s) to trigger on.
Left Button (BL)	<input checked="" type="checkbox"/>		Enable left button: Trigger an event by pressing the camera's left button.
Right Button (BR)	<input checked="" type="checkbox"/>		Enable right button: Trigger an event by pressing the camera's right button. Announce network data (during runtime) will be disabled by activating this event.

3.2.4 PIR Motion Sensor

Once the ExtIO has been attached and is connected, it will automatically activate its passive-infrared sensor (PIR) and deactivate the PIR sensor of the MOBOTIX camera.

All events, actions or messages that are involving the PIR sensor will not use the camera's sensor, but the PIR sensor of the ExtIO.

Open **Setup Menu > Event Settings** to set up the PIR sensor events.

Passive Infrared Detector (PI)	<input checked="" type="checkbox"/>	PIR Enable: Motion detected by the infrared sensor.
	<input type="text" value="50"/>	PIR Level: Trigger level [0..100].

3.2.5 Signal Inputs/Outputs

Once the ExtIO has been attached and is connected, it will automatically activate its signal inputs and outputs. Any signal inputs and outputs of a MOBOTIX camera (M12 and D12 models) will be deactivated automatically.

All events, actions or messages that are involving the signal inputs and outputs will not use the camera's inputs and outputs, but those of the ExtIO.

Open **Setup Menu > Event Settings** and **Setup Menu > Enhanced Signal Out Options** to set up the signal inputs and outputs.

Signal Input (SI)	<input checked="" type="checkbox"/> <div style="border: 1px solid gray; padding: 5px; margin: 5px 0;"> Open (high) Closed (low) Rising (low to high) Falling (high to low) <input checked="" type="checkbox"/> Change (Rising or Falling) </div> <input type="text" value="100"/>	Signal Input: This event is triggered by an external signal (pin 9-5). Select <i>Closed (low)</i> to trigger when loop connected to Signal Input is closed or <i>Open (high)</i> , when loop is opened. Trigger Condition: Select kind of trigger. De-Bounce Time: De-Bounce time for signal input in ms [100..2000 ms].
--------------------------	--	---

Attribute	Value	Explanation
Signal Out Arming	<input type="button" value="Enable"/> <input type="button" value="(no time table)"/>	Activate Enhanced Signal Out: <i>Enable:</i> activate Signal Out Action. <i>Off:</i> deactivate Signal Out Action. Test Signal Output 1: switch high and switch low Time Table Profile: Time table profile for time-controlled signal out. (Time Tables)
Signal Out Properties	<input checked="" type="checkbox"/> Signal Output 1 <input type="checkbox"/> Signal Output 2 <input type="button" value="On on Alarm"/> <input type="text" value="60"/> <input type="text" value="10"/>	Signal Output Pin: Select output pin for enhanced signal out action (check Manage Hardware Expansions). Note: make sure not to use the same output pin in Signal Out Action . Signal Output State: State of output pin on alarm. The initial value on camera start is the opposite state. Switch Time: Switch Signal Output (pin 1-5) to High for [0..86000] seconds. Dead Time: Timeout [0..3600 s] while detection is suspended.

3.2.6 Temperature Sensor

Once the ExtIO has been attached and is connected, it can use its temperature sensor in addition to the temperature sensor of the MOBOTIX camera.

Open **Setup Menu > Event Settings** to set up the temperature sensor event.

Temperature (TP)	<input checked="" type="checkbox"/> <div style="border: 1px solid gray; padding: 5px; margin: 5px 0;"> <input type="checkbox"/> Internal Sensor <input checked="" type="checkbox"/> ExtIO Temperature </div> <input type="button" value="Higher than"/> <input type="text" value="50.0"/> <input type="button" value="°C"/> <input type="button" value="First"/>	Temperature Enable: Trigger an event if the temperature is higher/lower than the temperature value set below. Temperature Sensor: Select the temperature sensor. Temperature Compare: Select the trigger condition. Temperature Level: Enter the temperature. Precision is one decimal digit. Temperature Unit: Select the temperature unit. Temperature Action: Start action(s): <i>First:</i> trigger only first time the condition is true. <i>Every:</i> trigger every time the condition is true.
-------------------------	---	--

To see a table with the latest temperatures of both the ExtIO's and the camera's temperature sensor, open **Admin Menu > Temperatures**.

3.3 Software Updates

MOBOTIX provides free-of-charge software updates for the ExtIO on www.mobotix.com (**Support > Software Downloads**). These updates contain new features and – if required – bugfixes. This means that you can upgrade an early ExtIO (USB only) with Ethernet connectivity.

To update the ExtIO software, load the new software into the MOBOTIX camera (Admin Menu > Update System Software). Note that you need a properly running and connected ExtIO for this to work. The software update to the ExtIO can be supplied both via an Ethernet connection and via USB. All settings of the MOBOTIX camera and the ExtIO remain unchanged by the software update.

Updating the software involves the following steps:

- (1) **Download the software from the Internet:** Download the update file for the ExtIO from www.mobotix.com to your computer (**Support > Software Downloads**).
Read the notes in the **readme file**.
- (2) **Connect and activate the ExtIO:** Make sure that the ExtIO is running and that it is properly connected to the MOBOTIX camera. The left LED of the ExtIO has to be permanently green.
- (3) **Upload the software to the ExtIO:** Read the notes in the **Admin Menu > Update System Software** dialog. Follow the instructions of the camera software to complete the installation.

Avoid any power failure or disruption of the USB or Ethernet connections while uploading the software.

Once you have started the software update of the ExtIO, avoid interrupting or stopping the process. Do not perform additional actions in your browser, do not load another website at the same time and do not close any browser windows.

While updating the software, the LEDs of the ExtIO show a specific blinking pattern. The status information of the upload process is displayed in a popup window of the camera's browser interface. Wait until the camera software prompts you for further actions.

- (4) **Reboot the camera:** Reboot your camera only when the camera software prompts you to do so. The ExtIO will automatically reboot after the software update has been completed. The connection between camera and ExtIO will be reestablished automatically.

3.4 Configuration Example

The following example of a door intercom system demonstrates one possible application and shows the steps for properly configuring a MOBOTIX D22M with an ExtIO using a USB connection.

Example: ExtIO as door intercom device with Video SIP and additional lights

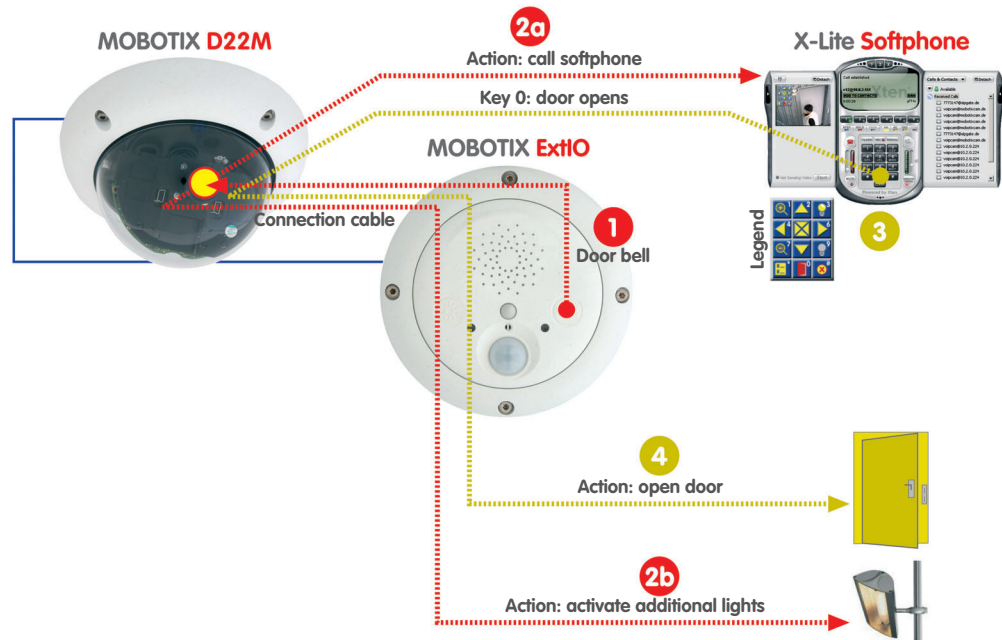

3.4.1 Functional Overview

A MOBOTIX camera and an ExtIO are used at the entrance of a building for access control purposes; the camera should also be able to open the door when instructed to do so.

If a visitor rings the doorbell key of the ExtIO **1**, the MOBOTIX camera activates an additional source of light near the entrance **2b**, plays back a voice message ("Welcome to xyz company ...") and establishes a video SIP connection to the receptionist's computer (or the guard on duty – **2a**).

The softphone on the receptionist's computer **3** signals an inbound video phone call from the camera at the entrance. The receptionist accepts the phone call and talks to the visitor via the microphone and the speaker of the ExtIO.

The image displayed on the softphone, i.e. the live video stream from the MOBOTIX camera allows for visually checking the visitor. The softphone's keys provide functions for selecting certain image areas and for zooming the image (keys 1, 7: zoom control, keys 2, 4, 6, 8: move image section, key 5: center image).

If the receptionist would like to open the door for the visitor, he/she activates the door opener **4** using the softphone key 0, allowing the visitor to enter the building. If required, the receptionist can manually switch the additional lights using the softphone keys **3**; key 3 switches the lights on and key 9 switches them off again.

In the meantime, the camera is automatically recording the video and audio stream on an SD card or Flash device in the MOBOTIX camera. This includes the sound from the ExtIO's microphone that is automatically transmitted to the MOBOTIX camera.

3.4.2 Overview of the Configuration Steps

Configure the MOBOTIX camera (section 2.2.3)

- 1) Activate arming of the camera
- 2) Configure recording
- 3) Activate and configure the BR event:
 - a) Switch additional lights (SO action)
 - b) Record and configure voice message (SD message)
 - c) Configure VoIP phone call (CL message)

Configure the softphone (section 2.2.4)

- 4) Start and configure the softphone

BR: Button Right
 SO: Signal Output
 SD: Audio (Sound)
 CL: Phone Call-Out

3.4.3 Configuring the MOBOTIX Camera

1) Activate arming of the camera

- Activate arming (**Setup Menu > General Event Settings**).

Activity	Value	Explanation
Arming	Enable	Arming: Arming for Recording, Actions and Messaging: <i>Enable:</i> activate all. <i>Off:</i> deactivate all. <i>Sl:</i> arming controlled by signal input. <i>CS:</i> arming controlled by custom signal as defined below. <i>From Master:</i> copies Main Event Arming state from master camera. <i>Slave Mode:</i> full arming slave mode.

2) Configure recording

- Set up event recording on an SD card/Flash device (**Admin Menu > Storage on External File Server / Flash Device**).

Storage on External File Server / Flash Device

Available Storage Targets

None Select this option to disable event recording to permanent storage.

NFS File Server NFS is the protocol commonly used to connect to UNIX/Linux file servers.

CIFS File Server CIFS is the new and recommended way of accessing Windows file servers or UNIX/Linux-based file servers running samba. It also allows the camera to use Active Directory Service (ADS) and Windows Domain Controller authentication credentials when connecting to the file server.

SMB File Server SMB is the obsolete mechanism to connect to Windows file servers. It is provided for backward compatibility only.

SD Flash Card Format...

USB Stick / Flash-SSD is currently not available as storage target. Port USB Connector is already in use by ExtIO (USB Connection).

External USB Harddisk is currently not available as storage target. Port USB Connector is already in use by ExtIO (USB Connection).

You can find more detailed information on setting up recording on SD cards/Flash devices in the MOBOTIX camera manuals and in section 8.3.6, *Recording on Flash, USB and SD Storage Devices*, in the *Software Manual*.

- **Activate VM event** and set up video motion window (**Setup Menu > Event Settings**).

Video Motion Window (VM)

0,600,440,80,80,a=25

Show Video Motion Window ID

On and highlight on event

0.3 lux

Video Motion Enable:
Motion detection using digital image analysis.

Video Motion Definitions (VM):
lens, x, y, width, height [, "a"=min. area] [, "am"=max. area] [, "s"=sensitivity]
x, y, width, height: the coordinate origin is in the lower left image corner, the upper right is positioned at 1279, 959
lens: 0=right, 1=left
min. area: [percent] 0..99, default 25
max. area: [percent] 0..99, default: not used
sensitivity: 0..99, default: 20 for regular, 10 for reference windows
For details refer to the [Video Motion](#) help page.

Add Rectangle

Show Video Motion Window ID:
Display the line number from the definition list above in the upper left corner of each window.

Video Motion Style for Group 1:
Appearance of motion window border.

Low-Light Suppression:
Disables motion detection if illumination drops below selected value. Can be set independently for each camera lens.

- **Activate recording for VM event (Setup Menu > Recording)**.

Activity	Value	Explanation
Arming	Enable	Arming: Arming for Recording, Actions and Messaging: <i>Enable:</i> activate all. <i>Off:</i> deactivate all. <i>SI:</i> arming controlled by signal input. <i>CS:</i> arming controlled by custom signal as defined below. <i>From Master:</i> copies Main Event Arming state from master camera. <i>Slave Mode:</i> full arming slave mode.
	(no time table)	Time Table Profile: Time table profile for time-controlled arming. (Time Tables)
Storage Settings		
Recording (REC)	Event Recording	Recording Mode: Type of event and story recording. <i>Snap Shot Recording:</i> stores single JPEG pictures. <i>Event Recording:</i> stores stream files for every event using MxPEG codec. <i>Continuous Recording:</i> continuously streams videodata to stream files using MxPEG codec.
	Include audio	Record Audio Data: Store audio data in stream file if available. Enable and configure microphone .
Start Recording	VM - Video Motion	Start Recording: Select the events which will start recording. Use [Ctrl]-Click to select more than one event. Events in brackets need to be activated first. EC or EL for filtered events.
	Max fps	Event Frame Rate: Recording speed if an event is detected, in frames per second.

3) Activate and configure the BR event

- Activate BR event (**Setup Menu > Event Settings**)

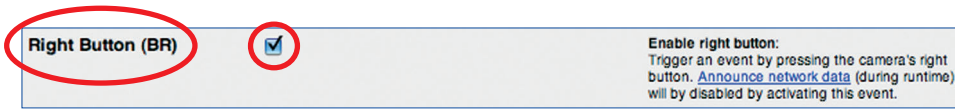

a) Switch additional lights (SO action)

- Activate action profile (for VM and BR events) and configure SO action (**Setup Menu > Actions**).

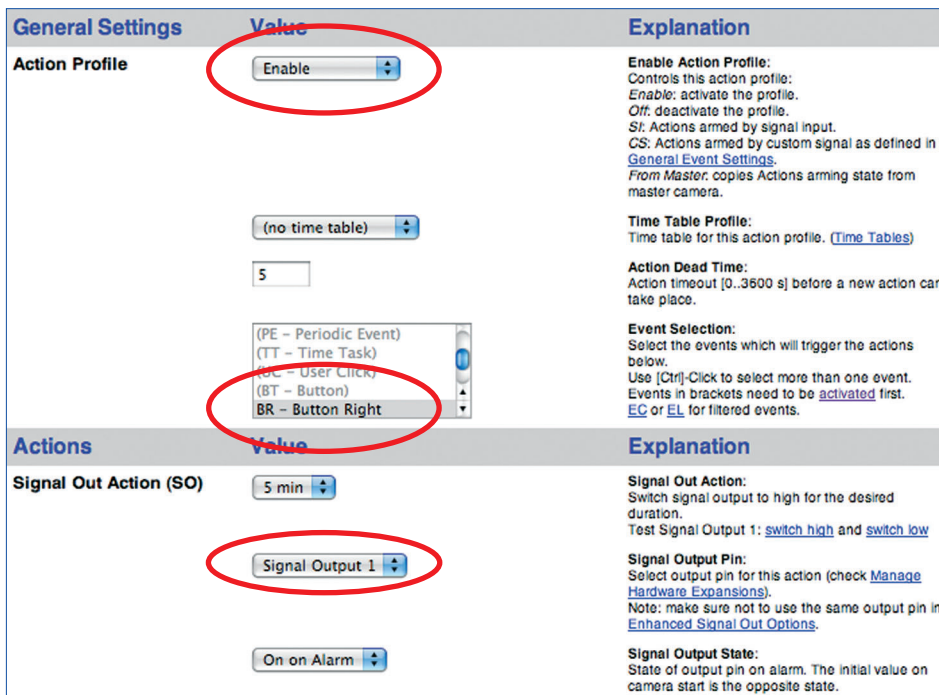

b) Record and configure voice message (SD message)

- Set **Audio Input** to *ExtIO* (audio is transmitted directly from the ExtIO's microphone; **Admin Menu > Loudspeaker and Microphone**).

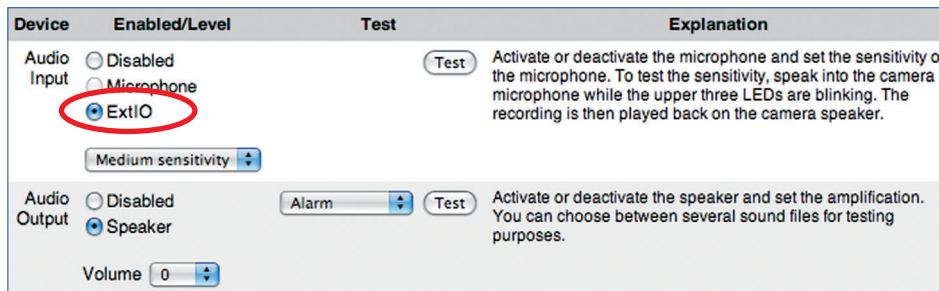

- Record the voice message using the ExtIO's integrated microphone (optional: upload sound file to the camera; **Admin Menu > Manage Audio Messages**).

Step ONE Record Call & Record

If your camera is connected to ISDN or VoIP is activated, press **Call & Record** and the camera will call you and record your voice message over the phone. To record a voice message using the integrated microphone, press **Record** and start recording the message as soon as the upper three LEDs are blinking.

Stored Voice Messages		
Message Name	File Size	Actions
audio_welcome	1 KBytes	Play Call & Play Delete
Total:		1 KBytes Free: 253 KBytes

- Activate message profile and configure SD message (for BR event) and select the recorded voice message (*audio_welcome*; **Setup Menu > Messaging 2**).

General Settings	Value	Explanation
Message Profile	Enable	Enable Message Profile: Controls this message profile. <i>Enable:</i> activate the profile. <i>Off:</i> deactivate the profile. <i>SI:</i> profile armed by signal input. <i>CS:</i> profile armed by custom signal as defined in General Event Settings . <i>From Master:</i> copies this message profile's arming state from the master camera.
	(no time table)	Time Table Profile: Time table for this message profile. (Time Tables)
	60	Messaging Dead Time: Messaging action timeout [0..3600 s] before a new action can take place.
	BR - Button Right	Event Selection: Select the events which will trigger a message. Use [Ctrl]-Click to select more than one event. Events in brackets need to be activated first. EC or EL for filtered events.
Actions		
Second File Transfer (FT2)	Off	FTP Profile: Transfer image to remote host using file transfer protocol. (FTP Profiles)
Sound on Event (SD2)	Enable	Sound Enable: Play one or more sounds on the loudspeaker if an event is detected. (Manage Audio Messages)
	audio_welcome	Play List: Use [Ctrl]-Click to select more than one audio message.

c) Configure VoIP phone call (CL message)

For more information on setting up the SIP telephony features of MOBOTIX cameras, read chapter 9, *Telephony Features* in the *Software Manual*.

- Configure the VoIP settings and activate VoIP (**Admin Menu > VoIP Settings**).

General Phone Settings	
VoIP: Enabled	Enable or disable Voice over IP. This software currently supports the SIP protocol. A valid SIP user address looks like this: <user name>@<domain>, e.g. sipphone@provider.com.
Hang up on Outgoing Calls: Disabled	Hang up this call, if an outgoing call is triggered and there is another call already active.
SIP Settings	
User Name: mxcam_accesscontrol	The <i>user name</i> part of the camera's SIP address (the part to the left of the '@' character) or login name for the SIP provider (in case they are not the same).
SIP Domain: 172.16.0.134	The <i>domain</i> part of the camera's SIP address (the part to the right of the '@' character).

Audio Codec Settings	
Use PCMA Codec <input checked="" type="checkbox"/>	Activate or deactivate the use of the PCMA codec.
Use GSM Codec <input type="checkbox"/>	Activate or deactivate the use of the GSM codec.
Use PCMU Codec <input type="checkbox"/>	Activate or deactivate the use of the PCMU codec.
Video Settings	
Video: Enabled	Enable or disable H.263 video.
Video Size: CIF	The video resolution.
Video Quality: 50%	Sets the quality of the video image. The lower the quality, the lower the required bit rate.

- Set up a phone profile (**Admin Menu > Phone Profiles**).

Profile	Configuration		
mxcamentrance <input type="checkbox"/> Delete	Phone Number or SIP Address	Dial Attempts	Dial Timeout
	softphone@172.16.0.134	1	10
	<input type="button" value="Add"/>		
Connection type:	SIP Video		
Message name:	Standard		
Confirm call with PIN code:	<input type="text"/>		
After the message has been sent:	Intercom		
Camera Remote Control:	On		
Hangup after:	Never		

Note: If you intend to use all audio modes (*Speak, Listen, Intercom*) make sure you have activated all options in the [Loudspeaker and Microphone](#) dialog.

Note: configure the remote control parameters (e.g. the dial-out profile) in the [Phone Call-In](#) dialog.

- Add CL message to messaging profile and select phone profile (**Setup Menu > Messaging 2**; SD message has already been configured).

Actions	Value	Explanation
Second File Transfer (FT2)	Off	FTP Profile: Transfer image to remote host using file transfer protocol. (FTP Profiles)
Sound on Event (SD2)	Enable CuckooClock Default Phonering Standard audio_welcome Randomize	Sound Enable: Play one or more sounds on the loudspeaker if an event is detected. (Manage Voice Messages) Play List: Use [Ctrl]-Click to select more than one audio message. Playback Sequence: Playback sequence of play list.
Second E-Mail (EM2)	Off	E-Mail Profile: Send image by e-mail. (E-Mail Profiles)
Second Phone Call-Out (CL2)	mxcamentrance	Phone Profile: Notify by telephone call. (Phone Profiles)

3.4.4 Configuring a Softphone

- Configure the softphone and make sure that it is running on the computer.

For more information on setting up a softphone for use with MOBOTIX cameras, read chapter 9, *Telephony Features* in the *Software Manual*.

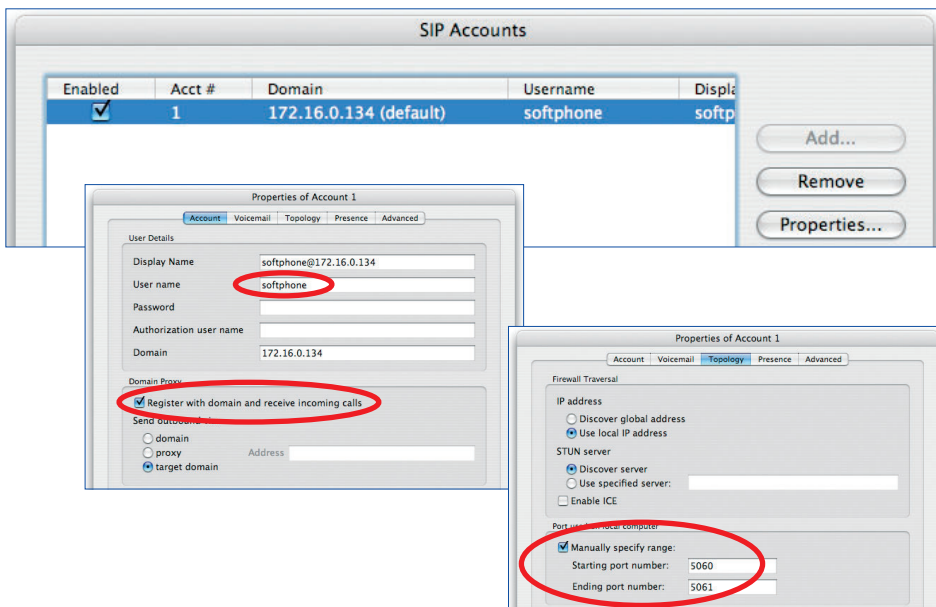

Declaration of Conformity

**Konformitätserklärung gemäß dem Gesetz über Funkanlagen und
Telekommunikationsendeinrichtungen (FTEG) und der Richtlinie 1999/5/EG (R&TTE)**
**Declaration of Conformity in accordance with the Radio and Telecommunications Terminal Equipment Act
(FTEG) and Directive 1999/5/EC (R&TTE Directive)**
**Déclaration de conformité selon la loi sur les équipements hertziens et les équipements terminaux de télécommunication
(FTEG) et la directive 1995/5/EC (R&TTE)**

Hersteller/verantwortliche Person: MOBOTIX AG
 Manufacturer/responsible person:
 Fabricant/personne responsable :

erklärt, dass das Produkt: Erweiterungsmodul
 declares that the product: Extension module
 déclare que le produit : Module d'extension

Typ: ExtIO
 Type:
 Type :

Telekommunikations(Tk-)endeinrichtung Erweiterungsmodul für MOBOTIX-Kameras
 Telecommunications terminal equipment Extension module for MOBOTIX cameras
 Equipement de terminal de télécommunication Module d'extension pour les caméras MOBOTIX

Verwendungszweck: Übertragung von Toninformationen
 Intended purpose: Transmission of audio information
 Le but suivi : Transmission du son

bei bestimmungsgemäßer Verwendung den grundlegenden Anforderungen des § 3 und den übrigen einschlägigen Bestimmungen des FTEG (Artikel 3 der R&TTE) entspricht.
 complies with the essential requirements of §3 and the other relevant provisions of the FTEG (article 3 of the R&TTE Directive), when used for its intended purpose.

est conforme aux exigences fondamentales du paragraphe 3 du FTEG (article 3 du R&TTE) et des autres clauses s'y rapportant.

Gesundheit und Sicherheit gemäß § 3 (1) 1. (Artikel 3 (1) a))
 Health and safety requirements pursuant to § 3 (1) 1. (article 3 (1) a))
 Santé et sécurité conformes au paragraphe 3 (1) 1. (article 3 (1) a))

angewendete harmonisierte Normen: EN 60950:2000 (NSR 73/23/EWG & 93/68/EWG)
 harmonised standards applied: (LVD 73/23/EWG & 93/68/EC)
 normes harmonisées : (Directive Basse Tension 73/23/EWG & 93/68/EC)

Schutzanforderungen in Bezug auf die elektromagn. Verträglichkeit § 3 (1) 2, Artikel 3 (1) b))
 Protection requirements concerning electromagnetic compatibility § 3 (1) 2, (article 3 (1) b))
 Exigences de protection concernant la compatibilité électromagnétique, paragraphe 3 (1) 2; (article 3 (1) b))

angewendete harmonisierte Normen: EN 61000-4-2 EN 55022:2006 (EMV-RL 1995/5/EG (R&TTE))
 harmonised standards applied: EN 61000-4-3 EN 55024:1998+ (EMCD 1995/5/EG (R&TTE))
 normes harmonisées : EN 61000-4-4 A1:2001+A2:2003 (Directive EMC 1995/5/EG (R&TTE))
 EN 61000-4-5 EN 61000-6-2:2005
 EN 61000-4-6

weitere angewendete Normen: EN 55022:2006 CFR 47, FCC Part 15B
 other harmonised standards applied: AS/NZS 3548 CISPR 22:2005 (mod.)
 autres normes harmonisées :

Anschrift: MOBOTIX AG
 Address: Luxemburger Str. 6
 Adresse : 67657 Kaiserslautern
 Germany

+ TK-Nr. / Phone number / N° de communication:

Fon: +49 (631) 3033-100
 Fax: +49 (631) 3033-190
 E-Mail: info@mobotix.com



Kaiserslautern, 26.08.2008

Ort, Datum
 Place & date of issue
 Lieu et date

Dr. Ralf Hinkel
 Vorstand/CEO, MOBOTIX AG

Name und Unterschrift
 Name and signature
 Nom et signature

MOBOTIX ... The HiRes Video Company



**All images in this manual are genuine MOBOTIX camera images.
Enjoy the image quality!**

Manufacturer:

MOBOTIX AG
Luxemburger Str. 6
67657 Kaiserslautern
Germany

Phone: +49 (631) 3033-103
Fax: +49 (631) 3033-190

<http://www.mobotix.com>
sales@mobotix.com

CEO:

Dr. Ralf Hinkel

Court of Registration:
Amtsgericht Kaiserslautern
Registration Number: HRB 3724

Tax Code: 19/650/0812/1
Tax Office: Kaiserslautern

VAT ID: DE 202203501

Download the newest version of this document from:
www.mobotix.com, **Support** section.



Technical information subject to change without notice!



ExtIO Opens New Horizons for Cameras

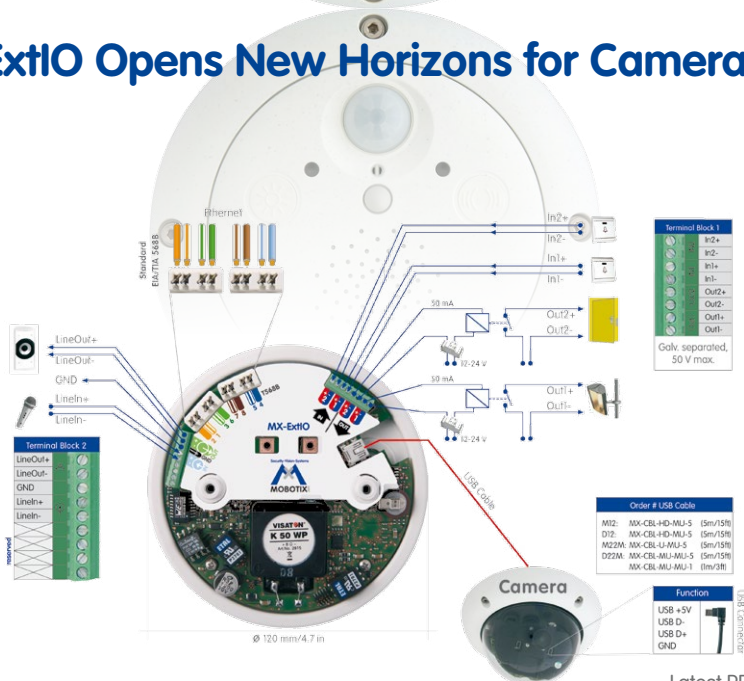

Latest PDF file:
www.mobotix.com > Support > Manuals

HiRes

6 Megapixel

4096 x 1536
 Software zoom

Skyline

Format free

Each image format
 freely definable

30 Frames/s

VGA (640 x 480)
 30 F/s Mega

Virtual PTZ

Digital pan, tilt,
 zoom

Backlight

Safe using CMOS
 without mechanical iris

Internal DVR

Internal via Flash,
 external via Network

Win/Lin/Mac

Recording

via Network on PC
 up to 1 Terabyte

Microphone & speaker

Audio

bi-directional via IP,
 variable framerates

SIP-Client with video

IP Telephony

Alarm notify,
 cam remote control

VideoMotion

Multiple windows
 precision pixel-based

-22 to +140 °F

Weatherproof

-30 to +60 °C, IP65,
 no heating necessary

IEEE 802.3af

PoE

Network power
 even in winter

Robust

No moving parts
 firing glass housing

Mac/Win/Easy

Licence free

Video-Management-
 Software

HiRes Video Innovations

The German company MOBOTIX AG is known as the leading pioneer in network camera technology and its decentralized concept has made high-resolution video systems cost efficient.

MOBOTIX AG • D-67722 Langmeil • Tel: +49-6302-9816-103 • Fax: +49-6302-9816-190 • sales@mobotix.com