

MOBOTIX S15D

FlexMount Dual Camera



Discreetly In The Background. Doubly Flexible.

With the S15D, up to two 5-megapixel sensor modules are each connected to a concealable camera housing via two-meter long cables. Thanks to its separation of camera housing and sensor modules, the S15D offers a broad range of installation and application scenarios.

- Weatherproof dual installation camera based on the optimized 5MP-MOBOTIX technology platform
- One or two separately connected, discreet miniature sensor modules
- Image sensor and microphone integrated directly into the sensor module
- Double Hemispheric equipment replaces up to eight cameras
- Integrated DVR functionality: Slot for MicroSD card (up to 64 GB)
- Functional expansion via MiniUSB and MxBus connector
- Intelligent movement sensors (MxActivitySensor)
- Can also be used as a Door Station camera or for mobile applications (EN 50155)

MOBOTIX Advantages

Extremely high-sensitive 5-megapixel sensors • All relevant events are automatically saved • Highly secure as motion sensors detect even the smallest movements and reduce the number of false alarms • Cost-effective as fewer cameras are needed thanks to HiRes panorama view • Maintenance-free with no heaters, fans or moving parts • Can be expanded thanks to encrypted two-wire bus (MxBus) • Synchronization via GPS satellite means data available in real time • Weatherproof from -30°C to 60°C (-22°F to 140°F) • No licensing or software fees, free-of-charge updates

Camera Housing (Core)



- Suitable for wall or ceiling mounting
- Robust and maintenance-free with no moving parts
- All available MOBOTIX sensor modules can be connected (L12 to L160)
- Rear metal plate offers optimum heat dissipation

Accessories

PTMount



- Dome mount manually adjustable in three directions
- With integrated sensor module (L12–L160)
- Allows for easy installation on the wall or ceiling
- Weatherproof according to IP65

SurroundMount



- For long, narrow rooms (e.g., hallways, buses, trains)
- Integrates 2 sensor modules (L12, L25, L51)
- For ceiling mounting at a 25° angle

DualMount



- Captures an area with 2 sensor modules (especially day/night)
- Supports all available sensor modules
- For ceiling mounting at a 25° angle

HaloMount/SpeakerMount

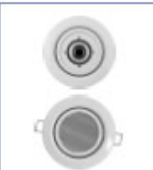

- Mount for sensor modules or standard illuminants (HaloMount)
- Extra speaker (SpeakerMount)
- Built for discreet and simple wall or ceiling mounting, can be tilted by 20°
- Metal, powder-coated or galvanized

SlopeMount 15°



- For mounting at a 15° angle
- Recommended for wall installation with a focus on the center of the room

MX-Overvoltage-Protection-Box-LSA/-RJ45



- Weatherproof network connector
- Surge protection up to 4,000 volts
- For connecting a network via patch cable or standard network cable

Mobile application



A sensor module mounted to the roof of a car captures the optical condition of a gas pipeline in China as the car passes by.

Technical Data	
Model versions	Sec (all combinations of 5MP day and night sensor modules possible, including LPF)
Lens options	12 to 160 mm format, horizontal angle 180° to 13°
Sensitivity	Color sensor: 0.25 lux at 1/60 s, 0.013 lux at 1 s B/W sensor: 0.05 lux at 1/60 s, 0.0025 lux at 1 s MxLEO – Lowlight Exposure Optimization
Image sensors	1/2.5" CMOS, 5 megapixels, progressive scan
Max. image size (per sensor)	Color: 2048 x 1536 (QXGA), B/W: 2048 x 1536 (QXGA)
Image formats (per sensor)	Freely selectable image format (160 x 120 up to 2048 x 1536); PTZ views: Surround (Quad), fisheye full image, normal, panorama, double panorama, panorama focus (3 views)
Max. frame rate, M-JPEG (live/recording)	VGA: 30 fps, MEGA/HD: 10 fps, QXGA: 4 fps, 6MEGA: 2 fps
Max. video rate MxPEG (live/recording/sound)	VGA: 30 fps, MEGA/HD: 30 fps, QXGA: 20 fps, 6MEGA: 8 fps
Image compression	MxPEG, M-JPEG, JPEG, H.264 (SIP video only)
Internal DVR	MicroSD Slot (recording inside the camera, up to 64 GB; 4-GB card preinstalled)
External storage	Directly on NAS and computer/server without additional recording software
Software (free of charge)	MxEasy video management software, MxControlCenter control center software, MOBOTIX App for iOS devices iOS 5.0 and higher
Image processing	Backlight compensation, automatic white balance, image distortion correction (including panorama image correction), motion detection, MxActivitySensor
Virtual PTZ (vPTZ)	Digital pan/tilt/zoom, continuous 8 x zoom, full image recording in the background
Alarm/events	Video motion sensor, MxActivitySensor, external signals, temperature sensor, microphone, shock detector, notification via e-mail, FTP, IP telephony (VoIP, SIP), visual/acoustic alarm, pre- and post-alarm images
Audio (with AudioMount or SpeakerMount)	Integrated microphone (per sensor module), lip-synchronous audio, intercom, sound recording
Interfaces	Ethernet 10/100, IPv4/IPv6, MiniUSB, MxBus; audio (IO); RS232 via MX-232-IO-Box (accessory)
Video telephony	VoIP/SIP, remote control via key code, event display, intercom function with accessory speaker (e.g., SpeakerMount)
Security	User/group management, HTTPS/SSL, IP address filter, IEEE 802.1x, intrusion detection, digital image signature
Certifications	EMC (EN 55022, CISPR 22, EN 55024, FCC Part15B, CFR 47, AS/NZS 3548), EN 50155, EN 61000-6-1/2
Power supply	Power over Ethernet (PoE in accordance with IEEE802.3af): PoE class variable (2/3) depending on operating mode; power consumption: typ. 4.5 or 5 watts (for 1 or 2 sensor modules)
Operating conditions	IP65 (DIN EN 60529), -30 ° to +60 °C (-22 ° to +140 °F)
Dimensions	W x H x D: 11.5 x 13 x 3.3 cm (camera housing/core), Ø x L: 4.3 x 6 cm (sensor module)
Weight	Camera Housing (core) approx. 444 g Sensor module approx. 91 g

For more information on the entire range of MOBOTIX accessories and additional information on the S15D, such as prices, manuals, video management software for computers and iOS devices, etc., please go to www.mobotix.com > **Products**. Or - if you would like to talk to us on the phone to get advice with our products, please call +49 06302 9816-103.

Camera Model	S15D-Sec
Lenses, Sensors (Optical, Sensor Modules And BlockFlexMount Sensor Modules)	
Hemispheric 12 mm (180° x 160°)	L12
Super Wide-Angle 25 mm (82° x 61°)	L25
Wide-Angle 38 mm (55° x 41°)	L38
Wide-Angle 51 mm (40° x 30°)	L51
Tele 76 mm (27° x 20°)	L76
Tele 160 mm (13° x 10°)	L160
Tele 320 mm (7° x 5°)	BlockFlexMount only
CSVario 28 – 63 mm (28° – 58°)	BlockFlexMount only
Image sensor with individual exposure zones (B/W sensor modules also available with integrated Long Pass Filter)	Color, B/W (any combination)
Sensor sensitivity in lux at 1/60 s /1 s	Color: 0,25/0,013 B/W: 0,005/0,0025
Image sensor resolution (each color or B/W sensor)	5MP (2592 x 1944)
Thermal Sensor Modules For S15D	see pages 7 to 9

Hardware Functions	
Protection class (camera body)	IP65
Temperature range -30 to +60°C/-22 to +140°F	•
Temporary internal DVR	64 MB
Internal DVR, ex works	4 GB (MicroSD)
Microphone (in sensor modules)/speaker	•/–
Passive infrared sensor (PIR)	–
Integrated temperature sensor	•
Shock detector	•
Power consumption (typical) with one/two sensor module(s), not with thermal sensor modules	< 4,5 watts/< 5 watts
Variable PoE class (factory default: class 3, with thermal sensor module class 3 always necessary)	2 or 3

Image Formats, Frame Rates, Image Storage	
Maximum image format (per sensor)	5MP (2592 x 1944)
Maximum frame rate (MxPEG, max. resolution)	10 fps (5MP)
CIF images with 4 GB MicroSD DVR	250,000
VGA images with 4 GB MicroSD DVR	125,000
HD images with 4 GB MicroSD DVR	40,000
QXGA images with 4 GB MicroSD DVR	20,000

- available ex works
- not available



Camera Model	S15D-Sec
General Functions	
Digital zoom (continuous) with panning	•
Codecs: Motion-JPEG/MxPEG/H.264 for SIP	•/•/•
Programmable exposure zones	•
Snapshot recording (pre/post-alarm images)	50
Terabyte ring buffer storage (internal/network)	•
Continuous recording with sound (0.2 to 30 fps)	•
Event recording with sound	•
Time and event control/flexible event logic	•/•
Weekly schedules/holidays	•
Web functionality (FTP, email)	•
Playback/QuadView and MultiView	•/•
Bidirectional sound in browser – extra speaker needed*	•
Logo generator, animated	•
Master/Slave arming	•
Several scheduled privacy zones	•
Customized voice messages – extra speaker needed*	•
VoIP telephony (audio/video, alert) – extra speaker needed*	•
Remote alarm notification (network message)	•
Signal inputs/outputs and RS232 via	MX-232-IO-Box
Programming interface (HTTP API)	•
Security Features (HTTPS/S/L, IP-based access control, IEEE 802.1X network authentication)	•
Video Analysis	
Video motion detector	•
MxAnalytics	–
MxActivitySensor	•
Video Management Software	
MxEasy (Windows/Mac OS X)	•
MxControlCenter (Windows)	•
MOBOTIX App (iOS)	•

* Note: No integrated microphone in a thermal sensor module

Delivered Parts S15D Core (Basis Module)

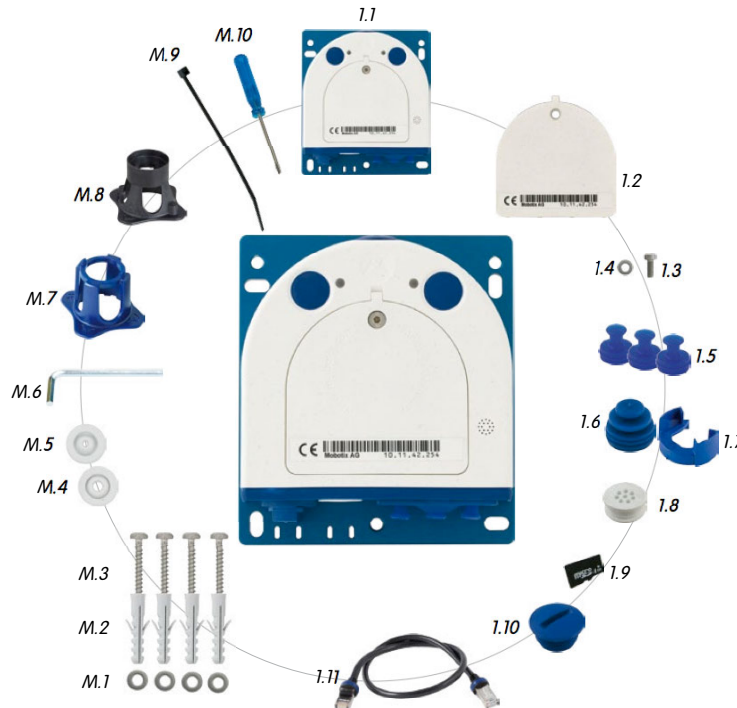

(Excerpt from the technical documentation: www.mobotix.com > Support > Manuals)

Bottom

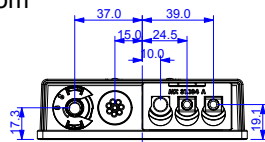

Side

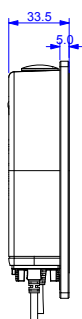

Front

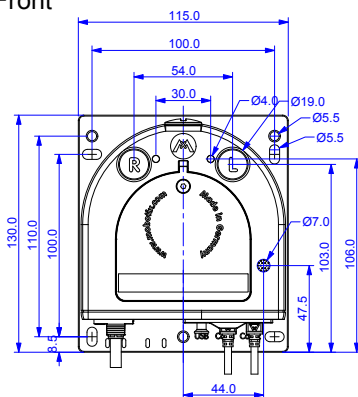

Example with L12 Sensor, ceiling mount.
Each extension gives you 40mm more space.
You can use more than one on every sensor.

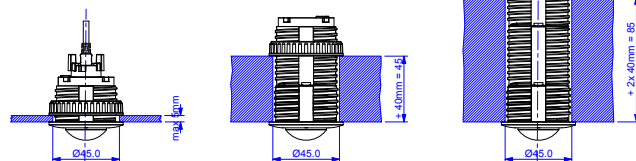

Top

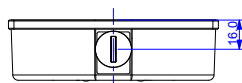

(Excerpt from technical drawings and 3D views: www.mobotix.com > Support > Image Database)

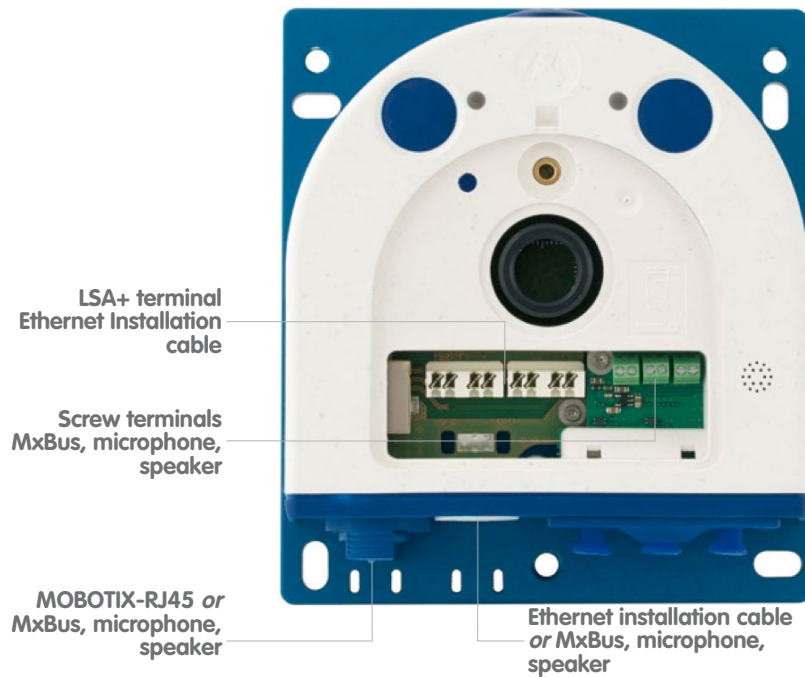
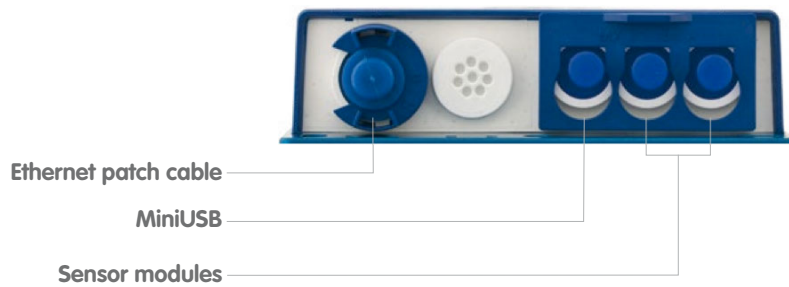
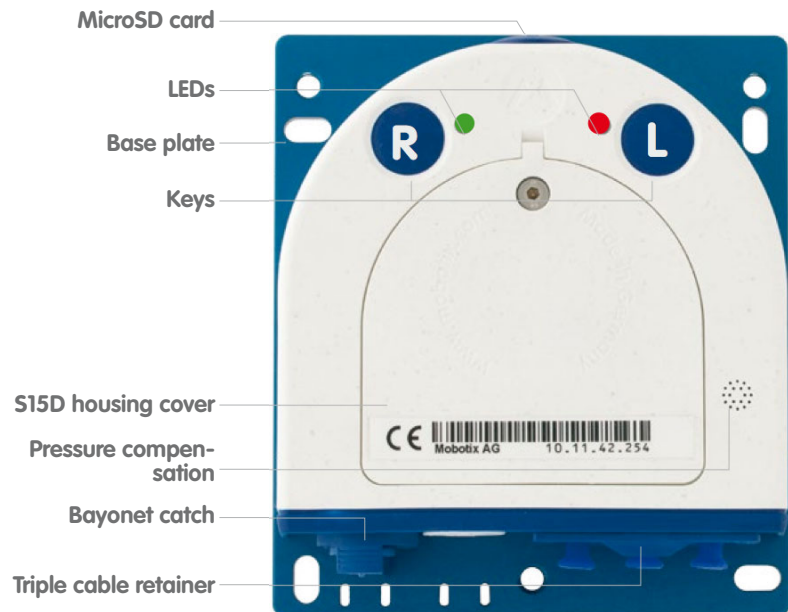

(S15D – Camera housing and connectors, excerpt from the technical documentation)

Thermal Sensor Modules For The S15D

The world's first flexible dual thermal camera

The thermal sensor modules measure the thermal radiation of objects, so that they can function in absolute darkness. Together with the **MxActivitySensor**, they can reliably detect motion in images at night. Only changes in position trigger a signal. Objects moving on the spot do not trigger a signal. The thermal sensor modules also have an advantage during the day since they can detect moving objects in shadows, semi-darkness, smoke, or behind bushes.

The MOBOTIX thermal sensor modules are designed for around-the-clock operation in industrial conditions and are certified as weatherproof according to IP66. Just like for the daylight modules, there are different focal lengths available for the thermal modules:

- **MX-SM-Thermal-L43** with a horizontal image angle of **45°**
- **MX-SM-Thermal-L65** with a horizontal image angle of **25°**
- **MX-SM-Thermal-L135** with a horizontal image angle of **17°**

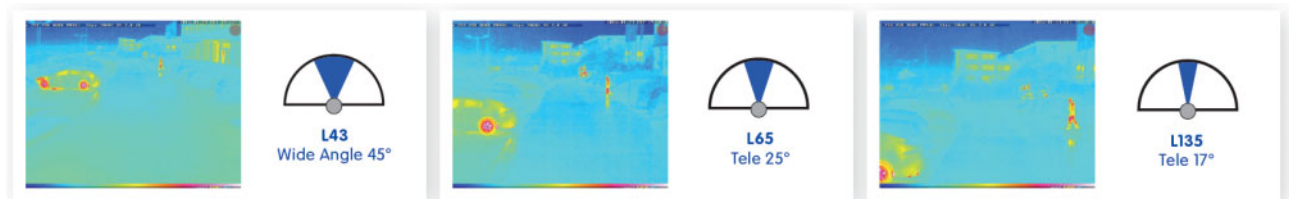
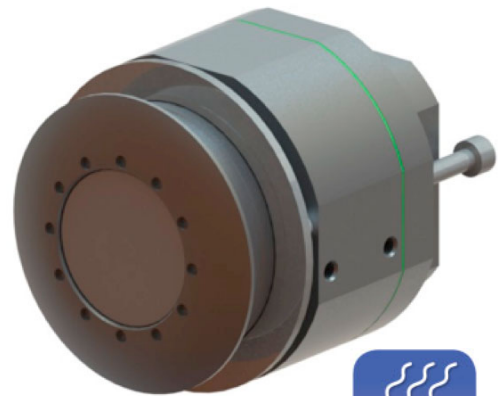

The S15D with thermal sensor module(s) in a weatherproof aluminum housing is **the world's first flexible dual thermal camera**. This is because, as is typical for the S15D, the new thermal sensor modules are also flexibly connected with the familiar, max. two-meter-long sensor cables to the camera housing, which makes efficient installations and customer-specific special installations very easy.

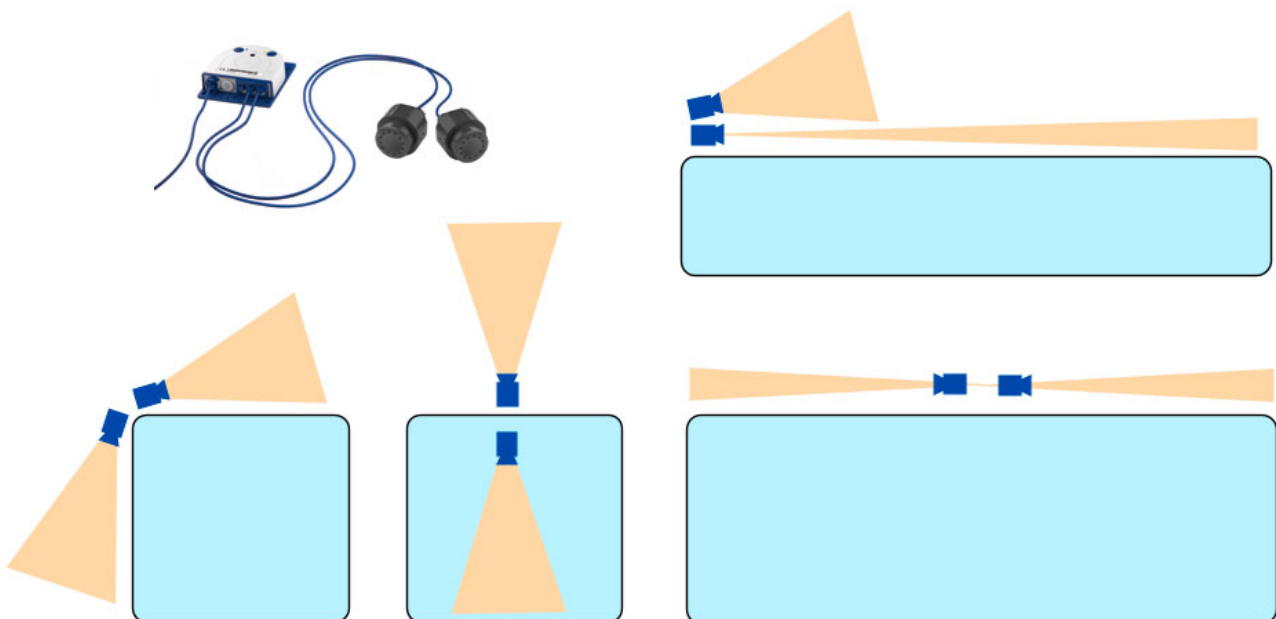

Figure: One camera secures two surveillance areas, for example **90° around a corner, indoor and outdoor areas, two areas with different focal lengths, left/right side.**

The following thermal sensor module combinations are possible with the S15D:

A. Mixed operation (1 x thermal sensor module, 1 x 5 MP sensor module):

The advantages of an S15D with a thermal sensor module and simultaneous daylight sensor lie in the combination of both images: brilliant 5-megapixel images during the day and in twilight hours and reliable motion detection at night.

B. Dual thermal operation (2 x thermal sensor module – only possible with the S15D, not with the M15D-Thermal):

Two thermal images of two different image areas with just one camera

C. Single thermal operation (1 x thermal sensor module):

One thermal image, thermal sensor module with flexible mounting

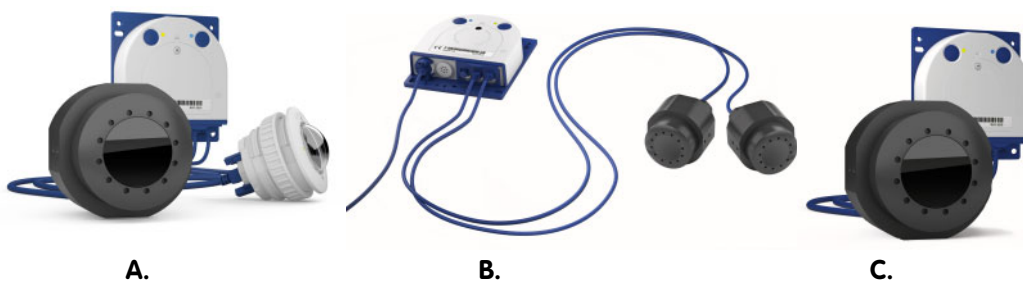

Retrofit or upgrade with thermal technology is possible at any time

In combination with the camera firmware version 4.2.1.43 or higher, every S15D can operate with thermal sensor modules and be converted into a high-end thermographic camera.

Maximum spacing between surveillance camera and detected object with the thermal sensor modules L43 to L135:

Recognition criteria according to EN 50132-7	L43 / 45°	L65 / 25°	L135 / 17°
Monitoring of humans	52 m	95 m	144 m
Detection of humans	26 m	47 m	72 m
Monitoring of cars	150 m	275 m	400 m
Detection of cars	58 m	140 m	200 m

Highly sensitive thermal sensor with NETD typically 50 mK (visualizes temperature differences starting at 0.05 °C/0.09 °F)

Unlike cameras with 5 MP image sensors, one of the decisive quality criteria for a thermal camera is not the image resolution, measured in pixels, but rather the camera's ability to capture the slightest differences in temperature and to produce an image that displays these differences in colors. The sensitivity of a thermal sensor is measured in millikelvin by the NETD, or Noise Equivalent Temperature Difference. MOBOTIX thermal cameras offer a sensor value of 50 mK, which places them in the top range.

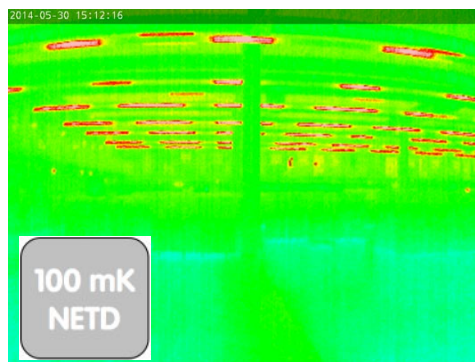
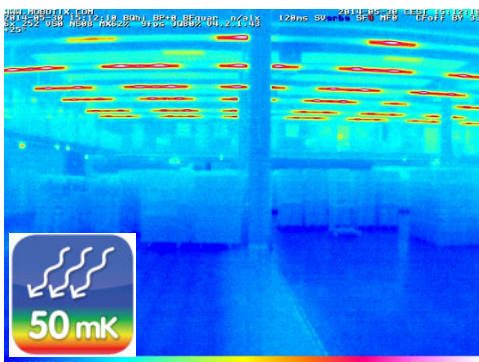

Warehouse:

Thanks to an NETD of 50 mK, the MOBOTIX thermal image (left) shows more details than a less powerful thermographic camera with an NETD of 100 mK (right)

Technical data - Thermal sensor modules for S15D	
Model versions	MX-SM-Thermal-L43/L65/L135, dual operation with an additional thermal sensor or MX sensor module (5 MP) possible on the S15D
Lens options for thermal image sensor	L43: 45°, L65: 25°, L135: 17° (horizontal image angle)
Sensitivity - thermal image sensor	NETD typically 50 mK (equivalent to 0.05 °C/0.09 °F), < 79 mK
Image sensor for thermal image sensor	Uncooled microbolometer with 336 x 252 pixels
Temperature measurement range	-40 °C to +550 °C/-40 °F to +1022 °F (temperature of objects to be detected)
Spectral range	7.5 to 13.5 µm
Maximum image size for thermal image sensor	Scalable up to 2592 x 1944 (5MP), automatically scaled to the image size of the MX sensor module with dual images
Maximum frame rate for thermal image sensor	9 fps (the camera's overall frame rate is reduced to a maximum of 9 fps when an MX sensor module and a thermal image sensor are displayed simultaneously)
Software functions for thermal image sensor (certain features only available with firmware version 4.2.1.43 and higher)	Optional off-color or black and white image, image mirroring, obscure image area, PTZ commands (pan, tilt, zoom), text and logo options, show event/action symbols, level displays in bars or diagrams, temperature control window
Power consumption for S15D with one/two thermal sensor module(s)	Typically 1.5 W per thermal sensor module; however, can only be used together with an S15D camera housing (versions A to C): A. Mixed operation (1 x thermal, 1 x optical): typically 6.5 W (7.5 W possible over the short term) B. Dual thermal operation (2 x thermal): typically 7 W (8 W possible over the short term) C. Single thermal operation (1 x thermal): typically 5.5 W (6.5 W possible over the short term)
Operating conditions	IP66, -30 °C to +60 °C
Material	Module housing: black anodized aluminum; pressure plate: V2A stainless steel; lens and protective glass lens: germanium
Weight / length / installation dimensions Thermal sensor modules	Weight: < 330 g (one thermal sensor module without sensor cable); total length: 78 mm; diameter of front panel: 57 mm; diameter of stainless steel pressure plate: 63 mm; bore diameter: 48 – 53 mm; maximum wall thickness for installation: 14 mm; alternative mounting with six screw threads on the side of the module for M4 screws, 4 mm thread depth
Delivered parts	Thermal sensor module, 3 mm Allen wrench used to install the pressure plate, Quick Install guide - the S15D camera housing (S15D-FlexMount Core) and sensor cable must be ordered separately!

NOTE: An S15D with one or two thermal sensor modules always requires PoE class 3 (factory default).

Attention – Special Export Regulations For Thermal Cameras Apply!

Cameras with thermographic image sensors ("thermal cameras") are subject to the special export regulations of the U.S.A. and the ITAR (International Traffic in Arms Regulation):

- According to the currently applicable export regulations of the U.S.A. and the ITAR, cameras with thermographic image sensors or parts thereof must not be exported to countries embargoed by the U.S.A. or the ITAR. At present, this applies to the following countries: Syria, Iran, Cuba, North Korea and Sudan. The same export ban applies to all persons and institutions listed in "The Denied Persons List" (see www.bis.doc.gov, "Policy Guidance > Lists of Parties of Concern").
- Under no circumstances can the camera itself or its thermographic image sensors be used in the design, the development or in the production of nuclear, biological or chemical weapons or in the weapons themselves.

Dimensions/Drilling Templates

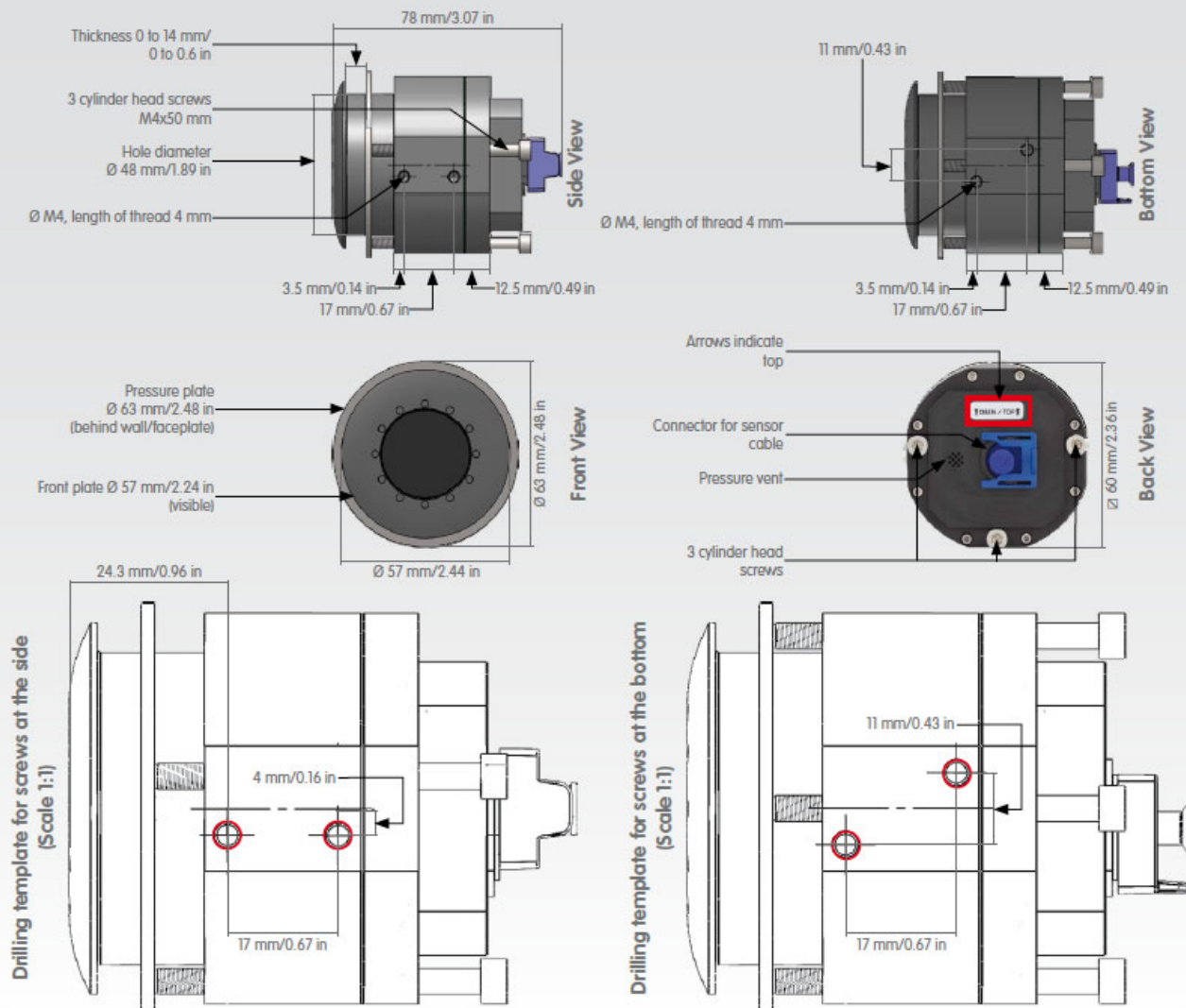

Standard Delivery

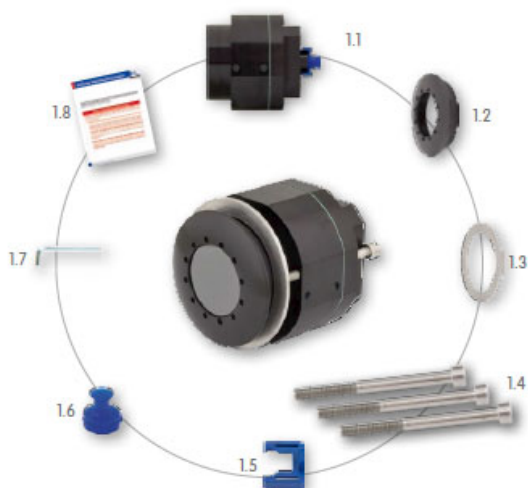

Item	Count	Part Name
1.1	1	MX-SM-Thermal-L43/65/135 body, black anodized
1.2	1	Front plate aluminum, black anodized (installed)
1.3	1	Pressure plate \varnothing 63 mm/2.48 in, stainless steel (installed)
1.4	3	Cylinder head screws M4x50 mm, stainless steel (installed)
1.5	1	Cable lock, blue (installed)
1.6	1	Sealing plug blue, small (installed)
1.7	1	Allen wrench 3 mm
1.8	1	Special export regulations German/English