

Planning and Designing Streets to be Safer and More Accessible for People with Vision Disabilities

A Toolkit for Montgomery County and the Metropolitan Washington Region

First Edition
October 2021

Contract No. 21-024

Submitted by Toole Design

Contents

Introduction	3
Key Facts about People with Vision Disabilities	4
Overview of Approaches and Lessons Learned in Other Communities and Countries.....	6
Principles of Accessible Design for People with Vision Disabilities	8
Process Tools	10
Engaging People with Vision Disabilities	10
Pre-Construction Accessibility Audit	12
Performance Evaluation.....	13
Post-Construction Education and Outreach.....	14
Regular Training on Accessible Planning and Design	15
Accessible Design Testing and Training Facility.....	16
Design Tools.....	17
Tactile Cues	17
Visual Cues	34
Audible Cues	39
Signage.....	45
Mobile Technologies.....	48
Designs.....	51
Pedestrian Access Routes	51
Crosswalks	57
Bus Stops	63
Appendices	71
Appendix A: Summary of Key National-Level Guidance Documents.....	72
Appendix B: Fenton Street Concept.....	75
Appendix C: Proposed Guidance for Temporary Pedestrian Paths During Routine Maintenance and Construction	91
Appendix D: Engagement Best Practices.....	95
Appendix E: January 11 Meeting Materials and Transcript.....	103
Appendix F: Countywide Survey Results	142
Appendix G: Fenton Street Survey Results.....	181

Introduction

Loss of sight can have a profound impact on a person's ability to navigate the built environment and take care of daily needs, particularly those needs associated with transportation. This report provides guidance for designing streets and outdoor public spaces in urban areas that are more accessible to people with low vision or vision loss. This report is intended for consideration by Montgomery County stakeholders as well as stakeholders across the Metropolitan Washington Region.

The report was developed for Montgomery County through support from the Metropolitan Washington Council of Government's (MWCOG) Transportation and Land Use Connections program. It is based on best practice research and a robust stakeholder engagement process in Montgomery County. The best practice research included outreach to local government officials, accessible design specialists, and disability advocacy groups in the United States, Canada, England, Scotland, the Netherlands, and Japan. The stakeholder engagement process emphasized input from people with vision disabilities but also involved people with other types of disabilities, including mobility-related disabilities. It included one online meeting, two online surveys, a series of stakeholder interviews, a design critique of a proposed concept for an intersection in downtown Silver Spring, and review by staff members from multiple Montgomery County agencies.

This report includes:

- Facts about people with vision disabilities that are important for planners and designers to consider when designing streets and outdoor public spaces.
- An overview of approaches taken and lessons learned in other communities and countries.
- Principles of accessible design within public rights-of-way for people with vision disabilities.
- A discussion of processes and design tools that may be helpful in developing streets that are more accessible to people with vision disabilities and other types of disabilities.
- A discussion of how these tools can be coordinated for specific street designs.
- Appendices, including a table listing key national-level documents for accessible design, design examples, guidance on maintaining accessibility in the case of temporary changes, and background material and documentation from the stakeholder engagement process.

Each guidance section includes a subsection on "Concerns About Existing Approaches." The bullets in this section are based on input provided by the Montgomery County Commission on People with Disabilities, people with vision disabilities during the engagement process for this project, as well as needs identified by people with vision disabilities through other projects.

While this guide was developed in collaboration with and for the Montgomery County DOT, it is intended to be a reference guide for use by all jurisdictions in the Metropolitan Washington region and beyond. Therefore, the best practices recommendations provided generally do not reference local regulations or how current local codes and regulations comply with recommendations.

Key Facts about People with Vision Disabilities

Planners and designers should consider the following facts when planning and designing streets and other outdoor public spaces.

- **People with vision disabilities constitute a significant and growing segment of the population.** According to a 2016 study by the National Institutes of Health, the number people with visual impairment or blindness in the United States is expected to double to more than 8 million by 2050, an increase largely driven by an aging population.
- **A small percentage of people with vision disabilities are totally blind.** Most retain some sight or light sensitivity, including approximately 85% of people classified as legally blind.
- **There are different types of vision disability.** Major categories include reduced visual acuity, peripheral field loss, central field loss, night blindness, and color blindness.
- **People with vision disabilities may have other disabilities.** For example, a person may be deafblind or have a vision disability with peripheral neuropathy, which affects the sense of touch.
- **People with vision disabilities travel independently to new places.** Their comfort with doing so depends on several factors, including their personality, the type of vision disability they have, and the degree to which the built environment accommodates them.
- **People with vision disabilities use a variety of personal mobility aids to get around.** Examples include long white canes, guide dogs, and mobile technologies.
- **Personal mobility aids have various strengths and weaknesses.** For example, long white canes are only capable of detecting obstacles up to about waist level and some cues, such as a change in surface texture, may or may not be detectable based on the cane tip or caning technique used.
- **Guide dogs do not make decisions on behalf of their handlers.** Handlers and guide dogs are trained to work as a team. When the handler considers it safe to cross, the handler signals to the guide dog to go forward. The guide dog then either proceeds or not based on seeing oncoming traffic. Guide dogs may not react to bicyclists and may not see cyclists coming from the right on a two-way bicycle facility. Guide dogs are also not trained to distinguish between pedestrian space and vehicular space in situations where curbs are lacking or lead a person to a destination based on a command like, "Take me to the bus stop."

Definitions

Partially sighted--means a person has partial vision, either in one or both eyes.

Low vision--refers to a severe visual impairment in which visual acuity is 20/70 or poorer in the better-seeing eye and cannot be improved with glasses or contacts.

Legally blind--means a person has corrected vision of 20/200 or worse in their best-seeing eye.

Totally blind--Refers to complete loss of sight.

In this document, people who fit into these categories are referred to collectively as **people with vision disabilities**.

- **Pedestrians with vision disabilities use many cues to assist them with navigation.** Key cues include curbs, landscaped strips, other detectable edges, detectable surfaces, contrasting colors and textures, sounds from traffic, accessible pedestrian signals (APS), and other pedestrians.
- **Pedestrians with vision disabilities use cues in different ways depending on their disability.** For example, a person with low vision is likely to rely heavily on visual cues while a person who is legally blind is likely to rely more on audible and tactile cues.
- **People with vision disabilities often rely heavily on their mental map of a street or expectations of how streets are laid out based on training and experience.** As a result, temporary changes to the street, such as changes due to construction or special events, and unconventional street designs may be disorienting.
- **Not all people with vision disabilities have received orientation and mobility training.** For many people vision loss happens later in life. They may not consider themselves as having a disability or be aware that training exists to help them.
- **Having a vision disability may create significant life challenges.** In addition to the day-to-day challenges of getting around and operating in a world optimized for people with “normal” vision, over a quarter of non-institutionalized people with vision disabilities live below the poverty line. Less than a third of working age, non-institutionalized people with vision disabilities have full-time employment.

Orientation and Mobility (O&M) are skills people with vision disabilities learn to navigate their environment safely and efficiently. Orientation refers to a person’s ability to know where they are in their environment, using both visual and nonvisual cues as well as tools to aid in orientation. Mobility refers to the person’s ability to move around safely in their environment, using both visual and nonvisual skills as well as tools to aid in safety, such as a white cane or guide dog. O&M training is provided by an Orientation and Mobility Specialist and can include learning to use a white cane, crossing a street, and riding public transportation, among other various skills used to navigate safely and independently.

Overview of Approaches and Lessons Learned in Other Communities and Countries

Over the past 30 years, jurisdictions across the United States have worked to improve accessibility for people with vision disabilities in the public rights of way. This work has been motivated by advocacy from the vision disability community and federal anti-discrimination laws and accessibility standards. It has largely centered on retrofitting curb ramps with detectable warning surfaces, as prescribed in the 2010 ADA standards, and more recently installing and retrofitting pedestrian signals with accessible pedestrian signals (APS) as prescribed in the Manual on Uniform Traffic Control Devices (MUTCD).

Relatively few jurisdictions in the United States have ventured beyond minimum federal accessibility requirements, although many have pursued improvements to the pedestrian realm that overlap with best practices for accessible design for people with vision disabilities. Those jurisdictions that have gone beyond the minimum requirements are generally large urban areas that are implementing separated bike lanes, shared spaces, and other street designs that are nonconventional or less common in the United States, often as part of a commitment to Complete Streets and Vision Zero.

These nonconventional street designs can create challenges for people with vision disabilities if appropriate design provisions are not included; however, federal accessibility guidance is currently limited. (See Appendix A for a summary of existing national level design guidance for people with vision disabilities). As a result, local jurisdictions are innovating and/or drawing on examples and lessons learned from abroad, often in response to feedback from local disability advocates.

Lessons Learned

- **Proactively engage people with vision disabilities throughout the street planning and design process.** Engagement is critical for:
 - Street designs where there is limited federal guidance on how to accommodate people with vision disabilities.
 - Intersection designs that are known to pose challenges for people with vision disabilities, such as T-intersections, skewed intersections, and roundabouts.
 - Street designs that involve changes to how people with vision disabilities access public transit.

Not only does proactive engagement yield better plans and designs, it can also help avoid unexpected costs associated with post-construction retrofits, lawsuits, and other inefficiencies.

- **Educate people on the goals and features of nonconventional street designs.** Many people in the United States have limited experience with nonconventional street designs like separated bike lanes, floating bus stops, shared spaces, and flush streets, so it is important to educate

Complete Streets and Vision Zero

Complete Streets is a street design philosophy that emphasizes designing streets that comfortably accommodate all transportation modes--not just cars.

Vision Zero is an approach to traffic safety that emphasizes the responsibility of street designers and political leaders for implementing systemic measures to reduce traffic fatalities and serious injuries, particularly changes to street designs that address the safety of vulnerable street users, including pedestrians, bicyclists, and people with disabilities.

them about the goals and features of these designs. Here the term “people” includes users of all modes expected to use the facility, including users with and without disabilities.

- **Monitor the performance of nonconventional street designs post-construction.** After a nonconventional street design is constructed, it is important to monitor how well it works for people with vision disabilities and others and identify adjustments needed to address safety and accessibility.
- **Be willing and able to tweak the design of streets and outdoor public spaces to better accommodate people with vision disabilities and other users.** It is not uncommon for nonconventional street and public space designs to require adjustments, even when the jurisdiction has pursued an inclusive engagement process.
- **Be consistent about applying tactile surfaces and make sure they are reliably detectable underfoot and with a long-white cane.** In some cases, jurisdictions have installed tactile surfaces inconsistently or incorrectly, e.g., for a decorative purpose in one location but a navigational purpose in another. This kind of installation or misuse of tactile guidance can be very confusing for people with vision disabilities. In other cases, jurisdictions have installed tactile surfaces intended for the benefit of pedestrians with vision disabilities that are not reliably detectable.

Additional notes about approaches taken elsewhere and lessons learned are integrated into the sections below.

Principles of Accessible Design for People with Vision Disabilities

Safety

Streets and other outdoor public spaces are safer for all users than they are today, especially vulnerable users such as people with vision disabilities.

Montgomery County has a goal of eliminating serious and fatal crashes by 2030, with a particular focus on vulnerable road users, including people with disabilities, pedestrians, and bicyclists.

Compliance

Streets and other outdoor public spaces comply with all applicable federal and state laws and standards.

Key federal laws and standards include but are not limited to:

- Section 504 of the Rehabilitation Act of 1973 (Section 504)
- The Americans with Disabilities Act of 1990 (ADA)
- United States Department of Transportation, ADA Standards for Transportation Facilities, 2006 (USDOT ADA Standards)
- United States Department of Justice, ADA Standards for Accessible Design, 2010 (USDOJ ADA Standards)
- United States Access Board, Proposed Accessibility Guidelines for Pedestrian Facilities in the Public Right-of-Way, 2011 with Proposed Supplement, Accessibility Guidelines for Pedestrian Facilities in the Public Right-of-Way; Shared Use Paths, 2013 (PROWAG)¹
- The Maryland Manual of Uniform Traffic Control Devices (MdMUTCD)

Inclusiveness

Plans and designs for streets and other outdoor public spaces are developed through an inclusive process that seeks to address diverse user needs.

Inclusiveness is an essential concept when designing for people with vision disabilities. If people with vision disabilities avoid using a public facility based on the belief that it is unsafe or uncomfortable, then the facility is not truly inclusive or accessible. In addition, it is important to consider the diverse needs of people with different types of vision disabilities. What works for a person who has low vision may not work for a person who is blind. What works for a person who is blind and has average hearing may not work for a person who is deafblind. The goal is to develop a range of solutions that addresses these diverse needs.

Consistency and Predictability

Streets and other outdoor public spaces are designed in a way that is consistent and predictable. A person with a vision disability should be able to navigate a street that they've never been to before.

Consistency and predictability helpful for all users but are critical for people with vision disabilities, who often rely on mental maps and assumptions about the built environment for navigation. If a tactile surface is used one way in one place and another way in another place, then it can be extremely

¹ PROWAG has not yet been adopted by the U.S. Department of Justice or the U.S. Department of Transportation; however, PROWAG provides a useful framework to help public entities meet their obligations to make their programs, services, and activities in the public right-of-way readily accessible to and usable by individuals with disabilities. For that reason, the Federal Highway Administration (FHWA) considers PROWAG a best practice for the design and construction of sidewalks, pedestrian facilities, and other elements in the public right-of-way.

confusing. Temporary changes in the built environment because of construction or other activities can also be confusing and disorienting if not handled appropriately.

Maintenance

All streets and outdoor public spaces are well-maintained.

It is especially important that elements such as APS, detectable warning surfaces, and crosswalk markings that are essential for navigation by pedestrians with vision disabilities are well-maintained.

Process Tools

This section discusses strategies that can be implemented as part of the planning, design, and post-construction process for a street or outdoor public space to improve safety and accessibility for people with vision disabilities. The discussion under each "tool" includes a description of the tool, a description of concerns expressed by people with vision disabilities about existing approaches, and recommended guidance for consideration by Montgomery County and other jurisdictions in the Metropolitan Washington Region.

Engaging People with Vision Disabilities

Engaging people with vision disabilities means going beyond the ADA requirements for accessible meetings and materials and proactively reaching out to people with vision disabilities and Orientation and Mobility Specialists to understand their experiences, solicit their input, and involve them in the decision-making process.

Concerns About Existing Approaches

- People with vision disabilities do not feel adequately involved in street design decisions that impact their lives. They are often not aware of street planning and design processes until after key decisions are made.
- The decisions that are made as part of street planning and design process can sometimes have negative effects on the ability of people with vision disabilities to get where they need or want to go safely and comfortably.
- Failure to adequately address needs of people with vision disabilities as part of street planning and design processes can sometimes result in costly retrofits and other unanticipated costs.



Figure 1: Charlie Crawford and Montgomery County Department of Transportation staff discussing concerns about the design of a floating bus stop in downtown Silver Spring. Mr. Crawford, who died in 2020, had a vision disability and was a tireless advocate for pedestrian safety and accessible transportation. (Source: MCDOT)

Recommended Guidance

Context

- People with a range of vision disabilities should be actively engaged in the transportation planning process, including in street planning and design projects from start to finish.
- Engaging people with vision disabilities is particularly important in the case of street designs that have not been tested locally or are not well-covered by federal accessibility guidance, such as shared spaces, separated bike lanes, floating bus stops, and roundabouts or other nonconventional intersection designs.

Application

- Project scopes, timelines, and budgets should account for the need to meaningfully engage people with vision disabilities. Meaningful engagement means solicitation of feedback from people with vision disabilities prior to making key project decisions and informing them about what is proposed in ways that are accessible to them, e.g., by providing tactile graphics of proposed street designs.
- A public participation plan should be developed for each project that clarifies how people with disabilities, including people with vision disabilities, will be proactively engaged at each stage in the project.
- People with vision disabilities should have an active role as project stakeholders, e.g., by establishing a project stakeholder committee that includes people with vision disabilities or representatives of organizations that represent them, such as the National Federation of the Blind, American Council of the Blind, AARP, or the local Center for Independent Living. Orientation and mobility specialists can also provide valuable insights on accessibility needs for people with vision disabilities. To identify additional contacts in other local groups, it may be helpful to reach out to the local government ADA Compliance Manager.
- People should be asked ahead of project meetings if they require any special accommodations and if so who to notify with their needs.
- Any project meetings or materials that are intended for the public should be accessible to people with vision disabilities. Best practices for meetings and meeting materials that are accessible to people with vision disabilities are outlined in Appendix D: Engagement Best Practices.
- Meeting materials in large print and/or an accessible format compatible with screen readers should be provided to participants at least 48 hours ahead of the meeting to allow sufficient time for review.



Figure 2: Tactile graphic developed for this project showing a preliminary concept for the intersection of Fenton Street and Ellsworth Drive in downtown Silver Spring.

Pre-Construction Accessibility Audit

An accessibility audit is an accessibility-focused assessment of an existing or proposed street design by an independent auditor or group of auditors with expertise in accessible design.

Concerns About Existing Approaches

- Important accessibility needs can be missed when the same group of people that developed a design is responsible for assessing it for accessibility. This is due to the difficulty this group may have evaluating the design dispassionately or their lack of experience with key aspects of accessible design, such as tactile guidance.
- When accessibility is assessed pre-construction, the focus is often on access for wheelchair users rather than people with other types of disabilities.
- Accessibility needs that are missed pre-construction can sometimes result in negative impacts on people with disabilities and costly retrofits and other unanticipated costs.

Recommended Guidance

Context

- For projects that impact pedestrians and involve a nonconventional design or are in areas where pedestrians with disabilities are concentrated, an accessibility audit should be considered. Audits should be performed upon development of a 15% design and again upon development of a 65% design.

Application

- The auditor should not be a member of the design team and should have expertise in accessible design for people with vision disabilities, including the application of [detectable warning surfaces](#), [detectable guidance surfaces](#), and other conventional and nonconventional techniques for assisting pedestrians with vision disabilities with navigation.
- The accessibility audit should include:
 - An assessment of the design's compliance with existing federal, state, and local accessibility guidelines, including PROWAG.
 - An assessment of potential impacts (positive and negative) of the proposed design on various groups of people with disabilities, including the spectrum of people with vision disabilities (overall acuity loss, depth perception loss, peripheral vision loss, central vision loss, total vision loss, color blindness, night blindness, etc.).
- The results of the audit should be compiled in a document and include recommendations for proposed designs and issues and mitigations for negative impacts.
- The audit documentation should be shared with the planner or designer, relevant local government agencies, and advisory bodies representing people with disabilities for review and comment.

Performance Evaluation

The goal of the performance evaluation is to determine if a street or outdoor public space design is achieving the goals and objectives established for it, including accessibility goals and objectives, and if those goals are not being met, to determine what can be done to improve outcomes. Performance evaluations can also inform development of similar designs in the future.

Concerns About Existing Approaches

- When nonconventional street designs are implemented, their effects on different types of users, including people with vision disabilities, are often not well understood or documented in the United States.
- Lack of information about these effects can: a) undermine awareness of issues that could be corrected either in the current design or a future design and b) lead to unsupported claims about a design's benefits or perceived shortcomings that can negatively influence implementation elsewhere.

Recommended Guidance

Context

- Performance evaluations should be conducted for street or outdoor public space designs that have not been extensively studied or implemented in the United States and/or locally.
- Performance evaluations should be considered for other types of designs, particularly if the circumstances under which they were implemented are atypical or if concerns have been raised about the design that would benefit from evaluation.

Application

- Goals and objectives related to accessibility for people with disabilities should be identified at the start of a project and included with other project goals and objectives.
- A plan for performance evaluation should be developed prior to implementation of the project. The plan should:
 - Clarify the purpose and timeline for the evaluation process, specify roles and responsibilities, establish performance measures, and detail data needs and methods.
 - Describe how and with whom evaluation results will be shared.
- A baseline study should be conducted to establish existing conditions relative to the goals and objectives for the project.
- A post-construction study should be performed to determine how the design performs against the baseline with respect to the goals and objectives for the project.
- If the post-construction study reveals deficiencies in the design that did not meet the performance measures, potential mitigations should be considered and implemented if practical to better achieve those performance measures.
- With nonconventional street designs, the need for minor post-construction design alterations should be anticipated and are not indicative of a failed design.

Involving key stakeholders in the development of an evaluation plan, and making the plan document and evaluation results available to the public, can help to develop a shared understanding of what success looks like and build support for the project.

Post-Construction Education and Outreach

Post-construction education and outreach involves efforts to inform members of the public of the features and goals of nonconventional street designs and how to use them.

Concerns About Existing Approaches

- There is a need for additional outreach to all potential users of nonconventional streets to educate them about the goals of these designs, how to navigate them, and how to interact safely with other users.
- People with vision disabilities often rely on mental maps and/or previous training or experience for navigation, which can make nonconventional designs especially challenging for them to navigate.

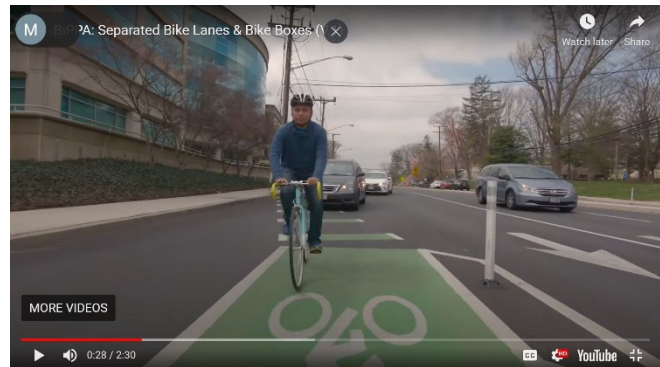

Figure 3: Screen capture of video produced by Montgomery County's Bicycle and Pedestrian Priority Areas (BiPPA) program to educate bicyclists and drivers about the County's new separated bike lanes. There is a need for additional education and outreach to people with vision disabilities.

Recommended Guidance

Context

- An outreach and education campaign should accompany installation of new nonconventional or outdoor public space designs. The campaign should target users of all modes expected to use the facility, including users with and without disabilities.

Application

- Local governments should coordinate with Orientation and Mobility Specialists and disability advocates on education and outreach activities.
- Potential education and outreach activities aimed at people with vision disabilities include:
 - Informational/educational pieces on media channels frequented by people with vision disabilities.
 - Informational/educational materials in a range of formats sent to disability groups, senior centers, and other relevant community groups for distribution.
 - Information posted in libraries, community centers, buses, and other public places.
 - Online or in-person meetings that target people with vision disabilities.
 - Training with an Orientation and Mobility Specialist at a testing facility or off-street location.
 - Training with an Orientation and Mobility Specialist at the location with the nonconventional design.
- Education and outreach materials should be provided in a variety of formats, as appropriate, including audio messages, large print, braille, and Spanish and other non-English languages.

Considerations

- Consider involving stakeholders with vision disabilities that were engaged in the planning or design process in education and outreach efforts.

Regular Training on Accessible Planning and Design

A series of trainings provided to relevant local government officials, engineers, and planners consisting of a baseline training and a series of follow-up trainings.

Concerns About Existing Approaches

- Local government officials, engineers, and planners often lack knowledge of certain facets of conventional accessible planning and tactile guidance, including issues that impact people with vision disabilities, which can result in these issues being overlooked.
- The fields of accessible planning and design are constantly changing. There is a need to periodically refresh and update the knowledge of key local government decisionmakers.

Recommended Guidance

Context

- Regular training on accessible planning and design should be provided to all local government officials, and any engineers and planners involved in planning and designing streets and outdoor public spaces.

Application

- A baseline training should be provided covering:
 - The legal framework for accessibility, including the Architectural Barriers Act of 1968, Rehabilitation Action of 1973, the Americans with Disabilities Act of 1990, key court decisions that impact how these laws are applied to the public right of way, the DOT and DOJ ADA standards, and PROWAG.
 - Requirements for accessible meetings and materials.
 - Techniques for proactively engaging people with disabilities, including people with vision disabilities, in street planning and design processes.
 - Existing federal, state, and local standards, guidelines, policies, and best practices for accessible street design.
 - Protocols for handling tactile guidance that are not covered in existing standards and guidelines.
- The baseline training materials should be updated every five years, or when significant laws are passed or standards adopted, to include new requirements, standards, and guidance.
- The baseline training should be provided to relevant new local government staff and consulting staff soon after the start of their employment.
- A refresher training should be provided to highlight key issues, provide updates, discuss changes or innovations, and respond to questions encountered on recent projects.
- Input on the training should be solicited from Orientation and Mobility Specialists, travel trainers, and others with knowledge about the experiences of people with vision disabilities and/or expertise on accessible design for people with vision disabilities.
- Trainings should also be provided to Orientation and Mobility Specialists, who may not be familiar with the use of guidance strips, tactile delineators, and other treatments.

Accessible Design Testing and Training Facility

An accessible design testing and training facility would enable people with vision disabilities to experience and provide feedback on nonconventional street and outdoor public space design concepts and technologies. The facility could be used by Orientation and Mobility specialists to update their knowledge and train people with vision disabilities, and would enable planners and engineers to test designs before deploying them. The facility could also be used to better understand the impacts of nonconventional designs and specialized surfaces, such as [guidance strips](#), on people who use various assistive mobility devices, such as wheelchairs and walkers.

Concerns About Existing Approaches

- There is currently no place locally or regionally where pedestrians with vision disabilities can test and provide feedback on nonconventional street and outdoor public space design concepts and technologies before they are implemented.
- There is currently no place locally or regionally where Orientation and Mobility Specialists can train pedestrians with vision disabilities on nonconventional street design concepts and technologies without exposing them to these concepts and technologies in real-world street conditions.

Recommended Guidance

- An accessible design testing and training facility should be established in Montgomery County or at another location in the Metropolitan Washington region that is accessible to Montgomery County residents.



Figure 4: The City of Portland built a mock-up of a "shared platform" bus stop in a parking lot, so that staff from different City agencies and representatives of several advocacy groups, including the Oregon Commission of the Blind and Oregon Walks, could experience the design and provide feedback on how it operated before the City moved forward with constructing a shared platform stop.

Design Tools

This section discusses specific features that can be incorporated into a design for a street or outdoor public space to help make it safer and/or more accessible to people with vision disabilities, including tactile cues, visual cues, audible cues, and signage. This section also discusses mobile technologies. The discussion under each "tool" includes a description of the tool, a description of concerns expressed by people with vision disabilities about existing approaches, and recommended guidance for consideration by Montgomery County and other jurisdictions in the Metropolitan Washington Region.

Tactile Cues

Tactile cues take advantage of a person's sense of touch to provide navigational information. People with vision disabilities typically receive this information through their hands and feet. Some people with vision disabilities use a long white cane to extend the reach of their hands. Others may use guide dogs that are trained to detect specific tactile cues, including curbs and curb ramps.

People who are legally blind or blind often rely heavily on tactile cues, particularly those who are deafblind. However, tactile cues are not the primary means of receiving navigational information for all or even most people with vision disabilities and some people with vision disabilities have disorders, such as peripheral neuropathy, that make it more difficult to detect tactile cues. Consequently, for a street to be accessible to the full spectrum of people with vision disabilities, it should also include [visual cues](#) and [audible cues](#) that help people with vision disabilities navigate.

Types of Tactile Cues

Tactile cues include:

- Detectable edges
- Detectable changes in surface texture
- Detectable changes in slope
- Tactile walking surface indicators
- Tactile delineator surfaces



Figure 5: Example of a vertical curb incorporated into a curb ramp design in Takoma Park. This design includes multiple tactile cues for orientation and alignment, including: 1) a detectable change in slope indicating a transition from the sidewalk and roadway; 2) a detectable warning surface marking the end of the curb ramp; and 3) a vertical curb incorporated into the curb ramp design that can be used for pedestrian alignment with the crosswalk.

Detectible edges

Detectable edges are linear features that have a vertical profile greater than 2.5" and are cane detectable, meaning that a person with a vision disability using a long white cane can reliably detect them with the cane. They include building faces, fences, curbs, landscaping, and other vertical features.

Curbs

Curbs are a particularly important form of detectable edge for people with vision disabilities because they often mark the boundary between the sidewalk and the travel way or the sidewalk and a landscaping feature.

Vertical curbs can be incorporated into crossing designs to help people with vision disabilities align to the crosswalk, e.g., as part of a curb ramp design or as part of a crossing island with a channelized pedestrian access route. (Figure 5)

To be reliably detectable to people with vision disabilities, curbs must be at least 2.5" high.² However, vertical curbs should generally not be used perpendicular to a pedestrian's logical path of travel because they can be a tripping hazard.

In addition to vertical curbs, curbs can be rolled or beveled to enable people with vision disabilities to detect them while still being traversable by people riding bicycles or using wheelchairs and suitable for conveying stormwater. (Figure 6)

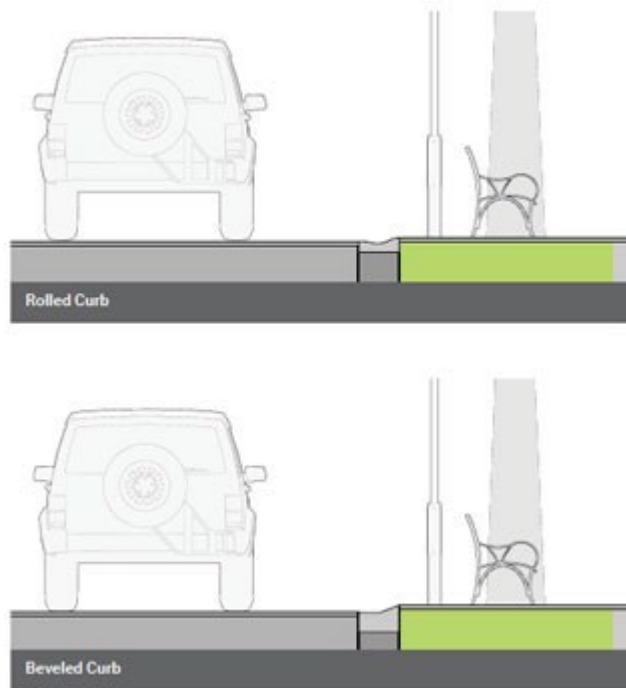

Figure 6: Examples of a rolled curb and a beveled curb. Curbs are a type of detectable edge. (Source: FHWA)

² Effective Kerb Heights for Blind and Partially Sighted People. https://www.ucl.ac.uk/civil-environmental-geomatic-engineering/sites/civil-environmental-geomatic-engineering/files/steps_project_for_guide_dogs_association.pdf

Raised trapezoidal delineators

Raised trapezoidal delineators (Figure 7) are like beveled curbs except that they have a bevel on both sides. This type of detectable edge treatment is most often used to delineate pedestrian and bicycle facilities in cases where the facilities are parallel and flush (i.e., at the same level and directly adjacent) and wheelchair users will generally not need to cross the bicycle facility (e.g., to access parking). Where maintaining access for wheelchair is needed, the tactile delineator surface is preferred. The tactile delineator surface is discussed in greater detail below.

Detectable changes in slope

A slope change can be used to indicate to people with vision disabilities that they are transitioning from one type of space to another. In a conventional street environment, one of the most familiar slope changes is a curb ramp, with the slope of the ramp indicating a transition between the sidewalk and the crosswalk. When the running slope of a ramp is not in line with the crosswalk, it can make it more difficult for a person with a vision disability to align properly to cross.³ Ramps that have a slope aligned with the crosswalk are called [directional curb ramps](#). This type of ramp is discussed in greater detail below.

Detectable changes in surface texture

People with vision disabilities expect that the accessible pedestrian routes (pedestrian access routes) will be untextured/smooth and be slip resistant when wet or dry. This expectation can be leveraged to provide valuable tactile navigation information. When a surface with a detectably different texture is installed adjacent to the pedestrian access route, it can indicate to people with vision disabilities that they are no longer in the pedestrian access route (Figure 8). Surfaces that are likely to be detectable to people with vision disabilities if installed adjacent to a smooth, concrete pedestrian access route include Belgian blocks, textured pavers, grass, ground cover, and other similar materials. Smooth brick may not be detectably different from a smooth concrete sidewalk.



Figure 7: Example of a raised trapezoidal delineator (white raised surface) in Montgomery County



Figure 8: Example from Malmo, Sweden showing how detectable changes in surface texture and tactile walking surface indicators can be used to provide tactile guidance to people with vision disabilities. The pedestrian access route is defined by a smooth surface with rougher surfaces on either side. In addition, a detectable guidance surface is arranged perpendicular to the pedestrian access route to guide people with vision disabilities to the mid-block crossing. A detectable warning surface indicates the end of sidewalk space and the beginning of the crosswalk. (Source: Tony Hull)

³ [Nonvisual Cues for Aligning to Cross Streets \(nih.gov\)](#).

Tactile walking surface indicators

Tactile walking surface indicators (TWSIs) are specialized surfaces that are installed on a walking surface to provide navigational information to people with vision disabilities. The two most used TWSIs, the [detectable warning surface](#) and [detectable guidance surface](#) are discussed in greater depth in the sections below.

Tactile delineator surfaces

Tactile delineator surfaces are another type of surface. They are meant to help people with vision disabilities identify the boundary between pedestrian and vehicular space in situations where a detectable edge, such as a curb, is not present. Tactile delineator surfaces can also be used to define the outside edges of crosswalks in situations where people with vision disabilities are more likely to veer outside the crosswalk.

Concerns About Existing Approaches

People with vision disabilities report the following challenges with existing tactile cues:

- Edge treatments that are not cane detectable, e.g., ropes and chains hung between bollards
- Long white canes getting caught in fencing for tree boxes and other landscaped areas
- Surface texture changes that are intended to be detectably different but are not, e.g., the transitions between concrete and smooth brick
- Surface texture changes in the pedestrian access route that are detectable but have a purely decorative purpose

Needs specific to [curb ramps](#), [detectable warning surfaces](#), [detectable guidance surfaces](#), and [tactile delineator surfaces](#) are discussed in the relevant sections below.

Recommended Guidance

- Tactile cues that are used in the public right-of-way should comply with PROWAG and federal, state, and local accessibility requirements (where applicable.)
- Tactile cues that are used in streets and outdoor public open spaces must be applied consistently. Consistency is especially important in the case of TWSIs and the tactile delineator surface, which are intended to convey specific information to people with vision disabilities.
- People with vision disabilities should be engaged in all street design processes that involve consideration of the detectable guidance surface or tactile delineator surface due to the lack of detailed federal guidance on these surfaces.
- When detectable changes in surface texture are contemplated as a method for providing navigational information to people with vision disabilities, the detectability of the change in surface texture should be verified by people with a range of vision disabilities, using a variety of different navigational techniques, prior to long-term installation. The verification process can be accomplished at a testing facility or through a pilot implementation. Through this process, minimum requirements for surfaces textures may be identified to better standardize the palette of allowable surfaces.



Figure 9: Example of a tactile delineator surface used in a shared space design in New Zealand (Source: Auckland Design Manual)

- Except at crosswalks, the boundary between pedestrian space and vehicular space should be defined with a detectable edge or delineator strip. The detectable edge should typically be a vertical curb; however, if the adjacent space is a bicycle facility a beveled curb or raised trapezoidal delineator may be a more appropriate edge treatment, particularly in constrained locations.
- On conventionally designed streets, where feasible and consistent with PROWAG, directional curb ramps should be installed instead of ramp styles that do not align with the crosswalk. Additional detail is provided below regarding [directional curb ramps](#).
- Where feasible and consistent with PROWAG, vertical curbs should be incorporated into curb ramp and pedestrian crossing island designs to help people with vision disabilities align to cross.
- Fences and other vertical elements intended as a detectable edge should be cane detectable and not pose a hazard to people with vision disabilities or other pedestrians. Bollards by themselves and bollards that are linked by chains or ropes or that have horizontal ornamental projections should be avoided if they are immediately adjacent to a pedestrian access route.
- Barriers installed around tree boxes and other landscaped areas to prevent people from walking on them should be designed to avoid catching the tips of white canes.

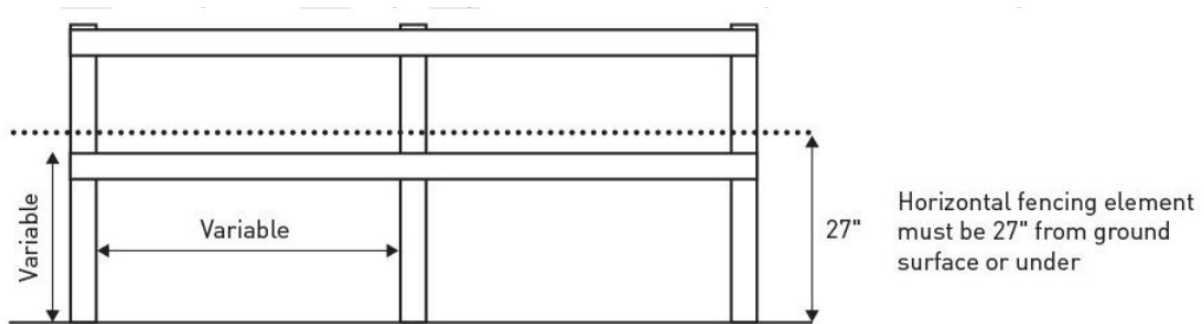

Figure 10: Example of fencing design for cane detectability. The cane detection range is up to 27" above the finished surface. (Source: Seattle Department of Transportation)

Directional Curb Ramps

Directional curb ramps are curb ramps where the direction of the ramp is aligned with the crosswalk.

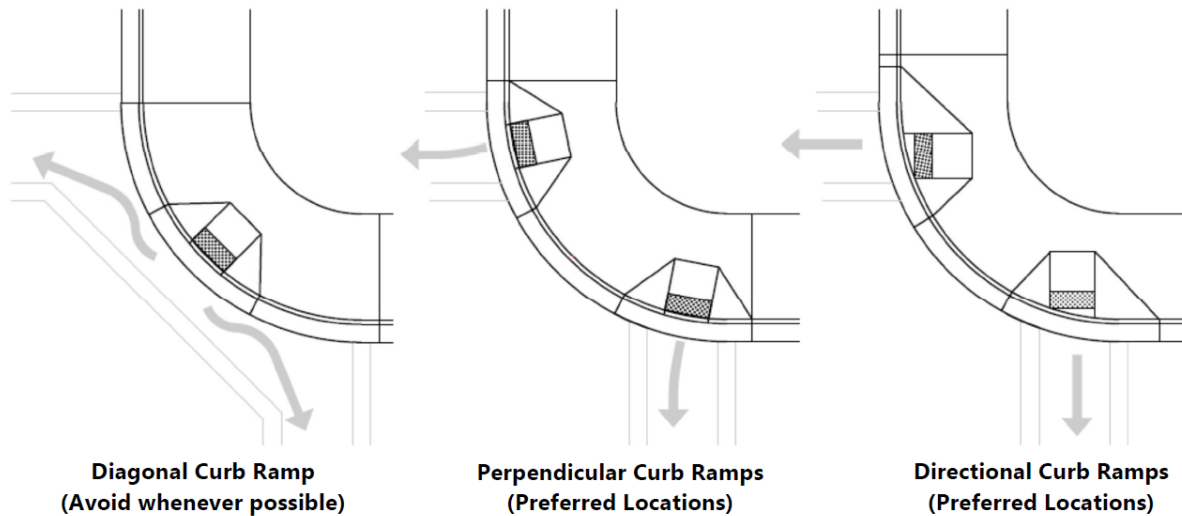

Figure 11: Graphic showing the distinction between the directional curb ramps and other ramp styles. (Source: San Diego Curb Ramp Design Guidelines)

Concerns About Existing Approaches

People with vision disabilities report the following challenges with different curb ramp orientation:

- Curb ramps that are not aligned with crosswalks make it more difficult for people with vision disabilities to orient properly to the crossing. The initial alignment at the start of the crossing can affect how likely a person with a vision disability is likely to stay within the crosswalk through the duration of the crossing. Curb ramps not aligned with crosswalks also require people using wheelchairs to reorient themselves at the bottom of curb ramps, thus increasing the time they may spend within the crosswalk.

Recommended Guidance

Context

- Directional curb ramps should be considered as the preferred design at all conventional crossing locations.
- On flush streets, there are no curb ramps but directional approaches to the crossings are best practice. An alignment cue can be provided by a vertical curb around planter islands and corner islands.

Key Dimensions and Characteristics

- Directional curb ramps should comply with PROWAG.

Application

- The ramp should be oriented so that the running slope/approach is aligned with the crosswalk.
- The grade breaks at the top and the bottom of the ramp should be perpendicular to the direction of the ramp run.
- The grade breaks should not be so abrupt that a wheelchair user might tip forward or backward.

- If the directional curb ramp has a triangular area at the bottom, this area should slope toward the flowline at 2.0% maximum. These triangular landing areas are necessary when the ramp is placed along a corner radius but is not perpendicular to the curbline. (Figure 11)
- To provide an additional alignment cue, consideration should be given to whether a vertical curb can be incorporated into the design along one or both sides of the ramp in lieu of a flared side. Such a design requires that the area behind the vertical curb is not a walkable surface, e.g., a landscaped area.
- In cases where the ramp is within a walkable area where pedestrians are crossing the ramp perpendicular to the slope of the ramp, flared sides should be provided.

Detectable Warning Surface

The detectable warning surface is a type of TWSI. Detectable warning surfaces are used to indicate the interface between a sidewalk and a travel lane or railroad crossing, locations with vertical drops (e.g. a transit platform), or a decision point.

Concerns About Existing Approaches

People with vision disabilities report the following challenges related to detectable warning surfaces:

- Curb ramps without detectable warning surfaces
- Wrap-around depressed curbs with detectable warnings at the crossing locations but no detectable edge or warning surface in other locations, leaving gaps where a person with a vision disability might unintentionally walk into the intersection (Figure 12)
- Detectable warning surfaces that don't contrast visually with the adjacent surfaces.
- Detectable warning surfaces that need repairs, particularly in locations where vehicles have driven over them.



Figure 12: Example of a wrap-around depressed curb in Montgomery County. There are detectable warning surfaces at the crosswalk but not in other parts of the depressed curb.

Recommended Guidance

Context

- Detectable warning surfaces should be installed in the following contexts per PROWAG:
 - Curb ramps
 - Blended transitions
 - Pedestrian refuge islands
 - Pedestrian at-grade rail crossings not located within a street or highway
 - Rail platforms not protected by screens or guards

- Bus platforms not protected by screens or guards (where the height of the curb is greater than 6"⁴)
- Rail boarding and alighting areas at street or sidewalk level not protected by a screens or guards
- In addition, detectable warning surfaces may be used in conjunction with the [detectable guidance surface](#), as prescribed below.

Key Dimensions and Characteristics

- The physical dimensions of the detectable warning surface should comply with PROWAG for conventional applications.
- The luminance contrast between the detectable warning surface and the adjacent surface must be 50% or greater using the Michelson contrast formula.

Application

- When used on curb ramps or blended transitions, the detectable warning surface must extend across the entire area of a curb ramp or blended transition that is level with the street.
- Detectable warning surfaces shall not be used to provide wayfinding for pedestrians with vision disabilities.
- Detectable warning surfaces shall not be used as a method for indicating the edge of the circulatory roadway at roundabouts.
- Detectable warning surfaces shall not be used as an edge treatment to indicate the boundary between the comfort zone and the shared zone of a shared space.
- Detectable warning surfaces shall not be used at crossings of residential and lower volume driveways.
- Detectable warnings surfaces should be considered at crossings of higher volume commercial driveways that are configured like street intersections (e.g., no driveway apron).

Michelson Contrast

Michelson contrast is commonly used for patterns where both bright and dark features are equivalent and take up similar fractions of the area. The Michelson contrast formula is:

$$\frac{L_{max} - L_{min}}{L_{max} + L_{min}}$$

L_{max} is the value of luminance on the darker surface. L_{min} is the value of luminance on the lighter surface.

Maintenance

- Detectable warning surfaces should be kept clear of snow, ice, and debris.
- Detectable warning surfaces should be replaced when damaged or when the luminance contrast between the surface and the adjacent surface is less than 50% using the Michelson contrast formula.

Considerations

- Although detectable warning surfaces are often used at detectable guidance surface junctions and termini in other countries, there is currently no federal or State of Maryland guidance on this use. However, current federal and state guidance documents do not limit nor prohibit the use of detectable warning surfaces as detectable guidance surface junctions and termini. See

⁴ [Transit Curbs | National Association of City Transportation Officials \(nacto.org\)](https://www.nacto.org)

[Junctions, Turns, and Termini](#) in the section on detectable guidance surfaces for more information on this use.

- A joint project of the Transit Cooperative Research Program and the National Cooperative Highway Research Program (TCRP B-46) is currently investigating surfaces that can be used as detectable guidance surface junctions. The project will result in publication of *A Guide to Tactile Wayfinding in Transportation Settings for Travelers Who Are Blind or Visually Impaired*. The guide was expected to be published in fall 2021; however, the timeline for delivery is now uncertain due to pandemic-related delays.

Detectable Guidance Surface (Guidance Strips)

The detectable guidance surface (Figure 13) is a type of TWSI used to indicate the direction of travel or, when placed perpendicular to the path of travel, a point of interest, such as a midblock crossing, bus stop, or access to an important building, destination, or information kiosk.

In other countries, people with vision disabilities are taught to walk on top of this surface. However, in the United States, people with vision disabilities are less familiar with detectable guidance surfaces and may be more likely to walk to the side. This behavior will likely change with familiarity, practice, and/or training.



Figure 13: Example of a detectable guidance surface.

This guide uses the term “guidance strip” to refer to detectable guidance surfaces, because detectable guidance surfaces are typically arranged in a line.

For more information on the detectable guidance surface, see:

ISO Standard 23599, Assistive Products for Blind and Vision-Impaired Persons -- Tactile Walking Surface Indicators

FHWA, Accessible Shared Streets: Notable Practices and Considerations for Accommodating Pedestrians with Vision Disabilities

Guidebook for the Proper Installation of Tactile Ground Surface Indicators (Braille Blocks): Common Installation Errors

Standards Australia/Standards New Zealand, Design for access and mobility – Part 4.1: Means to assist the orientation of people with vision impairment: Tactile ground surface indicators

CNIB Foundation, Clearing Our Path: Tactile Walking Surface Indicators

Concerns About Existing Approaches

People with vision disabilities report the following concerns related to guidance strips:

- Trouble navigating in situations where guidance strips might help, e.g., finding midblock crossings, bus stops, and important buildings, navigating transit stations and complex street environments
- Lack of familiarity with guidance strips and their purpose
- Surface mounted guidance strips can be tripping hazards
- Guidance strips may be challenging for wheelchair users to cross
- Guidance strips that are not reliably detectable underfoot, e.g., due to stepping over the surface when the surface is too narrow for the context or peripheral neuropathy

Recommended Guidance

Context

- Guidance strips should be prioritized for situations where other available navigational cues, such as curbs, building faces, and landscaping, do not provide sufficient information for people with vision disabilities to reliably navigate to their intended destination.
- Guidance strips should be prioritized to help people with vision disabilities navigate:
 - To and through high-capacity transit stations.
 - To midblock crossings.
 - To bus stops.
 - To the crosswalk at skewed intersections, intersections with curb extensions, or intersections with large corner radii.
 - Along and across shared spaces and flush streets.
 - Complex intersections, such as roundabouts and intersections with channelized turn lanes.
 - To important buildings and destinations.
 - Through large open plazas or spaces (e.g. at airports, bus stations).
 - To APS, accessible signage, public transportation ticket sales booths, and other points of interest.



Figure 14: Example of guidance strips used to direct pedestrians with vision disabilities to a floating bus stop in the Netherlands.

- Guidance strips must also comply with ADA requirements for vertical changes in level and horizontal openings.
- Guidance strips must be slip-resistant.
- The luminance contrast between the guidance strip and the adjacent surface must be 50% or greater using the Michelson contrast formula.
- The height, width, spacing, and length of guidance surface's raised bars should comply with the guidance provided by the International Standards Organization in ISO 23599 *Assistive Products for Blind and Vision-Impaired Persons—Tactile Walking Surface Indicators (2019)* (Figure 15). This guidance is based on international research regarding the detectability of guidance surfaces underfoot and with a long white cane.

W (in)	S (in)
0.67	2.25 - 3
0.8	2.35 - 3.15
1	2.55 - 3.25
1.2	2.75 - 3.35

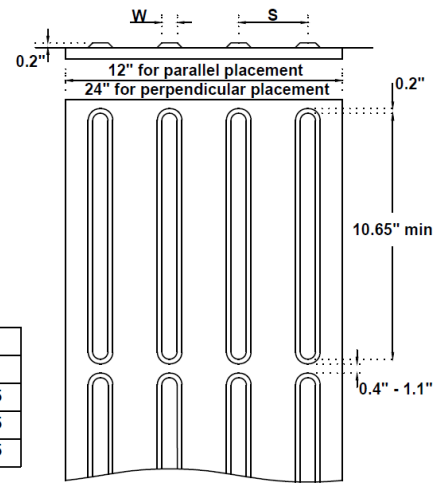

Figure 15: ISO guidance on guidance surface dimensions.
(Source: Adapted from ISO 23599)

- When guidance strips need to be detected by people with vision disabilities approaching perpendicular to the guidance strip, they should be a minimum of 24" in depth measured along the path of travel.
- When guidance strips need only be detected by people with vision disabilities walking parallel to the guidance strip, they should be a minimum of 12" depth.
- Guidance strip widths at intersection corners must consider that pedestrians can approach from multiple directions and should use the wider widths where people with vision disabilities walk both parallel and perpendicular to the guidance strips.
- Guidance strips should be cast in place or recessed rather than surface-mounted for greater durability and to avoid creating a tripping hazard.
- When guidance surfaces are installed as pre-manufactured panels or surface-mounted onto an existing ground or floor surface, the panels should have beveled edges. The base surface of the panels should be no more than 1/10 in (3 mm) above the existing surface.

Application

Placement within Pedestrian Access Route

- Guidance strips should be installed within an ADA-compliant pedestrian access route that is kept free of permanent or temporary obstructions, such as utility poles, bicycle racks, tree limbs, open doors, sandwich boards, outdoor seating, street vendors, etc. Guidance strips should not zig zag back and forth unnecessarily, contain confusing breaks (e.g., at a manhole cover), or be used for aesthetic purposes.
- When guidance strips are installed on a sidewalk or in an area of a shared space that is intended for the exclusive use of pedestrians, they should generally be placed towards the side of the pedestrian access route closest to the street or shared zone. This is the side of the pedestrian access route that is most consistent (e.g., it is not affected by different building setbacks). Also ,

placing guidance strips on this side minimizes impacts on wheelchair users, who can travel through the comfort zone and enter a building without having to cross a guidance strip.

- If there is a furniture (or buffer) zone between the pedestrian access route and a vehicular lane, bicycle lane, or shared zone, then the width between the guidance strip and the edge of the pedestrian access route closest to the furniture zone should be no less than 24" (12" in constrained rights of way).
- If there isn't a furniture (or buffer) zone between the pedestrian access route and a vehicular lane, bicycle lane, or shared zone, then, in addition to the offset recommended in the previous

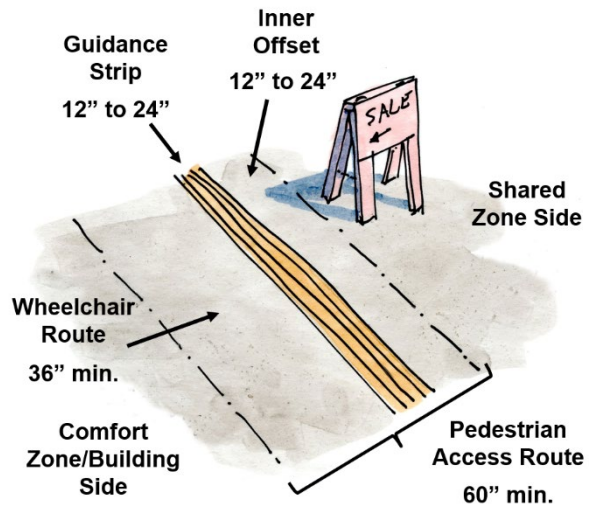

Figure 16: Ideal placement of guidance strip when there is a furniture (or buffer) zone between the pedestrian access route and a vehicular lane, bicycle lane, or shared zone.

bullet, there should either be a detectable curb edge or a delineator strip that is ideally 36" wide (24" minimum) in a flush or shared space design.

- Guidance strips should be installed in a way that minimizes impacts on pedestrians who use wheelchairs and other mobility devices. Designers should seek to maintain a minimum width of 3' within the pedestrian access route, on the building side of the guidance strip, that has a smooth surface and is unobstructed by guidance strips (except where guidance strips perpendicular to the pedestrian path of travel cross over the pedestrian access route).
- Guidance strips should not be installed within a pedestrian access route that is less than 5' wide.

Do Not Use as an Edge Treatment

- Guidance strips should not be used to define the edge between pedestrian space and vehicular lanes and should be offset as noted above. Guidance strips should also not be used to define the edge between a pedestrian comfort zone and the shared zone in a shared space design.

Coordination with Pedestrian Pushbuttons and Accessible Signage

- If a guidance strip is used to guide people with vision disabilities to a signalized intersection or signalized midblock crosswalk, its placement should be coordinated with the location of the APS pushbutton so that people with vision disabilities who follow the guidance strip will also be guided to within easy reach the pushbutton.
- Guidance strips should also be coordinated with accessible signage, so that people with vision disabilities following the strip are led to a location where they can access the signage.

Junctions, Turns, and Termini

- Where guidance strips cross, they should cross at angles as close to 90 degrees as feasible. The intersection of multiple guidance strips should be marked by a detectable warning surface that is 24" to 36" on each side, depending on the width of the intersecting guidance strips (24" if the widest intersecting guidance strip is 12" wide, 36" if the widest intersecting guidance strip is 24" wide).
- Where guidance strips turn, the appropriate treatment depends on the angle of the turn. If the angle of the turn is 30 degrees or more, the turn should be marked by a detectable warning surface. If the angle of the turn is less than 30 degrees, no detectable warning surface should be used. Detectable warning surfaces signal to people with vision disabilities that there is a decision point. Frequent or unnecessary stops and decision points may be inconvenient and frustrating. (Figure 17)
- Where possible, each end of a guidance strip should terminate at a detectable warning surface.

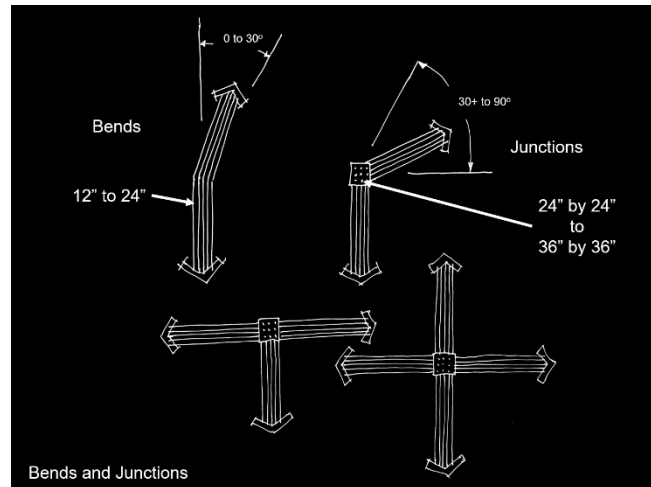

Figure 17: Illustration showing when and how to apply detectable warning surfaces at guidance strip junctions and turns.

Maintenance

- Guidance strips should be installed in a way that prevents the edges from lifting. The application should be durable enough to withstand expected use, including occasional motor vehicle traffic or snowplows if used in shared spaces where motor vehicle traffic and/or snowplows will be present.
- Guidance strips should be kept clear of snow, ice, leaves, and debris.
- Guidance strips should be replaced when damaged or when the luminance contrast between the surface and the adjacent surface is less than 50% using the Michelson contrast formula.
- Adjacent business and property owners should be educated about the purpose of guidance strips and why they and adjacent areas must always be kept clear of obstacles.
- Routes with guidance strips should be routinely inspected to identify and address cases where obstacles such as trash cans, sandwich boards, café seating, locked bicycles, and e-scooters impede use of the strips by a person with a vision disability.

Considerations

- Guidance strips are not currently addressed in any guidance documents published by the State of Maryland.
- Federal guidance on the guidance surface is limited to the FHWA publication *Accessible Shared Streets: Best Practices and Considerations for Accommodating Pedestrians with Vision Disabilities*, which includes a list of “notable practices” for the use of guidance surfaces focused on shared space implementation.⁵

⁵ Note that the guidance surface is referred to as a “directional indicator” in FHWA’s *Accessible Shared Streets*.

- The Transit Cooperative Research Program and the National Cooperative Highway Research Program study (TCRP B-46) is currently investigating the use of guidance strips and is expected to publish guidance on their use.



Figure 18: Guidance strips have been installed around the San Francisco Bay Area to help people with vision disabilities locate and navigate through BART transit stations. The images above are from a transit station in Contra Costa County. The indicators begin on the sidewalk about a block away from the station entrance and define a continuous path from the sidewalk, through the turnstiles, to the escalator and ultimately to the platform.

Tactile Delineator Surface (Delineator Strips)

The tactile delineator surface is a specialized tactile surface used to help people with vision disabilities identify the boundary between pedestrian and vehicular space in situations where a detectable edge, such as a curb, is not present. Example situations include shared spaces, flush streets, parallel flush pedestrian and bicycle facilities (e.g., a sidewalk-level separated bike lane next to a sidewalk), and crosswalks.

This guide uses the term “delineator strip” to refer to the tactile delineator surface, because the delineator strip surface is typically arranged in a line parallel with the travel way, separated bicycle facility, or shared zone.

This guide uses the term “crosswalk delineator strip” to refer to a type of delineator strip that is applied adjacent to and along both sides of a crosswalk to help people with vision disabilities identify where the edge of the crosswalk is located and reduce the potential for them to unintentionally veer outside the crosswalk.

Concerns About Existing Approaches

People with vision disabilities report the following concerns related to delineator strips:

- Trouble navigating in situations where delineator strips might help, e.g., crosswalks that are long or skewed, shared spaces, flush streets, parallel flush pedestrian and bicycle facilities
- Lack of familiarity with delineator strips

Recommended Guidance

Context

- Delineator strips should be considered for the following designs:
 - Flush streets
 - Shared spaces
 - Parallel flush pedestrian and bicycle facilities
- Crosswalk delineator strips may be used to define the edges of crosswalks, particularly when crosswalks are long (over 40' in length), at skewed intersections, or part of an intersection design that people with vision disabilities are likely to have difficulty navigating without veering outside of the crosswalk due to the lack of traffic sounds parallel to their path of travel, such as a T-intersection, roundabout, or intersection with channelized turn lane.

Key Dimensions and Characteristics

- Delineator strips should be reliably detectable and distinguishable underfoot and with a long white cane.

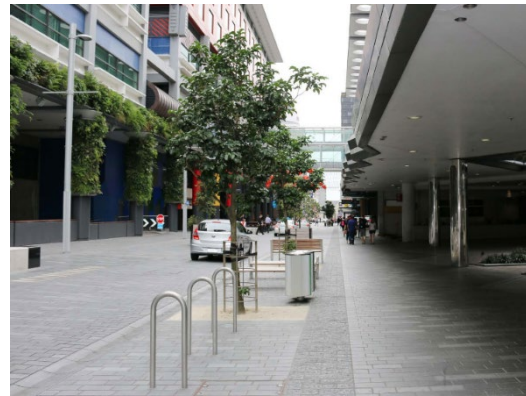

Figure 19: In New Zealand delineator strips (center of photo) are placed between the pedestrian access route and the furniture zone in shared space designs. This toolkit recommends that in a shared street design delineator strips be placed at the edge of the shared zone used by vehicular traffic and, unlike what is shown here, that they contrast visually with adjacent surfaces.

- When used to delineate pedestrian space from vehicular space in flush street, shared space, or parallel flush pedestrian and bicycle facility designs, delineator strips should be made of a rough-cut cobble that contrasts in color with adjacent surfaces.
- When used as a crosswalk edge, delineator strips should be made of a cobble that is imbedded in concrete so that it is durable enough to withstand expected motor vehicle traffic and snowplows and that contrasts in color with adjacent surfaces. Concrete headers should be installed on both sides of the crosswalk delineator strips to enhance durability.
- Delineator strips in shared spaces must be traversable by a person in a wheelchair.
- Delineator strips must not create a tripping hazard and must be slip resistant.
- Surfaces adjacent to delineator strips should have a contrasting color and texture to enhance the detectability of the delineator strips.
- When used to indicate the boundary between parallel flush pedestrian and bicycle facilities, delineator strips should ideally be 24" wide, although a minimum 12" wide delineator strip is acceptable if the pedestrian path of travel is parallel to the bicycle facility.
- When used to indicate the boundary between parallel flush pedestrian facilities and a shared space or flush street design, delineator strips should ideally be 36" wide (minimum of 24" wide).
- Crosswalk delineator strips should be a minimum of 12" wide.
- When used in shared street, flush street, and crosswalk delineator contexts, delineator strips must be designed to be traversable by bicyclists.

Important

Although this delineator strip surface was tested in New Zealand and determined to be both detectable by people with vision disabilities and accessible to people in wheelchairs, it is recommended that the County confirm detectability and accessibility with County stakeholders before implementing broadly, e.g., by installing it at a test or pilot location and inviting stakeholders for feedback.

Application

Shared Spaces and Flush Streets

- When used as part of a shared space design, delineator strips should be placed between the shared zone and comfort zone of the shared space.
- When used as part of a flush street design, delineator strips should be placed at the edge of the travel way.

Parallel Flush Pedestrian and Bicycle Facilities

- When used as part of a parallel flush pedestrian and bicycle facility design, delineator strips can be placed between the pedestrian and bicycle facility.

Crosswalks

- When used as part of a crosswalk design, delineator strips should:
 - Be placed adjacent to but outside of the crosswalk markings.
 - Start and end as close as possible to the edge of pedestrian space while allowing for drainage.
 - Be durable enough to withstand expected motor vehicle traffic and snowplows.
 - Be designed to be traversable by bicyclists.

Don't Use for Other Purposes

- Delineator strips should not be used for purposes other than those described above. For guidance along the pedestrian access route and to specific locations, mid-block crossings, etc., use [guidance strips](#).

Maintenance

- Delineator strips should be kept clear of snow and debris.

Considerations

- Delineator strips are not currently addressed in any guidance documents published by the State of Maryland or the federal government. However, current federal and state guidance documents do not limit the use of delineator strip surfaces.
- The recommendations in this document represent best practices from around the world and would represent a significant advancement in accessibility in Maryland.



Figure 20: The City of Seattle used guidance strips to help people with vision disabilities maintain their orientation through this crosswalk at skewed intersections. This toolkit recommends crosswalk delineator strips (rather than guidance strips) in this situation, since some people with vision disabilities interact with guidance strips by walking on top of them. This toolkit also recommends that crosswalk delineator strips be of a contrasting color to adjacent surfaces. (Source: Dongho Chang)

Visual Cues

Most people with vision disabilities have some sight. Visual cues take advantage of the sight they have to provide useful navigational information.

People with vision disabilities who are partially sighted or have low vision rely heavily on visual cues. Visual cues are also important for people who are legally blind but have some sight. However, people who are completely blind cannot use visual cues. Consequently, for a street to be accessible to the full spectrum of people with vision disabilities, it must also include [tactile cues](#) and [audible cues](#).

Types of Visual Cues

Visual cues include:

- Contrasting colors and shades.
- Familiar patterns.
- Lighting.

Contrasting Colors and Shades

Contrasting colors and shades can be extremely helpful navigational cues for people with vision disabilities. In a typical street environment, the sidewalk is made of concrete and the street is made of asphalt. The light gray color of the concrete contrasts with the adjacent landscaping or street color in a way that makes the sidewalk easier to follow. Contrasting colors can be similarly effective in other contexts, such as shared spaces, flush streets, and parallel flush pedestrian and bicycle facilities to help distinguish the pedestrian access route or differentiate between pedestrian and vehicular space. However, it's important to remember that some people are colorblind. Red and black may look very different to a person with full color vision but appear very similar to someone who is colorblind. Taking a photo of surfaces and displaying it in black and white can be a helpful way to determine whether the surfaces may contrast visually for a person who is colorblind (i.e., different shades).

Familiar Patterns

Familiar patterns can also be helpful to people with vision disabilities for navigation. For example, the familiar pattern of crosswalk markings can help people with vision disabilities distinguish it from other street areas. Familiar patterns can also lead to confusion if they are mimicked by other surfaces. (Figure 21)



Figure 21: People with low vision sometimes misinterpret a pattern of parallel light and dark colored bars like this as steps. The bars in this photo, taken near the main entrance to the Silver Spring Public Library, are purely decorative and serve no navigational purpose.

Lighting

Good lighting is critical to the effectiveness of visual cues, and is a visual cue in its own right since differences in lighting level can indicate to people with vision disabilities that they are moving from one type of space to another or arriving at a particular location, such as an entry. [Lighting](#) is discussed in greater detail in the sections below.

Concerns About Existing Approaches

People with vision disabilities report the following challenges with visual cues:

- Difficulty following the pedestrian access route due to the lack of color contrast between it and adjacent surfaces
- Failure to see obstacles due to lack of color contrast
- Tripping due to a failure to see curbs, steps, and other abrupt changes in elevation due to a lack of color contrast
- Tripping or loss of balance due to misinterpreting a series of light and dark bars perpendicular to the pedestrian path of travel as stairs
- Decorative patterns in the pedestrian access route creating confusion
- Abrupt changes in lighting level creating the illusion of a barrier or obscuring the visibility of barriers, curbs, steps, or other abrupt changes

Needs specific to crosswalk visibility and lighting are discussed in [high-visibility crosswalks](#) and [lighting](#) sections below.

Recommended Guidance

- The pedestrian access route should contrast visually with adjacent spaces and should generally be of a continuous and consistent color. Additional guidance regarding [pedestrian access routes](#) is provided below.
- TWSIs should contrast visually with the underlying surface. Additional guidance regarding [TWSI's](#) is provided above.
- The travel way should generally contrast visually with the delineator strip on flush streets.
- Changes in elevation, including curbs and wheel stops, should contrast visually with adjacent surfaces. Consider applying reflective paint to these locations, so they show up better in dark conditions when light is reflected off them.

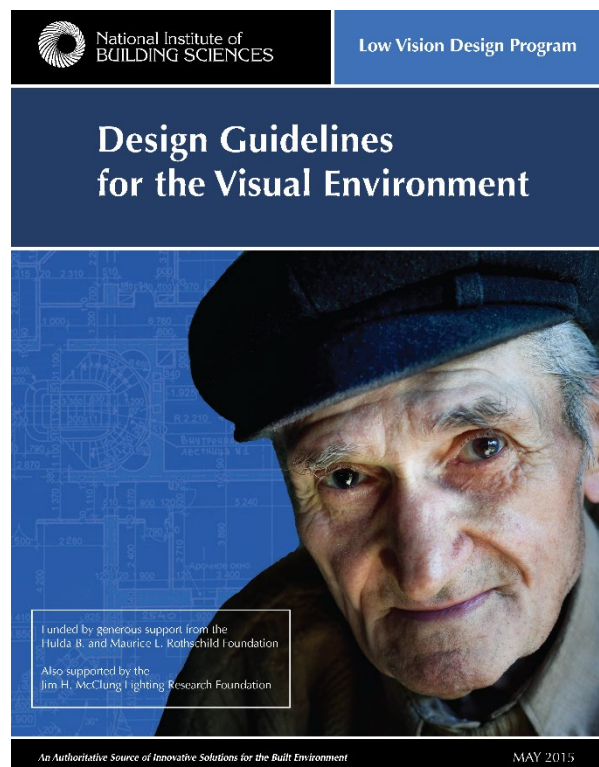

Figure 22: The National Institute of Building Sciences has developed performance criteria for surfaces and materials used in exterior spaces for pedestrians with low vision, including light reflectance value, minimum contrast, and maximum sheen. See Table 4D-2 in the guide.

- Vertical elements that are located within a pedestrian circulation path, ⁶ such as fences, bollards, and light poles, should contrast visually with the surface of the pedestrian circulation path and with other background colors in the public right of way.
- The selection of contrasting colors should consider whether people who are colorblind perceive the colors as contrasting.
- A series light and dark bars arranged perpendicular to the pedestrian path of travel on a pedestrian access route should be avoided, since this pattern may be misperceived by some people with vision disabilities as stairs.
- Patterns and colors that are used in the pedestrian access route should be used consistently within a block or section of roadway.
- Pedestrian routes should be provided with adequate, even lighting levels. Additional guidance on [lighting](#) is provided below.

High-Visibility Crosswalk Markings

High-visibility crosswalk markings come in a range of styles including continental, ladder, and zebra. They are easier for both drivers and pedestrians with low vision to see.

Concerns About Existing Approaches

People with vision disabilities report the following challenges with crosswalk markings:

- Difficulty maintaining the correct heading in the crosswalk due to faded crosswalk markings, lack of edge lines parallel to the path of pedestrian travel, long crossings, and/or adjacent surfaces that do contrast visually with the markings

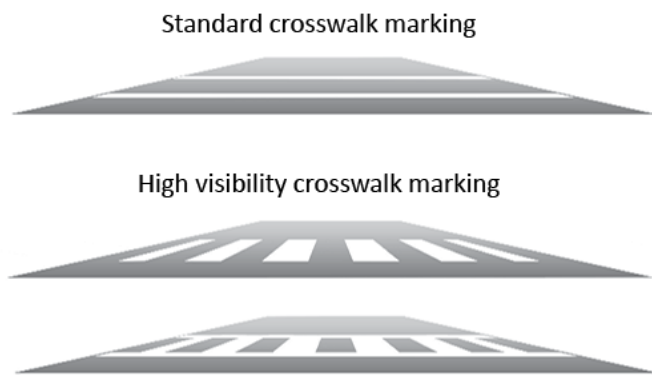

Figure 23: Examples of standard and high-visibility crosswalk markings

Recommended Guidance

Context

High-visibility crosswalk markings should be installed at:

- Signalized intersections.
- Intersections with relatively high pedestrian and/or motor vehicle volumes.
- Midblock crossings.
- Skewed or long crossings (over 40').
- Locations where there is a higher concentration of people with vision disabilities.

Application

- The ladder-style high-visibility crosswalk marking should be preferred. Many people with low vision favor the ladder-style marking, because the transverse edge lines help them maintain the

⁶ PROWAG defines pedestrian circulation path as “a prepared exterior or interior surface provided for pedestrian travel in the public right-of-way.”

correct heading in the crosswalk.⁷ Studies have also demonstrated that ladder-style markings are the most visible to drivers and have the greatest impact on driver behavior.⁸

- At stop controlled and signalized intersection, high-visibility crosswalk markings should be paired with stop bars and appropriate signing to encourage drivers to stop in advance of the crosswalk. At uncontrolled multilane crossings, the stop bar should be set back 20 to 50 feet from the crosswalk to avoid multiple threat crashes.
- Roadway surfaces adjacent to and within high-visibility crosswalks should contrast visually with the white crosswalk markings.

Maintenance

- High-visibility crosswalk markings should be inspected regularly.
- Markings that are damaged or faded should be replaced when they are near or at minimum retro reflectivity levels, or when they are deemed by inspection to be damaged and not effective at communicating to drivers and pedestrians, including pedestrians with low vision.

Lighting

Lighting enables pedestrians to navigate streets in dark or low-light conditions, allowing them to see, recognize, and react to obstacles, read street signs, and recognize the facial expressions and movements of fellow travelers. For people with vision disabilities, the task of discerning wayfinding cues and avoiding hazards can be especially difficult in dark, low light, or high glare conditions.

Effective street lighting for navigation depends on the following factors:

- Illuminance—the amount of light reaching a surface for pedestrians, measured in foot-candles
- Luminance—reflected light, or brightness, measured in candelas per square inch
- Contrast (or Luminance Contrast)—the difference between luminance of an object and its immediate background or adjacent object, e.g., difference in light reflected from detectable surfaces and adjacent sidewalk
- Uniformity—the evenness of light, which must be balanced with contrast so that objects in the visual field don't all look the same
- Glare—brightness that causes discomfort or loss of visual performance or visibility.⁹

Light levels for ease of pedestrian navigation are typically calculated with lighting software. Inputs include the design parameters of the area to be lit, the activity level of the area (high use area vs. lower use area), and the type of available luminaire.

Needs Not Being Met by Existing Approaches

People with vision disabilities report the following challenges with lighting:

- Lack of lighting in general, with midblock crossings specifically called out as locations where more lighting is needed
- Lighting that is uneven, creating a series of dark and light spaces

⁷ [NCHRP-03-78b Final-Guidelines.pdf \(ncsu.edu\)](#)

⁸ [HVC \(ny.gov\), http://www.bv.transports.gouv.qc.ca/mono/1068376.pdf](#)

⁹ City and County of Denver Street Lighting Design Guidelines and Details. Accessed via https://www.denvergov.org/content/dam/denvergov/Portals/705/documents/guidelines/PWES-012.2-Street_Lighting_Design_Guidelines.pdf

- Lighting that is too bright or glaring

Recommended Guidance

Context

- Lighting should be provided to illuminate the pedestrian access route, crosswalks, transit stops, stairs, and ramps.
- Pedestrian lighting should be provided on corridors with high pedestrian volumes or where a pedestrian safety and access need has been identified that requires supplemental lighting focused on pedestrian areas. Pedestrian lighting is lighting whose primary function is to illuminate sidewalks and other pedestrian areas,
- Visual information that is important for wayfinding should be illuminated so it can be seen in dark or low-light conditions. This includes, but is not limited to, signs, maps, and TWSIs.

Lighting Levels

- Pedestrian access routes should be illuminated at a minimum average illumination level of 1.0 Foot-candles.¹⁰
- Pedestrian access routes should have a uniformity ratio of 3:1.¹¹
- If lighting levels change, e.g. from light to dark, a gradual transition should be provided to prevent temporary blindness.

Pedestrian-Scale Lighting

- Pedestrian-scale light should:
 - Be even and consistent in quality.
 - Avoid the creation of strong shadows, dark areas, glare, or hot spots.
- Pedestrian-scale lighting should be 9-14 feet tall.
- Since pedestrian-scale light poles are shorter than street lighting, they should be placed at more frequent intervals. The exact frequency depends on the height of the poles and other factors.
- A light loss factor (LLF) should be included to account for drops in light levels over time due to wear, dirt, and aging equipment.



Figure 24: Example of pedestrian-scale lighting in Seattle. (Source: Dongho Chang)

Crosswalk Lighting

- Per FHWA guidance, luminaires should be located at least 10 feet from the crosswalk and positioned to light the side of the pedestrian facing the approaching vehicle.

¹⁰ Design Standards and Guidelines, City of Los Angeles Department of Public Works Bureau of Street Lighting. <https://bsl.lacity.org/downloads/business/BSLDesignStandardsAndGuidelines0507Web.pdf>

¹¹ Design Guidelines for the Visual Environment--Low Vision Design Program. [Design Guidelines for the Visual Environment | National Institute of Building Sciences \(nibs.org\)](https://www.nibs.org/design-guidelines-for-the-visual-environment)

Considerations

- Consider enhancing pavement, building, and other edges used for wayfinding with lighting or photoluminescent material.
- Trees, signs, and other vertical elements should not interfere with the output from light poles.
- Care should be taken to avoid lighting vertical objects from the front at the same level as they are lighted from the back, which creates a neutral vertical contrast and makes it difficult to distinguish the vertical element from its background.
- When positioning lights, care should be taken to avoid light trespass and pollution.

Audible Cues

People with vision disabilities can use their sense of hearing to take advantage of audible cues to navigate. People who are legally blind or blind often rely heavily on audible cues. People with low vision tend to focus less on audible cues than on visual cues, while people who are deafblind generally cannot take advantage of audible cues. Consequently, for a street to be accessible to the broad spectrum of people with vision disabilities, it must also include [tactile cues](#) and [visual cues](#).

Types of Audible Cues

Audible cues include:

- Traffic sounds, including the sounds of motor vehicle engines and tires.
- The sounds of other pedestrians.
- Differences in the sounds surfaces make when tapped on by a long white cane.
- Differences in the way sounds echo off objects in the environment.
- Distinctive sounds, such as the sound of a fountain.
- Accessible pedestrian signals (APS).
- Audible messaging.

Traffic Sounds

Traffic sounds are a particularly important navigational cue for people with vision disabilities. People with vision disabilities use the sounds of parallel traffic as a cue for maintaining alignment in crosswalks and on sidewalks, parallel traffic surging forward as a cue for when to cross if APS are not provided, and perpendicular traffic as a cue for arriving at an intersection.

Traffic sounds may become a less reliable audible cue in the future due to the electrification of the motor vehicle fleet. Although NHTSA now requires electric and hybrid electric vehicles to emit a noise when traveling below 18 mph¹², electric and hybrid electric vehicles are still generally quieter than vehicles with internal combustion engines and may be more difficult for people with vision disabilities to detect increasing the importance of providing other alternative cues.

Concerns About Existing Approaches

People with vision disabilities report the following challenges with audible cues:

- Difficulty hearing traffic sounds, APS, and other important audible cues due to ambient noise.
- Difficulty hearing bicycles, scooters, and electric vehicles.
- Difficulty hearing and/or interpreting traffic sounds at certain types of crossings, including channelized turn lane crossings, T-intersection crossings, bike lane crossings, and roundabout crossings.

¹² [Federal Register :: Federal Motor Vehicle Safety Standard No. 141, Minimum Sound Requirements for Hybrid and Electric Vehicles](#)

- Difficulty navigating along and across pedestrianized streets and shared spaces due to the lack of traffic sounds.

Recommended Guidance

- APS should be installed at all signalized crossings with a pedestrian signal and all pedestrian hybrid beacon crossings. Additional guidance on APS is provided below.
- Audible information devices should be installed at all crossings supported by rectangular rapid flashing beacons or warning beacons that are triggered by a pedestrian pushbutton or passive pedestrian detection.
- Consideration should be given to how the design and use of a public space may affect the ability of people with vision disabilities to hear audible cues such as traffic noise, APS, and speech messaging. Appropriate adjustments should be made to mitigate potential negative impacts.
- Consideration should be given to making relatively quiet vehicles such as electric cars and bicycles more audible at unsignalized pedestrian crossing locations through the use of technologies such as textured/audible pavement or vehicle detection.
- Consideration should be given to how additional audible cues can be incorporated into a street design to facilitate navigation by people with vision disabilities, including audible messaging or signage and surfaces that make distinctive sounds when tapped on using a white cane.
- Echoey spaces should be avoided. The sound distortion caused by echoey spaces can make it harder for people with vision disabilities to distinguish sounds and determine where they are coming from, which can affect navigation.

Accessible Pedestrian Signals

Accessible pedestrian signals (APS) are devices integrated or affixed to the pedestrian signal poles at pedestrian crossings that provide information about “Walk” and “Don’t Walk” intervals in audible and tactile formats to assist pedestrians who are blind or have low vision.¹³ APS can be configured to provide information about street names and intersection geometry with speech messages, braille, raised print, maps, and diagrams. APS can also be configured to provide audible beacons that can help people with vision disabilities maintain their alignment while crossing long crosswalks.



Figure 25: Accessible Pedestrian Signal with raised arrow button.

¹³ “Proposed Accessibility Guidelines for Pedestrian Facilities in the Public Right-of-Way”, Advisory R209, United States Access Board. [access-board.gov/files/prowag/PROW-SUP-SNPRM-2013.pdf](https://www.access-board.gov/files/prowag/PROW-SUP-SNPRM-2013.pdf)

Concerns About Existing Approaches

People with vision disabilities report the following challenges with APS:

- Difficulty hearing APS locator tones above ambient background noise
- APS that are too loud
- APS pushbuttons that are not in predictable locations
- APS pushbuttons that are too far from the crosswalk
- APS pushbuttons that are too low, e.g., difficult to reach for a person navigating with a guide dog (Figure 26)
- APS pushbuttons that are difficult to reach from a wheelchair (Figure 27)
- APS that are malfunctioning
- Tactile arrows on APS pushbuttons that are not aligned with the crosswalk



Figure 26: Person with guide dog having difficulty reaching an APS pushbutton that is too low.



Figure 27: Person in wheelchair can't reach APS pushbutton button due to large concrete base.

Recommended Guidance

Context

- Pedestrian signal heads should be provided for all crosswalks/pedestrian street crossings that are supported by a traffic control signal or pedestrian hybrid beacon.
- Where pedestrian signals are provided, they should include APS. Audible information devices should also be installed at all RRFB-supported crossings.
- APS are required at all newly constructed or reconstructed intersections where pedestrian signals are installed.

- Existing pedestrian signals should include APS when the signal controller and software are altered, or the signal head is replaced.
- APS are required for all signals that incorporate a leading pedestrian interval, protected left turn, or exclusive pedestrian phase.
- APS are required on median islands if the pedestrian clearance time is sufficient only to cross from the curb or shoulder to a median that is at least 6' wide.
- APS are required for each multilane segment of a roundabout or channelized turn pedestrian crossing, including on the splitter island (roundabouts) or for the turn lane crossing (channelized turn lanes), where applicable.¹⁴
- The following types of intersections should be prioritized for APS retrofits:
 - T-intersections
 - Intersections with large turning radii or curb extensions
 - Intersections with long crosswalks (over 40')
 - Skewed intersections
 - Intersections with channelized turn lanes
 - Roundabouts
 - Other complex intersections, e.g., intersections where more than two streets intersect-
- APS should be installed upon request along a specific route of travel for an individual or group of individuals who are blind or have low vision.

Application

- APS must comply with the MUTCD and should comply with PROWAG.

Location and Spacing

- APS pushbuttons must be located:
 - Lateral placement--Between the edge of the crosswalk line (no less than 5 feet) and the side of the curb ramp.
 - Longitudinal placement--Between 1.5 and 6 feet from the edge of the curb ramp, shoulder, or pavement.
- When the crossing is served by a ramp, the pushbutton should generally be placed at the top of the ramp on the side that is opposite to parallel traffic. (Figure 28)
- The pushbutton must be within a 10" reach of a level landing area that is at least 4' by 4' and has a level surface (slope less than 2%). This ground space must connect to or overlap the pedestrian access route that connects to the crossing.
- Two pedestrian pushbuttons on a corner should be separated by a distance of at least 10'.

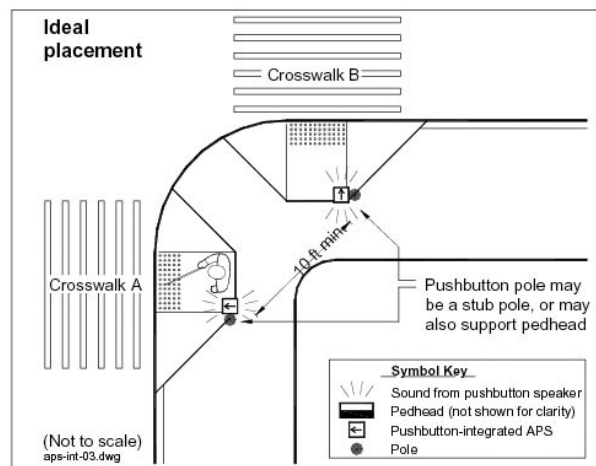

Figure 28: Ideally accessible pedestrian signal pushbuttons are placed at the top of the curb ramp on the side of the ramp opposite parallel traffic. SOURCE: NCHRP: Research Results Digest 278

¹⁴ <https://www.access-board.gov/prowag/chapter-r3-technical-requirements/#r3064-channelized-turn-lanes-at-roundabouts>
<https://www.access-board.gov/prowag/chapter-r3-technical-requirements/#r3065-channelized-turn-lanes-at-other-signalized-intersections>

- Pedestrian clearance times should be calculated based on the time needed for a pedestrian standing at the APS location to travel across the crosswalk to the opposite side of the traveled way.

Pushbutton

- APS pushbuttons should be provided even in cases where pedestrian signals do not require a pushbutton for signal activation to enable people with vision disabilities to take advantage of APS features, such as speech messaging and additional crossing time.
- APS pushbuttons should emit a locator tone that can be heard above ambient background noise. The locator tone should adjust automatically to changes in level of ambient background noise.
- The face of the pushbutton must be aligned parallel to the crosswalk that it serves.
- A tactile arrow that can provide a vibrotactile walk indication should be included on the pushbutton to indicate the direction of the crosswalk it serves.
- The pushbutton shall be mounted at a height of 42" min. to 48" max. above the sidewalk or finished pedestrian surface measured to the midpoint of the button.
- The pushbutton shall be 2" minimum in diameter.
- A maximum of 5 lbs. of pressure shall be required to push the button and activate the pedestrian signal.

Sign

- A sign must be located directly adjacent to the pushbutton to explain the purpose of the device and how to use it. The sign should include both visual and braille information.
- The adjacent sign must clearly indicate the direction of the crosswalk that it serves.
- At complex intersections or crossings, consider providing a tactile map of the intersection near the APS for additional wayfinding guidance. The map should comply with the guidance in PROWAG regarding protruding objects.

Walk Indication

- When the walk signal is activated, the tactile arrow on the pushbutton must vibrate to indicate to people with vision and hearing difficulties that they may cross the intersection.
- When the walk signal is activated an audible signal or speech message must be emitted from the APS to indicate to people with vision disabilities that they may cross.
- The audible signal must dynamically adjust its intensity to be heard above variable levels of ambient background noise.
- If two APS devices are located less than 10' apart, they must use an audible speech message to indicate which walk signal is on.
- For walk signals concurrent with vehicle signals, the speech messages must indicate that a walk signal is on and the street that the crossing applies to.
- For walk signals in an exclusive pedestrian phase (e.g. pedestrian scramble phase), the speech message must indicate that the walk signal is on for all crosswalks.
- If a leading pedestrian interval is implemented, the walk indication must remain on until after parallel traffic is given the green light. Otherwise, people with vision disabilities who wait for the surge of parallel traffic because they are uncertain whether they are hearing the correct APS may have insufficient time to cross.
- When the walk signal is off, a speech message is not required. If it is used, the speech message must begin with the term "wait" to indicate that the "do not walk" signal is active.

Extended Press Pushbutton Features

- Extended presses of the pedestrian pushbutton may be used to activate additional features of the device such as additional walking time, an audible beacon, or additional speech messaging if these additional features were required in the APS specification.
- If an extended press is used, pushes less than one second must activate only the walk signal, while pushes greater than one second must activate the walk signal and additional features.

Audible Beacons

Audible beacons is the use of an audible signal to help pedestrians with vision disabilities maintain the correct heading while in the crosswalk. The signal is usually triggered by an extended press of the APS pushbutton and is broadcast from a speaker on the far side of the crossing directed at the middle of the crosswalk.

- Audible beacons should be considered to help people with vision disabilities orient to cross and maintain the proper heading while crossing in the following situations, as specified by the MUTCD:
 - Crosswalks longer than 70 feet, if not divided by a median where an APS is already installed
 - Skewed crosswalks
 - Intersections with irregular geometry
 - Crosswalks where beacons is requested by an individual with vision disabilities
 - Intersections where the use of beacons is considered beneficial
- Audible beacons are discouraged in the case of channelized turns and split phasing due to the possibility of the signal being heard at the wrong crosswalk.
- The audible beacons loudspeaker should:
 - Be mounted at the far end of the crosswalk within the width of the crosswalk.
 - Be mounted at a height of 7' to 10' above the pavement.
 - Be pointed toward the middle of the associated crosswalk (i.e., the centerline of the road).

Maintenance

- *Accessible Pedestrian Signals – A Guide to Best Practices* suggests conducting a checkup of APS units on a regular basis to avoid malfunctions that could lead to dangerous misinformation for people with vision disabilities. In addition, checkups should be performed after any repairs to intersection signals, poles, controllers and after any changes to signal timing.
- Some common failures need to be checked at every inspection, such as:
 - The raised arrow button may not vibrate correctly or is missing or pointing in the wrong direction.
 - The WALK indications tone or speech may have stopped working or be delayed.
 - Pushbutton may be stuck or malfunctioning.
 - The noise response may not respond correctly, is going slower or not responding at all.
- Locator tones and audible beacons should also be checked every six months. The locator tone may be too slow or have ceased to respond. Wiring, tone level, and orientation should be checked at every inspection.¹⁵
- In addition to regular proactive maintenance, the public should be encouraged to report APS that are not working properly, e.g., by posting a visual and tactile sticker on the APS poles noting to “Call 311 if not working.” It is important to make sure that call center staff are educated in how to verify the exact location and problems encountered.

¹⁵ http://www.apsguide.org/chapter7_maintenance.cfm

Considerations

- Consider installing APS that can be activated using a mobile device in addition to the pushbuttons. These systems can also provide information about intersection geometry, location, WALK, DON'T WALK, directionality, and clearance on a person's smartphone. There are multiple potential advantages, including that they provide a touchless option for APS activation for people with smartphones, which can help prevent the spread of germs and viruses.
- Achieving the appropriate APS volume and signal time of day duration can be challenging. APS volumes have been reported to be a nuisance after peak hour traffic volumes have subsided. While APS may require a high audible volume during peak traffic times, the same volume in the evening can be a nuisance in some locations, such as residential areas.

In Austin, the high audible volumes of APS in the evenings and early mornings were reported as a problem. As a result, the volumes are now automatically lowered between 8:00 p.m. and 5:00 a.m.

Signage

There are many different types of signs. Some signs provide directions, warnings, or other information exclusively for pedestrians. These are called pedestrian signs below. Other signs, such as street name signs, are intended to provide information to both pedestrians, motorists, and other street users. Still other signs identify the routes served by transit stops, which are referred to as transit signs.

Signs can be visual, audible, and tactile, and potentially all three. The most common type of sign is visual. Most people with vision disabilities retain some vision and do not know braille, especially older adults who experience vision loss later in life. Consequently, visual signage can be extremely helpful for wayfinding for many people with vision disabilities when legible.

Concerns About Existing Approaches

People with vision disabilities report the following challenges with signage:

- Difficulty seeing wayfinding signs (font too small, too high up, poorly illuminated)
- Difficulty seeing signs at transit stops from a distance
- Difficulty seeing street signs at crossings
- Lack of tactile and audible signs
- Tactile/Braille signs that are difficult to reach and/or placed in locations where they're unlikely to be found
- Signs that obstructed the pedestrian access route, particularly temporary signs such as sandwich boards or work zone signs

Recommended Guidance

Context

- Pedestrian signs should be provided to effectively guide pedestrians of all abilities to key destinations, including:
 - Transit stations
 - Bus stops
 - Libraries/community resources
 - Hospitals/health care facilities
 - Civic offices
- Pedestrian signs should also be provided to help people with vision disabilities navigate in atypical situations where they might otherwise have difficulty navigating. Examples include complex intersections and floating bus stops.

Key Dimensions and Characteristics

- Pedestrian signs should comply with requirements in [PROWAG R402](#) for protruding objects ([PROWAG R210](#) in the case of shared use paths) and [PROWAG R410](#) for finish and contrast, character height, height from finished surface, stroke thickness, character spacing, and line spacing.
- Pedestrian signs should be provided in formats that are accessible to people with vision disabilities, including visual and tactile formats.^{16,}

Application

Legibility and Font

- The minimum character height on pedestrian signs should comply with the guidance in Table 1.
- The lettering used on pedestrian signs should be in a conventional sans serif font.
- If the lettering is visual only (no tactile properties), then it should be a mix of uppercase and lowercase characters. If the lettering is also meant to be read by touch, then it should be all uppercase.¹⁷
- The lighting and positioning of the signage should be carefully considered to avoid glare under all expected lighting conditions.
- Internally illuminated or backlit signs should be avoided because they may be difficult to see for persons with low vision due to glare.

¹⁶ Requirements for tactile and braille signage can be found in Section 703 of the [USDOJ ADA Standards](#).

¹⁷ [Clearing Our Path: Letter Size, Type Style and Distance](#)

Table 1: Minimum Character Height Guidance from PROWAG R410

Height to Finish Surface From Baseline Character	Horizontal Viewing Distance	Minimum Character Height
3.3 ft to less than or equal 5.8 ft	Less than 6.0 ft	0.625 in
3.3 ft to less than or equal 5.8 ft	6.0 feet and greater	0.625 in, plus .0125 in per 1.0 ft of viewing distance above 6.0 ft.
Greater than 5.8 ft to less than or equal to 10.0 ft	Less than 15.0 ft	2 in
Greater than 5.8 ft to less than or equal to 10.0 ft	15.0 ft and greater	2 in, plus 0.125 in per 1.0 ft of viewing distance above 15.0 ft
Greater than 10.0 ft	Less than 21.0 ft	3 in
Greater than 10.0 ft	21.0 ft and greater	3 in, plus 0.125 in per 1.0 ft of viewing distance above 15.0

Location

- Pedestrian signs should be placed in locations that are consistent, predicable, and accessible to people with vision disabilities.
- Pedestrian signs are particularly important at decision points, points where people with vision disabilities are likely to have trouble navigating (e.g., because of nonconventional street designs), and points where people with vision disabilities and other pedestrians may need reassurance, such as along a lengthy pathway.
- Pedestrian signs should be approachable via a pedestrian access route to a point close enough for pedestrians with a vision disability to access the sign content.
 - Signage that provides only visual information should ideally be placed at eye level (approximately 5' above the walking surface) outside the pedestrian circulation route.¹⁸ However, if the sign protrudes into a pedestrian circulation route more by more than 4", then it must be 7' above the walking surface.
 - Signage that includes tactile information should be placed at a height of 42" min. to 48" max. The face of the sign must be within 10" reach of a 4' by 4' level landing located adjacent to the sign.
 - If information on the sign is provided in an audible format, people with vision disabilities must be able to get close enough to trigger and hear the audible message.
- Pedestrian signs should be legible to people with vision disabilities from various vantage points, and enough space should be provided near the sign to enable multiple people to view it at once.

Other Signage

- Street name signs for cross streets along a pedestrian path of travel should be provided at all intersections. Ideally, these signs are visible to a pedestrian with corrected vision of 20/200 in their best eye without having to cross the street at the intersection.

Considerations

- Consider using distinctive sign pole shapes and colors to provide navigational information. For example, poles with a distinctive shape and color can be used as bus stop markers.

¹⁸ [Clearing Our Path: Location of Signs](#)

- Consider how the location of a sign may impact other roadway users. [Section 2D.50 of the MdMUTCD](#) provides guidance on how to locate pedestrian wayfinding signs to avoid confusing drivers.
- Where possible, consider installing pedestrian signs on the same post as motor vehicle signs to reduce the number of posts along a roadway. This may require round or square posts to allow signs to be installed at different orientations.

Mobile Technologies

A variety of mobile technologies exist to assist people with vision disabilities with wayfinding by identifying routes, detecting obstacles, and determining the location of front doors, bus stops, or other destinations. These technologies fall into two basic categories: stand-alone units and smartphone applications.

Stand-alone units are generally more expensive but do not require the user to own or know how to use a smartphone. A common example of a stand-alone unit with GPS is the [Victor Reader Trek](#) by Humanware, which can provide turn by turn directions to an exact point, indicate nearest address and direction of travel, etc., though other standalone units have been developed over the past 20-years.

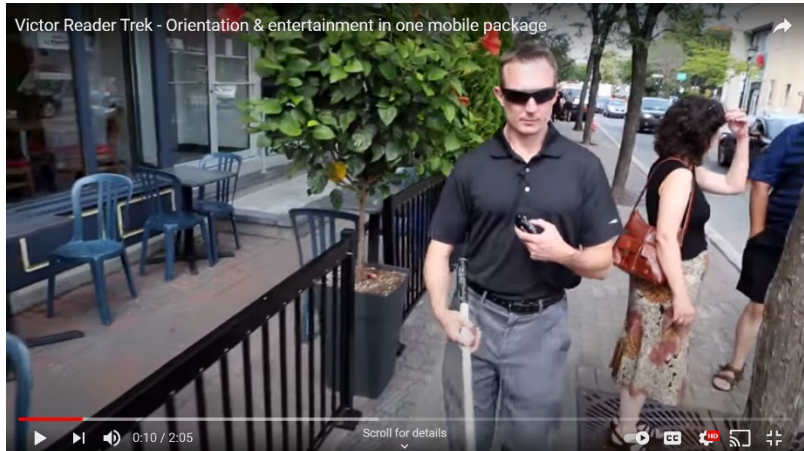

Figure 29: Screenshot from a promotional video for the Victor Reader Trek by Humanware.

Smartphone applications come in multiple types. Several apps specialize in turn-by-turn navigation for people with vision disabilities, including [BlindSquare](#), [WeWalk](#), [Nearby Explorer](#), and [GetThere](#). These apps rely on information gathered through the phone's GPS and Bluetooth capabilities as well as crowdsourced information from platforms like FourSquare and OpenStreetMap.

Apps specific to public transit are also available. For example, [BlindWays](#) uses crowd-sourced data and Bluetooth beacons to guide users to bus stops and help them avoid nearby obstacles. An app called [NaviLens](#) is being piloted by New York City's Metropolitan Transit Authority to direct users to bus stops and navigate train stations. The app translates visual signs to audio and provides information on the bus or train using QR-style codes.¹⁹

Some apps connect people with vision disabilities to sighted people. Volunteers or agents then direct the app user through live video calls. [Be My Eyes](#), [BeSpecular](#), and [Viz Wiz](#) are examples of this type of app.

¹⁹ <https://www.intelligenttransport.com/transport-news/110722/mta-smartphone-app-blind-low-vision-bus-riders/>

Other apps use artificial intelligence (AI) to read text and describe objects through a smartphone camera. [Seeing AI](#), [TapTapSee](#), and [Aipoly Vision](#) are examples of this type.

Finally, an app, called [PedPal](#), which is being developed by Carnegie Mellon University with funding from FHWA, uses connected vehicle technology and adaptive traffic signal control systems to enable pedestrians to communicate their crossing time needs and desired crossing direction to traffic signals without having to locate and push a pedestrian pushbutton.

Concerns About Existing Approaches

Many people with vision disabilities find mobile technologies helpful for navigation; however, people with vision disabilities also reported several challenges with these technologies, including:

- Lack of familiarity/comfort with mobile technologies.
- Mobile technologies that rely on GPS mapping are sometimes unable to guide people with vision disabilities to specific destinations such as bus stops and front doors with a high degree of accuracy.
- Difficulty paying attention to mobile technologies while actively navigating the street, such as balancing audible instructions with audible cues from the street or other road users.
- Lack of information about temporary changes to the built environment, such as construction-related sidewalk closures.

Recommended Guidance

- Local governments can do several things to support mobile technologies, including:
 - Publicizing the availability of mobile technologies.
 - Partnering with accessibility services.
 - Supporting data collection for accessibility mapping. Most turn-by-turn navigation apps draw information from web mapping products such as FourSquare, OpenStreetMap, and Google Maps. Transportation agencies can participate in these products to ensure information on points of interest, street design, and transit is up to date. Such participation allows local data to be reflected accurately in multiple accessible mobile apps without having to partner with each app’s developer.
- In the metropolitan region, WMATA is pursuing a Beacon Wayfinding Project that combines Bluetooth beaconing technology with a mobile application to assist customers with disabilities in finding Metrobus stops and navigating transit centers and Metrorail stations.²⁰ Local governments may wish to partner with WMATA in piloting this technology and/or implement a similar technology at bus stops and transit stations in their jurisdiction.

Considerations

- Mobile technologies have benefits for some people with vision disabilities and are increasingly used, particularly by younger people with vision disabilities.

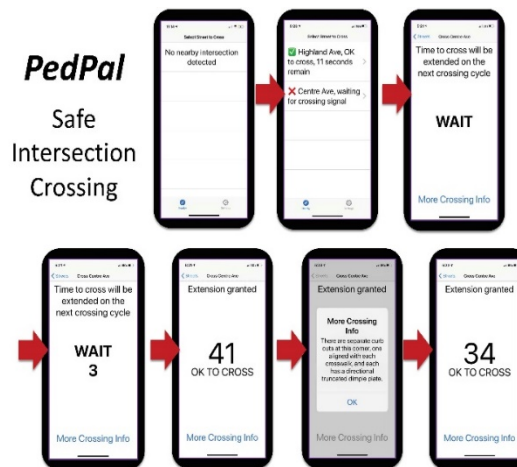

Figure 30: PedPal, a mobile app developed by Carnegie Mellon University, communicates to adaptive traffic signals to extend the walk period and indicates to the user when it is safe to cross.

²⁰ [Metro to launch new app and website to help riders with disabilities navigate rail and bus - The Washington Post](#)

- There are privacy concerns associated with some technologies due to the potential for the capture and resale of personal data to third parties, often for advertising purposes. Most mobile technologies need access to information on the user's location. While users can clear location data from an app, it can be difficult to do so. Many people often want to store personal addresses long-term. In addition to location information, mobile applications may store and sell audio, image, or video information.²¹
- Privacy concerns can also arise from eavesdropping. Bystanders can see magnified fonts or hear screen readers. This visual or aural eavesdropping can share personal information, such as the app user's destination, with bystanders.²²
- Mobile technologies can be expensive²³ and may require users to own devices, such as smartphones, headphones, or smart glasses. Not all people with vision disabilities can afford these expenses.
- Older adults constitute a large and growing portion of people with vision disabilities. Older adults may be less likely to own or feel comfortable using mobile technologies than younger adults, although there are training programs available through the Columbia Lighthouse for the Blind, American Council for the Blind, and other similar organizations.

²¹ Kuriakose, B., Shrestha, R., & Sandnes, F. E. (2020). Tools and Technologies for Blind and Visually Impaired Navigation Support: A Review. *IETE Technical Review*, 1-16.

²² Ahmed, T., Hoyle, R., Connelly, K., Crandall, D., & Kapadia, A. (2015, April). Privacy concerns and behaviors of people with visual impairments. In *Proceedings of the 33rd Annual ACM Conference on Human Factors in Computing Systems* (pp. 3523-3532).

²³ <https://wcblind.org/2018/07/gps-technology/>

Designs

This section focuses on specific design types, include sidewalk designs, crosswalk designs, and bus stop designs, showing how the process and design tools discussed above can be integrated to create designs that are safer and more accessible to people with vision disabilities. The discussion under each design type includes a description of the tool, a description of concerns expressed by people with vision disabilities about existing approaches, and recommended guidance for consideration by Montgomery County and other jurisdictions in the Metropolitan Washington Region.

Pedestrian Access Routes

Pedestrian access routes are a continuous and unobstructed path of travel provided for pedestrians with disabilities within or coinciding with a pedestrian circulation path in the public right-of-way or in an outdoor public space.²⁴

A distinguishable pedestrian access route is not always provided and can be difficult for people with vision disabilities to find if: a) the pedestrian access route location is not intuitive; b) it blends with adjacent spaces; or c) if it is not made obvious for people with vision disabilities via tactile guidance. A curved or winding pedestrian access route is more difficult for people with vision disabilities to follow and more difficult for frequent users to memorize. People with low vision or night blindness may have difficulty navigating a pedestrian access route at night or in low-light conditions when familiar visual cues, such as the contrasting color of a sidewalk or path, are obscured by darkness.

Recommended Guidance

- A pedestrian access route should be provided within:
 - Sidewalks and other pedestrian circulation paths located in the public right-of-way or outdoor public spaces.
 - Pedestrian street crossings and at-grade rail crossings, including medians and pedestrian refuge islands.
 - Overpasses, underpasses, bridges, and similar structures.
- The pedestrian access route should meet PROWAG requirements for minimum clear width. Additional space is needed to account for doors, awnings, sidewalk cafes, and other obstacles, as well as tactile guidance in complex situations. Additional space can also be helpful to people with vision disabilities to maneuver with a long cane or guide dog, although pedestrian access routes that are extremely wide can pose navigation challenges to people with vision disabilities due to reduced visual, tactile and auditory orientation cues.
- The surface of any pedestrian access route must be firm, stable, and slip resistant, and should meet PROWAG requirements for running slope, cross slope, and vertical changes in level.
- In order to be accessible, a pedestrian access route must be free of all permanent or temporary obstacles such as streetlights, utility poles and equipment cabinets, fire hydrants, sign posts and signs, parking meters, trash receptacles, benches, cafe seating, transit shelters, kiosks, bicycle racks, bicycles, e-scooters, planters and planted trees, bollards, and street sculptures. Objects between 27" and 80" tall must not protrude more than 4" into any portion of the pedestrian access route and must not reduce the clear width required for a pedestrian access route.

²⁴ PROWAG defines pedestrian circulation path as "a prepared exterior or interior surface provided for pedestrian travel in the public right-of-way." Pedestrian circulation paths must include a pedestrian access route, but all portions of a pedestrian circulation route are not held to the same standards as the pedestrian access route, e.g., they may contain inaccessible features such as stairs.

- The pedestrian access route must connect to accessible elements, spaces, and facilities in the public right-of-way, such as: pedestrian signals and pedestrian pushbuttons, accessible street furniture, accessible transit stops and transit shelters, accessible on-street parking spaces and parking meters and parking pay stations serving those parking spaces, and accessible passenger loading zones.
- A pedestrian access route in the public right-of-way should connect to accessible routes at building and facility site arrival points.
- Pedestrian access routes should be provided with adequate, even lighting levels. Lighting design and surface materials should not produce glare. See [Lighting](#) above for additional detail.
- Pedestrian access routes should be linear and intuitive, avoiding unnecessary zig zags or curves.
- In cases where the path of a pedestrian access route is not intuitive, guidance strips will help people with vision disabilities stay within it. The path of a pedestrian access route may not be intuitive if it is not straight or is not distinguished by other detectable cues, such as a building or edge line.

Sidewalks

Concerns About Existing Approaches

People with vision disabilities report the following challenges/needs with sidewalks:

- Missing sidewalks
- Narrow sidewalks
- Sidewalks with tripping hazards, e.g., vertical heaves, missing bricks, mud, scooters, bicycles, etc.
- Sidewalks with protruding objects, e.g., branches, guy wires, signs, boxes on poles
- Café/restaurant seating obstructing the sidewalk, particularly on narrow sidewalks
- Driveways, curbs, and street corners that are difficult to detect
- Sidewalks that slope toward the roadway
- Sidewalks without landscaped buffers between the sidewalk and street
- Sidewalks without a detectable edge between the sidewalk and a parking area



Figure 31: A person with vision disabilities uses a long white cane to navigate a brick sidewalk. Brick sidewalks can be tripping hazards if the bricks are not well maintained.

Recommended Guidance

Key Dimensions and Characteristics

- Sidewalks should be provided on one or both sides of streets, as specified in the Montgomery County Code and Complete Streets Design Guidelines.
- Sidewalks must contain a pedestrian access route that complies with the guidance in the pedestrian access route section above as well as the width requirements in the Montgomery County Complete Streets Design guide for pedestrian clear zones. Wherever feasible, the pedestrian clear zone should meet or exceed the default clear zone width indicated in the Complete Streets Design Guide. The minimum width is only acceptable if the default width cannot be achieved due to right-of-way constraints.
- Sidewalks should follow the straightest feasible path along the fronts of the adjacent buildings or other destinations. In the case of outdoor public space, sidewalks should generally be parallel to the adjacent street. Sidewalks should not wind in and out or curve unnecessarily.
- The pedestrian access route within the sidewalk should be made of concrete with a brushed finish. In the absence of tactile guidance and delineator strips, adjacent zones should contrast visually and texturally with this surface. Brick sidewalks and pedestrian access routes should generally be avoided due to their tendency to become uneven.

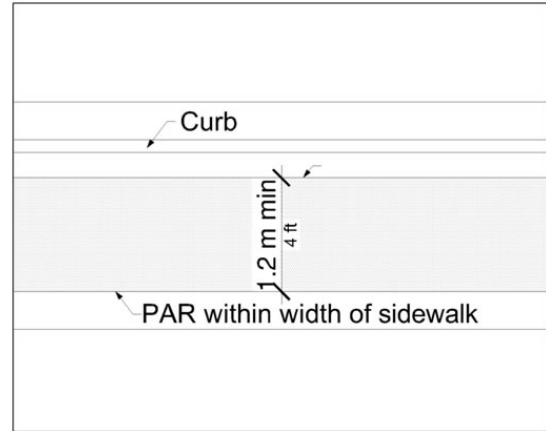

Figure 32: Minimum continuous clear width for a pedestrian access route on a sidewalk. (Source: [PROWAG R302.3](#))

Buffer/Furniture Zone

- Wherever possible, there should be a buffer zone/furniture zone between the sidewalk and travel way.
- Features in the buffer zone should be arranged in a continuous linear fashion. Where possible, elements within the buffer zone should be combined to minimize clutter, e.g., attach signs to light poles.

Bicycle and Scooter Parking

- Freestanding elements like bike racks should be placed outside of the pedestrian circulation path.
- In central business districts and town centers, there should be designated parking locations for dockless shared bicycles and e-scooters that do not conflict with the pedestrian access route. Dockless vehicle operators should be required to deploy to designated parking locations. Dockless vehicle operators should be required to incentivize users to use park in designated locations.

Sidewalk Repair and Maintenance

- A proactive sidewalk inspection and repair program should be established that results in all sidewalks being inspected and repaired on a cyclical basis.
- There should be a quick and efficient process for handling sidewalk safety hazards identified through 311 and other mechanisms in the immediate term, including marking hazardous conditions with high contrast paint.
- Standards should be established to: a) regulate overhanging trees, edging, and protrusions to ensure sidewalk accessibility; and b) clarify property owner related responsibilities. An edging

ordinance should require property owners to trim and maintain vegetation along abutting sidewalks as needed to maintain a minimum four- or five-foot clear width. A protrusion ordinance should specify that objects protruding more than four inches into the pedestrian access route must be shorter than 27 inches or taller than 80 inches, or a curb must be built around them.

Considerations

- Consider implementing “no park” and/or “no ride” zones for dockless mobility, especially in areas with high pedestrian activity.

Shared Spaces

A shared space is a space in which the boundary between pedestrian space and vehicular space is blurred to create a flexible and inviting public space that is both safe and comfortable for pedestrians and open to vehicular traffic at reduced speeds. This is accomplished through a range of design features meant to distinguish shared spaces from conventional streets, often including, but not limited to, a lack of curbs and limited or no traffic control devices.

Shared spaces can be streets, intersections, plazas, squares, and other types of spaces. In a shared space, the expectation is that most pedestrians can and will use the entire space, while vehicular traffic may be limited to a shared zone and designated parking and loading/unloading areas.

If shared spaces are not designed to include tactile guidance, then shared spaces can be challenging for people with vision disabilities to navigate, because of the lack of conventional cues such as curbs, defined crossing locations, and traffic controls. Unlike conventional streets, with their clearly defined spaces, rules, and controls, interactions on shared spaces are meant to be negotiated, and the means of negotiation is primarily visual—eye contact, nods, gestures. The ambiguity of shared spaces is what causes motorists to slow down and pay more attention, improving safety outcomes.

Recommended Guidance

Engagement

- Since poorly designed shared spaces can create significant navigational challenges for people with vision disabilities, people with a range of vision disabilities, Orientation and Mobility Specialists, and others with expertise on how people with different types of vision disabilities navigate should be actively engaged early in the planning and design process.

Overall Design

- The design of shared spaces should clearly convey to drivers that they are entering a different type of space where pedestrians have priority and drivers should proceed slowly and cautiously. This can be accomplished in a variety of ways (e.g., with paving materials and colors that clearly distinguish the space from the asphalt and concrete used on conventional streets, enclosure, the arrangement of street furniture and trees, and the absence of conventional cues).

Comfort Zone

- Where there is sufficient right-of-way, shared spaces should include a zone that is intended primarily for pedestrians. This zone is referred to as a "comfort zone."²⁵

²⁵ Where there is insufficient right-of-way for a comfort zone, judgment must be used to determine the best way to make the space accessible to people with vision disabilities.

- Comfort zones must include pedestrian access routes and should generally be provided on both sides of the shared zone. If a comfort zone is only provided on one side, additional consideration should be given to destination access on the side without a comfort zone.
- Delineator strips should be used to mark the boundary between the comfort zone and the shared zone, except at defined crossing locations, in which case a detectable warning surface must be used.
- Guidance strips can be used to help pedestrians with vision disabilities stay within the pedestrian access route. Guidance strips should be used to guide people with vision disabilities to defined crossing locations.
- At transition points between the comfort zone and a conventional street, the design should communicate a clear change in environment (e.g., through a detectable change in surface texture, differently colored pavement/pavers, scale, cross-section, and/or other cues).
- One of the reasons that shared spaces work is due to the ambiguity of the zones. If the shared zone appears like the territory of the motorist, then they will feel ownership and command the space. However, the design needs to inform motorists to not use the comfort zone. That design message can be made through material changes, such as delineator strips, street furniture, street trees, the drainage line (i.e., the lowest part of the shared space that may be indicated by a French drain, valley gutter, brick pattern change, etc.), and/or other elements.

Furniture Zone

- A “furniture zone” is optional and can be used between the shared zone and the pedestrian access route, along the whole route or along parts of the route. The functions of the furniture zone is to provide a place for street trees, signs, fire hydrants, benches, newspaper racks, dining areas, kiosks, etc.

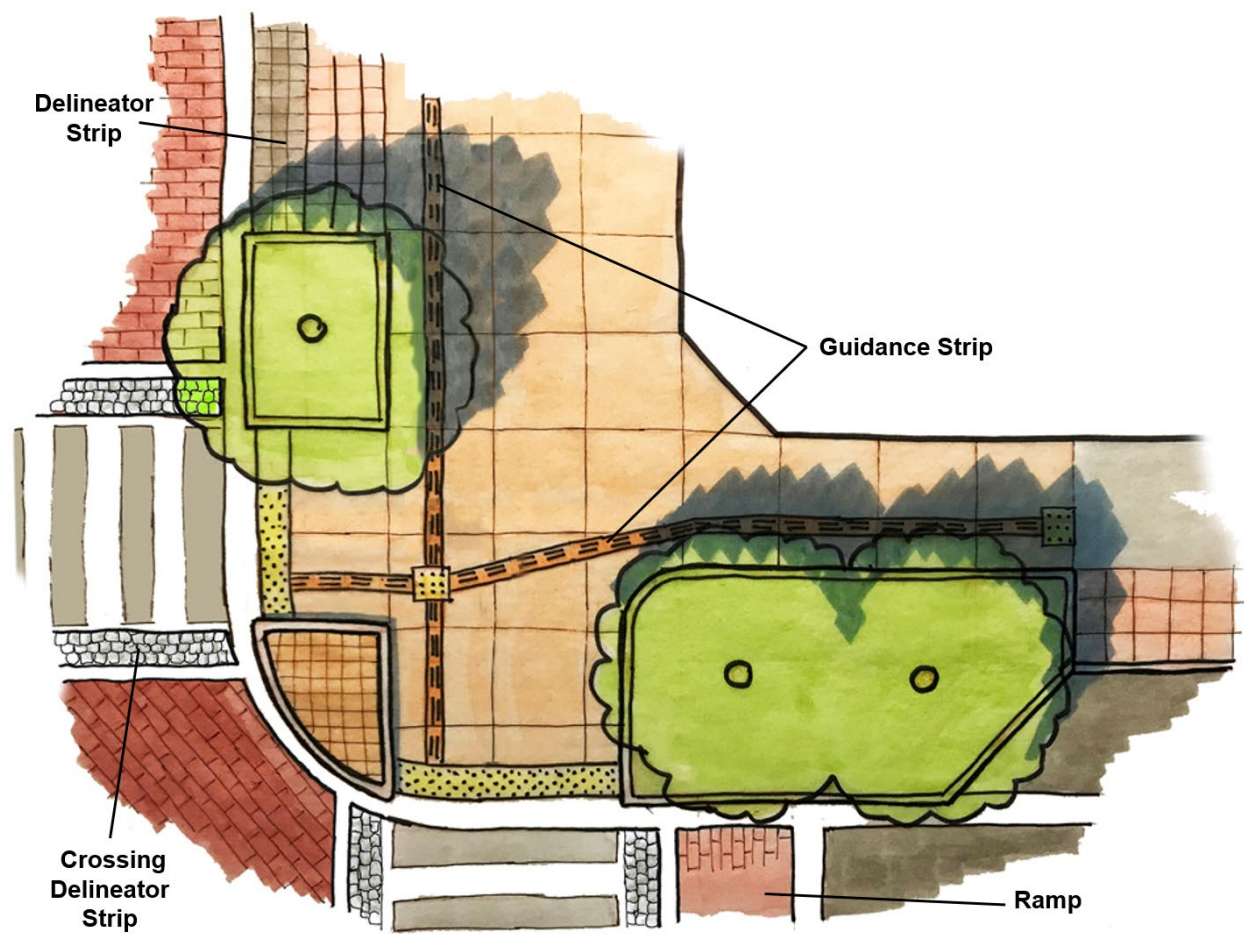

Figure 33: Illustration of how guidance strips, delineator strips and other tactile cues can be used to help pedestrians with vision disabilities stay within the pedestrian access route and find crossings in a shared space or flush street design. The street shown here is a flush street, but the arrangement of tactile cues shown here could also be applied to a shared space.

Flush Streets

A flush street is a street without curbs that operates as a conventional street much of the time but can be closed to motorists for festivals, farmers markets, and other activities.

Despite the lack of curbs, flush streets have sidewalks and vehicular travel lanes that are clearly delineated. There are traffic controls and designated crosswalks as on other conventional streets, and pedestrians are expected to use the sidewalk and cross at designated crosswalks, except when the street is closed to vehicular traffic.

If tactile guidance or contrasting furniture zones are not provided, flush streets can be challenging for people with vision disabilities to navigate due to the lack of curbs.

Recommended Guidance

Engagement

- Since poorly designed shared spaces can create significant navigational challenges for people with vision disabilities, people with a range of vision disabilities, Orientation and Mobility Specialists, and others with expertise on how people with different types of vision disabilities navigate should be actively engaged in the planning and design process.

Sidewalks

- Flush streets should include sidewalks that comply with the guidance in the [Sidewalks](#) section above.

Navigational Cues

- Flush streets must incorporate sufficient navigational cues to prevent people with vision disabilities, including people with vision disabilities who are deafblind, from inadvertently crossing from the sidewalk into vehicular lanes when the flush street is not closed to motor vehicle traffic. Cues may be included but are not limited to:
 - A delineator strip or a well-defined, linear buffer/furniture zone defined with landscaped strips, street furniture, and/or a surface textures and colors that contrast with the pedestrian access route on the sidewalk.
 - The use of guidance strips and delineator strips as described in the Shared Space, Guidance Surface, and Delineator strip surface sections above.

Crosswalks

A crosswalk is a zone in a street where pedestrians have the legal right-of-way. Uncontrolled crossings at intersections are legally defined as crosswalks regardless of whether they are marked with crosswalk markings. Crosswalks can exist at midblock locations if they are marked.

Recommended Guidance

- Crosswalks should generally be marked with ladder-style high visibility markings. See [High-Visibility Crosswalk Markings](#) above for guidance on location where ladder-style high-visibility crosswalk markings should be prioritized.

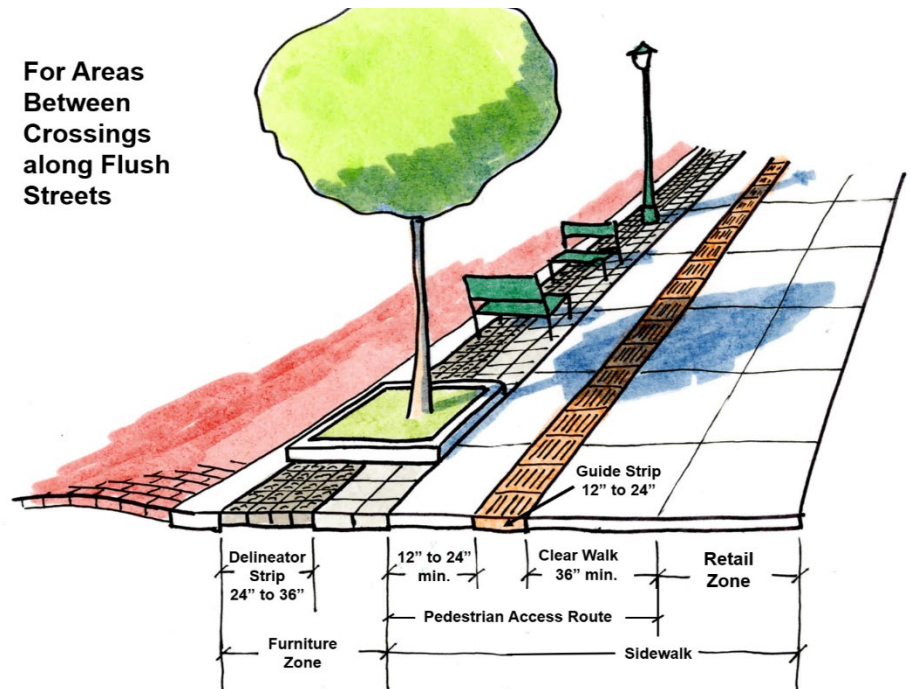

Figure 34: Illustration of cues that can be used to prevent pedestrians with vision disabilities from crossing into vehicular lanes unintentionally, including guidance strips, delineator strips, and a well-defined furniture zone.

- Crosswalks at signalized intersections should be supported by an APS. The pedestrian clearance time should be calculated based on the time needed for a pedestrian standing at the APS location to travel across the crosswalk to the opposite side of the traveled way. A walking speed lower than the 3.5 feet per second should be considered for this calculation at locations where there is a higher concentration of people with vision disabilities.
- Where pedestrian signals are provided, they should include an APS.
- Crosswalks should include a pedestrian access route that meets PROWAG requirements, whether marked or not.
- Crosswalks should be straight and either in line with or perpendicular to pedestrian access routes on the sidewalk. They should not be offset from the pedestrian access route on the sidewalk or skewed.
- Crosswalks should be as short as possible to reduce pedestrian exposure to motor vehicle traffic and make it easier for people with vision disabilities to maintain the proper heading to the other side of the crosswalk. Wherever possible, curb extensions should be installed to shorten pedestrian crossing distances and provide space for directional curb ramps aligned with each crossing.
- In cases where crosswalks are long (over 40'), a pedestrian refuge island, crossing [delineator strips](#) at the edges of the crosswalk, and/or [beaconing APS](#) should be considered as part of the crosswalk design.
 - Pedestrian refuge islands must be at least 6' wide and should be channelized (i.e., vertical curbs on both sides) where the pedestrian access route crosses the island. The channelized pedestrian access route on the island should be aligned with the crosswalk and should have detectable warning surfaces at the entry and extend across the entire pedestrian access route per PROWAG.
 - For wider pedestrian refuge island, consider incorporating short ramps that ramp up and down an inch or two at the entry and exit points of the refuge island to further signal to people with vision disabilities that they are on an island and reduce ponding in the refuge area.²⁶
- Measures should be incorporated into the design to encourage drivers to slow down and yield to pedestrians in the crosswalk. Slower motor vehicle speeds also help people with vision disabilities determine when it is safe to cross.

²⁶ This advice comes from NCHRP 834.

Intersection Crosswalks

Concerns About Existing Approaches

People with vision disabilities report the following challenges at intersection crosswalks:

- Locating crosswalks at skewed intersections, T-intersections, and intersections with large curb radii or curb extensions due to them not being in the expected location, e.g., further from the pedestrian path of travel in the case of a curb extension
- Orienting to the crosswalk when the curb ramp does not align with the crosswalk or the corner consists of a wrap-around blended transition
- Determining when it is safe to cross at T-intersections, intersections with channelized turn lanes, and roundabouts (due to the lack of traffic parallel to the crossing)
- Maintaining the correct heading in the crosswalk at T-intersections and intersections with crosswalks that are long and/or skewed



Figure 35: This crossing of Wayne Avenue at Fenton Street is both relatively long and skewed. In addition, there are wrap-depressed corners at both ends. These characteristics can make it difficult for a person with a vision disability to align properly to and maintain the correct heading when in the crosswalk.

Recommended Guidance

Key Dimensions and Characteristics

- Intersection crosswalks should comply with the guidance above for [crosswalks](#).
- Newly constructed intersections should ideally be designed so that the intersecting streets cross at approximately 90-degree angles.
- Corner radii should be minimized. The Montgomery County Complete Streets Design Guide provides specific guidance about how to minimize corner radii while accommodating the turning needs of vehicles.
- On conventional streets, two directional curb ramps should be provided on each corner. On flush streets, two approaches should be provided.
- If the intersection is signalized, APS with a locator tone should be installed on each corner.

- Channelized right turn lanes should be highly discouraged, because they present a number of challenges to pedestrians with vision disabilities, including the challenge, in most cases, of crossing free-flowing motor vehicle traffic, i.e., without signalization or STOP control.²⁷
- When a leading pedestrian interval is implemented, right turn on red restrictions should be implemented. (Note that leading pedestrian intervals should only be implemented where there is an APS.)

Skewed Intersections

- Detectable edges, such as landscaped strips and/or guidance strips, should be used to help people with vision disabilities find the crosswalk location.
- On conventional streets, directional curb ramps should be used to help people with vision disabilities align properly to cross.
- [Crosswalk delineator strips](#) and/or [beaconing APSs](#) should be used to help people with vision disabilities maintain their heading while in the crosswalk.

T-Intersections

- Guidance strips should be used to help people with vision disabilities find crosswalk locations at the top of the T-intersection.
- [Crosswalk delineator strips](#) and/or [beaconing APS](#) should be used to help people with vision disabilities maintain their heading while in the crosswalk.

Wrap-Around Depressed Curbs

- Wrap-around depressed curbs should generally be avoided. When incorporated into an intersection design:
 - Detectable edges and/or guidance strips should be used to help people with vision disabilities find the crosswalk locations and align with the crosswalk.
 - The detectable edges and/or guidance strips used to help people with vision disabilities find the crosswalk location should be coordinated with an APS pushbutton with a tactile arrow (or bollard with a tactile arrow, in the case of an unsignalized crossing with depressed curbs) that is aligned with the crosswalk.
 - [Crosswalk delineator strips](#) and/or [beaconing APS](#) should be used to help people with vision disabilities maintain their heading while in the crosswalk.

Channelized Turn Lanes and Roundabouts

- Channelized turn lanes should be avoided.
- When incorporated into an intersection design, channelized turn lanes and roundabouts should comply with PROWAG and should comply with NCHRP 834.
- Since poorly designed channelized turn lanes and roundabouts can create significant navigational challenges for people with vision disabilities, people with a range of vision disabilities, Orientation and Mobility Specialists, and others with expertise on how people with different types of vision disabilities navigate should be actively engaged in the planning and design process.

²⁷ According to the Montgomery County Complete Streets Design Guide, “Channelized right turn lanes (often called slip lanes) are designed to encourage the uncontrolled flow of right turns at fast speeds. **This design is not recommended for Complete Street intersections and removal of existing channelized right turn lanes should be pursued during road reconstruction projects in locations where pedestrians are permitted.**”(Bolding in original text.)

- In addition, the following key features should be incorporated into the design (Figure 36):
 - [Guidance strips](#) should be used to help people with vision disabilities find the crosswalk locations and align properly to cross.
 - [Crosswalk delineator strips](#) should be used to help people with vision disabilities maintain their heading while in the crosswalk.
 - Audible (textured) paving should be considered to make cars audible when exiting the circulatory roadway (roundabout) or entering the channelized turn lane.
 - Measures to slow motor vehicle speeds should be included, such as raised crossings and roadway geometry that discourages high-speed turns.

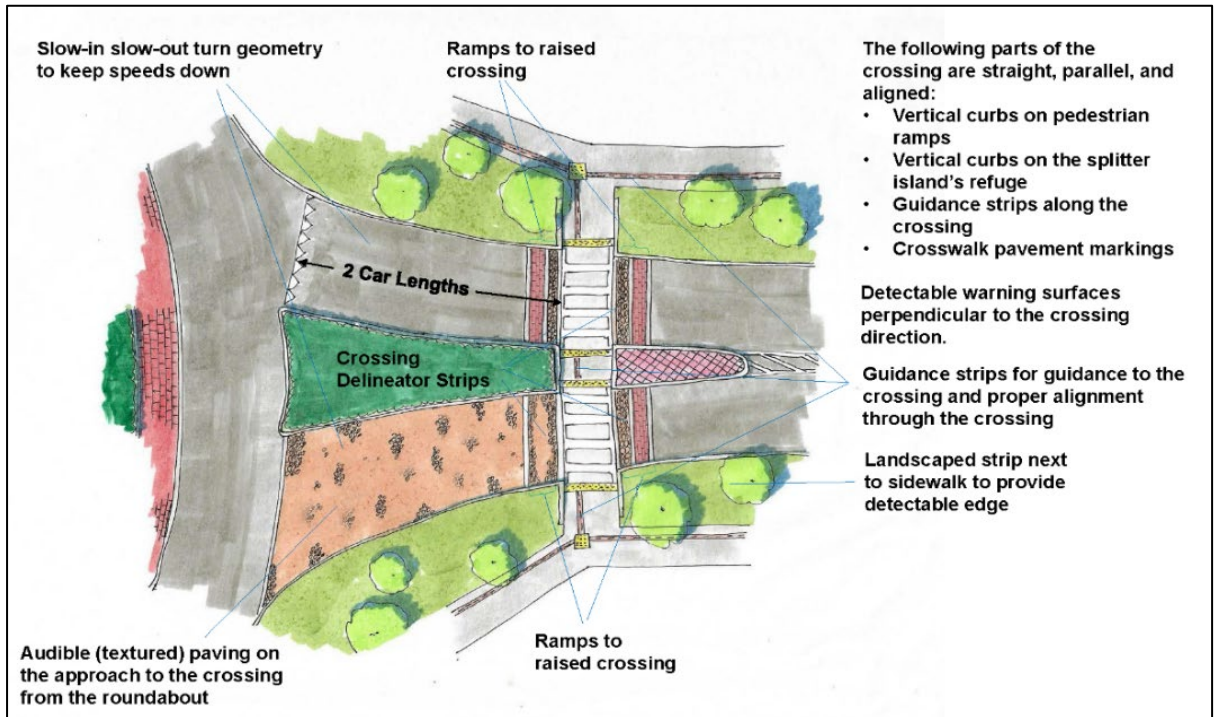

Figure 36: Illustration of key features of roundabout designs that are accessible to people with vision disabilities, including the use and placement of guidance strips, crosswalk delineator strips, audible paving, and traffic calming.

Midblock Crosswalks

Concerns About Existing Approaches

People with vision disabilities report the following challenges at midblock crosswalks:

- Locating the crosswalk without cues such as cross traffic and curbs perpendicular to the path of travel
- Determining when it is safe to cross due to the lack of parallel traffic sounds
- Safety concerns associated with unsignalized midblock crossings, particularly those where there is more than one travel lane in same direction

Recommended Guidance

- The crosswalk should be designed so that it is straight and perpendicular to the street.
- A guidance strip should be installed to guide people with vision disabilities from the sidewalk to the crosswalk. The guidance strip should:
 - Be at least 2' wide.
 - Be perpendicular to the pedestrian path of travel on the sidewalk.
 - Extend across the entire pedestrian access route, except for the space needed for pedestrian warning surface termini.
 - Connect to the detectable warning surface at the crosswalk.
 - Have a detectable warning surface at the sidewalk-end of the guide strip so there is no confusion about the intentional ending of the guide strip (and, in the case of the example in Figure 37, an obstacle/wall).
 - Be coordinated with the location of the APS pushbutton, so that people with vision disabilities can easily find it.
 - Be arranged to provide 3' of pedestrian clear space to enable wheelchair users to access the crosswalk without having to roll one wheel on top of the guidance strip when traveling parallel to it.
- For conventional streets, directional curb ramps should be installed at each end of the crossing.
- The crosswalk should be marked with high-visibility, ladder-style crosswalk markings.
- Crossing delineator strips should be installed on each side of the crosswalk to reduce the potential for a person with a vision disability to veer outside of the crosswalk.
- If the crossing is uncontrolled, it should be supported with midblock pedestrian crossing signs. Pedestrian crossing signs can improve motor vehicle yielding at midblock crossings and help pedestrians with low vision locate the crossing.
- The crosswalk should be well-lit so that drivers can see pedestrians and pedestrians, including those with disabilities, can see the crosswalk. A vertical illuminance level of 20 lux measured at a height of 1.5 meters (5 feet) from the roadway is recommended.²⁸



Figure 37: Example of guidance strip used to guide pedestrians with vision disabilities to a midblock crosswalk in Melbourne, Australia.

²⁸ <https://www.fhwa.dot.gov/publications/research/safety/08053/08053.pdf>

- If there is a parking lane, curb extensions should be installed to minimize pedestrian crossing distance, improve visibility between pedestrians and drivers, and encourage driver yielding.
- If the crossing involves more than two motor vehicle travel lanes in one direction, a pedestrian hybrid beacon should be installed. Pedestrian hybrid beacons should also be considered at midblock crossings with fewer lanes to improve safety and accessibility.

Bus Stops

Safe, comfortable, and convenient access to bus stops is extremely important for people with vision disabilities. Many people with vision disabilities depend on transit for travel to jobs, shopping, healthcare, education, and other personal needs.

Concerns About Existing Approaches

People with vision disabilities report the following challenges at bus stops:

- Finding stop locations, particularly when located midblock or in urban areas without continuous landscaped buffers between sidewalks and streets
- Determining which bus lines are served by a stop
- Determining the correct bus if multiple buses pull up at the same time
- Signs that are difficult to read from a distance
- Lack of audio and tactile signage
- Inadequate lighting
- Vegetation impeding access
- Lack of direct access to nearby destinations via an accessible route
- Changes in bus service (e.g., due to construction)

Recommended Guidance

Key Dimensions and Characteristics

- Bus stops must comply with the 2006 DOT Standards and should comply with PROWAG R308.

Locations and Layouts

- Bus stops should be located at predictable locations near intersections and crosswalks.
- Bus stop layouts should be consistent, understanding that some variation will likely be required due to site specific conditions.

Pedestrian Access Route

- A pedestrian access route complying with the [pedestrian access route](#) guidance above must be provided between the bus stop landing pad, the adjacent sidewalk, bus stop amenities, such as shelters and benches, and the closest adjacent crosswalk and/or street crossing.
- Direct pedestrian access routes should also be provided between the bus stop and key destinations within 1/4 mile of the bus stop.

Guidance Strips and Detectable Warning Surfaces

- A guidance strip should be installed perpendicular to the pedestrian path of travel on the sidewalk to alert people with vision disabilities to the presence of the bus stop (similar to those used to indicate midblock crossings). The guidance strip should:
 - Be at least 2' wide.
 - Extend across the entire pedestrian access route, except for any space needed for detectable warning surface termini.
- The guidance strip should connect to detectable warning surfaces at both ends.
 - One detectable warning surface should indicate the location of the boarding area at the street edge. This detectable warning surface should be 24" wide and 48" long.
 - The other detectable warning surface should indicate the terminus of the guidance strip on the opposite side the pedestrian access route (furthest from the street). This detectable warning surface should be 36" square.
- The guidance strip and detectable warning surface should be installed in a way that minimizes impacts on pedestrians who use wheelchairs and other mobility devices. Specifically, the pedestrian access route between the sidewalk and bus landing should include a minimum width of 3' that has a smooth surface and is unobstructed by guidance strips.

Bus Stop Signage

- Bus stop signage should comply with the guidance in the [signage section](#) and [PROWAG R410](#), and should include a tactile information panel.

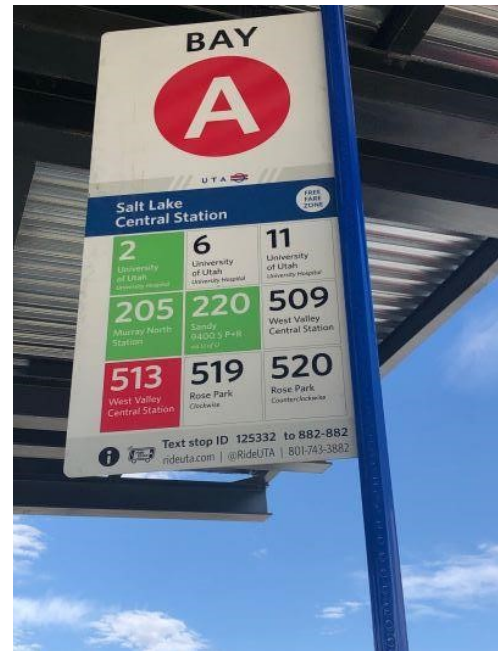

Figure 38: The Utah Transportation Authority new bus stop sign features a blue pole with the octagonal shape that makes it easier for people with vision disabilities to distinguish. (Source: Utah Transportation Authority)

- Bus stop signage should be posted between 24" and 36" from the roadway edge. Signage should be posted at a location that can be easily accessed by a person with a vision disability standing on the detectable warning surface at the boarding area.
- Bus stop signage should be mounted on a pole that has a distinctive shape and distinctive high-contrast color and is used consistently at all bus stops. The shape and color of the pole can be a helpful tactile cue for people with vision disabilities.
- Consider installing a Bluetooth beaconing system on bus stop sign poles or shelters to help guide people with vision disabilities to the stop and provide information on bus routes served and real time information about upcoming bus arrivals.

Shelters and Amenities

- Bus stop shelters should be considered at all bus stops. In addition to providing a place for transit users to be protected from the weather as they wait, shelters can make bus stops easier for people with vision disabilities to find. For people with low vision, they may be easier to see than bus stop signage. For people who are blind, they may echo sound in a way that helps them locate the stop.
- If the shelter is made of transparent glass, the glass should include high-contrast banding at eye level so that people with vision disabilities do not inadvertently walk into it.
- Glass panels should extend as close to the ground as possible to be cane-detectable and should be of a consistent width from top to bottom to prevent overhead or tripping hazards.
- Other elements of the shelter as well as amenities such as benches and trash receptacles should be cane-detectable, of a visually contrasting color, and located so as not to obstruct accessible use of the stop.
- Shelters should be well-lit and provide audible and tactile signage and tactile transit maps.

Other Guidance

- Audible announcements should be provided from the transit vehicle for people with vision disabilities waiting on the bus stop landing pad to let them know the vehicle has arrived and the route name.

Floating Bus Stops

Montgomery County has begun installing floating bus stops. Floating bus stops are a bus stop design that is often installed along with separated bike lanes to improve bicyclist safety by reducing bus/bike conflicts and to reduce conflicts between pedestrians, bicyclists, and scooter riders on the sidewalk. The bike lane is routed behind the bus stop, requiring pedestrians to cross a bike lane when traveling to or from the platform where the bus stop is located.

Concerns About Existing Approaches

People with vision disabilities report the following challenges at floating bus stops:

- Additional challenges finding stops due to the location of the platform, which is unexpected and difficult to detect from the sidewalk
- The inconvenience of having to travel across a bike lane to the bus stop platform to determine what bus(es) it serves
- Distinguishing the bike lane from the sidewalk

- Determining when it is safe to cross the bike lane due to the relative silence of bicyclists and scooter riders, uncertainty they will yield, and inability to determine when they have yielded
- Bicyclists failing to recognize that they have a vision disability and misinterpreting their hesitation before crossing as a signal that they do not intend to cross
- Guide dogs not trained to cross bike lanes or pay attention to bikes
- Cyclists coming from two directions (in the case of a two-way separated bike lane)
- Lack of consistency in floating bus stop design in Montgomery and throughout the Metropolitan Region²⁹
- Lack of familiarity with using a floating bus stop
- Lack of maneuvering space for people using wheelchairs and walkers
- Disorientation when disembarking at a floating bus stop
- Lack of shade on the bus platform

Recommended Guidance

Engagement

- Since poorly designed floating bus stops can create significant navigational challenges for people with vision disabilities, people with a range of vision disabilities, Orientation and Mobility Specialists, and others with expertise on how people with different types of vision disabilities navigate should be actively engaged in the planning and design process.

Key Dimensions and Characteristics

- Floating bus stops must comply with the 2006 DOT Standards and should comply with PROWAG R308.
- The design of the floating bus stop should provide clear sight lines between pedestrians approaching the bike lane crossings and bicyclists.

Location and Layouts

- Wherever possible, floating bus stops should be integrated with signalized crosswalks supported by APS.
- Floating bus stop layouts should be consistent, understanding that some variation will likely be required due to site specific conditions.

One- or two-way separated bike lane

- On two-way streets, one-way separated bike lanes on each side of the street should be preferred over a two-way separated bike lane on one side of the street, recognizing that there may be circumstances under which a one-way configuration is not the best solution due to the location of existing bicycle facilities, right-of-way constraints, and other circumstances.

Guidance Strips and Detectable Warning Surfaces

- A guidance strip should be installed perpendicular to the pedestrian path of travel on the sidewalk to alert people with vision disabilities to the presence of the bus stop and direct them to the crosswalk optimized for their use (e.g., the signalized crosswalk where the floating bus stop is integrated with a signalized intersection). The guidance strip should:
 - Be at least 2' wide.
 - Extend across the entire pedestrian access route, except for any space needed for detectable warning surface termini.

²⁹ The District of Columbia, City of Alexandria, and Arlington County have all recently implemented floating bus stop designs.

- Be arranged to provide 3' of pedestrian clear space to enable wheelchair users to access the crosswalk without having to roll one wheel on top of the guidance strip when traveling parallel to it..
- The guidance strip should connect to detectable warning surfaces at both ends.
 - One detectable warning surface should be located at the edge of the ramp or blended transition per PROWAG.
 - The other detectable warning surface should indicate the terminus of the guidance strip on the opposite side of the pedestrian access route (furthest from the street) or a junction with another guidance strip. This detectable warning surface should be 36" square.
- There should be detectable warning surfaces at both ends of the bike lane crosswalk and at both ends of the street crossing, per PROWAG, if the floating bus stop is integrated with an intersection crossing.
- There should also be detectable warning surfaces at guidance strip junctions and termini as described in Detectable Guidance Surface (Guidance Strips) above.
- Crossing delineator strips should be used on either side of the crossing across the travel way. In circumstances where the crossing of the bike lane is skewed, crossing delineator strips may be used across the bike lane.

Bike Lane Design

- The bike lane should be colored green for the length of the floating bus stop island to distinguish it from a motor vehicle lane or shared use path.
- Except at designated crosswalk locations, there should be a [detectable edge](#) or [delineator strip](#) between the sidewalk and bike lane to prevent people with vision disabilities from unintentionally crossing into the bike lane.
- Measures should be implemented on the crosswalk approaches to encourage more predictable bicyclist behavior and yielding. The following measures should be considered:
 - Vertical and horizontal deflection of the bike lane
 - Bike lane narrowing
 - Stop bars or yield markings
 - In-street pedestrian crossing signs
 - 6" solid yellow line positioned between opposing bike traffic (2-way separated bike lanes)
- Consideration should be given to how to make bicyclists more audible to pedestrians with vision disabilities crossing the bike lane, e.g., applying an audible surface to the bike lane on the bike lane approaches or using passive detection linked to a speaker at the crossing that produces a sound when bicyclists are approaching.

Crosswalks and APSs

- All crosswalks connecting to a floating bus stop should be [high-visibility, ladder-style crosswalks](#).
- If the floating bus stop is integrated with a crosswalk at a signalized intersection, APS should be provided on the sidewalk at both ends of the crosswalk. These APS should provide audible messaging indicating what street the crosswalk crosses and that a floating bus stop is integrated into it, e.g., "The WALK sign is on to cross Fenton Street. This crosswalk includes a floating bus stop serving bus(es) *[list of buses served]*."
- Depending on the width of the platform, either one or two APS should be provided in the pedestrian refuge median that accesses the platform. The APS should be positioned in locations that can be easily reached when in the pedestrian refuge.

- The APS next to the bike lane should provide audible messaging indicating that the crosswalk crosses a bike lane and what street the bike lane is on, e.g., “The WALK sign is on to cross the bike lane on Fenton Street.”
- The APS next to the street should provide audible messaging indicating what street the crosswalk crosses, e.g., “The WALK sign is on to cross Fenton Street.”
- Consideration should be given to making relatively quiet vehicles such as electric cars and bicycles more audible at unsignalized pedestrian crossing locations. Technologies such as textured/audible pavement or vehicle detection may be used to address this issue.

Bus Platform Design

- The platform should be at least 10' wide.
- People with vision disabilities should be guided between boarding and alighting locations and the crosswalk(s) optimized for their use by detectable edges, guidance strips, and/or other cues.
- If guidance strips are used, they should be arranged to provide 3' of pedestrian clear space along the pedestrian access route to enable wheelchair users to follow it without having to roll one wheel on top of the guidance strip. A space measuring 4' by 4' that is free of guidance strips is desirable at locations where people in wheelchairs need to turn.
- The boarding location should be marked by a detectable warning surface located at the street edge. This detectable warning surface should be 24" wide and 48" long.
- Railings at the back of the platform (bike lane side) should be used to channelize pedestrians to designated crossing locations. Railings should be a maximum of 3 feet tall, cane-detectable, and colored to contrast visually with the background color.
- A shy distance of at least 6" should be provide between the edge of the bike lane and the railing/bus shelter to avoid catching the handlebars of cyclists.
- The height of the platform should generally not exceed 6". In cases where the platform is higher than the 6" (standard sidewalk height), a detectable warning surface must be placed along the length of the street side of the platform that is not protected by screens or guards.

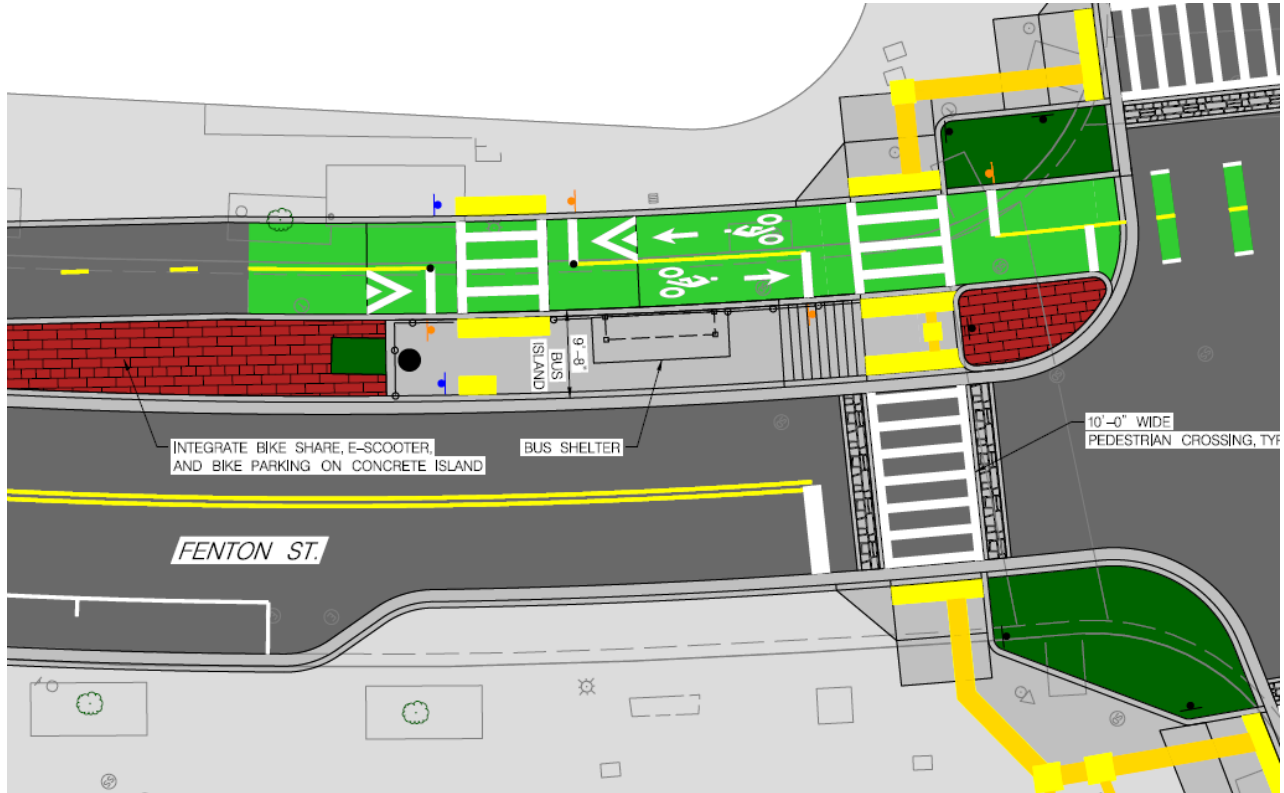

Figure 39: Preliminary design for a floating bus stop at the intersection of Fenton Street and Ellsworth Drive illustrating several of the design elements discussed in this section, including guidance strips, detectable warning surfaces, and high-visibility ladder-style crosswalks.

Shelters and Amenities

- Shelters and amenities associated with floating bus stops should comply with the guidance on [shelters and amenities](#) above.
- If a transit shelter is provided on the platform, the position of the shelter must be carefully considered to preserve sight lines between pedestrians approaching the crosswalks serving the bus platform and bicyclists using the separated bike lane.

Signage

- Signage for floating bus stops should comply with the guidance on [bus stop signage](#) above.
- In addition, signage with visual contrast, raised letters, and braille should be provided on the sidewalk to inform people with vision disabilities of the presence of a floating bus stop, the buses it serves, and how to navigate it. There should be one visual and tactile sign for each crosswalk connecting to the bus stop platform.
- If the floating bus stop is integrated with a signalized crossing, the visual and tactile signage for the crossing that is integrated should be co-located with the APS serving the two crosswalks connecting to the bus stop (i.e., the crosswalk across the bike lane and the crosswalk across the street).

- Signage on the sidewalk should be positioned so that a person with a vision disability who follows the guidance strip across the sidewalk can easily reach it from the top of the ramp, if a ramp is provided, or from the detectable warning surface at the crossing.

Other Guidance

- Audible announcements should be provided from the transit vehicle for people with vision disabilities waiting on the platform to let them know the vehicle has arrived and the route name.
- Audible announcements should be provided for people with vision disabilities inside the bus to inform them of bus stops that are floating bus stops and generally how to navigate the stops, e.g., “Next stop, Ellsworth Drive. This stop is a floating bus stop. Exit right for signalized crossing.”

Appendices

Appendix A: Summary of Key National-Level Guidance Documents

Table 2 provides a list of key national-guidance documents with guidance on accessible design for people with vision disabilities.

Table 2: Guidance Documents Reviewed--Full Title and Abbreviated Title

Full Title	Abbreviated Title
Key Guidance Documents	
United States Department of Transportation, Americans with Disabilities Act (ADA) Standards for Transportation Facilities, 2006	DOT ADA Standards
United States Department of Justice, ADA Standards for Accessible Design, 2010	DOJ ADA Standards
United States Access Board, Proposed Accessibility Guidelines for Pedestrian Facilities in the Public Right-of-Way, 2011, with Proposed Supplement, Accessibility Guidelines for Pedestrian Facilities in the Public Right-of-Way; Shared Use Paths, 2013	PROWAG
Federal Highway Administration, Manual on Uniform Traffic Control Devices for Streets and Highways, 2009 (with 2012 revisions)	MUTCD
Other National-Level Guidance Documents	
Federal Highway Administration, Accessible Shared Streets: Notable Practices and Considerations for Accommodating Pedestrians with Vision Disabilities	FHWA Accessible Shared Streets
Federal Highway Administration, Separated Bike Lane Planning and Design Guide, 2015	FHWA Separated Bike Lane Guide
Federal Highway Administration, Achieving Multimodal Networks: Applying Design Flexibility and Reducing Conflicts, 2016	FHWA Achieving Multimodal Networks Guide
FHWA Alternative Intersection Design resources (http://safety.fhwa.dot.gov/intersection/alter_design/)	FHWA Alternative Intersection Guidance
American Association of State Highway and Transportation Officials, Guide for Planning, Design, and Operation of Pedestrian Facilities, 2004	AASHTO Ped Guide
American Association of State Highway and Transportation Officials, Guide for the Development of Bicycle Facilities, 2012	AASHTO Bike Guide
American Association of State Highway and Transportation Officials, A Policy on Geometric Design of Highways and Streets, 2011	AASHTO Green Book
American Association of State Highway and Transportation Officials, Guide for Geometric Design of Transit Facilities on Highways and Streets, 2014	AASHTO Transit Guide

Full Title	Abbreviated Title
American Association of State Highway and Transportation Officials , Roadway Lighting Design Guide, 2005	AASHTO Lighting Guide
National Association of City Transportation Officials, Urban Bikeway Design Guide, 2014	NACTO Bikeway Design Guide
National Association of City Transportation Officials, Urban Street Design Guide, 2013	NACTO Urban Street Design Guide
National Association of City Transportation Officials, Transit Street Design Guide, 2016	NACTO Transit Street Design Guide
NCHRP Report 672--Roundabouts Informational Guide	NCHRP 672
NCHRP Report 674--Crossing Solutions at Roundabouts and CTLs for Pedestrians with Vision Disabilities	NCHRP 674
NCHRP Report 834--Guidelines for the Application of Crossing Solutions at Roundabouts and Channelized Turn Lanes for Pedestrians with Vision Disabilities	NCHRP 834
TCRP Report 175--Guidebook on Pedestrian Crossings of Public Transit Rail Services	TCRP 175
United States Access Board--Detectable Warnings: Synthesis of U.S. and International Practice, 2000	Detectable Warning Synthesis

Among the key documents, the *Proposed PROWAG* and *MUTCD* provide the most detailed design guidance on the navigational needs of pedestrians with vision disabilities.

- The *Proposed PROWAG* provides detailed guidance on accessible pedestrian signals, detectable warning surfaces, curb ramps, protruding objects, pedestrian crossing islands, sidewalks, shared use paths, and roundabouts.
- The *MUTCD* provides detailed regulations and recommendations regarding pedestrian signs, crosswalk markings, accessible pedestrian signals, and bicycle facility pavement markings, signs, and signals.

Among the other national-level guidance documents, *FHWA Accessible Shared Streets*, *FHWA Separated Bike Lane Guide*, *AASHTO Ped Guide*, *NACTO Urban Street Design Guide*, *NCHRP 672*, *NCHRP 834*, and *TCRP 175* provide the most relevant guidance.

- *FHWA Accessible Shared Streets* provides guidance on how to design shared spaces for people with vision disabilities. It also provides general guidance on the use of the detectable guidance surface, which is called a “directional indicator” in the text.
- The *FHWA Separated Bike Lane Guide* provides guidance regarding the design of separated bike lanes, including general considerations for pedestrians with vision disabilities.
- The *AASHTO Ped Guide* provides a general description of the characteristics and needs of pedestrians with vision disabilities and includes guidance on crosswalks, curb ramps, midblock crossings, and roundabouts.
- Among the reviewed guidance documents, the *NACTO Urban Street Design Guide* provides the only guidance that addresses streets where pedestrians, bicyclists, and motor vehicles are intended to share space, including general considerations for pedestrians with vision disabilities.

- *NCHRP 672* provides guidance about the design of bike ramps at roundabouts and recommendations related to pedestrian refuge island and median cut-through design, some of which have been further investigated and changed as a result of *NCHRP 834*.
- *NCHRP 834* addresses navigational issues for pedestrians who are blind at roundabouts and channelized turn lanes (CTLs) with a chapter discussing issues and photos of potential solutions. *NCHRP 834* also includes a chapter of design checks related to wayfinding, some of which is transferable to other types of complex intersections.
- *TCRP 175* includes a case study on how to accommodate pedestrians with vision disabilities when designing transit platforms that are in the middle of the street. This information may also be helpful in considering the design of floating bus islands.

Appendix B: Fenton Street Concept

The toolkit that comprises the main body of this document was developed for the Montgomery County Department of Transportation (MCDOT) with support from the Metropolitan Washington Council of Government's (MWCOG) Transportation and Land Use Connections program. Another component of the project is a concept design for a specific location in downtown Silver Spring. This appendix represents that element of the project. It presents a proposed concept for the intersection of Fenton Street and Ellsworth Drive in downtown Silver Spring to make the intersection safer and more accessible to people with vision disabilities. It also includes recommendations for Fenton Street between Ellsworth Drive and Thayer Avenue that build on an existing 15% design. The recommendations are based on the project toolkit and issues identified through the project public input process and fieldwork.

Background

The MCDOT selected Fenton Street between Ellsworth Drive and Thayer Avenue (study area) as the design focus for this project for several reasons:

- Concerns about the accessibility of Fenton Street were raised at the January 2021 stakeholder meeting for this project. See [Appendix E](#).
- The intersection of Fenton Street and Ellsworth Drive was identified as a challenge in the countywide survey conducted for the project. See [Appendix F](#).
- Fenton Street is currently in the process of being redesigned to include a two-way separated bike lane with floating bus stops as part of the Fenton Street Cycletrack Project. Concerns from people with vision disabilities in the County about the safety and accessibility of floating bus stops provided the impetus for the MCDOT's application to MWCOG this project.
- Fenton Street includes a future Purple Line station at the Silver Spring Public Library.

A preliminary 15% preferred concept for the Fenton Street Cycletrack Project was selected by the Montgomery County Council in February 2021. The challenge for the Project Team was to evaluate the provided 15% concept and recommend changes to the design to improve safety and accessibility for people with vision disabilities prior to completion of a 30% design, which is expected in fall 2021.

Public Input Process

The content of this appendix was informed by review of the 15% concept, two online surveys (one of which focused on Fenton Street - see [Appendix G](#)) interviews with stakeholders, fieldwork in the study area, a follow up meeting with the stakeholders to receive feedback on the Team's concept recommendations, and feedback from the Montgomery County Commission on People with Disabilities and various stakeholders within Montgomery County government.

The interviewees included six individuals with vision disabilities and two individuals with mobility disabilities, both of whom were familiar with the challenges people with vision disabilities face in the built environment in Montgomery County. Several of the interviewees are active in key stakeholder organizations for people with vision disabilities in Montgomery County, including the Montgomery County Commission on People with Disabilities, the American Council of the Blind, the National Federation of the Blind, and the Washington Metropolitan Area Transit Authority (WMATA). All but one stakeholder interview was conducted in the field on Fenton Street. A tactile graphic was developed for the interviews to help the interviewees understand the 15% concept and facilitate discussion about floating bus stops (see Figure 2 in the toolkit).

Issues and Recommendations

This section provides a summary of the issues identified in the review of the 15% design and/or in existing conditions for the study area and the Project Team’s recommendations for addressing the issues, including recommended changes to the 15% design and other recommendations.

Full Study Area

Issues

- There are concerns about the safety and accessibility of floating bus stops, as described in [Concerns About Existing Approaches](#) in the Floating Bus Stop section of the toolkit. Although the 15% design includes a key innovation intended to address these concerns, i.e., integration of floating bus stops with signalized intersections, it leaves out key design details and does not fully address the concerns of people with vision disabilities.
- The design shows brick pavers in the sidewalk pedestrian access route at several locations. Brick pavers require more regular maintenance to avoid becoming a tripping hazard. Even when well-maintained, bricks sidewalks can be bumpy and uncomfortable for people using wheelchairs and walkers.
- The design shows Continental-style crosswalk markings. Continental-style crosswalk markings are the current County standard; however, people with vision disabilities prefer the ladder-style markings because they have edge lines that help them maintain their heading as they cross.
- The design shows curb ramps that are not aligned with the crosswalk. Curb ramps that are not aligned with the crosswalks can make it more difficult for pedestrians with vision disabilities to align for the crossing, particularly curb ramps that are misaligned by over 15 degrees.³⁰
- The design does not show the proposed location of APS pushbuttons, a feature that should be considered early in the design to ensure the location is reasonable and accessible. Currently, APS are not always located in consistent and predictable locations. Some pushbuttons are located more than 6 feet from the top of the curb ramp. For example, an APS pushbutton at the corner of Fenton Street and Bonifant Street is located more than 10 feet from the top of the curb ramp it serves, making it difficult for a person with a vision disability to hear the audible WALK indication when waiting at the curb to cross.
- There are concerns about maintenance along the study area. These concerns include snow and ice removal from floating bus stop platforms, curb ramps, and other pedestrian infrastructure. In addition, several maintenance issues that impact safety and accessibility for people



Figure 40: Example of a damaged detectable warning surface at the intersection of Fenton Street and Wayne Avenue.

³⁰ Alan C. Scott, Janet M. Barlow, David A. Guth, Billie Louise Bentzen, Christopher M. Cunningham, Richard Long J Vis Impair Blind. Author manuscript; available in PMC 2015 Jan 30. Published in final edited form as: J Vis Impair Blind. 2011 Oct; 105(10): 648–661. <https://www.ncbi.nlm.nih.gov/pmc/articles/PMC4311395/>

with vision disabilities were observed during stakeholder interviews on Fenton Street, including malfunctioning APSs, faded crosswalk markings, potholes in the crosswalk, and broken/missing detectable warning surfaces (Figure 40).

Recommendations

General

- The County should adjust the Fenton Street Cycletrack design to follow the guidance in the toolkit wherever feasible.
- The County should conduct an accessibility audit upon completion of the 30% design for the Fenton Street Cycletrack. General guidance for pre-construction accessibility audits is provided in the [Pre-Construction Accessibility Audit](#) section of the toolkit.
- The County should conduct a post-construction performance evaluation of the project and make all feasible adjustments to improve safety and accessibility for people with vision disabilities. General guidance for performance evaluations is provided in the [Performance Evaluation](#) section of the toolkit.
- The County should collaborate with providers of GPS mapping data to ensure that the data for Fenton Street is updated when the street is reconstructed to reflect relocated bus stops and other changes.

Floating Bus Stops

- The County should implement the recommendations in the toolkit regarding [floating bus design](#).
- The County should strive to make floating bus stop designs as consistent and predictable as possible along the Fenton Street corridor as well as throughout the County.
- The County should pursue a region-wide summit on floating bus stop design to promote design consistency and accessibility across the region. MWCOCG may be able to help coordinate this summit.
- The County should coordinate with RideOn and WMATA to develop bus stop signage that is accessible to people with vision disabilities and is mounted on a distinctively shaped sign pole.
- The County should reach out to WMATA about participating in its bus stop beaconing project.
- The County should coordinate with RideOn and WMATA to provide in-bus announcements to alert people on the bus to the presence of floating bus stops and provide basic guidance on how to navigate them.
- The County should coordinate with RideOn and WMATA to provide information on how to find and navigate floating bus stops on trip planning websites and apps, and train customer service agents on how to provide this information verbally to a person with a vision disability who calls for assistance.
- The County should implement a post-construction education and outreach campaign. General guidance for such campaigns is provided in the [Post-Construction Education and Outreach](#) section of the toolkit. The campaign should emphasize bicyclist yielding to pedestrians at floating bus stop crosswalks, educate bicyclists about the specific challenges people with vision disabilities face when crossing bike lanes, and provide guidance to bicyclists and people with vision disabilities on how to communicate with each other when a pedestrian with a vision disability is crossing the bike lane. The campaign should also seek to inform pedestrians with

vision disabilities about the rationale for implementing floating bus stops, how to navigate them, and how to report any safety or accessibility concerns they encounter.

- The County should monitor interactions between bicyclists and pedestrians at floating bus stop crosswalks after construction to determine if additional measures are needed to address issues of safety and accessibility for all users, including physical changes to the design, education, and enforcement.

Crosswalks

- The design should be updated to replace all existing Continental-style crosswalk markings with [ladder-style crosswalk markings](#).

Curb ramps

- The design should be updated so that the curb ramps that are currently misaligned with the crosswalks they serve are aligned as much as possible and out of alignment no more than 15 degrees maximum. See [Directional Curb Ramps](#) in the toolkit.

APSS

- The design should be updated to show APS locations that are compliant with the guidance in this toolkit and are consistent and predictable. See [Accessible Pedestrian Signals](#) in the toolkit.

Maintenance

- The County should develop and implement a plan for snow and ice clearance along the Fenton Street corridor, including clearance of snow and ice from sidewalks, curb ramps, bicycle lanes, and bus platforms and waiting areas. The plan should not depend on compliance with County snow removal laws by individual property owners.
- The County should develop and implement a plan to regularly inspect the study area to ensure that pedestrian access routes are free of temporary obstacles such as café seating and inappropriately parked scooters and that pedestrian infrastructure is in a state of good repair and compliant with accessibility standards and guidelines. Particular attention should be paid to APS, crosswalk markings, tactile walking surface indicators, lighting, accessible signage, and other elements that are critical for safety and navigation for people with vision disabilities.
- The County should provide visual and tactile signage at key locations along the Fenton Street corridor to inform pedestrians about who to contact to report malfunctioning APS, broken tactile walking surface indicators, inappropriately parked scooters and bicycles, café seating blocking the pedestrian access route, and other safety and accessibility concerns.

Intersection of Fenton Street and Ellsworth Drive

Issues

- This intersection is expected to operate will like a T-intersection in the future, with limited to no motor vehicle access to Ellsworth Drive west of Fenton Street. T-intersections present navigation challenges to people with vision disabilities who rely in part on the sounds of parallel traffic to maintain the correct heading while crossing. The 15% design (Figure 41) does not sufficiently address these navigational challenges for the Fenton Street crossing. The Fenton Street crossing is still unnecessarily long, with an 18 foot wide thru/right-turn lane on the northbound approach and two receiving lanes on the opposite side of the intersection. There are also few cues to help pedestrians with vision disabilities align properly to cross and no visual or tactile edges to the crosswalks to help pedestrians maintain the proper heading once in the crosswalk.
- The design shows a floating bus stop at Fenton Street and Ellsworth Drive that is integrated with a signalized crossing, as are other floating bus stops proposed for the study area. However, there is concern that signal integration will not be as effective in this location at slowing bicycle traffic due to the de facto T-intersection configuration, which lacks the deterrent effect of motor vehicle cross traffic on bicyclist non-compliance.
- Buskers and loud music from speakers near the intersection makes it difficult to hear APS and other sounds that some people with vision disabilities rely on for navigation, such as traffic sounds and the sounds of other pedestrians.
- It is challenging for some people with vision disabilities to navigate between curb ramps on the southeast (Veterans Plaza) corner of the intersection, because this corner has a large corner radius and is adjacent to a large open plaza. Curb ramps are typically closer together and buildings and other detectable edges are usually present to define intersection corners and help pedestrians with vision disabilities navigate them.
- It is challenging for some people with vision disabilities to navigate through Veterans Plaza to the Silver Spring Civic Building due to the lack detectable edges and other navigation cues. The Civic Building is the site of numerous events, including public meetings on transportation plans and designs.
- One of the plaza's entrances from Fenton Street includes a series of steps. The steps are not arranged in a familiar staircase pattern where one step comes directly after another, but rather have extended horizontal areas between them, which makes the location of each step harder to predict. In addition, the steps, which are made of the same light-colored concrete as the horizontal sections, are difficult to distinguish, particularly in certain types of light or in low light conditions. Finally, the silver-colored railing that runs down the middle of the steps is hard to distinguish against the light-colored concrete.³¹

³¹ There are other steps in the Fenton Plaza design that have similar characteristic (e.g., the steps from Ellsworth Drive) and should be considered for improvements similar to those recommended on the following page.

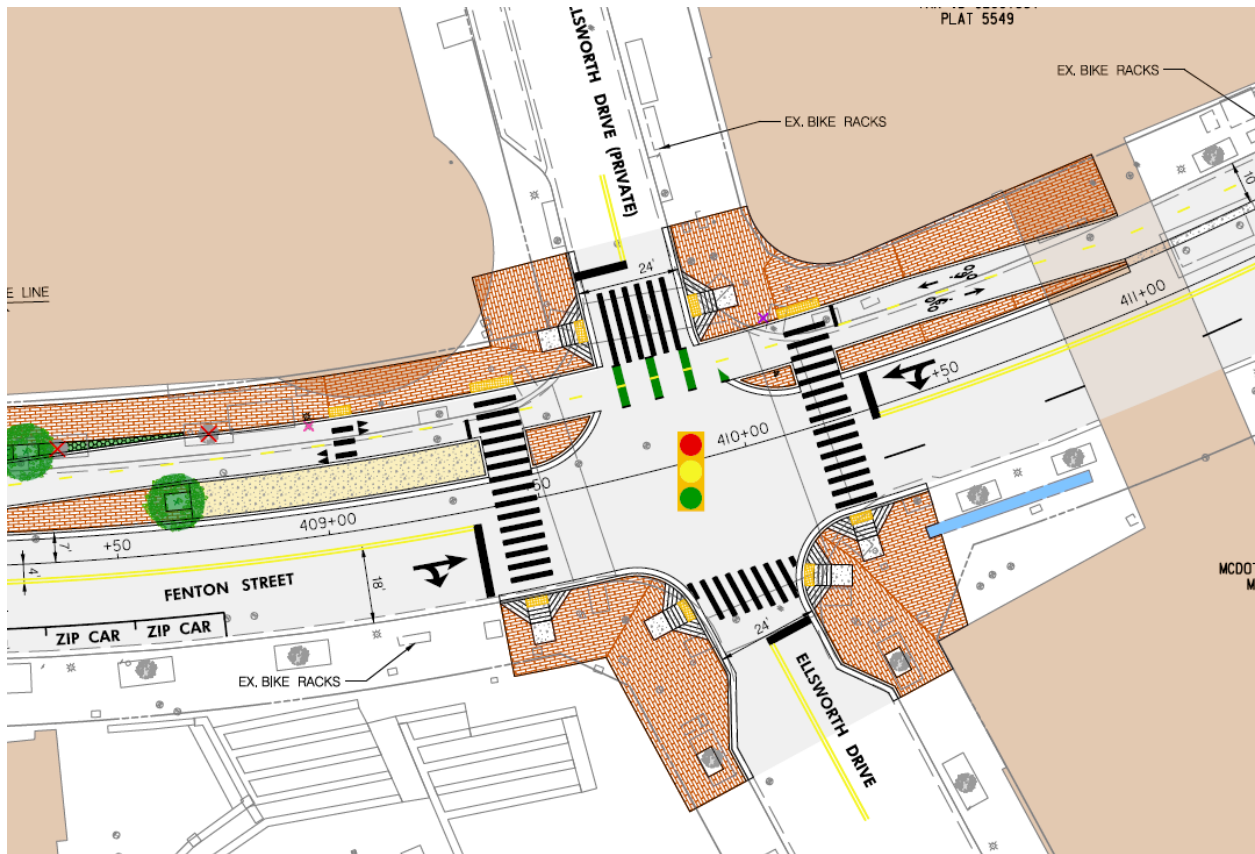

Figure 41: Existing 15% design for the intersection of Fenton Street and Ellsworth Drive

Recommendations

- The design should be updated as shown in Figure 42 below.
- The County should consider designating an area in Veterans Plaza for buskers and musical programming that is away from the intersection.
- The volume of the APS serving the intersection should adjust in response to ambient background noise. The APS should be loud enough to be heard above ambient background noise but not so loud that they mask other sounds that are useful for navigation, such as traffic sounds and the sounds of other pedestrians.
- The APS serving the floating bus stop crosswalks should include modified speech messaging, as recommended in the [Floating Bus Stops](#) section of the toolkit. In addition, visual and tactile signage should be provided on the sidewalk to inform people with vision disabilities of the presence of a floating bus stop and the buses it serves. There should be one visual and tactile sign for each crosswalk connecting to the bus stop platform.
- The steps from Fenton Street into Veterans Plaza should have nosings that contrast visually with the light-concrete color of the pathway, and the railing that runs down the middle of the steps should also be replaced with a contrasting color railing.
- Lighting should be provided as recommended in the [Lighting](#) section of the toolkit.

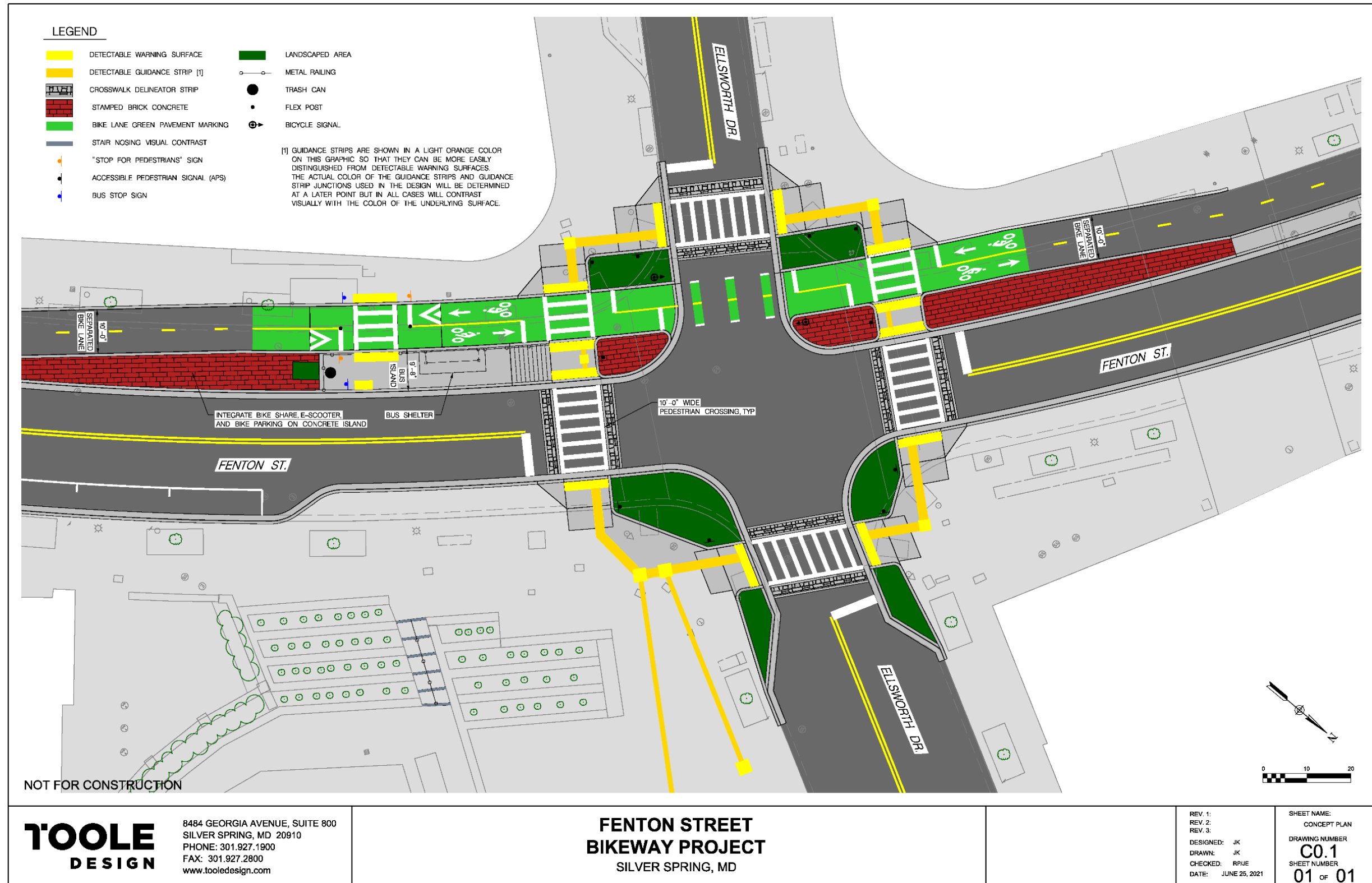

Figure 42: Recommended updates to 15% design for Fenton Street and Ellsworth Drive

Intersection of Fenton Street and Wayne Avenue

Issues

- The County has limited control over the design of Wayne Avenue and how it is traversed by the Purple Line. Wayne Avenue is a state road and the Purple Line is being constructed by Purple Line Transit Partners.
- In the 15% design (Figure 43), the crosswalk across the western leg of the intersection is long and extremely skewed with curb ramps that are not directional. A pedestrian with a vision disability traveling from north to south is very likely to veer outside of the marked crosswalk, potentially into the designated crossing area for bikes or across the Purple Line Tracks. The other crosswalks are also potentially challenging to navigate for a person with a vision disability, due to their length, ramps that are not aligned with crosswalks (e.g., southeast corner), and the lack of visual or tactile crosswalk edge lines.
- It is unclear from the 15% design and from Purple Line design documents provided to the Project Team in April 2021 how pedestrians are expected to navigate between curb ramps on the southwest corner of the intersection and what active pedestrian control is proposed. Furthermore, the landing at the top of the curb ramp on this southwest corner appears to be within the dynamic envelope of the LRT system, which is not safe, accessible, or permissible.

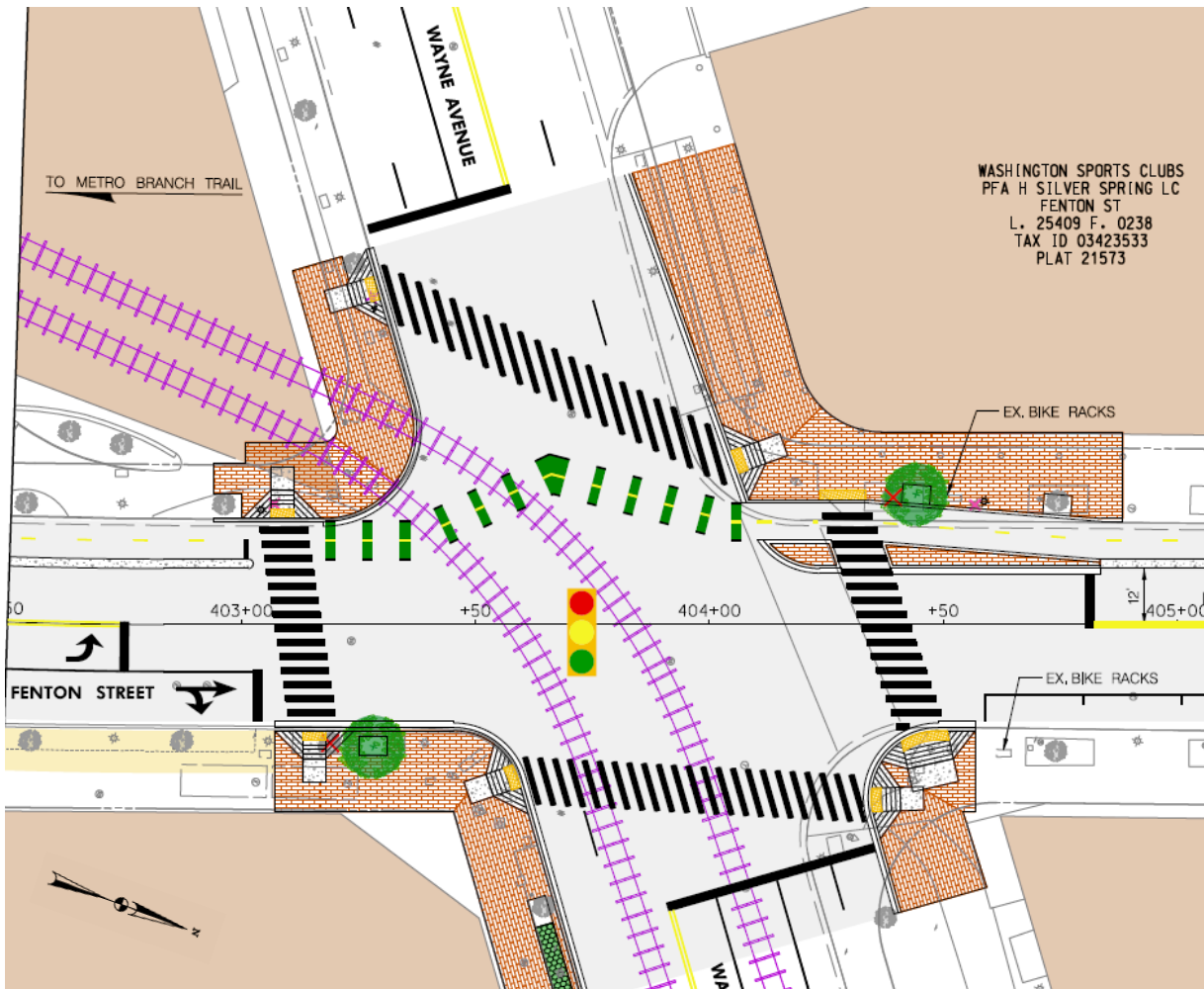

Figure 43: Existing 15% design for the intersection of Fenton Street and Bonifant Street

Recommendations

- The County should engage with SHA and Purple Line Transit Partners on the issue of access for people with vision disabilities and advocate for adjustments to the intersection design to better accommodate them. Recommended adjustments include directional curb ramps, beaoning APS, ladder-style high-visibility crosswalks, and crosswalk delineator strips. A beaoning APS and/or crosswalk delineator strips are particularly needed for the crosswalk across the west leg of the intersection, because of how misaligned it is with the path of travel on the sidewalk. A pedestrian only signal phase may also be considered given the high volumes of pedestrian traffic, which would allow the western crosswalk to be shortened without concern for conflicts between pedestrians and turning motorists.

Silver Spring Public Library/Purple Line Station Access

Issues

The County has limited control over the design of the Purple Line Station at the Silver Spring Public Library.

- Navigating to the Silver Spring Public Library entrances is currently not intuitive (Figure 44) and could become even more challenging with the addition of the Purple Line station. This is true for people with normal vision and even more so for people with vision disabilities. Existing challenges include:



Figure 44: View from Wayne Avenue toward the Fenton Street entrance of the Silver Spring Public Library.

- A paving pattern that is purely decorative, visually confusing (e.g., might be misinterpreted as steps), and not helpful for defining pathways to library entrances.
- Entrances that are in nonintuitive locations, visually understated, and inadequately signed, with the primary signage being large vehicle-oriented signs that do not contrast visually with the background of the library façade.
- In addition there are significant safety concerns for people with vision disabilities, including an unfenced wall drop-off on the approach to the Fenton Street library entrance (Figure 45) from the southeast corner of the intersection, a curbed bioretention area near the intersection of Fenton Street and Bonifant Street that poses a trip and fall hazard, and steps that do not have contrasting nosings.



Figure 45: Unfenced wall drop off on the approach to the Fenton Street library entrance.

Recommendations

- The County should engage with Purple Line Partners and the Silver Spring Public Library on the issue of access for people with vision disabilities and advocate for adjustments to the design to better accommodate them. Recommended adjustments include:
- Define accessible pathways to library entrances and Purple Line platforms with a consistent color and texture, guidance strips, detectable edges (e.g., landscaping), and other cues.

- Add/improve visual and tactile wayfinding signage. Visual signage should have high-contrast, easy-to-read lettering that is legible to pedestrians with low vision. Signage should be placed in predictable locations that are accessible to people with vision disabilities.
- Add color contrasting nosings to all steps.
- Add color contrasting railings to the wall drop-off and the bioretention area.
- In addition, the County should:
 - Provide orientation training to people with vision disabilities on the layout of the Silver Spring Library Station.
 - Provide training to people with vision disabilities on how to use the Purple Line.
 - Collaborate with WMATA and the Silver Spring library to provide informational resources to people with vision disabilities, including tactile maps and improved website information. For example, the Silver Spring Public Library website could improve its “directions” page with information about how to locate library entrances, including photos of the entrances to make them easier to recognize.

Intersection of Fenton Street and Bonifant Street

Issues

- In the 15% design (Figure 47), the crosswalks at this intersection are relatively long and skewed and do not have visual or tactile edge lines. The curb ramps on the southeast and southwest corners are also not aligned with the crosswalks they serve. With this configuration, it is very likely that a pedestrian with a vision disability will veer outside of the marked crosswalks.
- Some crosswalks are shown with only detectable warnings without curb ramps. It is unclear how these crossings will be made accessible based on the 15% design.
- The APS pushbuttons that are currently located on the northwest corner are located too far from the edge of the curb ramps they serve (over 10’ in the case of the curb ramp serving the Bonifant Street crossing) and the signal pole foundation makes them difficult for a person in a wheelchair to reach. (Figure 46) The 15% design does not indicate where these APS pushbuttons will be located when Fenton Street is reconstructed or whether they will be retained on the existing signal pole.



Figure 46: The distance between this APS pushbutton and the top of the curb ramp serving the crosswalk across Bonifant Street is more than 10 feet.

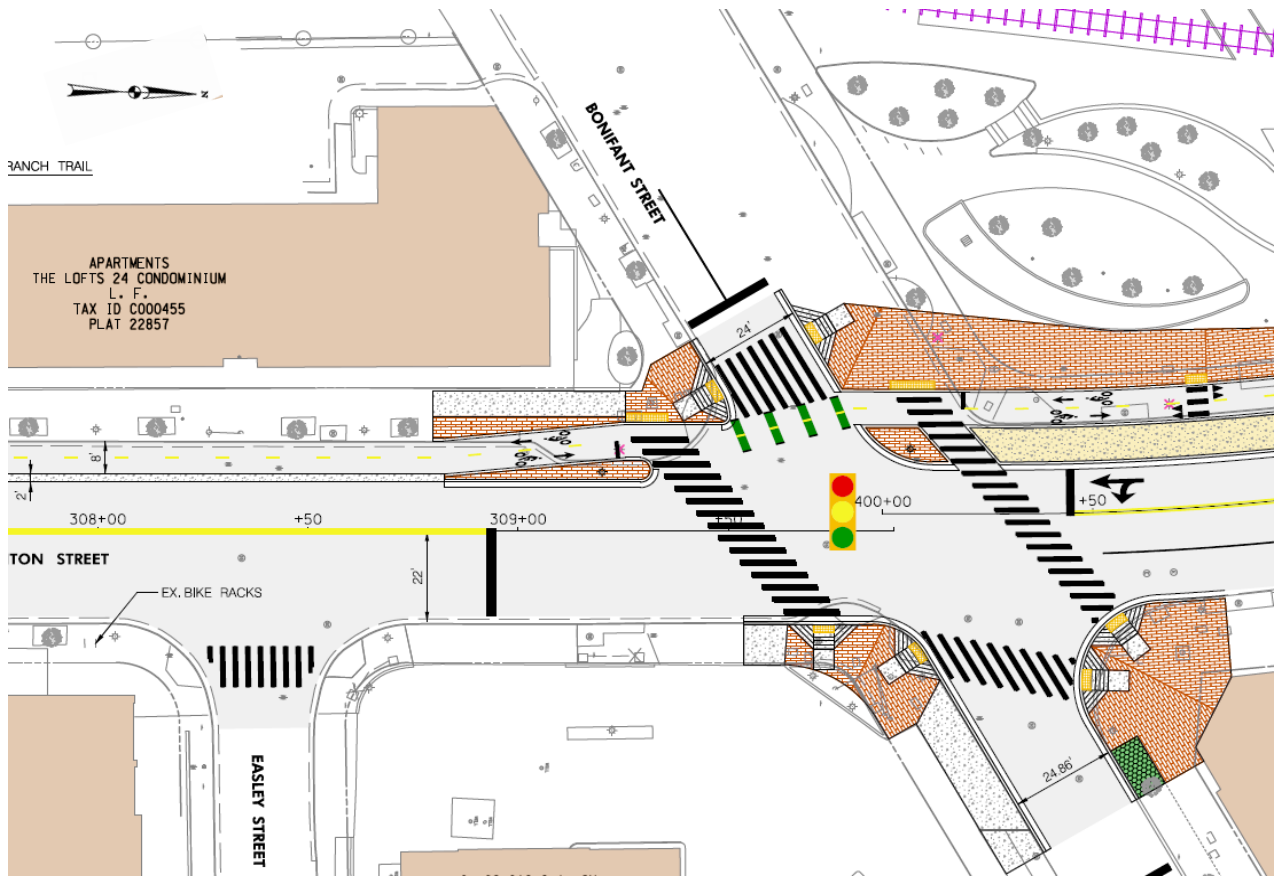

Figure 47: Existing 15% design for the intersection of Fenton Street and Bonifant Street

Recommendations

- To shorten pedestrian crossing distance and provide space for directional ramps, the County should modify the design to include curb extensions into Fenton Street on the north east and southeast corners of this intersection. This would require narrowing the 22' wide lane shown on the northbound approach to the intersection and removing one of the two receiving lanes directly north of the intersection with buses stopping in-lane. A lane for eastbound turns onto Wayne Avenue could still be provided north of the intersection.
- The design should be updated to show APS that comply with the guidance on locating APS pushbuttons provided in the Accessible Pedestrian Signals section of the toolkit.

East side of Fenton Street (Bonifant Street to Easley Street)

Issues

- The 15% design does not include any changes to this segment.
- This segment is difficult for pedestrians with vision disabilities to navigate due to:
 - The narrowness of the sidewalk, which is exacerbated by light poles positioned in the middle of the sidewalk and Citgo gas station fencing, which includes brick columns that protrude into the sidewalk. (Figure 48)
 - Two wide driveways to the Citgo gas station property, which create potential conflict points between motor vehicles and pedestrians, and which lack detectable edges on the gas station side, creating a poorly defined and difficult to navigate space.



Figure 48: Sidewalk in front of Citgo gas station

Recommendations

The County should consider modifying the 15% design as follows:

- Close the Citgo gas station driveway access closest to the Bonifant Street intersection.
- Widen the sidewalk to provide a landscaped buffer space between the sidewalk and street.
- Relocate the pedestrian-scale lighting into the sidewalk buffer.
- Adjust the design of the remaining Citgo driveway from Fenton Street so that it ramps up through the buffer space, has an ADA-compliant cross slope as it passes over the sidewalk, and has a tactile delineator strip on the gas station side of the sidewalk to define the boundary with the gas station property.
- Adjust the fencing to not protrude into the pedestrian access route on the sidewalk.

Intersection of Fenton Street and Easley Street

Issues

- The curb ramps at this intersection are not aligned with the crosswalk.
- The level landing provided at the top of the ramp on the northeast corner is not ADA-compliant.

Recommendations

The County should consider modifying the 15% design as follows:

- Construct curb extensions into Fenton Street on both corners to provide space for directional ramps and an ADA-compliant level landing on the north side of the crossing. The curb extension on the north side will be a continuation of the recommended sidewalk widening.

Fenton Street (Easley Street to Thayer Avenue)

Issues

- The driveway into the Safeway parking lot (west side of street) is extremely wide and wider than the parking lot access, creating difficulty for people with vision disabilities to identify the active area of the driveway. (Figure 49)
- The crossing at the narrow driveway between the Safeway and 1810 Fenton Street is configured as an intersection crossing with ramps. The ramps have detectable warning surfaces along their entire length, which is unnecessary and creates an uncomfortable walking experience. (Figure 50)
- The café seating on the east side of the street extends into the pedestrian access route. (Figure 51).
- The sidewalk in front of the Exxon station is challenging to navigate for the same reasons as the sidewalk in front the Citgo station, including pedestrian-scale lighting that creates pinch points, fencing with protruding brick columns, and two wide gas station driveways.



Figure 49: View of Safeway driveway crossing.



Figure 50: View of ramps to driveway between Safeway and 1810 Fenton Street.



Figure 51: Cafe seating extends into the pedestrian access route on the sidewalk.

Recommendations

The County should consider modifying the 15% design as follows:

- Narrow the width of the Safeway parking garage to only be as wide as the ingress/egress lanes from the parking garage.
- The driveway between the Safeway and 1810 Fenton Street is a low-volume residential driveway and should be modified to include a standard driveway apron that maintains the elevation of the sidewalk and prioritize pedestrian access across this location.
- Close the Exxon gas station driveway access closest to the Thayer Avenue intersection.
- Widen the sidewalk between the second Exxon driveway on Fenton street and Thayer Avenue to provide a landscaped buffer space between the sidewalk and street.
- Relocate the pedestrian-scale lighting into the buffer.
- Adjust the design of the second Exxon driveway so that it ramps up through the buffer space, has an ADA-compliant cross slope as it passes over the sidewalk, and has a tactile delineator strip on the gas station side of the sidewalk to define the boundary with the gas station property.
- Adjust the fencing to not protrude into the pedestrian access route on the sidewalk.

In addition, the County should educate the restaurant owners along this segment about the necessity of keeping café seating out of the pedestrian access route and conduct regular inspections to ensure that is being done.

Appendix C: Proposed Guidance for Temporary Pedestrian Paths During Routine Maintenance and Construction

Routine maintenance and construction can temporarily block pedestrian access routes or make them unsafe for pedestrians to use, resulting in the need to establish a temporary pedestrian path around the work zone. These changes can be particularly challenging for people with vision disabilities who often rely on mental maps for navigation.

Concerns About Existing Approaches

Pedestrians with vision disabilities report the following challenges associated with construction activities:

- Lack of a safe, accessible, and convenient temporary pedestrian paths.
- Insufficient information about construction-related changes and how to navigate them, e.g., finding relocated bus stops during construction of the Sarbanes Transit Center.
- Construction equipment that protrudes into the pedestrian access route, creating a hazard, e.g., the feet of a construction barrier extending into the pedestrian access route, which can cause a person to trip.

Recommended Guidance

General

- Construction activities should maintain access for pedestrians in their existing conditions for as long as possible.
- When construction or maintenance work must block a pedestrian access route or makes it unsafe to use, an alternative temporary pedestrian path should be provided.
- Temporary traffic control, including temporary paths of travel, must comply with the [MdMUTCD Part 6](#).
- Temporary paths of travel must be safe, convenient, legible, and easy-to-use for all pedestrians, including pedestrians with vision disabilities.
- At a minimum, temporary paths of travel should be defined using standardized equipment, colors, language, and procedures to minimize confusion.
- Detours should maintain connections to transit services, businesses, and amenities that are along the original path of travel. If access to these connections is not apparent, pedestrians should be directed to them with signage that is accessible to people who are blind or have low vision.
- Temporary paths should be clean, well-maintained, and free of debris, equipment, and other obstructions at all times.

Minimize detour

- Design temporary pedestrian paths as close as possible to corresponding original paths.
- Wherever possible, keep temporary pedestrian paths as simple as possible and minimize the necessity for road crossings. Same-side travel is preferred over street crossings.
- Avoid the need for pedestrians to retrace their steps or travel out of their way to follow a temporary pedestrian path.

Provide seamless transitions

- Provide a smooth, continuous, hard surface throughout the entire length of the temporary pedestrian path.
- Ensure that temporary pedestrian paths are free of sharp edges, uneven grading, and obstructions or hazards that can cause tripping and falling (such as concrete supports for temporary fences) or that create barriers to the use of mobility aids, such as wheelchairs or scooters. Vertical discontinuities along the pedestrian access route should not exceed ½

inch. Vertical discontinuities between ¼ inch and ½ should be beveled with a slope not steeper than 50 percent.

Separate pedestrians from vehicles

- Keep worksite vehicles, equipment, operations, and vehicular traffic away from temporary paths of travel.
- If vehicles and equipment must travel through pedestrian access routes, use flaggers to direct vehicle and pedestrian traffic.

Communication

- Information should be provided to pedestrians of all abilities on how to navigate temporary pedestrian paths safely.
- At a minimum, information on temporary pedestrian paths should be communicated through visual and tactile signage installed on the approaches to the work zone. See [Signage](#) in the toolkit for additional guidance.
- Audible information devices with speech messaging are also recommended, especially in cases where the temporary pedestrian path would not be intuitive to a person with a vision disability, e.g., because channelization devices are discontinuous along the temporary pedestrian path.
- When a longer-term project is planned (e.g., more than two days of closure), consideration should be given to providing information about temporary paths through other communication channels, e.g. websites, neighborhood listervs, social media, including communication channels that are accessible to and used by people with vision disabilities.
- Messaging about temporary pedestrian paths should be simple, direct, and easy to understand. It should include any specialized information relevant to people with disabilities, such as the presence of ramps, where the temporary path ends, or whether alternative access routes to businesses are available.
- Signs should be maintained for cleanliness, legibility, and correct positioning along temporary pedestrian paths. Replace signs that have lost significant legibility.



Figure 52: Example of an audible speech messaging device posted in advance of a work zone.

Barriers

- Detectable barriers (e.g., barricades) should be used for sidewalk closures.
- Hand-level detectable barriers should be used to delineate temporary pedestrian paths through or around a work zone. (Figure 53)
- Barriers should be detectable by users of long canes and visible to people with low vision.
 - They should have a solid toe rail with the top edge at 6" above the ground and the bottom edge no higher than 1.5" above the ground.
 - A continuous top railing should be mounted on the barrier at a height of 36"-42" with diagonal stripes having at least a 70% contrast.
 - Top rail shall be parallel to the toe rail so that people can use the rail as a guide for their hands for wayfinding.

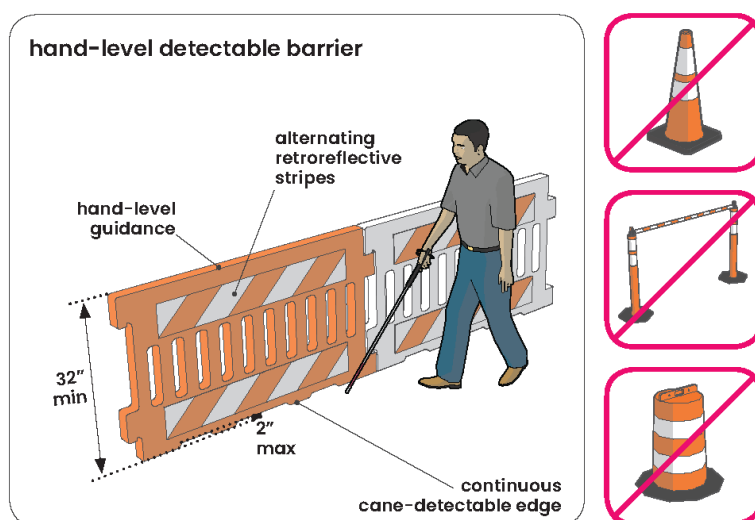
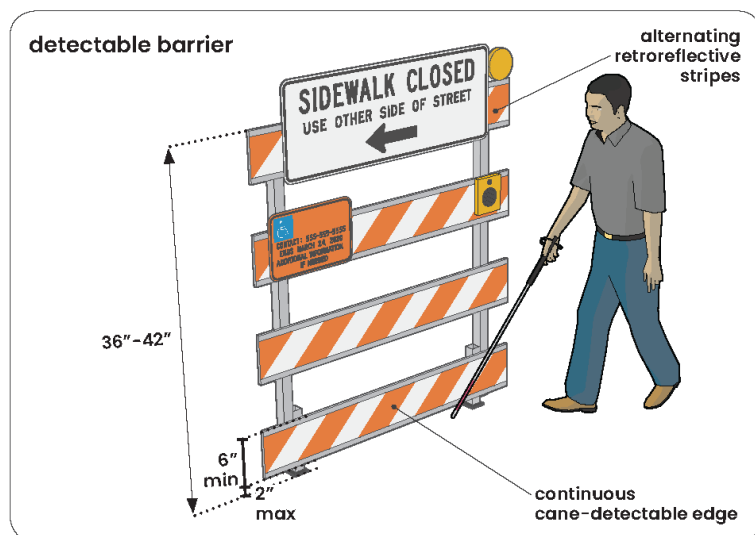

Figure 53: Detectable barriers and hand-level detectable barriers.

- Joints between barriers should be closed and flush to prevent canes and small wheels from being trapped.
- Tape, rope, and or plastic chains should not be used to link segments of barriers, since they are not cane-detectable.

Removal

- Remove all temporary devices, ramps, signs, etc. when projects conclude. When work is suspended for short periods of time, remove and adequately store or cover temporary traffic control devices that are not in use.
- When there is no longer a need for a particular temporary pedestrian path, be sure to remove all related physical and online information.

For additional guidance on providing temporary pedestrian paths in work zones, see FHWA's [Applying the Americans with Disabilities Act in Work Zones: A Practitioner Guide](#).

Appendix D: Engagement Best Practices

This section includes basic principles and practical tips for engaging people with disabilities in street planning and design processes. It has been adapted [from *Engaging People with Disabilities and Street Design and Planning: 11 Tips for Getting it Right*](#), a resource guide developed by Toole Design.

Basic Principles

Aim for engagement, not just accessibility

People with disabilities can and should be included in planning and design processes at different levels. At a minimum, meetings and online materials must be accessible to people with disabilities. This is a legal requirement. However, “engaging” people with disabilities involves going beyond the baseline. It means proactively reaching out to people with disabilities to understand their experiences, solicit their input, and involve them in decisions.

Engage people with different types of disabilities as well as advocates for people with disabilities and professionals who work with them

There are many different types of disabilities and many ways of living with disability. For instance, in the category of people with vision disabilities, there are people with reduced visual acuity, peripheral field loss, central field loss, total vision loss, night blindness, and color blindness, to name just the major subcategories. In addition, some people with vision disabilities use a cane (of which there are several types), some use a guide dog, and some rely on a human guide. Others may use no specialized mobility aids at all. Finally, income, race/ethnicity, gender, neighborhood context, access to training, and other attributes influence the experience of disability. Street plans and designs need to account for this diversity. The best way to ensure this is by proactively engaging people with a range of disabilities, coping strategies, and backgrounds in street planning and design processes, and by engaging people or organizations that have a deep familiarity with this diversity and can offer their expertise.

Engage people with disabilities throughout the entire process

People with disabilities and advocates for people with disabilities should be engaged throughout the transportation planning, design, and implementation process. They should be involved in crafting the project vision and goals, evaluating existing conditions, identifying and prioritizing alternatives, reviewing designs, and evaluating outcomes. Some of these steps are highlighted in greater detail below.

Allow enough time and budget

Engaging people with disabilities is not something that can be done at the last minute or cheaply. You need to plan ahead and ensure that your budget will enable you to accommodate people with disabilities as part of the process. Potential costs including paying for interpretation services (American Sign Language, Deaf-Blind, CART³²), and paying for materials that are accessible to people with vision disabilities, such as websites and documents that can be read by a screen reader, braille documents, or tactile graphics.

Use inclusive language and imagery

As planners and designers, our choice of words, and the way we portray (or fail to portray) people in our work, can send a powerful signal about who our plans and designs are for and how we think about them. When working with a specific person with a disability, it is best practice to ask the person which terms they prefer to describe their disability. When referring to people with disabilities more broadly, it is generally recommended to use “people first” language, e.g., “a person who is

³². Communication Access Realtime Translation

deaf” not “deaf person.” Imagery also matters. Showing images of people with disabilities in the materials that are developed for a project can help convey that people with disabilities are valued and encouraged to participate, and that the process and its outcomes are designed to serve their needs.

Practical Tips

Tip 1: Lay the groundwork for engaging people with disabilities

As planners and designers, there are several steps we can take to lay the groundwork for planning and design processes that successfully engage people with disabilities. These steps can and should happen outside of specific projects. They include:

- Continually working to improve our knowledge of inclusive public participation processes and effective engagement of people with disabilities.
- Reviewing current planning practices and the roles that people with disabilities play in key decision-making. Tools such as the IAP2 Spectrum of Public Participation can be useful in this review. (See next page.)
- Incorporating best practices for inclusive public participation and engagement of people with disabilities in agency/organization standard procedures, e.g., by developing a public participation plan for the agency/organization.
- Developing a list of key community stakeholders who represent people with disabilities or have an enhanced focus on accessibility (see textbox).
- Cultivating ongoing relationships with key community stakeholders on accessibility issues.

Key Stakeholders for Accessibility Issues

For people with vision disabilities

- Orientation and Mobility Specialists
- National Federation for the Blind (click here for state and local affiliates)
- American Council of the Blind (click here for state affiliates)
- Guide dog user groups

For people with hearing disabilities

- National Association of the Deaf (click here for state affiliates)
- Hearing Loss Association of America (click here for local chapters)

For people with intellectual and developmental disabilities

- Arc (click here for local chapters)
- American Association of Intellectual and Developmental Disabilities (AAIDD)—click here for local chapters.

With an enhanced focus on accessibility

- AARP (click here for local chapters)
- Senior centers/senior groups

Additional local organizations specializing in support and services for people with disabilities, or communities or demographics that include high numbers of people with disabilities, exist in most places and should be involved in street planning and design processes

Tip 2: Include engaging people with disabilities in the project scope, budget, and timeline

The parameters for engagement are set well before any meetings or outreach take place. The project scope, budget, and timeline are key determinants. If the project scope fails to highlight engagement of people with disabilities, or if the timeline and budget make real engagement infeasible, then it likely won't happen on the level it should. The project scope, budget, and timeline should:

- Clearly state that improving access for people with disabilities is a project goal.
- Include engagement of people with disabilities as an explicit element of the public outreach and engagement scope throughout the project.
- Allow enough time and resources (both financial and staff) for effective engagement of people with disabilities.
- Allow for flexibility based on input from people with disabilities and organizations that represent them.

Tip 3: Develop a public participation plan that targets people with disabilities

A project-specific public participation plan can help clarify how people with disabilities will be included in a project. The plan should include:

- Goals and metrics for engaging people with disabilities.
- A strategy and timeline for soliciting input from people with disabilities at every stage in the process.
- Milestones for determining whether people with disabilities are being effectively engaged and changing course if something isn't working, e.g., reviewing participation levels after each public meeting or at regular intervals during an online survey.
- A methodology for evaluating how well a project engaged people with disabilities and lessons learned at project closeout, including direct feedback from people with disabilities about how the process worked for them, which might be solicited through targeted surveys, focus groups, and interviews.

Tip 4: Involve people with disabilities in project oversight and decision-making

Truly engaging people with disabilities involves going beyond simply making it possible for them to participate. It requires involving them in decision-making. One practical way to do this is to establish a project oversight or steering committee that includes people with disabilities and their advocates. It is important; however, that the committee have real power and influence over the direction of the project. Otherwise, including people with disabilities in the committee amounts to tokenism.

Tip 5: Involve people with disabilities in existing conditions analysis

Existing conditions analysis establishes the foundation for project recommendations. If this analysis fails to identify the barriers to access that people with different types of disabilities face, then those barriers are unlikely to be fully addressed by the project recommendations. When done thoroughly and completely, with a deliberate focus on the needs of people with disabilities, existing conditions analysis can help identify accessibility barriers that would not have been considered otherwise, resulting in project outcomes that better serve people with disabilities. Best practices include:

- Consult directly with people with disabilities about existing conditions. It is important to understand the transportation needs of people with a range of disabilities as well as the barriers they face in the transportation system. What destinations do they need to access in their daily lives? What modes are they likely to use to get there? What barriers and other considerations shape their transportation decisions? How does this experience vary

depending on disability type, income, race/ethnicity, gender, and other attributes? One of the best ways to collect the answers to these questions is to consult with people with disabilities directly.

- Conduct a pedestrian or bicycle audit in the project area that includes people with a range of disabilities and others who are very familiar with the safety and accessibility they face. A group like this is much more likely to identify accessibility barriers. Observing these barriers in the field, and the challenges people with disabilities in the group experience navigating them, makes the barriers more tangible and immediate to all involved, and this shared experience can help build consensus about what the needs are and possible ways of addressing them.
- Review data from the U.S. Census Bureau and other locally available sources to determine where people with disabilities and older adults are concentrated and where to focus planning and design efforts. A 2016 CDC study found that the likelihood of having any type of disability was three times higher for adults with incomes below the poverty level compared to adults with incomes twice the poverty level. This likelihood goes up to five times higher in the case of mobility disabilities. At the same time, people in lower income neighborhoods are less likely to have access to a private car and more likely to rely on walking, bicycling, and public transportation, amplifying the need for these modes to be accessible.
- Understand that systems for establishing existing conditions and needs based on resident reporting are likely to be biased. It is common for agencies to rely on resident reporting systems, such as 311, to identify locations where there may be a safety or accessibility issue such as a heaved sidewalk or missing curb ramp. Overreliance on such systems for understanding existing conditions and needs is likely to result in a bias toward wealthier neighborhoods where people have more time, greater access to cell phones, and greater comfort and confidence engaging government institutions for their benefit. At the same time, it is likely to miss lower income neighborhoods where people with disabilities are more likely to be concentrated.

Tip 6: Encourage people with disabilities to participate in the public participation process

- Reach out directly to people with disabilities and their advocates to invite them to participate in public participation activities. Ask about transportation needs and offer to help with these needs, e.g., by coordinating rides.
- Advertise meetings and other public participation activities through organizations that serve people with disabilities (e.g. Easter Seals, Lighthouse for the Blind, AARP, etc.). Consider setting up an opt-in automated phone call system to improve awareness among older adults.
- Establish a Section 508-compliant project website and have a 508 compliance specialist on hand to help ensure project materials are accessible.³³

³³ Section 508 guidance requires federal agencies, and state agencies who choose to adopt this guidance, to provide accessible versions of all websites and materials provided digitally to the public. However, even in cases where Section 508 does not apply, most websites are still required to be accessible. See [Do Section 508 Accessibility Standards Apply to My Website?](#) for additional details.

Tip 7: Choose locations and times for public outreach activities that are accessible to people with disabilities

- Hold public outreach activities, such as public meetings, focus groups, walkabouts, pop-up tabling and other in-person events in locations that are served by public transit and accessible to people with a range of disabilities. Ask yourself, could a person who uses a wheelchair access this location? Could a person with a vision, hearing, or cognitive disability?
- Make sure activities are scheduled at times when public transit and paratransit systems are operational and can be easily used for access to and from the activity. Provide information on transit access as part of the meeting announcement.
- Make sure there are no physical barriers at the activity location that may impact a participant's ability to get to and move around the space freely and that the lighting is good. Arrange tables, chairs, and other objects to facilitate access by people who have mobility assistance devices, personal care devices, care team members, service animals, etc.
- Appoint a greeter (or greeters) to provide verbal information about the meeting, including directions to the meeting room and bathroom. Incorporate verbal information about bathroom locations and other logistical matters in a "housekeeping" segment at the beginning of the meeting.
- Give people the option of participating in the meeting remotely or move the entire meeting online.

Accessible Virtual Meeting Best Practices

Due to the COVID-19 pandemic, most public engagement for transportation planning and design projects has shifted to online, virtual spaces. The growing comfort with these spaces among facilitators and participants presents an enormous opportunity to engage historically underrepresented groups. In the case of people with disabilities, common barriers, such as travel to meetings, physical barriers within meeting spaces, and lack of access to interpreters, either do not apply or are more easily addressed. However, the shift to virtual spaces also comes with new barriers and challenges, including the need for Internet access, lack of familiarity with online engagement tools, and poor audio-visual quality.

Rooted in Rights, a non-profit organization that focuses on amplifying the voices of people with disabilities, recently released two best-practice resources on accessible virtual meetings that address some of these challenges. The guidance considers accommodations for people with vision, hearing, and intellectual and developmental disabilities in online meeting spaces.

- "Make Your Video Calls Accessible" produced in partnership with King County:
<https://www.kingcounty.gov/depts/dnrp/wtd/capital-projects/active/coal-creek-sewer-upgrade.aspx>
- "How to Make Your Virtual Meetings and Events Accessible to the Disability Community"
<https://rootedinrights.org/how-to-make-your-virtual-meetings-and-events-accessible-to-the-disability-community/>

Tip 8: Make it possible for people with disabilities to fully participate in public outreach activities and proactively engage them during the activity

- Ask what special accommodations people may need to fully participate in meetings and other public outreach activities. Do not assume that no accommodations are needed unless you ask.
- Provide advance copies of meeting materials in accessible electronic formats, including detailed presentation notes with descriptions of images and graphics or “alt text.” See *Provide Accessible Materials* below for additional information.
- Print enlarged copies of presentations for people with low vision, who may be able to read close up but not at a distance.
- Make sure visual materials use high-contrast colors. Avoid using similar colors like blue and purple to demonstrate a concept.
- Use tactile maps or 3-D models to help illustrate key design concepts. Allow enough time for review.
- Provide detailed verbal descriptions of visual elements that are important for understanding, such as presentation graphics or images.
- Provide and use microphones. All presenters should use a microphone, and microphones should be available for participants to use during group discussion periods. Be deliberate about speaker placement (and seating someone with a hearing impairment) when using microphones.
- Hire interpreters for deaf and deaf-blind attendees.
- Speak slowly and clearly, using simple, direct language.
- Actively engage people with disabilities in planning processes. Ask them about their experiences navigating the built environment and their thoughts on plans and designs.

Tip 9: Provide accessible materials

- Use plain language in written materials. Avoid jargon.
- Make sure that electronic documents can be read by screen readers. This is critical for materials that have complicated layouts. Flow logic and text hierarchy checks in Adobe Acrobat are great first steps for checking not only if a document is screen-reader compliant, but also that it makes sense when read through a screen reader.³⁴

Tip 10: Set up phone, online, and mail-back feedback opportunities

- Regardless of where and when public outreach activities are scheduled, or whether meetings are in-person or virtual, some people will not be able to attend due to scheduling conflicts and other reasons. To address this, planners and designers should provide feedback opportunities outside scheduled activities. Examples include online surveys and feedback forms sent by direct mail with pre-stamped envelopes. Individual interviews by phone may also be an effective strategy, particularly while physical distancing is required due to COVID-19.
- Encourage participants to share these feedback opportunities with their community contacts to expand the meeting’s reach.

³⁴. Additional resources on Adobe’s steps and checks for accessible PDFs are available online from Adobe at <https://helpx.adobe.com/acrobat/using/create-verify-pdf-accessibility.html>.

Tip 11: Involve people with disabilities in post-construction evaluation

It is important to evaluate street designs post-construction to determine whether they are performing as intended and to identify any needed tweaks. It can be particularly helpful to involve people with disabilities in this work, since they are best positioned to identify accessibility barriers. Involving people with disabilities at this stage is particularly important for newer street designs, such as separated bike lanes and shared streets, since official guidance on how to make these designs accessible is limited.

Appendix E: January 11 Meeting Materials and Transcript

January 11 Meeting Slides

Meeting Transcript

Silver Spring Wayfinding/Safety for People with Vision Disabilities Project Jan. 11 Public Meeting Transcript

[Matt] So I just admitted a few more people. But I think it is six. It's a little after 6:30. So we're gonna go ahead and get started, and if anyone joins us, they can join us in progress. So before we get into things, my name is Matt Johnson and I am a project manager with the Montgomery County Department of Transportation. And I do want to start off by thanking all of you for taking the time this evening to join us. I think this is going to be a good conversation and we're really looking forward to the feedback that you will give it tonight. This project is about finding ways that Montgomery County can improve both wayfinding and safety for people who have a vision disability. And this is a project that's been funded through a grant from the Metropolitan Washington Council of Governments. We also have joining us this evening Toole Design. They are the consultants on the project who are helping us with constructing the toolkit and the initial design work for our pilot location. So Jim, you mind advancing the slide? And I do want to point out that we do have closed captioning available, so if you would like to see the closed captions, you can click the "closed caption" button on the bottom of your screen. It may be in the "more" menu if it does not appear directly there. And we also have American Sign Language interpretation which you should be able to see on your screen.

So with that, I'm going to go over some goals for the meeting and then we're going to introduce the people who are here to help us out tonight. What we want to do first off is inform you about the project and talk about some future opportunities for public engagement for you to give us input on the project. We would like to talk about how we've developed an understanding of people who have visual impairments and how they navigate in the world. And we want to hear that from you. We also want to get feedback from you about the challenges that you face. And then finally we're going to introduce and get some feedback on the design principles that are leading our efforts to create the toolkit to address the navigation challenges and the safety challenges that you face when you're navigating in the world.

Jim, next slide please. So the agenda tonight. We're going to start off with some housekeeping. We'll do introductions and then we'll introduce the project. We'll talk about our understanding of people who have vision disabilities and understanding those challenges that you face. We're going to talk about the principles and tools for designing for people with vision disabilities. We'll take some questions and comments, and then we'll go over next steps. Next slide, Jim.

So in terms of housekeeping-- Do we have another slide after this, Jim? Yeah, so this-- The call-- the Zoom is being recorded, so please be aware that anything you say or put in the chat window is being recorded. We will post the recording of this meeting to our website in a few days once we've had a chance to make sure it's cut and captioned properly. So if you if you were not able to-- you're all at

the meeting, but if you have any friends who are not able to attend the meeting or if you would like to review this meeting recording later, you will be able to access it on our website. Next slide, Jim.

Just some ground rules for the meeting. Please try and speak slowly and clearly and I know I'm guilty of accelerating so I'm going to try and keep myself in check and not go too fast. We'd like you to try and keep any remarks to 30 seconds or less so that other people have a chance to speak. We can always come back to you if you have a lot to say and I know that there you probably all have a lot that you want to give us uh information wise so we would love to hear that but let's try and make sure that we give everyone a chance to speak. As a general rule please identify yourself before you give your comments um and if you are referencing a slide or anything that's been said previously please make sure you are clear about what you're referencing so that we're all on the same page. Jim.

[Other speaker] So can I say something real quickly please? I am blind and if you can add to the general rule that the presenters describe the slides that they're presenting, because I am blind and I'm sure there are other blind people in the audience. Thanks.

[Matt] Yes, we absolutely will describe the slides. There are no graphics on the slides that have been up so far. So all that's on the slides are the text that I've been saying. But we will describe any pictures or graphics that are on the slides. That's a very good point so thank you for bringing that up.

I mentioned this at the beginning but in case anyone joined since then you are all muted when you when you joined but you do have the ability to unmute yourself. We would like you to try and use the "raise hand" feature if you would like to speak, but don't do that quite yet, because we're going to take a poll in just a minute. In order to speak you will need to unmute yourself and if you'd like to use the chat feature you can communicate with us via the chat feature.

Go ahead Jim. And Katie, is there anything else you wanted to add to that, Katie?

[Katie] Hi everyone, this is Katie Heuser from Toole Design. And I just wanted to note that the chat feature we only have enabled so you can talk with the meeting host, just for ease of all those using screen readers. For those of you using computers, if you're having trouble reading text on Zoom it may be something on your operating page. If you're using Windows you can open settings. Click on "ease of access menu". In this window you can make the text bigger or make the icons bigger. We have a screenshot of how to do so. If you're using a Mac computer you can open system preferences. Click on the "display" menu option. On that tab, you can select "scaled" and depending on the type of computer that you have, you can select "larger text" or choose a resolution that is best for you.

Next slide.

If some of you are listening via your phone and you have your computer open as well, we appreciate if you please link your audio. You can find your Participant ID on your screen as shown in that screenshot, and you can access your audio settings by clicking on the arrow next to "join audio" on the bottom left hand of your computer. Once you get that number, you can type in on your telephone #, the Participant ID, and then # again. This is just helpful so that we know who you are, and it links your audio to your video.

[Jeremy] And the the Participant ID number is 3-7-5-3-0-0.

[Matt] No. No. That's not-- That's just the one that's in the example. You would have your own unique ID.

[Jeremy] My apologies, my apologies. Sorry.

[Katie] Thanks, Jeremy. Yeah so the Participant ID is specific to you.

Next slide.

If you're new to Zoom, you'll notice that there is a toolbar on the bottom of your screen with a couple of options. This includes "mute", "start video", the "participants" window, and the "chat" box. If you don't see this tool box you may need to maximize your window by clicking on the outline square in the upper right hand corner. And we have a screenshot of how to do that on our slide. If you click on the chat icon, the chat window pops up in a small area where you can ask questions or ask comments to the host. And please note that you cannot communicate with others during this meeting, just the meeting host.

Next slide. Raising your hand is going to be very important during this meeting. If you'd like to speak, we encourage you to raise your hand in Zoom. And there are multiple ways to do this. If you have dialed in through your phone, go ahead and dial * 9 to raise your hand. Again that's * 9. If you're using the Zoom app, the "raise hand" function is on the lower right hand corner. If you're on your computer and it's a PC, you can use the keyboard shortcut ALT Y. Again that's ALT Y. And if you're on your Mac, you can use Option Y. Again that's Option Y. That's to raise your hand.

Throughout this meeting we will have you comment, but we encourage you to raise your hand before you speak. Now we would encourage you to raise your hand and it's only if you have a vision disability or have experienced vision loss. This will help our meeting moderator, Matt, to make a note of this on your name within Zoom so that we know who to prioritize during our discussion later on in the meeting.

Raise your hand if you have a vision disability or experience vision loss, we would very much appreciate it. And keep them up please.

Yeah I can explain how to find the "raise hand". If you're using- if you're on your computer, and if you're looking through the participants window, which you can open up on the bottom. Once you open the participant window, look at the very bottom. There's three tiny dots. And you should be able to click "raise hand" through there. It also may be easier just to use a keyboard shortcut. If you're on a PC, you can do ALT Y. And if you're on a Mac, you can do Option Y. And if you have dialed on your phone, you can dial * 9.

We appreciate everyone raising their hand. If you do have vision disability we are renaming you in Zoom to help with our conversation later on in our meeting.

Excellent. So as I was saying, we appreciate everyone raising their hand later on in the meeting, so that we know that you would like to speak. Once we see your raised hand, we can call on your name and we will then have to unmute you. As we said before everyone enters the meeting muted. So we must unmute you before you could talk. The easiest way to do that is the meeting host, which will be me, will go ahead and unmute you. And this can happen either if you are using a computer or have dialed in. If you request to speak and I choose you, I'll go ahead and unmute you and you must accept this request. This looks like a small window that says the host will like you to unmute, and you can go ahead and press the enter button to be able to speak. And similarly if you're on your phone you will get a message saying the host would like you to mute, and you can go ahead and dial * 6 and that will enable you to speak to the group.

There are a couple other ways you could unmute yourself if needed. We would prefer the meeting host to unmute you, but if you do need to know, you can dial * 6, if you're on your telephone. if you're on your Zoom app, you can click on mute or unmute on the lower left hand corner. Similarly with the computer platform, if you're on a PC you can use the keyboard shortcut ALT A. And if you're on a Mac, use Command Shift A.

We'd appreciate seeing all of your beautiful faces if you are willing to. So we do encourage you to turn your video on during this meeting. You can do that by clicking the "start video" button on the bottom left of your screen. The keyboard shortcuts include ALT V for PC and Command Shift V for Mac. And again if you're willing, we'd appreciate your video.

Thank you. Any questions, again, please go ahead and use the chat function. Which I see some now.

And that's all for me.

[Matt] Thank you, Katie. One second; let me just change the spotlight so I'm back on the screen here. And we did get a chat from Donna, about the Zoom does not allow hosts to unmute people. That's true. We cannot unmute you without your consent, but we can we can request that you unmute yourself. You also have that ability. So if you raise your hand, we will say "you're welcome to unmute yourself and speak now", but if you're having trouble we can send a message to you saying we would like you to unmute. So that's-- To be clear, we cannot unmute you without your consent.

I just want to introduce a few of the people who are here tonight. Again, to repeat, my name is Matt Johnson and I'm a project manager with the Montgomery County Department of Transportation. We also have with us from MCDOT, we have Hannah Henn and Darcy Buckley. Pat Shepherd is also here. She's our bikeways coordinator, she's here to observe. From Toole Design, we have Jim Elliott who is the project manager. On the consultant side we also have Ken Ray and Katie Heuser, who you just met. Marybeth Cleveland is with us as well, and she's gonna have some slides to go through later in the presentation. And then from the Montgomery County Department of Health and Human Services, we have Betsy Leucking and Shawn Brennan. So thank you to everyone who's helping us facilitate this meeting tonight and again thank you to all of you who are here tonight as guests. We don't have time to introduce all of you, but again we would like you to introduce yourself if it's the first time you're speaking tonight.

Next slide, please. So just to introduce the project, and again I mentioned some of this at the beginning, but we got a scope from the Metropolitan Washington Council of Governments to undertake a study of how the County and other jurisdictions can improve wayfinding and safety for people who have a vision disability. And the result of this project is going to be a toolkit of treatments for how we can better serve people who have vision disabilities. It will also include a 30% design for a pilot project in Silver Spring. Now, we have not identified the location of where that pilot project in Silver Spring is going to be yet. That is part of this process. So as we go through the process we're going to ask you to give us some feedback. I don't just mean tonight; I mean do it through the entire process about maybe where that could be, where would you like to see those improvements. And the toolkit will be used not just in Montgomery County but it's designed so that it can be used throughout the region. So potentially we could have some more standardized treatments across across the border, because I know that just like me, all of you are not only in Montgomery County; you also travel across borders to Washington DC, to Virginia, to other counties in Maryland. So one other thing to note is the project-- the completion date for the project is June of 2021. Our grant agreement requires us to have completed the project by then, so this is a pretty quick project. And over the next six months we're going to be working very hard to create this toolkit and the pilot design. Next slide, please.

Just some context and background: We were inspired to apply for this grant based on some feedback that we got from the Commission on People with Disabilities and some other County residents related to the installation of floating bus stops in Silver Spring. That was one of the primary genesis of this project. We also as a County have adopted Vision Zero, which is an effort-- a goal to reduce injuries and fatalities on our roadways to zero by 2030. People with disabilities are among the most vulnerable users on our roads and we really do need to take special care to design the roads in ways that improve safety and mobility for people who have those visual disabilities and other disabilities. So we are also committed to reducing greenhouse gas emissions. And creating alternatives to travel by car is a key part of reducing greenhouse gas emissions. So we're trying to find ways to introduce more friendly pedestrian and bicycle facilities as part of that part of that goal. So those are all-- that's all context for the project. Next slide, please. And I think Jim or Marybeth, I think this is your section.

[Marybeth] Yes, this is my section. Hi everybody, I'm Marybeth Cleveland, and I'll be talking about different types of vision loss and how people with vision loss navigate. My goal is to help the sighted people understand a little bit more about how the inability to access certain visual information can affect safety and navigation. But for the people here with vision loss, I hope it gets you thinking about what works for you in the environment and what does not work so that you can share that later in the meeting.

So, next slide. We're going to talk about types of vision loss. There's a photo on the right hand side with a person wearing a black backpack walking away she's on a wide urban sidewalk she's got a white cane in her left hand and a support cane in her right hand. There are many misconceptions about blindness. One is that all people who are blind read braille. But one that is even more common is that people who use white canes or guide dogs are totally blind. And the truth is that 85 percent of people with a vision disability have some remaining vision. Legal blindness is defined as having a visual acuity -- acuity meaning the sharpness of 20 over 200 -- in the best eye with best correction -- that's with glasses. So for what a person sees at-- for what a 20/20 person sees at 200 feet, the person with 20 over 200 would need to be at 20 feet. Now there are some people who have better than 20 over 200 vision and are legally blind due to their visual field restrictions down to 20 degrees. But vision loss can be difficult to define for some people because they can experience fluctuating vision depending on the light or the environment. A person can function very well during the day but as soon as the sun goes down, they might find navigating very challenging. I also have on the slide the Aira app vision simulator. You can put that on your phone and it teaches about different types of visual issues and demonstrates them through the phone on your camera, or through the camera on your phone.

Next slide. We're going to go through various types of vision loss--

[Matt] Marybeth but before you go on, we do have one person with their hand up. So, Kirsta if you would like to unmute yourself and give us your question, and if you can't unmute yourself, we can, we can do that. Did you have a question?

Kirsta?

[Matt] Okay, looks like Kirsta put her hand down, so go ahead.

[Marybeth] It might have been from earlier. Okay, so we're starting with this slide with which is overall acuity loss. This image is a faded unfocused photo. The bottom part of the frame shows a white sand color and a large reddish rectangle. A small black rectangle is found to the left of the reddish rectangle. There's some dark vertical lines scattered throughout the photo. Some are short, some are tall, and there's a blurry white triangle located on the left side and one on the right. This photo is very difficult to know what it is. People often tell me when they look around, they see colored blobs like we see in this photo. But if I said, you can hear birds, traffic sounds traffic sounds, and people milling around; you might be able to make a guess as to what we're looking at.

Next slide. The next slide is peripheral visual loss. This is actually the same photo that we had before, but the image is a dark gray opaque rectangle with an abstract shape opening in the middle. Through the opening, are people gathering in the distance. A small white and blue tent canopy is in the distance. This person has 20/20 vision, but he's experiencing peripheral vision loss, making it difficult to see anything that is not found directly in front of him. People who experience peripheral visual loss often have trouble traveling in dim lighting as well.

Next slide is central vision loss.

In contrast to the previous slide, this person is experi-- this person has peripheral or side vision, but has an occlusion in the center. So this is a a photo with a blur of colors. There's including white, reddish brown, black, and a sand color. But the photo has a dark circular obstruction in the center so this could be an example of macular degeneration or Stargardt's. The sharpness of vision is missing, so it makes it very difficult to read. And this person cannot look around that dark spot in the middle. The next slide is color blindness.

This isn't the same image, but now we see that it's a full courtyard. The colors are dimmed. People stand and sit in the center around tent style canopies. There are various waist-high pillars throughout the courtyard. Tall buildings are in the background, and trees flank the courtyard. Red and green is the most common type of colorblindness, so an example of someone that might have difficulty with color blindness is maybe reading the metro map because we name our trains and colors. Next slide.

This is total vision loss. This is just an image of a dark gray opaque rectangle. But this could easily have been a white rectangle. This person would still obviously benefit from the sound of the birds, the people milling around, the distant traffic sounds to determine something about the

environment. The next slide is normal vision. Again we've got a photo of a courtyard. Same photo. The colors are more bright. People are still standing and sitting in the center around blue and white tent-style canopies. The pillars are there in the courtyard. The tall buildings are in the background, and trees flank the courtyard. This is how someone with 20/20 vision would see. But now when you look at this, you can probably identify with someone with a vision loss. How they might use their vision, but how they might find it difficult to rely only on their vision.

The next slide. Night blindness. This is a photo that's very dark. There's several orange circles that are bright scattered throughout the photo. Some people experience difficulty traveling in dim light. In dim light, visual landmarks used in brighter settings are now missing. Color contrast is reduced at night and even at dusk. But because of the light, like in this photo we see the light shining-- it might be easier to see traffic lights or crosswalk lights.

Next slide. Pedestrians with low vision. Depth perception is a problem for so many people. Depth perception is the ability to perceive the world in three dimensions and judge the distance of an object. In order to have depth perception you need binocular vision. So if one eye is affected, even if that other eye is perfect, it can mean difficulty judging steps, judging location and speed of traffic. And this is crucial in street crossings, especially if it's uncontrolled crossings. Low vision is also reduced contrast sensitivity. Someone may have trouble distinguishing a hole from a shadow or a dark patch on the ground. And vision fluctuates a lot during the day due to lighting, going from outside to inside, or vice versa, maybe going from shaded area to the brightness. Reading signs can be difficult. But for people like peripheral vision loss, just locating the sign can also be very difficult.

Next slide. How pedestrians travel. This is not determined by the type of vision loss. There's other factors that come into play. Has this person had training? Training can improve confidence and skill and ability. Someone newly diagnosed might be more afraid to move around than someone who is born with a visual disability. Other factors might include health, stamina. Some people have vision loss and hearing loss. Some have neuropathy and they may have difficulty detecting different types of surfaces. Some people walk with a support cane. Some people walk with a walker. Some use a wheelchair to navigate. Goals can also vary. From getting safely to your mailbox, going to work, going to the store, riding public transportation, different personalities. Also some people are more adventurous. Some are more timid. Some people are outgoing. Some are shy. And different household dynamics; not just family support, but where people live. Do they have easy access to the community, to public transportation? Or do they live in a more of a residential area? Next slide.

Orientation and mobility.

Orientation and mobility is a specific type of training to people with a visual disability. It was created out of a need because people with vision loss required more specific training to learn how to access environmental information without sight. It's for anyone at any age. I am an orientation mobility specialist, O-M specialist. And I have worked with people as young as two. And right now I have

someone who's 97 years old. So it ranges. O-M is in two parts. Mobility is the ability to get around. So we're gonna start with the M. Next slide for mobility.

Mobility includes:

In mobility, a person uses visual skills and various low vision aids. Low vision aids can be as simple as wearing a hat or a visor or sunglasses to reduce the glare. But can also be something like a handheld telescope to read signs, or even apps on the phone that use the camera to read the signs. It's using human guide, canes, dogs, technology. Crossing streets of course is involved and using public transportation. Next slide.

Using visual skills. So learning how to scan and use that information to navigate safely. People have sometimes have a big fear of falling. So finding something like a handrail, or a yellow ramp, or the dark edge of the grass against the sidewalk is important to help somebody stay safe. Another fear is being able just to get where you want to go. So a visual clue could be people gathered at a corner could mean a bus stop. Or if you're looking for the metro station you might notice a long line of newspaper stands, or that sort of dark hole could indicate the entrance to the metro station.

The next slide. Another type of mobility is using the human guide. This is holding onto a person's arm to get around safely. There's a photo on this slide. It's a photo of a woman linking arms with another woman as they walk down an urban sidewalk. The person being guided can either offer directions to the guide or they might need help with their orientation.

In the next slide, we talk about the cane, the white cane as a tool. The cane is used to locate obstacles, landmarks, surface changes, and steps. It's also used as a tool to cross streets to alert drivers they might not see the car coming. This slide has a photo of people crossing in the crosswalk on a busy downtown street. One of the people has a visual disability and is using a cane. Next slide.

This slide talks about cane techniques and tips. People use different types of canes and different types of tips, different techniques. Some people use a more of a tactile approach and sweep the cane tip in a constant contact with the ground. This offers immediate information on terrain changes, but also sound changes. This person might use a rolling marshmallow tip or a rolling ball tip. In the right hand side of the slot slide we have pictures of different kinds of cane tips. Starting from left to right we have a marshmallow tip, then a ball tip, a pencil tip, and then a metal glide tip.

Some people use touch technique. So by tapping the cane left and right. But the cane tip is raised above the ground in between the two touches. This person might be using sound to navigate, or maybe they just want to move a little faster. Someone who uses sound might use a metal tip to hear

sound changes such as buildings or openings which this could be a form of echolocation. Next slide is about using the dog as a tool.

Unlike the cane, the dog avoids obstacles. So the landmarks used by a someone who uses a dog would be very different than someone who uses a cane. There's a photo on the slide. The person in the photo is walking with his guide dog. He's walking behind a bus shelter and he might be using the sound-- that the person who's walking might be using the sound, the sound change of the shelter as a landmark so he knows where he is. You can also teach the dog how to locate that bus stop as a landmark. Next slide.

Skills needed to cross the street. Now there's a lot of skills people learn when crossing a street. It's very different when you're visually impaired than when you're sighted. I just learned how to turn my head look left and right when I was learning how to cross streets. But when you have vision loss, it's more skills involved. You have to identify the location of a street, interpret the traffic using visual information and sounds, determine the type of traffic control-- stop sign or traffic light -- locate the crosswalk button if there is one. You need to learn how to line up, determine when it is safe to cross, initiate that crossing, staying aligned when crossing, and knowing how to recover from veering if you veer outside the crosswalk, and then identify when you have reached the other side of the street.

Next slide. Aligned during crossing.

I'm sorry. This is ways to identify a street corner. A person needs to identify that they're on a street corner because without knowing, it's possible to begin crossing a street without even realizing you're doing so. So it's important to identify that you're on a corner and some corners can be very difficult. When they're round, a person might not even realize he's going around a corner and may wonder what's happened to the street crossing that he's looking for. Clues used to identify a street corner include the sidewalk getting wider where the two sidewalks at the corner meet up. In urban areas, if walking near a building line, the building line rarely goes all the way to the corner, so someone might hear the open space when it drops away, or feel the wind pick up, or maybe the shadow of the building goes away. They reach the curb, or the slope, or maybe they hear the beep, beep, beep of the accessible pedestrian signal. Next slide. Lining up to cross.

A lot of skills are needed for lining up to cross. On this slide we have a photo. It's a very large corner. There's a large red brick sidewalk and a light colored ramp. There's a yellow detectable warning surface, but the ramp points into the direction of the intersection and the crosswalks flank the ramp.

People need to learn how to interpret the traffic when they're lining up. When evaluating the traffic and lining up, the visual and auditory information can be used. But a person needs to consider if the street is wide or maybe it's angled. So lining up is very difficult. It can be difficult to figure out what to do if you're using the ramp that's in this photo. People can also use the tactile arrow on the

accessible pedestrian signal. That can help with alignment, but sometimes the person has to use that arrow and then go back down to the corner and kind of get realigned. There's other clues available, like a grass line or a curb. And the presence of a ramp is helpful, but it's not helpful at all to use the ramp to line up. The tactile bumps on the ramp, the yellow bumps on the ramp, they're not used for alignment. It's just to alert the traveler that they're in an area where cars might be present when they step off those bumps. Next slide.

Staying aligned during crossing. This is how a person with vision loss can navigate an open space.

It's difficult, but understanding and using the flow of the parallel traffic is one of the keys. Using crosswalk lines when available, the movement of the other pedestrians, or the sound of the APS on the other side of the street can help you stay aligned. It's also helpful if you know if you're veering. And in this photo we have a crosswalk across several lanes of traffic. There are multiple cars lined up on the far side of the crosswalk and there's construction site and tall buildings found in the distance. But this is a wide space and could be very difficult to stay aligned for that entire crossing. Next slide.

Concentration required. So that was mobility and that's a lot. Mobility skills require a lot of concentration to be safe. But now we need to think about where we're going, which is an added level of concentration required. Next slide.

So orientation, the O part of O-M, ask the questions where am I? Where am I going? How will I get there? We're all familiar with GPS. But we don't use that everywhere we go. Different types of travelers may use different types of cues in their environment.

Next slide. Are we there yet? How does someone with vision loss stay oriented? Using visual clues. Like for their home, can include painting their mailbox bright yellow. Somebody could use tactile clues. Someone might detect a wooden fence with their cane just before they reach their destination, so they can use that clue to return back or to find the location again later. And I know right now touching things is very scary because of Covid, but without the good visual information this can be a necessary way to get information. Auditory cues: sounds in the environment are very helpful. Such as your neighbor's barking dog. Traffic sounds: some streets are very busy all the time and some are quiet, so if a person was walking on a busy street and then realized it became quiet that might be a clue that something went wrong with their route.

Next slide. Olfactory is the sense of smell. So this might be difficult if anybody has lost their sense of smell because of Covid, but I had one lady tell me that she could always find Starbucks by the smell of burnt coffee. Memory without the visual information. People with vision loss find they need to memorize their landmarks and when to turn. This is an added requirement for observation and concentration. Technology can really help, especially when our memory feels too full. I know I've used my own cell phone when I'm looking for my my car I recorded in my phone. There are many

apps with that people with vision loss use, such as apps that use the camera and either a real person on the other end to help or maybe artificial intelligence. There are gps tools specifically for people with visual disabilities. Personally, I like using Siri and saying where am I just to find the name of the street that I'm on. But sometimes you can push that APS-- that accessible pedestrian signal -- and it will announce the name of the street.

Next slide. Generalizing the environment. We have to make an educated guess with common characteristics so when you locate a handrail, what does that mean? This is a predictability that we all rely on when moving around. We look for and use predictability and commonalities. So the next slide.

We talk about locating an unfamiliar bus stop. People with vision loss don't always stick to the same familiar routes. They like to go places that they've never been before and it does require some guessing. It helps to plan ahead, but that's not always possible. You can use apps and electronic travel aids, but to find an unfamiliar bus stop you can make an educated guess by generalizing. Some bus stops are often actually 10 to 20 feet from a corner. Maybe there's a landing pad then an extension of the sidewalk that goes to the curb. Maybe there's a shelter. The bus stops will have a bus stop sign. In this County they look a certain way. They're not usually round but they're also the same shape, like a no parking sign. So I hope that got you thinking about how people with vision loss might navigate, but the challenges that people face when they're navigating.

[Jim] All right, thank you very much Mary. I'm Jim Elliott from Toole Design. Matt, did you-- were you-- did somebody have a question?

[Matt] We don't have any hands up right now, but now is a good chance to ask and see if there is anybody. If you want to raise your hand, again you can do that by pressing ALT Y or dialing * 9.

I'm not seeing any hands.

[Jim] okay I just thought I heard somebody breaking in there--

[Matt] Oh, we do have a hand now. Sorry. Looks like the phone number ends in 5301. You can unmute yourself and ask your question, if your phone number ends in 5301.

Go ahead.

[Brett] Yeah, this is Brett Roullier. Can you hear me?

[Matt] Yes we can hear you, Brett. Go ahead.

[Brett] I just had a question on slide 41 which shows a corner ramp that you talked about. I think it would be a much better idea for you to limit the use of corner ramps and that would avoid the problem of the curb ramp misaligning with the sidewalk-- with a crosswalk, rather than try and put the onus on the pedestrian to deal with the corner ramp. That's all.

[Matt] Thank you, Brett. That's a really good point. And I think the point of Marybeth's slides was to talk about how blind and low vision people have to navigate what's out there. And the fact of the matter is that that ramp is there. And there are many places like that. So but we, I think pretty much universally, on this call would agree with you that those are not ideal. And we would probably not build something like that today if we could avoid it. Sometimes there are geometric constraints and intersections that make it difficult to have ramps at right angles. But again, Marybeth's presentation was talking about what's out there now and I think we're going to get into how to make it better later in the presentation.

[Jim] Right. Yeah. So the next part--

[Matt] We have one more question, Jim. We have a question from the phone number ending in 5496. And then after that we're gonna go on with the presentation. We can handle questions later. So if your phone number ends in 5496, you can unmute yourself, again, by dialing uh * 6. And go ahead.

[Tom] Tom Bickford. I am a blind cane traveller. I recognize and have had problems with ramps, but they are also very helpful to people who use wheeled aids and for people who push grocery carts, child carrying devices, things like that. So it is part of the life and we just have to learn how to get along with them. Thanks.

[Matt] Thank you. All right, Jim. Go ahead with your slides.

[Jim] Okay, yeah. So the next part of the meeting is going to focus on on your feedback and specifically on the challenges people with vision disabilities face navigating urban environments in Montgomery County. We especially want to hear from people who have some kind of vision loss that affects their navigation as a pedestrian. So it's really great to hear those of you who have already spoken up. We're interested in people who are blind and people who have low vision and

others who may not consider themselves as having a disability but nevertheless have difficulty seeing in certain situations or times of day. We also like to hear from orientation and mobility specialists and others who have a deep familiarity with the challenges people with vision disabilities face when navigating urban environments.

We'd specifically like feedback on navigation challenges related to sidewalks, intersections and crossings, separated bike lanes and floating bus stops, and other public spaces. We'll take up each topic in sequential order beginning with sidewalks. We ask that if you have comments that are primarily related to one topic that you reserve them until that topic comes up. For example, if you'd like to relay feedback on separated bike lanes and floating bus stops, we ask that you wait until the floating bus stop question comes up before raising your hand.

A few additional notes on how we're going to manage this part of the meeting: please use the Zoom "raise hand" feature that Katie talked about earlier to indicate that you are interested in speaking. You can also use the chat feature if that works better for you. Katie will read out your chat messages after we go through all the verbal responses. We'll prioritize feedback from people who have a vision disability or vision loss and then move on to specialists and others. If you have a vision disability or vision loss, please say a little bit about the type of vision disability or vision loss you have. For example, you might say something like "hi this is Jane Doe. I have a low vision and use a long white cane for navigation."

If you are a specialist please say so. If you are affiliated with a group or organization in Montgomery County please indicate your affiliation. Finally, please keep your comments as concise as possible. We want to hear from as many of you as possible, tonight. We've set aside 5 to 15 minutes for each topic. I'll indicate exactly how much when we get to each question slide. Don't worry if you have a comment and we aren't able to fit it in given time constraints. We'll provide additional opportunities for feedback over the course of the project, including a survey we plan to send out later this week.

It's now time for our first question, which is: What do you find challenging about navigating sidewalks in Montgomery County? We've set aside 10 minutes for your response to this question. As a reminder, you can raise your hand on the phone by dialing * 9. On your computer, use the shortcut ALT Y.

[Matt] So we have Ancil Torres has a hand up. Ancil, and I apologize if I'm pronouncing that name wrong, but go ahead and unmute yourself and give us your comment.

[Ancil] Yes, hello?

[Matt] Yeah, we hear you. Go ahead.

[Ancil] Excellent. Yes, I live in downtown Silver Spring. I'm totally blind. And over the past year or so, I have been engaged in well, let's just say hyper-activism, with the County Council, the Montgomery County Council and also the County Attorney, on several issues having to do with navigating the sidewalk in downtown Silver Spring.

There's, there are so many. I think you said I should reserve my comments to 30 seconds. I think, well okay, my 30 seconds are probably up by now. But anyway, I'll get to them as quickly as I possibly can. For one thing, I came from New York City. Navigating in New York City, I use a white cane and I use it here as well. And the comparison is when I came here, I was surprised as to how many of the sidewalks in downtown Silver Spring have all kinds of street signs and obstacles literally in the middle of the sidewalk. In New York City, I don't remember that being much of a problem. That's one.

Another is there is a street corner right there at the corner of uh Colesville Road and Fenton Street. I believe that would be uh the north, I'm sorry, the southwest side corner, which is the side with the mall; the corner with the mall. The sidewalk there is completely flat, so it's very difficult for me to figure out wait, am I in the street or did I get off the sidewalk? I have never seen a sidewalk like that anywhere in the world and I have I have done some travel. I don't know why it is like that. I strongly would encourage the County to do something about that, or maybe you could do something about that in your project. I don't know.

But the biggest confrontation, the biggest problem that I've had, and this is a problem that does not normally come up in many of these kinds of forums, but it's in downtown Silver Spring at the corner of Fenton and Ellsworth, you have quite a number of buskers that perform at the street corner. And it's a problem. Basically what happens is that they crank up the volume of their amplifier very loud. So even if there are audio cues that you're supposed to be listening to, whether it's on the street, on the traffic light, the traffic signal pole, or just hearing the traffic, which also is an important cue for when you're crossing the street, or even just hearing people talk and walk because that helps me to stay within the the path that I'm supposed to walk. Because at that intersection, you also have a bit of an angle. And those are a little bit tricky. So it's not a simple straight walk. You sort of have to make sure you angle yourself appropriately otherwise you end off off track. I have been appealing to the County to find a way to restrict that level of noise disturbance at the intersection. There's a County ordinance that says that you're not supposed to make so much noise that interferes with the safety of others. It's on the books and they seem to just ignore the law. And it's almost like I feel like I have to file a lawsuit in order for them, in order to get the County to follow their own laws. And I find that very disturbing.

There's much more that I have to say, but I will stop there for now. Thanks.

[Matt] Well, thank you for the those comments, Ancil. That's a lot of information, and I think it's really good, really good, good information for us to hear. Our next commenter with their hand up is Christy Smith. So, Christy, if you could go ahead and speak.

[Christy] Hi. My name is Christy Smith. I have albinism, approximately 20/400 vision, and I use a guide dog from Guide Dogs for the Blind in California. I would like to echo everything the previous commenter said. That all resonates with me very strongly. I would like to add that sidewalks are difficult if the concrete or bricks are uneven. This a lot of times happens around trees with tree roots breaking them up and that can be a very difficult place to navigate. If you're using a cane, the cane gets trapped there, and it's just a tripping hazard. There are also often small gates around trees, if there are little dirt enclosures around the tree, there's a little gate there and those are also a hazard and just frankly an inconvenience. Canes get stuck in them and then if you're using a guide dog, especially in a dense urban environment, there are very few places to relieve your guide dog and it can be very difficult to find one of those. And so there have been many times that my guide dog has had to hop a fence around a tree. And that can put me in danger, because then the guide dog is trying to pull. And I may not know how high the gate is, if I can step over it, if they're what's safe on the other side, because the guide dog is kind of off-duty at that moment. So that's what I would add. Thank you very much.

[Matt] Thank you, Christy. I'm going to lower your hand. Next up, we have Brigid Dougherty. You can go ahead and speak, please.

[Brigid] Hi. Thanks. This is Brigid. I'm an orientation and mobility specialist. I work with Metro. Have been there for 12 plus years now. I also am blind. I have a small amount of tunnel vision at this. Some of what the others have said, with the sidewalk issues, especially in terms of how the gaps can grab at your cane. We are all used to, in some respects, this no matter where we are. And part of what, going back to what Marybeth said in her presentation, which was wonderful, the training piece, the learning of mobility is so important. So that when we are walking down sidewalks and encountering these difficulties we've had the training that we can sort of take a breath and figure out our next steps and make a plan. One of my pet peeves is the folks who are leaving the scooters uh on the sidewalks and I know that Montgomery County has made an effort, or is making an effort to address that concern, but I wanted to raise that here. I think that's a real problem, not just for those of us who are blind or have low vision, but for any pedestrian on the sidewalk.

And the other piece is that there are times when, Mr. Torres was speaking of the signage, that in addition to the signage and the scooters, and perhaps the gate around the trees, sometimes it just becomes so narrow-- the pathway becomes narrow, that not only for us, but I know someone who at one point for a time, had to use a power wheelchair. It can also affect the accessible pathway for others. So in the interest of universal design, all of those issues sort of coalesce into, let's keep the pathway free. Really glad you all are doing this meeting. Thanks.

[Matt] Thank you. Next up, we have Day El Mohammed.

[Day] Hello. Thank you very much. So my name is Day El Mohammed. I am visually impaired. I am speaking as an individual, but I am actually also on Montgomery County Commission for People with Disabilities, and so I know this is these are things that have come up um quite a bit in several of our meetings. I'm gonna stick to just sidewalks, also. And I'm gonna end up paralleling a little bit of what was said right before me. And that is, I love the examples what you're talking about. Those are a lot of the general kinds of obstacles, and things and challenges that folks with visual impairments face, such as myself. One of the things I would like to highlight are the the non-permanent obstacles that show up a lot. And those are things like those e-scooters without corrals that are bikes that are left. Because currently right now there's not really a penalty and there's not really an incentive. Either end. For folks to follow through on that. So that's just, it's one of these kind of, air quotes, temporary things that suddenly can pop. Construction and making sure that is clearly marked as another one. And the third one, which is one of those temporary things, sort of, that pops up, which I think is going to become a bigger issue going forward, that we should pay attention to, is how many eateries in downtown Silver Spring are engaging in outdoor eating and outdoor seating. And how much of that is going to increase as things are changing and how often is that has been a problem because of where things are. And they're constantly moving, so some of the more, I guess, movable obstacles that show up and what's being done to enforce and ensure that the the sidewalk space-- that a clear pathway continues to remain, because I know that tends to become problematic after a bit.

[Matt] All right, Thank you. Debbie Brown, you wanna unmute yourself and go ahead?

[Debbie] Yes. I'm blind and I use a white cane and there are most of what everybody has said, I certainly agree with. Just the additional things that I want to bring up is that we make sure that people have places to go in the first place. That what we need to build more spaces that are pedestrian-friendly in the first place, that a person can get to and should not have to cross miles, it feels like miles, of parking lot to get to shopping areas and all that. And when a bus stop goes to a mall, it ought to get you somewhere close to the mall, and not have to, you know, you can't even find, you don't even know where the stores are, because there are just the sidewalk doesn't even align with it. It's just full of parking lots. I mean I find the bus stop at Montgomery Mall. That's- you're never nowhere near the mall. Wheaton, you have to cross this perimeter lane with no light to get to the shopping center. And at places like Congressional Plaza, you are-- you've got to cross a whole large parking area between the sidewalk, where you would get either off the bus or from the metro at-- So that's another one of the issues that I don't know you're gonna you're not gonna get very far in this project. And I know that you're they're here for a particular issue and, but Montgomery County just could make the whole County instead of thinking about walkable communities you need to think about a completely walkable County.

[Matt] Thank you, Debbie. Jim how are we doing on time?

[Jim] We are at about 10 minutes for this topic, which is the time limit we set on it. So I think we should probably move on. And if there are additional comments, perhaps we can we can take them up later.

[Kirsta] Okay, can I speak to one-- a couple of those things that that you brought up?

[Matt] Sure, go ahead.

[Kirsta] Very quickly. I think I've seen solutions to some of this because all of those things resonate with me, and and I've certainly-- I grew up in this area and I really liked um everything that people have said. The sidewalk issues have, I've seen some solutions to those. Not so much the level walking spaces, but I do like the idea of encouraging more people to walk. And those of us with visual impairments, my name is Kirsta, and I have a number of those visual impairments. I have low vision. I'm visually impaired. I have fluctuating vision because of, I've I was diagnosed when I was quite young, and so it's fluctuating because my vision has, is deteriorating over the years. So I lose quite a bit over, you know, each year. I've lost more and more. I walk with a guide dog. I also walk with a cane, and so I trip often on those uneven areas. And those areas that have been smoothed down and opened up have been done a lot with landscaping. As people want you to walk more, they've done landscaping, which gives us a path, a wider path and something clearer, as long as it's made clearer, and some landscaping is done with um with grassy areas and those are very much appreciated by those of us with dogs. Also with a cane when it's easier to follow, they're wider and easier to follow so that kind of speaks to some of those of us who, you know, have asked for those spaces. Same thing with the parking lots. There have been some parking lots-- one of them is near me. I'm trying to think of the name of it, but there's a Giant. There's a lot of strip areas. They're very nice ones, but to strip areas with a lot of shops and a couple of big stores, and I think a Giant. And they've constructed from the area where the bus stops to through the shopping areas, they've they've constructed some walkways, and they've also constructed, so basically they're not very fancy areas that that have some landscaping, but it allows us to walk along them and get to all of the stores and to the walkways along the store.

We can follow the pathways, and I don't think it's that difficult to create those. But that gives us a solution. Construction is another problem for us, all of us. But as long as something even temporary was created that was smooth, if they don't create a smooth pathway and there's rough, loose gravel; things like that. That's a big problem. I've taken some real really serious falls from those, and I think, you know, that's something the County would would have a big problem with. Those of us that have have difficulties with that. So that's just a few suggestions that I had that might solve some of those temporary and long-term problems that all of us are facing. So, for what it's worth, you know, I think you've solved some of the problems. But just some attention to those issues would solve some of the the problems that that we're facing that's all I had to say.

[Matt] Thank you Kirsta. We're going to move on to the next question, but we will have time at the end, we will come back to let people chime in on things that we've already talked.

[Kirsta] Okay, I had to leave, so I wanted to make sure I said something. Thank you.

[Matt] Thank you. All right, Jim go ahead.

[Jim] Okay. Yeah. So our second question is: What do you find challenging about navigating intersections and crossings in Montgomery County? And by that, we mean street intersections and mid-block crossings. We've set aside 10 minutes for your responses to this question. Once again, you can raise your hand on the phone by dialing * 9. On your computer, use the shortcut ALT Y.

[Matt] So, Liliana Gillespie you had your hand that from before. Did you have-- did you also have a comment about intersections and crossings? You can go ahead and speak to that.

[Liliana] I had a question, or I guess an answer regarding the last question. I don't really have anything on this one.

[Matt] Okay. Well, why don't we-- you hold that, keep that in your your mind and we'll come back to it if we have time at the end. So thank you, I'm gonna go and put your hand down for now. Thank you. Cindy LaBon, you have your hand up. Did you want to talk about intersections and crossings?

You're on mute, Cindy.

[Cindy] Okay now I'm not.

[Matt] Yes, go ahead.

[Cindy] Okay. This is so ironic. I'm glad you came up with this question. I was going to mention it in the previous and let me say this: This is ironic. 10 years ago today, I attended a meeting at the Wheaton library about crossing streets, pedestrian signals, etc. Well, newsflash: 10 years later today I used the intersection at Muddy Branch Road and Diamondback Avenue. Now we had the old signal in there that was put in in the early 90s, and I was so excited. And I mean yes, I was thrilled to death. When in 20-- after me complaining several hundred times, they put in the new pedestrian signal. It worked for about three months. So last week-- this is so funny-- I am, I have a guide dog, Gardenia,

from Guiding Eyes for the Blind. And last week, because the trainers cannot come down to help assist us in renewing our guide application, I went out with somebody to do a video of my walking and crossing at Muddy Branch and Diamond. So as we're walking up the street, Muddy Branch, you hear "ding." Now to be honest with you, this pedestrian signal they put in is not near the corner, okay? So today I did my phone interview, and the trainer said 'what was that "ding"? Don't they have a signal? That corner so busy.' I said oh yeah, but it's been 10 years. And she looked back and saw in May 23rd, 2011 when I-- or 2012, I'm sorry, because I lost my vision at the middle of 2011. I did a walk with Del Rodman from Guiding Eyes, we complained to Montgomery County about the signal then not working. The new signal? Not working. And I want somebody to come out and physically meet me at that intersection.

Now fortunately, my dog being the diva that she is, and Marybeth knows; she worked with me before I got my dog, in mobility. And worked with me when I brought the dog home on that corner and the bus stop. And that was my first dog, and she's good and she mastered that corner last week perfectly. However, it's not a safe corner. It's very noisy and loud. It would be nice to have a signal by the corner, not halfway down Muddy Branch Road, towards, what's--? That's Great Seneca. it'd be nice to have it where I cross. I want someone to physically meet me so they can see exactly what I'm talking about. The corner is-- there's always accidents. And I'm sorry, but it is not safe. So fortunately my guide dog has survived eight and a half years that I've had her. She'll be 10 next week. But getting a new dog, I don't have to battle it out again. Just saying. That's my take.

[Matt] Well thank you, Cindy. And I will reach out to our signals team and see if we can't get someone to be--

[Cindy] Yeah, well I've heard that one before, like probably seven or eight times. So you can get in touch with me you know where I am.

[Matt] All right. Well thank you Cindy. Let's see. Our next next person with a hand up is Christy Smith. Christy, go ahead.

[Christy] Hi. I'll try to be brief. This is Christy Smith. I will say that auditory crosswalks are very rarely at the correct volume, and you would probably obviously think that if they're too quiet that that is an issue. And yes, many, many signals are too quiet. There's also one, and I haven't really been out of my house since March, so I don't know if this has been fixed. There's one that is located right outside of the Silver Spring Metro station that is, well at least was drastically too loud. And it made it really difficult to listen for the cars around that intersection, and it was very startling and surprising. So the volume is a big issue. Thank you very much.

[Matt] Thank you, Christy. Looks like, sorry we have Lauren. Lauren if you want to go ahead and do it yourself, go ahead.

[Lauren] Yeah. This is Lauren. Can you hear me?

[Matt] Yeah, go ahead.

[Lauren] Okay. Yeah, sorry sorry. I have low vision. But I still have vision that I can use, so I don't have to use a guide dog or white cane right now. But I guess with intersection and crosswalks, I think maybe a challenge for me would be at crosswalks. I mean I guess I don't know if this is really a design, it's sure more an enforcement issue, but just so many cars do not-- if it's not like a traffic light, if it sits across, so many cars and bicycles, especially, do not really obey the law that you're supposed to stop for a pedestrian crossing the crosswalk there. And I know that that's a challenge for, you know, gonna be a problem for people even with regular vision, but I think it's particularly challenging for those with visual impairments who may just, like with a limited depth of field like I have, may not see the car coming or the bike coming out of the corner of their eyes and they, you know, we expect the car to stop or the bicycle to stop. And I feel like I've had several very near misses, closer than I would have liked. So thank you.

[Matt] Thank you, Lauren. Looks like we have a phone number ending in 0589.

If your phone number ends in 0589, you can go ahead and unmute yourself. You can dial * 9 to unmute yourself. Go ahead.

[Jill] Hello, this is Jill. I have, I'm legally blind. I have a myriad of ophthalmological issues since birth. You name it, I've got it, except macular degeneration. The intersection when you come out of the Wheaton Metro and you make the right to go down to the traffic light to cross over to Wheaton Plaza. There's a concrete barrier around that entrance that allows you to enter into the crosswalk. Well I have very poor limited depth perception, and I have seen the concrete barrier. I haven't tripped over it, and what I have to do is walk around that concrete barrier and not step over it. Walk to my right, and then enter in the entrance area of it. So what I'm suggesting, I don't know why the concrete barrier is there, that there should be no concrete barrier there at all. Because I can't-- well I know it's there, but I'm saying I have no depth perception. If I didn't know it was there, I'd be flat on my face with a broken nose. So, and I'm sure there are other intersections in Montgomery County that are are like that, I don't know why the reason for the concrete barrier on on either side of that walkway entrance is. So that's my comment. Thank you very much.

[Matt] Thank you, Jill.

Looks like Wyndolin.

[Wyndolin] Hi. Yes, my name is Wyndolin, and I am legally blind and I use a guide dog. Sometimes, I also use my white cane. And one of my comments would be, kind of, you know, a little bit towards the sidewalk thing, but it definitely is an intersection crossing thing. I live here in downtown Silver Spring. With the increase in outdoor dining, there's a couple places on Georgia Avenue that I've noticed. Well one right now, an Ethiopian restaurant, has a tent up and you actually have to walk through the tent. I guess-- my guide dog and I were quite confused-- I guess you have to walk through the tent if you want to keep going on the sidewalk. But it's really-- that area is really narrow-- so then, you know, it's kind of close to one of the corners. And then I've also seen in that area, as well for other establishments, that, you know, they have, you know, chairs and tables and all that on the sidewalk. And sometimes they are near the intersections at times and makes it a little confusing for myself and my dog to to navigate around them. So that's one thing I would mention.

Another thing, too, about, that's, I guess, almost become a pet peeve of mine about the audible cross signals is there are tons of them. I don't have enough fingers and toes at this point, the ones I run into just maybe here in downtown Silver Spring that do not work. I don't know if they're shut off when there's construction at some point or what the issue is, but I think it would be good if it was well publicized how to report those. And, you know, it, you know, if there was a way to, you know, get information back that, you know, it's been fixed that-- there's at least two over here on Wayne Avenue and Dixon Avenue that I don't think they've worked for at least a year and a half. And so that's a big thing.

And then the last thing is: just to concur on what somebody said about crosswalks. I can't tell you how many times my guide dog and I have had to go out into an intersection to get around a sighted person in their car, who supposedly had enough vision to get their driver's license, but didn't read the part of the driver's manual. Those are my comments.

[Matt] Thank you, Wyndolin. And I will follow up with our signals team about the Wayne Avenue and Dixon Avenue APS signal. But what I can tell you is there's two ways that you can report these to us. The easiest is probably to dial 311. That's easy to remember. If you just dial 311 and make a report. You can also email. The email address is traffic, t-r-a-f-f-i-c, traffic ops, o-p-s. That's "traffic ops", not "traffic cops", but trafficops@montgomerycountymd.gov. And I'll put that in the chat. But that's another way you can email, and just email where, what intersection it is and what's wrong with it and we can get our team out there to try and address that. So--

[Wyndolin] Thank you. Thank you for that. Email is probably the best thing right now, because I will make a-- I'll it'd be better for me to just probably email a list than call 311 and keep somebody on the phone.

[Matt] Okay. And Jim, how are we how are we doing on time?

[Jim] We have about ten minutes for this question. So maybe one one more response and then we move on.

[Matt] Okay. I'm going to call on the phone number ending in 5301. if your phone number ends in 5301, you can go ahead and give us your comment. Go ahead.

[Brett] Yeah. This is a Brett Roullier again. I'd like to follow up on these maintenance issues people keep bringing up in the sidewalks and crosswalks. It's a real problem. I have noticed, I found out at the corner of Ramsey and Wayne Avenue that the Ramsey Avenue was constructed so poorly that the water was pooling right at the, right at the the curb of the ramp, bottom of the ramp through the crosswalk and freezing during the winter. And people were slipping and falling. I even talked to the crossing guard and she said this has been a continual problem. So I called up 311 and reported it, along with some missing bricks right in the same location. An inspector came by like within a week and they fixed the bricks and he confirmed that the, this pooling freezing water. It took me three years to get that intersection realigned. I must've made 20 phone calls to Montgomery County transportation. Not once did they ever call me back. I called up 311 customer service; they never could give me a response other than than the County's transportation is looking into it. Finally had to call the County Executive, and this is three years, and the County Executive ordered that it be fixed. There's a real process problem here, where it takes years and years to get-- and this is icing-- this is where people were falling and tripping and hurting themselves. And still took three years for that to get fixed through the 3-1-1 process. This is just like unacceptable. I guess there's no one that follows through on any of this stuff or inspects it or what. I don't know what's going on, but it's not working. That's all.

[Matt] All right. Well thank you for that comment, Brett. And I do apologize. We don't always get it right, but we are trying to do a better job. So thank you for those comments. Jim, why don't we go ahead and move on to the next item. I know we do still have two hands up. If you guys can--

[Ancil] I do have, I do have a comment.

[Matt] Okay, well we do want to try to make sure we get to the whole agenda. That's why we're we're trying to limit each item to 10 minutes. So if you can be really brief.

[Ancil] Yes, I will be as as brief as possible on this. My issue has to do with the audio producing signals and the way my Montgomery County or D-O-T tries to deal with the problem. When I reported my issue with the busker noise at the traffic intersection what they did was to simply increase the volume, thinking that that would fix it. But they don't seem to realize that there is a careful balancing of signal information that you get, that you use as a blind person when you cross the street, Because you'll never be able to compete with the volume of a busker, you need the traffic information, you need the traffic noises, you need the walking noises, and of course you need the

signal noises in order for you to navigate. And I hope that they start using professional consultants when coming up with solutions, and I'm assuming this is part of that process, or at least I hope it is.

[Matt] All right, thank you very much for that comment, Ancil. So go ahead, Jim and move on to the next, our next question.

[Jim] Yeah. So this is our third question: What do you find challenging about navigating separated bike lanes and floating bus stops?

For those of you who may be unfamiliar with floating bus stops, they're sometimes installed in conjunction with separated bike lanes. Getting to the stop from the sidewalk then requires crossing a bike lane to an island where the bus stop is located. We've set aside a little bit more time for this one; we know that there's been a lot of focus on it lately. So 15 minutes for this. On the phone, again, raise your hand by dialing * 9 and on the computer use the shortcut ALT Y.

[Matt] All right. Patrick Sheehan has his hand up, so Patrick you want to go ahead?

[Patrick] Thank you. Thank you, Matt. I appreciate you having this session tonight. I'm speaking on behalf of two points with respect to floating bus stops. We think that the design of these floating bus stops is dangerous. We would request a moratorium on any new construction, and we think that the floating bus stops, the ones that are up, should be dismantled. There are a couple things with the floating bus stops that are that are difficult. We understand that you're trying to take bicycles and scooters off the primary sidewalk, but the dedicated bike lanes and putting a bus stop in the middle of the street protects the bike riders, but does nothing for the blind person who has to cross that eight foot area while bikes are and e-scooters are zooming down the pathway. Hoping that the bikes and the e-scooters will stop on their own that's very dangerous. We're relying on the good decisions by bikes and e-scooters to do what is correct, and that's not helping guide dog users or blind people that can't hear them coming.

There are better solutions that are out there. John Hoobler has shown a bunch of us a shared platform that allows the bus stop to be still on the sidewalk, allows the bus to pull up, and gives the same advantage to bicyclists and e-scooters as they would have on a dedicated dedicated bike lane. I would suggest that before more construction goes forward, that you look at solutions like that.

My other point is that I think the process for making construction decisions like this is flawed. Obviously the the cycle community was consulted, but I don't think that the blind community was. You have Vision Zero that has issues with uh floating bus stops. You have the Pedestrian Master Plan that conflicts with the Bicycle Master Plan, you have Safe Routes to Schools Policy that is in place that doesn't, that conflicts with everything else. Your processes for putting and constructing safe

streets, pedestrians access areas, sidewalks-- it's not coordinated. And so you've got a construction issue. And I think those are two things that need to be checked into. Bring the right people to the table. Let's get construction that can work for both bicycles and pedestrians and e-scooters, because that's what's going to solve the problem. Thanks.

[Matt] All right. Thank you, Patrick. Those are good comments, and I know we've chatted before, and I look forward to continuing to chat with you as we work through this. So there's a lot of a lot of stuff that we need to work on, so thank you for those comments. Christy Smith, do you have your hand up? Go ahead.

[Christy] Yes, I'd like to echo what the previous commenter said. I completely agree with everything that was said. I would like to say as for myself it's very difficult to hear bicycles, so crossing bicycle lanes to me often feels even more dangerous than crossing a traditional roadway. Bicycle lanes do not always stop at an intersection such as in T-shaped intersections or at floating bus stops, meaning you may have to independently determine when it is safe to cross. And it can also be confusing to encounter barriers that separate separated bike lanes because they, from the top, often feel like construction cones. And so that can create a lot of anxiety and confusion.

[Matt] All right, thank you, Christy. Those are good comments as well. Looks like we don't have anyone else with their hand up right now so-- Oh, we just got a hand. Phone number ending in 5301, Brett.

[Brett] Yeah I'm here. I have some experience with these floating bus zones and bus stops and bike lanes in the District of Columbia, where they've proliferated quite a bit. And I would like to agree with the other two speakers that there are obvious problems for pedestrians especially pedestrians with disabilities trying to cross these, you know, dedicated bike areas, bike lanes and trying to access the floating zone, especially when the crossing is not at the intersection. The crossing is set back, you know, 40 or 50 feet from the intersection to get onto the floating island. So bicycles and scooters never adhere, never pay attention to these setback crossings. So it's just dangerous for the pedestrians trying to access the bus floating island. I agree that these need to be seriously looked at. I mentioned this to Matt when we were talking about the Fenton Street bike plan and certainly I agree with the first speaker, which, and I pointed this out to Matt, that these various plans, the Pedestrian Plan, the Bike Plan, you know, the Safe Routes to School Plan, the Fenton Bikeway; none of these plans are coordinated. It doesn't seem anybody there who is a disability specialist being consulted and reviewing these plans, because the conflicts are just, like, just continue. Thank you.

[Matt] Thank you, Brett. Let's see, Ancil, you have your hand up. Go ahead.

[Ancil] Yes, I have had some dealings with the floating bus stops in DC, and actually I believe I first encountered them when I traveled to Europe in downtown Amsterdam, and my first encounter with them was a bit terrifying, because I got off the bus didn't know anything about floating anything.

And did not realize that I was really in the middle of the road, and I almost got hit by a vehicle. So I would imagine if I had that problem, I'm sure other people who are blind could have that problem. And then the other thing is locating them. If you are blind and you're looking for a bus stop, you know, how are you supposed to figure out that this stop is in the middle of the, you know, the roadway.

And then the other thing, just a comment on these people that we are supposedly trying to protect, the bikers and the scooter folks, they are not, my experience with many of them, I'm sure it doesn't apply to everybody-- can't generalize like that-- but my encounter with them is that many of them are renegade users of the road. Many of them ride up on the sidewalk when they're not supposed to, and many of them, you know, sort of jostle their way through the traffic light because they feel that they don't have to obey traffic laws. And I know the reason why these these stops are being set up like that is because of their advocacy and they're heavily organized, they're very militant about it. And they combine with, you know, the green people, and, you know, so they're all concerned about, you know, supposedly in their health and well-being, but they could care less about us blind folks or disabled people who are negatively impacted by their lunacy. So I'm very much opposed to them because I believe that many of those, many of the folks are very, who advocate for these things, they are very selfish and they have no empathy for persons with disabilities. They can care less. Thank you.

[Matt] Thank you, Ancil. Next up, we have-- it looks like Jill.

Phone number ending in 0589, Jill, go ahead.

[Jill] Yes. Yes, sir. I did not get the list of questions that you are asking, so I figured this was my moment to say something targeted mainly to the Metrobuses in Montgomery County, the metro-- not-- the Ride On system in Montgomery County, and the Metro subway system throughout the Washington DC, Virg-- well not, I don't drive to-- well, Washington DC, Virginia and Montgomery County you're-- but mostly targeted to the metrobuses in Montgomery County. I used to be able to read the the number on the bus; I no longer can do that skill. I don't use a white cane or a dog at the moment, although my days are numbered for that task to learn. But most of the time on the metrobuses, they do not-- there are two things that they don't do. They don't-- the GPS doesn't verbally announce the the metro bus stop that you are at, Connecticut Avenue, Bel Pre Road, Arcola Avenue, blah blah blah. And also as the buses come up, until last week, you had to enter at the middle of the bus. The buses don't signal that this is a Y2, a Y7, or a Y8 I have learned over the last, almost three years, because I had a cornea surgery in Hopkins and I had a very, quote, sick cornea, and I had what was put over my cornea a Gunderson flap, which rendered me totally blind in my left

eye. I knew that going into surgery, so it was no big surprise, and I have learned from that surgery that I cannot track, visually track, too much of anything. So if the bus is coming up and I want the bus that's a Y7 or a Y8 that goes into Leisure World, the bus is moving so fast that I can't track the number on the bus. And again, they don't announce what the bus stop is. And I've gotten off several times at the at the wrong bus stop and, believe me, I know Georgia Avenue like the back of my hand, so I wish Metro would mandate, strongly mandate, that they use, you know, the GPS and announce those things. And I'm sure I'm a hundred percent right for people who are uh totally blind or have much, much, much less eyesight than I do. So that's my comment. I'm sorry that I was a little off tangent on screwing in on the the bus stop. I don't recognize, I don't remember bus stops that had bus lanes and buses in Montgomery County. Maybe I'll focus in on that when I'm running around on the bus. Okay thank you for my comment.

[Matt] Thank you, Jill. It's a good comment and we can-- We don't operate the metrobuses, but we can certainly try and get those comments to the appropriate people at Metro.

Dingram, you have your hand up.

[Dingram] Am I unmuted?

[Matt] Yes, go ahead.

[Dingram] Am I unmuted?

[Matt] We can hear you, go ahead.

[Dingram] Okay, I just had a quick comment about some of the new bike lanes that they're creating now. The two-way bike lanes where they've got them going in both directions on one side of the street, and I think those are incredibly difficult for those of us who can't see where we're going. It's bad enough to try to worry about bikes coming that are going in the same direction as the car, but when you've got to worry about bikes going in two directions it's just almost impossible to cross those things safely. That's my comment.

[Matt] All right, thank you for that that comment. Those are all the hands that were up, now. Anyone else have a comment related to floating bus stops or separated bike lanes.

[Susan] Can you hear me? Can you hear me?

[Matt] Yes.

[Susan] Thank you. This is Susan Crawford. And I apologize. For some reason, I can't get the keypad to work and I'm not finding the raise my hand. But thank you. Thank you. And I appreciate you having this forum tonight, and I would just like to echo all the others that follow Pat Sheehan's lead and ask that the County stop the installation of the floating bus stops. And my understanding is that there's a new model that several people have seen, that Pat, and Marybeth Cleveland, and Francie Gilman have seen. And it seems like it's very workable. It also has the advantage of saving the County a ton of money, because you don't have to move the bus shelter and everything else to an island. You leave it on the sidewalk, where it's needed. And so then someone could go to that shelter and you know usually there's a push button, or there's a braille and raised characters. And you can just identify if this is where you need to be. That's really crucial. Also if and when the County starts to plant trees again, that would provide shade and make it much more enjoyable. It is so intimidating to even think about using the floating bus stops. I mean it's just it's just not a good design for people who will use the bus. And if you want people to use the bus, then you need to make it safe and enjoyable. There's nothing enjoyable about it right now. But mainly it's a huge expense and it's not safe. And I urge that there'll be a moratorium on the floating bus stops and just proceed with the pilot on the new one that's being tried. And if that seems workable, go with that. And just leave the bus shelters on the curb. And it would be easy enough to put in the rumble strips along where the bicyclists would be coming up off the bikeway onto the sidewalk and across and then back down. And so that pedestrians could hear the bicyclists coming and then they would also have signage saying that they need to slow down. So that's my request. Thank you very much.

[Matt] Thank you, Susan for those comments. And Susan, I have to thank you also for actually going and meeting with us in the field several years ago with with your husband. I'm very sorry that we lost Charlie. He was a good advocate and so thank you for all the work that you've done to get the conversation going with us.

We did have a question in the comments from Akrum basically asking what the bus stop that Pat and Susan have asked about. And what's being referred to is what's called a shared bike lane/bus platform. And what this means, basically, is the bus stops in the roadway and then there's a raised platform. The bike lane is still right next to the bus. The bus does not pull into the bike lane, because the bike lane is raised. And immediately behind that bike lane is the sidewalk with the bus stop. So what this means is people who are boarding the bus still have to cross over the bike lane to get on the bus. But they don't have to cross over the bike lane to get to the bus stop or the bus shelter. And this presumes that when the bus is present, then cyclists will stop as pedestrians cross over the bike lane, but they they would still have to cross over the bike lane, just to be clear. And Montgomery County is looking at constructing one of those as an interim bus stop up in Germantown. DC has at least one that I'm aware of. I'm not sure if they have any others that are constructed, but there's one that's located at M Street and 24th Street NW that's basically very similar to that.

[Seth] Hey Matt, this is Seth Morgan. I can't get my ALT Y to work, but I would like to make a comment if I may.

[Matt] Yeah, go ahead.

[Seth] Thank you. Yeah, I am the chair of the Commission on People with Disabilities, and Matt you and I and multiple other members of your department have met with us on numerous occasions. I do want to point out that while we are emphasizing the vision impaired individuals in this discussion, that the whole issue of floating bus stops are a problem for people with people who are in wheelchairs, people who have hearing impairment. These are dangerous entities for those individuals as well, and one of the, to echo one of the comments that was made earlier, one of the problems that we have, obviously, is that cooperation from users of the bicycles has not been particularly good, and I never understood that, because it takes two to have an accident. It's not like the bike rider is going to come out of a collision safely, and it's only going to endanger the person with a disability. But for whatever reason, we can't seem to get them on board to make these floating bus stops safer. One of the things that I have recommended in the past, including calling for a moratorium on them until we could get it straightened out, but one thing that I think is very important is an on-demand flashing red light that would stop, and and I we we even discussed putting a barrier there, although I think that's less likely to happen, but at a very minimum, a flashing red light that is impossible to ignore that would specifically stop or potentially stop the bicycle riders as they approach the area where people are crossing to get to the floating bus stops. But again I think I would like that to be an important part of the discussion. I think, I don't believe that everybody's a bicycle rider is out to not follow the rules, and I think we just have to make it more apparent for them when they have to be aware of what else is happening as they approach these floating bus stops. Thank you.

[Matt] All right. Thank you, Seth.

[Bong] Hey, Matt.

[Matt] Yes?

[Bong] I'm sorry. This is Bong. I just like to say something, if I could. So I'm Bong del Rosario. I am the director of transportation policy for the Maryland Department of Disabilities. And not to take away anything from from this meeting or Matt, but I do kind of want to echo what Seth was just mentioning and let everybody else know on this call, that if you'd like, I can ask Matt to drop my email in the chat for everyone to have, but as far as floating bus stops are concerned, you know, Matt and I have had a number of discussions along with MDOT as well and MTA as well for the other areas. But I would like to try to see it safer if the islands, you know, or the floating bus stops, you know, aren't going to be removed, which in my eyes, in my personal opinion, probably not, you

know. They could be as safe as possible for all users, and like Seth said, you know, mainly we talked about low vision and blind on this call, and it is bigger than that. It's not taking away from that, but it is bigger than that. I myself am a wheelchair user, so some of the safety precautions, you know, that come into question, as far as what to use for the low vision and for the blind community, for example the the rumble strips, they could be a little harsh on wheelchair users, especially those who are, you know, paralyzed from the neck down or the waist down. So it's all of us collectively coming together and trying to come up with better solutions. I think, and again, I think Matt just dropped my email in there, I had one session last month regarding floating bus stops. I do plan on having another one sometime in mid-February, and for those who are on the call that were on that call with me, I apologize I have not gotten the minutes out quite yet, well in full, but they will be coming shortly. I've had some issues getting the minutes, and then some computer issues at work, but again for those who have not been on the call, for those who are not familiar with me, I would love for you guys to, you know, email me with your inputs and so forth. And again, you know, I thank Matt for doing this meeting and including, you know, the floating bus stops in it as well.

[Matt] So I just want to do a quick time check. It's 8:22. We were originally scheduled for this meeting to go until 8:30. So I think we had one more question, and then we need to get into some next steps and things. So we're running a little bit late. So Jim if you want to go ahead and move on to the next item.

[Jim] Sure. So, next question is just kind of a catch-all for those of you who didn't get to to comment earlier about sidewalks, intersections, floating bus stops, or for those of you who wanted to to comment about other types of public spaces, now is your opportunity.

[Matt] And I will really ask you to keep it brief this time because we do want to make sure we get to the end and not keep people too late. Martha Levin.

[Martha] Yeah, hi. I'm blind in one eye and low vision in the other from neon optic nerve strokes, two of them at different times. And I live in a retirement community in Sandy Spring. I just wanted to share what I shared with you, Matt, earlier on an email about my experience at a Metro in Bethesda. Wasn't able to go down the escalator because I have a small service dog that I have, emotional support dog, in a stroller. And the elevator wasn't working, and somebody told me to pick up my dog fold the stroller and go down the escalator, and I said 'absolutely not'. I wasn't going to do that because it was dangerous, and bottom line I got some assistance from the help button at the elevator and got on Bus 46 to Wheaton Plaza, to Wheaton Metro and I was able to navigate from that. But it was really scary. I do use MetroAccess a lot. I haven't really had a lot of issues with that. And thank you for this forum, and, you know, thank people for sharing their other experiences. I get around with a support cane, not a white cane. It did me no good when I used the white cane.

[Matt] Thank you, Martha. Sonia Torres.

[Sonia] Yes. Hi. Can you hear me?

[Matt] Go ahead. Yes, we can hear you.

[Sonia] Yeah. Hi. Yeah, I am blind and use a white cane. I live in downtown Silver Spring. I would like to echo some of the sentiments that, of course, my husband Ancil Torres and, you know, other folks have said here. Particularly regarding sidewalks, and also crossing and intersections. One of the thing is that you know the sidewalks, I feel, is just they're just too crowded. There's just so many things on the sidewalks. You have benches, planters, bike racks, and this and that; all kinds of objects in the way. I just wish that there is, you know, you guys can make the sidewalks just for people to walk, you know, instead of crowding with all kinds of obstacles and objects in the way.

And also another thing is there should be some kind of a noise limitation, especially in downtown Silver Spring with those buskers and performers that they should not allow performers to perform at an intersection because it makes it really, really hard for blind people to cross streets when they're making a lot of noise, because we have we have to listen for the listen for the traffic and audio signals and all of that. It makes it really, really difficult for us to cross the street. And that's something that my husband and we have been facing \for many years now. And we have tried to reach out to MCDOT and nothing is really being done about this, and I think there should be some kind of limitation put on that, because that's just, it's very dangerous. It's not safe at all. Thank you.

[Matt] Thank you, Sonia. We have a couple hands left. Jim, I just wanted to check in and see how much longer do we think we need to finish off the presentation?

[Jim] Well, I was thinking about maybe skipping to the next really big question that we want to ask, which is about planning and engaging people with vision disabilities in the planning and design process. I think it would be great to get people's feedback on that.

Yeah, thinking that maybe we should should skip over some of the remaining presentation because of time.

[Matt] Yeah. So let's go ahead and do that, and if we still have a little bit of time left at the end, we could take some more questions and comments. We do want to get as many comments as we can, but we also want to be respectful of everyone's time. So go ahead and move on, Jim.

[Jim] Okay, so I'm going to blow by a few slides here. So I think this is a really important question that we'd really like your feedback on. It is: How do you think people with the County could do a better job of engaging people with vision disabilities in street planning and design projects?

Once again, on the phone raise your hand dialing * 9 and on the computer use the shortcut ALT Y.

[Matt] Okay I see Debbie Brown you have your hand up. Go Ahead.

[Debbie] All right. Good, it worked. Okay I am concerned that when you make a decision first of all we can't see architectural designs and we don't know sometimes what you're talking about. So I mean unfortunately I don't know why you decide you're going to do this right now and nobody can go anywhere and you're going to railroad something through and we can't check things out because, you know, there's a lot of places but we can't, you know, that people can't get out right now, but people need to be able to see what something is, so sometimes we might need an example if there's an example in the local area, that we can go and visit, of what you're going to do. We'd like to know where that is and see how it works because we don't always know what people are talking about. I didn't know what this stuff was until I saw one, you know, the floating bus stops and all that, so, you know, don't go gung-ho and designing something you might want to design some if it's really there's no other way to test it out, to design something somewhere and test it out. But that's the way, you know, we need to and, you know, we have a limited number of us and some of us that are on here we represent organizations of blind people, that Commission on Disabilities. It's, you know, it doesn't, you know, it doesn't necessarily represent and it doesn't, it's not required to represent all of the, you know, every disability. So if you're really concerned about blind people then you need the groups that are representing blind people to do that, and certainly we understand and to moderate with people with other disabilities. But it's not very representative of blind people, so that you need to find the groups. We're here so I'm a president of the chapter of the National Federation of the Blind. So, you need to call on us and so the groups you should know who we are, and find us when you plan to do any kind of new design of street design and sidewalk design we should be consulted.

[Matt] Thank you, Debbie. And those are good points and we have been trying to do a much better job of reaching out to the Commission and other people who have disabilities, and that's part of what this process is. We're here to reach out to you, so thank you for those comments. Let's see, I do see some hands that we've seen before, so I've been trying to call on people we have not heard from before. Eileen Klein, I don't think we've heard from you yet. Eileen, go ahead.

You may be on mute, Eileen. You can dial * 6 to unmute yourself, or--

[Eileen] Sorry. I was legally blind in 1998 and then through some surgeries I got my sight, and they've been watching me carefully. And then I lost it again in 2019, and that lasted a year, but it's back right now, and it's back good enough that I'm even driving a car. But I have some things and I know

we haven't discussed this and I'm not even sure if this is your purview, but in the topics when I signed up for this, I thought it was going to be traffic also. So I do have some things, like if they would put reflective paint on all of the roads and especially two lane roads with no shoulders, for instance. One of the most treacherous roads to me is Falls Road. In the rain or in the dark, it's virtually impossible. You cannot see the white paint on the road. It needs to be the yellow reflective paint with the little tiny beads in it. And also when you have islands, for instance Old Georgetown Road has, and there are, I call them islands, it's like a little sidewalk dividing the middle of the, you know, road going one way and versus one going the other, you can't see in the rain or the dark where those islands are. They need to be painted in the yellow reflective paint. This is good for not only people with disabilities, but anybody who's growing older. Their eyesight, everybody's eyesight gets poorer as we grow older, but yet nobody's going to give up driving as they get older. So it's just a safety for everyone concerned if they would use, no matter what it costs, the reflective paint.

The crosswalks. If they would have the flashing lights. In Rockville, we do have several places with the flashing lights. People just push a button and the light flashes all over the place; you can't miss it. But if they could do that on many more crosswalks, that would be really helpful, especially when the speed limit is like over 35 miles an hour, because you need time to stop and to prepare. And, you know, sometimes, like going down Wisconsin Avenue all of a sudden they'll stop because there's a crosswalk, and you don't know why the car in front of you is stopping. That would be helpful, too.

The other thing about highways is if we could label with larger road signs and give you at least three exits in advance, like they do in Baltimore. The Baltimore Beltway is great for giving you notice about when your exit is coming up. And that's enough. Thank you.

[Matt] Thank you, Eileen. Let's see, I see about three hands and we are past 8:30. So what I'd like to do is just, if we could, Jim, let's talk about next steps so people have an idea of where we're going. And then I don't mind staying a little bit longer to answer some questions. But let's go ahead and go on to the next steps, just so people have a sense where we're going. And then we'll come back and try and get any last comments.

[Jim] Okay. That sounds good. So here are the next steps. We'll send out a survey later this week to get additional feedback from you and others on the topics we discussed today. So if you didn't have an opportunity to to answer a question that we posed today or you have additional thoughts, you'll be able to do it through the survey. We're also going to attend this week's Commission on People with Disabilities meeting to receive additional feedback and answer questions. We are developing the draft toolkit that Matt mentioned, and once that's done we'll share it with stakeholders. There's also a pilot aspect of this project, as Matt mentioned earlier as well. The first step there is to identify the pilot location, so we're looking for your feedback on that and we'll be doing additional outreach for the for the pilot design, including conducting interviews with people who have vision disabilities to understand the specific challenges that they face at that location. And finally, there will be a report, a final report that includes the toolbox and the pilot drawings. The report is really just a first step for the County. As Matt mentioned, this is a really quick process, so we are developing a toolkit

that the county and the region can use, but there's more that needs to be done and we recognize that.

Anything I missed there, Matt.

[Matt] No, I think you got everything. That's good.

So, we, like I said, we already are past our time and we did skip over a couple of slides. I just wanted to talk really briefly, kind of, about what the toolkit, what sort of things we can get out of the toolkit. We heard a lot from you, from everyone who was here tonight, and I think that's really helpful feedback. One of the concerns we heard, for example, was obstructed sidewalks. So looking forward, our toolkit might recommend something like a clear path that's direct and is free of furniture. And we sort of get a sense of what, exactly what is necessary to really make that work. Another thing that we could consider are directional indicators. So-- we've used a little, used as very limited in Montgomery County, but you know how do you find an intersecting path when you're on a sidewalk maybe not at an intersection. So those are the sort of things that we're looking for to incorporate. We want to keep you all involved as we go through that process to understand what the trade-offs are, to help us understand things that you do or don't want. And so I know we heard from, I believe it was, Debbie who said, you know, we need to be involved in the process early on. Well, that's what we're here for. We're trying to get you involved as early as possible. I know that we didn't have time to get to everyone's comments. We did see a lot of hands and we did hear from a lot of people. So we still have, I think, three hands up. So I'm just gonna take an opportunity to call on those three people, and if you have any other comments or questions we are going to send a survey out in the next few days. It will go to everyone who registered for the meeting or expressed interest in the project. So it'll give you an additional opportunity to fill in any comments or questions or concerns you have about the project.

So with that, Liliana Gillespie, you have your hand up. Go ahead.

[Liliana] Hi, yes. I'm Liliana and I have retinous pigmentosa, so I am cannot see at night. I have very limited vision at night and it's-- I can see fine during the day, but the second it starts to get a little dark, can't see. And so I forget who mentioned it, but sidewalks and, oh where is it? University Boulevard, that intersection: absolutely horrendous being able to see. It doesn't have any kind of those blinkers or the audio. I can never tell when cars are coming.

It's just something for me, personally that even especially during the day, that it's just very difficult to maneuver. Again, I can't remember who mentioned the reflective lights throughout streets and that would also be something especially when I'm out at nighttime. Because, again, I can't really see things. So I have to really rely on kind of the vision that I do have. Somebody else brought up the street performers in downtown Silver Spring. That as well is a big thing for me, because they'll

usually be there in the evening. I mean, I'm trying to listen for sounds. It kind of interferes, because since I can't see at nighttime, my hearing is amplified. So I tend to rely on that. But excess sounds or not being able to hear anything at all is, kind of puts me in an even worse space than I would be just, than I am already. So I think just trying to control noise and just let light during the evening really helps me, and I'd like to see more of that in the area of Montgomery County.

[Matt] Thank you. Can-- you said there was an intersection at University. Would-- do you know what the cross street is? University and what?

[Liliana] Oh. I think it's Colesville. University Boulevard and Colesville Road.

[Matt] Okay. Thank you.

All right, we also have Jill. Phone number ending in 0589. Jill.

Go ahead, Jill.

[Jill] Hi, I'll just pass on my question and give somebody else a turn.

[Matt] Okay, thank you, Jill. Looks like Dingram, you have your hand up.

[Dingram] Okay, did I unmute?

[Matt] Yes, go ahead, Dingram.

[Dingram] Okay. I just had a couple of questions about sidewalks. And also intersections. A lot of the places where they put up the signals for the pedestrians to push to get the light activated for the crosswalk, they're nowhere close to where you would normally stand to cross that intersection. I don't know how they think we're going to be able to find those stupid things, because they're just not in logical places. They've also put these little curblets in a lot of places, and I'm not sure why. But they're a real tripping hazard. They should come around from one street and need to cross the other street, so those are really, really bad. In Bethesda, they've got one area where they had a nice sidewalk and they put up a new building and for some reason they decided it would make sense to put this little step at each end of the sidewalk, so about, I don't know the normal sidewalk width from the intersection, you have to step off a step and it's a graduated height curved raised step. So

again, it's white. They put a little white edge on it, so I guess they thought that was supposed to make it visible. But that's great if you can see it but if you can't it's a real, again, another tripping hazard. And then what everybody else has said about the sidewalks just being too cluttered. A lot of places, sidewalks are way too narrow and especially where they've got eating facilities, they tend to encroach badly on the sidewalk that's supposed to be kept clear for the pedestrians. People's chairs are left sticking out into them, etc and it just makes it very hazardous to walk around. Those are my main comments. Oh, one last thing: We have a lot of these metal boxes that are attached to telephone poles, and for some reason they often have put them so that they'd project into the area where you need to be walking, and you have to dodge them. But they're right at face level, or sometimes chest level. So your cane doesn't pick them up. If they were rotated around so that they weren't in the pedestrian pathway, that would be really helpful too. Those are just incredibly dangerous. Thanks.

[Matt] Okay, thank you. Those are good comments. Looks like our last hand up is uh Ancil. Go ahead, Ancil.

[Ancil] My final comments tonight have to do with recommendations, or a recommendation, for different things. One: the issue of controlling the bike traffic or regulating the bikes and the scooters at the floating bus stops. I don't know if this exists, but maybe we might want to look into it. Just like you have speed bumps for cars so that they must slow down at certain places, I think you might want to consider having some sort of speed bump equivalent for the bikes and the scooters, so that they don't go zooming past the intersection when they're supposed to either stop or slow down when people are trying to cross. As far as feedback from the community, I just like in technology, you have beta testers. Perhaps you may want to set up some sort of database of of people who wouldn't mind volunteering to provide their comments on things that you are considering so that we can give our feedback on it. I've had experience with Montgomery County where they spend a lot of time listening to you and then they just go about and do their own thing.

And which is most unfortunate. I almost feel sometimes like I've wasted my time in talking with them because, if you were going to go do what you want to do anyway, you know, why did you talk to me, you know? So that's my second recommendation. I'll stop there. Thanks.

[Matt] Thank you, Ancil. Well those are all the comments and questions that we have hands up for right now. So we have gone over our time by about 15 minutes. So I just want to close by saying thank you to everyone who joined us. I also want to thank our interpreters and our captioner for joining us this evening. But thank you to all of you for giving us your feedback your comments. We can't do this work without you, and we're going to continue to work with you over the next six months as we develop this toolkit, which we hope will be a way to create better standardization and better facilities for everyone throughout the region. Not just within Montgomery County, but to create a continuity of experience for people who are crossing the state line or crossing county lines. And we really do appreciate your feedback, so be on the lookout for the survey that's coming sometime this week to give us some additional feedback. And look forward to other invites for

public engagement as we go forward over the next couple months. So thank you very much, everyone. And I want to wish everyone a good evening and stay safe out there, Thank you.

Appendix F: Countywide Survey Results

Response Statistics

	Count	Percent
Complete	63	25.5
Partial	184	74.5
Disqualified	0	0
Totals	247	

1. Do you have difficulty with any of the following in a way that impacts your mobility as a pedestrian? (Check all that apply.)

Value	Percent	Count
Seeing	67.4%	64
Hearing	20.0%	19
Sense of touch	3.2%	3
Walking	38.9%	37
Balance	36.8%	35
Other - Write In (Required)	9.5%	9
Not applicable	14.7%	14

Other - Write In (Required)	Count
Doctor of Optometry	1
Fill forms when I go to a new doctor	1
Stress in crowded facilities.	1
caregiver to person with impaired vision	1
complex PTSD	1
issues of spine	1
standing long periods	1
wheel chair	1
Totals	8

2. Which of the following categories best describes you?

Value	Percent	Count
Person with a vision disability	35.5%	33
Person with vision loss that is not fully correctable	20.4%	19
Orientation and mobility specialist	5.4%	5
Caregiver, family member, friend, or advocate	25.8%	24
Other - Write In (Required)	12.9%	12
	Totals	93

Other - Write In (Required)	Count
Back problem sometimes interferes with walking	1
Disability - Mobility	1
I have problems getting around since I need walking stick.	1
Pedestrian and driver	1
Person with mobility and balance disability.	1
disabled person with gait and walking challenges	1
four joints with osteo-arthritis and put back together.	1
night vision problem	1
over 65	1
right eye	1
senior with limited balance issues & night blindness	1
teacher	1
Totals	12

3.If you have a vision disability or vision loss, which of the following categories best describes the type of vision disability or vision loss you have? (Check all that apply.)

Value	Percent	Count
Overall acuity loss	32.3%	30
Depth perception loss	38.7%	36
Peripheral vision loss or tunnel vision	25.8%	24
Central vision loss (e.g., macular degeneration)	17.2%	16
Total vision loss	10.8%	10
Color blindness	11.8%	11
Night blindness or difficulty seeing at night	39.8%	37
Other - Write In (Required)	10.8%	10
Not applicable	24.7%	23

Other - Write In (Required)	Count
Bilateral NAION	2
Anterior eschemic optic neuropathy	1
Light Sensitivity	1
Photophobia, Corneal sensitivity	1
Retinitis Pigmentosa	1
born with very low vision in one eye, not correctible; other vision problems developing;	1
cortical vision impairment	1
retina damage	1
retinitis pigmatois or RP Peripheral	1
Totals	10

4.If you have a vision disability or vision loss, does your vision disability or loss impact your ability to drive?

Value	Percent	Count
Yes, I am not legally able to drive at any time of day.	36.2%	34
Yes, I am not legally able to drive at night.	1.1%	1
Yes, I feel uncomfortable driving at any time of day.	8.5%	8
Yes, I feel uncomfortable driving at night.	24.5%	23
Not applicable	29.8%	28
	Totals	94

5.If you have a vision disability or vision loss, have you received orientation and mobility training or travel training?

Value	Percent	Count
Yes	25.0%	23
No	43.5%	40
Not applicable	31.5%	29
	Totals	92

6. What challenges do you experience as a pedestrian when navigating sidewalks?

Response
<p>I think the most challenging thing for people with a visual impairment is finding or getting a sense of direction. Perhaps it would be possible to create an app that could use sound to act like a beacon. The sound would intensify or increase in tempo/speed to help point people in the right direction as well as guiding them away from obstacles and away from streets.</p>
<p>most in business areas are too narrow, Add outdoor eating and it is impossible to walk by. Attractive bricks are stumbling hazards, even the slightest raise. Bikes and scooters left on walks are tripping hazards and decrease walking space. Raised curbs at intersections are tripping hazards --should be all ramps instead of partial raised curbs like in Wheaton on University Blvd across from Bank of America.</p>
<p>Balance issues</p>
<p>Blurred vision, inability to determine separation on medians Burtonsville Maryland is a prime example of areas with low immediate excess to safe bus location walking towards a highway to get to a bus does not make since. It's exhausting and very scary navigating the bus stops for seniors and disabled. I can't see at night my vision is blurry and lights irritation from incoming light</p>
<p>Sidewalks which also include drive ways can be difficult to detect, also corners which blend into the street have issues.</p>
<p>Someimes stumble over cracks and separations in sidewalks...have to look down and then might walk into someone or something.</p>
<p>I have trouble judging where the curb is as it blends in with the street causing trip and falls.</p>
<p>Identifying uneven sections of the walkway, and avoiding vehicles exiting buildings and crossing my path.</p>
<p>Continuity of sidewalks, cross walk signals with sound, accessibility, signs, lighting at night</p>
<p>In Meadowood. there are no sidewalks, and the difference between pavement level and grassy area is as much as 8 inches. I have fallen several times because of this unevenness. The cars go extremely fast, so it is not possible to walk in the road.</p>
<p>Crossing streets without lights that cue when safe to walk</p>
<p>Lack of APS or non functioning APS Poorly designed or maintained alternate path of travel during construction projects Cars not stopping for right turn on red Pavers/pavement not maintained Scooters, bicycles left haphazardly on sidewalk</p>
<p>I navigate with a guide dog. I struggle with temporary obstacles, when APS signals are malfunctioning, and when bus stops are temporarily relocated. I cannot hear bicycles coming, and floating bus stops or other intersections with a median can be very dangerous.</p>
<p>Not all crosswalks have audio prompts telling you when to cross. Signs on crosswalks aren't always bright enough during the day.</p>
<p>Unable to keep sight on cars making right turns when crossing roads.</p>
<p>Uneven sidewalks.</p>
<p>Uneven sidewalks and thresholds, wayfinding markers that aren't visible at wheelchair height, narrow curbcuts, vehicles blocking curbcuts, cars and shopping carts in parking space access</p>

Response

lanes, shopping carts blocking sidewalks, mud and rotting leaves across sidewalks, difficulty finding accessibility information online, poor understanding of accessibility issues in the general public, places with only parallel disabled parking spaces, disabled parking spaces located without considering the whole travel path

Most often encounter broken pavement, raised joints or large tree roots. Sometimes sunken pavement near crosswalk and sewer drains, poorly patched with blacktop or nothing.

Curb cuts with bumps make transiting with a walker more difficult and negatively impact balance.

Uneven pavement. Sight are in small print. Or too dark to read them. Length of time is not long enough for me to cross safely. Intersection are not marked for pedestrians crossing and cars generally disregard them anyway.

Insufficient time to cross at controlled intersections. Vehicles violating pedestrian right-of-way or "pushing" pedestrians to hurry across street. Bicyclists and scooter users ignoring pedestrian right-of-way.

Uneven and broken pavement.

In bad weather, sidewalks are often not cleared or are used to dump the piles of snow. Navigating can also be an issue if foliage remains untrimmed; canes do not detect that, so what ends up happening are branches right in the face. In areas without sidewalks, it's a choice between using the shoulder of the road or the road itself, and many drivers tend to not pay attention. When reaching street crossing, many sidewlks are badly constructed so that they slant a pedestrian into traffic instead of the crosswalk.

some sidewalks are very narrow which makes it inconvenient to get by.

Side walks at bus stops are narrow, some sidewalks don't connect, some stops are obscured by overhanging tree branches or bushes causing people to get closer to the curb to see oncoming buses, or buses fail to see people at stop and pass them for pick up, buses need to allow more time for some people to get to exit door and close to the sidewalk.

None

Sidewalks are cracked, lumpy and narrow

tilting driveways, cracks in sidewalks,glare makes it hard to see traffic lights and signals

Our street (Clearbrook Lane in Kensington) and others in the neighborhood do not have sidewalks for my son and (others to include those with disabilities, elderly, young children walking to school) who has mobility and balance issues. Also, some sidewalks are not wheelchair accessible due to telephone and other utility poles.

Where I live (Olney) the trees and other vegetation along the sidewalks are hardly maintained, often resulting in hazards along the way. Bicyclists are a real hazard on these sidewalks as well.

need extra time to cross the street. drivers often stop in the crosswalk making it dangerous to cross. need the ramps to continue walking-drivers block them so they can't be used.

There are many places where there are no cut outs. It is easier to navigate without having to step down or up curbs. There are not enough "smart traffic lights" which have info about how long you have to cross or talk to me (make beeps). The bus system to my house (20837) is limited so I am limited in my travel by public transportation. I have to rely totally on other forms of transportation.

Response

Drivers do not stop at lights and are not looking for pedestrians when they turn so I am fearful of going to certain intersections on foot. Some sidewalks are broken and harder to manage closer to DC.

My input is as a caregiver for my father who had vision/balance issues. Depth perception was a big issue on curbs and sidewalks.

Uneven pavements Projections into the walking area of boxes mounted on telephone poles, parking meters, fire hydrants, shop doors, chairs Driveways across sidewalks Poorly designed (many nw) intersections - curb cuts in the wrong place, pedestrian signals poorly located Right turn lanes at intersections that allow cars to zoom through the crosswalk or even just curved curbs at intersections that let them turn quickly. We can't see them coming and they aren't looking. Bicycles going fast on sidewalks expecting you to step out of the way but don't see them. Huge flower pots at corners at knee level often interfering with reaching crosswalk Construction interrupting sidewalks or making them very uneven, construction wall legs sticking into sidewalk area Abandoned bikes and scooters Crosswalk signals that just beep so you don't know which road is clear to cross Lack of working streetlights at intersections so can't even use my limited vision at night Those little metal fences around tree areas that you catch your foot on Steps built into what should be just a sloped sidewalk Changes in where the "walkable" pedestrian area is

Sidewalks that are not well maintained (buckling, holes, etc.) present a risk because I can trip and fall. I have age-related osteoporosis and falls can easily lead to fractures that would impede my ability to be independent.

there are no places to sit near major office buildings inside buildings to be safe from outside traffic and busy passage way with high walkability. This is particularly true with in unsupervised buildings and no service operator in buildings or near buildings. Just big vacant buildings with heavy doors and no accessibility buttons - especially in downtown Germantown business district near the Black Rock Theater and shopping center; and some buildings on Rockledge Drive in Bethesda, Maryland. If an individual with vision or walking challenges are in vacant lobbies, with no seating or access to a real person, especially when traveling alone, this makes you feel unwelcomed as a resident in the County.

I have great difficulty with overhanging branches or signs that extend wider than the support that my cane would pick up. With no peripheral vision I can only see one thing at a time so if there's foot traffic and tripping hazards (like benches fire hydrants cones and etc.) I cannot see both things at the same time. So unnatural hazards on the sidewalk or near the curb are dangerous to me.

big cracks in sidewalk and over grown greenery that impedes mobility.

Depending on the angle of the sun, I experience blind spots for short periods of time.

I cannot walk straight. I cannot see if the light is green or red. I cannot see the post allowing pedestrians to cross. I cannot see the button to press for stopping the traffic. I cannot read the address I am heading for.

Trip on uneven sidewalks and curb cuts.

Pavements are sometimes uneven in places; during winter months, sidewalks are not always shoveled or salted for safety. Some walkways are also too narrow for people to walk by in both directions.

I have no vision on the bottom of my eyes. I have trouble seeing any thing below in front of me. my central vision is 20/25. I am not comfortable in a store or shop. unless I no there's nothing on the floor, I have to have someone watching me. My upper peripheral is ok.

Response

Poor lighting or rain limit night visibility

Narrow sidewalks, danger crossing streets, construction site pedestrian area danger, public insensitivity such as failing to grant the right of way to handicap on sidewalks & public transportation, snow/ice removal on walkways, elevators periodically out without warning

our neighborhood does not even have sidewalks on most streets. But at least the streets that do have sidewalks have curb cuts now. all the sidewalks are still a bit narrow so other pedestrians have to leave the sidewalk to pass us.

I walk with a cane and cannot walk long distances due to back pain. I often have to look down to watch where I am stepping. I have difficulty walking on uneven surfaces.

Sidewalks that are crumbling or in disrepair are challenging to navigate

lots of crossings at street corners are not painted the bright yellow consistently in this area. poor depth perception- never have fallen walking on sidewalks. lots of areas to cross streets do not have lights such as on norwood road sandy spring. people drive too fast inspite of being near a retirement community

my answer got deleted by accident,. lots of sidewalk markings are not consistently painted yellow., crossings on norwood road sandy spring do not have flashing lights to slow people down or stop lights and it is right in front of friends house ccr. transportation over in this area of mc is so much different and lacking compared to gaithersburg, rockville and germantown- especially the bus times -only during rush hour where i lived in gaithersburg i could walk 2 blocks and catch a bus to the metro or to the mall anytime of day including weekends.

Broken concrete/sidewalks, tree roots bursting through sidewalk, low-hanging branches, wires from ground diagonally up to poles, deep puddles, ice, packed snow, private driveways with broken areas, cars parked across sidewalk at driveways, toys/ scooters/ bikes parked

Non working pedestrian signals, lights that are not sinked right, not enough pedestrian signals

Crosswalks require curb less sloping egress with tactile clues and audible walk signals (e.g. best if audible location information is also provided)

It is difficult to identify bus stops, or to read the information for connecting with schedule information. It is difficult to identify buses whose routes I am looking for. I cannot read the banners on the buses until I get them to stop in front of me.

I face a challenge when sidewalks are not available or are only available on one side of the street

Using my white cane, I have few problems navigating sidewalks. Curb cuts should be facing the crosswalks.

Sidewalks Too narrow; steeply sloped uneven or cracked and loose gravel or debris make for dangerous walking conditions.

I've heard people say that when restaurants have their tables and chairs on the sidewalk it makes much less space to walk and is sometimes hard for a guide dog to navigate, and white canes can get caught in the chair legs. And when whole streets are closed for restaurants, there's no clear path of travel. Some sidewalks are uneven, or cracked, a trip risk. Floating bus stops (below) are really a big frustration.

finding the curb and depth perception challenges

Response

Unexpected obstacles in the way for example bench, overhanging signs, fire hydrant in unexpected places and the like. Unmarked crush Street Especially in the middle of the block for bus stops.

Scooters and bicycles

Obstructions such as poles, bicycles and scooters that are litered on the sidewalk or they zoom past you.

7. What challenges do you experience as a pedestrian when navigating crossings where streets intersect?

Response
The sense of direction is crucial. Although there are audible warnings and cues at crosswalks and intersections, the sense of direction is crucial. Perhaps something could be done using Google maps?
Raised curbs that are supposed to funnel people into ramps. I have tripped & stumbled.. Better to have all ramps .
vision
Visibility, and traveling for long periods of time and access to immediate area with buses.
It becomes a problem when there is snow and I cannot reach the APS. businesses who do not clean the sidewalks or are close to the intersections are difficult to find.
Walk slow and sometimes don't see turning cars clearly.
There is usually not enough walk time to get across the intersection, and I sometimes am unable to see cars turning due to peripheral vision loss.
Identifying vehicles turning on red into my pathway.
Continuity of sidewalks, cross walk signs with sound, crossings in all directions that have crossing signals, lighting at night
No crosswalks, cars at excessive speed.
Knowing when safe to cross
Cars not stopping before right turn on red Lack of truncated domes Crosswalks where the there is a green left turn indicator so pedestrian never gets an opportunity to cross without a car Insufficient time for pedestrians to cross Diagonal curb cuts that provide no assistance with locating the cross walk
Bicycles regularly do not follow the rules of the road and make illegal turns when they do not have a green light. Many APS signals malfunction. Cracks in the road present a tripping hazard, and puddles along curb ramps can create a hazard in the winter.
All crosswalks require audio prompts.
Keeping sight on cars making right turn.
Not enough time to safely cross some wide city streets at designated crosswalks.
Low visibility, uneven and/or narrow curbscuts, no crossing time countdown, crosswalk markings worn down or hard to see, potholes, puddles in unlevel surfaces, debris in gutters
Please see above, and overgrown scrubs that hinder traffic visibility.
Other pedestrians and bicyclists do not yield to persons on walkers. The time for pedestrians to cross often is not sufficient for someone on a walker.

Response

There are few crossings marked in my neighborhood. Cars run stop signs and ignore pedestrians in the process of crossing unmarked intersections. Street signs are in small unreadable print. They are dark. Many streets are poorly lighted.

Poorly lit warning signs. Warning signs type/font too small or lack of background contrast. Poor marking of raised curbs or standouts, particularly where neutral colors produce ambiguous figure-ground contrast.

Curb cuts are small or not existing. Time to cross is short.

Frequently, drivers fail to pay attention, even when a pedestrian's time to cross comes. Many ramps are slanted so that they direct a pedestrian right into traffic, not the crosswalk. Roundabouts and long curves are also an issue because they tend to muffle or distort traffic sounds. Another problem occurs when drivers stop to let a blind pedestrian cross, holding up traffic and actually obscuring our ability to rely on traffic patterns to know when it's safe to walk. Audible cross signals are also a problem because not only can one not hear them well, malicious passers-by sometimes try to trick you into crossing streets by imitating them; they also do not always indicate a safe crossing when it really is safe.

It is difficult if there is no traffic lights or crosswalk.

Most often the lights change too quickly, a system to be able to adjust time needed to actually cross on an as needed basis could be considered. Also a prompt warning people that cars can turn right at the light. When prompted to cross the intersection the signal should also indicate the actual time allotted to make the crossing from one side to the other.

None

Have nearly been hit by speeding cars twice-Westbard Ave

I am in a scooter too and have hard time making out curb cuts

Some sidewalks/crosswalks are not wheelchair accessible (Cedar Lane and Dresden street in Kensington)

Too few of the controlled crosswalks have audible signals. The lighted "hand" by itself is impossible to discern in the sunlit day.

drivers not having enough respect to stay out of crosswalks and blocking the throughway. need extra time to cross street.

See above about "smart lights" and drivers not stopping at lights. I wish there was more information about the light system routinely for pedestrians.

My father had issues that made it hard for him to see distance along with the depth perception so knowing when to cross was hard.

Put some of these in above section One other is problems with missing covers for various holes in the street. They must get knocked off by cars and they never seem to be replaced. Some of them are in the crosswalks and my foot nearly fits into them. Very dangerous. I don't see them and my cane usually doesn't pick them up If I cross one street and then need to cross the next, flower pots often in the way or little "curbs" awkwardly shaped that I trip over. Can't always find signal buttons. At soem intersections there are left turning cars that run the red light badly and are coming through after the pedestrian walk signal starts sounding. I can't always see or hear them.

Response

Crossings where there are no crosswalks or inadequate lighting present a pedestrian safety issue. Crossings without a pedestrian push button for a walk signal present a pedestrian safety issue. Pedestrian walk signals that do not last enough time present a pedestrian safety issue.

There are no detectable warnings or surface indicators on sidewalk ramps before crossing the street. In many places, there is not intersection to maintain alignment during the crossing or to correct from initial misalignment of pathways.

My difficulty becomes hoarder when there is multiple lanes that have turning lanes left right and straight as I can't see more than one lane. The best is when I have a signal light that tells me went across in which direction.

Low visibility, not bright at night, cars not stopping for crossing.

The audio crossing alerts are a big help. However, it's a challenge to be sure cars are honoring the walk signals both visual and audio.

Can't see walk signs

Some intersections do not allow adequate time to cross; cars for not looking before making right turns on red lights. More than anything, cars do not yield right of way to pedestrians.

A little nervous.

observed that rain, dark clothing ,turning vehicles create create visibility issues.

See previous answers

we find the traffic moves very fast on our street and because we have no sidewalks on our streets and lots of cars parked on the sides it feels unsafe to take a walk with my daughter in a wheelchair. So we seldom take walks together my daughter just stays home.

I cannot move quickly and require additional time to cross an intersection

APS (accessible pedestrian signals) are often installed at large, plus-shaped intersections, which are actually easy to cross, rather than installing them at roundabouts, or T-shaped intersections, which are more challenging to a person with a visual impairment.

markings to cross street are not consistently painted yellow sometimes times to cross intersections are not long enough to get across a busy intersection. a voice to the timer or crossing signals would be nice even though i can hear fine.

uneven pavements. cracks in comcrete blocks

the crossing timers need to be longer and verbal as well as visual. more time needed at busy intersections and when near a housing community there needs to be flashing lights or a stop light to get people to slow down.

Drivers/ bicyclists texting or otherwise inattentive, uneven/broken asphalt, bushes overgrown making it hard to access buttons on poles, confusion as to which button controls the walk sign for which street (at large intersections), slippery gravel/ trash &/or deep puddles in area when first stepping off curb

Response

Vehicles having the right to turn on right start going right when I enter the cross walk or just have to make that right turn as I almost reach the sidewalk and have even gone up on the sidewalk just to make that turn!

Crosswalks require curb less sloping egress with tactile clues and audible walk signals (e.g. best if audible location information is also provided). Also road signage should be appropriate for spotting scope.

Cars don't always stop at crosswalks so I have to waive my arms to make sure they do. I cannot read the walk/don't walk signs where they exist.

I face a challenge when the stop light or walk signal is too brief for me to safely cross the street in time. Traffic circles are also a problem because often times cars don't yield to me when I am crossing in a crosswalk by a traffic circle

Turning lanes make it hard to find the crosswalk to cross safely. Islands at corners.

1. Crossing Channelized crossing lanes before crossing intersections. There is no way to accurately discern. 2. Hard to Avoid turning traffic. 3. Stop sign intersections are dangerous to pedestrians with visual impairment. Many drivers are not careful.

Drivers seem to be more in a hurry these days, not stopping for pedestrians at crosswalks -- that includes bicyclists. It's hard to hear the "beeps" for safe crossing when there's a lot of noise near the corner, from buskers, bands at the Veteran's Plaza, etc.

On Mark Street crossings without lights to warn drivers and bike riders that I need to pay attention. In some cities when you exit the sidewalk and shit so often very bright LED lights that vehicles and bicycles can see easily. The biggest problem on the bicycles and the electric cars which are silent.

Time given on big intersections And lights that are not working

APS (audible pedestrian signals) that are not functioning. No access to LPIs. Crosswalks not properly marked.

8. What challenges do you experience as a pedestrian when navigating mid-block crossings?

Response
Parked cars that obscure light lines, , speeding cars that don't watch for peds.
difficulty accessing when safe to go. All crossing should be where there is an accessible pedestrian signal
Burtonsville Maryland needs to provide solutions and access to bus terminals. Burtonsville MD areas McKnew, 198 East, Country Place Apartments, Columbia Pike refuses to have access to the buses its dangerous and unsafe for teens, seniors, disabled residents and tax payers we need access without having to walk down and up a highway.
If the street in question is a 6 lane highway and there is not enough lighting, it makes for a risky crossing. There is one near my workplace.
hard to walk fast when cars may speed up
Stepping on and off curbs and time allotted for crossing.
I never try this as it is too risky with my vision issues
We do not cross a mid-blocks due to safety
Too dangerous, can't do it.
Knowing when safe tom cross
Unable to know when it is safe to cross Concerns that drivers will not stop Lack of pedestrian activated crosswalk light
I avoid mid block crossings whenever possible unless I have a sighted guide. They are simply too dangerous. I would suggest adding lights or beeps controlled by a button to alert the cars of the presence of pedestrians.
None
Not enough time to safely cross some wide city streets at designated crosswalks.
Low visability, drivers who are confused about crossing rules
Pedest. Should know not to try if not an intersection.
There often are not curb cuts mid-block, so crossing on a walker mid-block would be impossible under those circumstances.
Speeding vehicles. Running of stop signs. Uneven curbs to step up on or no sidewalk at all.
Drivers ignore clearly marked pedestrian cross-walks. Lack of warning lights at cross-walks.
I discourage all people from crossing mid block because it's dangerous. Always cross at a light.
The biggest challenges with these are people idling in the crosswalk. This causes problems when trying to gauge traffic patterns, and it forces one to go out into traffic to get past.
N/A

Response

Mid block crossings are helpful but not many. Some are too narrow, aren't handicapped accessible, and don't warn on turning cars and makes it dangerous to cross. Cars stopping beyond crosswalks makes it difficult to cross and see oncoming cars.

None

Really dangerous, no ramped edges, No bike lane. Or space to make the transition between evels

sometimes hard when scooting to guage width between a builing and its ostrcting street lamp or orther impedimeny. Tilying driveways a problem too

Drivers don't always stop for the striped crosswalk alone. I feel safer crossing at the light.

drivers blocking the crosswalk at mid-block crossings.

I don't do this because there are few places to safely do this.

not applicable

Dcannot use midblock crosswalks that don't have lights. Cannot tell if cars are approaching and isn't worth the risk.

I do not do midblock crossings because they are unsafe and illegal. There have been 3 pedestrian deaths across from where I live because pedestrians did not cross at the pedestrian signal with the light.

It is hard to alert a drive if a car is coming and person who is visually impaired has challenges crossing the street.

I can't see two way traffic only one at a time and show when I'm in the middle of the street I have to depend on traffic to be honest and stop. Some do some don't and it's hard to know which ones are actually going to stop. The other issue is if there's a walking lane I need some kind of marker to find it like truncated dome's that signify a Crossing Lane.

I never cross mid-block simply because I can't be sure I've visually located any vehicle that might be coming toward me. Crossing walks at mid block crossing would be a help, especially those that warn vehicles that a pedestrian is crossing.

I don't know if it's my time to cross or not

Cars not yielding right of way to pedestrian crossings.

I only cross in cross walk.

persons in dark clothing are not very visible specially at night or in rain

Awareness if danger ahead

we can not do that because my daughter has a wheelchair.

I generally don't do this

Mid-block crossings are not safe for people with visual impairments unless they have a light stopping traffic and an APS so the person knows when to cross

Response

at norwood and quaker lane there should be stop signs or lights. very busy road and no one slows down. no other issues

vehicles not following traffic regulations

mid block at norwood and Quaker lane. no flashing lights no cross lights or even flashing lights or something to slow people down. not even speed bumps. norwood is very busy and dangerous. right in front of ccrc community

Getting run over by an inattentive driver or bicyclist/scooter/ jogger who hasn't seen me, uneven asphalt/ gravel when stepping off curb, encountering surprising unsafe landing spot when stepping back up off road, like unseen fence/ wire, muddy/slippery non-sidewalk area, ice

Won't do that at all! Wanna see my next Birthday and don't want to kill my guide dog! Besides she won't allow me to cross mid block!

Mid-block crossings are dangerous and should not be encouraged.

I do not attempt mid-block crossings.

I avoid mid block crossings because I am concerned about being able to cross safely that way

Finding where to find a crosswalk and deciding when to cross.

1. Drivers do not respect these. 2. Signage is often poor or too small. 3. Cars parked in sight lines- guide DOGS Are unable to see cars coming and drivers are unable to see Pedestrians

Haven't heard anyone talk about this.

Again not enough time to cross the street. Example Wisconsin avenue and white Flint Interesectioni

9. What challenges do you experience as a pedestrian when crossing bike lanes to floating bus stops?

Response
Cyclists are often more careless and aggressive than motorists! Bike lanes are particularly dangerous.
Totally unsafe. Should not be in busy urban areas. Bicyclists do not like to slow down
Anxiety as it relates to response time, identifying cross walks, bike lanes, no visible language for cueing or practical labeling.
I believe that bike lanes should be in the middle of the street. A blind person will have to wait a long time to get on the bus. We want to use public transportation not to avoid it.
Again blurred vision sometimes makes it hard to see...bikes sometimes too fast.
The risk of being hit by a bike due to them not making sound.
N/A
I have not experienced this bike lane situation, but as a frequent bus rider, request covers/shelters at all bus stops.
n/a
I am a friend who can see but who uses hearing aids and is a bit slower moving friend. I encountered a bike lane on a one way street, assumed bikes would be coming north like the one way traffic pattern. The bike lane permitted two way bike traffic. While I was looking for northbound bikes a cyclist going south, downhill yelled out something and startled me, swerved around me and almost hit me. I heard them yell but didn't hear what they actually said. They did not slow down at all. It was very unsettling. I know friends who are blind are really worried to try to use these bus stops because of fears of being hit crossing. Cyclists often don't stop because they don't want to lose momentum. A friend who is in a wheelchair was also worried about these bus stops because cyclists don't stop.
I avoid these stops because of the danger. It is also much more difficult to make sure I am boarding the correct bus if they stop at a floating stop. I support ACB's proposal regarding floating buses and add that buses should all have universal audio announcements of route number and direction.
Have not experienced.
Disrespectful bikers who will not even slow at these areas or obey traffic signals in the area.
Bicyclists often do not yield to persons on walkers.
It is difficult to cross making it much more lengthy to get across again car may cut you off.
Bus stops need to stand out visually from pavement and bike lane markings. Oftentimes, it is difficult to know where the bus stop edge begins, how it is distinguishable from adjacent lanes.
I have observed that bicyclists don't follow the "rules of the road"
Sometimes, there is not enough time to cross before the traffic cycle shifts.
N/A

Response
It's ok unless bikes fail to yield to pedestrians or obscure crossovers
None
I try to avoid. They scare me.
Haven't been hit yet.
buses not getting close enough to curb. i'm short and my legs not long enough to reach past six inches.
None so far.
not applicable
Can't tell a bike is coming and they are expecting me to watch out for them. In many countries, there are stop lights for bike lanes. That would be good here.
So the design inherently creates a hazard for pedestrians who will be hit by bikers. Why would anyone design such a hazard?
No proper access to detectable devices to help with crossing.
I find these very dangerous and frightening at least the ones I've tried to cross earlier in my travels. Without clear markers to cross and with no signal to stop the traffic electric cars and bicycles sometimes are difficult to find or identify. I also find in a four-lane street that often one lane will stop but the other doesn't and goes around the car that stops perhaps not seeing me or perhaps thinking they can beat me across the street before I cross the street.
Cyclists aren't educated to pedestrian safety. They have a tendency to cycle along bike lanes as if they have complete right of way.
I cannot see the special lanes
Majority of bike riders do not obey normal traffic rules. They feel they have right of way at all times.
no comment
Having to cross from one access area to another where buses, cyclists, cabs, etc. might interfere is terrifying to someone visually impaired when trying to navigate to get to or from metro stations.
gosh we can not really get to a bus stop.
I almost never use the bus
It's not possible to hear a bike coming until it's too late to avoid a crash.
no experience with this
no floating bus stops in my areas of travel
no experience with this at all.
?

Response

Guide Dog schools do not train our dogs let alone us to use floating bus stops! At this time none of the schools plan on training our dogs to use floating bus stops!

This is a problem best remedied by having an automatic audible alert for oncoming bicycles.

I have difficulty seeing bicycles and telling which way they are traveling or how fast.

I cannot hear bicyclist coming because the bicycles don't make noise so it is hard for me to know if there is a bicycle approaching me or not

No experience.

Big problem. Can't hear bikes coming. Dogs don't always recognize it!

I've heard great anger and frustration, at the confusing layout, that they are not standardized in size and layout, and that there was a lack of meaningful involvement of people with disabilities in the pre-planning stage. Guide dogs are not trained to navigate floating bus stops. There was no advance warning to the blind communities, so it was an immediate safety issue. It means costly retrofitting and a lack of trust in County planning.

First of all your difficult to find if you're not more clearly with truncated docs or some other message. The second thing is the silence vehicles that don't stop and you can't hear them.

I have not experienced this

There is no way to know whether bikes or scooters are coming down the bike lanes - you can't hear them. The pedestrian is totally dependent on the cyclist "doing the right thing". The design for the floating bus stop is a poor design. A shared platform with a bus stop on the sidewalk is much preferred.

10. What challenges do you experience as a pedestrian when attempting to navigate to or from transit stops and stations? We are interested in challenges you haven't mentioned above.

Response
I've personally helped people with visual impairments head towards the subway in silver spring. There needs to be some sort of guide or beacon people can use to guide them towards the entrance. I think that would be extremely helpful.
At Silver Spring station, lack of adequate lighting, even in daylight. Lack of signs that can be read farther away than 5 feet. I cannot walk all over the bus bay at most subway stations.
Bike lanes narrow the roads too much. Not safe to get in and out of car safely with oncoming traffic
Walking more than 20 minutes to get to a depot or bus stop.
The transit center built at Montgomery Mall did not help ride on users and blind individuals. There has to be a direct path from the transit center to the shopping center as drivers are not careful looking for walkers. A good example of walkway from bus stop to the main building is Montgomery college rockville campus.
Some of the signs blend in due to lack of maintenance; some signs are too small and transit areas/stations can be confusing.
N/A
Continuity of sidewalks throughout the county is a major problem. There are many places where the sidewalk ends and I am left wondering how to get to my destination.
n/a
At transit stations with multiple buses arriving and departing in the same limited area it is often hard to find a safe time to cross to exit the station or change buses. Departing buses will drive around parked buses and it appears dangerous . You start to cross and suddenly an unexpected bus pulls out around a parked bus. Some stations are not well lit which makes this worse in bad weather or winter afternoons and evenings. Sometimes hard to find designated crosswalks. Lighting at Bethesda Metro and Silver Spring Transit Center seem insufficient. Both stations seem somewhat unsafe at night without any coordinator or security on site to answer questions or assist when inebriated or otherwise intimidating people are 'hanging out'
Metro stations are fine. I use the Braille map provided by WMATA to describe the station layouts tactile-y, even though I can't read Braille. A similar map of bus bays outside of metro stations in MoCo would be very helpful to me. The layout of bus bays is very difficult to navigate. The Rosslyn station has auditory announcements to tell you which bus stops where if you push the button at each stop, which helps. I'm always concerned I'm at the wrong bus bay unless I can confirm for myself. Even then, the temporary stops around Silver Spring station meant that I missed my bus multiple times, even after asking RideOn staff for assistance in finding my stop.
Do not have access to public transit.
Lack of sidewalks, street furniture or plantings prevent bus drivers from seeing wheelchair users
Other walkers/rushers not considerate of slower/older/poor sighted walkers.
Bus transportation is very difficult because you have to get between the bus and side to see which bus is there. And audio announcement may help I understand it very loud at the stations

Response

Pathways between bus stops and station entrances/exits should be clearly marked, preferably with diagonal striped or "barber pole" markings. Insufficient sitting room for disabled persons, forcing them to stand or lean against walls for long periods of time.

N/a

Stops are either out of use or removed from the route without users being made aware of the alterations.

N/A

None

Signs, open doors, timing is all set too fast to process and navigate

Getting on and off busses in scooter is easy but turning around on bus is very very hard--stresses other passengers. Metro is easy. I can get to Sarbanes Center easily but route from home under construction and shifts a lot. I love the metro-- hard in DC on ground, easy in SSpring and Takoma

Locating the proper bay area for my connecting bus is always a challenge. The signs are usually at the top of a pole I can't read. I usually have to ask somebody where to go.

too much walking. have osteo-arthritis in four joints. makes it painful to walk and move.

I often do not know when the bus is coming. Even when the app, the bus may be wrong. I have tried to use the navigation system through Metro and have been unable to get to where I was planning on going because the bus did not arrive. Then I had to find alternate routes. When you have several buses to catch and one ends early it is very hard to navigate the system when the buses are early or do not come at all. Also, it would be better if the app (navigation system) through Metro could detect where I am (like car apps) and tell me if I am on the correct side of the street to catch the bus. It is scary when you are relying on something that is not easy to follow.

n/a

Can't tell if I'm actually at a bus stop if there is not a bus shelter. And can't tell which bus is stopping at that shelter if there is one. A little cut-out bus shape on the pole that I could feel would perhaps help.

Bus stops are often not located at the end of the block but somewhat farther up (Veirs Mill Rd. near University Blvd. West in 20902. That virtually tells bus riders to cross unsafely. All such bus stops need to be moved to the end of the block. Bus stops located on a narrow strip of land without a sidewalk or on a narrow sidewalk create a problem for pedestrians and bus riders. The sidewalks need to be broadened.

There are no detectable warnings or surface indicators on sidewalk ramps before crossing the street. In many places, there is not intersection to maintain alignment during the crossing or to correct from initial misalignment of pathways.

With my vision if I can see it I can read it but with my visual field being so small it's very difficult for me to find most signs. Where are you often I don't know where I am because I can't find street signs with the building signs for the street numbers or building numbers.

ride on is very poor in their scheduling times, bus drops me off at different stops than normal, low lighting in transit station.

Response

I frequent transit stations whenever possible. Vehicle alerts provided by visual alerts that pedestrians are crossing would be an improvement. Rockville has a system in place when crossing from the library to the T2 bus stop.

I do not use public transportation.

Seeing the bus stop sign route information and next train signs in metro stations.

Nothing more than what was cited above.

Getting on/off escalators during heavy foot traffic. Need audible direction indicators since "signs"/visuals are useless to those who cannot see them.

elevators being out of service are such a big hassle we just won't go places

It is often very difficult to find available handicap parking

The floating bus stops mentioned above are confusing and challenging to navigate

bolder identification of station stops

no help or assistance when elevators are not working and no other access to metros such as at nih/bethesda. someone suggested i pick up my dog, fold the stroller and walk down the escalator when i am visually challenged and walk with a cane- how stupid of a suggestion - and how unsafe. markings in metro like at wheaton plaza need to be more visible as to what directin the metro is going- like to glenmont or silver spring. no help on platforms

I've been advised to make eye contact with drivers at intersections before stepping off the curb. I cannot do this. I cannot even see whether there's a driver in a car. I have to rely on the driver being attentive & following the law. So I'm always in danger. Sometimes other helpful pedestrians have told me that a driver is waving us forward. But if I'm by myself I don't know & can't risk it. Drivers don't understand that I can't see them. Sometimes they sit there so long that I physically turn my body around so that I'm not oriented towards the crosswalk/street; that can be the only way that the driver understands to stop waiting for me to cross first. Even Ride-On & Metrobus drivers aren't always knowledgeable about low vision, hearing loss, & other invisible disabilities & I've heard them be very cruel sometimes to other pedestrians who look hale & hearty but have serious invisible disabilities. It can make people just decide to miss out & stay home.

Example: When at Shady Grove if a bus pulls up and my bus comes behind that bus, I have missed it because I don't know that it is there!

No specific problems.

Finding someone to help me find the bus I am transferring to. Drivers don't know.

Curved lanes are disorienting making it difficult to find destinations. Crossing lanes from one to the other to get to a stop, needs some form of audible marking. Poor signage & small signs are a problem in general. (An example would be the Friendship station on the red line)

Other than no announcement or a garbled announcement to identify the bus, I haven't heard anything.

At Wheaton bus station where ride on buses drop off in the middle of the street causing you to navigate across the street to get to the other side to board a metro bus.

Response

Construction going on at subway stations and poor lighting on the exterior of the stations.

11. Do you have any other comments about the challenges you face navigating outdoor public spaces in Montgomery County?

Response
<p>Please, please make sidewalks wide enough.. Inevitably a shop will place benches and tables on the walk, obscuring over half of the space. Add people's dogs, and there is much to trip over, and no room to pass another ped. going in the opposite direction.</p>
<p>Need more curb cuts</p>
<p>Burtonsville MD needs to accommodate everyone Burtonsville MD does not make sure low-income families, low-income disabled, have safe access. So State, County and Local jurisdictions is not concerned with safety accommodations for disabled, or low income.</p>
<p>Many intersections have the truncated domes or bumps which could be dangerous in ice and snow. these tiles become slippery and can trip a person.</p>
<p>Better placed signage.</p>
<p>It would be incredibly helpful to provide free transportation for the elderly, both with and without impaired vision. My father of 94 years old was continually challenged by his dependency on friends/family to drive him places. Those individuals including me helped him whenever possible, but we were not always available and his freedom to meet appointments and his needs were impaired as a result. Lack of accessible mobility also leads to depression in the disabled.</p>
<p>Sidewalks and sloped intersections would be wonderful.</p>
<p>Precovid I took the J2 bus to SS Transit Center every Sunday and transferred to the S2 returning later in the day. A woman who was blind and navigated with s cane was always on the J2. Every week there would be a change in where the temporary bus stops were set up, which side of Colesville was open for pedestrians to get to Georgia Ave (destination of the passenger who was blind). It was very confusing for everyone, particularly for those who were visually impaired. Signs were hard to find and many of the drivers were not able to answer questions.</p>
<p>Socially, I wish people had more education. I get many uncomfortable responses just because of my presence. People often try to silently evade my cane instead of letting me know verbally that they are there. I've also been harassed and chased because people accuse me of "faking" because I don't "look blind". I got a guide dog partly because I hoped that people would understand what guide dogs are better than canes. That is true, but they still do not know how to respond. Honestly, I get better responses from children because they seem to be learning about guide dogs and canes in school. Adults seem to have completely missed this vital education.</p>
<p>General lack of awareness in the wider community, failure to consult with disabled community during the final "finishing" stages of construction or design, leading to small but avoidable impediments to accessibility</p>
<p>Rude, impolite. or selfish riders who utilize seats designated for senior/handicapped.</p>
<p>Pedestrians and bicyclists often block sidewalks and do not step aside to allow a person on a walker to proceed.</p>
<p>I would like an easier safer way that I could get out and travel around without worrying about falling, or getting run over, pushed into traffic or Missing a bus because I couldn't read the name and number on it.</p>

Response

Uneven sidewalk surfaces are hazardous to navigate, particularly at night or during inclement weather.

More of the speaking/sound crossing lights would be helpful

None

Can't get to bank, post office, dollar store, WiFi locations. No short cuts. Terrible zoning!

Downtown Spring is good for mobility impaired handicapped person like me who is now visually impaired too. Wheaton needs much more work as does DC. Takoma could use better signage.

Navigation is more friendly in the city center areas of Silver Spring, Rockville and Bethesda but accessibility aids are few and far between in other areas.

people use handicapped seats and aren't handicapped. it's bad enough out there, i shouldn't have to ask for a seat, they should be empty in the first place.

We need more accessibility cut outs in curbs or sidewalks. We need more linkages to services when the bus is a commuter bus. We need clearly defined bike lanes so bikes are safer and pedestrians know where they can ride. The metro and bus system need to be cheaper so more people will utilize it. When it costs me almost \$10 to go one way into DC by bus and Metro..we have a very serious problem. How are we going to get people out of cars when it costs 4 times as much to take public transportation? Makes no sense. If NYC can do it, I do not know why we cannot.

Lighting must be dramatically increased. The C2/C4 bus stop on the north side of University Blvd. West and Sligo Creek Parkway has no light. It is completely unsafe for pedestrians and bus riders. A forthcoming street light will not help because it will be aimed in the wrong direction (south, not east).

no complete more research to increase good practices that help residents feel more inclusive.

If I had a working GPS that would tell me that I was at A bus stop or train station that would be wonderful. I'm not sure it could be done by bus number or especially when you're in a terminal. I just ask a lot of people and finally I'll get to where I have to go most people are pretty helpful if you can stop them or if you can get them to hear you with your iPods on her EarPods I should say. Of course that's a problem with a lot of cyclists that use ear pods and get lost in their music

Prompt repair of uneven or broken sidewalk pavement would prevent tripping and possible falls. If construction is taking place, safe access needs to be provided. Bethesda has some wooden walkways provided for pedestrians but needs more of them.

When I take a taxi I have trouble reading the fee and inserting my credit card in the slot

Need better larger signage

Majority of my issues/concerns deal with drivers not yielding when making right turns. Drivers are mainly looking for clearance from other cars and not looking at pedestrians at intersections.

I usually get out of car at the door and wait for driver to come help me.

Encourage wearing of clothes of lighter color or reflective material.

Accessibility without interference is a big deal as in congestion and construction obstacles.

Response

the parks that have paved trails are very nice and we enjoy going to them. Brookside Garden is one of our favorites!

Handicap parking is a major issue. There does not seem to be a consistent application/requirement for number of spaces. I.e. Some lots like Home Depot have Abundant spots. Others have little to none. It would be good if there were a county ordinance requiring a minimum number of spaces in close proximity to store and medical building entrances.

aside from the incident prev mentioned to Matt about access to the metro at NIH bethesda, i manage fairly well., i do not use a white cane, i use a support cane and travel with my small service esa dog in a stroller. when i cross the street i put him in the stroller. he is very cooperative and alert and really dont have any issues. i wish esa dogs would be considered as service dogs but no issues.

listen to us and make he appropriate changes

transportation like the bus times that buses come into sandy spring olney are so different and scarce in this area compared to gaithersburg and rockville and germantown,. here they only run during rush hour. i lived in gaithersburg and could walk 2 blocks to catch a bus to the mall/germantown or rockville or shady grove metro or rockville metro. here in olney sandy spring metro access and ability ride are none existent on weekends and only happen during rush hour. there are no flashing lights at norwood and quaker lane and it is right at a retirement community wc can be dangerous because norwood is a very busy road.

I used to really enjoy attending MoCo events in outdoor public spaces, but I'm not comfortable at them anymore because they often get so crowded & there's a lot of people walking inattentively/texting, etc. So many people feel like they have the right to put their hands on me to steer me like I'm a package. Public ignorance is really the worst. Of course, I might not feel that way if I'd been actually hit be a car. I know of 2 disabled people who both use support canes who got hit by inattentive drivers while they were walking in a crosswalk in a parking lot. Makes you feel like nowhere is actually safe.

Fortunately I have a guide dog so if there is a pole in the middle of the sidewalk she will go to the side of the pole away from traffic but if I was a cane user I view death in my pretend vision!

Just lowering the bus stop signs, and enlarging the print would make a big difference in helping people with low vision navigate using city buses.

Getting from bus stops to shopping centers across parking lots.

Enforce upkeep of clear passage on sidewalks & walkways. Landscape materials, growths of bushes or trees, construction materials, sidewalk furniture, and poorly maintained public walkways are a danger to everyone especially those with disabilities or visual challenges. Well-maintained walkways encourage people to walk rather than use cars. Let's make Montgomery county more eco-friendly and better for those with visual challenges. Thank you

bus schedules at bus stations are difficult to read

The installation of floating bus stops was poorly thought out giving preference to bikes and scooters at the expense of blind pedestrians. The recommendation violates vision zero recommendations, pedestrian master plan and is not consistent with complete street recommendations. The solution to the floating bus stop issue needs to be a consensus with cyclists, people with disabilities (particularly those with service animals)

12. How do you think people with the County could do a better job of engaging people with vision disabilities in street planning and design projects?

Response
I work for the county and every time I interact with a person who cannot see I ask if they need a guide because I know how important it is for people with disabilities to maintain some semblance of independence. They don't want pity and only want help when they actually need it. Helping them to be as independent as possible would be some of the kindest things people can do for anyone.
Experience walking with dark sunglasses smeared with vaseline ointment. Only the "real" experience can instruct someone who has never had vision difficulties.
Have people with disabilities involved before they are designed, not after they are built.
Actually create a committee of those individuals to help you and pay them a stipend for participating bring them in the planning room and watch them for 60 days traveling look at the time it took, the ease of access, and the safety related to using the product
Listen to us through meetings like this. When new construction happens, ask us for ideas. We live work and play in this county, we do not want to be restricted in our activities.
Have visually impaired persons on the team.
Phone surveys would be helpful. Those with vision impairment are unable to read or often to use computers. The question is how to reach and identify them. Maybe through mailings to every household asking family/friends to notify the county of those in need.
Ask for contacts.
Yes. This is a difficult issue to address. While there are critical issues facing those who are visually impaired people with other disabilities have challenges too
Blind people have a myriad of organizations and list servs. I suggest making efforts to reach out to them. I also wish that the DMV was trained to offer brochures on services for blind and low vision folks when they are identified at the DMV. We already have to identify ourselves as visually impaired at the DMV, so it wouldn't be an uncomfortable information collection to also offer us information about DORS, reporting APS signals, and other necessary community services when we have to get our special non drivers license ID. Information should also routinely be broadcast on blind radio stations.
Street signs could have larger lettering and advance notice could be given of more street crossings. uneven sidewalks could be repaired more frequently. More time could be allowed for crossing some wide, multi-lane crossings.
Surface maintenance, and promote politeness, courtcy and manners.
Enlarge print in the road /street signs Or make them audio or digital better stree lighting. Even sideways with clear marking with flat curbs reducing the need to step up or down. Which reduces falls. They have been some improvements but people like me don't feel safe walking in our neighborhood because of uneven pavement dark corners poor lighting.
Consult with vision-disabled persons during design/planning stages of construction, rather than after construction is underway. Consider use of virtual- or augmented-reality visualization tools to test different physical configurations, lighting environments and marking/signage displays. Conduct simulated walk-through presentations with panels of designers and disabled users

Response

People with the disability on the committee to advise "in real life" examples. Also have the designers test it all out themselves but with blindfolds on to see how they could maneuver.

Always make transit routes clear, and make sure that all drivers are aware of them.

Actually walk with them on streets, getting on transit, include them in product design.

Ask them. Invite input. Include fatigue and battery distance- better handicapped shuttl service

Keep us posted like this and engage us through emails and internet.

Hire more people with disabilities and set up an advisory panel of citizens with disabilities.

ask them what's works best for them.

There are so many ways to connect people to information that either you can request input on major projects by asking people to call or write in to join a taskforce or set up systems to talk with taskforces already created for people with disabilities to give input.

contacting the non-profits in the area that work with folks so you can speak with members.

Actualy go out on the street with a variety of folks with different levels/types of vision loss so they can actually demonstrate the issues.

Why not visit housing buildings where disabled residents and/or seniors live and hold meetings? This is post-pandemic. Now, you could have such meetings via Zoom and telephone.

Asking them what can they do to help pedestrians and persons with visual impairments.

I think we need better education about White canes and seeing eye dogs to pedestrians that don't understand what a white cane is and who uses it. I think it would be important for people to understand how to help somebody with a white cane or a dog. Too often people assume you're crossing the street if you're by a corner and they take your cane and try to put you where they think you should be instead of asking could you use help.

calling residents and reaching out to advocates

Crosswalks with vehicle alerts like Rockville has. Pedestrian safety walkways when construction is taking place. If it's private construction, the County needs to ensure pedestrian safety through regulation.

I have no idea

Yes on pedestrian walkways

Nothing else. I feel that the County has done a great job in modifying each intersection to accommodate disable person to safely cross. Dangers come from moving traffic.

Signs warning drivers to Stop at all stop signs like in leisure World Plaza.

Outreach to agencies--- health , senior etc.

By providing a clearer path with as much audible help as possible.

Sidewalks!! at least put them on one side of each street! This would make it safer for all pedestrians especially mothers with strollers and kids walking to school too!

Response

This is a good start. Using social media like Facebook would be helpful.

I appreciate that you are asking about and considering these issues! I hope the survey was shared with local chapters of NFB and ACB.

i like the idea of what this committee/project is planning on having a special site with special accessibility options for people with disabilities in general to try, then how long will it take for those to get instituted in the county

same comment, as above. follow through

hopefully the test sites projected will be shared with people of all disabilities to see how they can work and then who decides what areas they will be built and how long will that take.

Advertise heavily in groups/organizations that serve or have membership of people with vision impairments. I think all these have mailing lists: National Federation of the Blind--NFB-Sligo Creek; ACB- American Council of (for?) the Blind; AFB- American Foundation for the Blind;POV- Prevention of Blindness; CLB- Columbia Lighthouse for the Bind; Lions' Club chapters; DORS - Division of Rehabilitation Services; NEI at NIH- National Eye Institute @ National Institutes of Health; Leisure World Low Vision Group. I only learned about this survey because my sister sent me the link.

Ask us what you should do instead of dream with your own ideas! For those of us who have had vision do have some very good ideas so why not use our ideas!

Placards with simple instructions (Graphics) on how to best offer assistance to visually disabled individuals would be helpful.

Outreach like this.

Have representatives of the blind community on the planning committee.

I think the county made a good choice with zoom meetings inviting ACB members. Encouraging conversation in small groups is also an excellent way to develop interaction. Before Covid I know that several of us From this community contacted the county planners and were turned down for our efforts to be part of planning. So hopefully, in future there will be more interaction rather than less!

Best would be to hire a traffic engineer or planner who has a background in universal design and designing safe streets for pedestrians. Please do that! Work with the ADA Compliance Manager and the Commission on People with Disabilities to ensure that people with low vision and people who are blind are appointed to relevant advisory committees. Develop and maintain good relationships with the local chapters of the National Federation of the Blind and the American Council of the Blind, as well as the Washington Ear, Prevention of Blindness, the Lions Clubs, and others. Remember that just because you have one blind person on one committee doesn't mean you have blindness "covered" -- there are many types of blindness and each person's navigation abilities are unique. Once individuals and organizations see a consistent effort to involve them in the planning process and decision making -- the earlier the better in the pre-planning checklist -- then being engaged with County planners will be seen as meaningful and rewarding.

Reach out with dates and times for ALL to attend,

Working with individuals from the National Federation of the Blind and the The American Council of the blind to be included in the studies before installation of the floating bus stops.

13. Did you attend the public meeting on Monday, January 11?

Value	Percent	Count
Yes	23.4%	15
No	76.6%	49
	Totals	64

14.If you attended the meeting, how did you hear about the meeting?

Response
I saw the invitation in a county email announcement
Email Vision Zero Councilmember Glass
email
Through the MDOT email list. I only know about that email list because my partner is a county employee. I wouldn't have known otherwise because I purposefully avoid the larger (and more political/drama filled) blindness groups. I am on the Visually Impaired Empowered Women list, and I was surprised no mention of it was published there.
I knew about by my alert system
A friend
No
An email
n/a
I heard about it in emails but I couldn't attend due to prior commitments.
Was not able to attend.
N/A
I did not hear about it.
I didn't hear about the meeting
i live at friends house community in caring ccrc in sandy spring and the director of residential operations forwarded me the email, she knows i am visually challenged and a veteran that uses metro access alot. i was glad she did.
email through a friend
director of residential living forwarded the email to me as she knows i use metro access and am a dav with vision issues. thank you
Did not hear about it
From Montgomery County
Website
Through the website.
National Federation of the Blind of MD
ACB email and phone calls. Texting Reminders and updates are my favorite though. It is a very quick way to receive updates and quick communications.
Email from Betsy Luecking, I think.

Response
Email
Through email

15.If you attended the meeting, how satisfied were you with the accessibility of the meeting?

Value	Percent	Count
Very Dissatisfied	2.6%	1
Dissatisfied	2.6%	1
Neutral	2.6%	1
Satisfied	10.3%	4
Very Satisfied	23.1%	9
Not applicable	59.0%	23
	Totals	39

16. What could have been done to improve the accessibility of the meeting?

Response
Advertise at transportation areas bus depots
It was great. I thought all of the materials preceding the meeting were absolutely to the highest standard of accessibility. Those things tend to be a circus just cause large groups of blind people tend to be a frustrating mess, but you all did a good job of trying to keep people on topic.
I was not aware of the meeting.
Publish it more widely. I didn't know about it until after it had occurred.
N/a
I don't have a camera on my computer so I cannot access Zoom. I find it pretty useless to listen to a meeting via telephone if that were available. You can video-record such meetings (I have viewed Zoom meetings after the fact) in real time or broadcast them in real time (on the county TV channels).
n/a
N/A
Since I was unable to attend, I'm not sure how to answer. But I can think suggestions for future planning. Adequate signage and lighting to ensure. Grovenor/Strathmore station could use improved lighting and signage leading to the Performing Arts Center.
N/A
Was the meeting on line? Due to covid we could not attend any actual meeting
I didn't know there was a meeting
more time allowed- it was very interesting thank you
nothing. good job!
more time.to share but very interesting
Tell me about it with enough advance notice (at least a couple days)
You did an awesome job! Maybe because I offered some thoughts on how to operate a zoom meeting when blind or low vision are on the call! Now pass this own to the rest of the county meetings because they really suck!
The Zoom meeting worked for me.
1. Text reminders are appreciated. 2. Also, I commend those who made the educational slideshow about visual impairments. It was very informational. I would like to suggest that in future any educational materials of this sort be provided prior to meetings with the visually impaired. Most of us already have this information.
Don't know of anything

17. Would you describe yourself as... (Check all that apply.)

Value	Percent	Count
American Indian/Native American	6.3%	4
Asian/Pacific Islander	1.6%	1
Black/African American	7.9%	5
Hispanic/Latino	6.3%	4
White/Caucasian	69.8%	44
Other - Write In	4.8%	3
Prefer not to answer	14.3%	9

Other - Write In	Count
Asian Indian	1
Eastern-European American	1
Gay AF	1
Totals	3

19.What is your age?

Value	Percent	Count
25-34	3.2%	2
35-44	6.3%	4
45-54	12.7%	8
55-64	12.7%	8
65-74	42.9%	27
75+	19.0%	12
Prefer not to answer	3.2%	2
	Totals	63

Appendix G: Fenton Street Survey Results

Response Counts

	Count	Percent
Complete	22	25.9
Partial	63	74.1
Disqualified	0	0
Totals	85	

1. Do you have difficulty with any of the following in a way that impacts your mobility as a pedestrian? (Check all that apply.)

Value	Percent	Count
Seeing	43.8%	14
Hearing	15.6%	5
Walking	28.1%	9
Balance	40.6%	13
Other - Write In (Required)	9.4%	3
Not applicable	18.8%	6

Other - Write In (Required)	Count
Electric wheelchair user, cataracts - blurry vision	1
Confusion from loud, piercing noises, Tinnitus	1
I'm an electric wheelchair user. I have cataracts and a slight hearing loss.	1
Totals	3

2. Which of the following categories best describes you?

Value	Percent	Count
Person with a vision disability	25.8%	8
Person with vision loss that is not fully correctable	16.1%	5
Orientation and mobility specialist	19.4%	6
Caregiver, family member, friend, or advocate	16.1%	5
Other - Write In (Required)	22.6%	7
	Totals	31

Other - Write In (Required)	Count
Balance issues	2
Electric wheelchair user advocate w	1
Back issues . Endurance. Pain.	1
Electric wheelchair user with slight vision and hearing impairment who's an advocate.	1
Person with pain and walking issues	1
person with mobility disability	1
Totals	7

3.If you have a vision disability or vision loss, which of the following categories best describes the type of vision disability or vision loss you have? (Check all that apply.)

Value	Percent	Count
Overall acuity loss	21.2%	7
Depth perception loss	24.2%	8
Peripheral vision loss or tunnel vision	18.2%	6
Central vision loss (e.g., macular degeneration)	12.1%	4
Total vision loss	24.2%	8
Color blindness	12.1%	4
Night blindness or difficulty seeing at night	21.2%	7
Other - Write In (Required)	9.1%	3
Not applicable	42.4%	14

Other - Write In (Required)	Count
I don't have "Night blindness" but I have trouble seeing objects in the dark. QQ	1
Cataracts give me overall blurry vision and at night it's very difficult to see objects in the distance. Examples: signage, curb cuts, bumps in the sidewalk and pavement surfaces and intersections.	1
Inconsistent communication between eyes and brain under certain conditions, due to TBI	1
Totals	3

4.If you have a vision disability or vision loss, does your vision disability or loss impact your ability to drive?

Value	Percent	Count
Yes, I am not legally able to drive at any time of day.	37.5%	12
Yes, I am not legally able to drive at night.	3.1%	1
Yes, I feel uncomfortable driving at night.	15.6%	5
Not applicable	43.8%	14
	Totals	32

5.If you have a vision disability or vision loss, have you received orientation and mobility training or travel training?

Value	Percent	Count
Yes	38.7%	12
No	16.1%	5
Not applicable	45.2%	14
	Totals	31

6.How familiar are you as a pedestrian with Fenton Street between Ellsworth Drive and Thayer Avenue in downtown Silver Spring?

Value	Percent	Count
Not familiar	14.3%	3
Somewhat familiar	52.4%	11
Very familiar	33.3%	7
	Totals	21

7. Which intersection or midblock crossing on Fenton Street between Ellsworth Drive and Thayer Avenue do you find most challenging to navigate as a pedestrian?

Value	Percent	Count
Intersection of Ellsworth Drive and Fenton Street	11.8%	2
Midblock crossing across Fenton to/from Whole Foods and CVS	11.8%	2
Intersection of Wayne Avenue and Fenton Street	47.1%	8
Intersection of Bonifant Street and Fenton Street	11.8%	2
Intersection of Thayer Avenue and Fenton Street	5.9%	1
Not sure (but I'll describe below)	11.8%	2
	Totals	17

8.Fenton & Ellsworth--Why do you find the intersection or midblock crossing you selected in the previous question the most challenging to navigate?

Response

too busy an intersection as Elsworth Dr. is a short walk to Georgia Ave. where I can get the Y bus home.

1. Buskers, buskers, and buskers plus the Hare Krishna!!! As a totally blind person I need to hear the sounds of the vehicle traffic, the APS, and the people crossing with me to safely navigate across the street. For some reason Fenton and Ellsworth attracts the loudest buskers and Hare Krishna on the northeast and southeast corners of the intersection at the traffic light, often at the same time. They both seem to be competing to drown each other out. I often have to shout at them over their noise to turn down the volume to allow me to cross safely. Just Yesterday on my way to and back from grocery shopping at Whole Foods I had to scream and create a spectacle of myself to first tell the Luther Vandross impersonator on my side of the street and then the Hare Krishna across on the other side of the street to turn down the volume. I or no other blind person should have to make a scene just to safely cross the road anywhere in Maryland. Not all blind people are as aggressive as I am with dealing with those folks. Most blind people will just suck it up, risk their lives and make it across the street as best they could without saying anything to anyone. I initially suffered in silence and did just that. No more! That situation is a disaster waiting to happen. If God forbid, I get injured crossing that intersection because of Montgomery County neglect and lack of enforcement of the law someone will have to pay. No one will be able to say that I did not warn of the danger. I have been aggressively complaining about this to the two Marks: county attorney and County Executive; the various chiefs at MCDOT; various personalities at MCEPA, the Silver Spring regional manager, the Silver Spring civic center manager, the Montgomery Commission on the Disabled, my county council representative, my state delegate, and the police commander for the third district. They all seem to humor me and pretend like they are doing something about the problem, but the problem still persists today. They are all in a word, "clueless." The county ordinance says that no one is permitted to create a noise disturbance above 65 decibels in that area especially if it endangers the safety of the public. the ordinance says that the law must be liberally applied, and they do nothing. If I were to stage a protest and block the traffic signals so that sighted people cannot see the traffic light, I am sure that the police would not take the same relaxed attitude as they do with the buskers and Hare Krishna. Also, if I were to blast my stereo the police will also come running to give me a noise disturbance ticket. This is prejudicial and selective enforcement of the law. I guess the lives of blind people are not worth much in this county. Blind lives matter too!!!
2. Too much clutter around the crossing area that makes it difficult to find the APS signal box. The MCDOT planners, technicians, consultants, engineers, specialists, blind experts, as well as "chief cook and bottle washers" who placed the boxes and approved the installation of the various obstacles in two words are, "very clueless."
3. Poor MCDOT design and installed APS signals--in three more words "very hopelessly clueless."
4. Frequent APS outage.
5. Not always sure which intersection I am being told to cross. At one time the APS actually verbalized the street name to cross, but maybe it worked too well for blind people so the brain trust blind "experts" at MCDOT had to screw it up. Just in case there was any doubt, I believe that MCDOT has failed terribly at protecting the safety of blind people, and I believe that anyone who has anything to do with the implementation of the policies and design that permit these on-going safety issues should resign in disgrace yesterday.

9. Fenton & CVS Mid-block-- Why do you find the intersection or midblock crossing you selected in the previous question the most challenging to navigate?

Response
No traffic light nor stop sign for vehicles
Cars go too fast, and the slight curve of the street and rise of the street make it hard to see what's coming

10. Fenton & Wayne--Why do you find the intersection or midblock crossing you selected in the previous question the most challenging to navigate?

Response
I have not been there in a while, but I think the width was a problem, and I think it was easy to veer off the crossing. This is the case with several intersections in downtown Silver Spring.
Unsure traffic will stop...slow to cross
You have to walk all the way around to get to the library. Not happening.
right turn lanes only, vehicles pulling up into cross walk and amount of background noise at this intersection.
intersection traffic signals not clear
The width of the intersection makes it difficult.
Traffic before the pandemic was not regular and there was a lot of competing noise.
Wider street, sometimes APS is inoperable, not as familiar with next three street crossings.

11. Fenton & Bonifant--Why do you find the intersection or midblock crossing you selected in the previous question the most challenging to navigate?

Response

It's terrible, confusing for pedestrians cars and all people even the bikers don't know what they are doing it's crazy

Cars, Trucks, Busses move quickly and unpredictably on Fenton and make fast turns into and from cross-streets even if lights are Yellow/Red. Portions of Sidewalks are Pedestrian unsafe.

12. Fenton & Thayer--Why do you find the intersection or midblock crossing you selected in the previous question the most challenging to navigate?

Response

the sidewalks are uneven and sometimes it's challenging to find the corner to cross or I risk falling on the uneven sidewalks and it's difficult to find reliable landmarks.

13. Fenton & Wayne--Why do you find the intersection or midblock crossing you selected in the previous question the most challenging to navigate?

Response

I have not been there in a while, but I think the width was a problem, and I think it was easy to veer off the crossing. This is the case with several intersections in downtown Silver Spring.

Unsure traffic will stop...slow to cross

You have to walk all the way around to get to the library. Not happening.

right turn lanes only, vehicles pulling up into cross walk and amount of background noise at this intersection.

intersection traffic signals not clear

The width of the intersection makes it difficult.

Traffic before the pandemic was not regular and there was a lot of competing noise.

Wider street, sometimes APS is inoperable, not as familiar with next three street crossings.

13. Not Sure (But I'll Describe)--Why do you find the intersection or midblock crossing you selected in the previous question the most challenging to navigate?

Response

I'm a wheelchair user and at certain corners or crosswalks (Fenton and Bonifant) the APS base is too big and I cannot reach the button because my wheelchair can't get close enough. Some APS had the button too high up for me to reach and one was too low, below knee height. A lot of the APS that didn't have a cement base, the button was at the right height and very easy to use. Not all intersections had street signs, so you don't know where you are. At the corner of Wayne and Fenton, it's difficult to find the bus stop: there's a lamppost on the left and bus sign right impedes my ability to get on the bus. Also, there are flower beds along Fenton, so when you get off the bus from the back door you step into a flower bed. I couldn't read the ID # on the RideOn sign, please make the RideOn signs bigger. All ID #s should be high contrast and much larger font size.

14. What block of Fenton Street between Ellsworth Drive and Thayer Avenue do you find most challenging to navigate along as a pedestrian?

Value	Percent	Count
The block between Ellsworth Drive and the Wayne Avenue	13.3%	2
The block between Wayne Avenue and Bonifant Street	33.3%	5
The block between Bonifant Street and Easley Street	13.3%	2
The block between Easley Street and Thayer Avenue	20.0%	3
Not sure (but I'll describe below)	20.0%	3
	Totals	15

15. Ellsworth Drive to Wayne Avenue--Why do you find the block you selected in the previous question the most challenging to navigate? Is the sidewalk on one side of the street more challenging to navigate than the other? Please specify.

Response

Have to park in lot and be mobile and with enough endurance (length of walking) to navigate. No provisions - just a "sorry we want downtown S.S. to be a "walking community" (quote from the top). Library unusable...Restaurants ...

The sidewalks are too narrow and sometimes in bad shape

16. Wayne Avenue to Bonifant Street--Why do you find the block you selected in the previous question the most challenging to navigate? Is the sidewalk on one side of the street more challenging to navigate than the other? Please specify.

Response
It's a total mess and a vey dumb idea Get did of it all and return the area to NORMAL
Sidewalks are uneven, too narrow and many protrusions by parking meters, street signs, other impediments make walking and crossing navigation hard.
not sure
Not real familar with the sidewalks, I don't know this region very well. There is a lot of traffic which can be confusing.
Until the Purple Line is constructed, install a fence or guard rial around the open areas that have plants so people who are blind or have low vision and others are less likely to fall in.

17. Bonifant Street to Easley Street--Why do you find the block you selected in the previous question the most challenging to navigate? Is the sidewalk on one side of the street more challenging to navigate than the other? Please specify.

Response

Because of the narrow sidewalk and gas station entrances

The stretch between Bonifant and Thayer is challenging. 1. On the east side of that strip there is a light pole in the middle of the sidewalk. Further down at 8307 Fenton, there is a cafe that has a canopy table in the middle of the sidewalk. I also have quite a bit of difficulty even locating Easley Street. I don't even know that I have actually crossed the street until I get to Thayer. On the West side of the stretch The Safeway parking entrance is not always obvious unless a vehicle happens to be going in or out. Also, the entrance to the apartment building at 8310 Fenton has a very rugged abrupt drop as you walk past the driveway. In addition, a little further up from the entrance there is a fencing hedge bush that sticks out on the sidewalk with lots of thorny pointy twigs that scratch your face and arms if you happen to run into it.

18.Easley Street to Thayer Avenue--Why do you find the block you selected in the previous question the most challenging to navigate? Is the sidewalk on one side of the street more challenging to navigate than the other? Please specify.

Response
sidewalk is broken up and sometimes there are no landmarks to use.
construction activity

20. Aside from the block you discussed above, are there other blocks on Fenton Street between Ellsworth Drive and Thayer Avenue that you find challenging to navigate as a pedestrian? If so, which sidewalks and why are they challenging to navigate?

Response
No. those are the only two bus stops I use.,
Roder Road broken up sidewalks
Poles , curbs, narrow areas it's all a mess and I try to avoid the area but can't
Any where nearby parking is unavailable
All the blocks south and north of Ellsworth, and lighted intersection of Fenton with Colesville Road - where road pavement repairs are inadequate. Brick sidewalks are slippery & unsafe.
not sure
The west side of fenton between Bonafont and Wayne is difficult. It feels like threading a needle. If you do it exactly right you will make it just fine. If you do not, you can end up at the Library or mixed up in the plants. There are too many ways to go off the correct path. Maybe they need to put down a guide strip up that sidewalk as I have seen in Europe.
12 bb

21. Are there bus stops on Fenton Street between Ellsworth Drive and Thayer Avenue that you find challenging to navigate to as a pedestrian? If so, which bus stops and why are they challenging to navigate to?

Response
No
not sure what busses come along there moved away and I forgot what busses go there due to not having the necessary landmarks and uneven sidewalks it complicates travel.
All are a mess and it's the result of poor planning and an implementation without any consideration of the disabled
NA
N/A
do not use busses
If I was required to take a bus on a regular basis I am sure that I will be able to locate the bus stop. However, if I needed to locate a bus stop on that strip for the first time I have no clue how I would find it without asking someone for assistance.
I do not use bus stops in this area.
13 CC
I usually walk
See above about the bus stop near the corner of Wayne and Fenton. Shrubs and flowers should not impede passengers -- for example, there are too many bushes around the bus stop on Georgia at the corner of Ellsworth.

22. Other than bus stops, are there specific destinations on Fenton Street between Ellsworth Drive and Thayer Avenue that you find challenging to navigate to as a pedestrian? If so, which destinations and why are they challenging to navigate to?

Response
again, at Ellsworth Ave. and fenton St. to walk to Georgia Ave.
The subway has been changed so I do not know where every bus or train or cab stand is.
Fix it all and get rid of it, don't try to narrow it down, it's all bad
Library, Post office (congested and overbuild so minimal close parking for ease of use.
Locating the entrance to the library is difficult
not sure
the Library is perhaps the most difficult building entrance to locate. I have done it a few times and I still get frustrated trying to locate it. It is very ironic that business entrances are much easier to find than a government building on that strip. The County or the state folks who were responsible for approving the design and construction of the library must really hate disabled people. I would have to work very hard to come up with a worse design. That is true for both inside and outside of that building.
14 dd

23. Which sidewalk surface do you find the more accessible, concrete or brick?

Value	Percent	Count
Concrete	73.7%	14
Brick	15.8%	3
No preference	10.5%	2
	Totals	19

24.Are you aware of the Fenton Street Bikeway Study, which is exploring the potential for separated bike lanes on Fenton Street between Cameron Street and King Street?

Value	Percent	Count
Yes	27.3%	6
No	72.7%	16
	Totals	22

25.If you are aware of the study, how did you hear about it?

Response
commission on people with disabilities and other dot briefings
Through discussions with pedestrian advocates
Montgomery County
email
Orientation and Mobility Specialist colleagues
Through Montgomery County Planning discussions
County

26. How would you like to be informed about street planning and design projects in Montgomery County? Check up to 3 top options or let us know about additional options in the comment box.

Value	Percent	Count
Metropolitan Washington Ear	10.5%	2
NFB Newslite for the Blind	21.1%	4
Local television	42.1%	8
Local radio	63.2%	12
Neighborhood listserv	68.4%	13
County official or representative	68.4%	13

27. How would you like to be informed about street planning and design projects in Montgomery County? Check up to 3 top options or let us know about additional options in the comment box. - comments

Response
The county should reach out to blindness organizations. The county should make sure all of its county listservs, such as GoMontgomery, remain accessible so that anyone can sign up for them.
I am very interested in this study and would like to participate.
Survey after the damage
Information before legislation is passed so nearby communities are not blindsided and have the ability for input, to be heard and considered.
Large Type Street signage on site and around it. On-Line Announcements by MCDOT to area residents/businesses.
none of above
Also heard about it from other blind people.
Personal email from the Commission on People with Disabilities.
Montgomery County Commission on People with Disabilities and the wide variety of nonprofits and civic groups that serve people in Montgomery County, such as the local chapters of the National Federation of the Blind, American Council of the Blind, and Independence Now, so they can include information in their newsletters and on their websites.

28. Would you describe yourself as... (Check all that apply.)

Value	Percent	Count
American Indian/Native American	4.5%	1
Black/African American	9.1%	2
White/Caucasian	63.6%	14
Prefer not to answer	27.3%	6

29.What is your age?

Value	Percent	Count
45-54	15.8%	3
55-64	21.1%	4
65-74	52.6%	10
75+	10.5%	2
	Totals	19