

PANDUAN KONTRAKTOR DAN MENJILID DOKUMEN TENDER

1. Setiap satu pembelian Tender , kontraktor/ pembekal akan menerima ;
 - 1.1 Muka hadapan dokumen Tender yang telah dicetak dengan kertas berwarna, telah dicap dan diisi maklumat nama kontraktor / pembekal, tarikh dokumen dijual, tanda tangan wakil MPBP, nombor bilangan, dan nombor resit dan menyertakan salinan resit.
2. Pentender / Penyebutharga dikehendaki ;
 - 2.1 Muat turun dokumen Tender di laman web MPBP –aplikasi e-borang-Unit Perolehan dalam talian (<http://www.mpbp.gov.my/>) yang mengandungi dokumen tender.
 - 2.2 **Mencetak dokumen dengan kertas bersaiz A4 dalam format PDF :**
 1. Section A – Senarai Semakan Dokumen Wajib
 2. Section B – Arahan Pertender
 3. Section C – Borang Tender
 4. Section D – Declaration Of Non Collution
 5. Section H – Ringkasan Tender
 6. Section J – Senarai Kuantiti (BQ)
 7. Section K - Dokumen Sokongan (Borang A,B,C,D,F,E,G, CA,GA)
 - 2.3 Menjilid dokumen dengan mengikut susunan dan cara berikut :
 - 2.3.1 Muka hadapan asal yang telah diberikan (**Salinan tidak dibenarkan**)
 - 2.3.2 Dokumen yang telah dicetak
 - 2.3.3 Dokumen sokongan ; Salinan pendaftaran Kontraktor CIDB (Kerja), Sijil Perolehan Kerja Kerajaan (Kerja), Sijil PKK (Kerja), Sijil SSM (Bekalan dan Kerja), Penyata Bank 3 Bulan terakhir (Bagi Kerja G2 dan bekalan RM200,000 ke atas) , Kementerian Kewangan (Bekalan & Perkhidmatan) dan Lain-lain dokumen yang diperlukan dalam dokumen Sokongan.

- 2.3.4 Disusun semua dokumen di atas mengikut turutan dan dikepil di sebelah tepi kiri (atas , bawah dan tengah) dokumen.
- 2.4 Mengisi dan menandatangani borang-borang yang disediakan seperti biasa dan hendaklah dimasukkan ke dalam peti sebutharga di Jabatan Kewangan sebelum tarikh dan masa tutup sebutharga.

PERINGATAN

Mana-mana pihak kontraktor/pembekal yang cuba mencetak / menyalin lebih dari satu dokumen dalam satu belian dan membeli kepada pihak kontraktor yang lain dan kemudiannya cuba menyertai tender , jika dapat diketahui oleh pihak MPBP , kedua-dua pihak kontraktor akan dibatalkan penyertaan dan disenarai hitamkan. Kawalan akan dibuat berdasarkan pada muka hadapan yang diberi hanya satu setiap pembelian yang lengkap diproses oleh pihak MPBP.

**KERAJAAN MALAYSIA
MAJLIS PERBANDARAN BATU PAHAT**

TENDER NO : MPBP-1-2020

PROJECT : Kerja-Kerja Menurap Semula Jalan Dengan `Premix' Dan Menyelenggara Longkang Lorong Belakang Di Taman Putera Indah Serta Kerja-Kerja Berkaitan.

TABLE OF CONTENTS

SECTION	DESCRIPTION
A	Senarai Semakan Dokumen Wajib Dan Surat Akuan Pembida
B	Arahan Petender Dan Panduan Kontraktor
C	Borang Tender <i>JKR 203B-Pind5/2008</i>
D	Declaration Of Non Collution
E	Syarat-Syarat Kontrak Contract PWD 203A (Rev.1/2010)
F	Surat Setuju Terima
G	Spesifikasi Kerja
H	Ringkasan Tender
J	Senarai Kuantiti -Preamles Day Work Rate Labour & Plant -Kerja Awalan -Kerja Pembinaan Jalan dan Menyelenggara longkang
K	Dokumen sokongan -Borang A – Surat Pengakuan Kebenaran Maklumat dan Pengesahan Dokumen Yang Dikemukakan Oleh Pertender -Borang B - Maklumat Am Latar Belakang Pentender -Borang C – Data-data Kewangan -Borang D – Rekod Pengalaman Kerja -Borang E – Kakitangan Teknikal -Borang F - Keempunyaan Loji dan Peralatan Pembinaan Utama -Borang G – Senarai Kerja Kontrak -Borang CA- Laporan Bank / Institusi Kewangan Mengenai Kedudukan Kewangan Pentender -Borang GA –Laporan Penyeliaan Projek Atas Prestasi Kerja Semasa Pertender -Borang Garanti Bank Syarikat Insuran

Senarai Semakan Dokumen Wajib

SECTION A

Majlis Perbandaran Batu Pahat

SENARAI SEMAKAN DOKUMEN WAJIB

TARIKH BUKA TENDER :
 TARIKH TUTUP TENDER :
 TARIKH DOKUMEN DI TERIMA :

BIL	BUTIRAN DOKUMEN	PETENDER		KEGUNAAN PEJABAT		ULASAN
		ANDAKAN (!) PADA PETA		ANDAKAN (!) PADA PETA		
		ADA	TIADA	ADA	TIADA	
A	PENYATA BULAN BANK (<i>disahkan oleh Bank</i>)					
	1)					
	2)					
	3)					
B	LAPORAN KEWANGAN / SURAT SOKONGAN BANK (<i>Borang CA</i>) NAMA BANK					
	1)					
	2)					
C	PENGALAMAN KERJA 5 TAHUN KEBELAKANG					
	A) SURAT SETUJU TERIMA					
	B) PERAKUAN SIAP KERJA					
	C) SIJIL BAYARAN INTERIM TERAKHIR / SIJIL AKUAN AKHIR					
D	KAKITANGAN TEKNIKAL					
	A) SIJIL KELAYAKAN					
	B) SURAT PERLANTIKAN					
E	LOGI MILIK PENTENDER					
	A) KAD PENTENDER					
	B) RESIT PEMBELIAN / PERJANJIAN SEWA BELI					

TANDATANGAN & COP RASMI PENTENDER

.....

TARIKH :

SSD/5

SURAT AKUAN PEMBIDA

Bagi

(Tajuk dan Nombor Tender/Sebut Harga)

Saya, _____ (nama wakil syarikat) nombor K.P. _____ yang mewakili _____ (nama syarikat) nombor Pendaftaran _____ (MOF/PKK/CIDB/ROS/ROC/ROB) dengan ini mengisytiharkan bahawa saya atau mana-mana individu yang mewakili syarikat ini tidak akan menawar atau memberi rasuah kepada mana-mana individu dalam _____ (Nama Kementerian/Agensi) atau mana-mana individu lain, sebagai sogokan untuk dipilih dalam tender/sebut harga* seperti di atas. Bersama-sama ini dilampirkan Surat Perwakilan Kuasa bagi saya mewakili syarikat seperti tercatat di atas untuk membuat pengisytiharan ini.

2. Sekiranya saya atau mana-mana individu yang mewakili syarikat ini didapati cuba menawar atau memberi rasuah kepada mana-mana individu dalam _____ (Nama Kementerian/Agensi) atau mana-mana individu lain sebagai sogokan untuk dipilih dalam tender/sebut harga* seperti di atas, maka saya sebagai wakil syarikat bersetuju tindakan-tindakan berikut diambil :

- 2.1 penarikan balik tawaran kontrak bagi tender/sebut harga* di atas; atau
- 2.2 penamatan kontrak bagi tender/sebut harga* di atas; dan
- 2.3 lain-lain tindakan tatatertib mengikut peraturan perolehan Kerajaan.

3. Sekiranya terdapat mana-mana individu cuba meminta rasuah daripada saya atau mana-mana individu yang berkaitan dengan syarikat ini sebagai sogokan untuk dipilih dalam tender/sebut harga* seperti di atas, maka saya berjanji akan dengan segera melaporkan perbuatan tersebut kepada pejabat Suruhanjaya Pencegahan Rasuah Malaysia (SPRM) atau balai polis yang berhampiran.

Yang Benar,

(Nama dan No. KP)

Cop Syarikat :

- Catatan : i) * Potong mana yang tidak berkaitan
ii) Surat akuan ini hendaklah dikemukakan bersama Surat Perwakilan Kuasa

Arahan Petender

SECTION B

Majlis Perbadaran Batu Pahat

ARAHAN KEPADA PENENDER

Arahan dan syarat tender di bawah ini adalah sebahagian daripada kontrak dan hendaklah dipatuhi:-

1. Lokasi

Lokasi cadangan untuk kerja-kerja tersebut adalah jalan-jalan di **Kerja-Kerja Menurap Semula Jalan Dengan `Premix' Dan Menyelenggara Longkang Lorong Belakang Di Taman Putera Indah Serta Kerja-Kerja Berkaitan.**

2. Bayaran Dokumen

Penender yang berdaftar dan membuat bayaran sebagaimana syarat dalam kenyataan tender boleh mencetak di laman web Majlis Perbandaran Batu Pahat.

3. Penyediaan Tender

Penender adalah dikehendaki mengisi segala maklumat dengan sepenuhnya pada:-

- a. Borang Tender (diisi dengan lengkap)
- b. Ringkasan Tawaran atau Senarai Kuantiti.
- c. Jadual Kadar Harga
- d. Latar Belakang Kontraktor dan Borang Sokongan
 - i. Borang A - Surat Pengakuan Penender
 - ii. Borang B - Maklumat Am Penender (Disi dengan Lengkap)
 - iii. Borang C - Data-data Kewangan (Lampiran Penyata Kewangan tiga (3) bulan terakhir yang disahkan oleh bank, Lampiran Imbangan (Balance Sheet) untuk tahun kewangan terakhir dan Surat Pengesahan Kemudahan Overdraf (Jika ada).

Dokumen ini adalah wajib disertakan.

- iv. Borang CA - Laporan bank
- v. Borang GA - Laporan Prestasi Kontraktor
- vi. Borang E - Kakitangan Teknikal
- vii. Borang F - Keupayaan Loji
- viii. Borang G - Senarai Kerja Kontrak Semasa
- ix. Borang GA - Laporan Penyeliaan

Semua butiran ini hendaklah diisi dengan lengkap oleh Penender. Kegagalan mengisi maklumat atau memberi maklumat palsu, jika dikesan akan mengakibatkan tender ditolak atau/tindakan tatatertib diambil terhadap penender berkenaan.

Tulisan hendaklah terang dan dibuat dengan dakwat. Segala kesilapan hendaklah dipotong dengan cermat dan ditandatangani ringkas.

Jumlah harga pada ringkasan tawaran / senarai kuantiti hendaklah dipindahkan ke dalam borang tawaran dan sekiranya berlaku perbezaan di antara harga dalam jumlah ringkasan tawaran/ senarai kuantiti dengan harga di dalam Borang Tender, maka harga di dalam Borang Tender akan diambil kira.

4. Penyerahan Dokumen Tender

- a) Dokumen Tender yang telah diisi dengan lengkap hendaklah dimasukkan ke dalam sampul surat berlakri yang dicatatkan kepada **Yang Dipertua, Majlis Perbandaran Batu Pahat, Jalan Pejabat, 83000 Batu Pahat, Johor** dan di sebelah kiri atas sampul dicatatkan **No. Tender , Tajuk Tender** (sepertimana butiran di dalam iklan tawaran). Kemudian hendaklah dimasukkan ke dalam Peti Tender Majlis Perbandaran Batu Pahat pada masa dan tempat yang ditetapkan dalam Kenyataan Tender.

- b) Jika Dokumen Tender tidak diserahkan dengan tangan, Kontraktor hendaklah menghantar Dokumen tersebut dengan pos supaya tiba pada atau sebelum masa dan di tempat yang ditetapkan.
- c) Dokumen Tender yang diserahkan selepas masa yang ditetapkan atas sebab apa sekalipun, tidak akan dipertimbangkan.

5. Hak Kerajaan untuk Menerima/Menolak Tawaran Sebutharga

Kerajaan adalah tidak terikat untuk menerima Sebutharga yang terendah atau mana-mana Sebutharga atau memberi apa-apa sebab di atas penolakan sesuatu Sebutharga. Keputusan Jawatankuasa Sebutharga adalah muktamad.

6. Tempoh Sah Tender

Tender ini sah selama **90 hari** dari tarikh tutup Tender . Penender tidak boleh menarik balik Tender sebelum tamat tempoh sah. Pengesyoran tindakan tatatertib akan diambil sekiranya Penender menarik balik tender sebelum tamat tempoh tersebut.

7. Tindakan Tatatertib

Penender tidak perlu membayar wang sandaran tetapi sekiranya pentender enggan menerima tender setelah ditawarkan kepada selaras dengan keputusan yang telah dibuat, ataupun Penender menarik diri dari tender, pendaftaran akan digantung selama dua(2) tahun bagi kesalahan kedua kalinya, dan bagi kesalahan yang ketiga pendaftaran penender akan dibatalkan..

8. Bayaran Levi LPIP (Jika Berkaitan)

Semua tender yang bernilai RM500,000.00 ke atas akan dikenakan levi sebanyak 0.25% daripada jumlah kontrak kepada LPIPМ sebagaimana yang ditetapkan dalam seksyen 34 (2) Akta 520. Kegagalan penender yang Berjaya untuk membuat pembayaran akan mengakibatkan denda boleh dikenakan tidak melebihi RM50,000.00 dan tindakan sewajarnya ke atas pendaftaran di ambil. Pihak Kontraktor hendaklah memastikan semua arahan dari LPIPМ yang dikeluarkan dipatuhi.

9. Penjelasan Lanjut Mengenai Dokumen Tender

Sekiranya apa-apa maklumat, yang terkandung dalam Dokumen Tender ini tidak jelas dan bercanggah, penender boleh berhubung dengan **Majlis Perbandaran Batu Pahat, Johor Darul Takzim (Unit Perolehan)** di no talian **07-43410006 / 07- 43410008 / 07-4341045** untuk mendapatkan penjelasan lanjut.

..... (Tandatangan Kontraktor) (Tandatangan Saksi)
Nama :	Nama :
Jawatan :	Jawatan :
Alamat :	Alamat :
.....
.....
Tarikh :	Tarikh :

PANDUAN KEPADA PENENDER DAN SENARAI SEMAKAN MENGEMUKAKAN TENDER

Tender Untuk :

Kerja-Kerja Menurap Semula Jalan Dengan `Premix' Dan Menyelenggara Longkang Lorong Belakang Di Taman Putera Indah Serta Kerja-Kerja Berkaitan.

Nota

- a. Senarai semakan ini bertujuan bagi menolong pentender mengemukakan satu tender yang lengkap dan tanpa sebarang kesilapan. Semua penender adalah dinasihatkan supaya menggunakan senarai semakan ini bagi menyemak tender mereka sebelum menyerahkan tender masing-masing.
- b. Segala usaha telah diambil untuk menyenaraikan perkara-perkara yang lazimnya perlu diambil tindakan oleh seorang penender dalam mengemukakan tendernya. Walaupun begitu, adalah menjadi tanggungjawab penender sepenuhnya bagi menentukan lengkapnya sesuatu tender yang dikemukakannya itu.

Bil	Perihal Semakan	Tindakan/ catatan
1.0	<p data-bbox="280 758 440 789"><u>Semakan Am</u></p> <p data-bbox="280 821 1252 972">1.1 Naskah salinan Dokumen Tender yang diberikan kepada penender hendaklah mengandungi dokumen-dokumen sepertimana yang disenaraikan di dalam Dokumen Tender. Sila semak dan pastikan supaya dokumen-dokumen ini terdapat pada Naskah Dokumen Tender anda sebelum meninggalkan pejabat di mana Dokumen Tender dikeluarkan.</p> <p data-bbox="280 1003 1252 1308">1.2 Adalah menjadi tanggungjawab seorang penender untuk meneliti bahawa salinan-salinan itu adalah sebenarnya salinan-salinan dokumen yang termasuk dalam Dokumen Meja Tender. Jika terdapat apa-apa perbezaan atau percanggahan antara mana-mana salinan yang diberi kepada pentender dengan salinan dalam Dokumen Meja Tender atau antara-antara mana-mana dokumen yang termasuk di dalamnya maka adalah tanggungjawab penender untuk memohon secara bertulis kepada pihak yang mengeluarkan Dokumen Tender tidak lewat dari tujuh (7) hari sebelum tarikh akhir yang ditetapkan dalam Notis Tender bagi penyerahan tender supaya dibetulkan perbezaan atau percanggahan itu.</p> <p data-bbox="280 1339 1252 1461">1.3 Sila semak Dokumen Tender anda dengan Dokumen Meja Tender yang dipamerkan bagi menentukan supaya tidak ada mukasurat yang tertinggal (missing pages) atau diberi lebih dari yang sepatutnya (duplication of pages).</p> <p data-bbox="280 1493 1252 1614">1.4 Penender tidak dibenarkan membuat apa-apa perubahan atau tambahan kepada Borang Tender atau mana-mana Dokumen Tender yang lain yang boleh dianggap mengenakan had syarat atau perjanjian tambahan kepada syarat-syarat yang telah ditetapkan dalam Dokumen Tender oleh Kerajaan.</p> <p data-bbox="280 1646 1252 1824">Semua maklumat yang diisi oleh pentender hendaklah dengan menggunakan dakwat tidak mudah luntur. Jika terdapat sebarang kesilapan dalam mengisi maklumat, kesilapan tersebut hendaklah dibetulkan dengan cara memotong kesilapan tersebut dengan satu garisan bersih melintang dan ditandatangani ringkas oleh penender dan saksinya. Penggunaan pemadam getah atau kimia cecair adalah dilarang.</p>	

Bil	Perihal Semakan	Tindakan/ catatan
2.0	<p><u>Section D - Declaration of ' Non-Collusion'</u></p>	
	<p>Penender dikehendaki menurunkan tandatangan serta menulis No. Kad pengenalan dan tarikh surat ini ditandatangani. Surat ini adalah sebagai mengakui bahawa tiada pakatan di antara penender dengan penender yang lain semasa memasuki tender.</p>	
3.0	<p><u>Section C - Borang Tender</u></p>	
3.1	<p>Muka surat No. 3:</p>	
	<p>Para No. 3 : Tempoh penyiapan kerja perlu diisi</p>	
	<p>Para No. 4 : Isi dengan perkataan dan jumlah angka, amaun tender (hendaklah sama dengan jumlah di 'Final Summary')</p>	
3.2.	<p>Muka Surat No. 5 :</p>	
	<p>Para No. 12 : Isi tarikh, tandatangan penender (hendaklah seorang yang sah dibenarkan di sisi undang-undang untuk menandatangani kontrak bagi pihak syarikat penender). Turunkan Cop Syarikat penender. Isi maklumat dan tandatangan saksi.</p>	
4.0	<p><u>Section E- Borang Kontrak Setara (PWD From 203A – Rev. 1/2010)</u></p>	
	<p>Naskah borang ini (jika dimasukkan dalam dokumen tender) adalah untuk pengetahuan dan maklumat penender semata-mata. Ianya tidak perlu diisi pada peringkat tender.</p>	
5.0	<p><u>Section G- Senarai Kuantiti</u></p>	
5.1	<p><u>Am</u></p>	
	<p>5.1.1. Sila semak dokumen senarai kuantiti dan senarai dokumen di dokumen meja tender yang dipamerkan bagi menentukan tidak ada muka surat yang tertinggal (missing pages) atau terdapat muka surat yang sama dimasukkan lebih dari satu.</p>	
5.2	<p><u>Kerja Awalan (Preliminaries)</u></p>	
	<p>5.2.1. Jika terdapat mana-mana kerja awalan yang tidak melibatkan kos kepada penender maka ruang harga untuk item kerja tersebut hendaklah diisi dengan tanda (-)</p>	
5.3	<p><u>Menghargakan Senarai Kuantiti</u></p>	
	<p>5.3.1. Semua item yang dijadualkan didalam senarai kuantiti hendaklah dihargakan. Harga bagi setiap item hendaklah mencerminkan harga sebenar sebuah item itu. Sebarang usaha untuk memanipulasikan harga diantara item-item atau diantara bahagian-bahagian disenaraikan kuantiti adalah ditegah.</p>	

Bil	Perihal Semakan	Tindakan/ catatan
	<p data-bbox="370 218 1159 279">5.3.2. Mengumpul/menyatukan (bracketing) harga untuk beberapa item yang berlainan tidak digalakkan.</p> <p data-bbox="302 310 1003 338">5.4 <u>Mengira harga, menjumlah dan memindahkan jumlah</u></p> <p data-bbox="370 373 972 401">5.4.1. Semak pengiraan harga bagi setiap item.</p> <p data-bbox="370 432 878 459">5.4.2. Semak jumlah setiap muka surat</p> <p data-bbox="370 491 1159 583">5.4.3. Pastikan bahawa jumlah setiap muka surat yang berkenaan dipindahkan ke muka surat 'Final Summary' dengan betul.</p> <p data-bbox="370 615 1159 676">5.4.4. Pastikan bahawa jumlah setiap muka surat 'Collection' dipindah ke muka surat 'summary' dengan betul.</p> <p data-bbox="302 707 566 735">5.5 <u>'Final Summary'</u></p> <p data-bbox="370 766 1159 827">5.5.1. Pastikan bahawa jumlah di 'Final Summary' (dimana berkenaan) dipindah ke Borang Tender.</p> <p data-bbox="370 858 1159 919">5.5.2. Isi jumlah amaun tender dalam angka dan perkataan di ruang yang diperuntukkan.</p> <p data-bbox="370 951 1089 978">5.5.3. Isi tarikh, tandatangan dan Cop Syarikat Penender.</p> <p data-bbox="370 1010 922 1037">5.5.4. Isi maklumat dan tandatangan saksi.</p> <p data-bbox="302 1104 623 1131">5.6 <u>Daywork Rates & pLAN</u></p> <p data-bbox="376 1163 1159 1224">Penender hendaklah mengisi jadual kadar harga untuk tiap-tiap jenis buruh yang disenaraikan</p> <p data-bbox="376 1255 1159 1465">Penender hendaklah mengisi muatan/kuasa dan kadar harga bagi alat-alat jentera dan kenderaan yang disenaraikan. Jika alat-alat jentera dan kenderaan yang disenaraikan itu yang difikirkan tidak mencukupi untuk melaksanakan kerja-kerja berkenaan, maka penender, hendaklah menambah pada senarai berkenaan lain-lain jentera dan alat-alat yang akan digunakan olehnya berserta maklumat mengenainya.</p>	

Bil	Perihal Semakan	Tindakan/ catatan
6.0	<p data-bbox="256 264 928 296"><u>Tindakan atas Lampiran-lampiran di Dokumen Sokongan</u></p> <p data-bbox="290 323 784 354">6.1 <u>Borang A, B, C, D, E, F, G, CA, GA</u></p> <p data-bbox="367 384 1211 506">Semua butiran ini hendaklah diisi dengan betul dan lengkap. Kegagalan mengisi maklumat atau memberi maklumat palsu, jika dikesan akan mengakibatkan tender ditolak atau/tindakan tatatertib diambil terhadap penender berkenaan.</p> <p data-bbox="290 537 724 569">6.2 <u>Gerenti Bank Syarikat Insuran</u></p> <p data-bbox="386 598 711 657">i <u>Bon Perlaksanaan</u> - Gerenti Bank</p> <p data-bbox="290 688 586 720">6.3 <u>Lukisan (Jika Ada)</u></p> <hr data-bbox="360 804 1218 808"/> <p data-bbox="521 810 963 842">(Isi lampiran tambahan jika berkaitan)</p>	

Borang
Tender
(JKR 203B-
Pind
5/2008)

SECTION C

Majlis Perbadaran Batu Pahat

BORANG INI HENDAKLAH DIGUNAKAN JIKA KUANTITI
MENJADI SEBAHAGIAN DARIPADA KONTRAK

*(THIS FORM IS TO BE USED WHERE QUANTITIES FORM
PART OF THE CONTRACT)*

Kontrak No tahun 20

Contract No *Of*

bagi Kerja-Kerja tersebut di bawah ini yang dibuat pada haribulan
tahun oleh pihak-pihak yang bertandatangan di bawah ini, adalah berhubung dengan
Borang Tender ini yang menjadi sebahagian daripada Kontrak tersebut dan yang hendaklah dibaca
dan diertikan sedemikian.

for the under-mentioned Works entered into on the day of *by the*
undersigned parties, refers to this Form of Tender which is and shall be read and construed as
part of the said Contract.

.....
Tandatangan Kontraktor
Signature of Contractor

.....
Tandatangan Pegawai
Signature of Officer

(Nama Penuh.....)
Name in Full

(Nama Penuh)
Name in Full

No. Kad Pengenalan
Identity Card No.

No. Kad Pengenalan
Identity Card No.

Atas sifat.....
In the capacity of
yang diberikuasa dengan sepenuhnya
untuk menandatangani untuk dan bagi
pihak
duly authorised to sign for and on
behalf of

Jawatan.....
Designation
Untuk dan bagi pihak KERAJAAN
For and on behalf of GOVERNMENT

.....
Meteri atau Cop Kontraktor
Contractor's seal or chop

Saksi
Witness

Saksi
Witness

(Nama Penuh.....)
Name in Full

(Nama Penuh)
Name in Full

No. Kad Pengenalan
Identity Card No.

No. Kad Pengenalan
Identity Card No

Pekerjaan
Occupation

Jawatan
Designation

Alamat
Address

MAJLIS PERBANDARAN BATU PAHAT

**BORANG TENDER
(FORM OF TENDER)**

TENDER BAGI
TENDER FOR

**Kerja-Kerja Menurap Semula Jalan Dengan `Premix' Dan Menyelenggara Longkang Lorong
Belakang Di Taman Putera Indah Serta Kerja-Kerja Berkaitan.**

mengikut Pelan-Pelan No
in accordance with Drawings No.

dan lain-lain pelan terperinci yang diberi untuk menerangkannya.
and any other detail drawings supplied in amplification thereof.

Salinan-salinan Dokumen Meja Tender yang merangkumi Perjanjian Kontrak, Pelan-Pelan tersebut di atas, Senarai Kuantiti dan/atau Spesifikasi dan Dokumen Tender yang lain boleh dilihat di tempat yang dinyatakan dalam Notis Tender dalam masa waktu pejabat pada mana-mana hari bekerja hingga tarikh akhir yang ditetapkan bagi penyerahan tender.

Copies of the Tender Table Documents comprising the Contract Agreement, the above-mentioned Drawings, Specification and other Tender Documents may be seen at the place specified in the Tender Notice during office hours on any working day until the final date fixed for the submission of tenders.

Kepada:
To

YANG DI PERTUA

.....
MAJLIS PERBANDARAN BATU PAHAT
.....

(Pihak menerima tender)

TUAN,

Di bawah dan tertakluk kepada Syarat-Syarat Membuat Tender yang dilampirkan bersama ini, yang bertandatangan di bawah ini adalah dengan ini membuat tender dan menawarkan untuk melaksana dan menjalankan Kerja dan peruntukan-peruntukan dan membekalkan semua buruh, bahan dan loji dan segala benda dari tiap-tiap jenis yang masing-masing disebut, ditunjuk, diperihal dan dimaksudkan dalam, atau yang hendaklah ditakrifkan daripada Dokumen Tender, yang hendaklah dilaksanakan dan dibekalkan oleh pihak Kontraktor, bagi Kerja yang diperihalkan di atas, dengan menepati Dokumen Tender tersebut bagi jumlah wang pukal yang disebutkan di bawah ini.

Under and subject to the Conditions of Tendering annexed hereto, the undersigned does hereby tender and offer to execute and perform the Works and provisions and supply all labour, materials and plants and everything of every kind respectively named, shown, described and alluded to in, or to be inferred from the Tender Documents, to be executed and supplied on the part of the Contractor, for the Works above described, in conformity with the said Tender Documents for the lump sum named herein below.

+ Borang ini hendaklah digunakan jika kuantiti menjadi sebahagian daripada kontrak
This form is to be used where quantities form part of the contract

2. Yang bertandatangan di bawah ini bersetuju menjadi terikat oleh dan tunduk kepada Syarat-Syarat Kontrak dan Senarai Kuantiti yang terletak harganya dan/atau Spesifikasi tersebut dan bersetuju bahawa sebelum Surat Setujuterima Tender dikeluarkan, harga atau kadar harga dalam Senarai Kuantiti hendaklah diteliti dan diselaraskan oleh Pegawai Penguasa dengan memastikan kemunasabahannya tanpa mengubah amaun yang dinyatakan di dalam Borang Tender.

The undersigned agrees to be bound by and submit to the Conditions of Contract and priced Bills of Quantities and Specification and agrees that before the issuance of the Letter of Acceptance, the prices or rates in the Bills of Quantities shall be scrutinized and adjusted by the Superintending Officer as to its reasonableness without altering the amount as stated in the Form of Tender.

Senarai Kuantiti yang terletak harganya tersebut, selepas diperbetulkan atau diselaraskan sebagaimana yang diperuntukkan dalam Syarat-Syarat Kontrak, hendaklah menjadi asas bagi menilaikan bayaran interim dan apa-apa perubahan yang mungkin diarahkan oleh Pegawai Penguasa dari semasa ke semasa.

The said priced Bills of Quantities after rectification or adjustment as provided in the Conditions of Contract, shall form the basis of valuation for interim payment and any variation which may from time to time be ordered by the Superintending Officer.

3. Dan selanjutnya, yang bertandatangan di bawah ini bersetuju menyiapkan Kerja itu dalam masa **15 minggu** dari tarikh pemilikan tapakbina atau dalam apa-apa tempoh lanjutan yang diperuntukkan dalam Syarat-Syarat Kontrak.

And further, the undersigned agrees to complete the Works within days/weeks/months from the date of possession of site or within such extended time as by the Conditions of Contract provided.*

4. Jumlah amaun Tender ini ialah jumlah wang pukal sebanyak Ringgit Malaysia.....
The total amount of the Tender is the lump sum of Ringgit Malaysia

.....
.....

iaitu, RM.....
i.e.

5. Yang bertandatangan di bawah ini berharap dibenarkan membuat tender, dalam sedikit masa lagi bagi kerja berikut yang mana dijalankan secara langsung oleh yang bertandatangan di bawah ini dalam perjalanan biasa perniagaannya dan yang baginya Wang Kos Prima atau Wang Peruntukan Sementara telah dimasukkan dalam amaun Tender ini:

The undersigned desires to be permitted to tender in due course, for the following work which the undersigned in the ordinary course of business directly carries out and for which Prime Cost or Provisional Sums have been included in the amount of this Tender:

.....
.....
.....
.....

* Petender dikehendaki memotong yang tidak berkenaan.
The tenderer to delete whichever is not applicable

6. Bahawasanya adalah diketahui bahawa Kerajaan sentiasa berhak menyetujui atau menolak Tender ini, sama ada ianya lebih rendah atau lebih tinggi daripada tender-tender yang lain, atau sama amaunnya. Yang bertandatangan di bawah ini bersetuju yang Tender ini akan berterusan sah dan tidak akan ditarik balik dalam tempoh sembilan puluh (90) hari dari tarikh akhir yang ditetapkan bagi penyerahan tender dan bersetuju bahawa tiada apa-apa had, syarat atau perjanjian lain akan dikenakan oleh kami selepas tarikh tersebut.

Whereas it is understood that the Government reserves the right to accept or to refuse this Tender, whether it be lower or higher than any other tender, or of the same amount. The undersigned agrees that this Tender shall remain valid and shall not be withdrawn within ninety (90) days from the final date fixed for the submission of tenders and agrees that no other term, condition or stipulation shall be imposed by us after the said date.

7. Yang bertandatangan di bawah ini berniat, jika Tender ini disetujui, memilih salah satu daripada bentuk Bon Pelaksanaan seperti berikut:

The undersigned intends, in the event of acceptance of this Tender, to choose one of the following form of Performance Bond:

- * (i) Jaminan Bank / Bank Islam / Bank Pembangunan Malaysia Berhad (BPMB) / Bank Perusahaan Kecil dan Sederhana Malaysia (Bank SME) atau *Bank / Islamic Bank / Bank Pembangunan Malaysia Berhad (BPMB) / Bank Perusahaan Kecil dan Sederhana Malaysia (SME Bank) Guarantee or*
- * (ii) Jaminan Syarikat Kewangan atau *Finance Company Guarantee or*
- * (iii) Jaminan Insurans/Takaful atau *Insurance/Takaful Guarantee or*
- * (iv) Wang Jaminan Pelaksanaan yang dikenakan potongan sebanyak sepuluh peratus (10%) daripada setiap bayaran interim sehingga mencapai jumlah lima peratus (5%) daripada Jumlah Harga Kontrak.
Performance Guarantee Sum whereby ten percent (10%) of each interim payment shall be deducted until the total amount deducted aggregate to a sum equivalent to five percent (5%) of the Contract Sum.

8. Yang bertandatangan di bawah ini bersetuju, jika Tender ini disetujui, mendeposit, dengan seberapa segera yang praktik selepas penerimaan Surat Setujuterima Tender tetapi sebelum bermulanya Kerja, perkara-perkara berikut:

The undersigned agrees, in the event of acceptance of this Tender, to deposit as soon as is practicable after the receipt of the Letter of Acceptance of Tender but before the commencement of the Works, the following:

- (a) Bon Pelaksanaan (jika petender memilih kaedah Jaminan Bank / Bank Islam / BPMB / Bank SME / Insurans / Takaful atau Syarikat Kewangan sahaja) dan jikalau gagal dikemukakan pada tarikh milik tapak, Kerajaan berhak untuk melaksanakan kaedah Wang Jaminan Pelaksanaan;
Performance Bond (if the tenderer opts for Bank / Islamic Bank / BPMB / SME Bank / Insurance / Takaful or Finance Company Guarantee) and failure to submit the said bond by the date of possession of site shall entitle the Government to implement the Performance Guarantee Sum option;

* Petender dikehendaki memotong yang tidak berkenaan.
The tenderer to delete whichever is not applicable.

- (b) Polisi Insurans Tanggungan Awam (iaitu insurans terhadap bencana kepada orang-orang dan kerosakan kepada harta) atau Nota Liputan berserta dengan resit bagi premium yang telah dibayar;
Insurance Policy for Public Liability (ie. insurance against injury to persons and damage to property) or the Cover Note together with receipt of premium paid in respect thereof;
- (c) Polisi Insurans Kerja atau Nota Liputan berserta dengan resit bagi premium yang telah dibayar;
Insurance Policy for Works or the Cover Note together with receipt of premium paid in respect thereof;
- (d) Nombor pendaftaran di bawah Skim Keselamatan Sosial Pekerja (PERKESO);
Registration number under Employee's Social Security (SOCSO) Scheme;

Yang bertandatangan di bawah ini selanjutnya bersetuju menandatangani Polisi-polisi Insurans yang berkenaan dalam tempoh tidak lewat daripada tiga puluh (30) hari selepas Nota Liputan diserahkan.

The undersigned further agrees to deposit the relevant Insurance Policies within a period of not later than thirty (30) days after the Cover Notes has been submitted.

9. Yang bertandatangan di bawah ini bersetuju jika kerja-kerja gagal dimulakan dalam tempoh dua (2) minggu dari tarikh milik tapak, pengambilan kerja di bawah kontrak akan ditamatkan sejajar dengan Fasal 51.1(a)(i) Syarat-Syarat Kontrak.

The undersigned agrees that if the undersigned fails to commence works within two (2) weeks from the date of possession, his employment under the Contract shall be terminated in accordance with Clause 51.1(a)(i) of the Conditions of Contract.

10. Yang bertandatangan di bawah ini dengan ini juga bersetuju bahawa Borang Tender ini berserta Surat Setujuterima Tender (jika ada) hendaklah menjadi kontrak yang mengikat antara kita.

The undersigned hereby also agrees that this Form of Tender together with the Letter of Acceptance of Tender (if any) shall constitute a binding contract between us.

11. Yang bertandatangan di bawah ini mengesahkan, selepas menyemak sendiri, bahawa dokumen-dokumen dan pelan-pelan yang digunakan oleh yang bertandatangan di bawah ini untuk menyusun Tender ini adalah salinan-salinan yang sebenarnya bagi dokumen-dokumen dan pelan-pelan yang dimasukkan dalam Dokumen Meja Tender.

The undersigned confirms, after a personal scrutiny, that the documents and drawings used by the undersigned in compiling this Tender are true copies of the documents and drawings included in the Tender Table Documents.

12. Yang bertandatangan di bawah ini bersetuju bahawa:

The undersigned agrees that:

- (a) jika Tender ini ditarik balik sebelum tamatnya Tempoh Sah Tender atau apa-apa tempoh lanjutan, atau
if this Tender is withdrawn before the expiry of the Tender Validity Period or any extended period thereof, or
- (b) jika yang bertandatangan di bawah ini mengenakan apa-apa had, syarat atau perjanjian tambahan kepada Tender ini selepas tarikh akhir yang ditetapkan bagi penyerahan tender atau,
if the undersigned imposes any additional term, condition or stipulation to the Tender after the final date fixed for the submission of tenders or,

- (c) jika sekiranya Tender telah disetujuterima, yang bertandatangan di bawah ini enggan dan tidak melaksanakan Perjanjian Kontrak yang formal atau mendeposit Bon Pelaksanaan (jika petender memilih kaedah Jaminan Bank / Bank Islam / Bank Pembangunan Malaysia Berhad (BPMB) / Bank Perusahaan Kecil dan Sederhana Malaysia (Bank SME) / Insurans/ Takaful atau Syarikat Kewangan sahaja) sebagaimana dikehendaki oleh Syarat-Syarat Kontrak atau tidak meneruskan Kerja, maka, dalam mana-mana hal itu, tanpa menyentuh apa-apa hak lain yang ada padanya, Kerajaan sentiasa berhak mengambil tindakan tatatertib terhadap yang bertandatangan di bawah ini atau membatalkan pendaftaran yang bertandatangan di bawah ini sebagai kontraktor Kerajaan, sebagaimana difikirkan perlu oleh Kerajaan.
- in the event that the Tender having been accepted, the undersigned refuses and fails to execute the formal Contract Agreement or to deposit the Performance Bond (if the tenderer opts for Bank / Islamic Bank / Bank Pembangunan Malaysia Berhad (BPMB) / Bank Perusahaan Kecil dan Sederhana Malaysia (SME Bank) / Insurance/Takaful or Finance Company Guarantee) as required by the Conditions of Contract or fails to proceed with the Works, then, in any of such event, without prejudice to any other rights it may possess, the Government reserves the right to take disciplinary action against the undersigned or to cancel the registration of the undersigned as a Government contractor, as the Government deems fit.*

Bertarikh pada..... haribulan..... 20.....
Dated this day of 20

.....
 Tandatangan Petender
Signature of Tenderer

Nama Penuh :
Name in full

Atas sifat :
In the capacity of

yang diberikuasa dengan sempumanya
 untuk menandatangani Tender ini untuk
 dan bagi pihak:
*duly authorised to sign this Tender for and
 on behalf of:*

.....
 Meterai atau cap Petender
Tenderer's seal or chop

Saksi :
Witness

Nama Penuh :
Name in full

Pekerjaan :
Occupation

Alamat :
Address

.....

SYARAT-SYARAT MEMBUAT TENDER (CONDITIONS OF TENDERING)

1. Keseluruhan Kerja yang dinyatakan dalam Dokumen Tender yang ditunjukkan di atas Meja Tender (kemudian dari ini disebut "Dokumen Meja Tender") akan diberi secara Kontrak.

The whole of the Works set forth in the Tender Documents exhibited on the Tender Table (hereinafter referred to as the "Tender Table Documents") will be let on Contract.

2. (a) Tiap-tiap petender mestilah menyerahkan, dalam suatu sampul surat bertutup dan bermeterai yang dialamatkan sebagaimana ditetapkan dalam Notis Tender, suatu tender yang sah dalam Borang Tender yang diperuntukkan, bersama dengan salinan Senarai Kuantiti yang diisi dan ditandatangani dengan sempurna. Borang Tender yang tak lengkap atau tak bertandatangan akan ditolak.

Each tenderer must submit, enclose and seal in an envelope addressed as stipulated in the Tender Notice, a genuine tender on the Form of Tender provided, together with the copy of the Bills of Quantities duly filled in and signed. Form of Tender which is incomplete or unsigned shall be disqualified.

(b) Tiap-tiap petender mestilah mencatatkan, dalam ruang yang diperuntukkan dalam Borang Tender, masa yang akan dikehendakinya bagi menyiapkan Kerja itu.

Each tenderer must enter, in the space provided on the Form of Tender, the time he will require to complete the Works.

(c) Petender hendaklah meletakkan harga dalam Senarai Kuantiti yang hendaklah diisi dengan dakwat dan ditandatangani dengan sempurna oleh petender. Sebelum Surat Setujuterima dikeluarkan, harga atau kadar harga dalam Senarai Kuantiti hendaklah diteliti dan diselaraskan oleh Pegawai Penguasa dengan memastikan kemunasabahnannya tanpa mengubah amaun yang dinyatakan di dalam Borang Tender.

The tenderer shall price the Bills of Quantities which shall be duly filled in ink and signed by the tenderer. Before the issuance of the Letter of Acceptance, prices or rates in the Bills of Quantities shall be scrutinized and adjusted by the Superintending Officer as to its reasonableness without altering the amount as stated in the Form of Tender.

3. Jika mana-mana petender:

Should any tenderer:

(a) menarik balik tendernya sebelum tamat Tempoh Sah Tender atau apa-apa tempoh lanjutan, atau

withdraw his tender before the expiry of the Tender Validity Period or any extended period thereof, or

(b) mengenakan had, syarat atau janji tambahan selepas tarikh akhir yang ditetapkan bagi penyerahantender (dan dalam hal yang sedemikian ianya hendaklah disifatkan sebagai penarikan balik tender ini), atau

impose additional terms, conditions or stipulations after the final date fixed for the submission of tenders (in which case it shall be deemed to be a withdrawal of this tender), or

- (c) jika sekiranya tender telah disetujuterima, enggan dan tidak melaksanakan Perjanjian Kontrak yang formal atau mendeposit Bon Pelaksanaan (jika petender memilih kaedah Jaminan Bank / Bank Islam / Bank Pembangunan Malaysia Berhad (BPMB) / Bank Perusahaan Kecil dan Sederhana Malaysia (Bank SME) / Insurans/ Takaful atau Syarikat Kewangan sahaja) atau tidak meneruskan Kerja;
whose tender has been accepted, refuse and fail to execute the formal Contract Agreement or to deposit the Performance Bond (if the tenderer opts for Bank / Islamic Bank / Bank Pembangunan Malaysia Berhad (BPMB) / Bank Perusahaan Kecil dan Sederhana Malaysia (SME Bank) /Insurance/Takaful or Finance Company Guarantee) or fails to proceed with the Works;

maka, dalam mana-mana hal itu, Kerajaan hendaklah, tanpa menyentuh apa-apa hak lain yang ada padanya, sentiasa berhak mengambil tindakan tatatertib terhadap yang bertandatangan di bawah ini atau membatalkan pendaftaran petender sebagai kontraktor Kerajaan, sebagaimana difikirkan perlu oleh Kerajaan.

then, in any of such events, the Government, without prejudice to any other rights it may possess, reserves the right to take disciplinary action against the undersigned or to cancel the registration of the tenderer as a Government contractor, as the Government deems fit.

4. Tiada apa-apa perubahan atau tambahan yang tidak dibenarkan boleh dibuat kepada Borang Tender atau mana-mana Dokumen Tender yang lain.

No unauthorised alteration or addition shall be made to the Form of Tender or any other Tender Documents.

5. (a) Tender-tender dan dokumen-dokumen berhubung dengannya yang dinyatakan dalam Klausula 2 di atas, mestilah diserahkan di tempat dan pada atau sebelum masa yang ditetapkan dalam Notis Tender bagi penyerahan tender.

Tenders and documents in connection therewith as specified in Clause 2 above, must be delivered to the place and at or before the time stipulated in the Tender Notice for the submission of Tenders.

- (b) Jika sesuatu tender tidak diserahkan dengan tangan, petender mestilah menguruskan bagi tendernya dan dokumen-dokumennya yang lain dihantar dengan pos supaya sempat sampai di tempat yang ditetapkan tidak lewat dari masa yang ditetapkan.

In the case of a tender not being delivered by hand, the tenderer must arrange for his tender and other documents to be posted in time to reach the stipulated place not later than the stipulated time.

- (c) Mana-mana tender yang diserahkan selepas masa yang ditetapkan, berbangkit dari apa jua sebab, tidak akan dipertimbangkan.

Any tender delivered after the stipulated time, from whatever cause arising, will not be considered.

- (d) Tiada apa-apa jua perbelanjaan yang ditanggung oleh petender bagi menyediakan tendernya boleh dibayar kepadanya.

In no case will any expenses incurred by a tenderer in the preparation of his tender be allowed.

6. Jika sekiranya atas permintaannya, seseorang petender diberikan salinan-salinan sesuatu Dokumen Tender, maka adalah menjadi tanggungjawabnya seorang diri untuk meneliti salinan-salinan itu dan memuaskan hatinya bahawa salinan-salinan itu adalah sebenarnya salinan-salinan dokumen yang termasuk dalam Dokumen Meja Tender. Jika sekiranya terdapat apa-apa perbezaan atau percanggahan antara mana-mana salinan yang diberi kepada petender dengan salinan dalam Dokumen Meja Tender atau antara mana-mana dokumen yang termasuk di dalamnya, maka adalah menjadi tanggungjawabnya seorang diri untuk memohon secara bertulis kepada Pegawai Penguasa supaya dibetulkan perbezaan atau percanggahan itu tidak lewat dari tujuh (7) hari sebelum tarikh akhir yang ditetapkan dalam Notis Tender bagi penyerahan tender. Apa-apa jawapan yang hendak dibuat oleh Pegawai Penguasa atas permohonan itu hendaklah dibuat dengan cara Memorandum Tender yang hendaklah dihantar kepada semua petender. Memorandum Tender itu hendaklah menjadi sebahagian daripada Dokumen Tender dan Tender yang diterima akan disifatkan sebagai berdasarkan pada huraian, ubahsuaian atau perluasan kepada dokumen asal yang mengandunginya.

In the event of any tenderer being supplied at his request, with copies of any of the Tender Documents, it shall be the sole responsibility of the tenderer to scrutinize such copies and satisfy himself that they are exact copies of those included in the Tender Table Documents. In the event of any difference or discrepancy being found between any such copies supplied to the tenderer and those in the Tender Table Documents or between any documents included therein, it shall be the sole responsibility of the tenderer to apply in writing to the Superintending Officer, to have the difference or discrepancy rectified, not later than seven (7) days before the final date fixed in the Tender Notice for the submission of tenders. Any reply the Superintending Officer may make to such application shall be by way of a Tender Memorandum which will be sent to all tenderers. Such Tender Memorandum shall become part of the Tender Documents and Tenders received will be deemed to have been based on the explanations, modification or extension to the original document that they contain.

7. Petender hendaklah disifatkan telah memeriksa dan meneliti Tapakbina dan sekitarnya dan telah berpuas hati sebelum menyerahkan tendernya tentang jenis bumi dan lapisan tanah, bentuk dan jenis Tapakbina, takat dan jenis kerja, bahan dan barang yang perlu bagi menyiapkan Kerja, cara-cara perhubungan dengan dan akses ke Tapakbina, tempat tinggal yang mungkin dikehendaki dan pada amnya hendaklah mendapatkan sendiri segala maklumat yang perlu tentang risiko, luarjangka dan segala hal keadaan yang mempengaruhi dan menjejaskan tendernya.

The tenderer shall be deemed to have inspected and examined the Site and its surroundings and to have satisfied himself before submitting his tender as to the nature of the ground and sub-soil, the form and nature of the Site, the extent and nature of the work, materials and goods necessary for the completion of the Works, the means of communication with and access to the Site, the accommodation he may require and in general to have obtained for himself all necessary information as to risks, contingencies and all circumstances influencing and affecting his tender.

8. Tender-tender hendaklah terus sah selama tempoh sembilan puluh (90) hari dari tarikh akhir bagi penyerahan tender sebagaimana yang ditetapkan dalam Notis Tender (dalam Syarat-Syarat Membuat Tender ini disebut "Tempoh Sah Tender") dan tempoh ini boleh dengan persetujuan bersama dilanjutkan jika dan apabila perlu.

Tenders shall remain valid for a period of ninety (90) days from the final date for submission of tenders stipulated in the Tender Notice (herein referred to as the "Tender Validity Period") and such period may by mutual agreement be extended as and when necessary.

9. Kerajaan tidak boleh terikat menyetujui tender yang rendah sekali atau sesuatu tender dan juga tidak terikat untuk memberi apa-apa sebab atas penolakan sesuatu tender.

The Government shall not be bound to accept the lowest or any tender, nor to assign any reason for the rejection of any tender.

10. Petender yang berjaya (jika ada) hendaklah diberitahu tentang tendernya dengan surat (disebut "Surat Setujuterima Tender") dalam Tempoh Sah Tender atau apa-apa tempoh lanjutan. Petender tersebut hendaklah dengan seberapa segera yang praktik tetapi sebelum bermulanya Kerja mendeposit dengan Pegawai Penguasa, perkara-perkara berikut:

The successful tenderer (if any) shall be notified of his tender by a letter (referred to as "Letter of Acceptance of Tender") within the Tender Validity Period or any extended period thereof. The said tenderer shall as soon as is practicable but before the commencement of the Works deposit with the Superintending Officer the following:

(a) Bon Pelaksanaan (jika petender memilih kaedah Jaminan Bank / Bank Islam / Bank Pembangunan Malaysia Berhad (BPMB) / Bank Perusahaan Kecil dan Sederhana Malaysia (Bank SME) / Insurans/ Takaful atau Syarikat Kewangan sahaja) berjumlah sebanyak 5% daripada Jumlah Harga Kontrak dan jikalau gagal dikemukakan pada tarikh milik tapak, Kerajaan berhak untuk melaksanakan kaedah Wang Jaminan Pelaksanaan;

Performance Bond (if the tenderer opts for Bank / Islamic Bank / Bank Pembangunan Malaysia Berhad (BPMB) / Bank Perusahaan Kecil dan Sederhana Malaysia (SME Bank) / Insurance/Takaful or Finance Company Guarantee) amounting to 5% of Contract Sum and failure to submit the said bond by the date of possession of site, shall entitle the Government to implement the Performance Guarantee Sum option;

(b) Polisi Insurans Tanggungan Awam (iaitu insurans terhadap bencana kepada orang-orang atau kerosakan kepada harta) atau Nota Liputan berserta dengan resit bagi premium yang telah dibayar;

Insurance Policy for Public Liability (i.e. insurance against injury to persons or damage to property) or Cover Note together with receipt of premium paid in respect thereof,

(c) Polisi Insurans Kerja atau Nota Liputan berserta dengan resit bagi premium yang telah dibayar;

Insurance Policy for Works or Cover Note together with receipt of premium paid in respect thereof;

(d) Nombor pendaftaran di bawah Skim Keselamatan Sosial Pekerja (PERKESO);

Registration numbers under the Employee's Social Security (SOCSO) Scheme.

Petender tersebut hendaklah selanjutnya mendeposit Polisi-polisi Insurans yang berkenaan dalam tempoh tidak lewat daripada tiga puluh (30) hari selepas Nota Liputan diserahkan.

The said tenderer shall further deposit the relevant Insurance Policies within a period of not later than thirty (30) days after the Cover Notes has been submitted.

11. Semua jadual butir-butir yang dilampirkan kepada Dokumen Tender hendaklah diisi dan diserahkan oleh petender berserta dengan tendernya.

All schedules of particulars attached to the Tender Documents shall be completed and submitted by the tenderer together with his tender.

12. Tiap-tiap notis yang hendak diberi kepada petender bolehlah diposkan ke alamatnya yang dinyatakan dalam tender itu dan pengeposan itu hendaklah disifatkan sebagai penyampaian yang sempurna akan notis itu.

Every notice to be given to a tenderer may be posted to the tenderer's address given in the tender and such posting shall be deemed good service of such notice.

13. Perkataan "petender yang berjaya" hendaklah bererti bahawa petender yang mana tendernya telah diluluskan dan disetujuterima oleh Kerajaan.

The word "successful tenderer" shall mean that the tenderer whose tender has been approved and accepted by the Government.

14. Perkataan "petender" dalam Syarat-Syarat ini hendaklah disifatkan sebagai termasuk dua orang atau lebih.

The word "tenderer" in these conditions shall be deemed to include two or more persons.

15. Jika petender tidak mematuhi Syarat-Syarat tersebut di atas mengenai apa-apa jua hal maka tendernya boleh ditolak.

Non-compliance with the above conditions in any respect shall render the tender liable to rejection.

16. Syarat-Syarat Membuat Tender ini, setakat mana Syarat-Syarat itu mungkin menyentuh pelaksanaan Kontrak ini, hendaklah disifatkan menjadi sebahagian daripada Kontrak ini.

These Conditions of Tendering, in so far as they affect the execution of the Contract, shall be deemed to form part of the Contract.

Declaration Of Non Collusion

SECTION D

Majlis Perbadaran Batu Pahat

DECLARATION OF NON-COLLUSION

The essence of selective tendering is that the client shall receive bona fide competitive tenders from all firm tendering in recognition of this principle, we certify that this is a bona fide tender, intended to be competitive, and that we have not fixed or adjustable the amount of the tender by or in accordance with any other persons. We also certify that we have not and we undertake that we will not, at any time, before the returnable date of this tender:-

- a) Communicate to any person other than the person calling for those tenders the amount or approximate amount of the proposed tender, except where the disclosure, in confidence, of the approximate amount of the tender is necessary to obtain insurance premium quotations required for the preparation of tender;
- b) Enter into any agreement with any other persons that he shall refrain from tendering or as to the amount of any tender to be submitted;
- c) Offer of pay or give, agree to pay or give any sum of money or valuable consideration indirectly to any person for doing or having done or causing or having caused to be done in relation to any other tender or proposed tender for the said work any act or thing of the sort described above.

In this certificate the word "Person" includes any persons and any body or association, corporate or association, corporate or incorporate; "any agreement" includes any such transaction formed or informed, and whether legally binding or not.

.....
Authorized Signatory For
Partnership/Company

I.C. No. :

Date :

Syarat-
Syarat
Kontrak
(PWD
203A Rev
1/2010)

SECTION E

Majlis Perbadaran Batu Pahat

GOVERNMENT OF MALAYSIA

**STANDARD FORM OF CONTRACT TO BE USED
WHERE BILLS OF QUANTITIES FORM PART OF
THE CONTRACT**

P.W.D. FORM 203A (Rev. 1/2010)

**CONDITION OF CONTRACT
TO BE USED WHERE BILLS OF QUANTITIES
FORM PART OF THE CONTRACT**

PWD FORM 203A (Rev. 1/2010)

This form has been approved by Attorney General's Chamber

TABLE OF CONTENTS

Clause		Page
1.0	DEFINITIONS AND INTERPRETATIONS	1
2.0	CONTRACT PERIOD	3
3.0	THE S.O. AND S.O.'S REPRESENTATIVE	3
4.0	S.O.'S RIGHT TO TAKE ACTION	4
5.0	S.O.'S INSTRUCTIONS	4
6.0	SCOPE OF CONTRACT	5
7.0	CONTRACT SUM	6
8.0	CONTRACT DOCUMENTS	6
9.0	REPRESENTATIONS, WARRANTIES AND UNDERTAKINGS OF THE CONTRACTOR	7
10.0	OBLIGATIONS OF THE CONTRACTOR	8
11.0	INSPECTION OF SITE	8
12.0	PROGRAMME OF WORK	9
13.0	PERFORMANCE BOND/PERFORMANCE GUARANTEE SUM	10
14.0	INDEMNITY IN RESPECT OF PERSONAL INJURIES AND DAMAGE TO PROPERTY	10
15.0	INSURANCE AGAINST PERSONAL INJURIES AND DAMAGE TO PROPERTY	11
16.0	INDEMNITIES TO GOVERNMENT IN RESPECT OF CLAIMS BY WORKMEN	12
17.0	EMPLOYEES' SOCIAL SECURITY ACT, 1969	12
18.0	INSURANCE OF WORKS	13
19.0	SETTING OUT	14
20.0	UNFIXED MATERIALS AND GOODS	14
21.0	COMPLIANCE WITH THE LAW	15
22.0	DESIGN	15
23.0	EMPLOYMENT OF WORKMEN	16
24.0	VARIATIONS	18
25.0	VALUATION OF VARIATION	18
26.0	BILL OF QUANTITIES	19
27.0	MEASUREMENT OF WORKS	20
28.0	PAYMENT TO CONTRACTOR AND INTERIM CERTIFICATES	20
29.0	ADJUSTMENT OF CONTRACT SUM	21
30.0	FLUCTUATION OF PRICE	21
31.0	FINAL ACCOUNT AND PAYMENT CERTIFICATE	21
32.0	EFFECT OF S.O.'S CERTIFICATES	22
33.0	DEDUCTION FROM MONEY DUE TO CONTRACTOR	22
34.0	PRIME COST / PROVISIONAL SUMS	22

Clause		Page
35.0	MATERIALS, GOODS AND WORKMANSHIP	23
36.0	INSPECTION AND TESTING OF MATERIALS, GOODS AND EQUIPMENT	23
37.0	CONSTRUCTIONAL PLANT, EQUIPMENT, VEHICLES AND MACHINERIES	24
38.0	POSSESSION OF SITE	24
39.0	COMPLETION OF WORKS	25
40.0	DAMAGES FOR NON-COMPLETION	26
41.0	SECTIONAL COMPLETION	27
42.0	PARTIAL OCCUPATION/TAKING OVER BY GOVERNMENT	27
43.0	DELAY AND EXTENSION OF TIME	28
44.0	CLAIMS FOR LOSS AND EXPENSE	29
45.0	INVESTIGATION BY THE GOVERNMENT AND OTHER PERSONS IN CASE OF ACCIDENT, FAILURE OR OTHER EVENT	30
46.0	ACCESS FOR WORKS, <i>ETC.</i>	30
47.0	SUB-CONTRACT OR ASSIGNMENT	31
48.0	DEFECTS AFTER COMPLETION	31
49.0	UNFULFILLED OBLIGATIONS	32
50.0	SUSPENSION OF WORKS	32
51.0	EVENTS AND CONSEQUENCES OF DEFAULT BY THE CONTRACTOR	33
52.0	TERMINATION ON NATIONAL INTEREST	36
53.0	TERMINATION ON CORRUPTION, UNLAWFUL OR ILLEGAL ACTIVITIES	36
54.0	PAYMENTS UPON SUSPENSION AND TERMINATION ON NATIONAL INTEREST	37
55.0	EVENTS AND CONSEQUENCES OF DEFAULT BY THE GOVERNMENT	37
56.0	CERTIFICATE OF TERMINATION COSTS	38
57.0	SURVIVING RIGHTS	39
58.0	EFFECT OF FORCE MAJEURE	39
59.0	SITE AGENT AND ASSISTANTS	40
60.0	NOMINATED SUB-CONTRACTORS AND/OR NOMINATED SUPPLIERS	40
61.0	PAYMENT TO NOMINATED SUB-CONTRACTOR OR SUPPLIERS	41
62.0	NO LIABILITY OF GOVERNMENT TO NOMINATED AND/OR SUB- CONTRACTOR OR SUPPLIER	41
63.0	RESPONSIBILITIES OF CONTRACTOR TO NOMINATED AND / OR SUB- CONTRACTORS OR SUPPLIERS	42
64.0	INTELLECTUAL PROPERTY RIGHTS	42
65.0	ANTIQUITIES	42
66.0	ARBITRATION	43
67.0	NOTICE, <i>ETC.</i>	44
68.0	SAFETY AT THE SITE	45

Clause		Page
69.0	ADVANCE PAYMENT	45
70.0	AMENDMENT	46
71.0	CONFIDENTIALITY	46
72.0	STAMP DUTY	47
73.0	SEVERABILITY	47
74.0	WAIVER	47
75.0	LAWS APPLICABLE	47
76.0	SUCCESSORS BOUND	47
77.0	EPIDEMICS AND MEDICAL ATTENDANCE	48
78.0	TECHNOLOGY TRANSFER	48
79.0	GENERAL DUTIES AND PERFORMANCE STANDARD	48
80.0	RESTRICTION AND PROCEDURE ON USE OF IMPORTED MATERIALS AND GOODS	48
81.0	TIME	49

Appendices shall have the meaning given below or ascribed in the clauses or Appendix item to which reference is made:

- (a) **“Contract”** means this contract and the appendices attached hereto;
- (b) **“Contract Documents”** means the documents forming the tender and acceptance thereof including:
- Form of Tender;
 - Letter of Acceptance of Tender;
 - Contract Drawings;
 - Bills of Quantities;
 - Specifications;
 - Treasury's Instructions;
 -
 -
 -
- and all these documents shall be complementary to one another;
- (c) **“Contractor”** means the person or persons, sole proprietor, partnership, firm or company whose tender for the Works has been accepted and who has or have signed this Contract and includes the Contractor's personal representatives, heirs, successors, executors, administrators, servant and agent;
- (d) **“Contract Period”** means the time frame stipulated in clause 2;
- (e) **“Contract Sum”** means the sum stipulated in clause 7;
- (f) **“Date for Completion”** means the date fixed and stated in Appendix or any other date as provided for in clause 39;
- (g) **“Defects Liability Period”** means the period stated in Appendix or if none stated, the period is twelve (12) months from the date of practical completion certified by the S.O. as provided for under clause 39.3;
- (h) **“Nominated Sub-Contractor” or “Nominated Supplier”** means all specialist, merchants, tradesmen and others executing any work or services, or supplying any materials or goods for which Prime Cost Sum (or P.C. Sums) are included in the Bills of Quantities or which the S.O. has given written instructions in regard to the expenditure of Provisional Sum and who may be nominated by the S.O. and employed by the Contractor as Sub-contractors or Suppliers;
- (i) **“On-Cost Charges”** means any cost and expenses reasonably incurred by the Government;
- (j) **“Officer Named”** means officer empowered to take action on behalf of the Government pertaining to clauses
- (k) **“Prime Cost” or** means a sum for works or services to be executed by a Nominated Sub-Contractor or sums for materials or goods to be

- abbreviation "P.C. Sum"** obtained from a Nominated Supplier;
- (l) **"Provisional Sum"** means a sum for work or for the supply of goods or materials which cannot be defined or detailed at the time the tender documents are issued;
- (m) **"Site"** means the land and other places on, above, under, in or through which the Works are to be executed and any other lands or places provided or approved by the Government for working space or any other purposes as may be specifically designated in this Contract and whether the same may be on the Site or not;
- (n) **"S.O."** means the Superintending Officer who shall beand/or his successors in office;
- (o) **"S.O.'s Representatives"** means any person or persons delegated or authorised in writing by the S.O. to perform any of the duties of the S.O. as may be from time to time notified in writing to the Contractor by the S.O. pursuant to clause 3.3(a) of this Contract;
- (p) **"Works"** means the works specified in the Contract Documents and shall include temporary works.

1.2 Interpretation

- (a) The terms "approved or approval" and "directed or direction" wherever used in this Contract shall be in writing.
- (b) Words importing the singular include the plural and vice versa where the context requires.
- (c) The headings are for convenience of reference only and shall not be deemed to be part of this Contract or be taken into consideration in the interpretation or construction of this Contract.
- (d) Unless otherwise specifically stated, a reference in this Contract and the Appendices to any clause means that clause in this Contract.
- (e) This Contract and the Appendices are to be read as a whole and the effect or operation of any clause in this Contract or item in or entry in the Appendices shall, unless otherwise specifically stated, be read subject to any relevant qualification or modification in any other clauses in this Contract or item in or entry in the Appendices.

2.0 CONTRACT PERIOD

The Contract Period shall be for a period of commencing from ending on

3.0 THE S.O. AND S.O.'S REPRESENTATIVE

3.1 Duties of S.O. and S.O.'s Representative

The S.O. shall be responsible for the overall supervision and direction of the Works. All matters regarding the Works shall be dealt with by the Contractor with the S.O.

3.2 S.O.'s Representative

- (a) The S.O. may from time to time appoint such number of S.O.'s Representative as he deems fit.
- (b) The S.O.'s Representative shall be responsible to the S.O. and his duties are to watch and supervise the Works and to test and examine any materials or goods to be used or workmanship employed in connection with the Works.

3.3 S.O.'s Authority to Delegate

- (a) The S.O. may from time to time in writing delegate to the S.O.'s Representative any of the powers and authorities vested in the S.O. as listed in the letter of delegation and shall furnish to the Contractor a copy of all such written delegation of powers and authorities.
- (b) Any instruction or approval given by the S.O.'s Representative to the Contractor within the terms of such delegation shall bind the Contractor and the Government as though it had been given by the S.O. PROVIDED THAT failure of the S.O.'s Representative to disapprove any work or material shall not prejudice the power of the S.O. thereafter to disapprove such work or materials and to order the pulling down, removal or breaking up thereof.
- (c) If the Contractor is not satisfied with any decision of the S.O.'s Representative, the Contractor shall refer the matter to the S.O. who shall confirm, reverse or vary the decision of the S.O.'s Representative.
- (d) The delegation under this clause shall not preclude the S.O. from himself exercising or performing at any time any of the delegated powers and duties.

4.0 S.O.'S RIGHT TO TAKE ACTION

4.1 Notwithstanding any provision in this Contract it is hereby agreed that:

- (a) the power of the S.O. to issue instruction requiring a variation under clause 24 shall be subject to the financial limits as set out in Appendix 1 hereto. If the instruction for a variation under clause 24 is more than the financial limits as set out in the Appendix 1, the S.O. shall obtain the prior written approval of the relevant authorities of the Government; and
- (b) the right to act on behalf of the Government in respect of any matter which arises out of the provisions of clauses 51, 52, 53, 58 and 66 shall be exercised by the Officer Named in Appendix 1;

4.2 The Contractor shall not be entitled to extension of time or any additional cost or expense or whatsoever arising from compliance with this clause 4.

5.0 S.O.'S INSTRUCTIONS

5.1 The S.O. may from time to time issue further drawings, details and/or written instructions (all of which are hereafter collectively referred to as "S.O.'s instructions") in regard to-

- (a) the Variation as referred to in clause 24 hereof;
- (b) any discrepancy in or between the Contract Documents as referred to in clause 8.2(b) hereof;

- (c) the removal from the Site of any materials or goods brought thereon by the Contractor and the substitutions of any other materials or goods therefore;
- (d) the removal and/or re-execution of any works executed by the Contractor;
- (e) the dismissal from the Works of any person mentioned in clause 23.6 hereof employed thereupon;
- (f) the opening up for inspection of any work covered up;
- (g) the amending and making good of any defects whatsoever under clause 48;
- (h) any matter which is necessary and incidental to the carrying out and completion of the Works under this Contract; and
- (i) any matter in respect of which the S.O. is expressly empowered by this Contract to issue instructions.

5.2 All instructions issued by the S.O. shall be in writing. The Contractor shall forthwith comply with all instructions issued to him by the S.O. If such instruction is given orally, the S.O. shall then issue a written instruction within seven (7) days from the date of such oral instruction is given.

5.3 If within seven (7) days after receipt of a written notice from the S.O. requiring compliance of an instruction and the Contractor does not comply therewith, then the S.O. without prejudice to any other rights or remedies available to the Government under this Contract, undertake the work departmentally or employ and pay another Contractor or any other persons to execute any work whatsoever which may be necessary to give effect to such instruction. All costs and expenses incurred in connection with such employment (including On-Cost Charges), shall be deducted from any money due or to become due to the Contractor under this Contract, and failing which such deductions shall be recovered from the Performance Bond or as a debt due from the Contractor.

5.4 The Contractor shall be responsible for all costs and expenses incurred by the Government in carrying out the Works under clause 5.3 and On-Cost Charges (calculated by applying the Percentage of On-Cost Charges stated in Appendix hereto to the amount incurred). The Government shall be entitled to deduct such costs, expenses and On-cost Charges or any part thereof from any monies due or to become due to the Contractor under this Contract or to recover the same from the Performance Bond or as a debt due from the Contractor.

6.0 SCOPE OF CONTRACT

6.1 The Contractor shall upon and subject to this Contract, construct and complete the Works using materials, goods and workmanship of the quality and standards therein specified in accordance with best industry practice.

6.2 The Contractor shall also undertake any consequential work in relation to the construction and completion of Works on the Site i.e. removal/diversion of public sewer, water mains, electrical mains, gas mains and telephone mains and the installation of permanent connections thereto shall be borne by the Government. The Government shall reimburse the Contractor for such costs by adding it to the Contract Sum PROVIDED THAT such cost have not already been included in the Contract Sum by way of a Provisional Sum or otherwise.

PROVIDED FURTHER any temporary connection shall be obtained by the Contractor with no additional cost to the Government for purpose of carrying out their work.

6.3 The Contractor shall also make good any defect, imperfection, shrinkage or any other fault whatsoever which may appear during the Defects Liability Period in accordance with clause 48 hereof.

7.0 CONTRACT SUM

The Government hereby covenants to pay the Contractor in consideration of the construction and completion of the Works and making good of any defects whatsoever to the Works the sum of Ringgit:

.....
..... (RM.....) or such other sum as shall become payable under and at the times and in the manner specified in this Contract.

8.0 CONTRACT DOCUMENTS

8.1 Custody of the Contract Documents

- (a) The Contract shall be prepared in two (2) original copies. The original copies of the Contract shall remain in the custody of the S.O. and the Contractor.
- (b) Immediately after the execution of this Contract, the S.O. shall furnish to the Contractor without any charge (unless he shall have been previously furnished) with:
 - (i) two (2) copies of the Contract Drawings; and
 - (ii) two (2) copies of the unpriced Bills of Quantities and (if requested by the Contractor) one copy of the priced Bills of Quantities.
- (c) The S.O. shall, as and when necessary and without charge to the Contractor, furnish him with two (2) copies of such further working drawings or details as are reasonably necessary either to explain and amplify the Contract Drawings or the Specification (if any) or to enable the Contractor to construct and complete the Works in accordance with this Contract. PROVIDED THAT nothing contained in the said working drawings or details shall impose any obligation beyond those imposed by the Contract Documents.
- (d) The Contractor shall keep one copy of the Contract Drawings, the Specification (if any), unpriced Bills of Quantities, priced Bills of Quantities (if any) and other like documents referred to in sub-clause (c) hereof on the Site and the S.O. shall at all reasonable times have access to the same.
- (e) Upon final payment being made pursuant to the issuance of Final Account and Payment Certificate under clause 31, the Contractor shall return to the S.O. all drawings, details, specifications, unpriced copy of Bill of Quantities and priced Bill of Quantities, if any.
- (f) None of the documents hereinbefore mentioned shall be used by the Contractor for any purpose other than this Contract.

8.2 Sufficiency of Contract Documents

- (a) The Contract documents are to be taken as mutually explanatory of one another. The Contractor shall provide everything necessary for the proper execution of the Works until its completion according to the true intent and meaning of the Contract Documents taken together whether the true intent and meaning may or may not be particularly shown or described PROVIDED THAT it can be reasonably inferred therefrom.
- (b) If the Contractor shall find any discrepancy in or divergence between any two or more of the Contract Documents including a discrepancy or divergence between parts of any one of them, he shall immediately give to the S.O. a written notice specifying the

discrepancy or divergence and the S.O. shall issue instructions in regard thereto PROVIDED ALWAYS that such discrepancy or divergence shall not vitiate this Contract.

9.0 REPRESENTATIONS, WARRANTIES AND UNDERTAKINGS OF THE CONTRACTOR

9.1 Representations and Warranties

The Contractor hereby represents and warrants to the Government that—

- (a) it is a corporation validly existing under the laws of Malaysia*;
- (b) the Contractor has obtained a valid registration with the Construction Industry Development Board;
- (c) it has the corporate power to enter into and perform its obligations under this Contract and to carry out the transactions and to carry on its business as contemplated by this Contract*;
- (d) it has taken all necessary corporate actions to authorize the entry into and performance of this Contract and to carry out the transactions contemplated by this Contract*;
- (e) as at the execution date, neither the execution nor performance by it of this Contract nor any transactions contemplated by this Contract will violate in any respect any provision of—
 - (i) its Memorandum and Articles of Association; or
 - (ii) any other document or agreement which is binding upon it or its asset*;
- (f) no litigation, arbitration, tax claim, dispute or administrative proceeding is presently current or pending or, to its knowledge, threatened, which is likely to have a material adverse effect upon it or its ability to perform its financial or other obligations under this Contract;
- (g) this Contract constitutes a legal, valid and binding obligation of the Contractor and is enforceable in accordance with its terms and conditions;
- (h) it has necessary financial and technical capability to undertake the Works,

and the Contractor acknowledges that the Government has entered into this Contract in reliance on its representations and warranties as aforesaid.

9.2 Undertakings of the Contractor*

The Contractor undertakes that-

- (a) it shall comply with all requirements, statutory or otherwise, regulating or relating to the conduct, trade, business or profession of a contractor, and the Contractor shall be fully and solely liable for all costs incurred thereby;

* applicable only if the Contractor is a company registered under the Companies Act 1965.

- (b) it shall pay all taxes that may be imposed on the profits made in respect of this Contract in accordance with the applicable laws; and
- (c) it shall ensure that all his employees, including non-Malaysian personnel, comply with all relevant laws to which they are subject to including payment of income tax, which in respect thereto the Contractor shall make such deductions from the salaries of his employees as may be lawfully imposed by the relevant authority.

10.0 OBLIGATIONS OF THE CONTRACTOR

The Contractor shall—

- (a) construct, complete, test and commission the Works in accordance with the Specifications, Contract Drawings and any other documents specified in the Contract Documents;
- (b) perform the Works in a proper manner and in accordance with good management practice and to the best advantage of the Government;
- (c) take all appropriate measures expected of a contractor providing similar works to ensure that the Works comply with the requirements of this Contract;
- (d) perform the Works and discharge its obligations as contained in this Contract by exercising professional judgment and practice, requisite skill, care and diligence. In performing the Works, the Contractor shall provide well-outlined procedures in the form agreed by the Government for reporting and co-ordination purposes;
- (e) at all times perform the Works in such manner as will always safeguard and protect the Government's interest in relation to the Works and take all necessary and proper steps to prevent abuse or uneconomical use of facilities, if any, made available by the Government to the Contractor;
- (f) inform the Government immediately in writing of the occurrence of any factor or event, which is likely to affect the Works. Such notification shall not be construed as a discharge of any of the Contractor's obligations under this Contract;
- (g) provide and maintain throughout the Contract Period such number, categories of qualified and competent personnel necessary to perform the Works;
- (h) provide and maintain at its own cost and expense all equipment and materials necessary for the proper and effective performance of the Works;
- (i) instruct and supervise its staffs and sub-contractor in carrying out the Works' repairs and other works in relation to the Works;
- (j) make good any defect, imperfection, shrinkage or any other fault whatsoever which may appear during the Defects Liability Period; and
- (k) carry out any other obligations and responsibilities under this Contract.

11.0 INSPECTION OF SITE

11.1 The Contractor shall be deemed to have inspected and examined the Site and its surroundings and to have satisfied himself before submitting his tender as to the following:

- (a) the nature of the ground and subsoil;

- (b) the form and nature of the Site;
- (c) the extent and nature of the work, materials and goods necessary for the completion of the Works;
- (d) the means of communication with and access to the Site;
- (e) the accommodation he may require; and
- (f) in general to have obtained for himself all necessary information as to risks, contingencies and all circumstances influencing and affecting his tender.

11.2 Any information or document forwarded by the Government to the Contractor shall not relieve the Contractor of his obligations under the provisions of this clause.

12.0 PROGRAMME OF WORK

12.1 Within fourteen (14) days from the receipt of the Letter of Acceptance by the Government, the Contractor shall submit to the S.O for his approval -

- (a) a work programme for the carrying out of the Works (hereinafter referred to as "Work Programme") in such form and details as determined by the S.O. showing the detail activities of the Works so as to enable the Government to monitor the progress thereof; and
- (b) a general description in writing, of the arrangements and methods of construction which the Contractor proposes to adopt for the carrying out of the Works.

12.2 The S.O shall within (....) days after receipt of the Contractor's programme:

- (i) approve the Work Programme in writing; or
- (ii) reject the Work Programme in writing with reasons and/or request modifications; and/or
- (iii) request the Contractor to supply further information to clarify or substantiate the Work Programme or to satisfy the S.O as to its reasonableness having regard to the Contractor's obligations under the Contract,

PROVIDED THAT if none of the above actions is taken within the said period of (....) days the S.O shall be deemed to have approved the Work Programme as submitted.

12.3 The Contractor shall upon receipt from the S.O any request under clause 12.2(ii) or (iii) resubmit a modified Work Programme or provide further information as requested.

12.4 If at any time it should appear to the S.O that the actual progress of Works does not conform to the approved Work Programme referred to herein before the Contractor shall produce, at the request of the S.O., a revised Work Programme showing the modifications to the approved Work Programme necessary to ensure completion of the whole Works within the time for completion provided for in clause 39 hereof or extended time granted pursuant to clause 43 hereof.

12.5 The submission to and approval by the S.O or the S.O's Representative of such Work Programme or the furnishing of such particulars shall not relieve the Contractor of any of his duties or responsibilities under this Contract.

13.0 PERFORMANCE BOND/PERFORMANCE GUARANTEE SUM

- 13.1(a) The Contractor shall, on the date of the possession of Site, provide a Performance Bond or Performance Guarantee Sum as the case may be substantially in the form as in Appendix issued by an approved licensed bank or financial institution incorporated in Malaysia in favour of the Government for a sum equivalent to five percent (5%) of the total Contract Sum as specified in Appendix to secure the due performance of the obligations under this Contract by the Contractor. The Performance Bond shall remain valid and effective until twelve (12) months after the expiry of the Defect Liability Period or the issuance of the Certificate of Completion of Making Good Defects, whichever is the later.
- (b) If the Contractor fails to submit the said Performance Bond as specified in sub-clause (a) above on the date of possession of site, then the Contractor shall be deemed to have opted for Performance Bond in the form of Performance Guarantee Sum as provided for under clause 13.2 hereof.
- 13.2 The Contractor may opt for a Performance Bond in the form of Performance Guarantee Sum in lieu of the Bank, Insurance or Finance Company Guarantee as specified in clause 13.1 hereof whereby deductions of ten percent (10%) shall be made from the first interim payments and subsequent interim payment until the total amount deducted aggregate to a sum equivalent to five (5) percent of the Contract Sum. The amount deducted shall be retained by the Government up to twelve (12) months after the expiry of the Defect Liability Period or the issuance of the Certificate of Completion of Making Good Defects, whichever is the later.
- 13.3 Notwithstanding anything contained in this Contract, the Government shall be entitled at any time to call upon the Performance Bond, wholly or partially, in the event that the Contractor fails to perform or fulfil its obligations under this Contract and such failure is not remedied in accordance with this Contract.
- 13.4 If a payment is made to the Government pursuant to any claim under the Performance Bond, the Contractor shall issue to the Government further security in the form of additional performance bond or bonds for an amount not less than the amount so paid to the Government on or prior to the date of such payment so that the total sum of the Performance Bond shall be maintained at all times at the value specified in clause 13.1(a).
- 13.5 The Performance Bond (or any balance thereof remaining for the credit of the Contractor) may be released or refunded to the Contractor on the completion of making good of all defects, shrinkages or other faults which may appear during the Defects Liability Period and upon the giving of the Certificate of Completion of Making Good Defects for the whole of the Works under clause 48.
- 13.6 Notwithstanding the above, in the event that this Contract is terminated under clause 51 hereof the said Performance Bond or any balance thereof shall be forfeited.

14.0 INDEMNITY IN RESPECT OF PERSONAL INJURIES AND DAMAGE TO PROPERTY

- 14.1 The Contractor agrees with the Government that—
- (a) it shall perform all of its obligations under this Contract at its own risk and releases, to the fullest extent permitted by law, the Government and their agents and servants from all claims and demands of every kind resulting from any accident, damage, injury or death arising from the carrying out of the Works except where such accident, damage, injury or death is caused or contributed to by any act or omission or negligence of the Government or its agents and servants. The Contractor expressly agrees that in the absence of any such act, omission or negligence as aforesaid the Government shall have no responsibility or liability whatsoever in relation to such accident, damage, injury or death;

- (b) it shall indemnify and keep indemnified the Government from and against all actions, suits, claims or demands, proceedings, losses, damages, compensation, costs (including legal cost), charges and expenses whatsoever to which the Government shall or may be or become liable in respect of or arising from—
- (i) the negligent use, misuse or abuse by the Contractor or its personnel, servants, agents or employees appointed by the Contractor;
 - (ii) any loss or damage to property or injury of whatsoever nature or kind and howsoever or wherever sustained or caused or contributed to by carrying out of the Works by the Contractor to any person and not caused by the negligence or wilful act, default or omission of the Government, its agents or servants; or
 - (iii) any loss, damage or injury from any cause whatsoever to property or persons affected by the Works to the extent to which the same is occasioned or contributed to by the act, omission, neglect, breach or default of the Contractor or personnel, servants, agents or employees; and
- (c) the obligations under this clause shall continue after the expiry or earlier termination of this Contract in respect of any act, deed, matter or thing happening before such expiration or termination of this Contract.

14.2 The Contractor shall indemnify, protect and defend at its own cost and expense, the Government and its agents and servants from and against all actions, claims and liabilities arising out of acts done by the Contractor in the performance of this Contract.

15.0 INSURANCE AGAINST PERSONAL INJURIES AND DAMAGE TO PROPERTY

15.1 Taking of Insurance

- (a) Without prejudice to his liability to indemnify the Government under clause 14 hereof, the Contractor shall, as a condition precedent to the commencement of any work under this Contract, effect and maintain such insurances whether with or without an excess amount as specified in Appendix hereto as are necessary to cover the liability of the Contractor and all sub-contractors, whether nominated or otherwise.
- (b) Such insurance shall be for the purpose of personal injuries or death, damage or loss to property, movable or immovable, arising out of, or in the course of, or by reason of the execution of the Works and caused by any negligence, omission, breach of contract or default of the Contractor or any sub-contractor, whether nominated or otherwise, or of any servants or agents of the Contractor or of any such sub-contractor, whether nominated or otherwise. Where an excess amount is specified in Appendix, the Contractor shall bear the amount of such excess. The policy or policies of insurance shall contain a cross liability clause indemnifying each of the jointly insured against claims made by on him by the other jointly insured.
- (c) Such insurance as referred to under sub-clause (a) hereof shall be effected with an insurance company as approved by the Government and maintained in the joint names of the Government and Contractor and all sub-contractors, whether nominated or otherwise. Such insurance shall cover from the period of the date of possession of site until the date of issuance of Certificate of Making Good Defects for any claim occasioned by the Contractor or any sub-contractor in the course of any operations carried out by the Contractor or any sub-contractor for the purpose of complying with his obligations under Clause 48 hereof.

15.2 Production of Policies

It shall be the duty of the Contractor to produce and shall deposit the relevant policy or policies of the insurance together with receipts in respect of premiums paid to the S.O., whether demanded or not.

15.3 Default in Insuring

If the Contractor fails to effect or renew such insurances as are required to be effected and maintained under this Contract, the Government or the S.O. on its behalf may effect or renew such insurance and shall be entitled to deduct a sum equivalent to the amount in respect of the premiums paid and On-Cost Charges (calculated by applying the 'Percentage for On-cost Charges' stated in Appendix hereto to the premiums paid), from any money due or to become due to the Contractor under this Contract or to recover the same from the Performance Bond or as a debt due from the Contractor.

15.4 Cancellation of Insurance

- (a) The Contractor shall ensure that any insurance policy effected hereto shall only be cancelled by the insurer after the expiry of thirty (30) days from the date of receipt by the Government of a written notice from the insurer advising of such impending cancellation PROVIDED THAT the Contractor has been issued with the Certificate of Making Good Defects in accordance with clause 48.
- (b) The Contractor shall not at any time permit or cause to be done any act, matter or thing which may result in any insurance effected by virtue of this Contract being vitiated or rendered void or voidable or whereby the rate of the premium on any insurance effected shall be liable to be increased.

15.5 Loss or Damage Occasioned by Insured Risk

- (c) In the event of any damage or loss occurring during the performance of this Contract, the Contractor shall repair, replace or make good such damage or loss from the amount of insurance claimed, if sufficient, or if insufficient, using his own resources.

16.0 INDEMNITIES TO GOVERNMENT IN RESPECT OF CLAIMS BY WORKMEN

16.1 Workmen Compensation

- (a) The Contractor shall be liable for and shall indemnify and keep indemnified the Government and its officers or servants from all liabilities arising out of claims by any workman employed by the Contractor in and for the performance of this Contract for payment of compensation under or by virtue of the Workmen's Compensation Act 1952 and the Employee's Social Security Act 1969 or any other law amending or replacing such law and from all costs and expenses incidental and consequential thereto.
- (b) The Contractor shall effect and maintain throughout the Contract Period a "Workmen Compensation Insurance" or any other applicable insurance for its personnel, servants, agents or employees required under the laws of Malaysia.

17.0 EMPLOYEES' SOCIAL SECURITY ACT, 1969

17.1 Registration with SOCSO

Without prejudice to his liability to indemnify the Government under clause 16, the Contractor shall register or cause to register all local workmen employed in the execution of the Works and who are subject to registration under the Employee's Social Security Scheme ("the SOCSO Scheme") in accordance with the Employee's Social Security Act 1969 or any subsequent modification or re-enactment of the said Act. For the purpose of this sub-clause, the term "local workmen" shall include workmen who are Malaysian citizens and those who have permanent resident status.

17.2 Contribution to SOCSO

The Contractor shall submit the Code Number and Social Security Numbers of all the workmen registered under the SOCSO scheme to the S.O. for verification. The Contractor shall make payment of all contribution from time to time on the first contribution day on which the same ought to be paid and until the completion of this Contract and it shall be the duty of the Contractor to produce to the S.O. contribution statement or payment vouchers as evidence of payment of such contribution, whether demanded or not.

17.3 Default in Complying with SOCSO

If the Contractor fails to comply with the terms of this Clause, the Government or the S.O. on its behalf may without prejudice to any other remedy available to the Government for breach of any terms of this Contract:

- (a) withhold an amount from any money which would otherwise be due to the Contractor under this Contract and which in the opinion of the S.O. will satisfy any claims for compensation by workmen that would have been borne by SOCSO Scheme had the Contractor not made default in maintaining the contribution; and/or
- (b) pay such contributions as have become due and remain unpaid and deduct the amount of such contributions including On-Cost Charges (calculated by applying the Percentage of On-Cost Charges stated in Appendix to the contributions paid), from any money due or to become due to the Contractor under this Contract, and failing which such contributions shall be recovered from the Performance Bond or as a debt due from the Contractor.

18.0 INSURANCE OF WORKS

18.1 Taking of Insurance

- (a) The Contractor shall in the joint names of the Government and the Contractor insure against loss and damage by fire, lightning, explosion, storm, tempest, flood, ground subsidence, bursting or overflowing of water tanks, apparatus or pipes, aircraft and other aerial devices or articles dropped therefrom, riot and civil commotion, all work executed and all unfixd materials and goods, delivered to, placed on or adjacent to the Works and intended therefore (but excluding temporary buildings, plant, tools and equipment owned or hired by the Contractor or any sub-contractor, nominated or otherwise) to the full value thereof (plus any amount which may be specifically stated in Appendix or elsewhere in the Contract Documents) and shall keep such work, materials and goods so insured until the completion of the whole of the Works, notwithstanding any arrangement for Sectional Completion or Partial Occupation by the Government under this Contract. Such insurance policy or policies shall provide expressly for payment in the first place to the Government of any insurance monies due under the policy or policies.
- (b) The said insurance with or without an excess clause as specified in Appendix hereto shall be effected with an insurance company approved by the S.O. and it shall be the duty of the Contractor to produce to the S.O. the said policy or policies and the receipts in respect of the premium paid. Where an excess clause is specified in Appendix, the Contractor shall bear the amount of such excess.

18.2 Default in Insuring

If the Contractor fails to effect or renew such insurance as are necessary under this clause, the Government or the S.O. on its behalf may renew such insurance and pay the premium in respect thereof and deduct the amount so expended including On-Cost Charges (calculated by applying the 'Percentage of On-cost Charges' stated in Appendix to the premiums paid), from any money

due or to become due to the Contractor under this Contract, and failing which such premium shall be recovered from the Performance Bond or as a debt due from the Contractor.

18.3 Payment of Insurance in the Event of any Loss/Damage

Upon the occurrence of any loss or damage to the Works or unfixed materials or goods prior to the date the Works has been certified as practically completed by the S.O. in the Certificate of Practical Completion, the Contractor shall notwithstanding that settlement of any insurance claim has not been completed, with due diligence restore, replace or repair the same, remove and dispose of any debris and proceed with the carrying out and completion of the Works. All money if and when received from the insurance under this clause shall be paid in the first place to the Government and then (less any such amounts as are specifically required in Appendix or elsewhere in the Contract Documents) be released to the Contractor by instalments on the certificate for payment issued by the S.O., calculated as from the date of receipt of the money in proportion to the extent of the work of restoration, replacement or repair and the removal and disposal of debris previously carried out by the Contractor. The Contractor shall not be entitled to any payment in respect of the work of restoration, replacement or repair and the removal and disposal of debris other than the money received under the said insurance.

18.4 Cancellation of Insurance Policy

The Contractor shall ensure that any insurance policy effected hereto shall only be cancelled by the insurer after the expiry of thirty (30) days from the date of receipt by the Government of a written notice from the insurer advising of such impending cancellation PROVIDED THAT the Contractor has been issued with the Certificate of Making Good Defects in accordance with clause 48.

19.0 SETTING OUT

19.1 The Contractor shall be responsible for the true and proper setting out of the Works and for the correctness of the positions, levels, dimensions and alignments of all parts of the Works and for the provisions of all necessary instruments, appliances and labour in connection therewith.

19.2 If at any time during the progress of the Works any error in the positions, levels, dimensions or alignments of any part of the Works is discovered, the Contractor shall at his own expense rectify such error unless such error is based on incorrect data supplied in writing by the S.O.'s Representative in which case the expense of rectifying shall be borne by the Government.

19.3 If at any time during the progress of the Works, any error shall appear or arise in the setting-out required to construct the Works or in the position, levels, dimensions or alignment of any part of the Works, the Contractor, on being required to do so by the S.O., shall at his own expense rectify such error to the satisfaction of the S.O. The checking of any setting out of or of any line or level by the S.O. shall not in any way relieve the Contractor of his responsibility for the correctness thereof and the Contractor shall carefully protect and preserve all things used in the setting-out required for the construction of the Works until the S.O. agrees that the said things may be abandoned.

19.4 The Contractor shall give to the S.O. without charge such information as may be required by the S.O. to enable him to check the setting-out required for the construction of the Works including interpreting any marks made by the Contractor for the purpose of setting out.

20.0 UNFIXED MATERIALS AND GOODS

Unfixed materials and goods delivered to, placed on or adjacent to the Site and intended for incorporation therein, shall not be removed except for use upon the Works, unless the S.O. has consented in writing to such removal. Where the S.O. has included the value of such materials or

goods in any certificate in accordance with clause 28, under which the Contractor has received payment, such materials and goods shall become the property of the Government, but the Contractor shall remain responsible for loss or damage to the same.

21.0 COMPLIANCE WITH THE LAW

21.1 The Contractor shall comply in all respects (including the giving of all notices and the paying of all fees required) with any law, regulation or by-law, or any order or directive issued by any public authority or public service company (hereinafter referred to as "Statutory Requirements"), relating to the Works or, in the case of public authority or public service company, with those systems the same are or will be connected. The Contractor shall submit to the S.O. all approvals received by the Contractor in connection therein. The Contractor shall keep the Government indemnified against all penalties and liability of every kind for breach of any such Statutory Requirements.

21.2 If after the Date of Tender (as specified in Appendix) there is any change or amendment in any written law, regulations and by-laws which necessitates any variation to the Works, the Contractor shall, before making such variation, give to the S.O. a written notice specifying and giving the reason for such variation and apply for the S.O.'s instruction in respect of the matter.

22.0 DESIGN

22.1 Design Liability

- (a) Notwithstanding any design and specifications supplied by the Government, if the Contractor is required under this Contract to undertake the design of any part of the Works which is a stand alone design as determined by the Government, the Contractor shall ensure that such design is suitable, functional, safe, compatible and integrates with the design and specifications of the Works and it shall be undertaken, approved and endorsed by a competent and registered professional.
- (b) The Contractor shall submit to the S.O. all drawings, specifications, calculations and any other relevant information pertaining to the stand alone design for approval. No work shall commence without prior written consent of the S.O.
- (c) The Contractor shall be fully responsible and guarantee the Government that the stand alone design, integration, execution of the Works, materials and workmanship for the Works or part of the Works are independent of fault, suitable, functional, safe and compatible with the requirements of the Government.
- (d) The approval of the stand alone design by the S.O pursuant to sub-clause (b) shall not absolve the Contractor from its responsibility under sub-clause (c) and the Contractor shall be liable and shall fully indemnify and keep the Government indemnified for any design defects, damage, inadequacies or insufficiency of such design.

22.2 Design Guarantee Bond

- (a) The Contractor shall provide a Design Guarantee Bond for the stand alone design issued by an approved licensed bank or financial institution of the sum of Ringgit ... (RM...) amounting to 5% of the value of the said part of the Works substantially in the form as in Appendix [.....] upon or before the issuance of the Certificate of Practical Completion of the Works as a security for the Contractor's obligations and warranties under Clause 22.1. Such Design Guarantee Bond shall remain valid for a period of 5 years from the date of practical completion of the Works.
- (b) If any defect or damage shall occur to that particular part of the Works as a result of any defect, fault, insufficiency, imperfection, shrinkages or inadequacy in the stand alone

design including workmanship, materials or equipment which has become defective arising from design fault then the approved licensed bank or financial institution issuing the Design Guarantee Bond pursuant to sub-clause (a) above shall pay to the Government, on demand by the Government in writing notwithstanding any objection by the Contractor or any third party, the sum of..... being equal to 5% of the value of the said part of the Works or such part thereof as may be demanded.

- (c) If the Design Guarantee Bond is not deposited with the Government in accordance with sub-clause (a) above, the Government shall have the right to claim from the Performance Bond the sum of Ringgit (RM...) being equal to 5% of the value of the said part of the Works or such part thereof as may be demanded
- (d) If a payment is made to Government pursuant to clause (b), the Contractor shall ensure that further security in the form of an additional Design Guarantee Bond for an amount no less than the amount so paid to Government shall be issued to Government prior to or upon the date of such payment. If any of the issued Design Guarantee Bond were to expire prior to the validity period, a replacement Design Guarantee Bond shall be issued to Government on or prior to the date of expiry of the first mentioned Design Guarantee Bond in an amount not less than the amount of that Design Guarantee Bond.

23.0 EMPLOYMENT OF WORKMEN

23.1 Workmen

- (a) The Contractor shall employ, in the execution of this Contract, only Malaysian citizens as workmen.
- (b) If in any particular trade or skill required to complete the Works, the Contractor can show to the satisfaction of the S.O. that Malaysian citizens are not available, then the Contractor may employ non-Malaysian citizens subject to the approval of the Government.
- (c) The Contractor shall on the commencement of the Works furnish to the Jabatan Tenaga Kerja of the State in which this Contract is performed all particulars connected with this Contract and such returns as may be called for from time to time in respect of labour employed by him on for the execution of this Contract, in accordance with the requirements of the Employment Act 1955, Employment (Restriction) Act 1968, and Internal Security (Registration of Labour) Regulation 1960 or any subsequent modification or re-enactment thereof.
- (d) The Contractor shall maintain on the Site at all times during the progress of the Works an up to date register containing particulars of all workers employed by him.
- (e) The Contractor shall cause his sub-contractors (including 'labour only' sub-contractors) and Nominated Sub-Contractors to comply with the provisions of this clause.

23.2 Compliance with Employment Act 1955, etc.

In the employment of workmen for the execution of this Contract, the Contractor shall comply, and shall cause his sub-contractors (including "labour only" sub-contractors) and Nominated Sub-Contractors to comply with all the requirements of the Employment Act 1955, Employment (Restriction) Act 1968, Employee's Provident Fund Act 1951, the Industrial Relations Act 1967 and any other law relating to the employment of workmen, or any subsequent modification or re-enactment thereof. PROVIDED THAT the Contractor shall not be entitled to any claim for additional costs and payments whatsoever in respect of his compliance with this clause.

23.3 Days and Hours of Working

No work shall be done on:

- (a) the weekly day of rest;
- (b) any public holiday which is recognised in the state where this Contract is being carried out; or
- (c) between the hours of six in the evening and six in the following morning;

without the written permission of the S.O. PROVIDED THAT when such written application of the Contractor is approved by the S.O., the Contractor shall comply fully with all the requirements of the Employment Ordinance 1955 in regard thereto or any subsequent modification or re-enactment thereof and shall bear any costs for compliance therewith, and any extra costs incurred by the Government in connection with the supervision of the Works.

23.4 Wages Books and Time Sheets

- (a) The Contractor shall keep and shall cause his sub-contractors (including "labour only" sub-contractors) and Nominated Sub-Contractors to keep proper wages books and time sheets showing wages paid to and the time worked by all workmen employed by him and his sub-contractors as aforesaid in and for the performance of this Contract.
- (b) The Contractor shall produce such wages books and time sheets on demand for inspection by any persons duly authorised by the S.O.
- (c) The Contractor shall furnish to the S.O. or S.O.'s Representative such information relating to the wages and conditions of employment of such workmen as the S.O. may from time to time require.

23.5 Default in Payment of Wages

In the event of default in the payment of –

- (a) any money in respect of wages; and/or
- (b) payment in respect of Employees Provident Fund Contributions,

of any workmen employed by the Contractor or his sub-contractors (including "labour only" sub-contractors) and Nominated Sub-contractors in and for the performance of this Contract, which a claim has been filed with the Department of Labour, then the S.O. shall make payment to the Director General of Labour and/or Employees Provident Fund, as the case may be, out of any monies at any time due to the Contractor under this Contract and such payment shall be deemed to be a payment made to the Contractor by the Government under and by virtue of this Contract.

23.6 Discharge of Workmen

- (a) The Contractor shall employ in and about the execution of the Works only such persons as are of good character, careful, skilled and experienced in their respective vocations and trades.
- (b) The S.O. shall be at liberty to object to and require the Contractor to remove immediately from the Site any person employed by the Contractor in or about the execution of the Works who in the opinion of the S.O. misconducts himself or is incompetent or negligent in the proper performance of his duties. Such person shall not again be employed upon the Works without the prior written permission of the S.O.

- (c) Any person so removed from the Works shall be replaced without delay by a substitute approved by the S.O. PROVIDED THAT the Contractor shall not be entitled to any claim for any expense whatsoever incurred by him in respect of any direction given by the S.O. under this clause.

24.0 VARIATIONS

- 24.1 The S.O. may issue instructions requiring a Variation in a form of a Variation Order. No variation required by the S.O. shall vitiate this Contract. Upon the issuance of such Variation Order, the Contractor shall forthwith comply with the Variation Order issued by the S.O.
- 24.2 The term 'Variation' means a change in the Contract Document which necessitates the alteration or modification of the design, quality or quantity of the Works as described by or referred to therein and affects the Contract Sum, including:
- (a) the addition, omission or substitution of any work;
 - (b) the alteration of the kind or standard of any of the materials, goods to be used in the Works; or
 - (c) the removal from the Site of any work executed or materials or goods brought thereon by the Contractor for the purposes of the Works other than work, materials or goods which are not in accordance with this Contract.
- 24.3 Any variation made under this clause shall not relieve the Contractor from his obligations under clause 22.1(c).

25.0 VALUATION OF VARIATION

- 25.1 All variations instructed in writing by the S.O. in accordance with clause 24 hereof shall be measured and valued by the S.O. The valuation of Variations, unless previously or otherwise agreed, shall be made in accordance with the following rules:
- (a) the rates in the Bills of Quantities after adjustment if necessary as provided in clauses 26.6 and 26.7 hereof, shall determine the valuation of work of similar character and executed under similar conditions as work priced therein;
 - (b) the said rates, where work is not of similar character or executed under similar conditions as aforesaid, shall be the basis of rates for the same, so far as may be reasonable, failing which a fair valuation thereof shall be made by the S.O.;
 - (c) the rates in the Bills of Quantities shall determine the valuation of items omitted, PROVIDED THAT if the omission substantially vary the conditions under which any remaining items of work are carried out, the rates of such remaining items shall be valued under rule (b);
- 25.2 Where work cannot properly be measured or valued, the S.O. may allow daywork price as specified in Appendix. Unless otherwise provided in the Bills of Quantities, the daywork prices for the purpose of this Contract shall be taken to mean the actual net cost to the Contractor of his materials, plant and labour for the work concerned. The Contractor shall be paid daywork prices, plus fifteen percent (15%), which shall include for the cost of all ordinary plant, tools, scaffolding, supervision and profit. PROVIDED ALWAYS that as a condition precedent to any right to any payment the Contractor shall produce vouchers, receipts and wage books specifying the time for labour and plant employed and materials used to the S.O. not exceeding seven (7) days after the work shall have been done.

- 25.3 The amount of variations shall be certified by the S.O. and added to or deducted from the Contract Sum as the case may be and the amount shall be adjusted accordingly.

26.0 BILL OF QUANTITIES

Basis of Contract Sum

- 26.1 The quality and quantity of the Works as set out in the Bills of Quantities shall be the basis of the Contract Sum. Any error in description or quantity or omission of Works from the Bills of Quantities shall not vitiate this Contract but shall be rectified and the amount in respect of such rectification shall be added to or deducted from the Contract Sum as the case may be.
- 26.2 The Government reserves the right to adjust the prices and rates in the Bills of Quantities submitted by the Contractor to ensure their reasonableness before acceptance of tender and the decision of the Government shall be final.
- 26.3 Any adjustment of the prices and/or rates in the Bills of Quantities required under clause 26. 2 and any arithmetical error or omission in the prices or rates and/or calculations of the Contractor in the Bills of Quantities shall before the signing of this Contract be so rectified and adjusted that when correctly calculated, the total amount in the Summary of the Bills of Quantities shall represent the same amount as the tender amount in the Form of Tender. The tender amount shown in the Form of Tender shall remain unaltered but the nett aggregate amount of the difference between the total adjusted amount in the Summary of the Bills of Quantities and the tender amount shown in the Form of Tender, whether a nett deduction or nett addition, shall be calculated as a percentage of the total adjusted amount shown in the Summary of the Bills of Quantities and all prices and/or rates throughout the Bills of Quantities shall be subject to such percentage discounts or premiums as the case may be. Provided always that Provisional and Prime Cost Sums shall be excluded from such calculation and shall not be subject to such percentage discount or premium.

Standard Method of Measurement

- 26.4 The Bills of Quantities, unless otherwise expressly stated in respect of any specified item or items, shall be deemed to have been prepared in accordance with the principles of the Standard Method of Measurement of Building Works as published by the Institution of Surveyors (Malaysia) or Civil Engineering Method of Measurement published by Institution of Civil Engineers (London) or Method of Measurement as set out in Bill of Quantities.

Provisional Quantities

- 26.5 Unless where the quantities of the Works or any part thereof are stated as 'provisional' in the Bills of Quantities such quantities are firm and the Works shall not be subject to re-measurement unless the Bills of Quantities are proven to be erroneous and shall be dealt with under clause 26.1.
- 26.6 Where the quantities of Works are stated as "provisional" in the Bills of Quantities, such quantities are the estimated quantities which shall not be taken as the actual and correct quantities of Works to be executed by the Contractor in the fulfilment of his obligations under the Contract. The amount to be paid to the Contractor in respect of such Works upon completion of this Contract shall be ascertained by remeasurement of the work as it is actually executed and valued in accordance with clause 25.1 hereof, after adjustment if necessary as provided in clause 25.3 hereof.
- 26.7 For the purpose of clause 26.6, the amount to be paid to the Contractor shall be set off against the amount for such work in the Bills of Quantities, and the balance shall be added to or deducted from the Contract Sum as the case may be.

27.0 MEASUREMENT OF WORKS

- 27.1 The S.O. shall, when he requires any part or parts of the Works to be measured or remeasured for the purposes of clauses of Variation under clause 24 and provisional quantities under clause 26.5, give reasonable notice to the Contractor who shall attend or send a qualified agent to assist the S.O. or S.O.'s Representative in making such measurement and shall furnish all particulars required by the S.O.. Should the Contractor fail to attend or neglect or omit to send such agent, then the measurement made by the S.O. or approved by him shall be taken to be the correct measurement of the work.
- 27.2 Upon the completion of the measurement pursuant to clause 27.1, the S.O. shall supply the Contractor with such measurement in respect of the said parts.

28.0 PAYMENT TO CONTRACTOR AND INTERIM CERTIFICATES

- 28.1 When the Contractor has executed work including delivery to or adjacent to the Works of any unfixed materials or goods intended for incorporation into the Works in accordance with the terms of this Contract and their total value of work thereof has reached the sum referred to in Appendix, the S.O. shall at that time make the first valuation of the same.
- 28.2 Thereafter, once (or more often at the discretion of the S.O.) during the course of each succeeding month the S.O. shall make a valuation of the works properly executed and of unfixed materials and goods delivered to or adjacent to the Site, provided the total value of work properly executed and the value of unfixed materials and goods as specified in clause 28.4 hereof, delivered to the Site intended for incorporation into the Works in each subsequent valuation shall not be less than the sum referred to in Appendix.
- 28.3 Within fourteen (14) days from the date of any such valuation being made and subject to the provision mentioned in clause 28.1, the S.O. shall issue an Interim Certificate stating the amount due to the Contractor from the Government. PROVIDED THAT the signing of this Contract shall not be a condition precedent for the issue of the first Interim Certificate (and no other) so long as the Contractor has returned the Letter of Acceptance of Tender duly signed and has deposited with the S.O. or the Government the relevant insurance policies under clauses 15 and 18 hereof.
- 28.4 The amount stated as due in an Interim Certificate shall, subject to any agreement between the Parties as to payment by stages, be the estimated total value of the work properly executed and up to ninety percent (90%) of the value of the unfixed materials and goods delivered to or adjacent to the Site intended for incorporation into the permanent Works up to and including the date the valuation was made, less any payment (including advance payment) previously made paid under this Contract. PROVIDED THAT such certificate shall only include the value of the said unfixed materials and goods as and from such time as they are reasonably and properly and not prematurely delivered to or adjacent to the Site and adequately protected against weather, damage or deterioration.
- 28.5 This clause shall not apply to any unfixed materials and goods which are supplied and delivered by Nominated Suppliers for which payment shall be made for the full value of the unfixed materials and goods.
- 28.6 Within a number of days as stated in Appendix (or if none stated then within thirty (30) days of the issue of any such Interim Certificate), the Government shall make a payment to the Contractor as follows:
- (a) where the Performance Bond is in the form of a Banker's, Insurance or Finance Company Guarantee, payment shall be made on the amount certified as due to the Contractor in the said Interim Certificate; or
 - (b) where the Performance Bond is in the form of a Performance Guarantee Sum, payment of ninety percent (90%) on the amount certified as due to the Contractor shall be made

with the remaining ten percent (10%) being retained by the Government as a Performance Guarantee Sum. PROVIDED THAT when the sum retained is equivalent to five percent (5%) of the Contract Sum then in any subsequent Certificate, payment shall be made on the full amount certified as due to the Contractor.

29.0 ADJUSTMENT OF CONTRACT SUM

The amount to be added to or deducted from the Contract Sum in respect of expense or loss due to fees and charges in relation to the supply of water and electricity and permanent connections to water, electricity, telephone and sewerage mains under clause 6.2, variations under clause 24, rectification of errors in Bill of Quantities under clause 26.3, fluctuation of price under clause 30, payment of P.C. Sums and Provisional Sums under clause 34, opening up work for inspection and testing of materials or goods and executed work under clause 35.2, loss and expense under clause 44 and costs of disposal of fossils, *etc.* under clause 65 hereof, shall be certified by the S.O.

30.0 FLUCTUATION OF PRICE

In accordance with the Special Provisions to the Conditions of Contract for Fluctuation of Price as contained in Appendix (if applicable), the amount payable by the Government to the Contractor upon the issue by the S.O. of an Interim Certificate under clause 28 hereof shall be increased or decreased accordingly. The net total of any such increases or decreases shall be given effect to in determining the Contract Sum.

31.0 FINAL ACCOUNT AND PAYMENT CERTIFICATE

- 31.1 As soon as is practicable but not later than three (3) months after the issuance of the Certificate of Practical Completion, the Contractor shall submit full particulars complete with receipts, vouchers records that would substantiate the Contractor's claim under clause 44 together with any documents, supporting vouchers and any explanation and calculations including documents relating to the accounts of Nominated Sub-Contractors or Nominated Suppliers, which may be necessary to enable the Final Account to be prepared by the S.O. PROVIDED ALWAYS the Contractor had given the notice of claim in writing within the stipulated time or times in the said provisions.
- 31.2 If the Contractor fails to submit full particulars of all claims within the stipulated period, the S.O. shall forthwith make the assessment based on the available documents submitted by the Contractor for the purpose of the Final Account. The Government shall be discharged from all liabilities in connection with the claims.
- 31.3 Within three (3) months after the expiry of the Defects Liability Period for the whole of the Works or three (3) months after the issue of the Certificate of Completion of Making Good Defects under clause 48 hereof, whichever is the later, the S.O. shall issue the Final Certificate.
- 31.4 The Final Certificate shall be supported by documents, and full particulars complete with receipts, vouchers records showing the S.O.'s final valuation of Works and any amount determined in clause 31.1 in accordance with the terms of this Contract. After setting out or allowing for all payments or other expenditure of the Government or any permitted deductions made by the Government or the S.O. on its behalf, the Final Certificate shall state any final balance due from the Government to the Contractor or from the Contractor to the Government, as the case may be, which shall thereupon become the debt payable. Such certificate shall also take account of any outstanding permitted deductions not yet made by the Government under the terms of this Contract whether by way of liquidated damages or otherwise.

- 31.5 No final payment due to the Contractor under the Final Certificate, shall be made unless and until the Contractor shall have satisfied the S.O. by means of a Statutory Declaration made by or on behalf of the Contractor to the effect that the workmen who have been employed by the Contractor on the Works including workmen employed by sub-contractors, whether nominated or otherwise (including "labour only" sub-contractors) have received all wages due to them in connection with such employment, and that all dues or contributions under the Employment Act 1955, the Employee's Social Security Act 1969, the Employee's Provident Fund Act 1965 and any other laws relevant to the employment of workmen, have been paid.

32.0 EFFECT OF S.O.'S CERTIFICATES

No certificate of the S.O. under any provision of this Contract shall be considered as conclusive evidence as to the sufficiency of any work, materials or goods to which it relates, nor shall it relieve the Contractor from his liability to amend and make good all defects, imperfections, shrinkages, or any other faults whatsoever as provided by this Contract. In any case, no certificate of the S.O. shall be final and binding in any dispute between the Government and the Contractor if the dispute is brought whether before an arbitrator or in the Courts.

33.0 DEDUCTION FROM MONEY DUE TO CONTRACTOR

The Government or the S.O. on its behalf shall be entitled to deduct any money owing from the Contractor to the Government under this Contract from any sum which may become due or is payable by the Government to the Contractor under this Contract or any other contracts to which the Government and Contractor are Parties thereto. The S.O. in issuing any certificate under clauses 28 and 31, shall have regard to any such sum so chargeable against the Contractor, provided always that this provision shall not affect any other remedy to which the Government may be entitled for the recovery of such sums.

34.0 PRIME COST / PROVISIONAL SUMS

- 34.1 In respect of any and every Prime Cost or P.C. Sum provided in the Contract, the amount due to any Contractor shall be determined by deducting the said Prime Cost or P.C. Sum and the relevant profit and/or attendance charges from the Contract Sum and substituting for the same with the actual amount due to relevant Nominated Sub- Contractor or Nominated Supplier as valued in accordance with the relevant sub-contract and the sums due to any Contractor by way of profit and/or attendance charges at the rates or prices stipulated in the Contract Documents (if any).
- 34.2 The Provisional Sum may be expended at such times and in such amounts as the S.O. may direct. Such sum if not used either wholly or in part shall be deducted from the Contract Sum. The value of works which are executed by the Contractor in respect of Provisional Sums shall be ascertained in accordance with clause 25 hereof. The said value of such work executed by the Contractor shall be set off against all such Provisional Sums and the balance shall be added to or deducted from the Contract Sum as the case may be.
- 34.3 Any work to be executed, or materials or goods to be supplied for which Provisional Sums are provided in the Bills of Quantities may, if the S.O. so decides, be treated as P.C. Sum items and shall be dealt with in accordance with clause 34.1.
- 34.4 Where the Contractor in the ordinary course of his business directly carries out works for which P.C. Sums are provided in the Bills of Quantities and where such works are set out in Appendix hereto and the S.O. is prepared to accept tenders from the Contractor for such works the Contractor shall be permitted to tender for the same or any of them without prejudice to Government's right to reject the lowest or any tender. If the tender of the Contractor for any work

included in the P.C. Sum is accepted, such tender shall be held to include the profit and attendance charges, and the Contractor shall not be entitled to the profit and attendance charges as contained in the Bills of Quantities notwithstanding any provision to the contrary under clause 34.1.

35.0 MATERIALS, GOODS AND WORKMANSHIP

- 35.1 All materials, goods and workmanship shall be of the respective kinds and standards described in the Specification and of good quality and in accordance with the standard of the workmanship in the industry. The Contractor shall upon the request of the S.O. furnish him with the relevant certificates and/or vouchers to prove that the materials and goods comply with the Specification.
- 35.2 The Contractor shall, entirely at his own cost, provide samples of materials and goods for testing purposes. The Contractor shall, when instructed by the S.O. to open up for inspection any work covered up, or arrange for or carry out any test of any materials or goods (whether or not already incorporated in the Works) or of any executed work which the S.O. may in writing require and the cost of such opening up or testing (together with the cost of making good in consequence thereof) shall be added to the Contract Sum unless provided for in the Bills of Quantities by way of Provisional Sums or otherwise or unless the inspection or test shows that the work, materials or goods are not in accordance with this Contract.
- 35.3 The Contractor shall pay all duties and taxes which may be imposed by law, such as customs duties and sales tax, on all materials, goods and equipment, whether purchased or imported in the Contractor's name or his agent, which are incorporated in the Works or used directly in the construction, completion or maintenance of the Works.
- 35.4 Except where otherwise specified, the Contractor shall pay all tonnage and other royalties, rent fees and other payments or compensation (if any) for getting stone, sand, gravel, clay or other materials required for the Works.

36.0 INSPECTION AND TESTING OF MATERIALS, GOODS AND EQUIPMENT

- 36.1 Further to his the Contractor's obligations under clause 10, the Contractor shall submit to the S.O. for his approval, proposals for inspecting the design and setting out of the Works and testing the materials and workmanship to ensure that the Contractor's obligations under the Contract are fulfilled.
- 36.2 The Contractor shall carry out the inspection and tests approved under clause 36.5 or elsewhere in the Contract and such further tests as the S.O. may reasonably require, including to open up for inspection any work covered up or to carry out any test of any materials or goods (whether or not already incorporated in the Works or any executed Works).
- 36.3 The S.O. may issue instructions to the Contractor to remove from the Site or rectify any work, goods which are not in accordance with this Contract at his own cost.
- 36.4 The Contractor shall, as may be required by the S.O. from time to time, provide such assistance, instruments, machines, labour and materials as are normally required for the purpose of examining, measuring and testing of any work, as well as and the quality, weight or quantity of the materials used, and shall supply samples of materials before incorporation in the Works for testing.
- 36.5 Unless the Contract otherwise provides, the cost of making any test shall be borne by the Contractor if such test is:
- (a) proposed by the Contractor; or

(b) clearly intended by or provided for in the Contract.

36.6 Notwithstanding anything in clause 36.5, if the Contractor carries out any further test as required by the S.O. pursuant to clause 36.2 and the result of such test shows the workmanship or materials is not in accordance with the provisions of the Contract, then the cost of such test shall be borne by the Contractor. But if the result of such test shows the workmanship or materials comply with the provisions of the Contract, then the cost of such test shall be borne by the Government.

37.0 CONSTRUCTIONAL PLANT, EQUIPMENT, VEHICLES AND MACHINERIES

37.1 The Contractor shall pay all port dues including (but not by way of limitation) wharfage dues, pilotage fees, anchorage, berthage and mooring fees, quarantine dues, loading portorage and overtime fees for constructional plant, equipment, vehicles and machineries for use directly in connection with the construction, completion of the works brought into and despatched from Malaysia by the Contractor (or in his name by agents).

37.2 The Contractor shall furnish to the S.O. all such shipping documents, invoices and other documentation as may be required by the Customs Authorities in connection with the importation of goods, materials, constructional plant, equipment, vehicles and machineries.

37.3 In the case of constructional plant, equipment, vehicles, and machineries imported on the Contractor's behalf by importing agents and the like both the shipping documents and the invoices of the original suppliers or manufacturers must indicate clearly that the consignment is for the Contractor's account.

37.4 The procedure in respect of the requirements of the foregoing shall be determined by the Customs Authorities. The Contractor shall make written application to the S.O. and shall provide the relevant documentation of all constructional plant, equipment, vehicles and machineries to be imported into Malaysia not less than forty-five (45) days before the arrival of the said constructional plant, equipment, vehicles and machineries.

37.5 The Contractor shall pay all charges and other expenses in connection with the landing and shipment of all constructional plant materials and other things of whatsoever nature brought into or despatched from Malaysia for the purpose of the Contract.

37.6 The Contractor shall make his own arrangement in obtaining clearance through the Customs of constructional plant, equipment, vehicles and machineries. However, if required, the S.O.'s assistance may be sought.

37.7 Under this Contract, the Contractor shall be required to furnish all lists of constructional plant, equipment, vehicles and machineries to the S.O. whether the constructional plant, equipment, vehicles and machineries are hired or acquired.

38.0 POSSESSION OF SITE

38.1 No work under this Contract shall commence unless and until the Performance Bond stipulated under clause 13 and such insurance policy as specified under clauses 15 and 18 shall have been deposited with the Government, PROVIDED THAT for the purposes of this clause only (but for no other), if the Contractor shall produce to the Government the cover note of the said insurance policy and the receipt of premium paid, it shall be a sufficient discharge of his obligations under this clause.

38.2 Unless the Contract Documents shall otherwise provide, possession of the Site as complete as may reasonably be possible but not so as to constitute a tenancy, shall be given on or before the "Date for Possession" stated in the Letter of Acceptance to the Contractor who shall thereupon

and forthwith commence the Works (but subject to clause 38.1) and regularly and diligently proceed with and complete the Works on or before the Date for Completion as stated in Appendix.

- 38.3 The "Date for Completion" of the Works as referred to under clause 39 hereof shall be calculated from the said "Date for Possession". PROVIDED ALWAYS that the possession of Site may be given in section or in parts and any other restrictions upon possession of the Site shall be stated in the Appendix to these Conditions or in the Contract Documents.
- 38.4 In the event of any delay in giving possession of the Site from the "Date for Possession" as stated in Letter of Acceptance or delay in giving any section or part of the Site as provided in clause 38.3, the S.O. may issue instructions in regard to the revision of the "Date for Possession" and the "Date for Completion" shall be appropriately revised under clause 43.1(h) hereof, but the Contractor shall not be entitled to claim for any loss or damage caused by such delay in giving possession of the Site, nor shall he be entitled to terminate this Contract.
- 38.5 In the event that the giving of the possession of the whole Site is delayed beyond ninety (90) days of the "Date for Possession" stated in the Letter of Acceptance, the S.O. shall give written notice to the Contractor of the causes of such delay. Upon the receipt of the said written notice issued by the S.O., the Contractor may, inform the S.O. in writing of its decision within fourteen (14) days of receipt of the said notice either to:
- (a) agree to proceed with the Works when the Site is subsequently made available, in which case clause 38.4 shall apply in particular, the Contractor shall not be entitled to claim for any loss or damage caused by such delay in giving possession of the Site, or
 - (b) terminate this Contract, without prejudice to any other rights or remedies that the Government and the Contractor may have as a result of the termination.
- 38.6 In the event that the giving of possession of any section or part of the Site (whether provided for in clause 38.3 or otherwise) is delayed beyond ninety (90) days from the Date of Possession stated in the Appendix or the date the Contractor is scheduled to commence work on that section or part of the Works in accordance with the approved programme of Works as referred to in clause 12 hereof as the case may be, then the S.O. shall give written notice to the Contractor of the causes of such delay. Upon receipt of the said written notice, the Contractor may inform the S.O. in writing, within fourteen (14) days of receipt of the said notice of its decision either to:
- (a) agree to proceed with the Works when the section or part of the Site is subsequently made available, in which case sub-clause 38.5(a) above shall apply and in particular, the Contractor shall not be entitled to claim for any loss or damage caused by such delay as aforesaid; or
 - (b) request for S.O.'s instruction to omit the relevant section or part of the Works from the Contract. If the S.O. agrees to such request then the relevant section or part of the Works shall be duly omitted and deemed to be a variation to the Contract. Such variation shall not vitiate this Contract. If the S.O. does not agree to such request as aforesaid, then the Contractor shall be entitled to claim for any loss and/or expenses caused by and in respect of such delay beyond ninety (90) days as aforesaid.

39.0 COMPLETION OF WORKS

- 39.1 Subject to clauses 38.3 and 41, the Contractor shall complete the whole of the Works on or before the "Date for Completion" as stated in the Appendix or such extended time as may be allowed under clause 43 hereof.
- 39.2 If the Contractor considers that the works have achieved practical completion, the Contractor shall notify the S.O. in writing to that effect.

- 39.3 Within 14 days of receipt of such notice, the S.O. shall carry out testing/ inspection of the Works. Pursuant to such inspection/testing, the S.O. shall –
- (a) issue the Certificate of Practical Completion to the Contractor if in his opinion the whole Works have reached Practical Completion and have satisfactorily passed any inspection/test carried out by the S.O. The date of such completion shall be certified by the S.O. and such date shall be the date of the commencement of the Defects Liability Period as provided in clause 48 hereof; or
 - (b) give instruction to the Contractor specifying all defective works which are required to be completed by the Contractor before the issuance of the Certificate of Practical Completion.
- 39.4 If the S.O. has given instruction pursuant to clause 39.3(b), no Certificate of Practical Completion shall be issued to the Contractor until the Contractor has effectively carried out the remedial work within reasonable period to the satisfaction of the S.O.
- 39.5 The Works shall not be regarded as practically complete unless it has fulfilled the following:
- (a) the Works have been completed in accordance with the terms and conditions of this Contract;
 - (b) the Government can have full, proper and beneficial use of the Works for their intended purpose, notwithstanding that there may be works of a very minor defects PROVIDED THAT such works do not prevent or diminish the full, proper and beneficial use as aforesaid;
 - (c) the Works have passed any commissioning tests required in the Contract Document;
 - (d) the Works shall be made available to the Government in a condition fit for occupation; and
 - (e) all the essential services, including access roads, landscape, car parks, drains, sanitary, water and electricity installation, fire hydrant, sewerage and refuse disposal equipment and fire lifts specified in this Contract.
- 39.6 When the whole of the Works have reached practical completion to the satisfaction of the S.O., the date of such completion shall be certified by him and such date shall be the date of the commencement of the Defects Liability Period as provided in clause 48 hereof.

40.0 DAMAGES FOR NON-COMPLETION

- 40.1 If the Contractor fails to complete the Works by the Date for Completion or within any extended time granted pursuant to clause 43, the S.O. shall forthwith issue a Certificate of Non-Completion to the Contractor.
- 40.2 Without prejudice to the Government's right to terminate this Contract, when the S.O. issues the Certificate of Non-Completion, the Government shall be entitled to recover from the Contractor, Liquidated and Ascertained Damages calculated at the rate stated in Appendix 1 from the period of the issuance of the Certificate of Non-Completion to the date of issuance of Certificate of Practical Completion or the date of termination of this Contract. The S.O. may deduct such Liquidated and Ascertained Damages from any money due or to become due to the Contractor, failing which such damages shall be recovered from the Performance Bond or as a debt due from the Contractor. The S.O. shall inform the Contractor in writing of such deduction.
- 40.3 The Liquidated and Ascertained Damages stated in Appendix 1 shall be deemed to be a reasonable amount of loss which the Government will suffer in the event that the Contractor is in

breach of this clause. The Contractor by entering into this Contract agrees to pay to the Government the said amount(s) if the same become due without the need of the Government to prove his actual damage or loss.

- 40.4 The payment or deduction of such Liquidated and Ascertained Damages shall not relieve the Contractor from his obligation to complete the Works or from any of its obligations and liabilities under the Contract.

41.0 SECTIONAL COMPLETION

- 41.1 Where different completion dates for different sections or parts of the Works are stated and identified in Appendix or elsewhere in the Contract Documents and different and separate Liquidated and Ascertained Damages are provided for each section or part of the Works, the provisions of this Contract in regard to:

- (a) Certificate of Practical Completion;
- (b) Delay and Extension of Time;
- (c) Liquidated Ascertained Damages; and
- (d) Defects Liability Period,

but not Insurance of the Works under clause 18, Performance Bond under clause 13 and final payment on the Final Certificate under clause 31 hereof shall, in the absence of any express provision to the contrary elsewhere in the Contract Documents apply as if each such section or part was the subject of a separate and distinct contract between the Government and the Contractor.

- 41.2 For the avoidance of doubt, nothing contained in clause 41.1 shall entitle the Contractor to the release of the whole or any part of the Performance Bond or Performance Guarantee Sum deposited by him. The Performance Bond or Performance Guarantee Sum shall be released or be refunded only upon the issue of the Certificate of Making Good Defects of the whole of the Works or in respect of the last section of the Works, as the case may be.

42.0 PARTIAL OCCUPATION/TAKING OVER BY GOVERNMENT

- 42.1 If at any time before the whole of the Works have reached practical completion pursuant to clause 39, the Government with the consent of the Contractor (which consent shall not be unreasonably withheld) shall take possession of and occupy any part or parts of the same (any such part being hereinafter in this Clause referred to as 'the relevant part'), then notwithstanding anything expressed or implied elsewhere in this Contract.

Certificate of Partial Occupation

- (a) within seven (7) days from the date on which the Government shall have taken possession of the relevant part, the S.O. shall issue a Certificate of Partial Occupation in respect of the relevant part stating the estimated value of the said relevant part, and for all the purposes of this Clause (but for no other) the value so stated shall be deemed to be the total value of the said relevant part;

Defects Liability Period

- (b) for the purposes of clauses 39 and 48 hereof, the relevant part shall be deemed to have reached practical completion and the Defects Liability Period in respect of the relevant

part shall be deemed to have commenced on the date on which the Government shall have taken possession and occupied thereof;

Certificate of Making Good Defects

- (c) at the end of the Defects Liability Period of the relevant part and if in the opinion of the S.O. any defect, imperfection, shrinkage or any other fault whatsoever in respect of the relevant part which he may have required to be made good under clause 48.1, shall have been made good by the Contractor, the S.O. shall issue a certificate to that effect;

Reduction of Liquidated Ascertained Damages

- (d) if, before the time of completion of the whole of the Works or, if applicable any section, a Certificate of Practical Completion has been issued for any part of the Works or of a section, the rate of the liquidated and ascertained damages for delay in completion of the remainder of the Works or of that section shall, for any period of delay after the date stated in such Certificate of Practical Completion, be reduced in the proportion which the value of the part so certified bears to the value of the whole of the Works or section, as applicable;

Insurance of the Works

- (e) notwithstanding the partial occupation by the Government of the relevant part the Contractor shall insure and keep insured the Works in the manner as stipulated under clause 18 and the Contractor shall give notice to the insurer of such partial occupation; and

Performance Bond Not Affected

- (f) it is expressly agreed that nothing contained in the preceding paragraphs shall entitle the Contractor to the release of the Performance Bond or any part thereof deposited by him under clause 13 hereof, the intention being that the said Performance Bond or any part thereof shall be released or refunded only upon the completion of making good all defects, imperfections, shrinkages or other faults which may appear during the Defects Liability Period and upon the giving of the Certificate of Completion of Making Good Defects for the whole of the Works under clause 48 hereof.

43.0 DELAY AND EXTENSION OF TIME

43.1 Upon it becoming reasonably apparent that the progress of the Works is delayed, the Contractor shall forthwith give written notice to the S.O as to the causes of delay and relevant information with supporting documents enabling the said officer to form an opinion as to the cause and calculation of the length of delay. If in the opinion of the S.O the completion of the Works is likely to be delayed or has been delayed beyond the Date for Completion stated in Appendix 1 or beyond any extended Date for Completion previously fixed under this Clause due to any or more of the following events:

- (a) force majeure as provided under clause 58;
- (b) exceptionally inclement weather;
- (c) suspension of Works under clause 50;
- (d) directions given by the S.O., consequential upon disputes with neighbouring owners provided the same is not due to any act, negligence or default of the Contractor or any sub-contractor, nominated or otherwise;

- (e) S.O.'s instructions issued under clause 5 hereof, PROVIDED THAT such instructions are not issued due to any act, negligence, default or breach of this Contract by the Contractor or any sub-contractor, nominated or otherwise;
- (f) the Contractor not having received in due time instructions in regard to the nomination of sub-contractors and/or suppliers provided in this Contract, necessary instructions, drawings or levels for the execution of the Works from the S.O. due to any negligence or default of the S.O. PROVIDED THAT the Contractor shall have specifically applied in writing on a date which having regard to the Date for Completion stated in Appendix or to any extension of time then fixed under this clause, was neither unreasonably distant from nor unreasonably close to the date on which it was necessary for him to receive the same;
- (g) delay in giving possession of the Site as provided under clause 38.4 hereof other than claim in effecting insurance and Performance Bond;
- (h) delay on the part of artists, tradesmen or others engaged by the Government in executing work not forming part of this Contract;
- (i) the Contractor's inability for reason beyond his control and which he could not reasonably have foreseen at the date of closing of tender of this Contract to secure such goods, materials and/or services as are essential to the proper carrying out of the Works; or
- (j) delay on the part of the Nominated Sub-contractors and/or Nominated Suppliers to perform their works, due to reasons as stated above in sub-clauses (a) to (i),

then the S.O. may if he is of the opinion that the extension of time should be granted, so soon as he is able to estimate the length of the delay beyond the date or time aforesaid issue a Certificate of Delay and Extension of Time giving a fair reasonable extension of time for completion of the Works.

PROVIDED THAT all such delays are not due to any act, negligence, default or breach of contract by the Nominated Sub-contractor and/or Nominated Supplier and/or the Contractor, or any of the servants or agents of such Nominated Sub-contractor or Nominated Supplier or the Contractor.

PROVIDED ALWAYS that the Contractor has taken all reasonable steps to avoid or reduce such delay and shall do all that may reasonably be required to the satisfaction of the S.O. to proceed with the Works.

PROVIDED FURTHER that the Contractor shall not be entitled to any extension of time where the instructions or acts of the S.O. are necessitated by or intended to remedy any default of or breach of contract by the Contractor.

44.0 CLAIMS FOR LOSS AND EXPENSE

- 44.1 If at any time during the regular progress of the Works or any part thereof has been materially affected by reason of delays as stated under clause 43.1 (c), (d), (e), (f) and (h), and the Contractor has incurred direct loss and/or expense beyond that reasonably contemplated and for which the Contractor would not be reimbursed by a payment made under any other provision in this Contract, then the Contractor shall within thirty (30) days of the occurrence of such event or circumstances or instructions give notice in writing to the S.O. of his intention to claim for such

direct loss or expense together with an estimate of the amount of such loss and/or expense, subject always to clause 44.2 hereof.

- 44.2 As soon as is practicable but not later than ninety (90) days after practical completion of the Works, the Contractor shall submit full particulars of all claims for direct loss or expense under clause 44.1 together with all supporting documents, vouchers, explanations and calculations which may be necessary to enable the direct loss or expense to be ascertained by the S.O.. The amount of such direct loss or expense ascertained by the S.O. shall be added to the Contract Sum.
- 44.3 If the Contractor fails to comply with clauses 44.1 and 44.2, he shall not be entitled to such claim and the Government shall be discharged from all liability in connection with the claim.

45.0 INVESTIGATION BY THE GOVERNMENT AND OTHER PERSONS IN CASE OF ACCIDENT, FAILURE OR OTHER EVENT

Where the Government, its employee or any person or body appointed or authorised by it carries out any investigation in relation to any accident, failure or other event which has occurred to, in or in connection with the Works or any part thereof for the purpose of determining the cause or reason for the said accident, failure or event, the Contractor shall render all such necessary assistance and facilities as may be required by the Government, its employee or such person or body, including the giving of access to all specifications, designs, records and other available information relating to the Works.

46.0 ACCESS FOR WORKS, ETC.

46.1 Access for S.O.

- (a) The S.O. and any person authorised by the S.O. shall at all times have access to the Works and to the factories, workshops or other places of the Contractor or of any sub-contractor or supplier where any equipment, materials, goods or work are being manufactured, fabricated, assembled, prepared or stored for the Contract.
- (b) Where any such equipment, materials, goods or work are being manufactured, fabricated, assembled, prepared or stored in the factories, workshops or other places of a sub-contractor or supplier, the Contractor shall by a term in the sub-contract secure a similar right of access to those factories, workshops or other places for the S.O. and any person authorised by the S.O., and shall take reasonable steps required of him by the S.O. to enforce or assist in enforcing such right.
- (c) Any person so removed from the Works shall be replaced without delay by a substitute approved by the S.O.; PROVIDED THAT the Contractor shall not be entitled to any claim for any expense whatsoever incurred by him in respect of any direction given by the S.O. under this Clause.

46.2 Access for Other Contractors and Workmen

The Contractor shall in accordance with the requirements of the S.O. afford all reasonable access and facilities to any other person engaged by the Government and their workmen and of any other constituted authorities for the purposes of executing any work on or near the Site.

47.0 SUB-CONTRACT OR ASSIGNMENT

- 47.1 The Contractor shall not without the prior written consent of the S.O. (which consent shall not be unreasonably delayed or withheld) sub- contract the design for any portion of the Works under clause 22 of this Contract. Where the S.O. consents to any sub-contract under this clause, such consent shall not in any way absolve the obligations of the Contractor under clause 10.
- 47.2 The Contractor shall not sub- contract the whole or any substantial part of the Works without the prior written consent of the S.O. (which consent shall not be unreasonably delayed or withheld). Any such consent, if given, shall not relieve the Contractor from any liability or obligation under this Contract and he shall be responsible for the due observance by such sub-contractors, of all the terms, stipulations and conditions under this Contract.
- 47.3 Notwithstanding any sub-contract made pursuant to clauses 47.1 and 47.2, the Contractor shall be fully responsible for the acts, defaults or neglects of any sub-contractor, including 'labour only' sub-contractors, his agents, servants or workmen as if they were the acts, defaults or neglects of the Contractor, his agents, servants or workmen; PROVIDED THAT the provision of labour on a piecework basis shall not be deemed to be a sub-contract under this clause.
- 47.4 It shall be a condition in any sub-contract which has been consented to by the Government that upon termination of the Contractor's employment under the Contract, the employment of the sub-contractor under the sub-contract shall terminate immediately. No claim whatsoever shall be made by the Contractor and/or sub-contractor against the Government for any work done or materials or goods supplied.
- 47.5 If the Contractor sub-contracts the Works, in whole or in part, to any person without getting prior written consent of the S.O. as provided under this clause, the S.O. shall have the right to instruct the Contractor to forthwith terminate such sub-contract and the Contractor shall be liable for all costs and expense relating to such termination.
- 47.6 The Contractor shall not assign the Contract or any part thereof, or any benefit or interest therein or thereunder otherwise than by way of assignment in favour of the Contractor's banker or any financial institution or Corporation of any monies due or to become due under this Contract without prior written consent of the S.O.

48.0 DEFECTS AFTER COMPLETION

48.1 Completion of Outstanding Work and Remedying Defects

- (a) At any time during the Defects Liability Period as stated in Appendix hereto (or if none stated the period is twelve (12) months from the date of practical completion of the Works), any defect, imperfection, shrinkage or any other fault whatsoever which may appear and which are due to materials or goods or workmanship not in accordance with this Contract, the S.O. shall issue written instruction to the Contractor to make good such defects, imperfections, shrinkages or any other fault whatsoever at the Contractor's own cost. The Contractor shall complete all such works with due expedition or within such time as may be specified by the S.O.
- (b) Without prejudice to sub-clause (a), any defect, imperfection, shrinkage or any other fault whatsoever which may appear during the Defects Liability Period to be made good by the Contractor, shall be specified by the S.O. in the Schedule of Defects which he shall deliver to the Contractor not later than fourteen (14) days after the expiration of the Defects Liability Period. The defects, imperfections, shrinkages or any other fault whatsoever specified in the Schedule of Defects shall be made good by the Contractor at his own costs and to be completed within a reasonable time but in any case not later than three (3) months after the receipt of the said Schedule. PROVIDED THAT the S.O.

shall not be allowed to issue any further instruction requiring the Contractor to make good of any defect, imperfection, shrinkage or any other fault whatsoever after the issuance of the said Schedule of Defects or after fourteen (14) days from the expiration of the said Defects Liability Period, whichever is the later.

48.2 Default in Remedying Defects

If the Contractor shall fail to comply with either clause 48.1(a) and/or 48.1(b) within the time so specified, the materials or works so affected may be made good in such manner as the S.O. may think fit, in which case the costs incurred including On-Cost Charges (calculated by applying the Percentage of On-Cost Charges stated in Appendix to the costs incurred), shall be deducted from any money due or to become due, to the Contractor under this Contract and failing which such costs shall be recovered from the Performance Bond or as a debt due from the Contractor.

48.3 Diminution in Value of Works

If any defect, imperfection, shrinkage or any other fault whatsoever is such that, in the opinion of the S.O., it shall be impracticable or inconvenient to the Government to have the Contractor to remedy the same, the S.O. shall ascertain the diminution in the value of the Works due to the existence of such defects, imperfections, shrinkages or any other fault whatsoever. The amount of such diminution shall be recoverable by the Government from the Contractor as a debt due under the Contract and failing which such diminution shall be recovered from the Performance Bond.

48.4 Certificate of Completion of Making Good Defects

When in the opinion of the S.O. the Contractor has made good the defects, imperfections, shrinkages or any other fault whatsoever which he is required to make good under clauses 48.1(a) or (b), or both, the S.O. shall issue a certificate to that effect, and the date specified in such certificate shall be the date on which the Contractor has completed making good such defects, imperfections, shrinkages or any other fault whatsoever. The said Certificate shall be referred to as the "Certificate of Completion of Making Good Defects".

49.0 UNFULFILLED OBLIGATIONS

Notwithstanding the issue of the Certificate of Completion of Making Good Defects under clause 48.4 hereof the Contractor and the Government shall remain liable for the fulfilment of any obligation incurred under the provisions of the Contract, prior to the issue of the said certificate, which remains unfulfilled at the time such certificate is issued, and for the purpose of determining the nature and extent of any such obligation, the Contract shall be deemed to remain in force between the Parties hereto.

50.0 SUSPENSION OF WORKS

50.1 Suspension and Resumption of Works

- (a) The S.O. may at any time instruct the Contractor to suspend part or all of the Works.
- (b) Upon receipt of such written instruction, the Contractor shall suspend part or all of the Works for such time and in such manner as specified in the instruction and shall duly protect, store and secure the Works or such part of the Works against any deterioration, loss or damage.
- (c) During the suspension period, the Contractor shall continue to perform its obligations under this Contract, which are not affected by the instruction to suspend, including the obligation to effect and maintain insurances and Performance Bond.

- (d) The S.O. may instruct the Contractor to resume the Works at any time thereafter. Upon receipt of such instruction the Contractor shall resume the Works and the Parties shall jointly examine the Works affected by the suspension. The Contractor shall make good any deterioration or defect in or loss of the Works which has occurred during the suspension. The Contractor shall also take all necessary actions to mitigate the expenses incurred

50.2 Extension of Time

If the Contractor suffers delay and/or incurs expenses in complying with the instruction under clause 50.1(a), and in resumption of the Works, and if such delay and/or expenses was not foreseeable by the Contractor, the Contractor shall give notice for extension of time under clause 43 and the provisions thereof shall apply accordingly. PROVIDED THAT the Contractor shall not be entitled to such extension if the suspension is due to a cause attributable to the Contractor and he shall not be entitled to payment of loss and expense if he –

- (a) fails to take measures specified in clause 50.1(b); and
- (b) fails to take all necessary action to mitigate the expenses incurred.

In the event such suspension shall continue for a period exceeding twelve (12) months, the Parties shall then discuss whether to mutually terminate the Contract or suspend the Works for a further period.

50.3 Consequences of Mutual Termination

- (a) If the Contract is mutually terminated under this clause-
 - (i) clause 51.1(c)(i) shall be applicable; and
 - (ii) payment obligations including all costs and expenditure incurred by the Government and the Contractor shall be ascertained in accordance with clause 54.

51.0 EVENTS AND CONSEQUENCES OF DEFAULT BY THE CONTRACTOR

51.1 Default of Obligations

(a) Events of Default

In the event the Contractor -

- (i) fails to commence works at the Site within two (2) weeks after the Date for Possession;
- (ii) suspends or abandons the carrying out of the Works or any part thereof for a continuous period of (....) days;
- (iii) fails to proceed regularly and diligently with the performance of his obligations under the Contract;
- (iv) fails to execute the Works in accordance with the Contract;
- (v) persistently neglects to carry out his obligations under the Contract;

- (vi) refuses or persistently neglects to comply with a written notice from the S.O. in relation to any defective work or equipment, materials or goods which are defective or do not meet the requirements of the Contract;
- (vii) fails to comply with the provisions of clause 47; or
- (viii) fails to comply with any terms and conditions of this Contract,

then the Government shall give written notice to the Contractor specifying the default, and requiring the Contractor to remedy such default within fourteen (14) days of the receipt of the default notice or any period determined by the Government.

(b) Termination

If the Contractor fails to remedy the breach within such period, the Government shall have the right to forthwith terminate this Contract by giving a written notice to that effect

(c) Consequences of Termination

If this Agreement is terminated under clause 51.1(b) -

- (i) the Contractor shall -
 - (A) forthwith cease all operations of the Works;
 - (B) carry out any protection works so as to secure the Site, equipment, goods, materials therein against any deterioration, loss or damage and to do all things necessary so as to leave the Site in a clean and tidy condition;
 - (C) remove its personnel and workmen from the Site;
 - (D) vacate the Site within the time stipulated by the S.O., remove all temporary buildings, plant, tools, equipment, goods and unfixed materials which have not been paid by the Government, as specified by the S.O. Failing which, the Government may (but without being responsible for any loss or damage) remove and sell any such property belonging to the Contractor, holding the proceeds, less all cost incurred, to the credit of the Contractor;
 - (E) either -
 - (aa) terminate all third party contracts entered into by the Contractor for the purposes of this Contract;
 - (bb) assign to the Government, if so required by the S.O., at no cost or expense to the Government, the benefit of any agreement for the supply of materials or goods and/or for the execution of any work or services for the purposes of this Contract; or
 - (cc) allow such third party to enter into a contract with the Government or any person deemed necessary by the Government for the purpose of completing the Works;

PROVIDED THAT the Government shall not be obliged to pay any third party for any materials or goods delivered or any work executed or services for the purposes of this Contract (whether before or after the date of termination) for which the Government has paid but the Contractor has failed to make payment to the third party;

- (F) at no cost to the Government, hand over to the Government all plans, designs, specification and other relevant documents relating to the Works;
 - (G) pay to the Government for any losses and damages as a result of termination of this Contract in the manner provided under clause 56; and
 - (H) not be released from any of its obligations under the Contract.
- (ii) the Government shall –
- (A) call upon the Performance Bond or forfeit the Performance Guarantee Sum;
 - (B) enter and repossess the Site;
 - (C) be entitled to carry out and complete the Works on its own or employ any other person to carry out and complete the Works; and
 - (D) be entitled to claim against the Contractor for any losses, costs, expenses and damages suffered as a result of termination of this Contract in the manner provided under clause 56.
- (iii) for the avoidance of doubt, the Parties hereby agree that the Contractor shall not be entitled to any form of losses including loss of profit, damages, claims or whatsoever upon termination of this Contract under this clause.

51.2 General Default

(a) Events of Default

If at any time during the Contract Period-

- (i) the Contractor becomes bankrupt;
- (ii) the Contractor becomes insolvent or compounds with or enters into an arrangements or compositions with its creditors;
- (iii) an order is made or resolution is effectively passed for the winding-up of the Contractor (except for the purpose of restructuring or amalgamation with the written consent of the Government, which consent shall not be unreasonably withheld);
- (iv) a provisional liquidator, receiver or manager of its business or undertaking duly appointed, or possession taken by or on behalf of creditors or debenture holders secured by a floating charge of any property comprised in or subject of the floating charge; or
- (v) execution is levied against a substantial portion of the Contractor's assets,

then the Government shall have the right to terminate this Contract forthwith by giving notice to that effect.

(b) **Consequences of Termination**

- (i) In the event the termination of this Contract under clause 51.2 takes place, clauses 51.1(c)(i) and 51.1(c)(ii) shall apply.
- (ii) For the avoidance of doubt, the Parties hereby agree that the Contractor shall not be entitled to any form of losses including loss of profit, damages, claims or whatsoever upon termination of this Contract under this clause.

52.0 TERMINATION ON NATIONAL INTEREST

52.1 Termination

- (a) Notwithstanding any provision of this Contract, the Government may terminate this Contract by giving not less than thirty (30) days written notice to that effect to the Contractor (without any obligation to give any reason thereof) if the Government considers that such termination is necessary for national interest, national policy or national security.
- (b) For the purpose of this clause, what constitutes "national interest", "national policy" and "national security", shall be solely made and determined by the Government and such determination shall for all intent and purposes be final and conclusive and shall not be open to any challenge whatsoever.

52.2 Consequences of Termination

Upon such termination of this Contract under clause 52.1-

- (a) payment obligations including all costs and expenditure incurred by the Government and the Contractor shall be ascertained in accordance with clause 54; and
- (b) clause 51.1(c)(i) and clause 51.1(c)(ii)(B) and (C) shall apply.

53.0 TERMINATION ON CORRUPTION, UNLAWFUL OR ILLEGAL ACTIVITIES

53.1 Termination

Without prejudice to any other rights of the Government, if the Company, its personnel, servants or employees is convicted by a court of law for corruption or unlawful or illegal activities in relation to this Contract or any other agreement that the Contractor may have with the Government, the Government shall be entitled to terminate this Contract at any time, by giving immediate written notice to that effect to the Contractor.

53.2 Consequences of Termination

Upon such termination under clause 53.1 –

- (a) the Government shall be entitled to all losses, costs, damages and expenses including any incidental costs and expenses incurred by the Government arising from such termination;
- (b) clause 51.1(c)(i) and (ii) shall apply; and

- (c) for the avoidance of doubt, the Parties hereby agree that the Contractor shall not be entitled to any other form of losses including loss of profit, damages, claims or whatsoever upon termination of this Contract.

54.0 PAYMENTS UPON SUSPENSION AND TERMINATION ON NATIONAL INTEREST

54.1 If this Contract is terminated under clause 50 or clause 52, the amount to be paid (in so far as such amounts or items have not already been covered by payments on account made to the Contractor) shall be the following:

- (a) the value of all work carried out up to the date of termination;
- (b) the amounts payable in respect of any preliminary items so far as the Work or service comprised therein has been carried out or performed and a proper proportion of any such items which have been partially carried out or performed;
- (c) the cost of materials or goods reasonably ordered for the Works which have been delivered to the Contractor or of which the Contractor is legally liable to accept delivery (such materials or goods becoming the property of the Government upon such payment being made to the Contractor);
- (d) a sum being the amount of any expenditure reasonably incurred by the Contractor in so far as such expenditure has not been recovered by any other payments referred to in this sub-clause; and
- (e) the reasonable cost of any protection works and removal of equipment and site facilities pursuant to termination as provided under this Contract,

PROVIDED THAT such amount to be paid by the Government shall be confined only to those items as are clearly and expressly stated in sub-clauses (a)-(e) above.

54.2 For the avoidance of doubt, the Parties hereby agree that the Contractor shall not be entitled to any other form of losses including loss of profit, damages, claims or whatsoever other than stipulated under clause 54.1(a)-(e). The Parties further agree that the amount agreed above by the Government shall constitute as a full and final settlement between the Parties.

54.3 Upon termination of this Contract under clause 50 and clause 52, a final account of this Contract shall be prepared and issued by the S.O.

55.0 EVENTS AND CONSEQUENCES OF DEFAULT BY THE GOVERNMENT

Default of Obligations

(a) Events of Default

If the Government without any reasonable cause fails to perform or fulfil any of its obligations which adversely affects the Works,

then the Contractor may issue a notice specifying the default by the Government and requiring the Government to remedy the same within the period specified therein taking into account the nature of the remedy to be carried out by the Government or such other period as may be agreed by both Parties from the date of receipt of such notice.

(b) Termination

If the Government fails to remedy the default period specified in such notice issued under Clause 55 (a) within the stipulated period time therein, the Contractor shall have the right to forthwith terminate this Contract by giving a written notice to that effect.

(c) Consequences of Termination

If this Contract is terminated under Clause 55 (b)

- (i) the Government shall pay to the Contractor –
 - (a) the value of the Works carried out up to the date of termination;
 - (b) the amounts payable in respect of any preliminary items so far as the Work or service comprised therein has been carried out or performed and a proper proportion of any such items which have been partially carried out or performed;
 - (c) the cost of materials or goods reasonably ordered for the Works which have been delivered to the Contractor or of which the Contractor is legally liable to accept delivery (such materials or goods becoming the property of the Government upon such payment being made to the Contractor); and
 - (d) a sum being the amount of any expenditure reasonably incurred by the Contractor in so far as such expenditure has not been recovered by any other payments referred to in this sub-clause.
- (ii) For the avoidance of doubt, the Parties hereby agree that the Contractor shall not be entitled to any other form of losses including loss of profit, damages, claims or whatsoever upon termination of this Contract.

56.0 CERTIFICATE OF TERMINATION COSTS

56.1 As soon as the arrangements for the completion of the Works made by the Government enable the S.O. to make a reasonably accurate assessment of the ultimate cost to the Government of completing the Works following the termination of the Contractor's employment and the engagement of other contractors or persons, and the amount of direct loss and/or damage caused to the Government due to the termination has been ascertained by the S.O., then the S.O. may issue a certificate (hereinafter referred to as the "Certificate of Termination Costs") stating the Completion Cost (hereinafter defined) and the Final Contract Sum (hereinafter defined).

56.2 The Completion Cost comprises the following sums, costs or expenditure:

- (a) the sums previously paid to the Contractor by the Government;
- (b) the sums paid or payable to other contractors or persons engaged by the Government to complete the Works;
- (c) any sums paid to sub-contractors or suppliers under clause 61;
- (d) any costs or expenditure incurred or to be incurred including On-Cost Charges incurred by the Government in completing the Works; and
- (e) the amount of direct loss and/or damage caused to the Government due to the termination.

56.3 The Final Contract Sum comprises of the following amounts or sums:

- (a) the amount which would have been payable under the Contract on completion in accordance with the Contract, allowing any variations or other matters which would have resulted in an adjustment of the original Contract Sum; and
- (b) any other sums which the Government might be entitled under the terms of the Contract to deduct from the original Contract Sum,

had the Contractor's employment not been terminated.

- 56.4 The Certificate of Termination Costs shall state the difference between the Final Contract Sum and the Completion Cost. If the Final Contract Sum is less than the Completion Cost, the difference shall be a debt payable by the Contractor to the Government and if greater the difference shall be a debt payable by the Government to the Contractor.
- 56.5 The Certificate of Termination Costs shall be binding and conclusive on the Contractor as to the amount of such loss or damage specified therein.
- 56.6 In the event the completion of the Works being undertaken departmentally, allowance shall be made, when ascertaining the amount to be certified as costs and expense incurred by the Government, for cost of supervision, interest and depreciation on plant and all other usual overhead charges and profit as would be incurred if the Works were completed by other contractors or persons.

57.0 SURVIVING RIGHTS

Any termination under this Contract shall not affect the liability of either Party hereto for any of its acts or omissions during the period of the Contract and both Parties shall thereafter continue to be so liable and shall keep the other Party hereto indemnified and hold harmless in respect of any claims arising therefrom.

58.0 EFFECT OF FORCE MAJEURE

- 58.1 Neither the Government nor the Contractor shall be in breach of its obligations under this Contract if it is unable to perform its obligation under this Contract (or any part of thereof), other than the payment obligations as a result of the occurrence of an Event of Force Majeure.
- 58.2 An "Event of Force Majeure" is an event beyond the control of both Parties which are:
 - (a) war (whether declared or not), hostilities, invasion, act of foreign enemies;
 - (b) insurrection, revolution, rebellion, military or usurped power, civil war, terrorism;
 - (c) natural catastrophe including but not limited to earthquakes, floods, subterranean spontaneous combustion or any operation of the forces of nature against which an experienced contractor could not reasonably have been expected to take precautions;
 - (d) nuclear explosion, radioactive or chemical contamination or radiation (unless caused by the negligence act, omission or default of the Contractor, its agents or personnel);
 - (e) pressure waves caused by aircraft or other aerial devices traveling at sonic or supersonic speeds; and
 - (f) riot, commotion or disorder, unless solely restricted to employees of the Contractor or its personnel, servants or agents.

- 58.3 If an Event of Force Majeure occurs by reason of which either Party is unable to perform any of its obligation under this Contract (or any part thereof), the Party shall inform the other Party immediately of the occurrence of that Event of Force Majeure with full particulars thereof and the consequences thereof.
- 58.4 If either Party considers the Event of Force Majeure to be of such severity or to be continuing for such period of time that it effectively frustrates the original intention of this Contract, then the Parties may agree that this Contract may be terminated upon mutual agreement of the Parties.
- 58.5 If this Contract is terminated by an Event of Force Majeure pursuant to the above clause, all rights and obligations of the Parties under this Contract shall forthwith terminate and neither Party shall have any claim against the other Party and neither Party shall be liable to each other save for any rights and liabilities accruing prior to the occurrence of the Event of Force Majeure.
- 58.6 Neither Party shall be entitled to rely upon the provisions above if both Parties reasonably determine that an Event of Force Majeure has not occurred.
- 58.7 For avoidance of doubt, the Parties shall continue to perform those parts of those obligations not affected, delayed or interrupted by an Event of Force Majeure and such obligations shall, pending the outcome of this clause continue in full force and effect.

59.0 SITE AGENT AND ASSISTANTS

Unless otherwise provided elsewhere in this Contract, the Contractor shall keep constantly on the Site a competent, efficient, suitability qualified, experienced and good character site agent and his assistants in each trade as may be necessary who must be capable of receiving instructions in Bahasa Malaysia, and in default it shall be the responsibility of the Contractor to provide replacement for them and all wages and other expenses in connection with the employment of such replacement site agent and assistants. Any directions, explanations or instructions given to such site agent by the S.O. shall be deemed to have been given to the Contractor under this Contract.

60.0 NOMINATED SUB-CONTRACTORS AND/OR NOMINATED SUPPLIERS

- 60.1 The S.O. shall obtain tenders for Nominated Sub-Contractor's or Nominated Supplier's work or services, or for the supply of materials or goods in respect of which Prime Cost Sums or Provisional Sums are included in the Bills of Quantities, and the Contractor shall, on the written instruction of the S.O., enter into such sub-contracts with the Nominated Sub-Contractor or Nominated Supplier as the case may be and such sub-contracts shall be in the form as referred to in clause 60.2(b).
- 60.2 The S.O. shall not nominate as a sub-contractor or a supplier in connection with the Works:
- (a) a person against whom the Contractor shall make in writing within twenty one (21) days from the date of the S.O.'s instruction under clause 60.1 hereof what the S.O. considers to be reasonable objection;
 - (b) a person who will not enter into a sub-contract with terms and conditions as provided in the Government standard form of sub-contract for Nominated Sub-contractor (Form PWD 203N) or for Nominated Supplier (Form PWD 203P), as the case may be; or
 - (c) a person who will not give to the Government such indemnity with terms and conditions as provided in the Government standard form of Letter of Indemnity for Nominated Sub-contractors (Form PWD 203N7) or for Nominated Suppliers (Form PWD 203P7), as the case may be.

- 60.3 If pursuant to clause 60.2, the Contractor is not required to enter into a sub-contract with a Nominated Sub-contractor or Nominated Supplier, as the case may be, the S.O. shall do one or more of the following:
- (a) nominate an alternative sub-contractor or supplier, as the case may be, in which case clause 60.2 hereof shall apply;
 - (b) by order under clause 24 vary the Works or the work or services, materials or goods, the subject of the Prime Cost Sums or Provisional Sum as aforesaid, including if necessary the omission of any such work or services, materials or goods so that they may be provided by workmen, contractors or suppliers, as the case may be, employed by the Government either concurrently with the Works or at some other date in which case the Contractor shall not be entitled to claim for any losses therefrom; or
 - (c) in accordance with clause 34.4 arrange for the Contractor to execute such work or services, or to supply such materials or goods.

61.0 PAYMENT TO NOMINATED SUB-CONTRACTOR OR SUPPLIER

61.1 The S.O. in issuing Interim Certificates under clause 28 or the Final Certificate under clause 31 hereof shall state separately the amount of interim or final payment due to each Nominated Sub-Contractors or Suppliers which amount subject to clause 61.2 hereof, shall be paid by the Government direct to the Nominated Sub-contractors or Suppliers. The amount paid by the Government direct to the Nominated Sub-contractors or Suppliers shall be deemed to be a payment to the Contractor by the Government under and by virtue of this Contract.

61.2 Subject to the relevant provisions in the sub-contract (Form PWD 203N or Form PWD 203P as the case may be), the Contractor shall be entitled to be paid and the Government may pay to the Contractor out of any money otherwise due to a Nominated Sub-contractors or Suppliers:

- (a) any amount which the Government or the S.O. on its behalf in exercise of any rights under this Contract has deducted from any money due to the Contractor and such deduction is in respect of some act or default solely of the Nominated Sub-contractors or Suppliers, his servants or agents;
- (b) any amount agreed by the Nominated Sub-Contractor or Suppliers as due to the Contractor, or any amount awarded in arbitration or litigation in favour of the Contractor which arises out of or under the sub-contract; and
- (c) the amount of any claim for loss and/or expense actually incurred by the Contractor by reason of any breach or failure to observe the provisions of the sub-contract by the Nominated Sub-contractors or Suppliers under the sub-contract.

61.3 Any amount paid to the Contractor in accordance with this clause shall be deemed to be a payment to the Nominated and/or Sub-Contractors or Suppliers under the sub-contract.

62.0 NO LIABILITY OF GOVERNMENT TO NOMINATED AND/OR SUB-CONTRACTOR OR SUPPLIER

Nothing in clauses 60 or 61 or anything else contained in this Contract shall render the Government in any way liable to any Nominated and/or Sub-Contractor or Supplier.

63.0 RESPONSIBILITIES OF CONTRACTOR TO NOMINATED AND/OR SUB-CONTRACTORS OR SUPPLIERS

63.1 The Contractor shall be fully responsible to ensure that the Nominated Sub-Contractor or Suppliers shall conform with the terms and conditions of this Contract and shall be fully responsible for the acts, defaults or breach of any terms and/or conditions of this Contract by the Nominated Sub-Contractors or Suppliers on their part in the same way as for his own or those of other sub-contractors or suppliers engaged by himself. The Government shall in no circumstances be liable to the Contractor for the default of any Nominated Sub-Contractors or Suppliers.

63.2 In the event of repudiation or abandonment of his sub-contract by any Nominated Sub-contractor or Supplier, or the determination by the Contractor of the employment of the Nominated Sub-contractor or Supplier for any reason whatsoever under the sub-contract, the Contractor shall do one of the following :

- (a) with the consent of the S.O. (such consent not to be unreasonably withheld) employ another competent sub-contractor or supplier to complete the sub-contract; or
- (b) undertake to complete the sub-contract himself.

PROVIDED THAT in any of such events the Contractor is entitled to be paid the same sum for the work or services to be executed, or materials or goods to be supplied, as would have been payable had the original Nominated Sub-contractor or Supplier completed the sub-contract without any default on its part.

64.0 INTELLECTUAL PROPERTY RIGHTS

64.1 The Copyright and all other proprietary rights whatsoever in the Works and other material developed and supplied by the Contractor pursuant to or under this Contract shall vest in and shall be the sole property of the Government and the Contractor shall not during or at any time after completion of the Works or after the expiry or termination of this Contract, in any way, question or dispute the ownership of the Government. The proprietary rights in the Works shall vest in the Government free and clear of all liens, claims and encumbrances on the Works.

64.2 The Contractor shall be responsible for any claim that the equipment supplied infringes a patent, copyright or registered design.

64.3 If the Government's use or possession of the equipment is likely to constitute an infringement, then the Contractor shall promptly and at its own expenses procure for the Government the right to continue using and possessing the equipment; or modify or replace the equipment so as to avoid the infringement (in which event the Contractor shall compensate the Government for the amount of any direct loss or damage sustained or incurred by the Government during such modification or replacement).

64.4 The Contractor shall indemnify the Government against any claim for the infringement of any letters patent, copyright or registered designs by the use of any equipment or of information supplied under this Contract and against all costs and damages which the Government may incur in any action for which such infringements or for which the Government may become liable in any such action.

65.0 ANTIQUITIES

65.1 All fossils, coins, antiquities and other objects of interest or value which may be found on the Site or in excavating the same during the progress of the Works shall become absolute property of the Government and upon discovery of such an object the Contractor shall forthwith-

- (a) not to disturb the object and shall cease work if and in so far as the continuance of the work would endanger the object or prevent or impede its excavation or its removal;
 - (b) take all steps which may be necessary to preserve the object in the exact position and condition in which it was found; and
 - (c) inform the S.O. of the discovery and precise location of the object.
- 65.2 The S.O. shall issue instructions in regard to what is to be done concerning the object reported by the Contractor under clause 65.1 and (without prejudice to the generality of his power) such instructions may require the Contractor to permit the examination, excavation or removal of the object by a third party. Any such third party shall for the purpose of clause 15 be deemed to be a person for whom the Government is responsible and not to be a sub-contractor.
- 65.3 If compliance with the provisions of clause 65.1 or with an instruction issued under clause 65.2 has involved the Contractor in direct loss and/or expense for which he would not be reimbursed by a payment made under any other provisions of this Contract then the amount of such loss and/or expense shall be added to the Contract Sum.

66.0 ARBITRATION

- 66.1 If any dispute or difference shall arise between the Government and the Contractor out of or in connection with the contract, then parties shall refer such matter, dispute or difference to the officer named in Appendix for a decision.
- 66.2 The officer named in Appendix's decision shall be in writing and shall subject to clause 66.4 hereof, be binding on the Parties until the completion of the Works and shall forthwith be given effect to by the Contractor who shall proceed with the Works with all due diligence whether or not notice of dissatisfaction is given by him.
- 66.3 If the Parties –
- (a) fails to receive a decision from the officer named in the Appendix within forty-five (45) days after being requested to do so; or
 - (b) is dissatisfied with any decision of the officer named in the Appendix,
- then such dispute or difference shall be referred to arbitration within forty-five (45) days to an arbitrator to be agreed between the Parties and failing such agreement, to be appointed by the Director of the Regional Centre for arbitration in Kuala Lumpur on the application of either Party hereto. Such arbitration shall be heard at the Kuala Lumpur Regional Centre for Arbitration and shall be conducted in accordance with the rules for arbitration of the Kuala Lumpur Regional Centre for Arbitration using the facilities and the system available at the Centre.
- 66.4 Such reference, except on any difference or dispute under clause 51 hereof shall not be commenced until after the completion or alleged completion of the Works or determination or alleged determination of the Contractor's employment under this Contract, or abandonment of the Works, unless with the written consent of the Government and the Contractor.
- 66.5 In the event that such consent has been obtained in accordance with clause 66.4, the reference of any matter, dispute or difference to arbitration pursuant to this clause and/or the continuance of any arbitration proceedings consequent thereto shall in no way operate as a waiver of the obligations of the parties to perform their respective obligations under this Contract.
- 66.6 In any arbitration proceedings conducted pursuant to clause 66.3, the Parties may make any counter claim in relation to any dispute or difference arising from the Contract.

- 66.7 Upon every or any such reference the costs of such incidental to the reference and award shall be in the discretion of the Arbitrator who may determine the amount thereof, or direct the amount to be taxed as between solicitor and client or as between party and party, and shall direct by whom and to whom and in what manner the same be borne, award and paid.
- 66.8 The award of the Arbitrator shall be final and binding on the Parties.
- 66.9 In the event of the death of the arbitrator or his unwillingness or inability to act, then the Government and the Contractor upon agreement shall appoint another person to act as the arbitrator, and in the event the Government and the Contractor fail to agree on the appointment of an arbitrator, an arbitrator shall be appointed by the Director of the Regional Centre for Arbitration in Kuala Lumpur.
- 66.10 In this clause, "reference" shall be deemed to be reference to arbitration within the meaning of the Arbitration Act 2005.
- 66.11 The arbitration shall be governed by the Arbitration Act 2005 and the laws of Malaysia.

67.0 NOTICE, ETC.

- 67.1 Any notice, approval, consent, request or other communication required or permitted to be given or made under this Contract shall be in writing in Bahasa Malaysia or English language.
- 67.2 Such notice shall be effected by:
- (i) hand delivery or courier and an acknowledgement of receipt obtained;
 - (ii) leaving the notice at the registered office or site office of the Contractor in which case it shall be deemed to have been duly delivered; or
 - (iii) registered post in which case it shall be deemed to have been received seven (7) days after the date of posting.
- 67.3 The address of the Government and the Contractor is as shown below or such other address as either party may have notified the sender:

to the Government:

Address:

to the Contractor:

Address:

- 67.4 It shall be the duty of the parties to notify the other if there is a change of address or entity by giving a written notice within fourteen (14) days. In the event of the Contractor failing to notify the S.O. of such an address or any change in his address, such written notices and instructions shall be deemed to have been served upon the Contractor if they are sent in the manner stated above to the address stated in this Contract or to the Contractor's site office.

68.0 SAFETY AT THE SITE

68.1 Compliance with Safety Requirements

The Contractor shall comply with all relevant laws, regulations, rules, by-laws, directive or order by the relevant authorities on the requirements of safety-at-work ("Safety Requirements") and shall ensure his personnel, workmen and sub-contractors at all times during the execution of Works comply with such Safety Requirements.

68.2 Submission of Safety Programme

- (a) Within 14 days from the receipt of the Letter of Acceptance by the Government, the Contractor shall submit to the S.O a safety programme to ensure that all construction activities required for the execution of the Works are carried out in a safe manner and in compliance with Safety Requirements.
- (b) The safety programme shall be subject to the approval of the S.O. The submission to and approval by the S.O of the safety programme shall not relieve the Contractor of any of his obligations and liabilities pertaining to the safety requirement under the Contract.

68.3 Safety Officer and Personnel

- a) The Contractor shall appoint a suitably qualified and experienced person as safety officer who shall be responsible for compliance with Safety Requirements and all safety matters relating to the Works. The Contractor shall, from time to time, provide such other personnel and resources as may be required to ensure the effective implementation of the safety programme on Site.
- b) The Contractor shall conduct training programmes for all workmen including workmen of his sub-contractors for compliance with the Safety Requirements.

68.4 Safety Measures

- (a) The Contractor shall ensure that the constructional plant together with all other tools and equipment and other items used in the execution of the Works are in a safe, sound and good condition and capable of performing the functions for which they are intended.
- (b) The Contractor is responsible for instituting a safe method of construction on Site for all the workers and shall ensure that his sub-contractors whether nominated or otherwise institute the same method of construction for their workers.
- (c) Without limiting his liability under the Contract, the Contractor shall provide all workmen on Site with the necessary safety equipment including but not limited to safety boots, safety helmets and protective clothing.

69.0 ADVANCE PAYMENT

- 69.1 The Contractor shall be entitled to an advance payment on the Contract amounting to 25% of the value of the Contract Sum less Provisional Sums (hereinafter referred to as the "Builder's Work") but subject to a maximum of RM10 million on compliance with the following conditions:

- (a) on return of the Letter of Acceptance duly signed by the Contractor together with the Performance Bond (if any), insurance policies, confirmation from SOCSO Authorities and the receipts for all premium paid;
- (b) production of a Banker's/Insurance/Finance Company Guarantee in the approved format equal in value to the advance proposed to be paid;
- (c) Submission of the Banker's Guarantee / Insurance Guarantee / Financial Company Guarantee not later than 3 months from the date of possession of Site.

69.2 The advance payment shall be recouped when the cumulative total value of the Builder's Work executed and certified (including the amount certified for materials on site) reaches (25%) twenty five percent of the total contract value of Builder's Work, by way of a fixed percentage deduction from the total certified value of the Builder's Work executed (including the amount certified for materials on site) during the period covered by an Interim Payment Certificate, in all the subsequent Interim Payment Certificates on the basis that the advance payment made shall be fully recovered in the Interim Payment Certificate in which the cumulative total certified value of the Builder's Work executed (including the amount certified for materials on site) reaches seventy-five (75) percent of the total contract value of the Builder's work*. The deduction shall be calculated as follows:

$$\$ D = 200 \frac{A}{B} \text{ percent of } \$ P$$

Where \$ D = cumulative deduction to be made in Interim Payment Certificate,

\$ A = total amount of advance paid,

\$ B = total contract value of Builder's Work

\$ P = gross certified value of Builder's Work executed (including the amount certified for materials on site) or agreed cumulative scheduled payments in excess of 25% of \$ B

69.3 The liability under the advance guarantee shall be terminated upon realization by the Government of the full sum of advance paid. However if the full sum of the advance paid cannot be realized before the completion date of the contract or any authorised extension thereof or the case of the contract been determined before the date of the determination, then the balance of the advance repayable to the Government shall be recovered from the advance guarantee.

70.0 AMENDMENT

No modification, amendment or waiver of any of the provisions of this Contract shall be effective unless made by mutual consent and made in writing by way of supplementary agreement specifically referring to this Contract and duly signed by the Parties. The provisions in respect of such amendment, variation or modification thereof shall be supplemental to and be read as integral part of this Contract which shall remain in full force and effect as between both Parties.

71.0 CONFIDENTIALITY

71.1 This Contract and all such drawings, records, data, books, reports and all matters pertaining hereto shall be considered as confidential matter and shall not be disclosed to any third party without prior written mutual agreement, save and except where-

- (a) disclosure of such information is necessary for the purposes of raising finance to undertake the obligations of the Contractor under this Contract;
- (b) disclosure of such information is made to the Contractor's consultants, auditors or advisers;
- (c) disclosure of such information is required by law or by any government agency or for the performance of any obligations under this Contract; or
- (d) the information has entered public domain.

71.2 Where information has been disclosed to third parties pursuant to clause 69.1, the Contractor undertakes to ensure that such third parties shall not disclose the information to any other third party.

71.3 The restrictions contained in this clause shall survive the termination of this Contract and shall continue to bind both Parties without limit in point of time.

72.0 STAMP DUTY

The Contractor shall solely bear the stamp duties, legal costs and fees in the preparation and execution of this Contract and anything incidental thereto.

73.0 SEVERABILITY

If any provision of this Contract is held to be illegal or is invalid under any laws or regulations effective and applicable during the term of this Contract such provision shall be fully severable and this Contract shall be construed as if such illegal or invalid provision had never comprised as part of this Contract and the remaining provisions of this Contract shall remain in full force and effect and shall not be affected by the illegal or invalid provision or by its severance from this Contract.

74.0 WAIVER

Failure by any Party to enforce at any time, any provision of this Contract shall not be construed as a waiver of its right to enforce the breach of such provision or any other provision in this Contract or as a waiver of any continuing, succeeding or subsequent breach of any provision or other provision of this Contract.

75.0 LAWS APPLICABLE

This Contract shall be governed by and construed in accordance with the laws of Malaysia and the Parties irrevocably submit to the exclusive jurisdiction of the courts of Malaysia.

76.0 SUCCESSORS BOUND

This Contract shall be binding upon the respective successors-in-title of the Parties.

77.0 EPIDEMICS AND MEDICAL ATTENDANCE

- 77.1 The Contractor shall maintain the Site in clean and sanitary condition and shall comply with all requirements of the Government Health and Sanitary Authorities. In the event of any outbreak of illness of an epidemic nature, the Contractor shall comply with and carry out such regulations, orders and requirements as may be made by the Government or the local medical or health authorities for the purpose of dealing with and overcoming the same.
- 77.2 The Contractor shall ensure that sufficient first aid kits are made available at suitable locations on the Site.

78.0 TECHNOLOGY TRANSFER

If the Contractor appoints foreign professionals, the Contractor shall endeavour to ensure that the employees of the Government are trained or exposed to the expertise of such foreign professionals pursuant to a programme for technology transfer.

79.0 GENERAL DUTIES AND PERFORMANCE STANDARD

79.1 Industry Practice

The Contractor shall provide and perform the Works in a proper manner in accordance with good management and best industry practice and to the best advantage of the Government and shall comply with all law, statutes and any guidelines or direction issued by the Government to the contractor from time to time.

79.2 Competency

The Contractor shall provide and perform its obligations under this Contract and take all appropriate measures expected of a competent company using due care and skills of a professional person providing similar service or works to ensure that the Works comply with the terms and conditions of this Contract.

79.3 Government's Interest

The Contractor shall at all times perform the Works in such manner as will always safeguard and protect the Government's interest and take all necessary and protect the Government' interest take all necessary and proper steps to prevent abuse and in accordance with the provisions of this Contract.

80.0 RESTRICTION AND PROCEDURE ON USE OF IMPORTED MATERIALS AND GOODS

- 80.1 The Contractor shall use local goods/materials as listed in the 'Senarai Bahan/Barangan Buatan Tempatan' issued by IKRAM QA Services Sdn. Bhd. and/or issued by SIRIM QA Services Sdn. Bhd., whichever is relevant. If the Contractor fails to comply with this requirement, the Government may reject the goods/materials which are found to be not in compliance with this requirement.
- 80.2 For local goods/materials not listed as aforesaid, such goods/materials may be allowed if prior testing and certification from IKRAM QA Services Sdn. Bhd. or SIRIM QA Services Sdn. Bhd., whichever is relevant, has been obtained. Where such testing cannot be carried out by IKRAM

QA Services Sdn. Bhd. or SIRIM QA Services Sdn. Bhd. the Contractor may, with the S.O.'s prior approval, have the testing to be done by another agency.

- 80.3 Under no circumstances shall the Contractor be permitted to incorporate or supply imported materials, plant, equipment, vehicles or other goods into the Works or forming part of the scope of the Works except those approved by the Government, prior to the execution of the Contract. The Contractor shall at his own cost entirely substitute any materials, plant, equipment, vehicles or other goods proposed to be imported but not approved by the Government, with suitable local materials, plant, equipment, vehicles or other goods, including making any necessary subsequential changes or adjustment to the design of the Works to accommodate such substitution, all to the concurrence of the S.O..
- 80.4 The Contractor shall ensure that the procurement of approved imported materials, plant, equipment, vehicles or other goods are obtained directly from the country of origin based on F.O.B. or other similar basis. The transportation and insurance of such imported materials, plant, equipment, vehicles or other goods from the country of origin to the Site shall be arranged by the Contractor through the Government's Multi Modal Transport Operators (hereinafter referred to as MTO) as listed in Appendix. The Contractor shall allow in his tender all costs and time required in complying with the requirements of this Clause including the cost required for the services provided by the MTO.
- 80.5 The Contractor shall submit documentary evidence of compliance with this clause to the S.O. within one (1) month from the date of each delivery to the Site of such materials, plant, equipment, vehicles or other goods.

81.0 TIME

Time whenever mentioned shall be of the essence of this Agreement.

IN WITNESS WHEREOF the Parties hereto have executed this Agreement on the day and year first above written.

SIGNED for and on behalf of)
)
THE GOVERNMENT OF MALAYSIA)
)

in the presence of:)
)

*¹The Common Seal of)
)
)
(Co. No. :))

was hereunto affixed)
in the presence of:)

.....
Director
Name :
NRIC No.:

.....
Director/Secretary
Name :
NRIC No.:

¹ applicable only if the Contractor is a company registered under the Companies Act 1965

APPENDIX TO THE CONDITIONS OF CONTRACT

Clause
4.1(a)

Officer(s) empowered to approve variations according to the limits as set out in Treasury's Instructions No. 202 as amended.

Financial Limits	Officer

4.1(b) Officer(s) empowered to take action on behalf of the Government in respect of:

Clauses 51, 52, 53, 58 and 66.....

13 Performance Bond

Amount of Guarantee RM.....

Guarantor Bank/Insurance Company/
Finance Company

Guarantee No.

15

Minimum insurance cover for any one accident or series of accidents arising out of one event RM.....

Policy No.....

Period of insurance.....

15.1 (b)

Amount of excess RM.....

APPENDIX TO THE CONDITIONS OF CONTRACT - (Cont'd)

Clause		
17	SOCSSO Scheme registration number..
18	Amount to be added to full value of Contract Sum as the insured sum	RM.....
	Total Amount Insured	RM.....
		Policy No.....
		Period of insurance
18 (b)	Amount of excess	RM.....
21.2	Date of Tender
28.1	Value of work to be executed including materials and goods to be delivered before First Interim Certificate will be issued	RM.....
28.2	Value of work to be executed including materials and goods to be delivered before each subsequent Interim Certificate will be issued	RM.....
28.6	Period for honouring payment certificate (if none stated, then within thirty (30) days of the issue of the Certificate)
34.4	Work covered by P.C. Sums for which the Contractor will be permitted to tender
38.2	'Date for Possession' of the Site
39.1	'Date for Completion' for whole of the Works.
40.2	Liquidated and Ascertained Damages at the rate of	RM.....per.....

APPENDIX TO THE CONDITIONS OF CONTRACT - (Cont'd)

Clause

41.1 Sectional Completion:

Identification of Sections or parts	Date for Possession [Clause 38.3]	Date for Completion	Liquidated & Ascertained Damages

48.1(a) Defects Liability Period (if none stated, then the period is twelve (12) months)

5.3, 5.4, 15.3, 17.3(b), 18.2 Percentage of on-cost charges 5%

48.2, 56.2(d) Percentage of on-cost charges 10%



JKR Malaysia,
Jalan Sultan Salahuddin
50580 Kuala Lumpur

APPENDIX TO THE CONDITIONS OF CONTRACT

Clause

4.1(a) Officer(s) empowered to approve variations according to the limits as set out in Treasury's Instructions No.202 as amended.

Financial Limits	Officer
1. Tidak melebihi 20% daripada Nilai kontrak	Yang di Pertua Majlis Perbandaran Batu Pahat
2. Melebihi 20% daripada nilai kontrak	Ketua Setiausaha Kementerian Kewangan

4.1(b) Officer(s) empowered to take Action on behalf of the Government in respect of :

**Yang di Pertua Majlis
Perbandaran Batu Pahat**

Clauses 51,52,53, 58 and 66... ..

13 Performance Bond

Amount of Guarantee **5% daripada Harga Kontrak**

Guarantor Bank/Insurance Company/
Finance Company **akan dikemukakan oleh kontraktor**

Guarantee No. **akan dikemukakan oleh kontraktor**

15 Minimum insurance cover for any one accident or series of accidents arising out of one event **10% daripada Harga Kontrak**

Policy No **akan dikemukakan oleh kontraktor**

Period of insurance..... **Tempoh Kontrak + Tempoh Tanggungan
Kecacatan + 14 hari + 3 bulan**

15.1 (b) Amount of excess **Tiada Berkaitan**

APPENDIX TO THE CONDITIONS OF CONTRACT - (Cont'd)

Clause

17	SOCSSO Scheme registration number....	<u>akan dikemukakan oleh kontraktor.</u>
18	Amount to be added to full value of Contract Sum as the insured sum	<u>Tidak Berkaitan</u>
	Total Amount Insured	<u>Tidak Berkaitan</u>
	Policy No.....	<u>Tidak Berkaitan</u>
	Period of insurance	<u>Tidak Berkaitan</u>
18 (b)	Amount of excess	RM..... <u>Tidak Berkaitan</u>
21.2	Date of Tender	<u>akan ditentukan kemudian</u>
28.1	Value of work to be executed including materials and goods to be delivered before First Interim Certificate will be issued <u>RM 1,000.00</u>
28.2	Value of work to be executed including materials and goods to be delivered before each subsequent Interim Certificate will be issued	<u>RM 1,000.00</u>
28.6	Period for honouring payment certificate (if none stated, then within thirty (30) days of the issue of the Certificate) <u>30 hari</u>
34.4	Work covered by P.C. Sums for which the Contractor will be permitted to tender <u>Tidak Berkaitan</u>
38.2	'Date for Possession' of the Site	<u>akan ditentukan kemudian</u>
39.1	'Date for Completion' for whole of the Works....	<u>akan ditentukan kemudian</u>
40.2	Liquidated and Ascertained Damages at the rate of <u>Kadar BLR Semasa</u> x Harga Kontrak	RM...per.. Satu (1)\hari.. 356 hari

APPENDIX TO THE CONDITIONS OF CONTRACT - (Cont'd)

Clause

41.1 Sectional Completion:

Identification of Sections or parts	Date for Possession [Clause 38.3]	Date for Completion	Liquidated & Ascertained Damages

48.1(a) Defects Liability Period (if none stated, then the period is twelve (12) months) **Twenty Four (24) months**

5.3, 5.4, 15.3 Percentage of on-cost charges 5%
17.3(b), 18.2,

48.2 Percentage of on-cost charges 10%
56.2(d)

Surat Setuju Terima

SECTION F

Majlis Perbadaran Batu Pahat

No. Tender/Kontrak :*No.Tender/ Kontrak.....

LAMPIRAN 8
(Versi Bahasa Malaysia)**SURAT SETUJU TERIMA**
(Bagi Tender Kerja)
Untuk Perolehan Bagi Kerja PembinaanRujukan Kami :Rujukan Agensi.....
Tarikh :Tarikh.......... Nama Syarikat
..... Alamat Syarikat
.....

Tuan,

Tender Untuk : Tajuk Tender
No. *Tender/ Kontrak : No. * Tender/ Kontrak

Dengan ini dimaklumkan bahawa Kerajaan telah bersetuju menerima tawaran tender tuan dengan harga sebanyak Ringgit Harga kontrak dalam perkataan (RM... Harga kontrak dalam angka.....) yang merupakan harga kontrak bagi tempoh kontrak selama . Hari/Minggu/Bulan/Tahun..... tertakluk kepada dokumen tender menjadi sebahagian daripada perolehan ini dan Surat Setuju Terima ini berserta dengan **Lampiran A** kepada Surat Setuju Terima iaitu maklumat terperinci kontrak (selepas ini disebut sebagai "Surat ini").

2. Dengan pengakuan penerimaan Surat ini berserta lampiran berkaitan, suatu kontrak yang mengikat terbentuk di antara Kerajaan dengan syarikat tuan. Satu dokumen kontrak hendaklah ditandatangani dalam kadar segera dengan memasukkan semua terma sebagaimana dokumen tender serta semua terma dalam **Lampiran A**. Sehingga dokumen kontrak tersebut ditandatangani, Surat ini hendaklah terus mengikat kedua-dua pihak.

3. Pelarasan harga dan kadar harga dalam *Jadual Kadar Harga dan/atau Ringkasan Tender atau Senarai Kuantiti, mengikut yang mana berkenaan setelah diteliti dan diselaraskan oleh Kerajaan tentang kemunasabahannya, yang mana akan menjadi sebahagian daripada terma-terma kontrak. Walau bagaimana pun, Jumlah Harga Kontrak seperti di atas adalah kekal tidak berubah.

4. Tarikh milik tapak seperti yang disebutkan dalam Syarat-syarat Kontrak ialah pada.....hh/bb/tttt..... . Walau bagaimanapun, tuan adalah diingatkan bahawa tiada kerja boleh dibuat **melainkan** jika tuan telah mengemukakan kepada Kerajaan dokumen-dokumen berikut:

- * (a) suatu bon pelaksanaan yang tidak boleh dibatalkan yang berjumlah Ringgit Nilai bon dalam perkataan (RM... Nilai bon dalam angka.....) dan jikalau Bon Pelaksanaan gagal dikemukakan pada tarikh milik tapak, Kerajaan berhak untuk melaksanakan kaedah Wang Jaminan Pelaksanaan;
Bon Pelaksanaan hanya dikenakan kepada perolehan yang bernilai RM200,000 dan ke atas sahaja.
- * (b) suatu polisi Insurans Tanggungan Awam (iaitu insurans terhadap bencana kepada orang-orang dan kerosakan kepada harta) nilai insurans tidak kurang daripada Ringgit..... Nilai insurans dalam perkataan (RM... Nilai insurans dalam angka);
- * (c) suatu polisi Insurans Kerja yang berjumlah: Ringgit..... Nilai insurans dalam perkataan (RM... Nilai insurans dalam angka);
- * (d) nombor Kod Majikan di bawah Skim PERKESO dan/atau Polisi Pampasan Pekerja,

mengikut ketetapan seperti di **Lampiran A**. Walau bagaimanapun, bagi memulakan kerja-kerja dan bukan maksud lain, tuan boleh menyerahkan Nota-nota Liputan bagi maksud polisi-polisi insurans tersebut dan

1 daripada 11

Tandatangan & Cop (Kerajaan) :
Tandatangan & Cop (Syarikat) :

No. Tender/Kontrak :*No.Tender/ Kontrak.....

resit-resit premium yang telah dibayar itu kepada Pegawai Penguasa. Tuan dikehendaki menyerahkan Polisi-polisi Insurans yang berkenaan (jika belum diserahkan) menurut perenggan 5 di atas, dalam tempoh tidak lewat 30 hari daripada tarikh penyerahan Nota-nota Liputan. Apa-apa kegagalan dalam mematuhi kehendak di perenggan ini dalam tempoh masa yang ditetapkan, boleh mengakibatkan Surat ini terbatal dan Kerajaan tidaklah dengan apa-apa cara jua bertanggung terhadap tuan **melainkan jika** penepian bertulis diberikan oleh orang yang diberi kuasa, bagi kerja yang perlu dibuat dengan segera atau serta-merta apabila kelewatan itu akan memudarat dan menjejaskan perkhidmatan dan kepentingan awam.

5. Setelah arahan dikeluarkan oleh Kerajaan, tuan dikehendaki melaksanakan kerja dalam tempoh yang ditetapkan dan kualiti kerja tersebut hendaklah memuaskan hati serta memenuhi kehendak Kerajaan. Sekiranya tuan gagal melaksanakan kerja dalam tempoh yang ditetapkan, Kerajaan berhak membatalkan arahan yang dikeluarkan dan/atau mengenakan *Liquidated & Ascertained Damages* (LAD) seperti yang ditetapkan dalam **Lampiran A**.

*6. Syarikat tuan juga adalah dikehendaki melaksanakan program Skim Latihan 1Malaysia (SL1M) seperti yang ditetapkan oleh Kerajaan berdasarkan harga kontrak dengan bilangan minimum peserta SL1M sebanyak ...Bil. minimum peserta SL1M.....orang tanpa sebarang kos kepada Kerajaan. Bilangan minimum peserta yang diperlukan hendaklah dikira berdasarkan formula di bawah:

$$\frac{1\% \times \text{Harga Kontrak}^*}{\text{RM24,000}^{**}}$$

*Bagi tujuan pengiraan SL1M, Harga Kontrak adalah harga kerja pembina

**Elaun SL1M (RM2,000 seorang x 12 bulan)

Perenggan ini terpakai sekiranya Harga Kontrak **melebihi nilai ambang** dan syarikat dikehendaki untuk melaksanakan Program SL1M berdasarkan 1PP/PK 1.2.

*6. Syarikat tuan juga adalah digalakkan melaksanakan program Skim Latihan 1Malaysia (SL1M) seperti yang ditetapkan oleh Kerajaan.

Perenggan ini terpakai sekiranya Harga Kontrak **di bawah nilai ambang** dan syarikat digalakkan untuk melaksanakan Program SL1M berdasarkan 1PP/PK 1.2.

7. Bagi tujuan program SL1M ini, syarikat tuan adalah dikehendaki untuk:

- (a) mengemukakan Jadual Pelaksanaan Program SL1M berdasarkan tempoh kontrak kepada Sekretariat SL1M untuk kelulusan dalam tempoh dua (2) minggu selepas tarikh pengakuan penerimaan Surat ini oleh syarikat tuan;
- (b) melaksanakan program ini mengikut Jadual Pelaksanaan Program SL1M yang diluluskan oleh Sekretariat SL1M;
- (c) mengemaskini maklumat berkaitan pengalaman syarikat melaksanakan program SL1M dalam sistem ePerolehan di Kementerian Kewangan atau sistem di Lembaga Pembangunan Industri Pembinaan Malaysia (CIDB), mengikut mana yang berkaitan;
- (d) mengemukakan sijil atau surat pengesahan oleh Sekretariat SL1M kepada Agensi sebaik sahaja pelaksanaan program SL1M selesai; dan
- (e) mengemukakan laporan berkaitan pelaksanaan program SL1M kepada Sekretariat SL1M.

*8. Sekiranya syarikat tuan gagal mematuhi mana-mana terma di perenggan 7 dan 8 atau arahan oleh Kerajaan, Kerajaan berhak untuk tidak mempertimbangkan sebarang tawaran kontrak baharu atau pelanjutan kontrak pada masa hadapan kepada syarikat tuan.

Perenggan ini terpakai sekiranya Harga Kontrak melebihi nilai ambang dan syarikat dikehendaki untuk melaksanakan Program SL1M berdasarkan 1PP/PK 1.2. Bagi Harga Kontrak di bawah nilai ambang, perenggan ini hendaklah dipotong.

9. Syarikat tuan juga adalah diingatkan bahawa Kerajaan berhak untuk membatalkan Surat ini sekiranya:

2 daripada 11

Tandatangan & Cop (Kerajaan) :

Tandatangan & Cop (Syarikat) :

Pihak Kerajaan : Pegawai yang diberi kuasa oleh Menteri di bawah seksyen 2 Akta Kontrak Kerajaan 1949 untuk menandatangani kontrak

Pihak Syarikat : Penama pada sijil pendaftaran untuk menandatangani Surat ini

No. Tender/Kontrak :*No.Tender/ Kontrak.....

- (a) syarikat tuan gagal mematuhi mana-mana terma di perenggan 5 dalam tempoh masa yang ditetapkan;
- (b) syarikat tuan gagal mematuhi mana-mana terma yang dinyatakan dalam Surat Akuan Pembida Berjaya;
- (c) syarikat tuan gagal memulakan kerja dalam tempoh dua (2) minggu dari tarikh milik tapak;
- (d) syarikat tuan telah membuat salah nyataan (*misrepresentation*) atau mengemukakan maklumat palsu semasa berurusan dengan Kerajaan bagi perolehan ini atau melakukan apa-apa perbuatan lain, seperti memalsukan maklumat dalam Sijil Akuan Pendaftaran Syarikat, mengemukakan bon pelaksanaan atau dokumen lain yang palsu atau yang telah diubah suai;
- (e) syarikat tuan membenarkan Sijil Akuan Pendaftaran Syarikat disalahgunakan oleh individu/syarikat lain;
- (f) syarikat tuan terlibat dalam membuat pakatan harga dengan syarikat-syarikat lain atau apa-apa pakatan sepanjang proses tender sehingga dokumen kontrak ditandatangani;
- (g) syarikat tuan telah memberikan subkontrak sama ada sepenuhnya atau sebahagiannya perkhidmatan tanpa kelulusan Kerajaan terlebih dahulu. Sekiranya Kerajaan meluluskan permohonan syarikat tuan untuk memberikan subkontrak sebahagian kerja atau keseluruhan kerja, kelulusan tersebut adalah tertakluk kepada syarikat tuan mengikat perjanjian hak (*Deed Of Assignment*) dengan Subkontraktor terlebih dahulu;
- (h) syarikat gagal menyempurnakan kerja dalam tempoh yang ditetapkan seperti di **Lampiran A**;
- (i) syarikat tuan gagal mematuhi mana-mana terma/arahan di dalam dokumen tender;
- (j) syarikat tuan/ pemilik/ rakan kongsi/ pengarah telah disabitkan atas kesalahan jenayah di dalam atau luar Malaysia;
- (k) syarikat tuan digulungkan;
- (l) syarikat tuan membekal barang-barang yang tidak tulen, bukan baharu atau yang terpakai;
- (m) kontraktor gagal/mungkir dalam melaksanakan tanggung jawabnya sepertimana ditetapkan dalam Syarat-syarat Kontrak;
- (n) syarikat tuan tidak mendapat kelulusan daripada Kerajaan terlebih dahulu bagi apa-apa penjualan atau pemindahan ekuiti sepanjang tempoh kontrak ini berkuat kuasa; atau
- (o) terdapat perkara yang melibatkan kepentingan awam atau keselamatan dan kepentingan negara.

10. Sekiranya Surat ini dibatalkan atas alasan seperti yang ditetapkan di **perenggan 9**, Kerajaan tidak akan bertanggungjawab terhadap apa-apa kerugian syarikat tuan termasuk kerugian masa hadapan.

11. Bersama-sama Surat ini disertakan Surat Akuan Pembida Berjaya dan Surat Akuan Sumpah Syarikat seperti di **Lampiran B** dan **Lampiran C** untuk ditandatangani oleh syarikat tuan dan dikembalikan bersama-sama dengan Surat ini.

12. Syarikat tuan juga adalah dikehendaki untuk mengemukakan dokumen berikut bersama-sama dengan Surat ini yang telah ditandatangani balas oleh tuan, untuk kelulusan Pegawai Penguasa sebelum memulakan kerja di tapak bina:

3 daripada 11

Tandatangan & Cop (Kerajaan) :

Tandatangan & Cop (Syarikat) :

No. Tender/Kontrak :*No.Tender/ Kontrak.....

- (a) Senarai nama subkontraktor berserta pengalamannya dengan menyatakan bahagian kerja yang terlibat; dan
- (b) Program Kerja bagi pelaksanaan projek ini.

13. Berdasarkan kepada Tempoh Siap Kerja yang ditenderkan selama **Tempoh dalam angka**..... hari/minggu/bulan*, Tarikh Siap untuk seluruh kerja-kerja di bawah kontrak ini ialah pada **dd/mm/yyyy**.....

14. Surat ini dihantar kepada syarikat tuan dalam tiga (3) salinan. Sila kembalikan ke pejabat ini salinan asal dan kedua berserta lampiran yang berkaitan yang telah ditandatangani dengan sempurna oleh syarikat tuan dan saksi syarikat tuan tidak melebihi *3/7/14 hari dari tarikh Surat ini diterima untuk tindakan kami selanjutnya. Apa-apa kegagalan dalam mematuhi kehendak di perenggan ini dalam tempoh masa yang ditetapkan boleh mengakibatkan Surat ini terbatal dan Kerajaan tidaklah dengan apa-apa jua bertanggungjawab terhadap syarikat tuan.

Sekian, terima kasih.

“BERKHIDMAT UNTUK NEGARA”

Saya yang menurut perintah,

Tandatangan Pegawai yang diberi kuasa oleh Menteri di bawah seksyen 2 Akta Kontrak Kerajaan 1949 untuk menandatangani kontrak

.....
(Nama Penuh Pegawai)
Jawatan Pegawai

Tandatangan & Cop (Kerajaan) :
Tandatangan & Cop (Syarikat) :

No. Tender/Kontrak :*No.Tender/ Kontrak.....

PENGAKUAN PENERIMAAN SURAT SETUJU TERIMA DAN LAMPIRAN YANG BERKAITAN OLEH SYARIKAT

Dengan ini disahkan bahawa yang bertandatangan di bawah ini mengakui penerimaan Surat ini dan lampiran yang berkaitan yang rujukannya ialahRujukan Agensi..... bertarikhTarikh SST ditandatangani oleh Menteri..... dan bersetuju dengan terma dan syarat yang terkandung dalam Surat ini tanpa syarat yang mana salinan kepada Surat ini telah pun disimpan, dan selanjutnya disahkan bahawa tiada apa-apa terma, syarat atau stipulasi tambahan kepada yang terkandung dalam dokumen tender dan Surat ini telah dikenakan.

Tandatangan Syarikat

.....
 Nama Penuh :
 No. Kad Pengenalan :
 Alamat :
 Tarikh :

Tandatangan Saksi Syarikat

.....
 Nama Penuh :
 No. Kad Pengenalan :
 Alamat :
 Tarikh :

Meterai atau Cop Syarikat

**potong mana yang tidak berkenaan*

Tandatangan & Cop (Kerajaan) :
 Tandatangan & Cop (Syarikat) :

No. Tender/Kontrak :*No.Tender/ Kontrak.....

Lampiran A**BUTIRAN KONTRAK**

Tajuk Tender

-
1. **Pendaftaran Syarikat Dengan Suruhanjaya Syarikat Malaysia (SSM) Atau Pendaftaran Koperasi Dengan Suruhanjaya Koperasi Malaysia (SKM) (jika berkaitan)**
 - 1.1 No. Pendaftaran : Nombor pendaftaran
 - 1.2 Tempoh Sah Laku : Tempoh sah laku sijil pendaftaran
 2. **Pendaftaran dengan Lembaga Pembangunan Industri Pembinaan Malaysia (CIDB) Di Bawah Perakuan Pendaftaran Kontraktor**
 - 2.1 No. Pendaftaran : Nombor pendaftaran dengan CIDB di bawah sijil ini
 - 2.2 Tempoh Sah Laku : Tempoh sah laku sijil ini
 - 2.3 Gred : Gred Kontraktor yang ditauliahkan di bawah sijil ini
 - 2.4 Kategori : Kategori Pendaftaran dengan CIDB di bawah sijil ini
 - 2.5 Pengkhususan : Bidang pengkhususan yang didaftarkan oleh kontraktor berkaitan untuk tender ini
 3. **Pendaftaran dengan Lembaga Pembangunan Industri Pembinaan Malaysia (CIDB) Di Bawah Sijil Perolehan Kerja Kerajaan (jika berdaftar)**
 - 3.1 No. Pendaftaran : Nombor pendaftaran dengan CIDB di bawah sijil ini
 - 3.2 Tempoh Sah Laku : Tempoh sah laku sijil ini
 - 3.3 Gred : Gred Kontraktor yang ditauliahkan di bawah sijil ini
 - 3.4 Kategori : Kategori Pendaftaran dengan CIDB di bawah sijil ini
 - 3.5 Pengkhususan : Bidang pengkhususan yang didaftarkan oleh kontraktor berkaitan untuk tender ini
 4. **Pendaftaran dengan Bahagian Pembangunan Kontraktor dan Usahawan (BPKU) (Sijil Bumiputera) (jika berdaftar)**
 - 4.1 No. Pendaftaran : Nombor pendaftaran dengan BPKU
 - 4.2 Tempoh Sah Laku : Tempoh sah laku sijil ini
 - 4.3 Gred Kontraktor : Gred Kontraktor yang ditauliahkan di bawah sijil ini
 5. **Pendaftaran dengan Pusat Pendaftaran Kontraktor Kerja, Bekalan Perkhidmatan Negeri Sabah (PUKONSA) (jika berdaftar)**
 - 5.1 No. Pendaftaran : Nombor pendaftaran dengan PUKONSA
 - 5.2 Tempoh Sah Laku : Tempoh sah laku sijil PUKONSA
 - 5.3 Gred Kontraktor : Gred Kontraktor yang ditauliahkan di bawah sijil ini

6 daripada 11

Tandatangan & Cop (Kerajaan) :

Tandatangan & Cop (Syarikat) :

No. Tender/Kontrak :*No.Tender/ Kontrak.....

- 5.4 Kepala : Kepala yang didaftarkan oleh kontraktor berkaitan untuk tender ini
Sub Kepala yang didaftarkan oleh kontraktor berkaitan untuk tender ini
- 5.5 Sub Kepala :

6. **Pendaftaran dengan Unit Pendaftaran Kontraktor dan Juruperunding, Pejabat Setiausaha Kewangan Negeri Sarawak (UPKJ) (jika berdaftar)**

- 6.1 No. Pendaftaran : Nombor pendaftaran dengan UPKJ
- 6.2 Tempoh Sah Laku : Tempoh sah laku sijil UPKJ
- 6.3 Gred Kontraktor : Gred Kontraktor yang ditauliahkan di bawah sijil ini
- 6.4 Kod Bidang : Kod bidang yang didaftarkan oleh kontraktor berkaitan untuk tender ini

7. **Harga dan Tempoh Kontrak**

- 7.1 Harga Tender (butiran harga seperti di **Lampiran A1**) : RM..... Harga Tender yang telah disetujui terima
Lampiran A1 adalah merupakan borang dalam dokumen tender dengan harga yang ditandatangani oleh syarikat.
- 7.2 Harga Kontrak : RM Harga Tender
- 7.3 Tempoh Kontrak : Hari/Minggu/Bulan/Tahun
- 7.4 Tarikh Milik Tapak : DD/MM/YYYY
- 7.5 Tarikh Siap Kerja : DD/MM/YYYY

8. ***Bon Pelaksanaan**

- 8.1 Kadar Bon Pelaksanaan : 5%
- 8.2 Formula Bon Pelaksanaan : 5% x RM Harga Kontrak
- 8.3 Nilai Bon Pelaksanaan : Dalam angka
- 8.4 Bentuk Bon Pelaksanaan : Jaminan Bank/ Bank Islam/ Bank Pembangunan Malaysia Berhad; atau Jaminan Syarikat Kewangan; atau Jaminan Insurans/ Takaful.
Jikalau Bon Pelaksanaan gagal dikemukakan pada tarikh milik tapak, Kerajaan berhak untuk melaksanakan kaedah Wang Jaminan Pelaksanaan
- 8.5 Tempoh Sah Laku : *Dari tarikh kuat kuasa kontrak sehingga 12 bulan selepas tamat Tempoh Tanggungan Kecacatan (DLP) – bagi projek bernilai sehingga RM10 juta; atau
*Dari tarikh kuat kuasa kontrak sehingga 24 bulan selepas tamat Tempoh Tanggungan Kecacatan (DLP) – bagi projek bernilai melebihi RM10 juta.

7 daripada 11

Tandatangan & Cop (Kerajaan) :

Tandatangan & Cop (Syarikat) :

No. Tender/Kontrak :*No.Tender/ Kontrak.....

Mengikut format yang ditetapkan oleh Kerajaan seperti di **Lampiran A4**

Lampiran A4 akan disediakan oleh Agensi berdasarkan format 1PP/PK4

9. *Polisi Insurans Kerja

- 901 Nilai Polis : RM..... Nilai dalam angka (berdasarkan Harga Kontrak dan di mana berkaitan, termasuk amaun yang perlu ditambah kepada nilai penuh Harga kontrak sebagai nilai yang diinsuranskan).
- 902 Tempoh Perlindungan : Meliputi tempoh kontrak

10. *Polisi Insurans Tanggungan Awam

- 10.1 Nilai Polisi : RM..... Nilai dalam angka (berdasarkan Harga Kontrak)
- 10.2 Tempoh Perlindungan : Meliputi tempoh kontrak, tempoh tanggungan kecacatan dan 3 bulan 14 hari.

11. Kenaan Liquidated & Ascertained Damages (LAD)

(Lewat menyiapkan kerja mengikut jadual yang ditetapkan)

- 11.1 Formula : Formula adalah berdasarkan ketetapan seperti di 1PP berkaitan Surat Setuju Terima
- 11.2 Kadar sehari : RM..... Nilai dalam angka

12. *Skim Latihan 1Malaysia (SL1M) (jika berkaitan)

(Bagi perolehan yang telah melebihi nilai ambang berdasarkan 1PP/PK1.2)

- 12.1 Tertakluk kepada pelaksanaan Program SL1M : Ya / Tidak (Berdasarkan nilai ambang yang ditetapkan dalam 1PP/PK1)
- 12.2 Bilangan minimum peserta SL1M : peserta

Formula:

1% X Harga Kontrak*

RM24,000**

**potong mana yang tidak berkenaan*

Tandatangan & Cop (Kerajaan) :

Tandatangan & Cop (Syarikat) :

No. Tender/Kontrak :*No. Tender/ Kontrak

Salinan Kepada :

Ketua Setiausaha Perbendaharaan
Bahagian Perolehan Kerajaan
Aras 4 Blok Utara
Kementerian Kewangan
Presint 2

62592 PUTRAJAYA

(u.p. : Ketua Seksyen Dasar Perolehan)

Pejabat Ketua Pegawai Eksekutif
Ibu Pejabat Lembaga Hasil Dalam Negeri Malaysia
Menara Hasil

Aras 18, Persiaran Rimba Permai, Cyber 8

63000 CYBERJAYA

Ketua Eksekutif
Lembaga Pembangunan Industri Pembinaan Malaysia
Tingkat 10, No. 45, Menara Dato' Onn
Pusat Dagangan Dunia Putra
Jalan Tun Ismail

50480 KUALA LUMPUR

Ketua Setiausaha
Kementerian Kerja Raya Malaysia
Bahagian Pembangunan Kontraktor dan Usahawan
Aras 5, Blok Menara, Menara Usahawan
No. 18, Persiaran Perdana, Presint 2

62652 PUTRAJAYA

(u.p. : Setiausaha Bahagian)

Sekretariat
Majlis Perundangan
Gaji Negara
Kementerian Sumber Manusia
Aras 7, Blok D3, Kompleks D

62530 PUTRAJAYA

Ketua Pengarah
Unit Perancang Ekonomi
Jabatan Perdana Menteri
Aras 2, Blok B5
Pusat Pentadbiran Kerajaan Persekutuan

62502 PUTRAJAYA

(u.p. : Ketua Sekretariat SL1M)

Tandatangan & Cop (Kerajaan) :
Tandatangan & Cop (Syarikat) :

No. Tender/Kontrak :*No. Tender/ Kontrak.....

Lampiran B**SURAT AKUAN PEMBIDA BERJAYA
(Tajuk dan Nombor Rujukan *Sebut Harga/Tender)**

Saya, nombor K.P. yang mewakili
(nama syarikat)..... nombor pendaftaran (*MOF/CIDB/SSM) dengan ini
mengisytiharkan bahawa saya atau mana-mana individu yang mewakili syarikat ini tidak akan menawar
atau memberi rasuah kepada mana-mana individu dalam atau mana-
mana individu lain, sebagai ganjaran untuk dipilih dalam *sebut harga/tender seperti di atas. Bersama ini
dilampirkan Surat Perwakilan Kuasa bagi saya mewakili syarikat seperti tercatat di atas untuk membuat
pengisytiharan ini.

2. Sekiranya saya atau mana-mana individu yang mewakili syarikat ini didapati bersalah menawar
atau memberi rasuah kepada mana-mana individu dalam(nama kementerian/agensi).....
atau mana-mana individu lain sebagai ganjaran mendapatkan *sebut harga/tender seperti di atas, maka
saya sebagai wakil syarikat bersetuju tindakan-tindakan berikut diambil:

- 2.1 penarikan balik tawaran kontrak bagi *sebut harga/tender di atas; atau
- 2.2 penamatan kontrak bagi *sebut harga/tender di atas; dan
- 2.3 lain-lain tindakan mengikut peraturan perolehan Kerajaan yang berkuat kuasa.

3. Sekiranya terdapat mana-mana individu cuba meminta rasuah daripada saya atau mana-mana
individu yang berkaitan dengan syarikat ini sebagai ganjaran mendapatkan *sebut harga/tender seperti di
atas, maka saya berjanji akan dengan segera melaporkan perbuatan tersebut kepada pejabat Suruhanjaya
Pencegahan Rasuah Malaysia (SPRM) atau balai polis yang berhampiran.

Yang Benar,

.....
(Nama dan No. KP)

Cop Syarikat :

Catatan:

- i) * Potong mana yang tidak berkenaan
- ii) Surat akuan ini hendaklah dikemukakan bersama Surat Perwakilan Kuasa

Tandatangan & Cop (Kerajaan) :
Tandatangan & Cop (Syarikat) :

Spesifikasi Kerja

SECTION G

Majlis Perbadaran Batu Pahat

STANDARD SPECIFICATIONS FOR BUILDING WORKS 2014



TABLE OF CONTENTS

	PAGE
SECTION A : PRELIMINARIES AND GENERAL CONDITIONS	A/1 - A/30
SECTION B : EXCAVATION AND EARTHWORKS	B/1 - B/14
SECTION C : FOUNDATION WORKS AND WORKS BELOW LOWEST FLOOR LEVEL	C/1 - C/42
SECTION D : CONCRETE WORKS	D/1 - D/44
SECTION E : NON-STRUCTURAL WALL SYSTEM	E/1 - E/10
SECTION F : SEWERAGE WORKS	F/1 - F/10
SECTION G : ROOFING WORKS	G/1 - G/8
SECTION H : TIMBER, JOINERY AND IRONMONGERY WORKS	H/1 - H/30
SECTION I : CEILING WORKS	I/1 - I/10
SECTION J : STRUCTURAL STEEL AND METAL WORKS	J/1 - J/6
SECTION K : PLASTERING, PAVING AND TILING WORKS	K/1 - K/14
SECTION L : WATER RETICULATION, INTERNAL PLUMBING SYSTEM AND SANITARY FITTINGS	L/1 - L/14
SECTION M : RAIN WATER COLLECTION	M/1 - M/6
SECTION N : GLAZING WORKS	N/1 - N/4
SECTION O : PAINTING WORKS	O/1 - O/8
SECTION P : ROADS AND HARDSTANDING	P/1 - P/11
SECTION Q : FENCING AND GATES	Q/1 - Q/2
SECTION R : LANDSCAPING AND TURFING WORKS	R/1 - R/10
SECTION S : DRAINAGE WORKS	S/1 - S/8
SECTION T : SIGNAGE WORKS	T/1 - T/4

TABLE OF CONTENTS

SECTION A: PRELIMINARIES AND GENERAL CONDITIONS

	PAGE
1. Scope Of Works	A/1
2. Abbreviations	A/1
3. Standards	A/1
4. Contract Documents	A/2
5. Adjoining Property	A/3
6. Goods, Materials And Workmanship	A/3
7. Use Of Local Materials	A/3
8. Sustainable Materials And Products	A/4
9. Metrication	A/4
10. Ordering	A/4
11. Supply Of Materials By Government	A/4
12. Shop Drawings, Samples And Mock-Ups	A/5
13. Contractor's Plant	A/5
14. Construction Plan	A/5
15. Project Signboard	A/6
16. Progress Photographs	A/6
17. Sufficient Notice To Local Authorities	A/7
18. Access And Temporary Roads	A/7
19. Temporary Diversion And Relocation Of Existing Overhead And Underground Services	A/7
20. Temporary Water And Power Supplies For The Works	A/7
21. Site Security	A/7
22. Care And Protection	A/8
23. Legislation And Regulations	A/8
24. Drainage, Erosion And Sediment Control	A/8
25. Access Roads And Maintenance Of Existing Roads	A/9
26. Control Of Workmen, Plant And Machinery At Site	A/10
27. Particulars Of Employees	A/10
28. Contractor's Temporary Accommodation And Facilities For Workmen Living On Site	A/10
29. Contractor's Office And Storage	A/11
30. Office Accommodation For S.O.	A/12
31. Telephone For S.O.	A/12
32. Site Items For S.O./ Office Equipment And Facilities	A/13
33. Material Testing Laboratory And Staff	A/14
34. Survey Instruments And Personnel	A/14
35. Safe Working Area	A/15
36. Safety, Health And Welfare	A/16
37. Sanitation	A/17
38. Waste Management	A/17
39. Environmental Protection Works	A/17
TABLE A1 : Submission Of Documents	A/18
40. Water And Air Quality, Noise And Vibration Control	A/18
41. Nominated Sub-contractors	A/19
42. Nominated Suppliers	A/21
43. Coordination Of Mechanical And Electrical Services	A/21
44. Keeping The Site Tidy	A/22
45. As-built Drawings	A/22
46. Clearing, Cleaning And Making Good On Completion	A/23

TABLE OF CONTENTS

SECTION A: PRELIMINARIES AND GENERAL CONDITIONS

	PAGE
APPENDIX A/1 : Legislation And Regulations	A/24
APPENDIX A/2 : List Of S.O.'s Facilities And Equipment	A/25
APPENDIX A/3 : List Of S.O.'s Transport Service	A/26
APPENDIX A/4 : List Of Laboratory Equipment	A/27
APPENDIX A/5 : Requirements Of Safety And Health Plan (S-Plan)	A/28
APPENDIX A/6 : Requirements Of Safety And Health Report	A/29
APPENDIX A/7 : TABLE A2 : Environmental Quality Standards To Be Complied With By The Contractor	A/30

 JKR MALAYSIA	SECTION A: PRELIMINARIES AND GENERAL CONDITIONS	No. Dokumen : JKR 20800-0183-14 No. Keluaran : 01 No. Pindaan : 00 Tarikh : 29 Januari 2014 Muka Surat : A/1
--	--	--

1. Scope Of Works

- 1.1 The Works covered in this Contract comprise the provision by the Contractor at his own risk and cost of all materials, scaffolding, tools, plant, labour, transport, water, light and everything else necessary for the construction and completion of
.....all to the approval of the S.O.
- 1.2 The Conditions of Contract for the Works, which is embodied in the Form of Contract (Form PWD 203 / Form PWD 203A), shall be read in conjunction with this Specification. A copy of the Form of Contract is available for inspection on the Tender Table on any working day up to the time appointed for receiving tenders. If the tenderer considers that any of the clauses of the Contract involves expenses, he shall allow for the money value of such clauses in his Tender.

2. Abbreviations

- 2.1 The following abbreviations appearing in these Specifications have their meanings as assigned against them:

- (i) B.Q. - Bills of Quantities
- (ii) CIAST - Pusat Latihan Pengajar dan Kemahiran Lanjutan
- (iii) CIDB - Construction Industry Development Board
- (iv) CoW - Clerk of Works
- (v) DGFR - Director General of Fire and Rescue
- (vi) DOE - Department of Environment
- (vii) DOSH - Department of Occupational Safety and Health
- (viii) EMP - Environmental Management Plan
- (ix) JKR - Jabatan Kerja Raya
- (x) MOH - Ministry of Health
- (xi) MSMA - Manual Saliran Mesra Alam
- (xii) MTIB - Malaysian Timber Industry Board
- (xiii) PDRM - Polis Diraja Malaysia
- (xiv) P.E. - Professional Engineer
- (xv) R.O.W. - Right Of Way
- (xvi) S.O. - Superintending Officer
- (xvii) S.P. - System Provider
- (xviii) SIRIM - Standards and Industrial Research Institute of Malaysia
- (xix) SPAN - Suruhanjaya Perkhidmatan Air Negara

3. Standards

- 3.1 All Standards referred to in this Specification together with any addenda issued shall be deemed to be the editions current at the time of Tender. If the Malaysian Standard (MS) exists, which the S.O. deems to be equivalent to the British or other Standard specified, then the MS shall be followed. Other equivalent standards specifying superior material may be used with the approval of the S.O.
- 3.2 In the event of any discrepancy between the provision of this Specification and the provision within the relevant Standards or Codes of Practice (CP) as mentioned in this Specification, then the provision of this Specification shall take precedence.

ⁱ Refer to details in the B.Q./Summary of Tender

 <p>JKR MALAYSIA</p>	<p>SECTION A: PRELIMINARIES AND GENERAL CONDITIONS</p>	<p>No. Dokumen : JKR 20800-0183-14 No. Keluaran : 01 No. Pindaan : 00 Tarikh : 29 Januari 2014 Muka Surat : A/2</p>
--	---	---

3.3 The following references shall mean:

- (i) AASHTO - The American Association of State Highway and Transportation Officials
- (ii) ANSI - American National Standards Institute
- (iii) API - American Petroleum Institute Specification
- (iv) AS/NZS - Australian/New Zealand Standard
- (v) ASTM - The American Society for Testing and Materials
- (vi) AWWA - American Water Works Association
- (vii) BS - British Standards Specification as issued by the British Standards House, London (the latest amendment)
- (viii) CNS - China National Standard
- (ix) CP - British Standard Code of Practice issued by the Council for Code of Practice in Great Britain (the latest amendment)
- (x) DIN - German Institute for Standardisation
- (xi) EN - European Standard which is a standard that has been adopted by one of the three recognized European Standardisation Organisations (ESOs), that is CEN (European Committee for Standardization), CENELEC (European Committee for Electrotechnical Standardisation) and ETSI (European Telecommunications Standards Institute)
- (xii) JIS - Japanese Industrial Standard
- (xiii) MS - Malaysian Standards as issued by the Standards and Industrial Research Institute of Malaysia (the latest amendment)

4. Contract Documents

4.1 The Contract Documents shall consist of:

- (i) PWD Form of Contract (for contract based on Drawings and Specification or for contract based on Quantities);
- (ii) Form of Tender;
- (iii) Letter of Acceptance of Tender;
- (iv) Special Provisions to the Conditions of Contract as listed in the PWD Form of Contract;
- (v) Contract Drawings;
- (vi) Specifications;
- (vii) Summary of Tender (for contract based on Quantities, this item is part of the B.Q.);
- (viii) Schedule of Rates (for contract based on Drawings and Specifications) or B.Q. (for contract based on Quantities);
- (ix) Any other relevant documents included therein.

4.2 The documents shall be taken as mutually explanatory of each other and in case of any discrepancy or inconsistency, the following rules shall apply:

- (i) The Conditions of Contract (PWD Form 203/ PWD Form 203A) shall take preference over all other documents.
- (ii) Special Provisions to Conditions of Contract shall take preference over Conditions of Contract.
- (iii) In Drawings, large scale details shall take preference over small scale Drawings.
- (iv) The Addendum Specification shall take preference over the Standard Specifications and Drawings.
- (v) Drawings shall take preference over Standard Specifications.

 <p>JKR MALAYSIA</p>	<p>SECTION A: PRELIMINARIES AND GENERAL CONDITIONS</p>	<p>No. Dokumen : JKR 20800-0183-14 No. Keluaran : 01 No. Pindaan : 00 Tarikh : 29 Januari 2014 Muka Surat : A/3</p>
--	---	---

- 4.3 Any discrepancies shall be referred as soon as possible to the S.O. who shall decide which shall be followed.

5. Adjoining Property

Where the property adjoining the Site is in constant use by the Employer/adjoining owners and occupiers, the Contractor shall arrange and carry out the Works so as to cause minimum interference or interruption to the use of adjoining properties including roads, footpaths, other access and any existing services thereto. He shall comply with all instructions or directions given by the S.O. in these matters.

6. Goods, Materials And Workmanship

- 6.1 Materials and workmanship throughout the Works shall be in accordance with the Drawings and Specifications and to the approval of the S.O.
- 6.2 Where required, all works shall be executed by competent and skilled workers in the related field.
- 6.3 Wherever in this Specification any proprietary goods or materials are specified, goods or materials of alternative manufacture may be considered for acceptance provided they comply in all respect as regards to appearance and quality, and are approved by the S.O.
- 6.4 If, however, the Contractor has shown beyond reasonable doubt that the specified goods or materials cannot be obtained and the S.O. is satisfied with regard to the non-availability of the goods and materials, the benefit of cost savings, if any, resulting from the Contractor's proposal or substitution of goods or materials approved by the S.O., shall be deducted from the Contract Sum.

7. Use Of Local Materials

- 7.1 The Contractor shall use locally manufactured materials and goods as listed in the 'Senarai Bahan/Barangan Binaan Buatn Tempatan' issued by IKRAM QA Services Sdn. Bhd. and/or 'Senarai Bahan/Barangan Buatn Tempatan' issued by SIRIM QA Services Sdn. Bhd., whichever is relevant. If the Contractor fails to comply with this requirement, a penalty shall be imposed and/or the materials supplied shall be rejected.
- 7.2 The locally manufactured materials and goods which are not listed aforesaid, may be permitted if the materials have been tested and certified by IKRAM QA Services Sdn. Bhd. or SIRIM QA Services Sdn. Bhd. whichever is relevant. If the testing cannot be carried out by IKRAM QA Services Sdn. Bhd. or SIRIM QA Services Sdn. Bhd., the Contractor may apply and, subject to the approval of the S.O., carry out the testing by other agencies.
- 7.3 Under no circumstances will the Contractor be permitted to incorporate or supply imported materials, plant, equipment, or other goods into the Works or forming part of the scope of the Works except those approved by the Government, prior to the execution of the Contract. The Contractor shall substitute any materials, plant, equipment, or other goods proposed to be imported but not approved by the Government, with suitable local materials, plant, equipment, or other goods, including making any necessary sub-sequential changes or adjustments to the design of the Works to accommodate such substitution, all to the concurrence of the S.O.

 <p>JKR MALAYSIA</p>	<p>SECTION A: PRELIMINARIES AND GENERAL CONDITIONS</p>	<p>No. Dokumen : JKR 20800-0183-14 No. Keluaran : 01 No. Pindaan : 00 Tarikh : 29 Januari 2014 Muka Surat : A/4</p>
--	---	---

7.4 The Contractor shall ensure that the procurement of approved imported materials, plant, equipment, or other goods are obtained directly from the country of origin based on Free On Board (F.O.B) or other similar basis. The transportation and insurance of such imported materials, plant, equipment, or other goods from the country of origin to the Site shall be arranged by the Contractor through approved Government's Multi Modal Transport Operators (MTO). The Contractor shall allow in his tender all costs and time required in complying with the requirements of this clause including the cost required for the services provided by the MTO.

7.5 The Contractor shall submit documentary evidence of compliance with this clause to the S.O. within one (1) month from the date of each delivery to the Site of such materials, plant, equipment, vehicles or other goods.

8. Sustainable Materials And Products

8.1 Notwithstanding the materials and products shown on the Drawings or specified herewith, the Contractor is encouraged to propose, at no additional cost, alternative equivalent materials or "Green" products to be used in the Works, subject to the approval of the S.O., such as:

- (i) Environmentally friendly materials or "Green" products that are certified under the SIRIM Eco-Label certification or any labels under the Global Eco-Label Network (GEN) certification.
- (ii) Products self-declared "Green" by the manufacturer with certification from recognised independent certifying bodies and not a member of GEN.

9. Metrication

Unless otherwise specified hereinafter or shown on the Drawings, only materials of metric dimension shall be used for the Works. Materials of equivalent imperial dimension may only be used if the Contractor can satisfy the S.O. that the required materials are not available in metric dimension.

10. Ordering

The Contractor shall place his orders for specified materials at the earliest possible date after notification of acceptance of tender or at such times as may be specifically stated for any particular material.

11. Supply Of Materials By Government

11.1 If the Contractor fails for any reason to supply any materials, which he has contracted to supply, or if he fails to supply any such materials in sufficient time to enable the Contract to be completed by the agreed date for completion, the Government may supply any portion, or all of such materials.

11.2 If the Government supplies such material, the cost in respect thereof to be borne by the Contractor shall be either the current market rates or the actual cost to the Government, whichever is greater, plus 5% on cost charges.

11.3 The cost to be borne by the Contractor, as detailed above, shall be deducted from any money due or to become due to the Contractor under this Contract and failing which such costs shall be recovered from the Performance Bond or as a debt due from the Contractor.

 JKR MALAYSIA	SECTION A: PRELIMINARIES AND GENERAL CONDITIONS	No. Dokumen : JKR 20800-0183-14 No. Keluaran : 01 No. Pindaan : 00 Tarikh : 29 Januari 2014 Muka Surat : A/5
--	--	--

- 11.4 No action by the S.O. under this clause shall be deemed in any way to affect or modify the right of the Government to claim for damages in the event of the Contractor's failure to complete the Works by the agreed date of completion.

12. Shop Drawings, Samples And Mock-ups

- 12.1 The Contractor shall submit for approval relevant shop drawings as requested by the S.O.
- 12.2 The Contractor shall submit samples of materials or execute samples of workmanship for the S.O.'s approval, and for further samples as required until the samples submitted or executed are in accordance with this Specification.
- 12.3 The Contractor shall prepare sample installations as required to match specified works in all respects before proceeding with work. Mock-up units approved and accepted by the S.O. shall be referred as the Standard of comparison for the work.
- 12.4 The Contractor shall submit for approval as requested by the S.O., manufacturer's specifications, installation instruction, general recommendation for the work, including certified laboratory test reports and other data required to show compliance with these specifications.

13. Contractor's Plant

- 13.1 The Contractor shall provide, erect, keep insured, maintain and remove on completion all requisite scaffolding, hoist, ladder, staging, tarpaulins, tools, vehicles, tackles and other plants and apparatus (excluding piling and pile testing equipment), as required by all trades as are necessary for the execution of the Works.
- 13.2 All mechanical plant used by the Contractor shall be of such type, size and capacity suitable to the type and nature of the Works and site conditions where the Works are to be executed.
- 13.3 The Contractor shall take note the required crange for the erection and completion of precast components and to ensure that the said cranes are or will be available during the construction stages.

14. Construction Plan

- 14.1 Within fourteen (14) days after the receipt of the Letter of Acceptance, the Contractor shall submit to the S.O. for his approval the following:
- 14.1.1 Programme of Works
- 14.1.1.1 A detailed work programme using the Critical Path Method (CPM) including electronic and printed copies of all data. The programme shall be presented in the form of Gantt chart and network diagrams indicating, among others the critical activities, interface dates and resources required to complete the works within the Contract period. The Contractor shall be required to update all information and maintain the planned programme weekly/monthly using the CPM or as instructed by the S.O.
- 14.1.1.2 The work programme shall be prepared and maintained by trained and qualified personnel.

 <p>JKR MALAYSIA</p>	<p>SECTION A: PRELIMINARIES AND GENERAL CONDITIONS</p>	<p>No. Dokumen : JKR 20800-0183-14 No. Keluaran : 01 No. Pindaan : 00 Tarikh : 29 Januari 2014 Muka Surat : A/6</p>
--	---	---

14.1.2 Method statements

14.1.2.1 The Contractor shall also furnish in writing to the S.O. or S.O's Representatives particulars of the Contractor's method statements for carrying out such works and of the construction plant and temporary works, if any, which the Contractor intends to supply, use or construct as the case may be. The submission to and approval by the S.O. or the S.O.'s Representatives of such programme or the furnishing of such particulars shall not relieve the Contractor of any of his duties or responsibilities under the Contract.

14.1.2.2 If at any time it should appear to the S.O that the actual progress of the Works does not conform to the approved programme the Contractor shall submit for approval, a revised programme showing the modifications to the previously approved programme and additional resources necessary to ensure the completion of the whole Works within the approved contract period.

14.1.3 Contractor's organisation chart

The Contractor shall submit to the S.O. the organisation chart of his project team showing the personnel involved, their designations and relationship including their roles and responsibilities.

14.1.4 Schedules

14.1.4.1 The Contractor shall submit the following schedules:

- (i) Maintenance and Calibration Schedule of the plant and equipment to be used in the Works.
- (ii) Inspection and Testing Schedule of the plant and equipment, itemising the type and frequency of inspection and testing.

15. Project Signboard

The Contractor shall provide, erect, paint and maintain a project signboard in Bahasa Melayu as shown on the relevant drawing or as directed by the S.O. The signboard shall be erected at a prominent position at the Site as approved by the S.O.

16. Progress Photographs

16.1 The Contractor shall take progress photographs at monthly intervals or more frequent as directed by the S.O. The photographs to be taken from different angles as approved by the S.O. and the average number of photographs shall be sufficient enough to show the progress of the Works. For building works, the average number per month shall not be less than six (6) per block of building.

16.2 The Contractor shall supply six (6) sets of bound printed copies of the approved photographs, all properly titled and dated. The photographs shall also be provided in jpeg or other approved format with each image set at minimum size of 1280 x 960 pixels and at resolution of 72 pixels per inch and submitted to the S.O. monthly, in compact discs or removable storage.

 <p>JKR MALAYSIA</p>	<p>SECTION A: PRELIMINARIES AND GENERAL CONDITIONS</p>	<p>No. Dokumen : JKR 20800-0183-14 No. Keluaran : 01 No. Pindaan : 00 Tarikh : 29 Januari 2014 Muka Surat : A/7</p>
--	---	---

17. Sufficient Notice To Local Authorities/Utility Providers/Regulatory Bodies

- 17.1 The Contractor shall give sufficient notice to the relevant Local Authorities/Utility Providers/Regulatory Bodies before commencing or to inspect any works in relation to their scope of services. Failure to give sufficient notice shall not entitle the Contractor to extension of time due to any subsequent delays in connection with the Works.
- 17.2 Any notice given to the above mentioned authorities shall also be copied to the S.O.

18. Access And Temporary Roads

The Contractor shall provide and maintain all necessary temporary entrance to the Site and temporary culverts, tracks, bridges, et cetera for access to and within the Site as long as required to the approval of the S.O. The position where the site access is to be made shall be as indicated on the site plan or as approved by the S.O. and the Contractor shall make all arrangements and obtain all approvals and permissions required at his own cost.

19. Temporary Diversion And Relocation Of Existing Overhead And Underground Services

- 19.1 Before commencing any excavation, et cetera, the Contractor shall enquire from the various authorities whether any underground pipes, cables, et cetera are present on the Site and if so, he shall make arrangements for the disconnection, removal and if necessary, the relocation and reconnection of such services and pay all necessary cost and fees in connection with all temporary diversion and relocation of existing services.
- 19.2 If during excavation, the Contractor comes across any underground cables, et cetera, he shall immediately stop work and refer to the S.O. for further instructions and make arrangements for the disconnection, et cetera The Contractor shall be responsible for making good all damage to the cables, et cetera, and shall indemnify the Government against any claims as a result of such damage.

20. Temporary Water And Power Supplies For The Works

- 20.1 The Contractor shall provide adequate power supplies for temporary lighting and for the execution of the works. Electricity shall be obtained from Tenaga Nasional Berhad (TNB) or the local electricity supply company. Where such electricity supply cannot be provided, generator set(s) may be used but safety precautions must be taken. The use of kerosene lamps shall not be allowed.
- 20.2 The Contractor shall provide all water required for the use in the Works including paying all associated costs and fees and providing and removing all temporary plumbing and storage facilities on completion.

21. Site Security

The Contractor shall provide all necessary personnel and lighting for the security of the site at all times until completion of the whole Works.

	SECTION A: PRELIMINARIES AND GENERAL CONDITIONS	No. Dokumen : JKR 20800-0183-14 No. Keluaran : 01 No. Pindaan : 00 Tarikh : 29 Januari 2014 Muka Surat : A/8
---	--	--

22. Care And Protection Of Materials And Works

The Contractor shall provide and maintain everything necessary for proper protection of materials and Works from any damage by weather, carelessness or otherwise. Any damage caused shall be made good at the Contractor's own cost to the approval of the S.O.

23. Legislation And Regulations

- 23.1 The Contractor shall at all times comply with the provisions of all statutes and other related legislation currently in force regarding the environment, safety and health as listed in APPENDIX A/1 including any revisions to the current regulations.
- 23.2 The Contractor shall be liable for and shall indemnify the Government against any damages, expenses, liability, losses, claims, prosecution, proceedings, fines and penalties caused by any non-compliance or contravention of the above legislation and regulations.

24. Drainage, Erosion And Sediment Control

- 24.1 The Contractor shall execute the Erosion and Sediment Control Plan (ESCP) and all control measures as shown on the Drawings in such a manner and order as directed by the S.O. that will minimize accelerated erosion and sedimentation during the construction phase. The Contractor shall be responsible for compliance with MSMA relating to erosion and sediment control.
- 24.2 The Contractor shall execute ESCP which provides for inspection of erosion and sediment control devices and facilities on a weekly basis and following precipitation events, as well as maintenance, replacement or repairs to inadequate or damaged controls and devices to ensure effective and efficient operation.
- 24.3 The contractor shall maintain all the temporary works regularly throughout the construction period, or as directed by the S.O. and making good of any damaged portions during the course of the works.
- 24.4 The Contractor shall make proper provision for the drainage of surface water from the work site including rainwater from surrounding areas which drain on to the site.
- 24.5 The Contractor shall provide, form, fix and maintain such pumps, chutes, walls, drains, bunds and other temporary works necessary for the proper drainage of the Site so that no ponding, flooding or other damage or disturbance is caused to areas surrounding the works throughout the duration of the Contract.
- 24.6 Silt/Sediment traps shall be constructed as shown on the Drawings. The silt/sediment traps shall be maintained regularly throughout the contract period, including desilting when full or as directed by the S.O. and making good of any damaged portions during the course of the Works. The desilted material shall be transported to disposal site approved by the S.O.
- 24.7 The Contractor shall construct construction stabilization access as shown on the Drawing unless otherwise directed by the S.O. for reducing tracking of mud and dirt onto public's roads by Contractor's vehicles. The construction stabilization access can be made from aggregates, asphaltic concrete and concrete based on longevity, required performance and site condition. The use of asphalt concrete grindings for stabilized construction access/roadway shall be not allowed. Stabilized construction access shall be maintained by the Contractor until

 JKR MALAYSIA	SECTION A: PRELIMINARIES AND GENERAL CONDITIONS	No. Dokumen : JKR 20800-0183-14 No. Keluaran : 01 No. Pindaan : 00 Tarikh : 29 Januari 2014 Muka Surat : A/9
--	--	--

construction staging requires removal or upon final stabilization of the construction site. Upon removal of the stabilized construction access, the area shall be graded and stabilized.

- 24.8 The Contractor shall construct wash trough as shown on the Drawing unless otherwise directed by the S.O. for cleaning all debris, dirt and mud from the wheels and tyres of Contractor's vehicles leaving the Site. The position of the wash trough shall be as indicated on the site plan or as approved by the S.O. The wash trough shall be maintained regularly throughout the contract period as directed by the S.O.
- 24.9 The Contractor shall construct temporary waterway crossing as shown on the Drawing unless otherwise directed by the S.O., for providing erosion-free access point across a waterway for contractor's vehicles or equipment and may be necessary to prevent contractor's equipment from causing erosion of the waterway and tracking of pollutants into the waterway.
- 24.10 The Contractor shall install check dam as shown on the Drawings unless otherwise directed by the S.O., for preventing erosion by reducing the velocity of storm water flows in diversion channel in steep terrain. The check dam shall be constructed of rocks or logs which are secured against damage during significant floods. It shall be of sufficient height and spacing to allow small pools to form between each one and also promote sedimentation behind the dam. The check dam shall be inspected after each rainfall and when a sediment accumulation of approximately one third (1/3) of the check dam height is observed, the sediment shall be removed.
- 24.11 The Contractor shall construct protection works to the drainage inlets and outlets as shown on the Drawings unless otherwise directed by the S.O. for trapping sediment and debris. The drainage inlet and outlet protection works may consist of rock, grouted rip-rap, concrete rubble, gravel, sand bag, wire mesh or trash screen shall be constructed in such a manner that will facilitate cleanout and disposal of trapped sediment / debris and minimizes interference with construction activities.

25. Access Roads And Maintenance Of Existing Roads

- 25.1 All access roads to the site shall be built away from the existing watercourses, streams and rivers with proper drainage system and be paved for a distance of at least 10 m from where these access roads join existing roads.
- 25.2 The Contractor shall maintain all access roads including the drainage system throughout the construction period to the satisfaction of the S.O.
- 25.3 Where the Contractor uses existing/private roads as his access, he shall be responsible for any damage to the existing roads, bridges, drains, culverts, roadside furniture, and all other appurtenances and services on such roads caused by any work carried out by him throughout the construction period. The Contractor shall repair any damages and reinstate the same to their original condition to the satisfaction of the S.O.
- 25.4 All temporary diversion affecting public/private roads must be approved by the Government, private landowners and the S.O. All such diversions must be equipped with temporary diversion signs and comply with the current JKR requirements Adequate workmen for controlling traffic diversion must be provided.

	SECTION A: PRELIMINARIES AND GENERAL CONDITIONS	No. Dokumen : JKR 20800-0183-14 No. Keluaran : 01 No. Pindaan : 00 Tarikh : 29 Januari 2014 Muka Surat : A/10
---	--	---

- 25.5 If the Contractor fails to carry out his obligations as stated above, the S.O. shall carry out such maintenance and restoration and all costs incurred shall be borne by the Contractor or deducted from any money due or to become due to the Contractor under this Contract.

26. Control Of Workmen, Plant And Machinery At Site

- 26.1 The Contractor shall be responsible for controlling all persons under his employment and those employed by his sub-contractors, merchants and haulers at the work site and shall take all necessary precautions to prevent damage and nuisance of any kind and shall indemnify the Government against any claim arising therefrom.
- 26.2 The Contractor shall ensure, so far as is practicable, the safety, health and welfare at work of all his workmen including:
- (i) The provision and maintenance of plant and system of work that is safe and without risks to health;
 - (ii) Ensuring safety and absence of risks to health in connection with the use or operation, handling, storage and transport of plant and substances;
 - (iii) The provision for such information, instruction, training and supervision as is necessary to ensure the safety and health at work of his workmen;
 - (iv) The maintenance of place of work condition, the provision and maintenance of the means of access to and egress from place of work that are safe and without risks;
 - (v) The provision and maintenance of a working environment for his workmen that is safe, without risks to health, and adequate as regards facilities for their welfare at work;
 - (vi) Ensuring all workmen have a valid CIDB Green Cards before entering the construction site.

27. Particulars Of Employees

The Contractor shall on each working day furnish to the S.O., maintain and update a full list of all his workers including all workers employed by his sub-contractors or Nominated Sub-contractors on the work site giving all particulars in the format as approved by the S.O.

28. Contractor's Temporary Accommodation And Facilities For Workmen Living On Site

- 28.1 The Contractor shall provide and maintain all temporary accommodation and facilities including temporary lighting, plumbing and water storage for his labour and staff living on Site. Such accommodation shall be in the form of standard cabins or constructed of plywood and/or metal deck or of other materials approved by the S.O. and provided with adequate facilities to the approval of the S.O., in accordance with the following requirements:
- (i) The location of the accommodation quarters shall be to the approval of the S.O. before the erection and shall be such as to avoid obstruction and nuisance to the Works and public, and shall be laid out in an approved and orderly manner.
 - (ii) Under no circumstances shall the accommodation be provided in buildings under construction.

 <p>JKR MALAYSIA</p>	<p>SECTION A: PRELIMINARIES AND GENERAL CONDITIONS</p>	<p>No. Dokumen : JKR 20800-0183-14 No. Keluaran : 01 No. Pindaan : 00 Tarikh : 29 Januari 2014 Muka Surat : A/11</p>
--	---	--

- (iii) The temporary accommodation shall be provided with adequate ventilation and lighting. The sleeping area or resting area shall not be less than 5 m² per person. Each accommodation unit shall be maintained, kept tidy and clean at all times.
- (iv) The accommodation quarters shall not be more than two storeys high. Common areas for dining, recreation and praying purposes shall be provided.
- (v) Plywood used shall be new and of minimum thickness 12 mm. The external walls shall be painted.
- (vi) The Contractor shall provide adequate temporary toilets (not less than one (1) no. for every twenty five (25) workmen) and bathing place with necessary water, septic tank and drainage in accordance with DOE and/or Local Authority requirements. It shall be maintained in a clean and sanitary condition at all times to the satisfaction of the S.O./ Ministry of Health (MOH)/ Local Authority. All wastewater must be treated such that its effluent meets the requirements of all existing legislation and regulations.
- (vii) A separate area shall be provided for cooking.
- (viii) Water used for consumption shall be obtained directly from water authority mains. Where such water supply is not available, potable water shall be provided from sources approved by the S.O. Potable water shall comply with the requirements of the guidelines issued by the MOH.
- (ix) The Contractor shall appoint a person to be responsible for keeping and maintaining a register of the workmen and other persons occupying the site accommodation.
- (x) No rearing of animals shall be allowed at the Site.
- (xi) Proper provision shall be made for the disposal of all waste and refuse.

29. Contractor's Office And Storage

29.1 The Contractor shall provide and maintain on the Site in positions as approved by the S.O. the following adequate, secure and weatherproof temporary building(s) for use during the execution of the Contract.

- (i) Office for Contractor's use
- (ii) Shed for storage of cement with the floor raised 300 mm above the ground.
- (iii) Shed for bar-bending and similar Works
- (iv) Store for chemical / hazardous substance
- (v) Store for other building materials
- (vi) +.....

29.2 The Contractor shall store or stack at all times, all materials, tools, et cetera in a safe and orderly manner so as not obstruct any passageway or place of work.

⁺ Insert other item if required

 JKR MALAYSIA	SECTION A: PRELIMINARIES AND GENERAL CONDITIONS	No. Dokumen : JKR 20800-0183-14 No. Keluaran : 01 No. Pindaan : 00 Tarikh : 29 Januari 2014 Muka Surat : A/12
--	--	---

30. Office Accommodation For S.O.

- 30.1 The Contractor shall provide and maintain a site office for the use of the JKR supervisory staff all in accordance with JKR design type as shown on the relevant Drawings inclusive of all fittings and furniture as stated therein.
- 30.2 The Contractor is permitted to provide relocatable site office as an alternative to the JKR design type. The quality of such relocatable site office shall be of equivalent standard but not inferior to the JKR design type and shall be equipped with similar fittings and furniture as indicated in the JKR design site office.
- 30.3 Where relocatable site office is to be provided, the Contractor shall submit details of the relocatable site office together with his tender. Such details shall include the name of the manufacturer, floor area and layout, list of fittings and furniture and brochures (if available). The Contractor shall also indicate whether the proposed site office is new or had been previously used.
- 30.4 Unless otherwise shown on the Drawings, the office is to be sited, positioned and constructed as approved by the S.O.
- 30.5 The Contractor is also permitted to rent a premise of equivalent floor area and standard not inferior to the JKR design type and equipped with similar furniture, fittings and equipment. Where a rented premise is to be provided, the Contractor shall submit details, which shall include the layout and a list of furniture and fittings to be provided to the S.O. for approval.
- 30.6 The Contractor shall make proper arrangement for and pay all charges in connection with conservancy. The site office shall comply with local building by-laws. It shall be erected or provided by the Contractor and approved by the S.O. within four (4) weeks from the date of possession of Site.
- 30.7 On completion of the Works, unless otherwise instructed, the site office with all fittings and furniture shall become the property of the Contractor and shall be removed from the Site forthwith.

31. *Telephone For S.O.

- 31.1 The Contractor shall provide a telephone at the S.O.'s site office for the sole use of the S.O. and his representatives in connection with the supervision and administration of the Contract and pay for all installation, rental, call charges and disconnection.
- 31.2 The Contractor shall arrange for the installation of a permanent telephone line including provision of internet access for the exclusive use of the S.O. and his representatives in connection with the supervision and administration of the Contract and pay for all installation, rental, call charges and disconnection.
- 31.3 Where a telephone exchange is not within practical distance, a mobile telephone shall be provided and the Contractor shall pay for all charges.

* Delete if not applicable.

	SECTION A: PRELIMINARIES AND GENERAL CONDITIONS	No. Dokumen : JKR 20800-0183-14 No. Keluaran : 01 No. Pindaan : 00 Tarikh : 29 Januari 2014 Muka Surat : A/13
---	--	---

32. *Site Items For S.O./Office Equipment And Facilities

32.1 Safety Facilities

32.1.1 The Contractor shall provide the following items for the use of the S.O. and his supervisory staff throughout the duration of the Contract which comply with the DOSH requirements:

- (i) Safety boots
- (ii) Safety helmets
- (iii) Safety harness and life lines
- (iv) Protective gloves
- (v) Safety goggles
- (vi) Safety jackets of reflective type
- (vii) Ear plugs and muffs
- (viii) Dust masks
- (ix) +.....
- (x) +.....

32.1.2 Suitable types of fire extinguishers shall be installed and maintained at required locations on the Site throughout the Contract period.

32.2 Office Equipment And Facilities

32.2.1 The Contractor shall provide the equipment and facilities as listed in APPENDIX A2 for the use of the S.O., his representatives and staff. All equipment and facilities provided shall be new, delivered, tested and installed within four (4) weeks from the date of possession of Site.

32.2.2 The facilities provided shall be maintained by the Contractor or his appointed agent throughout the contract period until six (6) months after the issuance of the Certificate of Practical Completion. Maintenance shall include all necessary monthly servicing according to the manufacturer specifications and supply of accessories and consumables.

32.2.3 Upon six (6) months after the issuance of the Certificate of Practical Completion, the equipment shall be returned to the Contractor.

32.2.4 If the Contractor fails to provide or maintain any equipment or facilities as listed in APPENDIX A/2 the Government shall have the right to procure the equipment from other sources or maintain it and all expenses arising shall be borne by the Contractor and an appropriate adjustment shall be made to the Contract Sum.

32.3 Transport Services For The S.O And His Staff

32.3.1 The Contractor shall provide suitable transportation service by means of vehicle(s) including licensed and competent driver(s) as stipulated in APPENDIX A/3.

32.3.2 The Contractor shall ensure that the vehicle(s) is/are in a good and well maintained condition subject to certification from PUSPAKOM at every six (6) months.

+ Insert other items if required.

	SECTION A: PRELIMINARIES AND GENERAL CONDITIONS	No. Dokumen : JKR 20800-0183-14 No. Keluaran : 01 No. Pindaan : 00 Tarikh : 29 Januari 2014 Muka Surat : A/14
---	--	---

- 32.3.3 The vehicle(s) shall be in the custody of the Contractor at all times and be readily available for the use of the S.O and his staff.
- 32.3.4 The Contractor shall provide comprehensive insurances to cover all drivers and passengers, and ensure that all road tax is valid throughout the period of service.
- 32.3.5 Replacement vehicle(s) shall be provided when the normal vehicle is not available such as during periods of servicing, maintenance or repair. If the Contractor fails to provide the required transport, the officer shall have the option to arrange alternative transport and the Contractor shall bear the expenses incurred.
- 32.3.6 Upon six (6) months after the issuance of the Certificate of Practical Completion, the vehicle(s) shall be returned to the Contractor.

33. Material Testing Laboratory And Staff

- 33.1 Where specified, the Contractor shall provide a testing laboratory within the site with a minimum floor area 60 m² all in accordance with the relevant drawings including water and electricity supply. The Laboratory shall be equipped with the necessary equipment required to carry out the tests as identified in APPENDIX A/4 (List of Laboratory Equipment). The Contractor shall be responsible for the maintenance of the Laboratory and all equipment including all necessary calibration throughout the duration of the Contract. The laboratory may be jointly used by the S.O. and the Contractor.
- 33.2 Alternatively the Contractor may rent a premise of equivalent floor area and standard not inferior to that of the JKR specified type with similar fittings and necessary equipment as identified in APPENDIX A/4.
- 33.3 All tests shall be carried out by qualified laboratory assistant(s) / technician(s) and shall be witnessed and approved by the S.O.
- 33.4 Subject to the S.O.'s approval, the Contractor may also propose an accredited laboratory approved by SIRIM as an alternative to the construction of a testing laboratory.
- 33.5 All works subject to laboratory test shall not be permitted to commence until the laboratory and necessary equipment have been provided or the accredited laboratory has been approved by the S.O.
- 33.6 All equipment shall be returned to the Contractor six (6) months after the issuance of the Certificate of Practical Completion.

34. *Survey Instruments And Personnel

The Contractor shall provide for the sole use of the S.O. and his staff all such instruments, equipment and survey personnel as may be required until six (6) months after the issuance of the Certificate of Practical Completion. The Contractor shall ensure that all instruments and equipment are maintained in good working condition at all times.

* Delete if not applicable

	SECTION A: PRELIMINARIES AND GENERAL CONDITIONS	No. Dokumen : JKR 20800-0183-14 No. Keluaran : 01 No. Pindaan : 00 Tarikh : 29 Januari 2014 Muka Surat : A/15
---	--	---

35. Safe Working Area

- 35.1 The Contractor shall supply, erect, maintain and remove on completion of the Works, adequate, protective and security hoarding and such other safety measures necessary to ensure the safety of the public and others who may be on or within the vicinity of the Site.
- 35.2 The Contractor shall supply, erect and dismantle scaffolding and working platform with safety nettings by competent person(s) under the direct supervision of a designated person under the relevant Act.
- 35.3 For construction works above 15 m high, the Contractor shall submit scaffolding and working platform design certified by a P.E. to the S.O.
- 35.4 The Contractor shall supply, erect, maintain and dismantle catch platform during demolition of structure or other related exterior works at more than 12 m high and shall be constructed and maintained not more than 6 m below the storey from which the demolition works are being carried out. Such platform shall be designed and certified by a P.E. for safety prior to erection. Catch platform shall not be used for storage of material or be used as working platforms or walkways.
- 35.5 The Contractor shall erect, maintain and remove safety barricades, fencing, railing, screen wire netting and toe board for maintaining safe working environment during the works.
- 35.6 The Contractor shall provide, maintain and remove guardrails or board fences and temporary foot walks with adequate overhead protection for public walkways and thoroughfares during the Works.
- 35.7 The Contractor shall cordon off working areas and provide public control and safety measures where lifting operations, moving, shifting, transferring works are carried out outside the hoarded up area of the worksite.
- 35.8 The Contractor shall provide and maintain safe working conditions with sufficient illumination wherever persons are required to work or pass. For passageways, stairways and landings, the illumination shall be not less than 50 lux.
- 35.9 The Contractor shall ensure that all electrical and mechanical tools and equipment are inspected by a competent or designated person where relevant.
- 35.10 The Contractor shall hold a valid certificate of fitness for steam boiler, unfired pressure vessel or hoisting machine other than a hoisting machine driven by manual power so long as such machineries remain in service.
- 35.11 For work in confined spaces, the Contractor shall;
 - 35.11.1 Ensure that closed tanks with restricted means of entry and exit, open manholes, trenches, pipes, flues, ducts, ceiling voids, basements and other places where there is inadequate ventilation and/or the air is either contaminated or oxygen deficient, be tested before entry to determine that there are adequate levels of oxygen present, and that dangerous amounts of flammable and or poisonous gases are not present.
 - 35.11.2 Establish a safe work system and adopt entry permit system for workers who will be carrying out their work in confined spaces.

 JKR MALAYSIA	SECTION A: PRELIMINARIES AND GENERAL CONDITIONS	No. Dokumen : JKR 20800-0183-14 No. Keluaran : 01 No. Pindaan : 00 Tarikh : 29 Januari 2014 Muka Surat : A/16
--	--	---

36. Safety, Health And Welfare

- 36.1 The Contractor shall be required to provide a complete First Aid Kit as stated under Factory and Machinery (Safety, Health And Welfare) Regulation 1970 which shall be kept and properly maintained in the Contractor's site office. The kit shall be in the charge of either the Contractor's site representative or some other responsible person who shall be on the Site during all working hours to ensure that the first aid facilities are available without delay at all times when Works is in progress. At least one (1) designated person of the Contractor's staff shall be trained in first aid duties.
- 36.2 The Contractor shall refrain from dumping and/or depositing any form of materials that are capable of collecting water which afford breeding places for mosquitoes, rodents, insects and vermin of any kind. All excavation and any portion of the site where water stagnates or accumulates shall be kept dry by pumping, bailing or other operations. The Contractor shall pay all charges as may be required by the MOH and/or Local Authority and employ whatever destructive measures as are necessary.
- 36.3 All Works shall be carried out without unreasonable noise level and dust emission. The Contractor shall take measures to ensure that all equipment and machinery are in proper working condition so as to minimize the amount of noise and dust generated. The S.O. may require the Contractor to submit a proposal on how to reduce excessive noise and dust.
- 36.4 The Contractor is prohibited from discharging oil and grease to any water course. Storage tanks for oil and grease shall be placed on concrete base with upstand edges to contain any spillage. Any spilled oil and grease shall be promptly removed by the Contractor. The Contractor shall collect and store used oil, grease and other scheduled wastes and dispose these according to methods approved by DOE.
- 36.5 Where the contract period is more than six weeks, the Contractor shall register with DOSH within seven (7) days after commencement of Works.
- 36.6 All safety measures shall be carried out in accordance with Occupational Safety and Health Act (OSHA) 1994 and relevant local by-laws. The Contractor shall be held solely responsible for all accidents arising from any negligence in this respect. The Contractor shall employ throughout the entire contract period a competent and qualified person as Safety and Health Practitioner as below:
- (i) Site Safety Supervisor (SSS) to be stationed minimum 15 hours a week for all projects.
 - (ii) Safety and Health Officer (SHO) to be stationed full time for contracts worth more than RM20 million.
- 36.7 The Contractor shall ensure all sub-contractors who employ more than 20 persons shall appoint a Contractor Safety Supervisor (CSS) to be stationed minimum 5 hours a week;
- 36.8 The Contractor shall submit Safety and Health Plan (S-Plan) in writing duly signed by the Director of the company to the S.O. within one (1) month after the receipt of the Letter of Acceptance. The S-Plan shall be as per APPENDIX A/5. The Contractor shall submit revised S-Plan whenever required.
- 36.9 The Contractor shall form a Safety and Health Committee in accordance with the Occupational Safety and Health Regulations 1996 and organise meetings at minimum once in every three (3) months.

 <p>JKR MALAYSIA</p>	<p>SECTION A: PRELIMINARIES AND GENERAL CONDITIONS</p>	<p>No. Dokumen : JKR 20800-0183-14 No. Keluaran : 01 No. Pindaan : 00 Tarikh : 29 Januari 2014 Muka Surat : A/17</p>
--	---	--

- 36.10 The Contractor shall conduct Occupational Safety and Health (OSH) related training and programmes for the workmen including sub-contractors.
- 36.11 The Contractor shall carry out site safety and health inspections and submit monthly safety and health reports to the S.O. in accordance with APPENDIX A/6.
- 36.12 The Contractor shall provide and maintain safety and health statistic scoreboard at the entrance of site office and workplace.
- 36.13 The Contractor shall provide and maintain adequate traffic safety signage, warning signs and warning lights at place of Works and close proximity to public.
- 36.14 The Contractor shall provide and maintain traffic control by competent persons including provision of flagmen where Works is in close proximity to public roads.
- 36.15 The Contractor shall carry out site safety and health audits as per DOSH requirements and/or instructed by the S.O.

37. Sanitation

- 37.1 The Contractor shall provide and maintain sufficient temporary toilets at appropriate locations on site as approved by the S.O. Toilets shall be complete with adequate water closets, urinals, hand-basins with proper sanitary system and maintained in a clean and sanitary condition in accordance with the requirements of the MOH.
- 37.2 All wastewater must be treated such that its discharged effluent meets the requirements of all existing legislation and regulations.

38. Waste Management

- 38.1 The contractor shall ensure all waste generated on site shall be managed in accordance with the Solid Waste And Public Cleansing Management Act 2007 and Environmental Quality Act 1974 as follows:
 - (i) The Contractor shall submit in the approved format the Construction Waste Management Plan (CWMP) to the S.O. for approval within fourteen (14) days from the date of site possession.
 - (ii) The Contractor shall provide Roll-On Roll Off (RORO) for construction waste and Mobile Garbage Bin (MGB) for domestic waste
 - (iii) The Contractor shall provide a minimum of one (1) location on site for segregation and collection of construction and domestic waste.
 - (iv) The Contractor shall appoint a licensed contractor(s) to collect the construction waste, scheduled waste and domestic waste from the site to approved locations for disposal or to recycle the waste.

39. Environmental Protection Works

- 39.1 Environmental Management Plan (EMP)
 - 39.1.1 The Contractor shall prepare the EMP for the following situations:
 - (i) Projects worth more than RM20 Million including earthworks.

 <p>JKR MALAYSIA</p>	<p>SECTION A: PRELIMINARIES AND GENERAL CONDITIONS</p>	<p>No. Dokumen : JKR 20800-0183-14 No. Keluaran : 01 No. Pindaan : 00 Tarikh : 29 Januari 2014 Muka Surat : A/18</p>
--	---	--

- (ii) Project sites located in Environmental Sensitive Area (ESA) as defined in the National Physical Plan by Jabatan Perancangan Bandar dan Desa (JPBD).
- (iii) Projects where Environmental Impact Assessment (EIA) has been carried out.

39.1.2 The EMP shall be prepared by a registered environmental consultant and submitted to the S.O. for approval within fourteen (14) days from the date of possession of Site. The EMP shall be concise, up to date and site specific. The EMP shall make reference to the following but not limited to:

- (i) DOE format for the preparation of EMPs.
- (ii) The approved EIA report and conditions imposed (if any).

39.1.3 The Contractor shall submit the following documents as per TABLE A1 to the S.O. for approval:

TABLE A1: SUBMISSION OF DOCUMENTS

Documents	No. Of Copies	Reporting Frequency	Timing
EMP	5	Once only (to be updated when necessary)	Within 14 days from the date of possession of site
Environmental Quality Report (EQR)	5	Monthly	14 days after monitoring*
Environmental Monitoring And Audit Report (EMAR)	5	Quarterly	14 days after audit *
Closure Audit Report (CAR)	5	Once Only	14 days prior to issuance of Certificate of Practical Completion*

Note * to be carried out by registered environmental consultant

39.2 Environmental Officer (E.O)

39.2.1 The Contractor shall appoint a person to be responsible to ensure the implementation of the EMP and to monitor and report on the site compliance on a daily basis.

40. Water And Air Quality, Noise And Vibration Control

40.1 The Contractor shall carry out monitoring of water and air quality, noise and vibration as indicated in the EMP and tests to be carried out by accredited laboratories. Parameters to be tested are as specified in TABLE A2 (APPENDIX A/7).

40.2 Air Quality

40.2.1 The Contractor is not allowed to carry out open burning of cleared vegetation, debris and construction waste et cetera, shall not be allowed unless prior approval is obtained from the Director General of the DOE.

40.2.2 The Contractor shall provide suitable spraying equipment for regular spraying of water over the existing roads, tracks and access roads, near settlements, completed as well as incomplete road and other barren areas of the site used by the contractor especially during the dry season or as and when directed by the S.O.

 <p>JKR MALAYSIA</p>	<p>SECTION A: PRELIMINARIES AND GENERAL CONDITIONS</p>	<p>No. Dokumen : JKR 20800-0183-14 No. Keluaran : 01 No. Pindaan : 00 Tarikh : 29 Januari 2014 Muka Surat : A/19</p>
--	---	--

- 40.2.3 When the Contractor's trucks or equipment utilizes public or private roadways, all dirt and materials shall be removed from the trucks/ equipment by hosing, lorry wash-trough, et cetera before leaving the site.
- 40.2.4 The Contractor shall provide for the prompt removal of all dirt and other materials spilled from his or his sub-contractor's vehicles on public or private roadways.
- 40.2.5 For Contractor's trucks carrying sand, aggregates, earth and other loose construction materials liable to spillage, tarpaulin must be used to cover such open trucks when passing through villages and settlements or on all roadways.
- 40.2.6 The Contractor shall also ensure dust control at quarry / batching plant (if any) complies with environmental requirement as stipulated in the Environmental Quality (Clean Air) Regulations, 1978.

40.3 Vibration Control

- 40.3.1 The Contractor shall ensure that at any time, the vibration levels resulting from his works at or across real property boundary should not exceed the Recommended Limit as Specified in TABLE A2 (APPENDIX A/7). No person unless duly authorized by law or carrying out legitimate duties shall use explosives or results in explosions which create a vibration disturbance across a real property boundary or on a public space or right of way.
- 40.3.2 The Contractor shall comply with the general recommendations set out in DOE Interim Planning Guidelines for Vibration Limits and Control in the Environment together with any specific requirements described in the Contract.
- 40.3.3 The Contractor shall indemnify and keep indemnified the Government, S.O. and the S.O.'s Representatives against any liability for damages on account of vibration disturbance created while or in carrying out of the works and from and against all claims, demands, proceedings, damages, costs charges and expenses whatever in regard or in relation to such liability.

41. Nominated Sub-contractors

- 41.1 The Contractor shall allow in his tender price for attendance and facilities upon all Nominated Sub-contractors. Such attendance and facilities shall include the following:
 - (i) Ascertaining from Nominated Sub-contractors all particulars relating to their work in regard to sizes and positions in which chases, holes, mortices, et cetera are required to be formed or left.
 - (ii) Making good of walls, ceilings, floors, roofs, et cetera and finishes thereto including touching up of all paintwork necessitated, damaged or disturbed by the Nominated Sub-contractor's work.
 - (iii) Supplying all setting out information.
 - (iv) Giving all necessary dimensions and taking responsibility for their accuracy.
 - (v) Affording free and full use of standing scaffolding whilst it remains erected on the Site.

 <p>JKR MALAYSIA</p>	<p>SECTION A: PRELIMINARIES AND GENERAL CONDITIONS</p>	<p>No. Dokumen : JKR 20800-0183-14 No. Keluaran : 01 No. Pindaan : 00 Tarikh : 29 Januari 2014 Muka Surat : A/20</p>
--	---	--

- (vi) Affording free and full use of storage accommodation for materials, equipment and plant which are for incorporation into the Works and/or which require protection against weather and deterioration, messrooms, sanitary and welfare facilities.
 - (vii) Providing site space only for Nominated Sub-contractor's temporary office, workshops, workmen's accommodation and storage of materials, tools, plant and equipment which are not for incorporation into the Works and not requiring protection against weather or deterioration.
 - (viii) Providing temporary water supply, electric power supply, artificial lighting and paying all fees and charges for fuel, water and electricity consumed including for testing and commissioning of the whole Nominated Sub-contractor's works.
 - (ix) Liaising with the relevant supply/service authorities for the expeditious installation of the connections for permanent water and electricity supplies in the Works making available such supplies to the Nominated Sub-contractors; and paying all fees and charges for such installation, deposits for such supplies/services on behalf of the Government. All such payments made, shall be reimbursed to the Contractor on production of receipted bills.
 - (x) Providing competent personnel in compliance with the latest Electricity Regulations to take responsibility for the operation of the electrical installation from the time the permanent electricity supply is made available until testing, commissioning and handing over of the Works.
 - (xi) Protecting, watching and taking full responsibility for all Nominated Sub-contractor's work and unfixed materials and goods intended for use thereon.
 - (xii) Removing rubbish and debris off the Site and cleaning the Works internally and externally.
- 41.2 It is deemed that the Nominated Sub-contractor shall include in the sub-contract Sum, inter alia, the costs in connection with the following:
- (i) Unloading, getting in, storing and all handling and hoisting of these materials, plant and tools into required positions.
 - (ii) Providing, erecting, maintaining and removing of all his temporary office, workshops and workmen's accommodation including paying all assessment and other charges.
 - (iii) Connecting to temporary water and power supplies made available by the Contractor for the execution of the Works, supplying and running distribution pipes, hoses, cables, leads, electrical gear, et cetera but excluding payment for water and electricity consumed.
 - (iv) Provision of fuel, gas, steam, oil lubricants, chemicals and everything else necessary (other than water and electricity) for the test running and commissioning of the Sub-contract Works.
 - (v) Any scaffolding, staging, et cetera that are required for the Sub-contract Works not covered by sub-section 41.1(v) above.

 <p>JKR MALAYSIA</p>	<p>SECTION A: PRELIMINARIES AND GENERAL CONDITIONS</p>	<p>No. Dokumen : JKR 20800-0183-14 No. Keluaran : 01 No. Pindaan : 00 Tarikh : 29 Januari 2014 Muka Surat : A/21</p>
--	---	--

42. Nominated Suppliers

The Contractor shall allow in his tender, price for attendance upon all Nominated Suppliers which is to include taking delivery, unloading, setting in, checking and accepting delivery, returning empties, handling, storing and hoisting of the materials/goods supplied by the Nominated Suppliers. Packing and carriage to Site shall be borne by the Nominated Supplier unless specifically stated to the contrary.

43. Coordination Of Mechanical And Electrical Services

43.1 General

This section shall describe the scope of works, qualifications, competency, roles and responsibilities of the Mechanical and Electrical (M & E) Services Coordination Team.

43.2 Scope Of Work

43.2.1 The Contractor shall be responsible for coordinating the implementation of all M & E works and related activities within the project scope. For this purpose the Contractor shall appoint M & E Services Coordinators full time on site during the whole duration of the works. The appointment shall be approved by the S.O.

43.2.2 The Contractor shall ensure all M & E requirements are implemented in a timely manner and adequately integrated with all services involved such as architectural, structural and other related services.

43.2.3 The Contractor shall conduct regular coordination meetings among all sub-contractors, nominated or otherwise, from related disciplines to evaluate and resolve all issues or problems regarding integration and coordination of all services.

43.3 Minimum Requirement Of M & E Services Coordinator Based On Project Cost As Followed:

Project Cost (RM)	Minimum Requirement Of M & E Coordinator
between 10 to 50 million	1 Engineer & 1 CoW
more than 50 million	1 Engineer & 2 CoW

43.4 Qualification And Competency Of M & E Coordinators

43.4.1 Engineer

Degree in related engineering field with minimum three (3) years of working experience in building construction.

43.4.2 Clerk of Works (CoW)

Diploma in related engineering field with minimum five (5) years of working experience in building construction.

 JKR MALAYSIA	SECTION A: PRELIMINARIES AND GENERAL CONDITIONS	No. Dokumen : JKR 20800-0183-14 No. Keluaran : 01 No. Pindaan : 00 Tarikh : 29 Januari 2014 Muka Surat : A/22
--	--	---

43.5 Responsibilities Of M & E Services Coordinator

43.5.1 The M & E Services Coordinator shall be responsible, on behalf of the Contractor for :

- (i) Guiding the overall M & E works and implementation of related activities within the project scope and providing timely and relevant information.
- (ii) Ensuring that all layout, schematic, detail and Builder's Work in Connection (BWIC) drawings (for architectural, structural, mechanical and electrical works) are received from the S.O.
- (iii) Supervising all the installation and construction works to ensure the works are sufficiently coordinated.
- (iv) Identifying and resolving issues or problems related to integration and coordination of services by producing coordinated services drawing, new method of installation and et cetera.

44. Keeping The Site Tidy

44.1 The Contractor shall make every effort to keep the Site in a reasonably clean and tidy condition for the duration of the Works. He shall, in addition, from time to time and on the completion of any area of the Works or where directed by the S.O., remove rubbish, surplus materials, or any other construction debris from such areas as may be attributable to his work under this Contract and generally maintain the Site in a satisfactory condition, to the approval of the S.O.

44.2 The Contractor shall gather up and clear away all rubbish as it accumulates during the progress of the Works at least twice each week at times approved by the S.O. The services shall be continued until the completion of the Works. Garbage or construction waste shall be disposed in a locally available landfill or hauled to disposal sites approved by the S.O.

45. As-built Drawings

45.1 The Contractor shall provide and deliver to the S.O. approved As-built drawings after completion of each section of the Works in the form of :

- (i) Four (4) sets of As-built drawings as actually constructed pertaining to the Works including all services and facilities systems and all supporting documents such as Operation and Maintenance Manual, Testing and Commissioning Certificates. All As-built drawings for building works shall show the immovable asset registration coding in accordance with the Government's "Immovable Asset Code System" (Sistem Kod Aset Tak Alih - SKATA).
- (ii) Four (4) sets of Digital Copies in AutoCAD (.dwg) format to be stored in compact discs or removable storage.
- (iii) Four (4) sets of Digital Copies in Acrobat (.pdf) format to be stored in compact discs or removable storage.

45.2 The As-built drawings supplied shall be comprehensive and to the satisfaction of the S.O. as to allow for a complete understanding of the Works as they were actually built incorporating all Works arising from variations, expenditure of Provisional Sums and Prime Cost Sums.

45.3 The As-built drawings shall be endorsed by a Professional Architect/Engineer/Surveyor registered with the respective Professional Boards in Malaysia.

 <p>JKR MALAYSIA</p>	<p>SECTION A: PRELIMINARIES AND GENERAL CONDITIONS</p>	<p>No. Dokumen : JKR 20800-0183-14 No. Keluaran : 01 No. Pindaan : 00 Tarikh : 29 Januari 2014 Muka Surat : A/23</p>
--	---	--

46. Clearing, Cleaning And Making Good On Completion

- 46.1 The Contractor shall ensure the existing roadside drains bounding the Site are clear of any building debris, earth, et cetera, at all times before handing over of the Works to the S.O. upon completion.
- 46.2 Upon completion of the Works, the Contractor shall remove and clear away from Site all temporary buildings, temporary works, temporary installation and equipment, and ensure the Site is in a clean and tidy condition.
- 46.3 Before handing over of the Works, the Contractor shall scrub all floors, pavings, staircases et cetera and clean out all gutters, gulleys, manholes, sumps and drains. The Contractor shall also clean all glass panes and leave every part of the completed Works included in this Contract in a clean, sound and tidy condition to the approval of the S.O.

 <p>JKR MALAYSIA</p>	<p>SECTION A: PRELIMINARIES AND GENERAL CONDITIONS</p>	<p>No. Dokumen : JKR 20800-0183-14 No. Keluaran : 01 No. Pindaan : 00 Tarikh : 29 Januari 2014 Muka Surat : A/24</p>
--	---	--

APPENDIX A/1

LEGISLATION AND REGULATIONS

1. BS 5228: Code of Practice for Noise control on Construction and Demolition Site
2. Construction Industry Development Board Act, 1994
3. Electricity Regulations, 1994
4. Electricity Supply Act, 1990
5. Environmental Quality Act (EQA), 1974
6. Explosives Act, 1957
7. Factory and Machinery Act (FMA), 1967 Rev 2006 and Regulations under the Act.
8. Federal Territory (Planning) Act 1982 (Act 267)
9. Fire Services Act, 1988
10. Forestry Act 1984 (Act 313)
11. Guidelines For Hazard Identification, Risk Assessment And Risk Control, 2008, DOSH
12. Guidelines for Public Safety and Health at Construction Sites, 2007, DOSH
13. Guidelines for the Prevention of Falls at Workplaces, 2007, DOSH
14. Guidelines On Occupational Safety And Health In Tunnel Construction, 1998, DOSH
15. Guidelines on Occupational Vibration, 2003, DOSH
16. Industry Code of Practice for Safe Working in A Confined Space, 2010, DOSH
17. Irrigation Areas Act, 1953
18. Land Conservation Act 1960 (Act 385)
19. Local Government Act, 1976
20. MS 2318: Code of Practice for Demolition of Buildings, 2010
21. National Land Code (Act 56 of 1965)
22. Occupational Safety and Health Act (OSHA), 1994 and Regulations under the Act.
23. Protection of Wildlife Act, 1972 (Act 76)
24. Solid Waste and Public Cleansing Management Act 2007 (Act 672)
25. Standard OHSAS 18001
26. Street, Drainage and Building Act, 1974
27. Street, Drainage and Building Act, 1974: Act 133 and Amendment, 1978
28. The Radiation Protection (Basic Safety Standards) Regulations 1987
29. Town and Country Planning Act 1976, (Act 172)
30. Uniform Building By-Law (UBBL), 1984
31. Workers Minimum Amenities Act 1990 (Act 446)

 <p>JKR MALAYSIA</p>	SECTION A: PRELIMINARIES AND GENERAL CONDITIONS	No. Dokumen : JKR 20800-0183-14 No. Keluaran : 01 No. Pindaan : 00 Tarikh : 29 Januari 2014 Muka Surat : A/25
--	--	---

APPENDIX A/2

LIST OF S.O.'S FACILITIES AND EQUIPMENT

 <p>JKR MALAYSIA</p>	SECTION A: PRELIMINARIES AND GENERAL CONDITIONS	No. Dokumen : JKR 20800-0183-14 No. Keluaran : 01 No. Pindaan : 00 Tarikh : 29 Januari 2014 Muka Surat : A/26
--	--	---

APPENDIX A/3

LIST OF S.O.'S TRANSPORT SERVICES

 <p>JKR MALAYSIA</p>	SECTION A: PRELIMINARIES AND GENERAL CONDITIONS	No. Dokumen : JKR 20800-0183-14 No. Keluaran : 01 No. Pindaan : 00 Tarikh : 29 Januari 2014 Muka Surat : A/27
--	--	---

APPENDIX A/4

LIST OF LABORATORY EQUIPMENT

 <p>JKR MALAYSIA</p>	<p>SECTION A: PRELIMINARIES AND GENERAL CONDITIONS</p>	<p>No. Dokumen : JKR 20800-0183-14 No. Keluaran : 01 No. Pindaan : 00 Tarikh : 29 Januari 2014 Muka Surat : A/28</p>
--	---	--

APPENDIX A/5

REQUIREMENTS OF SAFETY AND HEALTH PLAN (S-PLAN)

1. Project Introduction and Scope of Works associated with OSH;
2. Contractor's Authorised and Updated OSH Policy;
3. Contractor's Organisation Chart and Safety And Health Committee (SHC) Chart which shall describing the staff involved including list of duties and responsibilities;
4. Communication, Consultation and Involvement of each member of the Contractor's project team as shown in the Item (c), including their relationship, interfacing and cooperation of workmen for successful implementation of the project. The planning shall taking account control of any OSH related complaints, advice, OSH programmes and awareness, SHC meeting's schedule, and solving OSH related issues;
5. Contractor's Authorised Updated Compliance List on OSH Legislation and Other Related Requirements;
6. List of Prohibited foods and drinks including drugs and medicines;
7. List of Personal Protective Equipment at Works;
8. Schedule of OSH Trainings and Programmes to all workmen including sub-Contractor;
9. Emergency Response Plan;
10. Safe Work System on Temporary Electricity Installation Works;
11. Safe Operational Procedures;
12. Format of Incident investigation report;
13. Format of Daily Reporting on Incident Statistic;
14. Chemical Safety Data Sheets or Material Safety Data Sheets;
15. Health Precaution on workmen: Medical Report (Health Surveillance), noise prevention;
16. Sanitation for workmen;
17. Safety Signage and Traffic Control;
18. Hazard Identification, Risk Assessment and Risk Control (HIRARC);

 <p>JKR MALAYSIA</p>	<p>SECTION A: PRELIMINARIES AND GENERAL CONDITIONS</p>	<p>No. Dokumen : JKR 20800-0183-14 No. Keluaran : 01 No. Pindaan : 00 Tarikh : 29 Januari 2014 Muka Surat : A/29</p>
--	---	--

APPENDIX A/6

REQUIREMENTS OF SAFETY AND HEALTH REPORT

1. Related OSH programme;
2. Incident statistic from daily notification of any accidents, near misses, lost time injuries, death and ill-health with actions taken; in accordance with OSH (Notification of Accident, Dangerous Occurrence, Occupational Poisoning and Occupational Disease) Regulations 2004. The Contractor shall be held solely responsible for all incidents arising from any negligence in this respect;
3. Related OSH issues on complaints, Non-compliance, damages and actions taken;
4. Status on S-Plan and HIRARC;
5. List of workmen permit, CIDB Green Card, tools and machineries;
6. Traffic and other related safety control.

 JKR MALAYSIA	SECTION A: PRELIMINARIES AND GENERAL CONDITIONS	No. Dokumen : JKR 20800-0183-14
		No. Keluaran : 01
		No. Pindaan : 00
		Tarikh : 29 Januari 2014
		Muka Surat : A/30

APPENDIX A/7

TABLE A2 : ENVIRONMENTAL QUALITY STANDARDS TO BE COMPLIED WITH BY THE CONTRACTOR

Aspects	Parameter	JKR EMS Set Target	Environment Quality (Sewage) Regulations, 2009		National Water Quality Standards (NWQS)	
			Standard A	Standard B	Class IIA	Class IIB
Soil	Soil loss	Minimum earthwork Phase construction ≤ 6 berms/benches for slopes (≤ 6m per berm) Reuse topsoil				
Water ^{1,2}	Turbidity	≤ 200 NTU	-	-	≤ 50 NTU	
	Suspended Solid	≤ 100 mg/l	≤ 50 mg/l	≤ 100 mg/l	≤ 50 mg/l	
	Biochemical Oxygen Demand ₅ @ 20°C (BOD) ₅	≤ 50 mg/l	≤ 20 mg/l	≤ 50 mg/l	≤ 3 mg/l	
	Chemical Oxygen Demand (COD)	≤ 100 mg/l	≤ 120 mg/l	≤ 200 mg/l	≤ 25 mg/l	
	pH	5.5 – 9	6 – 9	5.5 – 9	6-9	
	E-Coli	≤ 400 counts / 100 ml	-	-	≤100 counts/ 100ml	≤400 counts / 100 ml
	Dissolved Oxygen(DO)	≥ 4 mg/l	-	-	5-7 mg/l	
	Oil and Grease	≤ 10 mg/l	≤ 5 mg/l	≤ 10mg/l	≤ 40 µg /l, N	
	Ammoniacal Nitrogen (river)	-	≤ 10 mg/l	≤ 20mg/l	≤ 0.3 mg /l	
Air ³	Total Suspended Particulate (TSP) (24hr) Particulate Matter (PM10) (24hr)		≤260 µg/m ³ /day ≤150 µg/m ³ /day			
Noise ⁴	Equivalent Noise Level (L _{eq}), L ₁₀ , L ₉₀	Receiving Land Use (residential)				
		Day time (7.00 am – 7.00 pm) L ₉₀ ≤ 60 dBA; L ₁₀ ≤75 dBA; L _{max} ≤ 90 dBA;				
		Evening (7.00 pm – 10.00 pm) L ₉₀ ≤55 dBA; L ₁₀ ≤70 dBA; L _{max} ≤ 85 dBA;				
		Night time (10.00 pm – 7.00 am) Noise Sensitive Areas : L _{Aeq} ≤40 dBA				
		Suburban Areas : L _{Aeq} ≤ 45 dBA Urban Areas : L _{Aeq} ≤ 50 dBA				
Vibration ⁵	Vertical Vibration Peak Velocity (mm/s)		Not more than 3 mm/s at receiver location or across real property boundary.			

Reference:

- 1) 2nd Schedule (Regulation 7), Environmental Quality (Sewage) Regulations 2009, Environmental Quality Act 1974.
 - (i) Standard A: For location with downstream water intake
 - (ii) Standard B: For location with no downstream water intake
 - 2) National Water Quality Standards for Malaysia
 - (i) Class IIA: Water Supply II – conventional treatment required
 - a) Fishery II – sensitive aquatic species
 - (ii) Class IIB: Recreational use with body contact
 - 3) Recommended Malaysian Guidelines on Ambient Air Quality
 - 4) Schedule 1 & Schedule 6, Planning Guidelines for Environmental Noise Limits & Control, (DOE, 2004)
 - 5) Planning Guidelines for Vibration Limits and Control of the Environment (DOE, 2004)
- Note: N - No visible floatable materials or debris or no objectionable odour, or no objectionable taste

TABLE OF CONTENTS

SECTION B: EXCAVATION AND EARTHWORKS

	PAGE
1. General	B/1
2. Site Clearing, Grubbing And Stripping Topsoil	B/1
3. Demolition Of Existing Structures	B/2
4. Relocation Of Existing Utilities And Services	B/2
5. Excavation Works	B/2
TABLE B1 : Grading Limits Of Materials For Replacement Of Excavated Material	B/6
6. Filling Works	B/8
TABLE B2 : Frequency Of Control Test For Earth Embankment	B/11
7. Protection And Maintenance For Erosion Control	B/13

 <p>JKR MALAYSIA</p>	<p>SECTION B : EXCAVATION AND EARTHWORKS</p>	<p>No. Dokumen : JKR 20800-0183-14 No. Keluaran : 01 No. Pindaan : 00 Tarikh : 29 Januari 2014 Muka Surat : B/1</p>
--	---	---

1. General

- 1.1 This work shall consist of all the required excavation within the limits of the Works. It shall include the removal and proper utilization and hauling, or disposal of all excavated materials, and constructing, shaping and finishing of all earthworks over the entire extent of the Works, in conformity with the Drawings and these Specifications.
- 1.2 The excavation and earthworks shall be executed in such a manner and order as approved by the S.O. The Contractor shall be responsible for compliance with by-laws and regulations relating to earthworks.
- 1.3 Excavation in rock and/or hard material shall respectively be measured and paid for as extra over to excavation and earthworks in accordance with the Provisional B.Q. The Contractor shall give reasonable notice to the S.O. to examine, classify the excavation and to take measurement prior to breaking up.
- 1.4 For contract based on Specifications and Drawings, unless otherwise provided in the Contract, for the purpose of pricing the excavation and earthworks, the whole excavation shall be assumed to be without rock and/or hard material as defined hereunder.
- 1.5 For contract based on Quantities, the pricing shall be in accordance with the B.Q.
- 1.6 Computation of volume of rock excavation for payment shall be based on nett volume excavated as shown on the Drawings.
- 1.7 The Contractor shall comply with all statutory requirements and regulations such as payment of royalties and environmental protection for removal of unsuitable material and borrow materials.

2. Site Clearing, Grubbing And Stripping Topsoil

- 2.1 This work shall consist of clearing, grubbing and stripping topsoil in the areas within the limits of Works designated hereunder and/or shown on the Drawings and/or directed by the S.O., and of clearing only in other areas designated hereunder and/or shown on the Drawings and/or directed by the S.O., all as specified herein and as required by the S.O. The work shall also include the demolition and disposal of structures in the said areas, except where otherwise provided for in the Contract, as specified herein and as required by the S.O.

2.1.1 Site clearing

Clearing shall consist of cutting and/or taking down, removal and disposal of everything above ground level, including objects such as walls, fences, drains and other obstructions, except such trees, vegetation, structures or parts of structures and other things which are designated in the Contract to remain, to be protect as satisfied under SECTION R : LANDSCAPING AND TURFING WORKS. The material to be cleared shall include but not necessarily be limited to trees, stumps (parts above ground), logs, brushwood, undergrowth, long grasses, crops, loose vegetable matter and structures (except those structures whose removal or clearance is otherwise provided for in the Contract). Clearing shall also include levelling of obsolete dikes, terraces, ditches, et cetera, unless otherwise directed by the S.O.

 <p>JKR MALAYSIA</p>	<p>SECTION B : EXCAVATION AND EARTHWORKS</p>	<p>No. Dokumen : JKR 20800-0183-14 No. Keluaran : 01 No. Pindaan : 00 Tarikh : 29 Januari 2014 Muka Surat : B/2</p>
--	---	---

2.1.2 Grubbing

Grubbing shall consist of removal and disposal of surface vegetation, bases of stumps, roots, underground parts of structures, and other obstructions to a depth of at least 0.50 m below ground level, with the agreement of the S.O.

2.1.3 Stripping topsoil

Stripping topsoil shall consist of the removal of topsoil to an average depth of at least 100 mm below ground level, and its stockpiling for use in the Works, and/or its disposal, as directed by the S.O.

2.1.4 Disposal

All materials resulting from site clearing, grubbing and stripping topsoil shall be removed and disposed of as approved by the S.O. in accordance with Environmental Quality Act 1974(Act 127) and Solid Waste and Public Cleansing Management Act 2007 (Act 672).

3. Demolition Of Existing Structures

- 3.1 Major structures are those which cannot practicably be cleared by bulldozer and/or hydraulic excavator, whose demolition requires pneumatic tools, explosives and/or other specialized equipment. A brief description of each major structure (if any) and depth to which extent it shall be demolished is given in the B.Q.
- 3.2 All fences, buildings, structures, and encumbrances of any character within the limits of the limits of the Works, except those to be removed by others or designated to remain, shall be demolished and removed by the Contractor.
- 3.3 Materials designated in the Contract or directed by the S.O. to be salvaged, shall be carefully removed and stored, and shall be the property of the Government.

4. Relocation Of Existing Utilities And Services

- 4.1 The Contractor's attention is specially drawn to his responsibilities under the Clause headed 'Damage to Property' of the Condition of Contract.
- 4.2 Before commencing on any excavation, the Contractor or his representative shall accompany the S.O. on a site inspection to identify the presence of underground cables, water or other service pipes at or in the vicinity of such excavation. Thereafter, the Contractor shall carry out the excavation work in a manner and sequence as approved by the S.O.
- 4.3 If during excavation, the Contractor's workmen uncover any cables, water or other service pipes, work shall be stopped immediately and shall not be again started until the matter has been reported to the S.O. who will notify the appropriate local authority, and subsequently issue whatever directions he deemed appropriate.

5. Excavation Works

5.1 General Requirements

- 5.1.1 The work shall include the excavation of all types of material, backfilling, compaction, forming embankments and slopes, et cetera, as is necessary

 <p>JKR MALAYSIA</p>	<p>SECTION B : EXCAVATION AND EARTHWORKS</p>	<p>No. Dokumen : JKR 20800-0183-14 No. Keluaran : 01 No. Pindaan : 00 Tarikh : 29 Januari 2014 Muka Surat : B/3</p>
--	---	---

for the completion of the works up to the formation levels, in accordance with the lines, grades, dimensions, shapes and typical cross-sections shown on the Drawings and to the approval of the S.O.

- 5.1.2 The Contractor shall provide where necessary temporary water courses, ditches, drains, pumping or other means of maintaining the earthworks free from water. Such provision shall include carrying out the work of forming the cuttings and embankments in such a manner that their surfaces have at all times a sufficient gradient to enable them to shed water and prevent water ponding.
- 5.1.3 In pumping water out from excavation and in the lowering of water table the Contractor shall pay due regard to the stability and settlement of all structures.
- 5.1.4 Adequate means for trapping silt shall be provided on all temporary drainage systems. Similar arrangements shall be made for all earthworks including excavation whether for pile trenches, foundations or cuttings.
- 5.1.5 Should the surface of completed areas be damaged by erosion or by any other causes, the Contractor shall at his own cost make good such areas to the approval of the S.O.
- 5.1.6 The Contractor shall exercise care in preventing wastage of suitable material needed for embankment or fill construction.

5.2 Definitions

5.2.1 Formation level

Formation level means the final earthwork level after cutting or filling.

5.2.2 Common excavation

Common excavation shall mean excavation in any materials which are not rock or hard materials as defined in sub-sections 5.2.5 and 5.2.6.

5.2.3 Unsuitable materials

5.2.3.1 Unsuitable materials shall include:

- (i) Running silt, peat, logs, stumps, roots, grass and other vegetable matter, perishable or toxic material, slurry or mud; or
- (ii) Organic clay and organic silt; or
- (iii) Any material
 - a) which is susceptible to spontaneous combustion; or
 - b) which is clay having a liquid limit exceeding 80% and/or a plasticity index exceeding 55%; or
 - c) which has a loss of weight greater than 2.5% on ignition.

5.2.3.2 Materials that are soft or unstable merely because they are too wet or too dry for effective compaction shall not to be classified as unsuitable, unless otherwise classified by the S.O.

 <p>JKR MALAYSIA</p>	<p>SECTION B : EXCAVATION AND EARTHWORKS</p>	<p>No. Dokumen : JKR 20800-0183-14 No. Keluaran : 01 No. Pindaan : 00 Tarikh : 29 Januari 2014 Muka Surat : B/4</p>
--	---	---

5.2.4 Suitable materials

5.2.4.1 Suitable materials shall mean those materials other than the unsuitable materials defined in sub-section 5.2.3.

5.2.4.2 General fill shall generally comprise of suitable materials made up of either cohesive soil or cohesion less soil or mixture of both. The classification of cohesive and cohesion less soil shall be based on Soil Classification System set out in the latest MS 1056: Site Investigation.

5.2.4.3 Special fill shall comprise of material, which would otherwise be classified as general fill but which contains durable well-graded natural sand and gravel or crushed rock, other than argillaceous rock, or durable clean crushed demolition rubble of similar particle size and free from any contaminants.

5.2.5 Hard material

5.2.5.1 This shall mean any hard material which can be excavated using an excavator with minimum weight of 44 tonnes and nett horsepower rating of 321 brake horsepower with production rate not exceeding 50 m³ / hour. The excavator unit is to be in good condition and operated by experienced personnel.

5.2.5.2 Hard material shall exclude individual masses less than 0.5 m³.

5.2.5.3 Trial excavation shall be carried out using the above equipment to determine hard material. The trial excavation shall be carried out on a flat platform in order to develop the rated horsepower at maximum efficiency.

5.2.6 Rock

5.2.6.1 Rock shall mean material found in ledges or masses which can be excavated using the following equipment with production rate not exceeding 20 m³ / hour:

(i) Track-type tractor (dozer)

Equipment with minimum weight of 37 tonnes and nett horsepower rating of 305 brake horsepower or more (D8R or equivalent). The tractor unit is to be in good condition and operated by experienced personnel skilled in the use of ripping equipment; and

(ii) Ripping unit

The ripper to be attached to the above mentioned tractor shall have a minimum penetration force of 120 kN. The ripper shall have a single shank in good working condition with sharpened cutting point.

5.2.6.2 Trial excavation shall be carried out using the above equipment to determine rock.

5.2.6.3 Boulders or detached pieces shall only be regarded as rock if they individually exceed 0.5 m³. For determination of the volume of individual boulder, diameters of the boulder in three (3) orthogonal directions shall be taken. The average of the three (3)

 <p>JKR MALAYSIA</p>	<p>SECTION B : EXCAVATION AND EARTHWORKS</p>	<p>No. Dokumen : JKR 20800-0183-14 No. Keluaran : 01 No. Pindaan : 00 Tarikh : 29 Januari 2014 Muka Surat : B/5</p>
--	---	---

diameters shall be used to calculate the volume of boulder. Records of measurements and photographs shall be taken and kept to support the calculation of the volume of boulder.

5.3 Dimensional Tolerances

Slopes in cutting shall be trimmed mechanically to neat and even surfaces which shall have gradients not steeper than that shown on the Drawings. Widths of excavations shall not exceed the dimensions shown on the Drawings by more than 300 mm with encumbrance free to complete the Work, unless otherwise approved by the S.O.

5.4 Separation And Stockpiling Of Suitable Material

Where excavation reveals a combination of suitable and unsuitable materials, the Contractor shall, wherever the S.O. considers it practicable, carry out the excavation in such a manner that the suitable materials are excavated separately for use in the Works without contamination by the unsuitable materials.

5.5 Removal Of Excavated Material From Site

5.5.1 Trial pit shall be carried out prior to removal of material to be excavated to confirm water table and depth of excavation.

5.5.2 No excavated material shall be removed from the Site except on the direction or with the approval of the S.O. Should the Contractor be permitted to remove suitable materials from the Site to suit his operational procedure, then he shall make good any consequent deficit of fill material arising there from, at his own expense. Unless designated dump sites have been shown on the Drawings, the Contractor shall dispose of surplus suitable material at his own dump areas outside the Site as approved by the S.O.

5.6 Removal Of Unsuitable Material

5.6.1 Trial pit shall be carried out prior to removal of material to be excavated to confirm water table and depth of excavation.

5.6.2 Unsuitable material shall be excavated to such depth and over such area as shown on the Drawings and/or directed by the S.O. and be transported and disposed off in an approved manner. Unless approval of the S.O. to dump and spread the unsuitable material within the Site is obtained, the Contractor shall be responsible for providing his own dump site for such unsuitable material.

5.7 Replacement Of Excavated Material Under Standing Water

Where it is decided by the S.O. that replacement of excavated material shall be done under standing water, voids created due to removal of excavated material shall be backfilled with hard clean crushed rock, natural gravel or sand having grading within the respective limits specified in TABLE B1.

 JKR MALAYSIA	SECTION B : EXCAVATION AND EARTHWORKS	No. Dokumen : JKR 20800-0183-14
		No. Keluaran : 01
		No. Pindaan : 00
		Tarikh : 29 Januari 2014
		Muka Surat : B/6

TABLE B1: GRADING LIMITS OF MATERIALS FOR REPLACEMENT OF EXCAVATED MATERIAL

B.S. Sieve Size	% Passing By Weight
Crushed Rock or Gravel	
63.0 mm	100
37.5 mm	85 – 100
20.0 mm	0 – 20
10.0 mm	0 – 5
Sand	
10.0 mm	100
5.0 mm	90 – 100
1.18 mm	45 – 80
300 µm	10 – 30
150 µm	2 - 10

5.8 Sides Of Excavation

The Contractor shall ensure that at all times, the sides of the excavation are maintained in a safe and stable condition, and shall be responsible for the adequate provision of all shoring and strutting including sheet piling required for this purpose. All temporary works shall comply with the requirements of BS 5975.

5.9 Widening Cuts

5.9.1 The S.O. may instruct the Contractor or the Contractor himself may elect to obtain material for the Works by widening cuts. In the latter case, the Contractor shall first request permission in writing from the S.O.

5.9.2 Widening of cuts shall not be permitted beyond the limits of the road reserve.

5.9.3 Any additional costs and time incurred that resulted from widening cuts shall be borne by the Contractor.

5.10 Excavation Of Rock

5.10.1 Rock excavation shall be carried out by methods appropriate to site requirements as approved by the S.O. As far as is practicable the Contractor shall not use blasting methods for excavations.

5.10.2 Where the excavation is too hard to be performed by digging, dozing, scraping, ripping, splitting, breaking, jack picking or other such methods, the Contractor may make a written request to the S.O. for permission to blast. Such permission will be granted only if the S.O. is satisfied that all reasonable measures have been tried to carry out the excavation by methods other than blasting.

5.10.3 Where explosives are used, the Contractor shall provide a method statement and shall comply fully with requirements of these Specifications, or any direction, order, requirement or instruction given by the PDRM or any other authority competent to do so under any written law.

5.10.4 All material from rock excavations shall be used as far as is practicable in the Works.

5.10.5 Where the rock is of satisfactory quality, the Contractor may elect to crush and screen it to produce aggregates required for concrete, road base, sub-

 <p>JKR MALAYSIA</p>	<p>SECTION B : EXCAVATION AND EARTHWORKS</p>	<p>No. Dokumen : JKR 20800-0183-14 No. Keluaran : 01 No. Pindaan : 00 Tarikh : 29 Januari 2014 Muka Surat : B/7</p>
--	---	---

base, or other purposes with the prior approval of the S.O. Excavated rock needed for earthwork construction which the Contractor elects so to use for producing aggregate materials shall be replaced at the Contractor's own expense by borrow materials of satisfactory quality from alternative locations approved by the S.O.

5.10.6 Otherwise, excavated rock shall be used in the construction of embankment and fill, to the fullest practical extent, in either of the two (2) following ways:

- (i) Excavated rock shall be broken down to a maximum particle size of 300 mm and used as rock fill as described in sub-section 5.2.6;
- (ii) Excavated rock shall be broken down to a maximum particle size of 150 mm, blended with suitable earth fill material in a proportion not exceeding 1 rock to 1 earth, and used as common fill.

5.10.7 The Contractor may only waste excavated rock with the approval of the S.O. Excavated rock needed for earthwork construction which the Contractor elects to waste shall be replaced at the Contractor's own expense by borrow materials of satisfactory quality from alternative locations approved by the S.O.

5.11 Storage And Handling Of Explosives

Proper buildings or magazines, with separate compartments for detonators, in suitable positions for the storage of explosives in manner and quantities to be approved shall be provided in compliance with all authorities' requirements. The prevention of any unauthorised issue or improper use of any explosive brought on the Works shall be the responsibility of the Contractor and only experienced and qualified personnel shall be employed to handle explosives for the purpose of the Works.

5.12 Blasting

5.12.1 Explosives shall be used in the quantities and manner recommended by the manufacturers and blasting specialist. Blasting shall be restricted to such periods as the S.O. may prescribe and to comply with all authorities requirement. If, in the opinion of the S.O., blasting would be dangerous to persons or properties or to any finished work, or is being carried on in a reckless manner, he may prohibit it, and order the rock to be excavated by other means. The use of explosives in large blasts, that is exceeding 9 kg of explosive, as in seams, drifts, shafts, pits, or large holes, is prohibited unless authorised in writing by the S.O. Such authorisation shall not in any way relieve the Contractor of his liabilities under the Conditions of Contract.

5.12.2 All necessary precautions shall be taken to preserve the materials below and beyond the lines of all excavations in the soundest possible condition. Delayed blasting to reduce shock waves shall be used to avoid damage to concrete and other works already completed. As the excavation approaches its final lines, blasting with pre-splitting technique of approved drill hole spacing shall be carried out to reduce blast damage and create reasonably even finished surface by means of parallel drill holes perpendicular to the toe of the excavation and parallel to the finally required face.

5.13 Safety Measures

5.13.1 When blasting is carried out close to properties or roads, safety rules complying to authorities' requirements shall be strictly adhered to. Where necessary or as directed by the S.O., heavy mesh blasting mats shall be used to ensure that no damage is caused to persons or properties on or off

	SECTION B : EXCAVATION AND EARTHWORKS	No. Dokumen : JKR 20800-0183-14 No. Keluaran : 01 No. Pindaan : 00 Tarikh : 29 Januari 2014 Muka Surat : B/8
---	--	--

Site. Special care shall be taken in wet ground to ensure that individual explosions are reduced to such size as to preclude damage to any buildings or structures. Plaster shooting will not be permitted within 400 m of any building or structure. If traffic on any road or railway has to be interrupted for blasting operations, the Contractor shall obtain approval of his schedule for such interruption from the appropriate authorities and shall prove to the S.O. that he has obtained it, prior to the interruption.

5.13.2 When blasting is carried out with close proximity to sensitive structures and environmental sensitive areas, thresholds and criteria of vibration impact shall be established for monitoring purpose.

5.14 Insecure Material

The cut slopes shall be cleared of all rock fragments which move when pried with a crow-bar. The Contractor shall excavate any insecure material to an approved depth and build up the resulting spaces with Grade 15P/20 concrete or masonry using rock similar to the adjoining natural rock so as to ensure a solid face.

6. Filling Works

6.1 Material

6.1.1 Fill materials to form formation level shall be of suitable material obtained from excavation in cuttings. Where the quantity of such materials is inadequate, the Contractor shall obtain suitable materials from the designated borrow pits or from his own borrow pits which have been approved by the S.O.

6.1.2 The fill material shall be free from roots, grass, other vegetable material, clay lump or material of particles size larger than 150 mm.

6.1.3 Sand shall not be used as fill materials at outer edges of the embankment.

6.2 Borrow Pits

6.2.1 The Contractor shall be responsible for locating borrow pits. Designated borrow pits shown on the Drawings only indicate to the Contractor potential areas for borrow. Whether the Contractor obtains materials from the designated or his own borrow pit, it shall be his responsibility to ascertain the suitability of the pit with respect to the quantity and quality of the materials, which shall be subjected to the approval of the S.O.

6.2.2 The Contractor shall keep the borrow pits free from water ponding and the excavation neat and tidy. The contractor shall make sure the side-wall of the borrow pits is stable, protect the slope surface by turving and shall carry out other necessary erosion and environmental protection measures following the agreed method statement or as instructed by the S.O.

6.2.3 The following tests should be carried out for each 1,500 m³ of material to be placed or more frequent tests as required by the S.O. :

- (i) Atterberg limits
- (ii) Gradation analysis
- (iii) M.S 1056 Compaction Test (2.5 kg rammer method)

 <p>JKR MALAYSIA</p>	<p>SECTION B : EXCAVATION AND EARTHWORKS</p>	<p>No. Dokumen : JKR 20800-0183-14 No. Keluaran : 01 No. Pindaan : 00 Tarikh : 29 Januari 2014 Muka Surat : B/9</p>
--	---	---

6.3 Placement Of Fill Materials

- 6.3.1 All fill materials shall be deposited in layers and brought up at a uniform rate so that all parts of the Site reach finished level at the same time. The loose depth for each layer of fill shall be determined from the trial compaction. Each layer shall extend over the full width of the fill area and shall be compacted in accordance with the requirements of sub-section 6.4. Each compacted layer shall be maintained at all times with a sufficiently even surface of longitudinal and cross slope in order to drain away the surface water.
- 6.3.2 Where embankment is to be constructed on ground with a cross slope flatter than 1 (vertical) to 10 (horizontal) but steeper than 1 (vertical) to 30 (horizontal), the foundation material, except where this is rock, shall be scarified to a depth of 100 mm, blended with embankment fill material and compacted as described in sub-section 6.4.
- 6.3.3 Where embankment is to be constructed against existing embankment or on ground with a cross-slope steeper than 1 (vertical) to 10 (horizontal), the foundation shall be excavated in all materials (including hard rock) to form benches with horizontal and vertical faces from which construction of the embankment shall proceed. The benches shall be contiguous beneath the full width of the embankment, and shall be of a suitable width to accommodate construction equipment such as motor-graders, trucks, rollers, et cetera. Scarifying of the horizontal and vertical faces of the benches shall not normally be required, and the material excavated in forming the benches may normally be used as fill in the embankment as approved by the S.O.

6.4 Compaction

6.4.1 General

- 6.4.1.1 All materials used in embankments and as fill elsewhere shall be compacted as soon as practicable after being placed and spread. Compaction shall be undertaken to the requirements of this Section by plant approved by the S.O. All compaction requirements shall be controlled by means of field density measurement.
- 6.4.1.2 For compaction of embankment slope, the Contractor may either extend each compacted layer beyond the design slope surface by at least 600 mm then trim back to the required slope angle, or he may employ an agreed tow type roller to compact the sloping surface.

6.4.2 Compaction trials

- 6.4.2.1 The latest MS 1056 Compaction Test (2.5 kg rammer method) shall be used in determining the moisture versus density relation of soil.
- 6.4.2.2 The Contractor shall submit to the S.O. for his agreement the proposed method of compaction for each main type of material to be used in the embankment. This shall include the type of compaction plant for each type of material and the number of passes in relation to the loose depth of material to achieve desired compaction. The maximum loose thickness for fill shall generally be limited to 300 mm unless trial compaction shows

 <p>JKR MALAYSIA</p>	<p>SECTION B : EXCAVATION AND EARTHWORKS</p>	<p>No. Dokumen : JKR 20800-0183-14 No. Keluaran : 01 No. Pindaan : 00 Tarikh : 29 Januari 2014 Muka Surat : B/10</p>
--	---	--

compliance with larger loose thickness and with the approval from the S.O. The Contractor shall carry out field compaction trials, supplemented by any necessary laboratory investigations, as required by the S.O. This shall be done by using the procedures proposed by the Contractor for earthworks and shall demonstrate to the S.O. that all the specified requirements regarding compaction can be achieved. Compaction trials with the main types of material likely to be encountered shall be completed before the works with the corresponding materials will be allowed to commence. Each trial area shall be not smaller than 8 m x 15 m.

6.4.2.3 For earthwork compaction of less than 100 m³, trial compaction can be waived with approval from the S.O., but field density testing as per sub-section 6.4.4 is still remained necessary as and when instructed by the S.O.

6.4.3 Degree of compaction

The whole of the fill area shall be compacted to not less than 90% (for cohesive material) or 95% (for cohesion less material) of the maximum dry density determined in the latest MS 1056: Compaction Test (2.5 kg-rammer method), unless otherwise as shown on the Drawings.

6.4.4 Field density testing

Field density tests on each layer of compacted earth fill shall be carried out using the sand replacement method in accordance with the latest MS 1056 or by using other means of testing of comparable accuracy approved by the S.O.

6.4.5 Moisture control

6.4.5.1 Each layer of earth fill shall be processed as necessary to bring its moisture content to a uniform level throughout the material, suitable for compaction. The optimum moisture content as determined by the latest MS 1056: Compaction Test (2.5 kg rammer method) shall be used as a guide in determining the proper range of moisture content, preferably on the wet side, at which each soil type shall be compacted. Water shall be added in fine spray for consistent moisture absorption in the fill, or the material aerated and dried to adjust the soil to the proper range of moisture content to obtain the required density. A satisfactory method and sufficient equipment as approved by the S.O. shall be used for the furnishing and handling of water.

6.4.5.2 If the natural water content of suitable material is too high for the proper compaction to be carried out, the Contractor can either bring down the moisture content by aeration or drying or alternatively replace it with suitable materials of compactable moisture range at his own cost.

6.4.6 Air voids

To reduce potential of collapse compression of unsaturated cohesive fill due to wetting, the moisture content range at fill placement shall be controlled to achieve a compacted fill with allowable air void content not exceeding 5 %.

 <p>JKR MALAYSIA</p>	<p>SECTION B : EXCAVATION AND EARTHWORKS</p>	<p>No. Dokumen : JKR 20800-0183-14 No. Keluaran : 01 No. Pindaan : 00 Tarikh : 29 Januari 2014 Muka Surat : B/11</p>
--	---	--

6.5 Frequency Of Control Tests

6.5.1 For each compacted fill materials, the frequency of control tests shall be in accordance with TABLE B2. The control tests shall be evenly allocated to each compacted layer of the entire compacted fill. Each control test shall provide moisture content, dry density and air void content.

TABLE B2 : FREQUENCY OF CONTROL TEST FOR EARTH EMBANKMENT

Type of Material	Frequency of Test
Fill/ Imported material	1 test per 1500 m ³
Compacted material	1 test per 500 m ²

6.5.2 For California Bearing Ratio (CBR), the frequency of test shall not be less than one test per 4000 m² of compacted subgrade surface completed or otherwise as directed by the S.O.

6.5.3 If certain test methods are used for the reasons of speed and economy, calibration between such tests and the master test method as per latest MS 1056 shall be carried out at the interval of every 100 tests subject to the S.O. agreement. The calibration is material specific and shall be performed for each material type. The non-master test method with variation of more than ± 5 % shall be rejected.

6.6 Rock Fill Embankment

6.6.1 Rock used in rock fill embankments shall be of maximum particle size of 300 mm so that it can be deposited in horizontal layers, each not exceeding 500 mm in compacted depth and extending over the full width of the embankment except for any specified external cover to slopes or new formation level. The materials shall be spread and levelled by a crawler tractor weighing not less than 15 tonnes. Each layer shall consist of reasonably well graded rock and all large voids with averaging dimension of exceeding 150 mm shall be filled with broken fragments before the next layer is placed. The top surface and side slopes of embankments so formed shall be thoroughly blinded with approved fine graded material to seal the surface.

6.6.2 There shall be a transition layer between rock fill and earth fill or the top 300 mm of subgrade of at least 300 mm compacted thickness. This shall consist of uniformly graded crushed rock between 6 mm and 150 mm as approved by the S.O.

6.6.3 Each layer of rock used as rock fill in embankments shall be systematically compacted by at least 12 passes of a vibrating roller with a static load per 25 mm width of roll of at least 45 kg or a grid roller with load per 25 mm width of roll of at least 200 kg or other approved plant.

6.7 Filling On Soft Ground

6.7.1 Foundation treatment

6.7.1.1 Prior to forming embankment over soft ground, the soil over which fill material shall be placed shall be given strength improvement treatment as specified and to the details as shown on the Drawings or as directed or approved by the S.O. Treatment by

 <p>JKR MALAYSIA</p>	<p>SECTION B : EXCAVATION AND EARTHWORKS</p>	<p>No. Dokumen : JKR 20800-0183-14 No. Keluaran : 01 No. Pindaan : 00 Tarikh : 29 Januari 2014 Muka Surat : B/12</p>
--	---	--

means of replacement of unsuitable material shall be as specified in sub-sections 5.6 and 5.7.

6.7.1.2 The first layer of fill materials shall be deposited over the full width of the embankment and berms in thicknesses not more than 500 mm or as approved by the S.O. to sufficiently support earthwork machineries.

6.7.1.3 If fill materials are required to be placed under standing water, hard clean crushed rock, natural gravel or sand having grading within the respective limits specified in TABLE B1 shall be used to backfill the embankment not less than 300 mm above the standing water to receive compacted suitable fill thereafter.

6.7.2 Surcharge and staged construction

Where indicated in the Contract or directed by the S.O., the embankment shall be built to different heights in stages with or without surcharge and with allowance for consolidation time periods in between stages, all in accordance with the Contract. Where surcharge is specified, the Contractor shall be responsible for the provision of surcharge material and the removal and disposal of excess material on completion of consolidation or when directed by the S.O.

6.7.3 Geotechnical instrumentations

6.7.3.1 Geotechnical instruments shall be provided and installed by the Contractor in the positions as shown on the Drawings for the purpose of measuring intended reading at specified location(s) during and after the construction period. The details of geotechnical instruments shall be as shown on the Drawings and the Contractor shall be responsible for supplying, installing and maintaining the functionality of the geotechnical instruments as the work proceeds.

6.7.3.2 The Contractor shall take all necessary measures to protect geotechnical instruments from damage by plant and vehicles at all times and shall repair any such damage throughout the whole duration of the Works. Necessary visible barriers shall be installed around each geotechnical instruments wherever required.

6.7.4 Monitoring records

6.7.4.1 Joint recording of geotechnical instruments reading shall be conducted as specified. The monitoring records shall be submitted to the S.O. on an approved printed form to be supplied by the Contractor. Softcopy of monitoring records shall be submitted together with the hard copy records.

6.7.4.2 For the measurement of the volume that has settled below the original level of the foundation of the embankment, the measured settlement of each settlement gauge shall be used for volume computation following the method shown on the Drawings.

 <p>JKR MALAYSIA</p>	<p>SECTION B : EXCAVATION AND EARTHWORKS</p>	<p>No. Dokumen : JKR 20800-0183-14 No. Keluaran : 01 No. Pindaan : 00 Tarikh : 29 Januari 2014 Muka Surat : B/13</p>
--	---	--

7. Protection And Maintenance For Erosion Control

- 7.1 Where turfing is required for earthworks protection, they shall be planted immediately after cutting or filling as specified under SECTION R: LANDSCAPING AND TURFING WORKS.
- 7.2 Hydroseeding
- 7.2.1 Hydroseeding shall be carried out after the proposed slope surface exceeds 1000 m² or within two (2) weeks after cutting or one (1) week during monsoon season, whichever is earlier on all slopes and other areas as shown on the Drawings and/or directed by the S.O. Every measure should be taken to ensure that the grass seed properly germinate at the intended location as shown on the Drawings at Contractor's expense.
- 7.2.2 The Contractor shall submit to the S.O. for his consideration and approval, at least four (4) weeks in advance of the proposed work, full details of his proposed method of hydroseeding. The information submitted shall include, but not necessarily be limited to, a full description of the following aspects of the work:
- (i) the preparation of the areas to be hydroseeded, including if appropriate the amount of topsoil to be used and its method of application;
 - (ii) the details and results of investigations to determine which types of grass and legume are compatible with the soil in the areas to be seeded;
 - (iii) the types of grass and legume (if any) and strains of seed to be used, and the function, root and growth characteristics of each type;
 - (iv) the rates of application of the grass and legume seeds;
 - (v) the composition of fertiliser to be used at the time of hydroseeding and its rate of application;
 - (vi) the composition of fertiliser to be used after seeding, the times of application after hydroseeding, and the rates of application;
 - (vii) the type of mulch to be used and its method and rate of application;
 - (viii) the amounts of lime or other chemicals (if any) to be applied to improve the soil before, during and/or after hydroseeding;
 - (ix) the type and amounts of binding agent to be applied with the seeds, mulch, fertiliser, et cetera, as appropriate;
 - (x) the proportions and methods of preparation of the hydroseeding mix;
 - (xi) the equipment and methods to be used in preparing and placing the hydroseeding mix and other materials;
 - (xii) the cultivation and after-care of the seeded areas, including rates and frequencies of watering, fertilising, grass cutting and general maintenance for at least one (1) year after hydroseeding;
 - (xiii) the time after hydroseeding required for establishing permanent, dense growth of grasses, which will require minimal maintenance;

 <p>JKR MALAYSIA</p>	<p>SECTION B : EXCAVATION AND EARTHWORKS</p>	<p>No. Dokumen : JKR 20800-0183-14 No. Keluaran : 01 No. Pindaan : 00 Tarikh : 29 Januari 2014 Muka Surat : B/14</p>
--	---	--

(xiv) the temporary erosion protection materials used for protecting the seeds;

(xv) guarantees the success of the hydroseeding work.

7.2.3 All grass shall be regularly watered until the vegetation is satisfactorily established to the requirements of these Specifications. Any dead grass shall be replaced at the Contractor's own expense.

7.3 Creepers

7.3.1 Where creepers are introduced on gunited slopes, rocks or unsuitable materials, species shall be of Malaysian origin such as *ficus pumila*, *centrosema pubescens*, or to the agreement of the S.O.

7.3.2 The Contractor shall submit to the S.O. for his consideration and approval, at least four (4) weeks in advance of the proposed work, full details of his proposed method of planting the creepers. The information submitted shall include, but not limited to, a full description of the following aspects of the work:

- (i) the preparation of the areas to be planted with creepers, including the amount of topsoil if appropriate to be used and its method of application;
- (ii) the details and results of investigations to determine which types of creepers are compatible with the soil in the areas to be planted;
- (iii) the types of creepers to be used, and the function, root and growth characteristics of each type;
- (iv) the composition of fertilizer to be used at the time of planting the creepers and its rate of application;
- (v) the composition of fertilizer to be used after planting, the times of application and the rate of application;
- (vi) the amounts of lime or other chemicals (if any) to be applied to improve the soil before, during and/or after planting;
- (vii) the cultivation and after care of the areas, including rates and frequencies of watering, fertilizing and general maintenance for at least one (1) year after planting;
- (viii) the time after planting required for establishing permanent, dense growth of creepers, which will require minimal maintenance;
- (ix) guarantees the success of the creepers planting work.

7.3.3 All creepers shall be regularly watered until the vegetation is satisfactorily established to the requirements of these Specifications. Any dead creepers shall be replaced at the Contractor's own expense.

7.4 Temporary Slope Protection

7.4.1 Should the Contractor be unable to turf/hydroseed the exposed slopes within two (2) weeks after cutting or one (1) week during monsoon season, whichever is earlier, temporary protection measures such as covering with plastic sheeting or artificial cover to control erosion shall be taken.

TABLE OF CONTENTS

SECTION C: FOUNDATION WORKS AND WORKS BELOW LOWEST FLOOR LEVEL

	PAGE
1. Shallow Foundations	C/1
2. Deep Foundations	C/1
3. Subterranean Termites Treatment	C/36
4. Damp Proof Membrane (DPM)	C/37
5. Damp Proof Course (DPC)	C/37
6. Filling Under Floors, Aprons Et Cetera	C/38
7. Hardcore	C/38
TABLE C1 : Specification Of Precast Concrete Piles	C/39
TABLE C2 : Slump Range For Typical Concreting Situations	C/39
APPENDIX C/1 : Bending Strength For Precast Concrete Piles	C/40
TABLE C3 : Maximum Allowable Crack Width	C/40
TABLE C4 : Cracking Bending Moment (M_c) And Factor 'f' For Precast Reinforced Concrete Square Piles (RC Piles)	C/41
TABLE C5 : Cracking Bending Moment (M_c) And Factor 'f' For Precast Pretensioned Spun Concrete Piles (Spun Piles)	C/41
TABLE C6 : Cracking Bending Moment (M_c) And Factor 'f' For Precast Prestressed Concrete Square Piles - Class PC-X, Class PC-Y, Small Piles	C/42

 <p>JKR MALAYSIA</p>	<p>SECTION C : FOUNDATION WORKS AND WORKS BELOW LOWEST FLOOR LEVEL</p>	<p>No. Dokumen : JKR 20800-0183-14 No. Keluaran : 01 No. Pindaan : 00 Tarikh : 29 Januari 2014 Muka Surat : C/1</p>
--	---	---

1. Shallow Foundations

1.1 General

1.1.1 Shallow foundations are defined as those where the depths are less than 3 m below the finished ground level.

1.1.2 Unless otherwise specified, shallow foundations shall conform with MS 1756.

1.2 Confirmatory Bearing Capacity Of Soil

The Contractor shall conduct a Probe Test as stated in the Drawings to confirm the required design bearing capacity. The Contractor shall submit the Probe Test result to the S.O. for approval.

1.3 Excavation

1.3.1 Foundations shall be excavated to the levels and dimensions as shown on the Drawings, with sides trimmed and bottoms levelled and stepped as required.

1.3.2 All excavation shall be carried down to required level. On no account shall shallow foundations rest on made up or filled ground. Unless otherwise shown on the Drawings, the depths of foundation shall be decided on the site by the S.O. The Contractor shall at his own cost and expense, make good any over excavation below the required depth with suitable granular material or concrete as approved by the S.O.

1.4 Materials

1.4.1 Concrete

The materials and workmanship for concrete shall be as specified in SECTION D: CONCRETE WORKS.

1.4.2 Reinforcement

The steel reinforcement shall be as specified in SECTION D: CONCRETE WORKS.

2. Deep Foundations

2.1 General

Deep foundations are defined as those where the depths are more than 3 m below the finished ground level.

2.2 Piling Works

All piling works shall conform to BS 8004 and MS 1314 unless otherwise specified.

2.2.1 Definitions

2.2.1.1 Preliminary pile

A preliminary pile is a pile installed before the commencement of the main piling work for the purpose of establishing the

 <p>JKR MALAYSIA</p>	<p>SECTION C : FOUNDATION WORKS AND WORKS BELOW LOWEST FLOOR LEVEL</p>	<p>No. Dokumen : JKR 20800-0183-14 No. Keluaran : 01 No. Pindaan : 00 Tarikh : 29 Januari 2014 Muka Surat : C/2</p>
--	---	---

driving criteria for subsequent working piles and for confirming the adequacy of the design, dimensions and bearing capacity. This pile shall be treated as a working pile unless otherwise directed by the S.O.

2.2.1.2 Working pile

A working pile is a pile which is installed as part of the permanent foundation work.

2.2.1.3 Ultimate load

- (i) Where pile test is carried out, the Ultimate Load is defined as the constant load at which the pile continues to settle at a steady rate, or the load at which the maximum settlement of the pile during one (1) continuous loading cycle is one tenth of the pile base diameter or least dimension, whichever is the lesser.
- (ii) Where a pile test is not carried out, the Ultimate Load is defined as the calculated Ultimate Load, derived from appropriate static bearing capacity calculations.

2.2.1.4 Working load

The Working Load is the Design Load modified to allow for group effect, pile spacing or any other factors changing the efficiency of the total foundation from that of a single isolated pile, and is at least equal to the dead plus imposed loads on the pile together with downdrag or uplift loads as appropriate.

2.2.2 Soil investigation report

2.2.2.1 A soil investigation report shall be made available at the S.O.'s office for the Contractors information. The report is intended solely as a preliminary guide and neither the completeness nor the accuracy of the information provided is guaranteed. No responsibility is assumed by the S.O. for any opinion or conclusion given in the soil report.

2.2.2.2 The Contractor shall study the given soil report in detail and make his own interpretation of the information provided and to make due allowance for the effect of site conditions on his construction operations.

2.2.3 Method statement for construction operations

2.2.3.1 Two (2) weeks before the commencement of piling works, the Contractor shall submit to the S.O. a detailed method statement for the installation of piles. The method statement shall contain the following:

- (i) A detailed construction sequence;
- (ii) Shop Drawings showing details of all special requirements for the construction activities such as hoisting of piles, reinforcement cages, cast in fixing et cetera;
- (iii) Design calculation of key temporary works endorsed by a P.E.;

 <p>JKR MALAYSIA</p>	<p>SECTION C : FOUNDATION WORKS AND WORKS BELOW LOWEST FLOOR LEVEL</p>	<p>No. Dokumen : JKR 20800-0183-14 No. Keluaran : 01 No. Pindaan : 00 Tarikh : 29 Januari 2014 Muka Surat : C/3</p>
--	---	---

- (iv) Materials, plant and labour requirement at each construction stage;
- (v) Rate of production output based on resources allocated;
- (vi) Other information relevant to the piling works.

2.2.3.2 If requested by the S.O, the Contractor shall submit additional information pertaining to the method of construction (including temporary works and the use of the construction plant), calculation of the stresses, strain and deflection that will arise in the permanent works of any part thereof during construction.

2.2.3.3 The Contractor shall not change the methods which have been approved by the S.O. Approval by the S.O. of the Contractor's proposed methods of construction shall not in any way relieve the Contractor of any of his duties or responsibilities under the contract.

2.2.4 Setting out

Setting out shall be carried out using the data and reference points as shown on the Drawings. The pile position shall be marked with suitable identifiable pins, pegs or markers at least 300 mm length. The pins, pegs or markers should be driven to ground level and the location marked with contrasting material. If raking piles are to be installed then the setting out pins, pegs or markers is located in an offset position at piling platform level taking into account of depth to cut-off level and rake value of the pile. In addition, the alignment of pins, pegs or markers shall indicate the direction of the rake. Immediately before installation of the pile, the pile positions shall be checked by the Contractor again.

2.2.5 Position

For a pile cut off at or above ground level the maximum permitted deviation of the pile centre from the centre points shown on the Drawings shall not exceed 75 mm in any direction. For a pile cut off below ground level an increase in this tolerance of 150 mm is permitted in accordance with sub-sections 2.2.6 and 2.2.7 herein. No pile edge shall be nearer than 150 mm from the edge of any pile cap.

2.2.6 Verticality

The maximum permitted deviation of the finished pile from the vertical is 1 in 75.

2.2.7 Rake

The piling rig shall be set and maintained to attain the required rake. The maximum permitted deviation of the finished pile from the specified rake or the rake shown on the Drawings is 1 in 25.

2.2.8 Forcible corrections

Forcible corrections to concrete piles shall not be permitted. Forcible corrections may be permitted to specific types of piles if approved by the S.O. However, no forcible corrections shall be made to piles which have deviated beyond the permissible limits specified in sub-sections 2.2.5, 2.2.6 and 2.2.7.

	SECTION C : FOUNDATION WORKS AND WORKS BELOW LOWEST FLOOR LEVEL	No. Dokumen : JKR 20800-0183-14 No. Keluaran : 01 No. Pindaan : 00 Tarikh : 29 Januari 2014 Muka Surat : C/4
---	--	--

2.2.9 Piles out of alignment or position

The Contractor shall, if instructed by the S.O., extract and reinstall any pile which has deviated out of position or alignment by more than the specified limit, or alternatively the substructure shall be modified to the approval of the S.O. The cost of such extraction and reinstallation or any extra cost in the design and construction of a modified foundation shall be borne by the Contractor if such extra works have been made necessary due to the incompetency and/or negligence of the Contractor.

2.2.10 Unexpected ground conditions

The Contractor shall give a written notice immediately to the S.O any circumstances which, in the Contractor's opinion, indicate ground conditions that differ from those expected by him from interpretation of the soil investigation report. The Contractor shall submit to the S.O. a report which contains all information available to the Contractor that will materially assist the S.O in verifying the conditions reported, and to modify the design, if necessary.

2.2.11 Adjacent structures

2.2.11.1 The Contractor shall carry out a condition survey of adjacent properties to establish the condition of the existing structures and facilities prior to commencement of piling work. Condition Surveys shall be conducted by a registered building surveyor and the result of the survey shall be submitted to the S.O. for record.

2.2.11.2 The Contractor shall pay very careful attention to the construction constraints imposed by adjacent structures. The Contractor shall take adequate measures to ensure his piling works do not disturb or damage existing adjacent properties and foundations. The Contractor shall provide a proposal for monitoring adjacent properties for any detrimental effects arising from execution of the piling works, so that appropriate and timely preventive action can be taken to minimise damage. The Contractor's proposal and monitoring programme shall be certified by a P.E.

2.2.11.3 The Contractor shall be responsible for and shall bear the cost incurred including claims for damages arising from his execution of the piling works.

2.2.12 Existing services

The Contractor shall give all required notices to the appropriate utility authorities before commencement of piling works. The Contractor shall also locate existing services by piloting, protect existing services, rectify any damage or interference to them and provide temporary support while repairs are being carried out if so required.

2.2.13 Materials

2.2.13.1 Concrete

The materials and workmanship for concrete shall be as specified in SECTION D: CONCRETE WORKS.

 <p>JKR MALAYSIA</p>	<p>SECTION C : FOUNDATION WORKS AND WORKS BELOW LOWEST FLOOR LEVEL</p>	<p>No. Dokumen : JKR 20800-0183-14 No. Keluaran : 01 No. Pindaan : 00 Tarikh : 29 Januari 2014 Muka Surat : C/5</p>
--	---	---

2.2.13.2 Reinforcement

The steel reinforcement shall be as specified in SECTION D: CONCRETE WORKS.

2.2.13.3 Pile shoes

- (i) The type of pile shoes to be used shall be as shown on the Drawings and shall comply with the following as relevant:
 - a) "Chilled-hardened" cast iron shoes as used for making grey iron castings to BS EN 1561, Grade 10; or
 - b) Mild steel to BS EN 10025 or equivalent, Grade 50B; or
 - c) Cast steel to BS EN 10293, Grade A.
- (ii) Mild steel straps cast into the shoes shall be as shown on the Drawings. Rock shoes where required shall consist of wrought iron shoes and mild steel straps cast into "Chilled-hardened" cast iron blocks, as shown on the Drawings.
- (iii) The shoes shall be truly coaxial and firmly embedded on to end of the pile.

2.2.14 Supply of piles

The contractor shall only use precast concrete piles supplied by approved manufacturers. Before the commencement of piling work, the contractor shall notify the S.O. the name of the manufacturers. The Contractor shall provide the manufacturer mill certificate. All piles found damage during supplied should be taken out from site.

2.2.15 Handling and storage

2.2.15.1 The method and sequence of lifting, handling, transporting and storing piles shall be such that piles are not damaged or having crack width greater than 0.1 mm. Only the designed lifting and support points shall be used. During transport and storage, piles shall be placed on adequate supports located under the lifting points of the piles. Piles shall be stored and stacked on firm ground not liable to settlement under the weight of piles. The supports shall be vertically above one another. All piles within a stack shall be in groups of the same length. Packings of uniform thicknesses shall be provided between piles at the lifting points.

2.2.15.2 No piles shall be allowed for transportation before achieving concrete strength of 30 N/mm².

2.2.15.3 No pile shall be driven before the specified characteristic strength of appropriate grade of concrete has been achieved.

2.2.16 Welding

Unless otherwise specified, all welds shall be full penetration butt welds complying with the requirements of BS EN 12334.

	SECTION C : FOUNDATION WORKS AND WORKS BELOW LOWEST FLOOR LEVEL	No. Dokumen : JKR 20800-0183-14 No. Keluaran : 01 No. Pindaan : 00 Tarikh : 29 Januari 2014 Muka Surat : C/6
---	--	--

2.2.17 Welders' qualifications

2.2.17.1 All welding works shall be executed by qualified welders with valid certificate issued by approved Authorities such as CIAST.

2.2.17.2 Only welders who are qualified to BS EN 287-1 or who have attained a similar standard shall be employed on the Works. Proof of welders' proficiency shall be made available on request by the S.O.

2.2.18 Damage to piles

2.2.18.1 The Contractor shall execute the work in such a manner so as to minimise damage to piles.

2.2.18.2 All piles damaged during handling, transporting, pitching, and driving or at any other time shall be replaced by the Contractor at his own expense.

2.2.19 Safety precautions

The Contractor shall take safety precautions throughout the piling operation in accordance with the requirements of the relevant laws and by-laws.

2.2.20 Records

The Contractor shall keep records of the installation of each pile and shall submit two (2) signed copies of these records to the S.O. not later than the next working day after the pile has been installed. The signed records shall form part of the records for the Works. Any unexpected driving or boring conditions shall be noted in the records.

2.2.21 As-built locations plan

The Contractor shall submit an As-built pile location plan certified by a Licensed Surveyor to the S.O. within seven (7) working days of completion of the last pile. Partial as-built plan may be submitted throughout construction of the foundation for verification by the S.O.

2.3 Precast Reinforced Concrete Piles

2.3.1 Installation of precast reinforced concrete piles

2.3.1.1 Pitching of piles

Piles shall be pitched accurately in the positions as shown on the Drawings. At all stages during driving and until the pile has set or been driven to the required length, all exposed piles shall be adequately supported and restrained by means of leaders, trestles, temporary supports or other guide arrangements to maintain position and alignment and to prevent buckling and damage to the piles.

2.3.1.2 Driving of piles

(i) Each pile shall be driven continuously until the specified set and/or depth has been reached, unless otherwise approved by the S.O. The driving equipment used shall be

 <p>JKR MALAYSIA</p>	<p>SECTION C : FOUNDATION WORKS AND WORKS BELOW LOWEST FLOOR LEVEL</p>	<p>No. Dokumen : JKR 20800-0183-14 No. Keluaran : 01 No. Pindaan : 00 Tarikh : 29 Januari 2014 Muka Surat : C/7</p>
--	---	---

of such type and capacity to the approval of the S.O. A follower (long dolly) shall not be used unless approved by S.O., subject to the following requirements:

- a) The first pile in each pile system and every tenth pile driven thereafter shall be driven full length, without a follower, to verify that adequate pile length is being attained to develop the desired pile capacity.
 - b) The follower and pile shall be held and maintained in equal and proper alignment during driving;
 - c) The follower shall be of such material and dimension to permit the piles to be driven to the length determined necessary from the driving of the full length piles;
 - d) The final position and alignment of the first two (2) piles installed with follower in each substructure unit shall be verified to be in accordance with the location tolerances specified in sub-section 2.2.4 before additional piles are installed.
- (ii) Follower shall not be used in driving of raked pile.
- (iii) A detailed record of the driving resistance over the full length of each pile shall be kept. The log shall record the number of blows for every 0.5 m of pile penetration. The Contractor shall inform the S.O. without delay if an unexpected change in driving characteristics is encountered. Where required by the S.O. set shall be taken at approved intervals during the driving to establish the behaviour of the piles.
- (iv) A set shall be taken only in the presence of the S.O. unless otherwise approved. The Contractor shall provide all facilities to enable the S.O. to check driving resistances. The final set of a pile other than as friction pile, shall be recorded as the penetration in millimetres per 10 blows. The temporary compression of the pile shall be recorded if required.
- (v) When a set is being measured, the following requirements shall be met:
- a) The pile shall be in good condition, without damage or distortion;
 - b) The hammer blow shall be in line with the axis of the pile and the impact surface shall be flat and perpendicular to the hammer axis;
 - c) The hammer shall be in good condition, delivering the required energy per blow and operating correctly;
 - d) The rebound shall be measured and recorded accordingly.
- (vi) When an acceptable resistance or set appears to have been reached, the driving of pile should be suspended for an interval sufficient to permit the soil to recover from the disturbance of pile driving, and then resumed to determine whether there is any increase or decrease in resistance.

 <p>JKR MALAYSIA</p>	<p>SECTION C : FOUNDATION WORKS AND WORKS BELOW LOWEST FLOOR LEVEL</p>	<p>No. Dokumen : JKR 20800-0183-14 No. Keluaran : 01 No. Pindaan : 00 Tarikh : 29 Januari 2014 Muka Surat : C/8</p>
--	---	---

- (vii) In soils that dilate when disturbed e.g. silts and some shales, negative pore pressure can be set up temporarily and the driving resistance may fall as these pore pressure return to normal. In clays disturbance can cause positive pore pressure to develop and the strength of the soil may increase as these dissipate. The necessary time interval before redriving may vary from one (1) hour to two (2) hours for non-cohesive soils or two (2) days or more for clays.
- (viii) The resistance at the start of redriving is more likely to be representative of the true bearing value of the pile, and each redriving result should be taken into consideration when deciding the pile penetration length.
- (ix) Piles shall be driven in an approved sequence to minimise the detrimental effects of heave and lateral displacement of the ground. When required, careful levelling from a datum unaffected by the piling shall be made on the pile heads already driven, before and after driving subsequent piles. Piles which have been displaced vertically by more than 3 mm as a result of driving adjacent piles shall be redriven to the required resistance.

2.3.1.3 Preboring and jetting of piles

- (i) Piles shall not be prebored without the written approval of the S.O. Preboring of piles may be allowed for the following reasons:
 - a) To ease pile drivability by breaking through hard layers;
 - b) To reduce lateral soil displacement where this could cause damage to nearby structure;
 - c) To investigate and possibly deal with obstruction in the ground.
- (ii) The piles shall in contact with surrounding soil and the completed piles shall comply with the requirements of this Specification. Diameter of preboring shall be in accordance with sub-section 2.5.3.1 of this Specification. If boring is oversize, any gap between the tube and ground shall be filled with compacted sand prior driving the pile.
- (iii) In some soils, jetting may lift adjacent structure or cause undermining of nearby foundations. Pile shall not be jetted without the written approval of the S.O. Prior to jetting any pile, the Contractor shall submit to the S.O. details of the equipment to be used and the proposed method to be adopted.

2.3.1.4 Repair of damaged pile heads

- (i) If a pile is to be subjected to further driving, concrete in the damaged pile head shall be cut off square at sound concrete, and all loose particles shall be removed by wire brushing, followed by washing with water. Care shall be exercised to ensure that the reinforcement in the pile head is not in any way damaged. Any damaged

 <p>JKR MALAYSIA</p>	<p>SECTION C : FOUNDATION WORKS AND WORKS BELOW LOWEST FLOOR LEVEL</p>	<p>No. Dokumen : JKR 20800-0183-14 No. Keluaran : 01 No. Pindaan : 00 Tarikh : 29 Januari 2014 Muka Surat : C/9</p>
--	---	---

reinforcement shall be made good to the satisfaction of the S.O. The head shall be replaced with concrete of similar grade or higher.

- (ii) The new head shall be cast truly in line with the remainder of the pile and be properly cured and allowed to harden sufficiently to develop the strength necessary for further driving. If a pile has been driven to the required set or depth but the level of sound concrete of the pile is below cut-off level, the pile shall be made good to the cut-off level as described above so that the completed foundation will safely withstand the specified ultimate load.

2.3.1.5 Lengthening of piles

- (i) Where piles have to be lengthened, other than by means of welding of steel plates as detailed on the Drawings, the reinforcement shall be stripped of all surrounding concrete for a distance equal to forty (40) times the diameter of the main reinforcement measured from the pile head for spliced joints and 300 mm for butt welded joints and all lateral reinforcement shall be removed.
- (ii) The new concrete shall be of the same grade or higher as the original concrete on pile and shall be adequately compacted.
- (iii) The lengthening bars shall butt on the exposed bars in true alignment and shall be butt welded as specified or shall be spliced with bars of the same diameter as the main pile bars, 60 diameters in length and lapping the main bars for a distance of 40 diameters above and below the joint, and shall be securely bound with 1.63 mm soft annealed iron wire.
- (iv) New binders of similar size shall be provided and spaced at half the centres' of the binders in the main body of the pile and shall be securely bound with 1.63 mm soft annealed iron wire and the pile extended by concreting in properly constructed mounds to the length required.
- (v) Care shall be taken to form the joint between the old and new concrete as specified hereinbefore. The old concrete shall be adequately roughened and all loose particles shall be removed by wire brushing, followed by washing with clean water. The extension shall be truly in line at all stages of handling and driving with the remainder of the pile and be properly cured and allowed to harden sufficiently to develop the strength necessary for further driving.

2.3.1.6 Pile joint

The bending strength test of pile joint shall be done for laterally loaded pile only to determine the bending capacity at each respective joint. The test shall be done as in 2.3.1.7 provided that the joint is positioned at the centre of the span. The bending capacity at the pile joint shall be greater than the

	SECTION C : FOUNDATION WORKS AND WORKS BELOW LOWEST FLOOR LEVEL	No. Dokumen : JKR 20800-0183-14 No. Keluaran : 01 No. Pindaan : 00 Tarikh : 29 Januari 2014 Muka Surat : C/10
---	--	---

bending capacity of the pile body by 10%. The result shall be submitted to S.O for approval prior to driving of any pile.

2.3.1.7 Pile bending strength test

Pile bending strength test shall be performed in accordance with APPENDIX C/1 of this Specification.

2.3.1.8 Cutting and preparation of pile heads

(i) When a pile has been driven to the required set or depth, the head of the pile shall be cut off to the level specified or shown on the Drawings. This shall be done carefully to avoid shattering or otherwise damaging the rest of the pile. Any cracked or defective concrete shall be cut away and made good with new concrete properly bonded to the old. The length of reinforcing bars projecting above this level shall be as shown or specified on the Drawings. If the length of reinforcing bars left projecting is insufficient, then they shall be extended by either of the following methods :

a) Butt welding

aa) The extension bars shall butt on the projecting bars in true alignment and shall be butt welded in accordance with sub-section 2.7.4 of this Specification.

ab) Redriving of the piles shall only be allowed after the welded joints have sufficiently air cooled to 100°C or below.

b) Splicing

The projecting bars shall be stripped of all surrounding concrete as necessary to allow splices of length 60 diameters with extension bars. The extension bars shall be securely bound to the projecting bars with 1.63 mm soft annealed iron wire. The concrete of the pile shall be made good either before or together with the casting of the pile cap, all to the satisfaction of the S.O. Care shall be taken to avoid cracking or otherwise damaging the rest of the pile. Any cracked or defective concrete shall be cut away and made good with new concrete properly bonded to the old.

2.4 Prestressed Spun Concrete Piles

2.4.1 Materials

2.4.1.1 Concrete

The materials and workmanship for concrete shall be as specified in SECTION D: CONCRETE WORKS.

 <p>JKR MALAYSIA</p>	<p>SECTION C : FOUNDATION WORKS AND WORKS BELOW LOWEST FLOOR LEVEL</p>	<p>No. Dokumen : JKR 20800-0183-14 No. Keluaran : 01 No. Pindaan : 00 Tarikh : 29 Januari 2014 Muka Surat : C/11</p>
--	---	--

2.4.1.2 Reinforcement

- (i) The prestressing tendons and the non-prestressing reinforcement of the piles including workmanship shall be as specified in SECTION D: CONCRETE WORKS of this Specification and to the details as shown on the Drawings.
- (ii) Prestressing steel shall comply with JIS G3137 or BS 4486 or BS 5896 or ASTM A416 or equivalent.
- (iii) A certificate of conformance is required for every delivery of reinforcement.

2.4.1.3 Transfer of prestress

The minimum concrete cube strength at transfer should be 30 N/mm². All test cubes should be stored under same conditions as the piles.

2.4.1.4 End plates

Details of end plates of each length of pile shall be as shown on the Drawings. Each end plate shall be machine-finished and provided with a chamfer to accommodate the welding when two (2) lengths of pile are jointed.

2.4.1.5 Pile shoes

If specified, the type of pile shoes to be used shall be as shown on the Drawings and shall be in accordance with sub-section 2.2.13.3.

2.4.2 Installation of prestressed spun concrete piles

2.4.2.1 Pitching and driving of piles

Pitching and driving of piles shall be in accordance with sub-sections 2.3.1.1 and 2.3.1.2. Piles shall not be driven until the concrete has achieved the specified characteristic strength.

2.4.2.2 Lengthening of piles

Where lengthening of piles is required, the details of the joint shall be as shown on the Drawings and in accordance with sub-section 2.7.4. When two (2) lengths of pile are jointed, the end plates shall bear over their complete areas. Shims for packing shall not be accepted. For laterally loaded pile, the pile joint shall be in accordance with sub-section 2.3.1.5.

2.4.2.3 Cutting and preparation of pile heads

When a pile has been driven to the required set or depth, the head of the pile shall be cut off to the level specified or shown on the Drawings using a diamond cutter. Pile heads shall be constructed to details as shown on the Drawings.

	SECTION C : FOUNDATION WORKS AND WORKS BELOW LOWEST FLOOR LEVEL	No. Dokumen : JKR 20800-0183-14 No. Keluaran : 01 No. Pindaan : 00 Tarikh : 29 Januari 2014 Muka Surat : C/12
---	--	---

2.5 Bored Cast-in-situ Piles

2.5.1 Description

This work shall comprise the boring or grabbing, with or without casing, and subsequently filling the hole with plain or reinforced concrete to form bored cast-in-situ piles, all in accordance with this Specification and to the details shown on the Drawings.

2.5.2 Materials

2.5.2.1 Concrete

The materials and workmanship for concrete shall be as specified in SECTION D: CONCRETE WORKS. The grade of the concrete shall be as shown on the Drawings.

2.5.2.2 Reinforcement

The steel reinforcement shall be as specified in SECTION D: CONCRETE WORKS. The details of the steel reinforcement shall be as shown on the Drawings.

2.5.2.3 Permanent casings

Permanent casings which form part of the designed pile shall be as specified on the Drawings.

2.5.2.4 Support fluid

- (i) Support fluid material, bentonite, shall comply with the manufacturer's certificate and mix proportion. A certificate shall be obtained by the Contractor from the manufacturer of the bentonite powder, showing the properties of each consignment delivered to the site. This certificate shall be made available to the S.O. Test should be carried out at regular interval to ensure consistency of the batching process.
- (ii) Polymer can be used as an alternative to bentonite to maintain stability of the bores with the approval of the S.O.
- (iii) Bentonite or polymer shall be mixed thoroughly with water complying with MS 28 to make a suspension which will maintain the stability of the pile excavation for the period necessary to place concrete and complete construction. Preparation of the suspension shall comply with the manufacturer's instructions.
- (iv) Where saline or chemically contaminated ground water occurs, special precautions shall be taken to modify the bentonite suspension or pre-hydrate the bentonite in fresh water to render it suitable in all respects for the construction of piles.

	SECTION C : FOUNDATION WORKS AND WORKS BELOW LOWEST FLOOR LEVEL	No. Dokumen : JKR 20800-0183-14 No. Keluaran : 01 No. Pindaan : 00 Tarikh : 29 Januari 2014 Muka Surat : C/13
---	--	---

2.5.3 Boring Operations

2.5.3.1 Diameter of piles

- (i) The diameter of piles shall not be less than the specified designed diameter at any level throughout its length.
- (ii) The auger width shall be checked as necessary and recorded for each pile to ensure the specified diameter is achieved. A tolerance of +5% to 0% on the auger width is permissible.

2.5.3.2 Boring

- (i) Boring shall be carried down to the depth as required and directed by the S.O. When deemed necessary by the S.O., the Contractor shall take undisturbed soil samples while the pile is being bored. The samples shall be taken to an approved Laboratory for testing.
- (ii) Sampling and all subsequent handling and testing shall be carried out in accordance with BS EN ISO 1997, BS EN ISO 14688, BS EN ISO 14689, BS EN ISO 22475 and BS EN ISO 22476.
- (iii) Piles shall not be bored at a distance less than three (3) times diameter close to other piles which have recently been cast and which contain workable or unset concrete.

2.5.3.3 Drilling in rock

The Contractor shall submit a method statement when drilling in rock. Chiselling of rock may cause micro cracks in surrounding rock and is not allowed.

2.5.3.4 Temporary casings

- (i) Temporary casings of approved quality or an approved alternative method shall be used to maintain the stability of pile excavations which might otherwise collapse.
- (ii) Temporary casings shall be free from significant distortion. They shall be of uniform cross-section throughout each continuous length. During concreting they shall be free from internal projections and encrusted concrete which might prevent the proper formation of the piles being cast.

2.5.3.5 Stability of piling excavations using support fluid

Where the use of support fluid or a column of water is approved for maintaining the stability of boring, the level of fluid or column of water in the excavation shall be maintained such that the fluid pressure always exceeds the pressure exerted by the soil and external ground water and an adequate temporary casing shall be used in conjunction with the method to ensure the stability of the strata near ground level until concrete has been placed. The fluid water level shall be maintained at a level not less than 1 m above the level of the external ground water. In the event of a rapid loss of bentonite suspension, polymeric

 <p>JKR MALAYSIA</p>	<p>SECTION C : FOUNDATION WORKS AND WORKS BELOW LOWEST FLOOR LEVEL</p>	<p>No. Dokumen : JKR 20800-0183-14 No. Keluaran : 01 No. Pindaan : 00 Tarikh : 29 Januari 2014 Muka Surat : C/14</p>
--	---	--

fluids or water from the piling excavation, the excavation shall be backfilled with lean concrete or well compacted sand as specified in SECTION D: CONCRETE WORKS of this Specification without delay and the instructions of the S.O. shall be obtained prior to resuming boring at that location.

2.5.3.6 Spillage and disposal

- (i) All reasonable steps shall be taken to prevent the spillage of bentonite suspension or water on the site in areas outside the immediate vicinity of the boring operations. Discarded bentonite water shall be removed from the site without delay. The disposal of bentonite water shall comply with the regulations of the Local Authorities.
- (ii) Entrained solids shall be removed from the polymeric fluid by use of flocculants before disposal of the remaining fluid to the environmentally acceptable area.

2.5.3.7 Pumping of boreholes

Pumping from the borehole shall not be permitted unless a casing has been placed into the stable stratum to prevent the further ingress of water in significant quantities from other strata into the boring, or, unless it can be shown that pumping will not have a detrimental effect on the surrounding soil or its properties.

2.5.3.8 Continuity of construction

- (i) A pile constructed in the stable soil, without the use of temporary casings or other support, shall be bored and concreted without delay to ensure that the soil characteristics are not significantly altered. Sandy clays or clayey silts may soften significantly in less than twelve (12) hours. Where prolonged delay in construction arises, the bore may have to be backfilled with lean concrete as specified in SECTION D: CONCRETE WORKS of this Specification or well compacted sand to minimise deterioration of the shaft. The time interval between completion of boring and placing of concrete should be preferably within six (6) hours.
- (ii) If the pile excavation is carried out using permanent or temporary casing, the time period between completion of pile excavation and completion of concreting is recommended not to exceed twenty four (24) hours.

2.5.3.9 Enlarged pile bases

The enlarged pile base shall not be smaller than the dimensions specified and shall be concentric with the pile shaft to within 10% of the shaft diameter. A sloping surface of the frustum forming the enlargement shall make an angle to the horizontal of not less than 55°. At the specified diameter of the under ream at the perimeter of the base there shall be a minimum height of 150 mm.

 <p>JKR MALAYSIA</p>	<p>SECTION C : FOUNDATION WORKS AND WORKS BELOW LOWEST FLOOR LEVEL</p>	<p>No. Dokumen : JKR 20800-0183-14 No. Keluaran : 01 No. Pindaan : 00 Tarikh : 29 Januari 2014 Muka Surat : C/15</p>
--	---	--

2.5.3.10 Cleanliness of pile bases

On completion of boring, loose, disturbed or remoulded soil or fragments of rock shall be removed from the base of the pile.

2.5.3.11 Inspection

For dry boreholes, each hole shall be inspected prior to the placing of concrete in it. The inspection shall be carried out from the ground surface in the case where the borehole diameter is less than 1500 mm. Where the borehole diameter exceeds 1500 mm, adequate equipment shall be provided to enable the Contractor and the S.O. to descend into the borehole for the purpose of inspection. All works shall conform to the requirement of BS 5537: Safety Precaution in the Construction of Large Diameter Borehole for Piling and Other Purposes. For wet boreholes, i.e. holes filled with drilling fluid or water, a suitable probe shall be provided to ascertain the evenness and cleanliness of the pile base.

2.5.4 Placing of reinforcement

2.5.4.1 Joints in longitudinal bars

Reinforcement shall be such that the full strength of the bar is effective across the joint and the joint shall be made so that there is no relative displacement of the reinforcement during the construction of the pile and the spacing of the reinforcing bars shall be maintained in such a way that proper concreting shall not be impeded.

2.5.4.2 Positions of reinforcement

- (i) Adequate spacer blocks, guide tubes, and lifting wires shall be provided so as to maintain the reinforcing steel in the positions as specified.
- (ii) Where temporary casings are employed, the longitudinal reinforcement shall extend at least 1 m below the bottom of the casing so that movement of the reinforcement during extraction of the casing is minimised.

2.5.5 Concreting operations

2.5.5.1 Placing concrete

The method of placing and the workability of concrete shall be such that a continuous monolithic concrete shaft of the full cross-section is formed.

2.5.5.2 Workability of concrete

- (i) The workability of the concrete shall be determined by the slump test as described in M.S. 26.

 <p>JKR MALAYSIA</p>	<p>SECTION C : FOUNDATION WORKS AND WORKS BELOW LOWEST FLOOR LEVEL</p>	<p>No. Dokumen : JKR 20800-0183-14 No. Keluaran : 01 No. Pindaan : 00 Tarikh : 29 Januari 2014 Muka Surat : C/16</p>
--	---	--

- (ii) The suggested slump details for typical concreting situations shall be as specified in TABLE C2 of this Specification. The slump shall be measured at the time of discharge into the borehole.

2.5.5.3 Compaction

Internal vibrators shall not be used to compact concrete unless it can be satisfied that they will not cause segregation or arching of the concrete.

2.5.5.4 Placing concrete in dry borings

- (i) Approved measures shall be taken to avoid segregation and bleeding and to ensure that the concrete at the bottom of the pile is not deficient in grout.
- (ii) Where piles are vertical, concrete may be poured through a funnel with a length of tube so that the flow is directed and does not hit reinforcement bars or the side of the hole. Chutes extending to near the base shall be employed for raking piles of large diameter. For raking piles of small diameter, an enriched mix of 20% more cement shall be used in the first few batches of concrete to minimise segregation.

2.5.5.5 Placing concrete under water or support fluid

- (i) The concrete mix shall be 20% more cement content when placing is done under water.
- (ii) Concrete to be placed under water or support fluid shall be placed by tremie unless otherwise approved and shall not be discharged freely into the water or support fluid. Before placing concrete, measures shall be taken to ensure that there is no accumulation of silt or other material at the base of the boring.
- (iii) The hopper and pipe of the tremie shall be clean and watertight throughout. The pipe shall extend to the base of the boring and a sliding plug or barrier shall be placed in the pipe to prevent direct contact between the first charge of concrete in the pipe of the tremie and the water or support fluid. The tremie pipe shall at all times penetrate the concrete which has previously been placed and shall not be withdrawn from the concrete until the completion of concreting.
- (iv) At all times, a sufficient quantity of concrete shall be maintained within the tremie pipe to ensure that the pressure from it exceeds that from the water or support fluid. The internal diameter of the tremie pipe shall not be less than 150 mm for concrete made with 20 mm aggregate and not less than 200 mm for concrete made with 40 mm aggregate.
- (v) The tremie pipe shall be so designed that external projections are minimised, allowing the tremie pipe to pass through the reinforcing cage without causing damage or

	SECTION C : FOUNDATION WORKS AND WORKS BELOW LOWEST FLOOR LEVEL	No. Dokumen : JKR 20800-0183-14 No. Keluaran : 01 No. Pindaan : 00 Tarikh : 29 Januari 2014 Muka Surat : C/17
---	--	---

uplifting. The internal face of the tremie pipe shall be from projections.

2.5.6 Extraction of casing

2.5.6.1 Workability of concrete

Temporary casings shall be extracted while the concrete within them remains sufficiently workable to ensure that the concrete is not lifted.

2.5.6.2 Concrete level

- (i) When the casing is being extracted, a sufficient quantity of concrete shall be maintained within it to ensure that the pressure from external water, drilling fluid or soil is exceeded and that the pile is neither reduced in section nor contaminated.
- (ii) No concrete shall be placed in the bore once the bottom of the casing has been lifted above the top of the concrete. It shall be placed continuously as the casing is extracted until the desired head of concrete is obtained.
- (iii) Adequate precautions shall be taken in all cases where excess heads of water or drilling fluid could be caused as the casing is withdrawn because of the displacement of water or fluid by the concrete as it flows into its final position against the wall of the pile shaft. Where double casings are used in the boring, the proposed method of working shall be with the approval of the S.O.

2.5.6.3 Vibrating extractors

The use of vibrating extractors shall be permitted subject to the condition that work shall be carried out in such a manner and at such times as to minimise nuisance and disturbance.

2.5.7 Construction of pile heads

2.5.7.1 Water levels

In the event of the ground water level being higher than the required pile head casting level shown on the Drawings, the Contractor shall submit his proposals for approval prior to placing concrete. The pile head shall not be left below the ground water level unless approved precautions are taken.

2.5.7.2 Cutting and preparation of pile heads

The top of the pile shall be brought at least 300 mm or more as specified on the Drawings above the cut-off level of the pile to permit all laitance and weak concrete to be removed and to ensure that it can be properly keyed into the pile cap. Only hand held cutting equipment or hydraulic splitters shall be used. Pile heads shall be constructed to the details shown on the Drawings.

 <p>JKR MALAYSIA</p>	<p>SECTION C : FOUNDATION WORKS AND WORKS BELOW LOWEST FLOOR LEVEL</p>	<p>No. Dokumen : JKR 20800-0183-14 No. Keluaran : 01 No. Pindaan : 00 Tarikh : 29 Januari 2014 Muka Surat : C/18</p>
--	---	--

2.5.7.3 Temporary backfilling above pile casting level

After each pile has been cast, any empty bore remaining shall be protected and shall be carefully backfilled as soon as possible with well compacted sand.

2.5.7.4 Piling records

(i) Complete piling records shall be kept by the Contractor during pile installation. The Contractor shall submit in duplicate the following information to the S.O.:

- a) Signed records of all piles as the work proceeds. Individual pile record shall be submitted not later than noon of the next working day after the pile was installed. The signed records shall form record of the work. Any unexpected installation condition shall be noted in the record.
- b) Upon completion, compile a record of the work as carried out and provide As-built drawings. The Drawings shall be prepared and endorsed by the Licensed Surveyor.

(ii) The format of the record shall be approved by the S.O. and shall contain but not be limited to the following information where applicable:

- a) Date of concreting
- b) Concrete mix
- c) Method of concreting
- d) Standing ground water level
- e) Length of temporary casing
- f) Length of permanent casing
- g) Details of soil strata penetrated.
- h) Soil samples taken and in-situ tests carried out.
- i) Length and details of reinforcement.
- j) Estimated and actual volume of concrete required to form the pile shaft.

(iii) All record shall bear the names of person who records and person who checks.

2.5.8 Pressure grouting of piles

2.5.8.1 Post grouting of piles in sand shall be constructed to details as shown on the Drawings if encounter any base disturbance to ensure compatible performance of piles. Method of grouting shall be carefully controlled to prevent pile uplift and avoid other potential problems with prior approval of the S.O.

2.5.8.2 Pressure grouting shall not be used to compensate for poor pile construction practice.

 <p>JKR MALAYSIA</p>	<p>SECTION C : FOUNDATION WORKS AND WORKS BELOW LOWEST FLOOR LEVEL</p>	<p>No. Dokumen : JKR 20800-0183-14 No. Keluaran : 01 No. Pindaan : 00 Tarikh : 29 Januari 2014 Muka Surat : C/19</p>
--	---	--

2.6 Steel H-Section Piles

2.6.1 Description

This work shall comprise the supply and installation of steel H-section piles, inclusive of pitching and driving, lengthening and preparation of pile heads, all in accordance with this Specification and to the details shown on the Drawings.

2.6.2 Materials

All steel H-bearing piles shall comply with the requirement of BS EN 10025 and or BS EN 10029, BS EN 10210, BS EN 10113, BS 7668 or JIS A5526. The profile and grade to be used are as specified or as shown on the Drawings.

2.6.3 Manufacture and storage of steel H-section piles

2.6.3.1 Manufacturing tolerances

- (i) All piles shall be of the type and cross-sectional dimensions as designed. For standard rolled sections the dimensional tolerances and weight shall comply with the relevant standard. Length tolerance of H-section steel bearing piles shall be ± 50 mm in accordance with BS EN 10034.
- (ii) The rolling or proprietary tolerances for H-section steel bearing piles shall be such that the actual weight of the section does not differ from the theoretical weight by more than $\pm 2.5\%$.

2.6.3.2 Straightness of sections

- (i) For standard rolled sections the deviation from straightness shall be within the compliance provisions of BS EN 10034. When two (2) or more rolled sections are joined by butt-jointing, the deviation from straightness shall not exceed 1/600 of the overall length of the pile.
- (ii) For proprietary sections made up from rolled sections and for tubular piles, the deviation from straightness on any longitudinal face shall not exceed 1/600 of the length of the pile nor 5 mm in any 3 m length.
- (iii) Based on the results of pile driving resistance and/or load tests carried out on piles driven on the Site, the S.O. may from time to time order the lengths of piles to be modified.

2.6.3.3 Strengthening of piles

Unless otherwise approved by the S.O., the strengthening of the toe of the pile in lieu of a shoe or the strengthening of the head of a pile shall be made from material of the same grade as the pile and to the details as shown on the Drawings.

 <p>JKR MALAYSIA</p>	<p>SECTION C : FOUNDATION WORKS AND WORKS BELOW LOWEST FLOOR LEVEL</p>	<p>No. Dokumen : JKR 20800-0183-14 No. Keluaran : 01 No. Pindaan : 00 Tarikh : 29 Januari 2014 Muka Surat : C/20</p>
--	---	--

2.6.3.4 Marking of piles

Each pile shall be clearly marked with white undeletable marking at the flanged head showing its reference number and overall length. In addition, each pile shall be marked at intervals of 500 mm along its length before being driven. The length of piles to be supplied shall be as shown on the Drawings subject to revision by the S.O.

2.6.3.5 Handling and storage

- (i) All operations such as handling and transporting of piles shall be carried out in such a manner that damage to piles and their coatings is minimized. Piles that are damaged during handling and transporting shall be replaced by the Contractor at his own expense. All damaged and rejected piles shall be removed from the Site forthwith.
- (ii) Piles within a stack shall be in groups of the same length and on approved supports.

2.6.4 Installation of steel H-section piles

2.6.4.1 Pitching and driving of piles

Pitching and driving of piles shall be in accordance with sub-sections 2.3.1.1 and 2.3.1.2.

2.6.4.2 Lengthening of piles

- (i) Where lengthening of piles is required, the piles shall be jointed by butt welding. Butt welded joints shall be stiffened with plates fillet welded on all four (4) sides as detailed on the Drawings. All welding shall be continuous and complying with BS 638, BS EN 1011 and BS EN 1993 for arc welding and BS EN ISO 4577 for resistance welding as appropriate. The type and size of weld shall be as detailed on the Drawings.
- (ii) Weld tests shall be performed by radiographic or ultrasonic methods as specified. Provided that satisfactory results are being obtained, one (1) test of a length of 300 mm shall be made for 10% or more of the number of welded splices.
- (iii) Redriving of the piles shall only be allowed after the welded joints have sufficiently air cooled to 100°C or below.

2.6.4.3 Cutting and preparation of pile heads

- (i) When a pile has been driven to the required set or depth and before encasing in concrete, the piles shall be cut to within 20 mm of the levels shown on the Drawings. Pile heads shall be constructed to the details as shown on the Drawings.

 <p>JKR MALAYSIA</p>	<p>SECTION C : FOUNDATION WORKS AND WORKS BELOW LOWEST FLOOR LEVEL</p>	<p>No. Dokumen : JKR 20800-0183-14 No. Keluaran : 01 No. Pindaan : 00 Tarikh : 29 Januari 2014 Muka Surat : C/21</p>
--	---	--

- (ii) The remaining section which can be reused for lengthening of piles shall be stored and protected as directed by the S.O.

2.7 Steel Pipe Piles

2.7.1 Description

This work shall comprise the supply and installation of steel pipe piles, inclusive of pitching and driving, lengthening and preparation of pile heads, all in accordance with this Specification and to the details shown on the Drawings.

2.7.2 Materials

All steel pipes shall comply with BS EN 10296, BS EN 10297 and BS EN 10305 with regard to sectional dimensions and the steel shall comply with the requirements of BS EN 10113 or BS EN 10025.

2.7.3 Manufacture and storage of steel pipe piles

2.7.3.1 Welding

Unless otherwise specified, all welds shall be full penetration butt welds complying with the requirements of BS EN 12334.

2.7.3.2 Fabrication of piles

- (i) Pile lengths shall be set up so that the differences in dimensions are matched as evenly as possible. The length of piles to be supplied shall be as shown on the Drawings subject to revision by the S.O.
- (ii) Based on the results of pile driving resistance and/or load tests carried out on piles driven on the Site, the S.O. may from time to time order the lengths of piles to be modified.
- (iii) For tubular piles where the load will be carried by the wall of the pile, and if the pile will be subjected to loads that induce reversal of stress during or after construction, the external diameter at any section as measured by using a steel tape on the circumference shall not differ from the theoretical diameter by more than $\pm 1\%$.
- (iv) The ends of all tubular piles as manufactured shall be within a tolerance on ovality of $\pm 1\%$ as measured by a ring gauge for a distance of 100 mm at each end of the pile length.
- (v) The root edges or root faces of lengths of piles that are to be shop butt-welded shall not differ by more than 25% of the thickness of pile walls not exceeding 12 mm thick or by more than 3 mm for piles where the wall is thicker than 12 mm. When piles of unequal wall thickness are to be butt-welded, the thickness of the thinner material shall be the criterion.
- (vi) Pile lengths shall be set up so that the differences in dimensions are matched as evenly as possible.

 <p>JKR MALAYSIA</p>	<p>SECTION C : FOUNDATION WORKS AND WORKS BELOW LOWEST FLOOR LEVEL</p>	<p>No. Dokumen : JKR 20800-0183-14 No. Keluaran : 01 No. Pindaan : 00 Tarikh : 29 Januari 2014 Muka Surat : C/22</p>
--	---	--

2.7.3.3 Matching of pile lengths

Longitudinal shop seam welds and spiral seam welds of lengths of pipe piles forming a completed pile shall, whenever possible, be evenly staggered. However, if in order to obtain a satisfactory match of the ends of piles or the specified straightness, the longitudinal seams or spiral seams are brought closely to one (1) alignment at the joint, then they shall be staggered by at least 100 mm.

2.7.3.4 Straightness of piles

For standard rolled sections the deviation from straightness shall be within the compliance provisions of BS EN 10034 and in accordance with sub-section 2.6.3.2.

2.7.3.5 Fabrication of piles on site

When pile lengths are to be made up on Site, all test procedures and dimensional tolerances shall conform to the Specification for the supply of pipe materials. Adequate facilities shall be provided for supporting and aligning the lengths of pile.

2.7.3.6 Handling and storage

All piles within a stack shall be in groups of the same length and on approved supports. All operations such as handling, transporting and pitching of piles shall be carried out in a manner such that no damage occurs to piles and their coatings. Piles that are damaged during handling and transporting shall be replaced by the Contractor at his own expense. All damaged and rejected piles shall be removed from the Site forthwith.

2.7.3.7 Marking of piles

Each pile shall be clearly marked with white undeletable marking near the pile head showing its reference number and overall length. In addition, each pile shall be marked at intervals of 500 mm along its length before being driven. The length of piles to be supplied shall be as shown on the Drawings subject to revision by the S.O.

2.7.4 Workmanship

2.7.4.1 Welding procedures

- (i) The Contractor shall submit for approval, full details of the welding procedures and electrodes with Drawings and schedules as may be necessary. Tests shall be undertaken as may be required by the S.O. and shall be in accordance with the requirements of BS EN 288.
- (ii) All welding procedures shall have been qualified to BS EN ISO 15607, BS EN ISO 15609-1, BS EN ISO 15613 and BS EN ISO 15614-1 and the Contractor shall make available full details of the welding procedures and electrodes, with Drawings and schedules as may be

 <p>JKR MALAYSIA</p>	<p>SECTION C : FOUNDATION WORKS AND WORKS BELOW LOWEST FLOOR LEVEL</p>	<p>No. Dokumen : JKR 20800-0183-14 No. Keluaran : 01 No. Pindaan : 00 Tarikh : 29 Januari 2014 Muka Surat : C/23</p>
--	---	--

necessary. Tests shall be undertaken as may be required by the S.O.

2.7.4.2 Welders' qualifications

- (i) All welding works shall be executed by qualified welders with valid certificate issued by approved Authorities such as CIAST.
- (ii) Only welders who are qualified to BS EN 287-1 or who have attained a similar standard shall be employed on the Works. Proof of welders' proficiency shall be made available on request by the S.O.

2.7.4.3 Weld tests

- (i) During production of welded tube piles, at least one (1) radiograph approximately 300 mm long shall be required on each completed length as a spot check on weld quality. This shall be taken on a circumferential or longitudinal weld and its position shall be as directed by the S.O.
- (ii) For spirally welded piles, one (1) of the following tests shall be carried out:
 - a) For tubes of wall thickness 12 mm or less, three (3) spot check radiographs, one (1) at each end of each length of the tube as manufactured and one (1) at a position to be chosen at the time of testing by the S.O.; and spot check radiographs as required by the S.O. on the weld joints between strip lengths;
 - b) For tubes of any wall thickness, continuous ultrasonic examination over the whole weld, supplemented where necessary by radiographs to investigate defects revealed by the ultrasonic examination.
- (iii) Weld tests shall be performed by radiographic or ultrasonic methods as specified. Provided that satisfactory results are being obtained, one (1) test of a length of 300 mm shall be made for 10% or more of the number of welded splices in the case where the load will be carried by the wall or section of the pile will not normally exceed 10%.
- (iv) Results shall be made available to the S.O. within ten (10) days of completion of the tests.

2.7.4.4 Standards for welds

- (i) Longitudinal welds in tubular piles

For piles of longitudinal or spiral weld manufacture where the load will be carried by the wall of the pile, and if the pile will be subject to loads which induce reversal of stress during or after construction other than driving stresses, the standard for interpretation of non-destructive testing shall be the American Petroleum Institute Specification 5L. The

 <p>JKR MALAYSIA</p>	<p>SECTION C : FOUNDATION WORKS AND WORKS BELOW LOWEST FLOOR LEVEL</p>	<p>No. Dokumen : JKR 20800-0183-14 No. Keluaran : 01 No. Pindaan : 00 Tarikh : 29 Januari 2014 Muka Surat : C/24</p>
--	---	--

maximum permissible height of weld reinforcement shall not exceed 3.2 mm for wall thicknesses not exceeding 12.7 mm and 4.8 mm for wall thicknesses greater than 12.7 mm.

- (ii) Circumferential welds
 - a) For circumferential welds in tubular piles the same maximum height of weld reinforcement as specified above for longitudinal welds in tubular piles shall apply, the standard for interpretation of non-destructive testing shall be the American Petroleum Institute Specification 5L.
 - b) If the results of any weld test do not conform to the specified requirements, two (2) additional specimens from the same length of pile shall be tested. In the case of failure of one (1) or both of these additional tests, the length of pile covered by the test shall be rejected.

2.7.5 Protective coatings

2.7.5.1 The term 'coating' shall include the primer and the coats specified. If protective coatings are specified, the preparation of surfaces and the application of the coatings shall be carried out by skilled labour having experience in the preparation of the coatings specified.

2.7.5.2 Corrosion protection of permanent steel structure in accordance with environment classified as C4 according to BS EN ISO 12944-2 shall require durability resistance of 25 years.

2.7.5.3 The protective coating system shall comply with BS EN ISO 12944-5 and shall comprise of at least:

- (i) First coating or prime coat zinc epoxy of 0.08 mm thick
- (ii) Two (2) layers of Intermediate coating of 0.08 mm thick epoxy each layer
- (iii) Top coating of polyurethane of 0.08 mm thick

2.7.5.4 Surface preparation

- (i) Surface preparation to cleanliness SA 2 ½ in accordance with BS EN ISO 12944-4 and BS EN ISO 8501-1.
- (ii) Blast-cleaning shall be done after fabrication. Unless an instantaneous-recovery blasting machine is used, the cleaned steel surface shall be air-blasted with clean dry air and vacuum-cleaned or otherwise freed from abrasive residues and dust immediately after cleaning.

2.7.5.5 Application and type of primer

- (i) Immediately after surface preparation, the surface shall be coated with an approved primer or the specified coating to avoid recontamination. No primer coat shall be applied to

 <p>JKR MALAYSIA</p>	<p>SECTION C : FOUNDATION WORKS AND WORKS BELOW LOWEST FLOOR LEVEL</p>	<p>No. Dokumen : JKR 20800-0183-14 No. Keluaran : 01 No. Pindaan : 00 Tarikh : 29 Januari 2014 Muka Surat : C/25</p>
--	---	--

a metal surface which is not thoroughly dry. Within 4 hours after surface preparation, before visible deterioration takes place, the surface shall be coated with an appropriate primer or the specified coating.

- (ii) The primer shall be compatible with the specified coating and shall be such that if subsequent welding or cutting is to be carried out it shall not emit noxious fumes or be detrimental to the welding.

2.7.5.6 Control of humidity during coating

- (i) No coating shall be applied when the surface metal temperature is less than 3°C above the dew point temperature or when the humidity could have an adverse effect on the coat.
- (ii) When heating or ventilation is used to secure suitable conditions to allow coating to proceed, care shall be taken to ensure the heating or ventilation of a local surface does not have an adverse effect on adjacent surfaces or work already done.

2.7.5.7 Part to be welded

The coating within 200 mm of a weld shall be applied after welding. The method of application shall comply with the manufacturer's recommendations.

2.7.5.8 Thickness, number and colour of coats

- (i) The minimum dry film thickness of the finished coating, including the minimum dry film thickness of each coat and the minimum number of coats that are to be applied, shall be as specified and shown on the Drawings. Coatings shall be applied in accordance with the manufacturer's instructions.
- (ii) The nominal thickness of the finished coating and each coat shall be as specified. The average coat or finished coating thickness shall be equal to or greater than the specified nominal thickness. In no case shall any coat or finished coating be less than 75% of the nominal thickness. Each coat shall be applied after an interval that ensures the proper hardening or curing of the previous coat.
- (iii) Where more than one (1) coat is applied to a surface, each coat shall be different colour from the previous coat. The colour sequence and final coating colour shall be established prior to application of coatings.

2.7.5.9 Inspection of coatings and acceptability

- (i) The finished coating shall be generally smooth, of a dense and uniform texture and free from sharp protuberances or pin holes.

 <p>JKR MALAYSIA</p>	<p>SECTION C : FOUNDATION WORKS AND WORKS BELOW LOWEST FLOOR LEVEL</p>	<p>No. Dokumen : JKR 20800-0183-14 No. Keluaran : 01 No. Pindaan : 00 Tarikh : 29 Januari 2014 Muka Surat : C/26</p>
--	---	--

- (ii) Any coat damaged by subsequent processes or which has deteriorated to an extent such that proper adhesion of the coating may not be obtained or maintained, shall be recleaned to the original standard and recoated with the specified sequence of coats.
- (iii) The completed coating shall be checked for thickness and continuity by an approved magnetic gauge or detector. Areas where the thickness is less than that specified shall receive approved additional treatment.
- (iv) When specified, the completed coating shall be checked for adhesion by means of an adhesion test to BS EN ISO 2409, BS 3900-E6, carried out on 10% of the piles. The adhesion of any completed coating shall not be worse than Classification 2. If adhesion tests on the initial batch are satisfactory, then on further batches 1% of the piles shall be tested. Adhesion tests shall not be carried out until seven (7) days after coating.

2.7.6 Installation of steel pipe piles

2.7.6.1 Pitching and driving of piles

Pitching and driving of piles shall be in accordance with sub-sections 2.3.1.1 and 2.3.1.2.

2.7.6.2 Lengthening of piles

- (i) Unless otherwise approved, where lengthening of piles is required, the piles shall be jointed by butt welding along the entire periphery as detailed on the Drawings.
- (ii) Redriving of the piles shall only be allowed after the welded joints have sufficiently air cooled to 100°C or below.

2.7.6.3 Cutting and preparation of pile heads

When a pile has been driven to the required set or depth and before encasing in concrete, the pile shall be cut to within 20 mm of the levels shown on the Drawings and protective coatings shall be removed from the surfaces of the pile head 100 mm above the soffit of the concrete. Pile heads shall be constructed to details as shown on the Drawings.

2.7.6.4 Concreting of pile shaft

- (i) If concreting is specified or shown on the Drawings after the pile has been cut off to the specified level, the shaft shall be filled with concrete in a continuous operation. The method of placing shall be approved by the S.O.
- (ii) The reinforcement cage in the pile shall be made sufficiently rigid and kept in its correct position during concreting.
- (iii) The length of the reinforcing bars projecting above the pile cut off level shall be as shown on the Drawings.

 <p>JKR MALAYSIA</p>	<p>SECTION C : FOUNDATION WORKS AND WORKS BELOW LOWEST FLOOR LEVEL</p>	<p>No. Dokumen : JKR 20800-0183-14 No. Keluaran : 01 No. Pindaan : 00 Tarikh : 29 Januari 2014 Muka Surat : C/27</p>
--	---	--

2.8 Micropiles

2.8.1 Description

This work shall comprise the drilling of a hole, placing of reinforcement unit and subsequently filling the hole with grout to form micropiles, all in accordance with this Specification and to the details shown on the Drawings.

2.8.2 Materials

2.8.2.1 Reinforcement

The type of reinforcement to be used, the diameter and/or thickness, grade, yield strength and working stress shall be as specified or as shown on the Drawings.

2.8.2.2 Grout

- (i) Unless otherwise specified, the grout shall be non-shrink cement grout. The grout mix design such as the water-cement ratio, the minimum cement and grout strength at 7 and 28 days shall be as specified and shown on the Drawings.
- (ii) If admixtures are used, details of admixtures shall be submitted to the S.O. for approval before commencement of works. The use of the admixture shall fully comply with the manufacturer's instructions.

2.8.3 Drilling operations

2.8.3.1 Diameter of piles

The diameter of piles shall not be less than the specified/designed diameter at any level throughout its length and shall be in accordance with sub-section 2.5.3.1.

2.8.3.2 Drilling

The Contractor shall submit to the S.O. details of drilling equipment and drilling procedure for approval before commencement of works. Drilling operations shall be carried out in accordance with the relevant requirements of sub-section 2.5.3.

2.8.4 Grouting operations

2.8.4.1 Mixing and placing grout

- (i) The Contractor shall provide details of the method and equipment used in grout mixing. Further information such as grouting pressure, grouting procedure, grouting equipment and techniques employed in grouting underwater shall also be furnished for approval.
- (ii) Grout shall be mixed on Site and shall be free from segregation, slumping and bleeding. Grout shall be pumped into its final position in one (1) continuous

 <p>JKR MALAYSIA</p>	<p>SECTION C : FOUNDATION WORKS AND WORKS BELOW LOWEST FLOOR LEVEL</p>	<p>No. Dokumen : JKR 20800-0183-14 No. Keluaran : 01 No. Pindaan : 00 Tarikh : 29 Januari 2014 Muka Surat : C/28</p>
--	---	--

operation as soon as possible and in no case more than half an hour after mixing.

2.8.4.2 Testing grout

- (i) Grout shall be tested in accordance with BS EN 12390 and BS EN 196.
- (ii) Maximum bleed should be limited to 5%.
- (iii) If the grout cube as tested failed to satisfy the criteria as prescribed in Specification and Drawings, the pile constructed using this batch of grout shall be rejected. The contractor shall undertake all necessary additional and consequential remedial works to the approval of the S.O.

2.8.5 Construction of pile heads

2.8.5.1 Lengthening of piles

Where lengthening is required, the pile reinforcement unit shall be connected on Site to the details shown on the Drawings. Other means of jointing reinforcement shall be to the approval of the S.O.

2.8.5.2 Cutting and preparation of pile heads

Pile heads shall be constructed to the details as shown on the Drawings.

2.9 Pile Testing

2.9.1 General

2.9.1.1 In order to verify the working load, the Contractor shall carry out pile load test as shown on the Drawings and / or as instructed by the S.O. The Contractor shall give at least 48 hours notice of the commencement of construction of any preliminary pile which is to be test-loaded.

2.9.1.2 The design and construction of the load application system shall be satisfactory for the required test. These details shall be made available prior to the commencement testing.

2.9.2 Construction of pile to be tested

2.9.2.1 Notice of construction

The Contractor shall give at least 48 hours notice of commencement of construction of any preliminary pile which is to be tested.

2.9.2.2 Method of construction

Each preliminary test pile shall be constructed in a manner similar to that to be used for the construction of the working piles and by the used of similar equipment and material. Extra reinforcement and concrete of increase strength will be

 <p>JKR MALAYSIA</p>	<p>SECTION C : FOUNDATION WORKS AND WORKS BELOW LOWEST FLOOR LEVEL</p>	<p>No. Dokumen : JKR 20800-0183-14 No. Keluaran : 01 No. Pindaan : 00 Tarikh : 29 Januari 2014 Muka Surat : C/29</p>
--	---	--

permitted in the shafts of preliminary piles where necessary for carrying out the testing.

2.9.2.3 Boring or driving record

For each preliminary pile which is to be tested, a detailed record of the conditions experienced during boring or of the progress during driving, shall be made available daily, not later than noon on the next working day. Where soil samples are required to be taken or in-situ tests to be made, the Contractor shall present the results without delay.

2.9.2.4 Concrete test cube

- (i) Three (3) test cubes shall be made from the concrete used in the preliminary test pile and from the concrete used for building up the working pile. If the concrete pile is extended or capped for the purpose of testing, a further three (3) cubes shall be made from the corresponding batch of concrete. The cube shall be made and tested in accordance with SECTION D: CONCRETE WORKS of this Specification.
- (ii) The pile test shall not be started until the strength of the cubes taken from the pile exceed twice the average direct stress in any pile section under the maximum required test load and the strength of the cubes taken from the pile head or cap exceed twice the average stress at any point in the pile head or cap under the same load.

2.9.2.5 Cut-off level

- (i) The cut-off level for the preliminary test pile/working piles shall be as specified in the Drawings or as directed by the S.O.
- (ii) Where the cut-off level of working piles is below the ground level at the time of pile installation and where it is required to carry out a load test from that installation level, either allowance shall be made in the determination of the twice working load for friction which may be developed between the cut-off level and the existing ground level, or the piling may be sleeved appropriately or otherwise protected to eliminate friction which develop over the extended length.

2.9.2.6 Preparation for pile head for testing

- (i) For a pile that is tested in compression, the pile head or cap shall be formed to give the plane surface which is normal to the axis of the pile, sufficiently large to accommodate the loading and settlement measuring equipment and adequately reinforced or protected to prevent damage from the concentrated application of load from the loading equipment.
- (ii) For a pile that is tested in tension, means shall be provided for transmitting the test load axially without inducing moments in the pile. The connection between the

 <p>JKR MALAYSIA</p>	<p>SECTION C : FOUNDATION WORKS AND WORKS BELOW LOWEST FLOOR LEVEL</p>	<p>No. Dokumen : JKR 20800-0183-14 No. Keluaran : 01 No. Pindaan : 00 Tarikh : 29 Januari 2014 Muka Surat : C/30</p>
--	---	--

pile and the loading equipment shall be constructed in such a manner as to provide strength equal to the maximum load which is to be applied to the pile during the test with an appropriate factor of safety on the structural design.

2.9.2.7 Supervision

- (i) The setting up of pile testing equipment shall be carried out under competent supervision and the equipment shall be checked to ensure that the setting-up is satisfactory before the commencement of load test.
- (ii) All tests shall be carried out only under the direction of an experience and competent supervisor conversant with the test equipment and test procedures. All personal operating the test equipment shall have been trained in its use. The Curriculum Vitae of Tester(s) shall be submitted 48 hours prior testing works.

2.9.2.8 Notice of test

The Contractor shall give at least 24 hours notice of the commencement of the test. No load shall be applied to the test pile before the commencement of the specified test procedure.

2.9.3 Protection of testing equipment

2.9.3.1 Protection from weather

Throughout the test period, all equipment for measuring load and movement and beams shall be protected from adverse effects of sun, wind and precipitation. Temperature reading shall be taken at the start, end and at the maximum load of each loading cycle.

2.9.3.2 Prevention of disturbance

Construction activities and person who are not involved in the testing processes shall be kept at a sufficient distance from the test to avoid disturbance to any unavoidable activity and its effects.

2.9.4 Method of loading

2.9.4.1 Test load

- (i) The test load shall be applied in one (1) of the following ways:
 - a) By means of a jack which obtains its reaction from kentledge heavier than the required load;
 - b) By means of a jack which obtains its reaction from tension piles or other suitable anchors.
- (ii) In all cases the Contractor shall ensure that when the hydraulic jack and load measuring device are mounted on the pile head, the whole system shall be stable up to the maximum load to be applied.

 <p>JKR MALAYSIA</p>	<p>SECTION C : FOUNDATION WORKS AND WORKS BELOW LOWEST FLOOR LEVEL</p>	<p>No. Dokumen : JKR 20800-0183-14 No. Keluaran : 01 No. Pindaan : 00 Tarikh : 29 Januari 2014 Muka Surat : C/31</p>
--	---	--

- (iii) If in the course of carrying out a test, any unforeseen occurrence should take place, further loading shall not be applied until a proper engineering assessment of the conditions has been made and steps have been taken to rectify any fault.
- (iv) Where an inadequacy in any part of the system might constitute a hazard, means shall be provided to enable the test to be controlled from a position clear of the kentledge stack or test frame.
- (v) The hydraulic jack, pump, hoses, pipes, couplings and other apparatus to be operated under hydraulic pressure shall be capable of withstanding a pressure of one and a half (1.5) times the maximum pressure used in the test without leaking. Test certificate shall be submitted before carrying the test.
- (vi) The maximum test load expressed as a reading on the gauge in use shall be displayed and all operators shall be made aware of this limit.
- (vii) When method (a) is used, care shall be taken to ensure that the centre of gravity of the kentledge is on the axis of the pile. The nearest edge of the crib supporting the kentledge stack shall not be closer than 1300 mm to the surface of the test pile. Kentledge shall not be used for testing raked piles.
- (viii) When method (b) is used, all anchor piles shall be at a distance of at least three (3) piles shaft diameters from the test pile, centre to centre, and in no case shall they be less than 2000 mm from the test pile.
- (ix) If the anchor piles are to be permanent working piles, their levels shall be observed during application of the test load to ensure no residual uplift occurs.
- (x) Alternatively, the Contractor may propose the use of other types, patented or otherwise, in which case the requirements as below shall be fully complied with.

2.9.4.2 Contractor's load test system

The Contractor may propose to use other different types from those specified. The proposal shall be submitted to the S.O. at least 90 days before the date of testing. The suitability or adequacy of any system shall be determined by the S.O. In the event that the testing system proposed by the Contractor is acceptable, the Contractor shall obtain a P.E.'s endorsement on load settlement results.

2.9.4.3 Measuring apparatus

- (i) The Contractor shall provide apparatus for measuring settlement consisting of a primary system, at least one (1) auxiliary system, and a network of settlement reference points. Two (2) fixed independent benchmarks at least 15 m from the test site to monitor the settlement reference

 <p>JKR MALAYSIA</p>	<p>SECTION C : FOUNDATION WORKS AND WORKS BELOW LOWEST FLOOR LEVEL</p>	<p>No. Dokumen : JKR 20800-0183-14 No. Keluaran : 01 No. Pindaan : 00 Tarikh : 29 Januari 2014 Muka Surat : C/32</p>
--	---	--

point shall be established. If desired, the auxiliary system may also be referenced to these benchmarks.

- (ii) All measuring devices, scales and reference points with numbers or letters to ensure accurate data recording shall be clearly identified.

2.9.4.4 Reference beams and displacement measuring devices

- (i) At least three (3) Linear Variable Differential Transformers (LVDT) and a Readout Unit are to be used for measuring the displacement. DC/DC-type displacement transducer having at least 75 mm of travel and a linearity of 0.5 % or less shall be used. A Readout Unit having a minimum display of three (3) digits, capable of monitoring output from DC/DC - Type LVDT shall be provided.
- (ii) The measurement devices parallel to the longitudinal axis of the test pile and the axis of load application shall be aligned.
- (iii) An independent reference beam or beams shall be set up to enable measurement of the movement of the pile to be made to the required accuracy. The supports for beam shall be founded in such a manner and at such a distance from the test pile and reaction system that movement of the ground do not cause movement of the reference beam or beams which will affect the accuracy of the test. Embedded the references beam supports at least 3000 mm into the crown at a horizontal distance of not less than 3000 mm or ten (10) times pile diameters (whichever is greater) from the closest face of the test pile and from any reaction piles or supports for the weighted box of platform shall be provided. The beam must be free to move horizontally at one (1) end.
- (iv) A clear distance of 150 mm to 300 mm from the test pile to the references beam or any projection used to support LVDT shall be maintained. The beam and projections should be at about the same elevation as the attachments to the pile on which the measuring devices will bear. The LVDT supports to references beam shall be attached so as to allow the stem of each device to rest on a attachment to the pile sides. Hardway and pile attachment for LVDT devices shall be mounted using such materials as brass, aluminium or 303 series stainless steel, to avoid magnetic interference which the instruments. The pile attachments are angles, about 75 mm x 100 mm with the 100 mm dimension projecting from the pile. For round pile, these attachments shall be placed on the perimeter of the pile at a 120 degrees and an equal radial distance. For pile of other cross section, the attachments shall be placed at a convenient location as approved by the S.O.
- (v) Observation of any movements of the reference beam or beams shall be made and checking of the movement of the pile head relative to a remote reference datum shall be made and stopped at maximum load for each loading.

 <p>JKR MALAYSIA</p>	<p>SECTION C : FOUNDATION WORKS AND WORKS BELOW LOWEST FLOOR LEVEL</p>	<p>No. Dokumen : JKR 20800-0183-14 No. Keluaran : 01 No. Pindaan : 00 Tarikh : 29 Januari 2014 Muka Surat : C/33</p>
--	---	--

2.9.4.5 Auxiliary systems

- (i) This measuring system shall consist of one (1) or more of the following: wire, mirror and scale; surveyor's level and target rod; or, as alternatives, electrical or optical levels.

a) Wire, mirror and scale

Pile movement shall be determined by means of a single strand of wire drawn in front of graduated scale mounted on a mirror. This scale, at least 150 mm long and machine-divided in graduations of 250 µm, is mounted on a 75 mm x 150 mm mirror with metal and glass bonding adhesive or electrical tape. The mirror shall be attached directly to the pile oriented so that the mirror face is parallel to the reference beam. The mirror shall be mounted to the wire between the ends of the reference beam, with one (1) end fixed and the other is placed over a pulley with a weight in order to maintain tension. The wire shall be located so that it is level and within 20 mm of the mirror face.

b) Optical levelling method

aa) An optical levelling method by reference to a remote datum may be used.

ab) Where a level and levelling rod are used, the level and scale of the levelling rod shall be chosen to enable readings to be made to within an accuracy of 0.5 mm. A scale attached to the pile or pile cap may be used instead of levelling rod. At least two (2) reliable independent datum points shall be established. Each datum point shall be so situated as to permit a single setting up position of the level for all readings.

ac) No datum point shall be located where it can be affected by the test loading or other operations on or off the Site.

c) Alternative systems

Any other type of electrical or optical gauge yielding a precision equivalent to the primary system is acceptable as an alternative, provided prior written approval is obtained from the S.O.

2.9.4.6 Measurement of load

- (i) The test load shall be measured by a single load cell or proving ring calibrated in divisions not exceeding 1% of the maximum load to be applied. If an electronic transducer is used, each reading shall be immediately saved so that in case of power failure the readings are not lost.

- (ii) The load cell or proving ring shall be calibrated immediately prior to the test and a Certificate of Calibration shall be made available.

 <p>JKR MALAYSIA</p>	<p>SECTION C : FOUNDATION WORKS AND WORKS BELOW LOWEST FLOOR LEVEL</p>	<p>No. Dokumen : JKR 20800-0183-14 No. Keluaran : 01 No. Pindaan : 00 Tarikh : 29 Januari 2014 Muka Surat : C/34</p>
--	---	--

- (iii) All increments of load shall be maintained to within 1% of the specified load.
- (iv) A spherical seating of appropriate size shall be used to avoid eccentric loading. Care shall be taken to avoid any risk of buckling of the load application and measuring system. Load measuring and application devices shall be in short axial length in order to secure stability. The Contractor shall ensure that axial loading is maintained.
- (v) The loading equipment shall enable the load to be increased or decreased smoothly or to be held constant at any required value.

2.9.4.7 Measurement of settlement

Settlements shall be measured by use of a reference beam or wire supported independently of the load test pile, reaction pile or piles supporting reaction loads. Settlements shall be measured to the nearest 0.1 mm for reference beams or 0.5 mm for reference wires. The reference beam supports shall be located at least 3 mm from the load test pile, reaction pile or pile supporting reaction loads. The reference beams or wires shall be protected from the effects of temperature changes.

2.9.5 Testing procedure

2.9.5.1 General

- (i) The loading tests shall be carried out in accordance with sub-section 2.9.5.2.
- (ii) Prior to the performance of any load test, the Contractor shall submit to the S.O. for his approval, working Drawings showing the method and equipment he proposes to use in the performance of the load test and the measurement of settlements. Such submission shall include design calculations of lateral supports or other methods to be used in ensuring against buckling. Horizontal supports to ensure bucking stability shall be provided to the pile to be loaded whenever the ratio of the unsupported height to the least cross-sectional dimension is 20 or more. Horizontal supports shall provide full support without restraining the vertical movement of the pile in any way.

2.9.5.2 Maintained load test

- (i) The maintained load test shall be carried out as follows:
 - a) The Full Test Load (FTL) on a pile shall be twice the Working Load (WL) noted on the Drawings.
 - b) The load shall be applied in increment of 25% of the working load, up to the working load and appropriately smaller thereafter, until a maximum test load of twice the working load is reached. Each increment of load shall be applied as smoothly and as expeditiously as possible. Settlement readings

 <p>JKR MALAYSIA</p>	<p>SECTION C : FOUNDATION WORKS AND WORKS BELOW LOWEST FLOOR LEVEL</p>	<p>No. Dokumen : JKR 20800-0183-14 No. Keluaran : 01 No. Pindaan : 00 Tarikh : 29 Januari 2014 Muka Surat : C/35</p>
--	---	--

and time observations shall be taken before and after each new load increment.

- c) A time-settlement graph shall be plotted to indicate when the rate of settlement of 0.05 mm in 15 minutes is reached. A further increment of load shall be applied when this rate of settlement is achieved, or until a minimum time of 2 hours has elapsed, whichever is later. The process shall be repeated until the maximum test load is reached.
- d) The maximum test load shall then be maintained for a minimum of 24 hours, and time-settlement readings shall be taken at regular intervals, as for the earlier load stages.
- e) The test load shall then be decreased in four (4) equal stages, and time-settlement readings shall be as specified aforesaid, until the movement ceases. At least 60 minutes interval shall be allowed between the unloading decrements.
- f) During testing, if the result from the each LVDT differs by more than 20%, the Contractor shall release the load and recheck the arrangement of the load cell and redo the load test.
- g) Settlement readings shall be made immediately after and before every load increment is applied or removed.

2.9.6 Submission of results

2.9.6.1 Full test data and results from the readout unit shall be jointly signed by the S.O.'s representative and the Contractor's authorised agent immediately upon completion of the maintain load test, and shall consist of the following:

- (i) Stage of Loading
- (ii) Period for which the load was held
- (iii) Final load and load increment
- (iv) Maximum settlement

2.9.6.2 These are to be plotted as time-settlement graphs.

2.9.6.3 Interpretation of test results

- (i) The S.O.'s interpretation and conclusions on the test results shall be final. Unless otherwise specified, the pile so tested shall be deemed to have failed if:
 - a) The residual settlement after removal of the test load at working load exceeds [(diameter of pile or diagonal width for non-circular pile / 120) + 4] mm or 12.5 mm whichever is the lower value; or
 - b) The total settlement under the Working Load exceeds 12.5 mm; or

 <p>JKR MALAYSIA</p>	<p>SECTION C : FOUNDATION WORKS AND WORKS BELOW LOWEST FLOOR LEVEL</p>	<p>No. Dokumen : JKR 20800-0183-14 No. Keluaran : 01 No. Pindaan : 00 Tarikh : 29 Januari 2014 Muka Surat : C/36</p>
--	---	--

- c) The total settlement under twice the Working Load exceeds 38 mm, or 10% of pile diameter / width whichever is the lower value.

2.9.7 Completion of a test

2.9.7.1 Removal of test equipment

- (i) On completion of a test, all measuring equipment and load application devices shall be dismantled and checked. All other test equipment, including kentledge, beams and supporting structures shall be removed from the test pile location. Measuring and other demountable equipment shall be stored in a safe manner so that it is available for further tests, if required, or removed from site.
- (ii) Temporary tension piles and ground anchorages shall be cut off below ground level and off-cut materials removed from the site. The ground shall be made good to the original commencing surface level.

2.9.7.2 Preliminary test pile head

Unless otherwise specified, the head of each preliminary test pile shall be cut off below ground level, and off-cut materials removed from the site. The ground shall be made good to the original commencing surface level.

3. Subterranean Termites Treatment

- 3.1 The Contractor shall only appoint termite management company (TMC) that has adequate equipment, competency and skilled workers to perform expeditiously. The Contractor shall also ensure that the TMC engage workers who are licensed to apply the termiticide by the relevant authorities.
- 3.2 All methods of application and chemicals to be used for the treatment of subterranean termite infestation shall be in accordance to MS 8215: Protection of Buildings against Subterranean Termites - CP for Prevention, Detection and Treatment of Infestation.
- 3.3 The Contractor shall submit a termite management programme and provide the following in writing:
 - (i) a termite infestation report;
 - (ii) details of methods proposed and termiticides to be used.
- 3.4 The Contractor's termite management company shall submit the above proposal with the Material Safety Data Sheet, product label and brochure indicating the termiticide to be used to the S.O for approval.
- 3.5 Termiticide chemicals shall be applied in accordance with the manufacturer's recommendation and label instructions prior to the pouring of concrete to construct the ground slab or for binding. Notwithstanding the manufacturer's recommendation, the minimum surface application rate shall be 5 l/m² on all ground floor built-up areas including apron areas, and also on all areas extending one (1) m beyond the perimeter drain all around the building. In addition, termiticide chemical shall be sprayed on interfaces between the concrete ground beam and the hardcore at a minimum rate of 1 l/m.

 <p>JKR MALAYSIA</p>	<p>SECTION C : FOUNDATION WORKS AND WORKS BELOW LOWEST FLOOR LEVEL</p>	<p>No. Dokumen : JKR 20800-0183-14 No. Keluaran : 01 No. Pindaan : 00 Tarikh : 29 Januari 2014 Muka Surat : C/37</p>
--	---	--

- 3.6 Treatment shall not be performed just before or after heavy rain, unless the area to be treated can be physically protected to avoid leaching and runoff before the termiticide chemical has bound to the soil.
- 3.7 Immediately after spraying the chemical, all surfaces exposed to direct sunlight or rain shall be covered with an impervious black PVC sheet of minimum thickness of 0.08 mm to reduce the loss of chemical by UV light, alkaline wet concrete, leaching and runoff caused by rain on exposed treated soil. In the case of areas receiving blinding, the coverings shall be removed immediately prior to the placement of the blinding concrete.
- 3.8 As soon as practicable after the completion of anti-termite treatment and prior to the issuance of the Certificate of Practical Completion, the Contractor shall submit to the S.O., the anti-termite treatment specialist's Guarantee against any termite attack to the Works which may arise during a period of two (2) years from the date of Practical Completion of Works due to any defect, fault or ineffective anti-termite treatment. The terms of the Guarantee shall be such as shall be approved by the S.O.
- 3.9 The Contractor shall verify the ground-water table before soil treatment. For this purpose, the Contractor shall excavate trial holes of not less than 0.5 m deep measured from the level below the level of the soil to be treated. The restriction to soil treatment by virtue of this requirement shall not in any way affect or diminish the Contractor from any indemnity against termite attacks.

4. Damp Proof Membrane (DPM)

- 4.1 DPM shall be installed below the ground concrete floor level or as shown on the Drawings to prevent the rise of moisture or damp through the structure flooring.
- 4.2 Unless otherwise specified in the Drawings, the DPM shall be extruded polythene film with a nominal thickness of 0.5 mm. The nominal weight shall not be less than 0.45kg/m² and the tensile strength shall be not less than 44 MPa in accordance with ISO 527.
- 4.3 Unless the application surface is smooth it shall be blinded with compacted soft sand to guarantee a soft bed, free from any objects that may puncture the membrane during the installation or when concrete is applied.
- 4.4 When laying two (2) sheets of DPM, a minimum of 150 mm overlap shall be provided between each of the sheets and sealed with 100 mm wide jointing tape.
- 4.5 Any punctures in the membrane shall be patched with sheets of identical thickness lapped at least 150 mm away from the perforation edge and sealed with double sided pressure sensitive tape.
- 4.6 The DPM shall be covered with a protective layer or screed as soon as possible after the membrane has been installed. Care shall be taken when applying concrete or screed on top the DPM to avoid stretching or the DPM being displaced.

5. Damp Proof Course (DPC)

DPC shall comply with BS 8215: CP for design and installation of DPC in masonry construction and as specified in SECTION E: NON-STRUCTURAL WALL SYSTEM.

 <p>JKR MALAYSIA</p>	<p>SECTION C : FOUNDATION WORKS AND WORKS BELOW LOWEST FLOOR LEVEL</p>	<p>No. Dokumen : JKR 20800-0183-14 No. Keluaran : 01 No. Pindaan : 00 Tarikh : 29 Januari 2014 Muka Surat : C/38</p>
--	---	--

6. Filling Under Floors, Aprons Et Cetera

Filling shall be provided and laid under floors, aprons, et cetera where required. Filling shall be of suitable material as specified hereinbefore, deposited in layers not exceeding 155 mm loose thickness, and each layer well watered where necessary, rammed and compacted. No clay shall be used for filling under floors and aprons.

7. Hardcore

Where shown and required, approved hardcore consisting of good, sound broken bricks or stones shall be provided and laid to the thickness shown on the Drawings, well rammed, compacted and blinded with sand. All hardcore shall be well watered immediately prior to the depositing of concrete thereon.

 JKR MALAYSIA	SECTION C : FOUNDATION WORKS AND WORKS BELOW LOWEST FLOOR LEVEL	No. Dokumen : JKR 20800-0183-14
		No. Keluaran : 01
		No. Pindaan : 00
		Tarikh : 29 Januari 2014
		Muka Surat : C/39

TABLE C1: SPECIFICATION OF PRECAST CONCRETE PILES

Piles		Minimum Concrete Strength (N/mm ²)	Minimum Longitudinal Reinforcement	Minimum Cement Content (kg/m ³)	Type of Driving
Type	Class				
RC	M	45	1.2 % of cross sectional area	400	Hammer driven
	J	45	1.0 % of cross sectional area	400	Hammer driven
Spun pile	A	60	Minimum effective prestressed of 4 N/mm ²	420	Hammer driven
	B	60	Minimum effective prestressed of 5 N/mm ²	420	Hammer driven
	C	60	Minimum effective prestressed of 7 N/mm ²	420	Hammer driven
PC	X	60	Minimum effective prestressed of 5 N/mm ²	420	Hammer driven
	Y	60	Minimum effective prestressed of 7 N/mm ²	420	Hammer driven
PCS	1	60	Minimum effective prestressed of 3.5 N/mm ²	420	Hammer driven
	2	55	Minimum effective prestressed of 3.5 N/mm ²	420	Jacked-in
RCS	1	45	1.0 % of cross sectional area	400	Hammer driven
	2	45	0.8 % of cross sectional area	400	Jacked-in

NOTES:

- Concrete strength means *characteristic compressive strength* at 28 days.
- The nominal sizes and length for each class of piles are specified in Parts 3, 4, 5 or 6 of Malaysian Standard, whichever relevant.

Definitions:

- Precast reinforced concrete square pile (RC pile)
A pile made of concrete cast in a uniform four-sided cross section before driving into the ground. It shall be suitably reinforced mainly with steel bars.
- Precast prestressed concrete square pile (PC pile)
A pile described in definition No. 1 but suitably reinforced mainly with prestressing steel.
- Precast pretensioned spun concrete pile (Spun pile)
A hollow cylindrical pile made of concrete cast by centrifugal spinning before driving into the ground. It shall be suitably reinforced mainly with pretensioned prestressing steel.
- Small prestressed concrete square pile (PCS pile)
A small PC pile for sizes 200 mm and less.
- Small reinforced concrete square pile (RCS pile)
A small RC pile for sizes less than 200 mm.

TABLE C2: SLUMP RANGE FOR TYPICAL CONCRETING SITUATIONS

Typical Conditions of Use	Slump Range (mm)
Placed into water-free unlined bore. Widely spaced reinforcement leaving room for free movement between bars.	75 to 125
Where reinforcement is not spaced widely enough to give free movement between bars. Where casting level of concrete is within the casing. Where pile diameter is less than 600 mm.	100 to 175
Where concrete is to be placed by tremie under water or drilling fluid.	150 to collapse

 JKR MALAYSIA	SECTION C : FOUNDATION WORKS AND WORKS BELOW LOWEST FLOOR LEVEL	No. Dokumen : JKR 20800-0183-14 No. Keluaran : 01 No. Pindaan : 00 Tarikh : 29 Januari 2014 Muka Surat : C/40
---	--	---

APPENDIX C/1

BENDING STRENGTH FOR PRECAST CONCRETE PILES

Pile Body Strength Test

General

Bending strength test on the pile body shall be done to determine the ability of the pile to withstand the cracking bending moment (M_c) and the ultimate bending strength (M_u). The bending strength test of pile body shall be made by the application of vertical load P to the centre of the span, on the pile laid on two (2) supports which has a span equal to 3/5 of its length.

The applied bending moment shall be calculated from the following equation: -

$$M = \frac{1}{40}WL + \frac{P}{4} \left(\frac{3L}{5} - 1 \right)$$

Where,

- M is the applied bending moment (kNm);
- W is the weight of pile (kN);
- L is the length of pile (m); and
- P is the applied load (kN)

The cracking bending moment (M_c)

The pile shall be designed to withstand the cracking bending moment calculated based on the maximum allowable crack width as shown in TABLE C3. The pile is considered to have passed the requirement to withstand the cracking bending moment if when subjected to a test load equal to the cracking load (P_c) corresponding to the appropriate M_c , no crack exceeding the values in TABLE C3 occurs. The calculated values of M_c are given in TABLE C4, TABLE C5 and TABLE C6.

TABLE C3: MAXIMUM ALLOWABLE CRACK WIDTH

Types of pile	Maximum crack width (mm)
1 RC pile	0.20
2 Spun pile	0.05
3 PC and PCS pile	0.10
4 RCS pile	0.20

The ultimate bending moment (M_u)

The pile shall be tested to the largest applied load (P_{max}) until the pile failure occurs or until the applied load slightly exceeds the minimum ultimate load (P_{min-u}) which corresponds to the minimum ultimate bending strength, whichever comes first.

The minimum ultimate bending strength (P_{min-u}) is obtained by multiplying the cracking bending moment (M_c) by the factor f as given in.

The pile is considered to have passed the bend test if the pile does not fail when subjected to P_{min-u} load.

 JKR MALAYSIA	SECTION C : FOUNDATION WORKS AND WORKS BELOW LOWEST FLOOR LEVEL	No. Dokumen : JKR 20800-0183-14
		No. Keluaran : 01
		No. Pindaan : 00
		Tarikh : 29 Januari 2014
		Muka Surat : C/41

TABLE C4: CRACKING BENDING MOMENT (M_c) AND FACTOR ' f ' FOR PRECAST REINFORCED CONCRETE SQUARE PILES (RC PILES)

Nominal Pile Size (mm x mm)	Cracking Bending Moment, M_c (kN-m)		f	
	Class M	Class J	Class M	Class J
200 x 200	8.3	7.3	1.5	
225 x 225	-	-		
250 x 250	13.1	11.6	1.8	
275 x 275	-	-		
300 x 300	22.1	19.6	2.0	
325 x 325	-	-		
350 x 350	33.7	29.8		
375 x 375	-	-		
400 x 400	47.9	42.5		
450 x 450	65.0	57.8		

TABLE C5: CRACKING BENDING MOMENT (M_c) AND FACTOR ' f ' FOR PRECAST PRETENSIONED SPUN CONCRETE PILES (SPUN PILES)

Nominal Diameter (mm)	Class	Minimum Concrete Strength (N/mm^2)	Cracking Bending Moment (M_c) (kNm)	Factor ' f '	Effective Prestress (N/mm^2)
250	B	60	12	1.5	5.0
300	A	60	17	1.5	4.0
	B	60	20	1.5	5.0
350	A	60	26	1.5	4.0
	B	60	30	1.5	5.0
400	A	60	38	1.5	4.0
	B	60	43	1.5	5.0
	C	60	54	1.8	7.0
450	A	60	53	1.5	4.0
	B	60	60	1.5	5.0
	C	60	76	1.8	7.0
500	A	60	74	1.5	4.0
	B	60	84	1.5	5.0
	C	60	106	1.8	7.0
600	A	60	123	1.5	4.0
	B	60	141	1.5	5.0
	C	60	177	1.8	7.0
700	A	60	191	1.5	4.0
	B	60	218	1.5	5.0
	C	60	273	1.8	7.0
800	A	60	278	1.5	4.0
	B	60	318	1.5	5.0
	C	60	399	1.8	7.0
900	A	60	390	1.5	4.0
	B	60	445	1.5	5.0
	C	60	558	1.8	7.0
1000	A	60	527	1.5	4.0
	B	60	601	1.5	5.0
	C	60	755	1.8	7.0
1200	A	60	853	1.5	4.0
	B	60	973	1.5	5.0
	C	60	1217	1.8	7.0



**SECTION C : FOUNDATION
WORKS AND WORKS BELOW
LOWEST FLOOR LEVEL**

No. Dokumen : JKR 20800-0183-14
 No. Keluaran : 01
 No. Pindaan : 00
 Tarikh : 29 Januari 2014
 Muka Surat : C/42

TABLE C6: CRACKING BENDING MOMENT (M_c) AND FACTOR ' f ' FOR PRECAST PRESTRESSED CONCRETE SQUARE PILES –CLASS PC-X, CLASS PC-Y, SMALL PILES

Size (mm)	Class of Pile	Minimum Concrete Strength (N/mm ²)	Minimum Effective Prestress (N/mm ²)	Cracking Bending Moment, M_c (kNm)	Factor ' f '
125	PCS-1	60	3.5	2.9	1.5
	PCS-2	55	3.5	2.9	1.5
150	PCS-1	60	3.5	4.9	1.5
	PCS-2	55	3.5	1.5	1.5
175	PCS-1	60	3.5	7.8	1.5
	PCS-2	55	3.5	7.8	1.5
200	PCS-2	55	3.5	11.7	1.5
	PC-X	60	5.0	13.7	1.5
	PC-Y	60	7.0	16.4	1.7
250	PC-X	60	5.0	26.5	1.5
	PC-Y	60	7.0	31.7	1.7
300	PC-X	60	5.0	45.2	1.5
	PC-Y	60	7.0	54.2	1.7
350	PC-X	60	5.0	70.9	1.5
	PC-Y	60	7.0	85.2	1.7
400	PC-X	60	5.0	104.5	1.5
	PC-Y	60	7.0	125.9	1.7
450	PC-X	60	5.0	147.0	1.5
	PC-Y	60	7.0	177.4	1.7

TABLE OF CONTENTS

SECTION D: CONCRETE WORKS

	PAGE
1. General	D/1
2. Material	D/1
3. Concrete Conformity And Identity Testing	D/5
4. Production Of Concrete	D/10
5. Construction With Concrete	D/16
6. Steel Reinforcement	D/19
7. Formwork And Surface Finish For Structure	D/22
8. Mass And Lean Concrete	D/28
9. Building Accuracy	D/28
10. Apparatus	D/28
11. Precast Concrete Construction	D/28
12. Other Concrete Works	D/30
Figure D1 : Lift Shaft Enclosure	D/31
Figure D2 : Limit Of Accuracy Of Shaft Plumb On All Sides Of Shaft Enclosure	D/32
Figure D3 : Accuracy Of Structural Opening	D/32
Table D1 : Composition Of Common Cements	D/35
Table D2 : Testing Of Aggregates	D/36
Table D3 : Grading For Coarse Aggregate	D/36
Table D3A : Grading For Fine Aggregate	D/36
Table D4 : Admixture Acceptance Test Requirements	D/37
Table D5 : Prescribed Mixes For General Use Per Cubic Meter Of Concrete By Weight Batching	D/38
Table D5A : Proportion And Strength Requirements For Prescribed Mixes By Volume Batching	D/38
Table D6 : Durability Recommendations For Reinforced Or Prestressed Elements With An Intended Working Life Of At Least 50 Years	D/39
Table D6A : Minimum Cement Content For Maximum Aggregate Sizes Other Than 20 mm	D/40
Table D7 : Slump Classes	D/40
Table D7A : Compaction Classes	D/40
Table D7B : Vebe Classes	D/40
Table D7C : Flow Classes	D/40
Table D7D : Consistence Suitable For Different Uses Of In-situ Concrete	D/41
Table D7E : Maximum Total Chloride	D/41
Table D8 : Compressive Strength Classes For Normal Weight And Heavy Weight Concrete	D/41
Table D9 : Compressive Strength Classes For Light Weight Concrete	D/42
Table D10 : Minimum Rate Of Sampling For Assessing Conformity	D/42
Table D11 : Conformity Criteria For Compressive Strength	D/42
Table D12 : Compressive Strength Requirements For Prescribed Mix	D/43
Table D13 : Identity Criteria For Compressive Strength	D/43
Table D14 : Identity Criteria For Slump Specified As A Slump Class	D/43
Table D15 : Identity Criteria For Slump Specified As A Target Value	D/43
Table D16 : Recorded Data And Other Documents	D/44
Table D17 : Characteristic Strength Of Steel Reinforcement	D/44
Table D18 : Minimum Periods Between Concreting And Removal Of Forms	D/44

 <p>JKR MALAYSIA</p>	<p>SECTION D : CONCRETE WORKS</p>	<p>No. Dokumen : JKR 20800-0183-14 No. Keluaran : 01 No. Pindaan : 00 Tarikh : 29 Januari 2014 Muka Surat : D/1</p>
--	--	---

1. General

This section shall apply to the construction of all structures or parts of structures to be composed of concrete with or without steel reinforcement. The work shall be carried out all in accordance with this specification and the lines, levels, grades, dimensions and cross-sections shown on the Drawings and as required by the S.O.

2. Material

2.1 Cement

2.1.1 The cement to be used throughout the Work shall be cement obtained from SIRIM-certified manufacturer. The cement shall be described and complied with MS EN 197-1 as shown in TABLE D1.

2.1.2 Certificates of test

2.1.2.1 Manufacturers' certificates of test shall in general be accepted as proof of soundness. Additional tests shall be carried out on any cement which appears to have deteriorated through age, damage to containers, improper storage, or any other reason. The test shall be carried out at any approved laboratory in accordance with MS EN 196 at the expense of the Contractor. Any batch of cement that has been sampled and tested and found not to have complied with the requirements shall be rejected and removed from the Site.

2.1.2.2 The S.O. may, without tests being made, order that any bag of cement, a portion of the contents of which has hardened, or which appears to be defective in any other way, be removed from the Site.

2.1.3 Transportation and storage

The cement shall be transported to the Site in covered vehicles adequately protected against water. It shall be stored in a weatherproof cement store to the approval of the S.O. Cement stored in bags shall not be laid directly on the ground. It shall be taken for use in the Work in the order of its delivery into the store. Cement delivered in bulk shall be stored in purposely built silos of an approved design.

2.2 Aggregates

2.2.1 Aggregates shall be naturally occurring sand, granite or limestone, crushed or uncrushed, except as otherwise specified, and shall comply with MS EN 12620. They shall be obtained from a source approved by the S.O. Marine aggregates shall not be used.

2.2.2 Coarse aggregates

Coarse aggregates shall comply with MS EN 12620. For work below ground level, only crushed granite shall be used. Unless otherwise specified in the Drawings, tests shall be carried out according to MS 30. The property limits shall be as specified in TABLE D2. The maximum nominal size of aggregate shall be as specified in the Drawings.

	SECTION D : CONCRETE WORKS	No. Dokumen : JKR 20800-0183-14 No. Keluaran : 01 No. Pindaan : 00 Tarikh : 29 Januari 2014 Muka Surat : D/2
---	-----------------------------------	--

2.2.3 Fine aggregates

Fine aggregates shall comply with MS EN 12620. In the context of MS EN 12620, the term 'sand' is used to mean 'fine aggregate'. Unless otherwise specified in the Drawings, tests shall be carried out in accordance with MS 30. The property limits shall be as specified in TABLE D2.

2.2.4 Grading

2.2.4.1 Coarse aggregates

The grading of coarse aggregates shall be analysed as described in MS 30 and shall be within the limits specified in TABLE D3.

2.2.4.2 Fine aggregates

The grading of fine aggregates shall be analysed as described in MS 30 and shall be within the limits specified in TABLE D3A. However, for prescribed mixes Grading Limit M shall only be used.

2.2.5 Sampling and testing of aggregates

Where site mixing is used, samples of fine and coarse aggregates approved by the S.O. shall be kept on Site. These samples shall give a fair indication of the general quality of the aggregates for comparison with the aggregates delivered during the course of executing the work. Tests shall be carried out on samples of the latter, taken at intervals as required by the S.O., or whenever there is a change of source. The appropriate method of sampling and testing shall be in accordance with the standards as specified in TABLE D2. Any batch of aggregate rejected by the S.O. shall be removed from the Site.

2.2.6 Storage of aggregates

2.2.6.1 Separate storage facilities with adequate provision for drainage shall be provided for each different size of aggregate used.

2.2.6.2 Aggregate shall be handled and stored so as to minimize segregation and contamination.

2.3 Water

Water shall comply with the requirements of MS EN 1008. It shall be clean and free from materials deleterious to concrete in the plastic and hardened state and shall be from a source approved by the S.O. The S.O. may instruct the Contractor to carry out chemical tests at any approved laboratory at the expense of the Contractor. The Contractor shall make adequate arrangement to supply and store sufficient water at the Site for use in mixing and curing of concrete.

2.4 Admixtures

2.4.1 Suitable admixtures may be used in concrete mixes with the prior approval of or as directed by the S.O.

2.4.2 The admixtures, the sampling and testing of the admixtures and the information to be provided with the admixture supplied shall comply with MS EN 934/ BS EN 934-2

 <p>JKR MALAYSIA</p>	<p>SECTION D : CONCRETE WORKS</p>	<p>No. Dokumen : JKR 20800-0183-14 No. Keluaran : 01 No. Pindaan : 00 Tarikh : 29 Januari 2014 Muka Surat : D/3</p>
--	--	---

- 2.4.3 All admixtures shall be used strictly in accordance with manufacturer's recommendation.
- 2.4.4 Before allowing the admixture to be used in the Work, relevant tests based on trial mixes shall be carried out. A control mix shall be made using a conventional trial mix that is without using the admixture, to determine the free water: cement ratio and mix proportion required to give the specified strength with the required slump. Using the same mix proportion as in the control mix but with a modified water: cement ratio whenever necessary, a test shall be carried out using the recommended dosage of the admixture. The results of the relevant test obtained from the control mix and test mix shall be compared. The S.O. may allow the use of the admixture only when the results are found to be satisfactory and comparable to the effects as claimed by the manufacturer. The admixture acceptance test shall comply with the requirements specified in TABLE D4.
- 2.4.5 The uses of admixtures that are chloride based are not permitted for structural concrete containing reinforcement, prestressing tendons or other embedded metal. The Contractor shall submit documentary evidence on the contents of the admixture to be used.
- 2.4.6 When the Contractor proposes the use of super-plasticiser, special control tests shall be carried out with prior approval of the S.O. The tests shall be carried out in accordance with the latest standard and the manufacturer's recommendations.
- 2.4.7 If two or more admixtures are proposed to be used simultaneously in the same concrete mix, the Contractor shall furnish the S.O. with supporting data on their suitability and compatibility.

2.5 Classification Of Concrete Mixes

- 2.5.1 The concrete mix shall be designed concrete to MS523-1 and MS523-2 unless otherwise stated in the Drawings. However, prescribed concrete may be used subject to the following:
 - (i) The work is of minor nature or involving a small quantity of concrete,
 - (ii) Prior approval is given by the S.O.,
 - (iii) The Contractor shall be responsible for the strength of the concrete
 - (iv) Only CEM I cement is specified to be used
- 2.5.2 When other than CEM I cement is specified to be used, the concrete mix shall be of designed concrete only.

2.6 Prescribed Concrete

- 2.6.1 Prescribed concrete shall conform to MS 523-1 and MS 523-2. Prescribed concrete shall be as detailed in TABLE D5. The mix prescribed in the table does not require the use of admixture.
- 2.6.2 For small volume concreting work, volume batching is permitted provided prior approval of the S.O. is obtained. The proportion shall be as specified in TABLE D5A.

 <p>JKR MALAYSIA</p>	<p>SECTION D : CONCRETE WORKS</p>	<p>No. Dokumen : JKR 20800-0183-14 No. Keluaran : 01 No. Pindaan : 00 Tarikh : 29 Januari 2014 Muka Surat : D/4</p>
--	--	---

2.7 Designed Concrete

2.7.1 Designed concrete shall comply with the recommendations of MS523-1 and MS 523-2. The minimum cement content and maximum free water: cement ratio to be used shall be as shown on TABLE D6 and D6A.

2.7.2 The Contractor shall comply with the following requirements:

- (i) Notify the S.O. whether the designed concrete is to be produced as site-mixed or ready-mixed.
- (ii) If the Contractor chooses to use ready mix concrete, he shall notify the S.O. the name of the supplier, location of the ready mix plant, journey time taken to transport the concrete to the Site and production capacity of the plant
- (iii) Submit a mix design report covering all concrete mixes to the S.O. for approval. The designed concrete shall comply with the requirements specified in TABLE D6 and D6A.
- (iv) The Contractor shall ensure that the S.O. be permitted to visit or station his representative at the plant at any stage of the concrete production

2.8 Requirements For Concrete

2.8.1 Concrete grade

The grade of concrete to be used in the work shall be as stated in the Drawings and /or in the B.Q. (Concrete shall be designated as Grade X/Y where 'X' is minimum characteristic cylinder strength in N/mm², and 'Y' is minimum characteristic cube strength in N/mm². For prescribed mix, a suffix 'P' shall be added after 'X').

2.8.2 Cement content

2.8.2.1 Cement content in this specification shall refer to the total quantities of cement as approved in sub-section 2.1, or the total quantities of cementitious materials comprising Portland cement and other constituents complying to MS EN 197-1.

2.8.2.2 Minimum cement content

The minimum cement content shall be in accordance with TABLE D6 and D6A, unless otherwise shown on the Drawings

2.8.2.3 Maximum cement content

The maximum cement content shall not exceed 550 kg/m³ unless otherwise shown on the Drawings or as approved by the S.O.

2.8.3 Consistence

2.8.3.1 The consistence of the fresh concrete shall be judged by its suitability for the condition of handling and placing so that after compaction, it surrounds all reinforcement, tendons and ducts and completely fills the formwork. Consistence of the concrete shall be within one of the following limits:

- (i) Slump classes (Refer to TABLE D7)
- (ii) Compacting classes (Refer to TABLE D7A)

 <p>JKR MALAYSIA</p>	<p>SECTION D : CONCRETE WORKS</p>	<p>No. Dokumen : JKR 20800-0183-14 No. Keluaran : 01 No. Pindaan : 00 Tarikh : 29 Januari 2014 Muka Surat : D/5</p>
--	--	---

- (iii) Vebe classes (Refer to TABLE D7B)
- (iv) Flow classes (Refer to TABLE D7C)

2.8.3.2 Unless otherwise specified in the Drawings, consistence values expressed as slump and flow classes appropriate to different uses of concrete shall be as given in TABLE D7D.

2.8.4 Total chloride content

The total chloride content of the concrete mix arising from the aggregate or any other source shall not in any circumstances exceed the limits in TABLE D7E expressed as a percentage relationship between chloride ions and weight of cement in the mix. When necessary, tests shall be carried out in accordance with BS 1881: Part 124 for each grade of concrete, to demonstrate that these limits are not exceeded.

2.8.5 Maximum sulphate content

The total estimated sulphate content of any mix, including that present in the cement shall not exceed 4% by weight of cement in the mix. Where necessary, tests shall be carried out in accordance with BS 1881: Part 124 for each grade of concrete to demonstrate that this limit is not exceeded.

3. Concrete Conformity And Identity Testing

3.1 Evaluation Of Conformity

3.1.1 General

3.1.1.1 The contractor is responsible for the evaluation of conformity for specified requirements of the concrete. For this purpose, the contractor shall carry out the following tasks:

- (i) Initial test,
- (ii) Production control including conformity control

3.1.2 Concrete composition and initial testing

3.1.2.1 In the case of using a new concrete composition, initial testing shall be performed to provide a concrete that achieves the specified properties or intended performance with an adequate margin. The concrete design and design relationships shall be re-established in the case of a prescribed concrete.

3.1.2.2 New concrete composition shall be reviewed periodically to provide assurance that all concrete designs are still in accordance with the actual requirements, taking account of the change in properties of the constituent materials and the results of conformity testing on the concrete compositions.

3.1.3 Initial tests

3.1.3.1 Frequency of initial tests

Initial test shall be repeated if there has been a significant change either in the constituent materials or in the specified requirements on which the previous test were based.

 <p>JKR MALAYSIA</p>	<p>SECTION D : CONCRETE WORKS</p>	<p>No. Dokumen : JKR 20800-0183-14 No. Keluaran : 01 No. Pindaan : 00 Tarikh : 29 Januari 2014 Muka Surat : D/6</p>
--	--	---

3.1.3.2 Test conditions

- (i) In general, initial test shall be carried out on fresh concrete with a temperature $27\pm 2^{\circ}\text{C}$
- (ii) For the initial test of single concrete, at least three specimens from each of three batches shall be tested.
- (iii) The strength of a batch or load shall be taken to be the average of the test results. The result of the initial test on the concrete is the average strength of the batches or loads.

3.1.3.3 Criteria for adoption of initial tests

- (i) For assessing the properties of concrete, in particular those of fresh concrete, the differences between the type of mixer and mixing procedure applied during the initial test and those applied during actual production shall be taken into account.
- (ii) The compressive strength of the concrete with the composition to be adopted for the actual case shall exceed the values f_{ck} of TABLE D8 or TABLE D9 by an adequate margin. This margin shall be at least that need to satisfy the conformity criteria given in sub-section 4.2.1.3. The margin should be about twice the expected standard deviation, that means at least a margin of 6 N/mm^2 to 12 N/mm^2 depending on the production facilities, the constituent materials and the available background information about the variation.
- (iii) The consistence of the concrete shall be within the limits of the consistence class, at the time at which the concrete likely to be placed or in the case of ready mixed concrete, delivered.
- (iv) For other properties that are specified, the concrete shall meet the specified values with an appropriate margin.

3.2 Conformity Control For Designed Concrete

3.2.1 Conformity control for compressive strength

3.2.1.1 General

- (i) For normal-weight and heavy-weight concrete of strength classes from C8/10 to C55/67 or light-weight concrete from LC8/9 to LC55/60, sampling and testing shall be performed on individual concrete compositions.
- (ii) In the sampling and testing plan and the conformity criteria of individual concrete compositions distinction is made between initial production and continuous production.
- (iii) Initial production covers the production until at least 35 test results are available.
- (iv) Continuous production is achieved when at least 35 test result are obtained over a period not exceeding 12 months.

 <p>JKR MALAYSIA</p>	<p>SECTION D : CONCRETE WORKS</p>	<p>No. Dokumen : JKR 20800-0183-14 No. Keluaran : 01 No. Pindaan : 00 Tarikh : 29 Januari 2014 Muka Surat : D/7</p>
--	--	---

- (v) If production of an individual concrete composition, has been suspended more than 12 months, the criteria, sampling and testing plan given for initial production shall be adopted.
- (vi) During continuous production, the sampling and testing plan and the criteria for initial production may be adopted.
- (vii) If the strength is specified for a different age, the conformity is assessed on specimens tested at the specified age.
- (viii) Identity testing shall be carried out in accordance to 4.4 in order to verify that a defined volume comes from a conforming population.

3.2.1.2 Sampling and Testing

- (i) Samples of concrete shall be randomly selected and taken in accordance with EN 12350-1. The minimum rate of sampling and of testing of concrete shall be in accordance with TABLE D10 at the rate that gives the highest number of samples for initial or continuous production, as appropriate.
- (ii) The samples shall be taken after any water or admixtures are added to the concrete, but sampling before adding plasticizer to adjust the consistence is permitted where there is proof by initial testing that the plasticizer or super plasticizer in quality to be used has no negative effect on the strength of the concrete.
- (iii) The test result shall be that obtained from an individual specimen or the average of the results when two or more specimens made from one sample are tested at the same age.
- (iv) Where two or more specimens are made from one sample and the range of the test values is more than 15 % of the mean the result shall be disregarded unless an investigation reveals an acceptable reason to justify disregarding an individual test value.

3.2.1.3 Conformity criteria for compressive strength

- (i) Conformity assessment shall be made on test results taken during an assessment period that shall not exceed the last twelve months.
- (ii) Conformity of concrete compressive strength is assessed on specimens tested at 28 days in accordance with :
 - a) Groups of n non-overlapping or overlapping consecutive test results f_{cm} (Criterion 1)
 - b) Each individual test result f_a (Criterion 2)
- (iii) Conformity is confirmed if both the criteria given in TABLE D11 for either initial or continuous production are satisfied.
- (iv) Initially, the standard deviation shall be calculated from at least 35 consecutive test results taken over a period exceeding three months and which is immediately prior to the production period during which conformity is to be checked. This value shall be

 <p>JKR MALAYSIA</p>	<p>SECTION D : CONCRETE WORKS</p>	<p>No. Dokumen : JKR 20800-0183-14 No. Keluaran : 01 No. Pindaan : 00 Tarikh : 29 Januari 2014 Muka Surat : D/8</p>
--	--	---

taken as the estimate of the standard deviation (σ) of the population. The validity of the adopted value shall be verified during the subsequent production using Method 1 as stated below. However, Method 2 may be used if approved by the S.O.

a) Method 1

The initial value of standard deviation may be applied for the subsequent period during which conformity is to be checked, provided the standard deviation of the latest 15 results (s_{15}) does not deviate significantly from the adopted standard deviation. This is considered valid provided:

$$0.63 \sigma \leq s_{15} \leq 1.37 \sigma$$

Where the value of s_{15} lies outside these limits, a new estimate of σ shall be determined from last available 35 test results

b) Method 2

The new value of σ may be estimated from a continuous system and this value is adopted. The sensitivity of the system shall be at least that of Method 1.

3.3 Non-conformity Of Product

3.3.1 The following actions shall be taken by the Contractor in the event of non-conformity:

- (i) Check test results and if invalid, take action to eliminate errors;
- (ii) If non-conformity is confirmed e.g. by retesting, take corrective actions including a management review of relevant production control procedures;
- (iii) Where there is confirmed non-conformity with the specification that was not obvious at delivery, notice shall be given to the S.O. in order to avoid any consequential damage;
- (iv) Record actions on the items above

3.3.2 If the Contractor has given notice of non-conformity of the concrete or if the results of conformity tests do not fulfil the requirements, supplementary testing according to EN 12504-1 on cores taken from the structure or components or a combination of tests on cores and non-destructive tests on the structure or in structural components as given in EN 13791 shall be required by the S.O.

3.4 Identity Testing

3.4.1 General

Identity testing indicates whether the defined volume of concrete in question belongs to the same population as that verified as conforming with the characteristic strength via conformity assessment.

	SECTION D : CONCRETE WORKS	No. Dokumen : JKR 20800-0183-14 No. Keluaran : 01 No. Pindaan : 00 Tarikh : 29 Januari 2014 Muka Surat : D/9
---	-----------------------------------	--

3.4.2 Identity testing for compressive strength

3.4.2.1 Sampling and testing plan

- (i) The sampling rate for identity testing shall be as follows:
 - a) One sample per 10.0 m³ or every group of 10 batches for critical structures e.g. prestressed concrete, masts, cantilevers, columns, footing, pile caps, shear wall, retaining wall.
 - b) One sample per 20.0m³ or every group of 20 batches e.g. slabs, beams.
 - c) One sample per 50.0 m³ or every group of 50 batches e.g. raft foundation and mass concrete.
- (ii) Samples shall be taken from different batches or loads in accordance with EN 12350-1 Test specimens shall be prepared and cured in accordance with EN 12390-2. The compressive strength of the specimens shall be determined in accordance with EN 12390-3 The test result shall be that obtained from the average of the results of two or more specimens made from one sample for testing at the same age. Where the range of test values is more than 15% of the mean, the results shall be disregarded unless an investigation reveals an acceptable to justify disregarding an individual test value.

3.4.2.2 Cube strength at 7 days

One cube from each sample batch shall be tested for the seven (7) days compressive strength. The cube compressive strength shall not fall below the corresponding values given in TABLE D12 for prescribed concrete, and two-third (2/3) of the twenty eight (28) days compressive strength for designed concrete.

3.4.3 Identity criteria for compressive strength

3.4.3.1 Concrete under production control certification

- (i) Identity of concrete is assessed for each individual strength test result and the average non-overlapping discrete results as identified in TABLE D13.
- (ii) Concrete is deemed to come from a conforming population if both the criteria in TABLE D13 are satisfied for n results derived from strength tests on samples taken from the defined volume of concrete.

3.4.3.2 Concrete not under production control certification

From the defined volume of concrete, at least three (3) samples shall be taken for testing. The concrete is deemed to come from a conforming population if the conformity in sub-section 4.2.1.3 and TABLE D11 for initial production is satisfied.

 <p>JKR MALAYSIA</p>	<p>SECTION D : CONCRETE WORKS</p>	<p>No. Dokumen : JKR 20800-0183-14 No. Keluaran : 01 No. Pindaan : 00 Tarikh : 29 Januari 2014 Muka Surat : D/10</p>
--	--	--

3.4.4 Identity testing for slump and flow

3.4.4.1 Sampling and testing plan

- (i) The sampling shall be either:
 - a) In accordance with MS26-1-1; or
 - b) Measured using a spot sample obtained from the initial discharge, if concrete is delivered in a truck mixer or agitating equipment. The spot sample shall be taken after a discharge of approximately 0.3 m³ by taking six increments from the moving stream of the concrete in accordance with MS 26-1-1.
- (ii) The sample shall be remixed on a non-absorbent surface and tested for slump or flow. Slump shall be measured in accordance with MS 26-1-2. Flow shall be measured in accordance with MS 26-1-5.

3.4.5 Identity criteria for the slump of an individual batch

If the measured slump meets the requirements specified in TABLE D14 or is within the tolerance specified in TABLE D15, the identity test confirms that the batch conforms to MS 523: Part 1 with respect to consistence. For identity criteria for flow reference shall be made to Annex B of MS523-2.

4. Production Of Concrete

4.1 General

4.1.1 All concrete shall be subjected to production control under the responsibility of the contractor.

4.1.1.1 Production control comprises all measures necessary to maintain the properties of concrete in conformity to specified requirements. It includes:

- (i) selection of materials.
- (ii) concrete design.
- (iii) concrete production.
- (iv) inspection and tests.
- (v) the use of the results of test on constituent materials, fresh and hardened concrete and equipment.
- (vi) For ready-mixed concrete, inspection of equipment used in transporting fresh concrete.

4.2 Production Control System

The production control system shall contain adequately documented procedures and instructions. These procedures and instructions shall, where relevant, be established in respect of the control requirement as given in the TABLES D10, D11 and D16.

4.3 Supervision

The Contractor shall ensure the required standard of control over materials and workmanship. The S.O. shall be afforded all reasonable opportunities and facilities to

 <p>JKR MALAYSIA</p>	<p>SECTION D : CONCRETE WORKS</p>	<p>No. Dokumen : JKR 20800-0183-14 No. Keluaran : 01 No. Pindaan : 00 Tarikh : 29 Januari 2014 Muka Surat : D/11</p>
--	--	--

inspect the constituent materials and the production of concrete and to take samples for testing.

4.4 Site Mixed Concrete

- 4.4.1 The quantities of cement, fine aggregate and various sizes of coarse aggregate shall be measured by weight unless otherwise approved by the S.O. A separate weighing machine shall be provided for weighing the cement. Alternatively, the cement may be measured by using a whole number of bags in each batch. The quantity of water shall be measured by volume or by weight. Any solid admixtures to be added shall be measured by weight; liquid or paste admixtures shall be measured by volume or weight.
- 4.4.2 The batch weight of aggregate shall be adjusted to allow for the moisture content of the aggregate being used. All measuring equipment shall be calibrated on site or their calibration status established by certificates from accredited laboratories.
- 4.4.3 The mixing time shall be not less than two minutes and not more than five minutes or any other time recommended by the mixer manufacturer after all the ingredients have been placed in the mixer.
- 4.4.4 Mixers that have been out of use for more than 30 minutes shall be thoroughly cleaned before any fresh concrete is mixed. Unless otherwise agreed by the S.O., the first batch of concrete through the mixer shall contain only two thirds of the normal quantity of coarse aggregate. The mixer shall be thoroughly cleaned before changing from one type of cement to another.
- 4.4.5 The water content of each batch of concrete may be adjusted so as to produce concrete of the workability required. However care shall be taken to ensure the free water: cement ratio is maintained. The total amount of water added to the mix shall be recorded.

4.5 Ready Mixed Concrete

- 4.5.1 Ready mixed concrete are batched, either dry or wet, at a control plant and transported in purpose-made agitators operating continuously or truck mixers to the Site.
- 4.5.2 Ready mixed concrete shall comply with the requirements of designed concrete as in sub-section 3.2 and MS 523-1. All concrete materials, including water and admixtures shall be mixed in the plant and delivered to Site in purpose made truck mixers. No extra water or admixtures are allowed to be added after the concrete has left the plant.
- 4.5.3 Ready mixed concrete delivered to the Site shall be accompanied by delivery ticket and manufacturer's batching record stating the details of mix proportions by weight, the grade of concrete, type and size of aggregate, date and time of loading at plant, type and dosage of chemical admixtures and other relevant production details in suitable format, failing which the S.O, or his representative, shall immediately reject the total load of the concrete. The S.O, or his representative, and the contractor shall ensure the information provided in the delivery tickets and the manufacturer's batching record complies with the details of the approved 'designed concrete' and its corresponding consistence as in sub-section 3.2.1 before discharging the concrete.

 <p>JKR MALAYSIA</p>	<p>SECTION D : CONCRETE WORKS</p>	<p>No. Dokumen : JKR 20800-0183-14 No. Keluaran : 01 No. Pindaan : 00 Tarikh : 29 Januari 2014 Muka Surat : D/12</p>
--	--	--

4.5.4 Rejected concrete shall be removed from the Site. The delivery ticket shall be marked 'REJECTED'.

4.6 Transporting

Concrete shall be transported from the mixer to the formwork as rapidly as practicable by methods, which will prevent segregation or loss of any constituents or ingress of foreign matter or water and maintain the required workability. It shall be deposited as near as practicable in its final position to avoid rehandling or moving the concrete horizontally by vibration. The concrete shall be conveyed by chutes or concrete pumps only with permission from the S.O.

4.7 Placing

4.7.1 Placing of concrete in dry condition

4.7.1.1 For all concrete whether mixed on or off the site of the Work, each batch shall be placed and compacted within two (2) hours of adding the cement to the dry aggregates and within 45 minutes (or any other period of time based on the trial mix as per sub-sections 2.4 and 3.2.3 and approved by the S.O. if an admixture is used) of adding water to the cement and aggregate. Concrete shall not be placed in any part of the structure until the approval of the S.O. has been obtained. If concreting is not started within 24 hours of approval given, approval shall again be obtained from the S.O.

4.7.1.2 All formwork and reinforcement contained in it shall be clean and free from standing water immediately before the placing of concrete. Concreting shall be carried out continuously between and up to predetermined construction joints in one sequence of operation. It shall be thoroughly compacted by either hand tamping or mechanical vibration or both and shall be thoroughly worked into the corners. After tamping into place the concrete shall not be subjected to disturbance other than such as incidental to compaction by vibration. In the event of unavoidable stoppage in positions not predetermined, the concreting shall be terminated on a horizontal plane and against vertical surfaces by the use of stop boards. The location for termination shall be subjected to the approval of the S.O.

4.7.1.3 Fresh concrete shall not be placed against in-situ concrete which has been in position for more than 45 minutes unless a construction joint is formed in accordance with sub-section 6.1. When in-situ concrete has been in place for four hours, no further concrete shall be placed against it for a further 20 hours. Where retarding admixture has been used, the S.O. may approve variation to this limit.

4.7.1.4 Except where otherwise approved by the S.O., concrete shall be deposited in horizontal layers to a compacted depth not exceeding 450 mm when internal vibrators are used or 300 mm in all other cases. The surface of the concrete shall be maintained reasonably level during placing.

4.7.1.5 Concrete shall not be dropped into place from a height exceeding 1.5 m. However, higher drops may be allowed provided the mix has been well designed and proportioned. When trunking or chutes are used, they shall be kept clean and used in such a manner as to avoid segregation.

 <p>JKR MALAYSIA</p>	<p>SECTION D : CONCRETE WORKS</p>	<p>No. Dokumen : JKR 20800-0183-14 No. Keluaran : 01 No. Pindaan : 00 Tarikh : 29 Januari 2014 Muka Surat : D/13</p>
--	--	--

4.7.1.6 The Contractor shall maintain an experienced steel fixer at the site of reinforced concrete works during the placing of concrete to reposition any reinforcement which may be displaced.

4.7.2 Placing of concrete under water

4.7.2.1 No concrete shall be placed in flowing water. Underwater concrete if deemed unavoidable, shall be placed in position by Tremie pipes from the mixer. During and after concreting under water, pumping or dewatering operations in the immediate vicinity shall be suspended until the S.O. permits them to continue. Where the concrete is placed by a Tremie pipe, the following requirements shall be applicable: -

- (i) The hopper and tremie pipe shall be a closed system. The bottom of the Tremie pipe shall be kept as far as practicable beneath the surface of the placed concrete.
- (ii) The tremie pipe shall be large enough with due regard to the size of aggregate. For 20 mm aggregates, the Tremie pipe shall be of a diameter not less than 150 mm and for larger aggregates, a bigger diameter Tremie pipe approved by the S.O. shall be used.
- (iii) Unless otherwise agreed by the S.O., the first charge of concrete shall be placed with a sliding plug pushed down the Tremie pipe ahead of it to prevent mixing of concrete and water.
- (iv) The Tremie pipe shall always penetrate well into the concrete with an adequate margin of safety against accidental withdrawal if the pipe is surged to discharge the concrete.
- (v) The concrete shall be deposited wholly by Tremie pipe and the method of deposition shall not be changed part way up to prevent the laitance from being entrapped within the structure.
- (vi) All Tremie pipes shall be properly cleaned after use.

4.8 Placement Temperature

4.8.1 Placement temperature shall comply with MS 523-3 to prevent premature setting and loss of water during placing of concrete in the formwork and the following precautions shall be taken:

- (i) At the time of placing, no part of the concrete shall have a temperature exceeding 36°C. This may be achieved by cooling the water and aggregate prior to mixing.
- (ii) Concrete shall not be placed in forms or around reinforcement whose temperature exceeds 36°C. This can be achieved by providing shading or other means to protect from direct sunlight.
- (iii) Freshly placed concrete shall be protected from direct sunlight and from loss of moisture by covering, shading or other means.
- (iv) No concrete shall be placed when the air temperature at the point of deposition exceeds 36°C

4.8.2 However, higher temperatures may be allowed if specified in the Drawings.

	SECTION D : CONCRETE WORKS	No. Dokumen : JKR 20800-0183-14 No. Keluaran : 01 No. Pindaan : 00 Tarikh : 29 Januari 2014 Muka Surat : D/14
---	-----------------------------------	---

4.9 Compaction

- 4.9.1 Unless otherwise approved by the S.O., concrete shall be thoroughly compacted by vibration and thoroughly worked around the reinforcement, tendons or duct formers, around embedded fixtures and into corners of the formwork to form a dense, homogenous mass, free from voids and which will have the required surface finish when the formwork is removed. Vibration shall be applied continuously during the placing of each batch of concrete until the expulsion of air has practically ceased and in a manner which does not promote segregation of the ingredients.
- 4.9.2 The concrete maintained between the two walls of formwork shall be compacted by internal or external vibrators. Concrete in slabs with no formwork on its upper surface shall be compacted either by vibrators of the pan type or by a vibrating screen.
- 4.9.3 The internal vibrators shall be inserted and withdrawn slowly and at a uniform pace of approximately 100 mm per second. Compaction shall be deemed to be completed when cement mortar appears in an annulus around the vibrator. Over vibration leading to segregation of the mix must be avoided. The internal vibrators shall be inserted at points judged by the area of mortar showing after compaction, with a certain allowance made for overlapping and they shall not be allowed to come into contact with the formwork or the reinforcement and shall be inserted at a distance of not less than 75 mm from the formwork.
- 4.9.4 The pan vibrator shall be placed on the surface of the concrete, which shall have previously been tamped and leveled leaving an allowance in height for compaction until the cement mortar appears under the pan. The vibrator shall then be lifted and placed on the adjoining surface and this operation shall be repeated until the whole surface has been compacted. Alternatively, a vibrating screen spanning the full width of the surface may also be used.
- 4.9.5 Whenever vibration has to be applied externally, the design of formwork and disposition of vibration shall receive special consideration to ensure efficient compaction and to avoid surface blemishes. The vibration shall be such that there will be no excess water on the top surface on completion of compaction.
- 4.9.6 External vibrators shall be firmly secured to the formwork which must be sufficiently rigid to transmit the vibration and strong enough not to be damaged by it. Internal vibrators shall be capable of operating at not less than 10,000 cycles per minute and external vibrators at not less than 3,000 cycles per minute. Sufficient vibrators in serviceable condition shall be on Site so that spare equipment is always available in the event of breakdowns. Vibrators shall be operated by workmen skilled in their use.
- 4.9.7 Concrete shall not be subjected to any disturbance within 24 hours after compaction. No standing or flowing water shall be allowed to come into contact with exposed concrete surfaces during the first two (2) hours after placing and compaction of the concrete.
- 4.9.8 In the event where inadequate or improper compaction is suspected, the S.O. has the right to inspect and to carry out further tests. The tests may include non-destructive and destructive methods. All expenses incurred in carrying out such sampling, testing and remedial works shall be borne by the Contractor irrespective of whether the tests prove the structure to be sound or otherwise.

 <p>JKR MALAYSIA</p>	<p>SECTION D : CONCRETE WORKS</p>	<p>No. Dokumen : JKR 20800-0183-14 No. Keluaran : 01 No. Pindaan : 00 Tarikh : 29 Januari 2014 Muka Surat : D/15</p>
--	--	--

4.10 Curing And Protection

- 4.10.1 All concrete work shall be cured for the full period of curing which shall not be less than five (5) days for F1, F2, F3 and F4 surfaces, but not less than three (3) days for F11, F12, F13, F14 and F15 surfaces.
- 4.10.2 Curing and protection shall start immediately after compaction of the concrete to protect it from:
- (i) Impact damage such as shock, overloading or falling earth which may disrupt the concrete and interface with its bond to reinforcements.
 - (ii) Premature drying out from direct sunlight and wind.
 - (iii) Leaching out by rain and flowing water.
 - (iv) High internal thermal gradients.
- 4.10.3 Normal curing and protection
- 4.10.3.1 Concrete, after it is placed and until the expiration of the curing duration, shall not be allowed to dry out. Provision shall be made for adequate protection against direct sunlight and wind to allow the process of curing to complete within the specified period.
- 4.10.3.2 Curing and protection shall be accomplished by covering the exposed concrete surface with an impermeable material such as polyethylene sheet, which should be well sealed and fastened and if required, this treatment can be continued efficiently throughout the whole period of curing.
- 4.10.3.3 When the concrete has attained its final set, one of the following curing methods shall be adopted:
- (i) Water curing shall be accomplished by keeping the surface of the concrete continuously wet by ponding with water.
 - (ii) Curing may be accomplished by sealing in the water as specified above by covering with an approved waterproofed curing paper or plastic sheeting laid with airtight joints. It must be securely positioned to prevent displacement by wind and protected from tearing or other injury.
- 4.10.3.4 The use of other methods of curing may be deemed necessary when the concrete is subjected to high internal thermal gradient, or with large exposed surface area. The Contractor shall submit a method statement to the approval of the S.O.
- 4.10.3.5 In the event where the Contractor does not do proper curing, the S.O. has the right to inspect and to carry out further tests which may include destructive methods. All expenses incurred in carrying out such sampling, testing and remedial works shall be borne by the Contractor irrespective of whether the tests proved the structure to be sound or otherwise.
- 4.10.4 Accelerated curing
- 4.10.4.1 Elevated temperature curing may be used only with Ordinary Portland Cement.
- 4.10.4.2 After the completion of the placing of concrete, four (4) hours shall elapse before its temperature is raised, unless the Contractor is able

 <p>JKR MALAYSIA</p>	<p>SECTION D : CONCRETE WORKS</p>	<p>No. Dokumen : JKR 20800-0183-14 No. Keluaran : 01 No. Pindaan : 00 Tarikh : 29 Januari 2014 Muka Surat : D/16</p>
--	--	--

to prove that curing can start earlier by furnishing all the relevant supporting data to the S.O. The rise in temperature within any period of 30 minutes shall not exceed 10°C and maximum temperature attained shall not exceed 70°C unless it can be proven that any deviation from this provision shall not result in any detrimental effect to the concrete work. The rate of subsequent cooling shall not exceed the rate of heating. The use of accelerated curing methods for concrete containing other types of cement or any admixture or any additional materials shall be to the approval of the S.O.

5. Construction With Concrete

5.1 Construction Joints

- 5.1.1 Construction joints shall be made at the location as shown on the drawing and concreting work shall be carried out continuously up to the construction joints. If the position and detail of any construction joints is not described in the drawings, the Contractor shall propose and obtain the approval of the S.O. prior to commencement of concreting. The construction joints shall be made as few as possible with reasonable precautions against shrinkage. The joints shall be at right angles to the general direction of the member and shall take due account of shear and other stresses.
- 5.1.2 Concrete shall not be allowed to run to a feather edge and vertical joints shall be formed against a stop end. The top surface of a layer of concrete shall be level and flat unless design considerations make this undesirable. Joint lines shall be so arranged that they coincide with features of the finished work, wherever possible.
- 5.1.3 At horizontal construction joints, gauge strips about 25 mm width shall be placed inside the forms along all exposed surfaces to ensure a straight joint on those surfaces. Where a kicker (that is a starter stub) is used for the construction of walls and columns, it shall be at least 75 mm high, to be constructed monolithically with the base concrete.
- 5.1.4 Where vertical construction joints are necessary in mass concrete structures, reinforcing bars shall be placed across the joints so as to make the structure monolithic, all to the approval of the S.O.
- 5.1.5 Prior to recommencement of concreting on a joint, the surface of the concrete against which new concrete will be cast shall be free from laitance and shall be roughened to the extent that the coarse aggregate is exposed but not disturbed. Care shall be taken to avoid damaging the lines of the joint. Care shall also be taken that the joint surface is clean and damp but not wet and the exposed adjoining surfaces shall be of consistent colour. Immediately before the fresh concrete is placed against the joint, fresh rich cement mortar (1:2) shall be applied to the exposed surface.
- 5.1.6 Where the S.O. considers that special preparation is necessary, e.g. for an in-situ structural connection, preparation shall be carried out, preferably when the concrete has set but not hardened, by spraying with a fine spray of air and water or brushing with a stiff brush sufficiently to remove the outer mortar skin and expose the larger aggregates without disturbing them. Where this treatment is impracticable, sand blasting or a needle gun shall be used to remove the surface skin and laitance. Hardened surfaces shall be chipped manually or mechanically to be free from laitance and properly roughened to the extent that the coarse aggregates are being exposed.

 <p>JKR MALAYSIA</p>	<p>SECTION D : CONCRETE WORKS</p>	<p>No. Dokumen : JKR 20800-0183-14 No. Keluaran : 01 No. Pindaan : 00 Tarikh : 29 Januari 2014 Muka Surat : D/17</p>
--	--	--

5.2 Fixing Blocks, Brackets, Built In Bolts, Holes, Chases, Et Cetera

- 5.2.1 All fixing blocks, brackets, built in bolts, holes, chases, et cetera shall be accurately set out and formed and carefully sealed prior to the concrete being placed. It is the responsibility of the Contractor to obtain all such information for these items of work and to obtain the approval of the S.O. before incorporating such work prior to the concrete being placed.
- 5.2.2 Bolts and other inserts to be cast into the concrete shall be securely fixed to the formwork in such a way that they are not displaced during the concreting operations and that there is no loss of materials from the wet concrete through holes in the formwork.
- 5.2.3 Unless otherwise shown on the Drawings or instructed by the S.O., reinforcement shall be locally moved so that the minimum specified cover is maintained at the locations of inserts, holes, chases, et cetera. In the event where the minimum cover cannot be maintained, the Contractor shall take the necessary precautions to protect the reinforcements against corrosion by applying an approved coating materials to the reinforcements and the concrete cover.
- 5.2.4 Temporary plugs shall be removed and the threads of built in bolts shall be cleaned and greased before handing over any part of the Work.

5.3 Movement Joints.

- 5.3.1 Movement Joints, Expansion joints, contraction joints or other permanent structure joints shall be provided in the positions and constructed and sealed with waterproofing materials as detailed in the Drawings.
- 5.3.2 When forming movement joints, joint filler shall be fixed firmly to the first-placed concrete. If more than one strip is used within a joint, it is essential to butt the ends tightly or tape them together to prevent grout leakage restricting the closure of the joint.
- 5.3.3 It is essential that the concrete on both sides of the joint, when placed, is thoroughly compacted to form a dense uniform mass. Where stop ends comprise more than one element, particular care is necessary to ensure that joints between elements are sufficiently tight to allow no grout loss through them during compaction of the concrete.
- 5.3.4 Where flexible water stops are used, they shall be fixed so as to ensure that they are not displaced from their intended position during compaction of the concrete and that the concrete surrounding them is fully compacted. The design of the water stop should be practical and take account of the problems often associated with integral water stop construction in difficult placing conditions.
- 5.3.5 Water stops laid horizontally and located within the concrete mass shall be avoided since they attract the greatest risk of local honeycombing.
- 5.3.6 Unless otherwise shown on the Drawings, all exposed expansion joints shall be covered with 0.7 mm thick aluminium cover strips fixed with masonry nails at 300 mm centers.

 <p>JKR MALAYSIA</p>	<p>SECTION D : CONCRETE WORKS</p>	<p>No. Dokumen : JKR 20800-0183-14 No. Keluaran : 01 No. Pindaan : 00 Tarikh : 29 Januari 2014 Muka Surat : D/18</p>
--	--	--

5.4 Sealants And Special Materials

5.4.1 General

The installation method and the selection, mixing, application and curing of all joint waterproofing materials shall be in accordance with the manufacturer's recommendations. The Contractor may propose to use alternative joint waterproofing materials by submitting supporting technical information, test reports and samples of the proposed waterproofing materials to the S.O. for approval

5.4.2 Waterproofing materials

All waterproofing materials used at public access areas shall be protected with non-shrink grout covering

5.4.3 Water stops

5.4.3.1 Water stops shall be as specified in the Drawings and shall be installed and butt jointed according to BS 8007 and the manufacturer's recommendation.

5.4.3.2 Water stops shall be securely positioned in the formwork to prevent displacement during concreting.

5.4.4 Two-part polysulphide or two-part polyurethane sealant

5.4.4.1 Two-part polysulphide or two-part polyurethane sealant for external use shall comply with the following requirements:

- (i) Conformance to BS 4254
- (ii) Minimum joint movement capacity of $\pm 27.5\%$ of joint width at 27.5°C;
- (iii) Shore 'A' Hardness of $25 \pm$ at 27.5°C;
- (iv) Resistance to dilute acids, alkali and all kind of fuel

5.4.5 Preformed flexible strip sealant

5.4.5.1 Preformed flexible strip sealant shall comply with the following requirements:

- (i) Shall only be used in horizontal joints and be subjected to pressure
- (ii) throughout its length;
- (iii) Good adhesion
- (iv) Water resistant
- (v) Non-staining

5.4.6 Bitumen/rubber cold applied membrane

5.4.6.1 Bitumen/rubber cold applied membrane shall comply with the following requirements:

- (i) Minimum joint movement capacity of $\pm 10\%$ of joint width at 27.5°C
- (ii) 90% solid content;
- (iii) Resistant to dilute acid and alkali.

 <p>JKR MALAYSIA</p>	<p>SECTION D : CONCRETE WORKS</p>	<p>No. Dokumen : JKR 20800-0183-14 No. Keluaran : 01 No. Pindaan : 00 Tarikh : 29 Januari 2014 Muka Surat : D/19</p>
--	--	--

5.4.7 Hot-poured rubber/bitumen sealing compound

Hot-poured rubber/bitumen sealing compound shall comply with BS 2499.

5.4.8 Bituminous sheeting

5.4.8.1 Bituminous sheeting with non-asbestos fibre shall comply with the following requirements:

- (i) Resistant to lime water (no visual effect after two (2) weeks immersion)
- (ii) Maximum water absorption of 10% of dry weight
- (iii) Minimum tensile strength of 50 kg/cm²
- (iv) Ozone and ultraviolet resistant

5.4.9 Neoprene bearing pads

5.4.9.1 Neoprene bearing pads shall comply with the following requirements:

- (i) Shore 'A' Hardness of 60 ± 5 at 27.5°C
- (ii) Minimum rupture strength of 105 kg/cm²
- (iii) Minimum rupture elongation of 300%.

5.4.10 Polyurethane foam backing rods

5.4.10.1 Polyurethane foam backing rods used as sealant stops in panel joints shall have the following properties: -

- (i) Minimum compressibility of 75% of original volume at 27.5°C
- (ii) Excellent resilient properties;
- (iii) Density between 35 kg/cm³ and 45 kg/cm³
- (iv) Total resistance to common acids, lubricants and detergents
- (v) Total resistance to water infiltration by capillary action
- (vi) Suitability for up to 70°C.

6. Steel Reinforcement

6.1 General

The Work shall consist of furnishing and placing reinforcing steel in accordance with this specification and in conformity with the Drawings or as directed by the S.O.

6.2 Materials

6.2.1 Hot rolled mild steel and high yield bars shall comply with the requirements of MS 146. Cold worked steel bars shall comply with the requirements of BS 4461. Hard drawn mild steel wire shall comply with the requirements of MS 144.

6.2.2 Steel fabric reinforcement shall comply with the requirements of MS 145 and shall be delivered to the Site in flat sheets, unless otherwise specified.

6.2.3 Dowel bars shall be plain, round bars conforming to the requirements of MS 146. They shall be free from burring or other deformations restricting slippage in the concrete. Dowel bar sleeves used for debonding shall be of approved synthetic material. The closed end of the sleeve shall be filled with 25 mm thick compressible foam fillers and the sleeve shall fit tightly over the length of the bar to be debonded.

 <p>JKR MALAYSIA</p>	<p>SECTION D : CONCRETE WORKS</p>	<p>No. Dokumen : JKR 20800-0183-14 No. Keluaran : 01 No. Pindaan : 00 Tarikh : 29 Januari 2014 Muka Surat : D/20</p>
--	--	--

- 6.2.4 Before any reinforcement steel is brought to Site, the Contractor shall furnish the mill certificates of tests and these shall be submitted for acceptance by the S.O. In addition Contractor shall on request, furnish the S.O. with a test sheet from approved laboratories for any batch of bars, giving the results of each of the mechanical tests and/or chemical composition analysis required under the MS or any equivalent international standards approved by the S.O. The specified characteristic strength of steel reinforcement shall be as given in TABLE D17.
- 6.2.5 During the course of the work, any reinforcement found to be not in accordance with the MS or BS may be rejected by the S.O. notwithstanding any previous acceptance on the strength of the test certificates. The S.O. may call for additional tests to be made at the Contractor's expense on samples taken from the batch of the defective reinforcement. If the samples do not comply with the MS or BS, then the S.O. may reject the whole batch and instruct its removal from the Site.
- 6.2.6 Steel reinforcement shall be stored in clean and dry conditions. When placed in the work it shall be clean and free from loose rust, mill scale, oil, grease, paint, dirt or anything which may reduce its bond with concrete. If directed by the S.O., the steel bars shall be brushed or otherwise cleaned before use, at the Contractor's expense.
- 6.2.7 Binding wire shall be 1.6 mm diameter soft annealed steel wire complying with the requirements of BS 1052.

6.3 Construction Methods

6.3.1 Cutting and bending of reinforcement

- 6.3.1.1 Bars shall be of their correct lengths and bent to the exact shapes required before being fixed in the work.
- 6.3.1.2 Bars shall be cut and bent cold by the application of slow, steady pressure or in an approved bar-bending machine. Bending at temperatures in excess of 100°C may only be carried out with the S.O.'s approval and under his supervision. Except where otherwise indicated in the Drawings, bars shall be bent and measured in accordance with BS 4449.
- 6.3.1.3 Cold worked and hot rolled bars shall not be straightened or bent again once having been bent. Where it is necessary to bend the free end of mild steel reinforcement already cast in the concrete, the internal radius of the bend shall not be less than twice the diameter of the bar.
- 6.3.1.4 Special care shall be taken that the overall length of bars with multiple bends is accurate and that after bending and fixing in position the bars remain in place without wrap or twist.

6.3.2 Fixing of reinforcement

- 6.3.2.1 The number, size, length, shape, type and position of all reinforcing bars, links, spacer bars and other parts of the steel reinforcement, shall be in accordance with the Drawings.
- 6.3.2.2 Reinforcements shall be secured against displacement. Unless specified otherwise, the actual concrete cover shall be taken as the

	SECTION D : CONCRETE WORKS	No. Dokumen : JKR 20800-0183-14 No. Keluaran : 01 No. Pindaan : 00 Tarikh : 29 Januari 2014 Muka Surat : D/21
---	-----------------------------------	---

distance between face of concrete and the nearest steel surface. All intersecting bars shall be tied together with binding wire and the ends of the wire shall be turned into the main body of the concrete.

- 6.3.2.3 Reinforcement temporarily left projecting from the concrete at construction or other joints shall not be bent out of position during the periods in which concreting is suspended except with the approval of the S.O.
- 6.3.2.4 The Contractor shall take particular care that the reinforcement is laid out correctly in every aspect and temporarily suspended by annealed wire or supported on concrete blocks or other approved spacers in the forms to prevent displacement during the placing and compacting of concrete. Links shall tightly embrace the longitudinal reinforcement to which they shall be securely wired or spot welded. The top reinforcement in slabs shall be rigidly supported on mild steel 'chairs' or equivalent spaced in each direction to prevent sagging during concreting.
- 6.3.2.5 No concrete shall be placed until the reinforcement has been inspected and approved by the S.O.
- 6.3.3 Splicing
 - 6.3.3.1 Joints to reinforcement bars shall be effected by lapping of bars at positions shown on the Drawings. Where other types of joints are to be used, prior approval of the S.O shall be obtained and their use shall be strictly in accordance with manufacturer's recommendation, at the positions approved by the S.O.
- 6.3.4 Supporting and spacer blocks
 - 6.3.4.1 The size of supporting and spacer blocks required for ensuring that the reinforcement is correctly positioned shall be not more than 50mm x50mm consistent with their purpose, of a shape approved by the S.O., and designed so that they will not overturn when the concrete is placed.
 - 6.3.4.2 The nominal size of aggregates used shall be 10 mm. The concrete spacers shall be of at least the same strength and material's source as the concrete to be poured. Wires cast in these blocks for the purpose of tying them to the reinforcement shall be as described in sub-section 7.2.
 - 6.3.4.3 Spacers left in situ shall not impair the desired appearance or durability of the structure by causing spalling, rust staining or allowing the passage of moisture.
 - 6.3.4.4 Other types of spacers may be used only with the approval of the S.O.
- 6.3.5 Welding of reinforcement
 - 6.3.5.1 Welding workmanship, including welder qualification shall comply with sub-section 5 of JKR Standard Specification for structural Steel Work JKR No. 200600-0019-99.

 <p>JKR MALAYSIA</p>	<p>SECTION D : CONCRETE WORKS</p>	<p>No. Dokumen : JKR 20800-0183-14 No. Keluaran : 01 No. Pindaan : 00 Tarikh : 29 Januari 2014 Muka Surat : D/22</p>
--	--	--

- 6.3.5.2 Reinforcement in structures shall not be welded except where detailed in the Drawings or permitted in this specification.
- 6.3.5.3 Welding shall be carried out in accordance with BS EN 1011 and BS EN 60974. Butt welds shall be of the double V type and two butt weld bond tests shall be carried out on a specimen prepared to represent each form of the butt welded joint used in welding the reinforcement and for each position of welding. The method of making butt weld tests shall be as laid down in BS EN 17637. The specimen shall pass the test to the approval of the S.O. before using the joint, which the specimen represents. Welded joints shall not be made at bends in reinforcement. Unless otherwise approved by the S.O., joints in parallel bars of the principal tensile reinforcement shall be staggered in the longitudinal direction at a distance not less than the end anchorage length for the bar.
- 6.3.5.4 The S.O. shall be informed in advance of when welding is to be carried out so that he may supervise and inspect the work. Welding shall not be performed in the field during rain or other adverse conditions.

7. Formwork And Surface Finish For Structure

7.1 Design And Construction

7.1.1 Description

- 7.1.1.1 Formwork shall include all temporary or permanent forms required for forming the concrete, together with all temporary construction required for their support.
- 7.1.1.2 The Contractor is deemed to have made a study of the Drawings at tender stage and is aware of all areas of construction, requiring heavy and specially designed propping to provide the support and the necessary bracing for the stability of such propping.
- 7.1.1.3 The design and construction of formwork shall be carried out by a competent person. The Contractor shall identify all critical formwork design and submit the strength and deflection calculations and Drawings or the proposed design, certified by a Professional Engineer to the S.O. for prior approval. Notwithstanding any approval by the S.O. with respect to the design submitted by the Contractor, the responsibility or the adequacy and safety of the design shall remain with the Contractor. The Contractor shall also appoint a competent formwork coordinator whose duties would be similar to those outlined in BS 5975.
- 7.1.1.4 When the use of proprietary type of formwork is proposed by the Contractor, the design shall be certified by a Professional Engineer.
- 7.1.1.5 The formwork shall be sufficiently rigid and tight to prevent loss of grout or mortar from the concrete at all stages of construction and shall be appropriate for the methods of placing and compacting.
- 7.1.1.6 Formwork (including supports) shall be sufficiently rigid to maintain the forms in their correct position, shape, profile and dimensions. The supports shall be designed to withstand the worst combination of forces due to self-weight, formwork weight, formwork forces,

 <p>JKR MALAYSIA</p>	<p>SECTION D : CONCRETE WORKS</p>	<p>No. Dokumen : JKR 20800-0183-14 No. Keluaran : 01 No. Pindaan : 00 Tarikh : 29 Januari 2014 Muka Surat : D/23</p>
--	--	--

reinforcement weight, wet concrete weight, construction and wind loads, together with all incidental dynamic effects caused by placing, vibrating and compacting the concrete. Guidance on these loadings is given in The Concrete Society Manual Formwork - Guide to good practice, and in CIRIA Report 108, Concrete Pressure in Formwork, and in BS 5975. Vertical propping to formwork shall be carried down sufficiently far to provide the necessary support without overstressing the completed concrete structure.

7.1.1.7 Metal ties may only be used with the prior approval of the S.O. Where metal ties are permitted, the use of storey height steel soldiers shall be used to reduce the number of tie bolts required. Tie bolts with rubber or plastic cone against the form face are to be used to prevent unsightly grout loss. No metal part of any device for maintaining formwork in the correct location shall remain permanently within the specified concrete cover to the reinforcement. Except for ties used for anchoring void formers, all ties shall be at least 1.2 m apart and through bolts will not be permitted on exposed form finished faces. All holes left by ties shall be made good within one day of the removal of the formwork using a mortar of the same strength as the cast concrete. Metal ties which allow for holes through the concrete being cast shall not be permitted to be used in concrete for water-retaining structure, roof slabs and walls.

7.1.1.8 The formwork shall be so arranged as to be readily dismantled and removed from the cast concrete without shock, disturbance or damage. Where necessary, the formwork shall be so arranged that the soffit form, properly supported, can be retained in position for such period as may be required by the condition of the maturing concrete or the specification. If a component is to be prestressed whilst still resting on the soffit form, provision shall be made to allow for elastic deformation and any variation in weight distribution. As far as practicable, formwork joints shall coincide with construction joints.

7.1.2 Form lining

7.1.2.1 The type and treatment of any lining (plywood, metal, plastic, Controlled Permeability Formwork liner, et cetera) of the forms shall be appropriate to the concrete finish required.

7.1.2.2 The Controlled Permeability Formwork (CPF) liner shall have the following requirements:

- (i) The requirement for a special finish shall be as for traditional formwork finishes except that the formwork shall be covered by a CPF liner.
- (ii) CPF liner shall be used on all surfaces as detailed on the Drawings
- (iii) The CPF liner shall be a Water Bylaws Scheme - Approved Product for use with potable water in accordance with BS 6920.
- (iv) The CPF liner shall have the following properties:
 - a) Compression of less than 10% under a pressure 200 kPa.
 - b) Maximum pore size of less than 0.030 mm.
 - c) Minimum water retention capacity of 0.35 l/m².
 - d) Result in bleed water from the liner which is free from cement and fine aggregate particles.

 <p>JKR MALAYSIA</p>	<p>SECTION D : CONCRETE WORKS</p>	<p>No. Dokumen : JKR 20800-0183-14 No. Keluaran : 01 No. Pindaan : 00 Tarikh : 29 Januari 2014 Muka Surat : D/24</p>
--	--	--

- (v) The concrete cast against the CPF liner shall have an even uniformly textured matt finish and shall be free of blowholes and other surface blemishes. The use of the CPF liner shall meet the following performance requirements which should be demonstrated by the supply of test certificate:
 - a) The mean surface strength for the CPF cast face shall exceed that for the control face by at least 70%.
 - b) The mean 10 minute ISAT result for the CPF cast face shall be not more than 15% of that for the control face.
 - c) The mean depth of carbonation for the CPF cast face shall be not more than 15% of that for the control face.
 - d) The mean concentration of chlorides at a depth of 11mm from the CPF cast face shall be not more than 15% of that for the control face.
- (vi) The CPF liner shall be used once only. Release agents shall not be used with the liner and any residual release agent remaining on forms from previous use shall be removed.
- (vii) To ensure conformity with the performance requirements, the CPF liner is to be used in accordance with the manufacturer's technical guidelines.
- (viii) The CPF liner shall unless otherwise directed, be left in place on the concrete after formwork removal for the curing period specified by the S.O. It shall be kept wet and covered with plastic sheeting to promote efficient curing.

7.1.3 Projecting reinforcement, fixing devices

Where holes are needed in form to accommodate projecting reinforcement or fixing devices, care shall be taken to prevent loss of grout when concreting or damage when removing forms

7.2 Surface Finishes For Concrete

7.2.1 Control of colour

When specified in the Drawings, the Contractor shall obtain each constituent material from a single consistent source. The aggregates shall be free of any impurities that may cause staining. The mix proportions and the grading, particularly of the fine aggregate, shall be maintained constant. The same type of plywood or timber shall be used in formwork throughout similar exposed areas.

7.2.2 Formed surfaces

7.2.2.1 Formed concrete surfaces shall have one of the following classes of finish.

7.2.2.2 Unless otherwise specified, all exposed concrete surfaces shall be of Class F12, all unexposed surfaces shall be of Class F1. Other classes of finishes shall be used only where shown on the Drawings:

 <p>JKR MALAYSIA</p>	<p>SECTION D : CONCRETE WORKS</p>	<p>No. Dokumen : JKR 20800-0183-14 No. Keluaran : 01 No. Pindaan : 00 Tarikh : 29 Januari 2014 Muka Surat : D/25</p>
--	--	--

(i) Class F1

This finish shall be obtained by the use of properly designed forms of closely joined sawn timber or other approved material. Small blemishes caused by entrapped air or water may be expected but the surface shall be free from voids and honeycombing.

(ii) Class F2

This finish shall be obtained by the use of properly designed forms of closely jointed wrought boards, approved plywood or other approved material. Only very minor surface blemishes shall occur, with no staining or discoloration.

(iii) Class F3

- a) This finish shall be obtained by the use of properly designed steel forms or plastic coated plywood or wrought boards or other approved material.
- b) The surface shall be improved by carefully removing all fins and other projections, thoroughly washing down and then filling the most noticeable surface blemishes with a cement and fine aggregate paste to match the colour of the original concrete. Form release agents shall be carefully chosen to ensure that the surface shall not be stained or discolored. After the concrete has been properly cured, the surface shall be rubbed down where necessary, to produce a smooth and even surface.

(iv) Class F4

The requirements for Class F4 are as for Class F3 except that internal ties and embedded metal parts will be permitted. The ties shall be positioned only in rebates, or in other positions as shown on the Drawings or as agreed by the S.O.

(v) Class F11

The requirements for Class F11 surface finish are identical to those for Class F1 except that it shall be achieved using Controlled Permeability Formliners.

(vi) Class F12

The requirements for Class F12 surface finish are identical to those for Class F2 except that it shall be achieved using Controlled Permeability Formliners.

(vii) Class F13

The requirements for Class F13 surface finish are identical to those for Class F3 except that it shall be achieved using Controlled Permeability Formliners.

 <p>JKR MALAYSIA</p>	<p>SECTION D : CONCRETE WORKS</p>	<p>No. Dokumen : JKR 20800-0183-14 No. Keluaran : 01 No. Pindaan : 00 Tarikh : 29 Januari 2014 Muka Surat : D/26</p>
--	--	--

(viii) Class F14

The requirements for Class F14 surface finish are identical to those for Class F4 except that it shall be achieved using Controlled Permeability Formliners.

(ix) Class F15

The requirements for Class F15 are as for Class F4 except that plywood shutters lined with an approved patterned formliner shall be used to produce a patterned profile finish. Where possible, full height formliners shall be employed so that no horizontal joints in the liners are required. Tie holes shall be spaced so that they occur at overlap joints in the lining sheet.

7.2.3 Unformed surfaces

7.2.3.1 Class U1

The concrete shall be uniformly leveled and screened to produce a plain, ridged or broom roughened surface. No further work shall be applied to the surface unless it is used as the first stage for a Class U2 or Class U3 finish.

7.2.3.2 Class U2

After the concrete has hardened sufficiently, the concrete Class U1 surface shall be floated by hand or machine to produce a uniform surface free from screed marks.

7.2.3.3 Class U3

When the moisture film has disappeared and the concrete has hardened sufficiently to prevent laitance from being worked to the surface, a Class U1 surface shall be steel-trowelled under firm pressure to produce a dense, smooth uniform surface free from trowel marks.

7.2.3.4 Class U4

This finish is for surfaces that are to receive waterproofing systems. The concrete shall be levelled and floated to produce a uniform surface and immediately before the waterproofing operation this surface shall be water jetted or grit blasted to provide a lightly textured finish. The finished surface shall not deviate from the required profile by more than 5 mm over a 3 m gauge length or have any abrupt irregularities of more than 3 mm.

7.2.4 Trial panels for exposed form finished surfaces

7.2.4.1 In order to ensure that the specified formed finishes can be obtained by the method of construction proposed and to provide a standard by which the finishes in the Works can be assessed, trial panels shall be cast on Site. These panels shall be subjected to the S.O.'s approval before similar casting is permitted in the Works.

7.2.4.2 The trial panels shall employ the materials, plant and concrete mix proposed for the Works. They shall be at least a storey height and 1

 <p>JKR MALAYSIA</p>	<p>SECTION D : CONCRETE WORKS</p>	<p>No. Dokumen : JKR 20800-0183-14 No. Keluaran : 01 No. Pindaan : 00 Tarikh : 29 Januari 2014 Muka Surat : D/27</p>
--	--	--

m wide. They shall be of similar thickness and similarly reinforced as the elements they represent and shall incorporate all features which contribute to the final appearance of the Works.

7.3 Preparation Of Forms Before Concreting

7.3.1 Before concreting, all forms shall be thoroughly cleaned out, free from sawdust shavings, dust, mud or other debris. The inside surfaces of forms shall, unless otherwise approved by the S.O., be coated with an approved non-staining form oil or other approved material to prevent adhesion of the concrete. Such release agents shall be applied strictly in accordance with the manufacturer's recommendation and shall not come into contact with the reinforcement or prestressing tendons and anchorages. For any exposed surface only one release agent shall be used throughout the entire area.

7.3.2 All formwork shall be inspected by the S.O. after preparation and immediately prior to depositing concrete and no concrete shall be deposited until approval of the formwork has been obtained.

7.4 Removal Of Forms

7.4.1 The Contractor shall inform the S.O. and obtain his approval before striking any formwork, but such approval shall not relieve the Contractor of his responsibilities for the safety of the work.

7.4.2 Formwork shall be removed without such shock or vibration as would damage the concrete. A period of time shall elapse between the placing of the concrete and the removal of the formwork for various parts of the structure so as to suit the requirements for its curing.

7.4.3 The minimum periods between concreting and the removal of forms are given in TABLE D18. The periods stated in this table are based on the use of Ordinary Portland Cement. They may be changed with the approval of the S.O., if other types of cement as described in sub-section 2.1, admixtures as described in sub-section 2.4 are used. The result of the compressive strength obtained from cube strength at 7 days as described in sub-section 4.4.2.2 may also be used for early removal of forms provided always the Contractor provide proof of calculation to the S.O for approval.

7.4.4 For prestressed in-situ components, temporary supports shall not be removed until the components is stressed to the approval of the S.O.

7.4.5 Where it is intended that forms are to be reused, they shall be cleaned and made good to the approval of the S.O.

7.4.6 Following the removal of forms, no further loads shall be imposed upon the concrete until at least after the completion of the curing period or until such later time as in the opinion of the S.O. the concrete shall have attained sufficient strength to safely withstand such loads. Full design loads shall not be applied to any structure until all load bearing concrete is at least 28 days old.

7.5 Inspection And Making Good

7.5.1 The surface of the concrete shall be inspected for defects and for conformity to the surface finish specified and where appropriate, with approved sample finishes.

 <p>JKR MALAYSIA</p>	<p>SECTION D : CONCRETE WORKS</p>	<p>No. Dokumen : JKR 20800-0183-14 No. Keluaran : 01 No. Pindaan : 00 Tarikh : 29 Januari 2014 Muka Surat : D/28</p>
--	--	--

7.5.2 Subject to the strength and durability of the concrete being unimpaired, the making good of surface defects may be permitted but the level of acceptance shall be appropriate to the type and quality of the finish specified and ensure satisfactory permanence and durability.

7.5.3 Any remedial treatment of surfaces shall be approved by the S.O. following inspection immediately after removing the formwork and shall be carried out without delay.

8. Mass And Lean Concrete

Mass and lean concrete shall consist of cement, fine aggregate and coarse aggregate in the nominal ratio by volume of 1:3:6 and 1:4:8 respectively. However where a denser and more workable concrete can be produced by a variation in the ratio of the fine aggregate to that of coarse aggregate, this ratio may be varied within the limits (1:1½) and (1:3), provided that the volumes of fine and coarse aggregate, each measured separately, shall nevertheless equal the sum of the volumes of fine and coarse aggregate appropriate to the nominal mix. The concrete shall be mixed as described for reinforced concrete.

9. Building Accuracy

After removal of formwork, the Contractor shall take measurements as directed by the S.O. to check the deviation of the reinforced concrete works from specified dimensions shown on the Drawings. All measurements shall be recorded and submitted to the S.O. Any deviation in building accuracy shall comply with BS EN 13670.

10. Apparatus

10.1 The Contractor shall provide the following apparatus for use on the Site at all times:

- (i) Concrete slump test apparatus or flow test apparatus complying with MS 26. One set of the apparatus shall be provided for each concreting location.
- (ii) At least twelve (12) numbers of steel or cast iron moulds for casting 150 mm concrete test cubes and six (6) numbers of 100 mm mortar or grout test cube moulds complete with tamping bars and base plates in accordance with MS 26. A minimum number shall be provided such that no stripping of cubes is required prior to 24 hours setting and hardening period.
- (iii) Three (3) measuring cylinders of 250 ml capacity, graduated to measure to the nearest 2.0 ml., for determination of silt content (field setting method).
- (iv) An approved apparatus for measuring moisture content in fine aggregate.
- (v) One (1) electronic calculator with statistical functions.
- (vi) One (1) 300 mm steel rule.
- (vii) One (1) set of sieves in compliance with BS 410.
- (viii) Scale or balance 25 kg maximum capacity and weights.
- (ix) Trowel, shovel, spanner and other tools

11. Precast Concrete Construction

11.1 Manufacture Off Site

11.1.1 After the method of manufacture has been approved, no changes shall be made without the approval of the S.O.

 <p>JKR MALAYSIA</p>	<p>SECTION D : CONCRETE WORKS</p>	<p>No. Dokumen : JKR 20800-0183-14 No. Keluaran : 01 No. Pindaan : 00 Tarikh : 29 Januari 2014 Muka Surat : D/29</p>
--	--	--

11.1.2 The Contractor shall inform the S.O. in advance of the date of commencement of manufacture and casting of each type of precast concrete component.

11.1.3 When the S.O. requires tests to be carried out, none of the precast concrete components to which the tests relate shall be dispatched to the site until the tests have been completed and the results approved by the S.O.

11.1.4 All precast concrete components shall be indelibly marked to show the identification marking as specified in the Drawings, the production batch on which they were manufactured and the date on which the concrete was cast. If the components are symmetrical, the face that will be uppermost when the member is in its correct position in the work shall be clearly identified.

11.2 Storage

11.2.1 When the precast concrete components are stored, they shall be firmly supported only at the points specified in the Drawings. No accumulation of trapped water and deleterious matter shall be allowed in the components. Care shall be taken to avoid rust staining and efflorescence.

11.2.2 The precast concrete components shall be stacked in such a manner that their removal in correct order of age is facilitated.

11.3 Handling And Transport

The precast concrete components shall be lifted only at points specified in the Drawings or otherwise approved by the S.O. and shall be handled and placed without impact. The method of lifting, the type of equipment and transport to be used, and the minimum age of the components to be handled shall be to the approval of the S.O.

11.4 Assembly And Erection

11.4.1 The method of assembly and erection specified in the Drawings shall be strictly adhered to on site.

11.4.2 Immediately a unit of precast concrete component is in position, and before the lifting equipment is removed, temporary supports or connections between components as necessary, shall be provided. The final structural connections shall be completed as soon as is practicable.

11.5 Forming Structural Connections

11.5.1 For structural purposes, cement mortar shall compose of one (1) part of cement to one (1) part of sand (1:1), mixed with water so that the free water: cement ratio does not exceed 0.4 by weight and cement grout shall have a water: cement ratio between 0.4 and 0.6, or such other proportions as shall be directed by the S.O.

11.5.2 No structural connections shall be made until approval has been given by the S.O.

11.5.3 Unless otherwise approved by the S.O., the composition and the free water: cement ratio of the in-situ concrete or mortar used in any connection and the packing of joints shall be in accordance with the assembly instructions.

 <p>JKR MALAYSIA</p>	<p>SECTION D : CONCRETE WORKS</p>	<p>No. Dokumen : JKR 20800-0183-14 No. Keluaran : 01 No. Pindaan : 00 Tarikh : 29 Januari 2014 Muka Surat : D/30</p>
--	--	--

- 11.5.4 Levelling devices shall be released or removed only with the approval of the S.O.
- 11.5.5 Non load bearing joints between precast concrete components and adjoining structures shall be filled with appropriate grout and/or mortar protected by proprietary sealants and backing rod. They shall be waterproof.
- 11.5.6 Load bearing joints and connection shall be grouted, mortar packed or concreted. The respective mix design shall be free of lime and chloride. They shall be durable, waterproof, non-shrink and possess strength higher than that of precast concrete. Curing for at least three (3) days shall be provided. Designed mixes shall be submitted to the S.O. for approval.
- 11.5.7 The method of sampling and testing of grout and mortar shall be carried out according to MS 26. The compressive strength shall be determined by crushing test on 100 mm cubes. For each casting day and for each grade of grout and mortar, three samples shall be taken from three (3) separate batches. Two (2) cubes shall be cast from each sample for testing at seven (7) and 28 days. The appropriate strength requirement shall be considered to be satisfied if the average strength is greater than the specified characteristic strength.

11.6 Protection

At all stages of construction, precast concrete components and other concrete associated therewith shall be properly protected to prevent damage to permanently exposed surfaces, especially arises and other decorative features.

12. Other Concrete Works

12.1 Foundation

- 12.1.1 All reinforced concrete footings and pile caps shall be constructed according to the Drawings and to the exact depths required. The Contractor shall supply, maintain and remove any necessary planking and strutting, sheet piling and coffer dams, and shall by pumping or other approved means keep the excavation free from water.
- 12.1.2 The bottom of excavation shall be cleaned or if in loose or disturbed ground shall be well rammed, and the whole shall be approved before it is covered with a blinding layer of lean concrete not less than 50 mm thick. The required cover of concrete under the reinforcement shall be entirely above the blinding layer.

12.2 Pile Caps

- 12.2.1 Before commencing to construct pile caps, the Contractor shall check and verify the eccentricities and the cut-off levels of all piling works in the ground are as provided in the Drawings, and shall notify the S.O. in the event of any discrepancy.
- 12.2.2 The Contractor shall straighten the steel reinforcement projecting above the piles for anchoring pile caps, carry out excavation, erect formwork and temporary timbering for the construction of pile caps and ground beams.

	SECTION D : CONCRETE WORKS	No. Dokumen : JKR 20800-0183-14
		No. Keluaran : 01
		No. Pindaan : 00
		Tarikh : 29 Januari 2014
		Muka Surat : D/31

12.3 Lift Pits And Shafts

- 12.3.1 For lift pits below ground level, the concrete in the base slab and walls shall be of reinforced concrete with minimum cement content and maximum free water: cement ratio in accordance with the exposure XC3 in TABLE D6 and shall be constructed in operations which shall ensure water tightness in the structure below the ground level.
- 12.3.2 All external or internal wall surfaces of lift pits shall be waterproofed with three (3) coats of bitumen solution complying with BS 3416 or any other type of waterproofing material as approved by the S.O. The concrete surface shall be thoroughly cleaned and dried before application of the waterproofing material.
- 12.3.3 Lift shaft enclosures shall be made of reinforced concrete on all sides and constructed using steel formwork to ensure the accuracy of the structure in terms of verticality, shape, profile and dimensions. Refer to FIGURE D1.
- 12.3.4 All the inner surfaces of a lift shaft enclosure shall form a continuous flush surface without projection or recesses. Refer to FIGURE D1.
- 12.3.5 The lift shaft shall have a high degree of verticality. The limit of accuracy of shaft plumb for the full stretch of the lift shaft shall not exceed ± 30 mm. Refer to FIGURE D2.
- 12.3.6 The structural openings shall be vertically aligned one above the other for the full travel of the lift.
- 12.3.7 The structural opening shall be accurate to the specified dimensions. Deviations from the specified dimensions shall not exceed +12.5mm, -0mm. Refer to FIGURE D3.

FIGURE D1: LIFT SHAFT ENCLOSURE

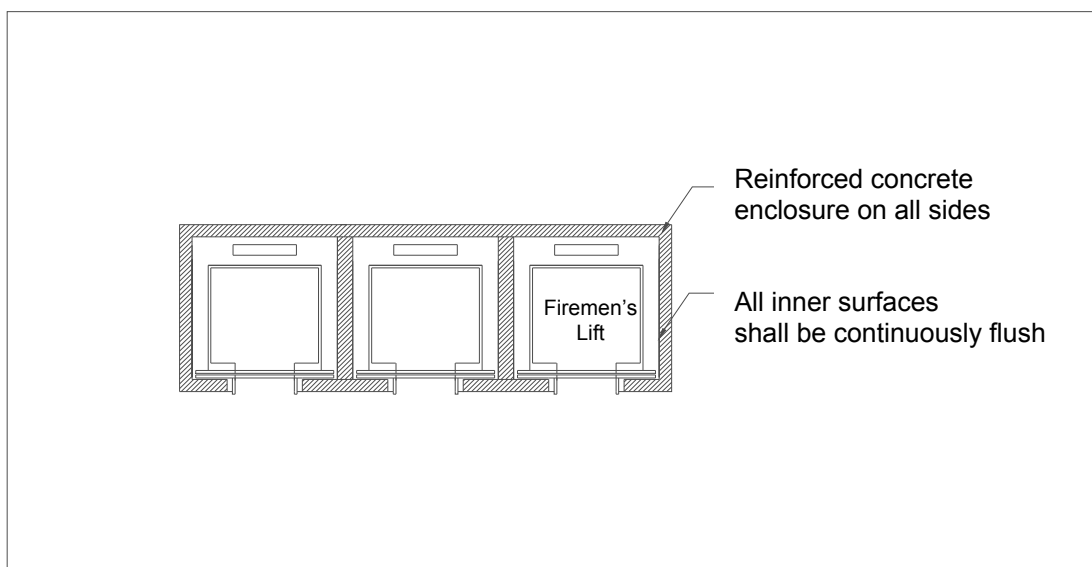

FIGURE D2: LIMIT OF ACCURACY OF SHAFT PLUMB ON ALL SIDES OF SHAFT ENCLOSURE

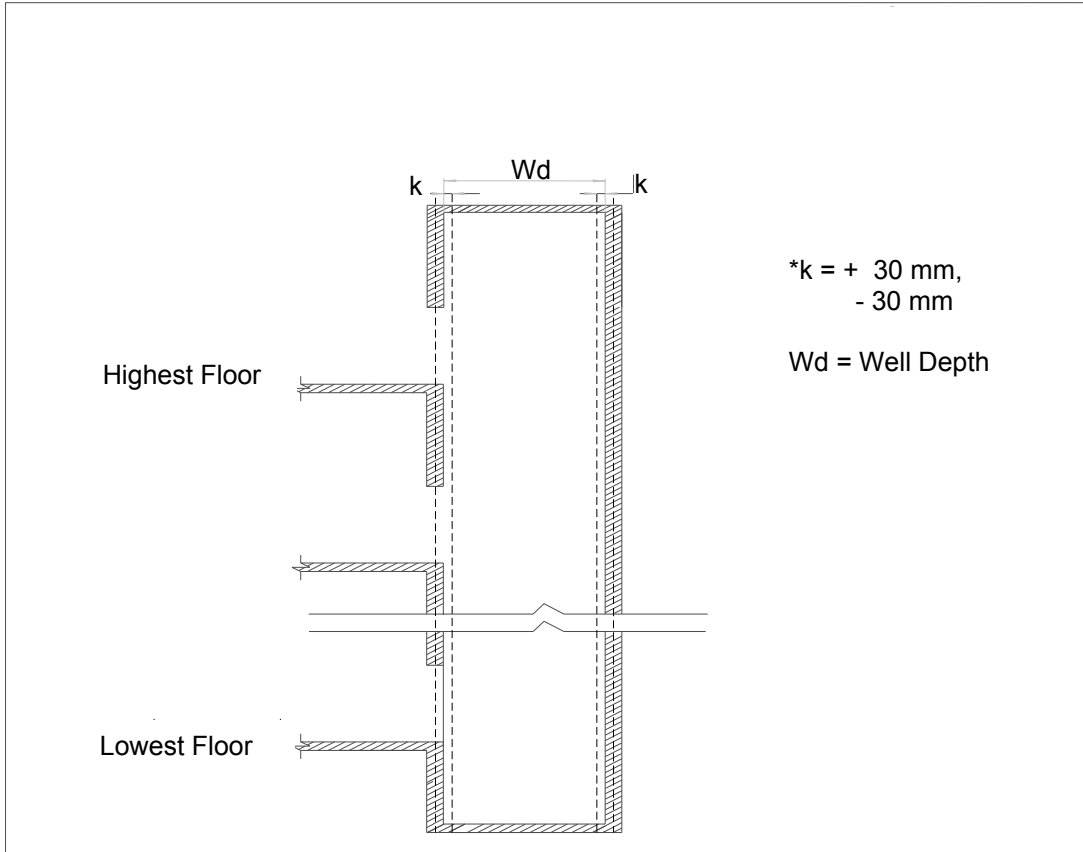
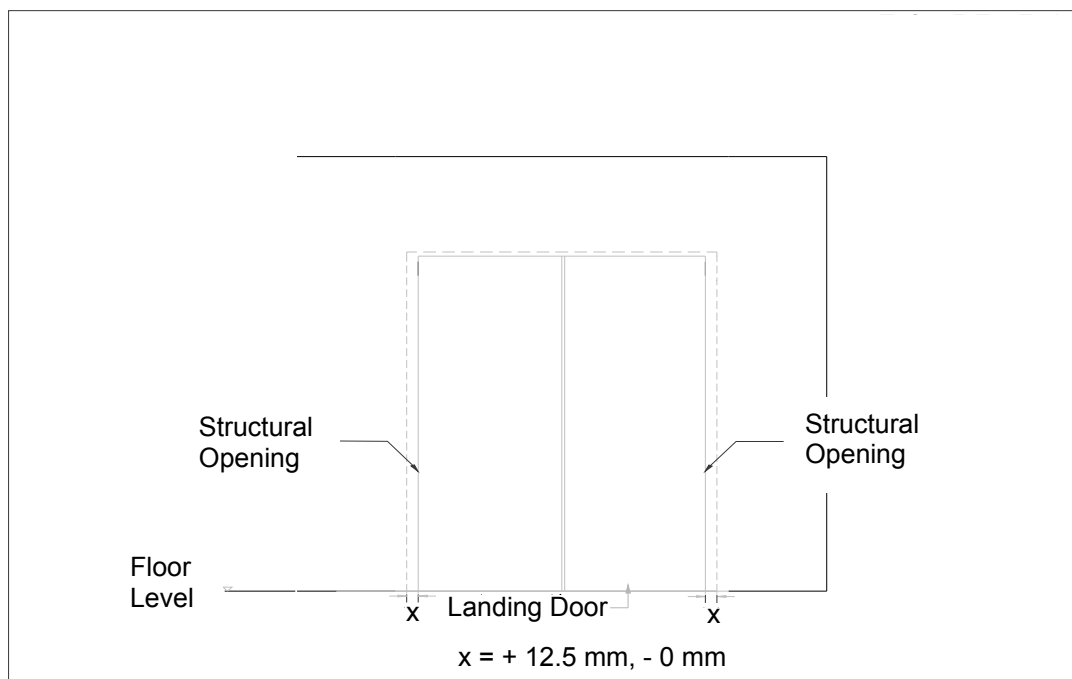

FIGURE D3: ACCURACY OF STRUCTURAL OPENING



	SECTION D : CONCRETE WORKS	No. Dokumen : JKR 20800-0183-14 No. Keluaran : 01 No. Pindaan : 00 Tarikh : 29 Januari 2014 Muka Surat : D/33
---	-----------------------------------	---

12.4 Floors

- 12.4.1 After initial set, the upper surface of cast-in-situ reinforced concrete floors shall be trowelled smooth with a steel float to true level and even surface. No screeding of any kind shall be applied to the floor slabs except where specified. Care shall be taken to ensure that the steel reinforcement is not displaced or lowered during trowelling.
- 12.4.2 For areas, which are to receive rendering or other finishes, the fresh concrete shall be trowelled to true level or as required using a long timber trowel. Before it hardens it shall be brushed with a stiff broom in one direction to give a rough and tidy surface.
- 12.4.3 The reinforced concrete ground floor slab shall not be laid directly onto earth surfaces. A blinding layer of 50 mm minimum thick of lean concrete as specified in sub-section 9.0 shall be laid on well prepared firm ground. Plastic sheeting or other suitable material with sufficient overlaps at joints, shall be laid on the blinding layer before any reinforcement is placed in position.

12.5 Toilet Floors

- 12.5.1 The Contractor shall ensure that all suspended floor for toilet areas are constructed to be watertight and leak proof. All construction method or alternative details proposed by the Contractor must be based on his acceptance of and compliance with the requirements for watertightness. The Contractor shall ensure that holes and fixings are properly constructed.
- 12.5.2 The floor must be concreted in one sequence of operation. No construction joints for toilet floor are to be allowed. All pipes and fittings encased in the concrete floor shall be provided with sleeves to the approval of the S.O and shall be built in-situ. No holes shall be left for later incorporation of fittings and no subsequent hacking of floor shall be made. Notwithstanding whatever shown on the Drawings, all toilet floor slabs shall have a minimum thickness of 150 mm.
- 12.5.3 Testing for watertightness
- The toilet floor areas should be ponded with water continuously over a period of 7 days. During this period the exposed soffit shall show no signs of leakage and remain dry. If any area is found not to be watertight, the Contractor must repair at his own expense.

12.6 Roofs

- 12.6.1 Reinforced concrete roofs shall be constructed to fall as shown on the Drawings and finished with steel trowelling, leaving the surface smooth and free from mortar droppings.
- 12.6.2 The base slab shall be concreted as described for concrete generally, ensuring thorough compactions by the use of a pan vibrator or a vibrating screen. Concrete shall be poured continuously between pre-determined construction joints as decided by the S.O., or as shown on the Drawings. Expansion joints, where applicable, shall be allowed and constructed exactly as indicated in the Drawings.

 <p>JKR MALAYSIA</p>	<p>SECTION D : CONCRETE WORKS</p>	<p>No. Dokumen : JKR 20800-0183-14 No. Keluaran : 01 No. Pindaan : 00 Tarikh : 29 Januari 2014 Muka Surat : D/34</p>
--	--	--

- 12.6.3 Unless otherwise specified or shown on the Drawings, waterproofing screed to reinforced concrete flat roof shall consist of a 32 mm thick screed reinforced with temperature steel.
- 12.6.4 The waterproofing screed shall consist of one (1) part of cement and three (3) parts of clean well-graded sand (1:3), and shall be mixed with an approved waterproofing agent and approved plasticizer in the proportion recommended by the manufacturer.
- 12.6.5 The temperature steel shall consist of a mesh 6 mm diameter mild steel bars at 150 mm centers each way, or alternatively steel fabric of MS 145. The temperature steel shall be placed directly on top of the base slab, and a minimum cover of 19 mm to top bars of the temperature steel shall be maintained.
- 12.6.6 The screed shall be laid after the base slab concrete has sufficiently hardened but not later than 36 hours after the concreting of the base slab, to obtain a thorough bond between the screed and the base slab. The surface shall be finished with a wood float, and followed by a steel trowel to a smooth finish.
- 12.6.7 Unless otherwise specified or shown on the Drawings, joints in the screed shall be allowed and located over the main roof beams and shall be filled with approved bituminous compound as soon as possible.
- 12.6.8 After the screed has been placed, the full area shall be properly protected and cured for a period of at least seven (7) days. Alternatively as soon as the screed has sufficiently hardened to withstand a man's weight without marking, an approved plastic sealing agent shall be sprayed in accordance with the manufacturer's recommendation.

12.7 Drips

Unless otherwise shown on the Drawings or directed by the S.O., a 15mm wide drip shall be formed along edges of soffits to concrete roof slabs, hoods, undersides of balconies, cantilevered beams and slabs and other parts of building where rain water is likely to adhere in drops.

12.8 Refuse Chutes

Where shown on the Drawings, all cast-in-situ reinforced concrete refuse chutes shall be constructed without bolt holes made through the chute walls. If such holes are unavoidable then they shall be completely grouted with cement mortar as specified in sub-section 6.2 or sealed and waterproofed by other means to prevent leakage to the approval of the S.O. Frames which shall not be of asbestos cement, shall be cast into refuse chute walls for fixing chute hoppers. Such frames shall be obtained from the same supplier of chute hoppers.



SECTION D : CONCRETE WORKS

No. Dokumen : JKR 20800-0183-14
 No. Keluaran : 01
 No. Pindaan : 00
 Tarikh : 29 Januari 2014
 Muka Surat : D/35

TABLE D1 : COMPOSITION OF COMMON CEMENTS

Main	Notation of 27 products (types of common cement)		Composition [percentage by mass ^{a)}]										Minor additional constituents	
			Main constituents											
			Clinker	Blast-furnace slag	Silica fume	Pozzolano		Fly ash		Burnt shale	Limestone			
						Natural	Natural calcine	siliceous	calcareous		L	LL		
K	S	D ^{b)}	P	Q	V	W	T	L	LL					
CEM I	Portland cement	CEM I	95 - 100	-	-	-	-	-	-	-	-	-	0 - 5	
		Portland-slag cement	CEM II /A-S	80 - 94	6 - 20	-	-	-	-	-	-	-	-	0 - 5
			CEM II /B-S	65 - 79	21 - 35	-	-	-	-	-	-	-	0 - 5	
CEM II	Portland-silica fume cement	CEM II /A-D	90 - 94	-	6 - 10	-	-	-	-	-	-	-	0 - 5	
		Portland types - pozzolana cement	CEM II /A-P	80 - 94	-	-	6 - 20	-	-	-	-	-	-	0 - 5
	CEM II /B-P		65 - 79	-	-	21 - 35	-	-	-	-	-	-	0 - 5	
	CEM II /A-Q		80 - 94	-	-	-	6 - 20	-	-	-	-	-	0 - 5	
			CEM II /B-Q	65 - 79	-	-	21 - 35	-	-	-	-	-	0 - 5	
	Portland-fly ash cement	CEM II /A-V	80 - 94	-	-	-	-	6 - 20	-	-	-	-	0 - 5	
		CEM II /B-V	65 - 79	-	-	-	-	21 - 35	-	-	-	-	0 - 5	
		CEM II /A-W	80 - 94	-	-	-	-	-	6 - 20	-	-	-	0 - 5	
		CEM II /B-W	65 - 79	-	-	-	-	-	21 - 35	-	-	-	0 - 5	
	Portland-burnt shale cement	CEM II /A-T	80 - 94	-	-	-	-	-	-	6 - 20	-	-	0 - 5	
		CEM II /B-T	65 - 79	-	-	-	-	-	-	21 - 35	-	-	0 - 5	
	Portland-limestone cement	CEM II /A-L	80 - 94	-	-	-	-	-	-	-	6 - 20	-	0 - 5	
		CEM II /B-L	65 - 79	-	-	-	-	-	-	-	21 - 35	-	0 - 5	
		CEM II /A-LL	80 - 94	-	-	-	-	-	-	-	-	6 - 20	0 - 5	
		CEM II /B-LL	65 - 79	-	-	-	-	-	-	-	-	21 - 35	0 - 5	
	Portland-composite cement ^{c)}	CEM II /A-M	80 - 94	6 to 20									0 - 5	
		CEM II /B-M	65 - 79	21 to 25									0 - 5	
	CEM III	Blast-furnace cement	CEM III /A	35 - 64	36 - 65	-	-	-	-	-	-	-	-	0 - 5
			CEM III /B	20 - 34	66 - 80	-	-	-	-	-	-	-	-	0 - 5
			CEM III /C	5 - 19	81 - 95	-	-	-	-	-	-	-	-	0 - 5
CEM IV	Pozzolanic cement ^{c)}	CEM IV /A	65 - 89	11 to 35						-	-	-	0 - 5	
		CEM IV /B	45 - 64	36 to 66						-	-	-	0 - 5	
CEM V	Composite cement ^{c)}	CEM V /A	40 - 64	18 - 30	18 to 30			-	-	-	-	0 - 5		
		CEM V /B	20 - 38	31 - 50	31 to 50			-	-	-	-	0 - 5		

^{a)} The values in the table refer to the sum of the main and minor additional constituents
^{b)} The proportion of silica fume is limited to 10%
^{c)} In Portland-composite cements CEM II/A-M and CEM II/B-M, in Pozzolanic cements CEM IV/A and CEM IV/B and in composite cements CEM V/A and CEM V/B the main constituents other than clinker shall be declared by designation of the cement

 JKR MALAYSIA	SECTION D : CONCRETE WORKS	No. Dokumen : JKR 20800-0183-14
		No. Keluaran : 01
		No. Pindaan : 00
		Tarikh : 29 Januari 2014
		Muka Surat : D/36

TABLE D2 : TESTING OF AGGREGATES

Properties	Type of Aggregate	Test Methods	Limits
Grading	Both	MS30	Table 3 and Table 4
Elongation Index	Coarse	MS30	Not exceeding 30%
Flakiness Index	Coarse	MS30	Not exceeding 35%
Water Absorption	Both	MS30	Not exceeding 8%
Clay Lumps	Coarse	MS30	Not exceeding 1% by weight
Clay, Silt and Dust	Fine	MS30	Not exceeding 3% by weight or 8% by vol.
Organic Impurities	Fine	MS30	Not exceeding 0.4%
Aggregate Crushing Value	Coarse	MS30	Not exceeding 40%
Soundness Test	Coarse	MS30	Loss in mass after 5 cycles shall not be more than 12% for sodium sulphate or 18% for magnesium sulphate.
Chloride Content	Both	MS30	Not exceeding 0.06% by weight of chloride ions
Sulphate Content	Both	MS30	Not exceeding 0.44% by weight of SO ₃

TABLE D3 : GRADING FOR COARSE AGGREGATE

Sieve size (BS410)	Percentage by mass passing BS 410 sieve for nominal sizes					
	Graded Aggregates			Single-sized Aggregate		
	40 mm to 5 mm	20 mm to 5 mm	14 mm to 5 mm	40 mm	20 mm	10 mm
50.0 mm	100	-	-	100	-	-
37.5 mm	90 to 100	100	-	85 to 100	100	-
20.0 mm	35 to 70	90 to 100	100	0 to 25	85 to 100	-
14.0 mm	25 to 55	40 to 80	90 to 100	-	0 to 70	100
10.0 mm	10 to 40	30 to 60	50 to 85	0 to 5	0 to 25	85 to 100
5.0 mm	0 to 5	0 to 10	0 to 10	-	0 to 5	0 to 25
2.36 mm	-	-	-	-	-	0 to 5

TABLE D3A : GRADING FOR FINE AGGREGATE

Sieve size (BS410)	Percentage by mass passing BS 410 sieve			
	Overall Limits	Additional limits for grading		
		C	* M	F
10.0 mm	100	-	-	-
5.0 mm	80 to 100	-	-	-
2.36 mm	60 to 100	60 to 100	65 to 100	80 to 100
1.18 mm	30 to 100	30 to 90	45 to 100	70 to 100
600 µm	15 to 100	15 to 45	25 to 80	55 to 100
300 µm	5 to 70	5 to 40	5 to 48	5 to 70
150 µm	0 to 15#	-	-	-
#	Increase to 20% for crushed rock fines, except when they are used for heavy-duty floors.			
*	For prescribed mix only Grading Limit M is applicable. See also sub-section 2.2.3(b)			
NOTE:	Individual sands may comply with the requirements of more than one grading. Alternatively some sands which satisfy the overall limits but may not fall within any one of the additional limit C, M or F may also be used provided that the supplier can satisfy the S.O that such materials can produce concrete of the required quality.			



SECTION D : CONCRETE WORKS

No. Dokumen : JKR 20800-0183-14
 No. Keluaran : 01
 No. Pindaan : 00
 Tarikh : 29 Januari 2014
 Muka Surat : D/37

TABLE D4 : ADMIXTURE ACCEPTANCE TEST REQUIREMENTS

Categories of Admixture	Water Reduction	Stiffening Time Time from completion of mixing to reach a resistance to penetration of:-			Minimum Strength as a percentage of the control mix	Age	Length change, Maximum shrinkage	
		0.5N /mm ²	3.5N /mm ²	27.5 /mm ²			Compressive	% of control
Type 1: Accelerator	-	More than 1hr.	Within 1hr. and 3hrs. earlier than control mix	At least 1hr. earlier than control mix	125 125 100 100	24 hrs. 3 days 7 days 28 days	135	0.010
Type 2: Retarder	-	At least 1hr. later than control mix	Within 1hr. and 3hrs. later than control mix	Not more than 3hrs. later than control mix	90 90 95	3 days 7 days 28 days	135	0.010
Type 3: Normal water-reducing	At least 5%	Within + 1hr. and - 1hr. of control mix	Within + 1hr. and - 1hr. of control mix	Within + 1hr. and - 1hr. of control mix	110 110 110	3 days 7 days 28 days	135	0.010
Type 4: Accelerating water-reducing	At least 5%	More than 1hr.	Within 1hr. and 3hrs. earlier than control mix	At least 1hr. earlier than control mix	125 125 100 100	24 hrs. 3 days 7 days 28 days	135	0.010
Type 5: Retarding water-reducing	At least 5%	At least 1hr. later than control mix	Within 1hr. and 3hrs. earlier than control mix	Not more than 3hrs. later than control mix	110 110 110	3 days 7 days 28 days	135	0.010

 JKR MALAYSIA	SECTION D : CONCRETE WORKS	No. Dokumen : JKR 20800-0183-14
		No. Keluaran : 01
		No. Pindaan : 00
		Tarikh : 29 Januari 2014
		Muka Surat : D/38

TABLE D5 : PRESCRIBED MIXES FOR GENERAL USE PER CUBIC METER OF CONCRETE BY WEIGHT BATCHING

Grades of Concrete	28-day Strength of Concrete (N/mm ²)	Nominal Max. Size of Aggregate (mm) 20			Max free water: cement ratios
		Workability	Medium	High	
		Consistence	25 - 75	75 - 125	
15P	15	CEM I (kg) Total aggregate(kg) *Fine aggregate (%)	280 1800 35 - 50	310 1750 35 - 50	0.6
20P	20	CEM I (kg) Total aggregate(kg) *Fine aggregate (%)	320 1800 25 - 40	350 1750 20 - 45	0.55
25P	25	CEM I (kg) Total aggregate(kg) *Fine aggregate (%)	360 1750 25 - 40	390 1700 30 - 45	0.5
30P	30	CEM I (kg) Total aggregate(kg) *Fine aggregate (%)	400 1700 25 - 40	430 1650 30 - 45	0.45

*Fine aggregate is expressed as a percentage by weight to the total weight of the dry aggregate

TABLE D5A : PROPORTIONS AND STRENGTH REQUIREMENTS FOR PRESCRIBED MIXES BY VOLUME BATCHING

Proportion (Grade)	Slump Limits (mm)	Cubic Meters of Aggregate Per 50 kg of CEM I		Max. Free Water: Cement Ratio	Quantity Of Water (Litres)	Strength of Concrete	
		Fine	Coarse (20mm)			At 7 Days (N/mm ²)	At 28 Days (N/mm ²)
1:1:2(30P)	25 - 50	0.035	0.07	0.45	22.5	20	30
1:1.5:3(25P)	25 - 50	0.05	0.1	0.5	25	17	25
1:2:4(20P)	25 - 50	0.07	0.14	0.55 - 0.6	27.5 - 30	14	20
1:3:6(15P)	25 - 50	0.10	0.20	0.6	30#	11	15

or as approved by S.O.



SECTION D : CONCRETE WORKS

No. Dokumen : JKR 20800-0183-14
 No. Keluaran : 01
 No. Pindaan : 00
 Tarikh : 29 Januari 2014
 Muka Surat : D/39

TABLE D6 : DURABILITY RECOMMENDATIONS FOR REINFORCED OR PRESTRESSED ELEMENTS WITH AN INTENDED WORKING LIFE OF AT LEAST 50 YEARS

Nominal cover ^{b)} mm	Compressive strength class where recommended, maximum water-cement ratio and minimum cement or combination content for normal-weight concrete ^{c)} with 20mm maximum aggregate size ^{d)}								Cement/ combination types	
	15+Δc	20+Δc	25+Δc	30+Δc	35+Δc	40+Δc	45+Δc	50+Δc		
Corrosion induced by carbonation (XC exposure classes)										
XC 1	C20/25 0.70 240	C20/25 0.70 240	C20/25 0.70 240	C20/25 0.70 240	C20/25 0.70 240	C20/25 0.70 240	C20/25 0.70 240	C20/25 0.70 240	C20/25 0.70 240	All in Table D1
XC2	-	-	C25/30 0.65 260	C25/30 0.65 260	C25/30 0.65 260	C25/30 0.65 260	C25/30 0.65 260	C25/30 0.65 260	C25/30 0.65 260	All in Table D1
XC3	-	C40/50 0.45 340	C30/37 0.55 300 C40/50 0.45 340	C28/35 0.60 280 C30/37 0.55 300	C25/30 0.65 260 C28/35 0.60 280	C25/30 0.65 260 C25/30 0.65 260	C25/30 0.65 260 C25/30 0.65 260	C25/30 0.65 260 C25/30 0.65 260	C25/30 0.65 260 C25/30 0.65 260	All in Table D1 except IVB-V IVB_V
Corrosion induced by chlorides (XS from sea water, XD other than sea water) Also adequate for any associated carbonation induced corrosion (XC)										
XD1	-	-	C40/50 0.45 360	C32/40 0.55 320	C28/35 0.60 300	C28/35 0.60 300	C28/35 0.60 300	C28/35 0.60 300	C28/35 0.60 300	All in Table D1
XS1	-	-	-	C45/5 0.35 380 C40/50 0.35 380 C32/40 0.40 380 C32/40 0.40 380	C35/45 0.45 360 C32/40 0.45 360 C25/30 0.50 340 C28/35 0.50 340	C32/40 0.50 340 C28/35 0.50 340 C25/30 0.50 340 C25/30 0.50 340	C32/40 0.50 340 C25/30 0.55 320 C25/30 0.55 320 C25/30 0.55 320	C32/40 0.50 340 C25/30 0.55 320 C25/30 0.55 320 C25/30 0.55 320	C32/40 0.50 340 C25/30 0.55 320 C25/30 0.55 320 C25/30 0.55 320	CEM I, IIA, IIB-S, SRPC IIB-V, IIIA IIIB IVB-V
XD2 or XS2	-	-	-	C40/50 0.40 380 C35/45 0.40 380 C32/40 0.40 380	C32/40 0.50 340 C28/35 0.50 340 C25/30 0.50 340	C28/35 0.55 320 C25/30 0.55 320 C20/25 0.55 320	C28/35 0.55 320 C25/30 0.55 320 C20/25 0.55 320	C28/35 0.55 320 C25/30 0.55 320 C20/25 0.55 320	C28/35 0.55 320 C25/30 0.55 320 C20/25 0.55 320	CEM I, IIA, IIB-S, SRPC IIB-V, IIIA IIIB, IVB-V
XD3	-	-	-	-	-	C45/55 0.35 380 C35/45 0.40 380 C32/40 0.40 380	C40/50 0.40 380 C28/35 0.45 360 C28/35 0.45 360	C35/45 0.45 360 C28/35 0.50 340 C25/30 0.50 340	C35/45 0.45 360 C28/35 0.50 340 C25/30 0.50 340	CEM I, IIA, IIB-S, SRPC IIB-V, IIIA IIIB, IVB-V
XS3	-	-	-	-	-	- C35/45 0.40 380 C32/40 0.40 380	C45/55 0.35 380 C32/40 0.45 360 C28/35 0.45 360	C40/50 0.40 380 C28/35 0.50 340 C25/30 0.50 340	C40/50 0.40 380 C28/35 0.50 340 C25/30 0.50 340	CEM I, IIA, IIB-S, SRPC IIB-V, IIIA IIIB, IVB-V

 JKR MALAYSIA	SECTION D : CONCRETE WORKS	No. Dokumen : JKR 20800-0183-14
		No. Keluaran : 01
		No. Pindaan : 00
		Tarikh : 29 Januari 2014
		Muka Surat : D/40

TABLE D6A: MINIMUM CEMENT CONTENT FOR MAXIMUM AGGREGATE SIZES OTHER THAN 20 MM

Limiting values given for 20 mm maximum aggregate size		Maximum aggregate size		
Maximum w/c ratio	Minimum cement or combination content Kg/m ³	≥ 40 mm	14 mm	10 mm
0.70	240	240	260	280
0.65	260	240	280	300
0.60	280	260	300	320
0.55	300	280	320	340
	320	300	340	360
0.50	320	300	340	360
	340	320	360	380
0.45	340	320	360	360
	360	340	380	380
0.40	380	360	380	380
	380	380	380	380

TABLE D7: SLUMP CLASSES

Class	Slump in mm
S1	10 to 40
S2	50 to 90
S3	100 to 150
S4	160 to 210
S5	≥ 220

TABLE D7A: COMPACTION CLASSES

Class	Degree Of Compactibility
C0	≥ 1.46
C1	1.45 to 1.26
C2	1.25 to 1.11
C3	1.10 to 1.04

TABLE D7B: VEBE CLASSES

Class	Vebe Time In Seconds
V0	≥31
V1	30 to 21
V2	20 to 11
V3	10 to 6
V4	5 to 3

TABLE D7C: FLOW CLASSES

Class	Flow Diameter In mm
F1	≤ 340
F2	350 to 410
F3	420 to 480
F4	490 to 550
F5	560 to 620
F6	≥ 630

 JKR MALAYSIA	SECTION D : CONCRETE WORKS	No. Dokumen : JKR 20800-0183-14
		No. Keluaran : 01
		No. Pindaan : 00
		Tarikh : 29 Januari 2014
		Muka Surat : D/41

TABLE D7D: CONSISTENCE SUITABLE FOR DIFFERENT USES OF IN-SITU CONCRETE

Use of concrete	Form of compaction	Consistence class	
		Normal-weight concrete	Lightweight concrete
Kerb bedding and braking	Tamping	S1	-
Floors and hand placed pavements	Poker or beam vibration	S2	S2
Strip footings	Poker or beam vibration and/or tamping	S3	-
Mass concrete foundations		S3	-
Blinding		S3	-
Normal reinforced concrete in slabs, beams, walls and columns		S3	S3
Sliding formwork construction		S3	S2
Pumped concrete		S3	F5
Vacuum processed concrete		S3	S3
Trench fill		Self-weight compaction	S4
In-situ piling	S4		-

TABLE D7E: MAXIMUM TOTAL CHLORIDE

Type or Use of Concrete	Maximum Total Percentage of Chloride Ions by Mass of Cement
Concrete containing embedded metal and made with cement complying with MS522	0.4
Prestressed Concrete and Heat-Cured Concrete containing embedded metal	0.1
Plain, non-structural concrete	No limit

Notes on Table 7:-

(1)% Chloride ions x 1.648 = % equivalent sodium chlorides.

(2)% Chloride ions x 1.56 = % equivalent anhydrous calcium chlorides.

TABLE D8 : COMPRESSIVE STRENGTH CLASSES FOR NORMAL WEIGHT AND HEAVY WEIGHT CONCRETE

Compressive strength class	Minimum characteristic cylinder strength $f_{ck,cyl}$ N/mm ²	Minimum characteristic cube strength $f_{ck,CUBE}$ N/mm ²
C8/10	8	10
C12/15	12	15
C16/20	16	20
C20/25	20	25
C25/30	25	30
C30/37	30	37
C35/45	35	45
C40/50	40	50
C45/55	45	55
C50/60	50	60
C55/67	55	67
C60/75	60	75
C70/85	70	85
C80/95	80	95
C90/105	90	105
C100/115	100	115

 JKR MALAYSIA	SECTION D : CONCRETE WORKS	No. Dokumen : JKR 20800-0183-14
		No. Keluaran : 01
		No. Pindaan : 00
		Tarikh : 29 Januari 2014
		Muka Surat : D/42

TABLE D9 : COMPRESSIVE STRENGTH CLASSES FOR LIGHT WEIGHT CONCRETE

Compressive strength class	Minimum characteristic cylinder strength $f_{ck,cyl}$ N/mm ²	Minimum characteristic cube strength $f_{ck,CUBE}$ N/mm ²
LC8/9	8	9
LC12/13	12	13
LC16/18	16	18
LC20/22	20	22
LC25/28	25	28
LC30/33	30	33
LC35/38	35	38
LC40/44	40	44
LC45/50	45	50
LC50/55	50	55
LC55/60	55	60
LC60/66	60	66
LC70/77	70	77
LC80/88	80	88

Other values may be used if the relationship between these and the reference cylinder strength is established with sufficient accuracy and is documented.

TABLE D10 : MINIMUM RATE OF SAMPLING FOR ASSESSING CONFORMITY

Production	Minimum rate of sampling for assessing conformity		
	First 50m ³ of production	Subsequent to first 50m ³ of production ^a	
		Concrete with production control certification	Concrete without production control certification
Initial (until at least 35 test results are obtained)	3 samples	1/200m ³ or 2/production week	1/150m ³ or 1/production day
Continuous ^b (when at least 35 test results are available)		1/400m ³ or 1/production week	

^a Sampling shall be distributed throughout the production and should not be more than 1 sample within each 25 m³

^b Where the standard deviation of the last 15 results exceeds 1,37σ, the sampling rate shall be increased to that required for initial production for the next 35 test results

TABLE D11 : CONFORMITY CRITERIA FOR COMPRESSIVE STRENGTH

Production	Number <i>n</i> of test results for compressive strength in the group	Criterion 1	Criterion 2
		Mean of <i>n</i> results (f_{cm}) N/mm ²	Any individual test result (f_{ci}) N/mm ²
Initial	3	$\geq f_{ck} + 4$	$\geq f_{ck} - 4$
Continuous	15	$\geq f_{ck} + 1,48\sigma$	$\geq f_{ck} - 4$

 JKR MALAYSIA	SECTION D : CONCRETE WORKS	No. Dokumen : JKR 20800-0183-14
		No. Keluaran : 01
		No. Pindaan : 00
		Tarikh : 29 Januari 2014
		Muka Surat : D/43

TABLE D12 : COMPRESSIVE STRENGTH REQUIREMENTS FOR PRESCRIBED MIX

Grades of Concrete	28-day Strength of Concrete N/mm ²	Cube Strength at 7 Days* N/mm ²	Average Cube Strength at 28 Days* N/mm ²
20P	20.0	14	20.0
25P	25.0	17	25.0
30P	30.0	20	30.0

*Only for CEM1

TABLE D13 : IDENTITY CRITERIA FOR COMPRESSIVE STRENGTH

Number n of test results for compressive strength from the defined volume of concrete	Criterion 1	Criterion2
	Mean of n results (f_{cm}) N/mm ²	Any individual test result (f_{cl}) N/mm ²
1	Not applicable	$\geq f_{ck} - 4$
2-4	$\geq f_{ck} + 1$	$\geq f_{ck} - 4$
5-6	$\geq f_{ck} + 2$	$\geq f_{ck} - 4$

NOTE: The identity criteria of table 13 give probability that a conforming concrete volume is rejected.

TABLE D14 : IDENTITY CRITERIA FOR SLUMP SPECIFIED AS A SLUMP CLASS

Specified Slump Class	Requirement			
	For composite samples taken in accordance with BS EN 12350-1		For spot samples taken from initial discharge	
	Not less than	Not more than	Not less than	Not more than
S1	0	60	0	70
S2	40	110	30	120
S3	90	170	80	180
S4	150	230	140	240
S5	210	-	200	-

NOTE : Dimension in millimeters

TABLE D15 : IDENTITY CRITERIA FOR SLUMP SPECIFIED AS A TARGET VALUE

Specified Target Slump	Tolerance	
	For composite samples taken in accordance with BS EN 12350-1	For spot samples taken from initial discharged
≤ 40	-20, +30	-30, +40
50 to 90	-30, +40	-40, +50
≥ 100	-40, +50	-50, +60

 JKR MALAYSIA	SECTION D : CONCRETE WORKS	No. Dokumen : JKR 20800-0183-14
		No. Keluaran : 01
		No. Pindaan : 00
		Tarikh : 29 Januari 2014
		Muka Surat : D/44

TABLE D16 : RECORDED DATA AND OTHER DOCUMENTS

Subject	Recorded data and other documents
Cements, aggregates, admixture, additions	Name of suppliers
Tests on mixing water (not required for potable water)	Date and place of sampling. Test results
Test on constituent materials	Date and test results
Composition of concrete	Concrete description Record of masses of constituents in batch or load Water/cement ratio Chloride content
Tests on fresh concrete	Date and place of sampling Location in structure Consistence (slump or other methods) Density Concrete temperature Air content Volume of concrete batch or load tested Number and codes of specimens to be tested Water/cement ratio
Tests on hardened concrete	Date of testing Code and ages of specimens Test results for density and strength Special remarks (e.g. unusual failure pattern of specimen)
Evaluation of conformity	Conformity/non-conformity with specifications
Additionally for ready mixed concrete	Location of work Numbers and dates of delivery tickets related to tests Delivery tickets

TABLE D17 : CHARACTERISTIC STRENGTH OF STEEL REINFORCEMENT

Type	Nominal Sizes (mm)	Specified Characteristic Strength, f_y (N/mm ²)
Hot rolled grade 250 (MS 146)	All sizes	250
Hot rolled grade 460 (MS 146)	All sizes	460
Cold worked (BS 4461)	All sizes	460
Hard drawn steel wire (MS 144)	Up to and including 12	485

TABLE D18 : MINIMUM PERIODS BETWEEN CONCRETING AND REMOVAL OF FORMS

Vertical faces of beams, wall, columns, piles, foundation plinths and precast components	3 days
Slabs (props left under)	4 days
Removal of props to slab	10 days
Beam soffits (props left under)	8 days
Removal of props to beams	21 days

Note: This table is applicable only for CEM1 cement. Where other types of cement, admixtures or additional material are to be used, the minimum periods between concreting and removal of forms shall be as approved by the S.O.

TABLE OF CONTENTS

SECTION E : NON-STRUCTURAL WALL SYSTEM

	PAGE
1. General	E/1
2. Bricks and Blocks	E/3
3. Walling	E/4

 JKR MALAYSIA	SECTION E : NON-STRUCTURAL WALL SYSTEM	No. Dokumen : JKR 20800-0183-14 No. Keluaran : 01 No. Pindaan : 00 Tarikh : 29 Januari 2014 Muka Surat : E/1
--	---	--

1. General

1.1 Cement

The cement, unless otherwise described, shall be CEM 1 complying with MS EN 197-1 and as specified under SECTION D: CONCRETE WORKS.

1.2 Sand

Sand for mortar shall comply with MS EN 12620 and as specified in SECTION D: CONCRETE WORKS.

1.3 Mortar

1.3.1 Mortar shall consist of one (1) part of cement to six (6) parts of sand, with the addition of an approved mortar plasticizer used strictly in accordance with manufacturer's recommendation. The ingredients for mortar shall be measured in proper gauge boxes and shall be mixed on a clean boarded platform or in an approved mechanical batch mixer.

1.3.2 All mortar shall be used within forty five (45) minutes of mixing and no remaking up of mortar shall be permitted thereafter.

1.3.3 Mortar for brickwork below damp proof course or ground floor level shall be in the proportion of one part of cement and three parts of sand.

1.4 Damp Proof Course

1.4.1 Unless otherwise shown on the Drawings, bituminous damp proof courses shall comply with BS 8215: Code of practice for design and installation of damp-proof courses in masonry construction. The bitumen damp proof membrane shall be two (2) ply with a nominal mass of 1840 g/m².

1.4.2 Bitumen damp proof course shall be in rolls to suit the thickness of walls or brickwork. The damp proof course shall be bedded on a level bed of cement mortar (1:1) and lapped at least 150mm or the width of the damp proof course at running joints and intersections.

1.4.3 In all cases of doubt as to the exact location of the damp proof course, the Contractor shall refer to the S.O. before laying the damp proof course. The damp proof course above ground shall be continuous for the whole length and thickness of the wall and be at least 150 mm above finished ground level to prevent moisture from the ground rising through the foundation to the wall above ground, which otherwise would make wall surfaces damp and damage wall finishes.

1.5 Loading

All internal lightweight partitions shall be constructed only for their intended purposes and any additional loadings shall be referred to the S.O. for approval.

1.6 Insulation (Acoustical and Thermal)

1.6.1 Unless otherwise specified or shown on the Drawings, acoustic wall panel and/or systems shall be constructed and calculated according to requirements of acoustic specialist and approved by S.O.'s approval.

 <p>JKR MALAYSIA</p>	<p>SECTION E : NON-STRUCTURAL WALL SYSTEM</p>	<p>No. Dokumen : JKR 20800-0183-14 No. Keluaran : 01 No. Pindaan : 00 Tarikh : 29 Januari 2014 Muka Surat : E/2</p>
--	--	---

- 1.6.2 Thermal insulation system shall comply with MS1020. Samples of the insulation material shall be submitted to the S.O for approval before they are used and subsequent delivery shall be up to the standard of samples approved.
- 1.6.3 Unless otherwise shown in the Drawings, glass wool insulation shall be 50mm thick. It shall have a conductive value of maximum 0.035 W/m²K (tested at a mean temperature of 20°C based MS1020 tested according to ASTM C177/C518). Glass wool insulation shall be fixed in accordance with the manufacturer's recommendation and to the approval of the S.O.
- 1.6.4 Where stone wool insulation is to be used, it shall be 50mm thick. It shall have a conductive value of maximum 0.035 W/m²K (tested at a mean temperature of 20°C based MS1020 tested according to ASTM C177/C518). Stone wool insulation shall be fixed in accordance with the manufacturer's recommendation and to the approval of the S.O.
- 1.6.5 Use of foam based insulation shall be prohibited due to health hazard. Foam based insulation release toxic substances when heated and burned.
- 1.7 Fire Rating
- 1.7.1 Unless otherwise specified or shown on the Drawings, fire rated walls and partitions system shall be constructed and calculated according to requirements and approval of the DGFR and compliance to the Uniform Building By-Law (UBBL).
- 1.7.2 The glass wool and stone wool insulation materials used shall comply with BS 476 - Fire tests on building materials and structures:
- (i) Non-combustibility test for materials
 - (ii) Method of test for fire propagation for products
 - (iii) Method of test to determine the classification of the surface spread of flame of products
- 1.8 Type Of Finishes To Walls And Partitions
- 1.8.1 Unless otherwise shown in the Drawings, all plastering works for brick walls shall include the wall surface area above ceiling finish level.
- 1.8.2 Unless otherwise specified or shown on the drawings, the appropriate type of finishes for walls and partitions shall be as specified in the Schedule of Finishes. Unless otherwise shown on the Drawings or described in the B.Q., The finishes and their dimensions shall be as specified in SECTION K: PLASTERING, PAVING AND TILING WORKS and SECTION O: PAINTING WORKS.
- 1.9 Samples And Mock-up
- 1.9.1 Samples and mock-up of wall construction shall be provided and approved by the S.O. prior to the commencement of the actual construction works. The size of the samples shall be determined by the S.O.
- 1.9.2 The samples and mock-up for walls and partitions shall include connections between the following components where applicable:
- (i) Floor to floor to a minimum of 5 meter length
 - (ii) Wall corners
 - (iii) Lintels

 JKR MALAYSIA	SECTION E : NON-STRUCTURAL WALL SYSTEM	No. Dokumen : JKR 20800-0183-14 No. Keluaran : 01 No. Pindaan : 00 Tarikh : 29 Januari 2014 Muka Surat : E/3
--	---	--

- (iv) Stiffeners
- (v) Door and window frames
- (vi) All other walls between different materials

2. Bricks And Blocks

2.1 General

All brick walls shall have G.I expanded/exmet mesh reinforcement with 750 mm x 5 mm diameter brickwork dowel bar complete with 75 mm right angle bent to hook onto brickwork at every 4th course.

2.2 Samples

Separate samples of each type of bricks and blocks taken at random from the load, shall be submitted to the S.O. for approval before the bricks and blocks are used. All subsequent deliveries shall generally be up to the standard of the samples approved. No soft, broken, twisted or otherwise defective bricks and blocks will be permitted to be used.

2.3 Clay Bricks

All ordinary clay bricks shall be machine-made, wire cut and shall be hard, well burnt, sound, square and clean all in accordance with MS 76.

2.4 Cement Sand Bricks And Hollow Blocks

2.4.1 All cement sand bricks and hollow blocks shall comply with MS 27.

2.4.2 The dimensions of blocks shall comply with MS 1064.

2.4.3 Wherever blocks are used, a modular sized block shall be used and constructed in accordance with the manufacturer's standards, requirements and method statements.

2.4.4 The composition of cement sand bricks and hollow blocks shall consist of a uniform mixture of sand and cement. The sand cement shall be mixed in the ratio of six (6) parts of sand to one (1) part of cement by volume in a mechanical mixer capable of taking one (1) bag of cement (50 kg of cement shall be taken as 0.035 cube). The sand used shall be as described hereinbefore and the maximum size shall pass through a 4.8 mm mesh BS sieve. The cement used shall be CEM 1 as described under SECTION D: CONCRETE WORKS.

2.4.5 The Contractor shall only use cement sand bricks and hollow blocks supplied by approved manufacturer.

2.4.6 The minimum permissible average compressive strength shall be 5.2 N/mm² for bricks and 2.8 N/mm² for hollow blocks per 10 samples taken at random from the Contractor's stock pile of 1000 or part thereof. All rejected or condemned bricks shall be removed from site at the Contractor's expense.

 <p>JKR MALAYSIA</p>	<p>SECTION E : NON-STRUCTURAL WALL SYSTEM</p>	<p>No. Dokumen : JKR 20800-0183-14 No. Keluaran : 01 No. Pindaan : 00 Tarikh : 29 Januari 2014 Muka Surat : E/4</p>
--	--	---

2.5 Autoclaved Aerated Concrete Block

- 2.5.1 Autoclaved aerated concrete blocks shall be high pressure steam cured consisting of a mixture of ordinary cement, sand and lime. The mix shall be free from asbestos or toxic substances.
- 2.5.2 Where autoclaved aerated concrete blocks are used in lieu of clay bricks, a modular sized block shall be used according to manufacturer's standards, requirements and method statements.
- 2.5.3 The autoclaved aerated concrete blocks shall have the following performance criteria:
- (i) dry density of between 500 kg/m³ and 700 kg/m³;
 - (ii) dimensional accuracy of ± 1.5 mm on all faces;
 - (iii) the minimum permissible compressive strength shall be 2.5 N/mm² per 10 samples taken at random from the contractor's stock pile of 1000 or part thereof;
 - (iv) minimum fire rating of two (2) hours.

2.6 Patented Brick And Block

Patented bricks and blocks shall comply with MS 27 and shall be used and laid strictly in accordance with the manufacturer's instructions.

2.7 Large Prefabricated Panels.

Large prefabricated panels when used shall conform to MS 1313 and shall be installed strictly in accordance with the manufacturer's recommendations.

3. Walling

3.1 Brick Walling

- 3.1.1 Unless otherwise specified or shown on the Drawings, the whole of the brickwork shall be constructed with standard size clay bricks in mortar as described and the surface left ready for plastering.
- 3.1.2 All clay bricks shall be soaked in a suitable tank or pit to be provided by the Contractor for at least half an hour before being laid and shall be kept wet whilst being laid. The top of walls left off shall be thoroughly wet before work is resumed. All constructed walling must be left wet and properly protected from the direct sunlight during the following day. The Contractor shall provide sufficient means to ensure that this is done.
- 3.1.3 Cement sand bricks shall not be soaked but dipped in water before being laid and all constructed brickwork shall be protected from direct sunlight during the day on which it is laid and also during the following day and the contractor shall provide sufficient means to ensure that this is done.
- 3.1.4 All bricks shall be properly bedded in mortar and all joints shall be thoroughly flushed up and raked out to a depth of 13 mm as the works proceeds. No joint shall exceed 10 mm in thickness.
- 3.1.5 Brickwork shall be carried up perfectly true and plumb in a uniform manner. No one portion being raised more than 1m above another at one time. No overhand work shall be permitted and scaffolding shall be carried up as the

 <p>JKR MALAYSIA</p>	<p>SECTION E : NON-STRUCTURAL WALL SYSTEM</p>	<p>No. Dokumen : JKR 20800-0183-14 No. Keluaran : 01 No. Pindaan : 00 Tarikh : 29 Januari 2014 Muka Surat : E/5</p>
--	--	---

work proceeds. The vertical points of every alternate course shall be kept perpendicular over one another, and all perpend, quoins, et cetera shall be kept strictly true and square.

- 3.1.6 All intersections and angles of walls shall be properly bonded together, and all walls and piers of lengths not multiples of brick sizes shall be cut and bonded in the best approved manner. No broken bricks shall be used except where required to form bonds.
- 3.1.7 All half brick (113 mm) walls shall be reinforced at every fourth course with approved reinforcement (for example exmet) commencing two courses above floor level. For block walling, reinforcement shall be at every second course commencing one course above floor level.
- 3.1.8 All brick walls shall be constructed on reinforced concrete beams in accordance with the Drawings. No brick walls except lightweight partitions are allowed to be constructed on reinforced concrete slabs.
- 3.1.9 Unless otherwise specified, all toilet perimeter walls shall be constructed using clay bricks. Cement sand bricks shall not be used for toilet walls.
- 3.1.10 All half brick walls shall be built in Stretcher Bond.
- 3.1.11 All other brickwork shall be built in English Bond or as shown on the Drawings.

3.2 Facing Brickwork

- 3.2.1 All facing brickwork shall be executed in first quality approved facing bricks in Stretcher or Flemish Bond as shown on the Drawings, properly bonded into any backing walls, piers, et cetera. Joints shall be raked out to a depth of 13 mm and point up in coloured cement mortar to approved tints, finished with a neat struck weathered joint.
- 3.2.2 Facing brickwork shall be kept perfectly clean and no rubbing down of brickwork will be allowed.

3.3 Stonework

- 3.3.1 Unless otherwise shown on the Drawings or described in the B.Q., all stone blocks used shall be of limestone or granite whichever is more readily available within the locality of the Site and shall be free from cracks, fissures or other defects to the approval of the S.O. The stone blocks shall in general, have their largest faces parallel. Unless otherwise required, the maximum thickness of the stone blocks shall in no case exceed the thickness of the wall or portion of the structure into which it is being built.
- 3.3.2 Stone walling shall be laid random uncoursed or random coursed as shown on the Drawings. Through or bonded stones shall be used at one stone per meter square for random coursed. Where backing brick wall is shown, the through stone shall be properly bonded in such brick wall.
- 3.3.3 Unless otherwise shown on the Drawings, all stonework shall be bedded in cement and sand mortar (1:3) mix and finished with a flushed joint rubbed down with sacking. All interstices between individual stones shall be filled with mortar. Finish to exposed surfaces or random walling shall be hammer-dressed.

 <p>JKR MALAYSIA</p>	<p>SECTION E : NON-STRUCTURAL WALL SYSTEM</p>	<p>No. Dokumen : JKR 20800-0183-14 No. Keluaran : 01 No. Pindaan : 00 Tarikh : 29 Januari 2014 Muka Surat : E/6</p>
--	--	---

3.4 Hollow Block Walling

The cement sand block wall shall be laid in the manner specified for brick wall. The hollow block shall not be soaked but dipped in water before laying. The hollow block wall shall be reinforced at every second course with reinforcement commencing one course above floor level.

3.5 Autoclaved Aerated Concrete Block Walling

3.5.1 Where shown on the Drawings and/or described in the B.Q. or as an alternative to clay bricks, the Contractor may use autoclaved aerated concrete blocks for non-load bearing walls and partitions. The autoclaved aerated concrete block work shall be constructed strictly in accordance with the manufacturer's recommendations. Any extra cost in connection therewith shall be borne by the Contractor.

3.5.2 The autoclaved aerated concrete block work shall be installed using an approved thin layer of adhesive mortar to all horizontals and perpend. The first course must be made true and level using a normal layer of mortar with thin layer of adhesive to fully seal the perpend. The thin layer of adhesive shall be applied using notched trowel to obtain an even distribution of adhesive to achieve joint thickness of 2 mm to 3 mm.

3.5.3 A damp-proof course slip-joint membrane shall be laid on top of the floor slab or beams before receiving the mortar bedding to allow for differential movement between the blocks and the supporting structure.

3.5.4 The autoclaved aerated concrete block work shall be laid in a manner that the vertical joint of the lower course shall be staggered at least 100 mm relative to the vertical joint of the overlaying course.

3.5.5 Unless otherwise directed and/or shown, where concrete block walls abut concrete faces, the face shall be flushed.

3.5.6 Control joints should be built into walls at spacing not greater than 8 m centres, and at locations in accordance with manufacturer's recommendation.

3.5.7 Care must be taken to keep the walls clean, strictly in accordance with the manufacturer's recommendation. Excess adhesive must be removed progressively.

3.5.8 In lieu of cement sand plastering, the wall surfaces may be finished with suitable surface coating that has the dual properties of being waterproof and water vapour permeable and shall be applied in accordance with the manufacturer's recommendation.

3.6 Parapet And Freestanding Wall

3.6.1 Any parapet and freestanding wall consisting of 155 mm thick brick wall including plastering on both sides shall only be constructed to a maximum height of 900 mm.

3.6.2 Where shown on the Drawings, freestanding walls above 900 mm in height shall be constructed as per the engineer's detail Drawings or to the S.O.'s approval.

 <p>JKR MALAYSIA</p>	<p>SECTION E : NON-STRUCTURAL WALL SYSTEM</p>	<p>No. Dokumen : JKR 20800-0183-14 No. Keluaran : 01 No. Pindaan : 00 Tarikh : 29 Januari 2014 Muka Surat : E/7</p>
--	--	---

3.6.3 Precast reinforced concrete copings shall be constructed on all external parapet and free standing walls. The reinforced concrete coping shall be laid to fall, complete with 12 mm half round throating.

3.6.4 Freestanding walls more than 3 m length vertically and horizontally shall be constructed with reinforced concrete stiffeners to engineer's detail and with the S.O's approval.

3.7 Lintel And Stiffener

3.7.1 Unless otherwise specified or shown on the Drawings, lintels shall be provided to all openings and to be sized accordingly by the Contractor to the S.O.'s approval.

3.7.2 Reinforced concrete stiffeners shall be constructed at every minimum of 3 m vertically and horizontally to strengthen brick and block wall system construction according to engineer's detail.

3.8 Fasteners

Unless otherwise shown on the Drawings, fasteners or cramps for frames, metal windows and precast units shall be built in at 1 m centres on the vertical side of the frame. Mild steel cramps shall be 25 mm x 3 mm x 225 mm long for fixing wooden frames, etc. One end of the cramp shall be turned up and screwed to back of the frame and the other end shall be split and fish-tailed for building in. Cramps which are to be fixed to concrete shall be embedded in concrete and built into brickwork as the work proceeds.

3.9 Cutting

All cuttings such as arches, sinks, setbacks, and projections shall be properly formed. Chases and holes through walls and slabs for the passage of pipes, wiring and the like shall be neatly cut or formed. Upon the installation of the services pipes, the chases and holes through walls shall be properly sealed (Fire Stop) to prevent fire spread as required by the DGFR and UBBL. Where plastering works are done on the cuttings, the surface shall be smooth and seamless.

3.10 Timber Framing For Partition

3.10.1 All timber used for the timber stud framings for partition walls shall be as specified in SECTION H: TIMBER, JOINERY AND IRONMONGERY WORKS.

3.10.2 Wall partition consisting of timber frames shall consist of vertical and horizontal studs. The studs shall consist of approved timber hardwood with a minimum size of 50 mm x 50 mm unless otherwise specified. All horizontal and vertical studs shall be constructed at a maximum spacing of 600 mm centres.

3.10.3 The top most horizontal frame, referred to as the top plate shall be bolted or nailed to the ceiling and continuously erected using timber or metal stiffener securely fixed to the slab to the S.O's approval. The timber and metal stiffeners shall be spaced at 1200 mm centres maximum.

3.10.4 The lowest horizontal frame, referred to as the bottom plate, shall be securely fixed using bolts or nails. All fixing to slabs, M12 expansion bolts shall be used at 1200 mm centres maximum with galvanized mild steel

 <p>JKR MALAYSIA</p>	<p>SECTION E : NON-STRUCTURAL WALL SYSTEM</p>	<p>No. Dokumen : JKR 20800-0183-14 No. Keluaran : 01 No. Pindaan : 00 Tarikh : 29 Januari 2014 Muka Surat : E/8</p>
--	--	---

strap to the floor to the S.O.'s approval. All fixings to timber slabs shall be fixed at 600 mm centres maximum.

- 3.10.5 Unless otherwise specified, dimension for timber panels shall comply with MS 1064.
- 3.10.6 Where proprietary timber partitions are used, they shall be constructed in accordance with the manufacturer's recommendations and to the S.O.'s approval.
- 3.10.7 Partitions, screens and vent panels, shall be constructed as detailed in the Drawings. Where shown, galvanized welded wire mesh or expanded metal of the required sizes and patterns shall be fixed to vent panels and window openings. The mesh shall be secured in position using rebated and mitred timber battens and screws.

3.11 Metal Framing For Partition

- 3.11.1 Steel sections such as, but not limited to metal framing and studs shall comply with ASTM C645, BS EN 14195, BS 7364 or other approved equivalent standards as appropriate, and to the approval of the S.O.
- 3.11.2 Unless otherwise specified, all metal framing for partitions shall be galvanized steel 62 mm C-Studs (vertical) and 64 mm U-tracks (horizontal) of 0.5 mm base metal thickness. The steel stud shall be manufactured from galvanized mild steel strip, steel grade Z2 with minimum yield strength of 210 N/mm² and zinc coating type Z275 minimum, complying with BS EN 10143.
- 3.11.3 The stud which is to support a joint shall have a minimum fixing face width of 32 mm for screw fixing and all other framing members shall not be less than 30 mm. Drywall screws shall be at least 10 mm longer than total thickness of plasterboards on each side of the partition wall. The plasterboards are laid staggered and fixed to the metal frames using drywall screws not exceeding 300 mm centres.
- 3.11.4 The top most U-frame (horizontal) shall be screwed to the ceiling and continuously erected using metal stiffener securely fixed to the slab. The metal studs directly supporting plasterboard sheets shall be spaced at 600 mm centres maximum. The bottom U-frame (horizontal) shall be securely fixed to the floor slab using bolts or screws. All fixing to slabs, M12 expansion bolts shall be used at 1200mm centres maximum with galvanized mild steel strap to the floor and to the S.O.'s approval.
- 3.11.5 Unless otherwise shown on the Drawings, the partitions shall not be erected more than 3000 mm height. Partitions which are more than 3000 mm height shall be supported by additional structural members, to structural engineer's detail and S.O.'s approval.
- 3.11.6 Partition above ceiling shall allow for cut out opening for service ducts or trunks and cable trays. The contractor shall coordinate with all subcontractors on the exact location and size of the openings. Any gaps around any pipe ducts through the partition shall be properly sealed with and approved fire smoke stop system. by the penetration collar protection specialist.
- 3.11.7 If full height partition has to be terminated below ventilation duct route parallel to the partitions, the stud of the partition shall be secured to the

 <p>JKR MALAYSIA</p>	<p>SECTION E : NON-STRUCTURAL WALL SYSTEM</p>	<p>No. Dokumen : JKR 20800-0183-14 No. Keluaran : 01 No. Pindaan : 00 Tarikh : 29 Januari 2014 Muka Surat : E/9</p>
--	--	---

support frame of the duct. In such cases, space between the duct and reinforced concrete soffit need not be sealed up.

- 3.11.8 The deflection of the metal frame partition system under service condition shall be controlled by the limit for the calculated deflection of the element chosen for the system and its intended use. The deflection shall not exceed $L/240$ or $L/360$ subject to the finishing material attached to the partition. Any system wall partition selected shall be installed strictly according to the manufacturer's specifications and details to the S.O.'s approval.

3.12 Plasterboard Partition

- 3.12.1 The type of plasterboard used shall comply with BS EN 520. The specified plasterboard shall carry class 'O' approval from DGFR. Unless otherwise specified the plasterboards used for the works shall be 12.5 mm thick with standard length of 3000 mm and shall be free of defects.
- 3.12.2 The deviations and tolerances shall be in accordance with BS 8212. When required, the deflection under load shall be determined in accordance with BS EN 520.
- 3.12.3 The appropriate type of sealant shall be used for the required type of plasterboard. Elastomeric sealants shall be used at the perimeter of the dry lining or partitioning to provide an airtight construction and to the approval of the S.O.
- 3.12.4 Jointing compound shall be of air drying or setting type, in accordance with BS EN 13963, and to the approval of the S.O. Jointing compound shall be applied as per manufacturer's recommendation and S.O.'s approval. The use of any additives to modify any of the properties of compounds shall not be permitted.
- 3.12.5 Jointing tape for plasterboards shall not be less than 48 mm wide and not exceeding 60 mm in accordance with ASTM C475 and the approval of the S.O.
- 3.12.6 Control joints shall be provided for a long continuous run of plasterboard wall spaced at not more than 9 m apart.
- 3.12.7 Corner beads shall be provided as reinforcement to permit construction of true, concealed angles with gypsum base and panels.
- 3.12.8 Provision shall be allowed for the plasterboard partition system to support surface mounted fixtures by incorporating independent support framing hidden behind or exposed on the partition surface to provide adequate and appropriate support and to the approval of the S.O.
- 3.12.9 Wherever possible, full length plasterboard sheets shall be used to eliminate the need for sheet end butt joints. Where possible, joints on opposite sides of framing should be arranged to occur between different framing members.
- 3.12.10 Plasterboard sheets shall be laid out to minimize butt joints and waste. Butt joints on adjoining sheets shall be staggered. Butt joints on opposite sides of the wall shall be staggered. The sheet shall be laid so that the vertical joints fall a minimum of 200 mm from the edge of the opening.

 <p>JKR MALAYSIA</p>	<p>SECTION E : NON-STRUCTURAL WALL SYSTEM</p>	<p>No. Dokumen : JKR 20800-0183-14 No. Keluaran : 01 No. Pindaan : 00 Tarikh : 29 Januari 2014 Muka Surat : E/10</p>
--	--	--

- 3.12.11 Fire resisting systems comprising of more than one layer of plasterboards, the joints in successive layers should be staggered. In the case of walls sheeted on both sides joints should be staggered on opposite sides of the wall.
- 3.12.12 Penetrations in the system shall only be allowed if installed in accordance to manufacturer's recommendation and tested at the Contractor's expenses. Penetration shall be strictly carried out in accordance with the requirements of the DGFR and to the recommendation approval of the S.O.
- 3.12.13 Fasteners shall have a corrosion-resistant finish and be appropriate for intended use, also in accordance with BS EN 14566 and BS 8212. The heads of fasteners shall be shaped so that they can be driven slightly below the surface of the plasterboard without punching through the paper liner.
- 3.12.14 Impact resistance of a partition system including gypsum plasterboard shall be determined in accordance with ISO 7892 and BS 5234-2.
- 3.12.15 The Contractor shall submit to the S.O., a manufacturer's warranty against any defect or damage to the proprietary plasterboard partition system which may arise during the period of five (5) years from the date of Certificate of Practical Completion. Terms of the warranty shall be such as shall be approved by the S.O.

3.13 Glass Partitions

- 3.13.1 Unless otherwise specified or shown on the Drawing, all fixed glass wall systems shall be 8 mm thick minimum, erected with stainless steel framing system for sizes up to 1200 mm x 4800 mm maximum installed to manufacturer's recommendation and to S.O.'s approval. For sizes more than 4800 mm, the panels shall be constructed according to manufacturer's recommendation and the installation shall be certified by a P.E.
- 3.13.2 Glass doors shall be installed complete with accessories as recommended by the manufacturer and to the S.O.'s approval.

TABLE OF CONTENTS
SECTION F : SEWERAGE WORKS

	PAGE
1. General	F/1
2. Material	F/1
3. Layout	F/1
4. Excavation	F/1
5. Pipes And Fittings	F/3
6. Joint For Sewer Pipes	F/3
7. Pipe Laying	F/3
8. Bedding, Haunching And Surround	F/4
9. Connections	F/5
10. Manholes, Inspection Chambers And Valve Chambers	F/5
11. Septic Tank And Sewage Treatment System	F/6
12. Connections To The Public Sewerage Line	F/7
13. Testing For Sewer Pipes Installation	F/7
14. Backfilling	F/9
 APPENDIX F/1: TABLE F1: Parameter Limits For Sewage And Industrial Effluents	 F/10

 <p>JKR MALAYSIA</p>	<p>SECTION F : SEWERAGE WORKS</p>	<p>No. Dokumen : JKR 20800-0183-14 No. Keluaran : 01 No. Pindaan : 00 Tarikh : 29 Januari 2014 Muka Surat : F/1</p>
--	--	---

1. General

The work to be done under this section unless otherwise shown or described in the B.Q. shall consist of the supply, delivery, construction and testing of all sewerage works and ancillary works, and all necessary works up to the point of final discharge of the effluent. In the case of discharge into the public sewer or the package sewage treatment plant, the work shall terminate up to and including the last manhole or intercepting trap of the system. This section of the work shall be carried out strictly in accordance with the appropriate by-laws and to the approval of the S.O.

2. Material

2.1 Cement, Sand, Aggregates And Bricks

- 2.1.1 Cement, sand and aggregates shall be as specified in SECTION D: CONCRETE WORKS. All bricks used unless otherwise shown in the Drawings or described in the B.Q. shall be clay bricks as specified in SECTION E: NON-STRUCTURAL WALL SYSTEM.

2.2 Sewerage Pipe

- 2.2.1 The Contractor shall only use sewer pipes from suppliers approved by SPAN and all materials shall be inspected and approved by the S.O. before being installed.
- 2.2.2 The Contractor shall submit the certificate and test report of sewer pipe to the S.O. for approval.
- 2.2.3 The Contractor shall make sure the sewer pipe is stored and/or stacked in such manner to prevent breakage.

3. Layout

The whole sewerage work shall be carried out according to the layout as shown on the Drawings.

4. Excavation

- 4.1 Generally, all excavation works in this section unless otherwise specified hereunder shall be as specified in SECTION B : EXCAVATION AND EARTHWORKS.
- 4.2 The Contractor shall carry out survey work to determine the sewer pipe alignment. Clearance from the building/road shall be 1 m. The pipe alignment shall be approved by the S.O. before the contractor starts the excavation works.
- 4.3 The trench shall be excavated to the depths intended or as shown on the Drawings and shall be finished and trimmed to the correct level and grade. Unless indicated otherwise, the bottom of the trench shall be graded so that the pipe invert slopes evenly between the appropriate outlet invert of the preceding manhole and the inlet invert of the next manhole.
- 4.4 The trench shall be excavated to such width so as to ensure that a minimum working space of 300 mm will be available on each side of the pipe when properly aligned. At all joints, the trench shall be excavated to give a minimum working space of not less than 300 mm all-round the joint.

 <p>JKR MALAYSIA</p>	<p>SECTION F : SEWERAGE WORKS</p>	<p>No. Dokumen : JKR 20800-0183-14 No. Keluaran : 01 No. Pindaan : 00 Tarikh : 29 Januari 2014 Muka Surat : F/2</p>
--	--	---

- 4.5 The sides of all excavation unless otherwise approved by the S.O. shall be cut vertical and where necessary shall be protected against caving in by timbering to the approval of the S.O. If the trench is more than 1.5 m, the contractor shall provide support for the trench to avoid collapse, settlement or movement of the banks.
- 4.6 The trench excavation shall not advance more than 100 m ahead of the completed backfilled pipeline. Pipe shall be laid in all trenches that have been excavated at the end of each day's work, unless the Contractor get approval from the S.O. to do otherwise.
- 4.7 It shall be the responsibility of the Contractor to protect and support all existing water pipes, gas and other conduits crossed by the excavation or work to be performed and to arrange for their temporary removal and subsequent replacement.
- 4.8 The trench should be excavated precisely to ensure the sewer pipe will be in the centre of the trench. The bottoms of the trenches for all sewers shall be carefully and truly graded, formed and lined according to the grades and dimensions as shown on the Drawings.
- 4.9 Should the ground be so wet or soft, and does not form a firm base for the pipe, if it is necessary in the opinion of the S.O. then the trench shall be excavated 225 mm below the level intended or shown on the Drawings and then brought to the correct level with good selected earth, quarry dust or sand well rammed into place. Such deepening of pipe trench and filling back shall be treated as a variation under the terms of the Contract. Should the bottom of the trench be inadvertently excavated below the specified level, it shall be brought back at the Contractor's expense to the correct level with good selected earth, quarry dust or sand carefully rammed into place.
- 4.10 The Contractor shall remove any water which collects in the trenches while sewer pipes are being laid. Water encountered shall be disposed of by the Contractor in a manner satisfactory to the S.O.
- 4.11 Excess material from the trench excavation shall be located 600 mm (minimum) away from the trench.
- 4.12 When excavating pipe trenches in roadway or other paved surfaces, the Contractor shall first remove all metal, slabs or bricks forming the existing pavement to the width of the trenches and reinstate to the approval of the S.O. after the trenches have been backfilled. The Contractor must make sure that not more than half of the width of a roadway shall be disrupted at any one time during the sewerage work.
- 4.13 Generally where rock is encountered in the trench excavation, it shall be removed to the approval of the S.O. Where layer of rock is encountered along the bottom of the excavation, it shall be cut and trimmed to the required level of the trench. All voids formed at the bottom of the trench by the removal of rocks shall be back filled to the required level with Grade 20P concrete or other suitable materials well rammed and compacted all to the approval of the S.O. Uneven surfaces of rocks at the bottom of the excavation due to the trimming shall be levelled and smoothen with sand blinding to the approval of the S.O.
- 4.14 If the works required pipe jacking, the Contractor shall provide method statement for S.O.'s review and approval.
- 4.15 The Contractor shall ensure that the work performed is safe and in compliance with Occupational Safety and Health Act (OSHA).

 <p>JKR MALAYSIA</p>	<p>SECTION F : SEWERAGE WORKS</p>	<p>No. Dokumen : JKR 20800-0183-14 No. Keluaran : 01 No. Pindaan : 00 Tarikh : 29 Januari 2014 Muka Surat : F/3</p>
--	--	---

5. Pipes And Fittings

- 5.1 Generally, all sewer pipes unless otherwise shown on the Drawings, shall be vitrified clay pipes (VCP) and fittings complying with MS 1061 and SPAN guidelines.
- 5.2 Sewer pipes used for gravity types of sewer shall be a minimum size of 150 mm for service connection and 225 mm for public sewer complying with Malaysian Sewerage Industry Guideline (MSIG).

6. Joint For Sewer Pipes

- 6.1 Unless otherwise approved by the S.O., joints of flexible and watertight type shall be used on all sewer pipes. The spigot and socket of each pipe shall be cleaned and lubricated before the running of each joint.
- 6.2 Couplings shall be made either of the same materials as the pipe or other material to the approval of the S.O. The pipes and coupling shall have accurately machined or molded tapered ends, the internal taper of the couplings matching the external taper of the pipes.

7. Pipe Laying

- 7.1 All pipes shall be laid in compliance with MS 1228 and in accordance with the sizes, locations, dimensions, grades and other particulars as shown in the Drawings. Each pipe shall be carefully inspected upon arrival at site. Sewer pipes shall be carefully stored. Defective pipes shall be marked and removed from the site forthwith.
- 7.2 Prior to fixing or laying all pipes and fittings shall again be carefully inspect for damage and only those found to be sound in every aspect shall be fixed or laid. Any pipes, specials, et cetera found to be damaged in any way shall be clearly marked, set aside and removed from the site.
- 7.3 No pipe shall be laid until the trench has been inspected and approved by the S.O.
- 7.4 The pipes shall be gently lowered into the trench by means approved by the S.O. No pipes shall be rolled or dropped into the trench. The pipe shall be laid true to alignment as shown in the Drawings or as instructed by the S.O. Interior and exterior of each pipe at the joint shall be thoroughly cleaned before the joint is made. Pipes shall be laid from the downstream end towards the upstream end.
- 7.5 To prevent the entry of earth and other materials into the pipes, the Contractor shall provide and fix suitable stops for efficiently closing all open ends of pipes in the trench while work is not actually being carried out at such open ends.
- 7.6 Socketed pipes shall be laid with the sockets laid against the direction of flow. At every position of pipe joints, the bedding shall be recessed sufficiently.
- 7.7 Where sewer pipes are to be laid on concrete bed, haunched or encased in concrete surrounds, these shall be as shown on the Drawings and as specified hereinafter.

 JKR MALAYSIA	SECTION F : SEWERAGE WORKS	No. Dokumen : JKR 20800-0183-14
		No. Keluaran : 01
		No. Pindaan : 00
		Tarikh : 29 Januari 2014
		Muka Surat : F/4

- 7.8 The sewer pipes shall be laid to the gradients as shown on the Drawings. Where the gradients are not shown in the drawings, the pipe shall be laid to the following gradients:

Size diameter (mm)	Gradient
100	1 : 60
150	1 : 80
225	1 : 110
250	1 : 120
300	1 : 140
375	1 : 170
450	1 : 200

- 7.9 The invert level of each pipe laid shall be checked during laying and immediately after laying as shown on the Drawings.
- 7.10 Where sewer pipes are laid above ground, they shall be supported at intervals to the details as shown on the Drawings or to the approval of the S.O.
- 7.11 All external underground sewer pipes shall have a minimum cover of 450 mm unless otherwise shown on the Drawings.
- 7.12 Clearance between sewer pipes and other services shall be a minimum of 100 mm (vertical and horizontal clearance).
- 7.13 Other Requirements
- 7.13.1 For easy identification of underground forced sewer mains, the layout shall be planted with marker posts at every 200 m length and at every change of pipe directions. Valve chambers provided shall have adequate access for operations and maintenance.
- 7.13.2 There shall be adequate site supervision during the construction. These documents must be submitted before acceptance and approval of construction:
- (i) Photographs showing sewer pipe laying during and after construction for all lengths.
 - (ii) Testing certificates.
 - (iii) Supervision certificates.
 - (iv) As-built drawings.

8. Bedding, Haunching And Surround

- 8.1 Concrete bed, haunching and surround shall be of concrete Grade 20P.
- 8.2 Typical bedding is to be used for all pipes under normal site condition unless directed by the S.O.
- 8.3 Only approved materials are allowed to be used for pipe embedment.
- 8.4 The bedding material shall be placed as soon as possible after the base of the trench is prepared and excess water has been removed.
- 8.5 Whenever the bedding is disturbed, the pipe shall be raised to allow for repair works to be done.

 <p>JKR MALAYSIA</p>	<p>SECTION F : SEWERAGE WORKS</p>	<p>No. Dokumen : JKR 20800-0183-14 No. Keluaran : 01 No. Pindaan : 00 Tarikh : 29 Januari 2014 Muka Surat : F/5</p>
--	--	---

- 8.6 Any pegs or other temporary aids for levelling works shall be removed before any pipe being laid.

9. Connections

- 9.1 The Contractor is to allow and provide for all bends, junctions, traps, gullies as shown on the Drawings or where necessary. If a gully is used, it shall be of the inlet type, and shall be set level on a concrete base, with a riser to finish 50 mm above the surrounding surface level, complete with concrete surrounds rendered on all sides and galvanized iron grating. Bends turned up to receive various stacks shall be set on concrete bases to the approval of the S.O. The bends at the foot of vertical stacks shall be of gentle radius type.
- 9.2 All underground fittings shall be completely surrounded in concrete and the Contractor shall allow for any additional excavation and jointing of pipes.

10. Manholes, Inspection Chambers And Valve Chambers

- 10.1 Manholes, inspection chambers and valve chambers shall be constructed with the sizes shown on the Drawings and MSIG guidelines. Unless otherwise shown or specified, all dimensions on the plan shall be the inside measurement.
- 10.2 Manholes and inspection chambers shall be protected by lining/coating to prevent corrosion of the concrete due to sulphide attack. Internal walls shall be either rendered with sulphate resistant cement mortar at least 20 mm thick or lined with PVC, HDPE or epoxy coating.
- 10.3 Manholes
- 10.3.1 Manhole covers and frames
- 10.3.1.1 Manhole covers and frames shall comply with Drawings and MSIG guidelines.
- 10.3.1.2 All surfaces of manhole covers and frames supplied shall be coated as stated in MSIG guidelines with either:
- (i) Hot applied bituminous material complying with BS 4147 Type I.
 - (ii) Cold applied bituminous material complying with BS 3416 Type II.
- 10.3.2 Manhole testing (before backfilling)
- 10.3.2.1 Water-tightness test shall be conducted where no visible leakage shall occur between the manhole cover and its seating in the frame when tested in accordance with MSIG guidelines.
- 10.3.2.2 A visual inspection shall be conducted on all the external and internal section of each manhole in accordance with MSIG guidelines. Particular attention shall be given to:
- (i) The slope of benching.
 - (ii) Joints to pipes.
 - (iii) Transitions at entry and exits.

 <p>JKR MALAYSIA</p>	<p>SECTION F : SEWERAGE WORKS</p>	<p>No. Dokumen : JKR 20800-0183-14 No. Keluaran : 01 No. Pindaan : 00 Tarikh : 29 Januari 2014 Muka Surat : F/6</p>
--	--	---

- (iv) Joints in the structure.
- (v) Quality of concrete finish.
- (vi) Water-tightness of manhole covers and surround.

10.4 Inspection Chambers

Unless otherwise as shown on the Drawings, inspection chambers shall be constructed in brickwork in cement mortar (1:2) and the brickwork shall be of clay bricks and constructed on Grade 20P concrete foundation. The thicknesses and sizes shall be as shown on the Drawings. Each inspection chamber shall have channels and open channel junctions of sizes as shown on the Drawings. Concrete benching shall be to a gradient of 1:6 and shall be of Grade 20P concrete finished with 19 mm steel troweled water proofed cement and sand (1:3) rendering. The internal sides of the inspection chambers shall be lined with 20 mm thick PVC, HDPE or epoxy coating. Externally, the exposed concrete or brick surfaces shall be rendered with 12 mm cement and sand mortar (1:3) and terminated 150 mm below the finished ground level. All internal angles shall be rounded off. Inspection chambers shall be provided with covers and unless specified or as shown on the Drawings, covers shall be medium duty 450 mm x 600 mm cast iron covers with air tight frames.

11. Septic Tank And Sewage Treatment System

- 11.1 Septic tank and sewage treatment system shall be constructed as shown on the Drawings and to the approval of the S.O.
- 11.2 All septic tank and sewage treatment system shall be approved only by SPAN. Prefabricated system by the S.P. shall be from the latest Treasury Contract Circular.
- 11.3 The quality limit for sewage effluent at the discharge point shall comply with Environmental Quality Act (EQA) 1974 or latest. The limit for sewage effluent at the discharge point shall comply with Standard A of EQA as in APPENDIX F/1.
- 11.4 Sewage Treatment System
 - 11.4.1 Prior to the installation of the sewage treatment system, the Contractor shall submit to the S.O. the system design, drawings, method of statement including structural, foundation, external work and M & E work duly certified by a P.E. registered with the Board of Engineers Malaysia.
 - 11.4.2 Sewage treatment system shall be approved by the Local Authority/Certified Agency before installation at site.
 - 11.4.3 The S.P. shall provide specification on construction and installation of the system and during these periods, the Local Authority/Certified Agency will carry out inspection to ensure the compliance of their requirements.
 - 11.4.4 Upon the completion of the installation of the sewage treatment system and prior to the issuance of the Certificate of Practical Completion, the Contractor shall submit the following documents to the S.O. for information and record:
 - (i) S.P.'s Guarantee against any defects or damages during a period of five (5) years from the date of Certificate of Practical Completion due to any defect, fault or insufficiency in design, material or workmanship or against any other failure which an experienced Contractor may reasonably contemplate but shall not include normal

 <p>JKR MALAYSIA</p>	<p>SECTION F : SEWERAGE WORKS</p>	<p>No. Dokumen : JKR 20800-0183-14 No. Keluaran : 01 No. Pindaan : 00 Tarikh : 29 Januari 2014 Muka Surat : F/7</p>
--	--	---

replacement and maintenance. The terms of the Guarantee shall be such as approved by the S.O.

- (ii) As-built drawings and Operation Manual and Maintenance (OMM) of the sewage treatment system certified by a P.E. registered with the Board of Engineers Malaysia.

12. Connections To The Public Sewerage Line

- 12.1 Connections to the public sewerage line, if any, shall be strictly carried out in accordance with requirements of the SPAN guidelines and to the approval of the S.O.

13. Testing For Sewer Pipes Installation

- 13.1 The Contractor shall carry out tests to the sewer pipes installation in accordance with the method of statement and requirements as described hereinafter. The Contractor shall give reasonable notice in writing to the S.O. before such tests to be carried out.
- 13.2 Testing of pipework shall be carried out and wherever possible, such testing shall be carried out from manhole to manhole. Short branch pipes connected to a main sewer between manholes shall be tested as one system with the main sewer. Long branches and manholes, shall be separately tested.
- 13.3 Subject to type of pipe and size, pipes shall be subjected to either low water pressure tests, CCTV test or any other test required by the MSIG guidelines and to the approval of the S.O.
- 13.4 Low Water Pressure Test
 - 13.4.1 The low water pressure test is commonly used for checking the water tightness of the joints and the integrity of the sewer pipes.
 - 13.4.2 For the water test, the pipe shall be subjected to an internal test pressure of 2 m head of water above the crown of the pipe at the higher end but not more than 7 m at the lower end. Steeply graded pipe shall be tested in such a manner that the above maximum heads is not exceeded.
 - 13.4.3 The test shall be carried out by filling the sewer with water slowly to the required head and bleed air from behind the upstream plugs. Maintain the water head for two (2) hours. Top up the water as required.
 - 13.4.4 Check the leakage at the plugs and the test apparatus during the pressurizing period and the constant pressure holding period. Release the water pressure if leakage occurs. Make the necessary repairs and adjustments before pressurizing again.
 - 13.4.5 Commence the test immediately after the last adjustment of water head in the preceding two (2) hours period.
 - 13.4.6 Add water to maintain the starting water head every five (5) minutes during the test period of 30 minutes. Record the total amount of water required for readjustment.

 <p>JKR MALAYSIA</p>	<p>SECTION F : SEWERAGE WORKS</p>	<p>No. Dokumen : JKR 20800-0183-14 No. Keluaran : 01 No. Pindaan : 00 Tarikh : 29 Januari 2014 Muka Surat : F/8</p>
--	--	---

13.4.7 The test is considered pass when:

- (i) The loss of water does not exceed 1 litre per hour linear meter per meter internal diameter for VCP and reinforced concrete pipes.
- (ii) There shall be no loss of water for pipe other than VCP and reinforced concrete pipes.
- (iii) There is no visible leakage at the joints for all pipe types.

13.5 Closed-circuit Television (CCTV) Testing (if required)

13.5.1 General

CCTV inspection where required shall be carried out to enable detection of sewer defects such as cracks, deformations, collapse, dislocation and et cetera which are not detected by normal means.

13.5.2 Inspection requirements

13.5.2.1 A CCTV Inspection Contractor registered with SPAN shall be appointed to carry out the inspection works.

13.5.2.2 General inspection coverage

Initial CCTV testing and inspection shall be conducted for a minimum 10% random selection of sewer pipes including all manholes and connections in accordance with SPAN guidelines.

13.5.2.3 High risk areas

- (i) 100% CCTV inspection shall be conducted for sewer pipes including manholes laid in the ground with high risk of failure and having the following characteristics:
 - a) Crossing under buildings, roads, railway, rivers and lakes including their reserve.
 - b) Crossing using pipe jacking method and horizontal drilling method.

13.5.3 Witness

Witness from the SPAN, S.O., consultant and contractor responsible for the construction of sewer shall be present during CCTV inspection.

13.5.4 Documentation

13.5.4.1 Within 7 days after completion of the inspection, the Contractor shall submit to the S.O. the following:

- (i) Two (2) copies of digital records; and
- (ii) One (1) copy of hardcopy report and recommendation

13.5.4.2 The format of the report and documentation shall be in accordance with MSIG guidelines. All documents shall be certified and duly signed by the qualified person responsible for the CCTV inspection declaring the authenticity of the recording submitted and done in accordance with the procedure stated in MSIG guidelines.

 <p>JKR MALAYSIA</p>	<p>SECTION F : SEWERAGE WORKS</p>	<p>No. Dokumen : JKR 20800-0183-14 No. Keluaran : 01 No. Pindaan : 00 Tarikh : 29 Januari 2014 Muka Surat : F/9</p>
--	--	---

13.5.5 During Defects Liability Period

If any blockages, damages, seepages occur to the sewer networks during the Defects Liability Period, the S.O. may require the Contractor to carry out further CCTV inspection to determine the cause within 24 hours.

14. Backfilling

- 14.1 After the pipes have been tested and approved, the trench shall be backfilled with approved fill material, free from rock and other hard material, well compacted around the pipes up to a level of at least 300 mm above the top of the pipes. After this has been approved, the remaining excavation shall be backfilled in 300 mm layers, each layer being well compacted. The bedding details and the types of fill material shall in accordance to Drawings and MSIG guidelines.
- 14.2 Trench support shall be progressively removed during the backfill work.
- 14.3 There shall be at least 300 mm of cover over the sewer pipe before light mechanical compaction can commence.
- 14.4 There shall be at least 1000 mm of cover (depth of backfill) over the sewer before heavy mechanical compaction can commence.

 JKR MALAYSIA	SECTION F : SEWERAGE WORKS	No. Dokumen : JKR 20800-0183-14
		No. Keluaran : 01
		No. Pindaan : 00
		Tarikh : 29 Januari 2014
		Muka Surat : F/10

APPENDIX F/1

TABLE F1: PARAMETER LIMITS FOR SEWAGE AND INDUSTRIAL EFFLUENTS

Parameter	Effluent discharge to rivers/stream				Effluent discharge to stagnant water bodies*			
	Standard A		Standard B		Standard A		Standard B	
	Absolute	Design	Absolute	Design	Absolute	Design	Absolute	Design
BOD5	20	10	50	20	20	10	50	20
SS	50	20	100	40	50	20	100	40
COD	120	60	200	100	120	60	200	100
AMN	10	5	20	10	5	2	5	2
Nitrate Nitrogen	20	10	50	20	10	5	10	5
Total Phosphorus	N/A	N/A	N/A	N/A	5	5	10	5
O&G	5	2	10	5	5	2	10	5

Notes :

- 1) N/A = not applicable
- 2) All values in mg/l unless otherwise stated
- 3) *Stagnant water bodies refer to enclosed water bodies such as lakes, ponds and slow moving watercourses where dead zone occur
- 4) A : Discharge upstream of water supply sources
- 5) B : Discharge downstream of water supply sources

TABLE OF CONTENTS

SECTION G : ROOFING WORKS

	PAGE
1. General	G/1
2. Interlocking Concrete Tiles	G/1
3. Clay Tiles	G/1
4. Pre-painted Aluminium Roofing Sheet	G/1
5. Concrete Flat Roofs	G/1
6. Pre-painted Steel Roofing Sheet	G/2
7. Roofing Sheet For Marine Environment (Coastal Areas)	G/4
8. Bituminous Corrugated Roofing Sheets	G/5
9. Bituminous Corrugated Roofing Tiles	G/5
10. Fibre-cement Corrugated Sheets	G/5
11. Heat Insulation	G/6

 <p>JKR MALAYSIA</p>	<p>SECTION G : ROOFING WORKS</p>	<p>No. Dokumen : JKR 20800-0183-14 No. Keluaran : 01 No. Pindaan : 00 Tarikh : 29 Januari 2014 Muka Surat : G/1</p>
--	---	---

1. General

- 1.1 Unless otherwise stated, the pitch and laps for each type of roof covering shall be strictly in accordance with the manufacturer's recommendation.
- 1.2 Unless otherwise approved, all roof covering pieces or accessories such as eaves, hips, ridges, valley et cetera, shall be of the same material as the general covering.

2. Interlocking Concrete Tiles

- 2.1 Interlocking concrete roof tiles shall be laid on timber or steel battens approved for roofing at spacing and tightly nailed or screwed as recommended by the manufacturer.
- 2.2 Unless otherwise specified, the concrete roof tiles shall be laid to slope in accordance to the manufacturer's recommended pitch and to the S.O's approval. The roof tiles shall conform to MS 797 and unless otherwise specified on the Drawings, it shall be laid on metal trusses system to engineer's detail and S.O's approval.
- 2.3 Tiling fillers consisting of 1:3 cement mortar as specified under SECTION E: NON-STRUCTURAL WALL SYSTEM, shall be provided at the feet of the rafters.
- 2.4 Verges, ridges, hips, valley tiles and complete with all roofing accessories shall be provided and laid to bond with the general roof tiling works in accordance with the manufacturer's recommendation.

3. Clay Tiles

- 3.1 Unless otherwise stated in the Drawings, clay tiles shall be of 470 mm (length) x 284 mm (horizontal width) pattern confirming to BS 402 and shall be free from cracks, chips and warps.
- 3.2 Clay tiles shall be laid with a minimum head lap of 95mm on timber or steel battens approved for roofing at spacing as recommended by the tile manufacturer. The tiles shall be firmly screwed or nailed at intervals as recommended by the roofing tile manufacturer and as approved by the S.O.
- 3.3 Ridge capping, hip and valley tiles complete with all roofing accessories shall be provided to match the general tiling works in accordance with the manufacturer's recommendation. All these shall be bedded in matching 1:3 coloured cement mortar.

4. Pre-painted Aluminium Roofing Sheet

Unless otherwise stated, where aluminium roofing sheets are to be used, they shall be of the type, gauge and finish as shown in the Drawings and to be fixed strictly in accordance with the manufacturer's recommendation.

5. Concrete Flat Roofs

Concrete flat roofs shall be as specified under SECTION D: CONCRETE WORKS.

 <p>JKR MALAYSIA</p>	<p>SECTION G : ROOFING WORKS</p>	<p>No. Dokumen : JKR 20800-0183-14 No. Keluaran : 01 No. Pindaan : 00 Tarikh : 29 Januari 2014 Muka Surat : G/2</p>
--	---	---

6. Pre-painted Steel Roofing Sheet

6.1 Unless otherwise stated, the metal roof decks shall comply with the following:

6.1.1 Materials

6.1.1.1 The roofing sheets shall be produced from aluminium/zinc alloy coated steel conforming to MS 1196: "Continuous Hot-Dip Aluminium/Zinc Coated Steel Sheet of Commercial, Drawing and Structural Qualities" and AS 1397 "Steel Sheet and Strip: Hot-Dip Zinc Coated or Aluminium/Zinc Coated".

6.1.1.2 The pre-painted finish over the aluminium/zinc alloy coated base steel shall conform to MS 2383: "Prefinished/Pre-painted Sheet Metal Products for Interior/Exterior Building Applications - Performance Requirements" and AS/NZS 2728: "Prefinished/Pre-painted Sheet Metal Products for Interior/Exterior Building Applications - Performance Requirements".

6.1.1.3 The exterior finish coat shall have a nominal film thickness of 20 µm over 5 µm thick corrosion inhibitive primer on top side or weather side. The backing coat shall be with nominal film thickness of 5 µm over 5 µm corrosion inhibitive primer.

6.1.1.4 Minimum steel yield strength shall be 550 MPa.

6.1.1.5 Minimum aluminium/zinc alloy coating mass shall be 150 g/m² (Coating Class AZ 150) on both surfaces conforming to ISO 9223 Category 3 (C3) environment.

6.1.1.6 The Contractor shall submit material warranty from the manufacturer in accordance with ISO 9223: "Corrosion of Metals and Alloys – Corrosivity of Atmosphere - Classification" of the project site and the format approved by the S.O. Material warranty shall be up to 25 years against perforation by corrosion, 15 years against flake and peel, 10 years against colour fading and 5 years against dirt staining.

6.1.1.7 The Contractor shall submit shop drawings for the S.O's approval prior to commencement of installation works.

6.1.2 Metal sheet profiles

6.1.2.1 Unless otherwise specified or shown in the Drawings, the metal sheet profile shall be of a concealed fixing system as approved by the S.O. The roofing sheets shall have the following minimum requirements:

- (i) Base Metal Thickness (BMT) = 0.42 mm.
- (ii) Cover width = 680 mm.
- (iii) Rib height = 40 mm.
- (iv) Coating = Pre-painted aluminium and zinc coated steel with AZ150 (150 g/m²) on both surfaces.

 <p>JKR MALAYSIA</p>	<p>SECTION G : ROOFING WORKS</p>	<p>No. Dokumen : JKR 20800-0183-14 No. Keluaran : 01 No. Pindaan : 00 Tarikh : 29 Januari 2014 Muka Surat : G/3</p>
--	---	---

6.1.2.2 Where pierced fixing system is specified or shown in the Drawings, the roofing sheet shall have the following minimum requirements:

- (i) Base Metal Thickness (BMT) = 0.42 mm.
- (ii) Cover width = 750 mm
- (iii) Rib height = 38 mm
- (iv) Coating = Pre-painted aluminium/zinc coated steel with AZ150 (150 g/m²) on both surfaces.

6.1.3 Fixing

6.1.3.1 Installation procedures shall conform to the recommendation of the manufacturer.

6.1.3.2 The roofing sheets shall be installed and fixed according to the following method:

- (i) Concealed fixing using approved clips compatible with the roofing sheet.
- (ii) Pierced fixing using approved fasteners compatible with the roofing sheet.

6.1.3.3 The roofing installer shall be registered with CIDB.

6.1.3.4 Metallic swarf and all other debris including nail, screws, mortar, construction materials et cetera shall be swept away from the roof area and gutters regularly, particularly at the end of each day's work and at completion of the installation works.

6.1.4 Clips and fasteners

6.1.4.1 Fasteners type shall comply with AS 3566 Class 3 and be certified as such by the supplier of fasteners.

6.1.4.2 The recommended type of fasteners shall conform to the following test:

- (i) Salt spray test - 1000 hours
- (ii) Kesternich test - 15 cycles.
- (iii) Humidity test - 1000 hours.
- (iv) UV test - 2000 hours.

6.1.4.3 All fasteners and screws shall be of the self-drilling type either concealed or screwed fixing, complete with preassembled ethylene propylene diene monomer (EPDM) rubber washers.

6.1.5 Flashing and capping

Approved 0.42 mm BMT ridge capping, flashing, capping and trimming shall be manufactured to the required shape and sizes. The flashing and capping materials used shall be from the same material as the roofing sheets.

6.1.6 Sealants

Only neutral cure silicone rubber sealant type Dow Corning 780 or equivalent shall be used conforming to AS 3902.

 <p>JKR MALAYSIA</p>	<p>SECTION G : ROOFING WORKS</p>	<p>No. Dokumen : JKR 20800-0183-14 No. Keluaran : 01 No. Pindaan : 00 Tarikh : 29 Januari 2014 Muka Surat : G/4</p>
--	---	---

6.1.7 Lightning conductors

Aluminium lightning conductor is recommended for use on steel roof system.

- 6.2 All fixing accessories shall be rust-resistant and of suitable design and construction as recommended by the manufacturer for the roofing system and as approved by the S.O. All fasteners and screws shall be of the self-drilling type either concealed or screwed fixing, complete with preassembled EPDM rubber washers.
- 6.3 Identification, storage and packaging of alum/zinc steel roof decking shall be strictly in accordance with the manufacturer's recommendation and comply with the S.O.'s requirements.
- 6.4 All roof decking sheets, capping, flashing et cetera or wall cladding shall be new, clean, regular, straight and true to shape with sharp defined profiles, free from cracks, chips, bends and defects detrimental to practical use or from other surface imperfections.
- 6.5 At Site, the sheets shall be lifted from the transport carrier by a crane and properly stacked clear of the ground, ready to be lifted up to the roof structure for laying. Where sheets are to be manually lifted, care should be taken not drag the sheets to avoid scraping away the surface coating.
- 6.6 Where storage is necessary, stack heights shall be kept to a minimum and the sheets shall be stacked in a sloping position. Sheets shall be stacked off a dry firm ground, under cover by tarpaulin or polythene sheets but ventilated and away from building operations. Should the stack sheets become wet, they shall be immediately dried to prevent staining and degradation of the surface coatings.
- 6.7 The Contractor shall be responsible for the absolute water-tightness of the roof and must ensure that the method of installation, fixing and fastening decking sheets, caps, flashings et cetera including acoustical, insulation and expansion joints, whenever required shall conform strictly to the manufacturer's recommendation.
- 6.8 The completed portions of the roof shall be clear of all metallic particles such as blind rivet shanks, screws, nuts, nails et cetera and dirty foot prints should be wiped off to avoid early deterioration/corrosion and discolouration. Damages to the coating shall be repaired with touch-up paint as recommended by the manufacturer and approved by the S.O.

7. Roofing Sheet For Marine Environment (Coastal Areas)

- 7.1 The Contractor shall select the correct type of metal sheet profile to be installed for coastal areas as recommended by the roof manufacturer and approved by the S.O.
- 7.2 Unless otherwise specified or shown in the Drawings, the roofing sheet for marine environment shall be metallic coated steel with minimum aluminium/zinc alloy coating mass of 200 g/m² (Coating Class AZ 200) on both surfaces conforming to ISO 9223 Category 4 (C4) and Category 5 (C5) environment.
- 7.3 Metallic coated steel shall be manufactured and certified by SIRIM according to MS 1196 'Continuous Hot-Dip Aluminium/Zinc Coated Steel Sheet of Commercial, Drawing and Structural Qualities' or AS 1397 'Steel Sheet and Strip: Hot-Dip Zinc Coated or Aluminium/Zinc Coated'.
- 7.4 The pre-painted finish (super polyester paint) type shall be used over the aluminium/zinc alloy coated base steel shall conform to MS 2383: "Prefinished/Pre-

 <p>JKR MALAYSIA</p>	<p>SECTION G : ROOFING WORKS</p>	<p>No. Dokumen : JKR 20800-0183-14 No. Keluaran : 01 No. Pindaan : 00 Tarikh : 29 Januari 2014 Muka Surat : G/5</p>
--	---	---

“painted Sheet Metal Products for Interior/Exterior Building Applications - Performance Requirements” and AS/NZS 2728: “Prefinished/Pre-painted Sheet Metal Products for Interior/Exterior Building Applications - Performance Requirements”

- 7.5 Fasteners used shall comply with AS 3566 Class 4 and be certified as such by the supplier of fasteners and to the approval of the S.O.
- 7.6 All fixings and associated components shall be manufactured from compatible metals and coated conforming to ISO 9223 Category 4 (C4) and Category 5 (C5) environment. Flashings shall be made from the same material as the roofing sheets.

8. Bituminous Corrugated Roofing Sheets

- 8.1 Unless otherwise shown on the Drawing, the bituminous corrugated roofing sheets shall have the following minimum requirements:
 - (i) Length = 2000 mm
 - (ii) Width = 950 mm
 - (iii) Cover width = 855 mm
 - (iv) Thickness = 3 mm
 - (v) Weight of material = 3.3 kg/m²
 - (vi) Thermal resistance R- value = 0.04 mK/W
 - (vii) Thermal conductivity = 0.066 W/mk
- 8.2 Unless otherwise shown on the Drawings, the Bituminous Corrugated Roofing Sheets shall be laid at a minimum roof pitch of 5° on timber battens at spacing and tightly nailed/screwed as recommended by the manufacturer.
- 8.3 Ridge capping, nails and screws shall be provided to match the roofing sheets while ridges, verges, eaves, hips, valleys, side-wall and end-wall details shall be fixed strictly in accordance with the manufacturer’s recommendation.

9. Bituminous Corrugated Roofing Tiles

- 9.1 Unless otherwise shown on the Drawing, the bituminous corrugated roofing tiles shall have the following minimum requirements:
 - (i) Length = 1060 mm
 - (ii) Width = 400 mm
 - (iii) Wave height = 40 mm
 - (iv) Thickness = 3 mm
- 9.2 Bituminous roofing tiles shall be laid at a minimum roof pitch of 9° and on timber or steel battens approved for roofing at spacing and tightly nailed/screwed as recommended by the manufacturer.
- 9.3 Ridge capping, nails and screws shall be provided to match the roofing tiles while ridges, verges, eaves, hips, valleys, side-wall and end-wall details shall be fixed strictly in accordance with the manufacturer’s recommendations.

10. Fibre-cement Corrugated Sheets

- 10.1 Fibre-cement corrugated sheets shall comply with MS 1224. The thickness of the sheets shall be 3 mm thick for shallow corrugation and 4 mm thick for medium

 <p>JKR MALAYSIA</p>	<p>SECTION G : ROOFING WORKS</p>	<p>No. Dokumen : JKR 20800-0183-14 No. Keluaran : 01 No. Pindaan : 00 Tarikh : 29 Januari 2014 Muka Surat : G/6</p>
--	---	---

corrugation. The cement shall comply with MS 522: Part 1. Asbestos processed or unprocessed shall not be added to fibre-cement sheets.

- 10.2 The surface intended to be exposed to the weather shall have a generally smooth finish. Variations of the surface appearance which do not impair the characteristics of the sheets as defined in MS 1224 are permitted.

11. Heat Insulation

11.1 General

Heat insulation system shall comply with MS 1020. Samples of the insulation material shall be submitted to the S.O for approval before they are used and subsequent delivery shall be up to the standard of samples approved.

11.2 Reflective Foil

11.2.1 Reflective foil shall be fire retardant double sided aluminium reflective foil bonded to reinforced high density polyethylene woven fabric.

11.2.2 The reflective foil materials used shall conform to fire safety requirements and BS 476: Fire Test on Building Materials and Structures on the following test:

- (i) Non-combustibility test for materials.
- (ii) Method of test for fire propagation for products.
- (iii) Method of test to determine the classification of the surface spread of flame.

11.2.3 Reflective foil properties shall conform to the following:

- (i) Thickness : 137 ± 20 micron thick.
- (ii) Grammage: 163 ± 10g / m².
- (iii) Tensile strength : 500 N / 50 mm (MD), 500 N / 50 mm (Cross Direction).
- (iv) Emissivity ASTM E408 ≤ 0.05(97±2%) / Reflectivity = 95%
- (v) Initial Tear resistance: ASTM D1004 >30N
- (vi) Tear Propagation: DIN53363 > 600 N/mm (CD) / 800 N/mm (MD)

11.2.4 Reflective foil material may be used on its own with all types of roofs except with metal decking roof. Where roof is of metal decking, the reflective insulation material shall be laid below stone wool or glass wool for effective thermal and acoustic performance.

11.2.5 The reflective foil material shall be installed strictly in accordance with the manufacturer's recommendation. A uniform air space of 20 mm between the tile roof covering and the insulation material shall be provided to ensure the effectiveness of the reflective surface. All punctures shall be effectively sealed with similar reflective material to prevent air leakage and moisture transfer.

11.2.6 The reflective foil surface shall be free from any thin film of oil, plastic or lacquer coatings. All dust and/or moisture, if any, shall be thoroughly cleaned prior to installation. All dust and/or trademarks shall be limited to a maximum of 5% of the total reflective area. The insulation material shall be fitted closely around electrical outlet boxes, plumbing and et cetera, and taped securely to eliminate gaps or voids through which air or water vapour might pass into the cooler space.

 <p>JKR MALAYSIA</p>	<p>SECTION G : ROOFING WORKS</p>	<p>No. Dokumen : JKR 20800-0183-14 No. Keluaran : 01 No. Pindaan : 00 Tarikh : 29 Januari 2014 Muka Surat : G/7</p>
--	---	---

11.3 Glass Wool Insulation

11.3.1 Unless otherwise shown in the Drawings, glass wool insulation shall be 75 mm thick. It shall have R-Value @ R2.0 m²KW (tested at a mean temperature of 20°C based MS1020 tested according to ASTM C177/C518). The glass wool insulation material used shall conform to BS 476 for Fire tests on building materials and structures on the following:

- (i) Non-combustibility test for materials.
- (ii) Method of test for fire propagation for products.
- (iii) Method of test to determine the classification of the surface spread of flame.

11.3.2 The glass wool insulation material used shall be of no added urea formaldehyde and as approved by the S.O. Glass wool insulation shall be fixed in accordance with the manufacturer's recommendations and to the approval of the S.O.

11.3.3 Where single skin metal roof is applied, galvanized wire mesh BRC 3316 or equivalent shall be used to support the reflective foil and the glass wool insulation.

11.4 Stone Wool Insulation

11.4.1 Unless otherwise shown in the Drawings, stone wool insulation shall be 50 mm thick minimum. It shall have R-Value @ R2.0 m²KW (tested at a mean temperature of 20°C based MS1020 tested according to ASTM C177/C518). The stone wool insulation material used shall conform to BS 476 for Fire tests on building materials and structures on the following:

- (i) Non-combustibility test for materials.
- (ii) Method of test for fire propagation for products.
- (iii) Method of test to determine the classification of the surface spread of flame.

11.4.4 The stone wool insulation shall conform to the following:

- (i) Thermal conductivity 0.034 - 0.036 W/mK at 20°C mean temperature tested in accordance to ASTM C518.
- (ii) Noise reduction coefficients (NRC) of up to 1.0 tested to BS EN ISO 354 at 50 mm thickness.
- (iii) Non-combustible according to BS 476 Part 4 or EN 13501-1 and melting point of at least 1000°C in accordance to ASTM E794.
- (iv) No CFCs, HFCs, HCFCs or asbestos shall be used in the manufacture of the product.
- (v) No perceptible odor shall be present when tested in accordance to ASTM C665.
- (vi) Not sustaining fungus growth under normal conditions according to ASTM C1338.
- (vii) The metal plates (steel and aluminium) in contact with the insulation shall show no corrosion greater than that observed on the comparative plates in contact with sterile cotton according to ASTM C665.
- (viii) Flame spread index less than zero (0) and smoke developed index less than five (5) according to ASTM E84.
- (ix) Total volatile organic compound (VOC) emission shall be less than 0.25 mg/m³ and particles emission shall be less than 0.02 mg/m³ tested according to ASTM D5116.
- (x) Moisture absorption shall be less than or equal to 0.04 % volume according to ASTM C1104/C1104M and water absorption shall be less

 <p>JKR MALAYSIA</p>	<p>SECTION G : ROOFING WORKS</p>	<p>No. Dokumen : JKR 20800-0183-14 No. Keluaran : 01 No. Pindaan : 00 Tarikh : 29 Januari 2014 Muka Surat : G/8</p>
--	---	---

than or equal to 0.5 kg/m² (short-term immersion) according to EN 1609.

- 11.4.3 The stone wool insulation material used shall be of no added urea formaldehyde and as approved by the S.O. Stone wool insulation shall be fixed in accordance with the manufacturer's recommendation and to the approval of the S.O.
- 11.4.4 The insulation material must be protected from the exposure of rain, water immersion and chemical contamination during the storage and installation. If the insulation are in contact with water, adequate drying time must be allowed to ensure that the insulation are completely dried prior to covering of the roof covers.
- 11.4.5 The stone wool insulation shall be installed to the thickness specified and place butt jointed. Wherever possible the Contractor shall avoid the compression of the insulation material.
- 11.4.6 Where single skin metal roof is applied, galvanized wire mesh BRC 3316 or equivalent shall be used to support the reflective foil and the stone wool insulation.

TABLE OF CONTENTS

SECTION H: TIMBER, JOINERY AND IRONMONGERY WORKS

	PAGE
1. General	H/1
2. Timber Grades And Size Tolerances	H/1
3. Treatment Of Timber	H/1
4. Moisture Content And Storage	H/3
5. Structural Assemblies Of Timber	H/3
6. Timber Joints	H/4
7. Prefabricated Timber Roof Truss System	H/5
8. Glued Laminated Timber For Structures	H/7
9. Carpentry Works	H/12
10. Joinery Works	H/13
11. Timber Floor Finish	H/13
12. Ceiling Timber Battens	H/13
13. Timber Partitions	H/14
14. Fascia And Barge Boards	H/14
15. External Boarding	H/14
16. Staircase And Balustrades	H/14
17. Timber Solid Panel Doors	H/15
18. PVC Doors	H/15
19. Products And Materials	H/15
20. Ironmongery	H/17
21. Built-in Furniture	H/17
TABLE H1 : Schedule Of Timber Grouping And Usage	H/20
TABLE H2 : Schedule Of Timber Species In Accordance With Strength Grouping (S.G)	H/21
TABLE H3 : Schedule Of Moisture Contents (M.C) Of Timber For Various Positions In Building	H/22
TABLE H4 : Natural Durability Classification Of Peninsular Malaysia Timbers For Ground Contact	H/23
TABLE H5 : Natural Durability Classification Of Sarawak Timbers For Ground Contact	H/24
TABLE H6 : Properties Of Malaysian Timber	H/25
TABLE H7 : Schedule Of Ironmongery	H/26
TABLE H8 : Timber Species For The Manufacturing Of Glued Laminated Timber Components	H/28
APPENDIX H/1 : Glued Laminated Timber Performance Warranty (Specimen)	H/29

 <p>JKR MALAYSIA</p>	<p>SECTION H : TIMBER, JOINERY AND IRONMONGERY WORKS</p>	<p>No. Dokumen : JKR 20800-0183-14 No. Keluaran : 01 No. Pindaan : 00 Tarikh : 29 Januari 2014 Muka Surat : H/1</p>
--	---	---

1. General

- 1.1 Unless otherwise specified or shown in the Drawings, the timber species used for the Works shall be as stated hereinafter in the TABLE H1. The strength grouping for timber shall be in accordance with MS 544 as shown hereinafter in the TABLE H2.
- 1.2 All carpentry and joinery work shall include all necessary notching, halving, morticing and tenoning, wedging, scarfing, dovetailing, sinking for heads of bolts and nuts and trimming for opening.
- 1.3 All carpentry work shall be left with a sawn surface except where particularly described to be wrot. All joinery shall be wrot and finished with sand paper as required and all sizes stated are the finished sizes. Sizes for carpentry shall be within the tolerances stated in sub-section 2.1 and sizes for joinery shall be within the tolerances stated in sub-section 2.2.
- 1.4 Unless otherwise indicated in the Drawings, all fire protection materials and systems must show evidence that they have been subjected to the fire resistance test in accordance with BS 476 or other approved equivalent standards.

2. Timber Grades And Size Tolerances

- 2.1 Unless otherwise specified, sawn timber for carpentry work shall be as stated hereunder:
 - (i) Select Grade - for roof truss
 - (ii) Standard Structural Grade - for structural work
 - (iii) Sound Grade - for General Market Specification (GMS) and strips
 - (iv) Serviceable Grade - for scantling
- 2.2 Grading shall be carried in accordance with the Malaysian Grading Rules (MGR) by timber graders registered with the MTIB. Every timber consignment shall be accompanied by the Grading Summary certified by the registered timber grader. The sizes of sawn timber, except where otherwise specified, shall be within the margin of permissible variations stated hereunder:
 - (i) For widths, depths or thicknesses not exceeding 75 mm - within 3 mm of the specified size
 - (ii) For widths, depths or thicknesses exceeding 75 mm - within 5 mm of the specified size.
- 2.3 The Contractor shall provide any necessary blocks, wedges or battens to compensate for irregular surfaces caused by any variations in size of timbers hereby permitted.
- 2.4 Unless otherwise specified, sawn timber for joinery work shall be of Sound Grade (General Market Specification (GMS) and Strips) and Serviceable Grade (Scantlings). The finished size for joinery, unless otherwise specified, shall be within the margin of permissible variation stated hereunder:
 - (i) For widths, within 3 mm of the specified finished size.
 - (ii) For thicknesses, within 2 mm of the specified finished size.

3. Treatment Of Timber

- 3.1 All timber except the heartwood of the naturally durable timbers as scheduled in TABLE H2 hereinafter and timber for formwork, scaffolding, and other temporary

 <p>JKR MALAYSIA</p>	<p>SECTION H : TIMBER, JOINERY AND IRONMONGERY WORKS</p>	<p>No. Dokumen : JKR 20800-0183-14 No. Keluaran : 01 No. Pindaan : 00 Tarikh : 29 Januari 2014 Muka Surat : H/2</p>
--	---	---

works shall be impregnated by means of vacuum pressure processes in accordance with MS 360 using copper/chrome/arsenic (CCA) wood preservatives conforming to MS 733 in the treatment plant registered with the MTIB.

- 3.2 If a timber component has sufficient natural resistance to decay and insect attack by virtue of the natural durability of its heartwood, it may be used without treatment even where the hazard exists. The natural durability classification of Peninsular Malaysia and Sabah and Sarawak timbers for ground contacts can be found in MS 360 and as shown in TABLE H4 and TABLE H5. Sapwood should not be used without preservative treatment
- 3.3 Unless otherwise specified, the average moisture content for all timber shall not exceed 25% in accordance with MS 360. The moisture content shall be determined in accordance with one of the methods given in MS 837.
- 3.4 All timber shall be sawn or planed before treatment to achieve the finished cross-section required. As far as possible, all cross-cutting, boring, drilling or other processing should be carried out before treatment.
- 3.5 The pH value of the treating solution shall not be higher than 3.0 when determined by a glass electrode or pH paper at ambient temperature in accordance with MS 360.
- 3.6 The net dry salt retention shall be determined in accordance with one of the methods given in MS 360 and MS 821. The minimum salt penetration shall be determined by one the test methods given in MS 833.
- 3.7 The material shall be collected by drilling to the required depth as recommended and shown in MS 360 -TABLE 4. It can also be collected by sawing to the required depths, and then chipped to the small size. Either sawdust or chipped materials shall be ground to fine powder.

3.7.1 The minimum nett dry salt retention for CCA shall be as shown in the table below:

No	Use	Minimum Net Dry Salt Retention For CCA
i)	Interior and above the ground	5.6 kg/m ³
ii)	Exterior and above the ground	8.0 kg/m ³
iii)	Exterior and in contact with the ground (other than foundation piles)	12.0 kg/m ³

3.7.2 All sapwood shall be fully penetrated by the preservative and for heartwood, the depth of penetration shall be 12 mm.

- 3.8 The Contractor, when required by the S.O. shall produce a certificate from a preservative treatment plant which certifies that timber required to be impregnated by means of vacuum pressure processes has been impregnated and has achieved the necessary nett dry salt retention. Notwithstanding the certificate, the S.O. reserves the right to carry out independent tests to determine the nett dry salt retention and the result so obtained shall be conclusive.

 <p>JKR MALAYSIA</p>	<p>SECTION H : TIMBER, JOINERY AND IRONMONGERY WORKS</p>	<p>No. Dokumen : JKR 20800-0183-14 No. Keluaran : 01 No. Pindaan : 00 Tarikh : 29 Januari 2014 Muka Surat : H/3</p>
--	---	---

3.8.1 Treatment certificate

3.8.1.1 A treatment certificate shall be produced for each batch of timber delivered from the treatment plant. The relevant charge sheets shall be attached with each treatment certificate. The following information shall appear on the certificate:

- (i) name and address of buyer;
- (ii) project title/reference;
- (iii) name of treating company;
- (iv) name of preservative(s) used;
- (v) average retention of preservative obtained;
- (vi) charge sheet number and date of treatment;
- (vii) species of timber treated together with sizes and volume;
- (viii) commodity and hazard class; and
- (ix) other registration number (where applicable)

3.8.1.2 The certificate shall be signed by authorized personnel of the treating company, certifying that the timber has been treated in accordance with MS 360.

4. Moisture Content And Storage

- 4.1 At the time of installation, the moisture content of the timber for the various applications shall not exceed that as specified in TABLE H3.
- 4.2 Moisture content for foundation piles, formworks and temporary works is not critical for these applications and therefore is not specified.
- 4.3 Moisture content of timber shall be determined in accordance with MS 837.
- 4.4 On delivery to the site, all timber other than timber for foundation piles, formworks and temporary works shall be properly open-stacked, under cover. Kiln dried timber shall be properly wrapped and stored under cover if it is not used immediately.

5. Structural Assemblies Of Timber

- 5.1 The workmanship and method of assembly of structural timber shall generally be in accordance with MS 544 and in particular, the following requirements:
 - (i) The quality of the surface, as finished, shall be appropriate to the position and use of the timber.
 - (ii) When grade or other necessary marks are removed, provisions shall be made for remarking in accordance with Malaysian Grading Rules. Surfaces at any joint in an assembly shall be such that the parts may be brought into contact over the whole area of the joint before connectors are inserted or any pressure or restraint from the fastening is applied. These surfaces shall have a good sawn or planed finish.
 - (iii) Bearing surfaces of notches and other cuttings shall be true and smooth and in appropriate relation to the other surfaces of the piece.
- 5.2 Notches other than at the ends of beams shall be U-shaped formed by parallel cuts to previously drilled holes. The diameter of the hole shall be equal to the width of the required notch.

 <p>JKR MALAYSIA</p>	<p>SECTION H : TIMBER, JOINERY AND IRONMONGERY WORKS</p>	<p>No. Dokumen : JKR 20800-0183-14 No. Keluaran : 01 No. Pindaan : 00 Tarikh : 29 Januari 2014 Muka Surat : H/4</p>
--	---	---

- 5.3 Where splitting is likely to have a deleterious effect, end sealing is recommended. For timbers known to split and check especially after installation, the ends of the boards and scantlings shall be protected with a coating designed to minimise end checking and checking and splitting. In severe cases where the ends and sides of heavy joists of timbers are liable to excessive split and check due to exposure to windward slanting sunlight, appropriate skirting or cover with a thin timber board shall be necessary.

6. Timber Joints

- 6.1 When solid timber members are to be jointed together using mechanical fasteners, the workmanship and method of assembly shall be in accordance with MS 544 Part 5. The mechanical fasteners are as listed below:

6.1.1 Nailed joint

Where necessary to avoid splitting, nails shall be driven into pre-drilled holes or diameter not greater than four-fifths of the diameter of the nails. Care shall be taken to avoid placing nails in any end split.

6.1.2 Screwed joint

Lead holes shall be used to ensure good workmanship in making screwed joints. The diameter of the hole for the shank shall be equal to the diameter of the shank, and for the threaded portion, the diameter of the hole shall not be greater than seven-eighth of the diameter of the root diameter of the screw thread adjacent to the shank. Care shall be taken to avoid placing screws in any end split.

6.1.3 Bolted joint

6.1.3.1 Bolt holes shall be drilled to diameters as close as possible to the nominal diameter of the bolt and in no case more than 2 mm larger than the bolt diameter. Care shall be taken to avoid placing a bolt in any end split. A minimum of one complete thread shall protrude from the nut.

6.1.3.2 A washer shall be fitted under the head of each bolt and under each nut. The minimum sizes of washers are as given in Part 6 of MS 544. Where joints using split-rings are to be used, as shown in the Drawings, the members of the joints shall be fitted together in their appropriate positions and clamped or spiked together before drilling. Alternatively, drilling jigs or multiple head boring machines may be used, or individual members may be marked out from the setting-out or by use of prepared templates.

6.1.3.3 If either of the latter methods is employed, sample members (usually the first ones produced) shall be carefully checked against the setting-out.

6.1.3.4 In all instances holes for bolt positions shall be accurately determined by reference to the point intersection of the centre lines of the member. Great care is necessary if the first set members marked out is to be used subsequently as drilling templates. Greater accuracy can usually be obtained by the use of special marking or drilling templates located by a pin at the intersection of the center lines.

 <p>JKR MALAYSIA</p>	<p>SECTION H : TIMBER, JOINERY AND IRONMONGERY WORKS</p>	<p>No. Dokumen : JKR 20800-0183-14 No. Keluaran : 01 No. Pindaan : 00 Tarikh : 29 Januari 2014 Muka Surat : H/5</p>
--	---	---

- 6.1.3.5 Bolts holes shall be drilled at right angles to the surface of the joint. The contact surfaces of the members should be grooved to the appropriate dimensions as given in Part 6 of MS 544.
- 6.1.3.6 Drilling and grooving may be done in a single operation; alternatively, if the hole is predrilled the pilot of the grooving tool shall fit in the bolt hole, thus centering the groove about the hole.
- 6.1.3.7 Care shall be taken to ensure that all chips and shavings are removed, and rings shall be expanded before being placed in the grooves.
- 6.1.3.8 The joint shall be finally assembled and bolts inserted. Washers of the correct dimension shall be placed under the head of the bolt and the nut, and the nut tightened to hold the members together.
- 6.1.3.9 Recess for shear-plate connectors shall be accurately cut by means of a suitable tool to be appropriate dimensions as given in MS 544 - Part 6.
- 6.1.3.10 Assembly of units shall be done on a level bed and in such a way as to avoid damage to any of the members and so that the finished structural units conform to detailed Drawings and specification supplied.
- 6.1.3.11 When assembly is to be performed on the site, one set of component parts shall be fitted together and dismantled prior to dispatch to the site, in order to ensure that the assembled structural units conform to the detailed Drawings and Specifications. Twisted or damaged members shall be replaced before erection on the site.
- 6.1.3.12 Before proceeding with bulk production, a complete assembly of one of each framed truss or other structural unit shall be checked to prove the accuracy of the templates, et cetera A similar check shall be carried out from time to time to control the wear and tear on templates and gauges.
- 6.1.3.13 Timber members and built-up units shall be marked in accordance with a marking diagram.

7. Prefabricated Timber Roof Truss System

- 7.1 All prefabricated components shall be manufactured only by reputable licensed truss suppliers and approved by the S.O. This supplier duly termed as 'System Provider' is responsible for the analysis, design, detailing, drawing, manufacture, material, handling and erection of the roof members, and their ancillary fixing components. The full requirement is outlined in the Specification for Prefabricated Timber Roof Trusses (JKR 20601-0190-12) or the latest edition published by JKR.
- 7.2 System Provider
 - 7.2.1 The System Provider (S.P.) is a supplier of a proprietary roof truss system appointed by the Contractor and approved by the S.O., which employs Quality Assurance procedures in the design, detailing, connection, bracing,

 <p>JKR MALAYSIA</p>	<p>SECTION H : TIMBER, JOINERY AND IRONMONGERY WORKS</p>	<p>No. Dokumen : JKR 20800-0183-14 No. Keluaran : 01 No. Pindaan : 00 Tarikh : 29 Januari 2014 Muka Surat : H/6</p>
--	---	---

erection criteria and manufacture of truss components for the structural roof truss system.

7.3 Duties Of Professional Engineer

7.3.1 The S.P. shall appoint a Professional Engineer (P.E.) whose duties shall include the following:

- (i) Preparation of roof truss analysis and design;
- (ii) Preparation of drawings;
- (iii) Design changes in every stage of work;
- (iv) Certification for completion of roof truss installation;
- (v) Final certification for roof truss installation prior to issuance of Certificate of Practical Completion for the whole Works to the Contractor.

7.4 Fabricator

All trusses shall only be assembled by licensed fabricators approved by the S.P. and registered with CIDB. A copy of the CIDB registration certificate shall be submitted to the S.O. for verification.

7.5 Installer

All installation works shall be executed and supervised by qualified personnel with valid certificates issued by CIDB. The S.O. shall verify the identification and qualification of the installer prior to the installation.

7.6 General Truss Limitation

7.6.1 Prior to any pre fabricated timber roof trusses works, the following general limitation shall be applied:

- (i) Maximum unsupported truss span 12 m with permitted deviation of ± 0.05 m.
- (ii) Maximum truss spacing of 1.2 m with permitted deviation of ± 0.025 m.
- (iii) The minimum basic wind speed shall be 35 m/s. However, the minimum basic wind speed shall be increased to 41 m/s for lightweight roof covering.
- (iv) Maximum roof pitch shall be of 45° .

7.7 Analysis, Design Report And Drawings Submission

7.7.1 The S.P. through the Contractor shall propose to the S.O. or his approval a roof truss system which is safe, functional and conforming to design standard. Submission of proposal shall include truss analysis, design report, and construction drawings. The truss analysis shall indicate all loads, load combinations, connections criteria, bracings and tie-down of the truss. Design output of the truss members, battens, connections, tie-down and wall plates, anchors, bracings, truss accessories, splicing and stiffeners where related to the analysis shall be included in the design report. (Refer to Appendix 3 of JKR 20601-0190-12)

7.7.2 All details in the construction drawings shall be sufficient to enable checking against the analysis and design report, by specifying and providing not limited to: the truss layout and configuration, timber grades, section properties of members, length of members in each truss configuration, properties of truss accessories, specification of fastener and

 <p>JKR MALAYSIA</p>	<p>SECTION H : TIMBER, JOINERY AND IRONMONGERY WORKS</p>	<p>No. Dokumen : JKR 20800-0183-14 No. Keluaran : 01 No. Pindaan : 00 Tarikh : 29 Januari 2014 Muka Surat : H/7</p>
--	---	---

anchor, tie-down and anchoring details and all types of connection details including the connection of all attachments to the trusses.

7.7.3 Technical specifications for fastener and anchor of which the design refers to shall also be submitted. Verification test certificate from an approved accredited laboratory on the technical parameter specified in the technical specifications shall be submitted upon request by the S.O.

7.8 Warranty

7.8.1 When a prefabricated timber roof truss system is used, the Contractor shall submit to the S.O. a warranty from the S.P. with the following provisions:

- (i) The products used are genuine and free from manufacturing defects;
- (ii) The prefabricated timber roof truss system is installed in accordance with the S.P.'s instructions, guidance and specifications that will deliver the specified level of performance;
- (iii) The warranty certificate shall cover a period of ten (10) years from the date of Certificate of Practical Completion against any defect or failure due to the installation and workmanship by the S.P.'s registered panel installer.

8. Glued Laminated Timber For Structures

8.1 General

8.1.1 This sub-section shall apply to the construction of all structures or parts of structures to be composed of glued laminated timber manufactured by gluing together individual pieces of dimensioned timber with or without steel joints and connectors. The work shall be carried out all in accordance with this specification and the lines, levels, grades, dimensions and cross-sections shown in the Drawings and as required by the S.O.

8.1.2 All glued laminated timber building components shall be manufactured and assembled by licensed glued laminated timber manufacturers approved by the S.O. The Contractor shall provide the necessary documents relating to the proposed manufacturer such as valid licenses or other certificates to the S.O. for approval prior to the commencement of any manufacturing work.

8.1.3 All glued laminated timber members shall be manufactured in a factory which has quality control and quality assurance procedures in place as approved by the S.O. The S.O. reserves the right to visit the factory before giving any approval.

8.1.4 Prior to fabrication, the Contractor shall notify the S.O. on the dates of tests that shall be carried out. The S.O. may appoint a representative in the event the S.O cannot be present during the tests. The Contractor shall forward a copy of the test results jointly certified by the manufacturer for the S.O.'s acceptance and approval.

8.2 Material

8.2.1 Timber

8.2.1.1 Unless specified otherwise, the timber species used for the manufacturing of glued laminated timber components shall be selected from Malaysian tropical hardwoods that satisfy the

 <p>JKR MALAYSIA</p>	<p>SECTION H : TIMBER, JOINERY AND IRONMONGERY WORKS</p>	<p>No. Dokumen : JKR 20800-0183-14 No. Keluaran : 01 No. Pindaan : 00 Tarikh : 29 Januari 2014 Muka Surat : H/8</p>
--	---	---

requirements for strength classes D40 to D70 when graded to Hardwood Structural Grade (HSG) in accordance with BS 5756. A list of timber species that satisfies the requirements is shown in TABLE H8 of this specification.

- 8.2.1.2 The timber species should attain sufficient natural durability and resistance to decay and insect attack as stipulated in MS 544: Part 10.
- 8.2.1.3 Timber of single species or a mixture of species can be used in a glued laminated timber structural frame, provided that it is proven to be suitable for the manufacturing of glued laminated timber by the qualification test given in MS 758. Lamination of a glued laminated timber member shall not be of a mixture of different timber species.
- 8.2.1.4 The visual strength grading for all timber used for structural works should be visually graded based on the grading requirements of MS 1714: Specification for Visual Strength Grading of Tropical Hardwood Timber. The visual grading shall be carried out by timber graders registered with MTIB.
- 8.2.1.5 The Contractor is to supply all timber used in the manufacturing of glued laminated timber component to be of Hardwood Structural Grade as defined under MS 1714.
- 8.2.2 Moisture content for non treated timber
 - 8.2.2.1 At assembly, the moisture content in every lamination shall be in the range of 8% to 15%. The range of moisture content of the laminations in a glued laminated timber member shall be not greater than 4%.
 - 8.2.2.2 Method for the determination of the moisture content of timber is as stipulated in MS 837.
- 8.2.3 Moisture content for treated timber
 - 8.2.3.1 At assembly, the moisture content in every lamination shall be in the range of 11% to 18%. The range of moisture content of the laminations in a glued laminated timber member shall be not greater than 4%.
 - 8.2.3.2 Method for the determination of the moisture content of timber is as stipulated in MS 837.
- 8.2.4 Adhesive
 - 8.2.4.1 The adhesive shall be capable of producing strong and durable joints, ensuring that the integrity of the bond is maintained throughout the intended lifetime of the structure. The adhesive shall meet the requirement for adhesive Type I and minimum Service Class 2 as stipulated in MS 758.
- 8.3 Laminations And Bonding
 - 8.3.1 The individual laminations shall be end jointed to the final length before planing.

 <p>JKR MALAYSIA</p>	<p>SECTION H : TIMBER, JOINERY AND IRONMONGERY WORKS</p>	<p>No. Dokumen : JKR 20800-0183-14 No. Keluaran : 01 No. Pindaan : 00 Tarikh : 29 Januari 2014 Muka Surat : H/9</p>
--	---	---

- 8.3.2 Grooving of laminations to reduce the effect of cupping is permitted. In each lamination one groove is permitted in the middle part of the cross section, with a maximum width of 4 mm and a maximum depth of one third of the lamination thickness. Grooves in adjacent laminations shall be staggered by at least the thickness of the laminations.
- 8.3.3 When laminations are jointed by finger joints these shall be produced in conformity with BS EN 385 or equivalent Malaysian standard.
- 8.3.4 Where a lamination for horizontal glued laminated timber consists of two boards side by side and the edges are not bonded, the edge-joints in adjacent laminations shall be staggered laterally by at least the lamination thickness. For members used in Service Class 2 the outer lamination on each face shall be edge-bonded. For members used in Service class 3 the outer four laminations on each face shall be edge-bonded.
- 8.3.5 Laminations in vertical glued laminated timber to be used in Service Class 2 are not required to be edge-bonded, but the edge joints in adjacent laminations shall be staggered by at least one third of the board width. In members to be used in Service Class 3 the outer laminations shall be edge-bonded.
- 8.3.6 The laminations shall be planed or similarly finished before bonding. The planing shall be carried out no more than twenty four (24) hours before bonding, unless the species and the storage environment are such that unacceptable surface changes will not take place. With species that are difficult to bond, e.g. have high resin content or where the laminations have been treated with preservative, planing shall be carried out within 6 hours of bonding. It is the responsibility of the glued laminated timber manufacturer to qualify any procedures used and to determine the permissible delay between machining and gluing.
- 8.3.7 The maximum permitted deviation from the average thickness within a lamination length of 1 m is 0.2 mm. Where non-gap-filling adhesives are used the limit deviation shall not exceed 0.1 mm. The difference in thickness over the cross-sectional width of the lamination shall be less than 0.15% of the width and in no case exceed 0.3 mm.
- 8.3.8 At the time of bonding the surfaces of laminations shall be clean. The adhesive spread shall be uniform and in sufficient quantity in accordance with the recommendations of the adhesive manufacturer.
- 8.4 Cramping
- 8.4.1 The cramping arrangement shall ensure a uniform pressure over the glue line. The pressure shall be that specified in the adhesive manufacturer's instructions for the adhesive used but in no case shall it be less than 0.7 N/mm². The application of pressure at a suitable temperature shall be completed within the closed assembly time, when a continuous 'squeeze out' or 'bead' along the edge of each glue line shall be produced.
- 8.4.2 For curved members higher cramping pressures shall be applied and in such a way that the laminations can slide over each other in the lengthwise direction to avoid open glue lines. Sufficient pressure shall be maintained during cramping. Tightening up shall be carried out as necessary, and in all cases immediately after initial cramping.

 <p>JKR MALAYSIA</p>	<p>SECTION H : TIMBER, JOINERY AND IRONMONGERY WORKS</p>	<p>No. Dokumen : JKR 20800-0183-14 No. Keluaran : 01 No. Pindaan : 00 Tarikh : 29 Januari 2014 Muka Surat : H/10</p>
--	---	--

8.5 Preservative Treatment

- 8.5.1 Where the timber used is not naturally durable (as specified in TABLE H2), it shall be preservative treated. The treatment of timbers shall be as specified in sub-section 3: Treatment of Timber of this specification.
- 8.5.2 If any other preservative chemical is used, contractor shall provide necessary documents as may be required by the S.O to prove the efficiency of the chemical treatment.

8.6 Coating Specification

- 8.6.1 All glued laminated timber members shall be coated with a minimum of two coats of clear construction sealer. The sealer shall be applied in accordance with the manufacturer's specification and to the S.O.'s approval. The Contractor shall rectify any damage to the coating after the erection has been carried out. The Contractor shall also provide details of the sealer used to the S.O. for record.
- 8.6.2 All glued laminated timber shall receive an additional coat of protective sealer before shipping/transport and shall be properly wrapped for protection during shipping/transport and erection. The wrapping should be left in place as long as possible until permanent protection from the weather is in place.

8.7 Submission Of Documentation

- 8.7.1 Prior to the manufacture and fabrication of the glued laminated timber, the Contractor shall provide two (2) copies of the following documents for the S.O.'s approval:
- (i) Particulars of the manufacturer
 - (ii) Quality assurance programme of the manufacturing process
 - (iii) Method statement for assembly, installation, handling and transportation
 - (iv) Manufacturer's fabrication drawings
 - (v) Manufacturer's assembly drawings
 - (vi) Grading summary of timber to be used in the manufacturing of glued laminated timber, issued by timber grader certified by MTIB
 - (vii) Results of qualification tests

8.8 Production Quality Control

- 8.8.1 The Contractor shall establish and maintain documented factory production control to ensure that the produced glued laminated timber members conform to the design requirement as demonstrated in the qualification tests.
- 8.8.2 From each work shift and each production line, a representative sample of end joint shall be drawn and tested in flatwise bending as described in BS EN 385. For each production line and shift the bending strength is acceptable is if one of the condition stated in sub-section 7.1.2 of MS 758:2001 is met.
- 8.8.3 Also, from each shift which gluing is carried out, one full cross-sectional specimen shall be taken for every press load or every 10 m³ of production. The specimen shall be cut from a cured glued laminated timber member produced during each work shift. If all tests for a three-month period satisfy

 <p>JKR MALAYSIA</p>	<p>SECTION H : TIMBER, JOINERY AND IRONMONGERY WORKS</p>	<p>No. Dokumen : JKR 20800-0183-14 No. Keluaran : 01 No. Pindaan : 00 Tarikh : 29 Januari 2014 Muka Surat : H/11</p>
--	---	--

the requirements the number of samples may be reduced to not less than half the number prescribed above.

- 8.8.4 The Contractor shall provide information on the glue line integrity, results of delamination tests and results of glue line shear test which shall not be less than as stipulated in MS 758.
- 8.8.5 The values for manufactured glued laminated timber shall not be less than the value for designed glued laminated timber. The values of the manufactured glued laminated timber properties shall be determined in accordance with MS 544: Part 2 or AS/NZS 4063.

8.9 Initial Qualification Tests

8.9.1 The Contractor shall be fully responsible to carry out qualification tests which shall be witnessed by the S.O. The Contractor shall carry out a qualification test whenever a new process or process change involving new adhesive, species combination, finger joint profile and lamination thickness.

8.9.2 Qualification tests

8.9.2.1 Unless otherwise stated and approved by the S.O. in writing, qualification tests shall be carried out on completed samples of glued laminated timber members before any actual manufacturing is allowed.

8.9.2.2 The tests shall cover the determination of characteristic strength of glued laminated timber member in bending, compression, tension and shear and characteristic modulus of elasticity in bending, and shall be determined by undertaking tests on completed 300 mm deep glued laminated timber members in accordance with AS/NZS 4063 and MS 758:2001.

8.9.2.3 The characteristic bending strength shall be obtained from flatwise bending test of the joint in the lamination.

8.9.3 The Contractor shall declare the manufactured glued laminated timber properties are as required by the designer and as shown in the drawings. The required properties to be declared are characteristic values for bending strength, modulus of elasticity, compression strength, shear strength and tension strength.

8.10 Handling And Installation

8.10.1 The Contractor shall submit the method statement of installation for the approval of the S.O. The method statement shall explain the sequence of erection of glued laminated timber and required safety measures. Glued laminated timber members shall be installed in accordance with the Assembly Drawings.

8.10.2 At all stages of construction, all glued laminated timber structural components shall be properly protected to prevent damage.

8.10.3 During on-site storage, glued laminated timber members shall be stored off the ground with spacer blocks spaced between members. The Contractor shall be responsible for the storage of glued laminated timber members properly at site to prevent bending, tipping or toppling of the members.

 <p>JKR MALAYSIA</p>	<p>SECTION H : TIMBER, JOINERY AND IRONMONGERY WORKS</p>	<p>No. Dokumen : JKR 20800-0183-14 No. Keluaran : 01 No. Pindaan : 00 Tarikh : 29 Januari 2014 Muka Surat : H/12</p>
--	---	--

- 8.10.4 Proper transit, storage and construction methods are required to avoid rapid changes in the moisture content of glued laminated timber members at site. If the storage at site takes longer period prior to installation than the Contractor shall ensure that, the wrapping of glued laminated timber members shall be cut on the underside to prevent the accumulation of water condensation.
- 8.10.5 During handling, correct lifting equipment shall be used. All glued laminated timber members must be protected from damages due to straps, chains and wire ropes.
- 8.10.6 During erection, glued laminated timber frame shall be properly braced that is permanent and temporary bracing to provide stability in accordance with the method statement prepared by the Contractor and approved by the S.O.
- 8.10.7 The Contractor shall ensure the accuracy of the prepared foundation, position of glued laminated timber structure, base plate and holding down bolts. Any discrepancies and deviations shall be remedied by the Contractor to S.O.'s approval before erection commences.
- 8.10.8 All end grains shall be protected from moisture or water accumulation by provision of permanent steel end capping.

8.11 Defects And Alteration

- 8.11.1 Glued laminated timber structures shall not have any debonding. Glued laminated timber structures affected by debonding shall be marked as 'Rejected' and removed from site.
- 8.11.2 No element of the glued laminated timber structures shall be cut, notched, detached from their connections or altered from its original condition after delivery to site without the prior written approval of the S.O.
- 8.11.3 Where defects exceeding the limits or permitted tolerances are detected, rectification works shall not be carried out unless with written approval of the S.O.

8.12 Warranty

- 8.12.1 The Contractor shall submit to the S.O. a performance warranty by the manufacturer to the Government on the performance of the glued laminated timber member against debonding which may occur during a period of ten (10) years from the date of practical completion. The terms of the performance warranty shall be as stipulated in APPENDIX H/1 and as approved by the S.O.

9. Carpentry Works

- 9.1 All carpentry shall be accurately set out in strict accordance with the Drawings and shall be framed together and securely fixed to the approval of the S.O. Timber framing shall be properly braced and checked, halve, screwed or bolted together as required. Longitudinal joints in plates, ridge, fascias, et cetera shall be formed over supports. Those timber members with lapped joints shall lap at least 150mm or twice the depth of the timber whichever is the greater. The brads, nails, screws, spikes, plugs, bolts, framing anchors and timber connectors shall be provided wherever necessary and as detailed. Other than those detailed, no joints are permitted in structural work unless prior permission is obtained from the S.O. No structural member shall be notched unless instructed by the S.O.

 <p>JKR MALAYSIA</p>	<p>SECTION H : TIMBER, JOINERY AND IRONMONGERY WORKS</p>	<p>No. Dokumen : JKR 20800-0183-14 No. Keluaran : 01 No. Pindaan : 00 Tarikh : 29 Januari 2014 Muka Surat : H/13</p>
--	---	--

- 9.2 For the carpentry works, timbers shall, as far as possible be in piece between continuing lengths. At corners, timbers shall be halved for materials of the same thickness, and sufficiently lapped for materials of different thicknesses.

10. Joinery Works

- 10.1 All doors, windows, louvers, screens and the like shall be constructed as shown in the Drawings. Frames shall be assembled at the commencement of the work and all members shall be carefully morticed and tenoned together but no wedging, pinning or gluing shall be done until the framing is prepared in readiness for immediate fixing. All doors, windows, louvers, screens and the like shall be properly stored on site.
- 10.2 Immediately before fixing in its final position, joinery shall be wedge and pinned by drawn hole pinning with 10 mm diameter Strength Group 1 and 2 timber dowels pins. The pins shall be left projecting until permission is given for flushing off. The methods of framing and putting together of all Works shall be approved by the S.O. before being executed. Any portions that warp, twist or develop any other defects shall be replaced before wedging up. All framed work shall be pinned before being framed together.
- 10.3 The choice of species for joinery should be based on working properties of timbers that is maximum percentage of shrinkage.
- 10.4 Jointing or connection for joinery that is nailed joint, screwed joint, coach screwed joint or bolted joint shall comply with MS 544 Part 5.

11. Timber Floor Finish

- 11.1 Unless otherwise shown in the Drawings, timber floors shall be constructed using 100 mm x 38 mm wrot, tongued and grooved boarding's, well cramped up and secret nailed to each joist or batten with 62 mm wire nails. Floor boarding shall be in long lengths with splayed heading joints and no two adjacent joints shall occur over the same joist. On completion, the flooring shall be planed, sanded and all gaps sealed with an approved sealer. The floor shall then be cleaned off and unless otherwise specified, it shall be finished with three coats of approved polyurethane paint applied strictly in accordance with the manufacturer's instructions.
- 11.2 Wrot timber skirting shall be provided where shown and as detailed in the Drawings. Skirting shall be in long lengths with splayed heading joints and with mitres, returns and ends neatly cut and fitted and fixed to grounds.
- 11.3 Where engineered timber flooring are specified or shown in the Drawings, it shall be finished with high abrasive protective overlay and a moisture barrier balancing film to be applied on timber flooring backing in accordance with the manufacturer's recommendations and S.O's approval.
- 11.4 Timber strip and parquet flooring shall be as specified in SECTION K: PLASTERING, PAVING AND TILING WORKS.

12. Ceiling Timber Battens

Where ceiling battens are used for ceilings, it shall be fixed to the frames with butt 'V' joint using nails or screws. Asbestos-free cement flat sheets for ceiling shall be 5 mm thick fixed to frames using mitred profiled timber cover battens and brass screws with rounded edge

 <p>JKR MALAYSIA</p>	<p>SECTION H : TIMBER, JOINERY AND IRONMONGERY WORKS</p>	<p>No. Dokumen : JKR 20800-0183-14 No. Keluaran : 01 No. Pindaan : 00 Tarikh : 29 Januari 2014 Muka Surat : H/14</p>
--	---	--

beading. Ceiling panels shall be set out symmetrically from the centre line of the ceiling. Suspended ceiling systems shall be as specified in SECTION I: CEILING WORKS.

13. Timber Partitions

Non-structural timber partitions shall be as specified under SECTION E: NON-STRUCTURAL WALL SYSTEM.

14. Fascia And Barge Boards

Unless otherwise shown on the Drawings, fascia and barge boards shall be 25 mm thick wrot timber and supplied in long lengths. The boards shall be fixed in whole lengths and where joints are necessary, they shall be scarfed jointed and the joints shall occur only over the ends of roof framing members and mitred corners. Board, 250 mm wide and less shall be in one width and those deeper shall be formed by multiple of boards jointed together by tongue and groove and 'V' joint.

15. External Boarding

- 15.1 Unless otherwise shown on the Drawings, all external boarding shall be formed with 150 mm x 19 mm horizontal, vertical or diagonal boarding in wrot pressure-treated timber in long lengths and to the sectional profile as detailed in the Drawings.
- 15.2 Unless otherwise shown, lapping for plain weather boarding shall be 38 mm. Boarding shall be secured to the frames using 75 mm galvanized steel nails and in the case of plain weather boarding, nails shall not be driven through the lapped portions. The exposed bottom ends of all external vertical boarding shall be splayed inward at an angle of 30 degrees and treated with preservatives.
- 15.3 The timber boarding shall be cleaned off and unless otherwise specified, it shall be finished with approved polyurethane base paint with UV protection applied strictly in accordance with the manufacturer's recommendations. The strength grouping for external timber flooring shall be in accordance with the Properties of Malaysian Timber as shown hereinafter in TABLE H6.
- 15.4 For coastal environments and exposed weather applications subjected to airborne salts deposition, metal connectors and fasteners used shall comply with AS 3566 Class 4 and be certified as such by the supplier of fasteners and to the approval of the S.O.
- 15.5 All fixings and associated components shall be manufactured from compatible metals and coated conforming to ISO 9223 Category 4 (C4) and Category 5 (C5) environment. Flashings shall be made from the same material as the roofing sheets.

16. Staircase And Balustrades

- 16.1 Unless otherwise shown in the Drawings, the Contractor shall prepare Shop Drawings as required for the Works. Prior to the fabrication and installation works, the Contractor shall submit the Shop Drawings to the S.O. for approval.
- 16.2 The preferred sizes for modular staircase and stair openings shall comply with MS 1064: Part 3.

 <p>JKR MALAYSIA</p>	<p>SECTION H : TIMBER, JOINERY AND IRONMONGERY WORKS</p>	<p>No. Dokumen : JKR 20800-0183-14 No. Keluaran : 01 No. Pindaan : 00 Tarikh : 29 Januari 2014 Muka Surat : H/15</p>
--	---	--

17. Timber Solid Panel Doors

- 17.1 All fire doors shall be of the appropriate Fire Resistance Period (FRP) in accordance with the Ninth Schedule of the Uniform Building By-Laws.
- 17.2 All fire doors including frames shall be constructed to a specification of the relevant FRP in accordance with MS 1073 and shall be tested by a laboratory, approved and certified by DGFR and have obtained a Product Certification Scheme from an accredited certification body.
- 17.3 All double leaf doors with rebated meeting stiles shall be provided with coordinating device so as to fit fully within the door openings with a gap of not more than 3mm between the frame and the edge of the door when closed.
- 17.4 Where shown on the Drawings, approved vision panel of suitable size shall be incorporated in the Fire Rated Door.
- 17.5 Flush doors shall generally comply with MS 1506: Specification for Wooden Door with plywood facing and strength group 1 and strength group 2 timber lipping, mitred around all edges. The plywood and strength group 1- 4 shall in all respects with the Specifications mentioned hereinbefore.
- 17.6 The preferred sizes for modular door sets shall comply with MS 1064: Part 4 and for modular windows shall comply with MS 1064: Part 5.

18. PVC Doors

- 18.1 Unless otherwise specified in the Drawings, PVC doors shall be of strong impact resistance and waterproof/moisture resistant laminated timber finish on both sides. Unless otherwise shown in the Drawings, the door shall be 38 mm thick.
- 18.2 PVC toilet doors shall be of full single panel of flush type. It shall be 100% waterproof, strong impact resistance and not be discoloured easily. Unless otherwise shown on the Drawings, the door shall be 38 mm thick. PVC door shall be delivered to the site complete with ironmongery as listed in the TABLE H7.

19. Products And Materials

- 19.1 Plywoods
 - 19.1.1 Unless otherwise specified, plywood used for interior and exterior purposes other than for formworks and temporary works shall be manufactured with Moisture Resistant (MR) bond and Weather and Boil Proof (WBP) bond respectively in compliance with MS 228. Boards which are to be painted or varnished shall be properly sanded down and holes and crevices filled with approved wood putty or filler.
 - 19.1.2 Plywood intended for use as shuttering board shall be of the Weather and Boil Proof (WBP) type.
 - 19.1.3 Plywood intended for structural use, shall be of Malaysian Basic Structural Grade (MBSG) rated or equivalent and shall comply with MS 544: Part 4.
 - 19.1.4 Plywood to be used in marine environment or severe wet conditions shall be in accordance with MS 544: Part 4.

 <p>JKR MALAYSIA</p>	<p>SECTION H : TIMBER, JOINERY AND IRONMONGERY WORKS</p>	<p>No. Dokumen : JKR 20800-0183-14 No. Keluaran : 01 No. Pindaan : 00 Tarikh : 29 Januari 2014 Muka Surat : H/16</p>
--	---	--

19.2 Blockboard

- 19.2.1 Blockboard shall comply with MS 1123. Fixing of blockboards shall generally be in accordance with the manufacturer's instructions.
- 19.2.2 Boards which are to be painted or varnished shall be properly sanded down and holes and crevices filled with approved wood putty or filler to the approval of the S.O.

19.3 Chipboards

- 19.3.1 Chipboards shall be of the type manufactured from wood chips or shavings combined with a thermosetting synthetic resin glue binder bonded and hot-pressed together and complying with MS 1036 for medium density chipboard. The type and quality of boards shall be approved by the S.O. The boards shall be fixed as detailed in the Drawings with a minimum edge distance of 12 mm for nailing.
- 19.3.2 Boards which are to be painted or varnished shall be properly sanded down and holes and crevices filled with approved wood putty or filler to the approval of the S.O.

19.4 Fibre Building Boards

- 19.4.1 All fibre building boards namely, Hard Board, Medium Board and Medium Density Fibre Board (MDF) shall comply with MS 1429 and MS 1912. The type and quality of Fibre building boards shall be as approved by the S.O. Perforated hardboards shall be not less than 3.2mm thick with maximum of 4.8mm perforation at 19mm centers unless otherwise stated in the Drawings.
- 19.4.2 All fibre building boards shall be fixed strictly in accordance with the manufacturer's instruction. Unless otherwise detailed in the drawings, the ceiling boards shall be butt and 'V' jointed.

19.5 Composite Boards

- 19.5.1 The type and quality of composite boards shall be as approved by the S.O. and shall be fixed strictly in accordance with the manufacturer's instruction.
- 19.5.2 Fixing of timber base composite boards shall comply with the manufacturer's instructions. Panels which are to be painted or varnished shall be properly sanded down and holes and crevices filled with approved wood putty or filler to the satisfaction of the S.O. Panels which are for wet prone area, shall comply with MS 1787.

19.6 Woodwool Slabs

- 19.6.1 Woodwool slab shall comply with MS 1036 and shall be of the type and quality as approved by the S.O. Unless otherwise specified in the Drawings, the slab shall be laid with its length at right angles to support, fixed strictly in accordance with the manufacturer's instruction.

19.7 Wood Cement Boards

- 19.7.1 Wood cement boards shall comply with the requirements of MS 934 or MS 544:Part 4. In fixing, the board must be supported on all four edges and at immediate positions at centres not exceeding 610 mm. Joints between

 <p>JKR MALAYSIA</p>	<p>SECTION H : TIMBER, JOINERY AND IRONMONGERY WORKS</p>	<p>No. Dokumen : JKR 20800-0183-14 No. Keluaran : 01 No. Pindaan : 00 Tarikh : 29 Januari 2014 Muka Surat : H/17</p>
--	---	--

boards shall occur on centers of supports. Minimum edge distance shall be 20 mm.

19.7.2 Boards which are to be painted shall be lightly sanded and any dust shall be removed from the surface with a piece of clean coarse cloth. Any filling compounds used shall be alkali-resistant. Fixing of the board shall be in accordance with the manufacturer's instructions.

19.8 High Pressure Laminate (HPL)

19.8.1 High Pressure Laminate is a thermoset paper/plastic composite, where decorative papers impregnated with melamine are consolidated over phenolic-impregnated craft papers at high temperature and pressure to form a homogenous laminate. Unless otherwise specified, HPL shall comply with MS 1787: Part 1-15 for durability.

19.9 Wood Plastic Composite (WPC)

19.9.1 WPC shall be made from minimum 70% rice husk and balance recycled HDPE. WPC solid decking system shall be of 145 mm (w) x 25 mm (t) fixed onto 300 mm c/c on Suspended Leveling System with hot dipped zinc-aluminium alloy coated steel with a minimum coating mass of AZ150 to AS/NZS 1397-2002 steel sheet grade G300 on to flat concrete slab with ENSS03 stainless steel clip, all in accordance with manufacturer's recommendation and S.O's approval.

20. Ironmongery

- 20.1 Unless otherwise shown on the Drawings, the Contractor shall supply and fix all ironmongery as listed in the TABLE H7 attached hereinafter, complete with fixing screws of the same material and finish.
- 20.2 Proper sockets shall be provided for all bolts to fix flush in floors, cills and door and window frames. Each lock shall be provided with three keys and no locks shall have identical keys, unless specifically required by the S.O.
- 20.3 All doors, windows, gates, joinery, et cetera, shall be provided with anti-rust heavy duty ironmongery appropriate for its function, complete with fixing screws of the same material and finish.
- 20.4 All doors shall be provided with door-stops, door-closers and other appropriate ironmongery where applicable or as shown on the Drawings.
- 20.5 The submission of ironmongery set shall have been tested and certified by SIRIM QA Services Sdn. Bhd. or approved equivalent.

21. Built-in Furniture

21.1 General

- 21.1.1 Built-in furniture shall be constructed and properly framed in wrot timber as shown on the Drawings. Where fittings are not to be painted, unless otherwise specified, they shall be stained and varnished as described under SECTION O: PAINTING WORKS.
- 21.1.2 All interior furniture works shall be coordinated with mechanical and electrical works and as approved by the S.O.

 <p>JKR MALAYSIA</p>	<p>SECTION H : TIMBER, JOINERY AND IRONMONGERY WORKS</p>	<p>No. Dokumen : JKR 20800-0183-14 No. Keluaran : 01 No. Pindaan : 00 Tarikh : 29 Januari 2014 Muka Surat : H/18</p>
--	---	--

- 21.1.3 All built-in furniture materials shall be protected wrapped in strong waterproof paper or polythene/polyethylene (PE) sheeting to protect against damp and scratching during transportation from the factory. The wrapping shall not be removed until installation starts.
- 21.1.4 Built-in furniture materials shall be unloaded and handled in a manner which will not result in damage, deformation or contamination to the built-in furniture materials.
- 21.1.5 Built-in furniture materials and loose furniture delivered to the site shall be properly stored by arranging them in stacks, keeping them properly wrapped and stored under cover if they are not used or assembled immediately.

21.2 Materials

- 21.2.1 All composite wood products, such as Medium Density Fibreboard (MDF) shall comply with MS 1429 and the use of Particleboards shall comply with MS 1912.
- 21.2.2 The formaldehyde emission for all composite wood products and wood based panels shall comply with MS 1787.
- 21.2.3 Laminates used in composite wood products shall comply with MS ISO 4586.
- 21.2.4 Unless otherwise specified in the Drawings or Specification the resin used in composite wood products shall be phenol-formaldehyde (PF), melamine-urea-formaldehyde (MUF), melamine-urea-phenol-formaldehyde (MUPF), polymeric diphenyl methane diisocyanate (PMDI) or polyurethane (PU).
- 21.2.5 Adhesive for wood and composite wood products shall be phenol-formaldehyde resin adhesive classified as weather-proof and boil-proof, in accordance with MS 908.
- 21.2.6 Thermoplastic fittings, such as handles and accessories, where applicable, shall be polyamide (PA) or polypropylene (PP). Thermoplastics shall comply with MS 2324.
- 21.2.7 Solid surface shall be non-porous, homogenous, stain and chemical resistant, fire resistant and with a composition of acrylic polymer, aluminium trihydrate filler and pigment.
- 21.2.8 Where timber species are used it shall be constructed and properly framed in wrot timber as detailed in the Drawings.

21.3 Component Assemblies

- 21.3.1 Unless otherwise stated in the Drawings, steel frames, where applicable, shall be square and flat with mitred, welded corners.
- 21.3.2 Screws shall have countersunk heads which shall comply with MS ISO 1482.
- 21.3.3 Hinges shall have a spring mechanism to lock the door in a close or open position, remain completely hidden behind the door and enable the door to open to 120 degrees.

 <p>JKR MALAYSIA</p>	<p>SECTION H : TIMBER, JOINERY AND IRONMONGERY WORKS</p>	<p>No. Dokumen : JKR 20800-0183-14 No. Keluaran : 01 No. Pindaan : 00 Tarikh : 29 Januari 2014 Muka Surat : H/19</p>
--	---	--

- 21.3.4 Drawer slides shall be epoxy powder coated metal, mounted from the bottom and provided with friction bearing-mounted nylon rollers.
- 21.3.5 Unless otherwise specified, drawers shall have the 'soft-close' and/or 'positive-close' functions, which are mechanisms enabling drawers to quietly shut, or which fully shut after being only partially pushed. Drawers can be lifted up and removed easily for cleaning purposes.
- 21.3.6 All drawers, unless otherwise specified, shall have $\frac{3}{4}$ extension and be able to sustain up to 25 kg. Kitchen cabinet drawers shall have full extension and be able to sustain up to 45 kg, which is suitable for large pots, pans and/or woks.
- 21.3.7 Drawers for storing small kitchen cutlery shall have thermoplastic inserts with subdivided compartments.
- 21.3.8 Drawer handles and cabinet pulls shall be ergonomic. Thermoplastic handles and pulls shall recess into the door panels. Metal handles and pulls that extrude shall either be epoxy powder coated and/or anodized aluminium.
- 21.3.9 Solid surface worktops and countertops shall be 12 mm thick, 600 mm deep with backsplash 100 mm high, with integral bowl, where applicable. Actual dimension of solid surface worktops shall be measured at site. Upon installation of the solid surface worktops, it shall be polished and set level to S.O's approval.
- 21.3.10 Unless otherwise specified, worktops and countertops shall have a flat edge finishing at the perimeter. Worktops and countertops shall be provided with holes and cut-outs for plumbing components, where applicable. All joints shall be inconspicuous and use the manufacturer's recommended adhesive and silicone sealant.
- 21.3.11 Built-in furniture sliding doors shall be fitted with guides or similar fittings, rollers or ball bearings, pull handles, stops and locking mechanisms.
- 21.3.12 Cabinet doors with glass inserts and/or panels shall be constructed with proper support to ensure that the glass remains securely fixed. Support shall be bedded in mastic with all interstices completely filled.
- 21.3.13 Glass inserts and/or panels and glass shelves, where applicable, which needs to be structurally strong shall be tempered glass. Tempered glass shall comply with MS 1498.
- 21.3.14 Cupboards, wardrobes, cabinets and shelves shall have peg-holes on either side internally, allowing for adjustable shelf height. Adjustable legs, if applicable, shall be of a proprietary system type as approved by the S.O.

 JKR MALAYSIA	SECTION H : TIMBER, JOINERY AND IRONMONGERY WORKS	No. Dokumen : JKR 20800-0183-14
		No. Keluaran : 01 No. Pindaan : 00 Tarikh : 29 Januari 2014 Muka Surat : H/20

TABLE H1: SCHEDULE OF TIMBER GROUPING AND USAGE

No	Typical Usage	Species
1	Structural frames 1.1 All columns, stilts and beams	SG4
2	Bearer to water tank	SG5
3	Staircase and component elements 3.1 Stinger & treads/Riser 3.2 Trimmer beams 3.3 Balustrades, nosing and handrails	SG5 SG5 SG5
4	Flooring 4.1 Floor bearers, joists and strutting for joists 4.2 Floor boardings 4.3 Gymnasium floor boarding 4.4 Parquet flooring 4.5 Skirtings	SG5 SG5 SG4 SG5 SG5
5	Walling 5.1 Wall and partition framings 5.2 External wall boardings 5.3 Internal wall boardings	SG5 SG5 SG7
6	Roof structures 6.1 Roof trusses, rafters, purlins, wall plates and other roof members 6.2 Fascia boards	SG4 SG5
7	Ceiling frames 7.1 Ceiling joists and spacers 7.2 Cover battens to joints of ceiling sheets 7.3 Ceiling strips and soffit battens	SG5 SG7 SG7
8	Door and window frames 8.1 All doors, windows, vent frames, grounds, stops and architraves 8.1.1 External usage 8.1.2 Internal usage	SG5 SG7
9	Furniture fitting 9.1 Built-in fittings and furniture in general 9.1.1 Carcassing 9.1.2 Lining/Panelling 9.1.3 Top 9.2 Workshop furniture top	SG5 SG7 SG5 SG5
10	Beading fillets and edgings in general	SG5



 JKR MALAYSIA	SECTION H : TIMBER, JOINERY AND IRONMONGERY WORKS	No. Dokumen : JKR 20800-0183-14
		No. Keluaran : 01
		No. Pindaan : 00
		Tarikh : 29 Januari 2014
		Muka Surat : H/21

TABLE H2: SCHEDULE OF TIMBER SPECIES IN ACCORDANCE WITH STRENGTH GROUPING (S.G)

S.G 1	S.G 2	S.G 3	S.G 4	S.G 5	S.G 6	S.G 7
A) Naturally Durable						
Balau	Belian	Bekak	Giam	Jati		
Bitis	Mata Ulat	Delek	Malabera	Tembusu		
Cengal	Kekatang	Keranji	Merbau			
Penaga			Resak			
B) Requiring Treatment						
	Bedaru	Agoho	Berangan	Alan Bunga	Bayur	Ara
	Kempas	Balau Merah	Dedali	Babai	Damar Minyak	Batai
	Merbatu	Kelat	Derum	Balik Angin Bopeng	Durian	Geronggang
	Mertas	Kembang Semangkuk	Kapur	Bintangor	Jelutung	Laran
		Kulim	Kasai	Brazil Nut	Jenitri	Pelajau
		Pauh Kijang	Keruntum	Gerutu	Jongkong	Pulai
		Penyau	Mempening	Kundur	Kasah	Sesenduk
		Perah	Meransi	Kedondong	Macang	Terentang
		Petaling	Meranti Bakau	Keledang	Medang	
		Ranggu	Merawan	Keruing	Melantai/ Kawang	
		Ru	Merpauh	Ketapang	Meranti Merah Muda	
		Surian Batu	Nyalin	Kungkur	Meranti kuning	
		Tualang	Perupuk	Melunak	Mersawa	
			Punah	Mempisang	Sengkurat	
			Rengas	Mengkulang	Terap	
			Simpoh	Meranti Merah Tua		
				Meranti Putih		
				Nyatuh		
				Penarahan		
				Petai		
				Ramin		
				Kayu Getah		
				Sengkuang		
				Sepetir		
				Tetebu		

Notes :

1. For naturally durable timbers, sapwood should be excluded. If sapwood is included, preservative treatment is necessary.(Source: MS 360:1986)
2. For timber requiring treatment, they should be amenable to preservative treatment.

 JKR MALAYSIA	SECTION H : TIMBER, JOINERY AND IRONMONGERY WORKS	No. Dokumen : JKR 20800-0183-14
		No. Keluaran : 01 No. Pindaan : 00 Tarikh : 29 Januari 2014 Muka Surat : H/22

**TABLE H3: SCHEDULE OF MOISTURE CONTENTS (M.C) OF TIMBER
FOR VARIOUS POSITIONS IN BUILDING**

Application	Maximum M.C. At Time Of Installation For Non Air-Conditioned Application	Maximum M.C. At Time Of Installation For Airconditioned Application (Kiln-Dried Timber)
Structural Components <ul style="list-style-type: none"> Columns, beams, bearer, studs, joists, ties and struts 	30% (Thickness >100mm) 25% (Thickness <100mm)	Not applicable Not applicable
Roofing <ul style="list-style-type: none"> Rafters, ties, struts, purlins and bracing battens 	25% 25%	Not applicable Not applicable
Staircase <ul style="list-style-type: none"> stringers, treads, trimmer beam and handrail balustrades 	19% 19%	12% 12%
Flooring <ul style="list-style-type: none"> floor boarding and parquetry skirtings 	19% 19%	12% 12%
Walling <ul style="list-style-type: none"> wall, partition framing external wall boardings internal wall boardings fascia boards 	19% 19% 19% 19%	12% Not applicable 12% Not applicable
Ceiling Frames <ul style="list-style-type: none"> cover battens to joints of ceiling sheets ceiling strips and soffit battens 	25% 19%	Not applicable 12%
Door & Window Frames <ul style="list-style-type: none"> door, window and vent frames including their stops and grounds door leaves, window and vent sashes 	19% 19%	12% 12%
Furniture <ul style="list-style-type: none"> built in fittings, furniture generally workshop furniture science laboratory tops 	19% 19% 19%	12% 12% 12%
Beading fillets and edgings generally	19%	12%

 JKR MALAYSIA	SECTION H : TIMBER, JOINERY AND IRONMONGERY WORKS	No. Dokumen : JKR 20800-0183-14
		No. Keluaran : 01
		No. Pindaan : 00
		Tarikh : 29 Januari 2014
		Muka Surat : H/23

**TABLE H4: NATURAL DURABILITY¹ CLASSIFICATION OF PENINSULAR MALAYSIA
TIMBERS FOR GROUND CONTACT**

Class 1	Class 2	Class 3		Class 4	
Very durable (More than 10 years)	Durable (5 to 10 years)	Moderately durable (2 to 5 years)		Not durable (Less than 2 years)	
Chengal	Balau	Agoho ²	Rengas	Api-api	Nyatoh ^{6c}
Giam	Bekak	Balau, red	Sepetir	Ara	Perapat
Penyau	Bitis	Bakau	Tumu	Berangan	Perah
Resak	Kasai	Bungor	Tualang	Balek angin	Perupok
Tempinis	Kapur ^{4a}	Derum	Telor buaya	Bintangor	Petai
	Nyatoh ^{6a}	Dedali	Pelong	Batai	Podo
	Merbau	Dedaru	Kerukup	Bayur	Pulai
	Mersawa	Delek	Brazil nut ²	Damar minyak	Putat
	Merbau lalat	Dungun	Keruntum	Dungun paya	Ramin
	Delinsem ²	Acacia ³	Keruing ^{8a,b,c}	Durian	Samak
	Malabera	Pauh kijang	Keledang ^{9a,b}	Engkabang	Sena
	Medang ^{5a,b}	Kapur ^{4b}	Mata ulat	Jelutong	Sawa luka
	Penaga	Kelat	Medang ^{5c}	Gaham badak	Sepul
	Pelajau	Kembang semangkok	Meranti, ^{7a,b,c,d,e} dark red	Geronggang	Sesenduk
	Pelawan	Kempas	Mempening	Gerutu	Sentang ³
	Ranggu	KerANJI	Mengkulang	Gading	Simpoh
	Surian batu	Gegatal	Meransi	Gapis	Sempilor
	Teak	Kulim	Merbatu	Meranti bakau	Terentang
	Tembusu	Kungkur	Merawan	Meranti, light red	Tapus
		Leban	Merbau kera	Jenitri	Terap
		Nyalas	Meranti, white	Jongkong	Tuai
		Pauh kijang	Mertas	Kasah	Tulang daing
		Petaling	Nyatoh ^{6b}	Kekabu	Ketapang
		Punah	Nyireh	Kawang	Rubberwood
			Nipis kulit	Keledang ^{9c,d,e}	Pine ³
				Kapur ^{4c}	Yemane ³
				Kayu malam	Coconut
				Kedondong	Tengkurung
				Kungkur	Penarahan
				Meranti, yellow	Keruing ^{8d,e}
				Laran	Meranti tembaga
				Lelayang	Machang
				Lilin	Medang ^{5d,e}
				Limpaga ²	Mempisang
				Ludai	Merbatu
				Merpauh	Melantai
					Minyak berok

NOTE. For reference to source of data see Bibliography

* The results were obtained from the graveyard test from the Forest Research Institute Malaysia test site.

¹ All samples taken from heartwood area except for the timber which their sapwood and heartwood cannot be differentiated. Timber of the same species but from different regions in Malaysia may have different durability classifications.

² The timber is not Peninsular Malaysia origin.

³ Plantation timber, originally from other countries.

^{4a} *Dryobalanops aromatica*

^{4b} *Dryobalanops rappa*

^{4c} *Dryobalanops oblongifolia*

^{5a} *Alseodaphne insignis*

^{5b} *Dehaasia nigrescens*

^{5c} *Cinnamomum porrectum*

^{5d} *Litsea firma*

^{5e} *Litsea megacarpa*

^{6a} *Palaquium impressinervium*

^{6b} *Palaquium maingayi*

^{6c} *Palaquium gutta*

^{7a} *Shorea uliginosa*

^{7b} *Shorea platyclados*

^{7c} *Shorea pauciflora*

^{7d} *Shorea singkawang*

^{7e} *Shorea curtisii*

^{8a} *Dipterocarpus sublamellatus*

^{8b} *Dipterocarpus crinitus*

^{8c} *Dipterocarpus verrucosus*

^{8d} *Dipterocarpus kerrii*

^{8e} *Dipterocarpus lowii*

^{9a} *Artocarpus interger*

^{9b} *Artocarpus lanceifolius*

^{9c} *Artocarpus dadah*

^{9d} *Artocarpus rigidus*

^{9e} *Artocarpus heterophyllus*

 JKR MALAYSIA	SECTION H : TIMBER, JOINERY AND IRONMONGERY WORKS	No. Dokumen : JKR 20800-0183-14
		No. Keluaran : 01
		No. Pindaan : 00
		Tarikh : 29 Januari 2014
		Muka Surat : H/24

TABLE H5: NATURAL DURABILITY¹ CLASSIFICATION OF SARAWAK TIMBERS FOR GROUND CONTACT

Class 1	Class 2	Class 3		Class 4	
Very durable (More than 10 years)	Durable (5 to 10 years)	Moderately durable (2 to 5 years)		Not durable (Less than 2 years)	
Belian	Kapur bukit	Baru	Kapur paji	Acacia	Bindang
Penyau	Kapur kelansau	Bedaru	Kapur paya	Alan	Geronggang
Selangan batu ²	Kawi	Kandis	Luis/Chengal pasir	Asam	Jadap
	Luis	Kasai	Medang luis kasar	Bajan	Jelawai
	Lun runcing	Leban	Mengkulang	Bayur	Jelutong
	Mertama	Nyireh	Mersawa kunyit	Bengang	Kayu cina
	Nyatoh ³	Pelajau	Petai belalang	Benuah	Kayu malam
	Rhu	Resak membangun	Sempilor	Binuang	Kelampayan
	Selangan batu ^{4a}	Seladah ^{4b, c}		Bintangor	Kembang semangkok
		Selumar		Bintawak	Kepayang babi
		Selunsur		Dungun	KerANJI
		Tapang		Durian	Keruing
		Urat mata		Empenit	Ketiau
				Entuyut	Kumpang
				Litoh	Legai
				Medang	Meranti, light red
				Menggris	Yellow flame
				Mersawa paya	Meranti, yellow
				Minggi	Mergasing
				Ngilas	Peran/bilat
				Nyatoh ^{5a, b}	Segera
				Pelai	Seladah ^{6a, b}
				Perah	Sentang
				Perupok	Simpoh Tampoi
				Petai	Tekalong
				Pitoh	Teruntum Ubah
				Ramin	Upi
				Resak paya	
				Sawih	

¹ The results were obtained from the graveyard test from Oya Road, Sibu test site. All samples taken from heartwood area except for the timber which their sapwood and heartwood cannot be differentiated. Timber of the same species but from different regions in Malaysia may have different durability classifications.

² *Shorea pulricostata*

³ *Palaquium rivulare*

^{4a, b, c} *Shorea flava, S. laecis, S. spp*

^{5a, b} *Dacryodes incurvata, Santira laevigata*

^{6a, b} *Palaquium pseudorostratum, Ganua motleyana*

 JKR MALAYSIA	SECTION H : TIMBER, JOINERY AND IRONMONGERY WORKS	No. Dokumen : JKR 20800-0183-14
		No. Keluaran : 01 No. Pindaan : 00 Tarikh : 29 Januari 2014 Muka Surat : H/25

TABLE H6: PROPERTIES OF MALAYSIAN TIMBER

Heavy Hardwoods				
No	Species	Strength	Tangential Movement	Air-dry density (kg/m ³)
1	Balau	Very strong	2.1 – 2.5%	850-1155
2	Merbau	Strong	2.1 – 2.5%	515-1040
3	Red Balau	Strong	2.1 – 2.5%	800-880
Medium Hardwoods				
1	Kelat	Strong	2.1 – 2.5%	495-1010
2	Kempas	Very strong	> 3.1%	770-1120
3	Keruing	Strong	2.6 – 3.0% 3.1%	690-945
4	Mengkulang	Strong	2.1 – 2.5%	625-895
5	Merpauh	Strong	1.5 – 2.0%	640-880
Light Hardwoods				
1	Bintagor	Moderately strong	1.5 – 2.0%	495-865
2	Dark Red Meranti	Moderately strong	< 1.5% 1.5 – 2.0%	560-865
3	Gerutu	Moderately strong	2.6 – 3.0%	575-880
4	Mersawa	Moderately strong	2.1 – 2.5%	515-735
5	Yellow Meranti	Moderately strong	1.5 – 2.0%	575-735

(Source: Choo KT, Gan KS & Lim SC, Movement of Seasoned Timber in Service, FRIM Technical Information Handbook No 18)



 JKR MALAYSIA	SECTION H : TIMBER, JOINERY AND IRONMONGERY WORKS	No. Dokumen : JKR 20800-0183-14
		No. Keluaran : 01 No. Pindaan : 00 Tarikh : 29 Januari 2014 Muka Surat : H/26

TABLE H7: SCHEDULE OF IRONMONGERY

Type of Doors, Windows etc.	Ironmongery for each type of doors, windows etc.
1. Single Leaf Door	
1.1.Plywood Flush Door	a) 3 Nos. of 102 mm x 76 mm x 2 mm galvanised steel hinges with nylon rings. b) 1 No. upright 3 lever mortice lockset with satin chrome lever handle furniture of approved manufacture with 2 Nos. chrome plated keys of different serial number for each building. c) 1 No. stainless steel door stopper.
1.2.Timber Panelled Door	a) 3 Nos. of 102 mm x 76 mm x 2 mm stainless steel hinges with nylon ring. b) 1 No. medium duty cylindrical lockset, 5 pin tumbler with knob and rose of stainless steel with hairline finish complete with 3 Nos. nickle-plated brass keys of different serial number for each building. c) 1 No. stainless steel door stopper.
2. Double Leaf Door	
2.1.Plywood Flush Door	a) 6 Nos. 102 mm x 76 mm x 2 mm stainless steel hinges with nylon rings. b) 1 Set Hollow Lever Handle Stainless Steel Mortice Lock Body with single key thumb turn cylinder. c) 1 No. solid brass mortice lock rebated part. d) 1 Set of 150 mm and 300 mm Flush Bolt Lever Type Stainless Steel. e) 1 No. dust socket medium. f) 2 Nos. stainless steel door stopper.
2.1.Timber Panelled Door	a) 6 Nos. 102mmx76mmx2mm stainless steel hinges with nylon rings. b) 1 No. cylindrical lock stainless steel, 5 pin tumbler with knob and rose of stainless steel with 3 nos nickle-plated brass keys c) 1 No. solid brass mortice lock rebated part. d) 1 Set of 150mm and 300mm Flush Bolt Lever Type Stainless Steel. e) 1 No. dust socket medium. f) 2 Nos. stainless steel door stopper.
3. PVC Door To Toilet /Bathroom Cubicles	a) 3 Nos. 102 mm x 76 mm x 2 mm stainless steel hinges with nylon rings. b) i) Residential Quarters - 1 No. stainless steel cylindrical lock with privacy locking device operated by turn from inside and knob handle. ii) Non-residential buildings - 1 No. stainless steel indicator bolt toilet. c) 1 No. hat & coat hook stainless steel.
4. Single Leaf Fire Rated Door	
4.1.Standard size of 800 mm x 2100 mm ½ hr & 1 hr fire rated door (Metal Frame & Timber Door)	a) 3 Nos. 127 mm x 89 mm x 2.5 mm heavy duty stainless steel hinges. b) 1 Set Hollow Lever Handle Stainless Steel Mortice Lock Body with single key thumb turn cylinder approved by DGFR. c) 1 No. stainless steel door stopper. d) 1 No. door closer. e) 1 No. floor spring for double swing door.
4.2.Standard size of 900 mm x 2100 mm ½ hr & 1 hr fire rated door (Metal Frame & Timber Door)	a) 3 Nos. 127 mm x 89 mm x 2.5 mm heavy duty stainless steel hinges. b) 1 Set Hollow Lever Handle Stainless Steel Mortice Lock Body with single key thumb turn cylinder approved by DGFR. c) 1 No. stainless steel door stopper. d) 1 No. door closer. e) 1 No. floor spring for double swing door.
4.3.Standard size of 900 mm x 2100 mm 2 hr fire rated door (Metal Frame & Timber Door)	a) 4 Nos. 127 mm x 89 mm x 2.5 mm heavy duty stainless steel hinges. b) 1 Set Hollow Lever Handle Stainless Steel Mortice Lock Body with single key thumb turn cylinder approved by DGFR. c) 1 No. stainless steel door stopper. d) 1 No. door closer. e) 1 No. floor spring for double swing door. f) 2 Nos. of ball bearings. g) 1 No. of heavy duty stainless steel latch with 75 mm long backset.
5. Double Leaf Fire Rated Door	
5.1.Standard size of 1200 mm x 2100 mm	a) 4 Nos. 127 mm x 89 mm x 2.5 mm heavy duty stainless steel hinges. b) 1 Set Hollow Lever Handle Stainless Steel Mortice Lock Body with single key thumb turn cylinder approved by DGFR. c) 1 No. solid brass mortice lock rebated part. d) 1 Set of 150 mm and 300 mm Flush Bolt Lever Type Stainless Steel. e) 1 No. dust socket medium. f) 2 Nos. stainless steel door stopper. g) 2 Nos. automatic door closer of hydraulically spring operated type (for swing doors) or of wire rope and weight type (for sliding doors). h) 2 Nos. floor spring for double swing door.

 JKR MALAYSIA	SECTION H : TIMBER, JOINERY AND IRONMONGERY WORKS	No. Dokumen : JKR 20800-0183-14
		No. Keluaran : 01
		No. Pindaan : 00
		Tarikh : 29 Januari 2014
		Muka Surat : H/27

Type of Doors, Windows etc.	Ironmongery for each type of doors, windows etc.
5.2. Standard size of 1800 mm x 2100 mm	a) 6 Nos. 127 mm x 89 mm x 2.5 mm heavy duty stainless steel hinges. b) 1 Set Hollow Lever Handle Stainless Steel Mortice Lock Body with single key thumb turn cylinder approved by DGFR. c) 1 No. solid brass mortice lock rebated part. d) 1 Set of 150 mm and 300 mm Flush Bolt Lever Type Stainless Steel. e) 1 No. dust socket medium. f) 2 Nos. stainless steel door stopper. g) 2 Nos. automatic door closer of hydraulically spring operated type (for swing doors) or of wire rope and weight type (for sliding doors). h) 2 Nos. floor spring for double swing door.
5.3. Standard size of 2400 mm x 2100 mm	a) 8 Nos. 127 mm x 89 mm x 2.5 mm heavy duty stainless steel hinges. b) 1 Set Hollow Lever Handle Stainless Steel Mortice Lock Body with single key thumb turn cylinder approved by DGFR. c) 1 No. solid brass mortice lock rebated part. d) 1 Set of 150 mm and 300 mm Flush Bolt Lever Type Stainless Steel. e) 1 No. dust socket medium. f) 2 Nos. stainless steel door stopper. g) 2 Nos. automatic door closer of hydraulically spring operated type (for swing doors) or of wire rope and weight type (for sliding doors). h) 2 Nos. floor spring for double swing door.
6. Single Leaf Fire Escape Door	a) 3 Nos. of 127 mm x 89 mm x 2.5 mm thick heavy duty stainless steel hinges. b) 1 complete set of approved make fire rated panic bolts.
7. Double Leaf Fire Escape Door	a) 6 Nos. of 127 mm x 89 mm x 2.5 mm thick heavy duty stainless steel butt hinges. b) 1 complete set of approved make fire rated panic bolts.
8. Glass Door	a) 1 Set Floor Spring. b) 1 Set Patch Fitting, door bottom, door top, lock clamp, over panel. c) 1 pair Pull handle 600 mm.
9. Aluminium Door	a) 3 Nos. 102 mm x 76 mm x 2 mm stainless steel hinges with nylon rings. b) 1 Set Hollow Lever Handle Stainless Steel Mortice Lock Body deadlock with single key thumb turn cylinder.
10. Kitchen Cabinet Door/ Workbench	a) Galvanised steel continuous 'piano' butt hinges. b) 1 No. 100 mm aluminium 'D' handle. c) 1 No. bales catch. d) 1 No. galvanised steel cupboard lock in satin chrome finish.
11. Wardrobe	a) 3 Nos. of 75 mm brass butt hinges (per door leaf). b) 2 Nos. 100 mm anodised aluminium barrel bolt (for double leaf doors) c) 1 No. 100 mm aluminium 'D' handle. d) Chromium plated steel clothes hanger rail. e) Steel cylinder cupboard lock in satin chrome finish.
12. Drawer	a) 1 No. steel cylinder drawer lock in satin chrome finish. b) 1 No. 100 mm aluminium 'D' handle.
13. Sliding and Folding Door/ Partition	a) Top or bottom running set sliding and folding door gear, complete with tracks, channel, brackets, roller guides, hangers and all necessary butt hinges, flush bolts and flush door pulls, etc. as recommended by the manufacturer. b) 1 No. upright 3 lever rebated mortice lockset for sliding and folding door with satin chrome lever handle furniture with 2 Nos. keys of different serial number for each building.
14. Straight Sliding Door	a) Top or bottom running set straight sliding door gear complete with tracks, brackets, hangers, roller guides, channels, door stops, flush brass bolts, brass flush pull etc. as recommended by the manufacturer. b) 1 No. upright 3 lever mortice lockset with satin chrome finish for straight sliding door with 2 Nos. keys of different serial number for each building.
15. Timber Casement Window	a) 2 Nos. 400 mm long approved electro-galvanised steel friction hinges. b) 1 No. approved brass with satin chrome finish combination handle and fastener.
16. Top Hung Casement Timber Window.	a) 2 Nos. 750 mm long approved electro-galvanised steel friction hinges. b) 1 No. approved brass with satin chrome finish automatic locking fastener.
17. Top Hung Vent/Sashes	a) 2 Nos. 400 mm long approved electro-galvanised steel friction hinges. b) 1 No. approved brass with satin chrome finish automatic locking fastener



**SECTION H : TIMBER, JOINERY
AND IRONMONGERY WORKS**

No. Dokumen : JKR 20800-0183-14
No. Keluaran : 01
No. Pindaan : 00
Tarikh : 29 Januari 2014
Muka Surat : H/28

**TABLE H8: TIMBER SPECIES FOR THE MANUFACTURING OF
GLUED LAMINATED TIMBER COMPONENTS**

Standard names	Strength class
Mengkulang	D40
Merbau Keruing	D50
Kapur Kempas	D60
Balau	D70

	SECTION H : TIMBER, JOINERY AND IRONMONGERY WORKS	No. Dokumen : JKR 20800-0183-14 No. Keluaran : 01 No. Pindaan : 00 Tarikh : 29 Januari 2014 Muka Surat : H/29
---	--	---

APPENDIX H/1

GLUED LAMINATED TIMBER PERFORMANCE WARRANTY (SPECIMEN)

1.0 Coverage of Performance Warranty

We the glued laminated timber Manufacturer hereby warrant that for a period of **ten (10) years** from the date of Practical Completion, the glued laminated timber system shall not be affected by the following defect:

a) Debonding

This condition occurs when the individual laminations of a glued laminated timber member become separated.

2.0 Procedure for Claims

- i) Any defect claims shall be made in writing and delivered by post or by hand to the Manufacturer.
- ii) A technical team from the Manufacturer will be dispatched to evaluate the nature of the claim. Should our findings conclude the defects as within the scope of warranty, then the Manufacturer shall make good such defects.
- iii) Should the Manufacturer's technical team conclude that the defects falls outside the scope of the warranty, the Manufacturer shall not be held responsible for the claim.
- iv) Should the Government disagree with the conclusion of the technical team pertaining to the defects in particular, then an independent third party competent in such technical evaluation shall be appointed to investigate the disputed defects.
- v) The appointment of independent third party competent in such technical evaluation shall only be appointed upon the mutual agreement between the Government and the Manufacturer.
- vi) The findings of the third party shall be conclusive and mutually accepted by the Government and the Manufacturer.
- vii) If the findings of the independent third party are within the coverage of this performance warranty, all cost shall be borne by the Manufacturer or otherwise such cost shall be borne by the Contractor.
- viii) All claims for the defects must be received by the Manufacturer not later than fourteen (14) days from the expiry of the warranty period.

MANUFACTURER

.....
.....

.....
Company Stamp

.....
Signature

Name:
Date:

WITNESS

.....
.....

.....
Company Stamp

.....
Signature

Name:
Date:

 <p>JKR MALAYSIA</p>	<p>SECTION H : TIMBER, JOINERY AND IRONMONGERY WORKS</p>	<p>No. Dokumen : JKR 20800-0183-14 No. Keluaran : 01 No. Pindaan : 00 Tarikh : 29 Januari 2014 Muka Surat : H/30</p>
--	---	--

BLANK PAGE

TABLE OF CONTENTS

SECTION I: CEILING WORKS

	PAGE
1. General	I/1
2. Submittals	I/1
3. Setting Out	I/1
4. Acoustic Requirements	I/2
5. Materials And Ceiling Components	I/2
6. Ceiling Suspension System	I/5

 <p>JKR MALAYSIA</p>	<p>SECTION I : CEILING WORKS</p>	<p>No. Dokumen : JKR 20800-0183-14 No. Keluaran : 01 No. Pindaan : 00 Tarikh : 29 Januari 2014 Muka Surat : I/1</p>
--	---	---

1. General

- 1.1 Unless otherwise specified or shown on the Drawings, all ceilings shall be Mineral Fiber Boards or as approved by the S.O. with class 'O' fire rating and all ceiling installation shall comply with the classification of fire spread as stipulated in the 8th Schedule Uniform Building By-Law 1984.
- 1.2 All ceilings shall be provided with service access to the ceiling void for maintenance of services above the ceiling space in accordance to the Drawings and approval of the S.O.
- 1.3 All sprinkler heads (drops) shall have 12.5 mm diameter oversize ring, sleeve or adaptor through the ceiling tile to allow for free movement of the sprinkler pipes. It shall also comply with the local fire regulations and to the S.O's approval.
- 1.4 The Contractor shall not commence the ceiling installation works until the building is effectively weather-tight and the work area of wet trades has been completed and dried.

2. Submittals

- 2.1 Unless otherwise specified, the Contractor shall submit shop drawings and design calculations for the complete proprietary ceiling system showing compliance to all specifications including the method of installation of the ceiling board/panels, hangers, fittings and all accessories duly certified by a P.E. registered with the Board of Engineers Malaysia.
- 2.2 The Contractor shall also submit floor plans showing the proposed location of the anchors prior to the casting of the floor slab for the approval of the S.O. The plans shall be endorsed by the P.E.
- 2.3 No installation of ceiling works shall commence until approval is given in writing by the S.O.

3. Setting Out

- 3.1 The ceiling layout shall be planned prior to installation to determine the grid configuration, direction et cetera to ensure that all fixings points are compatible with the structural members or other services, or both.
- 3.2 Mechanical and electrical services shall be completed before installation of the suspension systems. Down-lights or other services shall not rely on the ceiling panel for support. Suspension hangers may be installed before or during installation of services with the approval of the S.O.
- 3.3 The shop drawings used for the ceiling installation shall contain sufficient information to allow the installer to set out the ceiling grid. The finished height of the ceiling shall be shown clearly on the drawings.
- 3.4 Sufficient information should be clearly indicated on the drawings to enable the ceiling module and setting out points in each ceiling area applicable to all relevant trades to be established early. All trades shall work to the same setting out points and data.
- 3.5 The ceiling height in each area shall be marked in relation to the elevation benchmarks and then transferred by means of a water level, rotating laser or other

 <p>JKR MALAYSIA</p>	<p>SECTION I : CEILING WORKS</p>	<p>No. Dokumen : JKR 20800-0183-14 No. Keluaran : 01 No. Pindaan : 00 Tarikh : 29 Januari 2014 Muka Surat : 1/2</p>
--	---	---

approved devices. Setting out lines should be in both directions and squared accurately at the outset.

4. Acoustic Requirements

- 4.1 Acoustic requirements specified or shown on the Drawings, such as sound absorption, sound insulation and impact sound insulation shall be tested in accordance with BS EN 13964, BS EN ISO 140 or other acceptable standards.
- 4.2 A full test report shall be submitted to the S.O as proof of compliance. It shall relate to the entire specified system. Any variations shall be endorsed by the test laboratory or field testing. Test reports, comments and the testing authority shall be stated in the manufacturer's trade literature or be made available upon request or both.

5. Materials And Ceiling Components

5.1 Zinc-Coated And Aluminium/Zinc Coated Steel

Zinc-coated and aluminum/zinc-coated steel used for the construction of suspended ceiling components shall comply with MS 1196 or other equivalent Standards. The Contractor shall provide proof of compliance to the approval of the S.O. Where sections have been cut from zinc-coated or aluminium/zinc-coated sheets, the cut edges shall be treated with protective anti-rust paint to prevent corrosion. All pre-painted finish for ceilings shall be as specified under SECTION G: ROOFING WORKS.

5.2 Linear Strip Ceiling

Unless otherwise specified or shown on the Drawings, linear strip ceiling shall be aluminium pre-painted anodized comprising of 150mm width x 12.5mm deep x 0.6mm thick panel fixed in accordance to manufacturer's recommendation and to S.O's approval.

5.3 Plasterboard

5.3.1 All plasterboards dimensions, its tolerances and flexural breaking load shall comply with BS EN 520. The board shall carry class 'O' approval from DGFR.

5.3.2 Unless otherwise specified in the Drawings the size for plasterboard ceiling shall be 600 mm x 1200 mm x 9 mm thick minimum and shall be suspended from the soffit with adjustable hanger rods in accordance to manufacturer's recommendation and S.O's approval.

5.4 Plasterboard With Improved Core Adhesion At High Temperature (Type F)

The type of board and test requirements shall be in accordance with BS EN 520, and to the approval of the S.O. The board shall carry Class 'O' approval from DGFR.

5.5 Plasterboard With Reduced Water Absorption (Type H)

The types of moisture resistance board to receive paint finish shall be in accordance with BS EN 520 and to the approval of the S.O. The board shall carry Class 'O' approval from DGFR.

 <p>JKR MALAYSIA</p>	<p>SECTION I : CEILING WORKS</p>	<p>No. Dokumen : JKR 20800-0183-14 No. Keluaran : 01 No. Pindaan : 00 Tarikh : 29 Januari 2014 Muka Surat : 1/3</p>
--	---	---

5.6 Mineral Fibre Boards

5.6.1 Unless otherwise specified, the board size shall be 600 mm x 1200 mm x 15 mm thick square edges. The board shall carry Class 'O' approval from the DGFR and the minimum sag resistance shall be of RH 99.

5.6.2 Surface coating of the board shall be applied with vinyl latex paint in white colour at factory and the surface design of the board shall be to S.O.'s approval.

5.7 Fibre Cement Ceiling Panel

Fibre cement ceiling panel shall be asbestos free and shall be an autoclaved cellulose fibre cement flat board. The basic composition consists of cement, refined sand and cellulose fiber. The material shall be classified as Class 'O' and shall be 'Fire- Listed' under SIRIM QAS Fire Listing Scheme.

5.8 Acoustic Glass Wool Ceiling Panel

Acoustic glass wool ceiling panel shall be lightweight fibre glass wool material with high acoustical sound absorption of NRC: 0.90-1.00 (ASTMC 423). Unless otherwise specified the size of the panel shall be 600 mm x 1200 mm x 20 mm thick, square edge fixed to aluminium tee exposed grid systems, suspended from the soffit with adjustable hanger rods in accordance to manufacturer's recommendation and S.O.'s approval.

5.9 Glass Fibre Reinforced Gypsum (GRG)

5.9.1 GRG Boards are manufactured by glass fibre reinforced gypsum and comprise of non-combustible high grade gypsum casting plaster with glass fibre membranes. Unless otherwise specified shall be in sizes of 1200 mm X 900 mm x 9 mm thick. The board shall conform to the following:

Fire performance : GRG Boards are rated non-combustible as defined in BS 476: Part 4.

Dry Density : Approx. 1660 kg/m²

5.9.2 GRG boards shall be installed in accordance to the manufacturer's recommendation and to S.O.'s approval.

5.10 Cornice

5.10.1 Unless otherwise specified, cornice shall be provided of the same ceiling material for all plaster ceiling materials.

5.10.2 Cornice shall be fixed to the walls and ceiling using proprietary adhesive or as recommended by the manufacturer and approved by the S.O.

5.10.3 Large cornices shall be fixed using screws together with cornice adhesive as recommended by the cornice manufacturer and to SO's approval.

5.10.4 Cornice should be carried and handled carefully to avoid cracking the core or wrinkling the paper liner. Where possible, the contractor shall use full lengths of cornice and mitre all joints.

5.10.5 The Contractor shall ensure accurate and level placement by marking ceilings and walls with a line at the cornice edge.

 <p>JKR MALAYSIA</p>	<p>SECTION I : CEILING WORKS</p>	<p>No. Dokumen : JKR 20800-0183-14 No. Keluaran : 01 No. Pindaan : 00 Tarikh : 29 Januari 2014 Muka Surat : 1/4</p>
--	---	---

5.10.6 Cornice with shorter length shall be installed first followed by the longer lengths by bowing out to spring mitres fit into place.

5.11 Reinforcing/Joining Tape

The tape shall not be less than 50 mm wide perforated paper tape in accordance with ASTM C475 from an approved manufacturer, and to the approval of the S.O.

5.12 Jointing Compound

Jointing compound shall be pre-mixed multi-purpose gypsum based air drying type compound, in accordance with BS EN 13963 and to the approval of the S.O.

5.13 Sealants

Fire sealant for plasterboard with improved core adhesion at high temperature (Type F) and wet area sealant for plasterboard with reduced water absorption (Type H) shall be in accordance with BS 8212 and to the approval of the S.O. The appropriate type of sealant shall be used for the required type of plasterboard. Elastomeric sealants can be used at the perimeter of the dry lining or partitioning to provide an airtight construction and to the approval of the S.O.

5.14 Control Joint

Unless otherwise specified, control joints shall be provided in a long continuous runs of ceiling, spaced at not more than 9 m centers maximum and recommended by the manufacturer and to the approval of the S.O.

5.15 Anchors And Fasteners

5.15.1 Anchors to be used throughout the work shall be of Grade 4.6 black hexagon bolt and nut as specified in BS 4190: ISO Metric Black Hexagon Bolts, Screws and Nuts.

5.15.2 Where proprietary anchor is allowed to be proposed as alternative, the Contractor shall submit the details of the proposed anchor to the S.O for approval.

5.15.3 Notwithstanding the above, the alternative anchor proposed shall be made of carbon steel galvanized to minimum thickness of 5 µm or stainless steel in accordance to European Technical Approval Guideline ETAG 001 Metal Anchors for Use in Concrete.

5.15.4 The size of the alternative anchor shall not be less than 6 mm diameter (M6) with effective anchorage depth of not less than 26 mm measured from the soffit of the floor slab. The hole for the anchor shall be drilled using drill bit of nominal diameter 6 mm. The design resistance in all load directions shall not be more than 1.10 kN.

5.15.5 Shot-fired alternative anchors shall not be allowed. Shot-fired hybrid-pin alternative anchors shall not be used to install the suspended ceiling hangers to the concrete soffit.

5.15.6 Fasteners shall have a corrosion-resistant finish and be appropriate for intended use, in accordance with BS EN 14566. The heads of fasteners shall be shaped so that they can be driven slightly below the surface of the plasterboard without punching through the paper liner.

 <p>JKR MALAYSIA</p>	<p>SECTION I : CEILING WORKS</p>	<p>No. Dokumen : JKR 20800-0183-14 No. Keluaran : 01 No. Pindaan : 00 Tarikh : 29 Januari 2014 Muka Surat : 1/5</p>
--	---	---

6. Ceiling Suspension System

6.1 General

The Contractor shall provide 12 mm diameter Grade 4.6 black hexagon bolt and nut as specified in BS 4190: ISO Metric Black Hexagon Bolts, Screws and Nuts as anchors. The anchors shall be installed in the concrete slab during the casting of the floor at depth of not less than 75 mm measured from the soffit of the floor or as otherwise specified in the drawing.

6.2 Timber Fixed System

6.2.1 All timber materials used shall be treated and as specified under SECTION H: Timber, Joinery & Ironmongery Works. Ceiling boards shall be fixed to the frames with butt 'V' joint using nails or screws as recommended by the ceiling manufacturer and to S.O's approval.

6.2.2 All external ceiling shall be painted with weather resistant paint as specified under SECTION O: PAINTING WORKS.

6.3 Grid Ceiling Suspension System

6.3.1 Vertical suspension members

6.3.1.1 Ceiling hangers shall be galvanized mild steel suspension rods of minimum 4 mm diameter consisting of 2 pieces held together by a rod joiner (adjustable type galvanized suspension clips).

6.3.1.2 One end of the hanger shall be attached to a pre-drilled galvanized mild steel z-shaped soffit cleat 25 mm x 50 mm x 25 mm with minimum base metal thickness of 2 mm. The mild steel soffit cleat shall be fixed to the black hexagon anchor. The other end of the hanger shall be secured using proprietary locking clips to the primary T-section. The T-sections shall be fixed accordingly to the required ceiling level by adjusting the length of the ceiling hanger through the rod joiner.

6.3.1.3 Where black hexagon anchors cast in the soffit of the floor slab are not provided, pre-drilled galvanized mild steel z-shaped soffit cleat 25 mm x 50 mm x 25 mm with minimum base metal thickness of 2 mm shall be provided. The mild steel soffit cleat shall be fixed by drilling and inserting M6 x 30 mm zinc plated proprietary alternative anchor to the structural soffit at a distance 200 mm away from the wall and then spaced equal to or not more than 1200 mm centre to centre (c/c) to form the grid of the ceiling hanger.

6.3.1.4 One end of the ceiling hanger shall be connected by bolt and nut to the pre-drilled soffit cleat and the other end of the hanger shall be secured to the primary T-section using proprietary locking clips.

6.3.2 Horizontal suspension members

Perimeter wall angles shall be securely fixed to the adjacent perimeter walls using appropriate fixings forming part of the grid ceiling system as recommended by the manufacturer and approved by the S.O.

 <p>JKR MALAYSIA</p>	<p>SECTION I : CEILING WORKS</p>	<p>No. Dokumen : JKR 20800-0183-14 No. Keluaran : 01 No. Pindaan : 00 Tarikh : 29 Januari 2014 Muka Surat : 1/6</p>
--	---	---

6.4 Concealed Ceiling Suspension System (Soffit-ceiling Distance < 1800 mm)

Where shown on the Drawings or when the distance between the concrete soffit and the suspended ceiling board is less than 1800 mm in vertical height, the concealed ceiling suspension system shall be as follows:

6.4.1 Vertical suspension members

6.4.1.1 Ceiling hangers shall be galvanized mild steel 25 mm x 25 mm angle section with 0.5 mm base metal thickness or galvanized mild steel suspension rods of minimum 4 mm diameter.

6.4.1.2 One end of the hanger shall be attached to a pre-drilled galvanized mild steel z-shaped soffit cleat 25 mm x 50 mm x 25 mm with minimum base metal thickness of 2 mm. The mild steel soffit cleat shall be fixed to the black hexagon anchor. The other end of the hanger shall be secured using proprietary locking clips or suspension brackets to the primary channel.

6.4.1.3 Where black hexagon anchors cast in the soffit of the floor slab are not provided, pre-drilled galvanized mild steel z-shaped soffit cleat 25 mm x 50 mm x 25 mm with minimum base metal thickness of 2 mm shall be provided. The mild steel soffit cleat shall be fixed by drilling and inserting M6 x 30 mm zinc plated proprietary alternative anchor to the structural soffit at a distance 100 mm away from the wall and then spaced equal to or not more than 1000 mm c/c to form the grid of the ceiling hanger.

6.4.1.4 One end of the ceiling hanger shall be connected by bolt and nut to the pre-drilled soffit cleat and the other end of the hanger shall be secured using proprietary locking clips or suspension brackets to the primary channel.

6.4.2 Horizontal suspension members

6.4.2.1 Primary rigidized channel shall be 34 mm x 12 mm x 0.4 BMT at a distance of 100 mm away from the wall and spaced equal to or not more than 1000 mm c/c. and secured to the rigidized galvanized steel ceiling hangers using wafer head drywall screw M4.2 x13 mm length as recommended by the manufacturer and to the approval of the S.O.

6.4.2.2 Secondary rigidized galvanized steel channel 34 mm x 12 mm x 0.4 BMT shall be secured using proprietary locking clips or suspension brackets to the primary channel.

6.4.2.3 The primary and secondary channels shall be connected using galvanized proprietary locking clips or suspension brackets with minimum thickness of 0.8 mm and screwed as recommended by the manufacturer.

6.4.2.4 Unless otherwise specified, a single layer 9 mm thick plasterboard ceiling shall be screwed fixed at maximum distance of 200 mm c/c to the secondary channel as recommended by the manufacturer.

 <p>JKR MALAYSIA</p>	<p>SECTION I : CEILING WORKS</p>	<p>No. Dokumen : JKR 20800-0183-14 No. Keluaran : 01 No. Pindaan : 00 Tarikh : 29 Januari 2014 Muka Surat : 1/7</p>
--	---	---

6.5 Concealed Ceiling Suspension System (Floor-ceiling Distance > 1800 mm)

Where shown on the Drawings or when the distance between the concrete soffit and the suspended ceiling board exceeds 1800 mm in vertical height, the concealed ceiling suspension system shall be as follows:

6.5.1 Vertical suspension members

6.5.1.1 Ceiling hangers shall be galvanized mild steel suspension rods of not less than 4 mm diameter.

6.5.1.2 One end of the hanger shall be attached to a pre-drilled galvanized mild steel z-shaped soffit cleat 25 mm x 50 mm x 25 mm with minimum base metal thickness of 2 mm. The mild steel soffit cleat shall be fixed to the black hexagon anchor. The other end of the hanger shall be secured using proprietary locking clips or suspension brackets to the primary channel.

6.5.1.3 Where black hexagon anchors cast in the soffit of the floor slab are not provided, pre-drilled galvanized mild steel z-shaped iron soffit cleat 25 mm x 50 mm x 25 mm with minimum base metal thickness of 2 mm shall be provided. The mild steel soffit cleat shall be fixed by drilling and inserting M6 x 30 mm zinc plated proprietary alternative anchor to the structural soffit at a distance 200 mm away from the wall and then spaced equal to or not more than 1000 mm c/c to form the grid of the ceiling hanger.

6.5.1.4 One end of the ceiling hanger shall be connected by bolt and nut to the pre-drilled soffit cleat and the other end of the hanger shall be secured using proprietary locking clips or suspension brackets to the primary channel.

6.5.2 Horizontal suspension members

6.5.2.1 Primary channel shall be 38 mm x 12 mm placed at a distance of 100 mm away from the wall and spaced equal to or not more than 1000 mm c/c. The primary channel shall have the characteristic strength of at least 250 N/mm².

6.5.2.2 The dimension of the secondary channel shall be at not less than 48 mm x 20 mm place at 400 mm c/c and shall have the characteristic strength of at least 250 N/mm².

6.5.2.3 The primary and secondary channel shall be connected using galvanized proprietary locking clip with minimum thickness of 0.8mm and screw as recommended by the manufacturer.

6.5.2.4 Unless otherwise specified, a single layer 9 mm thick minimum plasterboard shall be screwed at maximum 200 mm c/c to the secondary channel as recommended by the manufacturer.

6.6 Performance And Installation Requirements

6.6.1 Suspended ceiling systems are not designed for and shall not be regarded as structural elements. Electrical wiring systems, including cable trays, conduits, junction boxes, lighting fixtures, air-conditioning ducts, air diffusers and other appurtenances shall not be placed directly on the ceiling and shall be independently supported.

 <p>JKR MALAYSIA</p>	<p>SECTION I : CEILING WORKS</p>	<p>No. Dokumen : JKR 20800-0183-14 No. Keluaran : 01 No. Pindaan : 00 Tarikh : 29 Januari 2014 Muka Surat : 1/8</p>
--	---	---

- 6.6.2 Suspended ceilings shall be designed to ensure that detrimental levels of water and condensation are not formed within or on the surfaces of the ceiling and related components and the ceilings shall be designed according to Class C conditions of BS EN 13964.
- 6.6.3 Other steel components of the substructure such as supporting member, perimeter trim, et cetera shall have a characteristic strength of at least 250 N/mm² and their tolerances shall comply with BS EN 13964. No bends or notches or drilling or other alterations from its original state are allowed on steel components unless allowed by the manufacturer.
- 6.6.4 Where not specified, tolerances for the ceiling shall comply with BS EN 13964. The maximum deflection between two suspension points shall not exceed L/500 where L is the suspension distance between the two points.
- 6.6.5 The top fixing of all suspension components shall be made to the primary structural framing element, unless specifically designed otherwise. The contractor shall ensure the fixings are of a corrosion-resistant material suitable for the intended application, and fixings shall be compatible with the material of the structure to which they are to be fitted.

6.7 Structural Steel Fixing

- 6.7.1 Self-drilling screws are not allowed for structural steel, unless specifically designed otherwise. These screws shall not be placed in tension unless specifically designed for that purpose.
- 6.7.2 Penetrations made into the structural steel by drilling shall be duly approved by the S.O.
- 6.7.3 Clips shall be installed strictly in accordance with the manufacturer's recommendations.

6.8 Cold Formed Truss/Timber Truss Fixing

- 6.8.1 Fixings to cold formed trusses shall be made of steel plate straps. Self-drilling screws are not allowed unless specifically designed otherwise. For the case of proprietary truss systems, the Contractor shall obtain written approval from the S.P. and the S.O.
- 6.8.2 Fixings to timber joists shall be made into the side of the timber, with five times the diameter of the fastener clear edge distances.

6.9 Glued Laminated Timber Fixing

Top fixing to glued laminated timber members shall only be allowed with the approval of a P.E. The glued laminated timber shall be fabricated as specified under SECTION H: TIMBER, JOINERY AND IRONMONGERY WORKS.

6.10 Concrete Fixing

- 6.10.1 No fasteners, either shot-fired or drilled into are allowed to be installed directly to a flat roof slab. Separate structural framing element shall be specifically designed, and approved by the S.O.
- 6.10.2 Fixing to aerated/lightweight concrete shall only be made in accordance with the manufacturer's recommendations.

 <p>JKR MALAYSIA</p>	<p>SECTION I : CEILING WORKS</p>	<p>No. Dokumen : JKR 20800-0183-14 No. Keluaran : 01 No. Pindaan : 00 Tarikh : 29 Januari 2014 Muka Surat : 1/9</p>
--	---	---

6.11 Purlin Fixing

6.11.1 Fixings shall be made of steel plate straps. No connections requiring drillings to the web/lip of the purlins are allowed, unless specifically designed otherwise.

6.11.2 Where flange connections are necessary, they should be made as close as possible to the web of the purlin, and design calculations shall be provided to ensure the structural capacity of the purlin is not compromised.

6.11.3 Fixings shall be selected and installed in accordance with the manufacturer's specification and approved by the S.O.

6.12 All concrete expansion bolts shall be installed in accordance with the manufacturer's recommendations taking due care to maintain minimum edge distances, spacing and embedment depth.

6.13 Ceiling hangers shall be installed in accordance to the ceiling system manufacturer's recommendation. Bends as means of leveling the ceiling or to avoid plenum services, shall not be made in the ceiling hangers. Where ceiling hangers cannot be secured at the specified spacing, secondary members shall be installed to manufacturer's recommendation.

6.14 In areas where the suspended ceiling is adjacent to rooms or areas with twenty four (24) hours air-conditioning and the concrete soffits are applied with PU foam, the ceiling suspension hanger shall be secured to the concrete soffit using M6 x 30 mm A4 stainless steel (DIN17440) anchor bolts as specified or shown on the Drawings.

6.15 Unless otherwise shown on the Drawings, plasterboard partitions shall be fixed to the primary framing members of the ceiling suspension system in accordance with of BS 8212.

6.16 Testing And Inspection

6.16.1 The Contractor shall carry out in-situ Pull-out Test for the anchors. The sampling rate shall be 5 samples for every 200 number of anchors installed. A load deflection curve shall be drawn for each sample and the maximum load tested shall not be less than twice the design load. Upon releasing the load the residual deflection shall not exceed 1 percent of total deflection. However, the design load shall not be taken as less than 0.5 kN and the point of testing shall be to the S.O.'s approval.

6.16.2 The Contractor shall inform the S.O. in writing to request for inspection and approval prior to closing up of the ceiling suspension system with ceiling panels.

6.17 Warranty

6.17.1 When a proprietary ceiling system is used, the Contractor shall submit to the S.O. a warranty from the manufacturer with the following provisions :

- (i) The products used are genuine and free from manufacturing defects;
- (ii) The ceiling system is installed in accordance with the manufacturer's recommendation, guidance and specifications that will deliver the specified level of performance;
- (iii) The warranty certificate shall cover a period of ten (10) years from the date of Certificate of Practical Completion against any defect or failure due to the installation and workmanship by the manufacturer's registered panel installer.

 <p>JKR MALAYSIA</p>	<p>SECTION I : CEILING WORKS</p>	<p>No. Dokumen : JKR 20800-0183-14 No. Keluaran : 01 No. Pindaan : 00 Tarikh : 29 Januari 2014 Muka Surat : I/10</p>
--	---	--

BLANK PAGE

TABLE OF CONTENTS

SECTION J: STRUCTURAL STEEL AND METAL WORKS

	PAGE
1. General	J/1
2. Hot Rolled Structural Steelworks	J/1
3. Prefabricated Cold Formed Steel Roof Trusses	J/1
4. Metal Frames For Doors And Windows	J/3
5. Collapsible Gates, Roller Shutters And Et Cetera	J/5
6. Sundries	J/5

 <p>JKR MALAYSIA</p>	<p>SECTION J : STRUCTURAL STEEL AND METAL WORKS</p>	<p>No. Dokumen : JKR 20800-0183-14 No. Keluaran : 01 No. Pindaan : 00 Tarikh : 29 Januari 2014 Muka Surat : J/1</p>
--	--	---

1. General

This section provides the generally applicable requirements for steel and metal for the construction of structures, building components and related works. All materials shall conform to the relevant Malaysian or British or European Standards.

2. Hot Rolled Structural Steelworks

2.1 All hot rolled structural steelwork design, materials, drawings, workmanship, protective treatment, fire protection and quality assurance shall be in accordance with the Specification for Structural Steelworks No. JKR 20601-0191-12 or the latest edition published by JKR.

2.2 Quality Assurance

The Contractor shall submit a Quality Assurance programme as specified in the Specification for Structural Steelworks as in sub-section 2.1.

2.3 Drawings

2.3.1 The Contractor shall prepare Drawings with details in accordance with MS EN 1993 or other relevant standards. The Drawings shall be certified by a Professional Engineer. He shall also prepare Drawings and arrangements of temporary steelworks for the different stages of construction in compliance with the requirements specified in the Specification for Structural Steelworks as in sub-section 2.1.

2.3.2 The Drawings to be submitted are as follows:

- (i) Fabrication drawings;
- (ii) Erection drawings;
- (iii) As-built drawings.

2.4 Records

2.4.1 The Contractor shall submit to the S.O., document and records which shall include but not limited to:

- (i) Document register;
- (ii) Drawings and design calculations and documentation registers;
- (iii) Certificates for materials and consumables;
- (iv) Calibration of equipment;
- (v) Weld procedures, concessions et cetera;
- (vi) Inspection and test reports;
- (vii) Delivery schedules and method statements;
- (viii) Surveys and final inspection results;
- (ix) Completion of erection and hand over certification.

3. Prefabricated Cold Formed Steel Roof Trusses

3.1 All prefabricated components shall be manufactured only by reputable licensed truss suppliers and approved by the S.O. This supplier duly termed as 'System Provider' is responsible for the analysis, design, detailing, drawing, manufacture, material, handling and erection of the roof members, and their ancillary fixing components. The full requirement is outlined in the Specification for Prefabricated Cold Formed Steel Roof Trusses (JKR 20601-0186-11) or the latest edition published by JKR.

 <p>JKR MALAYSIA</p>	<p>SECTION J : STRUCTURAL STEEL AND METAL WORKS</p>	<p>No. Dokumen : JKR 20800-0183-14 No. Keluaran : 01 No. Pindaan : 00 Tarikh : 29 Januari 2014 Muka Surat : J/2</p>
--	--	---

3.2 System Provider

The System Provider (S.P) is a supplier of a proprietary roof truss system appointed by the Contractor and approved by the S.O, which employs Quality Assurance procedures in the design, detailing, connection, bracing, erection criteria and manufacture of truss components for the structural roof truss system.

3.3 Duties Of Professional Engineer

3.3.1 The S.P. shall appoint a Professional Engineer (P.E.) whose duties shall include the following:

- (i) Preparation of roof truss analysis and design;
- (ii) Preparation of drawings;
- (iii) Design changes in every stage of work;
- (iv) Certification for completion of roof truss installation;
- (v) Final certification for roof truss installation prior to issuance of Certificate of Practical Completion for the whole Works to the Contractor.

3.4 Fabricator

All trusses shall only be assembled by licensed fabricators approved by the S.P. and registered with CIDB. A copy of CIDB registration certificate shall be submitted to the S.O. for verification.

3.5 Installer

All installation works shall be executed and supervised by qualified personnel with valid certificate issued by CIDB. The S.O. shall verify the identification and qualification of the installer prior to the installation.

3.6 General Truss Limitation

3.6.1 Prior to any pre fabricated cold formed roof trusses works, the following general limitation shall be applied:

- (i) Maximum unsupported truss span 13 m with permitted deviation of ± 0.05 m.
- (ii) Maximum truss spacing of 1.2 m with permitted deviation of ± 0.025 m.
- (iii) The minimum basic wind speed shall be 35 m/s. However, the minimum basic wind speed shall be increased to 41 m/s for lightweight roof covering.
- (iv) Minimum base steel thickness for main truss member shall be:
 - a) 1 mm for unsymmetrical section or open cross section;
 - b) 0.6 mm for symmetrical machine-manufactured box or closed cross section.
- (v) Minimum base steel thickness for other truss element shall be:
 - a) 0.5 mm for batten or purlin;
 - b) 1.2 mm for wall plate;
 - c) 1 mm for all bracings.

3.7 Analysis, Design Report And Drawings Submission

3.7.1 The S.P. through the Contractor shall propose to the S.O. for his approval a roof truss system which is safe, functional and conforming to design

 <p>JKR MALAYSIA</p>	<p>SECTION J : STRUCTURAL STEEL AND METAL WORKS</p>	<p>No. Dokumen : JKR 20800-0183-14 No. Keluaran : 01 No. Pindaan : 00 Tarikh : 29 Januari 2014 Muka Surat : J/3</p>
--	--	---

standard. Submission of proposal shall include truss analysis, design report, and construction drawings. The truss analysis shall indicate all loads, load combinations, connections criteria, bracings and tie-down of the truss. Design output of the truss members, battens, connections, tie-down and wall plates, anchors, bracings, truss accessories, splicing and stiffeners where related to the analysis shall be included in the design report. (Refer to Appendix 3 of JKR 20601-0186-11)

- 3.7.2 All details in the construction drawings shall be sufficient to enable checking against the analysis and design report, including specifying and providing the truss layout and configuration, steel grades, section properties of members, length of members in each truss configuration, properties of truss accessories, specification of corrosion protection, specification of fastener and anchor, tie-down and anchoring details and all types of connection details including the connection of all attachments to the trusses.
- 3.7.3 Technical specifications or mill certificates for base steel, fastener and anchor shall also be included in the submission. Verification test certificate from an approved accredited laboratory on the technical parameter specified in the technical specifications or mill certificates shall be submitted upon request by the S.O.

3.8 Warranty

- 3.8.1 When a prefabricated cold formed steel roof truss system is used, the Contractor shall submit to the S.O. a warranty from the S.P. with the following provisions:
- (i) The products used are genuine and free from manufacturing defects;
 - (ii) The prefabricated cold formed steel roof truss system is installed in accordance with the S.P.'s instructions, guidance and specifications that will deliver the specified level of performance;
 - (iii) The warranty certificate shall cover a period of ten (10) years from the date of Certificate of Practical Completion against any defect or failure due to the installation and workmanship by the S.P.'s registered panel installer.

4. Metal Frames For Doors And Windows

4.1 Steel Frames

- 4.1.1 The Contractor shall supply, assemble and fix steel frames for doors and windows as shown on the Drawings. The steel frames shall comply with BS 6510, and shall be from an approved source and shop-primed with two coats of red lead oxide or other approved rust resisting primer.
- 4.1.2 The steel frames shall be manufactured from sections rolled from good commercial grade galvanized mild steel in single sections, mechanically straightened with all corners pre-cut with a 45 degrees mitre joint giving a snug and accurate fit, fully electrically welded, and carefully ground and cleaned, or shall be mechanically jointed by an approved method.
- 4.1.3 All screws, nuts, bolts and washers shall be of stainless steel.
- 4.1.4 Steel frames shall be painted as specified in SECTION O: PAINTING WORKS.

 <p>JKR MALAYSIA</p>	<p>SECTION J : STRUCTURAL STEEL AND METAL WORKS</p>	<p>No. Dokumen : JKR 20800-0183-14 No. Keluaran : 01 No. Pindaan : 00 Tarikh : 29 Januari 2014 Muka Surat : J/4</p>
--	--	---

4.2 Aluminium Frames

- 4.2.1 The Contractor shall supply, assemble and fix aluminium frames for doors and windows as shown on the Drawings. Unless otherwise specified, all aluminium frames for windows shall be fabricated from sections extruded from aluminium alloy conforming to MS 832. All aluminium frames for glass sliding doors shall be fabricated from sections extruded from aluminium alloy and in compliance with MS 1017.
- 4.2.2 Unless otherwise shown on the Drawings or described in the Bills of Quantities, aluminium surfaces shall be natural anodised finish, free from alloy defects, dye marks, scratches and other surface blemishes in accordance with BS 3987 with an anodic coating of 15µ minimum thickness complying with BS EN 12373-1.
- 4.2.3 All coloured anodized finish to aluminium exposed surfaces shall be subject to the S.O.'s approval.
- 4.2.4 All aluminium extrusion or sheet exposed surfaces after anodizing and after colouring, if required by the S.O., shall be sealed, and the adequacy of the sealing shall be given special emphasis.
- 4.2.5 All fasteners such as bolts and screws shall be of stainless steel type A2-70 (minimum) in compliance with ISO 3506 or other suitable materials as specified in the Drawings. Rivets shall be stainless steel or aluminium alloy appropriate to the applications.
- 4.2.6 Extruded aluminium framing members shall be fabricated from designated alloys complying with MS 2289. Ancillary members such as sills, couplings and the like formed from sheet materials, they shall be fabricated from designated alloys complying with MS 2040.
- 4.2.7 Where friction stays and hinges are fastened onto the framing section, the portion that receives the fastener shall not be less than 2.5 mm thick.

4.3 Frames For Adjustable Louvre Windows

- 4.3.1 The Contractor shall supply, assemble and fix frames for adjustable louvre windows as shown on the Drawings in compliance with MS 1057.
- 4.3.2 Unless otherwise specified, the frames shall be of approved manufacture. The frames shall be supplied complete with weather seal and non-ferrous bearings, spring clips, locking device and weather stripping with all necessary spacing pieces. The frames, coupling mullions and spacer brackets shall be minimum 1.2 mm thick (18 SWG) or otherwise specified cold-rolled steel strip galvanised with hot-dipped process. Unless otherwise specified on the Drawings, the clips and pivots to receive the louvres shall be of durable nylon material and sample submitted shall be to S.O's approval.
- 4.3.3 The operating rods shall be 2.13 mm thick (14 SWG). The handle and lock shall be 2.642 mm thick (12 SWG) steel.
- 4.3.4 Unless otherwise specified, the finish shall be anodized coating of 15 µ (average) minimum complying with BS EN 12373-1.

 <p>JKR MALAYSIA</p>	<p>SECTION J : STRUCTURAL STEEL AND METAL WORKS</p>	<p>No. Dokumen : JKR 20800-0183-14 No. Keluaran : 01 No. Pindaan : 00 Tarikh : 29 Januari 2014 Muka Surat : J/5</p>
--	--	---

4.4 Accessories

4.4.1 Accessories for each steel or aluminium frame for doors and windows shall be supplied complete with:

- (i) Sufficient number of built-in stainless steel hinges as per Schedule of Ironmongery under SECTION H : TIMBER, JOINERY AND IRONMONGERY WORKS;
- (ii) Two (2) rubber buffers per closing jamb, to reduce noise and vibration;
- (iii) Welded mortar guard; Adjustable stainless steel striker plate with a gently curved lead-in edge; Removable spreader bars, to ensure a perfect square during transportation and installation; and
- (iv) Minimum of eight (8) pieces of 4 mm brick ties, to ensure a tight permanent fit.

4.5 Samples

Samples of steel or aluminium sections with complete accessories for the doors and windows, together with complete set of shop drawings of all works shall be submitted to the S.O's for approval prior to the commencement of any work.

4.6 Installation

4.6.1 Unless otherwise specified or shown on the Drawings, all types of window and door frames shall be fixed or installed using the sub-frame method in accordance with the manufacturer's recommendation and to the S.O's approval.

4.6.2 All joints on the window and door frames shall be sealed using polyurethane (PU) type joint sealant.

4.6.3 Where buildings are located near to the coastal area, the bolts, nuts and screws used shall be of stainless steel unless otherwise specified.

4.6.4 Unless otherwise specified in the Drawings, the adjustable louvre side frames shall fixed to the aluminium frames and shall be installed using the sub-frame method in accordance with the manufacturer's recommendation and to the S.O's approval.

5. Collapsible Gates, Roller Shutters And Et Cetera

The Contractor shall provide and fix approved collapsible steel gates, folding shutters, roller shutters and et cetera complete with all necessary accessories as approved by the S.O. to the sizes and positions as shown on the Drawings. Unless otherwise specified in the Drawings, they shall be galvanised and fixed in accordance with the manufacturer's instructions.

6. Sundries

6.1 Unless otherwise specified in the Drawings, mild steel shall be used for balustrades to staircases, verandahs, balconies, et cetera and shall be fixed as shown on the Drawings.

6.2 All iron and steel for the sundries shall be of the quality approved by the S.O. Screws and bolts shall have washers where appropriate. Hooks for carrying ceiling

 <p>JKR MALAYSIA</p>	<p>SECTION J : STRUCTURAL STEEL AND METAL WORKS</p>	<p>No. Dokumen : JKR 20800-0183-14 No. Keluaran : 01 No. Pindaan : 00 Tarikh : 29 Januari 2014 Muka Surat : J/6</p>
--	--	---

fans shall be formed from 13 mm diameter mild steel rods bolted to timber ceiling members or ragged into concrete.

- 6.3 Welded mesh, expanded metal, aluminium sheets et cetera shall be provided and fixed as shown on the Drawings.
- 6.4 Mild steel grilles, drain cover gratings shall be provided and fixed as shown on the Drawings. Unless otherwise stated, all steelwork shall be jointed by continuous welding.
- 6.5 Ant caps shall be of 16 gauge galvanised iron sheets formed to shape as shown on the Drawing. The caps shall be fixed between concrete stumps/brick piers or walls and timber posts or plates as required. The caps shall project 60 mm and inclined at 45⁰ from the surface.

TABLE OF CONTENTS

SECTION K: PLASTERING, PAVING AND TILING WORKS

	PAGE
1. General	K/1
2. Plaster Work	K/3
3. Paving Work	K/5
4. Tiling Work	K/8

 <p>JKR MALAYSIA</p>	<p>SECTION K : PLASTERING, PAVING AND TILING WORKS</p>	<p>No. Dokumen : JKR 20800-0183-14 No. Keluaran : 01 No. Pindaan : 00 Tarikh : 29 Januari 2014 Muka Surat : K/1</p>
--	---	---

1. General

1.1 Cement

1.1.1 The cement, unless otherwise described shall be Ordinary Portland Cement, complying with MS 522 as specified in SECTION D: CONCRETE WORKS or Masonry Cement complying with MS 794.

1.1.2 White and coloured cement shall be of approved manufacture.

1.2 Plasticiser

The plasticizer shall be of approved manufacture and used strictly in accordance with the manufacturer's recommendation.

1.3 Plasterlime

The plasterlime shall be of approved manufacture and shall comply with BS 890 and shall be applied strictly in accordance with the manufacturer's recommendation.

1.4 Sand

The sand for external rendering, internal plastering and floor screeding shall comply with MS 29 for fine aggregates. Sand for plastering using gypsum shall comply with MS 701.

1.5 Water

Water for mixing shall be clear and free from harmful matter as specified in SECTION D: CONCRETE WORKS.

1.6 Mixing

1.6.1 All mixing of mortar for plaster and screed shall be done by machine. Hand mixing shall only be allowed for small quantities and with the approval of the S.O. Hand mixing shall be done on a clean platform. The water content of the mix shall be only the minimum required to give a workable mix.

1.6.2 Mortar for plaster and screed shall be used up within forty five (45) minutes after mixing.

1.6.3 For gypsum plaster, mixes shall be used up within one (1) hour after mixing.

1.6.4 No remaking of the mix shall be permitted thereafter.

1.7 Surface Preparation

1.7.1 Where possible cement paving, screeding and rendering on concrete surface shall be laid while the concrete is still green that is after the final set but not later than twenty four (24) hours of laying concrete. The concrete surfaces shall be brushed with a stiff broom before it has hardened to remove laitance and give a roughened surface. Hardened concrete surfaces shall be thoroughly hacked to form a key to the approval of the S.O.

1.7.2 Before any paving, screeding or rendering is applied, all surfaces shall be thoroughly cleaned and wetted and be in damp state at the time the paving, screeding or rendering is applied.

 <p>JKR MALAYSIA</p>	<p>SECTION K : PLASTERING, PAVING AND TILING WORKS</p>	<p>No. Dokumen : JKR 20800-0183-14 No. Keluaran : 01 No. Pindaan : 00 Tarikh : 29 Januari 2014 Muka Surat : K/2</p>
--	---	---

1.7.3 Where plastering and rendering are to be applied in several coats, the surface of each preceding coat shall be scratched while still green to form key for the subsequent coat.

1.8 Bay

Paving and screeding shall be laid in alternate bays. On hardened concrete bases, each bay shall not exceed 15 m². On the surface where the concrete is still green, each bay shall not exceed 30 m². Where bays are not square, the ratio of the length between adjacent sides of each bay shall be approximately 1:1.5. The joints in paving screed shall coincide as nearly as possible with joints in the base.

1.9 Curing and Protection

Unless otherwise specified hereinafter, the screeds shall be cured for three (3) to seven (7) days after laying, and protected from rapid drying by covering with polyethylene sheets or tarpaulins and shall also be protected from any damage.

1.10 Making Good

1.10.1 Defective screeds shall be cut out and made good with fresh screed and sufficient time shall be allowed for the screed to dry prior to the laying of the floor finish.

1.10.2 Defective plastering and rendering shall be made good by cutting out the defective part to a rectangular shape, and the edges shall be undercut to form dovetail-key and finished flush with the surrounding work.

1.11 Samples

The Contractor shall supply the S.O. with samples of materials and/or sample of finished work for approval. Approved samples shall be kept at site for reference.

1.12 Tools

Proper tools shall be used for all scribing, scoring, splicing, smoothing edges, making angles et cetera of tiles, bricks and others so as to produce neat and fit joints.

1.13 Types Of Finishes

The appropriate type of finishes to be used in the various locations of the works shall be as shown on the Drawings or as tabulated in the schedule of finishes. Unless otherwise shown on the Drawings or described in the B.Q., the finishes and their dimensions shall be as specified hereinafter.

1.14 Cornices And Angles

1.14.1 The cornices and moulded work shall be clean and accurately formed to the section shown on the Drawings. All mitres, stops and enrichments and moulding shall follow the details as shown on the Drawings, all to the approval of the S.O.

1.14.2 All rounded and moulded angles shall be of the same material mix as the adjacent finish. For narrow reveal, splays and returns under 30 mm wide, Class D plaster to BS 1991 shall be used.

 <p>JKR MALAYSIA</p>	<p>SECTION K : PLASTERING, PAVING AND TILING WORKS</p>	<p>No. Dokumen : JKR 20800-0183-14 No. Keluaran : 01 No. Pindaan : 00 Tarikh : 29 Januari 2014 Muka Surat : K/3</p>
--	---	---

2. Plaster Work

2.1 Plain Plaster

- 2.1.1 Plain plaster shall consist of one (1) part masonry cement to six (6) parts sand by volume. Where CEM 1 is used, plasticizer or plasterlime shall be added to the mix in accordance with the manufacturer's instruction.
- 2.1.2 The plaster shall be applied in two coats generally to a total thickness of 20 mm to brickwall and 12 mm to soffits, beams, columns, brick-walls and other smooth surfaces.
- 2.1.3 The first coat shall consist of rough plastering to a thickness of 10 mm for 20 mm plainface, and 6 mm for 12 mm plainface. The second coat shall be finished with a steel trowel for internal surfaces and with a straight-edged wood float for external surfaces.
- 2.1.4 All external walls, unless otherwise specified shall be finished with rough surface cement plastering.
- 2.1.5 All internal walls, unless otherwise specified shall be finished with smooth skimmed surface cement plastering.

2.2 Granolithic Plaster

- 2.2.1 Granolithic plaster shall consist of by volume, two (2) parts cement, one (1) part sand, five (5) parts granite chipping passing 6mm mesh and retaining upon 3 mm mesh, applied in two (2) coats to a total thickness of 10 mm to a backing coat, finished smooth with wood float.
- 2.2.2 The backing coat shall consist of 12 mm thick plain plaster as described herein before. The finished surface shall be brushed lightly to achieve the required texture after it has reach initial set.
- 2.2.3 Shanghai plaster shall consist of two (2) parts approved coloured cement, one (1) part sand and five (5) parts of selected lime-stone chipping passing 6 mm mesh and retaining upon 3 mm mesh by volume applied in two (2) coats to a total thickness of 10 mm to the backing coat, finished smooth with wood float.
- 2.2.4 The backing coat shall consist of 12 mm thick plain plaster as described hereinbefore. The finished surface shall be brushed lightly to achieve the required texture after it has reached initial set.

2.3 Shanghai Plaster

- 2.3.1 Shanghai plaster shall consist of two (2) parts approved coloured cement, one (1) part sand and five (5) parts of selected lime-stone chipping passing 6 mm mesh and retaining upon 3 mm mesh by volume applied in two (2) coats to a total thickness of 10 mm to the backing coat, finished smooth with wood float.
- 2.3.2 The backing coat shall consist of 12 mm thick plain plaster as described hereinbefore. The finished surface shall be brushed lightly to achieve the required texture after it has reached initial set.

 <p>JKR MALAYSIA</p>	<p>SECTION K : PLASTERING, PAVING AND TILING WORKS</p>	<p>No. Dokumen : JKR 20800-0183-14 No. Keluaran : 01 No. Pindaan : 00 Tarikh : 29 Januari 2014 Muka Surat : K/4</p>
--	---	---

2.4 Textured Finish Plaster

- 2.4.1 Textured finish plaster shall consist of a 20 mm thick backing coat of plain plaster as described hereinbefore ruled into a plain and even surface and a finishing coat as on the Drawings and described hereinafter.
- 2.4.2 For rough cast finish, the mix shall consist of selected cement, sand and aggregate in the proportion to give the required finish to the approval of the S.O.
- 2.4.3 For Tyrolean finish, the mix shall consist of one (1) part selected coloured cement, and two (2) parts sand by volume applied to the backing coat by means of a Tyrolean machine in accordance with the manufacturer's recommendation. The finish shall be built up in three (3) layers to a total thickness of not exceeding 6 mm. Each coat shall be allowed to dry before the application of a subsequent coat.
- 2.4.4 For pebble-dash finish, the dry pebble for the finish shall be thrown onto the backing coat while the latter is still wet. The pebbles to be used shall be clean and of size and quality approved by the S.O.
- 2.4.5 For pebble-wash finish, the selection of pebbles shall be clean and of size, colour and quality approved by the S.O. The selected pebbles shall be mixed with plain plaster and applied while it is still wet in a single coat generally to a total thickness of 12 mm to a backing coat. The applied surface is tapped to set the pebbles in position. The pebbles shall be brushed and washed lightly to achieve the required texture after it has reached the initial set. Loose pebbles shall be placed back in position and by tapping the surface to set.

2.5 Gypsum Plaster

- 2.5.1 Gypsum plaster, or plaster of Paris, is produced as a proprietary dry plaster powder and when it is mixed with water, it re-forms into gypsum. The ratio of the gypsum powder mix to the amount of water shall be as recommended by the manufacturer.
- 2.5.2 The setting of unmodified plaster starts about ten (10) minutes after mixing and is complete in about forty five (45) minutes; but not fully set for seventy two (72) hours. The total gypsum plaster thickness for vertical and horizontal masonry and concrete surfaces shall be 16 mm.
- 2.5.3 The resulting paste hardens as it cools, forming a relatively soft, pliable finished product. Unlike mortar or cement, which dries much harder, gypsum plaster can be sanded or otherwise manipulated once cured, making it a good option for aesthetic, non-load bearing purposes.
- 2.5.4 Gypsum plaster is renowned for its use as an art medium and is often use in conservation works especially for decorative embellishment. It is also used to simulate the appearance of surfaces of wood, stone or metal.

2.6 Lime Plaster

- 2.6.1 Typical lime plaster mix shall consist of one (1) part lime putty to three (3) parts of washed, well graded sand. The lime putty is mixed at one (1) to three (3) ratios, creates a compact plaster.

 <p>JKR MALAYSIA</p>	<p>SECTION K : PLASTERING, PAVING AND TILING WORKS</p>	<p>No. Dokumen : JKR 20800-0183-14 No. Keluaran : 01 No. Pindaan : 00 Tarikh : 29 Januari 2014 Muka Surat : K/5</p>
--	---	---

2.6.2 Water is added to produce slaked lime (calcium hydroxide), which is sold as a wet putty or white powder. Water is added to the white powder mix as per the manufacturer's recommendation.

2.6.3 Water is added to the proprietary lime plaster mix as per the manufacturer's recommendation to form a workable paste prior to use. Lime plaster is used as an alternative to or in combination with ordinary Portland cement. It is commonly used for decorative works such as mural paintings on walls, ceilings or any type of flat surface.

2.6.4 Once the water is mixed it shall be stored in an air-tight container. Once exposed to the atmosphere, the calcium hydroxide turns back into calcium carbonate, causing the plaster to set.

2.7 Barium Plaster

The plastering of internal surfaces of X-Ray room walls shall be of barium plaster consisting of one (1) part cement, one (1) part barytes (barium sulphate) fines and three (3) parts barytes sand by volume.

2.8 Plaster to Sides of Manholes, Inspection Chambers and Septic Tanks

Plastering to sides of manholes, inspection chambers and septic tanks shall be as specified under SECTION F: SEWERAGE WORKS.

3. Paving Work

3.1 Cement Paving

3.1.1 Unless otherwise shown on the Drawings or described in the B.Q., cement paving shall be 20 mm thick consisting of one part cement to three parts sand by volume. The paving shall be thoroughly rammed within 30 minutes of laying and trowelled smooth after it has stiffened sufficiently to prevent laitance being brought to the surface. Paving to apron shall finish to a slight fall towards surface drains.

3.1.2 Unless otherwise shown on the Drawings or described in the B.Q., skirtings shall be formed to a height of 150 mm and thickness of 20 mm, coved at bottom and rounded at top.

3.2 Granolithic Paving

3.2.1 Granolithic paving shall be 20 mm thick, consisting of two (2) parts cement and five (5) parts granite chipping passing 6 mm mesh and retained upon 3 mm mesh by volume.

3.2.2 The chipping shall be washed and free from dust. The paving shall be trowelled smooth to proper level or fall where appropriate. After initial set the surface shall be brushed lightly to achieve the required textured finish.

3.2.3 Unless otherwise shown on the Drawings, granolithic skirting shall be 100mm high and 20 mm thick, coved at bottom and slightly rounded at top.

3.2.4 Unless otherwise shown on the Drawings or described in the B.Q., the edge of threshold and treads of concrete stairs shall be finished with 150 mm x 75 mm x 12 mm thick vitreous non-slip nosing tiles laid lengthwise bedded and pointed in 1:3 cement and sand mortar. The sides of open

 <p>JKR MALAYSIA</p>	<p>SECTION K : PLASTERING, PAVING AND TILING WORKS</p>	<p>No. Dokumen : JKR 20800-0183-14 No. Keluaran : 01 No. Pindaan : 00 Tarikh : 29 Januari 2014 Muka Surat : K/6</p>
--	---	---

stringers shall be finished with granolithic plaster worked to profile of treads and risers to the approval of the S.O.

3.3 In-situ Terrazzo

- 3.3.1 In-situ terrazzo shall consist of one (1) part approved coloured cement and three (3) parts selected limestone chipping passing through 12 mm mesh and retained upon 3 mm mesh by volume.
- 3.3.2 The terrazzo topping shall be 20 mm thick laid on 20 mm thick cement and sand (1:3) screed. The concrete base to receive the screed shall be thoroughly cleaned and wetted.
- 3.3.3 While laying the screed, aluminium or brass strips of size 32 mm wide x 3 mm thick shall be set in vertically on edge into the screed to form panels. Each panel shall not exceed 4 m² with top edges of the strips standing sufficiently high to finish flush with the finished terrazzo floor level. The terrazzo shall be trowelled to a dense even finish.
- 3.3.4 When sufficiently hard but not less than two (2) days after being laid it shall be rubbed down to a smooth surface by means of carborundum stone.
- 3.3.5 Tile impregnator then shall be applied strictly in accordance to the manufacturer's recommendation onto the terrazzo surface to prevent future staining.
- 3.3.6 Unless otherwise shown on the Drawings or described in the B.Q., the edge of the threshold and treads of concrete stairs shall be finished with 150 mm x 76 mm x 12 mm vitreous non-slip nosing tiles of approved colour laid lengthwise bedded and pointed. The sides of open stringers shall be finished with in-situ terrazzo working to profile of treads and risers to the approval of the S.O.

3.4 Waterproof Paving to Roof Slabs

Waterproof paving to roof slabs shall be as specified under SECTION D: CONCRETE WORKS.

3.5 Precast Concrete Paving

- 3.5.1 Unless otherwise shown on the Drawings or described in the B.Q., precast concrete paving slabs shall be of size 600 mm x 600 mm x 50 mm thick each and made of 1:2:4-20 mm concrete reinforced with 'A6' fabric reinforcement to MS 145. The top surfaces of slab shall be brushed with stiff broom or wire brush after the initial set to give a rough finish.
- 3.5.2 Paving slabs shall be laid to the pattern as shown on the Drawings or approved by the S.O. The slabs shall be bedded on 25 mm thick semi-dry cement and sand (1:3) screed laid on 100 mm thick properly compacted and blinded hardcore.
- 3.5.3 The joints between the paving slabs shall be 20 mm wide filled with cement mortar (1:3) and raked to a depth of 6 mm.

3.6 Interlocking Concrete Paving

- 3.6.1 Taking the existing sub-grade/soil conditions and the anticipated traffic loading into consideration, an adequate thickness of well compacted base course must be provided to ensure good pavement performance. Unless

 <p>JKR MALAYSIA</p>	<p>SECTION K : PLASTERING, PAVING AND TILING WORKS</p>	<p>No. Dokumen : JKR 20800-0183-14 No. Keluaran : 01 No. Pindaan : 00 Tarikh : 29 Januari 2014 Muka Surat : K/7</p>
--	---	---

otherwise specified, existing bitumen or concrete surfaces need not be removed and can act as good sub-grade.

- 3.6.2 Interlocking concrete paving blocks shall comprise of segmental interlocking concrete paving units laid on minimum 30 mm thick sand bedding course.
- 3.6.3 A layer of sand should be loosely spread and screed to a uniform thickness such that its compacted thickness would be approximately 30 mm thick. It is important that the sand layer remains undisturbed prior to the laying of blocks.
- 3.6.4 The grade of the concrete and thickness of the paving blocks shall be as detailed in the Drawings.
- 3.6.5 Concrete edge restraints shall be provided at the perimeter of the pavement to ensure the paving blocks are tightly abutted and to separate areas of different laying pattern.
- 3.6.6 The paving blocks are placed side by side on the sand bed with gaps of approximately 2 mm between adjoining blocks. The gap between the paving blocks shall be filled with fine sand of different grading to that required for the bedding sand.
- 3.6.7 The paving blocks can be cut to fit edges and awkward corners. The pavement which has been laid shall be compacted with a hand-guided plate vibrator until it is firmly embedded in the sand layer.
- 3.6.8 The general specification of the precast concrete paving blocks shall comply with MS 1380.
- 3.7 In-situ Concrete Paving Footpath
 - 3.7.1 In-situ concrete paving shall consist of 75 mm thick concrete of 1:3:6-20 mm mix by volume as specified in Section D: CONCRETE WORKS, laid on 100 mm thick properly compacted and blinded hardcore to panels as shown on the Drawings or as approved by the S.O.
 - 3.7.2 The concrete shall be well compacted and floated with a wooden float to smooth and even finish. After the concrete has achieved the initial set, the surface shall be brushed with stiff broom or wire brush to give a rough finish.
 - 3.7.3 The joints between the panels shall be filled with approved cold-poured polyurethane joint filler.
- 3.8 Brick Paving
 - 3.8.1 Bricks for paving shall be of semi-vitreous bricks 225 mm x 75 mm x 50 mm thick of approved quality and colour.
 - 3.8.2 The bricks shall be soaked as specified in SECTION E: NON-STRUCTURAL WALL SYSTEM before laying and shall be laid flat on 25 mm semi-dry cement and sand (1:3) screed with 6 mm spacing to the pattern as shown on the Drawings or as approved by the S.O.
 - 3.8.3 The screed shall be laid on 75 mm thick concrete (1:3:6-19mm) base founded on properly compacted and blinded 100 mm thick hardcore. The joints shall be filled with cement mortar (1:2) and finish flush.

 <p>JKR MALAYSIA</p>	<p>SECTION K : PLASTERING, PAVING AND TILING WORKS</p>	<p>No. Dokumen : JKR 20800-0183-14 No. Keluaran : 01 No. Pindaan : 00 Tarikh : 29 Januari 2014 Muka Surat : K/8</p>
--	---	---

4. Tiling Work

4.1 Ceramic Tile

- 4.1.1 In general all ceramic tiles manufactured locally are using the 'dry-pressed' manufacturing process and the ceramic tiles are categorized based on their water absorption rate as defined in the MS 1294, MS ISO 13006 or the International Standard Organization (ISO) Standards (ISO 13006).
- 4.1.2 The methods and materials used in the installation of ceramic tiles under normal internal conditions shall comply with MS 1294-1 and the installation of ceramic tiles under normal external conditions shall comply with MS 1294-2.
- 4.1.3 The installation of tiling works requires skilled operatives working safely using protective clothing and equipment where appropriate; workmanship shall comply with BS 8000-11 for ceramic tiles.
- 4.1.4 Unless otherwise shown on the Drawings, ceramic tiles to internal and external floor for heavy duty areas shall be vitrified with water absorption less than 0.5% [Classification Group Bla] also referred to as heavy duty tiles shall comply with MS ISO 13006 and the size shall be tiles 300 mm x 300 mm x 12 mm thick.
- 4.1.5 Unless otherwise shown on the Drawings, ceramic tiles to internal floor areas under normal condition shall be vitrified with water absorption less than 3% [Classification Group Bla or, Blb] shall be vitreous hard wearing non-slip glazed complying with MS ISO 13006 and the tile size shall be 300 mm x 300 mm.
- 4.1.6 Unless otherwise specified in the Drawings or described in the B.Q., ceramic tile skirting shall match the flooring tiles and shall be 300 mm x 100 mm laid lengthwise on cement and sand (1:3) screed as described. All angles to skirting shall be neatly cut to fit all abutments.
- 4.1.7 Unless otherwise specified in the Drawings, accessories such as skirting (bull nose or cove base), step tiles, step nosing, edging strips, angle tiles (internal and external), etc. shall be of an approved type standard manufacture from the same material to match flooring. Unless otherwise shown on the Drawings, skirting shall be 100 mm high, stair nosing shall be minimum 20 mm wide laid full length of the treads and of bull nose profile, and edging strips 25 mm wide.
- 4.1.8 Unless otherwise shown on the Drawings, ceramic tiles for internal walls shall be scuff-resistant glazed vitrified tiles with water absorption less than 6% [Classification Group Blb or Blla] shall comply with MS ISO 13006. Unless otherwise specified, the minimum tile size shall be of 300 mm x 300 mm.
- 4.1.9 Unless otherwise shown on the Drawings, ceramic tiles for external walls up to first floor height shall be scuff-resistant glazed vitrified tiles with water absorption less than 3% [Classification Group Bla or Blb] and shall comply with MS ISO 13006. The tiles maximum size shall be of 300 mm x 300 mm.
- 4.1.10 Unless otherwise shown on the Drawings, ceramic tiles for external walls used above first floor height shall be scuff-resistant glazed vitrified tiles with water absorption less than 0.5% [Classification Group Bla] shall

 <p>JKR MALAYSIA</p>	<p>SECTION K : PLASTERING, PAVING AND TILING WORKS</p>	<p>No. Dokumen : JKR 20800-0183-14 No. Keluaran : 01 No. Pindaan : 00 Tarikh : 29 Januari 2014 Muka Surat : K/9</p>
--	---	---

comply with MS ISO 13006. The tiles maximum size shall be of 300 mm x 300 mm.

- 4.1.11 Unless otherwise specified in the Drawings, all ceramic tiles for walls and floors shall be of 1st Grade or Grade A with approved surface finish & texture, colour and manufacture.
- 4.1.12 Ceramic tiles used for walls which have high water absorption characteristics shall be bedded with approved tile adhesive to the manufacturer's specification on 20 mm thick cement and sand (1:3) render which has sufficiently cured. The tiles shall be laid with 2 mm to 3 mm gap and all joints shall be filled with approved tile proprietary grout to match. Exposed edges of tiling shall be finished with rounded on edge tiles. Ceramic tiles of Classification Group BIII with water absorption >10% shall not be used under any conditions.
- 4.1.13 Porous tiles shall be soaked before fixing to prevent rapid suction and subsequent failure in bonding with the mortar bed. Tiles should be removed from their cartons and completely immersed in clean water for at least thirty (30) minutes. After soaking, they should be stacked tightly together, with the end tiles face outwards, on a clean surface and allowed to drain. Tiles classified in MS ISO 13006 in Groups BIIb and BIII require this saturation treatment; soaking of tiles of Group BIa, BIb and BIIa is unnecessary, refer to MS 1294-1.
- 4.1.14 Unless otherwise instructed by the manufacturer, the tiles should be fixed dry. All tile installation shall use approved type cementitious adhesives. The selection and application of ceramic tile adhesives for internal and external tile installations on walls and floors shall comply with MS ISO 13007-1 and MS 1294.
- 4.1.15 Grouts used shall be of proprietary grout with good working characteristics, low shrinkage and good adhesion to edges of the tiles complying with MS ISO 13007-3. The selection of the type of grout shall be to the manufacturer's recommendation. Sanded grout shall be used for tile joint width of 4 mm or more. Non-sanded grouts shall be used for installation in joints of 4 mm width or less. The application of ceramic tile grouts for internal and external tile installations on walls and floors shall comply with MS 1294.
- 4.1.16 Tiles shall be laid with joints not exceeding 3 mm wide to be filled with coloured grout. Admixtures shall be used in accordance with the manufacturer's recommendation and they shall not be added to the proprietary grout unless approved by the grout manufacturer. Admixtures are added for improving the resilience and reducing the water permeability of the hardened grout mortar.
- 4.1.17 Unless otherwise shown on the Drawings, movement joints should be located in the tiles installation to coincide and be continuous with all existing structural movement joints, although they are actually formed as separate joints isolated by suitable thickness of back-up material.
- 4.1.18 Unless otherwise shown on the Drawings, the movement joints with consultation with the designers shall be positioned at the following locations:
 - (i) Over existing and/or structural movement joints;
 - (ii) Where tiling abuts other materials;

 <p>JKR MALAYSIA</p>	<p>SECTION K : PLASTERING, PAVING AND TILING WORKS</p>	<p>No. Dokumen : JKR 20800-0183-14 No. Keluaran : 01 No. Pindaan : 00 Tarikh : 29 Januari 2014 Muka Surat : K/10</p>
--	---	--

- (iii) Where tiling is continuous across junctions of different background materials;
- (iv) In large tile areas, at internal vertical corners and at 3 m to 4.5 m centers horizontally and vertically; and
- (v) Where stresses are likely to be concentrated, for example at changes of alignment.

4.1.19 Unless otherwise specified in the Drawings, joint sealant materials for movement joints shall be selected and applied in accordance with the guidance given BS 6213.

4.1.20 Where large format ceramic tiles are required for walls and to be fixed above first floor height, they shall be secured by mechanical means. When the thickness of tile exceeds 12.5 mm and the weight of tile is more than 32 kg/m², mechanical fixing is recommended. All mechanical fixing methods shall be certified by a competent Professional Engineer and to the approval of the S.O.

4.1.21 Pull-out test shall be carried out after twenty eight (28) days installation for every maximum area 500 m² or on the tiles that are suspected of hollowness, at the instruction of the S.O.

4.1.22 Adhesion strength of the pull-out test shall exceed 0.5 N/mm² for walls with cement:sand mortar bedding or 1.0N/mm² with adhesive bedding. Pull-out test shall be carried out in accordance to MS ISO 13007-2 and as recommended by the tile adhesive manufacturer. Location and number of test point for the pull-out test shall be as requested by the S.O.

4.2 Precast Terrazzo Tiles

4.2.1 Unless otherwise shown on the Drawings, precast terrazzo tiles of an approved manufacture shall be 100 mm x 300 mm x 20 mm thick machine-pressed tiles comprising of 6 mm limestone aggregate and coloured cement.

4.2.2 The tiles shall be soaked prior to laying and shall be laid butt jointed on 20 mm thick semi-dry cement and sand screed. The laying shall be done while the screed is still green. All joints between the tiles shall be grouted with coloured cement to match.

4.2.3 The tiles shall be rubbed down to a smooth surface after a minimum of two days or laying by means of Carborundum stone. Tile impregnator shall then be applied strictly in accordance with the manufacturer's recommendation on to the terrazzo surface to prevent future staining.

4.2.4 Unless otherwise stated in the Drawings, nosing and edging tiles to edges of flooring and treads of concrete stairs shall be of an approved type and to match with the flooring accessories such as skirting (bull nose or cove base), step tiles, step nosing, edging strips, angle tiles (internal and external), etc. shall be of an approved type from the same material to match flooring.

4.2.5 Unless otherwise shown on the Drawings, skirting shall be 100 mm high, stair nosing shall be minimum 20 mm wide laid full length of the treads and of bull nose profile, and edging strips 25 mm wide.

 <p>JKR MALAYSIA</p>	<p>SECTION K : PLASTERING, PAVING AND TILING WORKS</p>	<p>No. Dokumen : JKR 20800-0183-14 No. Keluaran : 01 No. Pindaan : 00 Tarikh : 29 Januari 2014 Muka Surat : K/11</p>
--	---	--

4.3 Mosaic

- 4.3.1 Unless otherwise shown on the Drawings, mosaic tiling to floors shall be semi-glazed tiles and shall be of an approved colour and manufacture.
- 4.3.2 Unless otherwise shown on the Drawings, mosaic tiling to walls shall be fully glazed tile and shall be of approved colour and manufacture.
- 4.3.3 Unless otherwise shown on the Drawings or described in the B.Q., all skirting shall be 100 mm high to match floor tiling. The tiles at the bottom of the skirting shall be set at 45° to the horizontal and the top finished with cove tiles or edging strips to manufacturer's recommendation. The tiles required to form angles to skirting shall be neatly cut and fit to all abutments.
- 4.3.4 Mosaic tiling to floors shall be bedded on 20 mm thick semi-dry cement and sand (1:3) screed, laid on the concrete base which has been thoroughly cleaned and wetted.
- 4.3.5 Mosaic tiling to walls shall be evenly buttered with cement:sand mortar before bedding on 20 mm thick cement and sand (1:3) screed which has sufficiently cured. Alternatively the tiling shall be bedded with approved proprietary adhesive to manufacturer's recommendation onto the cement screed.
- 4.3.6 During bedding, the surface of the mosaic shall be checked and any unevenness shall be made good. Any misaligned or defective tiles shall be adjusted or replaced. All joints shall be grouted with approved proprietary grout or coloured cement and sand grout to match. The tiling shall be allowed to mature under damp condition for at least four (4) days before cleaning down.
- 4.3.7 The selection and application of tile adhesives for internal and external mosaic installations on walls and floors shall comply with MS ISO 13007-1. The selection and application of tile grouts for mosaic installations on walls and floors shall comply with MS ISO 13007-3.

4.4 Quarry Tiles

- 4.4.1 Quarry tiles shall be of non-slip type 150 mm x 150 mm x 12 mm thick complying with MS 1088, 1089, 1090 and 1091. The tiles shall be bedded on 20 mm thick semi-dry cement and sand (1:3) screed with joints about 2 mm wide, laid on the concrete base which has been thoroughly cleaned and wetted. All tiles shall be soaked overnight before laying.
- 4.4.2 All skirting shall be 100 mm high with rounded top edge to match the tiles flooring. The tiles required to form angles to skirting shall be neatly cut and fit to all abutments.

4.5 PVC Tiles/Sheets

- 4.5.1 PVC tiles or sheets shall be of approved type, pattern and colour. PVC tiles or sheets are to be of non-slip type and shall comply with MS 602. Tiles shall be 250 mm x 250 mm x 2 mm thick minimum. Sheets shall be 2 m roll width x 2 mm thick minimum.
- 4.5.2 Accessories such as skirting, stair nosing, edging strips etc. shall be of the same manufacture from similar material to match flooring. Unless otherwise described skirting shall be 100 mm high; stair nosing shall be 60

 <p>JKR MALAYSIA</p>	<p>SECTION K : PLASTERING, PAVING AND TILING WORKS</p>	<p>No. Dokumen : JKR 20800-0183-14 No. Keluaran : 01 No. Pindaan : 00 Tarikh : 29 Januari 2014 Muka Surat : K/12</p>
--	---	--

mm wide laid full length of the treads and of bullnose profiles; and edging strips shall be 25 mm wide.

- 4.5.3 The final appearance and performance of the floor covering will be determined and affected, in part, by the condition of the subfloor. It is essential that all subfloors are solid, smooth, flat, even, permanently dry, clean and free from all foreign materials such as dust, paint, grease, oils, solvents, curing and hardening compounds, sealers, asphalt and old adhesive residue. The dryness of the subfloor is of the utmost importance and it must be determined by testing the moisture level in the subfloor. Enough drying time must be allowed in the building program to achieve a relative humidity (RH) reading of below 75% or in compliance to the manufacturer's RH recommendation.
- 4.5.4 Installation area for the flooring must be clean, fully enclosed, weathertight and maintained at uniform temperature at least forty eight (48) hours prior to, during and after the installation is completed.
- 4.5.5 The tiles or sheet shall be laid and jointed on 20 mm thick cement and sand (1:3) screed subfloor with an approved proprietary waterproof adhesive strictly in accordance with manufacturer's recommendation. The screed shall be finished smooth with a steel trowel to an even surface and shall be dry, clean and free from dust and sand before laying the tiles and sheets. A self-leveling sub-floor smoothing compound shall be applied on uneven surfaces to provide a quality finish to receive the floor coverings or as recommended by the manufacturer.
- 4.5.6 For ground floor or basement areas, an approved damp proof membrane shall be installed prior to the application of sand/cement screeds.
- 4.5.7 Adhesive; when not specified otherwise, type to be as recommended and approved by the PVC tile/sheet covering manufacturer. Use acrylic adhesive/solvent based adhesive on dry, dustless sub floors in areas not subjected to spillages. Use two parts polyurethane adhesive on the sub-floors in areas subject to excessive spillage of water. Floors must be kept free of traffic until the PU adhesive is fully set, recommended minimum eight (8) hours.
- 4.5.8 The floor coverings should be adhered in acrylic adhesive or approved equivalent. All joints on the floor must be cut in, grooved and hot welded. Cove up skirting shall be 100 mm height, to enable the self-coving of the floor covering. In areas that are not subjected to spillages of water onto the wall surfaces, the top of the covering is to be finished with PVC capping seal. This should be adhered to the wall surface approximately 100 mm-150 mm high prior to self-coving floor covering. The material is than cut and fitted into the capping seal, capping seal should be adhered with contact adhesive.
- 4.5.9 In areas that are subjected to spillages of water onto the wall surfaces, the top of the covering is finished with aluminium trimming, a specially designed section for forming water-tight joint in conjunction with the surface of the wall finishes. It is recommended that the aluminium trim to be screwed on the wall surface.
- 4.5.10 Where area of excessive spillages of water, it is important that a watertight joint be achieved at junction of drains, gratings, access covers etc.
- 4.5.11 On completion, the flooring shall be well-cleaned and treated or polished in accordance with the manufacturer's recommendation.

 <p>JKR MALAYSIA</p>	<p>SECTION K : PLASTERING, PAVING AND TILING WORKS</p>	<p>No. Dokumen : JKR 20800-0183-14 No. Keluaran : 01 No. Pindaan : 00 Tarikh : 29 Januari 2014 Muka Surat : K/13</p>
--	---	--

4.6 Timber Strip Flooring

- 4.6.1 Unless otherwise shown on the Drawings, timber strip flooring shall be ready-made, laminated three (3) ply timber strips or floorboards of approved manufacture. The timber species for use in timber strip flooring shall be as specified in SECTION H: TIMBER, JOINERY AND IRONMONGERY WORKS.
- 4.6.2 The flooring shall be laid to the pattern as approved by the S.O, on 20 mm thick cement and sand (1:3) screed with an approved waterproof adhesive applied in accordance with manufacturer's recommendation. The screed shall be finished smooth with a steel trowel to an even surface and it shall be dry, clean and dust free before laying the timber strip flooring. After the adhesive has set, the timber strip flooring shall be sanded to a true smooth and even surface using suitable sanding machine. Any misaligned or defective timber strip shall be adjusted or replaced.
- 4.6.3 Unless otherwise shown on the Drawings or described in the B.Q., skirting to timber strip flooring shall consist of 100 mm x 12 mm thick wrot timber skirting rounded at the top, and fixed to the wall or column using 38 mm masonry nails spaced approximately at 600 mm centres in two (2) rows 26 mm away from the top and bottom edges. The nails shall be punched below the surface and the holes filled with approved putty. Any jointing of the skirting shall use splayed butt joints.
- 4.6.4 The face edges of the flooring shall be lined with wrot timber edging to match. The edging strips shall be 38 mm wide approximately x 12 mm thick fixed to the base using adhesive as specified hereinbefore, projecting 12 mm from the finished sides of floor slabs. Edging strips shall be jointed using glued splayed butt joints.
- 4.6.5 After sanding the flooring shall be cleaned, any gap sealed with approved sealer, stained and finished with three (3) coats of approved polyurethane paint. Each coat shall be applied strictly in accordance with the manufacturer's recommendation.

4.7 Parquet Tile Flooring

- 4.7.1 Unless otherwise shown on the Drawings, parquet tiles shall be ready-made 120 mm x 120 mm x 10 mm thick consisting of 120 mm x 25 mm x 10 mm pressure treated kempas, keruing or other approved medium hardwood timber battens. The timber species for use in parquet flooring shall be as specified in SECTION H: TIMBER, JOINERY AND IRONMONGERY WORKS.
- 4.7.2 The flooring shall be laid to the pattern as approved by the S.O, on 20 mm thick cement and sand (1:3) screed with an approved waterproof adhesive applied in accordance with manufacturer's recommendation. The screed shall be finished smooth with a steel trowel to an even surface and it shall be dry, clean and dust free before laying the parquet flooring. After the adhesive has set, the parquet flooring shall be sanded to a true smooth and even surface using suitable sanding machine. Any misaligned or defective parquet shall be adjusted or replaced.
- 4.7.3 Unless otherwise shown on the Drawings or described in the B.Q., skirting to parquet flooring shall consist of 100 mm x 12 mm thick wrot timber skirting rounded at the top, and fixed to the wall or column using 38 mm masonry nails spaced approximately at 600 mm centres in two (2) rows 26 mm away from the top and bottom edges. The nails shall be punched

 <p>JKR MALAYSIA</p>	<p>SECTION K : PLASTERING, PAVING AND TILING WORKS</p>	<p>No. Dokumen : JKR 20800-0183-14 No. Keluaran : 01 No. Pindaan : 00 Tarikh : 29 Januari 2014 Muka Surat : K/14</p>
--	---	--

below the surface and the holes filled with approved putty. Any jointing of the skirting shall use splayed butt joints.

4.7.4 The face edges of the flooring shall be lined with wrot timber edging to match. The edging strips shall be 38 mm wide approximately x 12 mm thick fixed to the base using adhesive as specified hereinbefore, projecting 12 mm from the finished sides of floor slabs. Any edging strips shall be jointed using glued splayed butt joints.

4.7.5 After sanding the flooring shall be cleaned, any gap sealed with approved sealer, stained and finished with three (3) coats of approved polyurethane paint and sanding between coats. Each coat shall be applied strictly in accordance with the manufacturer's recommendation. The required type of flooring finish shall be to S.O.'s approval.

4.8 Granite Slabs

4.8.1 Unless otherwise shown on the Drawings, granite slabs for flooring shall be 600 mm x 600 mm x 25 mm thick shall be bedded with cement: sand mortar or alternatively with 9 mm thick approved proprietary tile adhesive onto 25 mm thick cement and sand (1:3) screed as described hereinbefore. The slabs shall be laid butt-joint. Any gap shall be filled with approved mixture of adhesive and grout powder. After grouting, the surface then shall be polished, buffered and finished with a layer of impregnator.

4.8.2 If used in wet or exposed areas, or on ground floor, waterproofing system shall be installed prior to the laying of granite slabs. The floors or the exposed wet areas shall be applied with two coats of approved waterproof coating.

4.8.3 The reverse side of granite slabs in contact with the ground floor or exposed wet wall surface shall be applied with approved waterproof coating.

4.9 Marble Slab

4.9.1 Unless otherwise shown on the Drawings, marble slabs for flooring shall be 600 mm x 600 mm x 25 mm thick shall be bedded with cement: sand mortar or alternatively with 9 mm thick approved tile adhesive onto 25 mm thick cement and sand (1:3) screed. The slabs shall be laid butt-joint. Any gap shall be filled with approved mixture of the adhesive and grout powder. After grouting, the surface then shall be polished, buffered and finished with a layer of impregnator.

4.9.2 If used in wet or exposed areas, or ground floor, waterproofing system shall be installed prior to the laying of marble slabs. The floors or the exposed wet areas shall be applied with two coats of approved waterproofing coating.

4.9.3 The reverse side of marble slabs in contact with the ground floor or exposed wet wall surface areas shall be applied with approved waterproof coating.

TABLE OF CONTENTS

SECTION L : WATER RETICULATION, INTERNAL PLUMBING SYSTEM AND SANITARY FITTINGS

	PAGE
1. General	L/1
2. Products And Materials	L/1
3. Inspection	L/1
4. Water Reticulation	L/1
TABLE L1 : Widths Of Pipe Trenches	L/2
5. Internal Cold Water And Sanitary Plumbing System	L/10
6. Sanitary Fittings	L/10
APPENDIX L/1 : Schedule Of Sanitary Fittings	L/12

 <p>JKR MALAYSIA</p>	<p>SECTION L : WATER RETICULATION, INTERNAL PLUMBING SYSTEM AND SANITARY FITTINGS</p>	<p>No. Dokumen : JKR 20800-0183-14 No. Keluaran : 01 No. Pindaan : 00 Tarikh : 29 Januari 2014 Muka Surat : L/1</p>
--	--	---

1. General

The water reticulation and internal cold water plumbing works shall be executed by personnel with valid permits issued by SPAN as stipulated under Water Service Industry Act 2006. The Contractor shall be responsible for employing such personnel and all the work performed by them.

2. Products And Materials

- 2.1 All products and materials to be incorporated in the work shall be new and unused. Materials to be used within the scope of work shall be those approved by SPAN. When the quality of a material or process is not specifically set forth in the approved products and materials list, the Drawings, or the Specifications, the best available quality of the material or process shall be provided, subject to the approval of the S.O.
- 2.2 All products and materials shall be supplied by suppliers registered with SPAN. The Contractor shall provide proof to the S.O. in the form of a valid Confirmation Letter or Certificate of Registration issued by SPAN to the supplier. The products and materials shall also be subjected to other terms and conditions mentioned in these specifications.
- 2.3 All products and materials shall be of the makes and models tested and approved for use. It is the Contractor's responsibility to verify that products and materials received for the job conform to the current approved products and materials supplied by SPAN registered suppliers.
- 2.4 All products and materials furnished shall be subject to inspection for compliance with these specifications and all other appropriate specifications. The Contractor shall make application to the S.O. for inspection at least five (5) days in advance of starting any work.

3. Inspection

The S.O. shall at all times have access to the work wherever it is in preparation or progress and the Contractor shall provide proper facilities for such access and for inspection. The Contractor shall provide safe means to inspect the work. Failure or oversight of the S.O. or his representative to reject defective materials at the time of use, or to reject improper work at the time it is performed, shall not diminish the Contractor's obligations to comply with Drawings and Specifications. The Contractor shall remove and replace any faulty materials and work at no additional cost to the Government upon discovery of the defects or upon receipt of notice from the S.O. to do so.

4. Water Reticulation

4.1 Setting Out

All setting out for pipe laying works shall be performed by the Contractor's surveyor. Generally, stakes for alignment and grade shall be set at 10 m intervals. The survey shall conform to the lines, grades, and dimensions shown on the Drawings. The Contractor shall preserve all monuments, benchmarks, survey markers and stakes. In case of their removal or destruction by the Contractor or his employees, agents or subcontractors, the Contractor shall be liable for the cost of their replacement.

 <p>JKR MALAYSIA</p>	<p>SECTION L : WATER RETICULATION, INTERNAL PLUMBING SYSTEM AND SANITARY FITTINGS</p>	<p>No. Dokumen : JKR 20800-0183-14 No. Keluaran : 01 No. Pindaan : 00 Tarikh : 29 Januari 2014 Muka Surat : L/2</p>
--	--	---

4.2 Excavation

4.2.1 General

All general excavation works shall be as specified in SECTION C: EXCAVATION AND EARTHWORKS.

4.2.2 Excavation for pipe trenches

4.2.2.1 Before commencing the excavation of pipe trenches, the routes of the pipelines shall be pegged out accurately. Strong sight rails shall be fixed and maintained at each change of gradient, and at as many intermediate points as may be necessary but not exceeding 100 metres apart. On these rails shall be marked the centre line and level to which the pipes are to be laid, and such rails shall be maintained in position and at the correct level from the time the excavation commences until backfilling is completed. The run of pipe trenches opened up ahead of pipe laying operations at any one time shall not be more than:

- (i) 100 m if the pipe laying operations are in an urban area,
- (ii) 300 m if the pipe laying operations are in the side tables of a trunk road, or
- (iii) 600 m if the pipe laying operations are in unoccupied land schemes or housing estates under development or are in the side tables of minor rural roads.

4.2.2.2 The S.O. may, at his absolute discretion, vary the distances stated above if he considers that traffic, road, weather or physical conditions warrant the variation.

4.2.2.3 Unless the S.O. permits otherwise, the trenches shall be excavated to the widths given in TABLE L1.

TABLE L1: WIDTHS OF PIPE TRENCHES

External Pipe Diameter (D)	Width of Trench
Not exceeding 500 mm	D+300mm
Exceeding 500 mm	D+600mm

4.2.2.4 Where pipes are to be laid on a concrete bed, the width of the excavation at the bottom of the trench shall be the width of the underside of the concrete bed. At all joints the trench shall be so excavated as to give a working space of not less than 300 mm all around the joint. Where bends are made by deflecting pipes at joints the trench shall be widen to permit this operation. The sides of the trench shall be cut vertical, and where necessary, shall be protected against caving in by timbering to the approval of the S.O.

4.2.2.5 The trench shall be excavated to the depths intended or shown in the Drawings and shall be finished and trimmed accurately to level and grade.

4.2.2.6 Should the ground be so wet or soft that, in the opinion of the S.O., it does not form a firm base for the pipe, or should rock be encountered at the bottom of the trench, the trench shall be

	SECTION L : WATER RETICULATION, INTERNAL PLUMBING SYSTEM AND SANITARY FITTINGS	No. Dokumen : JKR 20800-0183-14 No. Keluaran : 01 No. Pindaan : 00 Tarikh : 29 Januari 2014 Muka Surat : L/3
---	---	--

excavated 250 mm below the level intended or shown in the Drawings and then brought back to the correct level with good selected earth or sand well rammed into place. Such deepening of pipe trench and filling back shall be treated as a variation under the terms of the Contract. Should the bottom of the trench be inadvertently excavated below the specified level, it shall be brought back, at the Contractor's expense, to the correct level with good selected earth or sand carefully rammed into place.

4.2.3 Excavation of road crossings

- 4.2.3.1 No trench is to be excavated in the carriageway unless specific approval has been given by the relevant road authority. The whole operation of excavation and reinstatement of the trench shall be completed as quickly as possible. The Contractor shall ensure that minimum interference to traffic flow is maintained at all times.
- 4.2.3.2 A joint site inspection shall be arranged by the Contractor before commencement of work if so requested by the road authority. After pegging out, the Contractor shall inform the road authority and the police of the actual date of commencement at least one week in advance of and on the day of commencement.
- 4.2.3.3 If specific approval has been given to lay services across the road by open excavation, proper cutting of the metalled pavement shall be done and the Contractor shall ensure that the top edges of the excavation are neat and straight.
- 4.2.3.4 All materials from the excavation, if accepted for backfilling shall be neatly stacked outside the carriageway. Where there is no place to stack the excavated materials outside the carriageway, shall excavated materials shall be removed from the work site immediately after excavation.
- 4.2.3.5 Where specific approval has been given by the road authority for half width construction, the traffic lanes may be reduced to not less than 5.0 m wide and where necessary, the shoulder should be strengthened to accommodate traffic load to the satisfaction of the S.O. by the Contractor and at the Contractor's cost.
- 4.2.3.6 Trenches shall be provided with adequate shuttering, walling and struts to prevent the adjoining road pavement from cracking and subsiding.
- 4.2.3.7 If a road diversion is required, the Contractor shall build it to the specifications of the road authority. It shall be maintained in good motorable condition until the reinstatement is completed.
- 4.2.3.8 Carriageway excavation across important and busy road and junctions shall be carried out during off-peak hours. The S.O. shall specify the appropriate times based on the merits of each case and such conditions shall be strictly adhered to by the Contractor.

 <p>JKR MALAYSIA</p>	<p>SECTION L : WATER RETICULATION, INTERNAL PLUMBING SYSTEM AND SANITARY FITTINGS</p>	<p>No. Dokumen : JKR 20800-0183-14 No. Keluaran : 01 No. Pindaan : 00 Tarikh : 29 Januari 2014 Muka Surat : L/4</p>
--	--	---

4.2.4 Excavation of rock in trench

Rock shall mean those geological strata of hard material which necessitate the use of blasting or approved pneumatic tools for their removal. Solid boulders found in trench excavations and foundation pits shall be considered as rock if such boulders are of size each exceeding 0.08 cubic metre. Shale and clay boulders shall not be classified as rock. The S.O.'s decision as to whether or not the material of the excavation is to be classified as rock shall be final. The Contractor shall be entitled to extra payment for rock excavation only if reasonable notice is given to the S.O. to examine and measure such material prior to breaking up. The volume of rock excavated shall be taken as its volume in-situ before it is broken up.

4.2.5 Pipe bedding

The pipe bedding and foundation shall be prepared according to the Drawings. No pipes shall be laid until the S.O. has inspected and approved the pipe bedding and foundation. Any work that has been carried out without the approval of the S.O. shall, on the instructions of the S.O., be uncovered or removed by the Contractor and reinstated to the S.O.'s approval at the Contractor's own expense

4.2.6 Crossing water courses

Where the pipeline crosses underneath streams, culverts and other water courses, the Contractor shall be deemed to have allowed for all additional measures necessary for the proper construction of the pipeline especially maintaining the flow of water.

4.2.7 Backfilling of pipe trenches

4.2.7.1 After the pipe laying has been approved by the S.O. and before the pipelines are tested, sufficient backfilling of the trenches will be permitted to prevent "snaking" and to maintain the pipes in position, but all joints shall be left exposed. In any other locality where the trench may be filled with water and cause flotation of the pipes, or elsewhere as may be decided by the S.O. the backfilling shall follow the pipe alignment as closely as possible.

4.2.7.2 In backfilling pipe trenches, only approved materials free from stones or rocks or other hard materials shall be carefully spread along the trench bottom between the pipes and the trench walls to a depth of about 150 mm and shall be hand rammed. Further layers each of about 150 mm thick of the same materials shall then be spread and rammed in the same manner up to the top of the pipes. The remainder of the backfilling may consist of coarse materials free from boulders and large earth clods. It shall be placed in layers each of 150 mm thickness and hand or mechanically rammed until the backfill is 300 mm above the top of the pipes. The rest of the trench backfill shall be in layers each of 300 mm thickness and compacted by a mechanical vibrating tamper to finish off slightly proud of the surrounding ground. The degree of compaction of each layer shall not be less than 95 % of the dry density obtainable using the BS 1377 Compaction Test. The Contractor shall make good any settlement to avoid formation of drains or gullies within the refilled trenches.

 <p>JKR MALAYSIA</p>	<p>SECTION L : WATER RETICULATION, INTERNAL PLUMBING SYSTEM AND SANITARY FITTINGS</p>	<p>No. Dokumen : JKR 20800-0183-14 No. Keluaran : 01 No. Pindaan : 00 Tarikh : 29 Januari 2014 Muka Surat : L/5</p>
--	--	---

- 4.2.7.3 Approved fill material to be used as backfill to the top of the pipes shall be uniform low plasticity granular material. The material shall be free from all organic or other materials subject to decay. Highly plastic or expansive soils or clay shall not be used. The filling material shall be readily compactable to its maximum density and must not form mud, or otherwise breakdown when wet.
- 4.2.7.4 Should the material being placed as fill or backfill while acceptable at the time of selection, become unacceptable to the S.O due to exposure to weather conditions or due to flooding or have become puddled, soft or segregated during the progress of the works, the Contractor shall, at his own expense, remove such damaged, softened or segregated material and replaced it with fresh approved material.
- 4.2.7.5 Where the pipeline crosses a road, approved sand shall be used as fill material up to the road formation level.
- 4.2.8 **Backfilling of excavations other than pipe trenches**
- 4.2.8.1 Backfilling of all excavations shall not be carried out until the Works therein have been inspected and approved by the S.O. In backfilling excavations other than pipe trench excavations, portions of the excavated materials may be used with the approval of the S.O. Where required, approved materials shall be brought to the site for backfilling works. The materials shall be deposited and spread in layers of not more than 300 mm deep, and each layer shall be thoroughly rammed by a mechanical vibrating tamper or smooth wheel roller and watered if required.
- 4.2.8.2 If so directed by the S.O., the backfilling shall be finished off slightly proud of the surrounding ground to allow for settlement, but the Contractor shall make good any settlement which may occur during the construction of the Works and during the Defects Liability Period of the Contract at his own expense.
- 4.2.9 **Road reinstatement**
- 4.2.9.1 Road reinstatement works shall be carried out by the Contractor to a standard equivalent or superior to the road condition existing prior to excavation and to the requirements of the relevant road authority and approval of the S.O.
- 4.2.9.2 All backfilling shall be done by the Contractor with approved sand. No organic soil, broken pre-mix or stones are to be used. The sand shall be compacted in 225 mm layers. The degree of compaction of each layer below the pavement course shall not be less than 95 % of the dry density obtainable using the BS 1377 Compaction Test. The Contractor shall bear the cost of such tests and shall make good any works which are found to be unsatisfactory.
- 4.2.9.3 Sand material shall be deposited in layers on both sides of the pipe simultaneously and thoroughly compacted and around the pipe working alternately on either side of the pipe until the trench has been filled up to the base course formation level.

	SECTION L : WATER RETICULATION, INTERNAL PLUMBING SYSTEM AND SANITARY FITTINGS	No. Dokumen : JKR 20800-0183-14 No. Keluaran : 01 No. Pindaan : 00 Tarikh : 29 Januari 2014 Muka Surat : L/6
---	---	--

4.2.9.4 The Contractor shall reinstate the road pavement by replacing, in the proper sequence, any block or metalling removed, to the requirements of the relevant road authority and the approval of the S.O. The road surface shall be reinstated with new materials of the type existing on site. Edges of the reinstated road pavement shall be straight and neatly finished to match the existing road to the satisfaction of the S.O.

4.2.9.5 In the absence of any written requirement, all reinstatement works shall be carried out within 24 hours after backfilling.

4.2.9.6 If the Contractor fails to carry out the reinstatement to the requirements of the relevant road authority and the satisfaction of the S.O., the S.O. or the relevant authority may proceed with such repairs and the cost of such reinstatement shall be recouped by the S.O. from the Contractor.

4.3 Pipeworks

4.3.1 Handling and laying pipelines

All handling, laying and testing of pipelines shall comply to the latest technical specifications from SPAN or other relevant standards and also to the manufacturer's requirements

4.3.2 Testing of pipelines

4.3.2.1 The Contractor shall provide all water required for filling, testing and retesting the pipelines, and any pumps, pipework fittings and pressure gauges required for the purpose.

4.3.2.2 Whenever a section (which shall not exceed 1000 m long in or adjacent to roads, or not exceeding 2000 m long in open ground) of any pipeline has been laid, jointed and part backfilled as specified, it shall be prepared for testing by sealing the open ends temporarily with stop ends. The stop ends shall be of cast iron or steel. The stop end at the lower end of the section of the pipeline shall be fitted with a valved inlet pipe for use to fill the section of the pipeline with water and the stop end at the higher end of the section of the pipeline shall be fitted with a valved air release vent pipe. A pressure gauge shall be connected to the valved inlet pipe. The pressure gauge shall have a dial of not less than 150 mm dia. and graduated to read up to 15 bars with 0.25 bar graduations. All pressure gauges shall be tested by the S.O. before use, and provisions shall be made for connecting the pressure gauge, if the S.O. so elects, to the valved inlet pipe.

4.3.2.3 The stop ends shall be braced to the satisfaction of the S.O. to withstand the end thrust which develops from water pressure. All weight, thrust and anchor blocks intended to prevent the vertical and lateral displacement of the pipes and specials shall have been properly completed and have attained an adequate strength before the tests are carried out. When gentle curves are effected by deflection pipes these pipes shall be securely packed with backfill to prevent movement.

 <p>JKR MALAYSIA</p>	<p>SECTION L : WATER RETICULATION, INTERNAL PLUMBING SYSTEM AND SANITARY FITTINGS</p>	<p>No. Dokumen : JKR 20800-0183-14 No. Keluaran : 01 No. Pindaan : 00 Tarikh : 29 Januari 2014 Muka Surat : L/7</p>
--	--	---

- 4.3.2.4 The section of the pipeline to be tested shall be filled with water of fair quality, free from sediment and from a source approved by the S.O.. The water shall be introduced into the section of the pipeline through the valved inlet in the stop end at the lower end of the section. During filling, provision shall be made for the air to escape from all high spots in the section by properly installing all air valves and from the air released vent pipe in the stop end at the higher end of the section. The pressure/strength test shall be carried out first. Each section of the pipelines shall be tested to a pressure of 16.0 bars head of water.
- 4.3.2.5 After the section of the pipeline has been filled with water for a period of not less than seven (7) days, more water shall be pumped into the section to raise the pressure slowly in increments of 10 m head of water with pause of one minute between each increment.
- 4.3.2.6 Should any appreciable drop in pressure be noted during one of these pauses the test shall be stopped until the cause of the pressure drop has been investigated and rectified. An engine driven pump may be used until 55 m head pressure is attained, and thereafter only a hand operated pump shall be used.
- 4.3.2.7 The pressure/strength test shall be considered to have been passed when the pressure gauge shows no reduction in pressure during the specified one minute pause and also during the period of ten (10) minutes after full test pressure has been attained. If these conditions are not satisfied a thorough inspection of the section of the pipeline shall be made. All defects shall be repaired and the test shall be repeated.
- 4.3.2.8 The leakage test shall then follow. The pressure shall be reduced to 10.5 bars head of water and shall be maintained as constant as possible for a period of 24 hours. Make-up water shall be pumped into the section of the pipeline from time to time to maintain this pressure. The leakage test shall be considered to have been passed if the make-up water pumped into the section of the pipeline does not exceed the allowable leakage calculated as: 0.05 l/mm of internal diameter per kilometer of pipe per 24 hours. If this specified rate of leakage is exceeded a thorough inspection of the section of the pipeline shall be made. All leaks discovered shall be repaired and the section shall be tested again.
- 4.3.2.9 Every section pipeline shall be tested as described above in the presence of the S.O. Testing may be carried out between sluice valves but not against the gates of the sluice valves.
- 4.3.2.10 All permanent thrust block provided at bends shall be concreted and sufficiently cured prior to permission being given for testing. No temporary strutting or temporary bracing will be permitted in lieu of the permanent thrust blocks as the tests are also to subject these blocks to the transmitted pressures.

4.3.3 Flushing and disinfecting pipelines

When the final connections have been made and the pipeline has been tested to the satisfaction of the S.O. it shall be thoroughly cleaned, disinfected and flushed in sections by the Contractor. Water for this

 <p>JKR MALAYSIA</p>	<p>SECTION L : WATER RETICULATION, INTERNAL PLUMBING SYSTEM AND SANITARY FITTINGS</p>	<p>No. Dokumen : JKR 20800-0183-14 No. Keluaran : 01 No. Pindaan : 00 Tarikh : 29 Januari 2014 Muka Surat : L/8</p>
--	--	---

purpose shall be obtained from the Local Water Authority and the Contractor shall pay all the charges incurred in connection therewith.

4.3.4 Non precast valve chambers

4.3.4.1 Valve chambers shall be constructed to the size shown on the Drawings. Unless otherwise specified, all dimensions on plan shall be inside measurement. Manhole covers shall comply with BS EN 124.

4.3.4.2 Unless otherwise shown in the Drawings all manholes and chambers shall be brickwork in cement mortar 1:2. The brickwork shall be constructed on prescribed concrete mix Grade 20P foundation unless shown otherwise. The thicknesses and sizes shall be as shown on the Drawings. The inside of the chambers and manholes shall be lined with 12mm thick cement plaster (1:2). Externally, the exposed concrete or block brick surfaces shall be plastered with 12 mm cement mortar (1:2) and terminated 150mm below the finished ground level. All internal angles shall be rounded off. Manholes and chambers shall provided with precast concrete cover unless otherwise specified on the Drawings. Approved typed wrought iron steps shall be built into the brick wall of all manholes and chambers of depth 2.0m or more and they shall be spaced not more than 300mm apart projecting 100mm over face of wall.

4.3.5 Precast chambers

Precast valve chambers shall be as shown on the Drawings and in accordance with SECTION D: CONCRETE WORKS. Chamber covers shall comply with BS EN 124.

4.3.6 Washout (scour valves location)

Washouts shall be constructed at locations specified in the Drawings or as may be directed by the S.O. The washout branches shall be connected to the pipeline by special washout tees and sluice valves. From the washout sluice valves HDPE pipes shall be laid to the nearest drain or stream. The discharge point shall be downstream.

4.3.7 Indicator post (pipe and valve markers)

The Contractor shall provide and fix indicator posts close to the centre line of pipes, at valves, washout and other points as directed by the S.O. The details of indicator posts are as shown on the Drawings.

4.3.8 Hot tapping

4.3.8.1 The Contractor shall submit a method statement as how to conduct the hot tap that has been approved by the State Water Authorities to the S.O. prior to commencement of the works.

4.3.8.2 Hot tapping shall only be done in the presence of the State Water Authorities' representative. The tapping mechanism shall be of the self-purging type so that cutting chips are removed from the tapping machine and do not enter the pipeline.

 <p>JKR MALAYSIA</p>	<p>SECTION L : WATER RETICULATION, INTERNAL PLUMBING SYSTEM AND SANITARY FITTINGS</p>	<p>No. Dokumen : JKR 20800-0183-14 No. Keluaran : 01 No. Pindaan : 00 Tarikh : 29 Januari 2014 Muka Surat : L/9</p>
--	--	---

4.3.8.3 All hot tap connections to existing pipelines, whether for mainline extension or service laterals, shall be performed by an authorised and qualified person.

4.3.8.4 The tapping machine shall be cleaned and disinfected prior to attachment to the tapping valve and saddle.

4.3.9 Pipe jacking

4.3.9.1 Placement of pipe by boring or jacking methods requires special S.O.'s approval for each instance. The methods and equipment used in boring and jacking operations shall be optional to the contractor, provided that the S.O. reviews them prior to any work.

4.3.9.2 The Contractor shall submit a method statement as how to conduct the pipe jacking operation to the S.O. for approval.

4.4 External water storage tanks (factory fabricated tanks)

4.4.1 The Contractor shall supply a new tank reservoir from a manufacturer specializing in the design, fabrication and erection of the approved water storage tanks.

4.4.2 The type of tanks that may be supplied and installed shall be only from the following type:

No	Product Name	Specified Conditions/ Requirements
1	Steel Tank with Lining or Coating (Non Corrugated Type) (Glass Fused/Glass Coated/Epoxy Lining/HDPE) Lining	Maximum capacity allowed for elevated tanks is 2.3 ML (500,000 gallons) and for ground storage tanks is 3.4 ML (750,000 gallons). Maximum height allowed is 5 m or 4 panels high whichever is lower. The minimum warranty period for the tank and sealant / lining shall be 10 years. The minimum thickness of PE/HDPE lining shall be 2.0 mm.
2	Cylindrical Steel Tank - Double Fold System	Maximum capacity allowed is 4.5 ML (1,000,000 gallons). Maximum height allowed is 5 m. The minimum warranty period for the tank and sealant / lining shall be ten (10) years.
3	Polyethylene Storage Tanks (PE Storage Tanks)	Tanks shall have interlocking mechanisms. Tanks shall only be allowed up to 3,785.4 L (1,000 gallons) capacity only. Multiple tanks on one tower structure shall be strictly not allowed.

4.4.3 The tank shown on the Drawings and specified herein shall be fabricated, supplied and installed by a manufacturer with a valid registration with SPAN.

 <p>JKR MALAYSIA</p>	<p>SECTION L : WATER RETICULATION, INTERNAL PLUMBING SYSTEM AND SANITARY FITTINGS</p>	<p>No. Dokumen : JKR 20800-0183-14 No. Keluaran : 01 No. Pindaan : 00 Tarikh : 29 Januari 2014 Muka Surat : L/10</p>
--	--	--

- 4.4.4 Installation of the tank shall be by the tank manufacturer or approved installer appointed by the manufacturer. The manufacturer shall be fully responsible for entire installation including tank erection, and the ultimate water tightness of the complete installation. Notwithstanding the above, the Contractor shall be fully responsible for the entire installation and completion of the final product.
- 4.4.5 Construction shall be governed by the Contract Drawings and specifications showing general dimensions
- 4.4.6 The water tank inclusive of all associated pipeworks shall be cleaned on completion, tested for watertightness and disinfected before it is commissioned.

5. Internal Cold Water And Sanitary Plumbing System

- 5.1 The installation of the abovementioned system shall comply with JKR 20500-0010-10 Standard Technical Specification for Internal Cold Water and Sanitary Plumbing System or the latest edition published by JKR.
- 5.2 All water supply plumbing and installation shall be executed in accordance with the relevant state water supply rules and to the approval of the state water authority / SPAN, notwithstanding any approval given by the S.O.
- 5.3 Technical Specification of Sanitary Plumbing System. All the workmanship and material for the supply, installation, testing & commissioning of all equipment and accessories for sanitary plumbing system shall comply with the following rules and regulation requirements:
- (i) Drainage, Sanitation and Sanitary Plumbing By-laws of the proposed Street, Drainage and Building Act 1974; and
 - (ii) Gravity Drainage Systems Inside Buildings, BS EN 12056:
 - a) Part 1 : General and Performance Requirements.
 - b) Part 2 : Sanitary Pipework, Layout and Calculation.
 - c) Part 5 : Installation and Testing, Instructions for Operation, Maintenance and Use.
 - (iii) CP For Design and Installation Of Sewerage System, MS 1228; and
 - (iv) Local Authority By-laws in force at time of installation; and
 - (v) Other relevant standards.

6. Sanitary Fittings

- 6.1 Fittings
- 6.1.1 Unless otherwise shown on the Drawings, all fittings including all necessary brackets and accessories shall be as scheduled in APPENDIX L/1 hereinafter. The Contractor shall be responsible for determining the type of trap required for each fitting. All necessary concrete backing shall be provided to fittings secured to floors.
- 6.1.2 Unless otherwise shown on the Drawings, the colour of sanitary ware shall be in white.

 <p>JKR MALAYSIA</p>	<p>SECTION L : WATER RETICULATION, INTERNAL PLUMBING SYSTEM AND SANITARY FITTINGS</p>	<p>No. Dokumen : JKR 20800-0183-14 No. Keluaran : 01 No. Pindaan : 00 Tarikh : 29 Januari 2014 Muka Surat : L/11</p>
--	--	--

6.2 Vanity Tops

- 6.2.1 Unless otherwise shown on the Drawings, a minimum thickness of 12 mm vanity tops of approved manufacture and colour shall be installed in accordance with the manufacturer's instructions. It shall be moulded as one solid piece with its top sloping gently towards the wash hand basin and having a slight upturn or kerb as its outer edges including backsplash to prevent water damage to wall and vanity back.
- 6.2.2 It shall be manufactured from non-porous composite product composed of polyester resin and calcium carbonate marble dust with the permanence of stone and an aesthetic appeal of natural marble or granite. The slab surface shall have a glossy finish, and protected by suitable polymer to ensure durability and impermeability. It shall be stain and chemical resistant, and UV stabilised.

6.3 Type Of Sanitary Fittings And Description

- 6.3.1 Unless otherwise shown or/and specified in the Drawings, the sanitary fittings shall be of the following:
- (i) All sanitary fittings shall be of white in colour, from an approved manufacturer, generally ensuite and complete with all necessary fittings.
 - (ii) Waste and bath overflows, chains and stays, shall be chromium plated brass to BS EN 274 Part 1-3.
 - (iii) Taps and combination tap assemblies shall be chromium plated brass to BS EN 200.

6.4 Wash Basin

- 6.4.1 Unless otherwise specified, wash basin shall be 600 mm x 410 mm x 200 mm earthenware plain edge sink in white fireclay complete with chromium plated tap, blank tap hole stopper, 30 mm 'p' trap with 40 mm seal, waste fittings, plug with chain and painted bracket supports to S.O.'s approval.
- 6.4.2 Where shown wash basins shall be to MS 147 of the following types as specified:
- (i) Under counter basin with overflow.
 - (ii) Wall hung basin with or without pedestal as specified.
 - (iii) Semi-recessed basin with or without overflow as specified.
 - (iv) Counter top basin with or without overflow as specified.
 - (v) Handicap basin.

 <p>JKR MALAYSIA</p>	<p>SECTION L : WATER RETICULATION, INTERNAL PLUMBING SYSTEM AND SANITARY FITTINGS</p>	<p>No. Dokumen : JKR 20800-0183-14 No. Keluaran : 01 No. Pindaan : 00 Tarikh : 29 Januari 2014 Muka Surat : L/12</p>
--	--	--

APPENDIX L/1

SCHEDULE OF SANITARY FITTINGS

No.	Item	Description
1	Wash Basin	<p>(i) Wash basin for domestic purposes shall be 560 mm x 410 mm in approved colour vitreous china complete with chromium plated tap, blank tap hole stopper, 30 mm 'p' trap with 40 mm seal, waste fittings with chrome-plated brass pop up waste and painted bracket supports.</p> <p>(ii) Clinical wash hand basins shall be wall hung vitreous type and not less than 600 mm in width complete with a wall mounted 175 mm long elbow action lever mixer with premix function. Clinical wash hand basins shall not have any overflow outlet, soap recess nor basin plug.</p>
2	Vanity tops	<p>(i) Vanity top as specified, with integrated sink as shown in the Drawings, complete with chromium-plated tap, blank tap hole stopper, 30 mm 'p' trap with 40 mm seal, waste fittings with chrome-plated brass pop up waste.</p> <p>(ii) Vanity top as specified, but with holes pre-punched to receive an under-counter vanity basin and tap respectively, as shown in the Drawings, complete with 555 mm x 415 mm under-counter vanity basin in vitreous china, complete with chromium-plated tap, 30mm 'p' trap with 40mm seal, waste fittings with chrome-plated brass pop up waste and painted bracket supports.</p>
3	Sinks	<p>(i) 915 mm x 460 mm, single bowl single drainer stainless steel sinks shall be to BS 1244, stainless steel grade 304 (0.8 to 0.9 mm) minimum thick, with satin finish to the size and configuration shown on the drawings with overflow and sound deadening pads under the sink and drainers.</p> <p>(ii) Metal sinks in stainless steel to size and shape as shown in the Drawings, complete with chromium plated tap as required, 40 mm waste water outlet, chrome-plated brass pop up waste and painted mild steel frames support.</p>
4	Water closet	<p>(i) Unless otherwise specified, water closet shall be pedestal closet in white vitreous china conforming to MS 1522 complete with pedestal pan, 'p' trap and ventilation outlet, plastic hinged seat and rubber buffers.</p> <p>(ii) Squatting closet in white vitreous china conforming to MS 1522 complete with pair of raised foot treads in white fire clay with 'p' trap and 40mm diameter uPVC flush pipe.</p>
5	Urinal	<p>(i) Single urinal bowl in white vitreous china conforming to MS 1799 and MS 147 complete with back inlets, hangers and steadying brackets, 40 mm outlet with hinged gratings and 50 mm uPVC waste pipe, chromium plated flush pipes and spreaders to suit the number of appliances.</p> <p>(ii) Urinal range of 2 or more bowls as (a) but with white vitreous china division between bowls.</p>
6	Cistern for Water Closet	<p>(i) Single flush 6 litres or dual-flush 6/3 liters low level vitreous china.</p> <p>(ii) Cistern conforming to MS 795 with 40 mm flush pipe, water inlet valve, 20 mm diameter overflow for discharge externally and chrome flushing lever handle.</p>

 <p>JKR MALAYSIA</p>	<p>SECTION L : WATER RETICULATION, INTERNAL PLUMBING SYSTEM AND SANITARY FITTINGS</p>	<p>No. Dokumen : JKR 20800-0183-14 No. Keluaran : 01 No. Pindaan : 00 Tarikh : 29 Januari 2014 Muka Surat : L/13</p>
--	--	--

		<p>(iii) 6 litres high level vitreous china cistern conforming to MS 795 with 40 mm flush pipe, water inlet valve, 20mm diameter overflow for discharge externally and chromed lever handle.</p> <p>(iv) Each flush cistern for w/c shall be tested as stipulated in the requirements of MS 795.</p>
7	Cistern for urinal	Single flush 2.5 litres urinal flushing cistern in white vitreous china conforming to MS 795 complete with chromium plated flushing inlet pipe, 20 mm diameter overflow for discharge externally and chrome lever handle.
8	Flush valve for Water Closet	<p>(i) Unless specified, W/C flush valve shall be low pressure single flush 6 litres gravity flush water closet valve. It shall have a non-hold-open feature or an automatic shut-off system.</p> <p>(ii) Vacuum Breaker is optional, only applicable to w/c flush valves intended to be connected to direct potable water mains. It's performance requires proper match of valve and w/c pan conforming to MS 1522.</p> <p>(iii) Each flush valve shall be made of metal (preferably copper alloy) and corrosion resistant. All exposed surfaces to the users shall be chromed plated or made of stainless steel.</p>
9	Flush valve for urinal	<p>(i) Urinal flush valve shall be Single flush 2.5 litres gravity flush valve. urinal It shall have a non-hold-open feature or an automatic shut-off system.</p> <p>(ii) Each urinal flush valve shall be made of metal (preferably copper alloy) and corrosion resistant. All exposed surfaces to the users shall be chromed plated or made of stainless steel.</p>
10	Shower fittings	Shower fittings shall be approved chromium plated brass easy clean valve, with 3" diameter shower face and Chromium plated stainless steel grade 304 arm.
11	All types of taps	All types of taps shall be approved chromium plated brass conforming to BS EN 200.
12	Hand Bidet	Bidet shall be chromium plated copper alloy nozzle, 1.2 m heavy duty double interlock stainless steel grade 304 flexible hose, chromium plated ABS plastic wall hanger and quarter turn angle valve.
13	Sanitary appliances	<p>(i) Unless otherwise specified or shown on the Drawings, the sanitary appliances shall be:</p> <p>a) Floor trap, Robe Hook, Towel Rail, Safety Grab Bar and Handicap Safety Grab Bar shall be in stainless steel grade 304 chrome plated.</p> <p>b) Soap Dispenser shall be in uPVC (LEAD FREE).</p> <p>c) Soap holder and toilet roll holder shall be in white earthenware (ceramic).</p>

 <p>JKR MALAYSIA</p>	<p>SECTION L : WATER RETICULATION, INTERNAL PLUMBING SYSTEM AND SANITARY FITTINGS</p>	<p>No. Dokumen : JKR 20800-0183-14 No. Keluaran : 01 No. Pindaan : 00 Tarikh : 29 Januari 2014 Muka Surat : L/14</p>
--	--	--

BLANK PAGE

TABLE OF CONTENTS

SECTION M : RAINWATER COLLECTION

	PAGE
1. Rainwater Goods	M/1
2. Rainwater Harvesting System	M/4
3. Testing and Commissioning	M/5

 <p>JKR MALAYSIA</p>	<p>SECTION M : RAINWATER COLLECTION</p>	<p>No. Dokumen : JKR 20800-0183-14 No. Keluaran : 01 No. Pindaan : 00 Tarikh : 29 Januari 2014 Muka Surat : M/1</p>
--	--	---

1. Rainwater Goods

1.1 Flashing

- 1.1.1 Unless otherwise shown in the Drawings, all flashing shall be of aluminium zinc alloy coated steel sheet, free from cracks, dross, scales, excess blisters and any other defects which might be detrimental to its wearing or working properties. Sheets shall be reasonably flat before forming and cutting.
- 1.1.2 All steel sheets used for flashing shall be 0.8 mm thick minimum. Flashing shall have a minimum depth of 200 mm with the upper edge turned into the wall and pointed in cement or approved sealant. Where nails or screws are used for fixing, they shall be of the heavily galvanized type.
- 1.1.3 All fasteners to be concealed where possible. Install work with laps, joints and seams that will be permanently watertight and weatherproof. All laps shall be at a minimum of 200 mm. The flashing work shall be performed by skilled workmen.
- 1.1.4 All fasteners used near marine environment shall comply with AS 3566 Class 4 and be certified as such by the supplier of fasteners and to the approval of the S.O.
- 1.1.5 All fixings and associated components near marine environment shall be manufactured from compatible metals and coated conforming to ISO 9223 Category 4 (C4) and Category 5 (C5) environment. Flashings shall be made from the same material as the roofing sheets.

1.2 Gutters

1.2.1 General

- 1.2.1.1 Where gutters are to be provided they shall conform to the shape, dimensions and materials shown on the Drawings, free from distortions and defects detrimental to water-tight system. All gutters shall be provided and fixed complete with all necessary angles, squares and obtuse, stop end, outlets and other necessary gutter fittings and to be supplied by the same manufacturer unless otherwise shown on the Drawings.
- 1.2.1.2 Gutter outlets shall be located at the position shown in the Drawings and each provided with leaf trap of the same material unless otherwise specified.
- 1.2.1.3 All gutters other than those of reinforced concrete shall be properly fixed and adequately supported and all necessary brackets shall be provided. Brackets shall be of the type and pattern that will conform to the profile of the gutter and unless otherwise as shown on the Drawings, shall be of galvanized steel screwed to the fascia.
- 1.2.1.4 Unless otherwise shown on the Drawings, the gutter shall be uPVC and shall be laid to a minimum fall of 12 mm in 1 m with properly constructed laps or joints laid in the direction of flow.

 <p>JKR MALAYSIA</p>	<p>SECTION M : RAINWATER COLLECTION</p>	<p>No. Dokumen : JKR 20800-0183-14 No. Keluaran : 01 No. Pindaan : 00 Tarikh : 29 Januari 2014 Muka Surat : M/2</p>
--	--	---

1.2.2 Aluminium gutters

1.2.2.1 Unless otherwise shown on the Drawings, all gutter linings, valley and eaves gutter shall be of aluminium and shall conform to the following sizes:

- (i) Gutter lining: 1.2 mm thick, 225 mm minimum depth against walls, 330 mm minimum width under roofing, to a fall of 50 mm in 3 m.
- (ii) Valley Gutter: 1.2 mm thick, turned under roofing 330 mm minimum each side
- (iii) Eaves Gutter: 1.2 mm thick jointed using soldered seams neatly and accurately executed.

1.2.2.2 Gutter linings and valley gutters shall be laid on 25 mm thick close timber boarding adequately supported.

1.2.3 Unplasticised Polyvinyl Chloride (uPVC) gutters

1.2.3.1 Unplasticised Polyvinyl Chloride gutters shall be lead free conforming to BS EN 607: 2004 for gutter profiles and fittings and BS EN 1462:2004 (Lead Free) for the gutter brackets. All gutters and fittings shall be installed as recommended by the manufacturer with a product warranty as approved by the S.O.

1.2.3.2 The gutter shall be jointed using solvent cement conforming to MS628:Pt.2 and in accordance with the manufacturer's instructions. Unless otherwise shown on the Drawings, expansion outlets shall be provided for the gutter as recommended by the gutter manufacturer and as approved by the S.O.

1.2.4 Galvanized Iron (G.I) gutters

1.2.4.1 All gutters shall be supplied by specialized manufacturers approved by the S.O. Each section shall be sufficiently rigid, edges and corners straight and the slopes perfectly uniform. G.I. gutters shall have the edges strengthened by suitable means.

1.2.4.2 Unless otherwise specified, the gutters shall have a minimum fall of 1 in 120. Adequate number of support brackets shall be provided so that there is no deflection even when the gutter is at full capacity. Each joint must have a support. Unless otherwise specified the supports shall be fabricated M.S. brackets. All junctions shall be thoroughly watertight. The joints may be made by riveting, bolting or soldering.

1.2.4.3 All joints between successive lengths of gutters shall have an overlap of at least 75 mm. The drop in the overlap shall always be in the direction of the fall of the gutter. Ends of gutters shall be closed watertight. Junction with rainwater down comers shall be made fully watertight and secured.

1.2.4.4 Gutters for marine environment shall be pre-painted finish with metallic coated steel with minimum aluminium/zinc alloy coating mass of 200g/ m² (Coating Class AZ 200) conforming to ISO 9223 Category 4 (C4) and Category 5 (C5) environment.

 <p>JKR MALAYSIA</p>	<p>SECTION M : RAINWATER COLLECTION</p>	<p>No. Dokumen : JKR 20800-0183-14 No. Keluaran : 01 No. Pindaan : 00 Tarikh : 29 Januari 2014 Muka Surat : M/3</p>
--	--	---

1.2.5 Stainless Steel gutters

- 1.2.5.1 Where shown on the Drawings, the stainless steel grade shall be in Grade 304 for normal atmosphere and Grade 316 for atmosphere with a high chloride content (e.g. near the sea, or in heavily industrialized areas) with standard bright mill finish.
- 1.2.5.2 Unless otherwise specified, the gutters shall have a minimum fall of 1:120. Adequate number of support brackets shall be provided so that there is no deflection even when the gutter is full capacity. Each joint must have a support. Unless otherwise specified the support brackets shall be of the same material. All junctions shall be thoroughly watertight. The joints may be made by riveting, bolting or soldering.
- 1.2.5.3 All joints between successive lengths of gutters shall have an overlap of at least 75 mm. The drop in the overlap shall always be in the direction of the fall of the gutter. Ends of gutters shall be closed watertight. Junction with rainwater down comers shall be made fully watertight and secured.

1.3 Rainwater Downpipes

1.3.1 General

- 1.3.1.1 All downpipes shall be provided complete with all necessary fittings including rainwater heads, rainwater shoes, radius, bends, pipe clips, offsets, leaf trap and everything else required.
- 1.3.1.2 Outlets in flat roof and balcony connected to downpipe shall be provided with an approved uPVC, or stainless steel grating. Outlet shall be neatly dressed including sealing as necessary prior to applying asphalt prime flanges of roof outlet with bitumen or proprietary roofing waterproofing material to manufacture recommendation and as approved by the S.O.

1.3.2 Unplasticised Polyvinyl Chloride (uPVC) downpipes

- 1.3.2.1 Unless otherwise shown on the Drawings, uPVC downpipes and fittings shall be lead free and comply with BS EN 12200-1:2000. The pipes shall be jointed with approved solvent cement in accordance with the manufacturer's instructions.
- 1.3.2.2 Where shown, approved circular uPVC downpipes shall comply with BS EN 1329-1:2000. The pipes shall be jointed with approved solvent cement in accordance with the manufacturer's instructions.
- 1.3.2.3 Where shown, approved uPVC pipes cast inside Reinforced Concrete Columns/Buried Underground, the downpipes shall comply with BS EN ISO 1452-2:2009 (heavy duty type). The pipes shall be jointed with approved solvent cement in accordance with the manufacturer's instructions.
- 1.3.2.4 Where shown, uPVC downpipes installed to side of walls or brick walls shall be fixed using special clips supplied by the gutter manufacturer. Pipe clips shall be installed at every 1.8 m interval along the downpipes.

 <p>JKR MALAYSIA</p>	<p>SECTION M : RAINWATER COLLECTION</p>	<p>No. Dokumen : JKR 20800-0183-14 No. Keluaran : 01 No. Pindaan : 00 Tarikh : 29 Januari 2014 Muka Surat : M/4</p>
--	--	---

- 1.3.2.5 Where shown, uPVC downpipe fixed to concrete soffit or suspended slab shall include approved hot dip galvanized steel hangers, installed to manufacturer's recommendation and to S.O.'s approval.

2. Rainwater Harvesting System

2.1. General

- 2.1.1. Rainwater harvesting system shall be provided complete with catchment area including all necessary accessories as specified and shown on the Drawings.
- 2.1.2. Harvested rainwater shall be strictly used for non-potable uses only. Non potable may include landscape irrigation, exterior washing and flushing of toilets.
- 2.1.3. The design and installation of the rainwater harvesting system shall be in accordance to Rainwater Harvesting Guidebook and MSMA by Jabatan Pengairan dan Saliran (JPS).

2.2. Pre Filtration

- 2.2.1. Pre filtration is required to keep sediment, leaves, contaminants and other debris from the system and to significantly cut down on maintenance by preventing organic build up in the storage tank.
- 2.2.2. All pre filtration devices may include the first-flush diversion systems, filters and screens designed to remove debris and dust from the captured rainwater before storage tank and should be of low maintenance.

2.3. Filter (If Applicable)

- 2.3.1. Where specified or shown on the Drawings, the filter shall be provided to remove suspended pollutants from the captured rainwater for flushing and non-potable use.
- 2.3.2. A filter unit system consists of a chamber and shall be filled with filtering media such as carbon fibre, coarse sand and gravel layers to remove debris and dirt from rainwater before it enters the storage tank. The selection and type of filtering media shall be to the S.O.'s approval.

2.4. Storage Tank

- 2.4.1. The Contractor shall provide rainwater harvesting storage tank as shown on the Drawings and as described under SECTION L: WATER RETICULATION, INTERNAL PLUMBING SYSTEM AND SANITARY FITTINGS.

2.5. Water Backup

- 2.5.1. The water backup system from the main water supply shall be provided to supply water when rainwater is not available in the rainwater tank
- 2.5.2. Any service pipe conveying potable to top-up a rain water tank containing non-potable water shall have a backflow preventer of the dual check valve type; and the service pipe shall terminate at least 255 mm above the overflow level of the rainwater tank.

 <p>JKR MALAYSIA</p>	<p>SECTION M : RAINWATER COLLECTION</p>	<p>No. Dokumen : JKR 20800-0183-14 No. Keluaran : 01 No. Pindaan : 00 Tarikh : 29 Januari 2014 Muka Surat : M/5</p>
--	--	---

2.6. Piping Works

- 2.6.1. The Contractor shall provide pipe works as shown on the Drawings and as described under SECTION L: WATER RETICULATION, INTERNAL PLUMBING SYSTEM AND SANITARY FITTINGS.
- 2.6.2. There shall be no cross connection between non-potable and potable water distribution system within the buildings.
- 2.6.3. Taps and outlets for non-potable water shall be clearly identified as 'Not For Drinking Purposes'.

2.7. Pumping System (If Applicable)

- 2.7.1. Where shown on the Drawings, the Contractor shall provide a pumping system as described in SECTION L: WATER RETICULATION, INTERNAL PLUMBING SYSTEM AND SANITARY FITTINGS.
- 2.7.2. The Contractor shall supply and install electrical motors, starters and electrical switchboard for the pumping system as described in VOLUME 2: ELECTRICAL WORKS.

3. Testing And Commissioning

- 3.1. On completion of the rainwater harvesting system installation, the Contractor shall notify the S.O that they are ready for inspection, testing and commissioning.
- 3.2. The Contractor shall carry out testing and commissioning to the S.O.'s approval as described in SECTION L: WATER RETICULATION, INTERNAL PLUMBING SYSTEM AND SANITARY FITTINGS.

 <p>JKR MALAYSIA</p>	<p>SECTION M : RAINWATER COLLECTION</p>	<p>No. Dokumen : JKR 20800-0183-14 No. Keluaran : 01 No. Pindaan : 00 Tarikh : 29 Januari 2014 Muka Surat : M/6</p>
--	--	---

BLANK PAGE

TABLE OF CONTENTS

SECTION N: GLAZING WORKS

	PAGE
1. General	N/1
2. Sealants	N/1
3. Glazing	N/1
4. Glazing Work To Timber Frames	N/1
5. Glazing Work To Metal Frames	N/2
6. Glazing Works To Louvred Window	N/2
7. Glazing To UPVC Frame	N/2
8. Frameless Glazing	N/2
9. Glazing Works To Patented Windows, Doors, Panels And Sky Lights.	N/3
10. Fixing Of Glass Blocks	N/3
11. Cleaning Upon Completion	N/3
 APPENDIX N/1 : Schedule Of Glass	 N/4

 <p>JKR MALAYSIA</p>	<p>SECTION N : GLAZING WORKS</p>	<p>No. Dokumen : JKR 20800-0183-14 No. Keluaran : 01 No. Pindaan : 00 Tarikh : 29 Januari 2014 Muka Surat : N/1</p>
--	---	---

1. General

- 1.1. Generally, all glass shall conform to MS 1135 and shall be free from bubbles, specks and other defects. Samples shall be submitted for the approval of the S.O.
- 1.2. Unless otherwise specified or shown on the Drawings, the type and minimum thickness of glass shall be as stated in the Schedule of Glass in APPENDIX N/1.

2. Sealants

- 2.1. Unless otherwise specified in the Drawings, sealants shall be silicone, rubber or other approved type applied in accordance with the manufacturer's instructions.
- 2.2. Joint sealant for aluminium profile shall be of silicone, polyurethane, polysulphide or other equivalent suitable for its intended use.
- 2.3. Joint sealant for uPVC profile shall be of silicone, polyurethane, polysulphide, ethylene propylene diene monomer (EPDM) rubber, thermoplastic elastomers (TPE) or other equivalent suitable for its intended use.
- 2.4. Joint sealant for non-structural use in building shall be and approved type and shall comply with BS EN 15651-2.
- 2.5. Joint sealant for structural use in building shall be an approved type and shall comply with BS EN 13022.

3. Glazing

- 3.1. All doors and windows, et cetera except louver windows shall be glazed as shown on the Drawings or the Schedule of Doors and Windows.
- 3.2. All glass shall be cut to size with 2 mm clearance all around the rebates. All exposed edges glass panes shall be rounded off.
- 3.3. All glazing works shall be carried out strictly in accordance with the manufacturer's instruction.
- 3.4. Figured or textured glass surface for windows shall be installed facing the interior.

4. Glazing Work To Timber Frames

- 4.1. The grooves and rebates to be glazed shall first be cleaned, primed with wood primer, painted with one coat of oil paint and allowed to dry, followed by the application of a thin bed of putty or synthetic sealant.
- 4.2. The glass panes shall then be properly placed and secured in the grooves or rebates with timber beadings as detailed in the Drawings.
- 4.3. Where the glass panes is to be secured with putty or synthetic sealants, the glass shall be placed and held in the grooves or rebates with approved sprigs driven at intervals of not exceeding 300 mm centres. The glass shall then be finally secured with back-putty or sealants finished true to profile or as detailed in the Drawings.
- 4.4. Installation of timber frames for doors and windows shall refer to SECTION H: TIMBER, JOINERY AND IRONMONGERY WORKS.

 <p>JKR MALAYSIA</p>	<p>SECTION N : GLAZING WORKS</p>	<p>No. Dokumen : JKR 20800-0183-14 No. Keluaran : 01 No. Pindaan : 00 Tarikh : 29 Januari 2014 Muka Surat : N/2</p>
--	---	---

5. Glazing Work To Metal Frames

- 5.1. The grooves and rebates to be glazed shall first be cleaned of rust and primed with an approved metal primer and allowed to dry, followed by the application of a thin bed of glazing putty or sealant. The glass panes shall then be placed and secured in the grooves and rebates with metal, aluminium beadings or neoprene rubber in accordance with the manufacturer's instructions or as detailed in the Drawings.
- 5.2. Where the glass panes is to be secured with putty, the panes shall be placed and held in the grooves or rebates with spring clips sets in holes in the frame. The glass shall then be finally secured with back-putty or synthetic sealants finished true to profile or as detailed in the Drawings.
- 5.3. Installation of metal frames for doors and windows shall refer to SECTION J: STRUCTURAL STEEL AND METAL WORKS.

6. Glazing Works To Louvred Window

- 6.1. The glass blades for fixed louvred window shall be properly housed in the grooves of the timber frames and secured in position with timber beadings as shown on the Drawings.
- 6.2. In the case of adjustable louvred windows, the louvred frames shall be fixed on to the vertical members of the window frame and secured with 20 mm long dome headed galvanized screws fixed at 200 mm centres. The louvre blades shall then be inserted and secured in the flanged clips, all in accordance with the manufacturer's instructions.
- 6.3. The position of handles shall be as shown on the Drawings.

7. Glazing To UPVC Frame

- 7.1. Generally, all glazing work to uPVC frame shall conform to BS EN 12608. All glazing works shall be carried out strictly in accordance with the manufacturer's instructions.
- 7.2. Unless otherwise specified in the Drawings, the frame shall be fitted at least 10 mm inwards from the outside edge of the face of the brickwork. It is essential that the windows are installed true and square by measuring the window's diagonals after the installation.
- 7.3. The gap between the window frame sill and brickwork shall be sealed with silicone sealant as approved by the S.O.

8. Frameless Glazing

- 8.1. Where shown, approved frameless glazing must conform to BS 5234, BS 6180 and BS 6399.
- 8.2. Unless otherwise shown on the Drawings, the jointing method for frameless glazing shall be strictly in accordance to the manufacturers' instructions.
- 8.3. The Contractor shall submit method statement for the fixing and installation of the frameless glazing system for the S.O.'s approval.

 <p>JKR MALAYSIA</p>	<p>SECTION N : GLAZING WORKS</p>	<p>No. Dokumen : JKR 20800-0183-14 No. Keluaran : 01 No. Pindaan : 00 Tarikh : 29 Januari 2014 Muka Surat : N/3</p>
--	---	---

9. Glazing Works To Patented Windows, Doors, Panels And Sky Lights.

Unless otherwise shown on the Drawings, the installation and glazing of patented windows, doors, roof-lights, etc. shall be strictly in accordance with the manufacturer's instructions.

10. Fixing Of Glass Blocks

- 10.1. Unless otherwise specified the size of the glass blocks shall be 190 mm x 190 mm x 80 mm and approved by the S.O. The glass blocks shall be laid butt-jointed in cement and sand mortar (1:4) by volume.
- 10.2. Before the first course is laid, the base to receive the glass blocks shall be coated with an approved bitumen emulsion or similar material.
- 10.3. Each panel of the glass blocks shall have a clearance of 13 mm at sides and top with surrounding structure. The clearance shall be filled with non-hardening compound and finished with detailed in the Drawings or as approved by the S.O.
- 10.4. Approved expanded metal reinforcement shall be provided at every forth course. Unless otherwise or specified in the Drawings, all joints between the blocks shall be pointed with white cement and the exposed areas of the non-hardening compound shall be painted to match the surrounding structure.

11. Cleaning Upon Completion

After installation, the fabricator shall remove any excess sealants, caulking, putty and other misplaced materials from all surfaces including adjacent work. The window frame and glass shall be cleaned thoroughly as recommended by the manufacturers. Cracked or defective panes shall be replaced to the approval of the S.O.

 JKR MALAYSIA	SECTION N : GLAZING WORKS	No. Dokumen : JKR 20800-0183-14 No. Keluaran : 01 No. Pindaan : 00 Tarikh : 29 Januari 2014 Muka Surat : N/4
--	----------------------------------	--

APPENDIX N/1

SCHEDULE OF GLASS

No.	Type of Glass	Minimum Glass Thickness (mm)	Application
1.	Clear Float Glass	5	<ul style="list-style-type: none"> • External use windows and doors • Interior framed glass screens, partitions • Display windows, showcases, display shelves • Furniture: Table-tops
2.	Tinted Float Glass	6	<ul style="list-style-type: none"> • External use on windows and doors • Interior framed glass screens, partitions • Display windows, showcases, display shelves • Furniture: Table-tops
3.	Clear Figured (obscured) Glass	5	<ul style="list-style-type: none"> • Windows • Furniture, display bases, house fittings, partitions etc. • Decoration eg. Front doors, display etc.
4.	Grey/Tinted Figured Glass	5	<ul style="list-style-type: none"> • Windows • Furniture, display bases, house fittings, partitions etc. • Decoration eg. Front doors, display etc.
5.	Toughened/Tempered Glass	6	<ul style="list-style-type: none"> • Furniture, interior decorations, table tops, showcases, partitions etc.
6.	Laminated Glass	6	<ul style="list-style-type: none"> • Skylights, glass roofs and the like • Animal observatory windows & aquariums • High security places eg. Burglar resistant showcases and the like. • Places where safety necessary eg. Verandah side panels and the like.
7.	Wired Glass i. Clear & Polished ii. Figured and Translucent	6	<ul style="list-style-type: none"> • Places where safety and security are important.
8.	Lead Glass - Laminated crystal clear glass with minimum 2 mm thick lead sheeting sandwiched in between.	9 mm total thickness	<ul style="list-style-type: none"> • X-Ray rooms

TABLE OF CONTENTS

SECTION O: PAINTING WORKS

	PAGE
1. General	O/1
2. Painting To Timberwork	O/2
3. Painting To Metalwork	O/2
4. Painting To Masonry Work	O/3
5. Treatment To Fair Face Surfaces	O/4
6. Epoxy Coatings	O/4
7. Silicone Paint	O/4
8. Painting On Floor Surfaces	O/4
9. Painting To Timber-based Products	O/5
10. Painting To Gypsum Board and The Like	O/5
11. Painting To Laboratory Bench Tops	O/6
12. Varnishing	O/6
13. Painting Works For Buildings In Coastal Areas.	O/6
14. Painting Works To Clinical Areas (Hygienic Areas)	O/7
15. Completion Of Painting Works	O/7
 APPENDIX O/1: Paint Performance Warranty (Specimen)	 O/8

 <p>JKR MALAYSIA</p>	<p>SECTION O : PAINTING WORKS</p>	<p>No. Dokumen : JKR 20800-0183-14 No. Keluaran : 01 No. Pindaan : 00 Tarikh : 29 Januari 2014 Muka Surat : O/1</p>
--	--	---

1. General

- 1.1 All paints to be used shall be those supplied by approved manufacturers. The quality of paints shall comply with MS 125 in respect of oil/enamel paints and MS 134 in respect of emulsion paints/acrylic paint.
- 1.2 Prior to commencing painting work, the Contractor shall submit the following to the S.O.:
 - (i) Name of the paint manufacturer and the manufacturer's certification that the paint conform to the relevant standard as specified in sub-section 1.1 hereof together with the proof that such certification have been verified by tests carried out by SIRIM or ISO in the last three (3) years.
 - (ii) The performance warranty by the manufacturer to the Government on the performance of the paint against any peeling, cracking, fungus/ algae growth and discoloration which may arise during a period of five (5) years or more from the date of practical completion due to insufficiency in material or workmanship. The terms of the performance warranty shall be as stipulated in APPENDIX O/1 and as approved by the S.O.
 - (iii) Name of the painting applicator as approved by the paint manufacturer including written evidence of the current approval.
 - (iv) A copy of the method statement including procedure for the painting works in accordance with these specification and manufacturer's instructions.
- 1.3 All paints shall be delivered to the Site in the manufacturer's original sealed containers unopened and shall be used strictly in accordance with the manufacturer's instructions.
- 1.4 Paints shall not be adulterated and any paint that has deteriorated shall not be used and shall be removed from the Site forthwith.
- 1.5 Unless otherwise specified in the Drawings, the types of paints to be used for the work on exposed surfaces shall be as stated in the 'Schedule of Paint Finish' attached hereinafter.
- 1.6 The colours and tints of paints shall be selected by the S.O. and the priming, undercoats and finishing coats shall be of approved differing tints and shall be obtained from the same manufacturer.
- 1.7 No painting shall be done under conditions which may jeopardize the quality of finish paintwork.
- 1.8 During painting, care shall be taken to prevent stain or damage to other works.
- 1.9 Surfaces to be painted shall be dry, free from dirt, oil, grease, old loose paint and other deleterious matter. All cracks shall be raked out and stopped and all holes and dents shall be filled.
- 1.10 Unless otherwise specified in the manufacturer's instructions, each coat of paint applied on timber or metal surfaces shall be allowed to dry and subsequently rubbed down lightly with sandpaper before the next coat is applied. Any dirt or dust shall be removed from preceding coats immediately before proceeding with application of the next coat.
- 1.11 All priming to shop fabricated components shall be done at shop.
- 1.12 All prime surfaces shall be inspected and approved by the S.O. before commencement of painting works.

 <p>JKR MALAYSIA</p>	<p>SECTION O : PAINTING WORKS</p>	<p>No. Dokumen : JKR 20800-0183-14 No. Keluaran : 01 No. Pindaan : 00 Tarikh : 29 Januari 2014 Muka Surat : O/2</p>
--	--	---

- 1.13 Finish surfaces shall be uniform in finish and colour and be free from brush marks or other defects.
- 1.14 Sample areas showing all tints of paints to be used shall be prepared by the Contractor as and when required by the S.O.

2. Painting To Timberwork

2.1 Painting To New Timberwork

- 2.1.1 Unless otherwise as shown on the Drawings, all exposed wrot surfaces of timber shall be painted as specified hereinafter.
- 2.1.2 Before painting to new timberwork, all knots shall be covered with knotting and all nail holes, cracks, et cetera shall be stopped with white lead and putty (1:3) and shall be primed with aluminium wood primer well brushed in.
- 2.1.3 Unless otherwise specified, the prepared surface shall be painted with one undercoat (alkyd undercoat) and shall be finished with two coats of premium semi-gloss fungus resisting alkyd paint or three (3) coats UV protection, low odour alkyd wood finish.
- 2.1.4 Timber decks shall be applied with three coats of scratch resistant, UV protection, fast drying low odour urethane alkyd wood finish. Each preceding coat shall be allowed to dry thoroughly and rubbed down lightly with fine sand paper and thoroughly cleaned before applying the next coat.
- 2.1.5 All timber surfaces abutting concrete or brickwork shall be primed before fixing or assembling.
- 2.1.6 All ironmongeries except hinges shall be removed before painting begins and shall be carefully re-fixed.

2.2 Repainting Existing Timberwork

Where repainting to existing timber work is specified, the following procedure shall be adhered to. If the surface is intact, it shall be rubbed down with fine sand paper to the approval of the S.O. Then one coat of undercoat shall be applied followed by two (2) coats of gloss enamel paint unless otherwise specified. Where cracking and flaking have occurred, the entire existing paint shall be removed by burning off or by use of paint remover as approved by the S.O. The surfaces shall then be thoroughly cleaned and shall be applied with one coat minimum wood primer followed by one (1) undercoat and unless otherwise specified in the Drawings, shall be finished with two (2) coats of gloss enamel paint.

3. Painting To Metalwork

3.1 Painting New Steel And Ironwork

The areas to be painted shall be cleaned down and be free from rust, scale, oil, grease, dirt and dust. One (1) coat of approved metallic primer shall be applied followed by one (1) coat of premium alkyd undercoat unless specified, and shall be finished with two (2) finishing coats of gloss/semi-gloss fungus resisting alkyd paint. Soil and vent pipes shall be primed as above and given two (2) coats of approved bituminous paint.

 <p>JKR MALAYSIA</p>	<p>SECTION O : PAINTING WORKS</p>	<p>No. Dokumen : JKR 20800-0183-14 No. Keluaran : 01 No. Pindaan : 00 Tarikh : 29 Januari 2014 Muka Surat : O/3</p>
--	--	---

3.2 Repainting Existing Steel And Ironwork

- 3.2.1 Where repainting to existing steel or ironwork is stated in the Drawings, the following procedure shall be adhered to. Where a firm surface exists, it shall be scuffed with fine sand paper to the approval of the S.O. and spot primed if necessary before the application of by one (1) coat of premium alkyd undercoat unless specified, and shall be finished with two (2) finishing coats of gloss/semi-gloss fungus resisting alkyd or gloss enamel paint.
- 3.2.2 If the old paint is in a bad, deteriorated condition the whole paint shall be removed by the use of approved paint remover or by scraping as approved by the S.O. The surface shall be thoroughly cleaned and shall be applied with one coat approved metallic primer, by one (1) coat of premium alkyd undercoat unless specified, and shall be finished with two (2) finishing coats of gloss/semi-gloss fungus resisting alkyd or gloss enamel paint.

3.3 Painting New Galvanized Ironwork

Where painting to new galvanized ironwork is specified, the surfaces shall be applied with one coat of approved self-etching quick drying metallic primer unless otherwise specified, and shall be finished with two finishing coats of gloss/semi-gloss fungus resisting alkyd paint or gloss enamel paint.

3.4 Repainting Existing Galvanized Ironwork

- 3.4.1 Where repainting to existing galvanized ironwork is specified, the following procedure shall be adhered to. If the surface is not corroded, it shall be slightly sanded and all dirt, oil, and grease removed by washing with an approved solvent and applied with one (1) coat of approved metallic primer unless otherwise specified, shall be finished with two (2) finishing coats of gloss/semi-gloss fungus resisting alkyd paint or gloss enamel paint. If the surface has corroded, the whole paint shall be removed by the use of approved paint remover or by scraping as approved by S.O.
- 3.4.2 When the surface is completely clean, it shall be applied with one coat approved metallic primer, unless otherwise specified, shall be finished with two finishing coats of gloss/semi-gloss fungus resisting alkyd paint or gloss enamel paint.

4. Painting To Masonry Work

4.1 Painting New Plastered/Masonry Surfaces

- 4.1.1 The new plastered or masonry surfaces shall be allowed to dry completely and shall be cleaned down to remove dust, dirt, plaster splashes, and the like. In case of old unpainted walls, all fungus, mosses, lichens and vegetative growth shall also be removed.
- 4.1.2 The cleaned surfaces of the external walls shall be applied with one coat of approved alkaline resisting primer and unless otherwise specified in the Drawings, followed with two (2) coats of ultra-violet (UV) weather resistant emulsion paint.
- 4.1.3 The external wall surfaces shall be applied with one (1) coat of approved alkaline resisting primer, unless otherwise stated in the Drawings, followed with two (2) coats of 100% acrylic with heat reflective and UV protected, and temperature reduction weather resistant emulsion paint for Green Ratings Certification as approved by the S.O.

 <p>JKR MALAYSIA</p>	<p>SECTION O : PAINTING WORKS</p>	<p>No. Dokumen : JKR 20800-0183-14 No. Keluaran : 01 No. Pindaan : 00 Tarikh : 29 Januari 2014 Muka Surat : O/4</p>
--	--	---

4.1.4 The internal wall surfaces shall be applied with one (1) coat of approved modified acrylic sealer, and unless otherwise as shown on the Drawings, followed with two (2) coats of low VOC acrylic paint.

4.2 Repainting Existing Plastered Or Masonry Surfaces

4.2.1 Where repainting to existing plastered or the masonry surface is specified, the following procedure shall be adhered to. All existing paint shall be removed by scraping and the surface shall be washed. All cracks and other imperfections shall be made good and the surface should be allowed to dry completely.

4.2.2 The surface shall then be applied with two (2) coats of any other type of water based emulsion paint as described hereinbefore for Painting New Plastered/Masonry Surfaces and as approved by the S.O.

4.3 Textured Wall

4.3.1 Natural Spray Granite textured wall shall be applied with one (1) coat of approved alkaline resisting acrylic primer, unless otherwise stated in the Drawings, followed with two (2) layers natural fine stone and ceramic chips texture with high build acrylic resin and two (2) clear finish coats.

4.3.2 Spray Tile textured wall shall be applied with one (1) coat of approved alkaline resisting acrylic primer, unless otherwise specified in the Drawings, followed with one (1) coat of spray tiles texture and two (2) coats of pure acrylic water based premium weather paint.

5. Treatment To Fair Face Surfaces

Surfaces that are to be left bare such as fair-face brickwork, fair-face concrete or stones and the like shall be thoroughly clean, dry and free from grease, dust and loose or flaking materials. The surfaces shall then be treated with an approved colourless silicon-based water repellent liquid applied in accordance with the manufacturer's instructions. The solution shall be applied in two (2) coats over the entire area and crevices by brushing.

6. Epoxy Coatings

Epoxy coatings shall be applied with one (1) coat of approved transparent epoxy sealer, followed with two (2) coats epoxy topcoat.

7. Silicone Paint

Silicone paint for external walls and ceiling shall be applied with one (1) coat of Pigmented Water Base Penetration Water Repellent and two (2) finishing coats of Breathable Silicone Paint of approved colour applied strictly in accordance with manufacturer's instruction.

8. Painting On Floor Surfaces

8.1 Painting on concrete drive way shall be applied with one (1) coat of floor primer at 100 µm DFT, followed by one (1) coat of floor glass flake at 300 µm DFT or floor non-slip aggregate (fine/medium) and followed with two (2) coats of floor polyurethane (PU) topcoat at 50 µm DFT per coat.

 <p>JKR MALAYSIA</p>	<p>SECTION O : PAINTING WORKS</p>	<p>No. Dokumen : JKR 20800-0183-14 No. Keluaran : 01 No. Pindaan : 00 Tarikh : 29 Januari 2014 Muka Surat : O/5</p>
--	--	---

- 8.2 Painting on car park parking bay floors shall be applied with one (1) coat of floor primer at 100 µm DFT, than followed with two (2) coats of floor polyurethane (PU) topcoat at 50 µm DFT per coat.
- 8.3 Painting on TNB sub-station internal floors shall be applied with one (1) coat of approved two-pack epoxy sealer, followed with two (2) coats of two pack epoxy floor coating at 50 µm DFT per coat, unless otherwise stated in the drawings

9. Painting To Timber-based Products

9.1 Chipboard Surfaces

- 9.1.1 Before painting, all nail holes, crevices and the like shall be stopped with white lead and putty (1:3). The surface shall then be smoothened by rubbing down with fine sand paper and finally cleaned to remove dust. Where the board is to be finished with enamel paint, one (1) undercoat and two (2) finishing coats of gloss enamel paint shall be applied. If the board is to be finished with emulsion paint, one (1) undercoat and two (2) coats of emulsion paint shall be applied.
- 9.1.2 Where repainting to existing enamel paint finished chipboard is required, the following procedure shall be adhered to. If the paintwork is still intact, it shall be rubbed down with fine sand paper to the approval of the S.O. Then one (1) coat of undercoat shall be applied followed by one (1) coat of gloss enamel paint.
- 9.1.3 Where cracking and flaking has occurred, the entire existing paint shall be removed by burning off, as approved by the S.O. The surfaces shall then thoroughly cleaned and shall be applied with one (1) undercoat and finished with two (2) coats of gloss enamel paint.
- 9.1.4 Where repainting to existing emulsion paint finished chipboard is required, the surface shall then be thoroughly cleaned and applied with two (2) coats of emulsion paint.

9.2 Hardboard Surfaces

Before painting to hardboard, all nail holes, crevices and the like shall be filled with approved putty. The surface shall then be applied with one (1) undercoat and two (2) coats of emulsion paint unless otherwise specified.

9.3 Wood Cement Board Surfaces

Before painting to wood cement board, all nail holes, crevices and the like shall be filled with approved filling compound of alkali resistant type. The surface shall then be lightly sanded and any dust should be removed from the surface with a piece of clean, coarse cloth. The surface shall then be applied with one (1) undercoat and two (2) coats of emulsion paint unless otherwise specified.

10. Painting To Gypsum Board And The Like

- 10.1 Before painting the surfaces shall be clean and free from dirt. The surfaces shall then be applied with one (1) undercoat and two (2) coats of emulsion paint. Similar procedure shall be followed where repainting to existing painted surfaces is required.

 <p>JKR MALAYSIA</p>	<p>SECTION O : PAINTING WORKS</p>	<p>No. Dokumen : JKR 20800-0183-14 No. Keluaran : 01 No. Pindaan : 00 Tarikh : 29 Januari 2014 Muka Surat : O/6</p>
--	--	---

11. Painting To Laboratory Bench Tops

- 11.1 Timber tops of benches in laboratories that are required to be painted shall be prepared as described hereinbefore for timber work. The surfaces shall then be applied with one (1) coat aluminium wood primer followed by one (1) coat approved chemical resistant primer and finished with two (2) coats of approved chemical resistant gloss enamel paint in accordance with manufacturer's instructions.
- 11.2 Where repainting to existing timber tops laboratory benches is required, the surfaces shall be rubbed down lightly with fine sand paper. The surfaces shall then be thoroughly cleaned and shall be applied with one (1) coat of approved chemical resistant primer followed by one (1) coat of approved chemical resistant gloss enamel paint.

12. Varnishing

12.1 Varnishing To New Timberwork

- 12.1.1 The surfaces to be varnished shall be smoothed with fine sand paper and all crevices, holes and the like, if any, shall be filled with approved whiting. It shall be clean, dry, free from dust, dirt and wax before the application of varnish. Unless otherwise approved by the S.O, the surfaces shall be applied with three (3) coats of approved UV protection, low odour alkyd wood finish or varnishing mixture used strictly in accordance with the manufacturer's instructions.
- 12.1.2 Where non patented products are allowed to be used, the varnishing mixture shall consists of methylated spirit, shellac and approved stain forming the first coat followed by one (1) coat of an approved mixture consisting of thinner and lacquer. The mixtures shall be of uniform consistency throughout. Unless otherwise specified in the Drawings, the finish shall be gloss and as approved by the S.O.
- 12.1.3 Timber deck surfaces shall be applied with three (3) coats of approved scratch resistant, UV protection, fast drying low odour urethane alkyd wood finish

12.2 Re-varnishing To Existing Timberwork

- 12.2.1 Where re-varnishing to timberwork is specified in the Drawings or described in the B.Q., the surface shall first be thoroughly scuffed to remove the existing varnish. The surface shall then be smoothed with fine sand paper, cleaned, dried and free from dust, dirt and wax. It shall then be varnished as described hereinbefore for new timberwork.

13. Painting Works For Buildings In Coastal Areas.

- 13.1 External walls shall be applied with one (1) coat of approved pliolite based alkaline resisting primer sealer, unless otherwise specified in the Drawings, followed with two (2) coats of elastomeric weather resistant paint of approved colour applied strictly in accordance to manufacturer's instruction.
- 13.2 Unless otherwise specified in the Drawings, the internal walls shall be applied with one (1) coat of approved water based alkaline resisting acrylic wall sealer, followed with two (2) coats of low volatile organic compounds (VOCs), alkyphenolethoxylate (APEO) free, formaldehyde free acrylic premium emulsion paint of approved colour applied strictly in accordance to manufacturer's instruction.

 <p>JKR MALAYSIA</p>	<p>SECTION O : PAINTING WORKS</p>	<p>No. Dokumen : JKR 20800-0183-14 No. Keluaran : 01 No. Pindaan : 00 Tarikh : 29 Januari 2014 Muka Surat : O/7</p>
--	--	---

- 13.3 Mild steel shall be applied with one (1) coat of zinc rich epoxy, one (1) coat of surface tolerance epoxy mastic and followed with two (2) coats of polyurethane topcoat.
- 13.4 Galvanized steel shall be applied with one (1) coat of surface tolerance epoxy mastic and followed with two (2) coats of polyurethane topcoat.
- 13.5 Roofing sheet coatings for marine environment shall refer to SECTION G: ROOFING WORKS.
- 13.6 Coatings of fasteners used shall comply with AS 3566 Class 4 and be certified as such by the supplier of fasteners and as approved by the S.O.

14. Painting Works To Clinical Areas (Hygienic Areas)

- 14.1 All external walls shall be applied with one (1) coat of approved siloxane primer sealer, unless otherwise stated in the Drawings, followed with two (2) coats of silicone emulsion water repellent paint applied strictly in accordance to manufacturer's instruction.
- 14.2 Internal walls shall be applied with one (1) coat of approved ultra-low VOCs alkaline resisting primer sealer, followed with two (2) coats of anti-bacteria, anti-fungus, low VOCs, 100% APEO free, formaldehyde free acrylic premium emulsion paint.

15. Completion Of Painting Works

- 15.1 On completion of paintwork, all paint marks inadvertently left on glass, floors, tiles and other surfaces shall be removed. Any stain or marking on finished paintwork shall be removed and touched up to the approval of the S.O.

 JKR MALAYSIA	SECTION O : PAINTING WORKS	No. Dokumen : JKR 20800-0183-14 No. Keluaran : 01 No. Pindaan : 00 Tarikh : 29 Januari 2014 Muka Surat : O/8
--	-----------------------------------	--

APPENDIX O/1

PAINT PERFORMANCE WARRANTY (SPECIMEN)

1. Coverage of Performance Warranty

We the paint Manufacturer hereby warrants that for a period of **five (5) years** from the date of Practical Completion, the paint system shall not be affected by the following defects:

- (i) **Peeling**
This condition is manifested when the paint film peels away or detaches from the substrate.
- (ii) **Cracking**
This condition is manifested by any visible cracking on the paint film other than that caused by plastering cracks and structural defects.
- (iii) **Fungus/Algae Growth**
This condition is established when there is a growth of micro-organisms on the surface of the paint films which would result in the marring of the appearance of the paint film through discoloration.
- (iv) **Discoloration**
This condition occurs when the coating loses its original colour in patches and excessive discoloration appears.

2. Procedure for Claims

- (i) Any defect claims shall be made in writing and delivered by post or by hand to the Manufacturer.
- (ii) A technical team from the Manufacturer will be dispatched to evaluate the nature of the claim. Should our findings conclude the defects as within the scope of warranty, then the Manufacturer shall make good such defects.
- (iii) Should the Manufacturer's technical team conclude that the defects falls outside the scope of the warranty, the Manufacturer shall not be held responsible for the claim.
- (iv) Should the Government disagree with the conclusion of the technical team pertaining to the defects in particular, then an independent third party competent in such technical evaluation shall be appointed to investigate the disputed defects.
- (v) The appointment of independent third party competent in such technical evaluation shall only be appointed upon the mutual agreement between the Government and the Manufacturer.
- (vi) The findings of the third party shall be conclusive and mutually accepted by the Government and the Manufacturer.
- (vii) If the findings of the independent third party are within the coverage of this performance warranty, all cost shall be borne by the Manufacturer or otherwise such cost shall be borne by the Contractor.
- (viii) All claims for the defects must be received by the Manufacturer not later than fourteen (14) days from the expiry of the warranty period.

MANUFACTURER

.....
.....

.....
Company Stamp

.....
Signature
Name:
Date:

WITNESS

.....
.....

.....
Company Stamp

.....
Signature
Name:
Date:

TABLE OF CONTENTS

SECTION P: ROADS AND HARDSTANDING

	PAGE
1. General	P/1
2. Flexible Pavement	P/1
TABLE P1 : Gradation Limits For Drainage Layer	P/2
TABLE P2 : Gradation Limits For Sub-base	P/3
TABLE P3 : Gradation Limits For Crushed Aggregate Roadbase	P/4
TABLE P4 : Gradation Limit For Wet-mix Roadbase	P/6
3. Horizontal Alignment, Surface Levels And Surface Regularity Of Pavement Courses	P/8
TABLE P5 : Tolerances In Surface Levels Of Pavement Courses	P/8
4. Shoulders	P/8
5. Concrete Pavement	P/10
6. Road Furniture	P/10
7. Street Lighting	P/10

 <p>JKR MALAYSIA</p>	<p>SECTION P : ROADS AND HARDSTANDING</p>	<p>No. Dokumen : JKR 20800-0183-14 No. Keluaran : 01 No. Pindaan : 00 Tarikh : 29 Januari 2014 Muka Surat : P/1</p>
--	--	---

1. General

The construction of roads and hardstanding shall generally be carried out only after completion of all drainage systems, services and ducts which may affect the Works, unless otherwise agreed by the S.O.

2. Flexible Pavement

2.1 Subgrade

2.1.1 Subgrade means that part of the embankment or existing ground in cutting which is immediately below the sub-base or lower sub-base of the road pavement and shoulders.

2.1.2 Material for the top 300 mm of subgrade shall have a minimum soaked laboratory California Bearing Ratio (CBR) as shown on the Drawing when compacted to 95% of the maximum dry density determined in the BS 1377 Compaction Test (4.5 kg Rammer Method). In the event CBR value not mentioned on the Drawing, a minimum CBR value of 5% shall be adopted.

2.1.3 Throughout the top 300 mm of subgrade, the materials shall be compacted to not less than 95% of the maximum dry density determined in the BS 1377 Compaction Test (4.5 kg Rammer Method).

2.1.4 In cut area, the top 300 mm of the subgrade shall be scarified and recompacted to 95% of the maximum dry density determined in the BS 1377 Compaction Test (4.5 kg Rammer Method). If the S.O. is fully satisfied that the subgrade in its natural state possesses a density exceeding the requirements, then the surface of the subgrade shall be trimmed and rolled to obtain a smooth finish.

2.1.5 Where the material in cut area is found to be unsuitable for use in the top 300mm of subgrade or to a suitable level to be determined by the S.O., it shall be removed and replaced with suitable material which shall be compacted as indicated above. Alternatively, stabilizing agent may be used subjected to the S.O. approval.

2.1.6 The subgrade shall be finished in a neat and workmanlike manner, and the widths of embankments and cuts shall be everywhere at least of those specified or shown in the Drawings on both sides of the centre line. The top surface of the subgrade shall have the required shape, superelevation, levels and grades and shall be finished everywhere to within + 10 mm and - 30 mm of the required level.

2.1.7 Where subgrade construction encounters rock surfaces:

(i) Rock surfaces extend over the whole width of the formation:

The rock surface shall be trimmed to a free draining profile, at or below formation levels. No high spot shall protrude above the formation level. Any voids or cavities more than 0.5 m below the formation level shall be filled up with approved lean concrete having seven (7) days cube strength greater than 7 N/mm². The rock surface shall then be brought up to the formation levels with approved crushed rock or gravel, regulated and blinded.

 JKR MALAYSIA	SECTION P : ROADS AND HARDSTANDING	No. Dokumen : JKR 20800-0183-14 No. Keluaran : 01 No. Pindaan : 00 Tarikh : 29 Januari 2014 Muka Surat : P/2
--	---	--

(ii) Rock outcrop occurs over part of the formation only :

The rock outcrop shall be cut down to a level not less than 300 mm below the formation level. The surface shall then be brought up to level with suitable subgrade material.

2.2 Drainage Layer

2.2.1 This work shall consist of furnishing, placing, compacting and shaping drainage layer on a prepared and accepted subgrade in accordance with this Specification and the lines, levels, grades, dimensions and cross-sections as shown on the Drawings and/or as directed by the S.O.

2.2.2 Coarse aggregate shall be screened crushed hard rock and fine aggregate shall be screened quarry dust or sand. The aggregate shall be well graded and lie within the limits as shown in TABLE P1.

TABLE P1: GRADATION LIMITS FOR DRAINAGE LAYER

B.S. Sieve Size (mm)	Percentage Passing by Weight
75.0	100
37.5	75 - 100
20.0	60 - 90
10.0	25 - 75
5.0	10 - 45
2.00	0 - 20
1.18	0 - 10

2.2.3 Notwithstanding any earlier approval of finished subgrade, the surface of the subgrade shall be, on completion of compaction and immediately before placing drainage layer, well closed and free from movement under the compaction plant and from ridges, cracks, loose material, pot holes, ruts or other defects. Any damage to or deterioration of the subgrade shall be made good in accordance with sub-section 2.1.

2.2.4 The material shall be transported, laid and compacted at a moisture content within the range + 1% to - 2% of the optimum moisture content determined in compliance with BS 5835 and without drying out or segregation.

2.2.5 The drainage layer shall be placed and compacted to the required width and thickness as shown on the Drawings, in one single layer.

2.2.6 The material shall be spread and lightly compacted with tracked spreading plant or other approved equipment with consideration given to the protection of the subgrade.

2.3 Sub-base

2.3.1 This work shall consist of furnishing, placing, compacting and shaping sub-base material on a prepared and accepted subgrade in accordance with this Specification and the lines, levels, grades, dimensions and cross-sections as shown on the Drawings and/or as directed by the S.O.

2.3.2 Sub-base shall be a natural or artificial mixture of locally available materials such as sand, gravel, crushed aggregate, et cetera, free from organic matter, clay lumps and other deleterious materials. It shall be well graded and conform to TABLE P2 and the following quality requirements:

 JKR MALAYSIA	SECTION P : ROADS AND HARDSTANDING	No. Dokumen : JKR 20800-0183-14
		No. Keluaran : 01
		No. Pindaan : 00
		Tarikh : 29 Januari 2014
		Muka Surat : P/3

- (i) The CBR of the sub-base shall not be less than 30% or as shown on the Drawings when compacted to 95% of the maximum dry density determined in the B.S. 1377 Compaction Test (4.5 kg rammer method) and soaked for 4 days under a surcharge of 4.5 kg. This shall involve carrying out a series of CBR tests at various dry densities, using the field moisture content. The field density must then be measured at a number of points using the sand replacement method and the CBR deduced from the mean of the field density measurements.
- (ii) If more than 10% of the material is retained on the BS 20.0 mm sieve, the whole material can be assumed without test to have a CBR value of 30% or more.
- (iii) The plasticity index when tested in accordance with BS 1377 shall be not more than 12.
- (iv) The 10% fines value when tested in accordance with MS 30 shall be not less than 30 kN.
- (v) The sand equivalent of aggregate fraction passing the No. 4 (4.75 mm) sieve when tested in accordance with ASTM D 2419 shall be not less than 45%.

TABLE P2 : GRADATION LIMITS FOR SUB-BASE

BS Sieve Size (mm)	Percentage Passing by Weight
75.0	100
37.5	85 - 100
20.0	65 - 100
10.0	45 - 100
5.0	25 - 85
0.600	8 - 45
0.075	0 - 10

The particle size shall be determined by the washing and sieving method of BS 1377.

- 2.3.3 Prior to placing any sub-base material, the underlying subgrade (particularly the top 300 mm of the subgrade) shall have been shaped and compacted in accordance with the provisions of sub-section 2.1 or sub-section 2.2 as appropriate. Notwithstanding any earlier approval of finished subgrade, the surface of the subgrade shall be, on completion of compaction and immediately before placing sub-base layer, well closed and free from movement under the compaction plant and from ridges, cracks, loose material, potholes, ruts or other defects. Any damage to or deterioration of the subgrade shall be made good in accordance with sub-section 2.1.
- 2.3.4 Sub-base material shall be transported, laid and compacted at a moisture content within the range + 1% to - 2% of the optimum moisture content without drying out or segregation.
- 2.3.5 Sub-base material shall be placed over the full width of the formation to the required thickness as shown on the Drawings or directed by the S.O. in one layer or more, each layer not exceeding 200 mm compacted thickness. Where two or more layers are required, they shall be of approximately equal thickness and none shall be less than 100 mm compacted thickness.
- 2.3.6 Each layer of sub-base shall be processed as necessary to bring its moisture content to a uniform level throughout the material suitable for compaction, and shall then be compacted using suitable compaction equipment approved by the S.O. to not less than 95% of the maximum dry density determined in the BS 1377 Compaction Test (4.5 kg rammer

 <p>JKR MALAYSIA</p>	<p>SECTION P : ROADS AND HARDSTANDING</p>	<p>No. Dokumen : JKR 20800-0183-14 No. Keluaran : 01 No. Pindaan : 00 Tarikh : 29 Januari 2014 Muka Surat : P/4</p>
--	--	---

method). Compaction shall be carried out in a longitudinal direction along the roadbed, and shall generally begin at the outer edge and progress uniformly towards the crown on each side in such a manner that each section receives equal compactive effort, all to the satisfaction of the S.O.

2.3.7 All loose, segregated or other defective areas shall be removed to the full thickness of the layer, and new sub-base material laid and compacted.

2.3.8 The sub-base shall be finished in a neat and workmanlike manner, and shall have an average thickness over any 100 m length not less than the required thickness. The top surface of the sub-base shall have the required shape, superelevation, levels and grades, and shall be everywhere within the tolerances as specified in sub-section 3.2.

2.4 Crushed Aggregate Roadbase

2.4.1 This work shall consist of furnishing, placing, compacting and shaping crushed aggregate roadbase material on a prepared and accepted subgrade or sub-base in accordance with this Specification and the lines, levels, grades, dimensions and cross-sections as shown on the Drawings and/or as directed by the S.O.

2.4.2 Crushed aggregate roadbase material shall be crushed rock, crushed gravel or a mixture of crushed rock and gravel, which shall be hard, durable, clean and essentially free from clay and other deleterious materials. The material shall conform to the following physical and mechanical quality requirements:

- (i) The plasticity index when tested in accordance with BS 1377 shall be not more than 6.
- (ii) The aggregate crushing value when tested in accordance with MS 30 shall be not more than 25%.
- (iii) The flakiness index when tested in accordance with MS 30 shall be not more than 25%.
- (iv) The weighted average loss of weight in the magnesium sulfate soundness test (5 cycles) when tested in accordance with AASHTO Test Method T 104 shall be not more than 18%.
- (v) The material shall have a CBR value of not less than 80% when compacted to 95% of the maximum dry density determined in the B.S. 1377 Compaction Test (4.5 kg rammer method) and soaked for 4 days under a surcharge of 4.5 kg
- (vi) The sand equivalent of aggregate fraction passing the No. 4 (4.75 mm) sieve when tested in accordance with ASTM D 2419 shall be not less than 45%.
- (vii) The gradation shall comply with the envelope as shown in TABLE P3.

TABLE P3 : GRADATION LIMITS FOR CRUSHED AGGREGATE ROADBASE

B.S. Sieve Size (mm)	Percentage Passing by Weight
50.0	100
37.5	85 - 100
28.0	70 - 100
20.0	60 - 90
10.0	40 - 65
5.0	30 - 55
2.00	20 - 40
0.425	10 - 25
0.075	2 - 10

The particle size shall be determined by the washing and sieving method of BS 1377.

 <p>JKR MALAYSIA</p>	<p>SECTION P : ROADS AND HARDSTANDING</p>	<p>No. Dokumen : JKR 20800-0183-14 No. Keluaran : 01 No. Pindaan : 00 Tarikh : 29 Januari 2014 Muka Surat : P/5</p>
--	--	---

- 2.4.3 Prior to placing any crushed aggregate roadbase material, the subbase shall have been constructed in accordance with the provisions of sub-section 2.3.
- 2.4.4 Crushed aggregate roadbase shall be placed to the required width and thickness as shown on the Drawings or directed by the S.O. in one layer or more, each layer not exceeding 200 mm compacted thickness.
- 2.4.5 Where two or more layers are required, each layer shall be of approximately equal thickness and none shall be less than 100 mm compacted thickness.
- 2.4.6 The material shall be spread using a motor grader of sufficient capacity or other approved mechanical spreader, at the optimum moisture content + 1%.
- 2.4.7 Compaction shall be carried out using suitable approved equipment, in a longitudinal direction, and begin at the lower edges and progress towards the crown, or in the case of superelevation towards the upper edge, in such a manner that each section receives equal compactive effort, sufficient to produce a density of not less than 95% of the dry maximum density as determined by BS 1377: Test 13.
- 2.4.8 Throughout the placing, adjustment of moisture content and compaction of crushed aggregate roadbase material, care shall be taken to maintain a uniform gradation of the material and prevent its separation into coarse and fine parts, all to the satisfaction of the S.O.
- 2.4.9 The crushed aggregate roadbase width shall be everywhere at least that specified or shown on the Drawings on both sides of the centre-line; and its average thickness over any 100 m length shall be not less than the required thickness.
- 2.4.10 The surface of the roadbase shall on completion of compaction and immediately before placing bituminous surfacing be well closed and free from movement under the compaction plant and from ridges, cracks, loose material, pot holes, ruts other defects.
- 2.4.11 All loose, segregated or otherwise defective areas shall be removed to the full thickness of the layer, and new material laid and compacted. The addition of fine material will not be permitted.
- 2.4.12 The surface shall be to the required level and grade and comply with the tolerances as specified in sub-section 3.2.

2.5 Wet-Mix Roadbase

- 2.5.1 This works shall consist of furnishing, placing, compacting wet-mix roadbase on a prepared and accepted sub-base in accordance with this Specification and the lines and levels as shown on the Drawings and/or as directed by the S.O.
- 2.5.2 Aggregate for wet-mix roadbase shall be crushed rock, crushed gravel or a mixture of crushed rock and gravel, which shall be hard, durable, clean and essentially free from clay and other deleterious materials.

 <p>JKR MALAYSIA</p>	<p>SECTION P : ROADS AND HARDSTANDING</p>	<p>No. Dokumen : JKR 20800-0183-14 No. Keluaran : 01 No. Pindaan : 00 Tarikh : 29 Januari 2014 Muka Surat : P/6</p>
--	--	---

2.5.3 The aggregate shall conform to the following physical and mechanical quality requirements:

- (i) The flakiness index when tested in accordance with MS 30 shall be not more than 25%.
- (ii) The aggregate crushing value when tested in accordance with MS 30 shall be not more than 25%.
- (iii) The weighted average loss of weight in the magnesium sulfate soundness test (5 cycles) when tested in accordance with AASHTO Test Method T 104 shall be not more than 18%.
- (iv) The sand equivalent of aggregate fraction passing the No. 4 (4.75 mm) sieve when tested in accordance with ASTM D 2419 shall be not less than 45%.
- (v) The gradation shall comply with the limits shown in TABLE P4.

TABLE P4 : GRADATION LIMIT FOR WET-MIX ROADBASE

B.S. Sieve Size (mm)	Percentage by Weight Passing
50.0	100
37.5	95 - 100
20.0	60 - 80
10.0	40 - 60
5.0	25 - 40
2.36	15 - 30
0.060	8 - 22
0.075	0 - 8

The particle size shall be determined by the washing and sieving method of BS 1377.

2.5.4 Notwithstanding any earlier approval of finished sub-base, prior to placing wet-mix roadbase material, any damage to or deterioration of the sub-base shall be made good in accordance with sub-section 2.3.

2.5.5 Wet-mix roadbase material shall be placed to the required width and thickness as shown on the Drawings or as directed by the S.O. in one layer or more, each layer not exceeding 200 mm compacted thickness. Where two or more layers are required, they shall be of approximately equal thickness and none shall be less than 100 mm compacted thickness.

2.5.6 The material shall be laid using a paving machine at moisture content + 0.5% of the optimum which shall be maintained during the compaction operation.

2.5.7 Compaction shall be carried out using suitable approved equipment in a longitudinal direction, and begin at the lower edges and progress towards the crown, or in the case of superelevation towards the upper edge, in such a manner that each section receives equal compactive effort, sufficient to produce a density of not less than 95% of the maximum dry density as determined by BS 1377: Test 13.

2.5.8 Throughout the placing, and compaction of wet-mix roadbase material, care shall be taken to maintain a uniform gradation of the material and prevent its separation into coarse and fine parts.

2.5.9 All loose, segregated or otherwise defective areas shall be removed to the full thickness of the layer, and new wet-mix roadbase material laid and compacted, the addition of fine aggregate only shall not be permitted.

 <p>JKR MALAYSIA</p>	<p>SECTION P : ROADS AND HARDSTANDING</p>	<p>No. Dokumen : JKR 20800-0183-14 No. Keluaran : 01 No. Pindaan : 00 Tarikh : 29 Januari 2014 Muka Surat : P/7</p>
--	--	---

- 2.5.10 The wet-mix roadbase width shall be everywhere at least that specified or shown on the Drawings on both sides of the centre-line. The average thickness measured over any 100 m length shall be not less than shown on the Drawings or specified and the minimum thickness measured at any one point shall be not less than the thickness shown or specified.
- 2.5.11 The surface of the wet-mix roadbase shall, on completion of compaction and immediately before placing bituminous surfacing, be well closed and free from movement under the compaction plant and from ridges, cracks, loose material, pot holes, ruts or other defects.
- 2.5.12 The surface shall be to the required level and grade and comply with the tolerances specified in sub-section 3.2.

2.6 Bituminous Pavement Courses

2.6.1 Bituminous prime coat

- 2.6.1.1 This work shall consist of the careful and thorough cleaning of the surface of a prepared and accepted unbound roadbase and cement-treated base (CTB), and the furnishing and application to the cleaned roadbase and CTB surface of a bituminous prime coat, all in accordance with this Specification and the lines, dimensions and cross-sections as shown on the Drawings and/or as directed by the S.O.
- 2.6.1.2 The materials, equipment and construction methods shall be in accordance with JKR Specification No. JKR/SPJ/2008-S4, sub-section 4.3.1 or the latest edition published by JKR.

2.6.2 Bituminous tack coat

- 2.6.2.1 This work shall consist of the careful and thorough cleaning of the surface of a prepared and accepted bituminous or bitumen primed pavement course, and the furnishing and application to the cleaned surface of a bituminous tack coat prior to the construction of an overlying bituminous pavement course, all in accordance with this Specification and the lines, dimensions and cross-sections as shown on the Drawings and/or as required by the S.O.
- 2.6.2.2 The materials, equipment and construction methods shall be in accordance with JKR Specification No. JKR/SPJ/2008-S4, sub-section 4.3.2 or the latest edition published by JKR.

2.6.3 Asphaltic concrete

- 2.6.3.1 This work shall consist of furnishing, placing, shaping and compacting asphaltic concrete binder course and/or wearing course on a prepared and accepted bituminous or bitumen primed pavement course, and shall include the careful and thorough cleaning of surfaces which are to be covered prior to the application of bituminous prime coat and tack coat. The work shall be carried out all in accordance with this Specification and the lines, levels, grades, dimensions and cross-sections as shown on the Drawings and/or as required by the S.O.

 JKR MALAYSIA	SECTION P : ROADS AND HARDSTANDING	No. Dokumen : JKR 20800-0183-14 No. Keluaran : 01 No. Pindaan : 00 Tarikh : 29 Januari 2014 Muka Surat : P/8
--	---	--

2.6.3.2 The materials, mix design, equipment and construction methods shall be in accordance with JKR Specification No. JKR/SPJ/2008-S4, sub-section 4.3.3 or the latest edition published by JKR.

3. Horizontal Alignment, Surface Levels And Surface Regularity Of Pavement Courses

3.1 Horizontal Alignment

The horizontal alignment shall be determined from the centerline of the pavement surface shown on the Drawings. The edges of the pavement as constructed and all other parallel construction lines shall be correct within a tolerance of + 50 mm and - 0 mm from the centre-line, except for kerbs, channel blocks and edge lines which shall be laid with a smooth alignment within a tolerance of + 25 mm and - 0 mm from the centre-line.

3.2 Surface Levels of Pavement Courses

3.2.1 The design levels of pavement courses shall be calculated from the vertical profile, crossfall and pavement course thicknesses shown on the Drawings. The level of any point on the constructed surface of a pavement course shall be the design level subject to the appropriate tolerances given in TABLE P5.

TABLE P5: TOLERANCES IN SURFACE LEVELS OF PAVEMENT COURSES

Pavement Course	Tolerance
Wearing Course	± 5 mm
Binder Course	± 5 mm
Roadbase	+ 0 mm to - 20 mm
Sub-base	+ 10 mm to - 20 mm

3.2.2 The combination of permitted tolerances in the levels of different pavement courses shall not result in a pavement thickness less than that shown on the Drawings. Each pavement course shall have an average thickness not less than that shown on the Drawings.

4. Shoulders

4.1 This work shall consist of furnishing, compacting and shaping earth, gravel or paved shoulder material on a prepared and accepted sub-base or subgrade, all in accordance with this Specification and the lines, levels, grades, dimensions and cross-sections as shown on the Drawings and/or as required by the S.O.

4.2 Materials

4.2.1 Paved shoulders

The bituminous surfacing and underlying pavement courses shall be constructed as described in the appropriate sections of this Specification.

4.2.2 Gravel shoulders

Gravel shoulder material shall conform to the requirements for gravel surfacing material set forth in JKR Specification No. JKR/SPJ/2008-S4, sub-section 4.1.3 or the latest edition published by JKR.

 <p>JKR MALAYSIA</p>	<p>SECTION P : ROADS AND HARDSTANDING</p>	<p>No. Dokumen : JKR 20800-0183-14 No. Keluaran : 01 No. Pindaan : 00 Tarikh : 29 Januari 2014 Muka Surat : P/9</p>
--	--	---

4.2.3 Earth shoulders

Earth shoulder material shall be suitable material as described in JKR Specification No. JKR/SPJ/2013-S2, sub-section 2.2 or the latest edition published by JKR.

4.2.4 Construction

4.2.4.1 Shoulders shall be constructed in stages or in one operation as directed or approved by the S.O., but in no instance shall a shoulder be built up to a level higher than that part of the abutting carriageway structure which has been completed and accepted.

4.2.4.2 Prior to placing any shoulder material, the underlying sub-base or subgrade shall have been shaped and compacted in accordance with the provisions of JKR Specification No. JKR/SPJ/2008-S4, sub-sections 4.1.2.3 and 2.2.7 or the latest edition published by JKR respectively, and the abutting carriageway structure course or courses shall likewise have been shaped and compacted in accordance with the provisions of the appropriate sub-sections of this Specification. Notwithstanding any earlier approval of the underlying and abutting pavement courses, any damage to or deterioration of these underlying and abutting pavement courses shall be made good to the satisfaction of the S.O. before shoulder construction proceeds.

4.2.4.3 Shoulders shall be placed to the required width and thickness as shown on the Drawings or as directed by the S.O. in one layer or more, each layer not exceeding 200 mm compacted thickness at the point of maximum thickness. Where two or more layers are required, they shall be of approximately equal shape and thickness, and none shall be less than 100 mm compacted thickness at the point of maximum thickness.

4.2.4.4 Each layer of shoulder material shall be processed as necessary to bring its moisture content to a uniform level throughout the material suitable for compaction, and shall then be compacted using suitable compaction equipment approved by the S.O. to not less than 95% of the maximum dry density determined in the BS 1377 Compaction Test (4.5 kg rammer method). Compaction shall be carried out in a longitudinal direction along the shoulder and shall generally begin at the outer edge and progress uniformly towards the carriageway, except on super-elevated curves where rolling shall begin at lower edge and progress uniformly towards the higher edge. In all cases, compaction shall be carried out in such a manner that each section receives compactive effort appropriate to its thickness, all to the satisfaction of the S.O.

4.2.4.5 Throughout the placing, adjustment of moisture content and compaction of shoulder material, care shall be taken to maintain a uniform gradation of the material and prevent its separation into coarse and separate parts, all to the satisfaction of the S.O.

4.2.4.6 Where shown on the Drawings or directed by the S.O., earth shoulders shall be turfed in accordance with JKR Specification

 <p>JKR MALAYSIA</p>	<p>SECTION P : ROADS AND HARDSTANDING</p>	<p>No. Dokumen : JKR 20800-0183-14 No. Keluaran : 01 No. Pindaan : 00 Tarikh : 29 Januari 2014 Muka Surat : P/10</p>
--	--	--

No. JKR/SPJ/2013-S2, sub-section 2.2.8 or the latest edition published by JKR.

- 4.2.4.7 Shoulders shall be finished in a neat and workmanlike manner. The total width of carriageway and shoulder shall be everywhere at least that specified or shown on the Drawings on both sides of the centre-line. The top surface of each shoulder shall have the required shape, super-elevation, levels and grades, shall be everywhere within 10 mm of the required plane, and shall provide a flush joint with the carriageway surface and shall be uniformly free draining away from the carriageway, all to the satisfaction of the S.O.

5. Concrete Pavement

Concrete Pavement works shall be in accordance with JKR Specification No. JKR/SPJ/1988, section 5: Portland Cement Concrete Pavement or the latest edition published by JKR.

6. Road Furniture

6.1 Corrugated Sheet Steel Beam Guardrail

The supply and method of installation of guardrails shall be in accordance with JKR Specification No. JKR/SPJ/1988, section 6, sub-section 6.1 or the latest edition published by JKR.

6.2 Traffic Signs

The supply and method of installation of traffic signs shall be in accordance with JKR Specification No. JKR/SPJ/1988, section 6, sub-section 6.2 or the latest edition published by JKR.

6.3 Road Markings

The supply and application of road markings shall be in accordance with JKR Specification No. JKR/SPJ/2012-S6, section 6, sub-section 6.3 or the latest edition published by JKR.

6.4 Concrete Kerb

The supply and installation of concrete kerb shall be in accordance with JKR Specification No. JKR/SPJ/1988, section 6, sub-section 6.4 or the latest edition published by JKR.

7. Street Lighting

The supply and installation of street lighting shall be in accordance with JKR Specification No. JKR/SPJ/2011-S7: Road Lighting or the latest edition published by JKR.

TABLE OF CONTENTS

SECTION Q: FENCING AND GATES

	PAGE
1. General	Q/1
2. Mild Steel Post And Bracings	Q/1
3. Chain Link Mesh, Straining	Q/1
4. Fencing	Q/1
5. Gates	Q/2
6. Painting Of Fence And Gates	Q/2

 <p>JKR MALAYSIA</p>	<p>SECTION Q : FENCING AND GATES</p>	<p>No. Dokumen : JKR 20800-0183-14 No. Keluaran : 01 No. Pindaan : 00 Tarikh : 29 Januari 2014 Muka Surat : Q/1</p>
--	---	---

1. General

- 1.1 Unless otherwise as shown on the Drawings, fencing shall be of chain link type as specified hereunder.
- 1.2 Unless otherwise as shown on the Drawings, the height of the fence shall be 1500 mm from the ground up to the full height of the chain link.
- 1.3 The fence shall be erected to the extent and location as shown on the site plan. Where fencing is to be located on the boundary of the Site, the Contractor shall ensure that its construction shall not infringe the adjoining properties.

2. Mild Steel Post And Bracings

- 2.1 Unless otherwise as shown on the Drawings, mild steel angle posts and bracings shall be of size 57 mm x 57 mm x 6 mm. All steel members for fencing and gates shall be free from rust, scales and other defects and shall be to the approval of the S.O. Previously used steel members shall not be used in the construction of new fencing and gates. Before delivery to the Site, the steel members for fencing and gates shall be pre-cut and assembled at the Contractor's workshop and painted with one coat of approved metallic primer.
- 2.2 Where three strands of barbed wires are required, a mild steel angle arm 430 mm long, of the same cross sectional dimension as the post shall be welded at the top of the post at 45° inclination. Where six strands of barbed wires are required, two pieces of mild steel angle arms as specified hereinbefore shall be welded to the top of each post forming the shape Y with each arm having three strands of barbed wires. The welding used shall be of continuous fillet welds. Necessary holes shall be made in the posts, arms and bracings for insertions of fixing bolts and clips.

3. Chain Link Mesh, Straining

Chain link mesh, straining wires and barbed wires shall be made of galvanized steel and of approved quality. The mesh shall be of size 64 mm made up of 3.25 mm (10 gauges) diameter wire. Straining wires shall be of 4.06 mm (8 gauges) diameters and barbed wires shall be of 2.64 mm (12 gauges) diameters.

4. Fencing

- 4.1 Unless otherwise as shown on the Drawings, the mild steel angle posts shall be erected at 3000 mm centres commencing from the gate post and the posts shall be embedded plumb in 1:3:6-25 mm concrete footings of size 250 mm x 250 mm x 600 mm deep. Mild steel angle bracings of the same cross sectional dimensions as the post shall be fixed at all corners, bends, junctions, gate posts and at every five bays of straight fencing.
- 4.2 The bracings shall be fixed at an inclination of 45° to the horizontal with top end bolted to the post, 300 mm below the top of the post and the bottom end encased in concrete footing as described hereinbefore.
- 4.3 The chain link mesh shall be stretched across the posts and secured in place using approved fencing clips. The end of chain link fencing abutting mild steel gate posts shall be fixed by means of 19 mm x 3 mm mild steel flat straps drawn through the mesh and bolted using 10 mm diameter mild steel bolts to 25 mm x 25 mm x 6 mm mild steel plates welded to the posts at equal intervals of 300 mm. Where gate posts are non-metal, the termination of the fencing at the gate shall be by means of

 <p>JKR MALAYSIA</p>	<p>SECTION Q : FENCING AND GATES</p>	<p>No. Dokumen : JKR 20800-0183-14 No. Keluaran : 01 No. Pindaan : 00 Tarikh : 29 Januari 2014 Muka Surat : Q/2</p>
--	---	---

another mild steel angle post fixed to one side of the gate post and strengthened by bracing as described hereinbefore. The chain link mesh shall then be strained by three strands of 4.06 mm (8 gauges) diameter galvanized steel straining wires threaded through the mesh and fixed to the posts.

- 4.4 Where shown on the Drawings, the bottom of the chain link mesh shall be buried in continuous 1:3:6-25 mm concrete curbs. Unless otherwise detailed in the Drawings, the cross-sectional dimension of curbs shall be 125 mm wide x 375 mm high with 150 mm protruding above the ground. The portion of the curb above the ground shall be rendered with 13 mm thick 1:6 cement render to a wood float finish.

5. Gates

The gates shall be constructed as shown on the Drawings.

6. Painting Of Fence And Gates

The metallic primer previously applied to the steelwork at the workshop shall be touched up where necessary. Unless otherwise specified, the posts, bracings and gates shall be finished with two (2) coats of approved aluminium paint.

TABLE OF CONTENTS

SECTION R: LANDSCAPING AND TURFING WORKS

	PAGE
1. General	R/1
2. Classifications And Characteristics Of Plants	R/1
3. Size Of Plants	R/1
4. Handling And Planting	R/3
5. Soil Mixture, Soil Conditioners And Chemical Fertilizers	R/4
6. Turfing	R/4
7. Football And Playing Fields	R/5
8. Relocation And Protection Of Existing Tress	R/8
9. Maintenance Of Plant And Turf	R/8
10. Final Handing Over	R/10

 <p>JKR MALAYSIA</p>	<p>SECTION R : LANDSCAPING AND TURFING WORKS</p>	<p>No. Dokumen : JKR 20800-0183-14 No. Keluaran : 01 No. Pindaan : 00 Tarikh : 29 Januari 2014 Muka Surat : R/1</p>
--	---	---

1. General

- 1.1 All landscaping works shall be as shown on the Drawings. Turfing works and tree planting shall be carried out in such a manner as to minimize risks of damage to turfs and plants, and stunted growth. Turfing on all slopes shall be carried out immediately after slopes are formed. Tree planting shall be carried out as soon as practicable.
- 1.2 All landscaping works shall start as early as possible so that trees and plants are well- grown, and fully adapted to the new environment when the project concerned is handed over upon completion.
- 1.3 All landscaping works shall be furnished, installed and maintained by the Contractor as specified herein, or as shown on the Drawings, using the best horticultural management, giving special attention to planting practices, soil mixtures, and application of agricultural chemicals.
- 1.4 Existing water elements such as lakes, ponds and streams shall be incorporated into the landscape design. Unless otherwise specified, mature existing trees shall be retained and incorporated into the landscape design. Replantation and relocation of the trees removed shall be considered as part of the landscaping works.

2. Classifications And Characteristics Of Plants

- 2.1 Plants shall mean trees, palms, shrubs, ground covers, and plants of others descriptions to be provided by the Contractor, as shown on the Drawings or listed in the plant schedules.
 - 2.1.1 Each tree shall possess characteristics of its variety and growth typical to such tree. All trees shall be well-branched, with straight trunks characteristic of the species, with well-shaped top and intact leader. The height shall be measured from the stem's earth line to the top of the tree.
 - 2.1.2 Palms shall have vigorous root system, crown of new leaves, proper color of leaves of adult palms, and sufficient hardlines. The height of palms shall be measured from the stem's earth line to the base of the first frond.
 - 2.1.3 Shrubs and vines shall possess characteristics and growth habits typical of their species. All shrubs shall be well-shaped and bushy, with well-spaced branches, and not skinny. The height of shrubs or vines shall be measured from the stem's earth line to the top branches.
 - 2.1.4 Ground cover is defined as any plant or groups of plant, other than grasses, which shall satisfactorily cover the ground, forming a compact and attractive cover.
- 2.2 All plants shall be in healthy growth condition, free from pests and diseases, and shall be representatives of their normal species or variety. All plants shall have well-branched heads and vigorous root systems, and shall be injury-free. Unless otherwise shown or specified in the Drawings, only nursery-grown plants shall be used. Plants which are potted or plastic-bag-grown shall not be root-bound.

3. Size Of Plants

- 3.1 The size of plants refers to plant table size that is the size that is required for planting out on sites. All plants shall have the following sizes:

 <p>JKR MALAYSIA</p>	<p>SECTION R : LANDSCAPING AND TURFING WORKS</p>	<p>No. Dokumen : JKR 20800-0183-14 No. Keluaran : 01 No. Pindaan : 00 Tarikh : 29 Januari 2014 Muka Surat : R/2</p>
--	---	---

3.1.1 Ground covers

Ground cover plants can be supplied in plastic bags. If supplied in 150 mm - size bags they shall have at least nine (9) cuttings per bag, and not less than 150 mm long.

3.1.2 Shrubs

Height of shrubs shall range between 150 mm and 1000 mm.

3.1.3 Trees

3.1.3.1 Trees shall be either container grown, or grown on the open ground. They shall be of the following three types:

i) Tree saplings

Tree saplings shall mean grown from seedlings or cuttings. They shall have straight main stems of not less than 1200 mm in height from the soil level to the lowest branch, and a stem diameter of not less than 12 mm, and a well-branching system.

ii) Rooted stump cutting

These refer to plants which can be easily grown from stem cuttings instead of from seeds. They shall have straight main stems of 2400 mm to 3000 mm in height, with a diameter ranging from 37 mm to 50 mm.

iii) Instant trees

An instant tree is generally referred, to the semi-mature tree with a minimum trunk height of 2000 mm for palms (measured from earth line to first frond) and 3000 mm for other which shall have well-spread branches.

3.1.4 Palms

3.1.4.1 Palms shall be either container-grown on the open ground, and shall be of two types:

i) Single-stem palm

These refer to palms with single main trunk. Their trunk height shall be not less than 1200 mm measured from the earth line to the base of the first frond.

ii) Cluster palms

The Palms referred to are those which grow in clusters. They shall have a minimum of three (3) palms clustered together, measuring 750 mm to 1000 mm from the earth line to the base of the first frond.

 <p>JKR MALAYSIA</p>	<p>SECTION R : LANDSCAPING AND TURFING WORKS</p>	<p>No. Dokumen : JKR 20800-0183-14 No. Keluaran : 01 No. Pindaan : 00 Tarikh : 29 Januari 2014 Muka Surat : R/3</p>
--	---	---

4. Handling And Planting

4.1 Handling

Plants shall be transported, handled and stored in such a manner as to prevent deterioration, damage or contamination. All plant materials shall be carefully protected and, if necessary, wrapped with hessian or gunny cloth during lifting, transportation, unloading and storage on site.

4.2 Planting

4.2.1 Pits/holes

4.2.1.1 Generally all pits for palms and trees shall not be less than 1000 mm x 1000 mm or 1/3 size bigger than the root ball, spaced at intervals as shown on the Drawings or approved by the S.O.

4.2.1.2 For shrubs, the pit size may be reduced to 500 mm x 500 mm deep (for big shrubs), or 300 mm x 300 mm x 300 mm deep (for medium shrubs). Alternatively, continuous trench 500 mm x 300 mm deep respectively, shall be formed where required.

4.2.1.3 The bottom of all pits and trenches shall be forked loose to a depth of 300 mm prior to backfilling with approved soil mixture before transplanting. All pits and trenches shall be soaked with water before planting.

4.2.1.4 Flower beds or trenches shall be made to the size as shown in the Drawings, and to a depth not exceeding 200 mm.

4.2.1.5 The distance for planting trees and palms shall be between 3000 mm to 5000 mm unless otherwise specified.

4.2.1.6 The distance for planting shrubs shall be between 150 mm to 300 mm unless otherwise specified.

4.2.1.7 For ground covers, planting works shall be carried out in zig-zag manner at distance between 100 mm to 150 mm unless otherwise specified.

4.2.2 Transplanting

4.2.2.1 Transplanting shall not be carried out in very hot, dry weather conditions which may result in initial drying out of the root system and/or scorching of leaves.

4.2.2.2 Immediately before transplanting, the plants shall be carefully removed from the nursery bags or pots. The plants shall be placed into the pits and the surround filled with approved black earth making sure that the roots are not excessively disturbed. The earth around the base of the stems shall be recessed slightly to facilitate watering.

4.2.3 Plants supports

All newly plants shall be supported either by staking, tying or guying. Stakes shall be of wood, still or plastic of an approved type, driven into the ground before planting so as not to damage the root ball or aerial parts of

 <p>JKR MALAYSIA</p>	<p>SECTION R : LANDSCAPING AND TURFING WORKS</p>	<p>No. Dokumen : JKR 20800-0183-14 No. Keluaran : 01 No. Pindaan : 00 Tarikh : 29 Januari 2014 Muka Surat : R/4</p>
--	---	---

plants. Stakes shall be long enough to the plants, with one (1) tie per stake set 150 mm from the bottom.

5. Soil Mixture, Soil Conditioners And Chemical Fertilizers

5.1 Soil Mixture

Soil mixture for ground planting and backfill shall be in the ratio of 1:3, i.e. 1 part to soil conditioner or organic materials to three (3) parts of top soil. Planter box soil mixture shall be in the ratio of 1:2:3, i.e. one (1) part of sand of sand to two (2) parts soil conditioner or organic materials to three (3) parts top soil.

5.2 Top Soil

Top soil shall consist of fertile and friable topsoil obtained from a well-drained flood-free site excavated from not more than 300 mm deep from ground level. It shall be of medium texture and without admixture of stones, lumps, plants or roots, and other extraneous matter. Topsoil material shall be obtained from excavated topsoil sourced or, if not available, from other sources as approved by the S.O.

5.3 Soil Conditioners (Manure And Compost)

Soil Conditioners shall be organic materials such as composed coconut, fiber, peat or other approved materials which shall be composed in a stable condition, free from toxic impurities and containing no substance injurious to plants. The organic matter with 45% - 55% moisture content and with Ph adjusted to 5.5 - 6.5 shall be used. All manure or compost used as additive to the soil mixture shall be procured from an approved source.

5.4 Chemicals Fertilizers

Chemicals fertilizers shall be granular slow release compound fertilizers with a minimum four (4) months release period at 32⁰ C. They shall be stored in waterproof sealed bags and kept under shelter. The Contractor shall submit manufacturer's technical data on the proposed fertilizer for the S.O.'s approval prior to the application of the fertilizer.

6. Turfing

6.1 Unless otherwise shown in the Drawings, turfing shall be provided to all exposed earth surfaces throughout the site. All surfaces to be turfed shall be completely cleared of all incidental Contractor's debris, stone and other obstructions.

6.2 The ground to be turfed shall be graded to fall toward surface water discharge line as shown in the Drawings, or approved by the S.O.

6.3 On level ground, minimum gradient of 1:60 shall be provided to eliminate ponding hollows. Any undesirable vegetation, debris, stumps or roots shall be grubbed up and removed from the site.

6.4 Top soil shall be provided on a prepared surface, and compacted to provide a suitable tilt for the growth of the turf. Before spreading the topsoil, the ground is to be trimmed and leveled and all roots of bushes and undesirable growth grubbed up and removed from the site.

6.5 All turfs shall be of good, healthy, dense indigenous cow grass (Axon Opus Compresses) from an approved source. The grass shall be of even density,

 <p>JKR MALAYSIA</p>	<p>SECTION R : LANDSCAPING AND TURFING WORKS</p>	<p>No. Dokumen : JKR 20800-0183-14 No. Keluaran : 01 No. Pindaan : 00 Tarikh : 29 Januari 2014 Muka Surat : R/5</p>
--	---	---

vigorous growth and green in color, forming a turf sufficiently fibrous to hold together when installed. They shall be free from mimosa, weeds or other foreign vegetation.

- 6.6 Each turf shall be approximately 300 mm x 300 mm x 50 mm thick with roots still attached to the soil. They shall be kept moist and in shade, and shall be planted within 24 hours of lifting. Samples of turfs to be used shall be submitted to the S.O. for approval before any turfs are brought in for use. The sources of material shall be stated by the Contractor.
- 6.7 Unless otherwise shown in the Drawings, close turfing shall be provided to slopes, and extending 2 m of the platform at the top and bottom of the slope, 1 m the sides of all drains, and 2 m wide of road shoulders, so that they cover the whole area without any space/gap between them.
- 6.8 Each sod shall be pegged in place with wooden/bamboo pegs 12 mm diameter and 200 mm long through the sod and into the soil base. These pegs shall be removed after the turf have firmly established. On steep slopes, netting in shall be laid onto the turfed areas for protection.
- 6.9 Unless otherwise shown in the Drawings, spot turfing shall be carried out on all level ground. The turf shall be laid at 450 mm center, embedded 25 mm in the top soil.
- 6.10 Turf shall be fertilized with approved slow release fertilizers high in Nitrogen content, one (1) month after planting at the rate of 60 gm/m² and evenly spread over the whole area. Turfs shall be well watered after each fertilizer application which shall be done once in every three months after grass cutting.
- 6.11 Grass cutting shall be done every three weeks after one (1) month growth/establishment by grass cutter/mover as often as in required to give a well trimmed sod not more than 25 mm in height for flat surface and not less than 50 mm on slope. All clippings shall be removed from the site before watering is carried out.

7. Football And Playing Fields

7.1 General

- 7.1.1 Unless otherwise specified hereinafter, turfing for football and playing fields shall be as specified hereinbefore. Turfing works shall start as soon as possible and shall be completed and fully established not later than three (3) months before the date of completion of the works.
- 7.1.2 The Contractor shall supply and install sub-soil drains as specified hereinafter at the locations and accordance with the lines, levels and grades shown in the Drawings and/or as directed by the S.O.

7.2 Materials

7.2.1 Sub-soil drain pipes

Subsoil drain pipes shall be of high Density Polyethylene (HDPE) perforated corrugated drainage pipe to DIN 16961 PT 1 and 2:1989 or equivalent, or Polyvinyl Chloride (PVC) pipes for subsoil drains complying with AS Specification 2439.1 or BS 3656 or equivalent, of diameter and lengths of pipe as shown on the Drawings.

 <p>JKR MALAYSIA</p>	<p>SECTION R : LANDSCAPING AND TURFING WORKS</p>	<p>No. Dokumen : JKR 20800-0183-14 No. Keluaran : 01 No. Pindaan : 00 Tarikh : 29 Januari 2014 Muka Surat : R/6</p>
--	---	---

7.2.2 Filter materials

Filter Materials shall consist of an angular, clean, hard and durable crush rock with uniformly sized particle of 14 mm, free from lumps of clay or organic matter.

7.2.3 Geo textile fabric

Geo textile fabric shall be of non-woven type thermally bonded with minimum weight of 100 g/m² or equivalent and shall be of approved manufacturer.

7.3 Site Preparation

The site area shall be completely cleared of all debris, large stones, discarded gravel and other unacceptable materials. The site shall then be graded to form a crown at the centre of the field with a minimum gradient of 1:300. The soil shall be of good texture and structure with the majority of the crumbs of size 1 mm to 2 mm and not contaminated with seeds, stolon or rhizomes of noxious weeds.

7.4 Trenching For Sub-soil Drain Pipes

Trenches shall be excavated and trimmed clean true to grade and alignment and the geo textile fabric shall be laid as shown on the Drawings. The fabric shall overlap the full width of the trench at the top. Where the fabric requires jointing along the trench, it shall overlap a minimum of 500 mm at the joint.

7.5 Laying And Jointing Subsoil Drain Pipe

Subsoil pipe shall be laid and bedded as shown on the Drawings. Subsoil drain pipe shall be jointed according to the manufacturer's recommendations.

7.6 Backfilling

The trench shall be backfilled with the filter material in layers not exceeding 150 mm loose thickness and uniformly compacted by suitable method approved by the S.O. to the level as shown in the Drawings. Care shall be taken that the pipe is not damaged or displaced.

7.7 Outlets

Outlets shall be constructed as shown in the Drawings and to the S.O.'s approval.

7.8 Laying Of Sand And Turf Mixture

7.8.1 The prepared surface of the field shall be laid with a first layer of 100 mm thick river sand or other suitable coarse grained granular materials and a second layer of 100 mm thick turf mixture before receiving the turf.

7.8.2 The Contractor shall carry out final gradient check prior to the turfing works.

7.8.3 Before turfing works commence, the Contractor shall submit samples of the turf mixture for the approval of the S.O. The turf mixture shall be laid to the required formation level and gradient.

7.8.4 The turf mixture shall have the following composition by weight of 4% - 5% organic matter, 12% - 15% clay and 81% - 85% river sand. The PH value for the root zone medium shall be 5 to 7.5.

 <p>JKR MALAYSIA</p>	<p>SECTION R : LANDSCAPING AND TURFING WORKS</p>	<p>No. Dokumen : JKR 20800-0183-14 No. Keluaran : 01 No. Pindaan : 00 Tarikh : 29 Januari 2014 Muka Surat : R/7</p>
--	---	---

7.9 Inspections

7.9.1 The Contractor shall give not less than twenty-four (24) hour notice prior to the commencement and upon completion of the under mentioned works. The Contractor shall not proceed with the next succeeding operation until specific approval has been given for the following:

- (i) Trench excavation.
- (ii) Trench lining with geo textile fabric and laying of subsoil drain pipe
- (iii) Filter material backfill
- (iv) Sand laying
- (v) Turf mixture
- (vi) Turfing work

7.10 Leveling Of Field

7.10.1 The Contractors shall water the turf at least twice a day or as instructed by the S.O. The rate of application and frequency of watering shall be sufficient to maintain the turf mixture in a moist condition to ensure proper and healthy growth of the turf even during the dry weather.

7.10.2 Water shall be applied as fine spray by means of suitable pumps and hose or sprinkler or any other method approved by the S.O so as not to disturb the turf mixture.

7.11 Weed Control

Weeding shall be carried out on the newly turfed area about ten (10) days after planting to get rid of foreign species and maintain a pure culture of Axonopus Compressus (Cow Grass). Weeding on a Continuous basis shall be carried out to prevent weeds from growing.

7.12 Fertilization

The first fertilization shall be carried out two (2) weeks after planting, using mechanical spreader. Subsequently, the fertilizer shall be applied at three (3) weeks interval.

7.13 Mowing

7.13.1 Mowing shall be carried out using properly sharpened and adjusted machine tools so that the turf is cut cleanly and no tearing takes place.

7.13.2 The first cut shall be carried out when the turf reaches 50 mm – 70 mm in height. The turf shall be cut to 25 mm – 30 mm in height. Subsequently, mowing shall be done at least once in every two (2) weeks.

7.14 Top Dressing

The Contractor shall, from time to time or whenever directed by the S.O. check the flatness of the field and if found uneven, rectify by top dressing with turf mixture and followed by proper compaction.

7.15 Maintenance During Defect Liability Period

7.15.1 The Contractor shall be responsible for carrying out full-time intensive maintenance of the turfing works for the entire duration of the Defect Liability Period of the Works.

 <p>JKR MALAYSIA</p>	<p>SECTION R : LANDSCAPING AND TURFING WORKS</p>	<p>No. Dokumen : JKR 20800-0183-14 No. Keluaran : 01 No. Pindaan : 00 Tarikh : 29 Januari 2014 Muka Surat : R/8</p>
--	---	---

7.15.2 The maintenance includes watering, weed control, fertilization, moving and top dressing, all as specified hereinbefore.

7.16 Handing Over Of The Works

On handing over of the works, the field shall be in good playable condition with all the full line markings to the dimensions as shown on the Drawings.

8. Relocation And Protection of Existing Tress

8.1 Relocation Of Trees

8.1.1 Where shown in the Drawings or if directed by the S.O, all existing trees having girth of 300 mm and below identified and marked for relocation, shall not be cut, but shall be dug up, prepared for, and relocated by the Contractor to other areas within, or in the vicinity of the site. In the event of any such trees being accidentally cut or damaged, the same shall be replaced with trees of equivalent size and species by the Contractor.

8.1.2 The Contractor shall protect and maintain the relocated trees by fencing to a height of 1.2 m, watering, manuring, pruning, and other necessary treatments throughout the contract period (including the Defects Liability Period) until satisfactory, growth is established. Any relocated trees which are accidentally damage, or fail to re-grow satisfactorily within the Defect Liability Period, Shall be replaced accordingly at the Contractor own cost.

8.2 Protection of Trees Retained On Site

8.2.1 All existing trees having girth of 800 mm and above identified and marked by the S.O. or as shown in the Drawings to be retained on site, shall be protected and maintained by fencing to a height of 1.2 m, watering manuring, pruning and other necessary treatments throughout the contract (including the Defects Liability Period) so as not to jeopardize their growth.

8.2.2 The ground around the tree spread shall be protected to prevent contamination from materials and chemicals detrimental to plant growth. Method of protection shall be to the approval of the S.O. in the event of any such trees being accidentally or otherwise out or damaged, the same shall be replaced by the Contractor with trees equivalent size and species at his own cost.

9. Maintenance of Plant and Turf

9.1 General

9.1.1 After planting and prior to the onset of the maintenance period, the Contractor shall be responsible for carrying out all necessary measures to ensure that all plant materials and turfing thrive and become established, and that the landscaped areas are kept in a clean and tidy condition.

9.1.2 The Contractor shall protect and maintain the plants and turfing from any damage and destruction, by way of watering, manuring and tilling, any by staking and fencing, where necessary, to support and protect the plants, until the end of the Defects Liability Period. All plants and turfs which are defective and/ or fail to grow within the Defect Liability Period or as instructed by the S.O. shall be replaced immediately and/ or replanted accordingly, at the Contractor's own cost.

 <p>JKR MALAYSIA</p>	<p>SECTION R : LANDSCAPING AND TURFING WORKS</p>	<p>No. Dokumen : JKR 20800-0183-14 No. Keluaran : 01 No. Pindaan : 00 Tarikh : 29 Januari 2014 Muka Surat : R/9</p>
--	---	---

9.1.3 Unless otherwise specified, all maintenance works shall be carried out complying to the minimum standard as detailed out in the 'Garis Panduan Pengurusan Dan Penyelenggaraan Projek Landskap' (latest edition) by Jabatan Perancang Bandar & Desa, Kementerian Perumahan Dan Kerajaan Tempatan. During the Defects Liability Period, the Contractor is required to implement the maintenance works as follows:

- (i) Water the plants twice (2) per day.
- (ii) Feeding the plants with fertilizers (NPK Green) 15:15:15 once (1) every month for the first six (6) months and as needed after six (6) months onwards. Application of the fertilizer shall be as specified hereinafter, and as recommended by the fertilizer manufacturer.
- (iii) Weeding/Hoeing and Site Cleaning
- (iv) Disease and Pest Control
- (v) Plants Replacement
- (vi) Mulching
- (vii) Trimming/Pruning

9.1.4 The Contractor shall provide persons who are competent and experienced for organizing and running the maintenance programs during the Defects Liability Period, at the Contractor's own cost.

9.1.5 The Contractor shall be responsible for the use of all materials, labour and equipment. Any injury to plants caused by such materials, labour and equipment shall be corrected and repaired at the Contractor's own cost.

9.1.6 The Contractor shall carry out all necessary measures to ensure that all plants thrive and become established within this period. All landscaped areas shall be inspected at monthly intervals and lists of remedial works shall be issued upon each inspection within seven (7) working days. All items on the remedial work list shall be executed before the next scheduled inspection.

9.2 Weeding And Hoeing

Weeding and hoeing shall be done frequently, depending on weed growth or whenever directed to do so by the S.O. The Contractor shall be responsible for maintaining areas close the base of trees or shrubs. Weeding shall be done manually either by hand, hoe or garden tools at least once a month, with care taken not to wound plant stems.

9.3 Fertilizers And Application Rate

9.3.1 Feedings to plants shall be done with approved organic manure or slow release fertilizers at regular intervals to maintain healthy growth. The S.O. reserves the right to request the Contractors to use any kind of fertilizer, let it be straight mixture, complex or slow release, at the Contractor's own cost.

9.3.2 Six (6) applications shall be required during the maintenance period. The first shall be carried out during the second (2nd) month after planting. The second and subsequent applications shall be worked into the soil above the roots and lightly watered in. the fertilizer shall be applied, preferable, when the plants are in their active stage of growth.

9.3.3 Slow release fertilizers shall be applied strictly in accordance with the manufacturer's directions and recommendations.

 <p>JKR MALAYSIA</p>	<p>SECTION R : LANDSCAPING AND TURFING WORKS</p>	<p>No. Dokumen : JKR 20800-0183-14 No. Keluaran : 01 No. Pindaan : 00 Tarikh : 29 Januari 2014 Muka Surat : R/10</p>
--	---	--

- 9.3.4 The Contractor shall take note that plant feeding shall be carried out only after all other maintenance works like weeding, hoeing and trimming or pruning have been carried out.

10. Final Handing Over

- 10.1 Two weeks before the expiry of the Defects Liability Period a joint final inspection shall be held with the S.O. to review the requirements for any alteration or replacement in order to gain approval for Final Handing Over.
- 10.2 At the time of Final Inspection, all areas under this contract shall be free from weeds, neatly cultivated and raked, and all plant boxes in good order. Grass shall be neatly cut and all clippings removed. No bare patches of earth shall be visible in turf or planting areas unless otherwise specified.
- 10.3 If any portions of the works are found to be not acceptable, under the terms and intent of the Drawings and specifications, the Contractor shall carry out immediate remedial works to S.O's acceptance before the date of Final Handing Over. The cost of all remedial works shall be borne by the Contractor.

TABLE OF CONTENTS
SECTION S: DRAINAGE WORKS

	PAGE
1. General	S/1
2. Excavation And Backfilling	S/1
3. Materials	S/3
TABLE S1 : Grading Limits For Sand Backfill	S/3
TABLE S2 : Grading Limit For Granular Backfill Other Than Sand	S/4
4. Surface Water Drains	S/4
TABLE S3 : Maximum Steepness Of The Side Slopes	S/5
5. Subsoil Drain	S/6
6. Sumps	S/6
7. Culverts	S/6
8. On-site Detention Pond	S/7

 <p>JKR MALAYSIA</p>	<p>SECTION S : DRAINAGE WORKS</p>	<p>No. Dokumen : JKR 20800-0183-14 No. Keluaran : 01 No. Pindaan : 00 Tarikh : 29 Januari 2014 Muka Surat : S/1</p>
--	--	---

1. General

- 1.1 All drainage works shall be in accordance with the JKR Standard Specification for Drainage Works in Building Projects No. 20601-0195-13 or the latest edition published by JKR and the requirements of the MSMA.
- 1.2 The works shall include the construction of surface drains, sumps, culverts, subsoil drains, and other drainage structures in accordance with these Specifications or as directed by the S.O.
- 1.3 Drainage works shall be constructed to the lines, levels, grades and cross-sections shown on the Drawings or as directed by the S.O.
- 1.4 Final discharge point shall be identified and approved by the S.O. Where necessary, the existing drainage system shall be upgraded in order to ensure they are fully functional.

2. Excavation And Backfilling

- 2.1 The Contractor shall notify the S.O. sufficiently in advance of the beginning of any excavation so that cross-section elevations and measurements shall be taken of undisturbed ground. The natural ground adjacent to the structure shall not be disturbed without permission of the S.O. The excavation works shall be carried out so as not to cause any danger or obstruction to the traffic or public.
- 2.2 All excavation shall be inspected and approved by the S.O. prior to further work being carried out.
 - 2.2.1 Excavation of hard materials/rock
 - 2.2.1.1 Hard materials/rock encountered in the trench excavation shall be removed to the approval of the S.O. Layer of rock encountered along the bottom of the excavation shall be cut and trimmed to the required level.
 - 2.2.1.2 Voids formed at bottom of the trench due to the removal of rocks shall be backfilled to the required level with 20 mm Grade 20P concrete or other suitable materials, well rammed and compacted all to the approval of the S.O.
 - 2.2.1.3 Jagged surfaces of rocks at the bottom of the excavation due to the trimming shall be levelled and smoothed with sand blinding to the approval of the S.O.
 - 2.2.2 Excavation of soft materials

When, in the opinion of the S.O. the foundation material is soft or otherwise unsuitable, the Contractor shall remove and insert foundation fill material or concrete as specified or shown on the Drawings or directed by the S.O. It shall be placed and compacted in layers not more than 150 mm thick or as directed by the S.O.
 - 2.2.3 Excavation for drain trenches
 - 2.2.3.1 The trench shall be excavated to a depth of 150 mm less than the depths intended or shown on the Drawings. The remaining excavation shall be carried out immediately prior to the placing of blinding materials.

 <p>JKR MALAYSIA</p>	<p>SECTION S : DRAINAGE WORKS</p>	<p>No. Dokumen : JKR 20800-0183-14 No. Keluaran : 01 No. Pindaan : 00 Tarikh : 29 Januari 2014 Muka Surat : S/2</p>
--	--	---

2.2.3.2 Should the bottom of the trench be inadvertently excavated below the specified level, it should be brought back at the Contractor's expense to the correct level with good selected earth or sand, carefully rammed into place.

2.2.4 Excavation for culvert

2.2.4.1 The earthworks at the required location shall be constructed to a level at least 600 mm above the top of culverts design levels or to the top of subgrade levels, whichever is lower. The culverts specified to be constructed in trench conditions shall be excavated in accordance with sub-section 2.2.5.

2.2.4.2 Where drainage conditions or other circumstances so require, the S.O. shall direct the Contractor to construct the culvert without first constructing the earthworks to the level specified above, in which case excavation, and foundation preparation shall be in accordance with sub-section 2.2.6.

2.2.5 Trench method

2.2.5.1 The trench to receive culvert shall have sufficient width and depth to enable the placing of bedding material. The bottom of the trench shall be trimmed to suitably smooth plane surface which shall be kept free from water, all to the satisfaction of the S.O.

2.2.5.2 The hard material excavated shall be replaced with suitable material uniformly compacted in layers of not more than 150 mm compacted thickness to provide satisfactory support for the culvert, all to the satisfaction of the S.O.

2.2.6 Open ground method

2.2.6.1 Where existing ground levels are above top bedding material design levels and firm foundation materials are encountered, excavation and foundation preparation shall be similar to the described in trench method above. Otherwise a firm foundation plane shall be prepared, which shall be essentially free draining along the line of the culvert by trimming the existing ground, or such fill as it is necessary to place and compact, over a width sufficient to permit satisfactory construction of the pipe bedding, all to the satisfaction of the S.O.

2.2.6.2 Where soft or unstable soil is encountered in the foundation, it shall be excavated over a width of at least 1.5 times the outside of each side of the culvert centre-line to the depth directed by the S.O., and replaced with suitable material uniformly compacted in layers of not more than 150 mm compacted thickness to provide satisfactory support for the pipe, all to the satisfaction of the S.O.

2.3 Backfilling

2.3.1 Drainage trenches shall be backfilled immediately after completion of drain laying or installation of culverts and as soon as the S.O. has inspected and given his approval.

2.3.2 Backfilling with approved fill materials shall be placed evenly in layers not exceeding 150 mm. To provide uniform support, loose thickness of fill materials on both sides of the drain shall be thoroughly compacted with

 <p>JKR MALAYSIA</p>	<p>SECTION S : DRAINAGE WORKS</p>	<p>No. Dokumen : JKR 20800-0183-14 No. Keluaran : 01 No. Pindaan : 00 Tarikh : 29 Januari 2014 Muka Surat : S/3</p>
--	--	---

mechanical rammers. This procedure shall be followed for the whole depth of drain section.

2.3.3 All spaces excavated under this Specification and not occupied by a permanent structure shall be backfilled with material free from large lumps, wood and extraneous material.

3. Materials

3.1 Basic construction materials shall comprise the following;

3.1.1 Granular bedding material

The foundations shall be of granular bedding material suitably graded broken rubble, crushed stone, crushed gravel, sand or other material as shown on the Drawings or as directed by the S.O.

3.1.2 Concrete

Concrete for blinding, bedding and cast-in-situ drains shall be as shown in the Drawings and as specified in SECTION D : CONCRETE WORKS.

3.1.3 Ordinary backfill material

3.1.3.1 Ordinary backfill material shall be of suitable material such as medium stiff clay, clayey sand or other approved soils. The maximum particle size of the backfill material shall be 50 mm.

3.1.3.2 Materials from swamps, peats or top soils and other highly organic clay or silt, materials containing logs, stumps or boulders, which are susceptible to combustion, and any other materials which, by virtue of their physical or chemical composition or at their moisture content will not compact properly, shall not be used for filling.

3.1.4 Granular backfill material

3.1.4.1 Granular backfill material shall be sand, crushed stone, crushed gravel or a mixture of crushed and natural aggregates, shall be essentially free from vegetative and other organic matter and clay, and shall not contain lateritic or concretionary materials. The material shall conform to the following physical and mechanical quality requirements:

- (i) The fines shall be non-plastic;
- (ii) Sand shall have a gradation conforming to the envelope shown in TABLE S1;
- (iii) Material other than sand shall have a gradation conforming to one of the envelopes shown in TABLE S2.

TABLE S1 : GRADING LIMITS FOR SAND BACKFILL

B.S. Sieve Size	% Passing By Weight
10.0 mm	100
5.0 mm	90 - 100
1.18 mm	45 - 80
300 µm	10 - 30
150 µm	2 - 10

 JKR MALAYSIA	SECTION S : DRAINAGE WORKS	No. Dokumen : JKR 20800-0183-14
		No. Keluaran : 01
		No. Pindaan : 00
		Tarikh : 29 Januari 2014
		Muka Surat : S/4

TABLE S2 : GRADING LIMIT FOR GRANULAR BACKFILL OTHER THAN SAND

B.S Sieve Size	% Passing By Weight		
	A	B	C
37.5 mm	100	-	-
28.0 mm	70 -100	100	-
20.0 mm	60 - 90	70 - 100	100
10.0 mm	45 - 75	45 - 75	-
5.0 mm	30 - 60	35 - 65	45 - 75
2.0 mm	20 - 50	25 - 50	30 - 60
425 µm	10 - 30	10 - 30	15 - 35
75 µm	0 - 2	0 - 2	0 - 2

3.1.4.2 The granular backfill shall be placed in layers not to exceed 150 mm in depth and each layer shall be thoroughly compacted by means of packers or mechanical tampers to a relative compaction of not less than 95% Standard Proctor Density for the backfill material at optimum moisture content.

4. Surface Water Drains

4.1 Surface drains shall be constructed with regard to both operation and ease of maintenance and adequate gradient shall be provided to enable self-cleansing flow.

4.2 Where gradient designed is not practical or above the finished level, the Contractor shall submit their proposal for the approval of the S.O.

4.3 Reinforced concrete struts shall be provided for all drain side walls exceeding 1.0 m height. Handrails shall be provided for open drains more than 1.5 m width.

4.4 Types Of Surface Drains

4.4.1 Surface drains of all types shown on the Drawings shall be constructed either unlined or lined using cast in situ concrete, precast or porous concrete drain sections or stone pitching.

4.4.2 Unlined (earth) drains

4.4.2.1 The Contractor shall refer to approved plans for location, extent and construction details as shown on the Drawing, or otherwise directed by the S.O.

4.4.2.2 Excavation for unlined/earth drains shall be trimmed to form a smooth, firm surface to the required lines, levels, grades and cross-sections as shown on the Drawings or as directed by the S.O.

4.4.2.3 Any areas of over excavation shall be made good to the satisfaction of the S.O., all at the expense of the Contractor.

4.4.2.4 The sides of cut drain shall not be steeper than 1:1.5 (V:H), while fill slopes shall not be steeper than 1:2 (V:H). The surface water shall be discharges to a stable outlet such that soil erosion is prevented from occurring.

 <p>JKR MALAYSIA</p>	<p>SECTION S : DRAINAGE WORKS</p>	<p>No. Dokumen : JKR 20800-0183-14 No. Keluaran : 01 No. Pindaan : 00 Tarikh : 29 Januari 2014 Muka Surat : S/5</p>
--	--	---

4.4.3 Lined drain

4.4.3.1 Lined drains shall be constructed from material proven to be structurally sound and durable and have satisfactory jointing systems. Unless otherwise stated in the Drawings, the maximum steepness of the side slopes for lined open drains shall be as indicated in TABLE S3.

TABLE S3: MAXIMUM STEEPNESS OF THE SIDE SLOPES

Drain lining	Maximum steepness of the maximum side slopes (V:H)
Concrete, brickwork and blockwork	Vertical
Stone Pitching	1:1.5
Grassed/Vegetated, rock riprap	1:2

4.4.3.2 All concrete works shall conform to the requirement in SECTION D: CONCRETE WORKS of this Specification or unless otherwise specified.

4.4.3.3 Lined drains shall be constructed by the following means ;

(i) Cast-in-situ concrete drains

- a) Cast-in-situ concrete drains shall be Grade 25P concrete unless otherwise stated. Weep holes shall be cast in-situ as shown on the Drawings or as directed by the S.O.
- b) Where the concrete grade is found to be of the lower grade, the S.O. shall request the Contractor to do the rectification work according to the requested proper method.

(ii) Precast concrete drain

- a) Precast concrete block iverts shall be of the shapes and dimensions as shown on the Drawing and shall be of Grade 25P concrete or unless otherwise specified.
- b) The joint shall be grouted with cement mortar Grade 15P and weep holes shall be provided as shown on the Drawing or as directed by the S.O.
- c) The S.O. shall have access to the casting yards where the proprietary precast concrete product are being utilized. A copy of the manufacturer's test certificate shall be provided to the S.O.
- d) All inspections shall be conducted in the present of the S.O. and any rectification works shall be carried out any accordance to the method as approved by the S.O.

 <p>JKR MALAYSIA</p>	<p>SECTION S : DRAINAGE WORKS</p>	<p>No. Dokumen : JKR 20800-0183-14 No. Keluaran : 01 No. Pindaan : 00 Tarikh : 29 Januari 2014 Muka Surat : S/6</p>
--	--	---

(iii) Cascade drains

Cascade drains shall be constructed from precast concrete drain units and laid stepping on a 150 mm thick bed of mass concrete of Grade 15P as shown on the Drawings or as approved by the S.O.

5. Subsoil Drain

- 5.1 This work shall include supply and installation of subsoil drains, constructed in accordance with these Specifications at locations as shown on the Drawing and/or as directed by the S.O.
- 5.2 Minimum gradient of 1:100 shall be provided for the drain to discharge into existing stormwater system, open drain, creek or pond in the area. The discharge shall not create an unwanted bog.
- 5.3 The lateral drain shall have a minimum slope of 1:100 to ensure water always flowing even though there are undulations and laid at 2 m spacing at 45⁰ to the main pipes/collector drain.

6. Sumps

- 6.1 Sumps shall be constructed as accordance to the Drawing or as directed by the S.O. to facilitate changes in level and flow within a drainage system. All sumps shall be covered either by concrete slab or galvanized steel grating hinged to the seating frame on the sumps for safety purposes.
- 6.2 Unless otherwise as shown on the Drawings, sumps of depth less than 1.5 m (internal depth) shall be made up of brickwalls of minimum 225 mm thickness. Sump of depth (internal depth) more than 1.5 m shall use reinforced concrete Grade 20P.

7. Culverts

- 7.1 The work shall comprise of supply and installation of either reinforced concrete pipe culverts or precast box culverts, including the end treatment components such as headwall, wingwalls, aprons and sumps and channel protection works, all in accordance with these Specifications and details as shown on the Drawings.

7.2 Culvert Bedding

- 7.2.1 Type A bedding shall consist of Grade 20P concrete and complying with SECTION D: CONCRETE WORKS.
- 7.2.2 Type B bedding shall consist of clean, natural sand or gravelly sand of suitable gradation and quality with maximum particle size of not more than 12 mm.

7.3 Culvert Components

Culvert shall be constructed with barrel and end treatments including headwalls, endwalls, wingwalls, outlet protection, inlet improvement and debris control structures.

 <p>JKR MALAYSIA</p>	<p>SECTION S : DRAINAGE WORKS</p>	<p>No. Dokumen : JKR 20800-0183-14 No. Keluaran : 01 No. Pindaan : 00 Tarikh : 29 Januari 2014 Muka Surat : S/7</p>
--	--	---

7.4 Pipe Culverts

- 7.4.1 Pipe for culvert shall be of spun reinforced concrete of approved manufacturers complying with MS 881 and approved by the S.O. with spun concrete collars or spigot and socket type as shown on the Drawing.
- 7.4.2 The S.O. reserves the right to request for test certificates and to request for tests to be carried out on samples, all at the Contractor's own cost.

7.5 Precast Box Culverts

- 7.5.1 Box culverts shall be of precast concrete of approved manufacturer complying with MS 1293 or any equivalent alternative acceptable and approved by the S.O.
- 7.5.2 Unless otherwise shown on the Drawings, the box shall be capable of withstanding a proof load test of 112.5 kN applied over an area of 320 mm x 320 mm at any position on the cover slab. The S.O. reserves the right to call for test certificates on the concrete boxes supplied.
- 7.5.3 Individual sections of the box shall be rejected because of such defects specified herein before for pipe culverts.
- 7.5.4 Precast box culverts shall be laid on Type B bedding with layer of crushed aggregate of maximum particle size not exceeding 50 mm as shown on the Drawings or directed by the S.O.
- 7.5.5 The maximum gap between each culvert shall not be more than 13 mm and the difference in level shall less than 3 mm. The gap shall be filled with cement mortar (1:3) with smooth finished.
- 7.5.6 To ensure uniform bearing, a layer of cement grout shall be spread along the top of the walls of the invert where the lid shall sit.

8. On-site Detention Pond

- 8.1 On-site detention (OSD) pond shall be constructed in accordance to the Drawings and conform to the requirements of MSMA.
- 8.2 Unless otherwise stated in the Drawings, the side slopes of basins shall not be steeper than 1 (V): 6 (H). Fence and warning signs shall be provided.
- 8.3 The construction of detention pond shall include the system components at the inlet, storage and outlet zone to cater outflow discharges without causing adverse effects on downstream properties.
- 8.4 Maintenance shall be done periodically or as and when the silt has accumulated to half of the pond height.

 <p>JKR MALAYSIA</p>	SECTION S : DRAINAGE WORKS	No. Dokumen : JKR 20800-0183-14 No. Keluaran : 01 No. Pindaan : 00 Tarikh : 29 Januari 2014 Muka Surat : S/8
--	-----------------------------------	--

BLANK PAGE

TABLE OF CONTENTS

SECTION T: SIGNAGE WORKS

	PAGE
1. General	T/1
2. Copper Plating	T/2
3. Aluminium	T/2
4. Paint Finish	T/2
5. Screen Printing Works	T/3
6. Vinyl Graphic Stickers	T/3
7. Stainless Steel	T/3
8. Acrylic	T/3
9. Installation And Fixing Works	T/3
10. Labeling For Registration Of Immoveable Asset Components	T/4

 <p>JKR MALAYSIA</p>	<p>SECTION T : SIGNAGE WORKS</p>	<p>No. Dokumen : JKR 20800-0183-14 No. Keluaran : 01 No. Pindaan : 00 Tarikh : 29 Januari 2014 Muka Surat : T/1</p>
--	---	---

1. General

- 1.1 All interior architectural signage shall be of acrylic plastic as approved by the S.O. unless otherwise specified in the Drawings. All panel sign surfaces shall be flat and smooth, constructed to remain flat under installed conditions within tolerance of plus or minus 1 mm measured diagonally.
- 1.2 All signage works shall comply with the regulatory requirements currently enforced and shall comply with MS 1184: Universal Design and Accessibility in The Built Environment - CP and Government Immoveable Asset Code System (*Sistem Kod Aset Tak Alih - SKATA*) as referred to sub-section 10.
- 1.3 Unless otherwise stated in the Drawings, the panel and lettering size, profiles and dimensional requirements of interior panel signage shall be as follows:
 - 1.3.1 The standard thickness of cast-acrylic matt clear sheets shall be not less than 4 mm.
 - 1.3.2 Raised lettering and graphic symbols shall be of 0.8 mm thickness obtained by using acrylic applique and chemically welded to sign panels.
 - 1.3.3 The type of panel material and size of letterings shall be as indicated in the Schedule of Signage prepared by the manufacturer to the S.O.'s approval.
- 1.4 Graphic content and style of signage shall be in accordance with the Schedule of Signage, Shop Drawings and comply with the requirements indicated below:
 - 1.4.1 Panel material shall be acrylic with machine-routed raised copy applied to surface of panel, along with "raster-method" Grade 2 braille beads, or pictograms and other artwork to be reverse applied vinyl or silk-screened process in colours as indicated.
 - 1.4.2 For background colours, provide Pantone Matching System (PMS) coloured coatings, including inks and paints, that are recommended by acrylic manufacturer for optimum adherence to surface, and that are non-fading for application intended.
 - 1.4.3 Raised copy shall be machine routed copy, provide manufacturer's full range of solid to applique colours to the S.O.'s approval.
- 1.5 Location, accessories and mounting positions of signs shall comply with MS 1184, manufacturer's recommendations and as approved by the S.O.
- 1.6 Wall mounted panel signs shall be mounted to wall surfaces using methods indicated below:
 - (i) Vinyl-tape mounting: use double-sided very high bond (VHB) tape to adhere signs to smooth, non-porous surfaces.
 - (ii) Silicone-adhesive mounting: Use liquid-silicone adhesive recommended by manufacturer to attach signs to porous, irregular, or vinyl-coated surfaces. Use double-sided foam tape to hold sign in position until silicone adhesive has fully cured.
 - (iii) Mechanical fasteners: Use non-removable mechanical fasteners placed through pre-drilled holes in sign face, or through shim plate. Use proper anchors at masonry walls as recommended by manufacturer. Attach sign panel to shim plate using vinyl-tape method as described above.

 <p>JKR MALAYSIA</p>	<p>SECTION T : SIGNAGE WORKS</p>	<p>No. Dokumen : JKR 20800-0183-14 No. Keluaran : 01 No. Pindaan : 00 Tarikh : 29 Januari 2014 Muka Surat : T/2</p>
--	---	---

- (iv) Where signs are scheduled or indicated to be mounted on glass, to provide matching acrylic back plate at reverse-side of glass to conceal mounting materials.
- (v) After installation, soiled sign surfaces shall be cleaned and protected from damage.

1.7 During the Contractor's drawings preparation phase, the Contractor shall provide full size mock-up samples of each type as required for inspection and subsequent approval by the S.O.

2. Copper Plating

- 2.1 Surface preparation of the copper plate is to be done before plating process. Cleaning process should include, degreasing, spray washing, immersion washing, stripping and or coating removal. Copper plate is to be pre-treated to receive plating treatment. Thickness of copper plating is to be of minimum 3-5 µm. All copper plating should be a thick film coating with excellent levelling to cover all surface irregularities to improve the general aesthetics.
- 2.2 Where grainy texture is required, the copper plate should be allowed to run in copper sulphate bath or copper cyanide based solution bath for a longer period.

3. Aluminium

- 3.1 Aluminium sign panels shall be preferably supported by extruded aluminium extrusions for both internal and external signs complying with the requirements of MS 2289: Aluminium and Aluminium Alloy - Extruded Shapes.
- 3.2 Aluminium sheets where otherwise stated for construction shall be of minimum 3 mm thick with welded angles for support. The sub-contractor is to ensure that no tin-canning or deflection effect on the sign-face. Where tin-canning effect appears on the sign face, the nominated sub-contractor is to remove and replace the sign panel.
- 3.3 Aluminium sheets used shall comply with the requirements of MS 2040: Aluminium and Aluminium Alloys - Sheets and Coiled Sheets - Specification. The alloy selected will be of a temper suitable for cutting.
- 3.4 Where signs required more than one standard size aluminium panel, the jointing shall be performed in accordance to BS 1473 by using rivets or screws with welded angles to the main panels. The joint shall than be fine sand, smoothen to be flushed to be seen as one and no butt-line joint, division or separation is to be seen.
- 3.5 All aluminium sections shall be fabricated from aluminium alloy B6063-T5 complying with the requirements of MS 2289: Aluminium and Aluminium Alloy-Extruded Shapes.
- 3.6 The aluminium shall be electronically anodized in matte finish for etched aluminium required for the fire door sign.

4. Paint Finish

Unless otherwise specified, all painting works shall be carried out as specified in SECTION O: PAINTING WORKS.

 <p>JKR MALAYSIA</p>	<p>SECTION T : SIGNAGE WORKS</p>	<p>No. Dokumen : JKR 20800-0183-14 No. Keluaran : 01 No. Pindaan : 00 Tarikh : 29 Januari 2014 Muka Surat : T/3</p>
--	---	---

5. Screen Printing Works

- 5.1 Applications of screen-printing works shall be in accordance to the Specification Drawings. The Contractor shall ensure high accuracy in registration and workmanship.
- 5.2 Silkscreen ink shall be of two (2) pack-serical poly-screen with Ultra Violet protective agents against colour fading. All finished screen printed text or graphics shall be coated with a layer of 2-pack polyurethane clear coat matte finish.

6. Vinyl Graphic Stickers

- 6.1 Unless otherwise specified in the Drawings and Specifications, vinyl graphic stickers shall be used as recommended by the manufacturer and approved by the S.O.
- 6.2 Unless otherwise specified in the Drawings, all illuminated graphics shall be of translucent graphic films and non-illuminated signs shall be translucent opaque graphic films as approved by the S.O.
- 6.3 All vinyl graphics shall be precision cut by computers with no jagged edge. Minimum performance of vinyl stickers shall be to the approval of the S.O.

7. Stainless Steel

- 7.1 Stainless steel shall be austenitic, non-magnetic, using grade 304 or 316 to BS EN 10088 and BS 1449 Part 2 for plate, sheet and strip and BS 970 where relevant. Stainless steel plate and component with hairline finish for all internal signs shall be of grade 304 4B.
- 7.2 Stainless steel plate and component for all external signs shall be of marine grade 316 with alloy addition of molybdenum to prevent specific forms of corrosion.
- 7.3 Stainless steel fasteners, bolts, screws, bolts, washers and other fixing components shall be of Grade A2 or Grade A4 to BS EN ISO 3506.

8. Acrylic

- 8.1 Acrylic used for the external signage shall be of high impact acrylic. Extruded acrylic shall not be acceptable. The Contractor shall comply with the required thickness of the acrylic as shown on the Drawings.

9. Installation And Fixing Works

- 9.1 The Contractor shall submit a works programme and method statements for the installation of all internal and external signs. The Contractor is to include in their method statement on safety processes, measures to be taken and procedures while erecting the external signs.
- 9.2 Unless otherwise shown on the Drawings, all base plates for external signs shall be galvanized steel plates with drawings and calculation certified by P.E.

 <p>JKR MALAYSIA</p>	<p>SECTION T : SIGNAGE WORKS</p>	<p>No. Dokumen : JKR 20800-0183-14 No. Keluaran : 01 No. Pindaan : 00 Tarikh : 29 Januari 2014 Muka Surat : T/4</p>
--	---	---

10. Labeling For Registration Of Immoveable Asset Components

- 10.1 The code and format for labelling of components shall be as stipulated in the Government's:
- (i) Immoveable Asset Code System (Sistem Kod Aset Tak Alih – SKATA); and
 - (ii) Immoveable Asset Data Collection Guidelines (Garis Panduan Pengumpulan Data Aset Tak Alih – PeDATA).
- 10.2 All labels for the registration of the asset components shall comply with the regulatory requirements currently enforced and shall comply with the relevant International and/or Malaysian Standards.
- 10.3 Labels for the assets must be durable and withstand exposure to extreme conditions such as chemicals, temperature, weather, oils and detergents. The labels must also be able to withstand the rigour of cleaning schedule, maintenance and repairs.
- 10.4 Unless otherwise stated in the Drawings, minimum requirements for asset component labels shall be as follows:
- (i) Normal Condition – vinyl stickers.
 - (ii) Extreme Condition - steel / aluminium plate.
- 10.5 Asset component labels shall be affixed to the asset in a position that is easily accessible for readability while the asset is in normal operating position (Refer to PeDATA).
- 10.6 Labels shall be located on clean, smooth, flat surfaces where possible, and on surfaces that provide direct visual access to a label scanner and its operator.

Ringkasan Tender

SECTION H

Majlis Perbadaran Batu Pahat

**Kerja-Kerja Menurap Semula Jalan Dengan `Premix' Dan Menyelenggara Longkang
Lorong Belakang Di Taman Putera Indah Serta Kerja-Kerja Berkaitan.**

FINAL SUMMARY

BIL	DESCRIPTIONS	FROM PAGES NO	AMOUNT (RM)
1	KERJA AWALAN DAN KERJA-KERJA MENURAP DAN MENYELENGGARA LONGKANG		
	JUMLAH		

.....
(Signature of Tendered)

Name :

Designation :

Address :

.....

.....

Date :

.....
(Signature of Witness)

Name :

:

Address :

.....

.....

Date :

Senarai Kuantiti

SECTION J

Majlis Perbadaran Batu Pahat

Preambles To Daywork Rate

SECTION J

Majlis Perbadaran Batu Pahat

PREAMBLES TO DAYWORK RATES

1. Daywork rates or prices shall only be used for payment for works executed on a Daywork basis pursuant to Clause 25.2 of the Conditions of Contract. No work shall be carried out on a Daywork basis except when ordered in writing by the Superintending Officer.

2. The Contractor/Tenderer shall insert the Dayworks Rates/Prices for labour and plant as listed in the schedules/tables appearing hereinafter. However, such Dayworks Rates/Prices inserted by the Contractor/Tenderer shall be subjected to the agreement of the Superintending Officer as to the reasonableness and shall before the signing of the Contract be adjusted as the Superintending Officer may reasonable require. He may also be required to justify the Daywork Rates/Prices tendered by him requested by the Superintending Officer.

3. The rates entered for labour shall be deemed to include all on-costs associated with the employment of such labour including (inter alia), head office charges, overhead charges, profit, site supervision and staff, insurances, wages, travelling time and expanses, subsistence allowances, time lost due to inclement weather, bonus, holiday and sick pay, and any other employee's fringe benefit(s), small tools and consumable stores, temporary tracks, ladders, staging scaffolding and all items of a similar nature unless these are provided or set-up exclusively for daywork.

4. The wages of gangers and leading hands working with their gangs shall be paid for at the appropriate rates, but the time of walking gangers, sub-foremen and foremen will not be included and shall be deemed to be included in the rates entered for labour under site supervision and staff.

5. Only time on work actually done will be allowed. A "DAY" is considered to be normal working day 8 hours. Fractions of a day will be paid for "PRO RATA". No allowance shall be made for tea breaks, rest periods, standing/idling or travelling time whether on or off the Site.

6. Payment for overtime work, if chargeable and approved by the S.O. shall be made at the rates entered herein, but the times so worked as overtime shall be adjusted in the same proportion as that used for paying the normal workmen on the Site and approved by the S.O. Thus if a man works 1 hour overtime for which the rate payable is double time, payment shall be made for 2 hours at the rate entered in the Daywork Schedule.

Notes: Overtime is working time over and above 8 hours per working day including Saturday or 48 hours a week.

The cost of special watching and lighting necessitated by daywork shall be included in the rates.

7. As a condition precedent to any right to any payment, the Contractor shall produce for verification to the Superintending Officer, vouchers, receipts and wages books specifying the time and labour and plant employed and materials used as per clause 25.2 of the Conditions of Contract.
8. The Daywork Rates/Prices for plant shall apply to all plant irrespective whether the plant is hired or owned by the Contractor. The rates/prices shall cover all the contractor's obligations whatsoever in providing and maintaining such plant at the place of work including fuel, lubricants and other consumable spares, overhauls repairs, maintenance and replacement, all auxiliary/ancillary equipment necessary for efficient operation and use of the plant, overhead charges and profit but excluding operator/driver and attendant (who shall be paid separately as labour).
9. Payment for mechanically operated plant shall be made only at such times as the plant is engaged in daywork and shall exclude all standing, idle or down time.
10. If any workmen or items of plant on daywork do not readily belong to any classification included in the Schedule or inserted by the Contractors at the time of tendering, the S.O. shall determine the equivalent classification to be adopted for such workmen or items of plant, and payment for such will be made accordingly.
11. The daywork rates entered hereunder and agreed by the S.O. shall not be further subjected to the fifteen percent (15%) addition as stipulated in Clause 25.2 of the Conditions of Contract.

DAYWORK RATES/PRICES FOR LABOUR

Note: The Rates entered below shall be inclusive of the fifteen percent (15%) addition as stipulated in Clause 25.2 of the Conditions of Contract

ITEM	DESCRIPTION	RATE PER MAN-DAY (RM)
1	General Labour	
2	Ganger/Chargehand	
3	Concretor	
4	Mason	
5	Carpenter/Joiner	
6	Steel Bar Bender and Fixer	
7	Pneumatic Tool Operator	
8	Welder	
9	Rigger/Driller	
10	Fitter	
11	Pavior/Plasterer	
12	Drainlayer	
13	Lorry Driver	
14	Watchman	
15	Plant/Excavator Operator/Driver	
16	Electrician	
17	Metal Worker	

DAYWORK RATES/PRICES FOR PLANT

Note: The Rates entered below shall be inclusive of the fifteen percent (15%) addition as stipulated in Clause 25.2 of the Conditions of Contract

ITEM	DESCRIPTION	RATE PER HOUR (RM)
1	Backhoe	
2	Dragline	
	RB 19	
	RB22	
	RB30	
3	Excavator	
	Up to 0.5m ³	
	0.5m ³ to 1.0m ³	
	over 1.0m ³	
4	Excavator hydraulic operated	
	Up to 0.5m ³	
	0.5m ³ to 1.0m ³	
	over 1.0m ³	
5	Face Shovel	
	Model 920	
	Model 950	
	Model 966	
6	Back pusher	
7	Vibrating Roller 15 tonne	
8	Compressor	

DAYWORK RATES/PRICES FOR PLANT

Note: The Rates entered below shall be inclusive of the fifteen percent (15%) addition as stipulated in Clause 25.2 of the Conditions of Contract

ITEM	DESCRIPTION	RATE PER HOUR (RM)
9	Bulldozer Model D4 Model D6 Model D8	
10	Tractor	
11	Mobile Crane 3 tonne 16 tonne 25 tonne 35 tonne 40 tonne	
12	Motor Grader	
13	Dumper Up to 1.5m ³ 1.5m ³ to 3.5m ³	
14	Steel Roller 8 tonne 12 tonne	
15	Low Loader	

DAYWORK RATES/PRICES FOR PLANT

Note: The Rates entered below shall be inclusive of the fifteen percent (15%) addition as stipulated in Clause 25.2 of the Conditions of Contract

ITEM	DESCRIPTION	RATE PER HOUR (RM)
16	Lorry 6 tonne 8 tonne 10 tonne	
17	Tipper without road tax 6 tonne 10 tonne	
18	Tipper with road tax 6 tonne 10 tonne Concrete	
19	mixer Concrete mixer 7/5 Concrete mixer 10/7 Concrete mixer 14/10 Concrete mixer 21/14	
20	Water Pump 3" Diameter 6 Diameter 8 Diameter	

DAYWORK RATES/PRICES FOR PLANT

Note: The Rates entered below shall be inclusive of the fifteen percent (15%) addition as stipulated in Clause 25.2 of the Conditions of Contract

ITEM	DESCRIPTION	RATE PER HOUR (RM)
21	Welding and cutting set complete Oxy – acetylene Electric	
22	Drilling machine complete with all necessary equipment.	
23	Others*	

Kerja Awalan

SECTION J

Majlis Perbadaran Batu Pahat

Kerja Pembinaan

SECTION J

Majlis Perbadaran Batu Pahat

**MAJLIS PERBANDARAN BATU PAHAT
JADUAL KADAR HARGA**

**Kerja-Kerja Menurap Semula Jalan Dengan `Premix' Dan Menyelenggara Longkang Lorong
Belakang Di Taman Putera Indah Serta Kerja-Kerja Berkaitan.**

- Catata
- 1) *Pemborong adalah dinasihatkan supaya melawat dan meninjau tapak bina sebelum memasuki tawaran sebutharga. Sebarang butiran yang tidak diperhargakan adalah dianggap telah dimasukkan kedalam butiran lain dan haruslah dilaksanakan.*
 - 2) *Harga adalah termasuk kerja-kerja pengawalan lalulintas semasa pembinaan dijalankan*
 - 3) *Sebarang Item yang tidak dinyatakan dalam jadual kadar harga ini tetapi dikehendaki dalam spesifikasi dan skop kerja, hendaklah dimasukkan ke dalam salah satu butiran dalam jadual kadar harga.*
 - 4) *Pemborong haruslah menghargakan sesuatu sebutharga sepenuhnya mengikut lukisan terperinci atau lampiran yang disediakan dengan merujuk kepada spesifikasi/huraian kerja dalam Jadual Kadar Harga.*
 - 5) **ALL PROVISIONAL QUANTITY**

Bil.	Huraian Kerja	Unit	Kuanti ti	Kadar (RM)	Jumlah (RM)
1.0	<u>KERJA-KERJA PERMULAAN (PRELIMINARIES)</u> Kadar harga bagi kerja-kerja permulaan termasuk pematuhan kepada syarat-syarat sebutharga dan perkara berikut:-				
1.1	<u>Bon Perlaksanaan</u> Bon Perlaksanaan 5% daripada harga kontrak RM200,000.00 ke atas. (Sekiranya pihak kontraktor tidak memilih bon perlaksanaan, Kontraktor telah dianggap telah memilih Wang Jaminan Perlaksanaan 5% yang akan dipotong daripada harga kontrak)	L/Sum	-	-	-
1.2	<u>Insuran</u> 1.2.1 Polisi insuran Pekerja (Workmens Compensation-WL) 1.2.2 Polisi Insuran Semua Risiko (CAR) ATAU (Polisi Insuran Tanggungan Awam (P.L) dan Insuran Kerja (WL) (Takaful Malaysia Insist Amilat)	L/Sum	-	6,000.00	6,000.00
1.3	<u>Laporan Kemajuan & Gambar Projek</u> Penyediaan Laporan perlaksanaan kerja dan gambar foto kedudukan kerja-kerja sebelum, semasa dan selepas dilaksanakan dengan menggunakan kamera jenis digital dalam bentuk Hard Copy dan Soft Copy (PEN DRIVE).	L/Sum	-	500.00	500.00
JUMLAH DI BAWA KE HADAPAN (C/F)					6,500.00

Bil.	Huraian Kerja	Unit	Kuanti	Kadar (RM)	Jumlah (RM)
JUMLAH DI BAWA DARI BELAKANG (B/F)					6,500.00
1.4	<u>Peralatan Keselamatan</u> Kerja-kerja menyediakan peralatan keselamatan seperti kon, papan tanda, pengawal bendera, lampu pada waktu malam dan lain-lain peralatan yang difikirkan perlu oleh pihak kontraktor dalam tempoh kerja dijalankan	L/Sum	-	3,000.00	3,000.00
1.5	<u>Papan Tanda</u> Menyediakan Papan Tanda Projek sebagaimana Standard Spesifikasi Majlis Perbandaran Batu Pahat.	L/Sum	-	500.00	500.00
JUMLAH DI BAWA KE HADAPAN (C/F)					10,000.00

Bil.	Huraian Kerja	Unit	Kuanti ti	Kadar (RM)	Jumlah (RM)																																																																												
JUMLAH DI BAWA DARI BELAKANG (B/F)					10,000.00																																																																												
2.0	<u>KERJA-KERJA PEMBINAAN JALAN</u>																																																																																
	2.1 Mengadakan tenaga kerja/jentera bagi kerja-kerja pembersihan tapak sebelum dan selepas kerja-kerja premix dijalankan serta kerja-kerja lain yang berkaitan dengannya.	m ²	10620																																																																														
	2.2 Kerja-kerja membekal dan menyembur "Bituminous tack Coat" pada kadar 0.44 liter/M2.	m ²	76144																																																																														
	2.3 Kerja-kerja membekal, menghampar dan melapis "Asphaltic Concrete Wearing Course" (ACWC 10) dengan ketebalan mampat 40mm menggunakan 1 ton "Vibrating roller"	m ²	5500																																																																														
	2.4 Kerja-kerja membekal, menghampar dan melapis "Asphaltic Concrete Wearing Course" (ACWC 14) dengan ketebalan mampat 50mm menggunakan 8 ton "Vibrating roller" dan "Pneumatic tyre roller".																																																																																
	Jalan-Jalan adalah sebagaimana senarai di bawah:-																																																																																
	<table border="1"> <thead> <tr> <th>No</th> <th>Nama Jalan</th> <th>(m)</th> <th>Lebar(m)</th> </tr> </thead> <tbody> <tr><td>1</td><td>J PUTERA INDAH 2/5</td><td>450</td><td>7.5</td></tr> <tr><td>2</td><td>J PUTERA INDAH 2/6</td><td>450</td><td>7.5</td></tr> <tr><td>3</td><td>J PUTERA INDAH 2/5 B</td><td>800</td><td>7.5</td></tr> <tr><td>4</td><td>J PUTERA INDAH 2/5 C</td><td>89</td><td>7.5</td></tr> <tr><td>5</td><td>J PUTERA INDAH 2/5 D</td><td>97</td><td>7.5</td></tr> <tr><td>6</td><td>J PUTERA INDAH 2/5 E</td><td>95</td><td>7.0</td></tr> <tr><td>7</td><td>J PUTERA INDAH 2/5 F</td><td>93</td><td>7.0</td></tr> <tr><td>8</td><td>J PUTERA INDAH 8/1</td><td>1,031</td><td>7.5</td></tr> <tr><td>9</td><td>J PUTERA INDAH 8/1A</td><td>338</td><td>7.5</td></tr> <tr><td>10</td><td>J PUTERA INDAH 8/1B</td><td>419</td><td>7.5</td></tr> <tr><td>11</td><td>J PUTERA INDAH 8/1C</td><td>430</td><td>7.5</td></tr> <tr><td>12</td><td>J PUTERA INDAH 8/1D</td><td>474</td><td>7.5</td></tr> <tr><td>13</td><td>J PUTERA INDAH 8/2</td><td>637</td><td>7.5</td></tr> <tr><td>14</td><td>J PUTERA INDAH 8/3</td><td>545</td><td>7.5</td></tr> <tr><td>15</td><td>J PUTERA INDAH 8/4</td><td>160</td><td>7.5</td></tr> <tr><td>16</td><td>J PUTERA INDAH 8/5</td><td>183</td><td>7.5</td></tr> <tr><td>17</td><td>J PUTERA INDAH 8/6</td><td>130</td><td>7.5</td></tr> <tr><td>18</td><td>J PUTERA INDAH 8/7</td><td>221</td><td>7.5</td></tr> </tbody> </table>	No	Nama Jalan	(m)	Lebar(m)	1	J PUTERA INDAH 2/5	450	7.5	2	J PUTERA INDAH 2/6	450	7.5	3	J PUTERA INDAH 2/5 B	800	7.5	4	J PUTERA INDAH 2/5 C	89	7.5	5	J PUTERA INDAH 2/5 D	97	7.5	6	J PUTERA INDAH 2/5 E	95	7.0	7	J PUTERA INDAH 2/5 F	93	7.0	8	J PUTERA INDAH 8/1	1,031	7.5	9	J PUTERA INDAH 8/1A	338	7.5	10	J PUTERA INDAH 8/1B	419	7.5	11	J PUTERA INDAH 8/1C	430	7.5	12	J PUTERA INDAH 8/1D	474	7.5	13	J PUTERA INDAH 8/2	637	7.5	14	J PUTERA INDAH 8/3	545	7.5	15	J PUTERA INDAH 8/4	160	7.5	16	J PUTERA INDAH 8/5	183	7.5	17	J PUTERA INDAH 8/6	130	7.5	18	J PUTERA INDAH 8/7	221	7.5				
No	Nama Jalan	(m)	Lebar(m)																																																																														
1	J PUTERA INDAH 2/5	450	7.5																																																																														
2	J PUTERA INDAH 2/6	450	7.5																																																																														
3	J PUTERA INDAH 2/5 B	800	7.5																																																																														
4	J PUTERA INDAH 2/5 C	89	7.5																																																																														
5	J PUTERA INDAH 2/5 D	97	7.5																																																																														
6	J PUTERA INDAH 2/5 E	95	7.0																																																																														
7	J PUTERA INDAH 2/5 F	93	7.0																																																																														
8	J PUTERA INDAH 8/1	1,031	7.5																																																																														
9	J PUTERA INDAH 8/1A	338	7.5																																																																														
10	J PUTERA INDAH 8/1B	419	7.5																																																																														
11	J PUTERA INDAH 8/1C	430	7.5																																																																														
12	J PUTERA INDAH 8/1D	474	7.5																																																																														
13	J PUTERA INDAH 8/2	637	7.5																																																																														
14	J PUTERA INDAH 8/3	545	7.5																																																																														
15	J PUTERA INDAH 8/4	160	7.5																																																																														
16	J PUTERA INDAH 8/5	183	7.5																																																																														
17	J PUTERA INDAH 8/6	130	7.5																																																																														
18	J PUTERA INDAH 8/7	221	7.5																																																																														
JUMLAH DI BAWA KE HADAPAN (C/F)																																																																																	

Bil.	Huraian Kerja	Unit	Kuanti ti	Kadar (RM)	Jumlah (RM)
JUMLAH DI BAWA DARI BELAKANG (B/F)					
19	J PUTERA INDAH 8/8	216	7.5		
20	J PUTERA INDAH 12/1	203	7.0		
21	J PUTERA INDAH 12/2	230	7.0		
22	J PUTERA INDAH 12/9	296	7.0		
23	LB ANTARA J PUTERA INDAH 2/4B & 2/4C	168	5.0		
24	LB ANTARA J PUTERA INDAH 2/4C & 2/4D	166	5.0		
25	LB ANTARA J PUTERA INDAH 2/4D & 2/4E	166	5.0		
26	LB ANTARA J PUTERA INDAH 2/4E & 2/4F	166	5.0		
27	LB ANTARA J PUTERA INDAH 2/4F & 2/4G	165	5.0		
28	LB ANTARA J PUTERA INDAH 2/5B & 2/5C	87	5.0		
29	LB ANTARA J PUTERA INDAH 2/5C & 2/5D	87	5.0		
30	LB ANTARA J PUTERA INDAH 2/5D & 2/5E	85	5.0		
31	LB ANTARA J PUTERA INDAH 2/5F & 2/5G	84	5.0		
32	LB ANTARA J PUTERA INDAH 2/5G & 2/5H	83	5.0		
33	LB ANTARA J PUTERA INDAH 2/5H & 2/5J	165	5.0		
34	LB J PUTERA INDAH 1/6B	185	5.0		
35	LB ANTARA J PUTERA INDAH 1/6B & 1/6C	184	5.0		
36	LB ANTARA J PUTERA INDAH 1/6E & 1/6A	68	5.0		
37	LB ANTARA J PUTERA INDAH 1/6D & 1/6E	63	5.0		
38	LB J PUTERA INDAH 1/7A	166	5.0		
39	LB J PUTERA INDAH 1	105	5.0		
40	LB ANTARA J PUTERA INDAH 1/5 & 1/6	157	5.0		
41	LB ANTARA J PUTERA INDAH 1/4 & 1/5	158	5.0		
42	LB ANTARA J PUTERA INDAH 1/2 & 1/3	166	5.0		
43	LB ANTARA J PUTERA INDAH 1/3A & 1/2	166	5.0		
Jumlah Keluasan Jalan			m ²	70644	
JUMLAH DI BAWA KE HADAPAN (C/F)					

Bil.	Huraian Kerja	Unit	Kuantiti	Kadar (RM)	Jumlah (RM)
JUMLAH DI BAWA DARI BELAKANG (B/F)					
3.0	<u>GARISAN JALAN</u> Kerja-kerja membuat garisan jalan menggunakan "Hot Applied Thermoplastic with (10%) Glass Bead" berwarna putih/kuning dengan ketebalan 3mm dan lebar 100mm hingga 150mm.				
3.1	Garisan Tanda Berhenti (Warna Putih) 300mm lebar <i>(Sebagaimana Keterangan gambar dilampirkan)</i>	No	44		
3.2	Garisan Tengah Jalan (Warna Putih) 100mm lebar <i>(Sebagaimana Keterangan gambar dilampirkan)</i>	m	3794		
4.0	<u>PERABUT JALAN</u> Kerja-kerja membekal dan memasang papan tanda di simpang jalan dengan menggunakan 'HIP Reflective Sticker ' (JKR ATJ 2E/87 (Pindaan 2011) JKR 21300-0033-12) lain-lain kerja yang berkaitan dengannya.				
4.1	Papan Tanda Berhenti, saiz tiang 1800mm tinggi x 75mm diameter jenis 'Galvanised' di tampal 'HIP Reflective Sticker' hitam dan putih, di tanam pada kedalaman 450mm x 300mm x 300mm. <i>(Sebagaimana Keterangan gambar dilampirkan)</i>	Nos	44		
4.2	Papan Tanda Nama Jalan, saiz tiang 2400mm tinggi x 75mm diameter jenis ' Galvanised' di tanam pada kedalaman 450mm x 300mm x300mm. <i>(Sebagaimana Keterangan gambar dilampirkan)</i>	Nos	44		
JUMLAH DI BAWA KE HADAPAN (C/F)					

Bil.	Huraian Kerja	Unit	Kuanti ti	Kadar (RM)	Jumlah (RM)
JUMLAH DI BAWA DARI BELAKANG (B/F)					
5.0	<u>HUMP</u>				
	5.1 Kerja-Kerja membekal dan memasang serta Papan Tanda Sementara (G.I. Sheet, Aluminium Composite Panel) Serta Kerja-kerja Membuka semula Setelah Kerja-Kerja Pembinaan dan Mengecat Garisan Hump Siap Dijalankan (Sebagaimana Keterangan gambar dilampirkan)				
	i. Papan Tanda Berukuran 900mmx500mm ('AWAS')	Nos	30		
	ii. Papan Tanda Berukuran 900mmx500mm ('AWAS Kerja -kerja Pembinaan Hump Sedang Dijalankan')	Nos	30		
	iii. Garisan Cat 'Roadline Non Reflective White' Sementara (75mm lebar x 20m per hump)	m	300		
	iv. Kon Reflector	Nos	30		
	5.2 Kerja-kerja membekal tenaga kerja, bahan-bahan dan jentera untuk kerja-kerja membina hump berukuran lebar $\geq 1500\text{mm}$ - 2500mm tinggi $\pm 100\text{mm}$ (mengikut seperti pelan dilampirkan) kerja-kerja termasuk dengan membekal dan memasang 2 papan tanda , kerja-kerja mengecat hump dan traverse bar (10 Nos) dengan menggunakan hot applied Thermoplastic with (10%) Glass Bead serta membekal dan memasang 6 Nos 'Road Stud' serta lain-lain kerja berkaitan. (Sebagaimana Keterangan gambar dilampirkan)	Nos	15		
6.0	<u>UJIAN SAMPEL PREMIX</u>				
	Kerja-kerja untuk membuat ujian-ujian ke atas sampel-sampel Premix' sebagaimana di dalam penentuan kerja.				
	6.1 Ujian 'Core Sampel'				
	i. Ujian ketebalan 'Premix' (Coring test)	Nos	140		
	ii. Compaction Test	Nos	60		
	6.2 Ujian 'Loose Sampel'				
	i. Sieve Analsis	Set	20		
	ii. Bitumen Content	Set	20		
JUMLAH DI BAWA KE HADAPAN (C/F)					

Bil.	Huraian Kerja	Unit	Kuantiti	Kadar (RM)	Jumlah (RM)
JUMLAH DI BAWA DARI BELAKANG (B/F)					
7.0	<u>LAIN -LAIN KERJA BERKAITAN</u>				
	7.1 Mengadakan tenaga kerja, jentera untuk kerja-kerja mengorek /membuang longkang dan tembok sediada ke tempat buangan sendiri.	m	1466		
	7.2 Kerja-kerja membekal / memasang ' P.C Drain U-Shape ' saiz 450mm x 450mm approve by SIRIM . Kadar harga adalah meliputi kerja-kerja tanah, 250mm tebal 'Crusher Run', 'Sand back filling' termasuk , 'joining with cement mortar' dan lain-lain kerja yang berkaitan dengannya.	m	1466		
	7.3 Kerja-kerja membekal/memasang 'approved precast box culvert 600mm x 600mm Approve by SIRIM . Kadar harga adalah meliputi kerja-kerja tanah (back filling) 50mm thick beam conc. 100 mm dia. X 16.0 meter bakau pile at 300mm c/c, 230 thick bricks headwall, joining with cement mortar, thick bricks headwall,dan konkrit permukaan 3" yang di potong berserta BRCA6 dan premix semula permukaan jalan yang dipotong bagi kerja yang berkaitan dengannya.	m	66		
	7.4 Kerja-kerja membekal/memasang 'approved precast box culvert 750mm x 750mm Approve by SIRIM . Kadar harga adalah meliputi kerja-kerja tanah (back filling) 50mm thick beam conc. 100 mm dia. X 16.0 meter bakau pile at 300mm c/c, 230 thick bricks headwall, joining with cement mortar, thick bricks headwall,dan konkrit permukaan 3" yang di potong berserta BRCA6 dan premix semula permukaan jalan yang dipotong bagi kerja yang berkaitan dengannya.	m	20		
	7.5 Kerja-kerja membekal, merata dan memampatkan lapisan crusher-run untuk diisi diruang kosong di kiri dan kanan longkang serta kerja-kerja meratakan dan menambak bahu jalan dan kerja-kerja yang berkaitan dengannya.	m3	226		
JUMLAH DI BAWA KE HADAPAN (C/F)					

Bil.	Huraian Kerja	Unit	Kuanti	Kadar (RM)	Jumlah (RM)
JUMLAH DI BAWA DARI BELAKANG (B/F)					
	7.6 Kerja-kerja membina tembok penahan dari jenis batu bata ikat 9" purata ketinggian 450mm tinggi, palang penguat jika perlu serta kerja-kerja kemas dan kerja-kerja lain yang berkaitan dengannya	m2	660		
	7.6 kerja-kerja Memecahkan dan membina semula crossing slab bagi laluan keluar masuk sebagaimana asal serta kerja-kerja lain yang berkaitan dengannya saiz 1500mmx600mmx75mm	nos	126		
	7.7 Kerja-kerja membina sump saiz 2 x 2 x 2 dengan menggunakan batu bata 9" serta kemas dan kerja-kerja lain yang berkaitan	nos	24		
KOS KESELURUHAN PROJEK					



NOT TO SCALE

TAJUK KERJA:

TAJUK LUKISAN:

PELAN TERPERINCI
PEMBINAAN BONGGOL

NO LUKISAN:



MAJLIS PERBANDARAN BATUPAHAT

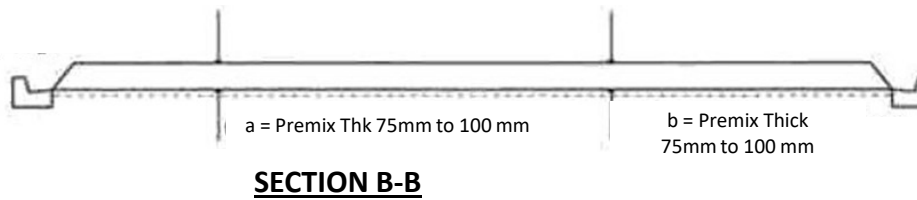
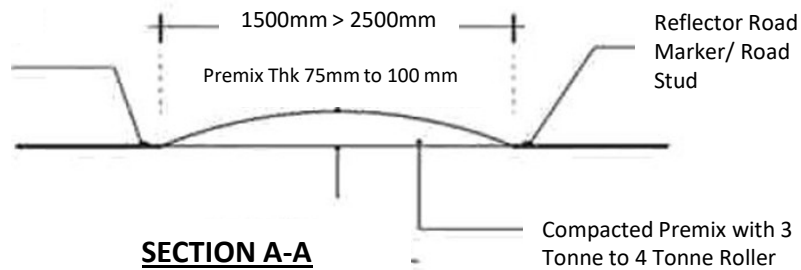
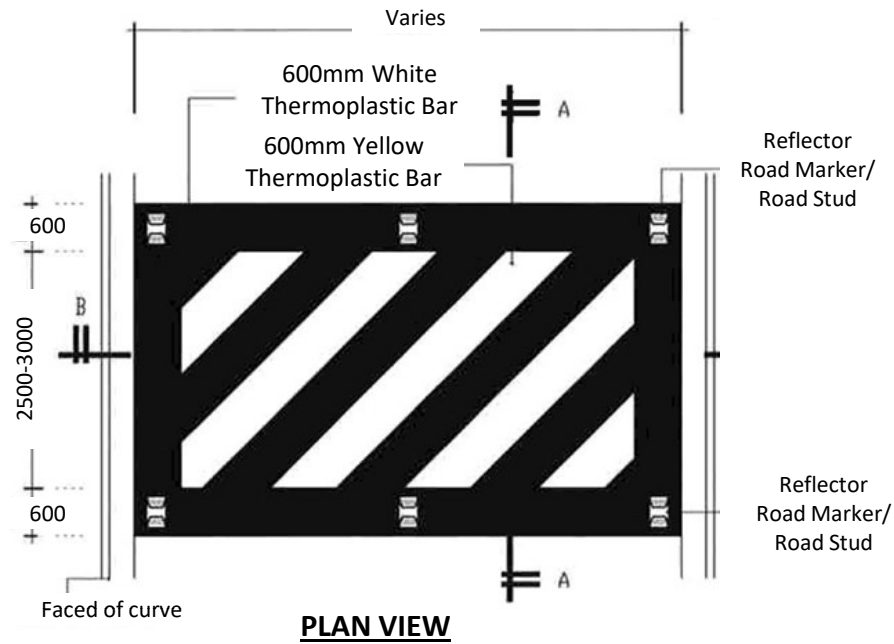

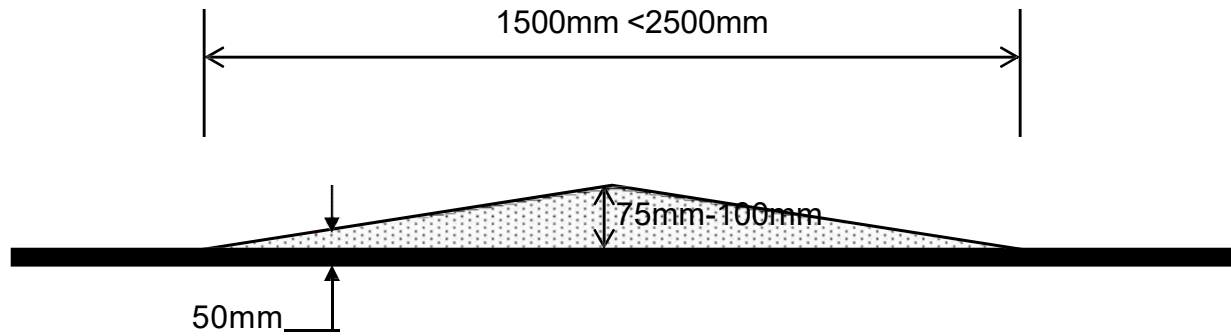

TAJUK KERJA:

TAJUK LUKISAN:
PELAN TERPERINCI
BONGGOL

NO LUKISAN:



MAJLIS PERBANDARAN BATUPAHAT

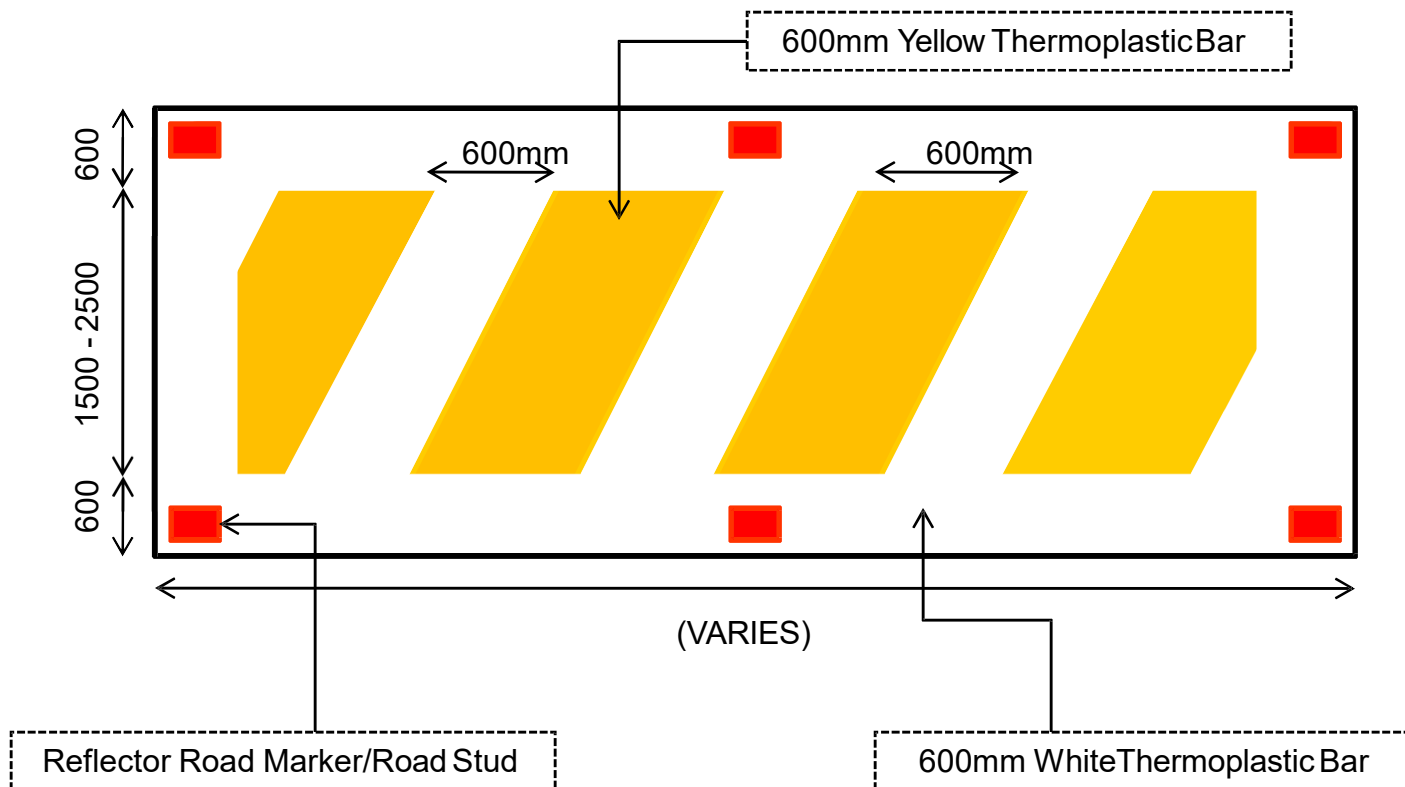



NOT TO SCALE

TAJUK KERJA:

TAJUK LUKISAN:
PELAN TERPERINCI
PAPAN TANDA
PAPAN BERHENTI

NO LUKISAN:



MAJLIS PERBANDARAN BATUPAHAT

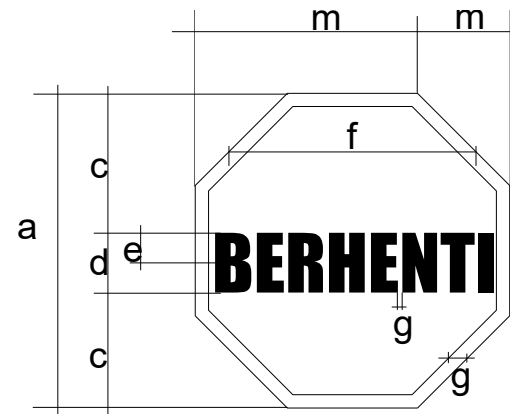

SIGN	DIMENSIONS (mm)									
	a	b	c	d	e	f	g	h	i	m
MINIMUM	600	16	200	200	100	510	20	10	248	176
OTHER SIZE	900	24	300	300	150	765	30	15	732	264

WARNA:
LATARBELAKANG - MERAH
BORDER - PUTIH
TULISAN -PUTIH

**STICKER : HIGH INTENSITY PRISMATIC SHEETING (HIP) –
JKR ATJ 2E/87(PINDAAN 2011) JKR 21300-0033-12**

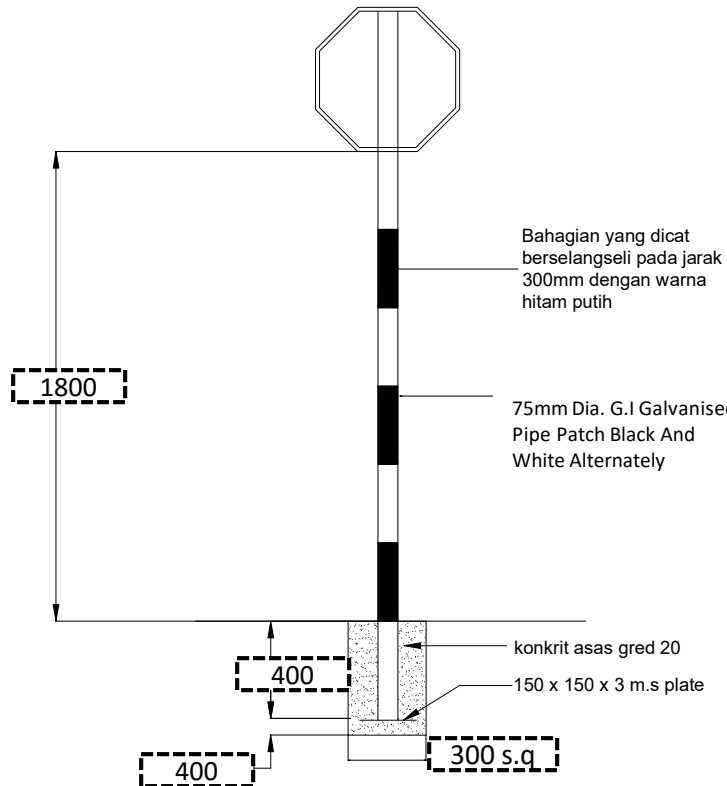

PELAN TERPERINCI PAPAN TANDA BERHENTI



NOT TO SCALE

TAJUK KERJA:

TAJUK LUKISAN:

PELAN TERPERINCI
PAPAN TANDA
'NO ENTRY'

NO LUKISAN:



MAJLIS PERBANDARAN BATUPAHAT

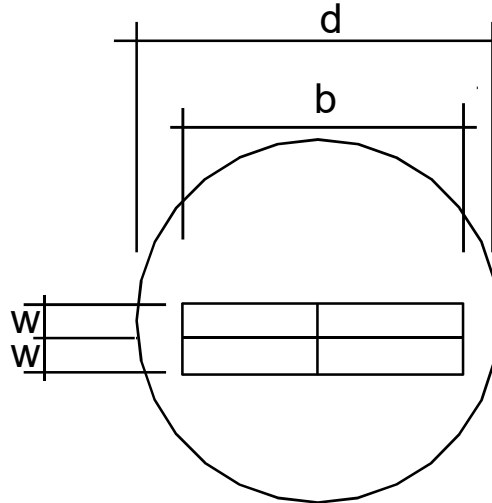

SIGN	DIMENSIONS (mm)		
	d	b	w
MINIMUM	600	400	50
NORMAL	750	500	62.5

WARNA:
LATARBELAKANG - MERAH
SIMBOL - PUTIH

STICKER : HIGH INTENSITY PRISMATIC SHEETING (HIP) –
JKR ATJ 2E/87(PINDAAN 2011) JKR 21300-0033-12

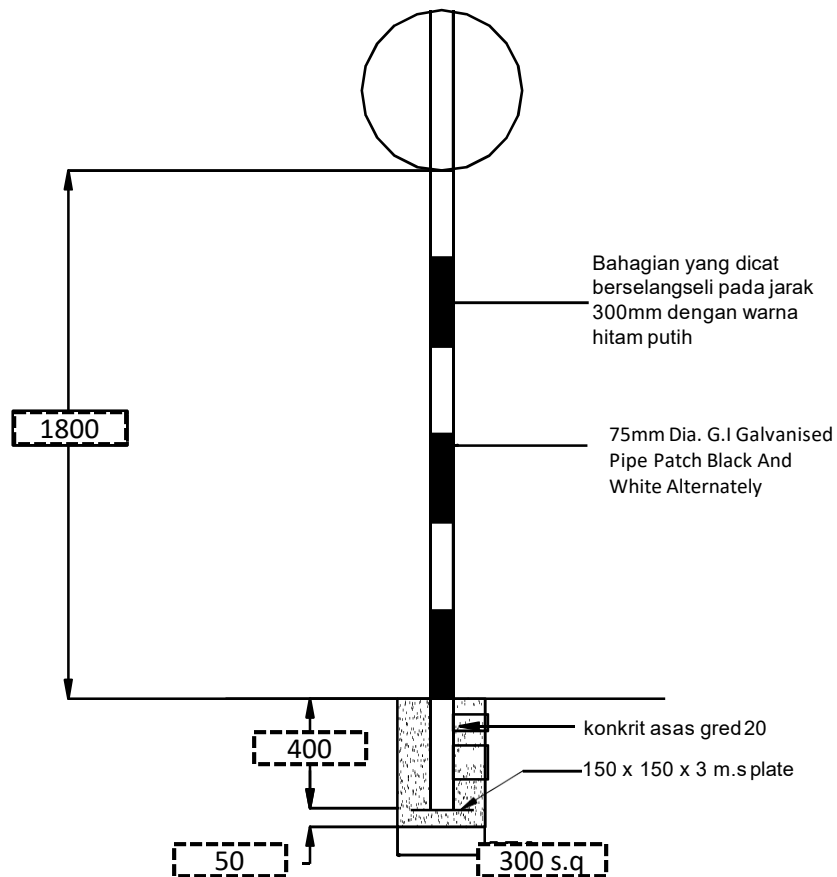

PELAN TERPERINCI PAPAN TANDA 'NO ENTRY'

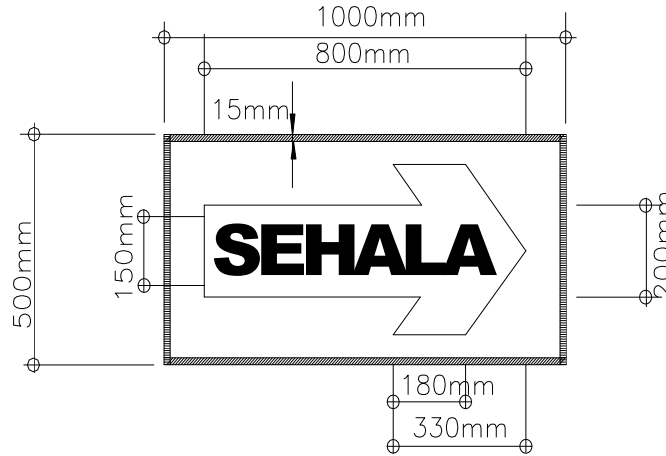
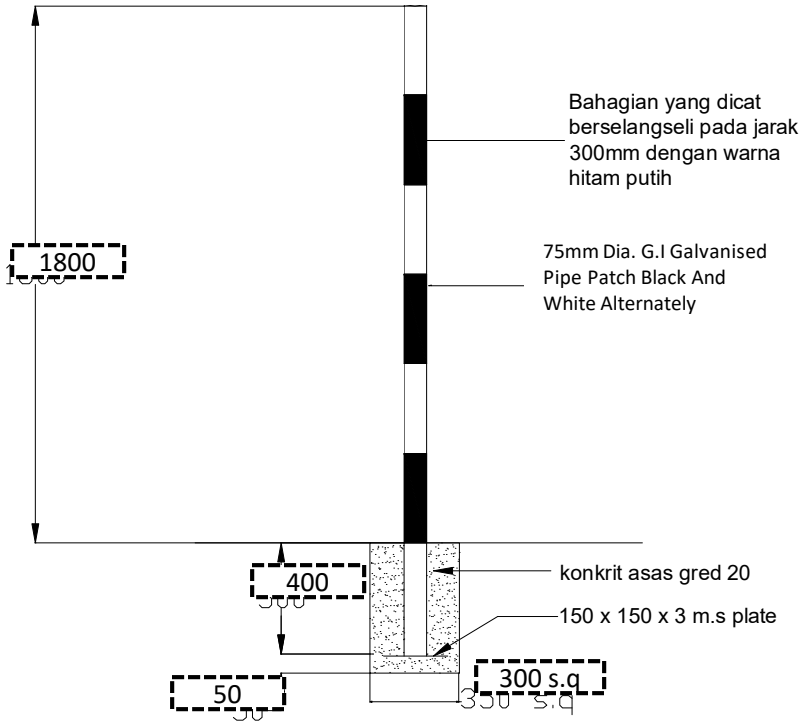

NOT TO SCALE

TAJUK KERJA:

TAJUK LUKISAN:
PELAN TERPERINCI
PAPAN TANDA
SEHALA

NO LUKISAN:

PELAN TERPERINCI PAPAN TANDA SEHALA



MAJLIS PERBANDARAN BATUPAHAT

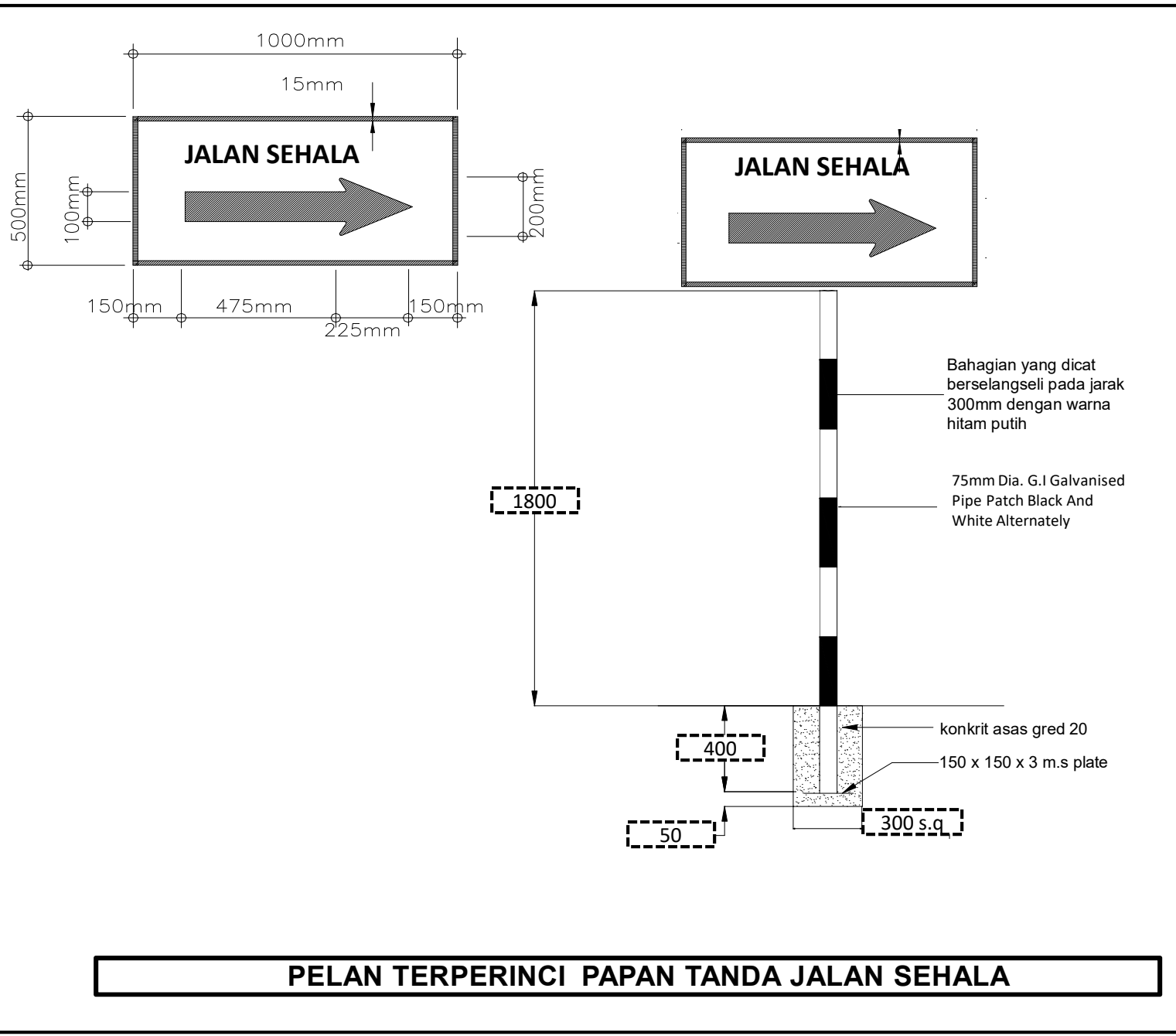

 NOT TO SCALE

TAJUK KERJA:

TAJUK LUKISAN:
 PELAN TERPERINCI
 PAPAN TANDA
 SEHALA

NO LUKISAN:





NOT TO SCALE

TAJUK KERJA:

TAJUK LUKISAN:
PELAN TERPERINCI
PAPAN TANDA
LAMPU ISYARAT

NO LUKISAN:



MAJLIS PERBANDARAN BATUPAHAT

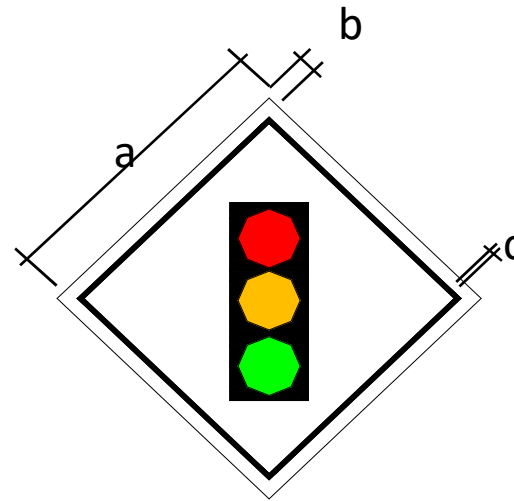

SIGN	DIMENSIONS (mm)		
	a	b	c
MINIMUM	400	10	10
NORMAL	600	10	15
OTHER SIZES	750	15	20
	900	15	25

STICKER : HIGH INTENSITY PRISMATIC SHEETING (HIP) –
JKR ATJ 2E/87(PINDAAN 2011) JKR 21300-0033-12

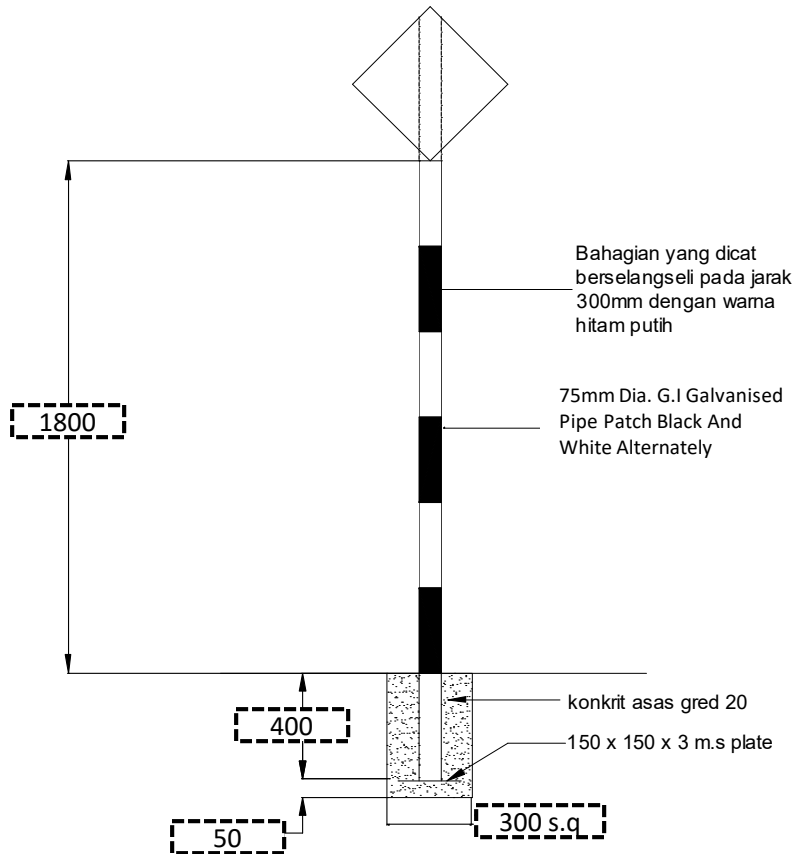

PELAN TERPERINCI PAPAN TANDA LAMPU ISYARAT

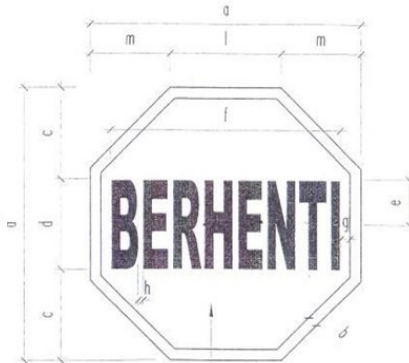

STOP AT INTERSECTION
 USED IN CASE WHERE A DRIVER SHALL STOP BEFORE ENTERING A PRIORITY OR MAJOR ROAD

SIGN	DIMENSION (MILLIMETERS)									
	a	b	c	d	e	f	g	h	i	m
MINIMUM	600	16	200	200	100	510	20	10	248	176

COLOR
 BACKGROUND – RED
 BORDER – WHITE
 LETTERING – WHITE

10 S.W.G SIC 14 Sign Face of Aluminium Alloy With Adhesive Materials
 a) Background – Reflective Red
 b) Lettering – Reflective White

75mm Dia. G.I Galvanised Pipe Patch Black And White Alternately

Existing Ground Level

300mm X 300mm X 450mm Depth Grade 20 Concrete Footing

100mmX100mmX3mm THK MS Plate Welded To Post

FRONT ELEVATION

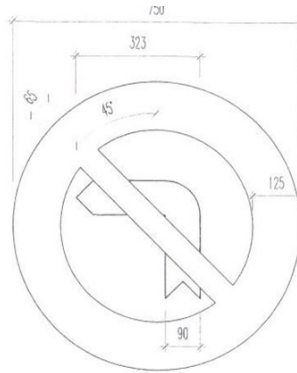

NO LEFT TURN
COLOR
 CIRCLE AND DIAGONAL - RED
 SYMBOL – WHITE
 BACKGROUND – WHITE

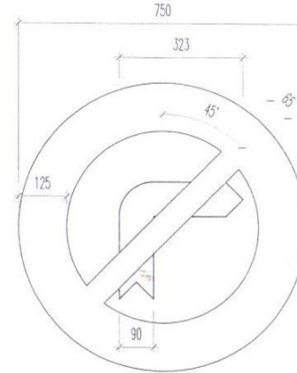

NO RIGHT TURN
COLOR
 CIRCLE AND DIAGONAL - RED
 SYMBOL – WHITE
 BACKGROUND – WHITE

STICKER : HIGH INTENSITY PRISMATIC SHEETING (HIP) –
JKR ATJ 2E/87(PINDAAN 2011) JKR 21300-0033-12

PELAN TERPERINCI PAPAN TANDA



 NOT TO SCALE

TAJUK KERJA:

TAJUK LUKISAN:
 PELAN TERPERINCI
 PAPAN TANDA

NO LUKISAN:

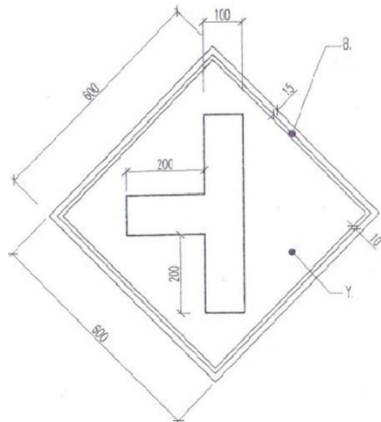



ROAD JUNCTION ON THE LEFT

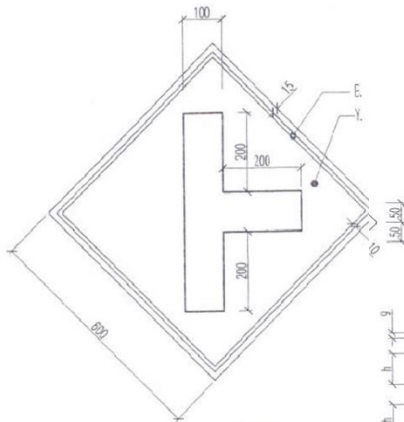

ROAD JUNCTION ON THE RIGHT

LEGEND (FOR ROD JUNCTION ON LEFT & RIGHT)

DIMENSIONS (Millimetres).																					
a	b	c	d	e	f	g	h	j	k	l	m	n	p	q	r	s	t	u	v	w	x
750	20	15	80	200	100	625	40	100	45	250	290	200	340	200	200	95	165	15	15	50	70

ABBEVIATION

- R- RED
- B- BLACK
- W- WHITE
- Y- YELLOW
- B-BLUE

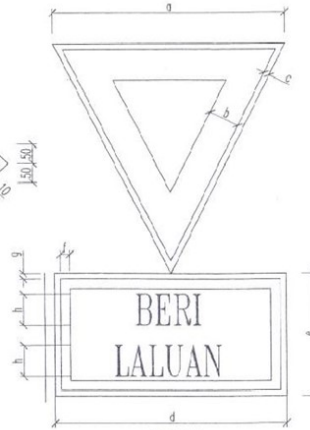

GIVE WAY

SIGN	DIMENSION (millimetre)							
	a	b	c	d	e	f	q	h
MINIMUM	600	80	15	600	320	25	15	80
NORMAL	750	100	20	600	320	25	15	80

COLOR

- SYMBOL -WHITE
- BACKGROUND - WHITE

LETTER PLAT : LAETTERING & BORDER – RED
 LETTERING : SERIES 2 WITH MEDIUM SPACING

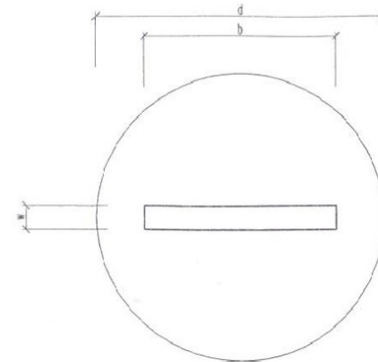

NO ENTRY FOR ANY VEHICLE
SCALE 1: 10

LEGEND (NO ENTRY FOR ANY VEHICLE)

SIGN	DIMENSION (millimetre)		
	d	b	w
MINIMUM	600	400	50
NORMAL	750	500	32.5

COLOR

- SYMBOL -WHITE
- BACKGROUND - RED



NOT TO SCALE

TAJUK KERJA:

TAJUK LUKISAN:

PELAN TERPERINCI
 PAPAN TANDA

NO LUKISAN:



MAJLIS PERBANDARAN BATUPAHAT

PELAN TERPERINCI PAPAN TANDA

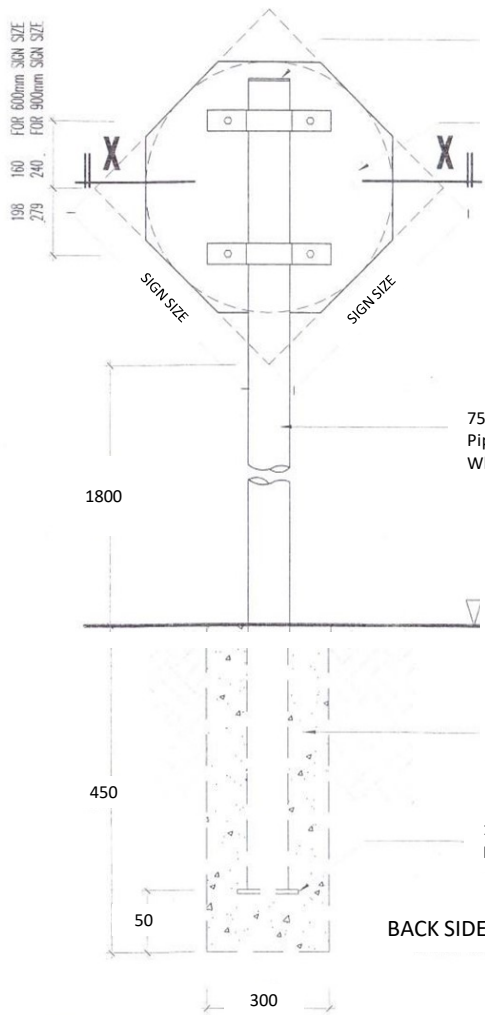

5mm THK MS CAP Plate
Welded To Post Or
Approved Plastic Cap Level

10 S.W.G SIC 14 Sign Face
of Aluminium Alloy

75mm Dia. G.I Galvanised
Pipe Patch Black And
White Alternately

BACK SIDE ELEVATION

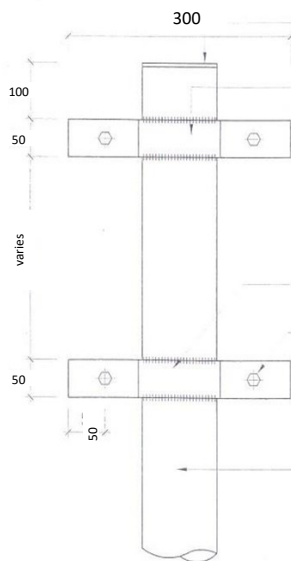

BACK SIDE ELEVATION DETAIL

5mm THK MS CAP Plate
Welded To Post Or
Approved Plastic Cap Level

50mm X 3mm THK MS
Flat Welded To Post

50mm X 3mm THK MS
Flat Welded To Post

8mm Dia. Galvanised
Bolt and Nut

75mm Dia. G.I
Galvanised Pipe Patch
Black And White
Alternately

SIDE ELEVATION DETAIL

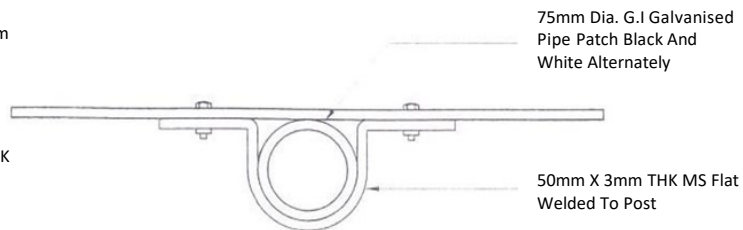

SECTION X-X

LEDGE DETAIL

STICKER : HIGH INTENSITY PRISMATIC SHEETING (HIP) –
JKR ATJ 2E/87(PINDAAN 2011) JKR 21300-0033-12

PELAN TERPERINCI PAPAN TANDA



NOT TO SCALE

TAJUK KERJA:

TAJUK LUKISAN:
PELAN TERPERINCI
PAPAN TANDA

NO LUKISAN:



MAJLIS PERBANDARAN BATUPAHAT

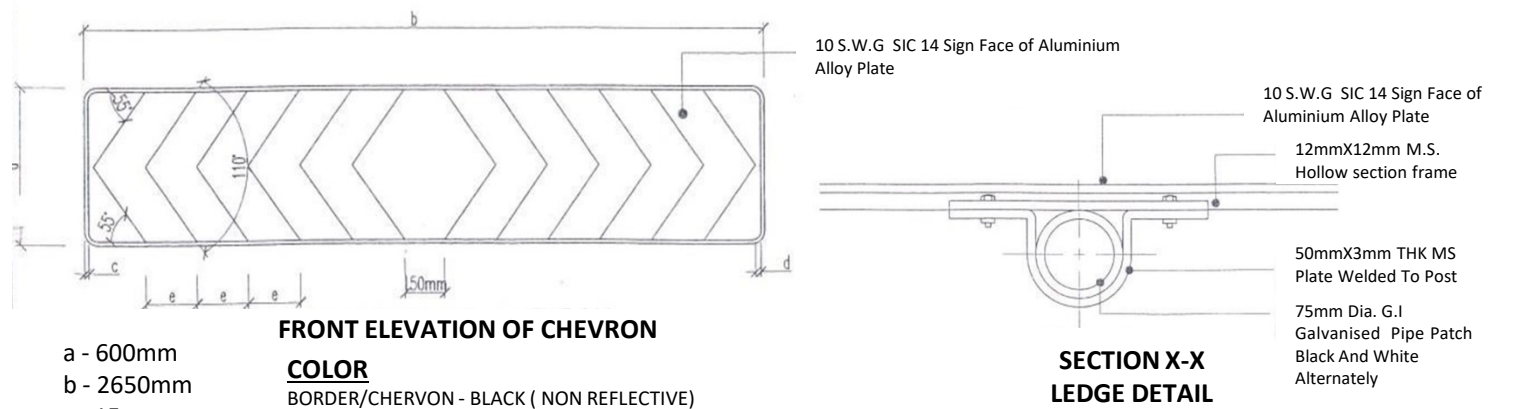
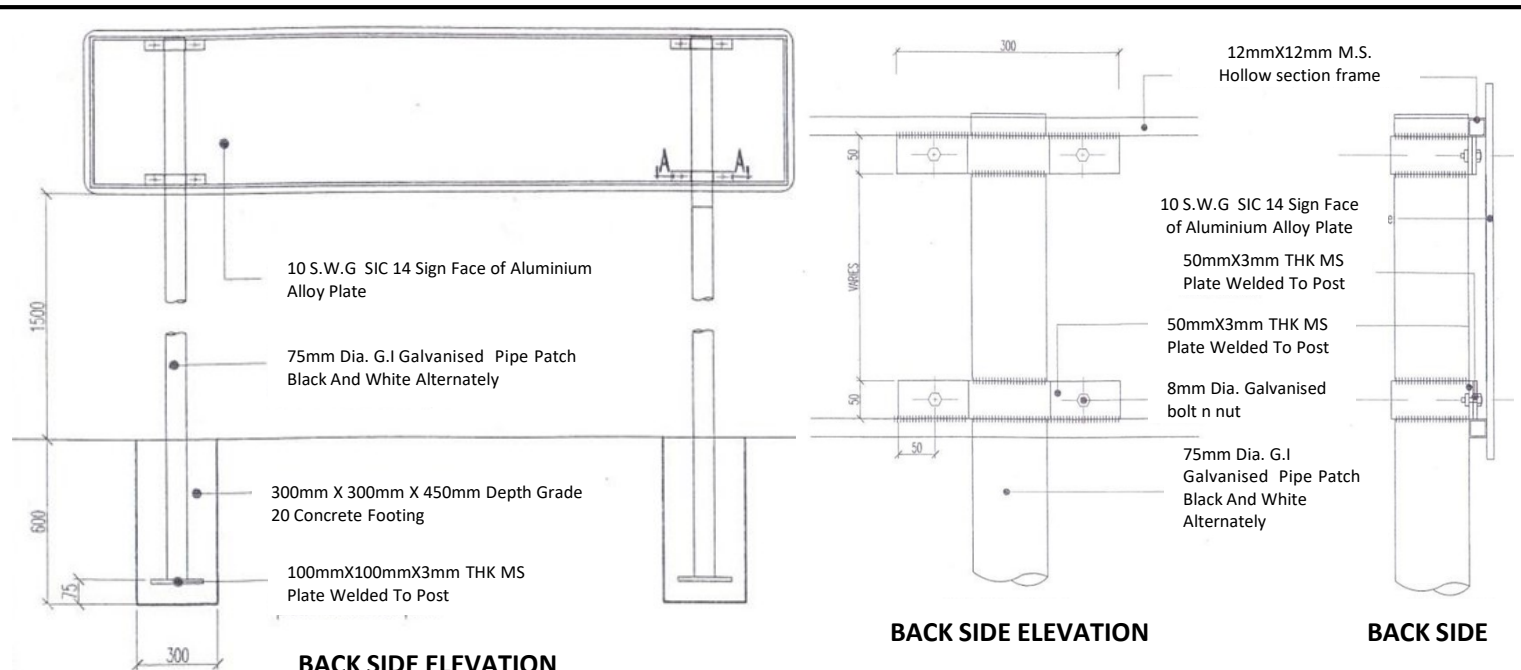

- a - 600mm
- b - 2650mm
- c - 15mm
- d - 20mm
- e - 200mm

COLOR
 BORDER/CHEVRON - BLACK (NON REFLECTIVE)
 BACKGROUND – WHITE (REFLECTIVE)
 NOTE:
 Sign Shall not be placed less than 1.8m from edge of road
 mounting height 1.5m from level bottom edge of sign

STICKER : HIGH INTENSITY PRISMATIC SHEETING (HIP) –
JKR ATJ 2E/87(PINDAAN 2011) JKR 21300-0033-12

PELAN TERPERINCI PAPAN TANDA 'CHEVRON'



 NOT TO SCALE

TAJUK KERJA:

TAJUK LUKISAN:
 PELAN TERPERINCI
 PAPAN TANDA
 'CHEVRON'

NO LUKISAN:

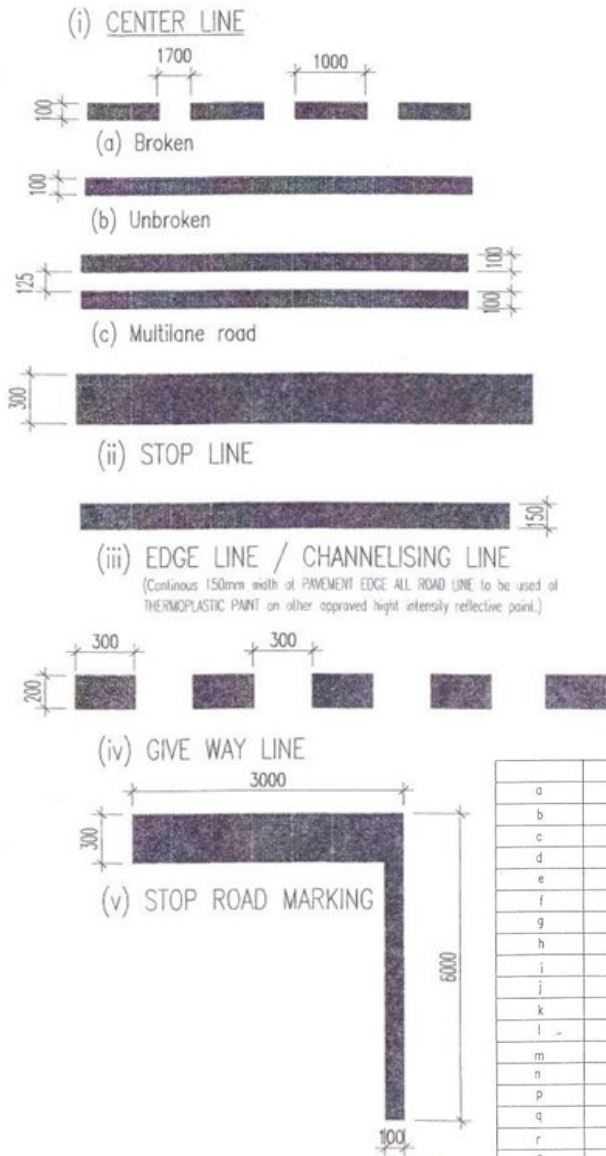



	URBAN ROAD	URBAN ROAD
a	3000	5000
b	1875	3125
c	1125	1875
d	1950	3250
e	825	1375
f	185	315
g	280	470
h	1835	3065
i	750	1250
j	690	1150
k	375	625
l	430	720
m	600	1000
n	637.5	1062.5
p	750	1250
q	450	750
r	975	1625
s	1500	2500

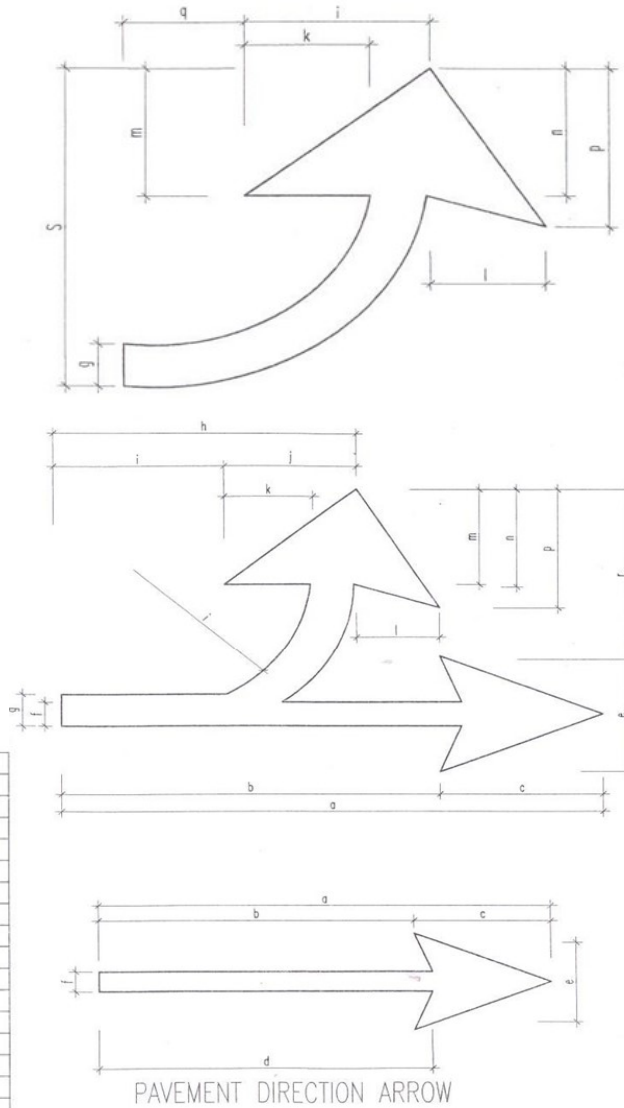

NOT TO SCALE

TAJUK KERJA:

TAJUK LUKISAN:
 PELAN TERPERINCI
 GARISAN JALAN DAN
 'ARROW'

NO LUKISAN:



MAJLIS PERBANDARAN BATUPAHAT

PELAN TERPERINCI GARISAN JALAN DAN 'ARROW'

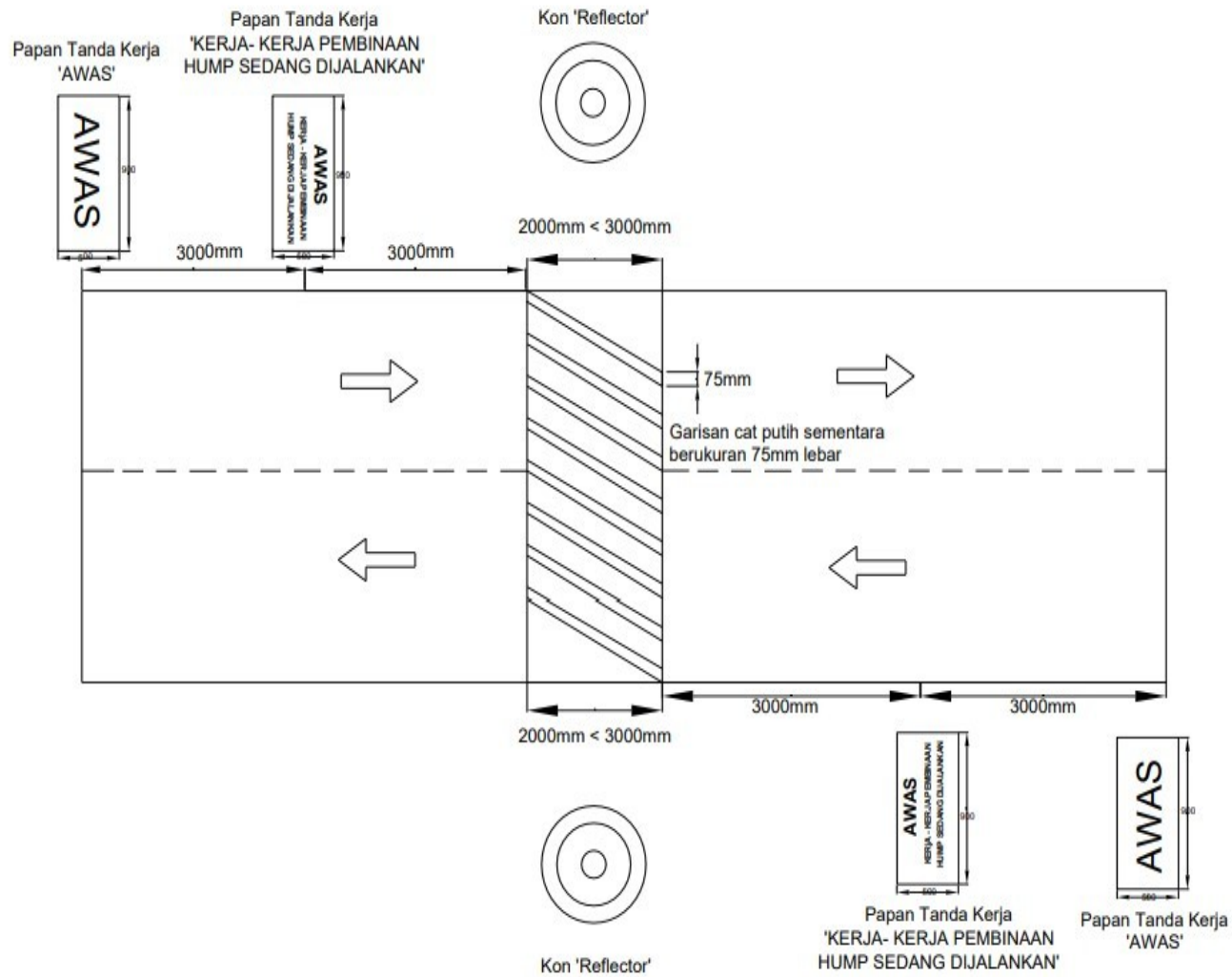

**PAPAN TANDA KESELAMATAN SEMENTARA
'WARNING TEMPORARY TRAFFIC SIGN'**



NOT TO SCALE

TAJUK KERJA:

TAJUK LUKISAN:

PELAN TERPERINCI
PAPAN TANDA
KESELAMATAN
SEMENTARA

NO LUKISAN:



MAJLIS PERBANDARAN BATUPAHAT



NOT TO SCALE

TAJUK KERJA:

TAJUK LUKISAN:

PELAN TERPERINCI
PAPAN TANDA
NAMA JALAN

NO LUKISAN:

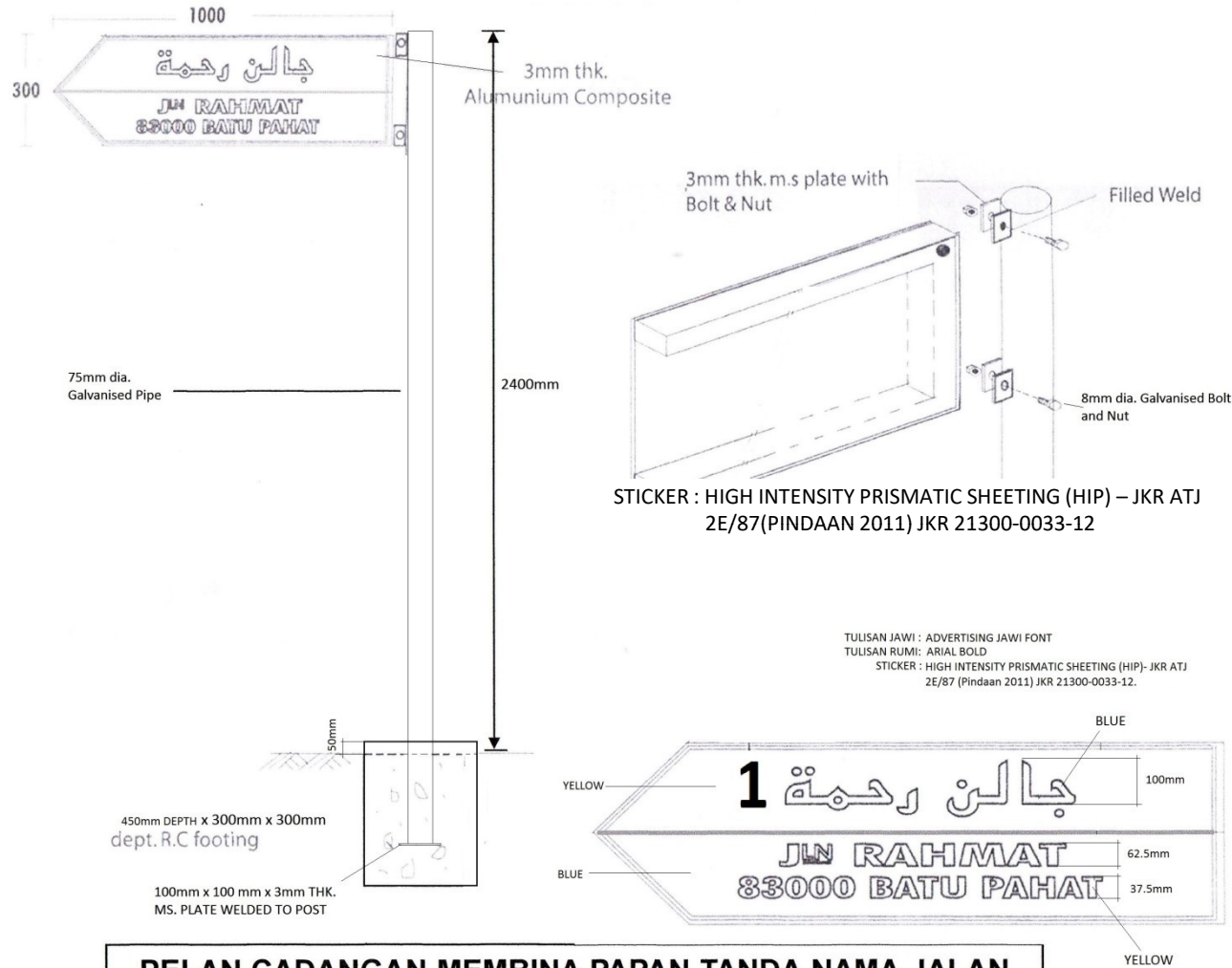

MAJLIS PERBANDARAN BATU PAHAT

Dokumen Sokongan
Borang A,
B,C,D,E,F,G,CA,GA
dan Borang Garanti
Bank Syarikat
Insuran

SECTION K

Majlis Perbadaran Batu Pahat

**SURAT PENGAKUAN KEBENARAN MAKLUMAT DAN KESAHAN DOKUMEN YANG
DIKEMUKAKAN OLEH PETENDER**

Nama Kontraktor :

Alamat :
.....
.....

Kepada :
.....
.....

(Pihak yang akan menilai tender)

Tuan,

MAKLUMAT LATAR BELAKANG, KEWANGAN DAN TEKNIKAL PETENDER

1. Kami telah membaca dengan teliti semua arahan-arahan yang terkandung dalam Arahan Kepada Petender termasuk arahan yang menghendakkan kami mengemukakan maklumat-maklumat dan dokumen-dokumen mengenai perkara di atas bersama-sama dokumen tender kami semasa mengemukakan Tender ini untuk membolehkan pihak **MAJLIS PERBANDARAN BATU PAHAT** menilai keupayaan kami untuk melaksanakan kerja yang ditender, semasa penilaian Tender.
2. Kami faham dan mengambil maklum bahawa penilaian Tender ini akan mengambil kira dan mementingkan keupayaan kami melaksanakan kerja yang ditender. Justeru itu tender kami akan hanya ditimbang untuk diperakukan kepada Lembaga Tender untuk disetujui terima sekiranya kami didapati berkeupayaan untuk melaksanakan projek yang ditender, mengikut penilaian pihak **MAJLIS PERBANDARAN BATU PAHAT** berasaskan maklumat-maklumat dan dokumen-dokumen yang kami kemukakan.
3. Kami juga mengambil maklum bahawa kami dikehendaki mengemukakan semua maklumat dan dokumen-dokumen yang diminta bersama-sama tender kami sebelum Tender ditutup dan maklumat-maklumat atau dokumen-dokumen yang dikemukakan kemudian daripada itu tidak akan diterima untuk diambil kira dalam penilaian keupayaan kami.
4. Kami mengaku bahawa maklumat-maklumat dan data-data yang kami berikan bersama-sama ini Borang **B , C , CA , D , E , F , G & GA** dan dokumen-dokumen yang kami sertakan bersamanya setahu kami adalah semuanya benar dan sah pada semua segi dan kami telah mengambil maklum dan sedar akan tindakan yang boleh diambil **MAJLIS PERBANDARAN BATU PAHAT** terhadap kami dan / atau tender kami, sekiranya mana-mana maklumat, data-data dan dokumen yang kami berikan itu didapati tidak benar atau palsu.
5. Kami dengan ini memberi kuasa kepada mana-mana pegawai **MAJLIS PERBANDARAN BATU PAHAT**, jurutera-jurutera projek, bank dan institusi kewangan lain, dan lain-lain atau mana-mana orang atau firma yang berkenaan untuk memberikan maklumat-maklumat yang dianggap perlu dan dimainta oleh pihak **MAJLIS PERBANDARAN BATU PAHAT** untuk menyemak maklumat-maklumat yang kami berikan atau untuk mendapatkan maklumat tambahan. Walau bagaimanapun, kami tetap bertanggungjawab di atas maklumat-maklumat dan dokumen-dokumen yang kami berikan bersama-sama ini.

Yang Benar,

(Tandatangan Pentender)

Tarikh : _____

Nama Penuh : _____

No. Kad Pengenalan : _____

Atas Sifat : _____

yang diberikuasa dengan sepenuhnya untuk menandatangani Tender ini
untuk dan bagi pihak :

(Meteri atau Cop Pentender)

(Tandatangan Saksi)

Tarikh : _____

Nama Penuh : _____

No. Kad Pengenalan : _____

Pekerjaan : _____

Alamat : _____

BORANG B – MAKLUMAT AM LATARBELAKANG PETENDER

1. Nama :

2. Alamat :

.....

.....

No. Telefon : No. Fax :

3. Pendaftaran dengan CIDB :(Sertakan Salinan Pendaftaran)

i) No. Pendaftaran :

ii) Tarikh Daftar : Sah Sehingga :

iii) Kategori Dan Pengkhususan :

4. Pendaftaran Sijil Perolehan Kerja Kerajaan dengan CIDB:(Sertakan Salinan Pendaftaran)

i) No. Pendaftaran :

ii) Tarikh Daftar : Sah Sehingga :

5. Pendaftaran Taraf Bumiputera dengan PKK :(Sertakan Salinan Pendaftaran)

i) No. Pendaftaran :

ii) Tarikh Daftar : Sah Sehingga :

6. Bagi Syarikat Sdn. Bhd. nyatakan :

i) Modal dibenarkan : RM.....

ii) Modal dibayar : RM.....

7. Perniagaan Utama lain, jika ada :

a) sejak

b) sejak

8. Ahli-ahli Syarikat

i) Ahli-ahli Lembaga Pengarah

Nama	Jawatan	Saham Modal Dipegang

ii) Ahli-ahli Pengurusan

Nama	Jawatan	Saham Modal Dipegang

BORANG C – DATA-DATA KEWANGAN (FINANCIAL DATA)

A. **Ringkasan harta dan liabiliti** seperti yang ditunjukkan dalam Lembaran Imbangan (Balance Sheet)* yang diaudit bagi tahun kewangan terakhir:-

Asset* (A)	Liabiliti* (B)	Nilai Kewangan (Worth) (A-B)
Semasa : RM	Semasa : RM	Modal
Tetap : RM	Tetap : RM	Pusingan : RM
Jumlah : RM	Jumlah : RM	Modal
-----	-----	Tetap : RM
-----	-----	'Nett Worth': RM

B. **Akaun Wang Ditangan (Cash In Hand)****

1. Nama dan Alamat Bank dimana akaun dibuka:

.....

2. Nombor Akaun :

C. **Kemudahan Kredit** (jika ada)+

1. Nama dan Alamat bank/Institusi Kewangan yang memberi kemudahan kredit:

.....

2. Bentuk dan baki amaun yang boleh digunakan untuk projek pembinaan.

i) Overdraf atau Talian Kredit :	RM	
ii) Overdraf bercagar :	RM	
iii) Pinjaman Tetap yang akan/layak diperoleh untuk projek :	RM	
iv)	RM	
Jumlah :	RM	-----

* Sila sertakan salinan Akaun Syarikat bagi tahun kewangan terakhir atau sekiranya tiada, bagi tahun kewangan sebelumnya bagi tender Gred G3, G4, G5 & G6 / tiga (3) tahun kewangan terakhir bagi tender Gred G7, yang disahkan dan diaudit oleh Juru Audit bertauliah (certified Accountant) bagi menyokong data-data yang diberi. Tender yang tidak disertakan dengan Akaun ini akan ditolak.

** Sila sertakan salinan Penyata Bulanan Bank bagi tiga (3) bulan terakhir yang telah disahkan oleh bank sebelum tarikh tutup Tender. Tender yang tidak disertakan dengan penyata ini akan ditolak.

+ Sila dapat dan sertakan Laporan Sulit daripada pihak Bank/Institusi Kewangan atas format seperti Borang CA, dalam satu sampul berlakri.

CONFIDENTIAL

**FORM CA – BANK/FINANCIAL INSTITUTION REPORT ON
FINANCIAL STANDING OF TENDERER**

(This form is to be filled by the bank or other financial institution in which the tenderer has any credit facilities and is to be handed to the tenderer in a sealed envelope which is to be part of his tenderer submission)

To :
.....
.....
(Director of DID)

Tenderer's Name :

Project :
.....
.....

A. Credit facilities which can be utilized for the project

Approved credit facilities and minimum additional credit facilities eligible to the Tenderer are as follows:-

<u>Form of Credit Facility</u>	<u>Balance from amount approved</u>	<u>Additional minimum to be approved*</u>	<u>Total</u>
i) Overdraft	RM.....	RM.....	RM.....
ii) Secured overdraft	RM.....	RM.....	RM.....
iii) Credit line	RM.....	RM.....	RM.....
iv) Fixed loan eligible for project	RM.....	RM.....	RM.....
v)	RM.....	RM.....	RM.....
Total:	_____	_____	_____

*(if project is awarded to Tenderer)

B. Comments on Tenderer's account and financial standing

Officer's Signature : For on behalf of
Name in full :
Designation :
Date : (Name and seal of Company)

REKOD PENGALAMAN KERJA
(Senarai semua kerja yang disiapkan dalam lima (5) tahun lepas)

Bil	NAMA KONTRAK / PROJEK *	NILAI KONTRAK (RM)	NILAI PENTENDER BERTANGGUNG JAWAB (RM) **	TEMPOH KONTRAK ***	TARIKH MILIK TAPAK	TARIKH SIAP		Nama dan Alamat Pegawai Penguasa/ Jurutera Perunding	Nama dan Alamat Majikan
						KONTRAK	SEBENAR		

* Salinan Perakuan Siap Kerja bagi setiap kerja yang disenaraikan hendaklah disertakan.

** Hanya perlu diisi sekiranya pentender melaksanakan kerja sebagai ahli syarikat gabungan.

*** Tempoh Kontrak hendaklah termasuk lanjutan masa yang diluluskan.

FORM E – TECHNICAL STAFF

(Detail of technical staff employed at the time of tender)

*NAME AND I/C NO.	AGE	**PROFESSIONAL / ACADEMIC QUALIFICATION	YEAR QUALIFIED	DATE OF EMPLOYMENT	POST HELD/ PRESENT DUTIES	PAST EXPERIENCE (POST HELD, NAME OF PROJECT, EMPLOYER'S NAME & PERIOD OF EMPLOYMENT)

* A copy of EPF statement 'A' for every staff for the last month of contribution shall be submitted.

** A copy of certificate of qualification or membership of Professional Bodies shall be submitted.

FORM F – LIST OF CONSTRUCTION PLANT AND EQUIPMENT

(The Tenderer is to insert below the particulars of the Plant and Equipment he owns or proposes to use for the Works)

DESCRIPTION (TYPE, MODEL, MAKE AND CAPACITY)	NUMBERS OF EACH TYPE	OWNED/LEASED	YEAR OF MANUFACTURER	PLACED STORED/ PRESENTLY USED	REMARKS

Important Note : Documentary evidence to prove ownership or leasing of plant/equipment listed above must be submitted together with the tender.

FORM G – LIST OF CURRENT CONTRACTS

The Tenderer is to insert below the particulars of all project currently undertaken by him

NAME & DESCRIPTION OF PROJECTS*	CLIENT CONTRACT NOS. OR NAME OF EMPLOYER	NAME AND ADDRESS OF PROJECT ENGINEER	CONTRACT VALUE (RM)	DATE OF COMMENCEMENT	COMPLETION PERIOD** (WEEKS)	PROGRESS OF WORKS		
						DATE	SCHEDULE %	ACTUAL %

* If the Tenderer has no current project the word 'NIL' shall be inserted.

** A completion period shall include any approved extension of time.

Note : Submission of Form GA for each current contract listed above is **COMPULSORY**

SULIT

BORANG GA – LAPORAN PENYELIA PROJEK ATAS PRESTASI KERJA SEMASA PETENDER

(Borang ini hendaklah dilengkapkan oleh Penyelia Projek atau Pembantu Kanannya yang mengawasi projek apabila diminta berbuat demikian oleh Petender dan hendaklah dihantar oleh Petender bersama Dokumen Tender dalam satu sampul berlakri)

Kepada :

.....

.....

Nama Kontraktor :

Nama Projek Yang Dilaksanakan :

.....

No. Kontrak : Harga Kontrak :

Tarikh Milik Tapak : Tempoh Kontrak : minggu/bulan

Tarikh Siap Asal :

Lanjutan Masa Yang Telah Diluluskan (jika ada) : Hari

Tarikh Siap Dilanjutkan :

Kemajuan Kerja (berdasarkan kerja yang telah dilaksanakan) :

Pencapaian sebenar : _____ % Mengikut Jadual : _____ %

Ulasan-ulasan mengenai Prestasi Kontraktor:

Kriteria	Cemerlang	Baik	Sederhana	Lemah
1 Pengurusan Tapak				
2 Pentadbiran				
3 Perancangan / Kemajuan				
4 Kualiti Kerja				

(sila tandakan ' / ' pada ruangan yang berkaitan)

Nyatakan apa-apa kepujian dan/atau kelemahan kontraktor dan juga apa-apa tindakan/ perakuan yang diambil/dipertimbang berhubung dengan prestasi Kontraktor semasa melaksanakan Kontrak

.....

.....

.....

.....
Tandatangan Penyelia Projek

Nama :

Jawatan : Tarikh :

**JAMINAN BANK/JAMINAN SYARIKAT KEWANGAN/
JAMINAN INSURANS UNTUK BON PELAKSANAAN
(KONTRAK KERJA)**

Sebagai balasan kepada Kontrak No. yang dibuat antara Kerajaan Malaysia, (kemudian daripada ini dirujuk sebagai “Kerajaan”) dan, (kemudian daripada ini dirujuk sebagai “Kontraktor”) bagi (namakan projek), (kemudian daripada ini dirujuk sebagai “Kontrak”) kami yang bertandatangan di bawah, (kemudian daripada ini dirujuk sebagai “Penjamin”) atas permohonan Kontraktor, mengaku janji yang tak boleh batal untuk memberi Jaminan kepada Kerajaan ke atas pelaksanaan yang sepatutnya Kontrak tersebut rnengikut cara sebagaimana yang terdapat kemudian daripada ini.

MAKA Penjamin dengan ini bersetuju dengan Kerajaan seperti berikut:

- 1 . Apabila sahaja Kerajaan membuat tuntutan bertulis, maka Penjamin hendaklah dengan serta merta membayar kepada Kerajaan nilai yang ditentukan dalam tuntutan tersebut tanpa mengira sama ada terdapat apa-apa bantahan atau tentangan daripada Kontraktor atau Penjamin atau mana-mana pihak ketiga yang lain dan tanpa bukti atau bersyarat. Dengan syarat sentiasanya bahawa jumlah tuntutan yang dibuat tidak melebihi sebanyak Ringgit (nyatakan nilai jaminan dalam perkataan) (RM) dan bahawa tanggungan Penjamin untuk membayar kepada Kerajaan di bawah Perjanjian ini tidak melebihi nilai tersebut di atas.
2. Kerajaan berhak untuk membuat apa-apa tuntutan sebahagian jika dikehendaknya dan jumlah kesemua tuntutan sebahagian itu hendaklah tidak melebihi nilai Ringgit (nyatakan nilai jaminan dalam perkataan) (RM) dan liabiliti Penjamin untuk membayar kepada Kerajaan jumlah yang disebutkan terdahulu hendaklah dikurangkan dengan perkadaraan yang bersamaan dengan apa-apa bayaran sebahagian yang telah dibuat oleh Penjamin.
3. Penjamin tidak boleh dibebaskan atau dilepaskan dari Jaminan ini oleh sebarang perkiraan yang dibuat antara Kontraktor dan Kerajaan sama ada dengan atau tanpa persetujuan Penjamin atau oleh sebarang perubahan tentang kewajipan yang diaku janji oleh Kontraktor atau oleh sebarang penangguhan sama ada dari segi pelaksanaan, masa, pembayaran atau sebaliknya.
4. Jaminan ini adalah jaminan yang berterusan dan tak boleh batal dan hendaklah berkuat kuasa sehingga (kemudian daripada ini disebut “Tarikh Mati Asal”) (*Initial Expiry Date*) iaitu dua belas (12) bulan selepas tarikh tamat tempoh kecacatan atau dalam keadaan dimana kontrak dibatalkan, satu (1) tahun selepas tarikh kontrak dibatalkan. Penjamin hendaklah melanjutkan Tarikh Mati Asal (*Initial Expiry Date*) Jaminan ini untuk tempoh tambahan selama tidak melebihi satu (1) tahun daripada Tarikh Mati Asal (*Initial Expiry Date*) (kemudian daripada ini disebut “Tarikh Mati Lanjutan”)

(*Extended Expiry Date*) apabila diminta oleh Kerajaan dan jaminan ini adalah dengan ini dilanjutkan. Jumlah agregat maksimum yang Kerajaan berhak di bawah Perjanjian ini mestilah sentiasa dipastikan tidak melebihi jumlah Ringgit (nyatakan nilai Jaminan dalam perkataan) (RM).

5. Apa-apa tanggungjawab dan tanggungan Penjamin di bawah Perjanjian ini hendaklah luput apabila Perjanjian ini tamat pada Tarikh Mati Asal (*Initial Expiry Date*) atau Tarikh Mati Lanjutan (*Extended Expiry Date*) melainkan jika sebelumnya Kerajaan telah meminta secara bertulis kepada Penjamin untuk membayar sejumlah wang tertentu yang masih belum dijelaskan mengikut peruntukan kontrak.

6. SEMUA TUNTUTAN BERKAITAN DENGAN JAMINAN INI, JIKA ADA, MESTILAH DITERIMA OLEH PIHAK BANK/SYARIKAT KEWANGAN/SYARIKAT INSURANS DALAM TEMPOH SAH LAKU JAMINAN INI ATAUPUN DALAM MASA EMPAT (4) MINGGU DARI TAMATNYA TARIKH JAMINAN INI, MENGIKUT MANA YANG LEBIH KEMUDIAN.

PADA MENYAKSIKAN HAL DI ATAS pihak-pihak kepada Perjanjian ini telah menurunkan tandatangan dan meteri mereka pada hari dan tahun yang mula-mula tertulis di atas.

Ditandatangani untuk)
dan bagi pihak Penjamin) Nama:
dihadapan) Jawatan:
Cop Bank/Syarikat
Kewangan/Syarikat Insurans:

.....
(Saksi)

Nama :
Jawatan :
Cop Bank/Syarikat Kewangan/Syarikat Insurans: