

Index

Opti Frames

11-20

- Opti frame 14 mm / *Opti frame 14 mm*
- Opti frame 25 mm / *Opti frame 25 mm*
- Opti frame in Colours / *Opti frame in Colours*

Poster Frames

21-50

- Snap Frames / *Klapprahmen*
- Fire Resistant Snap Frame / *Brandschutzsichere Klapprahmen*
- Basic Snap Frame / *Basic Snap Frame*
- Double Colour Frame / *Doppelfarbige Klapprahmen*
- Paperboard / *Paperboard*
- Security Frames / *Sicherheitsklapprahmen*
- Window Frame / *Fensterrahmen*
- Window Sign / *Window Sign*
- Lockable Snap Frame / *Abschliessbare Klapprahmen*
- Lockable Window Frame / *Abschliessbare Fensterrahmen*
- Lockable Weatherproof Frame / *Abschliessbare, wetterfeste Klapprahmen*
- Double Sided Snap Frame / *Doppelseitige Klapprahmen*
- Magnetic Frame / *Magnetic Frame*
- Weatherproof Frame / *Wetterfeste Klapprahmen*

Slide-in Frames

51-54

- Counter Slide-in Frame / *Info Topper*
- Double Sided Slide-in Frame / *Doppelseitiger Einschubrahmen*
- Single Sided Slide-in Frame / *Einseitiger Einschubrahmen*

Poster Holders

55-62

- Poster Clamp / *Poster Klemmleiste Clamp*
- Newage Poster Clamp / *Poster Klemmleiste Clamp "neu"*
- Poster Snap / *Poster Klemmleiste Snap*
- Wood Magnetic Poster Snap / *Wood Magnetic Poster Snap*
- Poster Fast / *Poster Klemmleiste Fast*
- Stretch Frame / *Spannrahmen*
- Outdoor Flap Gripper / *Outdoor Flap Gripper*

Door Signs

63-70

- Door Signs / *Türschilder*
- Desktop Sign / *Tischbeschilderungssystem*
- Wall Sign System / *Wandbeschilderungssystem*
- Sign Systems / *Sign Systems*
- Standoff Mount Acrylic Sign / *Standoff Mount Acrylic Sign*

Presentation Systems

71-86

- Clipboard / *Clipboard*
- Fast Note / *Fast Note*
- Whiteboards / *Whiteboards*
- Reference Racks / *Reference Racks*
- Easels / *Easels*

Menuboards

87-102

- Flexible Menuboards / *Flexibles Menüboard*
- Flexible Menuboard with Ledbox / *Flexibles Menüboard mit LED Klapprahmen*
- Telescoping Menuboards / *Telescoping Menuboards*
- ARC Menuboard / *ARC Menuboard*
- Folder Menuboard / *Folder Menuboard*
- Restaurant Boards / *Restaurant Boards*
- Curved Menuboard / *Curved Menuboard*
- Simplicistic Curved Menuboard / *Simplicistic Curved Menuboard*
- Curved Menuboard with Acryled / *Curved Menuboard with Acryled*
- Classical Menuboard / *Klassisches Menüboard*
- Decorative Menuboard / *Dekoratives Menüboard*
- Adjustable Menuboard / *Verstellbares Menuboard*

Pavement Signs

103-146

- A Board / *Kundenstopper*
- Eco A Board / *Eco Kundenstopper*
- Retractable A Board / *Retractable A Board*
- Premium A Board with Logo / *Premium Kundenstopper mit Topschild*
- Premium A Board with Profile Logo / *Premium Kundenstopper mit Topschildprofil*
- Opti Frame A Board / *Opti Kundenstopper*
- Weatherproof A Board / *Wetterfester Kundenstopper*
- Slide-in A Board / *Kundenstopper mit Einschub*
- Write-on A Board / *Beschreibbarer Kundenstopper*
- Easy Go A Board / *Esay Go Kundenstopper*
- Wood Look A Board / *Holz optik Kundenstopper*
- Basic Wood A Board / *Basic Wood A Board*
- SwingPro&WindPro Plus / *SwingPro&WindPro Plus*
- SwingPro&WindPro Lite / *SwingPro&WindPro Lite*
- Slide-in SwingPro&WindPro / *SwingPro&WindPro mit Einschub*
- Wood WindPro / *Wood WindPro*
- Illuminated WindPro® with LED / *WindPro® mit LED Beleuchtung*
- WindPro with LED Plus / *WindPro with LED Plus*
- Swingmaster / *Swing Master*
- Eco Swingmaster / *Eco Swing Master*
- Waterbase Wind Sign / *Wind Sign mit Wassertank*
- Eco Waterbase Wind Sign / *Eco Wind Sign mit Wassertank*
- Magnetic Iron A Board / *Magnetischer Stahl Kundenstopper*
- Rectangular Iron A Board / *Rechteckiger Stahl Kundenstopper*
- Al Maki / *Al Maki Kundenstopper*
- Wood Maki / *Wood Maki*
- Street SignPro / *Street SignPro*
- Master Signs / *Master Signs*
- PS Boards / *Kunststoff Kundenstopper*
- Waterbase Pavement Signs / *Strassenaufsteller aus Kunststoff*

Outdoor Displays

147-156

- Bicycle Stands / *Bicycle Stands*
- PET Refreshing Corners / *PET Refreshing Corners*

Wood Display

157-176

- Easy Wood Frame / *Einfacher Holzrahmen*
- Frameless Wooden Frame / *Schreibtafel Ohne Rahmen*
- Wood Slide-in Frame / *Wood Slide-in Frame*
- Wooden Stopper
- Wooden Host
- Wood A Board Indoor / *Wood A Board Indoor*
- Wood A Board Outdoor / *Wood A Board Outdoor*
- Timber Chalk Board / *Timber Chalk Board*
- Wood Chalk Floor Stand / *Wood Chalk Floor Stand*
- Wood Dry Erase Floor Stand / *Wood Dry Erase Floor Stand*
- Wall Mount Wooden Card Holder / *Wall Mount Wooden Card Holder*
- Nature Line Writing Board / *Nature Line Writing Board*
- Wood Magazine Rack for Wall / *Wood Magazine Rack for Wall*
- Free Standing Wood Magazine Rack / *Free Standing Wood Magazine Rack*
- Desktop Wooden Card Holder / *Desktop Wooden Card Holder*
- Counter Wood Chalk Frame / *Counter Wood Chalk Frame*
- Desktop Easel / *Desktop Easel*
- Petite Desktop Easel / *Petite Desktop Easel*
- Wooden Roll Stand / *Wooden Roll Stand*
- Wood Folding Luggage Rack / *Wood Folding Luggage Rack*
- Foldable Wood Box / *Foldable Wood Box*

Que Control Systems

177-180

- Q Belt / *Q Belt*
- Q Rope / *Q Rope*

Info Stands

181-186

- Infoboard / *Infoständer*
- Oval Infoboard / *Ovalfuss-Infoständer*
- Eco Infoboard / *Eco Infoständer*
- Sign Holder / *Sign Holder*

Illuminated Products

187-208

- Buy Max LEDbox / *Buy Max LEDbox*
- Best Buy LEDbox / *Best Buy LEDbox*
- Smart LEDbox 25 mm / *Smart LEDbox 25 mm*
- Smart LEDbox 35 mm / *Smart LEDbox 35 mm*
- Weatherproof Smart LEDbox 35 mm / *Smart LEDbox 35 mm Wetterfest*
- Lockable Weatherproof Smart LEDbox 35 mm / *Smart LEDbox 35 mm Abschliessbar/wetterfest*
- Magneco LEDbox / *Magneco LEDbox*
- Magnetic Smart LEDbox / *Magnetische Smart LEDbox*
- Convex LEDbox / *Convex Leuchtkasten*
- Acryled for Wall Mounting / *Acryled für Wandmontage*
- LEDA Illuminated Magnetic Totem / *LEDA Illuminated Magnetic Totem*
- Totem / *Leuchtsäule*
- Mono Totem / *Postersäule*

Frameboards

209-212

- Frameboard 9mm / *Info-Rahmen 9mm*
- Magnetic Glass Boards / *Magnetische Glastafel*

Showboards

213-220

- Universal Showboards / *Universal Showboards*
- Showboards / *Showboards*
- Office Boards / *Office Boards*

Noticeboards

221-224

- Noticeboards / *Noticeboards*
- Noticeboards With Led Light / *Noticeboard mit LED Beleuchtung*
- Noticeboards With Logo / *Noticeboard mit Topschild*

Printable Solutions

225-246

- Maxi Frames / *Maxi Rahmen*
- Star Maxi LED / *Star Maxi LED*
- Power LED / *Power LED*
- Maxi Frame Totem with LED / *Maxi Frame Totem with LED*
- Omni Frames / *Omni Rahmen*
- Omni A Board / *Omni Kundenstopper*

Banners

247-256

- Easy Swap / *Easy Swap*
- Poster Trap / *Poster Trap*
- Quick Banners / *Quick Banners*
- Newage Quick Banner / *Quick Banner "neu"*
- Smart Banners / *Smart Roll Banner*
- Eco-Roller / *Roll Banner Eco*
- Practical X Banner / *Practical X Banner*

Brochure Sets

257-294

- Novel Free Standing Leaflet Display / *Novel Prospektständer mit Zentralprofilgestell*
- Free Standing Leaflet Display / *Prospektständer mit Zentralprofilgestell*
- Free Standing Banner Set / *Bannersystem mit Zentralprofilgestell*
- Free Standing Slide-in Frame / *Zentralprofilgestell mit Einschubrahmen*
- Free Standing Convex Box / *Convex- Leuchtdisplay mit Zentralprofilgestell*
- Free Standing Leaflet Dispensers / *Zentralprofilgestell für Prospekthalter*
- Free Standing Leaflet with Side Shelves / *Zentralprofilgestell mit seitlichen Prospekthaltern*
- Cocktail Brochure Sets / *Prospekthalter Cocktail*
- Prime Wall Unit / *Prime Broschürenspender für die Wand*
- Portable Leaflet Dispensers / *Portable Leaflet Dispensers*
- Multiside Brochure Sets / *Multiside Prospektständer (mehrseitig)*
- Brochure Sets / *Prospektständer*
- Decorative Brochure Stands / *Dekorativer Prospektständer*
- Pillar Brochure Stand / *Pillar Prospektständer*
- Zick-Zacks / *Zick-Zacks*
- Zick-Zack Lite / *Zick-Zack Lite*
- Newage Portable Zick-Zack / *Newage tragbarer Zick-Zack*
- Wood Zick-Zack / *Wood Zick-Zack*
- Foldable Zick-Zacks / *Foldable Zick-Zacks*
- Foldable Wood Counters / *Foldable Wood Counters*
- Heavy Duty Literature Rack / *Heavy Duty Literature Rack*
- Rapid Brochure Set / *Rapid Prospektständer*
- Tower Stands / *Tower Stands*
- Wood Poster Stand / *Wood Poster Stand*
- Monoblock / *Monoblock*

Digital Solutions

295-304

- TV Stand / *TV Stand*
- Counter Tablet Holders / *Counter Tablet Holders*
- Tablet Kiosks / *Tablet Kiosks*

Exhibition Displays

305-312

- Panset / *Rahmen-Faltdisplay*
- Pop-up / *Pop-up-Faltdisplay*
- Crown Truss / *Crown Truss*

Counter Displays

313-328

- Panset Counters / *Falt-Theke*
- Pop-up Counter / *Pop-up Counter*
- Promostands / *Promotiontheke*
- Wood Podium / *Wood Podium*
- Tempered Glass Podium / *Tempered Glass Podium*

Leaflet Dispensers

329-356

- Tabletop L Frame / *Tabletop L Frame*
- Cross Frame / *Kreuzrahmen*
- Leaflet Dispensers / *Prospekthalter*
- Multiple Pocket Leaflet Dispensers / *Mehrlagige Prospekthalter*
- Wall Mount Leaflet Dispensers / *Prospekthalter für die Wandmontage*
- Clear Brochure Holder T Type / *Klare Prospekthalter in T Form*
- Clear Brochure Holder L Type / *Klare Prospekthalter in L Form*
- L Type with front Pocket / *Klare Prospekthalter in L Form mit Tasche*
- Swing Wing / *Swing Wing*
- PET Pocket / *PET Pocket*
- Upright Leaflet Holder / *Upright Speisekartenhalter*
- Oval Leaflet Holder / *Oval Speisekartenhalter*
- Acrylic Sign / *Acrylic Sign*
- Duo Desktop Menu Holders / *Duo Desktop Menu Holders*
- Fort Desktop Menu Holders / *Fort Desktop Menu Holders*
- Curved Menu Holder / *Curved Menu Holder*
- Ticket Holder / *Ticket Holder*
- Card Holder 2 Sided / *Card Holder 2 Sided*
- Pyramid Card Holder Single Sided / *Pyramid Card Holder Single Sided*
- Wood Clip Board / *Wood Clip Board*
- Table Top Chalk Mini A Board / *Table Top Chalk Mini A Board*
- Nature Line Table Top Chalk A Board / *Nature Line Table Top Chalk A Board*
- Arc Menu Holder / *Arc Menu Holder*
- Tumble Box / *Wahlurne*
- Puzzle Tumble Box / *Puzzle Wahlurne*
- Free Standing Puzzle Tumble Box / *Puzzle Wahlurnenständer*
- Tip Box / *Tip Box*
- Business Card Holder / *Visitenkartenspendler*

Office Facilities

357-366

- Coat Hangers / *Coat Hangers*
- Wastebaskets / *Wastebaskets*
- 2 Step Plastic Stepstool / *2 Step Plastic Stepstool*
- No Slip Key Board Tray / *No Slip Key Board Tray*
- Universal Monitor Stand / *Universal Monitor Stand*
- Workstations / *Workstations*

Accessories

367-372

- Hangers / *Aufhaenger*
- Baskets / *Körbe*
- Shelves / *Ablagen*
- Header Holder & Header / *Topsildhalterungen und Topschilder*
- Bags / *Taschen*
- Levertool / *Öffnungsapparate*
- Separator / *Separatoren*
- Chalkboard Marker / *Tafelstifte*
- Panel / *Panele*
- Lighting Components / *Beleuchtungselemente*
- Others / *Diverses*

SemiProducts

373-384

- Profiles / *Profile*
- Corners / *Eckverbinder*
- Connectors / *Verbindungselemente*
- End Caps / *Endkappen*
- Springs / *Federn*
- Hangers / *Aufhaenger*
- Pipes / *Rohre*
- Feet / *Füße*
- Counter Support / *Aufstellfüße*
- Logo / *Topschilder*
- Shelf / *Ablagen*
- Power Supply / *Schalt-Netzteile*
- Panel / *Panele*
- Base / *Wassertank*
- Others / *Diverses*

Extrusion Lines

385-388

- PET lines / *PET Extrusionsanlagen*
- HIPS Lines / *HIPS Extrusionsanlagen*
- Sizing & Recycling / *Dimensionierung und Recycling (Widergewinnung)*

General Information

389-390

- Symbols / *Symbole*
- RAL Chart / *RAL Farben*
- Paper sizes / *Papierformate*

Presentation

Established 30 years ago, M&T Displays has been organized with the commitment to catch the unrivalled standards in products and service of Point of Sale and Display world. In total of 30,000 sq meter factory area, we present 21 different products groups, and over 6000 articles; all designed, moulded and manufactured in plant. From design to manufacturing, we continue to invest in new technologies while upgrading our capabilities. Passing years has made no changes on our M&T values which are;

- Universal business ethics,
- Reliability,
- Innovation,
- Pursuit of excellence.
- Caring customer service for maximum satisfaction.

The success of our firm generates from well organized skilled professionals, investment in equipment and manpower, with a flexible production which fully carries out the needs of our dealers. Those combined with our principle act & respond on the same day, superlative quality and long years experience in providing effective solutions, bring up the desirable results for outdoor and indoor displays.

The relationship with our clients based on providing outstanding levels of service, communication and confidence, has created the M&T Displays' reputation which we are aware of its serious responsibility.

We again point out that Our displays systems offer you solutions today for your communication needs in future.

Unser Unternehmen M&T Displays wurde 1993 mit dem Ziel gegründet die unvergleichlich schnell anwachsenden Anforderungen in der Welt der vertriebsfördernden Werbemittel zu treffen .

Auf einer Produktionsflaeche von 30.000 m2 werden vom Design, Formung bis zur Produktion 21 verschiedenen Produktgruppen und 6000 verschiedene Produkte im eigenen Hause hergestellt. Vom Design bis zur Produktion investieren wir in aktuelle Technologien und erhöhen somit unser Produktionspotential. Wir haben in den vielen Jahren an unseren speziellen Werten wie

- Universelle Geschaefthethik
- Zuverlaessigkeit
- Innovation
- ausgezeichnete Qualitaetsanforderungen
- max. Kundenzufriedenheit durch exellerten Kundenservice nichts verlohren.

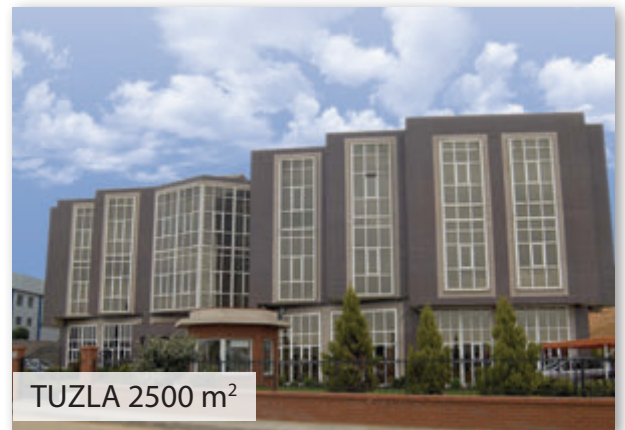
Der Erfolg unserer Firma liegt in der professionellen Organisation, laufende Investition in Ausstattung und Arbeitskraefte und in unserer flexiblen Produktion, die wir laufend den Bedürfnissen unserer Kunden anpassen. Wir kombinieren diese mit dem Prinzip " handle & antworte am gleichen Tag". Hervorragende Qualitaet und langjaehrige Erfahrung an der Darlegung effektivster Lösungen tragen zur Herstellung der erwünschten Resultate von Innen-und Aussendisplays bei.

Die Beziehung zu unseren Kunden basiert auf hervorragender Dienstleistungsebene, das heisst reibungslose Verstaendigung und Zufriedenheit haben das seriöse Ansehen von M&T Displays erschaffen, dessen Verantwortung wir uns bewusst sind.

Wir möchten nochmals darauf hinweisen, dass unsere Displaysysteme Ihnen heute die Lösungen für die Kommunikationsanforderungen von morgen anbieten.



ŞEKERPINAR 16000 m²



TUZLA 2500 m²



HANOVER 3250 m²



BUDAPEST 2800 m²

ISO 9001:2015 / ISO 27001 Certification

We gained the quality certificate, ISO 9001:2015, which is the best guarantee that our services meet the highest requirements.

Being first in our business does not come easily. It is earned by understanding our customers and by consistently providing the products and services that meet or exceed the expectations. As our business continues to evolve, we recognize that our customers' expectations of quality will only become higher.

At M&T, we are committed to meeting our customers expectations for the quality of the products and services that we provide. We personally affirm this commitment. However, this quality objective can be achieved only if everyone in our organization is involved. Therefore, a quality system has been established at M&T, which involves every employee.

In autumn 2008 TÜV Turkey certified M&T with ISO 9001:2008, which confirms that M&T's quality management system responsible for controlling the planning, implementation and maintenance of contact centers and software developments meets international requirements. The certificate will be supervised every year.

What the certificate means:

The process of gaining the ISO certificate involves satisfaction of very strict criteria and passing of complex exams. Certification focuses especially on the standards of provided services, internal processes, approach to customers, manipulation with goods and others.

This quality system gives our employees a systematic method for continuous improvement by establishing a reliable way to take actions toward improving products and services.

M&T Displays ist mit ISO 9001:2015 zertifiziert. Dies ist die Beste Garantie, dass unsere Dienstleistungen den höchsten Anforderungen entsprechen. Marktführer zu sein, ist nicht einfach in unserer Branche. Es ist schwer verdient, indem wir unsere Kunden verstehen und ihnen fortlaufend die Produkte und Dienstleistungen unterbreiten die ihren Erwartungen entsprechen oder sogar überschreiten. Wir garantieren persönlich für dieses Engagement. Diese Qualitätsersparung kann nur erzielt werden, wenn jeder Mitarbeiter in diese Organisation involviert ist. Es wurde deshalb für M&T ein spezielles Qualitätssystem entwickelt, welches wirklich jeden Mitarbeiter einschliesst.

Herbst 2008 wurde M&T Displays Qualitätsverwaltungssystem mit ISO 9001:2008 von TÜV RHEINLAND /TURKEI ausgezeichnet, welches die Verfolgung der Planung, Erfüllung und Wartung der Kontakzentren und der Softwareentwicklungen nach internationalen Anforderungen ermöglicht. Das Zertifikat wird jährlich verfolgt und erneuert.

Was das Zertifikat bedeutet:

Der Prozess der ISO Zertifikation beinhaltet die Befriedigung von sehr strengen Arbeitskriterien und das Bestehen von komplizierten Prüfungen. Das Zertifikat spezialisiert sich auf die Standarde der dargelegten Dienstleistungen, interne Prozesse, Annäherung an Kunden und Manipulation mit Waren und anderem.

Dieses Qualitätssystem gibt unseren Mitarbeitern eine systematische Methode zur laufenden Verbesserung, indem ein zuverlässiger Weg für die Improvisation von Produkten und Dienstleistungen ermöglicht wird.



THE INTERNATIONAL REC STANDARD



2020 TÜRKİYE HİN İLK 1000 İHRACATÇI FİRMASI
TOP 1000 EXPORTERS OF TURKEY

Our Marketing Tools

Practical tools to help you reach more customers !

MT Displays is proud to offer some marketing tools for its partners. These tools help the partners to be known in the market better and sales people to know more about the products that enables them to sell more.

MT Displays provide various printed and electronic materials for its partners. Product catalogues, digestive brochures for exhibitions, product presentations, new product introductions are some of the examples of all offered for use of partners. Showroom kits, promotion sets, sample bags and introduction boxes are prepared for use of sales and marketing team to introduce the products to your customers.

We have a new website "Displayshowroom". In this platform we index our products not with product specifications, but rather displaying the environments they are best to use for efficient marketing. We collect several photos from all over the world presenting locations where our products are used, such as supermarkets, shopping malls, schools, restaurants, hotels, conferences, tobacco shops etc...

All of these tools are designed for MT Displays' partners to comprehend our products fully, launch and sell them in their market easily.

The more you know, the more you sell!

There are many tools to reach the same target.

Praktische Anwendungen die Ihnen helfen mehr Kunden zu erreichen!

MT Displays bietet verschiedene Marketinganwendungen für seine Partner. Diese Anwendungen helfen den Partnern um sich im Markt besser zurecht zu finden und dem Verkaufsteam mehr Wissen über die Produkte zu geben damit der Verkauf noch mehr gefördert wird.

MT Displays gewährt seinen Partnern eine vielseitige Palette an Druck- und E-Medien. Produktkataloge, diverse Broschüren für Messen, Produktpräsentationen, Neu-Produktvorstellungen sind einige Beispiele die wir unseren Partnern ermöglichen.

Showroom-Kits, Promotionssets, Mustertaschen und Vorstellungsboxen sind vorbereitet für den Gebrauch im Verkaufsteam um die Produkte noch effektiver vorstellen zu können.

Wir haben eine neue Homepage "Displayshowroom". Auf dieser Seite werden wir die Produkte nicht mit technischen Details ausstatten, sondern mehr die Anwendungsbereiche präsentieren damit das Verkaufsteam besser auf den Kunden eingehen kann.

Wir sammeln mehrere Fotos von unseren Produkten aus der ganzen Welt die bereits verwendet werden, z.B in Supermärkten, Einkaufszentren, Schulen, Restaurants, Hotels, Konferenzräumen, Einzelhandel etc.

All diese Anwendungen sind erstellt damit MT Displays Partner einen besseren Überblick über unsere Produkte haben, um sie besser zu verstehen und sie besser zu vermarkten.

Je mehr Sie wissen, desto mehr können Sie verkaufen.

Es sind viele Anwendungen vorhanden um das selbe Ziel zu erreichen.



Some of our Marketing Tools	Sales Price	Type of support	Code
www.mtdisplays.com	free	internet	
www.displayacademy.com (can be linked)	free	internet	
www.displayshowroom.com	free	internet	
www.omni-frame.com (can be linked)	free	internet	
www.opti-frame.com (can be linked)	free	internet	
Mail Shots	free	direct mailing	
Product Picture Gallery	free	on media	
Company Presentation	free	on media	
Product Presentation	free	on media	
You Tube Product Movies	free	internet	
Display iPad Application	free	internet	
Product Leaflet	free	pdf file	
Product Leaflet	free	printed media	
2023 Global Display Catalogue	€ 3,75	printed media	1200784
Wall Sign Promotion Box	€ 20	sample box	PRJ0100493
MT Displays printed Bag (textile)	€ 20	bag	1006022
Maxi Frame Introduction	€ 25	sample box	PRJ0100177
Presentation Sample Box	€ 25	sample box	PRJ0100378
A Board with Frame Samples	€ 50	stand	UAB325HCB2X5000
Opti Stand	€ 130	stand	PRJ100597
Omni Frame Promo Bag	€ 50	sample box	PRJ0100791
Displays Promo Bag	€ 150	"red sample bag"	PRJ0099021
Power LED Sample Kit	€ 50	sample kit	PRJ0101209
Crown Truss Sample Kit	€ 50	sample kit	UCT15BKC01
Crown Truss Trolley Kit	€ 100	introduction kit	UCT15BKC02
Crown Truss Showroom Kit	€ 220	product sample	UCT15BKC03
Bronze Showroom Pack	€ 500	showroom kit	PRJ0100909
Silver Showroom Pack	€ 850	showroom kit	PRJ0100910
Golden Showroom Pack	€ 1.200	showroom kit	PRJ0100911
Product Training	TBA	Showroom	
Open House	TBA	Showroom	



Our Marketing Tools



A Board with Frame Samples



A Board with Frame Samples



Wall Sign Promotion Box



Maxi Frame Introduction



Displays Promo Bag



Presentation Sample Box



Omni Frame Promo Bag



Crown Truss Showroom Kit



Crown Truss Trolley Kit



Power LED Sample Kit



Global Display Catalogue



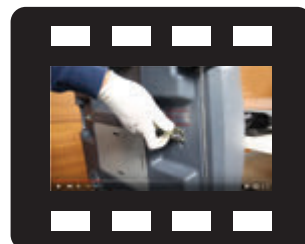
Jet Catalogue



Crown Truss Sample Kit



Product Leaflet



YouTube Product Movies



Product Picture Gallery

Our Marketing Tools

Product Training

Product training and assembling sessions are great offer to know more about the products' unique selling points, competitive analyses in different markets and more. Sales people get the chance to touch the product before they really start selling in the market. MT Displays already offers the following services which help to develop the knowledge of the distributor's sales force and direct product marketing to their customers. These services are as follows:

- General product trainings to distributors,
- New product presentations to distributors,
- Product presentations on distributor's customer events,
- Sharing general market information, trends, efficient business and sales models, product offers for different end-uses.

The above mentioned trainings and presentations should be planned in advance and in time, together with the distributor for full benefit of the program.

Fair support in products and Showroom Support

Our programme includes such offers because both offers support the sales growth of the distributor on a local fair. With a communicated showroom offer, MT Display emphasizes the importance of a showroom and with a support distributors would take in consideration to expose the products in a visible way. Showroom support would be more long term than Fair Support and is more focused on new products and premium products in the range.

Various Product Photos

We propose to use USB stick and load a lot of information. Using a USB stick also time saving during trainings; beside it is a professional tool, modern and environmental friendly. USB stick is available everywhere and can be loaded with more information in a fast way, customized before trainings or customer visits with the necessary data.

"Key to success!"

Focus on internet and Digital Media

MT Displays also keeps up with today's developing technology. MT Displays Apple i-Pad application is a great tool for presentations to customers. It provides practical access to products' technical details, presentations and mounting videos. Besides some anonymous web pages such as www.opti-frame.com and www.displayacademy.com which partners use as their own webpages. Besides both webpages are up-to-date with image and information downloads. MT Displays main webpage www.mtdisplays.com.tr is updated very often with the purpose of releasing latest information about MT Displays activities and products.

We are living already in a world where internet has stronger marketing power compared to other solutions and it is more direct because it gets to people/customers who are for sure interested. MT Display iPad application is a very good idea and a great option. Shows clearly a unique and modern approach to the market.

Produkt Schulungen

Produktschulungen und Montageschulungen sind ein einzigartiges Angebot um mehr Erfahrung, Verkaufsargumentationen, wettbewerbsfähige Analysen in verschiedenen Märkten durchzuführen. Das Verkaufsteam erhält hier eine Chance das Produkt anzugreifen bevor sie diese erst am markt verkaufen. Mt Displays bietet diese Möglichkeiten bereits an, welche seinen Distributoren dabei hilft den Verkauf zu forcieren und bei deren Kunden das direkte Marketing ermöglicht. Diese Unterstützungen sind wie folgt:

- *Generelle Produktschulungen bei den Distributoren*
- *NeuProduktvorstellungen bei den Distributoren*
- *Produktpräsentationen bei Distributoren Events für deren Kunden*
- *Teilen von Marktanalysen, Trends, Effiziente Geschäftsmodelle und Verkaufsstrategien, Produktangebote für verschiedene Endkunden.*

Die oben genannten Schulungen und Präsentationen sollten im Vorhinein und bedacht geplant werden, gemeinsam mit dem Distributor um das Programm auch so effizient und erfolgreich wie möglich zu gestalten.

Unterstützungen für den Messeauftritt und für den Showroom

Unser Programm enthält diese Unterstützungen weil beide Möglichkeiten den Verkaufswachstum unserer Partner auf einer lokalen Messe fördert. Auf diesem Wege, möchten wir unsere Partner dazu bewegen, und auf die Wichtigkeit darauf aufmerksam machen wie wichtig es ist unsere Produkte auch visuell darzustellen. Die Showroom-Förderung ist eine längere Unternehmung als die Messen-Unterstützung und ist mehr auf neue Produkte und auf Premiumprodukte fokussiert.

Verschieden Produktbilder

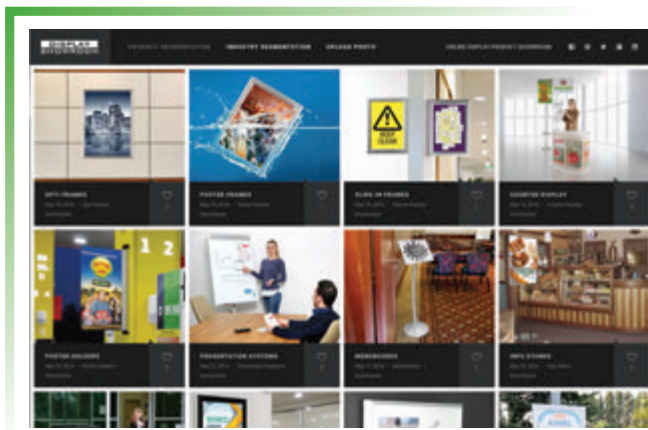
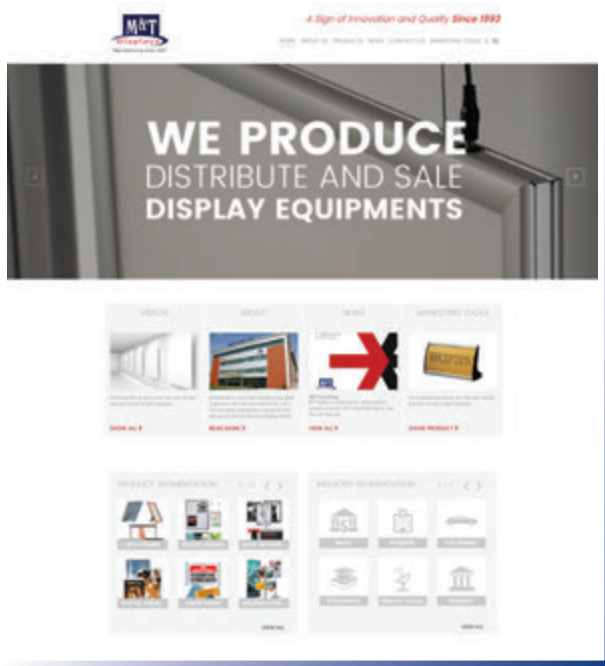
Wir schlagen hier den USB Stick vor und laden viele Informationen auf diese. Die Verwendung von einem USB Stick spart sehr viel Zeit während den Produktschulungen; nebenbei ist es ein professionelles Tool, modern und umweltfreundlich. Der USB Stick ist überall verfügbar und kann mit mehr Informationen auf einem schnelleren Weg versehen werden, Kundenspezifisch natürlich mit den notwendigen Mitteln bestückt bevor man den Kunden besucht.

„Der Schlüssel zum Erfolg!“

Fokus auf Internet und digitaler Medien

MT Displays ist stets auf dem neuesten Stand der Technik. MT Displays Apple i-Pad Applikation ist ein hervorragendes Tool für Präsentationen bei Kunden. Es ermöglicht ein einen praktischen Zugang zu den Produkten, technischen Details, Präsentationen und Montagevideos. Neben den anonymen Webseiten wie www.opti-frame.com und www.displayacademy.com welche unsere Partner benutzen können, als wären es die eigenen. Beide Seiten sind stets up-to-date mit Bildern und informativen Downloads. Die Hauptseite von MT Displays www.mtdisplays.com.tr wird sehr häufig aktualisiert mit dem Zweck um die letzten Erneuerungen und Informationen von MT Displays Ereignissen und Produkten.

Wir leben mittlerweile in einer Welt wo das Internet eine stärkere Marketingkraft hat als vergleichbar andere Möglichkeiten und ist direkter weil es direkte Zielgruppen mit Interesse anspricht. MT Displays i-Pad Applikation ist eine sehr gute Idee und eine gute Option. Bringt dem Markt eine transparente und einzigartige Annäherung.





Product Training



Fair Stand



Fair Stand



Showroom



Fair Stand



Fair Stand



Opti Frames®

- Opti Frame® 14 mm
 - 14 mm Silver Anodised
 - 14 mm Black
 - 14 mm Wood Effect
- Opti Frame® 25 mm
 - 25 mm Silver Anodised
 - 25 mm Black
 - 25 mm Wood Effect
- Opti Frame® in Colours
 - 14 mm Silber Eloxiert
 - 14 mm Holz Optik
 - 14 mm Schwarz
 - 25 mm Silber Eloxiert
 - 25 mm Schwarz
 - 25 mm Holz Optik
- Opti Frame® in Colours





Watch video at our website www.mtdisplays.com

With our patented product, we aim to bring a new dimension of performance to retail display frames.

Our R&D team has focused their extensive knowledge on transforming production processes to create a completely new type of front loading display frame;

Opti-Frame not only delivers multi functional applications with a variety of mounting options, but is specifically engineered to offer very competitive pricing in response to the demands of the competitive snap frame market.

The product is protected worldwide by relevant patent applications and disposes of DE and OHIM certifications.

Our opti frame family progressively welcomes new additions in sizes.

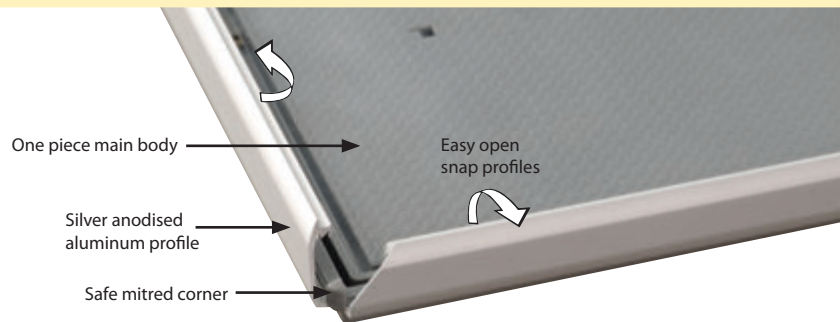
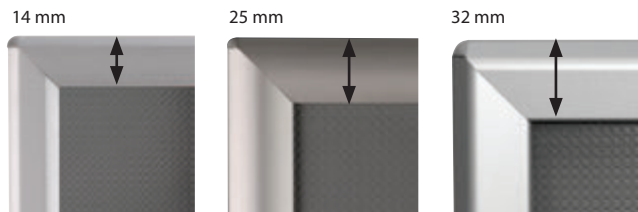
Mit unserem Produkt, haben wir versucht eine neue Dimension in den Verkauf der Display Rahmen zu bringen. Unsere Forschungsabteilung hat sich schwerwiegend darauf konzentriert, eine komplett neue Art von Rahmen zu entwickeln, indem verschiedene Produktionsprozesse zum Einsatz gebracht werden.

Der OPTI Rahmen bietet nicht nur verschiedene Einsatzmöglichkeiten durch verschiedene Montage-optionen, sondern wurde auch dafür entwickelt, um mit aggressiven Preisen den Forderungen der Klapprahmenbranche gerecht zu werden.

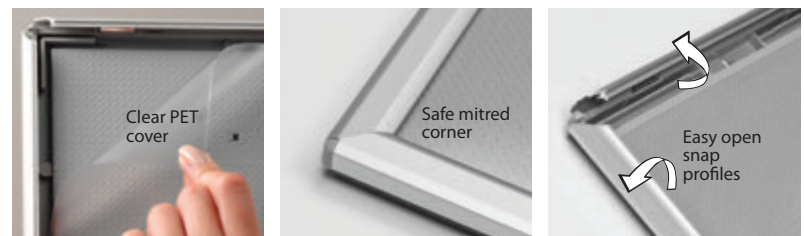
Das Produkt ist auf der ganzen Welt patentiert und ist im Besitz der DE und OHIM Zertifikate.

Unsere Opti Frame Familie wird schrittweise neue Ergänzungen in den Größen begrüßen.

Profile Type



Frame Colour



Smart design with distinctive features... "no sharp edges"

Optimised use! goes on counter, goes on wall...

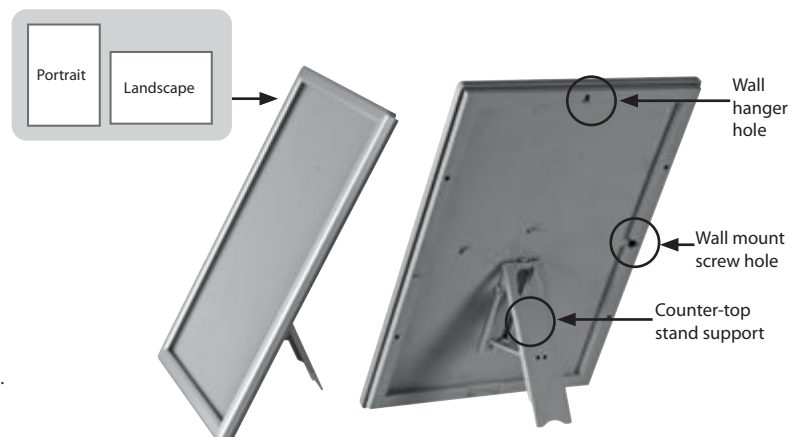
Low cost snap frames with advanced design

Multi functional use

Poster Size	PROFILE OPTIONS						Counter Support
	14 mm Profile		25 mm Profile		32 mm Profile*		
	Mitred	Round	Mitred	Round	Mitred	Round	
A1	x	x	✓	✓	✓	✓	x
A2	x	x	✓	✓	x	x	x
A3	x	x	✓	✓	x	x	x
A4	✓	✓	✓	✓	x	x	✓
A5	✓	✓	x	x	x	x	✓
A6	✓	✓	x	x	x	x	✓
B2	x	x	✓	✓	✓	✓	x
5"X7"	✓	x	x	x	x	x	✓
8"X10"	✓	x	x	x	x	x	✓
8,5"X11"	x	x	✓	x	x	x	✓
11"X17"	x	x	✓	x	x	x	x
22"X28"	x	x	✓	x	x	x	x

Opti Frame can be used for signage needs of many locations; Offices, hotels, hospitals, schools, airports, stores, apartments and many more...
*32 mm subject to MOQ.

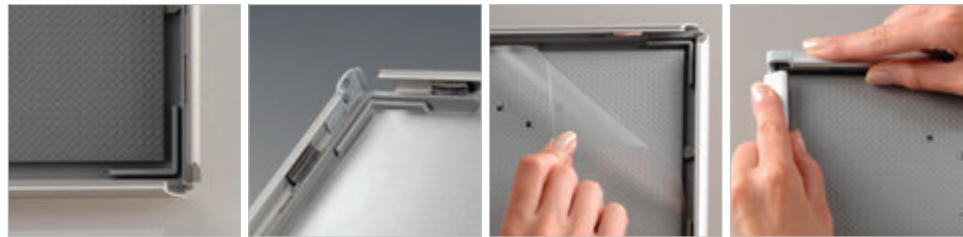
Der Opti Frame kann an mehreren Orten eingesetzt werden; Büros, Hotels, Krankenhäuser, Schulen, Flughäfen, Einzelhandel, Wohnungen und viele mehr...
*Mit einer Mindestbestellung von 32 mm.



Opti Frames®



Watch video at our website www.mtdisplays.com



14 mm / 45° - Round

- Gray color backing and counter support.
- The front profiles are silver-anodized.
- Mitred and round corner options are available.
- Eco-friendly.
- The product is protected worldwide by all relevant patent applications.
- Anti-glare poster cover sheet.

14 mm / 45° - Rondo

- Graue Rückwand und Aufsteller.
- Obere Profile sind silber eloxiert.
- In Gehrung und Rondo erhältlich.
- Naturfreundlich.
- Das Produkt ist auf der ganzen Welt patentiert.
- Anti-reflex PET Schutzfolie.



Opti Frame comes ready for wall mounting with 2 holes on both long sides. Wall hanging is also available with wall hanger holes; placed on one of short and long sides. Opti Frame is packed individually in a cardboard box. Storage conditions: Goods should be stored at 0°C-35°C in a dry place. Store in the original package. *Der Optiframe hat 2 Montagebohrungen an den langen Seiten und kann auch mit festen Aufhängungen an die Wand montiert werden. Opti Frame wird in Kartons einzelverpackt geliefert. Die Produkte sollten bei 0°C - 35°C in einer trockenen Umgebung gelagert werden. Einlagerung in der original Verpackung.*



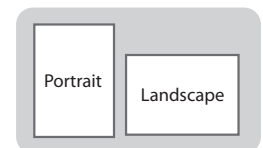
Optional counter support offers a new counter stand position available as standard in each unit in portrait and landscape position. Rounded mitred corners ensure maximum safety in public areas. *Mit dem zusätzlichen Aufsteller kann der Rahmen wahlweise in horizontal oder vertikal auf dem Tisch zum Einsatz gebracht werden. Bei den Artikeln mit Gehrung sind die Ecken zusätzlich abgerundet gegen Verletzungsgefahr.*



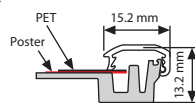
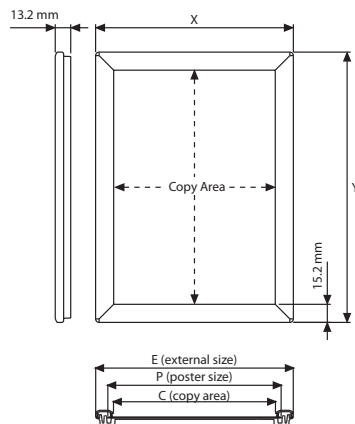
Suitable for silk screen printing, max. letter height is 7 mm. *Der 14 mm Opti Rahmen kann auch per Siebdruck bedruckt werden (max. Buchstabenhöhe 7 mm).*



Multi functional use



Patent: PCT/TR06/000018 - WO 2007/126397 - EP 2016574 - DE 20 2006 020 145 - US 2009/211 134 - AU 2006342800 - CN 101473363 - CA 2654307 - UA 2008 13893 - EA 200802174/26 - IN WO 2007/126397 - ZA 2008/09638 - TR 2007 05704 - OHIM 831235-0001,2,3,4



MATERIAL : Silver anodised aluminium PROFILE : 14 mm 45° - 14 mm Round						WEIGHT	PACKING SIZE
MITRED ARTICLE	ROUND ARTICLE	EXTERNAL (x-y)	POSTER	COPY	DESCRIPTION	WITH PACKING	*W X H X D
UCP145N0A5	UCP140N0A5	169 X 231 mm	148 X 210 mm	138 X 200 mm	Without support	0,250 kg	185 X 250 X 24 mm
UCP145N0A6	UCP140N0A6	126 X 169 mm	105 X 148 mm	95 X 138 mm	Without support	0,140 kg	140 X 190 X 24 mm
UCP145N1A5	UCP140N1A5	169 X 231 mm	148 X 210 mm	138 X 200 mm	With support	0,265 kg	185 X 250 X 24 mm
UCP145N1A6	UCP140N1A6	126 X 169 mm	105 X 148 mm	95 X 138 mm	With support	0,155 kg	140 X 190 X 24 mm

MATERIAL : Silver anodised aluminium PROFILE : 14 mm 45°						WEIGHT	PACKING SIZE
ARTICLE	EXTERNAL (x-y)	SIZE	POSTER	COPY	DESCRIPTION	WITH PACKING	*W X H X D
UCP145N057	148 X 199 mm	5" X 7" inch	127 X 178 mm	117 X 168 mm	Without support	0,260 kg	170 X 220 X 24 mm
UCP145N157	148 X 199 mm	5" X 7" inch	127 X 178 mm	117 X 168 mm	With support	0,260 kg	170 X 220 X 24 mm

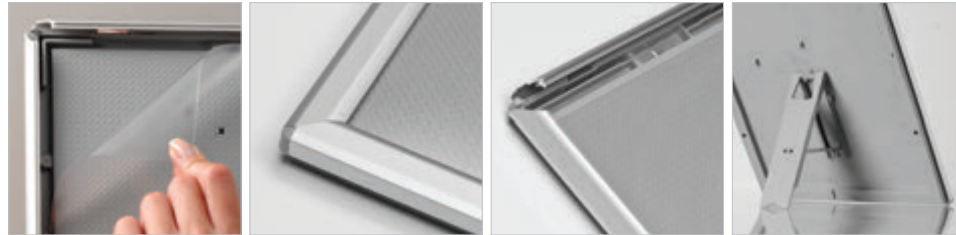
*W:Width H: Height D: Depth



Opti Frames®



Watch video at our website www.mtdisplays.com



14 mm / 45° - Round

- Gray color backing and counter support.
- The front profiles are silver-anodized.
- Mitred and round corner options are available.
- Eco-friendly.
- The product is protected worldwide by all relevant patent applications.
- Anti-glare poster cover sheet.

14 mm / 45° - Rondo

- Graue Rückwand und Aufsteller.
- Obere Profile sind silber eloxiert.
- In Gehrung und Rondo erhältlich.
- Naturfreundlich.
- Das Produkt ist auf der ganzen Welt patentiert.
- Anti-reflex PET Schutzfolie.



Opti Frame comes ready for wall mounting with 2 holes on both long sides. Wall hanging is also available with wall hanger holes; placed on one of short and long sides. Opti Frame is packed individually in a cardboard box. Storage conditions: Goods should be stored at 0°C-35°C in a dry place. Store in the original package.

Der Optiframe hat 2 Montagebohrungen an den langen Seiten und kann auch mit festen Aufhängungen an die Wand montiert werden. Opti Frame wird in Kartons einzelverpackt geliefert. Die Produkte sollten bei 0°C - 35°C in einer trockenen Umgebung gelagert werden. Einlagerung in der original Verpackung.



Optional counter support offers a new counter stand position available as standard in each unit in portrait and landscape position. Rounded mitred corners ensure maximum safety in public areas.

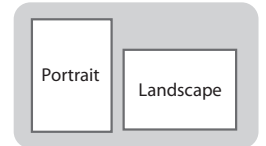
Mit dem zusätzlichen Aufsteller kann der Rahmen wahlweise in horizontal oder vertikal auf dem Tisch zum Einsatz gebracht werden. Bei den Artikeln mit Gehrung sind die Ecken zusätzlich abgerundet gegen Verletzungsgefahr.



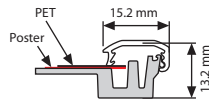
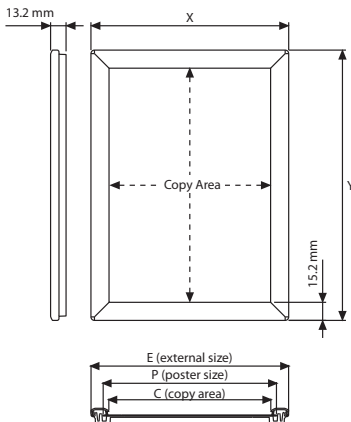
Suitable for silk screen printing, max. letter height is 7 mm. Der 14 mm Opti Rahmen kann auch per Siebdruck bedruckt werden (max. Buchstabenhöhe 7 mm).



Multi functional use



Patent: PCT/TR06/000018 - WO 2007/126397 - EP 2016574 - DE 20 2006 020 145 - US 2009/211134 - AU 2006342800 - CN 101473363 - CA 2654307 - UA 2008 13893 - EA 200802174/26 - IN WO 2007/126397 - ZA 2008/09638 - TR 2007 05704 - OHIM 831235-0001,2,3,4



MATERIAL : Silver anodised aluminium PROFILE : 14 mm 45° - 14 mm Round							WEIGHT	PACKING SIZE
MITRED ARTICLE	ROUND ARTICLE	EXTERNAL (x-y)	SIZE	POSTER	COPY	DESCRIPTION	WITH PACKING	*W X H X D
UCP145NOA4	UCP140NOA4	231 X 318 mm	A4	210 X 297 mm	200 X 287 mm	Without support	0,250 kg	185 X 250 X 24 mm
UCP145N1A4	UCP140N1A4	231 X 318 mm	A4	210 X 297 mm	200 X 287 mm	With support	0,140 kg	140 X 190 X 24 mm
UCP145N000	-	224 X 275 mm	8" X 10" inch	203 X 254 mm	193 X 244 mm	Without support	0,265 kg	185 X 250 X 24 mm
UCP145N100	-	224 X 275 mm	8" X 10" inch	203 X 254 mm	193 X 244 mm	With support	0,155 kg	140 X 190 X 24 mm

* W:Width H: Height D: Depth



Opti Frames®



Watch video at our website www.mtdisplays.com



14 mm / 45° - Black

- Black color backing and counter support.
- The front profiles have black powder coating RAL 9005.
- Eco-friendly.
- The product is protected worldwide by all relevant patent applications.
- Anti-glare poster cover sheet.

14 mm / 45° - Schwarz

- Schwarze Rückwand und Aufsteller.
- Obere Profile sind Schwarz Ral 9005 pulverbeschichtet.
- Naturfreundlich.
- Das Produkt ist auf der ganzen Welt patentiert.
- Anti-reflex PET Schutzfolie.



Opti Frame comes ready for wall mounting with 2 holes on both long sides. Wall hanging is also available with wall hanger holes; placed on one of short and long sides. Opti Frame is packed individually in a cardboard box. Storage conditions: Goods should be stored at 0°C-35°C in a dry place. Store in the original package.

Der Optiframe hat 2 Montagebohrungen an den langen Seiten und kann auch mit festen Aufhängungen an die Wand montiert werden. Opti Frame wird in Kartons einzeln verpackt geliefert. Die Produkte sollten bei 0°C - 35°C in einer trockenen Umgebung gelagert werden. Einlagerung in der original Verpackung.



Optional counter support offers a new counter stand position available as standard in each unit in portrait and landscape position. Rounded mitred corners ensure maximum safety in public areas.

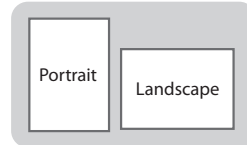
Mit dem zusätzlichen Aufsteller kann der Rahmen wahlweise in horizontal oder vertikal auf dem Tisch zum Einsatz gebracht werden. Bei den Artikeln mit Gehrung sind die Ecken zusätzlich abgerundet gegen Verletzung Gefahr.



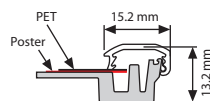
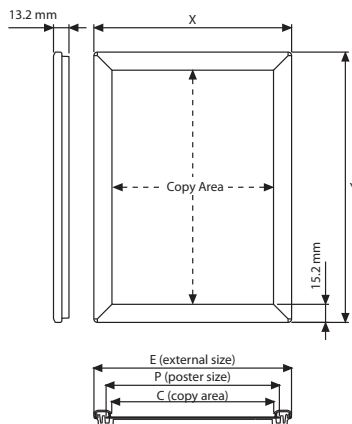
Suitable for silk screen printing, max. letter height is 7 mm. Der 14 mm Opti Rahmen kann auch per Siebdruck bedruckt werden (max. Buchstabenhöhe 7 mm).



Multi functional use



Patent: PCT/TR06/000018 - WO 2007/126397 - EP 2016574 - DE 20 2006 020 145 - US 2009/211134 - AU 2006342800 - CN 101473363 - CA 2654307 - UA 2008 13893 - EA 200802174/26 - IN WO 2007/126397 - ZA 2008/09638 - TR 2007 05704 - OHIM 831235-0001,2,3,4



MATERIAL : Black powder coated RAL 9005 PROFILE : 14 mm 45°					WEIGHT	PACKING SIZE
ARTICLE	EXTERNAL (x-y)	POSTER	COPY	DESCRIPTION	WITH PACKING	*W X H X D
UCP145B0A5	169 X 231 mm	148 X 210 mm	138 X 200 mm	Without support	0,250 kg	185 X 250 X 24 mm
UCP145B0A6	126 X 169 mm	105 X 148 mm	95 X 138 mm	Without support	0,140 kg	140 X 190 X 24 mm
UCP145B1A5	169 X 231 mm	148 X 210 mm	138 X 200 mm	With support	0,265 kg	185 X 250 X 24 mm
UCP145B1A6	126 X 169 mm	105 X 148 mm	95 X 138 mm	With support	0,155 kg	140 X 190 X 24 mm

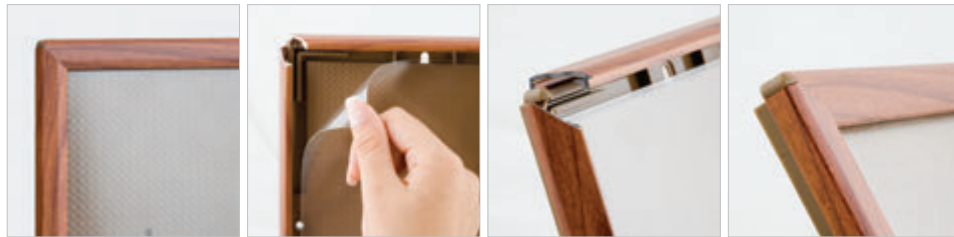
*W:Width H: Height D: Depth



Opti Frames®



Watch video at our website www.mtdisplays.com



14 mm / 45° - Wood Effect

- Wooden color backing and counter support.
- The front profiles have a wood effect finish.
- Eco-friendly.
- The product is protected worldwide by all relevant patent applications.
- Anti-glare poster cover sheet.

14 mm / 45° - Holz Optik

- Zur Holzoptik farblich abgestimmte Rückwand und Aufsteller.
- Obere Profile mit Holzoptik.
- Naturfreundlich.
- Das Produkt ist auf der ganzen Welt patentiert.
- Anti-reflex PET Schutzfolie.



Opti Frame comes ready for wall mounting with 2 holes on both long sides. Wall hanging is also available with wall hanger holes; placed on one of short and long sides. Opti Frame is packed individually in a cardboard box. Storage conditions: Goods should be stored at 0°C-35°C in a dry place. Store in the original package.

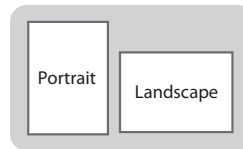
Der Optiframe hat 2 Montagebohrungen an den langen Seiten und kann auch mit festen Aufhängungen an die Wand montiert werden. Opti Frame wird in Kartons einzelverpackt geliefert. Die Produkte sollten bei 0°C – 35°C in einer trockenen Umgebung gelagert werden. Einlagerung in der original Verpackung.



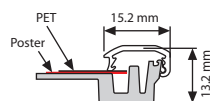
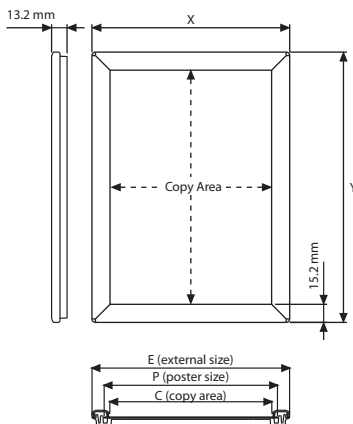
Optional counter support offers a new counter stand position available as standard in each unit in portrait and landscape position. Rounded mitred corners ensure maximum safety in public areas. *Mit dem zusätzlichen Aufsteller kann der Rahmen wahlweise in horizontal oder vertikal auf dem Tisch zum Einsatz gebracht werden. Bei den Artikeln mit Gehrung sind die Ecken zusätzlich abgerundet gegen Verletzungsgefahr.*



Multi functional use



Patent: PCT/TR06/000018 - WO 2007/126397 - EP 2016574 - DE 20 2006 020 145 - US 2009/211134
 - AU 2006342800 - CN 101473363 - CA 2654307 - UA 2008 13893 - EA 200802174/26 - IN WO
 2007/126397 - ZA 2008/09638 - TR 2007 05704 - OHIM 831235-0001,2,3,4



MATERIAL: Wood Look Effect PROFILE: 14 mm 45°					WEIGHT	PACKING SIZE
ARTICLE	EXTERNAL (x-y)	POSTER	COPY	DESCRIPTION	WITH PACKING	*W X H X D
UCP145WOA5	169 X 231 mm	148 X 210 mm	138 X 200 mm	Without support	0,250 kg	185 X 250 X 24 mm
UCP145WOA6	126 X 169 mm	105 X 148 mm	95 X 138 mm	Without support	0,140 kg	140 X 190 X 24 mm
UCP145W1A5	169 X 231 mm	148 X 210 mm	138 X 200 mm	With support	0,265 kg	185 X 250 X 24 mm
UCP145W1A6	126 X 169 mm	105 X 148 mm	95 X 138 mm	With support	0,155 kg	140 X 190 X 24 mm

*W:Width H: Height D: Depth



Opti Frames®



Watch video at our website www.mtdisplays.com



25 mm / 45° - Round

- Gray color backing and counter support.
- The front profiles are silver-anodized.
- Mitred and round corner options are available.
- Eco-friendly.
- The product is protected in world by all required patent applications.
- Anti-glare poster cover sheet.

25 mm / 45° - Rondo

- Graue Rückwand und Aufsteller.
- Obere Profile sind silber eloxiert.
- In Gehrung und Rondo erhaltlich.
- Naturfreundlich.
- Das Produkt ist auf der ganzen Welt patentiert.
- Anti-reflex PET Schutzfolie.



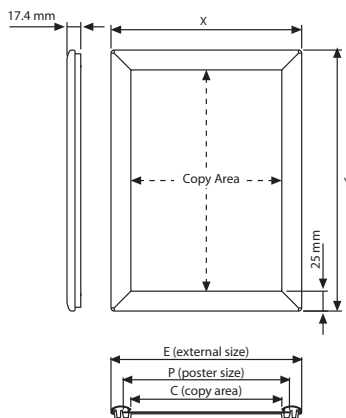
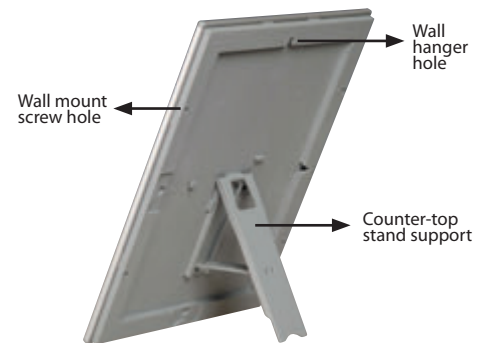
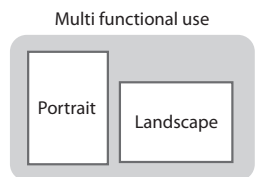
Opti Frame comes ready for wall mounting with 2 holes on both long sides. Wall hanging is also available with wall hanger holes; placed on one of short and long sides. Opti Frame is packed individually in a cardboard box. Storage conditions: Goods should be stored at 0°C-35°C in a dry place. Store in the original package. *Der Optiframe hat 2 Montagebohrungen an den langen Seiten und kann auch mit festen Aufhängungen an die Wand montiert werden. Optiframe wird in Kartons einzelverpackt geliefert. Die Produkte sollten bei 0°C – 35°C in einer trockenen Umgebung gelagert werden. Einlagerung in der original Verpackung.*



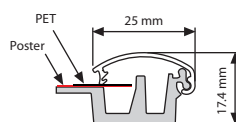
Optional counter support offers a new counter stand position available as standard in each unit in portrait and landscape position for size of A4. Rounded mitred corners ensure maximum safety in public areas. *Mit dem zusätzlichen Aufsteller kann der Rahmen in DIN A4 wahlweise in horizontal oder vertikal auf dem Tisch zum Einsatz gebracht werden. Bei den Artikeln mit Gehrung sind die Ecken zusätzlich abgerundet gegen Verletzungsgefahr auf öffentlichen Plätzen.*



25 mm profile is suitable for silk screen printing, max. letter height is 15 mm. *Der 25 mm Opti Rahmen kann auch per Siebdruck bedruckt werden (max. Buchstabenhöhe 15 mm).*



Patent: PCT/TR06/000018 - WO 2007/126397 - EP 2016574 - DE 20 2006 020 145 - US 2009/211134 - AU 2006342800 - CN 101473363 - CA 2654307 - UA 2008 13893 - EA 200802174/26 - IN WO 2007/126397 - ZA 2008/09638 - TR 2007 05704 - OHIM 831235-0001,2,3,4



MATERIAL : Silver anodised aluminium PROFILE : 25 mm 45° - 25 mm Round						WEIGHT	PACKING SIZE
MITRED ARTICLE	ROUND ARTICLE	EXTERNAL (x-y)	POSTER	COPY	DESCRIPTION	WITH PACKING	*W X H X D
UCP255NOA4	UCP250NOA4	241 X 328 mm	210 X 297 mm	191 X 278 mm	Without support	0,495 kg	250 X 350 X 24 mm
UCP255N1A4	UCP250N1A4	241 X 328 mm	210 X 297 mm	191 X 278 mm	With support	0,520 kg	250 X 350 X 24 mm
UCP255NOA3	UCP250NOA3	328 X 451 mm	297 X 420 mm	278 X 401 mm	Without support	0,835 kg	350 X 460 X 24 mm
UCP255NOA2	UCP250NOA2	451 X 625 mm	420 X 594 mm	401 X 575 mm	Without support	1,230 kg	460 X 660 X 24 mm

* W:Width H: Height D: Depth



Opti Frames®



Watch video at our website www.mtdisplays.com



25 mm / 45° - Round

- Gray color backing and counter support.
- The front profiles are silver-anodized.
- Mitred and round corner options are available.
- Eco-friendly.
- The product is protected in world by all required patent applications.
- Anti-glare poster cover sheet.

25 mm / 45° - Rondo

- Graue Rückwand und Aufsteller.
- Obere Profile sind silber eloxiert.
- In Gehrung und Rondo erhaltlich.
- Naturfreundlich.
- Das Produkt ist auf der ganzen Welt patentiert.
- Anti-reflex PET Schutzfolie.



Opti Frame comes ready for wall mounting with 2 holes on both long sides. Wall hanging is also available with wall hanger holes; placed on one of short and long sides. Opti Frame is packed individually in a cardboard box. Storage conditions: Goods should be stored at 0°C-35°C in a dry place. Store in the original package. *Der Optiframe hat 2 Montagebohrungen an den langen Seiten und kann auch mit festen Aufhängungen an die Wand montiert werden. Optiframe wird in Kartons einzelverpackt geliefert. Die Produkte sollten bei 0°C – 35°C in einer trockenen Umgebung gelagert werden. Einlagerung in der original Verpackung.*



Optional counter support offers a new counter stand position available as standard in each unit in portrait and landscape position for size of A4. Rounded mitred corners ensure maximum safety in public areas. *Mit dem zusätzlichen Aufsteller kann der Rahmen in DIN A4 wahlweise in horizontal oder vertikal auf dem Tisch zum Einsatz gebracht werden. Bei den Artikeln mit Gehrung sind die Ecken zusätzlich abgerundet gegen Verletzungsgefahr auf öffentlichen Plätzen.*



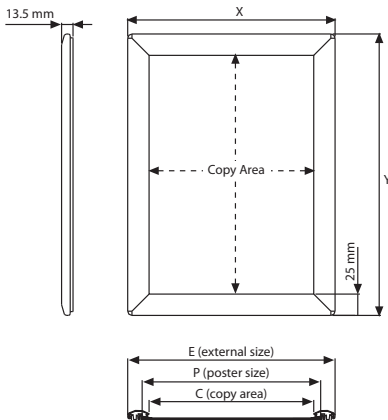
25 mm profile is suitable for silk screen printing, max. letter height is 15 mm. *Der 25 mm Opti Rahmen kann auch per Siebdruck bedruckt werden (max. Buchstabenhöhe 15 mm).*



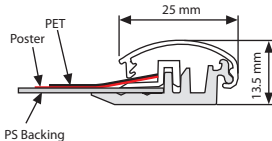
A1



B2



Patent: PCT/TR06/000018 - WO 2007/126397 - EP 2016574 - DE 20 2006 020 145 - US 2009/211134
 - AU 2006342800 - CN 101473363 - CA 2654307 - UA 2008 13893 - EA 200802174/26 - IN WO
 2007/126397 - ZA 2008/09638 - TR 2007 05704 - OHIM 831235-0001,2,3,4



MATERIAL : Silver anodised aluminium PROFILE : 25 mm 45° - 25 mm Round					WEIGHT	PACKING SIZE
MITRED ARTICLE	ROUND ARTICLE	EXTERNAL (x-y)	POSTER	COPY	WITH PACKING	*W X H X D
UCP255NOB2	UCP250NOB2	534 X 734 mm	500 X 700 mm	484 X 684 mm	1,530 kg	550 X 750 X 24 mm
UCP255NOA1	UCP250NOA1	628 X 875 mm	594 X 841 mm	578 X 825 mm	2,245 kg	650 X 900 X 24 mm
UCP255NO22	-	589,9 X 742,2 mm	22" X 28"	539,8 X 692,2 mm	1,830 kg	600 X 750 X 24 mm



*W:Width H: Height D: Depth

Opti Frames®



Watch video at our website www.mtdisplays.com



25 mm / 45° - Black & Wood Effect

- Black & Wooden color backing and counter support.
- The front profiles have black powder coating RAL 9005
- Eco-friendly.
- The product is protected worldwide by all relevant patent applications.
- Anti-glare poster cover sheet.

25 mm / 45° - Schwarz & Holz Optik

- Schwarze & Holzoptik farblich abgestimmte Rückwand und Aufsteller.
- Obere Profile sind Schwarz Ral 9005 Pulverbeschichtet.
- Naturfreundlich.
- Das Produkt ist auf der ganzen Welt patentiert.
- Anti-reflex PET Schutzfolie.



Opti Frame comes ready for wall mounting with 2 holes on both long sides. Wall hanging is also available with wall hanger holes; placed on one of short and long sides. Opti Frame is packed individually in a cardboard box. Storage conditions: Goods should be stored at 0°C-35°C in a dry place. Store in the original package. *Der Optiframe hat 2 Montagebohrungen an den langen Seiten und kann auch mit festen Aufhängungen an die Wand montiert werden. Optiframe wird in Kartons einzeln verpackt geliefert. Die Produkte sollten bei 0°C – 35°C in einer trockenen Umgebung gelagert werden. Einlagerung in der original Verpackung.*



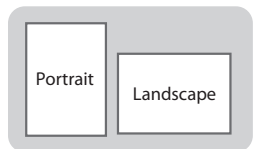
Optional counter support offers a new counter stand position available as standard in each unit in portrait and landscape position for size of A4. Rounded mitred corners ensure maximum safety in public areas. *Mit dem zusätzlichen Aufsteller kann der Rahmen in DIN A4 wahlweise in horizontal oder vertikal auf dem Tisch zum Einsatz gebracht werden. Bei den Artikeln mit Gehrung sind die Ecken zusätzlich abgerundet gegen Verletzungsgefahr auf öffentlichen Plätzen.*



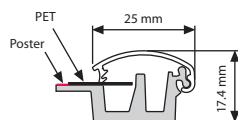
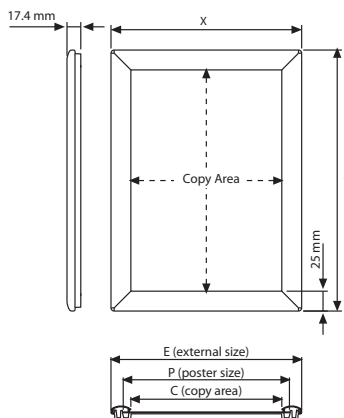
25 mm profile is suitable for silk screen printing, max. letter height is 15 mm. *Der 25 mm Opti Rahmen kann auch per Siebdruck bedruckt werden (max. Buchstabenhöhe 15 mm).*



Multi functional use



Patent: PCT/TR06/000018 - WO 2007/126397 - EP 2016574 - DE 20 2006 020 145 - US 2009/211134 - AU 2006342800 - CN 101473363 - CA 2654307 - UA 2008 13893 - EA 200802174/26 - IN WO 2007/126397 - ZA 2008/09638 - TR 2007 05704 - OHIM 831235-0001,2,3,4



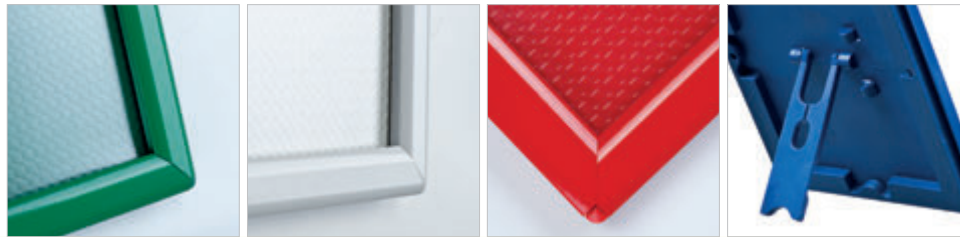
MATERIAL : Wood Look Effect PROFILE : 25 mm 45°					WEIGHT	PACKING SIZE
ARTICLE	EXTERNAL (x-y)	POSTER	COPY	DESCRIPTION	WITH PACKING	*W X H X D
UCP255W0A4	241 X 328 mm	210 X 297 mm	191 X 278 mm	Without support	0,495 kg	250 X 350 X 24 mm
UCP255W1A4	241 X 328 mm	210 X 297 mm	191 X 278 mm	With support	0,520 kg	250 X 350 X 24 mm

MATERIAL : Black powder coated RAL 9005 PROFILE : 25 mm 45°					WEIGHT	PACKING SIZE
ARTICLE	EXTERNAL (x-y)	POSTER	COPY	DESCRIPTION	WITH PACKING	*W X H X D
UCP255B0A3	328 X 451 mm	297 X 420 mm	278 X 401 mm	Without support	0,835 kg	350 X 460 X 24 mm
UCP255B0A4	241 X 328 mm	210 X 297 mm	191 X 278 mm	Without support	0,495 kg	250 X 350 X 24 mm
UCP255B1A4	241 X 328 mm	210 X 297 mm	191 X 278 mm	With support	0,520 kg	250 X 350 X 24 mm
UCP255B122	589,9 X 742,2 mm	22" X 28"	539,8 X 692,2 mm	Without support	1,830 kg	600 X 750 X 24 mm

*W:Width H: Height D: Depth



Opti Frame® now in colours



Spring colours in Opti Frame
Multi-functional Opti Frame is now available in colours. New colours in 3 different sizes, now on counters and goes on wall. No minimum ordering quantity for 5 new colours. Fits well in all colour environments.

Frühlingsfarben bei Opti Frame
Der multi-funktionelle Opti Frame ist nun auch in farben standartmässig erhältlich. Neue Farben in 3 verschiedenen Grössen können auf den Theken oder an der Wand Einsatz finden. Keine Mindestabnahmemengen mehr für 5 neue Farben. Überall wo es farbig zugehen soll!



6 Colours

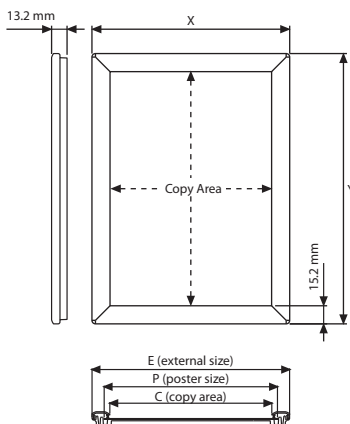


in different sizes

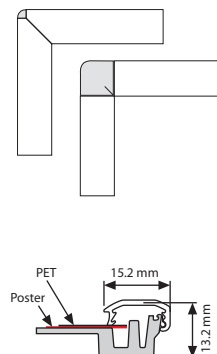


Stands on counter

Opti®
Frame
www.opti-frame.com



2 different corner options



MATERIAL : Silver anodised aluminium PROFILE : 14 mm 45° - 14 mm Round					WEIGHT	PACKING SIZE
ARTICLE	COLOUR	EXTERNAL (x-y)	POSTER	COPY	WITH PACKING	*W X H X D
UCP145E1A4	RAL 6029-Green	231 X 318 mm	210 X 297 mm	200 X 287 mm	0,520 kg	250 X 350 X 24 mm
UCP145E1A5	RAL 6029-Green	169 X 231 mm	148 X 210 mm	138 X 200 mm	0,250 kg	185 X 250 X 24 mm
UCP145E1A6	RAL 6029-Green	126 X 169 mm	105 X 148 mm	95 X 138 mm	0,140 kg	140 X 190 X 24 mm
UCP145H1A4	RAL 9003-White	231 X 318 mm	210 X 297 mm	200 X 287 mm	0,520 kg	250 X 350 X 24 mm
UCP145H1A5	RAL 9003-White	169 X 231 mm	148 X 210 mm	138 X 200 mm	0,250 kg	185 X 250 X 24 mm
UCP145H1A6	RAL 9003-White	126 X 169 mm	105 X 148 mm	95 X 138 mm	0,140 kg	140 X 190 X 24 mm
UCP145L1A4	RAL 5002-Blue	231 X 318 mm	210 X 297 mm	200 X 287 mm	0,520 kg	250 X 350 X 24 mm
UCP145L1A5	RAL 5002-Blue	169 X 231 mm	148 X 210 mm	138 X 200 mm	0,250 kg	185 X 250 X 24 mm
UCP145L1A6	RAL 5002-Blue	126 X 169 mm	105 X 148 mm	95 X 138 mm	0,140 kg	140 X 190 X 24 mm
UCP145R1A4	RAL 3020-Red	231 X 318 mm	210 X 297 mm	200 X 287 mm	0,520 kg	250 X 350 X 24 mm
UCP145R1A5	RAL 3020-Red	169 X 231 mm	148 X 210 mm	138 X 200 mm	0,250 kg	185 X 250 X 24 mm
UCP145R1A6	RAL 3020-Red	126 X 169 mm	105 X 148 mm	95 X 138 mm	0,140 kg	140 X 190 X 24 mm
UCP145Y1A4	RAL 1021-Yellow	231 X 318 mm	210 X 297 mm	200 X 287 mm	0,520 kg	250 X 350 X 24 mm
UCP145Y1A5	RAL 1021-Yellow	169 X 231 mm	148 X 210 mm	138 X 200 mm	0,250 kg	185 X 250 X 24 mm
UCP145Y1A6	RAL 1021-Yellow	126 X 169 mm	105 X 148 mm	95 X 138 mm	0,140 kg	140 X 190 X 24 mm
UCP145B1A4	RAL 9005-Black	231 X 318 mm	210 X 297 mm	200 X 287 mm	0,520 kg	250 X 350 X 24 mm
UCP145B1A5	RAL 9005-Black	169 X 231 mm	148 X 210 mm	138 X 200 mm	0,250 kg	185 X 250 X 24 mm
UCP145B1A6	RAL 9005-Black	126 X 169 mm	105 X 148 mm	95 X 138 mm	0,140 kg	140 X 190 X 24 mm

* W:Width H: Height D: Depth





Poster Frames

•Snap Frames

- 15 mm
- 20 mm
- 25 mm
- 25 mm Golden Look Effect
- 25 mm Black Anodised
- 25 mm Chrome Look Effect
- 25 mm Stainless Steel Look
- 25 mm Wood Look Effect
- 25 mm Coloured Snap Frame
- 30 mm
- 32 mm
- 32 mm with Safe Corner
- 38 mm
- 45 mm
- 46 mm

•Fancy Frame

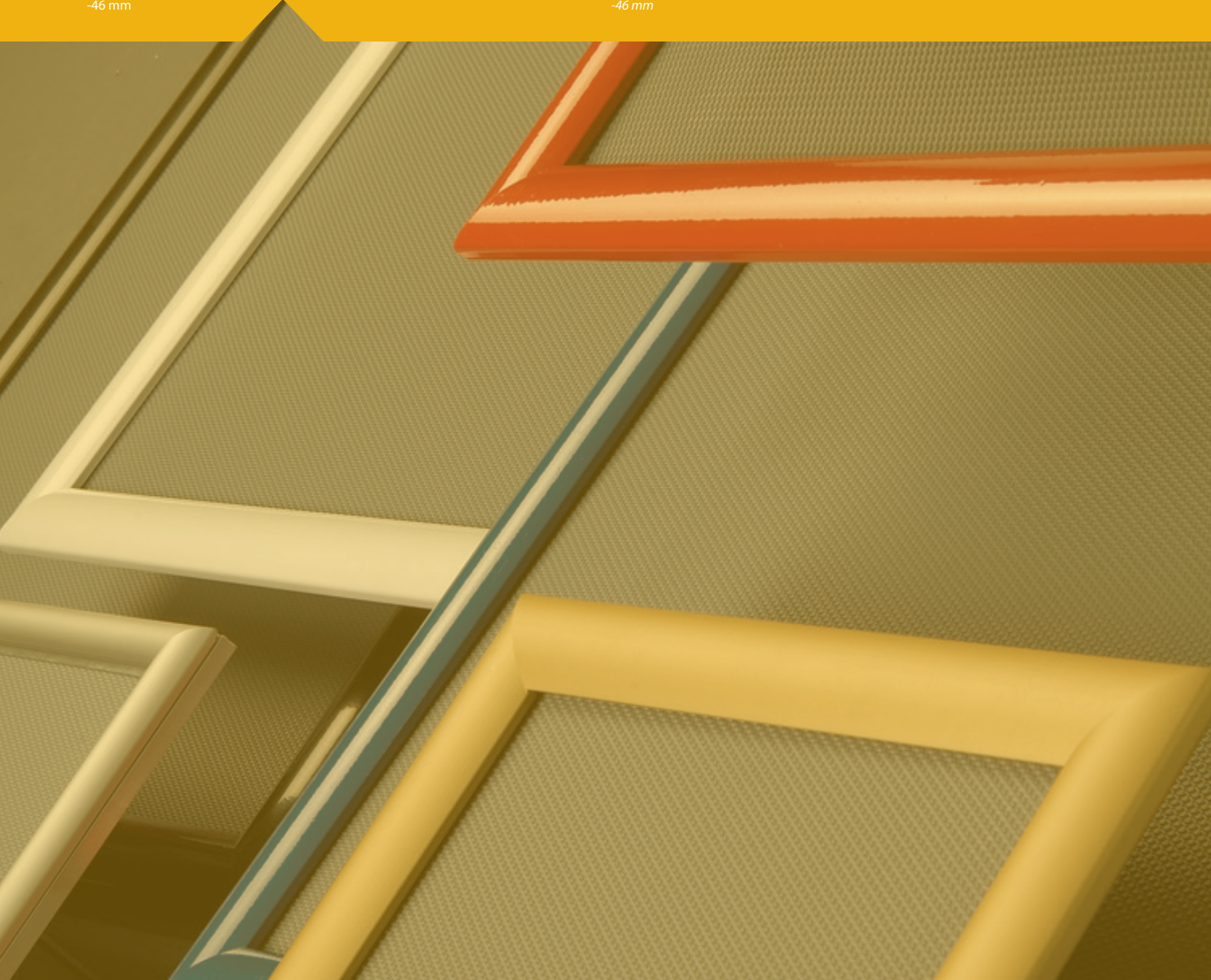
- Basic Snap Frame
- Fire Resistant Snap Frame
- Double Colour Frame
- Paperboard
- Security Frame
- Double Sided Snap Frame
- Window Frame
- Window Sign
- Lockable Snap Frame
- Lockable Window Frame
- Lockable Waterproof Frame
- Weatherproof Frame
- Magnetic Frame Single Sided
- Magnetic Frame Double Sided

•Klapprahmen

- 15 mm
- 20 mm
- 25 mm
- 25 mm Golden Look Effect
- 25 mm Black Anodised
- 25 mm Chrome Look Effect
- 25 mm Stainless Steel Look
- 25 mm Wood Look Effect
- 25 mm Pulverbeschichtete Snap Frames
- 30 mm
- 32 mm
- 32 mm with Safe Corner
- 38 mm
- 45 mm
- 46 mm

•Fancy Frame

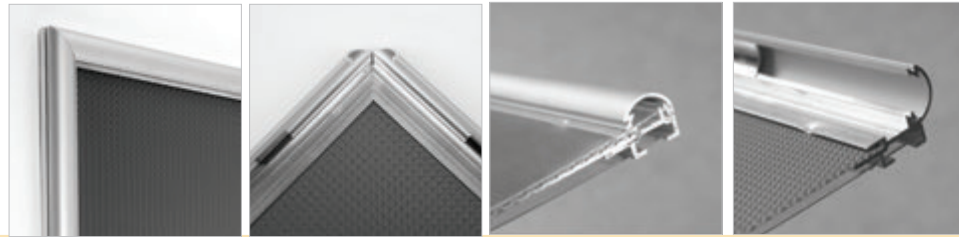
- Basic Snap Frame
- Brandschutzsichere Klapprahmen
- Doppelfarbige Klapprahmen
- Paperboard
- Sicherheitsklapprahmen
- Doppelseitige Klapprahmen
- Fensterrahmen
- Window Sign
- Abschliessbare Klapprahmen
- Abschliessbare Fensterrahmen
- Abschliessbare , wetterfeste Klapprahmen
- Wetterfeste Klapprahmen
- Magnetic Frame Single Sided
- Magnetic Frame Double Sided



Snap Frames



Watch video at our website www.mtdisplays.com



15 mm Profile / 45°

- Ideal for small-sized posters.
- Natural silver-anodized and various RAL colors are available.
- Mitred corners.
- Anti-glare poster cover sheet.

15 mm Profile / 45°

- Ideal für kleine Postergößen.
- Erhältlich in Natursilber eloxiert oder in verschiedenen RAL-Farben.
- Auf Gehrung.
- Anti-reflex PET Schutzfolie.

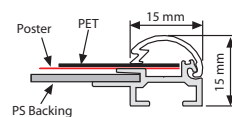
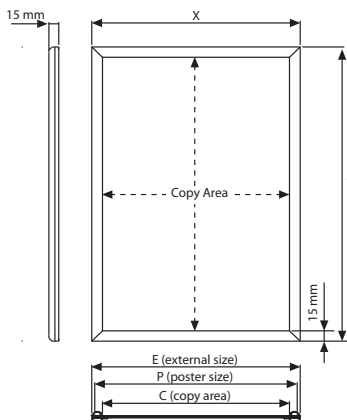


Each frame includes wall mounting accessories (4 screws & 4 plugs). Each frame is packed individually in a cardboard box.

Jeder Klapprahmen beinhaltet Wandbefestigung (4 Schrauben und Dübel). Jeder Klapprahmen ist im Karton einzeln verpackt.



Suitable for silk screen printing, max. letter height is 8 mm.
Für Siebdruck geeignet max. Buchstabenhöhe 8 mm.



MATERIAL : Silver anodised aluminium PROFILE : 15 mm 45°				WEIGHT	PACKING SIZE
ARTICLE	EXTERNAL (x-y)	POSTER	COPY	WITH PACKING	*W X H X D
UCN155N0A5	158 X 220 mm	148 X 210 mm	128 X 190 mm	0,320 kg	170 X 250 X 21 mm
UCN155N0A4	220 X 307 mm	210 X 297 mm	190 X 277 mm	0,450 kg	210 X 330 X 21 mm
UCN155N0A3	307 X 430 mm	297 X 420 mm	277 X 400 mm	0,700 kg	350 X 460 X 21 mm
UCN155N0A2	430 X 604 mm	420 X 594 mm	400 X 574 mm	1,100 kg	460 X 660 X 21 mm
UCN155N0A1	604 X 851 mm	594 X 841 mm	574 X 821 mm	2,080 kg	650 X 910 X 21 mm
UCN155N0B2	510 X 710 mm	500 X 700 mm	480 X 680 mm	1,800 kg	560 X 760 X 21 mm
UCN155N0B1	710 X 1010 mm	700 X 1000 mm	680 X 980 mm	3,400 kg	760 X 1060 X 21 mm
UCN155N023	518 X 772 mm	508 X 762 mm	488 X 742 mm	1,850 kg	570 X 820 X 21 mm

*W:Width H: Height D: Depth



Snap Frames



Watch video at our website www.mtdisplays.com



20 mm Profile / 45°

- Ideal for small-sized posters.
- Natural silver-anodized and different RAL colors are available.
- Mitred corners.
- Anti-glare poster cover sheet.

20 mm Profile / 45°

- Ideal für kleine Postergrößen.
- Erhältlich in Natursilber eloxiert oder in verschiedenen RAL-Farben.
- Auf Gehrung.
- Anti-reflex PET Schutzfolie.



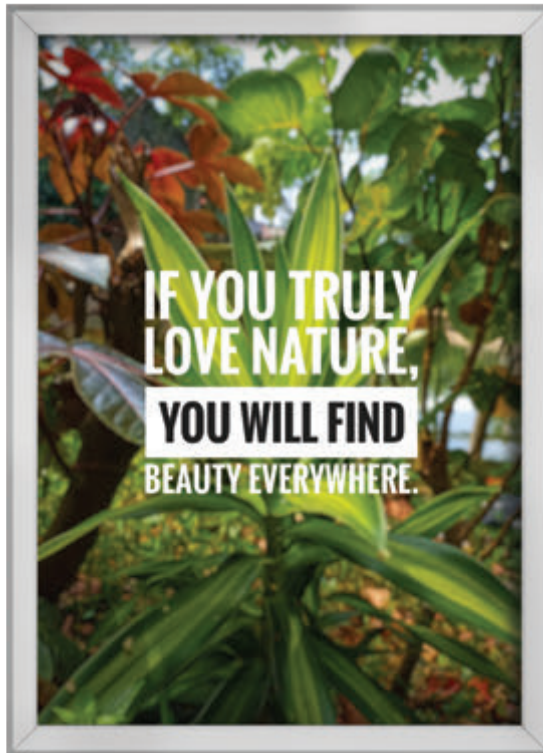
Each frame includes wall mounting accessories (4 screws & 4 plugs). Each frame is packed individually in a cardboard box. *Jeder Klapprahmen beinhaltet Wandbefestigung (4 Schrauben und Dübel). Jeder Klapprahmen ist im Karton einzeln verpackt.*



"Optional hangers" permit easy mounting. *Optionell erhältliche Aufhänger ermöglichen die leichte Montage.*



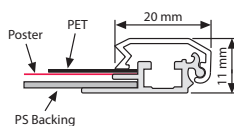
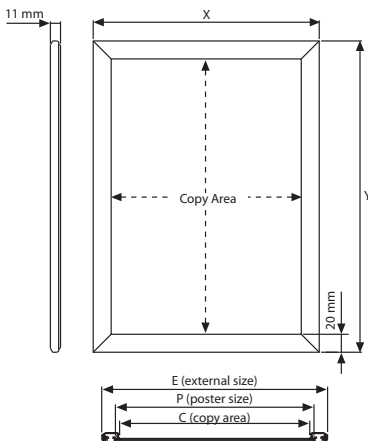
Suitable for silk screen printing, max. letter height is 11 mm. *Für Siebdruck geeignet max. Buchstabenhöhe 11 mm.*



UYUP057000
Optional counter support for A4 and A3. Frames to be ordered specially for compatibility. *Der optionale Aufstellfuss für A4- und A3-Rahmen müssen aus Kompatibilitätsgründen speziell bestellt werden*



UYAA011010
Optional V Hanger
Optionaler V Aufhänger



MATERIAL : Silver anodised aluminium PROFILE : 20 mm 45°				WEIGHT	PACKING SIZE
ARTICLE	EXTERNAL (x-y)	POSTER	COPY	WITH PACKING	*W X H X D
UCN205N0A4	240 X 327 mm	210 X 297 mm	202 X 289 mm	0,480 kg	250 X 350 X 21 mm
UCN205N0A3	327 X 450 mm	297 X 420 mm	289 X 412 mm	0,750 kg	350 X 460 X 21 mm
UCN205N0A2	450 X 624 mm	420 X 594 mm	412 X 586 mm	1,220 kg	460 X 660 X 21 mm
UCN205N0A1	624 X 871 mm	594 X 841 mm	586 X 833 mm	2,240 kg	650 X 900 X 21 mm
UCN205N0B2	530 X 730 mm	500 X 700 mm	492 X 692 mm	1,450 kg	550 X 750 X 21 mm
UCN205N0B1	730 X 1030 mm	700 X 1000 mm	692 X 992 mm	2,970 kg	750 X 1050 X 21 mm
UCN205N023	538 X 792 mm	508 X 762 mm	500 X 754 mm	1,450 kg	560 X 810 X 21 mm
UCN205N034	792 X 1046 mm	762 X 1016 mm	754 X 1008 mm	3,150 kg	810 X 1070 X 21 mm

*W:Width H: Height D: Depth



Snap Frames



Watch video at our website www.mtdisplays.com



25 mm Profile / 45° - Round

- Ideal for posters of every size.
- Natural silver-anodized and different RAL colors are available.
- Mitred and Round corner alternatives.
- Anti-glare poster cover sheet.

25 mm Profile / 45° - Rondo

- Ideal für jede Postergrösse.
- Erhältlich in Natursilber eloxiert oder in verschiedenen RAL-Farben.
- Auf Gehrung oder Rondo als Alternative.
- Anti-reflex PET Schutzfolie.



Each frame includes wall mounting accessories (4 screws & 4 plugs). Each frame is packed individually in a cardboard box. *Jeder Klapprahmen beinhaltet Wandbefestigung (4 Schrauben und Dübel). Jeder Klapprahmen ist im Karton einzeln verpackt.*



"Optional hangers" permit easy mounting. *Optionell erhältliche Aufhänger ermöglichen die leichte Montage.*



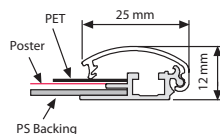
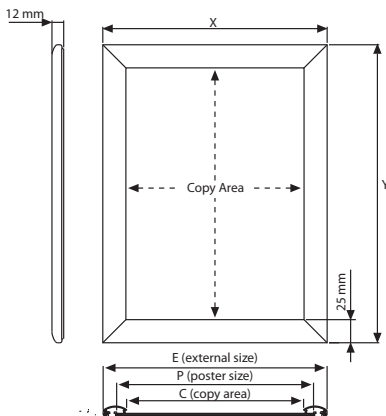
Suitable for silk screen printing, max. letter height is 15 mm. *Für Siebdruck geeignet max. Buchstabenhöhe 15 mm.*



UYAA011010
Optional V Hanger
Optionaler V Aufhänger



UYUP057000
Optional counter support for A4 and A3. Frames to be ordered specially for compatibility. *Der optionale Aufstellfuss für A4- und A3-Rahmen müssen aus Kompatibilitätsgründen speziell bestellt werden*



MATERIAL : Silver anodised aluminium PROFILE : 25 mm 45° - 25 mm Round					WEIGHT	PACKING SIZE
MITRED ARTICLE	ROUND ARTICLE	EXTERNAL (x-y)	POSTER	COPY	WITH PACKING	*W X H X D
UCN255N0A4	UCN250N0A4	240 X 327 mm	210 X 297 mm	192 X 279 mm	0,500 kg	260 X 350 X 21 mm
UCN255N0A3	UCN250N0A3	327 X 450 mm	297 X 420 mm	279 X 402 mm	0,760 kg	350 X 460 X 21 mm
UCN255N0A2	UCN250N0A2	450 X 624 mm	420 X 594 mm	402 X 576 mm	1,230 kg	460 X 660 X 21 mm
UCN255N0A1	UCN250N0A1	624 X 871 mm	594 X 841 mm	576 X 823 mm	2,245 kg	650 X 900 X 21 mm
UCN255N0B2	UCN250N0B2	530 X 730 mm	500 X 700 mm	482 X 682 mm	1,600 kg	550 X 750 X 21 mm
UCN255N0B1	UCN250N0B1	730 X 1030 mm	700 X 1000 mm	682 X 982 mm	2,970 kg	750 X 1050 X 21 mm
UCN255N023	UCN250N023	538 X 792 mm	508 X 762 mm	490 X 744 mm	1,650 kg	560 X 810 X 21 mm
UCN255N034	UCN250N034	792 X 1046 mm	762 X 1016 mm	744 X 998 mm	3,400 kg	800 X 1070 X 21 mm
UCN255N046	UCN250N046	1046 X 1554 mm	1016 X 1524 mm	998 X 1506 mm	6,000 kg	1070 X 1590 X 21 mm

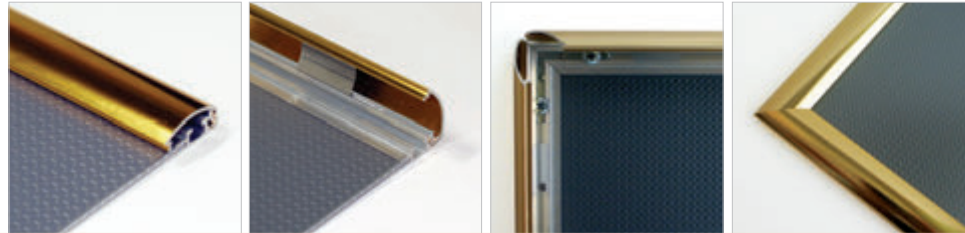
* W:Width H: Height D: Depth



Snap Frames



Watch video at our website www.mtdisplays.com



25 mm Profile / 45° Golden Look Effect

- Attractive brightness on the profile.
- Ideal for posters of every size.
- Mitred corners.
- Anti-glare poster cover sheet.

25 mm Profile 45° Golden Look Effect

- Angenehm glänzende Profile.
- Ideal für jede Postergröße.
- Gehrung.
- Anti-reflex PET Schutzfolie.

25 mm Profile / 45° Black Anodised

- Attractive black anodised effect on the profile.
- Ideal for posters of every size.
- Mitred corners.
- Anti-glare poster cover sheet.

25 mm Profile / 45° Black Anodised

- Attraktive schwarz eloxierte Profile.
- Ideal für jede Postergröße.
- Gehrung.
- Anti-reflex PET Schutzfolie.



Each frame includes wall mounting accessories (4 screws & 4 plugs). Each frame is packed individually in a cardboard box. *Jeder Klapprahmen beinhaltet Wandbefestigung (4 Schrauben und Dübel). Jeder Klapprahmen ist im Karton einzeln verpackt.*



'Optional hangers' permit easy mounting. *Optionell erhältliche Aufhänger ermöglichen die leichte Montage.*



Golden Look Effect



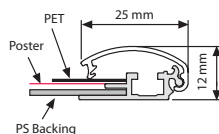
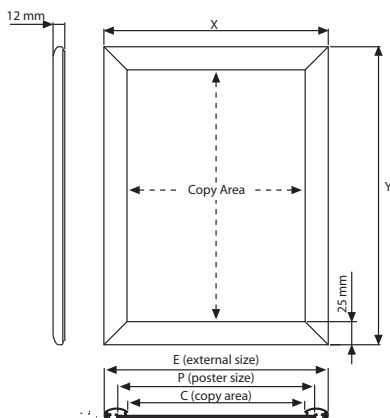
Black Anodised



UYAA011010
Optional V Hanger
Optionaler V Aufhänger



UYUP057000
Optional counter support for A4 and A3. Frames to be ordered specially for compatibility. *Der optionale Aufstellfuss für A4- und A3-Rahmen müssen aus Kompatibilitätsgründen speziell bestellt werden*



MATERIAL : Golden Look Effect & Black Anodised Effect PROFILE : 25 mm 45°					WEIGHT	PACKING SIZE
GOLD	BLACK	EXTERNAL (x-y)	POSTER	COPY	WITH PACKING	*W X H X D
UCN255G0A4	UCN255B0A4	240 X 327 mm	210 X 297 mm	192 X 279 mm	0,500 kg	260 X 350 X 21 mm
UCN255G0A3	UCN255B0A3	327 X 450 mm	297 X 420 mm	279 X 402 mm	0,760 kg	350 X 460 X 21 mm
UCN255G0A2	UCN255B0A2	450 X 624 mm	420 X 594 mm	402 X 576 mm	1,230 kg	460 X 660 X 21 mm
UCN255G0A1	UCN255B0A1	624 X 871 mm	594 X 841 mm	576 X 823 mm	2,245 kg	650 X 900 X 21 mm
UCN255G0B2	UCN255B0B2	530 X 730 mm	500 X 700 mm	482 X 682 mm	1,600 kg	550 X 750 X 21 mm
UCN255G0B1	UCN255B0B1	730 X 1030 mm	700 X 1000 mm	682 X 982 mm	2,970 kg	750 X 1050 X 21 mm
UCN255G0Z3	UCN255B0Z3	538 X 792 mm	508 X 762 mm	490 X 744 mm	1,650 kg	560 X 810 X 21 mm
UCN255G0Z4	UCN255B0Z4	792 X 1046 mm	762 X 1016 mm	744 X 998 mm	3,400 kg	800 X 1070 X 21 mm
UCN255G0A6	UCN255B0A6	1046 X 1554 mm	1016 X 1524 mm	998 X 1506 mm	6,000 kg	1070 X 1590 X 21 mm

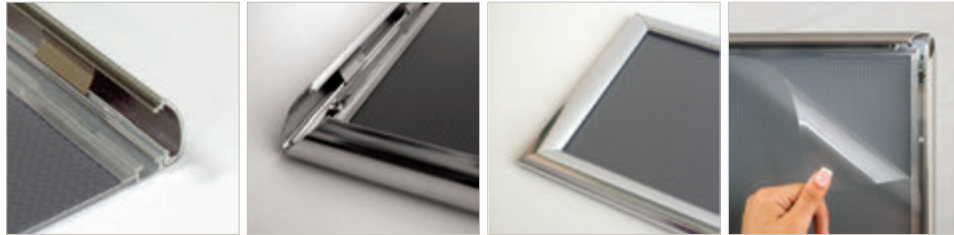
*W:Width H: Height D: Depth



Snap Frames



Watch video at our website www.mtdisplays.com



25 mm Profile / 45° Chrome Look Effect

- Attractive chrome brightness on the profile.
- Ideal for posters of every size.
- Mitred corners.
- Anti-glare poster cover sheet.

25 mm Profile / 45° Chrome Look Effect

- Angenehm glänzende Profile.
- Ideal für jede Postergröße.
- Gehrung.
- Anti-reflex PET Schutzfolie.

25 mm Profile / 45° Stainless Steel Look

- Attractive stainless steel look effect on the profile.
- Ideal for posters of every size.
- Mitred corners.
- Anti-glare poster cover sheet.

25 mm Profile / 45° Stainless Steel Look

- Angenehm glänzende Profile.
- Ideal für jede Postergröße.
- Gehrung.
- Anti-reflex PET Schutzfolie.



Each frame includes wall mounting accessories (4 screws & 4 plugs). Each frame is packed individually in a cardboard box. *Jeder Klapprahmen beinhaltet Wandbefestigung (4 Schrauben und Dübel). Jeder Klapprahmen ist im Karton einzeln verpackt.*



"Optional hangers" permit easy mounting. *Optionell erhältliche Aufhänger ermöglichen die leichte Montage.*



Chrome Look Effect



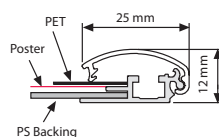
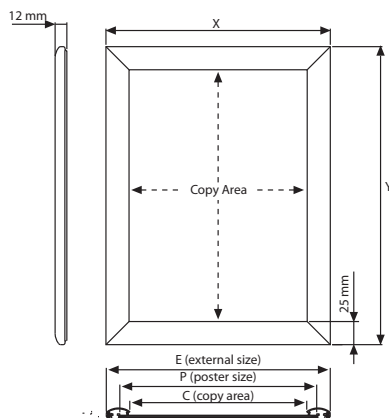
Stainless Steel Look



UYAA011010
Optional V Hanger
Optionaler V Aufhänger



UYUP057000
Optional counter support for A4 and A3. Frames to be ordered specially for compatibility. *Der optionale Aufstellfuss für A4- und A3-Rahmen müssen aus Kompatibilitätsgründen speziell bestellt werden*



MATERIAL : Chrome Look Effect & Stainless Steel Look PROFILE : 25 mm 45°					WEIGHT	PACKING SIZE
CHROME	STAINLESS	EXTERNAL (x-y)	POSTER	COPY	WITH PACKING	*W X H X D
UCN255K0A4	UCN255S0A4	240 X 327 mm	210 X 297 mm	192 X 279 mm	0,500 kg	260 X 350 X 21 mm
UCN255K0A3	UCN255S0A3	327 X 450 mm	297 X 420 mm	279 X 402 mm	0,760 kg	350 X 460 X 21 mm
UCN255K0A2	UCN255S0A2	450 X 624 mm	420 X 594 mm	402 X 576 mm	1,230 kg	460 X 660 X 21 mm
UCN255K0A1	UCN255S0A1	624 X 871 mm	594 X 841 mm	576 X 823 mm	2,245 kg	650 X 900 X 21 mm
UCN255K0B2	UCN255S0B2	530 X 730 mm	500 X 700 mm	482 X 682 mm	1,600 kg	550 X 750 X 21 mm
UCN255K0B1	UCN255S0B1	730 X 1030 mm	700 X 1000 mm	682 X 982 mm	2,970 kg	750 X 1050 X 21 mm
UCN255K023	UCN255S023	538 X 792 mm	508 X 762 mm	490 X 744 mm	1,650 kg	560 X 810 X 21 mm
UCN255K034	UCN255S034	792 X 1046 mm	762 X 1016 mm	744 X 998 mm	3,400 kg	800 X 1070 X 21 mm
UCN255K046	UCN255S046	1046 X 1554 mm	1016 X 1524 mm	998 X 1506 mm	6,000 kg	1070 X 1590 X 21 mm

*W:Width H:Height D:Depth



Coloured Snap Frames



25 mm Profile / 45° Coloured Snap Frames

- Powdercoated silky finish
- Ideal for posters of every size.
- Mitred corners.
- Anti-glare poster cover sheet

25 mm Profile / 45° Pulverbeschichtete Snap Frames

- Pulverbeschichtetes seidiges Finish
- Ideal für jede Postergröße.
- Gehrung.
- Anti-reflex PET Schutzfolie.



Each frame includes wall mounting accessories (4 screws & 4 plugs). Each frame is packed individually in a cardboard box. *Jeder Klapprahmen beinhaltet Wandbefestigung (4 Schrauben und Dübel). Jeder Klapprahmen ist im Karton einzeln verpackt.*



Custom sizes are available. *Sondergrößen sind verfügbar.*



Optional hangers* permit easy mounting. *Optionell erhältliche Aufhänger ermöglichen die leichte Montage.*



Black



White



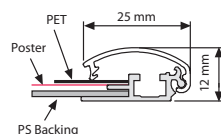
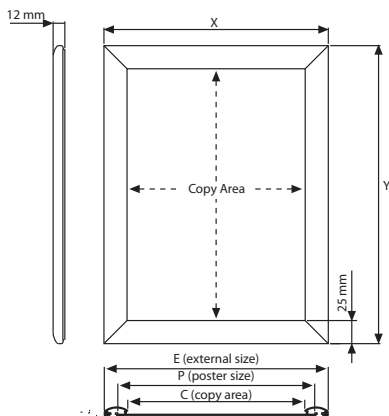
Red



UYAA011010
Optional V Hanger
Optionaler V Aufhänger



UYUP057000
Optional counter support for A4 and A3. Frames to be ordered specially for compatibility. *Der optionale Aufstellfuss für A4- und A3-Rahmen müssen aus Kompatibilitätsgründen speziell bestellt werden*



MATERIAL : Powdercoated Silky Finish PROFILE : 25 mm 45°						WEIGHT	PACKING SIZE
RED	WHITE	BLACK	EXTERNAL (x-y)	POSTER	COPY	WITH PACKING	*W X H X D
UCN25530A4	UCN25520A4	UCN25510A4	240 X 327 mm	210 X 297 mm	192 X 279 mm	0,500 kg	260 X 350 X 21 mm
UCN25530A3	UCN25520A3	UCN25510A3	327 X 450 mm	297 X 420 mm	279 X 402 mm	0,760 kg	350 X 460 X 21 mm
UCN25530A2	UCN25520A2	UCN25510A2	450 X 624 mm	420 X 594 mm	402 X 576 mm	1,230 kg	460 X 660 X 21 mm
UCN25530A1	UCN25520A1	UCN25510A1	624 X 871 mm	594 X 841 mm	576 X 823 mm	2,245 kg	650 X 900 X 21 mm
UCN25530A0	UCN25520A0	UCN25510A0	871 X 1219 mm	841 X 1189 mm	823 X 1171 mm	4,750 kg	880 X 1230 X 21 mm
UCN25530B2	UCN25520B2	UCN25510B2	530 X 730 mm	500 X 700 mm	482 X 682 mm	1,600 kg	550 X 750 X 21 mm
UCN25530B1	UCN25520B1	UCN25510B1	730 X 1030 mm	700 X 1000 mm	682 X 982 mm	2,970 kg	750 X 1050 X 21 mm
UCN25530B0	UCN25520B0	UCN25510B0	1030 X 1430 mm	1000 X 1400 mm	982 X 1382 mm	5,800 kg	1040 X 1440 X 21 mm

*W:Width H: Height D: Depth



Snap Frames



25 mm Profile / 45° Wood Effect

- Attractive wooden finish effect on the profile.
- Ideal for posters of every size.
- Mitred corners.
- Anti-glare poster cover sheet.

25 mm Profile / 45° Wood Look Effect

- Attraktive Holzoptik auf den Profilen.
- Ideal für jede Postergröße..
- Gehrung.
- Anti-reflex PET Schutzfolie

25 mm Profile / 45° Light Effect

- Attractive light wood finish effect on the profile.
- Ideal for posters of every size.
- Mitred corners.
- Anti-glare poster cover sheet.

25 mm Profile / 45° Light Effect

- Attraktive Licht Holzoptik auf den Profilen.
- Ideal für jede Postergröße..
- Gehrung.
- Anti-reflex PET Schutzfolie



Each frame includes wall mounting accessories (4 screws & 4 plugs). Each frame is packed individually in a cardboard box. *Jeder Klapprahmen beinhaltet Wandbefestigung (4 Schrauben und Dübel). Jeder Klapprahmen ist im Karton einzeln verpackt.*

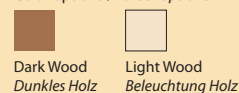


"Optional hangers" permit easy mounting. *Optionell erhältliche Aufhänger ermöglichen die leichte Montage.*



Suitable for silk screen printing, max. letter height is 15 mm. *Für Siebdruck geeignet max. Buchstabenhöhe 15 mm.*

Color options / Farbenoptionen



Wood Look Effect



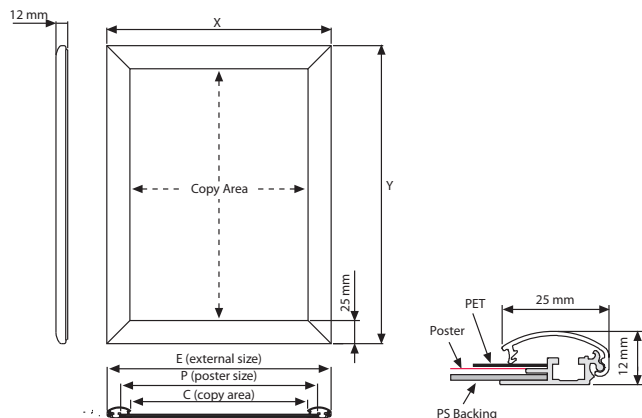
Light Wood Effect



UYAA011010
Optional V Hanger
Optionaler V Aufhänger



UYUP057000
Optional counter support for A4 and A3. Frames to be ordered specially for compatibility. *Der optionale Aufstellfuss für A4- und A3-Rahmen müssen aus Kompatibilitätsgründen speziell bestellt werden*



MATERIAL : Wood Look Effect PROFILE : 25 mm 45°					WEIGHT	PACKING SIZE
DARK WOOD	LIGHT WOOD	EXTERNAL (x-y)	POSTER	COPY	WITH PACKING	*W X H X D
UCN255W0A4	UCN255W1A4	240 X 327 mm	210 X 297 mm	192 X 279 mm	0,500 kg	260 X 350 X 21 mm
UCN255W0A3	UCN255W1A3	327 X 450 mm	297 X 420 mm	279 X 402 mm	0,760 kg	350 X 460 X 21 mm
UCN255W0A2	UCN255W1A2	450 X 624 mm	420 X 594 mm	402 X 576 mm	1,230 kg	460 X 660 X 21 mm
UCN255W0A1	UCN255W1A1	624 X 871 mm	594 X 841 mm	576 X 823 mm	2,245 kg	650 X 900 X 21 mm
UCN255W0B2	UCN255W1B2	530 X 730 mm	500 X 700 mm	482 X 682 mm	1,600 kg	550 X 750 X 21 mm
UCN255W0B1	UCN255W1B1	730 X 1030 mm	700 X 1000 mm	682 X 982 mm	2,970 kg	750 X 1050 X 21 mm
UCN255W023	UCN255W123	538 X 792 mm	508 X 762 mm	490 X 744 mm	1,650 kg	560 X 810 X 21 mm
UCN255W034	UCN255W134	792 X 1046 mm	762 X 1016 mm	744 X 998 mm	3,400 kg	800 X 1070 X 21 mm
UCN255W046	UCN255W146	1046 X 1554 mm	1016 X 1524 mm	998 X 1506 mm	6,000 kg	1070 X 1590 X 21 mm

*W:Width H: Height D: Depth



Snap Frames



Watch video at our website www.mtdisplays.com



30 mm Profile / 45° - Round

- Ideal for posters of every size.
- Natural silver-anodized and various RAL colors are available.
- Mitred and Round corner alternatives.
- Anti-glare poster cover sheet.

30 mm Profile / 45° - Rondo

- Ideal für jede Postergröße.
- Erhältlich in Natursilber eloxiert oder in verschiedenen RAL-Farben.
- Auf Gehrung oder Rondo als Alternative.
- Anti-reflex PET Schutzfolie.



Each frame includes wall mounting accessories (4 screws & 4 plugs). Each frame is packed individually in a cardboard box. *Jeder Klapprahmen beinhaltet Wandbefestigung (4 Schrauben und Dübel). Jeder Klapprahmen ist im Karton einzeln verpackt.*



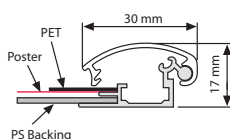
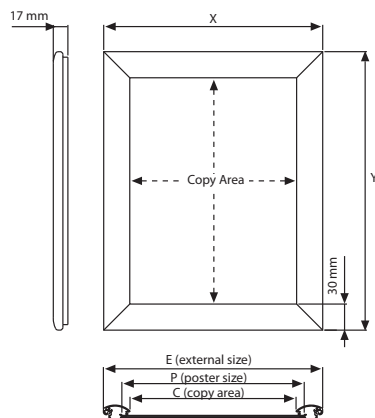
"Optional hangers" permit easy mounting. *Optionell erhältliche Aufhänger ermöglichen die leichte Montage.*



Suitable for silk screen printing, max. letter height is 20 mm. *Für Siebdruck geeignet max. Buchstabenhöhe 20 mm.*



UYAA011010
Optional V Hanger
Optionaler V Aufhänger



MATERIAL : Silver anodised aluminium PROFILE: 30 mm 45° - 30 mm Round					WEIGHT	PACKING SIZE
MITRED ARTICLE	ROUND ARTICLE	EXTERNAL (x-y)	POSTER	COPY	WITH PACKING	*W X H X D
UCN305N0A4	UCN300N0A4	253 X 340 mm	210 X 297 mm	195 X 282 mm	0,680 kg	260 X 360 X 31 mm
UCN305N0A3	UCN300N0A3	340 X 463 mm	297 X 420 mm	282 X 405 mm	0,950 kg	360 X 460 X 31 mm
UCN305N0A2	UCN300N0A2	463 X 637 mm	420 X 594 mm	405 X 579 mm	1,510 kg	460 X 670 X 31 mm
UCN305N0A1	UCN300N0A1	637 X 884 mm	594 X 841 mm	579 X 826 mm	2,750 kg	660 X 910 X 31 mm
UCN305N0B2	UCN300N0B2	543 X 743 mm	500 X 700 mm	485 X 685 mm	1,950 kg	560 X 760 X 31 mm
UCN305N0B1	UCN300N0B1	743 X 1043 mm	700 X 1000 mm	685 X 985 mm	3,400 kg	760 X 1060 X 31 mm
UCN305N023	UCN300N023	551 X 805 mm	508 X 762 mm	493 X 747 mm	2,100 kg	570 X 820 X 31 mm
UCN305N034	UCN300N034	805 X 1059 mm	762 X 1016 mm	747 X 1001 mm	3,600 kg	820 X 1080 X 31 mm
UCN305N046	UCN300N046	1059 X 1567 mm	1016 X 1524 mm	1001 X 1509 mm	6,750 kg	1070 X 1590 X 31 mm

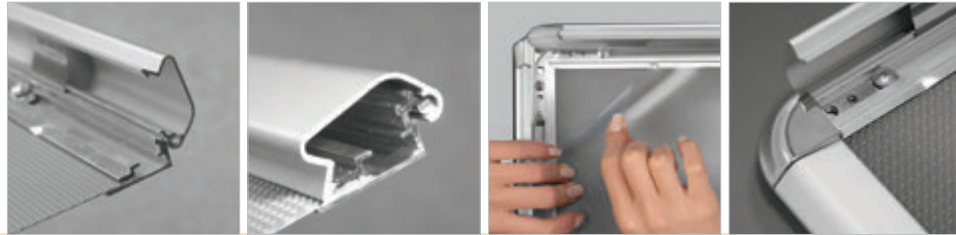
*W:Width H: Height D: Depth



Snap Frames



Watch video at our website www.mtdisplays.com



32 mm Profile / 45° - Round

- Ideal for posters of every size.
- Natural silver-anodized and various RAL colors are available.
- Mitred and Round corner alternatives.
- Anti-glare poster cover sheet.

32 mm Profile / 45° - Rondo

- Ideal für jede Postergrosse.
- Erhältlich in Natursilber eloxiert oder in verschiedenen RAL-Farben.
- Auf Gehrung oder Rondo als Alternative.
- Anti-reflex PET Schutzfolie.



Each frame includes wall mounting accessories (4 screws & 4 plugs). Each frame is packed individually in a cardboard box. *Jeder Klapprahmen beinhaltet Wandbefestigung (4 Schrauben und Dübel). Jeder Klapprahmen ist im Karton einzeln verpackt.*



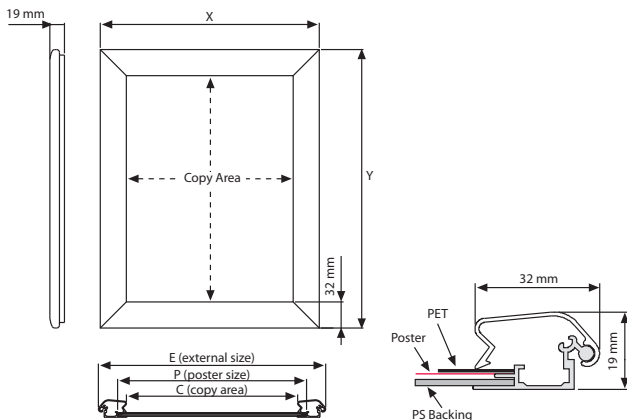
"Optional hangers" permit easy mounting. *Optionell erhältliche Aufhänger ermöglichen die leichte Montage.*



Suitable for silk screen printing, max. letter height is 16 mm. *Für Siebdruck geeignet max. Buchstabenhöhe 16 mm.*



UYAA011010
Optional V Hanger
Optionaler V Aufhänger



MATERIAL : Silver anodised aluminium PROFILE : 32 mm 45° - 32 mm Round					WEIGHT	PACKING SIZE
MITRED ARTICLE	ROUND ARTICLE	EXTERNAL (x-y)	POSTER	COPY	WITH PACKING	*W X H X D
UCN325NOA3	UCN320NOA3	340 X 463 mm	297 X 420 mm	277 X 400 mm	1,080 kg	360 X 460 X 31 mm
UCN325NOA2	UCN320NOA2	463 X 637 mm	420 X 594 mm	400 X 574mm	1,500 kg	460 X 670 X 31 mm
UCN325NOA1	UCN320NOA1	637 X 884 mm	594 X 841 mm	574 X 821 mm	2,590 kg	660 X 910 X 31 mm
UCN325NOA0	UCN320NOA0	884 X 1232 mm	841 X 1189 mm	821 X 1169 mm	4,500 kg	910 X 1270 X 31 mm
UCN325NOB2	UCN320NOB2	543 X 743 mm	500 X 700 mm	480 X 680 mm	1,950 kg	560 X 760 X 31 mm
UCN325NOB1	UCN320NOB1	743 X 1043 mm	700 X 1000 mm	680 X 980 mm	3,570 kg	760 X 1060 X 31 mm
UCN325NOB0	UCN320NOB0	1043 X 1443 mm	1000 X 1400 mm	980 X 1380 mm	6,000 kg	1070 X 1480 X 31 mm
UCN325NO23	UCN320NO23	551 X 805 mm	508 X 762 mm	488 X 742 mm	2,050 kg	570 X 830 X 31 mm
UCN325NO34	UCN320NO34	805 X 1059 mm	762 X 1016 mm	742 X 996 mm	3,600 kg	830 X 1080 X 31 mm
UCN325NO46	UCN320NO46	1059 X 1567 mm	1016 X 1524 mm	996 X 1504 mm	6,750 kg	1080 X 1590 X 31 mm

*W:Width H: Height D: Depth



Snap Frame 32 mm with Safe Corner





Watch video at our website www.mtdisplays.com




Converting a frame of pointed mitred corners into one of Rounded corners. If you like mitred corners, you are going to like safe corners. Through the use of those soft and safe Rounded corners, just on the edge, appear warm, friendly and healthy. Just pass your fingers over them, on the top edge of the frame and ask yourself how appealing it is. You can take them in frames, A boards; in all over where 32 mm frame profile is designed to be used for. You can take the new chance and change the harsh, right-angled corners and give it rounded corners instead. Anti-glare poster cover sheet.

Verwandelt einen Rahmen mit spitzen Gehrungsecken in abgerundete Gehrungsecken. Wenn Sie Gehrungsecken bevorzugen, werden Sie gefallen an den Safe Corner Ecken finden. Durch den Einsatz der kleinen runden, sanften Ecken, erscheinen spitze Gehrungsecken schon viel freundlicher, wärmer und sicherer. Streichen Sie einfach nur mit der Hand über die Ecken, Sie werden es sofort bemerken. Wenn Sie die Person für Gehrungsecken sind, werden Sie diese Verarbeitung bevorzugen. Diese Ecken können in allen Rahmen, A Boards überall wo 32 mm Profil bevorzugt wird zum Einsatz kommen. Nutzen Sie die Gelegenheit Ihren Gehrungsecken eine abgerundete Optik zu verleihen. Anti-reflex PET Schutzfolie.

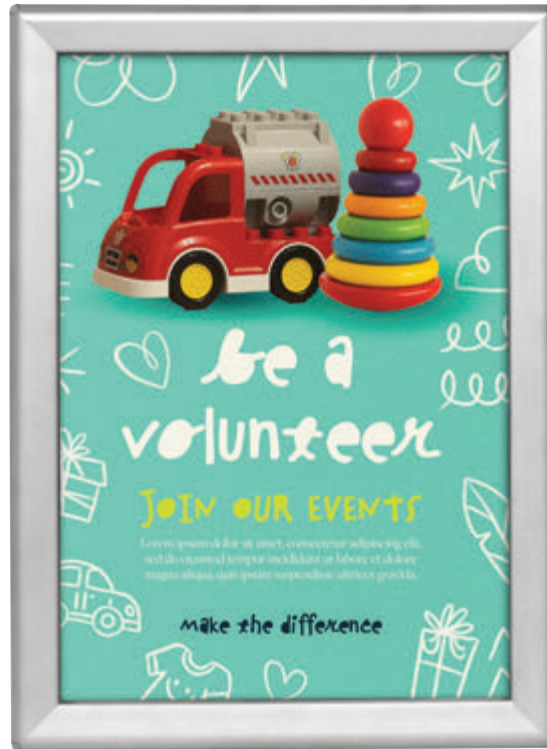
 Each frame includes wall mounting accessories (4 screws & 4 plugs). Each frame is packed individually in a cardboard box.
Jeder Klapprahmen beinhaltet Wandbefestigung (4 Schrauben und Dübel). Jeder Klapprahmen ist im Karton einzeln verpackt.

 "Optional hangers" permit easy mounting.
Optionell erhältliche Aufhänger ermöglichen die leichte Montage.

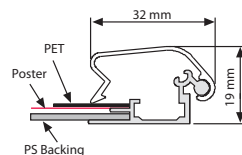
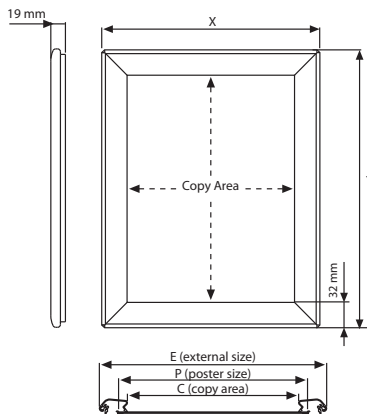
 Suitable for silk screen printing, max. letter height is 16 mm.
Für Siebdruck geeignet max. Buchstabenhöhe 16 mm.



Safe edges



UYAA011010
 Optional V Hanger
 Optionaler V Aufhänger



MATERIAL : Silver anodised aluminium PROFILE : 32 mm Safe				WEIGHT	PACKING SIZE
ARTICLE	EXTERNAL (x-y)	POSTER	COPY	WITH PACKING	*W X H X D
UCN321NOA3	340 X 463 mm	297 X 420 mm	277 X 400 mm	1,080 kg	360 X 460 X 31 mm
UCN321NOA2	463 X 637 mm	420 X 594 mm	400 X 574 mm	1,500 kg	460 X 670 X 31 mm
UCN321NOA1	637 X 884 mm	594 X 841 mm	574 X 821 mm	2,590 kg	660 X 910 X 31 mm
UCN321NOA0	884 X 1232 mm	841 X 1189 mm	821 X 1169 mm	4,500 kg	910 X 1270 X 31 mm
UCN321NOB2	543 X 743 mm	500 X 700 mm	480 X 680 mm	1,950 kg	560 X 760 X 31 mm
UCN321NOB1	743 X 1043 mm	700 X 1000 mm	680 X 980 mm	3,570 kg	760 X 1060 X 31 mm
UCN321NOB0	1043 X 1443 mm	1000 X 1400 mm	980 X 1380 mm	6,000 kg	1070 X 1480 X 31 mm
UCN321NO23	551 X 805 mm	508 X 762 mm	488 X 742 mm	2,050 kg	570 X 830 X 31 mm
UCN321NO34	805 X 1059 mm	762 X 1016 mm	742 X 996 mm	3,600 kg	820 X 1080 X 31 mm
UCN321NO46	1059 X 1567 mm	1016 X 1524 mm	996 X 1504 mm	6,750 kg	1060 X 1570 X 31 mm

*W:Width H: Height D: Depth



Snap Frames



38 mm Profile / 45°

- Ideal for posters of every size.
- Natural silver-anodized and various RAL colors are available.
- Mitred corners.
- Anti-glare poster cover sheet.

38 mm Profile / 45°

- Ideal für jede Postergrosse.
- Erhältlich in Natursilber eloxiert oder in verschiedenen RAL-Farben.
- Auf Gehrung.
- Anti-reflex PET Schutzfolie.



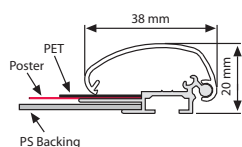
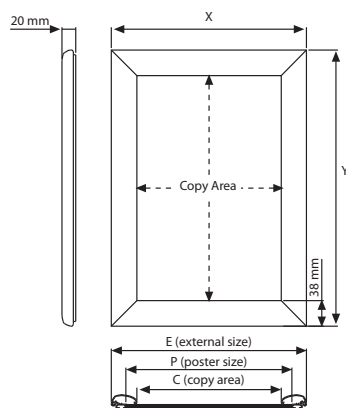
Each frame includes wall mounting accessories (4 screws & 4 plugs). Each frame is packed individually in a cardboard box.
Jeder Klapprahmen beinhaltet Wandbefestigung (4 Schrauben und Dübel). Jeder Klapprahmen ist im Karton einzeln verpackt.



Suitable for silk screen printing, max. letter height is 20 mm.
Für Siebdruck geeignet max. Buchstabenhöhe 20 mm.



UYAA011010
 Optional V Hanger
 Optionaler V Aufhänger



MATERIAL : Silver anodised aluminium PROFILE : 38 mm 45°				WEIGHT	PACKING SIZE
ARTICLE	EXTERNAL (x-y)	POSTER	COPY	WITH PACKING	*W X H X D
UCN385NOA3	342 X 465 mm	297 X 420 mm	266 X 389 mm	1,020 kg	360 X 460 X 31 mm
UCN385NOA2	465 X 639 mm	420 X 594 mm	389 X 563 mm	1,750 kg	460 X 670 X 31 mm
UCN385NOA1	639 X 886 mm	594 X 841 mm	563 X 810 mm	2,900 kg	660 X 910 X 31 mm
UCN385NOA0	886 X 1234 mm	841 X 1189 mm	810 X 1158 mm	4,600 kg	910 X 1270 X 31 mm
UCN385NOB2	545 X 745 mm	500 X 700 mm	469 X 669 mm	1,950 kg	560 X 760 X 31 mm
UCN385NOB1	745 X 1045 mm	700 X 1000 mm	669 X 969 mm	3,500 kg	760 X 1060 X 31 mm
UCN385NO23	553 X 807 mm	508 X 762 mm	477 X 731 mm	2,050 kg	570 X 830 X 31 mm
UCN385NO34	807 X 1061 mm	762 X 1016 mm	731 X 985 mm	3,820 kg	820 X 1080 X 31 mm

*W:Width H: Height D: Depth



Snap Frame



Watch video at our website www.mtdisplays.com



45 mm Profile / 45°

- Ideal for large-scale posters.
- Natural silver-anodized and various RAL colors are available.
- Mitred corners.
- Anti-glare poster cover sheet.

45 mm Profile / 45°

- Ideal für jede Postergrosse.
- Erhältlich in Natursilber eloxiert oder in verschiedenen RAL-Farben.
- Auf Gehrung.
- Anti-reflex PET Schutzfolie.



Each frame includes wall mounting accessories (4 screws & 4 plugs).
Each frame is packed individually in a cardboard box.
*Jeder Klapprahmen beinhaltet Wandbefestigung (4 Schrauben und Dübel).
Jeder Klapprahmen ist im Karton einzeln verpackt.*



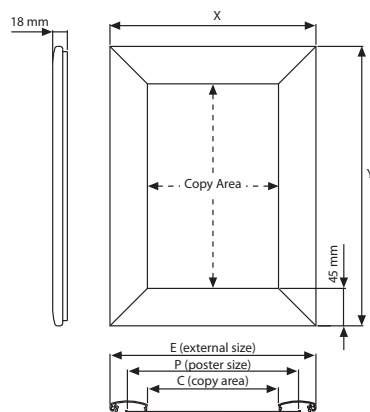
"Optional hangers" permit easy mounting.
Optionell erhältliche Aufhänger ermöglichen die leichte Montage.



Suitable for silk screen printing, max. letter height is 25 mm.
Für Siebdruck geeignet max. Buchstabenhöhe 25 mm.



UYAA011010
Optional V Hanger
Optionaler V Aufhänger



MATERIAL : Silver anodised aluminium PROFILE : 45 mm 45°				WEIGHT		PACKING SIZE	
ARTICLE	EXTERNAL (x-y)	POSTER	COPY	WITH PACKING	*W X H X D		
UCN455N0A3	340 X 463 mm	297 X 420 mm	252 X 375 mm	1,250 kg	360 X 480 X 31 mm		
UCN455N0A2	463 X 637 mm	420 X 594 mm	375 X 549 mm	1,800 kg	480 X 670 X 31 mm		
UCN455N0A1	637 X 884 mm	594 X 841 mm	549 X 796 mm	2,840 kg	660 X 910 X 31 mm		
UCN455N0A0	884 X 1232 mm	841 X 1189 mm	796 X 1144 mm	5,500 kg	910 X 1270 X 31 mm		
UCN455N0B2	543 X 743 mm	500 X 700 mm	455 X 655 mm	2,600 kg	560 X 760 X 31 mm		
UCN455N0B1	743 X 1043 mm	700 X 1000 mm	655 X 955 mm	4,000 kg	760 X 1060 X 31 mm		
UCN455N0B0	1043 X 1443 mm	1000 X 1400 mm	955 X 1355 mm	6,500 kg	1060 X 1460 X 31 mm		
UCN455N023	551 X 805 mm	508 X 762 mm	463 X 717 mm	3,200 kg	570 X 820 X 31 mm		
UCN455N034	805 X 1059 mm	762 X 1016 mm	717 X 971 mm	4,150 kg	820 X 1080 X 31 mm		
UCN455N046	1059 X 1567 mm	1016 X 1524 mm	971 X 1479 mm	7,200 kg	1070 X 1590 X 31 mm		

*W:Width H: Height D: Depth



Snap Frame



46 mm Profile / 45° - Round

- Ideal for large-scaled posters.
- Natural silver-anodized and various RAL colors are available.
- Mitred and Round corner alternatives.
- Anti-glare poster cover sheet.

46 mm Profile / 45° - Rondo

- Ideal für jede Postergröße.
- Erhältlich in Natursilber eloxiert oder in verschiedenen RAL-Farben.
- Auf Gehrung oder Rondo als Alternative.
- Anti-reflex PET Schutzfolie.



Each frame includes wall mounting accessories (4 screws & 4 plugs). Each frame is packed individually in a cardboard box.
Jeder Klapprahmen beinhaltet Wandbefestigung (4 Schrauben und Dübel). Jeder Klapprahmen ist im Karton einzeln verpackt.



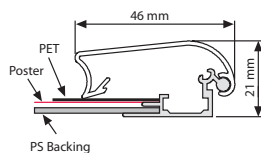
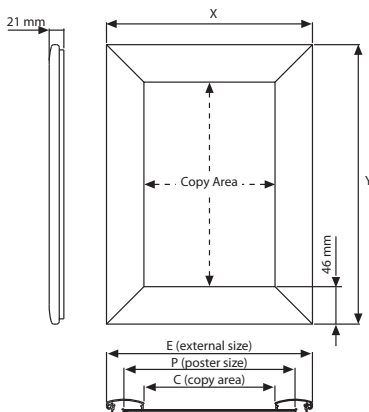
"Optional hangers" permit easy mounting.
Optionell erhältliche Aufhänger ermöglichen die leichte Montage.



Suitable for silk screen printing, max. letter height is 28 mm.
Für Siebdruck geeignet max. Buchstabenhöhe 28.



UYAA011010
 Optional V Hanger
 Optionaler V Aufhänger



MATERIAL : Silver anodised aluminium PROFILE : 46 mm 45° - Round					WEIGHT	PACKING SIZE
MITRED ARTICLE	ROUND ARTICLE	EXTERNAL (x-y)	POSTER	COPY	WITH PACKING	*W X H X D
UCN465N0A3	UCN460N0A3	340 X 463 mm	297 X 420 mm	252 X 375 mm	1,250 kg	360 X 480 X 31 mm
UCN465N0A2	UCN460N0A2	463 X 637 mm	420 X 594 mm	375 X 549 mm	1,800 kg	480 X 670 X 31 mm
UCN465N0A1	UCN460N0A1	637 X 884 mm	594 X 841 mm	549 X 796 mm	3,100 kg	660 X 910 X 31 mm
UCN465N0A0	UCN460N0A0	884 X 1232 mm	841 X 1189 mm	796 X 1144 mm	5,800 kg	910 X 1270 X 31 mm
UCN465N0B2	UCN460N0B2	543 X 743 mm	500 X 700 mm	455 X 655 mm	2,220 kg	560 X 760 X 31 mm
UCN465N0B1	UCN460N0B1	743 X 1043 mm	700 X 1000 mm	655 X 955 mm	3,960 kg	760 X 1060 X 31 mm
UCN465N0B0	UCN460N0B0	1043 X 1443 mm	1000 X 1400 mm	955 X 1355 mm	6,900 kg	1060 X 1460 X 31 mm
UCN465N023	UCN460N023	551 X 805 mm	508 X 762 mm	463 X 717 mm	3,200 kg	570 X 820 X 31 mm
UCN465N034	UCN460N034	805 X 1059 mm	762 X 1016 mm	717 X 971 mm	4,150 kg	820 X 1080 X 31 mm
UCN465N046	UCN460N046	1059 X 1567 mm	1016 X 1524 mm	971 X 1479 mm	7,200 kg	1070 X 1590 X 31 mm

* W:Width H: Height D: Depth



Fancy Frame





Watch video at our website www.mtdisplays.com




Fancy Frame, with a snap open design, is a simple to use framing system that makes changing graphics easy. The Fancy Frames are in different sizes and fits in decoartive use of picture frames serving the needs of advertisers and decorators. These clip frames differ from conventional snap frame designs due to the decorative form. This decorative design catches viewer's attention on the displayed advertisements. Having a more stylish design than traditional models, these picture frames will capture the eyes within any commercial environment. Suitable to use in shops, retail stores, restaurants, hotel receptions, banks and waiting areas. Anti-glare poster cover sheet.

Fancy frame als Klapprahmenprofil ermöglicht durch leichtes Auswechseln der Einlage eine gute Möglichkeit der Präsentation. Der Fancy frame ist in verschiedenen Größen erhältlich und bietet die dekorative Möglichkeit des Klapprahmeneinsatzes und kommt somit den Bedürfnissen Ihrer Kunden entgegen. Das dekorative Profil ist ein Blickfang und bietet gegenüber den traditionellen Klapprahmen die Möglichkeit eines stilvollen Designs. Geeignet für den Einsatz in Geschäften, Restaurants, Hotels, Banken und Warteräumen. Anti-reflex PET Schutzfolie.

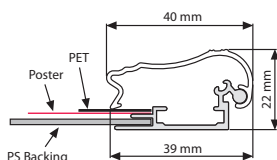
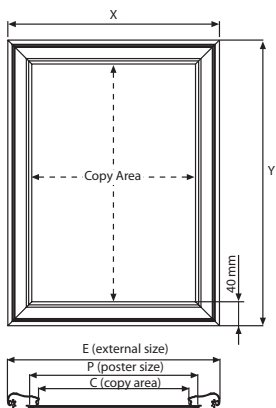
 Each frame includes the wall fixing, (4 screws & 4 plugs). Each frame is packed individual in carton box. *Jeder Klapprahmen beinhaltet Wandbefestigung (4 Schrauben und Dübel). Jeder Klapprahmen ist im Karton einzeln verpackt.*

 "Optional hangers" help easy mounting. *Optionell erhältliche Aufhänger ermöglichen die leichte Montage.*

 Suitable for silk-screen printing max. letter height is 16 mm. *Für Siebdruck geeignet max. Buchstabenhöhe 16 mm.*



UYAA011010
Optional V Hanger
Optionaler V Aufhänger



MATERIAL : Silver anodised aluminium PROFILE : 40 mm 45°				WEIGHT	PACKING SIZE
ARTICLE	EXTERNAL (x-y)	POSTER	COPY	WITH PACKING	*W X H X D
UCF40SN0A4	265 X 352 mm	210 X 297 mm	188 X 275 mm	0,860 kg	260 X 350 X 31 mm
UCF40SN0A3	352 X 475 mm	297 X 420 mm	275 X 398 mm	1,240 kg	360 X 460 X 31 mm
UCF40SN0A2	475 X 649 mm	420 X 594 mm	398 X 572 mm	1,900 kg	460 X 670 X 31 mm
UCF40SN0A1	649 X 896 mm	594 X 841 mm	572 X 819 mm	3,155 kg	660 X 910 X 31 mm
UCF40SN0A0	896 X 1244 mm	841 X 1189 mm	819 X 1167 mm	5,600 kg	910 X 1270 X 31 mm
UCF40SN0B2	555 X 755 mm	500 X 700 mm	478 X 678 mm	2,340 kg	560 X 760 X 31 mm
UCF40SN0B1	755 X 1055 mm	700 X 1000 mm	678 X 978 mm	4,120 kg	760 X 1060 X 31 mm
UCF40SN0B0	1055 X 1455 mm	1000 X 1400 mm	978 X 1378 mm	7,880 kg	1070 X 1480 X 31 mm
UCF40SN023	563 X 817 mm	508 X 762 mm	486 X 740 mm	2,465 kg	570 X 830 X 31 mm
UCF40SN034	817 X 1071 mm	762 X 1016 mm	740 X 994 mm	4,540 kg	820 X 1080 X 31 mm
UCF40SN046	1071 X 1579 mm	1016 X 1524 mm	994 X 1502 mm	8,340 kg	1080 X 1590 X 31 mm

* W:Width H: Height D: Depth



Basic Snap Frame





Watch video at our website www.mtdisplays.com




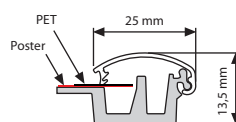
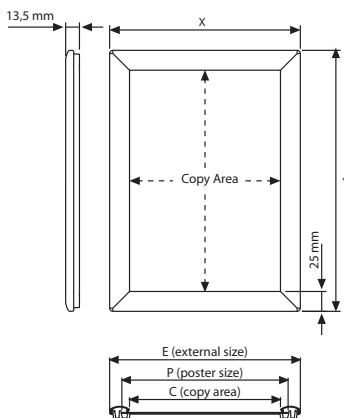
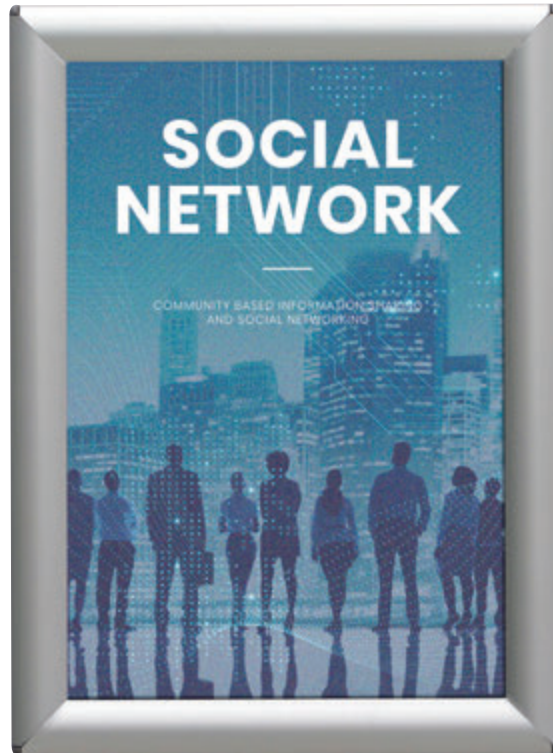
Use of patent protected, aluminium made Basic Snap Frame is fairly easy. To load or change a graphic, simply snap open the four spring-loaded frame edges, remove the anti-glare transparent cover and place graphic, picture, photo, poster and or artwork as required, then snap close the frame edges. The corners of this frame are mitred with safe round edges. Can be used for portrait or landscape (vertical or horizontal). An excellent way to get attention when you want to display pictures, photos, posters, documents or certificates, marketing advertisements, promotions, important messages.

Die Verwendung des patentgeschützten, aus Aluminium gefertigten Basic Snap Frame ist ziemlich einfach. Um eine Grafik zu laden oder zu ändern, klappen Sie einfach die vier federbelasteten Rahmenkanten auf, entfernen Sie die blendfreie transparente Abdeckung und platzieren Sie Grafik, Bild, Foto, Poster und/oder Grafik nach Bedarf und schließen Sie dann die Rahmenkanten. Die Ecken dieses Rahmens sind mit sicheren Rundkanten auf Gehrung geschnitten. Kann für Hoch- oder Querformat (vertikal oder horizontal) verwendet werden. Eine ausgezeichnete Möglichkeit, um Aufmerksamkeit zu erregen, wenn Sie Bilder, Fotos, Poster, Dokumente oder Zertifikate, Marketinganzeigen, Werbeaktionen oder wichtige Nachrichten anzeigen möchten.

 Basic Snap Frame comes ready for wall mounting with 2 holes on both long sides. Wall hanging is also available with wall hanger holes; placed on one of short and long sides. Basic Snap Frame is packed individually in a cardboard box. Der Basic Snap Frame hat 2 Montagebohrungen an den langen Seiten und kann auch mit festen Aufhängungen an die Wand montiert werden. Basic Snap Frame wird in Kartons einzelverpackt geliefert.

 Available as standard in each unit in portrait and landscape position. Standardmäßig in jedem Gerät im Hoch- und Querformat erhältlich.

 25 mm profile is suitable for silk screen printing, max. letter height is 15 mm. Der 25 mm Opti Rahmen kann auch per Siebdruck bedruckt werden (max. Buchstabenhöhe 15 mm).



MATERIAL : Silver&Black anodised aluminium PROFILE : 25 mm 45°				WEIGHT	PACKING SIZE (10 Pcs)	
SILVER	BLACK	EXTERNAL (x-y)	POSTER	COPY	WITH PACKING	*W X H X D
UCB255N0A4	UCB255B0A4	241 X 328 mm	210 X 297 mm	191 X 278 mm	3,08 kg	260 X 350 X 16 mm

*W:Width H: Height D: Depth



Fire Resistant Snap Frame 25 mm



Watch video at our website www.mtdisplays.com



25 mm Profile / 45°

- Fire classified for EN13501-1 Class B s1 d0, hardly inflammable
- 25mm wide silver anodised profile with mitred corners.
- Bayer B1 fire resistant anti-reflex poster protection.
- Perfect for educational, commercial and public places.

25 mm Profile / 45°

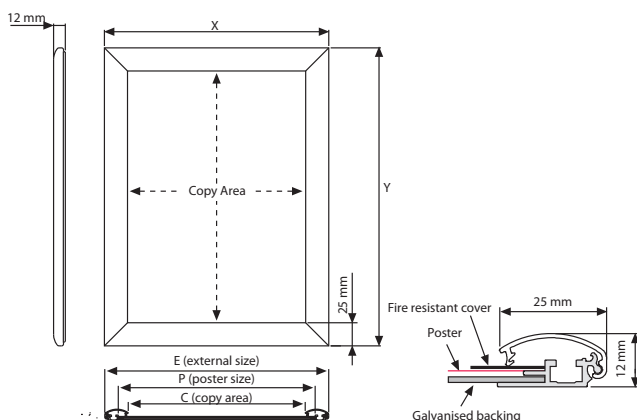
- Feuer klassifiziert für EN13501-1 Class B s1 d0 schwer entflammbar
- Profil mit 25 mm Breite, Silber eloxiert, mit Gehrungsecken.
- Bayer B1 Brandschutz-Anti-Reflex-Plakatschutz.
- Ideal für die Ausstattung von Schulen und öffentlichen Gebäuden.

Fire Resistant Snap Frames supplied without screws and wall plugs.
Brandschutzsichere Klapprahmen werden ohne Schrauben und Dübel geliefert

No assembly required.
Kein Werkzeug verfügbar.



UYAA011010
Optional V Hanger
Optionaler V Aufhänger



MATERIAL : Silver anodised aluminium PROFILE : 25 mm 45°					WEIGHT	PACKING SIZE
SILVER	BLACK	EXTERNAL (x-y)	POSTER	COPY	WITH PACKING	*W X H X D
UCFR255NA4	UCFR255BA4	240 X 327 mm	210 X 297 mm	192 X 279 mm	0,500 kg	260 X 350 X 21 mm
UCFR255NA3	UCFR255BA3	327 X 450 mm	297 X 420 mm	279 X 402 mm	0,760 kg	350 X 460 X 21 mm
UCFR255NA2	UCFR255BA2	450 X 624 mm	420 X 594 mm	402 X 576 mm	1,230 kg	460 X 660 X 21 mm
UCFR255NA1	UCFR255BA1	624 X 871 mm	594 X 841 mm	576 X 823 mm	2,245 kg	650 X 900 X 21 mm
UCFR255NA0	UCFR255BA0	871 X 1219 mm	841 X 1189 mm	823 X 1171 mm	4,750 kg	880 X 1230 X 21 mm
UCFR255NB2	UCFR255BB2	530 X 730 mm	500 X 700 mm	482 X 682 mm	1,600 kg	550 X 750 X 21 mm
UCFR255NB1	UCFR255BB1	730 X 1030 mm	700 X 1000 mm	682 X 982 mm	2,970 kg	750 X 1050 X 21 mm
UCFR255NB0	UCFR255BB0	1030 X 1430 mm	1000 X 1400 mm	982 X 1382 mm	5,800 kg	1040 X 1440 X 21 mm

*W:Width H: Height D: Depth





Double Colour Frame




Double colour frame is a snap open design, provided with 2 colour presence. Corporate colours, aesthetic appearance, contrast concepts highlight the product for various applications. Double colour frame in different sizes serve different needs & projects of advertisers and decorators. Having a more stylish design & 2 colour presence, different then traditional models, capture the eyes within any commercial environment. Anti-glare poster cover sheet.

Der doppelfarbige Rahmen ist ein Klapprahmenprofil in zwei Farben. Harmonisierende Farben, ästhetische Optik, Kontrast unterscheiden den Artikel von herkömmlichen Rahmen. Der doppelfarbene Rahmen dient verschiedenen Anforderungen und Ansprüchen von Dekorateurs und Werbefachleuten. Das dekorative Profil ist ein Blickfang und bietet gegenüber den traditionellen Klapprahmen die Möglichkeit eines stilvollen Designs. Anti-reflex PET Schutzfolie.

 Each frame includes wall mounting accessories (4 screws & 4 plugs). Each frame is packed individually in a cardboard box. *Jeder Klapprahmen beinhaltet Wandbefestigung (4 Schrauben und Dübel). Jeder Klapprahmen ist im Karton einzeln verpackt.*

 "Optional hangers" permit easy mounting. *Optionell erhältliche Aufhänger ermöglichen die leichte Montage.*

 Suitable for silk screen printing, max. letter height is 15 mm. *Für Siebdruck geeignet max. Buchstabenhöhe 15 mm.*



Outer profiles silver, inner profiles black

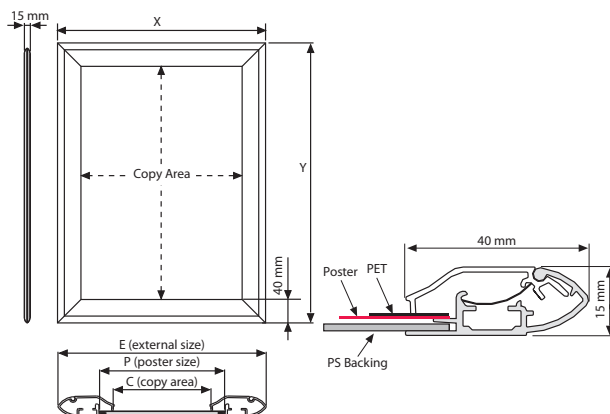


Outer profiles black, inner profiles silver

2 colours in 1 frame



UYAA011010
Optional V Hanger
Optionaler V Aufhänger



MATERIAL : Silver anodised aluminium PROFILE : 40 mm 45°				WEIGHT	PACKING SIZE	
OUTER BLACK-INNER SILVER	OUTER SILVER-INNER BLACK	EXTERNAL (x-y)	POSTER	COPY	WITH PACKING	*W X H X D
UCC405BNA4	UCC405NBA4	269 X 356 mm	210 X 297 mm	191 X 278 mm	0,750 kg	290 X 390 X 31 mm
UCC405BNA3	UCC405NBA3	356 X 479 mm	297 X 420 mm	278 X 401mm	1,250 kg	390 X 510 X 31 mm
UCC405BNA2	UCC405NBA2	479 X 653 mm	420 X 594 mm	401X 575 mm	1,850 kg	510 X 690 X 31 mm
UCC405BNA1	UCC405NBA1	653 X 900 mm	594 X 841 mm	575 X 822 mm	2,650 kg	690 X 940 X 31 mm
UCC405BNA0	UCC405NBA0	900 X 1248 mm	841 X 1189 mm	822 X 1170 mm	5,550 kg	930 X 1310 X 31 mm
UCC405BNB2	UCC405NBB2	559 X 759 mm	500 X 700 mm	481 X 681 mm	2,450 kg	590 X 790 X 31 mm
UCC405BNB1	UCC405NBB1	759 X 1059 mm	700 X 1000 mm	681 X 981 mm	4,330 kg	780 X 1100 X 31 mm
UCC405BN23	UCC405NB23	567 X 821 mm	508 X 762 mm	489 X 743 mm	2,520 kg	600 X 860 X 31 mm
UCC405BN34	UCC405NB34	821 X 1075 mm	1000 X 1400 mm	743 X 997 mm	4,700 kg	850 X 1110 X 31 mm

* W:Width H: Height D: Depth





Paper Board




Paperboards is a snap open design, paper holder. Suitable for indoor use and in portrait position. Provided with 2 clear plastic clips for each paper, one product can present 4x A4, 6x A4 or 9x A4 options. 2 colour presence serve different needs & design of environment. Paperboard is suitable for office use, as announcement boards, schools, markets and hospitals. Anti-glare poster cover sheet.

Paperboard dient zum festhalten von Papieren im Innenbereich. Der Artikel wird in Hochformat, mit zwei Klipsen pro Seite ausgestattet, angeboten. Das Produkt ist in den Grössen 4xA4, 6xA4 oder 9xA4 erhältlich. Die Zweifarbigkeit des Rahmens passt sich jedem Umfeld an. Das Paperboard ist für den Bürogebrauch, zur Präsentation von Mitteilungen ideal. Anti-reflex PET Schutzfolie.

 Each frame includes wall mounting accessories (4 screws & 4 plugs). Each frame is packed individually in a cardboard box. *Jeder Klapprahmen beinhaltet Wandbefestigung (4 Schrauben und Dübel). Jeder Klapprahmen ist im Karton einzeln verpackt.*

 "Optional hangers" permit easy mounting. *Optionell erhältliche Aufhänger ermöglichen die leichte Montage.*

 Suitable for silk screen printing, max. letter height is 15 mm. *Für Siebdruck geeignet max. Buchstabenhöhe 15 mm.*



Outer profiles black, inner profiles silver

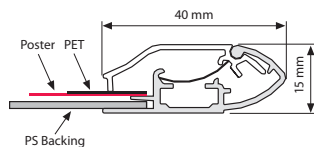
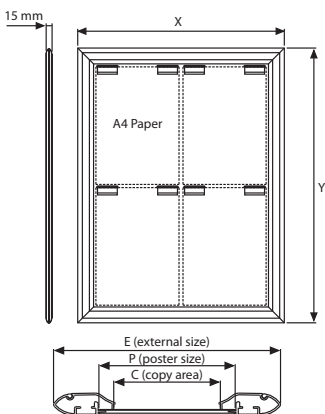


Outer profiles silver, inner profiles black

2 colours in 1 frame



UYAA011010
Optional V Hanger
Optionaler V Aufhänger



MATERIAL : Silver anodised aluminium PROFILE : 40 mm 45°					WEIGHT	PACKING SIZE
ARTICLE	EXTERNAL (x-y)	PAPER AREA	CAPACITY	DESCRIPTION	WITH PACKING	*W X H X D
UPB405BN04	522 X 694 mm	442 X 614 mm	4 X A4	Outer Black-Inner Silver	2,050 kg	540 X 720 X 31 mm
UPB405BN06	742 X 694 mm	662 X 614 mm	6 X A4	Outer Black-Inner Silver	2,900 kg	720 X 760 X 31 mm
UPB405BN09	742 X 999 mm	662 X 919 mm	9 X A4	Outer Black-Inner Silver	4,100 kg	760 X 1020 X 31 mm
UPB405NB04	522 X 694 mm	442 X 614 mm	4 X A4	Inner Silver-Outer Black	2,050 kg	540 X 720 X 31 mm
UPB405NB06	742 X 694 mm	662 X 614 mm	6 X A4	Inner Silver-Outer Black	2,900 kg	720 X 760 X 31 mm
UPB405NB09	742 X 999 mm	662 X 919 mm	9 X A4	Inner Silver-Outer Black	4,100 kg	760 X 1020 X 31 mm

* W:Width H: Height D: Depth



Security Frame 25 mm - 42 mm



Watch video at our website www.mtdisplays.com



- Ideal for medium-sized posters.
- It is a secure hard-to-open profile.
- Suitable for open-air use or highly frequented areas accessible to the public.
- Natural silver-anodized and various RAL colors are available.
- Anti-glare poster cover sheet.

- *Ideal für verschiedene Postergrößen.*
- *Ein schwer aufklappbares Sicherheitsprofil.*
- *Für den Gebrauch an öffentlichen Plätzen mit viel Menschenverkehr geeignet.*
- *Erhältlich in Natursilber eloxiert oder in verschiedenen RAL-Farben.*
- *Mit Antireflex PET Schutzfolie.*

Each frame includes wall mounting accessories (4 screws & 4 plugs). Each frame is packed individually in a cardboard box.
Jeder Klapprahmen beinhaltet Wandbefestigung (4 Schrauben und Dübel). Jeder Klapprahmen ist im Karton einzeln verpackt.

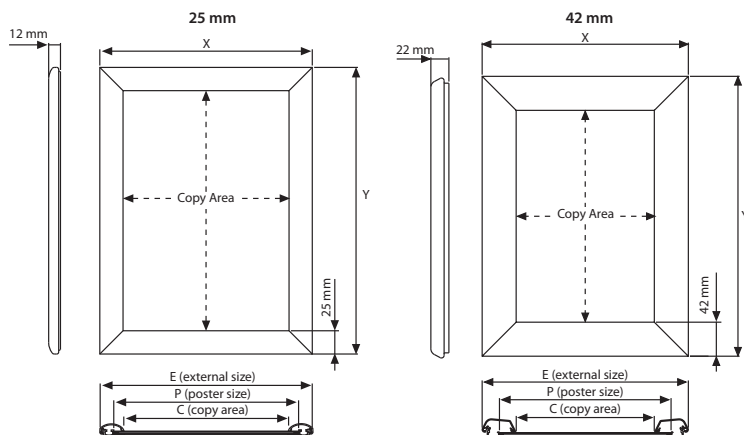
"Optional hangers" permit easy mounting.
Optionell erhältliche Aufhänger ermöglichen die leichte Montage.

Suitable for silk screen printing, max. letter height is 15 mm for 25 mm. Suitable for silk screen printing, max. letter height is 21 mm for 42 mm. The lever tool should be ordered separately, not included in the original pack.
Für Siebdruck geeignet max. Buchstabenhöhe 15 mm für 25 mm. Für Siebdruck geeignet max. Buchstabenhöhe 21 mm für 42 mm. Der Öffnungsapparat ist optional erhältlich und wird nicht mitgeliefert.



25 mm

42 mm



UYAA011010
Optional V Hanger
Optionaler V Aufhänger



UYUP047000
Levertool 15mm
Öffnungsapparat 15 mm



UYUP047100
Levertool 42mm
Öffnungsapparat 42 mm

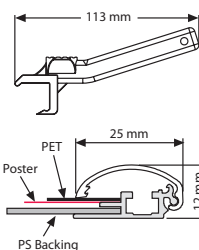
MATERIAL : Silver anodised aluminium PROFILE : 25 mm Security				WEIGHT	PACKING SIZE
ARTICLE	EXTERNAL (x-y)	POSTER	COPY	WITH PACKING	*W X H X D
UCZ255N0A4	240 X 327 mm	210 X 297 mm	190 X 277 mm	0,550 kg	290 X 390 X 31 mm
UCZ255N0A3	327 X 450 mm	297 X 420 mm	277 X 400 mm	0,850 kg	390 X 510 X 31 mm
UCZ255N0A2	450 X 624 mm	420 X 594 mm	400 X 574 mm	1,350 kg	510 X 690 X 31 mm
UCZ255N0A1	624 X 871 mm	594 X 841 mm	574 X 821 mm	2,500 kg	690 X 940 X 31 mm
UCZ255N0B2	530 X 730 mm	500 X 700 mm	480 X 680 mm	1,700 kg	930 X 1310 X 31 mm
UCZ255N0B1	730 X 1030 mm	700 X 1000 mm	680 X 980 mm	3,300 kg	590 X 790 X 31 mm
UCZ255N023	538 X 792 mm	508 X 762 mm	488 X 742 mm	1,800 kg	780 X 1100 X 31 mm
UCZ255N034	792 X 1046 mm	762 X 1016 mm	742 X 996 mm	4,000 kg	600 X 860 X 31 mm
UCZ255N046	1046 X 1554 mm	1016 X 1524 mm	996 X 1504 mm	7,300 kg	850 X 1110 X 31 mm

MATERIAL : Silver anodised aluminium PROFILE : 42 mm Security				WEIGHT	PACKING SIZE
ARTICLE	EXTERNAL (x-y)	POSTER	COPY	WITH PACKING	*W X H X D
UCZ425N0A3	340 X 463 mm	297 X 420 mm	256 X 379 mm	1,250 kg	370 X 480 X 31 mm
UCZ425N0A2	463 X 637 mm	420 X 594 mm	379 X 553 mm	1,820 kg	460 X 670 X 31 mm
UCZ425N0A1	637 X 884 mm	594 X 841 mm	553 X 800 mm	2,760 kg	660 X 910 X 31 mm
UCZ425N0A0	884 X 1232 mm	841 X 1189 mm	800 X 1148 mm	4,800 kg	910 X 1270 X 31 mm
UCZ425N0B2	543 X 743 mm	500 X 700 mm	459 X 659 mm	2,100 kg	560 X 760 X 31 mm
UCZ425N0B1	743 X 1043 mm	700 X 1000 mm	659 X 959 mm	3,715 kg	760 X 1060 X 31 mm
UCZ425N023	551 X 805 mm	508 X 762 mm	467 X 721 mm	2,250 kg	570 X 820 X 31 mm
UCZ425N034	805 X 1059 mm	762 X 1016 mm	721 X 975 mm	4,000 kg	820 X 1080 X 31 mm
UCZ425N046	1059 X 1567 mm	1016 X 1524 mm	975 X 1483 mm	7,900 kg	1070 X 1590 X 31 mm

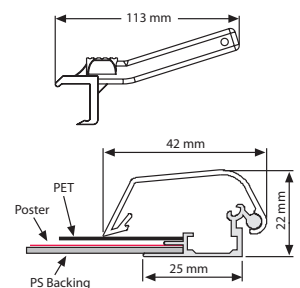
*W:Width H:Height D:Depth



Levertool / Öffnungsapparat
ARTICLE: UYUP047000



Levertool / Öffnungsapparat
ARTICLE: UYUP047100



Double Sided Snap Frame 25 mm



Watch video at our website www.mtdisplays.com



A suitable way to present your messages and posters in spaces where you have no wall mounting possibilities. If suspended from the ceiling via wire cables in front of shop windows, the posters can be viewed both from the inside and from the outside. Anti-glare poster cover sheet.

Ein praktischer Weg um Nachrichten und Poster an Plätzen zu präsentieren, wo eine Wandbefestigung nicht möglich ist. Die Präsentation des Rahmens mit Seilen an Schaufenstern, ermöglicht die Ansicht von innen und aussen. Anti-reflex PET Schutzfolie.

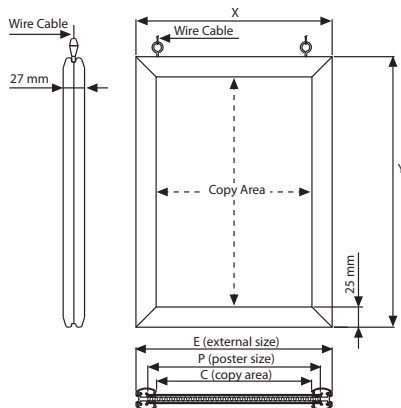
Each frame is packed individually in a cardboard box. Each frame includes hanging hooks for suspension. *Jeder Klapprahmen ist einzeln verpackt. Jeder Klapprahmen beinhaltet Haken zum aufhängen.*

Frames are provided with portrait/vertical assembly slots. In case of landscape/horizontal use, please indicate with the order. *Klapprahmen ahmen sind mit senkrechten/vertikalen Montageschlitzen versehen. Bei Verwendung im Quer-/Querformat bitte bei der Bestellung angeben.*

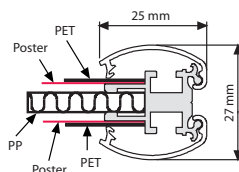
All accessories are optional, not included in the original box. Suitable for silk screen printing, max. letter height is 12/14 mm. *Zubehör ist optional erhältlich und sind in der Verpackung nicht inbegriffen. Für den Siebdruck geeignet, max. Buchstabenhöhe 12/14 mm.*

Free hanging hook, comes with frames in standard. *Haken zum Aufhängen wird standertmaessig mit den Rahmen geliefert.*

Optional accessories
Optionelles Zubehör



Hanging Kit
UYAA001030 for small sizes. (A4 to B1)
UYAA001130 for big sizes.
(30"x40" to 40"x60")
Hanger kit to be ordered separately.



MATERIAL : Silver anodised aluminium PROFILE : 25 mm 45°				WEIGHT	PACKING SIZE
ARTICLE	EXTERNAL (x-y)	POSTER	COPY	WITH PACKING	*W X H X D
UCD255N2A4	240 X 327 mm	210 X 297 mm	192 X 279 mm	0,900 kg	260 X 360 X 35 mm
UCD255N2A3	327 X 450 mm	297 X 420 mm	279 X 402 mm	1,435 kg	360 X 480 X 35 mm
UCD255N2A2	450 X 624 mm	420 X 594 mm	402 X 576 mm	2,100 kg	460 X 670 X 35 mm
UCD255N2A1	624 X 871 mm	594 X 841 mm	576 X 823 mm	3,100 kg	660 X 910 X 35 mm
UCD255N2B2	530 X 730 mm	500 X 700 mm	482 X 682 mm	2,800 kg	560 X 760 X 35 mm
UCD255N2B1	730 X 1030 mm	700 X 1000 mm	682 X 982 mm	4,500 kg	760 X 1060 X 35 mm
UCD255N223	538 X 792 mm	508 X 762 mm	490 X 744 mm	3,600 kg	570 X 820 X 35 mm
UCD255N234	792 X 1046 mm	762 X 1016 mm	744 X 998 mm	4,700 kg	820 X 1080 X 35 mm
UCD255N246	1046 X 1554 mm	1016 X 1524 mm	998 X 1506 mm	7,250 kg	1070 X 1590 X 35 mm

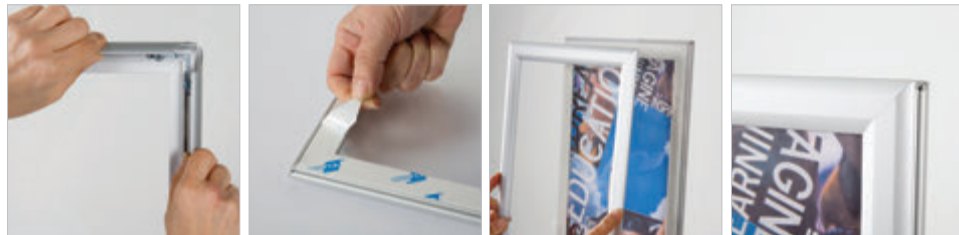
*W:Width H: Height D: Depth



Window Frames 25 mm & 32 mm



Watch video at our website www.mtdisplays.com



The Window Frame system is available in 25 mm profile. You can easily change the poster by opening the front profile. 2 anti-reflex PET covers use, posters can be displayed both indoor & outdoor. The system includes decorative back profile to hide the double-sided adhesive tape which holds the frame to the window. Anti-glare poster cover sheet.

Fensterrahmen sind im 25 mm Profil erhältlich. Leicht aufklappbare Vorderprofile ermöglichen das schnelle auswechseln des Posters. Es befindet sich je Seite eine Anti-reflex Folie, Poster können somit von Innen und Aussen präsentiert werden. Der dekorative Konterrahmen verdeckt das doppelseitige Klebeband, welches zur Fixierung des Rahmens an der Scheibe verwendet wird. Anti-reflex PET Schutzfolie.

Double PET cover, double-sided tape a round the frame internal & external. Each frame is packed individually in a cardboard box.
Zwei Schutzfolien, doppelseitiges Klebeband auf Rahmen und Konterrahmen. Jeder Klapprahmen ist einzeln verpackt.

! Please clean the surface before applying the double-sided tape for better application. Suitable for silk screen printing, max. letter height is 15 mm. Flächen vor dem anbringen des doppelseitigen Klebebands gründlich reinigen, um besseren Halt zu gewährleisten. Für den Siebdruck geeignet, max. Buchstabenhöhe 15 mm.



25 mm profile



32 mm profile

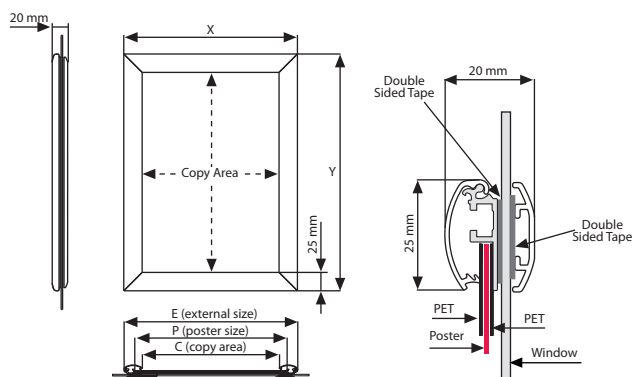
MATERIAL : Silver anodised aluminium PROFILE : 25 mm 45°				WEIGHT	PACKING SIZE
ARTICLE	EXTERNAL (x-y)	POSTER	COPY	WITH PACKING	*W X H X D
UCW255N4A4	240 X 327 mm	210 X 297 mm	192 X 279 mm	0,620 kg	260 X 350 X 21 mm
UCW255N4A3	327 X 450 mm	297 X 420 mm	279 X 402 mm	0,900 kg	350 X 460 X 21 mm
UCW255N4A2	450 X 624 mm	420 X 594 mm	402 X 576 mm	1,075 kg	460 X 660 X 21 mm
UCW255N4A1	624 X 871 mm	594 X 841 mm	576 X 823 mm	2,070 kg	650 X 900 X 21 mm
UCW255N4B2	530 X 730 mm	500 X 700 mm	482 X 682 mm	1,350 kg	550 X 750 X 21 mm
UCW255N4B1	730 X 1030 mm	700 X 1000 mm	682 X 982 mm	2,700 kg	750 X 1050 X 21 mm
UCW255N423	538 X 792 mm	508 X 762 mm	490 X 744 mm	1,400 kg	560 X 810 X 21 mm
UCW255N434	792 X 1046 mm	762 X 1016 mm	744 X 999 mm	2,900 kg	800 X 1070 X 21 mm
UCW255N446	1046 X 1554 mm	1016 X 1524 mm	998 X 1506 mm	5,150 kg	1070 X 1590 X 21 mm

MATERIAL : Silver anodised aluminium PROFILE : 32 mm 45°				WEIGHT	PACKING SIZE
ARTICLE	EXTERNAL (x-y)	POSTER	COPY	WITH PACKING	*W X H X D
UCW325N4A4	253 X 340 mm	210 X 297 mm	190 X 277 mm	0,810 kg	260 X 360 X 31 mm
UCW325N4A3	340 X 463 mm	297 X 420 mm	277 X 400 mm	1,020 kg	360 X 480 X 31 mm
UCW325N4A2	463 X 637 mm	420 X 594 mm	400 X 574 mm	1,680 kg	460 X 670 X 31 mm
UCW325N4A1	637 X 884 mm	594 X 841 mm	574 X 821 mm	2,580 kg	660 X 910 X 31 mm
UCW325N4A0	884 X 1232 mm	841 X 1189 mm	821 X 1169 mm	4,600 kg	910 X 1270 X 31 mm
UCW325N4B2	543 X 743 mm	500 X 700 mm	480 X 680 mm	1,950 kg	560 X 760 X 31 mm
UCW325N4B1	743 X 1043 mm	700 X 1000 mm	680 X 980 mm	3,500 kg	760 X 1060 X 31 mm
UCW325N4B0	1043 X 1443 mm	1000 X 1400 mm	980 X 1380 mm	6,000 kg	1060 X 1460 X 31 mm
UCW325N423	551 X 805 mm	508 X 762 mm	488 X 742 mm	2,050 kg	570 X 820 X 31 mm
UCW325N434	805 X 1059 mm	762 X 1016 mm	742 X 996 mm	3,600 kg	820 X 1080 X 31 mm
UCW325N446	1059 X 1567 mm	1016 X 1524 mm	996 X 1504 mm	6,750 kg	1070 X 1590 X 31 mm

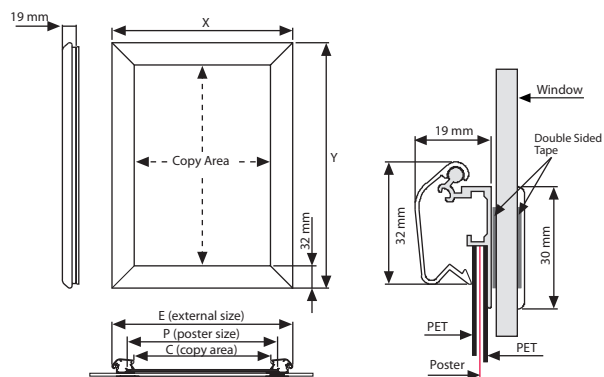
* W:Width H: Height D: Depth



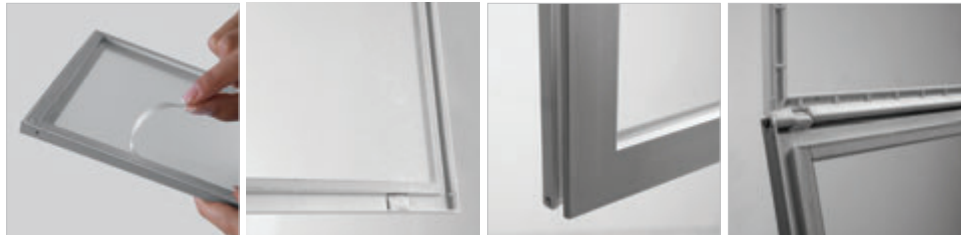
25 mm profile



32 mm profile






Window Sign



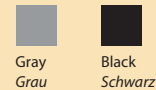
Plastic injected Window Sign is a practical solution for places where messages changes very often. It is suitable for posters printed double sided or 2 posters printed in single sided. Matching decorative profiles complete the view from outside the window. Available in Black and Grey as standard. Anti-glare poster cover sheet.

Schnell und einfach. Gefertigt aus dem Spritzgussverfahren ist der Window Sign eine praktische Lösung für Orte an denen Poster sehr schnell und oft ausgetauscht werden müssen. Es ist geeignet für Poster die beidseitig bedruckt sind oder einseitig bedruckt sind. Der Konterrahmen vervollständigt die Optik von außen. Verfügbar in Schwarz und Grau. Anti-reflex PET Schutzfolie.

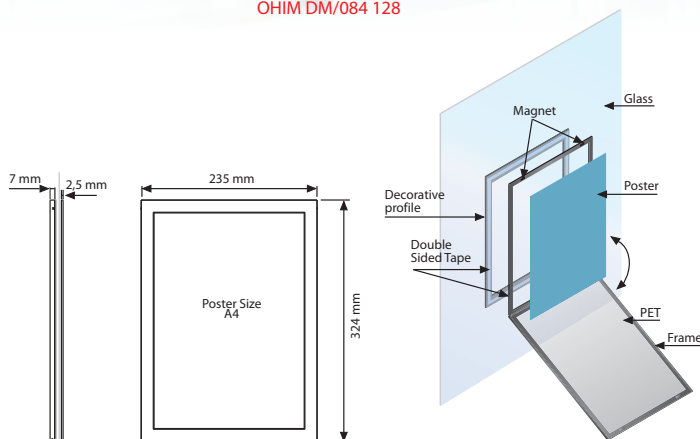
-  Magnets help locking the frame. Frames are packed 10 pcs in a box. Mit einem Klickmagnet System versehen zur Schließung des Rahmens
-  Complete with adhesive tape for fixing on the window. Please clean the surface before applying the double side for better application. Mit rundum doppelseitigem Klebeband versehen zur Montage am Fenster
-  Suitable for A4 size posters. Geeignet für A4 Poster.



Color options / Farbenoptionen



Patent Pending
OHIM DM/084 128



MATERIAL : Plastic injected					WEIGHT	PACKING SIZE
ARTICLE	EXTERNAL (x-y)	POSTER	COPY	DESCRIPTION	WITH PACKING	*W X H X D
UCWP10B0A4	235 X 324 mm	210 X 297 mm	200 X 287 mm	Magnetic / Ral 9005	3,500 kg	250 X 350 X 21 mm
UCWP10N0A4	235 X 324 mm	210 X 297 mm	200 X 287 mm	Magnetic / Ral 9006	3,500 kg	250 X 350 X 21 mm

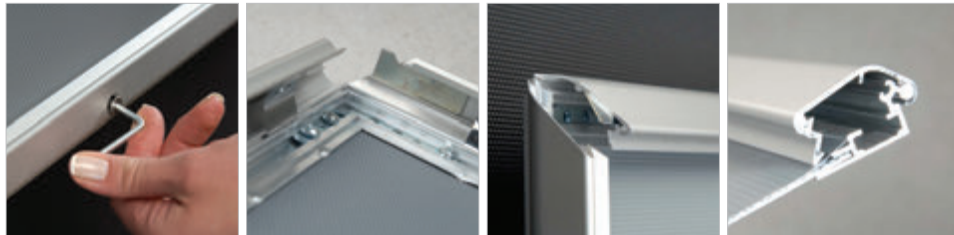
*W:Width H: Height D: Depth



Lockable Snap Frame



Watch video at our website www.mtdisplays.com



The four sides of the lockable frame open sequentially. The last profile is held in place with a screw on top that can be opened with its key. This system ensures your poster is never accessed by unauthorized third parties. Anti-glare poster cover sheet.

Vier Seitenprofile sind aufeinander folgend aufzuklappen. Auf dem unteren Profil in der Mitte befindet sich eine Imbusschraube mit deren Hilfe man den Klapprahmen gegen unbefugtes Öffnen abschliessen kann. Anti-reflex PET Schutzfolie.



Each frame includes an allen key to open the locked profile. Each frame includes wall fixing (4 screws & 4 plugs). Jeder Klapprahmen beinhaltet einen Imbusschlüssel um die abgesschlossenen Profile öffnen zu können. Jeder Klapprahmen beinhaltet Wandbefestigung. (4 Schrauben und Dübel)



"Optional hangers" permit easy mounting. Optionell erhältliche Aufhänger ermöglichen die leichte Montage.



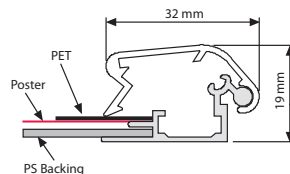
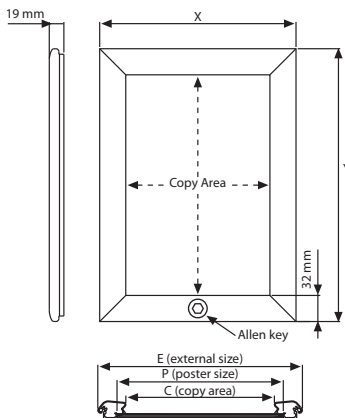
Suitable for silk screen printing, max. letter height is 16 mm. Für Siebdruck geeignet max. Buchstabenhöhe 16 mm.



UYAA011010
Optional V Hanger
Optionaler V Aufhänger



Secured with allen key

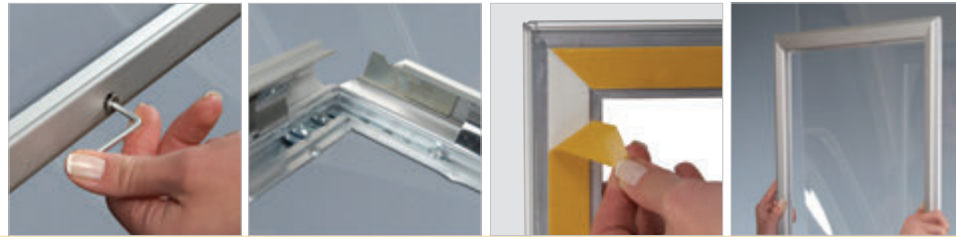


MATERIAL : Silver anodised aluminium PROFILE : 32 mm 45°				WEIGHT	PACKING SIZE
ARTICLE	EXTERNAL (x-y)	POSTER	COPY	WITH PACKING	*W X H X D
UCL325NOA4	253 X 340 mm	210 X 297 mm	190 X 277 mm	0,800 kg	260 X 360 X 31 mm
UCL325NOA3	340 X 463 mm	297 X 420 mm	277 X 400 mm	1,170 kg	360 X 480 X 31 mm
UCL325NOA2	463 X 637 mm	420 X 594 mm	400 X 574 mm	1,680 kg	460 X 670 X 31 mm
UCL325NOA1	637 X 884 mm	594 X 841 mm	574 X 821 mm	3,100 kg	660 X 910 X 31 mm
UCL325NOA0	884 X 1232 mm	841 X 1189 mm	821 X 1169 mm	5,600 kg	910 X 1270 X 31 mm
UCL325NOB2	543 X 743 mm	500 X 700 mm	480 X 680 mm	2,600 kg	560 X 760 X 31 mm
UCL325NOB1	743 X 1043 mm	700 X 1000 mm	680 X 980 mm	3,800 kg	760 X 1060 X 31 mm
UCL325NOB0	1043 X 1443 mm	1000 X 1400 mm	980 X 1380 mm	6,120 kg	1060 X 1460 X 31 mm
UCL325NO23	551 X 805 mm	508 X 762 mm	488 X 742 mm	3,150 kg	570 X 820 X 31 mm
UCL325NO34	805 X 1059 mm	762 X 1016 mm	742 X 996 mm	4,000 kg	830 X 1080 X 31 mm
UCL325NO46	1059 X 1567 mm	1016 X 1524 mm	996 X 1504 mm	7,100 kg	1070 X 1590 X 31 mm

* W:Width H: Height D: Depth



Lockable Window Frame



The lockable Window Frame system is available in a 32 mm profile. Thanks to 2 anti-reflex PET covers, your posters can be displayed both indoor & outdoor. The system includes a decorative back profile to hide the double-sided adhesive tape holding the frame up to the window. As the tape surrounds the whole frame, it prevents any water flow from the outside in order to keep your poster dry. The profiles open sequentially and the lockable system ensures your poster is never accessed by unauthorized third parties. Anti-glare poster cover sheet.

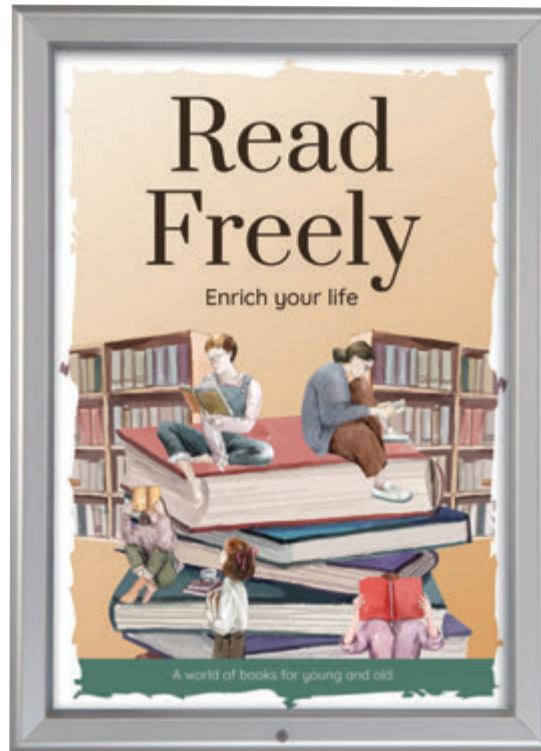
Abschliessbare Fenster-Klapprahmen sind im 32 mm Profil erhältlich. Es befindet sich je Seite eine Anti-reflex Folie, Poster können somit von Innen und Aussen präsentiert werden. Der dekorative Konterrahmen verdeckt das doppelseitige Klebeband, welches zur Fixierung des Rahmens an der Scheibe verwendet wird. Das Klebeband ist rundherum angebracht und verhindert, das Einlaufen von Wasser in den Rahmen und haellt somit das Poster trocken. Aufeinander folgend aufklappbare Profile und das Abschliesssystem verhindern unbefugten Eingriff. Anti-reflex PET Schutzfolie.



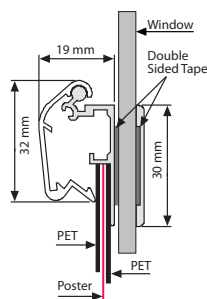
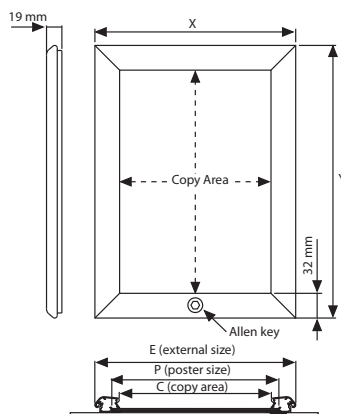
Each Frame includes an allen key to open the locked profile. Double PET cover, double-sided tape aRound the frame internal & external. Each frame is packed individually in a cardboard box. Jeder Klapprahmen beinhaltet einen Imbusschlüssel um die abgeschlossenen Profile öffnen zu können. Zwei Schutzfolien, doppelseitiges Klebeband auf Rahmen und Konterrahmen. Jeder Klapprahmen ist einzeln verpackt.



Please clean the surface before applying the double-sided tape for better application. Suitable for silk screen printing, max. letter height is 16 mm. Flächen vor dem Anbringen des doppelseitigen Klebebands gründlich reinigen, um besseren Halt zu gewährleisten. Für den Siebdruck geeignet, max. Buchstabenhöhe 16 mm.



Secured with allen key



MATERIAL : Silver anodised aluminium PROFILE : 32 mm 45°				WEIGHT	PACKING SIZE
ARTICLE	EXTERNAL (x-y)	POSTER	COPY	WITH PACKING	*W X H X D
UCK325N4A4	253 X 340 mm	210 X 297 mm	190 X 277 mm	0,680 kg	260 X 360 X 31 mm
UCK325N4A3	340 X 463 mm	297 X 420 mm	277 X 400 mm	0,950 kg	360 X 480 X 31 mm
UCK325N4A2	463 X 637 mm	420 X 594 mm	400 X 574 mm	1,790 kg	460 X 670 X 31 mm
UCK325N4A1	637 X 884 mm	594 X 841 mm	574 X 821 mm	2,750 kg	660 X 910 X 31 mm
UCK325N4A0	884 X 1232 mm	841 X 1189 mm	821 X 1169 mm	5,500 kg	910 X 1270 X 31 mm
UCK325N4B2	543 X 743 mm	500 X 700 mm	480 X 680 mm	2,200 kg	560 X 760 X 31 mm
UCK325N4B1	743 X 1043 mm	700 X 1000 mm	680 X 980 mm	3,450 kg	760 X 1060 X 31 mm
UCK325N4B0	1043 X 1443 mm	1000 X 1400 mm	980 X 1380 mm	6,000 kg	1060 X 1460 X 31 mm
UCK325N423	551 X 805 mm	508 X 762 mm	488 X 742 mm	2,400 kg	570 X 820 X 31 mm
UCK325N434	805 X 1059 mm	762 X 1016 mm	742 X 996 mm	3,600 kg	820 X 1080 X 31 mm
UCK325N446	1059 X 1567 mm	1016 X 1524 mm	996 X 1504 mm	6,750 kg	1070 X 1590 X 31 mm

* W:Width H: Height D: Depth



Lockable Weatherproof Frame



Watch video at our website www.mtdisplays.com



The four sides of the lockable frame open sequentially. The last profile is held in place with a screw on top that can be opened with its key. This system ensures your poster is never accessed by unauthorized third parties. Suitable for outdoor use. The product has water drainage slots (for details see assembly sheet). Anti-glare poster cover sheet.

Vier Seilenprofile sind aufeinander folgend aufzuklappen. Auf dem unteren Profil in der Mitte befindet sich eine Imbusschraube mit deren Hilfe man den Klapprahmen gegen unbefugtes Öffnen abschliessen kann. Für den Aussengebrauch geeignet. Das Produkt hat Wasserabläufächer (für Details siehe Montageanleitung). Anti-reflex PET Schutzfolie.



Each frame includes an allen key to open the locked profile. Each frame includes wall fixing (4 screws & 4 plugs).
*Jeder Klapprahmen beinhaltet Wandbefestigung (4 Schrauben und Dübel).
 Jeder Klapprahmen ist im Karton einzeln verpackt.*



"Optional hangers" permit easy mounting.
Optionel erhältliche Aufhänger ermöglichen die leichte Montage.

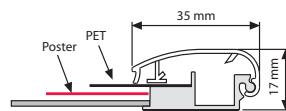
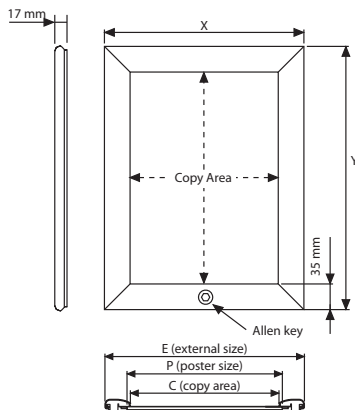


Suitable for silk screen printing, max. letter height is 16 mm. Please use the pull sticker to take off the cover. Please place the poster inside the water wick around the inner frame. Für den Siebdruck geeignet, max. Buchstabenhöhe 16 mm. Mit dem Pull Sticker ist ein leichtes Abheben der Schutzfolie gewährleistet. Das Poster innerhalb der Wasserabdichtung, welches sich in dem Rahmen befindet, platzieren.



UYAA011010
 Optional V Hanger
 Optionaler V Aufhänger

PCT/EP2018/060515



MATERIAL : Silver anodised aluminium PROFILE : 35 mm 45°				WEIGHT	PACKING SIZE
ARTICLE	EXTERNAL (x-y)	POSTER	COPY	WITH PACKING	*W X H X D
UCV355NOA4	276 X 363 mm	210 X 297 mm	206 X 293 mm	0,730 kg	280 X 365 X 23 mm
UCV355NOA3	363 X 486 mm	297 X 420 mm	293 X 416 mm	1,105 kg	365 X 490 X 23 mm
UCV355NOA2	486 X 660 mm	420 X 594 mm	416 X 590 mm	1,750 kg	490 X 670 X 23 mm
UCV355NOA1	660 X 907 mm	594 X 841 mm	590 X 837 mm	2,990 kg	670 X 920 X 23 mm
UCV355NOA0	907 X 1255 mm	841 X 1189 mm	837 X 1185 mm	5,820 kg	920 X 1270 X 23 mm
UCV355NOB2	566 X 766 mm	500 X 700 mm	496 X 696 mm	2,330 kg	572 X 780 X 23 mm
UCV355NOB1	766 X 1066 mm	700 X 1000 mm	696 X 996 mm	4,000 kg	780 X 1072 X 23 mm
UCV355NOB0	1066 X 1466 mm	1000 X 1400 mm	996 X 1396 mm	7,240 kg	1072 X 1480 X 23 mm
UCV355NO23	574 X 828 mm	508 X 762 mm	504 X 758 mm	2,560 kg	580 X 834 X 23 mm
UCV355NO34	828 X 1082 mm	762 X 1016 mm	758 X 1012 mm	4,350 kg	834 X 1088 X 23 mm
UCV355NO46	1082 X 1590 mm	1016 X 1524 mm	1012 X 1520 mm	8,000 kg	1088 X 1600 X 23 mm



*W:Width H: Height D: Depth

Weatherproof Frame 25 mm



Watch video at our website www.mtdisplays.com



- Suitable for use under outdoor conditions.
- Ideal for posters of every size.
- Natural silver-anodized with different available in RAL colors.
- Mitred corners.
- There are water drainage slots on the product (for details see assembly sheet).
- Anti-glare poster cover sheet.

- *Passend für Außenbenutzung.*
- *Ideal für alle Postergrößen.*
- *Erhältlich in Natursilber eloxiert oder in verschiedenen RAL-Farben.*
- *Auf Gehrung.*
- *Das Produkt hat Wasserabläufächer (für Details siehe Montageanleitung).*
- *Anti-reflex PET Schutzfolie.*

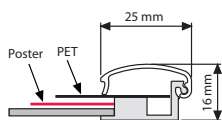
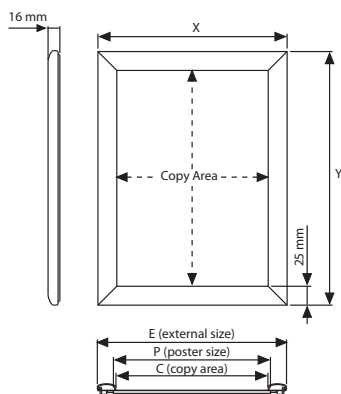
Each frame includes wall mounting accessories (4 screws & 4 plugs). Each frame is packed individually in a cardboard box. *Jeder Klapprahmen beinhaltet Wandbefestigung (4 Schrauben und Dübel). Jeder Klapprahmen ist im Karton einzeln verpackt.*

"Optional hangers" permit easy mounting. *Optionell erhältliche Aufhänger ermöglichen die leichte Montage.*

Please use the pull sticker to take off the cover. Please place the poster inside the water wick a round the poster area of the frame. *Mit dem Pull Sticker ist ein leichtes Abheben der Schutzfolie gewährleistet. Das Poster innerhalb der Wasserabdichtung, welches sich um die Posterfläche befindet, platzieren.*



Patent Pending
TR 2006 06254
PCT/TR 2006/000064



MATERIAL : Silver anodised aluminium PROFILE : 25 mm 45°				WEIGHT	PACKING SIZE
ARTICLE	EXTERNAL (x-y)	POSTER	COPY	WITH PACKING	*W X H X D
UCH255NOA4	259 X 346 mm	210 X 297 mm	208 X 295 mm	0,635 kg	260 X 360 X 31 mm
UCH255NOA3	346 X 469 mm	297 X 420 mm	295 X 418 mm	0,960 kg	360 X 460 X 31 mm
UCH255NOA2	469 X 643 mm	420 X 594 mm	418 X 592 mm	1,570 kg	460 X 670 X 31 mm
UCH255NOA1	643 X 890 mm	594 X 841 mm	592 X 839 mm	2,700 kg	660 X 910 X 31 mm
UCH255NOB2	549 X 749 mm	500 X 700 mm	498 X 698 mm	2,100 kg	560 X 760 X 31 mm
UCH255NOB1	749 X 1049 mm	700 X 1000 mm	698 X 998 mm	3,900 kg	760 X 1060 X 31 mm
UCH255NO23	557 X 811 mm	508 X 762 mm	506 X 760 mm	2,380 kg	570 X 830 X 31 mm
UCH255NO34	811 X 1065 mm	762 X 1016 mm	760 X 1014 mm	4,090 kg	820 X 10180 X 31 mm




*W:Width H: Height D: Depth


Weatherproof Frame 35 mm




- Suitable for use in outdoor conditions.
- Ideal for posters of every size.
- Natural silver-anodized with different available in RAL colors.
- Mitred corners.
- There are water drainage holes on the product (for details see assembly sheet).
- Anti-glare poster cover sheet.

- *Passend für Außenbenutzung.*
- *Ideal für alle Postergrößen.*
- *Erhältlich in Natursilber eloxiert oder in verschiedenen RAL-Farben.*
- *Auf Gehrung.*
- *Das Produkt hat Wasserabläufächer (für Details siehe Montageanleitung).*
- *Anti-reflex PET Schutzfolie.*

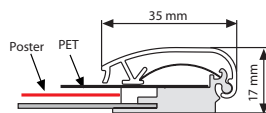
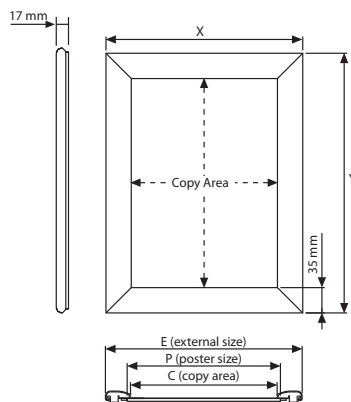
 Each frame includes wall mounting accessories (4 screws & 4 plugs). Each frame is packed individually in a cardboard box. *Jeder Klapprahmen beinhaltet Wandbefestigung (4 Schrauben und Dübel). Jeder Klapprahmen ist im Karton einzeln verpackt.*

 "Optional hangers" permit easy mounting. *Optionell erhältliche Aufhänger ermöglichen die leichte Montage.*

 Please use the pull sticker to take off the cover. Please place the poster inside the water wick a round the poster area of the frame. *Mit dem Pull Sticker ist ein leichtes Abheben der Schutzfolie gewährleistet. Das Poster innerhalb der Wasserabdichtung, welches sich um die Posterfläche befindet, plazieren.*



Patent Pending
TR 2006 06254
PCT/TR 2006/000064



MATERIAL : Silver anodised aluminium PROFILE : 35 mm 45°				WEIGHT	PACKING SIZE
ARTICLE	EXTERNAL (x-y)	POSTER	COPY	WITH PACKING	*W X H X D
UCH355N0A4	276 X 363 mm	210 X 297 mm	206 X 293 mm	0,730 kg	280 X 365 X 23 mm
UCH355N0A3	363 X 486 mm	297 X 420 mm	293 X 416 mm	1,105 kg	365 X 490 X 23 mm
UCH355N0A2	486 X 660 mm	420 X 594 mm	416 X 590 mm	1,750 kg	490 X 670 X 23 mm
UCH355N0A1	660 X 907 mm	594 X 841 mm	590 X 837 mm	2,990 kg	670 X 920 X 23 mm
UCH355N0A0	907 X 1255 mm	841 X 1189 mm	837 X 1185 mm	5,820 kg	920 X 1270 X 23 mm
UCH355N0B2	566 X 766 mm	500 X 700 mm	496 X 696 mm	2,330 kg	572 X 780 X 23 mm
UCH355N0B1	766 X 1066 mm	700 X 1000 mm	696 X 996 mm	4,000 kg	780 X 1072 X 23 mm
UCH355N0B0	1066 X 1466 mm	100 X 1400 mm	996 X 1396 mm	7,240 kg	1072 X 1480 X 23 mm
UCH355N023	574 X 828 mm	508 X 762 mm	504 X 758 mm	2,560 kg	580 X 834 X 23 mm
UCH355N034	828 X 1082 mm	762 X 1016 mm	758 X 1012 mm	4,350 kg	834 X 1088 X 23 mm
UCH355N046	1082 X 1590 mm	1016 X 1524 mm	1012 X 1520 mm	8,000 kg	1088 X 1600 X 23 mm

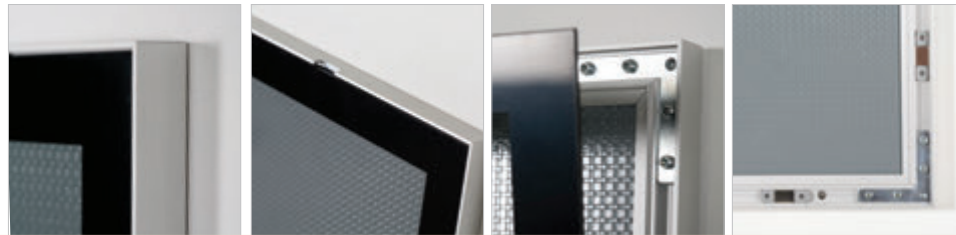
* W:Width H: Height D: Depth



Magnetic Frame Single Sided



Watch video at our website www.mtdisplays.com



A poster frame with magnetic cover brings new style to frames. It is very slim and elegant and different than most frames available. Can be used landscape or portrait.

Ein Posterrahmen mit Magnetabdeckung bringt neuen Stil zu Rahmen. Es ist sehr schmal und elegant und anders als die meisten zur Verfügung stehenden Rahmen. Kann in Hochformat oder Querformat verwendet werden.

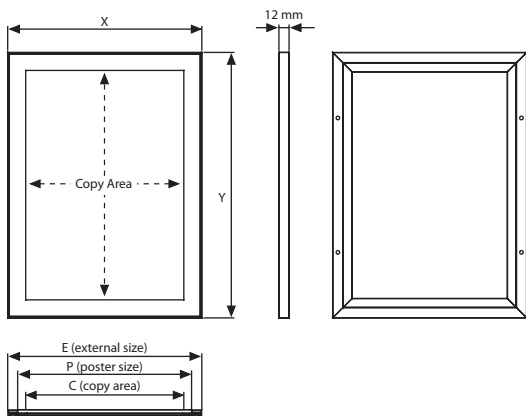
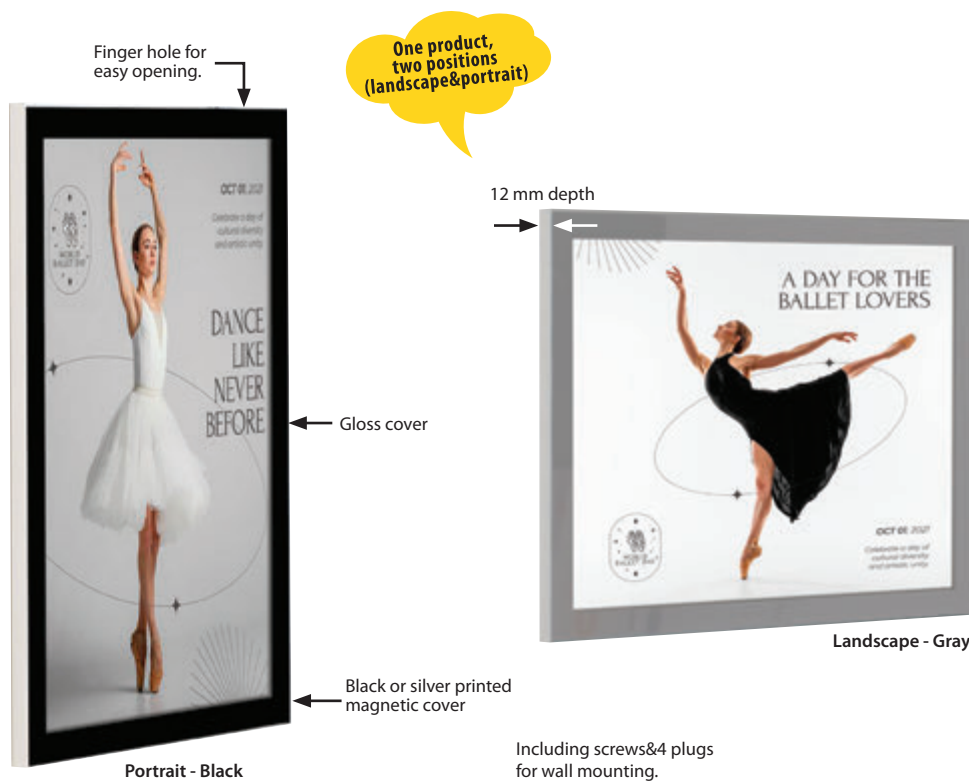
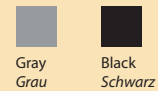


Complete with wall fixing components. No assembly required. *Komplett mit Wandbefestigungskomponenten. Keine Montage erforderlich.*



Hidden finger hole on the short profile for easy opening of magnetic cover. *Verstecktes Fingerloch auf dem kurzen Profil vereinfacht das Öffnen der Magnetabdeckung.*

Color options / *Farbenoptionen*



MATERIAL : Silver anodised aluminium						WEIGHT	PACKING SIZE
SILVER	BLACK	EXTERNAL (x-y)	POSTER	COPY	DESCRIPTION	WITH PACKING	*W X H X D
UCMONTB0A4	UCMOBTB0A4	237 X 324 mm	210 X 297 mm	193 X 280 mm	Landscape-Portrait	0,575 kg	250 X 340 X 21 mm
UCMONTB0A3	UCMOBTB0A3	324 X 447 mm	297 X 420 mm	280 X 403 mm	Landscape-Portrait	1,010 kg	340 X 455 X 21 mm
UCMONTB0A2	UCMOBTB0A2	447 X 621 mm	420 X 594 mm	403 X 577 mm	Landscape-Portrait	1,800 kg	460 X 660 X 21 mm
UCMONTB0A1	UCMOBTB0A1	621 X 868 mm	594 X 841 mm	577 X 824 mm	Landscape-Portrait	3,400 kg	640 X 890 X 21 mm
UCMONTB0A0	UCMOBTB0A0	868 X 1216 mm	841 X 1189 mm	824 X 1172 mm	Landscape-Portrait	6,300 kg	880 X 1230 X 21 mm
UCMONTB0B2	UCMOBTB0B2	527 X 727 mm	500 X 700 mm	483 X 683 mm	Landscape-Portrait	2,800 kg	540 X 740 X 21 mm
UCMONTB0B1	UCMOBTB0B1	727 X 1027 mm	700 X 1000 mm	683 X 983 mm	Landscape-Portrait	5,500 kg	745 X 1040 X 21 mm
UCMONTB023	UCMOBTB023	535 X 789 mm	508 X 762 mm	491 X 745 mm	Landscape-Portrait	2,950 kg	550 X 800 X 21 mm
UCMONTB034	UCMOBTB034	789 X 1043 mm	762 X 1016 mm	745 X 999 mm	Landscape-Portrait	5,750 kg	800 X 1055 X 21 mm

*W:Width H: Height D: Depth



Magnetic Frame Double Sided



Watch video at our website www.mtdisplays.com



A poster frame with magnetic cover brings new style to frames. It is elegant and different than most frames available. Double Sided Magnetic Frame can be easily used landscape or portrait by adjusting suspension cable manually.

Ein Posterrahmen mit Magnetabdeckung bringt neuen Stil zu Rahmen. Es ist elegant und anders als die meisten zur Verfügung stehenden Rahmen. Der doppelseitige Magnetrahmen kann sehr einfach in Querformat oder in Hochformat mit einer manuell einstellbaren Aufhängekabel verwendet werden..

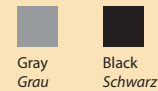


Complete with wall fixing components. No assembly required.
Komplett mit Wandbefestigungskomponenten. Keine Montage erforderlich.



Hidden finger hole on the short profile for easy opening of magnetic cover.
Verstecktes Fingerloch auf dem kurzen Profil vereinfacht das Öffnen der Magnetabdeckung.

Color options / Farboptionen



Gray
Grau

Black
Schwarz

One product,
two positions
(landscape & portrait)

19 mm depth



Landscape - Black

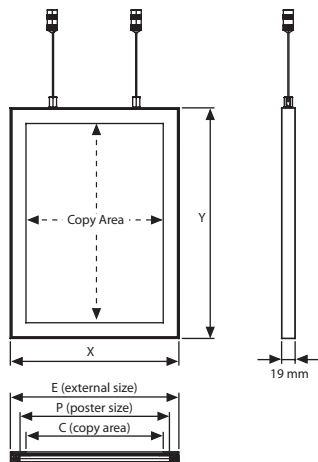
- Black or silver printed magnetic cover
- Scratch resistant gloss cover
- Finger hole for easy opening.

Including suspension kit.

2 meter



Portrait - Gray



MATERIAL : Silver anodised aluminium						WEIGHT	PACKING SIZE
SILVER	BLACK	EXTERNAL (x-y)	POSTER	COPY	DESCRIPTION	WITH PACKING	*W X H X D
UCMONCBOA4	UCMOBCBOA4	237 X 324 mm	210 X 297 mm	193 X 280 mm	Landscape-Portrait	0,750 kg	260 X 380 X 30 mm
UCMONCBOA3	UCMOBCBOA3	324 X 447 mm	297 X 420 mm	280 X 403 mm	Landscape-Portrait	1,300 kg	350 X 500 X 30 mm
UCMONCBOA2	UCMOBCBOA2	447 X 621 mm	420 X 594 mm	403 X 577 mm	Landscape-Portrait	2,100 kg	475 X 680 X 30 mm
UCMONCBOA1	UCMOBCBOA1	621 X 868 mm	594 X 841 mm	577 X 824 mm	Landscape-Portrait	3,800 kg	645 X 920 X 30 mm
UCMONCBOA0	UCMOBCBOA0	868 X 1216 mm	841 X 1189 mm	824 X 1172 mm	Landscape-Portrait	6,800 kg	900 X 1270 X 30 mm
UCMONCBOB2	UCMOBCBOB2	527 X 727 mm	500 X 700 mm	483 X 683 mm	Landscape-Portrait	3,100 kg	550 X 780 X 30 mm
UCMONCBOB1	UCMOBCBOB1	727 X 1027 mm	700 X 1000 mm	683 X 983 mm	Landscape-Portrait	5,900 kg	750 X 1090 X 30 mm
UCMONCBO23	UCMOBCBO23	535 X 789 mm	508 X 762 mm	491 X 745 mm	Landscape-Portrait	2,200 kg	560 X 840 X 30 mm
UCMONCBO34	UCMOBCBO34	789 X 1043 mm	762 X 1016 mm	745 X 999 mm	Landscape-Portrait	6,100 kg	810 X 1100 X 30 mm

*W:Width H: Height D: Depth





Slide-in Frames

- Counter Slide-in Frame
- Double Sided Slide-in Frame
- Single Sided Slide-in Frame

- Info Topper
- Doppelseitiger Einschubrahmen
- Einseitiger Einschubrahmen



Counter Slide-in Frame



Watch video at our website www.mtdisplays.com



A new model of counter stand slide-in frame. Practical to change posters by sliding them in & out. Ready for shipment with 2 PET covers, an end plastic wick on the open side & a double-sided tape at the bottom feet. This product is delivered in the landscape position for standard articles. An optional portrait position is available. The frame is suitable for outdoor use when equipped with a sealing rubber on the open edge. The sealing rubber is supplied free of charge with every unit.

Ein neues Produkt: Einschubrahmen als Infotopper. Praktisches Auswechseln des Posters durch ein- und herauschieben. Der Artikel wird mit 2 Schutzfolien, einem Dichtungsband an der Einschubseite und einem doppelseitigen Klebeband an der unteren Seite des Fußes geliefert. Der Artikel wird standardmäßig in Querformat geliefert, kann jedoch auch in Hochformat bestellt werden. Das Produkt kann im Außeneinsatz verwendet werden, falls das Dichtungsband montiert wurde. Das Dichtungsband wird bei jedem Produkt serienmäßig mitgeliefert.

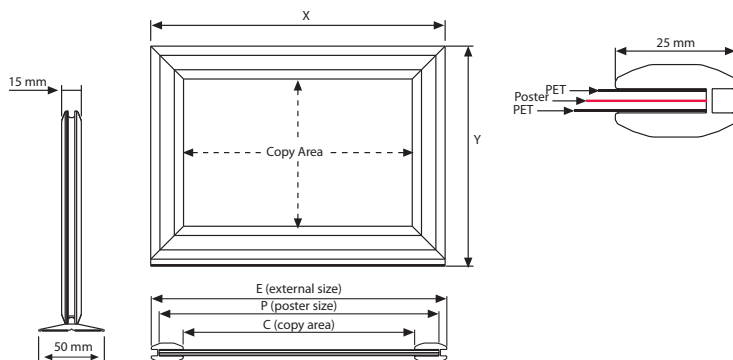
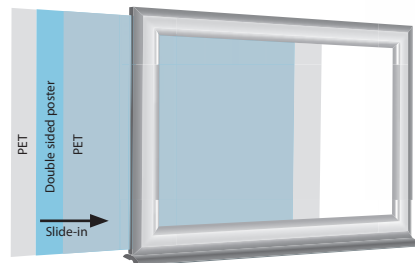
! Please clean the surface before applying the double sided tape for better application. Suitable for silk screen printing, maximum letter height is 9 mm. Vor dem Anbringen des doppelseitigen Klebebands, Fläche gründlich reinigen, um besseren Halt zu gewähren. Für Siebdruck geeignet, max. Buchstabenhöhe 9 mm.



A4 size portrait



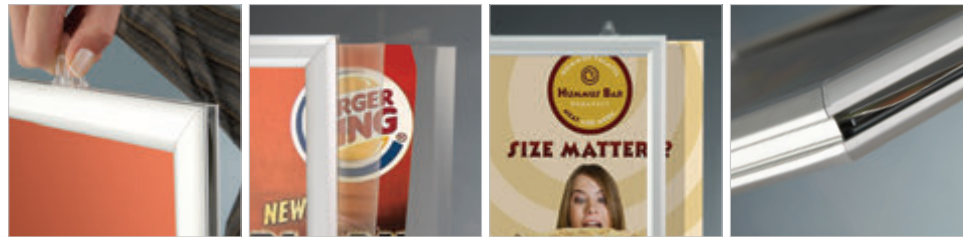
A4 size landscape



MATERIAL : Silver anodised aluminium				WEIGHT	PACKING SIZE
ORIENTATION	EXTERNAL(x-y)	POSTER	COPY	WITH PACKING	*W X H X D
LANDSCAPE	224 X 167 mm	210 X 148 mm	174 X 112 mm	0,652 kg	190 X 270 X 65 mm
LANDSCAPE	311 X 229 mm	297 X 210 mm	261 X 174 mm	0,862 kg	260 X 360 X 65 mm
LANDSCAPE	434 X 316 mm	420 X 297 mm	384 X 261 mm	1,204 kg	340 X 470 X 65 mm
ORIENTATION	EXTERNAL(x-y)	POSTER	COPY	WITH PACKING	*W X H X D
LANDSCAPE	162 X 229 mm	148 X 210 mm	112 X 174 mm	0,652 kg	190 X 270 X 65 mm
LANDSCAPE	224 X 316 mm	210 X 297 mm	174 X 261 mm	0,862 kg	260 X 360 X 65 mm
LANDSCAPE	311 X 439 mm	297 X 420 mm	261 X 384 mm	1,204 kg	340 X 470 X 65 mm

*W:Width H: Height D: Depth

Double Sided Slide-in Frame



Portrait & Landscape

A practical frame enabling you to easily change your posters by sliding the graphics in & out. The double PET cover in the frame protects your poster from any sun and light effects.

Hochformat & Querformat

Durch müheloses ein- und ausschieben, praktisches Auswechseln des Posters. Die beidseitige PET Schutzfolie schützt Ihre Poster vor Sonne und Lichteinflüssen.



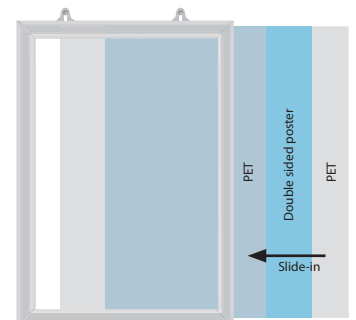
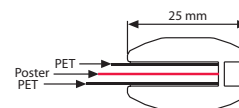
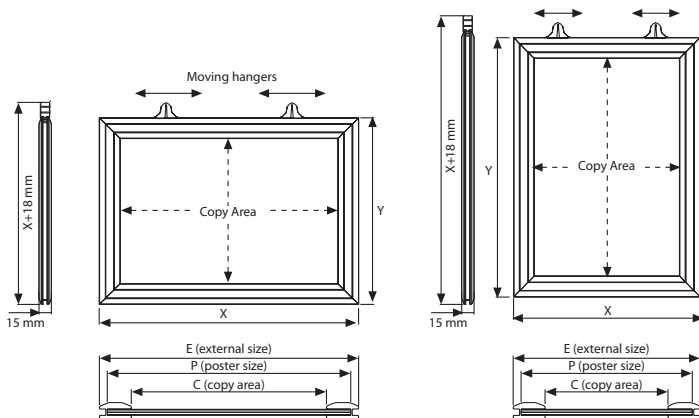
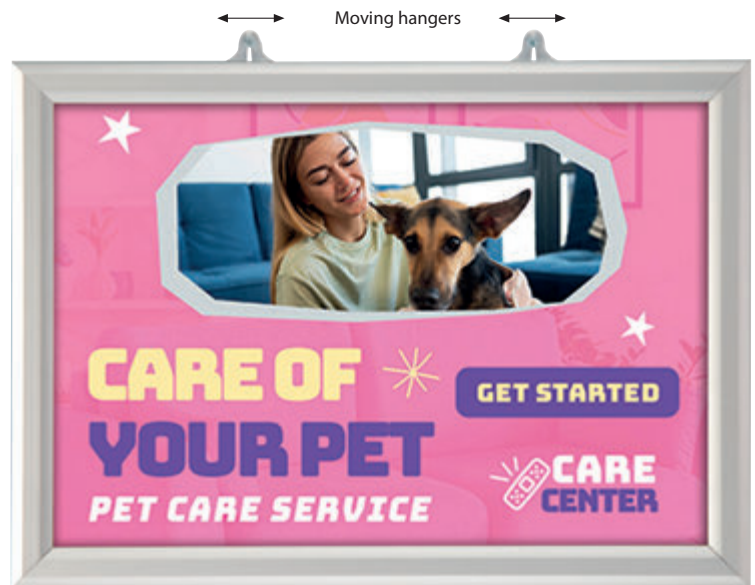
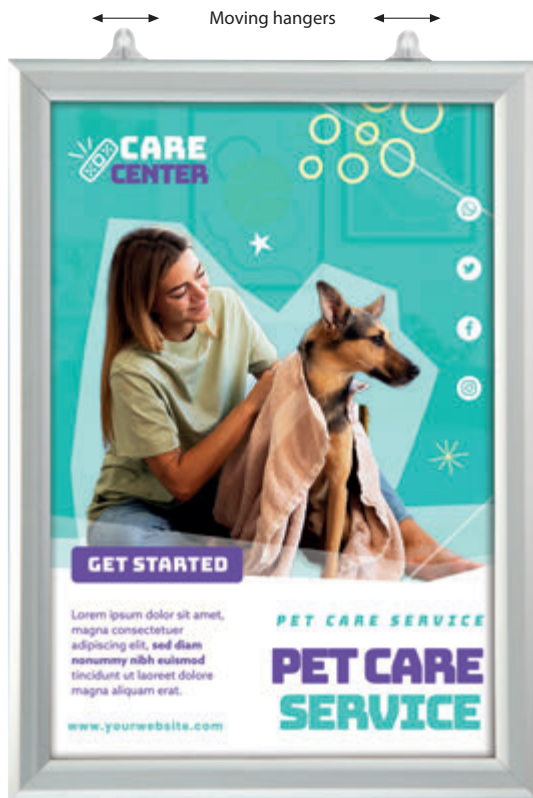
Each frame includes 2 suspension hangers. Each frame is packed individual in carton box. Jeder Rahmen beinhaltet je zwei Aufhänger. Jeder Rahmen ist im Karton einzeln verpackt.



Moving hangers provide easy positioning for hanging. Verschiebbare Aufhänger dienen zur leichten Aufhängung.



Suitable for silk screen printing, max. letter height is 9 mm. Für den Siebdruck geeignet max. Buchtabenhöhe 9 mm.



MATERIAL : Silver anodised aluminium					WEIGHT	PACKING SIZE
PORTRAIT	LANDSCAPE	EXTERNAL (x-y)	POSTER	COPY	WITH PACKING	*W X H X D
UCS255N1A4	UCS255N2A4	224 X 311 mm	210 X 297mm	174 X 261 mm	0,495 kg	250 X 350 X 21 mm
UCS255N1A3	UCS255N2A3	311 X 434 mm	297 X 420 mm	261 X 384 mm	0,708 kg	350 X 460 X 21 mm
UCS255N1A2	UCS255N2A2	434 X 608 mm	420 X 594 mm	384 X 558 mm	1,180 kg	460 X 660 X 21 mm
UCS255N1A1	UCS255N2A1	608 X 855 mm	594 X 841 mm	558 X 805 mm	1,870 kg	650 X 900 X 21 mm
UCS255N1B2	UCS255N2B2	514 X 714 mm	500 X 700 mm	464 X 664 mm	1,500 kg	550 X 750 X 21 mm
UCS255N123	UCS255N223	522 X 776 mm	508 X 762 mm	472 X 726 mm	1,595 kg	560 X 810 X 21 mm



* W:Width H: Height D: Depth

Single Sided Slide-in Frame



Watch video at our website www.mtdisplays.com



The same unit can be used both in landscape & portrait positions. A practical frame enabling you to easily change your posters by sliding the graphics in & out.

Der Rahmen kann in Hoch- und Querformat eingesetzt werden. Durch müheloses ein- und ausschieben, praktisches Auswechseln des Posters.



Each frame includes wall mounting accessories (4 screws & 4 plugs)
Each frame is packed individual in carton box. Color options black & silver-anodized.

Jeder Rahmen beinhaltet Wandbefestigung (4 Schrauben und Dübel). Jeder Rahmen ist im Karton einzeln verpackt. Standard Farboptionen: silber eloxiert und Ral Schwarz pulverbeschichtet.



No easy access to poster, suitable for highly frequented traffic areas.
Passend für Orte mit viel Menschenverkehr.



Suitable for silk screen printing, max. letter height is 13 mm.
Für den Siebdruck geeignet max. Buchtabenhöhe 13 mm.

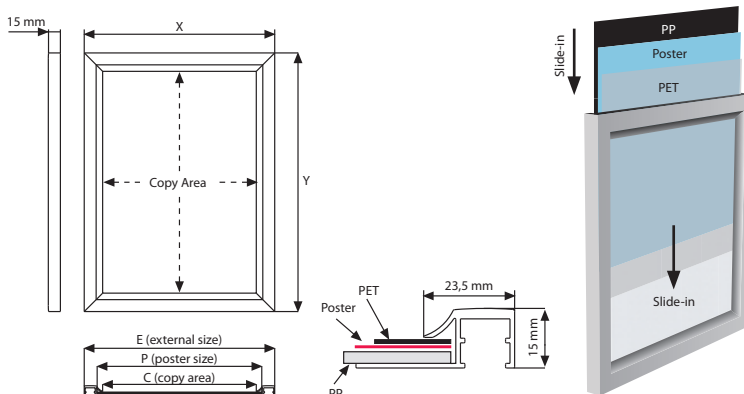
Color options / Farboptionen



Silver
Silber



Black
Schwarz



MATERIAL : Silver anodised aluminium				WEIGHT	PACKING SIZE
ARTICLE	EXTERNAL(x-y)	POSTER	COPY	WITH PACKING	*W X H X D
UCS245N1A4	243 X 330 mm	210 X 297 mm	196 X 283 mm	0,320 kg	260 X 350 X 21 mm
UCS245N1A3	330 X 453 mm	297 X 420 mm	283 X 406 mm	0,700 kg	350 X 460 X 21 mm
UCS245N1A2	453 X 627 mm	420 X 594 mm	406 X 580 mm	1,100 kg	460 X 660 X 21 mm
UCS245N1A1	627 X 874 mm	594 X 841 mm	580 X 827 mm	2,200 kg	650 X 900 X 21 mm
UCS245N1B2	533 X 733 mm	500 X 700 mm	486 X 686 mm	1,350 kg	550 X 750 X 21 mm
UCS245N123	541 X 795 mm	508 X 762 mm	494 X 748 mm	1,510 kg	560 X 810 X 23 mm

*W:Width H: Height D: Depth





Poster Holders

- Poster Clamp
- Newage Poster Clamp
- Poster Snap
- Wood Magnetic Poster Snap
- Poster Fast
- Stretch Frame
- Outdoor Flap Gripper

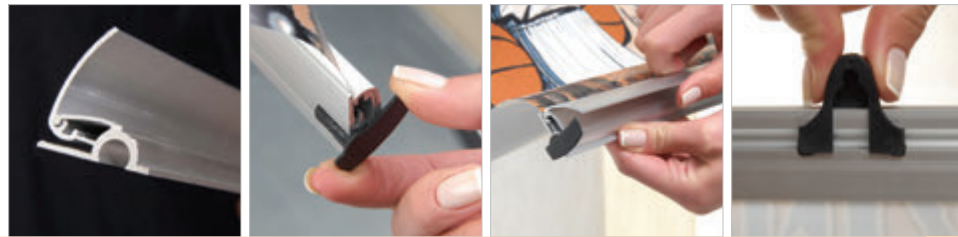
- Poster Klemmleiste Clamp
- Poster Klemmleiste Clamp "neu"
- Poster Klemmleiste Snap
- Magnetischer Poster-Klemmleiste aus Holz
- Poster Klemmleiste Fast
- Spannrahmen
- Outdoor Flap Gripper



Poster Clamp 30 mm



Watch video at our website www.mtdisplays.com



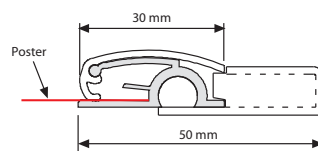
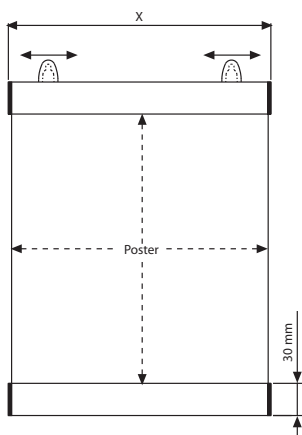
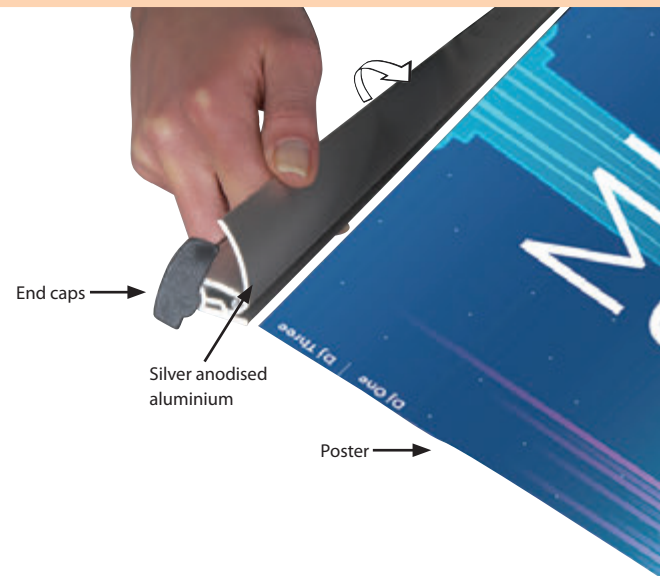
Suitable for heavier and bigger posters in thickness 50 micron - 500 micron. One set includes the end caps on both profiles and the hangers on the top profile.

Passend für schwere und grosse Poster der Materialstärke 50-500 Micron. Ein Set besteht aus oberem und unterem Profil mit Endkappen und Aufhängern am oberen Profil.

In top clamp 15 mm poster & in bottom clamp 15 mm poster is placed within the clamping system. Single packed as set in plastic bags. Turning end caps help to slide the poster in. Das obere und untere Klemmleistenprofil bedeckt das Poster um 15 mm. Als Set in Plastikbeutel verpackt. Drehbare Endkappen ermöglichen das leichte Einschieben des Posters.

No tool assembly. Hangers are suitable for wall mounting & ceiling suspension. Montage ohne Werkzeugbenutzung. Die Aufhänger sind für die Wand- und Deckenbefestigung geeignet.

Moving hangers permit easy assembly. Once used a with thicker than 500 micron posters, the clamp may not hold thinner materials for the next use. Suitable for silk screen printing, max. letter height is 18 mm. Verschiebbare Aufhänger dienen der leichten Montage. Bei dem Gebrauch von dickeren Materialien als 500 Micron kann bei der nächsten Verwendung kein einwandfreies Festhalten gewährleistet werden. Für den Siebdruck geeignet, max. Buchstabenhöhe 18 mm.

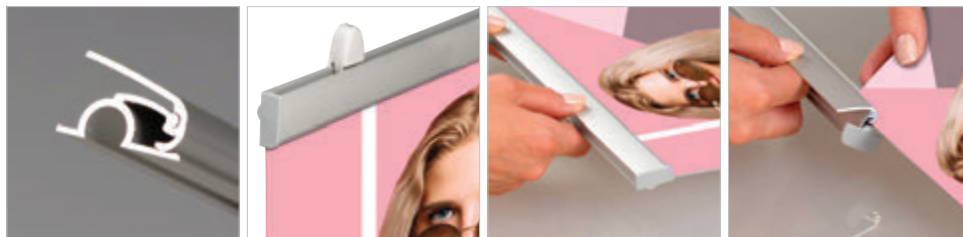


MATERIAL : Silver anodised aluminium			WEIGHT	PACKING SIZE
ARTICLE	EXTERNAL (x)	POSTER	WITH PACKING	*W X H X D
UPCOOSN021	216 mm	210 mm	9,570 kg	220 X 260 X 320 mm (50 pcs)
UPCOOSN030	306 mm	300 mm	12,000 kg	220 X 360 X 320 mm (50 pcs)
UPCOOSN042	426 mm	420 mm	18,500 kg	220 X 480 X 320 mm (50 pcs)
UPCOOSN050	506 mm	500 mm	22,200 kg	220 X 560 X 320 mm (50 pcs)
UPCOOSN060	606 mm	600 mm	26,600 kg	220 X 660 X 320 mm (50 pcs)
UPCOOSN070	706 mm	700 mm	31,000 kg	220 X 760 X 320 mm (50 pcs)
UPCOOSN085	856 mm	850 mm	19,000 kg	180 X 910 X 220 mm (25 pcs)
UPCOOSN100	1006 mm	1000 mm	22,000 kg	180 X 1070 X 220 mm (25 pcs)

*W:Width H: Height D: Depth





Newage Poster Clamp 25 mm




A newly created series of poster clamps offers competitive solutions. Suitable for posters in thickness 50 micron / 500 micron. One set includes end caps on both profiles and hangers on the top profile.

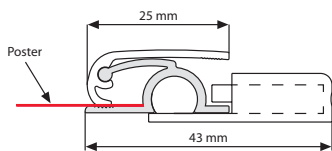
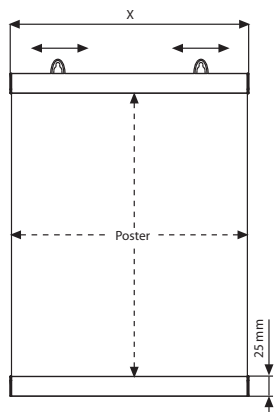
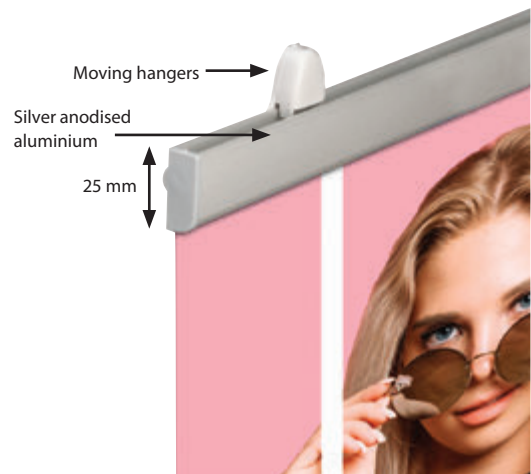
Dieses speziell entwickelte Profil bietet preisliche Wettbewerbsvorteile. Passend für schwere Poster der Materialstärke 50-500 Micron. Ein Set besteht aus oberem und unterem Profil mit Endkappen und Aufhängern am oberen Profil.

 In top clamp 10 mm poster and in bottom clamp 10 mm poster is placed within the clamping system. Single packed as set in plastic bags. Turning end caps help to slide the poster in. Das obere und untere Klemmleistenprofil bedeckt das Poster um 10 mm. Als Set in Plastikbeutel verpackt. Drehbare Endkappen ermöglichen das leichte Einschleiben des Posters.

 No tool assembly. Hangers are suitable for wall mounting and ceiling suspension. Moving hangers allow easy assembly. Montage ohne Werkzeugbenutzung. Verschiebbare Aufhänger helfen der leichten Montage und sind für die Wand- und Deckenbefestigung geeignet.

 Product is not recommended for use in special sizes wider than 1000 mm and longer than 2000 mm. Suitable for silk screen printing, max. letter height is 15 mm.

Dieses Produkt wird bei der Nutzung von grösseren Werbeflächen als 1000x2000 mm nicht empfohlen. Für den Siebdruck geeignet, max. Buchstabenhöhe 15 mm.



MATERIAL : Silver anodised aluminium			WEIGHT	PACKING SIZE
ARTICLE	EXTERNAL (x)	POSTER	WITH PACKING	*W X H X D
UPC10SN021	213 mm	210 mm	7,300 kg	220 X 260 X 320 mm (50 pcs)
UPC10SN030	303 mm	300 mm	10,550 kg	220 X 360 X 320 mm (50 pcs)
UPC10SN042	423 mm	420 mm	13,800 kg	220 X 480 X 320 mm (50 pcs)
UPC10SN050	503 mm	500 mm	16,800 kg	220 X 560 X 320 mm (50 pcs)
UPC10SN060	603 mm	600 mm	20,300 kg	220 X 660 X 320 mm (50 pcs)
UPC10SN070	703 mm	700 mm	22,800 kg	220 X 760 X 320 mm (50 pcs)
UPC10SN085	853 mm	850 mm	13,800 kg	180 X 910 X 220 mm (25 pcs)
UPC10SN100	1003 mm	1000 mm	17,250 kg	180 X 1070 X 220 mm (25 pcs)
UPC10SN120	1203 mm	1200 mm	21,000 kg	180 X 1260 X 220 mm (25 pcs)

*W:Width H: Height D: Depth



Poster Snap



Watch video at our website www.mtdisplays.com



One set includes the upper and the bottom profiles with the end caps on both profiles and the hangers on the top profile. Improved rubber foam for poster suspension.

Ein Set besteht aus oberem und unteren Profil mit Endkappen und Aufhängern am oberen Profil.



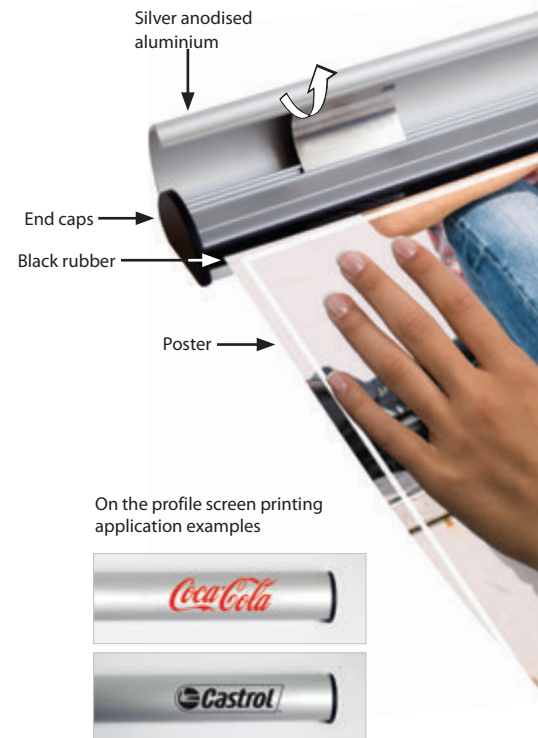
In top snap 10 mm poster & in bottom snap 10 mm poster is placed within the clamping system. Single packed as a set in plastic bags. Das obere und untere Klemmleistenprofil bedeckt das Poster um 10 mm. Als Set in Plastikbeutel verpackt.



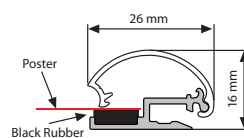
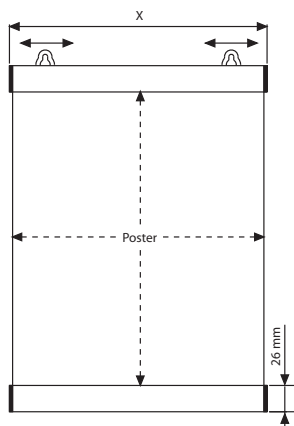
No tool assembly. Montage ohne Werkzeugbenutzung.



Moving hangers permit easy assembly. Suitable for silk screen printing, max. letter height is 10 mm. Verschiebbare Aufhänger helfen der leichten Montage. Für den Siebdruck geeignet, max. Buchstabenhöhe 10 mm.



Patent TR 2005 01301
PCT/EP2018/060515



MATERIAL : Silver anodised aluminium PROFILE : 26 mm			WEIGHT	PACKING SIZE
ARTICLE	EXTERNAL (x)	POSTER	WITH PACKING	**W X H X D
UPT26SN021	216 mm	210 mm	5,700 kg	220 X 260 X 320 mm (50 pcs)
UPT26SN030	306 mm	300 mm	8,500 kg	220 X 360 X 320 mm (50 pcs)
UPT26SN042	426 mm	420 mm	11,500 kg	220 X 480 X 320 mm (50 pcs)
UPT26SN050	506 mm	500 mm	13,200 kg	220 X 560 X 320 mm (50 pcs)
UPT26SN060	606 mm	600 mm	17,000 kg	220 X 660 X 320 mm (50 pcs)
UPT26SN070	706 mm	700 mm	19,000 kg	220 X 760 X 320 mm (50 pcs)
UPT26SN085	856 mm	850 mm	12,000 kg	180 X 910 X 220 mm (25 pcs)
UPT26SN100	1006 mm	1000 mm	13,500 kg	180 X 1070 X 220 mm (25 pcs)

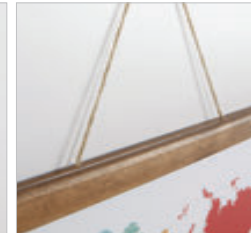
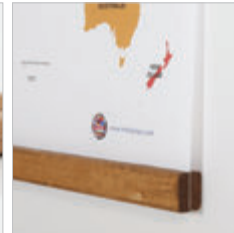


*W:Width H: Height D: Depth

Wood Magnetic Poster Snap



Watch video at our website www.mtdisplays.com



Wood Magnetic Poster Snap is made of beech wood, which is hard and strong. It has a fine, tight grain and even texture. It is treated only with heat, water and water vapour during the entire production process. So it is free of any chemical additions. Having contemporary and traditional style, Wood Magnetic Poster Snap has modern vintage look. It suits every decoration in offices, restaurants, cafes, boutiques, bookstores, bakeries and many more. You can effortlessly display your poster, advertisement and even your menu at your business. It has a wide range of uses. Its vintage and modern style will help you to get impressive results to pass your message onto your audience.

Der Wood Magnetic Poster Snap ist aus Buchenholz gefertigt. Hat eine feine, dichte Körnung und eine gleichmäßige Textur. Während des gesamten Produktionsprozesses wird es nur mit Wärme, Wasser und Wasserdampf behandelt. Es ist also frei von jeglichen chemischen Zusätzen. Mit zeitgenössischem und traditionellem Stil hat Wood Magnetic Poster Snap einen modernen Vintage-Look und passt zu jeder Dekoration in Büros, Restaurants, Cafés, Boutiquen, Buchhandlungen, Bäckereien und vielem mehr.



Dark wood



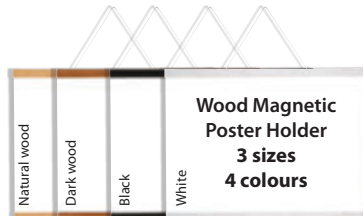
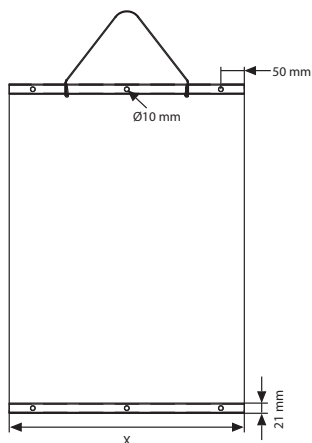
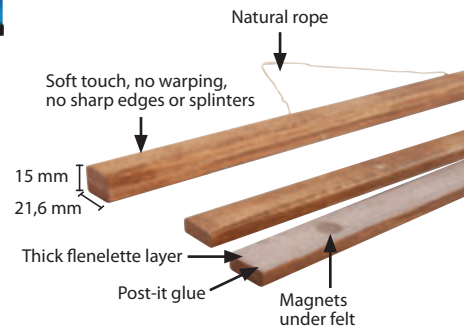
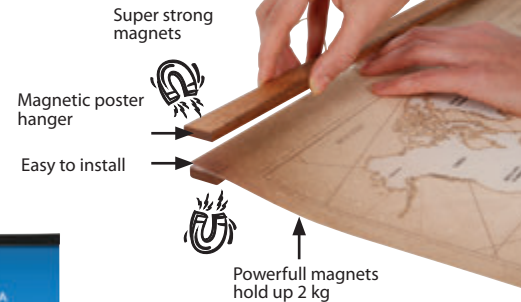
Natural wood



Black



White



Poster Snap include
 • 2 upper bars
 • 2 lower bars
 • Natural rope for hanging
 • Super strong magnets for easy application

MATERIAL : Wood			WEIGHT	PACKING SIZE (50 Pcs)
ARTICLE	SIZE (x)	DESCRIPTION	WITH PACKING	*W X H X D
UPTWOSD400	400 mm	Dark wood	11,500 kg	280 X 440 X 220 mm
UPTWOSD500	500 mm	Dark wood	14,000 kg	280 X 540 X 220 mm
UPTWOSD600	600 mm	Dark wood	16,600 kg	280 X 640 X 220 mm
UPTWOSN400	400 mm	Natural wood	11,500 kg	280 X 440 X 220 mm
UPTWOSN500	500 mm	Natural wood	14,000 kg	280 X 540 X 220 mm
UPTWOSN600	600 mm	Natural wood	16,600 kg	280 X 640 X 220 mm
UPTWOSB400	400 mm	Black	11,500 kg	280 X 440 X 220 mm
UPTWOSB500	500 mm	Black	14,000 kg	280 X 540 X 220 mm
UPTWOSB600	600 mm	Black	16,600 kg	280 X 640 X 220 mm
UPTWOSW400	400 mm	White	11,500 kg	280 X 440 X 220 mm
UPTWOSW500	500 mm	White	14,000 kg	280 X 540 X 220 mm
UPTWOSW600	600 mm	White	16,600 kg	280 X 640 X 220 mm

* W:Width H: Height D: Depth



Poster Fast



Watch video at our website www.mtdisplays.com



Suitable for heavier and bigger posters in thickness 10 micron - 500 micron. A double-sided poster holder. One set includes end caps on both profiles and hangers on the top profile. The product is supplied with 40 mm see/clear co-extrusion components inside which hold the poster.

Passend für schwere und grosse Poster der Materialstärke 10-500 Micron. Doppelseitig nutzbare Posterhalterung. Ein Set besteht aus oberem und unterem Profil mit Endkappen und Aufhängern am oberen Profil. Der Artikel wird mit 40 mm see/clear Profilen in den Klemmprofilen geliefert, um das Poster zu fixieren.



In top snap 10 mm poster & in bottom snap 10 mm poster is placed within the clamping system. Single packed as a set in plastic bags.

Das obere und untere Klemmleistenprofil bedeckt das Poster um 10 mm. Als Set in Plastikbeutel verpackt.



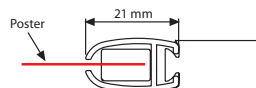
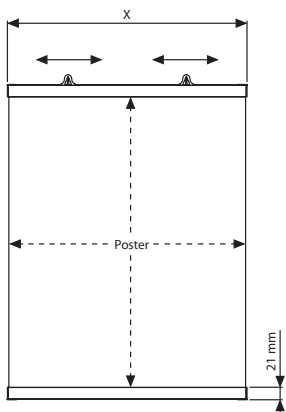
No tool assembly. Turning end caps help to slide the poster in. Moving hangers permit easy assembly. Hangers are suitable for wall mounting & ceiling suspension. *Montage ohne Werkzeugbenutzung. Drehbare Endkappen ermöglichen das leichte Einschieben des Posters, verschiebbare Aufhänger helfen der leichten Montage und sind für die Wand- und Deckenbefestigung geeignet.*



Suitable for silk screen printing, max. letter height is 10 mm. *Für den Siebdruck geeignet, max. Buchstabenhöhe 10 mm.*



Double sided



MATERIAL : Silver anodised aluminium			WEIGHT	PACKING SIZE
ARTICLE	EXTERNAL (x)	POSTER	WITH PACKING	*W X H X D
UPF21SN021	215 mm	210 mm	5,300 kg	220 X 260 X 320 mm (50 pcs)
UPF21SN030	305 mm	300 mm	6,900 kg	220 X 360 X 320 mm (50 pcs)
UPF21SN042	425 mm	420 mm	9,450 kg	220 X 480 X 320 mm (50 pcs)
UPF21SN050	505 mm	500 mm	11,000 kg	220 X 560 X 320 mm (50 pcs)
UPF21SN060	605 mm	600 mm	13,000 kg	220 X 660 X 320 mm (50 pcs)
UPF21SN070	705 mm	700 mm	15,500 kg	220 X 760 X 320 mm (50 pcs)
UPF21SN085	855 mm	850 mm	9,200 kg	180 X 910 X 220 mm (25 pcs)
UPF21SN100	1005 mm	1000 mm	10,500 kg	180 X 1070 X 220 mm (25 pcs)
UPF21SN120	1205 mm	1200 mm	12,500 kg	180 X 1260 X 220 mm (25 pcs)

*W:Width H: Height D: Depth



Stretch Frame



Watch video at our website www.mtdisplays.com



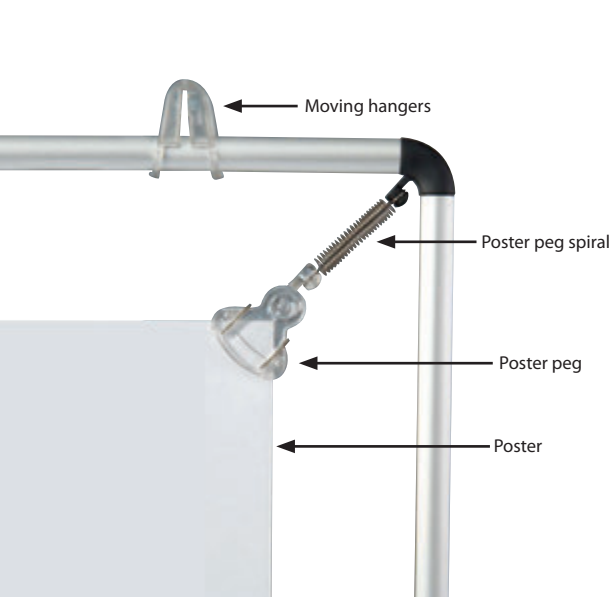
A lightweight frame that stretches the poster from 4 corners. The poster can be easily changed with the help of plastic clips. It is available in standard anodized silver. Other colors are available upon request. Two plastic hangers for both wall mounting and ceiling suspension are included. The plastic clips stretched from the corners place the poster in the center without spoiling or harming the poster paper.

Das Poster wird von allen 4 Ecken in den leichtgewichtigen Rahmen gespannt. Leichter Austausch des Posters durch die Plastikklipse. Standardmässig in silber eloxiert erhältlich. Der Artikel beinhaltet 2 Plastikaufhänger, die sich für die Wand- und Deckenbefestigung eignen. Die gefederten Plastikklipse halten das Poster stramm zentriert und verhindern, dass das Postermaterial verzogen oder beschädigt wird.

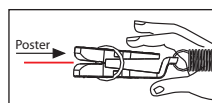
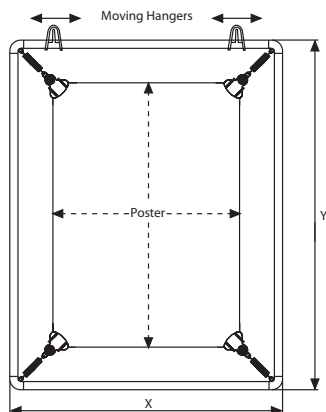
Single packed unassembled in carton boxes with an easy-to-understand instruction sheet. Each pack includes 4 clips & 2 hanger. Demontiert, einzeln mit Montageanleitung verpackt. Jedes Set beinhaltet 4 Klipse und 2 Aufhänger.

Hangers are suitable for wall mounting & ceiling suspension. Die Aufhänger sind für die Wand- und Deckenbefestigung geeignet.

Recommended poster material is paper, any heavier material such as vinyl or textile may damage the springs at the corner. Accessories such as suction caps & ceiling hangers are optional. Suitable for silk screen printing, max. letter height is 8 mm. Es wird Papier als Postermaterial empfohlen, schwereres Material wie Textilien oder Vinly können die Federn an den Plastikklipsen beschädigen. Saugnäpfe oder Seilaufhängungen sind optional erhältlich. Für Siebdruck geeignet, max. Buchstabenhöhe 8 mm.



Stretch Frame packing



MATERIAL : Silver anodised aluminium			WEIGHT	PACKING SIZE (50 pcs)
ARTICLE	EXTERNAL (x-y)	POSTER	WITH PACKING	*W X H X D
UPSCN000A4	310 X 397 mm	210 X 297 mm	0,220kg	420 X 570 X 220 mm
UPSCN000A3	397 X 520 mm	297 X 420 mm	0,265 kg	420 X 700 X 220 mm
UPSCN000A2	520 X 694 mm	420 X 594 mm	0,340 kg	420 X 870 X 220 mm
UPSCN000A1	694 X 941 mm	594 X 841 mm	0,432 kg	420 X 1110 X 220 mm
UPSCN000B2	600 X 800 mm	500 X 700 mm	0,380 kg	420 X 970 X 220 mm
UPSCN000B1	800 X 1100 mm	700 X 1000 mm	0,510 kg	420 X 1260 X 220 mm

*W:Width H: Height D: Depth



Outdoor Flap Gripper



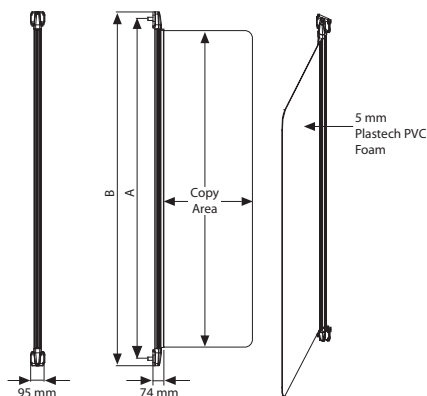
Watch video at our website www.mtdisplays.com



Outdoor Flap Gripper offers innovative solutions for your advertising needs. It is designed to mount rigid panels onto outer walls using both sides of display poster. Then it gets the attention of 2-way traffic. It accepts rigid panels in 5mm thicknesses. EN certified wall fixing increase the security of the product in use. Fixing is covered by plastic end caps to provide clean finish to the product.

Der Outdoor Flap Gripper bietet eine innovative Lösung für Ihre Werbungen. Dieses Produkte wurde entwickelt um widerstandsfähige Platten im Außenbereich an Wänden zu montieren. Mit der doppelseitigen Funktion erhält es die Aufmerksamkeit von beiden Seiten. Es können 5mm starke Platten verwendet werden. En zertifizierte Wandmontage erhöht die Sicherheit des Produktes. Die Schrauben sind mit Plastik endkappen abgedeckt um einen sauberen Abschluss zu erzielen.

- Wall fixing and panel fixing included. Wandmontage und Plattenmontage Sets inkludiert.
- PVC foam Panels are optional. PVC Schaumplatten optional erhältlich.
- Max height 1500 mm & max. width 600 mm. Max. Höhe 1500 mm und max. Breite 600 mm.



Wall fixing screws of Outdoor Flap Gripper are included in the pack which are CE certified multi-expansion long plugs. Special anti-corrosion coated screw is made of zinc coated steel and plastic sleeve made of high quality of nylon. It is confirmed for outdoor fixing on various exterior building surfaces such as concrete, solid or honeycomb brick, hollow dense or hollow light aggregate block, aerated concrete and solid stone.



Das Wandmontage Zubehör des Outdoor Flap Gripper ist im Lieferumfang enthalten welche auch CE zertifiziert sind. Spezielle anti-korrosion beschichteten Schrauben sind hergestellt aus Zink und einer Plastikhülle aus hoher Nylonqualität. Geeignet und bestätigt für den Gebrauch an diversen Aussenfassaden wie Beton, Solid oder Wabenziegeln, dichten Hohl oder leichten Hohl Block, belüfteten Beton oder solidem Stein.

PANEL : 5 mm Plastech PVC Foam		MATERIAL : Silver anodised aluminium - excluding panel				WEIGHT	PACKING SIZE
ARTICLE	POSTER SIZE	ARTICLE	POSTER SIZE	COPY AREA	A	B	*W X H X D
UYOFG10610	620 X 1000 mm	UOFG00N100	620 X 1000 mm	600 X 1000 mm	1075 mm	1120 mm	4,600 kg 110 X 1170 X 95 mm
UYOFG10612	620 X 1200 mm	UOFG00N120	620 X 1200 mm	600 X 1200 mm	1275 mm	1320 mm	5,500 kg 110 X 1370 X 95 mm
UYOFG10615	620 X 1500 mm	UOFG00N150	620 X 1500 mm	600 X 1500 mm	1575 mm	1620 mm	6,700 kg 110 X 1670 X 95mm

*W:Width H: Height D: Depth





Door Sign

- Door Signs
 - 15 mm
 - 26 mm
- Desktop Sign
- Wall Sign System
- Wall Sign Double Sided
- Sign Systems
 - ABS Plastic Braille Signs
 - Aluminum Panel Braille Signs
 - Standoff Mount Acrylic Sign

- Türschilder
 - 15 mm
 - 26 mm
- Tischbeschilderungssystem
- Wandbeschilderungssystem
- Doppelseitige Wandschild
- Sign Systems
 - ABS Plastic Braille Signs
 - Aluminum Panel Braille Signs
 - Standoff Mount Acrylic Sign



Door Signs 15 mm - 25 mm



Watch video at our website www.mtdisplays.com



Suitable for use in open-air spaces or public areas such as schools, offices, hospitals, etc.. It is an elegant and practical product. You merely need to open the front profile in order to change your documents. An anti-reflex PET cover protects your documents from tearing and suffering damage. It can be used both in portrait and landscape positions.

Ein elegantes Produkt welches in Schulen, Ausbildungsstätten, Büros, Krankenhäuser u.a sehr praktisch zum Einsatz gebracht werden kann. Durch leicht zu öffnende Profile können Dokumente leicht ausgewechselt werden. Die antireflex Schutzfolie schützt Ihre Dokumente vor Schmutz und Beschädigung. Der Artikel kann sowohl in Hochformat als auch im Querformat zum Einsatz gebracht werden.

Each door sign includes adhesive tape & mounting instruction sheet.
Jedes Paket enthält doppelseitiges Klebeband und eine Montageanleitung.

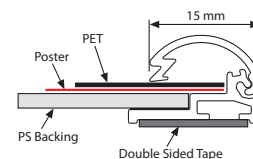
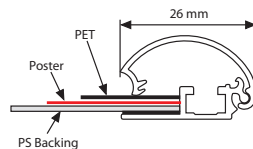
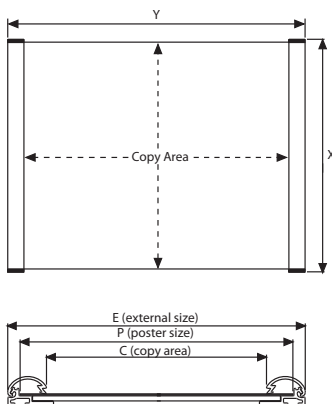
15 mm in top snap 8 mm poster & in bottom snap 8 mm poster is placed within the clamping system. 26 mm in top snap 11 mm poster & in bottom snap 11 mm poster is placed within the clamping system. Please clean the surface before applying the double-sided tape for better application.
Das Poster wird oben und unten um 8 mm durch die Klemmleisten verdeckt. Flächen vor dem anbringen des doppelseitigen Klebebands gründlich reinigen, um besseren Halt zu gewährleisten.



15 mm



26 mm



15 mm : Silver anodised aluminium Poster Snap				WEIGHT	PACKING SIZE
ARTICLE	EXTERNAL (x-y)	POSTER	COPY	WITH PACKING	*W X H X D
UDS150NOA7	79 X 115 mm	74 X 105 mm	74 X 84 mm	0,745 kg	120 X 200 X 100 mm (15 Pcs)
UDS150NOA6	110 X 158 mm	105 X 148 mm	105 X 127 mm	0,600 kg	120 X 200 X 100 mm (5 Pcs)
UDS150NOA5	153 X 220 mm	148 X 210 mm	148 X 189 mm	2,880 kg	245 X 350 X 80 mm (20 Pcs)
UDS150NOA4	215 X 307 mm	210 X 297 mm	210 X 276 mm	2,530 kg	245 X 350 X 80 mm (10 Pcs)
UDS150NA43	104 X 220 mm	99 X 210 mm	99 X 189 mm	2,880 kg	245 X 350 X 80 mm (30 Pcs)

26 mm : Silver anodised aluminium Poster Snap				WEIGHT	PACKING SIZE
ARTICLE	EXTERNAL (x-y)	POSTER	COPY	WITH PACKING	*W X H X D
UDS0001050	56 X 177 mm	50 X 148 mm	50 X 126 mm	0,620 kg	120 X 200 X 100 mm (10 pcs)
UDS0002050	111 X 177 mm	105 X 148 mm	105 X 126 mm	0,545 kg	120 X 200 X 100 mm (5 pcs)
UDS0003050	111 X 326 mm	105 X 297 mm	105 X 275 mm	1,680 kg	245 X 350 X 80 mm (10 pcs)
UDS0004050	154 X 239 mm	148 X 210 mm	148 X 188 mm	0,930 kg	245 X 350 X 80 mm (10 pcs)
UDS0005050	216 X 326 mm	210 X 297 mm	210 X 275 mm	1,405 kg	245 X 350 X 80 mm (5 pcs)

*W:Width H: Height D: Depth





Desktop Sign




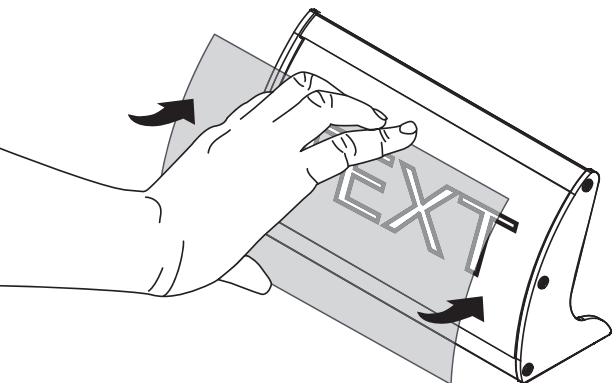
Offering a complete range, aluminium wall sign profiles are design to enable usage on a counter to match Wall Signs. Desktop Sign is fixed to a convenient reading angle to be seen by the customers easily. It is suitable for receptions, restaurants, cafés and many more. It is a practical product to change the message very often.

Aluminium Wall Sign Profile sind konzipiert um einen vergleichbaren Einsatz mit dem Wall Sign auf Theken zu ermöglichen. Der Desktop Sign wird in einem sehr bequemen Lesewinkel für Kunden ausgeliefert. Perfekt geeignet für Rezeptionen, Restaurants, Cafés und noch viele andere Bereiche.

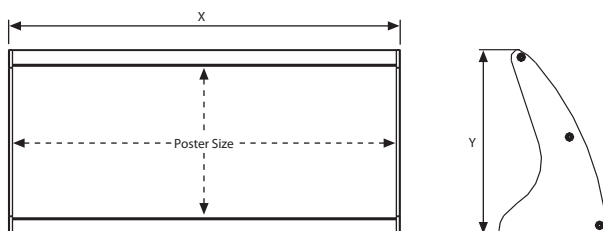
 Use the suction cup enclosed to easily remove the insert. Verwenden Sie den Saugnapf um den Inhalt leicht hervor zu heben.

 Compatible signage methods; printed papers from common printers, cut vinyl, digitally printed vinyl, screen-printed materials. Kompatible Druckverfahren; bedrucktes Papier von herkömmlichen Druckern, Vinyl, digital bedrucktes Vinyl, Materialien bedruckt im Siebdruckverfahren. Eine Antireflexfolie bietet Schutz und eine klare Sicht auf die Mitteilung.

 Suitable for paper, plastic or any flexible material up to 1 mm thick. Geeignet für Papier, PVC, oder andere flexible Materialien bis zu einer Stärke von 1mm.



Suction Cup / UYAA006010



DESKTOP SIGN: Silver anodised aluminium			WEIGHT	PACKING SIZE
ARTICLE	EXTERNAL (x-y)	POSTER SIZE	WITH PACKING	*W X H X D
UMDS740N15	155 X 82 mm	74 X 150 mm	0,200 kg	110 X 180 X 75 mm
UMDS740N20	205 X 82 mm	74 X 200 mm	0,250 kg	110 X 230 X 75 mm
UMDS740N25	255 X 82 mm	74 X 250 mm	0,350 kg	110 X 280 X 75 mm
UMDS105N15	155 X 110 mm	105 X 150 mm	0,250 kg	140 X 170 X 85 mm
UMDS105N20	205 X 110 mm	105 X 200 mm	0,350 kg	140 X 230 X 85 mm
UMDS105N25	255 X 110 mm	105 X 250 mm	0,400 kg	140 X 280 X 85 mm
UMDS105N30	305 X 110 mm	105 X 300 mm	0,450 kg	140 X 330 X 85 mm
UMDS148N20	205 X 148 mm	148 X 200 mm	0,400 kg	180 X 230 X 95 mm
UMDS148N25	255 X 148 mm	148 X 250 mm	0,450 kg	180 X 280 X 95 mm
UMDS148N30	305 X 148 mm	148 X 300 mm	0,500 kg	180 X 320 X 95 mm

*W:Width H: Height D: Depth



Wall Sign System



Watch video at our website www.mtdisplays.com



Fast and simple!

The Wall Sign system is a perfect solution for wall posters and signs. It allows clear visibility for the poster and has an aesthetic curved shape. The stylish curved Wall Sign system in various sizes suits the room sign and way finding needs within the building. Designed for paper inserts and is offered in variety of profile types to match different projects. The front cover is anti-reflex which is flexed into place after inserting the paper. Poster inserts can be created from common inkjet or laser printers. Printed-paper inserts may be in portrait or landscape outline and various sizes fitting in 4 profile types.

Schnell und einfach!

Das Wall Sign System ist eine perfekte Lösung für Poster und Markierungen. Es ermöglicht die klare Sichtbarkeit des Posters und hat eine elegante gerundete Form. Der Artikel zeichnet Räume aus und verhilft im Gebäude Ihren richtigen Weg zu finden. Für Papiereinlagen entwickelt und wird in verschiedenen Profiltypen für verschiedene Zwecke angeboten. Die Schutzfolie ist antireflex und wird auf die Papiereinlage aufgelegt. Die Postereinlagen können mit herkömmlichen Tinten- oder Laserdruckern gedruckt werden. Papiereinlagen in Hoch- oder Querformat können dem Gebrauch entsprechend mit 4 verschiedenen Profiltypen eingesetzt werden.



Each sign includes double sided tape, one suction cup and mounting instruction sheet. Jeder Artikel wird mit doppelseitigem Klebeband, einem Sauger und einer Montageanleitung geliefert.



Use the suction cup to easily remove the inserts from the signs by simply attaching it to the inserts and pulling. Benutzen Sie den Sauger um die Schutzfolie abzuheben und die Einlagen auszutauschen, indem Sie den Sauger ansaugen lassen und leicht ziehen.



Compatible signage methods; printed papers from common printers, cut vinyl, digitally printed vinyl, screen-printing. Please clean the surface before applying the double-sided tape for better application. Variable Einlagemöglichkeiten, Drucke von herkömmlichen Druckern, zugeschnittenes Vinyl Digital bedrucktes Vinyl; Siebdrucke. Flächen vor dem anbringen des doppelseitigen Klebebands gründlich reinigen, um besseren Halt zu gewährleisten.



148 x 300 mm



105 x 250 mm



74 x 150 mm



52 x 150 mm



Flat cap



Arc cap



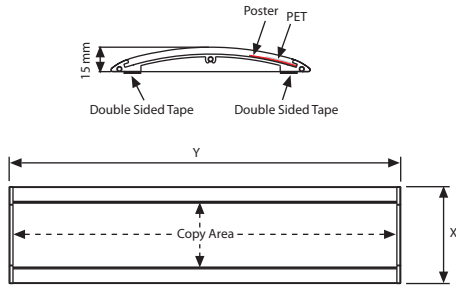
Double sided tape



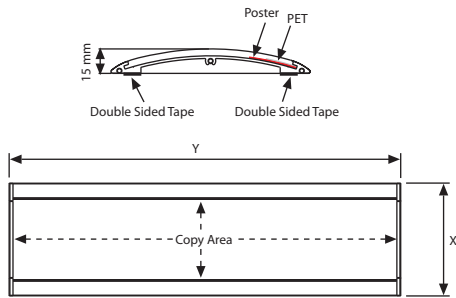
Suction cup



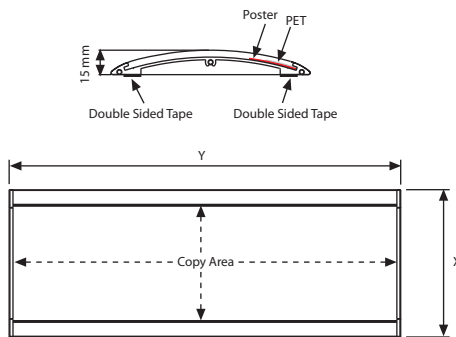
Model 52 mm



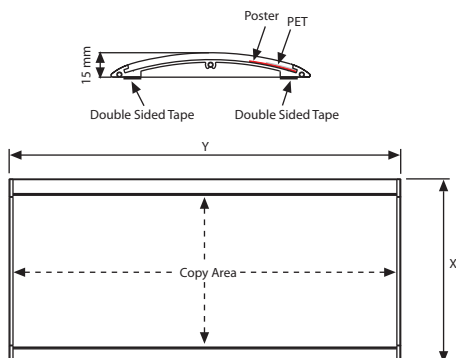
Model 74 mm



Model 105 mm



Model 148 mm



WALL SIGN SYSTEM 52 mm : Silver anodised aluminium					WEIGHT	PACKING SIZE (10 Pcs)
ARTICLE	MODEL	EXTERNAL (x-y)	POSTER	COPY	WITH PACKING	*W X H X D
UDS520NA10	Flat Endcap	68 X 106 mm	52 X 100 mm	46 X 100 mm	0,670 kg	160 X 140 X 100 mm
UDS520NA15	Flat Endcap	68 X 156 mm	52 X 150 mm	46 X 150 mm	0,985 kg	160 X 190 X 100 mm
UDS520NA20	Flat Endcap	68 X 206 mm	52 X 200 mm	46 X 200 mm	1,300 kg	160 X 240 X 100 mm
UDS520NA25	Flat Endcap	68 X 256 mm	52 X 250 mm	46 X 250 mm	1,615 kg	160 X 290 X 100 mm
UDS520NA30	Flat Endcap	68 X 306 mm	52 X 300 mm	46 X 300 mm	1,930 kg	160 X 340 X 100 mm
UDS520NA35	Flat Endcap	68 X 356 mm	52 X 350 mm	46 X 350 mm	2,245 kg	160 X 390 X 100 mm
UDS520NA40	Flat Endcap	68 X 406 mm	52 X 400 mm	46 X 400 mm	2,560 kg	160 X 440 X 100 mm
UDS520NA45	Flat Endcap	68 X 456 mm	52 X 450 mm	46 X 450 mm	2,875 kg	160 X 490 X 100 mm
UDS520NB10	Arc Endcap	68 X 106 mm	52 X 100 mm	46 X 94 mm	0,670 kg	160 X 140 X 100 mm
UDS520NB15	Arc Endcap	68 X 156 mm	52 X 150 mm	46 X 144 mm	0,985 kg	160 X 190 X 100 mm
UDS520NB20	Arc Endcap	68 X 206 mm	52 X 200 mm	46 X 194 mm	1,300 kg	160 X 240 X 100 mm
UDS520NB25	Arc Endcap	68 X 256 mm	52 X 250 mm	46 X 244 mm	1,615 kg	160 X 290 X 100 mm
UDS520NB30	Arc Endcap	68 X 306 mm	52 X 300 mm	46 X 294 mm	1,930 kg	160 X 340 X 100 mm
UDS520NB35	Arc Endcap	68 X 356 mm	52 X 350 mm	46 X 344 mm	2,245 kg	160 X 390 X 100 mm
UDS520NB40	Arc Endcap	68 X 406 mm	52 X 400 mm	46 X 394 mm	2,560 kg	160 X 440 X 100 mm
UDS520NB45	Arc Endcap	68 X 456 mm	52 X 450 mm	46 X 444 mm	2,875 kg	160 X 490 X 100 mm

WALL SIGN SYSTEM 74 mm : Silver anodised aluminium					WEIGHT	PACKING SIZE (10 Pcs)
ARTICLE	MODEL	EXTERNAL (x-y)	POSTER	COPY	WITH PACKING	*W X H X D
UDS740NA15	Flat Endcap	90 X 156 mm	74 X 150 mm	68 X 150 mm	1,080 kg	210 X 190 X 100 mm
UDS740NA20	Flat Endcap	90 X 206 mm	74 X 200 mm	68 X 200 mm	1,430 kg	210 X 240 X 100 mm
UDS740NA25	Flat Endcap	90 X 256 mm	74 X 250 mm	68 X 250 mm	1,780 kg	210 X 290 X 100 mm
UDS740NA30	Flat Endcap	90 X 306 mm	74 X 300 mm	68 X 300 mm	2,100 kg	210 X 340 X 100 mm
UDS740NA35	Flat Endcap	90 X 356 mm	74 X 350 mm	68 X 350 mm	2,460 kg	210 X 390 X 100 mm
UDS740NA40	Flat Endcap	90 X 406 mm	74 X 400 mm	68 X 400 mm	2,510 kg	210 X 440 X 100 mm
UDS740NA45	Flat Endcap	90 X 456 mm	74 X 450 mm	68 X 450 mm	2,860 kg	210 X 490 X 100 mm
UDS740NA50	Flat Endcap	90 X 506 mm	74 X 500 mm	68 X 500 mm	3,22 kg	210 X 540 X 100 mm
UDS740NB15	Arc Endcap	90 X 156 mm	74 X 150 mm	68 X 144 mm	1,080 kg	210 X 190 X 100 mm
UDS740NB20	Arc Endcap	90 X 206 mm	74 X 200 mm	68 X 194 mm	1,430 kg	210 X 240 X 100 mm
UDS740NB25	Arc Endcap	90 X 256 mm	74 X 250 mm	68 X 244 mm	1,780 kg	210 X 290 X 100 mm
UDS740NB30	Arc Endcap	90 X 306 mm	74 X 300 mm	68 X 294 mm	2,100 kg	210 X 340 X 100 mm
UDS740NB35	Arc Endcap	90 X 356 mm	74 X 350 mm	68 X 344 mm	2,460 kg	210 X 390 X 100 mm
UDS740NB40	Arc Endcap	90 X 406 mm	74 X 400 mm	68 X 394 mm	2,510 kg	210 X 440 X 100 mm
UDS740NB45	Arc Endcap	90 X 456 mm	74 X 450 mm	68 X 444 mm	2,860 kg	210 X 490 X 100 mm
UDS740NB50	Arc Endcap	90 X 506 mm	74 X 500 mm	68 X 494 mm	3,220 kg	210 X 540 X 100 mm

WALL SIGN SYSTEM 105 mm : Silver anodised aluminium					WEIGHT	PACKING SIZE (10 Pcs)
ARTICLE	MODEL	EXTERNAL (x-y)	POSTER	COPY	WITH PACKING	*W X H X D
UDS105NA25	Flat Endcap	120 X 256 mm	105 X 250 mm	99 X 250 mm	2,350 kg	270 X 290 X 100 mm
UDS105NA30	Flat Endcap	120 X 306 mm	105 X 300 mm	99 X 300 mm	2,830 kg	270 X 340 X 100 mm
UDS105NA35	Flat Endcap	120 X 356 mm	105 X 350 mm	99 X 350 mm	3,260 kg	270 X 390 X 100 mm
UDS105NA40	Flat Endcap	120 X 406 mm	105 X 400 mm	99 X 400 mm	3,740 kg	270 X 440 X 100 mm
UDS105NA50	Flat Endcap	120 X 506 mm	105 X 500 mm	99 X 500 mm	4,700 kg	270 X 540 X 100 mm
UDS105NA60	Flat Endcap	120 X 606 mm	105 X 600 mm	99 X 600 mm	5,860 kg	270 X 640 X 100 mm
UDS105NB25	Arc Endcap	120 X 256 mm	105 X 250 mm	99 X 244 mm	2,350 kg	270 X 290 X 100 mm
UDS105NB30	Arc Endcap	120 X 306 mm	105 X 300 mm	99 X 294 mm	2,830 kg	270 X 340 X 100 mm
UDS105NB35	Arc Endcap	120 X 356 mm	105 X 350 mm	99 X 344 mm	3,260 kg	270 X 390 X 100 mm
UDS105NB40	Arc Endcap	120 X 406 mm	105 X 400 mm	99 X 394 mm	3,740 kg	270 X 440 X 100 mm
UDS105NB50	Arc Endcap	120 X 506 mm	105 X 500 mm	99 X 494 mm	4,700 kg	270 X 540 X 100 mm
UDS105NB60	Arc Endcap	120 X 606 mm	105 X 600 mm	99 X 594 mm	5,860 kg	270 X 640 X 100 mm

WALL SIGN SYSTEM 148 mm : Silver anodised aluminium					WEIGHT	PACKING SIZE (10 Pcs)
ARTICLE	MODEL	EXTERNAL (x-y)	POSTER	COPY	WITH PACKING	*W X H X D
UDS148NA30	Flat Endcap	162 X 306 mm	148 X 300 mm	142 X 300 mm	3,360 kg	360 X 340 X 100 mm
UDS148NA35	Flat Endcap	162 X 356 mm	148 X 350 mm	142 X 350 mm	3,960 kg	360 X 390 X 100 mm
UDS148NA40	Flat Endcap	162 X 406 mm	148 X 400 mm	142 X 400 mm	4,540 kg	360 X 440 X 100 mm
UDS148NA50	Flat Endcap	162 X 506 mm	148 X 500 mm	142 X 500 mm	5,660 kg	360 X 540 X 100 mm
UDS148NA60	Flat Endcap	162 X 606 mm	148 X 600 mm	142 X 600 mm	6,860 kg	360 X 640 X 100 mm
UDS148NA65	Flat Endcap	162 X 656 mm	148 X 650 mm	142 X 650 mm	7,410 kg	360 X 690 X 100 mm
UDS148NB30	Arc Endcap	162 X 306 mm	148 X 300 mm	142 X 294 mm	3,360 kg	360 X 340 X 100 mm
UDS148NB35	Arc Endcap	162 X 356 mm	148 X 350 mm	142 X 344 mm	3,960 kg	360 X 390 X 100 mm
UDS148NB40	Arc Endcap	162 X 406 mm	148 X 400 mm	142 X 394 mm	4,540 kg	360 X 440 X 100 mm
UDS148NB50	Arc Endcap	162 X 506 mm	148 X 500 mm	142 X 494 mm	5,660 kg	360 X 540 X 100 mm
UDS148NB60	Arc Endcap	162 X 606 mm	148 X 600 mm	142 X 594 mm	6,860 kg	360 X 640 X 100 mm
UDS148NB65	Arc Endcap	162 X 656 mm	148 X 650 mm	142 X 644 mm	7,410 kg	360 X 690 X 100 mm



*W:Width H: Height D: Depth

Wall Sign Double Sided



Watch video at our website www.mtdisplays.com



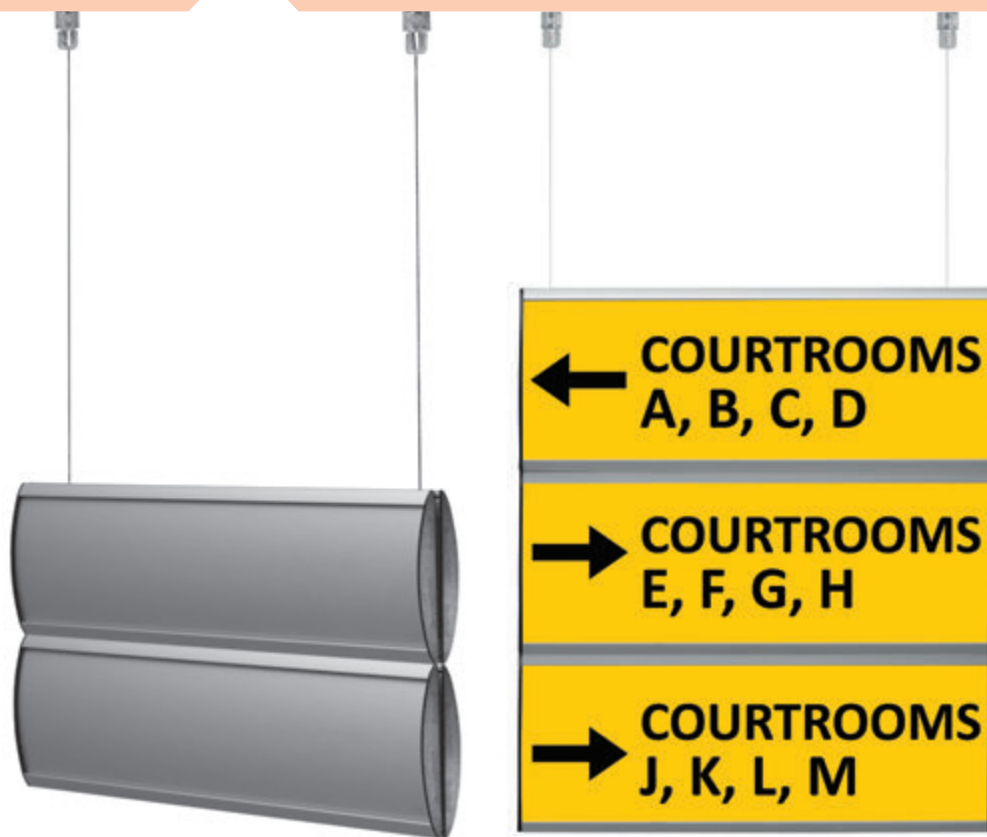
Fast and Simple! Aluminium wall sign profiles are designed to create horizontally curved double sided suspended signs. Using your stock of single sided profiles, product offerings can be increased to double sided suspension style. Double Sided Wall Sign is suitable as directional signs, way finding. Suspension cables enclosed enables flexible positioning of the sign. Black endcaps complete the look.

Schnell und einfach. Die Aluminium Profile sind konzipiert um horizontale gewölbte doppelseitige Wegweiser bestens zu positionieren. Durch aneinanderstecken der einseitigen Profile kann man hier die doppelseitigen Wallsign erhalten. Die doppelseitigen Wallsign sind geeignet für direkte Wegweiser. Die beigelegten Montageseile ermöglichen eine flexible Montage der Wegweiser. Schwarze Endkappen vervollständigen die Optik.

Use the suction cup enclosed to easily remove the insert. Peel the tape on the backing and stick for easy application. Der beigelegte Saugnapf ermöglicht das Auswechseln des Inhaltes. Ziehen Sie die Folie auf der Rückseite ab und kleben Sie das Produkt einfach an.

Compatible signage methods; printed papers from common printers, cut vinyl, digitally printed vinyl, screen-printed materials. Kompatible Druckmethoden geeignet, bedrucktes Papier, vinyl, digital bedrucktes vinyl.

Ceiling suspension is included in the pack (8m wire cable & 2 x ceiling hanger). Individually packed. Das Aufhänageset ist erhältlich als Paket (8m Seil & und 2 Aufhänger). Einzelverpackung.



- ✓ Anti-reflex PET covers ensure clarity of message.
- ✓ Easy to access poster with suction cup provided in the pack.
- ✓ Easy to update messages. Suitable for paper, plastic or any flexible material up to 1mm thick.
- ✓ Available in standard sizes as well as bespoke sizes (subjected to moq).
- ✓ For more than 5 layers please contact to your sales executive.
- ✓ Antireflex Folie bietet Schutz und eine klare Sicht auf die Nachricht
- ✓ Der beigelegte Saugnapf ermöglicht das Einfache auswechseln des Inhaltes
- ✓ Sehr bequemer Austausch der Nachricht. Geeignet für Papier, PVC oder einem anderen flexible Material bis zu einer Stärke von 1mm.
- ✓ Erhältlich in Standardmaßen so wie auch in Sondermaßen (vorausgesetzt einer gewissen Mindestabnahmemenge)
- ✓ Für mehr als 5 Reihen, kontaktieren Sie bitte Ihren Kundenbetreuer



Suction Cup / UYAA006010



Fixing components (UYPDS00002)
Suspension set (UYPDS00001)

WALL SIGN DOUBLE SIDED		
ARTICLE	DESCRIPTION	WEIGHT
UYPDS00001	Double Sided Suspension Set / 2x4 m fishnet & 2xCeiling Hanger	0,450 kg
UYPDS00002	Double Sided Fixing Set (4 Pcs)	0,050 kg



Maximum recommended length: 500 mm


	WALL SIGN DOUBLE SIDED: Silver anodised aluminium				
	SINGLE LAYER	2-LAYER	3-LAYER	4-LAYER	5-LAYER
74 mm	✓	✓	✓	✓	✓
105 mm	✓	✓	✓	✓	
148 mm	✓	✓	✓		

ABS Plastic Braille Signs & Aluminum Panel Braille Signs



Aluminium Braille Toilet Signs are plastic framed. The signs are incorporated a combination of tactile text and printed text. It is available in Men and Women options. Easy to apply with double sided tape provided on the back of each sign.

Diese Plastik Rahmen haben ein Maß von 150x150mm. Diese Zeichen verfügen über einen bedruckten Text und einer blinden Schrift in einem. Der Text ist als „Frauen“ und „Männer“ verfügbar. Einfache Montage durch doppelseitiges Klebeband angebracht auf der Rückseite der Zeichen.

 Peel the tape and stick backing for easy application. Please clean the surface before applying the double-sided tape for better application. Ziehen Sie die Schutzschicht ab und kleben Sie die Rückseite an die Oberfläche. Flächen vor dem anbringen des doppelseitigen Klebebands gründlich reinigen, um besseren Halt zu gewährleisten.

ABS Plastic Braille Signs



WOMEN, Braille signs. With double-side tape on the back.



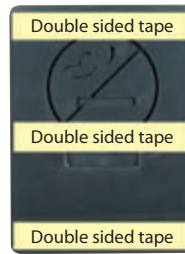
MEN, Braille signs. With double-side tape on the back.



EXIT, braille signs. With double-side tape on the back.



NO SMOKING, braille signs. With double-side tape on the back.



Back side

5x5 Aluminium Panel Braille Signs



127x127 mm -No Smoking, Silver Plastic Frame Aluminum Panel With Braille

6x8 Aluminium Panel Braille Signs



150x200 mm-Men, Silver Plastic Frame Aluminum Panel With Braille



150x200 mm-Female, Silver Plastic Frame Aluminum Panel With Braille

6x6 Aluminium Panel Braille Signs



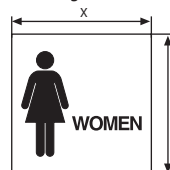
150x150 mm-Men, Silver Plastic Frame Aluminum Panel With Braille



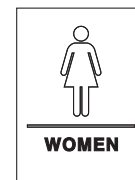
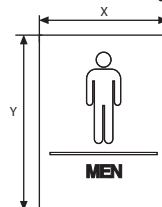
150x150 mm-Female, Silver Plastic Frame Aluminum Panel With Braille



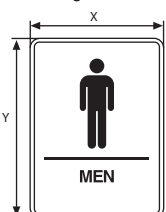
6x6 Aluminium Panel Braille Signs



ABS Plastic Braille Signs



6x8 Aluminium Panel Braille Signs



ABS PLASTIC BRAILLE SIGN: Plastic					BRAILLE SIGN: Aluminium			WEIGHT	PACKING SIZE
ARTICLE	EXTERNAL (x-y)	DESCRIPTION	WITH PACKING	WEIGHT	ARTICLE	EXTERNAL (x-y)	DESCRIPTION	WITH PACKING	*W X H X D
TDFY010002	150 X 200 mm	Silver - Men	0,180 kg	235 X 330 X 235 mm (50 pcs)	TDFL110002	127 X 127 mm	5X5 / Silver	0,066 kg	235 X 420 X 205 mm (50 pcs)
TDFY020002	150 X 200 mm	Silver - Women	0,180 kg	235 X 330 X 235 mm (50 pcs)	TDFL050002	150 X 150 mm	6X6 / Silver - Men	0,112 kg	235 X 420 X 205 mm (50 pcs)
TDFY090002	150 X 200 mm	Silver - No Smoking	0,180 kg	235 X 330 X 235 mm (50 pcs)	TDFL060002	150 X 150 mm	6X6 / Silver - Women	0,112 kg	235 X 420 X 205 mm (50 pcs)
TDFY100002	150 X 200 mm	Silver - Exit	0,180 kg	235 X 330 X 235 mm (50 pcs)	TDFL070002	150 X 200 mm	6X8 / Silver - Men	0,142 kg	235 X 420 X 205 mm (50 pcs)
					TDFL080002	150 X 200 mm	6X8 / Silver - Women	0,142 kg	235 X 420 X 205 mm (50 pcs)

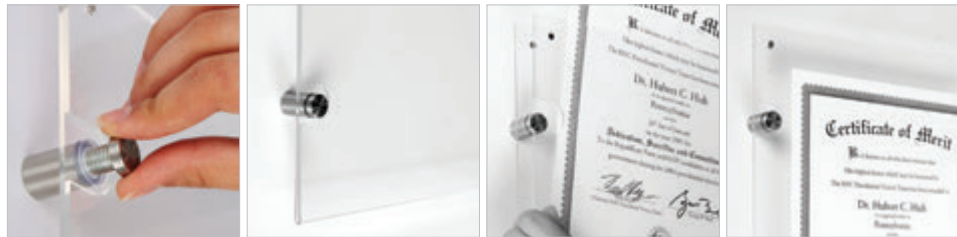


*W:Width H: Height D: Depth

Standoff Mount Acrylic Sign





Watch video at our website www.mtdisplays.com

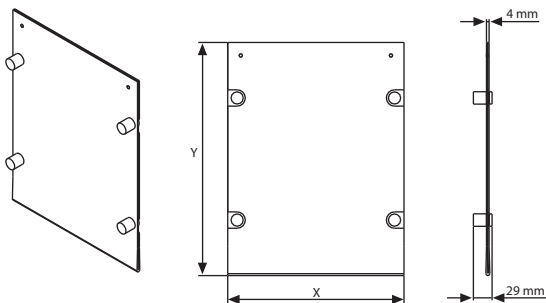


Designed as frameless, Standoff Mount Acrylic Sign is a practical display system allowing to change poster when it is still on the wall by sliding. It is suitable for environments where the advertisement or promotions are changed very often such as offices, meeting rooms, travel agents, hotels, restaurants and many more. Standoff Mount Acrylic Sign is also suitable for branding.

Der rahmenlose Standoff Mount Acrylic Sign ist ein praktisches Display System welches den Posterwechsel auch direkt an der Wand ermöglicht durch seitliches einschieben. Es ist geeignet für Umgebungen wo sehr häufig ein Posterwechsel durchgeführt wird; wie zum Beispiel Büro, Konferenzräume, Reiseagenturen, Hotels, Restaurants und viele mehr. Standoff Mount Acrylic Sign ist auch für Logodrucke geeignet.

 Peel off the film.
Vor Gebrauch den Schutzfilm abziehen.

 Handle with care during transportation. Peel of the film over the product before use.
Seien Sie beim Transport vorsichtig. Ziehen Sie die Schutzfolie ab bevor Sie das Produkt verwenden.



UYPSMS0010
Fixing kit included.

MATERIAL : Clear acrylic 2 mm			WEIGHT	PACKING SIZE
ARTICLE	EXTERNAL (x-y)	POSTER SIZE	WITH PACKING	*W X H X D
USMS0000A4	270 X 357 mm	210 X 297 mm	2,900 kg	300 X 460 X 45 mm (5 Pcs)
USMS0000A3	357 X 480 mm	297 X 420 mm	4,700 kg	380 X 590 X 45 mm (5 Pcs)
USMS0000A2	480 X 654 mm	420 X 594 mm	2,300 kg	500 X 690 X 40 mm

*W:Width H: Height D: Depth





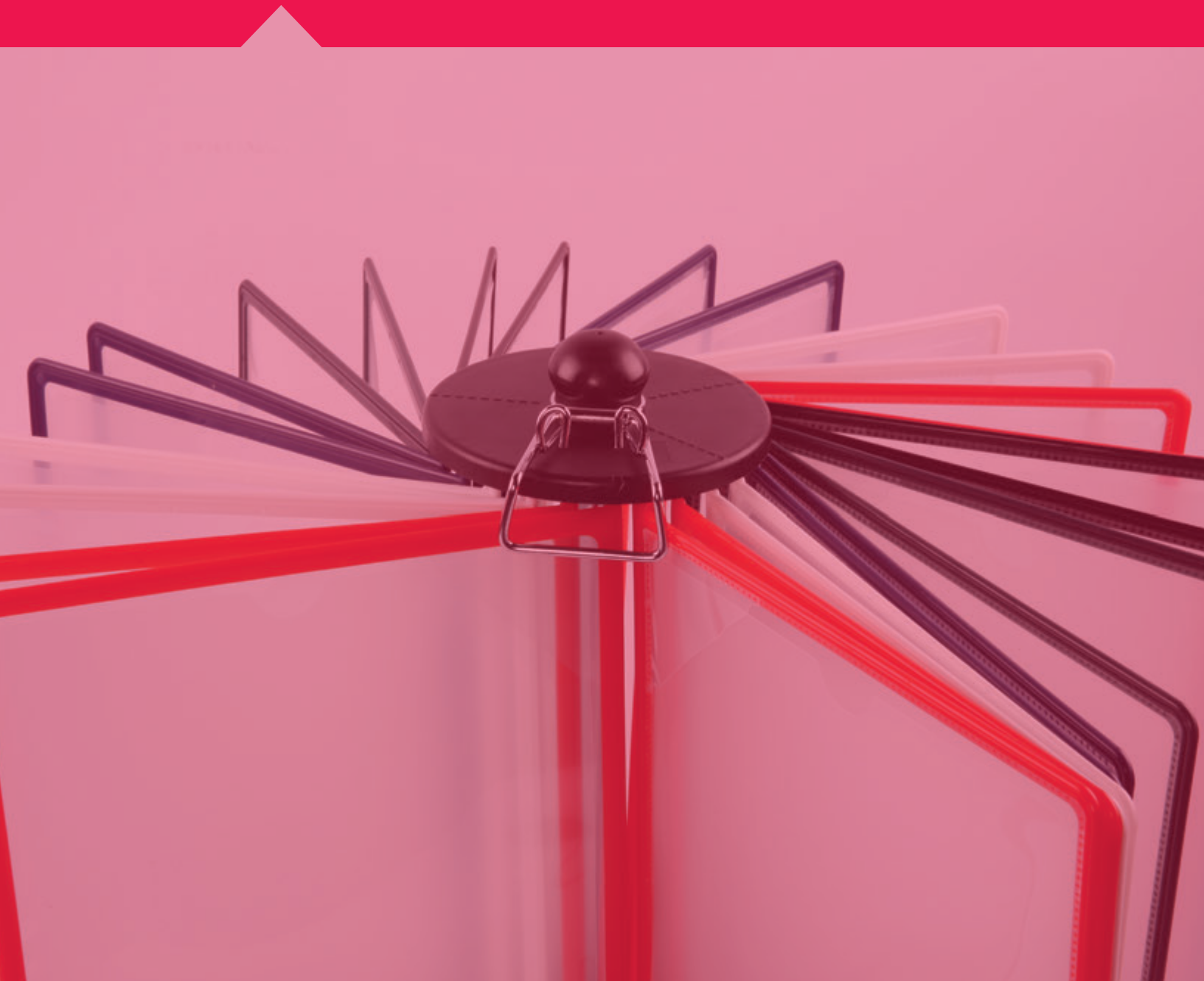
Presentation Systems

- Clipboard
- Fast Note
- White Boards
- Reference Racks
 - Table Top Reference Rack
 - 360° Rotating Reference Rack
 - Adjustable Reference Rack System
 - Adjustable Reference Rack with Round Base
 - Flexible Reference Rack System
 - Wall Mount Reference Rack Plastic & Steel
 - Free Standing Reference Rack
 - Floor Standing Reference Rack

- Easels
 - Portable Easel
 - Wood Portable Easel
 - Modern Easel
 - Art Easel
 - Basic Easel

- Clipboard
- Fast Note
- White Boards
- Reference Racks
 - Table Top Reference Rack
 - 360° Rotating Reference Rack
 - Adjustable Reference Rack System
 - Adjustable Reference Rack with Round Base
 - Flexible Reference Rack System
 - Wall Mount Reference Rack Plastic & Steel
 - Free Standing Reference Rack
 - Floor Standing Reference Rack

- Easels
 - Portable Easel
 - Wood Portable Easel
 - Modern Easel
 - Art Easel
 - Basic Easel



Clip Board



Watch video at our website www.mtdisplays.com



Heavy duty, textured steel Clip Board is designed for the most demanding environments such as healthcare, offices, catering and any outdoor work. Stain free surface allows easy cleaning of the product. It is complete with silver anodised, strong and high capacity snap-open clip. Round corners allows using in busy work areas.

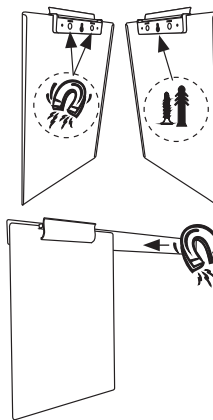
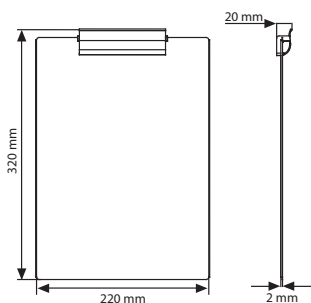
Gefertigt aus robustem Stahl und entwickelt für anspruchsvolle Umgebungen wie im Medizinbereich, Büros, Caterings und Außeneinsätzen. Die Fleckverhindernde Oberfläche ermöglicht ein sehr leichtes säubern des Produktes. Komplett Silber eloxiert, und ein starkes Klappsystem runden das Produkt ab. Die abgerundeten Kanten bieten Einsatz in jedem Bereich.

Suitable for A4 papers. Standard with paper clip and magnet on the back. Peel the tape and stick backing for easy application. Please clean the surface before applying the double-sided tape for better application. Geeignet für Größen. Standard mit einem Magnet-Aufhänger Set versehen. Ziehen Sie die Schutzschicht ab und kleben Sie die Rückseite an die Oberfläche. Flächen vor dem anbringen des doppelseitigen Klebbands gründlich reinigen, um besseren Halt zu gewährleisten.

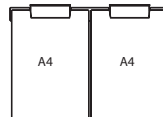
Optional steel bar for hanging in multiples of A4. Should be ordered separately! Steel bar has double sided tape at the back for wall application. Optional Aluminiumleiste für Verwendung mehrerer Clipboards A4.



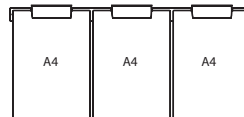
1XA4 Clip Board
Steel bar length 300x35 mm



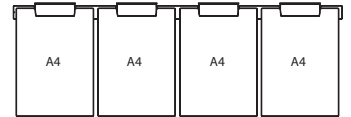
2XA4 Clip Board
Steel bar length 460x35 mm



3XA4 Clip Board
Steel bar length 700x35 mm



4XA4 Clip Board
Steel bar length 940x35 mm



Magnetic buttons
UYUP397000

MATERIAL : Steel powder coated			WEIGHT	PACKING SIZE
ARTICLE	DESCRIPTION	CAPACITY	WITH PACKING	*W X H X D
UCIB0000A4	CLIP BOARD	A4	0,390 kg	250 X 350 X 21 mm
UCIBD002A4	CLIP BOARD WALL UNIT	2 X A4	0,200 kg	80 X 120 X 125 mm (5 Pcs)
UCIBD003A4	CLIP BOARD WALL UNIT	3 X A4	0,295 kg	80 X 120 X 125 mm (5 Pcs)
UCIBD004A4	CLIP BOARD WALL UNIT	4 X A4	0,390 kg	80 X 120 X 125 mm (5 Pcs)

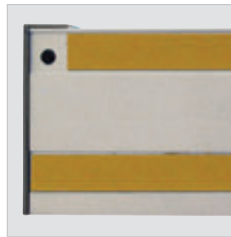


*W:Width H: Height D: Depth

Fast Note



Watch video at our website www.mtdisplays.com



Fast Note is a product which enables you to hang your papers, notes, pictures or photos without magnets or pins. It has a slim and compact design. Thanks to the cylinders in the profile you can easily keep the paper inside. Fast Note is suitable for restaurants, agencies, studios, hospitals, hotels, conference rooms, houses and offices. The standard color is anodized silver. Other colors and sizes are available upon request. You can either assemble the product on the wall by fixing the holes on the profile with screws and wall-plugs or apply the double-sided tape at any given point.

Fast Note ist ein Produkt, mit dem Notizen, Papiere, ohne Magnete oder Nadeln festgehalten werden können. Es hat ein dünnes, handliches Design. Die Rollkugeln im Profil bieten festen Halt. Passend für Agenturen, Werkstätten, Krankenhäuser, Hotels Konferenzräume und Büros. Standardfarbe ist silber eloxiert. Andere Masse und Farben stehen zur Auswahl. Das Produkt kann durch die verdeckten Bohrungen mit dem Dübelset an die Wand montiert werden oder mit dem doppelseitigem Klebeband an die Wand geklebt werden.



It is user friendly. Fixing set (screw and double-sided tape) and manual is supplied with each product. Suitable for use of posters / paper min. 0,1 mm, max. 0,8 mm thickness. *Benutzerfreundliches Produkt. Jedes Paket enthält Montageanleitung, Dübel / Schrauben und doppelseitiges Klebeband.*



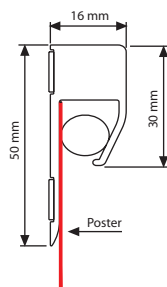
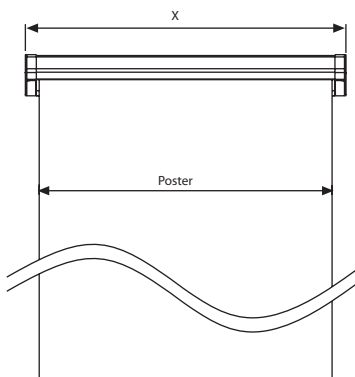
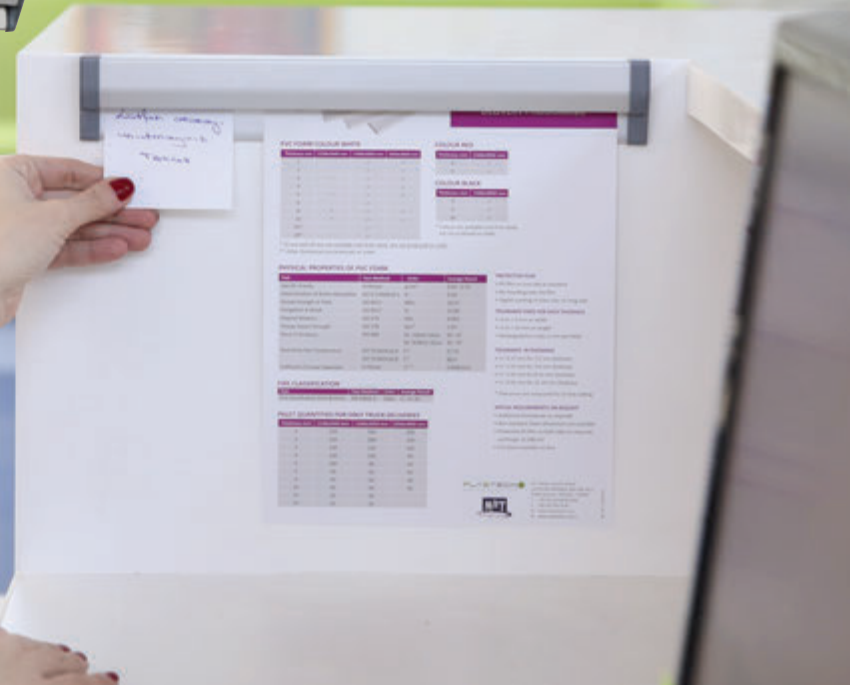
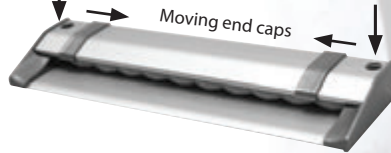
Suitable for silk screen printing, max. letter height is 14 mm. *Für den Siebdruck geeignet, max. Buchstabenhöhe 14 mm.*



Discreet mounting holes

Discreet mounting holes

Moving end caps



MATERIAL : Silver anodised aluminium			WEIGHT	PACKING SIZE (50 pcs)
ARTICLE	EXTERNAL (x)	POSTER	WITH PACKING	*W X H X D
UFN000N031	335 mm	310 mm	8,000 kg	220 X 360 X 320 mm (50 pcs)
UFN000N050	525 mm	500 mm	12,900 kg	220 X 560 X 320 mm (50 pcs)
UFN000N058	605 mm	580 mm	14,400 kg	220 X 640 X 320 mm (50 pcs)
UFN000N088	905 mm	880 mm	11,000 kg	180 X 940 X 220 mm (25 pcs)
UFN000N100	1025 mm	1000 mm	12,000 kg	180 X 1060 X 220 mm (25 pcs)
UFN000N118	1205 mm	1180 mm	14,250 kg	180 X 1240 X 220 mm (25 pcs)
UFN000N150	1525 mm	1500 mm	18,000 kg	180 X 1560 X 220 mm (25 pcs)



*W:Width H: Height D: Depth

Rotatable Model White Boards Magnetic & Dry Wipe Double Sided



Double sided magnetic drywipe and revolving Whiteboard which offers one side plain smooth surface and the other side allows inserting papers together with drywipe surface.

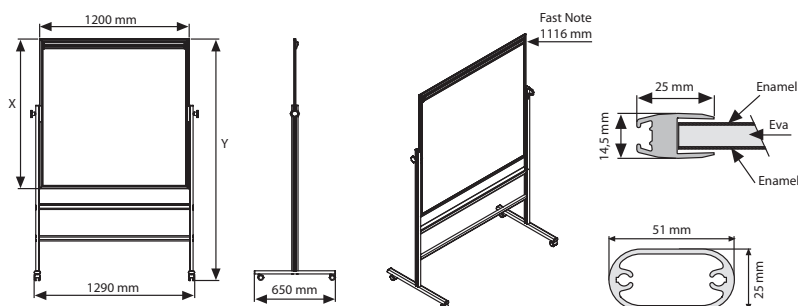
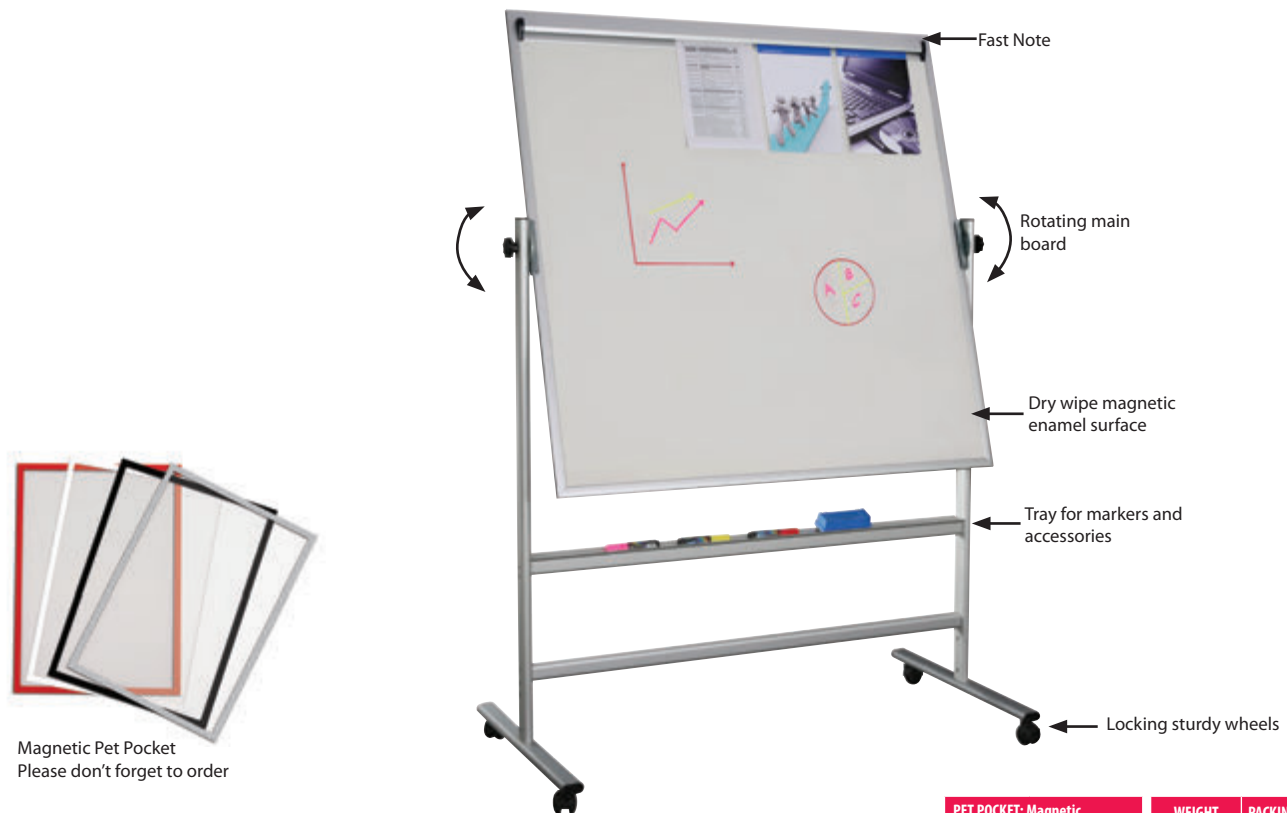
Sturdy Aluminium framed Whiteboards available in large sizes for presentations, training rooms, hanging artworks, maps and charts. The Fast Note on the other side allows inserting various sheets of paper and it is held in place with specially designed rollers. Easy to move the board with locking wheels.

Doppelseitiger wiederbeschreibbare und drehbare Magnettafel welche beidseitig Papierhalterungen bietet. Ausgestattet mit Aluminiumrahmen ist dieses Produkt verfügbar in verschiedenen Größen für Präsentationen, Konferenzräume und Ausstellungsräume. Das Fastnote System auf beiden Seiten ermöglicht das Anbringen von Papier und wird gehalten mittels speziell konzipierten Rollen. Leicht transportierbar mit Lenkrädern die mit einer Bremse ausgestattet sind. Die Tafel ist 360grad drehbar.

For use with drywipe pens. Each board includes a set of magnets. Geeignet für Boardmarker.

Fast Note is ideal for 0,10-0,80mm thicknesses of materials. Fast Note kann alle Materialien mit einer Stärke zwischen 0,10 – 0,80mm halten.

Accessories (erase & marker) are not included. Zubehör (Lösch & Marker) sind nicht inkludiert.



PET POCKET: Magnetic		WEIGHT	PACKING SIZE (10 Pcs)
ARTICLE	DESCRIPTION	WITH PACKING	*W X H X D
UPCMOR00A4	Magnetic A4 Red	0,400 kg	250 X 350 X 21 mm
UPCMOB00A4	Magnetic A4 Black	0,400 kg	250 X 350 X 21 mm
UPCMOW00A4	Magnetic A4 White	0,400 kg	250 X 350 X 21 mm
UPCMOG00A4	Magnetic A4 Gray	0,400 kg	250 X 350 X 21 mm
UPCMOG00A5	Magnetic A5 Gray	0,380 kg	170 X 250 X 21 mm
UPCMOB00A5	Magnetic A5 Black	0,380 kg	170 X 250 X 21 mm

MATERIAL : Silver anodised aluminium				WEIGHT	PACKING SIZE
ARTICLE	BOARD	EXTERNAL (x)	Y	WITH PACKING	*W X H X D
UWBON1290	1200 X 900 mm	900 mm	1787 mm	15,100 kg	1380 X 1750 X 90 mm
UWBON1212	1200 X 1200 mm	1200 mm	1937 mm	18,050 kg	1380 X 1900 X 90 mm
UWBON1215	1200 X 1500 mm	1500 mm	2237 mm	22,200 kg	1380 X 2200 X 90 mm

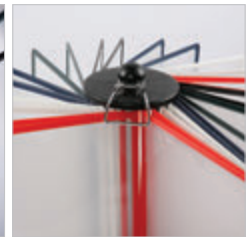
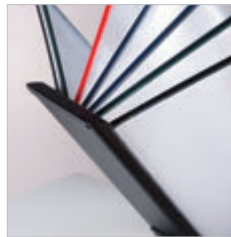
*W:Width H:Height D:Depth



Table Top & 360° Rotating Reference Racks



Watch video at our website www.mtdisplays.com



Steel stand with PET pockets, Table Top Reference allows you to organize busy environments.

Do not forget to order pockets separately. Pockets are double sided, allowing you to display 20 pages at a time. The table top reference rack features a black sturdy steel body.

Stand für den Tisch mit PET Taschen. Das Produkt ermöglicht Ihnen sich in Ihrem Arbeitsalltag leicht zu sortieren. Jede Tasche kann 2 Poster präsentieren. Die Taschen sind sehr leicht einzuhängen. Vergessen Sie nicht die Taschen separat zu bestellen. Das Produkt kann 10 Taschen zugleich aufnehmen und somit 20 Seiten präsentieren. Das Table Top Reference Rack besteht aus schwarzem robustem Stahl.



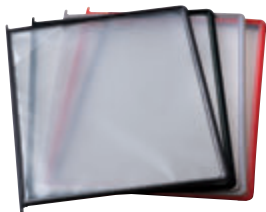
Holds 10 pockets at a time in one rack. Kann 10 Taschen zugleich aufnehmen.



Pockets should be ordered separately. Pockets available in Red, Black and Grey. Taschen müssen separat bestellt werden. Taschen verfügbar in Rot, Schwarz und Grau.



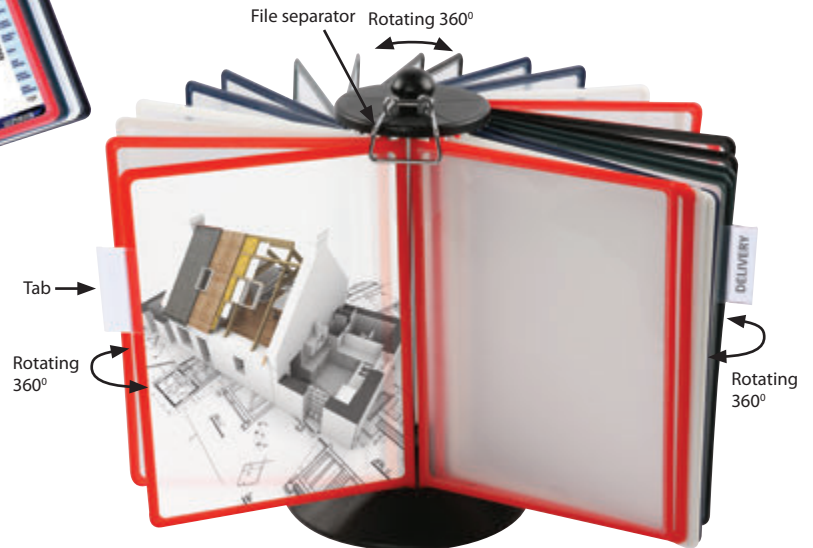
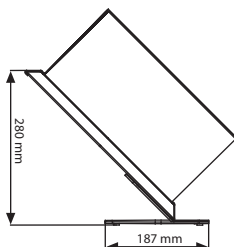
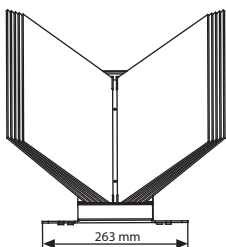
Table Top Reference Rack



Please don't forget to order. 10 pcs of 1 colour in a box.

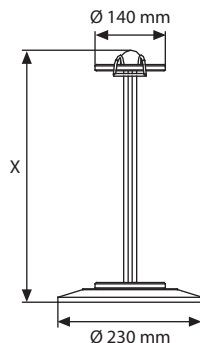


Table Top Reference Rack



360° Rotating Reference Rack

360° Rotating Reference Rack



POSTER POCKET			WEIGHT	PACKING SIZE(10 Pcs)
ARTICLE	PAPER SIZE	DESCRIPTION	WITH PACKING	*W X H X D
TAB0590304	210 X 297 mm	Red	0,550 kg	390 X 550 X 590 mm
TAB0590301	210 X 297 mm	Black	0,550 kg	390 X 550 X 590 mm
TAB0590309	210 X 297 mm	Grey	0,550 kg	390 X 550 X 590 mm

TABLE TOP : Silver anodised aluminium			WEIGHT	PACKING SIZE
ARTICLE	PAPER SIZE	DESCRIPTION	WITH PACKING	*W X H X D
URK01N00A4	210 X 297 mm	Silver	0,500 kg	290 X 480 X 160 mm
URK01B00A4	210 X 297 mm	Black	0,500 kg	290 X 480 X 160 mm

360° ROTATING: Plastic				WEIGHT	PACKING SIZE
ARTICLE	PAPER SIZE	X	DESCRIPTION	WITH PACKING	*W X H X D
TAB5897001	210 X 297 mm	415 mm	Black	2,620 kg	265 X 420 X 265 mm

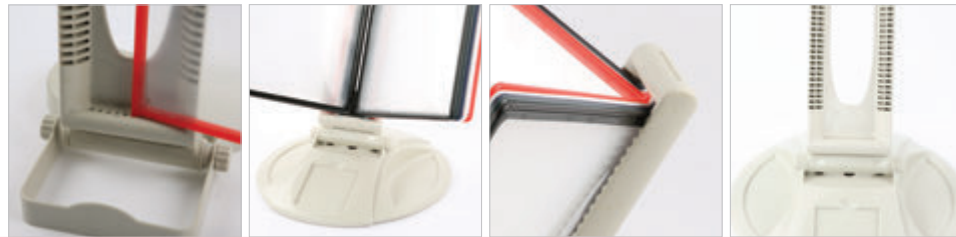
*W:Width H: Height D: Depth



Adjustable Reference Rack Systems



Watch video at our website www.mtdisplays.com



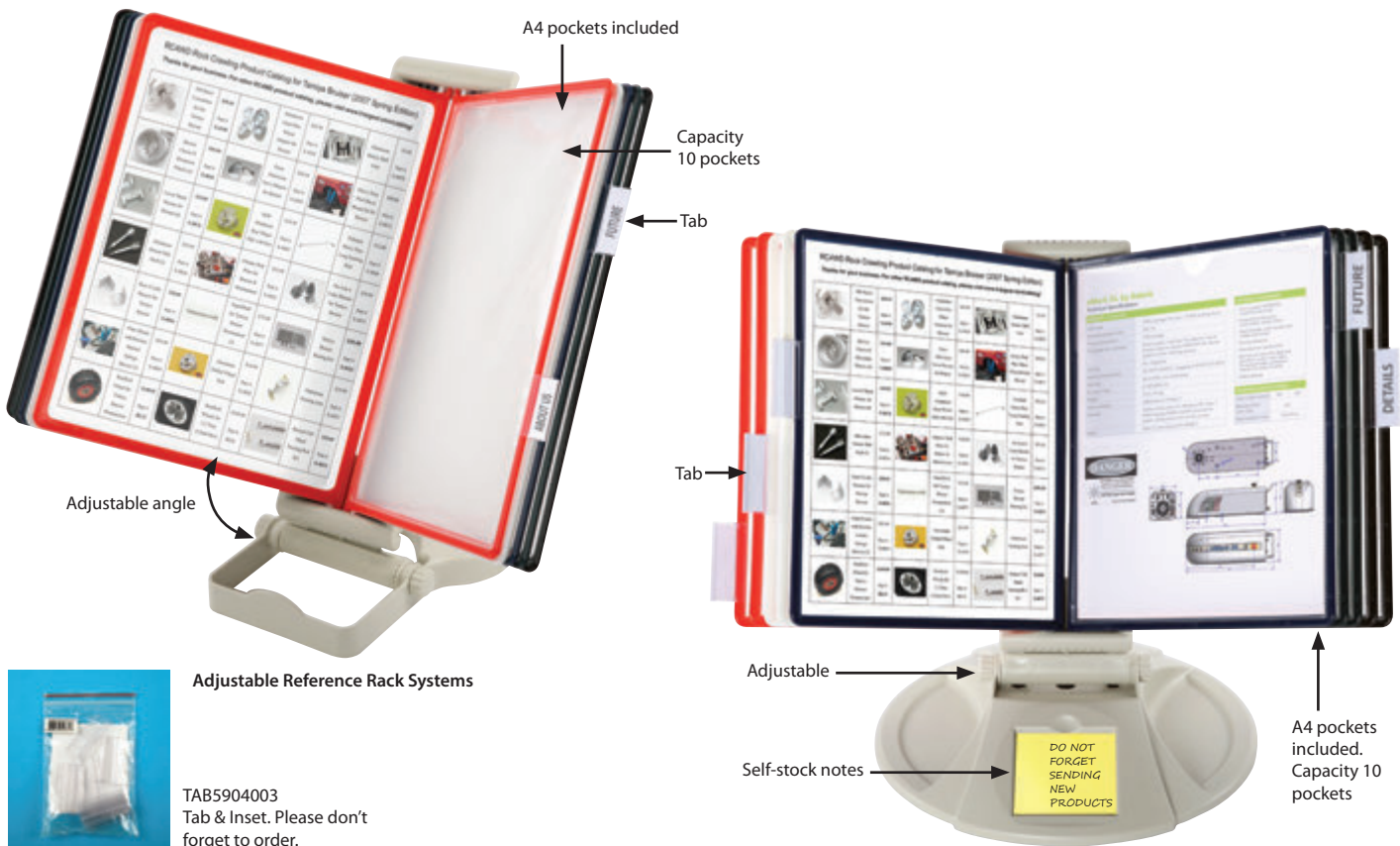
Heavy base Adjustable Rack System has capacity of 10 display pockets. It allows adjusting the angle to comfortable eye level. 10 x pockets are included in the system.

Der Adjustable Reference Rack System verfügt über einen sehr schweren Fuß und verfügt über 10 Postertaschen. Das Produkt kann auf den gewünschten Winkel eingestellt werden. 10 Taschen sind im Lieferumfang enthalten.

Holds 10 pockets at a time. Packed un assembled. Kann 10 Taschen zugleich aufnehmen. Demontiert geliefert.

Sturdy base for a stable and secure unit. Robuster Fuß für eine optimale Standfestigkeit.

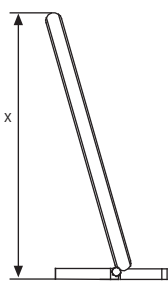
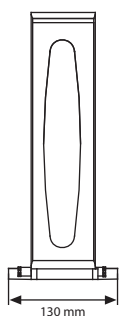
Mix colour pockets are included in the pack. Verschieden farbige Taschen sind der Packung beigelegt.



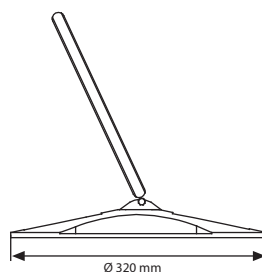
Adjustable Reference Rack Systems

TAB5904003
Tab & Inset. Please don't forget to order.

Adjustable Reference Rack Systems



Adjustable Reference Rack with Round Base



Adjustable Reference Rack with Round Base

MATERIAL - Plastic				WEIGHT	PACKING SIZE
ARTICLE	PAPER SIZE	X	DESCRIPTION	WITH PACKING	*W X H X D
TAB5868002	210 X 297 mm	400 mm	White - Round Base	1,620 kg	135 X 390 X 325 mm
TAB5899002	210 X 297 mm	405 mm	White	2,750 kg	105 X 390 X 265 mm

POSTER POCKET				WEIGHT	PACKING SIZE (10 Pcs)
ARTICLE	PAPER SIZE	DESCRIPTION	WITH PACKING	*W X H X D	
TAB0590304	210 X 297 mm	Red	0,550 kg	390 X 550 X 590 mm	
TAB0590301	210 X 297 mm	Black	0,550 kg	390 X 550 X 590 mm	
TAB0590309	210 X 297 mm	Grey	0,550 kg	390 X 550 X 590 mm	

*W:Width H: Height D: Depth



Flexible Reference Rack System



Watch video at our website www.mtdisplays.com



This Reference Rack System is flexible in every means. It can rotate 360 round, height can be adjusted up to 355 mm and the reading angle is adjustable as required. 10 pockets are included in the pack to displays 20 pages at a time.

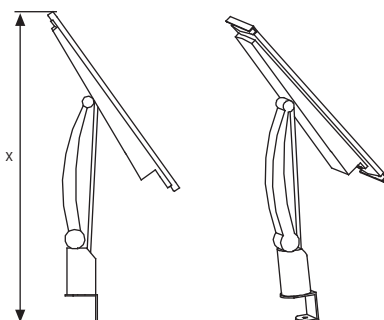
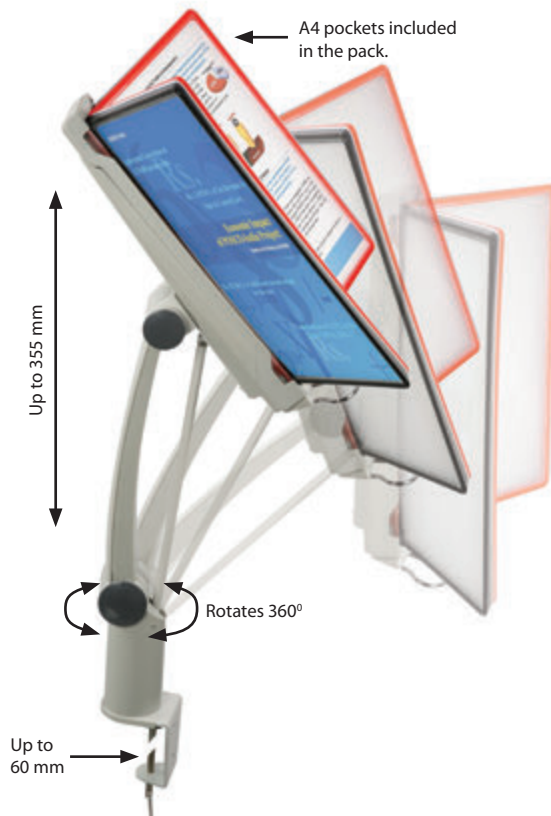
Dieser Reference Rack System ist flexibel in jeder Hinsicht. Es ist komplett um 360° drehbar und die Höhe kann bis zu 355mm Höhe eingestellt werden und das Produkt kann auf den gewünschten Winkel eingestellt werden. 10 Taschen sind im Lieferumfang enthalten.



Holds 10 pockets at a time in one rack. Kann 10 Taschen zugleich aufnehmen.



Mix colour pockets are included in the pack. Verschieden farbige Taschen sind der Packung beigelegt.



TAB5904003
Tab & Inset. Please don't forget to order.

MATERIAL : Plastic				WEIGHT	PACKING SIZE
ARTICLE	PAPER SIZE	X	DESCRIPTION	WITH PACKING	*W X H X D
TAB5845002	210 X 297 mm	625 mm	White	2,250 kg	155 X 480 X 265 mm

POSTER POCKET			WEIGHT	PACKING SIZE(10 Pcs)
ARTICLE	PAPER SIZE	DESCRIPTION	WITH PACKING	*W X H X D
TAB0590304	210 X 297 mm	Red	0,550 kg	390 X 550 X 590 mm
TAB0590301	210 X 297 mm	Black	0,550 kg	390 X 550 X 590 mm
TAB0590309	210 X 297 mm	Grey	0,550 kg	390 X 550 X 590 mm

* W:Width H: Height D: Depth



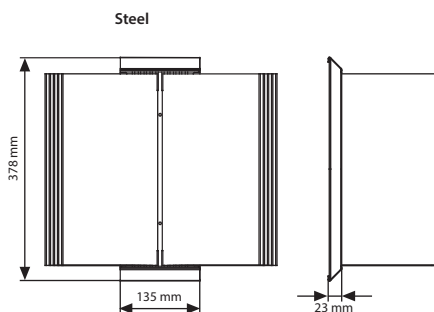
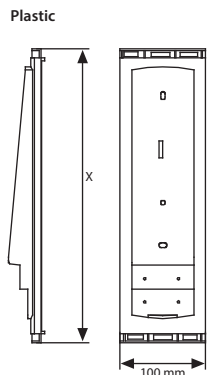
Wall Mount Reference Rack Plastic & Steel



Wall mount Reference Rack is offered plastic or steel. Both products can be fixed to required height. Wall fixing components are included in the pack. Plastic Reference Rack is completed with pockets whereas steel Reference Rack allows for choosing your own colour of pockets. These products are suitable for different office environment when space is limited. Capacity is 10 pockets to display 20 pages at a time.

Der Reference Rack geeignet für die Wandmontage wird aus Kunststoff oder Stahl angeboten. Beide Produkte können in der gewünschten Höhe fixiert werden. Das Wandmontageset ist in der Verpackung enthalten. Der Kunststoff Reference Rack ist inkludiert mit Taschen, während der Stahl Reference Rack ermöglicht die Farbauswahl von den Taschen. Dieses Produkt eignet sich für verschiedene Büroumgebungen, wo Platzmangel herrscht. Die Kapazität beträgt 10 Taschen um 20 Seiten auf einmal anzuzeigen.

- Holds 10 pockets at a time. Packed unassembled. Kann 10 Taschen zugleich aufnehmen. Demontiert geliefert.
- Sturdy base for a stable and secure unit. Robuster Fuß für eine optimale Standfestigkeit.
- Mix colour pockets are included in the pack. Verschieden farbige Taschen sind der Packung beigelegt.



Pockets in 3 colours
Each colour boxed in 10 pcs.
Please don't forget to order.

Red
 Black
 Grey

Rot Schwarz Grau



TAB5904003
Tab & Inset.
Please don't forget to order.

POSTER POCKET			WEIGHT	PACKING SIZE(10 Pcs)
ARTICLE	PAPER SIZE	DESCRIPTION	WITH PACKING	*W X H X D
TAB0590304	210 X 297 mm	Red	0,550 kg	390 X 550 X 590 mm
TAB0590301	210 X 297 mm	Black	0,550 kg	390 X 550 X 590 mm
TAB0590309	210 X 297 mm	Grey	0,550 kg	390 X 550 X 590 mm



* W:Width H: Height D: Depth

MATERIAL : Powder coated steel			WEIGHT	PACKING SIZE
ARTICLE	PAPER SIZE	DESCRIPTION	WITH PACKING	*W X H X D
URK03N00A4	210 X 297 mm	Silver	0,500 kg	160 X 420 X 31 mm
URK03B00A4	210 X 297 mm	Black	0,500 kg	160 X 420 X 31 mm



* W:Width H: Height D: Depth

MATERIAL : Plastic				WEIGHT	PACKING SIZE
ARTICLE	PAPER SIZE	X	DESCRIPTION	WITH PACKING	*W X H X D
TAB5935002	210 X 297 mm	355 mm	White	1,00 kg	95 X 380 X 265 mm



* W:Width H: Height D: Depth

Free Standing Reference Rack



Sturdy aluminum pole with double channels.

Each pocket displays 2 brochures. Pockets flip easily. Do not forget to order pockets separately. Hold 10 pockets at the a time. Allows extra frame and brochure holders to add on when need be.

Robuste Aluminiumstange mit 2 Kanälen.

Stand mit PET Taschen. Das Produkt ermöglicht Ihnen sich in Ihrem Arbeitsalltag leicht zu sortieren. Jede Tasche kann 2 Poster präsentieren. Die Taschen sind sehr leicht einzuhängen. Vergessen Sie nicht die Taschen separat zu bestellen. Das Produkt kann 10 Taschen zugleich aufnehmen und somit 20 Seiten präsentieren. Ermöglicht die Anbringung von Rahmen und Broschüren Halter falls gewünscht.



Holds 10 pockets at a time. Packed unassembled. Kann 10 Taschen zugleich aufnehmen Demontiert geliefert.



Sturdy base for a stable and secure unit. Robuster Fuß für eine optimale Standfestigkeit.



Pockets should be ordered separately. Pockets available in Red, Black and Grey. Taschen müssen separat bestellt werden. Taschen verfügbar in Rot, Schwarz und Grau.



4 packs. See info chart for pack sizes. 4 Packungen. Siehe Infodiagramm für Packungsgrößen.

MATERIAL : Silver anodised aluminium			WEIGHT	PACKING SIZE
ARTICLE	PAPER SIZE	DESCRIPTION	WITH PACKING	*W X H X D
URK04N00A4	210 X 297 mm	Silver	14,000 kg	90 X 1950 X 95 mm / 480 X 480 X 50 mm 460 X 660 X 21 mm / 160 X 420 X 31 mm
URK04B00A4	210 X 297 mm	Black	14,000 kg	90 X 1950 X 95 mm / 480 X 480 X 50 mm 460 X 660 X 21 mm / 160 X 420 X 31 mm

POSTER POCKET			WEIGHT	PACKING SIZE(10 Pcs)
ARTICLE	PAPER SIZE	DESCRIPTION	WITH PACKING	*W X H X D
TAB0590304	210 X 297 mm	Red	0,550 kg	390 X 550 X 590 mm
TAB0590301	210 X 297 mm	Black	0,550 kg	390 X 550 X 590 mm
TAB0590309	210 X 297 mm	Grey	0,550 kg	390 X 550 X 590 mm





* W:Width H: Height D: Depth

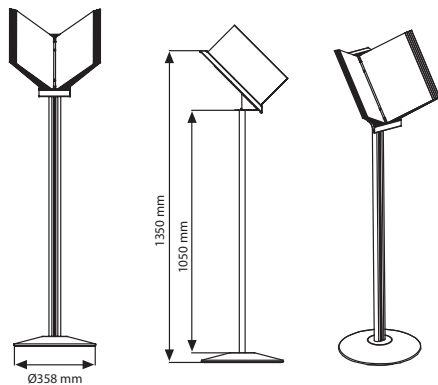
Floor Standing Reference Rack



Steel stand with PET pockets, Table Top Reference allows you to organize busy environments. Pole constructed heavy aluminium extrusion. Each pocket displays 2 brochures. Pockets flip easily. Do not forget to order pockets separately. Holds 10 pockets at a time allowing to display 20 pages.

Stand mit PET Taschen. Das Produkt ermöglicht Ihnen sich in Ihrem Arbeitsalltag leicht zu sortieren. Jede Tasche kann 2 Poster präsentieren. Die Taschen sind sehr leicht einzuhängen. Vergessen Sie nicht die Taschen separat zu bestellen. Das Produkt kann 10 Taschen zugleich aufnehmen und somit 20 Seiten präsentieren.

-  Holds 10 pockets at a time. Packed unassembled. Kann 10 Taschen zugleich aufnehmen. Demontiert geliefert.
-  Study base for a stable and secure unit. Robuster Fuß für eine optimale Standfestigkeit.
-  Pockets should be ordered separately. Pockets available in Red, Black and Grey. Taschen müssen separat bestellt werden. Taschen verfügbar in Rot, Schwarz und Grau.
-  3 packs. See info chart for pack sizes. 3 Packungen. Siehe Infodiagramm für Packungsgrößen.



MATERIAL : Silver anodised aluminium			WEIGHT	PACKING SIZE
ARTICLE	PAPER SIZE	DESCRIPTION	WITH PACKING	*W X H X D
URK05N00A4	210 X 297 mm	Silver Rack	9,200 kg	70 X 1120 X 40 mm / 380 X 390 X 50 mm 160 X 420 X 110 mm
URK05B00A4	210 X 297 mm	Black Rack	9,200 kg	70 X 1120 X 40 mm / 380 X 390 X 50 mm 160 X 420 X 110 mm

POSTER POCKET			WEIGHT	PACKING SIZE (10 Pcs)
ARTICLE	PAPER SIZE	DESCRIPTION	WITH PACKING	*W X H X D
TAB0590304	210 X 297 mm	Red	0,550 kg	390 X 550 X 590 mm
TAB0590301	210 X 297 mm	Black	0,550 kg	390 X 550 X 590 mm
TAB0590309	210 X 297 mm	Grey	0,550 kg	390 X 550 X 590 mm



*W:Width H: Height D: Depth

Portable Easel



Watch video at our website www.mtdisplays.com



Portable Easel is made of aluminium and steel, it is durable and suitable for various environments. Textured black finish gives smart look for Portable Easel. 5 different positions allow displaying various sizes of frames. Foldable feet helps transporting and storing. Simply spread the two legs apart, and the unit is ready for use. Suitable for restaurants, boutiques, art galleries, classrooms or more.

Portable Easel besteht aus Aluminium und Stahl, ist widerstandsfähig und verwendbar für verschiedene Umgebungen. Strukturiertes Schwarz verleiht einen stilvolles Aussehen für tragbare Portable Easel. 5 verschiedene Positionen ermöglichen das Anzeigen der Rahmen in verschiedenen Grössen. Zusammenklappbare Füße helfen beim Transport und Lagerung. Einfach die einzelnen Beine ausbreiten und das Teil ist bereit zum Gebrauch. Geeignet für Restaurants, Boutiquen, Kunstgalerien, Klassenzimmer oder mehr.

It holds frames from B2 up to A0. Ist geeignet für die Größen von DIN B2 bis DIN A0

No tool assembly. Kein Werkzeug nötig.

Packed unassembled with an easy to understand instructions. Unmontiert verpackt mit einer leicht verständlichen Anleitung für die Montage.

Color options / Farboptionen

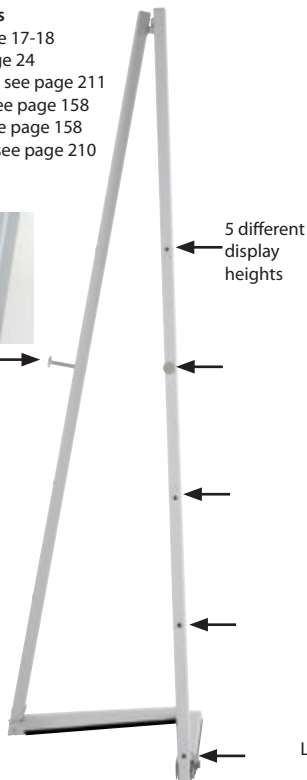


Optional Accessories

- Opti Frame see page 17-18
- Snap Frame see page 24
- Magnetic Glassboard see page 211
- Easy Wood Frame see page 158
- Frameless Frame see page 158
- Frameboard 9 mm see page 210



Mobile peg



5 different display heights



Snap frame optional accessories

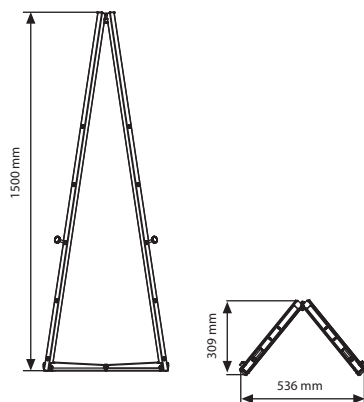


Black Snap Frame see page 27



Lock Rubber feet Lock

Foldable feet



MATERIAL: Steel			WEIGHT	PACKING SIZE
ARTICLE	SIZE	DESCRIPTION	WITH PACKING	*W X H X D
UPESLOG015	1500 X 536 X 309 mm	Gray	4,550 kg	100 X 1570 X 50 mm
UPESLOB015	1500 X 536 X 309 mm	Black	4,550 kg	100 X 1570 X 50 mm

*W:Width H: Height D: Depth



Portable Wood Easel



Watch video at our website www.mtdisplays.com



Practical and foldable, Wood Portable Easel is a good solution for presentation for business and art purposes. Its modern and traditional look will create a huge impact on your advertisement. You can adjust the mobile peg depending on the size of your picture. It is made of beech wood. It is suitable for both outdoor and indoor usage as it is made of beech wood. It is packed assembled in a sturdy box. The perfect way to get attention for display marketing advertisements, restaurant menu, promotions, important messages or any personal notes. It can be used in a multipurpose setting, such as of business, office, outdoors, markets, cafes, events like conventions, weddings, birthdays, parties and more.

Der Praktische und faltbarer Wood Portable Easel ist eine gute Lösung für Präsentationen für geschäftliche und künstlerische Zwecke. Sein modernes und traditionelles Aussehen wird einen großen Einfluss auf Ihre Werbung haben. Sie können den mobilen Stift je nach Größe Ihres Bildes anpassen. Es ist aus Buchenholz gefertigt. Es ist sowohl für den Außen- als auch für den Innenbereich geeignet, da es aus Buchenholz besteht. Mit einem stabilen Karton verpackt. Der perfekte Weg, um Aufmerksamkeit für Display-Marketing-Anzeigen, Restaurantmenüs, Werbeaktionen, wichtige Nachrichten oder persönliche Notizen zu erregen. Es kann in einer Mehrzweckumgebung verwendet werden, z. B. im Geschäft, im Büro, im Freien, auf Märkten, in Cafés, bei Veranstaltungen wie Kongressen, Hochzeiten, Geburtstagen, Partys und mehr.



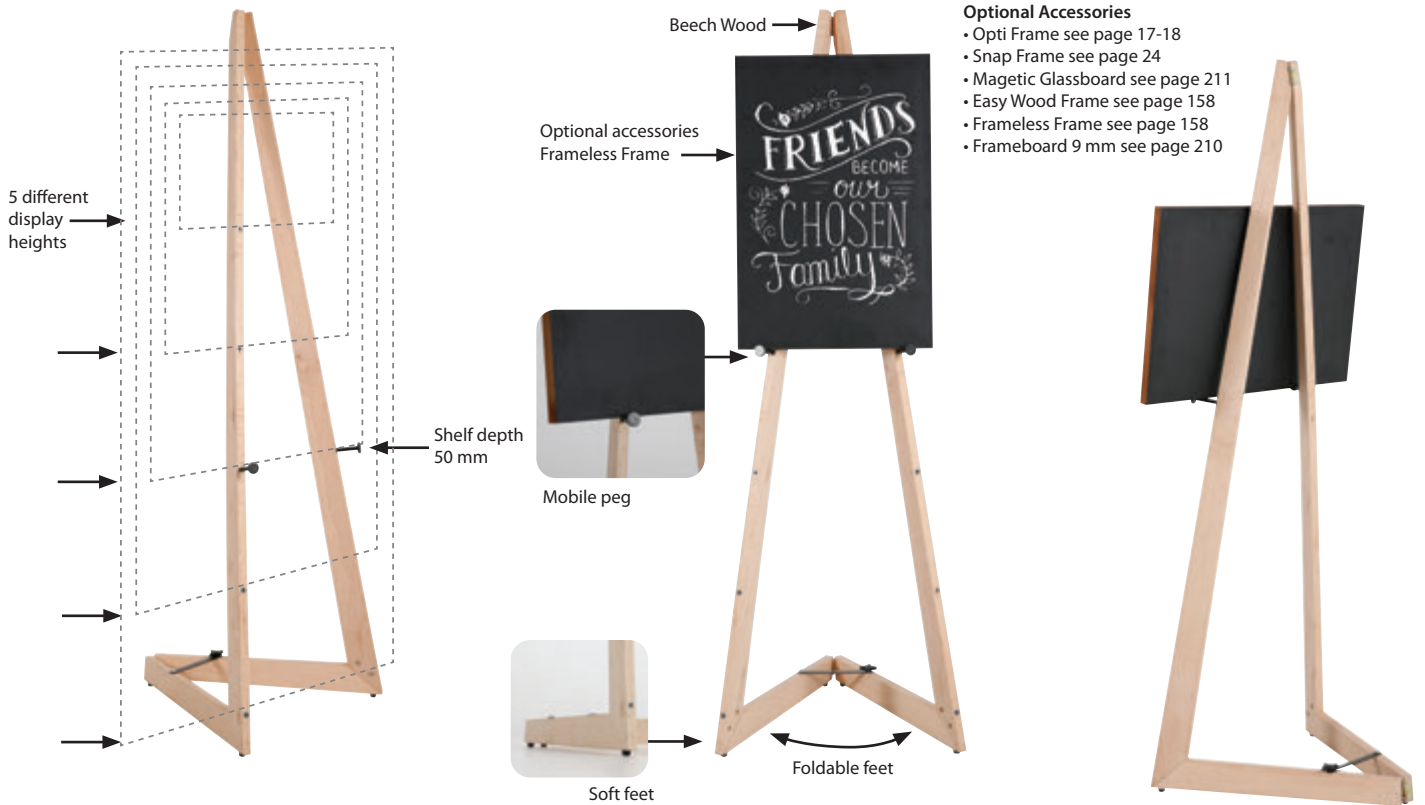
It holds frames from B2 up to A0. Ist geeignet für die großen von DIN B2 bis DIN A0.



Please order the accessories separately. Packed unassembled with an easy to understand instructions. Bitte bestellen Sie das Zubehör separat. Unmontiert verpackt mit einer leicht verständlichen Anleitung für die Montage. Das Zubehör bitte separat bestellen.

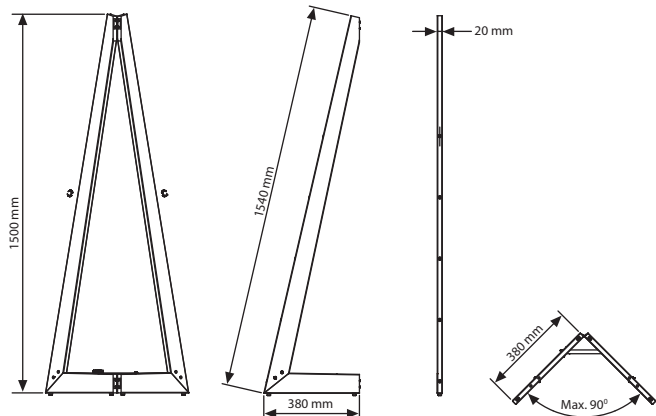


Assembly in 10 seconds. Montiert in 10 Sekunden.



Optional Accessories

- Opti Frame see page 17-18
- Snap Frame see page 24
- Magnetic Glassboard see page 211
- Easy Wood Frame see page 158
- Frameless Frame see page 158
- Frameboard 9 mm see page 210



Don't forget to order Chalkboard Marker
UYAKLM1251 - Colour Marker
UYAKLM1250 - White Marker

MATERIAL : Beech wood		WEIGHT	PACKING SIZE
ARTICLE	DESCRIPTION	WITH PACKING	*W X H X D
UWPESLN010	Natural Wood	3,950 kg	150 X 1670 X 50 mm
UWPESLD010	Dark Wood	3,950 kg	150 X 1670 X 50 mm

*W:Width H: Height D: Depth



Modern Easel



Watch video at our website www.mtdisplays.com



Made of Beechwood, Easel is a solid product for commercial use. Adjustable easel accommodates varying canvas sizes. It is made to be sturdy, strong, and will last in retail settings. Adjustable back support ensures stability of the easel and comfortable use at different angles. It folds flat for easy storage.

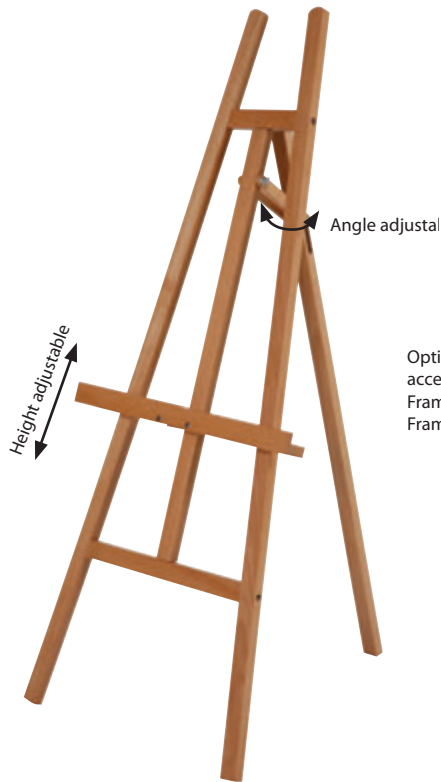
Der Easel ist hergestellt aus Buchenholz und somit sehr solide in seiner Ausführung. Die verstellbare Staffelei bietet Halt für verschiedene Größen von Unterlagen. Widerstandsfähig, robust und für den Einzelhandel brauchbar hergestellt. Die Halterung auf der Rückseite bietet halt und kann in verschiedene Winkel positioniert werden. Klappbar für leichte Lagerung.



It holds frames from B2 up to A0. Ist geeignet für die Größen von DIN B2 bis DIN A0.



Please order the accessories separately. Das Zubehör bitte separat bestellen.

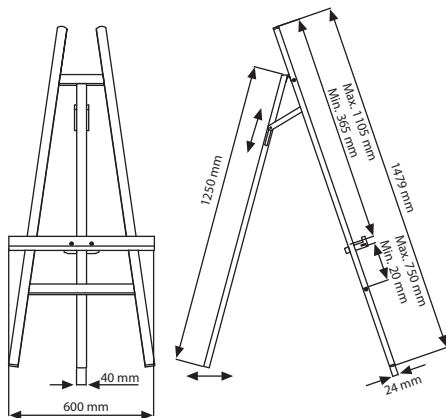


Optional accessories
Frameless
Frame



Optional Accessories

- Opti Frame see page 17-18
- Snap Frame see page 24
- Magnetic Glassboard see page 211
- Easy Wood Frame see page 158
- Frameless Frame see page 158
- Frameboard 9 mm see page 210



Don't forget to order
Chalkboard Marker
UYAKLM1251 - Colour Marker
UYAKLM1250 - White Marker

MATERIAL: Beech Wood		WEIGHT	PACKING SIZE
ARTICLE	SIZE	WITH PACKING	*W X H X D
USLM000015	600 X 790 X 1480 mm	5,000 kg	115 X 1530 X 75 mm

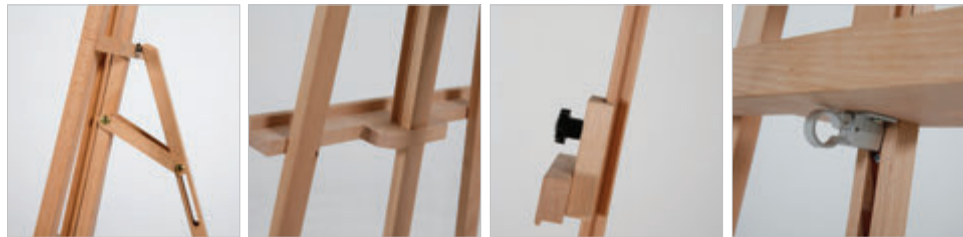
*W:Width H: Height D: Depth



Art Easel



Watch video at our website www.mtdisplays.com



Made of Beechwood, Easel is a solid product for commercial use. Adjustable easel accommodates varying canvas sizes. It is made to be sturdy, strong, and will last in retail settings. Adjustable back support ensures stability of the easel and comfortable use at different angles. It folds flat for easy storage.

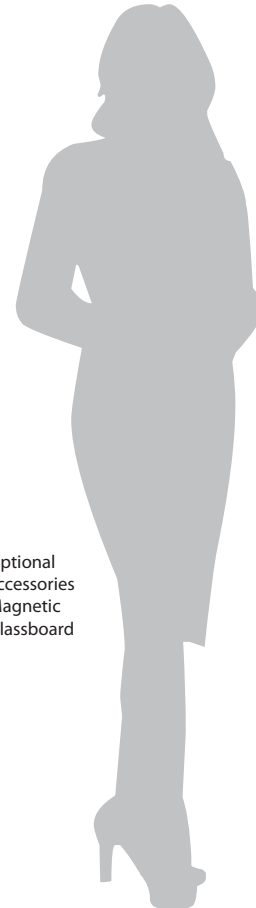
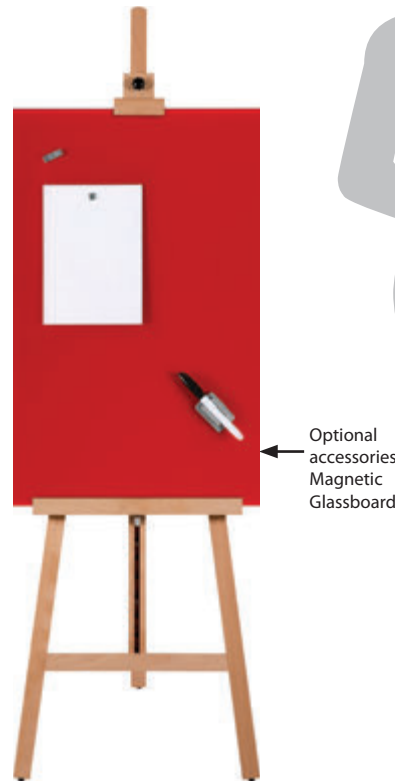
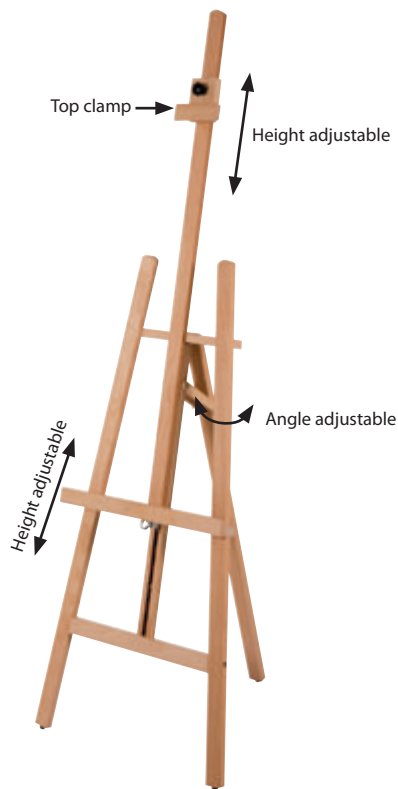
Der Easel ist hergestellt aus Buchenholz und somit sehr solide in seiner Ausführung. Die verstellbare Staffelei bietet Halt für verschiedene Größen von Unterlagen. Widerstandsfähig, robust und für den Einzelhandel brauchbar hergestellt. Die Halterung auf der Rückseite bietet halt und kann in verschiedene Winkel positioniert werden. Klappbar für leichte Lagerung.



It holds frames from B2 up to A0. Ist geeignet für die Größen von DIN B2 bis DIN A0.

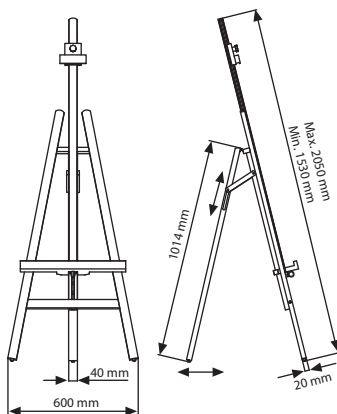


Please order the accessories separately. Das Zubehör bitte separat bestellen.



Optional Accessories

- Opti Frame see page 17-18
- Snap Frame see page 24
- Magnetic Glassboard see page 211
- Easy Wood Frame see page 158
- Frameless Frame see page 158
- Frameboard 9 mm see page 210



Don't forget to order
Chalkboard Marker
UYAKLM1251 - Colour Marker
UYAKLM1250 - White Marker

MATERIAL: Beech Wood		WEIGHT	PACKING SIZE
ARTICLE	SIZE	WITH PACKING	*W X H X D
USLA000012	600 X 550 X 1530 mm	5,500 kg	135 X 1240 X 85 mm

*W:Width H: Height D: Depth



Basic Easel



Watch video at our website www.mtdisplays.com



Basic Easel is made of Fir wood which is one of the most strongest woods used for furniture. Basic Easel is an economic solution for many type of business. Height adjustable easel accommodates varying canvas sizes. It is made to be sturdy, strong, and will last in retail settings. Adjustable back support and chain ensures stability of the easel and comfortable use at different angles. It folds flat for easy storage.

Basic Easel ist aus Kiefernholz gefertigt, einem der kräftigsten Hölzer für Möbel. Basic Easel ist eine wirtschaftliche Lösung für jede Art von Geschäft. Die höhenverstellbare Staffelei bietet Raum für unterschiedliche Leinwandgrößen. Es ist robust und stark und wird im Einzelhandel standhalten. Verstellbare Rückenlehne und Kette sorgen für Stabilität der Staffelei und bequemen Einsatz an verschiedenen Plätzen. Es lässt sich flach zusammenfallen und einfach verstauen.



It holds frames from B2 up to A0. Ist geeignet für die großen von DIN B2 bis DIN A0.



Please order the accessories separately. Das Zubehör bitte separat bestellen.

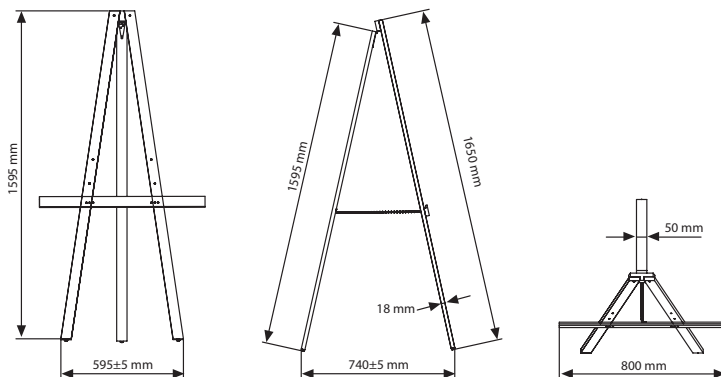
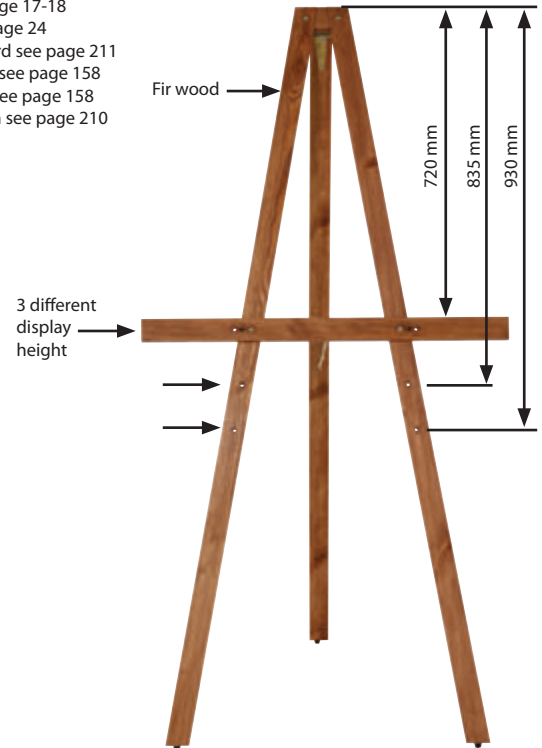


Assembly in 10 seconds. Montiert in 10 Sekunden.



Optional Accessories

- Opti Frame see page 17-18
- Snap Frame see page 24
- Magnetic Glassboard see page 211
- Easy Wood Frame see page 158
- Frameless Frame see page 158
- Frameboard 9 mm see page 210



Don't forget to order
Chalkboard Marker
UYAKLM1251 - Colour Marker
UYAKLM1250 - White Marker

MATERIAL : Fir wood			WEIGHT	PACKING SIZE
ARTICLE	SIZE (x-y)	DESCRIPTION	WITH PACKING	*W X H X D
USLBN00016	595 X 740 mm	Natural Wood	5,00 kg	155 X 1720 X 80 mm
USLBD00016	595 X 740 mm	Dark Wood	5,00 kg	155 X 1720 X 80 mm

*W:Width H: Height D: Depth



Basic Easel





Menuboards

- Flexible Menuboards
 - Flexible Menuboard with Ledbox
 - Telescoping Menuboard Slide-in Frame
 - Telescoping Menuboard Snap Frame
 - ARC Menuboard
 - Folder Menuboard
 - Restaurant Boards
 - Curved Menuboard
 - Curved Menuboard New Colours
 - Simplistic Curved Menuboard
 - Curved Menuboard with Acryled
 - Classical Menuboard
 - Decorative Menuboard
 - Adjustable Menuboard
- Flexibles Menüboard
 - Flexibles Menüboard mit LED Klapprahmen
 - Telescoping Menuboard Slide-in Frame
 - Telescoping Menuboard Snap Frame
 - ARC Menuboard
 - Folder Menuboard
 - Restaurant Boards
 - Curved Menuboard
 - Curved Menuboard New Colours
 - Simplistic Curved Menuboard
 - Curved Menuboard with Acryled
 - Klassisches Menüboard
 - Dekoratives Menüboard
 - Verstellbares Menüboard



Flexible Menuboard



Watch video at our website www.mtdisplays.com



Genuine design, one product, multifunctional. With our newly designed product, we would like to bring a new dimension of performance in menuboards. The Flexible Menuboard fulfills multiple functions thanks to its adjustable height and paper position applications through various standing angles on the back. The height of the unit, the landscape/portrait positioning and the eye catching view angle are all flexible. The product is protected worldwide by all required patent and design applications. It has already been certified in DE (Germany), FR (France), US (United States of America), JP (Japan) and OHIM (European union) papers. The worldwide patent is pending.

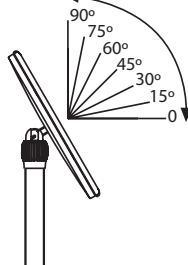
Einzigartiges Design, ein Produkt mehrere Positionen. Mit diesem Produkt haben wir neue Dimensionen in die Einsatzmöglichkeiten des Menuboards gebracht. Das Flexible Menuboard hat mehrere Funktionen wie Höhen-und Formateinstellungen und auch Winkeleinstellungen die von der Rückseite des Rahmens vorgenommen werden können. Dieses Produkt ist patentrechtlich in Deutschland, USA; Japan und in der EU geschützt, die Weltweite Patentierung ist noch nicht abgeschlossen.

Packed unassembled with an easy-to-understand instruction sheet. Demontiert mit Montageanleitung und Befestigungselementen einzeln verpackt.

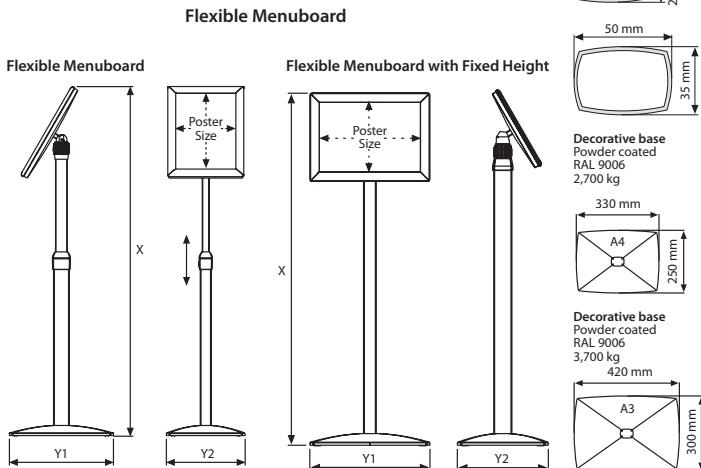
Heavy base provides stability in highly frequented areas. Die schwere, elegante Fussplatte sorgt für Standfestigkeit an Orten mit viel Menschenverkehr.



One product, two positions (landscape & portrait)



Patent : TR 2007 06354 - TR 2007 03453 - PCT/TR 2007/000131 - DE 20 2007 016 574 - OHIM 000748223-0001,2 - FR 760305 - US 29/295.750 - US D 597, 764 S - JP 2007-022472 - JP 2007-022473 - CN 200730321542.4 - CN 200730321543.



FLEXIBLE MENUBOARD FIXED HEIGHT : Silver anodised aluminium						WEIGHT	PACKING SIZE
ARTICLE	X	Y1	Y2	POSTER	DESCRIPTION	WITH PACKING	*W X H X D
UDMB7005A4	967 mm	330 mm	250 mm	297 X 210 mm	Landscape	5,165 kg	285 X 1030 X 102 mm
	1010 mm	330 mm	250 mm	210 X 297 mm	Portrait	5,165 kg	285 X 1030 X 102 mm
UDMB7005A3	1014 mm	420 mm	300 mm	420 X 297 mm	Landscape	6,745 kg	365 X 1110 X 102 mm
	1076 mm	420 mm	300 mm	297 X 420 mm	Portrait	6,745 kg	365 X 1110 X 102 mm

FLEXIBLE MENUBOARD : Silver anodised aluminium						WEIGHT	PACKING SIZE	
ARTICLE	X max.	X min.	Y1	Y2	POSTER	DESCRIPTION	WITH PACKING	*W X H X D
UDMB6005A4	1205 mm	865 mm	330 mm	250 mm	297 X 210 mm	Landscape	5,165 kg	285 X 1030 X 102 mm
	1250 mm	910 mm	330 mm	250 mm	210 X 297 mm	Portrait	5,165 kg	285 X 1030 X 102 mm
UDMB6005A3	1250 mm	910 mm	420 mm	300 mm	420 X 297 mm	Landscape	6,745 kg	365 X 1110 X 102 mm
	1310 mm	970 mm	420 mm	300 mm	297 X 420 mm	Portrait	6,745 kg	365 X 1110 X 102 mm

*W:Width H: Height D: Depth

Flexible Menuboard with Ledbox



Watch video at our website www.mtdisplays.com



Genuine Design, One product, Multi function. Flexible Menuboard with Ledbox bring a new dimension of performance in menuboards. It is in multi functional service of height and paper position application with variety of standing angles at the back. The height of the unit, landscape/portrait positioning or even eye catching view angle is flexible. The product is protected in world with all required patent and design applications and already certified with DE (Germany), FR(France), US (United States of America), JP (Japan) and OHIM (European union) papers. PCT worldwide patent is pending. Special treated acrylic and LED technology illuminates prints homogeneously. Silver and black models are available in A4&A3 sizes. Black is only available at fixed height.

Einzigartiges Design, ein Produkt mehrere Positionen. Mit diesem Produkt haben wir neue Dimensionen in die Einsatzmöglichkeiten des Menuboards gebracht. Das flexible Menuboard hat mehrere Funktionen wie Höhen- und Formateinstellungen und auch Winkeleinstellungen, die von der Rückseite des Rahmens vorgenommen werden können. Der Artikel ist auf der ganzen Welt patentrechtlich geschützt. In Deutschland (DE), Frankreich (FR), USA (US), Japan (JP) und OHIM (EU) ist der Artikel bereits patentiert, der weltweite Gebrauchsmusterschutz ist noch nicht komplett abgeschlossen. Die speziell behandelte Acrylplatte und LED Technologie sorgen für eine gleichmäßige Beleuchtung. Es werden in Silber und Schwarz farbigen Versionen in den Formaten A4 und A3 angeboten.

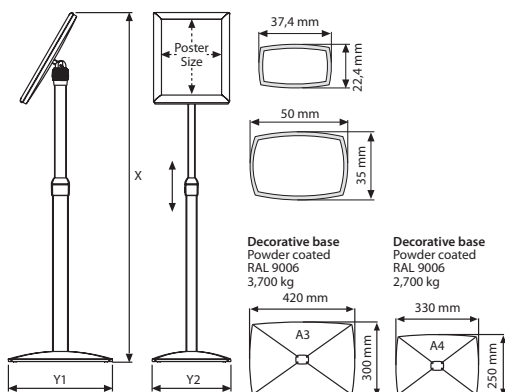
All units pass CE/UL PAT test. Packed with quality certificates & 3,5 meter electrical cable. UK and US plugs should be mentioned on order. Packed unassembled with an easy instruction sheet. Alle Produkte sind CE/UL Pat getestet and werden mit Qualitätszertifikaten geliefert. 3,5 m Stromkabel. Falls UK und USA Stecker gewünscht ist, die Angabe bei Bestellung erforderlich. Der Artikel wird demontiert mit Montagelanleitung und Befestigungselementen einzeln verpackt geliefert.

Led illumination saves up to 60% energy cost. Heavy base provide stability in crowded areas. Die LED Beleuchtung spart bis zu 60% Energieverbrauch. Die schwere, elegante Fussplatte sorgt für Standfestigkeit an Orten mit viel Menschenverkehr.

Color options / Farboptionen



Patent: TR 2007 06354 - TR 2007 03453 - PCT/TR 2007/000131 - DE 20 2007 016 574 - OHIM 000748223-0001,2 - FR 760305 - US 29/295.750 - US D 597, 764 S - JP 2007-022472 - JP 2007-022473 - CN 200730321542.4 - CN 200730321543.



MATERIAL : Silver anodised aluminium							WEIGHT	PACKING SIZE	
ARTICLE	X max.	X min.	Y1	Y2	POSTER	DESCRIPTION	LIGHTING	WITH PACKING	*W X H X D
UFML00N0A4	1205 mm	865 mm	330 mm	250 mm	297 X 210 mm	Silver Landscape	3000-3300 W	5,970 kg	285 X 1030 X 102 mm
	1250 mm	910 mm	330 mm	250 mm	210 X 297 mm	Silver Portrait	3000-3300 W	5,970 kg	285 X 1030 X 102 mm
UFML00N0A3	1250 mm	910 mm	420 mm	300 mm	420 X 297 mm	Silver Landscape	2800-3000 W	8,220 kg	365 X 1110 X 102 mm
	1310 mm	910 mm	420 mm	300 mm	297 X 420 mm	Silver Portrait	2800-3000 W	8,220 kg	365 X 1110 X 102 mm
UFML10B0A4	fixed height	fixed height	330 mm	250 mm	297 X 210 mm	Black Landscape	3000-3300 W	5,970 kg	285 X 1030 X 102 mm
	fixed height	fixed height	330 mm	250 mm	210 X 297 mm	Black Portrait	3000-3300 W	5,970 kg	285 X 1030 X 102 mm
UFML10B0A3	fixed height	fixed height	420 mm	300 mm	420 X 297 mm	Black Landscape	2800-3000 W	8,220 kg	365 X 1110 X 102 mm
	fixed height	fixed height	420 mm	300 mm	297 X 420 mm	Black Portrait	2800-3000 W	8,220 kg	365 X 1110 X 102 mm

* W:Width H: Height D: Depth



Telescoping Menuboard Slide-in Frame



Watch video at our website www.mtdisplays.com



Telescoping Menuboard Double Sided is equipped with Slide in Frame which provides view from both sides. Its telescoping feature allows adjusting the height of advertisement. Slide-in Frame makes the change of poster easy. It is suitable for use in hotels, galleries, museums, restaurants, lobby, bars, etc. Simply slide out the old protection cover, and then place your double sided poster in between and slide in the frame. A heavy duty steel base stabilizes the height adjustable pole. It is available in the sizes A3 and A4 both in landscape & portrait positions in the same Product.

Telescoping Menuboard Slide-in Frame Doppelseitig ist mit einem Einschubrahmen ausgestattet, der den Anblick von beiden Seiten ermöglicht. Die Teleskopfunktion ermöglicht die Einstellung der Höhe. Einschubrahmen erleichtert das Wechseln des Posters. Es eignet sich für den Einsatz in Hotels, Galerien, Museen, Restaurants, in der Lobby, in Bars usw. Ziehen Sie einfach die Antireflex-Abdeckungen heraus, legen Sie Ihr doppelseitiges Poster dazwischen und schieben es in den Rahmen. Eine robuste Stahlplatte stabilisiert die höhenverstellbare Profil. Es ist in den Größen A3 und A4 sowohl im Querformat & Hochformat in einem Produkt erhältlich.



Telescoping Menuboards are packed unassembled with an easy-to-understand instruction sheet & fixing elements and 2 anti-reflex pet covers. Telescoping Menuboards werden mit einem leicht verständlichen Anleitungsblatt und Befestigungselementen sowie 2 Antireflex-Abdeckungen geliefert.



Height adjustable with help of clamp. Mit Hilfe der Klemme höhenverstellbar.



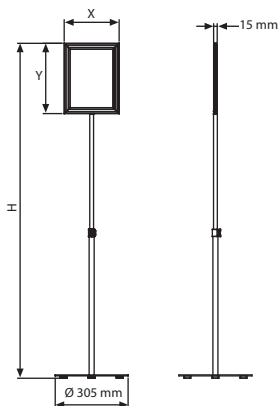
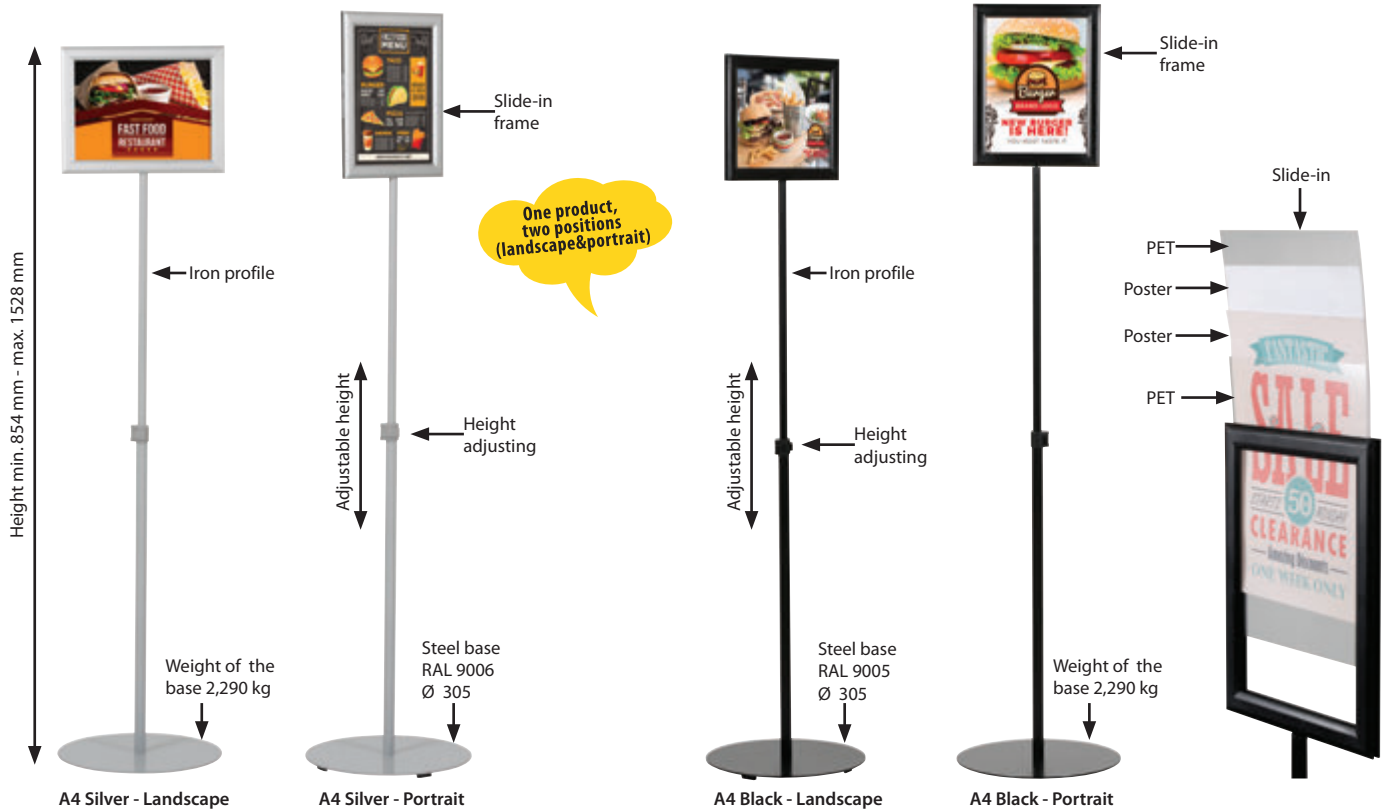
Adjustable to portrait or landscape position. Einstellbar auf Hoch- oder Querformat.



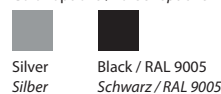
1 pack. See info chart for pack sizes. 1 Packung. Siehe Packungsgrößen.



Assembly time approx 35 seconds. Montagezeit ca. 35 Sekunden.



Color options / Farboptionen



MATERIAL : Silver & black anodised aluminium							WEIGHT	PACKING SIZE
ARTICLE	EXTERNAL (x-y)	POSTER	COPY	H min.	H max.	DESCRIPTION	WITH PACKING	*W X H X D
UMBD20BA4	224X 311 mm	210 X 297 mm	174 X 261 mm	914 mm	1405 mm	A4 portrait / Black	4,100 kg	395 X 690 X 60 mm
				854 mm	1318 mm	A4 landscape / Black		
UMBD20BA3	311 X 434 mm	297 X 420 mm	261 X 384 mm	1064 mm	1528 mm	A3 portrait / Black	4,400 kg	395 X 830 X 60 mm
				941 mm	1405 mm	A3 landscape / Black		
UMBD20NA4	224X 311 mm	210 X 297 mm	174 X 261 mm	914 mm	1405 mm	A4 portrait / Silver	4,100 kg	395 X 690 X 60 mm
				854 mm	1318 mm	A4 landscape / Silver		
UMBD20NA3	311 X 434 mm	297 X 420 mm	261 X 384 mm	1064 mm	1528 mm	A3 portrait / Silver	4,400 kg	395 X 830 X 60 mm
				941 mm	1405 mm	A3 landscape / Silver		



*W:Width H: Height D: Depth

Telescoping Menuboard Snap Frame



Watch video at our website www.mtdisplays.com



Telescoping Menuboard with Snap Frame, is equipped with Snap Frame which provides landscape and portrait adjustment easily. Its telescoping feature allows adjusting the height of advertisement. Snap Frame makes the change of poster easy. It is suitable for use in hotels, galleries, museums, restaurants, lobby, bars, etc. A heavy duty steel base stabilizes the height adjustable pole. It is available in the sizes A3 and A4 both in landscape & portrait positions in the same product.

Das Teleskop-Menuboard Snap Frame ist mit Klapprahmen ausgestattet, der die Einstellung von Quer- und Hochformat problemlos ermöglicht. Die Teleskopfunktion ermöglicht die Einstellung der Höhe. Der Klapprahmen erleichtert das Wechseln des Posters. Es ist für den Einsatz in Hotels, Galerien, Museen, Restaurants, Lobby, Bars usw. geeignet. Eine robuste Stahlplatte stabilisiert die höhenverstellbare Profil. Es ist in den Größen A3 und A4 sowohl im Querformat als auch im Hochformat im selben Produkt erhältlich.

Color options / Farbenoptionen



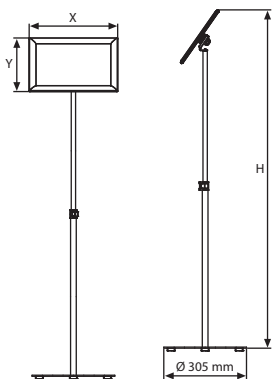
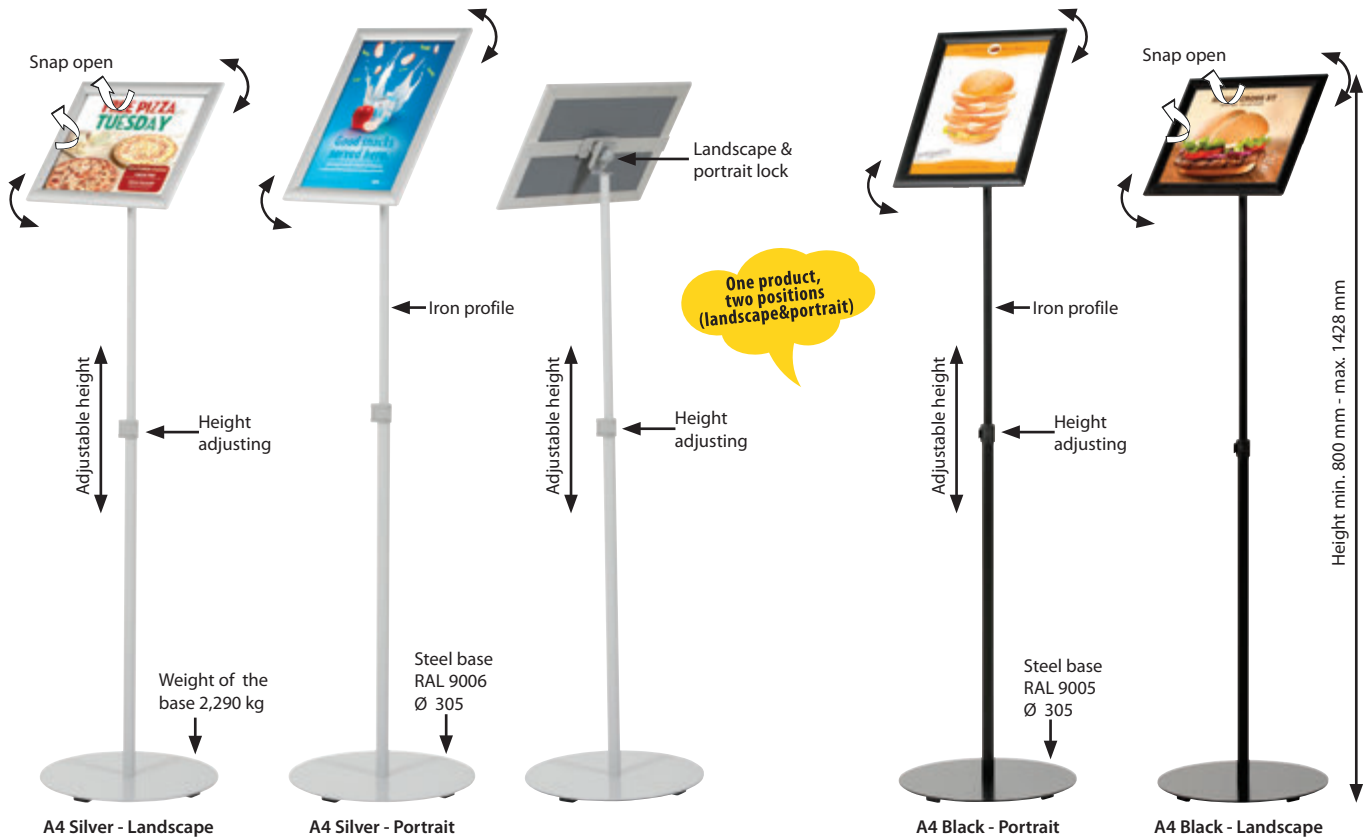
Packed unassembled with an easy-to-understand instruction sheet & fixing elements and 1 anti-reflex pet covers. Height adjustable with help of clamp. Unmontiert verpackt mit einem leicht verständlichem Anleitungsblatt, Befestigungselemente und eine Antireflex-Abdeckung.

Height adjustable with help of clamp. Mit Hilfe der Klemme höhenverstellbar.

Adjustable to portrait or landscape position. Einstellbar auf Hoch- oder Querformat.

1 pack. See info chart for pack sizes. 1 Packung. Siehe Packungsgrößen.

Assembly time approx 35 seconds. Montagezeit ca. 35 Sekunden.



MATERIAL : Silver & black anodised aluminium PROFILE : 25 mm 45°							WEIGHT	PACKING SIZE
ARTICLE	EXTERNAL (x-y)	POSTER	COPY	H min.	H max.	DESCRIPTION	WITH PACKING	*W X H X D
UMBTS10BA4	240 X 327 mm	210 X 297 mm	192 X 279 mm	845 mm	1305 mm	A4 portrait / Black	4,250 kg	395 X 690 X 60 mm
				800 mm	1260 mm	A4 landscape / Black		
UMBTS10BA3	327 X 450 mm	297 X 420 mm	279 X 402 mm	968 mm	1428 mm	A3 portrait / Black	4,600 kg	395 X 830 X 60 mm
				923 mm	1383 mm	A3 landscape / Black		
UMBTS10NA4	240 X 327 mm	210 X 297 mm	192 X 279 mm	845 mm	1305 mm	A4 portrait / Silver	4,250 kg	395 X 690 X 60 mm
				800 mm	1260 mm	A4 landscape / Silver		
UMBTS10NA3	327 X 450 mm	297 X 420 mm	279 X 402 mm	968 mm	1428 mm	A3 portrait / Silver	4,600 kg	395 X 830 X 60 mm
				923 mm	1383 mm	A3 landscape / Silver		

*W:Width H: Height D: Depth



ARC Menuboard



Watch video at our website www.mtdisplays.com



Arc Menuboard is a stylish menu or brochure holder with its curved design for modern environment. It is equipped with steel base for stability. anti-reflex magnetic poster cover holds poster in place which enables users to quickly change out messages or prints without having to use any tools. It is a practical solutions for banks, hotels and other businesses to advertise in their lobbies or just restaurants and cafes. It is available in the sizes A3 and A4 both in landscape & portrait positions in the same product.

Arc Menuboard ist ein stilvoller Menü- oder Broschürenhalter mit seinem geschwungenen Design für eine moderne Umgebung. Es ist mit einer Stahlbasis für Stabilität ausgestattet. Das antireflex-magnetische Poster Schutzfolie hält das Poster an Ort und Stelle, sodass Benutzer Nachrichten oder Drucke schnell und ohne Werkzeug austauschen können. Es ist eine praktische Lösung für Banken, Hotels und andere Unternehmen, in ihren Lobbys oder nur in Restaurants und Cafés zu werben. A4 und A3 Formate in Hoch-und Querformat erhältlich.

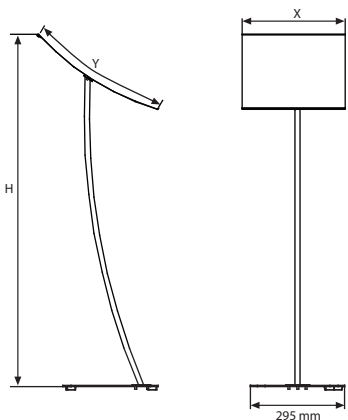
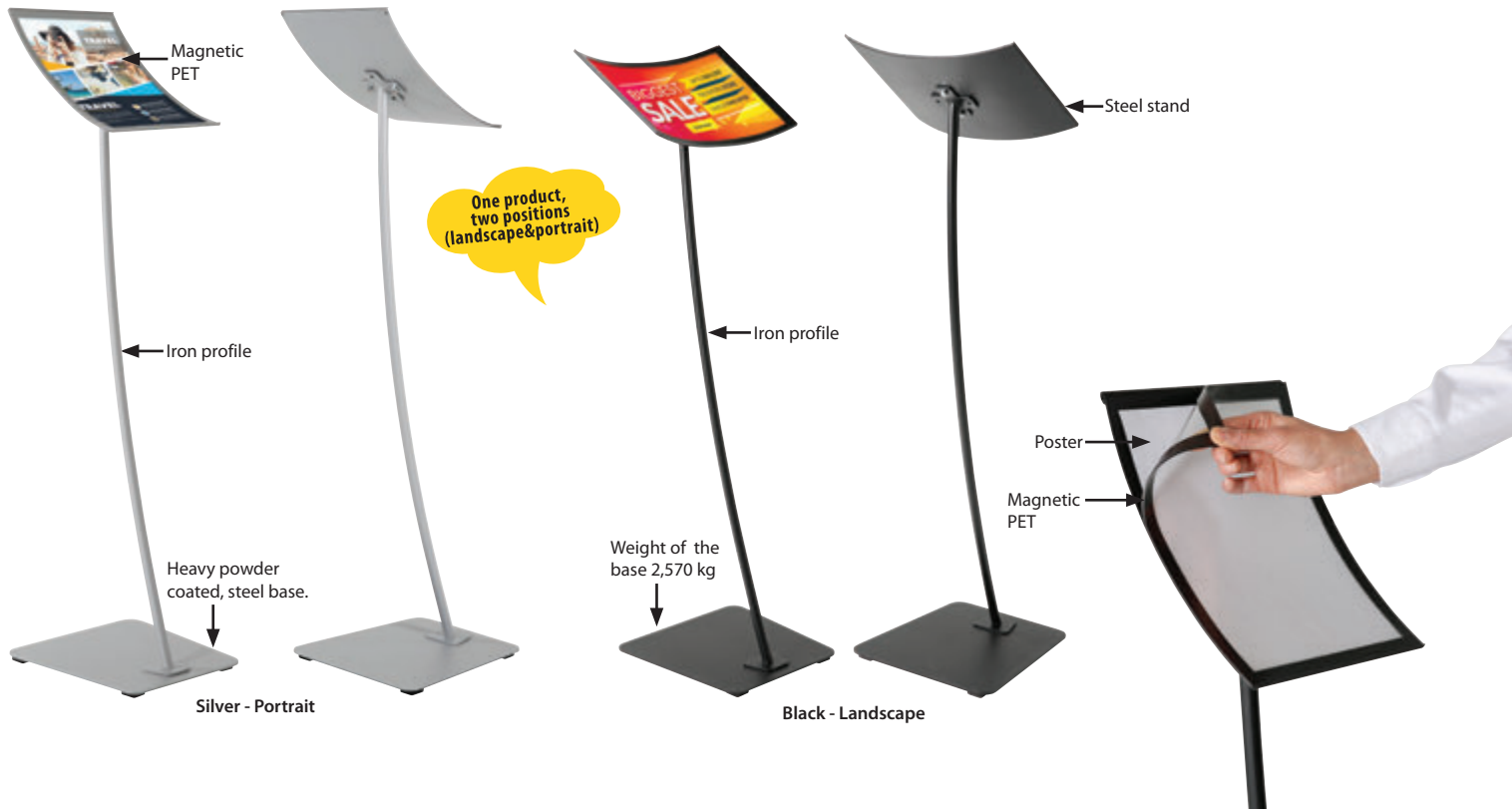
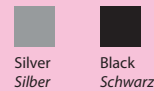
Packed unassembled with easy-to-understand instruction sheet & fixing kit
Demontiert mit Montageanleitung und Befestigungselementen einzeln verpackt und Befestigungselementen einzeln verpackt.

Magnetic anti reflex poster cover included.
Magnetische Antireflex-Posterabdeckung enthalten.

2 packs. See info chart for pack sizes.
2 Packungen. Siehe Infodiagramm für Packungsgrößen.

Assembly time approx 40 seconds.
Montiert in 40 Sekunden.

Color options / Farbenoptionen



MATERIAL : Silver anodised aluminium						WEIGHT	PACKING SIZE
ARTICLE	DESCRIPTION	EXTERNAL (x-y)	POSTER	COPY	H	WITH PACKING	*W X H X D
UAMBOPOBA4	Black	240 X 327mm	210 X 297 mm	206 X 293 mm	1090 mm	4,600 kg	330 X 1010 X 80 mm
UAMBOPOBA3	Black	325 X 450 mm	297 X 420 mm	293 X 416 mm	1115 mm	5,140 kg	370 X 1030 X 85 mm
UAMBOPOGA4	Silver	240 X 327 mm	210 X 297 mm	206 X 293 mm	1090 mm	4,600 kg	330 X 1010 X 80 mm
UAMBOPOGA3	Silver	325 X 450 mm	297 X 420 mm	293 X 416 mm	1115 mm	5,140 kg	370 X 1030 X 85 mm
UAMBOPOB81	Black	246 X 310 mm	8.5" X 11"	212 X 276 mm	1080 mm	4,600 kg	330 X 1010 X 80 mm
UAMBOPOB17	Black	308 X 462 mm	11" X 17"	276 X 428 mm	1125 mm	5,140 kg	370 X 1030 X 85 mm
UAMBOPOG81	Silver	246 X 310 mm	8.5" X 11"	212 X 276 mm	1080 mm	4,600 kg	330 X 1010 X 80 mm
UAMBOPOG17	Silver	308 X 462 mm	11" X 17"	276 X 428 mm	1125 mm	5,140 kg	370 X 1030 X 85 mm

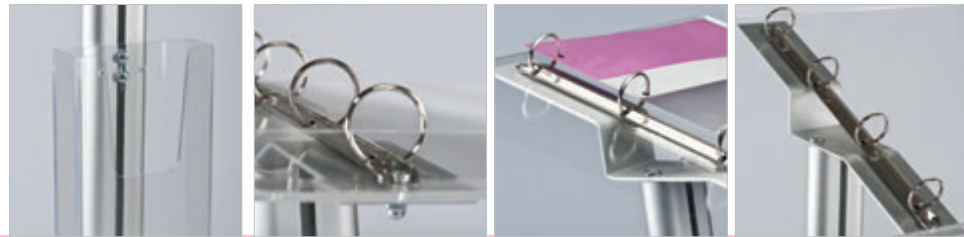
*W:Width H: Height D: Depth



Folder Menuboard



Watch video at our website www.mtdisplays.com



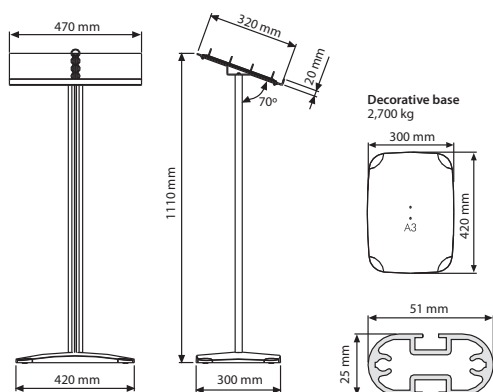
The Folder Menuboard has a transparent acrylic shelf catching the eye level. It has a ring binder available to hold 2x A4 individual menu pages. With the usage of the channeled elliptic profile and any acrylic or steel shelf, a frame can quickly reveal the advantages of the product.

Infoständer mit transparenter Acryl-Ablage und Ordnermechanik zum Blättern in DIN A4 Dokumenten wie Speisekarten oder Preislisten.

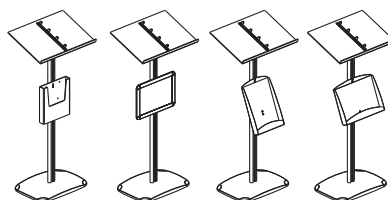
Folder Menuboards are packed unassembled with an easy-to-understand instruction sheet & fixing elements. *Demonstriert mit Montageanleitung und Befestigungselementen einzeln verpackt.*

Heavy elegant base provides stability. *Die schwere, elegante Fussplatte sorgt für Standfestigkeit*

As optional accessory, extra shelves can be added to the leg. *Optionell erhältliches Zubehör, extra Acrylablagen können an das Standprofil montiert werden.*



Some possible Variations/Mögliche Variationen.



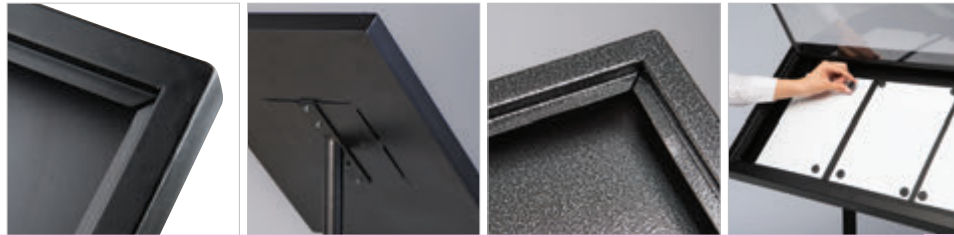
MATERIAL : Anodised aluminium & Acrylic			WEIGHT	PACKING SIZE
ARTICLE	CAPACITY	DESCRIPTION	WITH PACKING	*W X H X D
UDMB2002A4	2 X A4	Silver	6,850 kg	380 X 1070 X 50 mm
UDMB2802A4	2 X A4	Black	6,850 kg	380 X 1070 X 50 mm

SHELF			WEIGHT	PACKING SIZE
ARTICLE	CAPACITY	DESCRIPTION	WITH PACKING	*W X H X D
UFSL002100	2 X A5	Steel shelf	1,485 kg	340 X 290 X 63 mm
UFSL003100	2 X A5	Acrylic shelf	0,890 kg	340 X 290 X 63 mm
UFSL002200	1 X A4	Steel shelf	1,165 kg	250 X 370 X 63 mm
UFSL003200	1 X A4	Acrylic shelf	0,810 kg	250 X 370 X 63 mm
UFSL003300	1 X (8.5"x11")	Acrylic shelf	0,610 kg	240 X 270 X 55 mm

*W:Width H: Height D: Depth






Restaurant Boards



Heavy duty outdoor Restaurant board is ideal for displaying menus, special offers, events and more. Restaurant Boards are designed smart to cover magnetic tape on the cover with Black silk screen printing. These versatile menuboards are produced with durable steel material to suit outdoor conditions. Steel base covered with soft material to protect the floors. Textured black or Black-Grey finishes offers options to users. It is easy to change the message. It captures the customer's attention in all frequented traffic areas.

Stabiler und schwerer Restaurant Board ist ideal um Menukarten zu präsentieren, spezielle Angebote, Veranstaltungen und noch viele mehr. Dezent entwickelt, um auch das Magnetband mit einem schwarzen Druck zu verstecken. Diese vielseitigen Menuboards werden produziert mit langhaltendem Stahl um auch im Außeneinsatz den wetterbedingungen gerecht zu werden. Der Stahlfuß ist ausgestattet mit einem Gummi, damit die Böden vor Kratzern geschützt werden. Die schwarze oder grau-schwarze Variante bietet verschiedene Optionen. Es ist sehr einfach die Inhalte zu wechseln. Dieses Produkt ist ein Blickfang in allen Bereichen.

-  Suitable for outdoor use. Geeignet für den Außenbereich.
-  Magnets included in each product. Magnetic cover. Magnete in jedem Produkt beinhaltet. Magnetische Schutzfolie.
-  Single leg can be adjusted to portrait or landscape position. Hochformat und Querformat bei der ein Fuß Variante möglich.
-  3 packs. See info chart for pack sizes. 3 Packungen. Siehe Infodiagramm für Packungsgrößen.

Color options / Farboptionen

-  Black
Schwarz
-  Hammered Black
Gehämmertes schwarz

One product, two positions (landscape & portrait)



Powder coated base 9,00 kg

4XA4 Black Hammered

4XA4 Black

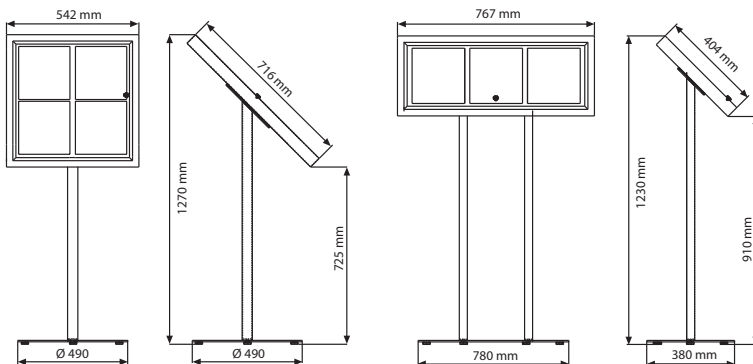


Powder coated base 11,00 kg

3XA4 Black Hammered



Magnetic buttons UYUP397000



MATERIAL : Black & black hammered powder coated				WEIGHT	PACKING SIZE
ARTICLE	CAPACITY	DESCRIPTION	HEIGHT	WITH PACKING	*W X H X D
UMB00B04A4	4 X A4	Black	1270 mm / Portrait	23,600 kg	220 X 1120 X 65 mm
					520 X 520 X 30 mm
					600 X 770 X 80 mm
UMB00N04A4	4 X A4	Hammered Black	1205 mm / Landscape	23,600 kg	220 X 1120 X 65 mm
					520 X 520 X 30 mm
					600 X 770 X 80 mm
UMB00B03A4	3 X A4	Black	1230 mm / Landscape	21,800 kg	410 X 810 X 30 mm
					180 X 1120 X 55 mm
					430 X 790 X 80 mm
UMB00N03A4	3 X A4	Hammered Black	1230 mm / Landscape	21,800 kg	410 X 810 X 30 mm
					180 X 1120 X 55 mm
					430 X 790 X 80 mm

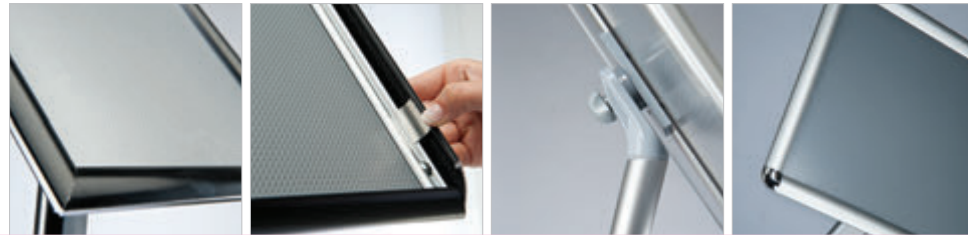
*W:Width H: Height D: Depth



Curved Menuboard



Watch video at our website www.mtdisplays.com



The Curved Menuboard has both a silver & a black finish. Our new stylish Curved Menuboard captures the customers attention in all frequented traffic areas. The Curved Menuboard is suitable for use in hotels, galleries, museums, restaurants, lobby bars, etc. It is available in A4 and A3 portrait and landscape positions.

Der gebogene Menühalter ist in silber und schwarz erhältlich. Der elegant gebogene Menuboard ist ein Blickfang an allen Plätzen mit viel Menschenverkehr. Passend für Hotels, Gallerien, Museen, Restaurants, Hoteleingängen oder Bars. A4 und A3 Formate in Hoch- und Querformat erhältlich.

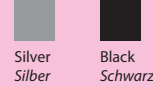


Menu boards are packed unassembled with complete instructions and fixing hardware for assembly. Demontiert mit Montageanleitung und Befestigungselementen einzeln verpackt.



Heavy elegant base provides stability. Die schwere, elegante Fussplatte sorgt für Standfestigkeit.

Color options / Farbenoptionen

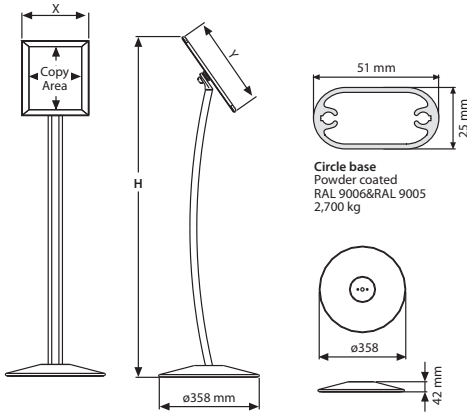


One product, two positions (landscape & portrait)



Adapter A4 Brochure Holder A5 Brochure Holder

BROCHURE HOLDER		PACKING SIZE	WEIGHT
ARTICLE	DESCRIPTION	WITH PACKING	*W X H X D
UYPMB00A4	Adapter for A4 Brochure Holder (30 Pcs)		
UYPMB00A5	Adapter for A5 Brochure Holder (45 Pcs)		
UMSDMB00A4	A4 Brochure Holder (30 Pcs)	10,400 kg	520 X 630 X 250 mm
UMSDMB00A5	A5 Brochure Holder (45 Pcs)	8,900 kg	540 X 630 X 190 mm



MATERIAL : Black aluminium PROFILE : 25 mm 45°							WEIGHT	PACKING SIZE
MITRED ARTICLE	EXTERNAL (x-y)	POSTER	COPY	HEIGHT	DESCRIPTION	WITH PACKING	*W X H X D	
UCUMB00A4	240 X 327 mm	210 X 297 mm	192 X 279 mm	1212 mm	A4 portrait	4,050 kg	470 X 1100 X 67 mm	
				1176 mm	A4 landscape			
UCUMB00A3	327 X 450 mm	297 X 420 mm	279 X 402 mm	1262 mm	A3 portrait	4,350 kg	470 X 1100 X 67 mm	
				1212 mm	A3 landscape			

MATERIAL : Silver aluminium PROFILE : 25 mm 45° - 25 mm Round							WEIGHT	PACKING SIZE
MITRED ARTICLE	ROUND ARTICLE	EXTERNAL (x-y)	POSTER	COPY	HEIGHT	DESCRIPTION	WITH PACKING	*W X H X D
UCUMBN00A4	UCUMBN00A4	240 X 327 mm	210 X 297 mm	192 X 279 mm	1212 mm	A4 portrait	4,050 kg	470 X 1100 X 67 mm
					1176 mm	A4 landscape		
UCUMBN00A3	UCUMBN00A3	327 X 450 mm	297 X 420 mm	279 X 402 mm	1262 mm	A3 portrait	4,350 kg	470 X 1100 X 67 mm
					1212 mm	A3 landscape		



*W:Width H: Height D: Depth

Curved Menuboard New Colours






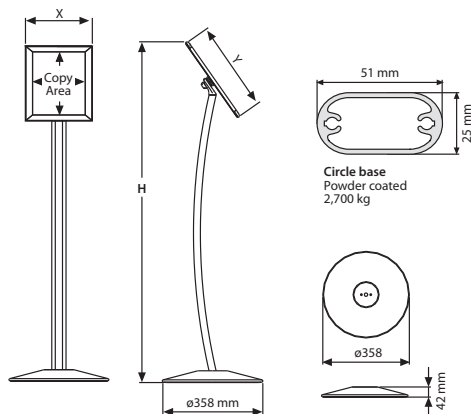
Watch video at our website www.mtdisplays.com



Stylish Curved Menuboard captures the customers attention in all frequented traffic areas. The Curved Menuboard is suitable for use in hotels, galleries, museums, restaurants, lobby, bars, etc.. It is available in A4 and A3 portrait and landscape positions. With modern and fashionable colours, it is suitable for in front of cars in a car showroom, exhibition grounds, museums, hotel or restaurant halls, etc.

Der stilvolle Curved Menuboard zieht die Aufmerksamkeit der Kunden in allen frequentierten Verkehrsbereichen auf sich. Der Curved Menuboard eignet sich für den Einsatz in Hotels, Galerien, Museen, Restaurants, Lobbys, Bars usw. Es ist in den Formaten A4 und A3 im Hoch- und Querformat erhältlich. Mit modernen und modischen Farben eignet es sich für vor Autos in Autohäusern, Messegeländen, Museen, Hotel- oder Restoranthallen usw.

-  Menu boards are packed unassembled with complete instructions and fixing hardware for assembly.
Demontiert mit Montageanleitung und Befestigungselementen einzeln verpackt.
-  Heavy elegant base provides stability.
Die schwere, elegante Fussplatte sorgt für Standfestigkeit.
-  Assembly in 60 seconds.
Montiert in 60 Sekunden



MATERIAL : Aluminium PROFILE : 25 mm 45°						WEIGHT	PACKING SIZE
ARTICLE	EXTERNAL (x-y)	POSTER	COPY	HEIGHT	DESCRIPTION	WITH PACKING	*W X H X D
UCUMB105A4	240 X 327mm	210 X 297 mm	192 X 279 mm	1212 mm	Copper - A4 portrait	4,050 kg	470 X 1100 X 67 mm
				1176 mm	Copper - A4 landscape		
UCUMB105A3	327 X 450 mm	297 X 420 mm	279 X 402 mm	1262 mm	Copper - A3 portrait	4,350 kg	470 X 1100 X 67 mm
				1212 mm	Copper - A3 landscape		
UCUMB205A4	240 X 327mm	210 X 297 mm	192 X 279 mm	1212 mm	White Pearl - A4 portrait	4,050 kg	470 X 1100 X 67 mm
				1176 mm	White Pearl - A4 landscape		
UCUMB205A3	327 X 450 mm	297 X 420 mm	279 X 402 mm	1262 mm	White Pearl - A3 portrait	4,350 kg	470 X 1100 X 67 mm
				1212 mm	White Pearl - A3 landscape		
UCUMB305A4	240 X 327mm	210 X 297 mm	192 X 279 mm	1212 mm	Earth - A4 portrait	4,050 kg	470 X 1100 X 67 mm
				1176 mm	Earth - A4 landscape		
UCUMB305A3	327 X 450 mm	297 X 420 mm	279 X 402 mm	1262 mm	Earth - A3 portrait	4,350 kg	470 X 1100 X 67 mm
				1212 mm	Earth - A3 landscape		
UCUMB405A4	240 X 327mm	210 X 297 mm	192 X 279 mm	1212 mm	Rose - A4 portrait	4,050 kg	470 X 1100 X 67 mm
				1176 mm	Rose - A4 landscape		
UCUMB405A3	327 X 450 mm	297 X 420 mm	279 X 402 mm	1262 mm	Rose - A3 portrait	4,350 kg	470 X 1100 X 67 mm
				1212 mm	Rose - A3 landscape		



Simplistic Curved Menuboard



Watch video at our website www.mtdisplays.com



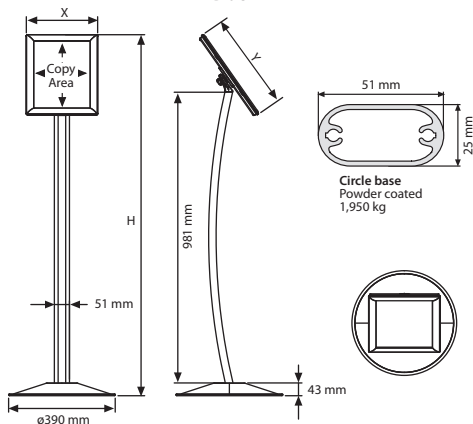
Weather and rust resistant durable poster stand, Simplistic Curved Menuboard is stylish and captures the customers attention in all frequented traffic areas. It is made of aluminium post and frame and steel base. Rubber edge base prevents slipping on wet floors. Simplistic Curved Menuboard is suitable for use in hotels, galleries, museums, restaurants, lobby, bars, etc.. It is available in A4 and A3 portrait and landscape positions and in black, anthracite and gold colours.

Der Wetter- und rostbeständige, langlebige Posterständer Simplistic Curved Menuboard ist stilvoll und zieht die Aufmerksamkeit der Kunden in allen frequentierten Verkehrsbereichen auf sich. Gummikantenbasis verhindert das Verrutschen auf nassen Böden. Das vereinfachte gebogene Menüboard eignet sich für den Einsatz in Hotels, Galerien, Museen, Restaurants, Lobbys, Bars usw. Es ist in den Formaten A4 und A3 im Hoch- und Querformat sowie in den Farben Schwarz, Anthrazit und Gold erhältlich.

Antireflective / Non-glare lens included. Entspiegelte / blendfreie Linse enthalten.

1 box.
1 box.

Color options / Farbenoptionen



MATERIAL : Aluminium PROFILE : 25 mm 45°							WEIGHT	PACKING SIZE
ARTICLE	EXTERNAL (x-y)	POSTER	COPY	HEIGHT PORTRAIT	HEIGHT LANDSCAPE	DESCRIPTION	WITH PACKING	*W X H X D
UCUMSB05A4	240 X 327 mm	210 X 297 mm	192 X 279 mm	1218 mm	1182 mm	Black	4,900 kg	535 X 1120 X 70 mm
UCUMSB05A3	327 X 450 mm	297 X 420 mm	279 X 402 mm	1264 mm	1218 mm	Black	5,500 kg	535 X 1120 X 70 mm
UCUMSB05A2	450 X 624 mm	420 X 594 mm	402 X 576 mm	1336 mm	1269 mm	Black	6,100 kg	615 X 1130 X 70 mm
UCUMSG05A4	240 X 327 mm	210 X 297 mm	192 X 279 mm	1218 mm	1182 mm	Gold	4,900 kg	535 X 1120 X 70 mm
UCUMSG05A3	327 X 450 mm	297 X 420 mm	279 X 402 mm	1264 mm	1218 mm	Gold	5,500 kg	535 X 1120 X 70 mm
UCUMSG05A2	450 X 624 mm	420 X 594 mm	402 X 576 mm	1336 mm	1269 mm	Gold	6,100 kg	615 X 1130 X 70 mm
UCUMSA05A4	240 X 327 mm	210 X 297 mm	192 X 279 mm	1218 mm	1182 mm	Anthracite Grey	4,900 kg	535 X 1120 X 70 mm
UCUMSA05A3	327 X 450 mm	297 X 420 mm	279 X 402 mm	1264 mm	1218 mm	Anthracite Grey	5,500 kg	535 X 1120 X 70 mm
UCUMSB05A2	450 X 624 mm	420 X 594 mm	402 X 576 mm	1336 mm	1269 mm	Anthracite Grey	6,100 kg	615 X 1130 X 70 mm

*W:Width H: Height D: Depth



Curved Menuboard with Acryled



Watch video at our website www.mtdisplays.com



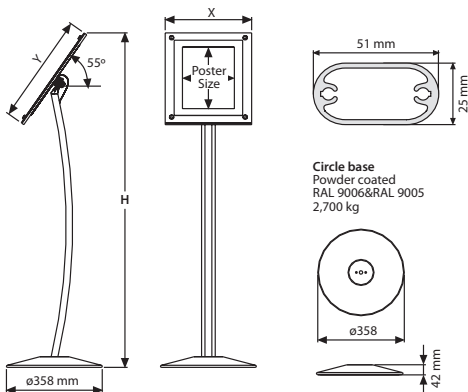
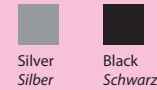
Curved Menuboard with Acryled has both silver & black finish. Curved Menuboard is suitable to use in hotels, galleries, museums, restaurants, lobby, bars. Available in A4 and A3 portrait and landscape positions. Special treated acrylic and LED technology illuminates prints homogenous. The edgelit Acryled monts on Curved Menuboard both portrait & landscape. Poster placed in position by 2 clear clips on 2 short sides.

Das Curved Menuboard wird in silver und Schwarz Versionen angeboten. Der Artikel ist zum Einsatz in Hotels, Gallerien, Museen, Restaurants, Lobby und Bars geeignet. Die A4 und A3 Formate sind in Hoch- und Querformat erhältlich. Die speziell behandelte Acrylplatte und LED Technologie sorgen für eine gleichmässige Beleuchtung der Einlage. Das montierte Acryled kann in Hoch- und Querformat eingesetzt werden. Das Poster kann durch die Klipse an den kurzen Seiten ohne festzuhalten fixiert werden.

All units pass CE/UL PAT test. Packed with quality certificates & 3,5 meter electrical cable. UK and US plugs should be mentioned on order. *Alle Produkte sind CE/UL Pat getestet and werden mit Qualitätszertifikaten geliefert. 3,5 m Stromkabel. Falls UK und USA Stecker gewünscht ist die Angabe bei Bestellung erforderlich.*

Led illumination saves up to 60% energy cost. Heavy base provide stability. *Die LED Beleuchtung spart bis zu 60% Energieverbrauch. Die schwere, elegante Fussplatte sorgt für Standfestigkeit an Orten mit viel Menschenverkehr.*

Color options / Farboptionen



MATERIAL : Silver & Black aluminium & Acrylic						WEIGHT	PACKING SIZE
SILVER	BLACK	EXTERNAL (x-y)	POSTER	COPY	HEIGHT	WITH PACKING	*W X H X D
UCUALN00A4	UCUALB00A4	323 X 410 mm	210 X 297 mm	192 X 279 mm	1250 mm	7,150 kg	365 X 1110 X 102 mm
					1215 mm		
UCUALN00A3	UCUALB00A3	410 X 533 mm	297 X 420 mm	279 X 402 mm	1250 mm	5,550 kg	530 X 1350 X 110 mm
					1303 mm		



*W:Width H: Height D: Depth

Classical Menuboard

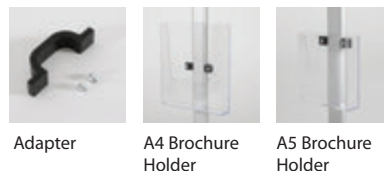
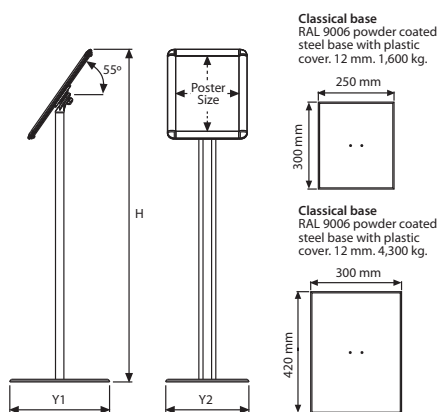


The Menuboard with a sight angle that catches the eye level. It is available in the sizes A3 and A4 both in landscape & portrait positions. The height of this model is 1000 mm.

Der Sichtwinkel des Rahmens ist in Augenhöhe. A4 und A3 Formate in Hoch- und Querformat erhältlich. Höhe von dieser Ausführung ist 1000 mm.

Menu boards are packed unassembled with an easy-to-understand instruction sheet & fixing elements. Demontiert mit Montageanleitung und Befestigungselementen einzeln.

Suitable for wet floors. Für nasse Böden geeignet.



BROCHURE HOLDER		PACKING SIZE	WEIGHT
ARTICLE	DESCRIPTION	WITH PACKING	*W X H X D
UYPMBH00A4	Adapter for A4 Brochure Holder (30 Pcs)		
UYPMBH00A5	Adapter for A5 Brochure Holder (45 Pcs)		
UMSDMB00A4	A4 Brochure Holder (30 Pcs)		
UMSDMB00A5	A5 Brochure Holder (45 Pcs)		

MATERIAL : Silver anodised aluminium PROFILE : 25 mm 45° 25 mm Round								WEIGHT	PACKING SIZE	
MITRED ARTICLE	ROUND ARTICLE	EXTERNAL (x-y)	POSTER	COPY	Y1	Y2	HEIGHT	DESCRIPTION	WITH PACKING	*W X H X D
UCMB1N05A4	UCMB1N00A4	240 X 327 mm	210 X 297 mm	192 X 279 mm	300 mm	250 mm	1000 mm	A4 portrait	3,400 kg	290 X 980 X 65 mm
					300 mm	250 mm	964 mm	A4 landscape		
UCMB1N05A3	UCMB1N00A3	327 X 450 mm	297 X 420 mm	279 X 402 mm	420 mm	300 mm	1200 mm	A3 portrait	5,850 kg	380 X 1150 X 65 mm
					420 mm	300 mm	1150 mm	A3 landscape		



*W:Width H: Height D: Depth

Decorative Menuboard



Watch video at our website www.mtdisplays.com



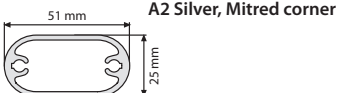
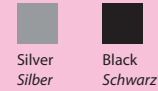
The Menuboard with a sight angle that catches the eye level. The decorative base provides an elegant look. It is available in the sizes A4, A3 and A2 in portrait & landscape positions. The fixed height of the A4 model is 1000 mm. The height of the A3 model is 1200 mm.

Der Sichtwinkel des Rahmens ist in Augenhöhe. Die dekorative Fussplatte verleiht Eleganz. A4, A3 und A2 Format in Hoch- und Querformat erhältlich. Maximale Höhe von A4 ist 1000 mm, maximale Höhe von A3 ist 1200 mm.

Menuboards are packed unassembled with an easy-to-understand instruction sheet & fixing elements. Demontiert mit Montageanleitung und Befestigungselementen einzeln verpackt.

Heavy elegant base provides stability. Die schwere, elegante Fussplatte sorgt für Standfestigkeit.

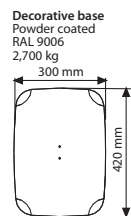
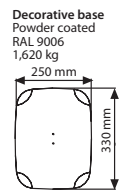
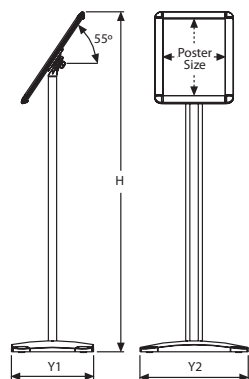
Color options / Farbenoptionen



A2 Silver, Mitred corner

A3 Black, Mitred corner

A4 Silver, Round corner



MATERIAL : Silver anodised aluminium PROFILE : 25 mm 45° - 25 mm Round										WEIGHT	PACKING SIZE
MITRED ARTICLE	ROUND ARTICLE	EXTERNAL (x-y)	POSTER	COPY	Y1	Y2	HEIGHT	DESCRIPTION		WITH PACKING	*W X H X D
UDMB1N05A4	UDMB1N00A4	240 X 327 mm	210 X 297 mm	192 X 279 mm	250 mm	330 mm	1000 mm	A4 portrait / Silver	3,400 kg	290 X 980 X 65 mm	
					250 mm	330 mm	964 mm	A4 landscape / Silver			
UDMB1B05A4	UDMB1B00A4	240 X 327 mm	210 X 297 mm	192 X 279 mm	250 mm	330 mm	1000 mm	A4 portrait / Black	3,400 kg	290 X 980 X 65 mm	
					250 mm	330 mm	964 mm	A4 landscape / Black			
UDMB1N05A3	UDMB1N00A3	327 X 450 mm	297 X 420 mm	279 X 402 mm	420 mm	300 mm	1200 mm	A3 portrait / Silver	5,850 kg	380 X 1150 X 65 mm	
					420 mm	300 mm	1150 mm	A3 landscape / Silver			
UDMB1B05A3	UDMB1B00A3	327 X 450 mm	297 X 420 mm	279 X 402 mm	420 mm	300 mm	1200 mm	A3 portrait / Black	5,850 kg	380 X 1150 X 65 mm	
					420 mm	300 mm	1150 mm	A3 landscape / Black			
UDMB1N05A2	UDMB1N00A2	451 X 625 mm	420 X 594 mm	401 X 575 mm	420 mm	300 mm	1272 mm	A2 portrait / Silver	8,100 kg	490 X 1110 X 55 mm	
					420 mm	300 mm	1200 mm	A2 landscape / Silver			
UDMB1B05A2	UDMB1B00A2	450 X 624 mm	420 X 594 mm	402 X 576 mm	420 mm	300 mm	1272 mm	A2 portrait / Black	8,100 kg	490 X 1110 X 55 mm	
					420 mm	300 mm	1200 mm	A2 landscape / Black			



*W:Width H: Height D: Depth

Adjustable Menuboard



Watch video at our website www.mtdisplays.com



The adjustable single-faced and double-faced menuboards are economic floor stands that can hold up to 3 frames both sided at once. They are easily adjustable to the eye level and suitable for various poster sizes in portrait or landscape options. The decorative base provides an elegant look. The items presented in the sizes A4 and A3 are suitable for portrait & landscape positions. A4 P/L Adjustable menuboard, round corners, max. height 1300mm. A3 P/L Adjustable menuboard, round corners, max. height 1500mm.

Die doppel- und einseitigen, verstellbaren Menüstände sind die wirtschaftlichen Bodenstände, die bis zu 3 Rahmen je Seite gleichzeitig halten können. Leicht einzustellen in Augenhöhe. Passend für die Präsentation von Hoch- und Querformat. Maximale Höhe von A4, Rondo des verstellbaren Menüständers ist 1300 mm, maximale Höhe von A3, Rondo des verstellbaren Menüständers ist 1500 mm.



Menuboards are packed unassembled with an easy-to-understand instruction sheet & fixing elements. Demontiert mit Montageanleitung und Befestigungselementen einzeln verpackt.



Supplied with stable heavy base, offers various options. Die schwere, elegante Fussplatte sorgt für Standfestigkeit.



UFSL002100

UFSL003100



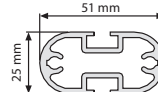
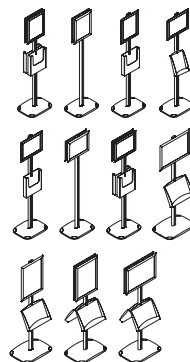
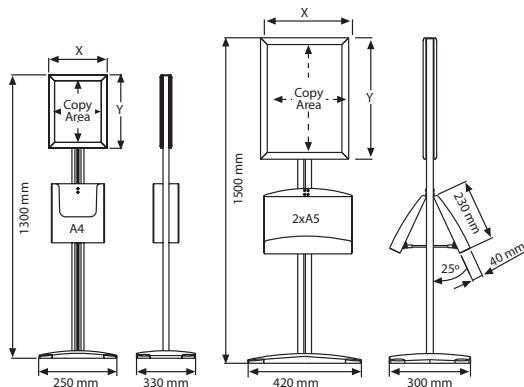
UFSL002200

UFSL003200



UFSL003300

Some possible variations / Mögliche Variationen.



SHELF			WEIGHT	PACKING SIZE
ARTICLE	CAPACITY	DESCRIPTION	WITH PACKING	*W X H X D
UFSL002100	2 X A5	Steel shelf	1,485 kg	340 X 290 X 63 mm
UFSL003100	2 X A5	Acrylic shelf	0,890 kg	340 X 290 X 63 mm
UFSL002200	1 X A4	Steel shelf	1,165 kg	250 X 370 X 63 mm
UFSL003200	1 X A4	Acrylic shelf	0,810 kg	250 X 370 X 63 mm
UFSL003300	1 X A4	Acrylic shelf	0,610 kg	240 X 270 X 55 mm

MATERIAL : Silver anodised aluminium PROFILE : 25 mm 45° - 25 mm Round					WEIGHT	PACKING SIZE
MITRED ARTICLE	ROUND ARTICLE	EXTERNAL (x-y)	POSTER	COPY	WITH PACKING	*W X H X D
UDMB1005A4	UDMB1000A4	239 X 326 mm	210 X 297 mm	192 X 279 mm	4,250 kg	320 X 1360 X 50 mm
UDMB1005A3	UDMB1000A3	327 X 450 mm	297 X 420 mm	279 X 402 mm	7,400 kg	380 X 1560 X 50 mm



*W:Width H: Height D: Depth

Restaurant Boards





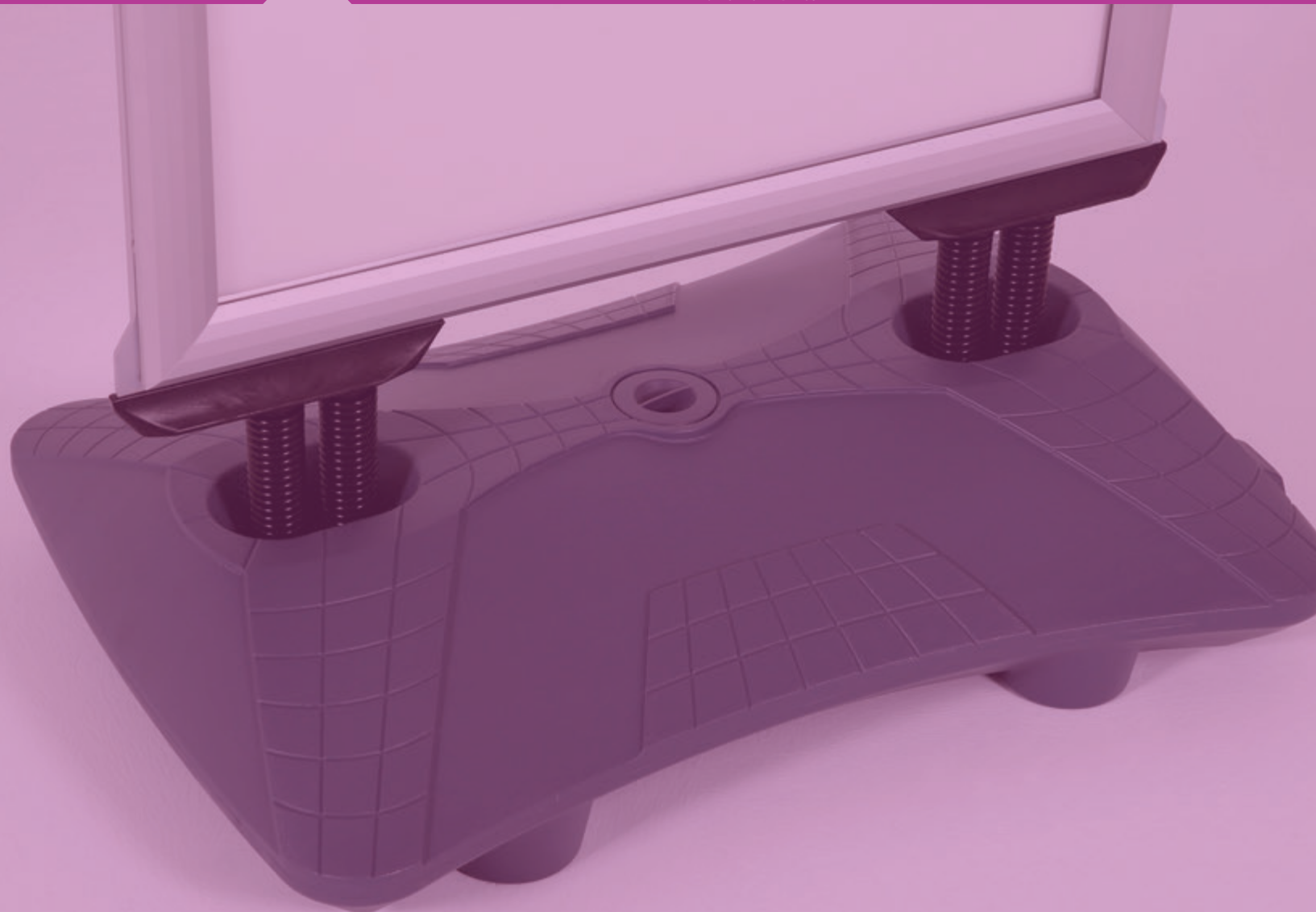
Pavement Signs

- A Board
- Eco A Board
- Retractable A Board
- Premium A Board with logo
- Premium A Board with Profile logo
- Opti Frame A Board
- Weatherproof A Board
- Slide-in A Board
- Write-on A Board
- Easy Go A Board
- Wood Look A Board
- Basic Wood A Board
- SwingPro®&WindPro® Plus
- SwingPro®&WindPro® Lite
- Slide-in SwingPro®&WindPro®
- Wood WindPro
- Illuminated WindPro® with LED
- WindPro with LED Plus

- Swingmaster
- Eco Swingmaster
- Waterbase Wind Sign
- Eco Waterbase Wind Sign
- Magnetic Iron A Board
- Rectangular Iron A Board
- Al Maki
- Wood Maki
- Street SignPro Deco
- Street SignPro Poster with Lens
- Street SignPro Poster without Lens
- Street SignPro Board
- Mini Street SignPro Board
- Master Sign Flex Poster
- Master Sign Flex Board
- Master Sign Fix Board
- PS Boards
- Waterbase Pavement Signs

- Kundenstopper
- Eco Kundenstopper
- Retractable A Board
- Premium Kundenstopper mit Topschild
- Premium Kundenstopper mit Topschildprofil
- Opti Kundenstopper
- Wetterfester Kundenstopper
- Kundenstopper mit Einschub
- Beschreibbarer Kundenstopper
- Easy go Kundenstopper
- Holz optik Kundenstopper
- Basic Wood A Board
- SwingPro®&WindPro® Plus
- SwingPro®&WindPro® Lite
- WindPro® mit Einschub
- Wood WindPro
- WindPro® mit LED Beleuchtung
- WindPro with LED Plus

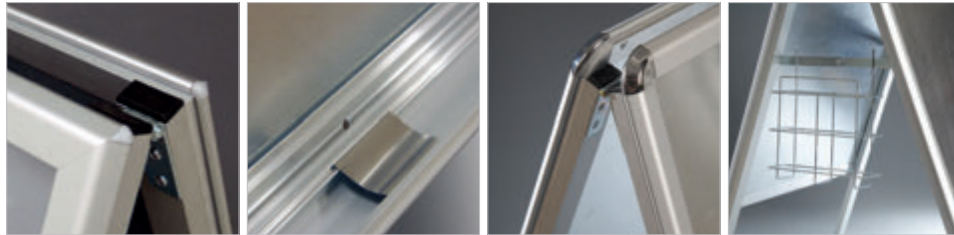
- Swing Master
- Eco Swing Master
- Wind Sign mit Wassertank
- Eco Wind Sign mit Wassertank
- Magnetischer Stahl Kundenstopper
- Rechteckiger Stahl Kundenstopper
- Al Maki Kundenstopper
- Wood Maki
- Street SignPro Deco
- Street SignPro Poster with Lens
- Street SignPro Poster without Lens
- Street SignPro Board
- Mini Street SignPro Board
- Master Sign Flex Poster
- Master Sign Flex Board
- Master Sign Fix Board
- Strassenaufsteller aus Kunststoff
- Kunststoff Kundenstopper



A Board



Watch video at our website www.mtdisplays.com



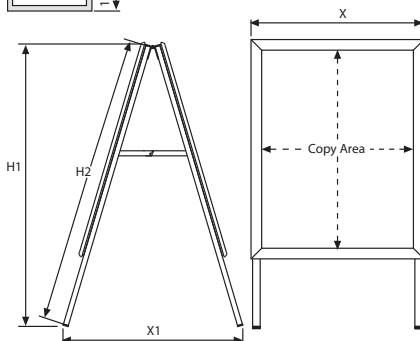
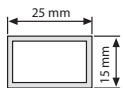
Header board and brochure basket options are available. Easy-to-open snap frame includes the anti-reflex cover in all standard A boards. Frame size alternatives are A2, A1, A0, 500x700 mm, 700x1000 mm, 20"x30" and 30"x40".

Wahlweise können Topschildhalterung und Prospektkorb angebracht werden. Alle Standard Kundenstopper beinhalten leicht zu öffnende Klapprahmen und Antireflex Schutzfolie. Verfügbare Klapprahmengrößen sind: A2, A1, A0, 500x700 mm, 700x1000 mm, 20"x30", 30"x40".

- Single packed with an easy-to-understand instruction sheet. Einzel verpackt in Kartons mit einfacher Montageanleitung.
- Heavy back panel provides stability. No tool assembly. Header accessories are not included. Should be ordered separate. Die schwere Rückwand trägt zur Standfestigkeit bei. Montage ohne Werkzeugbenutzung. Topschild, Zubehör sind optional erhältlich und müssen extra bestellt werden.
- Each unit has water drainage slots on bottom profiles. Jeder Artikel hat Wasserablauflöcher am unteren Profil.

Color options / Farbenoptionen

- Silver / Silber
- Black / RAL 9005 / Schwarz / RAL 9005



MATERIAL : Silver anodised aluminium & black / RAL 9005 powder coated PROFILE : 32 mm profile										WEIGHT	PACKING SIZE
MITRED SILVER	ROUND SILVER	MITRED BLACK	ROUND BLACK	SAFE CORNER	POSTER	X	X1	H1	H2	WITH PACKING	*W X H X D
UAB3250NA2	UAB3200NA2	UAB3250BA2	UAB3200BA2	UAB3210NA2	420 X 594 mm	463 mm	700 mm	905 mm	950 mm	6,200 kg	480 X 1000 X 112 mm
UAB3250NA1	UAB3200NA1	UAB3250BA1	UAB3200BA1	UAB3210NA1	594 X 841 mm	637 mm	800 mm	1100 mm	1150 mm	10,350 kg	750 X 1280 X 112 mm
UAB3251NA1	UAB3201NA1	UAB3251BA1	UAB3201BA1	UAB3211NA1	594 X 841 mm	637 mm	750 mm	1005 mm	1050 mm	10,200 kg	750 X 1180 X 112 mm
UAB3250NA0	UAB3200NA0	UAB3250BA0	UAB3200BA0	UAB3210NA0	841 X 1189 mm	884 mm	910 mm	1400 mm	1450 mm	18,510 kg	910 X 1520 X 112 mm
UAB3250NB2	UAB3200NB2	UAB3250BB2	UAB3200BB2	UAB3210NB2	500 X 700 mm	543 mm	700 mm	905 mm	950 mm	8,350 kg	650 X 1120 X 112 mm
UAB3250NB1	UAB3200NB1	UAB3250BB1	UAB3200BB1	UAB3210NB1	700 X 1000 mm	743 mm	850 mm	1195 mm	1250 mm	13,350 kg	840 X 1420 X 112 mm
UAB3250N23	UAB3200N23	UAB3250B23	UAB3200B23	UAB3210N23	508 X 762 mm	551 mm	700 mm	905 mm	950 mm	9,000 kg	650 X 1120 X 112 mm
UAB3250N34	UAB3200N34	UAB3250B34	UAB3200B34	UAB3210N34	762 X 1016 mm	805 mm	850 mm	1195 mm	1250 mm	13,800 kg	810 X 1280 X 112 mm

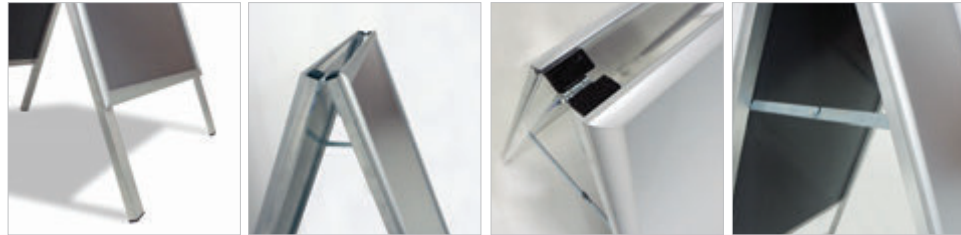
*W:Width H: Height D: Depth



Eco A Board



Watch video at our website www.mtdisplays.com



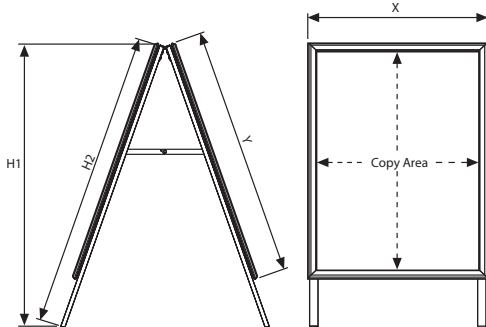
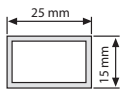
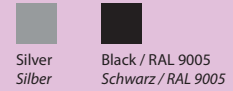
A double-sided customer stopper, practical to change the poster within. A1, 500x700 mm, 700x1000 mm sizes are available. 25 mm profile, snap frame. Round or mitred corner options are available. PS backing for indoor use on Eco Indoor A Board whereas galvanized backing for Eco Outdoor A Board. Both are offered with cost-saving mill finished legs.

Ein doppelseitiger Kundenstopper, praktisch für den Posteraustausch. A1, 500x700 mm, 700x1000 mm Standardmassen sind erhältlich. 25 mm Profil Klapprahmen Rondo oder Gehrung mit Polystyrol Rückwand für den Innengebrauch und pressblanken Standbeinen für die Kostensenkung.

Single packed with an easy-to-understand instruction sheet. Put on a high palette & eco packaging is used. Einzeln verpackt in ECO-Verpackung mit einfacher Montageanleitung, auf hohen Paletten geliefert.

No tool assembly. Each unit has water drainage slots on bottom profile. Montage ohne Werkzeugbenutzung.

Color options / Farbenoptionen



ECO INDOOR A BOARD: PS Backing + Mill Finish Legs PROFILE: 25 mm										WEIGHT	PACKING SIZE
SILVER MITRED	SILVER ROUND	BLACK MITRED	BLACK ROUND	POSTER	X	Y	H1	H2		WITH PACKING	*W X H X D
UAB25SHNA2	UAB25OHNA2	UAB25SHBA2	UAB25OHBA2	420 X 594 mm	450 mm	624 mm					510 X 1000 X 80 mm
UAB25SHNA1	UAB25OHNA1	UAB25SHBA1	UAB25OHBA1	594 X 841 mm	624 mm	871 mm	1005 mm	1050 mm		7,250 kg	720 X 1180 X 85 mm
UAB25SHNB2	UAB25OHNB2	UAB25SHBB2	UAB25OHBB2	500 X 700 mm	530 mm	730 mm	905 mm	950 mm		5,850 kg	630 X 1100 X 85 mm
UAB25SHNB1	UAB25OHNB1	UAB25SHBB1	UAB25OHBB1	700 X 1000 mm	730 mm	1030 mm	1100 mm	1200 mm		9,400 kg	800 X 1390 X 85 mm

ECO OUTDOOR A BOARD: Galvanized Backing + Mill Finish Legs PROFILE: 32 mm										WEIGHT	PACKING SIZE
MITRED SILVER	MITRED BLACK	ROUND SILVER	SAFE CORNER	POSTER	X	Y	H1	H2		WITH PACKING	*W X H X D
UAB325HNA2	UAB325HBA2	UAB320HNA2	UAB321HNA2	420 X 594 mm	463 mm	637 mm					510 X 1000 X 80 mm
UAB325HNA1	UAB325HBA1	UAB320HNA1	UAB321HNA1	594 X 841 mm	637 mm	884 mm	1005 mm	1050 mm		10,000 kg	720 X 1180 X 85 mm
UAB325HNA0	UAB325HBA0	UAB320HNA0	UAB321HNA0	841 X 1189 mm	884 mm	1232 mm					940 X 1510 X 90 mm
UAB325HNB2	UAB325HBB2	UAB320HNB2	UAB321HNB2	500 X 700 mm	543 mm	743 mm	905 mm	950 mm		7,900 kg	630 X 1080 X 85 mm
UAB325HNB1	UAB325HBB1	UAB320HNB1	UAB321HNB1	700 X 1000 mm	743 mm	1043 mm	1100 mm	1200 mm		12,740 kg	800 X 1390 X 85 mm

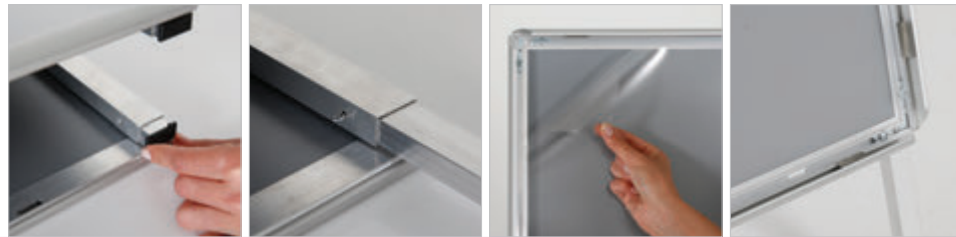
*W:Width H: Height D: Depth



Retractable A Board



Watch video at our website www.mtdisplays.com



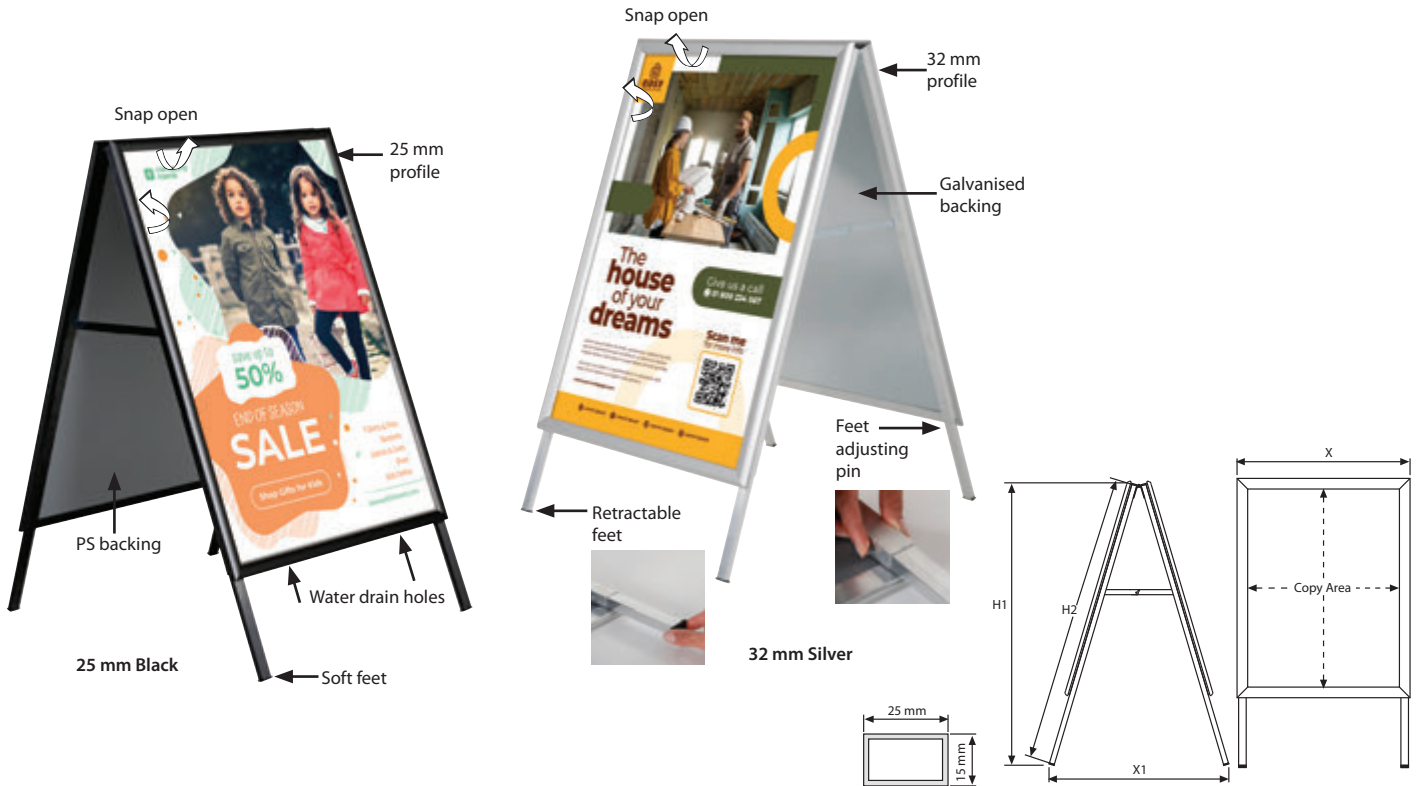
The Retractable A Board offers excellent possibilities for in- and outdoor advertising. Thanks to their Retractable feet, it will save space by transport. Thanks to their easy handling, they can be set up or stowed away very quickly. Long-term use as well as short-term use are possible. The Retractable A Board is made of Rust-proof Aluminium and available in 25 and 32mm profiles as a Double sided Pavement sign.

Das Retractable A Board bietet hervorragende Möglichkeiten für die Innen- und Außenwerbung. Dank ihrer einziehbaren Füße findet sie einen sicheren Platz beim Transport. Dank ihrer einfachen Handhabung lassen sie sich sehr schnell aufbauen oder verstauen. Sowohl eine Langzeitanwendung als auch eine Kurzzeitanwendung sind möglich. Die einziehbare A-Tafel besteht aus rostfreiem Aluminium und ist in 25- und 32-mm-Profilen als doppelseitiges Gehwegschild erhältlich.

- Single packed with an easy-to-understand instruction sheet. Einzel verpackt in Kartons mit einfacher Montageanleitung.
- Heavy back panel provides stability. No tool assembly. Header accessories are not included. Should be ordered separate. Die schwere Rückwand trägt zur Standfestigkeit bei. Montage ohne Werkzeugbenutzung. Topschild, Zubehör sind optional erhältlich und müssen extra bestellt werden.
- Each unit has water drainage slots on bottom profiles. Jeder Artikel hat Wasserabläufächer am unteren Profil.

Color options / Farbenoptionen

- Silver / Silber
- Black / RAL 9005 / Schwarz / RAL 9005



MATERIAL : Silver anodised aluminium & Black PROFILE : 25 mm & 32 mm profile										25 mm profile		32 mm profile		
25 MM SILVER	25 MM BLACK	X	32 MM SILVER	32 MMBLACK	X	DESCRIPTION	POSTER	X1	H1	H2	WITH PACKING	*W X H X D	WITH PACKING	*W X H X D
UAB25ORNA2	UAB25ORBA2	450 mm	UAB32ORNA2	UAB32ORBA2	463 mm	Round Corners	420 X 594 mm	525 mm	705 mm	715 mm	4,00 kg	480 X 660 X 70 mm	5,100 kg	490 X 670 X 90 mm
UAB25ORNA1	UAB25ORBA1	624 mm	UAB32ORNA1	UAB32ORBA1	637 mm	Round Corners	594 X 841 mm	733 mm	995 mm	1020 mm	7,200 kg	660 X 900 X 70 mm	8,400 kg	670 X 910 X 90 mm
UAB25ORNA0	UAB25ORBA0	871 mm	UAB32ORNA0	UAB32ORBA0	884 mm	Round Corners	841 X 1189 mm	976 mm	1320 mm	1370 mm	10,200 kg	900 X 1250 X 70 mm	17,900 kg	910 X 1260 X 90 mm
UAB25ORNB1	UAB25ORBB1	530 mm	UAB32ORNB1	UAB32ORBB1	543 mm	Round Corners	700 X 1000 mm	639 mm	860 mm	880 mm	8,000 kg	760 X 1060 X 70 mm	11,100 kg	770 X 1070 X 90 mm
UAB25ORNB2	UAB25ORBB2	730 mm	UAB32ORNB2	UAB32ORBB2	743 mm	Round Corners	500 X 700 mm	846 mm	1145 mm	1180 mm	5,000 kg	560 X 760 X 70 mm	6,400 kg	570 X 770 X 90 mm
UAB25SRNA2	UAB25SRBA2	450 mm	UAB32SRNA2	UAB32SRBA2	463 mm	Mitred Corners	420 X 594 mm	549 mm	720 mm	750 mm	4,000 kg	480 X 660 X 70 mm	5,100 kg	490 X 670 X 90 mm
UAB25SRNA1	UAB25SRBA1	624 mm	UAB32SRNA1	UAB32SRBA1	637 mm	Mitred Corners	594 X 841 mm	756 mm	1000 mm	1050 mm	7,200 kg	660 X 900 X 70 mm	8,400 kg	670 X 910 X 90 mm
UAB25SRNA0	UAB25SRBA0	871 mm	UAB32SRNA0	UAB32SRBA0	884 mm	Mitred Corners	841 X 1189 mm	997 mm	1330 mm	1400 mm	10,200 kg	900 X 1250 X 70 mm	17,900 kg	910 X 1260 X 90 mm
UAB25SRNB2	UAB25SRBB2	530 mm	UAB32SRNB2	UAB32SRBB2	543 mm	Mitred Corners	700 X 1000 mm	660 mm	870 mm	910 mm	5,000 kg	560 X 760 X 70 mm	6,400 kg	570 X 770 X 90 mm
UAB25SRNB1	UAB25SRBB1	730 mm	UAB32SRNB1	UAB32SRBB1	743 mm	Mitred Corners	500 X 700 mm	866 mm	1150 mm	1210 mm	8,000 kg	760 X 1060 X 70 mm	11,100 kg	770 X 1070 X 90 mm

*W:Width H: Height D: Depth



Premium A Board with Logo



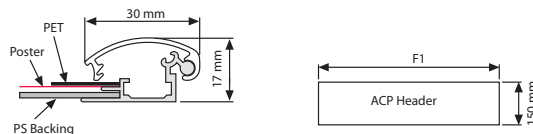
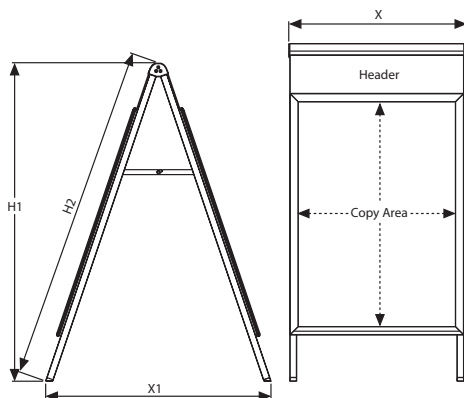
Watch video at our website www.mtdisplays.com



This heavy duty pavement sign is a perfect use for displaying posters and advertising signs with your own logo. Provides practical use, quick change-poster and logo. The replaceable aluminium composite plate is an ideal spot for a logo or a permanent message, suitable for outdoor conditions. You can print your logo directly or laminate on aluminium composite plate. The frame is hinged for easy transport and storage, with a locking stay to secure when open. Standard in silver anodised, available in standard RAL colours upon request with MOQ.

Dieser schwere Straßenaufsteller ist perfekt geeignet für das Präsentieren von Werbepostern und dem eigenen Logo. Einfacher und praktischer Gebrauch, sowie schnelles Poster und Logo wechseln runden dieses Produkt ab. Die auswechselbare Aluminium-Verbundplatte ist eine ideale Stelle um das eigene Firmenlogo oder eine dauerhafte Nachricht zu übermitteln, und natürlich wetterfest. Sie können Ihr Logo entweder direkt auf die Verbundplatte drucken, oder eben auch nur bekleben. Der Rahmen ist mit einem Scharnier ausgestattet, sodass man diesen sehr bequem tragen und einfach einlagern kann. Im aufgestellten Zustand, ist das Produkt mit einem Verschluss gesichert. Standardausführung ist Silber eloxiert, Ral Farben je nach Anfrage und bei einer gewissen Mindestabnahmemenge erhältlich.

- Single packed with an easy-to-understand instruction sheet. Einzeln verpackt in Kartons mit einfacher Montageanleitung.
- Heavy back panel provides stability. No tool assembly. Die schwere Rückwand trägt zur Standfestigkeit bei. Montage ohne Werkzeugbenutzung.
- Each unit has water drainage slots on bottom profiles. Jeder Artikel hat Wasserablauflöcher am unteren Profil.



MATERIAL : Silver anodised aluminium PROFILE : 30 mm profile								WEIGHT	PACKING SIZE
ARTICLE	POSTER	X	X1	H1	H2	F1	FEET	WITH PACKING	*W X H X D
UAPO305NA0	841 X 1189 mm	892 mm	1050 mm	1495 mm	1585 mm	884 mm	1534 mm	18,510 kg	950 X 1640 X 115 mm
UAPO305NA1	594 X 841 mm	645 mm	825 mm	1165 mm	1235 mm	637 mm	1184 mm	10,350 kg	700 X 1290 X 115 mm
UAPO305NA2	420 X 594 mm	471 mm	665 mm	930 mm	990 mm	463 mm	939 mm	6,200 kg	530 X 1040 X 115 mm
UAPO305NB1	700 X 1000 mm	751 mm	930 mm	1315 mm	1395 mm	743 mm	1344 mm	13,350 kg	810 X 1450 X 115 mm
UAPO305NB2	500 X 700 mm	551 mm	735 mm	1030 mm	1095 mm	543 mm	1044 mm	8,350 kg	600 X 1150 X 115 mm
UAPO305N23	508 X 762 mm	559 mm	775 mm	1090 mm	1160 mm	551 mm	1109 mm	8,500 kg	610 X 1210 X 115 mm
UAPO305N34	762 X 1016 mm	813 mm	940 mm	1330 mm	1410 mm	805 mm	1359 mm	13,800 kg	870 X 1460 X 115 mm



*W:Width H: Height D: Depth

Premium A Board with Profile Logo



Watch video at our website www.mtdisplays.com

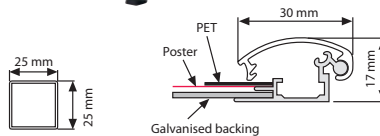
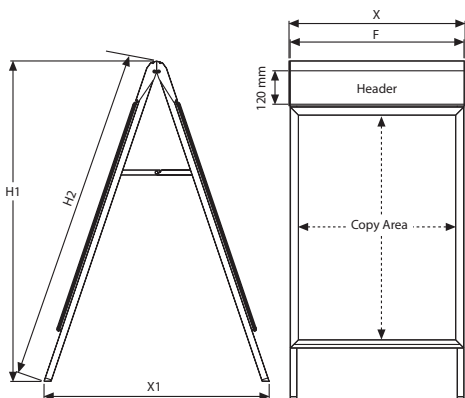


This heavy duty pavement sign is a perfect use for displaying posters and advertising signs with your own logo. Provides practical use, quick change-poster and logo. Aluminium profile is an ideal spot for a logo or a permanent message, suitable for outdoor conditions. You can laminate on aluminium header profile. Galvanised steel backing adds extra strength and stability. The frame is hinged for easy transport and storage, with a locking stay to secure when open. Standard in silver anodised, available in standard RAL colours upon request with MOQ.

Dieser schwere Straßenaufsteller ist perfekt geeignet für das Präsentieren von Werbepostern und dem eigenen Logo. Einfacher und praktischer Gebrauch, sowie schnelles Poster und Logo wechseln runden dieses Produkt ab. Das Aluminiumprofil ist eine ideale Stelle um das eigene Firmenlogo oder eine dauerhafte Nachricht zu übermitteln, und natürlich wetterfest. Sie können Ihr Logo direkt auf das Aluminiumprofil bekleben. Durch eine Blechrückwand wird eine zusätzliche Stabilität gewährt. Der Rahmen ist mit einem Scharnier ausgestattet, sodass man diesen sehr bequem tragen und einfach einlagern kann. Im aufgestellten Zustand ist das Produkt mit einem Verschluss gesichert. Standardausführung ist Silber eloxiert, Ral Farben je nach Anfrage und bei einer gewissen Mindestabnahmemenge erhältlich.

Single packed with an easy-to-understand instruction sheet. Einzelverpackt mit einer einfachen Montageanleitung.

Heavy back panel provides stability. No tool assembly. Each unit has water drainage slots on bottom profiles. Die schwere Rückwand trägt zur Standfestigkeit bei. Montage ohne Werkzeugbenutzung.



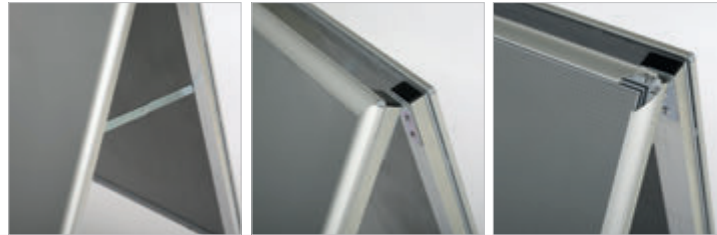
MATERIAL : Silver anodised aluminium PROFILE : 30 mm profile

ARTICLE	POSTER	HEADER PRINTING	X	X1	H1	H2	F1	FEET	WEIGHT	PACKING SIZE
									WITH PACKING	*W X H X D
UAP130SNA0	841 X 1189 mm	841 X 120 mm	892 mm	1050 mm	1495 mm	1585 mm	884 mm	1534 mm	18,510 kg	950 X 1640 X 115 mm
UAP130SNA1	594 X 841 mm	594 X 120 mm	645 mm	825 mm	1165 mm	1235 mm	637 mm	1184 mm	10,350 kg	700 X 1290 X 115 mm
UAP130SNA2	420 X 594 mm	420 X 120 mm	471 mm	665 mm	930 mm	990 mm	463 mm	939 mm	6,200 kg	530 X 1040 X 115 mm
UAP130SNB1	700 X 1000 mm	700 X 120 mm	751 mm	930 mm	1315 mm	1395 mm	743 mm	1344 mm	13,350 kg	810 X 1450 X 115 mm
UAP130SNB2	500 X 700 mm	500 X 120 mm	551 mm	735 mm	1030 mm	1095 mm	543 mm	1044 mm	8,350 kg	600 X 1150 X 115 mm
UAP130SN23	508 X 762 mm	508 X 120 mm	559 mm	775 mm	1090 mm	1160 mm	551 mm	1109 mm	8,500 kg	610 X 1210 X 115 mm
UAP130SN34	762 X 1016 mm	762 X 120 mm	813 mm	940 mm	1330 mm	1410 mm	805 mm	1359 mm	13,800 kg	870 X 1460 X 115 mm

*W:Width H: Height D: Depth



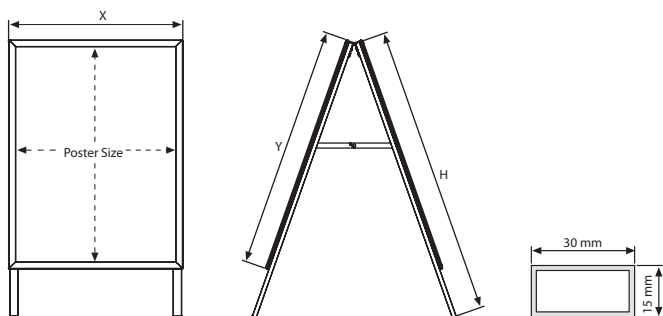
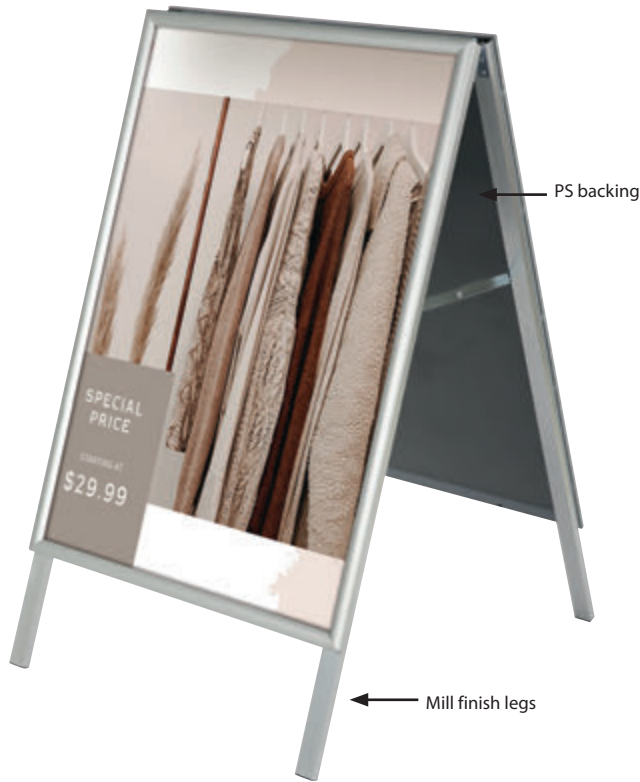
Opti Frame A Board



A new design for pavement sign needs! In our new opti family, we have just created a fresh design as a classical pavement sign A Board. This new product will not only offer new performance but also comes with competitive offers to support its distribution growth among all other pavement signs in the market. Provided with 25 mm & 32 mm profiles; only available in A1 size. Mitred and round corners are available, backing in PS is standard.

Ein neues Design für Strassenstände! Unsere OPTI Familie hat ein neues Mitglied als einen klassischen Strassenstände. Dieses Produkt bietet nicht nur eine bessere Performanz, gleichfalls bietet es gute Wettbewerbsmöglichkeiten auf dem Markt und fördert somit den Verkauf. Erhältlich in 25 mm und 32 mm Profil, wird nur in A1 Format, mit Rondo oder Gehrungsecken und standardmässig mit PS Rückwand angeboten.

- Single packed with an easy instruction sheet. Placed over high pallet and provided with eco packaging. Einzeln verpackt in Eco-Verpackung mit einfacher Montagelanleitung auf hohen Paletten geliefert.
- Rounded and safe mitred corners suit the product to health&safety conditions. Abgerundete Safe -Corner Gehrungsecken bieten Sicherheit.
- Mill finish legs require fitting on holes by the receiver. Each unit has water drainage slots on bottom profiles. Pressblanke Standbeine müssen an den Montagelöchern fixiert werden. Jeder Artikel hat Wasserabläufächer am unteren Profil.



MATERIAL : Silver anodised aluminium PROFILE : 25 mm profile						WEIGHT	PACKING SIZE
MITRED ARTICLE	ROUND ARTICLE	POSTER	X	Y	H	WITH PACKING	*W X H X D
UOAB255NA1	UOAB250NA1	594 X 841 mm	628 mm	875 mm	1050 mm	7,500 kg	720 X 1180 X 85 mm
UOAB255NA2	UOAB250NA2	420 X 594 mm	451 mm	625 mm	950 mm	4,500 kg	510 X 1100 X 85 mm
UOAB255NB2	UOAB250NB2	500 X 700 mm	534 mm	734 mm	950 mm	6,000 kg	630 X 1100 X 85 mm
MATERIAL : Silver anodised aluminium PROFILE : 32 mm profile						WEIGHT	PACKING SIZE
MITRED ARTICLE	ROUND ARTICLE	POSTER	X	Y	H	WITH PACKING	*W X H X D
UOAB325NA1	UOAB320NA1	594 X 841 mm	630 mm	877 mm	1050 mm	8,300 kg	720 X 1180 X 85 mm
UOAB325NB2	UOAB320NB2	500 X 700 mm	536 mm	736 mm	950 mm	6,500 kg	630 X 1100 X 85 mm



*W:Width H: Height D: Depth

Weatherproof A Board



Watch video at our website www.mtdisplays.com



35 mm weatherproof. Suitable for use under rainy outdoor conditions. When poster is placed inside the water wick, it is protected, weatherproof. Header board and brochure basket options are present. Easy-to-open snap frame includes the anti-reflex cover in all standard A boards. Frame size alternatives are A2, A1, 500x700 mm, 700x1000 mm, 20"x30", 30"x40" mm.

35 mm Wetterfest, passend für den Gebrauch unter Regen, bei Outdoor-Konditionen. Poster innerhalb des Dichtungsbandes legen, wetterfest. Wahlweise können Topschildhalterung und Prospektkorb angebracht werden. Alle Standard Kundenstopper beinhalten leicht zu öffnende Klapprahmen und Antireflex Schutzfolie. Verfügbare Klapprahmengrößen sind: A2, A1, 500x700 mm, 700x1000 mm, 20"x30", 30"x40" mm.

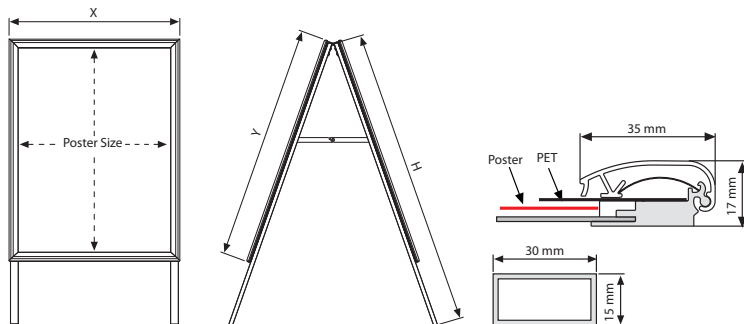
- Single packed with an easy mounting instruction sheet. Einzeln verpackt in Kartons mit einfacher Montageanleitung.
- No tool assembly. Header accessories are not included. Should be ordered separate. Montage ohne Werkzeugbenutzung. Topschild, Zubehöre sind optinel erhältlich und müssen extra bestellt werden.
- Each unit has water drainage slots on bottom profiles. Please use pull sticker to take off cover. Jeder Artikel hat Wasserabläufiger am unteren Profil. Benutzen Sie den Pull sticker, um die Schutzfolie abzuheben.



Header optional accessories. See page 122.



PCT/EP2018/060515



MATERIAL : Silver anodised aluminium PROFILE : 35 mm profile					WEIGHT	PACKING SIZE
ARTICLE	POSTER	X	Y	H	WITH PACKING	*W X H X D
UAB3550NA2	420 X 594 mm	482 mm	656 mm	950 mm	6,200 kg	510 X 1080 X 85 mm
UAB3550NA1	594 X 841 mm	656 mm	903 mm	1150 mm	7,850 kg	720 X 1180 X 85 mm
UAB3550NB2	500 X 700 mm	562 mm	762 mm	950 mm	8,350 kg	630 X 1100 X 85 mm
UAB3550NB1	700 X 1000 mm	762 mm	1062 mm	1250 mm	13,350 kg	800 X 1390 X 85 mm

*W:Width H: Height D: Depth



Slide-in A Board



Watch video at our website www.mtdisplays.com



Top opening Slide-in A Board is a practical product. Suitable for outdoor use. Available in Grey and Black finishes. Poster stands stable in between cover and backing. Rubber feet increase the product life as well as giving a clean finish to Slide-in A Board.

Das von oben zu öffnende Produkt verleiht dem A Board einen neuen Namen -Slide in A Board. Verfügbar in Silber und schwarzen Oberflächen. Das Poster ist stabil fixiert zwischen der Schutzfolie und der Rückwand. Die GummifüÙe verleihen dem Produkt eine längere Lebensdauer und bieten zu dem einen optische Abrundung beim Slide in A Board.

Single packed with an easy mounting instruction sheet. Einzeln verpackt im Karton mit einfacher Aufbauanleitung.

Bottom profile of sandwich slide-in panel provide easy application. Das Unterprofil bietet einen einfache Anwendung für die Einschubplatte.

No tool assembly. Montage ohne Werkzeug.

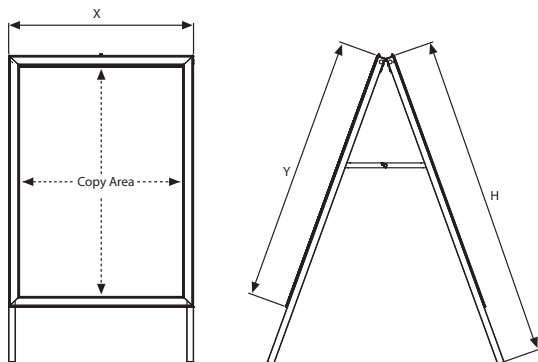
Color options / Farbenoptionen



Silver
Silber



Black
Schwarz



FRAME: Powder coated aluminium						WEIGHT	PACKING SIZE
GRAY	BLACK	EXTERNAL (x-y)	POSTER	COPY	H	WITH PACKING	*W X H X D
UABSON00A1	UABSOB00A1	651 X 907 mm	594 X 841 mm	571 X 827 mm	1150 mm	8,840 kg	720 X 1270 X 85 mm
UABSON00B1	UABSOB00B1	757 X 1066 mm	700 X 1000 mm	677 X 986 mm	1250 mm	10,550 kg	800 X 1390 X 85 mm

*W:Width H: Height D: Depth



Write-on A Board



Watch video at our website www.mtdisplays.com



Write-on A Boards are for use with water-base chalkpens and removable boardmarkers. The board is rigid and weatherproof. We sell pens individually and in sets Indoor and outdoor use. Anodised aluminium, stylish and durable.

Das Write – on A Board ist zur Benutzung mit Kreidestiften auf Wasserbasis oder abwischbaren Boardmarkern geeignet. Das A Board ist aus rigidem und wetterfestem Material. Spezielle Stifte werden in Sets angeboten. Der Artikel ist für den Innen – und Ausseneinsatz geeignet. Der Artikel besteht aus eloxiertem Aluminium, elegant und beständig.

Single packed with an easy mounting instruction sheet. Einzeln verpackt im Karton mit einfacher Aufbauanleitung.

No tool assembly. Montage ohne Werkzeug.



Legs black-black surface



Legs silver-black surface



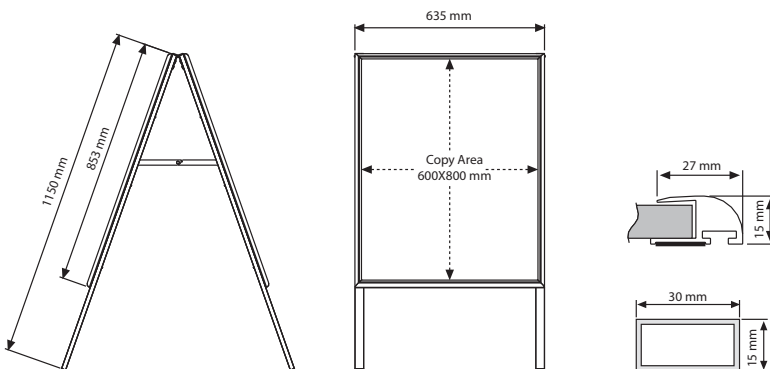
Legs silver-white surface



Legs black-white surface



Don't forget to order
Chalkboard Marker
UYAKLM1251 - Colour Marker
UYAKLM1250 - White Marker



MATERIAL : Silver anodised aluminium			WEIGHT	PACKING SIZE
ARTICLE	POSTER	DESCRIPTION	WITH PACKING	*W X H X D
UWABONWOF1	600 X 800 mm	Silver-White	7,900 kg	720 X 1270 X 85 mm
UWABONBOF1	600 X 800 mm	Silver-Black	7,900 kg	720 X 1270 X 85 mm
UWABOBWOF1	600 X 800 mm	Black-White	7,900 kg	720 X 1270 X 85 mm
UWABOBBOF1	600 X 800 mm	Black-Black	7,900 kg	720 X 1270 X 85 mm



* W:Width H: Height D: Depth

Easy Go A Board



Watch video at our website www.mtdisplays.com



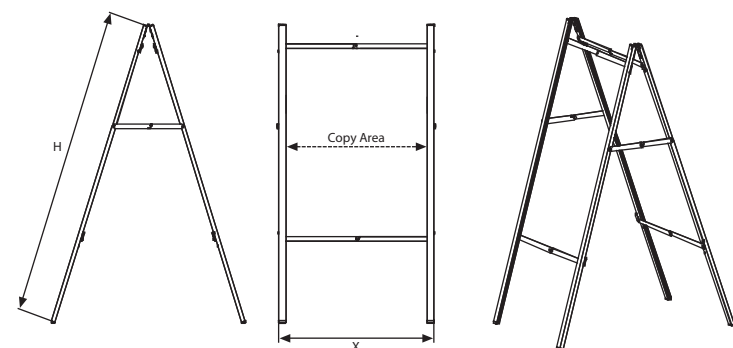
Easy go A Board is an ultraportable and easy to use model in A board range. With its unique foldable design, it is easy to carry and set up. There are 3 different panels that can be used in this model; chalkpanel, write-on panel, PVC Foam panel for direct printing. These panels will be slid into the channels of the legs. Suitable for max. 6 mm panels.

Der Easy go A Board ist der mobilste und der einfachste unter den A Boards. Mit der einzigartigen Faltechnik ist sehr handlich, einfach zu tragen und leicht aufzustellen. Das Propdukt kann mit 3 verschiedenen Platten verwendet werden; Kreidetafel, Schreibbare Tafel, PVC Schaumplatte für direkten Druck. Diese Platten werden in die seitlichen Kanäle an den Füßen eingeschoben. Geeignet für max. 6 mm Platten.

Unique foldable design. Easy to carry and set up. *Einzigartige Faltechnik. Einfach zu tragen und aufzustellen.*

No tool assembly. *Montage ohne Werkzeug.*

Panels excluded. Order separately. *Platten nicht inkludiert. Separat bestellen.*



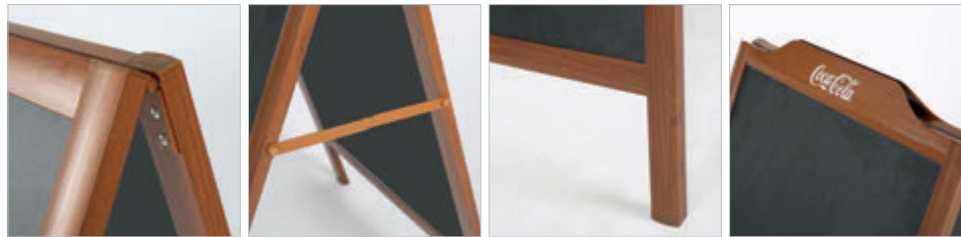
PANELS				WEIGHT	PACKING SIZE (2 Pcs)
CHALK PANEL	WRITE-ON PANEL	PVC FOAM PANEL	SIZE	WITH PACKING	*W X H X D
UYPEG100A1	UYPEG200A1	UYPEG300A1	594 X 841 mm	5,900 kg	115 X 1220 X 65 mm
UYPEG100B1	UYPEG200B1	UYPEG300B1	700 X 1000 mm	6,500 kg	115 X 1320 X 65 mm
UYPEG100B2	UYPEG200B2	UYPEG300B2	500 X 700 mm	5,000 kg	115 X 1020 X 65 mm
UYPEG10022	UYPEG20022	UYPEG30022	559 X 711 mm	5,100 kg	115 X 1020 X 65 mm
UYPEG10024	UYPEG20024	UYPEG30024	610 X 914 mm	6,000 kg	115 X 1220 X 65 mm

MATERIAL: Silver anodised aluminium					WEIGHT	PACKING SIZE
ARTICLE	POSTER	COPY	X	H	WITH PACKING	*W X H X D
UABEG00NA1	594 X 841 mm	576 X 841 mm	634 mm	1150 mm	5,900 kg	115 X 1220 X 65 mm
UABEG00NB2	500 X 700 mm	482 X 700 mm	540 mm	950 mm	5,000 kg	115 X 1020 X 65 mm
UABEG00NB1	700 X 1000 mm	682 X 1000 mm	740 mm	1250 mm	6,500 kg	115 X 1320 X 65 mm
UABEG00N22	559 X 711 mm	541 X 711 mm	599 mm	950 mm	5,100 kg	115 X 1020 X 65 mm
UABEG00N24	610 X 914 mm	592 X 914 mm	650 mm	1150 mm	6,000 kg	115 X 1220 X 65 mm

*W:Width H: Height D: Depth



Wood Look A Board





Wood Look A Board has aluminum profiles like standard A Boards but with wood look. It has a higher durability compared to real wood products.

Standard or custom shape header is available for personalization. 600 x 800mm writing area can be used with both chalk or water base chalk marker.

This is the right product for customers looking for warmth of wood look and durability.

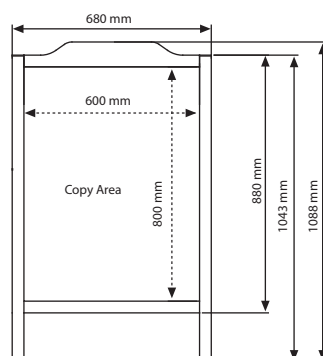
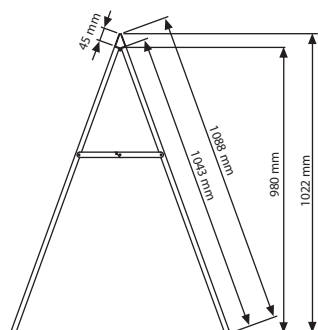
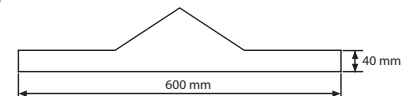
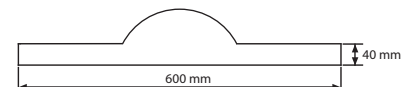
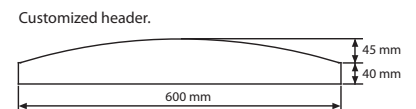
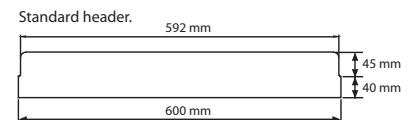
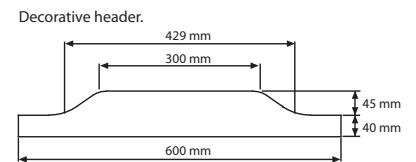
Der Wood Look A Board besteht aus Aluminium Profilen wie bei einem Standard A Board nur mit einer Holzoptik. Dieses Produkt hat eine höhere Haltbarkeit als echte Holzprodukte. Die Schreiboberfläche hat ein Maß von 600x800mm und kann mit Kreide oder mit wasserfesten Kreidemarkern verwendet werden. Das ist das richtige Produkt für Kunden die eine Holzoptik und lange Haltbarkeit zu gleich wünschen.

 Single packed with an easy mounting instruction sheet. Einzeln verpackt im Karton mit einfacher Aufbauanleitung.

 No tool assembly. Montage ohne Werkzeug.



Headers are optional accessories.



Don't forget to order
Chalkboard Marker
UYAKLM1251 - Colour Marker
UYAKLM1250 - White Marker

MATERIAL : Aluminium			WEIGHT	PACKING SIZE
ARTICLE	COPY AREA	DESCRIPTION	WITH PACKING	*W X H X D
UAWL0000F1	600 X 800 mm	without header	7,650 kg	760 X 1130 X 70 mm
UAWL1000F1	600 X 800 mm	with decorative header	7,850 kg	760 X 1130 X 70 mm

*W:Width H: Height D: Depth



Basic Wood A Board



Watch video at our website www.mtdisplays.com



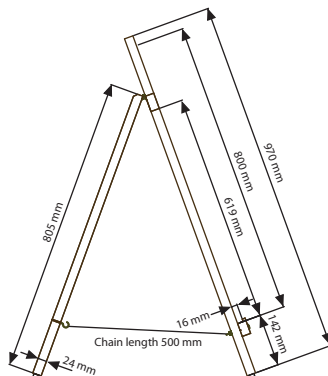
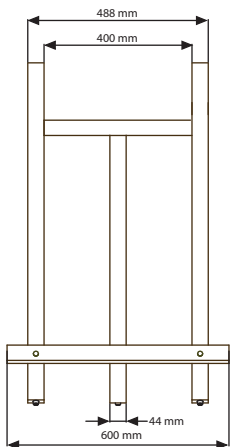
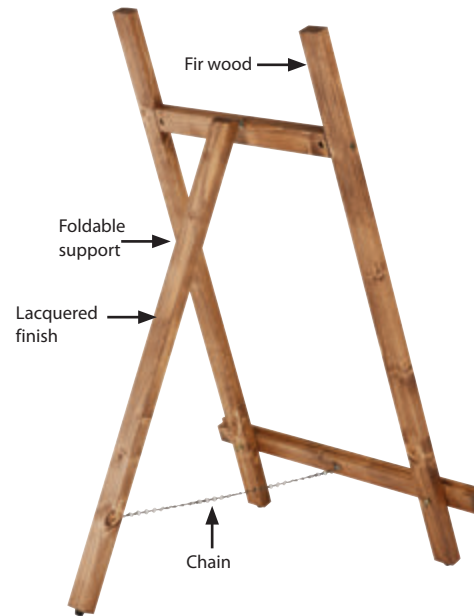
Basic Wood A Board is made of fir wood. Lacquered finish is applied for long term use. It has an adjustable back support and chain to adjust perfect placement. Soft feet prevent the product sliding and the surface scratching. It is an excellent friendly way to advertise your business. Also, Wood Chalk Floor Stand offers perfect solution where announcements change frequently such as bars, restaurants, hotels and many more. 3 size options are available. Suitable for use with Magnetic Chalkboard or Opti Frame. Magnetic Chalkboard or Opti Frame are optional.

Der Basic Wood A Board ist aus Tannenholz gefertigt. Lackiertes Finish wird für den Langzeitgebrauch aufgetragen. Es hat eine verstellbare Rückenstütze und eine Kette, um die perfekte Platzierung einzustellen. Weiche Füße verhindern ein Verrutschen des Produkts und ein Verkratzen der Oberfläche. Es ist eine ausgezeichnete freundliche Art, für Ihr Unternehmen zu werben. Außerdem bietet es die perfekte Lösung, wenn sich die Ankündigungen häufig ändern, wie z. B. Bars, Restaurants, Hotels und viele mehr. 3 Größenoptionen sind verfügbar. Geeignet für die Verwendung mit Magnetic Chalkboard oder Opti Frame. Magnetische Tafel oder Opti Frame sind optional.

Magnetic Chalkboard or Opti Frame are optional. Please do not forget to order. Bitte vergessen Sie nicht, die optionale magnetische Tafel oder den Opti-Rahmen zu bestellen.

Unassembled packaging. Unmontierte Verpackung.

No tools assembly. Assembly in 5 seconds. Montage in 5 Sekunden, kein Werkzeug erforderlich.



Don't forget to order
Chalkboard Marker
UYAKLM1251 - Colour Marker
UYAKLM1250 - White Marker

CHALKBOARD PANEL			WEIGHT	PACKING SIZE
ARTICLE	SIZE	DESCRIPTION	WITH PACKING	*W X H X D
UYPBAD1010	600 X 800 mm	Indoor	1,600 kg	630 X 80 X 30 mm
UYPBAD1020	600 X 800 mm	Outdoor	1,600 kg	630 X 80 X 30 mm

MATERIAL : Fir wood			WEIGHT	PACKING SIZE
ARTICLE	SIZE	DESCRIPTION	WITH PACKING	*W X H X D
UWBAD10000	610 X 970 mm	Black Chalkboard	1,940 kg	120 X 1140 X 70 mm

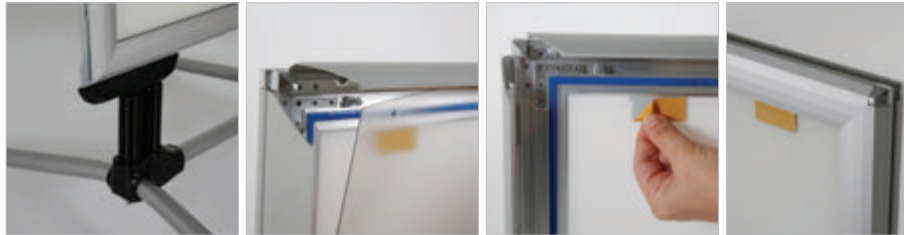


*W:Width H: Height D: Depth

SwingPro® Plus



Watch video at our website www.mtdisplays.com



With increase performance, SwingPro® Plus is more durable against outdoor conditions. It consists of 2 main articles: frame and the base. The gasket in frame provides high vacuuming to UV resistant poster protection to keep the poster dry. PET is fixed on the top profile to help easy poster change. The poster stickers which is suitable for re-use upto 100 times are also keep the poster in place avoid sliding down the frame get wet. No sharp edges and has steel springs for flexibility. Poster use is double sided.

Durch die verbesserte Leistung ist der SwingPro® Plus widerstandsfähiger gegen Aussenbedingungen. Es besteht aus 2 Hauptartikeln: Rahmen und Wassertank. Die Dichtung im Rahmen bietet hohen Vakuüm für die UV resistente PET Schutzfolie, um das Poster trocken zu erhalten. Um das Poster einfacher auszuwechseln, ist die PET Schutzfolie am oberen Profil fixiert. Die Posteraufkleber verhindern das verrutschen des Posters im Rahmen nach unten und somit auch die Nässe. Es hat keine scharfen Kanten und die Stahlfedern sorgen für Flexibilität. Doppelseitiger Einsatz.

Base standard in dark grey color or black. Other colors are available upon request. Ground wheels in upside position enable easy movement of the product. Wassertank standardmässig in dunkelgrau. Andere Farboptionen bitte anfragen. Durch integrierte Rollen an der Unterseite leicht zu transportieren.

Please note that if the frame of SwingPro Plus and WindPro Plus is required with a "HEADER" option, then the standard articles cannot be used, please contact our sales department for the articles with a header option. Please place the poster on stickers inside the water wick around the inner frame. Bitte beachten Sie, dass wenn der SwingPro Plus oder WindPro Plus mit Topschild erwünscht ist, unsere Standardartikel nicht eingesetzt werden können. Bitte wenden Sie sich dies bezüglich an Ihren Ansprechpartner in unserer Firma, um näheres über die Topschild Optionen dieses Artikels zu erfahren. Bitte platzieren Sie das Poster innerhalb des Dichtungsbandes.

Do not forget to order carry tool. Bitte vergessen Sie nicht das Tragwerkzeug zu bestellen.

Assembly in 65-75 seconds. Montiert in 65-75 Sekunden.

One top goes with 2 different bases.

Patent No: OHIM DM/098 297
PCT/EP2018/060515

Color options / Farbenoptionen
Silver Silber Black Schwarz

FRAME : Silver anodised aluminium					WEIGHT	PACKING SIZE	STEEL BASE : Powder coated iron						WEIGHT	PACKING SIZE	
SILVER	BLACK	EXTERNAL (x-y)	POSTER	COPY	WITH PACKING	*W X H X D	SILVER	BLACK	SIZE	FOR	H	W	D	WITH PACKING	*W X H X D
USWPP00NA1	USWPP00BA1	671 X 918 mm	594 X 841 mm	582 X 829 mm	8,000 kg	705 X 1180 X 40 mm	UTSM001000	UTSM001010	920 mm	20"X30"	1139 mm	690 mm	920 mm	3,500 kg	220 X 970 X 47 mm
USWPP00NA0	USWPP00BA0	918 X 1266 mm	841 X 1189 mm	829 X 1177 mm	12,000 kg	960 X 1545 X 40 mm				22"X28"	1088 mm	690 mm	920 mm	3,500 kg	220 X 970 X 47 mm
USWPP00NB1	USWPP00BB1	777 X 1077 mm	700 X 1000 mm	688 X 988 mm	10,200 kg	815 X 1320 X 40 mm				B2	1077 mm	690 mm	920 mm	3,500 kg	220 X 970 X 47 mm
USWPP00NB2	USWPP00BB2	577 X 777 mm	500 X 700 mm	488 X 688 mm	6,800 kg	610 X 1020 X 40 mm	UTSM002000	UTSM002010	1070 mm	A1	1218 mm	690 mm	1070 mm	4,000 kg	220 X 1180 X 47 mm
USWPP00NB3	USWPP00BB3	585 X 839 mm	508 X 762 mm	496 X 750 mm	7,960 kg	615 X 1100 X 40 mm				24"X36"	1292 mm	690 mm	1070 mm	4,000 kg	220 X 1180 X 47 mm
USWPP00NB4	USWPP00BB4	839 X 1093 mm	762 X 1016 mm	750 X 1004 mm	11,300 kg	875 X 1350 X 40 mm	UTSM003000	UTSM003010	1260 mm	B1	1377 mm	890 mm	1260 mm	4,600 kg	220 X 1310 X 47 mm
USWPP00NB22	USWPP00BB22	635 X 788 mm	559 X 711 mm	547 X 699 mm	6,100 kg	665 X 1030 X 40 mm				30"X40"	1393 mm	890 mm	1260 mm	4,600 kg	220 X 1310 X 47 mm
USWPP00NB24	USWPP00BB24	687 X 992 mm	610 X 915 mm	598 X 903 mm	9,000 kg	710 X 1240 X 40 mm				F0	1577 mm	890 mm	1420 mm	4,600 kg	220 X 1310 X 47 mm
USWPP00NB0	USWPP00BB0	918 X 1398 mm	853 X 1333 mm	841 X 1321 mm	13,000 kg	880 X 1500 X 40 mm	UTSM004000	UTSM004010	1420 mm	A0	1566 mm	890 mm	1420 mm	5,600 kg	220 X 1480 X 47 mm

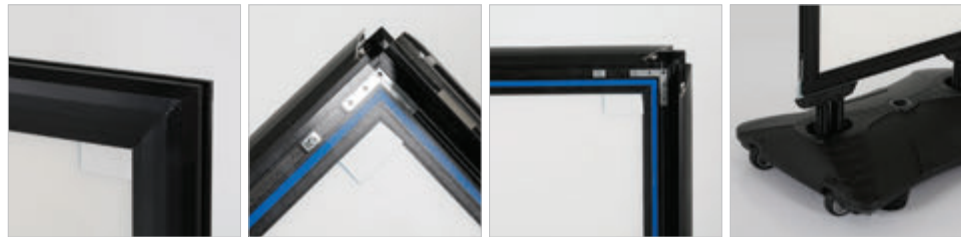
*W:Width H: Height D: Depth



WindPro® Plus



Watch video at our website www.mtdisplays.com



With increase performance, WindPro® Plus is more durable against outdoor conditions. It consists of 2 main articles: frame and the base. The gasket in frame provides high vacuuming to UV resistant poster protection to keep the poster dry. PET is fixed on the top profile to help easy poster change. The poster stickers which is suitable for re-use upto 100 times are also keep the poster in place avoid sliding down the frame get wet. No sharp edges and has steel springs for flexibility. Poster use is double sided.

Durch die verbesserte Leistung ist der WindPro® Plus widerstandsfähiger gegen Aussenbedingungen. Es besteht aus 2 Hauptartikeln: Rahmen und Wassertank. Die Dichtung im Rahmen bietet hohen Vakuüm für die UV resistente PET Schutzfolie, um das Poster trocken zu erhalten. Um das Poster einfacher auszuwechseln, ist die PET Schutzfolie am oberen Profil fixiert. Die Posteraufkleber verhindern das verrutschen des Posters im Rahmen nach unten und somit auch die Nässe. Es hat keine scharfen Kanten und die Stahlfedern sorgen für Flexibilität. Doppelseitiger Einsatz.

Base standard in dark grey color or black. Other colors are available upon request. Ground wheels in upside position enable easy movement of the product. Wassertank standardmässig in dunkelgrau. Andere Farboptionen bitte anfragen. Durch integrierte Rollen an der Unterseite leicht zu transportieren.

Please note that if the frame of SwingPro Plus and WindPro Plus is required with a "HEADER" option, then the standard articles cannot be used, please contact our sales department for the articles with a header option. Please place the poster on stickers inside the water wick around the inner frame. Bitte beachten Sie, dass wenn der SwingPro Plus oder WindPro Plus mit Topschild erwünscht ist, unsere Standardartikel nicht eingesetzt werden können. Bitte wenden Sie sich dies bezüglich an Ihren Ansprechpartner in unserer Firma, um näheres über die Topschild Optionen dieses Artikels zu erfahren. Bitte platzieren Sie das Poster innerhalb des Dichtungsbandes.

Do not forget to order carry tool. Bitte vergessen Sie nicht das Tragwerkzeug zu bestellen.

Assembly in 60 seconds. Montiert in 60 Sekunden.

One top goes with 2 different bases.



Snap open

Safe corner

Clear cover hanger

Adhesive poster tape

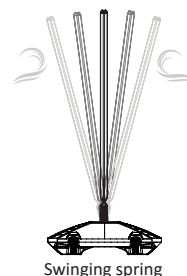
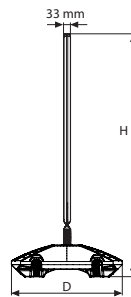
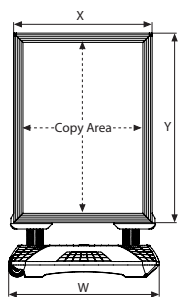
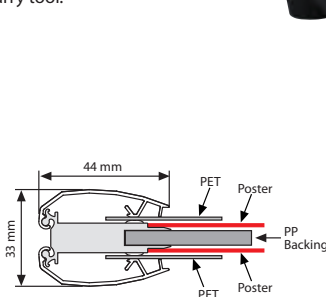


33 mm depth
44 mm design profile

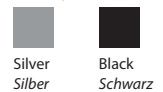
Newtech Waterbase

Steel Base

Patent No: OHIM DM/098 297
PCT/EP2018/060515



Color options / Farbenoptionen



FRAME : Silver anodised aluminium					WEIGHT	PACKING SIZE	NEWTECH WATERBASE: HLDPE						WEIGHT	PACKING SIZE	
SILVER	BLACK	EXTERNAL (x-y)	POSTER	COPY	WITH PACKING	*W X H X D	SILVER	BLACK	SIZE	FOR	H	W	D	WITH PACKING	*W X H X D
USWPP00NA1	USWPP00BA1	671 X 918 mm	594 X 841 mm	582 X 829 mm	8,000 kg	705 X 1180 X 40 mm	UTWM003000	UTWM003010	720 X 530 mm	20"X30"	1089 mm	720 mm	530 mm	4,480 kg	555 X 750 X 178 mm
USWPP00NA0	USWPP00BA0	918 X 1266 mm	841 X 1189 mm	829 X 1177 mm	12,000 kg	960 X 1545 X 40 mm				22"X28"	1038 mm	720 mm	530 mm		
USWPP00NB1	USWPP00BB1	777 X 1077 mm	700 X 1000 mm	688 X 988 mm	10,200 kg	815 X 1320 X 40 mm				24"X36"	1242 mm	720 mm	530 mm		
USWPP00NB2	USWPP00BB2	577 X 777 mm	500 X 700 mm	488 X 688 mm	6,800 kg	610 X 1020 X 40 mm				B2	1027 mm	720 mm	530 mm		
USWPP00N23	USWPP00B23	585 X 839 mm	508 X 762 mm	496 X 750 mm	7,960 kg	615 X 1100 X 40 mm				A1	1168 mm	720 mm	530 mm		
USWPP00N34	USWPP00B34	839 X 1093 mm	762 X 1016 mm	750 X 1004 mm	11,300 kg	875 X 1350 X 40 mm	UTWM004000	UTWM04010	900 X 630 mm	30"X40"	1343 mm	900 mm	630 mm	6,850 kg	605 X 930 X 178 mm
USWPP00N22	USWPP00B22	635 X 788 mm	559 X 711 mm	547 X 699 mm	6,100 kg	665 X 1030 X 40 mm				B1	1327 mm	900 mm	630 mm		
USWPP00N24	USWPP00B24	687 X 992 mm	610 X 915 mm	598 X 903 mm	9,000 kg	710 X 1240 X 40 mm				A0	1516 mm	900 mm	630 mm		
USWPP00NF0	USWPP00BF0	918 X 1398 mm	841 X 1321 mm	853 X 1333 mm	13,000 kg	880 X 1500 X 40 mm				F0	1242 mm	900 mm	630 mm		

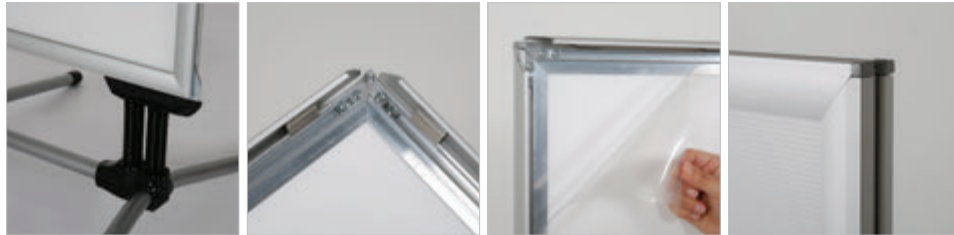
*W:Width H: Height D: Depth



SwingPro® Lite



Watch video at our website www.mtdisplays.com



SwingPro® Lite is heavy and robust waterbase pavement sign for outdoor. It consists of 2 main articles: frame and the base. No sharp edges and has steel springs for flexibility. Poster use is double sided. Recommended to use film posters.

SwingPro® Lite ist ein schweres und robustes Strasseaufsteller für den Aussenbereich. Es besteht aus 2 Hauptartikeln: Rahmen und Wassertank. Es hat keine scharfen Kanten und die Stahlfedern sorgen für Flexibilität. Doppelseitiger Einsatz.

Color options / Farbenoptionen



Silver
Silber

Black
Schwarz

Base standard in dark grey color or black. Other colors are available upon request. Ground wheels in upside position enable easy movement of the product. Wassertank standardmässig in dunkelgrau. Andere Farboptionen bitte anfragen. Durch integrierte Rollen an der Unterseite leicht zu transportieren.

Please note that if the frame of SwingPro Lite and WindPro Lite is required with a "HEADER" option, then the standard articles cannot be used, please contact our sales department for the articles with a header option. Bitte beachten Sie, dass wenn der SwingPro Lite oder WindPro Lite mit Topschild erwünscht ist, unsere Standardartikel nicht eingesetzt werden können. Bitte wenden Sie sich dies bezüglich an Ihren Ansprechpartner in unserer Firma, um näheres über die Topschild Optionen dieses Artikels zu erfahren.

This product is not waterproof, but suitable to use outdoor. Dieses Produkt ist nicht wasserfest, aber geeignet für den Aussengebrauch.

Assembly in 65-75 seconds. Montiert in 65-75 Sekunden.

Snap open

Safe corner

33 mm design profile

Strong PP backing

One top goes with 2 different bases.

WEAT-RESISTANT

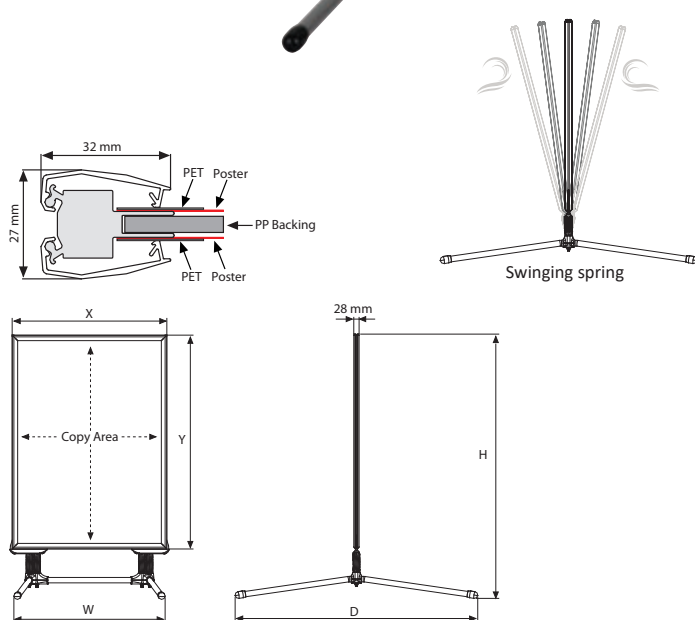
WIND RESISTANT

28 mm depth

Newtech Waterbase

Steel Base

Patent No: OHIM DM/098 297



STEEL BASE : Powder coated iron							WEIGHT	PACKING SIZE
SILVER	BLACK	SIZE	FOR	H	W	D	WITH PACKING	*W X H X D
UTSM001000	UTSM001010	920 mm	22" X 28"	1049 mm	690 mm	920 mm	3,500 kg	220 X 970 X 47 mm
			B2	1038 mm	690 mm	920 mm	3,500 kg	220 X 970 X 47 mm
UTSM002000	UTSM002010	1070 mm	A1	1179 mm	690 mm	1070 mm	4,000 kg	220 X 1180 X 47 mm
			24" X 36"	1253 mm	690 mm	1070 mm	4,000 kg	220 X 1180 X 47 mm
UTSM003000	UTSM003010	1260 mm	B1	1338 mm	890 mm	1260 mm	4,600 kg	220 X 1310 X 47 mm
			30" X 40"	1354 mm	890 mm	1260 mm	4,600 kg	220 X 1310 X 47 mm
			28" X 44"	1455 mm	890 mm	1260 mm	4,600 kg	220 X 1310 X 47 mm
UTSM004000	UTSM004010	1420 mm	A0	1527 mm	890 mm	1420 mm	5,600 kg	220 X 1480 X 47 mm

FRAME : Silver anodised aluminium					WEIGHT	PACKING SIZE
SILVER	BLACK	EXTERNAL (x-y)	POSTER	COPY	WITH PACKING	*W X H X D
USWPL00NA1	USWPL00BA1	632 X 879 mm	594 X 841 mm	568 X 815 mm	6,385 kg	680 X 1140 X 35 mm
USWPL00NA0	USWPL00BA0	879 X 1227 mm	841 X 1189 mm	815 X 1163 mm	9,000 kg	925 X 1490 X 35 mm
USWPL00NB1	USWPL00BB1	738 X 1038 mm	700 X 1000 mm	674 X 974 mm	8,115 kg	785 X 1300 X 35 mm
USWPL00NB2	USWPL00BB2	538 X 738 mm	500 X 700 mm	474 X 674 mm	5,050 kg	585 X 1000 X 35 mm
USWPL00NZ2	USWPL00BZ2	597 X 749 mm	559 X 711 mm	533 X 685 mm	5,450 kg	645 X 1010 X 35 mm
USWPL00NZ4	USWPL00BZ4	648 X 953 mm	610 X 915 mm	584 X 889 mm	6,540 kg	690 X 1215 X 35 mm
USWPL00N34	USWPL00B34	800 X 1054 mm	762 X 1016 mm	736 X 990 mm	8,500 kg	845 X 1315 X 35 mm
USWPL00N84	USWPL00B84	749 X 1155 mm	711 X 1117 mm	685 X 1091 mm	9,000 kg	795 X 1415 X 35 mm

*W:Width H: Height D: Depth



WindPro® Lite



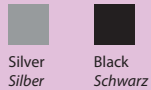
Watch video at our website www.mtdisplays.com



SwingPro® Lite is heavy and robust waterbase pavement sign for outdoor. It consists of 2 main articles: frame and the base. No sharp edges and has steel springs for flexibility. Poster use is double sided. Recommended to use film posters.

SwingPro® Lite ist ein schweres und robustes Strasseaufsteller für den Aussenbereich. Es besteht aus 2 Hauptartikeln: Rahmen und Wassertank. Es hat keine scharfen Kanten und die Stahlfedern sorgen für Flexibilität. Doppelseitiger Einsatz.

Color options / Farbenoptionen



Base standard in dark grey color or black. Other colors are available upon request. Ground wheels in upside position enable easy movement of the product.

Wassertank standardmässig in dunkelgrau. Andere Farboptionen bitte anfragen. Durch integrierte Rollen an der Unterseite leicht zu transportieren.

Please note that if the frame of SwingPro Lite and WindPro Lite is required with a "HEADER" option, then the standard articles cannot be used, please contact our sales department for the articles with a header option.

Bitte beachten Sie, dass wenn der SwingPro Lite oder WindPro Lite mit Topschild erwünscht ist, unsere Standardartikel nicht eingesetzt werden können. Bitte wenden Sie sich dies bezüglich an Ihren Ansprechpartner in unserer Firma, um näheres über die Topschild Optionen dieses Artikels zu erfahren.

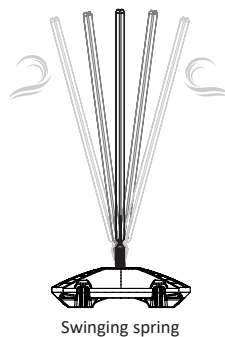
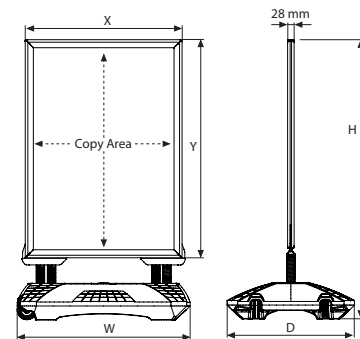
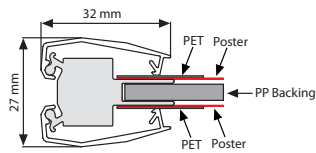
! This product is not waterproof, but suitable to use outdoor. Dieses Produkt ist nicht wasserfest, aber geeignet für den Aussengebrauch.

⌚ Assembly in 60 seconds. Montiert in 60 Sekunden.

One top goes with 2 different bases.

Patent No: OHIM DM/098 297

UYUP480945
Optional carry tool.



NEWTECH WATERBASE : HLDPE							WEIGHT	PACKING SIZE
SILVER	BLACK	SIZE	FOR	H	W	D	WITH PACKING	*W X H X D
UTWM003000	UTWM003010	720 X 530 mm	22" X 28"	999 mm	720 mm	530 mm	4,480 kg	555 X 750 X 178 mm
			24" X 36"	1203 mm	720 mm	530 mm		
		A1	1129 mm	720 mm	530 mm			
		B2	988 mm	720 mm	530 mm			
UTWM004000	UTWM04010	900 X 630 mm	28" X 44"	1405 mm	900 mm	630 mm	6,850 kg	605 X 930 X 178 mm
			30" X 40"	1304 mm	900 mm	630 mm		
		B1	1288 mm	900 mm	630 mm			
		A0	1477 mm	900 mm	630 mm			

FRAME : Silver anodised aluminium					WEIGHT	PACKING SIZE
SILVER	BLACK	EXTERNAL (x-y)	POSTER	COPY	WITH PACKING	*W X H X D
USWPLO0NA1	USWPLO0BA1	632 X 879 mm	594 X 841 mm	568 X 815 mm	6,385 kg	680 X 1140 X 35 mm
USWPLO0NA0	USWPLO0BA0	879 X 1227 mm	841 X 1189 mm	815 X 1163 mm	9,000 kg	925 X 1490 X 35 mm
USWPLO0NB1	USWPLO0BB1	738 X 1038 mm	700 X 1000 mm	674 X 974 mm	8,115 kg	785 X 1300 X 35 mm
USWPLO0NB2	USWPLO0BB2	538 X 738 mm	500 X 700 mm	474 X 674 mm	5,050 kg	585 X 1000 X 35 mm
USWPLO0NZ2	USWPLO0BZ2	597 X 749 mm	559 X 711 mm	533 X 685 mm	5,450 kg	645 X 1010 X 35 mm
USWPLO0NZ4	USWPLO0BZ4	648 X 953 mm	610 X 915 mm	584 X 889 mm	6,540 kg	690 X 1215 X 35 mm
USWPLO0N34	USWPLO0B34	800 X 1054 mm	762 X 1016 mm	736 X 990 mm	8,500 kg	845 X 1315 X 35 mm
USWPLO0N84	USWPLO0B84	749 X 1155 mm	711 X 1117 mm	685 X 1091 mm	9,000 kg	795 X 1415 X 35 mm

*W:Width H: Height D: Depth



Slide-in SwingPro® & WindPro®



Watch video at our website www.mtdisplays.com



Top opening Slide-in WindPro is a well designed outdoor product. Poster is secured in the lockable frame and stands firm between the cover and backing. Safe corners of the frame complies health and safety regulations. The springs stabilize the poster and frame in outdoor conditions.

Das von oben zu öffnende Produkt ist ein sehr schön gefertigtes Produkt für den Außenbereich. Das Poster ist geschützt in dem verschließbaren Rahmen und ist stabil zwischen Schutzfolie und Rückwand. Die besonders abgerundeten Kanten bieten besondere Sicherheit und minimieren das Risiko auf Verletzungsgefahr. Die Federn stabilisieren das Poster und den Rahmen im Außengebrauch.

Single packed in 2 boxes with an easy mounting instruction sheet. Einzelpverpackt in 2 Kartone mit einer einfachen Montageanleitung.

Bottom profile of sandwich slide-in panel provide easy application. Das Unterprofil bietet einen einfache Anwendung für die Einschubplatte.

Heavy long feet on the base provide stability. Schwere Stahlfüße gewährleisten Standfestigkeit.

Color options / Farbenoptionen



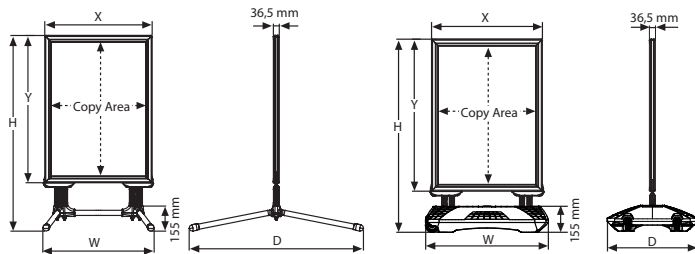
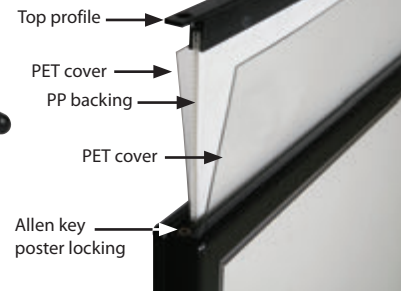
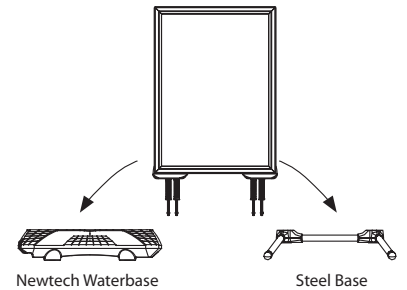
Silver
Silber

Black
Schwarz



Patent No: OHIM DM/098 297

One top goes with 2 different bases.



FRAME : Silver anodised aluminium					WEIGHT	PACKING SIZE
SILVER	BLACK	EXTERNAL (x-y)	POSTER	COPY	WITH PACKING	*W X H X D
USWS000N22	USWS000B22	631 X 783 mm	559 X 711 mm	551 X 703 mm	8,105 kg	680 X 1050 X 47 mm
USWS000N24	USWS000B24	682 X 986 mm	610 X 914 mm	602 X 906 mm	9,590 kg	750 X 1270 X 47 mm
USWS000N74	USWS000B74	758 X 1088 mm	686 X 1016 mm	678 X 1008 mm	11,29 kg	820 X 1340 X 47 mm

STEEL BASE : Powder coated aluminium						WEIGHT	PACKING SIZE
SILVER	BLACK	FOR	H	W	D	WITH PACKING	*W X H X D
UTSM002000	UTSM002010	559 X 711 mm	1083 mm	690 mm	1070 mm	4,000 kg	220 X 1180 X 47 mm
UTSM002000	UTSM002010	610 X 914 mm	1286 mm	690 mm	1070 mm	5,600 kg	220 X 1180 X 47 mm
UTSM003000	UTSM003010	686 X 1016 mm	1388 mm	890 mm	1260 mm	4,600 kg	220 X 1310 X 47 mm

NEWTech WATER BASE						WEIGHT	PACKING SIZE
SILVER	BLACK	FOR	H	W	D	WITH PACKING	*W X H X D
UTWM003000	UTWM003010	559 X 711 mm	1028 mm	720 mm	530 mm	4,480 kg	555 X 750 X 178 mm
UTWM003000	UTWM003010	610 X 914 mm	1231 mm	720 mm	530 mm	4,480 kg	555 X 750 X 178 mm
UTWM004000	UTWM004010	686 X 1016 mm	1333 mm	900 mm	630 mm	6,850 kg	605 X 930 X 178 mm



* W:Width H: Height D: Depth

Wood WindPro



Watch video at our website www.mtdisplays.com



The Patent protected double sided Wood WindPro is made of beech wood. Its base is made of sturdy HDPE. Lacquered finish is applied on the frame for long term outdoor use. The chalk surface is suitable for chalk pen use and it is magnetic. You can add your advertisements and announcements with using magnetic PET cover, magnets or you can write on it. PET cover, magnets and writable surface allows you to change and organize your notes currently. Strong springs keep the product in balance under windy weather conditions. It is tested against wind up to 90kmh.

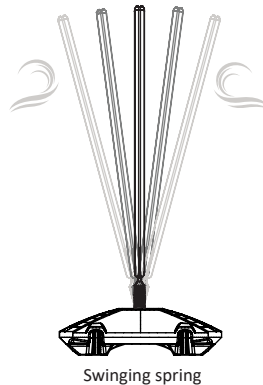
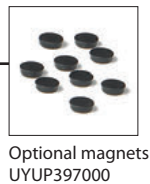
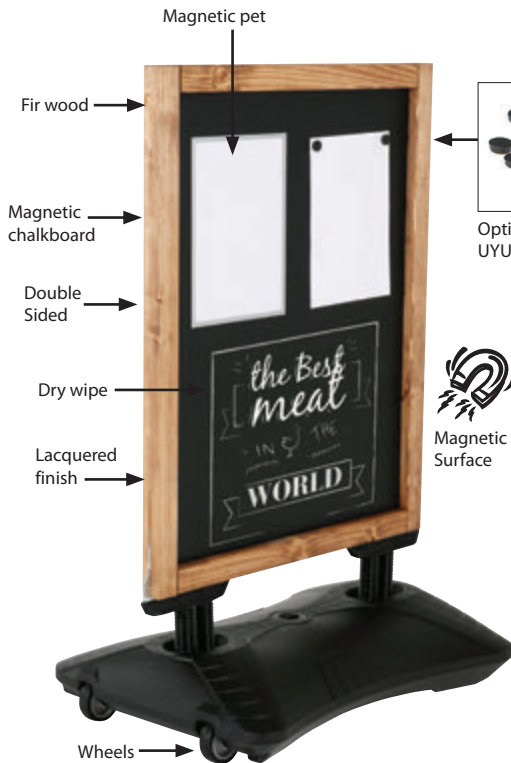
Der Patentgeschütztes doppelseitiges Wood WindPro ist aus Buchenholz gefertigt. Der Wassertank besteht aus stabilem HDPE. Das lackierte Finish wird auf den Rahmen für den langfristigen Einsatz im Freien aufgetragen. Die Kreideoberfläche ist für Kreidestifte geeignet und ist magnetisch. Sie können Ihre Werbung und Ankündigungen mit magnetischen PET-Hüllen oder Magneten hinzufügen oder darauf schreiben. PET-Hülle, Magnete und beschreibbare Oberfläche ermöglichen es Ihnen, Ihre Notizen jederzeit zu ändern und zu organisieren. Starke Federn halten das Produkt bei windigen Wetterbedingungen im Gleichgewicht. Der Wood WindPro ist gegen Wind bis zu 90 km/h getestet.

Do not forget to order magnetic PET cover, magnets and chalk pen. Bitte vergessen Sie nicht, die optionale PET-Hülle, Magnete oder Kreidestifte zu bestellen.

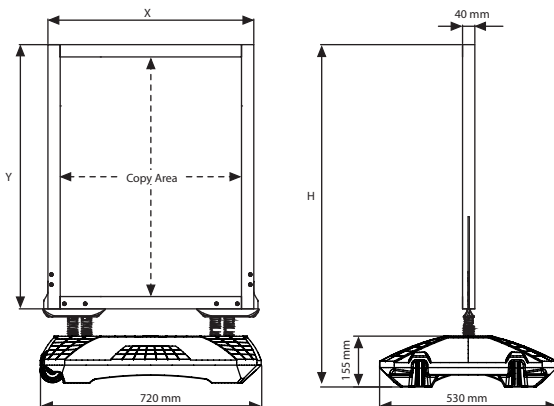
Tested against wind up to 90kmh. Getestet gegen Wind bis zu 90 km/h.

Assembly in 60 seconds. Montage in 60 Sekunden

2 boxes. 2 boxes.



Magnetic pet is an additional option, please do not forget to order



FRAME : Fir wood				WEIGHT	PACKING SIZE
ARTICLE	EXTERNAL (x-y)	COPY AREA	H	WITH PACKING	*W X H X D
USWPWOOD10	540 X 760 mm	460 X 680 mm	1003 mm	8,150 kg	590 X 1020 X 60 mm
USWPWOOD20	670 X 860 mm	590 X 780 mm	1103 mm	10,100 kg	720 X 1120 X 60 mm

NEWTECH WATERBASE: HDPE			WEIGHT	PACKING SIZE
ARTICLE	SIZE	FOR	WITH PACKING	*W X H X D
UTWM003010	720 X 530 mm	460 X 680 mm	4,480 kg	555 X 750 X 178 mm
		590 X 780 mm		



*W:Width H: Height D: Depth

WindPro Slim



Watch video at our website www.mtdisplays.com



WindPro Slim is a double-sided stopper as pavement sign. It is suitable for outdoor use. Frame is made of sturdy aluminium. Poster is secured by standing firm between cover and backing. 2xAnti-reflex poster protection and a separator are included. It is suitable for 22x60 inch poster. It is equipped with water fillable heavy base which is made of HDPE. Water capacity is 24lt. Total weight is 27,5 kg when full with water. It is equipped with wheels for easy carriage. Colour options are silver and black.

Der WindPro Slim ist ein doppelseitiger Kundenstopper. Es ist für den Außenbereich geeignet. Rahmen ist aus stabilem Aluminium. Das Poster wird durch festen Stand zwischen dem profil und der Unterlage gesichert. 2x Anti-Reflex-Plakatschutz und ein Trenner sind im Lieferumfang enthalten. Es ist für 22 x 60-Zoll-Poster geeignet und ist mit einem wassertank ausgestattet, der aus HDPE besteht. Wasserkapazität ist 24lt. Das Gesamtgewicht beträgt 27,5 kg mit Wasser gefüllt ist. Es ist mit Rädern für einen einfachen Transport ausgestattet. Farboptionen sind Silber und Schwarz als standart.

2xAnti-reflex poster protection and a separator are included. Wasserkapazität ist 24lt. Das Gesamtgewicht beträgt 27,5 kg, mit Wasser.

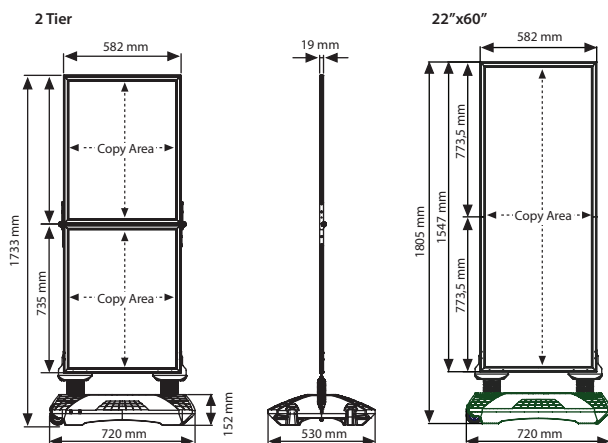
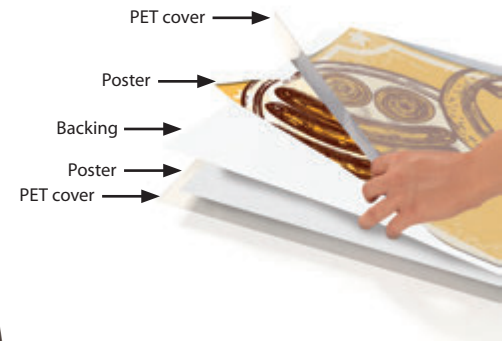
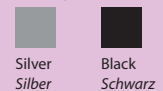
Water capacity is 24lt. Total weight is 27,5 kg when full with water. 2x Anti-Reflex-Plakatschutz PET und ein Trenner sind im Lieferumfang enthalten.

Equipped with water fillable HDPE heavy base. Ausgestattet mit einem HDPE-Wassertank.

Assembly in 75 seconds. Montage in 75 Sekunden.

2 boxes. 2 boxes.

Color options / Farboptionen



WINDPRO SLIM 22"X60"				WEIGHT	PACKING SIZE
ARTICLE	EXTERNAL (x-y)	POSTER	COPY	WITH PACKING	*W X H X D
USWPS00B26	582 X 1547 mm	559 X 1524 mm	534 X 1499 mm	14,490 kg	160 X 160 X 630 mm 650 X 1070 X 46 mm 555 X 750 X 178 mm

WINDPRO SLIM 2 TIER				WEIGHT	PACKING SIZE
SILVER	BLACK	POSTER	COPY	WITH PACKING	*W X H X D
USWPS0N222	USWPS0B222	559 X 712 mm	534 X 687 mm	13,000 kg	710 X 1100 X 100 / 570X 770 X 190 mm



*W:Width H: Height D: Depth

Mix and Match



Watch video at our website www.mtdisplays.com

Newtech Waterbase

Small

- Printing area: 300x80mm.
- Base Weight: 3,5kg.
- Water Capacity: 24lt.
- Weight when full with water: 27,5kg.

Large

- Printing area: 450x90mm.
- Base Weight: 5kg.
- Water Capacity: 40lt.
- Weight when full with water: 45kg.

Small

- Printing area: 300x80mm.
- Base Weight: 3,5kg.
- Water Capacity: 24lt.
- Weight when full with water: 27,5kg.

Large

- Printing area: 450x90mm.
- Base Weight: 5kg.
- Water Capacity: 40lt.
- Weight when full with water: 45kg.

Roto Waterbase

Small Base

- Used in A1, B2, 20"x30" sizes.
- Weight when empty is 5 kg.
- Weight when filled with water is 35 kg.
- Small base can take in 30 litres of water.

Large Base

- Used in A0, B1, 30"x40" sizes.
- Weight when empty is 6,5 kg.
- Weight when filled with water is 43 kg.
- Large base can take in 36,5 litres of water.

Kleiner Wassertank

- Für die Masse A1, B2, 20"x30"
- Wassertank Gewicht ohne Wasser 5 kg.
- Wassertank Gewicht mit Wasser 35 kg.
- Füllmenge 30 Liter.

Grosser Wassertank

- Für die Masse A0, B1, und 30"x40"
- Wassertank Gewicht ohne Wasser 6,5 kg.
- Wassertank Gewicht mit Wasser 43 kg.
- Füllmenge 36,5 Liter.

WindPro Plus



SwingPro Plus



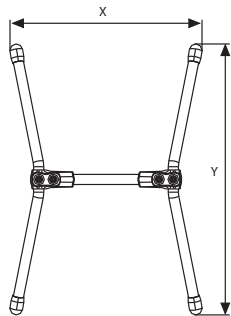
SwingPro Lite



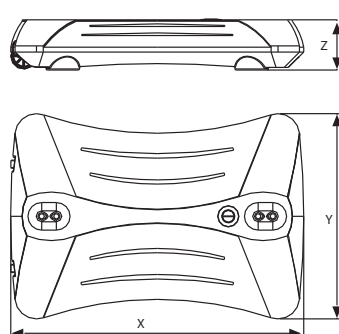
WindPro Lite



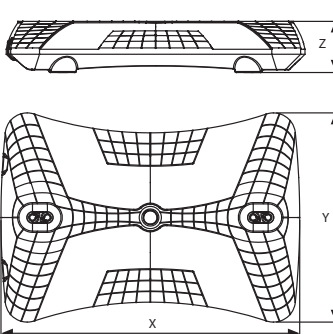
Steel Base



Roto Waterbase



Newtech Waterbase



UYUP480945
Optional carry tool for WindPro.

STEEL BASE		
ARTICLE	SIZE (x-y)	DESCRIPTION
UTSM004000	890 X 1420 mm	X Large-Grey
UTSM004010	890 X 1420 mm	X Large-Black
UTSM003000	890 X 1260 mm	Large-Grey
UTSM003010	890 X 1260 mm	Large-Black
UTSM002000	690 X 1070 mm	Medium-Grey
UTSM002010	690 X 1070 mm	Medium-Black
UTSM001000	690 X 920 mm	Small-Grey
UTSM001010	690 X 920 mm	Small-Black

ROTO WATERBASE		
ARTICLE	SIZE (x-y-z)	DESCRIPTION
UTWM002000	900 X 630 X 155 mm	Large-Grey
UTWM002010	900 X 630 X 155 mm	Large-Black
UTWM001000	720 X 580 X 155 mm	Small-Grey
UTWM001010	720 X 580 X 155 mm	Small-Black

NEWTech WATERBASE		
ARTICLE	SIZE (x-y-z)	DESCRIPTION
UTWM004000	900 X 630 X 155 mm	Large-Grey
UTWM004010	900 X 630 X 155 mm	Large-Black
UTWM003000	720 X 530 X 155 mm	Small-Grey
UTWM003010	720 X 530 X 155 mm	Small-Black

The weights are approximate values per each base.
Die Gewichte sind Durchschnittswerte für jeden Wassertank.

- Weekly 3,000pcs production capacity.
- Assembly in 65seconds.
- Suitable for use -20°C degrees.



See movie at our website
www.mtdisplays.com.tr

Illuminated WindPro® with LED



Watch video at our website www.mtdisplays.com



MT Displays' innovative and user friendly Illuminated WindPro with LED is an eye-catcher product will attract consumers to message and place. Energy saving and bright modes are applied with switch easily. Life PO4 battery which provides high power on low weight is hidden on the base to give a neat look at Illuminated WindPro. Lockable UV polycarbonate covers and locked battery compartment keep the poster and battery in safe. The upper frame is weatherproof non-snap body, has elastic rope that hinges the cover and can be secured via 12 locks. The installation of visual is very simple by inserting the visual upwards into metal poster clips.

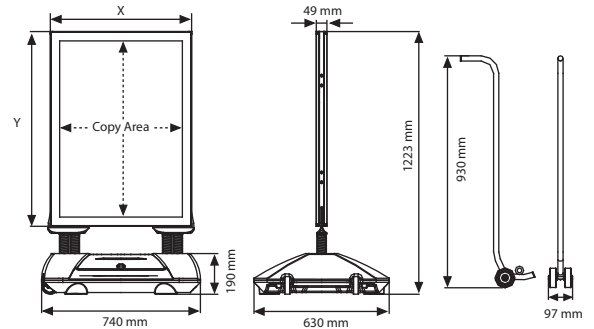
MT displays innovativstes und benutzerfreundliches Illuminated WindPro with LED ist ein Blickfang der Ihre Kunden auf die übertragene Präsentation aufmerksam macht. Mittels einem Schalter sind Energiesparende und sehr helle Leuchtoptionen verfügbar und sehr einfach bedienbar. Die PO4 Batterie, welche bei einem sehr geringen Eigengewicht eine sehr hohe Leistung bietet, ist versteckt im Wassertank des Illuminated Windpro Led und verliert somit nichts an seiner Optik. Verschießbare Polycarbonat Abdeckungen und ein verschließbares Batteriefach bieten zu dem ganzen noch einen Schutz. Das Oberprofil ist wetterfest und hat keinen Klapprahmen, hat Seile zum offen halten der Abdeckung und 12 Schlösser zum verschließen. Das Einlegen des Poster ist sehr einfach mittels 2 metall Posterhalterungen.

Charging unit included. Battery can't be charged in the product. Chrome coated zamak mited look and yet soft finish corners. Ladegerät inkludiert. Die Batterie kann nicht in dem Produkt geladen werden. Verchromtes Zamak in Gehringsoptik und abkantete weiche Ecken.

Battery will be shipped at full charge capacity see digital LED indication on battery to recharge. Die Batterie wird voll aufgeladen geliefert, kontrollieren auch Sie die digitale Batterieanzeige für den Leistungskapazität der Batterie.

3 packs. See info chart for pack sizes. 3 Packungen. Siehe Infodiagramm für Packungsgrößen.

A unique solution as a Pavement Sign with battery



In case of any claim, user is required to return product or any parts to manufacture for analyses at their cost. As long as the manufacturer confirms the problem is a manufacturing fault, the replacement can be provided. This applies for all illuminated products. Im Falle eines Reklamationsanspruchs muss das Produkt oder das Teil des Produktes dem Hersteller zur Analyse auf eigene Kosten zurückgeschickt werden. Erst wenn der Hersteller nach der Analyse bestätigt, dass das Problem ein Herstellungsfehler ist, kann der Ersatz zur Verfügung gestellt werden. Dies ist für alle beleuchteten Produkte verbindlich.

MATERIAL : Silver & black powder coated frame & waterbase				WEIGHT	PACKING SIZE
ARTICLE	EXTERNAL (x-y)	POSTER	COPY	WITH PACKING	*W X H X D
USWL000NA1	658 X 907 mm	594 X 841 mm	572 X 821 mm	37,900 kg	840 X 1420 X 112 mm / 680 X 780 X 198 mm 230 X 970 X 105 mm



WindPro with LED Plus



Watch video at our website www.mtdisplays.com



WindPro with LED Plus is an illuminated and double-sided stopper as pavement sign. It is battery operated and equipped with locked battery compartment. Battery charger is included. Click clack snap open system provides easy poster change and frame has safe corners. It is structured with clear anti-reflex PET Cover. Springs keeps WindPro with LED Plus in balance. Weatherproof IP56, suitable to use for outdoor conditions. Filling with water capacity is 40 kg. It has an optional carry tool.

Der WindPro mit LED Plus ist ein beleuchteter und doppelseitiger Kundenstopper. Es ist batteriebetrieben und mit einem verschließbaren Batteriefach ausgestattet. Batterieladegerät ist im Lieferumfang enthalten. Das Click-Clack-Snap-Open-System ermöglicht einen einfachen Posterwechsel und der Rahmen hat sichere Ecken. Es ist mit einer klaren Antireflex-PET strukturiert. Federn halten WindPro mit LED Plus im Gleichgewicht. Wetterfest IP56, geeignet für den Outdoor bereich. Die Füllmenge mit Wasser beträgt 40 kg. Es verfügt über ein optionales Tragwerkzeug.

Charger unit is included. Battery cannot be charged in the product. Ladegerät ist im Lieferumfang enthalten. Der Akku kann im Produkt nicht geladen werden.

Weatherproof IP56, suitable to use for outdoor conditions. Wetterfest IP56, geeignet für den Einsatz im Outdoor bereich.

Assembly in 60 seconds. Montage in 60 Sekunden.

2 boxes. 2 boxes.

Safe corner

Snap open

PC protector

Clear cover hanger

Clear Anti-Reflex PET Cover

Swinging spring

Springs

Power cord

RF Receiver

Logo area, max height 4 mm

Approx. weight is 40 kg when filled with water.

Wheels

Locked battery compartment

1011199C000 - LiFePO4 25.6V 7.5A Rechargeable battery 25,6V 7,5A LiFePO4 model battery

1011200C000 - LiFePO4 29.2V 1.35A Battery charger for LiFePO4 29,2V 1,35A

Battery compartment

Switch

Remote Control

Weatherproof IP56

Illuminated by LED Technology

WindPro tool UYUP480945

Dimensions: 1204 mm (height), 740 mm (width), 189 mm (depth), 630 mm (base width), 35 mm (rod diameter). Copy Area is indicated.

Patent No: OHIM DM/098 297



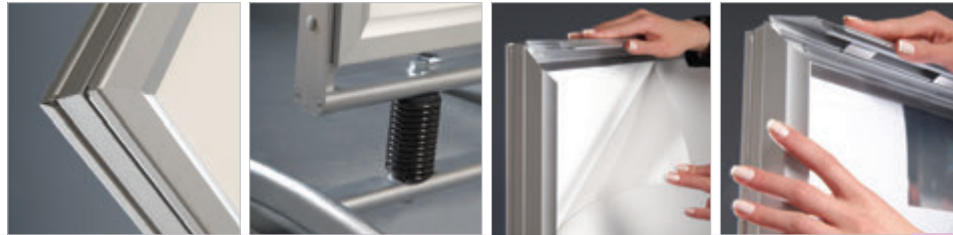
In case of any claim, user is required to return product or any parts to manufacture for analyses at their cost. As long as the manufacturer confirms the problem is a manufacturing fault, the replacement can be provided. This applies for all illuminated products. Im Falle eines Reklamationsanspruchs muss das Produkt oder das Teil des Produktes dem Hersteller zur Analyse auf eigene Kosten zurückgeschickt werden. Erst wenn der Hersteller nach der Analyse bestätigt, dass das Problem ein Herstellungsfehler ist, kann der Ersatz zur Verfügung gestellt werden. Dies ist für alle beleuchteten Produkte verbindlich.

MATERIAL : Black powder coated frame & waterbase				WEIGHT	PACKING SIZE
ARTICLE	EXTERNAL (x-y)	POSTER	COPY	WITH PACKING	*W X H X D
USWLP00BA1	671 X 918 mm	594 X 841 mm	582 X 829 mm	29,000 kg	720 X 1250 X 45 / 680 X 780 X 200 mm




*W:Width H: Height D: Depth


Swingmaster




Various sizes are available all with mitred corners. Poster use is double sided. A rubber seal is incorporated which, in addition to the over size anti-glare PET cover, helps to make the product waterproof. The double sided product with its easy to open frame has steel springs for flexibility and stability.

In verschiedenen Größen erhältlich und die Ecken sind auf Gehrung geschnitten. Beidseitiger Einsatz. Es ist eine Dichtung eingearbeitet, die zusätzlich mit der übergrossen antireflex Schutzfolie den Artikel waterproof macht. Die Federn auf der Unterseite des leicht zu öffnenden Klapprahmens, fördern die Beweglichkeit und verhindern das Umkippen.

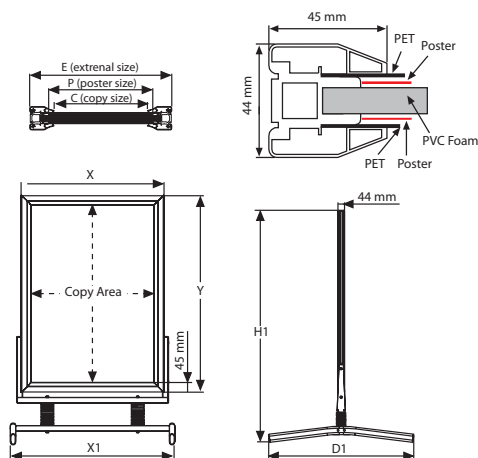
 The product is packed unassembled with an easy mounting instruction sheet & fixing set. Einzelner verpackt in Kartons mit einfacher Montageanleitung und Befestigungsmaterial.

 Suitable for windy outdoor conditions. Suitable for rainy conditions, the rubber seal around the frame protect the poster within. Round corners raise the safety level on the pavement. Ideal für den Ausseneinsatz. Wasserfest durch umlaufende Abdichtung auf dem Unterprofil. Abgerundete Ecken für Ihre Sicherheit.

 Heavy long feet on the base provide stability. Schwere Stahlfüsse gewährleisten Standfestigkeit.



Snap open



MATERIAL : Silver anodised aluminium					WEIGHT	PACKING SIZE	LEG		
ARTICLE	EXTERNAL (x-y)	POSTER	COPY	H1	WITH PACKING	*W X H X D	X1	D1	SPRINGS
UASMO00NA2	492 X 666 mm	420 X 594 mm	402 X 576 mm	1010 mm	10,200 kg	580 X 930 X 115 mm	554 mm	900 mm	2
UASMO00NA1	666 X 913 mm	594 X 841 mm	576 X 823 mm	1150 mm	16,160 kg	1200 X 800 X 115 mm	728 mm	1050 mm	2
UASMO00NA0	913 X 1261 mm	841 X 1189 mm	823 X 1171 mm	1500 mm	25,000 kg	1500 X 1050 X 115 mm	975 mm	1400 mm	2
UASMO00NB2	572 X 772 mm	500 X 700 mm	482 X 682mm	1010 mm	13,850 kg	1050 X 700 X 115 mm	634 mm	900 mm	2
UASMO00NB1	772 X 1072 mm	700 X 1000 mm	682 X 982 mm	1310 mm	20,050 kg	1350 X 900 X 115 mm	834 mm	1240 mm	2
UASMO00NB0	1072 X 1472 mm	1000 X 1400 mm	982 X 1382 mm	1710 mm	28,000 kg	1650 X 1270 X 115 mm	1134 mm	1600 mm	2
UASMO00N23	580 X 834 mm	508 X 762 mm	490 X 744 mm	1072 mm	14,000 kg	1050 X 730 X 115 mm	642 mm	900 mm	2
UASMO00N34	834 X 1088 mm	762 X 1016 mm	744 X 998 mm	1326 mm	20,600 kg	1350 X 970 X 115 mm	896 mm	1240 mm	2
UASMO00N46	1088 X 1596 mm	1016 X 1524 mm	998 X 1506 mm	1834 mm	29,500 kg	1800 X 1200 X 75 mm	1150 mm	1600 mm	2

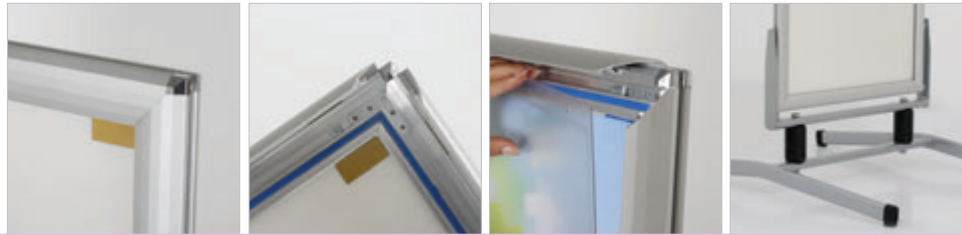
* W:Width H: Height D: Depth



Eco Swingmaster



Watch video at our website www.mtdisplays.com



Various sizes are available all with safe mitred corners. Its round corners do not have sharp edges. After the closure of the side profiles, the rubber seal inside the swingmaster in addition with over size PET makes the product waterproof. The easy-to-open snap frame includes an anti-reflex cover suitable for external use when equipped with a water wick. Product is double sided. The steel springs provide the flexibility to ensure stability.

In verschiedenen Größen erhältlich und die Ecken sind auf Gehrung geschnitten. Beidseitiger Einsatz. Es ist eine Dichtung eingearbeitet, die zusätzlich mit der übergrossen antireflex Schutzfolie den Artikel waterproof macht. Die Federn auf der Unterseite des leicht zu öffnenden Klapprahmens, fördern die Beweglichkeit und verhindern das Umkippen.

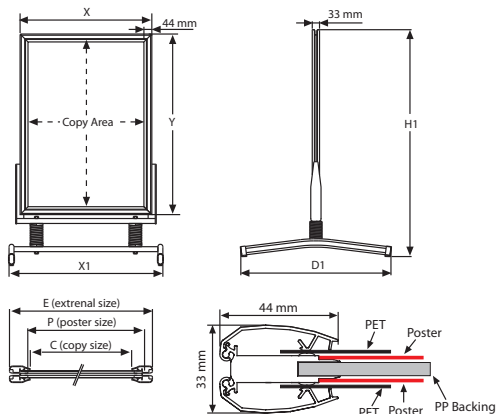
The product is packed unassembled with an easy mounting instruction sheet & fixing set. Einzel verpackt in Kartons mit einfacher Montageanleitung und Befestigungsmaterial.

Suitable for windy outdoor conditions. Suitable for rainy conditions, the rubber seal around the frame protect the poster within. Round corners raise the safety level on the pavement. Ideal für den Ausseneinsatz. Wasserfest durch umlaufende Abdichtung auf dem Unterprofil. Abgerundete Ecken für Ihre Sicherheit.

Heavy long feet on the base provide stability. Schwere Stahlfüsse gewährleisten Standfestigkeit.



PCT/EP2018/060515



MATERIAL : Silver anodised aluminium					WEIGHT	PACKING SIZE	LEG		
ARTICLE	EXTERNAL (x-y)	POSTER	COPY	H1	WITH PACKING	*W X H X D	X1	D1	SPRINGS
UESM000NA2	479 X 671 mm	420 X 594 mm	408 X 582 mm	905 mm	10,000 kg	620 X 920 X 105 mm	610 mm	850 mm	2
UESM000NA1	671 X 918 mm	594 X 841 mm	582 X 829 mm	1170 mm	15,750 kg	810 X 1170 X 105 mm	785 mm	1050 mm	2
UESM000NA0	918 X 1266 mm	841 X 1189 mm	829 X 1177 mm	1540 mm	21,250 kg	1050 X 1510 X 105 mm	1030 mm	1400 mm	2
UESM000NB2	577 X 777 mm	500 X 700 mm	488 X 688 mm	1015 mm	11,900 kg	710 X 950 X 105 mm	690 mm	905 mm	2
UESM000NB1	777 X 1077 mm	700 X 1000 mm	688 X 988 mm	1340 mm	18,250 kg	910 X 1250 X 105 mm	890 mm	1240 mm	2
UESM000NB0	1077 X 1477 mm	1000 X 1400 mm	988 X 1388 mm	1765 mm	25,200 kg	1210 X 1650 X 105 mm	1195 mm	1600 mm	2
UESM000N22	635 X 788 mm	559 X 711 mm	547 X 699 mm	1040 mm	12,300 kg	755 X 935 X 105 mm	642 mm	900 mm	2
UESM000N23	585 X 839 mm	508 X 762 mm	496 X 750 mm	1075 mm	12,300 kg	710 X 990 X 105 mm	728 mm	900 mm	2
UESM000N24	687 X 992 mm	610 X 915 mm	598 X 903 mm	1245 mm	15,500 kg	710 X 1050 X 105 mm	728 mm	1050 mm	2
UESM000N34	839 X 1093 mm	762 X 1016 mm	750 X 1004 mm	1360 mm	19,000 kg	965 X 1290 X 105 mm	896 mm	1240 mm	2
UESM000N46	1093 X 1601 mm	1016 X 1524 mm	738 X 1512 mm	1890 mm	26,000 kg	1220 X 1805 X 105 mm	1150 mm	1600 mm	2



*W:Width H: Height D: Depth

Waterbase Wind Sign



Watch video at our website www.mtdisplays.com



Various sizes are available all with mitred corners. After the closure of the side profiles, the rubber seal inside the wind sign in addition with over size PET makes the product waterproof. The easy-to-open snap frame includes an anti-reflex cover suitable for external use when equipped with a water wick. Product is double sided. The steel springs provide the flexibility to ensure stability. The wheels enable the movement of the units.

In verschiedenen Größen erhältlich und die Ecken sind auf Gehrung geschnitten. Beidseitiger Einsatz. Es ist eine Dichtung eingearbeitet, die zusätzlich mit der übergrossen antireflex Schutzfolie den Artikel waterproof macht. Die Federn auf der Unterseite des leicht zu öffnenden Klapprahmens, fördern die Beweglichkeit und verhindern das Umkippen Der Wassertank ist durch die Räder leicht bewegbar.

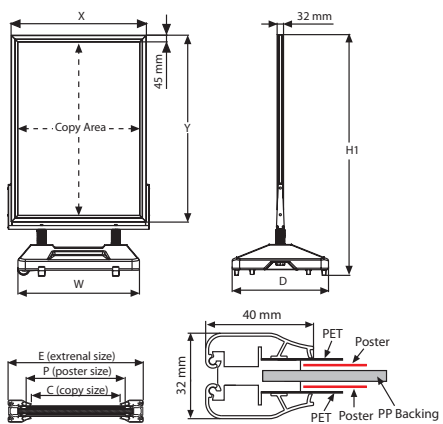
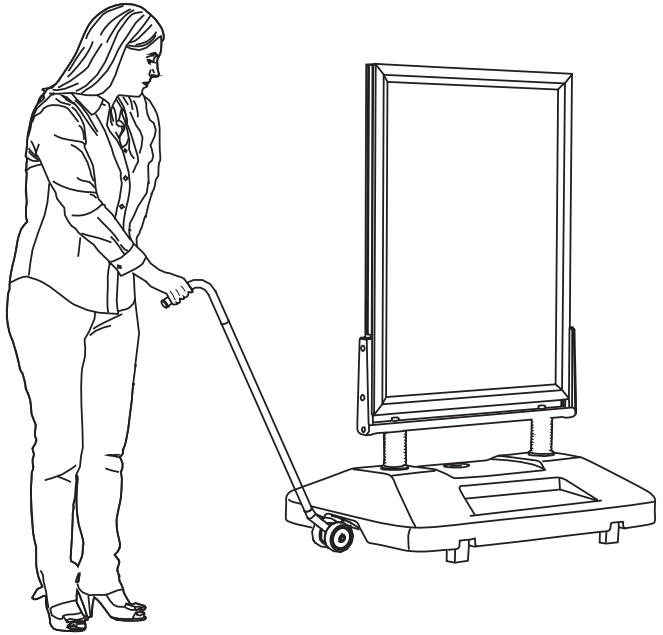
The product is packed unassembled. Water base of A2, A1, 500x700 mm 20 kg. Water base of A0, 700x1000 mm 33 kg. Each product comes unassembled with easy-to-understand instruction sheet & fixing set. Unmonitert verpackt. Wassertankgewicht für die Masse A2, A1, 500x700 ist 20 kg. Wassertankgewicht für das Mass A0 und 700x1000 ist 33 kg. Jeder Artikel wird demontiert mit Montageanleitung und Befestigungsmaterial geliefert

Base standard in metallic grey color. Other colors are available upon request. Suitable for windy & rainy conditions, protects the poster within. Ground wheels in upside position facilitate movement of the product. Wassertank standardmässig in dunkelgrau. Andere Farboptionen bitte anfragen. Passend für regnerische und windige Standorte. Durch integrierte Räder an der Unterseite leicht zu transportieren.

2 packs. See info chart for pack sizes. 2 Packungen. Siehe Infodiagramm für Packungsgrößen.



UYUP480945
Optional carry tool.



MATERIAL : Silver anodised aluminium					MAIN BODY		WATER BASE	
ARTICLE	EXTERNAL (x-y)	POSTER	COPY	H1	WEIGHT WITH PACKING	PACKING SIZE *W X H X D	WEIGHT WITH PACKING	PACKING SIZE *W X H X D
UWWM000NA2	462 X 666 mm	420 X 594 mm	402 X 576 mm	975 mm	8,300 kg	920 X 520 X 75 mm	8,500 kg	570 X 720 X 240 mm
UWWM000NA1	666 X 913 mm	594 X 841 mm	576 X 823 mm	1220 mm	12,160 kg	1200 X 720 X 75 mm	11,500 kg	670 X 840 X 240 mm
UWWM000NA0	913 X 1261 mm	841 X 1189 mm	823 X 1171 mm	1600 mm	19,200 kg	1550 X 1000 X 75 mm	11,500 kg	670 X 840 X 240 mm
UWWM000NB2	572 X 772 mm	500 X 700 mm	482 X 682mm	1080 mm	10,000 kg	1050 X 650 X 75 mm	8,500 kg	570 X 720 X 240 mm
UWWM000NB1	772 X 1072 mm	700 X 1000 mm	682 X 982 mm	1415 mm	15,000 kg	1420 X 850 X 75 mm	11,500 kg	670 X 840 X 240 mm
UWWM000NB0	1072 X 1472 mm	1000 X 1400 mm	1018 X 1418 mm	1835 mm	18,000 kg	1120 X 1820 X 75 mm	13,200 kg	750 X 1070 X 240 mm
UWWM000NZ3	580 X 834 mm	508 X 762 mm	490 X 744 mm	1140 mm	10,650 kg	1100 X 630 X 75 mm	8,500 kg	570 X 720 X 240 mm
UWWM000N34	834 X 1088 mm	762 X 1016 mm	744 X 998 mm	1430 mm	15,800 kg	1420 X 900 X 75 mm	11,500 kg	670 X 840 X 240 mm
UWWM000N46	1088 X 1596 mm	1016 X 1524 mm	998 X 1506 mm	1960 mm	20,000 kg	1140 X 1940 X 75 mm	13,200 kg	750 X 1070 X 240 mm



* W:Width H: Height D: Depth

Eco Waterbase Wind Sign



Watch video at our website www.mtdisplays.com



Various sizes are available all with safe mitred corners. Its round corners do not have sharp edges. After the closure of the side profiles, the rubber seal in addition with over size PET makes the product waterproof. The easy-to-open snap frame includes an anti-reflex cover. The steel springs provide the flexibility to ensure stability. The wheels ensure the movement of the unit. Product is double sided.

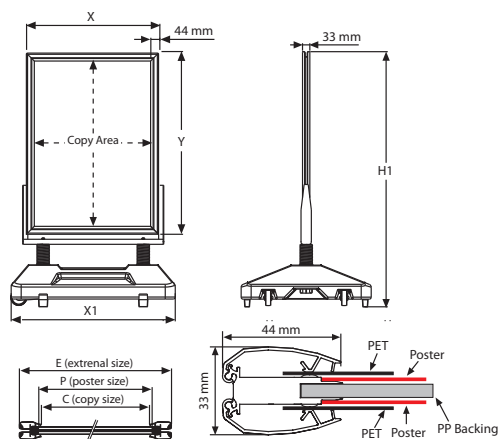
In verschiedenen Grössen erhältlich und die Ecken sind auf Gehrung geschnitten. Beidseitiger Einsatz. Es ist eine Dichtung eingearbeitet, die zusätzlich mit der übergrossen antireflex Schutzfolie den Artikel waterproof macht. Die Federn auf der Unterseite des leicht zu öffnenden Klapprahmens, fördern die Beweglichkeit und verhindern das Umkippen. Der Wassertank ist durch die Räder leicht bewegbar.

Each product comes unassembled with an easy-to-understand instruction sheet & fixing set. Jeder Artikel wird demontiert mit.

Suitable for rainy & windy conditions, protects the poster within. Ground wheels in upside position facilitate movement of the product. Round corners raise the safety level on the pavement. The standard color of is metallic grey while other colors are available upon request. Passend für regnerische und windige Standorte. Durch integrierte Räder an der Unterseite leicht zu transportieren. Abgerundete Ecken verhindern scharfe Kanten. Wassertank standardmässig in dunkelgrau. Andere Farboptionen bitte anfragen.

Heavy base provides stability. Der schwere Wassertank sichert die Standfe.

2 packs. See info chart for pack sizes. 2 Packungen. Siehe Infodiagramm für Packungsgrößen. stigkeit.



PCT/EP2018/060515

MATERIAL : Silver anodised aluminium

ARTICLE	EXTERNAL (x-y)	POSTER	COPY	H1
UEWM000NA2	479 X 671 mm	420 X 594 mm	408 X 582 mm	1020 mm
UEWM000NA1	671 X 918 mm	594 X 841 mm	582 X 829 mm	1280 mm
UEWM000NA0	918 X 1266 mm	841 X 1189 mm	829 X 1177 mm	1655 mm
UEWM000NB2	577 X 777 mm	500 X 700 mm	488 X 688 mm	1130 mm
UEWM000NB1	777 X 1077 mm	700 X 1000 mm	688 X 988 mm	1435 mm
UEWM000NB0	1077 X 1477 mm	1000 X 1400 mm	988 X 1388 mm	1865 mm
UEWM000N22	635 X 788 mm	559 X 711 mm	547 X 699 mm	1150 mm
UEWM000N23	585 X 839 mm	508 X 762 mm	496 X 750 mm	1190 mm
UEWM000N24	687 X 992 mm	610 X 915 mm	598 X 903 mm	1355 mm
UEWM000N34	839 X 1093 mm	762 X 1016 mm	750 X 1004 mm	1455 mm
UEWM000N46	1093 X 1601 mm	1016 X 1524 mm	1004 X 1512 mm	1875 mm

MAIN BODY		WATER BASE	
WEIGHT	PACKING SIZE	WEIGHT	PACKING SIZE
WITH PACKING	*W X H X D	WITH PACKING	*W X H X D
4,700 kg	540 X 940 X 40 mm	8,500 kg	570 X 720 X 240 mm
8,000 kg	705 X 1180 X 40 mm	11,500 kg	670 X 840 X 240 mm
12,000 kg	960 X 1545 X 40 mm	11,500 kg	670 X 840 X 240 mm
6,200 kg	615 X 1020 X 40 mm	8,500 kg	570 X 720 X 240 mm
10,200 kg	815 X 1320 X 40 mm	11,500 kg	670 X 840 X 240 mm
13,200 kg	1115 X 1720 X 40 mm	13,200 kg	750 X 1070 X 240 mm
6,100 kg	665 X 1030 X 40 mm	8,500 kg	570 X 720 X 240 mm
7,960 kg	615 X 1100 X 40 mm	8,500 kg	570 X 720 X 240 mm
9,000 kg	710 X 1240 X 40 mm	11,500 kg	670 X 840 X 240 mm
11,300 kg	875 X 1350 X 40 mm	11,500 kg	670 X 840 X 240 mm
14,100 kg	1140 X 1860 X 40 mm	13,200 kg	750 X 1070 X 240 mm

*W:Width H: Height D: Depth



Waterbase Wind Sign Base

Small Base

- Used in 500x700 mm, 20"x30", A2 sizes.
- Weight when empty is 8 kg.
- Weight when filled with water is 36 kg.
- Small base can take in 28 liters of water.

Kleiner Wassertank

- Für die Masse 500x700 mm, 20"x30", A2
- Gewicht ohne Wasser 8 kg.
- Gewicht mit Wasser 36 kg.
- Füllmenge 28 Liter.

Medium Base

- Used in A1, A0, 700x1000 mm, 30"x40" sizes.
- Weight when empty is 9 kg.
- Weight when filled with water is 46 kg.
- Medium base can take in 37 liters of water.

Mittelgrosser Wassertank

- Für die Masse A1, A0, 700x1000mm 30"x40"
- Gewicht ohne Wasser 9 kg.
- Gewicht mit Wasser 46 kg.
- Füllmenge 37 Liter.

Large Base

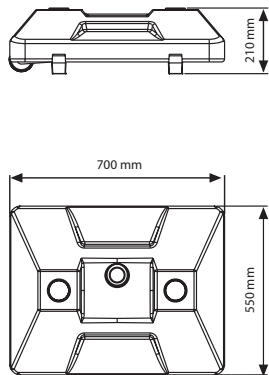
- Used in 1000x1400 mm, 40"x60" sizes.
- Weight when empty is 15 kg.
- Weight when filled with water is 69 kg.
- Large base can take in 54 liters of water.

Grosser Wassertank

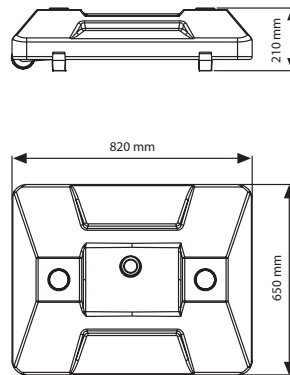
- Für die Masse 1000x1400 mm und 40"x60"
- Gewicht ohne Wasser 15 kg.
- Gewicht mit Wasser 69 kg.
- Füllmenge 54 Liter.

The weights are approximate values per each base.
Die Gewichte sind Durchschnittswerte für jeden Wassertank.

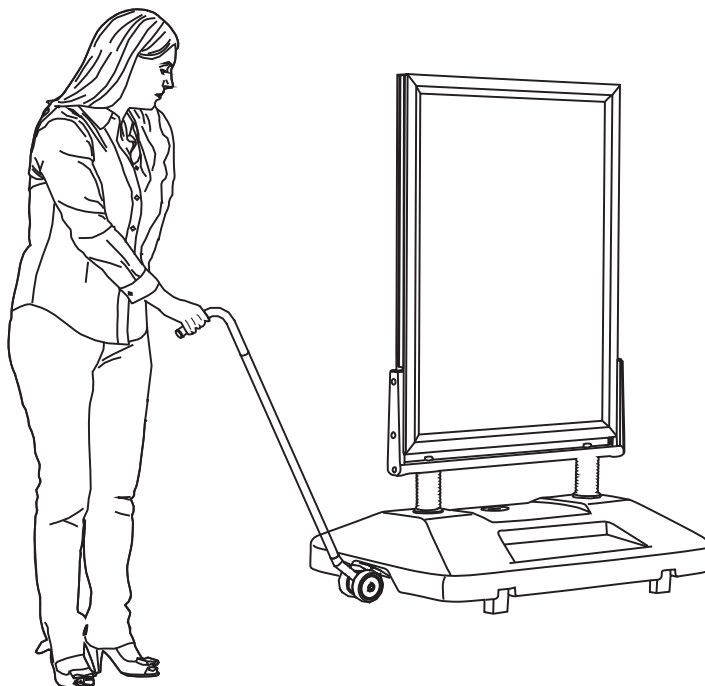
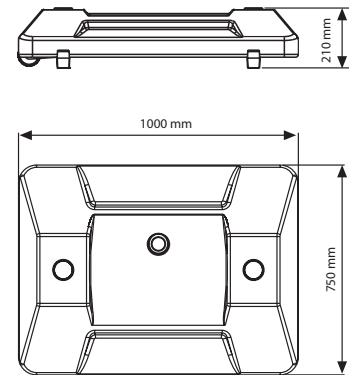
Small Base



Medium Base



Large Base



WIND SIGN BASE			WEIGHT	PACKING SIZE
ARTICLE	DESCRIPTION	SPRINGS	WITH PACKING	*W X H X D
UYUP406820	Small base	2	8,100 kg	570 X 720 X 240 mm
UYUP406810	Medium Base	2	11,500 kg	840 X 670 X 240 mm
UYUP406840	Large Base	2	14,00 kg	1020 X 770 X 240 mm

*W:Width H:Height D:Depth

Pavement Sign Headers

SwingPro® Lite Header
WindPro® Lite Header

SwingPro® Plus Header
WindPro® Plus Header

Eco Swingmaster Header
Eco Waterbase Wind Sign Header

A Board Header
Eco Aboard Header
A Board with Safe Corner Header



SwingPro® Lite



SwingPro® Plus



Eco Swingmaster



A Board 32 mm



WindPro® Lite

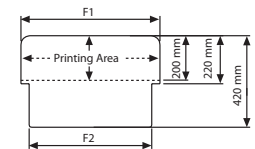


WindPro® Plus



Eco Waterbase Wind Sign

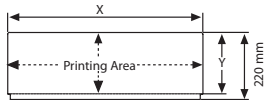
Header / Topschild



HEADER: 4 mm PVC Foam		WEIGHT	
25 MM	F1	F2	WITH PACKING
UYFT2500A2	449 mm	372 mm	459 X 430 mm
UYFT2500A1	623 mm	546 mm	633 X 430 mm
UYFT0000B2	529 mm	452 mm	539 X 430 mm
UYFT0000B1	729 mm	652 mm	739 X 430 mm

HEADER: 4 mm PVC Foam		WEIGHT	
32 MM	F1	F2	WITH PACKING
UYFT0000A2	460 mm	382 mm	0,675 kg
UYFT0000A1	640 mm	562 mm	0,850 kg
UYFT0000A1	640 mm	562 mm	0,850 kg
UYFT0000A0	890 mm	812 mm	1,500 kg
UYFT0000B2	540 mm	462 mm	0,750 kg
UYFT0000B1	740 mm	662 mm	1,400 kg
UYFT000023	548 mm	470 mm	0,800 kg
UYFT000034	802 mm	724 mm	1,450 kg

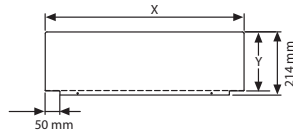
Header / Topschild



HEADER: 3 mm PVC Foam		WEIGHT	
ARTICLE	PRINTING AREA (x-y)	WITH PACKING	
UYFT0040A1	632 X 200 mm	2,650 kg	
UYFT0040A0	879 X 200 mm	3,680 kg	
UYFT0040B2	538 X 200 mm	2,250 kg	
UYFT0040B1	738 X 200 mm	3,090 kg	
UYFT004022	597 X 200 mm	2,500 kg	
UYFT004024	648 X 200 mm	2,700 kg	
UYFT004034	800 X 200 mm	3,350 kg	
UYFT004084	750 X 200 mm	3,100 kg	

* W:Width H: Height D: Depth

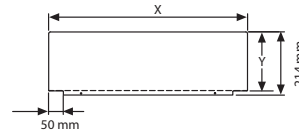
Header / Topschild



HEADER: 3 mm PVC Foam		WEIGHT	
ARTICLE	PRINTING AREA (x-y)	WITH PACKING	
UYFT0050A1	671 X 200 mm	2,640 kg	
UYFT0050A0	918 X 200 mm	3,615 kg	
UYFT0050B1	777 X 200 mm	3,060 kg	
UYFT005022	635 X 200 mm	2,500 kg	
UYFT005023	585 X 200 mm	2,300 kg	
UYFT005024	687 X 200 mm	2,700 kg	
UYFT005034	839 X 200 mm	3,350 kg	
UYFT005046	1093 X 200 mm	4,500 kg	
UYFT0050F0	877 X 200 mm	3,500 kg	

* W:Width H: Height D: Depth

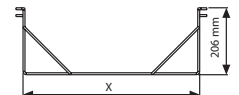
Header / Topschild



HEADER: 3 mm PVC Foam		WEIGHT	
ARTICLE	PRINTING AREA (x-y)	WITH PACKING	
UYFT0050A2	479 X 200 mm	1,885 kg	
UYFT0050A1	671 X 200 mm	2,640 kg	
UYFT0050A0	918 X 200 mm	3,615 kg	
UYFT0050B2	577 X 200 mm	2,270 kg	
UYFT0050B1	777 X 200 mm	3,060 kg	
UYFT0050B0	1077 X 200 mm	4,240 kg	
UYFT005022	635 X 200 mm	2,500 kg	
UYFT005023	585 X 200 mm	2,300 kg	
UYFT005024	687 X 200 mm	2,700 kg	
UYFT005034	839 X 200 mm	3,350 kg	
UYFT005046	1093 X 200 mm	4,500 kg	

* W:Width H: Height D: Depth

Header Holder /
Topschild Halter



HEADER HOLDER		WEIGHT	
25 MM	X	WITH PACKING	
UYTT2500A2	392 mm	0,500 kg	
UYTT2500A1	566 mm	0,600 kg	
UYTT0000B2	472 mm	0,560 kg	
UYTT0000B1	672 mm	0,650 kg	

HEADER HOLDER		WEIGHT	
32 MM	X	WITH PACKING	
UYTT0000A2	405 mm	0,600 kg	
UYTT0000A1	579 mm	0,800 kg	
UYTT0000A1	579 mm	0,850 kg	
UYTT0000A0	826 mm	0,900 kg	
UYTT0000B2	485 mm	0,750 kg	
UYTT0000B1	685 mm	0,850 kg	
UYTT000023	493 mm	0,750 kg	
UYTT000034	747 mm	0,870 kg	

* W:Width H: Height D: Depth

Magnetic Iron A Board



Stable & heavy pavement sign, used from both sides. There is a magnetic cover placed over the poster. The poster sizes are A1, 500x700 mm, 700x1000 mm. Other sizes are available upon request. Suitable for highly frequented public areas.

Stabiler, schwerer, doppelseitiger Strassenständer Das Poster ist mit einer Magnetfolie bedeckt. Erhältliche Postermasse A1, 500x700 mm, 700x1000 mm etc. Passend für öffentliche Orte mit viel Menschenverkehr.



Product is packed single & assembled.
Das Produkt wird montiert verpackt geliefert.



No tool assembly. Finger hole allows for an easy change of the poster. Header is standard supplied and provides space for corporate logo. Montage ohne Werkzeugbenutzung. Die Öffnung für den Finger hilft den leichten Austausch des Posters. Topschild ist Standard er bietet Ihren Platz für ein Logo.



Heavy steel feet provide stability. Backing tray is galvanized in standard product, powder coating is optional. Comes in black, silver, white color options. Die schweren Stahlflüsse sichern die Standfestigkeit. Das Standardprodukt wird mit verzinkter Rückwand geliefert. Pulverbeschichtung ist optional zu bestellen. In schwarz, silber, weiss erhältlich.

Color options / Farbenoptionen



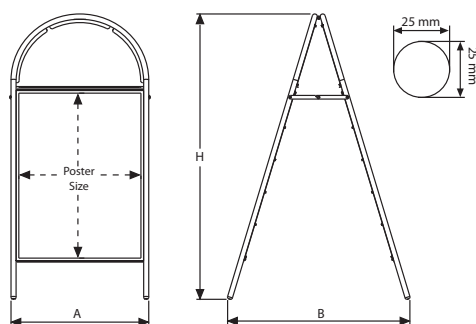
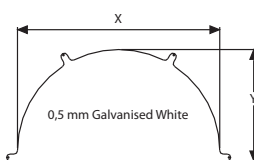
Silver
Silber

Black
Schwarz

White
Weiß



Header / Topschild



ARTICLE	POSTER	X	Y
UABD255NA2	420 X 594 mm	420 mm	240 mm
UABD255NA1	600 X 850 mm	600 mm	330 mm
UABD255NB2	500 X 700 mm	500 mm	280 mm
UABD255NB1	700 X 1000 mm	700 mm	380 mm
UABD255N23	508 X 762 mm	508 mm	284 mm
UABD255N34	762 X 1016 mm	762 mm	411 mm

MATERIAL : Iron A Board					WEIGHT	PACKING SIZE
ARTICLE	POSTER	A	B	H	WITH PACKING	*W X H X D
UABD255NA2	420 X 594 mm	500 mm	700 mm	1065 mm	12,700 kg	590 X 1120 X 75 mm
UABD255NA1	600 X 850 mm	680 mm	900 mm	1410 mm	18,500 kg	710 X 1510 X 75 mm
UABD255NB2	500 X 700 mm	580 mm	700 mm	1150 mm	15,000 kg	610 X 1320 X 75 mm
UABD255NB1	700 X 1000 mm	780 mm	1000 mm	1630 mm	22,000 kg	810 X 1750 X 75 mm
UABD255N23	508 X 762 mm	588 mm	850 mm	1220 mm	15,300 kg	610 X 1320 X 75 mm
UABD255N34	762 X 1016 mm	842 mm	1000 mm	1630 mm	18,500 kg	810 X 1800 X 75 mm

*W:Width H: Height D: Depth



Rectangular Iron A Board



Watch video at our website www.mtdisplays.com



Stable & heavy pavement sign, used from both sides. There is a magnetic cover placed over the poster. Suitable for highly frequented public areas.

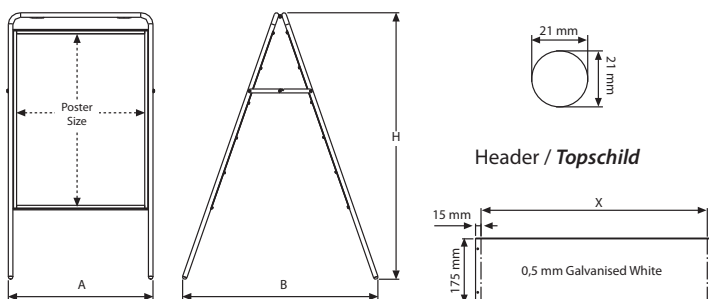
Stabiler, schwerer doppelseitiger Strassenständer. Das Poster ist mit einer Magnetfolie bedeckt. Passend für Orte mit viel Menschenverkehr.

Product is packed single & assembled. Das Produkt wird einzeln montiert verpackt.

No tool assembly. Finger hole allows for an easy change of the poster. Montage ohne Werkzeugbenutzung. Die Öffnung für den Finger hilft zum leichtesten Austausch des Posters.

Heavy steel feet provide stability. Backing tray is galvanized as a standard product, powder coating is optional. Comes in black, silver, white color options. Die schweren Stahlfüße sichern die Standfestigkeit. Das Standart Produkt wird mit versuchter Rückwand geliefert. Pulverbeschichtung ist optionell zu bestellen. In schwarz, silber, weiß erhältlich.

Color options / Farbenoptionen



MATERIAL : Iron A Board						WEIGHT	PACKING SIZE
WITH HEADER	POSTER	A	B	H	X	WITH PACKING	*W X H X D
UABD211NA2	420 X 594 mm	492 mm	700 mm	1050 mm	450 mm	10,650 kg	520 X 1140 X 80 mm
UABD211NA1	594 X 841 mm	666 mm	900 mm	1230 mm	624 mm	15,170 kg	690 X 1350 X 80 mm
UABD211NB2	500 X 700 mm	572 mm	900 mm	1230 mm	530 mm	12,780 kg	620 X 1350 X 80 mm
UABD211NB1	700 X 1000 mm	772 mm	1000 mm	1425 mm	730 mm	17,830 kg	800 X 1550 X 80 mm
UABD211N23	508 X 762 mm	580 mm	900 mm	1230 mm	538 mm	13,395 kg	620 X 1350 X 80 mm

WITHOUT HEADER	POSTER	A	B	H		WITH PACKING	*W X H X D
UABD210NA2	420 X 594 mm	492 mm	700 mm	1050 mm		9,950 kg	520 X 1140 X 80 mm
UABD210NA1	594 X 841 mm	666 mm	900 mm	1230 mm		14,300 kg	690 X 1350 X 80 mm
UABD210NB2	500 X 700 mm	572 mm	900 mm	1230 mm		12,050 kg	620 X 1350 X 80 mm
UABD210NB1	700 X 1000 mm	772 mm	1000 mm	1425 mm		16,810 kg	800 X 1550 X 80 mm
UABD210N23	508 X 762 mm	580 mm	900 mm	1230 mm		12,650 kg	620 X 1350 X 80 mm

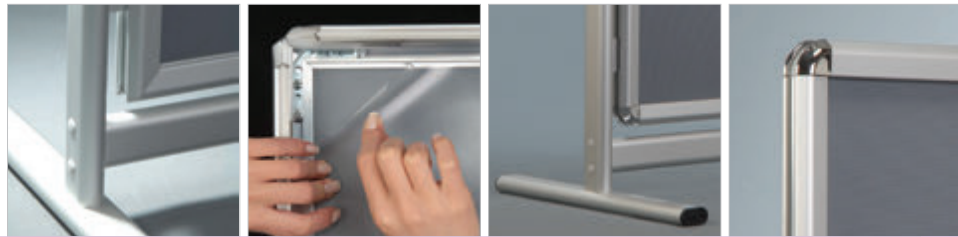
*W:Width H: Height D: Depth



Al Maki



Watch video at our website www.mtdisplays.com



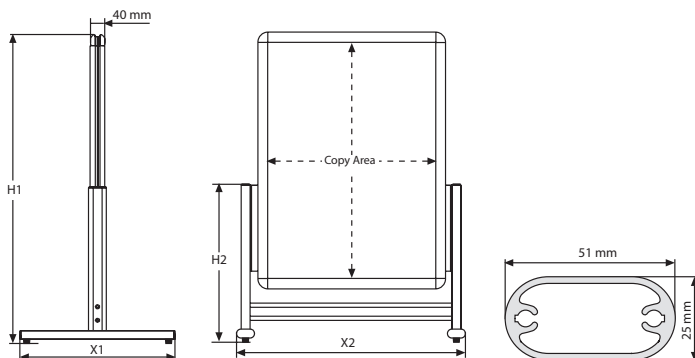
A double-sided customer stopper, practical to change the poster within. A1, 500x700 mm, 700x1000 mm sizes are available. 32 mm profile, snap frame. Round or mitred corner options.

Ein doppelseitig anwendbarer Kundenstopper mit praktischem Posteraustausch Erhältliche Masse A1, 500x700 mm, 700x1000 mm. 32 mm Klapprahmen Profile. Wahlweise Rondo oder auf Gehrung.

The product is packed unassembled with an easy mounting instruction sheet & fixing set. *Einzel in verpackt in Kartons mit einfacher Montageanleitung und Befestigungsmaterial.*

Suitable for windy outdoor conditions. Suitable for rainy conditions, protect the poster within. *Ideal für den Ausseninsatz. Wasserfest durch umlaufende Abdichtung auf dem Unterprofil.*

Heavy long feet on the base provide stability. Thick & solid backing for outdoor use. *Schwere Stahlfüsse gewährleisten Standfestigkeit. Starke und feste Rückwand für den Aussen einsatz.*



MATERIAL : Silver anodised aluminium PROFILE : 32 mm Round						WEIGHT	PACKING SIZE
ARTICLE	POSTER	X1	X2	H1	H2	WITH PACKING	*W X H X D
UAM321CNA1	594 X 841 mm	700 mm	760 mm	1030 mm	540 mm	8,250 kg	750 X 1080 X 70 mm
UAM321CNB2	500 X 700 mm	550 mm	660 mm	880 mm	460 mm	6,000 kg	600 X 850 X 70 mm
UAM321CNB1	700 X 1000 mm	700 mm	860 mm	1180 mm	540 mm	14,100 kg	840 X 1240 X 70 mm



* W:Width H: Height D: Depth

Wood Maki





Watch video at our website www.mtdisplays.com




Wood Maki is made of fir wood. Lacquered finish is applied for long term use in outdoor conditions. Double sided sliding in and out design makes the chalkboard easy to change. It offers perfect solution where announcements change frequently such as bars, restaurants, hotels and many more. Also, Wood Maki is an excellent friendly way to advertise your business. Chalk surface is suitable for chalk pen use. Its magnetic surface is suitable for magnetic PET pocket and magnet pin use. Soft feet prevent the product sliding and the surface scratching. 3 size options are available.

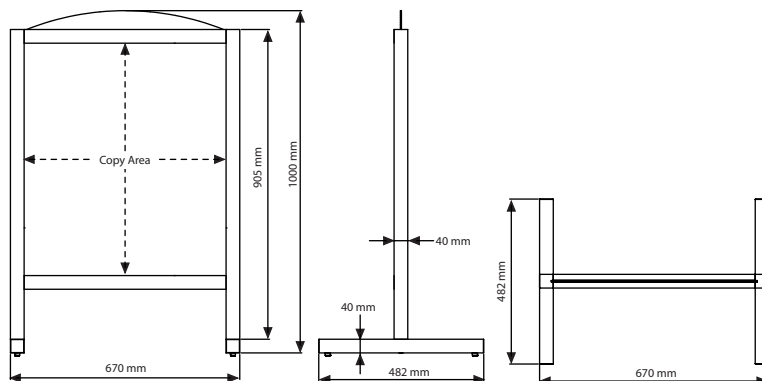
Der Wood Maki ist aus Tannenholz gefertigt. Die lackierte Oberfläche wird für den langfristigen Einsatz im Freien aufgetragen. Das doppelseitige Design zum Ein- und Auschieben erleichtert das Wechseln der Tafel. Es bietet die perfekte Lösung für häufig wechselnde Ankündigungen wie Bars, Restaurants, Hotels und viele mehr. Außerdem ist Wood Maki eine ausgezeichnete freundliche Art, Ihr Unternehmen zu bewerben. Die Kreideoberfläche ist für die Verwendung mit Kreidestiften geeignet. Seine magnetische Oberfläche eignet sich für magnetische PET-Taschen und Magnetstifte. Weiche Füße verhindern ein Verrutschen des Produkts und ein Verkratzen der Oberfläche. 3 Größenoptionen sind verfügbar.

 Do not forget to order magnetic PET cover, magnets and chalkboard marker. *Vergessen Sie nicht, die magnetische PET-Hülle, Magnete und Tafelmarker zu bestellen.*

 Unassembled packaging. *Unmontierte Verpackung.*

 Assembly in 40 seconds. *Montage in 40 Sekunden.*

 2 boxes. *2 boxes.*



Don't forget to order
Chalkboard Marker
UYAKLM1251 - Colour Marker
UYAKLM1250 - White Marker

FRAME : Fir wood				WEIGHT	PACKING SIZE
ARTICLE	CHALKBOARD SIZE	COPY AREA	DESCRIPTION	WITH PACKING	*W X H X D
UWMC06078	600 X 780 mm	590 X 680 mm	Dark Wood-Outdoor	7,680 kg	700 X 960 X 60 mm

*W:Width H: Height D: Depth



Street SignPro Deco



Watch video at our website www.mtdisplays.com

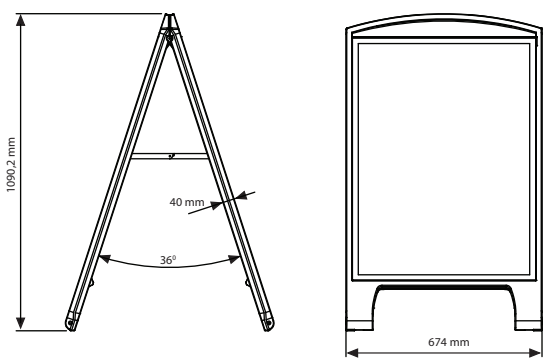


Street Sign Pro Deco which is innovative and a patent protected product. Long-lasting and resistance to direct sunlight. Suitable for In- Outdoor usage as a weather-resistant product. Easy transport with one sided wheels. Moulded-in handle hidden inside, access available when product is folded. Very easy to open with a coin. Half-way-top-opening cover, don't need to take of the whole cover completely. PVC grip profile can insert into the channel very easily. Space saving product for storage.

Street Sign Pro Deco ist ein innovatives und patentgeschütztes Produkt. Langlebig und beständig gegen direkte Sonneneinstrahlung. Als witterungsbeständiges Produkt für den Innen- und Außenbereich geeignet. Einfacher Transport durch einseitige Räder. Eingeformter, innen verborgener Griff, Zugriff möglich, wenn das Produkt zusammengeklappt ist. Sehr einfach mit einer Münze zu öffnen. Deckel mit halber Öffnung nach oben, muss nicht vollständig abgenommen werden. PVC-Griffprofil lässt sich sehr leicht in den Kanal einführen. Platzsparendes Produkt zur Aufbewahrung.

- Patented product. Patentiertes produkt
- Posters in the format 594x841mm. Poster im Format 594x841mm.
- Setup in 20 seconds. Aufbau in 20 Sekunden.
- 1 boxes. 1 boxes.

Color options / Farbenoptionen



MATERIAL : Durable HDPE				WEIGHT	PACKING SIZE
ARTICLE	SIZE	COPY SIZE	DESCRIPTION	WITH PACKING	*W X H X D
UPSD1200A1	594 X 841 mm	589,5 X 836,4 mm	Black	13,000 kg	720 X 1190 X 105 mm
UPSD1300A1	594 X 841 mm	589,5 X 836,4 mm	Gray	13,000 kg	720 X 1190 X 105 mm
UPSD1400A1	594 X 841 mm	589,5 X 836,4 mm	Beige	13,000 kg	720 X 1190 X 105 mm

*W:Width H: Height D: Depth



Street SignPro Poster with Lens



Watch video at our website www.mtdisplays.com



Made of durable plastic, Street SignPro Poster with Lens is outdoor double sided sign frame which holds two signs in size of 24" (W) x 36" (H). Recessed sign area helps to protect poster faces. It is built with a molded-in handle for easy transport. Equipped with scissors on both sides, so SignPro does not slide and damaging sign faces. It is foldable for space saving in storage. No need to fill up with water or sand as it is already constructed with heavy materials. It is available in White, Black and Grey. Street SignPro Frame with lens has a frame with anti-reflex graphic protection. This unique feature helps keeping the graphic in place sturdily. Frame is locked with hidden locking to avoid unnecessary access to poster.

Street SignPro with Lens ist aus strapazierfähigem Kunststoff gefertigt und verfügt über einen doppelseitigen Schildrahmen für den Außenbereich. Hält zwei Schilder in der Größe 24" (B) x 36" (H). Der vertiefte Schildbereich schützt die Oberfläche der Poster. Es ist mit einem eingearbeiteten Griff für einen einfachen Transport ausgestattet. SignPro with Lens ist mit Schere an beiden Seiten ausgestattet, kann somit nicht zusammenklappen und die Schildoberflächen beschädigen. Es ist aus Platzgründen platzsparend zusammenlegbar. Wasser oder Sand aufzufüllen ist nicht notwendig, da das Produkt bereits Eigengewicht hat. Es ist in den Farben Weiß, Schwarz und Grau erhältlich. Street SignPro Poster with Lens verfügt über einen Rahmen mit Antireflex-Grafikschutz. Diese einzigartige Funktion trägt dazu bei, die Grafik zu schützen. Der Rahmen ist mit einer verdeckten Verriegelung versehen, um einen unnötigen Zugriff auf die Grafik zu vermeiden.

Max poster thickness is 0,2 mm. Die maximale Plakatstärke beträgt 0,2 mm.

No tool assembly. Montage ohne Werkzeug.

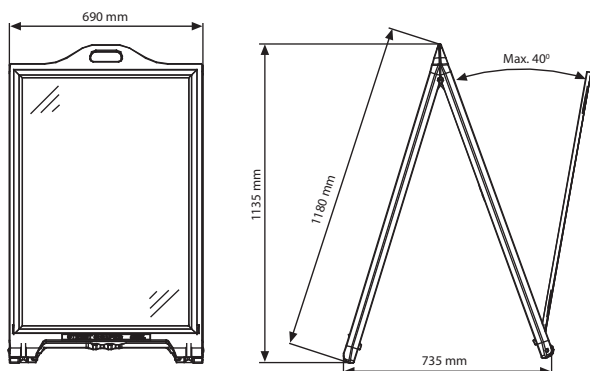
Color options / Farbenoptionen



Street SignPro Poster with Lens- Black



Street SignPro Poster with Lens- White



Patent Pending: PCT/EP2017/052765

MATERIAL : PE				WEIGHT	PACKING SIZE
WHITE	BLACK	SIZE	COPY SIZE	WITH PACKING	*W X H X D
UPSP110024	UPSP120024	610 X 915 mm	594 X 900 mm	16,800 kg	740 X 1250 X 250 mm

*W:Width H: Height D: Depth



Street SignPro Poster without Lens



Watch video at our website www.mtdisplays.com



Made of durable plastic, Street SignPro Poster without Lens is outdoor double sided sign frame which holds two signs in size of 24" (W) x 36" (H). Recessed sign area helps to protect poster faces. It is built with a molded-in handle for easy transport. Equipped with scissors on both sides, so SignPro does not slide and damaging sign faces. It is foldable for space saving in storage. No need to fill up with water or sand as it is already constructed with heavy materials. It is available in White, Black and Grey. Street SignPro Frame without lens allows using rigid graphic. This unique feature helps keeping the graphic in place sturdily. Frame is locked with hidden locking to avoid unnecessary access to rigid poster.

Street SignPro without Lens ist aus strapazierfähigem Kunststoff gefertigt und verfügt über einen doppelseitigen Schildrahmen für den Außenbereich. Hält zwei Schilder in der Größe 24 "(B) x 36" (H). Der vertiefte Schildbereich schützt die Oberfläche der Poster. Es ist mit einem eingearbeiteten Griff für einen einfachen Transport ausgestattet. SignPro with Lens ist mit Schere an beiden Seiten ausgestattet, kann somit nicht zusammenklappen und die Schildoberflächen beschädigen. Es ist aus Platzgründen platzsparend zusammenlegbar. Wasser oder Sand aufzufüllen ist nicht notwendig, da das Produkt bereits Eigengewicht hat. Es ist in den Farben Weiß, Schwarz und Grau erhältlich. Street SignPro Frame without Lens ermöglicht die Verwendung rigider Grafiken. Diese einzigartige Funktion trägt dazu bei, die Grafik zu schützen. Der Rahmen ist mit einer verdeckten Verriegelung versehen, um einen unnötigen Zugriff auf die Grafik zu vermeiden.

Max poster thickness is 5 mm.
Die maximale Plakatstärke beträgt 5 mm.

No tool assembly.
Montage ohne Werkzeug.

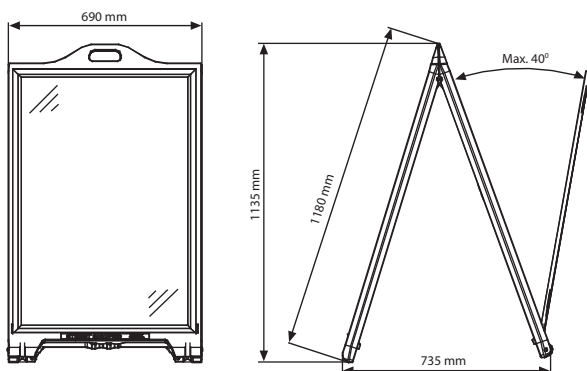
Color options / Farboptionen



Street SignPro Poster without Lens - White



Street SignPro Poster without Lens - Black



Patent Pending: PCT/EP2017/052765

MATERIAL : PE				WEIGHT	PACKING SIZE
WHITE	BLACK	SIZE	COPY SIZE	WITH PACKING	*W X H X D
UPSP210024	UPSP220024	610 X 915 mm	590 X 898 mm	14,850 kg	740 X 1250 X 250 mm

*W:Width H: Height D: Depth



Street SignPro Board



Watch video at our website www.mtdisplays.com



Made of durable plastic, Street SignPro Board is outdoor double sided sign frame which holds two signs in size of 24" (W) x 36" (H). Recessed sign area helps to protect poster faces. It is built with a molded-in handle for easy transport. Equipped with scissors on both sides, so SignPro does not slide and damaging sign faces. It is foldable for space saving in storage. No need to fill up with water or sand as it is already constructed with heavy materials. It is available in White, Black and Grey. Street SignPro Board is for laminating self-adhesive sticker.

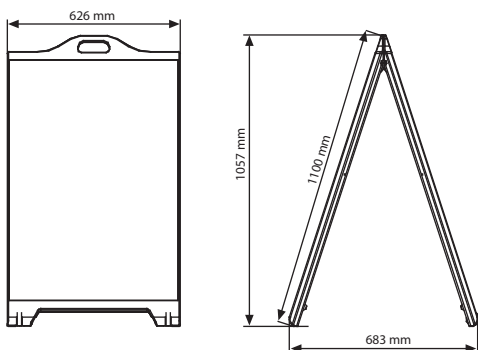
Street SignPro Board ist aus strapazierfähigem Kunststoff gefertigt und verfügt über einen doppelseitigen Schildrahmen für den Außenbereich. Hält zwei Aufkleber in der Größe 24 "(B) x 36" (H). Der vertiefte Schildbereich schützt die Oberfläche der Aufkleber. Es ist mit einem eingearbeiteten Griff für einen einfachen Transport ausgestattet. SignPro ist mit Scheren an beiden Seiten ausgestattet, kann somit nicht zusammenklappen und die Aufkleberoberflächen beschädigen. Es ist aus Platzgründen platzsparend zusammenlegbar. Wasser oder Sand aufzufüllen ist nicht notwendig, da das Produkt bereits Eigengewicht hat. Es ist in den Farben Weiß, Schwarz und Grau erhältlich. Street SignPro Board dient zum Laminieren von selbstklebenden Aufklebern.

Max poster thickness is 5mm.
Die maximale Plakatstärke beträgt 5 mm.

Self-adhesive sticker is recommended with surface preparation.
Selbstklebende Aufkleber werden mit Oberflächenschutz empfohlen.

Optional well nut is available. 6 well nuts recommended per sign frame, total 12 well nuts per Street SignPro Board. Optional sind Einnietmutter erhältlich . 6 Stk. Einnietmutter pro Seite , insgesamt 12 Stk Einnietmutter pro Produkt.

Color options / Farbenoptionen



Optional well nuts (12 Pcs) UYSP00010X1000

Recommended graphic materials: self-adhesive poster to stick-on or vinyl sheeting, fluted PP, metal, Plastech PVC foam board to apply with well nut.

MATERIAL : HDPE			WEIGHT	PACKING SIZE
WHITE	BLACK	GRAPHIC SIZE	WITH PACKING	*W X H X D
UPSP310024	UPSP320024	610 X 915 mm	13,600 kg	740 X 1250 X 250 mm

*W:Width H: Height D: Depth



Mini Street SignPro Board



Watch video at our website www.mtdisplays.com



Simple plastic pavement board for multiple purposes. PS Display is suitable for inkjet printing and adhesive folio. Easy to move and store. Suitable to write on with water base chalk pens. Recommended graphic materials: self-adhesive poster to stick-on or vinyl sheeting, fluted PP, metal, Plastech PVC foam board to apply with well nut.

Kleiner Kundenstopper, PS Display eignet sich für Tintenstrahldruck und Klebefolie. Einfach zu bewegen und zu lagern. Geeignet zum Beschreiben mit Kreidestiften auf Wasserbasis. Empfohlene Grafikmaterialien: selbstklebendes Poster zum Aufkleben oder Vinylfolie, geriffeltes PP, Metall, Plastech-PVC-Schaumplatte zum Anbringen mit Wellnutt.

- Patented product. Patentiertes produkt
- Posters in the format 630x500mm. Poster im Format 630x500mm.
- Setup in 10 seconds. Aufbau in 10 Sekunden.
- 1 boxes. 1 boxes.

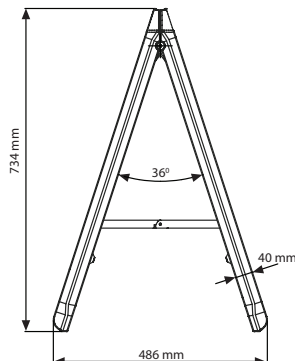
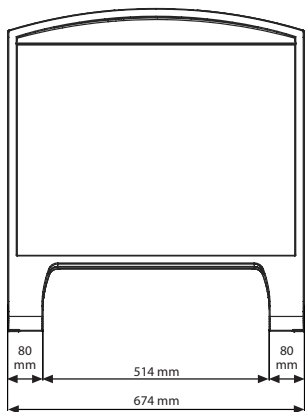
Color options / Farbenoptionen



Recommended graphic materials: self-adhesive poster to stick-on or vinyl sheeting, fluted PP, metal, Plastech PVC foam board to apply with well nut.



Yellow



Easy to carry
Product weight 5 kg



MATERIAL : Durable HDPE			WEIGHT	PACKING SIZE
ARTICLE	GRAPHIC SIZE	DESCRIPTION	WITH PACKING	*W X H X D
UPSDM50010	630 X 550 mm	Yellow	6,000 kg	720 X 800 X 105 mm
UPSDM30010	630 X 550 mm	Gray	6,000 kg	720 X 800 X 105 mm

*W:Width H: Height D: Depth

Master Sign Flex Poster



Watch video at our website www.mtdisplays.com

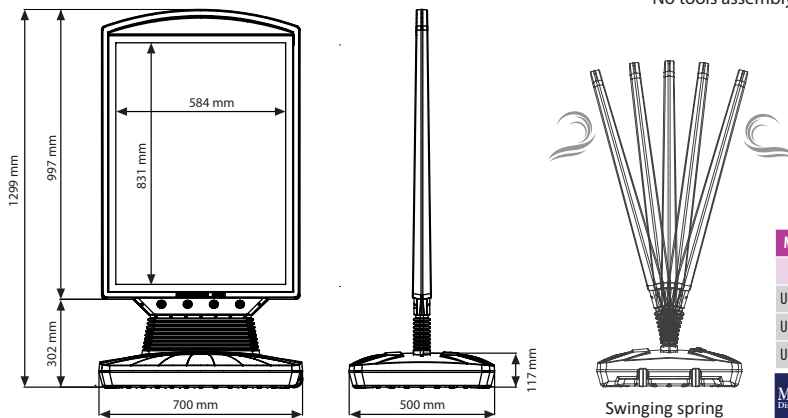


Made of durable plastic, Master Sign Flex poster is outdoor double sided sign frame which holds two signs in size of 594 X 841mm. It is built with a molded-in handle for easy transport and available in Beige, Black, Brown and Grey. It has a free space for your logo application at the top. The top side can be used as a handle while transporting. The base and the body are made of weather-resistant HDPE (high-density polyethylene), which makes this sidewalk sign holder ideal for outdoor use.

Das aus stabilem Kunststoff gefertigte Master Sign Flex Poster ist ein doppelseitiger Schildrahmen für den Außenbereich, der zwei Poster in der Größe von 594 x 841 mm aufnehmen kann. Es ist mit einem eingegossenen Griff für einfachen Transport ausgestattet und in den Farben Beige, Schwarz, Braun und Grau erhältlich. Es hat oben einen freien Platz für Ihre Logo-Applikation. Die Oberseite kann beim Transport als Griff verwendet werden. Die Basis und der Körper sind aus witterungsbeständigem HDPE (Polyethylen hoher Dichte), wodurch dieser Gehwegschildhalter ideal für den Außenbereich geeignet ist.

- Patented product. Patentiertes Produkt
- Weatherproof and flexible. Wetterfest und Flexibel.
- Posters in the format 594x841mm. Poster im Format 594x841mm.
- Setup in 30 seconds. Aufbau in 30 Sekunden.
- 2 boxes. 2 boxes.

Color options / Farboptionen



MATERIAL : Durable HDPE				WEIGHT	PACKING SIZE
ARTICLE	SIZE	COPY SIZE	DESCRIPTION	WITH PACKING	*W X H X D
UPFS3100A1	594 X 841 mm	584 X 831 mm	Silver- Black	15,000 kg	700 X 1260 X 75 / 530 X 740 X 135 mm
UPFS3200A1	594 X 841 mm	584 X 831 mm	Beige - Brown	15,000 kg	700 X 1260 X 75 / 530 X 740 X 135 mm
UPFS3300A1	594 X 841 mm	584 X 831 mm	Black - Black	15,000 kg	700 X 1260 X 75 / 530 X 740 X 135 mm

*W:Width H: Height D: Depth



Master Sign Flex Board



Watch video at our website www.mtdisplays.com



Our genuine patented (PATENT WIPO083329) sidewalk sign holder Master Sign Flex board provides maximum exposure for your signage. It is double Sided. You can display two, self-adhesive posters at the same time. Equipped with caster wheels for easy transport. It has a free space for your logo application at the top. The top side can be used as a handle while transporting. The base and the body are made of weather-resistant HDPE (high-density polyethylene), which makes this sidewalk sign holder ideal for outdoor use.

Patentierter (PATENT WIPO083329) Kundenstopper Master Sign Flex Board bietet maximale Sichtbarkeit für Ihre werbung. Es ist doppelseitig. Sie können zwei selbstklebende Poster gleichzeitig ausstellen. Ausgestattet mit Rädern für einfachen Transport. Platz für Ihre Logo-Applikation. Die Oberseite kann beim Transport als Griff verwendet werden. Die Basis und der Körper sind aus witterungsbeständigem HDPE (Polyethylen hoher Dichte), wodurch dieser Gehwegschildhalter ideal für den Außenbereich geeignet ist.

- Patented product (PATENT WIPO083329). Patentiertes produkt (PATENT WIPO083329).
- Weatherproof and flexible. Wetterfest und Flexible.
- Self-adhesive poster in the format 420x600mm to stick on. Selbstklebendes Poster im Format 420x600mm zum Aufklebe.
- Assembly in 10 seconds. Aufbau in 30 Sekunden.
- 2 boxes. 2 boxes.
- Color options / Farbenoptionen
 - Beige
 - Black Schwarz
 - Grey Grau

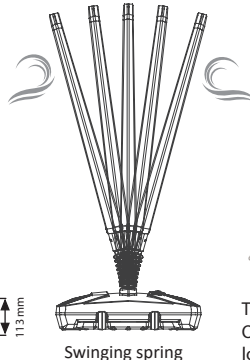
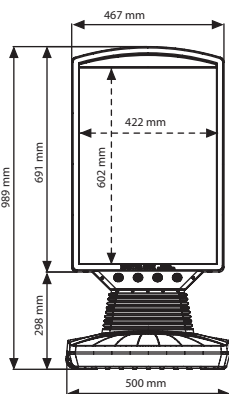
Beige - Brown

- Finger handle
- Attach sign using well nuts
- Durable HDPE
- Maximum water capacity is 12 liter
- Push-up wheels
- Logo area, max. print size 200 x 30 (h) mm.
- Self adhesive poster
- Shrinking tolerance ± 1,5 mm
- Flex, swinging spring
- Product weight 5,5 kg
- No tools assembly

Recommended graphic materials: self-adhesive poster to stick-on or vinyl sheeting, fluted PP, metal, Plastech PVC foam board to apply with well nut.

Mix & Match

- Self adhesive poster
- Self adhesive chalkboard foil
- Black-Black
- Black-Silver
- Self adhesive dry wipe foil
- Self adhesive poster
- Silver-Black
- Silver-Silver



Optional Well Nut (12 Pcs) UYPSP00010X1000



TZZZ998701 Optional cable lock kit 2100 mm



Don't forget to order Chalkboard Marker UYAKLM1251 - Colour Marker UYAKLM1250 - White Marker

MATERIAL : Durable HDPE			WEIGHT	PACKING SIZE
ARTICLE	POSTER SIZE	DESCRIPTION	WITH PACKING	*W X H X D
UPFES1100A2	420 X 600 mm	Black - Silver	6,250 kg	495 X 955 X 60 / 430 X 530 X 110 mm
UPFES1200A2	420 X 600 mm	Brown - Beige	6,250 kg	495 X 955 X 60 / 430 X 530 X 110 mm
UPFES1300A2	420 X 600 mm	Black-Black	6,250 kg	495 X 955 X 60 / 430 X 530 X 110 mm

* W:Width H: Height D: Depth



Master Sign Fix Board



Watch video at our website www.mtdisplays.com



Patented sign holder Master Sign Fix Board takes all the attention on the sidewalk, suitable with 420x600mm self-adhesive poster to stick-on or vinyl sheeting, fluted PP, metal, Plastech PVC foam board to apply with well nut (Optional). free space for your logo application at the top. The top side can be used as a handle while transporting. The base and the body are made of weather-resistant HDPE (high-density polyethylene), which makes this sidewalk sign holder ideal for outdoor use.

Der patentierte Master Sign Fix Board lenkt die Aufmerksamkeit auf dem Bürgersteig, geeignet für 420 x 600mm selbstklebendem Poster zum Aufkleben oder Vinylfolie, geriffeltes PP, Metall, Plastech-PVC-Schaumplatte zum Anbringen mit Mutter (optional). Freier Platz für Ihre Logo-Applikation oben. Die Oberseite kann beim Transport als Griff verwendet werden. Die Basis und der Körper sind aus wetterfestem HDPE, wodurch dieser Kundenstopper ideal für den Außenbereich geeignet ist.

Well nut and Chalkboard markers are optional. Wellnut- und Chalkboard-Marker sind optional

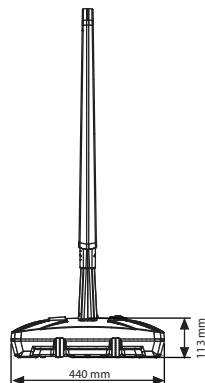
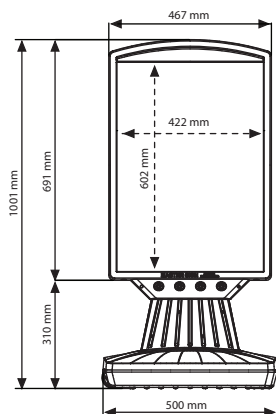
Weatherproof. Wetterfest

420x600mm size self-adhesive poster to stick-on. Selbstklebendes Poster im Format 420x600mm zum Aufkleben.

Assembly in 10 seconds. Aufbau in 30 Sekunden.

2 boxes. 2 boxes

Color options / Farbenoptionen



Optional Well Nut (12 Pcs)
UYPS00010X1000



Don't forget to order Chalkboard Marker
UYAKLM1251 - Colour Marker
UYAKLM1250 - White Marker



TZZZ998701
Optional cable lock kit 2100 mm

MATERIAL : Durable HDPE		WEIGHT	PACKING SIZE
ARTICLE	POSTER SIZE	WITH PACKING	*W X H X D
UPFS2100A2	420 X 600 mm	5,450 kg	495 X 955 X 60 / 430 X 530 X 110 mm
UPFS2200A2	420 X 600 mm	5,450 kg	495 X 955 X 60 / 430 X 530 X 110 mm
UPFS2300A2	420 X 600 mm	5,450 kg	495 X 955 X 60 / 430 X 530 X 110 mm

*W:Width H: Height D:Depth



Street SigPro Match / Master Sign Match

Street SignPro Poster with Lens & without Lens



Street SignPro Board



Mini Street SignPro Board



Street SignPro Deco



SPECIFICATIONS / FRAMES	STREET SIGNPRO WITH LENS	STREET SIGNPRO WITHOUT LENS	STREET SIGNPRO BOARD	MINI STREET SIGNPRO BOARD	STREET SIGNPRO DECO
GRAPHIC SIZE	24" x 36" / 610 x 915 mm	24" x 36" / 610 x 915 mm	24" x 36" / 610 x 915 mm	24.80" x 19.76" / 630 x 502 mm	594 x 841 mm / 23.39" x 33.11"
PROFILE MATERIAL & PROFILE SIZE	Aluminium 1.10" / 28 mm PET 1 mm UV resistant and antireflex	Aluminium 1.10" / 28 mm	-	-	PVC
PROTECTION COVER	HDPE	Without	Without	Without	PET 1 mm UV resistant and antireflex
BACKING MATERIAL	14,5 kg	HDPE	HDPE	HDPE	HDPE
PRODUCT WEIGHT	0.59" / 15 mm	13 kg	8 kg	5 kg	11,5 kg
PRINT ON PROFILE	White and Black	0.59" / 15 mm	-	-	-
COLOR	With poster tape for re-use around 100 times	White and Black	White and Black	Yellow and Silver	Silver, Beige and Black
NON-SLIP POSTER TAPE	0.01" - 0.16" thick / 0,2 mm - 4 mm thick	Without	Without	Without	Without
POSTER THICKNESS	-	Max. 0.20" / 5 mm board	Self adhesive poster to stick-on or vinyl sheeting, fluted PP, metal or Plastech PVC Foam board to apply with well nut	Self adhesive poster to stick-on or vinyl sheeting, fluted PP, metal or Plastech PVC Foam board to apply with well nut	Max thickness 0.078" / 2mm
LOGO PRINTING SIZE	2 wheels	-	-	11.81" x 1.57" / 300 mm x 40 mm (h)	11.81" x 1.57" / 300 mm x 40 mm (h)
WHEELS		2 wheels	2 wheels	Without	2 wheels

Master Sign Flex Poster



Master sign Flex Board

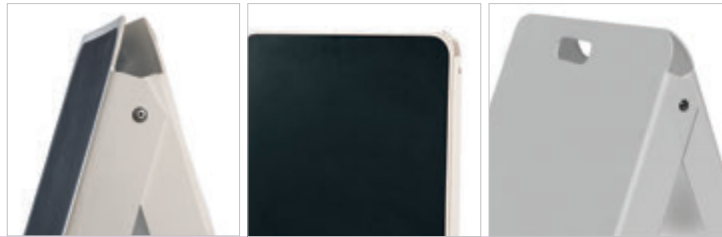


Master Sign Fix Board




SPECIFICATIONS / FRAMES	MASTER SIGN FLEX POSTER	MASTER SIGN BOARD FLEX	MASTER SIGN BOARD FIX
GRAPHIC SIZE	23.39" x 33.11" / 594 x 841 mm	16.54" x 23.62" / 420 x 600 mm	16.54" x 23.62" / 420 x 600 mm
PROTECTION COVER	PET 1 mm UV resistant and antireflex	-	-
BACKING MATERIAL	HDPE	HDPE	HDPE
PRODUCT WEIGHT	2.65 lbs / 12 kg	12.13 lbs / 5,5 kg	9.92 lbs / 4,5 kg
BASE WATER CAPACITY	23 lt	12 lt	12 lt
COLOR	Silver & Black, Black & Black, Beige & Brown	Black & Silver, Silver & Silver, Black & Black, Silver & Black, Beige & Brown	Black & Silver, Silver & Silver, Black & Black, Silver & Black, Beige & Brown
POSTER THICKNESS	Max thickness 0.078" / 2mm	Self adhesive poster to stick-on or vinyl sheeting, fluted PP, metal or Plastech PVC Foam board to apply with well nut	Self adhesive poster to stick-on or vinyl sheeting, fluted PP, metal or Plastech PVC Foam board to apply with well nut
LOGO PRINTING SIZE	11.81" x 1.57" / 300 mm x 40 mm (h)	7.87" x 1.18" / 200 mm x 30 mm (h)	7.87" x 1.18" / 200 mm x 30 mm (h)
WHEELS	2 wheels	2 wheels	2 wheels


PS Boards




Simple plastic pavement board for multiple purposes. PS Display is suitable for inkjet printing and adhesive folio. Easy to move and store. Suitable to write on with water base chalk pens.

Schlichter Strassenständer aus Plastik, der für jede Gelegenheit anwendbar ist. Ist für Inkjet Druck sowie Folie geeignet. Dieser Ständer ist leicht von der Stelle zu bewegen und einfach aufzubewahren. Kann auch mit schwarzer Tafelfolie geliefert werden.

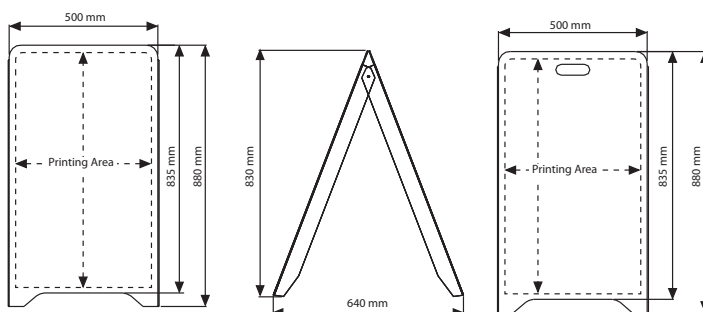
 Product is single packed. Einzeln verpackt.

 No tool assembly. Montage ohne Werkzeugbenutzung.

 Suitable for chalk pens. We sell pens individually in handy sets. Passend für Kreidebeschriftung. Spezielle Stifte werden auf angeboten.



Chalkboard Marker
UYKLM1251 - Colour Marker
UYKLM1250 - White Marker



MATERIAL : Polystyrene				WEIGHT	PACKING SIZE
ARTICLE	SIZE	PRINTING AREA	MODEL	WITH PACKING	*W X H X D
UPYP000000	500 X 880 mm	480 X 815 mm	PS Board	4,300 kg	530 X 910 X 80 mm
UPYPE00000	500 X 880 mm	480 X 815 mm	Carry PS Board	4,300 kg	530 X 910 X 80 mm
UPYP001000	500 X 880 mm	480 X 815 mm	PS Chalk Board	4,300 kg	530 X 910 X 80 mm

* W:Width H: Height D: Depth



Waterbase Pavement Signs



Watch video at our website www.mtdisplays.com



Stable, heavy and enduring pavement sign. Suitable to set aside in parking areas, play grounds, shop entrances and busy pavement roads; especially for windy areas. Standard in metallic RAL 9006 color. By opening the plastic stoppers, you can pour in either water or sand to make the stand heavier.

Stabile, schwere und robuste Strassenaufsteller, die auf Parkplätzen, Eingängen von Einkaufshäusern und auch an Plätzen mit viel Menschenverkehr dekorativ einzusetzen sind. Standardfarbe ist RAL 9006. Durch Wasser- und Sandfüllung durch die Kappen auf der oberen Seite kann man das gewünschte Gewicht erreichen.

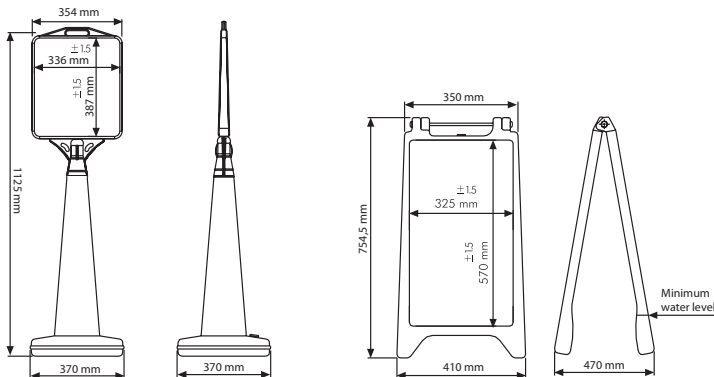
- The product is packed unassembled. Printing area has a +/- 1,5mm tolerance in size. Das Produkt wird demontiert verpackt geliefert. Druckfläche hat +/- 1,5mm Toleranz in der Größe.
- No tool assembly. Montage ohne Werkzeugbenutzung.
- Heavy base provides stability. Suitable for outdoor conditions. Stickers are not included in the original box. Die schwere Fussplatte sorgt für Standfestigkeit. Für den Aussengebrauch geeignet. Abgebildete Aufkleber werden nicht mitgeliefert.



Maximum water capacity is 4,5 liter.
Max. Wasserkapazität 4,5 liter.



Maximum water capacity is 5 liter.
Max. Wasserkapazität 5 liter.



MATERIAL: High density polyethylene			WEIGHT	PACKING SIZE
ARTICLE	MODEL	WEIGHT with water	WITH PACKING	*W X H X D
UWPS005000	Pyramid	5,5 kg	3,565 kg	400 X 700 X 400 mm
UWPS001000	A Board	8 kg	3,560 kg	420 X 720 X 125 mm

*W:Width H: Height D: Depth



Outdoor Displays

- Bicycle Stands
 - Oval Bicycle Stand
 - Round Bicycle Stand
 - Angled Bicycle Wall Stand
 - Oval Bicycle Wall Stand
- PETS Refreshing Corner
 - PETS Refreshing Corner with Waterproof Frame
 - PETS Refreshing Corner with Header

- Bicycle Stands
 - Oval Bicycle Stand
 - Round Bicycle Stand
 - Angled Bicycle Wall Stand
 - Oval Bicycle Wall Stand
- PETS Refreshing Corner
 - PETS Refreshing Corner with waterproof frame
 - PETS Refreshing Corner with Header



Oval Bicycle Stand





Watch video at our website www.mtdisplays.com




Oval Bicycle Stand is suitable for ground surface use. It is made of hot sturdy galvanised steel. Oval Bicycle Stand offers a perfect solution for storage. It is the best secure option for protecting your bike from theft. One module includes 440 X 480 mm and 440 X 330 bicycle stand profile. It is suitable for both small and large bicycle wheels. One module is 700 mm. Profiles can be interlocked each other for multiple use and there is no need for assembly for interlocking process. End caps are attached to the profiles.

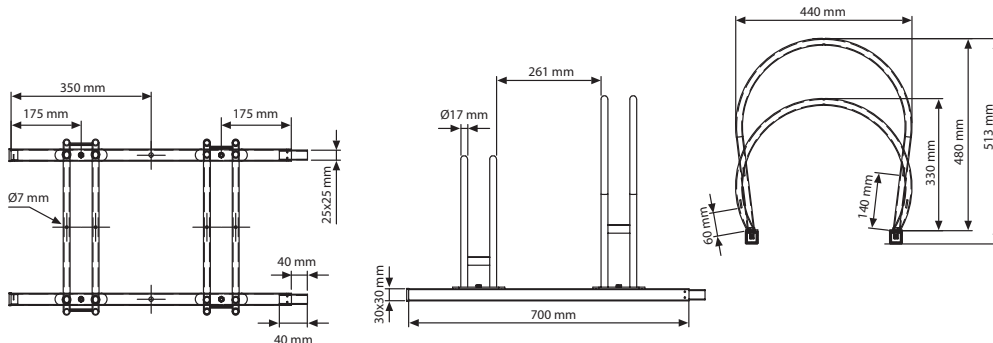
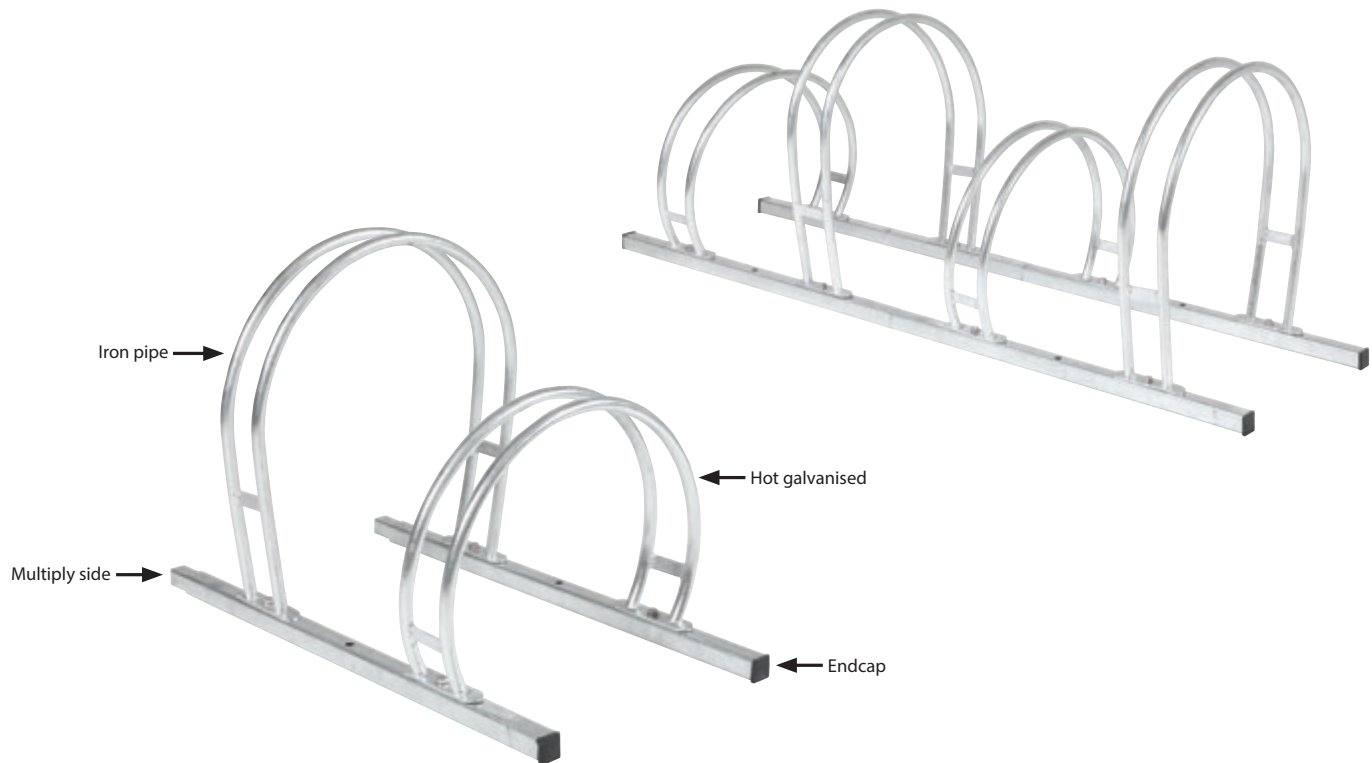
Der Oval Bicycle Stand ist für den Einsatz auf dem Boden geeignet. Es besteht aus feuerverzinktem Stahl und bietet eine perfekte Lösung für den parken. Es ist die beste sichere Option, um Ihr Fahrrad vor Diebstahl zu schützen. Ein Modul beinhaltet 440 x 480 mm und 440 x 330 Fahrradständerprofil. Es ist sowohl für kleine als auch für große Fahrräder geeignet. Ein Modul ist 700 mm lang. Die Profile können zur Mehrfachverwendung miteinander verriegelt werden und es ist keine Montage für den Verriegelungsvorgang erforderlich. An den Profilen sind Endkappen angebracht.

 One module includes 440 X 480 mm and 440 X 330 bicycle stand profile.
Ein Modul umfasst 440 x 480 mm und 440 x 330 Fahrradständerprofil.

 Profiles are optional for multiple use.
Profile sind optional für mehrfache Verwendung.

 Assembly in 60 seconds.
Montage in 60 Sekunden.

Multiply the bike stand



MATERIAL: Iron		WEIGHT	PACKING SIZE
ARTICLE	DESCRIPTION	WITH PACKING	*W X H X D
UOBS001000	Hot Galvanised	7,250 kg	470 X 780 X 165 mm



* W:Width H: Height D: Depth

Oval Bicycle Stand Finish





Watch video at our website www.mtdisplays.com




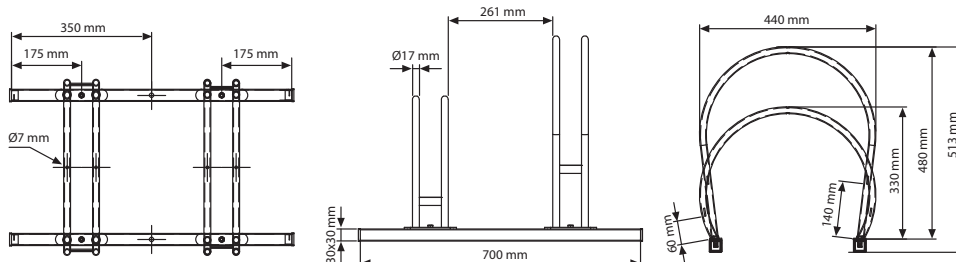
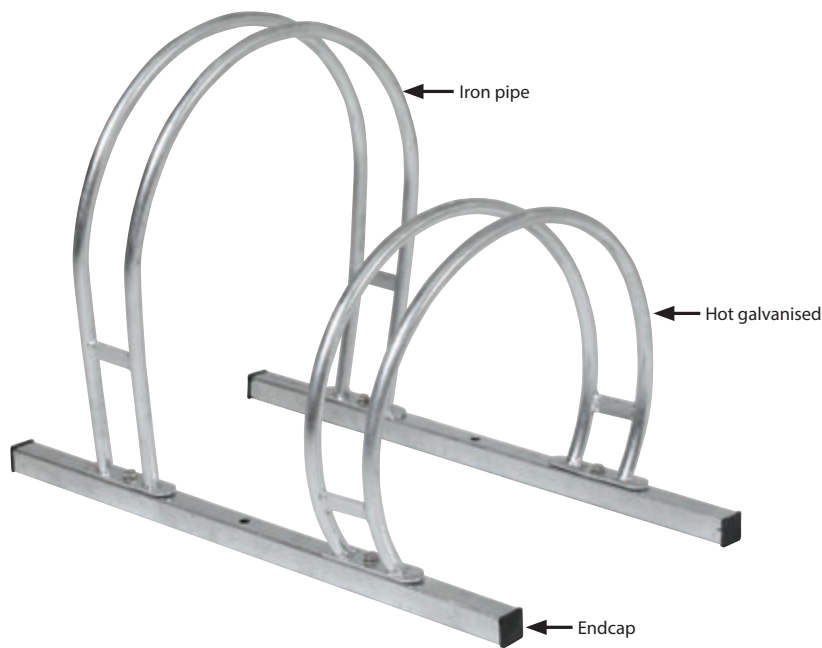
Oval Bicycle Stand is suitable for ground surface use. It made of hot sturdy galvanised steel. Oval Bicycle Stand offers a perfect solution for storage. It is the best secure option for protecting your bike from theft. One module includes 440 X 480 mm and 440 X 330 bicycle stand profile. It is suitable for both small and large bicycle wheels. One module is 700 mm. Profiles can be interlocked each other for multiple use and there is no need for assembly for interlocking process. End caps are attached to the profiles.

Der Oval Bicycle Stand ist für den Einsatz auf dem Boden geeignet. Es besteht aus feuerverzinktem Stahl und bietet eine perfekte Lösung für den parken. Es ist die beste sichere Option, um Ihr Fahrrad vor Diebstahl zu schützen. Ein Modul beinhaltet 440 x 480 mm und 440 x 330 Fahrradständerprofil. Es ist sowohl für kleine als auch für große Fahrräder geeignet. Ein Modul ist 700 mm lang. Die Profile können zur Mehrfachverwendung miteinander verriegelt werden und es ist keine Montage für den Verriegelungsvorgang erforderlich. An den Profilen sind Endkappen angebracht.

 One module includes 440 X 480 mm and 440 X 330 bicycle stand profile.
Ein Modul umfasst 440 x 480 mm und 440 x 330 Fahrradständerprofil.

 Profiles are optional for multiple use.
Profile sind optional für mehrfache Verwendung.

 Assembly in 60 seconds.
Montage in 60 Sekunden.



MATERIAL: Iron		WEIGHT	PACKING SIZE
ARTICLE	DESCRIPTION	WITH PACKING	*W X H X D
UOBS002000	Finish Hot Galvanised	6,600 kg	470 X 735 X 165 mm



*W:Width H: Height D: Depth

Round Bicycle Stand



Watch video at our website www.mtdisplays.com



Round Bicycle Stand is suitable for ground surface use. It is made of hot sturdy galvanised steel. Round Bicycle Stand offers a perfect solution for storage. It is the best secure option for protecting your bike from theft. One module includes X2 440 X 330 bicycle stand profiles. One module has 700 mm width. Profiles can be interlocked each other for multiple use and there is no need for assembly for interlocking process. End caps are attached to the profiles.

Der Round Bicycle Stand ist für den Einsatz auf dem Boden geeignet. Es besteht aus feuerverzinktem Stahl. Der runde Fahrradständer bietet eine perfekte Lösung für die Aufbewahrung. Es ist die beste sichere Option, um Ihr Fahrrad vor Diebstahl zu schützen. Ein Modul beinhaltet X2 440 X 330 Fahrradständerprofile. Ein Modul hat eine Windung von 700 mm. Die Profile können zur Mehrfachverwendung miteinander verriegelt werden und es ist keine Montage für den Verriegelungsvorgang erforderlich. An den Profilen sind Endkappen angebracht.



One module includes 2x 440 x 330mm bicycle stand profiles.
Ein Modul enthält 2x 440 X 330mm Fahrradständerprofile.

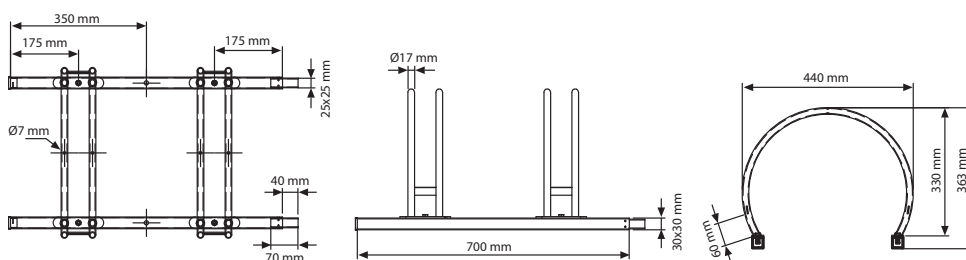
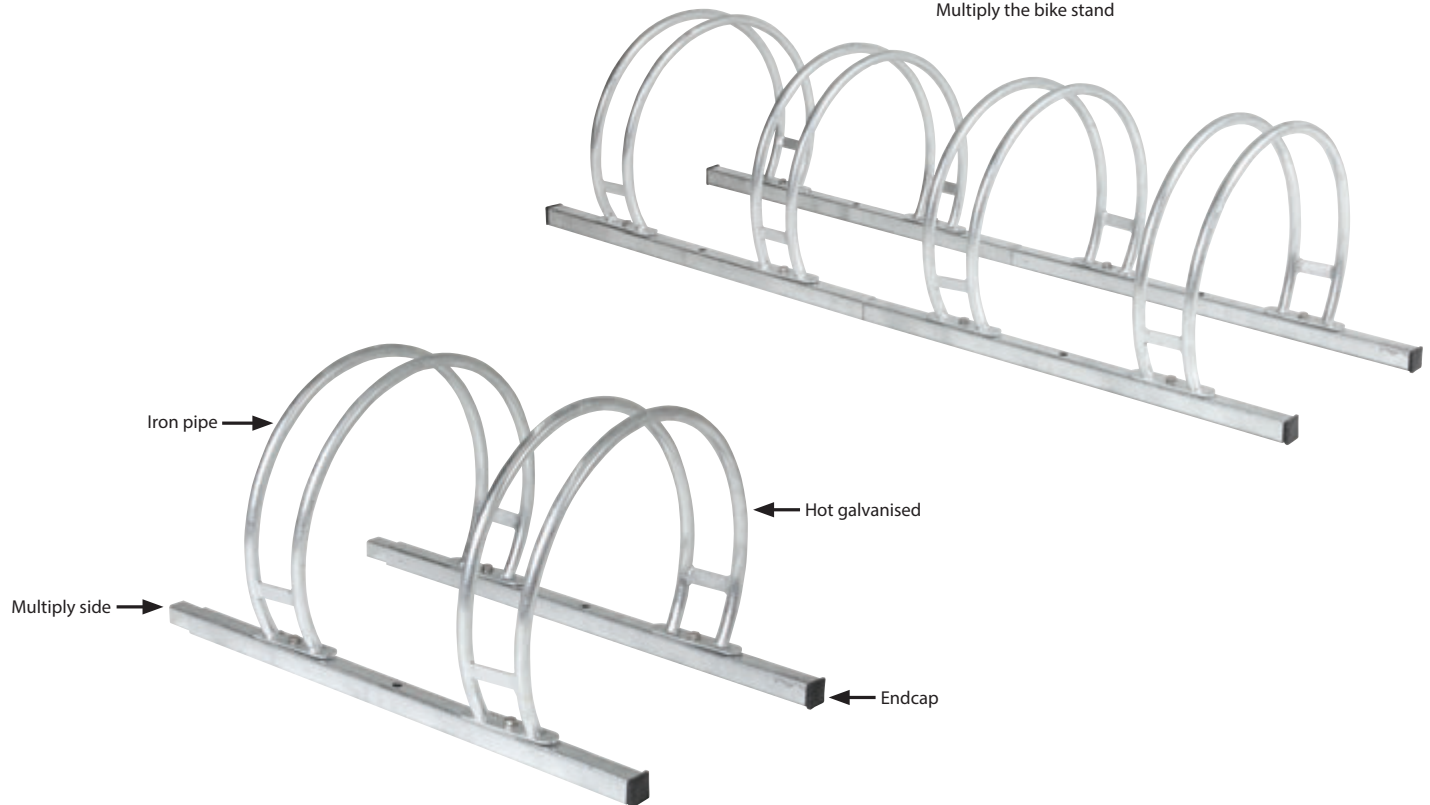


Profiles are optional for multiple use.
Profile sind optional für mehrfache Verwendung.



Assembly in 60 seconds.
Montage in 60 Sekunden.

Multiply the bike stand



MATERIAL: Iron		WEIGHT	PACKING SIZE
ARTICLE	DESCRIPTION	WITH PACKING	*W X H X D
UOBSR01000	Hot Galvanised	6,850 kg	470 X 780 X 165 mm

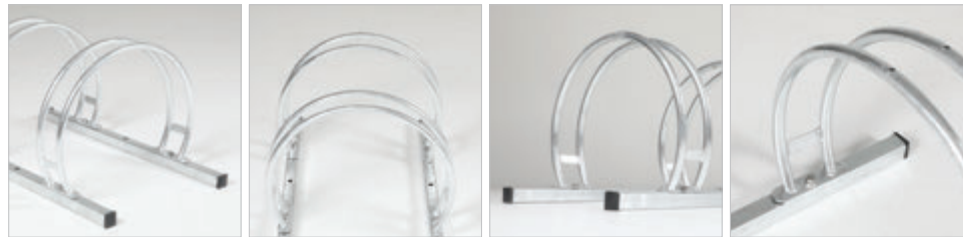


* W:Width H: Height D: Depth

Round Bicycle Stand Finish



Watch video at our website www.mtdisplays.com



Round Bicycle Stand is suitable for ground surface use. It is made of hot sturdy galvanised steel. Round Bicycle Stand offers a perfect solution for storage. It is the best secure option for protecting your bike from theft. One module includes X2 440 X 330 bicycle stand profiles. One module has 700 mm width. Profiles can be interlocked each other for multiple use and there is no need for assembly for interlocking process. End caps are attached to the profiles.

Der Round Bicycle Stand ist für den Einsatz auf dem Boden geeignet. Es besteht aus feuerverzinktem Stahl. Der runde Fahrradständer bietet eine perfekte Lösung für die Aufbewahrung. Es ist die beste sichere Option, um Ihr Fahrrad vor Diebstahl zu schützen. Ein Modul beinhaltet X2 440 X 330 Fahrradständerprofile. Ein Modul hat eine Windung von 700 mm. Die Profile können zur Mehrfachverwendung miteinander verriegelt werden und es ist keine Montage für den Verriegelungsvorgang erforderlich. An den Profilen sind Endkappen angebracht.



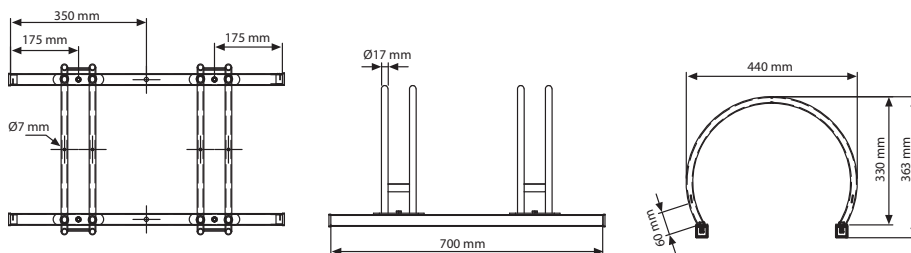
One module includes 2x 440 x 330mm bicycle stand profiles.
Ein Modul enthält 2x 440 X 330mm Fahrradständerprofile.



Profiles are optional for multiple use.
Profile sind optional für mehrfache Verwendung.



Assembly in 60 seconds.
Montage in 60 Sekunden.



MATERIAL: Iron		WEIGHT	PACKING SIZE
ARTICLE	DESCRIPTION	WITH PACKING	*W X H X D
UOBSR02000	Finish Hot Galvanised	6,150 kg	470 X 735 X 165 mm

* W:Width H: Height D: Depth



Angled Bicycle Wall Stand



Watch video at our website www.mtdisplays.com



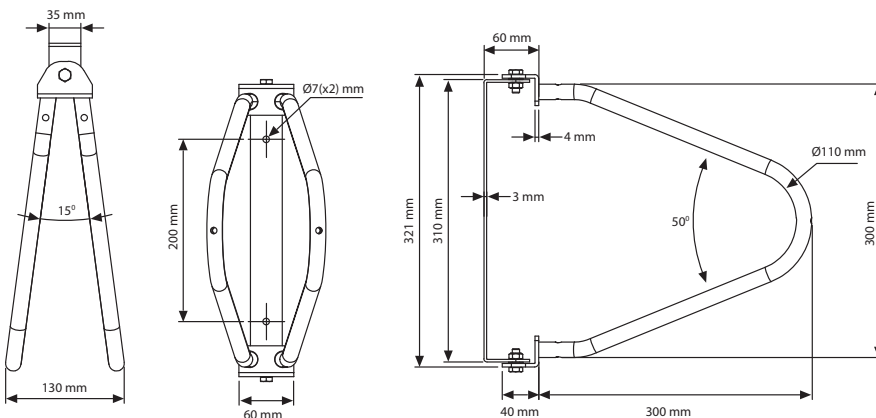
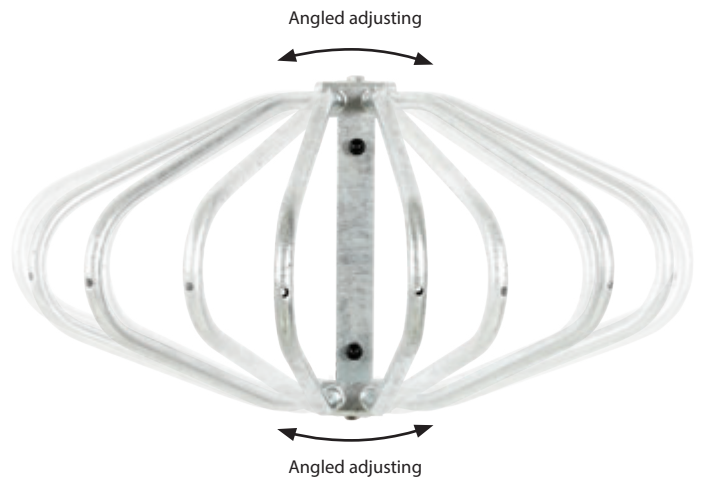
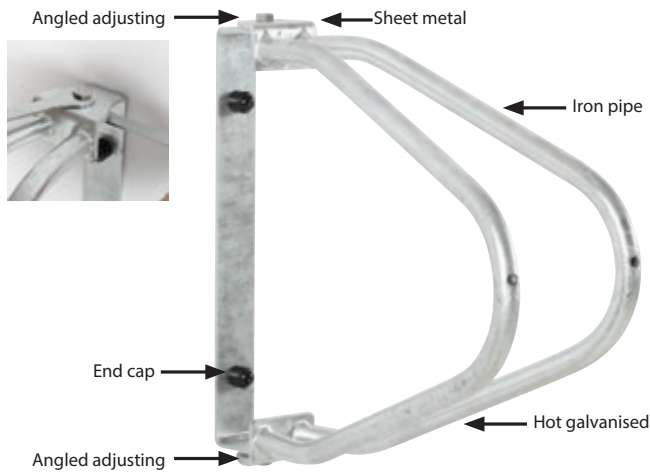
Angled Bicycle Wall Stand is suitable for wall mounting. It is made of hot sturdy galvanised steel. Angled Bicycle Wall Stand offers a perfect solution for storage. It is the best secure option for protecting your bike from theft. One module includes 2 stopper and 1 bicycle wall stand. The angle can be adjusted by widening the top screw. 2 screw and anchor are included for assembly.

Der Angled Bicycle Wall Stand ist für die Wandmontage geeignet. Es besteht aus feuerverzinktem Stahl. Der abgewinkelte Wandständer für Fahrräder bietet eine perfekte Lösung für die Aufbewahrung. Es ist die beste sichere Option, um Ihr Fahrrad vor Diebstahl zu schützen. Ein Modul beinhaltet 2 Stopper und 1 Fahrradwandständer. Der Winkel kann durch Aufweiten der oberen Schraube eingestellt werden. 2 Schrauben und Dübel sind für die Montage enthalten.

One module includes bicycle wall stand that has 2 stopper.
Ein Modul enthält einen Fahrradwandständer mit 2 Stoppern.

The angle can be adjusted.
Der Winkel lässt sich verstellen.

Assembly in 60 seconds.
Montage in 60 Sekunden.



MATERIAL: Iron		WEIGHT	PACKING SIZE
ARTICLE	DESCRIPTION	WITH PACKING	*W X H X D
UOBSAW000	Hot Galvanised	2,100 kg	355 X 380 X 145 mm



*W:Width H: Height D: Depth

Oval Bicycle Wall Stand



Watch video at our website www.mtdisplays.com



Oval Bicycle Wall Stand is suitable for wall mounting. It is made of hot sturdy galvanised steel. Oval Bicycle Wall Stand offers a perfect solution for storage. One module includes X2 bicycle wall stand that has 4 stopper. 4 screw and anchor are included for assembly.

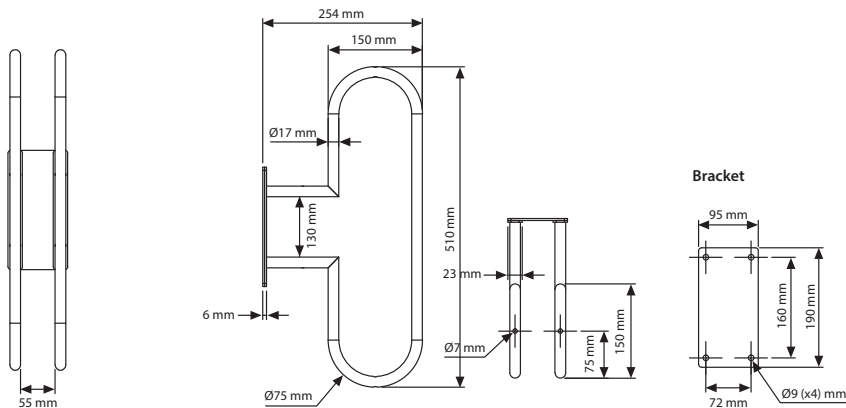
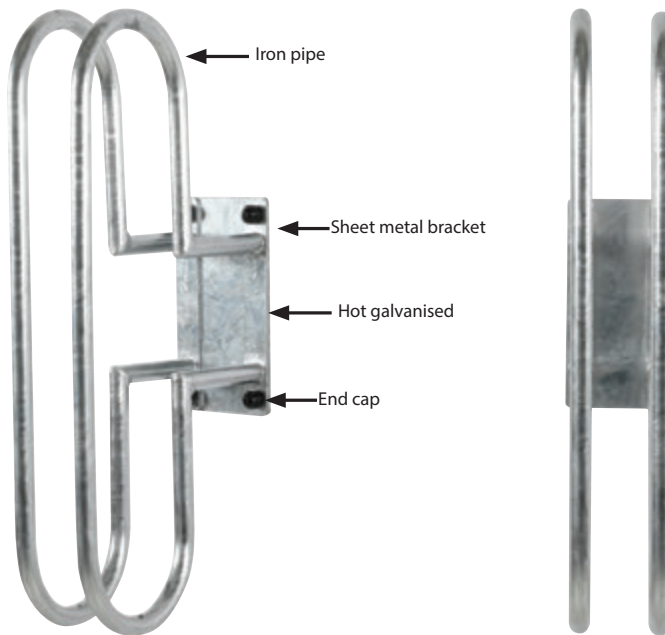
Der Oval Bicycle Wall Stand ist für die Wandmontage geeignet. Es besteht aus feuerverzinktem Stahl. Der ovale Fahrradwandständer bietet eine perfekte Lösung für die Aufbewahrung. Ein Modul enthält einen X2-Fahrradwandständer mit 4 Stoppern. 4 Schrauben und Dübel sind für die Montage enthalten.



One module includes X2 bicycle wall stand that has 4 stopper.
Ein Modul enthält einen X2-Fahrradwandständer mit 4 Stoppern.



Assembly in 60 seconds.
Montage in 60 Sekunden.



MATERIAL: Iron		WEIGHT	PACKING SIZE
ARTICLE	DESCRIPTION	WITH PACKING	*W X H X D
UOBSOW0000	Hot Galvanised	2,850 kg	290 X 545 X 65 mm



*W:Width H: Height D: Depth

PETS Refreshing Corner with Weatherproof Frame



Watch video at our website www.mtdisplays.com



Pets Refreshing Corner With Weatherproof Frame is ideal for small-sized animals. It is easy to change poster with its click clack snap open working principle. It is equipped with anti-glare poster cover sheet. Frame has natural silver or black anodized aluminium options. RAL colour options are available as well. Black rubber wick at the bottom prevents sliding. Suitable for feeding dogs, cats and other small pets. PETS Refreshing Corner offers you a perfect solution for pet-friendly facility like restaurants, hotels and shopping centres. It creates a friendly atmosphere to your advertisement for your retail business. You can make your advertisement while our friends are feeding themselves.

Pets Refreshing Corner mit wetterfestem Rahmen ist ideal für kleine Haustiere. Es ist einfach, das Poster mit seinem Klick-Klack-Funktionsprinzip zu wechseln. Ausgestattet mit PET-Plakatdeckblatt. Rahmen mit Optionen aus silber oder schwarz eloxiertem Aluminium. RAL-Farboptionen sind ebenfalls verfügbar. Schwarzer Gummidocht an der Unterseite verhindert ein Verrutschen. Geeignet zum Füttern von Hunden, Katzen und anderen kleinen Haustieren. PETS Refreshing Corner bietet Ihnen eine perfekte Lösung für haustierfreundliche Einrichtungen wie Restaurants, Hotels und Einkaufszentren.

Max length is 2200 mm and max perimeter is 6400 mm.
Die maximale Länge beträgt 2200 mm und der maximale Umfang 6400 mm.

2 water bowls are included.
2 Wassernäpfe sind im Lieferumfang enthalten.

Made of safe material and the dimension of the product is designed for easy access to food. Hergestellt aus sicherem Material und die Abmessungen des Produkts sind für einen einfachen Zugang zu Lebensmitteln ausgelegt.

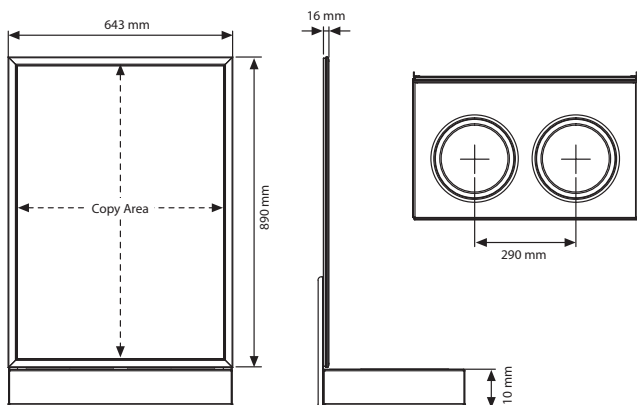
Assembly in 75 seconds.
Montage in 75 Sekunden.

2 boxes.
2 boxes.

Snap open



Snap open



MATERIAL: Sheet metal					WEIGHT	PACKING SIZE
ARTICLE	EXTERNAL (x-y)	POSTER	COPY	DESCRIPTION	WITH PACKING	*W X H X D
UOPRN100A1	643 X 890 mm	594 X 841 mm	592 X 839 mm	Silver	10,600 kg	450 X 670 X 125 / 670 X 1030 X 55 mm
UOPRB100A1	643 X 890 mm	594 X 841 mm	592 X 839 mm	Black	10,600 kg	450 X 670 X 125 / 670 X 1030 X 55 mm

*W:Width H:Height D:Depth



PETS Refreshing Corner with Header



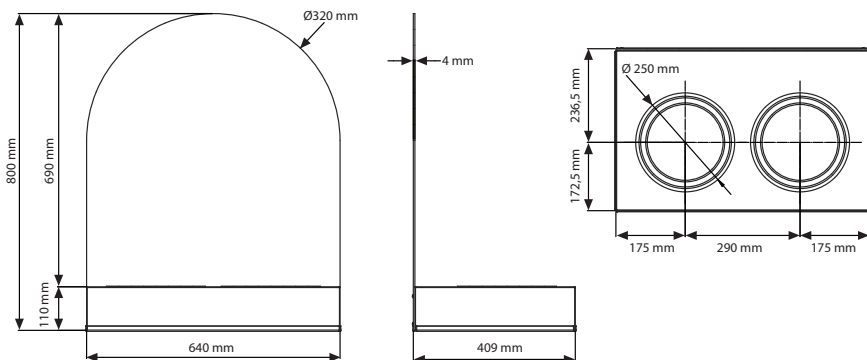
Watch video at our website www.mtdisplays.com



Pets Refreshing Corner With Header is ideal for small-sized PET's. Header panel is made of aluminium and suitable for printing. RAL colour options are available. Black rubber wick at the bottom prevents sliding. 2 water bowls are included. It is made of safe material and the dimension of the product is designed for easy access to food. Suitable for feeding dogs, cats and other small pets. PETS Refreshing Corner offers you a perfect solution for pet-friendly facility like restaurants, hotels and shopping centres. It creates a friendly atmosphere to your advertisement while our friends are feeding themselves.

Pets Refreshing Corner With Header ist ideal für kleine Haustiere. Header-Panel ist aus Aluminium und zum Bedrucken geeignet. RAL-Farboptionen sind verfügbar. Schwarze GummifüÙe an der Unterseite verhindern ein Verrutschen. 2 WassernäÙe sind im Lieferumfang enthalten. Die Abmessungen des Produkts sind für einen einfachen Zugang zu Lebensmitteln ausgelegt. Geeignet zum Füttern von Hunden, Katzen und anderen kleinen Haustieren. Bietet eine perfekte Lösung für haustierfreundliche Einrichtungen wie Restaurants, Hotels und Einkaufszentren

-  Header panel is suitable for printing. Header-Panel ist zum Bedrucken geeignet.
-  2 water bowls are included. 2 WassernäÙe sind im Lieferumfang enthalten.
-  Made of safe material and the dimension of the product is designed for easy access to food. Hergestellt aus sicherem Material und die Abmessungen des Produkts sind für einen einfachen Zugang zu Lebensmitteln ausgelegt
-  Assembly in 75 seconds. Montage in 75 Sekunden.
-  2 boxes. 2 boxes.



MATERIAL: Sheet metal		WEIGHT	PACKING SIZE
ARTICLE	DESCRIPTION	WITH PACKING	*W X H X D
UOPRN20010	Silver	10,400 kg	450 X 670 X 125 / 675 X 830 X 35 mm



* W:Width H: Height D: Depth

PETS Refreshing Corner with Weatherproof Frame





Wood Displays

- Wooden Frames
 - Easy Wood Frame
 - Frameless Wooden Frame
- Wood Slide-in Frame
- Wood A Board Indoor
- Wood A Board Outdoor
- Timber Chalk Board
- Wood Chalk Floor Stand
- Wood Dry Erase Floor Stand
- Nature Line Writing Board
- Wall Mount Wooden Card Holder
- Wood Magazine Rack for Wall

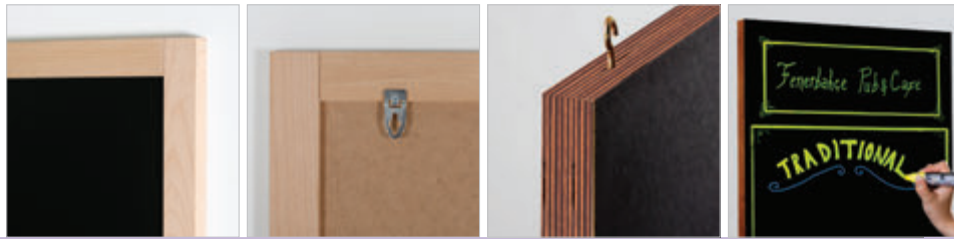
- Free Standing Wood Magazine Rack
- Desktop Wooden Card Holder
- Counter Wood Chalk Frame
- Desktop Easel
- Petite Desktop Easel
- Wooden Roll Stand
- Wood Folding Luggage Rack
- Foldable Wood Box

- Holzrahmen
 - Einfacher Holzrahmen
 - Schreibtafel Ohne Rahmen
- Wood Slide-in Frame
- Wood A Board Indoor
- Wood A Board Outdoor
- Timber Chalk Board
- Wood Chalk Floor Stand
- Wood Dry Erase Floor Stand
- Nature Line Writing Board
- Wall Mount Wooden Card Holder
- Wood Magazine Rack for Wall

- Free Standing Wood Magazine Rack
- Desktop Wooden Card Holder
- Counter Wood Chalk Frame
- Desktop Easel
- Petite Desktop Easel
- Wooden Roll Stand
- Wood Folding Luggage Rack
- Foldable Wood Box



Wooden Frames



Suitable for the display of messages in restaurants, cafés, bars, malls, offices and education centers. The erasable surface enables you to erase your messages and transmit them to your audience while keeping them updated. You can use a chalkboard pen to write on the black surface. There are also special water-based and scent-free markers. We sell chalk pens individually 2 in convenient sets.

Holzrahmen als Angebotstafel sind ideal für Restaurants, Cafés, Bars, Büros und Schulen geeignet. Die abwischbare Oberfläche ermöglicht Ihnen schnelles ändern Ihrer Informationen während Ihnen Aufmerksamkeit zugewendet ist. Sie können Tafelstifte auf schwarzen Oberflächen benutzen, oder auch geruchsfreie Boardmarker auf wasserbasis können auf weiss beschichteten Holztafeln eingesetzt werden. Wir bieten in 2 verschiedenen Versionen Tafelstifte an.



Each unit comes ready with mounting set, and easy to assemble instruction sheet. Jeder Artikel wird mit leicht verständlicher Montageanleitung und Befestigungsmaterial geliefert.



Chalkboard pens are not included in the original pack, should be ordered separate. For spotless removing of chalk pens from surface, please use window & glass cleaner otherwise clean with damp cloth. Tafelstifte werden nicht mitgeliefert und müssen extra bestellt werden. Um eine fleckenfreie Entfernung der Tafelstiftschicht von der Oberfläche zu gewährleisten, benutzen Sie bitte Fenster- oder Glasreiniger oder zumindest ein feuchtes Tuch.

Easy to wipe off

Windows, board and all non-porous surfaces.



Easy Wood Frame

← Beech wood



← Easel order separately. See page 84



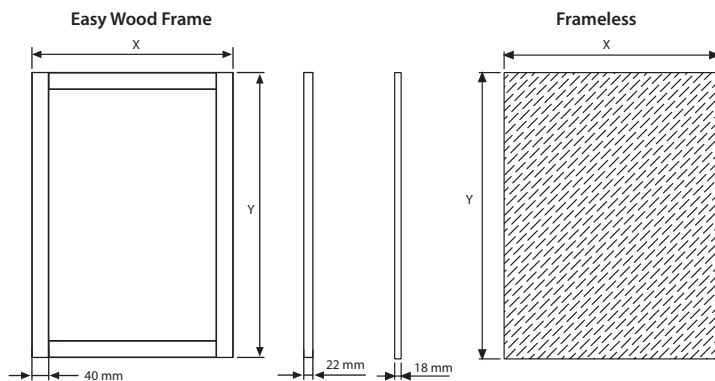
Frameless Wooden Frame



→ Easel order separately. See page 83.



Don't forget to order Chalkboard Marker UYAKLM1251 - Colour Marker UYAKLM1250 - White Marker



FRAMELESS : Fir wood			WEIGHT	PACKING SIZE
ARTICLE	SIZE	DESCRIPTION	WITH PACKING	*W X H X D
UWFF010034	300 X 400 mm	Black Chalkboard	0,795 kg	320 X 430 X 24 mm
UWFF010046	400 X 600 mm	Black Chalkboard	1,230 kg	420X 630 X 24 mm
UWFF010049	400 X 900 mm	Black Chalkboard	1,995 kg	420 X 930 X 24 mm
UWFF010068	600 X 800 mm	Black Chalkboard	2,070 kg	620 X 830 X 24 mm
UWFF010061	600 X 1150 mm	Black Chalkboard	2,915 kg	620 X 1230 X 24 mm
UWFF010081	800 X 1200 mm	Black Chalkboard	4,530 kg	820 X 1230 X 24 mm

EASY WOOD FRAME : Beech wood					WEIGHT	PACKING SIZE
NATURAL WOOD	DARK WOOD	EXTERNAL	SIZE	DESCRIPTION	WITH PACKING	*W X H X D
UWSS010034	UWSS010034	380 X 480 mm	300 X 400 mm	Black Chalkboard	1,060 kg	400 X 510 X 24 mm
UWSS010046	UWSS010046	480 X 680 mm	400 X 600 mm	Black Chalkboard	1,650 kg	500 X 710 X 24 mm
UWSS010049	UWSS010049	480 X 980 mm	400 X 900 mm	Black Chalkboard	3,065 kg	500 X 1010 X 24 mm
UWSS010068	UWSS010068	680 X 880 mm	600 X 800 mm	Black Chalkboard	3,400 kg	700 X 910 X 24 mm
UWSS010061	UWSS010061	680 X 1230 mm	600 X 1150 mm	Black Chalkboard	4,340 kg	700 X 1310 X 24 mm
UWSS010081	UWSS010081	880 X 1280 mm	800 X 1200 mm	Black Chalkboard	5,050 kg	900 X 1310 X 24 mm

*W:Width H: Height D: Depth



Wood Slide-in Frame



Watch video at our website www.mtdisplays.com



Wood Podium is made of Beech plywood wood. It is a good lectern solution with 15 degrees viewing angle for ergonomic posture. It has an interior shelf for keeping notes and presentation materials organized. Poster clamp in front of the stand allows you to present your brand's logo for a professional fixture. Can be used at business conferences, universities, hotels, or even trade shows. To ensure sustainability of the quality, wood podium holders are lacquered finished.

Wood Podium besteht aus Buchensperrholz. Es ist eine gute Pultlösung mit einem Betrachtungswinkel von 15 Grad für eine ergonomische Haltung. Es verfügt über ein Innenregal für Notizen und Präsentationsmaterial. Dank der Poster-Klammer können Sie ihr Markenlogo professionel präsentieren. Kann bei Geschäftskonferenzen, Universitäten, Hotels oder sogar Messen eingesetzt werden. Um die Nachhaltigkeit der Qualität zu gewährleisten, werden Holzpodesthalter lackiert.



Packed unassembled with an easy-to-understand instruction sheet & fixing elements. Unmontiert verpackt mit einem leicht verständlichem Anleitungsblatt und Befestigungselementen.



With and without wheel options are available. Optional mit und ohne Räder erhältlich.



10 mm poster is placed within the clamping system. End caps help to slide the poster in and keep. Das 10-mm-Poster wird in das Klemmsystem eingelegt. Bewegliche Endkappen helfen um das Poster einzuschieben.



1 pack. See info chart for pack sizes. 1 Packung. Siehe Packungsgrößen.



Assembly time approx 120 seconds. Montagezeit ca. 120 Sekunden.



Natural Wood

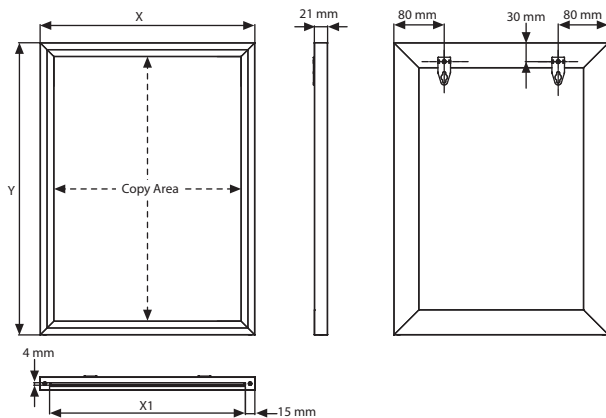


Hanger mounting for double sided use.



Landscape & portrait wall mounting

Dark Wood



Don't forget to order Chalkboard Marker
UYAKLM1251 - Colour Marker
UYAKLM1250 - White Marker

MATERIAL : Beech wood					WEIGHT	PACKING SIZE
DARK WOOD	NATURAL WOOD	EXTERNAL (x-y)	COPY AREA	X1	WITH PACKING	*W X H X D
UWSFD000A4	UWSFN000A4	254 X 341 mm	210 X 297 mm	224 mm	0,590 kg	280 X 370 X 30 mm
UWSFD000A3	UWSFN000A3	341 X 464 mm	297 X 420 mm	311 mm	0,960 kg	370 X 490 X 30 mm
UWSFD000A2	UWSFN000A2	464 X 638 mm	420 X 594 mm	434 mm	1,550 kg	490 X 660 X 30 mm
UWSFD000A1	UWSFN000A1	638 X 885 mm	594 X 841 mm	608 mm	2,600 kg	670 X 910 X 30 mm
UWSFD00081	UWSFN00081	260 X 324 mm	8.5" X 11"	230 mm	0,580 kg	280 X 340 X 30 mm
UWSFD00017	UWSFN00017	324 X 476 mm	11" X 17"	294 mm	0,950 kg	340 X 500 X 30 mm
UWSFD00018	UWSFN00018	502 X 654 mm	18" X 24"	472 mm	1,650 kg	520 X 670 X 30 mm
UWSFD00022	UWSFN00022	603 X 756 mm	22" X 28"	573 mm	2,200 kg	620 X 770 X 30 mm
UWSFD00024	UWSFN00024	654 X 959 mm	24" X 36"	624 mm	2,900 kg	680 X 980 X 30 mm

* W:Width H:Height D:Depth



Wood A Board Indoor



It is made of solid wood. MDF backing is suitable for closed areas. The erasable surface enables for erasing the messages and transmit them to your audience while keeping as updated. Chalkboard pen can be used for black surfaces to display the messages. Also water-based and scent free markers are proper for writing on it. Suitable for indoor places such as restaurants, cafes, bars, malls, offices and education centers.

Es besteht aus einer massiven Holzkonstruktion. Die MDF Rückwand bietet die Verfügbarkeit für den Einsatz im Innenbereich. Die abwischbare Oberfläche ermöglicht Ihnen schnelles ändern Ihrer Information während Ihnen Aufmerksamkeit zugewendet ist. Um Ihre Informationen weiterzuleiten, können Tafelstifte auf schwarzer Oberfläche benutzt werden. Auch geruchsfreie Boardmarker auf wasserbasis können verwendet werden. Passend für den Inneneinsatz in Restaurants, Cafes, Bars, Einkaufszentren, Büros und Schulen.

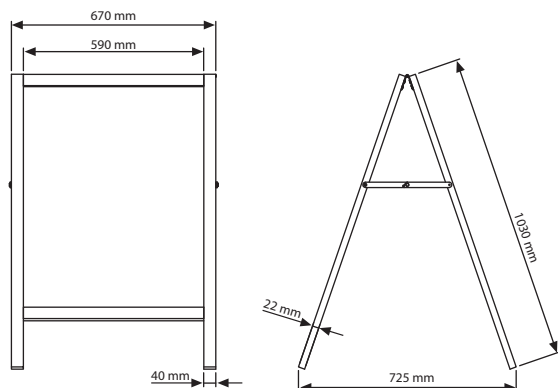


Each unit comes ready to use without any tool for assembly.

Jeder Artikel wird fertig zum Einsatz geliefert.



Chalkboard pen should be ordered separately. Tafelstifte müssen extra bestellt werden.



Don't forget to order
Chalkboard Marker
UYAKLM1251 - Colour Marker
UYAKLM1250 - White Marker

MATERIAL : Beech wood			WEIGHT	PACKING SIZE
ARTICLE	SIZE	DESCRIPTION	WITH PACKING	*W X H X D
UWID006078	590 X 780 mm	Black chalkboard	8,470 kg	715 X 1050 X 55 mm

*W:Width H: Height D: Depth



Wood A Board Outdoor



It is made of solid wood. Aluminum composite backing provides availability for open air usage for Outdoor A Board.

The erasable surface enables for erasing the messages and transmit them to your audience while keeping as updated easily. Chalkboard pen can be used for black surfaces to display the messages. Also water-based and scent free markers are proper for writing on it. Suitable for outdoor places such as restaurants, cafes, bars, malls, offices and education centers.

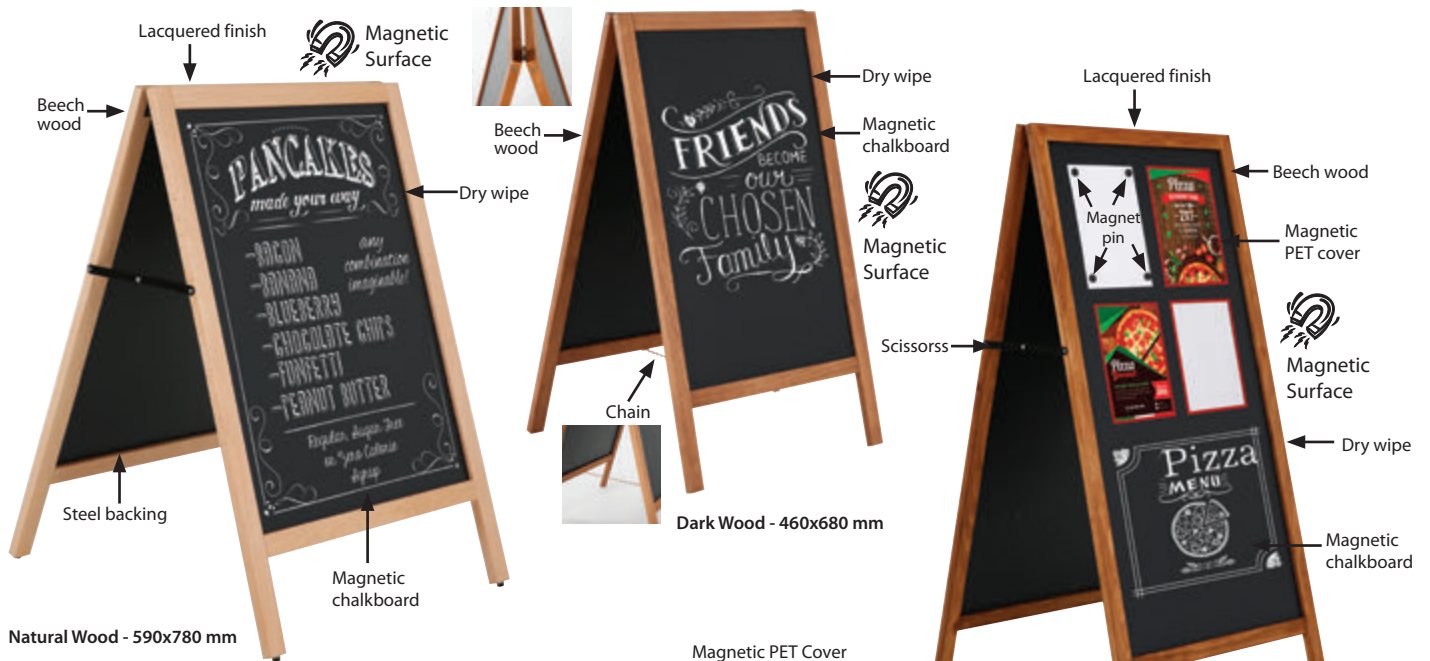
Der Rahmen besteht aus einer massiven Holzkonstruktion. Die Aluminium-Verbundplatte an der Rückwand bietet die Verfügbarkeit für den Einsatz im Aussenbereich des Outdoor A-Boards. Die abwischbare Oberfläche ermöglicht Ihnen schnelles ändern Ihrer Information während Ihnen Aufmerksamkeit zugewendet ist. Um Ihre Informationen weiterzuleiten, können Tafelstifte auf schwarzer Oberfläche benutzt werden. Auch geruchsfreie Boardmarker auf wasserbasis können verwendet werden. Passend für den Ausseneinsatz in Restaurants, Cafes, Bars, Einkaufszentren, Büros und Schulen.



Each unit comes ready to use without any tool for assembly. Jeder Artikel wird fertig zum Einsatz geliefert.



Chalkboard pen should be ordered separately. Henge and chain is different on 460x680 mm than other sizes which aims to increase performance of small size. Tafelstifte müssen extra bestellt werden. Scharnier und Kette unterscheiden sich bei der Größe 460 x 680 mm von anderen Größen, speziell um die Leistung des Artikels in kleinen Größen zu steigern.



Natural Wood - 590x780 mm

Dark Wood - 460x680 mm

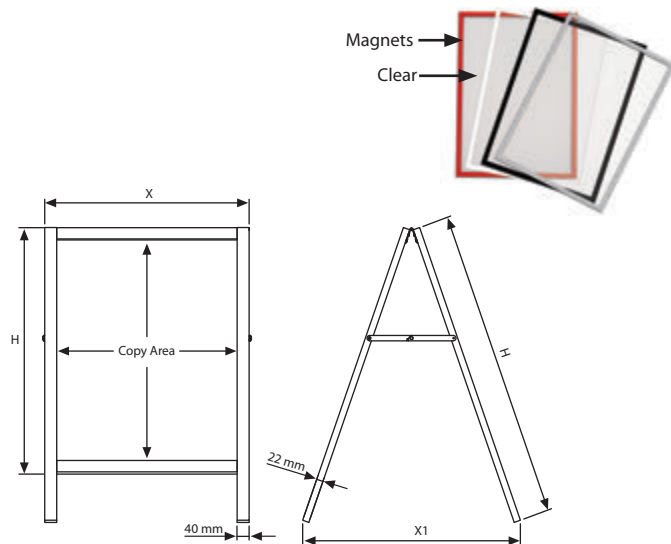
Dark Wood - 590x1190 mm

Magnetic PET Cover
Please don't forget to order

MAGNETIC PET COVER		
ARTICLE	SIZE	COLOUR
UPCMOR00A4	210 X 297 mm	Red
UPCMOB00A4	210 X 297 mm	Black
UPCMOW00A4	210 X 297 mm	White
UPCMOG00A4	210 X 297 mm	Grey
UPCMOG00A5	105 X 148 mm	Grey
UPCMOB00A5	105 X 148 mm	Black



Don't forget to order
Chalkboard Marker
UYAKLM1251 - Colour Marker
UYAKLM1250 - White Marker



MATERIAL - Beech wood						WEIGHT	PACKING SIZE
ARTICLE	EXTERNAL (x-y)	SIZE	DESCRIPTION	H	X1	WITH PACKING	*W X H X D
UWOD004668	540 X 760 mm	460 X 680 mm	Natural Wood	950 mm	510 mm	7,800 kg	560 X 950 X 60 mm
UWOD004668	540 X 760 mm	460 X 680 mm	Dark Wood	950 mm	510 mm	7,800 kg	560 X 950 X 60 mm
UWOD006078	670 X 860 mm	590 X 780 mm	Natural Wood	1050 mm	560 mm	8,470 kg	715 X 1050 X 55 mm
UWOD006078	670 X 860 mm	590 X 780 mm	Dark Wood	1050 mm	560 mm	8,470 kg	715 X 1050 X 55 mm
UWOD006012	670 X 1270 mm	590 X 1190 mm	Natural Wood	1450 mm	750 mm	15,160 kg	715 X 1490 X 60 mm
UWOD006012	670 X 1270 mm	590 X 1190 mm	Dark Wood	1450 mm	750 mm	15,160 kg	715 X 1490 X 60 mm

*W:Width H: Height D: Depth



Timber Chalk Board



Watch video at our website www.mtdisplays.com



Timber Chalk Board is made of solid Beech wood. Slide in panels are galvanised steel sheets which ensures for outdoor use as heavy and rust-free. The erasable surface enables for erasing the messages and transmit them to your audience while keeping as updated easily. Slide in panels are double sided to make sure timely use of A Frame. So two different messages of advertisement can be stored on the panels. Chalk or chalkboard water-based pen can be used for black surfaces to display the messages. Suitable for outdoor places such as restaurants, cafes, bars, malls, offices and many more.

Timber Chalk Board ist aus massivem Buchenholz gefertigt. Einschubplatten sind aus verzinktem Stahlblech, was für den Außeneinsatz schwer und rostfrei ist. Die abwischbare Oberfläche ermöglicht das schnelle ändern und weiterleiten von Nachrichten. Die Einschubplatten sind doppelseitig, um einen schnellen Einsatz des Rahmens zu gewährleisten. So können zwei verschiedene Werbemeldungen auf den Panelen gehalten werden. Auf Wasser basierende Tafelstifte oder Kreide können für Ihre Meldungen auf den schwarze Oberflächen verwendet werden. Geeignet für Außenbereiche wie Restaurants, Cafés, Bars, Einkaufszentren, Büros und vieles mehr.

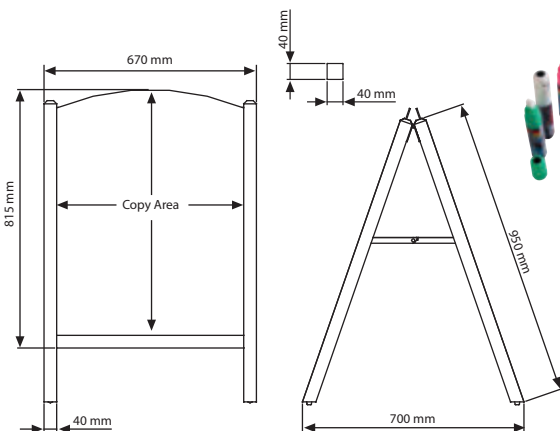
Each unit comes ready to use
Jeder Artikel wird fertig zum Einsatz geliefert.

Chalkboard pen and magnetic covers should be ordered separately.
Tafelstifte und Magnetabdeckungen müssen extra bestellt werden.

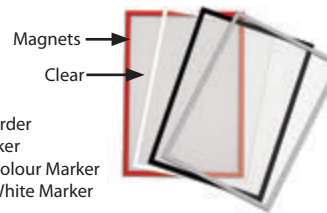


Magnetic PET Cover
Please don't forget to order

MAGNETIC PET COVER		
ARTICLE	SIZE	COLOUR
UPCMOR00A4	210 X 297 mm	Red
UPCMOB00A4	210 X 297 mm	Black
UPCMOW00A4	210 X 297 mm	White
UPCMOG00A4	210 X 297 mm	Grey
UPCMOG00A5	105 X 148 mm	Grey
UPCMOB00A5	105 X 148 mm	Black



Don't forget to order
Chalkboard Marker
UYAKLM1251 - Colour Marker
UYAKLM1250 - White Marker



MATERIAL : Fir wood				WEIGHT	PACKING SIZE
ARTICLE	SIZE	COPY	DESCRIPTION	WITH PACKING	*W X H X D
UWTCO06078	600 X 780 mm	590 X 775 mm	Natural Wood-Outdoor	13,820 kg	690 X 1030 X 110 mm
UWTCO06078	600 X 780 mm	590 X 775 mm	Dark Wood-Outdoor	13,820 kg	690 X 1030 X 110 mm
UWTCN06078	600 X 780 mm	590 X 775 mm	Natural Wood-Indoor	10,680 kg	690 X 1030 X 110 mm
UWTCDI6078	600 X 780 mm	590 X 775 mm	Dark Wood-Indoor	10,680 kg	690 X 1030 X 110 mm




*W:Width H: Height D: Depth


Wood Chalk Floor Stand




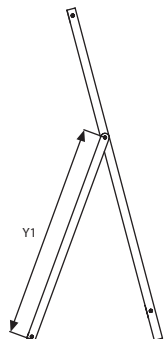
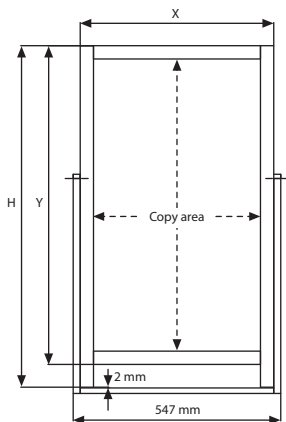
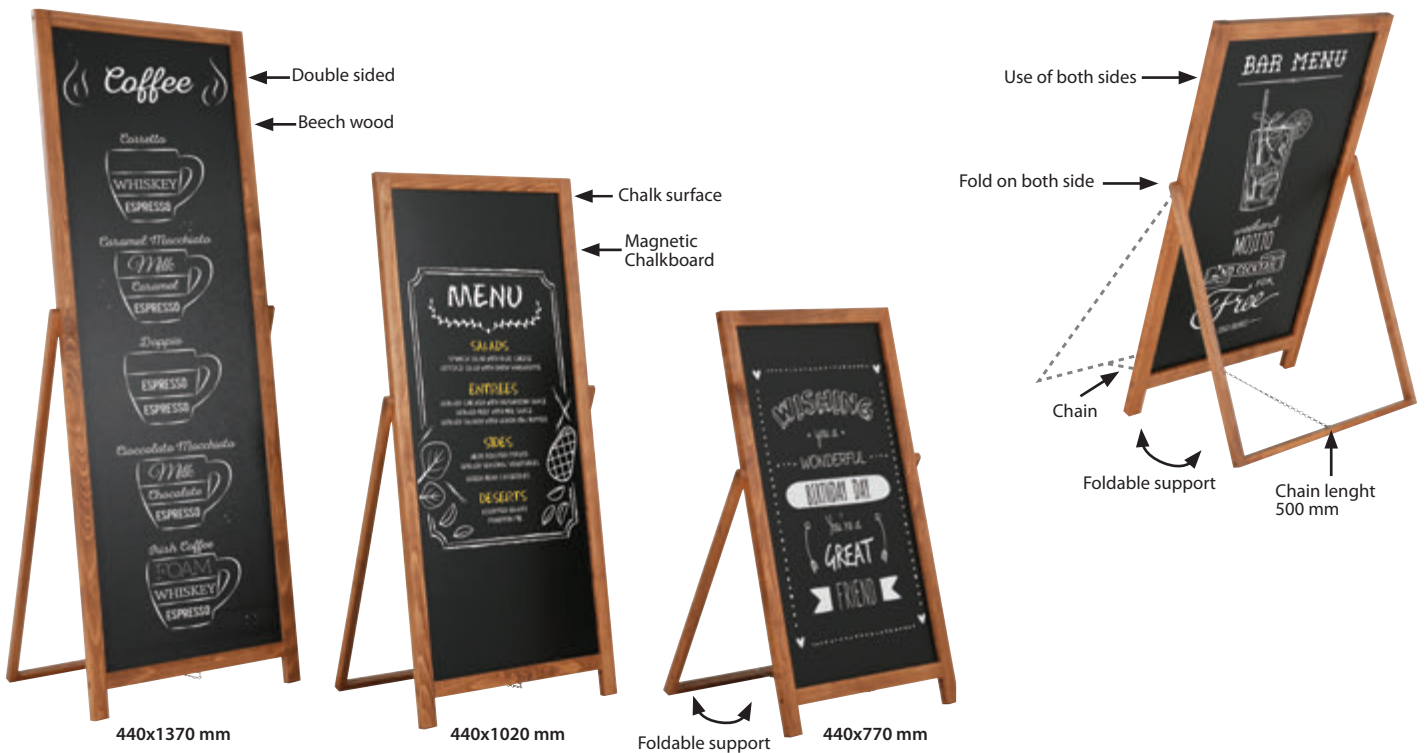
Wood Chalk Floor Stand is made of beech wood. Lacquered finish is applied for long term use. It has a double sided dry-wipe chalk surface. Foldable support can be used on both sides. Chain provides stability. It is an excellent friendly way to advertise your business. Also, Wood Chalk Floor Stand offers perfect solution where announcements change frequently such as bars, restaurants, hotels and any more. 3 size options are available.

Der Wood Chalk Floor Stand ist aus Buchenholz gefertigt. Lackiertes Finish wird für den Langzeitgebrauch aufgetragen. Es hat eine doppelseitige, trocken abwischbare Kreideoberfläche. Faltbare Stütze beidseitig verwendbar. Kette sorgt für Stabilität. Es ist eine ausgezeichnete freundliche Art, für Ihr Unternehmen zu werben. Außerdem bietet der Wood Chalk Floor Stand die perfekte Lösung, wenn sich Ankündigungen häufig ändern, wie z. B. in Bars, Restaurants, Hotels und mehr. 3 Größenoptionen sind verfügbar.

 Do not forget to order chalkboard marker. Vergessen Sie nicht, Tafelmarker zu bestellen.

 Unassembled packaging. Unmontierte Verpackung.

 Assembly in 10 seconds. Montage in 10 Sekunden.



Don't forget to order Chalkboard Marker
UYAKLM1251 - Colour Marker
UYAKLM1250 - White Marker

MATERIAL : Beech wood						WEIGHT	PACKING SIZE
ARTICLE	EXTERNAL (x-y)	COPY AREA	H	Y1	DESCRIPTION	WITH PACKING	*W X H X D
UWCFS0D010	510 X 840 mm	440 X 770 mm	900 mm	566,5 mm	Dark Wood	3,900 kg	575 X 950 X 43 mm
UWCFS0D020	510 X 1090 mm	440 X 1020 mm	1150 mm	701,5 mm	Dark Wood	4,650 kg	575 X 1230 X 43 mm
UWCFS0D030	510 X 1140 mm	440 X 1370 mm	1500 mm	866,5 mm	Dark Wood	5,900 kg	575 X 1560 X 43 mm

*W:Width H: Height D: Depth






Wood Dry Erase Floor Stand



Wood Dry Erase Floor Stand is made of fir wood. It has a double sided magnetic and dry-wipe chalkboard surface. It offers a perfect solution where announcements change frequently such as bars, restaurants, hotels and its wooden look creates a friendly atmosphere to your business advertisement. Foldable support can be used on both sides. Chain provides stability. 3 size options are available.

Der Wood Dry Erase Floor Stand ist aus Tannenholz gefertigt. Es hat eine doppelseitige magnetische und trocken abwischbare Tafeloberfläche. Es bietet eine perfekte Lösung für häufig wechselnde Ankündigungen wie Bars, Restaurants, Hotels und schafft durch seine Holzoptik eine freundliche Atmosphäre für Ihre Geschäftsanzeige. Faltbare Stütze beidseitig verwendbar. Kette sorgt für Stabilität. 3 Größenoptionen sind verfügbar.

-  Do not forget to order chalkboard marker. Vergessen Sie nicht, Tafelmarker zu bestellen.
-  Unassembled packaging. Unmontierte Verpackung.
-  Assembly in 10 seconds. Montage in 10 Sekunden.



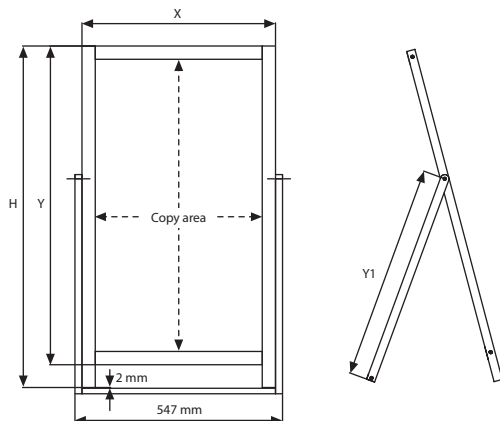
440x770 mm



440x1020 mm



440x1370 mm



Don't forget to order Chalkboard Marker UYAKLM1251 - Colour Marker UYAKLM1250 - White Marker

MATERIAL : Fir wood						WEIGHT	PACKING SIZE
ARTICLE	EXTERNAL (x-y)	COPY AREA	H	Y1	DESCRIPTION	WITH PACKING	*W X H X D
UWDFS0D010	510 X 840 mm	440 X 770 mm	900 mm	566,5 mm	Dark Wood	3,900 kg	600 X 970 X 45 mm
UWDFS0D020	510 X 1090 mm	440 X 1020 mm	1150 mm	701,5 mm	Dark Wood	4,650 kg	600 X 1220 X 45 mm
UWDFS0D030	510 X 1140 mm	440 X 1370 mm	1500 mm	866,5 mm	Dark Wood	5,900 kg	600 X 1570 X 45 mm

*W:Width H: Height D: Depth



Nature Line Writing Board



Suitable for the display of messages in restaurants, cafés, bars, malls, offices and education centers. The erasable surface enables you to erase your messages and transmit them to your audience while keeping them updated. You can use a chalkboard pen to write on the black surface. There are also special water-based and scent-free markers. We sell chalk pens individually 2 in convenient sets.

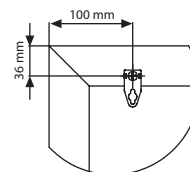
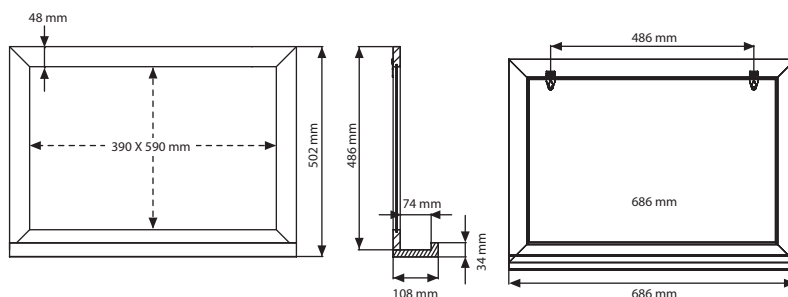
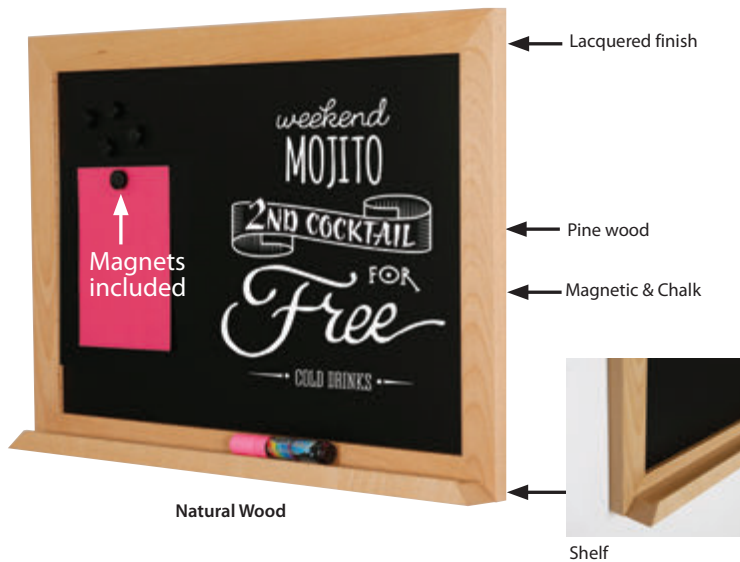
Holzrahmen als Angebotstafel sind ideal für Restaurants, Cafés, Bars, Büros und Schulen geeignet. Die abwischbare Oberfläche ermöglicht Ihnen schnelles ändern Ihrer Informationen während Ihnen Aufmerksamkeit zugewendet ist. Sie können Tafelstifte auf schwarzen Oberflächen benutzen, oder auch geruchsfreie Boardmarker auf wasserbasis können auf weiss beschichteten Holztafeln eingesetzt werden. Wir bieten in 2 verschiedenen Versionen Tafelstifte an.



Each unit comes ready with mounting set, and easy to assemble instruction sheet. *Jeder Artikel wird mit leicht verständlicher Montageanleitung und Befestigungsmaterial geliefert.*



Chalkboard pens are not included in the original pack, should be ordered separate. For spotless removing of chalk pens from surface, please use window & glass cleaner otherwise clean with damp cloth. *Tafelstifte werden nicht mitgeliefert und müssen extra bestellt werden. Um eine fleckenfreie Entfernung der Tafelstiftschrift von der Oberfläche zu gewährleisten, benutzen Sie bitte Fenster- oder Glasreiniger oder zumindest ein feuchtes Tuch.*



4 magnetic buttons included in the box



Don't forget to order Chalkboard Marker
UYAKLM1251 - Colour Marker
UYAKLM1250 - White Marker

MATERIAL : Pine Wood			WEIGHT	PACKING SIZE
ARTICLE	PANEL SIZE	DESCRIPTION	WITH PACKING	*W X H X D
UWNLWONOF2	400 X 600 mm	Natural Wood - Black Chalkboard	2,280 kg	570 X 730 X 45 mm
UWNLWODOF2	400 X 600 mm	Dark Wood - Black Chalkboard	2,280 kg	570 X 730 X 45 mm



*W:Width H:Height D:Depth

Wall Mount Wooden Card Holder



Watch video at our website www.mtdisplays.com



Wall Mount Wooden Card Holder is designed to store and information packages in one convenient location. It is constructed of lacquered finished beech wood. Clear Acrylic pockets provide a full view of flyers or brochures stored in. The pockets are tiered one on top of each other. It provides you gain a wider area in offices, banks, schools, hospitals, hotels and more.

Der Kartenhalter aus Holz für die Wandmontage dient zur Aufbewahrung von Informationspaketen an einem geeigneten Ort. Es ist aus lackiertem Buchenholz gefertigt. Durchsichtige Acrylfächer bieten einen vollständigen Überblick über die darin befindlichen Flyer oder Broschüren. Die Fächer sind übereinander positioniert. Es spart Platz in Büros, Banken, Schulen, Krankenhäusern, Hotels und mehr.



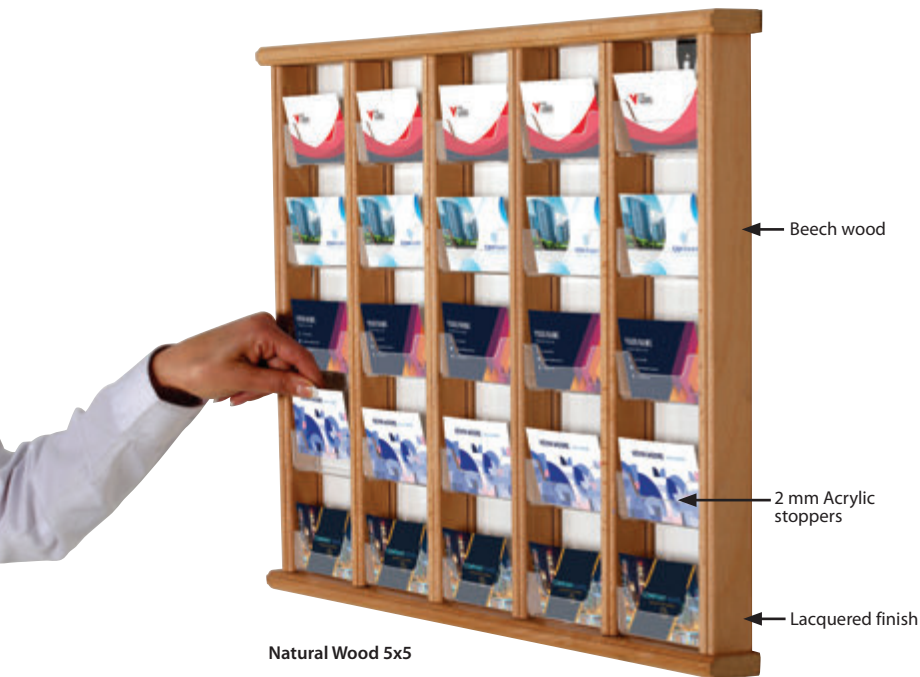
Each unit comes ready to use without any tool for assembly.
Jeder Artikel wird fertig zum Einsatz geliefert.
Es wird kein Werkzeug benötigt.



Complete with wall hangers.
Komplett mit Wandaufhängern.



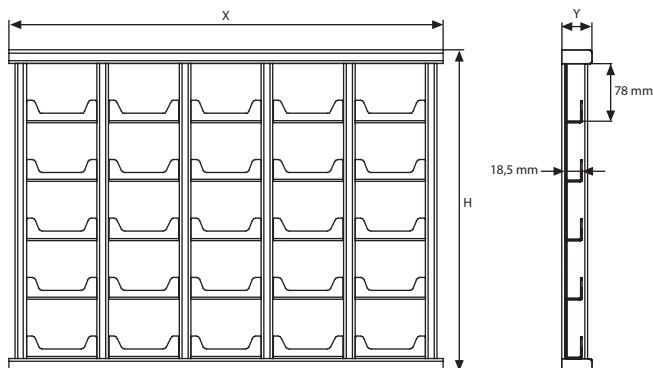
Assembly time approx 30 seconds.
Aufbauzeit ca. 30 Sekunden.



Natural Wood 5x5



Dark Wood 3x5



MATERIAL : Beech wood						WEIGHT	PACKING SIZE
ARTICLE	CAPACITY	DESCRIPTION	X	Y	H	WITH PACKING	*W X H X D
UWCHWN0035	3 X 5	Natural Wood	370 mm	40 mm	440 mm	2,000 kg	400 X 470 X 60 mm
UWCHWN0055	5 X 5	Natural Wood	590 mm	40 mm	440 mm	2,900 kg	460 X 610 X 60 mm
UWCHWD0035	3 X 5	Dark Wood	370 mm	40 mm	440 mm	2,000 kg	400 X 470 X 60 mm
UWCHWD0055	5 X 5	Dark Wood	590 mm	40 mm	440 mm	2,900 kg	460 X 610 X 60 mm

* W:Width H: Height D: Depth



Wood Magazine Rack for Wall







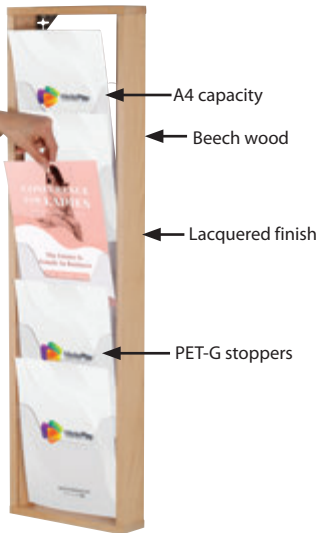
Watch video at our website www.mtdisplays.com



Wood Magazine Rack for Wall is designed to store and organize magazines, catalogs, flyers and information packages in one convenient location. It is one of the best and space saving organizers for busy areas. Back and sides are constructed of lacquered finished beech wood. Clear PET G pockets provide a full view of flyers or brochures stored in. The pockets are tiered one on top of each other. It provides you gain a wider area in travel agents, offices, banks, schools, hospitals, hotels and more. Mountseasily on the wall.

Wood Magazine Rack for Wall kann Magazine, Kataloge, Flyer und Informationspakete an einem geeigneten Ort präsentieren und organisieren. Es ist einer der besten und platzsparendsten Organisatoren für stark frequentierte Bereiche. Rückseite und Seiten sind aus lackiertem Buchenholz gefertigt. Durchsichtige PET G-Taschen bieten einen vollständigen Überblick über die präsentierten Flyer oder Broschüren. Die Taschen sind übereinander gesetzt. Es spart Platz in Reisebüros, Büros, Banken, Schulen, Krankenhäusern, Hotels und mehr. Leichte Montage an der Wand.

-  Product is packed assembled. Produkt ist zusammengebaut verpackt.
-  Complete with wall hangers. Mit Wandaufhängern.
-  No tool assembly & ready to use. Keine Werkzeugmontage und sofort einsatzbereit.
-  Assembly time approx 80 seconds. Montagezeit ca. 80 Sekunden.



Natural Wood 1x5 A4



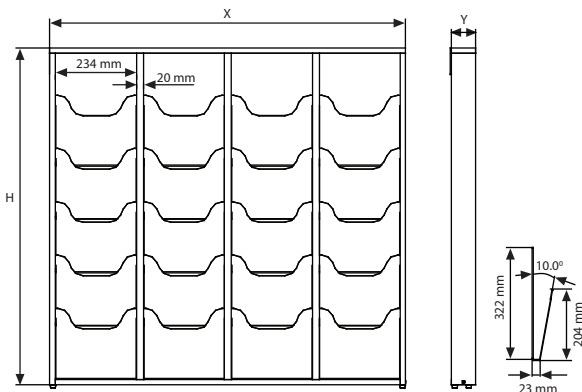
Dark Wood 2x5 A4



Natural Wood 3x5 A4



Dark Wood 4x5 A4



MATERIAL : Beech wood							WEIGHT	PACKING SIZE
ARTICLE	POSTER SIZE	CAPACITY	DESCRIPTION	X	Y	H	WITH PACKING	*W X H X D
UWMRWN15A4	5 X A4	1 X 5 A4	Natural Wood	265 mm	75 mm	966 mm	3,800 kg	290 X 1050 X 90 mm
UWMRWN25A4	10 X A4	2 X 5 A4	Natural Wood	520 mm	75 mm	966 mm	6,500 kg	540 X 1050 X 90 mm
UWMRWN35A4	15 X A4	3 X 5 A4	Natural Wood	775 mm	75 mm	966 mm	10,400 kg	800 X 1050 X 90 mm
UWMRWN45A4	20 X A4	4 X 5 A4	Natural Wood	1020 mm	75 mm	966 mm	12,000 kg	1055 X 1050 X 90 mm
UWMRWD15A4	5 X A4	1 X 5 A4	Dark Wood	265 mm	75 mm	966 mm	3,800 kg	290 X 1050 X 90 mm
UWMRWD25A4	10 X A4	2 X 5 A4	Dark Wood	520 mm	75 mm	966 mm	6,500 kg	540 X 1050 X 90 mm
UWMRWD35A4	15 X A4	3 X 5 A4	Dark Wood	775 mm	75 mm	966 mm	10,400 kg	800 X 1050 X 90 mm
UWMRWD45A4	20 X A4	4 X 5 A4	Dark Wood	1020 mm	75 mm	966 mm	12,000 kg	1055 X 1050 X 90 mm

*W:Width H: Height D: Depth



Free Standing Wood Magazine Rack



Watch video at our website www.mtdisplays.com



Free Standing Wood Magazine Rack is designed to store and organize magazines, catalogs, flyers and information packages in one convenient location. Back and sides are constructed of lacquered finished beech wood. Clear PET G pockets provide a full view of flyers or brochures stored in. The pockets are tiered one on top of each other. It provides you gain a wider area in offices, banks, schools, hospitals, hotels and more.

Free Standing Wood Magazine Rack ist für die Aufbewahrung und Organisation von Zeitschriften, Katalogen, Flyern und Informationspaketen an geeigneten Orten konzipiert. Rückseite und Seiten sind aus lackiertem Buchenholz gefertigt. Klare PET G-Taschen bieten einen vollständigen Überblick über die darin befindlichen Flyer oder Broschüren. Die Taschen sind übereinander positioniert. Es spart Platz in Büros, Banken, Schulen, Krankenhäusern, Hotels und mehr.



Product is packed unassembled with an easy to understand instruction for assembly.
Das Produkt ist nicht zusammengebaut verpackt, mit einer leicht verständlichen Montageanleitung.



Complete with fixing components.
Komplett mit Befestigungselementen.



Easy to assemble.
Leicht zusammenzubauen.



Assembly time approx 30 seconds.
Aufbau ca. 30 Sekunden.



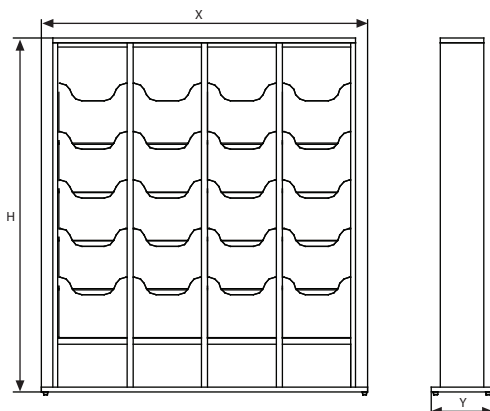
- A4 capacity →
- Beech wood →
- Lacquered finish →
- PET-G stoppers →

Natural Wood 1x5 A4

Dark Wood 2x5 A4

Natural Wood 3x5 A4

Dark Wood 4x5 A4



MATERIAL : Beech wood							WEIGHT	PACKING SIZE
ARTICLE	POSTER SIZE	CAPACITY	DESCRIPTION	X	Y	H	WITH PACKING	*W X H X D
UWMRFN15A4	10 X A4	1 X 5 A4	Natural Wood	345 mm	205 mm	1175 mm	10,200 kg	290 X 1190 X 195 mm
UWMRFN25A4	20 X A4	2 X 5 A4	Natural Wood	600 mm	205 mm	1175 mm	16,850 kg	550 X 1190 X 195 mm
UWMRFN35A4	30 X A4	3 X 5 A4	Natural Wood	845 mm	205 mm	1175 mm	24,450 kg	800 X 1190 X 195 mm
UWMRFN45A4	40 X A4	4 X 5 A4	Natural Wood	1090 mm	205 mm	1175 mm	31,450 kg	1055 X 1190 X 195 mm
UWMRFD15A4	10 X A4	1 X 5 A4	Dark Wood	345 mm	205 mm	1175 mm	10,200 kg	290 X 1190 X 195 mm
UWMRFD25A4	20 X A4	2 X 5 A4	Dark Wood	600 mm	205 mm	1175 mm	16,850 kg	550 X 1190 X 195 mm
UWMRFD35A4	30 X A4	3 X 5 A4	Dark Wood	845 mm	205 mm	1175 mm	24,450 kg	800 X 1190 X 195 mm
UWMRFD45A4	40 X A4	4 X 5 A4	Dark Wood	1090 mm	205 mm	1175 mm	31,450 kg	1055 X 1190 X 195 mm

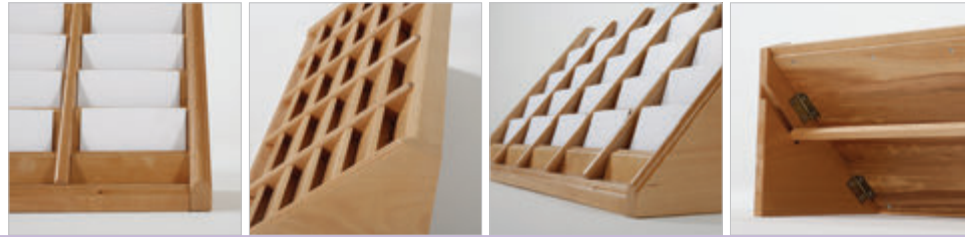
*W:Width H: Height D: Depth



Desktop Wooden Card Holder



Watch video at our website www.mtdisplays.com



Desktop Wooden Card Holder is designed to store and organize business cards, folded brochures and maps in one convenient location for busy areas. It is constructed of lacquered finished beech wood. The pockets are tiered one on top of each other showing enough of stored card or brochure. It provides you gain a wider area in offices, banks, travel agents, hospitals, hotels and more. Folded flaps provides flat packing and comfort for storage. Slide in support bar keeps the unit stable in use.

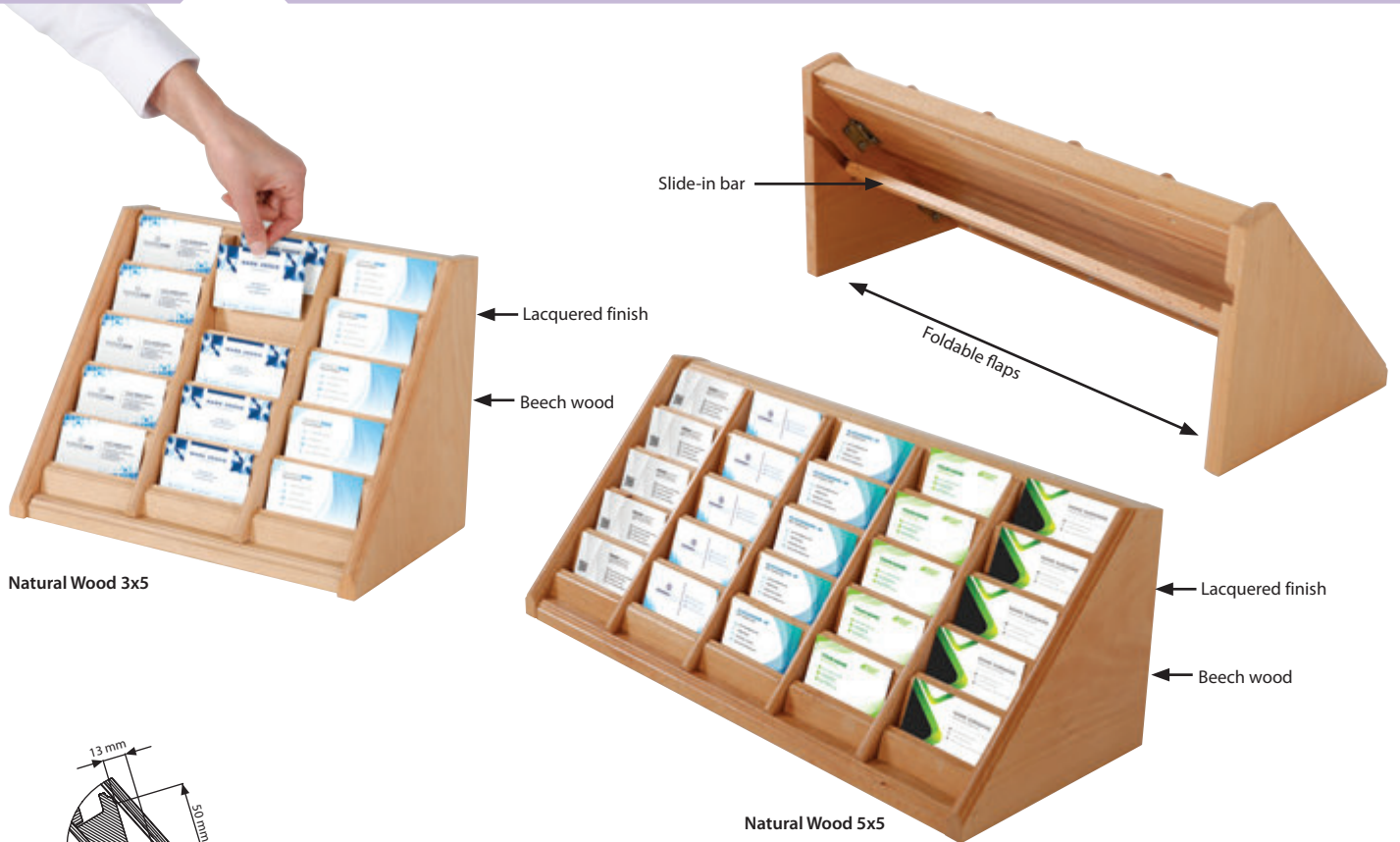
Der Kartenhalter aus Holz ist zum Aufbewahren und Organisieren von Visitenkarten, gefalteten Broschüren und Karten vorgesehen. Es ist aus lackiertem Buchenholz gefertigt. Die Taschen sind übereinander positioniert und zeigen eingelegte Karten oder Broschüren in ausreichender Menge. Es spart Platz in Büros, Banken, Reisebüros, Krankenhäusern, Hotels und mehr. Die faltbaren Klappen sorgen für eine flache Verpackung und Komfort bei der Lagerung. Durch das Einschieben der Stütze bleibt der Kartenhalter im Einsatz stabil.



Each unit comes ready to use without any tool for assembly. Jeder Artikel wird fertig zum Einsatz geliefert.

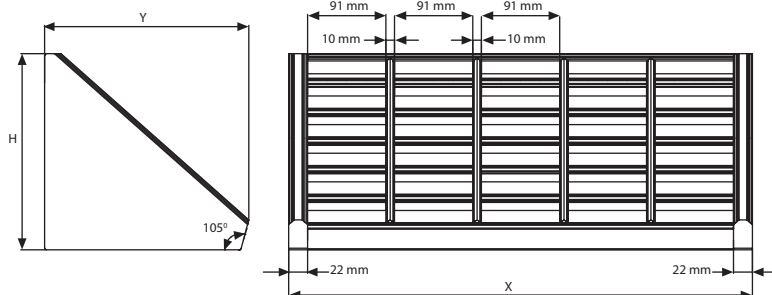
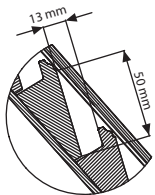


Complete with flaps and support bar. Komplett mit Klappen und Stütze.



Natural Wood 3x5

Natural Wood 5x5



MATERIAL : Beech wood						WEIGHT	PACKING SIZE
ARTICLE	CAPACITY	DESCRIPTION	X	Y	H	WITH PACKING	*W X H X D
UWCHDN0035	3 X 5	Natural Wood	340 mm	240 mm	228 mm	2,850 kg	360 X 400 X 80 mm
UWCHDN0055	5 X 5	Natural Wood	540 mm	240 mm	228 mm	4,05 kg	360 X 600 X 80 mm

*W:Width H: Height D: Depth



Counter Wood Chalk Frame



Counter Wood Chalk Frame is made of beech wood. Lacquered finish is applied for long term use. Foldable support provides stability. It is suitable for desktop usage and 3 size options are available. Its wooden look creates a friendly atmosphere to your business, menu or announcements. It has a dry-wipe chalkboard surface that easy to change notes. Chalkboard marker is optional.

Der Counter Wood Chalk Frame ist aus Buchenholz gefertigt. Lackiertes Finish wird für den Langzeitgebrauch aufgetragen. Faltbare Stütze sorgt für Stabilität. Es ist für den Desktop-Einsatz geeignet und es stehen 3 Größenoptionen zur Verfügung. Die Holzoptik verleiht Ihrem Geschäft, Ihrer Speisekarte oder Ihren Ankündigungen eine freundliche Atmosphäre. Es hat eine trocken abwischbare Tafeloberfläche, auf der sich Notizen leicht ändern lassen. Tafelmarker ist optional.



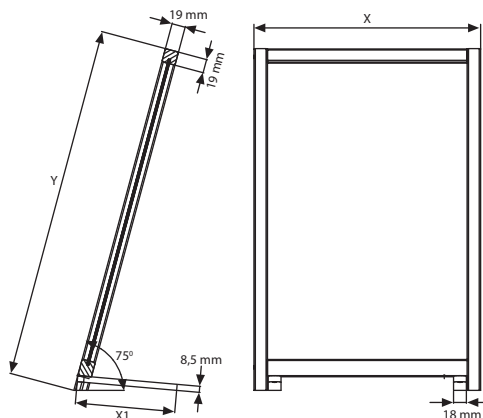
Do not forget to chalkboard marker. *Optionale Tafelmarker nicht vergessen.*



Unassembled packaging. *Unmontierte Verpackung.*



Assembly in 10 seconds. *Montage in 10 Sekunden.*



Don't forget to order Chalkboard Marker
UYAKLM1251 - Colour Marker
UYAKLM1250 - White Marker

MATERIAL : Beech wood					WEIGHT	PACKING SIZE
ARTICLE	EXTERNAL (x-y)	SIZE	X1	DESCRIPTION	WITH PACKING	*W X H X D
UWCFD00057	165 X 235 mm	5" X 7" - 127 X 177,8 mm	60 mm	Dark Wood - Black Chalkboard	0,350 kg	190 X 260 X 30 mm
UWCFD00081	254 X 341 mm	8.5" X 11" - 215,9 X 279,4 mm	100 mm	Dark Wood - Black Chalkboard	0,600 kg	280 X 360 X 30 mm
UWCFD00017	318 X 496,5 mm	11" X 17" - 279,4 X 431,8 mm	140 mm	Dark Wood - Black Chalkboard	0,950 kg	340 X 510 X 30 mm



* W:Width H: Height D: Depth

Desktop Easel



Desktop Easel is made of beech wood. Lacquered finish is applied for long term use. Chalkboard is included. It is suitable for desktop usage. Its modern and traditional combination wooden look creates a friendly atmosphere to your business, menu or announcements. It has a dry-wipe chalkboard surface that easy to change notes. Natural rope provides stability. Its foldable flat design is space saving.

Die Tischstaffelei ist aus Buchenholz gefertigt. Lackiertes Finish wird für den Langzeitgebrauch aufgetragen. Tafel ist im Lieferumfang enthalten. Es ist für den Desktop-Einsatz geeignet. Seine moderne und traditionelle Kombination aus Holzoptik schafft eine freundliche Atmosphäre für Ihr Geschäft, Ihre Speisekarte oder Ihre Ankündigungen. Es hat eine trocken abwischbare Tafeloberfläche, auf der sich Notizen leicht ändern lassen. Natürliches Seil sorgt für Stabilität. Sein faltbares flaches Design ist platzsparend.



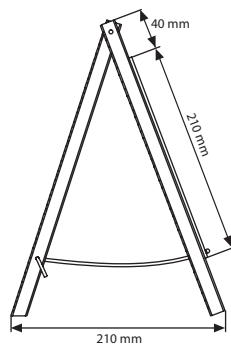
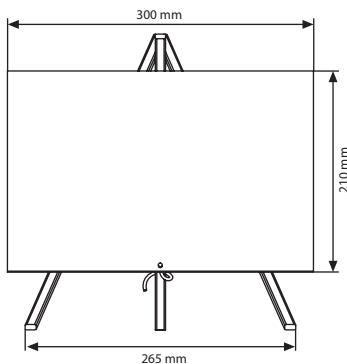
Chalkboard is included. Do not forget to chalkboard marker.
Tafel ist enthalten, Optionale Tafelmarker nicht vergessen zu bestellen.



Unassembled packaging.
Unmontierte Verpackung.



Assembly in 10 seconds.
Montage in 10 Sekunden.



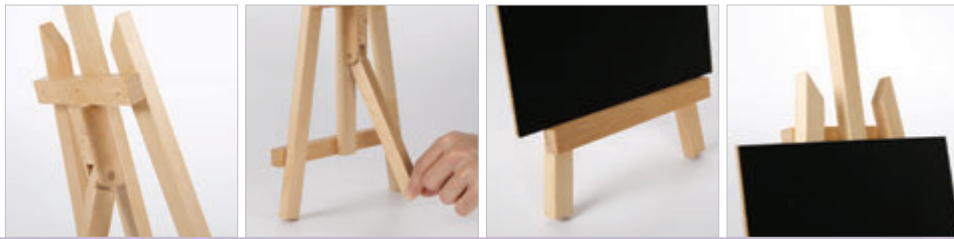
Don't forget to order
Chalkboard Marker
UYAKLM1251 - Colour Marker
UYAKLM1250 - White Marker

MATERIAL : Beech wood			WEIGHT	PACKING SIZE
ARTICLE	SIZE	DESCRIPTION	WITH PACKING	*W X H X D
UWDECD00A4	8.5" X 11" - 215,9 X 279,4 mm	Dark Wood - Black Chalkboard	0,700 kg	330 X 370 X 22 mm






*W:Width H: Height D: Depth

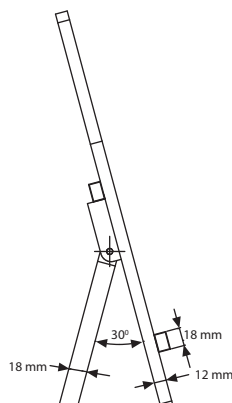
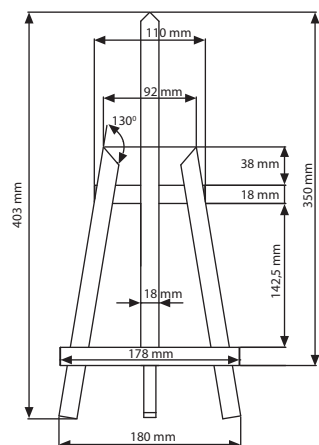
Petite Desktop Easel



Petite Desktop Easel is made of beech wood. Lacquered finish is applied for long term use. Its modern and traditional combination wooden look creates a friendly atmosphere to your business, menu or announcements. Adjustable back support helps to achieve perfect placement. Its foldable flat design is space saving. Optional chalk panel max. size is A4.

Die Petite Desktop Staffelei ist aus Buchenholz gefertigt. Lackiertes Finish wird für den Langzeitgebrauch aufgetragen. Seine moderne und traditionelle Kombination aus Holzoptik schafft eine freundliche Atmosphäre für Ihr Geschäft, Ihre Speisekarte oder Ihre Ankündigungen. Die verstellbare Rückenstütze hilft, eine perfekte Platzierung zu erreichen. Sein faltbares flaches Design ist platzsparend. Optionale Kreidetafel max. Größe ist A4.

-  Do not forget to chalk panel and chalkboard marker. Tafel- und Tafelmarker nicht vergessen.
-  Optional chalk panel max. size is A4. Optionale Kreidetafel max. Größe ist A4.
-  Assembly in 10 seconds. Montage in 10 Sekunden.



Don't forget to order
Chalkboard Marker
UYAKLM1251 - Colour Marker
UYAKLM1250 - White Marker

MATERIAL : Beech wood		WEIGHT	PACKING SIZE
ARTICLE	SIZE (x-y)	WITH PACKING	*W X H X D
UWDEPN0010	410 X 180 mm	0,310 kg	210 X 430 X 55 mm

* W:Width H: Height D: Depth






Wooden Roll Stand

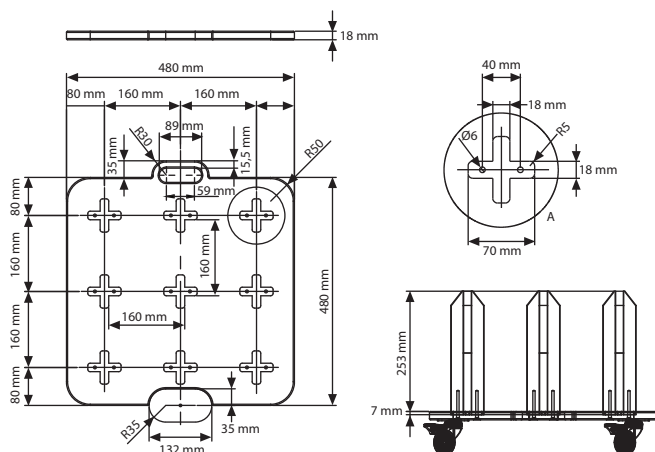
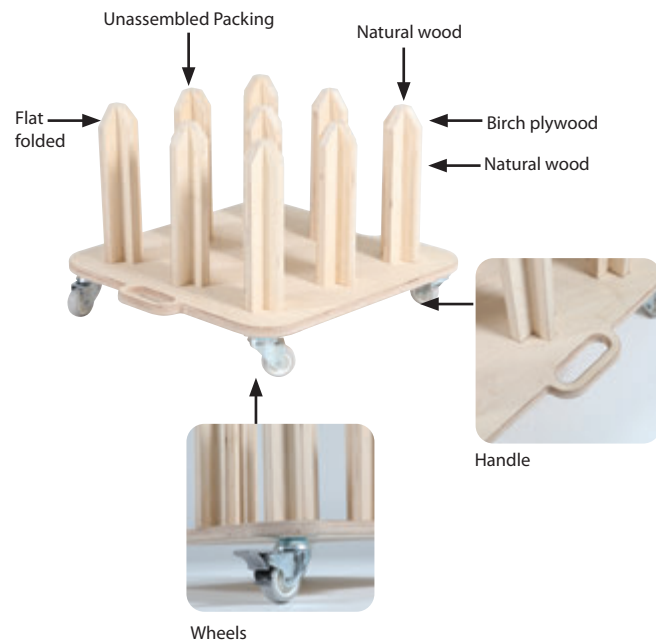


Wooden Roll Stand is made of plywood. Lacquered finish is applied for long term use. It has 9 rolls capacity. It has 4 wheels that 2 of them are caster wheels. Equipped with handle for easy carriage.

Der Wooden Roll Stand ist aus Sperrholz gefertigt. Lackiertes Finish wird für den Langzeitgebrauch aufgetragen. Es hat eine Kapazität von 9 Rollen mit 4 Rädern, von denen 2 Lenkrollen sind. Ausgestattet mit Griff für einfachen Transport.

-  Has 9 rolls capacity.
Hat eine Kapazität für 9 Rollen.
-  Unassembled packaging.
Unmontierte Verpackung.
-  Assembly in 10 seconds.
Montage in 10 Sekunden.

4 wheels, 2 with casters



Don't forget to order
Chalkboard Marker
UYAKLM1251 - Colour Marker
UYAKLM1250 - White Marker

MATERIAL : Beech wood			WEIGHT	PACKING SIZE
ARTICLE	SIZE	DESCRIPTION	WITH PACKING	*W X H X D
UWRSON0000	480 X 480 mm	Natural Wood	8,800 kg	500 X 540 X 100 mm

*W:Width H:Height D:Depth







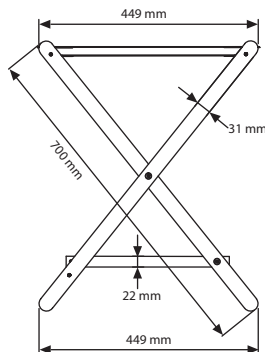
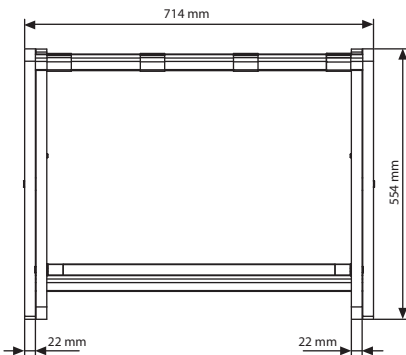
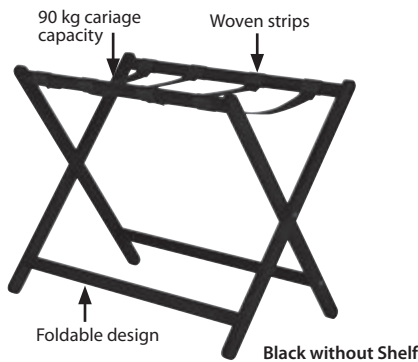
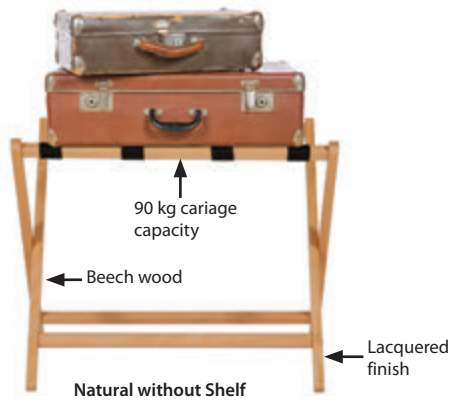
Wood Folding Luggage Rack



Wood Folding Luggage Rack is made of beech wood. Lacquered finish is applied for long term use. It is equipped with woven strips. Its shelf has 90 kg carriage capacity. It has with or without shelf options. Foldable flat design is space saving.

Der klappbare Gepäckträger aus Holz ist aus Buchenholz gefertigt. Lackiertes Finish wird für den Langzeitgebrauch aufgetragen. Es ist mit gewebten Streifen ausgestattet. Sein Regal hat eine Tragfähigkeit von 90 kg. Es hat mit oder ohne Regaloptionen. Faltpbares flaches Design ist platzsparend.

-  With or without shelf options. Mit oder ohne Regaloptionen.
-  Shelf has 90 kg carriage capacity. Regal hat eine Tragfähigkeit von 90 kg.
-  Assembly in 10 seconds. Montage in 10 Sekunden.
-  1 box. 1 box.



MATERIAL : Beech wood			WEIGHT	PACKING SIZE
WITHOUT SHELF	WITH SHELF	DESCRIPTION	WITH PACKING	*W X H X D
UWFLR1N000	UWFLR2N000	Natural Wood	3,900 kg	730 X 740 X 80 mm
UWFLR1D000	UWFLR2D000	Dark Wood	3,900 kg	730 X 740 X 80 mm
UWFLR1B000	UWFLR2B000	Black	3,900 kg	730 X 740 X 80 mm

* W:Width H: Height D: Depth

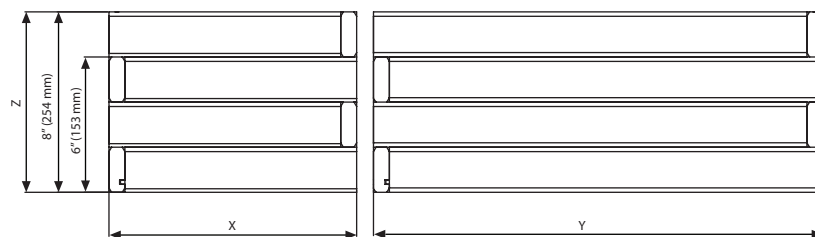
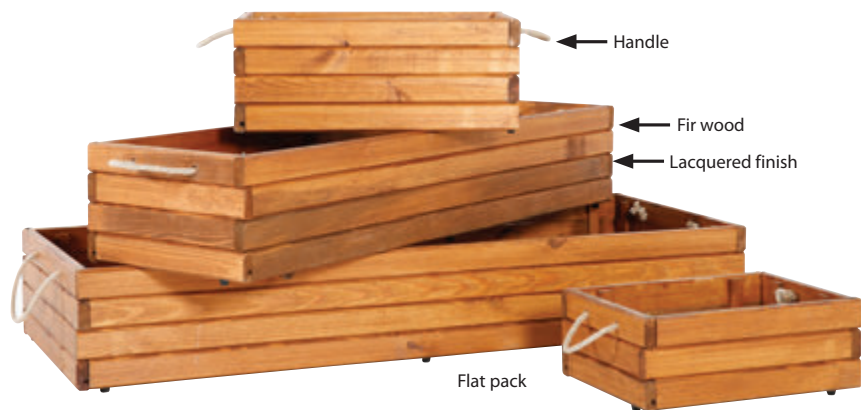


Foldable Wood Box



Foldable Wood Box is made of solid pine wood. Suitable for use in restaurants, cafés and various retail stores for decorative purpose or separate different areas. Can be used for store items like plants, pottery, or other decorative items. Rustic look makes these wood boxes both practical and decorative. 2 rope handles on each side help to hold the box.

Der Foldable Wood Box ist aus massivem Kiefernholz gefertigt. Geeignet für den Einsatz in Restaurants, Cafés und verschiedenen Einzelhandelsgeschäften zu Dekorationszwecken oder zur Trennung verschiedener Bereiche. Kann zum Aufbewahren von Gegenständen wie Pflanzen, Töpferwaren oder anderen Dekorationsgegenständen verwendet werden. Der rustikale Look macht diese Holzkisten sowohl praktisch als auch dekorativ. 2 Seilgriffe auf jeder Seite helfen, die Box zu halten.



MATERIAL : Fir wood			WEIGHT	PACKING SIZE
ARTICLE	SIZE (x-y-z)	DESCRIPTION	WITH PACKING	*W X H X D
UWFBM01116	11" X 16" X 6" - 280 X 407 X 153 mm	Dark Wood	2,750 kg	340 X 450 X 65 mm
UWFBM01420	14" X 20" X 8" - 356 X 508 X 204 mm	Dark Wood	4,000 kg	430 X 550 X 65 mm
UWFBM01432	14" X 32" X 8" - 356 X 813 X 204 mm	Dark Wood	5,250 kg	430 X 850 X 65 mm
UWFBM01445	14" X 45" X 8" - 356 X 1143 X 204 mm	Dark Wood	9,000 kg	430 X 1190 X 65 mm
UWFBM02050	20" X 50" X 8" - 508 X 1270 X 204 mm	Dark Wood	10,000 kg	590 X 1310 X 63 mm

*W:Width H:Height D:Depth



Wood Chalk Floor Stand





Que Control Systems

- Q Belt
- Q Belt for Wall
- Q Rope Knob Top
- Q Rope Flat Top

- Q Belt
- Q Belt for Wall
- Q Rope Knob Top
- Q Rope Flat Top



Q Belt



Watch video at our website www.mtdisplays.com



Retractable crowd control system, Q Belt, is ready to use in place which offers a choice of post finishes combined with a selection of belt colours. It is suitable to be used wherever people come together. Such as airports, cinema halls, hotels, museums etc. 4 way pole provides the flexibility to create the optimum pedestrian flow. Retractable tape is controlled with tension to keep the tape straight when the tape is moved or pulled out. Q Belt is constructed from sturdy, durable steel. It features with rubberized and heavy weight base.

Einziehbares Menschenleitsystem. Der Q Belt ist nun verfügbar für Orte an denen Menschenleitsysteme gebraucht werden und erhältlich in verschiedenen Farben. Dieses Produkt ist vorgesehen für Ansammlungen von Menschen jeglicher Art. Das Band befindet sich auf Zug sobald es herausgezogen wurde. Der Q Belt besteht aus robustem langlebigem Stahl. Ist ausgestattet mit einem Gummi und einem zusätzlichen Gewicht am Fuß.

2,9 mt tape (+/- 50 mm) is available in 3 colour: Black, Red and Blue.
2,9 meter (+/- 50 mm) Ausführung ist verfügbar mit 3 Farben : Schwarz, Rot, Blau/

Post and base is available in Silver, Chrome, Black and White.
Ständer und Fuß sind vorhanden in Silber, Chrom, Schwarz und Weiß

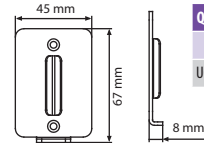
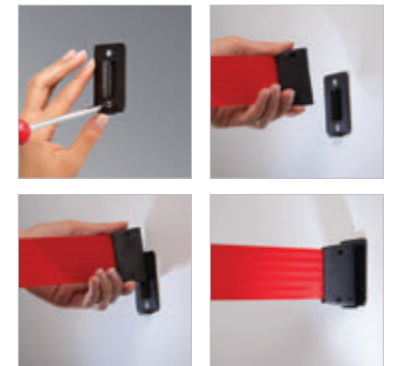
Tape is suitable for branding in printing size of max 40x2700mm. Belt length may change between 2100-2900mm depending on belt color and double side printing option and print design.
Das Band ist in der maximalen Grösse 40x2700mm bedruckbar. Die Bandlänge variiert je nach Farbe zwischen 2100-2900 mm. Auch beidseitig bedruckbar.

2 packs. See info chart for pack sizes.
2 Packungen. Siehe Infodiagramm für Packungsgrößen.

Choice of 3 Belt colours:
Wahl von 3 Gürtelfarben :



Q Belt For Wall



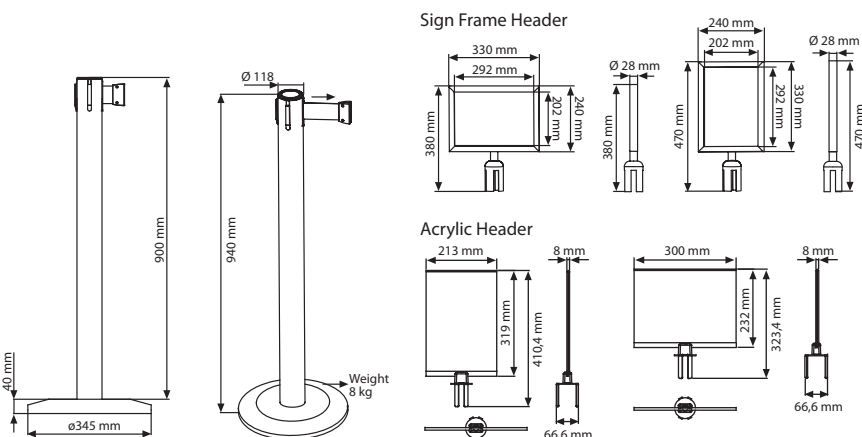
Q BELT FOR WALL : Steel	
ARTICLE	DESCRIPTION
UQBL0WC00	Black wall connection

HEADER: Acrylic		WEIGHT	PACKING SIZE
ARTICLE	DESCRIPTION	WITHPACKING	*W X H X D
UQBL0011A4	Portrait, A4	1,000 kg	245 X 335 X 75 mm
UQBL0012A4	Landscape, A4	1,000 kg	245 X 335 X 75 mm

HEADER: Sign Frame		WEIGHT	PACKING SIZE
ARTICLE	DESCRIPTION	WITHPACKING	*W X H X D
TWBSFH0305	Barrier Sign Frame, Horizontal, Black A4	1,500 kg	350 X 410 X 80 mm
TWBSFV0305	Barrier Sign Frame, Vertical, Black A4	1,500 kg	260 X 490 X 80 mm
TWBASF0405	Adaptor Of Sign Frame		80 X 130 X 85 mm

MATERIAL : Steel post		WEIGHT	PACKING SIZE
ARTICLE	DESCRIPTION	WITHPACKING	*W X H X D
UQBL01BB00	Black-Black Tape	9,360 kg	100 X 970 X 125 mm / 390 X 390 X 60 mm
UQBL01BR00	Black-Red Tape	9,360 kg	100 X 970 X 125 mm / 390 X 390 X 60 mm
UQBL01BL00	Black-Blue Tape	9,360 kg	100 X 970 X 125 mm / 390 X 390 X 60 mm
UQBL01GB00	Grey-Black Tape	9,360 kg	100 X 970 X 125 mm / 390 X 390 X 60 mm
UQBL01GR00	Grey-Red Tape	9,360 kg	100 X 970 X 125 mm / 390 X 390 X 60 mm
UQBL01GL00	Grey-Blue Tape	9,360 kg	100 X 970 X 125 mm / 390 X 390 X 60 mm
UQBL01CB00	Chrome-Black Tape	9,360 kg	100 X 970 X 125 mm / 390 X 390 X 60 mm
UQBL01CL00	Chrome-Blue Tape	9,360 kg	100 X 970 X 125 mm / 390 X 390 X 60 mm
UQBL01CR00	Chrome-Red Tape	9,360 kg	100 X 970 X 125 mm / 390 X 390 X 60 mm

*W:Width H: Height D: Depth



Q Rope Knob Top

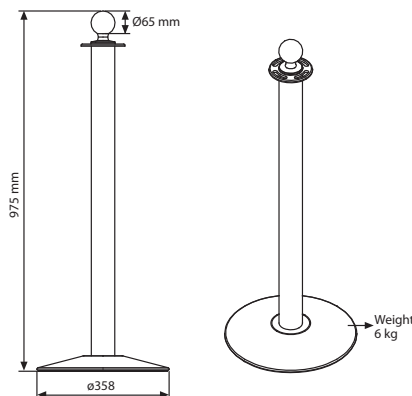
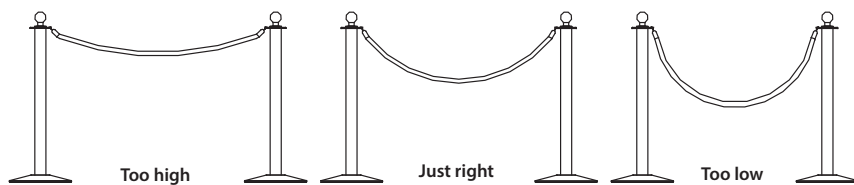
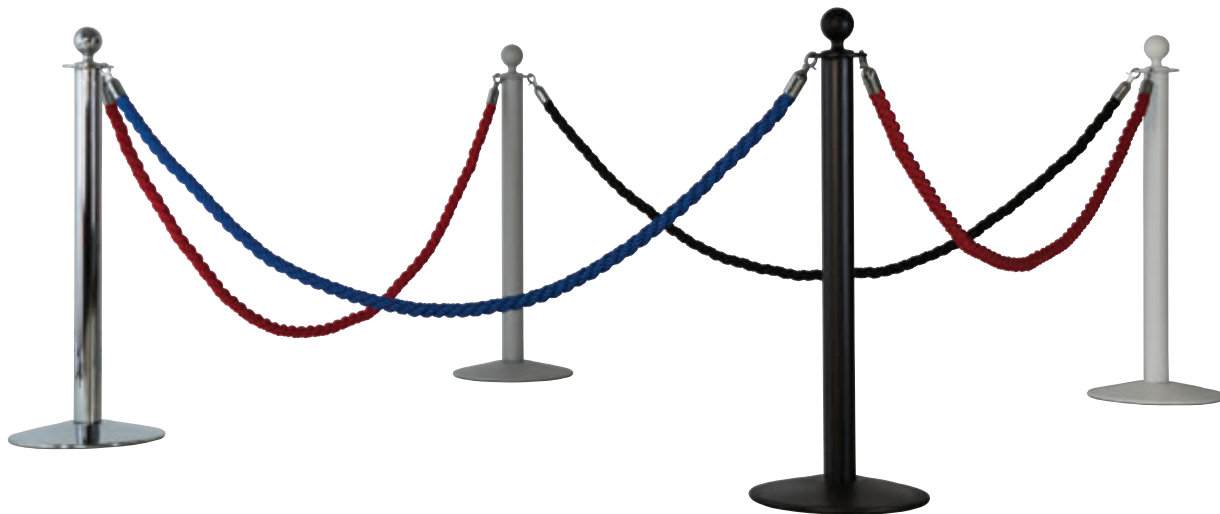


Strong and high quality Q Rope is ready to use. It is constructed from sturdy, durable steel. 4-way pole provides flexibility for the use. Ideal in banks, hotels, receptions, retail shops and anywhere that required a crowd management system. Contemporary finish of the pole with knob-flat-top offers differentiation. Q Rope incorporate twisted design barrier rope, which looks high quality and professional. It features with rubberized base.

Der starke und qualitativ hochwertige Q Rope ist nun bereit für den Einsatz. Konstruiert aus einem robusten und langlebigen Stahl. Die Ausrichtung kann in 4 verschiedenen Richtungen erfolgen und ist somit sehr flexibel im Einsatz. Das zeitgenössische Design mit der Kugel oder der gewölbten Version auf der ober Seite des Q Rope bietet verschiedene Versionen. Der Fuß ist mit einem Gummi ausgestattet.

- 2mt rope is available in 3 colour: Black, Red and Blue. 2meter Ausführung ist verfügbar mit 3 Farben : Schwarz, Rot, Blau.
- Post and base is available in Gray, Chrome, Black and White. Ständer und Fuß sind vorhanden in Grau, Chrom, Schwarz und Weiß.
- Sold as individual components. Als einzelne Komponenten erhältlich.
- 2 packs. See info chart for pack sizes. 2 Packungen. Siehe Infodiagramm für Packungsgrößen.

Choice of 3 Rope colours:
Wahl von 3 Gürtelfarben :



MATERIAL : Steel		WEIGHT	PACKING SIZE
ARTICLE	DESCRIPTION	WITHPACKING	*W X H X D
UQRPP1B010	Black - Knob Top. W/out Weight W/out Rope	6,250 kg	140 X 970 X 140 mm / 390 X 390 X 60 mm
UQRPP1G010	Grey - Knob Top. W/out Weight W/out Rope	6,250 kg	140 X 970 X 140 mm / 390 X 390 X 60 mm
UQRPP1C010	Chrome - Knob Top. W/out Weight W/out Rope	6,250 kg	140 X 970 X 140 mm / 390 X 390 X 60 mm
UQRPP1W010	White - Knob Top. W/out Weight W/out Rope	6,250 kg	140 X 970 X 140 mm / 390 X 390 X 60 mm
UQRPOOL000	Blue-Chrome / only rope	0,950 kg	120 X 460 X 95 mm
UQRPOOB000	Black-Chrome / only rope	0,950 kg	120 X 460 X 95 mm
UQRPOOR000	Red-Chrome / only rope	0,950 kg	120 X 460 X 95 mm
TWBTRT0201	Red-Gold / only rope	0,950 kg	120 X 460 X 95 mm

*W:Width H: Height D: Depth



Q Rope Flat Top



Strong and high quality Q Rope is ready to use. It is constructed from sturdy, durable steel. 4-way pole provides flexibility for the use. Ideal in banks, hotels, receptions, retail shops and anywhere that required a crowd management system. Contemporary finish of the pole with knob-flat-top offers differentiation. Q Rope incorporate twisted design barrier rope, which looks high quality and professional. It features with rubberized base.

Der starke und qualitativ hochwertige Q Rope ist nun bereit für den Einsatz. Konstruiert aus einem robusten und langlebigen Stahl. Die Ausrichtung kann in 4 verschiedenen Richtungen erfolgen und ist somit sehr flexibel im Einsatz. Das zeitgenössische Design mit der Kugel oder der gewölbten Version auf der ober Seite des Q Rope bietet verschiedene Versionen. Der Fuß ist mit einem Gummi ausgestattet.



2m rope is available in 3 colour: Black, Red and Blue. 2meter Ausführung ist verfügbar mit 3 Farben : Schwarz, Rot, Blau.



Post and base is available in Gray, Chrome, Black and White. Ständer und Fuß sind vorhanden in Grau, Chrom, Schwarz und Weiß.

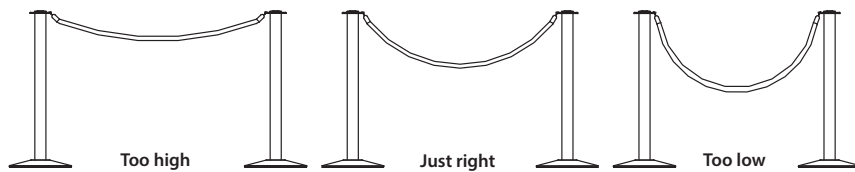


Sold as individual components. Als einzelne Komponenten erhältlich.



2 packs. See info chart for pack sizes. 2 Packungen. Siehe Infodiagramm für Packungsgrößen.

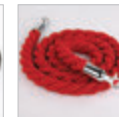
Choice of 3 Rope colours:
Wahl von 3 Gürtelfarben :



Blue-Chrome Length 2 m.



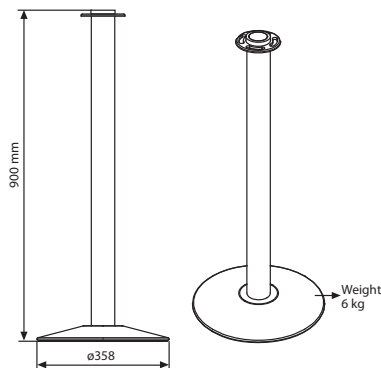
Black-Chrome Length 2 m.



Red-Chrome Length 2 m.



Red-Gold Length 3 m.



MATERIAL : Steel		WEIGHT	PACKING SIZE
ARTICLE	DESCRIPTION	WITHPACKING	*W X H X D
UQRPP1B020	Black - Flat Top. W/out Weight W/out Rope	6,250 kg	140 X 970 X 140 mm / 390 X 390 X 60 mm
UQRPP1G020	Grey - Flat Top. W/out Weight W/out Rope	6,250 kg	140 X 970 X 140 mm / 390 X 390 X 60 mm
UQRPP1C020	Chrome - Flat Top. W/out Weight W/out Rope	6,250 kg	140 X 970 X 140 mm / 390 X 390 X 60 mm
UQRPP1W020	White - Flat Top. W/out Weight W/out Rope	6,250 kg	140 X 970 X 140 mm / 390 X 390 X 60 mm
UQRPOOL000	Blue-Chrome / only rope	0,950 kg	120 X 460 X 95 mm
UQRPOOB000	Black-Chrome / only rope	0,950 kg	120 X 460 X 95 mm
UQRPOOR000	Red-Chrome / only rope	0,950 kg	120 X 460 X 95 mm
TWBTRT0201	Red-Gold / only rope	0,950 kg	120 X 460 X 95 mm



*W:Width H: Height D: Depth



Info Stand

- Infoboard
- Oval Infoboard
- Eco Infoboard
- Sign Holder

- Infoständer
- Ovalfuss-Infoständer
- Eco Infoständer
- Sign Holder



Infoboard



Single Sided / Double Sided

Single faced acrylic shelves and wheels can be added to the info boards. An anti-reflex PET cover is presented in each unit. 32 mm profile snap frame is used.

Einseitig / Doppelseitig

Für den einseitigen Info-Ständer müssen Akrylablagen und Rollen separat bestellt werden. Antireflex PET Schutzschfolie ist jedem Artikel beigelegt. 32 mm Klapprahmenprofil wird eingesetzt.



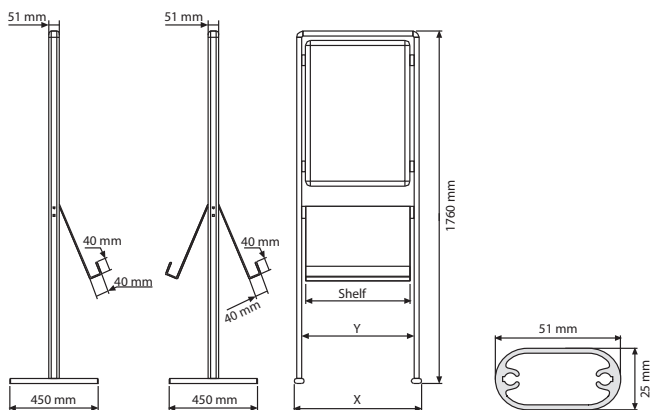
The product is packed unassembled with an easy-to-understand instruction sheet & fixing elements. Das Produkt wird demontiert mit Montageanleitung und Befestigungselementen verpackt geliefert.



Wheels can be ordered optionally. Die Lenkrollen sind optional erhältlich.



Acrylic shelves should be ordered separately. Die Akrylablagen sind nicht inbegriffen und müssen ergänzend bestellt werden.



SINGLE SIDED : Silver anodised aluminium				WEIGHT	PACKING SIZE	SHELF : 4 mm acrylic	
ARTICLE	POSTER	X	Y	WITH PACKING	*W X H X D	SINGLE SIDED	MAX. CAPACITY
UIB200TNA1	594 X 841 mm	756 mm	680 mm	8,800kg	770 X 1780 X 70 mm	UYRT0003A4	3 X A4
UIB200TNB2	500 X 700 mm	660 mm	584 mm	8,000 kg	660 X 1780 X 70 mm	UYRT0002A4	2 X A4
UIB200TNB1	700 X 1000 mm	860 mm	784 mm	11,000 kg	870 X 1780 X 70 mm	UYRT0003A4	3 X A4
DOUBLE SIDED : Silver anodised aluminium				WEIGHT	PACKING SIZE	SHELF : 4 mm acrylic	
ARTICLE	POSTER	X	Y	WITH PACKING	*W X H X D	DOUBLE SIDED	MAX. CAPACITY
UIB200CNA1	594 X 841 mm	756 mm	680 mm	11,100 kg	770 X 1780 X 70 mm	UYRC0003A4	6 X A4
UIB200CNB2	500 X 700 mm	660 mm	584 mm	9,500 kg	660 X 1780 X 70 mm	UYRC0002A4	4 X A4
UIB200CNB1	700 X 1000 mm	860 mm	784 mm	13,750 kg	870 X 1780 X 70 mm	UYRC0003A4	6 X A4

*W:Width H: Height D: Depth



Oval Infoboard



Watch video at our website www.mtdisplays.com



Oval Info board is a double-sided economy floor stand. The black PVC in middle of 2 posters prevent light transmission. Available in A1, A2, B2 and 20"x30" poster sizes.

Das Ovale Infoboard ist unser ekonomischer doppelseitiger Flurständer. Die schwarze PVC Folie, die sich zwischen den beiden Postern befindet, dient zur Lichtabweisung. Verfügbar in den Massen A1, A2, B2 und 20" x 30".

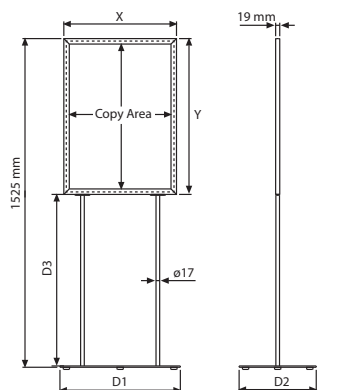
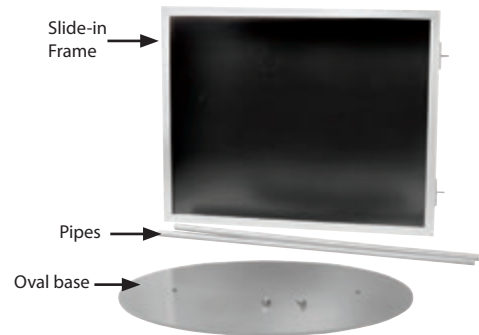
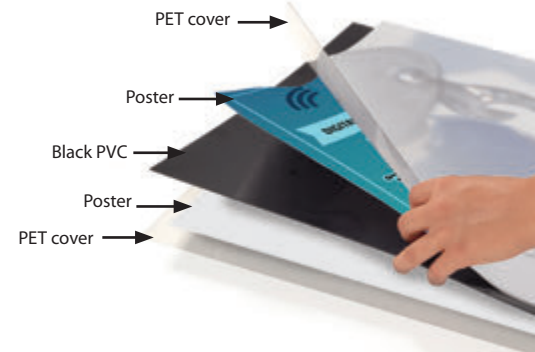
The product is packed unassembled with an easy-to-understand instruction sheet & fixing elements hardware. Das Produkt wird demontiert mit Montageanleitung und Befestigungselementen verpackt geliefert.

Delivered with poster protective set that includes 2 clear + 1 black sheet. Der Artikel wird mit Posterschutzeset mit zwei klaren und einer schwarzen Folie geliefert.

Heavy base provides stability. Die schwere Fussplatte sichert die Standfestigkeit.

2 packs. See info chart for pack sizes. 2 Packungen. Siehe Infodiagramm für Packungsgrößen.

Color options / Farbenoptionen



MATERIAL : Silver & black anodised aluminium									WEIGHT	PACKING SIZE
SILVER	BLACK	POSTER	COPY	EXTERNAL (x-y)	D1	D2	D3	WITH PACKING	*W X H X D	
UIBS10N0A2	UIBS10COA2	420 X 594 mm	392 X 566 mm	443 X 617 mm	480 mm	350 mm	902 mm	11,400 kg	540 X 930 X 53 mm / 370 X 520 X 23 mm	
UIBS10N0A1	UIBS10COA1	594 X 841 mm	566 X 813 mm	617 X 864 mm	560 mm	358 mm	655 mm	13,400 kg	680 X 910 X 53 mm / 370 X 580 X 23 mm	
UIBS10N0B2	UIBS10COB2	500 X 700 mm	472 X 672 mm	523 X 723 mm	560 mm	358 mm	796 mm	12,800 kg	580 X 830 X 53 mm / 370 X 580 X 23 mm	
UIBS10N023	UIBS10C023	508 X 762 mm	480 X 734 mm	531 X 785 mm	560 mm	358 mm	734 mm	12,800 kg	580 X 830 X 53 mm / 370 X 580 X 23 mm	

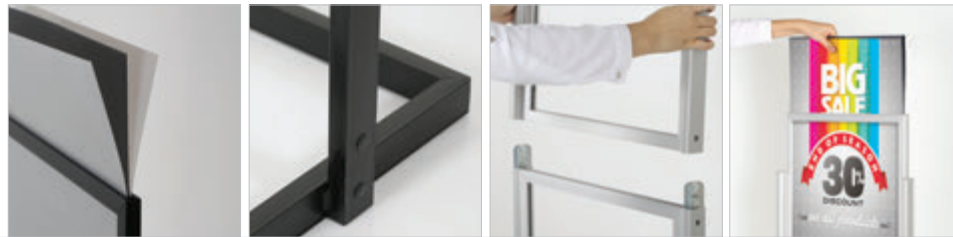
*W:Width H: Height D: Depth



Eco Infoboard



Watch video at our website www.mtdisplays.com



Eco Info board is a new double-sided economy floor stand. The black PVC in middle of 2 posters prevent light transmission. Easy to change poster by simply sliding in through the channels of the stand. Eco Info board has different models that can go up to 2 or 3 tier and display max. 6 posters at once. It is suitable for public spaces & the square base provides stability.

Eco Infoboard ist ein neuer doppelseitiger ekonomischer Bodenständer. Die schwarze PVC Folie, die sich zwischen den beiden Postern befindet, dient zur Lichtabweisung. Mit Hilfe des Kanals ist ein leichter Einschub der Poster gewährleistet. Der Eco Infoboard kann bis zu 2 oder 3 Reihen erhöht werden, so dass max. 6 Poster gleichzeitig präsentiert werden können. Passend für öffentliche Plätze, da durch den quadratischen Fuss Stabilität gewährleistet wird.

The product is packed unassembled with an easy-to-understand instruction sheet & fixing elements hardware. Das Produkt wird demontiert mit Montageanleitung und Befestigungselementen verpackt geliefert.

Delivered with poster protective set that includes 2 clear + 1 black sheet. Der Artikel wird mit Posterschutzset mit zwei klaren und einer schwarzen Folie geliefert.

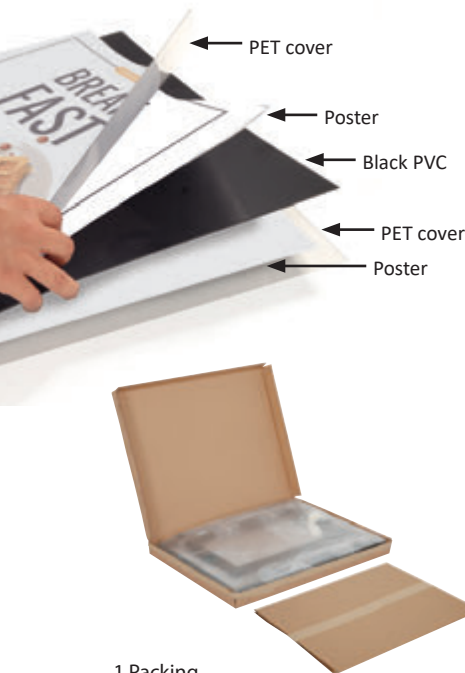
1 packs. 1 Packungen.

Color options / Farbenoptionen



Silver
Silber

Black
Schwarz



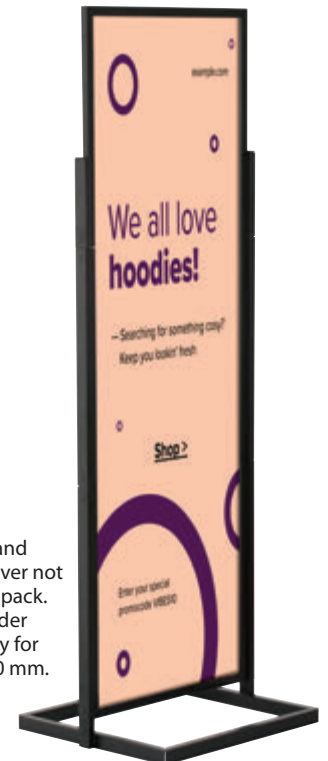
1 Packing
Delivered with poster protective set that includes 2 clear + 1 black sheet sizes for A1 and B2.



1 Tier - Black

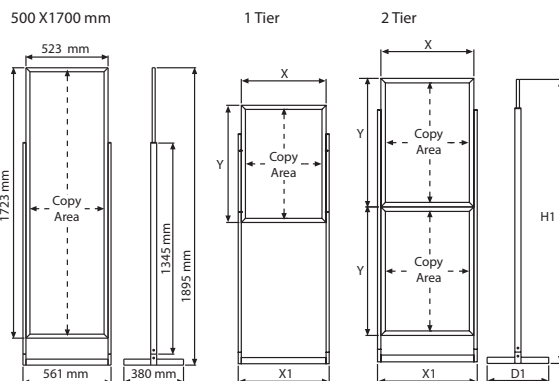


2 Tier - Silver



500 X 1700 mm - Black

Backing and poster cover not included pack. Please order separately for 500x1700 mm.



MATERIAL : Silver & black aluminium			
ARTICLE	POSTER	COPY	MODEL
UIBS20N1S1	500 X 1700 mm	472 X 1672 mm	Silver anodised
UIBS20C1S1	500 X 1700 mm	472 X 1672 mm	Black powder coated

1 TIER : Silver & black aluminium									
SILVER	BLACK	POSTER	COPY	X	X1	Y	D1	H	
UIBS20N1A1	UIBS20C1A1	594 X 841 mm	566 X 813 mm	617 mm	656 mm	864 mm	380 mm	1595 mm	
UIBS20N1B2	UIBS20C1B2	500 X 700 mm	472 X 672 mm	523 mm	562 mm	723 mm	380 mm	1595 mm	

2 TIER : Silver & black aluminium									
SILVER	BLACK	POSTER	COPY	X	X1	Y	D1	H	
UIBS20N2A1	UIBS20C2A1	594 X 841 mm	566 X 813 mm	617 mm	656 mm	864 mm	450 mm	1820 mm	
UIBS20N2B2	UIBS20C2B2	500 X 700 mm	472 X 672 mm	523 mm	562 mm	723 mm	380 mm	1595 mm	

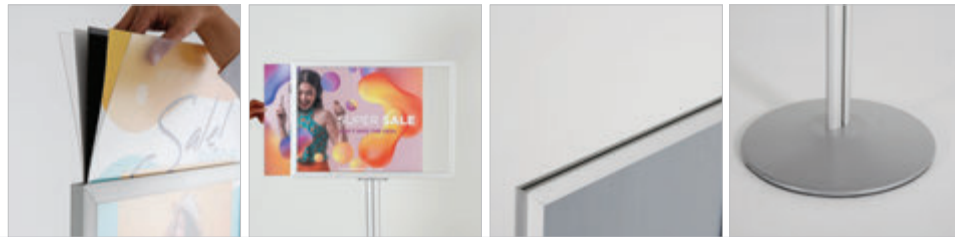


* W:Width H: Height D: Depth

Sign Holder



Watch video at our website www.mtdisplays.com



Sign Holder Stand is a perfect advertising solution in a store or reception as a result of double sided frame for back-to-back prints. A dual-sided display helps to maximise your floor space whilst allowing your advertising message to be seen by people around. Constructed with durable parts it is recommended for use in outdoor conditions. As the poster is top loaded, it is easy to place or replace with only one person. This durable marketing stand makes any product advertisement more attractive and stylish! Each Sign Holder Stand with weighted base to ensure sturdiness and durability in busy environments. It is a good advertising stand for hotels, travel agents, shows offices and even more.

Der Sign Holder Stand ist eine perfekte Werbung Lösung in einem Geschäft oder Rezeption als Folge doppelseitiger Rahmen für Back-to-Back-Drucke. Der Doppelseitiges Display hilft, Ihren Boden zu maximieren Platz und ermöglicht gleichzeitig Ihre Werbebotschaft um von Leuten in der Umgebung gesehen zu werden. Konstruiert mit langlebige Teile, für die es empfohlen wird Bedingungen im Freien. Da das Poster von oben geladen wird, Es ist einfach, nur durch eine Person zu platzieren oder zu ersetzen. Dieser langlebige Marketingständer macht jedes Produkt Werbung attraktiver und stilvoller! Jeder Schildhalterständer mit gewichteter Basis, um sicherzustellen Robustheit und Haltbarkeit in stark frequentierten Umgebungen. Es ist ein guter Werbepostering für Hotels, Reisen Agenten, Ausstellungsbüros und noch mehr.



The product is packed unassembled with an easy-to-understand instruction sheet & fixing elements hardware.

Das Produkt wird demontiert mit Montageanleitung und Befestigungselementen verpackt geliefert.



Delivered with poster protective set that includes 2 clear + 1 black sheet.

Der Artikel wird mit Posterschutzset mit zwei klaren und einer schwarzen Folie geliefert.



1 packs.
1 Packungen.

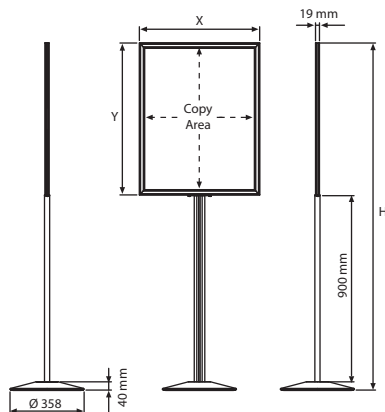
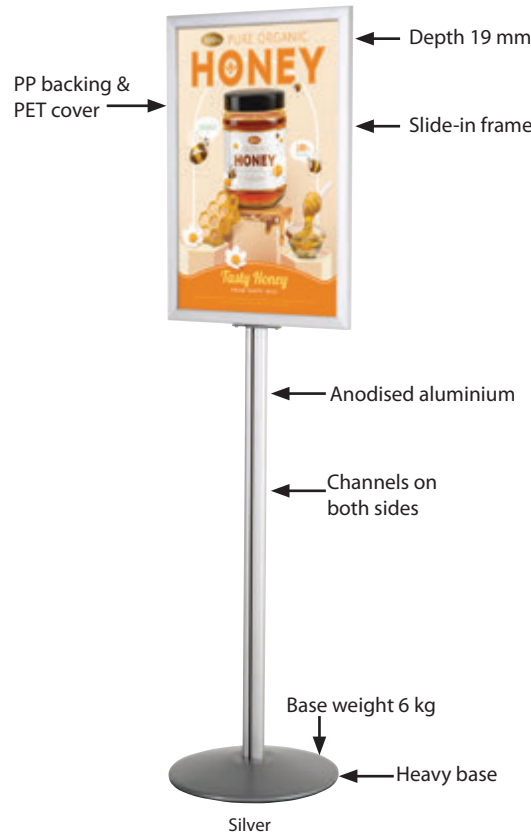
Color options / Farbenoptionen



Silver
Silber



Black
Schwarz



MATERIAL : Silver & black aluminium							WEIGHT	PACKING SIZE
ARTICLE	DESCRIPTION	EXTERNAL (x-y)	POSTER	COPY	HEIGHT PORTRAIT	HEIGHT LANDSCAPE	WITH PACKING	*W X H X D
UIBSHN00A2	Silver	443 X 617 mm	420 X 594 mm	392 X 566 mm	1560 mm	1387 mm	9,200 kg	975 X 530 X 52 mm
UIBSHN00A1	Silver	617 X 864 mm	594 X 841 mm	566 X 813 mm	1808 mm	-	9,800 kg	975 X 705 X 52 mm
UIBSHB00A2	Black	443 X 617 mm	420 X 594 mm	392 X 566 mm	1560 mm	1387 mm	9,200 kg	975 X 530 X 52 mm
UIBSHB00A1	Black	617 X 864 mm	594 X 841 mm	566 X 813 mm	1808 mm	-	9,800 kg	975 X 705 X 52 mm



*W:Width H: Height D: Depth

Sign Holder





Illuminated Products

- Buy Max LEDbox
- Best Buy LEDbox
- Smart LEDbox 25 mm
- Smart LEDbox 35 mm
- Weatherproof Smart LEDbox 35 mm
- Lockable Weatherproof Smart LEDbox 35 mm
- Magneco LEDbox
- Magnetic Smart LEDbox
- Convex LEDbox
- Acryled for Wall Mounting
- LEDA Illuminated Magnetic Totem
- Totem
- Mono Totem

- Buy Max LEDbox
- Best Buy LEDbox
- Smart LEDbox 25 mm
- Smart LEDbox 35 mm
- Smart LEDbox 35 mm Wetterfest
- Smart LEDbox 35 mm Abschliessbar/wetterfest
- Magneco LEDbox
- Magnetische Smart Ledbox
- Convex Leuchtkasten
- Acryled für Wandmontage
- LEDA Illuminated Magnetic Totem
- Leuchtsäule
- Postersäule



Ultra Slim "SMART LEDBOX.."



Please check illuminated products manual before you start using your products. MT Displays products are designed and developed for long term use when maintained as per the information provided in this manual. Brief descriptions and detailed technical information of our standard illuminated display products are provided to aid the user during the use of the units. For custom products, similar information can be provided to user upon request.

Single and double-sided options are available. The specially treated acrylic in the middle provides a homogenous lighting. The depth of the Slim box is 19 mm and the snap front loaded snap Frame is 25 mm, 35 mm or 50 mm. All aluminum structures are silver-anodized. The article disposes of a built-in on/off switch. The LED illumination saves up to 60% energy costs (compared to fluorescent technology) while offering an increased life expectancy.

Our attractive high quality and functional illuminated LED boxes excel with high carbon efficiency which reduces with LED compared to traditionally lit light boxes operating with fluorescent lamps. They are available from A4 up to AO off the shelf while other sizes are available on a custom order basis.

Thanks to its light weight, its slim profile design and its low voltage requirements, the LED box allow mounting at any desired point with access to a regular electrical outlet. The unique frame extrusion offers a wide range of mounting or hanging options.

The Ultra Slim LED Box is extremely durable - it contains no fragile tubes or bulbs, and no glass, making it an ideal choice for highly frequented traffic areas.

These LED light panels are an ideal choice for a wide range of indoor applications including retail point-of-purchase, tradeshow displays, menu boards, movie theaters, sports facilities, shopping malls, casinos, and more.

Einseitige oder doppelseitige Ausführungen sind erhältlich. Das speziell behandelte Acryl in der Mitte ermöglicht homogene Lichtverteilung. Die dünne Baukastentiefe beträgt 19 mm mit einem 25 mm, 35 mm oder 50 mm Profil Klapprahmen. Das Aluminium ist silber eloxiert. Der eingebaute Schalter ermöglicht ein- und ausschalten. Die LED Beleuchtung spart bis zu 60% Energiekosten (verglichen mit Leuchtstofflampen) und haben eine erhöhte Lebenserwartung.

Unsere qualitätsvolle, ansprechende und funktionelle Ledbox mit reduzierter Kohlenstoffabgabe gegenüber traditionellen Leuchtkästen mit Leuchtstofflampen ist in den Massen A4 bis A0 standardmässig erhältlich, nach speziellen Massen wird auf Wunsch gefertigt.

Die leichte, mit feinem Profildesign und geringen Spannungsbedürfnissen ausgestattete Ledbox kann überall an Orten mit normaler Stromzufuhr eingesetzt werden. Die einzigartige Rahmenkonstruktion bietet weite Möglichkeiten der Montage oder Aufhängung.

Die extra dünne Ledbox ist äusserst resistent, beinhaltet keine zerbrechlichen Teile wie Glass und ist eine ideale Lösung für Orte mit viel Menschenverkehr.

Diese Led Lichtpaneele bieten ideale Lösungen in Hinsicht Innenraumanbringungen wie z.B Verkaufspunkten, Messen, Theater, Sport Centern, Einkaufszentren, Casinos etc.

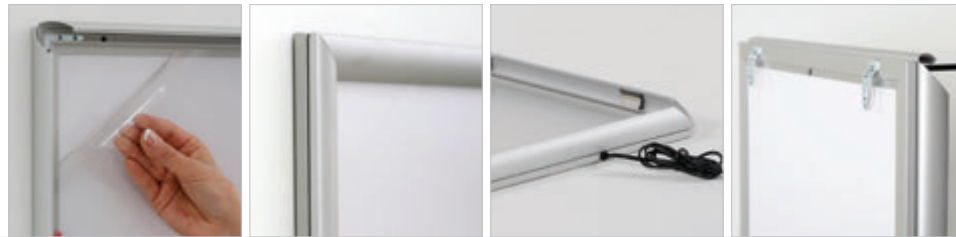


! In case of any claim, user is required to return product or any parts to manufacturer for analyses at their cost. As long as the manufacturer confirms the problem is a manufacturing fault, the replacement can be provided. This applies for all illuminated products.
Im Falle eines Reklamationsanspruchs muss das Produkt oder das Teil des Produktes dem Hersteller zur Analyse auf eigene Kosten zurückgeschickt werden. Erst wenn der Hersteller nach der Analyse bestätigt, dass das Problem ein Herstellungsfehler ist, kann der Ersatz zur Verfügung gestellt werden. Dies ist für alle beleuchteten Produkte verbindlich.

Buy Max LEDbox Single Sided



Watch video at our website www.mtdisplays.com



Ultra slim single sided Buy Max LEDbox with 18 mm thickness is an attractive custom sign solution for a wide range of indoor applications. 25 mm profile Snap Frame makes the change of poster easy. Even illumination is achieved by specially treated acrylic. Illuminated Buy Max LEDbox will capture the attention of passersby easily wherever it is mounted.

Die ultraflache, einseitige Buy Max LEDbox mit 18 mm Stärke ist eine attraktive Lösung für eine Vielzahl individueller Anwendungen im Innenbereich. Das 25 mm-Klapprahmenprofil erleichtert das Wechseln der Einlage. Eine gleichmäßige Ausleuchtung wird durch speziell behandeltes Acryl erzielt. Buy Max LEDbox lenkt die Aufmerksamkeit der Passanten auf sich, egal wo diese montiert ist.

All units pass CE/UL PAT tests and are supplied with their quality certificates. Delivered with 2,5 meter long cable and EU plug. UK and US plugs should be specified with order.

Alle Geräte bestehen CE / UL-PAT-Tests und werden mit ihren Qualitätszertifikaten geliefert. Lieferung mit 2,5 Meter langem Kabel und EU-Stecker. UK- und US-Stecker sollten bei der Bestellung angegeben werden.

LED illumination saves up to 60% energy costs (compared to fluorescent technology).
LED-Beleuchtung spart bis zu 60% Energiekosten (im Vergleich zur Leuchtstofftechnologie).

Has no switch. Complete with built-in power supply, anti-reflex poster cover and wall plugs.
Ohne Schalter, Komplett mit eingebautem Netzteil, antireflex Schutzabdeckung und Schrauben Montageset.

1 pack. See info chart for pack sizes.
1 Packung. Siehe Packungsgrößen.

No tool assembly is required.
Es ist keine Werkzeugmontage erforderlich.

Color options / Farbenoptionen



Silver
Silber



Black
Schwarz

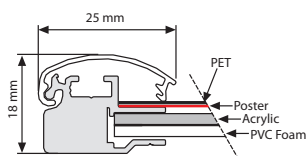
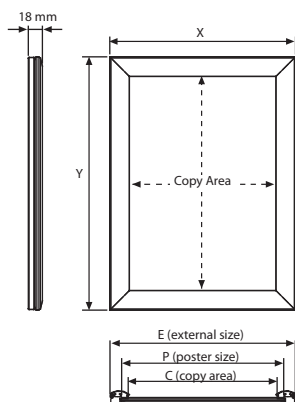


2 wall hangers are standard in each product. Moving hangers let the mounting in portrait and landscape position.
2 Aufhänger sind bei jedem Produkt standard. Die beweglichen Aufhänger ermöglichen Hoch- und Quermontage.



Article / UYUP445550
Optional dimmer to go with LED illuminated frame. Simply jack the dimmer in frame and then into powersupply. It adjust the light from dark to max lux of LED illuminated frame.
Optionaler Dimmer für LED-beleuchtetem Rahmen...
Den Dimmer einfach in die Büchse vom Rahmen und dann ins Netzteil stecken. Einstellbares Licht von dunkel bis max. Lichtstärke vom LED-beleuchteten Rahmen.

- Improved Led technology for improved luminance.
- Pre-treated light guided panel diffuses light even & powerful.
- CE listed electrical components.
- 18 mm, thickness lightbox we ever sell.
- Offers evenly diffused lux in all sizes.
- Snap - open frame for easy poster change.
- Saves up to 60% energy costs.



MATERIAL : Silver anodised aluminium PROFILE: 25 MM						WEIGHT	PACKING SIZE
SILVER	BLACK	EXTERNAL (x-y)	POSTER	COPY	LIGHTING	WITH PACKING	*W X H X D
ULM2STN0A4	ULM2STB0A4	242 X 329 mm	210 X 297 mm	190 X 277 mm	1300-1500 LUX	1,050 kg	255 X 400 X 35 mm
ULM2STN0A3	ULM2STB0A3	329 X 452 mm	297 X 420 mm	277 X 400 mm	1200-1400 LUX	1,550 kg	345 X 520 X 35 mm
ULM2STN0A2	ULM2STB0A2	452 X 626 mm	420 X 594 mm	400 X 574 mm	900-1100 LUX	2,500 kg	465 X 695 X 35 mm
ULM2STN0A1	ULM2STB0A1	626 X 873 mm	594 X 841 mm	574 X 821 mm	1300-1500 LUX	4,500 kg	640 X 960 X 35 mm
ULM2STN0B2	ULM2STB0B2	532 X 732 mm	500 X 700 mm	480 X 680 mm	1100-1300 LUX	3,150 kg	545 X 800 X 35 mm
ULM2STN0B1	ULM2STB0B1	732 X 1032 mm	700 X 1000 mm	680 X 980 mm	1400-1600 LUX	5,800 kg	745 X 1100 X 35 mm
ULM2STN023	ULM2STB023	540 X 794 mm	508 X 762 mm	488 X 742 mm	1200-1300 LUX	3,150 kg	555 X 860 X 35 mm
ULM2STN034	ULM2STB034	794 X 1048 mm	762 X 1016 mm	742 X 996 mm	1100-1300 LUX	6,450 kg	810 X 1115 X 35 mm

* W:Width H: Height D: Depth



Best Buy LEDbox Single Sided



Watch video at our website www.mtdisplays.com



Very slim single sided Best Buy LEDbox with 18 mm thickness is an ideal choice for wide range of indoor applications. High illumination is achieved by specially treated acrylic and provides a homogenous illumination. Homogenous and brilliant Best Buy LEDbox will get the attention of consumers easily wherever it is mounted.

Sehr schmale einseitige Best Buy LEDbox mit 18 mm Einbautiefe ist eine ideale Wahl für eine große Anzahl an Anwendungsbereichen im Innenbereich. Eine hohe Ausleuchtung wird mittels speziell behandelten Akrylplatten erreicht und bietet zudem eine homogene Verteilung. Die homogene und brillante Best Buy LEDbox zieht ganz einfach die Blicke Ihrer Kunden auf sich, wo immer diese auch montiert wurde.

All units pass CE/UL PAT tests and are supplied with their quality certificates. Delivered with 3,5 meter long cable and EU plug. UK and US plugs should be specified with order. *Alle Produkte sind CE/UL Pat getestet und werden mit den entsprechenden Zertifikaten geliefert. Wird mit 3,5 m Kabel und EU Stecker geliefert, UK oder US Stecker müssen bei Bestellung speziell aufgeführt werden.*

LED illumination saves up to 60% energy costs (compared to fluorescent technology). *Die LED Beleuchtung spart bis zu 60% Energiekosten (verglichen mit Leuchtstofflampen) und haben eine erhöhte Lebenserwartung*

Has no switch and comple with built-in powersupply, antireflex poster cover and wall hangers. *Hat keinen Schalter und ist fertiggestellt mit eingebautem Netzteil, Anti-Reflex Plakat Abdeckung und Wandaufhänger.*

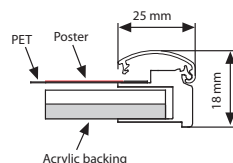
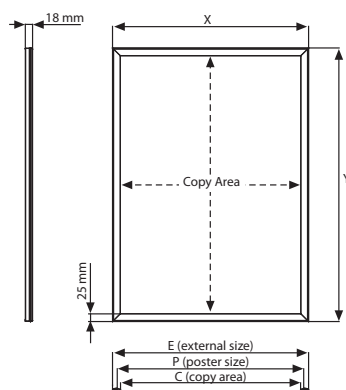
Color options / Farboptionen



25 mm snap frame



Article / UYUP445550
Optional dimmer to go with LED illuminated frame.. Simply jack the dimmer in frame and then into powersupply. It adjust the light from dark to max lux of LED illuminated frame. *Optionaler Dimmer für LED-beleuchtetem Rahmen...*
Den Dimmer einfach in die Büchse vom Rahmen und dann ins Netzteil stecken. Einstellbares Licht von dunkel bis max. Lichtstärke vom LED-beleuchteten Rahmen.



MATERIAL : Silver anodised aluminium PROFILE: 25 MM						WEIGHT	PACKING SIZE
SILVER	BLACK	EXTERNAL (x-y)	POSTER SIZE	COPY	LIGHTING	WITH PACKING	*W X H X D
ULB25TN0A4	ULB25TB0A4	240 X 327 mm	210 X 297 mm	189 X 276 mm	3000-3300 LUX	1,320 kg	255 X 435 X 35 mm
ULB25TN0A3	ULB25TB0A3	327 X 450 mm	297 X 420 mm	276 X 399 mm	2800-3000 LUX	1,880 kg	345 X 520 X 35 mm
ULB25TN0A2	ULB25TB0A2	450 X 624 mm	420 X 594 mm	399 X 573 mm	2400-2700 LUX	2,830 kg	465 X 695 X 35 mm
ULB25TN0A1	ULB25TB0A1	624 X 871 mm	594 X 841 mm	573 X 820 mm	1900-2100 LUX	5,000 kg	640 X 960 X 35 mm
ULB25TN0A0	ULB25TB0A0	871 X 1219 mm	841 X 1189 mm	820 X 1168 mm	1500-1800 LUX	8,940 kg	885 X 1290 X 35 mm
ULB25TN0B2	ULB25TB0B2	530 X 730 mm	500 X 700 mm	479 X 679 mm	2100-2400 LUX	3,550 kg	545 X 800 X 35 mm
ULB25TN0B1	ULB25TB0B1	730 X 1030 mm	700 X 1000 mm	679 X 979 mm	1700-2000 LUX	6,580 kg	745 X 1100 X 35 mm
ULB25TN017	ULB25TB017	310 X 462 mm	280 X 432 mm	259 X 411 mm	2800-3000 LUX	1,830 kg	325 X 535 X 35 mm
ULB25TN022	ULB25TB022	589 X 742 mm	559 X 712 mm	538 X 691 mm	2000-2200 LUX	3,710 kg	605 X 845 X 35 mm
ULB25TN023	ULB25TB023	538 X 792 mm	508 X 762 mm	487 X 741 mm	2200-2500 LUX	3,810 kg	555 X 860 X 35 mm
ULB25TN024	ULB25TB024	640 X 945 mm	610 X 915 mm	589 X 894 mm	1900-2100 LUX	6,520 kg	655 X 1015 X 35 mm
ULB25TN034	ULB25TB034	792 X 1046 mm	762 X 1016 mm	741 X 995 mm	1700-2000 LUX	7,170 kg	810 X 1115 X 35 mm

*W:Width H: Height D: Depth





Best Buy LEDbox Double Sided




Very slim double sided Best Buy LEDbox with 30mm thickness is an ideal choice for wide range of indoor applications. High illumination is achieved by specially treated acrylic and provides a homogenous illumination. Homogenous and bright Best Buy LEDbox will get the attention of consumers easily wherever it is mounted.

Sehr schmale beidseitig Best Buy LEDbox mit 30mm Einbautiefe ist eine ideale Wahl für eine große Anzahl an Anwendungsbereichen im Innenbereich. Eine hohe Ausleuchtung wird mittels speziell behandelten Akrylplatten erreicht und bietet zudem eine homogene Verteilung. Die homogene und brillante Best Buy LEDbox zieht ganz einfach die Blicke Ihrer Kunden auf sich, wo immer diese auch montiert wurde.

 All units pass CE/UL PAT tests and are supplied with their quality certificates. Delivered with 3,5 meter long cable and EU plug. UK and US plugs should be specified with order. *Alle Produkte sind CE/UL Pat getestet und werden mit den entsprechenden Zertifikaten geliefert. Wird mit 3,5 m Kabel und EU Stecker geliefert, UK oder US Stecker müssen bei Bestellung speziell aufgeführt werden.*

 LED illumination saves up to 60% energy costs (compared to fluorescent technology). *Die LED Beleuchtung spart bis zu 60% Energiekosten (verglichen mit Leuchtstofflampen) und haben eine erhöhte Lebenserwartung.*

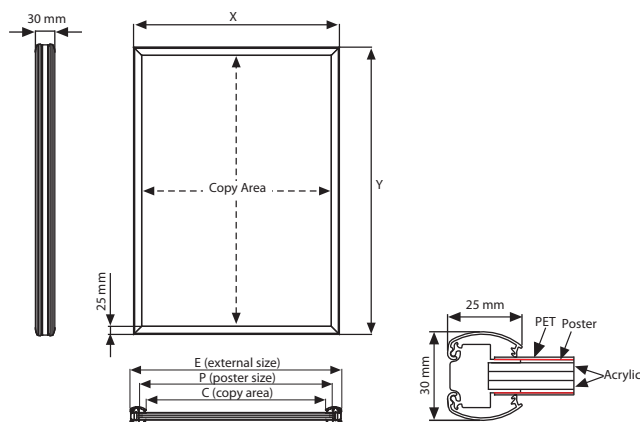
 Complete with 3,5m long power supply and suspension kit, but without switch. *Inklusive 3,5m langem Kabel-Netzteil und Aufhänger set für den Rahmen, jedoch ohne ein und aus Schalter*



Standard hanging kit for all sizes: 2 meters x 2 pcs wire cable and 2 ceiling hangers. *2 Aufhänger sind bei jedem Produkt standart für Jedes Produkt. Bewegliche Aufhänger ermöglichen die Hoch-und Quermontage.*



Article / UYUP445550
Optional dimmer to go with LED illuminated frame.. Simply jack the dimmer in frame and then into powersupply. It adjust the light from dark to max lux of LED illuminated frame. *Optionaler Dimmer für LED-beleuchtetem Rahmen...*
Den Dimmer einfach in die Büchse vom Rahmen und dann ins Netzteil stecken. Einstellbares Licht von dunkel bis max. Lichtstärke vom LED-beleuchteten Rahmen.



MATERIAL : Silver anodised aluminium PROFILE: 25 MM					WEIGHT	PACKING SIZE
ARTICLE	EXTERNAL (x-y)	POSTER SIZE	COPY	LIGHTING	WITH PACKING	*W X H X D
ULB25CNOA4	240 X 327 mm	210 X 297 mm	189 X 276 mm	2800-3000 LUX	1,530 kg	255 X 435 X 40 mm
ULB25CNOA3	327 X 450 mm	297 X 420 mm	276 X 399 mm	2400-2600 LUX	2,390 kg	345 X 520 X 40 mm
ULB25CNOA2	450 X 624 mm	420 X 594 mm	399 X 573 mm	2100-2300 LUX	3,970 kg	465 X 695 X 40 mm
ULB25CNOA1	624 X 871 mm	594 X 841 mm	573 X 820 mm	1800-2000 LUX	7,410 kg	640 X 960 X 40 mm
ULB25CNOA0	871 X 1219 mm	841 X 1189 mm	820 X 1168 mm	1200-1400 LUX	13,680 kg	885 X 1290 X 40 mm
ULB25CNOB2	530 X 730 mm	500 X 700 mm	479 X 679 mm	2000-2200 LUX	5,170 kg	545 X 800 X 40 mm
ULB25CNOB1	730 X 1030 mm	700 X 1000 mm	679 X 979 mm	1600-1800 LUX	10,130 kg	745 X 1100 X 40 mm
ULB25CNO17	310 X 462 mm	280 X 432 mm	259 X 411 mm	2400-2600 LUX	2,350 kg	325 X 535 X 40 mm
ULB25CNO22	589 X 742 mm	559 X 712 mm	538 X 691 mm	1900-2100 LUX	5,760 kg	605 X 845 X 40 mm
ULB25CNO23	538 X 792 mm	508 X 762 mm	487 X 741 mm	2000-2200 LUX	5,650 kg	555 X 860 X 40 mm
ULB25CNO24	640 X 945 mm	610 X 915 mm	589 X 894 mm	1800-2000 LUX	8,520 kg	655 X 1015 X 40 mm
ULB25CNO34	792 X 1046 mm	762 X 1016 mm	741 X 995 mm	1600-1800 LUX	11,180 kg	810 X 1115 X 40 mm

*W:Width H:Height D:Depth



Smart LEDbox 25 mm Single Sided



Watch video at our website www.mtdisplays.com



Very slim single sided Smart LEDbox with 19mm thickness is an ideal choice for wide range of indoor applications. High illumination is achieved by specially treated acrylic and provides a homogenous illumination. The built-in on/off button and outer power supply help long product life. Homogenous and brilliant Smart LEDbox will get the attention of consumers easily wherever it is mounted.

Sehr schmale einseitige Smart ledbox mit 19mm Einbautiefe ist eine ideale Wahl für eine große Anzahl an Anwendungsbereichen im Innenbereich. Eine hohe Ausleuchtung wird mittels speziell behandelten Akrylplatten erreicht und bietet zudem eine homogene Verteilung. Der eingebaute Ein-Ausschalter und ein externes Netzteil ermöglichen eine lange Lebensdauer. Die homogene und brillante Smart Ledbox zieht ganz einfach die Blicke Ihrer Kunden auf sich, wo immer diese auch montiert wurde.

All units pass CE/UL PAT tests and are supplied with their quality certificates. Delivered with 2,5 meter long cable and EU plug. UK and US plugs should be specified with order. *Alle Produkte sind CE/UL Pat getestet und werden mit den entsprechenden Zertifikaten geliefert. Wird mit 2,5 m Kabel und EU Stecker geliefert, UK oder US Stecker müssen bei Bestellung speziell aufgeführt werden.*

LED illumination saves up to 60% energy costs (compared to fluorescent technology). *Die LED Beleuchtung spart bis zu 60% Energiekosten (verglichen mit Leuchtstofflampen) und haben eine erhöhte Lebenserwartung.*

The lightweight SMART LED BOX with slim profile design and low voltage requirements allow mounting at any given point with access to a regular electrical outlet. The unique frame extrusion offers a wide range of mounting or hanging options. *Die leichte, mit feinem Profildesign und geringen Spannungsbedürfnissen ausgestattete Ledbox kann überall an Orten mit normaler Stromzufuhr eingesetzt werden. Die einzigartige Rahmenkonstruktion bietet weite Möglichkeiten der Montage oder Aufhängung.*

19 mm depth



25 mm snap frame

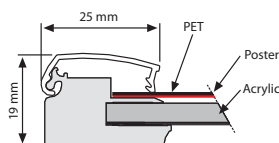
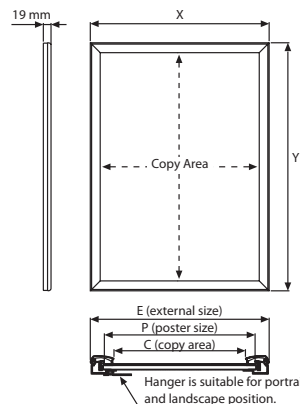


2 wall hangers are standard in each product. Moving hangers let the mounting in portrait and landscape position. *2 Aufhänger sind bei jedem Produkt standart. Die beweglichen Aufhänger ermöglichen Hoch-und Quermontage.*



Article / UYUP445550
Optional dimmer to go with LED illuminated frame. Simply jack the dimmer in frame and then into powersupply. It adjust the light from dark to max lux of LED illuminated frame. *Optionaler Dimmer für LED-beleuchtetem Rahmen... Den Dimmer einfach in die Büchse vom Rahmen und dann ins Netzteil stecken. Einstellbares Licht von dunkel bis max. Lichtstärke vom LED-beleuchteten Rahmen.*

- Improved Led technology for improved luminance.
- Pre-treated light guided panel diffuses light even & powerful.
- CE listed electrical components.
- 19 mm, thinnest lightbox we ever sell.
- Offers evenly diffused lux in all sizes.
- Snap - open frame for easy poster change.
- Saves up to 60% energy costs.



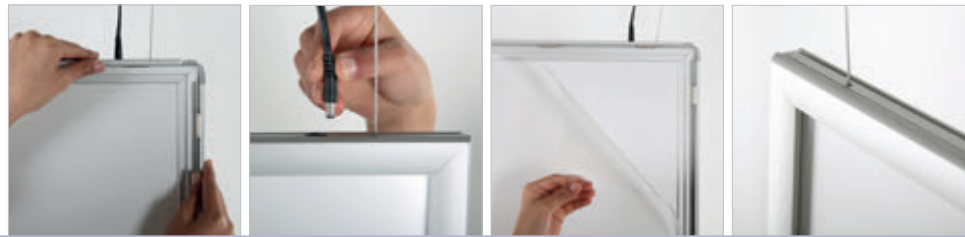
On/off switch button

MATERIAL : Silver anodised aluminium PROFILE: 25 MM					WEIGHT	PACKING SIZE
ARTICLE	EXTERNAL (x-y)	POSTER	COPY	LIGHTING	WITH PACKING	*W X H X D
ULD25TN0A4	242 X 329 mm	210 X 297 mm	190 X 277 mm	1700-2000 LUX	1,100 kg	260 X 420 X 46 mm
ULD25TN0A3	329 X 452 mm	297 X 420 mm	277 X 400 mm	3300-3600 LUX	1,820 kg	350 X 540 X 46 mm
ULD25TN0A2	452 X 626 mm	420 X 594 mm	400 X 574 mm	3000-3300 LUX	2,960 kg	470 X 720 X 46 mm
ULD25TN0A1	626 X 873 mm	594 X 841 mm	574 X 821 mm	2700-3000 LUX	6,530 kg	650 X 960 X 46 mm
ULD25TN0A0	873 X 1221 mm	841 X 1189 mm	821 X 1169 mm	2500-2800 LUX	10,280 kg	890 X 1290 X 46 mm
ULD25TN0B2	532 X 732 mm	500 X 700 mm	480 X 680 mm	2900-3200 LUX	4,850 kg	560 X 820 X 46 mm
ULD25TN0B1	732 X 1032 mm	700 X 1000 mm	680 X 980 mm	2500-2800 LUX	8,710 kg	780 X 1100 X 46 mm
ULD25TN023	540 X 794 mm	508 X 762 mm	488 X 742 mm	2900-3200 LUX	5,130 kg	570 X 870 X 46 mm
ULD25TN034	794 X 1048 mm	762 X 1016 mm	742 X 996 mm	2500-2800 LUX	9,250 kg	820 X 1120 X 46 mm



* W:Width H: Height D: Depth

Smart LEDbox 25 mm Double Sided



Very slim double sided Smart LEDbox with 27,5mm thickness is an ideal choice for wide range of indoor applications. High illumination is achieved by specially treated acrylic and provides a homogenous illumination. The built-in on/off button and outer power supply help long product life. Homogenous and brilliant Smart LEDbox will get the attention of consumers easily wherever it is mounted. The product is equipped with ceiling hangers and cables in portrait position in standard articles.

Sehr schmale doppelseitige Smart ledbox mit 27,5mm Einbautiefe ist eine ideale Wahl für eine große Anzahl an Anwendungsbereichen im Innenbereich. Eine hohe Ausleuchtung wird mittels speziell behandelten Akrylplatten erreicht und bietet zudem eine homogene Verteilung. Der eingebaute Ein-Ausschalter und ein externes Netzteil ermöglichen eine lange Lebensdauer. Die homogene und brillante Smart Ledbox zieht ganz einfach die Blicke Ihrer Kunden auf sich, wo immer diese auch montiert wurde. Das Produkt ist ausgestattet mit einem Deckenmontageset für hochformat in der Standardausführung.

All units pass CE/UL PAT tests and are supplied with their quality certificates. Delivered with 2,5 meter long cable and EU plug. UK and US plugs should be specified with order. *Alle Produkte sind CE/UL Pat getestet und werden mit den entsprechenden Zertifikaten geliefert. Wird mit 2,5 m Kabel und EU Stecker geliefert, UK oder US Stecker müssen bei Bestellung speziell aufgeführt werden.*

LED illumination saves up to 60% energy costs (compared to fluorescent technology). *Die LED Beleuchtung spart bis zu 60% Energiekosten (verglichen mit Leuchtstofflampen) und haben eine erhöhte Lebenserwartung.*

The lightweight SMART LED BOX with slim profile design and low voltage requirements allow mounting at any given point with access to a regular electrical outlet. The unique frame extrusion offers a wide range of mounting or hanging options. *Die leichte, mit feinem Profildesign und geringen Spannungsbedürfnissen ausgestattete Ledbox kann überall an Orten mit normaler Stromzufuhr eingesetzt werden. Die einzigartige Rahmenkonstruktion bietet weite Möglichkeiten der Montage oder Aufhängung.*

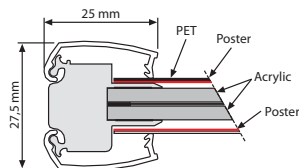
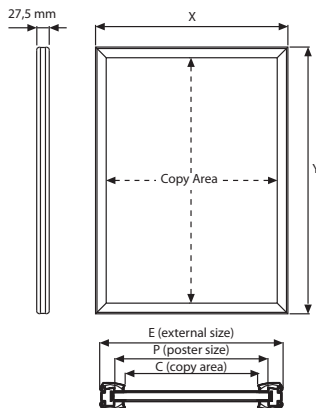


Standard hanging kit for all sizes: 2 meters x 2 pcs wire cable and 2 ceiling hangers. *2 Aufhänger sind bei jedem Produkt standart für Jedes Produkt. Bewegliche Aufhänger ermöglichen die Hoch-und Quermontage.*



Article / UYUP445550
Optional dimmer to go with LED illuminated frame. Simply jack the dimmer in frame and then into powersupply. It adjust the light from dark to max lux of LED illuminated frame. *Optionaler Dimmer für LED-beleuchtetem Rahmen... Den Dimmer einfach in die Büchse vom Rahmen und dann ins Netzteil stecken. Einstellbares Licht von dunkel bis max. Lichtstärke vom LED-beleuchteten Rahmen.*

- Improved Led technology for improved luminance.
- Pre-treated light guided panel diffuses light even & powerful.
- CE listed electrical components.
- 27,5 mm, thinnest double sided ledbox we ever sell.
- Offers evenly diffused lux in all sizes.
- Snap - open frame for easy poster change.
- Saves up to 60% energy costs.



MATERIAL : Silver anodised aluminium PROFILE: 25 MM					WEIGHT	PACKING SIZE
ARTICLE	EXTERNAL (x-y)	POSTER	COPY	LIGHTING	WITH PACKING	*W X H X D
ULD25CN0A4	242 X 329 mm	210 X 297 mm	190 X 277 mm	1500-1800 LUX	1,600 kg	260 X 420 X 46 mm
ULD25CN0A3	329 X 452 mm	297 X 420 mm	277 X 400 mm	2000-2300 LUX	2,490 kg	350 X 540 X 46 mm
ULD25CN0A2	452 X 626 mm	420 X 594 mm	400 X 574 mm	1800-2000 LUX	4,220 kg	470 X 720 X 46 mm
ULD25CN0A1	626 X 873 mm	594 X 841 mm	574 X 821 mm	1600-1800 LUX	8,430 kg	650 X 960 X 46 mm
ULD25CN0B2	532 X 732 mm	500 X 700 mm	480 X 680 mm	1700-1900LUX	6,450 kg	560 X 820 X 46 mm
ULD25CN023	540 X 794 mm	508 X 762 mm	488 X 742 mm	1700-1900 LUX	6,900 kg	570 X 870 X 46 mm



*W:Width H: Height D: Depth

Smart LEDbox 35 mm Single Sided



Watch video at our website www.mtdisplays.com



The specially treated acrylic in the middle provides a homogenous lighting. Single Sided Smart Ledboxes are 29 mm in thickness. The article disposes of a built-in on/off switch. These LED light panels are an ideal choice for a wide range of indoor applications. Max. poster size available is 1200x2415 mm. Improved laser treatment to increase lighting efficiency.

Das speziell behandelte Acryl in der Mitte ermöglicht homogene Lichtverteilung. Die dünne Baukastentiefe betraegt 29 mm. Der eingebaute Schalter ermöglicht ein- und ausschalten. Diese Led Lichtpanele bieten ideale Lösungen in Hinsicht Innenraumbearbeitungen. Max. poster format von diesem Artikel erhältlich ist 1200x2415 mm. verbesserte Lazerbearbeitung für bessere Lichtverteilung.

All units pass CE/UL PAT test and comes along with Quality Certificates and with 2,5 m electrical cable, UK and US plugs should be mentioned on order. *Alle Produkte sind CE/UL Pat getestet und werden mit den entsprechenden Zertifikaten geliefert.*

LED illumination save up to 60% energy costs (compared to flourescent technology) with an increased life expectancy. *Die LED Beleuchtung spart bis zu 60% Energiekosten (verglichen mit Leuchtstofflampen) und haben eine erhöhte Lebenserwartung.*

The SMART LED BOX's lightweight, and low voltage allow it to be mounted anywhere there's access to a regular electrical outlet, and the unique frame extrusion offers a wide range of mounting or hanging options. *Die leichte, mit feinem Profildesign und geringen Spannungsbedürfnissen ausgestattete Ledbox kann überall an Orten mit normaler Stromzufuhr eingesetzt werden. Die einzigartige Rahmenkonstruktion bietet weite Möglichkeiten der Montage oder Aufhängung.*

29 mm depth



35 mm snap frame



On/off switch button

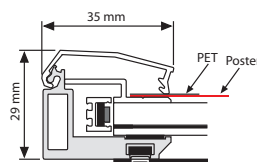
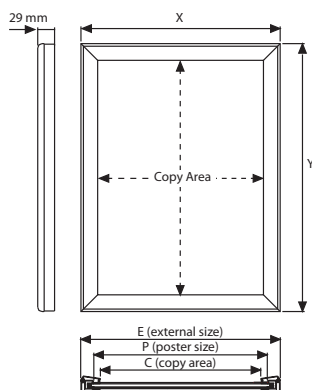
- Improved surface laser treatment for improved luminance
- CE listed electrical components.
- Offers evenly diffused lux in all sizes.
- Saves up to 60% energy costs.



2 wall hangers are standard in each product. Moving hangers let the mounting in portrait and landscape position. *2 Aufhänger sind bei jedem Produkt standart. Die beweglichen Aufhänger ermöglichen Hoch- und Quermontage.*



Article / UYUP445550
Optional dimmer to go with LED illuminated frame.. Simply jack the dimmer in frame and then into powersupply. It adjust the light from dark to max lux of LED illuminated frame. *Optionaler Dimmer für LED-beleuchtetem Rahmen... Den Dimmer einfach in die Büchse vom Rahmen und dann ins Netzteil stecken. Einstellbares Licht von dunkel bis max. Lichtstärke vom LED-beleuchteten Rahmen.*



MATERIAL : Silver anodised aluminium PROFILE: 35 MM					WEIGHT	PACKING SIZE
ARTICLE	EXTERNAL (x-y)	POSTER	COPY	LIGHTING	WITH PACKING	*W X H X D
ULD35TNOA4	257 X 344 mm	210 X 297 mm	187 X 274 mm	4200-4500 LUX	2,910 kg	320 X 510 X 70 mm
ULD35TNOA3	344 X 467 mm	297 X 420 mm	274 X 397 mm	3900-4200 LUX	3,560 kg	410 X 630 X 70 mm
ULD35TNOA2	467 X 641 mm	420 X 594 mm	397 X 571 mm	3500-3900 LUX	5,505 kg	530 X 810 X 70 mm
ULD35TNOA1	641 X 888 mm	594 X 841 mm	571 X 818 mm	3000-3300LUX	9,285 kg	710 X 1060 X 70 mm
ULD35TNOA0	888 X 1236 mm	841 X 1189 mm	818 X 1166 mm	2500-2800 LUX	16,080 kg	960 X 1400 X 70 mm
ULD35TNOB2	547 X 747 mm	500 X 700 mm	477 X 677 mm	3000-3300 LUX	6,928 kg	710 X 910 X 70 mm
ULD35TNOB1	747 X 1047 mm	700 X 1000 mm	677 X 977 mm	2600-2900 LUX	12,065 kg	810 X 1210 X 70 mm
ULD35TNOB0	1047 X 1447 mm	1000 X 1400 mm	977 X 1377 mm	2000-2300 LUX	23,195 kg	1110 X 1610 X 70 mm
ULD35TNO23	555 X 809 mm	508 X 762 mm	485 X 739 mm	3000-3300 LUX	7,965 kg	620 X 970 X 70 mm
ULD35TNO34	809 X 1063 mm	762 X 1016 mm	739 X 993 mm	2600-2900 LUX	13,670 kg	870 X 1220 X 70 mm
ULD35TNO46	1063 X 1571 mm	1016 X 1524 mm	993 X 1501 mm	2000-2300 LUX	26,340 kg	1120 X 1740 X 70 mm




*W:Width H: Height D: Depth


Smart LEDbox 35 mm Double Sided




The specially treated acrylic in the middle provides a homogenous lighting. Double Sided Smart Ledboxes are 39 mm in thickness. The article disposes of a built-in on/off switch. These LED light panels are an ideal choice for a wide range of indoor applications. Max. poster size available is 1016x1600 mm. Improved laser treatment over acrylic to increase lighting efficiency.

Das speziell behandelte Acryl in der Mitte ermöglicht homogene Lichtverteilung. Die dünne Baukastentiefe betraegt 39 mm. Der eingebaute Schalter ermöglicht ein- und ausschalten. Diese Led Lichtpanele bieten ideale Lösungen in Hinsicht Innenraumanbringungen. Max. poster format von diesem Artikel erhältlich ist 1016x1600 mm. verbesserte Lazerbearbeitung für bessere Lichtverteilung.

 All units pass CE/UL PAT test and comes along with Quality Certificates and with 2,5 m electrical cable, UK and US plugs should be mentioned on order. *Alle Produkte sind CE/UL Pat getestet und werden mit den entsprechenden Zertifikaten geliefert.*

 LED illumination save up to 60% energy costs (compared to flourescent technology) with an increased life expectancy. *Die LED Beleuchtung spart bis zu 60% Energiekosten (verglichen mit Leuchtstofflampen) und haben eine erhöhte Lebenserwartung*

 The SMART LED BOX's low voltage requirements allow it to be mounted anywhere there's access to a regular electrical outlet, and the unique frame extrusion offers a wide range of mounting or hanging options. *Die leichte, mit feinem Profildesign und geringen Spannungsbedürfnissen ausgestattete Ledbox kann überall an Orten mit normaler Stromzufuhr eingesetzt werden. Die einzigartige Rahmenkonstruktion bietet weite Möglichkeiten der Montage oder Aufhängung.*



35 mm
snap frame



On/off switch button

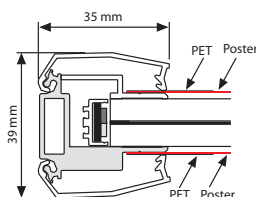
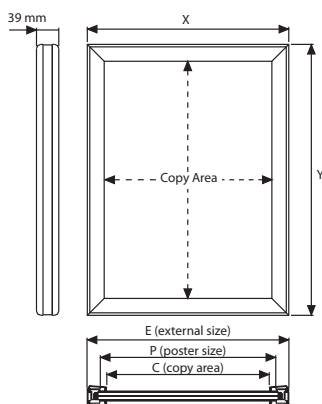


Standard hanging kit for all sizes: 2 meters x 2 pcs wire cable and 2 ceiling hangers. *2 Aufhänger sind bei jedem Produkt standart für Jedes Produkt. Bewegliche Aufhänger ermöglichen die Hoch- und Quermontage.*



Article / UYUP445550
Optional dimmer to go with LED illuminated frame. Simply jack the dimmer in frame and then into powersupply. It adjust the light from dark to max lux of LED illuminated frame. *Optionaler Dimmer für LED-beleuchtetem Rahmen... Den Dimmer einfach in die Büchse vom Rahmen und dann ins Netzteil stecken. Einstellbares Licht von dunkel bis max. Lichtstärke vom LED-beleuchteten Rahmen.*

- Improved surface laser treatment for improved luminance.
- CE listed electrical components.
- Offers evenly diffused lux in all sizes.
- Saves up to 60% energy costs.



MATERIAL : Silver anodised aluminium PROFILE: 35 MM					WEIGHT	PACKING SIZE
ARTICLE	EXTERNAL (x-y)	POSTER	COPY	LIGHTING	WITH PACKING	*W X H X D
ULD35CNOA1	641 X 888 mm	594 X 841 mm	571 X 818 mm	2100-2400 LUX	15,100 kg	720 X 1010 X 60 mm
ULD35CNOA0	888 X 1236 mm	841 X 1189 mm	818 X 1166 mm	1800-2100 LUX	20,750 kg	965 X 1380 X 60 mm
ULD35CNOB1	747 X 1047 mm	700 X 1000 mm	677 X 977 mm	2000-2300 LUX	17,340 kg	815 X 1170 X 60 mm
ULD35CNOB0	1047 X 1447 mm	1000 X 1400 mm	977 X 1377 mm	1500-1800 LUX	27,000 kg	1120 X 1570 X 60 mm
ULD35CNO34	809 X 1063 mm	762 X 1016 mm	739 X 993 mm	2000-2300 LUX	15,000 kg	910 X 1180 X 60 mm
ULD35CNO46	1063 X 1571 mm	1016 X 1524 mm	993 X 1501 mm	1500-1800 LUX	28,850 kg	1170 X 1700 X 60 mm

* W:Width H: Height D: Depth



Weatherproof Smart LEDbox 35 mm Single Sided



The specially treated acrylic in the middle provides a homogenous lighting. Single Sided Smart Ledboxes are 30 mm in thickness. These LED light panels are an ideal choice for a wide range of outdoor applications. Max. poster size available is 1016x1930 mm. Improved laser treatment to increase lighting efficiency. Power supply in IP67 standard. Overall product in IP65 standard. Ultimate isolation of water drainage inside LED frame and connection of electrical cable.

Das speziell behandelte Acryl in der Mitte ermöglicht homogene Lichtverteilung. Die Baukastentiefe beträgt 30 mm. Diese Led Lichtpaneele bieten ideale Lösungen in Hinsicht Outdoor Anbringungen. Maximale mögliche Postergröße von diesem Artikel ist 1016x1930 mm. Verbesserte Laserbearbeitung zur besseren Lichtverteilung. Das Komplettprodukt hat IP65 Standard in Hinsicht Isolation der Stromverbindungen und Wassereinlass in den Rahmen.

All units pass CE/UL PAT test and comes along with Quality Certificates and with 2,5 m electrical cable, UK and US plugs should be mentioned on order. Cable length can be extended up to 7 meter by additional cables. *Alle Produkte sind CE/UL Pat getestet und werden mit den entsprechenden Zertifikaten geliefert.*

LED illumination save up to 60% energy costs (compared to flourescent technology) with an increased life expectancy. *Die LED Beleuchtung spart bis zu 60% Energiekosten (verglichen mit Leuchtstofflampen) und haben eine erhöhte Lebenserwartung*

The SMART LED BOX's lightweight, low voltage requirements allow it to be mounted anywhere there's access to a regular electrical outlet, and the unique frame extrusion offers a wide range of mounting or hanging options. *Die leichte, mit feinem Profildesign und geringen Spannungsbedürfnissen ausgestattete Ledbox kann überall an Orten mit normaler Stromzufuhr eingesetzt werden. Die einzigartige Rahmenkonstruktion bietet weite Möglichkeiten der Montage oder Aufhängung.*



- Improved Led technology and laser treatment.
- IP67 and CE listed electrical Components.
- Offers evenly diffused lux in all sizes.



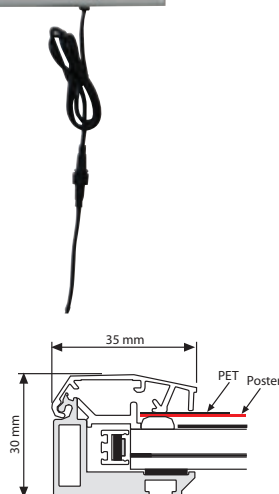
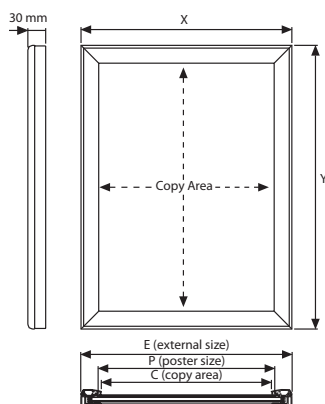
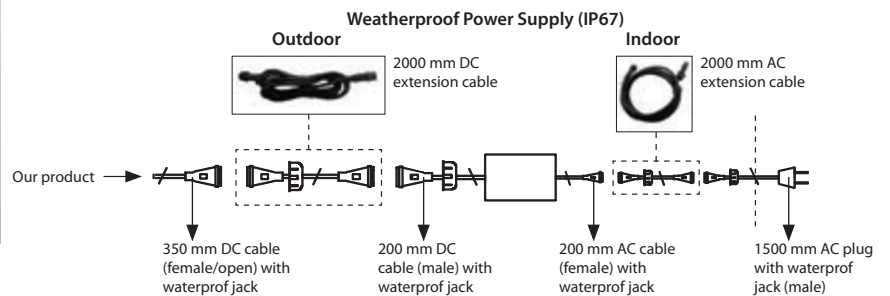
PCT/EP2018/060515



2 wall hangers are standard in each product. Moving hangers let the mounting in portrait and landscape position. *2 Aufhänger sind bei jedem Produkt standard. Die beweglichen Aufhänger ermöglichen Hoch- und Quermontage.*



Mobile cable outlet, from the edge and from the back of the aluminum box. *Beweglicher Kabelausgang am unteren Rand. Durch die Beweglichkeit kann das Kabel auch hinten ausgeführt werden.*



MATERIAL : Silver anodised aluminium PROFILE: 35 MM					WEIGHT	PACKING SIZE
ARTICLE	EXTERNAL (x-y)	POSTER	COPY	LIGHTING	WITH PACKING	*W X H X D
ULS35TNOA4	271 X 358 mm	210 X 297 mm	201 X 288 mm	2600-2900 LUX	2,250 kg	320 X 510 X 70 mm
ULS35TNOA3	358 X 481 mm	297 X 420 mm	288 X 411 mm	2700-3000 LUX	3,660 kg	410 X 630 X 70 mm
ULS35TNOA2	481 X 655 mm	420 X 594 mm	411 X 585 mm	1800-2100 LUX	5,720 kg	530 X 810 X 70 mm
ULS35TNOA1	655 X 902 mm	594 X 841 mm	585 X 832 mm	1600-1900 LUX	9,700 kg	710 X 1060 X 70 mm
ULS35TNOA0	902 X 1250 mm	841 X 1189 mm	832 X 1180 mm	1200-1500 LUX	16,420 kg	960 X 1400 X 70 mm
ULS35TNOB2	561 X 761 mm	500 X 700 mm	491 X 691 mm	1600-1900 LUX	7,180 kg	710 X 910 X 70 mm
ULS35TNOB1	761 X 1061 mm	700 X 1000 mm	691 X 991 mm	1400-1700 LUX	12,455 kg	810 X 1210 X 70 mm
ULS35TNOB0	1061 X 1461 mm	1000 X 1400 mm	991 X 1391 mm	1000-1200 LUX	23,680 kg	1110 X 1610 X 70 mm
ULS35TNO23	569 X 823 mm	508 X 762 mm	499 X 753 mm	1600-1900 LUX	8,240 kg	620 X 970 X 70 mm
ULS35TNO34	823 X 1077 mm	762 X 1016 mm	753 X 1007 mm	1400-1700 LUX	14,010 kg	870 X 1220 X 70 mm
ULS35TNO46	1077 X 1585 mm	1016 X 1524 mm	1007 X 1515 mm	1000-1200 LUX	26,870 kg	1120 X 1740 X 70 mm

*W:Width H:Height D:Depth



Lockable Weatherproof Smart LEDbox 35 mm Single Sided



Lockable weatherproof smart ledbox: Outdoor Smart LEDbox has been improved for using in public places with higher security. Sequentially opening profiles with an allen key keep your poster safe. High and even illumination gets consumer attention to your message.

Ein für den Außeneinsatz gedachtes Produkt das vor allem im Gebiet verwenden kann die höher Sicherheitsansprüche haben. Mit einem Inbusschlüssel und sequentiell öffnenden Profilen ist das Poster vor dritten Geschützt. Sehr Hohe Leuchtkraft zieht die Blicke der Kunden direkt auf Ihre Botschaft.

All units pass CE/UL PAT test and comes along with Quality Certificates and with 2,5 m electrical cable, UK and US plugs should be mentioned on order. Cable lenght can be extended up to 7 meter by additional cables. *Alle Produkte sind CE/UL Pat getestet und werden mit den entsprechenden Zertifikaten geliefert.*

LED illumination save up to 60% energy costs (compared to flourescent technology) with an increased life expectancy. *Die LED Beleuchtung spart bis zu 60% Energiekosten (verglichen mit Leuchtstofflampen) und haben eine erhöhte Lebenserwartung*

The SMART LED BOX's lightweight, low voltage requirements allow it to be mounted anywhere there's access to a regular electrical outlet, and the unique frame extrusion offers a wide range of mounting or hanging options. *Die leichte, mit feinem Profildesign und geringen Spannungsbedürfnissen ausgestattete Ledbox kann überall an Orten mit normaler Stromzufuhr eingesetzt werden. Die einzigartige Rahmenkonstruktion bietet weite Möglichkeiten der Montage oder Aufhängung.*

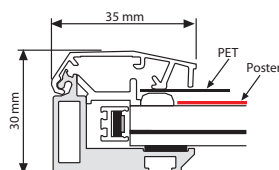
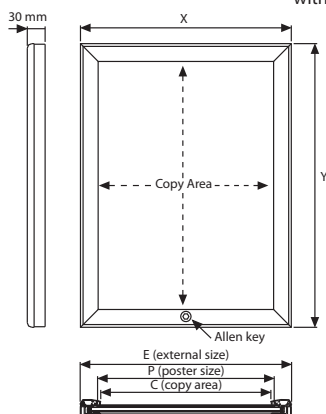


- Improved Led technology and laser treatment.
- IP67 and CE listed electrical Components.
- Offers evenly diffused lux in all sizes.



PCT/EP2018/060515

Locking frame with allen key

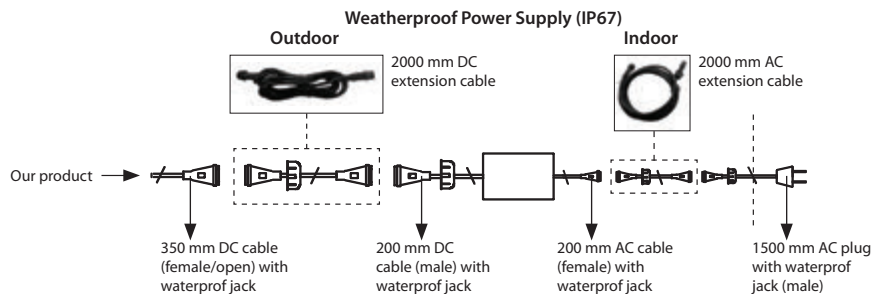


2 wall hangers are standard in each product. Moving hangers let the mounting in portrait and landscape position. *2 Aufhänger sind bei jedem Produkt standart. Die beweglichen Aufhänger ermöglichen Hoch- und Quermontage.*



Mobile cable outlet, from the edge and from the back of the aluminum box.

Beweglicher Kabelausgang am unteren Rand. Durch die Beweglichkeit kann das Kabel auch hinten ausgeführt werden.



MATERIAL : Silver anodised aluminium PROFILE: 35 MM					WEIGHT	PACKING SIZE
ARTICLE	EXTERNAL (x-y)	POSTER SIZE	COPY	LIGHTING	WITH PACKING	*W X H X D
ULH35TN0A4	271 X 358 mm	210 X 297 mm	201 X 288 mm	2600-2900 LUX	2,250 kg	320 X 520 X 83 mm
ULH35TN0A3	358 X 481 mm	297 X 420 mm	288 X 411 mm	2700-3000 LUX	3,660 kg	410 X 640 X 83 mm
ULH35TN0A2	481 X 655 mm	420 X 594 mm	411 X 585 mm	1800-2100 LUX	5,720 kg	530 X 820 X 83 mm
ULH35TN0A1	655 X 902 mm	594 X 841 mm	585 X 832 mm	1600-1900 LUX	9,700 kg	710 X 1070 X 83 mm
ULH35TN0A0	902 X 1250 mm	841 X 1189 mm	832 X 1180 mm	1200-1500 LUX	16,420 kg	960 X 1410 X 83 mm
ULH35TN0B2	561 X 761 mm	500 X 700 mm	491 X 691 mm	1600-1900 LUX	7,180 kg	710 X 920 X 83 mm
ULH35TN0B1	761 X 1061 mm	700 X 1000 mm	691 X 991 mm	1400-1700 LUX	12,455 kg	810 X 1220 X 83 mm
ULH35TN0B0	1061 X 1461 mm	1000 X 1400 mm	991 X 1391 mm	1000-1200 LUX	23,680 kg	1110 X 1620 X 83 mm
ULH35TN023	569 X 823 mm	508 X 762 mm	499 X 753 mm	1600-1900 LUX	8,240 kg	620 X 980 X 83 mm
ULH35TN034	823 X 1077 mm	762 X 1016 mm	753 X 1007 mm	1400-1700 LUX	14,010 kg	870 X 1230 X 83 mm
ULH35TN046	1077 X 1585 mm	1016 X 1524 mm	1007 X 1515 mm	1000-1200 LUX	26,870 kg	1120 X 1750 X 83 mm

*W:Width H: Height D: Depth



Magneco LedBox Single Sided



Watch video at our website www.mtdisplays.com



Very Slim, Magneco LEDbox is a new generation in LEDboxes. With a practical magnetic protection cover, it is very easy to change the poster. High and even illumination level attracts consumers to the message. Hidden finger hole to take off the acrylic cover prevents public access to the poster.

Der sehr leichte Magneco LED Leuchtrahmen ist die neue Generation im Bereich der LED Leuchtrahmen. Der praktische Magnetabdeckung ermöglicht einfach das gewünschte Poster beliebig zu wechseln. Durch die hohe und homogene Leuchtkraft wird die Aufmerksamkeit der Kunden sehr angezogen. Der versteckte Griffloch mit einer Acrylabdeckung verhindert den Fremdzugang zum Poster.

All units pass CE/UL PAT tests and are supplied with their quality certificates. Delivered with 3,5 meter long cable and EU plug. UK and US plugs should be specified with order. *Alle Produkte sind CE/UL Pat getestet und werden mit den entsprechenden Zertifikaten geliefert. Wird mit 2,5 m Kabel und EU Stecker geliefert, UK oder US Stecker müssen bei Bestellung speziell aufgeführt werden.*

LED illumination saves up to 60% energy costs (compared to fluorescent technology). *Die LED Beleuchtung spart bis zu 60% Energiekosten (verglichen mit Leuchtstofflampen) und haben eine erhöhte Lebenserwartung*

Complete with 3,5m long power supply, wall hangers and acrylic cover. Without switch. *Komplett mit 3,5m langen Stromversorgung, Wandaufhänger und Acryl Abdeckung. Ohne ein und aus Schalter.*

Color options / Farbenoptionen



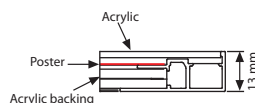
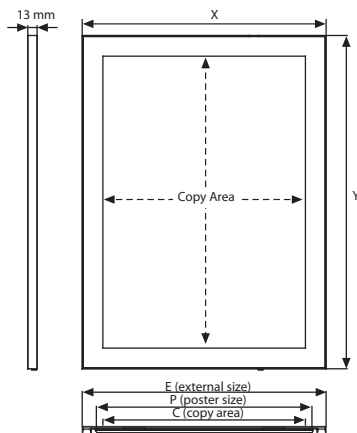
Hanger



Article / UYUP445550

Optional dimmer to go with LED illuminated frame. Simply jack the dimmer in frame and then into powersupply. It adjust the light from dark to max lux of LED illuminated frame.

Optionaler Dimmer für LED-beleuchtetem Rahmen... Den Dimmer einfach in die Büchse vom Rahmen und dann ins Netzteil stecken. Einstellbares Licht von dunkel bis max. Lichtstärke vom LED-beleuchteten Rahmen.



MATERIAL : Silver & black anodised aluminium						WEIGHT	PACKING SIZE
SILVER	BLACK	EXTERNAL (x-y)	POSTER SIZE	COPY	LIGHTING	WITH PACKING	*W X H X D
ULDMENOB44	ULDMEB0BA4	250 X 337 mm	210 X 297 mm	192 X 279 mm	3000-3600 LUX	1,120 kg	265 X 445 X 35 mm
ULDMENOB43	ULDMEB0BA3	337 X 460 mm	297 X 402 mm	279 X 402 mm	3000-3300 LUX	1,760 kg	355 X 530 X 35 mm
ULDMENOB42	ULDMEB0BA2	460 X 634 mm	420 X 594 mm	402 X 576 mm	2700-3000 LUX	2,870 kg	475 X 705 X 35 mm
ULDMENOB41	ULDMEB0BA1	634 X 881 mm	594 X 841 mm	576 X 823 mm	2300-2600 LUX	5,420 kg	650 X 970 X 35 mm
ULDMENOB40	ULDMEB0BA0	881 X 1229 mm	841 X 1189 mm	823 X 1171 mm	1600-1800 LUX	9,960 kg	895 X 1300 X 35 mm
ULDMENOB2	ULDMEB0BB2	540 X 740 mm	500 X 700 mm	482 X 682 mm	2200-2500 LUX	3,740 kg	555 X 810 X 35 mm
ULDMENOB1	ULDMEB0BB1	740 X 1040 mm	700 X 1000 mm	682 X 982 mm	1800-2100 LUX	7,170 kg	755 X 1110 X 35 mm
ULDMENOB17	ULDMEB0B17	320 X 472 mm	280 X 432 mm	262 X 414 mm	2800-3000 LUX	1,710 kg	340 X 540 X 35 mm
ULDMENOB22	ULDMEB0B22	599 X 752 mm	559 X 712 mm	541 X 694 mm	2000-2200 LUX	3,910 kg	620 X 820 X 35 mm
ULDMENOB23	ULDMEB0B23	548 X 802 mm	508 X 762 mm	590 X 744 mm	2200-2500 LUX	3,940 kg	565 X 870 X 35 mm
ULDMENOB24	ULDMEB0B24	650 X 955 mm	610 X 915 mm	592 X 897 mm	1900-2100 LUX	7,200 kg	670 X 1025 X 35 mm
ULDMENOB34	ULDMEB0B34	802 X 1056 mm	762 X 1016 mm	747 X 998 mm	1800-2100 LUX	7,870 kg	820 X 1125 X 35 mm

* W:Width H: Height D: Depth



Magneco LEDbox Double Sided



Watch video at our website www.mtdisplays.com



Magneco LEDbox: A new generation in LEDboxes. With a practical magnetic protection cover, it is very easy to change the poster. High illumination level attracts consumers to the message. The lightweight Magneco double sided and low voltage requirements allow mounting at any given point with access to a regular electrical outlet.

Der Magneco LED Leuchtrahmen ist die neue Generation im Bereich der LED Leuchtrahmen. Die praktische Magnetabdeckung ermöglicht einfach das gewünschte Poster beliebig zu wechseln. Durch die hohe und homogene Leuchtkraft wird die Aufmerksamkeit der Kunden sehr angezogen. Der leichte Magneco doppelseitig und mit niedriger Stromspannung Anforderung ermöglicht die Montage an jedem gegebenen Punkt mit Zugang zu einer regulären Steckdose.

All units pass CE/UL PAT tests and are supplied with their quality certificates. Delivered with 3,5 meter long cable and EU plug. UK and US plugs should be specified with order. *Alle Produkte sind CE/UL Pat getestet und werden mit den entsprechenden Zertifikaten geliefert. Wird mit 3,5 m Kabel und EU Stecker geliefert, UK oder US Stecker müssen bei Bestellung speziell aufgeführt werden.*

LED illumination saves up to 60% energy costs (compared to fluorescent technology). *Die LED Beleuchtung spart bis zu 60% Energiekosten (verglichen mit Leuchtstofflampen) und haben eine erhöhte Lebenserwartung.*

Complete with 3,5m long power supply and suspension kit. Without switch. *Inklusive 3,5m langem Kabel-Netzteil und Aufhänger set für den Rahmen, jedoch ohne ein aus Schalter.*

Color options / Farbenoptionen



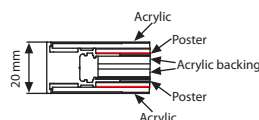
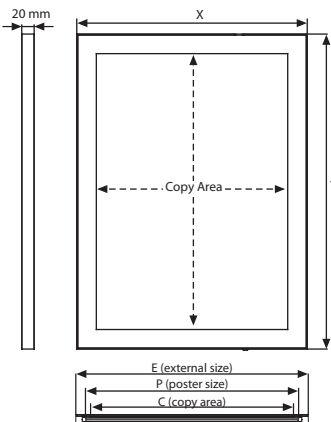
One product, two positions (landscape & portrait)



Standard hanging kit for all sizes: 2 meters x 2 pcs wire cable and 2 ceiling hangers. *2 Aufhänger sind bei jedem Produkt standard für Jedes Produkt. Bewegliche Aufhänger ermöglichen die Hoch- und Quermontage.*



Article / UYUP445550
Optional dimmer to go with LED illuminated frame.. Simply jack the dimmer in frame and then into powersupply. It adjust the light from dark to max lux of LED illuminated frame. *Optionaler Dimmer für LED-beleuchtetem Rahmen... Den Dimmer einfach in die Büchse vom Rahmen und dann ins Netzteil stecken. Einstellbares Licht von dunkel bis max. Lichtstärke vom LED-beleuchteten Rahmen.*



MATERIAL : Silver & black anodised aluminium						WEIGHT	PACKING SIZE
SILVER	BLACK	EXTERNAL (x-y)	POSTER SIZE	COPY	LIGHTING	WITH PACKING	*W X H X D
ULDMEBCBA4	ULDMEBCBA4	250 X 337 mm	210 X 297 mm	192 X 279 mm	2800-3000 LUX	1,770 kg	265 X 445 X 35 mm
ULDMEBCBA3	ULDMEBCBA3	337 X 460 mm	297 X 420 mm	279 X 402 mm	2400-2600 LUX	2,850 kg	355 X 530 X 35 mm
ULDMEBCBA2	ULDMEBCBA2	460 X 634 mm	420 X 594 mm	402 X 576 mm	2100-2300 LUX	4,750 kg	475 X 705 X 35 mm
ULDMEBCBA1	ULDMEBCBA1	634 X 881 mm	594 X 841 mm	576 X 823 mm	1800-2000 LUX	9,250 kg	650 X 970 X 35 mm
ULDMEBCBA0	ULDMEBCBA0	881 X 1229 mm	841 X 1189 mm	823 X 1171 mm	1200-1400 LUX	17,150 kg	895 X 1300 X 40 mm
ULDMEBCB2	ULDMEBCB2	540 X 740 mm	500 X 700 mm	482 X 682 mm	2000-2200 LUX	6,250 kg	555 X 810 X 35 mm
ULDMEBCB1	ULDMEBCB1	740 X 1040 mm	700 X 1000 mm	682 X 982 mm	1600-1800 LUX	12,380 kg	755 X 1100 X 35 mm
ULDMEBCB17	ULDMEBCB17	320 X 472 mm	280 X 432 mm	262 X 414 mm	2400-2600 LUX	2,930 kg	340 X 540 X 35 mm
ULDMEBCB22	ULDMEBCB22	599 X 752 mm	559 X 712 mm	541 X 694 mm	1900-2100 LUX	6,930 kg	620 X 820 X 35 mm
ULDMEBCB23	ULDMEBCB23	548 X 802 mm	508 X 762 mm	590 X 744 mm	2000-2200 LUX	6,850 kg	565 X 870 X 40 mm
ULDMEBCB24	ULDMEBCB24	650 X 955 mm	610 X 915 mm	592 X 897 mm	1800-2000 LUX	10,010 kg	670 X 1025 X 35 mm
ULDMEBCB34	ULDMEBCB34	802 X 1056 mm	762 X 1016 mm	747 X 998 mm	1600-1800 LUX	13,600 kg	820 X 1125 X 35 mm

*W:Width H: Height D: Depth



Magnetic Smart LEDbox



Watch video at our website www.mtdisplays.com



Magnetic Smart LEDbox: A new generation in LEDboxes. With a practical magnetic protection cover, it is very easy to change the poster. High illumination level attracts consumers to the message.

Eine neue Generation im Bereich der LED Leuchtrahmen. Mit einer sehr praktischen Magnetabdeckung, ist sehr leicht das gewünschte Poster beliebig zu wechseln. Durch innovatives Design und einfache Bedienung sticht dieses Produkt heraus.

Durch die extreme Leuchtkraft wird die Aufmerksamkeit der Kunden extrem angezogen.

All units pass CE/UL PAT test and comes along with Quality Certificates and with 2,5 m electrical cable, UK and US plugs should be mentioned on order.
Alle Produkte sind CE/UL Pat getestet und werden mit den entsprechenden Zertifikaten geliefert.

LED illumination save up to 60% energy costs (compared to fluorescent technology) with an increased life expectancy.
Die LED Beleuchtung spart bis zu 60% Energiekosten (verglichen mit Leuchtstofflampen) und haben eine erhöhte Lebenserwartung

Please use the built in cover lever button next to on/off switch button.
Bitte verwenden Sie den Knopf um die Schutzscheibe zu lösen. Dieser befindet sich direkt neben dem Ein-Ausschalter.



24 mm depth



Article / UYUP445550

Optional dimmer to go with LED illuminated frame.. Simply jack the dimmer in frame and then into powersupply. It adjust the light from dark to max lux of LED illuminated frame.

Optionaler Dimmer für LED-beleuchtetem Rahmen...

Den Dimmer einfach in die Büchse vom Rahmen und dann ins Netzteil stecken. Einstellbares Licht von dunkel bis max. Lichtstärke vom LED-beleuchteten Rahmen.

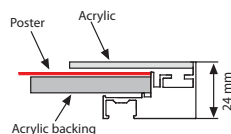
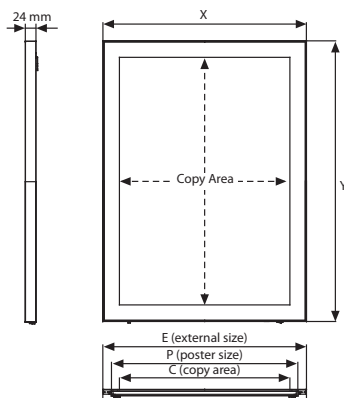


Improved LED Technology & laser surface treatment

Magnetic clear cover

Clear clips to hold the poster

On/off switch button

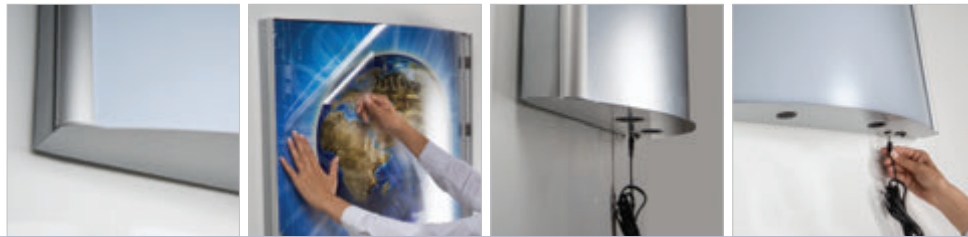


MATERIAL : Silver anodised aluminium					WEIGHT	PACKING SIZE
ARTICLE	EXTERNAL (x-y)	POSTER	COPY	LIGHTING	WITH PACKING	*W X H X D
ULDMON00A4	250 X 337 mm	210 X 297 mm	185 X 272 mm	5500-6000 LUX	1,900 kg	280 X 460 X 40 mm
ULDMON00A3	337 X 460 mm	297 X 420 mm	272 X 395 mm	5000-5400 LUX	3,300 kg	370 X 590 X 40 mm
ULDMON00A2	460 X 634 mm	420 X 594 mm	395 X 569 mm	4600-4900 LUX	5,300 kg	490 X 760 X 40 mm
ULDMON00A1	634 X 881 mm	594 X 841 mm	569 X 816 mm	3500-3800 LUX	9,000 kg	670 X 1010 X 40 mm
ULDMON00A0	881 X 1229 mm	841 X 1189 mm	816 X 1164 mm	2800-3200 LUX	15,800 kg	910 X 1350 X 40 mm
ULDMON00B2	540 X 740 mm	500 X 700 mm	475 X 675 mm	4000-4300 LUX	6,700 kg	570 X 860 X 40 mm
ULDMON00B1	740 X 1040 mm	700 X 1000 mm	675 X 975 mm	3000-3300 LUX	11,900 kg	770 X 1160 X 40 mm

*W:Width H:Height D:Depth



Convex LEDbox



Single faced convex boxes are available in various sizes. Access to posters is by snap frame profiles on each long side. The surface is opal acrylic. The snap has a 25 mm profile. Convex Lightbox includes a PET cover which is ideal to illuminate your duratrans & posters without shining. Best to be with printings on backlit film or duratrans.

Einseitige Konvex Leuchtkästen sind in verschiedenen Klapprahmengrößen erhältlich. Wann immer gewünscht, ermöglichen die zwei Klapprahmen an den beiden langen Seiten schnelles Auswechseln des Displaymaterials. Die Auflagefläche besteht aus opalem Acryl, 25 mm Klapprahmen und Antireflex PET Schutzfolie, welches die Lichtreflektion auf Ihrer Diaprsentation oder dem Poster verhindert



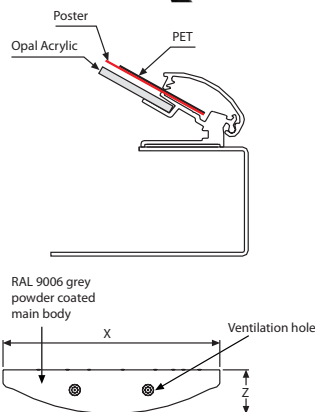
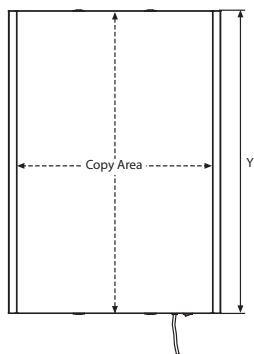
All units pass CE/UL PAT test and are supplied with their quality certificates. Comes along with 2,5 m electrical cable. UK and US plugs should be mentioned on order. *Alle Produkte sind CE/UL Pat getestet and werden mit Qualitätszertifikaten geliefert. 2,5 m Stromkabel. Falls UK und USA Stecker gewünscht ist die Angabe bei Bestellung erforderlich.*



Illumination save up to 60% energy cost with an increased life expectancy. *Die LED Beleuchtung spart bis zu 60% Energieverbrauch und erhöht somit die Lebenserwartung des Produktes*



Product is wall mounting, no further hanging accessories are included in the original pack. *Das Produkt ist geeignet für die Wandmontage, kein weiteres Hängerset ist in der Originalverpackung inkludiert.*



MATERIAL : Silver anodised aluminium					WEIGHT	PACKING SIZE
ARTICLE	EXTERNAL (x-y-z)	POSTER	COPY	LIGHTING	WITH PACKING	*W X H X D
UCLB25LNA4	224 X 300 X 71 mm	210 X 297 mm	185 X 297 mm	2800-3300 LUX	1,800 kg	280 X 340 X 80 mm
UCLB25LNA3	308 X 423 X 82 mm	297 X 420 mm	273 X 420 mm	2500-3000 LUX	3,100 kg	335 X 445 X 95 mm
UCLB25LNA2	424 X 597 X 98 mm	420 X 594 mm	395 X 594 mm	2000-2300 LUX	5,800 kg	450 X 625 X 110 mm
UCLB25LNA1	592 X 844 X 120 mm	594 X 841 mm	570 X 841 mm	2500-2700 LUX	11,000 kg	625 X 875 X 130 mm
UCLB25LNB2	500 X 703 X 110 mm	500 X 700 mm	475 X 700 mm	2200-2500 LUX	7,750 kg	530 X 725 X 120 mm
UCLB25LNB3	510 X 765 X 108 mm	508 X 762 mm	484 X 762 mm	1800-2200 LUX	7,980 kg	540 X 780 X 120 mm

*W:Width H: Height D: Depth



AcryLed for Wall Mounting



Watch video at our website www.mtdisplays.com



Ultra slim and clear Acryled. The edge-lit acryled mounts portrait or landscape for various types of signage. Edge-lit Acryled lights up poster in sizes of A4, A3, A2. Acryled lit with LEDs use less power than traditional illuminated signage. Poster is placed in between the specially treated acrylic & cover acrylic sheet & fixed in position by two clear clips on two short sides. Products is available in 2 colours; silver and black. Compared to traditional articles in the market, Acryled provides easy poster change when unit keeps mounted on the wall.

Ultra dünn der glasklare Acryled. Der Artikel kann in Hoch-oder Querformat für verschiedene Einsatzmöglichkeiten benutzt werden. Der Artikel kann in den Posterformaten A4, A3 und A2 eingesetzt werden. Acryled mit LED verbraucht weniger Energie als herkömmlich beleuchtete Artikel mit Leuchtstoffröhren. Das Poster wird zwischen die speziell behandelte Acrylplatte und dem bedeckenden Acryl gelegt und mit zwei Klipsen an beiden kurzen Seiten festgehalten. Das Product ist in zwei Standartfarben erhältlich. Verglichen mit den traditionellen Artikeln auf dem Markt ermöglicht der Acryled ein einfaches Auswechseln des Posters, ohne es komplett von der Wand abzumontieren.



All units pass CE/UL PAT test and are supplied with their quality certificates. Comes along with 2,5 m electrical cable. UK and US plugs should be mentioned on order. *Alle Produkte sind CE/UL Pat getestet and werden mit Qualitätszertifikaten geliefert. 2,5 m Stromkabel. Falls UK und USA Stecker gewünscht ist die Angabe bei Bestellung erforderlich.*

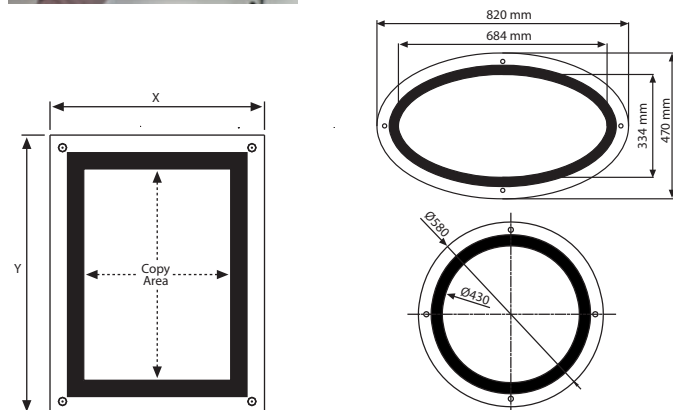


Illumination save up to 60% energy cost with an increased life expectancy. *Die LED Beleuchtung spart bis zu 60% Energieverbrauch und erhöht somit die Lebenserwartung des Produktes*



Acryled's lightweight and low voltage requirements allow it to be mounted anywhere there's access to regular electrical outlet. *Acryled's Leichtgewichtigkeit und Niederspannung ermöglichen den Einsatz an allen herkömmlichen Orten mit normaler Stromversorgung.*

Color options / Farboptionen



MATERIAL : Treated illuminated acrylic					WEIGHT	PACKING SIZE
ARTICLE	EXTERNAL (x-y)	POSTER	COPY	DESCRIPTION	WITH PACKING	*W X H X D
UACLON00A4	323 X 410 mm	210 X 297 mm	194 X 281 mm	Square - Silver	2,500 kg	370 X 530 X 75 mm
UACLON00A3	410 X 533 mm	297 X 420 mm	281 X 404 mm	Square - Silver	3,480 kg	460 X 650 X 75 mm
UACLON00A2	533 X 707 mm	420 X 594 mm	404 X 578 mm	Square - Silver	5,400 kg	580 X 830 X 75 mm
UACLON00A1	707 X 954 mm	594 X 841 mm	578 X 825 mm	Square - Silver	11,000 kg	680 X 1000 X 850 mm
UACLB00A4	323 X 410 mm	210 X 297 mm	194 X 281 mm	Square - Black	2,500 kg	370 X 530 X 75 mm
UACLB00A3	410 X 533 mm	297 X 420 mm	281 X 404 mm	Square - Black	3,480 kg	460 X 650 X 75 mm
UACLB00A2	533 X 707 mm	420 X 594 mm	404 X 578 mm	Square - Black	5,400 kg	580 X 830 X 75 mm
UACLB00A1	707 X 954 mm	594 X 841 mm	578 X 825 mm	Square - Black	11,000 kg	680 X 1000 X 850 mm
UACLYN0000	Ø580 mm	Ø 446	Ø 430	Circle - Silver	5,500 kg	630 X 700 X 75 mm
UACLYB0000	Ø580 mm	Ø 446	Ø 430	Circle - Black	5,500 kg	630 X 700 X 75 mm
UACLEN0000	820 X 470 mm	700 X 350 mm	684 X 334 mm	Elliptical - Silver	6,500 kg	520 X 930 X 75 mm
UACLB0000	820 X 470 mm	700 X 350 mm	684 X 334 mm	Elliptical - Black	6,500 kg	520 X 930 X 75 mm

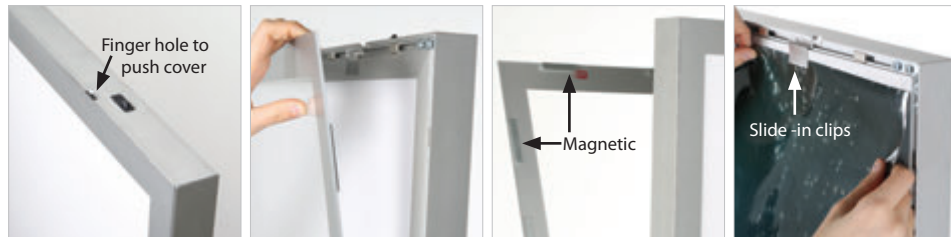
*W:Width H: Height D: Depth



LEDA Illuminated Magnetic Totem



Watch video at our website www.mtdisplays.com



Indoor large display, LEDA is a slim LED illuminated totem. High quality LEDA provides bright images with high illumination. Magnetic acrylic cover has a hidden access so it prevents from public access easily. It is made of powder coated steel base and aluminium profiles to provide stability. Easy to assemble with enclosed mounting instructions.

LEDA ist ein dünnes, beleuchtetes LED Totem für Innenbereiche mit grossem Displayfläche. LEDA bietet mit seiner Leuchtkraft und hoher Qualität helle perfekt beleuchtete Werbemöglichkeit an. Die Magnetische Acryl Abdeckung hat einen versteckten Zugang und verhindert somit den Fremdzugang von aussen. Der LEDA besteht aus pulverbeschichtetem Stahlgestell und Aluminiumprofilen, die für Stabilität sorgen. Mit der anliegende Montageanleitung einfach zu montieren.

All units pass CE/UL PAT tests and are supplied with their quality certificates. Delivered with 2,5 meter long cable and EU plug. UK and US plugs should be specified with order. Alle Produkte sind CE/UL Pat getestet und werden mit den entsprechenden Zertifikaten geliefert. Standard Kabellänge für den Artikel ist 2,5m und wird EU Stecker geliefert, UK oder US Stecker müssen bei Bestellung speziell aufgeführt werden.

LED illumination saves up to 60% energy costs (compared to fluorescent technology). Die LED Beleuchtung spart bis zu 60% Energiekosten (verglichen mit Leuchtstofflampen) und haben eine erhöhte Lebenserwartung.

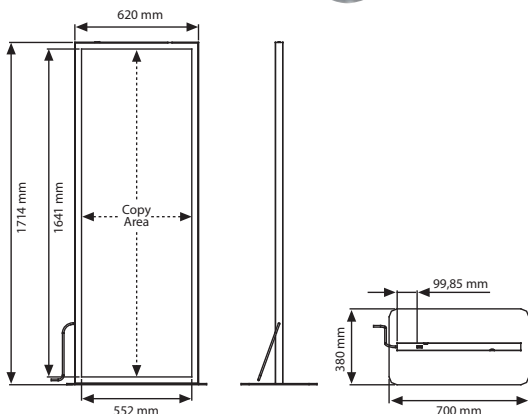
Complete with low voltage 6A powersupply. Komplett mit Niederspannung 6A Netzteil.

2 packs. See info chart for pack sizes. 2 Packungen. Siehe Infodiagramm für Packungsgrößen.

Color options / Farboptionen



- Improved LED technology for improved luminance
- Pre-treated light guided panel diffuses light even & powerful.
- CE listed electrical components.
- Offers evenly diffused lux
- Saves up to 60% energy costs.



MATERIAL : Silver & black anodised aluminium						WEIGHT	PACKING SIZE
ARTICLE	DESCRIPTION	EXTERNAL (x-y)	POSTER	COPY	LIGHTING	WITH PACKING	*W X H X D
UMLD37B000	Black	620 X 1708 mm	594 X 1682 mm	552 X 1641 mm	1900-2100 LUX	41,500 kg	690 X 1800 X 85 mm / 410 X 740 X 30 mm
UMLD37N000	Silver	620 X 1708 mm	594 X 1682 mm	552 X 1641 mm	1900-2100 LUX	41,500 kg	690 X 1800 X 85 mm / 410 X 740 X 30 mm



*W:Width H: Height D: Depth

Totem



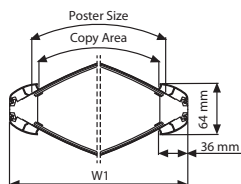
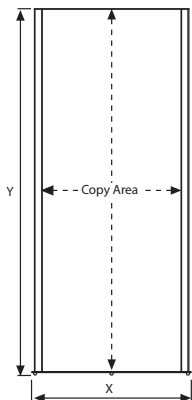
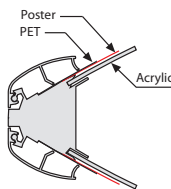
Stylish and practical free-standing light column. Illuminates posters printed on backlit film or duratrans. The snap frames enable you to change the display material easily whenever desired. Product is double sided. One can simply open the front profile to change the poster. The hinged door, magnetic cover closing & plastic pegs on both sides add value to the unit provide easy poster replacement.

Die Klapprahmen ermöglichen ein schnelles Auswechseln Ihres Displaymaterials, wann immer Sie wünschen. Der Standpylon kann doppelseitig eingesetzt werden. Die Schutzfolie mit Gelenktür und magnetischer Schliessung, die Plastikhalter für Ihr Poster steigern den Wert des Produktes.

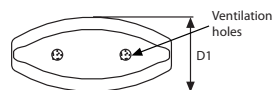
Each unit is packed unassembled with an easy instruction sheet. Delivered with 2 m electrical cable & plug. UK plug must be specified in order. *Jeder Artikel wird demontiert mit Montageanleitung verpackt geliefert. 2 m Stromkabel mit Stecker, UK Stecker müssen bei Bestellung speziell aufgeführt werden.*

Each unit has a ventilation hole. PVC hinge on one side & magnetic cover allows for an easy change of the poster. All units have passed CE/UL Pat tests & are delivered with their certificates. *Jeder Artikel hat Entlüftungskanäle. Die PVC Folie als Gelenktür und die magnetische Schliessung tragen zum leichten Auswechseln Ihres Posters bei. Alle Produkte sind CE/UL Pat getestet und werden mit den entsprechenden Zertifikaten geliefert.*

2 packs. See info chart for pack sizes. *2 Packungen. Siehe Infodiagramm für Packungsgrößen.*



Top part
RAL 9006 grey powdercoated



MATERIAL : Silver anodised aluminium							WEIGHT	PACKING SIZE
ARTICLE	EXTERNAL (x-y)	POSTER	COPY	D1	W1	LIGHTING	WITH PACKING	*W X H X D
UTTM001000	650 X 1720 mm	600 X 1700 mm	580 X 1700 mm	350 mm	628 mm	1 X 58 W	28,000 kg	670 X 1750 X 85 mm / 380 X 680 X 45 mm
UTTM002000	750 X 1720 mm	700 X 1700 mm	680 X 1700 mm	350 mm	723 mm	1 X 58 W	30,800 kg	770 X 1750 X 85 mm / 380 X 780 X 45 mm
UTTM003000	850 X 1720 mm	800 X 1700 mm	780 X 1700 mm	370 mm	820 mm	2 X 58 W	36,500 kg	870 X 1750 X 85 mm / 400 X 880 X 45 mm



*W:Width H: Height D: Depth

Mono Totem



Non-snap Mono Totem is offered with and without light. Poster is placed on 2 long sides by slide-in to profile channel. Available sizes are 500x1700 mm and 600x1700 mm. Mono Totem presents poster as double sided. Smooth & durable aluminium construction provides stability. For illuminating options, please contact your Sales Executive.

Das Mono Totem mit dem nicht klappbaren Profil wird ohne Beleuchtung angeboten mit und ohne. Das Poster wird durch das Einschieben in die zwei langen Seitenkanäle festgehalten. Das Mono Totem ist für den beidseitigen Gebrauch. 500x1700 mm, 600x1700 mm werden als Standardmasse angeboten. Glattes, langlebiges Aluminium bietet der Konstruktion Stabilität. Für beleuchtete Optionen, fragen Sie bitte Ihre Kundenbetreuung.

Each unit is packed unassembled with an easy-to-understand instruction sheet and fixing hardware for assembly. Jeder Artikel wird demontiert mit Montageanleitung und Befestigungsmaterial geliefert.

Heavy elegant base provides stability. Die schwere Bodenplatte sorgt für Stabilität.

All illuminated items pass CE/UL tests and are delivered with certificates. Alle beleuchteten Produkte haben CE/UL tests und werden mit den Zertifikaten geliefert.

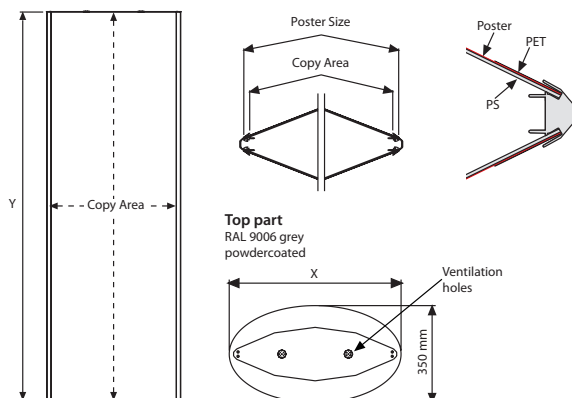
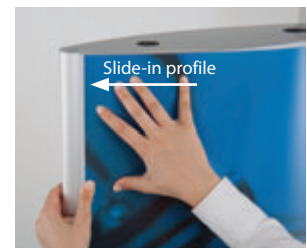
2 packs. See info chart for pack sizes. 2 Packungen. Siehe Infodiagramm für Packungsgrößen.



Mono Totem



Mono Totem with Light



MATERIAL : Silver anodised aluminium					WEIGHT	PACKING SIZE
ARTICLE	EXTERNAL (x-y)	POSTER	COPY	DESCRIPTION	WITH PACKING	*W X H X D
UTTME10500	520 X 1700 mm	500 X 1700 mm	470 X 1700 mm	without light	18,000 kg	570 X 1750 X 60 mm / 370 X 540 X 40 mm
UTTME10600	620 X 1700 mm	600 X 1700 mm	570 X 1700 mm	without light	20,000 kg	670 X 1750 X 60 mm / 370 X 640 X 40 mm
UTTME00500	520 X 1700 mm	500 X 1700 mm	470 X 1700 mm	with light	19,000 kg	570 X 1750 X 60 mm / 370 X 540 X 40 mm
UTTME00600	620 X 1700 mm	600 X 1700 mm	570 X 1700 mm	with light	21,000 kg	670 X 1750 X 60 mm / 370 X 640 X 40 mm



* W:Width H: Height D: Depth

Smart LEDbox Product Programme (Production & Availability)

Size Available	25mm Indoor LEDbox		35mm Indoor LEDbox		35mm Outdoor/ Lockable LEDbox	Best Buy LEDbox		Magneco LEDbox		Magnetic LEDbox	Convex LEDbox	AcryLED	Buy Max LEDbox
	single	double	single	double	single	single	double	single	double	single	single	single	single
A4 / 297 x 210	ULD25TNOA4	ULD25CNOA4	ULD35TNOA4	ULD35CNOA4	ULS35TNOA4	ULB25TNOA4	ULB25CNOA4	ULDMEN0BA4	ULDMENCB4A	ULDMON0A4	UCLB25LNA4	UACLON0A4	ULM25TNOA4
A3 / 420 x 297	ULD25TNOA3	ULD25CNOA3	ULD35TNOA3	ULD35CNOA3	ULS35TNOA3	ULB25TNOA3	ULB25CNOA3	ULDMEN0BA3	ULDMENCB3A	ULDMON0A3	UCLB25LNA3	UACLON0A3	ULM25TNOA3
A2 / 594 x 420	ULD25TNOA2	ULD25CNOA2	ULD35TNOA2	ULD35CNOA2	ULS35TNOA2	ULB25TNOA2	ULB25CNOA2	ULDMEN0BA2	ULDMENCB2A	ULDMON0A2	UCLB25LNA2	UACLON0A2	ULM25TNOA2
A1 / 841 x 594	ULD25TNOA1	ULD25CNOA1	ULD35TNOA1	ULD35CNOA1	ULS35TNOA1	ULB25TNOA1	ULB25CNOA1	ULDMEN0BA1	ULDMENCB1A	ULDMON0A1	UCLB25LNA1	UACLON0A1	ULM25TNOA1
A0 / 1189 x 841	ULD25TNOA0	X	ULD35TNOA0	ULD35CNOA0	ULS35TNOA0	ULB25TNOA0	ULB25CNOA0	ULDMEN0BA0	ULDMENCB0A	ULDMON0A0	UCLB25LNA0	UACLON0A0	X
B2 / 700 x 500	ULD25TNOB2	ULD25CNOB2	ULD35TNOB2	ULD35CNOB2	ULS35TNOB2	ULB25TNOB2	ULB25CNOB2	ULDMEN0B2	ULDMENCB2B	ULDMON0B2	UCLB25LNB2	UACLON0B2	ULM25TNOB2
B1 / 1000 x 700	ULD25TNOB1	X	ULD35TNOB1	ULD35CNOB1	ULS35TNOB1	ULB25TNOB1	ULB25CNOB1	ULDMEN0B1	ULDMENCB1B	ULDMON0B1	UCLB25LNB1	UACLON0B1	ULM25TNOB1
B0 / 1400 x 1000	X	X	ULD35TNOB0	ULD35CNOB0	ULS35TNOB0	X	X	X	X	X	X	X	X
20" x 30" / 508 x 762	ULD25TNO23	ULD25CNO23	ULD35TNO23	ULD35CNO23	ULS35TNO23	ULB25TNO23	ULB25CNO23	ULDMEN0B23	ULDMENCB23	ULDMON023	UCLB25LNB23	UACLON023	ULM25TNO23
30" x 40" / 762 x 1016	ULD25TNO34	X	ULD35TNO34	ULD35CNO34	ULS35TNO34	ULB25TNO34	ULB25CNO34	ULDMEN0B34	ULDMENCB34	ULDMON034	UCLB25LNB34	UACLON034	ULM25TNO34
40" x 60" / 1016 x 1524	X	X	ULD35TNO46	ULD35CNO46	ULS35TNO46	X	X	X	X	X	X	X	X
11" x 17" (USA) 279.4 x 431.8	ULD25TNO17	ULD25CNO17	ULD35TNO17	ULD35CNO17	ULS35TNO17	ULB25TNO17	ULB25CNO17	ULDMEN0B17	ULDMENCB17	ULDMON017	UCLB25LNB17	UACLON017	ULM25TNO17
22" x 28" (USA) 558.8 x 711.2	ULD25TNO22	ULD25CNO22	ULD35TNO22	ULD35CNO22	ULS35TNO22	ULB25TNO22	ULB25CNO22	ULDMEN0B22	ULDMENCB22	ULDMON022	UCLB25LNB22	UACLON022	ULM25TNO22
24" x 36" (USA) 609.6 x 914.4	ULD25TNO24	X	ULD35TNO24	ULD35CNO24	ULS35TNO24	ULB25TNO24	ULB25CNO24	ULDMEN0B24	ULDMENCB24	ULDMON024	UCLB25LNB24	UACLON024	ULM25TNO24
Max(w x h) mm	850 x 1200	600 x 900	1200 x 2415	1016 x 1600	1000 x 1900	850 x 2000	850 x 2000	850 x 1200	850 x 1200	850 x 1200	850 x 1250	850 x 1200	700 x 1000

*Max perimeter is 4000mm in condition of short profile is max 850mm and long profile is max 1500mm.

Power Consumption	25mm Indoor LEDbox		35mm Indoor LEDbox		35mm Outdoor/ Lockable LEDbox	Best Buy LEDbox		Magneco LEDbox		Magnetic LEDbox	Convex LEDbox	AcryLED	Buy Max LEDbox
	single	double	single	double	single	single	double	single	double	single	single	single	single
A4 / 297 x 210	11W / 0,92A	12W / 1A	12W / 1A	19W / 1,41A	12W / 1A	7W / 0,58A	9,5W / 0,79A	7W / 0,58A	9,5W / 0,79A	12W / 1A	4,2W / 0,35A	6W/0,5A	6,5W/0,55A
A3 / 420 x 297	18W / 1,44A	18W / 1,5A	18W / 1,44A	26W / 2,16A	18W / 1,44A	11W / 0,91A	14W / 1,16A	11W / 0,91A	14W / 1,16A	18W / 1,44A	6,4W/0,53A	18W/1,44A	10W/0,85A
A2 / 594 x 420	23W / 1,92A	24W / 2A	23W / 1,91A	36W / 3A	23W / 1,91A	14W / 1,16A	20W / 1,66A	14W / 1,16A	20W / 1,66A	23W / 1,91A	8,5W / 0,71A	23W/1,92A	15W/1,25A
A1 / 841 x 594	35W / 2,83A	36W / 3A	35W / 2,83A	52W / 4,33A	35W / 2,83A	21W / 1,75A	25W / 2,08A	21W / 1,75A	25W / 2,08A	35W / 2,83A	26,5W / 2,2A	35W/2,83A	20,5W/1,7A
A0 / 1189 x 841	48W / 4A	X	48W / 4A	72W / 6A	48W / 4A	29W / 2,4A	40,5W / 3,39A	29W / 2,4A	40,5W / 3,39A	48W / 4A	55W / 4,6A	48W/4A	X
B2 / 700 x 500	27W / 2,24A	28W / 2,33A	27W / 2,24A	41W / 3,33A	27W / 2,24A	17W / 1,41A	24W / 2A	17W / 1,41A	24W / 2A	27W / 2,24A	13,2W / 1,1A	27W/2,24A	17W/1,4A
B1 / 1000 x 700	41W / 3,33A	X	41W / 3,33A	61W / 5A	41W / 3,33A	25W / 2,08A	35W / 2,9A	25W / 2,08A	30W / 2,5A	41W / 3,33A	26,5W / 2,2A	41W/3,33A	25W/2,1A
B0 / 1400 x 1000	X	X	58W / 4,8A	87W / 7,16A	58W / 4,8A	X	X	X	X	X	X	X	X
20" x 30" / 508 x 762	31W / 2,56A	32W / 2,66A	31W / 2,56A	46W / 3,83A	31W / 2,56A	17W / 1,41A	26W / 2,16A	17W / 1,41A	26W / 2,16A	31W / 2,56A	19,3W / 1,6A	31W/2,56A	18W/1,5A
30" x 40" / 762 x 1016	41W/3,36A	X	41W / 3,36A	62W / 5A	41W / 3,36A	25W / 2,08A	36W / 3,02A	25W / 2,08A	36W / 3,02A	41W / 3,36A	26,5W / 2,2A	41W/3,36A	23W/1,9A
40" x 60" / 1016 x 1524	X	X	60W / 5A	94W / 7,5A	60W / 5A	X	X	X	X	X	X	X	X
11" x 17" (USA) 279.4 x 431.8	18W / 1,44A	18W / 1,5A	18W / 1,44A	26W / 2,16A	18W / 1,44A	10W / 0,84A	16,6W / 1,22A	10W / 0,84A	16,6W / 1,22A	18W / 1,44A	6,4W/0,53A	18W/1,44A	X
22" x 28" (USA) 558.8 x 711.2	27W / 2,24A	28W / 2,33A	27W / 2,24A	41W / 3,33A	27W / 2,24A	17,6W / 1,5A	24W / 2A	17,6W / 1,5A	24W / 2A	27W / 2,24A	13,2W / 1,1A	27W/2,24A	X
24" x 36" (USA) 609.6 x 914.4	41W / 3,33A	X	41W / 3,33A	61W / 5A	41W / 3,33A	22,5W / 1,9A	31W / 2,6A	22,5W / 1,9A	31W / 2,6A	41W / 3,33A	30W / 2,6A	41W/3,33A	X

Power Supply Recommended (12 Vdc, Ampere)	25mm Indoor LEDbox		35mm Indoor LEDbox		35mm Outdoor/ Lockable LEDbox	Best Buy LEDbox		Magneco LEDbox		Magnetic LEDbox	Convex LEDbox	AcryLED	Buy Max LEDbox
	single	double	single	double	single	single	double	single	double	single	single	single	single
A4 / 297 x 210	1A	2A	1A	2A	2A	1A	1A	1A	1A	2A	1A	1A	1A
A3 / 420 x 297	2A	2A	2A	3A	2A	1A	2A	1A	2A	2A	1A	2A	1A
A2 / 594 x 420	3A	3A	3A	4A	3A	2A	2A	2A	2A	3A	2A	3A	2A
A1 / 841 x 594	4A	4A	4A	6A	4A	2A	3A	2A	3A	4A	3A	4A	2A
A0 / 1189 x 841	5A	X	5A	9A	5A	3A	4A	3A	4A	5A	6A	5A	X
B2 / 700 x 500	3A	3A	3A	4A	3A	2A	3A	2A	3A	3A	2A	3A	2A
B1 / 1000 x 700	4A	X	4A	6A	4A	3A	4A	3A	4A	4A	3A	4A	3A
B0 / 1400 x 1000	X	X	6A	12A	6A	X	X	X	X	X	X	X	X
20" x 30" / 508 x 762	4A	4A	4A	5A	4A	2A	3A	2A	3A	4A	2A	3A	2A
30" x 40" / 762 x 1016	4A	X	4A	6A	4A	3A	4A	3A	4A	4A	3A	4A	3A
40" x 60" / 1016 x 1524	X	X	6A	12A	6A	X	X	X	X	X	X	X	X
11" x 17" (USA) 279.4 x 431.8	2A	2A	2A	3A	2A	1A	2A	1A	2A	2A	1A	2A	X
22" x 28" (USA) 558.8 x 711.2	3A	3A	3A	4A	3A	2A	3A	2A	3A	3A	2A	3A	X
24" x 36" (USA) 609.6 x 914.4	4A	X	4A	6A	4A	3A	3A	3A	3A	4A	3A	4A	X

LUX	25mm Indoor LEDbox		35mm Indoor LEDbox		35mm Outdoor/ Lockable LEDbox	Best Buy LEDbox		Magneco LEDbox		Magnetic LEDbox	Convex LEDbox	AcryLED	Buy Max LEDbox
	single	double	single	double	single	single	double	single	double	single	single	single	single
A4 / 297 x 210	2800-3200	1500-1800	4200-4500	2500-2800	2600-2900	3000-3300	2800-3000	3000-3600	2800-3000	5500-6000	2800-3300	2400-2900	1300-1500
A3 / 420 x 297	3300-3600	2000-2300	3900-4200	2200-2500	2700-3000	2800-3000	2400-2600	3000-3300	2400-2600	5000-5400	2500-3000	2400-2600	1200-1400
A2 / 594 x 420	3000-3300	1800-2000	3500-3900	2300-2700	1800-2100	2400-2700	2100-2300	2700-3000	2100-2300	4600-4900	2000-2300	2100-2300	900-1100
A1 / 841 x 594	2700-3000	1600-1800	3000-3300	2100-2400	1600-1900	1900-2100	1800-2200	2300-2600	1800-2000	3500-3800	2500-2700	1800-2200	1300-1500
A0 / 1189 x 841	2500-2800	X	2500-2800	1800-2100	1200-1500	1500-1800	1200-1400	1600-1800	1200-1400	2800-3200	2500-3000	1900-2300	X
B2 / 700 x 500	2900-3200	1700-1900	3000-3300	2100-2400	1600-1900	2100-2400	2000-2200	2200-2500	2000-2200	4000-4300	2200-2500	2000-2200	1100-1300
B1 / 1000 x 700	2500-2800	X	2600-2900	2000-2300	1400-1700	1700-2000	1600-1800	1800-2100	1500-1700	3000-3300	2500-3000	2100-2600	1400-1600
B0 / 1400 x 1000	X	X	2000-2300	1500-1800	1000-1200	X	X	X	X	X	X	X	X
20" x 30" / 508 x 762	2900-3200	1700-1900	3000-3300	2100-2400	1600-1900	2200-2500	2000-2200	2200-2500	2000-2200	3500-3800	1800-2200	2000-2200	1200-1300
30" x 40" / 762 x 1016	2500-2800	X	2600-2900	2000-2300	1400-1700	1700-2000	1600-1800	1800-2100	1600-1800	2800-3200	2000-2300	2100-2600	1100-1300
40" x 60" / 1016 x 1524	X	X	2000-2300	1500-1800	1000-2000	X	X	X	X	X	X	X	X
11" x 17" (USA) 279.4 x 431.8	3200-3500	1500-1800	3900-4200	2200-2500	2700-3000	2800-3000	2400-2600	2800-3000	2400-2600	5500-6000	2800-3300	2400-2600	X
22" x 28" (USA) 558.8 x 711.2	3300-3600	2000-2300	3000-3300	2300-2700	1800-2100	2000-2200	1900-2100	2000-2200	1900-2100	5000-5400	2500-3000	2100-2300	X
24" x 36" (USA) 609.6 x 914.4	3000-3300	X	2000-2300	2100-2400	1600-1900	1900-2100	1800-2000	1900-2100	1800-2000	4600-4900	2000-2300	1800-2200	X

Totem LED Product Programme (Production & Availability)

Size Available	LEDA Magnetic TOTEM	TOTEM	Decorative TOTEM	Mono TOTEM
Product Size - Poster Size	double	double	double	double
620 x 1708 - 594 x 1682 / Black	UMLD37B000	X	X	X
620 x 1708 - 594 x 1682 / White	UMLD37N000	X	X	X
560 x 1720 - 500 x 700	X	X	UTTM011040	X
650 x 1720 - 600 x 1700	X	UTTM001000	UTTM011010	X
750 x 1720 - 700 x 1700	X	UTTM002000	UTTM011020	X
850 x 1720 - 800 x 1700	X	UTTM003000	X	X
880 x 1720 - 841 x 1189	X	X	UTTM011030	X
520 x 1700 - 500 x 1700 / without light	X	X	X	UTTME10500
620 x 1700 - 600 x 1700 / without light	X	X	X	UTTME10600
520 x 1700 - 500 x 1700 / with light	X	X	X	UTTME00500
620 x 1700 - 600 x 1700 / with light	X	X	X	UTTME00600
Max(w x h) mm	700 x 2000	800 x 2000	880 x 1720	700 x 2000

Power Consumption	LEDA Magnetic TOTEM	TOTEM	Decorative TOTEM	Mono TOTEM
Product Size - Poster Size	double	double	double	double
620 x 1708 - 594 x 1682 / Black	X	X	18W (fluorescent)	X
620 x 1708 - 594 x 1682 / White	63W / 5,2A	X	X	X
560 x 1720 - 500 x 700	63W / 5,2A	X	X	X
650 x 1720 - 600 x 1700	X	58W (fluorescent)	18W (fluorescent)	X
750 x 1720 - 700 x 1700	X	58W (fluorescent)	36W (fluorescent)	X
850 x 1720 - 800 x 1700	X	2 x 58W (fluorescent)	X	X
880 x 1720 - 841 x 1189	X	X	2 x 36W (fluorescent)	X
520 x 1700 - 500 x 1700 / without light	X	X	X	X
620 x 1700 - 600 x 1700 / without light	X	X	X	X
520 x 1700 - 500 x 1700 / with light	X	X	X	58W (fluorescent)
620 x 1700 - 600 x 1700 / with light	X	X	X	58W (fluorescent)

Power Supply Recommended (12 Vdc, Ampere)	LEDA Magnetic TOTEM	TOTEM	Decorative TOTEM	Mono TOTEM
Product Size - Poster Size	double	double	double	double
620 x 1708 - 594 x 1682 / Black	6A	X	X	X
620 x 1708 - 594 x 1682 / White	6A	X	X	X
560 x 1720 - 500 x 700	X	X	Electronic Ballast	X
650 x 1720 - 600 x 1700	X	Electronic Ballast	Electronic Ballast	X
750 x 1720 - 700 x 1700	X	Electronic Ballast	Electronic Ballast	X
850 x 1720 - 800 x 1700	X	Electronic Ballast	X	X
880 x 1720 - 841 x 1189	X	X	Electronic Ballast	X
520 x 1700 - 500 x 1700 / without light	X	X	X	Electronic Ballast
620 x 1700 - 600 x 1700 / without light	X	X	X	Electronic Ballast
520 x 1700 - 500 x 1700 / with light	X	X	X	Electronic Ballast
620 x 1700 - 600 x 1700 / with light	X	X	X	Electronic Ballast

LUX	LEDA Magnetic TOTEM	TOTEM	Decorative TOTEM	Mono TOTEM
Product Size - Poster Size	double	double	double	double
620 x 1708 - 594 x 1682 / Black	1900-2100	X	X	X
620 x 1708 - 594 x 1682 / White	1900-2100	X	X	X
560 x 1720 - 500 x 700	X	X	1500-1900	X
650 x 1720 - 600 x 1700	X	1700-2000	1500-1800	X
750 x 1720 - 700 x 1700	X	1700-2000	1700-2000	X
850 x 1720 - 800 x 1700	X	2300-2700	X	X
880 x 1720 - 841 x 1189	X	X	1700-2000	X
520 x 1700 - 500 x 1700 / without light	X	X	X	1900-2200
620 x 1700 - 600 x 1700 / without light	X	X	X	1900-2200
520 x 1700 - 500 x 1700 / with light	X	X	X	1900-2200
620 x 1700 - 600 x 1700 / with light	X	X	X	1900-2200

- ✓ Standard colour: Silver Anodised
- ✓ Available in RAL colours (subject to MOQ)
- ✓ Power supply is provided with the unit to suit each of the product
- ✓ Luminance: 1900-3000lux (depending on size)
- ✓ Standard Packaging: Single units in polybag and box
- ✓ Low power consumption (see above average power consumption table for each size)
- ✓ Various plugs available such as European, UK, US and Australian
- ✓ Complies with EN55015 & EN61547.

POWER SUPPLY	
ARTICLE	DESCRIPTION
UYPLD00010	Power supply EU 3,34A 7/24
UYPLD00011	Power supply EU 6,67A 7/24
UYPLD00012	Power supply EU 8,5A 7/24
UYPLD00013	Power supply EU 11,5A 7/24

- ✓ Products are suitable to use 7/16.
- ✓ If 7/24 use required, please order individually as 7/24 power supplies as below:



In case of any claim, user is required to return product or any parts to manufacturer for analyses at their cost. As long as the manufacturer confirms the problem is a manufacturing fault, the replacement can be provided. This applies for all illuminated products.



LEDA Illuminated Magnetic Totem

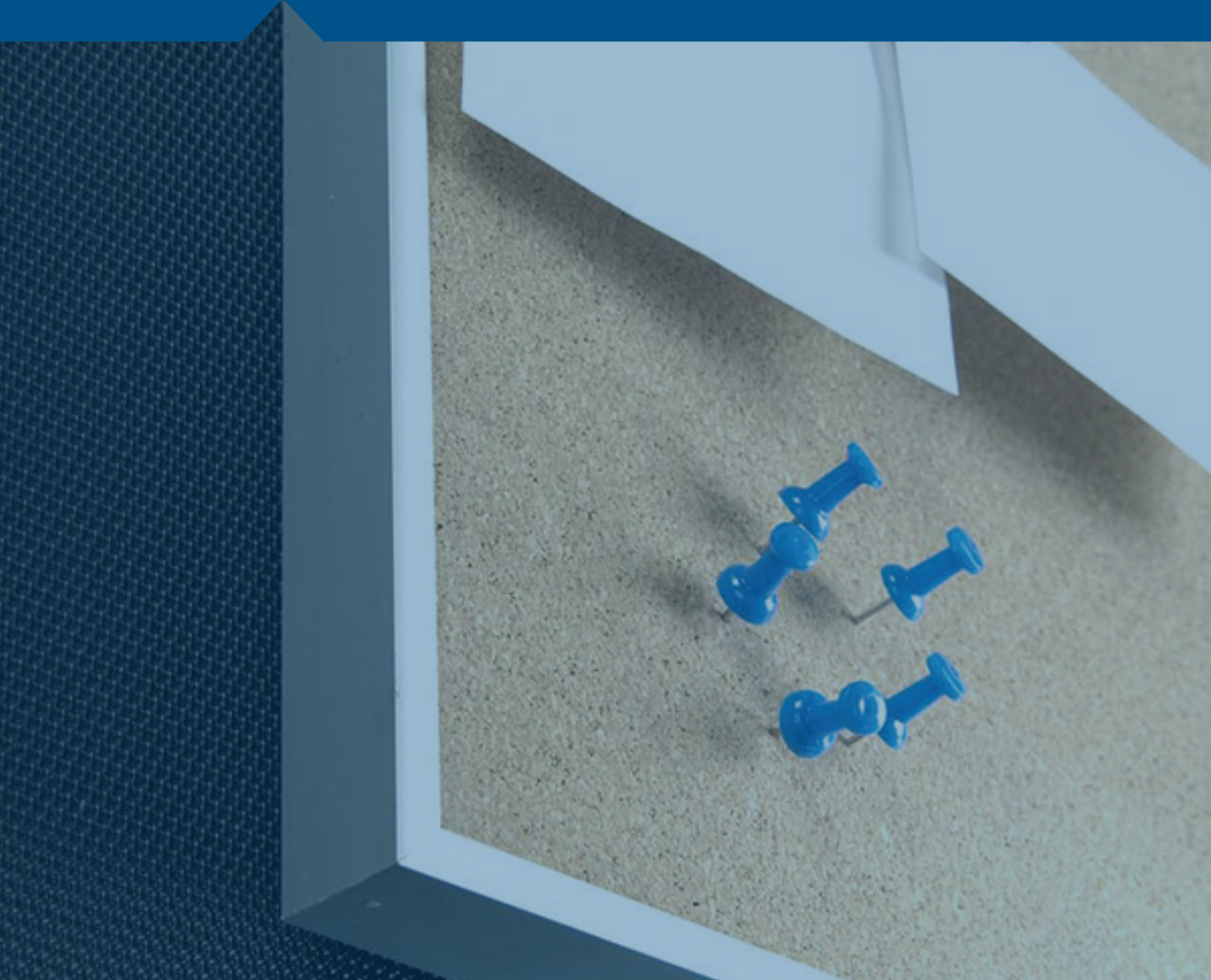




Frameboards

•Frameboard 9mm
•Magnetic Glass Board

•Info-Rahmen 9mm
•Magnetische Glastafel



Frameboard 9 mm



The frame board has a 3 different models; with cork backing, with a dry-wipe magnetic surface, with a cork&perforated steel backing. 4xA4, 6xA4, 9xA4 and 12xA4 paper capacity sizes are available and can be used both in portrait & landscape positions. Each unit includes a free set of pins & magnets. It is practical for use at offices, hospitals, home, school etc.

Der Korkrahmen ist in den Massen 4xA4, 6xA4, 9 xA4 und 12xA4 in Hoch-und Querformat erhältlich. Jeder Rahmen beinhaltet ein Nadelset. Der Korkrahmen ist ein praktisches Produkt für Haus, Büro, Schule, Krankenhaus etc.

Each frame includes a set of pins. Each frame is packed individual in carton box. *Jeder Rahmen beinhaltet ein Nadelset. Jeder Rahmen wird in Kartons einzeln verpackt.*

Easy to move hangers facilitate assembly. *Das einfache Verstellen der Aufhänger ermöglicht die leichte Montage.*

Max. available size 1200x2000 mm. *Max. Größe 1200x2000 mm.*



M&C



Cork

Magnetic

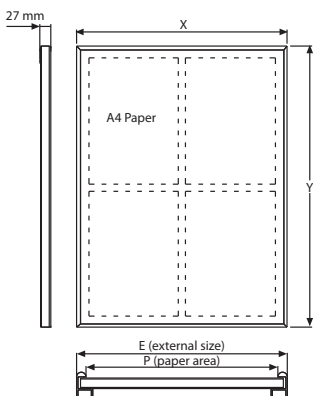
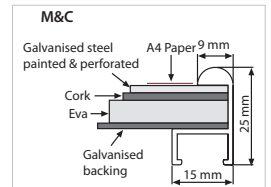
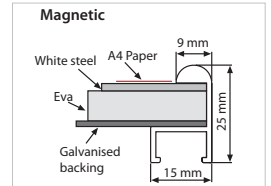
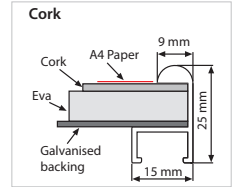


Photo of the hanger



Chalkboard Marker
UYKLM1251 - Colour Marker
UYKLM1250 - White Marker

Size of boards for all Frameboard models:

	6A4		9A4			12A4			
4A4	A4	A4	A4	A4	A4	A4	A4	A4	A4
	A4	A4	A4	A4	A4	A4	A4	A4	A4
	A4	A4	A4	A4	A4	A4	A4	A4	A4

MATERIAL : Silver anodised aluminium						WEIGHT WITH PACKING			PACKING SIZE
CORK	MAGNETIC	M&C	EXTERNAL (x-y)	PAPER AREA	CAPACITY	CORK	MAGNETIC	M&C	*W X H X D
U1CB95N144	U2CB95N144	U3CB95N144	505 X 675 mm	487 X 657 mm	4 X A4	2,950 kg	4,330 kg	4,400 kg	520 X 700 X 35 mm
U1CB95N164	U2CB95N164	U3CB95N164	505 X 995 mm	487 X 977 mm	6 X A4	4,305 kg	6,280 kg	6,055 kg	520 X 1010 X 35 mm
U1CB95N194	U2CB95N194	U3CB95N194	735 X 995 mm	717 X 977 mm	9 X A4	6,380 kg	8,460 kg	8,365 kg	740 X 1010 X 35 mm
U1CB95N114	U2CB95N114	U3CB95N114	965 X 995 mm	947 X 977 mm	12 X A4	8,465 kg	11,500 kg	10,845 kg	980 X 1010 X 35 mm

* W:Width H: Height D: Depth



Magnetic Glass Board



Watch video at our website www.mtdisplays.com



Both magnetic and dry wipe, Magnetic Glass Board offers a smart solution for offices, colleagues, meeting rooms, hotels, cafes and more. Red, Black and White colour options will suit various contemporary decoration. Tempered glass increases the strength against damages. Magnets, pen holder, eraser and pen included in the pack for comfortable immediate use.

Der Magnetic Glass Board ist magnetisch und trocken abwischbar und bietet eine dezente Lösung für Büro, Schulen, Konferenzräumen, Hotels, Cafes und vielen mehr. Das Produkt ist in 3 Farben erhältlich, rot, schwarz und weiß. Das temperierte Glas bietet Schutz gegen Beschädigungen. Magnete, Stifthalter, Wischer und Stift sind im Lieferumfang enthalten.



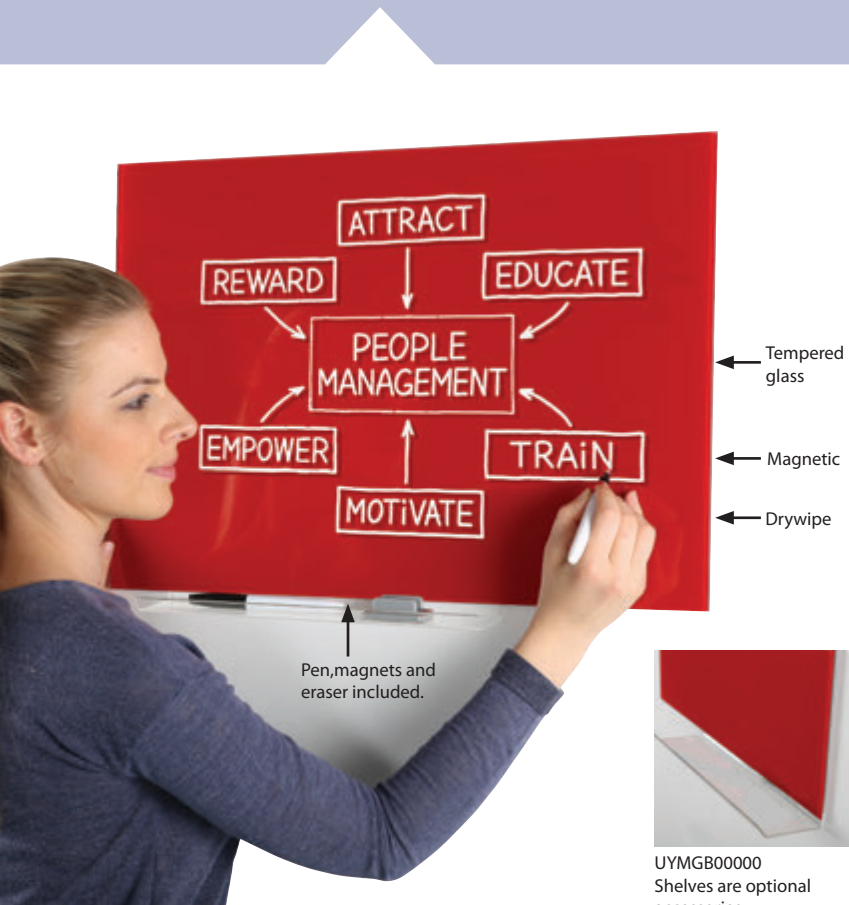
Each unit is packed individual in carton box. Jeder Rahmen wird in Kartons einzeln verpackt geliefert.



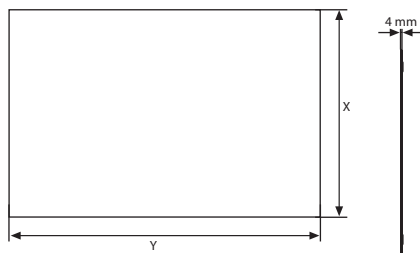
Landscape/portrait wall mounting. Das einfache Verstellen der Aufhänger ermöglicht die leichte Montage.



Accessories (rubber&marker&magnets) are included in the original box. Das Zubehör (Wischer&marker&magnete) sind in der original Verpackung enthalten.



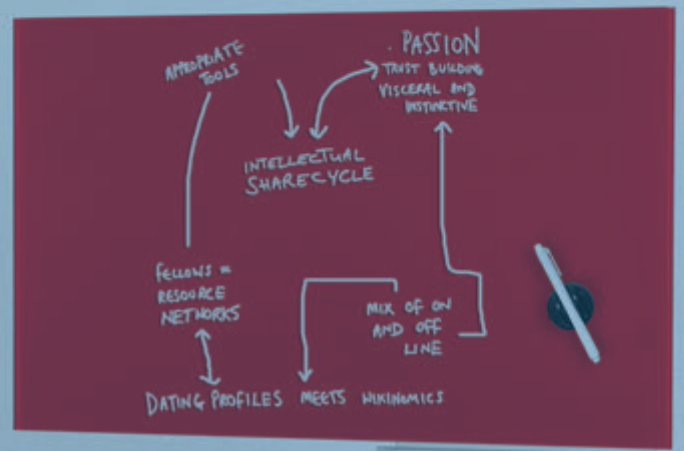
UYMGB00000 Shelves are optional accessories.



MATERIAL : Tempered glass			WEIGHT	PACKING SIZE
ARTICLE	SIZE (x-y)	COLOUR	WITH PACKING	*W X H X D
T00MGB0335	350 X 350 mm	White	1,600 kg	380 X 390 X 45 mm
T00MGB0135	350 X 350 mm	Black	1,600 kg	380 X 390 X 45 mm
T00MGB0435	350 X 350 mm	Red	1,600 kg	380 X 390 X 45 mm
T00MGB0345	450 X 450 mm	White	2,640 kg	480 X 490 X 45 mm
T00MGB0145	450 X 450 mm	Black	2,640 kg	480 X 490 X 45 mm
T00MGB0445	450 X 450 mm	Red	2,640 kg	480 X 490 X 45 mm
T00MGB0346	400 X 600 mm	White	3,120 kg	440 X 640 X 45 mm
T00MGB0146	400 X 600 mm	Black	3,120 kg	440 X 640 X 45 mm
T00MGB0446	400 X 600 mm	Red	3,120 kg	440 X 640 X 45 mm
T00MGB0369	600 X 900 mm	White	7,200 kg	680 X 980 X 65 mm
T00MGB0169	600 X 900 mm	Black	7,200 kg	680 X 980 X 65 mm
T00MGB0469	600 X 900 mm	Red	7,200 kg	680 X 980 X 65 mm
T00MGB0362	600 X 1200 mm	White	10,390 kg	695 X 1280 X 65 mm
T00MGB0162	600 X 1200 mm	Black	10,390 kg	695 X 1280 X 65 mm
T00MGB0462	600 X 1200 mm	Red	10,390 kg	695 X 1280 X 65 mm

TP 2 YEAR WARRANTY *W:Width H: Height D: Depth

Magnetic Glass Board





Showboards

- Universal Showboards
- Showboards
- Office Boards

- Universal Showboards
- Showboards
- Office Boards



Universal Poster Showboard



Watch video at our website www.mtdisplays.com



Slim and Sleek!

The lockable poster Display case, Universal Showboard is designed to display printed poster in different options. When seen on the wall, it looks like a snap frame with slim case which is 27 mm deep, 30mm profile and hidden lock on the side. It is suitable for public places or outdoor use under a shelter. It is easier to change the poster with hinged door and clips holding the poster.

Schlank und dezent!

Das verschließbare Gehäuse, Universal Showboard wurde entwickelt um bedruckte Poster in verschiedenen Formaten zu präsentieren. An der Wand montiert sieht es aus wie ein Klapprahmen mit einem schlanken 27 mm tiefen Gehäuse, 30mm Profil und dem Verschlussmechanismus auf der Seite. Dieses Produkt eignet sich ideal in öffentlichen Gebäuden oder im Außeneinsatz. Mit einer Scharnertür ist es sehr bequem das Poster zu wechseln und mittels Klammern wird das Poster in dem Produkt fixiert.



Each product includes 1 key set of single variation. Jeder Artikel beinhaltet einen Schlüsselset inkl. Ersatzschlüssel.



Each unit is supplied with a free set of clear plastic pegs to hold the poster. 2 stays at each end help to keep the cover door open. Jeder Artikel beinhaltet ein transparentes Posterhalterungsset, 2 Halterungen an der Innentür ermöglichen das Offenhalten der Tür und erleichtern die Benutzung des Schaukastens

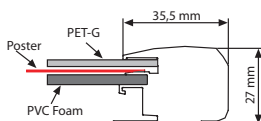
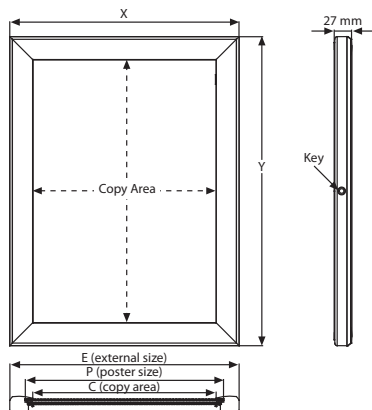
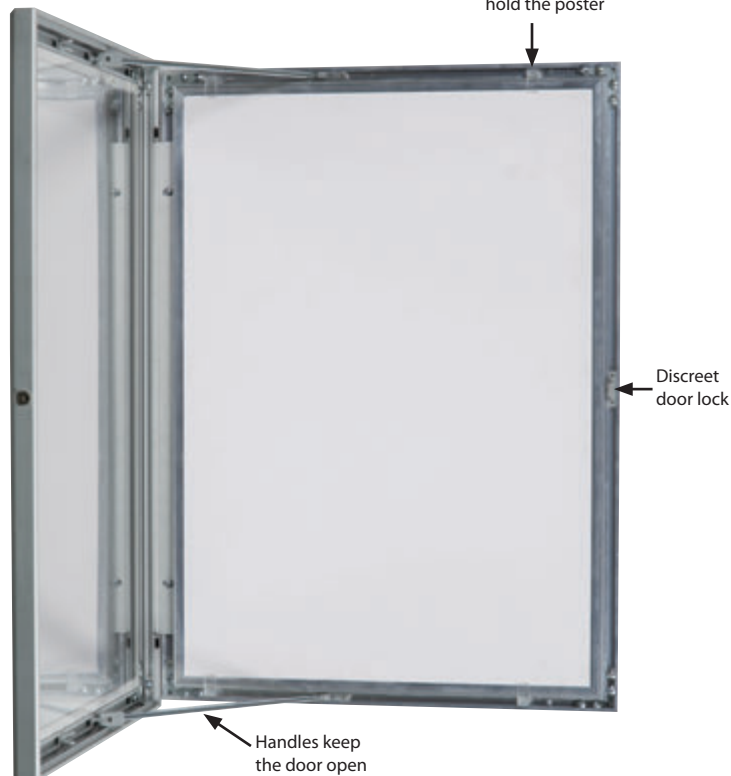


Please discard the protective film on the unit before use. Max. available size 1200x1800 mm. Bitte vor dem Einsatz die Schutzfolie abziehen. Max. Größe 1200x1800 mm.

27 mm thickness



Clear plastic pegs hold the poster

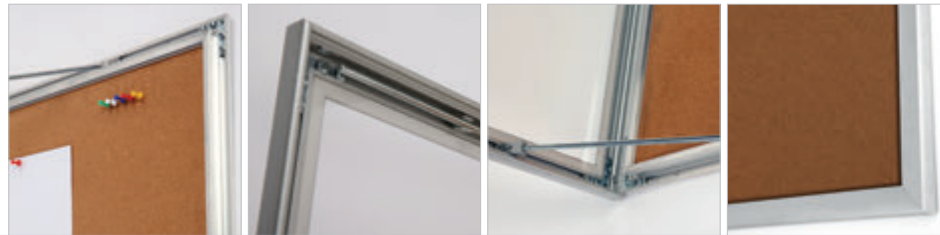


MATERIAL: Silver anodised aluminium					WEIGHT	PACKING SIZE
ARTICLE	EXTERNAL (x-y)	POSTER SIZE	COPY	KEY	WITH PACKING	*W X H X D
USBNU000A4	267 X 354 mm	210 X 297 mm	196 X 283 mm	1	1,750 kg	290 X 395 X 46 mm
USBNU000A3	354 X 477 mm	297 X 420 mm	283 X 406 mm	1	2,400 kg	380 X 515 X 46 mm
USBNU000A2	477 X 651 mm	420 X 594 mm	406 X 580 mm	1	3,400 kg	500 X 700 X 46 mm
USBNU000A1	651 X 898 mm	594 X 841 mm	580 X 827 mm	2	5,300 kg	680 X 940 X 46 mm
USBNU000A0	898 X 1246 mm	841 X 1189 mm	827 X 1175 mm	2	8,600 kg	920 X 1280 X 46 mm
USBNU000B2	557 X 757 mm	500 X 700 mm	486 X 686 mm	1	4,600 kg	580 X 800 X 46 mm
USBNU000B1	757 X 1057 mm	700 X 1000 mm	686 X 986 mm	1	7,200 kg	780 X 1100 X 46 mm
USBNU00023	565 X 819 mm	508 X 762 mm	494 X 748 mm	1	4,900 kg	590 X 860 X 46 mm
USBNU00034	819 X 1073 mm	762 X 1016 mm	748 X 1002 mm	2	7,500 kg	840 X 1115 X 46 mm



*W:Width H: Height D: Depth

Universal Showboard with Cork & Magnetic



Universal Showboard has 2 models; one with a cork backing and with a magnetic backing. It has a slim case which is 27 mm deep and 30 mm profile and hidden lock on the side. It is suitable for public places or outdoor use under a shelter.

Der Universal Showboard hat 2 Versionen; eine mit einer Korkwand und die eine mit einer Magnetwand. Ein 27 mm schmales Gehäuse, 30mm breite Profile und das versteckte Schloß seitlich am Gehäuse, runden dieses Produkt schön ab. Perfekt geeignet für öffentliche Bereiche und geeignet im Außenbereich unter einem Schutzdach.



Each product includes 1 key set of single variation. Jeder Artikel beinhaltet einen Schlüsselset inkl. Ersatzschlüssel.



Each unit is supplied with a free set of clear plastic pegs to hold the poster. 2 stays at each end help to keep the cover door open. Jeder Artikel beinhaltet ein transparentes Posterhalterungsset, 2 Halterungen an der Innentür ermöglichen das Offenhalten der Tür und erleichtern die Benutzung des Schaukastens



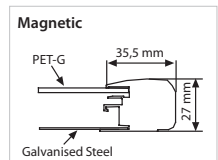
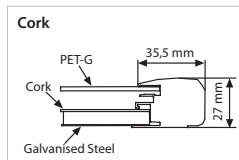
Please discard the protective film on the unit before use. Max. available size 1200x2000 mm. Bitte vor dem Einsatz die Schutzfolie abziehen. Max. Größe 1200x2000 mm.



Magnetic



Cork



Size of boards for all Universal Showboard models:

	6A4		9A4		
	A4	A4	A4	A4	A4
4A4	A4	A4	A4	A4	A4
	A4	A4	A4	A4	A4

MATERIAL : Silver anodised aluminium							WEIGHT	PACKING SIZE
CORK	MAGNETIC	EXTERNAL (x-y)	COPY	PAPER AREA	CAPACITY	KEY	WITH PACKING	*W X H X D
USBNU104A4	USBNU204A4	560 X 730 mm	489 X 659 mm	486 X 656 mm	4 X A4	1	6,500 kg	580 X 770 X 46 mm
USBNU106A4	USBNU206A4	560 X 1050 mm	489 X 979 mm	486 X 976 mm	6 X A4	2	8,400 kg	580 X 1090 X 46 mm
USBNU109A4	USBNU209A4	790 X 1050 mm	719 X 979 mm	716 X 976 mm	9 X A4	2	11,200 kg	810 X 1090 X 46 mm

* W:Width H: Height D: Depth

Poster Showboard



Watch video at our website www.mtdisplays.com



Ideal for displaying individual posters and single sheet menus. Suitable for outdoor use. Single key A2, A3, double key A1, A0, 500x700 mm, 700x1000 mm sizes are available. The cover can be opened up to 90 degrees. Each unit includes mounting screws and plugs. The profile width is 45 mm and the depth of the case is 30 mm.

Ideal für Poster oder einzelne Blätter. Für den Ausseneinsatz geeignet, da wasserfest. Die Masse A2 und A3 sind mit einem Schloss, die Masse A1, A0, 500x700 mm und 700x1000 mm sind mit doppeltem Schloss erhältlich. Die Tür lässt sich zu 90 Grad öffnen. Jeder Artikel beinhaltet Dübel und Schrauben zur Wandmontage. Die Profildbreite beträgt 45 mm, die Bautiefe ist 30 mm.



Each product includes 1 key set of single variation. Jeder Artikel beinhaltet einen Schlüsselsatz inkl. Ersatzschlüssel.



Each unit is supplied with a free set of clear plastic pegs to hold the poster. 2 stays at each end help to keep the cover door open. Jeder Artikel beinhaltet ein transparentes Posterhalterungsset, 2 Halterungen an der Innentür ermöglichen das Offenhalten der Tür und erleichtern die Benutzung des Schaukastens

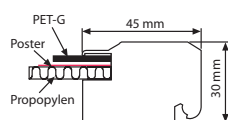
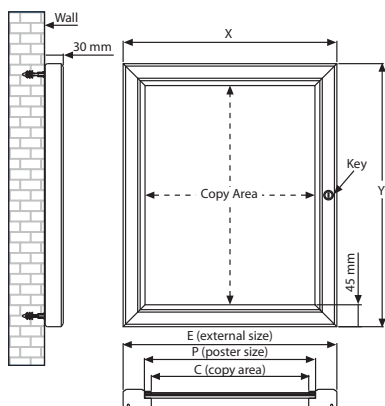


Please discard the protective film on the unit before use. Max. available size 1200x1800 mm. Bitte vor dem Einsatz die Schutzfolie abziehen. Max. Größe 1200x1800 mm.



Clear plastic pegs hold the poster

Handles keep the door open



MATERIAL : Silver anodised aluminium					WEIGHT	PACKING SIZE
ARTICLE	EXTERNAL (x-y)	POSTER	COPY	KEY	WITH PACKING	**W X H X D
USBN0000A3	367 X 490 mm	297 X 420 mm	277 X 400 mm	1	2,600 kg	400 X 510 X 60 mm
USBN0000A2	490 X 664 mm	420 X 594 mm	400 X 574 mm	1	3,840 kg	510 X 680 X 60 mm
USBN0000A1	664 X 911 mm	594 X 841 mm	574 X 821 mm	2	5,700 kg	680 X 930 X 60 mm
USBN0000A0	911 X 1259 mm	841 X 1189 mm	821 X 1169 mm	2	10,000 kg	930 X 1280 X 60 mm
USBN0000B2	570 X 770 mm	500 X 700 mm	480 X 680 mm	1	4,740 kg	590 X 790 X 60 mm
USBN0000B1	770 X 1070 mm	700 X 1000 mm	680 X 980 mm	2	8,000 kg	790 X 1090 X 60 mm
USBN000023	578 X 832 mm	508 X 762 mm	488 X 742 mm	1	5,160 kg	600 X 850 X 60 mm
USBN000034	832 X 1086 mm	762 X 1016 mm	742 X 996 mm	2	8,710 kg	850 X 1100 X 60 mm

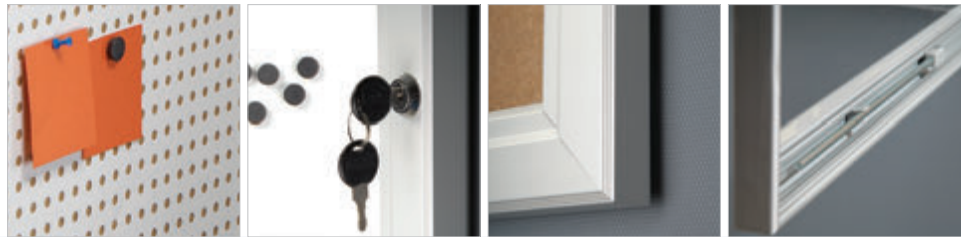
*W:Width H: Height D: Depth



Showboards



Watch video at our website www.mtdisplays.com



Suitable for outdoor use. It has 3 model; with a cork backing, with a magnetic backing, with a cork and perforated steel backing. Single key 4x A4, double key 6x A4, 9x A4 and 12x A4 sizes are available and can be used both in portrait & landscape positions. The cover can be opened to 90 degrees. Each unit includes easy wall mounting and a free set of pins & magnets. The profile width is 45 mm and the depth of the case 36 mm.

Für den Ausseneinsatz geeignet, da wasserfest. Der Artikel hat eine Korkrückwand und beinhaltet ein Nadelset. Das Mass 4x A4 ist mit einem Schloss, die Masse 6x A4, 9x A4 und 12x A4 sind mit doppeltem Schloss erhältlich. Das Produkt kann in Hoch- und Querformat eingesetzt werden. Die Tür lässt sich zu 90 Grad öffnen. Jeder Artikel beinhaltet Dübel und Schrauben zur Wandmontage. Die Profiltiefe beträgt 45 mm, die Bautiefe ist 36 mm.

- Each product includes 1 key set of single variation. Jeder Artikel beinhaltet einen Schlüsselset inkl. Ersatzschlüssel.
- Each unit includes a free of pins. 2 stays at each end help to keep the cover door open. Jeder Artikel beinhaltet ein Nadelset, 2 Halterungen an der Innentür ermöglichen das Offenhalten der Tür und erleichtern die Benutzung des Schaukastens.
- Please discard the protective film on the unit before use. Please throw away the silica gel on the cork before use. Max. available size 1200x2000 mm. Bitte vor dem Einsatz die Schutzfolie abziehen. Max. Größe 1200x2000 mm.

Size of boards for all Showboard models:

	6A4	9A4	12A4
4A4	A4 A4	A4 A4 A4	A4 A4 A4 A4
A4 A4	A4 A4	A4 A4 A4	A4 A4 A4 A4
A4 A4	A4 A4	A4 A4 A4	A4 A4 A4 A4



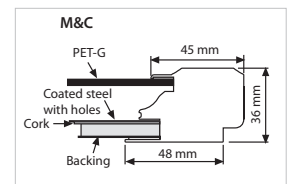
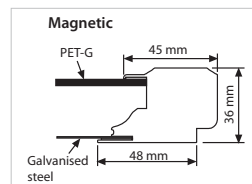
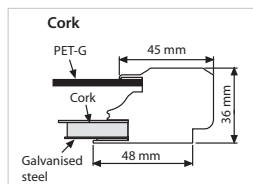
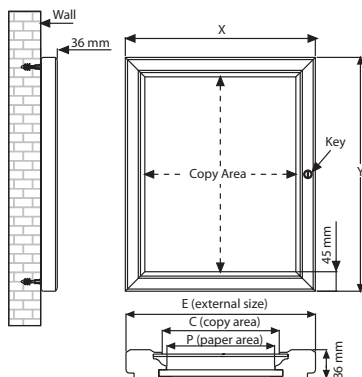
M&C



Magnetic



Cork



MATERIAL : Silver anodised aluminium							WEIGHT WITH PACKING			PACKING SIZE	
CORK	MAGNETIC	M&C	EXTERNAL (x-y)	COPY	PAPER AREA	CAPACITY	KEY	CORK	MAGNETIC	M&C	*W X H X D
USBN1004A4	USBN2004A4	USBN3004A4	585 X 755 mm	495 X 665 mm	483 X 653 mm	4 X A4	1	6,870 kg	6,000 kg	8,250 kg	620 X 780 X 60 mm
USBN1006A4	USBN2006A4	USBN3006A4	585 X 1075 mm	495 X 985 mm	483 X 973 mm	6 X A4	2	8,950 kg	8,350 kg	11,000 kg	620 X 1100 X 60 mm
USBN1009A4	USBN2009A4	USBN3009A4	815 X 1075 mm	725 X 985 mm	713 X 973 mm	9 X A4	2	12,500 kg	11,600 kg	15,100 kg	850 X 1100 X 60 mm
USBN1012A4	USBN2012A4	USBN3012A4	1045 X 1075 mm	955 X 985 mm	943 X 973 mm	12 X A4	2	15,400 kg	14,210 kg	19,000 kg	1080 X 1100 X 60 mm

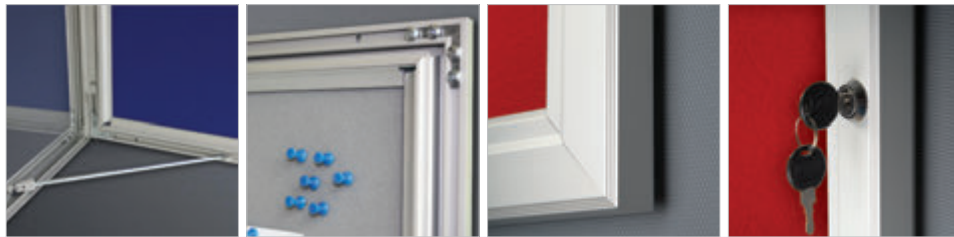
* W:Width H: Height D: Depth



Felt Showboard



Watch video at our website www.mtdisplays.com



Suitable for outdoor use. It has a felt backing that welcomes both Velcro and pins. Each unit includes a free set of pins. Single key 4xA4, double key 6xA4, 9xA4 and 12xA4 sizes are available and can be used both in portrait & landscape positions. The cover can be opened to 90 degrees. Each unit includes mounting screw and plugs for easy wall mounting and a free set of pins. The profile width is 45 mm and the depth of the case 36 mm.

Für den Ausseneinsatz geeignet, da wasserfest. Der Artikel hat eine Filzrückwand und beinhaltet ein Nadelset. Das Mass 4xA4 ist mit einem Schloss, die Masse 6xA4, 9xA4 und 12xA4 sind mit doppeltem Schloss erhältlich. Das Produkt kann in Hoch- und Querformat eingesetzt werden. Die Tür lässt sich zu 90 Grad öffnen. Jeder Artikel beinhaltet Dübel und Schrauben zur Wandmontage. Die Profilbreite beträgt 45 mm, die Bautiefe ist 36 mm.



Each product includes 1 key set of single variation.
Jeder Artikel beinhaltet einen Schlüsselset inkl. Ersatzschlüssel.



Each unit includes a free set of pins. 2 stays at each end help to keep the cover door open.
Jeder Artikel beinhaltet ein Nadelset, 2 Halterungen an der Innentür ermöglichen das Offenhalten der Tür und erleichtern die Benutzung des Schaukastens.



Please discard the protective film on the unit before use.
Bitte vor dem Einsatz die Schutzfolie abziehen.

Size of boards for all Showboard models:

	6A4	9A4	12A4
4A4	A4 A4	A4 A4 A4	A4 A4 A4 A4
A4	A4 A4	A4 A4 A4	A4 A4 A4 A4
A4	A4 A4	A4 A4 A4	A4 A4 A4 A4



Blue



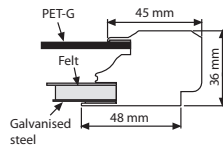
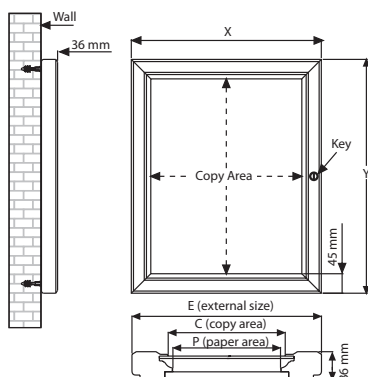
Gray



Green



Red



Choice of 4 felt colours / 4 Farbtönen

Pantone 429 C	Pantone 286 C	Pantone 3425 C	Pantone 200 C
Gray / Grau	Blue / Blau	Green / Grün	Red / Rot

MATERIAL : Silver anodised aluminium								WEIGHT	PACKING SIZE	
RED	BLUE	GRAY	GREEN	EXTERNAL (x-y)	COPY	PAPER AREA	CAPACITY	KEY	WITH PACKING	*W X H X D
USBN1104A4	USBN1204A4	USBN1404A4	USBN1304A4	585 X 755 mm	495 X 665 mm	483 X 653 mm	4 X A4	1	8,450 kg	620 X 780 X 60 mm
USBN1106A4	USBN1206A4	USBN1406A4	USBN1306A4	585 X 1075 mm	495 X 985 mm	483 X 973 mm	6 X A4	2	10,400 kg	620 X 1100 X 60 mm
USBN1109A4	USBN1209A4	USBN1409A4	USBN1309A4	815 X 1075 mm	725 X 985 mm	713 X 973 mm	9 X A4	2	14,100 kg	850 X 1100 X 60 mm
USBN1112A4	USBN1212A4	USBN1412A4	USBN1312A4	1045 X 1075 mm	955 X 985 mm	943 X 973 mm	12 X A4	2	18,000 kg	1080 X 1100 X 60 mm



*W:Width H: Height D: Depth

Office Boards



Suitable for indoor use. It has 2 different backing models. Each unit includes a free set of pins or magnets. Single key 4xA4, double key 6xA4, 9xA4 and 12xA4 sizes are available and can be used both in portrait & landscape positions. The cover can be opened to 90 degrees. Each unit includes mounting screw and plugs for easy wall mounting. The depth of the case is 35 mm.

Für den Inneneinsatz geeignet. Der Artikel wird mit 2 verschiedenen Rückwandalternativen angeboten und beinhaltet je nach dem entweder ein Nadelset oder ein Magnetset. Das Mass 4xA4 ist mit einem Schloss, die Masse 6xA4, 9xA4 und 12xA4 sind mit doppeltem Schloss erhältlich. Das Produkt kann in Hoch- und Querformat eingesetzt werden. Die Tür lässt sich zu 90 Grad öffnen. Jeder Artikel beinhaltet Dübel und Schrauben zur Wandmontage. Die Bautiefe ist 35 mm.

Each product includes 1 key set of single variation. Jeder Artikel beinhaltet einen Schlüsselsetinkl. Ersatzschlüssel.

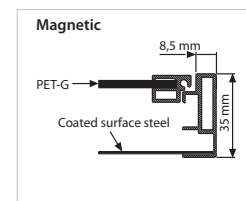
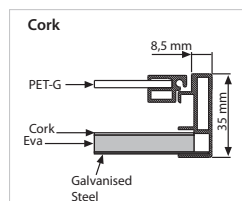
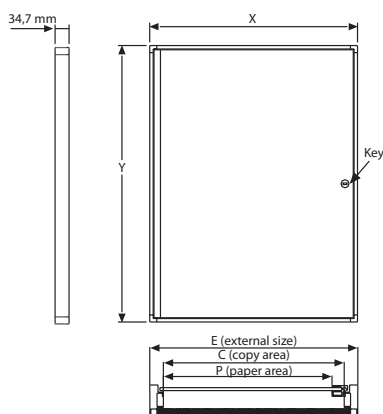
Please discard the protective film on the unit before use. Max. available size 704x977 mm (9xA4). Bitte vor dem Einsatz die Schutzfolie abziehen. Max. Größe 704x977 mm (9xA4).



Cork



Magnetic



MATERIAL : Silver anodised aluminium							WEIGHT WITH PACKING		PACKING SIZE
CORK	MAGNETIC	EXTERNAL (x-y)	COPY	PAPER AREA	CAPACITY	KEY	MAGNETIC	CORK	*W X H X D
USBN4004A4	USBN5004A4	515 X 685 mm	474 X 657 mm	487 X 657 mm	4 X A4	2	4,520 kg	4,300 kg	545 X 715 X 60 mm
USBN4006A4	USBN5006A4	515 X 1005 mm	474 X 977 mm	487 X 977 mm	6 X A4	2	6,495 kg	6,880 kg	545 X 1035 X 60 mm
USBN4009A4	USBN5009A4	745 X 1005 mm	704 X 977 mm	717 X 977 mm	9 X A4	2	8,670 kg	9,230 kg	770 X 1035 X 60 mm



* W:Width H: Height D: Depth

Universal Poster Showboard





Noticeboards

- Noticeboards
- Noticeboards with LED Light
- Noticeboards with Logo

- Noticeboards
- Noticeboard mit LED Beleuchtung
- Noticeboard mit Topschild



Noticeboards



Suitable for outdoor use. 4xA4, 6xA4, 9xA4, 12xA4 paper capacity sizes are available. Noticeboard can be used both in portrait and landscape positions. Each unit includes a free set of pins or magnets. The profile width is 70 mm and the depth of the case 50 mm.

Für den Ausseneinsatz geeignet, da wasserfest. Der Artikel ist in den Papierkapazitäten 4xA4, 6xA4, 9xA4 und 12xA4 erhältlich. Das Produkt kann in Hoch- und Querformat eingesetzt werden und beinhaltet je ein Magnetset. Die Profiltiefe beträgt 70 mm, die Bautiefe ist 50 mm.

Each product includes 2 mounting arms, 1 key set single variation & fixing set. Jeder Artikel beinhaltet zwei Montageleisten, Befestigungsmaterial und einen Schlüsselset inkl. Ersatzschlüssel.

Each unit comes with a free set of magnets. 2 handles at each end help to keep the cover door open. Jeder Artikel beinhaltet ein Magnetset, 2 Halterungen an der Innentür ermöglichen das Offenhalten der Tür und erleichtern die Benutzung des Schaukastens.

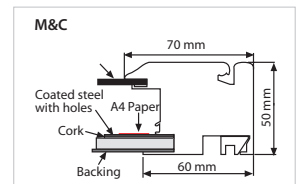
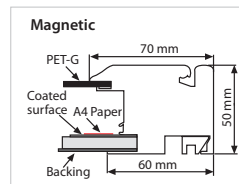
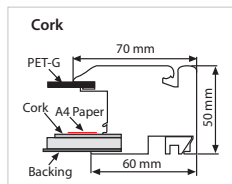
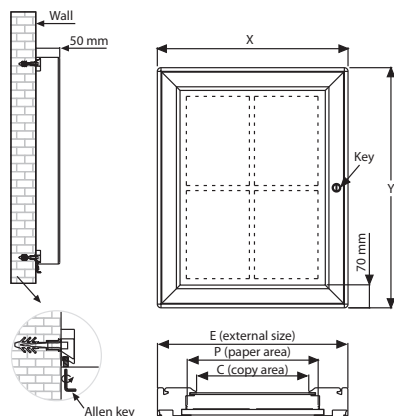
! Please do not drill the product while mounting, only use the mounting arms. Please throw away the protection film on the unit before use. Max. available size 1200x2000 mm. Bitte keine Bohrungen an dem Produkt vornehmen und bei der Wandmontage nur die Montageleisten benutzen. Bitte vor dem Einsatz die Schutzfolie abziehen. Max. Größe 1200x2000 mm.



Cork

M&C

Magnetic



MATERIAL : Silver anodised aluminium							WEIGHT WITH PACKING			PACKING SIZE	
CORK	MAGNETIC	M&C	EXTERNAL (x-y)	PAPER AREA	COPY	CAPACITY	CORK	MAGNETIC	M&C	*W X H X D	
UNBN0004A4	UNBN1004A4	UNBN2004A4	590 X 760 mm	483 X 653 mm	450 X 620 mm	4 X A4	8,500 kg	9,750 kg	9,750 kg	620 X 780 X 80 mm	
UNBN0006A4	UNBN1006A4	UNBN2006A4	590 X 1080 mm	483 X 973 mm	450 X 940 mm	6 X A4	11,250 kg	13,340 kg	13,300 kg	620 X 1100 X 80 mm	
UNBN0009A4	UNBN1009A4	UNBN2009A4	820 X 1080 mm	713 X 973 mm	680 X 940 mm	9 X A4	14,600 kg	17,600 kg	17,600 kg	850 X 1100 X 80 mm	
UNBN0012A4	UNBN1012A4	UNBN2012A4	1050 X 1080 mm	943 X 973 mm	910 X 940 mm	12 X A4	18,300 kg	22,220 kg	21,450 kg	1080 X 1100 X 80 mm	




*W:Width H: Height D: Depth


Noticeboard with LED Light




Suitable for outdoor use. LEDs on the top and the bottom of the profile illuminate the interior of the frame. 4xA4, 6xA4, 9xA4, 12xA4 paper capacity sizes are available. Noticeboard can be used both in portrait and landscape positions. Each unit includes a free set of pins or magnets. The profile width is 70 mm and the depth of the case 50 mm.

Für den Ausseneinsatz geeignet. LED - Streifen an beiden kurzen Seiten erhellen die Innenseite des Artikels. Der Artikel ist in den Papierkapazitäten 4xA4, 6xA4, 9xA4 und 12xA4 erhältlich. Das Produkt kann in Hoch- und Querformat eingesetzt werden und beinhaltet je ein Nadelset. Die Profiltiefe beträgt 70 mm, die Bautiefe ist 50 mm.

 Each product includes 2 mounting arms, 1 key set single variation & fixing set. Delivered with 3,5 meter long EU plug and cable. UK and US plug should be specified with order. All units pass CE/UL Pat test. Jeder Artikel beinhaltet zwei Montageleisten, Befestigungsmaterial und einen Schlüsselset inkl. Ersatzschlüssel. Alle Produkte sind CE/UL Pat getestet and werden mit Qualitätszertifikaten geliefert. 3,5 m Stromkabel. Falls UK und USA Stecker gewünscht ist die Angabe bei Bestellung erforderlich.

 Each unit comes with a free set of pins. 2 handles at each end help to keep the cover door open. Jeder Artikel beinhaltet ein Nadelset, 2 Halterungen an der Innentür ermöglichen das Offenhalten der Tür und erleichtern die Benutzung des Schaukastens.

 Please throw away the silicagel on the cork once the unit is opened. Please do not drill the product while mounting, only use the mounting arms. Please throw away the protection film on the unit before use. Max. available size 841x1189 mm. Bitte Silica Beutel vor Gebrauch entfernen. Bitte keine Bohrungen an dem Produkt vornehmen und bei der Wandmontage nur die Montageleisten benutzen. Bitte vor dem Einsatz die Schutzfolie abziehen. Max. Größe 841x1189 mm.



Size of boards for all Noticeboards models:

	6A4		9A4		
4A4	A4	A4	A4	A4	A4
	A4	A4	A4	A4	A4
	A4	A4	A4	A4	A4

MATERIAL : Silver anodised aluminium							WEIGHT WITH PACKING			PACKING SIZE
CORK	MAGNETIC	M&C	EXTERNAL (x-y)	PAPER AREA	COPIY	CAPACITY	CORK	MAGNETIC	M&C	*W X H X D
UNBNOL04A4	UNBN1L04A4	UNBN2L04A4	590 X 760 mm	483 X 653 mm	450 X 620 mm	4 X A4	8,500 kg	9,750 kg	9,750 kg	620 X 780 X 80 mm
UNBNOL06A4	UNBN1L06A4	UNBN2L06A4	590 X 1080 mm	483 X 973 mm	450 X 940 mm	6 X A4	11,250 kg	13,340 kg	13,300 kg	620 X 1100 X 80 mm
UNBNOL09A4	UNBN1L09A4	UNBN2L09A4	820 X 1080 mm	713 X 973 mm	680 X 940 mm	9 X A4	14,600 kg	17,600 kg	17,600 kg	850 X 1100 X 80 mm

* W:Width H: Height D: Depth



Noticeboard with Logo



Suitable for outdoor use, Noticeboard is designed further for logo applications or branding options. 4x A4, 6x A4, 9x A4 and 12x A4 paper capacity sizes are available. The profile with is 70mm and case depth is 40mm. It is produced by durable aluminium frames and vandal resistant glazing panels.

Geeignet für den Außeneinsatz. Der neue Noticeboard ist entwickelt für Logoapplikationen. 4x A4, 6x A4, 9x A4 und 12x A4 Aufnahmen sind verfügbar. Das Profil ist 70mm breit und das Produkt hat eine 40mm Bautiefe. Wird produziert aus langlebigem Aluminium und ist geschützt durch Vandalismus mittels einer speziellen Verglasung.



Each product includes 2 mounting arms, 1 key set single variation & fixing set.
Jeder Artikel beinhaltet zwei Montageleisten, Befestigungsmaterial und einen Schlüsselset inkl. Ersatzschlüssel.



Each unit comes with a free set of magnets. 2 handles at each end help to keep the cover door open.
Jeder Artikel beinhaltet ein Magnetset, 2 Halterungen an der Innentür ermöglichen das Offenhalten der Tür und erleichtern die Benutzung des Schaukastens.



Please do not drill the product while mounting, only use the mounting arms. Please throw away the protection film on the unit before use.
Bitte keine Bohrungen an dem Produkt vornehmen und bei der Wandmontage nur die Montageleisten benutzen. Bitte vor dem Einsatz die Schutzfolie abziehen.



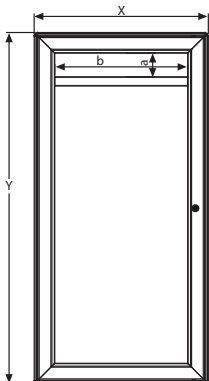
Magnetic



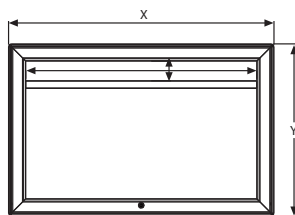
Cork



Portrait



Landscape



MATERIAL : Silver anodised aluminium

CORK	MAGNETIC	EXTERNAL (x-y)	PAPER AREA	LOGO (a-b)	CAPACITY	DESCRIPTION	WEIGHT WITH PACKING		PACKING SIZE
							CORK	MAGNETIC	*W X H X D
UNBN0504A4	UNBN1504A4	590 X 870 mm	483 X 653 mm	450 X 80 mm	4 X A4	Portrait	9,750 kg	10,780 kg	620 X 910 X 80 mm
UNBN0506A4	UNBN1506A4	590 X 1190 mm	483 X 973 mm	450 X 80 mm	6 X A4	Portrait	12,500 kg	14,600 kg	620 X 1230 X 80 mm
UNBN0509A4	UNBN1509A4	820 X 1190 mm	713 X 973 mm	680 X 80 mm	9 X A4	Portrait	16,800 kg	17,900 kg	870 X 1230 X 80 mm
UNBN0512A4	UNBN1512A4	1050 X 1190 mm	943 X 973 mm	910 X 80 mm	12 X A4	Portrait	20,400 kg	24,500 kg	1080 X 1230 X 80 mm
UNBN0704A4	UNBN1704A4	760 X 700 mm	653 X 483 mm	620 X 80 mm	4 X A4	Landscape	10,100 kg	11,130 kg	730 X 800 X 80 mm
UNBN0706A4	UNBN1706A4	1080 X 700 mm	730 X 483 mm	940 X 80 mm	6 X A4	Landscape	13,000 kg	14,530 kg	730 X 1120 X 80 mm
UNBN0709A4	UNBN1709A4	1080 X 930 mm	730 X 713 mm	940 X 80 mm	9 X A4	Landscape	17,350 kg	18,880 kg	960 X 1120 X 80 mm
UNBN0712A4	UNBN1712A4	1080 X 1160 mm	730 X 943 mm	940 X 80 mm	12 X A4	Landscape	21,400 kg	23,500 kg	1110 X 1200 X 80 mm



*W:Width H: Height D: Depth



Printable Solutions

- Maxi Frames
- River Maxi Frame
- Bay Maxi Frame
- Gulf Maxi Frame
- Lagoon Maxi Frame
- Ocean Maxi Frame
- Maxi Frame with LED
- Star Maxi LED
- Wood Maxi Frame
- Power LED
- Maxi Frame Totem with LED
- Semi Products for Maxi Frame
- Omni Frame
- Omni A Board

- Maxi Rahmen
- River Maxi Rahmen
- Bay Maxi Rahmen
- Gulf Maxi Rahmen
- Lagoon Maxi Rahmen
- Ocean Maxi Rahmen
- Maxi Frame with LED
- Star Maxi LED
- Wood Maxi Frame
- Power LED
- Maxi Frame Totem with LED
- Ersatzteile für Maxi Rahmen
- Omni Rahmen
- Omni Kundenstopper



Maxi Frames



It offers a fresh new look to today's display atmosphere which is an alternative to frame systems, Banners, Pop-Ups by applying a printed fabric's installation into the Maxi profile with a sewed or taped nylon strip. The product is a stunning combination of Aluminum and Digital Printing Machines where they unite with a fabric. The attractive point of the product is when it is looked at the front side, you are unable to see the Aluminium Parts of the frame which makes it look frameless.

The details of packaging of the product are:

- All the MAXI FRAMES are individually packed.
- Profiles and connector parts for the required sizes are boxed unassembled.
- Nylon strip is included in each frame.
- Fixing tools are included in each package. Just the feet for Double Sided Ocean Maxi frame must be ordered separately and 4 feet models are available.

Our Maxi Frame Range consists of mainly 5 different profile options. These profiles are designed to make 3 different models of Single Sided MAXI FRAMES, and 2 models of Double Sided MAXI FRAMES. Our standard Maxi Frames are always supplied unassembled providing connectors, hanging parts, and nylon strips. For the double sided ceiling hanger model the hanging wire cable system in each box. Please note, ceiling hanger and 4 feet options should be ordered separately.

MAXI FRAME ist ein neues Highlight in der Welt der Displaysysteme und eine interessante Alternative zu herkömmlichen Rahmen-Banner, oder Pop-Up Systemen. Die Textilgrafik wird dabei mittels eines angenehmen Silikonkeder einfach in die Rahmennut gesteckt. Der Clou hierbei ist die perfekte Illusion der Rahmenlosigkeit durch gerade einmal 2 mm sichtbares Profil.

Und so wird Maxi Frame geliefert:

- Alle MAXI FRAME werden einzeln verpackt.
- Profile und Verbinder für die entsprechenden Rahmengrößen werden unmontiert, separat verpackt mitgeliefert.
- Der auf die Rahmengröße zugeschnittene Silikonkeder wird mitgeliefert.
- Das für Deckenabhangung von doppelseitigen Rahmen benötigte Abhänge-Set ist im Lieferumfang enthalten. Bei freistehender Anwendung, muß das gewünschte Fuß-Set 2 sind auch 4 Fussversionen möglich separat bestellt werden.

Das MAXI FRAME System besteht aus 5 Profilvarianten, von denen 3 für die einseitige Anwendung und 2 für doppelseitige Anwendungen entwickelt wurden. Es wird grundsätzlich demontiert mit Eckverbindern, Quertraversen mit Schlössern und passendem Silikonkeder geliefert. Bei doppelseitigen Rahmen ist das Deckenabhänge-Set im Lieferumfang enthalten. Das Zubehör für Wandmontage sowie die Fuß-Lösungen für doppelseitige Rahmen mit Füßen müssen separat bestellt werden.

- ✓ Standard colour: Silver Anodised
- ✓ Available in RAL colours (subject to MOQ)
- ✓ Power supply is provided with the unit to suit each of the product
- ✓ Luminance: 2000-3000lux (depending on size)
- ✓ Standard Packaging: Single units in polybag and box
- ✓ Low power consumption (see above average power consumption table for each size)
- ✓ Various plugs available such as European, UK, US and Australian
- ✓ Complies with EN55015 & EN61547.

POWER SUPPLY	
ARTICLE	DESCRIPTION
UYPLD00010	Power supply EU 3,34A 7/24
UYPLD00011	Power supply EU 6,67A 7/24
UYPLD00012	Power supply EU 8,5A 7/24
UYPLD00013	Power supply EU 11,5A 7/24

- ✓ Products are suitable to use 7/16.
- ✓ If 7/24 use required, please order individually as 7/24 power supplies as below:

In case of any claim, user is required to return product or any parts to manufacturer for analyses at their cost. As long as the manufacturer confirms the problem is a manufacturing fault, the replacement can be provided. This applies for all illuminated products.



Maxi Frame LED, Maxi Totem Product Programme (Production & Availability)

Size Available	25 mm / Star Maxi LED	50 mm / Star Maxi LED	34 mm / Maxi Frame
Poster Size	single	double	single
A4 / 297x210	UMLSTN00A4	UMLSCN00A4	UMLD3400A4
A3 / 420x297	UMLSTN00A3	UMLSCN00A3	UMLD3400A3
A2 / 594x420	UMLSTN00A2	UMLSCN00A2	UMLD3400A2
A1 / 841x594	UMLSTN00A1	UMLSCN00A1	UMLD3400A1
A0 / 1189x841	UMLSTN00A0	UMLSCN00A0	UMLD3400A0
B2 / 700x500	UMLSTN00B2	UMLSCN00B2	UMLD3400B2
B1 / 1000x700	UMLSTN00B1	UMLSCN00B1	UMLD3400B1
B0 / 1400x1000	X	X	UMLD3400B0
20"x30" / 508x762	UMLSTN0023	UMLSCN0023	UMLD340023
30"x40" / 762x1016	UMLSTN0034	UMLSCN0034	UMLD340034
40"x60" / 1016x1524	X	X	UMLD340046
Max (w x h) mm	850x1200	850x2000	1200x2415

Power Consumption	25 mm / Star Maxi LED	50 mm / Star Maxi LED	34 mm / Maxi Frame
Poster Size	single	double	single
A4 / 297x210	6,5W/0,54A	10W/0,8A	5W/0,4A
A3 / 420x297	11W/0,91A	12W/1A	15,5W/1,3A
A2 / 594x420	15W/1,25A	18W/1,5A	25W/2,05A
A1 / 841x594	21W/1,75A	25W/2,05A	33W/2,75A
A0 / 1189x841	28,5W/2,35A	33W/2,75A	47,5W/3,95A
B2 / 700x500	17,5W/1,45A	47,5W/3,95A	28W/2,4A
B1 / 1000x700	25W/2,05A	29W/2,4A	31W/2,6A
B0 / 1400x1000	X	X	58W/4,85A
20"x30" / 508x762	18,5W/1,55A	23W/1,9A	31W/2,6A
30"x40" / 762x1016	26W/2,1A	29W/2,4A	39,5W/3,3A
40"x60" / 1016x1524	X	X	58W/4,85A

Power Supply Recommended (12 Vdc, Ampere)	25 mm / Star Maxi LED	50 mm / Star Maxi LED	34 mm / Maxi Frame
Poster Size	single	double	single
A4 / 297x210	1A	1A	1A
A3 / 420x297	1A	2A	2A
A2 / 594x420	2A	3A	3A
A1 / 841x594	2A	3A	4A
A0 / 1189x841	3A	4A	6A
B2 / 700x500	2A	3A	3A
B1 / 1000x700	3A	4A	4A
B0 / 1400x1000	X	X	6A
20"x30" / 508x762	2A	3A	4A
30"x40" / 762x1016	3A	4A	4A
40"x60" / 1016x1524	X	X	6A

LUX	25 mm / Star Maxi LED	50 mm / Star Maxi LED	34 mm / Maxi Frame
Poster Size	single	double	single
A4 / 297x210	2400-2800	1200-1400	1900-2300
A3 / 420x297	2000-2200	1100-1300	3300-3900
A2 / 594x420	1400-1800	800-1100	2700-3300
A1 / 841x594	1000-1300	700-1100	2200-2400
A0 / 1189x841	800-1000	500-900	1600-1800
B2 / 700x500	1200-1500	900-1200	2400-2700
B1 / 1000x700	900-1200	700-1100	1700-1900
B0 / 1400x1000	X	X	1400-1800
20"x30" / 508x762	1200-1500	800-1200	2600-3000
30"x40" / 762x1016	900-1000	800-1000	1700-2000
40"x60" / 1016x1524	X	X	1400-1800

R011-28.08.2017

Maxi Frames



Single Sided MAXI FRAMES are provided in 3 different profiles in order of thickness:

a) Valet Profile: 15x22 mm profile. The Single Sided MAXI FRAMES made up with Valet Profile are named as RIVER MAXI FRAMES. Available Poster Sizes are: A4, A3, A2, A1, B2, B1, and 50x100cm.

b) Ace Profile: 32x8mm profile. The Single Sided MAXI FRAMES made up with Ace Profile are named as BAY MAXI FRAMES. Available Poster Sizes are: A4, A3, A2, A1, A0, B2, B1, B0, 50x10cm., 100x100cm., 100x150cm., and 100x200cm.

c) Dame Profile: 34x32 mm profile. The Single Sided MAXI FRAMES made up with Dame Profile are named as GULF MAXI FRAMES. Available Poster Sizes are: 100x200cm., 100x300cm., 150x200cm., 150x300cm., 200x200cm., and 200x300cm.

Double Sided MAXI FRAMES are provided in 2 different profiles.

a) Queen Profile: 45x15 mm profile - Suitable for ceiling suspension. The Double Sided MAXI FRAMES made up with Queen Profile are named as LAGOON MAXI FRAMES. Available Poster Sizes are: A4, A3, A2, A1, A0, B2, B1, B0, 50x10cm., 100x100cm., 100x150cm., and 100x200cm.

b) King Profile: 50x40 mm profile - Designed with feet for free standing. The Double Sided MAXI FRAMES made up with King Profile are named as OCEAN MAXI FRAMES. Available Poster Sizes are: 100x140cm., 100x150cm., 100x200cm., 100x225cm., 200x150cm., 200x200cm., 200x225cm., 300x150cm., 300x200cm., and 300x225cm.

We offer MAXI FRAMES both in standard sizes boxed unassembled and also in lengths and parts as semi products.

Find below all the Semi-Products that are used in MAXI FRAMES.

Clear Nylon Strip, Corner Cleat for MAXI FRAMES, Straight Cleat for H-Profile of MAXI FRAME, Square Corner Connector for MAXI FRAME, L-Type Corner Connector for MAXI FRAME, Hanging System including wire cable, Transparent or Gray Color Pull strip.

Find below the names of 4 different feet models:
Circle Feet, Hoop Feet, Baseball Feet, and Fillet Feet.

Für einseitige MAXI FRAMES können je nach Größe folgende Profile verwendet werden:

a) Valet Profil: 15x22 mm Profil. Die aus Valet-Profil bestehenden, einseitigen Rahmen werden RIVER MAXI FRAMES genannt und sind in DIN A4 bis DIN A1 sowie B2 bis B1 und 50x100 cm erhältlich.

b) Ace Profil: 32x8 mm Profil. Die aus Ace-Profil bestehenden, einseitigen Rahmen werden BAY MAXI FRAMES genannt und sind in DIN A4 bis DIN A0 sowie B2 bis B0 und 50x100 cm, 100x100 cm, 100x150 cm und 100x200 cm erhältlich.

c) Dame Profil: 34x32 mm Profil. Die aus Dame-Profil bestehenden, einseitigen Rahmen werden GULF MAXI FRAMES genannt und sind in 100x200 cm, 100x300 cm, 150x200 cm, 150x300 cm, 200x200 cm und 200x300 cm erhältlich.

Für doppelseitige MAXI FRAMES können je nach Größe folgende Profile verwendet werden:

a) Queen-Profil: 45x15 mm Profil. Die aus Queen-Profil bestehenden, doppelseitigen Rahmen werden LAGOON MAXI FRAMES genannt und sind in DIN A4 bis DIN A0 sowie B2 bis B0 und 50x100 cm, 100x100 cm, 100x150 cm und 100x200 cm erhältlich.

b) King-Profil: 50x40 mm Profil. Die aus King-Profil bestehenden, doppelseitigen Rahmen werden OCEAN MAXI FRAMES genannt und sind in 100x140 cm, 100x150 cm, 100x200 cm, 100x225 cm, 200x150 cm, 200x200 cm und 200x225, 300x150 cm, 300x200 cm und 300x225 cm erhältlich.

MAXI FRAMES werden sowohl in Standardgrößen unmontiert, als auch als Bausatz bestehend aus Profilen mit Zubehör geliefert.

Das gesamte Zubehör für MAXI FRAME besteht aus:

Silikonkeder, 45 Grad Schloss für Eckverbindung der Rahmen, gerades Schloss für Quertraversen, Rechteck-Eckverbinder für Rahmen, L-Eckverbinder für Rahmen, Drahtseil-Abhängeset, graue oder transparente Lasche zum Herausziehen der Grafik aus dem System.

Folgende Fußlösungen für MAXI FRAME sind erhältlich:
Kreis-Fuß, Baseball-Fuß, Oval-Fuß und Teller-Fuß.



River Maxi Single Sided



Valet Profile / 15x22 mm River Maxi Frame

The single-sided MAXI FRAMES that are made up of Valet Profile are named RIVER MAXI FRAMES.

Valet Profil / 15x22 mm River Maxi Frame

Die aus Valet-Profil bestehenden, einseitigen Rahmen werden RIVER MAXIFRAMES genannt.



Hang by using the assembling holes.
Aufhängung durch die Verbindungslöcher

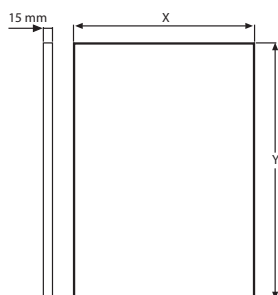
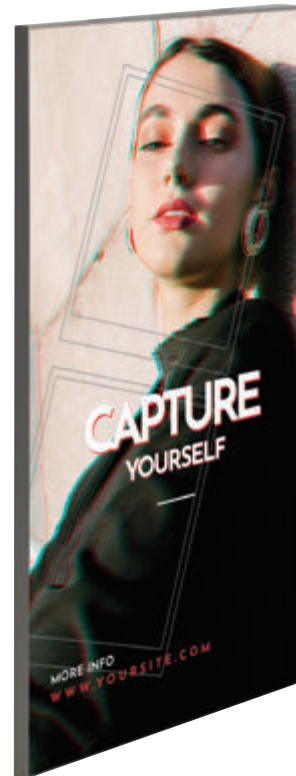
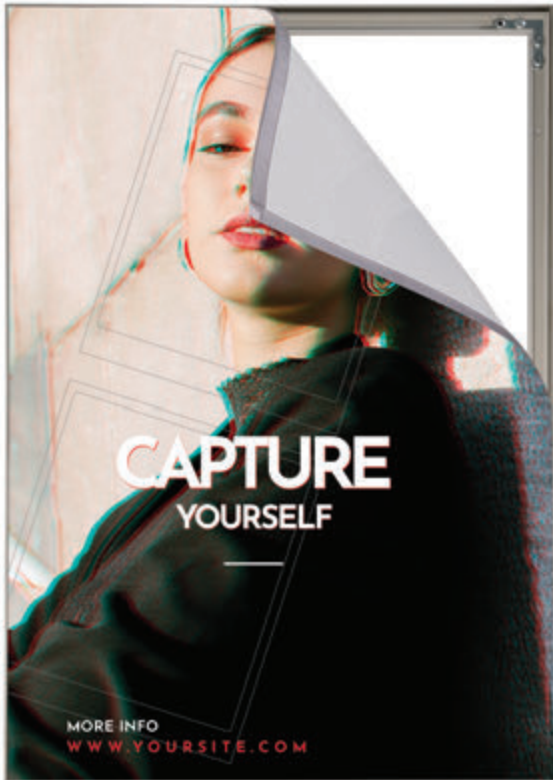


The thickness of the channel is 4 mm. Supplied nylon strip is 3 mm, recommended fabric thickness for digital printing is 0,5 mm. The pull sticker in 0,5 mm thickness must be sewed on the fabric to take out the poster from channels.

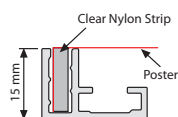
Die Kanalbreite ist 4 mm. Die Silikonkeder ist 3 mm dick, somit wird als Textilgrafik für den Digitaldruck 0,5 mm dicker Stoff empfohlen. Die transparente Lasche ist 0,5 mm dick und muss an eine Seite des Stoffes genäht werden, um das Herausziehen der Grafik zu ermöglichen.



13 mm on each side of the fabric into Maxi Profiles, in total 26 mm on each Fabric Poster is not seen on the poster. Please arrange accordingly. Fabric is not included within the original pack.
13 mm von jeder Stoffseite wird in die Rahmennut der Maxi Profile gesteckt, somit werden insgesamt 26 mm des Posterstoffes nicht sichtbar sein. Stoffmass entsprechend anlegen. Der Stoff ist in den Produktpaketen nicht inbegriffen



Valet Profile



Clear Nylon Strip



Suggested additional print shares for Maxi Frame's Fabric Posters

Between 200 - 750 mm	28 mm
Between 750 - 1500 mm	20 mm
Between 1500 - 3000 mm	15 mm

e.g. Maxi frame size: 1000x300 mm printed fabric size must be 1020x328 mm. But these values might vary according to the fabric material used.

z.B bei einer Maxi Frame Grösse von 1000x300 mm muss die Grösse der bedruckten Textilgrafik 1020x328 mm, sein Diese Angaben können je nach benutzter Stoffqualität differieren.

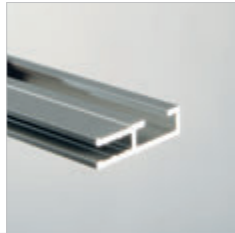
MATERIAL : Silver anodised aluminium

ARTICLE	EXTERNAL (x-y)	WEIGHT	PACKING SIZE
		WITH PACKING	*W X H X D
UMFR0000A4	210 X 297 mm	0,510 kg	45 X 350 X 70 mm
UMFR0000A3	297 X 420 mm	0,635 kg	45 X 470 X 70 mm
UMFR0000A2	420 X 594 mm	0,810 kg	45 X 650 X 70 mm
UMFR0000A1	594 X 841 mm	1,095 kg	45 X 890 X 70 mm
UMFR0000B2	500 X 700 mm	0,910 kg	45 X 750 X 70 mm
UMFR0000B1	700 X 1000 mm	1,230 kg	45 X 1050 X 70 mm
UMFR000510	500 X 1000 mm	1,130 kg	45 X 1050 X 70 mm

*W:Width H: Height D: Depth



Bay Maxi Single Sided



Ace Profile / 32x8 mm Bay Maxi Frame

The single-sided MAXI FRAMES that are made up of Ace Profile are named BAY MAXI FRAMES.

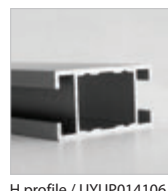
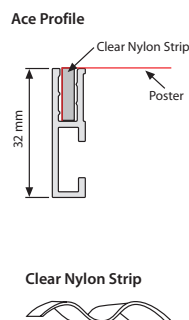
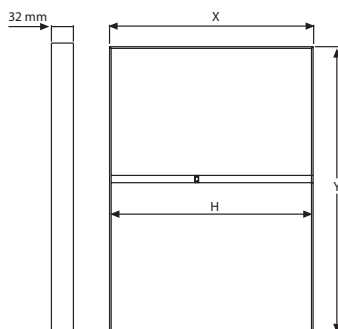
Ace Profil / 32x8 mm Bay Maxi Frame

Die aus Ace-Profil bestehenden, einseitigen Rahmen werden BAY MAXIFRAMES genannt.

Hang by using the Square Corner Connector pieces. For larger sizes of Bay Maxi Frame, H-Profile is included in the pack with the quantities shown in the table. *Aufhängung durch die Eckverbinder. Für Größere Grössen des Bay Maxi Rahmens werden Quertraversen den Produkten beigelegt. Anzahl der Quertraversen können Sie u.g Tabelle entnehmen.*

The thickness of the channel is 4mm. Supplied nylon strip is 3 mm, so recommended fabric thickness for digital printing is 0,5 mm. The pull sticker in 0,5 mm thickness must be sewed on the fabric for taking out the poster when fitted into the channels. *Die Kanalbreite ist 4 mm. Die Silikonkeder ist 3 mm dick, somit wird als Textilgrafik für den Digitaldruck 0,5 mm dicker Stoff empfohlen. Die transparente Lasche ist 0,5 mm dick und muss an eine Seite des Stoffes genäht werden, um das Herausziehen der Grafik zu ermöglichen.*

13 mm on each side of the fabric is fitted into Maxi Profiles, so 26 mm on each Fabric poster is not seen on the poster. Please arrange accordingly. Fabric is not included within the original pack. *13 mm von jeder Stoffseite wird in die Rahmennut der Maxi Profile gesteckt, somit werden insgesamt 26 mm des Posterstoffes nicht sichtbar sein. Stoffmass entsprechend anlegen. Der Stoff ist in den Produktpaketen nicht inbegriffen.*

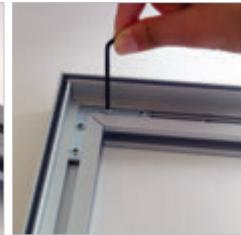
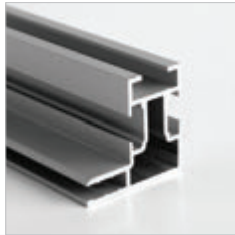


MATERIAL : Silver anodised aluminium				WEIGHT	PACKING SIZE
ARTICLE	EXTERNAL (x-y)	H (mm)	H (Pcs)	WITH PACKING	*W X H X D
UMFB0000A4	210 X 297 mm	-	-	0,560 kg	60 X 350 X 50 mm
UMFB0000A3	297 X 420 mm	-	-	0,710 kg	60 X 470 X 50 mm
UMFB0000A2	420 X 594 mm	-	-	0,900 kg	60 X 650 X 50 mm
UMFB0000A1	594 X 841 mm	-	-	1,230 kg	60 X 890 X 50 mm
UMFB0000A0	841 X 1189 mm	-	-	1,690 kg	60 X 1240 X 50 mm
UMFB0000B2	500 X 700 mm	-	-	1,030 kg	60 X 750 X 50 mm
UMFB0000B1	700 X 1000 mm	-	-	1,430 kg	60 X 1120 X 50 mm
UMFB0000B0	1000 X 1400 mm	983 mm	1	2,480 kg	60 X 1500 X 50 mm
UMFB000510	500 X 1000 mm	-	-	1,210 kg	60 X 1120 X 50 mm
UMFB001010	1000 X 1000 mm	-	-	1,530 kg	60 X 1050 X 50 mm
UMFB001015	1000 X 1500 mm	983 mm	1	2,800 kg	60 X 1550 X 50 mm
UMFB001020	1000 X 2000 mm	983 mm	1	3,100 kg	60 X 2050 X 50 mm

* W:Width H: Height D: Depth



Gulf Maxi Single Sided



Dame Profile / 34x32 mm Gulf Maxi Frame

The single-sided MAXI FRAMES that are made up of Dame Profile are named GULF MAXI FRAMES.

Dame Profil / 34x32 mm Gulf Maxi Frame

Die aus Dame-Profil bestehenden, einseitigen Rahmen werden GULF MAXIFRAMES genannt.



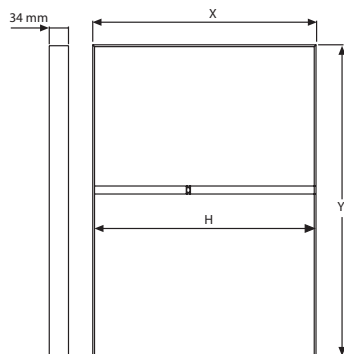
Hang by using the assembling holes. The profile edges have corner cleats and are connected by allen key. For larger sizes of Gulf Maxi Frame, H-Profile is included in the pack with the quantities shown in the table.
Aufhängung durch die Verbindungslöcher. Die Profilenden sind mit Eckschlössern versehen die mit dem Imbusschlüssel miteinander verbunden werden können. Für grössere Grössen des Gulf Maxi Rahmens werden Quertraversen den Produkten beigelegt. Anzahl der Quertraversen können Sie u.g Tabelle entnehmen.



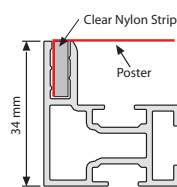
The thickness of the profile is 4 mm. Supplied nylon strip is 3 mm, so recommended fabric thickness for digital printing is 0,5 mm. The pull sticker in 0,5 mm thickness must be sewed on the fabric for taking out the poster when fitted into the channels.
Die Kanalbreite ist 4 mm. Die Silikonkeder ist 3 mm dick, somit wird als Textilgrafik für den Digitaldruck 0,5 mm dicker Stoff empfohlen. Die transparente Lasche ist 0,5 mm dick und muss an eine Seite des Stoffes genaht werden, um das Herausziehen der Grafik zu ermöglichen.



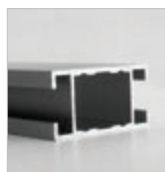
13 mm on each side of the fabric is fitted into Maxi Profiles, so 26 mm on each Fabric Poster is not seen on the poster. Please arrange accordingly. Fabric is not included within the original pack.
13 mm von jeder Stoffseite wird in die Rahmennut der Maxi Profile gesteckt, somit werden insgesamt 26 mm des Posterstoffes nicht sichtbar sein. Stoffmass entsprechend anlegen. Der Stoff ist in den Produktpaketen nicht inbegriffen.



Dame Profile



Clear Nylon Strip



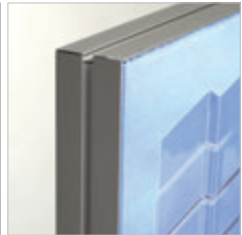
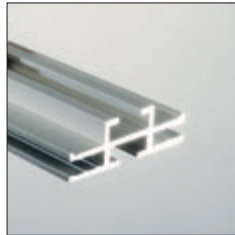
H profile / UYUP014106

MATERIAL : Silver anodised aluminium				WEIGHT	PACKING SIZE
ARTICLE	EXTERNAL (x-y)	H (mm)	H (Pcs)	WITH PACKING	*W X H X D
UMFG001020	1000 X 2000 mm	-	-	5,650 kg	70 X 208 X 115 mm
UMFG001030	1000 X 3000 mm	937 mm	1	7,820 kg	70 X 308 X 140 mm
UMFG001520	1500 X 2000 mm	-	-	6,600 kg	70 X 208 X 115 mm
UMFG001530	1500 X 3000 mm	1437 mm	1	8,970 kg	70 X 308 X 140 mm
UMFG002020	2000 X 2000 mm	-	-	7,450 kg	70 X 208 X 115 mm
UMFG002030	2000 X 3000 mm	1937 mm	2	11,180 kg	70 X 308 X 140 mm

* W:Width H: Height D: Depth



Lagoon Maxi Double Sided



Queen Profile / 45x15 mm Lagoon Maxi Frame
Used for ceiling hanging. The double-sided MAXI FRAMES that are made up of Queen Profile are named LAGOON MAXI FRAMES.

Queen-Profil / 45x15 mm Lagoon Maxi Frame
Die aus Queen-Profil bestehenden, doppelseitigen Rahmen werden LAGOON MAXIFRAMES genannt.

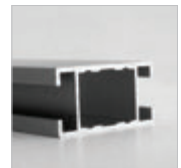
Suitable to hang from the ceiling. The profiles are connected to each other by the help of Square Corner Connector piece. For larger sizes of Lagoon Maxi Frame, H-Profile must be used. The special hanging pieces for fixing the ceiling with the wire cable, must be fixed into the top short side of the Lagoon Maxi Frame before the profiles are connected to each other.
Aufhängung durch Drahtseile. Die Profile werden mit Eckverbindern miteinander verbunden. Für grössere Grössen des Lagoon Maxi Rahmens müssen Quertraversen den Produkten beigelegt werden. Anzahl der Quertraversen können Sie u.g Tabelle entnehmen. Die Aufhänger für das Drahtseil müssen in das obere Profil eingesetzt werden, bevor die Profile miteinander verbunden werden.

The thickness of the profile is 4mm. Supplied nylon strip is 3 mm, so recommended fabric thickness for digital printing is 0,5 mm. The pull sticker in 0,5 mm thickness must be sewed on the fabric for taking out the poster when fitted into the channels.
Die Kanalbreite ist 4 mm. Die Silikonkeder ist 3 mm dick, somit wird als Textilgrafik für den Digitaldruck 0,5 mm dicker Stoff empfohlen. Die transparente Lasche ist 0,5 mm dick und muss an eine Seite des Stoffes genäht werden, um das Herausziehen der Grafik zu ermöglichen.

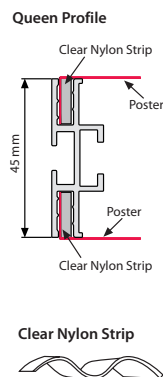
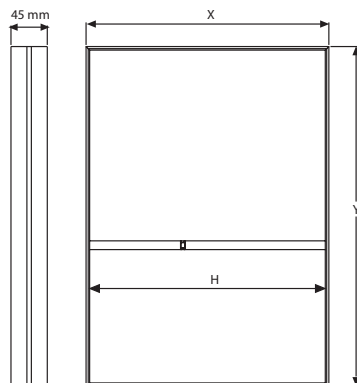
13 mm on each side of the fabric is fitted into Maxi Profiles, so 26 mm on each Fabric Poster is not seen on the poster. Please arrange accordingly. Fabric is not included within the original pack. Ceiling hangers are included in the original pack.
13 mm on each side of the fabric is fitted into Maxi Profiles, so 26 mm on each Fabric Poster is not seen on the poster. Please arrange accordingly. Fabric is not included within the original pack. The ceiling hangers are included in the original pack.



Hanging kit / UYUP460245



H profile / UYUP014106

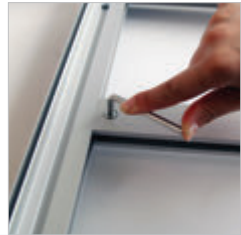
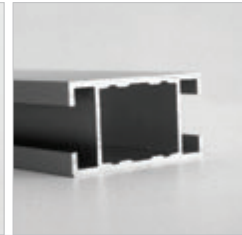
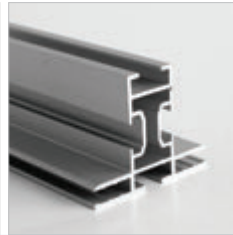


MATERIAL : Silver anodised aluminium				WEIGHT	PACKING SIZE
ARTICLE	EXTERNAL (x-y)	H (mm)	H (Pcs)	WITH PACKING	*W X H X D
UMFL0000A4	210 X 297 mm	-	-	0,800 kg	85 X 350 X 75 mm
UMFL0000A3	297 X 420 mm	-	-	1,020 kg	85 X 470 X 75 mm
UMFL0000A2	420 X 594 mm	-	-	1,410 kg	85 X 650 X 75 mm
UMFL0000A1	594 X 841 mm	-	-	2,070 kg	85 X 890 X 75 mm
UMFL0000A0	841 X 1189 mm	-	-	2,720 kg	85 X 1240 X 75 mm
UMFL0000B2	500 X 700 mm	-	-	1,690 kg	85 X 750 X 75 mm
UMFL0000B1	700 X 1000 mm	-	-	2,170 kg	85 X 1080 X 75 mm
UMFL0000B0	1000 X 1400 mm	972 mm	1	3,800 kg	110 X 1450 X 75 mm
UMFL000510	500 X 1000 mm	-	-	2,070 kg	85 X 1080 X 75 mm
UMFL001010	1000 X 1000 mm	-	-	2,510 kg	85 X 1080 X 75 mm
UMFL001015	1000 X 1500 mm	972 mm	1	3,710 kg	110 X 1550 X 75 mm
UMFL001020	1000 X 2000 mm	972 mm	1	4,300 kg	110 X 2050 X 75 mm

*W:Width H: Height D: Depth



Ocean Maxi



Watch video at our website www.mtdisplays.com

King Profile / 50x40 mm - Ocean Maxi Frame

Used with feet to be placed on a floor. The double-sided MAXI FRAMES that are made up of King Profile are named OCEAN MAXI FRAMES. Ocean Frame can be assembled with 4 different feet models. Before the assembly of the profile corners, the connector pieces for the feet need to be fitted into the profiles channels. Then, the feet are assembled over these connector pieces.

King-Profil / 50x40 mm - Ocean Maxi Frame

Wird mit den passenden Füßen auf dem Boden eingesetzt. Die doppelseitigen Maxi Frames aus dem King Profil werden Ocean Maxi Frames genannt. Wenn der Maxi Frame mit Füßen benutzt werden, können von 4 verschiedenen Fussalternativen ausgewählt werden. Die Verbindungsteile für die Füße müssen bevor die Ecken des Rahmen miteinander verbunden werden, in den Profilkanal eingeschoben werden. Danach können die Füße an die Verbindungsstücke montiert werden.



Ocean Maxi with Baseball feet



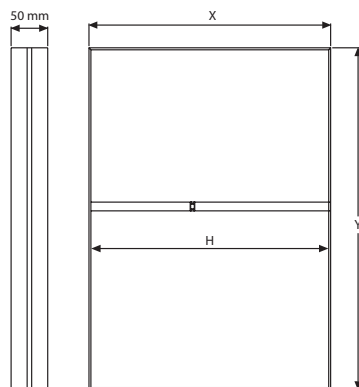
Ocean Maxi with Circle feet



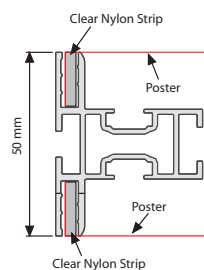
Ocean Maxi with Fillet feet



Ocean Maxi with Hoop feet



King Profile



OCEAN MAXI FRAME : Silver anodised aluminium				WEIGHT	PACKING SIZE
ARTICLE	EXTERNAL (x-y)	H (mm)	H (Pcs)	WITH PACKING	*W X H X D
UMF0001014	1000 X 1400 mm	-	-	5,050 kg	100 X 1450 X 140 mm
UMF0001015	1000 X 1500 mm	-	-	5,330 kg	100 X 1550 X 140 mm
UMF0001020	1000 X 2000 mm	-	-	6,160 kg	100 X 2080 X 140 mm
UMF0001022	1000 X 2250 mm	920 mm	1	7,340 kg	100 X 2280 X 140 mm
UMF0002015	1500 X 2000 mm	-	-	7,355 kg	100 X 2080 X 140 mm
UMF0002020	2000 X 2000 mm	-	-	8,100 kg	100 X 2080 X 140 mm
UMF0002022	2000 X 2250 mm	1920 mm	1	9,550 kg	100 X 2280 X 140 mm
UMF0003015	3000 X 1500 mm	1420 mm	1	10,220 kg	100 X 3080 X 140 mm
UMF0003020	3000 X 2000 mm	1920 mm	2	12,470 kg	100 X 3080 X 140 mm
UMF0003022	3000 X 2250 mm	2170 mm	2	13,040 kg	100 X 3080 X 140 mm

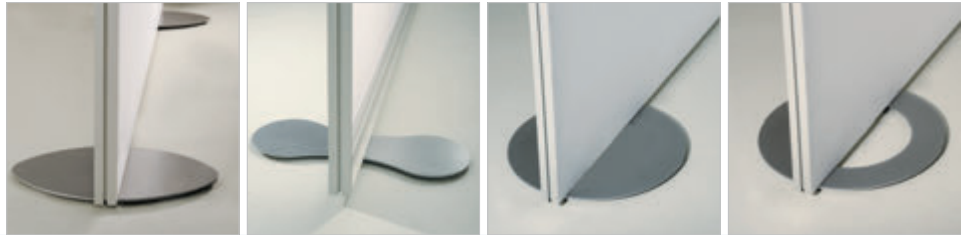
*W:Width H: Height D: Depth



Ocean Maxi



Watch video at our website www.mtdisplays.com



It can be used in 2 ways either by hanging to the ceiling or by fitting on 4 different designs of feet. The profiles edges have corner cleats and connected by allen key. For larger sizes of Ocean Maxi Frame, H-Profile must be used for stability. The special hanging pieces for fixing the ceiling with the wire cable, need be fixed into the top short side of the Ocean Maxi Frame before the profiles are connected to each other.

Der Artikel kann auf 2 verschiedenen Wegen zum Einsatz gebracht werden: Einmal durch die Drahtseilaufhängung oder indem eins der vier verschiedenen Fusslösungen eingesetzt wird. Die Profilenden sind mit Eckschlössern versehen die mit dem Imbusschlüssel miteinander verbunden werden können. Für grössere Größen des Gulf Maxi Rahmens werden Quertraversen den Produkten beigelegt. Anzahl der Quertraversen können Sie u.g Tabelle entnehmen. Die Aufhänger für das Drahtseil müssen in das obere Profil eingesetzt werden, bevor die Profile miteinander verbunden werden.



The thickness of the profile is 4mm. Supplied nylon strip is 3 mm, so recommended fabric thickness for digital printing is 0,5 mm. The pull sticker in 0,5 mm thickness must be sewed on the fabric for taking out the poster when fitted into the channels.

(Die Kanalbreite ist 4 mm. Die Silikonkeder ist 3 mm dick, somit wird als Textilgrafik für den Digitaldruck 0,5 mm dicker Stoff empfohlen. Die transparente Lasche ist 0,5 mm dick und muss an eine Seite des Stoffes genaht werden, um das Herausziehen der Grafik zu ermöglichen.)



13 mm on each side of the fabric is fitted into Maxi Profiles, so as overall 26 mm on each fabric poster is not seen on the poster. Please arrange accordingly. Fabric is not included within the original pack. Feet and ceiling hangers are not included in the original pack, please remember to place a separate order. 13 mm von jeder Stoffseite wird in die Rahmennut der Maxi Profile gesteckt, somit werden insgesamt 26 mm des Posterstoffes nicht sichtbar sein. Stoffmass entsprechend anlegen. Der Stoff ist in den Produktpaketen nicht inbegriffen.



Assembly in 45 seconds.
Montiert in 45 Sekunden.



Assembly of King Profile / Montage des King Profils



BASEBALL FEET : RAL 9006 Powder coated. 6mm steel.

ARTICLE	SIZE	WEIGHT
UYUP412273	450 X 300 X 6 mm	4,700 kg



HOOP FEET : RAL 9006 Powder coated. 6mm steel.

ARTICLE	SIZE	WEIGHT
UYUP412272	Ø 450 X 6 mm	4,400 kg



CIRCLE FEET : RAL 9006 Powder coated. 6mm steel.

ARTICLE	SIZE	WEIGHT
UYUP412271	Ø 450 X 6 mm	7,500 kg

Assembly of H Profile / Montage der Quertraversen



FILLET FEET : RAL 9006 Powder coated. 6mm steel.

ARTICLE	SIZE	WEIGHT
UYUP412274	500 X 180 X 6 mm	3,300 kg



FLAT FEET : RAL 9006 Powder coated. 6mm steel.

ARTICLE	SIZE	WEIGHT
UYUP412275	400 X 50 X 5 mm	7,200 kg

Maxi Frame with LED



Dame Profile / 34x32 mm Maxi Frame with LED

Used with wall mounting fixture on the back. The unit is single sided & edge-lit. Pre-treated light guided panel diffuses light even & powerful. Offers evenly diffused lux in all sizes.

Dame Profil / 34x32 mm Maxi Frame with LED

Wird mit Aufhängern auf der Rückseite geliefert. Das Produkt ist einseitig und bis in die Ecken beleuchtet. Bearbeitetes Lichtpanel sorgt für kraftvolle und ebene Lux Kraft in allen Größen.



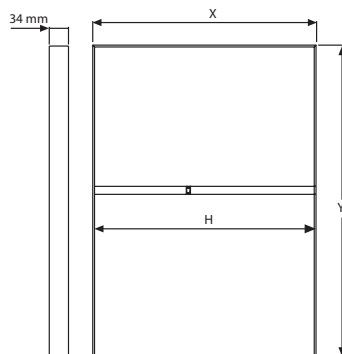
All units pass CE/UL Pat test and packed with quality certificates. 3.5 mt. electrical cable. UK and US plugs should be mentioned on order. *Alle Produkte sind CE/UL Pat getestet und werden mit Qualitätszertifikaten geliefert. 3,5 m Stromkabel. Falls UK und USA Stecker gewünscht ist die Angabe bei Bestellung erforderlich.*



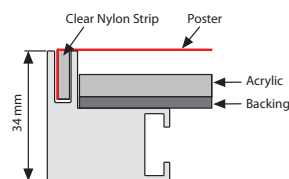
The thickness of the profile is 4mm. Supplied nylon strip is 3 mm, so recommended fabric thickness for digital printing is 0,5 mm. The pull sticker in 0,5 mm thickness must be sewed on the fabric for taking out the poster when fitted into the channels. *Die Kanalbreite ist 4 mm. Die Silikonkeder ist 3 mm dick, somit wird als Textilgrafik für den Digitaldruck 0,5 mm dicker Stoff empfohlen. Die transparente Lasche ist 0,5 mm dick und muss an eine Seite des Stoffes genaht werden, um das Herausziehen der Grafik zu ermöglichen.*



13 mm on each side of the fabric is fitted into Maxi Profiles, so 26 mm on each Fabric Poster is not seen on the poster. Please arrange accordingly. Fabric is not included within the original pack. *13 mm von jeder Stoffseite wird in die Rahmennut der Maxi Profile gesteckt, somit werden insgesamt 26 mm des Posterstoffes nicht sichtbar sein. Stoffmass entsprechend anlegen. Der Stoff ist in den Produktpaketen nicht inbegriffen.*



Dame Profile



Clear Nylon Strip



MATERIAL : Silver anodised aluminium					WEIGHT	PACKING SIZE
ARTICLE	EXTERNAL (x-y)	H (mm)	H (Pcs)	LIGHTING	WITH PACKING	*W X H X D
UMLD3400A4	210 X 297 mm	-	-	2200-2400 LUX	1,450 kg	230 X 330 X 43 mm
UMLD3400A3	297 X 420 mm	-	-	2200-2400 LUX	2,250 kg	320 X 450 X 43 mm
UMLD3400A2	420 X 594 mm	-	-	2200-2400 LUX	3,800 kg	440 X 630 X 43 mm
UMLD3400A1	594 X 841 mm	-	-	2200-2400 LUX	7,350 kg	620 X 870 X 43 mm
UMLD3400A0	841 X 1189 mm	-	-	2000-2200 LUX	15,100 kg	870 X 1210 X 43 mm
UMLD3400B2	500 X 700 mm	-	-	2200-2400 LUX	5,010 kg	520 X 730 X 430 mm
UMLD3400B1	700 X 1000 mm	-	-	2000-2200 LUX	9,950 kg	720 X 1030 X 43 mm
UMLD3400B0	1000 X 1400 mm	936 mm	1	-	20,000 kg	1020 X 1430 X 43 mm
UMLD340023	508 X 762 mm	-	-	2200-2400 LUX	5,400 kg	530 X 800 X 43 mm
UMLD340034	762 X 1016 mm	-	-	2000-2200 LUX	10,650 kg	790 X 1050 X 43 mm
UMLD340046	1016 X 1524 mm	952 mm	1	-	23,500 kg	1040 X 1560 X 43 mm

*W:Width H: Height D: Depth



Star Maxi LED Single Sided



Watch video at our website www.mtdisplays.com



With its very slim profile, 24mm, Star Maxi LED is a modern way of advertising. It is suitable for textile printed graphics. Practical poster application with clear tape provides smooth look. Complete with wall mounting accessories, Star Maxi LED is a practical advertising solution.

Mit seinem sehr schlanken Profil, 24mm, ist Star Maxi LED eine moderne Art der Werbung. Es eignet sich für Textildruckgrafiken. Praktische Posterapplikation mit Nylonkeder sorgt für ein geschmeidiges Aussehen. Komplett mit Zubehör zur Wandmontage ist Star Maxi LED eine praktische Werbelösung.



All units pass CE/UL Pat test and packed with quality certificates. 3,5 mt. electrical cable. UK and US plugs should be mentioned on order. *Alle Produkte sind CE/UL Pat getestet and werden mit Qualitätszertifikaten geliefert. 3,5 m Stromkabel. Falls UK und USA Stecker gewünscht ist die Angabe bei Bestellung erforderlich.*



The width of the channel is 4mm. Supplied nylon strip is 3 mm, so recommended fabric thickness for digital printing is 0,5 mm. The pull sticker in 0,5 mm thickness must be sewed on the fabric for taking out the poster when fitted into the channels. *Die Kanalbreite ist 4 mm. Die Silikonkeder ist 3 mm dick, somit wird als Textildruck für den Digitaldruck 0,5 mm dicker Stoff empfohlen. Die transparente Lasche ist 0,5 mm dick und muss an eine Seite des Stoffes genaht werden, um das Herausziehen der Grafik zu ermöglichen.*



13 mm on each side of the fabric is fitted into Maxi Profiles, so 26 mm on each Fabric Poster is not seen on the poster. Please arrange accordingly. Fabric is not included within the original pack. *13 mm von jeder Stoffseite wird in die Rahmennut der Maxi Profile gesteckt, somit werden insgesamt 26 mm des Posterstoffes nicht sichtbar sein. Stoffmass entsprechend anlegen. Der Stoff ist in den Produktpaketen nicht inbegriffen.*



Portrait

← 24 mm depth

One product, two positions (landscape & portrait)



2 wall hangers are standard in each product. Moving hangers let the mounting in portrait and landscape position. *2 Aufhänger sind bei jedem Produkt standart. Die beweglichen Aufhänger ermöglichen Hoch- und Quermontage.*

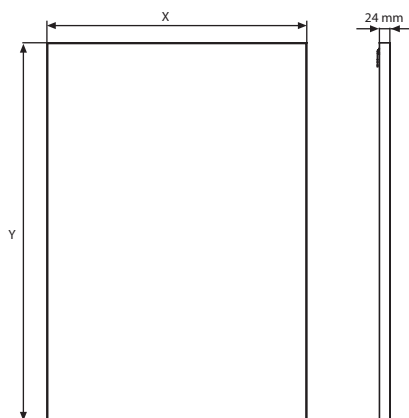


Landscape

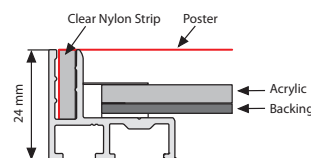


Optional dimmer to go with LED illuminated frame. Simply jack the dimmer in frame and then into powersupply. It adjust the light from dark to max lux of LED illuminated frame. *Optionaler Dimmer für LED-beleuchtetem Rahmen... Den Dimmer einfach in die Büchse vom Rahmen und dann ins Netzteil stecken. Einstellbares Licht von dunkel bis max. Lichtstärke vom LED-beleuchteten Rahmen.*

CE/UL approved.



Clear nylon stript
Please don't forget to order.
Including 7/16 power supply.



MAXIMUM SIZE: 850X1200 mm

MATERIAL : Silver anodised aluminium			WEIGHT	PACKING SIZE
ARTICLE	EXTERNAL (x-y)	LIGHTING	WITH PACKING	*W X H X D
UMLSTN00A4	210 X 297 mm	2400-2800 LUX	0,900 kg	260 X 410 X 70 mm
UMLSTN00A3	297 X 420 mm	2000-2200 LUX	1,200 kg	350 X 530 X 70 mm
UMLSTN00A2	420 X 594 mm	1400-1800 LUX	1,650 kg	470 X 700 X 70 mm
UMLSTN00A1	594 X 841 mm	1000-1300 LUX	2,250 kg	650 X 950 X 70 mm
UMLSTN00A0	841 X 1189 mm	800-1000 LUX	3,450 kg	890 X 1300 X 70 mm
UMLSTN00B2	500 X 700 mm	1200-1500 LUX	1,950 kg	550 X 810 X 70 mm
UMLSTN00B1	700 X 1000 mm	900-1200 LUX	2,600 kg	750 X 1110 X 70 mm
UMLSTN0023	508 X 762 mm	1200-1500 LUX	2,050 kg	560 X 880 X 70 mm
UMLSTN0034	762 X 1016 mm	900-1000 LUX	3,050 kg	820 X 1130 X 70 mm

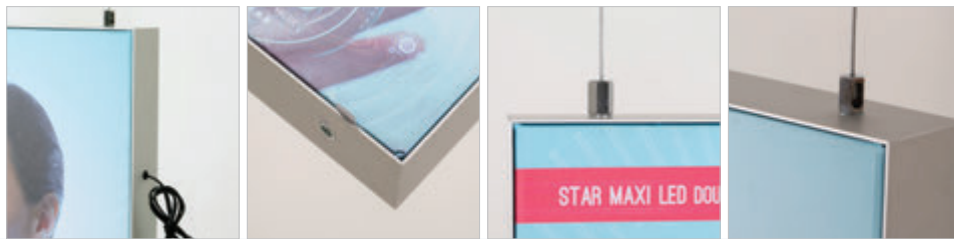
*W:Width H: Height D: Depth



Star Maxi LED Double Sided



Watch video at our website www.mtdisplays.com



With its slim profile, 50mm, double sided Star Maxi LED is a modern way of advertising. It is suitable for textile printed graphics. Practical poster application with clear tape provides smooth look. Complete with ceiling suspension system, Star Maxi LED is a practical advertising solution when message is required to be displayed both ways.

Mit seinem schlanken Profil, 50mm, ist die doppelseitige Star Maxi LED eine moderne Art der Werbung. Es eignet sich für Textildruckgrafik. Praktische Posterapplikation mit Nylonkeder sorgt für ein geschmeidiges Aussehen. Mit dem Deckenaufhängesystem ist Star Maxi LED eine praktische Werbelösung, wenn die Werbung in beide Richtungen angezeigt werden soll.

All units pass CE/UL Pat test and packed with quality certificates. 3,5 mt. electrical cable. UK and US plugs should be mentioned on order. Alle Produkte sind CE/UL Pat getestet and werden mit Qualitätszertifikaten geliefert. 3,5 m Stromkabel. Falls UK und USA Stecker gewünscht ist die Angabe bei Bestellung erforderlich.

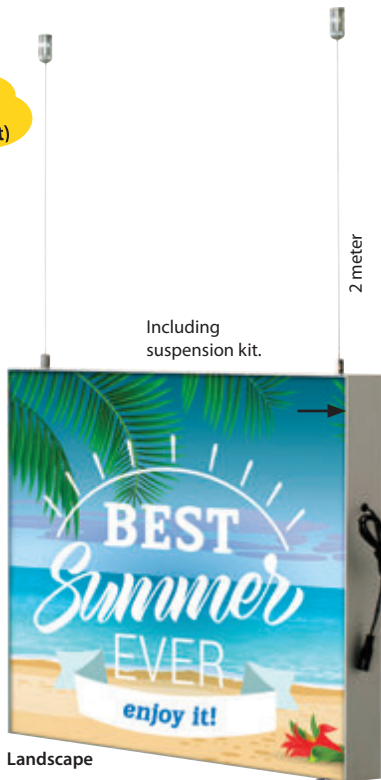
The width of the channel is 4mm. Supplied nylon strip is 3 mm, so Recommended fabric thickness for digital printing is 0,5 mm. The pull sticker in 0,5 mm thickness must be sewed on the fabric for taking out the poster when fitted into the channels. Die Kanalbreite ist 4 mm. Die Silikonkeder ist 3 mm dick, somit wird als Textilgrafik für den Digitaldruck 0,5 mm dicker Stoff empfohlen. Die transparente Lasche ist 0,5 mm dick und muss an eine Seite des Stoffes genaht werden, um das Herausziehen der Grafik zu ermöglichen.

13 mm on each side of the fabric is fitted into Maxi Profiles, so 26 mm on each Fabric Poster is not seen on the poster. Please arrange accordingly. Fabric is not included within the original pack. 13 mm von jeder Stoffseite wird in die Rahmennut der Maxi Profile gesteckt, somit werden insgesamt 26 mm des Posterstoffes nicht sichtbar sein. Stoffmass entsprechend anlegen. Der Stoff ist in den Produktpaketen nicht beigegeben.



Portrait

One product, two positions (landscape&portrait)



Including suspension kit.

50 mm depth

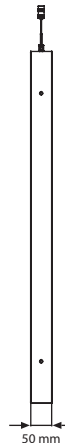
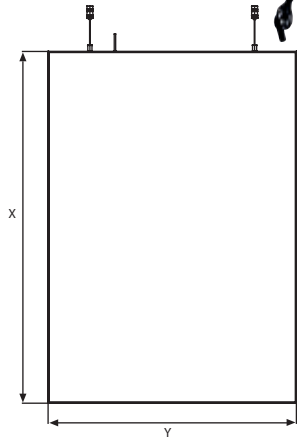
2 meter



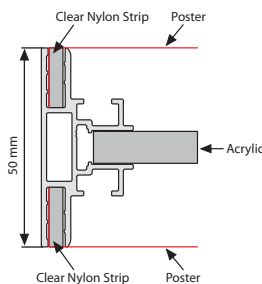
Standard hanging kit for all sizes: 2 meters x 2 pcs wire cable and 2 ceiling hangers. 2 Aufhänger sind bei jedem Produkt standart für Jedes Produkt. Bewegliche Aufhänger ermöglichen die Hoch-und Quermontage.



Optional dimmer to go with LED illuminated frame.. Simply jack the dimmer in frame and then into powersupply. It adjust the light from dark to max lux of LED illuminated frame. Optionaler Dimmer für LED-beleuchtetem Rahmen... Den Dimmer einfach in die Büchse vom Rahmen und dann ins Netzteil stecken. Einstellbares Licht von dunkel bis max. Lichtstärke vom LED-beleuchteten Rahmen.



Clear nylon stript Please don't forget to order. Including 7/16 power supply.



MATERIAL : Silver anodised aluminium			WEIGHT	PACKING SIZE
ARTICLE	EXTERNAL (x-y)	LIGHTING	WITH PACKING	*W X H X D
UMLSCN00A4	210 X 297 mm	1200-1400 LUX	1,750 kg	260 X 410 X 70 mm
UMLSCN00A3	297 X 420 mm	1100-1300 LUX	2,300 kg	350 X 530 X 90 mm
UMLSCN00A2	420 X 594 mm	800-1100 LUX	3,750 kg	470 X 700 X 90 mm
UMLSCN00A1	594 X 841 mm	700-1100 LUX	7,250 kg	650 X 950 X 90 mm
UMLSCN00A0	841 X 1189 mm	500-900 LUX	13,700 kg	890 X 1300 X 90 mm
UMLSCN00B2	500 X 700 mm	900-1200 LUX	6,750 kg	550 X 810 X 90 mm
UMLSCN00B1	700 X 1000 mm	700-1100 LUX	9,500 kg	750 X 1110 X 90 mm
UMLSCN0023	508 X 762 mm	800-1200 LUX	6,900 kg	560 X 880 X 90 mm
UMLSCN0034	762 X 1016 mm	800-1000 LUX	9,800 kg	820 X 1130 X 90 mm

*W:Width H: Height D: Depth



Wood Maxi Frame



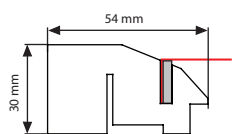
Wood Maxi Frame is made of Beech wood. Lacquered finish is applied for long term use. Its wood feature creates a friendly atmosphere to your business or announcements. Depth is 17 mm. It is single sided and suitable for wall mounting. Hanger is included. It is packed unassembled with fixing kit. Clear Strip excluded, order separately.

Der Wood Maxi Frame ist aus Buchen Holz gefertigt. Lackiertes Finish wird für den Langzeitgebrauch aufgetragen. Sein Holzelement schafft eine freundliche Atmosphäre für Ihr Geschäft oder Ihre Ankündigungen. Die Tiefe beträgt 17 mm. Es ist einseitig und für die Wandmontage geeignet. Aufhänger ist enthalten. Es ist unmontiert mit Befestigungssatz verpackt. Ohne transparenten Streifen, separat bestellen.

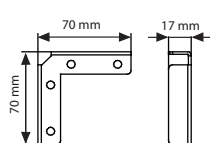
- Hanger is included. Aufhänger ist im Lieferumfang enthalten.
- Depth is 17 mm. Die Tiefe beträgt 17 mm.
- Assembly in 10 seconds. Montage in 10 Sekunden.
- 1 box. 1 box.



Wood Maxi Frame Profile
 Article: UYPMFWN020
 Wood Maxi profile 2m Natural Wood
 Article: UYPMFWD020
 Wood Maxi profile 2m Dark Wood



Wood Maxi Frame Corner
 Article: UYPMFWC00
 70x70 mm
 Wood Maxi Frame corner, 4 Pcs.



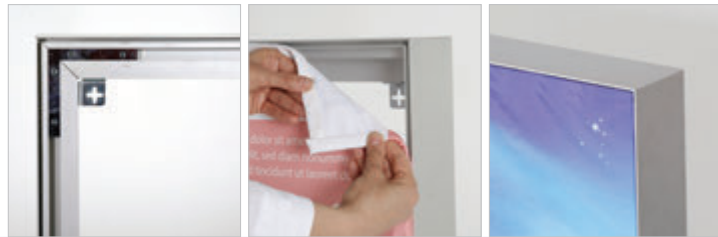
MATERIAL : Wood			WEIGHT	PACKING SIZE
ARTICLE	DESCRIPTION	SIZE	WITH PACKING	*W X H X D
UYPMFWN020	Natural Wood	2 m	26,700 kg	190 X 2060 X 150 mm
UYPMFWD020	Dark Wood	2 m	26,700 kg	190 X 2060 X 150 mm

MATERIAL : Wood			WEIGHT	PACKING SIZE
NATURAL WOOD	DARK WOOD	SIZE	WITH PACKING	*W X H X D
UMFWON01A2	UMFWOD01A2	420 X 594 mm	2,800 kg	160 X 710 X 70 mm
UMFWON01A1	UMFWOD01A1	594 X 841 mm	3,750 kg	160 X 960 X 70 mm
UMFWON01A0	UMFWOD01A0	841 X 1189 mm	5,100 kg	160 X 1310 X 70 mm
UMFWON01B1	UMFWOD01B1	700 X 1000 mm	4,400 kg	160 X 1120 X 70 mm
UMFWON01B0	UMFWOD01B0	100 x 1400 mm	6,000 kg	160 X 1520 X 70 mm

*W:Width H: Height D: Depth



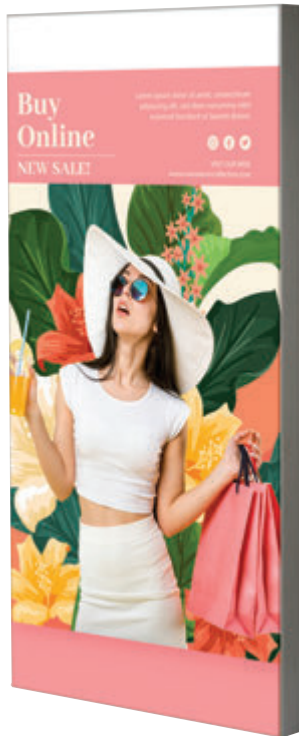
Power Maxi LED



Watch video at our website www.mtdisplays.com

The Power Maxi LED is a modern way of advertising with his slim 100mm profile, single or double sided. It is suitable for textile printed graphics. Practical poster application with clear tape provides smooth look. Completed with a ceiling suspension system, the Power Maxi LED is a special advertising solution when it comes to display advertising or messages. All units pass CE/UL Pat test and packed with quality certificates.

Der Power Maxi LED bietet mit seinem schmalen 100 mm Profil, ein- oder doppelseitig, eine moderne Art der Werbung. Es eignet sich für Textildruckgrafiken. Praktische Posterapplikation mit durchsichtigem Klebeband glattes Aussehen. Komplettiert mit einem Deckenabhängungssystem ist die Power Maxi LED eine besondere Werbelösung, wenn es darum geht, Werbung oder Botschaften zu präsentieren. Alle Einheiten bestehen den CE/UL-Pat-Test und sind mit Qualitätszertifikaten ausgestattet.

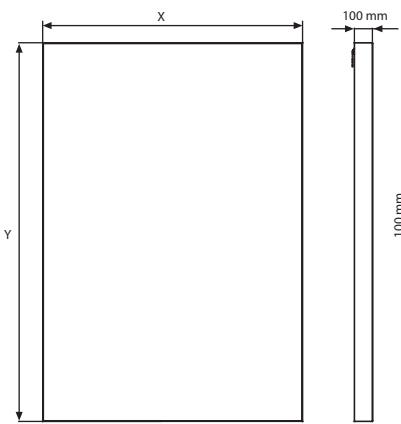


One product, two positions (landscape & portrait)

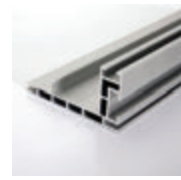


100 mm depth

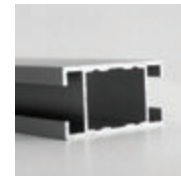
CE/UL Patent approved.



Parts



Power Maxi Led profiles 1000-5000 mm.



H Profiles



Red & black electrical cable 500-2500 mm.



Connectors: UYUP412270 Square Corner Connector for Power LED, included in each box.



Power Supplies 90W-160W.



Led Modules 3-S5 LED



Clear nylon strip. Please don't forget to order.

MAXIMUM SIZE: 2500X6000 mm

MATERIAL : Silver anodised aluminium

ARTICLE	EXTERNAL (x-y)
UMLPTN1525	1500 X 2500 mm
UMLPTN2020	2000 X 2000 mm
UMLPTN2030	2000 X 3000 mm
UMLPTN2540	2500 X 4000 mm



Maxi Frame Totem with LED Double Sided



Watch video at our website www.mtdisplays.com



Double sided LED Maxi Totem promotes the message with high and even illumination. Pre-treated light guided panel diffuses light even and powerfully. LED illumination saves up to 60% energy costs (compared to fluorescent technology).

Doppelseitiges LED Maxi Totem leitet die Aufmerksamkeit auf die Poster mit hoher und gleichmäßiger Ausleuchtung. Bearbeitetes Lichtpanel sorgt für kraftvolle und ebennässige Lux Kraft in allen Grössen. Die LED Beleuchtung spart bis zu 60% Energiekosten (verglichen mit Leuchtstofflampen) und haben eine erhöhte Lebenserwartung.



All units pass CE/UL PAT tests and are supplied with their quality certificates. Delivered with 2,5 meter long cable and EU plug. UK and US plugs should be specified with order. *Alle Produkte sind CE/UL Pat getestet und werden mit den entsprechenden Zertifikaten geliefert. Standard Kabellänge für den Artikel ist 2,5m und wird EU Stecker geliefert, UK oder US Stecker müssen bei Bestellung speziell aufgeführt werden.*



The thickness of the profile is 4mm. Supplied nylon strip is 3 mm, so recommended fabric thickness for digital printing is 0,5 mm. The pull sticker in 0,5 mm thickness must be sewed on the fabric for taking out the poster when fitted into the channels. *Die Kanalbreite ist 4 mm. Die Silikonkeder ist 3 mm dick, somit wird als Textilgrafik für den Digitaldruck 0,5 mm dicker Stoff empfohlen. Die transparente Lasche ist 0,5 mm dick und muss an eine Seite des Stoffes genaht werden, um das Herausziehen der Grafik zu ermöglichen.*



Complete with low voltage 6A powersupply. 13 mm on each side of the fabric is fitted into Maxi Profiles, so 26 mm on each. Fabric Poster is not seen on the poster. *Komplett mit Niederspannung 6A Netzteil. 13 mm von jeder Stoffseite wird in die Rahmennut der Maxi Profile gesteckt, somit werden insgesamt 26 mm des Posterstoffes nicht sichtbar sein. Stoffmass entsprechend anlegen. Der Stoff ist in den Produktpaketen nicht inbegriffen.*

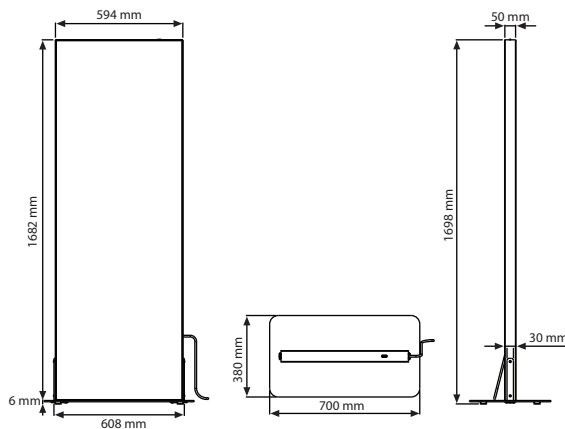


2 packs. See info chart for pack sizes. *2 Packungen. Siehe Infodiagramm für Packungsgrößen.*

MAXI
frame



CE/UL Patent approved.



Including 7/16 power supply.



Clear nylon strip
Please don't forget to order.

MAXIMUM SIZE: 2500X6000 mm

MATERIAL : Silver anodised aluminium				WEIGHT	PACKING SIZE
ARTICLE	EXTERNAL (x-y)	POSTER	LIGHTING	WITH PACKING	*W X H X D
UMTLN02A1	594 mm	594 X 1682 mm	2100-2600 LUX	14 kg/13,6 kg	625 X 1800 X 90 / 400 X 720 X 25 mm

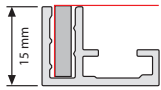
* W:Width H: Height D: Depth



Semi Products for Maxi Frames

Profiles of Maxi Frames / Profile der Maxi Rahmen

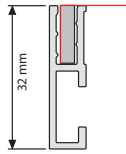
Valet Profile



Article: UYUP014103
Single Sided MAXI profile
VALET Profile Suitable for
RIVER MAXI 15x22 mm,
3 meters.

Art.Nr: UYUP014103
Einseitiges VALET Profil
VALET Profile wird
verwendet für RIVER MAXI
15x22 mm, 3 Meter Länge.

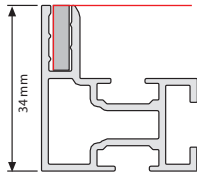
Ace Profile



Article: UYUP014105
Single Sided MAXI profile
ACE Profile Suitable for
BAY MAXI 32x8 mm,
3 meters.

Art.Nr: UYUP014105
Einseitiges ACE Profil
ACE Profil wird verwendet für
BAY MAXI 32x8 mm,
3 Meter Länge.

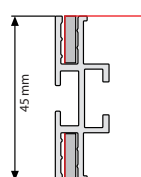
Dame Profile



Article: UYUP014102
Single Sided MAXI profile
Dame Profile Suitable
for GULF MAXI and
ILLUMINATED MAXI
34x32 mm, 3 meters.

Art.Nr: UYUP014102
Einseitiges DAME Profil
DAME Profile wird
verwendet für GULF MAXI
und ILLUMINATED MAXI
34x32 mm, 3 Meter Länge.

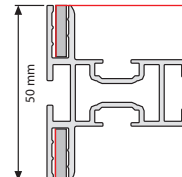
Queen Profile



Article: UYUP014104
Double Sided MAXI
profile QUEEN Profile
Suitable for LAGOON
MAXI 45x15 mm,
3 meters.

Art.Nr: UYUP014104
Doppelseitiges QUEEN-
Profil QUEEN Profile wird
verwendet für LAGOON
MAXI 45x15 mm,
3 Meter Länge.

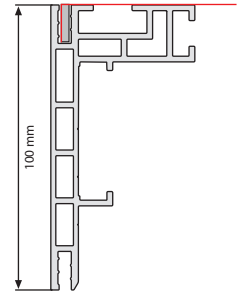
King Profile



Article: UYUP014101
Double Sided MAXI profile
KING Profile Suitable for
OCEAN MAXI 50x40 mm,
3 meters.

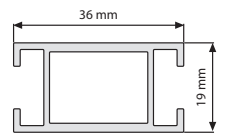
Art.Nr: UYUP014101
Doppelseitiges
KING-Profil KING Profile wird
verwendet für OCEAN MAXI
50x40 mm, 3 Meter Länge.

Power LED Profile



Article: UYPLPT1030
Power LED Profile.
100x50,5 mm. 3 meters.

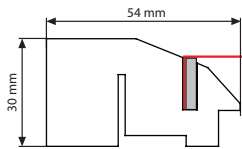
H Profile



Article: UYUP014106
H Profile, 36 x 19 mm, 3 meters.
Suitable for Ace, Dame, Queen
and King profiles.

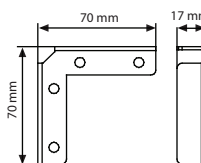
Art.Nr: UYUP014106 H-Profil
für Quertraversen 36x19 mm, 3
Meter Länge.
Geeignet für Ace, Dame, Queen
und King profile.

Wood Maxi Frame Profile



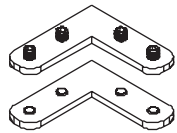
Article: UYPMFWN020
Wood Maxi profile 6 ft. Natural Wood
Article: UYPMFWD020
Wood Maxi profile 6 ft. Dark Wood

Wood Maxi Frame Corner



Article: UYPMFW0C00
Wood Maxi Frame corner,
4 Pcs.

Components of Maxi Frames / Komponenten der Maxi Rahmen



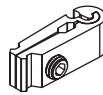
Article: UYUP412295
Corner Cleat for OCEAN & GULF.
Packed by 8.

Art.Nr: UYUP412295
Spann-Schloß 45° wird verwendet
für OCEAN & GULF. 8 Stk.



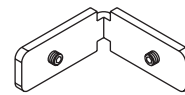
Article: UYUP412270
Square Corner Connector for
BAY, LAGOON and Power LED.
Packed by 10.

Art.Nr: UYUP412270
Rahmenverbinder wird verwendet
für BAY, LAGOON und Power LED.
10 Stk.



Article: UYUP412291
Straight Cleat for H profile.
Packed by 8.

Art.Nr: UYUP412291
Gerades Spann-Schloß für
Quertraverse. 8 Stk.



Article: UYUP412310
Straight Cleat for
H profile. Packed by 8.

Art.Nr: UYUP41231
Gerades Spann-Schloß
für Quertraverse. 8 Stk.



Article: UYUP025010
L TYPE Corner Connector for
RIVER. Packed by 10.

Art.Nr: UYUP025010
Eckverbinder kompl. mit Schrauben
für RIVER VPE. 10 Stk.



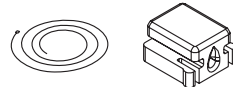
Article: UYUP412320
Flat Connector for Ocean, Gulf,
Lagoon and Bay Maxi frame profile.
Packed in 10.

Art.Nr: UYUP412320
Verbinder für Ocean, Gulf, Lagoon
und Bay Maxi frame profil. 10'er
Packung.



Article: UYUP412330
Flat Connector for Gulf Maxi
frame profile. Packed in 10.

Art.Nr: UYUP412330
Verbinder für Gulf Maxi frame
profil. 10'er Packung.



Article: UYUP460245
Hanging System including wire cable
for double sided MAXI. Packed by 8.

Art.Nr: UYUP460245
Drahtseil-Abhängung für doppelseitige
MAXI VPE. 8 Stk.



Article: UYUP460235
Clear Nylon Strip
13 x 3 mm, 100 meters.

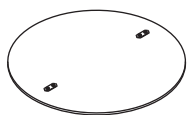
Art.Nr: UYUP460235
Silikon-Keder 13 x 3 mm,
100 meter.



Article: UYUP460220
Clear Nylon Strip with tape
13 x 3 mm, 50 meters.

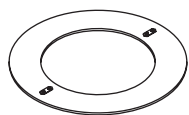
Art.Nr: UYUP460220
Silikon-Keder mit Klebeband
13 x 3 mm, 50 meter.

Feets of Maxi Frame (To be used with Double Sided King Profile) / Fusslösungen für Maxi Rahmen (benutzbar mit dem doppelseitigem King Profil)



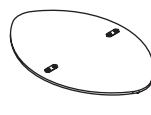
Article: UYUP412271
Circle Ø 450 x 6mm
single packed.

Art.Nr: UYUP412271
Teller-Fuß 450x6 mm
Einzel verpackt.



Article: UYUP412272
Hoop Ø 450 x 6mm
single packed.

Art.Nr: UYUP412272
Kreis-Fuß 450x6 mm
Einzel verpackt.



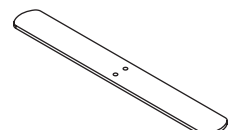
Article: UYUP412273
Baseball 450 x 300 x 6mm
single packed.

Art.Nr: UYUP412273
Oval-Fuß 450 x 300 x 6mm
Einzel verpackt.



Article: UYUP412274
Fillet 500 x 180 x 6mm
single packed.

Art.Nr: UYUP412274
Design-Fuß 500 x 180 x 6mm
Einzel verpackt.



Article: UYUP412275
Flat 450 x 50 x 5mm
single packed.

Art.Nr: UYUP412274
Design-Fuß 450 x 50 x 5mm
Einzel verpackt.

Maxi Frames Rubber Strip



Watch video at our website www.mtdisplays.com

Nylon strip application when sew on textile

Version 1.0 Maxi Frame rubber strip application existing in Maxi Frame Index. Through this specification development process, we opportunities for easy and fast product assembly and the potential to mount Maxi Frames free from sew-on process in exhibiton areas and event places. We invite your participation in following the below information over the increased performance for rubber strips when combined with double sided tape.

Due to the potential expansion of Maxi Frame, which is a high quality frame system composed of stylish aluminum profiles to create a 'frameless' look, in various applications and custom printed polyester fabric, there have been many requests for easy and sewing-free application of printing inward the profiles.

We redesigned the existing product focusing to purchase, and use of efficient components. For this purpose we concentrated on addition of double sided tape over existing rubber strip.

We defined the types of equipment to cover the new production process of rubber with correct tape and determined the appropriate means of testing the application in tension of various types and thicknesses.

We prepared the below assembly sheet and movie to better express the application and improvement over the taped rubber strip.

Application with double sided tape.

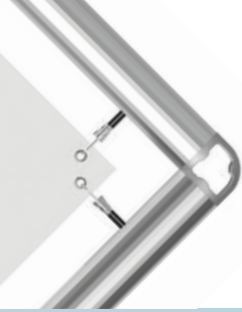


Application of nylon strip by sew-on process



Application of nylon strip by double sided tape





The sky is the limit
with our range of
outdoor banners!

OMNIFRAME

www.omni-frame.com

OHIM DM/084 725

Suitable for outdoor large format prints, Omni Frame is a large format Outdoor Banner System, made from lightweight aluminium. It is ideal for use with PVC eyelet banners. Omni Frame Banner System is used for large advertising areas which need to be changed regularly such as most forecourts and retail environments. It is also a great accompaniment for marquees and race events. Omni Frame is suitable for flat, large banners on buildings as well as mounting stand displays for indoor and outdoor use. The variable lengths of aluminium profile give you the ability to install banners in customised size. This banner holder is assembled quickly and easily, it is a real alternative to traditional billboards. These outdoor durable frames are permanently attached to the wall with the banner using elasticated straps. These are perfect displays for forthcoming events, special offers or sales, theatres, garden centres, retail outlets, sports halls, sporting venues, conferences, airports and public areas. Omni Frame has a smart design and all parts are robust, durable and reusable. The banner is easy to change. Customised sizes are available upon request. It is delivered parts unassembled to save from transport.

FEA TEST RESULTS OF OMNI FRAME

Omni Frame is tested for security in outdoor conditions.

Conditions: Without any back rest, Omni Frame is tested against windy conditions max 22,5 miles or 36km. Vinyl banner deforms and may not take previous form again based on the type and quality of material.

In case of 2-fold eyelet application, the banner keeps the form upto wind speed of 22miles. Test had been conducted with 5m x 10m Omni Frame with 1mm vinyl banner.

Result: Omni Frame is strong and stable for harsh weather conditions. Banner may get damaged depending on the banner and application. MT Displays recommends the apply eyelets 2-fold vinyl banner for harsh weather conditions.

Der Omni Frame ist ein Produkt für große Werbelösungen im Außenbereich. Hergestellt wird dieser aus einem leichten Aluminium. Perfekt geeignet für die Verwendung für PVC Poster mit Ösen. Das Omni Frame System wird für große Werbeflächen verwendet und erleichtert den Bannerwechsel welcher häufig geändert werden muss im Einzelhandel oder an Parkplätzen. Dieser ist auch ein großartiger Begleiter für Events und Rennveranstaltungen. Der Omni Frame eignet sich für flache, große Banner am Gebäude sowie auch am Montageständer im Innen – und Außenbereich. Durch die variablen Längen der Profile, erhalten Sie die Möglichkeit auch kundenspezifische Größen anzubieten. Dieser Banner Halter ist schnell und einfach montiert und bietet zudem eine echte Alternative zu traditionellen Werbetafeln. Die haltbaren Rahmen sind dauerhaft an die Wand montiert und halten das Banner mit elastischen Gummis. Somit auch ideal geeignet für Sonderangebote oder Verkäufe, Theater, Garten-Center, Einzelhandelsgeschäfte, Sporthallen, Sportstätten, Konferenzen, Flughäfen und öffentlichen Bereichen. Der Omni Frame ist sehr einfach gestaltet und alle Teile sind robust, langlebig und wiederverwendbar. Das Poster ist sehr leicht zu wechseln. Sondergrößen sind auf Anfrage erhältlich. Die Produkte werden aus transporttechnischen Gründen demontiert geliefert.

FEA TESTERGEBNISSE DER OMNI FRAME

Der Omni Frame wurde auf Sicherheit bei Einsatz im Außenbereich getestet.

Bedingungen: Ohne Rückenstütze wurde das Produkt auf eine Windstärke von 22,5 Meilen oder 36 km/h getestet. Das Vinyl wird deformiert und wird die Ursprungsform nicht mehr annehmen können, basierend natürlich je nach Material und Qualität. Im Falle einer 2 Ösen Applikation, behält das Vinyl die Form bis zu einer Windgeschwindigkeit von 22 Meilen/ h oder 35km/h. Der Test wurde mit den Produktmaßen von 5m x 10m Omni Frame und einem 1mm Vinyl ausgeführt.

Resultat: Der Omni Frame ist stabil unter strengen Wetterkonditionen. Das Vinyl wird wahrscheinlich beschädigt je nach Vinyl und Applikation. MT Displays empfiehlt die Anwendung der 2 Ösen Applikation unter rauen Wetterbedingungen.

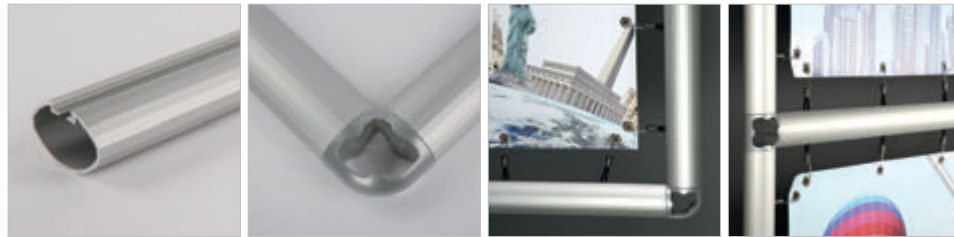


OHIM DM/084 725

Omni Frame



www.omni-frame.com

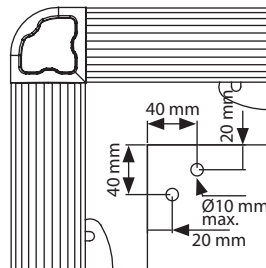
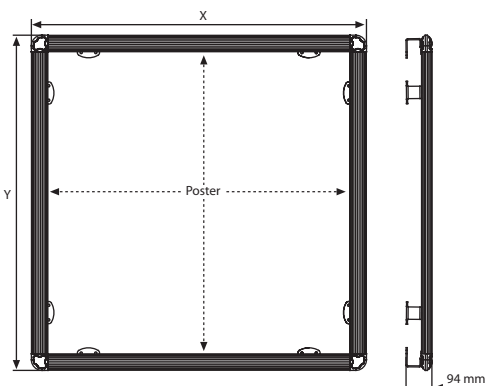


Fabric is the best recommended option for outdoor advertising. It shines with its light weight and durability among other alternatives such as PVC, Vinyl & Polyethylene. The advantages also include ease of application and compatibility with its stand. The plastic buttons are easily inserted into the channel on Omni Frame profiles. For renewal of the banner, the frame does not have to be unmounted. Poster can only be replaced by taking of the elastic hook.

Stoff ist die Beste empfohlene Option für die Außenwerbung. Dieser glänzt mit seinem geringen Gewicht und der Haltbarkeit gegenüber anderen Alternativen wie zB. PVC, Vinyl und Polyethylen. Die Vorteile sind: einfache Anwendung und die Kompatibilität in der Ausführung. Die Plastikhalterungen sind sehr einfach in den Kanal auf der Rückseite des Profils einzusetzen. Zum Auswechseln des Posters, muss der Rahmen nicht von der Wand abmontiert werden. Das Poster kann mit dem heraus nehmen der elastischen Haken ausgewechselt werden.



OHIM DM/084 725



The first eyelet should be placed on the corners 40 mm from the edges of poster used for Omni Frame. Please see below basic drawing. The other eyelets can be applied spacing 15-30 cm from the first eyelet depending on the environment to be used.



Omni Frame



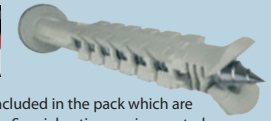
www.omni-frame.com

4 different application options



Omni Frame is a flexible outdoor display system with excellent durability to make combinations via several units for greater visual impact. Limited number of parts, offers solutions for any size request.

Der Omni Rahmen ist ein flexibles und ausgezeichnetes Haltbares Außendisplay um auch verschiedene Einheiten für größere Visualisierungen miteinander zu kombinieren. Eine limitierte Anzahl von Teilen bieten eine Lösung für Anfragen jeder Größe.



Wall fixing screws of Omni Frame are included in the pack which are CE certified multi-expansion long plugs. Special anti-corrosion coated screw is made of zinc coated steel and plastic sleeve made of high quality of nylon. It is confirmed for outdoor fixing on various exterior building surfaces such as concrete, solid or honeycomb brick, hollow dense or hollow light aggregate block, aerated concrete and solid stone.

Das Wandmontage Zubehör des Omni Frame ist im Lieferumfang enthalten welche auch CE zertifiziert sind. Spezielle anti-korrosion beschichteten Schrauben sind hergestellt aus Zink und einer Plastikhülle aus hoher Nylonqualität. Geeignet und bestätigt für den Gebrauch an diversen Aussenfassaden wie Beton, Solid oder Wabenziegeln, dichten Hohl oder leichten Hohl Block, belüfteten Beton oder solidem Stein.



UYPOM02000
Corner bracket
(Packed by 4 pcs), Ral 9006



UYPOM03000
T Connector
(Packed by 2 pcs), Ral 9006



UYPOM06000
Profile connector
(Packed by 2 pcs), Ral 9006



UYPOM04000
Wall fixing
(Packed by 4 pcs),
including screw set.



UYPOM05000
Plastic buttons
(Packed by 20 pcs)



TMC4010500
Clamp for banner,
White (Packed by 40 pcs)



TSH4010501
Black bungee cord with
stainless steel hook
(Packed by 40 pcs)



UYPOM07000
Elastic strap (50 meters)



Aluminium profile, silver
anodised.

Presentation Box / UYPOM00010



OMNI FRAME PROFILE		WEIGHT	PACKING SIZE
ARTICLE	LENGHT	WITH PACKING	*W X H X D
UYPOM01011	1100 mm	1,300 kg	55 X 1150 X 75 mm
UYPOM01016	1600 mm	1,800 kg	55 X 1650 X 75 mm
UYPOM01021	2100 mm	2,300 kg	55 X 2150 X 75 mm
UYPOM01026	2600 mm	2,800 kg	55 X 2630 X 75 mm
UYPOM01031	3100 mm	3,300 kg	85 X 1730 X 115 mm
UYPOM01036	3600 mm	4,000 kg	85 X 1970 X 115 mm
UYPOM01041	4100 mm	4,350 kg	85 X 2220 X 115 mm
UYPOM01046	4600 mm	5,000 kg	85 X 2470 X 115 mm
UYPOM01051	5100 mm	4,000 kg	85 X 2720 X 115 mm

OMNI FRAME: Silver anodised aluminium			WEIGHT	PACKING SIZE
ARTICLE	EXTERNAL (x-y)	POSTER SIZE	WITH PACKING	*W X H X D
UOMN001010	1221 X 1221 mm	1000 X 1000 mm	7,395 kg	215 X 1750 X 105 mm
UOMN001015	1221 X 1721 mm	1000 X 1500 mm	8,965 kg	215 X 2100 X 105 mm
UOMN001515	1721 X 1721 mm	1500 X 1500 mm	10,175 kg	215 X 2300 X 105 mm
UOMN001520	1721 X 2221 mm	1500 X 2000 mm	11,610 kg	215 X 2600 X 105 mm

OMNI FRAME SEMI PRODUCTS		WEIGHT	PACKING SIZE
ARTICLE	DESCRIPTION	WITH PACKING	*W X H X D
UYPOM02000	Corner Bracket (Packed by 4 pcs), Ral 9006	1,800 kg	95 X 240 X 165 mm
UYPOM03000	T Connector (Packed by 2 pcs), Ral 9006	0,900 kg	95 X 240 X 165 mm
UYPOM04000	Wall Fixing (Packed by 4 pcs), including screw set	2,000 kg	95 X 150 X 100 mm
UYPOM05000	Plastic Buttons (Packed by 20 pcs)	0,020 kg	
UYPOM06000	Profile Connector (Packed by 2 pcs), Ral 9006	0,400 kg	85 X 270 X 90 mm
TMC4010500	Clamp For Banner, White (Packed by 40 pcs)	0,520 kg	
TSH4010501	Black Bungee Cord with Stainless Steel Hook (Packed by 40 pcs)	0,420 kg	
UYPOM07000	Elastic Strap (50 meters)	0,100 kg	

*W:Width H: Height D: Depth



Insert and fix with screw.



Corner bracket made of aluminium injection metallic silver powder coated.

Insert banner buttons into the rear channel of the profile.



Omni A Board



www.omni-frame.com



Constructed aluminium, Omni A Board is a double sided, heavy outdoor banner system. It is ideal for use with PVC eyelet banners. Omni A Board is used for large advertising areas that the banner needs to be changed regularly or carried to different places. It is a great accompaniment for outdoor events, marquees and race. Omni Frame withstands approximately 42-50kph wind.

Gefertigt aus Aluminium und in einer doppelseitigen Ausführung ist der Omni A board ein sehr stabiles schweres Bannerprodukt für den Außeneinsatz. Es ist ideal für die Verwendung mit PVC Ösenposter. Eingesetzt bei großen Werbeflächen und wenn man das Poster regelmäßig wechseln oder das Produkt an verschiedenen Orten positionieren möchte. Ein großer Begleiter für Outdoor-Events, Festzelte und Rennveranstaltungen. Omni Frame hält einer Windgeschwindigkeit von 40-50km/h stand.

- Shipped unassembled. Demontiert geliefert.
- Banner and eyelets not included. Poster und Ösen nicht inkludiert.
- Plastic buttons and elastic hooks included enough for each size. Plastikhalter und elastische Haken genügend inkludiert.
- 2 packs. See info chart for pack sizes. 2 Packungen. Siehe Infodiagramm für Packungsgrößen.

Perfect outdoor use.

- Ease of transport, quick&easy installation.
- Flexible outdoor display with excellent durability.

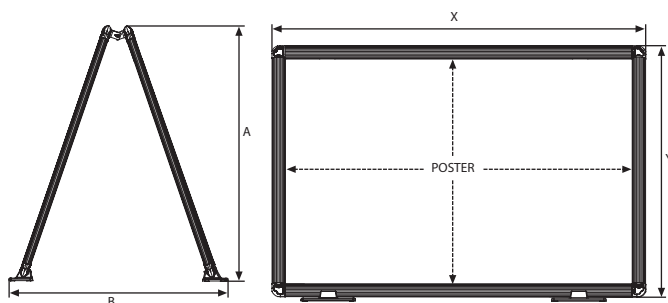


Carry bag

OHIM DM/084 725

1,2 kg Each feet.
Feet optional accessories.

BAG: Black	
ARTICLE	SIZE
UYPOM00010	265 X 2650 X 205 mm
UYPOM00020	265 X 1630 X 205 mm



OMNI A BOARD FEET / HINGE	
ARTICLE	DESCRIPTION
UYPOM09000	Feet for Omni Aboard, 4pcs per pack
UYPOM10000	Hinge for Omni Aboard, 2pcs per pack

OMNI FRAME: Silver anodised aluminium					WEIGHT	PACKING SIZE
ARTICLE	EXTERNAL (x-y)	POSTER SIZE	A	B	WITH PACKING	*W X H X D
UAOMN01510	1221 X 1721 mm	1000 X 1500 mm	1177 mm	986 mm	19,500 kg	265 X 1640 X 90 mm / 340 X 490 X 135 mm
UAOMN02510	1221 X 2721 mm	1000 X 2500 mm	1177 mm	986 mm	24,000 kg	275 X 2650 X 90 mm / 340 X 490 X 135 mm
UAOMN03012	1471 X 3221 mm	1250 X 3000 mm	1413 mm	1150 mm	28,500 kg	275 X 1600 X 145 mm / 340 X 500 X 195 mm



*W:Width H: Height D: Depth

Power Maxi LED

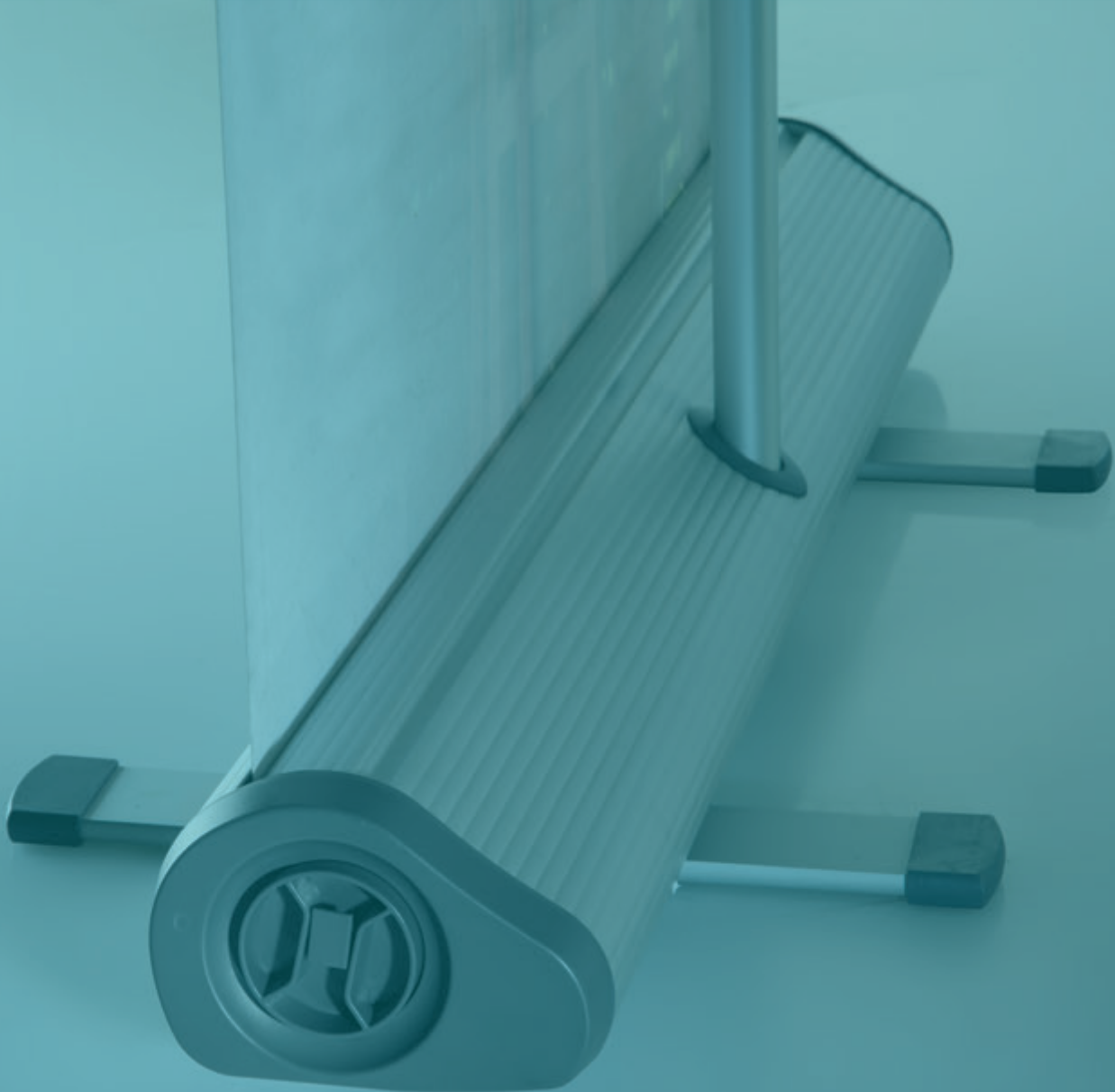




Banners

- Easy Swap
- Poster Trap
- Quick Banners
- Newage Quick Banner
- Smart Banners
- Eco-Roller
- Practical X Banner

- Easy Swap
- Poster Trap
- Quick Banners
- Quick Banner "neu"
- Smart Roll Banner
- Roll Banner Eco
- Practical X Banner



Easy Swap





Watch video at our website www.mtdisplays.com

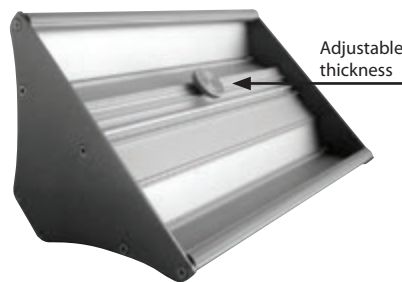
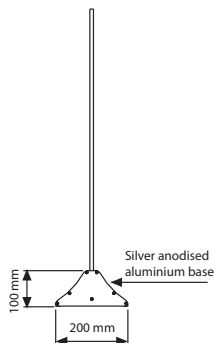
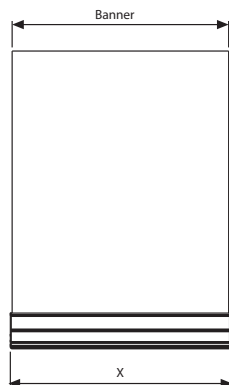


It is an economical and easy-to-use product. You just can put in your PVC foam poster with 5 to 10mm thickness and adjust the nut of fixing from the bottom part of the aluminum box. It can be used in all indoor areas such as schools, seminars, restaurant chains, showrooms, exhibition areas, malls and everywhere else.

Preisgünstig und einfach im Handling. Plattenstärken von 5 bis 10 mm werden eingeklemmt und mit einer Feststell-Schraube von unten fixiert. Ideal für den Inneneinsatz in Schulen, Restaurants, bei Messen oder in Einkaufszentren.

 Packed with an easy-to-understand instruction sheet. *Mit Montageanleitung verpackt*

 To change the poster boards, please loosen the fixing nut under the aluminum box. *Beim Wechseln der Platten bitte die Feststellschraube unter dem Artikel lösen*



MATERIAL : Silver anodised aluminium			WEIGHT	PACKING SIZE
ARTICLE	EXTERNAL (x)	POSTER	WITH PACKING	*W X H X D
UMS0100300	310 mm	300 mm	2,000 kg	220 X 340 X 117 mm
UMS0100600	610 mm	600 mm	3,100 kg	220 X 640 X 117 mm
UMS0100800	810 mm	800 mm	5,360 kg	220 X 840 X 117 mm
UMS0100900	910 mm	900 mm	6,030 kg	220 X 940 X 117 mm
UMS0101000	1010 mm	1000 mm	6,700 kg	220 X 1040 X 117 mm
UMS0101200	1210 mm	1200 mm	8,040 kg	220 X 1240 X 117 mm
UMS0101500	1510 mm	1500 mm	10,050 kg	220 X 1540 X 117 mm



*W:Width H: Height D: Depth

Poster Trap



Watch video at our website www.mtdisplays.com



The system is mainly based on screwing the 2 pieces of the bases to each other to stand the poster still. Adjustable thickness of poster. The maximum height of poster is 150cm. Base is double sided printable. Suitable for all indoor areas such as schools, seminars, restaurant chains, showrooms, exhibition areas, malls and everywhere else.

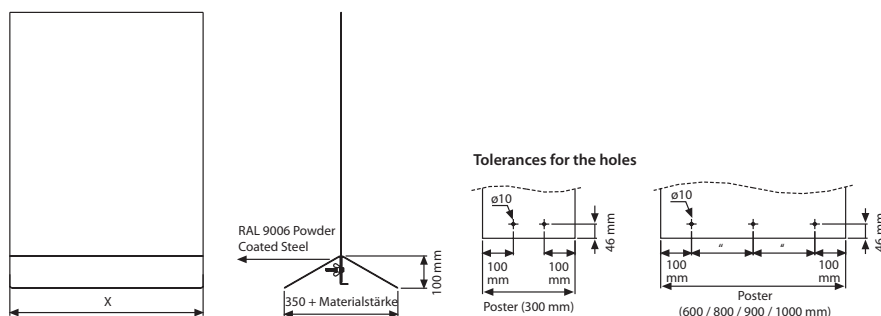
Das System besteht aus zwei Elementen, die miteinander verschraubt werden, um den Einleger zu fixieren und kann für Materialien in unterschiedlichen Stärken verwendet werden. Maximale Höhe der Einleger ist 150 cm. Beide Elemente können optional mit einem permanenten Branding versehen werden. Ideal für den Inneneinsatz in Schulen, Restaurants, bei Messen oder in Einkaufszentren.



Packed with an easy-to-understand instruction sheet. Mit Montageanleitung verpackt.



The holes on the plate should be $\varnothing 9$ mm. Die Löcher des Einlegers müssen einen Durchmesser von 9 mm haben.



MATERIAL : Steel, powder coated in RAL 9006			WEIGHT	PACKING SIZE
ARTICLE	EXTERNAL (x)	POSTER	WITH PACKING	*W X H X D
UMS0000300	300 mm	300 mm	3,460 kg	205 X 330 X 117 mm
UMS0000600	600 mm	600 mm	6,250 kg	205 X 630 X 117 mm
UMS0000800	800 mm	800 mm	8,100 kg	205 X 830 X 117 mm
UMS0000900	900 mm	900 mm	9,300 kg	205 X 930 X 117 mm
UMS0001000	1000 mm	1000 mm	10,400 kg	205 X 1030 X 117 mm



*W:Width H: Height D: Depth

Quick Banners



Watch video at our website www.mtdisplays.com



Quick banner display is a flexible and mobile poster clamp designed as a practical set that can be carried to conventions or exhibitions within its bag. This set does not require a wall to be mounted or a ceiling to be suspended.

Quick banner sind sehr mobile, flexibel anwendbare Posterklemmleisten, die in dazugehörigen Taschen überall mitzunehmen und unglaublich leicht aufzustellen sind. Sie brauchen keine Montierwände oder Decken zum Aufhängen.

Packed with an easy-to-understand instruction sheet. Mit Montageanleitung verpackt.

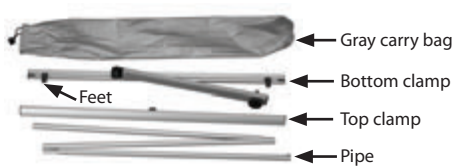


Single Sided

Patent Pending
TR 2005 01772

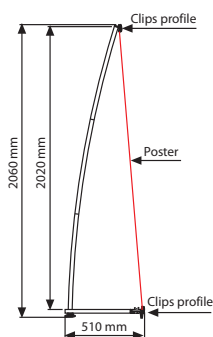


Double Sided

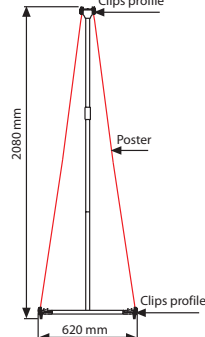


BAG		PACKING SIZE	
ARTICLE	MODEL	*W X H X D	
UYUP066000	800 mm	160 X	860 X 160 mm
UYUP067000	1000 mm	160 X	1060 X 160 mm

Single Sided



Double Sided



DOUBLE SIDED: Silver anodised aluminium				WEIGHT	PACKING SIZE (10 pcs)
ARTICLE	EXTERNAL (x-y)	POSTER	COPY	WITH PACKING	*W X H X D
UQB0C00N72	706 X 2030 mm	700 X 2000 mm	700 X 1970 mm	21,200 kg	380 X 860 X 175 mm
UQB0C00N82	806 X 2030 mm	800 X 2000 mm	800 X 1970 mm	23,300 kg	380 X 860 X 175 mm
UQB0C00N92	906 X 2030 mm	900 X 2000 mm	900 X 1970 mm	25,950 kg	380 X 1060 X 175 mm
UQB0C00N12	1006 X 2030 mm	1000 X 2000 mm	1000 X 1970 mm	26,800 kg	380 X 1060 X 175 mm

*W:Width H: Height D: Depth

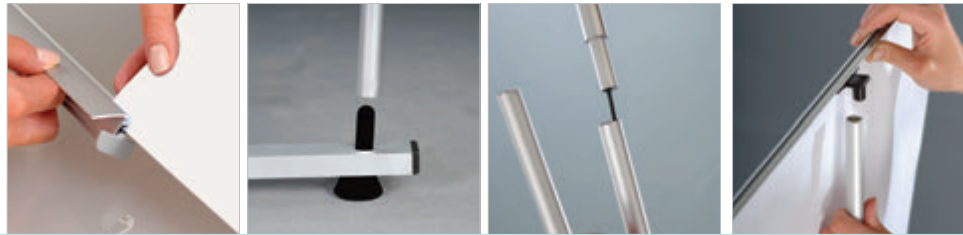


SINGLE SIDED: Silver anodised aluminium				WEIGHT	PACKING SIZE (10 pcs)
ARTICLE	EXTERNAL (x-y)	POSTER	COPY	WITH PACKING	*W X H X D
UQB0T00N72	706 X 2030 mm	700 X 2000 mm	700 X 1970 mm	14,600 kg	380 X 860 X 145 mm
UQB0T00N82	806 X 2030 mm	800 X 2000 mm	800 X 1970 mm	15,600 kg	380 X 860 X 145 mm
UQB0T00N92	906 X 2030 mm	900 X 2000 mm	900 X 1970 mm	16,400 kg	380 X 1060 X 145 mm
UQB0T00N12	1006 X 2030 mm	1000 X 2000 mm	1000 X 1970 mm	17,200 kg	380 X 1060 X 145 mm

*W:Width H: Height D: Depth



Newage Quick Banner



Newage Quick Banner display offers competitive solutions. Suitable to hold banners in thickness 50 micron / 500 micron. New Age Quick Banner is a flexible and mobile set that can be carried to conventions or exhibitions within its bag.

Unser neuer Quickbanner bietet preisliche Wettbewerbsvorteile. Geeignet für die Einklemmung von 50-500 Micron starken Bannern. Der Artikel kann in der optionell erhältlichen Tasche mit Leichtigkeit auf Ausstellungen und Messen eingesetzt werden.



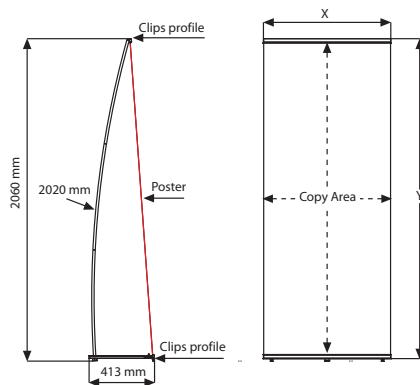
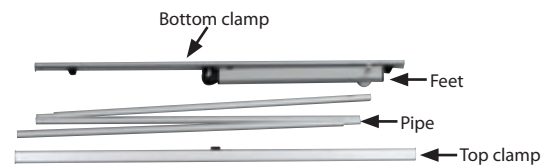
In top clamp 10 mm poster and in bottom clamp 10 mm poster is placed within the clamping system. Turning end caps help to slide the poster in. Durch die Einklemmleisten werden je 10 mm des Posters verdeckt. Die drehbaren Endkappen erleichtern das Einschleiben des Posters.



No tool assembly. Montage ohne Werkzeug.



Product is not recommended for special sizes wider than 1000 mm and longer than 2000 mm. Black carry bag should be ordered extra. Dieser Artikel wird für Posterflächen über 1000x2000 mm nicht empfohlen. Der schwarze Transportkoffer ist extra zu bestellen.



MATERIAL : Silver anodised aluminium				WEIGHT	PACKING SIZE (10 pcs)
ARTICLE	EXTERNAL (x-y)	POSTER	COPY	WITH PACKING	*W X H X D
UQBETO0N62	603 X 2030 mm	600 X 2000 mm	600 X 1980 mm	9,600 kg	380 X 860 X 145 mm
UQBETO0N72	703 X 2030 mm	700 X 2000 mm	700 X 1980 mm	10,200 kg	380 X 860 X 145 mm
UQBETO0N82	803 X 2030 mm	800 X 2000 mm	800 X 1980 mm	10,800 kg	380 X 860 X 145 mm
UQBETO0N92	903 X 2030 mm	900 X 2000 mm	900 X 1980 mm	11,500 kg	380 X 1060 X 145 mm
UQBETO0N12	1003 X 2030 mm	1000 X 2000 mm	1000 X 1980 mm	12,200 kg	380 X 1060 X 145 mm

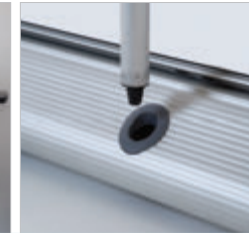
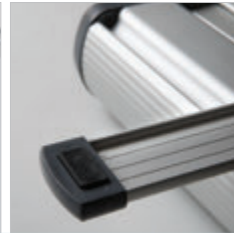


*W:Width H: Height D: Depth

Smart Roll Banner (Single Sided)



Watch video at our website www.mtdisplays.com



Smart Roll Banner; With the latest revision on Smart Roll Banner, M&T concentrated on both design and outlook features of the product&functionality. Pipe fixation addition, improved end caps provide a more stable product and the new revised design gives a more elegant look to the product. The aluminum body is silver anodised, stands at min 1000 mm, max 2300 mm high, has a unique telescopic pipe.

Smart Roll Banner, mit der letzten Produktverbesserung an dem Smart Rollbanner, hat sich M&T mehr auf Design optische Verbesserungen des Produktes und der Funktionalität fokussiert. Die zusätzliche Verbesserung am Teleskoprohr, verbesserte Endkappen verleihen dem Produkt eine gewisse Stabilität und durch das neue Design ersticht der Smart Rollbanner in einem eleganten und dezenten Design. Das Aluminiumgehäuse ist silber eloxiert, min. 1000mm und max. 2300mm ist mittels dem einzigartigen Teleskoprohr möglich.



Product comes ready to roll-up included into black carry bag
Der Artikel wird einsatzbereit in einer Transporttasche geliefert.



Has unique adjustable telescopic pipe.
Das Produkt hat ein einzigartiges, einstellbares Teleskoprohr.



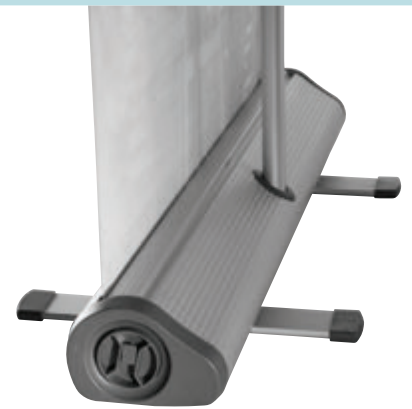
Please do not loosen the mechanism when the printing is assembled on the top position.
Den Aufrollmechanismus auf keinem Fall in aufgespanntem Zustand des Posters entriegeln.



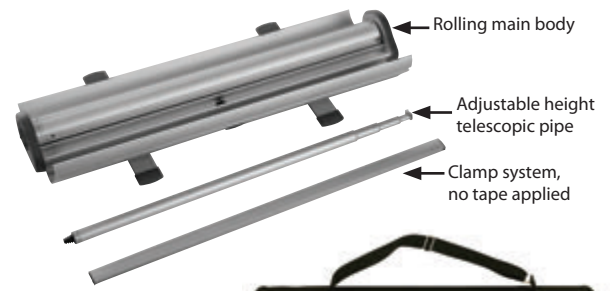
Improved design



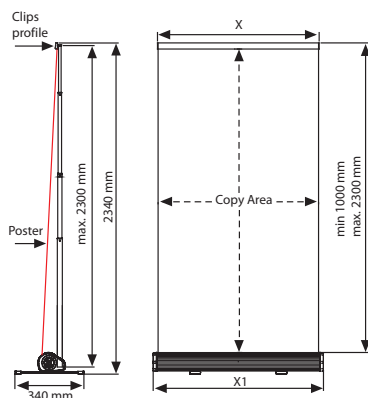
Stable pipe fixation



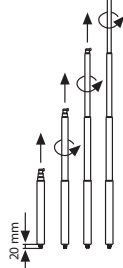
Patent Pending
PCT/TR 2005/000044
EP 05801071
DE 20 2004 021 229
OHIM DM 084 128



Transport bag



Telescopic Pipe



MATERIAL : Silver anodised aluminium			WEIGHT	PACKING SIZE
ARTICLE	X1	POSTER	WITH PACKING	*W X H X D
URBSTOON82	850 mm	800 mm	6,600 kg	180 X 910 X 180 mm
URBSTOON92	950 mm	900 mm	7,200 kg	180 X 1120 X 180 mm
URBSTOON12	1050 mm	1000 mm	7,700 kg	180 X 1120 X 180 mm

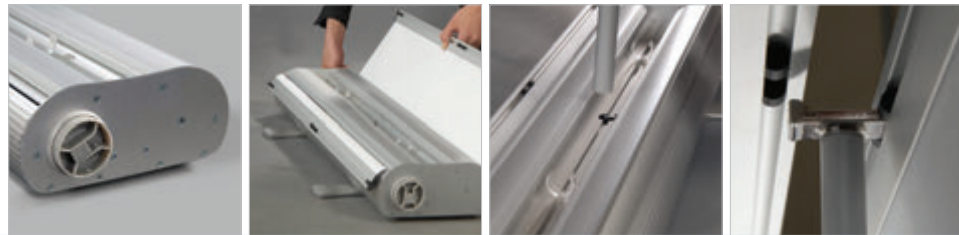


*W:Width H: Height D: Depth

Smart Roll Banner (Double Sided)



Watch video at our website www.mtdisplays.com



The Roll Banner display can be carried, even together with the printed art work, in its carry bag. The aluminum case is silver-anodized. Three sizes are available as standard. When assembled, it stands at min.1000 mm, max.2300 mm high. It has a unique telescopic pipe.

Rollbanner können inklusive dem Poster in der eigenen Tragetasche transportiert werden. Das Alu-Gehäuse ist silber eloxiert. Standardmaessig sind drei Größen erhaeltlich. Durch das einzigartige teleskopische Rundrohr, hat der Artikel montiert eine variable Höhe von 1000 mm - 2300 mm.



Product comes ready to roll-up optional black carry bag. Der Artikel wird einsatzbereit geliefert. Die schwarze Tragetasche ist optionell zu bestellen.



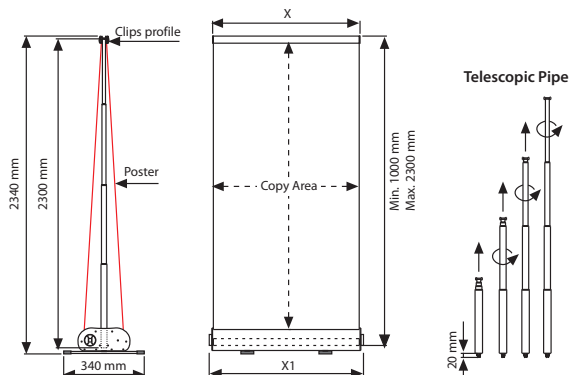
Has unique adjustable telescopic pipe. Das Produkt hat ein einzigartiges, einstellbares Teleskoprohr.



Please do not loosen the mechanism when the printing is assembled on the top position. Den Aufrollmechanismus auf keinem Fall in aufgespanntem Zustand des Posters entriegeln.



Patent Pending
PCT/TR 2005/000044
EP 05801071
DE 20 2004 021 229



BAG	WEIGHT		PACKING SIZE		WEIGHT	PACKING SIZE
ARTICLE	MODEL	WITH PACKING	*W X H X D		WITH BAG&PACKING	*W X H X D
UYUP070000	800 mm	2,850 kg	300 X 920 X 150 mm		10,500 kg	300 X 920 X 150 mm
UYUP071000	900 mm	3,110 kg	300 X 1120 X 150 mm		12,500 kg	300 X 1120 X 150 mm
UYUP072000	1000 mm	3,110 kg	300 X 1120 X 150 mm		13,500 kg	300 X 1120 X 150 mm

MATERIAL : Silver anodised aluminium					WEIGHT	PACKING SIZE
ARTICLE	EXTERNAL (x)	X1	POSTER	COPY	WITH PACKING	*W X H X D
URBSC00N82	806 mm	850 mm	800 mm	800 X 1930 mm	8,600 kg	240 X 880 X 130 mm
URBSC00N92	906 mm	950 mm	900 mm	900 X 1930 mm	9,300 kg	240 X 1080 X 130 mm
URBSC00N12	1006 mm	1050 mm	1000 mm	1000 X 1930 mm	10,000 kg	240 X 1080 X 130 mm

*W:Width H: Height D: Depth



Eco-Roller



Watch video at our website www.mtdisplays.com



The rolling cylinder comes ready at the point available to place in the art work. After the placement of the art work, the cylinder runs immediately once the pin on one end is off. The rolling cylinder can be set up and stretched in the required tightness.

Der Rollzylinder wird fertig zum Einsatz des Posters geliefert. Ist das Poster einmal eingelegt, dreht der Zylinder sich sofort wenn die Nadel auf der einen Seite entfernt wird. Der Rollzylinder kann auf die gewünschte Straffheit aufgezogen werden.



Product comes unassembled, packed with an easy-to-understand instruction sheet.
Das Produkt wird demontiert mit Montageanleitung geliefert.



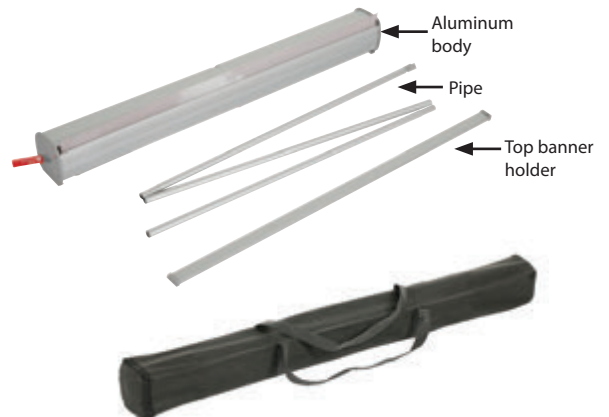
Stainless aluminum legs are suitable for public spaces.
Mit Rostfreien Aluminiumfüßen für den Aussenbereich geeignet.



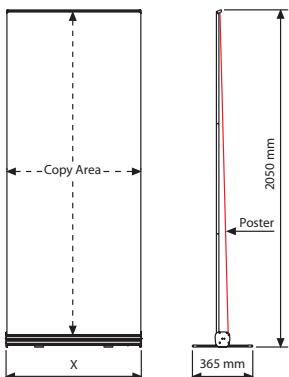
Black carry bag should be ordered separately.
Die schwarze Transporttasche ist optionell zu bestellen.



IMPROVED FOR 2018



Bag for Eco Roll Banner



BAG		PACKING SIZE
ARTICLE	MODEL	*W X H X D
UYUP070500	800 mm	310 X 470 X 210 mm
UYUP070600	1000 mm	310 X 470 X 210 mm

MATERIAL : Silver anodised aluminium				WEIGHT	PACKING SIZE
ARTICLE	POSTER	COPY	X	WITH PACKING	*W X H X D
URBET00N82	800 X 2000m	800 X 1970 mm	820 mm	2,460 kg	110 X 860 X 110 mm
URBET00N12	1000 X 2000 mm	1000 X 1970 mm	1020 mm	2,900 kg	110 X 1060 X 110 mm

*W:Width H: Height D: Depth



Practical X Banner



Watch video at our website www.mtdisplays.com



Practical X Banner is equipped with poster holder hooks at the top and bottom of the product. Poster is replaceable by taking off poster holders. Height is adjustable and lockable that offers 3 poster size options only in one product. Practical X Banner offers you a perfect solution in exhibitions, museum and restaurants. It is suitable for piled on high pallets. Bag is included.

Das praktische X-Banner ist mit Posterhalterhaken an der Ober- und Unterseite des Produkts ausgestattet. Plakat ist durch Abnehmen der Plakathalter austauschbar. Die Höhe ist einstellbar und arretierbar und bietet 3 Postergrößenoptionen nur in einem Produkt. Praktisches X Banner bietet Ihnen eine perfekte Lösung in Ausstellungen, Museen und Restaurants. Es eignet sich zum Stapeln auf hohen Paletten. Tasche ist inklusive.



Bag is included.
Tasche ist inklusive.



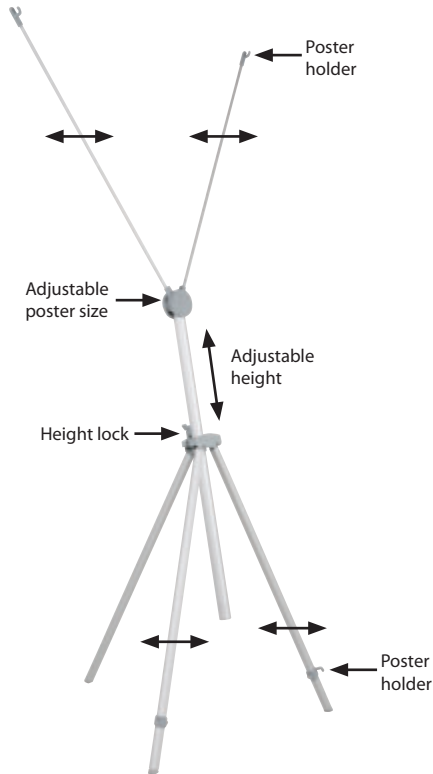
Offers 3 poster size options only in one product.
Bietet 3 Postergrößenoptionen nur in einem Produkt.



Assembly in 10 seconds.
Montage in 10 Sekunden.



1 box.
1 box



One product, three poster size



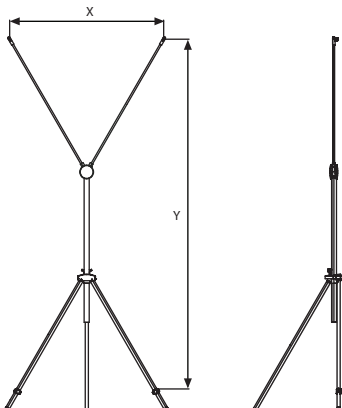
600 X 1800 mm



600 X 1800 mm



800 X 1800 mm



MATERIAL : Silver anodised aluminium				WEIGHT	PACKING SIZE (10 Pcs)
ARTICLE	X	Y	DESCRIPTION	WITH PACKING	*W X H X D
UPXBN00000			Practical X Banner	8,000 kg	210 X 460 X 940 mm
UYXPBP6016	600 mm	1600 mm	Vinyl poster	1,300 kg	160 X 160 X 630 mm
UYXPBP6018	600 mm	1800 mm	Vinyl poster	1,350 kg	160 X 160 X 630 mm
UYXPBP8018	800 mm	1800 mm	Vinyl poster	1,600 kg	160 X 160 X 630 mm



*W:Width H: Height D:Depth

Quick Banner





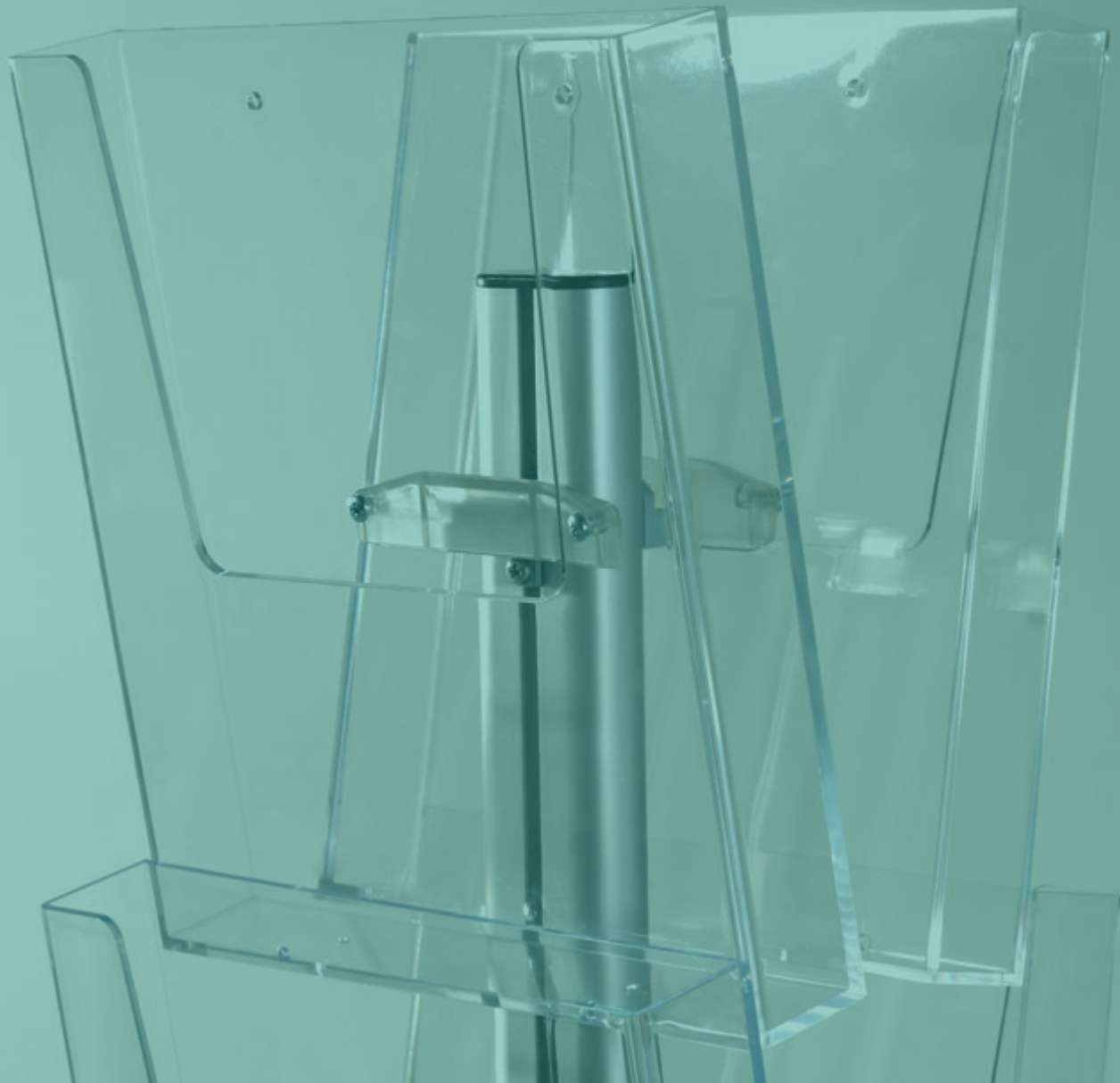
Brochure Sets

- Novel Free Standing Leaflet Display
- Free Standing Leaflet Display
- Free Standing Banner Set
- Free Standing Slide-in Frame
- Free Standing Convex Box
- Free Standing Leaflet Dispensers
- Free Standing Leaflet with Side Shelves
- Cocktail Brochure Sets
- Cocktail Brochure Sets for Wall
- Prime Wall Unit
- Portable Leaflet Dispensers
- Multiside Brochure Sets
- Multiside Brochure Set on Wheels
- Multiside Brochure Set Rotating
- Brochure Sets
- Decorative Brochure Stand

- Decorative Brochure Stand Plus
- Pillar Brochure Stand
- Zick-Zack
- Zic-Zack Lite
- Newage Portable Zick-Zack
- Wood Zick-Zack
- Foldable Zick-Zacks
- Foldable Wood Counters
- Heavy Duty Literature Rack
- Rapid Brochure Set
- Convex Tower Stands
- Basic Tower Stands
- Double Sided Tower Stands
- Tower Stands for Wall
- Wood Poster Stand
- Monoblock

- Novel Prospektständer mit Zentralprofilgestell
- Prospektständer mit Zentralprofilgestell
- Bannersystem mit Zentralprofilgestell
- Zentralprofilgestell mit Einschubrahmen
- Convex- Leuchtdisplay mit Zentralprofilgestell
- Zentralprofilgestell für Prospekthalter
- Zentralprofilgestell mit seitlichen Prospekthaltern
- Prospekthalter Cocktail
- Prospekthalter Cocktail für die Wand
- Prime Broschürensponder für die Wand
- Portable Leaflet Dispensers
- Multiside Prospektständer (mehrseitig)
- Multiside Prospektständer auf Rädern
- Multiside Prospektständer drehbar
- Prospektständer
- Dekorativer Prospektänder
- Dekorativer Prospektänder mit Topschild

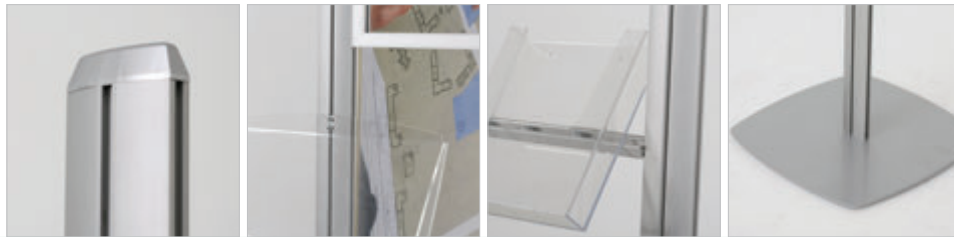
- Pillar Prospektständer
- Zick-Zack
- Zic-Zack Lite
- Newage Tragbarer Zick_Zack
- Wood Zick-Zack
- Foldable Zick-Zacks
- Foldable Wood Counters
- Heavy Duty Literature Rack
- Rapid Prospektständer
- Convex Tower Stands
- Basic Tower Stands
- Double Sided Tower Stands
- Tower Stands for Wall
- Wood Poster Stand
- Monoblock



Novel Free Standing Leaflet Display



Watch video at our website www.mtdisplays.com



New to our range, this robust, silver anodised Novel Free Standing brochure and sign system allows designing various styles to suit different environment. 4-channel profile holds accessories to make single sided or double sided display system.

Neu in unserem Sortiment ist dieses robuste, silber eloxierte Novel Free Standing Prospekt- und Schildersystem, das die Gestaltung verschiedener Variationen für unterschiedliche Umgebungen ermöglicht. Das 4 Kanal Profil hält die Zubehöre um einseitige oder doppelseitige Display Systeme zusammen zu stellen.

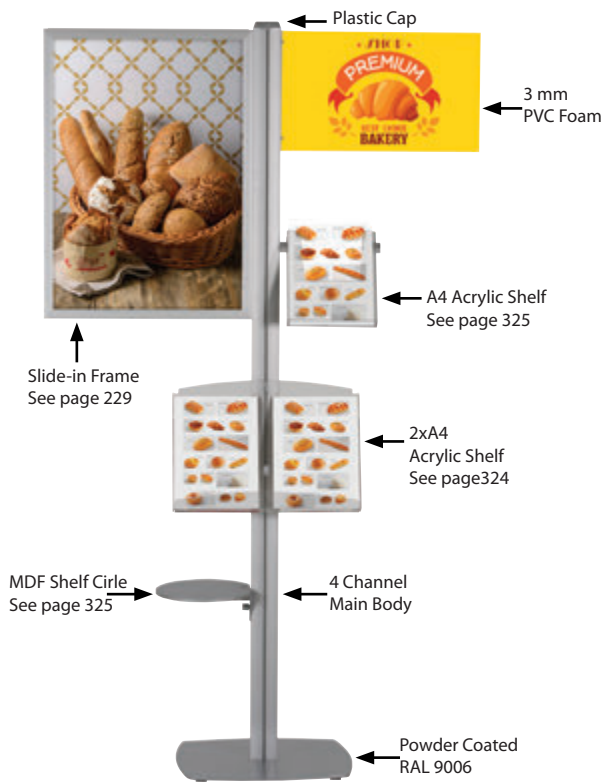
Product is packed unassembled with an easy-to understand instruction sheet & fixing set. Das Produkt wird demontiert mit einer Montageanleitung und Befestigungsmaterial geliefert.

Make up your own stand in your desired variation. Heavy & stable base for public spaces. Stellen Sie Ihren Ständer nach Ihrem eigenen Wunsch zusammen. Die schwere und stabile Fussplatte ermöglicht den Einsatz an Plätzen mit viel Menschenverkehr.

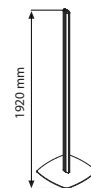
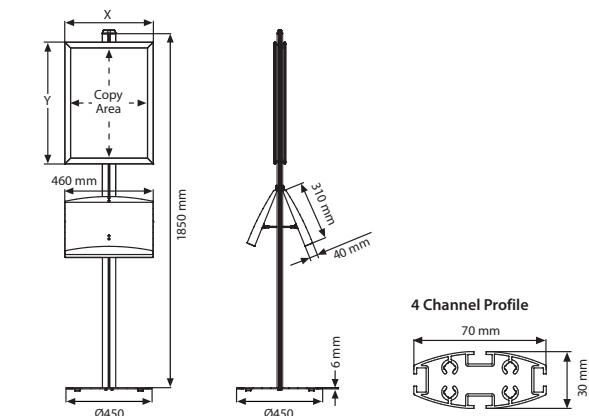
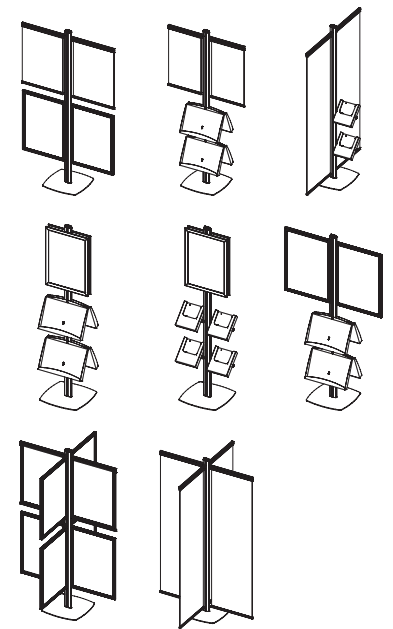
Please order the accessories separately. Das Zubehör bitte separat bestellen.

2 packs. See info chart for pack sizes. 2 Packungen. Siehe Infodiagramm für Packungsgrößen.

Assembled in 40 seconds. Montiert in 40 Sekunden.



Some possible variations using 4 channel profile
Variationen bei 4 Kanälen



MAINBODY WITH 4 CHANNEL: Powder coated in RAL 9006		WEIGHT	PACKING SIZE
ARTICLE	DESCRIPTION	WITH PACKING	*W X H X D
UFSL001200	Main body pole	2,450 kg	90 X 1930 X 45 mm
	Main body base	9,150 kg	480 X 480 X 45 mm

SNAP FRAME: 25 mm 45° - 25 mm round					WEIGHT	PACKING SIZE
MITRED ARTICLE	ROUND ARTICLE	EXTERNAL (x-y)	POSTER	COPY	WITH PACKING	*W X H X D
UFSL0000A2	UFSL0100A2	463 X 637 mm	420 X 594 mm	401 X 575 mm	1,230 kg	460 X 660 X 21 mm
UFSL0000A1	UFSL0100A1	637 X 884 mm	594 X 841 mm	575 X 822 mm	2,245 kg	650 X 900 X 21 mm
UFSL0000B2	UFSL0100B2	543 X 743 mm	500 X 700 mm	481 X 681 mm	1,600 kg	550 X 750 X 21 mm
UFSL0000B1	UFSL0100B1	743 X 1043 mm	700 X 1000 mm	681 X 981 mm	2,970 kg	750 X 1050 X 21 mm

*W:Width H: Height D: Depth



Free Standing Leaflet Display



2 Channel

An ideal brochure stand that permits an indoor use of different models. The fixing grooves on both sides of the central pole hold single-sided or double-sided frames and shelves separately or collectively at the same time. The frames are recommended for use in 30 mm profiles in both portrait or landscape position. The powder coated steel shelves are 1,2 mm thick, and the clear acrylic shelves are 4 mm thick.

2 Kanäle

Ein idealer Prospektständer der Ihnen verschiedene Variationen für den Inneneinsatz bietet. Die Kanäle an beiden Seiten des Mastprofils halten Ein- oder Doppelseitige Rahmen sowie einzelne oder mehrere Ablagen gleichzeitig. Für die Rahmen werden 30 mm Profile empfohlen. Die pulverbeschichteten Metallablagen sind 1,2 mm stark, während die transparenten Acrylablagen 4 mm stark sind.



Product is packed unassembled with an easy-to-understand instruction sheet & fixing set. Das Produkt wird demontiert mit einer Montagelanleitung und Befestigungsmaterial geliefert.



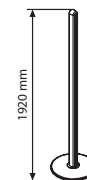
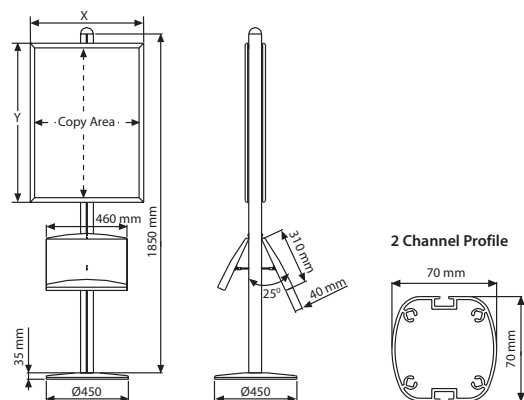
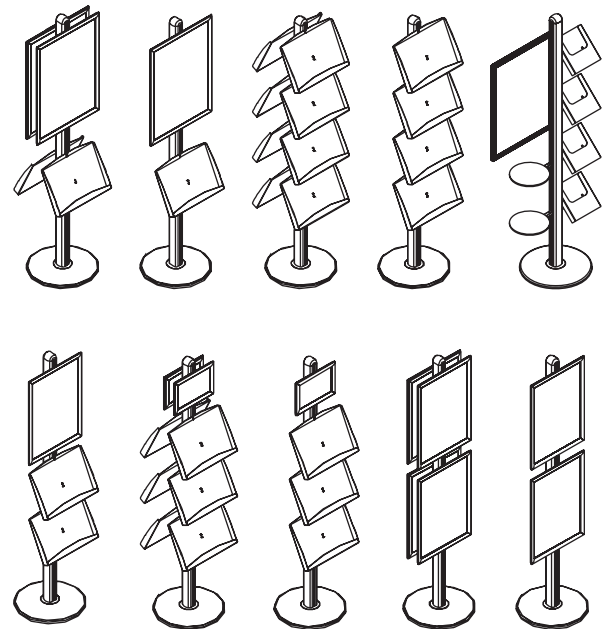
Make up your own stand in your desired variation. Heavy & stable base for public spaces. Stellen Sie Ihren Ständer nach Ihrem eigenen Wunsch zusammen. Die schwere und stabile Fussplatte ermöglicht den Einsatz an Plätzen mit viel Menschenverkehr.



2 packs. See info chart for pack sizes. 2 Packungen. Siehe Infodiagramm für Packungsgrößen.



Some possible variations using 2 channel profile
Variationen bei 2 Kanälen



MAINBODY WITH 2 CHANNEL: Powder coated in RAL 9006		
	WEIGHT	PACKING SIZE
ARTICLE	DESCRIPTION	WITH PACKING *W X H X D
UFSL001000	Main body pole	3,450 kg 80 X 1950 X 80 mm
	Main body base	8,950 kg 490 X 490 X 50 mm

SNAP FRAME: 25 mm 45° - 25 mm round				WEIGHT	PACKING SIZE
MITRED ARTICLE	ROUND ARTICLE	EXTERNAL (x-y)	POSTER	COPY	*W X H X D
UFSL0000A2	UFSL0100A2	463 X 637 mm	420 X 594 mm	401 X 575 mm	1,230 kg 460 X 660 X 21 mm
UFSL0000A1	UFSL0100A1	637 X 884 mm	594 X 841 mm	575 X 822 mm	2,245 kg 650 X 900 X 21 mm
UFSL0000B2	UFSL0100B2	543 X 743 mm	500 X 700 mm	481 X 681 mm	1,600 kg 550 X 750 X 21 mm
UFSL0000B1	UFSL0100B1	743 X 1043 mm	700 X 1000 mm	681 X 981 mm	2,970 kg 750 X 1050 X 21 mm

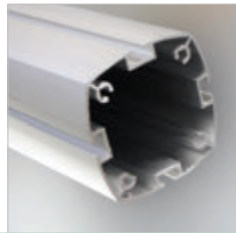


*W:Width H: Height D: Depth

Free Standing Leaflet Display



Watch video at our website www.mtdisplays.com



4 Channel

An ideal brochure stand that permits an indoor use of different models. The fixing grooves on four sides of the central pole hold single-sided or double-sided frames and shelves separately or collectively at the same time. The frames are recommended in 30 mm profiles to be used in both portrait or landscape position. The powder coated steel shelves are 1,2 mm thick and the clear acrylic shelves are 4 mm. Each shelf has a 2x4 capacity.

4 Kanäle

Ein idealer Prospektständer der Ihnen verschiedene Variationen für den Inneneinsatz bietet. Die Kanäle an den vier Seiten des Mastprofils halten Ein- oder Doppelseitige Rahmen sowie einzelne oder mehrere Ablagen gleichzeitig. Für die Rahmen werden 30 mm Profile empfohlen. Die pulverbeschichteten Metallablagen sind 1,2 mm stark, während die transparenten Acrylablagen 4 mm stark sind. Jede Ablage hat eine Kapazität von 2x4.



Product is packed unassembled with an easy-to-understand instruction sheet & fixing set. Das Produkt wird demontiert mit einer Montagelanleitung und Befestigungsmaterial geliefert.



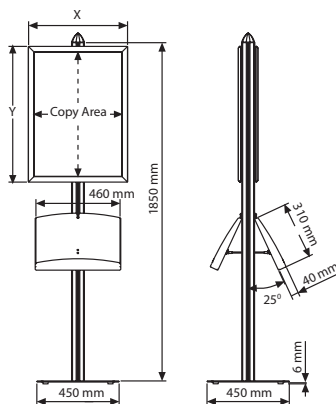
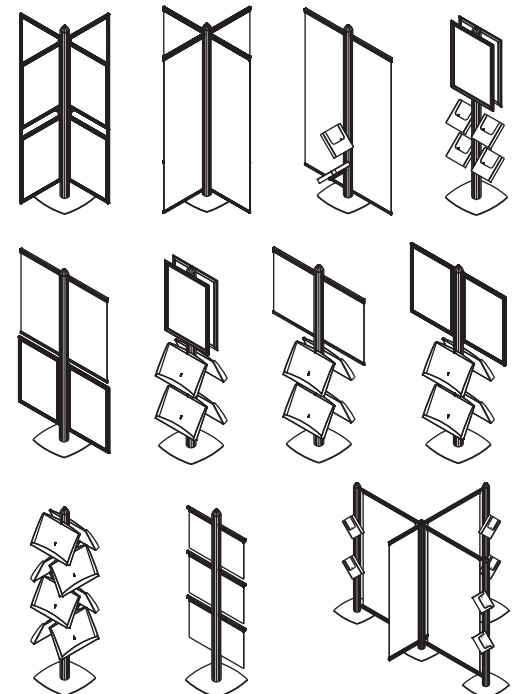
Make up your own stand in your desired variation. Heavy & stable base for public spaces. Stellen Sie Ihren Ständer nach Ihrem eigenen Wunsch zusammen. Die schwere und stabile Fussplatte ermöglicht den Einsatz an Plätzen mit viel Menschenverkehr.



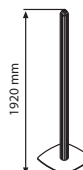
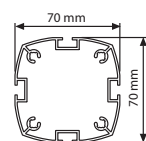
2 packs. See info chart for pack sizes. 2 Packungen. Siehe Infodiagramm für Packungsgrößen.



Some possible variations using 4 channel profile
Variationen bei 4 Kanälen



4 Channel Profile



MAINBODY WITH 4 CHANNEL: Powder coated in RAL 9006			
ARTICLE	DESCRIPTION	WEIGHT WITH PACKING	PACKING SIZE *W X H X D
UFSL001100	Main body pole	3,450 kg	80 X 1950 X 80 mm
	Main body base	8,950 kg	490 X 490 X 50 mm

POWDER COATED STEEL&ACRYLIC SHELF			
ARTICLE	CAPACITY	WEIGHT WITH PACKING	PACKING SIZE *W X H X D
UFSL002000	2 X A4 steel shelf	1,800 kg	360 X 470 X 60 mm
UFSL003000	2 X A4 acrylic shelf	1,400 kg	360 X 470 X 60 mm



* W:Width H: Height D: Depth

Free Standing Shelf



An ideal brochure stand that allows various different models for indoor use. The channels on both sides of the central pole hold slide-in frame one alone or more at the same time. Each banner arm comes along with the required fixing components.

Ein idealer Prospektstaender der Ihnen verschiedene Variationen für den Inneneinsatz bietet. Die Kanäle an beiden Seiten des Mastprofils halten Ein- oder Doppelseitige Einschubrahmen einzeln oder mehrere gleichzeitig. Jeder Rahmen wird mit entsprechendem Befestigungsmaterial geliefert.

Free Standing 2 channel model



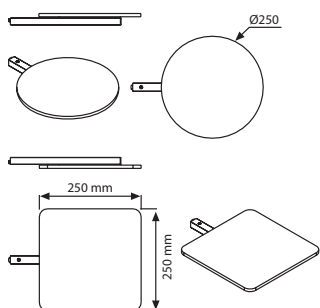
Free Standing 4 channel model



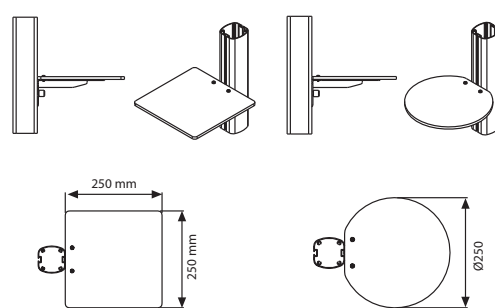
Novel Free Standing 4 channel model



Shelf options: 1. model



Shelf options: 2. model



SHELF OPTIONS 1: 8 mm MDF			WEIGHT	PACKING SIZE
ARTICLE	MODEL	WEIGHT CAPACITY	WITH PACKING	*W X H X D
UFSL002500	Circle	max. 1 kg	0,610 kg	260 X 350 X 35 mm
UFSL002510	Square	max. 1kg	0,705 kg	260 X 350 X 35 mm
SHELF OPTIONS 2: 8 mm MDF			WEIGHT	PACKING SIZE
ARTICLE	MODEL	WEIGHT CAPACITY	WITH PACKING	*W X H X D
UFSL002550	Circle	max. 5 kg	0,830 kg	270 X 285X 105 mm
UFSL002560	Square	max. 5 kg	1,010 kg	270 X 285X 105 mm

* W:Width H: Height D: Depth



Free Standing Banner Set



An ideal brochure stand that enables an indoor use of different models. The fixing grooves on both sides of the central pole hold single or double Banner arms separately or collectively at the same time. Each Banner arm is supplied with a Poster Fast set that allows easy change of the poster.

Ein idealer Prospektständer der Ihnen verschiedene Variationen für den Inneneinsatz bietet. Die Kanäle an beiden Seiten des Mastprofils halten ein oder zwei Bannersets einzeln oder gleichzeitig. Jedes Bannerset wird mit Poster Fast Klemmleisten geliefert, die das schnelle Auswechseln des Posters ermöglichen.



Product is packed unassembled with an easy-to-understand instruction sheet & fixing set. Das Produkt wird demontiert mit einer Montageanleitung und Befestigungsmaterial geliefert.



Make up your own stand in your desired variation. Heavy & stable base for public spaces. Stellen Sie Ihren Ständer nach Ihrem eigenen Wunsch zusammen. Die schwere und stabile Fussplatte ermöglicht den Einsatz an Plätzen mit viel Menschenverkehr.



Banner width is recommended minimum 400 mm, max 700 mm. Banner height is adjustable up to 1700 mm. Empfohlene Posterbreite ist zwischen 400 mm und max. 700 mm. Die Posterhöhe ist bis zu 1700 mm variabel.

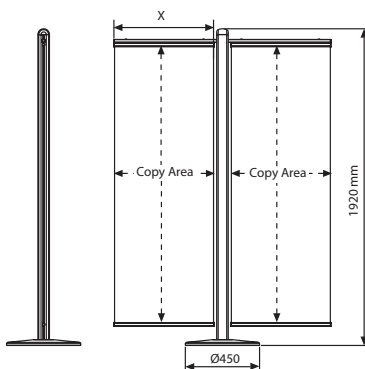
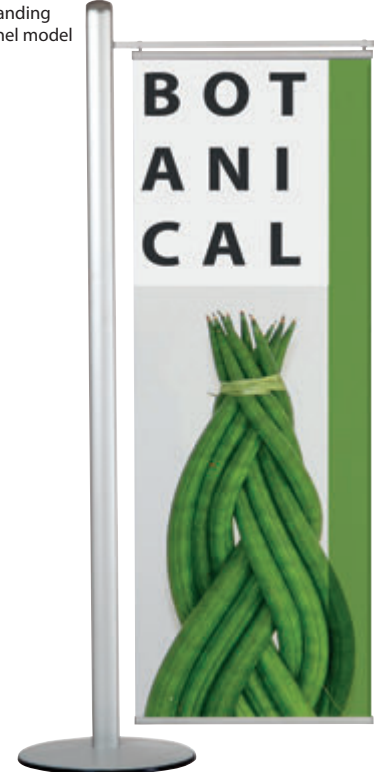
Novel Free Standing 4 channel model



Free Standing 4 channel model



Free Standing 2 channel model



MATERIAL : Silver anodised aluminium			WEIGHT	PACKING SIZE (20 Pcs)
ARTICLE	EXTERNAL (x)	POSTER	WITH PACKING	*W X H X D
UFSL110000	400 mm	400 mm	6,000 kg	230 X 460 X 120 mm
UFSL110100	500 mm	500 mm	7,200 kg	230 X 560 X 120 mm
UFSL110200	600 mm	600 mm	8,600 kg	230 X 660 X 120 mm
UFSL110300	700 mm	700 mm	10,000 kg	230 X 760 X 120 mm



*W:Width H: Height D: Depth

Free Standing Slide-in Frames



Watch video at our website www.mtdisplays.com



An ideal brochure stand that allows various different models for indoor use. The fixing grooves on both sides of the central pole hold slide-in frame one alone or more at the same time. Each Frame comes along with the required fixing components.

Ein idealer Prospektstaender der Ihnen verschiedene Variationen für den Inneneinsatz bietet. Die Kanäle an beiden Seiten des Mastprofils halten Ein- oder Doppelseitige Einschubrahmen einzeln oder mehrere gleichzeitig. Jeder Rahmen wird mit entsprechendem Befestigungsmaterial geliefert.



Product is packed unasssembled with an easy mounting instruction sheet & fixing set. Das Produkt wird demontiert mit einer Montageanleitung und Befestigungsmaterial geliefert.



Allows multiple variation, heavy & stable base for public space. Each slide-in frame includes a poster protective set of 2 clear + 1 black sheet which prevent the light transmission. Verschiedene Variationen sind möglich. Die schwere und stabile Fussplatte ermöglicht den Einsatz an Plätzen mit viel Menschenverkehr. Jeder Einschubrahmen ist mit 2 Stück Schutzfolien und einer schwarzen Folie als Zwischenwand ausgestattet, die den Lichtdurchlass verhindert.

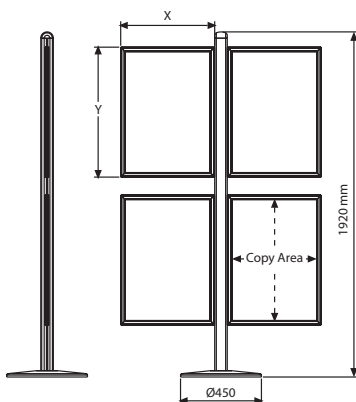
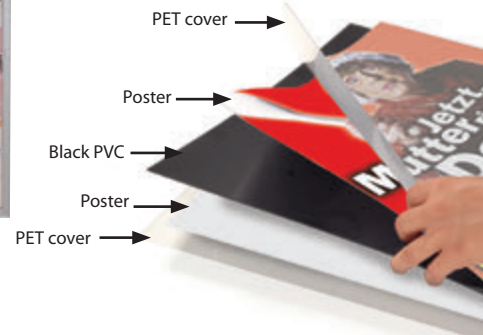
Novel Free Standing 4 channel model



Free Standing 4 channel model



Free Standing 2 channel model



MATERIAL : Silver anodised aluminium				WEIGHT	PACKING SIZE
ARTICLE	EXTERNAL (x-y)	POSTER	COPY	WITH PACKING	*W X H X D
UFSL130300	233 X 320 mm	210 X 297 mm	183 X 270 mm	0,825 kg	240 X 330 X 25 mm
UFSL130200	320 X 443 mm	297 X 420 mm	270 X 393 mm	1,200 kg	330 X 450 X 25 mm
UFSL130100	443 X 617 mm	420 X 594 mm	393 X 567 mm	1,820 kg	450 X 630 X 25 mm
UFSL130500	531 X 785 mm	508 X 762 mm	481 X 735 mm	2,700 kg	540 X 800 X 25 mm
UFSL130400	523 X 723 mm	500 X 700 mm	437 X 673 mm	2,800 kg	540 X 733 X 25 mm



* W:Width H: Height D: Depth

Free Standing Convex Box



Watch video at our website www.mtdisplays.com



Double sided display for indoor use. By the aid of snaps & hinged cover, one can easily change the poster on both sides. Brochure shelves can be added, if desired. Convex elegant look at eye-level to present your message.

Doppelseitiges Display für den Innenraumeinsatz. Mit Hilfe der Klapprahmenprofile und dem Scharniersystem der Schutzfolie, kann das Poster auf beiden Seiten leicht ausgewechselt werden. Auf Wunsch können Prospektablagen mit eingesetzt werden. Die elegante Konvexerscheinung in Augenhöhe ist ideal um Ihre Informationen zu präsentieren.



Product is packed unassembled with an easy-to-understand instruction sheet & fixing set. Das Produkt wird demontiert mit einer Montageanleitung und Befestigungsmaterial geliefert.



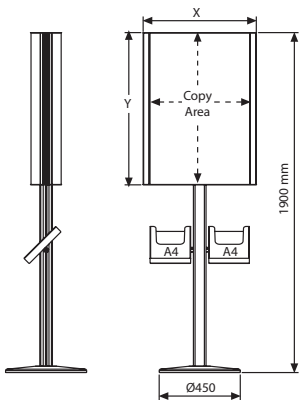
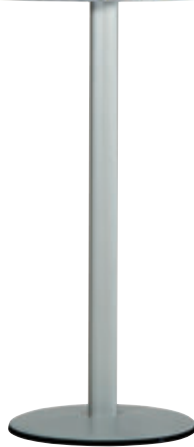
Heavy and stable base for public spaces. PVC hinged door, magnet cover & poster pegs provide easy change of poster on both sides. Die schwere und stabile Fussplatte ermöglicht den Einsatz an Plätzen mit viel Menschenverkehr. Die Schutzfolientür mit dem Scharniersystem, das Magnetband an der Schutzfolie und die Posterhalterungen, dienen zum leichten Posteraustausch auf beiden Seiten.



Shelves should be ordered separately. Die Prospektablagen sind getrennt zu bestellen.



3 packs. See info chart for pack sizes. 3 Packungen. Siehe Infodiagramm für Packungsgrößen.

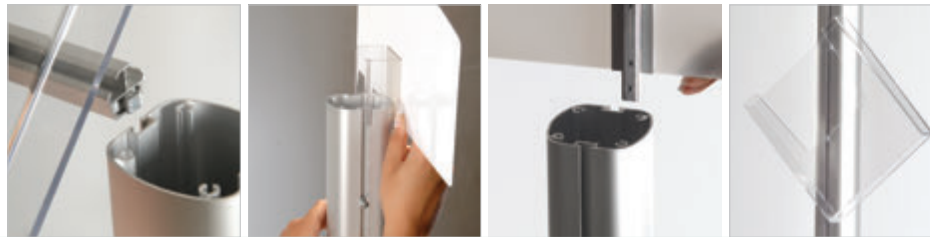


MATERIAL : Silver anodised aluminium					WEIGHT	PACKING SIZE
ARTICLE	SIZE	EXTERNAL (x-y)	POSTER	COPY	WITH PACKING	*W X H X D
UTTM014100	A2	460 X 600 mm	420 X 594 mm	398 X 594 mm	13,000 kg	500 X 645 X 75 mm
						80 X 1180 X 80 mm
UTTM014000	A1	625 X 846 mm	594 X 841 mm	572 X 841 mm	14,000 kg	490 X 490 X 50 mm
						675 X 890 X 75 mm
UTTM014200	B2	540 X 705 mm	500 X 700 mm	478 X 700 mm	13,500 kg	80 X 1030 X 80 mm
						490 X 490 X 50 mm
UTTM014300	20"x30"	550 X 767 mm	508 X 762 mm	486 X 762 mm	13,700 kg	580 X 750 X 75 mm
						590 X 810 X 75 mm
						80 X 1180 X 80 mm
						490 X 490 X 50 mm

*W:Width H: Height D: Depth



Free Standing Leaflet Dispensers & with Side Shelves



An ideal brochure stand that allows various different models for indoor use. The fixing grooves on both sides of the central pole hold slide-in frame one alone or more at the same time. Each frame comes along with the required fixing components. The elegant look brochure holder is designed to hold maximally 8xA4 brochure sets at a time. The acrylic logo header at size of 160 x 450 mm.

Ein idealer Prospektständer der Ihnen verschiedene Variationen für den Inneneinsatz bietet. Die Kanäle an beiden Seiten des Mastprofils halten Ein- oder Doppelseitige Einschubrahmen einzeln oder mehrere gleichzeitig. Jeder Rahmen wird mit entsprechendem Befestigungsmaterial geliefert.



Product is packed unasssembled with an easy mounting instruction sheet & fixing set. Das Produkt wird demontiert mit einer Montageanleitung und Befestigungsmaterial geliefert.



Allows multiple variation, heavy & stable base for public space. Each slide-in frame includes a poster protective set of 2 clear + 1 black sheet which prevent the light transmission. Verschiedene Variationen sind möglich. Die schwere und stabile Fussplatte ermöglicht den Einsatz an Plätzen mit viel Menschenverkehr. Jeder Einschubrahmen ist mit 2 Stück Schutzfolien und einer schwarzen Folie als Zwischenwand ausgestattet, die den Lichtdurchlass verhindert.



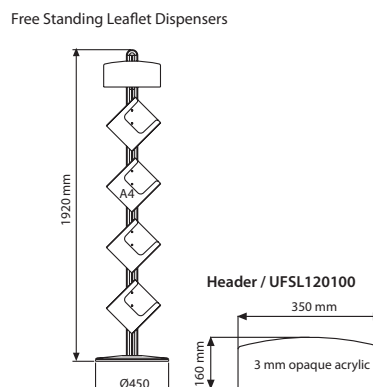
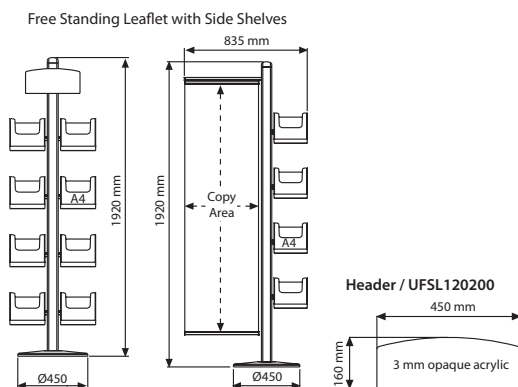
2 packs. See info chart for pack sizes. 2 Packungen. Siehe Infodiagramm für Packungsgrößen.



Free Standing Leaflet with Side Shelves



Free Standing Leaflet Dispensers



LEAFLET DISPENSERS : Clear Acrylic			WEIGHT	PACKING SIZE
ARTICLE	DESCRIPTION	SIZE	WITH PACKING	*W X H X D
UFSL120000	Acrylic Shelf	A4	0,410 kg	270 X 245 X 55 mm
UFSL120100	Header	350 X 160 mm	0,300 kg	195 X 365 X 22 mm
UFSL001000	Main body pole	1920 mm	3,450 kg	80 X 1950 X 80 mm
	Main body base	Ø450	8,950 kg	490 X 490 X 50 mm

SIDE SHELF : Clear Acrylic			WEIGHT	PACKING SIZE
ARTICLE	DESCRIPTION	SIZE	WITH PACKING	*W X H X D
UFSL140000	Acrylic Shelf	A4	0,830 kg	270 X 245 X 55 mm
UFSL140100	Acrylic Shelf	A5	0,510 kg	245 X 195 X 55 mm
UFSL140200	Acrylic Shelf	1/3 A4	0,335 kg	195 X 150 X 55 mm
UFSL120200	Header	450 X 160 mm	0,300 kg	175 X 465 X 55 mm
UFSL001000	Main body pole	1920 mm	3,450 kg	80 X 1950 X 80 mm
	Main body base	Ø450	8,950 kg	490 X 490 X 50 mm

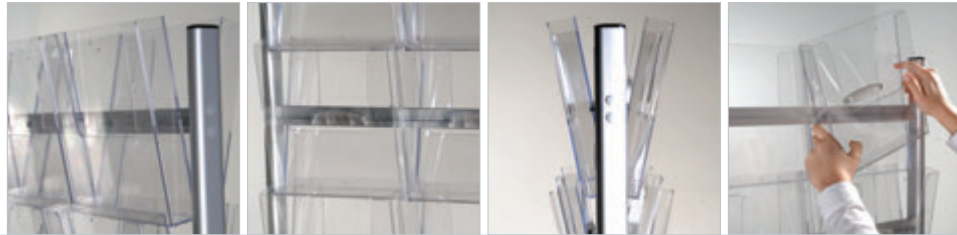


* W:Width H: Height D: Depth

Coctail Brochure Set



Watch video at our website www.mtdisplays.com



Easy to build, stylish brochure holder. Designed to hold various brochures fulfilling your personal wishes and needs. The connector structure offers you space for individual adjustment of the shelves. To complete a product, main body and required quantities of shelves need to be ordered separately.

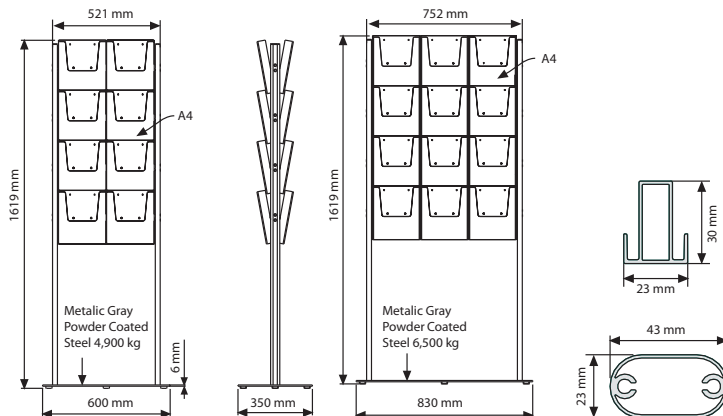
Stilvoller Prospekthalter, einfach aufzubauen. Ihren Bedürfnissen und Wünschen entsprechend können die Prospektablagen eingesetzt werden. Die Verbindungsstruktur bietet Ihnen Möglichkeiten für individuelle Anbringungen der Ablagen. Gestell und gewünschte Menge an Prospekthaltern müssen getrennt bestellt werden.

Product is packed unassembled with an easy mounting instruction sheet & fixing set. Das Produkt wird demontiert mit einer Montageanleitung und Befestigungsmaterial geliefert.

There are four plastic feet under the base. Unter der Fussplatte befinden sich vier Plastikfüsse

Please gently push the shelves over the connectors on the pole. The shelf connectors arrive at fixed positions on the profile. For individual adjustment please loosen the screws to make back or forth. UMSDA008A4 if you have them in your stock. Schieben Sie die Ablagen vorsichtig über die Verbindungsstücke auf den Standprofilen. Die Verbindungsstücke werden auf dem Standprofil montiert geliefert. Für individuelle Anwendungen, lösen Sie bitte zuerst die Schrauben, um die Verbindungsstücke verschieben zu können. Unsere Artikel UMSD008100 und UYUP490000 können bei diesem Artikel UMSDA008A4 eingesetzt werden, wenn Sie diese auf Lager haben.

2 packs. See info chart for pack sizes. 2 Packungen. Siehe Infodiagramm für Packungsgrößen.



MATERIAL : Silver anodised aluminium & acrylic shelf			WEIGHT	PACKING SIZE
ARTICLE	DESCRIPTION	SIZE	WITH PACKING	*W X H X D
UCBSG00024	Main body	2 X A4	3,900 kg	525 X 1640 X 55 mm
			5,300 kg	385 X 630 X 30 mm
UCBSG00034	Main body	3 X A4	6,050 kg	750 X 1640 X 55 mm
			5,650 kg	385 X 860 X 30 mm
UMSDA008A4	Acrylic Shelf & Adapter	8 X A4	3,550 kg	270 X 340 X 240 mm (8 Pcs)
UMSD008100	Acrylic Shelf	A4	12,900 kg	520 X 630 X 250 mm (30 Pcs)
UYUP490000	Adapter		0,210 kg	10 Pcs

*W:Width H: Height D: Depth



Coctail Brochure Set for Wall



Stunning and Innovative brochure holder that is designed to hold various pieces of Acrylic Brochure holders side by side at a time, and it depends referring your request of how many pieces will be put on a profile. It provides you gain a wider area in offices, banks, schools, hospitals, hotels and so etc...

Innovativer und hervorragender Prospekthalter, welches zur Fixierung je nach Bedarf von mehreren Acryl Prospekthaltern nebeneinander auf einem Profil geeignet ist. Es bietet Ihnen mehr Platz in Büroräumen, Banken, Schulen; Krankenhäusern, Hotels etc.



Product is packed unasssembled with an easy mounting instruction sheet & fixing set. Das Produkt wird unmontiert mit einer Montageanleitung und Montagematerial verpackt geliefert.



Products is available in semi-finished index for various other applications. Das Produkt wird auch als Ersatzteil für verschiedene Anwendungsmöglichkeiten geboten.



A4

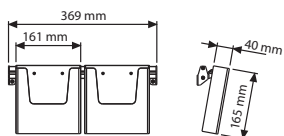


1/3 A4

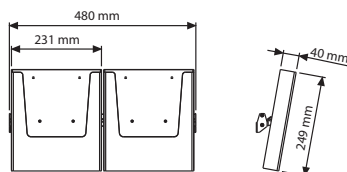


A5

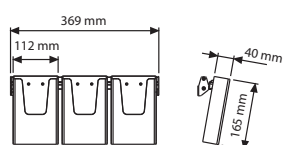
2 pcs x A5 Size



2 pcs x A4 Size



3 pcs x 1/3 A4 Size

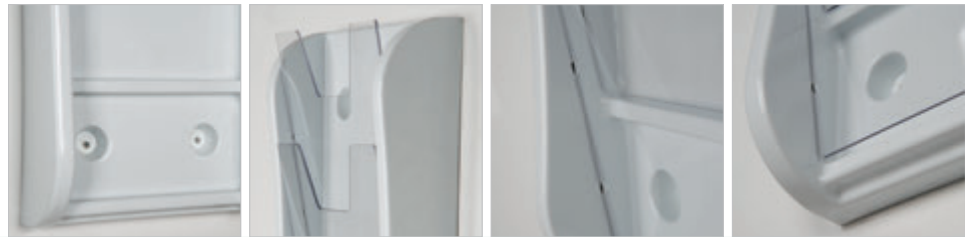


MATERIAL : Clear Acrylic			WEIGHT	PACKING SIZE
ARTICLE	POSTER	DESCRIPTION	WITH PACKING	*W X H X D
UCBSW200A4	210 X 297 mm	A4 Portrait	1,350 kg	270 X 500 X 90 mm
UCBSW200A5	148 X 210 mm	A5 Portrait	0,850 kg	185 X 405 X 90 mm
UCBSW30A43	105 X 210 mm	1/3 A4 Portrait	0,990 kg	185 X 405 X 90 mm

*W:Width H: Height D: Depth



Prime Wall Unit



Multiple-pocket leaflet dispenser, Prime Wall Unit tidies up the busy environment. It is also important tool for use in any office, lobby retail store or bank. The main body is produced by polystyrene material. This thermoformed body in aesthetic shape provides easy access to the leaflets or brochures. Clear PET-G pockets provide a full view of flyers or brochures stored in.

Mehrfacher Broschüren Spender. Ideal um sich im Alltagschaos Ordnung zu verschaffen. Auch in Büros, Rezeptionen, Einzelhandel oder in Banken ist dies ein wichtiges Arbeitsmittel. Das Grundgerüst schafft das Material Polystyrol. Der temperaturgeformte Körper ist sehr ästhetisch und ermöglicht einen leichten Zugang zu allen notwendigen Dokumenten oder Broschüren. Klare PET-G bieten eine freie Sicht auf alle Broschüren und deren Inhalte.



Available in White, Black and Grey.
Verfügbar in Weiß, Schwarz und Grau.

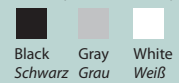


Pocket capacity:
A4 also suitable for 8,5"x11"
A5 also suitable for 6,5"x8"
A4/3 also suitable for 4"x9"
Kapazität:
A4 ist auch für 8,5"x11"
A5 ist auch für 6,5"x8"
A4/3 ist auch für 4"x9"



Supplied with wall fixings.
Geliefert mit dem notwendigen Zubehör.

Color options / Farbenoptionen



3xA4 White
3x(8.5"x11")



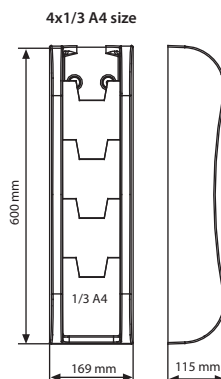
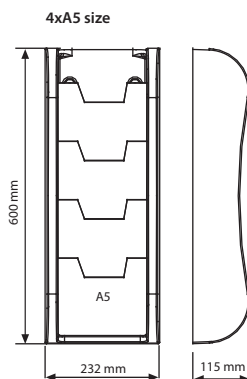
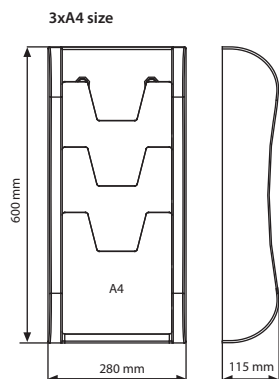
3xA4 Gray
3x(8.5"x11")



4xA5 White
4x(6.5x8)



4x1/3 A4 Black
4x(4"x19")



MATERIAL : PET-G & Clear Acrylic			WEIGHT	PACKING SIZE
ARTICLE	CAPACITY	DESCRIPTION	WITH PACKING	*W X H X D
UPW0G003A4	3 X A4	Gray	1,630 kg	310 X 630 X 140 mm
UPW0B003A4	3 X A4	Black	1,630 kg	310 X 630 X 140 mm
UPW0W003A4	3 X A4	White	1,630 kg	310 X 630 X 140 mm
UPW0G004A5	4 X A5	Gray	1,450 kg	260 X 630 X 140 mm
UPW0B004A5	4 X A5	Black	1,450 kg	260 X 630 X 140 mm
UPW0W004A5	4 X A5	White	1,450 kg	260 X 630 X 140 mm
UPW0G04A43	4 X 1/3A4	Gray	1,260 kg	200 X 630 X 140 mm
UPW0B04A43	4 X 1/3A4	Black	1,260 kg	200 X 630 X 140 mm
UPW0W04A43	4 X 1/3A4	White	1,260 kg	200 X 630 X 140 mm

* W:Width H: Height D: Depth



Portable Leaflet Dispensers



Made of polycarbonate, Portable Leaflet Dispensers provide both flexibility and saving from the space in the offices, shops and hotels and more. Transparent pockets offer a complete view of the brochure or fliers.

Die aus Polycarbonat hergestellten Portable Leaflet Dispensers bieten sowohl Flexibilität und sind auch platzsparend in Büros, Geschäften, Hotels und mehr. Transparente Taschen bieten einen kompletten Blick auf die Broschüren oder Flyers.



Complete with fixing components.
Komplett mit Befestigungskomponenten.



Additional pocket are available by order.
Zusätzliche Taschen sind auf Bestellung erhältlich.



3 X A4
3 X (8.5"X11")

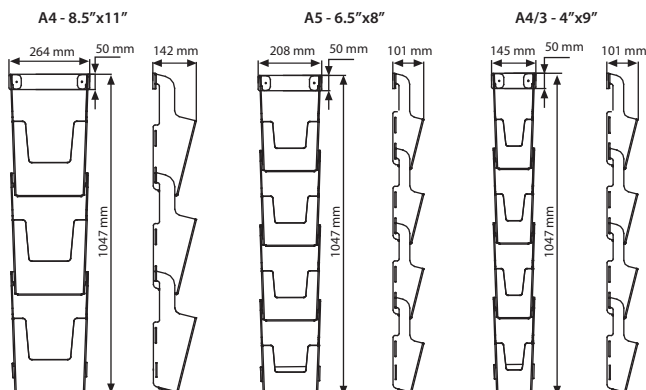


4 X A5
4 X (6.5"X8")



4 X A4/3
4 X (4"X9")

Flexible scratch resistant PC body



MATERIAL : PC body		WEIGHT	PACKING SIZE
ARTICLE	CAPACITY	WITH PACKING	*W X H X D
UPBW0030A4	3 X A4 - 8/5" X 11"	1,170 kg	270 X 540 X 150 mm
UPBW0040A5	4 X A5 - 6.5" X 8.5"	1,480 kg	150 X 540 X 120 mm
UPBW004A43	4X A4/3 - 4" X 9"	1,900 kg	215 X 540 X 120 mm

*W:Width H: Height D: Depth



Multiside Brochure Set 1 Pole



Multiside Brochure sets are developed to provide multiple variations at low costs. Based on 1, 3 or 4 poles, robust aluminum body with height of 1,5 meters, various number of shelves can be fitted to make a brochure set meeting your exact needs. To complete a product, main body and required quantities of shelves need to be ordered separately. Brochure holders are quickly and easily inserted.

Mehrseitige Prospektständer wurden entwickelt um vielfältige Variationen zu niedrigen Kosten zu bieten. Basierend auf einem, drei oder vier robustem Mastständer aus Aluminium mit einer Höhe von 1,5 m, können entsprechend Ablagen hinzugefügt werden, um einen Prospektständer Ihren Bedürfnissen entsprechend zu gestalten. Gestell und gewünschte Menge an Prospekthaltern müssen getrennt bestellt werden.



Product is packed unassembled with an easy-to-understand instruction sheet & fixing set. Das Produkt wird demontiert mit einer Montageanleitung und Befestigungsmaterial geliefert.



Heavy & stable base for public spaces. There are 4 plastic feet under the base. Die schwere und stabile Fussplatte ermöglicht den Einsatz an Plätzen mit viel Menschenverkehr



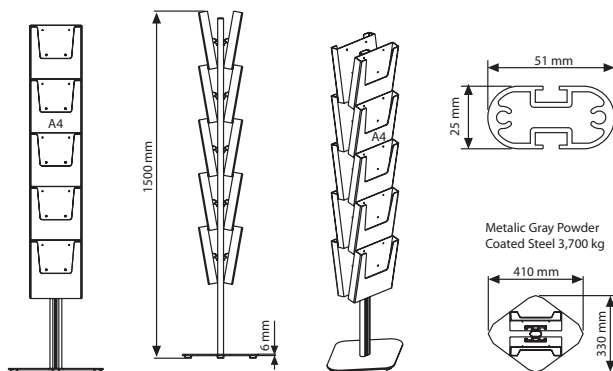
Shelves should be ordered separate. Please gently push the shelves over the connectors on the pole. The shelf connectors arrive at fixed positions. For individual adjustment please loosen the screws to move up and down.UMSDA008100 and UYUP490000 can be used to form UMSDA005A4 if you have them in your stock. Die Ablagen sind gesondert zu bestellen. Schieben Sie die Ablagen vorsichtig über die Verbindungsstücke auf den Standprofilen. Die Verbindungsstücke werden auf dem Standprofil montiert geliefert. Für individuelle Anwendungen, lösen Sie bitte zuerst die Schrauben, um die Verbindungsstücke nach oben oder unten verschieben zu können. Unsere Artikel UMSD008100 und UYUP490000 können bei diesem Artikel UMSDA005A4 eingesetzt werden, wenn Sie diese auf Lager haben.



2 packs. See info chart for pack sizes. 2 Packungen. Siehe Infodiagramm für Packungsgrößen.



UMBLG20523



MATERIAL : Anodised aluminium & clear acrylic			WEIGHT	PACKING SIZE
ARTICLE	DESCRIPTION	SIZE	WITH PACKING	*W X H X D
UMBSG205A4	Main body	5A4	1,890 kg	65 X 1520 X 65 mm
			4,090 kg	340 X 460 X 30 mm
UMBSG205A5	Main body	5A5	1,890 kg	65 X 1520 X 65 mm
			4,090 kg	340 X 460 X 30 mm
UMBSG20523	Main body	5X2A4/3	1,890 kg	65 X 1520 X 65 mm
			4,090 kg	340 X 460 X 30 mm
UMSDA005A4	Acrylic Shelf & Adapter	A4	2,500 kg	180 X 240 X 180 mm (5 Pcs)
UMSDA012A4	Acrylic Shelf & Adapter	A4	6,000 kg	270 X 400 X 270 mm (12 Pcs)
UMSDA000A5	Acrylic Shelf & Adapter	A5	3,200 kg	290 X 360 X 190 mm (12 Pcs)
UMSDA000A43	Acrylic Shelf & Adapter	1/3 A4	2,550 kg	250 X 320 X 180 mm (12 Pcs)
UMSDA02A43	Acrylic Shelf & Adapter	2X1/3 A4	4,350 kg	250 X 320 X 350 mm (12 Pcs)



*W:Width H: Height D: Depth

Multiside Brochure Set 3 Pole - 4 Pole



Multiside Brochure sets are developed to provide multiple variations at low costs. Based on 3 pole or 4 pole robust aluminum body at height of 1,5 meters, different number of shelves can be fitted to make a brochure set which meets your exact needs. To complete a product, main body and required quantities of shelves need to be ordered separately. Brochure holders are quickly and easily inserted.

Mehrseitige Prospektständer wurden entwickelt um vielfältige Variationen kostengünstig anzubieten. Basierend auf einem, drei oder vier Mastständer aus Aluminium mit einer Höhe von 1,5 m, können Ablagen hinzugefügt werden, um einen Prospektständer Ihren Bedürfnissen entsprechend zu gestalten. Gestell und gewünschte Menge an Prospekthaltern müssen getrennt bestellt werden.

Product is packed unassembled with an easy-to-understand instruction sheet & fixing set. Das Produkt wird demontiert mit einer Montageanleitung und Befestigungsmaterial geliefert.

Heavy & stable base for public spaces. There are 4 plastic feet under the base. Die schwere und stabile Fussplatte ermöglicht den Einsatz an Plätzen mit viel Menschenverkehr

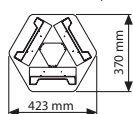
Shelves should be ordered separate. Please gently push the shelves over the connectors on the pole. The shelf connectors arrive at fixed positions. For individual adjustment please loosen the screws to move up and down.UMSDA005A4 and UYUP490000 can be used to form UMSDA005A4 if you have them in your stock. Die Ablagen sind gesondert zu bestellen. Schieben Sie die Ablagen vorsichtig über die Verbindungstücke auf den Standprofilen. Die Verbindungstücke werden auf dem Standprofil montiert geliefert. Für individuelle Anwendungen, lösen Sie bitte zuerst die Schrauben, um die Verbindungsstücke nach oben oder unten verschieben zu können. Unsere Artikel UMSD008100 und UYUP490000 können bei diesem Artikel UMSDA005A4 eingesetzt werden, wenn Sie diese auf Lager haben.

2 packs. See info chart for pack sizes. 2 Packungen. Siehe Infodiagramm für Packungsgrößen.

3 pole



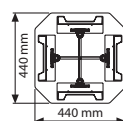
3 Side Base
Metalic Gray Powder
Coated Steel 5,600 kg



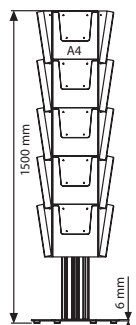
4 pole



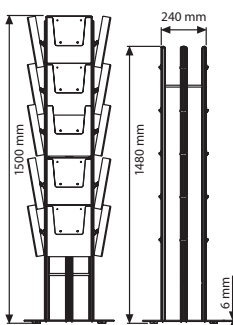
4 Side Base
Metalic Gray Powder
Coated Steel 8,700 kg



3 Side



4 Side



MATERIAL : Anodised aluminium & clear acrylic				WEIGHT 3 SIDE	PACKING SIZE 3 SIDE	WEIGHT 4 SIDE	PACKING SIZE 4 SIDE
3 SIDE	4 SIDE	DESCRIPTION	SIZE	WITH PACKING	*W X H X D	WITH PACKING	*W X H X D
UMBSG305A4	UMBSG405A4	Main body	5A4	1,890 kg	65 X 1520 X 65 mm	2,920 kg	290 X 1520 X 105 mm
UMBSG305A5	UMBSG405A5	Main body	5A5	4,090 kg	340 X 460 X 30 mm	9,080 kg	460 X 460 X 30 mm
UMBSG30523	UMBSG40523	Main body	5X2A4/3	1,890 kg	65 X 1520 X 65 mm	2,920 kg	290 X 1520 X 105 mm
UMBSG30523	UMBSG40523	Main body	5X2A4/3	4,090 kg	340 X 460 X 30 mm	9,080 kg	460 X 460 X 30 mm
UMSDA005A4	UMSDA005A4	Acrylic Shelf & Adapter	A4	2,500 kg	180 X 240 X 180 mm (5 Pcs)	2,500 kg	180 X 240 X 180 mm (5 Pcs)
UMSDA012A4	UMSDA012A4	Acrylic Shelf & Adapter	A4	6,000 kg	270 X 400 X 270 mm (12 Pcs)	6,000 kg	270 X 400 X 270 mm (12 Pcs)
UMSDA000A5	UMSDA000A5	Acrylic Shelf & Adapter	A5	3,200 kg	290 X 360 X 190 mm (12 Pcs)	3,200 kg	290 X 360 X 190 mm (12 Pcs)
UMSDA00A43	UMSDA00A43	Acrylic Shelf & Adapter	1/3 A4	2,550 kg	250 X 320 X 180 mm (12 Pcs)	2,550 kg	250 X 320 X 180 mm (12 Pcs)
UMSDA02A43	UMSDA02A43	Acrylic Shelf & Adapter	2X1/3 A4	4,350 kg	250 X 320 X 350 mm (12 Pcs)	4,350 kg	250 X 320 X 350 mm (12 Pcs)



*W:Width H: Height D: Depth

Multiside Brochure Set on Wheels



Multiside Brochure sets are developed to provide multiple variations at low costs. Based on 1 pole, 3 pole or 4 pole robust aluminium body at height of 1,6 meter, any number of shelves can be fitted to make a brochure set which meets your exact needs. To make a complete product, main body and required quantities of shelves need to be ordered separately. Product is freely rotatable and mobile in all directions over the wheels of the base providing flexibility in brochure presentation.

Mehrseitige Prospektständer wurden entwickelt um vielfältige Variationen zu niedrigen Kosten zu bieten. Basierend auf einem, drei oder vier robustem Mastständer aus Aluminium mit einer Höhe von 1,6 m, können entsprechend Ablagen hinzugefügt werden, um einen Prospektständer Ihren Bedürfnissen entsprechend zu gestalten. Gestell und gewünschte Menge an Prospekthaltern müssen getrennt bestellt werden. Das Produkt ist auf Rädern frei beweglich und drehbar.

Product is packed unassembled with an easy mounting instruction sheet & fixing set. Das Produkt wird demontiert mit einer Montageanleitung und Befestigungsmaterial geliefert.

Mobile & stable base for public space. There are 5 smooth rolling wheels under the base. Die mobile und stabile Fußplatte ermöglicht den Einsatz an Plätzen mit viel Menschenverkehr. Unter der Fußplatte befinden sich 5 Räder.

Shelves should be ordered separate. Please gently push the shelves over the connectors on the pole. The shelf connectors arrive at fixed positions. For individual adjustment please loosen the screws to move up and down. UMSD008100 and UYUP490000 can be used to form UMSDA005A4 if you have them in your stock. Die Ablagen sind gesondert zu bestellen. Schieben Sie die Ablagen vorsichtig über die Verbindungstücke auf den Standprofilen. Die Verbindungstücke werden auf dem Standprofil montiert geliefert. Für individuelle Anwendungen, lösen Sie bitte zuerst die Schrauben, um die Verbindungsstücke nach oben oder unten verschieben zu können. Unsere Artikel UMSD008100 und UYUP490000 können bei diesem Artikel UMSDA005A4 eingesetzt werden, wenn Sie diese auf Lager haben.

Color options : Silver-anodized & black
Farbenoptionen : schwarz und silber eloxiert.



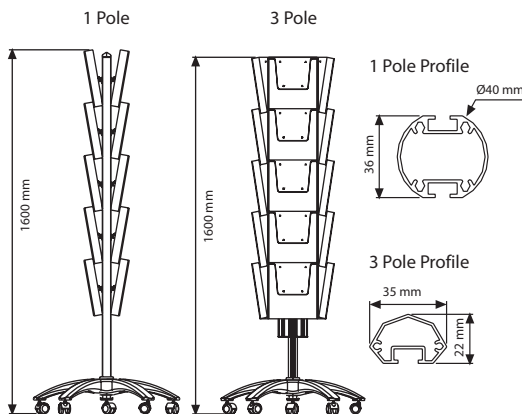
1 Pole Black



3 Pole Black



3 Pole Silver



MATERIAL : Aluminium & clear acrylic			
1 POLE	3 POLE	DESCRIPTION	SIZE
UMBSG2T5A4	UMBSG3T5A4	Silver main body	5A4
UMBBG2T5A4	UMBBG3T5A4	Black main body	5A4
UMSDA005A4	UMSDA005A4	Acrylic Shelf & Adapter	A4
UMSDA012A4	UMSDA012A4	Acrylic Shelf & Adapter	A4
UMSDA000A5	UMSDA000A5	Acrylic Shelf & Adapter	A5
UMSDA00A43	UMSDA00A43	Acrylic Shelf & Adapter	1/3 A4
UMSDA02A43	UMSDA02A43	Acrylic Shelf & Adapter	2X1/3 A4

1 POLE		3 POLE	
WEIGHT	PACKING SIZE	WEIGHT	PACKING SIZE
WITH PACKING	*W X H X D	WITH PACKING	*W X H X D
1,890 kg	700 X 1530 X 70 mm	1,900 kg	170 X 1330 X 146 mm
3,000 kg	710 X 720 X 186 mm	3,900 kg	710 X 720 X 186 mm
2,500 kg	180 X 240 X 180 mm (5 Pcs)	2,500 kg	180 X 240 X 180 mm (5 Pcs)
6,000 kg	270 X 400 X 270 mm (12 Pcs)	6,000 kg	270 X 400 X 270 mm (12 Pcs)
3,200 kg	290 X 360 X 190 mm (12 Pcs)	3,200 kg	290 X 360 X 190 mm (12 Pcs)
2,550 kg	250 X 320 X 180 mm (12 Pcs)	2,550 kg	250 X 320 X 180 mm (12 Pcs)
4,350 kg	250 X 320 X 350 mm (12 Pcs)	4,350 kg	250 X 320 X 350 mm (12 Pcs)

*W:Width H: Height D: Depth





Multiside Brochure Set Rotating






4 sided floor display, rotating on a central column which is mounted on a stable and elegant base. Height is 1600 mm, available in black and silver main body options. Shelves are clear in A4 all the time. Multiside Brochure sets have been developed to provide multiple variations at low costs. Different number of shelves can be fitted to make a brochure set which meets your exact needs.

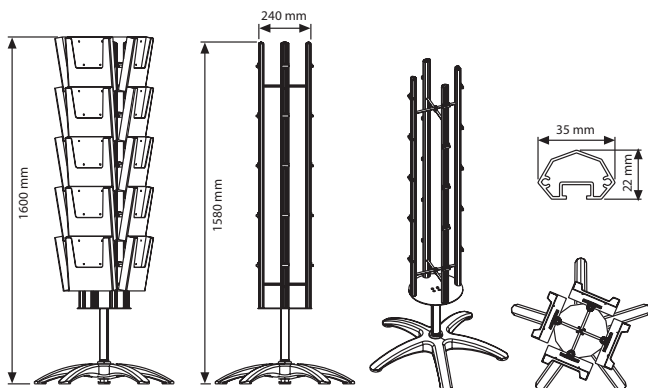
Vierseitige Prospektständer wurden entwickelt um vielfältige Variationen kostengünstig anzubieten. Basierend auf einem, drehbaren vier Mastständer aus Aluminium mit einer Höhe von 1,6 m, können entsprechend Ablagen hinzugefügt werden, um einen Prospektständer Ihren Bedürfnissen entsprechend zu gestalten. Gestell und gewünschte Menge an Prospekthaltern müssen bestellt werden.

 Product is packed unasssembled with an easy mounting instruction sheet & fixing set.
Das Produkt wird demontiert mit einer Montageanleitung und Befestigungsmaterial geliefert.

 Heavy & stable base for public space. While the main body is rotatable, the robust base is stable and still.
Die schwere und stabile Fussplatte ermöglicht den Einsatz an Plätzen mit viel Menschenverkehr. Während sich der Hauptkörper bewegt, bleibt die Fußplatte stabil und unbeweglich.

 Shelves should be ordered separate. Please gently push the shelves over the connectors on the pole. The shelf connectors arrive at fixed positions. For individual adjustment please loosen the screws to move up and down. UMSD008100 and UYUP490000 can be used to form UMSDA008A4 if you have them in your stock.
Die Ablagen sind gesondert zu bestellen. Schieben Sie die Ablagen vorsichtig über die Verbindungsstücke auf den Standprofilen. Die Verbindungsstücke werden auf dem Standprofil montiert geliefert. Für individuelle Anwendungen, lösen Sie bitte zuerst die Schrauben, um die Verbindungsstücke nach oben oder unten verschieben zu können. Unsere Artikel UMSD008100 und UYUP490000 können bei diesem Artikel UMSDA005A4 eingesetzt werden, wenn Sie diese auf Lager haben.

  Color options : Silver-anodized & black
Farbenoptionen : schwarz und silber eloxiert.



MATERIAL : Aluminium & clear acrylic			WEIGHT	PACKING SIZE
ARTICLE	DESCRIPTION	SIZE	WITH PACKING	*W X H X D
UMBSG4D5A4	Silver main body	5A4	2,920 kg	290 X 1520 X 105 mm
UMBBG4D5A4	Black main body	5A4	9,080 kg	460 X 460 X 30 mm
UMSDA005A4	Acrylic Shelf & Adapter	A4	2,500 kg	180 X 240 X 180 mm (5 Pcs)
UMSDA012A4	Acrylic Shelf & Adapter	A4	6,000 kg	270 X 400 X 270 mm (12 Pcs)
UMSDA000A5	Acrylic Shelf & Adapter	A5	3,200 kg	290 X 360 X 190 mm (12 Pcs)
UMSDA00A43	Acrylic Shelf & Adapter	1/3 A4	2,550 kg	250 X 320 X 180 mm (12 Pcs)
UMSDA02A43	Acrylic Shelf & Adapter	2X1/3 A4	4,350 kg	250 X 320 X 350 mm (12 Pcs)

*W:Width H: Height D: Depth



Brochure Sets



A brochure holder designed to keep minimum 6 / maximum 32 brochures at the same time in stores, galleries and banks. When used with 4 wheels it is free and mobile. Single or double-faced options are available. Transparent shelves are made of 4 mm acrylic, the legs are made of aluminum.

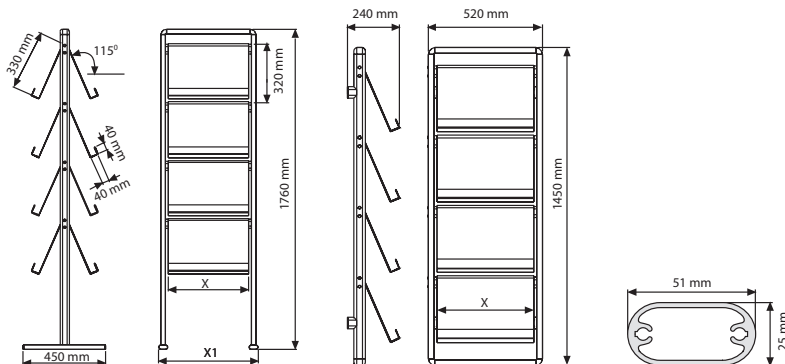
Ein Prospekthalter mit dem Sie gleichzeitig mindestens 6, maximal 32 Prospekte in Banken, Einkaufshäusern und Gallerien präsentieren können. Bei Benutzung mit 4 Stück Lenkrollen (optionell), ist der Ständer einfach hin und her zu bewegen. Einseitige oder doppelseitige Variationen sind erhältlich. Die transparenten Ablagen sind aus 4 mm Acryl, der Ständer aus Aluminium.



Product is packed unassembled with an easy-to-understand instruction sheet & fixing set. Das Produkt wird demontiert mit einer Montageanleitung und Befestigungsmaterial geliefert.



Wheels are optional, not included in the original pack. Shelves are packed separate in a protected box. Die Verpackung beinhaltet keine Lenkrollen. Diese sind gesondert zu bestellen. Die Ablagen sind getrennt in einem schützenden Karton verpackt.



FOR WALL : Silver anodised aluminium & acrylic shelf

ARTICLE	CAPACITY	WEIGHT WITH PACKING	PACKING SIZE *W X H X D
UBSSD10N24	8 X A4	13,000 kg	550 X 1500 X 130 mm

MATERIAL : Silver anodised aluminium & acrylic shelf

ARTICLE	CAPACITY	X	X1	WEIGHT WITH PACKING	PACKING SIZE *W X H X D
UBSSC10N24	16 X A4 double sided	440 mm	546 mm	8,250 kg	560 X 1780 X 80 mm
UBSST10N24	8 X A4 single sided	440 mm	546 mm	12,450 kg	560 X 1780 X 70 mm
UBSSC10N34	24 X A4 double sided	660 mm	766 mm	9,250 kg	780 X 1780 X 80 mm
UBSST10N34	12 X A4 single sided	660 mm	766 mm	15,850 kg	780 X 1780 X 70 mm
UBSSC10N44	32 X A4 double sided	880 mm	986 mm	11,250 kg	1000 X 1780 X 80 mm
UBSST10N44	16 X A4 single sided	880 mm	986 mm	19,400 kg	1000 X 1780 X 70 mm

*W:Width H: Height D: Depth



Decorative Brochure Stand Decorative Brochure Stand Plus



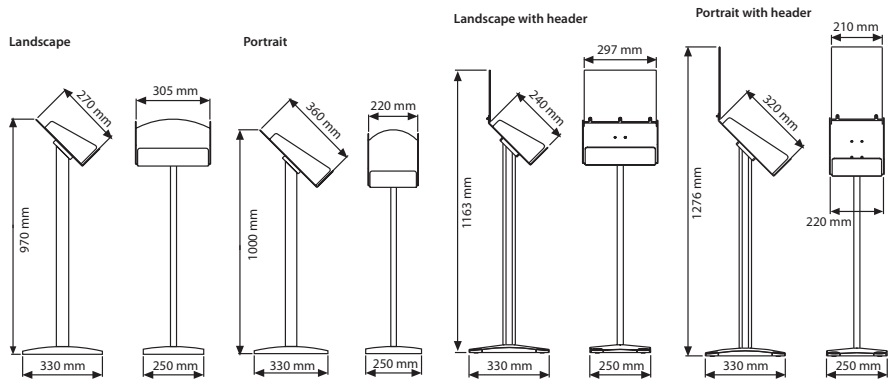
Watch video at our website
www.mtdisplays.com



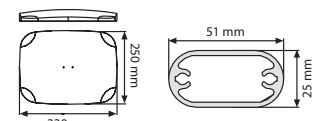
Decorative Brochure Stand is available in A4 size. It is easy to change top header in portrait & landscape positions. Height is 970 mm in landscape position and 1000 mm in portrait position. It has a perfectly convenient size in both portrait and landscape positions. Equipped with sturdy decorative powder coated base. Soft feet prevent the product sliding and the surface scratching. It is ideal for exhibition, museum, conference and showroom areas. Decorative Brochure Stand adds value to your brand's announcements or information brochures. Its modern and qualified look ensures your brands and its announcement attracts the attention deserve.

Der dekorative Prospektständer ist im A4-Format erhältlich. Es ist einfach, die Kopfzeile in Hoch- und Querformat zu ändern. Die Höhe beträgt 970 mm im Querformat und 1000 mm im Hochformat. Es hat sowohl im Hoch- als auch im Querformat eine perfekt praktische Größe. Ausgestattet mit einem stabilen, dekorativen, pulverbeschichteten Sockel. Weiche Füße verhindern ein Verrutschen des Produkts und ein Verkratzen der Oberfläche. Es ist ideal für Ausstellungs-, Museums-, Konferenz- und Showroombereiche. Der dekorative Prospektständer wertet die Ankündigungen oder Informationsbroschüren Ihrer Marke auf. Sein modernes und qualifiziertes Erscheinungsbild sorgt dafür, dass Ihre Marke und Ihre Ankündigung die verdiente Aufmerksamkeit erregen.

- Assembly kit included. Inklusive Montagesatz.
- Offers portrait & landscape positions. Bietet Positionen im Hoch- und Querformat.
- Assembly in 60 seconds. Montage in 60 Sekunden.
- 2 box. 2 boxes



Decorative base powdercoated 9006 1,62 kg

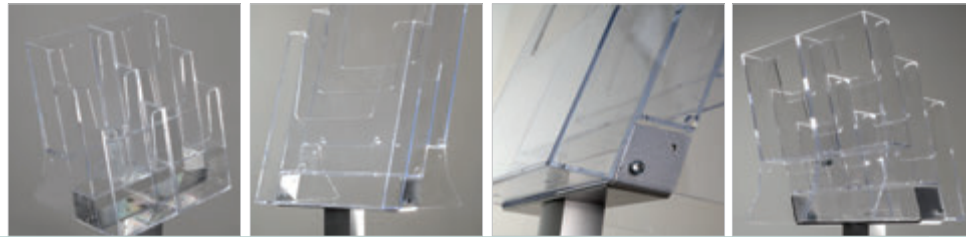


MATERIAL : Silver anodised aluminium & acrylic		WEIGHT	PACKING SIZE
ARTICLE	DESCRIPTION	WITH PACKING	*W X H X D
UDBS20Y0A4	A4 landscape with logo	3,980 kg	280 X 880 X 125 mm
UDBS20D0A4	A4 portrait with logo	3,980 kg	280 X 880 X 125 mm
UDBS10Y0A4	A4 landscape	3,450 kg	280 X 880 X 125 mm
UDBS10D0A4	A4 portrait	3,450 kg	280 X 880 X 125 mm

*W:Width H: Height D: Depth



Pillar Brochure Stand



New selection of literature display including injected counter top with a robust aluminum body. 3x A4 capacity and 6x 1/3 A4 capacity standards are available.

Eine neue Ausführung des Prospektständers mit Spritzguß-oberteil und Aluminium Gestell. 3x A4 Kapazitäten und 6x 1/3 A4 Kapazitäten sind standardmäßig zu beziehen.



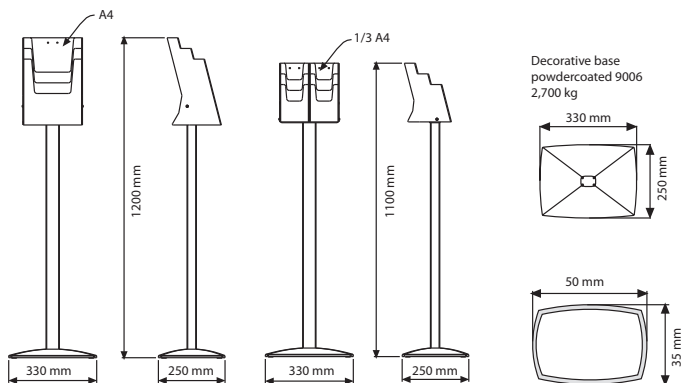
Packed unassembled with instruction sheet & fixing set. Der Artikel wird demontiert mit einer Montageanleitung und Befestigungsmaterial geliefert.



Heavy stable base for public spaces. Die schwere und stabile Fußplatte ermöglicht den Einsatz an Plätzen mit viel Menschenverkehr.



2 packs. See info chart for pack sizes. 2 Packungen. Siehe Infodiagramm für Packungsgrößen.



MATERIAL : Silver anodised aluminium & acrylic			
ARTICLE	SIZE	WEIGHT WITH PACKING	*W X H X D
UPBS3000A4	A4	4,230 kg	270 X 420 X 190 mm
		0,820 kg	70 X 870 X 45 mm
UPBS300A43	1/3 A4	4,070 kg	270 X 520 X 190 mm
		0,820 kg	70 X 870 X 45 mm



* W:Width H: Height D: Depth

Zick-Zack



Decorative legs are made of silver anodised aluminium ellipse profile, shelves are made of 10 mm acrylic. Metallic powdercoated base is made up of 8 mm aluminium or metallic powder coated base.

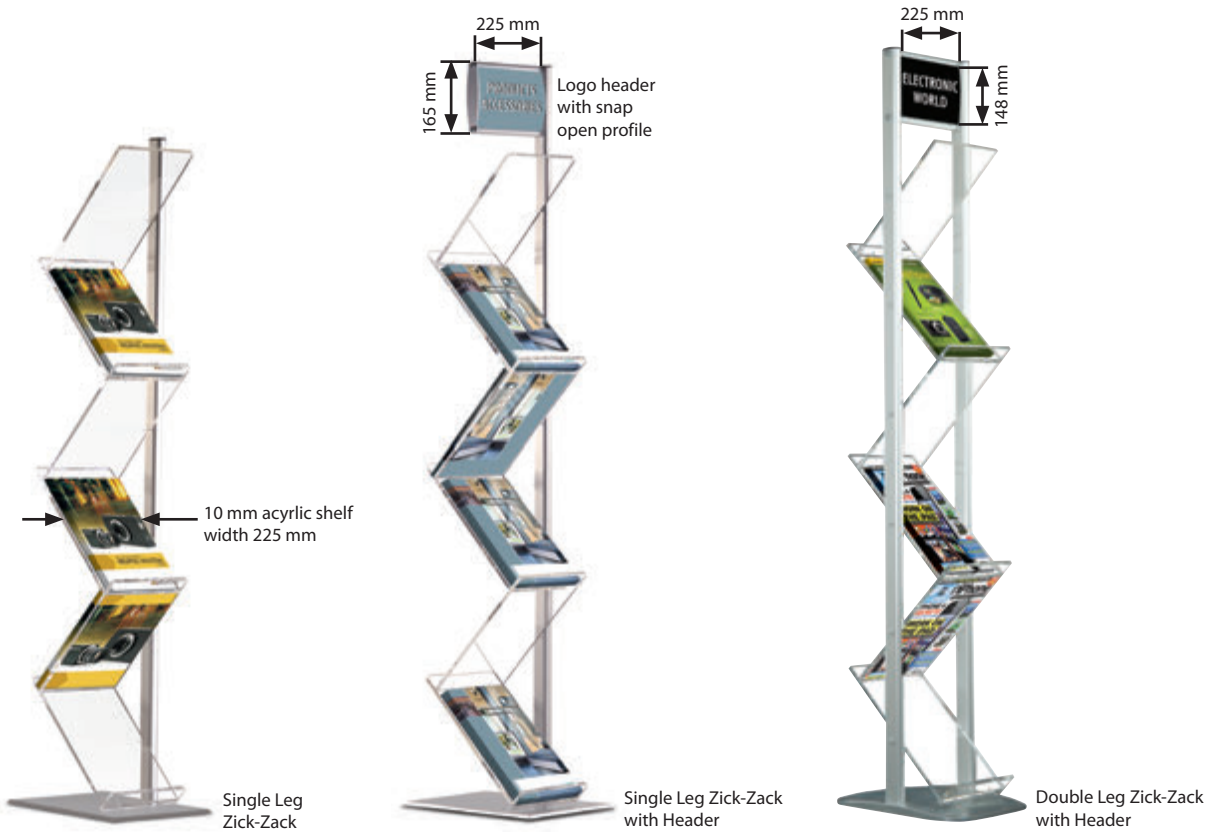
Das Seitenprofil besteht aus Ellipsenförmigem Aluminium und die Ablagen aus 10 mm Acryl. Die Fußplatte ist aus metallisch pulverbeschichtetem 8 mm Aluminium.

Product comes unassembled with instruction sheet. Das Produkt wird demontiert mit einer Montageanleitung und Befestigungsmaterial geliefert.

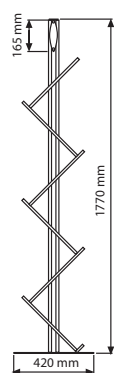
Easy to change header logo & message. Heavy stable base is suitable for public spaces. Leichtes Auswechseln des Logos im Topschild. Mit rostfreien Aluminiumfüßen für den Außenbereich geeignet.

Use the hole caps in the hardware set to cover the mounting holes. Benutzen Sie die mitgelieferten Plastikkappen um die Montagelöcher zu verdecken.

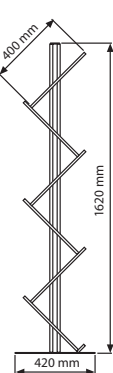
2 packs. See info chart for pack sizes. 2 Packungen. Siehe Infodiagramm für Packungsgrößen.



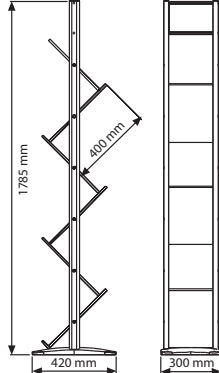
Single leg with header



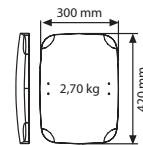
Single leg



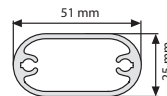
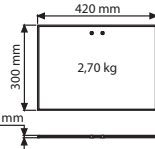
Double leg



Double Leg Base
Decorative base powdercoated 9006



Single Leg Base
8 mm RAL 9006 Powdercoated aluminium base



MATERIAL : Silver anodised aluminium
SHELF : Acrylic

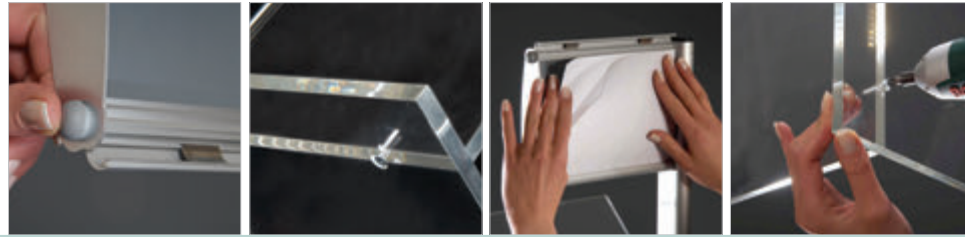
ARTICLE	MODELS	CAPACITY
UZZTAC1001	Single leg	6 X A4
UZZTAC1002	Single leg with header	6 X A4
UZZCAC1002	Double Leg	6 X A4

WEIGHT	PACKING SIZE
WITH PACKING	SHELF & BASE
11,350 kg	330 X 440 X 130 mm
11,500 kg	330 X 440 X 130 mm
13,350 kg	330 X 440 X 170 mm

*W:Width H: Height D: Depth



Zick-Zack Lite



Zick Zack Lite is developed to provide 6x A4 catalogues at one time with affordable price offer. Saving price of 25% over the classical Zick Zack in range. Based on metallic powder coated, semi-metal, plastic coated base; product stands stable and long life on floor in public places. Metallic colour base is 4,30 kg and transparent acrylic shelves are 8 mm. Stand is packed unassembled with friendly-to-apply instruction sheet. Products is inclusive of hole end caps and hardware set in each pack.

Zick Zack Lite wurde entwickelt um 6x A4 Kataloge zum erschwinglichen Preis zur gleichen Zeit greifbereit zu halten. Gegenüber unserem klassischem Zick Zack Standardprodukt ermöglicht dieses Produkt einen Preisvorteil von über 25%. Der Artikel ist metallisch pulverbeschichtet, mit Metall erschwertem, Plastik Spritzgussfuß. Der Artikel steht fest und stabil und ist langlebig an offiziellen Standorten. Der metallisch farbene Fuss ist 4,30 kg schwer und die transparenten Acrylregale sind 8 mm stark. Der Artikel wird demontiert mit leicht verständlicher Aufbauanleitung geliefert. In jedem Produktpaket befindet sich Montagematerial.

Product comes unassembled with instruction sheet. Das Produkt wird demontiert mit einer Montageanleitung und Befestigungsmaterial geliefert.

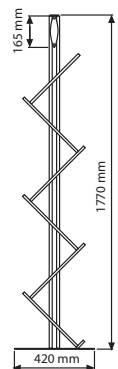
Easy to change header logo & message. Heavy stable base is suitable for public spaces. Leichtes Auswechseln des Logos im Topschild. Mit rostfreien Aluminiumfüßen für den Aussenbereich geeignet.

Use the hole caps in the hardware set to cover the mounting holes. Benutzen Sie die mitgelieferten Plastikkappen um die Montagelöcher zu verdecken.

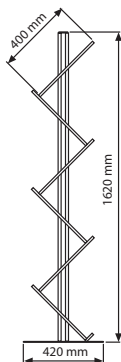
2 packs. See info chart for pack sizes. 2 Packungen. Siehe Infodiagramm für Packungsgrößen.



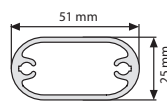
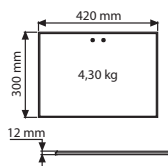
Single leg with header



Single leg



RAL 9006 Powdercoated steel base with plastic cover



MATERIAL : Silver anodised aluminium SHELF : Acrylic			WEIGHT	PACKING SIZE	
ARTICLE	MODELS	CAPACITY	WITH PACKING	SHELF & BASE	ELIPS PROFILE
UZZTL0001	Single leg	6 X A4	12,500 kg	330 X 440 X 130 mm	70 X 1670 X 50 mm
UZZTL0002	Single leg with header	6 X A4	12,500 kg	330 X 440 X 130 mm	70 X 1820 X 50 mm

*W:Width H: Height D: Depth



Newage Portable Zick-Zack



Watch video at our website www.mtdisplays.com



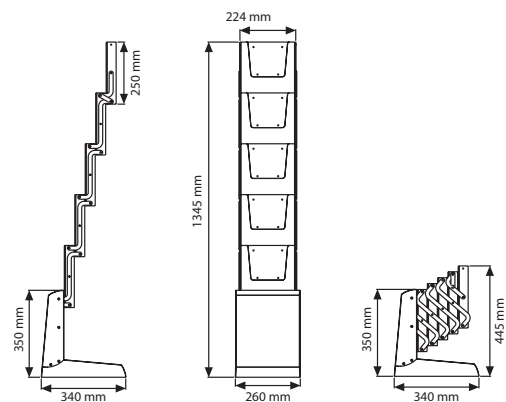
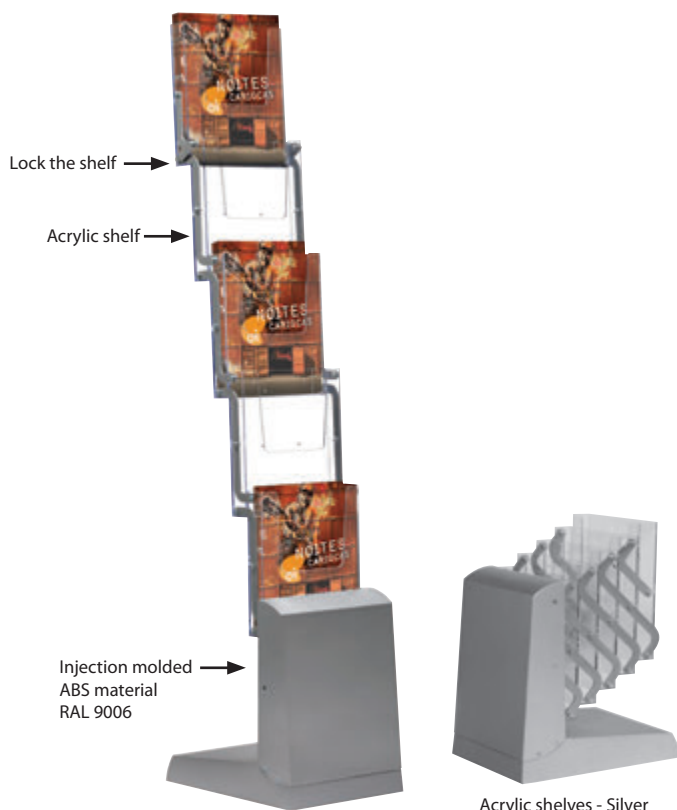
Restyled Newage Portable Zick-Zack is a foldable unit that provides 5 shelves of A4 capacity. Newage Portable Zick-Zack shelves allow to fold the unit while the brochures are still stored in. The size of the bag: 380 x 470 x 280 mm. It's a handy and smart product for mobile presentations and events.

Newage tragbarer Zick-Zack ist ein faltbarer Artikel, welches 5 Prospektfächer in A4 Kapazität bietet. Ausserdem kann der Newage tragbarer Zick-Zack mit beladenen Prospektfächern zusammengefasst werden. Masse der Targetasche: 380x470x280 mm. Ein perfektes Produkt für mobile Präsentationen.

Product is packed assembled, folded in single box. Das Produkt wird montiert, zusammengefasst in Einzelpackung angeboten.

No tool assembly, easy to build-up & ready to use. Aufbau ohne Werkzeuge, Fertig zum Einsatz

Lock the top shelf in position for stable display. Bag is provided optional. Der Artikel muss am obersten Prospektfach verriegelt werden, um Stabilität zu gewähren. Die Tasche wird Optionell angeboten.



MATERIAL : Clear & Grey RAL 9006			WEIGHT	PACKING SIZE
ARTICLE	CAPACITY	DESCRIPTION	WITH PACKING	*W X H X D
UZZEPS0100	5 X A4	Acrylic shelf with bag - Silver	5,500 kg	310 X 520 X 410 mm
UZZEPS0000	5 X A4	Acrylic shelf without bag - Silver	5,000 kg	310 X 520 X 410 mm
UZZEPS0100	5 X A4	Sheet metal shelf with bag - Black	5,500 kg	310 X 520 X 410 mm
UYUP072400	5 X A4	Bag	1,500 kg	310 X 520 X 410 mm

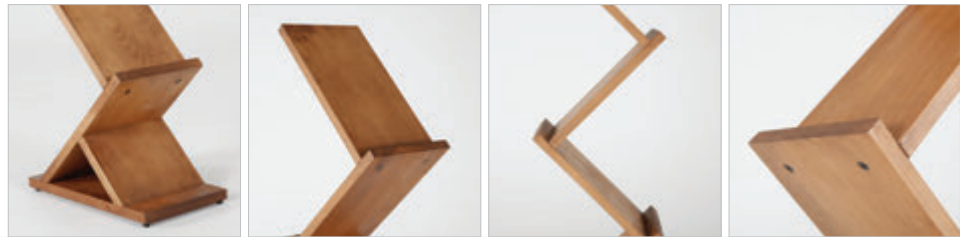
*W:Width H: Height D: Depth



Wood Zick-Zack



Watch video at our website www.mtdisplays.com



Wood Zick-Zack is made of beech wood. Lacquered finish is applied for long term use. It is resistant to the spill of food and fizzy drinks. It is double-sided and suitable for using 5 documents in A4 size. Its vintage and unique wood-grain look offers options. It can be used as a literature holder, magazine rack, brochure display stand, catalogue, leaflet, flier holder for fairs, shows, conferences, conventions, meetings, offices and showrooms. It creates a friendly atmosphere to your business advertisement.

Der Wood Zick-Zack ist aus Buchenholz gefertigt. Lackiertes Finish wird für den Langzeitgebrauch aufgetragen. Es ist beständig gegen das Verschütten von Speisen und kohlenensäurehaltigen Getränken. Es ist doppelseitig und für die Verwendung von 5 Dokumenten im A4-Format geeignet. Sein Vintage- und einzigartiger Holzmaserungs-Look bietet Optionen. Es kann als Prospekthalter, Zeitschriftenständer, Prospektständer, Katalog, Prospekt, Flyerhalter für Messen, Shows, Konferenzen, Tagungen, Besprechungen, Büros und Ausstellungsräume verwendet werden. Es schafft eine freundliche Atmosphäre für Ihre Geschäftsanzeige.



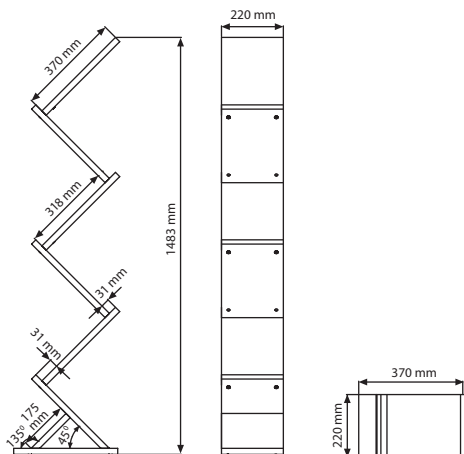
Resistant to the spill of food and fizzy drinks.
Beständig gegen das Verschütten von Speisen und kohlenensäurehaltigen Getränken



5 documents in A4 size.
5 Dokumente im A4-Format.



Assembly in 60 seconds.
Montage in 60 Sekunden.



MATERIAL : Beech wood		WEIGHT	PACKING SIZE
ARTICLE	CAPACITY	WITH PACKING	*W X H X D
UZZWD005A4	5 X A4 - 8.5" X 11"	9,600 kg	260 X 410 X 210 mm

* W:Width H: Height D: Depth



Foldable Zick Zack Perforated Shelves

1xA4

Single Sided



Watch video at our website www.mtdisplays.com



Foldable Zick-Zack is single sided. Its foldable flat design provides space saving and easy transportation. Locking system ensures safe use. Carrying handle provides easy carriage. Black carry bag is optional. It is single-sided and it suitable for using 4 documents in A4 size. It can be used as a literature holder, magazine rack, brochure display stand, catalogue, leaflet, flier holder for fairs, shows, conferences, conventions, meetings, offices and showrooms. It is very practical to set up in few seconds, by lifting up the brochure holders and locking the system at the bottom.

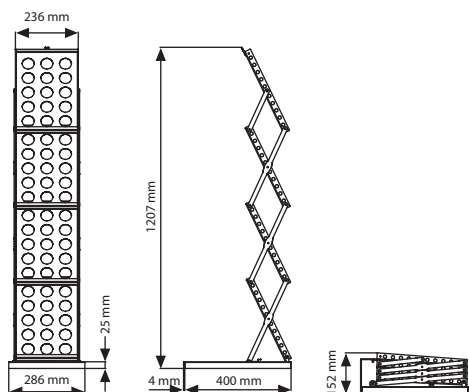
Der faltbare Zick-Zack ist einseitig. Sein faltbares flaches Design sorgt für Platzersparnis und einfachen Transport. Das Verriegelungssystem gewährleistet eine sichere Verwendung. Tragegriff sorgt für einfachen Transport. Schwarze Tragetasche ist optional. Es ist einseitig und für die Verwendung von 4 Dokumenten im A4-Format geeignet. Es kann als Prospekthalter, Zeitschriftenständer, Prospektständer, Katalog, Prospekt, Flyerhalter für Messen, Shows, Konferenzen, Tagungen, Besprechungen, Büros und Ausstellungsräume verwendet werden. Es ist sehr praktisch, es in wenigen Sekunden aufzubauen, indem die Prospekthalter hochgeklappt und das System unten verriegelt werden.

Black carry bag is optional. Schwarze Tragetasche ist optional.

4 documents in A4 size. 4 Dokumente im A4-Format.

Assembly in 60 seconds. Montage in 60 Sekunden.

Color options : Silver & black
Farbenoptionen : Schwarz und silber



MATERIAL: Sheet metal & wood			WEIGHT	PACKING SIZE
ARTICLE	CAPACITY	DESCRIPTION	WITH PACKING	**W X H X D
UFZHS10414	A4 - 8.5" X 11"	Single sided - 4 shelves	6,250 kg	190 X 330 X 440 mm

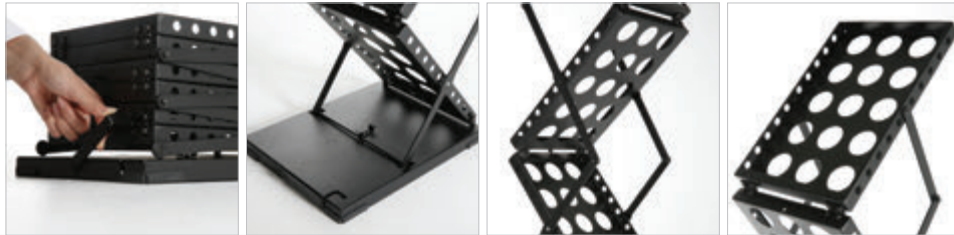


* W:Width H: Height D: Depth

Foldable Zick Zack Perforated Shelves 1xA4 Double Sided



Watch video at our website www.mtdisplays.com



Foldable Zick-Zack is double sided. Its foldable flat design provides space saving and easy transportation. Locking system ensures safe use. Carrying handle provides easy carriage. Black carry bag is optional. It is double-sided and it suitable for using 6 documents in A4 size. It can be used as a literature holder, magazine rack, brochure display stand, catalogue, leaflet, flier holder for fairs, shows, conferences, conventions, meetings, offices and showrooms. It is very practical to set up in few seconds, by lifting up the brochure holders and locking the system at the base.

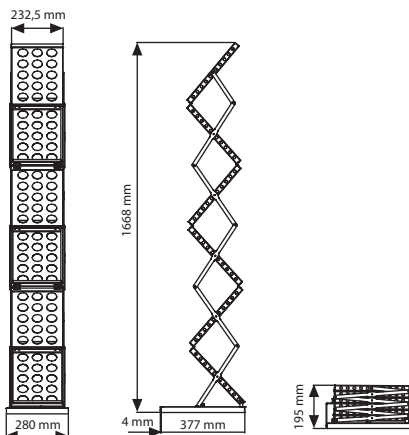
Der faltbare Zick-Zack ist doppelseitig. Sein faltbares flaches Design sorgt für Platzersparnis und einfachen Transport. Das Verriegelungssystem gewährleistet eine sichere Verwendung. Tragegriff sorgt für einfachen Transport. Schwarze Tragetasche ist optional. Es ist doppelseitig und eignet sich für 6 Dokumente im A4-Format. Es kann als Prospekthalter, Zeitschriftenständer, Prospektständer, Katalog, Prospekt, Flyerhalter für Messen, Shows, Konferenzen, Tagungen, Besprechungen, Büros und Ausstellungsräume verwendet werden. Es ist sehr praktisch, es in wenigen Sekunden aufzubauen, indem die Prospekthalter hochgeklappt und das System an der Basis verriegelt werden.

Black carry bag is optional. Schwarze Tragetasche ist optional.

5 documents in A4 size. 5 Dokumente im A4-Format.

Assembly in 60 seconds. Montage in 60 Sekunden.

Color options : Silver & black
Farbenoptionen : Schwarz und silber



MATERIAL: Sheet metal & wood			WEIGHT	PACKING SIZE
ARTICLE	CAPACITY	DESCRIPTION	WITH PACKING	*W X H X D
UFZHD10614	A4 - 8.5" X 11"	Double Sided - 6 shelves	8,600 kg	230 X 330 X 410 mm

*W:Width H: Height D: Depth



Foldable Wood Counter with Perforated Shelves

1xA4



Watch video at our website www.mtdisplays.com



Foldable Wood Counter with Perforated Shelves has 1xA4 capacity. Shelf carrying capacity is 1,5 kg. It has black body&dark wood top and black body&black top options. Its heavy steel base provides durability. Foldable flat design provides space saving and easy transportation. Locking system ensure safe use. Black carry bag is optional. It is very practical to set up in few seconds, by lifting up the brochure holders and locking the system at the bottom and top as well.

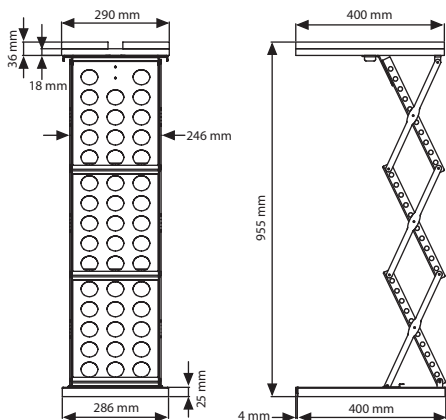
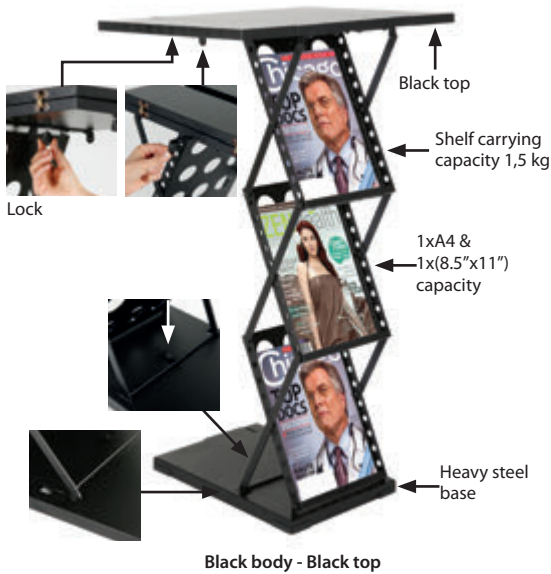
Faltbare Holztheke mit perforierten Regalen hat eine Kapazität von 1 x A4. Die Tragfähigkeit des Regals beträgt 1,5 kg. Es hat einen schwarzen Korpus und eine dunkle Holzplatte sowie Optionen mit schwarzem Korpus und schwarzer Oberseite. Seine schwere Stahlbasis sorgt für Langlebigkeit. Das faltbare flache Design bietet Platzersparnis und einfachen Transport. Verriegelungssystem sorgen für eine sichere Verwendung. Schwarze Tragetasche ist optional. Es ist sehr praktisch, es in wenigen Sekunden aufzubauen, indem die Prospekthalter hochgeklappt und das System sowohl unten als auch oben verriegelt werden.

Black carry bag is optional. Schwarze Tragetasche ist optional.

Has black body&dark wood top and black body&black top options. Hat Optionen mit schwarzem Korpus und dunkler Holzplatte sowie mit schwarzem Korpus und schwarzer Oberseite.

Assembly in 60 seconds. Montage in 60 Sekunden.

Color options : Silver & black
Farbenoptionen : Schwarz und silber



MATERIAL: Sheet metal & wood			WEIGHT	PACKING SIZE
ARTICLE	CAPACITY	DESCRIPTION	WITH PACKING	*W X H X D
UWFH1B0314	1 X A4 - 8.5" X 11"	Black body - Black top	8,700 kg	210 X 340 X 440 mm
UWFH1B1314	1 X A4 - 8.5" X 11"	Black body - Black top with bag	8,700 kg	210 X 340 X 440 mm
UWFH1D0314	1 X A4 - 8.5" X 11"	Black body - Dark wood top	8,700 kg	210 X 340 X 440 mm
UWFH1D1314	1 X A4 - 8.5" X 11"	Black body - Dark wood top with bag	8,700 kg	210 X 340 X 440 mm

*W:Width H: Height D: Depth



Foldable Wood Counter 2x A4



Watch video at our website www.mtdisplays.com



Foldable Wood Counter has 2x A4 capacity. Shelf carrying capacity is 3 kg. It has black body&black top, black body&dark wood top, silver body&black top, silver body&dark wood top, white body&dark wood top options. Its heavy steel base provides durability. Foldable flat design provides space saving and easy transportation. Locking system ensure safe use. Black carry bag is optional. It is very practical to set up in few seconds, by lifting up the brochure holders and locking the system at the bottom and top as well.

Die faltbare Holztheke hat eine Kapazität von 2 x A4. Die Tragfähigkeit des Regals beträgt 3 kg. Es hat schwarzen Korpus und schwarzes Oberteil, schwarzen Korpus und dunkles Holzoberteil, silbernen Korpus und schwarzes Oberteil, silbernen Korpus und dunkles Holzoberteil, weißen Korpus und dunkles Holzoberteil. Seine schwere Stahlbasis sorgt für Langlebigkeit. Das faltbare flache Design bietet Platzersparnis und einfachen Transport. Verriegelungssystem sorgen für eine sichere Verwendung. Schwarze Tragetasche ist optional. Es ist sehr praktisch, es in wenigen Sekunden aufzubauen, indem die Prospekthalter hochgeklappt und das System sowohl unten als auch oben verriegelt werden.



Black carry bag is optional. Schwarze Tragetasche ist optional.

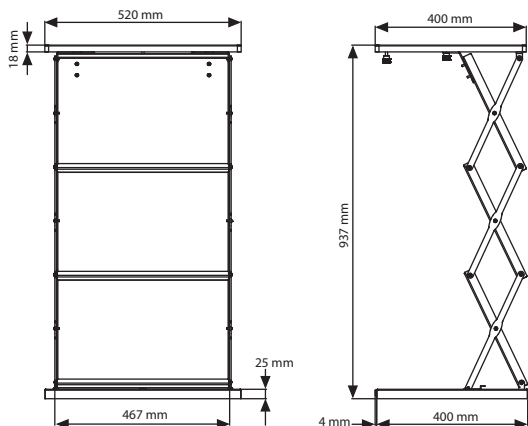
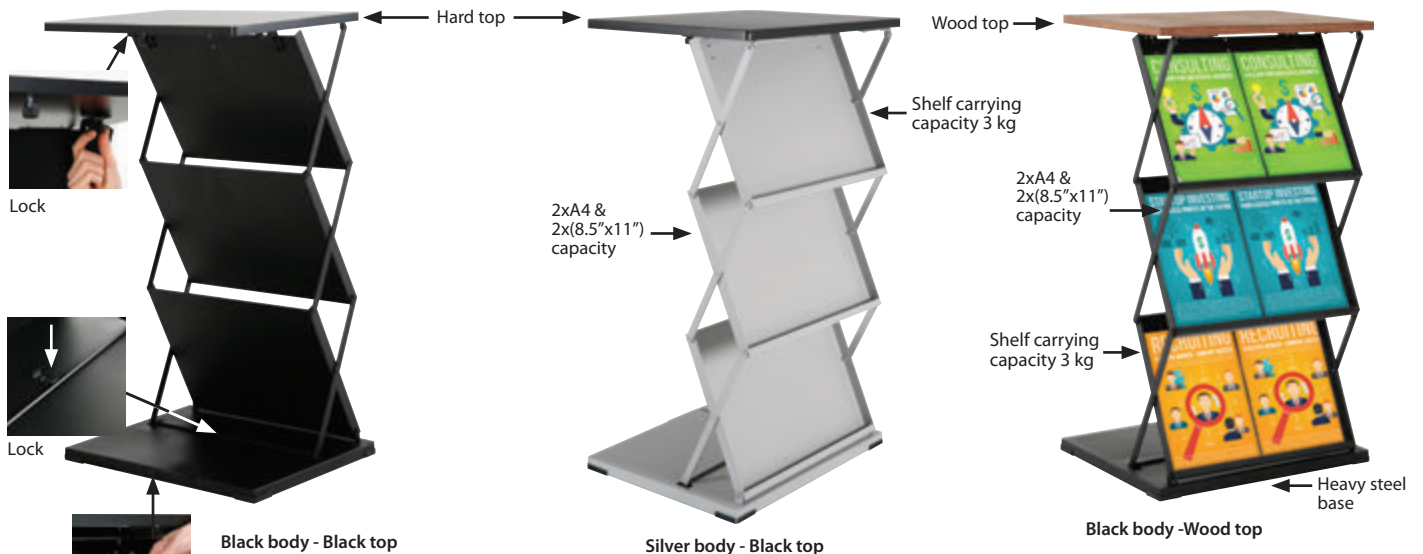


Has black body&black top, black body&dark wood top, silver body&black top, silver body&dark wood top, white body&dark wood top options. Optionen mit schwarzem Korpus und schwarzem Oberteil, schwarzem Korpus und dunklem Holzoberteil, silbernem Korpus und schwarzem Oberteil, silbernem Korpus und dunklem Holzoberteil, weißem Korpus und dunklem Holzoberteil.

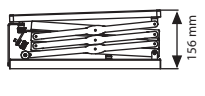


Assembly in 60 seconds. Montage in 60 Sekunden.

Color options : Silver, black and white
Farbenoptionen : Schwarz, silber und weiß



Black carry bag



MATERIAL: Sheet metal & wood			WEIGHT	PACKING SIZE
ARTICLE	CAPACITY	DESCRIPTION	WITH PACKING	*W X H X D
UWFC1B0324	2 X A4 - 8.5" X 11"	Black body - Black top	13,530 kg	430 X 560 X 150 mm
UWFC1B1324	2 X A4 - 8.5" X 11"	Black body - Black top with bag	14,000 kg	450 X 580 X 160 mm
UWFC1D0324	2 X A4 - 8.5" X 11"	Black body - Dark wood top	13,530 kg	430 X 560 X 150 mm
UWFC1D1324	2 X A4 - 8.5" X 11"	Black body - Dark wood top with bag	14,000 kg	450 X 580 X 160 mm
UWFC2B0324	2 X A4 - 8.5" X 11"	Silver body - Black top	13,530 kg	430 X 560 X 150 mm
UWFC2B1324	2 X A4 - 8.5" X 11"	Silver body - Black top with bag	14,000 kg	450 X 580 X 160 mm
UWFC2D0324	2 X A4 - 8.5" X 11"	Silver body-Dark wood top	13,530 kg	430 X 560 X 150 mm
UWFC2D1324	2 X A4 - 8.5" X 11"	Silver body-Dark wood top with bag	14,000 kg	450 X 580 X 160 mm
UWFC3W0324	2 X A4 - 8.5" X 11"	White body-Dark wood top	13,530 kg	430 X 560 X 150 mm
UWFC3W1324	2 X A4 - 8.5" X 11"	White body-Dark wood top with bag	14,000 kg	450 X 580 X 160 mm

*W:Width H: Height D: Depth



Foldable Wood Counter with Perforated Shelves 2xA4



Foldable Wood Counter with Perforated Shelves has 2xA4 capacity. The document holder has a perforated shelf design. It has black body&dark wood top, black body&black top and white body&white top options. Its heavy steel base provides durability. Foldable flat design provides space saving and easy transportation. Locking system ensure safe use. Black carry bag is optional. It is very practical to set up in few seconds, by lifting up the brochure holders and locking the system at the bottom and top as well.

Die Faltbare Holztheke mit perforierten Regalen hat eine Kapazität von 2 x A4. Der Dokumentenhalter hat ein perforiertes Regaldesign. Es hat einen schwarzen Körper und eine dunkle Holzplatte, einen schwarzen Körper und eine weiße Oberseite sowie weiße Körper und eine weiße Oberseite. Seine schwere Stahlbasis sorgt für Langlebigkeit. Das faltbare flache Design bietet Platzersparnis und einfachen Transport. Verriegelungssystem sorgen für eine sichere Verwendung. Schwarze Tragetasche ist optional. Es ist sehr praktisch, es in wenigen Sekunden aufzubauen, indem die Prospekthalter hochgeklappt und das System sowohl unten als auch oben verriegelt werden.

Black carry bag is optional. Schwarze Tragetasche ist optional.

Has black body&dark wood top, black body&black top and white body&white top options. Optionen mit schwarzem Korpus und dunklem Holzoberteil, schwarzem Korpus und schwarzem Oberteil sowie weißem Korpus und weißem Oberteil.

Assembly in 60 seconds. Montage in 60 Sekunden.

Color options : Silver, black and white
Farbenoptionen : Schwarz, silber und weiß

Black top

Lock

Lock

Lock

Black body -Black body

Product weight is 11 kg

Portable

Carrying handle

Shelf carrying capacity 3 kg

White top

2x A4 & 2x(8.5"x11") capacity

White body -White top

Product weight is 11 kg

Portable

Carrying handle

Shelf carrying capacity 3 kg

Heavy steel base

Wood top

2x A4 & 2x(8.5"x11") capacity

Black body -Wood top

Product weight is 11 kg

Portable

Carrying handle

Shelf carrying capacity 3 kg

Heavy steel base

No tool assembly

520 mm

18 mm

467 mm

25 mm

400 mm

937 mm

400 mm

4 mm

156 mm

Black carry bag

MATERIAL: Sheet metal & wood			WEIGHT	PACKING SIZE
ARTICLE	CAPACITY	DESCRIPTION	WITH PACKING	*W X H X D
UWFH1D0324	2 X A4 - 8.5" X 11"	Black body - Dark wood top	11,880 kg	430 X 560 X 150 mm
UWFH1D1324	2 X A4 - 8.5" X 11"	Black body - Dark wood top with bag	12,350 kg	450 X 580 X 160 mm
UWFH1B0324	2 X A4 - 8.5" X 11"	Black body - Black top	11,880 kg	430 X 560 X 150 mm
UWFH1B1324	2 X A4 - 8.5" X 11"	Black body - Black top with bag	12,350 kg	450 X 580 X 160 mm
UWFH3W0324	2 X A4 - 8.5" X 11"	White body - White top	11,880 kg	430 X 560 X 150 mm
UWFH3W1324	2 X A4 - 8.5" X 11"	White body - White top with bag	12,350 kg	450 X 580 X 160 mm

*W:Width H:Height D:Depth

M&T Displays 3 YEAR WARRANTY

Heavy Duty Literature Rack



Watch video at our website www.mtdisplays.com



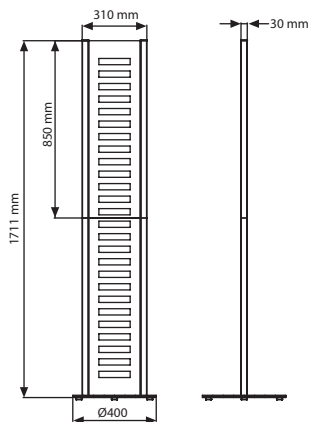
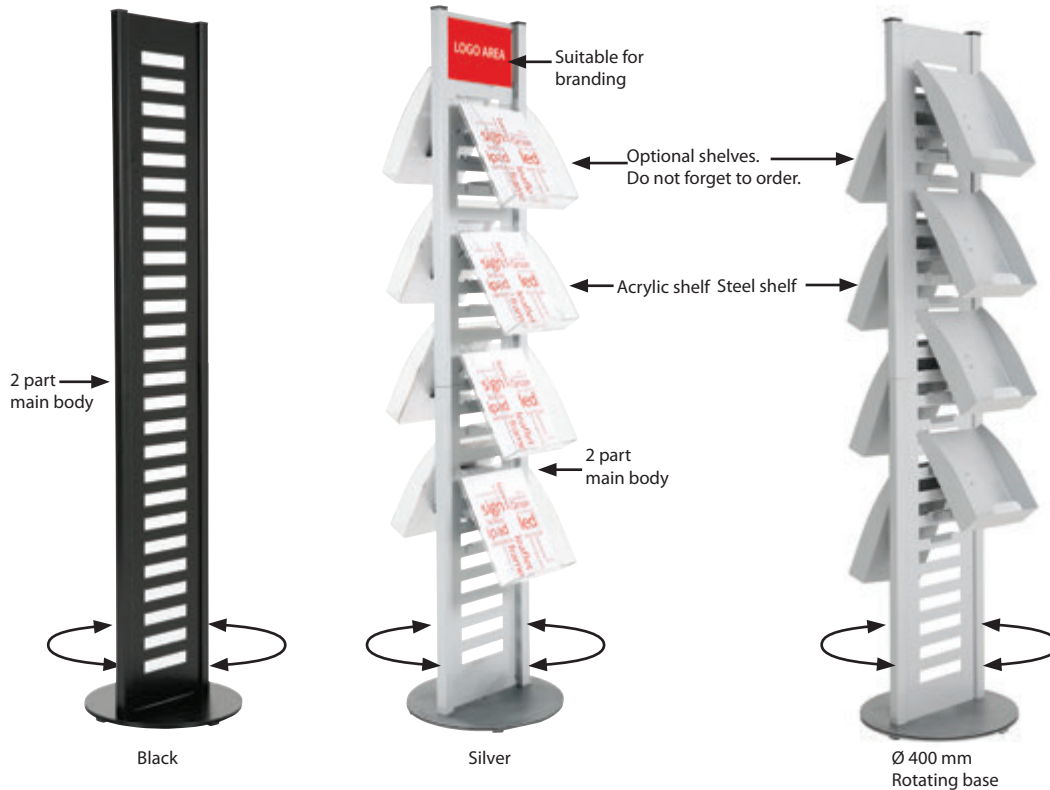
Heavy Duty Literature Rack is double sided and suitable for 4 brochure holders for each side in A4 size. It has steel or acrylic shelf options. Steel base can be combined with grey bracket or black bracket. It has logo area for branding. Height is 1711 mm. 400 mm rotating base is a great solution for displaying. Soft feet prevent the product sliding and the surface scratching.

Das robuste Prospektregal ist doppelseitig und geeignet für 4 Prospekthalter für jede Seite im A4-Format. Es hat Regaloptionen aus Stahl oder Acryl. Stahlsockel kann mit grauer oder schwarzer Halterung kombiniert werden. Es hat einen Logobereich für das Branding. Die Höhe beträgt 1711 mm. 400 mm drehbarer Sockel ist eine großartige Lösung für die Präsentation. Weiche Füße verhindern ein Verrutschen des Produkts und ein Verkratzen der Oberfläche.

! Has grey bracket or black bracket options. Hat Optionen für graue oder schwarze Klammern.

🕒 Assembly in 60 seconds. Montage in 60 Sekunden.

Color options : Silver-anodized & black
Farbenoptionen : schwarz und silber eloxiert.



MATERIAL : Steel				WEIGHT	PACKING SIZE
GREY	BLACK	SIZE	DESCRIPTION	WITH PACKING	*W X H X D
UHDL12G030	UHDL12B030	305 X 1700 mm	Main Body	18,500 kg	360 X 960 X 110 / 430 X 430 X 35 mm
UHDL0SG1A4	UHDL0SB1A4	A4 - 8.5"X11"	with Grey Bracket	2,750 kg	290 X 530 X 125 mm
UHDL0SG2A4	UHDL0SB2A4	A4 - 8.5"X11"	with Black Bracket	3,650 kg	290 X 530 X 125 mm



*W:Width H:Height D:Depth

Rapid Brochure Set



Rapid Brochure set has a stylish look and eye-catching shelves. A4 shelves are made of frosted acrylic and easily placed on the aluminum poles. Boxed in flat with unassembled shelves, it guarantees easy and safe transportation. Display your leaflets in retail stores or merchandising settings with Rapid brochure Sets. Header consists of 2 pieces. Front piece is clear and the back piece is frosted acrylic. You can put your paper poster in between these acrylics or apply printing directly on the clear or frosted acrylic pieces.

Rapid Prospektstaender hat Stil und blickfangende Ablagen. Die A4 Ablagen sind aus Acryl in Eisoptik und können einfach in den Ständer eingesetzt werden. Liegend unmontiert verpackt kann der Artikel sicher transportiert werden. Präsentieren Sie Ihre Prospekte, Kataloge oder Zeitschriften mit Rapid Prospekthalter in Einkaufszentren und Geschäften. Das Topschild besteht aus 2 Teilen. Die vordere Seite ist klar, die hintere Seite ist aus Acryl in Eisoptik. Sie können Ihr Poster zwischen diese zwei Teile legen oder das Acryl in Eisoptik direkt bedrucken.



Shelves are made of 4 mm frosted acrylic aluminum feet are RAL powder coated. Ablagen bestehen aus 4 mm Acryl. Die Aluminium Teile sind Ral Pulverbeschichtet.

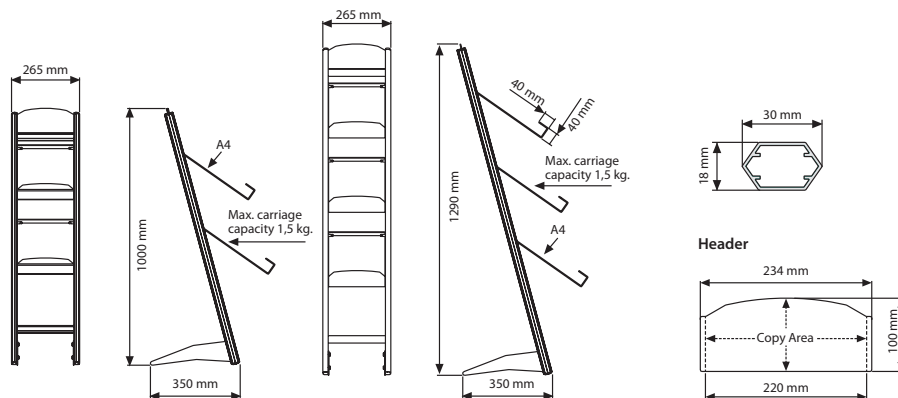
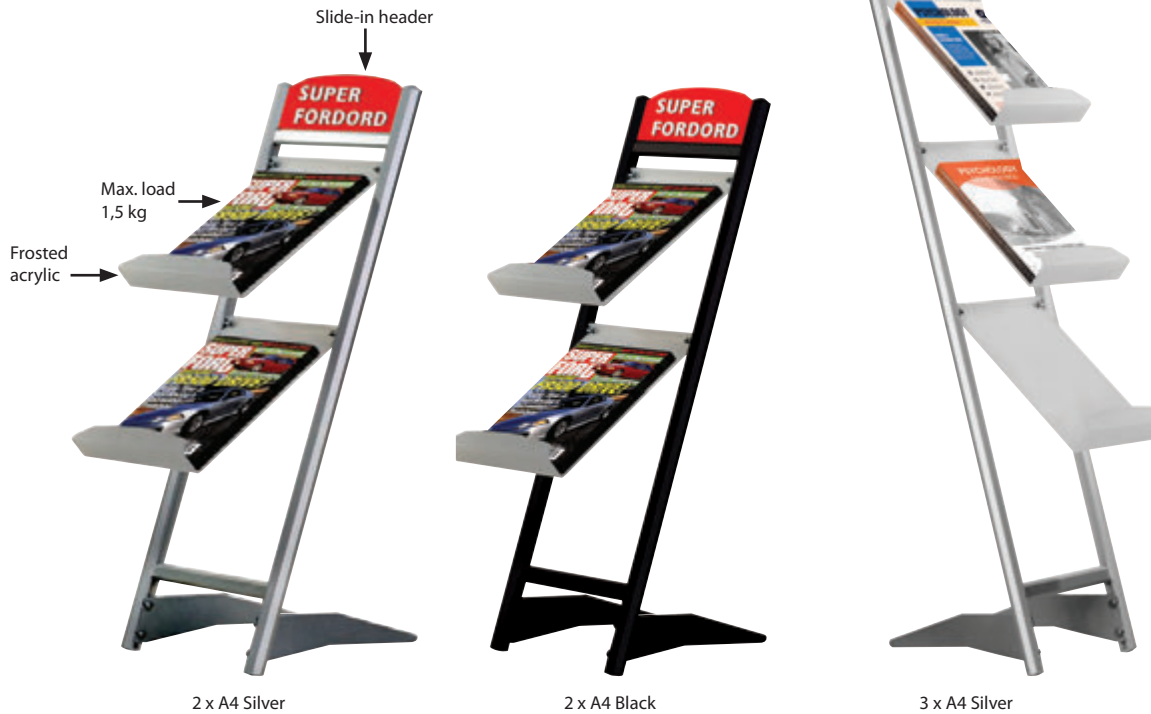


No tool assembly, easy to install & ready to use. Aufbau ohne Werkzeug und schnelle Bereitschaft zum Einsatz.



Place the two piece acrylic on the header and place in the logo paper, easy to change. Platzieren Sie die 2 Acrylscheiben auf das Topschild und schieben Sie Ihren Markennamen dazwischen. Leichter Austausch.

Color options : Silver-anodized & black
Farbenoptionen : schwarz und silber eloxiert.



MATERIAL : Silver and black anodised aluminium & acrylic			WEIGHT	PACKING SIZE
SILVER	BLACK	SIZE	WITH PACKING	*W X H X D
URDB0002A4	URDBB002A4	2 X A4	3,600 kg	280 X 1060 X 55 mm
URDB0003A4	URDBB003A4	3 X A4	4,450 kg	280 X 1390 X 55 mm

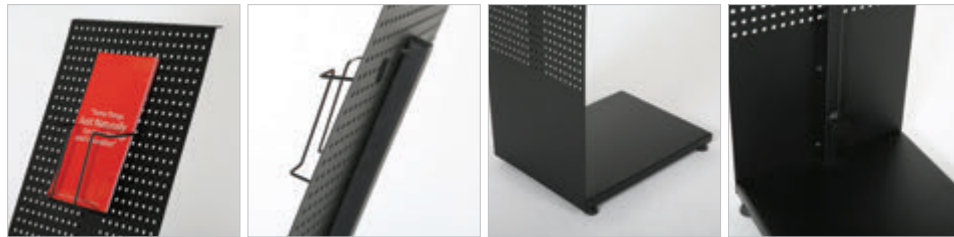


*W:Width H: Height D: Depth

Convex Tower Stand



Watch video at our website www.mtdisplays.com



This single sided brochure stand is suitable for use indoor. It has an elegant curved design. Holes on the stand allows personalization of brochure placement and size according to need. A4-A5-A6-A1/3A4 brochure holders are available. Quite stable with both its heavy base and design. Smooth lower part of brochure stand allows for branding. Curved Tower Stand is ideal for use at reception areas, educational institutions, travel agencies, hotels, offices, marketing events.

Der Einseitige Brochure Stand ist geeignet für den Innenbereich. Dieser hat ein elegantes gewölbtes Design. Die Löcher bieten eine individuelle Gestaltung der Prospektablagen der gewünschten Größen. A4-A5-A6-A1/3A4 Prospektablagen sind verfügbar. Sehr stabil mit dem schweren Boden und dem Design. Der glatte untere Bereich bietet die Möglichkeit für einen Druck. Ideal geeignet für Rezeptionen und Eingangshallen, Reiseagenturen, Hotels, Büros und Events.



Product is packed unassembled with an easy to understand instruction for assembly. Produkt ist demontiert verpackt mit einer einfachen Gebrauchsanleitung zur Montage.

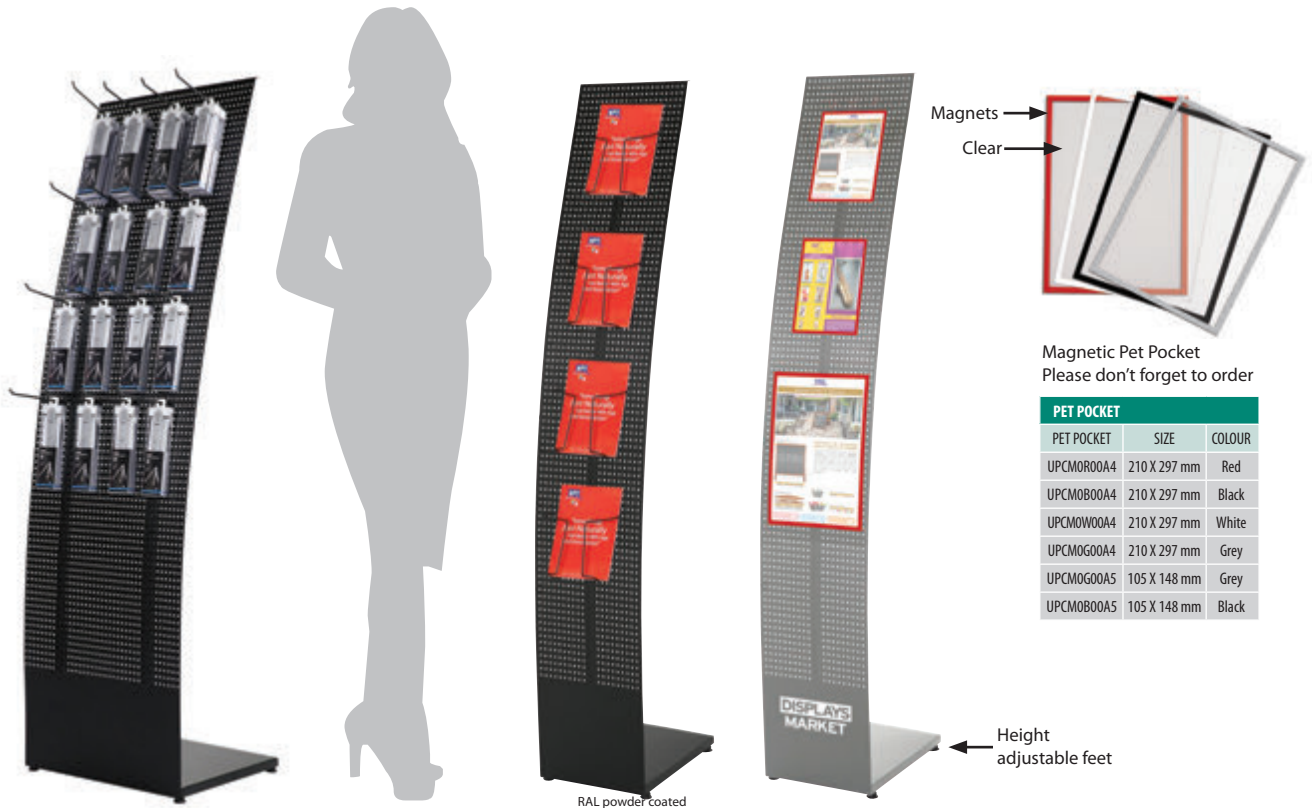


Make your own stand design with desired variation of brochure holder placement and size. Gestalten Sie Ihren gewünschten Stand mit den verschiedenen Prospekthaltern.



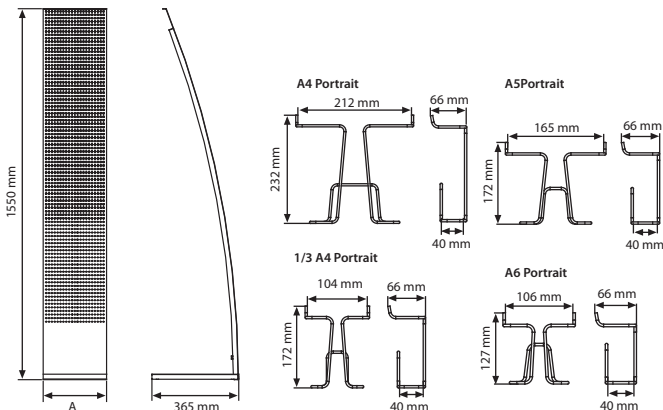
Brochure holders should be ordered separately. Die Prospekthalter müssen getrennt bestellt werden. Montagelöcher zu verdecken.

Color options : Silver & black
Farbenoptionen : Schwarz und silber.



Magnetic Pet Pocket
Please don't forget to order

PET POCKET		
PET POCKET	SIZE	COLOUR
UPCMOR00A4	210 X 297 mm	Red
UPCMB00A4	210 X 297 mm	Black
UPCMOW00A4	210 X 297 mm	White
UPCMOG00A4	210 X 297 mm	Grey
UPCMOG00A5	105 X 148 mm	Grey
UPCMB00A5	105 X 148 mm	Black



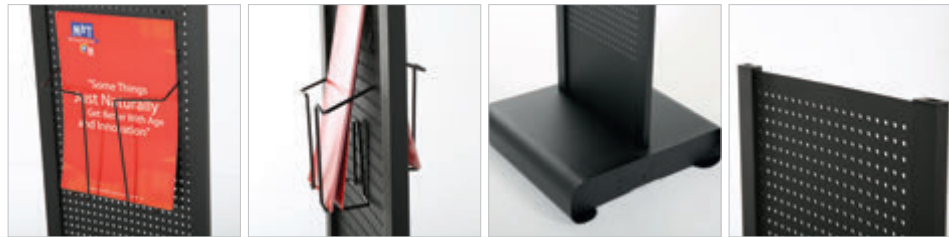
MATERIAL : Steel		WEIGHT	PACKING SIZE
ARTICLE	A	COLOUR	WITH PACKING
USTCO0G265	265 mm	Gray	9,500 kg
USTCO0B265	265 mm	Black	9,500 kg
USTCO0G460	460 mm	Gray	15,500 kg
USTCO0B460	460 mm	Black	15,500 kg



SHELF : Steel			
ARTICLE	POSTER	DESCRIPTION	COLOUR
UYPTSG00A4	210 X 297 mm	A4	Gray
UYPTSB00A4	210 X 297 mm	A4	Black
UYPTSG00A5	148 X 210 mm	A5	Gray
UYPTSB00A5	148 X 210 mm	A5	Black
UYPTSG00A6	105 X 148 mm	A6	Gray
UYPTSB00A6	105 X 148 mm	A6	Black
UYPTSG0A43	99 X 210 mm	1/3 A4	Gray
UYPTSB0A43	99 X 210 mm	1/3 A4	Black
UYPTSG0015	183 X 24 mm	Hook	Gray
UYPTSB0015	183 X 24 mm	Hook	Black

* W:Width H: Height D: Depth

Basic Tower Stand



Double Sided Brochure Stand is suitable for indoor environment. One straight module provides double side option. Only difference from Double sided Tower Stand is that; when a brochure holder is used on one side, it is not possible to hang another one on the opposite side to same holes. Holes on the stand allows personalization of brochure placement and size according to needs. A4-A5-A6-A1/3A4 brochure holders are available. Quite stable with both its heavy base and design. Smooth lower part of brochure stand allows for branding. Ideal for use at reception areas, educational institutions, travel agencies, hotels, offices, marketing events.

Der doppelseitige Brochure Stand ist geeignet für den Innenbereich. 1 gerades Modul bietet eine doppelseitige Funktion. Der einzige Unterschied zum Double Sided Tower Stand ist dass man hinter einem Prospekthalter keinen Halter auf der gegenüberliegenden Seite anbringen kann. Die Löcher bieten eine individuelle Gestaltung der Prospektablagen der gewünschten Größen. Die Löcher bieten eine individuelle Gestaltung der Prospektablagen der gewünschten Größen. A4-A5-A6-A1/3A4 Prospektablagen sind verfügbar. Sehr stabil mit dem schweren Boden und dem Design. Der glatte untere Bereich bietet die Möglichkeit für einen Druck. Ideal geeignet für Rezeptionen und Eingangshallen, Reiseagenturen, Hotels, Büros und Events.

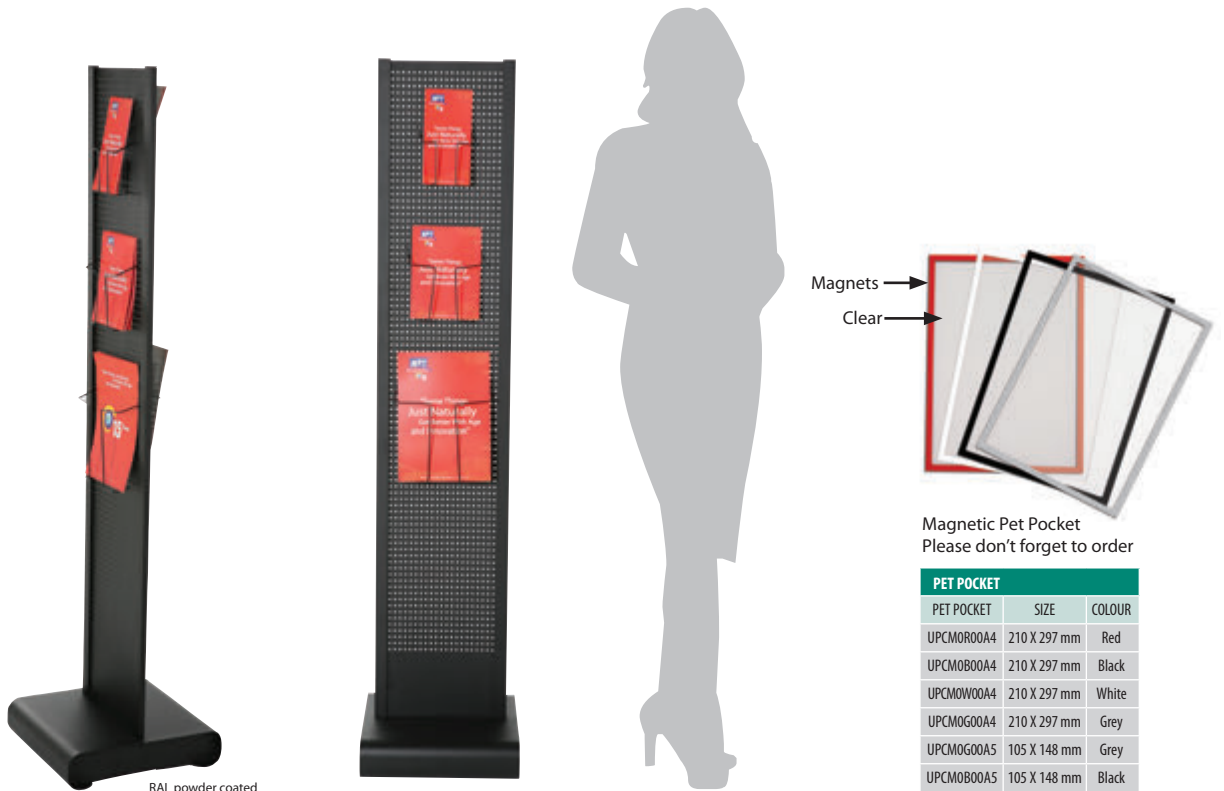
Product is packed unassembled with an easy to understand instruction for assembly. Produkt ist demontiert verpackt mit einer einfachen Gebrauchsanleitung zur Montage.

Make your own stand design with desired variation of brochure holder placement and size. Gestalten Sie Ihren gewünschten Stand mit den verschiedenen Prospekthaltern.

Brochure holders should be ordered separately. Die Prospekthalter müssen getrennt bestellt werden. Montagelöcher zu verdecken.

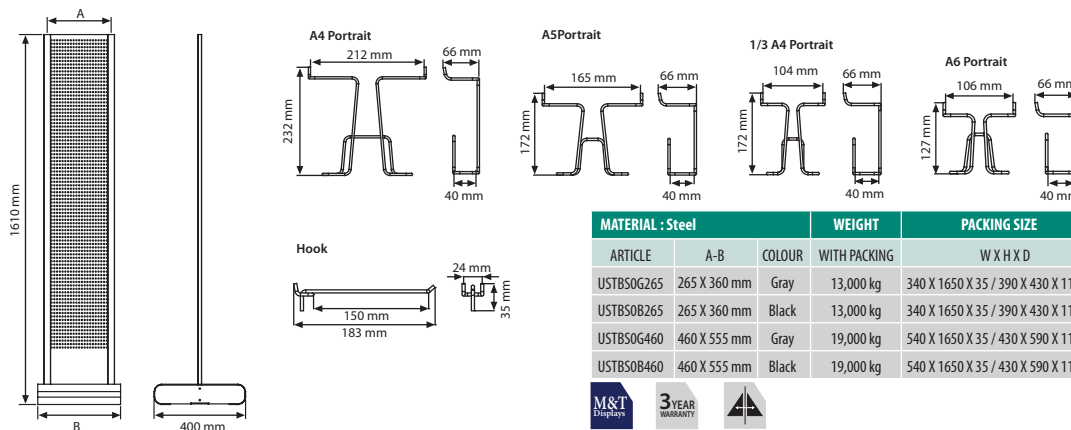
2 packs. See info chart for pack sizes. 2 Packungen. Siehe Infodiagramm für Packungsgrößen.

Color options : Silver & black
Farboptionen : Schwarz und silber.



Magnetic Pet Pocket
Please don't forget to order

PET POCKET		
PET POCKET	SIZE	COLOUR
UPCMOR00A4	210 X 297 mm	Red
UPCMOB00A4	210 X 297 mm	Black
UPCMOW00A4	210 X 297 mm	White
UPCMOG00A4	210 X 297 mm	Grey
UPCMOG00A5	105 X 148 mm	Grey
UPCMOB00A5	105 X 148 mm	Black



SHELF : Steel			
ARTICLE	POSTER	DESCRIPTION	COLOUR
UYPTSG00A4	210 X 297 mm	A4	Gray
UYPTSB00A4	210 X 297 mm	A4	Black
UYPTSG00A5	148 X 210 mm	A5	Gray
UYPTSB00A5	148 X 210 mm	A5	Black
UYPTSG00A6	105 X 148 mm	A6	Gray
UYPTSB00A6	105 X 148 mm	A6	Black
UYPTSG0A43	99 X 210 mm	1/3 A4	Gray
UYPTSB0A43	99 X 210 mm	1/3 A4	Black
UYPTSG0015	183 X 24 mm	Hook	Gray
UYPTSB0015	183 X 24 mm	Hook	Black

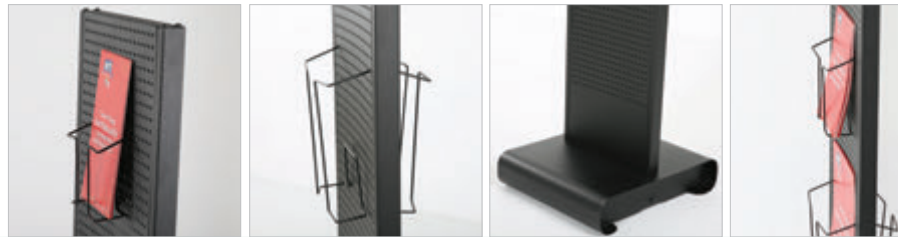
* W:Width H: Height D: Depth



Double Sided Tower Stand



Watch video at our website www.mtdisplays.com



This double sided brochure Stand can be used indoor. Two straight modules back to back provides space for more brochure holders. Holes on the stand allows personalization of brochure placement and size according to needs. A4-A5-A6-A1/3A4 brochure holders are available. Quite stable with both its heavy base and design. Smooth lower part of brochure stand allows for branding. Ideal for use at reception areas, educational institutions, travel agencies, hotels, offices, marketing events.

Der doppelseitige Brochure Stand ist geeignet für den Innenbereich. 2 gerade Module Rücken an Rücken bieten mehr Platz für Prospekthalter. Die Löcher bieten eine individuelle Gestaltung der Prospektablagen der gewünschten Größen. Die Löcher bieten eine individuelle Gestaltung der Prospektablagen der gewünschten Größen. A4-A5-A6-A1/3A4 Prospektablagen sind verfügbar. Sehr stabil mit dem schweren Boden und dem Design. Der glatte untere Bereich bietet die Möglichkeit für einen Druck. Ideal geeignet für Rezeptionen und Eingangshallen, Reiseagenturen, Hotels, Büros und Events.



Product is packed unassembled with an easy to understand instruction for assembly. Produkt ist demontiert verpackt mit einer einfachen Gebrauchsanleitung zur Montage.



Make your own stand design with desired variation of brochure holder placement and size. Gestalten Sie Ihren gewünschten Stand mit den verschiedenen Prospektaltern.



Brochure holders should be ordered separately. Die Prospektalter müssen getrennt bestellt werden. Montagelöcher zu verdecken.

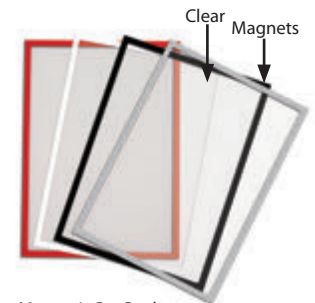


2 packs. See info chart for pack sizes. 2 Packungen. Siehe Infodiagramm für Packungsgrößen.

Color options : Silver & black
Farboptionen : Schwarz und silber.

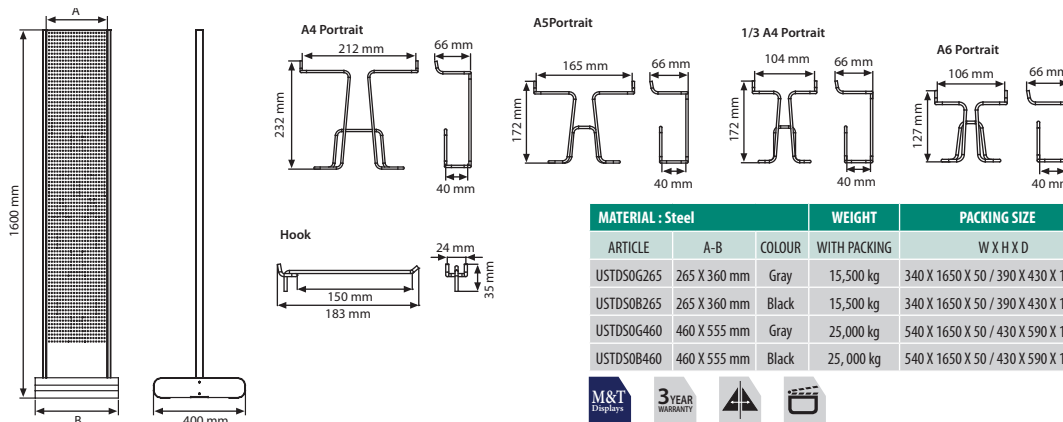


RAL powder coated



Magnetic Pet Pocket
Please don't forget to order

PET POCKET			
PET POCKET	SIZE	COLOUR	
UPCMOR00A4	210 X 297 mm	Red	
UPCMOB00A4	210 X 297 mm	Black	
UPCMOW00A4	210 X 297 mm	White	
UPCMOG00A4	210 X 297 mm	Grey	
UPCMOG00A5	105 X 148 mm	Grey	
UPCMOB00A5	105 X 148 mm	Black	



SHELF : Steel			
ARTICLE	POSTER	DESCRIPTION	COLOUR
UYPTS00A4	210 X 297 mm	A4	Gray
UYPTS00A4	210 X 297 mm	A4	Black
UYPTS00A5	148 X 210 mm	A5	Gray
UYPTS00A5	148 X 210 mm	A5	Black
UYPTS00A6	105 X 148 mm	A6	Gray
UYPTS00A6	105 X 148 mm	A6	Black
UYPTS00A3	99 X 210 mm	1/3 A4	Gray
UYPTS00A3	99 X 210 mm	1/3 A4	Black
UYPTS0015	183 X 24 mm	Hook	Gray
UYPTS0015	183 X 24 mm	Hook	Black

* W:Width H: Height D: Depth



Tower Stand for Wall



This Single Sided Brochure Stand is suitable for indoor use. One straight module that is hung on wall provides stable and noticeable brochure placement. Holes on the stand allows personalization of brochure placement and size according to needs. A4-A5-A6-A1/3A4 brochure holders are available. Ideal for use at reception areas, educational institutions, travel agencies, hotels, offices, marketing events.

Der einseitige Brochure Stand ist geeignet für den Innenbereich. 1 gerades Modul angebracht an der Wand bietet eine stabile Prospektablage. Die Löcher bieten eine individuelle Gestaltung der Prospektablagen der gewünschten Größen. Die Löcher bieten eine individuelle Gestaltung der Prospektablagen der gewünschten Größen. A4-A5-A6-A1/3A4 Prospektablagen sind verfügbar. Der glatte untere Bereich bietet die Möglichkeit für einen Druck. Ideal geeignet für Rezeptionen und Eingangshallen, Reiseagenturen, Hotels, Büros und Events.



Product is packed unassembled with an easy to understand instruction for assembly. Produkt ist demontiert verpackt mit einer einfachen Gebrauchsanleitung zur Montage.



Make your own stand design with desired variation of brochure holder placement and size. Gestalten Sie Ihren gewünschten Stand mit den verschiedenen Prospekthaltern.

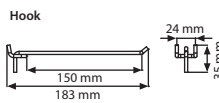
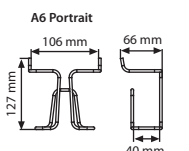
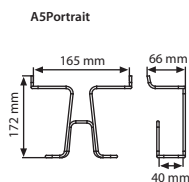
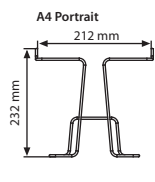
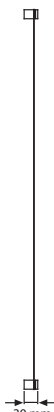
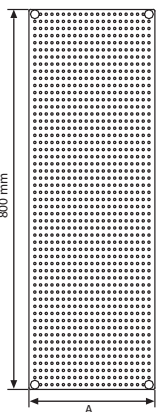


Brochure holders should be ordered separately. Die Prospekthalter müssen getrennt bestellt werden. Montagelöcher zu verdecken.

Color options : Silver & black
Farbenoptionen : Schwarz und silber.



RAL powder coated



MATERIAL : Steel		WEIGHT	PACKING SIZE
ARTICLE	A	COLOUR	WITH PACKING W X H X D
USTFWOG265	265 mm	Gray	3,000 kg 290 X 830 X 40 mm
USTFWOB265	265 mm	Black	3,000 kg 290 X 830 X 40 mm
USTFWOG460	460 mm	Gray	4,500 kg 490 X 830 X 40 mm
USTFWOB460	460 mm	Black	4,500 kg 490 X 830 X 40 mm



SHELF : Steel			
ARTICLE	POSTER	DESCRIPTION	COLOUR
UYPTSG00A4	210 X 297 mm	A4	Gray
UYPTSB00A4	210 X 297 mm	A4	Black
UYPTSG00A5	148 X 210 mm	A5	Gray
UYPTSB00A5	148 X 210 mm	A5	Black
UYPTSG00A6	105 X 148 mm	A6	Gray
UYPTSB00A6	105 X 148 mm	A6	Black
UYPTSG0A43	99 X 210 mm	1/3 A4	Gray
UYPTSB0A43	99 X 210 mm	1/3 A4	Black
UYPTSG0015	183 X 24 mm	Hook	Gray
UYPTSB0015	183 X 24 mm	Hook	Black

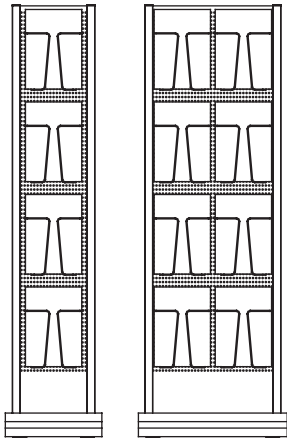
* W:Width H: Height D: Depth

Tower Stand

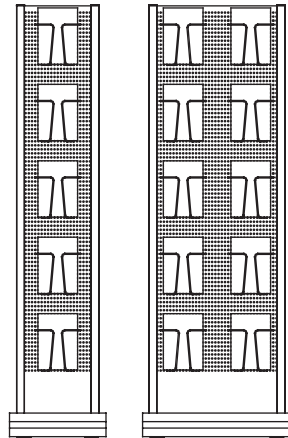
ARTICLE	CAPACITY				CAPACITY WEIGHT
	A4 (PCS)	A5 (PCS)	A6 (PCS)	1/3 A4 (PCS)	
USTTC00B265	4	5	12	10	20
USTTC00G265	4	5	12	10	20
USTTC00B460	8	10	18	15	40
USTTC00G460	8	10	18	15	40
USTTW0B265	8	10	24	20	40
USTTW0G265	8	10	24	20	40
USTTW0B460	16	20	36	30	80
USTTW0G460	16	20	36	30	80
USTDS0B265	8	10	24	20	40
USTDS0G265	8	10	24	20	40
USTDS0B460	16	20	36	30	80
USTDS0G460	16	20	36	30	80
USTCU0B265	4	5	12	10	20
USTCU0G265	4	5	12	10	20
USTCU0B460	8	10	18	15	40
USTCU0G460	8	10	18	15	40
USTBS0B265	8	10	24	20	40
USTBS0G265	8	10	24	20	40
USTBS0B460	16	20	36	30	80
USTBS0G460	16	20	36	30	80
USTFW0B265	2	3	8	6	10
USTFW0G265	2	3	8	6	10
USTFW0B460	4	6	12	9	20
USTFW0G265	4	6	12	9	20



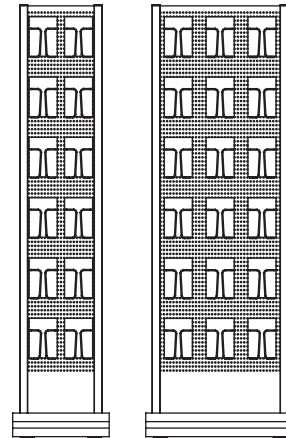
A4 Single sided for 265 mm for 4 pcs
A4 Single sided for 460 mm for 4 pcs



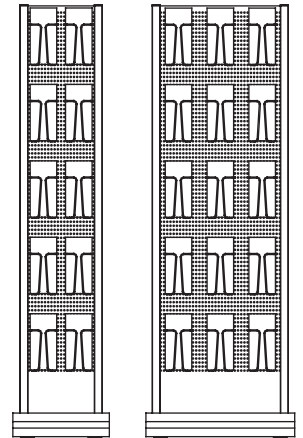
A5 Single sided for 265 mm for 5 pcs
A5 Single sided for 460 mm for 8 pcs



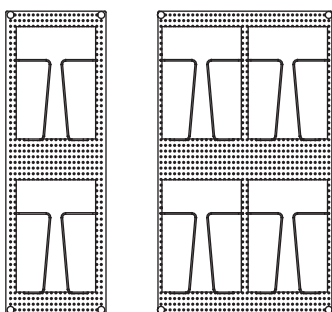
A6 Single sided for 265 mm for 12 pcs
A5 Single sided for 460 mm for 10 pcs



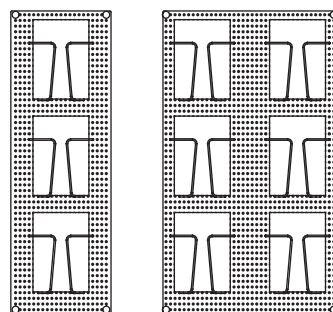
1/3 A4 Single sided for 265 mm for 10 pcs
1/3 A4 Single sided for 460 mm for 15 pcs



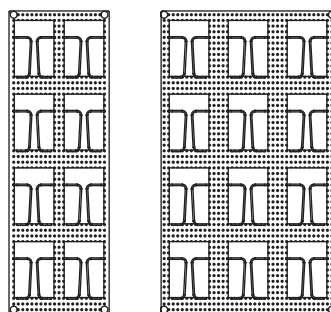
A4 for wall, 265 mm for 2 pcs
A4 for wall, 460 mm for 4 pcs



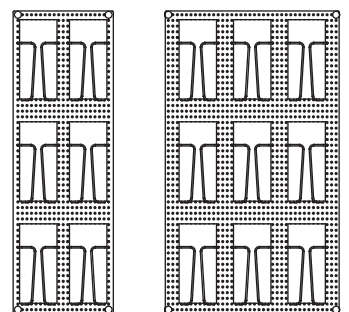
A5 for wall, 265 mm for 3 pcs
A5 for wall, 460 mm for 6 pcs



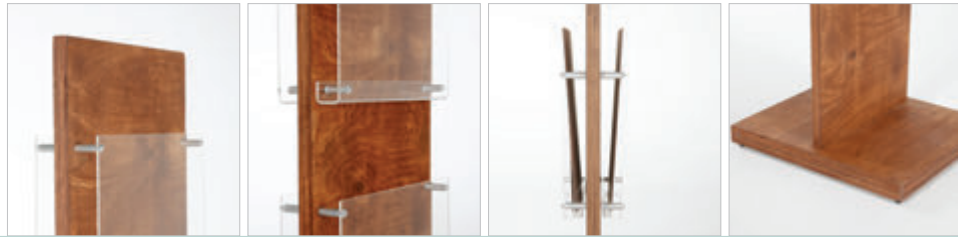
A6 for wall, 265 mm for 8 pcs
A6 for wall, 460 mm for 12 pcs



1/3 A4 for wall, 265 mm for 6 pcs
1/3 A4 for wall, 460 mm for 9 pcs



Wood Poster Stand



Wood Poster Stand is made of beech wood. It is double sided and suitable for 3 brochure holders for each side in A4 size. Lacquered finish is applied for long term use. Height is 1467 mm. It is resistant to the spill of food and fizzy drinks. Dark wood body & dark wood base and dark wood body & black base options are available. Soft feet prevent the product sliding and the surface scratching.

Der Holzplakatständer ist aus Buchenholz gefertigt. Es ist doppelseitig und geeignet für 3 Prospekthalter für jede Seite im A4-Format. Lackiertes Finish wird für den Langzeitgebrauch aufgetragen. Die Höhe beträgt 1467 mm. Es ist beständig gegen das Verschütten von Speisen und kohlenensäurehaltigen Getränken. Dunkles Holzgehäuse und dunkles Holzgestell sowie dunkles Holzgehäuse und schwarzes Gestell sind erhältlich. Weiche Füße verhindern ein Verrutschen des Produkts und ein Verkratzen der Oberfläche.

! Dark wood body & dark wood base and dark wood body & black base options.
Körper aus dunklem Holz und Basis aus dunklem Holz und Körper aus dunklem Holz und Basis aus schwarzem Holz.

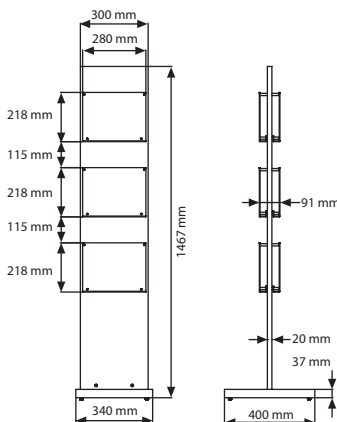
🕒 Assembly in 60 seconds.
Montage in 60 Sekunden.



Dark wood / Black



Dark wood / Dark wood



MATERIAL : Plywood			WEIGHT	PACKING SIZE
ARTICLE	CAPACITY	DESCRIPTION	WITH PACKING	*W X H X D
UWPSDD03A4	6 X A4	Dark wood / Dark wood	12,940 kg	380 X 1490 X 85 mm
UWPSDB03A4	6 X A4	Dark wood / Black	12,940 kg	380 X 1490 X 85 mm




*W:Width H: Height D: Depth

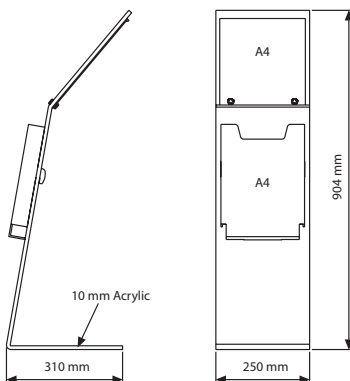
Monoblock



An elegant & classic clear stand to display an A4 size paper message on top, altering a pocket for literature packs in again an A4 size. Simple to change the message, eye-catching level of height. Suitable for use in galleries & showrooms accessible to the public.

Ein eleganter Ständer um auf der oberen Seite Ihre Mitteilungen in der DIN A4 Grösse zu präsentieren, während auf der unteren Seite entsprechende Informationsmaterialien in einer DIN A4 Tasche zur Abnahme bereit gestellt werden. Leichter Austausch Ihrer Mitteilungen in Blickfanghöhe. Passend für Orte mit viel Menschenverkehr wie Gallerien und Showrooms.

 The product is packed assembled ready for use. Das Produkt wird montiert, zum sofortigen Einsatz bereit geliefert.



MATERIAL : Acrylic		WEIGHT	PACKING SIZE
ARTICLE	CAPACITY	WITH PACKING	*W X H X D
UMNB001000	A4	4,900 kg	270 X 930 X 52 mm

* W:Width H: Height D: Depth





Digital Solutions

- Slim TV Stand
- Smart TV Stand
- Counter Tablet Holders
 - Semi Circle Tablet Holder
 - Pyramid Tablet Holder
- Universal Desktop Tablet Kiosk
- Tablet Kiosk
 - Universal Flexible Tablet Kiosk
 - Universal Curved Tablet Kiosk
 - Universal Novel Tablet Kiosk
 - Universal Novel Tablet Kiosk for Wall & Freestanding

- Slim TV Stand
- Smart TV Stand
- Counter Tablet Holders
 - Semi Circle Tablet Holder
 - Pyramid Tablet Holder
- Universal Desktop Tablet Kiosk
- Tablet Kiosk
 - Universal Flexible Tablet Kiosk
 - Universal Curved Tablet Kiosk
 - Universal Novel Tablet Kiosk
 - Universal Novel Tablet Kiosk for Wall & Freestanding



Slim TV Stand




Slim TV stand is a portable stand which is easy to move room-to-room for any reason. It is designed to hold flat-screen monitors between 30" and 50" that weigh less than 60 kg. The VESA-compatible bracket fits most brand names and models

Slim TV stand with wheels includes a 40 cm-wide shelf that can be positioned at 3 different levels along the floor-standing fixture for presentation accessories. The stand itself is also height adjustable, with 8 set heights at which a monitor may be positioned. This black rolling TV stand is equipped with locking wheels for easy movement. It provides comfortable use by adjusting the screen height and angle.


Suitable to use in all places where space is limited.

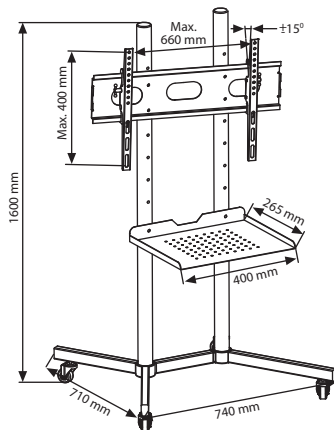
Slim TV-Ständer ist ein tragbarer Ständer, der sich leicht von einem Raum zum anderen bewegen lässt. Es ist für die Aufnahme von Flachbildschirmen zwischen 30" und 50" mit einem Gewicht von weniger als 60 kg ausgelegt. Die VESA-kompatible Aufhänger passt zu den meisten Markennamen und Modellen.

Slim TV-Ständer mit Rädern umfasst ein 40 cm breites Regal, das auf 3 verschiedenen Ebenen entlang der Stand Aufhänger für Präsentationszubehör positioniert werden kann. Der Ständer selbst ist höhenverstellbar, mit 8 Einstellhöhen, in denen ein Monitor positioniert werden kann. Dieser schwarzrollende TV-Ständer ist mit Feststellrädern für einfache Bewegung ausgestattet. Es bietet eine komfortable Nutzung durch Einstellen der Höhe und des Winkels des Bildschirms. Das Produkt ist geeignet für alle Orte, wo der Platz begrenzt ist.

 Suitable for screens 30" up to 50" and can carry up to 132lbs/59kg. Geeignet für Bildschirme von 30" bis 50" und bis zu 132lbs/59kg belastbar.

 Castored wheels. Lenkrollen.

 Easy mounting sheets enclosed. Einfache Montage durch beiliegende Montageanleitung.



MATERIAL: Black anodised aluminium		WEIGHT	PACKING SIZE
ARTICLE	DESCRIPTION	WITH PACKING	*W X H X D
UTVS10B000	Black	14,000 kg	430 X 730 X 65 mm - 120 X 147 X 65 mm






* W:Width H: Height D: Depth

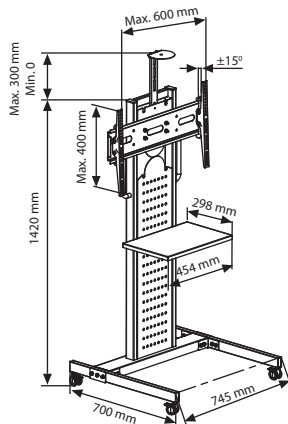
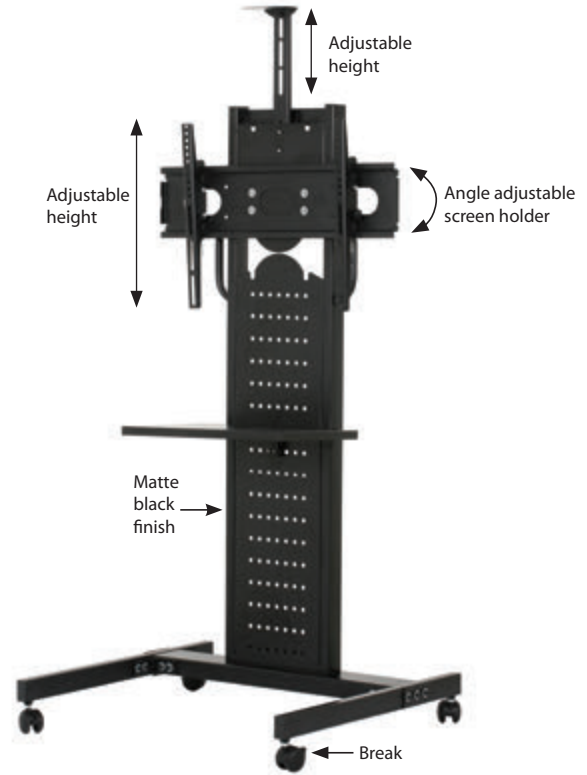
Smart TV Stand



This contemporary and easy use TV stand is suitable for modern offices and exhibitions where space is limited. It allows adjusting the screen height and angle for comfortable use. It is complete with height adjustable shelf.

Die einfache Nutzung vom TV-Ständer eignet sich für moderne Büros und Ausstellungen, wo der Platz begrenzt ist. Für einen komfortablen Einsatz ermöglicht der Ständer einstellbare Bildschirmhöhe. Es ist komplett mit höhenverstellbaren Einlegeboden ausgestattet.

-  Suitable for screens 30" up to 50" and can carry up to 132lbs/59kg. Geeignet für Bildschirme von 30" bis 50" und bis zu 132lbs/59kg belastbar.
-  Castored wheels. Lenkrollen.
-  Easy mounting sheets enclosed. Einfache Montage durch beiliegende Montageanleitung.



MATERIAL: Black anodised aluminium		WEIGHT	PACKING SIZE
ARTICLE	DESCRIPTION	WITH PACKING	*W X H X D
UTVS20B000	Black	14,380 kg	430 X 1340 X 75 / 400 X 880 X 100 mm



*W:Width H: Height D: Depth

Tablet Holders

Wide selection of tablet holders are suitable for most tablets, smart phones and laptops both in landscape and portrait positions. They are designed for ergonomic use, adjustable and with soft edges to protect furniture from scratches.

Eine weite Auswahl von Tablethaltern sind für die meisten Tablets, Smartphones und Laptops geeignet und sind sowohl in Quer- und Hochformat einsetzbar. Sie sind für den ergonomischen Einsatz konzipiert, verstellbar und mit weichen Kanten zum Schutz der Möbel vor Kratzern ausgestattet.

Semi Circle Tablet Holder

360° Rotating

Silver

Black

243 mm

189 mm

Color options : Silver-anodized & black.
Farbenoptionen : schwarz und silber eloxiert.

MATERIAL : ABS Plastic		WEIGHT	PACKING SIZE
ARTICLE	DESCRIPTION	WITH PACKING	*W X H X D
TGRIA30301	Black	0,450 kg	210 X 300 X 35 mm
TGRIA30309	Silver	0,450 kg	210 X 300 X 35 mm

* W:Width H: Height D: Depth

TP 2 YEAR WARRANTY

Pyramid Tablet Holder

One product, two positions (landscape & portrait)

Portrait

Landscape

360° rotating

360° rotating

5.51" / 140 mm

7.89" / 203 mm

6.61" / 168 mm

5.51" / 138 mm

MATERIAL : ABS Plastic		WEIGHT	PACKING SIZE
ARTICLE	DESCRIPTION	WITH PACKING	*W X H X D
TFRIA30303	White	0,495 kg	200 X 250 X 60 mm

* W:Width H: Height D: Depth

TP 2 YEAR WARRANTY



Universal Desktop Tablet Kiosk





Watch video at our website www.mtdisplays.com




Smart Solutions for Technological Devices! Desktop universal tablet stand offers smart solutions for introductions or presentations in offices or commercial environments. It is suitable for iPad1, 2, 3, 4, Air, Samsung Galaxy and most 9.7"-10.1" tablets. The tablet holder can be rotated to display landscape portrait positions and tablet is secured with a lockable case to reduce the risk of theft. The home button is covered to prevent interfering from the public. It is already inclined at a convenient fixed reading angle.

Elegante Lösung für technische Innovationen. Der Desktop universal tablet stand bietet eine elegante Lösung für Präsentationen im Büro oder in öffentlichen Gebäuden. Es ist geeignet für iPad1, 2, 3, 4, Samsung Galaxy und am meisten für 9.7"-10.1" Tablets. Der Ipad Halter kann in querformat oder im hochformat verwendet werden und geschützt wird der Ipad durch 2 Sicherheitsschrauben die das Risiko des Diebstahls minimieren. Die Home Taste wird hier durch die Abdeckung verdeckt um ein betätigen von anderen zu verhindern. Der Desktop universal tablet stand ist in einer bequem eingestellten Leseneigung werksmäßig verfügbar.

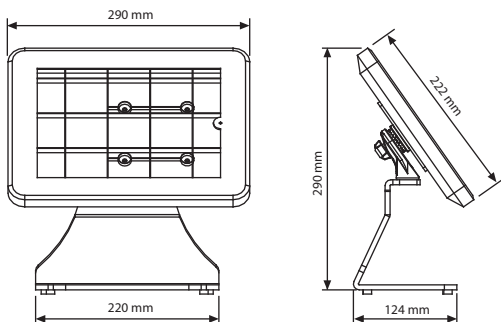
 Packed assembled. Demontiert verpackt mit einer einfachen Gebrauchsanleitung zur Montage

 USB cable is not included. Order separately. Fixing for floor mounting included. USB Kabel ist nicht inkludiert. Separat bestellen. Schrauben für Bodenfixierung inkludiert

 Closed home button. Verdeckter home knopf.



One product, two positions (landscape & portrait)



UYPPD0000
Lightning to 30-pin adapter. Packed by 10 pcs. You can use all type of Kiosk for iPad 4 too. 30 Pin Adapter / 10er Packing Sie können alle unsere Ipad Kiosk Produkte auch für den Ipad 4 benutzen.

MATERIAL : Steel & acrylic		WEIGHT	PACKING SIZE
ARTICLE	DESCRIPTION	WITH PACKING	*W X H X D
UUTMOB1800	Black	1,250 kg	325 X 240 X 130 mm



* W:Width H: Height D: Depth

Universal Flexible Tablet Kiosk



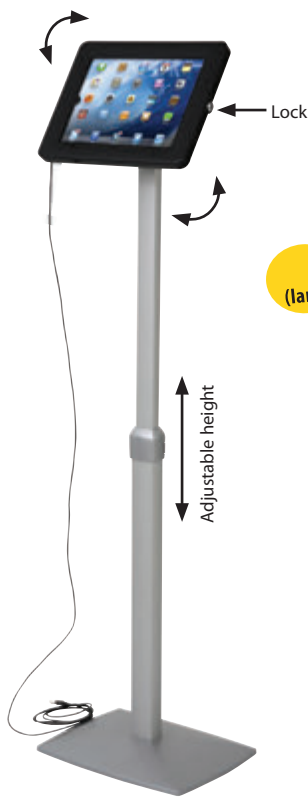
Watch video at our website www.mtdisplays.com



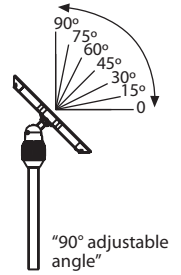
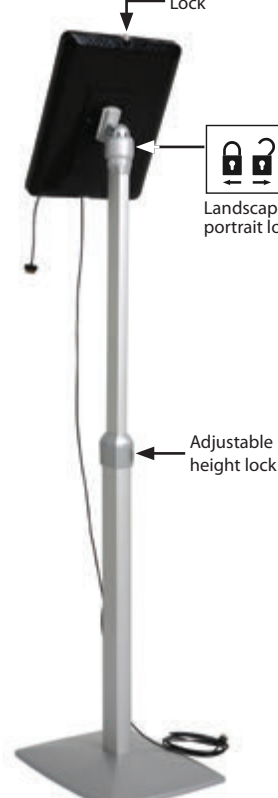
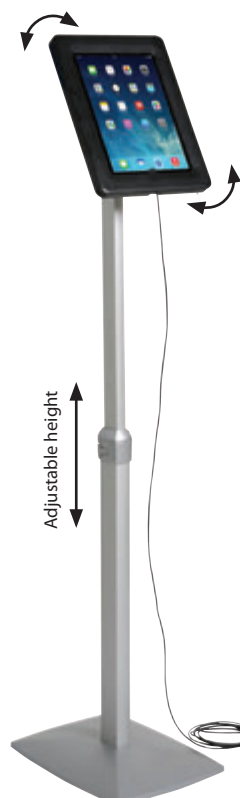
It is a genuine design for today's technological display solutions. The tablet holder can be rotated to display landscape portrait positions and adjusted to a required reading angle. The height of the kiosk can be adjusted to max 1220mm. when landscape and max 1245mm when portrait. Universal Flexible Tablet Kiosk is suitable for iPad1, 2, 3, 4, Air, Samsung Galaxy and most 9.7"-10.1" tablets. The tablet holder can be rotated to display landscape portrait positions and tablet is secured with a lockable case to reduce the risk of theft. The home button is covered to prevent interfering from the public. Universal Curved iPad Kiosk is suitable for retail purposes, trade shows and conventions as well as car galleries, furniture stores when the base is adjusted.

Ein unverwechselbares Design für die heutigen Display Lösungen. Der Ipadhalter kann in den Stellungen Hochformat und Querformat verwendet werden und ist zu dem in der Höhe verstellbar. Die Höhe des Ipad Kiosk kann maximal bis zu einem Maß von 1220mm querformat und 1245mm im hochformat adjustiert werden. Universal Flexible Tablet Kiosk ist geeignet für iPad1 , 2 , 3 , 4, Samsung Galaxy und am meisten für 9.7"-10.1" Tablets. Der Ipad Halter kann in querformat oder im hochformat verwendet werden und geschützt wird der Ipad durch 2 Sicherheitsschrauben die das Risiko des Diebstahls minimieren. Die Home Taste wird hier durch die Abdeckung verdeckt um ein Betätigen von anderen zu verhindern. Der Universal Curved Tablet Kiosk ist geeignet für Einzelhandel Zwecke, Produktvorstellungen, Präsentationen, Autohäuser und Möblaustellungen.

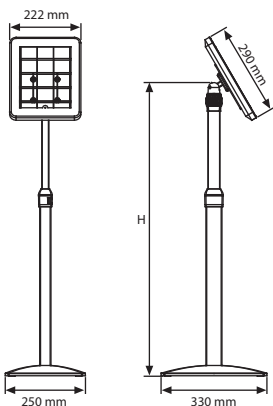
- Packed unassembled with an easy to understand instruction for assembly. Demontiert verpackt mit einer einfachen Gebrauchsanleitung zur Montage
- USB cable is not included. Order separately. Fixing for floor mounting included. USB Kabel ist nicht inkludiert. Separat bestellen. Schrauben für Bodenfixierung inkludiert
- Closed home button. Verdeckter home knopf.



One product, two positions (landscape & portrait)



Don't forget to order USB cable. Vergessen Sie nicht das USB-Kabel zu bestellen.



UYPPD0000
Lightning to 30-pin adapter. Packed by 10 pcs. You can use all type of Kiosk for iPad 4 too. 30 Pin Adapter / 10er Packung. Sie können alle unsere Ipad Kiosk Produkte auch für den Ipad 4 benutzen.

MATERIAL: Silver anodised aluminium			WEIGHT	PACKING SIZE
ARTICLE	Height Max.	Height Min.	WITH PACKING	*W X H X D
UUTFON000	1095 mm	785 mm	5,100 kg	285 X 1060 X 107 mm

*W:Width H: Height D: Depth



Universal Curved Tablet Kiosk



Watch video at our website www.mtdisplays.com



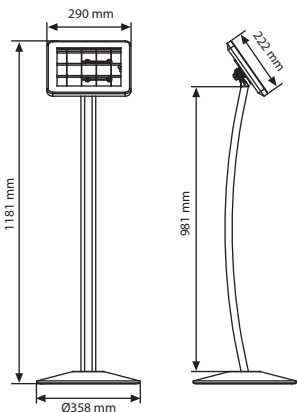
Smart Solutions for Technological Devices! With sleek design and matt finish, Universal Curved Tablet Kiosk captures customers' attention in all traffic areas. Universal Curved Tablet Kiosk is suitable for iPad1, 2, 3, 4, Air, Samsung Galaxy and most 9.7"-10.1" tablets. The tablet holder can be rotated to display landscape portrait positions and tablet is secured with a lockable case to reduce the risk of theft. The home button is covered to prevent interfering from the public. Universal Curved iPad Kiosk is suitable for retail purposes, trade shows and conventions as well as car galleries, furniture stores when the base is adjusted. It has a complete style with black cover and cable travelling through the pole.

Elegante Lösung für technische Innovationen! Mit einem geschmeidigen Design und einer matten Oberfläche zieht er die Blicke in allen Verkehrsflächen der Kunden auf sich. Es ist geeignet für iPad1, 2, 3, 4, Samsung Galaxy und am meisten für 9.7"-10.1" Tablets. Der Ipad Halter kann in Querformat oder im Hochformat verwendet werden und geschützt wird der Ipad durch 2 Sicherheitsschrauben die das Risiko des Diebstahls minimieren. Die Home Taste wird hier durch die Abdeckung verdeckt um ein Betätigen von anderen zu verhindern. Der Universal Curved Tablet Kiosk ist geeignet für Einzelhandel Zwecke, Produktvorstellungen, Präsentationen, Autohäuser und Möblaustellungen. Verfügt über ein komplettes Design in Schwarz und das Kabel wird durch das Profil verlegt und ist somit nicht sichtbar.

- Packed unassembled with an easy to understand instruction for assembly. Demontiert verpackt mit einer einfachen Gebrauchsanleitung zur Montage
- USB cable is not included. Order separately. Fixing for floor mounting included. USB Kabel ist nicht inkludiert. Separat bestellen. Schrauben für Bodenfixierung inkludiert
- Closed home button. Verdeckter home knopf.



Don't forget to order USB cable.
Vergessen Sie nicht das USB-Kabel zu bestellen.



TZZZ998701
Cable lock kit for iPad 2100mm.
Kabelschloss-Kit für iPad 21000 mm.



TSTDCI450B
Cable for all iPhones & iPads.
Kabel für alle iPhones & iPads.



TSTDICP40B
Cable for iPhone 4S, iPad 3 and earlier.
Kabel für iPhone 4S, iPad 3 und früher.



TSTDICP50B
Cable for iPhone 5, iPad 4 and later.
Kabel für iPhone 5, iPad 4 und höher.



TSTDCV80B
Cable V8, micro USB for Samsung, LG etc...
Kabel V8, micro-USB für Samsung, LG etc...



UYPPD0000
Lightning to 30-pin adapter. Packed by 10 pcs. You can use all type of Kiosk for iPad 4 too.
30 Pin Adapter / 10er Packung. Sie können alle unsere Ipad Kiosk Produkte auch für den Ipad 4 benutzen.

MATERIAL : Black anodised aluminium		WEIGHT	PACKING SIZE
ARTICLE	DESCRIPTION	WITH PACKING	*W X H X D
UUTC0B1B00	Black	4,880 kg	470 X 1110 X 67 mm

*W:Width H: Height D: Depth



Universal Novel Tablet Kiosk



Watch video at our website www.mtdisplays.com



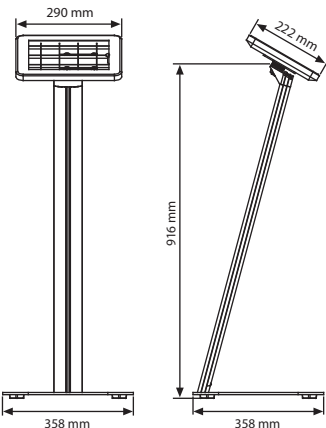
Smart Solutions for Technological Devices! Universal Novel Tablet Kiosk is suitable for iPad 1, 2, 3, 4, Air, Samsung Galaxy and most 9.7"-10.1" tablets. The tablet holder can be rotated to display landscape portrait positions and tablet is secured with a lockable case to reduce the risk of theft. USB cable travels through the pole for cleaner view. The home button is covered to prevent interfering from the public. Universal Novel iPad Kiosk is suitable for retail purposes, trade shows and conventions as well as car galleries, furniture stores when the base is adjusted.

Elegante Lösung für technische Innovationen. Es ist geeignet für iPad 1, 2, 3, 4, Samsung Galaxy und am meisten für 9.7"-10.1" Tablets. Der Ipad Halter kann in Querformat oder im Hochformat verwendet werden und geschützt wird der Ipad durch 2 Sicherheitsschrauben die das Risiko des Diebstahls minimieren. Das USB Kabel wird hier durch das Profil verlegt so dass man es von außen nichts sehen kann. Die Home Taste wird hier durch die Abdeckung verdeckt um ein Betätigen von anderen zu verhindern. Der Universal Novel Tablet Kiosk ist geeignet für Einzelhandel Zwecke, Produktvorstellungen, Präsentationen, Autohäuser und Möblaustellungen.

- Packed unassembled with an easy to understand instruction for assembly. Demontiert verpackt mit einer einfachen Gebrauchsanleitung zur Montage
- USB cable is not included. Order separately. Fixing for floor mounting included. USB Kabel ist nicht inkludiert. Separat bestellen. Schrauben für Bodenfixierung inkludiert
- Closed home button. Verdeckter home knopf.



Don't forget to order USB cable.
Vergessen Sie nicht das USB-Kabel zu bestellen.



TSTDCI450B
Cable for all iPhones & iPads.
Kabel für alle iPhones & iPads.



TSTDCIP40B
Cable for iPhone 4S, iPad 3 and earlier.
Kabel für iPhone 4S, iPad 3 und früher.



TSTDCIP50B
Cable for iPhone 5, iPad 4 and later.
Kabel für iPhone 5, iPad 4 und höher.



TSTDCV80B
Cable V8, micro USB for Samsung, LG etc...
Kabel V8, micro-USB für Samsung, LG etc...



TZZZ998701
Cable lock kit for iPad 2100mm.
Kabelschloss-Kit für iPad 21000 mm.



UYPPD0000
Lightning to 30-pin adapter. Packed by 10 pcs. You can use all type of Kiosk for iPad 4 too. 30 Pin Adapter / 10er Packung. Sie können alle unsere Ipad Kiosk Produkte auch für den Ipad 4 benutzen.

MATERIAL : Silver anodised aluminium		WEIGHT	PACKING SIZE
ARTICLE	DESCRIPTION	WITH PACKING	*W X H X D
UUTNON1B00	Silver	6,300 kg	380 X 1080 X 107 mm

*W:Width H:Height D:Depth



Universal Novel Tablet Kiosk for Wall & Freestanding



Watch video at our website www.mtdisplays.com



Smart Solutions for Technological Devices!
 Universal Novel Kiosk for wall or freestanding is suitable for iPad1, 2, 3, 4, Air, Samsung Galaxy and most 9.7"-10.1" tablets. The tablet holder can be rotated to display landscape portrait positions and tablet is secured with a lockable case to reduce the risk of theft. USB cable travels through the pole for cleaner view. The home button is covered to prevent interfering from the public. Universal Novel Kiosk is suitable for retail purposes, trade shows and conventions as well as car galleries, furniture stores. It is easily mounted on required height.

*Intelligente Lösungen für technologische Geräte!
 Universal Novel Kiosk für Wand oder freistehend eignet sich für iPad1, 2, 3, 4, Air, Samsung Galaxy und übliche 9,7"-10,1" Tablets. Der Tablet-Halter kann in Quer- und Hochformat gedreht werden, Das Tablet wird mit einem abschließbaren Gehäuse gesichert, um das Diebstahlrisiko zu verringern. Für eine saubere Ansicht fährt das USB-Kabel durch das Standrohr. Die Home-Taste ist abgedeckt, um äußere Interferenzen aus der Umwelt zu verhindern. Universal Novel Kiosk eignet sich für den Einzelhandel, Messen und Kongresse sowie Auto-Galerien, Möbelhäuser. Der Aufbau kann in Wunschhöhe leicht durchgeführt werden.*



Packed unassembled with an easy to understand instruction for assembly.
 Demontiert verpackt mit einer einfachen Gebrauchsanleitung zur Montage



USB cable is not included. Order separately. Fixing for floor mounting included.
 USB Kabel ist nicht inkludiert. Separat bestellen. Schrauben für Bodenfixierung inkludiert



Closed home button.
 Verdeckter home knopf.

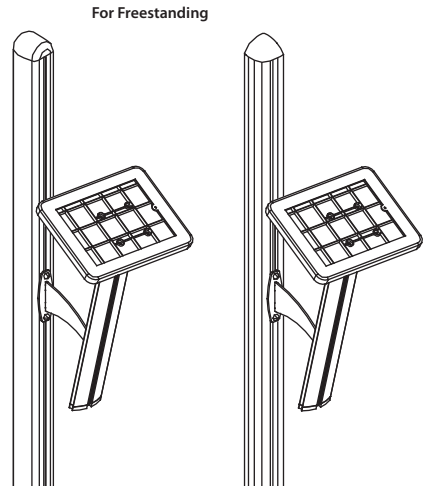
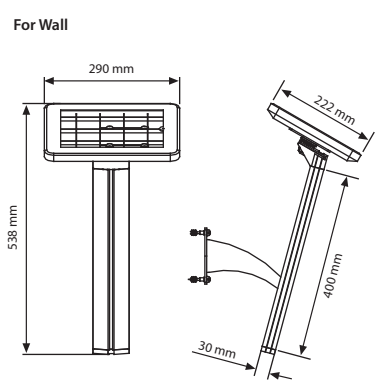
Color options : Silver-anodized & black.
 Farbenoptionen : schwarz und silber eloxiert.



TZZZ998701
 Cable lock kit for iPad 2100mm.
 Kabelschloss-Kit für iPad 21000 mm.



UYPPD0000
 Lightning to 30-pin adapter. Packed by 10 pcs. You can use all type of Kiosk for iPad 4 too.
 30 Pin Adapter / 10er Packung
 Sie können alle unsere Ipad Kiosk Produkte auch für den Ipad 4 benutzen.



MATERIAL : Silver anodised aluminium		WEIGHT	PACKING SIZE
ARTICLE	DESCRIPTION	WITH PACKING	*W X H X D
UUTWOB1800	for Wall / Black	2,250 kg	310 X 480 X 210 mm
UUTNFB1800	for Freestanding / Black	2,250 kg	310 X 480 X 210 mm

*W:Width H: Height D: Depth



Smart TV Stand

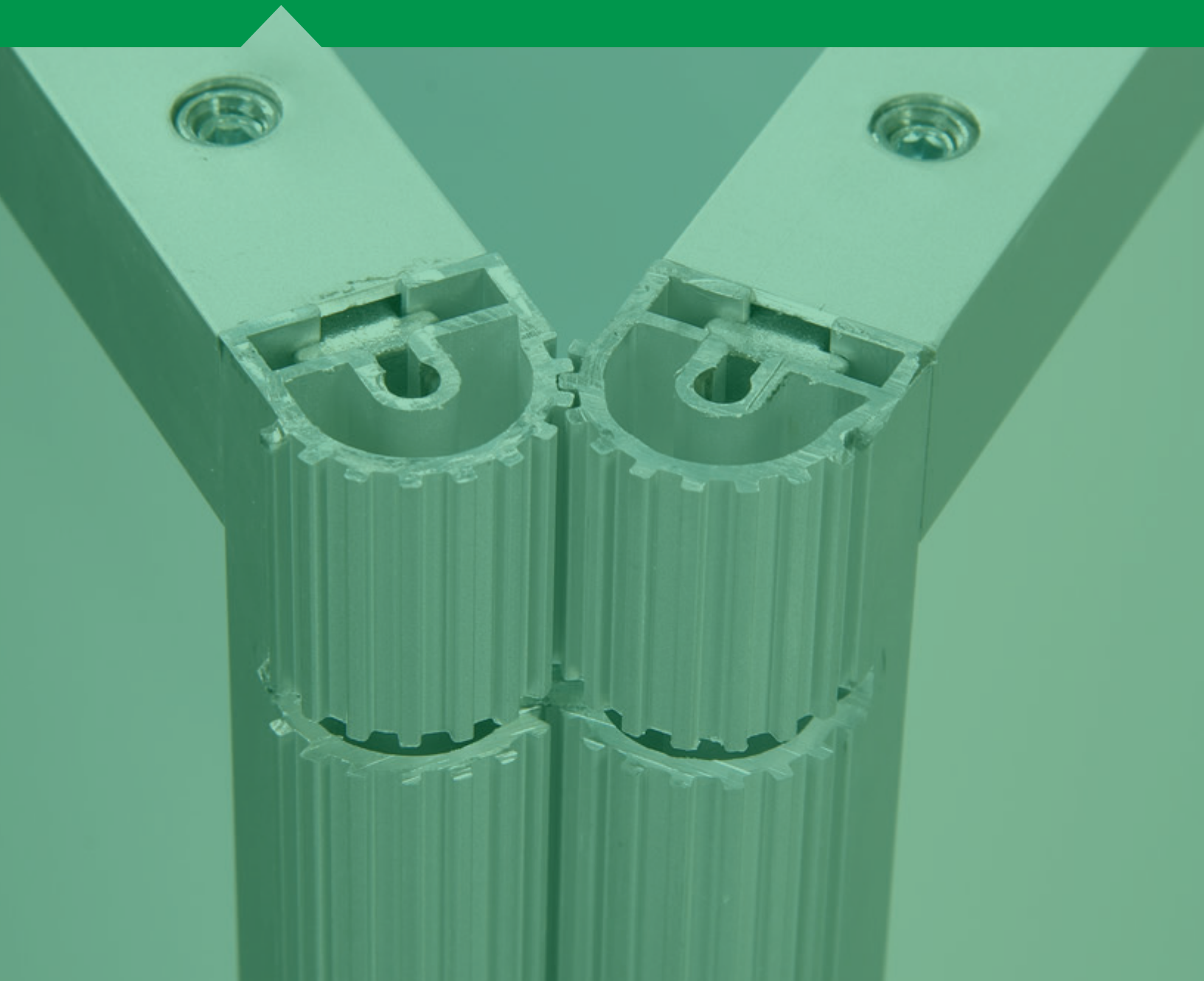




Exhibition Displays

- Panset
- Pop-up with Clips
- Pop-up with Magnetic
- Crown Truss

- *Rahmen-Faltdisplay*
- *Pop-up mit Klips*
- *Pop-up mit Magnet*
- *Crown Truss*



Panaset



Panaset exhibition system is a portable & friendly assembled panel construction. The durable framework of Panaset can be positioned between 0-360° The framework of the construction can be easily unassembled to permit a quick change of the panel inside.

Application of the inner panels

Open the top profiles by using an allen key. Take out the unprinted panels. After the application of the printings on the panels, slide them into the construction through the channels on both sides. Fix the top profiles in the side channels as shown in the photo. Use the allen key to firm the positioning of profiles. Repeat the same process for all the panels.

Panaset Wände sind tragbare Verbraucher freundliche Panel Konstruktionen. Die Scharnierkonstruktion ist von 0 bis 360 Grad schwenkbar. Alle Winkeleinstellungen sind möglich. Die robusten Aluminiumrahmen und-zargen sind sehr stabil. Die Füllpanele können durch leichtes Öffnen der Rahmen jederzeit ausgetauscht werden.

Abringung der inneren Kunststoffpanele
Öffnen Sie die Oberprofile mit Hilfe des Imbusschlüssels. Nehmen Sie die unbedruckten Paneele heraus. Führen Sie sie nach Bedruckung wieder in die gleichen Kanäle hinein. Setzen Sie die Oberprofile auf die Seitenprofile wie auf dem Foto gezeigt und ziehen Sie diese mit dem Imbusschlüssel fest. Wiederholen Sie das Verfahren an allen Paneelen.



Please consider during planning that the visual area of the graphic panel will diminish by 0,5 cm on every side because of the profile covering. Bitte berücksichtigen Sie bei der Gestaltung, daß jeweils 0,5 cm auf jeder Seite des Grafikpanels durch die Profile bedeckt werden.



3 packs. See info chart for pack sizes. 3 Packungen. Siehe Infodiagramm für Packungsgrößen.



Bag / UYUP076100
Panaset black carry bag main body for all size. Don't forget to order.
Schwarze Panasettragetasche für den Korp von allen Grössen. Vergessen Sie nicht, bestellen.



Bag / UYUP075100
Panaset black carry bag for logo for all size. Don't forget to order.
Schwarze Panasettragetasche für Logo von allen Grössen. Vergessen Sie nicht, bestellen.

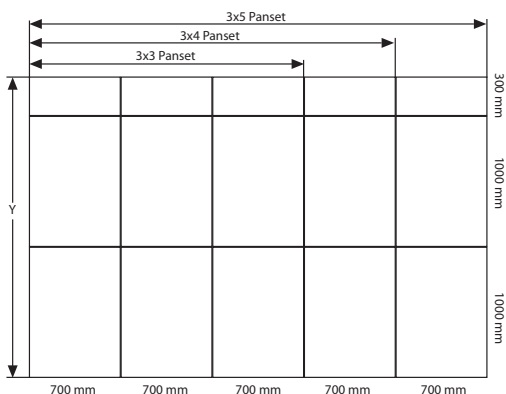
Assembly

Fix the header panels on the second floor panels first. On last step place in the bottom floor with the top part. Here is the complete Exhibition stand.

Montage

Befestigen Sie zunächst die mittleren Teile der Aufsatzblenden. Setzen Sie die Oberteile auf die Unterteile. Vervollständigen Sie somit die Faltschirm.

3x5 / 3x4 / 3x3 Panaset



MATERIAL : Silver anodised aluminium PANEL: Plastech PVC Foam				WEIGHT	PACKING SIZE
ARTICLE	EXTERNAL (x-y)	PANEL	HEADER	WITH PACKING	*W X H X D
UPNS000035	3500 X 2300 mm	700 X 1000 mm	300 X 700 mm	35,950 kg	350 X 760 X 140 mm
					760 X 1120 X 140 mm
					760 X 1120 X 140 mm
UPNS000034	2800 X 2300 mm	700 X 1000 mm	300 X 700 mm	29,530 kg	350 X 760 X 120 mm
					760 X 1120 X 120 mm
					760 X 1120 X 120 mm
UPNS000033	2100 X 2300 mm	700 X 1000 mm	300 X 700 mm	22,660 kg	350 X 760 X 80 mm
					760 X 1120 X 80 mm
					760 X 1120 X 80 mm



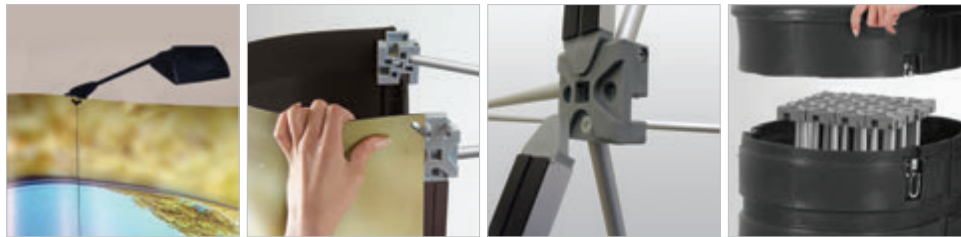
*W:Width H: Height D: Depth

Pop-up with Clips

Pop-up with Magnetic



Watch video at our website www.mtdisplays.com



Pop-up stands are still the most popular standard display for large graphic displays. They are easy to transport, light weight, simple pop-ups and packable into a roto-molded plastic carry bag for transportation. Pop-up displays have a variety of sizes 3x3, 3x4. Panels are fitted to create a round display. Lights are available upon request.

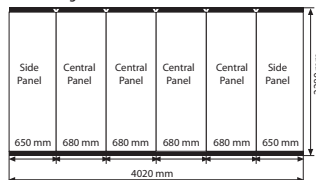
Pop-Up Ständer sind die populärsten standard Displays für die grossen Grafikdisplays. Sie sind leicht zu transportieren, leichtgewichtig, leicht aufstellbar und können leicht in der Plastiktasche transportiert werden. Sie werden in Variationen 3x3 und 3x4 angeboten. Die Paneele bilden einen Halbkreis. Die Beleuchtung ist extra zu bestellen.

- Product is packed unassembled. Das Produkt wird unmontiert verpackt geliefert.
- Simple pop-ups, no tool assembly. Aufbau ohne Werkzeug und schnelle Bereitschaft zum Einsatz.
- Lighting equipment is optional, not included in the original pack. Die Beleuchtung ist extra zu bestellen.

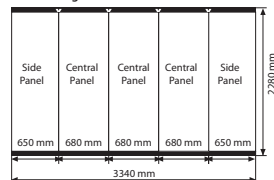


Transport bag / UPP0110000

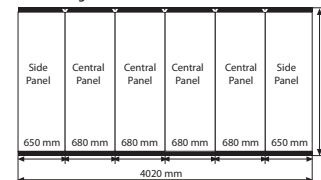
Pop-up with Clips
3x4 Printing Panel Sizes



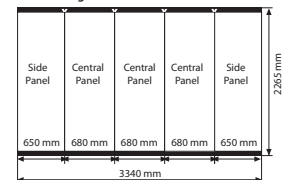
3x3 Printing Panel Sizes



Pop-up with Magnetic
3x4 Printing Panel Sizes



3x3 Printing Panel Sizes



Light / UYUP367130

POP-UP WITH CLIPS : Aluminium		WEIGHT	PACKING SIZE	POP-UP WITH MAGNETIC : Aluminium		WEIGHT	PACKING SIZE
ARTICLE	MODEL	WITH PACKING	*W X H X D	ARTICLE	MODEL	WITH PACKING	*W X H X D
UPPC120033	Pop Up 3x3 (with Bag)	30,120 kg	410 X 920 X 600 mm	UPPC220033	Pop Up 3x3 (with Bag)	29,080 kg	410 X 920 X 600 mm
UPPC120034	Pop Up 3x4 (with Bag)	34,550 kg	410 X 920 X 600 mm	UPPC220034	Pop Up 3x4 (with Bag)	35,300 kg	410 X 920 X 600 mm
UPPC130033	Pop Up 3x3 (with Bag& Lighting)	30,120 kg	410 X 920 X 600 mm	UPPC230033	Pop Up 3x3 (with Bag& Lighting)	30,620 kg	410 X 920 X 600 mm
UPPC130034	Pop Up 3x4 (with Bag& Lighting)	34,550 kg	410 X 920 X 600 mm	UPPC230034	Pop Up 3x4 (with Bag& Lighting)	35,300 kg	410 X 920 X 600 mm

POP-UP WITH MAGNETIC : Aluminium										WEIGHT	PACKING SIZE		
ARTICLE	MODEL	PVC PANEL				HOLDER				MAGNETIC BAR	MAGNETIC STRIPES	WITH PACKING	*W X H X D
		CENTRAL	QUANTITY	SIDE	QUANTITY	CENTRAL	QUANTITY	SIDE	QUANTITY				
UPPC200033	3 X 3	680 X 2265 mm	3	650 X 2265 mm	2	680 X 56 X 2 mm	6	650 X 56 X 0,8 mm	4	1 set 18 pcs	30 m (1 rulo)	22,150 kg	420 X 860 X 420 mm
UPPC200034	3 X 4	680 X 2265 mm	4	650 X 2265 mm	2	680 X 56 X 2 mm	8	650 X 56 X 0,8 mm	4	1 set 21 pcs	30 m (1 rulo)	25,000 kg	420 X 860 X 420 mm

POP-UP WITH CLIPS : Aluminium										WEIGHT	PACKING SIZE		
ARTICLE	MODEL	PVC PANEL				HOLDER				MAGNETIC BAR	MAGNETIC STRIPES	WITH PACKING	*W X H X D
		CENTRAL	QUANTITY	SIDE	QUANTITY	CENTRAL	QUANTITY	SIDE	QUANTITY				
UPPC100033	3 X 3	680 X 2280 mm	3	650 X 2280 mm	2	680 X 56 X 2 mm	6	650 X 56 X 0,8 mm	4	1 set 18 pcs	30 m (1 rulo)	21,600 kg	420 X 860 X 420 mm
UPPC100034	3 X 4	680 X 2280 mm	4	650 X 2280 mm	2	680 X 56 X 2 mm	8	650 X 56 X 0,8 mm	4	1 set 21 pcs	30 m (1 rulo)	25,310 kg	420 X 860 X 420 mm



*W:Width H: Height D: Depth

Pop-up Assembly



Slide the light properly into the spot ready on the top of the main construction. Please note that this optional item is not supplied with the pop-ups. If need be, 2 of lights come with 3x3 and 3 off lights come with 3x4.

The system is suitable for 2 lights in 3x3 and 3 lights in 3x4.

Schieben Sie den Beleuchtungsuntersatz in die dafür auf der oberen Seite der Konstruktion befindliche Stelle. Bedenken Sie bitte, dass die Beleuchtung extra bestellt werden muss und zwar 2 Stück für 3x3 und 3 Stück für 3x4.

Das System ist passend für 2 Stück für 3x3 und 3 Stück für 3x4.

Caution:

After the printing is applied on the black PVC panels, the brut sizes should be cut & resized to net panel sizes using at least trimming knives.

Warnung:

Nach Anbringung des Druckmaterials mit Bruttomaßen auf die schwarzen Paneele sind diese Paneele dann auf die Nettomaße mit Teppichschneider zurechtzuschneiden.

This pack includes; Pop-up 3x3

-  1 x Pop-up Wall Magnetic.
1 x Pop-up Wand Magnetic.
-  1 x Pop-up Wall Clips
1 x Pop-up Wand Klips
-  18 x Bars with magnetic tape inside its textile bag.
18 x Stangen mit Magnetband in der Textiltasche.
-  1 x Roll self adhesive magnetic tape.
1 x Roll kleisterig Magnetband.
-  2 x Black PVC (Magnetic: Brut:690X2310X0,4mm Net:650X2265X0,4mm)
3 x Black PVC (Magnetic: Brut:720X2310X0,55mm Net:680X2265X0,55mm)
2 x Black PVC (Clips: Brut: 690X2310X0,4mm Net:650X2280X0,4mm)
3 x Black PVC (Clips: Brut: 720X2310X0,55mm Net:680X2280X0,55mm)
2 x Schwarz PVC (Magnetic: Brut:690X2310X0,4mm Net:650X2265X0,4mm)
3 x Schwarz PVC (Magnetic: Brut:720X2310X0,55mm Net:680X2265X0,55mm)
2 x Schwarz PVC (Klips: Brut: 690X2310X0,4mm Net:650X2280X0,4mm)
3 x Schwarz PVC (Klips: Brut: 720X2310X0,55mm Net:680X2280X0,55mm)
-  2 x Hanging straps with slot (650x56x0,8mm)
2 x Simple straps (690x56x0,8mm)
2 x Hangende Riemen mit Slot (650x56x0,8mm)
2 x Normal Riemen (690x56x0,8mm)
-  3 x Hanging straps with slot (680x56x2mm)
3 x Simple straps (680x56x2mm)
3 x Hangende Riemen mit Slot (680x56x2mm)
3 x Normal Riemen (680x56x2mm)
-  2 x Hanging straps with magnet (650x56x0,8mm)
2 x Simple straps (650x56x0,8mm)
2 x Hangende Riemen mit Magnet (650x56x0,8mm)
2 x Normal Riemen (650x56x0,8mm)
-  2 x Hanging straps with magnet (650x56x0,8mm)
2 x Simple straps (650x56x2mm)
2 x Hangende Riemen mit Magnet (650x56x0,8mm)
2 x Normal Riemen (650x56x2mm)
-  2 x Lights when it is required.
2 x Beleuchtungsgeräte auf Wunsch.

This pack includes; Pop-up 3x4

-  1 x Pop-up Wall Magnetic.
1 x Pop-up Wand Magnetic.
-  1 x Pop-up Wall Clips
1 x Pop-up Wand Klips
-  21 x Bars with magnetic tape inside its textile bag.
21 x Stangen mit Magnetband in der Textiltasche.
-  1 x Roll self adhesive magnetic tape.
1 x Roll kleisterig Magnetband.
-  2 x Black PVC (Magnetic: Brut:690X2310X0,4mm Net:650X2265X0,4mm)
4 x Black PVC (Magnetic: Brut:720X2310X0,55mm Net:680X2265X0,55mm)
2 x Black PVC (Clips: Brut: 690X2310X0,4mm Net:650X2280X0,4mm)
4 x Black PVC (Clips: Brut: 720X2310X0,55mm Net:680X2280X0,55mm)
2 x Schwarz PVC (Magnetic: Brut:690X2310X0,4mm Net:650X2265X0,4mm)
4 x Schwarz PVC (Magnetic: Brut:720X2310X0,55mm Net:680X2265X0,55mm)
2 x Schwarz PVC (Klips: Brut: 690X2310X0,4mm Net:650X2280X0,4mm)
4 x Schwarz PVC (Klips: Brut: 720X2310X0,55mm Net:680X2280X0,55mm)
-  2 x Hanging straps with slot (650x56x0,8mm)
2 x Simple straps (690x56x0,8mm)
2 x Hangende Riemen mit Slot (650x56x0,8mm)
2 x Normal Riemen (690x56x0,8mm)
-  4 x Hanging straps with slot (680x56x2mm)
4 x Simple straps (680x56x2mm)
4 x Hangende Riemen mit Slot (680x56x2mm)
4 x Normal Riemen (680x56x2mm)
-  2 x Hanging straps with magnet (650x56x0,8mm)
2 x Simple straps (650x56x0,8mm)
2 x Hangende Riemen mit Magnet (650x56x0,8mm)
2 x Normal Riemen (650x56x0,8mm)
-  4 x Hanging straps with magnet (650x56x2mm)
4 x Simple straps (650x56x2mm)
4 x Hangende Riemen mit Magnet (650x56x2mm)
4 x Normal Riemen (650x56x2mm)
-  3 x Lights when it is required.
3 x Beleuchtungsgeräte auf Wunsch.

Crown Truss

15x15



Watch video at our website www.mtdisplays.com



Crown Truss System is developed for the display and exhibition industry for modular and practical advertisement purpose. It is made of strong and durable materials; aluminium, steel and composite. At the same time it is a lightweight and foldable truss construction. Very easy to assemble, disassemble, pack and carry.

Crown Truss System wurde für die Display- und Ausstellungsbranche für den modularen und praktischen Werbezweck entwickelt. Es besteht aus starken und haltbaren Materialien; Aluminium, Stahl und Verbundwerkstoff. Zur gleichen Zeit hat es eine leichte und faltbare Fachwerkkonstruktion. Es ist sehr einfach zu montieren, zu zerlegen, zu packen und zu tragen.



Design software is available on internet. Please ask for login details. Design-Software ist im Internet verfügbar. Bitte fragen Sie nach Login-Daten.



3 promotion packs are available; Sample Kit, Trolley Kit and Showroom Kits. 3 Aktionspakete sind verfügbar; Muster-Kit, Trolley-Kit und Showroom-Kits.



Technical data sheet available on request. Technisches Datenblatt auf Anfrage erhältlich.

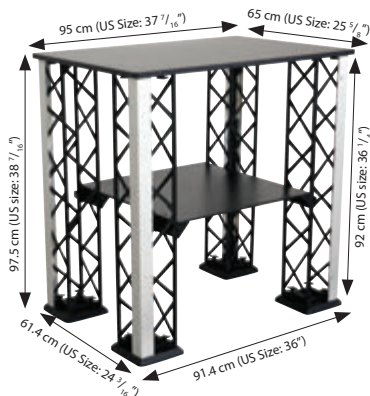
Color options / Farbenoptionen



Black / Schwarz
White / Weiß



Build your own display in 3D!



CROWN TRUSS COUNTER			WEIGHT	PACKING SIZE
BLACK	WHITE	MODEL	WITH PACKING	*W X H X D
UCT15BSP00	UCT15WSP00	With shelf	24,800 kg	800 X 1150 X 250 mm
UCT15BS010	UCT15WS010	Without shelf	19,500 kg	800 X 1150 X 250 mm

*W:Width H: Height D: Depth

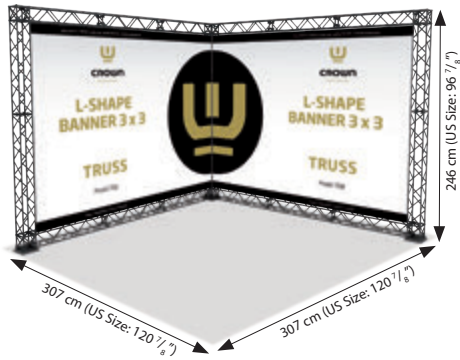


Crown Truss Models 15x15



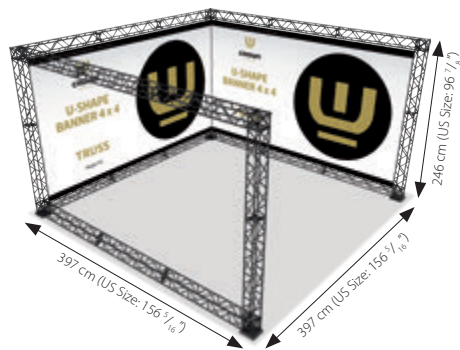
Model 768 / UCT15BM768

Truss L-Shape 3 x 3



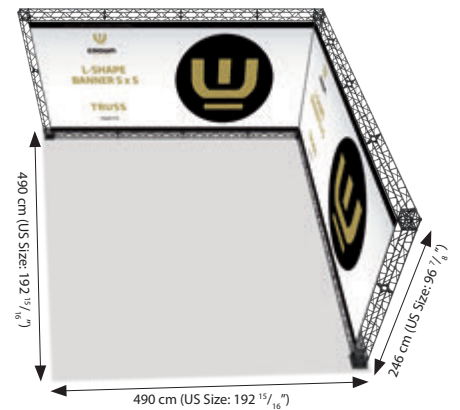
Model 771 / UCT15BM771

Truss U-Shape 4 x 4



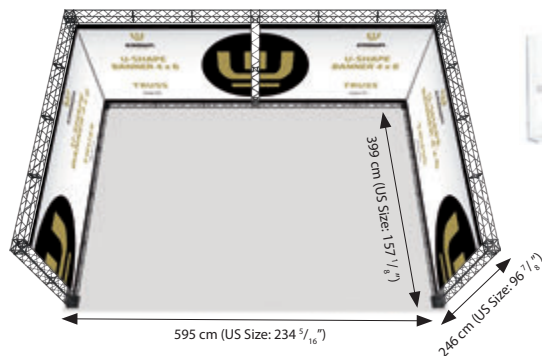
Model 772 / UCT15BM772

Truss L-Shape 5 x 5

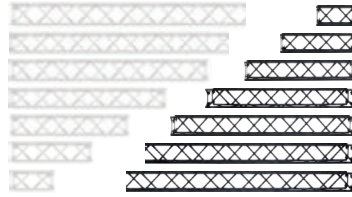


Model 775 / UCT15BM775

Truss U-Shape 4 x 6



Crown Truss Parts 15x15



MODULE 150X150 MM			WEIGHT	PACKING SIZE (5 Pcs)
BLACK	WHITE	SIZE	WITH PACKING	*W X H X D
UCT15BM030	UCT15WM030	300 mm	4,555 kg	285 X 330 X 210 mm
UCT15BM060	UCT15WM060	600 mm	7,360 kg	285 X 630 X 210 mm
UCT15BM090	UCT15WM090	900 mm	10,165 kg	285 X 930 X 210 mm
UCT15BM120	UCT15WM120	1200 mm	12,970 kg	285 X 1230 X 210 mm
UCT15BM150	UCT15WM150	1500 mm	15,775 kg	285 X 1530 X 210 mm
UCT15BM180	UCT15WM180	1800 mm	18,580 kg	285 X 1830 X 210 mm
UCT15BM210	UCT15WM210	2100 mm	21,385 kg	285 X 2130 X 210 mm

REGULAR BASE			WEIGHT	PACKING SIZE (5 Pcs)
BLACK	WHITE	SIZE	WITH PACKING	*W X H X D
UCT15BF220	UCT15WF220	190 X 190 mm	1,215 kg	200 X 200 X 150 mm

SIDE BASE			WEIGHT	PACKING SIZE (5 Pcs)
BLACK	WHITE	SIZE	WITH PACKING	*W X H X D
UCT15BF245	UCT15WF245	190 X 400 mm	2,170 kg	195 X 435 X 125 mm

MIDDLE BASE			WEIGHT	PACKING SIZE (5 Pcs)
BLACK	WHITE	SIZE	WITH PACKING	*W X H X D
UCT15BF260	UCT15WF245	190 X 600 mm	3,000 kg	195 X 635 X 125 mm

CORNER BLOCK		WEIGHT	PACKING SIZE (5 Pcs)
BLACK	WHITE	WITH PACKING	*W X H X D
UCT15BK800	UCT15WK800	5,200 kg	320 X 470 X 170 mm

CONNECTOR CROSS		WEIGHT	PACKING SIZE (5 Pcs)
BLACK	WHITE	WITH PACKING	*W X H X D
UCT15BAE00	UCT15WAE00	0,600 kg	170 X 170 X 80 mm

FOR BANNER HANGING		WEIGHT
ARTICLE	SIZE	WITH PACKING
UCT15BP030	300 mm	2,950 kg
UCT15BP060	600 mm	5,900 kg
UCT15BP090	900 mm	8,850 kg
UCT15BP120	1200 mm	11,800 kg
UCT15BP150	1500 mm	14,750 kg
UCT15BP180	1800 mm	17,700 kg
UCT15BP210	2100 mm	20,650 kg

CLIP-ON FITTING		WEIGHT
BLACK	WHITE	WITH PACKING
UCT15BBT00	UCT15WBT00	1,100 kg

CLIPS FOR BANNER			WEIGHT	PACKING SIZE (100 Pcs)
BLACK	WHITE	SIZE	WITH PACKING	*W X H X D
UCT15BAU00	UCT15WU00	Top clips	0,580 kg	130 X 205 X 110 mm
UCT15BAA00	UCT15WAA00	Bottom clips	0,675 kg	130 X 205 X 110 mm

SHELFS			WEIGHT	PACKING SIZE
BLACK	WHITE	SIZE	WITH PACKING	*W X H X D
UCT15BR062	UCT15WR062	600 mm	3,000 kg	265 X 620 X 70 mm
UCT15BR092	UCT15WR092	900 mm	4,150 kg	265 X 920 X 70 mm
UCT15BR122	UCT15WR122	1200 mm	5,300 kg	265 X 1220 X 70 mm
UCT15BR152	UCT15WR152	1500 mm	6,450 kg	265 X 1520 X 70 mm
UCT15BR440	UCT15WR440	L Shape	0,850 kg	415 X 415 X 70 mm
UCT15BRT00	UCT15WRT00	Shelf holder	0,200 kg	

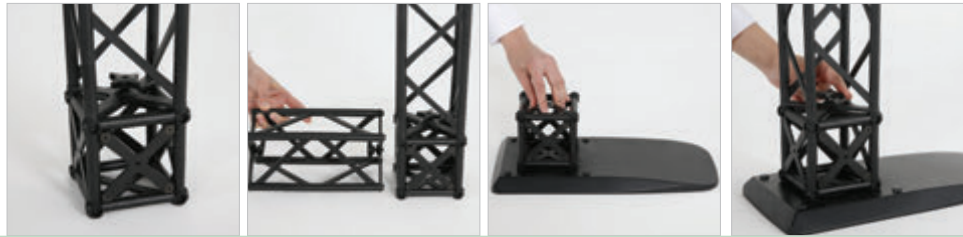
ACRYLIC HOLDER			WEIGHT	PACKING SIZE (5 Pcs)
BLACK	WHITE	SIZE	WITH PACKING	*W X H X D
UCT15BB0A4	UCT15WB0A4	A4	1,760 kg	265 X 305 X 235 mm
UCT15BB0A5	UCT15WB0A5	A5	1,130 kg	185 X 275 X 175 mm
UCT15BB4A3	UCT15WB4A3	1/3 A4	0,930 kg	175 X 175 X 185 mm

SPOTS		WEIGHT
ARTICLE	DESCRIPTION	WITH PACKING
UCT10BLT10	Spotlight 150 W	0,700 kg
UCT15BLT00	Spotlight fitting-Black	0,320 kg
UCT15WLT00	Spotlight fitting-White	0,320 kg




*W:Width H: Height D: Depth


Crown Truss 10x10



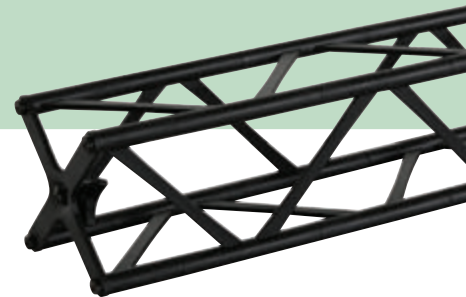
Crown Truss System 10x10 is developed for the display and exhibition industry for modular and practical advertisement purpose. It is made of strong and durable materials; aluminium, steel and composite. At the same time it is a lightweight truss construction. Very easy to assemble, disassemble, pack and carry.

Crown Truss System 10x10 wurde für die Display- und Ausstellungsbranche für den modularen und praktischen Werbezweck entwickelt. Es besteht aus starken und haltbaren Materialien; Aluminium, Stahl und Verbundwerkstoff. Zur gleichen Zeit hat es eine leichte Fachwerkkonstruktion. Es ist sehr einfach zu montieren, zu zerlegen, zu packen und zu tragen.

 White and Black colours available.
Weiße und schwarze Farben erhältlich.

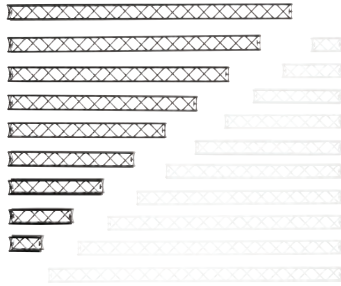
 Technical data sheet available on request.
Technisches Datenblatt auf Anfrage erhältlich.

Color options / Farboptionen



Crown Truss Parts 10x10

MODULE 100X100 MM			WEIGHT	PACKING SIZE (5 Pcs)
BLACK	WHITE	SIZE	WITH PACKING	*W X H X D
UCT10BM020	UCT10WM020	200 mm	2,720 kg	125 X 525 X 255 mm
UCT10BM040	UCT10WM040	400 mm	3,950 kg	125 X 525 X 455 mm
UCT10BM060	UCT10WM060	600 mm	5,200 kg	125 X 525 X 655 mm
UCT10BM080	UCT10WM080	800 mm	6,450 kg	125 X 525 X 855 mm
UCT10BM100	UCT10WM100	1000 mm	7,600 kg	125 X 525 X 1055 mm
UCT10BM120	UCT10WM120	1200 mm	8,950 kg	125 X 525 X 1255 mm
UCT10BM140	UCT10WM140	1400 mm	10,200 kg	125 X 525 X 1455 mm
UCT10BM160	UCT10WM160	1600 mm	11,400 kg	125 X 525 X 1655 mm
UCT10BM180	UCT10WM180	1800 mm	12,650 kg	125 X 525 X 1855 mm
UCT10BM200	UCT10WM200	2000 mm	13,900 kg	125 X 525 X 2055 mm



CORNER BLOCK		WEIGHT	PACKING SIZE (5 Pcs)
BLACK	WHITE	WITH PACKING	*W X H X D
UCT10BK800	UCT10WK800	3,410 kg	125 X 125 X 555 mm

CONNECTOR CROSS (5 Pcs)		WEIGHT	PACKING SIZE (5 Pcs)
BLACK	WHITE	WITH PACKING	*W X H X D
UCT10BAE00	UCT10WAE00	0,320 kg	125 X 125 X 105 mm

REGULAR BASE			WEIGHT	PACKING SIZE (5 Pcs)
BLACK	WHITE	SIZE	WITH PACKING	*W X H X D
UCT10BF220	UCT10WF220	190 X 190 mm	1,320 kg	205 X 205 X 155 mm



SIDE BASE			WEIGHT	PACKING SIZE (5 Pcs)
BLACK	WHITE	SIZE	WITH PACKING	*W X H X D
UCT10BF245	UCT10WF245	190 X 400 mm	2,170 kg	195 X 435 X 125 mm



MIDDLE BASE			WEIGHT	PACKING SIZE (5 Pcs)
BLACK	WHITE	SIZE	WITH PACKING	*W X H X D
UCT10BF260	UCT10WF245	190 X 600 mm	3,000 kg	195 X 635 X 125 mm



ACRYLIC HOLDER			WEIGHT	PACKING SIZE (5 Pcs)
BLACK	WHITE	SIZE	WITH PACKING	*W X H X D
UCT10BB0A4	UCT10WB0A4	A4	1,760 kg	265 X 305 X 235 mm
UCT10BB0A5	UCT10WB0A5	A5	1,130 kg	185 X 275 X 175 mm
UCT10BB0A3	UCT10WB0A3	1/3 A4	0,930 kg	175 X 175 X 185 mm



FOR BANNER HANGING		WEIGHT
ARTICLE	SIZE	WITH PACKING
UCT10BP020	200 mm	0,200 kg
UCT10BP040	400 mm	0,400 kg
UCT10BP060	600 mm	0,795 kg
UCT10BP080	800 mm	0,990 kg
UCT10BP120	1200 mm	1,390 kg
UCT10BP150	1500 mm	1,585 kg
UCT10BP180	1800 mm	1,980 kg



CLIP-ON FITTING		WEIGHT
BLACK	WHITE	WITH PACKING
UCT10BBT00	UCT10WBTO0	1,100 kg

CLIPS FOR BANNER			WEIGHT	PACKING SIZE (100 Pcs)
BLACK	WHITE	SIZE	WITH PACKING	*W X H X D
UCT10BAU00	UCT10WAU00	Top clips	0,580 kg	130 X 205 X 110 mm
UCT10BAA00	UCT10WAA00	Bottom clips	0,675 kg	130 X 205 X 110 mm



SPOTS		WEIGHT
ARTICLE	DESCRIPTION	WITH PACKING
UCT10BLT10	Spotlight 150 W	0,700 kg
UCT10BLT00	Spotlight fitting-Black	0,320 kg
UCT10WLT00	Spotlight fitting-White	0,320 kg



*W:Width H: Height D: Depth





Counter Displays

- Panset Counters
 - Pop-up Counter
 - Promostand
 - Petite Promostand
 - Rectangular Promostand
 - Circle Promostand
 - Bean Promostand
 - Seed Promostand
 - Wood Podium
 - Tempered Glass Podium
- Falt-Theke*
 - Pop-up Counter*
 - Promotiontheke*
 - Petite Promostand*
 - Rectangular Promostand*
 - Circle Promostand*
 - Bean Promostand*
 - Seed Promostand*
 - Wood Podium*
 - Tempered Glass Podium*



Panset Hexagonal Counter



Panset counters are ideal products with a light & compact structure. They can be carried to different locations and re-used many times. It is easy and quick to install. Different models meet your needs in the most convenient manner. These counters are lightweight and fit quickly in the corner of a car.

Die falt-Theken bieten ideale Lösungen für vielseitige Verwendungen an, da sie sehr leicht und kompakt sind. Mit ihrer Eigenschaft der schnellen Zusammenstellung ermöglichen sie dem Verwender eine leichte Handhabung. Je nach Ihrem Bedarf stehen verschiedene Ausführungen zur Auswahl.



After the panels are assembled, due to the fitting of panels inside the construction, the visual area is 0,5 cm smaller on all sides. Bitte berücksichtigen Sie bei der Gestaltung, daß jeweils 0,5 cm auf jeder Seite des Grafikpanels durch die profile verdeckt werden.

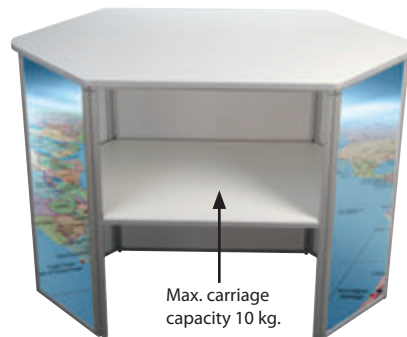


Please first fix the shelf and then the top plate. Black textile carry bag is optional. Befestigen Sie zunächst den Zwischenboden und danach die obere Tischplatte. Schwarze Transporttasche ist extra zu bestellen.

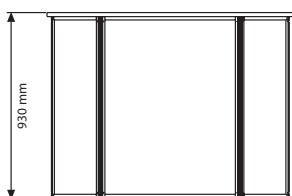
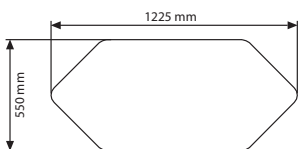
Wood Hexagonal Counter



Hexagonal Counter



Transport bag / UYUP074100



MATERIAL : Silver anodised aluminium PANEL: Plastech PVC Foam					WEIGHT	PACKING SIZE
ARTICLE	MODEL	PANEL	COPY	QUANTITY	WITH PACKING	*W X H X D
UPSM001000	Hexagonal	878 X 659 mm	866 X 647 mm	1	19,300 kg	720 X 1270 X 130 mm
		878 X 311 mm	866 X 301 mm	4		
UPSM007000	Wood Hexagonal	878 X 659 mm	866 X 647 mm	1	21,300 kg	720 X 1270 X 130 mm
		878 X 311 mm	866 X 301 mm	4		



*W:Width H: Height D: Depth

Panset Convex Counter



Panset counters are ideal products of light & compact structure, they can be carried to different locations and re-used many times. It is easy and fast in assembly. Different models offer you the most convenient choice for your needs. These lightweight counters fit quickly in the corner of a car.

Die Falthecken bieten ideale Lösungen für vielseitige Verwendungen an. Da diese sehr leicht und kompakt sind, ermöglichen Sie die Nutzung an verschiedenen Plätzen über mehrere Male. Schneller und leichter Aufbau. Die passenste Ausführung nach Ihrem Bedarf kann aus unserem Sortiment ausgewählt werden. Klein und handlich passt er in jede Autoecke.



After the panels are assembled, due to the fitting of panels inside the construction, the visual area is 0,5 cm smaller on all sides. Bitte berücksichtigen Sie bei der Gestaltung, daß jeweils 0,5 cm auf jeder Seite des Grafikpanels durch die profile verdeckt werden.

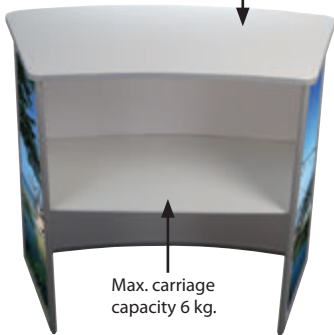


Please first fix the shelf and then the top plate. Black textile carry bag is optional. Befestigen Sie zunächst den Zwischenboden und danach die obere Tischplatte. Schwarze Transporttasche ist extra zu bestellen.

Convex Counter



Max. carriage capacity 15 kg.

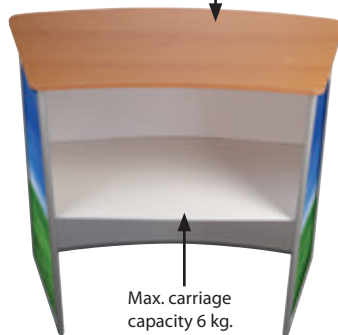


Max. carriage capacity 6 kg.

Wood Convex Counter



Max. carriage capacity 20 kg.

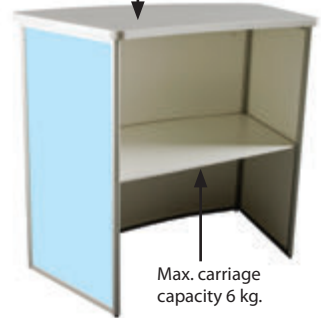


Max. carriage capacity 6 kg.

Midsize Convex Counter



Max. carriage capacity 15 kg.



Max. carriage capacity 6 kg.

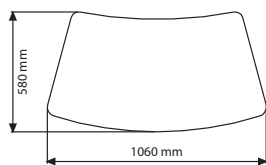


Transport bag / UYUP070200

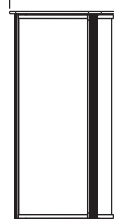
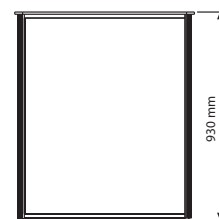
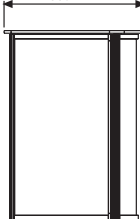
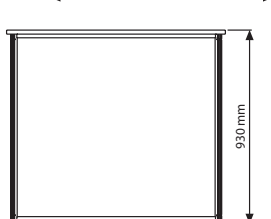
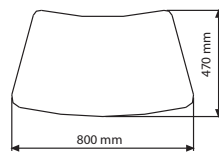


Transport bag / UYUP074000

Convex Counter



Midsize Convex Counter



MIDSIZE COUNTER : Silver anodised aluminium
PANEL: Plastech PVC Foam

ARTICLE	PANEL	COPY	QUANTITY
UPS0M0S2000	718 X 878 mm	709 X 866 mm	1
	335 X 878 mm	325 X 866 mm	2

WEIGHT	PACKING SIZE
WITH PACKING	*W X H X D
18,100 kg	950 X 1180 X 140 mm

CONVEX COUNTER : Silver anodised aluminium
PANEL: Plastech PVC Foam

ARTICLE	MODEL	PANEL	COPY	QUANTITY
UPS0M002000	Convex	878 X 980 mm	866 X 970 mm	1
		878 X 430 mm	866 X 420 mm	2
UPS0M008000	Wood Convex	878 X 980 mm	866 X 970 mm	1
		878 X 430 mm	866 X 420 mm	2

WEIGHT	PACKING SIZE
WITH PACKING	*W X H X D
20,100 kg	950 X 1180 X 140 mm
20,150 kg	950 X 1180 X 140 mm



* W:Width H: Height D: Depth

Pop-up Counter

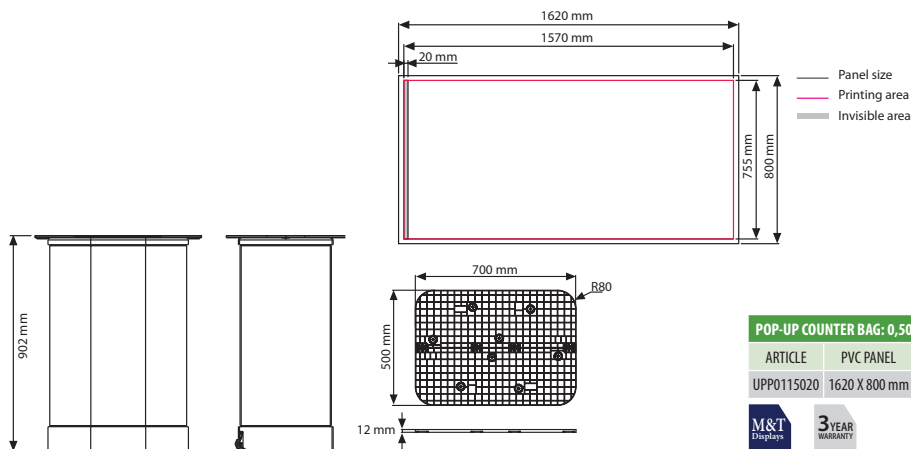


The pop-up counter offers an easy low-budget solution that can be carried to various locations and even re-used after many events. The counter can pop up in a second with no tools required.

Die Pop-up Theke bietet kostengünstige Lösungen, kann mobil an mehreren Veranstaltungen eingesetzt werden. Die Theke ist in Sekunden einsatzbereit ohne Werkzeugbedürfnisse einsatzbereit.



When we put the panel on the bag, the panel ends will overlap each other by 20 mm. Bitte berücksichtigen Sie bei der Gestaltung, dass sich auf der Rückseite in der Mitte 20 mm des Grafikpanels überlappen werden.



POP-UP COUNTER BAG: 0,50 mm, black PVC panel					WEIGHT	PACKING SIZE
ARTICLE	PVC PANEL	COPY SIZE	TOP PLATE	MAGNETIC BAR	WITH PACKING	*W X H X D
UPP0115020	1620 X 800 mm	1550 X 755 mm	700 X 500 mm	1 Pcs	13,010 kg	420 X 920 X 600 mm



*W:Width H: Height D: Dept

Promostand & Petit Promostand



This simple counter is suitable for exhibitions, demonstrations and other kinds of presentation. Produced in white plastic material, ready for any kind of decoration. Foldable and easy to transport and mount. Delivered with or without carry bag. We use powder coated steel pipes to hold 3 mm thick header panel made of Plastech PVC foam.

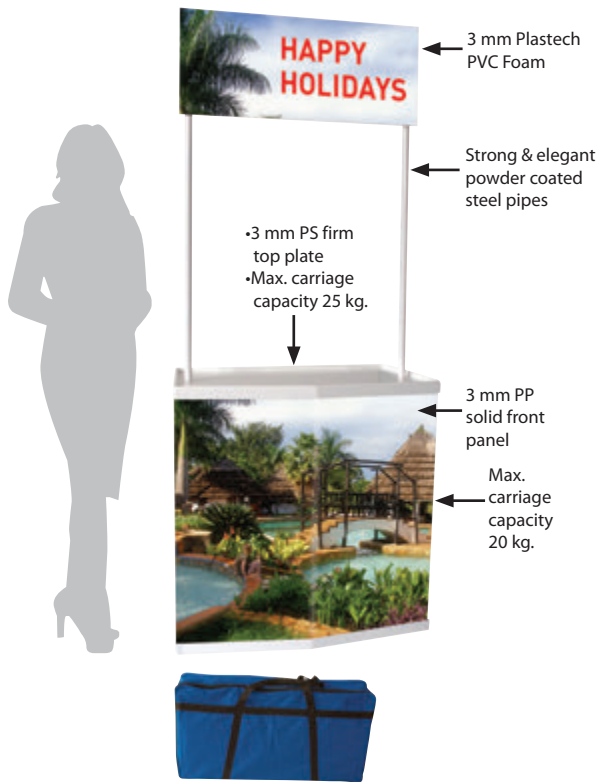
Diese einfache Theke ist geeignet für Ausstellungen, Vorführungen und verschiedene Arten von Präsentationen. Sie besteht aus weissem Kunststoff und passt zu jeder Dekoration. Leicht faltbar, leicht zu transportieren und leicht aufzubauen. Geliefert wird das Produkt auf Wunsch auch mit Transporttasche. Pulverbeschichtete Stahlrohre halten das 3 mm starke Topschild, aus Plastech PVC Schaumplatte.



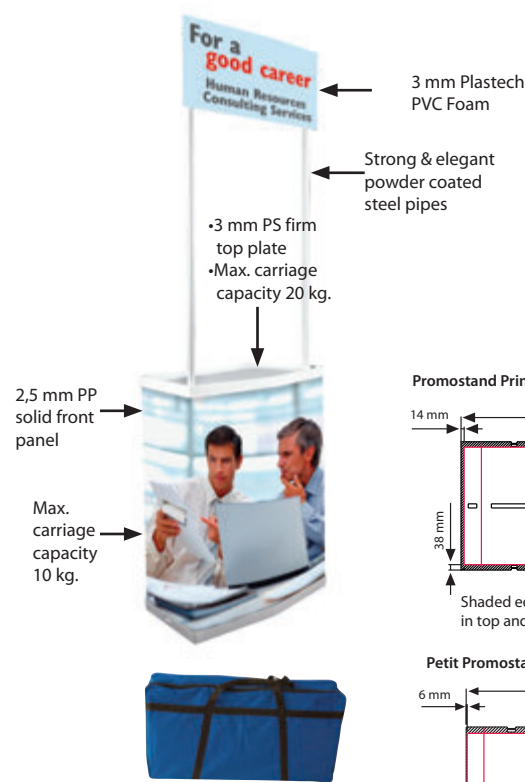
Product is packed unassembled with an easy-to-understand instruction sheet. Das Produkt wird demontiert mit einer Montageanleitung geliefert.



After the front panel is assembled due to fitting of panels inside the plastic construction, the visual area is 38 mm smaller on top & bottom ends. Thickness of front panel is 3 mm. Thickness of counter & shelves is 3 mm. Nach Anbringung der Werbeflächen an die Paneele werden, wegen der Befestigungen sowohl oben als auch unten 38 mm an Sichtfläche verloren gehen. Stärke des vorderen Panels ist 3 mm, Stärke der Abdeckplatte und der Zwischenablage ist 3 mm. Montage ohne Werkzeug.

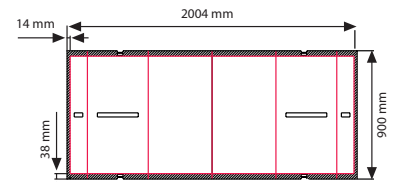


Transport bag / UYUP072200



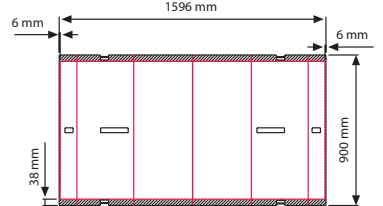
Transport bag / UYUP072300

Promostand Printing Size

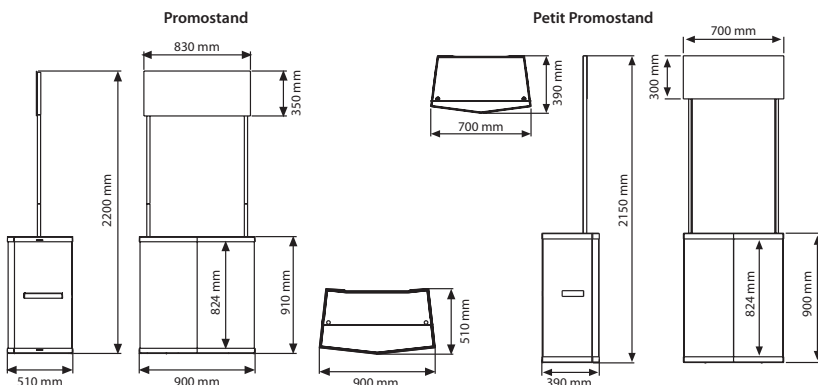


Shaded edges on the panel drawing are placed in top and bottom counter shelves.

Petit Promostand Printing Size



Shaded edges on the panel drawing are placed in top and bottom counter shelves.



PETIT PROMOSTAND : Plastic				WEIGHT	PACKING SIZE
ARTICLE	DESCRIPTION	PANEL SIZE	COPY SIZE	WITH PACKING	*W X H X D
UTSOON3000	Without bag	1596 X 900 mm	1584 X 824 mm	12,220 kg	450 X 1000 X 170 mm
UTSOON3100	With bag	1596 X 900 mm	1584 X 824 mm	12,740 kg	450 X 1000 X 170 mm
PROMOSTAND : Plastic				WEIGHT	PACKING SIZE
ARTICLE	DESCRIPTION	PANEL SIZE	COPY SIZE	WITH PACKING	*W X H X D
UTSOON5000	Without bag	2004 X 900 mm	1992 X 824 mm	13,600 kg	550 X 950 X 160 mm
UTSOON5100	With bag	2004 X 900 mm	1992 X 824 mm	14,100 kg	550 X 950 X 160 mm

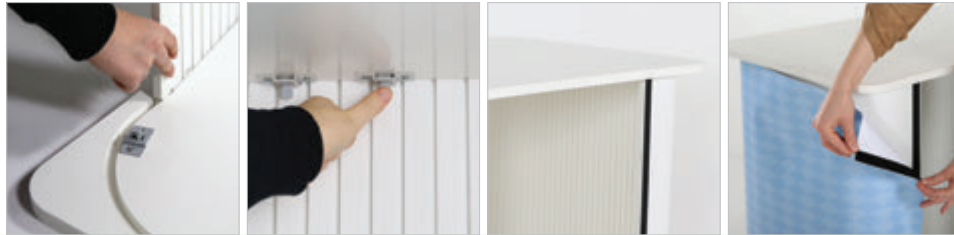
* W:Width H:Height D:Depth



Rectangular Promostand



Watch video at our website www.mtdisplays.com



This simple counter is suitable for all kind of promotion events for retail promotions such as exhibitions, supermarkets, demonstrations. Rectangular Promostand is a stock saving product. Ledge Rectangular Promostand that gives more space for item promoted. Header Rectangular Promostand allows for personalizing and helps the brand and promotion to be seen from a distance. Also offered with a choice of felt fabric in grey.

Diese einfache Theke ist geeignet für alle Arten von Events, Promotions, Ausstellungen, Messen, Einzelhandel, Demonstrationen. Der Rectangular Promostand ist ein platz sparender Lagerartikel. Der Ladder Rectangular Promostand ist ideal geeignet für Produktpräsentationen. Der Header Rectangular Promostand ist durch das aufgebrauchte Logo ideal um Aufmerksamkeit zu ziehen. Der Rectangular Promostand with Pole System bietet eine Vielzahl an Variationen mit Prospekthaltern, Postern und Logo. Abgerundet wird es mit einem optionalen grauen Filz in Grau.



Packed unassembled with an easy-to-understand instruction sheet. Demontiert verpackt mit einer einfachen Gebrauchsanleitung.



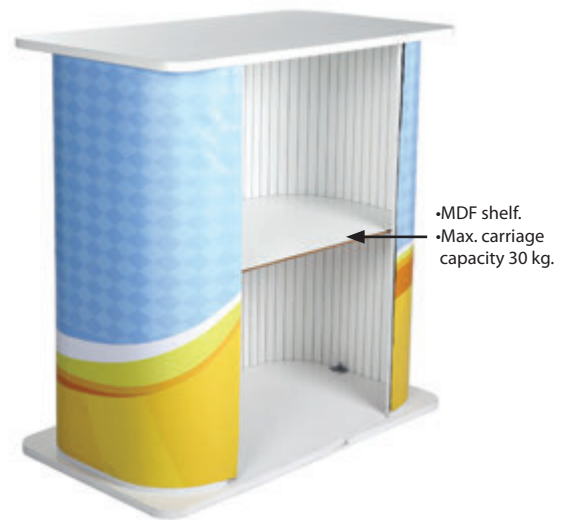
Flat - pack design. Flach verpackt.



Inner shelf, header, carry bag, brochure holders excluded. See Free Standing System pages for more accessory options. Regale, Topschild, Tragetasche, Prospekthalter nicht inkludiert. Sehen Sie auf den Free Stanging Katalogseiten nach für mehr Zubehör.



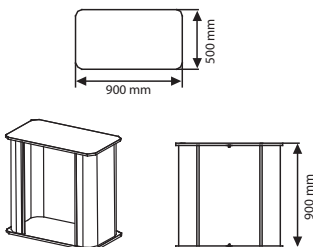
2 packs. See info chart for pack sizes. 2 Packungen. Siehe Infodiagramm für Packungsgrößen.



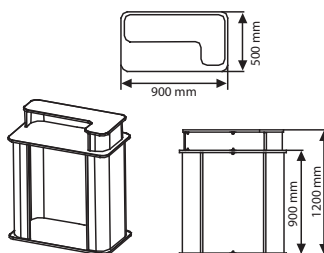
Don't forget to order separately

- Inner shelf
- Grey felt
- Carry bag
- Header
- Ledge

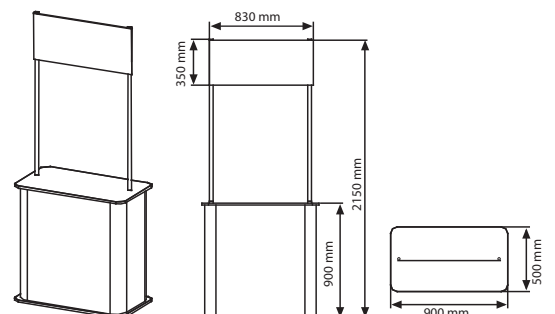
Rectangular Promostand



Rectangular Ledge Promostand



Rectangular Promostand with Header





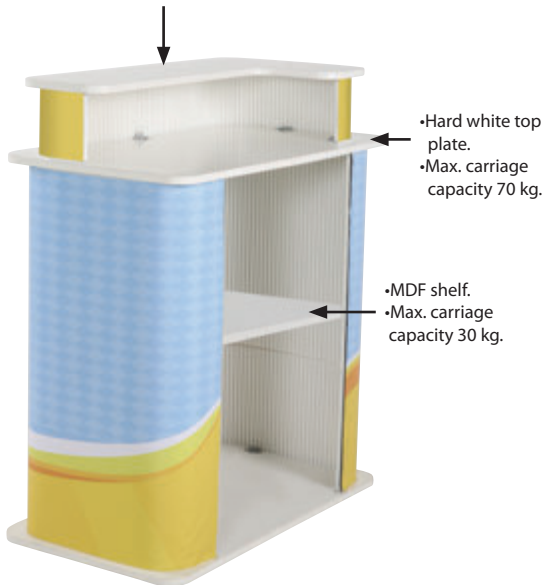
Watch video at our website www.mtdisplays.com

Rectangular Ledge Promostand



10 mm Multiwall PP

•Hard white top plate
•Max. carriage capacity 70 kg.



•Hard white top plate.
•Max. carriage capacity 70 kg.

•MDF shelf.
•Max. carriage capacity 30 kg.



Watch video at our website www.mtdisplays.com

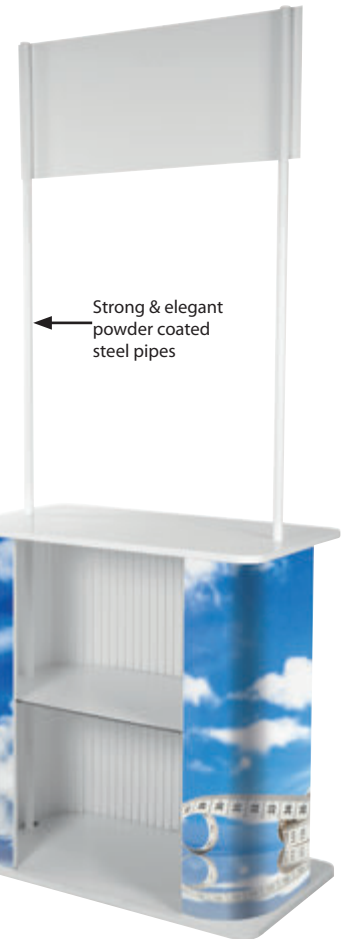
Rectangular Promostand with Header



3 mm PVC Foam

•Hard white top plate.
•Max. carriage capacity 70 kg.

Don't forget to order separately
• Inner shelf
• Grey felt
• Carry bag
• Header
• Ledge



Strong & elegant powder coated steel pipes

10 mm Multiwall PP



UYPOTS1050 Carry bag



UYPOTS0030 Velcro Roll with double sided tape 18 meters.



UYPOTS003G Grey felt only for Rectangular Promostand incl. Velcro set for 900 mm.

MATERIAL : Plastic				WEIGHT	PACKING SIZE
ARTICLE	DESCRIPTION	PANEL SIZE	PRINTING SIZE	WITH PACKING	*W X H X D
UTSD000909	w/out bag,w/out felt,w/out shelf	1849 X 892 mm	1815 X 865 mm	11,500 kg	535 X 940 X 70 / 200 X 940 X 200 mm
UTSD020909	with header,w/out bag,w/out felt,w/out shelf	1849 X 892 mm	1815 X 865 mm	14,300 kg	535 X 940 X 95 / 200 X 1240 X 200 mm
UTSD010912	Ledge w/out bag,w/out felt,w/out shelf	1849 X 892 mm	1815 X 865 mm	14,500 kg	570 X 1040 X 95 / 200 X 940 X 200 mm
UYPOTS0010	Inner shelf only,white	850 X 450 mm		1,750 kg	855 X 455 X 7 mm
UYPOTS0020	Inner shelf only for header ,white	850 X 450 mm		1,750 kg	855 X 455 X 7 mm
UYPOTS003G	Grey felt only incl.Velcro.	1870 X 865 mm	1870 X 865 mm	0,360 kg	250 X 250 X 100 mm

* W:Width H: Height D: Depth



3 YEAR WARRANTY



Circle Promostand



Watch video at our website www.mtdisplays.com



This round counter is suitable for all kind of promotion events for retail promotions such as exhibitions, supermarkets, demonstrations. Round shape takes attention and gives more space for visitors to examine items presented. Circle Promostand is a stock saving product. Keeping components available in stock as flat-pack, it enables to offer numerous of variations. Ledge Circle Promostand that gives more space for item promoted. Header Circle Promostand allows for personalizing and helps the brand and promotion to be seen from a distance. Also offered with a choice of felt fabric in grey.

Diese runde Theke ist geeignet für alle Arten von Events, Promotions, Ausstellungen, Messen, Einzelhandel, Demonstrationen. Die runde Form bietet mehr Platz für die auszustellenden Artikel. Hergestellt aus PP und einer MDF Ablage. Der Round Counter ist ein Platz sparender Lagerartikel. Das Zubehör ist auch flach verfügbar. Der Ladder Round Promostand ist ideal geeignet für Produktpräsentationen. Der Header Round Promostand ist durch das aufgebrachte Logo ideal um Aufmerksamkeit zu ziehen. Der Round Promostand with Pole System bietet eine Vielzahl an Variationen mit Prospekthaltern, Postern und Logo. Abgerundet wird es mit einem optionalen grauen Filz in Grau.



Packed unassembled with an easy-to-understand instruction sheet. Demontiert verpackt mit einer einfachen Gebrauchsanleitung.



Flat-pack design. Flach verpackt.



Inner shelf, header, carry bag, brochure holders excluded. See Free Standing System pages for more accessory options. Regale, Toppschild, Tragetasche, Prospekthalter nicht inkludiert. Sehen Sie auf den Free Standing Katalogseiten nach für mehr Zubehör.

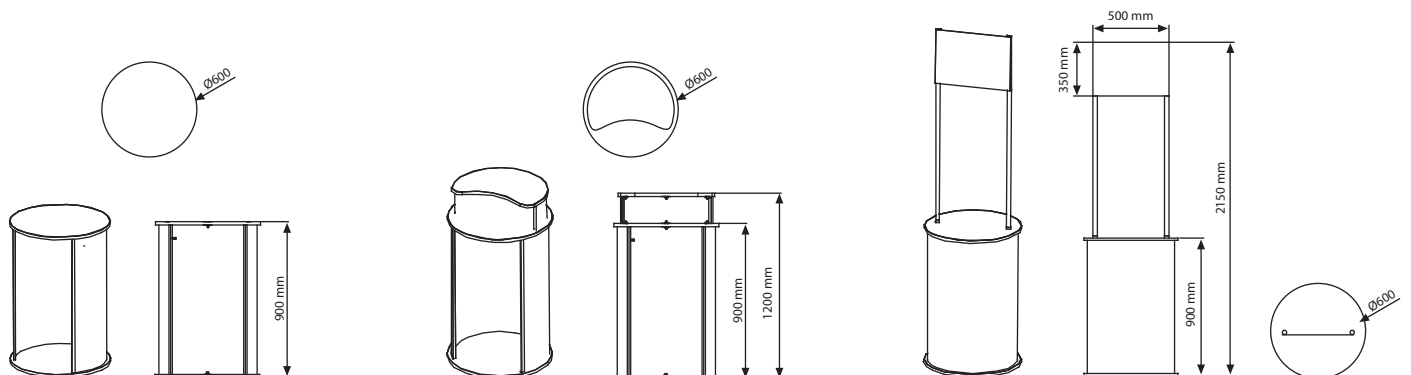


2 packs. See info chart for pack sizes. 2 Packungen. Siehe Infodiagramm für Packungsgrößen.



Don't forget to order separately

- Inner shelf
- Grey felt
- Carry bag
- Header
- Ledge





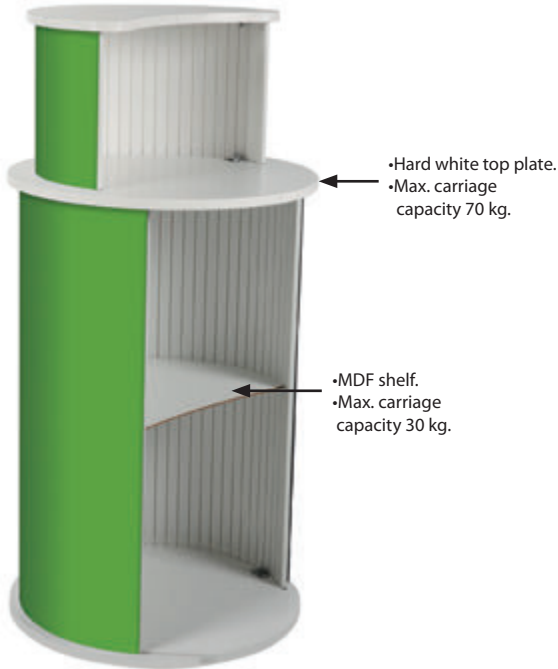
Watch video at our website www.mtdisplays.com

Circle Ledge Promostand



•Hard white top plate.
•Max. carriage capacity 70 kg.

10 mm Multiwall PP



•Hard white top plate.
•Max. carriage capacity 70 kg.

•MDF shelf.
•Max. carriage capacity 30 kg.



Watch video at our website www.mtdisplays.com

Circle Promostand with Header



3 mm PVC Foam

Strong & elegant powder coated steel pipes

•Hard white top plate.
•Max. carriage capacity 70 kg.

10 mm Multiwall PP

Max. carriage capacity 30 kg.

Don't forget to order separately

- Inner shelf
- Grey felt
- Carry bag
- Header
- Ledge



UYPOTS3050 Carry bag



UYPOTS0030 Velcro Roll with double sided tape 18 meters.



UYPOTSR03G Grey felt only for Circle Promostand incl. Velcro set for 900 mm.

MATERIAL : Plastic				WEIGHT	PACKING SIZE
ARTICLE	DESCRIPTION	PANEL SIZE	PRINTING SIZE	WITH PACKING	*W X H X D
UTSR000609	w/out bag,w/out felt,w/out shelf	1238 X 892 mm	1204 X 865 mm	7,500 kg	630 X 630 X 70 / 200* X 940 X 200 mm
UTSR020609	with header,w/out bag,w/out felt,w/out shelf	1238 X 892 mm	1204 X 865 mm	10,200 kg	630 X 630 X 95 / 200 X 1040 X 200 mm
UTSR010612	Ledge w/out bag,w/out felt,w/out shelf	1238 X 892 mm	1204 X 865 mm	9,700 kg	630 X 630 X 95 / 200 X 1240 X 200 mm
UYPOTSR010	Inner shelf only,white	550 X 415 mm		0,900 kg	555 X 420 X 7 mm
UYPOTSR020	Inner shelf only for header ,white	550 X 415 mm		0,900 kg	555 X 420 X 7 mm
UYPOTSR03G	Grey felt only incl. Velcro.	1253 X 865 mm	1253 X 865 mm	0,310 kg	250 X 250 X 100 mm

* W:Width H: Height D: Depth



Bean Promostand



Watch video at our website www.mtdisplays.com



This contemporary counter is suitable for all kind of promotion events for retail promotions such as exhibitions, supermarkets, demonstrations. Bean Promostand is a stock saving product. Keeping components available in stock as flat-pack, it enables to offer numerous of variations. Ladder Bean Promostand that gives more space for item promoted. Header Bean Promostand allows for personalizing. Also offered with a choice of felt fabric in grey.

Diese zeitgenössische Theke ist geeignet für alle Arten von Events, Promotions, Ausstellungen, Messen, Einzelhandel, Demonstrationen. Der Bean Promostand ist ein platz sparender Lagerartikel. Das Zubehör ist auch flach verfügbar, sodass man diese Artikel als Lagerartikel führen kann. Der Ladder Bean Promostand ist ideal geeignet für Produktpräsentationen. Der Header Bean Promostand ist durch das aufgebrachte Logo ideal um Aufmerksamkeit zu ziehen. Der Bean Promostand with Pole System bietet eine Vielzahl an Variationen mit Prospekthaltern, Postern und Logo. Abgerundet wird es mit einem optionalen grauen Filz in Grau.



Packed unassembled with an easy-to-understand instruction sheet. Demontiert verpackt mit einer einfachen Gebrauchsanleitung.



Flat-pack design. Flach verpackt.



Inner shelf, header, carry bag, brochure holders excluded. See Free Standing System pages for more accessory options. Regale, Toppschild, Tragetasche, Prospekthalter nicht inkludiert. Sehen Sie auf den Free Standing Katalogseiten nach für mehr Zubehör.



2 packs. See info chart for pack sizes. 2 Packungen. Siehe Infodiagramm für Packungsgrößen.

Don't forget to order separately

- Inner shelf
- Grey felt
- Carry bag
- Header
- Ledge

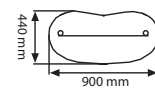
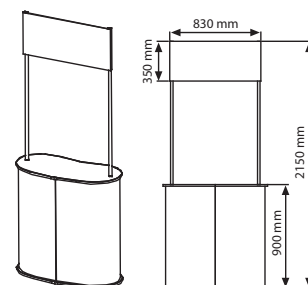
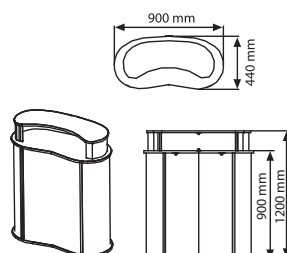
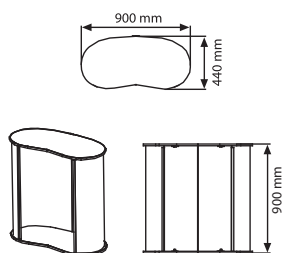
•Hard white top plate.
•Max. carriage capacity 70 kg.



← 10 mm Multiwall PP



•MDF shelf.
•Max. carriage capacity 30 kg.





Watch video at our website www.mtdisplays.com

Bean Ledge Promostand



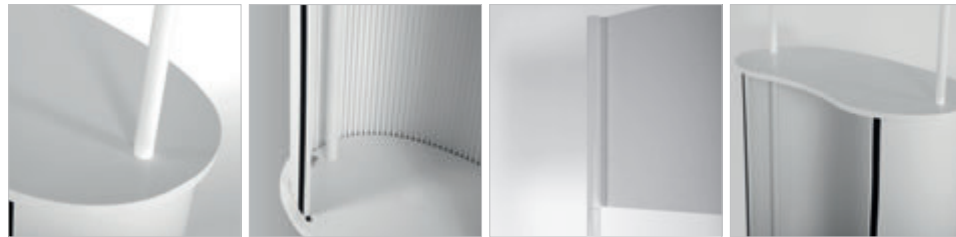
10 mm
Multiwall PP

•Hard white top plate.
•Max. carriage capacity 70 kg.



•Hard white top plate.
•Max. carriage capacity 70 kg.

•MDF shelf.
•Max. carriage capacity 30 kg.



Watch video at our website www.mtdisplays.com

Bean Promostand with Header



•Hard white top plate.
•Max. carriage capacity 70 kg.

Strong & elegant
powder coated
steel pipes

Don't forget to order
separately
• Inner shelf
• Grey felt
• Carry bag
• Header
• Ledge

3 mm
PVC Foam



•MDF shelf.
•Max. carriage capacity 30 kg.

10 mm
Multiwall PP



UYPOTS1050
Carry bag



UYPOTS0030
Velcro Roll with double
sided tape 18 meters.



UYPOTS003G
Grey felt only for Bean
Promostand incl.
Velcro set for 900 mm.

MATERIAL : Plastic				WEIGHT	PACKING SIZE
ARTICLE	DESCRIPTION	PANEL SIZE	PRINTING SIZE	WITH PACKING	*W X H X D
UTSB000909	w/out bag,w/out felt,w/out shelf	1557 X 892 mm	1523 X 865 mm	9,500 kg	470 X 940 X 70 / 200 X 940 X 200 mm
UTSB020909	with header,w/out bag,w/out felt,w/out shelf	1557 X 892 mm	1523 X 865 mm	12,200 kg	470 X 940 X 95 / 200 X 1240 X 200 mm
UTSB010912	Ledge w/out bag,w/out felt,w/out shelf	1557 X 892 mm	1523 X 865 mm	12,300 kg	510 X 1040 X 95 / 200 X 940 X 200 mm
UYPOTS0010	Inner shelf only,white	855 X 370 mm		1,200 kg	860 X 386 X 7 mm
UYPOTS0020	Inner shelf only for header ,white	855 X 370 mm		1,200 kg	860 X 386 X 7 mm
UYPOTS003G	Grey felt only incl.Velcro.	1575 X 865 mm	1575 X 865 mm	0,340 kg	250 X 250 X 100 mm

*W:Width H:Height D:Depth



Seed Promostand



Watch video at our website www.mtdisplays.com



Seed Promostand is suitable for all kind of promotion events for retail promotions such as exhibitions, supermarkets, demonstrations. With its unique seed shape, it takes attention and occupies small place where it stands. Seed Promostand is a stock saving product. Ledge Seed Promostand that gives more space for item promoted. Header Seed Promostand allows for personalizing. Seed Promostand with Pole System offers choice of shelves, banners, and header. Also offered with a choice of felt fabric in grey.

Der Seed Promostand ist geeignet für alle Arten von Werbeveranstaltungen, Einzelhandelsaktionen wie Ausstellungen, Supermärkte und Demonstrationen. Mit seiner einzigartigen Form zieht er sofort die Aufmerksamkeit auf sich und besetzt nur sehr wenig Platz. Das Produkt ist sehr platzsparend im Lager. Der Ladder Seed Promostand ist ideal geeignet für Produktpräsentationen. Der Header Seed Promostand ist durch das aufgebrachte Logo ideal um Aufmerksamkeit zu ziehen. Der Seed Promostand with Pole System bietet eine Vielzahl an Variationen mit Prospekthaltern, Postern und Logo. Abgerundet wird es mit einem optionalen grauen Filz in Grau.



Packed unassembled with an easy-to-understand instruction sheet. Demontiert verpackt mit einer einfachen Gebrauchsanleitung.



Flat - pack design. Flach verpackt.



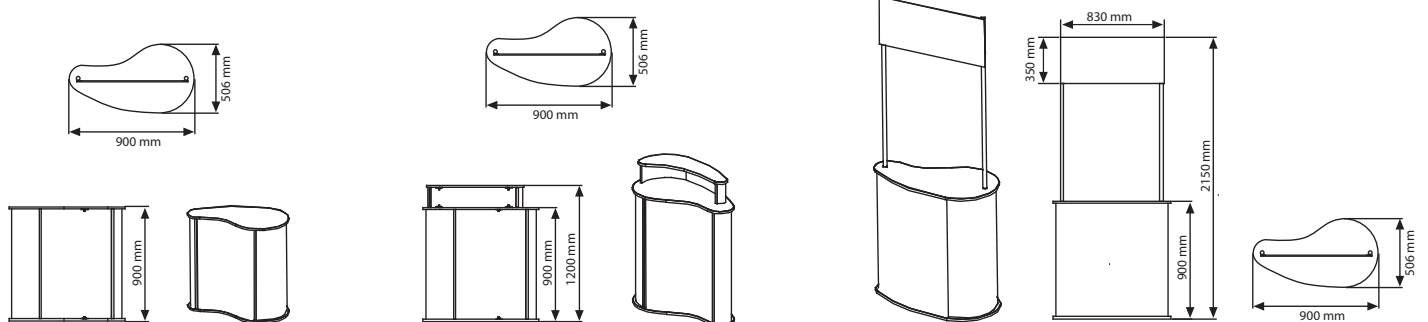
Inner shelf, header, carry bag, brochure holders excluded. See Free Standing System pages for more accessory options. Regale, Toppschild, Tragetasche, Prospekthalter nicht inkludiert. Sehen Sie auf den Free Standing Katalogseiten nach für mehr Zubehör.



2 packs. See info chart for pack sizes. 2 Packungen. Siehe Infodiagramm für Packungsgrößen.

Don't forget to order separately

- Inner shelf
- Grey felt
- Carry bag
- Header
- Ledge





Watch video at our website www.mtdisplays.com

Seed Ledge Promostand

- Hard white top plate.
- Max. carriage capacity 70 kg.



- Hard white top plate.
- Max. carriage capacity 70 kg.



Max. carriage capacity 30 kg.



UYPOTS0030
Velcro Roll with double sided tape 18 meters.

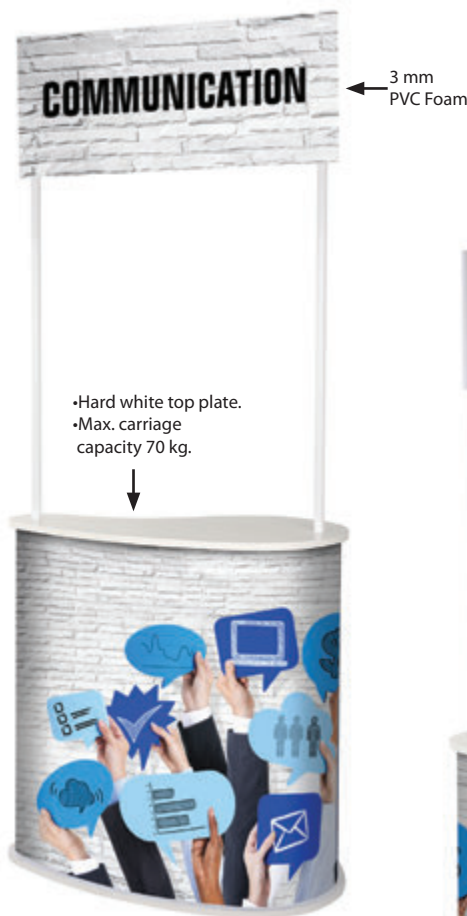


UYPOTSC03G
Grey felt only for Seed Promostand incl. Velcro set for 900 mm.



Watch video at our website www.mtdisplays.com

Seed Promostand with Header



- Hard white top plate.
- Max. carriage capacity 70 kg.



UYPOTS1050
Carry bag

Don't forget to order separately

- Inner shelf
- Grey felt
- Carry bag
- Header
- Ledge



Strong & elegant powder coated steel pipes

Max. carriage capacity 30 kg.

MATERIAL : Plastic				WEIGHT	PACKING SIZE
ARTICLE	DESCRIPTION	PANEL SIZE	PRINTING SIZE	WITH PACKING	*W X H X D
UTSC000909	w/out bag,w/out felt,w/out shelf	1530 X 892 mm	1496 X 865 mm	8,200 kg	535 X 940 X 70 / 200 X 940 X 200 mm
UTSC020909	with header,w/out bag,w/out felt,w/out shelf	1530 X 892 mm	1496 X 865 mm	11,000 kg	535 X 940 X 95 / 200 X 1240 X 200 mm
UTSC010912	Ledge w/out bag,w/out felt,w/out shelf	1530 X 892 mm	1496 X 865 mm	9,500 kg	570 X 1040 X 95 / 200 X 940 X 200 mm
UYPOTS0C10	Inner shelf only,white	850 X 444 mm		1,000 kg	855 X 449 X 7 mm
UYPOTS0C20	Inner shelf only for header ,white	850 X 444 mm		1,000 kg	855 X 449 X 7 mm
UYPOTS0C3G	Grey felt only incl.Velcro.	1560 X 865 mm	1560 X 865 mm	0,340 kg	250 X 250 X 100 mm
UTSC030909	Pole system,w/out bag or felt or shelf or header	1557 X 892 mm	1523 X 865 mm	10,800 kg	535 X 940 X 70 / 205 X 1320 X 145 mm
UYPOTS0C40	Header only for pole system	500 X 350 mm	500 X 350 mm	0,500 kg	320 X 510 X 30 mm
UYPOTS0P10	Inner shelf only for pole system,White	873 X 444 mm		1,150 kg	878 X 449 X 7 mm
UYPOTS0P3G	Grey felt only for pole system incl.Velcro	1583 X 865 mm	1583 X 865 mm	0,350 kg	250 X 250 X 100 mm

*W:Width H: Height D: Depth



3 YEAR WARRANTY

Variations & Seed Promostand with Pole System



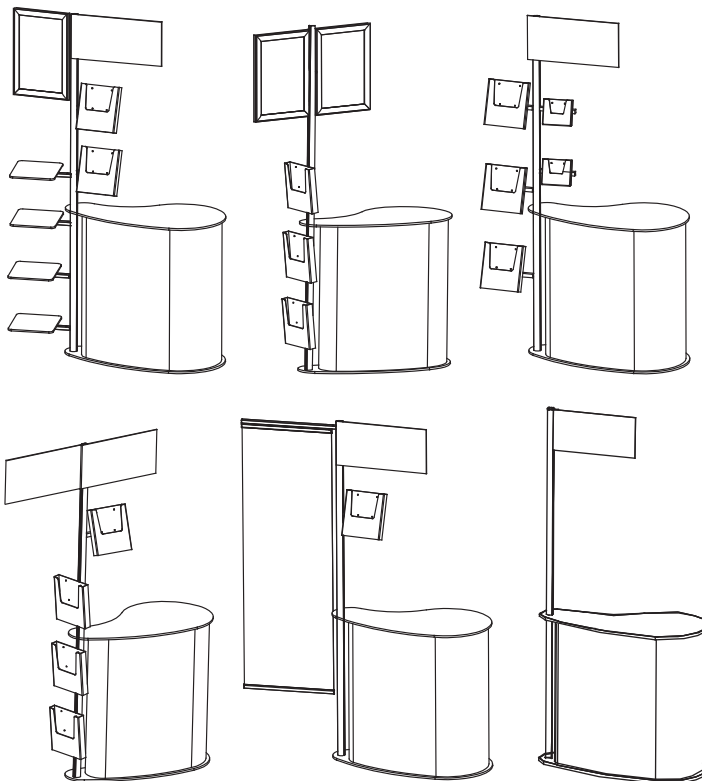
Watch video at our website www.mtdisplays.com



Make up your stand to fit your own wishes!

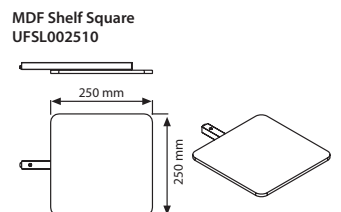
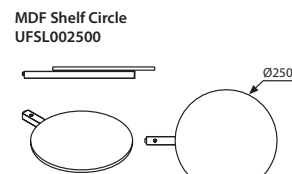
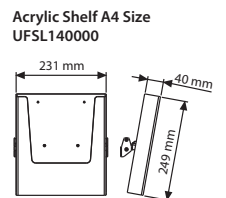


Mix and match your own stand!



Don't forget to order separately

- Inner shelf
- Grey felt
- Carry bag
- Header
- Ladder
- Circle & square shelves
- Leaflet holders
- Slide-in frames
- Banner holder



Wood Podium



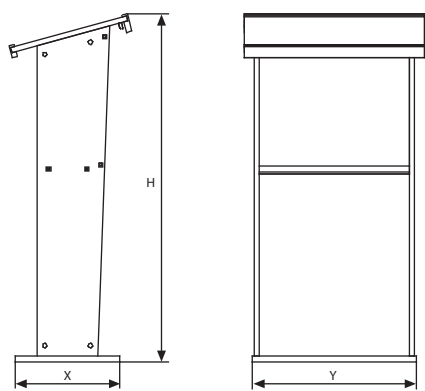
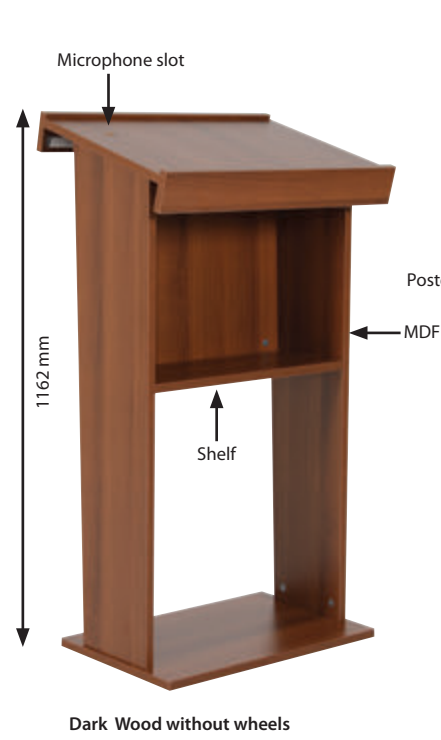
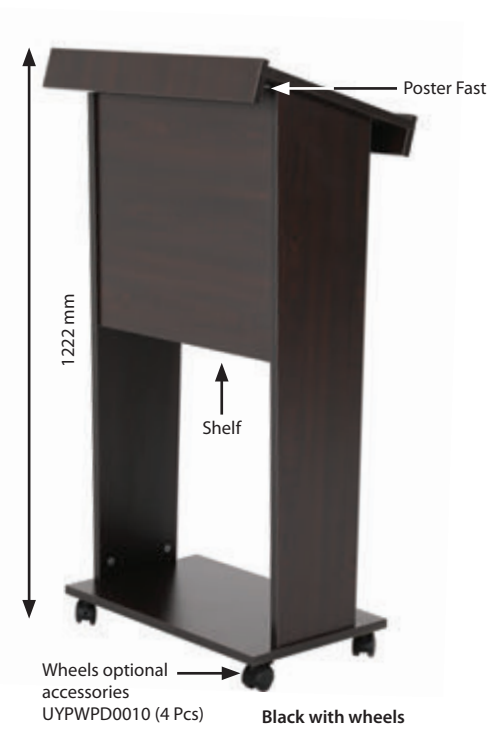
Watch video at our website www.mtdisplays.com



Wood Podium is made of MDF. It is a good lectern solution with 15 degrees viewing angle for ergonomic posture. It has an interior shelf for keeping notes and presentation materials organized. Poster clamp in front of the stand allows you to present your brand's logo for a professional fixture. Can be used at business conferences, universities, hotels, or even trade shows. To ensure sustainability of the quality, wood podium holders are lacquered finished.

Wood Podium besteht aus MDF. Es ist eine gute Pultlösung mit einem Betrachtungswinkel von 15 Grad für eine ergonomische Haltung. Es verfügt über ein Innenregal für Notizen und Präsentationsmaterial. Dank der Poster-Klammer können Sie ihr Markenlogo professionell präsentieren. Kann bei Geschäftskonferenzen, Universitäten, Hotels oder sogar Messen eingesetzt werden. Um die Nachhaltigkeit der Qualität zu gewährleisten, werden Holzpodesthalter lackiert.

- Packed unassembled with an easy-to-understand instruction sheet & fixing elements. Unmontiert verpackt mit einem leicht verständlichem Anleitungsbild und Befestigungselementen.
- With and without wheel options are available. Optional mit und ohne Räder erhältlich.
- 10 mm poster is placed within the clamping system. End caps help to slide the poster in and keeps. Das 10-mm-Poster wird in das Klemmsystem eingelegt. Bewegliche Endkappen helfen um das Poster einzuschieben.
- 1 pack. See info chart for pack sizes. 1 Packung. Siehe Packungsgrößen.
- Assembly time approx 120 seconds. Montagezeit ca. 120 Sekunden.



MATERIAL : MDF					WEIGHT	PACKING SIZE
ARTICLE	DESCRIPTION	X	Y	H	WITH PACKING	*W X H X D
UWPDD00000	Dark Wood	350 mm	550 mm	1162 mm	18,250 kg	510 X 1140 X 95 mm
UWPDB00000	Black	350 mm	550 mm	1162 mm	18,250 kg	510 X 1140 X 95 mm
UWPDL10000	Light Wood	350 mm	550 mm	1162 mm	18,250 kg	510 X 1140 X 95 mm

* W:Width H: Height D: Depth



Tempered Glass Podium



Watch video at our website www.mtdisplays.com

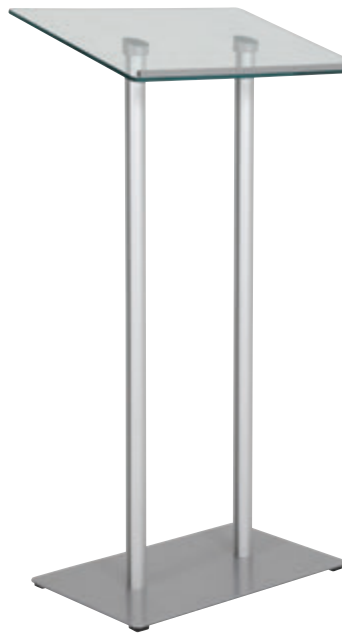


It is a good stand up presentation solution with 1115mm height and 15 degrees viewing angle for ergonomic posture. It has a document stopper to prevent sliding and keeping the presentation materials organized can be used on every occasion that needs to take the attention of the audience. Adding style to any speech, this stand-up podium can be used in conference rooms, meeting halls, and religious establishments to make presentations, in the classroom to give lectures, or in restaurants to keep reservations and waiting lists handy. This podium has a durable 8mm tempered glass top. The frame and base are made of aluminum and it has soft feet to prevent sliding.

Eine gute Präsentationslösung im Stehen mit einer Höhe von 1115 mm und einem Betrachtungswinkel von 15 Grad für eine ergonomische Haltung. Es hat einen Dokumentenstopper, um ein Verrutschen zu verhindern und die Präsentationsmaterialien organisiert zu halten. kann bei jeder Gelegenheit verwendet werden, die die Aufmerksamkeit des Publikums auf sich ziehen muss. Dieses Stehpodium verleiht jeder Rede Stil und kann in Konferenzräumen, Versammlungsräumen und religiösen Einrichtungen für Präsentationen, im Klassenzimmer für Vorträge oder in Restaurants verwendet werden, um Reservierungen und Wartelisten griffbereit zu halten. Dieses Podium hat eine haltbare 8 mm gehärtete Glasplatte. Der Rahmen und die Basis sind aus Aluminium und es hat weiche Füße, um ein Verrutschen zu verhindern.



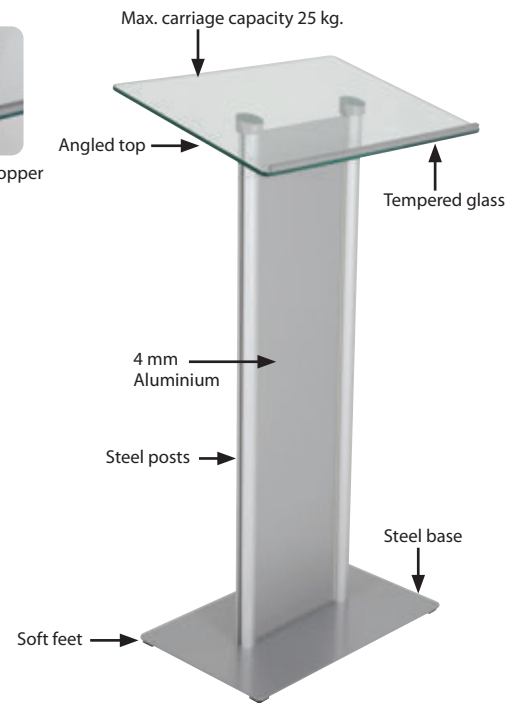
Aluminium Black with Front Panel



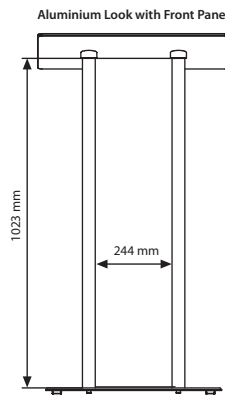
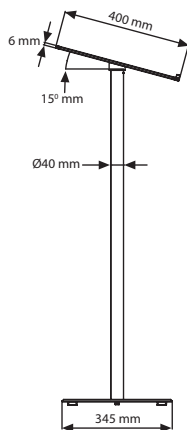
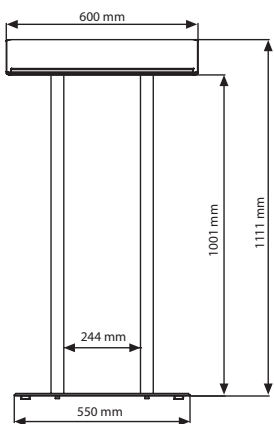
Aluminium Look



Document stopper



Aluminium Look with Front Panel



Led lamp is optional accessor. Don't forget to order.

MATERIAL : Glass & Steel		WEIGHT	PACKING SIZE
ARTICLE	DESCRIPTION	WITH PACKING	*W X H X D
UGPDN01000	Clear Glass, Chrome Look	15,300 kg	600 X 1310 X 100 mm
UGPDN02000	Clear Glass, Aluminium Look	13,000 kg	600 X 1310 X 90 mm
UGPDB02000	Clear Glass, Aluminium Black	13,000 kg	600 X 1310 X 90 mm
UGPDB02100	Clear Glass, Aluminium Black with Front Panel	14,300 kg	600 X 1310 X 90 mm
UGPDN02100	Clear Glass, Aluminium Look with Front Panel	14,300 kg	600 X 1310 X 90 mm

*W:Width H: Height D: Depth





Leaflet Dispensers

- Table Top L Frame
- Cross Frame
- Leaflet Dispensers
- Multiple Pocket Leaflet Dispensers
- Wall Mount Leaflet Dispensers
- Clear Brochure Holder T Type
- Clear Brochure Holder L Type
- L Type with front Pocket
- Swing Wing
- Pet Pocket
- Upright Leaflet Holder
- Oval Leaflet Holder
- Acrylic Sign
- Duo Desktop Menu Holder

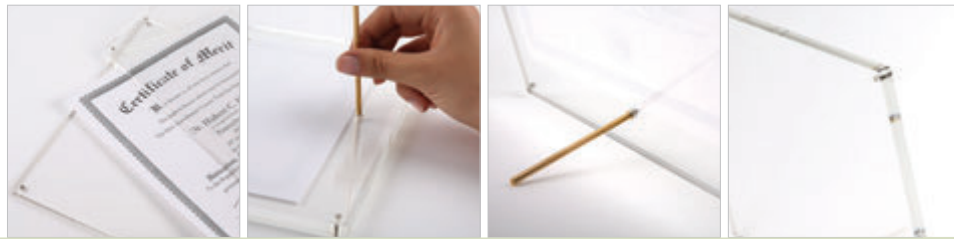
- Fort Desktop Menu Holder
- Curved Menu Holder
- Ticket Holder
- Card Holder 2 Sided
- Pyramid Card Holder Single Sided
- Wood Clip Board
- Table Top Chalk Mini A Board
- Nature Line Table Top Chalk A Board
- Arc Menu Holder
- Tumble Box
- Puzzle Tumble Box
- Free Standing Puzzle Tumble Box
- Tip Box
- Business Card Holder

- Table Top L Frame
- Kreuzrahmen
- Prospekthalter
- Mehrlagige Prospekthalter
- Prospekthalter für die Wandmontage
- Klare Prospekthalter in T Form
- Klare Prospekthalter in L Form
- Klare Prospekthalter in L Form mit Tasche
- Swing Wing
- PET Folientaschen
- Upright Speisekartenhalter
- Oval Speisekartenhalter
- Acrylic Sign
- Duo Desktop Menu Holder

- Fort Desktop Menu Holder
- Curved Menu Holder
- Ticket Holder
- Card Holder 2 Sided
- Pyramid Card Holder Single Sided
- Wood Clip Board
- Table Top Chalk Mini A Board
- Nature Line Table Top Chalk A Board
- Arc Menu Holder
- Tumble Box
- Puzzle Tumble Box
- Free Standing Puzzle Tumble Box
- Tip Box
- Visitenkartenspendler



Table Top L Frame



Contemporary poster or photo holder, Tabletop L Frame is suitable for both personal and commercial use. Transparent thick acrylic gets the attention on the poster. Easily portrait or landscape adaptable decorative stands provide a smart finish for Tabletop L Frame. It holds the poster in place firm with magnets.

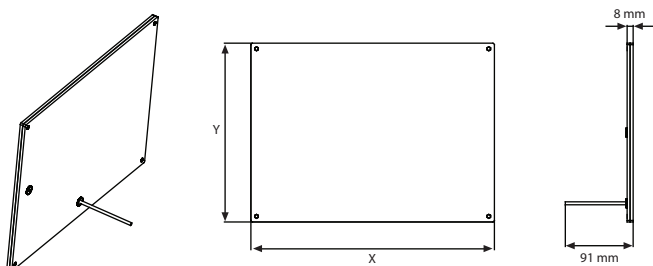
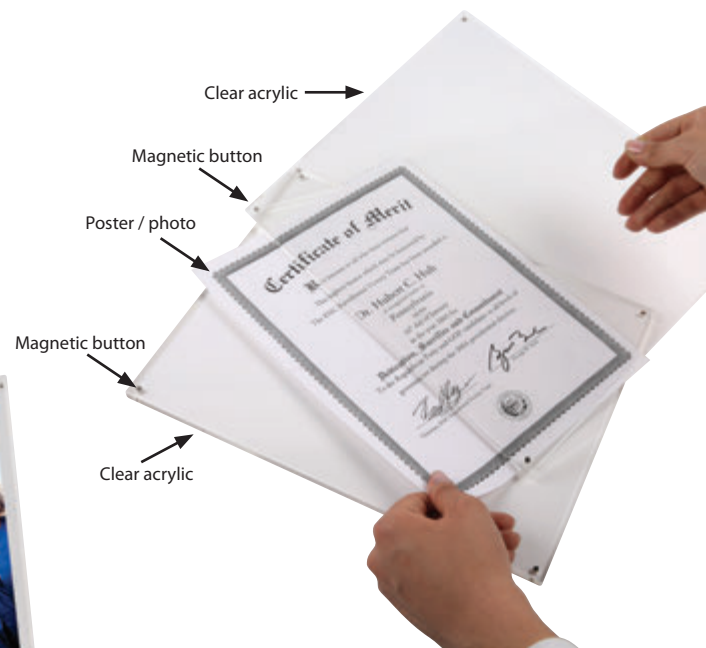
Moderner Poster oder Foto-Halter, der Tischplatten L-Rahmen ist geeignet für den privaten und kommerziellen Gebrauch. Die Aufmerksamkeit auf dem Poster bekommt der transparente dicke Acryl. Einfache Hochformat oder Querformat anpassungsfähige dekorative Stände bieten eine intelligente Oberfläche für Tischplatten L-Rahmen. Es hält das Poster am Platz mit Magneten.



Chrome coated support allows for portrait or landscape format display on table tops. *Verchromte Rückenstütze ermöglicht Hochformat oder Querformat Anzeige auf den Tischplatten.*



Please handle with care during transportation. Please peel of the film over the product before use. *Besondere Vorsicht beim Transport sind erforderlich. Vor Gebrauch den Schutzfilm auf den Artikeln abziehen.*



MATERIAL : Clear acrylic 4 mm				WEIGHT	PACKING SIZE (5 Pcs)
ARTICLE	EXTERNAL (x-y)	POSTER	DESCRIPTION	WITH PACKING	*W X H X D
UMSTTLFOA4	240 X 327 mm	210 X 297 mm	A4 Portrait	5,100 kg	270 X 360 X 65 mm
UMSTTLFOA5	178 X 240 mm	148 X 210 mm	A5 Portrait	2,900 kg	200 X 280 X 65 mm
UMSTTLFOA6	135 X 178 mm	105 X 148 mm	A6 Portrait	1,800 kg	160 X 220 X 65 mm

*W:Width H: Height D: Depth



Cross Frame



Clear sing holder, Cross Frame allows advertising many messages accepting 8 posters a time. Flat packed Cross Frame saves from space. Rounded corners provides elegant look to Cross Frame. Made of 2 mm clear acrylic.

Durchsichtiger Posteraufsteller, Der Cross Frame bietet eine Möglichkeit um 8 Poster zugleich zu präsentieren. Durch die flache Verpackung ist er auch sehr platz sparend. Die Abgerundeten Ecken verleihen dem Produkt eine elegante Optik. Bestehend aus 2 mm Acryl.

! Please handle with care during transportation. Please peel off the film over the product before use. *Besondere Vorsicht beim Transport sind erforderlich. Vor Gebrauch den Schutzfilm auf den Artikeln abziehen.*



4 X A5 Size

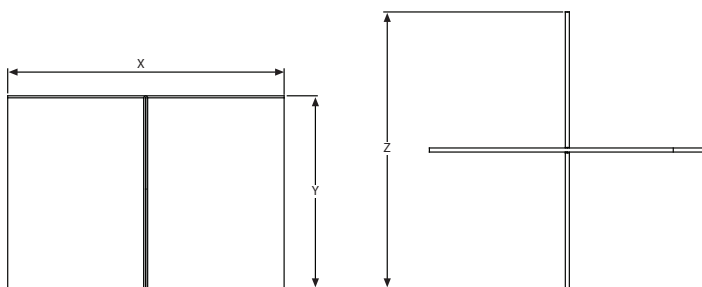


4 X A6 Size



Bottom part

Top part



MATERIAL : Clear acrylic 2 mm						WEIGHT	PACKING SIZE
ARTICLE	POSTER	CAPACITY	X	Y	Z	WITH PACKING	*W X H X D
UMSCR004A5	148 X 210 mm	4 X A5	215 mm	150 mm	215 mm	0,520 kg	150 X 340 X 50 mm
UMSCR004A6	105 X 148 mm	4 X A6	301 mm	212 mm	301 mm	0,350 kg	260 X 290 X 80 mm

*W:Width H:Height D:Depth



Leaflet Dispensers



Highly resistant transparent document holders. Format A4 is suitable for the display of all types of documents such as catalogues, brochures, cards for every need, etc... These high quality injection molded leaflet dispensers can be screen printed with logo on your request. Now it is ready with a unit divider for A4 portrait into A4/3 size.

Silk Screen Printing on Leaflet Dispensers
Minimum Pad Printing quantity is 200 pcs. Please note the printing operations may extend the lead times. During each printing operation, a visual image of logo is requested as a Illustrator file. The maximum printing area on the dispenser is as follows.

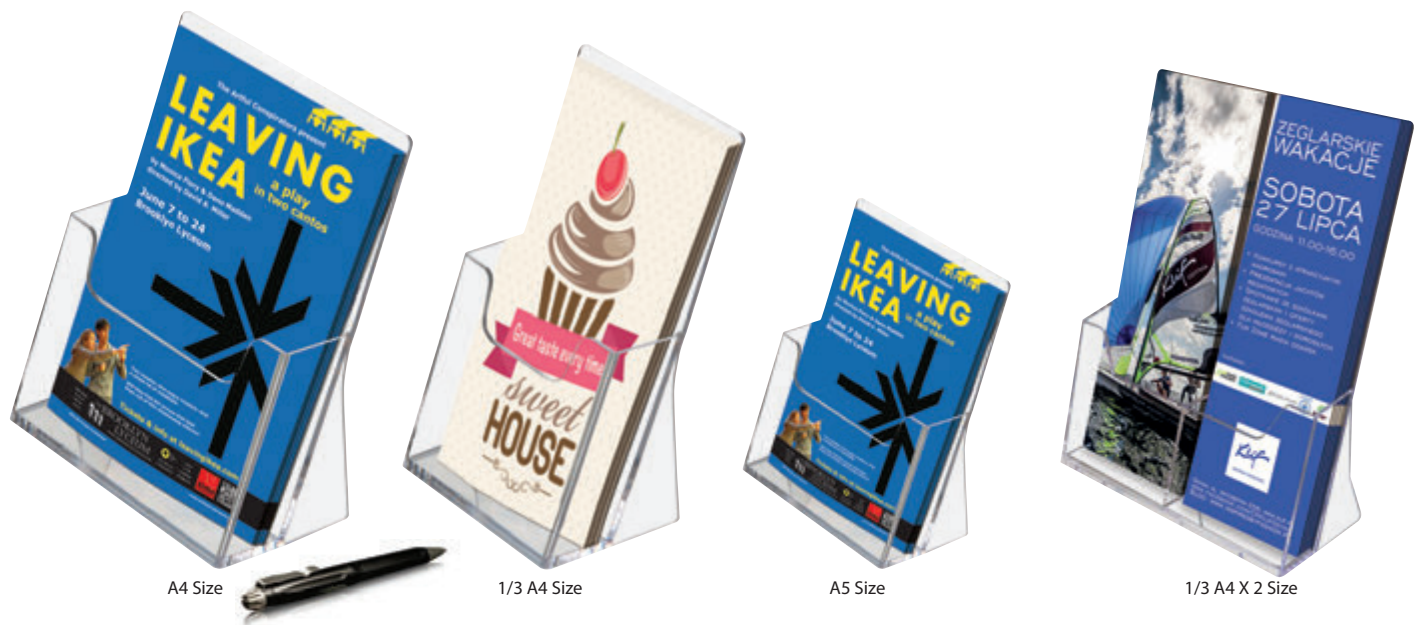
Widerstandsfähiger, transparenter Prospekthalter für die Größen DIN A4, A5, 1/3 A4. Zur Präsentation von Dokumenten wie Kataloge, Prospekte, Visitenkarten etc. je nach Bedarf. Je nach Wunsch kann auf dem hochwertigen Spritzgussartikel ein Siebdrucklogo angebracht werden. Jetzt auch mit T-Unterteiler für die Größen DIN A4 (Hochformat) verfügbar, der den Artikel in 2 mal 1/3 A4 verwandelt.

Siebdrucke auf Prospektaltern
Mindestbestellmenge ist 200 Stück. Bitte beachten Sie die Verlängerung der Produktionszeit bei Siebdruckanbringungen. Für den Druck sind Vorlagen des Druckes in Illustrator erforderlich. Die maximale Größe der Druckfläche auf die Prospektalter ist wie folgt :



Please handle with care during transportation. Besondere Vorsicht beim Transport sind erforderlich.

MATERIAL : Clear		
SIZE	PRINTING SIZE	DESCRIPTION
1/3 A4	40 X 90 mm	Landscape
A5	55 X 140 mm	Landscape
A4	70 X 200 mm	Landscape



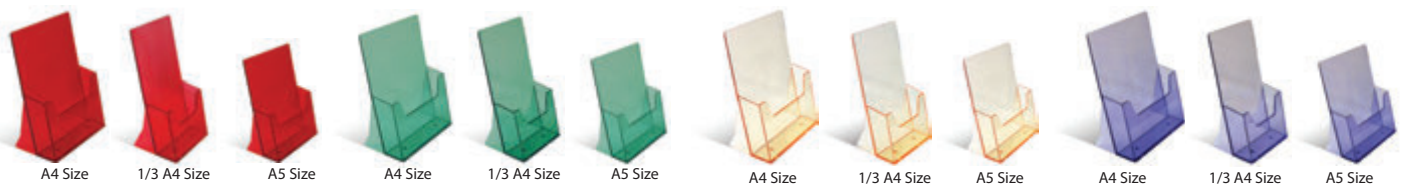
A4 Size

1/3 A4 Size

A5 Size

1/3 A4 X 2 Size

"Colour options RED GREEN YELLOW BLUE. Available with MOQ"



A4 Size

1/3 A4 Size

A5 Size

A4 Size

1/3 A4 Size

A5 Size

A4 Size

1/3 A4 Size

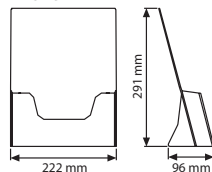
A5 Size

A4 Size

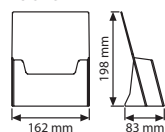
1/3 A4 Size

A5 Size

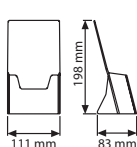
A4 Size



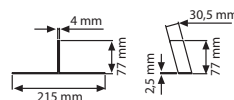
A5 Size



1/3 A4 Size



T Separator / UYUP449601



MATERIAL : Clear			WEIGHT	PACKING SIZE
ARTICLE	POSTER	DESCRIPTION	WITH PACKING	*W X H X D
UMSD001005	210 X 297 mm	A4 Portrait	8,350 kg	520 X 630 X 250 mm (20 pcs)
UMSD001004	148 X 210 mm	A5 Portrait	8,840 kg	520 X 630 X 250 mm (40 pcs)
UMSD001003	100 X 210 mm	1/3 A4 Portrait	7,300 kg	480 X 640 X 210 mm (50 pcs)

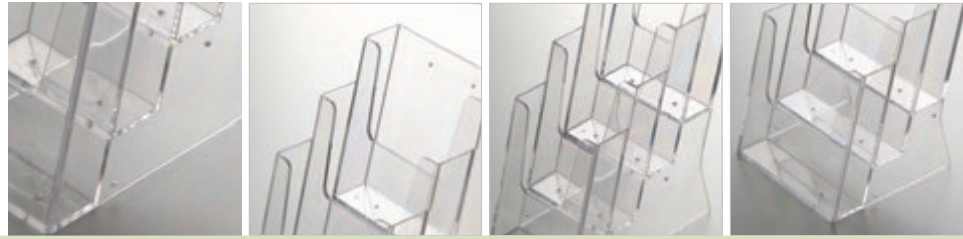
*W:Width H: Height D: Depth



Multiple Pocket Leaflet Dispensers



Watch video at our website www.mtdisplays.com



Highly resistant transparent document holders. Dispensers can be screen printed with corporate logo. Our products are made of the finest materials while providing the highest level of quality and clarity.

Widerstandfähiger, transparenter Prospekthalter. Die Artikel können per Siebdruck bedruckt werden. Die Artikel werden in höchster Qualität, aus den besten Rohmaterialien unter hohen Qualitätsforderungen hergestellt.

! Please handle with care during transportation. Besondere Vorsicht beim Transport sind erforderlich.



A4x3 Portrait



A5x3 Portrait

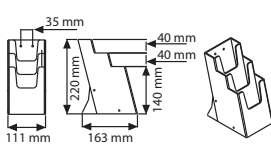


1/3 A4x3 Portrait

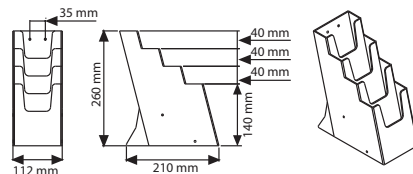


1/3 A4x4 Portrait

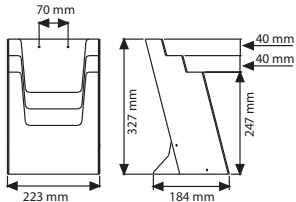
1/3 A4x3 Portrait



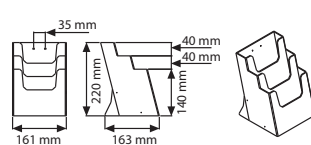
1/3 A4x4 Portrait



A4x3 Portrait



A5x3 Portrait



MATERIAL : Clear			WEIGHT	PACKING SIZE
ARTICLE	POSTER	DESCRIPTION	WITH PACKING	*W X H X D
UMSD003000	210 X 297 mm	A4 X 3 Portrait	2,100 kg	350 X 410 X 470 mm (4 pcs)
UMSD003050	100 X 210 mm	1/3 A4 X 4 Portrait	7,750 kg	380 X 700 X 360 mm (18 pcs)
UMSD004000	148 X 210 mm	A5 X 3 Portrait	6,280 kg	380 X 560 X 350 mm (12 pcs)
UMSD005000	100 X 210 mm	1/3 A4 X 3 Portrait	8,600 kg	380 X 830 X 250 mm (20 pcs)

*W:Width H: Height D: Depth



Wall Mount Leaflet Dispensers



Highly resistant transparent document holders. They can be mounted in any convenient location. They come in 4 sizes and the clear pocket is ideal for the display of menus, price lists, etc.. These high quality brochure holders can be screen printed. All models are in stock and ready for immediate shipment.

Silk Screen Printing on Wall Mount Leaflet Dispensers

The minimum pad printing quantity is 200 pcs. Please note the printing operations may extend the lead time. In each printing operation, a visual image of the logo is requested as a Illustrator file. The maximum printing area on the wall mount dispensers is as follows.

Widerstandsfähiger, transparenter Prospekthalter, kann an allen gewünschten Orten zum Einsatz gebracht werden. Dieser Prospekthalter wird in 4 verschiedenen Größen angeboten und die transparent eignet sich speziell für die Präsentation von Speisekarten, Preislisten usw. Die Artikel können per Siebdruck bedruckt werden und alle Größen sind kurzfristig lieferbar.

Siebdrucke auf Prospekthaltern für die Wandmontage
 Mindestbestellmenge ist 200 Stück. Bitte beachten Sie die Verlaengerung der Produktionszeit bei Siebdruckanbringungen. Für den Druck sind Vorlagen des Druckes in Illustrator erforderlich. Die maximale Grösse der Druckfläche auf die Prospekthalter ist wie folgt :

! Please handle with care during transportation. Besondere Vorsicht beim Transport sind erforderlich.

MATERIAL : Clear		
SIZE	PRINTING SIZE	DESCRIPTION
1/3 A4	60 X 90 mm	Portrait
A5	60 X 140 mm	Portrait
A4	60 X 200 mm	Portrait



A4 Size



A5 Size

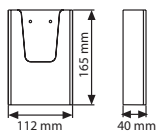


1/3 A4 Size

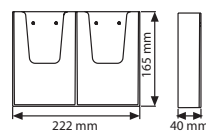


1/3 A4 X 2 Size

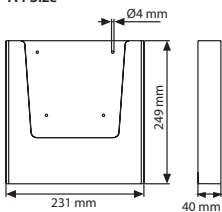
1/3 A4 Size



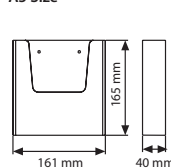
1/3 A4 X 2 Size



A4 Size



A5 Size

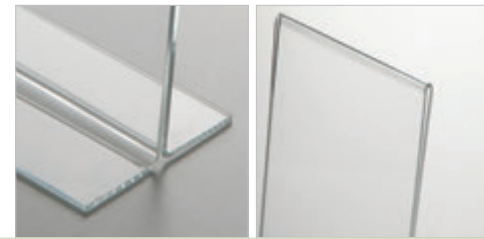


MATERIAL : Clear			WEIGHT	PACKING SIZE
ARTICLE	POSTER	DESCRIPTION	WITH PACKING	*W X H X D
UMSD008100	210 X 297 mm	A4 Portrait	12,900 kg	520 X 630 X 250 mm (30 pcs)
UMSD007000	148 X 210 mm	A5 Portrait	9,300 kg	540 X 640 X 190 mm (45 pcs)
UMSD006000	100 X 210 mm	1/3 A4 Portrait	9,250 kg	480 X 640 X 210 mm (60 pcs)
UMSD006010	100 X 210 mm	1/3 A4 X 2 Portrait	10,00 kg	480 X 640 X 210 mm (30 pcs)

* W:Width H: Height D: Depth



Clear Brochure Holder T Type



Highly resistant transparent document holders. Ideal for the display of menus at restaurants, price lists, etc... These high quality clear brochure holders can be screen printed with corporate logo. Non-standard sizes can be produced according to customer specification & needs; for printing and quantities, please contact our sales department.

Widerstandsfähiger, transparenter Prospekthalter, kann an allen gewünschten Orten zum Einsatz gebracht werden. Dieser Prospekthalter wird in verschiedenen Standardgrößen angeboten und die transparent eignet sich speziell für die Präsentation von Speisekarten, Preislisten usw. Individuell gewünschte Größen können nach Ihren Vorgaben produziert werden. Für gewünschte Drucke und Mindestmengen setzen Sie sich bitte mit unserem Verkauf in Verbindung.

! Please handle with care during transportation. Please peel of the film over the product before use. Besondere Vorsicht beim Transport sind erforderlich. Vor Gebrauch den Schutzfilm auf den Artikeln abziehen.



A4 Portrait



1/3 A4 Portrait



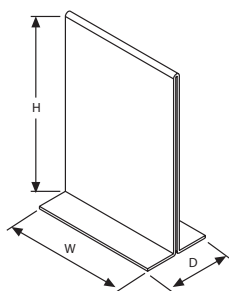
A5 Portrait



A6 Landscape



A5 Landscape



MATERIAL : Clear						WEIGHT	PACKING SIZE
ARTICLE	POSTER	DESCRIPTION	W	H	D	WITH PACKING	*W X H X D
UMSTDO1000	210 X 297 mm	A4 Portrait	210 mm	302 mm	105 mm	15,200 kg	485 X 485 X 350 mm (40 pcs)
UMSTYO1000	297 X 210 mm	A4 Landscape	300 mm	212 mm	105 mm	12,960 kg	485 X 485 X 350 mm (30 pcs)
UMSTDO2000	148 X 210 mm	A5 Portrait	150 mm	212 mm	75 mm	6,040 kg	340 X 370 X 240 mm (30 pcs)
UMSTYO2000	210 X 148 mm	A5 Landscape	210 mm	152 mm	75 mm	6,210 kg	340 X 370 X 240 mm (30 pcs)
UMSTDO3000	105 X 148 mm	A6 Portrait	105 mm	152 mm	75 mm	4,800 kg	265 X 385 X 180 mm (40 pcs)
UMSTYO3000	148 X 105 mm	A6 Landscape	150 mm	107 mm	75 mm	3,360 kg	265 X 385 X 180 mm (30 pcs)
UMSTDO4000	100 X 210 mm	1/3 A4 Portrait	105 mm	212 mm	75 mm	5,400 kg	340 X 370 X 240 mm (40 pcs)
UMSTYO4000	210 X 100 mm	1/3 A4 Landscape	210 mm	107 mm	75 mm	7,210 kg	340 X 370 X 240 mm (50 pcs)

*W:Width H: Height D: Depth



Clear Brochure Holder L Type & with Front Pocket



The highly resistant transparent document holders are ideal for the display of menus at restaurants, price lists, etc... These high quality clear brochure holders can be screen printed with a corporate logo. Non-standard sizes can be produced according to customer specification & needs; for printing and quantities, please contact our sales department.

Our new range of sign holders offers competitive solutions to effect a maximum outcome for your sales and marketing activities. The main advantage of the product is the pocket in front of the brochure holder, so that any poster, menu, advertising info can be put in. The advantageous pocket enables you to place your business card on the poster. This product can be produced in different sizes on request. Highly resistant transparent document holders. These high quality clear brochure holders can be screen printed with a corporate logo.

Widerstandsfähiger, transparenter Prospekthalter, kann an allen gewünschten Orten zum Einsatz gebracht werden. Dieser Prospekthalter wird in 4 verschiedenen Größen angeboten und die transparent eignet sich speziell für die Präsentation von Speisekarten, Preislisten usw. Individuell gewünschte Größen können nach Ihren Vorgaben produziert werden. Für gewünschte Drucke und Mindestmengen setzen Sie sich bitte mit unserem Verkauf in Verbindung.

Diese neue Serie von Prospekthaltern ermöglicht Ihnen maximale Ergebnisse bei Ihren Verkaufsförderungen. Der Hauptvorteil dieses Artikels ist, dass Sie bei der Präsentation Ihres Posters auch Informationsmaterial wie z.B Visitenkarten mit Ihren Kontaktdaten weitergeben können. Individuell gewünschte Größen können nach Ihren Vorgaben produziert werden.

! Please handle with care during transportation. Please peel of the film over the product before use. *Besondere Vorsicht beim Transport sind erforderlich. Vor Gebrauch den Schutzfilm auf den Artikeln abziehen.*



A4 Portrait



1/3 A4 Portrait



A5 Portrait



A4 with Front Pocket Portrait



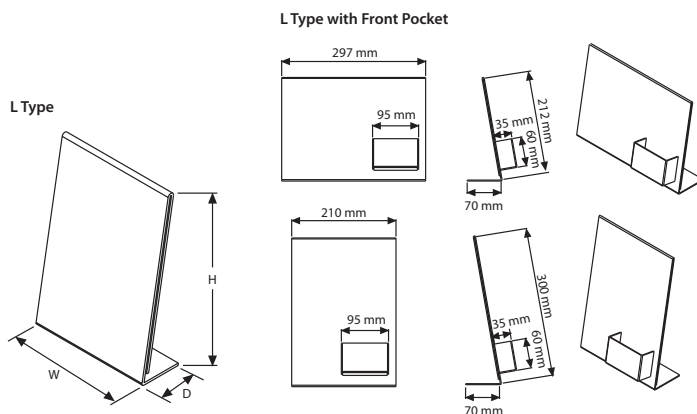
A5 Landscape



A6 Landscape



A4 with Front Pocket Landscape



L TYPE WITH FRONT POCKET: Clear			WEIGHT	PACKING SIZE
ARTICLE	POSTER	DESCRIPTION	WITH PACKING	*W X H X D
UMSLD1000	210 X 297 mm	A4 Portrait	4,250 kg	240 X 350 X 34 mm (10 pcs)
UMSLY1000	297 X 210 mm	A4 Landscape	4,450 kg	240 X 350 X 34 mm (10 pcs)

MATERIAL : Clear						WEIGHT	PACKING SIZE
ARTICLE	POSTER	DESCRIPTION	W	H	D	WITH PACKING	*W X H X D
UMSLD01000	210 X 297 mm	A4 Portrait	210 mm	305 mm	92 mm	13,220 kg	340 X 370 X 240 mm (40 pcs)
UMSLY01000	297 X 210 mm	A4 Landscape	300 mm	215 mm	92 mm	10,950 kg	340 X 370 X 240 mm (30 pcs)
UMSLD02000	148 X 210 mm	A5 Portrait	150 mm	215 mm	72 mm	7,270 kg	265 X 385 X 180 mm (40 pcs)
UMSLY02000	210 X 148 mm	A5 Landscape	210 mm	155 mm	72 mm	5,660 kg	265 X 385 X 180 mm (30 pcs)
UMSLD03000	105 X 148 mm	A6 Portrait	105 mm	155 mm	72 mm	2,850 kg	240 X 350 X 86 mm (30 pcs)
UMSLY03000	148 X 105 mm	A6 Landscape	150 mm	110 mm	52 mm	2,910 kg	240 X 350 X 86 mm (30 pcs)
UMSLD04000	100 X 210 mm	1/3 A4 Portrait	105 mm	215 mm	72 mm	7,710 kg	265 X 385 X 180 mm (65 pcs)
UMSLY04000	210 X 100 mm	1/3 A4 Landscape	210 mm	110 mm	62 mm	6,400 kg	265 X 385 X 180 mm (50 pcs)

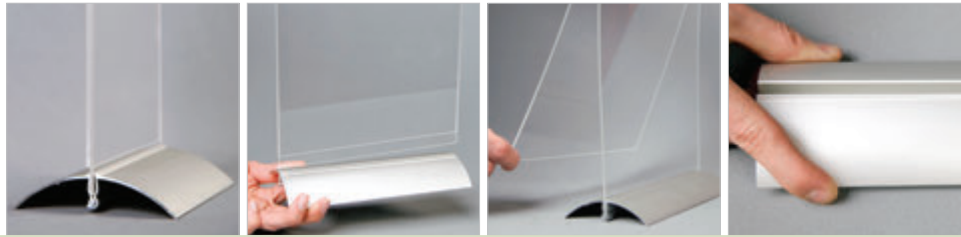
*W:Width H:Height D:Depth



Swing Wing



Watch video at our website www.mtdisplays.com



Classy menu holder with a clear acrylic pocket and stylish silver-anodized aluminum base. Acrylic pockets fits securely into aluminium base. Ideal for the display of menus. Non-standard sizes can be produced according to customer needs. The aluminum base is suitable for logo printing. Max letter height in printing is 14 mm. Several poster materials can be used with this base; PVC Foam, PS, PET. The thickness varies between 1-4 mm.

Ein klassischer Speisekartenhalter mit transparenter Acryltasche und elegantem Aluminiumfuss in silber eloxiert. Ideal für die Präsentation von Speisekarten. Individuell gewünschte Größen können nach Ihren Vorgaben produziert werden. Der Aluminiumfuss ist für Drucke geeignet, maximale Buchstabenhöhe ist 14 mm. Mit dem Aluminiumfuss können verschiedene Postermaterialien eingesetzt werden, wie PVC Schaumplatten Polystyrolplatten odet Pet Folien. Die Stärke der Materialien kann zwischen 1-4 mm variieren.

! Please handle with care during transportation. Please peel the film over the product before use. *Besondere Vorsicht beim Transport sind erforderlich. Vor Gebrauch den Schutzfilm auf den Artikeln abziehen.*



A4 Portrait

← Catch thickness min. 1 mm, max. 4 mm.



1/3 A4 Portrait



A5 Portrait



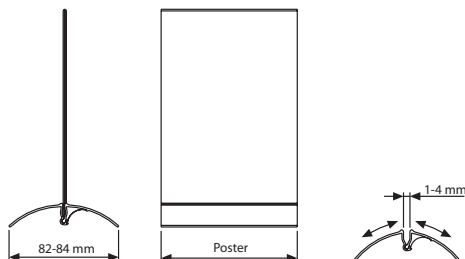
A5 Landscape

MATERIAL : Silver anodised aluminium			WEIGHT	PACKING SIZE
ARTICLE	POSTER	DESCRIPTION	WITH PACKING	*W X H X D
USWMONP100	100 mm	Aluminium base	0,690 kg	120 X 200 X 100 mm (12 pcs)
USWMONP105	105 mm	Aluminium base	0,690 kg	120 X 200 X 100 mm (12 pcs)
USWMONP148	148 mm	Aluminium base	0,540 kg	120 X 200 X 100 mm (6 pcs)
USWMONP210	210 mm	Aluminium base	2,990 kg	245 X 360 X 80 mm (28 pcs)
USWMONP297	297 mm	Aluminium base	3,190 kg	245 X 360 X 80 mm (20 pcs)

MATERIAL : Silver anodised aluminium & clear acrylic			WEIGHT	PACKING SIZE
ARTICLE	POSTER	DESCRIPTION	WITH PACKING	*W X H X D
USWMDNP0A7	74 X 105 mm	Aluminium base & Acrylic - Portrait	1,290 kg	120 X 200 X 100 mm (15 pcs)
USWMDNP0A3	100 X 210 mm	Aluminium base & Acrylic - Portrait	5,300 kg	245 X 350 X 86 mm (30 pcs)
USWMDNP0A6	105 X 148 mm	Aluminium base & Acrylic - Portrait	3,940 kg	245 X 350 X 86 mm (30 pcs)
USWMDNP0A5	148 X 210 mm	Aluminium base & Acrylic - Portrait	6,000 kg	245 X 350 X 86 mm (25 pcs)
USWMDNP0A4	210 X 297 mm	Aluminium base & Acrylic - Portrait	6,350 kg	245 X 350 X 86 mm (15 pcs)

ARTICLE	POSTER	DESCRIPTION	WITH PACKING	*W X H X D
USWMYNP0A7	105 X 74 mm	Aluminium base & Acrylic - Landscape	1,000 kg	120 X 200 X 100 mm (10 pcs)
USWMYNP0A3	210 X 100 mm	Aluminium base & Acrylic - Landscape	3,385 kg	245 X 350 X 86 mm (15 pcs)
USWMYNP0A6	148 X 105 mm	Aluminium base & Acrylic - Landscape	4,065 kg	245 X 350 X 86 mm (25 pcs)
USWMYNP0A5	210 X 148 mm	Aluminium base & Acrylic - Landscape	3,985 kg	245 X 350 X 86 mm (15 pcs)
USWMYNP0A4	297 X 210 mm	Aluminium base & Acrylic - Landscape	4,840 kg	245 X 350 X 86 mm (10 pcs)

* W:Width H: Height D: Depth



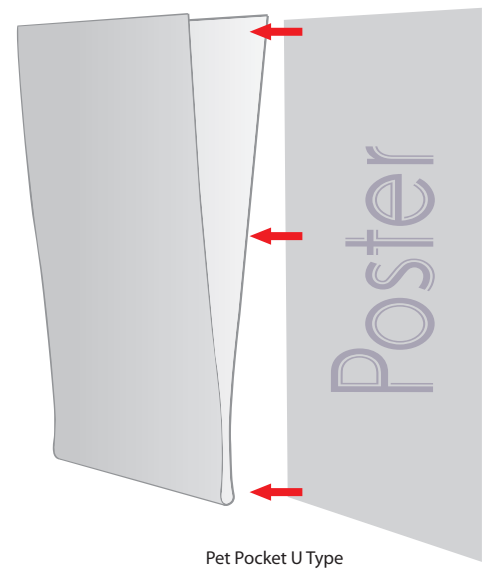
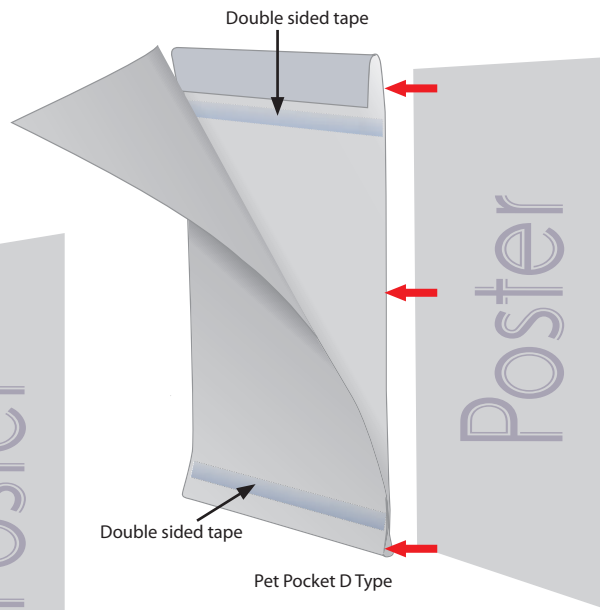
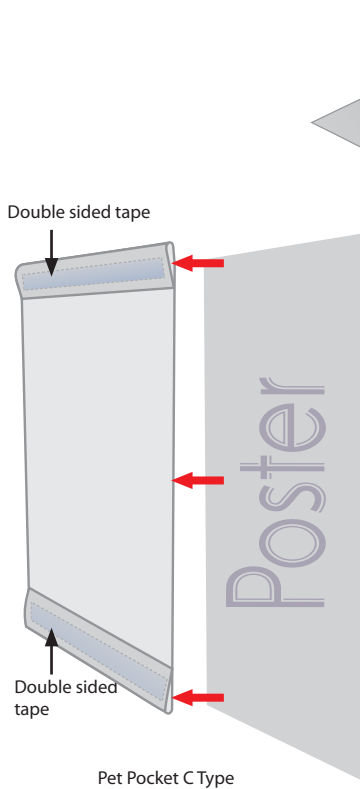
Pet Pocket U+C+D Type



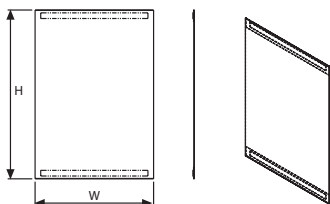
Anti-clear high resistant PET transparent clear document holders. Ideal for the display of menus at the restaurants, price lists, etc... They are suitable for screen printing. Non standard sizes can be produced to customer specification & needs; for printing and quantities please contact our sales executives.

Hoch resistenter, antireflex, transparenter PET Prospekthalter. Ideal um in Restaurants Menüs oder Preislisten zu präsentieren. Geeignet für Siebdruck. Gewünschte Masse können Kundenwünschen und Bedürfnissen entsprechend produziert werden. Für Druck und Mindestmengen fragen Sie bitte unser Verkaufsteam.

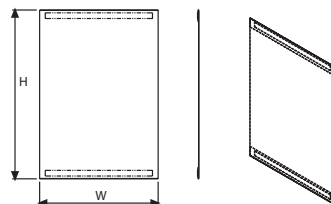
! Please handle with care during transportation. *Besondere Vorsicht beim Transport sind erforderlich.*



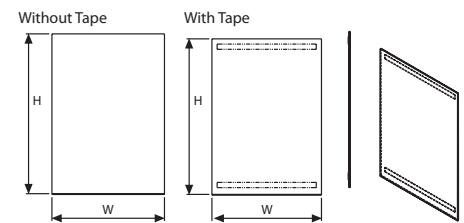
Pet Pocket D Type



Pet Pocket C Type

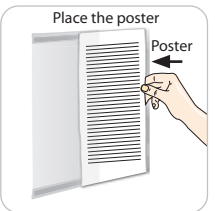
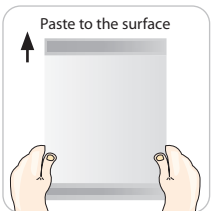
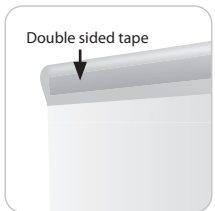
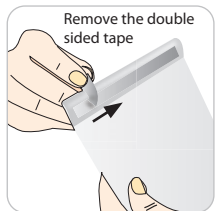


Pet Pocket U Type





Pet Pocket , no tools required, mount it in less than a minute!



PET POCKET U TYPE : Clear						WEIGHT	PACKING SIZE
WITHOUT TAPE	WITH TAPE	POSTER	DESCRIPTION	W	H	WITH PACKING	*W X H X D
UPCU0D00A4	UPCU1D00A4	210 X 297 mm	A4 portrait	210 mm	298 mm	4,600 kg	245 X 350 X 85 mm (25 Pcs)
UPCU0Y00A4	UPCU1Y00A4	297 X 210 mm	A4 landscape	297 mm	211 mm	4,600 kg	245 X 350 X 85 mm (25 Pcs)
UPCU0D00A5	UPCU1D00A5	148 X 210 mm	A5 portrait	148 mm	211 mm	2,400 kg	245 X 350 X 85 mm (50 Pcs)
UPCU0Y00A5	UPCU1Y00A5	210 X 148 mm	A5 landscape	210 mm	149 mm	2,400 kg	245 X 350 X 85 mm (50 Pcs)
UPCU0D00A6	UPCU1D00A6	105 X 148 mm	A6 portrait	105 mm	149 mm	1,400 kg	120 X 200 X 100 mm (50 Pcs)
UPCU0Y00A6	UPCU1Y00A6	148 X 105 mm	A6 landscape	148 mm	106 mm	1,400 kg	120 X 200 X 100 mm (50 Pcs)
UPCU0D00A7	UPCU1D00A7	74 X 105 mm	A7 portrait	74 mm	106 mm	1,400 kg	120 X 200 X 100 mm (100 Pcs)
UPCU0Y00A7	UPCU1Y00A7	105 X 74 mm	A7 landscape	105 mm	75 mm	1,400 kg	120 X 200 X 100 mm (100 Pcs)

PET POCKET D TYPE : Clear					WEIGHT	PACKING SIZE
ARTICLE	POSTER	DESCRIPTION	W	H	WITH PACKING	*W X H X D
UPCD1D00A2	420 X 594 mm	A2 portrait	420 mm	597 mm	4,000 kg	460 X 660 X 21 mm (10 Pcs)
UPCD1Y00A2	594 X 420 mm	A2 landscape	594 mm	423 mm	4,000 kg	460 X 660 X 21 mm (10 Pcs)
UPCD1D00A3	297 X 420 mm	A3 portrait	297 mm	423 mm	2,070 kg	350 X 460 X 21 mm (10 Pcs)
UPCD1Y00A3	420 X 297 mm	A3 landscape	420 mm	300 mm	2,070 kg	350 X 460 X 21 mm (10 Pcs)
UPCD1D00A4	210 X 297 mm	A4 portrait	210 mm	300 mm	2,070 kg	245 X 350 X 85 mm (25 Pcs)
UPCD1Y00A4	297 X 210 mm	A4 landscape	297 mm	213 mm	2,070 kg	245 X 350 X 85 mm (25 Pcs)
UPCD1D00A5	148 X 210 mm	A5 portrait	148 mm	213 mm	2,020 kg	245 X 350 X 85 mm (50 Pcs)
UPCD1Y00A5	210 X 148 mm	A5 landscape	210 mm	201 mm	2,020 kg	245 X 350 X 85 mm (50 Pcs)
UPCD1D00A6	105 X 148 mm	A6 portrait	105 mm	151 mm	1,170 kg	120 X 200 X 100 mm (50 Pcs)
UPCD1Y00A6	148 X 105 mm	A6 landscape	148 mm	108 mm	1,170 kg	120 X 200 X 100 mm (50 Pcs)

PET POCKET C TYPE : Clear					WEIGHT	PACKING SIZE
ARTICLE	POSTER	DESCRIPTION	W	H	WITH PACKING	*W X H X D
UPCC1D00A4	210 X 297 mm	A4 portrait	210 mm	300 mm	1,200 kg	245 X 350 X 85 mm (25 Pcs)
UPCC1Y00A4	297 X 210 mm	A4 landscape	297 mm	213 mm	1,200 kg	245 X 350 X 85 mm (25 Pcs)
UPCC1D00A5	148 X 210 mm	A5 portrait	148 mm	213 mm	1,500 kg	245 X 350 X 85 mm (50 Pcs)
UPCC1Y00A5	210 X 148 mm	A5 landscape	210 mm	151 mm	1,500 kg	245 X 350 X 85 mm (50 Pcs)
UPCC1D00A6	105 X 148 mm	A6 portrait	105 mm	151 mm	0,880 kg	120 X 200 X 100 mm (50 Pcs)
UPCC1Y00A6	148 X 105 mm	A6 landscape	148 mm	108 mm	0,880 kg	120 X 200 X 100 mm (50 Pcs)
UPCC1D00A7	74 X 105 mm	A7 portrait	74 mm	108 mm	1,180 kg	120 X 200 X 100 mm (100 Pcs)
UPCC1Y00A7	105 X 74 mm	A7 landscape	105 mm	77 mm	1,180 kg	120 X 200 X 100 mm (100 Pcs)

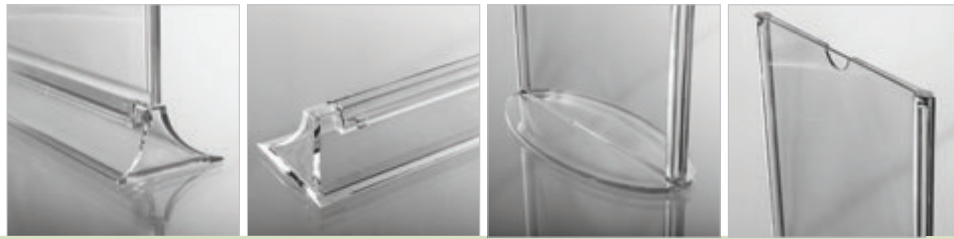
*W:Width H: Height D: Depth

*W:Width H: Height D: Depth



Upright Leaflet Holder

Oval Leaflet Holder



Upright Leaflet Holder

Upright leaflet holder is an ideal plastic frame for prints. It serves as a menu holder or frame for advertisements. It's a light weight and double sided unit. Prints are easy to change from top & sides.

Upright Speisekartenthalter

Dieser senkrecht stehende Prospekthalter ist ein idealer Plastikrahmen für Drucke. Es dient als Menühalter oder als Rahmen für Reklame. Der leichtgewichtige, beidseitige Artikel dient zum leichten Wechsel der Einlage von oben oder von den Seiten.

Oval Leaflet Holder

Modern style leaflet holder is light and affordable. Unit is injection molded, clear and double sided. Suitable for use as menucards in restaurants as leaflet holder in shops and any commercial environment.

Oval Speisekartenthalter

Moderner, erschwinglicher, leicht gewichtiger, beidseitiger Prospekthalter. Es handelt sich um einen Spritzgussartikel. Dient als Prospekthalter in Restaurants, Geschäften und diversen Plätzen.



Please handle with care during transportation.
Besondere Vorsicht beim Transport sind erforderlich.

Upright Leaflet Holder



A4 portrait



A5 portrait



A6 portrait

Oval Leaflet Holder



A4 portrait

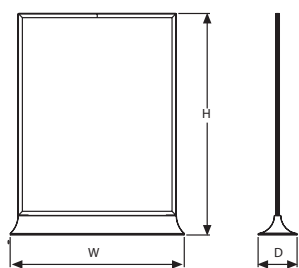


A5 portrait

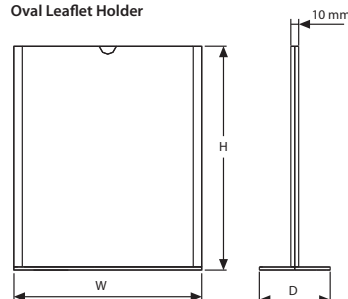


4" X 6" portrait

Upright Leaflet Holder



Oval Leaflet Holder



UPRIGHT LEAFLET HOLDER : Clear					WEIGHT	PACKING SIZE (25 Pcs)
ARTICLE	POSTER	W	H	D	WITH PACKING	*W X H X D
UMSDTLDN46	4" X 6"	130 mm	182 mm	40 mm	2,550 kg	210 X 320 X 290 mm
UMSDTLDN57	5" X 7"	160 mm	212 mm	46 mm	4,250 kg	240 X 370 X 360 mm
UMSDTLDN81	8,5" X 11"	250 mm	318 mm	56 mm	8,900 kg	430 X 700 X 260 mm
UMSDTLDNA6	A6	135 mm	180 mm	40 mm	2,875 kg	230 X 350 X 310 mm
UMSDTLDNA5	A5	180 mm	245 mm	46 mm	4,000 kg	270 X 400 X 410 mm
UMSDTLDNA4	A4	245 mm	336 mm	56 mm	9,100 kg	450 X 730 X 300 mm

OVAL LEAFLET HOLDER: Clear					WEIGHT	PACKING SIZE (25 Pcs)
ARTICLE	POSTER	W	H	D	WITH PACKING	*W X H X D
UMSDOLDN46	4" X 6"	124 mm	157 mm	65 mm	2,875 kg	290 X 330 X 200 mm
UMSDOLDN57	5" X 7"	150 mm	183 mm	70 mm	4,200 kg	340 X 360 X 230 mm
UMSDOLDN81	8,5" X 11"	240 mm	285 mm	90 mm	10,050 kg	430 X 540 X 330 mm
UMSDOLDNA5	A5	170 mm	215 mm	70 mm	4,780 kg	270 X 400 X 400 mm
UMSDOLDNA4	A4	232 mm	303 mm	90 mm	11,500 kg	360 X 480 X 520 mm

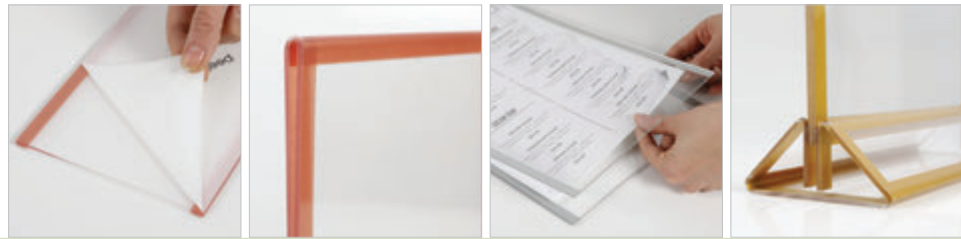
* W:Width H:Height D:Depth



Acrylic Sign



Watch video at our website www.mtdisplays.com

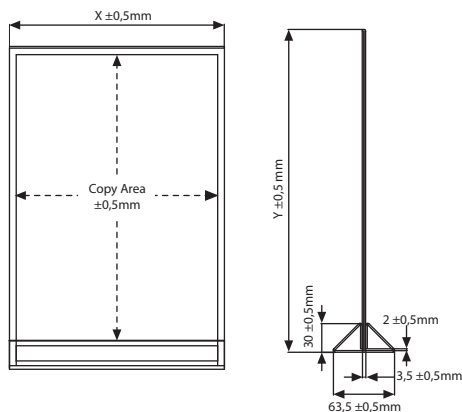


A great way to showcase promotions and advertisements. Made of acrylic with printed borders. Double Sided. Available in A4, A5 and A6 dimensions. 3 color options: Gold, Silver and Rose. Special colors available upon request. Easy poster change with 2 independent parts

Eine großartige Möglichkeit, Werbeaktionen und Anzeigen zu präsentieren. Aus Acryl mit aufgedruckten Rändern. Doppelseitig. Erhältlich in den Abmessungen A4, A5 und A6. 3 Farboptionen: Gold, Silber und Rose. Sonderfarben auf Anfrage erhältlich. Einfacher Plakatwechsel mit 2 unabhängigen Teilen.



Available sizes are A4, A5 and A6



MATERIAL : Acrylic					WEIGHT	PACKING SIZE
ARTICLE	EXTERNAL (x-y)	POSTER	COPY	DESCRIPTOIN	WITH PACKING	*W X H X D
UMSASPOGA4	223 X 335 mm	210 X 297 mm	209 X 296 mm	Gold	3,200 kg	290 X 400 X 170 mm (6 Pcs)
UMSASPORA4	223 X 335 mm	210 X 297 mm	209 X 296 mm	Rose	3,200 kg	290 X 400 X 170 mm (6 Pcs)
UMSASPOA4	223 X 335 mm	210 X 297 mm	209 X 296 mm	Silver	3,200 kg	290 X 400 X 170 mm (6 Pcs)
UMSASPOGA5	161 X 248 mm	148 X 210 mm	147 X 209 mm	Gold	3,600 kg	250 X 300 X 210 mm (12 Pcs)
UMSASPORAS5	161 X 248 mm	148 X 210 mm	147 X 209 mm	Rose	3,600 kg	250 X 300 X 210 mm (12 Pcs)
UMSASPOSA5	161 X 248 mm	148 X 210 mm	147 X 209 mm	Silver	3,600 kg	250 X 300 X 210 mm (12 Pcs)
UMSASPOGA6	118 X 186 mm	105 X 148 mm	104 X 147 mm	Gold	2,300 kg	230 X 350 X 165 mm (12 Pcs)
UMSASPORA6	118 X 186 mm	105 X 148 mm	104 X 147 mm	Rose	2,300 kg	230 X 350 X 165 mm (12 Pcs)
UMSASPOA6	118 X 186 mm	105 X 148 mm	104 X 147 mm	Silver	2,300 kg	230 X 350 X 165 mm (12 Pcs)

*W:Width H: Height D: Depth



Duo Desktop Menu Holder, Straight Cut & Vintage Cut



Modern style beech wood menu holder is light and affordable. Suitable for use in restaurants, retail stores and any commercial environment. Simply slide the leaflet into grooves of the wooden columns and place the menu between wooden columns and back support. Prints are easy to change from top. Duo Desktop Menu Holder are made of the finest materials while providing the highest level of quality. Basic and vintage styles offers options to users. To ensure sustainability of the quality in use, wood menu holders are lacquered finished which is resistant to spill of food and fizzy drinks.

Buchhalter aus Holz im modernen Stil ist leicht und erschwinglich. Geeignet für den Einsatz in Restaurants, Einzelhandelsgeschäften und in jeder kommerziellen Umgebung. Schieben Sie die Einlage einfach in die Nut der Holzsäulchen und platzieren Sie das Menü zwischen Holzsäulchen und Stütze. Einleger sind leicht von oben einzuschieben. Duo Desktop-Menühalter werden aus den besten Materialien hergestellt und bieten ein Höchstmaß an Qualität. Basic- und Vintage-Varianten stehen zur Auswahl. Um die Nachhaltigkeit der Qualität zu gewährleisten, sind Holzmenühalter lackiert, um die Resistenz gegen Verschütten von Speisen und Getränken zu erhöhen.



Acrylic or PET poster pockets and chalkboards are optional. Acryl- oder PET-Postertaschen und -tafeln sind optional.



Frooves of wooden columns is 4,5 mm which accepts acrylic or PET pockets and chalk board. Die Nut der Holzsäulchen ist 4,5 mm breit und eignen sich für Taschen aus Acryl oder PET sowie Kreidetafel.



Packed in multiples. Vielfachpackung.



Duo Desktop Menu Holder, Straight Cut, Dark Wood



Dark Wood - A4 PET optional



Dark Wood - A5 Acrylic optional



Dark Wood - A4 Chalkboard optional



Duo Desktop Menu Holder, Vintage Cut, Natural Wood



Natural Wood - 8.5"x11" Acrylic optional



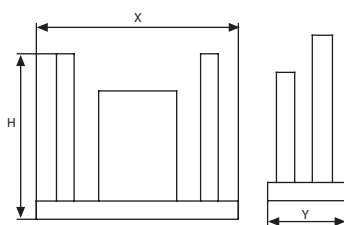
Natural Wood - 5x5"x8.5" PET optional



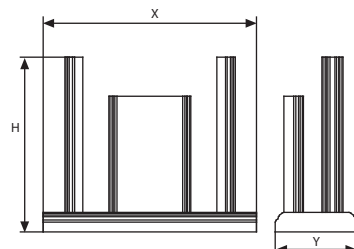
Natural Wood - 5.5"x8.5" Chalkboard optional

Do not forget to order PET, or Acrylic pockets or Chalkboard

Duo Desktop Menu Holder, Straight Cut



Duo Desktop Menu Holder, Vintage Cut



DUO DESKTOP MENU HOLDER, STRAIGHT CUT: Beech wood						WEIGHT	PACKING SIZE (2 Pcs)
ARTICLE	SIZE	DESCRIPTION	X	Y	H	WITH PACKING	*W X H X D
UWDMODNOA4	A4 - 8.5"x11"	Natural Wood	287 mm	85 mm	250 mm	1,675 kg	290 X 310 X 100 mm
UWDMODNOA5	A5 - 5.5"x8.5"	Natural Wood	220 mm	85 mm	180 mm	1,200 kg	220 X 240 X 100 mm
UWDMODDOA4	A4 - 8.5"x11"	Dark Wood	287 mm	85 mm	250 mm	1,675 kg	290 X 310 X 100 mm
UWDMODDOA5	A5 - 5.5"x8.5"	Dark Wood	220 mm	85 mm	180 mm	1,200 kg	220 X 240 X 100 mm

DUO DESKTOP MENU HOLDER, VINTAGE CUT: Beech wood						WEIGHT	PACKING SIZE (2 Pcs)
ARTICLE	SIZE	DESCRIPTION	X	Y	H	WITH PACKING	*W X H X D
UWDMVDNOA4	A4 - 8.5"x11"	Natural Wood	287 mm	85 mm	250 mm	1,657 kg	290 X 310 X 100 mm
UWDMVDNOA5	A5 - 5.5"x8.5"	Natural Wood	220 mm	85 mm	180 mm	1,200 kg	220 X 240 X 100 mm
UWDMVDDO4	A4 - 8.5"x11"	Dark Wood	287 mm	85 mm	250 mm	1,675 kg	290 X 310 X 100 mm
UWDMVDDO5	A5 - 5.5"x8.5"	Dark Wood	220 mm	85 mm	180 mm	1,200 kg	220 X 240 X 100 mm

*W:Width H: Height D: Depth



Fort Desktop Menu Holder, Straight Cut & Vintage Cut



Modern style, made of beech wood, Fort Desktop Menu Holder is light and affordable solution for restaurants, retail stores and any commercial environment. Simply slide the leaflet into grooves of the wooden columns. Prints are easy to change from top. Fort Desktop Menu Holder is made of the finest materials while providing the highest level of quality. Basic and vintage styles offers options to users. To ensure sustainability of the quality, wood menu holders are lacquered finished which is resistant to spill of food and fizzy drinks.

Der moderne, aus Buchenholz hergestellte Fort Desktop-Menühalter ist eine leichte und kostengünstige Lösung für Restaurants, Einzelhandelsgeschäfte und jede gewerbliche Umgebung. Schieben Sie den Druck einfach in die Nut der Holzsäulchen. Drucke sind leicht von oben zu wechseln. Der Fort Desktop-Menühalter besteht aus den besten Materialien und bietet höchste Qualität. Basic- und Vintage Varianten stehen zur Auswahl. Um die Nachhaltigkeit der Qualität zu gewährleisten, sind Holzmenühalter lackiert, um die Resistenz gegen Verschütten von Speisen und Getränken zu erhöhen.



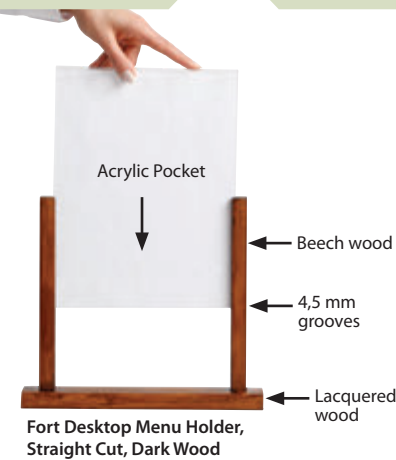
Acrylic or PET poster pockets and chalkboards are optional. Acryl- oder PET-Postertaschen und -tafeln sind optional.



Grooves of wooden columns is 4,5 mm which accepts acrylic or PET pockets and chalk board. Die Nut der Holzsäulchen ist 4,5 mm breit und eignen sich für Taschen aus Acryl oder PET sowie Kreidetafel.

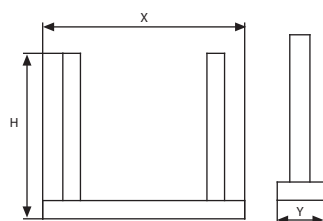


Packed in multiples. Vielfachpackung.

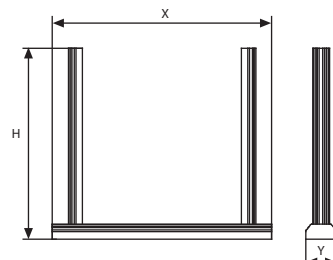


Do not forget to order PET, or Acrylic pockets or Chalkboard

Fort Desktop Menu Holder, Straight Cut



Fort Desktop Menu Holder, Vintage Cut



FORT DESKTOP MENU HOLDER, STRAIGHT CUT: Beech wood						WEIGHT	PACKING SIZE (2 Pcs)
ARTICLE	SIZE	DESCRIPTION	X	Y	H	WITH PACKING	*W X H X D
UWDMOFNOA4	A4 - 8.5"x11"	Natural Wood	287 mm	40 mm	250 mm	0,820 kg	290 X 310 X 100 mm
UWDMOFNOA5	A5 - 5.5"x8.5"	Natural Wood	220 mm	40 mm	180 mm	0,560 kg	220 X 240 X 100 mm
UWDMOFDOA4	A4 - 8.5"x11"	Dark Wood	287 mm	40 mm	250 mm	0,820 kg	290 X 310 X 100 mm
UWDMOFDOA5	A5 - 5.5"x8.5"	Dark Wood	220 mm	40 mm	180 mm	0,560 kg	220 X 240 X 100 mm

FORT DESKTOP MENU HOLDER, VINTAGE CUT : Beech wood						WEIGHT	PACKING SIZE (2 Pcs)
ARTICLE	SIZE	DESCRIPTION	X	Y	H	WITH PACKING	*W X H X D
UWDMVFNOA4	A4 - 8.5"x11"	Natural Wood	287 mm	40 mm	250 mm	0,820 kg	290 X 310 X 100 mm
UWDMVFNOA5	A5 - 5.5"x8.5"	Natural Wood	220 mm	40 mm	180 mm	0,560 kg	220 X 240 X 100 mm
UWDMVFDOA4	A4 - 8.5"x11"	Dark Wood	287 mm	40 mm	250 mm	0,820 kg	290 X 310 X 100 mm
UWDMVFDOA5	A5 - 5.5"x8.5"	Dark Wood	220 mm	40 mm	180 mm	0,560 kg	220 X 240 X 100 mm

*W:Width H:Height D:Depth



Curved Desktop Menu Holder



Modern style beech plywood menu holder is light and affordable. Suitable for use in restaurants, retail stores and any commercial environment. Simply slide the leaflets in to PET pocket and then slide the PET pocket in to grooves of the wooden columns. Prints are easy by sliding in. Curved Menu Holders are made of the finest materials while providing the highest level of quality. To ensure sustainability of the quality, wood menu holders are lacquered finished which is resistant to spill of food and fizzy drinks.

Buchsperrholz Menühalter im modernen Stil ist leicht und erschwinglich. Geeignet für den Einsatz in Restaurants, Einzelhandelsgeschäften und in jeder kommerziellen Umgebung. Schieben Sie einfach die Prospekte in die PET-Tasche und schieben Sie dann die PET-Tasche in die Rillen der Holzsäulen. Curved Desktop Menuboards werden aus den besten Materialien hergestellt und bieten ein Höchstmaß an Qualität. Um die Nachhaltigkeit der Qualität zu gewährleisten, sind Holzmenushalter lackiert, um die Resistenz gegen Verschütten von Speisen und Getränken zu erhöhen.



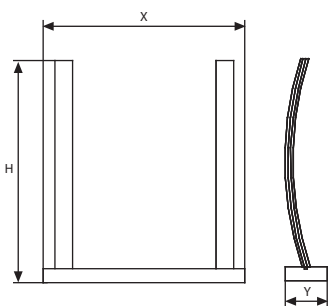
No tool assembly.
Keine Werkzeugmontage.



Channel of wooden columns is 4,2 mm.
Rillen der Holzsäule 4,2 mm.



PET pocket included.
PET-Tasche inbegriffen



MATERIAL : Beech wood							WEIGHT	PACKING SIZE (2 Pcs)
NATURAL WOOD	DARK WOOD	SIZE	X	Y	H	WITH PACKING	*W X H X D	
UWDMOCN0A5	UWDMOCDOA5	A5	220 mm	60 mm	225 mm	0,750 kg	250 X 280 X 80 mm	
UWDMOCN0A4	UWDMOCDOA4	A4	288 mm	60 mm	318 mm	1,000 kg	340 X 350 X 80 mm	
UWDMOCN058	UWDMOCDO58	5.5"X8.5"	220 mm	60 mm	225 mm	0,750 kg	250 X 280 X 80 mm	
UWDMOCN081	UWDMOCDO81	8.5"X11"	288 mm	60 mm	318 mm	1,000 kg	340 X 350 X 80 mm	




* W:Width H: Height D: Depth


Ticket Holder




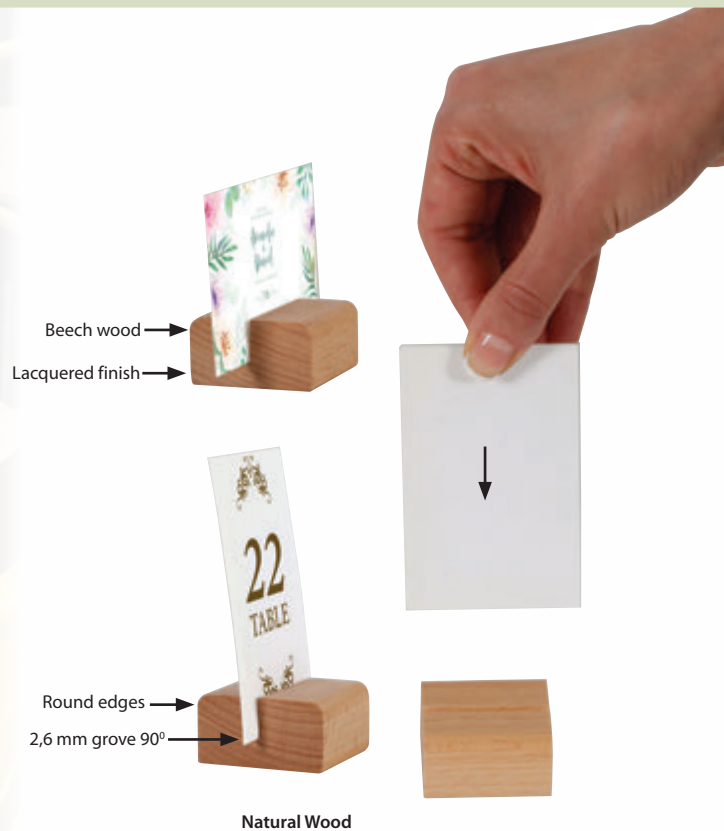
Made of solid Beech wood, Ticket Holders are mobile options for displaying menus, business cards, price tickets, gift cards or many other purposes. It is nicely lacquered finished with round corners. It is good for displaying both ways. Ticket Holder is suitable for both indoor and outdoor places such as shops, restaurants, cafes and bars. To ensure sustainability of the quality, Ticket Holders are lacquered finished which is resistant to spill of food and fizzy drinks.

Ticket Holders, aus massivem Buchenholz, sind mobile Optionen zur Präsentation von Menüs, Visitenkarten, Preislisten, Geschenkkarten oder vielen anderen Zwecken. Schön lackiert mit abgerundeten Ecken. Der Ticket Holder eignet sich sowohl für Innen- als auch für Außenbereiche wie Geschäfte, Restaurants, Cafés und Bars. Um die Nachhaltigkeit der Qualität zu gewährleisten, sind Holzmenushalter lackiert, um die Resistenz gegen Verschütten von Speisen und Getränken zu erhöhen.

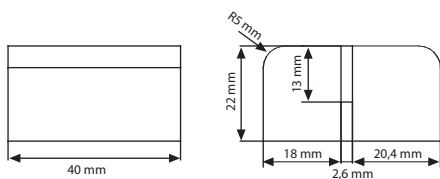
 Each unit comes ready to use.
Jeder Artikel wird fertig zum Einsatz geliefert.

 Groove is 2,6 mm and 90 degrees.
Die Nut ist 2,6 mm und 90 Grad.

 Packed in multiples. Suitable for silk screen printing, max. letter height is 12 mm.
Vielfachpackung. Für Siebdruck geeignet max. Buchstabenhöhe 12 mm.



Natural Wood



Dark Wood

MATERIAL : Beech wood			WEIGHT	PACKING SIZE (10 Pcs)
ARTICLE	SIZE	DESCRIPTION	WITH PACKING	*W X H X D
UWTHON0010	40 X 41 mm	Natural Wood	0,340 kg	105 X 105 X 80 mm
UWTHOD0010	40 X 41 mm	Dark Wood	0,340 kg	105 X 105 X 80 mm

* W:Width H: Height D: Depth



Card Holder 2 Sided



Made of solid Beech wood, Card Holder is double sided mobile options for displaying menus, business cards, price tickets, gift cards or many other purposes. It is nicely lacquered finished with round corners. It is good for displaying both ways. There are one channel on each side of Card holder one of which is 90 degrees angle and other one of which is 75 degrees angle. Card Holder is suitable for both indoor and outdoor places such as shops, restaurants, cafes and bars. To ensure sustainability of the quality, Card Holder is lacquered finished which is resistant to spill of food and fizzy drinks.

Der aus massivem Buchenholz gefertigte Kartenhalter ist eine doppelseitige mobile Option für die Präsentation von Menüs, Visitenkarten, Preislisten, Geschenkkarten oder vielen anderen Zwecken. Schön lackiert mit abgerundeten Ecken. Auf jeder Seite des Kartenhalters befinden sich 2 Nuten, von denen einer 90 Grad und der andere 75 Grad beträgt. Der Kartenhalter eignet sich sowohl für Innen- als auch für Außenbereiche wie Geschäfte, Restaurants, Cafés und Bars. Um die Nachhaltigkeit der Qualität zu gewährleisten, sind Holzmenushalter lackiert, um die Resistenz gegen Verschütten von Speisen und Getränken zu erhöhen.



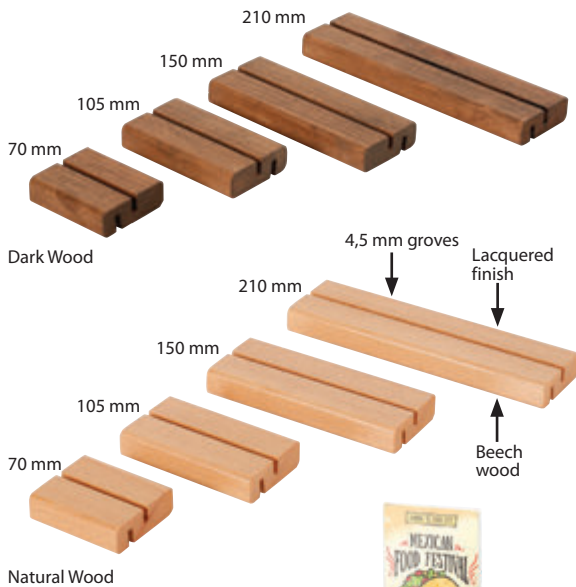
Each unit comes ready to use
Jeder Artikel wird fertig zum Einsatz geliefert.



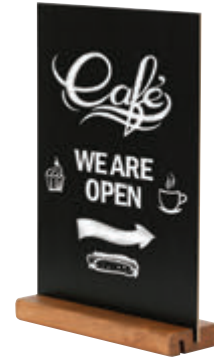
Both groove is 4,5 mm, one of which is 90 degrees and other one is 75 degrees.
Beide Nuten sind 4,5 mm, eine davon ist 90 Grad und die andere 75 Grad.



Packed in multiples. Suitable for silk screen printing, max. letter height is 18 mm.
Vielfachpackung. Für Siebdruck geeignet max. Buchstabenhöhe 18 mm.



Dark Wood 75°Angled
210 mm, Acrylic optional



Dark Wood 90°Angled
210 mm, Chalkboard optional



Dark Wood 90°Angled
150 mm, Acrylic optional



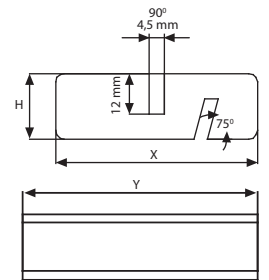
Natural Wood 90°Angled
105 mm, Acrylic optional



Natural Wood 75°Angled
105 mm, Chalkboard optional



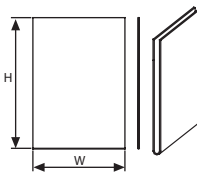
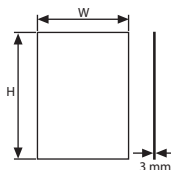
Natural Wood 75°Angled
70 mm, Acrylic optional



Do not forget to order PET, or Acrylic pockets or Chalkboard

ACRYLIC POCKET U TYPE				PET POCKET U TYPE			
ARTICLE	POSTER	W	H	ARTICLE	POSTER	W	H
UPCUAD00A4	210 X 297 mm	216 mm	300 mm	UPCUPD00A4	210 X 297 mm	216 mm	298 mm
UPCUAD00A5	148 X 210 mm	148 mm	214 mm	UPCUPD00A5	148 X 210 mm	148 mm	212 mm
UPCUAD00A6	105 X 148 mm	105 mm	152 mm	UPCUPD00A6	105 X 148 mm	105 mm	150 mm
UPCUAD00B1	216 X 280 mm	216 mm	284 mm	UPCUPD00B1	216 X 280 mm	216 mm	282 mm
UPCUAD00S8	140 X 216 mm	148 mm	220 mm	UPCUPD00S8	140 X 216 mm	148 mm	218 mm

CHALKBOARD			
ARTICLE	SIZE	W	H
UPCUWD00A4	210 X 297 mm	216 mm	300 mm
UPCUWD00A5	148 X 210 mm	148 mm	213 mm
UPCUWD00A6	105 X 148 mm	105 mm	148 mm
UPCUWD00B1	216 X 280 mm	216 mm	283 mm
UPCUWD00S8	140 X 216 mm	148 mm	219 mm



MATERIAL : Beech wood						WEIGHT	PACKING SIZE (10Pcs)
ARTICLE	SIZE	DESCRIPTION	X	Y	H	WITH PACKING	*W X H X D
UWCHON0070	70 mm	Natural Wood	60 mm	70 mm	20 mm	0,710 kg	100 X 150 X 140 mm
UWCHON0105	105 mm	Natural Wood	60 mm	105 mm	20 mm	1,050 kg	135 X 150 X 140 mm
UWCHON0150	150 mm	Natural Wood	60 mm	150 mm	20 mm	1,450 kg	180 X 150 X 140 mm
UWCHON0210	210 mm	Natural Wood	60 mm	210 mm	20 mm	2,000 kg	150 X 230 X 140 mm
UWCHOD0070	70 mm	Dark Wood	60 mm	70 mm	20 mm	0,710 kg	100 X 150 X 140 mm
UWCHOD0105	105 mm	Dark Wood	60 mm	105 mm	20 mm	1,050 kg	135 X 150 X 140 mm
UWCHOD0150	150 mm	Dark Wood	60 mm	150 mm	20 mm	1,450 kg	180 X 150 X 140 mm
UWCHOD0210	210 mm	Dark Wood	60 mm	210 mm	20 mm	2,000 kg	150 X 230 X 140 mm

*W:Width H:Height D:Depth






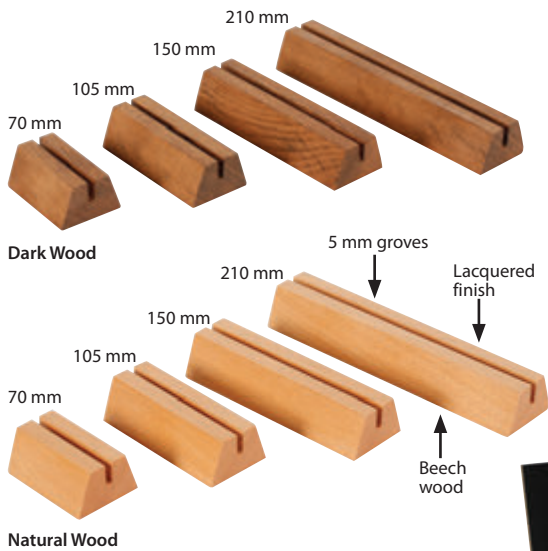
Pyramid Card Holder Single Sided



Made of solid Beech wood, Pyramid Card Holder is mobile option for displaying menus, business cards, price tickets, or many other announcement purposes. It is nicely lacquered finished with round corners. It is good for displaying both ways. Pyramid Card Holder is suitable for both indoor and outdoor places such as shops, restaurants, cafes and bars. To ensure sustainability of the quality, Pyramid Card Holders are lacquered finished which is resistant to spill of food and fizzy drinks.

Der aus massivem Buchenholz gefertigte Pyramid Card Holder ist eine mobile Option zum Anzeigen von Menüs, Visitenkarten, Preislisten oder vielen anderen Ankündigungszwecken. Es ist schön lackiert mit abgerundeten Ecken. Pyramid Card Holder eignet sich sowohl für Innen- als auch für Außenbereiche wie Geschäfte, Restaurants, Cafés und Bars. Um die Nachhaltigkeit der Qualität zu gewährleisten, sind Pyramid Card Holders lackiert, um die Resistenz gegen Verschütten von Speisen und Getränken zu erhöhen.

-  Each unit comes ready to use
Jeder Artikel wird fertig zum Einsatz geliefert.
-  Groove is 5 mm and 90 degrees. Suitable for branding.
Die Nut ist 5 mm und 90 Grad. Können mit Marke versehen werden
-  Packed in multiples. Suitable for silk screen printing, max. letter height is 25 mm.
In Vielfachpackungen. Für Siebdruck geeignet max. Buchstabenhöhe 25 mm.



Dark Wood - 210 mm
Acrylic optional



Dark Wood - 150 mm
Chalkboard optional



Dark Wood - 105 mm
Acrylic optional



Dark Wood - 70 mm
Chalkboard optional



Natural Wood - 210 mm
Chalkboard optional



Natural Wood - 150 mm
Acrylic optional

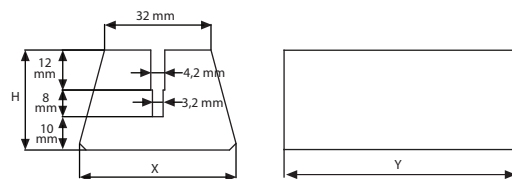


Natural Wood - 105 mm
Chalkboard optional



Natural Wood - 70 mm
Acrylic optional

Do not forget to order PET, or Acrylic pockets or Chalkboard



MATERIAL : Beech wood						WEIGHT	PACKING SIZE (10Pcs)
ARTICLE	SIZE	DESCRIPTION	X	Y	H	WITH PACKING	*W X H X D
UWCHPN0070	70 mm	Natural Wood	48 mm	70 mm	30 mm	0,710 kg	80 X 250 X 90 mm
UWCHPN0105	105 mm	Natural Wood	48 mm	105 mm	30 mm	1,050 kg	80 X 250 X 130 mm
UWCHPN0150	150 mm	Natural Wood	48 mm	150 mm	30 mm	1,450 kg	80 X 250 X 170 mm
UWCHPN0210	210 mm	Natural Wood	48 mm	210 mm	30 mm	2,000 kg	80 X 250 X 230 mm
UWCHPD0070	70 mm	Dark Wood	48 mm	70 mm	30 mm	0,710 kg	80 X 250 X 90 mm
UWCHPD0105	105 mm	Dark Wood	48 mm	105 mm	30 mm	1,050 kg	80 X 250 X 130 mm
UWCHPD0150	150 mm	Dark Wood	48 mm	150 mm	30 mm	1,450 kg	80 X 250 X 170 mm
UWCHPD0210	210 mm	Dark Wood	48 mm	210 mm	30 mm	2,000 kg	80 X 250 X 230 mm

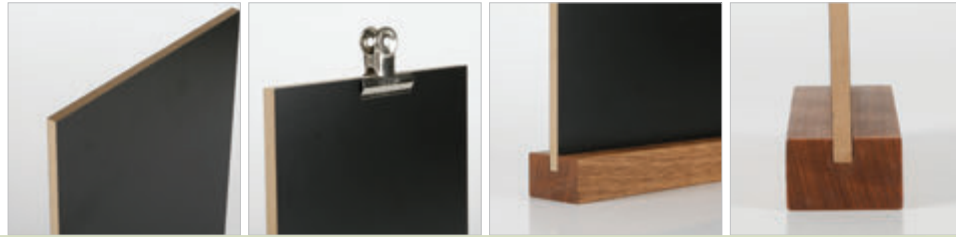
* W:Width H: Height D: Depth



Wood Clipboard



Watch video at our website www.mtdisplays.com



Wood Clipboard is made of beech wood and double sided. It has a dry-wipe chalk surface. A5 – 5"X8,5" and A4 – 8.5"X11" size options are available. Lacquered finish is applied for long term use. It is resistant to the spill of food and fizzy drinks. Its wooden and authentic look create a friendly atmosphere to your cafe, bar, bakery or restaurant. Its clip allows for fast and easy replacement of the daily menu. Its surface is suitable for printing so that customers can reach the digital menu with QR code.

Der Wood Clipboard ist aus Buchenholz und doppelseitig. Es hat eine trocken abwischbare Kreideoberfläche. A5 – 5"X8,5" und A4 – 8.5"X11" Größenoptionen sind verfügbar. Lackiertes Finish wird für den Langzeitgebrauch aufgetragen. Es ist beständig gegen das Verschütten von Speisen und kohlen säurehaltigen Getränken. Sein hölzernes und authentisches Aussehen schafft eine freundliche Atmosphäre in Ihrem Café, Ihrer Bar, Bäckerei oder Ihrem Restaurant. Sein Clip ermöglicht einen schnellen und einfachen Austausch des Tagesmenüs. Seine Oberfläche ist bedruckbar, sodass Kunden per QR-Code auf die digitale Speisekarte gelangen.

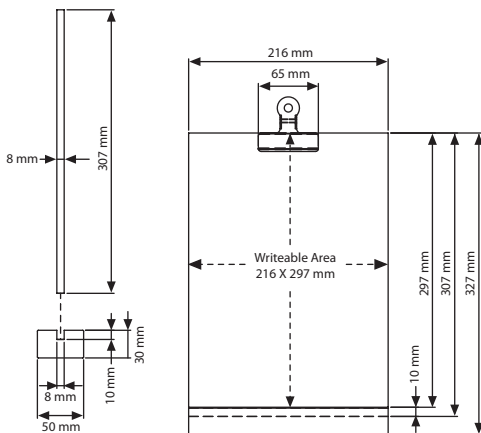
! A5 – 5"X8,5" and A4 – 8.5"X11" size options are available. A5 – 5"X8,5" und A4 – 8.5"X11" Größenoptionen sind verfügbar.

Assembly in 10 seconds. Montage in 10 Sekunden.



A4 - 8,5"X11"

A5 - 5"X8,5"



Don't forget to order
 Chalkboard Marker
 UYAKLM1251 - Colour Marker
 UYAKLM1250 - White Marker



MATERIAL : Beech wood		WEIGHT	PACKING SIZE (2 Pcs)
ARTICLE	SIZE	WITH PACKING	*W X H X D
UWCB000A5	A5 - 5"X8,5"	2,700 kg	185 X 345 X 270 mm
UWCB000A4	A4 - 8,5"X11"	2,700 kg	185 X 345 X 270 mm

*W:Width H:Height D:Depth



Table Top Chalk Mini A Board



Table Top Chalk Mini A Board is made of beech wood. Lacquered finish is applied for long term use. It has natural wood & black chalk surface, natural wood & white erasable surface and dark wood & black chalk surface, dark wood & white erasable surface options. White erasable surface version has magnetic surface and dry erase surface. Black chalk surface has dry erase surface. Its chain provides durability. Its foldable flat design provides space saving and easy transportation. Its wooden and authentic look create a friendly atmosphere to your cafe, bar, bakery or restaurant.

Table Top Chalk Mini A Board ist aus Buchenholz gefertigt. Lackiertes Finish wird für den Langzeitgebrauch aufgetragen. Es hat eine natürliche Holz- und schwarze Kreideoberfläche, eine natürliche Holz- und weiße löschbare Oberfläche und eine dunkle Holz- und schwarze Kreideoberfläche, dunkles Holz und eine weiße löschbare Oberfläche. Die Version mit weißer löschbarer Oberfläche hat eine magnetische Oberfläche und eine trocken abwischbare Oberfläche. Die schwarze Kreideoberfläche hat eine trocken abwischbare Oberfläche. Seine Kette sorgt für Langlebigkeit. Sein faltbares flaches Design sorgt für Platzersparnis und einfachen Transport. Sein hölzernes und authentisches Aussehen schafft eine freundliche Atmosphäre in Ihrem Café, Ihrer Bar, Bäckerei oder Ihrem Restaurant.

! Has natural wood & black chalk surface, natural wood & white erasable surface and dark wood & black chalk surface, dark wood & white erasable surface options. Hat natürliches Holz und schwarze Kreideoberfläche, natürliches Holz und weiße löschbare Oberfläche und dunkles Holz und schwarze Kreideoberfläche, dunkles Holz und weiße löschbare Oberflächenoptionen.

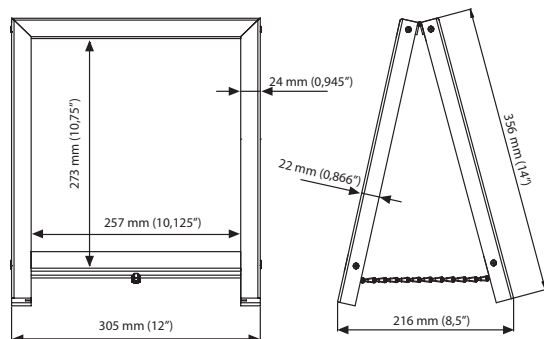
🕒 Assembly in 10 seconds. Montage in 10 Sekunden.



White Erasable Surface - Natural Wood



Black Chalk Surface - Dark Wood



MATERIAL : Beech wood				WEIGHT	PACKING SIZE
ARTICLE	EXTERNAL (x-y)	WRITING AREA	DESCRIPTOIN	WITH PACKING	*W X H X D
UWTTCBN012	12" X 14" / 305 X 356 mm	10.75" X 10.125" / 273 X 257 mm	Black Chalk Surface / Natural Wood	1,850 kg	330 X 380 X 60 mm
UWTTWCN012	12" X 14" / 305 X 356 mm	10.75" X 10.125" / 273 X 257 mm	White Erasable Surface / Natural Wood	1,850 kg	330 X 380 X 60 mm
UWTTCBD012	12" X 14" / 305 X 356 mm	10.75" X 10.125" / 273 X 257 mm	Black Chalk Surface / Dark Wood	1,850 kg	330 X 380 X 60 mm
UWTTCWD012	12" X 14" / 305 X 356 mm	10.75" X 10.125" / 273 X 257 mm	White Erasable Surface / DarkWood	1,850 kg	330 X 380 X 60 mm

*W:Width H: Height D: Depth



Nature Line Table Top Chalk A Board



Suitable for the display of messages in restaurants, cafés, bars, malls, offices and education centers. The erasable surface enables you to erase your messages and transmit them to your audience while keeping them updated. You can use a chalkboard pen to write on the black surface. There are also special water-based and scent-free markers. We sell chalk pens individually 2 in convenient sets.

Geeignet Nachrichten und infos in Restaurants, Cafés, Bars, Einkaufszentren, Büros und Bildungszentren. Die löschbare Oberfläche ermöglicht es Ihnen, Ihre zu löschen Nachrichten und übermitteln Sie sie an Ihr Publikum, während Sie sie auf dem Laufenden halten. Sie können einen Tafelstift verwenden, um auf der schwarzen Oberfläche zu schreiben. Es gibt auch spezielle Marker auf Wasserbasis und ohne Duftstoffe. Wir verkaufen Kreidestifte einzeln 2 in praktischen Sets.



Natural Wood

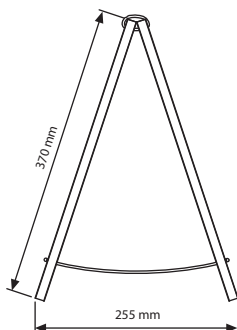
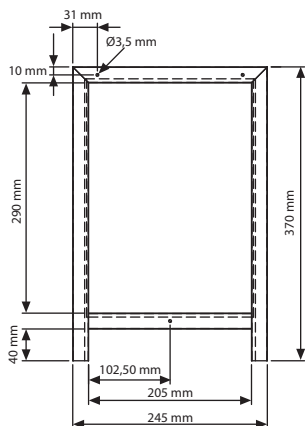


Natural rope



Dark Wood

Natural rope



Don't forget to order
Chalkboard Marker
UYAKLM1251 - Colour Marker
UYAKLM1250 - White Marker

MATERIAL : Fir wood				WEIGHT	PACKING SIZE
ARTICLE	EXTERNAL (x-y)	WRITING AREA	DESCRIPTOIN	WITH PACKING	*W X H X D
UWNLON00A4	245 X 370 mm	205 X 290 mm	Black Chalk Surface / Natural Wood	0,750 kg	280 X 400 X 35 mm
UWNL0D00A4	245 X 370 mm	205 X 290 mm	Black Chalk Surface / Dark Wood	0,750 kg	280 X 400 X 35 mm



* W:Width H:Height D:Depth

Arc Menu Holder






Watch video at our website www.mtdisplays.com

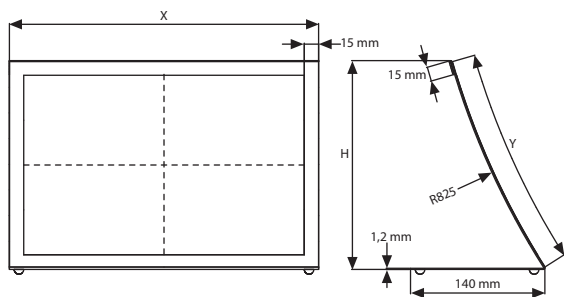


Modern style Arc Menu Holder features a curved design for more modernized appearance. With a contemporary design, this menu holder can be used to display notices, advertisements, graphics, menus and more. Flip up magnetic cover makes the change of poster easy. Simply flip up the anti-reflex cover and place the print underneath it. Suitable for use in restaurants, retail stores and any commercial environment.

Der Arc Menu Holder verfügt über ein geschwungenes Design für ein moderneres Erscheinungsbild. Mit einem zeitgemäßen Design kann dieser Menühalter zur Anzeige von Notizen, Anzeigen, Grafiken, Menüs und mehr verwendet werden. Eine aufklappbare Magnetabdeckung erleichtert das Wechseln des Posters. Klappen Sie einfach die Antireflex-Abdeckung hoch und platzieren Sie den Druck darunter. Geeignet für den Einsatz in Restaurants, Einzelhandelsgeschäften und in jeder kommerziellen Umgebung.

-  No assembly required.
Keine Montage erforderlich.
-  Unique curved design.
Einzigartiges geschwungenes Design.
-  Magnetic PET cover included.
Magnetische PET-Abdeckung inbegriffen.

Color options / Farbenoptionen



MATERIAL : Sheet metal								WEIGHT	PACKING SIZE (2 Pcs)
PORTRAIT	H	LANDSCAPE	H	EXTERNAL (x-y)	POSTER	COPY	DESCRIPTOIN	WITH PACKING	*W X H X D
UMSAMPOGA4	300 mm	UMSAMLOGA4	219 mm	324 X 237 mm	297 X 210 mm	294 X 180 mm	Silver	2,700 kg	185 X 345 X 270 mm
UMSAMPOBA4	300 mm	UMSAMLOBA4	219 mm	324 X 237 mm	297 X 210 mm	294 X 180 mm	Black	2,700 kg	185 X 345 X 270 mm
UMSAMPOG81	283 mm	UMSAMLOG81	202 mm	307 X 243 mm	11" X 8.5"	277 X 213 mm	Silver	2,650 kg	185 X 345 X 270 mm
UMSAMPOB81	283 mm	UMSAMLOB81	202 mm	307 X 243 mm	11" X 8.5"	277 X 213 mm	Black	2,650 kg	185 X 345 X 270 mm



*W:Width H: Height D: Depth

Tumble Box & Puzzle Tumble Box



Watch video at our website www.mtdisplays.com



The clear acrylic Tumble Box makes voting transparent, by granting the people insight into the box. Also this box helps to collect the demands, suggestions or complaints of workers in companies, restaurants or offices. Serves the collection of different tickets. Fits perfect in a counter with limited space. Accepts printing on surrounding walls. There is a lock system at its top keeping the documents safe inside at the front side of the cube.

Die durchsichtige Wahlurne macht Wahlen transparent und schützt trotzdem den Inhalt vor Diebstahl. Auch verhilft Ihnen diese Urne die Meinungen oder Wünsche Ihrer Mitarbeiter oder Kunden in Firmen, Restaurants oder Büros zu sammeln. Auch eine ausgezeichnete Lösung für Eintrittskarten. Nimmt wenig Platz in Anspruch und ermöglicht Ihnen die Anbringung von Drucken oder Aufklebern rundherum. Die Urne ist im Vorderteil abschliessbar und ermöglicht Ihnen sicheren Zugriff zu dem Inhalt.

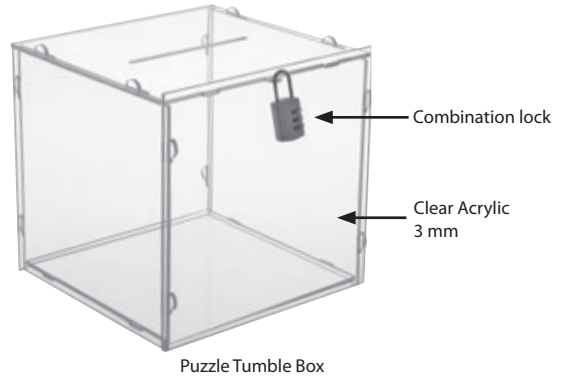
- Each box includes 1 key set of single variation. Jede Urne beinhaltet einen Ersatzschlüssel
- Please handle with care during transportation. Besondere Vorsicht beim Transport sind erforderlich.



Tumble Box Clear



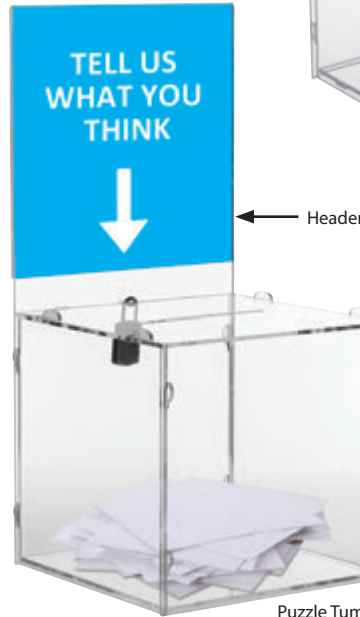
Tumble Box Opaque



Combination lock

Clear Acrylic 3 mm

Puzzle Tumble Box



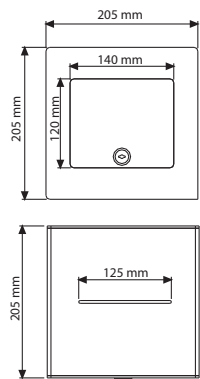
Header

Puzzle Tumble Box with Header

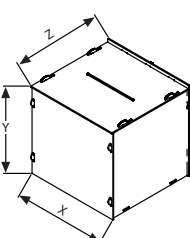


Flat pack

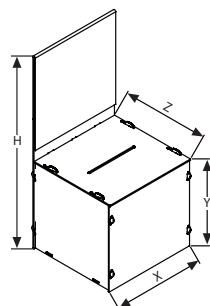
Tumble Box



Puzzle Tumble Box



Puzzle Tumble Box with Header



TUMBLE BOX : Acrylic		WEIGHT	PACKING SIZE
ARTICLE	DESCRIPTION	WITH PACKING	*W X H X D
UTBC050000	Clear	1,280 kg	240 X 250 X 240 mm
UTBC0W0000	Opaque	1,280 kg	240 X 250 X 240 mm

PUZZLE TUMBLE BOX : Clear acrylic 3 mm					WEIGHT	PACKING SIZE
ARTICLE	SIZE	EXTERNAL (x-y-z)	H	DESCRIPTION	WITH PACKING	*W X H X D
UTBPOS0085	215,9 X 279,4 mm	216 X 210 X 216 mm	-	Clear	1,500 kg	250 X 510 X 21 mm
UTBPOS0012	304,8 X 304,8 mm	305 X 299 X 305 mm	-	Clear	2,350 kg	350 X 680 X 21 mm
UTBPOS1085	215,9 X 279,4 mm	216 X 210 X 216 mm	445 mm	Clear with header	1,870 kg	250 X 510 X 21 mm
UTBPOS1012	304,8 X 304,8 mm	305 X 299 X 305 mm	630 mm	Clear with header	3,140 kg	350 X 680 X 21 mm

* W:Width H: Height D: Depth



Free Standing Puzzle Tumble Box



Watch video at our website www.mtdisplays.com



Locking Floor Standing Puzzle Box is suitable for different environment where the space is very tight. Easy to assemble with help of mounting sheet provided. Key and padlock securely protect the box content. Flat pack saves from space. This suggestion box is perfect for high traffic areas and suitable for tradeshow and fundraising even as well. Available in 2 sizes. It has a sturdy metal base which provide stability.

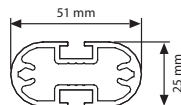
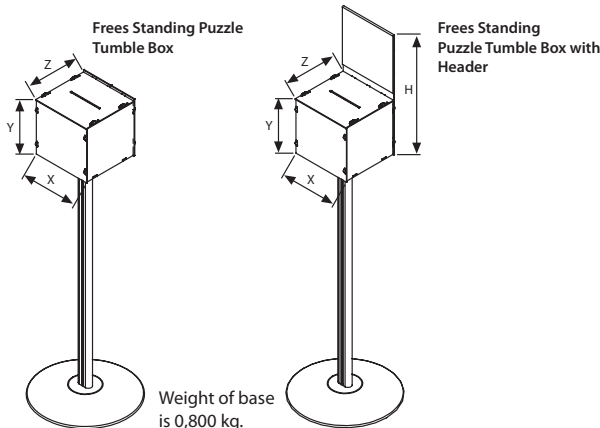
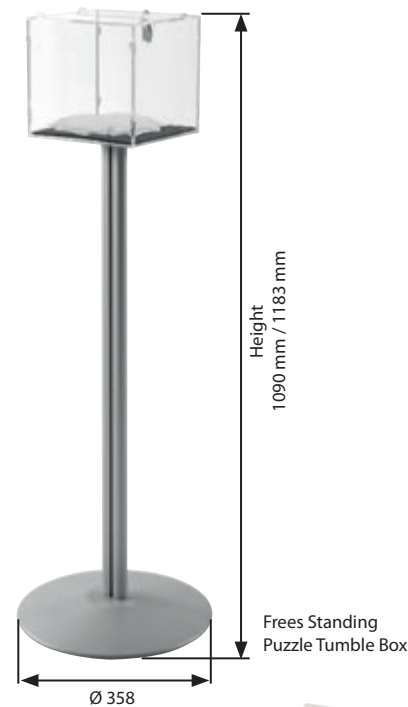
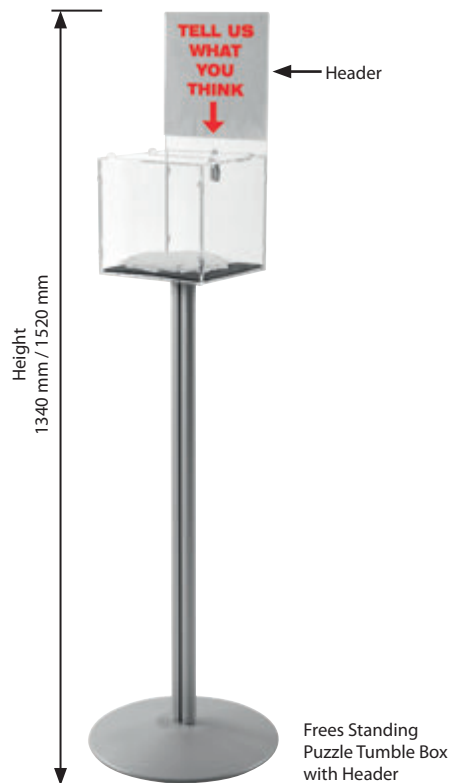
Die Verschießbare Puzzle Box ist geeignet für verschiedene Anwendungen wo nicht viel Platz geboten ist. Sehr einfach in der Montage mit der beigelegten Montageanleitung. Durch das Vorhängeschloss ist das Produkt stets sicher. Die flache Verpackung ist sehr Platzsparend. Diese Box ist perfekt für Orte mit hohem Menschenverkehr und bei Messeauftritten. Verfügbar in 2 Größen. Das Produkt hat eine robusten Metallfuß der für eine gute Stabilität sorgt.



Please handle with care during transportation. Please peel of the film over the product before use. Besondere Vorsicht beim Transport sind erforderlich. Vor Gebrauch den Schutzfilm auf den Artikeln abziehen.



Available with header and without header. Available in Opaque and Transparent finishes. Verfügbar mit Logo und ohne Logo. Verfügbar als durchsichtig und undurchsichtig.



MATERIAL : Clear acrylic 3 mm						WEIGHT	PACKING SIZE
ARTICLE	SIZE	EXTERNAL (x-y-z)	H	HEIGHT	DESCRIPTION	WITH PACKING	*W X H X D
UTBP1S0085	215,9 X 279,4 mm	216 X 210 X 216 mm	-	1094 mm	Clear	6,160 kg	430 X 920 X 70 mm
UTBP1S0012	304,8 X 304,8 mm	305 X 299 X 305 mm	-	1183 mm	Clear	7,500 kg	430 X 1120 X 70 mm
UTBP1S1085	215,9 X 279,4 mm	216 X 210 X 216 mm	445 mm	1340 mm	Clear with header	6,360 kg	430 X 920 X 70 mm
UTBP1S1012	304,8 X 304,8 mm	305 X 299 X 305 mm	630 mm	1520 mm	Clear with header	7,500 kg	430 X 1120 X 70 mm

*W:Width H: Height D: Depth



Tip Box

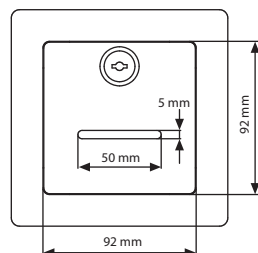
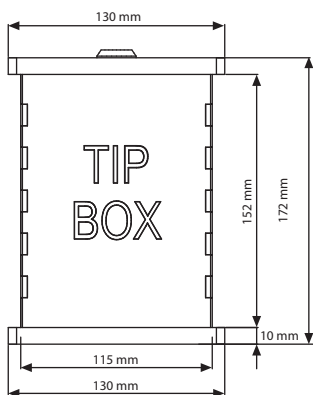
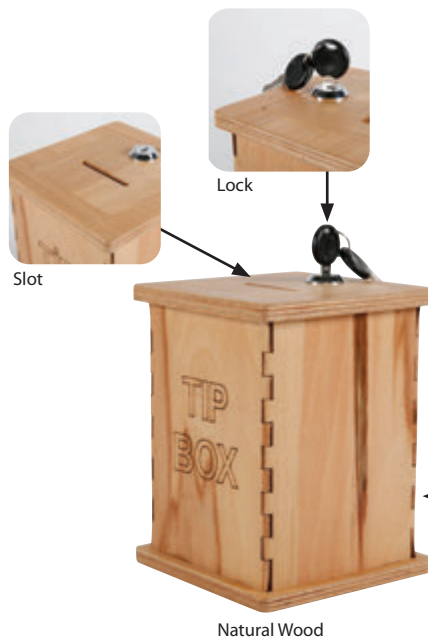
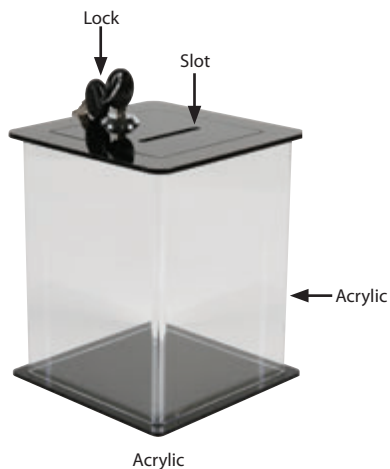


Tip box has natural, dark wood and acrylic options.
Locking system ensures safe use.

*Die Tip Box hat natürliche, dunkle Holz- und Acryloptionen.
Das Verriegelungssystem gewährleistet eine sichere
Verwendung.*

! Has natural, dark wood and acrylic options.
Hat natürliche, dunkle Holz- und Acryloptionen.

🕒 No assembly.
Keine Versammlung.



MATERIAL - Wood - Acrylic		WEIGHT	PACKING SIZE
ARTICLE	DESCRIPTION	WITH PACKING	*W X H X D
UTBXA00010	Clear with lock	0,550 kg	160 X 160 X 190 mm
UTBXWD0010	Dark Wood with lock	0,650 kg	160 X 160 X 210 mm
UTBXWN0010	Natural Wood with lock	0,650 kg	160 X 160 X 210 mm

*W:Width H: Height D: Depth



Business Card Holder



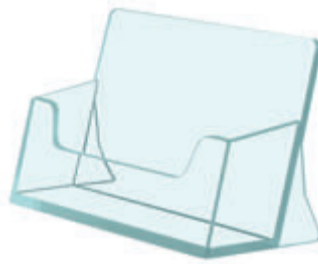
The clear Business Card Holder is good to organize your business and a perfect tool for professional appearance. This card holder is available in stock, ready for shipment and boxed in 40's.

Der transparente Visitenkartenhalter ermöglicht Ihnen die gute Organisation Ihrer Geschäfte und eine professionelle Erscheinung. Der Visitenkartenhalter ist jederzeit verfügbar und wird in 40 Stk Packungen angeboten.

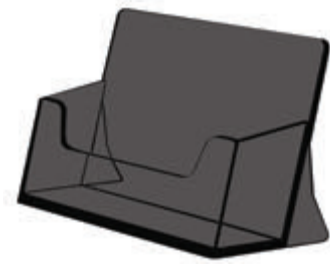
! Please handle with care during transportation. Besondere Vorsicht beim Transport sind erforderlich.



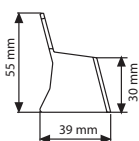
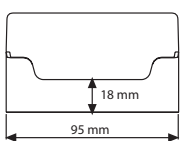
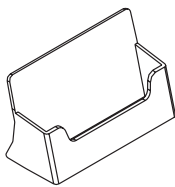
Clear



Turquoise



Black



MATERIAL : Clear		WEIGHT	PACKING SIZE
ARTICLE	DESCRIPTOIN	WITH PACKING	*W X H X D
UMSD009000	Clear	1,290 kg	245 X 350 X 86 mm (40 pcs)
UMSD009B00	Black	1,290 kg	245 X 350 X 86 mm (40 pcs)
UMSD009T00	Turquoise	1,290 kg	245 X 350 X 86 mm (40 pcs)

*W:Width H: Height D: Depth



Wood Clipboard





Office Facilities

- Coat Racks
 - Coat Hanger Stand
 - Spring Coat Rack
 - Pine Coat Rack
 - Sunflower Coat Rack
 - Fountain Coat Rack
 - Ladder Coat Rack
 - Maze Coat Rack

- Waste Baskets
 - Hotel Trash Can
 - Stainless Steel Push Can Dust Bin
 - Stainless Steel Waste Baskets
- 2 Step Plastic Stepstool
- No Slip Key Board Tray
- Universal Monitor Stand
- Adjustable Workstation
- Mobile Workstation

- Coat Racks
 - Coat Hanger Stand
 - Spring Coat Rack
 - Pine Coat Rack
 - Sunflower Coat Rack
 - Fountain Coat Rack
 - Ladder Coat Rack
 - Maze Coat Rack

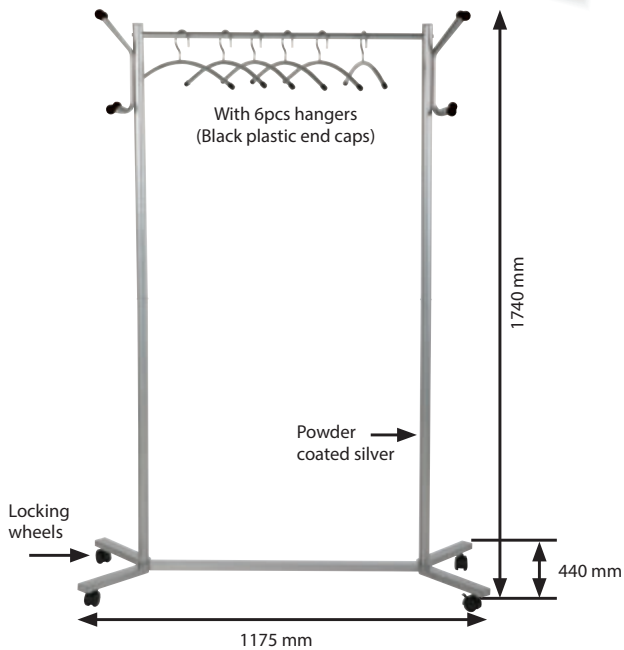
- Waste Baskets
 - Hotel Trash Can
 - Stainless Steel Push Can Dust Bin
 - Stainless Steel Waste Baskets
- 2 Step Plastic Stepstool
- No Slip Key Board Tray
- Universal Monitor Stand
- Adjustable Workstation
- Mobile Workstation



Coat Racks

Designed for beauty and function, these coat racks are suitable for home or office use. 8 different models are offered with different accessories and functions. All models are heavy and sturdy for stability. They support up to 25 kilograms in average.

Entworfen für ästhetisch und Funktion, sind diese Coat Racks für Haus- oder auch Bürogebrauch geeignet. 8 verschiedene Modelle werden mit abweichende Zubehör und Funktionen angeboten. Alle Modelle sind schwer und stabil. Sie unterstützen bis zu 25 Kilogramm im Durchschnitt.



Coat Hanger Stand

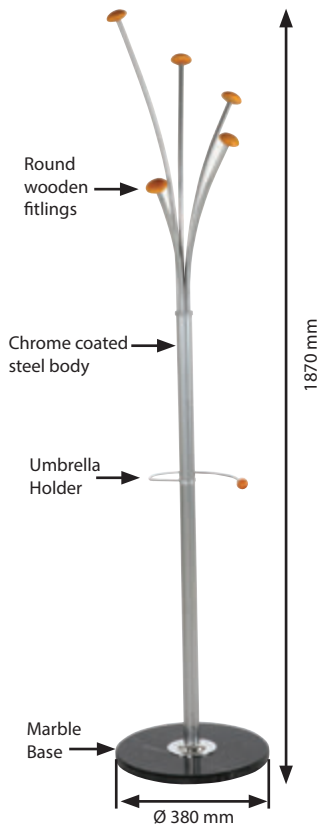


MATERIAL : Steel			WEIGHT	PACKING SIZE
ARTICLE	SIZE	DESCRIPTION	WITH PACKING	*W X H X D
TWJD000303	1175 X 440 X 1740 mm	Silver	5,600 kg	890 X 305 X 90 mm



*W:Width H: Height D: Depth

Spring Coat Rack

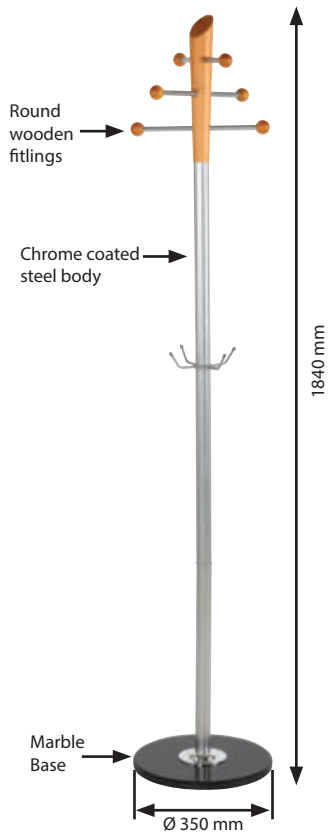


SPRING: Steel			WEIGHT	PACKING SIZE
ARTICLE	SIZE	DESCRIPTION	WITH PACKING	*W X H X D
TWJD856003	380 X 380 X 1870 mm	Silver	9,400 kg	720 X 387 X 88 mm

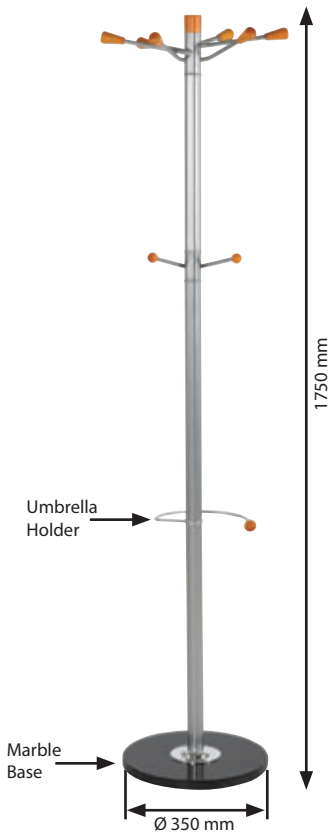
*W:Width H: Height D: Depth



Pine Coat Rack

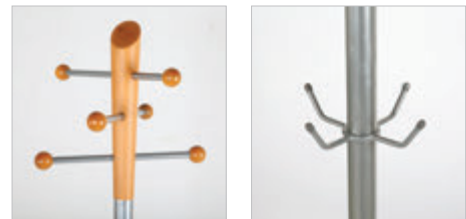


Sunflower Coat Rack



PINE: Steel			WEIGHT	PACKING SIZE
ARTICLE	SIZE	DESCRIPTION	WITH PACKING	*W X H X D
TWJD824403	350 X 350 X 1840 mm	Silver	7,900 kg	520 X 357 X 92 mm

*W:Width H: Height D: Depth

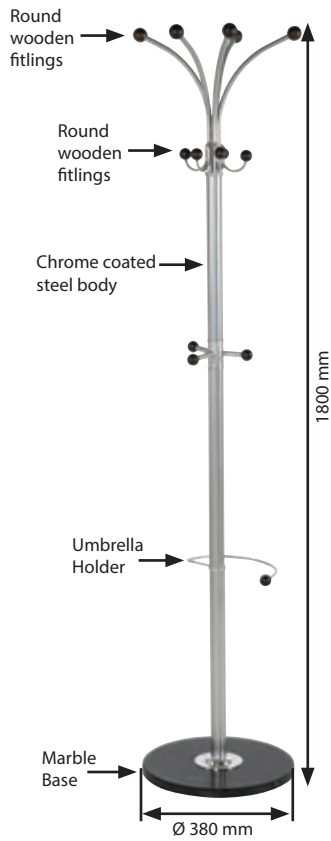


SUNFLOWER: Steel			WEIGHT	PACKING SIZE
ARTICLE	SIZE	DESCRIPTION	WITH PACKING	*W X H X D
TWJD815403	350 X 350 X 1750 mm	Silver	8,100 kg	590 X 365 X 135 mm

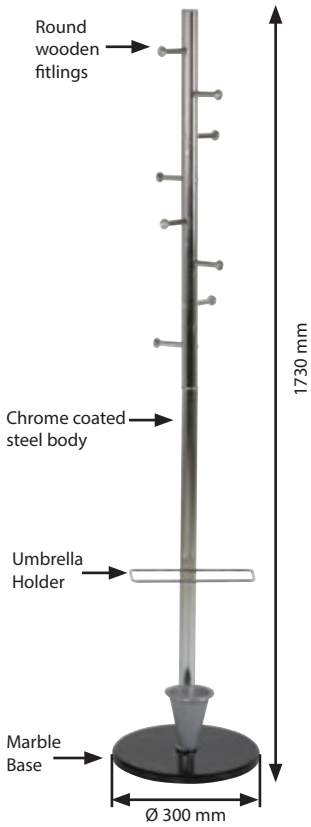
*W:Width H: Height D: Depth



Fountain Coat Rack



Ladder Coat Rack



FOUNDATION : Steel			WEIGHT	PACKING SIZE
ARTICLE	SIZE	DESCRIPTION	WITH PACKING	*W X H X D
TWJD888003	380 X 380 X 1800 mm	Silver	9,700 kg	590 X 387 X 95 mm



*W:Width H: Height D: Depth



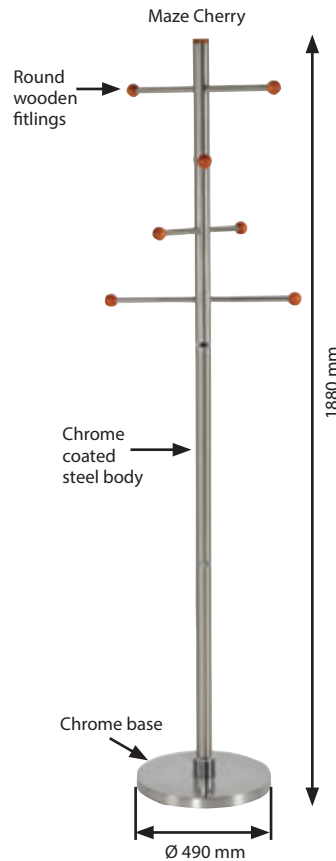
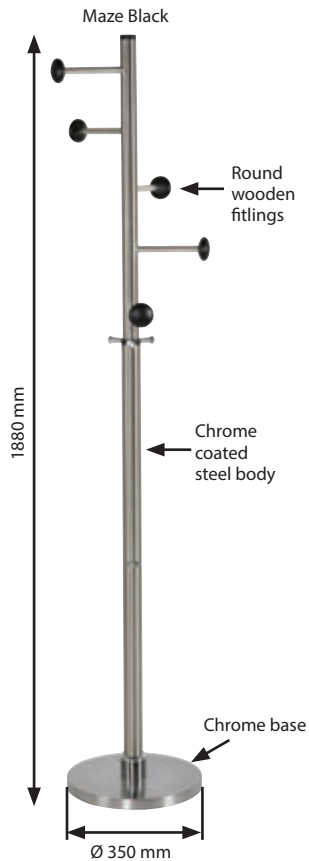
LADDER : Steel			WEIGHT	PACKING SIZE
ARTICLE	SIZE	DESCRIPTION	WITH PACKING	*W X H X D
TWJD828103	300 X 300 X 1730 mm	Silver	7,100 kg	880 X 310 X 120 mm



*W:Width H: Height D: Depth



Maze Coat Rack



MAZE : Steel			WEIGHT	PACKING SIZE
ARTICLE	SIZE	DESCRIPTION	WITH PACKING	*W X H X D
TXXY801001	490 X 490 X 1880 mm	Cherry	6,600 kg	715 X 90 X 375 mm
TXXY808A01	350 X 350 X 1880 mm	Black	6,800 kg	715 X 90 X 375 mm



*W:Width H: Height D: Depth

- Cherry wood or black knob accessoires
- Packaging: single packed
- Easy assembling
- Gross weight: 6,6 kg



Waste Baskets

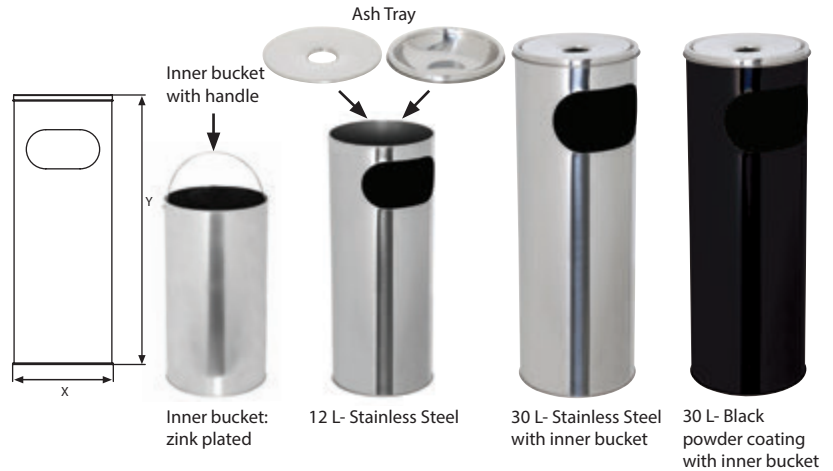
These Waste Baskets are mainly made of stainless steel for hygienic reasons. All models easily incorporate in contemporary office buildings, lounges, lobby or at an entryway to promote paper litter disposal. Available in different capacities, finishes and functions.

Diese Abfalleimer sind aus hygienischen Gründen hauptsächlich aus Edelstahl. Alle Modelle lassen sich leicht in zeitgenössische Bürogebäude, Lounges, Lobby's oder an einem Eingang für die richtige Abfallentsorgung integrieren. Erhältlich in verschiedenen Kapazitäten, Oberflächen und Funktionen.

Hotel Trash Can

MATERIAL : Stainless Steel				WEIGHT	PACKING SIZE
ARTICLE	SIZE (x-y)	DESCRIPTION	CAPACITY	WITH PACKING	*W X H X D
TJIHT95A01	Ø205 X 580 mm	Silver	12 L	2,100 kg	230 X 600 X 250 mm
TJIHT95B01	Ø300 X 605 mm	Silver-with inner bucket	30 L	3,900 kg	330 X 650 X 330 mm
TJIHT95B02	Ø300 X 605 mm	Black-with inner bucket	30 L	4,000 kg	330 X 650 X 330 mm

*W:Width H: Height D: Depth



Stainless Steel Push Can Dust Bin

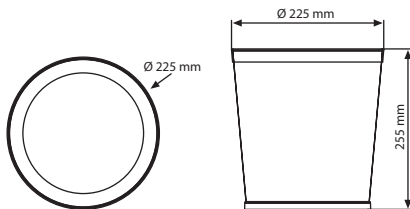


MATERIAL : Stainless Steel				WEIGHT	PACKING SIZE
ARTICLE	SIZE (x-y)	DESCRIPTION	CAPACITY	WITH PACKING	*W X H X D
TJIDB96C01	Ø350 X 760 mm	Silver	50 L	6,200 kg	380 X 800 X 380 mm

*W:Width H: Height D: Depth



Stainless Steel Waste Basket Singel Wall



MATERIAL : Stainless Steel			WEIGHT	PACKING SIZE
ARTICLE	DESCRIPTION	WEIGHT	WITH PACKING	*W X H X D
TJIWB93S01	Silver	0,750 kg	1,100 kg	250 X 290 X 250 mm
TJIWB93S02	Black	0,750 kg	1,100 kg	250 X 290 X 250 mm

*W:Width H: Height D: Depth



Algam

2 Step Stepstool



Watch video at our website www.mtdisplays.com



Stay safe while reaching higher places at office, library, shops or even at home. 2-Step Plastic Stepstool is a tool that can be easily used and available in 4 colors (Black, Red, Blue, Grey) to match your decoration. It tolerates up to 150kg without losing its looks. Can be easily moved around with spring loaded castors. Made from durable PP material.

Stehen Sie sicher wenn Sie versuchen höher gelegene Stellen erreichen wollen, ob Zuhause, im Büro, Bibliothek etc. Der Stepstool ist sehr einfach zu verwenden und kann in 4 verschiedenen Farben bestellt werden (Schwarz, Blau, Grau, Rot). Bis zu 150kg kann der Stepstool tragen. Kann sehr einfach mittels den Rollen bewegt werden.



Easily moved by the rollers.
Leicht zu transportieren mit Rollen.



Available in 4 colours : black, blue, grey, red.
Erhältlich in 4 Farben: schwarz, blau, grau, rot.



Maximum loading capacity 150kg.
Maximales Tragewicht 150 kg.



UPSS200002
Grey



UPSS200003
Red

← Antislip surface.



Max. load 150 kg



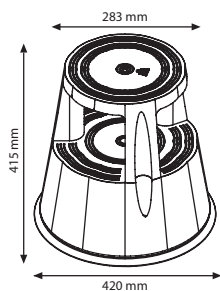
UPSS200001
Black



UPSS200004
Blue



Antislip rubber base. Locking wheel system.

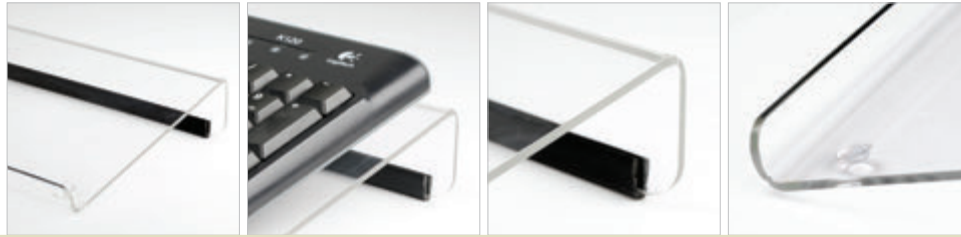


MATERIAL : PP		WEIGHT	PACKING SIZE
ARTICLE	DESCRIPTION	WITH PACKING	*W X H X D
UPSS200001	Black	2,450 kg	450 X 455 X 240 mm
UPSS200002	Grey	2,450 kg	450 X 455 X 240 mm
UPSS200003	Red	2,450 kg	450 X 455 X 240 mm
UPSS200004	Blue	2,450 kg	450 X 455 X 240 mm

*W:Width H: Height D: Depth




No-Slip Keyboard Tray

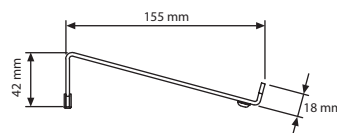
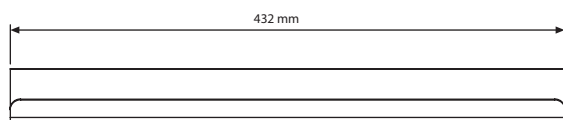


No-Slip Keyboard Tray is made of acrylic. It rises at a decent perfect angle and provides comfort to wrists, forearms and elbows. Rubber part at the bottom prevents slipping.

Die rutschfeste Tastaturablage besteht aus Acryl. Es steigt in einem anständigen, perfekten Winkel an und bietet Komfort für Handgelenke, Unterarme und Ellbogen. Gummiteil an der Unterseite verhindert ein Verrutschen.

! Rubber part at the bottom prevents slipping.
Gummiteil an der Unterseite verhindert ein Verrutschen.

 No assembly.
Keine Versammlung.



MATERIAL : Clear acrylic		WEIGHT	PACKING SIZE
ARTICLE	DESCRIPTOIN	WITH PACKING	*W X H X D
UMSKBS0017	Clear acrylic	0,450 kg	170 X 460 X 55 mm

*W:Width H: Height D: Depth





Universal Monitor Stand



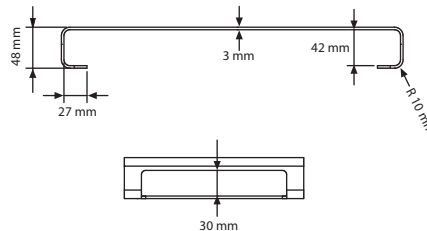
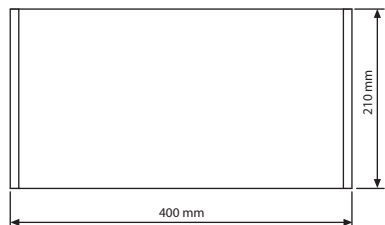
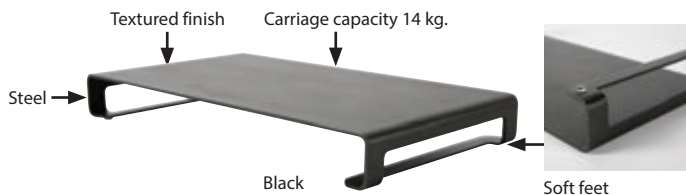
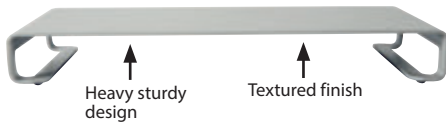
Universal Monitor Stand is made of steel and textured finish is applied. It provides such a perfect eye level view that prevent eye strain. Soft feet hold your monitor stable in place. Carriage capacity is 14 kg. Black, grey and white colour options are available.

Der universelle Monitorständer ist aus Stahl gefertigt und mit einer strukturierten Oberfläche versehen. Es bietet eine perfekte Sicht auf Augenhöhe, die eine Überanstrengung der Augen verhindert. Weiche Füße halten Ihren Monitor stabil an Ort und Stelle. Die Tragfähigkeit beträgt 14 kg. Als Farboptionen stehen Schwarz, Grau und Weiß zur Verfügung.

-  Carriage capacity is 14 kg. Die Tragfähigkeit des Wagens beträgt 14 kg.
-  No assembly. Keine Versammlung.



Gray



MATERIAL : Sheet metal		WEIGHT	PACKING SIZE (2 Pcs)
ARTICLE	DESCRIPTOIN	WITH PACKING	*W X H X D
UUMS01N000	Gray	2,000 kg	240 X 450 X 70 mm
UUMS01B000	Black	2,000 kg	240 X 450 X 70 mm
UUMS01W000	White	2,000 kg	240 X 450 X 70 mm

* W:Width H: Height D: Depth



Adjustable Workstation





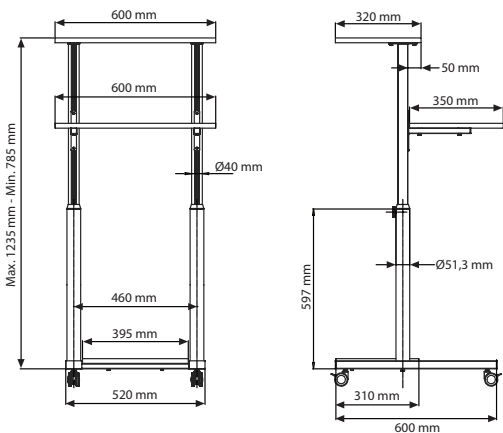
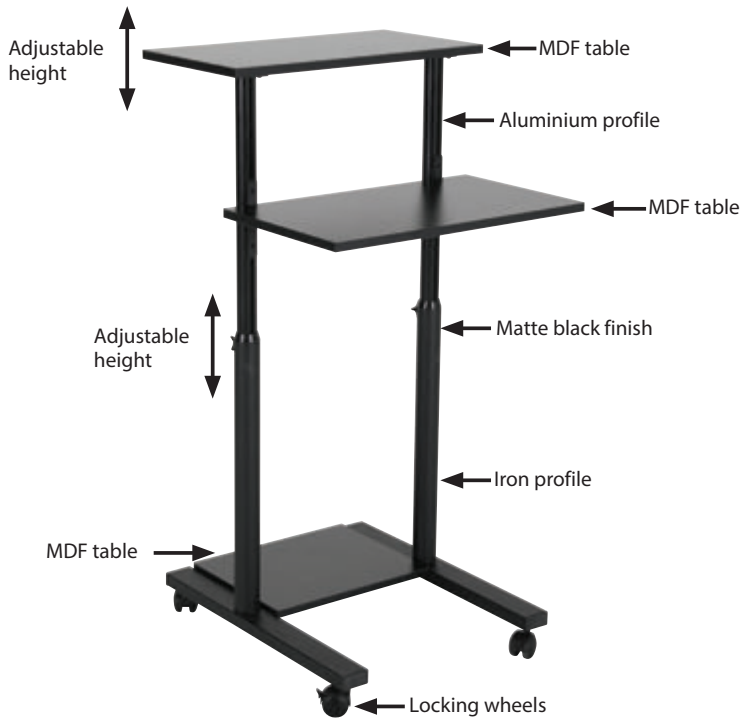
Watch video at our website www.mtdisplays.com



Adjustable Work Station is made of steel metal table and aluminum profile. Matte black finish is applied. Height is adjustable and lockable. Locking wheels provided stability. Sheet metal table has adjustable angle 0-30 that provides perfect eye level view.

Die verstellbare Arbeitsstation besteht aus einem Stahlmetalltisch und einem Aluminiumprofil. Es wird ein mattschwarzes Finish aufgetragen. Höhenverstellbar und arretierbar. Feststellbare Räder sorgen für Stabilität. Der Blechtisch hat einen einstellbaren Winkel von 0-30, der eine perfekte Sicht auf Augenhöhe bietet.

-  Die Tragfähigkeit des Wagens beträgt 14 kg. Die Tragfähigkeit des Wagens beträgt 14 kg.
-  No assembly. Keine Versammlung.



MATERIAL :Sheet metal	WEIGHT	PACKING SIZE
ARTICLE	WITH PACKING	*W X H X D
UAWSB00010	17,000 kg	675 X 820 X 105 mm

* W:Width H: Height D: Depth



Mobile Workstation





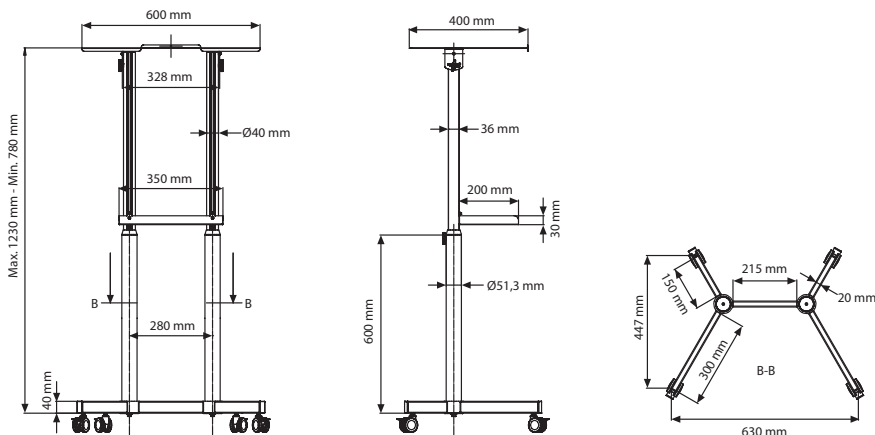
Watch video at our website www.mtdisplays.com



Mobile Work Station is made of MDF table and aluminium profile. Height is adjustable and lockable. Locking wheels provided stability. Sheet metal table has adjustable angle 0-30 that provides perfect eye level view.

Die mobile Arbeitsstation besteht aus einem MDF-Tisch und einem Aluminiumprofil. Höhenverstellbar und arretierbar. Feststellbare Räder sorgen für Stabilität. Der Blechtisch hat einen einstellbaren Winkel von 0-30, der eine perfekte Sicht auf Augenhöhe bietet.

-  Die Tragfähigkeit des Wagens beträgt 14 kg. Die Tragfähigkeit des Wagens beträgt 14 kg.
-  No assembly. Keine Versammlung.



MATERIAL : Sheet metal	WEIGHT	PACKING SIZE
ARTICLE	WITH PACKING	*W X H X D
UMWSB00010	11,500 kg	545 X 880 X 100 mm

* W:Width H: Height D: Depth





Accessories

- Hangers
- Baskets
- Shelves
- Header Holder & Header
- Bags
- Levertool
- Separator
- Chalkboard Marker
- Panel
- Adapter
- Lighting Components
- Other

- Aufhaenger
- Körbe
- Ablagen
- Topschildhalterungen und Topschilder
- Taschen
- Öffnungsapparate
- Separatoren
- Tafelstifte
- Platte
- Adapter
- Beleuchtungselemente
- Diverse



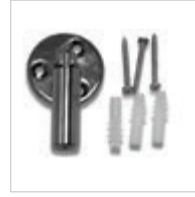
Accessories



Hanger / UYAA002100
Stopper on the frames for 25 mm double sided frames. Packed in 10.
Aufhänger / UYAA002100
Rahmenstopper für 25 mm doppelseitige Rahmen. In 10'er Packung.



Hanger / UYAA002200
Stopper on the frames for 32 mm double sided frames. Packed in 10.
Aufhänger / UYAA002200
Rahmenstopper für 32 mm doppelseitige Rahmen. In 10'er Packung.



Hanger / UYAA000000
Ceiling and floor hanger for double sided frames. Packed in 5.
Aufhänger / UYAA000000
Decken-und Boden Aufhänger für doppelseitige Rahmen. In 5'er Packung.



Hanger / UYAA001000
Ceiling hanger for double sided frames for A4 to A2, B1 and 20"x30". Packed in 10
Aufhänger / UYAA001000
Decken-und Boden Aufhänger für doppelseitige Rahmen. In 10'er Packung.



Hanger / UYAA001100
Ceiling hanging kit for sizes B1, A0, B0, 30"x40", 40"x60". Packed in 10.
Aufhänger / UYAA001100
Deckenaufhänger für die Größen B1, A0, B0, 30"x40", 40"x60". In 10'er Packung.



Hanger / UYAA007000
Plastic hanger for stretch frame. Packed in 10.
Aufhänger / UYAA007000
Plastikhänger für Strechrahmen. In 10'er Packung.



Hanger
Wire Cable.
Aufhänger
Drachtseil.

ARTICLE	SIZE
UYAA004000	1 meter
UYAA004002	2 meter
UYAA004020	20 meter



Hanger / UYAA006000
Suction cap for Stretch Frame. Packed in 10.
Aufhänger / UYAA006000
Saugnapf für Strechrahmen. In 10'er Packung.



Hanger / UYAA006010
Suction cap for Wall Sign System. Packed in 10.
Aufhänger / UYAA006010
Saugnapf für Wall Sign System. In 10'er Packung.



Hanger / UYAA005000
Ball chain for stretch frame.
Aufhänger / UYAA005000
Ballkette für Strechrahmen.



Baskets / UYTS3000A4
A board basket A4 size to hang on scissors.
Körbe / UYTS3000A4
A4 ABoardkorb um an die Klappleinrichtung zu hängen.



Shelf / UFSL002000
Steel shelf for Free Standing Leaflet.
Ablage / UFSL002000
Stahlablage für Free Standing Leaflet.



Shelf / UFSL003000
Acrylic shelf for Free Standing Leaflet.
Ablage / UFSL003000
Akrylablage für Free Standing Leaflet



Shelf / UFSL002100
2x A5 Steel shelf for Free Standing Leaflet & Adjustable menuboard.
Ablage / UFSL002100
2x A5 Stahlablage für Free Standing Leaflet



Shelf / UFSL003100
2x A5 Acrylic shelf for Free Standing Leaflet & Adjustable menuboard.
Ablage / UFSL003100
2x A5 Akrylablage für Free Standing Leaflet.



Shelf / UFSL002200
1x A4 Steel shelf for Free Standing Leaflet.
Ablage / UFSL002200
1x A4 Stahlablage für Free Standing Leaflet.

For the packing details and minimum quantities please contact our sales executives.
Über die Verpackung und minimale Menge, sprechen Sie mit Ihrem Verkaufsmanger.

Accessories



Shelf / UFSL120000
Acrylic shelf for Free Standing Leaflet Dispensers A4.
Ablage / UFSL120000
A4 Akrylablage für Free Standing Leaflet Dispensers.



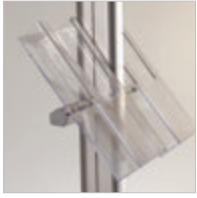
Shelf / UFSL003200
1x A4 Acrylic shelf for Free Standing Leaflet.
Ablage / UFSL003200
1x A4 Akrylablage für Free Standing Leaflet.



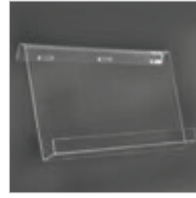
Shelf / UFSL003300
1x A4 Acrylic shelf for Free Standing.
Ablage / UFSL003300
1x A4 Akrylablage für Free Standing Leaflet.



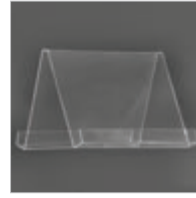
Shelf / UYMGB00000
Shelf for Magnetic Glass Board.
Ablage / UYMGB00000
Ablage für Magnetic Glass Board.



Shelf
Acrylic side shelf for Free Standing Leaflet.
Ablage
Akrylablage für Free Standing Leaflet.



Shelf
Single sided acrylic shelves for Infoboard and brochure sets.
Ablage
Einseitige Akrylablage für Infoboard und Broschürenset.



Shelf
Double sided acrylic shelves for Infoboard and brochure sets.
Ablage
Doppelseitige Akrylablage für Infoboard und Broschürenset.



Shelf / UFSL002560
MDF shelf for Free Standing Leaflet.
Ablage / UFSL002560
MDF-Ablage für Free Standing Leaflet.

ARTICLE	SIZE
UFSL140000	A4
UFSL140100	A5
UFSL140200	1/3 A4

ARTICLE	CAPACITY
UYRT0001A4	1X A4
UYRT0002A4	2 X A4
UYRT0003A4	3 X A4
UYRT0004A4	4 X A4

ARTICLE	CAPACITY
UYRC0001A4	1X A4
UYRC0002A4	2 X A4
UYRC0003A4	3 X A4
UYRC0004A4	4 X A4



Shelf / UFSL002500
MDF shelf for Free Standing Leaflet.
Ablage / UFSL002500
MDF-Ablage für Free Standing Leaflet.



Shelf / UFSL002550
MDF shelf for Free Standing Leaflet.
Ablage / UFSL002550
MDF-Ablage für Free Standing Leaflet.



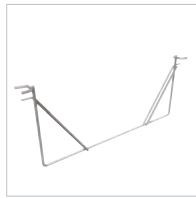
Shelf / UFSL002510
MDF shelf for Free Standing Leaflet.
Ablage / UFSL002510
MDF-Ablage für Free Standing Leaflet.



Header / UFSL120100
Free Standing Leaflet Dispensers header.
Topschild / UFSL120100 Free Standing Leaflet Dispensers Topschild.



Header / UFSL120200
Free Standing Leaflet Dispensers with Side Shelf header.
Topschild / UFSL120200 Free Standing Leaflet Dispensers mit Seitablagetopschild.



Header Holder
A Board wire header holder.
Topschild
A Board Topschildhalterung.

32 MM	25 MM	SIZE
UYTT0000A2	UYTT2500A2	420 X 594 mm
UYTT0000A1	UYTT2500A1	594 X 841 mm
UYTT0000A0	-	841 X 1189 mm
UYTT0000B2	UYTT2500B2	500 X 700 mm
UYTT0000B1	UYTT2500B1	700 X 1000 mm
UYTT000023	-	508 X 762 mm
UYTT000034	-	762 x 1016 mm



Header
A Board header (PVC Foam).
Topschild
A Boardtopschild (PVC).

32 mm	25 mm	SIZE
UYFT0000A2	UYFT2500A2	420 X 594 mm
UYFT0000A1	UYFT2500A1	594 X 841 mm
UYFT0000A0	-	841 X 1189 mm
UYFT0000B2	UYFT2500B2	500 X 700 mm
UYFT0000B1	UYFT2500B1	700 X 1000 mm
UYFT000023	-	508 X 762 mm
UYFT000034	-	762 x 1016 mm



Header
SwingPro® Lite & WindPro® Lite header (PVC Foam).
Topschild
SwindPro® Lite & WindPro® Lite Topschild (PVC).

ARTICLE	SIZE
UYFT0040A1	594 X 841 mm
UYFT0040A0	841 X 1189 mm
UYFT0040B2	500 X 700 mm
UYFT0040B1	700 X 1000 mm
UYFT004022	559 X 711 mm
UYFT004024	610 X 914 mm
UYFT004034	762 X 1016 mm
UYFT004084	711 X 1117 mm

For the packing details and minimum quantities please contact our sales executives.
Über die Verpackung und minimale Menge, sprechen Sie mit Ihrem Verkaufsmannager.

Accessories



Header
SwingPro® Plus & WindPro® Plus header (PVC Foam).
Topschild
SwindPro® Plus & WindPro® Plus Topschild (PVC).

ARTICLE	SIZE
UYFT0050A1	594 X 841 mm
UYFT0050A0	841 X 1189 mm
UYFT0050B1	500 X 700 mm
UYFT005022	559 X 711 mm
UYFT005023	508 X 762 mm
UYFT005024	610 X 914 mm
UYFT005034	762 X 1016 mm
UYFT005046	1016 X 1524 mm
UYFT0050F0	841 X 1321 mm



Header
Eco Swingmaster & Eco Waterbase Wind Sign header (PVC Foam).
Topschild
Eco Swingmaster & Eco Waterbase Wind Sign Topschild (PVC).

ARTICLE	SIZE
UYFT0050A2	420 X 594 mm
UYFT0050A1	594 X 841 mm
UYFT0050A0	841 X 1189 mm
UYFT0050B2	500 X 700 mm
UYFT0050B1	700 X 1000 mm
UYFT0050B0	1000 X 1400 mm
UYFT005022	559 X 711 mm
UYFT005023	508 X 762 mm
UYFT005024	610 X 914 mm
UYFT005034	762 X 1016 mm
UYFT005046	1016 X 1524 mm



Bag
Black carry bag for single sided Quick Banner, Adjustable Quick Banner, single sided Smart Roll Banner.
Tasche
Schwarze Tragetasche für einseitigen Quick Banner, einstellbaren Quick Banner, einseitigen Smart Roll Banner.

ARTICLE	SIZE
UYUP064000	800 mm
UYUP065000	1080 mm
UYUP066000	880 mm
UYUP067000	1030 mm



Bag
Black carry bag for double sided Smart Roll Banner.
Tasche
Schwarze Tragetasche für doppelseitigen Smart Roll Banner.

ARTICLE	SIZE
UYUP070000	800 mm
UYUP071000	1000mm



Bag
Black carry bag for Eco-roller.
Tasche
Schwarze Tragetasche für Eco-roller.

ARTICLE	SIZE
UYUP070500	800 mm
UYUP070600	1000 mm



Bag / UYUP072000
Black carry bag for Portable Zick-Zack 480 x 500 x 270 mm.
Tasche / UYUP072000
Schwarze Tragetasche für Mobil Zick-Zack 480 x 500 x 270 mm.



Bag / UYUP072400
Black carry bag for Newage Portable Zick-Zack 380 x 470 x 280 mm.
Tasche / UYUP072400
Schwarze Tragetasche für Newage Mobil Zick-Zack 380 x 470 x 280 mm.



Bag / UPP0110000
Pop-up carry bag for all size.
Tasche / UPP0110000
Tragetasche für Pop-up in allen Größen.



Bag
Bag for Promostands.
Tasche
Tasche für Promoständer.

ARTICLE	DESCRIPTION
UYUP072200	for Promostand
UYUP072300	for Petit Promostand
UYPOTS1050	for Seed, Rectangular, Circle, Bean Promostand
UYPOTS2050	for Seed Promostand with Pole System



Bag
Panset black carry bag.
Tasche
Schwarze Pansettragetasche.

ARTICLE	DESCRIPTION
UYUP075100	for logo for all size
UYUP076100	for main body for all size
UYUP070200	for Midesize Convex Panset counter table
UYUP074000	for Convex Panset counter table
UYUP074100	for Hexagonal Panset counter table



Levertool / UYUP047000
Levertool in Plastic for Security Frames 25 mm - 32 mm. Packed in 20. **Öffnungsapparat / UYUP047000**
Plastikhebel für 25 mm - 32 mm Abwehrrahmen. In 20'er Packung.



Levertool / UYUP047100
Levertool in Plastic for Security Frames 42 mm. Packed in 20. **Öffnungsapparat / UYUP047100**
Plastikhebel für 42 mm Abwehrrahmen. In 20'er Packung.

For the packing details and minimum quantities please contact our sales executives.
Über die Verpackung und minimale Menge, sprechen Sie mit Ihrem Verkaufsmanger.

Accessories



T Separator / UYUP449601
Separator for A4 Leaflet Dispensers. Packed in 20.
T Separator / UYUP449601
T-Separator für DIN A4 Prospekthalter.
In 20'er Packung.



Chalkboard Marker / UYAKLM1251
Colour chalkboard marker for Wood Display. 10 mm wide. 5 Pcs.
Tafelstifte / UYAKLM1251
Tafelstifte-bunt-für Holzartikel - 10 mm Breit. In 5 Stück Paketen.



Chalkboard Marker / UYAKLM1250
White chalkboard marker for Wood Display. 10 mm wide. 3 Pcs.
Tafelstifte / UYAKLM1250
Tafelstifte-weiß-für Holzartikel - 10 mm Breit. In 3 Stück Paketen.



Panel
Panel for Outdoor Flap Gripper.
Platte
Platte für Outdoor Flap Gripper.

ARTICLE	SIZE
UYOFG10610	600X1000mm
UYOFG10612	600X1200mm
UYOFG10615	600X1500mm



Panel
Easy go PVC Foam panel.
Platte
Easy go PVC Foam Platte.

PVC FOAM PANEL	SIZE
UYPEG300A1	594 X 841 mm
UYPEG300B1	500 X 700 mm
UYPEG300B2	700 X 1000 mm
UYPEG30022	559 X 711 mm
UYPEG30024	610 X 914 mm



Panel
Easy go chalk panel.
Platte
Easy go Kreidetafel.

CHALK PANEL	SIZE
UYPEG100A1	594 X 841 mm
UYPEG100B1	500 X 700 mm
UYPEG100B2	700 X 1000 mm
UYPEG10022	559 X 711 mm
UYPEG10024	610 X 914 mm



Panel
Easy go write-on panel.
Platte
Easy go beschreibbare Platte.

WRITE-ON PANEL	SIZE
UYPEG200A1	594 X 841 mm
UYPEG200B1	500 X 700 mm
UYPEG200B2	700 X 1000 mm
UYPEG20022	559 X 711 mm
UYPEG20024	610 X 914 mm



Chalkboard
Chalkboard for Duo & Fort Desktop Menu Holders, Card Holder 2 Sided and Pyramid Card holders.
Tafel
Tafel für Duo & Fort Desktop-Menühalter, Kartenhalter 2-seitig und Pyramidenkartenhalter.

ARTICLE	POSTER
UPCUWD00A4	210 X 297 mm
UPCUWD00A5	148 X 210 mm
UPCUWD00A6	105 X 148 mm
UPCUWD00B1	216 X 280 mm
UPCUWD0058	140 X 216 mm



Acrylic Pocket U Type
Acrylic pocket for Duo & Fort Desktop Menu Holders, Card Holder 2 Sided and Pyramid Card holders.
Acryltasche U-Typ
Acryltasche für Duo & Fort Desktop-Menühalter, Kartenhalter 2-seitig und Pyramidenkartenhalter.

ARTICLE	POSTER
UPCUAD00A4	210 X 297 mm
UPCUAD00A5	148 X 210 mm
UPCUAD00A6	105 X 148 mm
UPCUAD00B1	216 X 280 mm
UPCUAD0058	140 X 216 mm



PET Pocket U Type
PET pocket for Duo & Fort Desktop Menu Holders, Card Holder 2 Sided and Pyramid Card holders.
PET U-Typ
PET-Tasche für Duo & Fort Desktop-Menühalter, Kartenhalter 2-seitig und Pyramidenkartenhalter.

ARTICLE	POSTER
UPCUPD00A4	210 X 297 mm
UPCUPD00A5	148 X 210 mm
UPCUPD00A6	105 X 148 mm
UPCUPD00B1	216 X 280 mm
UPCUPD0058	140 X 216 mm



Grey Felt
Grey felt for Promostand.
Grau Filz
Grauem Filz für Promostand.

ARTICLE	DESCRIPTION	SIZE
UYPOTSC03G	for Seed Promostand	900 mm
UYPOTSP03G	for Seed Promostand with Pole System	900 mm
UYPOTSD03G	for Rectangular Promostand	900 mm
UYPOTSR03G	for Circle Promostand	Ø 600 mm
UYPOTSB03G	for Bean Promostand	900 mm



Dimmer / UYUP445550
Optional dimmer to go with LED illuminated frame... Simply jack the dimmer in frame and then into powersupply. It adjust the light from dark to max lux of LED illuminated frame.
Dimmer / UYUP445550
Optionaler Dimmer für LED-beleuchtetem Rahmen... Den Dimmer einfach in die Büchse vom Rahmen und dann ins Netzteil stecken. Einstellbares Licht von dunkel bis max. Lichtstärke vom LED-beleuchteten Rahmen.

For the packing details and minimum quantities please contact our sales executives.
Über die Verpackung und minimale Menge, sprechen Sie mit Ihrem Verkaufsmanger.

Accessories



Lighting Component / UYUP367130
Lighting for Pop-ups.
Beleuchtungselemente / UYUP367130
Beleuchtungskomponenten für Pop-up.



Poster Pocket
10 pcs of 1 colour in a box.
Poster Tasche
10 Stück von 1 Farbe in einer box.

ARTICLE	PAPER SIZE	DESCRIPTION
TAB0590304	210 X 297 mm	Red
TAB0590301	210 X 297 mm	Black
TAB0590309	210 X 297 mm	Grey



Adapter
Adapter for Brochure Holder.
Adapter
Adapter für Prospekthalter.

ARTICLE	DESCRIPTION
UYPMBH00A4	for A4 Brochure Holder (30 Pcs)
UYPMBH00A5	for A5 Brochure Holder (45 Pcs)



Other / UYUP397000
Magnetic buttons for Boards. Packed in 10.
Diverse / UYUP397000
Magnetnadeln für Boards. In 10'er Packung.



Other / UYUP397100
Pins for Boards.
Packed in 20.
Diverse / UYUP397100
Stecknadeln für Boards. In 20'er Packung.



Other / UYP0TS0030
Velcro Roll with double sided tape 18 meters.
Diverse / UYP0TS0030
Velcro-Rolle mit doppelseitigem Klebeband 18 Meter.



Other / TAB5904003
Tab & Inset.
Diverse / TAB5904003
Registerkarte & Einfügung.



Other / UYTFB00000
Acrylic magnetic tray for board marker . Packed in 1.
Diverse / UYTFB00000
Acryl Magnetablage für Boardmarker. In 1'er Packung.



Other / UQRP00B000
Black-Chrome rope for Q Ropes. Lenght 2 meters.
Diverse / UQRP00B000
Schwarz-Chrom Seil für Q-Ropes. Länge 2 Meter.



Other / UQRP00R000
Red-Chrome rope for Q Ropes. Lenght 2 meters.
Diverse / UQRP00R000
Rot-Chrom Seil für Q-Ropes. Länge 2 Meter.



Other / TWBTRT0210
Red-Gold rope for Q Ropes. Lenght 3 meters.
Diverse / TWBTRT0210
Rot-Gold Seil für Q-Ropes. Länge 3 Meter.



Other / UQRP00L000
Blue-Chrome rope for Q Ropes. Lenght 2 meters.
Diverse / UQRP00L000
Blau-Chrom Seil für Q-Ropes. Länge 2 Meter.



Other / TSTDVC80B
Cable V8, micro USB for Samsung, LG etc...
Diverse / TSTDVC80B
Kabel V8, micro-USB für Samsung, LG etc...



Other / TSTDIC1450B
Cable for all iPhones & iPads. 3m Black.
Diverse / TSTDIC1450B
Kabel für alle iPhones & iPads. 3m Schwarz.



Other / TSTDICP40B
Cable for iPhone 4S, iPad 3 and earlier. 3m Black.
Diverse / TSTDICP40B
Kabel für iPhone 4S, iPad 3 und früher. 3m Schwarz.



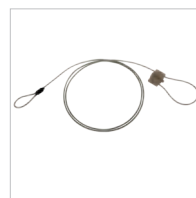
Other / TSDCIP50B
Cable for iPhone 5, iPad 4 and later. 3m Black.
Diverse / TSDCIP50B
Kabel für iPhone 5, iPad 4 und höher. 3m Schwarz.



Other / UYPPD00000
USB Adaptor Lightning to 30-pin
Diverse / UYPPD00000
Adapter Lightning auf 30pin.



Other / UYUP480945
WindPro Carriage tool.
Diverse / UYUP480945
Transport Hilfe für WindPro.



Other / TZZZ998701
Cable Lock System lenght 2000 mm, with combination lock.
Diverse / TZZZ998701
Kabelschloss System, Länge 2000mm, mit Kombinationsschloss

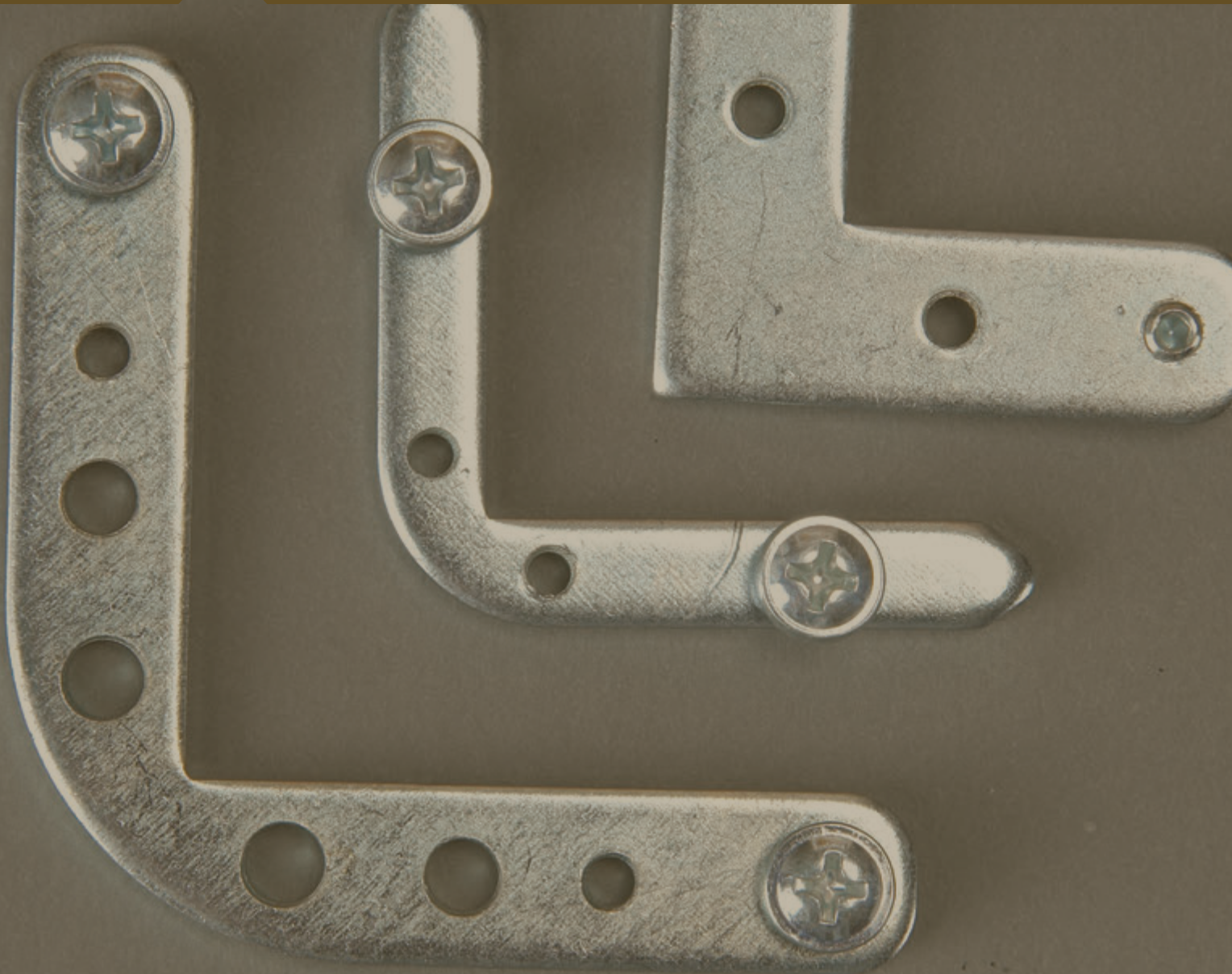
For the packing details and minimum quantities please contact our sales executives.
Über die Verpackung und minimale Menge, sprechen Sie mit Ihrem Verkaufsmanger.



Semi Products

- Profiles
- Corners
- Connectors
- End Caps
- Springs
- Hangers
- Pipes
- Feet
- Counter Support
- Logo
- Shelf
- Power Supply
- Panel
- Base
- Others

- Profil
- Eckverbinder
- Verbindungselemente
- Endkappen
- Federn
- Aufhaenger
- Rohre
- Füsse
- Aufstellfüsse
- Topschilder
- Ablage
- Schalt-Netzteile
- Panele
- Wassertank
- Diverses



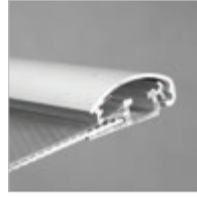
Semi Products



Profile / UYUP007700
15 mm Aluminium Snap profile set (top & bottom) in 3 meters without springs. Top Profile is silver anodized. Bottom profile is mill finished.
Profil / UYUP007700
15 mm Alu Snappprofilset (Ober- und Unterklemmleisten) in 3 m ohne Federn. Die Oberklemmleiste wird silber eloxiert. Die Unterklemmleiste ist pressblank.



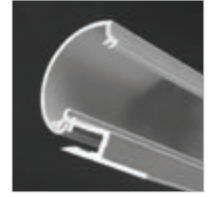
Profile / UYUP001000
20 mm Aluminium Snap profile set (top & bottom) in 3 meters without springs. Top Profile is silver anodized. Bottom profile is mill finished.
Profil / UYUP001000
20 mm Alu Snappprofilset (Ober- und Unterklemmleisten) in 3 m ohne Federn. Die Oberklemmleiste wird silber eloxiert. Die Unterklemmleiste ist pressblank.



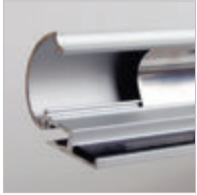
Profile / UYUP002000
25 mm Aluminium Snap profile set (top & bottom) in 3 meters without springs. Top Profile is silver anodized. Bottom profile is mill finished.
Profil / UYUP002000
25 mm Alu Snappprofilset (Ober- und Unterklemmleisten) in 3 m ohne Federn. Die Oberklemmleiste wird silber eloxiert. Die Unterklemmleiste ist pressblank.



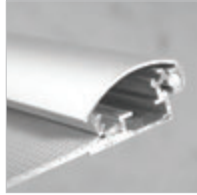
Profile / UYUP003400
26 mm Aluminium Snap profile set (top & bottom) in 3 meters without springs. Top Profile is silver anodized. Bottom profile is mill finished.
Profil / UYUP003400
26 mm Alu Snappprofilset (Ober- und Unterklemmleisten) in 3 m ohne Federn. Die Oberklemmleiste wird silber eloxiert. Die Unterklemmleiste ist pressblank.



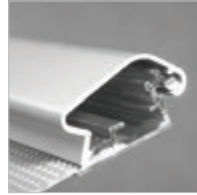
Profile / UYUP003300
26 mm Aluminium Poster Snap profile without springs & rubber. Top and bottom profiles are silver anodized.
Profil / UYUP003300
26 mm Aluminium Poster Snap profil ohne Federn und Gummi. Die Ober- und Unterklemmleisten sind silber eloxiert.



Profile / UYUP003000
26 mm Aluminium Poster Snap profile with springs & rubber. Top and bottom profiles are silver anodized.
Profil / UYUP003000
26 mm Aluminium Poster Snap profil mit Federn und Gummi. Die Ober- und Unterklemmleisten sind silber eloxiert.



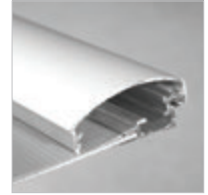
Profile / UYUP004000
30 mm Aluminium Snap profile set (top & bottom) in 3 meters without springs. Top Profile is silver anodized. Bottom profile is mill finished.
Profil / UYUP004000
30 mm Alu Snappprofilset (Ober- und Unterklemmleisten) in 3 m ohne Federn. Die Oberklemmleiste wird silber eloxiert. Die Unterklemmleiste ist pressblank.



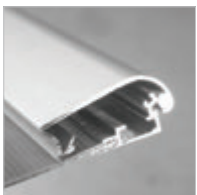
Profile / UYUP005000
32 mm Aluminium Snap profile set (top & bottom) in 3 meters without springs. Top Profile is silver anodized. Bottom profile is mill finished.
Profil / UYUP005000
32 mm Alu Snappprofilset (Ober- und Unterklemmleisten) in 3 m ohne Federn. Die Oberklemmleiste wird silber eloxiert. Die Unterklemmleiste ist pressblank.



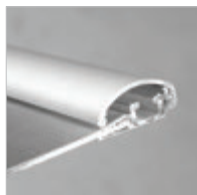
Profile / UYUP007800
38 mm Aluminium Snap profile set (top & bottom) in 3 meters without springs. Top Profile is silver anodized. Bottom profile is mill finished.
Profil / UYUP007800
38 mm Alu Snappprofilset (Ober- und Unterklemmleisten) in 3 m ohne Federn. Die Oberklemmleiste wird silber eloxiert. Die Unterklemmleiste ist pressblank.



Profile / UYUP007000
45 mm Aluminium Snap profile set (top & bottom) in 3 meters without springs. Top Profile is silver anodized. Bottom profile is mill finished.
Profil / UYUP007000
45 mm Alu Snappprofilset (Ober- und Unterklemmleisten) in 3 m ohne Federn. Die Oberklemmleiste wird silber eloxiert. Die Unterklemmleiste ist pressblank.



Profile / UYUP007200
46 mm Aluminium Snap profile set (top & bottom) in 3 meters without springs. Top Profile is silver anodized. Bottom profile is mill finished.
Profil / UYUP007200
46 mm Alu Snappprofilset (Ober- und Unterklemmleisten) in 3 m ohne Federn. Die Oberklemmleiste wird silber eloxiert. Die Unterklemmleiste ist pressblank.



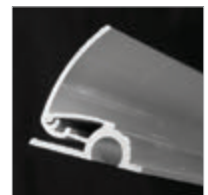
Profile / UYUP002100
25 mm Aluminium Security profile set (top & bottom) in 3 meters without springs. Top Profile is silver anodized. Bottom profile is mill finished.
Profil / UYUP002100
25 mm Alu Securityprofil (Ober- und Unterklemmleisten) in 3 m ohne Federn. Die Oberklemmleiste wird silber eloxiert. Die Unterklemmleiste ist pressblank.



Profile / UYUP008300
32 mm Aluminium Security profile set (top & bottom) in 3 meters without springs. Top Profile is silver anodized. Bottom profile is mill finished.
Profil / UYUP008300
32 mm Alu Securityprofil (Ober- und Unterklemmleisten) in 3 m ohne Federn. Die Oberklemmleiste wird silber eloxiert. Die Unterklemmleiste ist pressblank.



Profile / UYUP006000
42 mm Aluminium Security profile set (top & bottom) in 3 meters without springs. Top Profile is silver anodized. Bottom profile is mill finished.
Profil / UYUP006000
42 mm Alu Securityprofil (Ober- und Unterklemmleisten) in 3 m ohne Federn. Die Oberklemmleiste wird silber eloxiert. Die Unterklemmleiste ist pressblank.



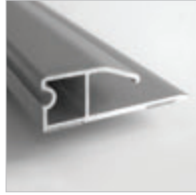
Profile / UYUP011000
Aluminium Poster Clamp profile. Top and bottom profiles are silver anodized.
Profil / UYUP011000
Alu Poster Clamp Profil. Die Oberklemmleiste und Unterklemmleiste sind silber eloxiert.

For the packing details and minimum quantities please contact our sales executives.
Über die Verpackung und minimale Menge, sprechen Sie mit Ihrem Verkaufsmanger.

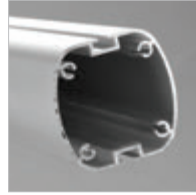
Semi Products



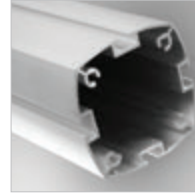
Profile / UYUP013200
Aluminium Newage Poster Clamp profile. Top and bottom profiles are silver anodized.
Profil / UYUP013200
Alu Newage Poster Clamp Profil. Die Oberklemmleiste und Unterklemmleiste sind silber eloxiert.



Profile / UYUP013100
Aluminium Fast Note Profile. 3 meters silver anodized.
Profil / UYUP013100
Aluminium Fast Note Profil. 3 meter silber eloxiert.



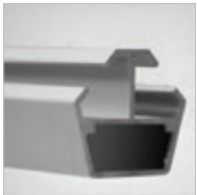
Profile / UYUP012500
Aluminium Leaflet profile 3 meters silver anodized.
Profil / UYUP012500
Aluminium Leaflet Profil 3 meter silber eloxiert.



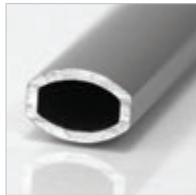
Profile / UYUP012550
Aluminium Leaflet profile 3 meters silver anodized.
Profil / UYUP012550
Aluminium Leaflet Profil 3 meter silber eloxiert.



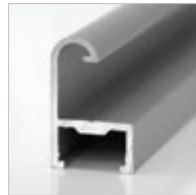
Profile / UYUP012650
Aluminium Novel Leaflet profile 3 meters silver anodized.
Profil / UYUP012650
Aluminium Novel Leaflet Profil 3 meter silber eloxiert.



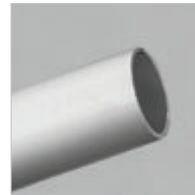
Profile / UYUP011900
Acrylic Side Shelf profile 3 meters silver anodized.
Profil / UYUP011900
Acrylic side shelf profil 3 meter silber eloxiert.



Profile / UYUP054000
Aluminium Strech profile 3 meters silver anodized.
Profil / UYUP054000
Aluminium Strech Profil 3 meter silber eloxiert.



Profile / UYUP007920
9 mm Frameboard profile 3 meters silver anodized.
Profil / UYUP007920
9 mm Frameboard Profil 3 meter silber eloxiert.



Profile / UYUP008000
Aluminium Circle Pipe profile 3 meters silver anodized Ø16.
Profil / UYUP008000
Aluminium Circle Pipe Profil 3 meter silber eloxiert. Ø16.



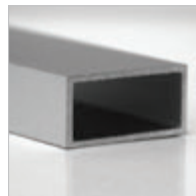
Profile / UYUP007600
Aluminium profile for Free Standing Banner Set.
Profil / UYUP007600
Aluminium Profil für Free Standing Banner Set.



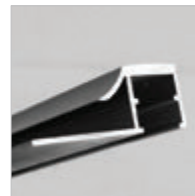
Profile / UYUP010000
51 mm Aluminium Elips profile silver anodized in 3 meters.
Profil / UYUP010000
51 mm Alu Elips Profil 3 meter silber eloxiert.



Profile / UYUP009000
43 mm Aluminium Elips profile silver anodized in 3 meters.
Profil / UYUP009000
43 mm Alu Elips Profil 3 meter silber eloxiert.



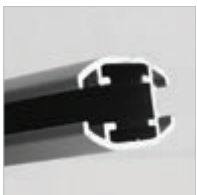
Profile / UYUP012000
Aluminium anodized profile rectangular.
Profil / UYUP012000
Aluprofil eloxiert rechteckig.



Profile / UYUP014850
Profile for single sided slide-in frame. 3 meters, 2 channels.
Profil / UYUP014850
Profil für Einseitige Einschubrahmen 3 meter, 2 Kanäle.



Profile / UYUP014950
Profile for single sided slide-in frame. 3 meters, 1 channels.
Profil / UYUP014950
Profil für Einseitige Einschubrahmen 3 meter, 1 Kanäle.



Profile / UYUP014800
Profile for double sided slide-in frame. 3 meters, 2 channels.
Profil / UYUP014800
Profil für Doppelseitige Einschubrahmen 3 meters, 2 Kanäle.



Profile / UYUP014900
Profile for double sided slide-in frame. 3 meters, 1 channels.
Profil / UYUP014900
Profil für Doppelseitige Einschubrahmen 3 meters, 1 Kanäle.



Profile / UYUP010510
Elips profile with channel.
Profil / UYUP010510
Elips profil mit Kanäl.



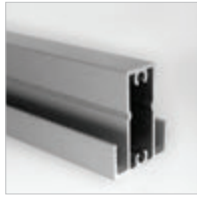
Profile / UYUP012800
Multiside Brochure set & Rapid Brochure set profile. 3 meters
Profil / UYUP012800
Multiside Brochure set & Rapid Brochure set profile. 3 meter.



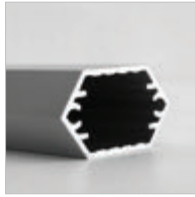
Profile / UYUP011200
Poster Fast profile 3 meters silver anodized.
Profil / UYUP011200
Poster Fast Profil 3 meter silber eloxiert.

For the packing details and minimum quantities please contact our sales executives.
Über die Verpackung und minimale Menge, sprechen Sie mit Ihrem Verkaufsmanger.

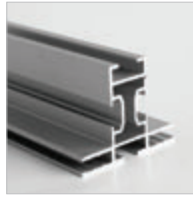
Semi Products



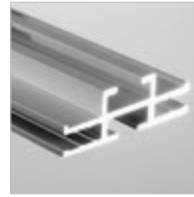
Profile / UYUP012400
Coctail Brochure set profile. 3 meters
Profil / UYUP012400
Coctail Brochure set profile. 3 meter.



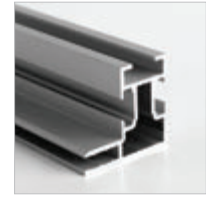
Profile / UYUP012900
Rapid Brochure set middle profile. 3 meters.
Profil / UYUP012900
Rapid Brochure set middle Profil. 3 meter.



Profile / UYUP014101
Double Sided Maxi profile. King Frame Profile. 3 meters. 50x40 mm.
Profil / UYUP014101
Double Sided Maxi Profil. King Frame Profil. 3 meter. 50x40 mm.



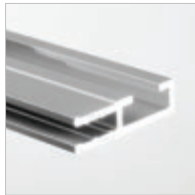
Profile / UYUP014104
Double Sided Maxi profile. Queen Frame Profile. 3 meters. 45x15 mm.
Profil / UYUP014104
Double Sided Maxi Profil. Queen Frame Profil. 3 meter. 45x15 mm.



Profile / UYUP014102
Single Sided Maxi profile. Dame Frame Profile. 3 meters. 34x32 mm.
Profil / UYUP014102
Single Sided Maxi Profil. Dame Frame Profil. 3 meter. 34x32 mm.



Profile / UYUP014103
Single Sided Maxi profile. Valet Frame Profile. 3 meters. 15x22 mm.
Profil / UYUP014103
Single Sided Maxi Profil. Valet Frame Profil. 3 meter. 15x22 mm.

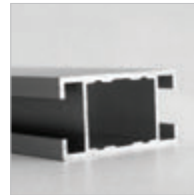


Profile / UYUP014105
Single Sided Maxi profile. Ace Frame Profile. 3 meters. 32x8 mm.
Profil / UYUP014105
Single Sided Maxi Profil. Ace Frame Profil. 3 meter. 32x8 mm.



Profile
Aluminium Power LED Maxi Frame profile.
Profil
Alu Power LED Maxi profil.

ARTICLE	SIZE
UYPLPT1010	1000 mm
UYPLPT1015	1500 mm
UYPLPT1020	2000 mm
UYPLPT1025	2500 mm
UYPLPT1030	3000 mm
UYPLPT1040	4000 mm
UYPLPT1050	5000 mm
UYPLPT1060	6000 mm

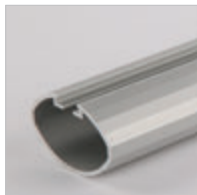


Profile / UYUP014106
H profile for Maxi frames. 3 meters. 36x19 mm.
Profil / UYUP014106
H Profil für Maxi frames. 3 meter. 36x19 mm



Profile
Wall Sign profile. 3 meters.
Profil
Wall Sign Profil 3 meter.

ARTICLE	SIZE
UYUP021900	52 mm
UYUP021910	74 mm
UYUP021920	94 mm
UYUP021930	105 mm
UYUP021940	148 mm



Profile
Aluminium profile for Omni Frame.
Profil
Omni Frame profil.

ARTICLE	SIZE
UYPOM01011	PRE.1100mm
UYPOM01016	PRE.1600mm
UYPOM01021	PRE.2100mm
UYPOM01026	PRE.2600mm
UYPOM01031	PRE.3100mm
UYPOM01036	PRE.3600mm
UYPOM01041	PRE.4100mm
UYPOM01046	PRE.4600mm
UYPOM01051	PRE.5100mm



Corner / UYUP027000
Round corner with connector for 32 mm profile. Packed in 10.
Eckverbinder / UYUP027000
Rondoecke mit Verbinder für 32 mm Profil. In 10'er Packung.



Corner / UYUP028000
Round corner with connector for 25 mm profile. Packed in 10.
Eckverbinder / UYUP028000
Rondoecke mit Verbinder für 25 mm Profil. In 10'er Packung.



Corner / UYUP029000
Round corner with connector for 30 mm profile. Packed in 10.
Eckverbinder / UYUP029000
Rondoecke mit Verbinder für 30 mm Profil. In 10'er Packung.



Corner / UYUP028500
Round corner with connector for 46 mm profile. Packed in 10.
Eckverbinder / UYUP028500
Rondoecke mit Verbinder für 46 mm Profil. In 10'er Packung.



Corner / UYUP027500
Round corner with connector for 26 mm profile. Packed in 10.
Eckverbinder / UYUP027500
Rondoecke mit Verbinder für 26 mm Profil. In 10'er Packung.



Corner / UYUP056000
Strech frame plastic corner. Packed in 4.
Eckverbinder / UYUP056000
Strechrahmenplastikecke. In 4'er Packung.



Connector / UYUP025600
Corner connector of frames for 46 mm. Packed in 10.
Verbindungselemente / UYUP025600
Eckverbinder für 46 mm Rahmen. In 10'er Packung.



Connector / UYUP025400
Corner fittings for lightbox profile. Packed in 10.
Verbindungselemente / UYUP025400
Eckverbinder für Leuchtkastenprofil. In 10'er Packung.

For the packing details and minimum quantities please contact our sales executives.
Über die Verpackung und minimale Menge, sprechen Sie mit Ihrem Verkaufsmanger.

Semi Products



Connector / UYUP445100
Free Standing unit connector for 25 mm Frame. Packed in 20.
Verbindungselemente / UYUP445100
Free Standing Unit Verbinder für 25 mm Rahmen. In 20'er Packung.



Connector / UYUP445000
Free Standing unit connector for 30/32 mm Frames & Poster Showboard. Packed in 20.
Verbindungselemente / UYUP445000
Free Standing Unit Verbinder für 30/32 mm Rahmen und Poster Showboard. In 20'er Packung.



Connector / UYUP445200
Free Standing connector for Steel & Acrylic Shelf without support arm. Packed in 20.
Verbindungselemente / UYUP445200
Free Standing Unit Verbinder für Stahl-und Akryl-lage. In 20'er Packung.



Connector / UYUP024000
Corner connector of frames for 20-25-26 mm. Packed in 10.
Verbindungselemente / UYUP024000
Eckverbinder für 20-25-26 mm Rahmen. In 10'er Packung.



Connector / UYUP445300
Free Standing connector for Noticeboard. Packed in 20.
Verbindungselemente / UYUP445300
Free Standing Unit Verbinder für Noticeboard. In 20'er Packung.



Connector / UYUP371100
Single Banner connector. Packed in 10.
Verbindungselemente / UYUP371100
Single Banner Verbinder. In 10'er Packung.



Connector / UYUP015000
Elips Profile connector for 51 mm. Packed in 8.
Verbindungselemente / UYUP015000
Elipsprofil Verbinder für 51 mm. In 8'er Packung.



Connector / UYUP016000
Elips Profile connector for 43 mm. Packed in 4.
Verbindungselemente / UYUP016000
Elipsprofil Verbinder für 43 mm. In 4'er Packung.



Connector / UYUP025000
Corner connector of frames for 30-32-42-45 mm. Packed in 10.
Verbindungselemente / UYUP025000
Eckverbinder für 30-32-42-45 mm Rahmen. In 10'er Packung.



Connector / UYUP025200
Corner connector of frames for 15 mm. Packed in 10.
Verbindungselemente / UYUP025200
Eckverbinder für 15 mm Rahmen. In 10'er Packung.



Connector / UYUP412295
Corner Cleat for Maxi Frame. Packed in 8.
Verbindungselement / UYUP412295
Eckverbinder für Maxi Frame. In 8 Stk Packung.



Connector / UYUP412291
Straight Cleat for H profile of Maxi Frame. Packed in 8.
Verbindungselement / UYUP412291
Verbinder für Quertraverse Maxi Frame. In 8 Stk Packung.



Connector / UYUP412270
Square corner connector for Maxi frame. Packed in 10.
Verbindungselement / UYUP412270
Eckverbinder für Maxi Frame. In 10'er Packung.



Connector / UYUP412310
Straight Cleat for H profile of Maxi Frame. Packed in 12.
Verbindungselement / UYUP412310
Eckverbinder für Quertraverse. In 12'er Packung.



Connector / UYUP412320
Flat Connector for Ocean, Gulf, Lagoon and Bay Maxi frame profile. Packed in 10.
Verbindungselement / UYUP412320
Verbinder für Ocean, Gulf, Lagoon und Bay Maxi frame profil. 10'er Packung.



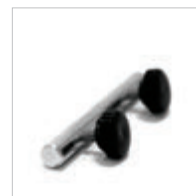
Connector / UYUP412330
Flat Connector for Gulf Maxi frame profile. Packed in 10.
Verbindungselement / UYUP412330
Verbinder für Gulf Maxi frame profil. 10'er Packung.



Connector / UYUP490000
Multiside & Cocktail Brochure set shelf connector. Packed in 10.
Verbindungselement / UYUP490000
Multiside & Cocktail Brochure Set shelf Verbinder In 10'er Packung.



Connector / UYUP290240
Shelf support for Free Standing. Packed in 10.
Verbindungselement / UYUP290240
Ablageverbinder für Free Standing. In 10'er Packung.



Connector / UYUP062000
Quick Banner connector with screws. Packed in 20.
Verbindungselement / UYUP062000
Quick Banner Verbinder mit Schrauben. In 20'er Packung.



Connector / UYUP364000
Frame connector for Panset Wall System. Packed in 10.
Verbindungselement / UYUP364000
Rahmeverbinder für Panset Wandsysteme. In 10'er Packung.

For the packing details and minimum quantities please contact our sales executives.
Über die Verpackung und minimale Menge, sprechen Sie mit Ihrem Verkaufsmanger.

Semi Products



Connector / UYAA017500
Connector for Fishing line.
Packed in 50.
Verbindungselement / UYAA017500
Verbinder für Angelschnur.
In 50'er Packung.



Connector / UYAA017000
Connector for wire cable.
Packed in 50.
Verbindungselement / UYAA017000
Verbinder für Angelschnur.
In 50'er Packung.



Connector / UYAA012500
Top connector for single sided frame. Packed in 20.
Verbindungselement / UYAA012500
Obere Verbinder für Einseitige Rahmen. In 20'er Packung.



Connector / UYAA012000
Bottom connector for single sided frame. Packed in 20.
Verbindungselement / UYAA012000
Untere Verbinder für Einseitige Rahmen. In 20'er Packung.



Connector / UYUP450180
Side stopper for Pop-ups.
Packed in 4.
Verbindungselement / UYUP450180
Stopper für Pop-ups. In 4'er Packung.



Connector / UYUP025700
Corner connector of double sided slide-in frame. Packed in 10.
Verbindungselement / UYUP025700
Eckverbinder für Doppelseitige Einschubrahmen. In 10'er Packung.



Connector
T connector for Elips Profile. Packed in 10.
Verbindungselemente / UYUPOM2000
T Verbinder für Elipsprofil. In 10'er Packung.

ARTICLE	DESCRIPTION
UYUP013000	for 51 mm
UYUP014000	for 43 mm



Connector / UYUPOM02000
Connector Bracket for Omni Frame
Verbindungselement / UYUPOM02000
Verbindungselement für Omni Rahmen.



Connector / UYUPOM03000
T Connector for Omni Frame.
Verbindungselement / UYUPOM03000
T-Verbinder für Omni Rahmen.



Connector / UYUPOM06000
Profile Connector for Omni Frame.
Verbindungselement / UYUPOM06000
Verbindungselement für Omni Rahmen.



Connector / UYUPOM04000
Wall Fixing for Omni Frame.
Verbindungselemente / UYUPOM04000
Wandmontage set für Omni Rahmen.



End Cap / UYUP021200
End caps for Fast Note hole cover. Packed in 10.
Endkappen / UYUP021200
Endkappen für Fast Note. In 10'er Packung.



End Cap / UYUP017000
End caps Elips profile for 51 mm. Packed in 10.
Endkappen / UYUP017000
Elipsprofil Endkappen für 51 mm. In 10'er Packung.



End Cap / UYUP017500
End cap of Elips profile with channel. Packed in 10.
Endkappen / UYUP017500
Endkappen für Elipsprofil mit kanal. In 10'er Packung.



End Cap / UYUP019010
Steel pipe end cap ø25 mm. Packed in 10.
Endkappen / UYUP019010
Metal Rohre Endkappe ø25 mm. In 10'er Packung.



End Cap / UYUP018000
End caps Elips profile for 43 mm. Packed in 10.
Endkappen / UYUP018000
Elipsprofil Endkappen für 43 mm. In 10'er Packung.



End Cap / UYUP019000
End caps for Rectangular. Packed in 10.
Endkappen / UYUP019000
Rechteckig Endkappen. In 10'er Packung.



End Cap / UYUP012300
End caps for Free Standing Banner Set. Packed in 10.
Endkappen / UYUP012300
Endkappen für Free Standing Banner Set. In 10'er Packung.



End Cap / UYUP449600
Poster profile end cap for Poster Fast. Packed in 10.
Endkappen / UYUP449600
Posterprofil Endkappen für Poster Fast. In 10'er Packung.



End Cap / UYUP020000
End caps for Quick Banner. Packed in 10.
Endkappen / UYUP020000
Endkappen für Quick Banner. In 10'er Packung.

For the packing details and minimum quantities please contact our sales executives.
Über die Verpackung und minimale Menge, sprechen Sie mit Ihrem Verkaufsmanger.

Semi Products



End Cap / UYUP021000
Poster Profile end cap for 26 mm. Packed in 10.
Endkappen / UYUP021000
Posterprofil Endkappen für 26 mm. In 10'er Packung.



End Cap / UYUP021500
Rapid Brochure set end cap. Packed in 10.
Endkappen / UYUP021500
Rapid Brochure set end cap. Packed in 10.



End Cap / UYUP012200
End caps for Acrylic Side Shelf. Packed in 10.
Endkappen / UYUP012200
Endkappen für Acrylic Side Shelf. In 10'er Packung.



End Cap / UYUP019500
Plastic cap for Free Standing. Packed in 2.
Endkappen / UYUP019500
Plastikkappe für Free Standing. In 2'er Packung.



End Cap / UYUP019600
Plastic cap for Free Standing. Packed in 2.
Endkappen / UYUP019600
Plastikkappe für Free Standing. In 2'er Packung.



End Cap / UYUP019400
Plastic cap for Novel Free Standing. Packed in 2.
Endkappen / UYUP019500
Plastikkappe für Novel Free Standing. In 2'er Packung.



End Cap / UYUP021400
End caps for Newage Poster Clamp. Packed in 10.
Endkappen / UYUP021400
Endkappen für Newage Poster Clamp. In 10'er Packung.



End Cap
Wall Sign Flat end caps Packed in 10.
Endkappen
Wall Sign flach. In 10'er Packung.

ARTICLE	SIZE
UYUP021700	52 mm
UYUP021710	74 mm
UYUP021720	105 mm
UYUP021730	148 mm
UYUP021740	94 mm



End Cap
Wall Sign Arc end caps Packed in 10.
Endkappen
Wall Sign gebogen Endkappen. In 10'er Packung.

ARTICLE	SIZE
UYUP021800	52 mm
UYUP021810	74 mm
UYUP021820	105 mm
UYUP021840	94 mm



End Cap / UYUP021100
End caps for Fast Note. Packed in 10.
Endkappen / UYUP021100
Endkappen für Fast Note. In 10'er Packung.



Spring
Packed in 500.
Federn
In 500'er Packung.

ARTICLE	FOR
UYUP110000	26 mm
UYUP030000	20 mm
UYUP031000	25 mm
UYUP032000	32 mm
UYUP032500	15 mm
UYUP032600	32 mm Security
UYUP300000	25 mm Security
UYUP310000	30 mm
UYUP350000	42 mm-46 mm
UYUP361000	45 mm



Spring / UYUP450110
Spring for Pop-ups. Packed in 1 pcs.
Federn / UYUP450110
Feder für Pop-ups. In 1'er Packung.



Hanger / UYAA018000
Hanger for 9 mm Frameboard. Packed in 10.
Aufhänger / UYAA018000
Hänger für 9 mm Frameboard. In 10'er Packung.



Hanger / UYAA011000
Metal hanger for Frame & Poster Snap. Packed in 10.
Aufhänger / UYAA011000
Metallhänger für Rahmen und PosterSnap. In 10'er Packung.



Hanger / UYAA011010
Metal portable hanger for Frame. Packed in 10.
Aufhänger / UYAA011010
Metall verschiebbar Hänger für Rahmen. In 10'er Packung.



Hanger / UYAA023000
Poster Gripper Hanger set. Packed in 10.
Aufhänger / UYAA023000
Poster Gripper Aufhängersset. In 10'er Packung.



Hanger / UYUP055000
Plastic hanger for Strech Frame. Packed in 10.
Aufhänger / UYUP055000
Plastikhänger für Strech Frame. In 10'er Packung.



Hanger / UYUP075000
Poster Snap hanger. Packed in 10.
Aufhänger / UYUP075000
Poster Snap Hänger. In 10'er Packung.



Hanger / UYUP076010
Newage Poster Clamp hanger. Packed in 10.
Aufhänger / UYUP076010
Newage Poster Clamp Hänger. In 10'er Packung.

For the packing details and minimum quantities please contact our sales executives.
Über die Verpackung und minimale Menge, sprechen Sie mit Ihrem Verkaufsmanger.

Semi Products



Hanger / UYUP076000
Poster Clamp hanger.
Packed in 10.
Aufhänger / UYUP076000
Poster Clamp Hänger.
In 10'er Packung.



Hanger / UYAA021000
Hanger for slide-in frame & poster fast set. Packed in 10.
Aufhänger / UYAA021000
Aufhänger für Slide-in Rahmen und Poster Fast set.
In 10'er Packung.



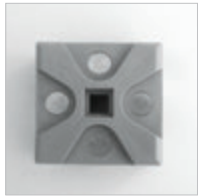
Hanger / UYAA010000
Pipe&Clamp connector for double sided Smart Banner. Packed in 5.
Aufhänger / UYAA010000
Rohr- und Clampverbinder für doppelseitige Smart Banner. In 5'er Packung.



Hanger / UYAA009000
Pipe&Clamp connector for single sided Smart Banner. Packed in 5.
Aufhänger / UYAA009000
Rohr- und Clampverbinder für einseitige Smart Banner. In 5'er Packung.



Hanger / UYAA008000
Pipe&Clamp connector for single sided Quick Banner. Packed in 5.
Aufhänger / UYAA008000
Rohr und Clamp Verbinder für einseitige Quick Banner. In 5'er Packung.



Hanger / UYUP450130
Magnetic body connector with magnets for magnetic Pop-up. Packed in 2.
Aufhänger / UYUP450130
Magnetische Verbinder für magnetische Pop-up.
In 2'er Packung.



Hanger / UYUP450140
Mechanic body connector with panel hanger for Pop-up with clips. Packed in 2.
Aufhänger / UYUP450140
Magnetische Verbinder für Klips Pop-up. In 2'er Packung.



Hanger / UYUP450150
Magnetic end cap for aluminium profile for magnetic Pop-up. Packed in 10.
Aufhänger / UYUP450150
Magnetische Endkappen für Aluminium Profile für magnetische Pop-up. In 10'er Packung.



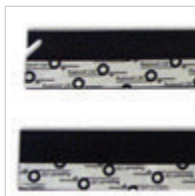
Hanger / UYUP450160
Mechanic end cap for aluminium profile for Pop-up with clips. Packed in 10.
Aufhänger / UYUP450160
Magnetische Endkappen für Aluminium Profile für Klips Pop-up. In 10'er Packung.



Hanger / UYUP450065
Clips bar with magnetic tape.
Aufhänger / UYUP450065
Klipsstreifen mit magnel Band.



Hanger / UYUP450075
Magnet bar with magnetic tape.
Aufhänger / UYUP450075
Magnetstreifen mit magnel Band.



Hanger
Top&bottom straps set for Pop-up with clips.
Aufhänger
Ober und Unter Straps set für Pop-up mit Klips.



Hanger
Top&bottom straps set for magnetic Pop-up.
Aufhänger
Ober und Unter Straps set für Magnetische Pop-up.



Hanger / UYUP460245
Hanging system including wire cable. Packed in 8.
Aufhänger / UYUP460245
Aufhängeset inkl. Drahtseil. In 8'er Packung.



Hanger / UYAA019000
Swinger strap. Packed in 8.
Aufhänger / UYAA019000
Swingerriemen. In 8'er Packung.

ARTICLE	FOR
UYUP450000	3X3
UYUP450010	3X4

ARTICLE	FOR
UYUP450020	3X3
UYUP450030	3X4



Pipes / UYUP061100
Telescopic pipe for double sided Smart Roll Banner
Rohre / UYUP061100
Teleskoprohr für doppelseitigen Smart Roll Banner.



Pipes / UYUP061000
Telescopic pipe for single sided Smart Roll Banner
Rohre / UYUP061000
Teleskoprohr für einseitigen Smart Roll Banner.



Pipes / UYUP053000
200 mm.
Rohre / UYUP053000
200 mm.



Pole / UYUP052000
2000 mm Quick pipe in 3 part.
Rohre / UYUP052000
2000 mm Quick Rohrelementen in 3 Teilen.



Feet / UYUP366000
Panset foot at the bottom for Panset Wall System. Packed in 10.
Fuße / UYUP366000
Pansetfuß in Pansetwand systeme. In 10'er Packung.

For the packing details and minimum quantities please contact our sales executives.
Über die Verpackung und minimale Menge, sprechen Sie mit Ihrem Verkaufsmanger.

Semi Products



Feet / UYUP023000
Plastic foot for Quick Banner.
Packed in 10.
Fuße / UYUP023000
Plastikfuß für Quick Banner.
In 10'er Packung.



Feet / UYUP022000
Base for Quick Banner.
Packed in 10.
Fuße / UYUP022000
Fuß für Quick Banner.
In 10'er Packung.



Feet / UYUP412273
Baseball 450x300x6 mm
for double sided king profile.
Fuße / UYUP412273
Baseball 450x300x6 mm für
doppelseitigen King Profil.



Feet / UYUP412271
Circle ø450x6 mm
for double sided king profile.
Fuße / UYUP412271
Circle ø450x6 mm für
doppelseitigen King Profil.



Feet / UYUP412272
Hoop ø 450x6 mm
for double sided king profile.
Fuße / UYUP412272
Hoop ø 450x6 mm für
doppelseitigen King Profil.



Feet / UYUP412274
Fillet 500x180x6 mm
for double sided king
profile.
Fuße / UYUP412274
Fillet 500x180x6 mm für
doppelseitigen King Profil.



Feet / UYUP412275
Flat 45x50x5 mm
for double sided king
profile.
Fuße / UYUP412275
Flat 45x50x5 mm für
doppelseitigen King Profil.



Counter Support / UYUP460200
For A4 Opti Frame.
Packed in 10.
Aufsteller / UYUP460200
Für A4 Opti Frame.
In 10'er Packung.



Counter Support / UYUP460100
For A4 Opti Frame.
Packed in 10.
Aufsteller
Opti Frame. In 10'er Packung.

ARTICLE	FOR
UYUP460100	A5
UYUP460000	A6



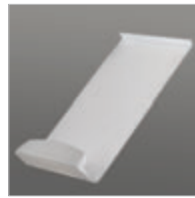
Counter Support / UYUP057000
U wire for Snap Frames.
Aufsteller / UYUP057000
U Draht für Klapprahmen.



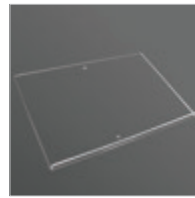
Logo / UYUP407400
Rapid brochure set
frosted logo.
Topschilder / UYUP407400
Rapid brochure set Logo
mit Eisoptik.



Logo / UYUP407500
Rapid brochure set
clear logo.
Topschilder / UYUP407500
Rapid brochure set
Transparentes Logo.



Shelf / UYR0007000
Rapid brochure set
frosted shelf.
Ablage / UYR0007000
Rapid brochure set
Ablage in Eisoptik.



Shelf / UYR0008000
Folder menuboard clear
acrylic shelf without ring.
Ablage / UYR0008000
Menuboard transparente
Ablage ohne Ring.



Shelf / UYUP057000
A4 shelf with connector.
Ablage
A4 Ablage mit Verbindungstück.

ARTICLE	PACKED IN
UMSDA005A4	5
UMSDA008A4	8



Shelf / UYUP073101
8.5"x11" shelf for
Portable Leaflet
Dispensers. Packed in 8.
Ablage / UYUP073101
Rapid brochure set Ablage
in Eisoptik.



Shelf / UYUP073103
6.5"x8" shelf for Portable
Leaflet Dispensers.
Packed in 8.



Shelf / UYUP073102
4"x9" shelf for
Portable Leaflet Dispensers.
Packed in 8.



Power Supply / UYPSWL0010
Spare Battery for WindPro
with LED.
Schalt-Netzteil / UYPSWL0010
Batterie für WindPro with LED.



Power Supply / UYPSWL0020
Charger for WindPro with LED.
Schalt-Netzteil / UYPSWL0020
Ladegerät für WindPro with LED.

For the packing details and minimum quantities please contact our sales executives.
Über die Verpackung und minimale Menge, sprechen Sie mit Ihrem Verkaufsmannager.

Semi Products



Power Supply
Power supply for Ledbox.
Daily use 7/16.
Schalt-Netzteil
Power supply für Ledbox.
Täglicher Gebrauch 7/16.



Power Supply
Power supply for Weatherproof
Ledbox. Daily use 7/16.
Schalt-Netzteil
Power supply für Ledbox.
Täglicher Gebrauch 7/16



Power Supply
Power supply for
Ledbox. Daily use 7/24.
Schalt-Netzteil
Power supply für Ledbox.
Täglicher Gebrauch 7/24



Panel
Anti-reflex PET Cover
for SwingPro® Plus &
WindPro® Plus.
Paneele
PET Schutzfolie für
SwingPro® Plus &
WindPro® Plus



Panel
Anti-reflex PET Cover
for SwingPro® Lite &
WindPro® Lite.
Paneele
PET Schutzfolie für
SwingPro® Lite &
WindPro® Lite

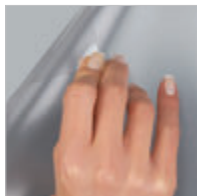
ARTICLE	DESCRIPTION
UYUP445441	Power supply US 1A
UYUP445450	Power supply EU 2A
UYUP445451	Power supply US 2A
UYUP445452	Power supply UK 2A
UYUP445460	Power supply EU 3A
UYUP445461	Power supply US 3A
UYUP445462	Power supply UK 3A
UYUP445490	Power supply EU 4A
UYUP445491	Power supply US 4A
UYUP445492	Power supply UK 4A
UYUP445510	Power supply EU 5A
UYUP445511	Power supply US 5A
UYUP445512	Power supply UK 5A
UYUP445520	Power supply EU 6A
UYUP445521	Power supply US 6A
UYUP445522	Power supply UK 6A

ARTICLE	DESCRIPTION
UYPLD0103A	Power supply EU 3A for Weatherproof LEDbox
UYPLD0303A	Power supply US 3A for Weatherproof LEDbox
UYPLD0203A	Power supply UK 3A for Weatherproof LEDbox
UYPLD0104A	Power supply EU 4A for Weatherproof LEDbox
UYPLD0304A	Power supply US 4A for Weatherproof LEDbox
UYPLD0204A	Power supply UK 4A for Weatherproof LEDbox
UYPLD0105A	Power supply EU 5A for Weatherproof LEDbox
UYPLD0305A	Power supply US 5A for Weatherproof LEDbox
UYPLD0205A	Power supply UK 5A for Weatherproof LEDbox
UYPLD0106A	Power supply EU 6A for Weatherproof LEDbox
UYPLD0306A	Power supply US 6A for Weatherproof LEDbox
UYPLD0206A	Power supply UK 6A for Weatherproof LEDbox

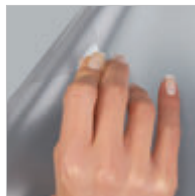
ARTICLE	DESCRIPTION
UYPLD00010	Power supply EU 3,34A 7/24 suitable
UYPLD02010	Power supply US 3,34A 7/24 suitable
UYPLD01010	Power supply UK 3,34A 7/24 suitable
UYPLD00011	Power supply EU 6,67A 7/24 suitable
UYPLD02011	Power supply US 6,67A 7/24 suitable
UYPLD01011	Power supply UK 6,67A 7/24 suitable
UYPLD00012	Power supply EU 8,5A 7/24 suitable
UYPLD02012	Power supply US 8,5A 7/24 suitable
UYPLD01012	Power supply UK 8,5A 7/24 suitable
UYPLD00013	Power supply EU 11,5A 7/24 suitable
UYPLD02013	Power supply US 11,5A 7/24 suitable
UYPLD01013	Power supply UK 11,5A 7/24 suitable

ARTICLE	SIZE
UYUP082010	539 X 810 mm
UYUP082020	590 X 760 mm
UYUP082030	641 X 963 mm
UYUP082040	793 X 1064 mm
UYUP082050	872 X 1237 mm
UYUP082060	625 X 889 mm
UYUP082070	731 X 1048 mm
UYUP082080	831 X 1248 mm
UYUP082000	531 X 748 mm

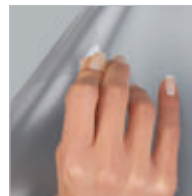
ARTICLE	SIZE
UYUP083010	559 X 712 mm
UYUP083020	610 X 915 mm
UYUP083030	712 X 1118 mm
UYUP083040	594 X 841 mm
UYUP083050	841 X 1189 mm
UYUP083060	500 X 700 mm
UYUP083070	700 X 1000 mm
UYUP083080	762 X 1016 mm



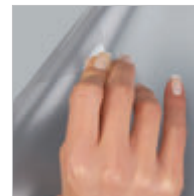
Panel
Anti-reflex PET cover for
25 mm-46 mm.
Paneele
PET Schutzfolie für
25 mm-46 mm



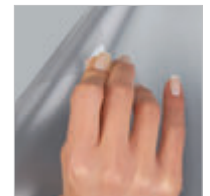
Panel
Anti-reflex PET Cover for
Waterproof Snap frame 35 mm.
Paneele
PET Schutzfolie für Wasserfeste
Klapprahmen 35 mm.



Panel
Anti-reflex PET Cover for
Waterproof Snap frame 25 mm.
Paneele
PET Schutzfolie für Wasserfeste
Klapprahmen 25 mm.



Panel
Anti-reflex PET Cover for
Lux Swing Master & Lux
Waterbase Wind Sign
Paneele
PET Schutzfolie für Lux Swing
Master & Lux Waterbase Wind Sign.



Panel
Anti-reflex PET Cover for
Eco Swing Master & Eco
Waterbase Wind Sign
Paneele
PET Schutzfolie für Eco
Swing Master & Eco
Waterbase Wind Sign.

ARTICLE	SIZE
UYUP083000	210 X 297 mm
UYUP084000	297 X 420 mm
UYUP085000	420 X 594 mm
UYUP033000	594 X 841 mm
UYUP086000	841 X 1189 mm
UYUP087000	500 X 700 mm
UYUP088000	700 X 1000 mm
UYUP089000	1000 X 1400 mm
UYUP090000	508 X 762 mm
UYUP091000	762 X 1016 mm
UYUP092000	1016 X 1524 mm

ARTICLE	SIZE	PET
UYUP088300	297 X 420 mm	341 X 464 mm
UYUP088310	420 X 594 mm	464 X 638 mm
UYUP088320	594 X 841 mm	638 X 885 mm
UYUP088330	841 X 1189 mm	885 X 1233 mm
UYUP088340	500 X 700 mm	544 X 744 mm
UYUP088350	700 X 1000 mm	744 X 1044 mm
UYUP088360	1000 X 1400 mm	1044 X 1444 mm
UYUP088370	508 X 762 mm	552 X 806 mm
UYUP088380	762 X 1016 mm	806 X 1060 mm
UYUP088390	1016 X 1524 mm	1060 X 1568 mm

ARTICLE	SIZE	PET
UYUP088400	297 X 420 mm	330 X 453 mm
UYUP088410	420 X 594 mm	453 X 627 mm
UYUP088420	594 X 841 mm	627 X 874 mm
UYUP088430	841 X 1189 mm	874 X 1222 mm
UYUP088440	500 X 700 mm	533 X 733 mm
UYUP088450	700 X 1000 mm	733 X 1033 mm
UYUP088460	1000 X 1400 mm	1033 X 1433 mm
UYUP088470	508 X 762 mm	541 X 795 mm
UYUP088480	762 X 1016 mm	795 X 1049 mm
UYUP088490	1016 X 1524 mm	1049 X 1557 mm

ARTICLE	SIZE	PET
UYUP088210	420 X 594 mm	449 X 623 mm
UYUP088220	594 X 841 mm	623 X 870 mm
UYUP079003	841 X 1189 mm	870 X 1218 mm
UYUP088230	500 X 700 mm	529 X 729 mm
UYUP088200	700 X 1000 mm	729 X 1029 mm
UYUP088240	1000 X 1400 mm	1029 X 1429 mm
UYUP088250	508 X 762 mm	537 X 791 mm
UYUP088260	762 X 1016 mm	791 X 1045 mm
UYUP088270	1016 X 1524 mm	1045 X 1553 mm

ARTICLE	SIZE
UYUP082010	539 X 810 mm
UYUP082020	590 X 760 mm
UYUP082030	641 X 963 mm
UYUP082040	793 X 1064 mm
UYUP082050	872 X 1237 mm
UYUP082060	625 X 889 mm
UYUP082070	731 X 1048 mm
UYUP082080	831 X 1248 mm
UYUP082090	1047 X 1572 mm
UYUP082000	531 X 748 mm

For the packing details and minimum quantities please contact our sales executives.
Über die Verpackung und minimale Menge, sprechen Sie mit Ihrem Verkaufsmanger.

Semi Products



Panel
Opal acrylic for Lightbox.
Paneele
Opalscheibe für Lightbox.

ARTICLE	SIZE
UYUP407010	297 X 420 mm
UYUP407040	420 X 594 mm
UYUP407030	594 X 841 mm
UYUP407020	841 X 1189 mm
UYUP407070	500 X 700 mm
UYUP407060	700 X 1000 mm
UYUP407050	1000 X 1400 mm
UYUP407080	508 X 762 mm
UYUP407090	762 X 1016 mm
UYUP407095	1016 X 1524 mm



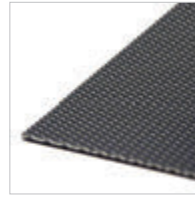
Panel
Opal acrylic Totem.
Paneele
Opalscheibe für Totem.

ARTICLE	SIZE
UYUP407120	600 X 1700 mm
UYUP407130	700 X 1700 mm
UYUP407140	800 X 1700 mm



Panel
Opal acrylic for Convex Lightbox.
Paneele
Opalscheibe für Convex Lightbox.

ARTICLE	SIZE
UYUP407210	297 X 420 mm
UYUP407220	420 X 594 mm
UYUP407230	594 X 841 mm
UYUP407240	841 X 1189 mm
UYUP407250	500 X 700 mm
UYUP407260	700 X 1000 mm
UYUP407270	508 X 762 mm
UYUP407280	762 X 1016 mm



Panel
Polystyrene Backing.
Paneele
Polystyrene Rückwand.

ARTICLE	SIZE
UYUP093000	210 X 297 mm
UYUP094000	297 X 420 mm
UYUP095000	420 X 594 mm
UYUP044000	594 X 841 mm
UYUP096000	841 X 1189 mm
UYUP097000	500 X 700 mm
UYUP046000	700 X 1000 mm
UYUP104000	1000 X 1400 mm
UYUP098000	508 X 762 mm
UYUP099000	762 X 1016 mm
UYUP100000	1016 X 1524 mm



Panel
Magnetic LEDbox cover.
Paneele
Magnetic LEDbox Abdeckung

ARTICLE	SIZE
UYPML100A4	210 X 297 mm
UYPML100A3	297 X 420 mm
UYPML100A2	420 X 594 mm
UYPML100A1	594 X 841 mm
UYPML100A0	841 X 1189 mm
UYPML100B2	500 X 700 mm
UYPML100B1	700 X 1000 mm
UYPML10023	508 X 762 mm
UYPML10034	762 X 1016 mm



Panel
Black PVC panel set.
Paneele
Polystyrene Folie.

ARTICLE	FOR
UYUP450050	3X4
UYUP450040	3X3



Panel / UYUP434050
PVC panel complete for Pop-up table.
Paneele / UYUP434050
Polystyrene Folie für Pop-up Theke.



Base
Waterbase Wind Sign base.
Wassertank
Wind Sign Wassertank.

ARTICLE	DESCRIPTION
UYUP406820	Small base
UYUP406810	Medium Base
UYUP406840	Large Base



Other / UYAA004500
Fishing Line.
Diverse / UYAA004500
Angelschnur.



Other / UYUP445600
Black foam tape for Poster Snap.
Diverse / UYUP445600
Schwarzes Schaumstoffband für Poster Snap.



Other / UYUP410300
Plastic Peg for Showboard. Packed in 10.
Diverse / UYUP410300
Plastikhalterung für Showboard. In 10'er Packung.



Other / UYUP360110
Screw and Wall Plug for Snap Frames. Packed in 10.
Diverse / UYUP360110
Schrauben und Befestigungsdübel für Klapprahmen. In 10'er Packung.



Other / UYUP406410
Wheel and its fixture for Waterbase. Packed in 10.
Diverse / UYUP406410
Rad und Befestigungs material für Wassertank.



Other / UYUP460235
Clear nylon strip. 100 meters.
Diverse / UYUP460235
Silikonkeder, 100 Meter.



Other / UYUP460220
Nylon strip with double sided tape. 50 meters.
Diverse / UYUP460220
Selbstklebender Silikonkeder, 50 Meter.



Other / UYUP449500
Plastic part in 40 mm for Poster Fast. Packed in 10.
Diverse / UYUP449500
Plastik Stück in 40 mm für Poster Fast. In 10'er Packung.



Other / UYUP021300
Roller for Fast Note. Packed in 10.
Diverse / UYUP021300
Roller für Fast Note. In 50'er Packung.



Other / UYUP368100
Hinge for A Board. Packed in 10.
Diverse / UYUP368100
Scharnier für A Board, 10'er Packung.



Other / UYUP080000
Scissors for A Board. Packed in 10.
Diverse / UYUP080000
Scheren für A Board in 10'er Packung.



Other / UYUP290200
Fixing hardware for Free Standing Leaflet Display. Packed in 10.
Diverse / UYUP290200
Befestigungs material für Free Standing Leaflet Display, 10'er Packung.

For the packing details and minimum quantities please contact our sales executives.
Über die Verpackung und minimale Menge, sprechen Sie mit Ihrem Verkaufsmanger.

Semi Products



Other / UYUP427520
Key for Universal Showboards.
Single packed.
Diverse / UYUP427520
Schlüssel für Universal
Showboards in einzeln verpackt.



Other / UYUP427500
Lock for Showboards.
Packed in 1.
Diverse / UYUP427500
Schloß für Showboard.
In 1'er Packung.



Other / UYUP450120
Light hanger for Pop-ups.
Packed in 5.
Diverse / UYUP450120
Lichthänger für Pop-ups.
In 5'er Packung.



Other / UYUP450170
Spring holder fork for
Pop-ups. Packed in 10.
Diverse / UYUP450170
Federhalter für Pop-ups.
In 10'er Packung.



Other / UYUP480510
Top plate of Pop-up table.
Diverse / UYUP480510
Obere Platte für Pop-up Theke.



Other / UYUP427510
Key D20 for Showboards &
Noticeboards. Packed in 10.
Diverse / UYUP427510
Schlüssel D20 für Showboards &
Noticeboards. In 10'er Packung.



Other / UYUP444000
Wheel for stands. Packed in 1.
Diverse / UYUP444000
Lenkrollen für Ständer.
In 1'er Packung.



Other / UYPOM05000
Plastic Button for Omni Frame.
Diverse / UYPOM05000
Plastik Knöpfe für Omni Frame.



Other / TMC4010500
Plastic Clips for Omni Frame.
Diverse / TMC4010500
Plastik Klemmen für Omni
Frame.



Other / TSH4010S01
Black Bungee Cord with Stainless
Steel Hook for Omni Frame.
Diverse / TSH4010S01
Elastischer Haken für Omni Frame



Other / UYPOM07000
Plastic Strap for Omni Frame.
Diverse / UYPOM07000
Elastischer Seil für Omni Frame.



Other / UYUP450100
Magnetic tape roll in 30 meters.
Diverse / UYUP450100
Magnetische Streifenrollen in
30 meter.



Other / UYUP365000
Cleat for Panset Wall System.
Packed in 10.
Diverse / UYUP365000
Klemme für Pansetwandssysteme.
In 10'er Packung.



Other / UYPSP00010x1000
Well nuts for Street SignPro
and Master Signs. (12 Pcs).
Diverse / UYPSP00010x1000
Nun Nüsse für Street SignPro
und Master Signs. (12 Stück).



M&T Industrial Sheets

•PET Lines
•HIPS Lines

•PET Extrusionsanlagen
•HIPS Extrusionsanlagen





PET Sheets

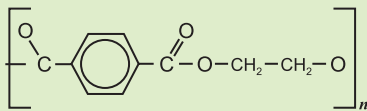


The PET line composes of one main extruder 75 dia. and one co-extruder dia. 45. It is a Battenfeld machine with a capacity of 650 kg/h as from 300 microns to 1500 microns. The surface options are matt/gloss and gloss/gloss. Transparent & colored alternatives are available. The maximum width is 1400mm. PET sheet line is integrated with very accurate Maxson sheet sizing unit. In addition to this, a 1 ton and 1 mm diameter capacity roll winder and an 8 pieces slitter in a standalone form wind and slit the sheets for the packaging industry. This machinery is fed by a fully automatic crystallizer and a dry air drier by Colortronic-Germany. A lot of alternative polymer sheets with antiblock-antislip agents, a UV stabilizer and optical brightener additives are available. The PET line with cold lamination units on both sides protects the film application while serving hot lamination for different sheet extrusion alternatives. For color options, please contact our sales department.

Die PET-Anlage ist mit einem 75 dia Haupt- und mit einem 45 dia Co-Extruder ausgestattet. Es handelt sich um eine Battenfeld Maschine mit einer Kapazität von 650 kg/Stunde und kann Folien in der Stärke von 300 micron bis 1500 Micron produzieren. Oberflächenoptionen sind: matt/matt, matt/gläzend, gläzend/glänzend. Auch sind transparente und farbige Alternativen erhältlich. Maximale Breite ist 1400 mm. Gleichzeitig wird mit der Maxson Dimensionierungsmaschine ein genauer Zuschnitt ermöglicht. Zusätzlich stehen eine 1 Tonne und 1 mm Durchmesser Kapazität Rollwickler und ein Rollenschneider (8 Stücke) zum Aufrollen oder zum zuschneiden der Rollen für die Verpackungsindustrie zur Verfügung. Der Vorschub wird mit einem voll automatischem Kristallisator und Trockenlufttrockner von Colortronic (Deutschland) geleistet. Eine breite Alternative von Polymerfolien mit blockierenden und rutschhemmenden Eigenschaften, UV Stabilisator oder optischen Aufhellern wird hinzukommend geboten. Die PET Extrusionsanlage hat die Möglichkeit eine Schutzfolie mit Kaltlaminiierung auf beide Seiten der PET Folie anzubringen. Auch sind Heisslaminiierungen für verschiedene Folienanwendungen möglich. Für Farboptionen wenden Sie sich bitte an unseren Verkauf.

Composition:

PET is an abbreviation of Polyethylene Terephthalate. Chemical composition is (C₁₀H₈O₄)_n

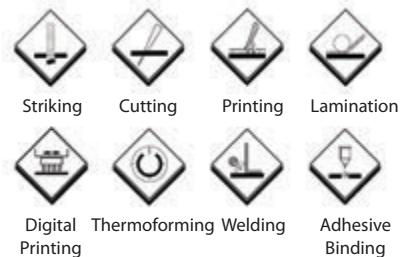


Application Areas : Signs. Food Packaging. Vacuum forming. Printing. Stationary. POS stands. White Goods Equipments. Construction Equipments.

Anwendungsbereiche : Schilder, Nahrungsmittelverpackungen, Vakuumformung, Druck, Stationäre Pos-Ständer, Haushaltsgeräte, Bauwesen.



Operating Processes





PET Delivery Programme

Special Requirements on Request

- MOQ: 1 pallet/article
- Each pallet max 1ton
- Custom sizes and colours available (subjected to MOQ)
- UV, corona or silicon treatments available (subjected to MOQ)
- Film surcharge €0.20/m² one one side, €0.40/m² on both sides.
- Available on reels



Rev. 02 - 02.05.2017

Production By Order - Transparent&White

Thickness	Sheet Size			Surface		Sheet / Pallet			Sheet / Pack		
	1000*1400	1250*2050	1400*3000	Matt	Gloss	1000*1400	1250*2050	1400*3000	1000*1400	1250*2050	1400*3000
0,30	✓	✓	n/a	✓	✓	2000	1000	n/a	100	50	n/a
0,40	✓	✓	✓	✓	✓	1400	700	400	100	50	20
0,50	✓	✓	✓	✓	✓	1000	600	350	50	50	n/a
0,60	✓	✓	✓	✓	✓	900	500	300	50	30	20
0,70	✓	✓	✓	✓	✓	750	450	250	50	30	20
0,75	✓	✓	✓	✓	✓	750	450	250	50	30	20
1,00	✓	✓	✓	✓	✓	540	300	180	50	30	20
1,50	✓	✓	n/a	✓	✓	350	200	100	30	20	n/a

PET Sheet Tolerances

Tolerance in Thickness		Rectangularity	Off Line Cutting Widht & Length Tolerances	On Line Cutting Widht & Length Tolerances	Number Of Sheet Tolerance On A Pack
0,3mm - 0,6mm	max ±20micron	Rectangularity off line cutting max ±1 mm	max ±2mm in length	max ±4mm in length	max ±%2 sheets
0,7mm - 1,0mm	max ±25micron	Rectangularity on line cutting max ±2 mm	max ±1mm in width	max ±2mm in width	
1,0mm - 1,5mm	max ±30micron				

Test Reports

Test	Dimension	Standard	Value
Density	g/cm ³	DIN EN ISO 1183	1,34
Modulus of elasticity (tensile)	Mpa	DIN EN ISO 527-3, 1B/50, 1 mm/min till 5 Mpa, in direction of production	2460
Tensile stress at yield	Mpa	DIN EN ISO 527-3, 1B/50, 1 mm/min till 5 Mpa, in direction of production	41,5
Elongation at yield	%	DIN EN ISO 527-3, 1B/50, 1 mm/min till 5 Mpa, in direction of production	2,3
Breaking strength (20 °C)	MPa	DIN EN ISO 527-3, 1B/50 in direction of production	31,8
Elongation at break	%	DIN EN ISO 527-3, 1B/50 in direction of production	15,3
Modulus of elasticity (flexion)	MPa	DIN EN ISO 178, 2 mm/min till 1,5%, then 10 mm/min	2250
Flexural strength at 3.5 % flexion	MPa	DIN EN ISO 178, 2 mm/min till 1,5%, then 10 mm/min	61,5
Flexural strength , maximum	MPa	DIN EN ISO 178, 2 mm/min till 1,5%, then 10 mm/min	64,8
Impact strength at +23 °C	KJ/m ²	DIN EN ISO 179-1/1eU, in direction of production, support distance 62 mm, 4 Joule Hammer	89,7
Impact strength notched at +23 °C	KJ/m ²	DIN EN ISO 179-1/1eU, in direction of production, support distance 62 mm, 0,54 Joule Hammer and 1 Joule hammer (ABS)	21,6
Vicat softening point	KJ/m ²	DIN EN ISO 306, 50 K/h, load 50 N, procedure B	95
Water vapor permeability	g/(m ² d)	DIN EN ISO 15106-3 at 23 °C, 85% to 0% relative humidity	3,32
Glass transition temperature	°C	DIN EN ISO 11357-2 at 20 K/min	1,1 and 107,2
Melting temperature (Peak)	°C	DIN EN ISO 11357-3 at 20 K/min	--- 2)
Crystallization temperature	°C	DIN EN ISO 11357-3 at 20 K/min	--- 2)
Shore D hardness	-	DIN 53505	80
Lineer coefficient of thermal expansion (23-80 °C)	10-5 1/K	ISO 11359-2, procedure B, 5 K/min in direction of production	9,7

Available From Stock - Transparent

Thickness mm	1250x2050 mm		1400x3000 mm	
	mat/gloss	gloss/gloss	mat/gloss	gloss/gloss
0,3	n/a	DS FILM	n/a	n/a
0,5	n/a	DS FILM	NO FILM	n/a
0,7	n/a	DS FILM	n/a	n/a
0,75	SS FILM	DS FILM	n/a	n/a
1	SS FILM	DS FILM	SS FILM	DS FILM
1,5	SS FILM	DS FILM	n/a	n/a

* DS FILM: Available as both side protected with film

* SS FILM: Available as gloss side protected with film

* NO FILM: Available as without film

Fire Classification

Country	Standard	Rating	Thickness	Colour
Germany	DIN EN ISO 11925-2	B2 (Indoors)	1 mm	Transparent
	DIN EN 13823			



HIPS Sheets



HIPS Line is available to produce one, two, three or five layers HIPS, ABS and ABS+PMMA sheets from 1 mm to 6mm thicknesses so different colors and with different additives. It is a Battenfeld machine. Although this line has a movable guillotine to cut the sheets according to customers' needs, the precise final cut is still conducted by a supplementary INPRO sheeter. This line is also fed by Colortronic driers and dosing equipments.

Die Polystyrolanlage ermöglicht die Produktion von ein, zwei, drei oder fünf-lagigen Polystyrol, ABS und ABS+PMMA, Platten von 1 mm bis 6 mm Staerke, in verschiedenen Farben und mit verschiedenen Zusatzstoffen. Es handelt sich um eine Battenfeld Maschine, die mit einer beweglichen Guillotine ausgestattet ist, um den Kundenwünschen entsprechend die Platten zu zerschneiden. Für die genaue Dimensionierung steht ein INPRO Querschneider zur Verfügung. Auch bei dieser Anlage wird der Vorschub mit einem voll automatischem Kristallisator und Trockenlufttrockner von Colortronic (Deutschland) geleistet.

	Minimum	Maximum
Thickness	1 mm	6 mm
Width	500 mm	2050 mm
Length	500 mm	6000 mm

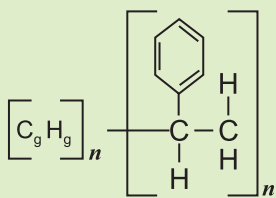
For special sizes and tolerances of up to 0,75 mm sheets can be ordered. Spezielle Masse bis zu einer Toleranz von 0,75 mm können bestellt werden.

HIPS Sheet						
Thickness	Sheet Sizes			Colour	Surface	Sheet quantity
mm	1000*1400	1250*2050	2050*3050			per pallet
0,75	x	x	x	White and Grey	Embossed and Smooth	900/500/200
1,00	x	x	x			700/350/150
1,50	x	x	x			450/250/100
2,00	x	x	x			350/185/75
3,00	x	x	x			225/125/50

The information and recommendations in this brochure are accurate and reliable to the best of our knowledge, however users should perform their own tests to determine the suitability of these products for their own particular purposes.

Die Informationen und Empfehlungen in diesem Katalog basieren dem letzten Stand unseres Wissens und sind vertrauenswürdig. Trotz allem sollte der Endverbraucher seine eigenen Tests über den Einsatz der Produkte nach seinen speziellen Wünschen durchführen, um den optimalen Gebrauch gewährleisten zu können.

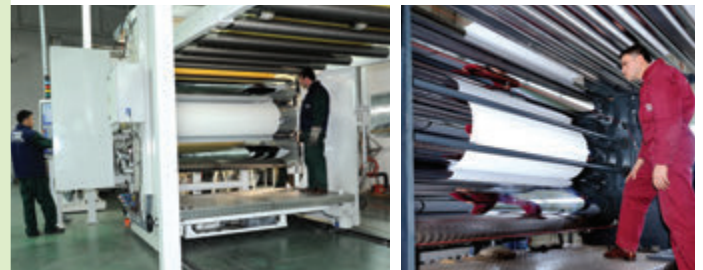
Composition:



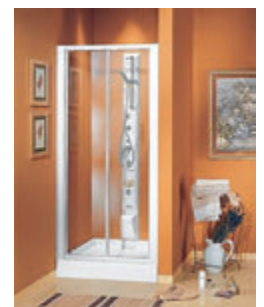
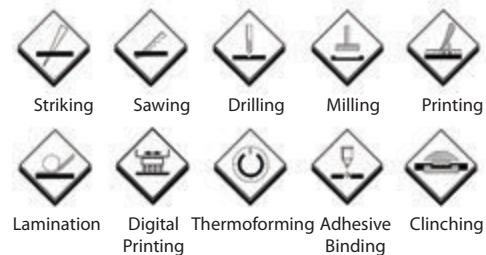
HIPS High impact polystyrene -5, + 80 C

Application Areas : Signs, White Goods Equipments (Refrigerator Interiors), Sanitary Sector (Shower Doors), Packaging, Electrical components, Toy components, Furniture Sector, Interior dividing panels.















Anwendungsbereiche : Schilder, Haushaltsgeraete (Innenwaende von Kühlschrænken), Sanitaerbereich (Duschentüren), Verpackungsindustrie, Elektrische Komponente, Spielzeugkomponente, Möbelindustrie, Innenraumtrennpaenele.



Operating Processes



Symbols

 Weatherproof Wasserdicht	 Wheels Optional Lenkrollen möglich	 Patented Patentiert	 Fittings Included Inklusive Befestigungsmaterial	 Use with Boardmarker Tafelmarker
 Round Corner Rondo	 Safe Corner Safe Corner	 Mitred Corner Gehrung	 Sliding Gleitend	 Magnetic Surface Magnetoberfläche
 Different Variation verschiedene Variationen	 Use with Pin Stecknadel	 Swing Door Flügel Tür	 With Support Mit Aufsteller	 Allen Key Inbusschlüssel
 Door Hinged mit Gelenktür	 Height Adjustable Höhenverstellbar	 Use Double Sided Tape Doppelseitiges Klebeband	 Movie Available Film verfügbar	 Slide Door Gleitende Tür
 Lock System mit Schlüssel	 Chalkboard Kreideboard	 Use with Velcro Klettverschluss	 M&T Displays M&T Products M&T Produkte	 Trade Products Trade-Produkte
 5 YEAR WARRANTY 5 Year Warranty 5 Jahre Garantie	 3 YEAR WARRANTY 3 Year Warranty 3 Jahre Garantie	 2 YEAR WARRANTY 2 Year Warranty 2 Jahre Garantie	 1 YEAR WARRANTY 1 Year Warranty 1 Jahre Garantie	 Fire Resistant Feuerresistent
 Wind Resistant Windabweisend	 Light Weight Leichtgewicht	 Exellent stability Ausgezeichnete Stabilität	 Easy Poster Change Einfacher Plakatwechsel	 Use with Magnet Buttons Magnetnadel
 Light Kit Licht-Kit	 Double Sided Doppelseitig	 Waterbase Unterplatte mit Wasserbehälter		

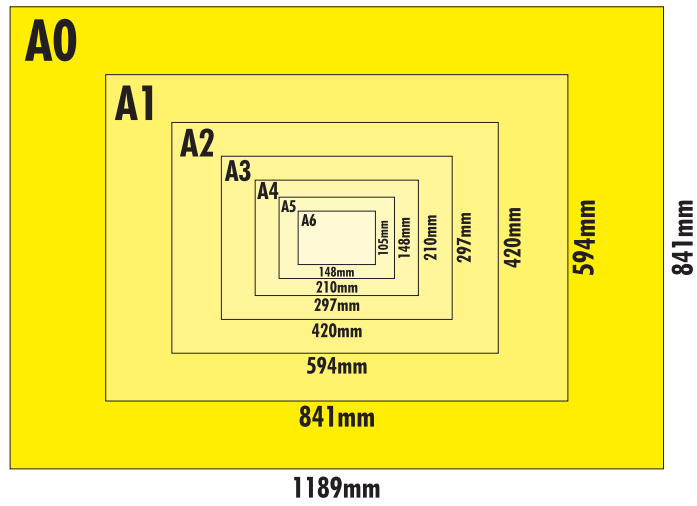
RAL Colour Chart

ral 1000	ral 1001	ral 1002	ral 1003	ral 1004	ral 1005	ral 1006	ral 1007	ral 1011	ral 1012	ral 1013	ral 1014	ral 1015	ral 1016	ral 1017	ral 1018
ral 1019	ral 1020	ral 1021	ral 1023	ral 1024	ral 1027	ral 1028	ral 1032	ral 1033	ral 1034	ral 2000	ral 2001	ral 2002	ral 2003	ral 2004	ral 2008
ral 2009	ral 2010	ral 2011	ral 2012	ral 3000	ral 3001	ral 3002	ral 3003	ral 3004	ral 3005	ral 3007	ral 3009	ral 3011	ral 3012	ral 3013	ral 3014
ral 3015	ral 3016	ral 3017	ral 3018	ral 3020	ral 3022	ral 3027	ral 3031	ral 4001	ral 4002	ral 4003	ral 4004	ral 4005	ral 4006	ral 4007	ral 4008
ral 4009	ral 5000	ral 5001	ral 5002	ral 5003	ral 5004	ral 5005	ral 5007	ral 5008	ral 5009	ral 5010	ral 5011	ral 5012	ral 5013	ral 5014	ral 5015
ral 5017	ral 5018	ral 5019	ral 5020	ral 5021	ral 5022	ral 5023	ral 5024	ral 6000	ral 6001	ral 6002	ral 6003	ral 6004	ral 6005	ral 6006	ral 6007
ral 6008	ral 6009	ral 6010	ral 6011	ral 6012	ral 6013	ral 6014	ral 6015	ral 6016	ral 6017	ral 6018	ral 6019	ral 6020	ral 6021	ral 6022	ral 6024
ral 6025	ral 6026	ral 6027	ral 6028	ral 6029	ral 6032	ral 6033	ral 6034	ral 7000	ral 7001	ral 7001	ral 7002	ral 7003	ral 7004	ral 7005	ral 7005
ral 7008	ral 7009	ral 7010	ral 7011	ral 7012	ral 7013	ral 7015	ral 7016	ral 7021	ral 7022	ral 7023	ral 7024	ral 7026	ral 7030	ral 7031	ral 7032
ral 7033	ral 7034	ral 7035	ral 7036	ral 7037	ral 7038	ral 7039	ral 7040	ral 7042	ral 7043	ral 7044	ral 8000	ral 8001	ral 8002	ral 8003	ral 8004
ral 8007	ral 8008	ral 8011	ral 8012	ral 8014	ral 8015	ral 8016	ral 8017	ral 8019	ral 8022	ral 8023	ral 8024	ral 8025	ral 8028	ral 9001	ral 9002
ral 9003	ral 9004	ral 9005	ral 9010	ral 9011	ral 9016	ral 9017	ral 9018								

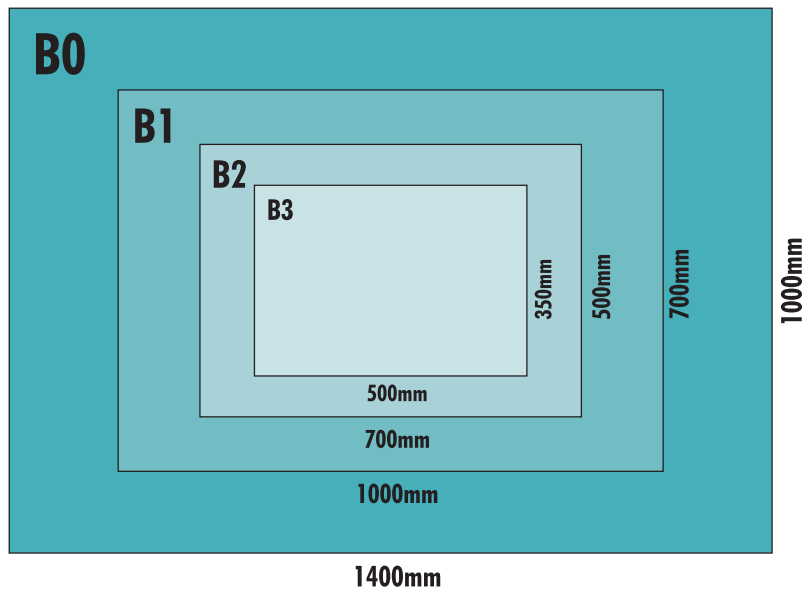
RAL Colour Chart is only for colour reference. Precise RAL colours should be selected from an original & professional chart.
Die RAL Chart ist nur für die Berufung. Die genau RAL Farben müssen aus die Originalchart ausgesucht werden.

Paper Size

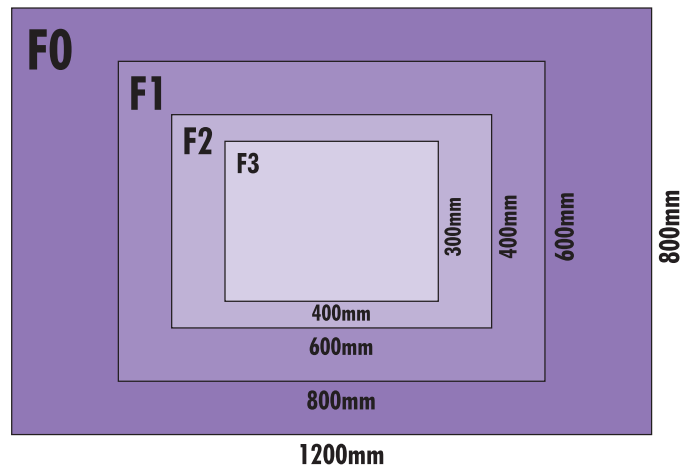
International ISO standard "A"



International ISO standard "B"



Local standard (for M&T) "F"



OPTI
FRAMES POSTER
HOLDER SNAP FRAME
SLIDE-IN FRAMES DOOR
SIGNS
DISPLAYS
WOOD
COUNTER
DISPLAYS
DIGITAL
SOLUTIONS
FRAMEBOARDS
PAVEMENT SIGNS
QUE CONTROL
SYSTEMS
LEAFLET
DISPENSERS
EXHIBITION
DISPLAYS
OFFICE
FACILITIES
BANNERS
SHOWBOARD
NOTICEBOARD
PRINTABLE SOLUTIONS
ILLUMINATED PRODUCTS
ACCESSORIES



MT DISPLAYS FACTORY
 Şekerpınar Cumhuriyet Mahallesi,
 Selin Sokak No:1 41400
 Çayırova / Kocaeli - TURKEY
 T: +90 262 658 88 80 (Pbx)
 F: +90 262 658 19 85
 info@mtdisplays.com.tr
 www.mtdisplays.com

MT DISPLAYS LLC
 1081 Hanover St.
 Wilkes-Barre, PA 18706
 Toll Free: +1 855-478-0652
 T: 201.636.4144
 F: 201.636.4145
 info@mtdisplaysllc.com
 www.mtdisplaysllc.com

MT DISPLAYS KFT
 Hungary, 2071 Páty, Prologis
 Park Budapest M1, DC2 épület
 T: +36 23 814 - 050
 info.hungary@mtdisplays.com.tr

www.displayshowroom.com
 www.omni-frame.com
 www.mt-digitalsignage.com
 www.opti-frame.com
 www.displayacademy.com