



OMPHALINA

ISSN 1925-1858



Newsletter of



Vol. V, No 1
Jan. 24, 2014



FORAY NEWFOUNDLAND AND LABRADOR

is an amateur, volunteer-run, community, not-for-profit organization with a mission to organize enjoyable and informative amateur mushroom forays in Newfoundland and Labrador and disseminate the knowledge gained.

Webpage: www.nlmushrooms.ca

ADDRESS

Foray Newfoundland & Labrador
21 Pond Rd.
Rocky Harbour NL
A0K 4N0
CANADA
E-mail: [info AT nlmushrooms DOT ca](mailto:info@nlmushrooms.ca)

BOARD OF DIRECTORS CONSULTANTS

Michael Burzynski

PRESIDENT

Geoff Thurlow

TREASURER

Faye Murrin

SECRETARY

Andrus Voitk

Past PRESIDENT

Jim Cornish

Jamie Graham

Tina Leonard

Anne Marceau

Michele

Piercey-Normore

Maria Voitk

Marian Wissink

MYCOLOGICAL

Dave Malloch

NB MUSEUM

AUDITOR

Gordon Janes

BONNELL COLE JANES

LEGAL COUNSEL

Andrew May

BROTHERS & BURDEN

OMPHALINA, newsletter of Foray Newfoundland & Labrador, has no fixed schedule of publication, and no promise to appear again. Its primary purpose is to serve as a conduit of information to registrants of the upcoming foray and secondarily as a communications tool with members.

Issues of **OMPHALINA** are archived in:

Library and Archives Canada's Electronic Collection <<http://epe.lac-bac.gc.ca/100/201/300/omphalina/index.html>>, and

Centre for Newfoundland Studies, Queen Elizabeth II Library (printed copy also archived) <<http://collections.mun.ca/cdm4/description.php?phpReturn=typeListing.php&id=162>>.

The content is neither discussed nor approved by the Board of Directors. Therefore, opinions expressed do not represent the views of the Board, the Corporation, the partners, the sponsors, or the members. Opinions are solely those of the authors and uncredited opinions solely those of the Editor.

Please address comments, complaints, contributions to the self-appointed Editor, Andrus Voitk:

seened AT gmail DOT com,

*... who eagerly invites contributions to **OMPHALINA**, dealing with any aspect even remotely related to mushrooms. Authors are guaranteed instant fame—fortune to follow. Authors retain copyright to all published material, and submission indicates permission to publish, subject to the usual editorial decisions. Issues are freely available to the public on the FNL website. Because content is protected by authors' copyright, editors of other publications wishing to use any material, should ask first. No picture, no paper. Material should be original and should deal with the mycota of Newfoundland and Labrador. Cumulative index and detailed Information for Authors available on our website.*

COVER

The beautiful, glistening, red variant of *Hygrocybe acutoconica*, August 31, 2011, Lomomd campground, Gros Morne National Park—the site of our 2014 Foray. The lead articles discuss the latest about the fate of *Hygrocybe*.

Oh, and no comments from the Editor this issue. If there were, they'd probably direct you to the back cover for information about changes to the time and place of our Foray.

But there aren't any. This issue begins our fifth year—what is there to say?

Happy 2014!

CONTENT

Editor's comments	Not this time!
The split of <i>Hygrocybe</i>	
<i>D. Jean Lodge</i>	2
The Bishop's sketchbook	7
The birth and fate of names	
<i>Lodge and Voitek</i>	8
Return of the Vikings	
<i>Andrus Voitek</i>	13
<i>Phellinus abietis</i>	
<i>Leif Ryvarden et al.</i>	15
Book review:	
Giant polypores & stoned reindeer	
<i>Robin McGrath</i>	18
Book review:	
Giant polypores & stoned reindeer	
<i>Zoe Brake</i>	19
<i>Mitrella borealis</i>	
<i>Gene Herzberg</i>	20
Dog poisoning	
<i>Andrus Voitek</i>	22
<i>Leucoagaricus americanus</i>	
<i>Andrus Voitek</i>	23
Mail basket	24
Partners	inside back cover
2014 Foray Notice	back cover

THE SPLITTING

of

Hygrocybe

D. Jean Lodge



The genus *Hygrocybe* probably contains more pretty mushrooms than any other. They provide an unrivalled bright, crisp and colourful delight to the eye—hands down, a photographer's favourite, drawing amateur and professional alike with their beauty. To the inquisitive they also provide an interesting subject for investigation, because, as mentioned in a past [OMPHALINA](#) article, how they make their living has not been elucidated.¹ It seems that they are not saprobes (decayers of organic material), as had long been thought, but what type of partnerships they have established, and with whom, remains unclear.

Recently, with the help of many collaborators, I completed a major study of the phylogeny of the Hygrophoraceae.² For many amateur as well as some professional mycologists the greatest changes are in several groups of species previously classified in the genus *Hygrocybe*. All but one of these evolutionary branches had previously been named as separate genera, so most are not new. Genera made by splitting groups from existing genera, leaving some species behind in the original genus, are called segregate genera. We were able to confirm (in many cases, reconfirm) the phylogenetic basis for these groupings, and to define their limits more accurately than has been the case before. Thus, now these groupings have a solid and well-defined basis, and should find widespread acceptance.

In this article I review the changes to the genus *Hygrocybe*, as they apply to its species identified in Newfoundland and Labrador.

Recognition of some of the segregate genera is optional, but recognizing one segregate and not the others in the same branch of the tree is not—you cannot pick and choose. For example, I notice that in the Foray Newfoundland & Labrador cumulative species list, you recognize *Humidicutis* as a good genus, separate from *Hygrocybe*. If you look at the phylogeny in Fig. 2, you will see that *Humidicutis* appears among several other branches assigned to the genera *Neohygrocybe*, *Porpolomopsis*, and *Gliophorus*, and the bold branch supporting this cluster indicates it is highly supported while the genus *Hygrocybe* in the strict sense appears on a separate, strongly supported branch. There is yet another strongly supported branch that is sister to the others corresponding to *Chromosera citrinopallida* and *C. lilacina* on one side, and species assigned to the new genus *Gloioxanthomyces nitida* and *G. vitellina* on the other side.

The sister relationship of *G. nitida* and *G. vitellina* was unraveled by David Boertmann³ in a previous issue of **OMPHALINA** that included DNA sequences of '*Hygrocybe*' *nitida* from Newfoundland. All of the species above the blue line in Fig. 2 can be referred to the genus *Hygrocybe*, as long as you don't recognize *H. marginata* and *H. pura* as belonging to *Humidicutis* rather than *Hygrocybe*. In other words, you can't recognize a genus that is embedded within another genus—that would make it polyphyletic.

My solution, together with most of my collaborators, is to recognize the segregate genera. Recognizing one genus previously segregated from *Hygrocybe*—*Cuphophyllus*—is inescapable. The molecular phylogeny in Fig. 1 shows that what you've recorded in NL as '*Hygrocybe*' *pratensis* and '*H.*' *borealis* belong to the genus *Cuphophyllus*—one of the basal, early diverging genera in the Hygrophoraceae near the backbone of the agaric fungi, while *Hygrocybe* is a later diverging group at the apex of the family. If one wanted to place these two groups in the same genus, the genus name would have to be *Hygrophorus* as it is the oldest name and the basis of the family name, and the genus would contain species that form lichens (e.g., *Lichenomphalia hudsoniana* and



Figure 1. Upper: Voucher photograph of the *Humidicutis pura* collection from Cape St. Mary's in 2006 (photo: Roger Smith). The smallest mushroom is in the herbarium of David Boertmann and a portion of the largest was sent to D.J. Lodge and then to Bryn Dentinger at the Royal Botanic Gardens Kew for sequencing and deposit. The drawing in Figure 3 comes from the latter. Lower: The habitat, where the collection was made (photo: Michael Burzynski). The yellow cross marks the location, which may explain why there is no in situ photo, just a voucher.

L. umbellifera, which are found in NL), species that form ectomycorrhizal symbioses with tree roots (e.g., *Hygrophorus eburneus*, *H. pudorinus* and *H. russula*, all found in NL), species that grow on wood (e.g., *Chrysomphalina chrysophylla*, found in NL) and species with amyloid spores (*Cantharellula umbonata*, which is in NL, and *Pseudoarmillariella ectypoides*). To avoid that unacceptable solution, everyone needs to recognize the genus *Cuphophyllus*.

PHYLOGENETIC GENERA WITHIN THE FORMER *HYGROCYBE*

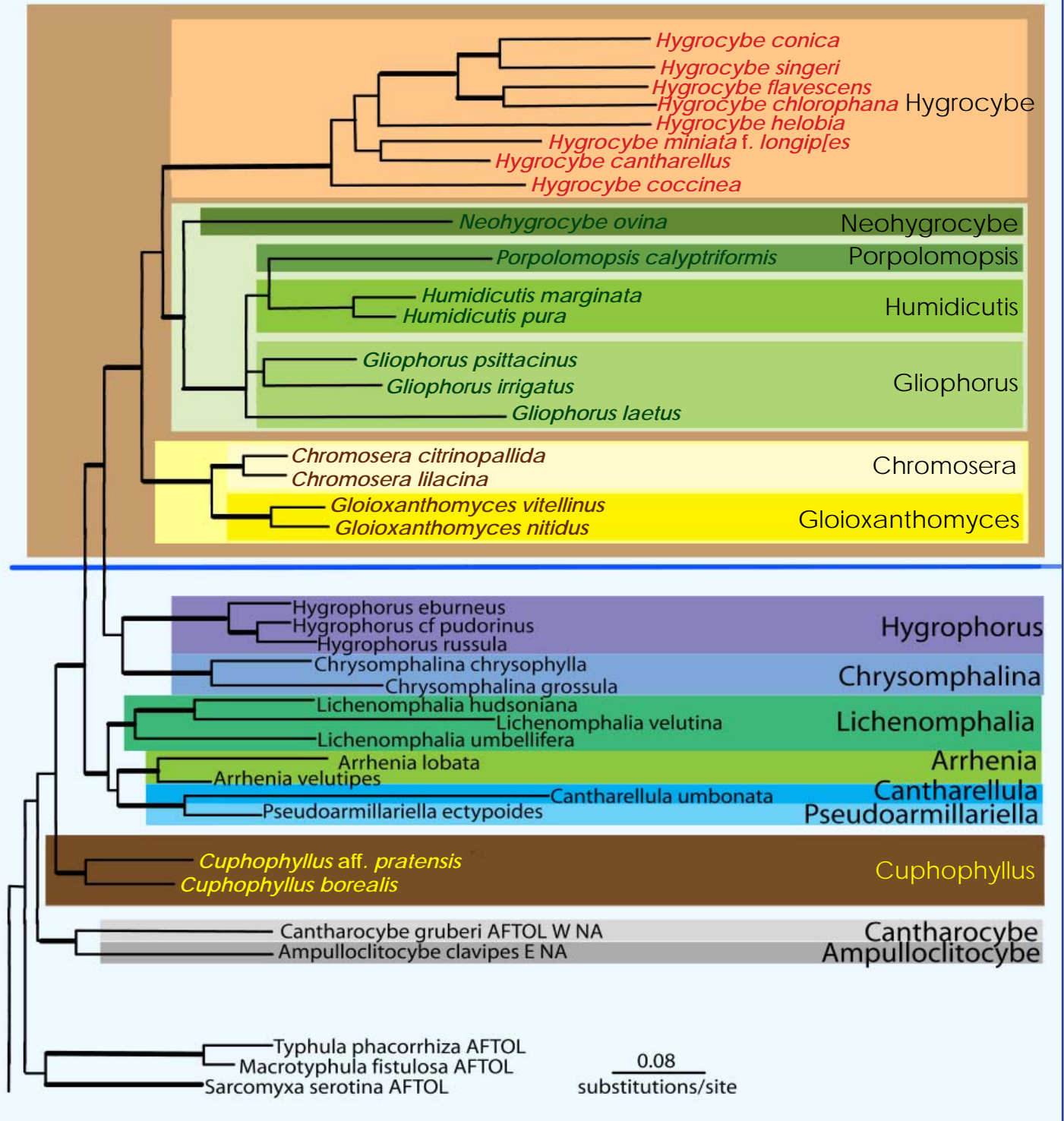
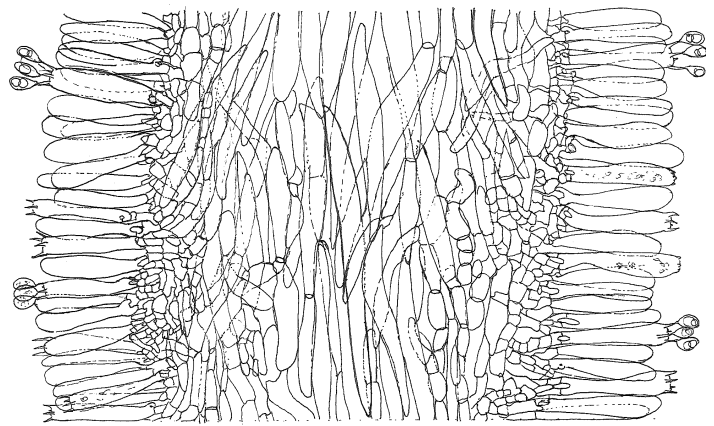

Figure 2. Phylogenetic tree including the genera previously classified in the genus *Hygrocybe* that are found in NL rooted with the coralloid fungi *Typhula phacorhiza* and *Macrotyphula fistulosa*. Note that *Cuphophyllus* is the most basal (diverged from the other agaric fungi earliest), whereas genus *Hygrocybe* diverged relatively late in this phylogenetic tree. The specimen of *Hygrocybe pura* from Cape St. Mary's is shown in its correct position within *Humidicutis*, something we were unable to show at the time of our original publication. Branches that are in bold have at least 70% support.

Hygrocybe The genus with the most species; colourful, red orange or yellow, but may stain black; may be dry or viscid; may be conical, dome shaped or indented; cap often scaly, at least minutely (loupe).	Chromosera Subarctic/subalpine, in heath; small; glutinous; brightly coloured; translucent; hygrophanous; colours fade (lilac to yellow and yellow to white).
<i>Hygrocybe acutoconica</i>	<i>Chromosera citrinopallida</i>
<i>Hygrocybe cantharellus</i>	<i>Chromosera lilacina</i>
<i>Hygrocybe ceracea</i>	Cuphophyllus
<i>Hygrocybe chlorophana</i>	Very broad central umbo or bump; caps often become opaque and chalky as they dry; considerable crossveining of gills, NL species not brightly coloured.
<i>Hygrocybe coccinea</i>	<i>Cuphophyllus borealis</i>
<i>Hygrocybe coccineocrenata</i>	<i>Cuphophyllus cinerellus</i>
<i>Hygrocybe conica</i>	<i>Cuphophyllus colemannianus</i>
<i>Hygrocybe conica</i> var. <i>chloroides</i>	<i>Cuphophyllus lacmus</i>
<i>Hygrocybe conica</i> var. <i>conicopalustris</i>	<i>Cuphophyllus pratensis</i>
<i>Hygrocybe constrictospora</i>	<i>Cuphophyllus radiatus</i>
<i>Hygrocybe flavescens</i>	Gliophorus
<i>Hygrocybe helobia</i>	Very slimy; may have bright colours or somewhat muted; Some coloured green or purple, unusual for mushrooms; colours fade and change over time. Gill edge may be gelatinized; gills often become carrot pink-orange on drying.
<i>Hygrocybe insipida</i>	<i>Gliophorus irrigatus</i>
<i>Hygrocybe miniata</i>	<i>Gliophorus laetus</i>
<i>Hygrocybe miniata</i> var. <i>mollis</i>	<i>Gliophorus psittacinus</i>
<i>Hygrocybe mucronella</i>	Gloioxanthomyces
<i>Hygrocybe phaeococcinea</i>	Gluey, brilliant yellow mushrooms with a thin, dark, slimy gill edge. One species only. Can be distinguished from yellow <i>Gliophorus</i> species by swollen cells, seen microscopically in the gill flesh, and does not develop carrot orange colour on drying.
<i>Hygrocybe punicea</i>	<i>Gloioxanthomyces nitida</i>
<i>Hygrocybe reidii</i>	Humidicutis
<i>Hygrocybe ruber</i>	Acutely conical in youth; cap cracks radially somewhat when expanded; may be brightly colourful, often with pink tint or carrot pinkish-orange in colour, with or without green; moist or viscid.
<i>Hygrocybe singeri</i> var. <i>albifolia</i>	<i>Humidicutis marginata</i>
<i>Hygrocybe</i> sp. nov.	<i>Humidicutis marginata</i> var. <i>olivacea</i>
<i>Hygrocybe splendissima</i>	<i>Humidicutis pura</i>
<i>Hygrocybe squamulosa</i>	
<i>Hygrocybe substrangulata</i> var. <i>rhodophylla</i>	
<i>Hygrocybe turunda</i>	
<i>Hygrocybe turunda</i> var. <i>sphagnophila</i>	

Table 1. Species formerly placed in the genus *Hygrocybe* that are found in Newfoundland and Labrador, assigned to their respective segregate genera, with a brief description of each genus. The “parent” *Hygrocybe* on the left, and the segregate and subsegregate genera on the right.

Figure 3. Drawing of cross section of a gill of the *Humidicutis pura* specimen. The basidia are on the outsides, some with sterigmata (prongs where spores are formed), some with developing spores attached. Note especially the bases of some of the basidia – they look like bow-legged cowboys. This form of clamp connection is typical of *Humidicutis*, *Porpolomopsis* and some species of *Gliophorus*. This sporulating layer is supported by the gill trama (flesh of the gill) in the middle. Characteristically, *Humidicutis* has very short hyphae (elongated cells, making “threads”) in the trama of the gill, as shown here, fitting well with *Humidicutis*, whereas the sister genus, *Porpolomopsis*, has long tapered cells.



Review of the FNL list and that of Andrus Voitk over the past 11 collecting seasons reveals 41 taxa that a decade ago would all be considered species of *Hygrocybe*. According to the findings of our study, these same 41 taxa are now divided among six genera: *Chromosera*, *Cuphophyllus*, *Gliophorus*, *Gloioxanthomyces*, *Humidicutis*, and *Hygrocybe*. Table 1 gives a brief description of each genus and places each identified Newfoundland and Labrador taxon into its currently correct genus.

Our work drew on FNL data in two areas. First, it was very helpful for us to have the relationship between the European *Gloioxanthomyces vitellinus* and the North American *G. nitidus* determined, as published in *OMPHALINA* (under the names *Hygrocybe vitellina* and *H. nitida*).³ We also had a white conical *Hygrocybe*, collected from Cape St. Mary's sent for examination. It had been examined by two of us, and both agreed that this was *Hygrocybe pura*. Morphologically, this species is very similar to *Porpolomopsis calyptriformis* (the old *Hygrocybe calyptriformis*), so that in the manuscript we assigned it to the genus *Porpolomopsis*, based on its looks. The sequencing results have since been completed, and analysis shows this specimen instead belongs to the sister genus, *Humidicutis*. Figure 1 shows the specimen and its habitat, and Figure 3 shows the microscopic cross section of its gill, revealing the typical short hyphae described for this species and genus. In addition to these direct contacts with your organization, many of the photographs used

in our manuscript were contributed by Renée Lebeuf, one of your Faculty for several years.

There is no need to be unhappy about learning new names for your beautiful waxcap mushrooms, because your own data contributed to the work that led to these discoveries! Moreover, if you study the genus descriptions and consider the listed species, you will probably discover that you have always noted that some *Hygrocybe* species differed from the majority. The pink tint to the orange *Humidicutis marginata* is a good clue to differentiate it from *Hygrocybe*, and it corresponds to a difference in pigment chemistry. Other segregate genera can be separated by the characters you may have noted in the past: copious gluten and lamellae that dry carrot pinkish-orange in *Gliophorus*, duller colours, or several other characters that make them different from the rest. There is an evolutionary basis for some these different characters, providing you with a great opportunity to check for differences with increased attention, in order to place your finds into their correct genus. I hope that this short explanation has given you an understanding why you will soon find some old friends with new names in your lists.

Acknowledgments

I thank my many coauthors of the original monograph, without which this selected review would not have been possible. I also thank Andrus Voitk, who assisted in drafting the manuscript. I thank my employer, The Center for Forest Mycology Research, USDA Forest Service, Northern Research Station.

References

1. Voitk A: Do you ever wonder how the organisms you encounter make their living? *OMPHALINA* 2(9):2. 2011.
2. Lodge DJ, Padamsee M & Matheny PB, Aime MC, Cantrell SA, Boertmann D, Kovalenko A, Vizzini A, Dentinger BTM, Kirk PM, Ainsworth AM, Moncalvo J-M, Vilgalys R, Larsson E, Lücking R, Griffith GW, Smith ME, Norvell LL, Desjardin DE, Redhead SA, Ovrebo CL, Lickey EB, Ercole E, Hughes KW, Courtecuisse R, Young A, Binder M, Minnis AM, Lindner DL, Ortiz-Santana B, Haight J, Læssøe T, Baroni TJ, Geml J, Hattori T: Molecular phylogeny, morphology, pigment chemistry and ecology in Hygrophoraceae (Agaricales). *Fungal diversity*, DOI 10.1007/s13225-013-0259-0. 2013.
3. Boertmann D: Update on *Hygrocybe nitida*. *OMPHALINA* 3(1):12-13. 2012.

Illustrations

Title banner: Cuphophyllus lacmus, not a Hygrocybe, even if you do not want to accept the other splits of the genus.

Left: Hygrocybe conica, beautiful and common species of such variability that its many varieties and forms should be reassessed and defined.





The Bishop's Sketchbook



THE BIRTH AND FATE OF NEW GENERIC NAMES

D Jean Lodge & Andrus Voitk

No student of natural history can have escaped the proliferation of new names in the last few decades, certainly evident in mycology. Of course, the most obvious need for a new name comes about when an organism is discovered whose existence was hitherto unknown, i.e. a species, genus, or larger group new to science. However, for the layman the sudden profusion of new names for seemingly old organisms or groups of organisms is causing some confusion and consternation, particularly when several names replace a former single name. In this discussion we shall use genera as an example to show how new names (new genera) come about and what happens to them after introduction.

In order to understand the organisms with which we share this world, we have tried to classify them, putting like with like in the belief that likeness indicates relatedness. It follows that when we find consistent differences between organisms, in order to keep like with like we also separate out differing groups. An example of this process was provided in a recent **OMPHALINA** article devoted to *Cystoderma*.¹ Careful study of the genus *Cystoderma* led Harri Harmaja to conclude that it contained two different groups of mushrooms, those with amyloid spores and those without.² To him these differences were sufficiently significant to warrant placing each in its own genus. This was done by leaving the mushrooms with amyloid spores in the original genus *Cystoderma*, and creating a new derivative or segregate genus, *Cystodermella*, for the species with inamyloid spores. Not all taxonomists agreed that this difference was sufficient to justify the rank of a new genus, and therefore some continued to use the genus name *Cystoderma* for both groups. Saar studied the molecular phylogeny of these mushrooms and discovered that phylogenetically the amyloid-spored group and the inamyloid-spored group have travelled along different evolutionary pathways from a common progenitor.³ In other words, the two differ genetically, as well as in the ability of their spores to react to iodine (rare exceptions

aside). Phylogeny supported Harmaja's observations, lending more weight to his decision to consider them different genera. Hence, it is likely that more taxonomists will accept the derived genus *Cystodermella*. If its use becomes accepted practice, *Cystodermella* will be considered a good genus in the sense that it is generally accepted as standing apart from its original "parent" genus, *Cystoderma*.

In mycology there are no absolute criteria that must be met to designate a new genus. Every taxonomist is free to describe observed differences—macroscopic, microscopic, ecological, chemical or phylogenetic—and propose a derived genus with a new name. Phylogeny has, however, certain guidelines. Since the aim is to lump like with like, a genus should be monophyletic—that is, "pure"; it should not contain other genera within it (that would make it polyphyletic). Thus, new genera are proposed when a genus is found to be polyphyletic, i.e. contain within it one or more other genera. At the same time, new genera cannot be created within existing genera, but must stand on their own.

Current taxonomy is based on phylogenetics, comparative analysis of genetic regions. The results can be illustrated by clade trees that trace the likely evolutionary path and show the relation of genera to each other—snippets from the Tree of Life. When genetic differences are found within genera previously thought to be

one, new branches appear. Significantly divergent new branches may be considered separate entities and given a new genus name, or they might be recognized at a lower rank such as subgenus or section. A prolific amount of molecular genetic investigation is discovering much unsuspected branching within groups, i.e. new potential derived genera. This is why so many new names are proposed.

Now that we know how such names come about, let us see what their fate is. As an example, let us consider the previous article, where one of us (DJL) describes the derived genera she and her coworkers supported with molecular phylogeny in the former genus *Hygrocybe*. Excluding *Cuphophyllus*, they supported six derived genera of which only one was 'new'. Since there are no absolute criteria for naming new genera, this becomes an active decision of each taxonomist. As with all decisions, there is judgment and opinion involved, both of which may vary with different observers. This means that there are choices, first for the investigator and second for the users. To explore these choices, we chose Figure 1, adapted from that article, but pared of individual species, and trimmed of all branches not pertaining to *Hygrocybe*, as it has been known in its wide sense for the last few decades. The branch that leads us to this group is A, arising from the root.

Let us first deal with the genus

Cuphophyllus, shown on branch X. Lodge mentioned that its acceptance as a good genus apart from *Hygrocybe* was unavoidable. At one time species of *Cuphophyllus* were considered part of the larger genus *Hygrocybe*. However, Lodge's article (see the phylogeny diagram in that article) presents phylogenetic evidence that the entire genus *Hygrophorus*, as well as the smaller genera of *Chrysomphalina*, *Lichenomphalia*, *Arrhenia*, *Cantharellula* and *Pseudoarmiraliella* come between branch X and Branch B. In other words, B and X are not the only branches that

rise off the B-X axis—the others have just been removed in our illustration for simplicity. As mentioned, if we wish to consider all the illustrated genera as one large genus, we need to include all the intervening genera as well and the name would have to be *Hygrophorus* rather than *Hygrocybe* as it is the oldest genus name in that group. That would create a very large genus, containing very many discrete groups that differ significantly in appearance, lifestyle and genetic make-up. For most people this is not a useful grouping of like with like. Therefore, with the current information

the only reasonable option seems to be to accept *Cuphophyllus* as a good genus.

Now, let us turn to Branch B. It splits into branches C and D. To our knowledge, there are no other intervening branches, so that one valid option is to consider everything on these branches as one genus. This produces a genus not too dissimilar from one earlier version of *Hygrocybe*, when most of what is now known as *Cuphophyllus* was considered a separate genus, at that time called *Camarophyllus*. This concept of *Hygrocybe* has worked

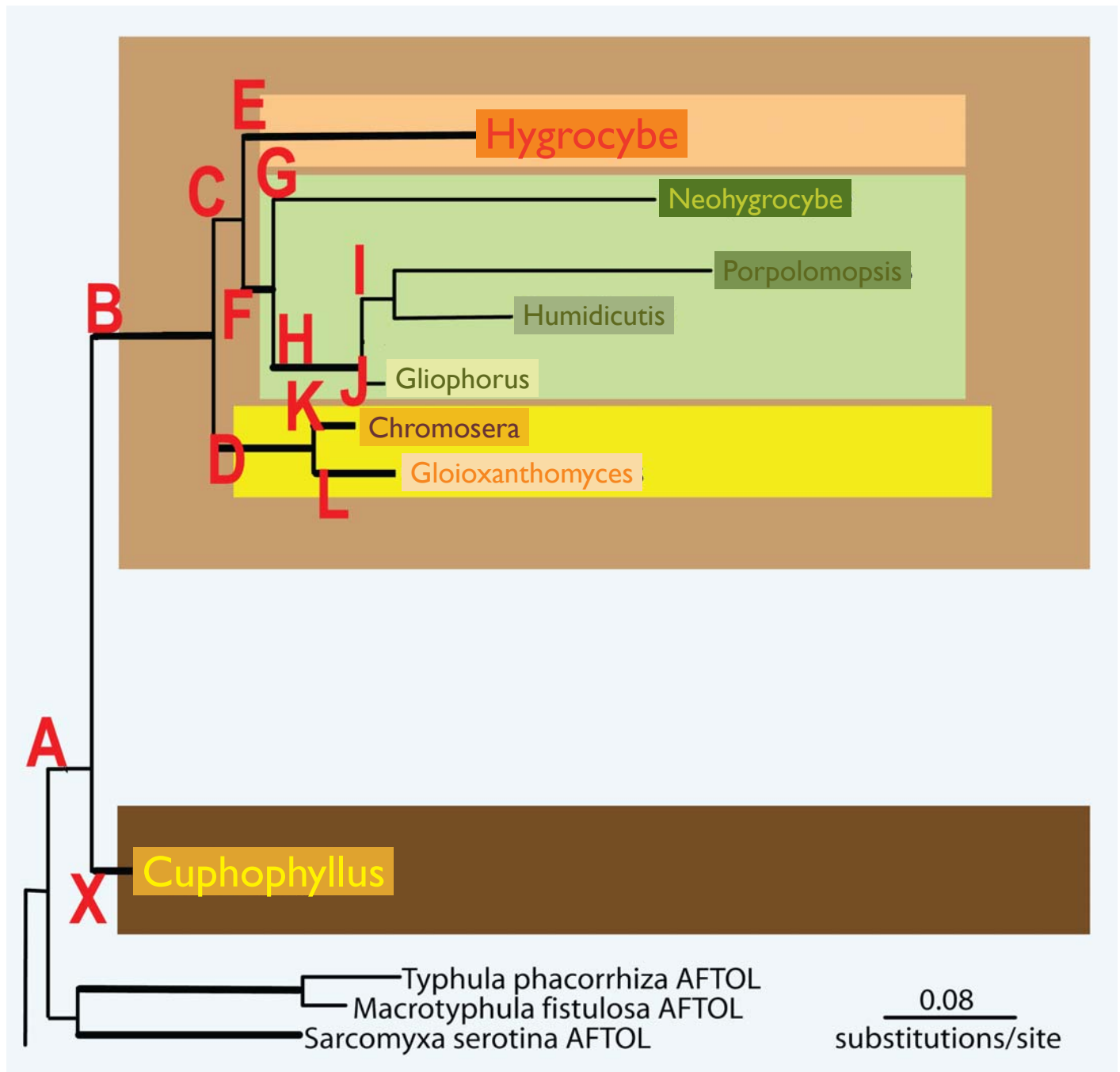

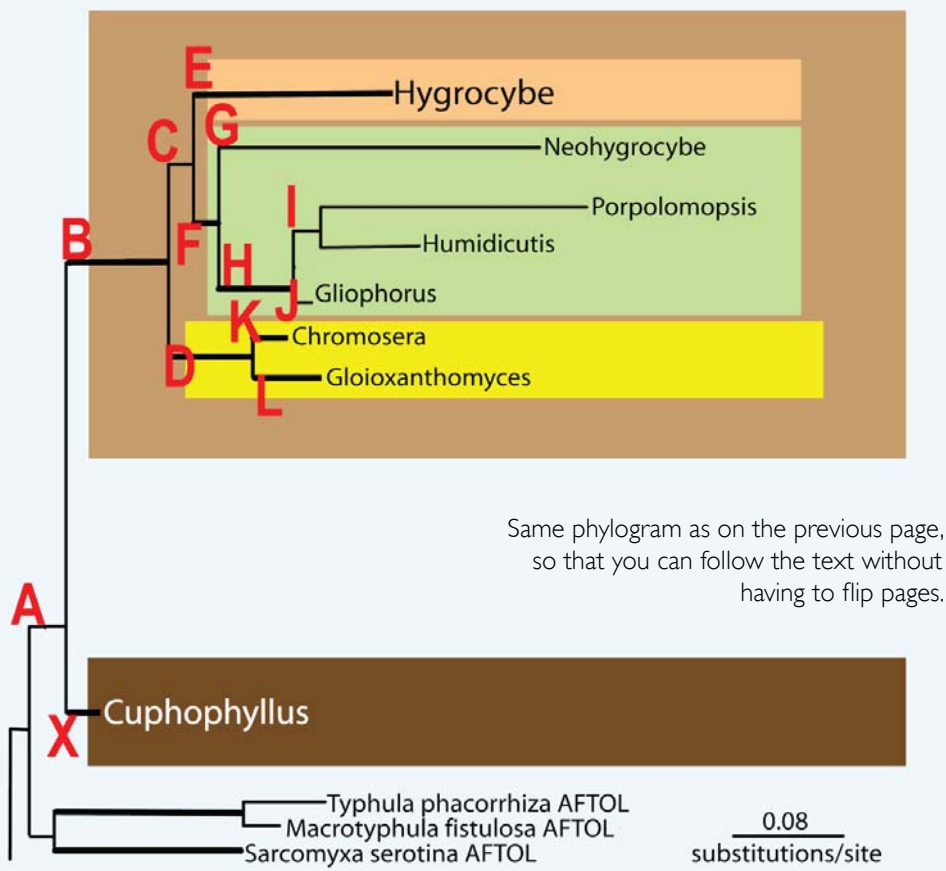

are chemically unrelated and give the species in branches E and F very different appearances. These considerations may influence you to separate genetically unlike groups. If you decide to separate E and F, you are automatically accepting *Neohygrocybe* as a valid genus. Your decision then is what to do with branch H. You may lump all into one genus (*Gliophorus*, named in 1958, which has priority over *Humidicutis* named the following year in 1959, and the limits of the genus would have to be expanded to absorb *Gliophorus* species). If not, you automatically accept *Gliophorus* as valid. Your last decision is whether to lump *Porpolomopsis* and *Humidicutis*, or accept both as valid genera. Each branch is well supported but the split that separates the two branches is not statistically significant, and they are morphologically similar. If you have come this far, why not go for broke and accept these as valid genera as well? Should you reject this split, you would join several mycologists who previously placed species of the younger genus, *Porpolomopsis*, in the older of the two named genera, *Humidicutis*. The type species of *Porpolomopsis* (*Hygrocybe calyptriformis*) has never been placed in *Humidicutis* but was thought to belong to *Hygrocybe* in branch E because its conical pileus with a splitting margin resembles that of *Hygrocybe conica* (the type species of *Hygrocybe*). *H.P. calyptriformis* would need to be transferred to *Humidicutis* in order to recognize the entire branch I as a single genus.

in the past, and may continue to do so. However, Lodge and coworkers have demonstrated a split of branch B into C and D. Branch D has good statistical support (indicated by a thick line), which means that the likelihood is over 70% that this genetic separation is a consistent or “true” finding. Because we can also identify other consistent differences between the genera on branch D and those on branch C, you may decide to acknowledge this difference, in order to keep with like.

If you opt to accept the split, your next choice is to decide what to do with the genera on branches C and D. Both are independent branches, so that a decision on one does not affect the decision on the other. The choice on branch D is simple: accept both genera, or reject *Gloioxanthomyces* (which was derived from *Hygrocybe* on branch C—either on the *Hygrocybe* branch E or the *Gliophorus* branch J, depending on the author) and transfer *Gloioxanthomyces* species to *Chromosera*. Branches K and L, leading to these genera, both enjoy high statistical support, so that if you put

a lot of value on such findings, you would likely support distinguishing between the two genera. You could summon support in the different habitat and looks of the two genera. *Gloioxanthomyces* has a gelatinized gill edge, similar to *Hygrocybe laeta* (*Gliophorus laetus*), but the cells that make up the flesh are distinctive. Or you may opt to continue considering differences in species of *Gloioxanthomyces* and *Chromosera* as minor, concluding that such differences are reasonable between otherwise similar species within one somewhat diverse genus. Note that branch D is a sister to C, containing all the other genera. Therefore, you can lump branches K and L or choose both, but not select only one.

If you chose to recognize branches C and D as valid splits, then regardless of what you chose to do with branch D, branch C presents you with several options. First, you may elect to lump all genera emanating from branch C as one genus, *Hygrocybe*. But both of its branches, E and F, have high statistical support, and the pigments that give these branches

Among this confusing profusion of permutations and combinations, three valid choices stand out. One option is to lump all derived genera (excluding *Cuphophyllus*) into one large *Hygrocybe*. Another is to decide, as did Lodge and her coworkers, to accept all proposed derived genera. A compromise is to accept three bigger genera: the “parent” *Hygrocybe*, one large genus flowing from branch F (needs descriptions and naming), and the small *Chromosera*, transferring into it species of the new

genus *Gloioxanthomyces*.

What happens now? How are the decisions made? Who “accepts” or “rejects” the proposed new derived genera? After all, if they were found to exist genetically, is that not the end of the discussion: they are there and therefore must be accepted?

Well, not exactly. The fate of these new genera now rests in the hands of the community of users, primarily taxonomists and mycologists, but also all others interested in fungi. Anybody wishing to talk about them with others must find a common language, including what to call them. Remember, there are no fixed rules, so incorporation of new proposals is left to usage. We already saw some of the decisions guiding such usage: an overly large and overly diverse genus, such as the super-*Hygrophorus*, containing *Cuphophyllus*, *Hygrophorus*, *Arrhenia*, basidiolichens and other genera, seemed to be undesirable. Why? Well, mostly because it did not seem helpful. It had in it so many species with distinctive characters that they would be difficult to organize in the mind without breaking them down into subgroups. At the same time, some of these organisms were so different, that this large genus did not seem to lump like with like, either in appearance or ecology. Much as overly large genera are not perceived to be helpful, overly small genera are also not helpful. If genera become very small, they offer very little advantage to the user over species, and a larger group would seem more desirable.

As we see, the size of the group influences the likelihood of its acceptance. Some 50 species split off the large genus *Cortinarius* likely will be perceived as helpful. Small genera of one to two species split off a large genus like *Entoloma* will not be equally helpful. Neither will the splitting of a small 12-species genus into ten little genera most with only one species, even if scientifically correct. Of course, the nature of the species may

override these considerations. For example, there really is no other mushroom remotely like *Polyozellus multiplex*, so placing it in a genus by itself will likely be accepted. Sometimes a new discovery creates an epiphany: “Aha! I always knew there was something different

about this group! Now I know.” Well, in that case the acceptance will be viewed as helpful to placing like with like, and its acceptance likely. Splitting in half a manageable genus of mushrooms that look alike and have the same lifestyle may be far less likely to gain acceptance. But if two similar genera are shown to have different genetic make-up on two different continents, the names are more likely to be accepted. Why? Because in this case it is perceived to provide some insight into their evolution, once the opportunity of exchanging genetic material is removed. In other words, the split is seen as helpful to our understanding of fungi.

These are the main factors that influence the usage and acceptance of proposed names. Of course, there are many others, because we human beings are moved in many and mysterious ways. For example, petty things like pronunciation no doubt influence decisions. “Polyozellus” is a foreign word, but seems to roll off the tongue smoothly, with an appealing aftertaste of chocolate and a hint of tobacco, so it is likely to be used. “Gloioxanthomyces” may find it has a tougher row to hoe. You may be surprised, but even the tongues of scientists have limits.



Polyozellus multiplex

But what about science, where is its place in this, you ask. Surely it should determine what is accepted or not. Of course, science does play a role, but it is not the final arbiter. If scientific evidence for a separation is overwhelming, it is accepted, even when morphologically incongruous. For example, when *Rickenella* was shown to be related to *Hymenochaete*, together with genera like *Phellinus*, *Trichaptum* and *Inonotus*, and far away from lookalikes *Hygrocybe* or *Mycena*, this was readily accepted as an example of parallel evolution. By the way, at the same time *Phellinus*, *Trichaptum* and *Inonotus* proved to be far away from their lookalikes *Fomitopsis* or *Trametes*. These splits were very helpful to lump genetically like with genetically like as an attempt to indicate relatedness.

This makes it clear that whether a proposed new name is accepted or not, the science behind its proposal remains equally valid. In the absence of absolute criteria for designating a genus, proposing a new genus on the basis of scientific evidence always involves some degree of judgement or opinion about the significance of the findings. Opinions differ, without altering the underlying facts.

Just as some may accept a genus with



Phellinus nigricans



Rickenella fibula



Hygrocybe cantharellus



Fomes fomitopsis

Non-intuitive or incongruous groupings. The two in the middle are not related. The two on the edges are not related. The two on the left are related. The two on the right are not related. Parallel evolution is the term used for the ability of an evolutionary line to (re)invent a shape or function when it proves advantageous. The

Hymenochateoid clade (two on the left), the Euagaric clade (3rd from left) and the Polyporoid clade (on the right) have all developed a gilled hymenium or a poroid conk fruiting body, as suited the occasion. Because this discovery gave new insights into evolution, these new larger groupings were readily accepted.

both slimy and viscid species while some may prefer to place each in a genus of its own, so some may accept a genus with some phylogenetic divergence, while others would prefer to place each branch in a genus of its own. Whichever decision becomes accepted custom, the slimy ones remain slimy and the ones on one evolutionary branch remain there. The system we have for ranking organisms is a tool, designed to help us place like with like, in our effort to understand nature around us. We strive for a perfectly balanced tool, not too bulky for use in fine situations, not too fine for a bigger job, and not too complicated to handle comfortably. Taxonomy is for us, not the mushrooms. This is why the word "helpful" appeared so many times in the discussion of why some new genera may be accepted or not. Not every perceived difference needs to be named, or if named, it may not require incorporation into taxonomy (or it may be recognized at a lower rank, a subgroup within a genus). It is the job

of the scientist to discover new things, including differences, and present them to both peers, and eventually us at large. It will then be up to collective usage over time, to determine what will be helpful if incorporated into the tool we use to understand nature.

Lodge and coworkers have done a large amount of work, dissecting out the phylogeny of the Hygrophoraceae and correlating the branches with previously named genera and subgroups within genera—all based on appearance and ecology. Most of the work was in sifting through the multiple names that have been applied to each group and applying the rules of nomenclature to determine which were the names that could be used (i.e., correct, validly published, and legitimate). Both the 'lumper' and 'splitter' naming approaches to *Hygrocybe* classification were presented by Lodge and co-workers in parallel so that users could decide for themselves which system is most useful to them. Science is perceived to

deal with absolutes, but certain aspects are democratic. It will be interesting to follow the fate of these segregate genera that were supported by molecular phylogeny, ecology, pigment chemistry and morphology. As an experiment, we shall adopt them all in our Foray Newfoundland & Labrador lists. Those of us with a distant best-before-date can then see which remain in general usage 10, 20, 25 or more years from now.

References

1. Saar I, Voitek A: *Cystoderma* and *Cystodermella* of Newfoundland and Labrador, *OMPHALINA* 4(7):6-13. 2013.
2. Harmaja H: *Amylolepiota*, *Clavicybe* and *Cystodermella*, new genera of the Agaricales. *Karstenia* 42 (2):39-48. 2002.
3. Saar I, Põldmaa K, Kõljalg U: The phylogeny and taxonomy of genera *Cystoderma* and *Cystodermella* (Agaricales) based on nuclear ITS and LSU sequences. *Mycological Progress* 8 (1):59-73. 2009.



No doubt everybody remembers the visit of the two Vikings, Gro Gulden and Jon-Otto Aarnæs from Norway to our foray in 2012. No doubt you also remember that one of the dreams of Gro was to visit the Viking site at L'Anse aux Meadows. Therefore, ere Foray greeted Eos, we arranged a small trip to the Great Northern Peninsula. In keeping with our policy of transparency, the journey was documented and published in word and picture ([OMPHALINA 3\(11\):16-23. 2012](#)).

The picture on the left comes from that report. Jon-Otto bade our Vikings partake a friendly spot of Norwegian Akvavit, after which he was consigned to the smithy bellows until the shakes wore off. What is the aftermath of letting a Norwegian Viking spur the fire of a Newfoundland Viking smithy? Again, pictures relate the tale.



Pholiota limonella. One of several larger, fleshy, yellow *Pholiota* species that grow in the province. Pholiotas are characterized by a brown sporeprint, broadly attached gills, a slimy, scaly cap and scaly lower stem, often with remnants of the veil hanging from the cap edge, or left as ring or ring zone on the stem. Some are edible, but serious poisonings and even fatalities have occurred when they have been confused with the deadly *Galerina marginata*. *Pholiota aurivella* looks like *P. limonella* and is the commoner of the two in mainland mushroom books. To date, we have only collected *P. limonella* in our province. The two have a readily apparent difference in spore size, allowing a secure identification.

Photos: Mike Sexton

Scarcely had a year passed, but out of the very base of the same anvil on which a nail had been pounded from iron heated by Jon-Otto's fire, there arose in thickest darkness, a mass so frightful of countenance, as to quake the bravest heart to its very foundation with calamitous portent of evils imminent. The grasping, devouring, many-headed monster struck horror, terror and desolation into every being fortunate to escape its clutching grasp, It became, in the words of Lord Lyton, "res detestabilis et caduca",* but scarce was the man to bring about the caduca part.

L'Anse aux Meadows was placed under the strictest quarantine, while brave men made every effort to contain this wicked pestilence.

It is writ in the sagas (Leif contemplates life, Vol III. Anno 978) that the evil that is released by Akvavit in a smithy, no man can contain. That is the curse of the Vikings, the curse that was blown by the bellows in Jon-Otto's shaking hands. And now, dear reader, that same nefarious curse blows its contagion on the wind, for its pernicious spores are spreading their contamination to wreak havoc all over our Island.

Lock up your smithies! Let no man rest easy!

And that, folks, is how FNL solved the mystery of why the original Vikings left.

Wouldn't you?

* A despicable thing, to be destroyed.

Phellinus abietis — AN OLD NEW SPECIES

FOR NEWFOUNDLAND & LABRADOR
AND NORTH AMERICA

Leif Ryvarden, Renée Lebeuf, Andrus Voitk

Phellinus abietis (P. Karst.) Jahn is a common species on different coniferous hosts, although preferably *Picea*, in the circumglobal boreal forests. Its brown pileate basidiocarps are perennial and occur singly, but more often in large numbers on dead but still standing trees, not uncommon also on living trees. Karsten's type specimen came from northern Finland collected on a dead *Picea abietis*.¹ For a long time that name was used for all specimens collected on *Picea abietis*, at least in Fennoscandia and Russia.

However, then M. A. Donk introduced *Phellinus chrysoloma* (Fries) Donk for such specimens, based on *Fomes chrysoloma* Fries 1861,² a name that had slept in oblivion because of uncertainty of its application. Fries collected his type specimen at Ultuna, just outside Uppsala in Sweden, an area inside the hemiboreal zone just south of "limes norrlandicus" i.e., the northern border for oak (*Quercus* spp) in Fennoscandia.

Such was the situation until T. Niemelä and his students started to examine and measure spores of specimens from all over Europe. Their conclusion was that there are two species, one boreal for which Karsten's

The two *Phellini*. Title banner and top photo: *Phellinus chrysoloma* in Newfoundland. Note a thicker cap that projects straight out, bending down at the very end only, thus exposing most of the hymenium (pore surface). Middle: *Phellinus abietis* in Norway. Bottom (photo: Roger Smith): *Phellinus abietis* from Terra Nova National Park. Note the thin cap that bends downwards to almost completely cover the resupinate part of the hymenium.



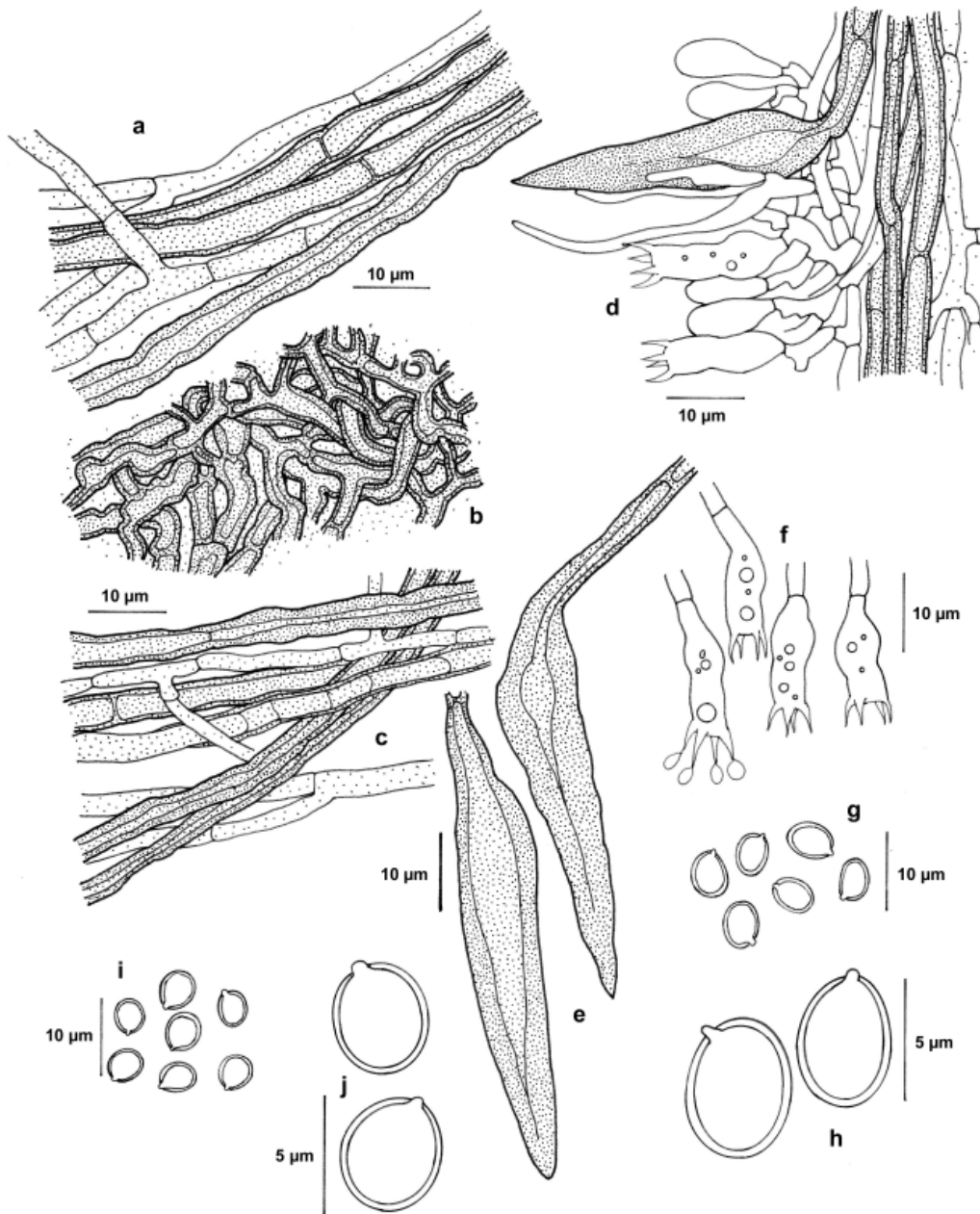

Phellinus abietis (T. Niemelä 7399, ex H) a, hyphae from upper surface; b, hyphae from dark zone; c, hyphae from context; d, section through hymenium; e, hyphenal setae; f, basidia; g, h, basidiospores. *Phellinus chrysoloma* (ex O. Miettinen 14146). i, j, basidiospores. Del. I. Melo. Drawing courtesy of Ireneia Melo.

name should be used, and one distinctly more southern, for which Fries's name should be applied (T. Niemelä pers comm.). The main difference lies in the spore shapes: *P. abietis* has ellipsoid spores, while those of *P. chrysoloma* are subglobose. This can easily be seen in the drawing, to be used in the forthcoming Poroid fungi of Europe by L. Ryvarden & I. Melo. In addition to differences in spore shape, there are minor differences in the shape of the

basidiocarps.

Peck, unaware of the situation in Europe, named a species within this complex as *Polyporus piceinus*. Whether this in due time will be accepted as a species of its own, will partly be based on DNA sequencing of a large number of representative North American and European specimens, and opinions on wide or narrow species concepts.

Phellinus pini is another species within this complex, but restricted, as the epithet indicates, to *Pinus* spp. Its basidiocarps occur often on living trees, not rarely high above the ground and it has in general larger and more irregular pores than seen in the species mentioned above. The spores are like those of *P. chrysoloma*, while the hyphenal setae are similar in all three species. The type specimen of *P. pini* came from Portugal.

Armed with this information AV reviewed the micromorphology of all our *P. chrysoloma* collections, both personal and the Foray collections. There were a total of 15 collections identified as *P. chrysoloma*. Of these, 13 had the spore shape and size characteristic for that species. Two had spore shape and size compatible with *P. abietis*. One of these, and a specimen of *P. chrysoloma* to act as control, were then reviewed independently by RL, in the

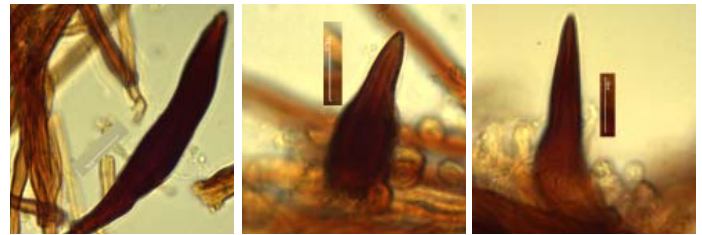
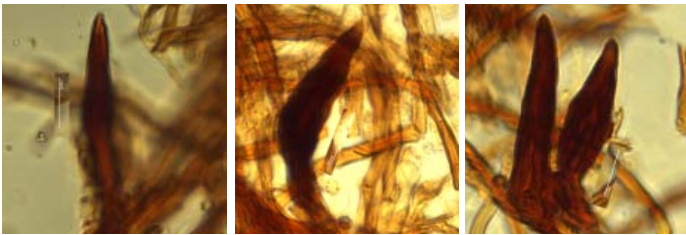
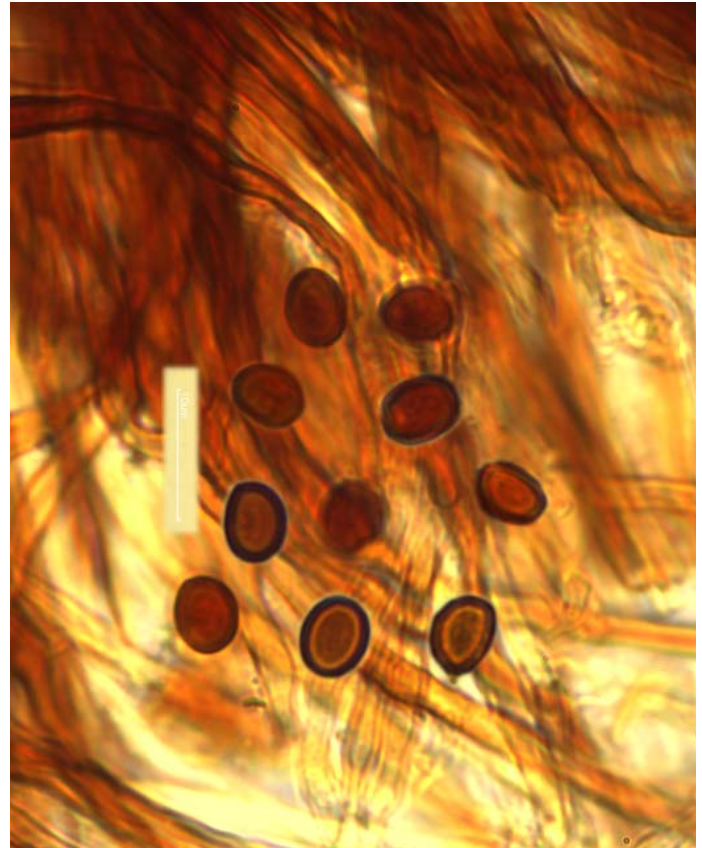
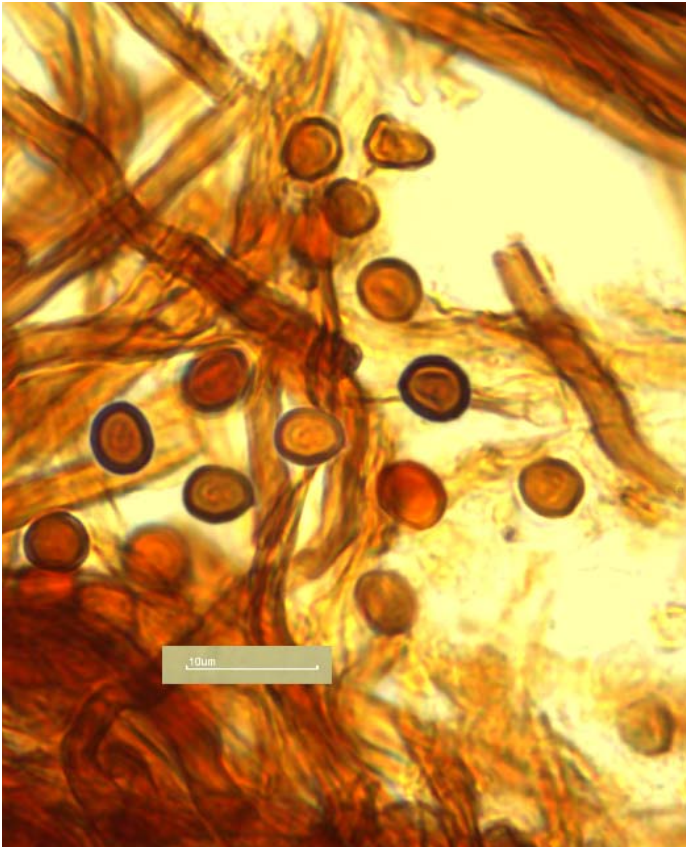

Microscopic appearance of our two species, *Phellinus chrysoloma* on the left and *P. abietis* on the right. Spores above and setae below. Note the bigger and more elliptical spores of *P. abietis*. The differences are not huge. We did not see any significant difference in the sharpness of the setae.

course of microphotography. The results agreed. The mathematical average Q value (length divided by width, a value which indicates the shape of the spores) was 1.1-1.2 for all 13 *P. chrysoloma* specimens, and 1.3 and 1.4 for the two specimens of *P. abietis*. We did not appreciate any difference in the sharpness of the setae.

Both the *P. abietis* collections come from Terra Nova National Park, an area of old growth spruce. Mature caps of *P. chrysoloma* tend to project straight out from the tree with the tip bent downwards. The two *P. abietis* caps were reflexed for almost the full length of the resupinate part of the conk, forming a dome over the hymenium.

The next time you collect in an old growth spruce forest and find a reflexed *Phellinus* with a sharp edge, you might check the spore shape. If the Q measures 1.3-1.4 you likely have the old new species, *P. abietis*. If the Q is less, your find is likely *P. chrysoloma*. And if you are in charge of a fungarium, you might want to spend a rainy Sunday measuring spore size of your *Phellinus chrysoloma* collections.

References

1. Karsten PA: Rysslands, Finlands och den Skandinaviska Halföens Hattsvampar. Bidrag till Kännnd Finlands Land och Folk 37:1-257. 1882.
2. Fries E: Hymenomyces novi vel minus cogniti in Suecia 1852-1860 observati. Öfers. Kung. Vetensk. Akad. Forhand. 18:19-34. 1861.

Book review

Robin McGrath

LAWRENCE MILLMAN

GIANT POLYPORES & STONED REINDEER RAMBLES IN KINGDOM FUNGI

Paperback
159 pp.
Komatik Press
Cambridge MA
2013

Available only by order from the author. Download order form from <www.lawrencemillman.com>

Send money order or cheque drawn on a US bank for \$20.00 US to

Lawrence Millman,
P.O. Box 381582
Cambridge, MA 02238
USA
l.millman@comcast.net

Lawrence Millman, author of **GIANT POLYPORES AND STONED REINDEER: RAMBLES IN THE KINGDOM FUNGI**, and a collector of aboriginal stories, has raised the ire of anthropologists, who dislike his tendency toward “readability rather than word for word accuracy.” They feel he plays fast and loose with some important cultural material, but then he also catches the scatological and trickster flavour of many of the stories he finds. Millman self-identifies as a mycologist, author, explorer and ethnographer. I am only beginning to be interested in mushrooms I cannot eat, so this review will limit itself primarily to the readability rather than the accuracy of his essays.

GIANT POLYPORES consists of 25 short pieces about “odd, obscure or rare species” of fungi that Millman has encountered in his travels. Three pieces are parodies (Sherlock Holmes, Dr. Faust and a modern-day Edmund Hillary as mycologists), while the rest are stories or essays, focusing on hunts or finds. More seasoned mycophiles may find the parodies funnier than I did, however I was

quite taken with a number of the essays.

All Millman’s pieces relate to fungi in some way, but under that rubric he also covers subjects as disparate as Antarctic exploration,

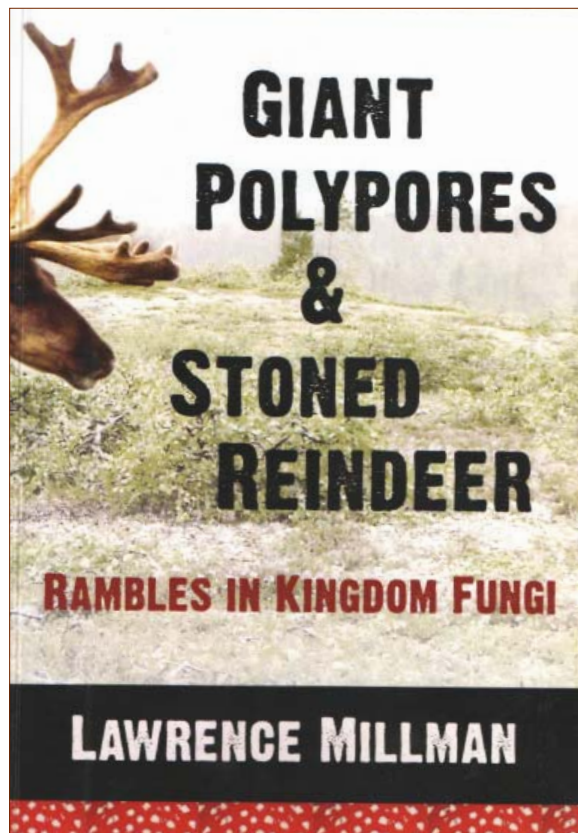

corruption in Honduras, the Tasmanian platypus, cheese and cannibalism. I was intrigued by notes he made while stoned on *Amanita muscaria*. Even I know that eating fly agaric is not really a

good idea. Millman clearly doesn’t like the trend among mycologists “to regard DNA sequencing as the pinnacle of their trade,” and is not fond of authority figures, but he makes mushrooming sound like a great adventure, an exclusive club with an exotic language.

Although I enjoyed the essays I have reservations about some of the work. After finding a crust fungus not previously known to exist in East Greenland, Millman assumes the sod-house in which it is growing is an ancient site. Learning it is a replica, he claims “a replica turf hut is no different from a genuine one.” I can think of a hundred ways replicas differ from the real thing, which is why no one gives grants to replica projects anymore.

Whether Millman’s work is of interest to mycologists will depend upon how reliable they find his mycological work, but it allows neophyte mushroomers such as

myself to dip a toe into the sea of knowledge that lies in wait for us. Most of the stories are accessible to the general reader, although a minimal mycological background helps to fully enjoy them.

Available only by order from the author. Download order form from <www.lawrencemillman.com> Send money order or cheque drawn on a US bank for \$20.00 US to

Lawrence Millman,
P.O. Box 381582
Cambridge, MA 02238
USA
l.millman@comcast.net

Book review

Zoe Brake

Paperback
159 pp.
Komatik Press
Cambridge MA
2013

LAWRENCE MILLMAN

GIANT POLYPORES & STONED REINDEER RAMBLES IN KINGDOM FUNGI

Never judge a book by its back cover!

“Millman’s a genius.”

So proclaims a quote strategically chosen for the back cover of Lawrence Millman’s **GIANT POLYPORES AND STONED REINDEER: RAMBLES IN THE KINGDOM FUNGI**. Usually such self-promotion would be enough for me to avoid an author. However, because I found the book at a friend’s place, I was curious and borrowed it.

A few pages into the book I found myself warming to my guide for whom the excitement of the hunt is the *raison d’être* to forage into forests, meander across meadows, wade into wetlands and squint into sands and soils ... all in search of the next new-to-me-or-you fungus.

Many of the stories have been published before, and these stories could certainly add spice to lighter publications, or lighten ponderous ones with their levity. Most stories told themselves well, although some might have fared better with

a bit less author intrusion. A small quibble is a wish that stories of a more even standard had been selected from his available stock for inclusion in this collection.

irreverent, or not, such as Stalinist-era repeat-imbibers of *A. muscaria* pushed out cargo doors of airborne planes ... to really fly high! Would you believe that mushrooms grow in Antarctica? Or that one Sami reindeer in Lapland can pull a sled faster than a five-dog team over ten-miles? Or ... but you will have to read the book to get all the stories.

Along the way, almost imperceptibly, Mr. Millman divulges interesting information about the fungi starring in his stories, along with lots of local colour. I particularly enjoyed the stories because I realized that I did not have to memorize spore sizes, gill attachments or other technical data, as this was not a textbook—it was an armchair adventure with a pleasant, *joie-de-vivre*-friendly hunter-gatherer.

Genius? Not truly. But his writing entertains, amuses and pleases—a valued commodity on a cold winter’s night in January in Newfoundland and Labrador.

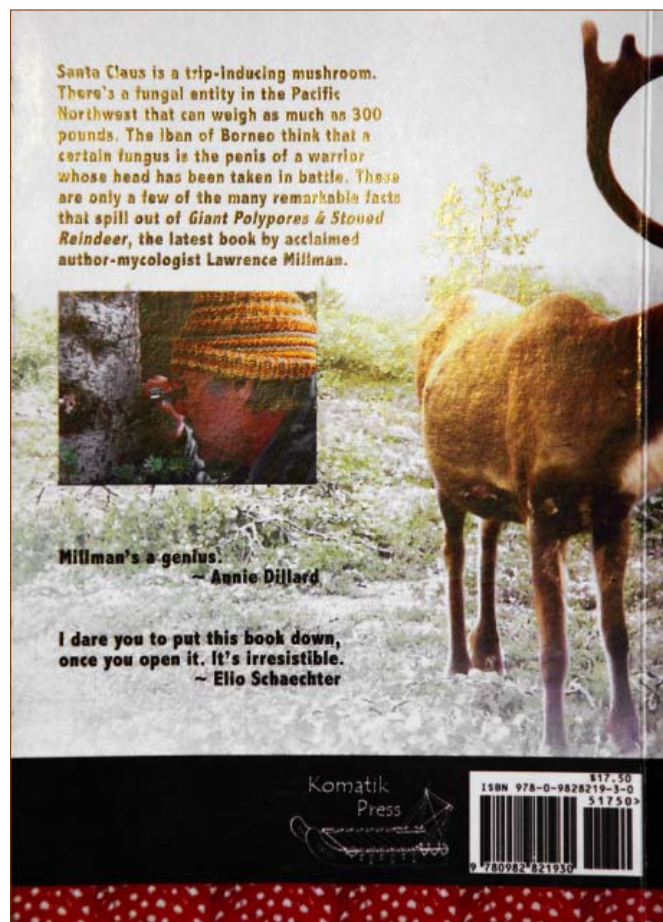

Mr. Millman takes the reader on many adventures in many locales, each with newfound friends, with enthusiasm and lightheartedness. He also imparts facts, irrelevant or

Gene Herzberg

MORE
on
MITRULA



In response to the request for additional *Mitrula* sightings ([OMPHALINA 4\(11\):16](#)) I attach pictures of *Mitrula elegans* taken below the Francophone Association on Ridge Road in St. John's on June 9, 2011 (photos, this page). I took samples to Faye Murrin who identified the species microscopically by spore size and shape, using the same Redhead reference cited in the article.

We also saw a *Mitrula* species on the Ochre Hill Trail in Terra Nova Park on the wildflower trip on August 3, 2011 (photo, next page).

Ed comment:

It is very gratifying to get a response to an appeal in an article. Also rewarding, because the second sighting immediately doubled the number of known species in Newfoundland and Labrador. August 3 is well outside the fruiting times of *M. elegans* and *M. lunulatospora*, and into the fruiting time of *M. borealis*. In the review, fruiting time turned out to be the most reliable indicator of species, so there should be little doubt that the species on the next page is *Mitrula borealis*. This is also the species most often reported to grow on submerged conifer duff, and the photo shows what appear to be needles and an end branch of balsam fir, supporting the identification made by fruiting time.



POISON CONTROL NOTES — DOG POISONINGS

. Andrus Voitk

Have you followed the annual North American Mycological Association's toxicology reports? If not, you may want to download the report for 2012 at <http://www.namyco.org/publications/mcillvainea/V22/toxicology_committee_report_2012.html>, published in *McIlvainea*, NAMA's technical journal, available free to the public. Accounts of poisoning to pets has become more prominent in these reports over the years. In 2012 there were 26 reported instances of dogs poisoned from eating mushrooms, ensuing in 11 deaths—a 42% mortality.

This account is prompted by two such e-mails coming to me within one week.

Dog 1

I am an overnight clinician at the Atlantic Veterinary College, where I saw an 8 month old Golden Retriever, female intact, who ate a mushroom from her owner's backyard this afternoon. She had loss of balance and seemed disoriented, restless and had muscle tremors at rest. She was given IV fluids and anti-emetics and she is improving. She remains bright and alert without other problems. The owner sent me a picture of the mushroom she ingested this afternoon (she just ate a small part of it) and I wonder if it is possible to identify it. The signs became apparent 4-5 hours after ingestion: only neurological signs and no vomiting or diarrhea. I got your number from the NAMA website, suggested to me by the animal poison control. Thank you for your help. EG-L, PEI

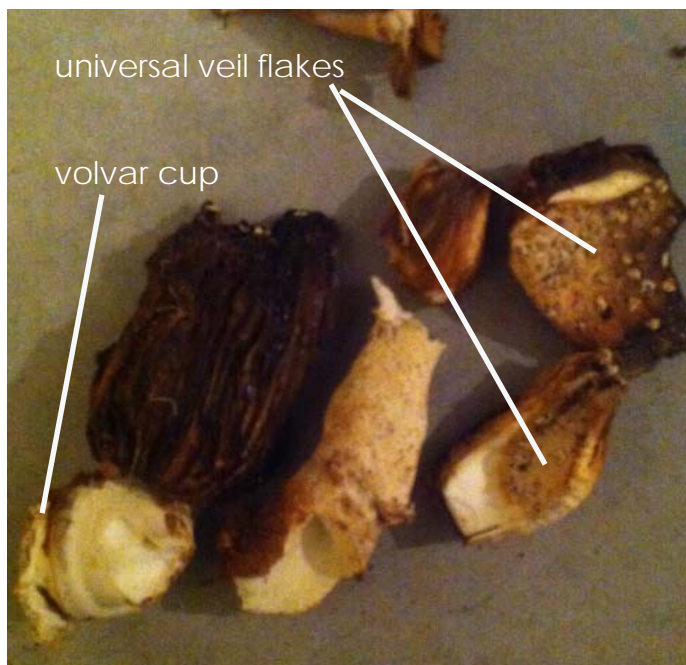

My experience with dog mushroom poisoning is zero. The picture of chewed bits retrieved from the garbage is predictably poor. Let's try to do the best we can with what we have. Two pieces of mushroom cap look to have flakes of residual universal veil on them, characteristic of several Amanita species. One piece of stem (possibly the lowest end) seems to have a volva or cup, again compatible with an Amanita species. Both findings are compatible with Amanita muscaria. The gill colouring does not fit, but perhaps it may be ignored as effect of being chewed, or any other environmental cause. The neurotoxin-like effects are compatible with Amanita muscaria poisoning.

That's as far as I can go, I'm afraid. If this is A. muscaria, the dog will likely survive, no worse for the experience, once it is over. If it is an Amanita with lethal amatoxin, the problems have only begun, and by this time survival is probably unlikely. Liver necrosis and organ failure take time to manifest clinically. However, amatoxins are usually heralded by initial gastrointestinal toxicity, so that the clinical picture would suggest reason for cautious optimism. I hope this helps a bit. av

Thank you very much for your help! The picture was taken by the owner after the mushroom was taken out of the garbage. 24 hrs after ingestion the dog is improving. She only ingested a small part of one mushroom and had no gastrointestinal signs, only neurological. Thank you again, EG-L

Great! av

The dog went home the next day, her symptoms almost completely resolved. EG-L

Dog 2

This morning my 20 pound King Charles Spaniel ate 1/2 of a mushroom head in the backyard. Can you please help me with this so I know whether or not he needs to see his vet. Thank you very much!

JT, Ontario

This looks like *Leucoagaricus americanus*, an edible and non-poisonous mushroom. It resembles a lethal *Amanita* in many ways, but my guess is that your dog is fine. It should grow on woody debris and stain yellow when rubbed, and red on injury. If that's so, you can relax.

Thank you! I appreciate your time. Dog Fine.

JT, Ontario

Ed notes: Sometimes even poor pictures have some clues. You do the best you can with what you have. And sometimes you get good pictures with many useful characters illustrated. This gives us an opportunity to introduce *Leucoagaricus americanus*.



Leucoagaricus americanus

is an uncommon, large, fleshy, white-spored mushroom with free gills and a ring that disappears in age. The cap has concentric rings of scales, much like *Chlorophyllum rhacodes* or the small and lethal *Lepiota cristata*, both of which it resembles.

It grows on woody debris, often in multiple small cespitose clusters. The whitish stem

darkens with age and may split as in JT's upper picture. The picture also shows the red staining (gills of second mushrooms from the right), a feature it shares with *Chlorophyllum rhacodes*. Also like the latter, it is a good edible. However, note that white spores, flakes on the cap, free gills and a ring are also characters of lethal *Amanita* species, so unless you know this is neither *Amanita* nor *Lepiota*, forego the meal!

THE MAIL BAG

OR WHY THE PASSENGER PIGEONS ASSIGNED TO SERVE THE LAVISH CORPORATE AND EDITORIAL OFFICES OF OMPHALINA GET HERNIAS



Happy new year!

Thought you'd be interested: I found *Fomitopsis ochracea* in both Alaska and the PNW—I tired the match test and it worked—the *F. pinicola* melted and *F. ochracea* gave off black smoke. I also found some *F. ochracea* while going through my *F. pinicola* slide collection, and that of Kit Skates Barnhart. Here is a beautiful picture of *F. ochracea* by Kit from the Pacific Northwest, which at the time we thought was *F. pinicola*.

Michael Beug

Since writing our Report on lichenized ascomycetes found at the 2013 Foray [OMPHALINA 4(10):50], John McCarthy was good enough to tell us that a more updated version of the unpublished checklist of NL lichens by Ahti, Clayden and McCarthy, not available to us at the time, revealed some changes. According to current information, the following finds are new to the province: *Diplotomma nivalis*, *Menegazzia terebrata*, *Polysporina simplex*, *Rhizocarpon hochstetteri*, *Rinodina tephrae*, *Xanthoparmelia hypofusca* and *X. viriduloumbrina*. The following provisionally identified species are also new, if further work confirms our provisional identifications: *Caloplaca arenaria* and *Sarcosagium campestre*.

Chris Deduke
Michele Piercey-Normore

The stuff on the caribou lichens was great. I had no idea there were so many kinds. I'll be paying much closer attention to them once the snow is gone.

Robin McGrath

Thank you for the wonderful most recent issue of OMPHALINA The guide to the reindeer lichens is outstanding and will get much use by us.

Gene Herzberg

I like the way you often introduce the interdependence of other beings and fungi. The focus on caribou to talk about reindeer lichens is a good example. It helps us see the role of these lichens as food for caribou, possibly its only food in the winter. I noticed caramelized reindeer moss used to add "local" flavour to menus in Fogo. Is this really necessary? Most of these lichens do not provide food value or significant flavour for us, and are just an affectation on the plate.

The Fogo caribou herd depends on lichens to survive. When you collect lichens, you are competing with the caribou. In the case of lichens you are removing entire organisms, not just fruiting bodies, as is the case with mushrooms. As your article explained, many are very slow to regenerate. Do we need this? Can we justify it?

JMW

OUR PARTNER ORGANIZATIONS

PEOPLE OF NEWFOUNDLAND AND LABRADOR, THROUGH
DEPARTMENT OF ENVIRONMENT AND CONSERVATION
PARKS AND NATURAL AREAS DIVISION
WILDLIFE DIVISION
DEPARTMENT OF NATURAL RESOURCES
CENTER FOR FOREST SCIENCE AND INNOVATION

PEOPLE OF CANADA, THROUGH
PARKS CANADA
TERRA NOVA NATIONAL PARK
GROS MORNE NATIONAL PARK

MODEL FOREST OF NEWFOUNDLAND AND LABRADOR
MEMORIAL UNIVERSITY OF NEWFOUNDLAND
ST. JOHN'S CAMPUS
GRENFELL CAMPUS

TUCKAMORE LODGE

QUIDI VIDI BREWING COMPANY

RODRIGUES WINERY

SHOREFAST FOUNDATION



FORAY

NEWFOUNDLAND AND LABRADOR

2014 2014 2014
2014 2014
2014 2014 2014
2014 2014
2014 2014 2014
2014 2014 2014

The second Decade

GROS MORNE NATIONAL PARK

A UNESCO WORLD HERITAGE SITE

Headquarters: *Killdevil Camp, Lomond, NL*

September 12-14, 2014

*Get to know our
MUSHROOMS
& LICHENS!*

GUEST FACULTY*

Joe Ammirati
Jeremy Hayward
Renée Lebeuf
Michele Piercey-Normore
André Paul
Scott Redhead
Roger Smith
Greg Thorn
Jukka Vauras

*tentative at the time of
publication

*Look on our website in
the spring of 2014 for
Registration Forms
& Information:*

www.nlmushrooms.ca