

## **CAN-bus Interface**

### **Steering wheel control**

#### **Interface-box**

#### **CX-401**

#### **Harnesses vehicle-specific**

#### **CX-0xx**

#### **Harnesses device-specific (optional)**

#### **ARC-1xx**

#### **Product features**

- Conversion of digital CAN-bus signals into analogue signals  
ACC, speed, lights, reverse gear, park distance control (optional cable CX-LS necessary)
- Adaptation of vehicle-specific radio ports to female ISO-connectors  
(for some vehicles only a universal harness with open ends available)
- Support/Starting of factory sound systems  
(not at all vehicles)
- Steering wheel control for after-market devices (optional)  
Alpine, Blaupunkt, Clarion, Digitaldynamic, JVC, Kenwood, Pioneer, Zenec
- With USB update-port for software-updates by consumer

## Contents

### 1. Prior to installation

- 1.1. Delivery contents
- 1.2. Check compatibility of vehicle
- 1.3. Setting the dip switches

### 2. Installation

- 2.1. Assignment of the 12pin Molex on CX-401
- 2.2. CX-401 LED functions
- 2.3. Connection example
- 2.4. Installation with vehicle-specific harness CX-0xx
- 2.5. Installation with universal harness CX-010
- 2.6. Installation acoustic signal of park distance control with CX-PI200(till SW 1.1.2)
- 2.7. Installation acoustic signal of park distance control with CX-LS (from SW 1.1.3)
- 2.8. Steering wheel functions
- 2.9. Onboard computer control Citroen and Peugeot for after-market radios

### 3. Vehicle-specific assignments CAN-bus

### 4. Specifications

### 5. Technical support

## Information

Changes/updates of the vehicle's software can cause malfunctions of the interface. We offer free software-updates for our interfaces for one year after purchase. To receive a free update, the interface must be sent in at own cost. Labor cost for and other expenses involved with the software-updates will not be refunded.

## 1. Prior to installation

Read the manual prior to installation. Technical knowledge is necessary for installation. The place of installation must be free of moisture and away from heat sources.

### 1.1. Delivery contents

*Take down the SW-version and HW-version of the CAN-box, and store this manual for support purposes.*

CAN-box  
CX-401  
HW \_\_\_\_\_  
SW \_\_\_\_\_



There is always a universal or vehicle-specific cable set CX-0xx needed.



Harness for steering wheel control (optional)  
ARC-1xx



### 1.2. Check compatibility of vehicle

The CX-401 provides depending on the vehicle ignition (I), speed signal (S), reverse gear (R), lighting (L), acoustic signal of park distance control (PDC) as an analogue signal, it powers up an existing factory sound-system (SS), allows the using of on-board computer system control (OCS) and supports the control of after market devices by steering wheel (SWC).

The link to the table shows which harness CX-0xx can be used for which vehicles and which functions of the CX-401 will be supported for this vehicle.



[http://www.caraudio-systems.de/can\\_bus\\_compatibility.pdf](http://www.caraudio-systems.de/can_bus_compatibility.pdf)

## 1.3. Setting the dip switches

To use the steering wheel control is dependent on the manufacturer of the after-market device a device-specific IR control cable ARC-1xx needed. The dip switches of the CAN-box CX-401 have to be set on the manufacturer/ port.



The following table shows the IR control cable and the dip switch settings for the supported manufacturers.

Harness	Description	Dip1	Dip2	Dip3
ARC-103	Control cable set for Blaupunkt (Mini-ISO connection)	on	off	off
ARC-104	Control cable set for Alpine	off	off	off
	Control cable set for Clarion	on	on	off
	Control cable set for JVC (Mini-Jack connection)	on	off	on
ARC-105	Control cable set for Kenwood (open wire)	on	on	on
	Control cable set for JVC (open wire)	on	off	on
ARC-106	Control cable set for Kenwood (DIN-connection)	on	on	on
ARC-107	Control cable set for Pioneer	off	on	on
	Blaupunkt (Mini-Jack connection)	off	on	off
ARC-108	Control cable set for Zenec and Digitaldynamic	off	off	on

## 2. Installation

**Switch off ignition and disconnect the vehicle's battery! If according to factory rules disconnecting the battery has to be avoided, it is usually sufficient to put the vehicle in sleep-mode. In case the sleep-mode does not show success, disconnect the battery with a resistor lead.**

Place of installation of the CX-401 is usually in the radio slot on the vehicle's radio port.

## 2.1. Assignment of the 12-pin Molex on CX-401

Cable colour	Assignment
Pin 1 ● pink	+12V ACC (Output) max.1.5A
Pin 2 ● blue	CAN-LOW (Input)
Pin 3 ● yellow/green (● yellow/red)	Speed signal (Output)
Pin 5 ● red	+ signal PDC (harness CX-LS)
Pin 6 ● red	+12V Permanent (Input)
Pin 7 ● orange	Lights (Output) max. 0.1A
Pin 8 ● yellow	CAN-HIGH (Input)
Pin 9 ● white	Reverse gear (Output) max. 1.5A
Pin 11 ● black	Ground signal PDC (harness CX-LS)
Pin 12 ● black	Ground

## 2.2. CX-401 LED functions

LED	Status	Funktion
● Red	Lights	Ignition is ON
● Blue	Flashes	CAN Bus is searched
● Blue	Lights	CAN Bus found

## 2.3. Connection example

Example of vehicle-specific harness CX-025 and IR control cable ARC-102 to a Blaupunkt head-unit.

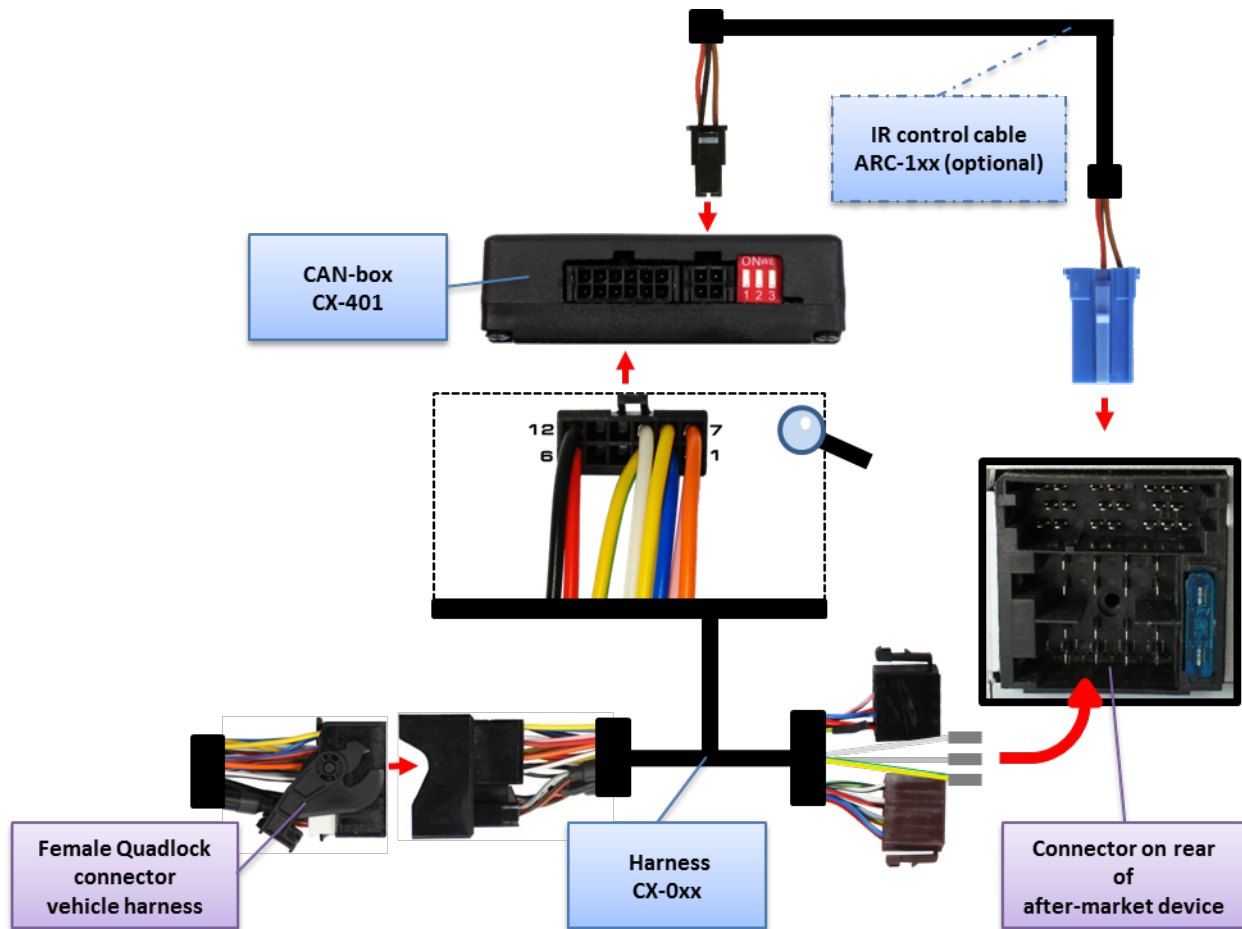

## 2.4. Installation with vehicle-specific harness CX-0xx

- a.) Persistent current, Ground, ACC signal (Z) and lights signal (L) are pinned in the female ISO-connector of the CX-0xx. If supported by the CX-401 connect speed signal (S) and reverse gear signal (R) to the corresponding pins of the after-market device.
- b.) Depending on equipment/vehicle the grey cable is occupied with the analogue phone mute signal. Connect to the corresponding pins of the after-market device.
- c.) Connect vehicle's female radio connector(s) to the corresponding male connector(s) of harness CX-0xx.
- d.) Connect harness CX-0xx to CAN-Box CX-401 via 12pin Molex.
- e.) Connect female ISO-connectors of harness CX-0xx to the ISO-connector of the after-market device.
- f.) Optional: Connect IR-control input of the after-market device to the 4pin Molex IR-control output of CAN-box CX-401 via the optional control cable ARC-1xx.

**Note for CX-035 (Ford):** ACC and illumination are not digital but analogue signals on some vehicles. In this case connect ACC (Quadlock, chamber A, pin 16; pink wire) and illumination (Quadlock, chamber A, pin 13; orange wire) between female 12pin MicroFit connector and female ISO connectors, using the plugs of the harness.

## 2.5. Installation with universal harness CX-010

- a.) Connect universal harness CX-010 according to **assignment of 12pin Molex on CX-401** to harness of the after-market device and to vehicle harness.
- b.) Optional: Connect IR-control input of the after-market device to the 4pin Molex IR-control output of CAN-box CX-401 via the optional control cable ARC-1xx.

## 2.6. Installation acoustic signal of park distance control with CX-PI200 (till SW 1.1.2)

- a.) Connect the black and red cable of the CX-PI200 (Piezo LSP to CX-028/CX-030/CX-033/CX-010) into the correlative pins of the female 12pin Molex connector of harness CX-0xx:



CX-PI200

(-) black cable - pin 11

(+) red cable - pin 5

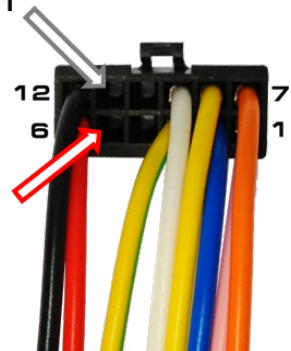

## 2.7. Installation acoustic signal of park distance control with CX-LS (from SW 1.1.3)

- b.) Connect the black and red cable of the CX-LS (LSP to CX-028/CX-030/CX-033/CX-010) into the correlative pins of the female 12pin Molex connector of harness CX-0xx:



CX-LS

(-) black cable - pin 11

(+) red cable - pin 5

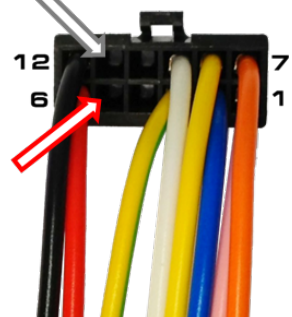



## 2.8. Steering wheel functions

Button	Function	Vehicle / radio support
<b>VOLUME + / -</b>	Volume up / volume down	All vehicle brands , all radio brands
<b>TRACK + / -</b>	Next track / radio station, previous track / radio station	All vehicle brands , all radio brands
<b>SOURCE</b>	Source switching	Compatible vehicle brands, all radio brands
<b>MUTE</b>	Mute ON/OFF	Compatible vehicle brands, all radio brands
<b>PICK UP PHONE / HANG UP PHONE</b>	Answer call / end call	Compatible vehicle brands, all radio brands
<b>PHONE</b>	Answer call <u>OR</u> end call	Compatible vehicle brands, all radio brands
<b>VOICE CONTROL</b>	Activation of voice control	Compatible vehicle brands, compatible radio brands

## 2.9. Onboard computer control Citroen and Peugeot for after-market radios

To control the onboard computer in Citroen and Peugeot vehicles the following functions can be selected by steering-wheel buttons:

<b>Select Menu</b>	long pressing "Source" (4s)
<b>ESC</b>	short pressing "Source"
<b>OK</b>	Vol+
<b>Menu up</b>	Wheel up
<b>Menu down</b>	Wheel down
<b>Menu Right</b>	Track+
<b>Menu Left</b>	Track-
<b>Mode</b>	long pressing "Tr+" (4s)
<b>Dark</b>	long pressing "Tr-" (4s)

Assignment of the steering-wheel buttons:

<b>Tr+</b>	pick up phone
<b>Tr-</b>	hang up phone
<b>Wheel up</b>	Tr+
<b>Wheel down</b>	Tr-

The assignments of the remaining steering-wheel buttons are identical to the label!

### 3. Vehicle-specific assignments - CAN-bus

As additional support the following pages give information about some vehicle-specific CAN-bus pin definitions. This **information** is **subject to change** and must be verified by the installer.

#### ALFA ROMEO

##### 147

Female 8-Pin ISO connector in radio slot  
 CAN High – Pin 1  
 CAN Low – Pin 3

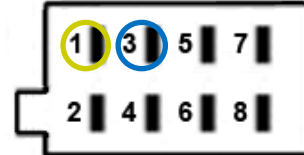

#### AUDI

##### A2, A3, A4, A6 till 01/05

Female Mini-ISO connector in radio slot  
 CAN High – Pin 7  
 CAN Low – Pin 12

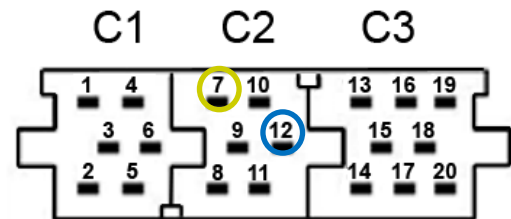

#### BMW

##### 1series E81, 3series E90, 5series E60

Female Quadlock-connector in radio slot  
 CAN High – Pin 11  
 CAN Low – Pin 9

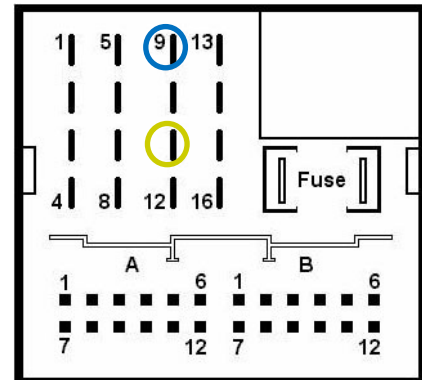

## Chrysler

Chrysler cars with female 22pin connector in radio slot  
 CAN High – Pin 10  
 CAN Low – Pin 13

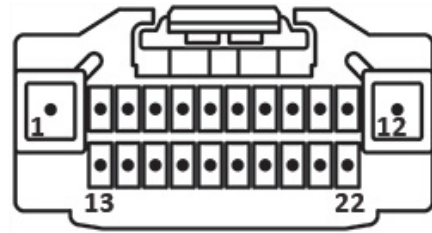

Chrysler cars with female 52pin connector in radio slot  
 CAN High – Pin 2  
 CAN Low – Pin 12

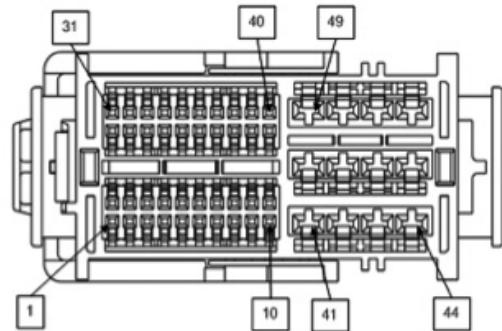

## CITROËN

**C4, C5** from 10/04  
 Female Quadlock-connector in radio slot  
 CAN High – Pin 10  
 CAN Low – Pin 13

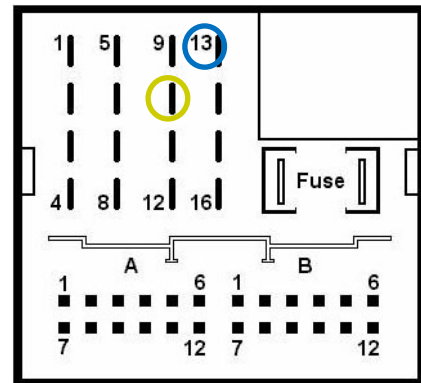

**Jumper II**  
 Female 52pin connector in radio slot  
 CAN High – Pin 2  
 CAN Low – Pin 12

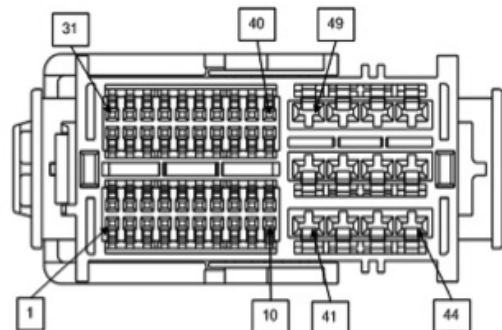

## Dodge

Dodge cars with female 22pin connector in radio slot

CAN High – Pin 10

CAN Low – Pin 13

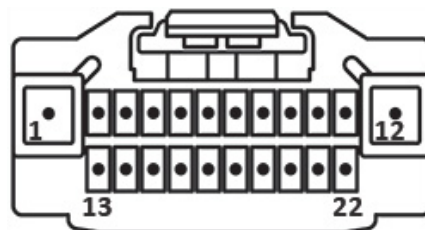

Dodge cars with female 52pin connector in radio slot

CAN High – Pin 2

CAN Low – Pin 12

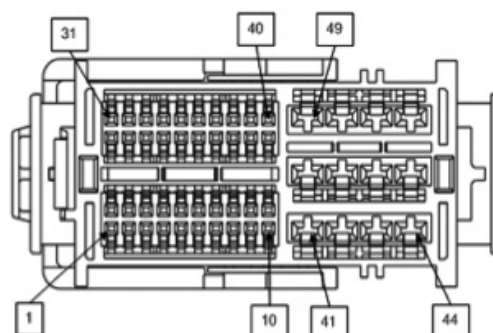

## FIAT

### Stilo, 500

Female 8pin ISO connector in radio slot

CAN High – Pin 1

CAN Low – Pin 3

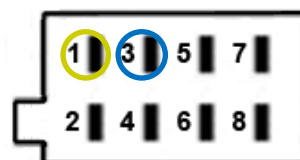

### Ducato as of 2013

Female 52pin connector in radio slot

CAN High – Pin 2

CAN Low – Pin 12

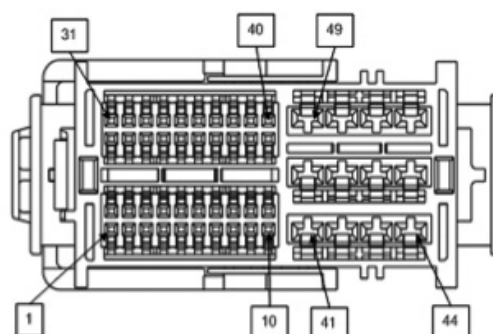

## FORD

**Focus, Focus C-MAX, S-MAX, Mondeo**  
 Female Quadlock connector in radio slot  
 CAN High – Pin 9  
 CAN Low – Pin 10

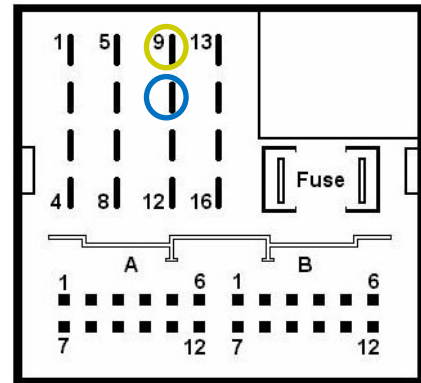

## Honda

**Accord (8G), CR-Z, Jazz (2G)**  
 Female 20pin connector in radio slot  
 CAN High – Pin 13  
 CAN Low – Pin 3

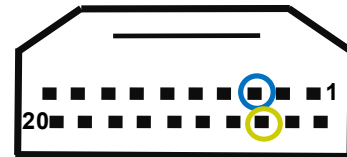

## JEEP/CHRYSLER

**Grand Cherokee, 300C**  
 Female 22-pin connector in radio slot  
 CAN High – Pin 5 (white / red)  
 CAN Low – Pin 6 (white)

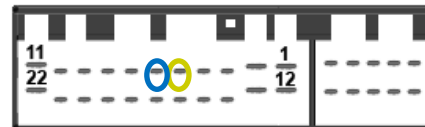

## LANCIA

**Ypsilon from 11/03**  
 Female 8-pin ISO connector in radio slot  
 CAN High – Pin 1  
 CAN Low – Pin 3

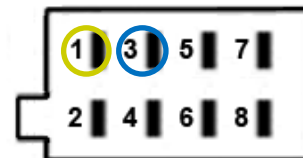

## MERCEDES BENZ

**CLK W208** after facelift, **CLK W209** till 03/04,  
**E-Class W210** from 09/99, **Viano**, **SL W230** from 07/04

Female 10pin ISO-connector in radio slot

CAN High – Pin 1

CAN Low – Pin 2

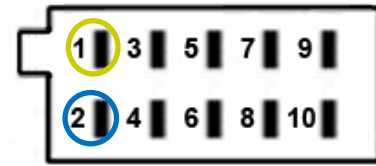

**A-Class W169** and **B-Class W245** with Audio5,

all MERCEDES with indoor CAN-bus

Female 8pin ISO connector in radio slot

CAN High – Pin 6

CAN Low – Pin 7

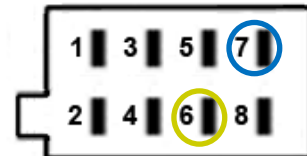

**A-Class W169** and **B-Class W245** with Audio20,

**C-Class W203** and **CLK W209** from 04/04,

**Viano W693**

Female Quadlock-connector in radio slot

CAN High – Pin 11

CAN Low – Pin 9

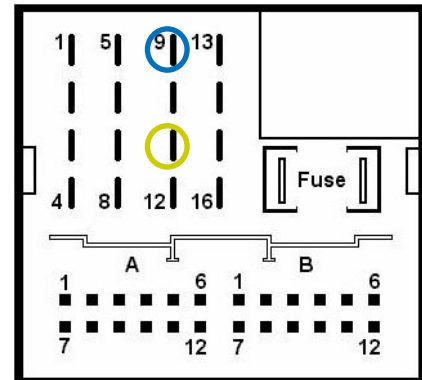

**E-Class W211** from 04/03, **CLS W219**, **SLK R171**

Female Quadlock-connector in radio slot

CAN High – Pin 1 (Kammer A)

CAN Low – Pin 2 (Kammer A)

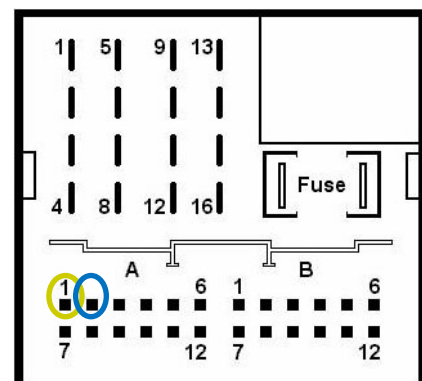

## MERCEDES BENZ

**Sprinter W907/W910** from 12/07  
 Female 26pin connector in radio slot  
 CAN High – Pin 7  
 CAN Low – Pin 20

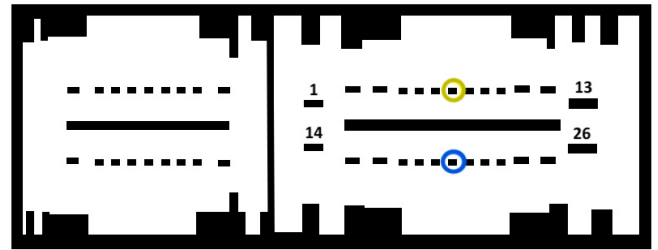

## OPEL

**Vectra C** till 07/04  
 Female Mini-ISO connector in radio slot  
 CAN High – Pin 7  
 CAN Low – Pin 10

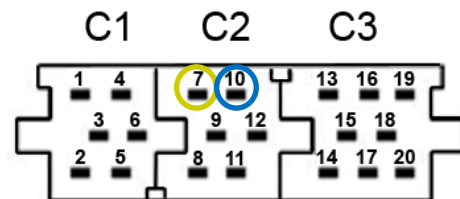

**Astra H , Corsa C, Meriva, Tigra Twin Top, Vectra C** from 08/04  
 Female Quadlock-connector in radio slot  
 CAN High – Pin 9  
 CAN Low – Pin 10

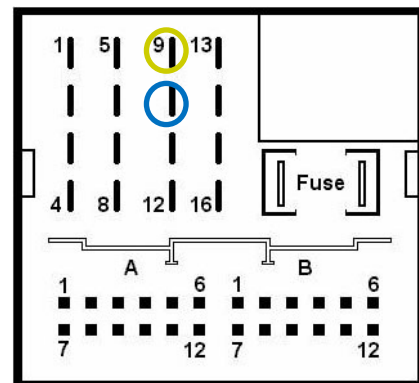

## PEUGEOT

**307, 407**  
 Female Quadlock-connector in radio slot  
 CAN High – Pin 10  
 CAN Low – Pin 13

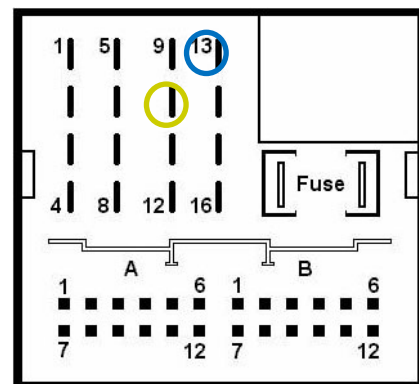

## PORSCHE

### Cayenne (9PA), Boxster (987), 911 (997)

Female Mini-ISO connector in radio slot

CAN High – Pin 1

CAN Low – Pin 2

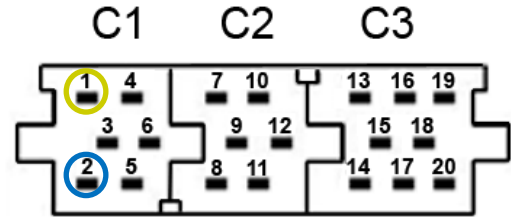

### Cayenne (92A), Panamera (970)

Female Quadlock-connector in radio slot

CAN High – Pin 11

CAN Low – Pin 9

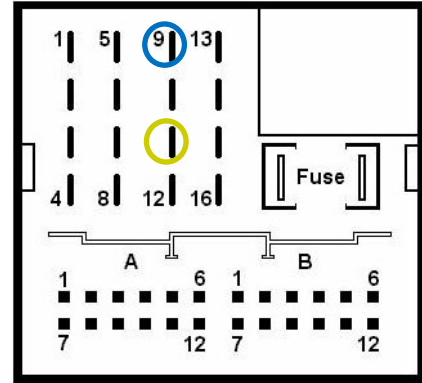

## SEAT

### Altea

Female Quadlock-connector in radio slot

CAN High – Pin 9

CAN Low – Pin 10

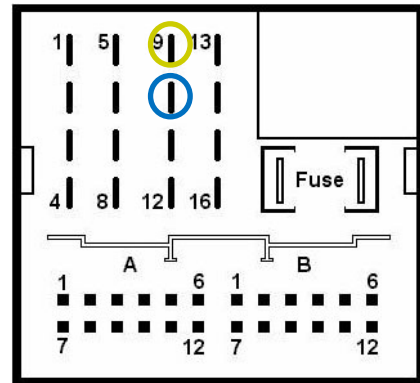

### Leon III

Female Quadlock-connector in radio slot

CAN High – Pin 6

CAN Low – Pin 12

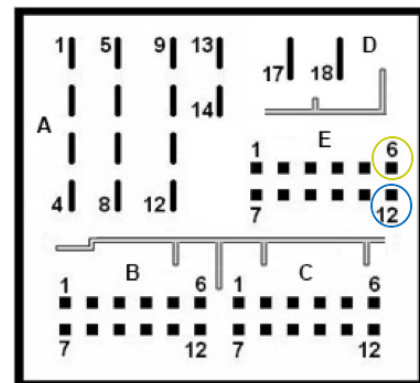



## ŠKODA

### Superb, Octavia I

Female Mini-ISO connector in radio slot

CAN High – Pin 8

CAN Low – Pin 9

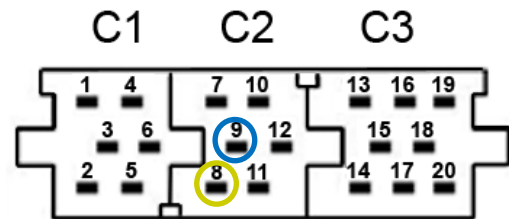

### Octavia II

Female Quadlock-connector in radio slot

CAN High – Pin 9

CAN Low – Pin 10

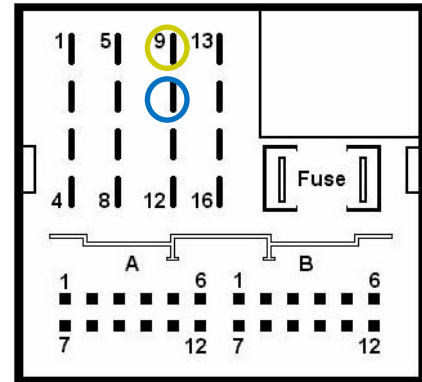

### Fabia III

Female Quadlock-connector in radio slot

CAN High – Pin 6

CAN Low – Pin 12

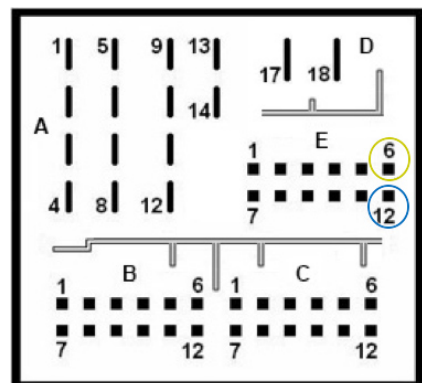

## VOLKSWAGEN

### Golf 4, Golf 5, Passat 3B, Caddy, Touran, Touareg, T5

Female Quadlock-connector in radio slot

CAN High – Pin 9

CAN Low – Pin 10

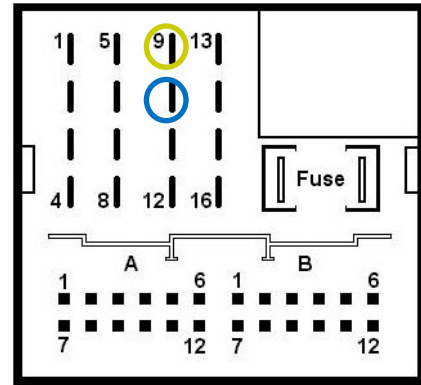

### Golf 7

Female Quadlock-connector in radio slot

CAN High – Pin 6

CAN Low – Pin 12

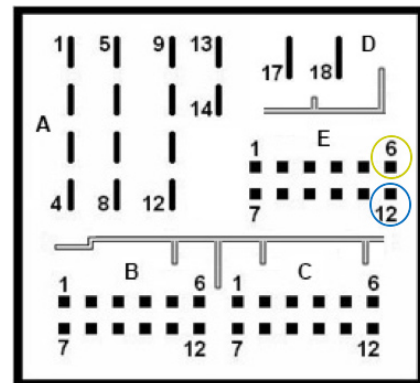

## VOLVO

### S60, V70

Female 12pin connector in radio slot

CAN High – Pin 7 (white)

CAN Low – Pin 8 (green)

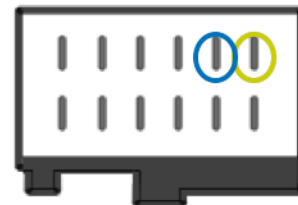

### XC90

Female 10-Pin connector in radio slot

CAN High – white cable (double occupied)

CAN Low – green cable (double occupied)



## 4. Specifications

Operation voltage	10.5 – 14.8V
Stand-by power drain	<1mA
Operation power drain	~50mA
Power consumption	0.07-40W
Temperature range	-30°C till +80°C
Weight	38g
Measurements (box only) W x H x D	71 x 22 x 50 mm

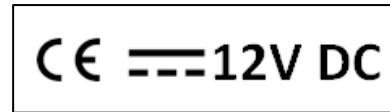

### Capacitance

ACC	max. 1.5A
Reverse Gear	max. 1.5A
Lights	max. 0.1A

## 5. Technical Support

**Caraudio-Systems Vertriebs GmbH**  
***manufacturer/distribution***  
In den Fuchslöchern 3  
D-67240 Bobenheim-Roxheim

email [support@caraudio-systems.de](mailto:support@caraudio-systems.de)

**Legal disclaimer:** Mentioned company and trademarks, as well as product names/codes are registered trademarks ® of their corresponding legal owners.