

**POLICE. FIRE. WATER.  
CAVE. MOUNTAIN.  
FLOOD. COASTGUARD.  
BOATING. OFFSHORE.  
AIR AMBULANCE.**

**Rescue Apparel & Equipment**

 **Designed & developed in the UK**

# SPECIALIST RESCUE EQUIPMENT

MANUFACTURED & SUPPLIED BY NORTHERN DIVER





Photo credit: Shoreham by sea at the Adur Centre  
Front cover photo: Lancaster search & rescue team

**Northern Diver has been established for over 40 years. We design and manufacture an exceptionally diverse range of rescue equipment.**

We are also the prime contractor to the Ministry of Defence for drysuits and diving equipment.

When it comes to rescue, over 200 organisations across the UK and overseas use our equipment – this includes over 95% of the UK's fire and rescue services.

**Need suits for an emergency or flood?**

We have a fast-response system in place to make sure everything you need is dealt with as quickly as possible. We hold a large amount of stock that's available for immediate delivery.

Bespoke drysuits are one of our main specialities. We have the ability to customise and develop equipment to meet your application and requirements.

Our brochure is also available to download or view online, as well as more information on our range of products and services.

**Visit - [www.ndiver-rescue.com](http://www.ndiver-rescue.com)**

**Find us on:**

Facebook - [northerndiveruk](https://www.facebook.com/northerndiveruk)  
Twitter - [@NorthernDiverUK](https://twitter.com/NorthernDiverUK)  
Instagram - [@ndiver\\_rescue](https://www.instagram.com/ndiver_rescue)

If you can't find what you're looking for, please contact us. If you would like to pay us a visit you are more than welcome or we can quickly travel to see you.

We are located in Appley Bridge, Lancashire - only 5mins from the M6 (J27). Manchester & Liverpool international airports are only 40 minutes away. Wigan North Western rail station is 2hrs from London Euston. We are more than happy to collect clients and return them after their visit.

Northern Diver International Ltd,  
East Quarry, Appley Lane North, Appley Bridge,  
Wigan, Lancashire, WN6 9AE, UK

**Meet the team.**



**Craig McColl**  
Sales Team Manager  
**Office**  
+44 (0) 1257 25 69 34  
**Mobile**  
+44 (0) 7854 25 20 13  
**Email**  
[craig@ndiver.com](mailto:craig@ndiver.com)



**Dan Cottrell**  
Sales Representative  
**Office**  
+44 (0) 1257 25 69 41  
**Mobile**  
+44 (0) 7961 289 728  
**Email**  
[dan@ndiver.com](mailto:dan@ndiver.com)



**Matthew Burrows**  
Sales Representative  
**Office**  
+44 (0) 1257 25 69 43  
**Mobile**  
+44 (0) 7703 298 234  
**Email**  
[matthewb@ndiver.com](mailto:matthewb@ndiver.com)

All members of the rescue department undergo water rescue training with Outreach Rescue and are qualified Swift Water Rescue Technicians.



Tanybwllch Farm,  
Bangor LL57 3HY  
+44 (0) 1248 60 15 46

## Book your demo day

We are available at your location to allow you to try and test our equipment.

## Training

We offer training days on life jacket servicing and the maintenance and repairs of suits.

## Products designed for you

Have a design in mind? We can help. We can work together to create a product that meets your teams requirements perfectly.



Photo credit: Herts Boat Rescue during Mud Training with the BAY SAR  
Morcombe Bay famous for dangerous tides, mud and quick sand

## WHAT OUR CUSTOMERS SAY ABOUT US

**“Great Equipment, Great Value and Great Service”**

**Rescue sled - “An excellent product. Lightweight, tough, easily transportable, quick to inflate”**

**“Northern Divers customer service is nothing short of amazing, I feel like a really valued customer.”**

**DS320 lightweight inflatable - “Easily transportable and deployable. It gives us great versatility in searching for casualties and transporting them and team members.”**

**Custom drysuit - “Good fit, good quality, Fantastic Price and fit for purpose. What else can be said....”**

**“Flexible warm and above all completely dry”**

**“The after sales service I received after purchasing this suit has been absolutely fantastic, I can’t praise the team enough - prompt and professional!”**

<b>06</b>	<b>Off the shelf, stock rescue suits</b>
<b>20</b>	<b>Suit repairs and alterations</b>
<b>22</b>	<b>Suit accessories and suit size guide</b>
<b>24</b>	<b>Made to measure bespoke suits</b>
<b>37</b>	<b>Thermal and heated garments</b>
<b>44</b>	<b>Search and rescue wetsuits</b>
<b>48</b>	<b>PFD’s and accessories</b>
<b>54</b>	<b>Life jackets and accessories</b>
<b>58</b>	<b>OTS communications</b>
<b>60</b>	<b>Helmets and hoods</b>
<b>65</b>	<b>Technical gloves</b>
<b>70</b>	<b>Water rescue boots</b>
<b>72</b>	<b>Knives and tools</b>
<b>74</b>	<b>Lighting</b>
<b>81</b>	<b>Reach &amp; wading poles</b>
<b>84</b>	<b>Wheeled bags and lightweight holdalls</b>
<b>87</b>	<b>100% waterproof sealed dry bags</b>
<b>90</b>	<b>Robust hard-shell cases</b>
<b>92</b>	<b>Medical/casualty bags and equipment</b>
<b>95</b>	<b>Throw bags/backpacks with floating line</b>
<b>98</b>	<b>Why buy our inflatable equipment?</b>
<b>100</b>	<b>Inflatable boat series</b>
<b>106</b>	<b>Inflatable sleds and rafts</b>
<b>111</b>	<b>Inflatable walkways and air tracks</b>
<b>113</b>	<b>Inflatable rescue boards and tubes</b>
<b>116</b>	<b>Inflation options</b>
<b>117</b>	<b>Customise your inflatable</b>
<b>119</b>	<b>Outboard motors and trailers</b>

**SOLAS Approved**



NB 2452/2017



**RESCUE  
AND RESPONSE  
DRYSUIT**

Designed for use in the most demanding conditions, ideal for fast water rescue and emergency response teams.

**SPECIFICATION**

- 210D Embratex breathable upper
- 450D Aquatex lower body
- Triple glued, sealed seams
- Front entry BDM metal dry zip
- Kevlar® knee/seat protection
- Reflective strips
- Zipped transporter pocket (left)
- Bellows notebook pocket (right)
- Adjustable internal braces
- Dunlop safety boots - composite toe cap and mid-sole foil

**ALTERATION OPTIONS**

1. Neoprene or latex seals
2. Available with socks or boots

**BRANDING OPTIONS**

1. Upper arm reflective strips
2. Left leg
3. Left zipped pocket
4. Chest or shoulders
5. Back panel

**STOCK SIZES**

S, M, ML, L, XL, XXL  
See below size chart

**INCLUDED WITH SUIT**

Maintenance kit and storage bag/  
changing mat

MENS	XS	S	M	MR	ML	MLR	MLT	L	LR	XL	XLR	XLT	XXL	XXLR	XXXL	XXXLR
HEIGHT	5'4 162 cm	5'6 168 cm	5'8 173 cm	5'8 173 cm	5'10 178 cm	5'10 178 cm	6' 183 cm	6' 183 cm	6' 183 cm	6'2 188 cm	6'2 188 cm	6'4 193 cm	6'4 193 cm	6'4 193 cm	6'6 198 cm	6'6 198 cm
WEIGHT	9 st 57 kg	10 st 63 kg	11 st 70 kg	13 st 83 kg	13 st 83 kg	14.5 st 92 kg	13 st 83 kg	14 st 89 kg	15.5 st 99 kg	15 st 95 kg	17 st 108 kg	15 st 95 kg	16 st 102 kg	18 st 114 kg	17 st 108 kg	19 st 120 kg
CHEST	36" 91 cm	38" 96 cm	40" 102 cm	42" 106 cm	42" 106 cm	44" 112 cm	42" 106 cm	44" 112 cm	46" 117 cm	46" 117 cm	48" 122 cm	46" 117 cm	48" 122 cm	50" 130 cm	50" 130 cm	54" 137 cm
C - FLOOR	30" 76 cm	31" 79 cm	32" 81 cm	32" 81 cm	33" 84 cm	33" 84 cm	33.5" 85 cm	33.5" 85 cm	33.5" 85 cm	34" 86 cm	34" 86 cm	35" 89 cm	35" 89 cm	35" 89 cm	36" 91 cm	36" 91 cm

Full range of size charts is available online at [www.ndiver-rescue.com](http://www.ndiver-rescue.com)



## Tri-laminate Drysuit

If you are looking for a tough and durable drysuit to keep you warm and dry this is the one. Cut and tear resistant designed to deliver great value and all-round performance.

The Arctic Survivor can be worn in conjunction with numerous thermal garments or combinations of thermal garments.

Thermalux undersuit, page 38, is ideal for UK

### SPECIFICATION

110D Decitex nylon tri-laminate  
Triple glued, sealed seams  
Rear entry YKK® plastic dry zip  
Neoprene neck & wrist seals  
Large knee/seat protection  
Reflective piping across shoulders  
Zipped transporter pocket (left)  
Bellows pocket (right)  
Adjustable internal braces  
Dacor style hard sole boots

### ALTERATION OPTIONS

1. Dry fly zip
2. Safety boots or socks

### BRANDING OPTIONS

Additional branding and logos can be applied upon request

### STOCK SIZES

S, M, ML, MLR, MLT, MR, L, LR, LT, XL, XLR, XLT, XXL, XXLR, XXXL  
See page 6 for size chart

### MTM SERVICE - YES

(APPROX 3-4 WEEKS DELIVERY)

### INCLUDED WITH SUIT

5.0mm hood, maintenance kit and storage bag/changing mat



### Footwear choices on drysuits

A range of boots, wellingtons and socks can be fitted as an option to any of our drysuits. Visit page 36 to view our range



A rescue suit designed for use by women working in Search & Rescue environments. Comfortable, warm and durable, this suit has a rear drop seat relief zip, more convenient and so no need to take off any other gear.

Made to measure available only. Contact us to build your spec.

### MTM OPTIONS

(APPROX 3-4 WEEKS DELIVERY)

Choose fabric and colour

Triple glued, sealed seams

Choose latex or neoprene seals

Choose front entry or rear entry

Choose BDM metal or YKK® plastic dry zips

Kevlar® knee and seat reinforcement

SOLAS reflective tape

Choose arm pockets:

Light stick pocket

Radio pocket

Dry arm pocket

Choose leg pockets:

Zipped pocket (shown)

Bellows pocket (velcro)

Map/note book pocket

Choose footwear:

Socks (latex or breathable)

Integral boots

(standard or safety)

### BRANDING OPTIONS

Additional branding can be applied upon request

### STOCK SIZES

MTM only not available off the shelf

### INCLUDED WITH SUIT

Maintenance kit and storage bag/ changing mat



#### Ladies Dry Convenience Zipper

More convenient, no need to take off any other gear.

Ideal for use with our 2-piece undersuits. The Thermicore page 40 or the Base Layer page 41



REAR ENTRY FRONT ENTRY



# STORM FORCE 4

## STYLES AVAILABLE

### Light duty

210D Embratex breathable fabric  
Front & rear entry options  
Double layer protection  
Colours: red/black

### Medium duty

320D Embratex breathable fabric  
Front entry only  
Kevlar® protection  
Colours:  
red/black, amber/black, red/navy

## SPECIFICATION

Embratex breathable tri-laminate  
Triple glued, sealed seams  
BDM metal dry zip  
Neoprene neck & wrist seals  
Knee/seat protection  
Reflective strips  
Adjustable internal braces  
Latex socks

## ALTERATION OPTIONS

Latex neck and wrist seals  
Any pockets in our range  
Breathable socks  
Integral boots

## BRANDING OPTIONS

Additional branding can be applied upon request

## STOCK SIZES

S, M, ML, L, XL, XXL, XXXL  
See page 6 for size chart

## INCLUDED WITH SUIT

Maintenance kit



# STORM FORCE 5

## Heavy duty tri-laminate drysuit

A high performance suit that offers a robust, durable and quality design.

Perfect for any rescue scenario. Reflective provides high visibility which is essential for night/low light rescue operations.

## SPECIFICATION

- 375D OT-083 membrane fabric
- Triple glued, sealed seams
- Front entry BDM metal dry zip
- Yamamoto superstretch neoprene neck & wrist seals (latex shown)
- Light stick pocket (left arm)
- Double layer reinforced knee/seat
- Reflective strips
- Bellows Velcro pocket (right)
- Adjustable internal braces
- Elasticated ankle gaitors
- Latex socks

## ALTERATION OPTIONS

- Latex neck and wrist seals
- Any pockets in our range
- Breathable socks
- Integral boots

## BRANDING OPTIONS

Additional branding upon request

## STOCK SIZES

S, M, ML, L, XL, XXL  
See page 6 for size chart

## MTM SERVICE - YES

(APPROX 3-4 WEEKS DELIVERY)

## INCLUDED WITH SUIT

Maintenance kit and storage bag/  
changing mat.

Shown with **Pro-Safe Rescue boots (page 70)**, note this suit has elasticated ankle gaitors and attached latex socks.

The **FLOOD** and **RESPONDER** suit is a low cost option for searches, wading, low level flooding, mud rescue and first responder scenarios.



Salopettes are completely dry

Used as an alternative when drysuits are not absolutely necessary



## 2 PIECE **FLOOD** RESCUE SUIT

### SPECIFICATION

Coated nylon fabric  
with taped seams  
Reflective piping & printing

#### **Overjacket:**

Neoprene neck and wrist seals  
Adjustable Velcro closure on neck  
Lightstick pocket (left arm)  
Adjustable Velcro waistband

#### **Salopette:**

Adjustable, quick release braces  
Quick release adjustable belt  
Splash proof zip  
Gusseted zipped chest pockets  
Elasticated ankle gaiters  
Latex socks

### STOCK SIZES

S, M, L, XL, XXL  
See page 6 for size chart

## **RESPONDER DRYSUIT**

### SPECIFICATION

Coated nylon fabric  
with taped seams  
Latex neck and wrist seals  
Rear entry YKK® plastic zip  
Lightstick pocket (left arm)  
Reflective piping, strips & printing  
Double layer knees/seat areas  
Elasticated ankle gaiters  
Latex socks

### STOCK SIZES

S, M, L, XL, XXL, XXXL  
See page 6 for size chart

### BRANDING OPTIONS

Additional branding can be applied  
to any suit upon request

### INCLUDED WITH SUITS

Maintenance kit and bag

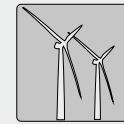

## SPECIALIST OFFSHORE EQUIPMENT TRANSIT SUIT

Made to meet the demands of the Offshore wind farms industry.

### SPECIFICATION

320D Embratex breathable fabric  
Triple glued, sealed seams  
Front entry YKK® plastic dry zip  
Yamamoto neoprene neck with fleece collar Integrated, fold away, high vis hood  
Yamamoto neoprene wrist seals with seal protectors  
Fully dry chest pockets  
Removable radio pocket (left chest)  
Integrated glove arm pockets  
Flexi-light arm pocket (right)  
ID pockets (left/right lower arms)  
2 bellows leg pockets  
Kevlar® knee/seat protection  
Reflective strips, piping and print  
Kevlar® coated breathable lightweight socks

**This suit is ideal to use with our Pro-Safe water rescue boots, see page 70.**

### BRANDING OPTIONS

Additional branding can be applied upon request

### STOCK SIZES

S, M, L, , XL, XXL, XXXL  
See page 6 for size chart

### INCLUDED WITH SUIT

A snap hook and a whistle located inside the chest pocket, 5mm neoprene gloves inside the arm pockets, maintenance kit and storage bag/changing mat



NB 2452/2017

**SOLAS Approved**



Flame retardant  
**BOATING**  
**OPERATIONS SUITS**

Designed for the Ministry of Defence Police boat ops team.

An exceptionally comfortable suit that can be customised on request.

#### SPECIFICATION

320D Embratex breathable fabric  
Triple glued, sealed seams  
Front entry YKK® plastic dry zip  
Neoprene neck seals  
Fleece-lined Velcro closing collar with fold away high vis hood  
Neoprene wrist seals  
Cuff protectors (Velcro adjustment)  
Velcro bellows pockets & zipped fully dry pockets (both arms)  
Adjustable elasticated inner braces  
Reflective strips & piping  
Velcro name badges (arms & chest)  
YKK® plastic fly zip with cover  
2 leg pockets (clear window on the right for ID card)  
Kevlar® knee/seat protection  
Ankle protectors (Velcro/zip closure)  
Dry breathable socks

**This suit is ideal to use with our Pro-Safe water rescue boots, see page 70.**

MTM SERVICE - YES  
(APPROX 3-4 WEEKS DELIVERY)  
Not available off the shelf

**INCLUDED WITH SUIT**  
Maintenance kit and storage bag/  
changing mat

**CLEARANCE  
PRICE**

**£425**

**\$560**



**BREATHABLE KEVLAR®  
BOATING OPERATIONS  
RESCUE DRYSUIT**

Manufactured from Tery of Japan breathable Kevlar®, all internal seams are taped. Excellent flexibility with the durability of Kevlar®.

YKK® Aquaseal® zip makes this front entry easy to put on and take off. Good flexibility makes it the ideal working suit either on board or for bank or river searches.

**SPECIFICATION**

Yamamoto neo neck/wrist seals  
Reflective strips for higher visibility in locations of your choice  
Elbow, seat and knee protection  
Zipped transporter pockets, left and right thighs  
Dacor style heavy duty boots in sizes UK 5-13 (US 6-14)

**BRANDING OPTIONS**

Additional branding crests, team names etc can be applied or fitted to the suit.

**STOCK SIZES**

S, M, ML, MLR, MLT, MR, L, LR, LT, XL, XLR, XLT, XXL, XXLR, XXXL  
See page 6 for size chart

**INCLUDED WITH SUIT**

Complete with hood and carry bag which folds out to make a changing mat.

**This suit is available at a special price please check our website or price list for latest details.**

[www.ndiver-rescue.com/kevlar-boating-ops-rescue-suit](http://www.ndiver-rescue.com/kevlar-boating-ops-rescue-suit)



# POLICE

## SURFACE/BOATING DRYSUIT

This suit has been supplied to Cambridge, Lancashire and Devon & Cornwall Constabularies.

### MTM OPTIONS

(APPROX 3-4 WEEKS DELIVERY)

Available in red or black

375D tri-laminate fabric

Triple glued, sealed seams

Latex or yamamoto neoprene seals

Front entry or rear entry

BDM metal dry zipper

Kevlar® knee/seat reinforcement

Checked Reflexite banding (arms)

Printed reflective banding (legs)

Available arm pockets:

- Light stick pocket

- Radio pocket

With your choice of leg pockets:

- Zipped pocket (shown)

- Bellows pocket (velcro)

- Map/note book pocket

The suit can be fitted with either breathable socks, dry safety boots or dacor style.

### BRANDING OPTIONS

Your choice of branding options

### INCLUDED WITH SUIT

Maintenance kit and storage bag/  
changing mat





**DIVEMASTER**

COMMERCIAL

## 5.5mm Neoprene Drysuit

The first choice of the UK's major commercial diving schools, UK MoD and many dive rescue and recovery teams. The Divemaster allows freedom of movement and real diving flexibility, as well as being exceptionally hard-wearing.

This suit gives the user a comfortable environment when diving and can be pitted against the harshest of diving scenarios, such as ice diving and long duration cold water diving.

### SPECIFICATION

- 5.5mm thickness
- Hyper-compressed neoprene
- Triple glued and rubber taped on all inside seams
- Liquid taped on the outside seams of the upper body
- Rear entry BDM 6 pitch heavy duty metal dry zip with zip flap
- Yamamoto neo neck & wrist seals
- Shoulder pads
- Inflation & exhaust valves with hose
- Bellows Velcro leg pocket (right)
- Zipped transporter leg pocket (left)
- Kavlar® knee protection
- Over printed seat protection
- Commercial hard sole boots

### STOCK SIZES

S, M, ML, MLR, MLT, MR, L, LR, LT, XL, XLR, XLT, XXL, XXLR, XXXL, XXXLR

See page 6 for size chart

**MTM SERVICE - YES**  
(APPROX 3-4 WEEKS DELIVERY)

### INCLUDED WITH SUIT

5.0mm hood, maintenance kit and carry bag/changing mat





**NEW**

# HYBRID

## Neoprene & Tri-laminate

This is the suit for you when you need the insulation qualities and buoyancy of 5.0mm neoprene on your body with the added flexibility and dexterity of 375 denier tri-laminate material on the arms and legs.

Ideal for sea-bed and river bed searches where the diver needs to crawl to make fingertip searches and police underwater work, scientific exploration, technical and cave diving.

### MTM OPTIONS

(APPROX 3-4 WEEKS DELIVERY)  
 375D flexible membrane arms/legs  
 5.0mm warm neoprene body  
 Triple glued, sealed seams  
 Latex or yamamoto neoprene seals  
 Neoprene warmer (Velcro closure)  
 Front or rear entry  
 BDM metal dry zip with zip flap  
 Overprinted protection on shoulders, arms & legs  
 Suit shown with large expandable bellows thigh pockets or pockets to your requirements  
 Kevlar® knee reinforcement  
 Reflective strips  
 Available with latex or breathable socks for use with our safety boots, or standard key-line dry rubber boots.

### INCLUDED WITH SUIT

5.0mm or 6.0mm hood, drysuit valves, inlet and air exhaust, hose, maintenance kit and carry bag which folds out to a changing mat



### Valves

Inflation valves with the standard Hansen or commercial CJEN connectors and adjustable auto dump exhaust valves.



### Optional 35mm Locking Cuff Dump

Simple open/locking operation with mushroom silicone seal stops water ingress when open.



## Contaminated Waters Specialist Rubber Drysuit

The ideal suit for:

Toxic incidents  
Chemical diving environments  
Contaminated waters

The best suit for extremely dangerous scenarios where chemical or biological non-permeability is essential to protect users from exposure.

### SPECIFICATION

#### Fabric construction:

Vulcanised laminated polymer sheets, polyester, high-grade rubber and EPDM which gives excellent strength, protection & durability

Bonded for life seams

Latex neck and wrist seals

Heavy duty BDM metal dry zip

Commercial grade valves fitted in standard diving positions

Reflective strips (upper arms)

### OPTIONS

Front and rear entry styles available

Select sizes available in black

**1000G suit** - fitted with rubber boot

**1600G suit** - fitted with safety boot

### STOCK SIZES

S, M, ML, MLR, L, LR, XL, XLR, XXL & XXLR

See page 6 for size chart

### INCLUDED WITH SUIT

Valves, hose, maintenance kit and storage bag

Diving in contaminated waters or attending toxic incidents should only be undertaken by competent qualified divers or rescue personnel. Further information regarding permeation and break through tests can be found on our website: [www.issuu.com/northerndiveruk/docs/thor-test-results](http://www.issuu.com/northerndiveruk/docs/thor-test-results)

# WADERS

DRY SALOPETTE STYLE



Functional and reliable, these utility waders will keep you dry from chest to toe. They've got the classic chest high design and incorporate easily adjustable suspenders.



## Stock suit.

### Custom tailoring.



We can help you tailor suits so they better support your teams in the field. If you need to add different elements to standard suits we provide, just ask. We can change neck, wrists, socks, and boots to suit your requirements. We can add pockets, fly zips, valves and Kevlar® reinforcement in high wear areas.

Please note: Tailoring options are dependent on the stock suit purchased. Please check with us which elements can be tailored on specific suits.

### Suit repairs.

With over 60 years of combined experience, our Repair Technicians are some of the best in the business. A dedicated and diligent team, they know how important it is that their work be perfect, every time.

Waiting times can vary dependent on our workload, however turnaround can sometimes be as fast as one day. If you need it your repairs for a certain time, please advise our team of this. You can check on current time frames prior to booking suits in.

Repairs Department: +44 (0) 1257 25 69 37  
Opening Times: Mon - Fri 8.30am to 5.00pm



## Book it in.

### Online repair system.

We now offer a full ONLINE repair and alterations service for our suits, this can include fixing leaks, adding new parts to your suit i.e. socks, seals, pockets or alterations.

We've made it easier for you to:

1. Book in your suit - from anywhere
2. Get updates and check on progress at any time
3. Accept quotations and easily pay online

All you need to do is log in to your online account to get started with the 8 steps to book your repair, [www.ndiver-rescue.com/login](http://www.ndiver-rescue.com/login)

#### **Not comfortable booking it in online?**

Don't worry, all suits that enter our repairs and alteration department now use the online system, once your suit(s) arrive we will book them onto your account for you, all you need to do is log in and view its progress or check the email updates that we send to the address on the account.

Photo credit: Louise, one of our Repairs Team Leaders in action. Using her 27 years' experience to cut and custom fit repairs & alterations.

## TAILOR AND REPAIR A STOCK SUIT

# Stock suits replaceable parts



The following suit parts can be used to tailor existing stock suits to specific requirements. Available options may vary dependant on the type of suit. Membrane and neoprene suits may not allow for all options shown to be applied, please use this as a guide only and contact the rescue department for specific details.

You can now book suits in online for repair and alteration, you will need to log in online to do this.



Yamamoto neoprene neck  
Standard inverted & short styles



Latex neck, can be fitted with a neoprene warmer



Hood attached to the suit  
Or supplied separate



Neoprene wrist seals  
Cuff covers/protectors available



Latex wrist seals can be fitted with neoprene warmers



Cuff systems fitted with user replaceable wrist seals or gloves



Replacement zips  
(metal and plastic)



Fly zips fitted with either full or semi protective zip covers



Shorten arms and legs



Lightstick arm pockets  
Std 180 x 70mm (7" x 2.8") or  
Flexi-light 125 x 47mm (5" x 1.9")



Radio pockets  
150 x 70 x 47mm  
(5.9" x 2.8" x 1.9")



Adjustable  
elasticated internal braces

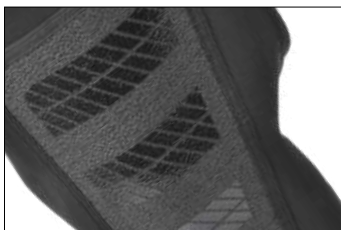

Replacement kneepads  
Double layer or Kevlar® available



Zipped transporter pockets  
Approx. 290 x 160 x 40mm  
(11.4" x 6.3" x 1.6")



Velcro closing bellows pockets  
Approx. 280 x 150mm  
(11" x 5.9")



Neoprene socks  
Approx. thickness 5.0mm



Breathable membrane socks



Latex socks



Drysuit boots or safety wellingtons (EN 12568/98) ideal for any drysuit.  
Wellingtons are chemical and hydrocarbon resistant.

## RESCUE SUIT

# Accessories & maintenance



### DRYSUIT HANGER

Drysuit boots are placed in the hanger head and the suit is then suspended upside down, allowing all the excess water to drain away. Inverted drying for a neoprene/membrane drysuit, manufactured from lightweight heavy-duty material.



### MULTI PURPOSE HANGER

Allows the upright drying of a wetsuit, drysuit, BCD or stab jacket, allowing all the excess water to drain away.



### SEAL LUBRICANT

Water based lubricant, extends the life of your neoprene seals and ease getting in/out of your drysuit - 200ml tube.



### TALC

Supplied in a handy 100g container, with a twist-lock dispenser. To lubricate latex neck/wrist seals.



### SUIT SEAL

For repairing holes/tears in drysuits and for use with our dry glove system. Size : 21g.



### SILICONE SPRAY

Water repellent or lube for rubber, plastic and metal. Protects against rust, salt-oxidation and corrosion.



### ZIP WAX

Easy, effective drysuit zip lubrication. Simply apply to dry clean drysuit zips to ensure smooth action & prolonged zip life.



### ZIP TECH™

Soft and easy to apply, this lubricant is designed to protect and lubricate all watertight and airtight plastic YKK® zippers.



## apollo bio seals

### DO YOU GET NECK & WRIST TRICKLE?

Heralded by DIVER magazine as **“truly keeping the water out”**. Some divers may experience a trickle of water down their seals now and again, usually as a result of a channel caused by a tendon. Hopefully not for much longer.

Apollo bio seals combat water ingress and work excellently. The seals simply slide over your neck and wrists, and form an effective bond with your drysuit seal, whether you use neoprene or latex seals.

The Cosmo-gel that the seals are made from is super soft and super stretchy (1300% - 1500% stretch). As you could deduce, they are very comfortable and mould to your skin brilliantly. On top of this, durability isn't compromised. This product is latex free.

## ENSURE A PERFECT FIT

# A guide to measuring for a suit

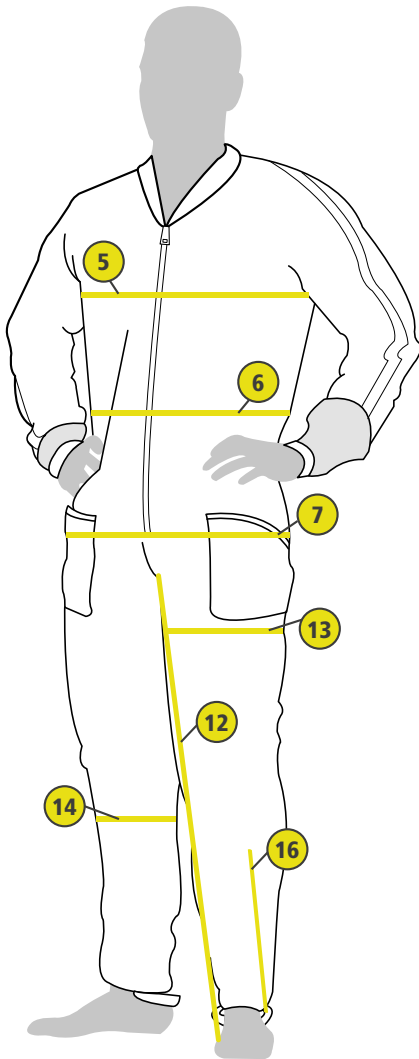

- 1 **Height** - to be measured against a wall
- 2 **Weight** - to be taken on accurate scales
- 3 **Neck** - taken over bare skin below Adam's Apple with the tape resting on your shoulders
- 4 **Wrist** - taken over bare skin behind wrist bone
- 5 **Chest** - taken around the fullest part, just under your breasts/pecs, and measure around the torso while keeping the tape parallel to the floor
- 6 **Waist** - taken around a relaxed waist, about a 1/2 inch above your bellybutton, exhale and measure before inhaling again
- 7 **Hips** - taken across the widest part of your hips/buttocks. Measure all the way around while keeping the tape parallel to the floor
- 8 **All round body** - taken from hollow front of neck through legs (up in crotch) up to base of neck
- 9 **Neck to wrist** - taken from base of neck to wrist bone
- 10 **Forearm** - taken around the fullest part with finger inside tape
- 11 **Bicep** - Relax the muscle, taken around the fullest part with finger inside tape
- 12 **Crotch - floor** - up in the crotch down to floor
- 13 **Thigh** - taken around fullest part with finger inside tape
- 14 **Calf** - taken around fullest part with finger inside tape
- 15 **Actual shoe size** - not your trainer size

Try to measure over the undersuit you intend to wear if possible. If not please make sure you have noted that measurements have been taken without an undersuit to make sure you get the best possible fit.

When taking measurements, stand tall with muscles relaxed and feet together.

**Do not measure yourself.** Get a second person to do it for you, as accuracy is essential for a good fitting suit.

When measuring, apply constant pressure to the tape (so it doesn't sag) without pinching the skin. We recommend using a tailors measuring tape.

### NEED HELP?

An experienced member of staff that is familiar with the measuring process can assist you in this task should you need it.

Call +44 (0) 1257 25 44 44 or email [rescue@ndiver.com](mailto:rescue@ndiver.com), our team will analyse your measurements and calculate your optimum suit size, alternatively if your local visit us in store.

### SHOE SIZE?

Determining your proper shoe size is essential to a comfortable fit.

If you don't know it you can measure yourself or visit your nearest shoe store for an accurate result.

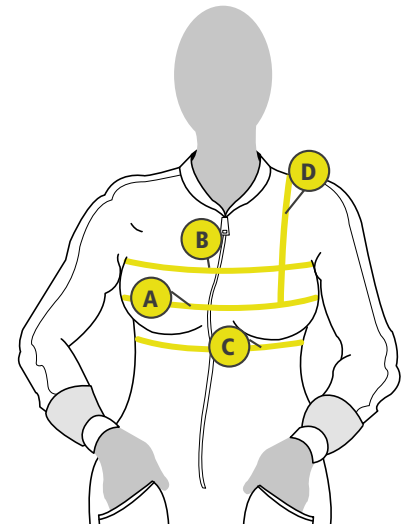

### ADDITIONAL LADIES MEASUREMENTS

- A **Chest** - taken across your nipples and measure around the largest part of your chest. Be sure to keep the tape parallel to the floor.
- B **Chest above bust** - taken under armpits with tape parallel to the floor.
- C **Under bust** - taken around the fullest part, just under your breasts, and measure around the torso while keeping the tape parallel to the floor
- D **Shoulder to bust** - taken from top of shoulder to centre of bust

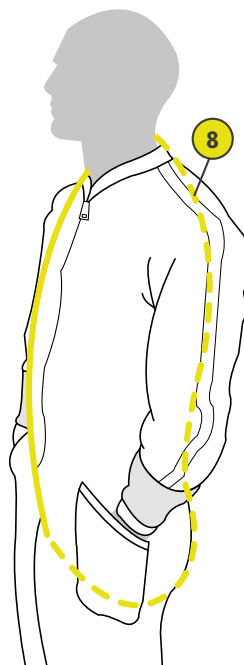
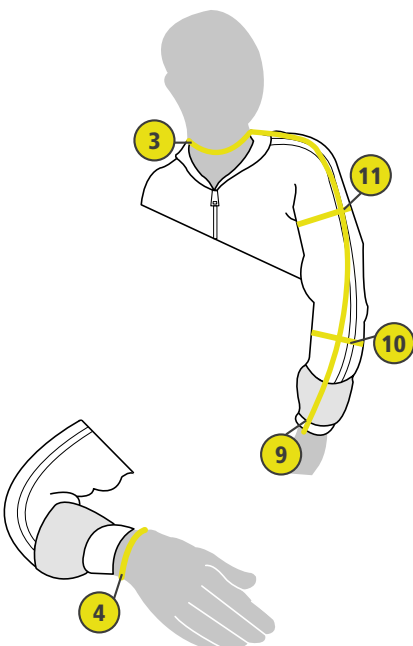

Photo credit: DPPI SEE, Romania







# MTM RESCUE SUITS

**MADE TO MEASURE. CUSTOM TAILORED.**

We specialise in bespoke suits, look through this section to see examples of past suit orders and all the information you need to start to build your own rescue suits!



St Abbs Lifeboats



Hope Cove Lifeboats



County Durham and Darlington



Irish Civil Defence



Bay Search and Rescue Team



Buxton Mountain Rescue Team

YOUR SPECIFICATION. OUR EXPERTISE.

## Made-to-measure rescue suits



Photo credit: West Midlands Ambulance

### I want a suit, what happens next?

Initially, your appointed contact will work with you to establish what you need. Depending on your preference, we can visit you, for larger orders or you can visit us, or we can simply communicate by telephone or email.

Our design team will then work to ensure every detail is covered perfectly. You will receive a PDF proof of the suit design to approve. Only when you are happy with the design will the production process begin.

### Designing your suit.

We want to supply a suit that perfect for you. Each element of the suit will need to be chosen,

1. Entry styles  
Pages 28, 29 and 30 for inspiration
2. Fabrics see page 31, 32 and 33
3. Neck, wrists, zips, embellishments, pockets, kneepads and footwear all need to be specified.  
Pages 34, 35 and 36 for details.

Our design team will then work to ensure every detail is covered perfectly. You will receive a PDF proof of the suit design to approve. Only when you are happy with the design will the production process begin.

### Need help with sizing?

Our experienced staff members are familiar with the measuring process and can assist you with this task, should you need it.

Download our measuring guide:  
[www.ndiver-rescue.com/downloads](http://www.ndiver-rescue.com/downloads)

Videos on how to measure yourself correctly for a suit can be found on our YouTube channel in the 'Suit How To Videos' playlist:  
[www.youtube.com/NorthernDiverUK](http://www.youtube.com/NorthernDiverUK)

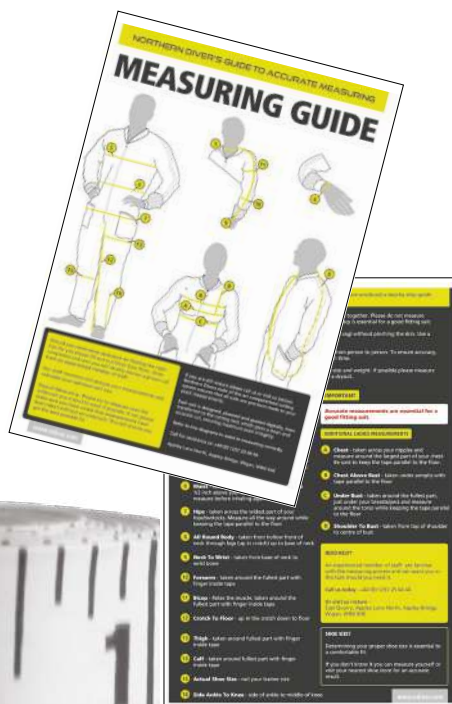
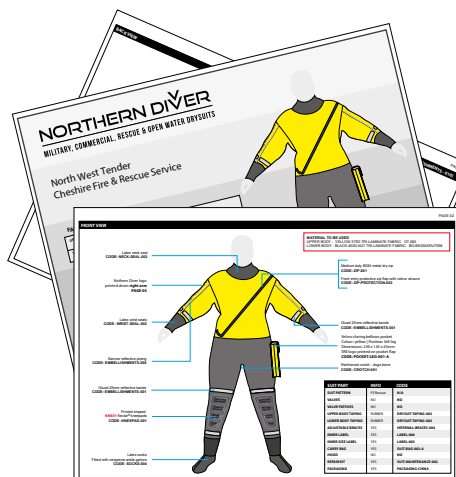

DO YOU NEED SOME INSPIRATION?

## Examples of front, rear and BIB entry style suits

All suits shown are custom made to measure orders. Build a suit to any specification you require. Changing seals, fabrics and entry options as well as adding arm / leg pockets, branding, reflective panels and more.

### FRONT ENTRY STYLE

Is the most popular drysuit for rescue and boating operations.

This design makes entering the suit simple and assistance free.

The zip runs diagonally from the left shoulder to the waist on the right hand side.



Photo credit: Avon Fire & Rescue



Finland Offshore Rescue Team



Merseyside Fire & Rescue Instructor



HART Department Of Health



**Devon & Cornwall  
Police Constabulary**



**West Midlands  
Search & Rescue Team**



**Gloucestershire  
Police Team**



**Royal Berkshire  
Water Rescue Team**



**Gwynedd Council  
Maritime Unit**



**Greater Manchester  
Fire & Rescue Team**



**South East Europe D.P.P.I.  
Disaster Preparedness & Prevention Initiative**



**Borderforce UK  
Central Region**

## REAR ENTRY STYLE

Rear entry zips run between the shoulders. Assistance is needed to close the zip.



Photo credits: Merseyside Fire & Rescue Training



St Caiman River Rescue, Ireland



Mundesley Lifeboat - Search & Rescue Team



Instructor Style Drysuit



## BIB ENTRY STYLE

Our unique pattern, designed with the zip fitted around the waist and secures via a quick release buckle at the front. Entering the suit is just as simple as front entry styles.



Photo credit: Bay Search & Rescue



Hollis Search & Rescue Team



Warwickshire Fire & Rescue Team



Portuguese Helicopter Search & Rescue Team

## CHOOSE SUIT FABRIC

Our membrane fabric is a sandwich of three layers: a carrier layer of 40g polyester, 15-20 coats of butyl rubber solution and an outer layer of one of the listed materials below. Choose one material or a combination of fabrics.

### AF808.

#### Chemical resistant

A rubber material with excellent resistance to chemical permeation and general pollution ingress. Bright yellow colour provides easy identification of users location. Nonstick surface assists cleaning.  
**Used for coastguard mud rescue suits**

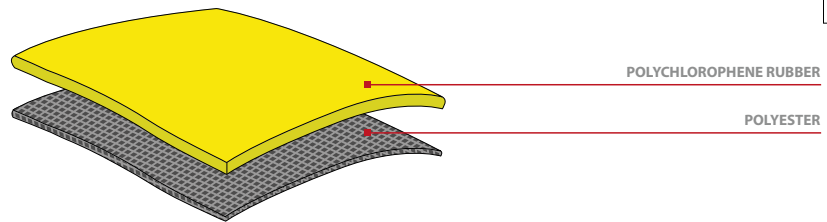

Colours available:



### Amber.

#### Decitex nylon

High tear strength  
 Soft touch  
 Excellent adhesion  
 Chemical & water resistant  
 Air and water tight  
 Easy clean  
**Used for the Arctic Survivor suit**

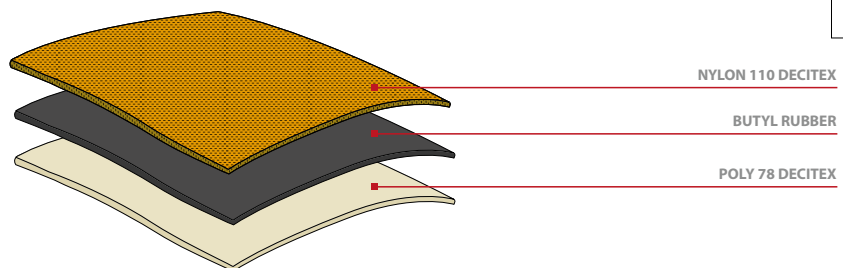

Colours available:



### 210D & 400D.

#### Tritex nylon

High tear strength  
 Soft touch  
 Excellent adhesion  
 Chemical & water resistant  
 Cold resistant ( - 60°C )  
 Ultra violet light resist ( UV )  
 Air and water tight  
 400D in black  
 210D in amber  
**Used for coastguard training suits**

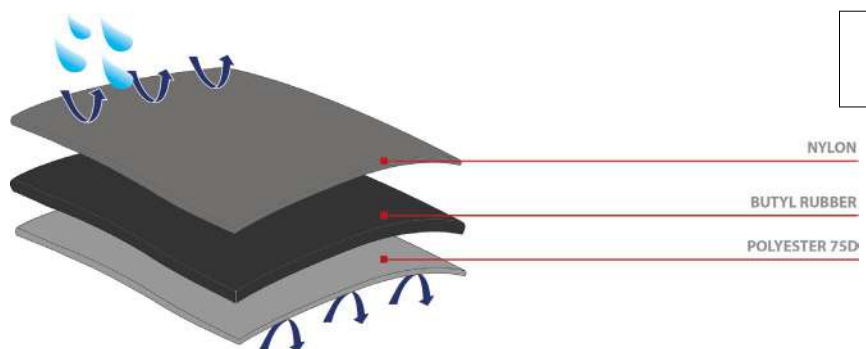

Colours available:



### 320D.

#### Embratex tri-Lam

320D fully breathable embratex cotton feel nylon with water repellent coating.

Tested to - EN ISO 14225-2:2005 for sea water resistance and EN ISO 15027-1:2002 for materials, fabrics and components, fire resistance, temperature cycling, leakage, performance, dexterity & mobility. Using the Test Methods specified in EN ISO 15027-3:2002

**Used in most rescue suits**

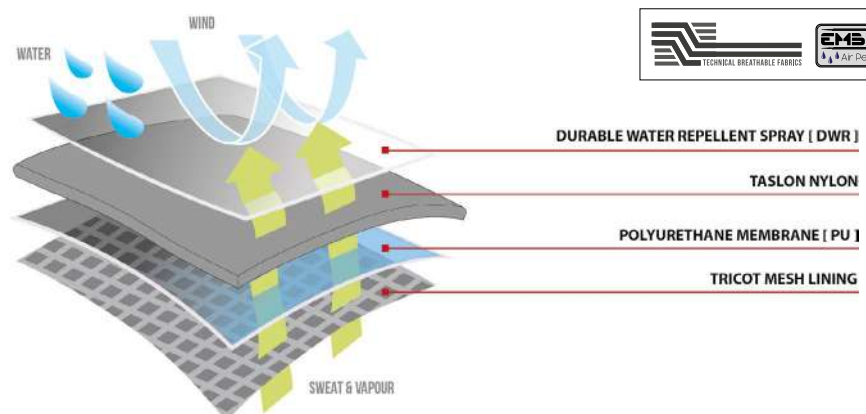

Colours available:



375D.

## Tri-laminate

Wind and waterproof  
Strong durable fabric  
Resistance to abrasion and tearing  
2 layers combined for a flexible finish  
High performance  
Medium weight  
**Most popular used material**

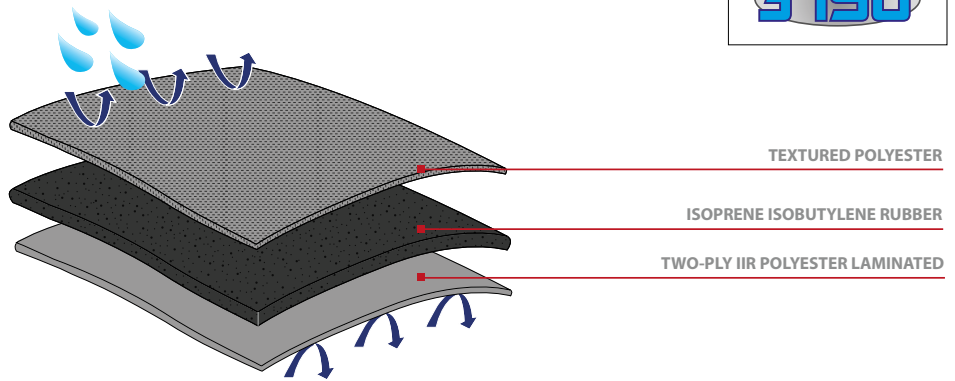

Colours available:



450D Fire retardant.

## Nomex® tri-Laminate

The tough, woven structure of Nomex® is extremely strong, has high heat resistance, is flame retardant (it doesn't melt or drip) and doesn't react with water.

Nomex® is a registered trademark for flame-resistant meta-aramid material developed by DuPont Nomex®  
**Used for police boating ops suits**

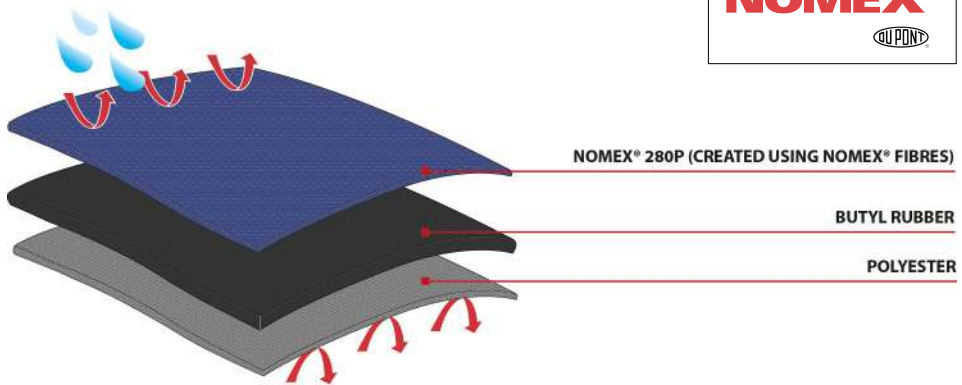

Colours available:



450D.

## Aquatex tri-Laminate

The tightly woven face fabric is proven to be incredibly resistant to abrasion and tearing. In addition to its strength, Aquatex is very comfortable, proving a popular choice for boat handlers and rescue personnel who wear their suits for many long hours at a time.

Butyl Rubber is sandwiched between two layers of polyester to create a durable and flexible fabric  
**Preferred material for training**

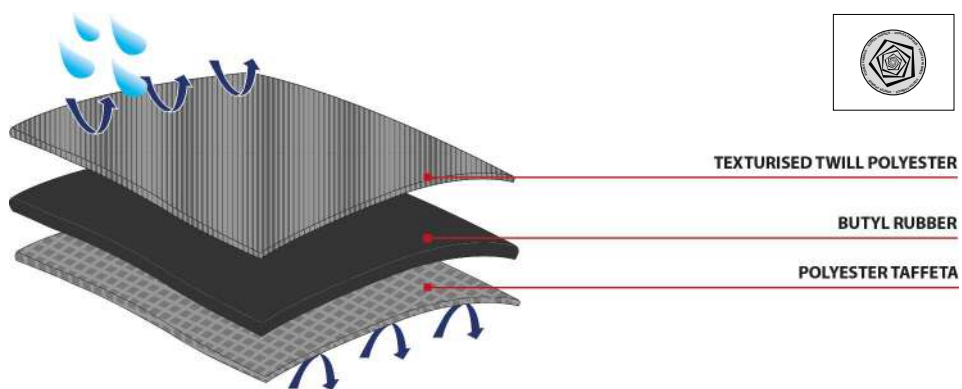

Colours available:







500D.

## Cortex tri-Laminate

Renowned for its hard-wearing abilities, Cortex resists scuff and scrapes with its strong Cordura® outer layer. Cortex is often chosen for the lower half of a drysuit when a stronger body is required.

Cortex also offers unsurpassed durability and tear resistance and is an ideal choice for technical divers and divers who appreciate quality construction and performance.

**Used for Military training suits**

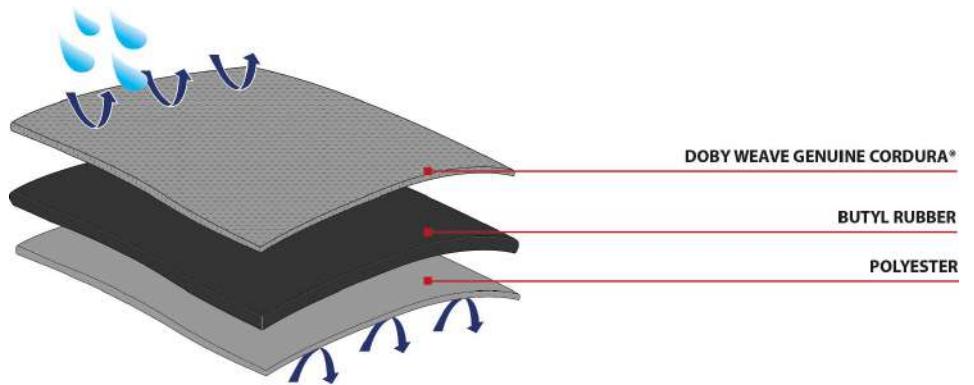

Colours available:



## Yamamoto superstretch.

### Smooth skin neoprene

The most flexible neoprene in the Yamamoto range. Super light-weight, stretchy/flexible.

Its abrasion resistance is higher than standard nylon fabrics making it very suitable for drysuits.

The thickness of the neoprene varies dependent on suit specifications. Standard nylon lining : Has a stretchable soft/ smooth texture

**Also ideal and super comfortable for neck and wrist seals.**

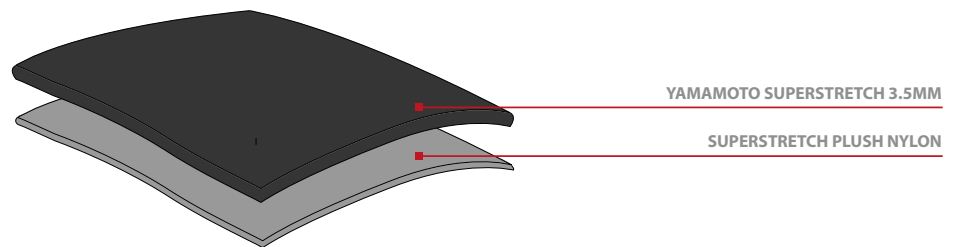

Kevlar® **KN203** without an anti slip coating for improved flexibility.

## KN203 & KN601.

### Kevlar®

Kevlar® : light weight, good abrasion-resistance, durability and high in performance. Versatile and strong Kevlar® fibre is more than just a series of threads.

DuPont™ Kevlar® fibres are used in a variety of Northern Diver apparel to help make them safer, stronger and more durable.

A silky soft man made fibre - 5x stronger than steel, combining great strength with lightweight flexibility. For use in high wear areas.

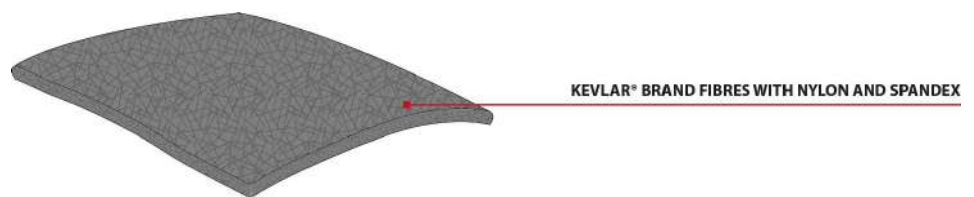

Kevlar® **KN601** is treated with an anti slip coating for improved grip.

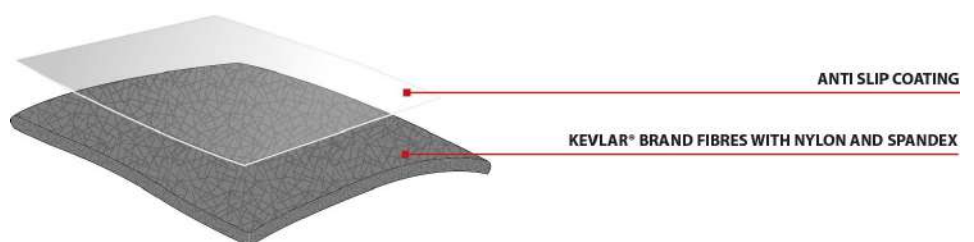

DuPont™ and KEVLAR® are trademarks or registered trademarks of E.I. du Pont de Nemours and Company

# CUSTOM BUILD YOUR SUIT FROM HEAD TO TOE

The next 3 pages show the different suit parts you can choose to create your suit.

## NECK & WRIST SEALS



Neoprene neck - standard inverted



Latex neck - standard



Latex neck with neoprene warmer



Neoprene neck with chaffing protector



Neoprene wrist - standard



Latex wrist - standard



Latex wrist with neoprene warmer



Neoprene wrist with protective cuff  
Printed to assist seal removal

## ZIPS & ZIP PROTECTION



Medium duty 8 pitch BDM metal dry zip



Standard YKK® Aquaseal® dry zip



YKK® Aquaseal® zip with T-bar zip puller



Front entry zip flap with Velcro closure



Rear entry zip flap with Velcro closure



Front entry "flush" zip protection



1. Waist / BIB entry, front view



2. Shows the Military version with the zip open.

## EMBELLISHMENTS



Reflective bands  
25 & 50mm (1" & 2")



Reflexite® prismatic bands  
25 & 50mm (1" & 2")



Wide reflective piping



SOLAS tape reflective strips



Printed reflective panels



Encapsulated panels

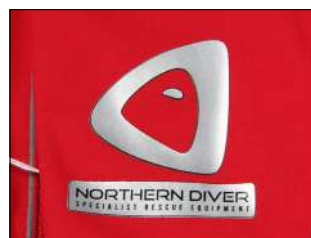

Printed logos / crests



Removable badges

## ARM POCKETS



Radio pocket  
50mm x 170mm (2" x 6.7")



Lightstick pocket  
70mm x 180mm (2.7" x 7")



Splash proof zip arm pockets



Small bellows pocket  
100mm x 175mm (3.4" x 6.9")



EPIRB pocket  
95mm x 160mm (3.7" x 6.3")



Flexi-light stick pocket  
125 x 47mm (5" x 1.9")



Flexi-light sticks. Up to 40 hrs burn time  
Press 1 low power, 2 high power, 3 flashing

## LEG POCKETS



Velcro closing bellows pocket  
145mm x 230mm (5.7" x 9")



Zipped transporter pocket  
150mm x 230mm (5.9" x 9")



Notebook pocket  
145mm x 230mm (5.7" x 9")

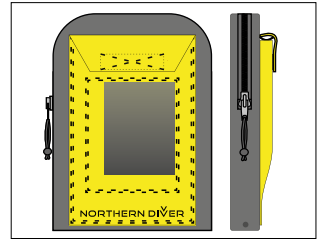

Zipped transporter pocket with scribble  
pad front - 150mm x 205mm (5.9" x 8")



Bellows pocket with map pocket on front  
145mm x 230mm (5.7" x 9")



Large expanding bellows pocket with  
clear ID holder - 180mm x 250mm (7" x 9.9")



Bellows pocket with knife loops  
See knife section for your choice



Fit a internal or external stainless steel  
D-ring to any of our pockets

## KNEEPAD, SEAT AND ANKLE PROTECTION



Kevlar® kneepads



Reinforced Kevlar® seat area



Neoprene gaiters to cover top of boots



Elasticated gaiters to cover top of boots

## FOOTWEAR



Durable hard sole boots - type 1



PVC safety wellington



Quattro® super safety wellington



Neoprene socks - standard



Latex socks - 2D & 3D



Latex socks with neoprene warmers



Fully breathable and membrane socks



Breathable socks with Kevlar® protection

## WHAT'S INCLUDED WITH EACH SUIT?



Hood are available in various styles and colours. Skin skin face seals for full face masks and bright red with reflective panels for rescue, see page 64

Storage bag and changing mat.  
Changing mat shown in use (below)



Adjustable elasticated internal braces



Suit maintenance kit



## Metalux temperate undersuit



Metalux® is one of the most lightweight, high-performance insulating materials available. It retains its thermal integrity throughout the life of the garment and is designed to reflect thermal radiation and reduce air movement, even when wet or compressed.

### SPECIFICATION

- Light ripstop nylon outer shell with a fleece-lined inner over the metalux layer
- Quick-drying
- Bacteria and fungus resistant
- Stretch thermalskin cuffs and foot stirrups
- Two way YKK® front zipper
- Zipped chest pocket and two hip pockets
- Complete with drawstring mesh bag

### 100g TEMPERATE

TOG rating 4.2

This model is most commonly used for UK winter conditions.

### STOCK SIZES

S, M, ML, MLR, MR, MLT, L, LR, LT, XL, XLR, XLT, XXL, XXLR, XXXL, XXLR

See size chart below

### RELATED PRODUCTS

The base layer technical thermal, see page 41, is ideal for use under the Metalux for extreme cold conditions.

Metalux Arctic 200/300g | Metalux Temperate | Thermalux | Thermicore | Thermicore Sub Zero X | Bodyline/Thermalskin | Inncore | Arctic Base

	S	M	MR	ML	MLT	MLR	L	LT	LR	XL	XLT	XLR	XXL	XXLR	XXXL	XXLR
HEIGHT (FT)	5'4 - 5'7	5'7 - 5'9	5'7 - 5'9	5'9 - 5'11	6'0	5'9 - 5'11	5'11 - 6'1	6'2	5'11 - 6'1	6'2	6'4	6'2 - 6'4	6'2 - 6'4	6'2 - 6'4	6'4 - 6'5	6'6+
HEIGHT (CM)	164.5 - 173	173 - 175	173 - 175	175 - 180	185	180 - 185	180 - 185	188	180 - 185	188	193	188 - 193	188 - 193	188 - 193	193 - 195	199+
WEIGHT (ST)	9 - 10	10 - 11.5	12	12 - 13.5	13.5	15	13 - 14	14.5	16	14.5	16.5	17	16 - 17.5	18.5	18.5 - 19.5	19.5+
WEIGHT (KG)	57 - 63.5	63.5 - 73	76	76 - 85.5	85.5	95	82.5 - 89	92	101.5	92	102	108	101.5 - 111	117	117 - 120	120+
CHEST (CM)	91 - 96.5	96.5 - 101.5	106.5	101.5 - 106.5	101 - 106.5	112	106.5 - 111.5	106.5 - 111.5	117	111.5 - 117	112 - 117	123	117 - 123	130	127 - 132	132+
CHEST (IN)	36 - 38	38 - 40	42	40 - 42	40 - 42	44	42 - 44	42 - 44	46	44 - 46	44 - 46	48	46 - 48	51	50 - 52	52+

Full range of size charts is available online at [www.ndiver-rescue.com](http://www.ndiver-rescue.com)

WARMTH & COMFORT

## Thermalux 1 piece undersuit



### No.1 choice for fire and rescue

A 4oz nylon shell encapsulates a high tech Lycra® fleece for superb insulation and flexibility. Thermalux undersuits offer a lightweight solution to keeping warm.

### SPECIFICATION

- Comfortable and incredibly flexible
- 100% breathable outer shell
- Outer nylon shell assists with donning
- Lies smoothly against suit seals
- High tech fleece/lycra mix
- Absorbing micro-fleece lining
- Superb insulation
- Quick-drying & ultra lightweight
- Bacteria & fungus resistant
- Stretch lycra panels provide flexibility in shoulders, lower back & under arms
- Exceptional freedom of movement, without sacrificing warmth
- Thermalskin cuffs, elasticated thumb loops & foot stirrups ensure the garment stays in position during use
- Pockets on the hips
- Non magnetic two way YKK® zip
- Drawstring mesh bag supplied

### STOCK SIZES

XS, S, M, ML, MLR, L, LR, XL, XLR, XXL, XXLR  
See page 37 for size chart

### TOG RATING

2.3



### Long/short sleeved rash vests

In a multitude of colours. Ideal beneath your undersuit or wetsuit to glide with your body movements.  
Sizes: S, M, L, XL, XXL



# Bodycore SRE stretch fleece undersuit



## Low cost high quality thermal

Suitable for general use in warmer months & as an additional base layer in colder months. Available in 2 variants, the Bodycore & the thicker version the Sub Zero.

Fits closely to the body to maximise its thermal performance & ensure that you remain comfortable when diving.

## SPECIFICATION

- Durable outer shell
- 1 layer super-soft fleece lining
- Seams are flat lock stitched
- Integrated foot stirrups
- Elastic thumb stirrups

## SUB ZERO DUAL FLEECE UNDERSUIT

Is a super-soft dual layer fleece, perfect for more extreme conditions.

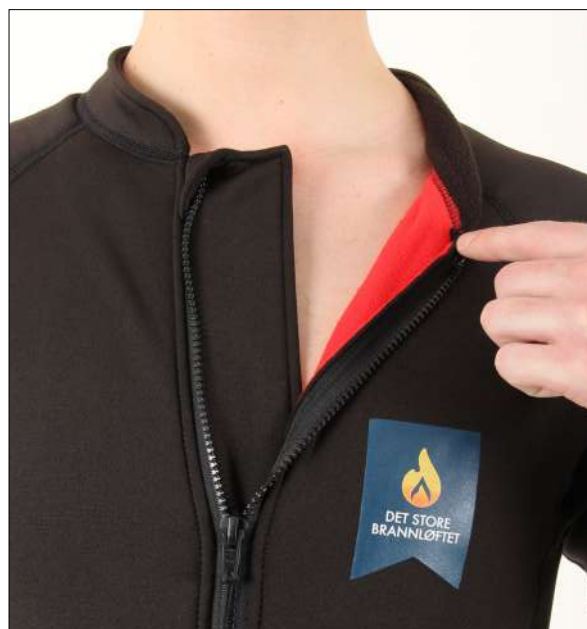

## STOCK SIZES

S, M, ML, L, XL, XXL, XXXL  
See page 37 for size chart

## TOG RATINGS

Bodycore: 0.6  
Bodycore Sub Zero: 1.4



## 3 piece undersuit

Provides fantastic thermal protection, above or below the surface. Fits closely to the body to maximise its thermal performance & ensure that you remain comfortable when working, diving or in rescue situations.

### SPECIFICATION

- Printed outer shell
- 1 layer super-soft fleece lining
- Seams are flat lock stitched
- Super-soft fleece comfort collar
- Integrated foot stirrups
- Elasticated adjustable waistband
- Elastic thumb stirrups
- Includes HotSox
- Supplied with drawstring carry bag

## SUB ZERO DUAL FLEECE UNDERSUIT

Is a super-soft dual layer fleece, perfect for more extreme conditions with an additional zipped right arm pocket.

### STOCK SIZES

S, M, ML, L, XL, XXL, XXXL  
See page 37 for size chart

### TOG RATINGS

Thermicore: 0.6  
Thermicore Sub Zero: 1.4







## Bodyline tropical suit

Can be used as a tropical swimming suit or as a base layer with our undersuits. Cavers have also adopted the Northern Diver Bodyline for use beneath caving suits for comfort and warmth on long trips underground. Even members of some mountain rescue teams wear this undersuit for cold nights on the hills.

### SPECIFICATION

- Close fitting - fits like a "second skin"
- Moisture wicking fleece & stretch lycra
- Velcro closing neck tab
- Breathable & lightweight
- Reliable blind stitched seams
- Elasticated thumb loops
- Built in foot stirrups
- Front entry zip

### STOCK SIZES

S, M, ML, L, XL, XXL  
See page 37 for size chart

### TOG RATING

0.2



## TECHNICAL THERMAL

## Base layer 2 piece undersuit

Increasingly popular thermal

### SPECIFICATION

- Breathable
- Moisture wicking
- Ergonomic design
- Lightweight and durable
- Thumb and foot stirrups
- Helps maintain core body temp
- Wear alone or layer with thermals
- Machine washable

### STOCK SIZES

S, M, L, XL  
Size chart available online



## ELECTRACORE

# Rechargeable heated vest, ideal under drysuits.



## Provide heat to give complete warmth to the body when working in cold conditions.

The Northern Diver 'Electracore' heated vest has been designed and manufactured with your comfort and warmth in mind. The three heat settings allow you to pick a temperature that suits you and if it happens that you want to raise or lower the temperature, the switch has been positioned in an easy to reach position to the left of your midriff – ensuring that even when you're wearing your rescue suit, the button remains easy to access.

The 'Electracore' has been made using a flexible 3.0mm black neoprene shell along with a snug fleece inner lining maintaining comfort for the user, whilst also insulating and reflecting the heat back on to the body, so even if the vest is turned off, there will still be noticeable thermal benefits.

The colour of the On/Off button will identify the heat of the vest. With up to a ten-hour run time, the 'Smart' Lithium-Ion battery will last for several dives.

The built in heat panels are waterproof, CE approved and conforms to EN 61000-6-1:2019, EN 61000-6-3:2007/A 1 :2011/AC:2012. Note the battery is not waterproof.

**This garment has been designed to be worn underneath a dry suit when being used in and around water.**

### Why use a heat vest?

Working efficiency increases

Working safety increases

Mobility is better (no need to wear multiple layers)

Comfort increases

### STOCK SIZES

S, M, L, XL, XXL

1000 MA	High Setting	Mid Setting	Low Setting
Temperature	50 degrees	40 degrees	25 degrees
Run Times	4 hours	7 hours	10 hours
Colour Of Light	Red	Blue	Green





# DRYSOX

**WATERPROOF, BREATHABLE PROTECTION**

**Certified to: BS EN ISO 12947-2**

Moisture-wicking, anti-bacterial, breathable & 100% waterproof socks, designed with a tri-layer fabric for top performance. Perfect for countless applications in wet conditions where it's essential to keep your feet warm, dry & comfortable. Lightweight, high performance, easy to wash & a seamless perfect fit. Designed to stop ingress of water, dirt or sand.

Features:

- Antibacterial & moisture wicking
- Lightweight & comfortable
- Seamless perfect fit, high performance
- Easy to wash
- Calf and knee length options
- Materials: Oeko-Tex 100 certified
- Sizes available: UK 4-12 (US 5-13)



### HotSox

They keep your feet warm  
Mid length with high wicking fleece  
Flat lock stitched with no raised seams  
Sizes available: UK 3-13 (US 4-14)



### Bodyline socks

Keep your feet even warmer  
Flat lock stitched with no raised seams  
Heel protector & cut to fit perfectly  
Sizes available: UK 5-13 (US 6-14)



### Temperate socks

3.0mm superstretch neoprene  
Low profile flat lock stitched seams  
Smooth finish & comfortable fit  
Sizes available: UK 5-10 (US 6-11)



### 4.0mm Search & Rescue Wetsuit Front entry style with separate hood

Ideal for helicopter/search and rescue operations  
 High vis red and yellow superstretch neoprene  
 Ti-Ax® Thermacote® titanium lining  
 Front entry YKK® zip  
 Triple-glued & blind-stitched seams  
 Smooth-skin neoprene neck  
 Velcro closing collar  
 Smooth-skin neoprene wrist & ankle seals  
 Strong pad elbows, knees and seat areas

**Sizes:** S, M, L, XL, XXL



### 4.0mm Search & Rescue Wetsuit 2 Piece with separate matching hood

High vis one piece full suit with a shortie over jacket  
 Superstretch neoprene and Ti-Ax Thermacote titanium lining  
 Front entry YKK® zips with non-chafe tab collar  
 Triple-glued & blind-stitched seams  
 Both fitted with front leg pocket and plastic D-ring  
 One piece is fitted with arm pockets  
 Smooth-skin neck, wrist and ankle seals  
 Kevlar® knee pads

**Sizes:** S, S-W, M, M-EW, L-W, XL, XXL, XXL-S, XXL-ES  
 W = WIDE, E = EXTRA, S = SHORT. *Limited stock available.*



## LOGO YOUR KIT

We can assist you to design and develop a crest or logo or what ever you require to be heat applied to your garment.

**Examples show Mauritius Fire & Rescue service branding.**



### **We carry a large selection of wet boots**

Manufactured from a flexible neoprene with a unique titanium lining for fantastic heat retention and additional comfort.

Colour: black  
(other colours to order)  
Sizes UK 3-13  
(US 4-14)





## 7.0mm Superstretch Wetsuit

### Rear entry style with separate hood

- Superstretch neoprene
- Ti-Ax® Thermacote® titanium lining
- Rear entry horizontal YKK® zip
- Triple-glued & blind-stitched seams
- Smooth-skin neoprene neck
- Velcro closing collar
- Smooth-skin neoprene wrist & ankle seals
- Strong pad knee, seat & inner crotch areas

**Sizes:** S, M, ML, L, XL

## Superstretch Rear Entry Wetsuit

### Available in 3.0mm and 5.0mm

- Superstretch neoprene
- Ti-Ax® Thermacote® titanium lining
- Rear entry vertical YKK® zip
- Triple-glued & blind-stitched seams
- Smooth-skin neoprene neck with Velcro closing tab
- Smooth-skin neoprene wrist and ankle seals
- Adjustable Velcro fastener on the back of the neck
- Protective elbow and knee pads

**Sizes:** S, M, ML, L, XL, XXL



**5.5mm/6.5mm Semi Tech Wetsuit**  
**2 Piece with separate matching hood**

5.5mm long john with Ti-Ax Thermacote titanium lining, integrated Thermal Shield vest and rear entry YKK® zip  
 6.5mm shortie with Ti-Ax Thermacote titanium lining and front entry YKK® zip  
 Triple-glued & blind-stitched seams  
 Shortie can be worn over the long john for colder waters  
 Smooth-skin wrist and ankle seals  
 Zipped ankle and wrist warmers

**Sizes:** S, M, L, XL, XXL



**4.0mm/6.0mm Storm Wetsuit**  
**Front entry style with separate hood**

Superstretch neoprene with a front entry YKK® zip  
 Mainly 6.0mm, with 4.0mm thickness in areas requiring extra flexibility (underarms, elbows, knees and crotch)  
 Ti-Ax® Thermacote® titanium lining  
 Triple-glued & blind-stitched seams  
 Smooth-skin neoprene neck with Velcro closing collar  
 Smooth-skin neoprene wrist & ankle seals  
 Strong pad knee and seat areas

**Sizes:** S, M, ML, MLT, L, LT, XL, XLT, XXL, XXXL



All Northern Diver PFDs benefit from a tough 500D Ripstop Cordura® outer combined with internal ISO approved flotation foam.

**Evo Pro 5 & Evo Pro 6 sizing:**

**Medium (>90N)**

Chest up to 106cm (42"), weight 76kg (167.5lb)

**Large (110N)**

Chest up to 116cm (46"), weight 95kg (209.4lb)

**XL (>120N)**

Chest up to 142cm (56"), weight 115kg (253.5lb)

**Encapsulated panels sizing:**

S: 150x50mm (5.9"x 2"), L: 300x100mm (11.8"x 3.9")

Custom printed with logos upon request



## ARCTIC SURVIVOR eVOPRO<sup>5</sup>

**EN 12402-5:2006 & 12402-6:2006**

**Specification**

- 50mm (2") quick release chest harness
- Includes cowtail, carabiner and 316 stainless steel O-ring, the self locking carabiner is CE approved and conforms to EN 12275:2013, EN 362:2004/B), kN26 (↔) & kN9 (↕)
- Adjustable shoulder straps with reflective stitching
- 25mm (1") Reflexite® prismatic bands
- 4-way lash tabs on the front and rear
- Plastic d-rings (bottom of the pockets)
- Single-handed quick release buckles
- Two front Velcro close cargo pockets with internal plastic D-rings/clip-in points and drain holes
- Removable orange pealess whistle on fixed cord
- 25mm (1") removable crotch/leg straps (black)
- Removable encapsulated ID on the rear (customisable)
- Reinforced stitching strengthens high wear areas



Photo credit: US rescue team training, Wisconsin



This personal flotation device is  
**US Coastguard Approved**

# EVOPRO<sup>6</sup>

## ARCTIC SURVIVOR

**EN 12402-5:2006 & 12402-6:2006**



### Specification

- 50mm (2") quick release chest harness
- Includes cowtail, carabiner and 316 stainless steel O-ring
- The self locking carabiner is CE approved and conforms to EN 12275:2013, EN 362:2004/B), kN26 (↔) & kN9 (↕)
- Padded adjustable shoulder straps with reflective detailing
- Snag resistant strap storage pockets for excess webbing
- Fail Safe System load tested to 3.2kN and meets ISO 12402 test standards
- 25mm (1") Reflexite® prismatic bands
- 4-way lash tabs on the front, shoulders and rear
- Plastic d-rings (top and bottom of the pockets)
- Single-handed quick release buckles
- Two front Velcro close cargo pockets with internal plastic D-rings/clip-in points and drain holes
- Removable orange pealess whistle on retractable cord
- 25mm (1") removable crotch/leg straps (high vis yellow)
- 2 removable encapsulated IDs on the rear (customisable)
- Removable light stick pocket on the rear, attaches to the fabric tab and houses our Flexi-lights which are available in 5 colours (see lighting section for product info)
- Anti slip waist prevents PFD from riding up when in use
- Internal hand warmer/documents pockets
- Reinforced stitching strengthens high wear areas
- Supplied in drawstring storage bag



**Evo X PFD sizing:**

**Medium (>75N)**

Chest up to 106cm (42"), weight 76kg (167.5lb)

**Large (80N)**

Chest up to 116cm (46"), weight 95kg (209.4lb)

**XL (>85N)**

Chest up to 142cm (56"), weight 115kg (253.5lb)

**ARCTIC SURVIVOR**

# EVO X

**EN 12402-5:2006 & 12402-6:2006**

**Specification**

38mm (1.5") quick release chest harness

Includes cowtail, carabiner and

316 stainless steel O-ring

The self locking carabiner is CE approved and conforms to

EN 12275:2013, EN 362:2004/B), kN26 (↔) & kN9 (↕)

Quick release fix-loc buckle

Padded adjustable shoulder straps with reflective detailing

Snag resistant strap storage pockets for excess webbing

Fail Safe System load tested to 3.2kN and meets

ISO 12402 test standards

25mm (1") Reflexite® prismatic bands

Narrow reflective piping

Tough grip shoulder panels

Front and rear 4-way lash tabs

Plastic D-rings

Zipped front pouch

Removable orange pealeless whistle on retractable cord

25mm (1") removable crotch/leg straps (high vis yellow)

2 removable encapsulated IDs on the rear (customisable)

Removable light stick pocket on the rear, attaches to the

fabric tab and houses our Flexi-lights which are available in 5 colours (see lighting section for product info)

Anti slip waist prevents PFD from riding up when in use

Reinforced stitching strengthens high wear areas

Internal hand warmer/documents pockets

Supplied in drawstring storage bag

Photo credit: MVS Rushdon Unit



# RESCUE 900P

EN 12402-5:2006



### Specification

- Cowtail tether and twist lock carabiner (optional)
- Quick release chest harness
- Adjustable shoulder straps with reflective stitching
- Snag resistant strap keeper pouches
- 4-way lash tab and fixed plastic D-ring on the chest
- Removable SOLAS tape reflective panel on rear
- Zippered pockets (mesh right side and neoprene left side)
- Fold away pouch on rear designed to house a throw bag
- 25mm (1") removable crotch/leg straps (black)
- Supplied with a whistle

### Rescue 900P PFD sizing:

#### Medium (>75N)

Chest up to 106cm (42"), weight 76kg (167.5lb)

#### Large (80N)

Chest up to 116cm (46"), weight 95kg (209.4lb)

#### XL (>85N)

Chest up to 142cm (56"), weight 115kg (253.5lb)



Rear throw bag pouch

## MODIFY YOUR OWN BESPOKE PFD...

Any style of custom PFD can be designed for you. Change colours, pocket styles/sizes, encapsulated panel sizes and artworks, add more features or remove anything you don't like. A minimum MoQ will apply to custom PFD orders.

Contact the rescue team to arrange a .pdf specification to be created.



# PFD Accessories.



**COWTAIL (yellow or black)**

Unstretched: 500mm (19.7") including ring  
Stretched 950mm (37.4") including ring

EN 12275:2013  
EN 362:2004/B



**DUAL LOCK SAFETY CARABINERS**

Overall length: 125mm (4.9"), gate opening: 23mm (0.9"), MSS 26kN, CE Approved



**CUSTOM ENCAPSULATED PANELS**

Custom logo (min MoQ of 15 pcs will apply)  
300x100mm (11.8"x3.9") or 100x50mm (3.9"x1.9")



**CARABINER & SLING**

25mm (0.9") black webbing  
Sling length: 5m (16'4")



**PFD CROTCH STRAP**

One size  
Adjustable



**PEA-LESS MARINE WHISTLE**

One size, non corrosive  
Orange only

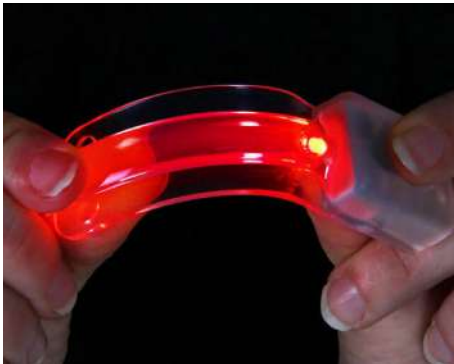

The modern alternative  
to chemical light sticks

**FLEXI-LIGHT STICKS - Dimensions: 110 x 25 x 12mm**

Available in 5 colours  
Visit lighting section for more product information



**REMOVABLE FLEXI-LIGHT POCKETS**

One size: 150x50x30mm (5.9"x1.9"x1.2")  
Secure Velcro attachment



## RESCUE SLING AND TAPE

Versatile piece of safety kit that rolls up compactly and fits neatly in PFD front pocket. Ideal for use in rescue situations.

Materials: 25mm (0.9") nylon tape

### 4m (13'1) Sling

Used as a towing sling or anchor  
Two sewn end loops  
Weight: 146g | Bright red colour

### 5m (16'4) Tape

One sewn end loop  
Weight: 188g  
High vis yellow colour



# LUG POUCH

SELECT THE POUCH TO SUIT YOUR RESCUE



Specifically designed to offer excellent utility in any rescue environment. The Lug Pouch can carry anything from Carabiners, Prusiks & Flexi-Lights to Medical equipment & can be stored on the Lug Pouch Storage Bag prior to use, ready for any call-out.

### Lug Pouch Key Features

- Velcro securely fastens to PFDs & Storage Bag
- Securely fits to Velcro panel on our Evo Pro 5 & 6 PFDs
- Accessible storage without adding cumbersome to jacket
- Space to fit custom removable Encapsulated Panel
- Additional space to attach our Flexi-Light sticks
- Webbing loop for easy & quick one-handed removal
- Large interior space with split compartment
- Mesh exterior removes the risk of any water build up
- Size: 305 x 160 x 40mm (12" x 6.3" x 1.6") approx.

### Storage Bag Key Features

- Easy loading & storage of multiple Lug Pouches
- Quickly accessible
- Space for 8 Lug Pouches
- 25mm (0.9") strong webbing carry handles
- Versatile 316 stainless steel snaphook clips & D-rings
- Folds down to a compact, transportable size
- Storage bag size: 700 x 750mm (27.6" x 29.5") approx.



Flexi-light sticks available to buy separate

Encapsulated panels available to buy separate

Rescue sling & tape available to buy separate

Carabiners available to buy separate



Designed with Mountain Rescue England & Wales, P.B

EN 12402-2

## 275N Automatic Life Jacket

*It is virtually impossible to ship, by air, CO2 cartridges.*



Supplied with a 60g (2.1oz) CO2 inflation cylinder, the Northern Diver Arctic Survivor 275N life jacket is a high performance device for offshore use and severe environmental conditions, when maximum protection is required or where heavy waterproof clothing is being worn.

This life jacket helps prevent drowning of those who cannot help themselves, for example if they are unconscious.

This life jacket has been designed in consultation with rescue training organisations responsible for training the emergency services. It can be customised with logos.

### SPECIFICATION

- 60g (2.1oz) CO2 auto inflation cartridge
- Whistle and oral inflation tube
- Flexi-Light stick pocket fitted to the left side of jacket, please note Flexi-light is not included
- Adjustable crotch straps

*\*This item cannot be guaranteed to self right in all instances when unconscious user wearing heavy waterproofs or clothing. During tests it has been proved to self right in the vast majority of cases.*

### STOCK SIZES

One/adjustable



### COLOURS

Red or blue

Model (Chris) wearing the 275N life jacket fully inflated, watch the video at [ndiver-rescue.com](http://ndiver-rescue.com)



Packed down size:  
H: 30cm (11.8")  
W: 18cm (7")  
D: 10cm (3.9")

# SOLAS APPROVED 275N Twin Chamber Life Jacket



0098/2019



The 275N life jacket has two independent chambers, two UML automatic inflators with manual activation cords and an additional Halkey Roberts oral inflator. A waist strap and two crotch straps, all of which with quick-release buckles, secure the life jacket. A light beacon, buddy line and 4-way lash tab (for attaching objects) are also included.

## SPECIFICATION

Red PVC outer shell, thickness of PVC: 0.5mm (0.2")

Weight of PVC: 630g (22.2oz) per sq/m

Breaking strength is over 120kg (264lb)

Two UML automatic inflators

One Halkey-Roberts oral inflator

Rescue light

Buddy pouch with over 1m (3'3) of line

Harness loop

4-way lash tab (left side)

UTX signal whistle

Locator beacon window, 80x45mm (3.1"x1.8")

50mm (1.9") SOLAS certified reflective tape

316 stainless-steel adjuster

Lifting loop

Dual YKK® 25mm (1") quick burst zipper

Life jacket weight: 1.6kg (3.5lb)

Inflated LxWxH: 70x40x5cm (27.5" x 15.7" x 2")

Two independent bladders, urethane coated bladder material for superior strength and durability

Bladder fabric thickness: 0.3mm (0.01")

Bladder weight: 280g (9.9oz) per sq/m

Quick release crotch straps with reflective detailing

## STOCK SIZES

One/adjustable

Model (Dan Cottrell) shown with the 275N Twin Chamber life jacket fully inflated. View inflation of the jacket online at [www.ndiver-rescue.com](http://www.ndiver-rescue.com)



EN 12402-3

## 150N Manual and Automatic Life Jackets



Our superior in-water performance jackets are highly visible when inflated. Available in two styles, manual and automatic, these classic life jackets are compact and comfortable for everyday use, suitable for swimmers and non-swimmers in both coastal and offshore waters, these jackets can be used in all weather conditions.

### Choose which jacket is best for you.

The manual life jacket works by operation from the user, via a pull chord that fires a pin triggering the canister to inflate the life jacket. Users must be conscious to operate these jackets.

The automatic life jacket works with element in the inflation mechanism reacting with water and auto triggers the gas cartridge, which inflates the jackets air chambers. Perfect for unconscious casualties.

### SPECIFICATIONS

- Velcro closing burst jacket
- Holds a 33g (1.2oz) CO2 inflation cylinder
- Pea-less whistle and inflation tube
- 4-way lash tab located on the left
- 50mm (1.9") SOLAS certified reflective tape
- Heavy duty harness belt
- Integrated harness offers a 316 stainless steel buckle including a 'D ring' for attaching a life line
- Compact & light weight design
- Quick release crotch straps
- Zipped pocket located on the left
- Durable, long lasting outer cover

### STOCK SIZES

One/adjustable





## LIFE JACKET SERVICING COURSES



We are authorised to service, maintain and repair various life jacket types.

We will inspect and pressure test your life jacket, replace out of date, faulty, or corroded parts and issue a service certificate.

All life jackets will undergo a rigorous inspection by a fully qualified technician to ensure it is fit for purpose and maximise its performance if needed in an emergency.

We advise life jackets should be serviced every 12 months by a qualified agent.

We offer servicing courses to groups and individuals, contact Craig McColl for course dates and prices +44 (0) 1257 25 69 34

## Life Jacket. Accessories

### What is the difference between a life jacket and a buoyancy vest?

Buoyancy aids cannot be guaranteed to turn an unconscious body over and it will not support your body in the water. Life jackets, if properly worn and in good condition, are designed to keep your airways clear of water, even if you are unconscious or injured.



ANNUAL SERVICE KIT

INCLUDES CO2 CARTRIDGE



ANNUAL SERVICE KIT

WITHOUT CO2 CARTRIDGE



RE-ARMING KIT

ONE SIZE



CO2 CARTRIDGES

60g (2.1oz) and 33g (1.2oz) sizes



## SPRAY HOOD

Designed to fit over your head and inflated life jacket to make you more visible and to reduce the amount of spray you inhale. Supplied in a storage pouch that attaches to the life jacket via Velcro fastener.

Hood size: one

Pouch size:

120 x 120mm (4.7" x 4.7")



### OTS guardian full face mask

Designed to meet the demanding needs of today's Commercial/Professional Diver, it leverages the best features found on other FFMs with unique features designed by OTS.

The second stage regulator is horizontally mounted close to the diver's face. This design minimizes the difference in ambient pressure exerted on the second stage diaphragm and on the diver's body irrespective of the diver's position—eliminating the need for manual adjustments.

A locking mechanism secures the second stage to the mask to allow removal for post-dive cleaning and storage. As a safety precaution, the locking mechanism is located inside the mask to prevent accidental release during diving.

Another noteworthy design feature is the use of a double face seal. This allows a single mask to fit more faces. No more use of rubber tubing to fit smaller faces, measuring faces to order the right size FFM, or not being able to share masks amongst large and smaller faced divers.

### OTS spectrum full face mask

The best of both worlds for divers. You can enjoy the benefits of a FFM while also using your own regulators, thus eliminating the large costs sometimes associated with Full Face Masks.

The Spectrum offers exceptional viewing and a wide field of vision. The Spectrum FFM is designed for water temperatures below 10°C and it's suitable for cold-water diving applications, however, please remember that ultimately the 2nd stage regulator being used dictates its cold water performance.

Tested to meet EN 250:20141 European Standards and has a maximum diving depth of 50m (164'). It's also been tested and meets EN12021 which is for diving applications with breathing air.

### Switch block with bail out indicator

Ergonomically designed solution to a single point breathing system. The switch block was developed to allow the diver to switch from main cylinder to reserve with one handed easy action.

Once switched to the bail out cylinder, the LED light will protrude and illuminate. The luminous insert is also visible on the switch.

30 hour burn time (constant) on the light. When the battery gets low (1 hour remaining) the light will flash to indicate low battery. The LED light is very easily replaceable. The complete shaft unit is available as a spare part which is simply & quickly replaced by a circlip.

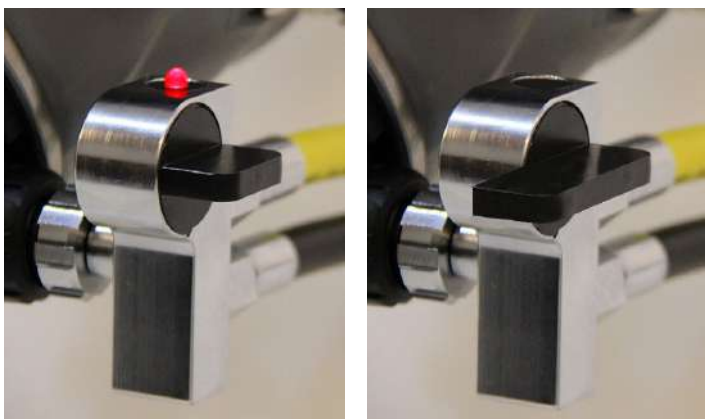

Standard switch block without bail indicator also available



**OTS EM-OTS2**

**Dual earphones & microphone**

Designed to allow the user to connect either hard-wire or through-water communications to a helmet or full face mask (ffm).

Configured with Hot Mic® noise cancelling, salt-water resistant, pressure-resistant studio quality microphone



**OTS buddy phone**

**Through-water transceivers**

Excellent through-water communications in a compact, affordable platform. It includes voice menus via push-to-talk button to control channel, volume, squelch & a patented Hot Mic® or Super Mic®



**OTS SSB-2010**

**4-channel diver unit**

5 watt diver unit designed with professional search & rescue teams in mind. Standard features include: voice-operated transmitter, push-to-talk control, squelch, earphone volume, voice menu, removable transducer, & a heavy-duty design



**OTS MK-7**

**Buddyline 2-diver station**

A compact, self-contained air intercom that gives clear communications in the 4-wire mode (round robin). Specifically designed for search & rescue teams to have an underwater communication device that required minimal set-up time



**OTS**

**ComBox 1-diver station**

A compact, self-contained one diver air intercom, the ComBox allows clear 2-wire communications using a powerful 20-watt amplifier. With a rugged PTT control & "silver bullet" front speaker, the ComBox will deliver years of reliable service



**OTS MK2**

**DCI 2-diver station**

The versatile MK2-DCI provides one or two divers with clear communications in either 2-wire or 4-wire mode. In 4-wire mode, up to 6 divers can be 'stacked' & communicating with each other



**OTS SP-100D-2**

**2-Channel Station**

The SP-100D2 uses state-of-the-art digital signal processing (DSP) circuitry to ensure great performance & clarity. It operates with all single side-band acoustic underwater devices within range & on the same frequency. Compact & operates on 16 AA alkaline batteries



**OTS STX-101**

**4-Channel Station**

The Aquacom® STX-101 surface transceiver is a 5-watt, multi-channel, single side-band underwater telephone designed with the professional search & rescue teams in mind. The STX-101 offers four channels that match the SSB-2010

**We carry a full range of commercial diving equipment see our website for more information**  
[www.ndiver-commercial.com](http://www.ndiver-commercial.com)

# Manta

## SAR Helmets

High performance multi-role technical rescue helmet for the most demanding work environment, with the facility to fit a variety of accessories.

Used by many Fire, SAR, Coastguard, Ambulance and Rescue teams around the world.

There are 3 variants of the Manta available: MH/2, MH/3 & MH/4.

### Conforms to:

- EN 14052:2005
- High performance safety helmet PAS 028:2002
- Marine safety helmet FS/ATV1
- Quad & ATV helmet
- EN 1384 Equestrian helmet
- EN 352-3:1997 Hearing protection
- EN 166:2002 Industrial eye protection
- EN 12492 Working at height / Mountaineering
- EN 397 (Flame Resistance)
- NFPA1951:2007 Protective ensembles for technical rescue
- NFPA1952:2010 Surface Water Operations Protective Clothing & Equipment, 2010 Edition
- ANSI Z89.1 Type 2 Class C American National Standard for Industrial Head Protection

- EN 16471:2014 fire fighters helmets for wildland fire fighting **(MH/4 ONLY)**
- EN 16473:2014 fire fighters helmets for technical rescue **(MH/4 ONLY)**

Meets US & Canadian Coastguard requirements

### Features

- Impact protection:
  - Crown=100 joules
  - Side/Front/Rear = 90 joules
- Shell thickness: 3-6mm (0.1"- 0.2")
- Liner thickness: 18-22mm (0.7"- 0.9")
- Helmet weight: 550g (19.4oz)
- High impact ABS shell
- Available in up to 9 colours
- Removable ventilation covers (available in black or reflective)
- Good ventilation and airflow
- Internal retractable visor fitted
- Secure 4-point chin strap
- SOLAS approved reflective tape
- Easy lockable adjustment ratchet
- Head circumference:
  - 52-62cm (20.4"- 24.4")
- Deluxe replaceable sweatband
- Easy attachment of accessories



### Manta helmet uses:

- Working at height
- Urban climbing
- Abseil & rope access
- Search and rescue
- Quad bike
- All terrain vehicles (ATV)
- Ambulance
- Emergency medical services (EMS)
- Water rescue and swift water rescue
- Powerboat, RIBS & hovercraft
- Confined space
- Chemical, bacteriological, radiological and nuclear environments
- Tactical assistance
- Snowmobile and jet ski
- Equestrian & animal rescue
- Industrial safety
- Forestry and wildfire fire fighting
- Maritime rescue
- Coastal border security
- Arboriculture



MH/4 MANTA



CUSTOM LOGOS AVAILABLE



MH/3 MANTA



MH/2 MANTA

COMPATIBLE WITH ALL MODELS

## Manta Helmet Accessories



### Ear defenders

A compact, self-contained air intercom that



### Integral visor

Available in amber or clear



### Half marine visor

Made from strong clear thermoplastic



### Full face marine visor

For extra protection



### Star helmet pad (self adhesive)

Used inside the helmet for added comfort



### Basic nylon ratchet harness

Cost effective replacement sweatband



### Deluxe ratchet harness

Includes extra padding for added comfort



### Clip torch mount

Low profile mount for all your lighting needs



### Helmet torch bracket

Self adhesive backing



### SOLAS reflective tape

Highly reflective for low light situations



### Photo luminescent vent covers

Glow in the dark increasing the visibility



### Coloured vent covers

Available in black, green, red and yellow

## Safety Helmet.

### ELE V8

A compact, durable and lightweight helmet, certified to EN 12492 (working at height). Inside the Ele V8's ABS outer shell there's an EPS foam lining and removable cushioning to keep you comfortable. Furthermore, ten ventilation points feature on the helmet, all of which are protected with mesh to prevent debris from entering. The vents also allow water to flow through the helmet when it's used in water.

The helmet's size can be quickly adjusted with the convenient twist mechanism at the rear, and the padded chin strap is also adjustable. Secures with a Fastex-style clasp.

The Elev8 is equipped with mounting points for ear defenders, a visor and a headlamp – all of which are available separately.

Durable ABS outer shell  
 EPS foam inner lining  
 Removable, washable cushioning  
 Ventilation slots with mesh protection  
 Twist action size adjustment system  
 Adjustable, padded chin strap  
 Branding and reflective panels available upon request  
 Impact resistance: 100 joules (crown), 90 joules (sides, front/rear)  
 Head circumference: 51-62cm (20"- 24.4")



**Half visor - scratch and fog-resistant**  
 EN 166-2002, EN 14458-2004,  
 ANSI Z87.1-2010



**Ear defenders**  
 Attaches easily via helmet mounting points  
 Compatible with the Elev8 only

## GLARE HEAD TORCH



**CAN BE USED WITH ANY OF OUR HELMETS**  
 SEE LIGHTING SECTION FOR MORE INFORMATION

## UNIVERSAL HELMET MOUNT



Compatible with ND torches, page 74



The mount fits most helmets  
 Compatible with a range of torches  
 Easy to assemble  
 Perfect for night time rescues  
[www.ndiver.com/universal-helmet-mount](http://www.ndiver.com/universal-helmet-mount)

# Extreme Rescue. Seahawk

Conforms to EN 1385:2012

All-round protection great for white and swift water rescue.

The split-mould injection process creates a very rigid shell and an ergonomic “negative draft” shape that follows the natural curves of the head, protecting the forehead and base of the cranium.

ABS plastic shell  
Extends to ears for added protection and stability  
Twist lock adjustment  
Lightweight

Colours: gloss red, white and orange, matte yellow and black  
Head circumference: 55-62cm (21.7”- 24.4”)



**BRANDING AVAILABLE ON ALL HELMETS - EXAMPLES BELOW**



Above: Kinder Mountain Rescue Team



Above: North Yorkshire Fire & Rescue Service



Above: Woodhead & Kinder Mountain Rescue Teams



Above: Buckinghamshire Search & Rescue Service



Above: West Midlands Search & Rescue Team



Above: Devon & Cornwall Police Service

## Logo Your Helmets

We are able to add branding to our range of helmets.

We can specially design logos for you. A small fee will apply.

Reflective vinyl lettering or bespoke shaped panels can be applied. The following colours are available:

- Reflective blue
- Reflective silver/white
- Reflective red
- Reflective yellow

Other colours can be printed but would not be reflective.

Team logos in full colour can be printed and applied in any position on any helmet.

# Do you feel the cold?

Use neoprene caps or hoods for that added bit of comfort and warmth.



Photo credit: HART Ambulance



### 2.0mm neoprene skull cap

Superstretch neoprene  
Velcro closing chin strap  
low profile design for comfort  
Great for cold environments  
Sizes: S/M, L/XL



Internal pocket for comms radio

### 2.0 & 5.0mm comms hoods

Superstretch neoprene  
Comms cables fixtures for a radio headset  
Perforated ear pieces  
Vents for pressure equalisation  
Sizes: S, M, L, XL, XXL



### 4.0mm reversible hoods

Superstretch neoprene  
Yellow high visibility for training purposes  
Reverse to black for covert ops  
Vents for pressure equalisation  
Sizes: S, M, L, XL, XXL



### 6.0mm boating operations hoods

Superstretch neoprene  
Nose, mouth & ear vents allow for communication systems to be used  
Vents for pressure equalisation  
Sizes: S, M, L, XL, XXL



### 6.5mm skin/skin face seal hoods

Superstretch neoprene  
Plush thermal inner layer  
Smooth skin outer face seal  
Ideal for use with full face masks  
Vents for pressure equalisation  
Sizes: S, M, L, XL, XXL



### 6.5mm supervent hoods

Superstretch neoprene  
Plush thermal inner layer  
MA heavy duty, anti Velcro outer lining for increased longevity  
Vents for pressure equalisation  
Sizes: S, M, L, XL, XXL



# Series V4 Slim Style Dry Glove Ring System 2020

Loss of movement or manual dexterity, due to cold hands, can be dangerous during a dive, as well as being uncomfortable for the diver. Maintaining hand warmth and a divers ability to efficiently operate their essential diving equipment, is vital to safe diving and maintaining a high level of dive comfort. Northern Diver are proud to manufacture and continue to innovate our revolutionary concept in dry diving glove systems.

Fitting this dry glove system to your own drysuit is easy, as the package includes the unique bespoke fitting tool, sealing adhesive and a sealing adhesive application brush.

Compatible with neoprene or membrane drysuits, using latex or neoprene wrist seals. Once fitted to a divers suit, the unique twin-safe locking ring mechanism, allows quick and easy glove engagement and the equally quick release of the dry gloves, without the need for assistance.

**Gloves conform to the requirements of European Directive 89/686/EEC and to the European standards EN420:2003 + A1:2009 and EN374:2003, EN388:2003**

### [ Ansell Extra™ glove ]

Extremely high resistance to many ketones, salts, detergents, alcohols, alkalis and fats  
100% cotton flock lining provides a softer more comfortable glove that helps absorb perspiration  
100% natural rubber with no filters  
Excellent resistance to mechanical hazards plus increased chemical protection  
Chlorinated for better grip and increased chemical resistance  
Heavy duty handling where sensitivity is also required

### [ Thermal fleece inner glove ]

Thermal 4-way stretch fleece  
Flat lock stitched seams for comfort  
Snug fit around wrist area for additional thermal protection  
Removable for warmer waters or for use post dive

### [ Package includes ]

Ansell Extra™ gloves  
Thermal fleece inner gloves  
2 (smaller lightweight) glove modules  
3 sealing rings  
Locking tool  
Adhesive sealant  
Instructional video available online



The same unrivalled quality with a new streamlined design

Ring modules are half the size of their predecessor making them lightweight with less bulk and a more movement for the user.



### What's in the kit:



Ansell Extra™ gloves



Fleece inner gloves



Dry glove rings



Suit seal

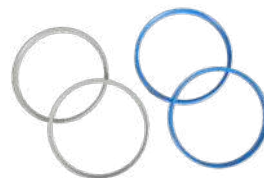

Sealing rings



Locking tool

**Northern Diver's Dry Glove System is suitable for both arctic conditions & contaminated water environments.**



Photo credit: Steve Smith

S, M, L, XL

How to video: [www.ndiver.com/dry-glove-ring-system-black](http://www.ndiver.com/dry-glove-ring-system-black)

Warmth & comfort

## Gloves designed for rescue scenarios



**SUPERSTRETCH**

2MM

5MM

7MM

### HEAVY DUTY NEOPRENE GLOVES

These gloves are manufactured from our unique 4-way superstretch neoprene and come with liquid taped seams and reinforced glass powder printing in high wear areas. The inside of the gloves are lined with a Ti-Ax™ super-warm titanium inner lining. Additional high-grip silicone overprint texturing, super flexibility and comfort.

Sizes: S, M, L, XL, XXL



**SUPERSTRETCH**

2MM

5MM

7MM

### COMFORTABLE & WARM NEOPRENE GLOVES

These gloves are manufactured from our unique 4-way super-stretch neoprene. They are reported to be the easiest of all our gloves to put on and take off.

These gloves are available in 2.0mm, 5.0mm and 7.0mm neoprene. For warmer water or surface use, we recommend the 2.0mm option. Our 5.0mm and 7.0mm options are ideal for cooler conditions, where thicker gloves are essential. Even at top thickness, these gloves don't compromise dexterity.

Sizes: S, M, L, XL, XXL



**STORMFORCE**  
SPECIALIST RESCUE EQUIPMENT

4MM

### NEOPRENE GLOVES WITH RUBBER MOLDED PALM

Our Stormforce gloves combine comfort and warmth. The palm area is constructed from a textured rubber which gives excellent grip and does not compromise on flexibility. Water migration is minimised with the addition of an elasticated hook and loop fastening wrist strap.

Sizes: S, M, L, XL, XXL



Photo credit: HART Ambulance



## SEMI DRY GLOVES



5.0mm neoprene gloves suitable for a wide range of diving conditions where you want to keep your hands warm and your gloves securely in place for the duration of the dive.

Neotex wrist seals on the Arctic Survivor gloves form a 'water lock' system. This seal system ensures no flush from the gloves, keeping your hands warm.

The neoprene ensures a comfortable, close fit for optimal dexterity - in or out of the water. The textured finish on the palms gives additional support.

Sizes: S, M, L, XL, XXL

## HEAVY DUTY SEMI DRY GLOVES



5.0mm neoprene gloves finished with liquid taped seams and a tough silicone over print for the more heavy duty user, the extra protection helps to provide a longer life-span.

Neotex wrist seals on the Arctic Survivor gloves form a 'water lock' system. This seal system ensures no flush from the gloves, keeping your hands warm.

Sizes: S, M, L, XL, XXL

## DRYSKIN NEOPRENE GLOVES



A 5.0mm superstretch neoprene glove with an internal dry seal ring to keep water out and a thermal fleece internal liner. The liner improves the flexibility of the glove but also adds an efficient insulating layer that is quick drying and very smooth against the skin.

The internal dry seal ring keeps your hands drier for longer to keep them warm. Silicone printed palms add extra grip to hold onto things. External seams are sealed for protection to stop them from unpicking or coming loose.

Sizes: S, M, L, XL, XXL

# GLOVES FOR ALL CONDITIONS



## OPTIMUM

3MM

5MM

Our Optimum gloves are available in 3.0mm and 5.0mm options and feature a Ti-Ax® Thermacote® heat-reflecting lining. These gloves are manufactured from a high-grade polymer, with additional protective Diamondflex and our Super-Tack embossed palms and fingers for heightened control and grip.

A tight-fitting wrist seal is essential to minimise water migration, but it can make the glove difficult to pull on over your hand. Our Optimum gloves feature a wrist zip to allow the necessary expansion when required and select models feature a Velcro closing wrist strap to reduce flushing and keep you warm.

Sizes: S, M, L, XL, XXL

## 3D Shaped OPTIMUM Zipped Gloves

Available in:  
5.0mm Temperate  
3.0mm Tropical

Catering for both extremes of temperature without the loss of dexterity and warmth.

Sizes:  
S, M, L, XL, XXL



A moulded shape fit along with our Glideskin seal makes donning easy for the user. Factors complemented by the added security of a Long YKK® plastic zip with velcro closing zip tab.

With pre-bent fingers and anti-slip grip, the gloves perform really well. Super comfortable because of the pattern and the unique four-way stretch neoprene. Flat-locked stitched and triple glued seams ensure the durability and longevity of the glove is maximised to the fullest.



## KEVLAR GLOVES

3MM 5MM

For more extreme conditions, these DuPont™ Kevlar® enhanced gloves give extra strength and protection, without compromising on hand comfort, ease of use or underwater hand dexterity.

The 3.0mm thickness option provides the ultimate combination of flexibility and luxurious superstretch neoprene comfort, with hard-wearing Kevlar® protection.

The 5.0mm thickness option, designed for more extreme conditions or colder environments, ideal when additional thermal protection is required, resulting in the ultimate hard-wearing commercial glove.

Sizes: S, M, L, XL, XXL



## AMARA PALM NEOPRENE GLOVES

SPECIALIST RESCUE EQUIPMENT 2MM

Designed specifically for rescue services. Manufactured from 2.0mm neoprene, with Amara suede on the palm and finger area, for an enhanced grip and the durability is improved further, with a double reinforced palm area.

The Velcro closure wrist system also enhances security and keeps flushing to a minimum, for added confidence and additional comfort.

Sizes: S, M, L, XL, XXL



## AMARA PALM ZIPPED PADDED NEOPRENE GLOVES

2MM

A glove based on our original, very popular, amara palm SRE glove. This version includes a zip on the wrist for easier donning. Manufactured from 2.0mm neoprene the zipped SRE glove has the same amara palm and finger areas with the added features of padded panels that are overprinted for improved comfort, non-slip grip and abrasion protection.

The gloves include a super soft plush thermal lining ensuring you hands are warm and comfortable in any conditions.

Sizes: S, M, L, XL, XXL



## NEOPRENE GLOVES

3MM 4MM 5MM

These neoprene gloves combine comfort, warmth and flexibility.

The palm, fingers and thumb feature a hard-wearing protective coating. Water migration is minimised with the addition of an elasticated Velcro wrist strap. Available in 3.0, 4.0 and 5.0mm.

Sizes: S, M, L, XL, XXL

Certified to: EN 20345:2011

## PRO-SAFE WATER RESCUE BOOTS

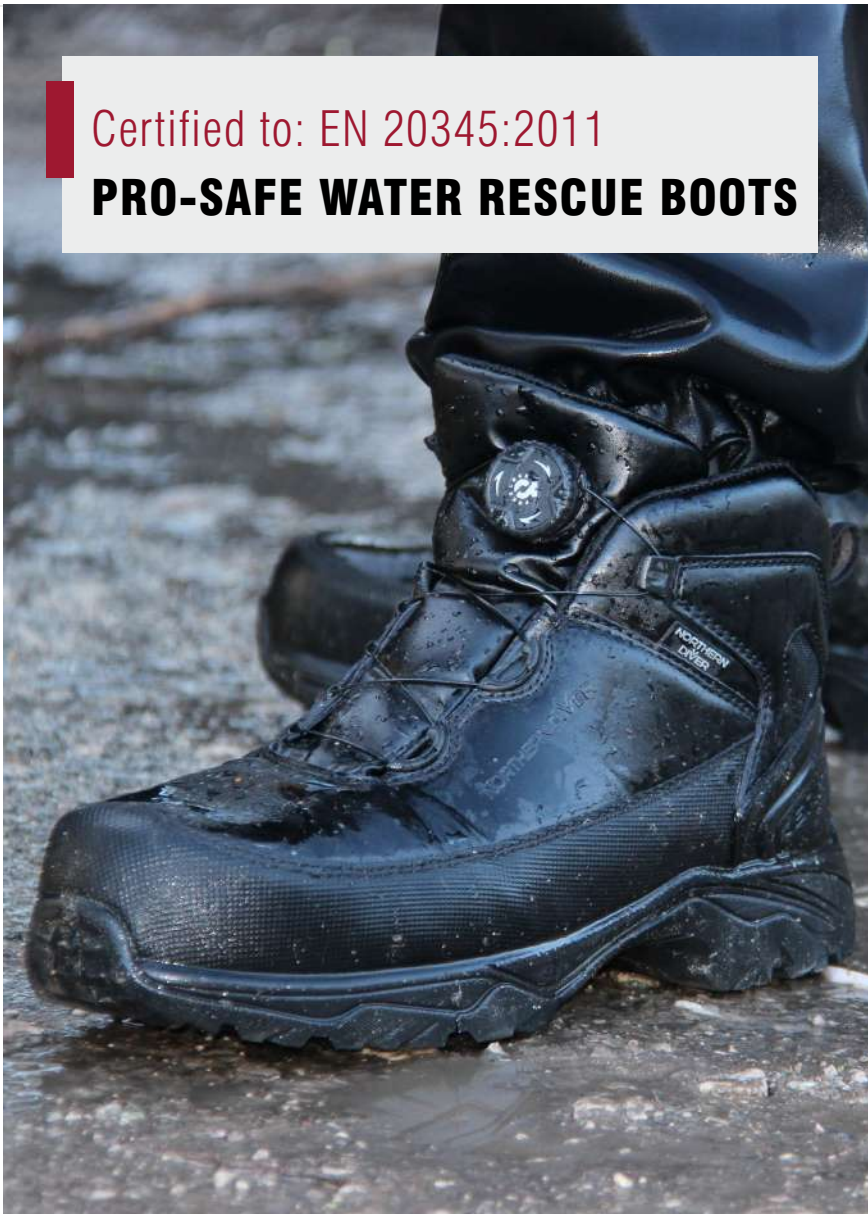

Our latest design of water safety boot. Provides exceptional comfort, control, grip and protection in water and on land.

Featuring the Freelock fast lace system and wide opening makes the process of putting on the boots super quick.

Composite mid-sole and toe protection make the boots extremely lightweight and additional layers along the side of the boot keeps the foot securely in place. The lacing system is a super strong synthetic weave which will last the life of the boots. Layers along the front and sides of the boot help withstand knocks and sharp objects from puncturing or scraping the boots.

Build: synthetic leather, PU heel, mesh inner  
Anti-static, oil resistant/slip resistant outsole  
Double stitched seams for added strength  
Lightweight composite mid-sole/toe protection  
Penetration-resistant mid sole  
Padded ankle collar for extra ankle protection  
Reinforced PU outer heel cage  
Freelock fast lace system  
Low-profile to ensure no snag hazards  
3 generous reinforced mesh drainage holes  
Ventilated & moulded foot bed  
Extra long pull on loop - easy use with gloves  
Weight: 600g per boot

Sizes: UK 3-14 (US 4-15)



## Freestyle Safety Water Rescue Boots

Provides comfort, control and protection, allowing rescue professionals to feel confident to perform their tasks on dry land or in/around water. Built using both synthetic and natural materials, which conform to EN ISO 20345:2011.

Lightweight, protected toe-caps

S3 slip resistance

Conform to the SB, S1 and S2 requirements

High quality rubber EVA non-slip sole and composite toe  
Exceptional grip on wet or unstable surfaces, moss, sea-weed and many other hazardous surfaces

Impact resistant to 200 joules, antistatic and have water absorption/water penetration properties

Energy absorption around the heel

Strengthened stitch seams for long term durability

Abrasion resistant with external heel protection

Wicked inner lining and drain holes on the inner side

Neoprene insoles provide extra comfort

Velcro closing straps for a quick release system

Sizes : UK 5-14 (US 6-15)



## Rock swim safety boots

Complies with the EC directive for Personal Protective Equipment (Directive 89/686/EEC) and meets the requirements of the European standard EN ISO 20345:2004.

All terrain boots

Expels water through the side vents to increase comfort

Allows wearer to perform tasks on dry land, in/under water

Can be worn with/without socks

Fins can be directly fitted over the boots

Far greater protection than the standard rock swim boots, essential when more substantial PPE is required

Maximum comfort & control

Composite toe & mid-sole foil

Rugged hi-grip heavy-duty outer sole

Oil and chemical resistant

Suitable for use in/out of water (fitted with drain holes)

Multi-point Velcro securing straps

External ankle protection

Cladding protection on heel, toe & sides

Fabric: nylon and synthetics



Sizes: UK 5-13 (US 6-14)



## Rock swim boots

Designed to be used with most models of drysuit, with attached latex or neoprene socks or material socks. These boots expel water post-dive, for additional foot protection (after diving) on a boat deck or back on land.

Offers the user excellent grip on boats & boarding ladders. Comfortable to wear for swimming and diving. Ideal for all terrains and our ISBO military fins are ideal to wear with these boots.

Suitable for use in/out of water

Lace up

Multi-point 'Velcro' securing straps & ankle strap

Fitted internal neoprene socks

Rugged hi-grip heavy-duty outer sole

Oil and chemical resistant

External ankle protection

Cladding protection on heel, toe & sides

Drainage points on both sides of the boot

Fabric: nylon and synthetics

Sizes: UK 5-13 (US 6-14)



**ISBO fins** have a large enough foot pocket making them compatible with the water rescue and rock swim boots.

## Rescue essentials

# Knives/tools (stainless steel and titanium)



## MULTI TOOL/KNIFE

**1 FREE WITH EVERY ORDER OVER £100/\$100**

Developed with the emergency medical and rescue services in mind. The tools multi-functionality makes it indispensable for many of life's situations.

Tool length (closed) 115mm (4.5")  
 Large blade, 78mm (3") length  
 Phillips screwdriver, 28mm (1.1") length  
 Window breaker, 5 x 25mm (0.2" x 0.9")  
 F/head screwdriver, 5 x 30mm (0.5" x 1.9")  
 Crate opener, 5 x 30mm (0.5" x 1.9")  
 Cap/bottle opener, 2mm (0.08")  
 Wire stripper, 2mm (0.08")  
 Reamer/punch, 28mm (1.1") length  
 Seat belt cutter, 88mm (3.5") length  
 Tweezers, 40mm (1.6") length  
 Toothpick, 42mm (1.7") length  
 Disc saw for shatterproof glass, 82mm (3.2") length  
 Luminescent yellow casing  
 Nylon cord, 85mm (3.3") length  
 Nylon pouch (Velcro closure)



## FOLDING KNIFE

90mm (3.5") blade  
 316 Marine Stainless Steel  
 ABS and poly PU coated handle for grip  
 Line cutter and thumb opening slot  
 Folds for safety when not in use  
 Rear anchor point  
 Available in yellow and black



## KN48

70mm (2.8") twin edge stainless steel blade  
 Serrated/sharp edge and line cutter  
 2.5mm (0.1") chisel point safety blade  
 Protective hard plastic sheath  
 Thumb-lock quick release system  
 Comfort handle / rear anchor point  
 Webbing, BCD, PFD, hose or rope attachments

## KN-20 Stainless Steel Sharp Tip Knife



110mm (4.4") stainless steel blade  
 5mm (0.2") sharp tip  
 Blade: serrated & sharp edges  
 Built in line cutter  
 Smooth cutting, light-weight, durable & strength-saving  
 Includes rubber leg straps  
 High quality plastic sheath protects knife  
 Compact quick-release mechanism features a one-hand release  
 Available colours: blue, yellow, grey, silver



## SQUEEZE LOCK RESCUE KNIFE

75mm (3") blade length  
 Blunt tip safety blade  
 Blade: serrated and sharp edges  
 Built in line cutter  
 316 stainless steel blade construction  
 Easy squeeze secure locking system  
 Hard plastic yellow protective sheath  
 Compact and portable safety knife  
 Attaches to your BCD or PFD  
 Allows for quick emergency access



## LDK RESCUE TITANIUM

75mm (3") titanium twin-edged blade  
 3.0mm (0.1") chisel point safety blade  
 Protective hard plastic sheath  
 Push button quick release catch  
 Handle with rear anchor point  
 Quick locate knife handle insert  
 Variable width attachment system  
 Bracket to attach 50mm (1.9") webbing



## KN-42B Stainless Steel Blunt Tip Knife



120mm (4.75") stainless steel blade  
Blunt tip blade  
Blade: serrated & sharp edges  
Built in line cutter  
Smooth cutting & lightweight  
Durable & strength-saving  
High quality plastic sheath to protect the knife, and rubber leg straps are included.  
Smart quick lock / release system on the sheath for diver easy operating.  
Available colours: neon yellow, blue, black



## KN167

78mm (3") twin edge blade  
3.0mm (0.1") chisel point safety blade  
Serrated/sharp edge and line cutter  
Hard plastic protective sheath  
Push button quick release system  
Solid nylon comfort handle  
Webbing, BCD or PFD attachment  
Available in high-vis yellow or black



## ALPHA TITANIUM

120mm (4.7") titanium blade  
Designed for the UK military  
Ideal general purpose knife  
Super sharp  
Lightweight  
Positive lock mechanism  
Black plastic hard-case sheath



## KN166P

80mm (3.1") stainless steel serrated blade  
2.5mm (0.1") curve point safety blade  
Single sided blade  
Solid nylon handle with rear strike  
Soft webbing protective sheath  
Comfort handle  
Rear anchor point



## SCISSOR KNIFE

90mm (3.5") stainless steel blade  
Reduced risk of rusting  
Sharp tip blade with serrations  
2 in 1 knife with scissor function  
Chromium plating on blades  
Compact quick-release sheath  
BC mounting kits are included



## GK ELITE

176mm (6.9") stainless steel blade  
Heavy duty commercial knife  
Ultra sharp serrated edge  
High impact luminescent sheath  
Includes security shock cord  
Stainless steel split D-rings  
Twin aluminium carabiner clips give multiple attachment options

## BREAK GLASS EMERGENCY ESCAPE HAMMER



Sharp blade in the handle that cuts easily through seat belts.



Hardened steel pointed end designed to break the glass to aid escape. Double sided head shatters windows quickly/easily, allowing safe, quick escape.

# Varilux LD Max

## Rechargeable, 1300-2600lm torch

Black & Gold Range

This sleek new addition to the Varilux range is a great addition to your lighting range. The anodised aluminium body provides a tough exterior and the matt black finish makes the Varilux LD Max stand out from the rest of the range.

The 2600 lumens at full power is bright enough for the darkest of environments and depth tested to 100m (328'), this new torch is a great addition to any kit. The LD Max boasts a burn time of 3 hours on full power and 5 hours on the lower setting (1300 lumen).

The removable tail cap on the LD Max allows easy access to the charging point. Supplied with USB charging cable, it can be charged by connecting into a power adaptor, laptop or power bank.

### Specification

Burn time : 3h-5h (2600lm-1300lm)  
Beam distance: 300m (984')  
Beam angle: 8°  
Impact resistance: 1.5m (4'9)  
Depth rating: 100m (328')  
Material: Anodised aluminium  
Colour: Black/gold  
LED: 1 x CREE XHP50.2  
LED lifespan: 100,000 h  
Brightness: 2600 lumen  
Color temp: Cold white light 6500K  
Mode: High / low / stepless dimming with memory function  
Battery: 2 x 26650 7.2V, 5000 mAh  
Switch design: Push-button switch  
Lens: 4mm (0.2") polycarbonate lens  
Length x head dia.size:  
232 x 54mm (9.1"x 2.1")  
Weight  
(torch): 305g (10.8oz)  
(torch+batteries): 505g (17.8oz)

### What's Included?

Varilux LD Max torch x1  
26650 lithium-ion battery x2  
USB charging cable x1  
Spare O ring x3  
Lanyard x1  
Tail cap lubricant x 1  
Hard storage case x 1  
User manual x1

VARIABLE  
BURNTIME HOURS  
3.0 ← TO → 5.0

LUMENS  
LOW - 1300  
HIGH - 2600

RECHARGEABLE  
BATTERY



Length: 232mm (9.1")  
Reflector: 54mm (2.1")



# Varilux Zoom

## Rechargeable, 1000lm, adjustable beam torch

Black & Gold Range

Our new addition to the Northern Diver 'Black and Gold Range' is a fantastic option for all. A body sculpted from anodized aircraft aluminium, a magnetic push switch located on the tail cap and a depth rating of 100m (328') represents the thought behind the design to make this one of the toughest torches.

The three white light settings make the 'Varilux Zoom' a fantastic multi-purpose torch. High (1000 Lumen), Flashing and an innovative 'Zoom' mechanism will allow you to alter the beam width by over 800% setting the Varilux Zoom apart from any other torch in the range.

A built in Samsung 18650 Battery will give you up to 10hrs burn time and allow you to charge directly, with no need to remove a battery.

### Specification

Burn time : 2h-10h (1000lm-1000lm)  
 Beam distance: 1000m (3280')  
 Impact resistance: 0.5m (1'6)  
 Depth rating: 100m (328')  
 Material: Anodised aluminium  
 Colour: Black/gold  
 LED: 1 x CREE XPL  
 LED lifespan: 100,000 h  
 Brightness: 1000 lumen  
 Color temp: White light  
 Mode: High/flash/beam width adjust  
 Battery: Samsung 18650 3.7V, 2600mAh  
 Switch design: Magnetic push switch  
 Lens: Convex PMMA lens  
 Length x head dia x tail dia size:  
 165 x 54 x 35mm (6.5" x 2.1" x 1.4")  
 Handle bar length: 118mm (4.6")  
 Weight  
 (torch): 354g (12.5oz)  
 (torch and batteries): 840g (29.6oz)

### What's Included?

Varilux Zoom torch x1  
 SamSung 18650 battery x 1 (built-in)  
 USB charging cable & wall plug x 1  
 Spare O-ring x 1  
 Lanyard x 1  
 Tail cap lubricant x 1  
 Hard storage case x 1  
 User manual x1

VARIABLE  
 BURNTIME HOURS  
 2.0 ← TO → 10

LUMENS  
 1000

RECHARGEABLE  
 BATTERY



## Varilux 3500 Torch

### Rechargeable

### 200-3500 lumens

### Super powerful

The Varilux 3500's output is, you guessed it, an incredible 3500 lumens. This output is supplied by four CREE XM-L2 LEDs.

Output is varied with the top-mounted magnetic slide switch. You're good for one and a half hours of burn time on the highest setting and 40 hours on the lowest setting.

Just like the other torches in the Varilux family, the Varilux 3500 is manufactured from aircraft grade aluminium and is supplied with rechargeable batteries and a useful carry case.

#### Specification

Burn time: 1.5h - 40h (200lm-3500lm)  
 Beam distance: 1000m (3280')  
 Peak beam intensity: 90000cd  
 Impact resistance: 0.5m (1'6)  
 Depth rating: 100m (328')  
 Material: anodised aluminium  
 LED: 4x CREE XM-L2  
 LED lifespan: 100000 h  
 Brightness: 3500 lumen  
 Mode: High/dimming  
 Battery: 26650 3.7 V, 4000 mAh  
 Switch design: magnetic slide switch  
 Lens: coated glass lens  
 Size: 217x69x130mm (8.5"x2.7"x5.1")  
 Weight:  
 (torch): 586g (20.7oz)  
 (torch+batteries): 772g (27.2oz)  
 (torch+battery+charger):924g (32.6oz)

#### What's included?

Varilux 3500 torch x 1  
 26650 battery x2  
 26650 battery charger x1  
 Spare O ring x3  
 Tail cap lubricant x1  
 Hard storage case x 1  
 User manual x1

#### Compatible with

Varilux wrist mount  
 Universal helmet mount

VARIABLE  
 BURNTIME HOURS  
 1.5 ← TO → 40

LUMENS  
 LOW - 200  
 HIGH - 3500

RECHARGEABLE  
 BATTERY



Length: 217mm (8.5")  
 Reflector: 69mm (2.7")



4x CREE XM-L2 LEDs



Magnetic sliding switch



Batteries removed from the bottom

All our underwater lights & torches depth tested to 100m (328')

**varilux** FAMILY

## Varilux Travel Torch Rechargeable 80-1000 lumens

The new Varilux Travel has an increased output, useful new features and the same car charging capability that made the original Varilux Travel so popular.

The Varilux Travel II R's output is controlled via a magnetic induction switch. Pressing once switches the light on at full power – 1000 lumens' worth. At this point, output can be gradually decreased by pressing and holding the switch. When the required output is reached, releasing the switch will maintain this output. Pressing once more switches the light off.

### Specification

Burn time: 2h - 40h (80lm-1000lm)  
Beam distance: 1000m (3280')  
Peak beam intensity: 30000cd  
Impact resistance: 1m (3'3)  
Depth rating: 100m (328')  
Material: anodised aluminium  
LED: 1x CREE XM-L2  
LED lifespan: 100000 h  
Brightness: 1000 lumen  
Mode: High/dimming  
Battery: 26650 3.7V, 4000 mAh  
Switch design: magnetic slide switch  
Lens: coated glass lens  
Size: 161x45mm (6.3"x1.8")  
Weight:  
(torch): 232g (8.1oz)  
(torch+batteries): 324g (11.4oz)

### What's included?

Varilux travel torch x 1  
26650 battery x1  
Intelligent USB battery charger x1  
Car adapter x1  
Spare O ring x3  
Tail cap lubricant x1  
Hard storage case x 1  
User manual x1

### Compatible with

Varilux wrist mount  
Universal helmet mount

VARIABLE  
BURNTIME HOURS  
2.0 ← TO → 40

LUMENS  
LOW - 80  
HIGH - 1000

RECHARGEABLE  
BATTERY



Length: 161mm (6.3")  
Reflector: 45mm (1.8")



Full power



20% power remaining



Battery fits in tail cap



In car charging



All our underwater lights & torches depth tested to 100m (328')

**varilux** FAMILY

## Varilux Micro Torch Rechargeable 80-800 lumens

The new Varilux Micro is rechargeable and capable of producing 800 lumens for 1.5 hours. Being part of the Varilux family, the Varilux Micro R of course has a variable output, producing the lowest output of 80 lumens for 24 hours. Like other models in the range, output is varied via the top-mounted magnetic slide switch.

Producing much more power than its small and slim profile might suggest, you may wish to use this torch as either a backup or primary lighting source.

### Specification

Burn time: 1.5h - 24h (80lm-800lm)  
Beam distance: 500m (1640')  
Peak beam intensity: 20000cd  
Impact resistance: 1m (3'3)  
Depth rating: 100m (328')  
Material: anodised aluminium  
LED: 1x CREE XM-L2  
LED lifespan: 100000 h  
Brightness: 800 lumen  
Mode: High/dimming  
Battery: 18650 3.7V, 2200 mAh  
Switch design: magnetic slide switch  
Lens: coated glass lens  
Size: 147x35mm (5.8"x1.4")  
Weight:  
(torch): 153g (5.4oz)  
(torch+batteries): 197g (6.9oz)

### What's included?

Varilux micro torch x 1  
18650 battery x1  
Intelligent USB battery charger x1  
Spare O ring x3  
Tail cap lubricant x1  
Hard storage case x 1  
User manual x1

### Compatible with

Varilux wrist mount  
Universal helmet mount



Length: 147mm (5.8")  
Reflector: 35mm (1.4")



Moulded textured grip handle



Intelligent USB battery charger



Left to right: lube, torch and charger



Variable magnetic slide switch

Torch length:  
140mm (5.5")



### Mini quest powerful LED torch

Single 1W LED - 160 lumens output  
Upgraded 'silent' strobe unit  
Strobe visible up to 2 miles away  
Continuous burn time of up to 6 hours  
Depth tested to 50m (164')  
Magnetic 'function' switch  
One-piece impact resistant ABS body  
Twin attachment points  
Perfect emergency signalling device  
Handy to attach to a BCD or keep in your BCD pocket as a back-up torch  
Twin anchor points (fit 32mm webbing)  
Weight: 0.188kg (6.6oz)  
Supplied with wrist lanyard  
Requires 3 x AA batteries (not supplied)

Torch length:  
170mm (6.7")



### Fusion X4 torch

Super high 310 lumens output  
Natural daylight colour temp 5300K  
8.5hr total continuous burn time  
New optically enhanced reflector  
Philips Lumileds T 3w Luxeon LED  
Depth tested to 95m (311')  
Tough poly carbonate body  
Aluminium head  
Protective rubber casing  
Colour temperature of 5300K  
Double O-ring seals  
External magnetic on/off switch  
Weight: 0.462kg (16.3oz)  
4 x AA alkaline batteries (supplied)  
Supplied with wrist lanyard

Torch length:  
170mm (6.7")



### Mini quest powerful LED torch

230 lumens output  
Powerful 'spot' beam  
8.5hr total continuous burn time  
Variable output technology  
100% full power output for 3.5hrs, which then gradually decreases over the remaining  
NEW Philips Lumileds 3w Luxeon LED  
Depth tested to 95 metres  
Tough poly carbonate body with an aluminium torch head  
Double O-ring seals  
Rear mounted magnetic on/off switch  
Optional helmet mount  
Weight: 0.327kg (11.5oz)  
4 x AA alkaline batteries (supplied)

## GLARE HEAD TORCH



Simple push button operation  
Burn time: 1min-100hrs  
Brightness: 280lm-12lm  
4 modes (s.high, high, mid, low)  
Beam distance: 120m (393')  
Impact distance: 1.5m-3m (4.9'-9'8)  
IPX7 rating  
CREE-XP-G2 LED light  
Flick down red diffuser  
Material - ABS  
Adjustable torch head  
Adjustable non-slip head strap  
Low battery warning light  
Integrated SOS whistle  
Weight: 0.232kg (8.2oz)  
3x AA batteries

#### Diffuser Open White spotlight

Gives a white spot beam, for when long range vision or a brighter light is required.



#### Diffuser Closed Red floodlight

Spreads and softens the beam. Creates a manageable amount of light for when close range vision is required and so that it doesn't dazzle other people.



**GLARE HEAD TORCH CAN BE USED WITH ANY OF OUR HELMETS**

# flexi-light <sup>V3</sup>

Northern Diver are constantly using feedback to enhance the evolution of our products, our new and improved Flexi-light stick is no different.

We have enhanced the prominence of the on/off switch to allow the user to more easily activate the light when wearing a thicker glove.

## Operation

- Press 1. On/constant. Low power (40hr burn time)
- Press 2. Constant. High power (22hr burn time)
- Press 3. Flashing (42hr burn time)
- Press 4. Off

## Specifications

- Output: 8 lumens
- Visible distance: up to 3000m (9842')
- Depth tested: 100m (328')
- Double sealed construction
- Flexible silicone body
- 5 colours + IR (wavelength: 625-635 NM)
- RoHS Compliant Polyurethane
- Repeated use with on/off modes

## A range of uses

- Military: covert ops
- Rescue teams
- Underwater: diving
- Outdoors: camping, dog walks, trekker/hikers

## Optional fixtures:

- Adhesive backed 3M™ tape
- Adhesive backed 3M™ foam
- 3M™ hook Velcro backing

All light sticks can be used with the nylon Flexi-Light Clip (below)



[www.flexiblelightsticks.com](http://www.flexiblelightsticks.com)

**FLEXIBLE - LED - LIGHT STICK - RESCUE  
MILITARY - REUSABLE**



**NEW IMPROVED  
PUSH BUTTON ACTIVATION**

Photo credit: Hampshire Search & Rescue Training

Depth Rated  
**100m  
328'**



**The modern alternative to chemical light sticks**

Dimensions: 110 x 25 x 12mm (4.3" x 0.9" x 0.5")

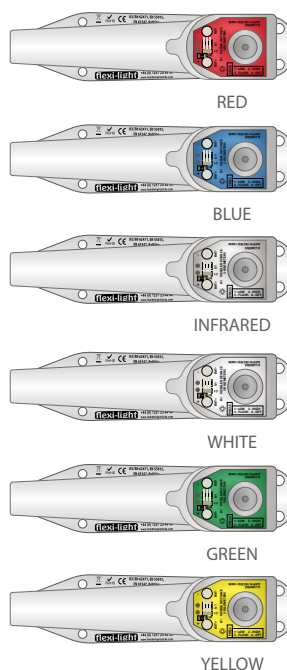

**NEW IMPROVED  
Easy press-to-operate button**

We have designed multiple fixing options depending on what your using the flexi-light for. Below shows a pocket that fits the light stick in perfectly and clips securely to a specially installed drysuit anchor point.





# Extendable carbon fibre Lightweight reach poles

The reach poles provide a rapid, agile method to reach a conscious in-water casualty. The poles can equally be used to retrieve items from the water. The lightweight, durable carbon fibre make it easy to operate at such lengths. Pole sections cannot be fully separated, each section has a clamp that unlocks a section and enables easy adjustment for fast extraction and retraction. On the tip of the pole is an aluminium bayonet fitting for use with the poles quick-release accessories.

## What lengths are available?



Extended: 4.5m (14'8), retracted: 1.6m (5'2)



Extended: 6m (19'7), retracted: 1.8m (5'9)



Extended: 9m (29'5), retracted: 2m (6'6)



Extended: 15m (49'2), retracted: 2.2m (7'2)

## What is supplied with each reach pole?



### TELESCOPIC REACH POLE

Weight and dims vary with pole length chosen  
4x pole length available (see above)



### GRAPPLE HOOK

Dims: 36x25x25cm (14.2"x 9.8"x 9.8")  
Weight: 0.95kg (2.09lb)



### SHEPHERD'S CROOK

Dims: 33x17x3cm (13"x 6.7"x 1.2")  
Weight: 0.38kg (0.84lb)



### EXTENSION POLE

Dims: 41x3x3cm (16.1"x 1.9"x 1.9")  
Weight: 0.18kg (0.39lb)



### INFLATABLE BUOY

Dims: 24.5x21x78cm (9.6"x 8.3"x 30.7")  
Weight: 0.7kg (1.54lb)



### STORAGE BAG

Dims: 44x38x22cm (17.3"x 14.9"x 8.7")  
Weight: 0.2kg (0.44lb)



Pole material:  
carbon fibre  
Clamps material: reinforced resin  
Attachments: 316 stainless steel  
Rubber base

Carbon fibre and corrosion resistant materials and accessories the lightest in their class



Additional accessories available for use with our reach rescue poles



## SEE BEYOND YOUR SCOPE

With our range of reach poles & camera attachment.



### GO PRO ATTACHMENT

Dims: 10.5x5x3.5cm (4.1"x 1.9"x 1.4")  
Weight: 0.09kg (0.19lb)  
Note: camera not included



### WATER RESCUE JAWS

Dims closed: 38x70x9cm (14.9"x 27.6"x 3.5")  
Dims open: 109x70x9cm (42.9"x 27.6"x 3.5"), weight: 1.1kg (2.43lb)



### NET ATTACHMENT

Dims: 6x3x3cm (2.4"x 1.2"x 1.2")  
Weight: 0.1kg (0.22lb), rubber adaptor & net not included



### NARROW HOOK

Dims: 38x19x3cm (14.9"x 7.5"x 1.2")  
Weight: 0.3kg (0.66lbs)



### REPLACEMENT BUOY

Dims: 24.5x21x7.8cm (9.6"x 8.3"x 30.7")  
Weight: 0.7kg (1.54lb)



### REPLACEMENT EXT- POLE

Dims: 41x3x3cm (16.1"x 1.9"x 1.9")  
Weight: 0.18kg (0.39lb)



### REPLACEMENT STORAGE BAG

Dims: 44x38x22cm (17.3"x 14.9"x 8.7")  
Weight: 0.2kg (0.44lb)

## Lightweight and highly visible Floating wading poles

Our rescue wading poles are compact, robust and lightweight. Produced to the highest standard and sealed with a protective coating to protect against the elements. The base of our wading poles are fitted with a weighted non-slip foot which is designed to provide good grip in the water.

### Yellow 1.6m (5'2) wading pole

Moulded hand grip at the top  
Construction: fibre glass tubing  
Non-slip foot  
Weight: 0.8kg (1.76lb)

### Orange 1.8m (5'9) wading pole

T-bar top handle  
Lower hand grip (L 30cm/11'8)  
Construction: fibre glass tubing  
Non-slip rubber stopper  
Weight: 0.6kg (1.32lb)

### Orange 1.8m (5'9) Telescopic wading pole

Adjustable via the clamp closure  
Top/bottom pole do not separate  
T-bar top handle  
Lower hand grip (L 30cm/11'8)  
Construction: fibre glass tubing  
Non-slip nylon rubber stopper  
Weight 0.7kg (1.54lb)

### Reflective depth markers

These can be added in-house by our creative team, any depth marking can be applied. You must request these a order stage.

\*Additional fee may apply

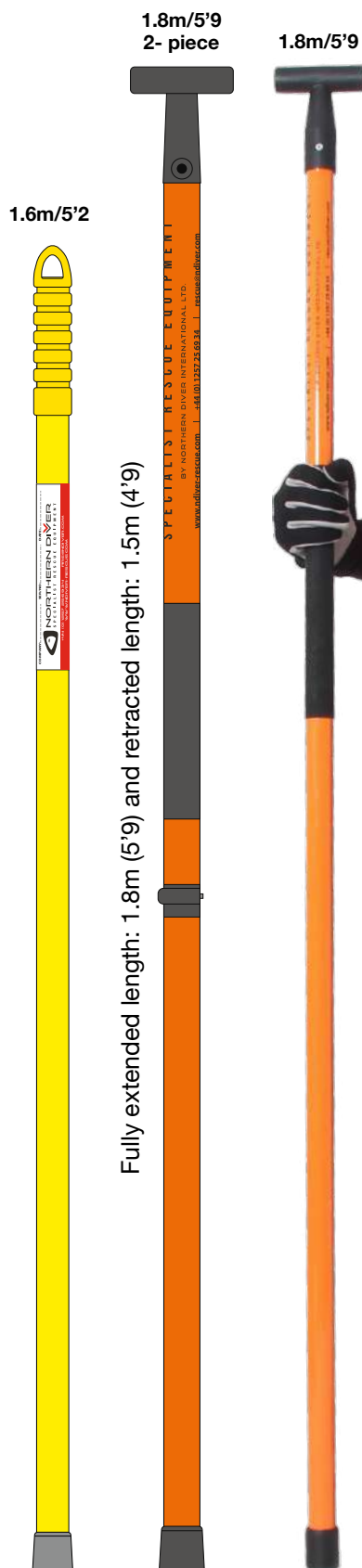
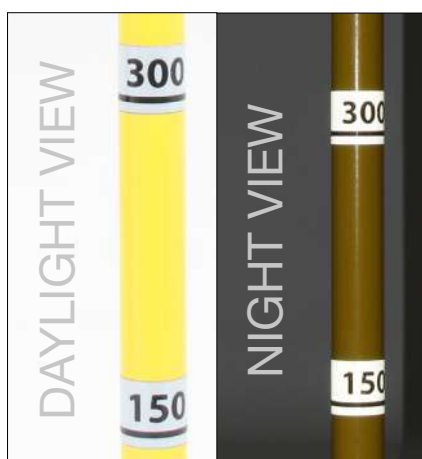

Travel dive bags

## A range of wheeled and lightweight holdalls



### Voyager Cabin

**Ideal for Ryan air and other low cost airlines**  
**Complete with smooth roll wheels and telescopic handle**

Ripstop nylon fabric  
Top-mounted 'comfort' carry handle  
Metallic red two stage telescopic handle and four smooth wheels  
Shoulder strap - attaches to either side of the bag  
Generous main compartment with tablet pocket  
Northern diver tablet case included  
Velcro closing documents side pockets  
Discreet back zipped pocket - perfect for passport and wallet  
Boarding pass pouch on the rear  
Plastic clip inside to attach the security gels and cosmetics bag  
LxWxH: 20x38x54cm (7.9" x14.9" x 21.2")  
Volume: 40L, weight: 3kg (6.1lb)  
Includes: tablet case, airport friendly liquids bag and luggage tag



### Voyager Quest and Maxi Quest

**Clamshell opening travel bags with rugged all terrain wheels**

Ultra-durable Cordura® and ripstop nylon fabrics  
Top-mounted 'comfort' carry handle  
Extra-reinforced lockable telescopic pull handle  
Zipped top fin compartment  
Zipped side and end pocket  
Rigid heavy duty PVC curved base  
Two heavy duty wheels  
Wheel and corner guards  
Includes: wash bag and luggage tag

#### Quest

LxWxH: 72x36x44cm (28.3"x 14.2" x17.3")  
Volume: 114L, weight: 5.4kg (11.9lb)

#### Maxi Quest

Length: 81cm, width: 39cm, height: 44cm  
Volume: 139L, weight: 6.1kg (13.4lb)



### Voyager Lightweight and All Terrain

**With handy 'trunkie' tow handle and smooth roll wheels**

Top-mounted carry handle  
Handles at both ends  
Removable tow strap  
Protective PVC base  
Plastic runners on base  
Wheel and corner guards  
Two zipped compartments  
One large main and one small end pocket  
ID card window  
Includes: wash bag

#### Lightweight

LxWxH: 81x40x42cm (31.9"x 15.7" x 16.5")  
Volume: 136L, weight: 3.5kg (7.7lb)  
Ripstop nylon fabric

#### All Terrain Lightweight

LxWxH: 81x40x42cm (31.9"x 15.7" x 16.5")  
Volume: 136L, weight: 4.1kg (9.0lb)  
Washable hard-duty PVC fabric



NDB5.

## 160L & 110L Military Holdalls

Our NDB5 bag range is constructed from PVC top spec material and is fully washable inside and out.

This strong and spacious holdall is ready for action across a wide range of transport scenarios. It's capacity should swallow up your bulky gear with ease.

These bags are renowned for their robust construction and durability making them the first choice for countless divers all over the world and are also supplied to the UK MOD who only use the best.

Spacious main compartment D-zip opening with a weather protective zipper flap  
Internal mesh pockets  
Additional reinforcement on the base  
Comfortable top-mounted handle  
Four compression straps  
Webbing loops running down both sides of the bag – can be used with a carabiner or similar to attach items  
Adjustable and removable alpine-cut shoulder straps with an ergonomic fit  
Twin haul handles on either end  
Washable inside and out  
Inner zipped nylon bag included  
Optional roll up changing mat\*  
Available in blue, black and red  
Two size options 160L & 110L

Capacity: 160L (NDB5)  
LxWxH  
97x45x37cm (38.2"x 17.7"x 14.6")  
Weight : 3.5kg (7.7lb)

Capacity: 110L (NDB5-S)  
LxWxH  
70x45x37cm (27.5"x 17.7"x 14.6")  
Weight : 3kg (6.1lb)

Available in blue, red and black.



Inner dry clothes bag above is supplied with every NDB5 bag.  
LxWxH  
55x38x20cm (21.7"x 14.9"x 7/9")



The bag range has been modified to include changing mat attachments (please note the 160L NDB5 blue military holdall does not include mat).

All NDB5 bags have adjustable, removable alpine-cut shoulder straps. Please note the style of NDB5 bags may vary from photos shown.

Optional changing mat



Custom branding available  
Above shows BARB and below  
British Divers Marine Life Rescue.



NDB5.

## 45L Mini Holdall

Our mini is constructed from a highly visible ripstop nylon material with reflective silver trim.

D-zip opening with a weather protective zipper flap  
Internal mesh pockets  
Comfortable top-mounted handle  
Webbing loops running down both sides of the bag – can be used with a carabiner or similar to attach items  
Adjustable alpine-cut shoulder strap for use on the left or right  
Twin haul handles on either end  
Available in orange/silver

LxWxH  
50x29x25cm (19.7"x 11.4"x 9.8")  
Capacity: 45L  
Weight : 0.8kg (1.8lb)



Wash bag included



Strap can be easily stored away



Quick release removable strap

**WE CAN LOGO YOUR BAGS - CONTACT US TO DISCUSS DESIGNS**



## 80L NDB10 Scuba Holdall

Designed for military use  
Hard-wearing Cordura®  
Large capacity main pocket  
Separate end pocket  
Additional fin pocket  
Heavy duty top carry handle  
Padded shoulder strap  
Corrosion resistant zips

Length 73cm (28.7")  
Width 30cm (11.8")  
Height 34cm (13.4")  
Capacity: 80L  
Weight: 1.5kg (3.3lb)



## 80L Lightweight Mesh Holdall

Compact and durable  
Padded air mesh walls  
Quick drying time  
Front sleeve/pocket  
Easy to travel with/carry  
Padded carry handles  
D-rings for shoulder strap  
Corrosion resistant zips

Length 74cm (29.1")  
Width 34cm (13.4")  
Height 32cm (12.6")  
Capacity: 80L  
Weight: 1kg (2.2lb)

100% dry welded lightweight bags  
**Airtight and watertight range**

**DRY SEAL CLOSURE**

**DRY SEAL ROLL TOP BAGS**

Dry seal bags are sure to keep your kit safe and dry - designed for anything from recreational to rescue to military use.

Manufactured from a strong, high quality 420D TPU  
 Durable, flexible and available in colours red and black  
 Other colours may be available to order upon request  
 Secure 100% watertight closure  
 The dry seal creates a vacuum like seal that will not let water in  
 Simply press the dry seal together for an extremely strong closure  
 Users are advised not to force the bags open as they have a very tight, completely leak-proof closure, incorrect opening could compromise the seal  
 Fitted with an air purge valve to help compress kit inside a  
 Supplied with an adjustable removable shoulder strap  
 Quick release buckles and high quality plastic D-rings

- 120L HxWxD: 103x37x37cm (40.6"x 14.6"x 14.6"), weight: 1.2kg (2.6lb)
- 50L HxWxD: 76x28x28cm (29.9"x 11"x 11"), weight: 0.8kg (1.8lb)
- 20L HxWxD: 60x23x23cm (23.6"x 9"x 9"), weight: 0.6kg (1.3lb)
- 10L HxWxD: 48x18x18cm (18.9"x 7"x 7"), weight: 0.5kg (1.1lb)



Grip the bag seal with both hands, inserting thumbs through the grip tabs



Squeeze and kink the seal into both hands and create an "S" shape



The bag will unseal automatically if you use the points above correctly



**ROLL TOP DRY BAGS**

Heavy-duty PVC  
 Roll-top quick release buckle system  
 Securely close and seal  
 Convenient carry handle  
 Keeps the water out or in (for wet items)  
 12L is perfect for stowing inside a canoe/kayak  
 51L and 117L include a detachable shoulder strap to assist with transporting a heavier load.  
 Available in 3 sizes and 4 colours

- 117L HxWxD: 75x38x38cm (29.5"x 15"x 15")  
 Weight: 0.7kg (1.54lb)
- 51L HxWxD: 54x30x30cm (21.6"x 11.8"x 11.8")  
 Weight: 0.4kg (0.88lb)
- 12L HxWxD: 35x20x20cm (13.8"x 7.9"x 7.9")  
 Weight: 0.2kg (0.44lb)

All bags can have your logo printed, you can see print examples (right).  
 Left to right: Surrey Search & Rescue Team, BARB SAR & Project Yatching.



## Fully Dry Roll Top Holdall 90L Subpac

Manufactured from the same strong black 420D TPU that our latest dry bag range is made from. This roll top holdall holds an incredible 90L and is fitted with the same 100% water/air tight dry seal. Completely leak proof this bag will not fail you in any scenario.

Fitted with an air purge valve to help compress your kit and supplied with adjustable alpine-cut shoulder straps which have built in quick release buckles for when you want to remove and store straps away.

Designed with one large spacious compartment to fill with your kit and fitted with multiple compression straps to reduce the size of the bag when needed. Also featuring high quality plastic D-rings and webbing loops that run down either side of the bag can be used with a carabiner or similar to attach your equipment.

All bags can be customised to suit the user with name and/or logos. You must contact the team to discuss these requirements.

Capacity: 90L  
Height: 75cm (29.5")  
Width: 40cm (15.7")  
Depth: 30cm (11.8")  
Weight: 1.7kg (3.74lb)



Subpacs dry seal opening keeps your kit 100% dry



Ends of the bag fitted with comfortable rubber handles



## Fully Dry Roll Top Rucksack 78L Voyager

Manufactured from a very heavy duty PVC backed Cordura® material, for excellent abrasion resistance. Bag also has a fully washable interior.

Features a roll-down top to keep the water out. The bag also keeps the water in if you are transporting wet items.

Includes a four-point compression strap system to reduce the height (if the bag is not filled to capacity).

Easy carrying, using the attached padded and adjustable rucksack straps or the top mounted webbing handle. Can be fitted with inflation and exhaust valves.

Dry bag on the left shows an example of a printed, full colour logo for CMI Services.

Capacity: 78L  
LxHxW: 26x75x40cm (10.2"x 29.5"x 15.7")  
Weight: 0.7kg (1.54lb)





# 100% dry and waterproof Zipped welded rucksacks

## 60L Zipped Daysack

A large watertight and airtight bag weighing only 880g (1.94lb). The dry bag is manufactured from 500 denier PVC and has welded seams for extra reinforcement. The YKK® high compression dry zip is protected with PU tape.

The bag has adjustable, padded shoulder straps and is load tested to 100kg (220lb), including the lift strap between the shoulder straps. Can be fitted with inflation and exhaust valves.

Capacity: 60L  
LxHxW: 24x62x39cm (9.4"x 24.4"x 15.3")  
Weight: 0.85kg (1.87lb)



Dry bag branded for Mauritius Fire & Rescue Service

## Fully Welded Zipped Dry Bags With MOLLE Systems

A watertight, airtight and lightweight bag with integrated MOLLE system. Manufactured from a black nylon TPU CN and has welded seams for extra reinforcement.

The bags have adjustable, padded shoulder straps and are load tested to 100kg (220lb). Fitted with compression straps, 50mm (2") plastic d-rings, reinforced corners and an inflation/deflation tube (lockable to prevent accidental deflation).

Designed with MOLLE system panels welded to the front and sides, making it easy for users to effortlessly attach any MOLLE compatible bag or equipment to it.

Our Utility pouch (shown right) is a perfect example of kit or equipment that can be easily attached to the bags. The 25mm (1") webbing straps, with press stud closure, on the back of the utility dry bag are specially designed for effortless attachment to any MOLLE compatible dry bag.

Custom branding is available in reflective or full colour, contact us to discuss.



\*MOLLE System (Modular Lightweight Load-carrying Equipment).

**Utility Pouch**  
Capacity: 3L  
Length: 25cm (9.8")  
Width: 15cm (5.9")  
Depth: 8cm (3.1")  
Weight: 0.2kg (0.44lb)  
Colours: red or black



**Large Bergen**  
Capacity: 240L  
Length: 100cm (39.3")  
Width: 40cm (15.7")  
Depth: 60cm (23.6")  
Weight: 3.9kg (8.6lb)  
Colours: black

**Zipped Day Sack**  
Capacity: 60L  
Length: 69cm (27.2")  
Width: 37cm (14.6")  
Depth: 23cm (9")  
Weight: 1.6kg (3.5lb)  
Colours: black

# R.A.I.D.

## CASES

**Robust**  
**Airtight**  
**IP67**  
**Dustproof**



*High performance against breakage and defects from outdoor use with a lifetime guarantee!*



### **3 LITRE R.A.I.D CASE**

CODE: CASE-RAID-3L-191213  
LxWxD:  
219\*183\*154mm (8.62\*\*7.2\*\*6.06")  
WEIGHT: 1.1kg (2.46lb)



### **6.5 LITRE R.A.I.D CASE**

CODE: CASE-RAID-6.5L-231815  
LxWxD:  
270\*231\*185mm (10.63\*\*9.09\*\*7.28")  
WEIGHT: 1.4kg (3.09lb)



### **15 LITRE R.A.I.D CASE**

CODE: CASE-RAID-15L-433015  
LxWxD:  
450\*340\*160mm (17.2\*\*13.3\*\*6.2")  
WEIGHT: 2.2kg (4.85lb)



### **17.9 LITRE R.A.I.D CASE**

CODE: CASE-RAID-17.9L-382718  
LxWxD:  
410\*342\*204mm (16.14\*\*13.46\*\*8.03")  
WEIGHT: 3.98kg (8.77lb)



### **35.5 LITRE R.A.I.D CASE**

CODE: CASE-RAID-35.5L-483720  
LxWxD:  
520\*431\*236.5mm (20.47\*\*16.96\*\*9.31")  
WEIGHT: 6.5kg (14.33lb)



### **84 LITRE R.A.I.D CASE**

CODE: CASE-RAID-84-584433  
LxWxD:  
670\*508\*355mm (26.38\*\*20\*\*13.98")  
WEIGHT: 10.92kg (24.07lb)



### **113 LITRE R.A.I.D CASE**

CODE: CASE-RAID-113L-764830  
LxWxD:  
830\*566\*325mm (33.5\*\*21.89\*\*12.95")  
WEIGHT: 12kg (26.46lb)



### **154 LITRE R.A.I.D CASE**

CODE: CASE-RAID-154L-764840  
LxWxD:  
851\*556\*429mm (33.5\*\*21.89\*\*16.89")  
WEIGHT: 16.67kg (36.75lb)

More information available online for each R.A.I.D case. Visit [www.raidcase.com](http://www.raidcase.com)

Paralenz can be mounted to helmets and inflatable equipment

# PARALENZ® DIVE CAMERA

Built in depth sensor and user friendly design  
Robust Aerograde Aluminium and titanium  
Depth rated to 250m (820')  
Titanium screws are corrosion resistant  
Scratch resistant for a tougher camera  
Built in WiFi and Bluetooth to download pictures/video to a smart device  
T-rails mounting points

LANGUAGE: EN



reddot design award



## Waterproof VHF Radio Cases

We can supply a range of handheld radio cases, contact for details



210 Walkie-Talkie

228 Small Classic

248 Large Classic

229 VHF PRO

240 TrailProof VHF PRO

239

214 Stormproof

IPX8

IPX8

IPX8

IPX8

IPX7

IPX6



Rapid first aid response

## Medical range of bags and equipment



### 75L Medical Backpack

Designed to carry medical equipment  
Capable of carrying a gas cylinder  
Manufactured from heavy duty top span PVC  
Secured with an arched zip  
Top-mounted carry handle  
Adjustable, padded shoulder straps  
Waist strap for extra stability and weight distribution  
Bright red in colour with reflective taping

Supplied with:

4x removable medical equipment bags (two small, one medium, one large), 1x removable gas cylinder bag (for use with 5L cylinder or smaller) and a rescue encapsulated panel, 300x100mm (11.8" x 3.9")

Main compartment:

HxWxD: 57x44x25cm (22.4" x 17.3" x 9.8")

Front pocket:

HxWxD: 45x30x9cm (17.7" x 11.8" x 3.5")

Volume: 75L, weight: 1.2kg (2.64lb)



### 46L Responder Sport

Tough and practical backpack, offering flexibility to organise kit and providing easy access in emergencies.

Green top span PVC, water resistant/wipe clean

Transparent pocket for interchangeable panels

Dual front pocket

Clamshell opening for fast, easy access

Lined with quilted diamond velvet nylon

2 Velcro padded cylinder protectors

4 zipped removable internal compartments

HD splash proof zips with 'easy grab' zip pullers

Comfort carry handles and adjustable shoulder straps

Moulded back support padding for comfort

Reflective safety strips and piping

Main compartment:

HxWxD: 58x40x20cm (22.8" x 15.7" x 7.9")

Front pocket:

HxWxD: 35x32x5cm (13.8" x 12.6" x 2")

Volume: 46L, weight: 1.5kg (3.3lb)



### 23L Professional Responder

Organises kit and gives easy access in an emergency.

Green top span PVC, water resistant and wipe clean

Transparent pocket on front for interchangeable panels

Clamshell opening for fast, easy access

Lined with quilted diamond velvet nylon

Velcro close padded cylinder protector fitted

3 zipped removable internal compartments

Heavy duty splash proof zips

Comfortable carry handles on both the top and side

Adjustable shoulder straps

Moulded back support padding for added comfort

Reflective safety strips and piping

HxWxD: 60x32x12cm (23.6" x 12.6" x 4.7")

Volume: 23L, weight: 1kg (2.2lb)

## MEDICAL RESCUE

# Metalux 200g casualty bag

**METALUX**  
◆ 200G ◆

This Metalux casualty care bag has been developed for use in the harshest of conditions. Perfect for air ambulance, mountain rescue and search and rescue.



Designed & developed for  
Yorkshire Air Ambulance

Registered Charity No. 1084305

If this bag was to be saturated in water it would still keep its thermal properties and keep the casualty warm.

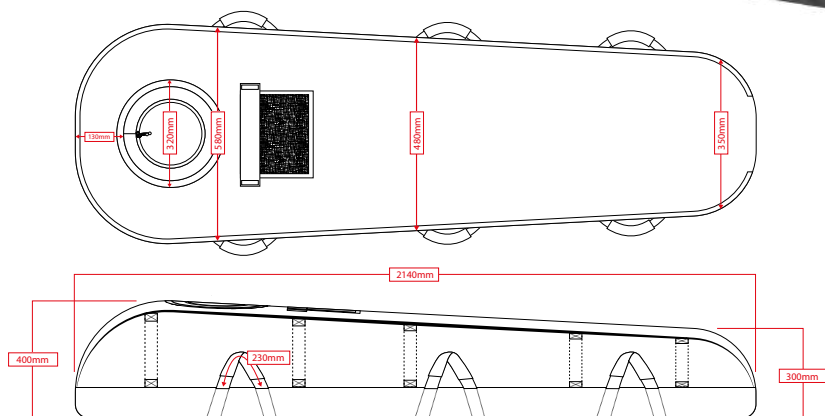

This casualty bag has been designed to meet the specifications of the Yorkshire Air Ambulance.

### Construction

Outside bag: black Metalux 200gsm  
Internal build: synthetic resinous wadding & tin foil thermal film  
Inside bag: red thermal soft fleece  
Fixed 8mm neoprene mat built in  
High wear nylon base

### Other features

Lightweight  
Comfortable and warm for casualties  
6x 2 way plastic zippers for quick and easy access to all parts of the bag  
8x neoprene padded carry handles built into bags base for extra strength  
10x elasticated compression straps  
Circular drawstring panel to keep casualties head/neck fully insulated  
Mesh documents pocket with Velcro closure, dims approx 350mm x 295mm  
Machine washable  
Easy to roll up and stow away  
Carry handle on top

Rolled dimensions, LxWxH:  
70x30x25cm (27.5"x 11.8"x 9.8")  
Weight: 4.5kg (9.9lb)  
TOG rating: 4.3  
200gsm thermal tin foil film inner build

Team branding can be added for an extra fee please contact us for details.





## Body Recovery Training Manikin

Ideal for Police dive teams training to recover bodies from inland waterways and from under ice. A variant of the Man Overboard manikin but is designed to sink instead of float. Extensively used by Police Forces and Fire Services across the UK, USA Coastguard.

The tough nylon mesh carcass allows the water to penetrate quickly when submerged and drain on recovery. Strong webbing loop at the back allows easy handling, storage and suspension for drying. Realistic facial features and wig enable identification by touch in poor visibility.



## Conscious Casualty Training Manikin

This manikin was designed in consultation with Surf Life Saving Australia as a water rescue dummy for IRB Racing, IRB driver training and tube rescue practice. It is also suitable for jet ski rescue training and other general water rescue scenarios. Extensively used by Surf Life Saving Australia and IRM Racing Teams.

Arms are built aloft to simulate a live volunteer. Bright orange overalls and SOLAS reflective tape on the head make this manikin highly visible in open water. Durable PVC sleeves on the lower leg to reduce drag during extraction and strips running from the shoulders to knees allow flexibility in and out of water but prevent the manikin from being too 'floppy'.



## Man Overboard Training Manikin

Ideal for man overboard search and rescue exercises in the open ocean, streams, lakes or other inland waterways. Extensively used by UK Ministry of Defence Army and Navy. RNLI (Royal National Lifeboat Institution). All UK Fire & Rescue Services, Offshore operators, Coastguards & Lifeguards, Inland Water Rescue Teams, Shipping & Fishing industries.

Floats horizontally, vertically or at 45 degrees, to simulate a live person or dead body – achieved by redistributing foam pieces within the overalls in a matter of seconds. The tough nylon mesh carcass allows the water to penetrate quickly, allowing the legs to drop beneath the surface, leaving only the head and shoulders visible, if desired.



## Search & Rescue Training Manikin

Designed for man overboard search and rescue exercises in the open ocean, streams, lakes or other inland waterways. Extensively used by Police and police dive teams, Royal Navy, Offshore operators, Coastguards & Lifeguards, Inland Water Rescue Teams, Shipping & Fishing industries.

Similar to the Man Overboard manikin, but with black overalls and mesh hood to reduce visibility. Floats horizontally, vertically or at 45 degrees, to simulate a live person or dead body – achieved by redistributing foam pieces within the overalls in a matter of seconds. Comes complete with overalls, boots and mesh hood.

Photo credit: UK ISAR, Firefighters from Metropolitan Brigade



15m (49') to 30m (98')  
**Throw bags  
 with reflective line**



The throw & re-pack characteristics along with robust & reliable design ensure they're an industry favourite



Throw bags contain a length of specialist rope and can be thrown out to an in-water casualty so that they can be pulled to safety if they are conscious and able to assist.

Useful in swift water rescue situations as they can be thrown into the water ahead of the moving casualty. The bags are often attached to the rescuer's personal protective equipment for quick access.

Available with 15m (49'), 20m (65'), 25m (82') & 30m (98') rope lengths, these throw bags feature a reflective floating safety line that has a continuous stranded polypropylene core which provides flotation to the wear-resistant braided nylon sheath as well as reflective bands on the outside of the bag, making it particularly useful in poor visibility/at night.

All the sizes of our throw bags are supplied complete with the nylon webbing guide belt (also available to buy separately), for use with the integrated guide belt webbing loops on the bags.



A quick release waist belt worn for carrying throw bag lines. It features a double ended quick release strap for attaching a throw bag, meaning easy access to throw lines whether left or right handed, and a large quick release front buckle.

**Storage bag:**

- Ripstop Cordura® nylon
- Drawstring neck closure
- Mesh draining base
- Rapid drying time
- High visibility reflective bands
- Great for use at night
- Quick-clip attachment point

**8mm (0.3") reflective technical floating polypropylene line:**

- Load tested to 900kg (1984lb)
- High resistance to rotting/ mildew
- Braided sheath over the main load bearing core, sheath provides up to 25% of ropes strength, absorbs most abrasion and protects the load-bearing core

<b>15m (49')</b> L: 27cm (10.6") D: 11cm (4.3") W: 0.7kg (1.54lb)	<b>20m (65')</b> L: 35cm (13.8") D: 11cm (4.3") W: 0.9kg (1.98lb)	<b>25m (82')</b> L: 38cm (14.9") D: 11cm (4.3") W: 1.1kg (2.42lb)	<b>30m (98')</b> L: 40cm (15.7") D: 11cm (4.3") W: 1.2kg (2.64lb)
--	--	--	--

60m (196'), 100m (328'), & 200m (656') rope

## Rescue back packs with floating line



### 60m (196') & 100m (328') backpack With 10mm (0.4") reflective floating line

#### Storage bag:

- Ripstop Cordura® nylon
- Yellow/black bag for 60m (196') line
- Blue/black bag for 100m (328') line
- Drawstring neck closure allows for easy access to contents
- Quick-clip line attachment point
- High visibility reflective bands
- Reflective piping stitched in seams
- Fully adjustable padded rucksack carrying straps
- Internal stainless steel D-ring
- D-ring can be used as attachment point for rope
- Removed/use rope on its own
- Safety label printed on the bag

#### Rope:

- 10mm (0.4") reflective technical floating polypropylene line
- 60m (196') or 100m (328') lengths
- Load tested to 900kg (1984lb)
- Floats in water
- High resistance to rotting/ mildew
- Braided sheath over the main load bearing core
- Sheath provides up to 25% of the ropes strength, absorbs most of the abrasion and protects the load-bearing core



### 100m (328') technical backpack With 10mm (0.4") floating canyon line

#### Storage bag:

- Ripstop Cordura® nylon
- Drawstring neck closure allows for easy access to contents
- Quickclip line attachment point
- High visibility reflective bands
- Reflective piping stitched in seams
- Fully adjustable padded rucksack carrying straps
- Interior stainless steel D-ring can be used as attachment point for rope
- Removed/use rope on its own
- Safety label printed on the bag

#### Rope:

- 100m (328') of 10mm (0.4") technical floating HUMWPE rope:
- Load tested to 4000kg (8818lb)
- Floats in water / self-lubricating
- High resistance to chemicals, water and ultraviolet light
- Excellent vibration damping
- Highly resistant to flex fatigue
- Low coefficient of friction
- Good resistance to abrasion
- Minimal absorption of water
- Great abrasion resistance







## 200m (656') backpack With 8.5mm (0.3") reflective floating line

### Storage bag:

- Ripstop Cordura® nylon
- Drawstring neck closure allows for easy access to contents
- Quickclip line attachment point
- High visibility reflective bands
- Reflective piping stitched in seams
- Fully adjustable padded rucksack carrying straps
- Interior stainless steel D-ring can be used as attachment point for rope
- Removed/use rope on its own
- Safety label printed on the bag

### Rope:

- 200m (656') of 8.5mm (0.3") reflective technical floating polypropylene line
- Load tested to 900kg (1984lb)
- Floats in water/ high resistance to rotting/ mildew
- Braided sheath over the main load bearing core
- Sheath provides up to 25% of the ropes strength, absorbs most of the abrasion and protects the load-bearing core



## Rope on a reel

Any rope Northern Diver supply can most likely be sold on a reel or drum to a length of your choice. **Contact to discuss.**



## Pro Throw Bags Supplied with reflective line



**We have a new throw bag in development.**

**Built in throwing handle**

**Dependable and tough**

**Polyethylene-sheathed grab loop makes it super quick and easy to hook on a carabiner**

**Conical shaped bag, extra wide opening, accurate throws and easy repacking**

**Internal flotation and floating rescue rope keep the bag on top of the water**

**High vis colour so it can be easily seen**



Photo credit: Shoreham by sea, The Adur Centre, various rescue teams



Photo credit: Shoreham by sea, The Adur Centre, various rescue teams



Photo credit: Lancashire Fire & Rescue Service



Photo credit: Warwickshire Fire & Rescue Service

# SRE

INFLATABLE  
SERIES



Our inflatable brand was established by the founder of Northern Diver over 30 years ago under the name Osprey. Development began at Northern Diver's Appley Bridge factory when 2500+ inflatable boats were produced in the UK and sold worldwide.

Good design and quality manufacture have always been a hallmark of the Northern Diver brand and soon became equally associated with the inflatable equipment we produced due to our expertise in the specialist rescue, commercial and military sectors.

It's from this heritage that we continue to offer our ever growing range of inflatable equipment from leisure and performance to commercial and lightweight series.

We have an inflatable to suit your every possible need and if you can't find it we will look to create it for you.

## WHY CHOOSE AN SRE INFLATABLE?

- Safe/effective in rescue operations
- Rapid-deployment for rescuers
- Easy to recover a man overboard
- Highly manoeuvrable
- Efficient in shallow waters
- Fast inflation system
- Floor options, removable or light (boats)
- Large buoyancy tubes
- Safe and stable
- Heavy duty and lightweight
- Easy to fold and to carry
- Transportable by a two men crew
- Easy maintenance
- Fully equipped to deploy in the field

Over 200 organisations across the UK and overseas use our Specialist Rescue Equipment - including over 95% of the UK's fire services.

## You can rely on SRE inflatable equipment

**Obtain incomparable style with SRE inflatables.** Easy to stow, our compact inflatable equipment can more than hold their own against competitor models. Their ability to plane at full capacity makes these crafts equally comfortable for crew and passengers. They're highly manoeuvrable and efficient even in shallow waters.

**Competitively priced,** you're sure to find a great inflatable option for you from our range. They're heavy duty but surprisingly lightweight as well as being easy to maintain and inflate. Their fast inflation is why they're easy to rapidly deploy in rescue operations.

**Built with safety in mind,** our inflatable equipment offers outstanding life spans for their owners. The large diameter tubes provide buoyancy and improved stability, and our range is CE approved. Every inflatable is designed and built to the highest standards of efficiency and safety, and your chosen model will be reassuringly safe, seaworthy, buoyant and stable.

Our inflatable equipment is proven to be safe and effective on the water. Professionals expect and demand top performance, quality and reliability, that's why they chose specialist rescue equipment (SRE) by Northern Diver.

## Made to last - ISO 9001 quality

**WHY PVC?** Modern polymers, which make up what is generally called PVC, is totally different from what is imagined. During testing in arctic Russia at -30°C our boats and rafts performed perfectly. Testing at the other extreme, +45°C, in the heat of summer again resulted in no problems. Please note we would suggest to cover the craft up when not in use. Direct sunlight in the long term will degrade any polymer.

From factory to you, we control and monitor quality to ensure you get quality, in build and design. We use the best available technology and materials in inflatable's, using either Double Walled Fabric (DWF) Hypalon or PVC, to ensure a quality end product.

This provides you with a craft that is virtually unaffected by weather, even the excesses of heat, cold or humidity. The make up of the design also protects against, fuel, oil, strong sunlight and everyday abrasion.

The use of the DWF construction method means we eradicate pin-holes, cracks and surface air-bubbles on all inflatable floors.

Also, Double Walled Fabric (DWF) means our inflatable equipment is more air tight and can withstand a higher maximum air pressure to allow us to use it on any kind of model. Our passion for quality further extends to our top quality components and additional parts.

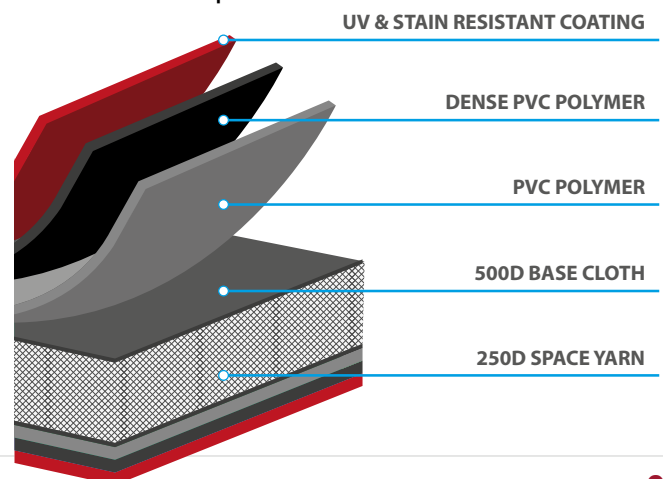

# Leisure Boat Series

Combine style, performance, and functionality

Made from PVC fabric, the Leisure Series boats are lightweight and give guaranteed flexibility and reliability in all-weather conditions.



**Accessories included:** both the Navajo and the Apache boats come with paddles, paddle holders, oar locks, maintenance kit, double action pump and storage bag.

## 3.2m (10'4) Navajo Inflatable with Aluminium floor and inflatable keel

With a maximum capacity of 4 on 2 benches, the Navajo is a small but mighty option for a range of applications.

Spec Details	3.2m (10'4) Navajo
Max. loading	4 persons, 650kg (1433lb)
Outer dims	L: 3.2m (10'4), W: 1.52m (5'0)
Internal width	700mm (27.6")
Tube dia.	410mm (16.1")
Aluminium floor	4 folding panels (15kg/33lb)
Weight	47kg/103lb (inflatable only)
Chambers	3 + inflatable keel
Max. tube pressure	.35bar/ 5 psi
Max. pressure inflatable floor	.7bar/ 10psi
Handles, lines, benches	2+1, life lines, 2 benches
Reccomended outboard	15HP Max. or Electric
Colours	Grey with blue trim
Reinforced rubbing strakes	Boat tubes + underside keel

## 3.6m (11'8) Apache Inflatable with Aluminium floor and inflatable keel

Our 3.6m (11'8) inflatable, the Apache gives you more space for an extra person without compromising on stability or speed.

Spec Details	3.6m (11'8) Apache
Max. loading	5 persons, 800kg (1763lb)
Outer dims	L: 3.6 (11'8), W: 1.7m (5'6)
Internal width	800mm (31.5")
Tube dia.	450mm (17.7")
Aluminium floor	4 folding panels (15kg/33lb)
Weight	59kg/130lb (inflatable only)
Chambers	3 + inflatable keel
Max. tube pressure	.35bar/ 5 psi
Max. pressure inflatable floor	.7bar/ 10psi
Handles, lines, benches	2+1, life lines, 2 benches
Reccomended outboard	20HP Max. or Electric
Colours	Grey with blue trim
Reinforced rubbing strakes	Boat tubes + underside keel

# Alloy Hull Performance Boat Series

Take your leisure time at a performance pace

Our first alloy hull RIB makes these lightweight RIBs easy to transport and launch. Designed with a classic inflatable look and functionality to provide a lot of quality in a compact package.



## 3.8m (12'5) RIB Inflatable Boat with alloy hull

Spec Details	3.8m (12'5) RIB
Max. loading	6 persons, 1150kg (2535lb)
Outer dims	L: 3.8m (12'5), W: 1.7m (5'6)
Internal width	700mm (27.6")
Tube dia.	420mm (16.5")
Floor	Aluminium deck with bow locker
Weight	100kg (220lb)
Chambers	3
Max. tube pressure	.35bar/ 5 psi
Max. pressure inflatable floor	.7bar/ 10psi
Handles, lines, benches	2+1, life lines, jockey console seat
Recommened outboard	20HP Max. or Electric
Colours	Grey with blue trim
Reinforced rubbing strakes	Boat tubes

## 6m (19'7) Dive RIB / Work Boat Inflatable Boat with aluminium floor

Built to last, using high quality components and with generous interior dimensions, it handles superbly on the water. The largest in our standard range, the RIB features one man steering column, under deck 150L fuel tank, alloy powder coated A-frame, bow storage and anchor locker.

Spec Details	6m (19'7) Dive RIB
Max. loading	9 persons, 1980kg (4365lb)
Outer dims	L: 6m (19'7), W: 2.6m (8'5)
Internal width	1500mm (4'9)
Tube dia.	550mm (21.7")
Floor	Aluminium deck
Weight	340kg (749lb)
Chambers	5
Max. tube pressure	.35bar/ 5 psi
Max. pressure inflatable floor	.7bar/ 10psi
Handles, lines, benches	2+2, life lines, jockey console seat
Recommened outboard	150HP Max. or Electric
Colours	Navy blue with red trim
Reinforced rubbing strakes	Boat tubes



Photo credit: Staffordshire Fire & Rescue Service

# Commercial Boat Series

For work on the water

Built tough so they work hard for rugged private and commercial use. The Commercial series boats are a lightweight, utility option. Packed with high performance features, these versatile aluminium floored boats are the perfect solution for a range of uses.

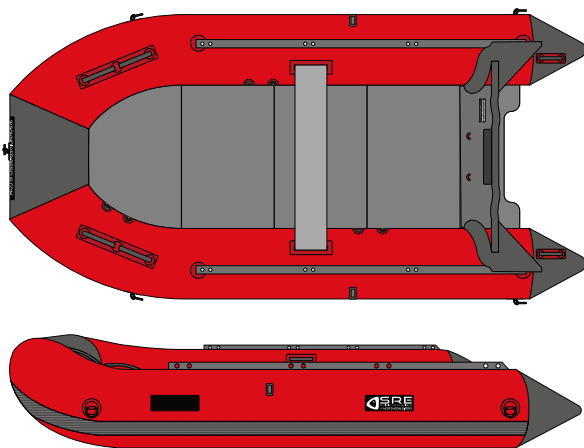

Photo credit: MVS Rushdon Unit, Sarah Smith, PR Officer

## DS320 Commercial Inflatable with aluminium floor & stainless steel bow tow point

Spec Details	DS320
Max. loading	4 persons, 650kg (1433lb)
Outer dims	L: 3.2m (10'4), W: 1.52m (5'0)
Internal width	700mm (27.6")
Tube dia.	420mm (16.5")
Aluminium floor	4 folding panels (15kg/33lb)
Weight	36kg/79lb (inflatable only)
Chambers	3 + inflatable keel
Max. tube pressure	.35bar/ 5 psi
Max. pressure inflatable floor	.7bar/ 10psi
Handles, lines, benches	2+2, life lines, 1 bench
Recommened outboard	15HP Max. or Electric
Colours	red with black trim <sup>1</sup>

## DS360 Commercial Inflatable with aluminium floor & stainless steel bow tow point

Spec Details	DS360
Max. loading	6 persons, 750kg (1653lb)
Outer dims	L: 3.6m (11'8), W: 1.52m (5'0)
Internal width	700mm (27.6")
Tube dia.	450mm (17.7")
Aluminium floor	4 folding panels (15kg/33lb)
Weight	48kg/105lb (inflatable only)
Chambers	3 + inflatable keel
Max. tube pressure	.35bar/ 5 psi
Max. pressure inflatable floor	.7bar/ 10psi
Handles, lines, benches	2+2, life lines, 2 benches
Recommened outboard	20HP Max. or Electric
Colours	red with black trim <sup>1</sup>

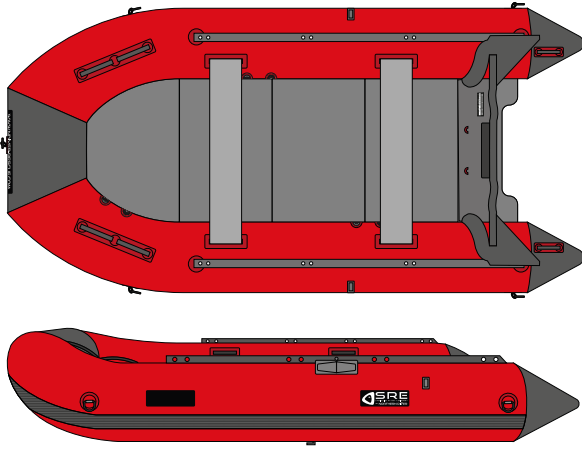

Photo credit: Caldervally Search & Rescue Team

**DS400 Commercial Inflatable  
with aluminium floor & stainless steel bow tow point**

Spec Details	DS400
Max. loading	8 persons, 1200kg (2645lb)
Outer dims	L: 4m (13'1), W: 1.9m (6'2)
Internal width	940mm (37")
Tube dia.	480mm (18.9")
Aluminium floor	4 folding panels (18kg/39lb)
Weight	70kg/154lb (inflatable only)
Chambers	3 + inflatable keel
Max. tube pressure	.35bar/ 5 psi
Max. pressure inflatable floor	.7bar/ 10psi
Handles, lines, benches	2+2, life lines, 2 benches
Recommened outboard	30HP Max. or Electric
Colours	red with black trim <sup>1</sup>

**DS360 Commercial Inflatable  
with aluminium floor & stainless steel bow tow point**

Spec Details	DS460
Max. loading	8 persons, 1300kg (2866lb)
Outer dims	L: 4.6m (15'0), W: 1.9m (6'2)
Internal width	940mm (37")
Tube dia.	480mm (18.9")
Aluminium floor	5 folding panels (22kg/48lb)
Weight	85kg/187lb (inflatable only)
Chambers	4 + inflatable keel
Max. tube pressure	.35bar/ 5 psi
Max. pressure inflatable floor	.7bar/ 10psi
Handles, lines, benches	2+2, life lines, 2 benches
Recommened outboard	40HP Max. or Electric
Colours	red with black trim <sup>1</sup>



Photo credit: HART Ambulance

**DS500 Commercial Inflatable  
with aluminium floor & stainless steel bow tow point**

Spec Details	DS500
Max. loading	10 persons, 1500kg (3306lb)
Outer dims	L: 5m (16'4), W: 2m (6'6)
Internal width	1030mm (40.5")
Tube dia.	500mm (19.7")
Aluminium floor	5 folding panels (22kg/48lb)
Weight	110kg/242lb (inflatable only)
Chambers	5 + inflatable keel
Max. tube pressure	.35bar/ 5 psi
Max. pressure inflatable floor	.7bar/ 10psi
Handles, lines, benches	2+2, life lines, 2 benches
Recommened outboard	50HP Max. or Electric
Colours	red with black trim <sup>1</sup>

**All boats include:** soft grip carry handles, grab handles, double grab handles, oar locks, stainless steel D-rings, a bow handle or towing eye and at least one boat bench<sup>2</sup>. **Included accessories:** 2x 165cm (65") T-bar paddles (designed to float), Inflation valve fittings<sup>2</sup>, maintenance kit<sup>3</sup>, Storage bag<sup>4</sup>, HP2 inflation hand pump

1. Yellow, black, orange and green also available to order made to measure. 2. Number of benches is determined by boat size, the 3.2m (10'4) in the Commercial and lightweight series only have one bench, all other models include 2 benches. 3. Number included is dependent on inflatable boat size. 4. Material colour included in kit will match that of the inflation. 5. Bag may differ from photo shown

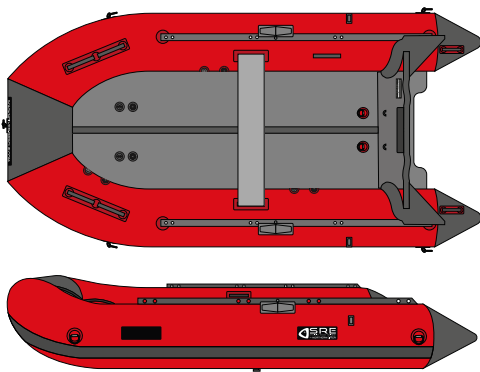

Photo credit: North Yorkshire Fire & Rescue Service

## Inflatable Hull Boat Series

Lightweight and easy to handle and launch

The lightweight inflatable hull series with DWF is easily transportable by a two-man crew. The floor panels, when inflated, come together to give the boat a keel. The Lightweight series are easy to carry, stow and fold. All of the boats in this series come complete with keel rubbing strake and have a lifting handle that's also a towing eye combined in one. The DWF system of drop threads between two flat rubber composites gives a high pressure, fully flat surface, as strong as a traditional aluminium floor without the weight.



### DS320 Lightweight Inflatable with inflatable floor & stainless steel bow tow point

Spec Details	DS320
Max. loading	4 persons, 900kg (1984lb)
Outer dims	L: 3.2m (10'4), W: 1.52m (5'9)
Internal width	700mm (27.6")
Tube dia.	420mm (16.5")
Inflatable floor	Drop thread, 80mm (3.1")
Weight	36kg (79lb)
Chambers	3 tubes + 2 floor
Max. tube pressure	.35bar/ 5 psi
Max. pressure inflatable floor	.7bar/ 10psi
Handles, lines, benches	2+2, ¾ life lines, 1 bench
Recommened outboard	15HP Max. or Electric
Colours	red with black trim <sup>1</sup>
Reinforced rubbing strakes	Boat tubes + underside keel
Lifting stainless steel D-rings	4
Transom mounted tow eyes	2



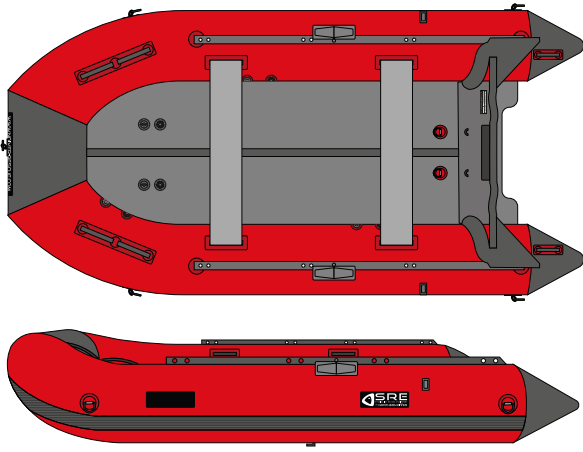

### DS400m Lightweight Inflatable with inflatable floor & stainless steel bow tow point

Spec Details	DS400
Max. loading	8 persons, 1500kg (3306lbs)
Outer dims	L: 4m (13'1), W:1.9m (6'2)
Internal width	940mm (37")
Tube dia.	480mm (18.9")
Inflatable floor	Drop thread, 80mm (3.1")
Weight	58kg (128lb)
Chambers	4 tubes + 2 floor
Max. tube pressure	.35bar/ 5 psi
Max. pressure inflatable floor	.7bar/ 10psi
Handles, lines, benches	2+2, ¾ life lines, 2 benches
Recommened outboard	25HP Max. or Electric
Colours	red with black trim <sup>1</sup>
Reinforced rubbing strakes	Boat tubes
Lifting stainless steel D-rings	4
Transom mounted tow eyes	2

### Available to order: DS500m Lightweight Inflatable with inflatable floor & stainless steel bow tow point

Spec Details	DS500
Max. loading	10 persons, 1950kg (4299lb)
Outer dims	L: 5m (16'4), W:2m (6'6)
Internal width	1030mm (40.5")
Tube dia.	500mm (19.7")
Inflatable floor	Drop thread, 100mm (3.9")
Weight	80kg (176lb)
Chambers	5 tubes + 2 floor
Max. tube pressure	.35bar/ 5 psi
Max. pressure inflatable floor	.7bar/ 10psi
Handles, lines, benches	2+2, ¾ life lines, 2 benches
Recommened outboard	40HP Max. or Electric
Colours	red with black trim <sup>1</sup>
Reinforced rubbing strakes	Boat tubes + underside keel
Lifting stainless steel D-rings	4
Transom mounted tow eyes	2

#### All boats include:

Soft grip carry handles, grab handles, double grab handles, oar locks, stainless steel D-rings, a bow handle or towing eye and at least one boat bench<sup>2</sup>

#### Included accessories:

2x 165cm (65") T-bar paddles (designed to float), Inflation valve fittings<sup>2</sup>, maintenance kit<sup>3</sup>, Storage bag<sup>4</sup>, HP2 inflation hand pump

1. Yellow, black, orange and green also available to order made to measure

2. Number of benches is determined by boat size, the 3.2m (10'4) in the Commercial and lightweight series only have one bench, all other models include 2 benches.

3. Number included is dependent on inflatable boat size

4. Material colour included in kit will match that of the inflation

5. Bag may differ from photo shown

RR2.

2.6m (8'5)

## Water Rescue Sled

The perfect water rescue craft for use in rivers; flooded urban/coastal areas, mountains and lakes.

The RR2 Rescue Sled is lightweight and portable, both inflated and deflated. It is easy to manoeuvre and can be paddled, pulled by hand or towed by a jet ski, boat or small hovercraft.

The RR2 Rescue Sled was developed as a casualty transfer system for use in shallows and mud. The unit handles extremely well in accessing areas that rescue boats cannot reach, providing a stable working platform for marine rescue. The unit is easily towed, paddled or line transferred and packs down to a small, easy to handle size making a versatile and effective system.

Further developments of the RR2 Rescue Sled led to trials in conjunction with Swift Water Rescue techniques. The Swift Water system allows the sled to quickly access rescue situations in fast flows of water.

The sled has been used operationally with jet skis and fast rescue craft for the recovery of casualties. When clipped to the side of a fast rescue craft or pontoon, the sled will act as a platform enabling easy recovery of secured casualties, swimmers or divers. A variety of stretchers can be located on top of the sled and used with a four-point lifting harness.

Two sleds can be joined together with a twining rig providing a very stable platform with casualty access between the hulls. Twinned sleds operated with two rescue personnel make high-risk rescue situations a safer option. The innovative properties of the unit's design allows it to be applied to other hazardous environments including ice, snow or wetlands.

### What's Included?

- 1x Twin Blade Paddle
- 2x Inflation Valve Fittings
- 1x HP2 Inflation Hand Pump
- 1x Storage Bag
- 1x Repair Kit & Tools

Sleds are available in 5 colours  
Red, yellow, green, orange  
and black. We can add custom  
logos to any inflatable please  
call to discuss your designs.



Spec Details	RR2 Rescue Raft
Overall length	300cm (118")
Overall width	100cm (39.4")
Internal width	n/a
Sponson/pontoon dia.	n/a
Floor materials	DWF
Floor thickness	15cm (5.9")
Weight	18kg (39.7lb)
Carton/packing dims.	110x60x28cm (43.3"x 23.6"x 11")
Chambers	1
Max inlet fill	0.7bar/10psi
SS316 stainless steel D-rings	4S+10M+5L
Handles	6+5
Max loading	450kg (992lb)
Max persons	2+1

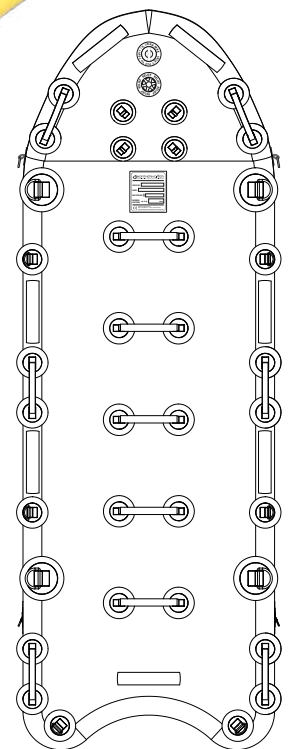

1x Twin blade paddle (230cm/90.6")  
Note paddles have been designed to float.



1x HP2  
inflation  
pump

1x repair kit



2x inflation valve fittings



1x storage bag



Bag may differ from photo shown

RR3.

**3.0m (9'8)**

## Water Rescue Sled

Water rescue craft for use in rivers; flooded urban and coastal areas; mountains and lakes. The RR3 Rescue Sled is lightweight and portable, both inflated and deflated. It is easy to manoeuvre and can be paddled, pulled by hand or towed by a jet ski, boat or small hovercraft.

### What's included?

- 1x Twin Blade Paddle
- 2x Inflation Valve Fittings
- 1x HP2 Inflation Hand Pump
- 1x Storage Bag
- 1x Repair Kit & Tools

### Specification

- Overall length - 300cm (118")
- Overall width - 113cm (44.5")
- Internal width - 73cm (28.7")
- Sponson/pontoon dia. - 20cm (7.9")
- Floor materials - DWF
- Floor thickness - 10cm (3.9")
- Weight - 22kg (48.5lb)
- Carton/packing dims: 110x50x32cm (43.3"x 19.7"x 12.6")
- Chambers - 2+1
- Max inlet fill (sponsons) - 0.35bar/5psi
- Max inlet fill (floor) - 0.7bar/10psi
- 316 stainless steel D-rings - 4S+7M
- Handles - 6+4
- Max loading - 650kg (1433lb)
- Max persons - 4+1



Photo credit: HART Ambulance

Inlet & relief valves



5 colour options

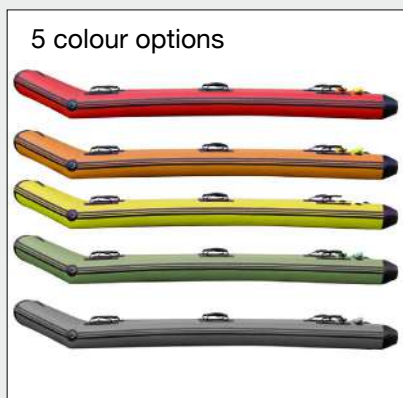

Photo credit: Calder Valley

RR4. Our Most Popular!

**3.6m (11'8)**

## Water Rescue Sled

**EXCELLENT PERFORMANCE. SUPERB HANDLING. INCREDIBLY VERSATILE. A STABLE PLATFORM IN ALL CONDITIONS.**

Water rescue craft for use in rivers; flooded urban and coastal areas; mountains and lakes. The RR4 Rescue Sled is lightweight and portable, both inflated and deflated. It is easy to manoeuvre and can be paddled, pulled by hand or towed by a jet ski, boat or small hovercraft.

### What's included?

- 1x Twin Blade Paddle
- 3x Inflation Valve Fittings
- 1x HP2 Inflation Hand Pump
- 1x Storage Bag
- 1x Repair Kit & Tools

### Specification

- Overall length - 360cm (141.7")
- Overall width - 116cm (45.7)
- Internal width - 70cm (27.6)
- Sponson/pontoon dia. - 23cm (9")
- Floor materials - DWF
- Floor thickness - 15cm (5.9")
- Weight: 31kg (68.3lb)
- Carton/packing dims: 110x60x35cm (43.3"x 23.6"x 13.8")
- Chambers - 2+1
- Max inlet fill (sponsons) - 0.35bar/5psi
- Max inlet fill (floor) - 0.7bar/10psi
- 316 stainless steel D-rings - 4S+15M
- Handles - 5+4
- Max loading - 750kg (1653lb)
- Max persons - 5+1

Inlet & relief valves



5 colour options



Photo credit: SARA, River Monnow flooded, Skenfrith & Monmouth



Photo credit: HART Ambulance



Photo credit: County Durham & Darlington FRS

## RR5. Self Righting

# 4.7m (15'4) Rapid Deployment Raft

### IDEAL FOR WATER, MUD & ICE!

The RR5 Rapid Deployment Raft is perfect for fast-response and ice rescue. The raft surrounds one or more rescuers in an ultra buoyant and protective inflated perimeter.

The RR5 allows a rescuer or rescue team to quickly reach a victim and safely retrieve them from the ice or a cold water rescue scene.

The rescuer or rescue team can easily carry the RR5 to the edge of the ice, step into the craft, and run out across the ice to reach a victim.

While on the ice, they are protected from falling through a fracture into the water. In a combination ice and open water situation, the RR5 can be paddled across open water or broken ice and water by one or two rescue technicians.

Perfect for rapid response ice rescue equipment and should be part of every rescue responder kit.

#### Features

- Fits in the boot of most vehicles
- Strong, durable and stable
- Versatile and low maintenance
- Launch without access to boat ramp
- On scene/in action in seconds
- Available in 5 colours

#### Whats Included?

- 2x T-Bar Paddles
- 3x Inflation Valve Fittings
- 1x HP2 Inflation Hand Pump
- 1x Storage Bag
- 1x Repair Kit & Tools

#### Spec Details

- Overall length - 470cm (185")
- Overall width - 140cm (55.1")
- Internal width - 70cm (27.6)
- Sponson/pontoon dia. - 35cm (13.8")
- Floor materials - DWF
- Floor thickness - 8cm (3.1")
- Weight: 42kg (92.6lb)
- Carton/packing dims: 110x60x40cm (43.3"x 23.6"x 15.7")
- Chambers - 2+1
- Max inlet fill (sponsons) - 0.35bar/5psi
- Max inlet fill (floor) - 0.7bar/10psi
- 316 stainless steel D-rings - 6M
- Handles - 14+4
- Max loading - 850kg (1873lb)
- Max persons - 5+1

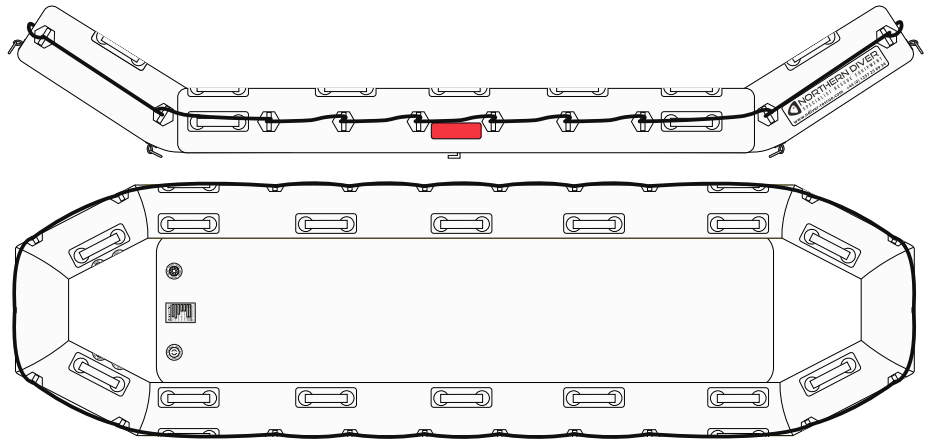

Why not design your own?

We can create bespoke inflatables please contact us to discuss your requirements.



Photo credit: SDIS 37, Loire River, Tours, Central France



Photo credit: SDIS 37, Loire River, Tours, Central France



RR-Max.

**3mx2m (9'8x6'6)**

## Rescue Raft

Manufactured from 15cm (5.9") drop stitch and PVC with built in inflation points and valves in multiple places.

The RR-MAX has 13 316 stainless steel 40mm (1.6") d-rings, 5 lifting handles plus another 4 handles on the non-slip floor.

Inflatable is shown in red but the RR-MAX is available red, yellow, black, green and orange. Team branding can also be applied.

A cylinder can be connected to the inflatable for quick and easy inflation, multiple hoses could also be used for even faster inflation!

Watch the video to view our raft being inflated in approx 2 minutes.

Video can be found in the product page on our website : [www.ndiver-rescue.com](http://www.ndiver-rescue.com)

### Features

- Non-slip top surface
- Strong, durable and stable
- Drop stitch construction
- Versatile and low maintenance
- 5 colours available

### Whats Included?

- 1x Twin Blade Paddle
- 3x Inflation Valve Fittings
- 1x HP2 Inflation Hand Pump
- 1x Storage Bag
- 1x Repair Kit & Tools

### Spec Details

- Overall length - 300cm (118")
- Overall width - 200cm (78.7")
- Internal width - 130cm (51.2")
- Sponson/pontoon dia. - 35cm (13.8")
- Floor materials - DWF
- Floor thickness - 15cm (5.9")
- Weight: 37kg (81.6lb)
- Carton/packing dims: 130x60x40cm (51.2"x 23.6"x 15.7")
- Chambers - 3+1
- Max inlet fill (sponsons) - 0.35bar/5psi
- Max inlet fill (floor) - 0.7bar/10psi
- 316 stainless steel D-rings - 13M
- Handles - 5+4
- Max loading - 1000kg (2204lb)
- Max persons - 8

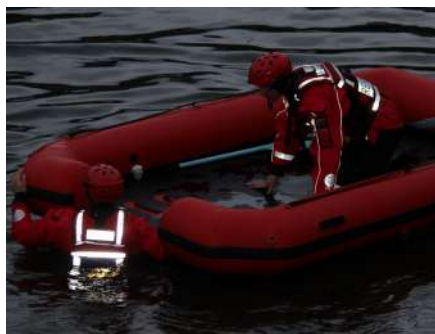

Rafts are available in 5 colours  
Red, yellow, green, orange and black.  
We can add custom logos to any inflatable please call to discuss your designs.

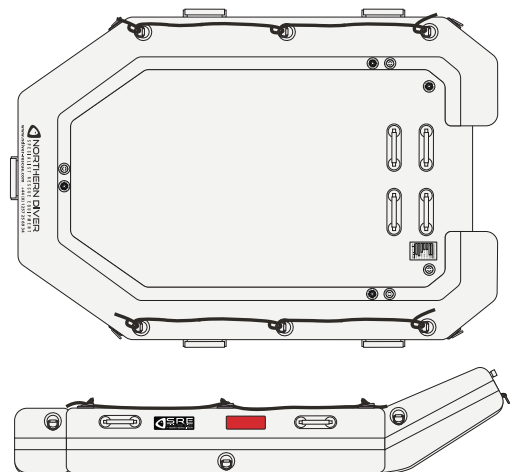

Inflatable.

## Walkways / Paths

Our Inflatable Walkways are versatile pieces of equipment that can be used as a path, platform, pontoon or raft.

2 sponsons running underneath the Walkway give it excellent stability.

As well as water and unstable terrain, it can also be used on ice.

The Inflatable Walkway is available in 2m (6'6), 5m (16'4) as standard and custom sizes can be ordered please contact us to discuss your options.

### What's Included?

- 1+ Inflation Valve Fittings
- 1x HP2 Inflation Hand Pump
- 1x Storage Bag
- 1x Repair Kit & Tools

### Why not design your own?

We can create bespoke inflatable's please contact us to discuss your requirements.



### BRAND YOUR INFLATABLE

Your team crest, slogan or any other artwork can be added to your inflatable. Options are available for logos to be applied direct to the inflatable or produced on a removable badge.

Removable badges bond to the inflatable using a strong hook and loop Velcro. Contact our sales team to discuss your printing options.

Length 2m (6'6), 5m (16'4), 8m (26'2) & 10m (32'8) available. Custom walkway sizes can be arranged upon request in any colour.



5m (16'4) walkway  
River Douglas, Wigan

2m (6'6), 5m (16'4) & 10m (32'8) shown above

Spec Details	5m Walkway	2m Walkway
Overall length	500cm (196")	200cm (78.8")
Overall width	120cm (47.2")	120cm (47.2")
Internal width	n/a	n/a
Sponson/pontoon dia.	30cm (11.8")	30cm (11.8")
Floor materials	DWF	DWF
Floor thickness	10cm (3.9")	10cm (3.9")
Weight	37kg (81.6lb)	25kg (55.1lb)
Carton/packing dims.	125x68x40cm (49"x 26.8"x 15.7")	
Chambers	2+1	2+1
Max inlet fill (sponsons)	0.35bar/5psi	0.35bar/5psi
Max inlet fill (floor)	0.7bar/10psi	0.7bar/10psi
SS316 stainless steel D-rings	4L+22M	4L+12M
Handles	4	4
Max loading	750kg (1653lb)	300kg (661lb)
Max persons	7+1	3

### Lightweight & portable

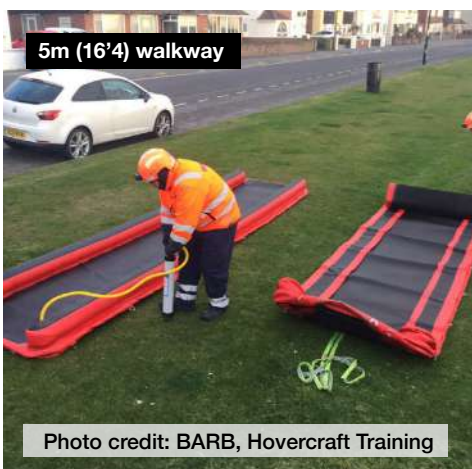

5m (16'4) walkway

Photo credit: BARB, Hovercraft Training



Walkways can be used upside down as Oxfordshire FRS demonstrate in the photo left (8m walkway shown).

Inflatable.

## Air Tracks

Our air tracks are perfect for casualty recovery, temporary pontoon, rescue platform or access path. It offers clearance on ice, mud flats and unstable terrain.

Available in various sizes, from 1m (3'3) to 10m (32'8) in length. For increased capacity several inflatable paths can be connected together. Connected lengthways to extend the path, or sideways to create a rescue raft.

This inflatable is compact and portable, packing away neatly into a storage bag (supplied). It can be inflated and deployed quickly allowing rescue personnel to react within minutes.

### Features

- Non-slip top surface
- Strong, durable and stable
- Drop stitch construction
- 8cm (3.1") floor thickness
- Max pressure 0.7bar / 10psi
- Inflation & relief valves fitted
- Versatile and low maintenance
- Guide lines available fitted on D-rings running parallel
- 5 colours available

### What's Included?

- 1 (or) 2 Inflation Valve Fittings
- 1x HP2 Inflation Hand Pump
- 1x Storage Bag
- 1x Repair Kit & Tools



Soft comfort grip handles



Logos available as shown above

**Lengths**  
**1m (3'3), 2m (6'6), 5m (16'4), 8m (26'2) & 10m (32'8) available.**  
**Custom walkway sizes can be arranged upon request.**



Photo credit: MVS Rushdon Unit - using a 2m (6'6) air track



Photo credit: Environment Agency



2m (6'6) & 1m (3'3) air tracks shown above

Spec Details	10m (32'8)	8m (26'2)	5m (16'4)	2m (6'6)	1m (3'3)
Overall length	1000cm (393.7")	800cm (314.9")	500cm (196.8")	200cm (78.7")	100cm (39.4")
Overall width	140cm (55.1")	140cm (55.1")	140cm (55.1")	100cm (39.4")	100cm (39.4")
Internal width	n/a	n/a	n/a	n/a	n/a
Sponson/pontoon dia.	n/a	n/a	n/a	n/a	n/a
Floor materials	DWF	DWF	DWF	DWF	DWF
Floor thickness	8cm (3.1")	8cm (3.1")	8cm (3.1")	8cm (3.1")	8cm (3.1")
Weight	38kg (83.8lb)	32.5kg (71.7lb)	25kg (55.1lb)	8kg (17.6lb)	3kg (6.6lb)
Carton/packing dims.	140x35x38cm	140x35x35cm	140x35x30cm	105x35x15cm	110x35x10cm
Chambers	1	1	1	1	1
Max inlet fill	0.7bar/10psi	0.7bar/10psi	0.7bar/10psi	0.7bar/10psi	0.7bar/10psi
SS316 stainless steel D-rings	28+	25+	20+	4+	4+
Handles	4	4	4	2	2
Max loading	840kg (1851lb)	672kg (1481lb)	420kg (925lb)	120kg (264lb)	60kg (132lb)
Max persons	8+1	6+1	4	1	1



Designed For You.

## Rescue Life Board

Easy to transport and set up, lightweight and super strong, our inflatable rescue board is for use when the casualty is conscious and able to hold on to the board.

Towed behind a personal water craft (PWC), the board can reach the casualty in a quick, agile manner, which is pivotal in swift/rough water rescue scenarios.

In calmer conditions, the board can be used to swim out to the casualty, rather than with a PWC, and can be used to carry the casualty to safety with the rescuer swimming and pushing the board.

Contact us if this is not quite your spec, subject to order quantities we can alter the size, shape, amount of handles and amount of D-rings. The board is also available in Hypalon rather than PVC.

### What's Included?

- 1x Inflation Valve Fittings
- 1x HP2 Inflation Hand Pump
- 1x Storage Bag
- 1x Repair Kit & Tools

### Spec Details

- Overall length - 185cm (72.8")
- Overall width - 105cm (41.3")
- Internal width - N/A
- Sponson/pontoon dia. - N/A
- Floor materials - DWF
- Floor thickness - 15cm (5.9")
- Weight: 14kg
- Carton/packing dims: 105x63x22cm (41.3"x 24.8"x 8.7")
- Chambers - 1
- Max inlet fill (floor) - 0.7bar/10psi
- 316 stainless steel D-rings
- 2M+5L
- Handles - 12
- Max loading - coming soon
- Max persons - 1+1

### Why not design your own?

We can create bespoke inflatables please contact us to discuss your requirements.

**Built for performance, integrity, and durability.  
Simple to prepare, easy to transport.**



Photo credit: SDIS 37, Loire River, Tours, Central France



Photo credit: Salvataggio Rescue

Any size, colour and specification of inflatable can be manufactured.

Contact us to discuss your requirements.



Inflatable.

## 10m (32'8) Rescue Tubes

The Inflatable Rescue Tube is a first response solution for water rescue and invaluable in situations where the casualty is conscious and able to assist.

The system can be deployed in numerous ways during a rescue operation, depending on the prevailing conditions.

On flowing water, the inflated tube can be positioned at an angle across the flow to provide a buoyant lifeline for waterborne casualties. The angled tube aids water rescue by allowing a safe, controlled route to safety.

The tube can be directed from a safe land position towards a conscious casualty. The tube wraps around the casualty and secures. It can then be pulled back to land with the casualty.

The tube is easy to carry into remote locations i.e. mountain tarns and gorges.

Lightweight  
Stainless steel 316 marine grade  
D-rings located every 2m (6'6)  
along the tube  
High visibility  
Available in any colour  
Custom lengths upon request  
Inflates by hand pump or from a  
compressed air cylinder

### What's Included?

1x Inflation Valve Fittings  
1x HP2 Inflation Hand Pump  
1x Storage Bag  
1x Repair Kit & Tools



Photo credit: Lancashire FRS



Photo credit: MVS Rushdon Unit, Sarah Smith, PR Officer



Photo credit: Outreach Rescue



Need another length?  
Contact us we can  
manufacture and length  
you require.

Photo credit: Outreach Rescue



## 2.4m (7'9) Inflatable Raft

### Ideal small river/flood rescue raft

Heavy duty, commercial build  
 An easy carry for 2 operators  
 Portable when deflated, easy to store  
 Colours: red/grey or yellow/grey  
 Length 240cm (94.5")  
 Tube diameter 34cm (13.4")  
 Air chamber 2+1  
 Supplied with inflation pump, repair kit and paddles



## 3.3m (10'8) Inflatable Catamaran

### Ideal for pulling casualties from the water

Versatile watercraft  
 Commercial build  
 Compatible with our outboards  
 Colours: yellow/black  
 Length 330cm (130")  
 Tube diameter 42cm (13.4")  
 Air chamber 3+1  
 Supplied with inflation pump, removable air deck floor, 2 benches, repair kit and 2 paddles  
[www.ndiver-rescue.com/inflatables/inflatable-catamaran](http://www.ndiver-rescue.com/inflatables/inflatable-catamaran)



## 3.9m (12'8) Inflatable Kayak

### Ideal heavy duty work kayak

Use on rivers, lakes, bays and calm oceans  
 Easy to carry  
 Fast and stable design  
 Colours: blue/black  
 Length 390cm (154")  
 Tube diameter 42cm (16.5")  
 Air chamber 3+1  
 Supplied with inflation pump, 2 removable seats, repair kit and 2 paddles



## 2.69m (10'6)

### Inflatable Paddle Board

### Designed to deliver an enhanced performance on calm or choppy water and offer an ideal stable platform

Excellent performance in all water conditions with exceptional construction and durability  
 Length 269cm (106")  
 Width 81.3cm (32")  
 Depth 15cm (6")  
 Supplied with central 22cm (8.5") removable fin, storage backpack, ankle strap, adjustable 3-pc fibreglass paddle, inflation pump and repair kit  
 Colours: green/blue or white/blue

# Inflation options

Every inflatable boat comes with a hand or foot pump as standard. However, we can provide options to help you inflate quicker and with less effort, for when you need to get on the water fast.



## 1. Saturn Reg Inflation Kit

Usually found as part of one of our regulator kits or packages, the Saturn Reg is the first stage regulator used with diving cylinders. For boats, it'll still be used with a cylinder to assist speedier chamber inflation of our Wren inflatable boats.

Designed for use with either DIN 300bar or A-Clamp 232bar diving cylinders, the Saturn reg inflation kit is set at 2.5 bar outlet pressure and fitted with a 2m boat inflation hose for use with our range of inflatables.

## 2. 3-tap Saturn Reg Inflation Kit

If you've got a real need for speed when it comes to inflating your Wren boat, get the Saturn Reg Inflation Kit with our 3 tap pressure valves.

With the traditional Saturn you can inflate the boat chambers quickly but only one at a time. So that we can better support speedier inflation times, our engineers have now developed the 3-tap system on our Saturn regulators. This means that from one cylinder you can fill 3 chambers on your Wren inflatable boat at once, reducing the time it takes to get out on the water.



## 12V Speedy Air Pump GP80 with Croc Clips

This Speedy GP80 Air Pump is an incredible high-pressure, dual action, automatic 12 volt pump. Designed to blow up inflatable boats with no effort at all. It's super easy to use and reliable, just set the pressure gauge and press the on button. The pump will then inflate your boat to its correct pressure and stop automatically.



The PSI on the air pump is adjustable from 2.2 PSI up to a maximum of 12 PSI. By delivering around 200 litres/minute, this electric pump, when attached to a battery via the crocodile clips, will inflate a boat in around half the time it would take with a hand pump.

The high-pressure inflator pump automatically stops at the pressure level that you select, ensuring your inflatable won't overfill. It's also ideal for deflating.

## Mains Power Speedy Air Pump Max Series

Our high-pressure inflator pump, 1200W at maximum power, is dual action and designed to blow up inflatables with no effort at all. The pump will inflate your equipment to its correct pressure and stop automatically. At just 1.9kg (4.18lb), the Max Series AC pump is also easily transportable between mains points, making it a great choice for those wanting easier inflation options.



The Genovo Power Max-1200 is an ideal AC pump for blowing up inflatables. The Mains Power Speedy Air Pump Max Series has a maximum output flow of 2100L/min with a maximum air pressure of 31KPa.



## Brand Your Inflatable

### Mountain rescue on an inflatable?

When not climbing mountains they play a great part in flood and river rescue.

With our in-house creative team and up to date printer SRE can help you personalise your craft. We can develop any full colour logo or badge instantly.

On most of our inflatable range we fit loop Velcro panels to allow the simple application of names, logos and reflective tapes which can easily be changed if they become worn.



**BUCKS SEARCH AND RESCUE**

**BSAR 1**  
www.ndiver-rescue.com

## Made To Order Inflatable's

Speak to us about the exact specification you need.

Your craft in 5 easy steps, choose:

1. the size
2. inflatable or fold away aluminium floor
3. material (PVC or Hypalon)
4. 1 of 5 colour options
5. then talk to us about branding.

Consult with us about the included parts if you need to make changes. Why not add additional extras to really personalise it for you? We can reinforce transoms, add rubber reinforcements, storage pockets and additional D-rings.

### Save time ... with our one-stop-shop.

We can help you complete your craft with an electric or petrol outboard and we are agents for most leading road trailer manufacturers.

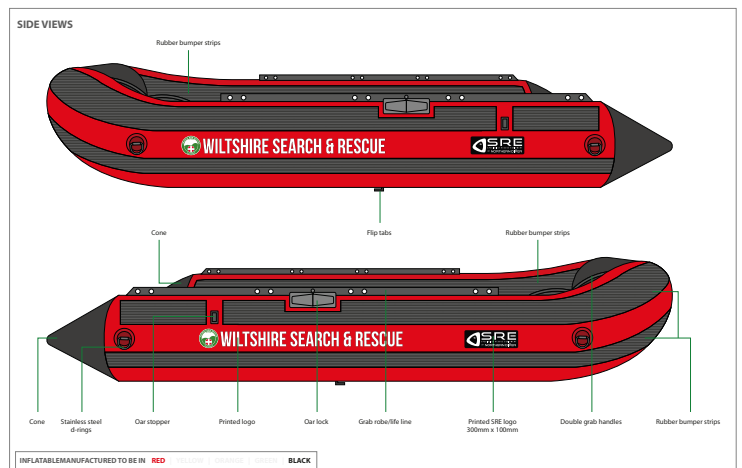
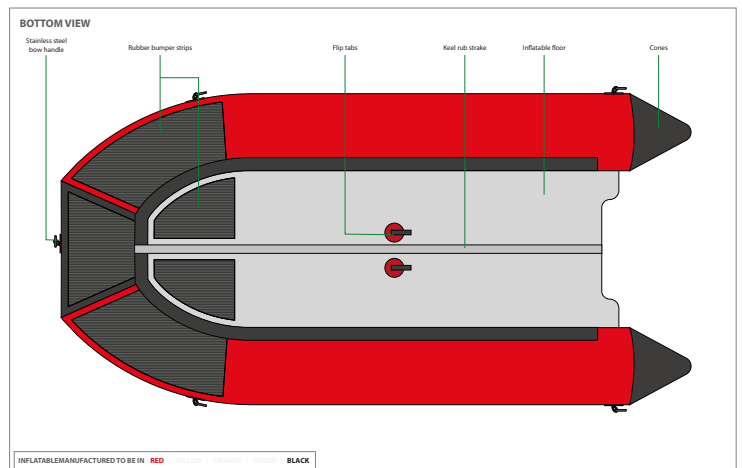
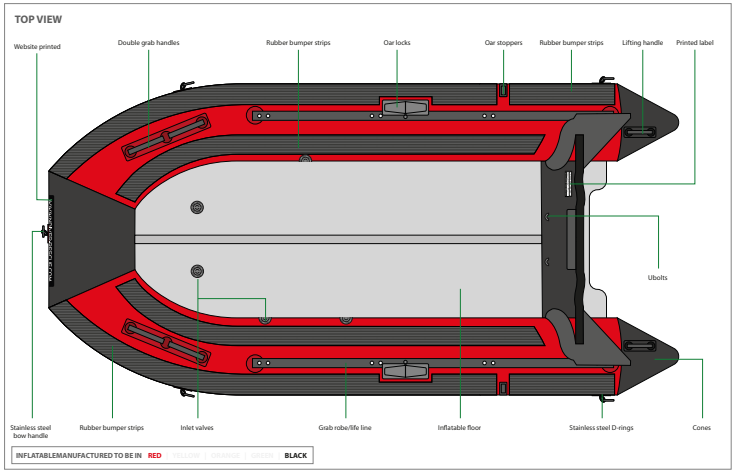

Velcro fixed logo



Glued logo strip



# Neraus NRS Series High Performance Electric Outboards

Low noise, reliable and more power for your money.

Choose a Neraus NRS series and you'll quickly see why they're the best value electric motor on the market.

Designed for salt and/ or freshwater use, they have anti-corrosion and anti-dust properties in their design. Every model in the Neraus NRS series comes complete with a transom bracket, telescopic handle, 5 forward and 3 reverse speeds.

The transom bracket enables you to easily lift the motor and adjust it's height to avoid objects in shallow water. The nylon mount bracket enables a 90 degree lever-lock system. Neraus brackets are super strong.

The 2-blade machete propeller is flexible and has a weedless design. The full aluminium head is finished with a specialised marine paint to further improve it's life. You will always know how much battery life is left with via the 10-level LED power indicator.

AWM standard US cable and UL certificate.



Model No.	Thrust		Input power	Shaft length	
	lbs	kg		in	m
NRS-32L	32	14.5	12V, 26A 312W	28"	0.712
NRS-36L	36	16.3	12V, 29A 348W	30"	0.762
NRS-40L	40	18.1	12V, 34A 408W	30"	0.762
NRS-46L	46	20.9	12V, 40A 480W	36"	0.915
NRS-55L	55	25.0	12V, 52A 624W	36"	0.915
NRS-62L	62	28.2	12V, 58A 696W	26"	0.661
NRS-86L	86	37.2	24V, 48A 1152W	40"	1.016





## Sail 95D31R maintenance-free Battery

Voltage 12V, Capacity 80ah, 600 A  
LxWxH: 310x182x256mm (12.2"x 7.2"x 10")  
Weight: 20.4kg (45lb)

Sail batteries maintain power even in low temperature conditions. It has a long service life.



## Smart Power Battery Box

Suitable for batteries up to 100ah capacity  
Internal LxWxH: 355x190x260mm (13.9"x 7.5"x 10.2")  
Carry weight: 35kg (77.2lb)

This Smart Power battery box is a unique 12volt power station. It quickly, easily and safely stores and distributes power from a 12volt marine battery directly to your appliances.

The power outlets available through the battery box lid consist of a:

- Positive and a negative wing nut thread for eyelet 12v terminal connection
- 5v USB socket, great for recharging a phone or tablet
- DC12V (cigarette lighter type) socket with 10amp breaker on socket
- 60amp breaker on 12volt connections

The box also has a battery power gauge that displays the power condition of the installed battery via an LED display. This indicates the residual power in the battery.







## 4 Stroke Parsun Outboard Motors

Cost-effective, clean and powerfully efficient.

Parsun Outboard Motors offer you performance, quality and reliability for enjoyable and safe boating. We're proud to be one of their distributors. The Parsun brand is going from strength to strength, with their quality equal to that of top outboard manufacturers, but at a much more cost-effective price point. Parsun is now one of the strongest suppliers on the international outboard market because of the quality, value and efficiency the boat engines offer.

The F9.8 series are lighter and more compact than the F15 series, however the compromise is the smaller fuel tank capacity. Both series have options that enable you to choose your tiller position, start option and shaft length. This means you're sure to find the right outboard option for your inflatable boat.



For perfect pairing options contact us.



Way of Life!

**THE**  
**ULTIMATE**  
**4-STROKE OUTBOARD**

## Suzuki 4-stroke Outboard Motors

Reliability, with a compact, high performance design

Suzuki offer powerful, reliable and fuel-efficient boat engines. Every engine across their ranges is specifically designed for marine use. Their user-friendly motors are supported by their 50 years of industry leading innovation.

High performance, lightweight, compact and low on fuel consumption: you really can have it all in one!

For perfect pairing options contact us.



Photo credit: Staffordshire Fire & Rescue Service





## Bunk-Style Road Trailers For Inflatables

We'll work with the manufacturers to ensure that we get you the most suitable trailer for your SRE inflatable at the best price possible.

Bunk trailers are adjustable, so your boat gets maximum protection. The trailers are fitted with sealed for life bearings.

Fully welded and hot dip galvanised, the trailers we supply conform to current road use regulations.



## 22.5M DIVING TEST TANK



We are almost there, hopefully our new 22.5m dive tank will be open for business in March 2020. See the video on You Tube at [www.youtube.com/NorthernDiverUK](http://www.youtube.com/NorthernDiverUK)

## CONTACT US.

### Craig McColl - Sales Team Manager

Office: +44 (0) 1257 25 69 34  
Mobile: +44 (0) 7854 25 20 13  
Email: [craig@ndiver.com](mailto:craig@ndiver.com)

### Dan Cottrell - Sales

Office: +44 (0) 1257 25 69 41  
Mobile: +44 (0) 7961 289 728  
Email: [dan@ndiver.com](mailto:dan@ndiver.com)

### Matthew Burrows - Sales

Office: +44 (0) 1257 25 69 43  
Mobile: +44 (0) 7703 298 234  
Email: [matthewb@ndiver.com](mailto:matthewb@ndiver.com)

## Visit our website [www.ndiver-rescue.com](http://www.ndiver-rescue.com)

For new product releases, latest news, more item information, size guides, manuals etc. You may also find special offers. Why not open an account? Buy online for overnight deliveries to most locations.

## VISIT US.

### Northern Diver International Ltd Group

East Quarry, Appley Lane North, Appley Bridge, Wigan, WN6 9AE. Tel: +44 (0) 1257 25 44 44  
We are located just off J27 of the M6, 40 mins from Liverpool or Manchester airports and our main rail station in Wigan is only 2 hrs from London Euston. If you are visiting we are more than happy to collect you from either airport or train station and return you.



SPECIALIST RESCUE EQUIPMENT  
[WWW.NDIVER-RESCUE.COM](http://WWW.NDIVER-RESCUE.COM)



UNDERWATER ENGINEERING, COMBAT  
SYSTEMS AND SONAR NAVIGATION  
[www.ndiver-military.com](http://www.ndiver-military.com)



COMMERCIAL DIVING SUPPLIES  
& UNDERWATER TOOLS  
[WWW.NDIVER-COMMERCIAL.COM](http://WWW.NDIVER-COMMERCIAL.COM)



SPORT AND RECREATIONAL  
OPENWATER SUITS & EQUIPMENT



DEFENCE SUBMERSIBLES INTERNATIONAL  
[WWW.DEFENCESUBMERSIBLES.COM](http://WWW.DEFENCESUBMERSIBLES.COM)

SRE INFLATABLE STRUCTURES



OFFSHORE RENEWABLES, SUITS  
LIFEJACKETS & APPAREL



LIFE SUPPORT SYSTEMS  
DESIGN AND MANUFACTURE  
TRAINING AND QUALITY MANAGEMENT