

**NEMO**USA

**NEMO**<sup>USA</sup>

*Made in Italy*



# EVERY DAY NEMO BRINGS IDEAS INTO LIGHT AND LIGHTING PROJECTS INTO EXPRESSIVE CREATIONS

Our collections march to the exciting new beat of LED technology. We build fascinating and unique products that shake lighting preconceptions and shape spaces into attractive and timeless settings. NEMO is committed to being a leader in the LED movement both for our partners who use our products and for us who envision them.









# TABLE OF CONTENTS

*Visual Index*

*Alphabetical Index*



P. 12  
**3 TUBES**  
*C. Kalpakian*



P. 56  
**ALYA**  
*G. Rosa*



P. 194  
**AM4C / AS41C**  
*F. Albini, F. Helg,  
A. Piva, M. Albini*



P. 196  
**AM4Z / AS41Z**  
*F. Albini, F. Helg,  
A. Piva, M. Albini*



P. 250  
**ANITA**  
*M. Barbaglia*



P. 22  
**KEPLER**  
*A. Miyake*



P. 200  
**LINESCAPES**  
*Nemo Studio*



P. 226  
**MACONDO**  
*G. Spini*



P. 281  
**MAGA**



P. 248  
**MONTEREY**



P. 254  
**ASTEROIDE**



P. 238  
**CANNA NUDA (GLASS)**  
*P. Castiglioni  
R. Menghi*



P. 184  
**COUPOLE**  
*F. Albini*



P. 86  
**CROWN**  
*Jehs+Laub*



P. 95  
**CROWN PLANA**  
*Jehs+Laub*



P. 72  
**NUVOLA**  
*M. Bellini*



P. 136  
**PROJECTEUR 165**  
*Le Corbusier*



P. 132  
**PROJECTEUR 365**  
*Le Corbusier*



P. 240  
**SIRIUS**  
*C. Colombo*

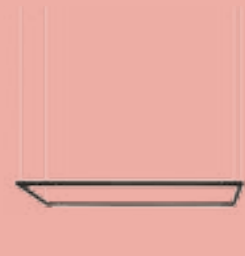

P. 41  
**SPIGOLO**  
*Studiocharlie*



P. 242  
**DONNA**  
*S. Marcato*



P. 282  
**EASTON**



P. 273  
**ELF 9**  
*S. Blackman*



P. 272  
**ELF 15**  
*S. Blackman*



P. 78  
**ELLISSE**  
*F. Palazzari*



P. 20  
**TRU**  
*R. Paoli*



P. 106  
**UMA**  
*G. Tintori*



P. 256  
**GALAXY LUX**



P. 70  
**GIÒ**  
*Angeletti Ruzza Design*



P. 60  
**GHALYA**  
*G. Rosa*



P. 230  
**ILIUM**  
*Foster+Partners*



P. 2  
**IN THE WIND**  
*A. Miyake*

FLOOR

TABLE



P. 190  
**AM2C/AM2Z**  
*F. Albinì, F. Helg,  
A. Piva, M. Albinì*



P. 114  
**BORNE BÉTON**  
*Le Corbusier*



P. 178  
**CLARITAS**  
*V. Magistretti  
M. Tedeschi*



P. 102  
**CROWN**  
*Jehs+Laub*



P. 242  
**DONNA**  
*S. Marcato*



P. 188  
**AMIN**  
*F. Albinì, F. Helg,  
A. Piva, M. Albinì*



P. 186  
**AS1C**  
*F. Albinì, F. Helg,  
A. Piva, M. Albinì*



P. 118  
**BORNE BÉTON PETITE**  
*Le Corbusier*



P. 246  
**DONNA**  
*S. Marcato*



P. 110  
**DOVE**  
*M. Barbaglia,  
M. Colombo*



P. 154  
**ESCARGOT**  
*Le Corbusier*



P. 204  
**LINESCAPES**  
*Nemo Studio*



P. 50  
**MAIS PLUS QUE CELA  
JE NE PEUX PAS**  
*R. Ricciotti*



P. 122  
**PARLIAMENT**  
*Le Corbusier*



P. 216  
**PRISMA**  
*M. Pollice*



P. 230  
**ILIUM**  
*Foster+Partners*



P. 182  
**KUTA**  
*V. Magistretti*



P. 54  
**MINI MAIS PLUS QUE  
CELA JE NE PEUX PAS**  
*R. Ricciotti*



P. 68  
**PANAMA BATTERY**  
*Euga Design*



P. 156  
**PIVOTANTE À POSER**  
*Ch. Perriand*



P. 128  
**PROJECTEUR 365**  
*Le Corbusier*



P. 36  
**SPIGOLO**  
*Studiocharlie*



P. 16  
**TRU**  
*R. Paoli*



P. 136  
**PROJECTEUR 165**  
*Le Corbusier*



P. 48  
**SPIGOLO**  
*Studiocharlie*





P. 14  
**TUBES LARGE**  
*C. Kalpakian*



P. 168  
**APPLIQUE À VOLET PIVOTANT**  
*Ch. Perriand*



P. 150  
**APPLIQUE DE MARSEILLE**  
*Le Corbusier*



P. 238  
**CANNA NUDA**  
*P. Castiglioni  
R. Menghi*



P. 260  
**ECLIPSE**



P. 275  
**OVAL**



P. 162  
**POTENCE PIVOTANTE**  
*Ch. Perriand*



P. 166  
**POTENCE PIVOTANTE MINI**  
*Ch. Perriand*



P. 134  
**PROJECTEUR 165**  
*Le Corbusier*



P. 130  
**PROJECTEUR 365**  
*Le Corbusier*



P. 268  
**ELF SERIES**  
*S. Blackman*



P. 28  
**FLACA**  
*R. Paoli*



P. 258  
**H SERIES**



P. 262  
**JANEIRO**



P. 274  
**KRIS / KRIS KRIS**



P. 252  
**SOLEIL**



P. 46  
**SPIGOLO**  
*Studiocharlie*



P. 278  
**TANGO**  
*S. Blackman*



P. 284  
**VANA**



P. 62  
**WALL SHADOWS**  
*C. Kalpakian*



P. 228  
**MACONDO**  
*G. Spini*



P. 142  
**LAMPE DE MARSEILLE**  
*Le Corbusier*



P. 146  
**LAMPE DE MARSEILLE MINI**  
*Le Corbusier*



P. 108  
**LOGO**  
*M. Barbaglia,  
M. Colombo*



P. 182  
**KUTA**  
*V. Magistretti*



P. 280  
**MAGA**



P. 276  
**MATRIX**



P. 234  
**NORMA**  
*M. Barbaglia,  
S. Blackman*



P. 76  
**NUVOLA**  
*M. Bellini*



P. 32  
**OLYMPIA**  
*D. e M. Fuksas*



P. 220  
**REGULUS SYSTEM**  
*G. Fossina, C. Forcolini*

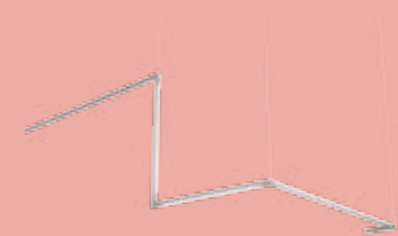

P. 208  
**LINESCAPES SYSTEM**  
*Nemo Studio*

<i>P. 56</i>	<b>ALYA</b> <i>G. Rosa</i>	CROWN PLANA MEGA	<i>P. 182</i>	<b>KUTA</b> <i>V. Magistretti</i>	<i>P. 122</i>	<b>PARLIAMENT</b> <i>Le Corbusier</i>
<i>P. 186</i>	<b>ALBINI COLLECTION</b> <i>F. Albini, F. Helg, A. Piva, M. Albini</i>	CROWN PLANA MINOR		KUTA WALL	<i>P. 156</i>	<b>PIVOTANTE À POSER</b> <i>Ch. Perriand</i>
	AM1N	CROWN SUMMA		KUTA TABLE	<i>P. 162</i>	<b>POTENCE PIVOTANTE</b> <i>Ch. Perriand</i>
	AM2C	CROWN WALL	<i>P. 142</i>	<b>LAMPE DE MARSEILLE</b> <i>Le Corbusier</i>	<i>P. 216</i>	<b>PRISMA</b> <i>M. Pollice</i>
	AM2Z	<b>DONNA</b> <i>S. Marcato</i>		LAMPE DE MARSEILLE	<i>P. 128</i>	<b>PROJECTEUR</b> <i>Le Corbusier</i>
	AM4C	DONNA FLOOR		LAMPE DE MARSEILLE MINI		PROJECTEUR 165 CLIP
	AM4Z	DONNA PENDANT	<i>P. 200</i>	<b>LINESCAPES</b> <i>Nemo Studio</i>		PROJECTEUR 165 PENDANT
	AS1C	DONNA TABLE		LINESCAPES FLOOR		PROJECTEUR 165 WALL/CEILING
	AS41C	<b>DOVE</b> <i>M. Barbaglia, M. Colombo</i>		LINESCAPES PENDANT		PROJECTEUR 365 FLOOR
	AS41Z	<b>EASTON</b>	<i>P. 208</i>	<b>LINESCAPES SYSTEM</b> <i>Nemo Studio</i>		PROJECTEUR 365 PENDANT
<i>P. 250</i>	<b>ANITA</b> <i>M. Barbaglia</i>	<b>ECLIPSE</b>		LIGHTING BARS		PROJECTEUR 365 WALL/CEILING
<i>P. 168</i>	<b>APPLIQUE PIVOTANT</b> <i>Ch. Perriand</i>	<b>ELF SERIES</b> <i>S. Blackman</i>		CONNECTIONS	<i>P. 220</i>	<b>REGULUS SYSTEM</b> <i>G. Fassina, C. Forcolini</i>
	APPLIQUE À VOLET PIVOTANT	<b>ELLISSE</b> <i>F. Palazzari</i>		POWER SUPPLIES	<i>P. 240</i>	<b>SIRIUS</b> <i>C. Colombo</i>
	APPLIQUE À VOLET PIVOTANT DOUBLE	ELLISSE PENDANT DOUBLE	<i>P. 108</i>	<b>LOGO</b> <i>M. Barbaglia, M. Colombo</i>	<i>P. 252</i>	<b>SOLEIL</b>
	APPLIQUE À VOLET PIVOTANT PLIÉ	ELLISSE PENDANT MAJOR	<i>P. 226</i>	<b>MACONDO</b> <i>G. Spini</i>	<i>P. 36</i>	<b>SPIGOLO</b> <i>Studiocharlie</i>
<i>P. 150</i>	<b>APPLIQUE DE MARSEILLE</b> <i>Le Corbusier</i>	ELLISSE PENDANT MINOR		MACONDO PENDANT		SPIGOLO FLOOR
<i>P. 254</i>	<b>ASTEROIDE</b>	<b>ESCARGOT</b> <i>Le Corbusier</i>		MACONDO WALL/CEILING		SPIGOLO PENDANT
<i>P. 114</i>	<b>BORNE BÉTON</b> <i>Le Corbusier</i>	<b>FLACA</b> <i>R. Paoli</i>	<i>P. 280</i>	<b>MAGA</b>		SPIGOLO TABLE
	BORNE BÉTON GRAND	<b>GALAXY LUX</b>		MAGA PENDANT		SPIGOLO WALL
	BORNE BÉTON PETITE	<b>GIÒ</b> <i>Angeletti Ruzza Design</i>		MAGA WALL	<i>P. 278</i>	<b>TANGO</b>
<i>P. 238</i>	<b>CANNA NUDA</b> <i>P. Castiglioni, R. Menghi</i>	<b>GHALYA</b> <i>G. Rosa</i>	<i>P. 50</i>	<b>MAIS PLUS QUE CELA JE NE PEUX PAS</b> <i>R. Ricciotti</i>	<i>P. 16</i>	<b>TRU</b> <i>R. Paoli</i>
	CANNA NUDA PENDANT	<b>H SERIES</b>		MAIS PLUS QUE CELA JE NE PEUX PAS		TRU FLOOR
	CANNA NUDA WALL/CEILING	<b>ILIUM</b> <i>Foster+Partners</i>		MINI MAIS PLUS QUE CELA JE NE PEUX PAS		TRU PENDANT
<i>P. 178</i>	<b>CLARITAS</b> <i>V. Magistretti, M. Tedeschi</i>	ILIUM PENDANT	<i>P. 276</i>	<b>MATRIX</b>	<i>P. 10</i>	<b>TUBES</b> <i>C. Kalpakian</i>
<i>P. 184</i>	<b>COUPOLE</b> <i>F. Albini</i>	ILIUM TABLE	<i>P. 248</i>	<b>MONTEREY</b>		TUBES LARGE WALL
<i>P. 86</i>	<b>CROWN</b> <i>Jehs+Laub</i>	<b>IN THE WIND</b> <i>A. Miyake</i>	<i>P. 234</i>	<b>NORMA</b> <i>M. Barbaglia, S. Blackman</i>		TUBES 3 PENDANT
	CROWN FLOOR	IN THE WIND FLOOR	<i>P. 72</i>	<b>NUVOLA</b> <i>M. Bellini</i>	<i>P. 106</i>	<b>UMA</b> <i>G. Tintori</i>
	CROWN MAGNUM	IN THE WIND PENDANT HORIZONTAL		NUVOLA PENDANT	<i>P. 284</i>	<b>VANA</b>
	CROWN MAJOR	IN THE WIND PENDANT VERTICAL		NUVOLA WALL	<i>P. 62</i>	<b>WALL SHADOWS</b> <i>C. Kalpakian</i>
	CROWN MINOR	<b>JANEIRO</b>	<i>P. 32</i>	<b>OLYMPIA</b> <i>D. e M.o Fuksas</i>		WALL SHADOWS GRAND
	CROWN MULTI	<b>JANEIRO K</b>		OLYMPIA APPLIQUE		WALL SHADOWS LONG
	CROWN PLANA	JANEIRO K EMERGENCY		OLYMPIA WITH ARM		WALL SHADOWS MOYEN
	CROWN PLANA LINEA	<b>KEPLER</b> <i>Arihiro Miyake</i>	<i>P. 275</i>	<b>OVAL</b>		WALL SHADOWS PETIT
	CROWN PLANA MAJOR	<b>KRIS / KRIS KRIS</b>	<i>P. 68</i>	<b>PANAMA BATTERY</b> <i>Euga Design</i>		



## CONTEMPORARY

*We like the search for the new.  
Among other things, because  
there are no given rules,  
but infinite possibilities for  
charismatic ideas.*



# IN THE WIND

*Arihiro Miyake*

Floor and pendant lamps for warm and widespread LED lighting. The body is manufactured through a technology of torsion and misalignment of the extruded aluminum bar allowing for 360° LED emission. This technology was extensively studied by Nemo. Heads are in die-casted aluminum. Diffusers are in opal metacrylate. Heads, base and arms are painted in matt white, matt black, titan grey or gold. For the floor version, switch and dimmer are on the cable.



*In The Wind pendant vertical gold*

*“In a time in which the light source itself can even be designed according to each object, the question would be how the lighting design should meet technology and how the light should look like. My answer is a simple, yet very fresh attempt, free from ready-made ideas, and rules based on classic lighting sources. In The Wind is a way to the future”.*

Arihiro Miyake



**PENDANT HORIZONTAL LED**

Linear LED | diffused, 360° | 3x20W | CCT 3000K |  
 5700lm | typ cri 83 | dimmable, 1-10V | 120V |  
 IP 20 (indoor, dry location)  
 note cable length 16.4' max, metal cable length 9.8'

- ITW LWW 53 structure white
- ITW LNW 53 structure black
- ITW LGW 53 structure gold
- ITW LDW 53 structure titan grey

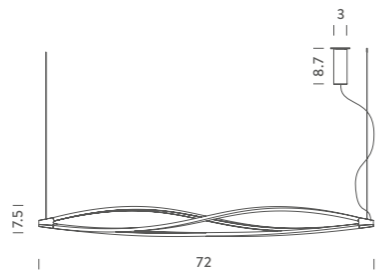

**PENDANT VERTICAL LED**

Linear LED | diffused, 360° | 3x20W | CCT 3000K |  
 5700lm | typ cri 83 | dimmable, 1-10V | 120V |  
 IP 20 (indoor, dry location)  
 note cable length 9.8' max

- ITW LWW 52 structure white
- ITW LNW 52 structure black
- ITW LGW 52 structure gold
- ITW LDW 52 structure titan grey



*In The Wind pendant horizontal titan grey*



*In The Wind floor black*  
 Vincenzo De Cotiis architect - Private residence  
 NEXT PAGE *In the Wind pendant vertical white*

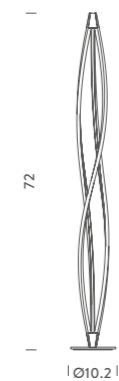

FLOOR LED

Linear LED | diffused, 360° | 3x20W | CCT 3000K  
 | 5700lm | typ cri 83 | 120V | dimmable | IP 20  
 (indoor, dry location) | note dimmer on cable,  
 cable length 11.5'

- ITW LWW 21 structure white
- ITW LNW 21 structure black
- ITW LGW 21 structure gold
- ITW LDW 21 structure titan grey





*In The Wind pendant horizontal white - Vincenzo De Cotiis architect - Private residence*

# TUBES

*Charles Kalpakian*



Family of pendant and wall lamps with elements in extruded aluminum. Opal polycarbonate diffusers for warm and ambient lighting. Adjustable elements in the wall version.

*Tubes 3 copper/white and white/white*



*“Suspended without gravity,  
enlightened with technology”.*

Charles Kalpakian

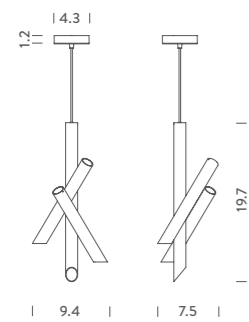

#### TUBES 3 PENDANT LED

LED | 14.5W | CCT 2700K | 1500lm | typ cri 80 |  
dimnable, TRIAC | 120V | IP 20 (indoor, dry  
location)

*note cable length 9.8" max*

- TTB LWC 51 structure white/copper
- TTB LWW 51 structure white/white

*Tubes 3 copper/white*



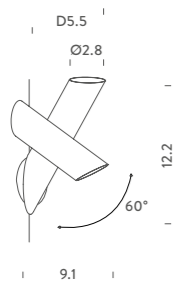

**TUBES LARGE WALL LED**

LED board | diffused | 2x13W | 2x1200lm |  
 typ cri 80 | CCT 2700K | dimmable TRIAC | 120V |  
 IP 20 (indoor, dry location)  
 note one element orientable 60°

- TTU LWD 31 structure white/grey
- TTU LWG 31 structure white/light gold
- TTU LWW 31 structure white/white



*Tubes Large wall white/white*  
 NEXT PAGE white/grey

# TRU

*Roberto Paoli*

Floor lamp with body in extruded aluminum, heads and base in die-casted aluminum, diffusers in opal and transparent metacrylate. Structure painted in matt white or black. The uplight LED source provides a warm and diffused flood, while the back LED creates an indirect ambient lighting.





*“Try to move while looking at the Tru and crossing an observation point. You find that you lose the perception of the vertical element holding the light source and the lamp will look like a very thin object mysteriously lit”.*

Roberto Paoli

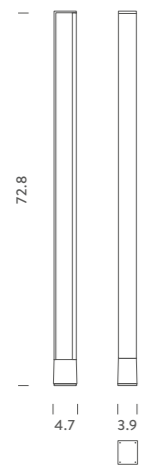

#### FLOOR LED

Linear LED+LED board | up+back, indirect |  
41+16W | CCT 3000K | typ cri 83 | 4080+2660lm |  
double dimming | push on board | 120V |  
IP 20 (indoor, dry location)  
*note cable length 14.7'*

- TRU LWW 24 *structure white*
- TRU LNN 24 *structure black*



*Tru floor white*



Horizontal pendant lamps with double linear LED source. Body in extruded aluminum. Heads in injection molded blended polymeric material, with diffusers in opal metacrylate. Structure painted in matt white. Available with uplight and downlight flood, total up or total down.

## SECTIONS

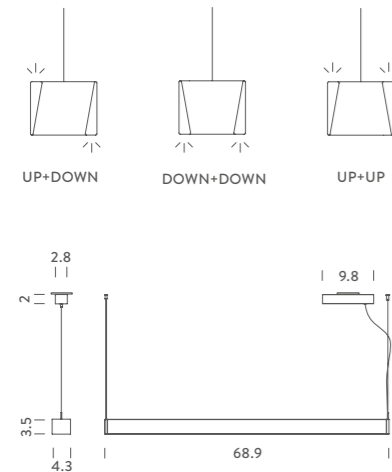

## PENDANT UP+DOWN

Linear LED | up+down | 2x41W | CCT 3000K | typ cri 83 | 2x4080lm | dimmable, push on board | 120V | IP 20 (indoor, dry location)  
note metal cable length 9.8', electric cable length 16.4'

○ TRU LWW 5A *structure white*

## PENDANT UP+UP

Linear LED | up+up | 2x41W | CCT 3000K | typ cri 83 | 2x4080lm | dimmable, push on board | 120V | IP 20 (indoor, dry location)  
note metal cable length 9.8', electric cable length 16.4'

○ TRU LWW 5B *structure white*

## PENDANT DOWN+DOWN

Linear LED | down+down | 2x41W | CCT 3000K | typ cri 83 | 2x4080lm | dimmable, push on board | 120V | IP 20 (indoor, dry location)  
note metal cable length 9.8', electric cable length 16.4'

○ TRU LWW 5C *structure white*



*Tru pendant horizontal down + down white*



# KEPLER

*Arihiro Miyake*



*Kepler downlight black*

*“Kepler is a lighting sculpture with many faces. It could be one of the new aesthetics resulted from the developments of industrial technique and design methods”.*

Arihiro Miyake

Pendant lamp in epoxy-coated aluminum, in matt white or black. Available in uplight and downlight versions for widespread and comfortable lighting. The endless line is made through a 3-dimensional deformation process of extruded aluminum, designed using the mathematics of Moebius ribbons.



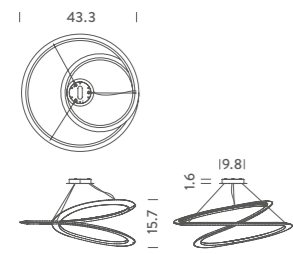

**UPLIGHT**

- ETL -  
LISTING  
PENDING

Linear LED | indirect | 65W | 6300lm |  
typ cri 83 | CCT 2700K | dimmable 1-10V | 120V |  
IP 20 (indoor, dry location)  
note cable length 8.2' max

- KEP LWW 53 structure white
- KEP LNN 53 structure black

**DOWNLIGHT**

- ETL -  
LISTING  
PENDING

Linear LED | directv | 65W | 6300lm |  
typ cri 83 | CCT 2700K | dimmable 1-10V | 120V |  
IP 20 (indoor, dry location)  
note cable length 8.2' max

- KEP LWW 54 structure white
- KEP LNN 54 structure black

*Kepler black uplight* NEXT PAGE  
*Kepler white uplight*



# FLACA

*Roberto Paoli*



*Flaca white*

Wall lamp, double output for flood uplight and downlight.  
Die-casted aluminum, with sandblasted Pyrex diffuser or opal metacrylate for the LED version. Body painted in matt white, moka, champagne or anthracite.



Flaca Moka



Flaca Champagne



Flaca Black



Flaca White

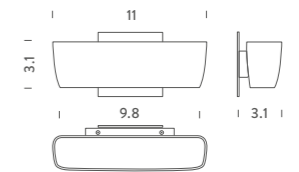

WALL LED

2xLED board | up+down | 20+10W |  
CCT 3000K | 2000+1000lm | typ cri 83 |  
dimnable 1-10V | 120V | IP 20 (indoor, dry location)

- FLA LWW 32 structure white
- FLA LDW 32 structure champagne
- FLA LBW 32 structure moka
- FLA LXW 32 structure anthracite



# OLYMPIA

*Doriana and Massimiliano Fuksas*

Wall adjustable lamps with molded diffuser in sandblasted polycarbonate matt white, for widespread warm lighting. Stem in black painted aluminum, ABS wall stem.

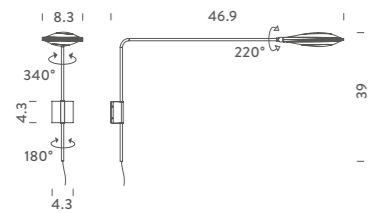

## WALL LED

LED | diffused, 360° | 20W | CCT 2700K |  
3200lm | 120V | IP 20 (indoor, dry location)

*note* arm version: cable length 9.1', switch on cable,  
applique version: dimmable TRIAC

*with arm*

● OLY LNN 31 structure black

*applique*

● OLY LNN 32 structure black

*Olympia with arm*





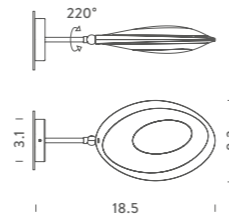

*Olympia applique*  
NEXT PAGE *Olympia with arm*



# SPIGOLO

*Studiocharlie*





Floor, wall/ceiling, pendant and table lamps based on an extruded and tubular aluminum structure connected with molded ABS joints. In white or black painted finish and polycarbonate opaline diffuser. The joints enable the profiles to house LED sources which can be rotated 360° to produce direct or indirect lighting. The floor version is designed to provide a virtual divider of ambience, while the wall/ceiling versions provide a versatile and comfortable ambience. LED sources are dimmable with a warm tone.

*“Spigolo light is architecture itself: with its subtle profile it designs places and suggests new interpretations of the space”.*

Studiocharlie





Spigolo wall, pendant vertical and horizontal, black finishing

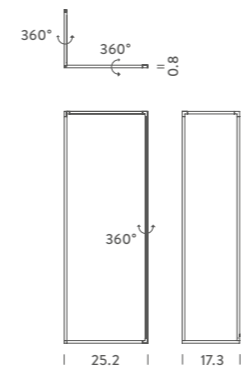

FLOOR LED

3xLinear LED | triple, diffused | 8+12+41W | CCT 3000K | 800+1200+4100lm | typ cri 83 | mono switch dimmable | 120V | IP 20 (indoor, dry location) | *note* orientable diffusers 360°, dimmer on cable, cable length 14.7'

- SPI LWW 22 structure white
- SPI LNN 22 structure black

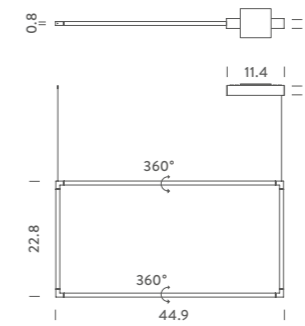

PENDANT VERTICAL LED

2xLinear LED | double, diffused | 24+24W | CCT 3000K | 2400+2400lm | typ cri 83 | mono switch/dimmable 1-10V | 120V | IP 20 (indoor, dry location) | *note* orientable diffusers 360°, cable length 9.8' max

- SPI LWW 51 structure white
- SPI LNN 51 structure black

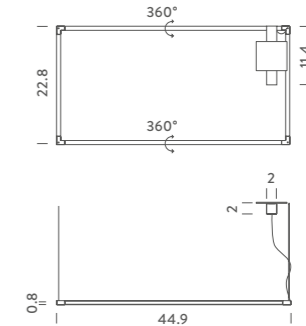

PENDANT HORIZONTAL LED

2xLinear LED | double, diffused | 24+24W | CCT 3000K | 2400+2400lm | typ cri 83 | mono switch/dimmable 1-10V | 120V | IP 20 (indoor, dry location) | *note* orientable diffusers 360°, cable length 16.4', metal cable length 9.8' max, decentralized canopy

- SPI LWW 52 structure white
- SPI LNN 52 structure black

-ETL-  
LISTING  
PENDING

-ETL-  
LISTING  
PENDING









*Spigolo black pendant horizontal*



---

**WALL/CEILING LED**

Linear LED | orientable, diffused | 20W |  
 CCT 3000K | 2000lm | typ cri 83 | 120V |  
 IP 20 (indoor, dry location)  
*note orientable 360°*

- SPI LWW 31 *structure white*
  - SPI LNN 31 *structure black*
- 

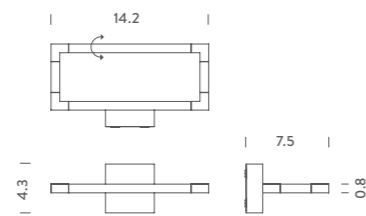



Table lamp in aluminum, in painted white or black finish.  
Polycarbonate ABS joints and opal metacrylate diffusers  
that can rotate 360°.

---

TABLE LED

Linear LED | orientable, diffused 360° | 7.2W |  
720lm | typ cri 80 | CCT 2700K | 120V |  
IP 20 (indoor, dry location)  
*note cable length 9.8', switch on cable*

- SPI LWW 11 *structure white*
  - SPI LNN 11 *structure black*
- 

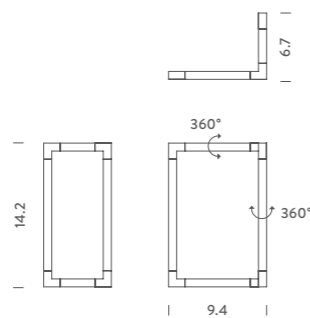

*Spigolo table black*

# MAIS PLUS QUE CELA JE NE PEUX PAS

*Rudy Ricciotti*

Floor and table lamp, raw metal, for warm and widespread lighting.  
Available also in the Mini version.  
Each lamp is handcrafted with small aesthetic and finishing  
differences making each lamp unique.

*“This project was born with industrial  
wastes but less than  
this I am not able.  
And so, this lamp is called  
Mais plus que cela  
je ne peux pas”.*

Rudy Ricciotti

*Mais plus que cela je ne peux pas*





#### FLOOR LED

Linear LED | direct/indirect | 10W | 1000lm |  
 typ cri 83 | CCT 2700K | 120V |  
 IP 20 (indoor, dry location)  
 note cable length 9.8', switch on cable

● RIC LMM 21 structure raw metal

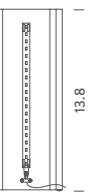



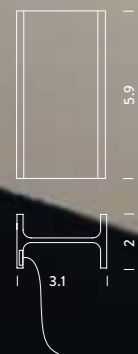

Indoor table lamp in raw metal for warm and widespread lighting. Each lamp is handcrafted with small aesthetic and finishing differences making each lamp unique.

#### MINI TABLE LED

Linear LED | direct/indirect | 2,4W | 340lm |  
typ cri 80 | CCT 2700K | 120V | IP 20 (indoor, dry  
location) | note switch on cable, cable length 9.8',  
lamps are sold three by three.

● RCM LMM 1M structure raw metal

*Mini Mais plus que cela je ne peux pas*



# ALYA

*Gabriele Rosa*



Light LED pendant lamp with diffused light, 70% up and 30% down. Arms in extruded aluminum, central body in die-casted aluminum. Diffuser in opaline methacrylate. Available in matt white finish with or without a remote control.

*Alya white*



*“Three slender luminous arms recall a gesture, or a drawing in the air, rather than a material object. Alya’s fluid shapes are the result of a natural bend in the aluminium that houses the LED”.*

Gabriele Rosa

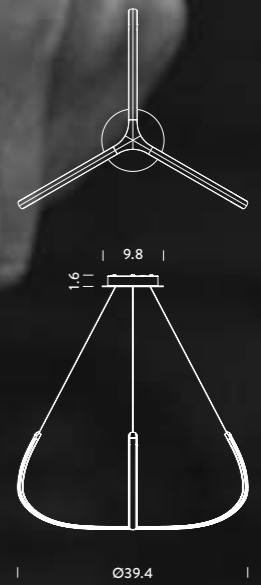

#### PENDANT LED

Linear LED | upright, diffused | 35W | typ cri 83 | CCT 3000K | 4870lm | dimmable, push, 1-10V | 120V | IP 20 (indoor, dry location)  
note cable length 8.2' max

- ALY LWW 51 structure white
  - ALY LNN 51 structure black
- remote
- ALY LWW 52 structure white
  - ALY LNN 52 structure black



# GHALYA

*Gabriele Rosa*

Pendant LED lamp for warm diffused lighting, with 70% uplight and 30% downlight. Dimmability of the center downlight spot follows the dimmability of the linear LED sources of the lamp arms. Arms in extruded aluminum, central body in die-casted aluminum. Diffuser in opaline methacrylate. Available in white, matt black or titan grey.

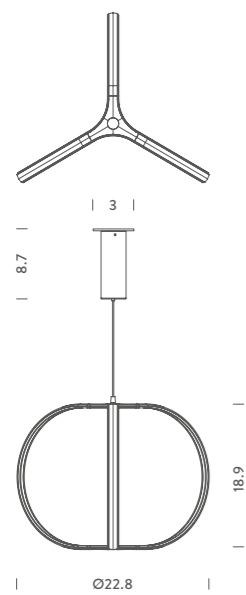

## PENDANT LED

Linear LED+Spot LED | diffused+spot | 46W+5W |  
 typ cri 83 | CCT 2700K | 5280+600lm |  
 mono switch, dimmable, 1-10V | 120V |  
 IP 20 (indoor, dry location)  
 note cable length max 8.2'

- GHA LWW 51 structure white
- GHA LNN 51 structure black
- GHA LDD 51 structure titan grey



# WALL SHADOWS

*Charles Kalpakian*

Family of wall lamps for diffused LED lighting. Available in several sizes in matt white powder coated aluminum.

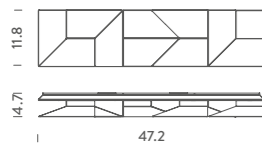

## WALL LONG LED

LED board | diffused indirect | 30W | 2320lm |  
typ cri 80 | CCT 3000K | dimmable 1-10V | 120V |  
IP 20 (indoor, dry location)

○ WSH LWW 34 *structure white*

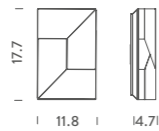

## WALL MOYEN LED

LED board | diffused indirect | 11W | 870lm |  
typ cri 80 | CCT 3000K | dimmable 1-10V | 120V |  
IP 20 (indoor, dry location)

○ WSH LWW 33 *structure white*

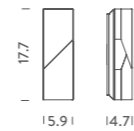

## WALL PETIT LED

LED board | diffused indirect | 8W | 580lm |  
typ cri 80 | CCT 3000K | dimmable 1-10V | 120V |  
IP 20 (indoor, dry location)

○ WSH LWW 32 *structure white*





---

WALL GRAND LED

LED board | diffused indirect | 59W | 4640lm | typ cri  
80 | CCT 3000K | dimmable 1-10V, push | 120V |  
IP 20 (indoor, dry location)

● WSH LW 31 *structure white*

---

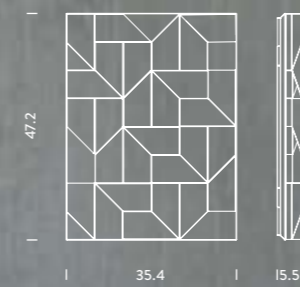



*“Blurring the lines between an industrial design piece and a sculptural masterpiece, this illuminator acts as a spatial focal point when displayed within one’s home”.*

Charler Kalpakian



# PANAMA MINI BATTERY

*Euga Design*

Table lamp, cordless portable rechargeable LED sources for widespread lighting suitable for domestic and work places. Aluminum structure, polycarbonate diffuser with anti-glare treatment.

## MINI BATTERY TABLE LED

LED board | down, diffused | 4W | CCT 2700K | 500lm | typ cri 83 | dimmable | 120V |

IP 20 (indoor, dry location)

*note approx. 7 hours battery life, 3.5 hours recharge time approx, cable length 3.9'*

● PNM LXX 12 *structure coal black*

○ PNM LWW 12 *structure white textured*

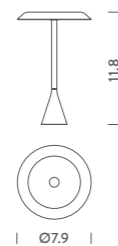

*Panama Mini Battery white*



# GIÒ

Angeletti Ruzza Design



LED pendant lamp in painted white aluminum with opal polycarbonate diffuser for widespread light. Dimmable.

PENDANT LED

LED board | down, diffused | 30W | CCT 3000K | 3800lm | typ cri 83 | dimmable, 1-10V | 120V | IP 20 (indoor, dry location)  
 note cable length 8.2' max

○ GIO LWW 53 structure white

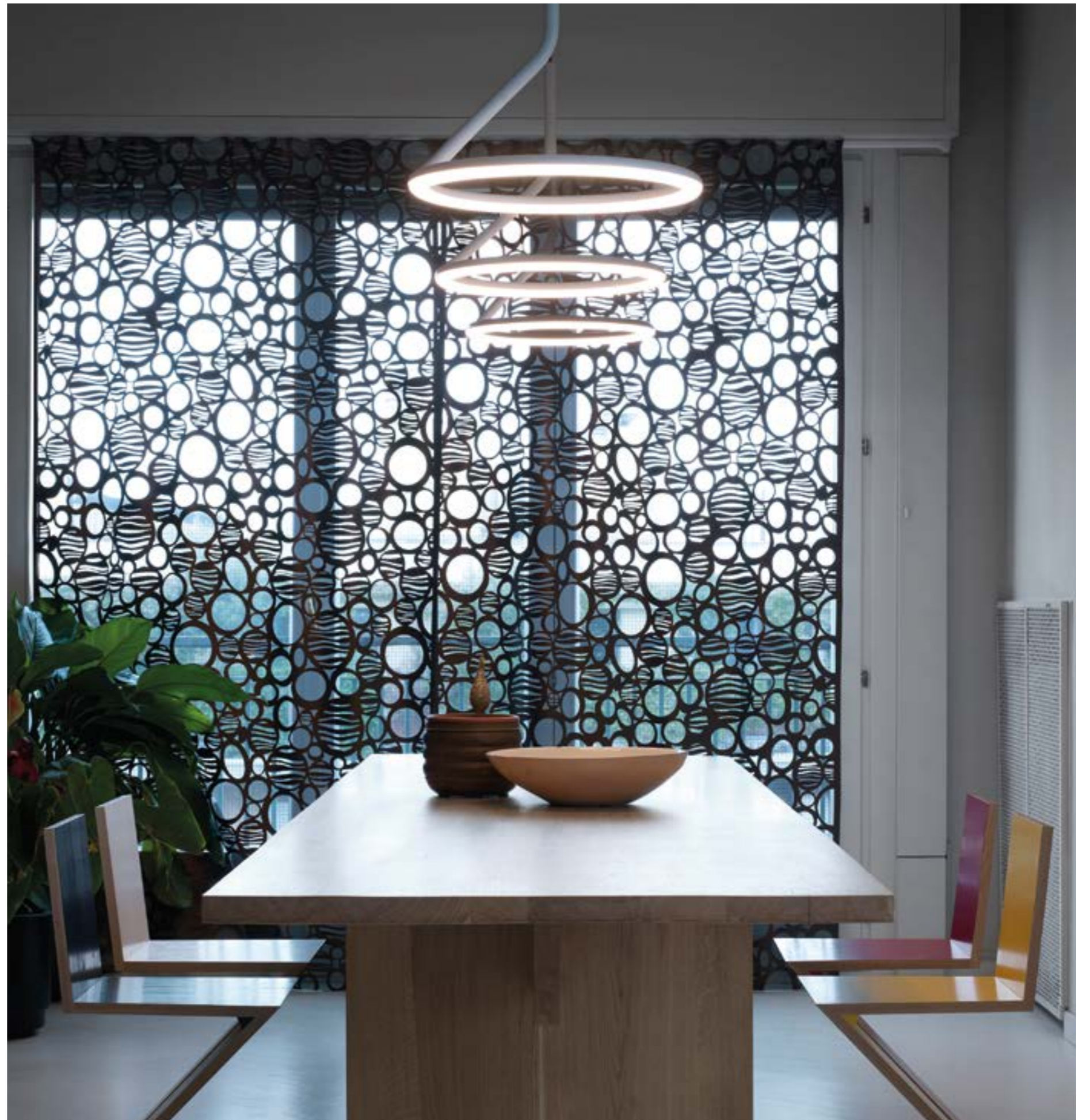
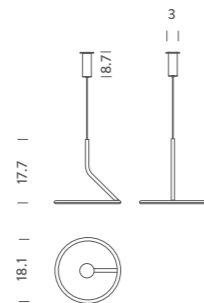



# NUVOLA

Mario Bellini 1974

*“My ‘cloud’ designed to illuminate the office (and, why not, the home too) might today be thought of as a prescient allusion to Steve Jobs’ vision of the ‘cloud’”.*

Mario Bellini

Pendant, wall/ceiling lamps in natural opal polyethylene, in rotational molding. Full lighting for widespread and comfortable output. The pendant version is fastened to the ceiling with three adjustable suspension cables, with a template included. White canopy freely adjustable on the ceiling. The wall/ceiling version is composed of one of the two blocs (deep or flat). For the pendant version, DALI driver on request.



Nuvola pendant at Palazzo Reale, Milan - "Giotto e L'Italia" bookshop



#### PENDANT FLUO

G5 T5 (FH-HO) | diffused | 3x54W | dimmable,  
DALL on request | 120V | IP 20 (indoor, dry  
location) | *note* cable length 9.8' max

○ NUV PWW 51 *structure white*

#### WALL LED 7.8"

LED | diffused | 80W | CCT 3000K | 7900lm |  
typ cri 80 | dimmable 1-10V | 120V

○ NUV LWW 31 *structure white*

#### WALL LED 14.5"

LED | diffused | 80W | CCT 3000K | 7900lm |  
typ cri 80 | dimmable 1-10V | 120V

○ NUV LWW 32 *structure white*

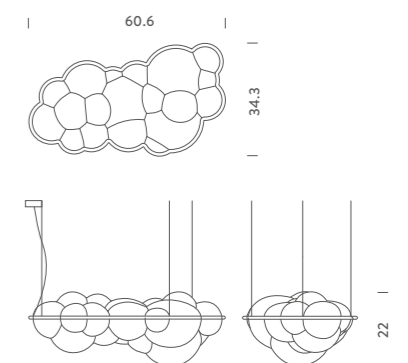

"Pianeta Ufficio" presentation by MARCATRE - 1974 - ph. Gabriele Basilico





# ELLISSE

*Federico Palazzari*

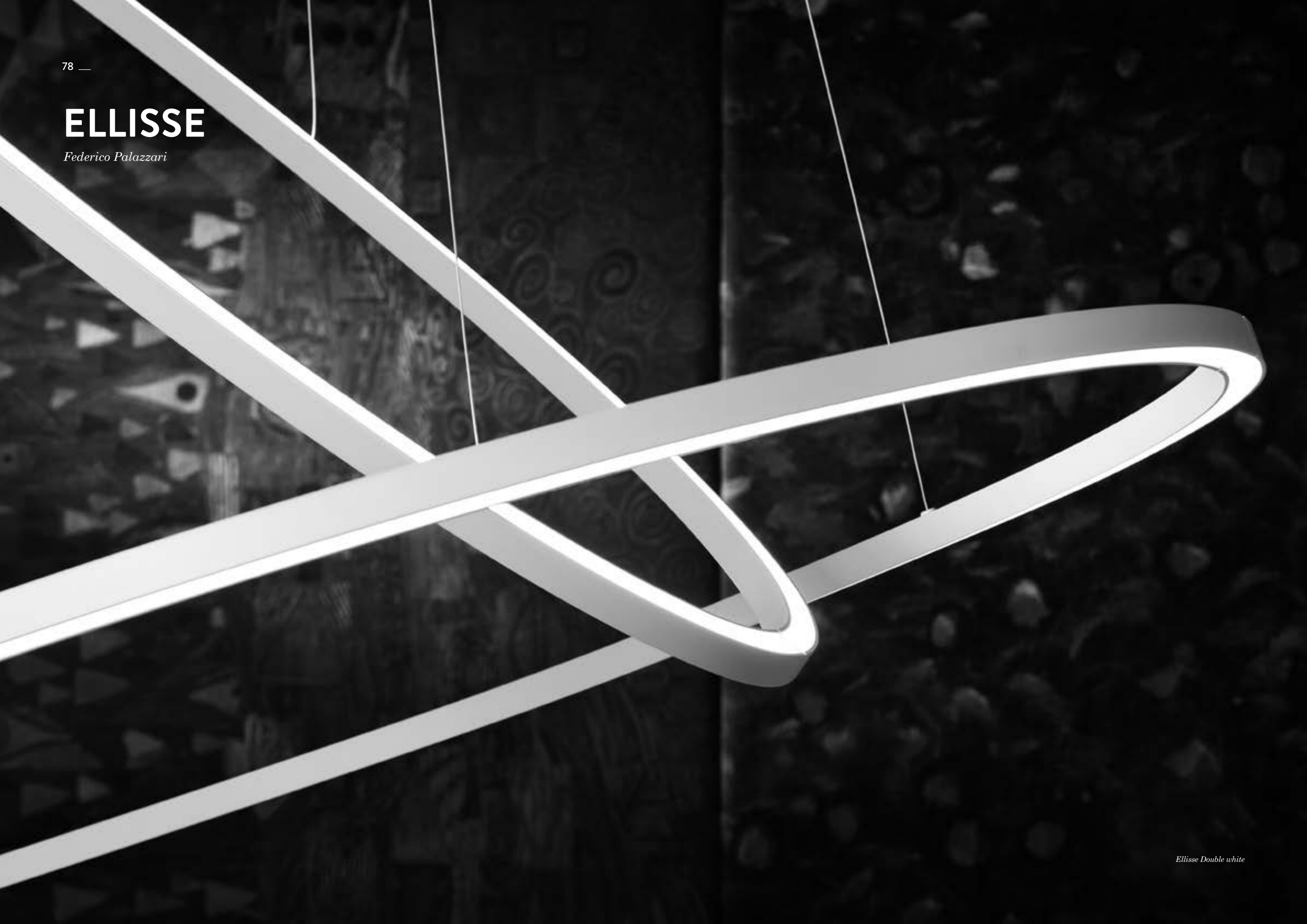

LED pendant lamp, available in three versions: major, minor and double. Widespread direct or indirect lighting. Extruded aluminum, painted in matt white or black, polished, or glossy gold anodized. Opaline diffuser. Ellisse is manufactured through a proprietary technology to combine the extruded bars.







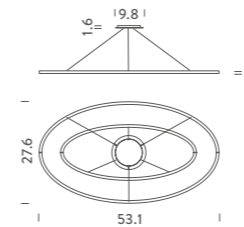

#### PENDANT DOUBLE LED

— ETL —  
LISTING  
PENDING

Linear LED | diffused uplight (minor), diffused  
downlight (major) | 90W | 5400+3900lm | typ cri  
80 | CCT 3000K (gold version: 2700K) | dimmable,  
1-10V | 120V | IP 20 (indoor, dry location)  
*note cable length 8.2' max*

- ELP LWW 56 structure white
- ELP LNW 56 structure black
- ELP LGW 56 structure gold polished anodized
- ELP LLW 56 structure polished aluminum

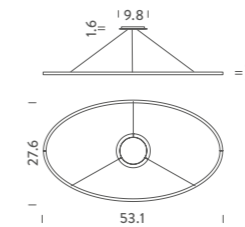

#### PENDANT MAJOR LED

— ETL —  
LISTING  
PENDING

Linear LED | diffused orientable | 78W | typ cri 80 |  
CCT 3000K (gold version: 2700K) | 7800lm |  
dimmable 1-10V | 120V | IP 20 (indoor, dry location)  
*note cable length 8.2' max*

##### uplight

- ELP LWW 53 structure white
- ELP LNW 53 structure black
- ELP LGW 53 structure gold polished anodized
- ELP LLW 53 structure polished aluminum

##### downlight

- ELP LWW 54 structure white
- ELP LNW 54 structure black
- ELP LGW 54 structure gold polished anodized
- ELP LLW 54 structure polished aluminum

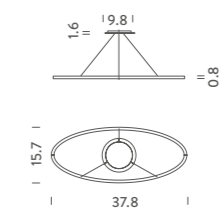

#### PENDANT MINOR LED

— ETL —  
LISTING  
PENDING

Linear LED | diffused orientable | 54W | typ cri 80 |  
CCT 3000K (gold version: 2700K) | 5400lm |  
dimmable 1-10V | 120V | IP 20 (indoor, dry location)  
*note cable length 8.2' max*

##### uplight

- ELP LWW 51 structure white
- ELP LNW 51 structure black
- ELP LGW 51 structure gold polished anodized
- ELP LLW 51 structure polished aluminum

##### downlight

- ELP LWW 52 structure white
- ELP LNW 52 structure black
- ELP LGW 52 structure gold polished anodized
- ELP LLW 52 structure polished aluminum

*Ellisse Minor downlight, finishing white*



# CROWN

*Jehs+Laub*

Family of pendant chandeliers, wall and floor lamps, with modular structure in die-casted aluminum and sandblasted glass diffusers. Structure in hand polished aluminum, glossy gold plated or painted in matt white, matt black or gold. Nemo LED G9 kit available. Widespread light. Double switch for the Summa and Magnum versions. Transparent cable. Red cable on request.







Crown Minor gold plated

Crown Multi polished

**CROWN MAJOR  
PENDANT LED**

LED G9 QT-14 | diffused | 30x3W | dimmable  
according to bulb | 120V | IP 20 (indoor, dry location)  
note cable length 11.4' max, bulb included:  
G9 LED NEMO (p.287)

- CRO HWT 52 structure white
- CRO HLT 52 structure polished
- CRO HNT 52 structure black
- CRO HGW 52 structure gold
- CRO HOW 52 structure gold plated

—UL—  
LISTING  
PENDING

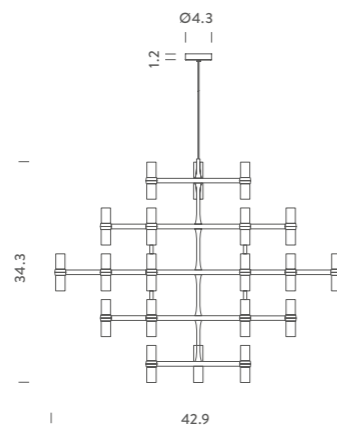

**CROWN MINOR  
PENDANT LED/HALO**

Halopin G9 QT-14 | diffused | 12x25W | dimmable  
according to bulb | 120V | IP 20 (indoor, dry location)  
note cable length 8.2' max, bulb included:  
G9 Halo, available G9 LED kit NEMO (p.287)

- CRO HWT 51 structure white
- CRO HLT 51 structure polished
- CRO HNT 51 structure black
- CRO HGW 51 structure gold
- CRO HOW 51 structure gold plated

—UL—  
LISTING  
PENDING

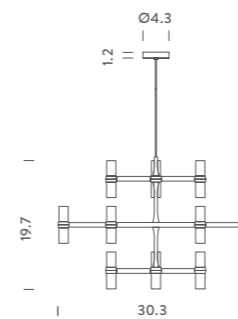

**CROWN MULTI  
PENDANT LED/HALO**

Halopin G9 QT-14 | diffused | 15x25W | dimmable  
according to bulb | 120V | IP 20 (indoor, dry location)  
note cable length 8.2' max, bulb included:  
G9 Halo, available G9 LED kit NEMO (p.287)

- CRO HWW 58 structure white
- CRO HLW 58 structure polished
- CRO HNW 58 structure black
- CRO HGW 58 structure gold
- CRO HOW 58 structure gold plated

—UL—  
LISTING  
PENDING

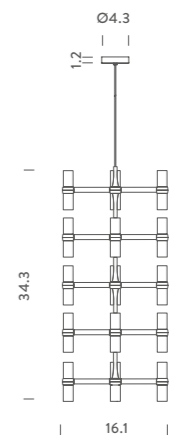





Crown Summa polished at Galleria Rizzoli - Milan

*“Nature, again and again, inspires us to design - like the ‘crown’, which comes from a snowflake”.*

Jehs+Laub

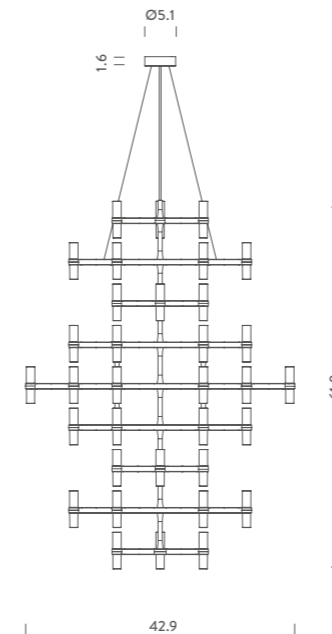

**CROWN SUMMA  
PENDANT LED**

LED G9 QT-14 | diffused | 48x3W | dimmable  
according to bulb, double switching | 120V |  
IP 20 (indoor, dry location)  
note cable length 11.5' max, bulb included:  
G9 LED NEMO (p.287)

- CRO HWW 59 structure white
- CRO HLW 59 structure polished
- CRO HNW 59 structure black
- CRO HGW 59 structure gold
- CRO HOW 59 structure gold plated





Crown Magnum at Hotel Bayerischer Hof Lindau / Arch. Elwert & Stottele / Klaus Sporer

**CROWN MAGNUM  
PENDANT LED**

LED G9 QT-14 | diffused | 42x3W |  
 dimmable according to bulb, double switching | 120V |  
 IP 20 (indoor, dry location) | note cable length  
 11.4' max, bulb included: G9 LED NEMO (p.287)

- CRO HWW 5A structure white
- CRO HLW 5A structure polished
- CRO HNW 5A structure black
- CRO HGW 5A structure gold
- CRO HOW 5A structure gold plated

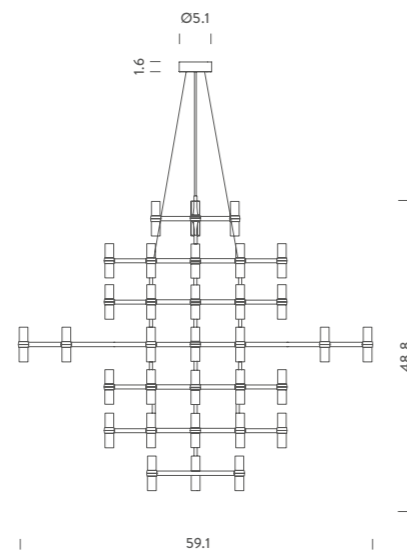



*Crown Plana Minor black*





*Crown Plana Minor polished*



*Crown Plana Mega white*



Crown  
gold plated



Crown  
polished

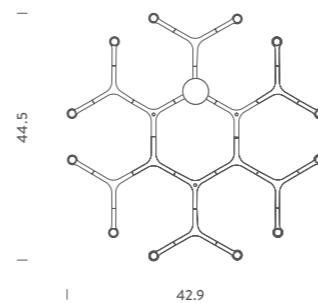
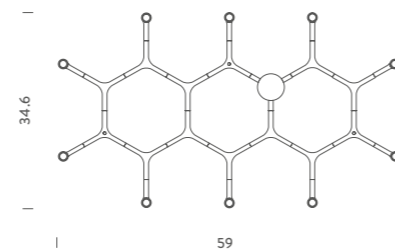
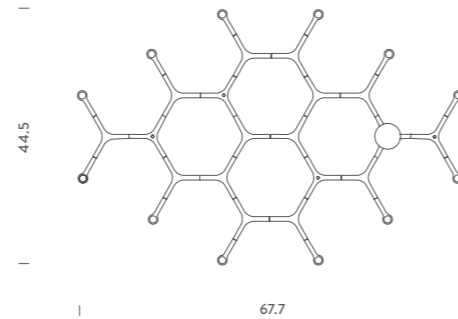
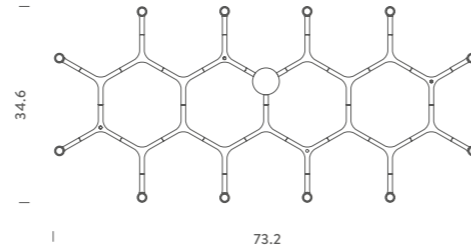
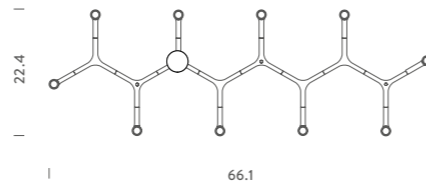

CROWN PLANA LINEA  
PENDANT LED/HALO

Halopin G9 QT-14 | diffused | 10x25W | dimmable  
according to bulb | 120V | IP 20 (indoor, dry location)  
note cable length 8.2' max, bulb included:  
G9 Halo, available G9 LED kit NEMO (p.287)

- CRO HWW 54 structure white
- CRO HLW 54 structure polished
- CRO HNW 54 structure black
- CRO HGW 54 structure gold
- CRO HOW 54 structure gold plated

—UL—  
LISTING  
PENDING

CROWN PLANA MAJOR  
PENDANT LED/HALO

Halopin G9 QT-14 | diffused | 12x25W | dimmable  
according to bulb | 120V | IP 20 (indoor, dry location)  
note cable length 8.2' max, bulb included:  
G9 Halo, available G9 LED kit NEMO (p.287)

- CRO HWW 53 structure white
- CRO HLW 53 structure polished
- CRO HNW 53 structure black
- CRO HGW 53 structure gold
- CRO HOW 53 structure gold plated

—UL—  
LISTING  
PENDING

CROWN PLANA MEGA  
PENDANT LED/HALO

Halopin G9 QT-14 | diffused | 12x25W | dimmable  
according to bulb | 120V | IP 20 (indoor, dry location)  
note cable length 8.2' max, bulb included:  
G9 Halo, available G9 LED kit NEMO (p.287)

- CRO HWW 57 structure white
- CRO HLW 57 structure polished
- CRO HNW 57 structure black
- CRO HGW 57 structure gold
- CRO HOW 57 structure gold plated

—UL—  
LISTING  
PENDING

CROWN PLANA  
PENDANT LED/HALO

Halopin G9 QT-14 | diffused | 10x25W | dimmable  
according to bulb | 120V | IP 20 (indoor, dry location)  
note cable length 8.2' max, bulb included:  
G9 Halo, available G9 LED kit NEMO (p.287)

- CRO HWW 56 structure white
- CRO HLW 56 structure polished
- CRO HNW 56 structure black
- CRO HGW 56 structure gold
- CRO HOW 56 structure gold plated

—UL—  
LISTING  
PENDING

CROWN PLANA MINOR  
PENDANT LED/HALO

Halopin G9 QT-14 | diffused | 12x25W | dimmable  
according to bulb | 120V | IP 20 (indoor, dry location)  
note cable length 8.2' max, bulb included:  
G9 Halo, available G9 LED kit NEMO (p.287)

- CRO HWW 55 structure white
- CRO HLW 55 structure polished
- CRO HNW 55 structure black
- CRO HGW 55 structure gold
- CRO HOW 55 structure gold plated

—UL—  
LISTING  
PENDING



Crown  
black



Crown  
gold

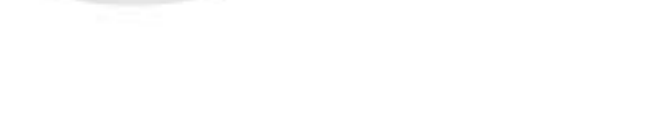

Crown  
white

*Crown  
Minor*



*Crown  
Major*

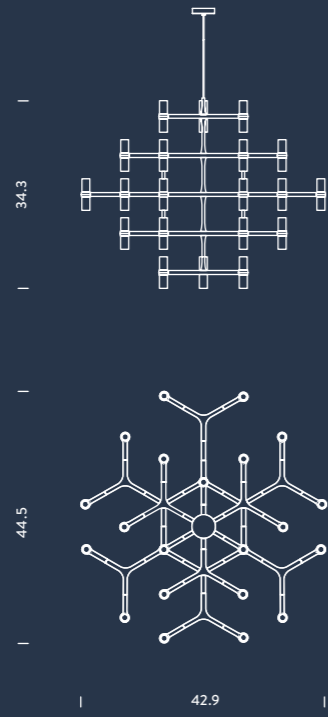

*Crown  
Multi*



*Crown  
Summa*

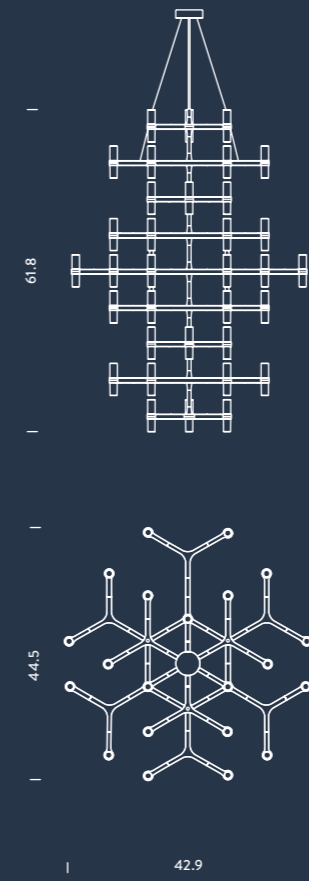

*Crown  
Magnum*

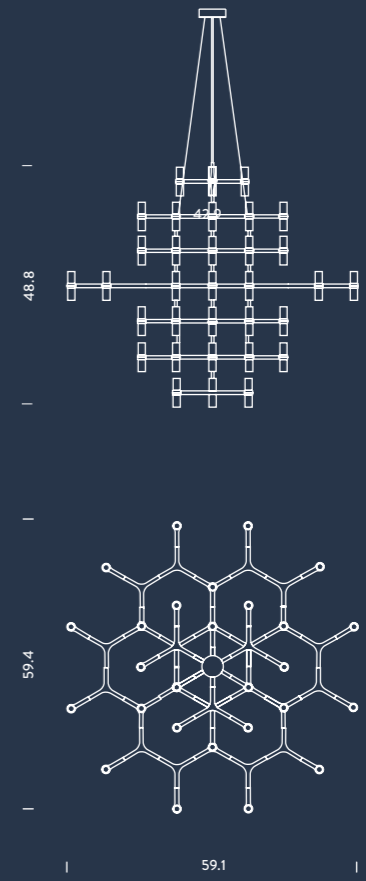

*Crown  
Plana Mega*

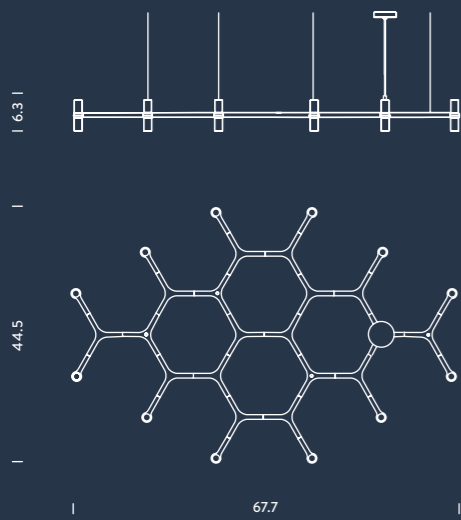

*Crown  
Plana Major*

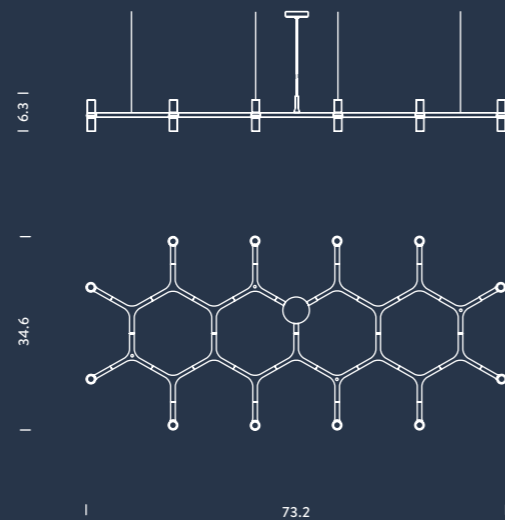

*Crown  
Plana Minor*

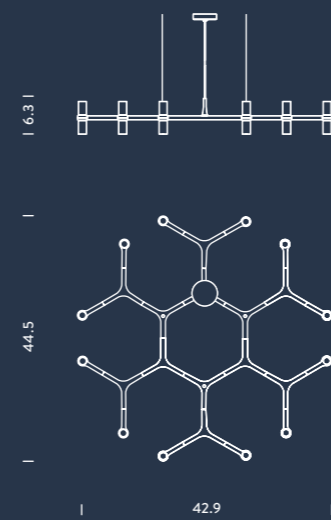

*Crown  
Plana*

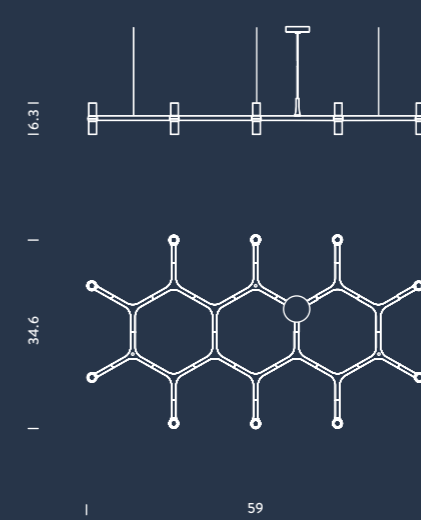

*Crown  
Plana Linea*

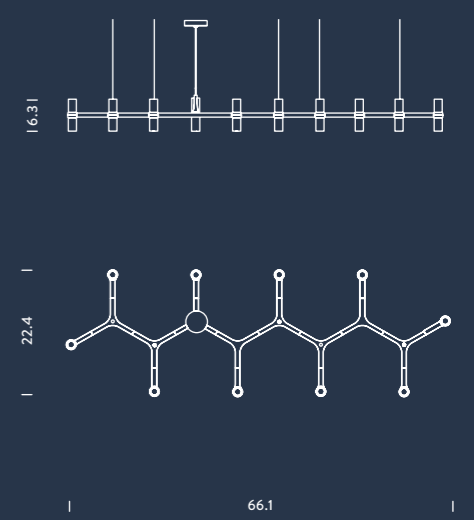



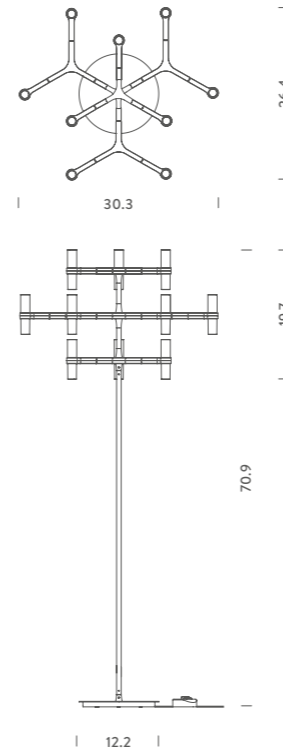

CROWN FLOOR LED/HALO

Halopin G9 QT-14 | diffused | 12x25W | dimmable according to bulb | 120V | IP 20 (indoor, dry location)  
*note* dimmer on cable, cable length 8.9', bulb included: G9 Halo, available G9 LED kit NEMO (p.287)

- CRO HWW 21 *structure white*
- CRO HLW 21 *structure polished*
- CRO HNW 21 *structure black*
- CRO HGW 21 *structure gold*
- CRO HOW 21 *structure gold plated*

—UL—  
LISTING  
PENDING

Modular structure wall lamps in die-casted aluminum with sandblasted glass diffusers. Available in hand polished glossy aluminum or gold plated finish, or painted in matt white, black or gold.

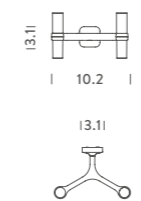
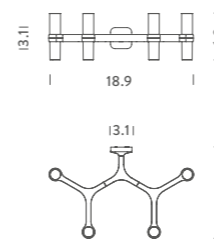

**CROWN WALL 4 LED/HALO**

Halopin G9 QT-14 | diffused | 4x60W | dimmable | 120V | IP 20 (indoor, dry location)  
*note* bulb included: G9 Halo, available G9 LED kit NEMO (p.287)

- CRO HWW 32 structure white
- CRO HLW 32 structure polished
- CRO HNW 32 structure black
- CRO HGW 32 structure gold
- CRO HOW 32 structure gold plated

UL LISTING PENDING

**CROWN WALL 2 LED/HALO**

Halopin G9 QT-14 | diffused | 2x60W | dimmable | 120V | IP 20 (indoor, dry location)  
*note* bulb included: G9 Halo, available G9 LED kit NEMO (p.287)

- CRO HWW 31 structure white
- CRO HLW 31 structure polished
- CRO HNW 31 structure black
- CRO HGW 31 structure gold
- CRO HOW 31 structure gold plated

UL LISTING PENDING

*Crown Wall 4 gold*  
 PREVIOUS PAGE:  
*Crown Wall 2 polished*

# UMA

Giancarlo Tintori



Very large pendant lamp with steel structure and transparent metacrylate tubes arranged according to a fractal model to provide widespread light.

## PENDANT FLUO

2G11, TC-L | diffused | 2x80W | 120V |  
IP 20 (indoor, dry location)  
*note* cable length 9.8' max, bulb included

○ UMA PTT 51 *structure* transparent

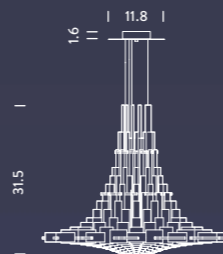



# LOGO

*Mario Barbaglia, Marco Colombo 1991*

Wall LED and halogen lamps with adjustable head, in aluminum and molded ABS. Available in black or silver grey. In the LED version the perforated reflector is painted in black. Widespread adjustable light.

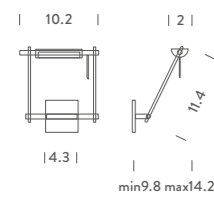

## WALL LED

LED board | orientable 140° | 17W | CCT 2700K  
| 1900lm | typ cri 83 | 120V | IP 20 (indoor, dry location)

●● LOG LNN 31 *structure black/black*

## WALL HALO

R7s (4.5") | orientable 140° | 250W |  
dimnable | 120V | IP 20 (indoor, dry location)

●● LOG KNN 31 *structure black*

●● LOG KDD 32 *structure grey*



*Logo wall LED*

# DOVE

*Mario Barbaglia, Marco Colombo 1984*

Table light with medium-flood beam, ideal as a task or as a reading light. Body in polycarbonate, arm supports in molibdenum steel. Painted in matt black. Double intensity switch.

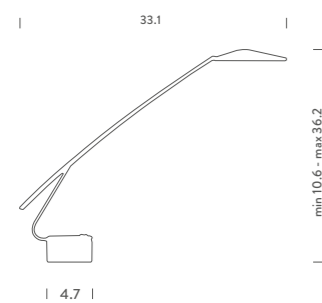

## TABLE HALO

GY 6,35 QT-12 | direct, orientable | 50W |  
double intensity | 120V | IP 20 (indoor, dry location)  
note switch on board, cable length 7.2'

● DOV HNN 11 structure black







## MASTERS

*“ We call it the Master collection. If you look around our boutique then you’ll notice that we make no special distinction. Because however important the design heritage may be for us, it is equally important that we develop coherent products from it today.”*



# BORNE BÉTON

*Le Corbusier 1952*



Concrete floor and table lamps, conceived for the Unité d'Habitation de Marseille and for Bhakra Dam, Sukhna Dam in India in 1952. Each lamp is a handcrafted product: small aesthetic and finishing differences between one lamp and the other, make them unique.

*Borne Béton Grande*



*“Contour and profile are  
a pure creation of the mind;  
they call for the plastic artist”.*

Le Corbusier





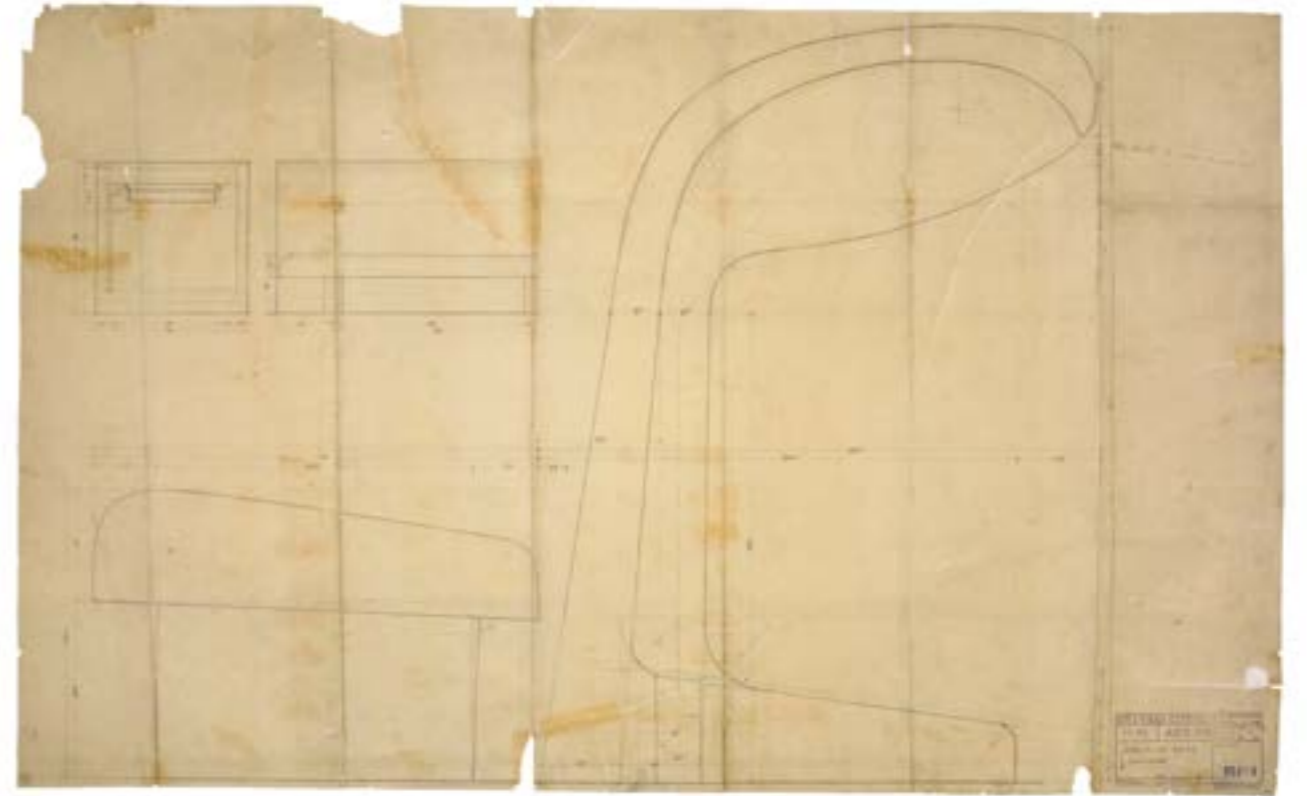

#### FLOOR GRANDE LED

LED board | direct | 38.4W | 3840lm | typ cri 80 |  
 CCT 3000K | dimmable | 120V |  
 IP 20 (indoor, dry location)  
 note cable length 8.8', dimmer on cable

● BBG LDW 22 *structure concrete*

#### TABLE PETITE LED

LED board | direct | 19.2W | 1920lm | typ cri 80 |  
 CCT 3000K | dimmable | 120V |  
 IP 20 (indoor, dry location)  
 note cable length 8.8', dimmer on cable

● BBP LDW 21 *structure concrete*

#### TABLE PETITE HALO

Halo R7s | direct | 250W | dimmable | 120V |  
 IP 20 (indoor, dry location)  
 note cable length 8.8', dimmer on cable

● BBP HDD 21 *structure concrete*

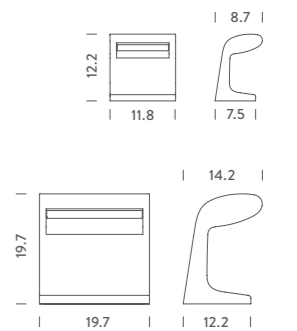





*"La Luce" exhibition at Biennale Interieur 2016*

# PARLIAMENT

*Le Corbusier 1963*





Le Corbusier designed the Parliament lamp for the Chandigarh Parliament in India. Floor lamp, double adjustable emission, in painted aluminum with diffusers in matt black and yellow or whitewash and grey. Whitewash internal diffusers. Stem matt grey.

---

**FLOOR HALO**

E26, A60 | double, direct+indirect | 2x52W |  
 dimmable according to bulb | 120V |  
 IP 20 (indoor, dry location)  
*note cable length 8.8', dimmer on cable*

- ○ PAR EDW 21 *structure whitewash/grey*
  - ○ PAR ENG 21 *structure black/yellow*
- 



*Parliament yellow/black*

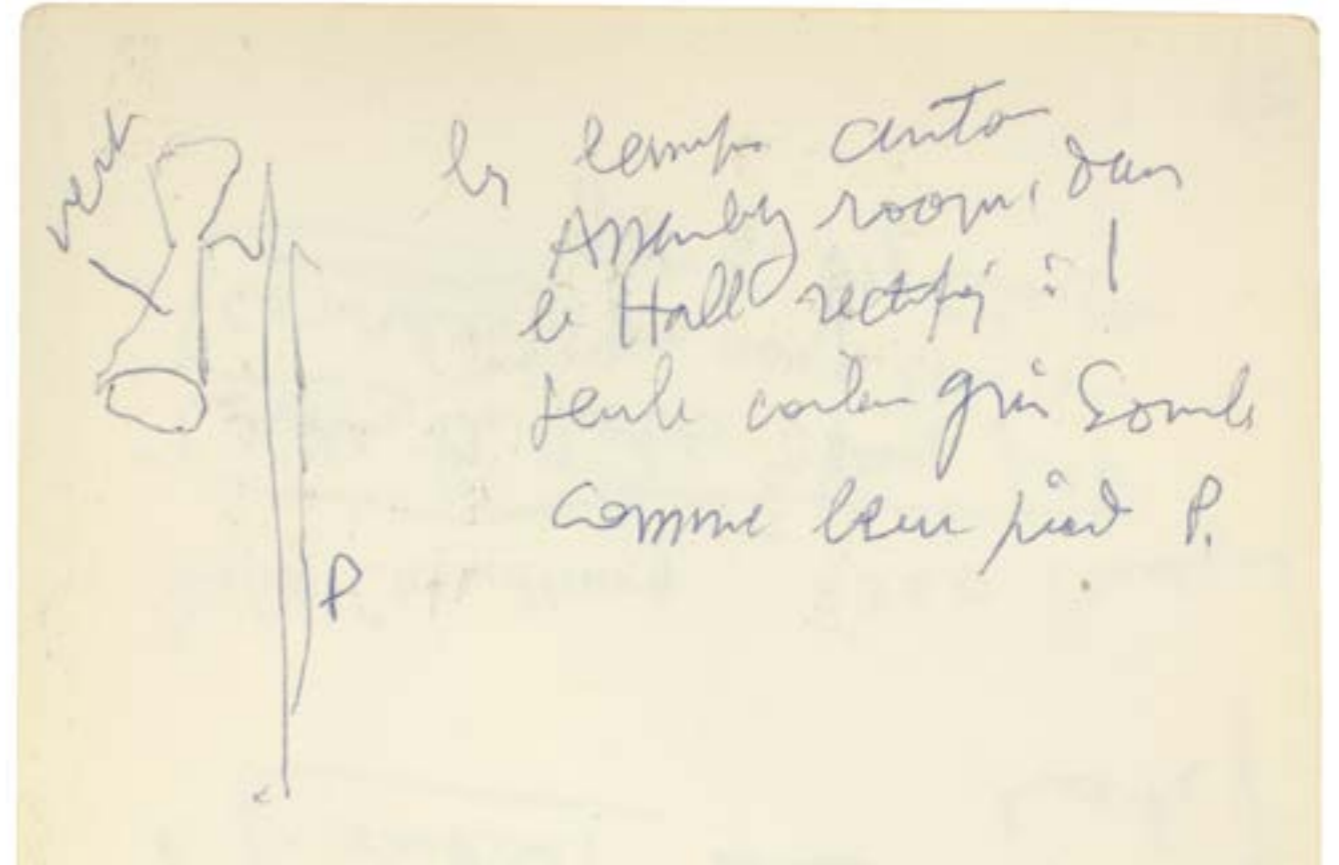
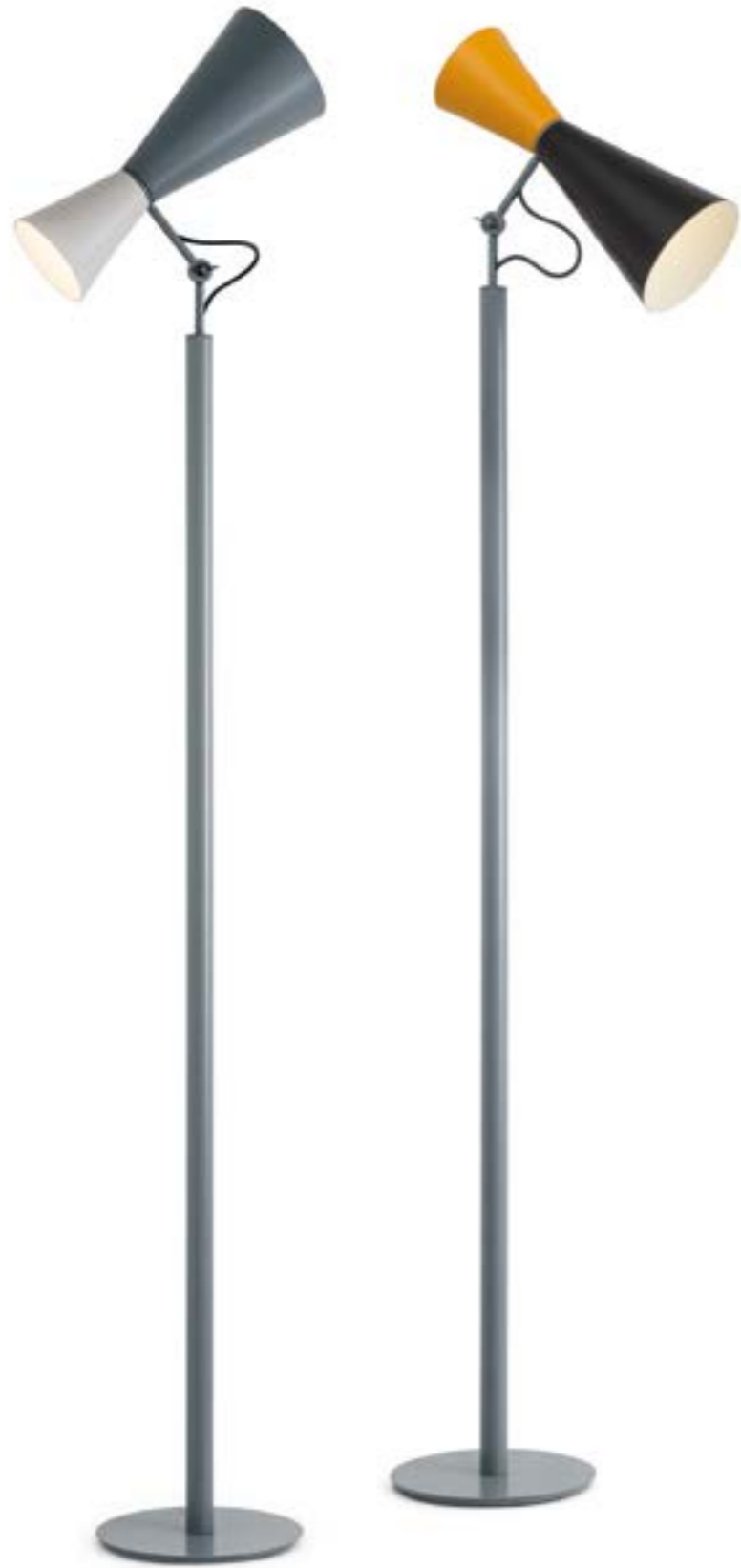



# PROJECTEUR

*Le Corbusier 1954*

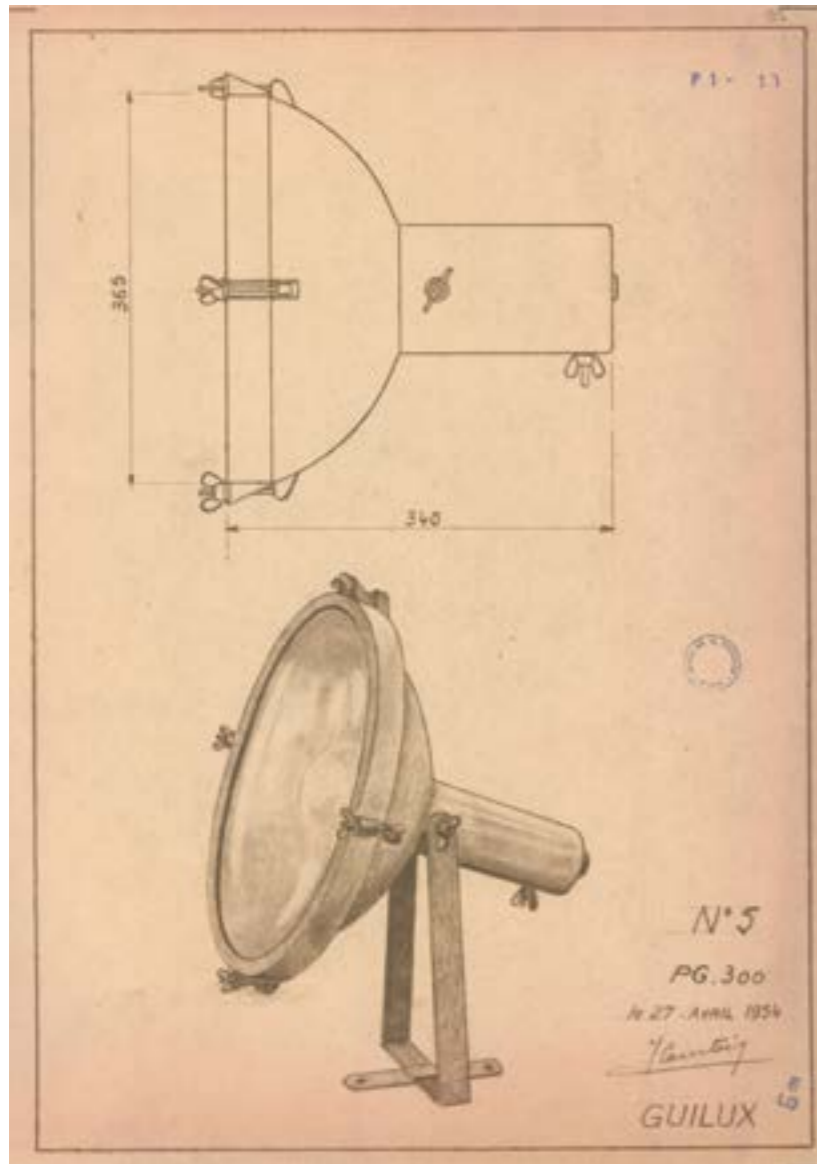

The Projecteur of Le Corbusier was designed for the Chandigarh High Court, India, in 1954. Aluminum body painted in night blue, white sand or moka. Diffuser glass curved and sandblasted in the inner part. Painted body, base and canopies. Screws and small metal parts black chromed. Available in the floor, wall/ceiling and pendant versions.







PENDANT HALO/FLUO/LED

E26 bulb | direct, spot | 150W | dimmable,  
according to bulb | 120V | IP 20 (indoor, dry location)  
*note* cable length 9.8'

- PRJ EDW 51 *structure* night blue
- PRJ EWS 51 *structure* white sand
- PRJ EMS 51 *structure* moka

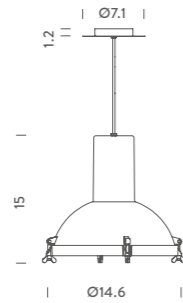

WALL/CEILING HALO/FLUO/LED

E26 bulb | direct, spot | 150W | dimmable,  
according to bulb | 120V | IP 20 (indoor, dry location)  
*note* orientable

- PRJ EDW 3A *structure* night blue
- PRJ EWS 3A *structure* white sand
- PRJ EMS 3A *structure* moka

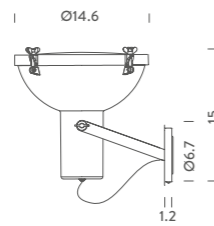

FLOOR HALO/FLUO/LED

E26 bulb | direct, spot | 150W | switch on cable |  
120V | IP 20 (indoor, dry location)  
*note* orientable, cable length 9'

- PRJ EDW 2A *structure* night blue
- PRJ EWS 2A *structure* white sand
- PRJ EMS 2A *structure* moka

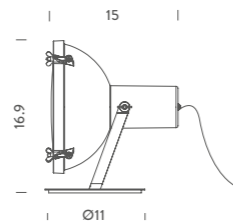

*Projecteur 365 wall night blue and  
floor white sand finishing*







*Projecteur 365 pendant, finishings: moka,  
night blue and white sand*







Mini adjustable version of the Projecteur 365. Available in the clamp, wall/ceiling and pendant versions. Aluminum body painted in night blue, white sand or moka. Diffuser glass curved and sandblasted in the inner part. Clamp and canopies painted in matt black, screws and small metal parts in black chrome. Diffused and adjustable light output. E26 socket allows the use of fluorescent and LED sources.





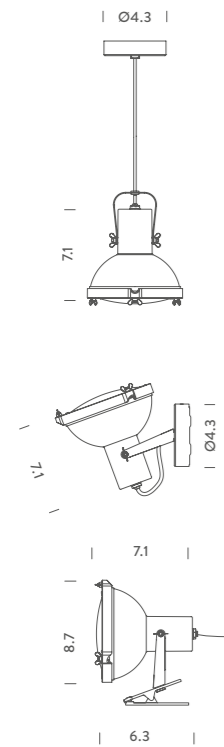

FLUO/LED

E26 bulb | direct, spot | 23W | 120V | IP 20 (indoor, dry location) | *note orientable, max bulb H 4.3"* | dimmable according to bulb, pendant version: cable length 6.9', pincer clip version: switch on cable, max clip opening 1.1", cable length 6.6'

Pincer clip

- PRP FDW 11 structure night blue
- PRP FWS 11 structure white sand
- PRP FMW 11 structure moka



Wall/ceiling

- PRP FDW 31 structure night blue
- PRP FWS 31 structure white sand
- PRP FMW 31 structure moka



Pendant

- PRP FDW 51 structure night blue
- PRP FWS 51 structure white sand
- PRP FMW 51 structure moka



Projecteur 165 pendant, finishings: moka, night blue and white sand







*Projecteur 165 Pincer Clip, Jean Colonna, Paris*





Le Corbusier

Lampe de Marseille

Pablo Picasso

# LAMPE DE MARSEILLE

*Le Corbusier 1949/52*

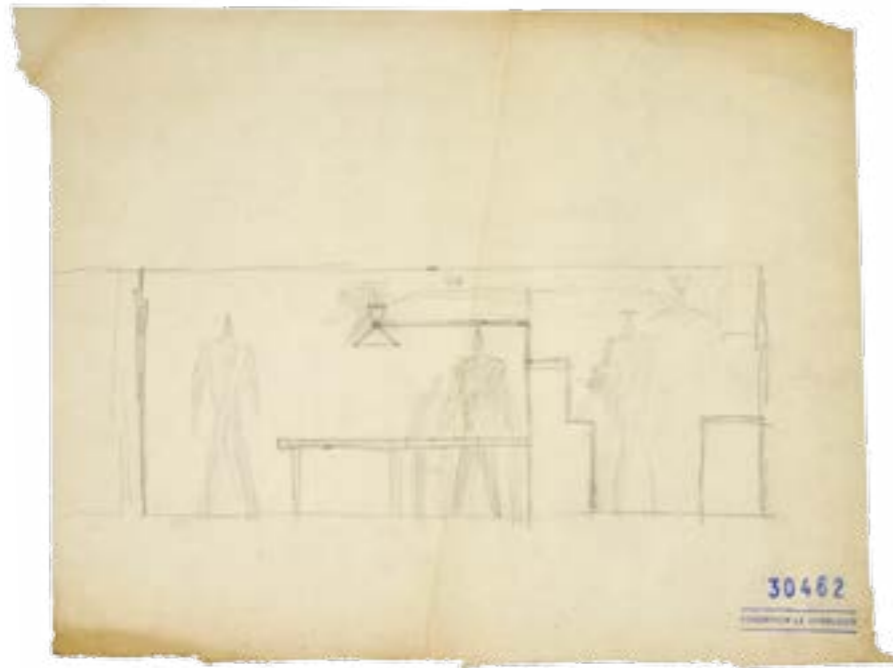

Designed by Le Corbusier for the Unité d'Habitation of Marseille in 1949/1952, it is an adjustable wall lamp with two joints on the arm and a rotating wall fixing. Spun aluminum diffuser available with matt grey or whitewash body and white interior. Double switch on the cable for functional and adjustable direct and indirect lighting.



*Lampe de Marseille whitewash*





## WALL HALO/FLUO/LED

E26 Ø4.3" (down)+A60 (up) | double emission, direct+indirect | 2x70W | mono switch, on cable | 120V | IP 20 (indoor, dry location) | *note* installation with cable+plug, cable length 4.9'+4.2'

● LDM EDD 31 *structure* matt grey  
● LDM EWW 31 *structure* whitewash

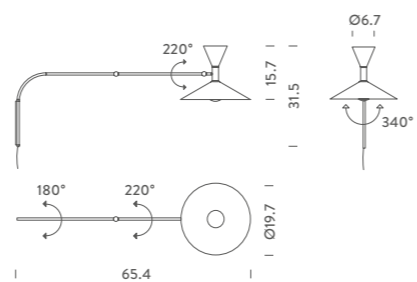

*“In his Decorative Art, Le Corbusier writes about “machines for sitting, for classifying, for lighting”, in 1924. Among the illustrations of the famous essay, he uses a suspension of industrial production as an up-to-date object, counter-posed to the nonsense of the period lightings, so widely available at that time. He starts his battle for the affirmation of a functional and linear design, practical and versatile, with durable materials and formal choices, that goes far beyond the moods of decorative fashions.”*

*Lampe de Marseille grey*

Domitilla Dardi, design historian



Mini version of the Lampe de Marseille. Aluminum with spun aluminum diffuser available in matt grey or whitewash body and white interior. Switch on the cable. Functional and adjustable light output.

WALL HALO/FLUO/LED

E12 P45 | double emission, direct and indirect |  
2x46W | mono switch, on cable | 120V |  
IP 20 (indoor, dry location)  
note installation with plug, cable length 1.3'+3.9'

- LMM EDD 31 structure matt grey
- LMM EWW 31 structure whitewash

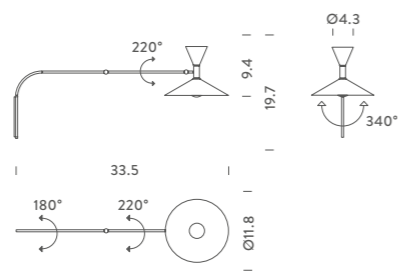

Lampe de Marseille Mini whitewash  
NEXT PAGE: Lampe de Marseille Mini grey







Lampe de Marseille Mini whitewash

# APPLIQUE DE MARSEILLE

*Le Corbusier 1938/39*



Le Corbusier designed the Applique de Marseille for his Paris apartment at Rue Nungesser et Coli. Wall lamp, double emission, in aluminum painted in matt grey or whitewash, with white internal diffusers.

WALL HALO/FLUO/LED

E26, A60 | double emission, direct+indirect |  
2x52W | 120V | dimmable according to bulb |  
IP 20 (indoor, dry location)

● ADM EDD 31 structure matt grey  
● ADM EWW 31 structure whitewash

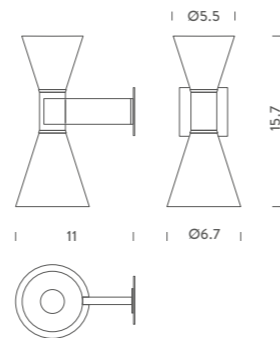

*Applique de Marseille grey* PREVIOUS PAGE  
*Applique de Marseille whitewash*



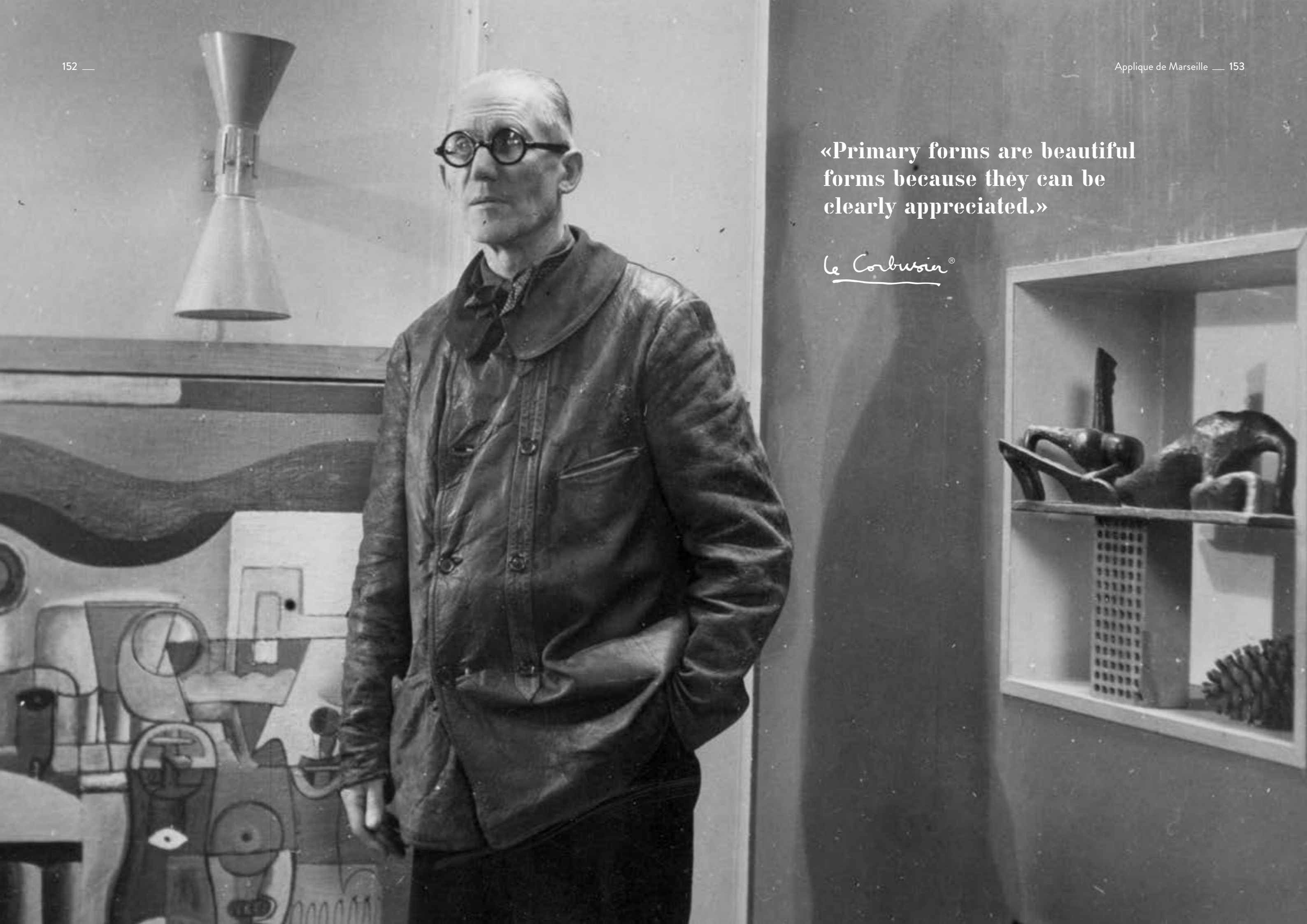

«Primary forms are beautiful forms because they can be clearly appreciated.»

Le Corbusier<sup>®</sup>

# ESCARGOT

*Le Corbusier 1951/52*

Limited edition sculptural floor lamp. Body in aged cast brass. Inner reflector is a curved surface in anodized aluminum, reflecting the light hidden in the body, for widespread indirect output.



## FLOOR HALO

E40 A90 | widespread indirect output | 300W | 120V | IP 20 (indoor, dry location)  
*note* dimmable according to bulb, dimmer on cable, black textile cable length 11.5'

● ESC EGG 11 *structure* brass

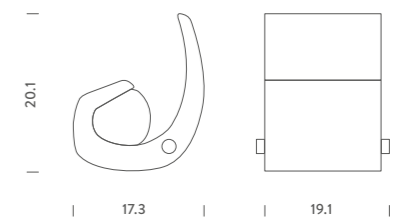



# PIVOTANTE À POSER

*Charlotte Perriand 1950*

Table lamp with a cylindrical body, open on two sides.  
Two diffusers rotate to allow the opening and closure of the light  
beam in order to adjust the light in a direct or indirect way.  
Base in steel painted in matt grey, body in rolled metal sheet  
painted in white, yellow or blue. Switch on cable.

*Pivotante à Poser white and yellow*





TABLE HALO/FLUO/LED

E26, A60 | orientable | 60W | 120V |  
 IP 20 (indoor, dry location)  
 note switch on cable, cable length 8.2'

- PAP EDW 11 structure white
- PAP EDG 11 structure yellow
- PAP EDB 11 structure blue



*Pivotante à Poser white, blue and yellow*

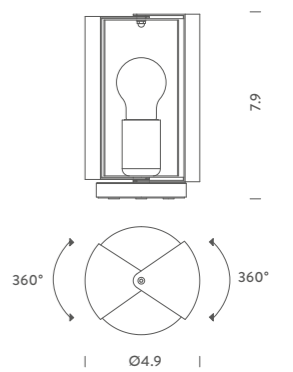



«... after all, design is about responding to the gestures of the human being. Then there is a side even beyond this, which has to do with a sort of harmony with oneself, with one's environment; this kind of awareness affects everything.»

*Ch Perriand*

Charlotte Perriand





# POTENCE PIVOTANTE

*Charlotte Perriand 1938*





Wall lamp, body in aluminum and metal, painted matt black.  
Diffuser is a opal glass bubble. Arm fixed to the wall and rotates  
horizontally 180°. Power cable with plug and dimmer.  
Available also in the Mini version.

---

WALL LED/HALO

B15d | 150W | dimmable | 120V |

IP 20 (indoor, dry location)

*note* dimmer on cable, cable length 4.9'+5.6' halo  
bulb included, installation with cable and plug

● POT HNW 31 *structure* black

---





#### MINI WALL LED/HALO

Halopin G9 QT-14 | diffused | 4W | 400 lm |  
2700K | 120V | IP 20 (indoor, dry location)  
*note* switch on cable, LED dimmable bulb included,  
max power allowed 25W Halo bulb, cover for direct  
wall electrical installation (no plug), dimmable  
(only with direct wall electrical installation),  
cable length 8.2'

- POM HNW 31 structure black  
Direct wall installation cover
- POM ATT 31 structure black

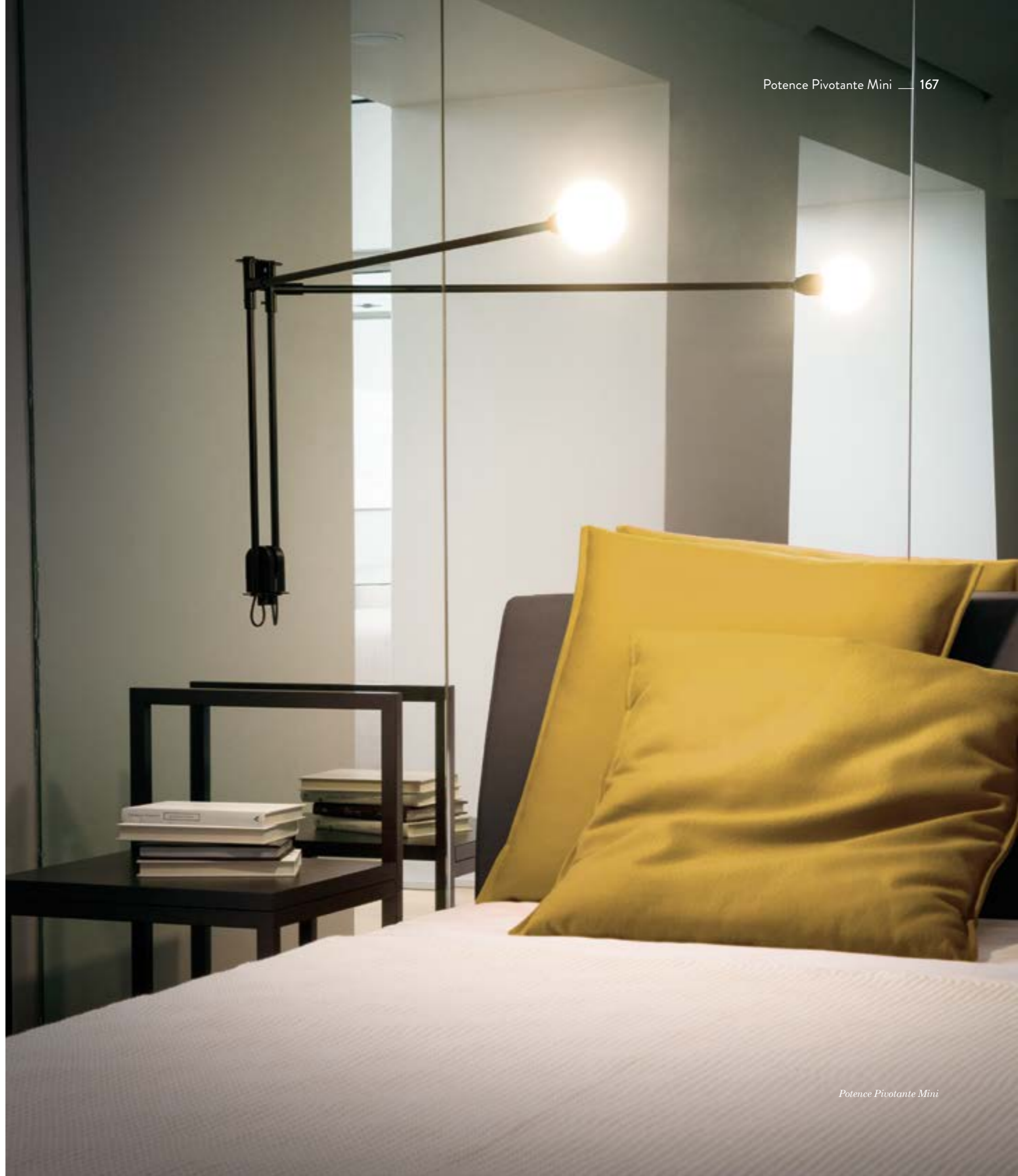



# APPLIQUE À VOLET PIVOTANT

Charlotte Perriand 1962/77

Wall lamps with adjustable aluminum volet and metal body. Body painted in white, volet in natural or black anodized aluminum, or mirror stainless steel. For the small versions E12 and LED, the volet could be painted in red, yellow or blue. E12 version with integrated switch, cable and plug for a simple and free installation. Indirect output towards the wall and orientable flood beam.

Applique à volet Pivotant E12 black, CLS Architects, Zurich, ph. Delfino Sisto Legnani

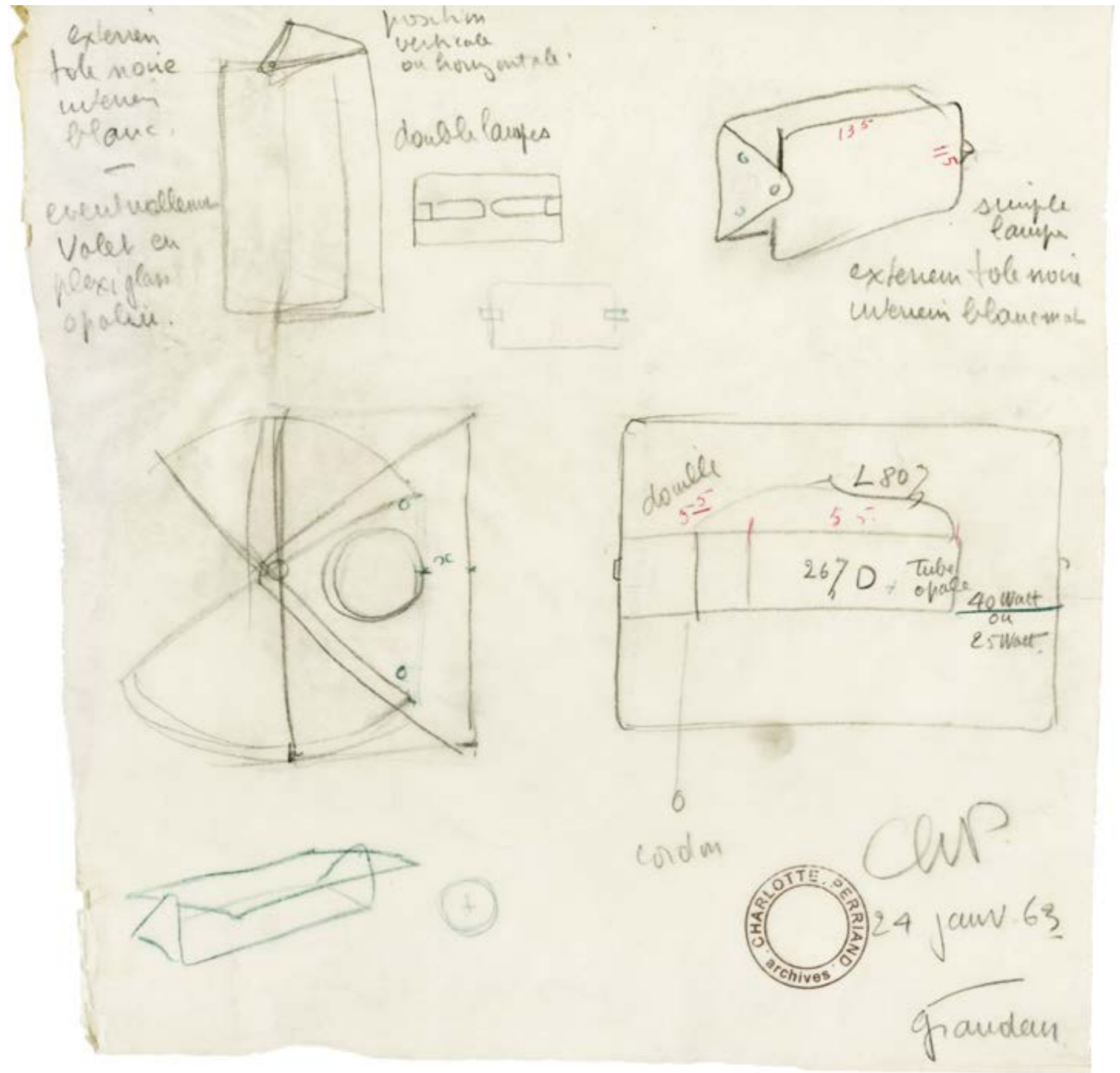







*«Charlotte Perriand's lightings [...] aren't lightings of a "designer" but of an "architect", that play with volumes and dimensions, as an architectural element of a combination, to let space "sing".»*



Applique à Volet Pivotant LED, red / halo, aluminum / E12, blue



Applique à Volet Pivotant plié halo aluminum / double, black

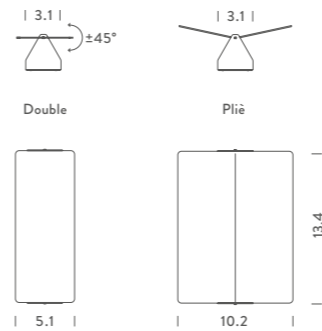
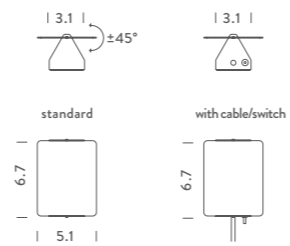
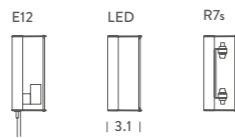

WALL LED

LED board | indirect orientable | 10W | 1000lm | typ  
cri 83 | CCT 3000K | 120V |  
IP 20 (indoor, dry location)

- AVP LWD 31 volet aluminum anodized
- AVP LWN 31 volet black anodized
- AVP LWR 31 volet red
- AVP LWG 31 volet yellow
- AVP LWB 31 volet blue
- AVP LWH 31 volet inox mirror

WALL HALO/FLUO/LED

E12 QT-DE | indirect orientable | 40W |  
switch on board | 120V | IP 20 (indoor, dry location)  
note blub Ømax 1.18", cable length 3.6'

- AVP EWD 31 volet aluminum anodized
- AVP EWN 31 volet black anodized
- AVP EWR 31 volet red
- AVP EWG 31 volet yellow
- AVP EWB 31 volet blue
- AVP EWH 31 volet inox mirror



WALL HALO

R7s (3") | indirect orientable | 80W |  
120V | IP 20 (indoor, dry location)  
note dimmable according to bulb

- AVP HWD 31 volet aluminum anodized
- AVP HWN 31 volet black anodized
- AVP HWH 31 volet inox mirror

WALL LED

LED board | indirect orientable | 2x10W |  
2000lm | typ cri 83 | CCT 3000K | 120V |  
IP 20 (indoor, dry location)

- Double
- AVP LWD 33 volet aluminum anodized
  - AVP LWN 33 volet black anodized
  - AVP LWH 33 volet inox mirror
- Plié
- AVP LWD 32 volet aluminum anodized
  - AVP LWN 32 volet black anodized

WALL HALO/FLUO/LED

E12 QT-DE | indirect orientable | 2x40W |  
120V | IP 20 (indoor, dry location)  
note blub Ømax 1.18", cable length 3.6'

- Double
- AVP EWD 33 volet aluminum anodized
  - AVP EWN 33 volet black anodized
  - AVP EWH 33 volet inox mirror
- Plié
- AVP EWD 32 volet aluminum anodized
  - AVP EWN 32 volet black anodized



WALL HALO

R7s (3") | indirect orientable | 2x80W |  
120V | IP 20 (indoor, dry location)  
note dimmable according to bulb

- Double
- AVP HWD 33 volet aluminum anodized
  - AVP HWN 33 volet black anodized
  - AVP HWH 33 volet inox mirror
- Plié
- AVP HWD 32 volet aluminum anodized
  - AVP HWN 32 volet black anodized





Vico Magistretti

# CLARITAS

Vico Magistretti, Mario Tedeschi 1946

Claritas is the first lamp designed by Vico Magistretti, produced with Mario Tedeschi in 1946. The lamp is made of bent metal tubes, painted in black. Parts of the structure are in chromed metal. Aluminum diffuser painted in black with white interior.

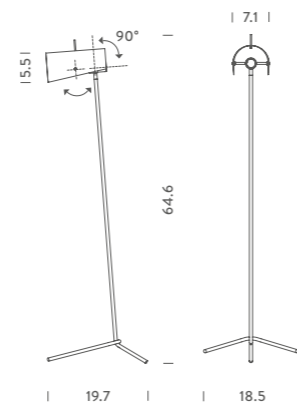

## FLOOR HALO

E26 A60 | indirect, orientable | 100W |  
dimmable according to bulb | 120V | IP 20 (indoor, dry  
location)

*note* dimmer on cable, cable length 7.2'

● CLA ENN 21 *structure* black





*“The most important thing for me is conceptual simplicity, which is usually translated into constructive clarity. A conceptually simple object could be made just using the telephone”.*

Vico Magistretti





# KUTA

Vico Magistretti 1979

Table and wall lamps with a circular reflector in aluminum, which shields the lighting distribution, giving the effect of a solar eclipse. The circular screen is painted in white and black, the stem and the small metal parts are chromed and base in white marble.

Kuta wall

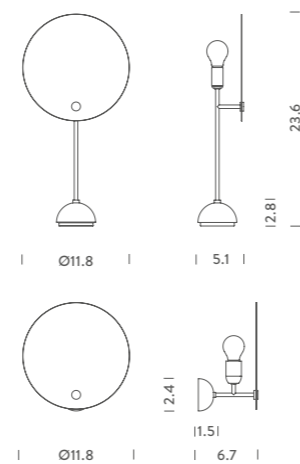

HALO/FLUO/LED

E26 A60 | indirect | 100W | 120V |

IP 20 (indoor, dry location)

note dimmable according to bulb (wall),  
cable length 6.7' (table)

Wall

○ ● KUT EWN 31 structure white/black

Table

○ ● KUT EWN 11 structure white/black



Kuta table



# COUPOLE

*F. Albin*

Large pendant lamp in spun aluminum, available in white or matt black (with white inner part), or bright anodized gold, copper, natural aluminum. The E26 socket allows the use of fluorescent, LED and halogen sources.

## PENDANT HALO/FLUO/LED

E26 QT-32 | down, diffused | 250W | dimmable,  
according to bulb | 120V | IP 20 (indoor, dry location)  
*note cable length 8.2' max*

- ALB EWW 53 *structure white*
- ALB ENW 53 *structure black/white*
- ALB EGG 53 *structure light gold anodized*
- ALB ECC 531 *structure copper anodized*
- ALB EDD 53 *structure aluminum anodized*

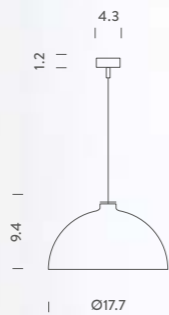

# AS1C

*F.Albini, F.Helg, A.Piva, M.Albini 1969*

Table lamp with structure in chromed or black chromed metal. Cup-shaped diffuser, in opal white glass. Flood beam distribution, dimmer on the cable.

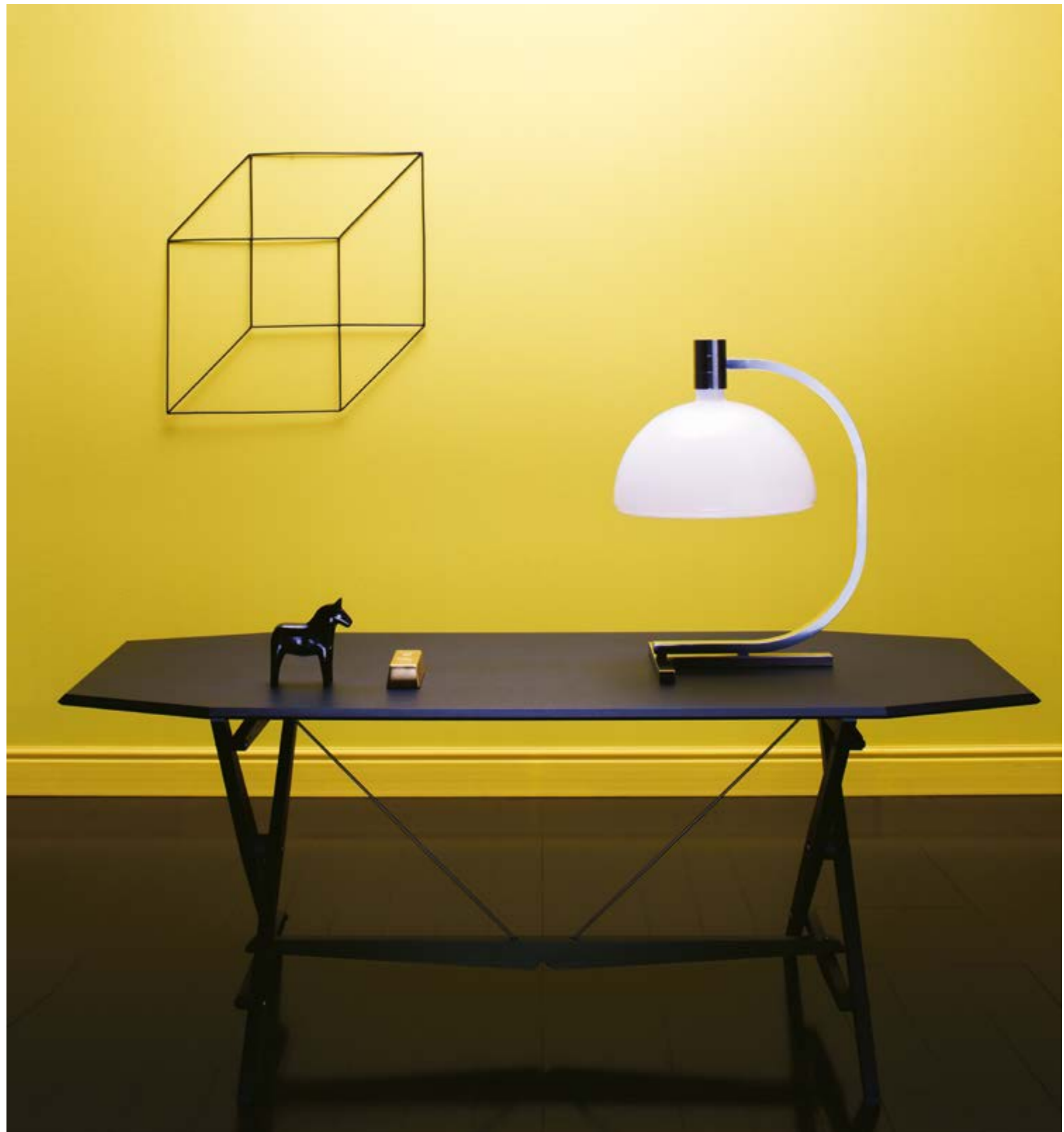

## TABLE HALO

E26 QT-32 | diffused | 150W | dimmable,  
according to bulb | 120V | IP 20 (indoor, dry location)  
*note dimmer on cable*

- ALB EHW 15 *structure chrome*
- ALB ENW 15 *structure black chrome*

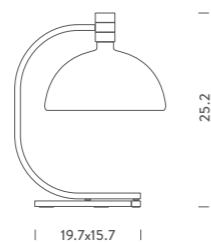



# AM1N

*F.Albini, F.Helg, A.Piva, M.Albini 1969*

Table lamp with chromed metal structure.  
Onion-shaped diffuser, in opal white glass.  
Flood beam distribution, dimmer on the cable.

---

## TABLE HALO

E26 QT-32 | diffused | 150W | dimmable,  
according to bulb | 120V | IP 20 (indoor, dry location)  
*note dimmer on cable*

○● ALB EHW 14 *structure chrome*

---

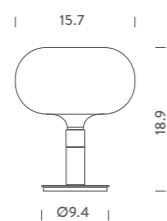

# AM2C

*F.Albini, F.Helg, A.Piva, M.Albini 1969*

Floor lamp with chromed structure.  
Cup-shaped diffuser in opal white glass.  
Flood beam distribution, dimmer on the cable.

---

## FLOOR HALO

E26 QT-32 | diffused | 250W | dimmable, according to bulb | 120V | IP 20 (indoor, dry location)  
*note dimmer on cable*

○● ALB EHW 22 *structure chrome*

---





# AM2Z

*F.Albini, F.Helg, A.Piva, M.Albini 1969*

Floor lamp. Structure and diffuser in chromed, black chromed or white metal.

Uplight flood beam distribution, dimmer on the cable.



## FLOOR HALO

E26 QT-32 | diffused | 250W | dimmable,  
according to bulb | 120V | IP 20 (indoor, dry location)  
*note dimmer on cable*

- ALB EWW 22 *structure white*
- ALB EHH 22 *structure chrome*
- ALB ENN 22 *structure black chrome*



# AM4C/AS41C

*F.Albini, F.Helg, A.Piva, M.Albini 1969*



Pendant lamps with chromed metal parts. Cupshaped diffuser, in opal white glass. Flood beam distribution. AS41C: chromed revolving and jointed arm in steel profile, with cable clamp to adjust the cable length.

## PENDANT HALO/FLUO/LED

E26 QT-32 | diffused | 250W | dimmable,  
according to bulb | 120V | IP 20 (indoor, dry location)  
*note with arm: orientable arm, arm total length:39.3"*

*AM4C cable length 4.4' max*

- ALB EHW 53 structure chrome
- AS41C, with arm, cable length 8.2' max
- ALB EHW 54 structure chrome

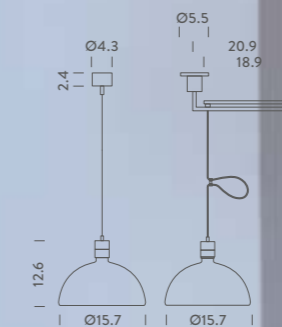



# AM4Z/AS41Z

*F.Albini, F.Helg, A.Piva, M.Albini 1969*



Pendant lamps with metal parts and chromed diffuser.  
Downlight flood beam. AS41Z: chromed revolving  
and jointed arm in steel profile, with clamp to adjust  
the cable length.

## PENDANT HALO/FLUO/LED

E26 QT-32 | diffused | 250W | dimmable,  
according to bulb | 120V | IP 20 (indoor, dry location)  
*note with arm: orientable arm, arm total length:39.3"*

*AM4Z cable length 4.4' max*

● ALB EHH 53 structure chrome

*AS41Z with arm, cable length 8.2' max*

● ALB EHH 54 structure chrome

● ALB ENN 54 structure black chrome

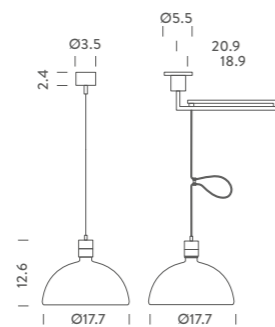



## ESSENTIALS

*We work for the eyes.  
And the light is what  
matters, essentially.*



# LINESCAPES

*Nemo Studio*

Family of floor and pendant elements, with an efficient, highly versatile, linear luminous output. Body in extruded aluminum and opal white polycarbonate diffuser. White or black finishing with elements in grey painted on the floor version.



*Linescapes pendant horizontal white*



PENDANT L77

Linear LED | diffused orientable 360° | 42W | 4080lm | typ cri 80 | CCT 3000K | dimmable 1-10V | 120V | IP 20 (indoor, dry location) | *note* metal cable length 9.8' electrical cable length 16.4'

- LIN LWW 58 *structure* white
- LIN LNN 58 *structure* black

-ETL-  
LISTING  
PENDING

PENDANT L51

Linear LED | diffused orientable 360° | 24W | 2100lm | typ cri 80 | CCT 3000K | dimmable 1-10V | 120V | IP 20 (indoor, dry location) | *note* metal cable length 9.8', electrical cable length 16.4'

- LIN LWW 57 *structure* white
- LIN LNN 57 *structure* black

-ETL-  
LISTING  
PENDING

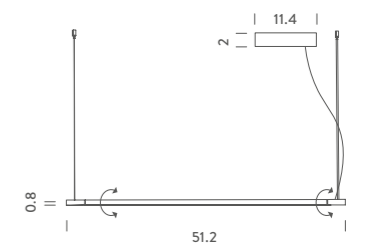
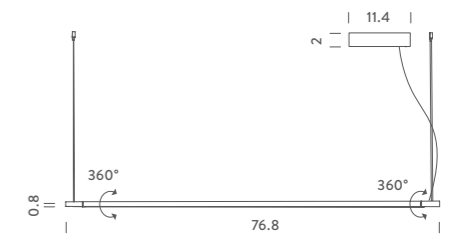





FLOOR LED

Linear LED | diffused | 46W | 4560lm |  
 typ cri 80 | CCT 3000K | dimmable | 120V | IP 20  
 (indoor, dry location)  
 note dimmer on cable, cable length 8.2'

- LIN LWD 21 structure white/grey
- LIN LND 21 structure black/grey



Linescapes floor white





# LINESCAPES SYSTEM

*Nemo Studio*

Linescapes is a modular system that is completely changing the approach to high performance diffused direct and indirect lighting. The singular modules are connected by quick molded ABS connectors, which enable rapid jack installation and a 360° rotation. The different elements allow the composition of continuous lines and edges, with luminous efficiency and an excellent diffusion degree, through an opaline polycarbonate diffuser. The system has been studied to provide user friendly maintenance. Nemo has efficiently solved the problem of replacing LED built-in sources, whereby the singular lighting elements can be easily changed.











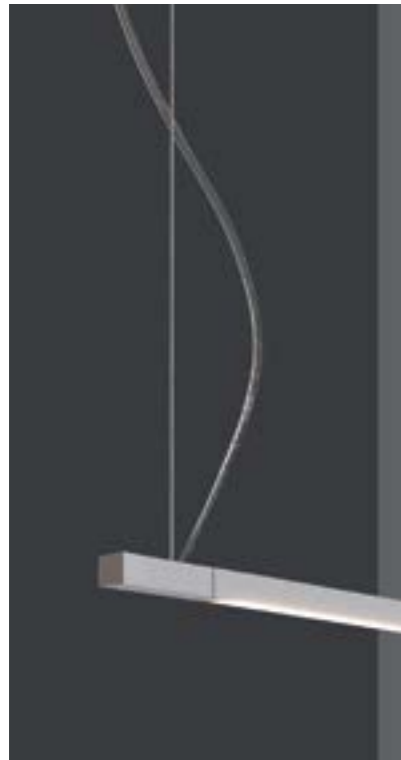

Horizontal start

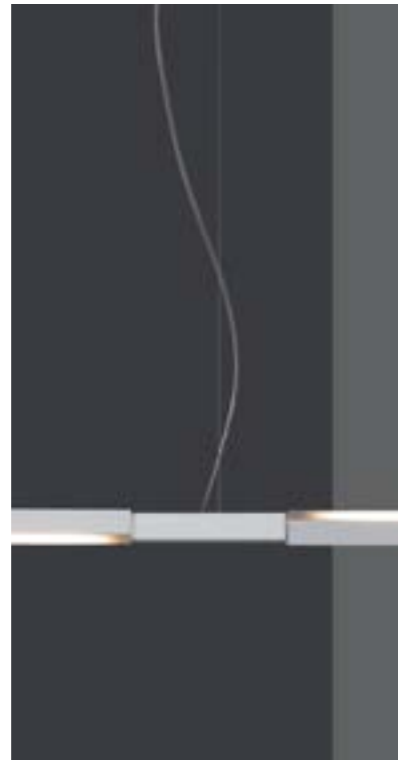

Central supply



Down vertical angle and up vertical angle



Down vertical angle and up vertical angle



Horizontal angle

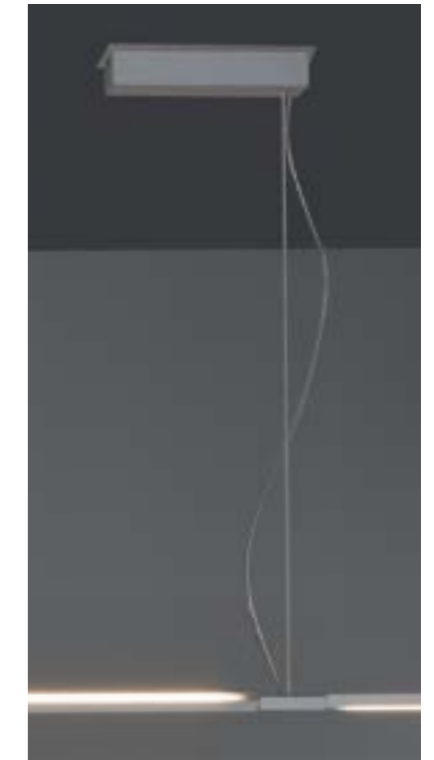

Central supply and 60W power supply

## LIGHTING BARS

66.9"

Linear LED | diffused orientable | 40W | 3970lm |  
typ cri 80 | CCT 3000K | 24V DC

● LSS LN1 51 black ○ LSS LW1 51 white

41.7"

Linear LED | diffused orientable | 24W | 2400lm |  
typ cri 80 | CCT 3000K | 24V DC

● LSS LN2 51 black ○ LSS LW2 51 white

22"

Linear LED | diffused orientable | 12W | 1200lm |  
typ cri 80 | CCT 3000K | 24VDC

● LSS LN3 51 black ○ LSS LW3 51 white

14.2"

Linear LED | diffused orientable | 7W | 700lm |  
typ cri 80 | CCT 3000K | 24 VDC

● LSS LN4 51 black ○ LSS LW4 51 white

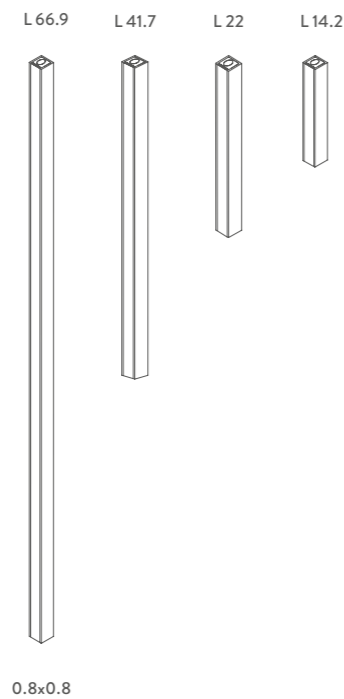

## CONNECTIONS

### VERTICAL START

● LSS CN1 51 black ○ LSS CW1 51 white

### VERTICAL END

● LSS CN6 51 black ○ LSS CW6 51 white

### HORIZONTAL START

● LSS CN2 51 black ○ LSS CW2 51 white

### HORIZONTAL END

● LSS CN3 51 black ○ LSS CW3 51 white

### CENTRAL SUPPLY

● LSS CN4 51 black ○ LSS CW4 51 white

### CENTRAL

● LSS CN5 51 black ○ LSS CW5 51 white

### CENTRAL ONEWAY

● LSS CN7 51 black ○ LSS CW7 51 white

### UP VERTICAL ANGLE

● LSS AN1 51 black ○ LSS AW1 51 white

### DOWN VERTICAL ANGLE

● LSS AN2 51 black ○ LSS AW2 51 white

### HORIZONTAL ANGLE

● LSS AN3 51 black ○ LSS AW3 51 white

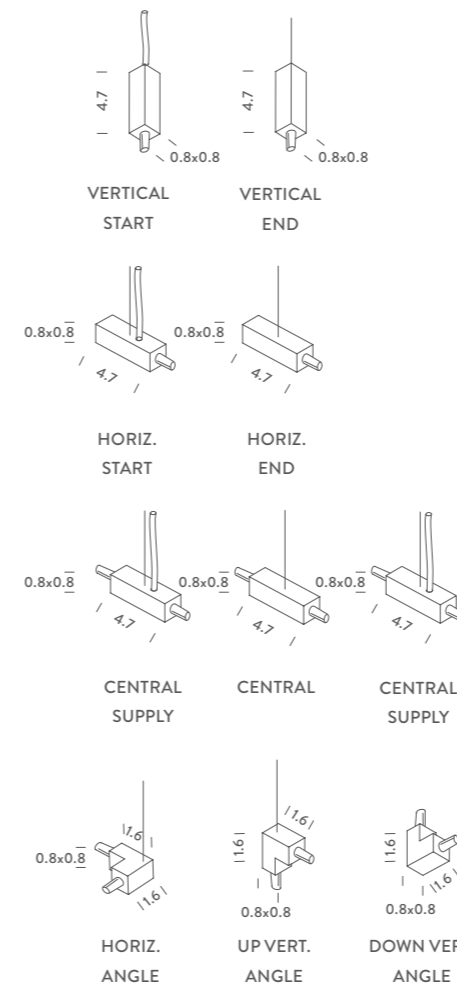

## POWER SUPPLIES

### 60W dimmable 1-10V

● LSS PN6 51 black ○ LSS PW6 51 white

### 90W dimmable 1-10V

● LSS PN9 51 black ○ LSS PW9 51 white

*note: additional drivers available on the basis  
of a specific project.*

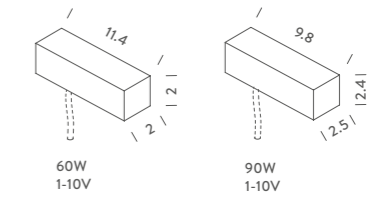

## ACCESSORIES

### CEILING PLATE

for recessed ceiling application

● LSS PNR 51 black ○ LSS PWR 51 white

*note: driver not included*

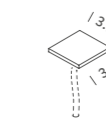



# PRISMA

*Marco Pollice*

LED floor/table lamp for diffused indirect light. In powder-coated matt white extruded aluminum with an opal white polycarbonate diffuser. Built-in dimmable power supply. Push dimmer on the cable.



---

**FLOOR/TABLE LED**

LED board | diffused uplight | 16W | 2460lm |  
 typ cri 80 | CCT 3000K | dimmable | 120V | IP 20  
 (indoor, dry location)  
*note* dimmer on cable, cable length 8.2'

○ PRI LWW 21 *structure white*

---

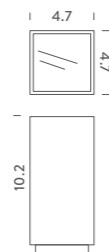



# REGULUS SYSTEM

*Giancarlo Fassina, Carlo Forcolini*



Range of fittings with a technical structure and two arms in extruded aluminum. Diffuser in white, transparent metacrylate. Aluminum parts can be painted in silver grey or, on demand, matt white. All versions with uplight and downlight output, for an extremely functional, widespread and adjustable lighting.



*Regulus wall cantilevered*





Regulus ceiling tige

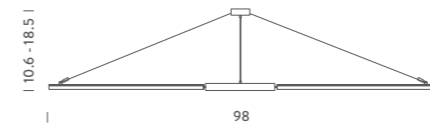

**CEILING TIGE 10.6\"/>
 98\"/>
 LED**

Linear LED | direct / indirect | 2x30W | 2x3900lm | typ cri 83 | CCT 3000K | 120V | IP 20 (indoor, dry location)

- Dimmable direct*  
 ●○ RED L3W 44 structure aluminum  
*Dimmable indirect*  
 ●○ RED L3W 43 structure aluminum

**CEILING TIGE 18.5\"/>
 98\"/>
 LED**

Linear LED | direct / indirect | 2x30W | 2x3900lm | typ cri 83 | CCT 3000K | 120V | IP 20 (indoor, dry location)

- Dimmable direct*  
 ●○ RED L3W 46 structure aluminum  
*Dimmable indirect*  
 ●○ RED L3W 45 structure aluminum

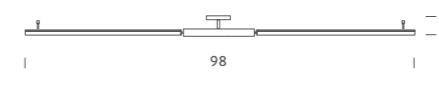

**CEILING 98\"/>
 LED**

Linear LED | direct | 2x30W | 2x3900lm | typ cri 83 | CCT 3000K | 120V | IP 20 (indoor, dry location)

- Dimmable*  
 ●○ RED L3W 51 structure aluminum

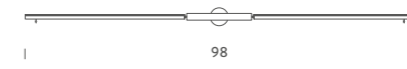

**WALL 98\"/>
 LED**

Linear LED | direct / indirect | 2x30W | 2x3900lm | typ cri 83 | CCT 3000K | 120V | IP 20 (indoor, dry location)

- Dimmable*  
 ●○ RED L3W 31 structure aluminum

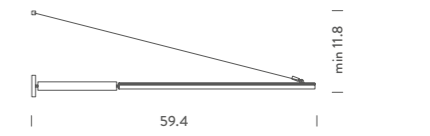

**WALL CANTILEVERED 59.4\"/>
 LED**

Linear LED | direct / indirect | 30W | 3900lm | typ cri 83 | CCT 3000K | 120V | IP 20 (indoor, dry location)

- Dimmable direct*  
 ●○ RED L3W 34 structure aluminum  
*Dimmable indirect*  
 ●○ RED L3W 33 structure aluminum





## GLASS

*After all, while searching for a comfortable light, you will always rediscover the pure and pleasant way to diffuse light is through glass. An ancient yet contemporary material.*

# MACONDO

*Gregorio Spini*

Family of pendant and wall/ceiling lamps. Diffuser made of mouth blown triplex glass and fitting in chromed metal. Pendant available in three sizes. Light fitting in chromed metal.



*Macondo pendant medium and small*



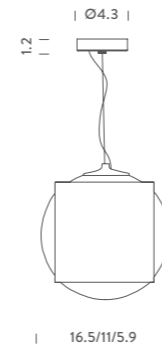

PENDANT SMALL HALO/FLUO/LED

E26 | diffused | 40W | dimmable according to bulb | 120V | IP 20 (indoor, dry location)  
note cable length 7.9' max

MAC EHW 51 structure chrome

PENDANT MEDIUM HALO/FLUO/LED

E26 | diffused | 100W | dimmable according to bulb | 120V | IP 20 (indoor, dry location)  
note cable length 7.9' max

MAC EHW 52 structure chrome

PENDANT LARGE HALO/FLUO/LED

E26 | diffused | 200W | dimmable according to bulb | 120V | IP 20 (indoor, dry location)  
note cable length 7.9' max

MAC EHW 53 structure chrome

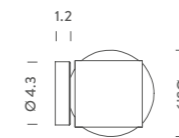

WALL/CEILING SMALL HALO/FLUO/LED

E26 | diffused | 40W | dimmable according to bulb | 120V | IP 20 (indoor, dry location)

MAC EHW 31 structure chrome

# ILIUM

*Foster+Partners*

Table and pendant lamps with a diffused and dimmable light output. Fluorescent, halogen and LED sources, according to versions. Body with inner diffuser in opal polymeric (pendant LED version excluded) and outer diffuser in transparent barrel glass. Base of the table version is in polished steel.



*Ilium Pendant LED*





*Ilium pendant E26,*  
NEXT PAGE: *Ilium table*



PENDANT LED

LED board | downlight | 6W | CCT 3000K | 980lm | typ cri 85 | 120V | IP 20 (indoor, dry location) | note cable length 9.8'

29.5"  
○● ILI LHC 51 structure chrome

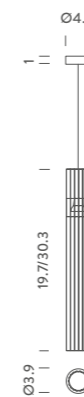

PENDANT HALO/FLUO/LED

E26 halo par20 bulb suggested | downlight, flood | 50W | dimmable, according to bulb | 120V | IP 20 (indoor, dry location) | note cable length 9.8'

19.7"  
○● ILI HHC 52 structure chrome  
30.3"  
○● ILI HHC 51 structure chrome

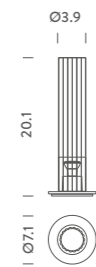

TABLE HALO

E26 halo par20 bulb suggested | flood | 50W | dimmable, according to bulb | 120V | IP 20 (indoor, dry location) | note dimmer on cable, cable length 9.8'

○● ILI HHC 11 structure chrome

# NORMA

Mario Barbaglia, Steve Blackman

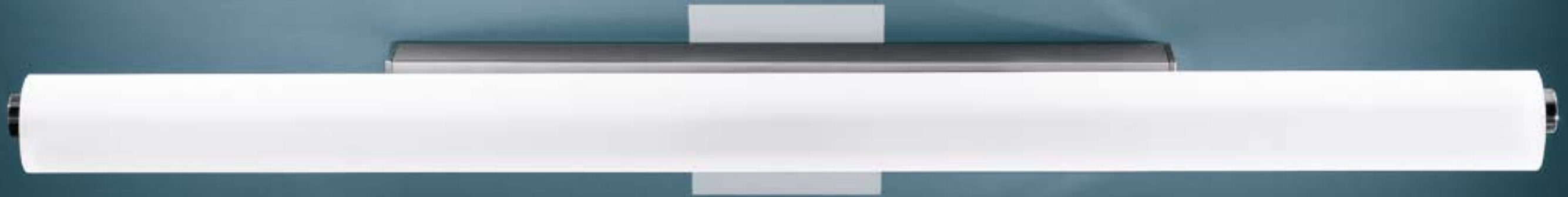

LED and halogen wall lamps with widespread light. Tube diffuser in sandblasted Pyrex or in opal metacrylate (LED), mounted on a glossy polished aluminum structure.

Norma 65 LED



## 25.6" WALL LED

LED board | diffused | 20W | 2200lm |  
typ cri 83 | CCT 3000K | 120V |  
IP 40 (indoor, dry and damp location)  
*note* horizontal and vertical mounting

●● NOR LLW 32 structure polished diffusor PMMA

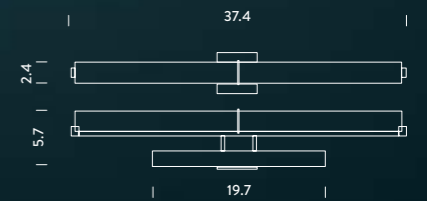

## 37.4" WALL LED

LED board | diffused | 35W | 3300lm |  
typ cri 83 | CCT 3000K | 120V |  
IP 40 (indoor, dry and damp location)  
*note* horizontal and vertical mounting

●● NOR LLW 33 structure polished diffusor PMMA



## 25.6" WALL HALO

R7s (2.8") | diffused | 3x60W | dimmable |  
120V | IP 40 (indoor, dry and damp location)  
*note* horizontal mounting only

●● NOR HLW 32 structure polished diffusor Pyrex





9.8" WALL LED

LED board | diffused | 20W | CCT 3000K | 2000lm |  
typ cri 83 | 120V | IP 40 (indoor, dry and damp  
location) | *note* horizontal and vertical mounting

○● NOR LLW 31 *structure polished diffuser PMMA*

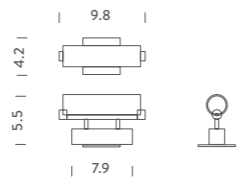

9.8" WALL HALO

R7s (4.5") | diffused | 250W | dimmable |  
120V | IP 40 (indoor, dry and damp location)  
*note* horizontal mounting only

○● NOR HLW 31 *structure polished diffuser Pyrex*

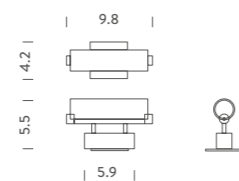

Norma 25.6" PREVIOUS PAGE: Norma 9.8" Halo

# CANNA NUDA

Piero Castiglioni, Roberto Menghi



Pendant, ceiling or wall lighting fixtures finished with a satin nickel metal structure connected with a sanded glass cylinder. Available in different lengths. LED and halogen versions available.

*Canna Nuda Ceiling at Grand Théâtre de Provence, Aix en Provence, Gregotti associates*

## PENDANT LED/HALO

G9 | diffused | 75W | dimmable, according to bulb | 120V | IP 20 (indoor, dry location) | *note* LED version with kit LED NEMO (p.297), cable length 9.8' max

L19.7"

○● CAN HSW 51 *structure satin nickel*

L29.5"

○● CAN HSW 52 *structure satin nickel*

## WALL/CEILING LED/HALO

G9 | diffused | 75W | dimmable, according to bulb | 120V | IP 20 (indoor, dry location) | *note* LED version with kit G9 LED NEMO (p.287)

L19.7"

○● CAN HSW 41 *structure satin nickel*

L29.5"

○● CAN HSW 42 *structure satin nickel*

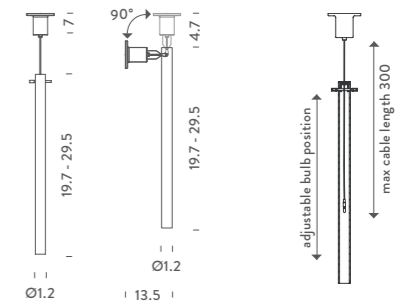



# SIRIUS

*Carlo Colombo*

Pendant lamp, widespread light. Diffuser in opal white triplex blown glass. Structure in shiny polished die-casted aluminum. NEMO G9 Kit LED on request.

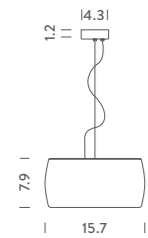

## PENDANT LED/HALO

Halopin G9 QT-14 | diffused | 6x40W | dimmable  
according to bulb | 120V | IP 20 (indoor, dry location)  
*note* LED version with kit G9 LED NEMO  
(p.297), cable length 6.6' max

○● SIR HLW 51 *structure* nickel



# DONNA

*Stefano Marcato*



Floor, table and pendant lamps, widespread output. Steel structure and duplex blown glass diffuser. Matt nickel structure, opal white glass. Lux version (table and floor) with chromed structure, black base and glass or chromed structure, white base and glass. Dimmable (lux minor excluded). Fluorescent, LED and halogen sources with E26 socket.

*Donna Table Lux black*









Donna Table Minor Lux white

#### FLOOR HALO

E26 A60 | diffused | 200W | dimmable,  
according to bulb | 120V | IP 20 (indoor, dry location)

##### Standard

○ ○ ○ DON ESW 21  
glass/stem/base white/satin/satin

##### Lux

○ ○ ○ DLU EHW 21  
glass/stem/base white/chrome/white

● ● ● DLU EHN 21  
glass/stem/base black/chrome/black

##### Lettura

○ ○ ○ DON ESW 22  
glass/stem/base white/satin/satin

#### TABLE HALO/FLUO/LED

E26 A60 | diffused | 100W | chromed  
versions dimmable, according to bulb | 120V |  
IP 20 (indoor, dry location) | switch on cable

##### Standard

○ ○ ○ DOM ESW 11 glass/stem/base white/satin/  
satin

##### Lux

○ ○ ○ DLU EHW 13 glass/stem/base white/  
chrome/white

● ● ● DLU EHN 13 glass/stem/base black/  
chrome/black

#### TABLE MINOR FLUO/HALO

E12 P45 | diffused | 60W | chromed versions  
dimmable, according to bulb | 120V |  
IP 20 (indoor, dry location) | switch on cable

##### Standard

○ ○ ○ DON ESW 11  
glass/stem/base white/satin/satin

##### Lux

○ ○ ○ DLU EHW 11  
glass/stem/base white/chrome/white

● ● ● DLU EHN 11  
glass/stem/base black/chrome/black

#### PENDANT FLUO/HALO

E26 A60 | diffused | 150W | dimmable,  
according to bulb | 120V | IP 20 (indoor, dry location)  
note cable length 6.6' max

○ DON ESW 51 structure white  
● DON ESN 51 structure black

#### PENDANT MINOR FLUO/HALO

E12 P45 | diffused | 60W | dimmable,  
according to bulb | 120V | IP 20  
(indoor, dry location) | note cable length 6.6' max

○ DON ESW 52 structure white  
● DON ESN 52 structure black

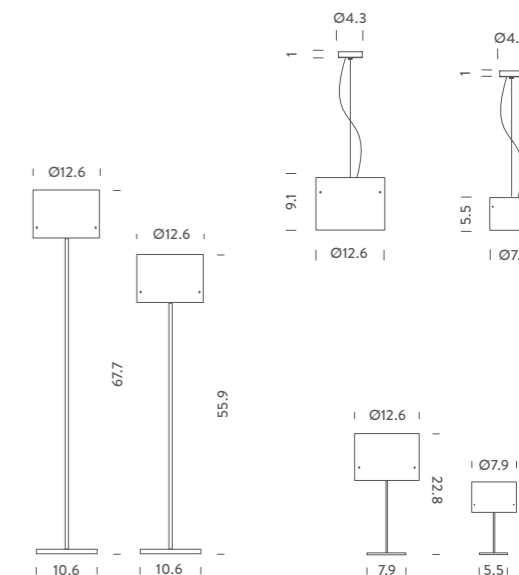



# MONTEREY

Pendant lamp made with a fine linen shade, tempered glass diffuser, satin nickel finished canopy and a clear cord. Shade is available in white, black, oyster, or red. Mounts to standard 4" octagonal junction box.



PENDANT HALO/FLUO/LED

E26 A19 | downlight | 3x75W | dimmable, according to bulb | 120V | IP 20 (indoor, dry location)  
*note cable length 4.9' max*

- ○ MONTEREY-WHT  
*trim satin nickel, shade white linen*
- ○ MONTEREY-BLK  
*trim satin nickel, shade black linen*
- ○ MONTEREY-OYS  
*trim satin nickel, shade oyster linen*
- ○ MONTEREY-RED  
*trim satin nickel, shade red linen*

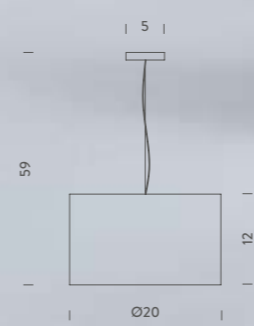

*Monterey black, PREVIOUS PAGE. Monterey red and oyster white*

# ANITA

Mario Barbaglia



Large pendant lamp in triplex blown glass, opal white, widespread light. Particulars in chromed metal.

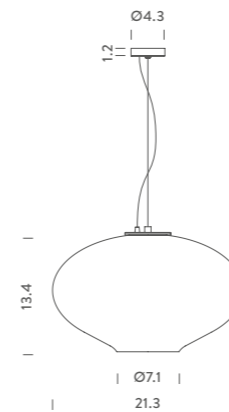

---

## PENDANT HALO/FLUO/LED

E26 A60/QT-32 | diffused | 150/250W | dimmable  
according to bulb | 120V | IP 20 (indoor, dry location)  
*note cable length 8.2' max*

○● ANI EHW 51 *structure chrome*

---



# SOLEIL

Wall and ceiling lamp, widespread light. Triplex opal white glass with metal base and crystal edge. Suitable for dry locations. Mounts to 4" octagonal junction box.

## 13" WALL / CEILING G24q-3

G24q-3 | diffused | 26W | 120V  
IP 20 (indoor, dry location)



● SOLEIL S F *structure white/ opal white glass*

## 13" WALL / CEILING GU24

GU24 | diffused | 2x26W | 120V  
IP 20 (indoor, dry location)  
*note bulb included*



● SOLEIL S G *structure white/ opal white glass*

## 13" WALL / CEILING E26

E26 | diffused | 75W | 120V | dimmable  
IP 20 (indoor, dry location)



● SOLEIL S *structure white/ opal white glass*

## 13" WALL / CEILING LED

LED | diffused | 15W | 3045K | 1260lm  
typ cri 83 | 120V | IP 20 (indoor, dry location)  
Triac wall dimming switch; Recom. dimmer: Lutron  
Toggle C-L, Part No. TGCL-153PH



● SOLEIL S LED *structure white/ opal white glass*

## 16" WALL / CEILING G24q-3

G24q-3 | diffused | 2x26W | 120V  
IP 20 (indoor, dry location)



● SOLEIL M F *structure white/ opal white glass*

## 16" WALL / CEILING GU24

GU24 | diffused | 2x26W | 120V  
IP 20 (indoor, dry location)  
*note bulb included*



● SOLEIL M G *structure white/ opal white glass*

## 16" WALL / CEILING E26

E26 | diffused | 2x75W | dimmable | 120V  
IP 20 (indoor, dry location)



● SOLEIL M *structure white/ opal white glass*

## 16" WALL / CEILING LED

LED | diffused | 15W | 3045K | 1325lm  
dimmable | 120V | IP 20 (indoor, dry location)  
Triac wall dimming switch; Recom. dimmer: Lutron  
Toggle C-L, Part No. TGCL-153PH



● SOLEIL M LED *structure white/ opal white glass*

## 20" WALL / CEILING G24Q-3

G24Q-3 | diffused | 2x26W | 120V  
IP 20 (indoor, dry location)



● SOLEIL L F *structure white*

## 20" WALL / CEILING GU24

GU24 | diffused | 2x26W | 120V  
IP 20 (indoor, dry location)  
*note bulb included*



● SOLEIL L G *structure white*

## 20" WALL / CEILING E26

E26 | diffused | 2x75W | dimmable | 120V  
IP 20 (indoor, dry location)



● SOLEIL L *structure white*

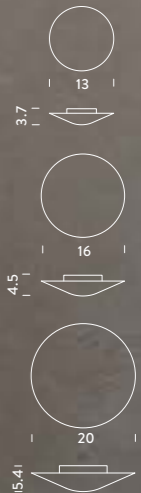

# ASTEROIDE

Pendant lamp in triplex blown glass, opal matt white. Metal parts chromed or painted in white. Mounts to a 4" octagonal junction box and is field adjustable. Available in four sizes and two lamp options. Custom heights are available upon request.

## 10" PENDANT GU24

GU24 | diffused | 26W | 120V | IP 20 (indoor, dry location) | *note* bulb included

- M2805G  
*structure* Chrome Trim/Opal White Glass
- M2869G  
*structure* White Trim/Opal White Glass

## 12" PENDANT GU24

GU24 | diffused | 26W | 120V | IP 20 (indoor, dry location) | *note* bulb included

- M2793G  
*structure* Chrome Trim/Opal White Glass
- M2857G  
*structure* White Trim/Opal White Glass

## 16" PENDANT GU24

GU24 | diffused | 26W | 120V | IP 20 (indoor, dry location) | *note* bulb included

- M2797G  
*structure* Chrome Trim/Opal White Glass
- M2861G  
*structure* White Trim/Opal White Glass

## 20" PENDANT GU24

GU24 | diffused | 42W | 120V | IP 20 (indoor, dry location) | *note* bulb included

- M2801G  
*structure* Chrome Trim/Opal White Glass
- M2865G  
*structure* White Trim/Opal White Glass



## 10" PENDANT E26 A19

E26 A19 | diffused | 100W | 120V | dimmable | IP 20 (indoor, dry location)

- M2805  
*structure* Chrome Trim/Opal White Glass
- M2869  
*structure* White Trim/Opal White Glass

## 12" PENDANT E26 A19

E26 A19 | diffused | 100W | 120V | dimmable | IP 20 (indoor, dry location)

- M2793  
*structure* Chrome Trim/Opal White Glass
- M2857  
*structure* White Trim/Opal White Glass

## 16" PENDANT E26 A19

E26 A19 | diffused | 100W | 120V | dimmable | IP 20 (indoor, dry location)

- M2797  
*structure* Chrome Trim/Opal White Glass
- M2861  
*structure* White Trim/Opal White Glass

## 20" PENDANT E26 A19

E26 A19 | diffused | 150W | 120V | dimmable | IP 20 (indoor, dry location)

- M2801  
*structure* Chrome Trim/Opal White Glass
- M2865  
*structure* White Trim/Opal White Glass





# GALAXY LUX

Pendant lamp with triplex opal white glass, chrome trim with white or red cord. Mounts to a standard 4" octagonal junction box and is field adjustable. Available in three sizes and two lamp options. Custom heights are available upon request. Self-ballasted compact fluorescents with an E26 base can also be used with these fixtures.



## 10" PENDANT GU24

GU24 | diffused | 24W | 120V | IP 20 (indoor, dry location) *note bulb included*

- GALLUXP10 G-WHT *structure white cord/opal white glass*  
 GALLUXP10 G-RED *structure red cord/opal white glass*

## 10" PENDANT E26

E26 A19 | diffused | 100W | 120V | IP 20 (indoor, dry location)

- GALLUXP10 I-WHT *structure white cord/opal white glass*  
 GALLUXP10 I-RED *structure red cord/opal white glass*

## 12" PENDANT GU24

GU24 | diffused | 26W | 120V | IP 20 (indoor, dry location) *note bulb included*

- GALLUXP12 G-WHT *structure white cord/opal white glass*  
 GALLUXP12 G-RED *structure red cord/opal white glass*

## 12" PENDANT E26

E26 A19 | diffused | 100W | 120V | IP 20 (indoor, dry location)

- GALLUXP12 I-WHT *structure white cord/opal white glass*  
 GALLUXP12 I-RED *structure red cord/opal white glass*

## 16" PENDANT GU24

GU24 | diffused | 26W | 120V | IP 20 (indoor, dry location) *note bulb included*

- GALLUXP16 G-WHT *structure white cord/opal white glass*  
 GALLUXP16 G-RED *structure red cord/opal white glass*

## 16" PENDANT E26

E26 A19 | diffused | 100W | 120V | IP 20 (indoor, dry location)

- GALLUXP16 I-WHT *structure white cord/opal white glass*  
 GALLUXP16 I-RED *structure red cord/opal white glass*

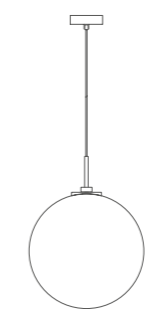

| 10 - 12 - 16 |

# H SERIES



Wall lamps made with glass bowls or circular discs with glass diffusers which provide generous uplight and diffused downlight. The H Series ranges from one to five lamps. Polished chrome finish. Mounts to standard 4" octagonal junction box.



H1200 SERIES / H1201 WALL

XENON DCB | uplight+diffused downlight | 75W  
dimnable | 120V | IP 20 (indoor, dry and damp location)  
*note bulb included*

○● H1201C *structure polished chrome/white*

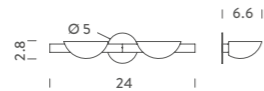

H1200 SERIES / H1224 WALL

XENON DCB | uplight+diffused downlight | 2x75W  
dimnable | 120V | IP 20 (indoor, dry and damp location)  
*note bulb included*

○● H1224C *structure polished chrome/white*

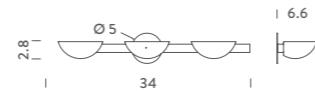

H1200 SERIES / H1236 WALL

XENON DCB | uplight+diffused downlight | 3x75W  
dimnable | 120V | IP 20 (indoor, dry and damp location)  
*note bulb included*

○● H1236C *structure polished chrome/white*

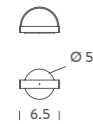

H1400 SERIES / H1406 WALL

XENON DCB | uplight+diffused downlight | 75W  
dimnable | 120V | IP 20 (indoor, dry and damp location)  
*note bulb included*

●● H1406C *structure polished chrome/frosted*  
●● H1406SC *structure satin chrome/frosted*

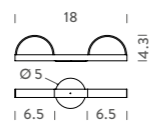

H1400 SERIES / H1418 WALL

XENON DCB | uplight+diffused downlight | 2x75W  
dimnable | 120V | IP 20 (indoor, dry and damp location)  
*note bulb included*

●● H1418C *structure polished chrome/frosted*  
●● H1418SC *structure satin chrome/frosted*

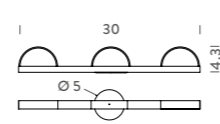

H1400 SERIES / H1430 WALL

XENON DCB | uplight+diffused downlight | 3x75W  
dimnable | 120V | IP 20 (indoor, dry and damp location)  
*note bulb included*

●● H1430C *structure polished chrome/frosted*  
●● H1430SC *structure satin chrome/frosted*

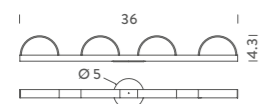

H1400 SERIES / H1436 WALL

XENON DCB | uplight+diffused downlight | 4x75W  
dimnable | 120V | IP 20 (indoor, dry and damp location)  
*note bulb included*

●● H1436C *structure polished chrome/frosted*  
●● H1436SC *structure satin chrome/frosted*

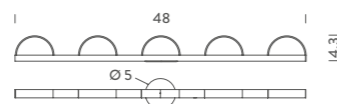

H1400 SERIES / H1448 WALL

XENON DCB | uplight+diffused downlight | 5x75W  
dimnable | 120V | IP 20 (indoor, dry and damp location)  
*note bulb included*

●● H1448C *structure polished chrome/frosted*





# ECLIPSE

Wall/ceiling lamp with triplex opal white glass diffuser.  
 Chrome or white decorative metal ring with set screw mountings.  
 Available in three sizes and multiple lamp options.

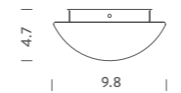

### 9.8" - GX24Q-1 WALL/CEILING

Gx24q-1 | diffused | 13W | 120V | IP 20 (indoor, dry location)

- M3156 trim white
- M3148 trim chrome

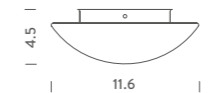

### 11.6" - GX24Q-3 WALL/CEILING

Gx24Q-3 | diffused | 26W | 120V | IP 20 (indoor, dry location)

- M3204 trim white
- M3196 trim chrome

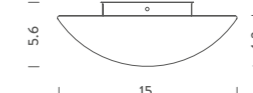

### 15" - GX24Q-3 WALL/CEILING

Gx24Q-3 | diffused | 26W | 120V | IP 20 (indoor, dry location)

- M3254 trim white
- M3246 trim chrome



### 9.8" - GU24 WALL/CEILING

GU24 | diffused | 18W | 120V | IP 20 (indoor, dry location)  
*note bulb included*

- M2570G trim white
- M2554G trim chrome



### 11.6" - GU24 WALL/CEILING

GU24 | diffused | 18W | 120V | IP 20 (indoor, dry location)  
*note bulb included*

- M2558G trim white
- M2542G trim chrome



### 15" - GU24 WALL/CEILING

GU24 | diffused | 2x13W | 120V | IP 20 (indoor, dry location)  
*note bulb included*

- M2562G trim white
- M2546G trim chrome



### 9.8" - LED WALL/CEILING

LED | diffused | 15W | 120V | CCT 3045K | 1260lm |  
 Triac wall dimming switch; Recom. dimmer: Lutron  
 Toggler C-L, Part No. TGCL-153PH | IP 20 (indoor,  
 dry location)

- M2570LED trim white
- M2554LED trim chrome



### 11.6" - LED WALL/CEILING

LED | diffused | 15W | 120V | CCT 3045K | 1260lm |  
 Triac wall dimming switch; Recom. dimmer: Lutron  
 Toggler C-L, Part No. TGCL-153PH | IP 20 (indoor,  
 dry location)

- M2558LED trim white
- M2542LED trim chrome



### 15" - LED WALL/CEILING

LED | diffused | 15W | 120V | CCT 3045K | 1260lm |  
 Triac wall dimming switch; Recom. dimmer: Lutron  
 Toggler C-L, Part No. TGCL-153PH | IP 20 (indoor,  
 dry location)

- M2562LED trim white
- M2546LED trim chrome



### 9.8" - E26 WALL/CEILING

E26 | diffused | 2x40W | 120V |  
 IP 20 (indoor, dry location)

- M2570 trim white
- M2554 trim chrome



### 11.6" - E26 WALL/CEILING

E26 | diffused | 2x40W | 120V |  
 IP 20 (indoor, dry location)

- M2558 trim white
- M2542 trim chrome



### 15" - E26 WALL/CEILING

E26 | diffused | 2x60W | 120V |  
 IP 20 (indoor, dry location)

- M2562 trim white
- M2546 trim chrome



# JANEIRO



Decorative flushmount series offering a complete range of sizes and lamp options. Diffuser made with triplex blown glass for excellent light diffusion. Body is painted white with matt opal white glass and hidden screws. Wall or ceiling mount to a standard 4" octagonal junction box.





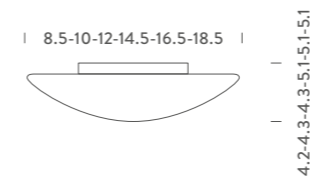

8.5" WALL/CEILING E26

E26 | diffused | 60W | dimmable | 120V | IP 20 (indoor, dry location)

○ M330 structure white



10" WALL/CEILING E26

E26 | diffused | 2x40W | dimmable | 120V | IP 20 (indoor, dry location)

○ M334 structure white



12" WALL/CEILING E26

E26 | diffused | 2x40W | dimmable | 120V | IP 20 (indoor, dry location)

○ M338 structure white



14.5" WALL/CEILING E26

E26 | diffused | 2x60W | dimmable | 120V | IP 20 (indoor, dry location)

○ M342 structure white



16.5" WALL/CEILING E26

E26 | diffused | 2x60W | dimmable | 120V | IP 20 (indoor, dry location)

○ M3468 structure white



18.5" WALL/CEILING E26

E26 | diffused | 2x75W | dimmable | 120V | IP 20 (indoor, dry location)

○ M346 structure white



8.5" WALL/CEILING GU24

GU24 | diffused | 13W | 120V | IP 20 (indoor, dry location) note bulb included

○ M330G structure white



10" WALL/CEILING GU24

GU24 | diffused | 18W | 120V | IP 20 (indoor, dry location) note bulb included

○ M334G structure white



12" WALL/CEILING GU24

GU24 | diffused | 2x13W | 120V | IP 20 (indoor, dry location) note bulb included

○ M338G structure white



14.5" WALL/CEILING GU24

GU24 | diffused | 2x13W | 120V | IP 20 (indoor, dry location) note bulb included

○ M342G structure white



16.5" WALL/CEILING GU24

GU24 | diffused | 2x13W | 120V | IP 20 (indoor, dry location) note bulb included

○ M3468G structure white



18.5" WALL/CEILING GU24

GU24 | diffused | 2x18W | 120V | IP 20 (indoor, dry location) note bulb included

○ M346G structure white



8.5" WALL/CEILING G24-Q1

G24-q1 | diffused | 13W | 120V | IP 20 (indoor, dry location)

○ M10050 structure white



10" WALL/CEILING G24-Q1

G24-q1 | diffused | 13W | 120V | IP 20 (indoor, dry location)

○ M10051 structure white



12" WALL/CEILING G24-Q3

G24-q3 | diffused | 26W | 120V | IP 20 (indoor, dry location)

○ M10052 structure white



14.5" WALL/CEILING G24-Q3

G24-q3 | diffused | 26W | 120V | IP 20 (indoor, dry location)

○ M10053 structure white



16.5" WALL/CEILING G24-Q3

G24-q3 | diffused | 26W | 120V | IP 20 (indoor, dry location)

○ M10054 structure white



18.5" WALL/CEILING G24-Q3

G24-q3 | diffused | 2x26W | 120V | IP 20 (indoor, dry location)

○ M10055 structure white



8.5" WALL/CEILING LED

LED board | diffused | 15W | 3045K | 1260lm | typ cri 83 | 120V | IP 20 (indoor, dry location) | Triac wall dimming switch; Recom. dimmer: Lutron Toggler C-L, Part No. TGCL-153PH

○ M330LED structure white



10" WALL/CEILING LED

LED board | diffused | 15W | 3045K | 1260lm | typ cri 83 | 120V | IP 20 (indoor, dry location) | Triac wall dimming switch; Recom. dimmer: Lutron Toggler C-L, Part No. TGCL-153PH

○ M334LED structure white



12" WALL/CEILING LED

LED board | diffused | 15W | 3045K | 1260lm | typ cri 83 | 120V | IP 20 (indoor, dry location) | Triac wall dimming switch; Recom. dimmer: Lutron Toggler C-L, Part No. TGCL-153PH

○ M338LED structure white



14.5" WALL/CEILING LED

LED board | diffused | 15W | 3045K | 1260lm | typ cri 83 | 120V | IP 20 (indoor, dry location) | Triac wall dimming switch; Recom. dimmer: Lutron Toggler C-L, Part No. TGCL-153PH

○ M342LED structure white



# JANEIRO K

The Janeiro K offers the same triplex glass features as the Janeiro series except the glass twists and locks into place. The Janeiro K also has an additional 21.5" option and is available in LED for all sizes. Janeiro K Emergency has an electronic ballast, high power factor, class 120/277V battery back up included with test switch and LED indicator light.



### EMERGENCY

2Gx13 | diffused | 2x26W | 120V | IP 20 (indoor, dry location)

- 12" ○ M10122-EM26W structure white
- 14.5" ○ M10123-EM26W structure white
- 16.5" ○ M10124-EM26W structure white
- 18.5" ○ M10246-EM26W structure white

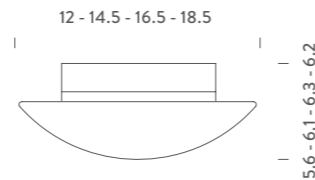

### 8.5" WALL/CEILING E26

E26 | diffused | 60W | dimmable | 120V | IP 20 (indoor, dry location)

- M10120 structure white



### 10" WALL/CEILING E26

E26 | diffused | 2x40W | dimmable | 120V | IP 20 (indoor, dry location)

- M10121 structure white



### 12" WALL/CEILING E26

E26 | diffused | 100W | dimmable | 120V | IP 20 (indoor, dry location)

- M10122 structure white



### 8.5" WALL/CEILING GU24

GU24 | diffused | 13W | 120V | IP 20 (indoor, dry location) note bulb included

- M10120G structure white



### 10" WALL/CEILING GU24

GU24 | diffused | 18W | 120V | IP 20 (indoor, dry location) note bulb included

- M10121G structure white



### 12" WALL/CEILING GU24

GU24 | diffused | 26W | 120V | IP 20 (indoor, dry location) note bulb included

- M10122G structure white



### 8.5" WALL/CEILING G24-Q1

G24-q1 | diffused | 13W | 120V | IP 20 (indoor, dry location)

- M10120F structure white



### 10" WALL/CEILING G24-Q1

G24-q1 | diffused | 13W | 120V | IP 20 (indoor, dry location)

- M10121F structure white



### 12" WALL/CEILING G24-Q3

G24-q3 | diffused | 26W | 120V | IP 20 (indoor, dry location)

- M10129 structure white



### 8.5" WALL/CEILING LED

LED board | diffused | 15W | 3045K | 1260lm | typ cri 83 | 120V | IP 20 (indoor, dry location) | Triac wall dimming switch; Recom. dimmer: Lutron Toggler C-L, Part No. TGCL-153PH

- M10120LED structure white



### 10" WALL/CEILING LED

LED board | diffused | 15W | 3045K | 1260lm | typ cri 83 | 120V | IP 20 (indoor, dry location) | Triac wall dimming switch; Recom. dimmer: Lutron Toggler C-L, Part No. TGCL-153PH

- M10121LED structure white



### 12" WALL/CEILING LED

LED board | diffused | 15W | 3045K | 1260lm | typ cri 83 | 120V | IP 20 (indoor, dry location) | Triac wall dimming switch; Recom. dimmer: Lutron Toggler C-L, Part No. TGCL-153PH

- M10122LED structure white



### 14.5"/16.5"/18.5" WALL/CEILING E26

E26 | diffused | 2x75W | dimmable | 120V | IP 20 (indoor, dry location)

- 14.5" ○ M10123 structure white
- 16.5" ○ M10124 structure white
- 18.5" ○ M10246 structure white



### 16.5"/18.5"/21.5" WALL/CEILING LED

LED board | diffused | 25W | 3045K | 2400lm | typ cri 83 | 120V | IP 20 (indoor, dry location) | Triac wall dimming switch; Recom. dimmer: Lutron Toggler C-L, Part No. TGCL-153PH

- 16.5" ○ M10124LED structure white
- 18.5" ○ M10246LED structure white
- 21.5" ○ M10247LED structure white



### 14.5"/16.5"/18.5"/21.5" WALL/CEILING GU24

GU24 | diffused | 2x18W | 120V | IP 20 (indoor, dry location) note bulb included

- 14.5" ○ M10123G structure white
- 16.5" ○ M10124G structure white
- 18.5" ○ M10246G structure white
- 21.5" ○ M10247G structure white



### 21.5" WALL/CEILING E26

E26 | diffused | 3x60W | dimmable | 120V | IP 20 (indoor, dry location)

- M10247 structure white



### WALL/CEILING LED 14.5"

LED board | diffused | 15W | 3045K | 1260lm | typ cri 83 | 120V | IP 20 (indoor, dry location) | Triac wall dimming switch; Recom. dimmer: Lutron Toggler C-L, Part No. TGCL-153PH

- M10123LED structure white



### WALL/CEILING G24-q3

E26 | diffused | 2x26W | 120V | IP 20 (indoor, dry location)

- 14.5" ○ M10130 structure white
- 16.5" ○ M10131 structure white
- 18.5" ○ M10132 structure white
- 21.5" ○ M10133 structure white

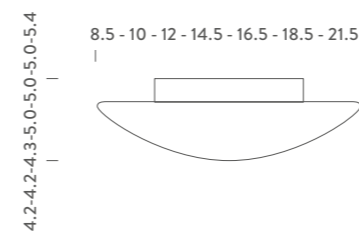



# ELF SERIES

Stephen Blackman

Elf Series, features luminous tubes of opal glass and clean lines. The series ranges from a two lamp wall sconce to a six light chandelier. Mounts to standard 4" octagonal junction box. Available in multiple lamp options.



Elf 1

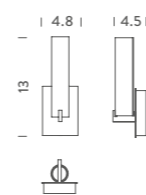

### ELF1 - 2GX7 WALL

2Gx7 | diffused | 13W | 120/277V |  
IP 20 (indoor, dry and damp location)

ADA

- ELF1F-120V structure satin nickel
- ELF1F-277V structure satin nickel



### ELF1 - XENON WALL

XENON DCB | diffused | 2x60W | dimmable | 120V  
IP 20 (indoor, dry and damp location)  
*note bulb included*

ADA

- ELF1I structure satin nickel
- ELF1I-PN structure polished nickel



### ELF1 - LED WALL

LED | diffused | 12W | 3000K | 900lm | 120V |  
Triac wall dimming switch; Recom. dimmer: Lutron  
Toggle C-L, Part No. TGCL-153PH |  
IP 20 (indoor, dry and damp location)

ADA

- ELF1LED structure satin nickel

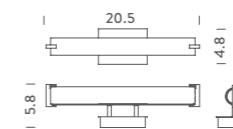

### ELF2 - 2GX7 WALL

2Gx7 | diffused | 2x13W | 120/277V |  
IP 20 (indoor, dry and damp location)  
*note horizontal or vertical mount*

- ELF2F-120V structure satin nickel
- ELF2F-277V structure satin nickel



### ELF2 - XENON WALL

XENON DCB | diffused | 3x60W | dimmable | 120V  
IP 20 (indoor, dry and damp location)  
*note horizontal or vertical mount, bulb included*

- ELF2I structure satin nickel
- ELF2I-PN structure polished nickel



### ELF2 - LED WALL

LED | diffused | 23.5W | 3000K | 1800lm | 120V |  
Triac wall dimming switch; Recom. dimmer: Lutron  
Toggle C-L, Part No. TGCL-153PH |  
IP 20 (indoor, dry and damp location)  
*note horizontal or vertical mount*

- ELF2LED structure satin nickel
- ELF2I-PNLED structure polished nickel

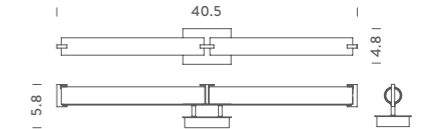

### ELF3 - 2GX7 WALL

2Gx7 | diffused | 4x13W | 120/277V |  
IP 20 (indoor, dry and damp location)  
*note horizontal or vertical mount*

- ELF3F-120V structure satin nickel
- ELF3F-277V structure satin nickel



### ELF3 - XENON WALL

XENON DCB | diffused | 6x60W | dimmable | 120V  
IP 20 (indoor, dry and damp location)  
*note horizontal or vertical mount, bulb included*

- ELF3I structure satin nickel
- ELF3I-PN structure polished nickel



### ELF3 - LED WALL

LED | diffused | 47W | 3000K | 3600lm | 120V |  
Triac wall dimming switch; Recom. dimmer: Lutron  
Toggle C-L, Part No. TGCL-153PH |  
IP 20 (indoor, dry and damp location)  
*note horizontal or vertical mount*

- ELF3LED structure satin nickel
- ELF3I-PNLED structure polished nickel



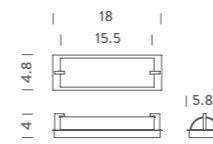

ELF4 - XENON WALL



XENON DCB | diffused 2x60W | 120V | dimmable | IP 20 (indoor, dry and damp location) *note* horizontal or vertical mount, opal white glass diffuser, bulb included

ELF4 structure satin nickel

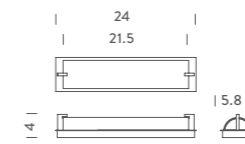

ELF5 - XENON WALL



XENON DCB | diffused 4x60W | 120V | dimmable | IP 20 (indoor, dry and damp location) *note* horizontal or vertical mount, opal white glass diffuser, bulb included

ELF5 structure satin nickel

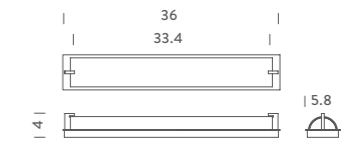

ELF6 - XENON WALL



XENON DCB | diffused 6x60W | 120V | dimmable | IP 20 (indoor, dry and damp location) *note* horizontal or vertical mount, opal white glass diffuser, bulb included

ELF6 structure satin nickel

ELF4 - LED WALL



LED | diffused | 23.5W | 3000K | 1800lm | 120V | Triac wall dimming switch; Recom. dimmer: Lutron Toggler C-L, Part No. TGCL-153PH | IP 20 (indoor, dry and damp location) *note* horizontal or vertical mount, opal white glass diffuser

ELF4LED structure satin nickel

ELF5 - LED WALL



LED | diffused | 23.5W | 3000K | 1800lm | 120V | Triac wall dimming switch; Recom. dimmer: Lutron Toggler C-L, Part No. TGCL-153PH | IP 20 (indoor, dry and damp location) *note* horizontal or vertical mount, opal white glass diffuser

ELF5LED structure satin nickel

ELF6 - LED WALL



LED | diffused | 47W | 3000K | 3600lm | 120V | Triac wall dimming switch; Recom. dimmer: Lutron Toggler C-L, Part No. TGCL-153PH | IP 20 (indoor, dry and damp location) *note* horizontal or vertical mount, opal white glass diffuser

ELF6LED structure satin nickel

Elf 5



Elf 36

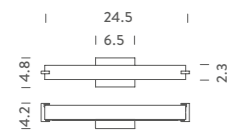

ELF24 - FLUO WALL



T5 HO | diffused | 24W | 120V | IP 20 (indoor, dry and damp location) *note* horizontal or vertical mount, opal white acrylic diffuser

ELF24FT5SN structure satin nickel  
  ELF24FT5CH-PN structure polished nickel

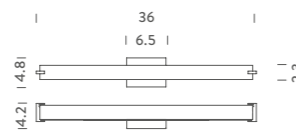

ELF36 - FLUO WALL



T5 HO | diffused | 36W | 120V | IP 20 (indoor, dry and damp location) *note* horizontal or vertical mount, opal white acrylic diffuser

ELF36FT5SN structure satin nickel  
  ELF36FT5CH structure polished nickel

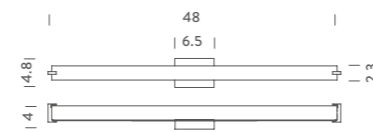

ELF48 - FLUO WALL



T5 HO | diffused | 36W | 120V | IP 20 (indoor, dry and damp location) *note* horizontal or vertical mount, opal white acrylic diffuser

ELF48FT5SN structure satin nickel  
  ELF48FT5CH structure polished nickel





Elf 15



Elf 9

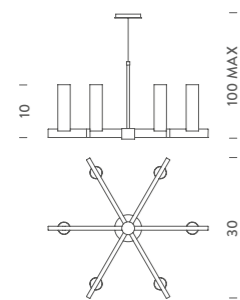

ELF15 - XENON PENDANT

XENON DCB | diffused | 6x60W | 120V | dimmable | IP 20 (indoor, dry location)  
*note* cable length 8.3' max, opal white glass diffuser, bulb included

● ○ ELF15 *structure* satin nickel



ELF9 - XENON PENDANT

XENON DCB | diffused | 6x60W | 120V | dimmable | IP 20 (indoor, dry location)  
*note* cable length 5' max, opal white glass diffuser, bulb included

● ○ ELF9 *structure* satin nickel

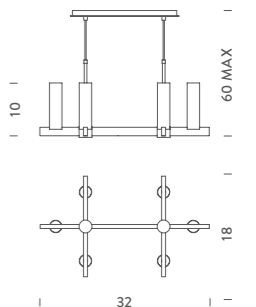

# KRIS / KRIS KRIS



Wall and ceiling lamp, with diffuser in opal blown glass and base in white epoxy-coated metal. Kris with two cuttings in the glass for a direct and widespread lighting.

**KRIS WALL/CEILING**  
Ø12" HALO/FLUO/LED



E26 A19 | diffused | 2x60W | 120V |  
IP 20 (indoor, dry and damp location)

● M2901 structure white

**KRIS KRIS WALL/CEILING**  
Ø12" HALO/FLUO/LED



E26 A19 | diffused | 100W | 60V |  
IP 20 (indoor, dry and damp location)

● M7000 structure white

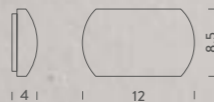

Kris

# OVAL



Wall mount fixture made with triplex opal white glass with painted white or chrome metal base. Mounts to standard 4" octagonal junction box. Suitable for dry and damp locations. Available in multiple lamp options.

## WALL GU24

GU24 | diffused | 18W | 120V |  
IP 20 (indoor, dry location)  
*note* bulb included

- M3279G structure white
- M3271G structure chrome



## WALL E26

E26 | diffused | 60W | 120V |  
IP 20 (indoor, dry location)

- M3279 structure white
- M3271 structure chrome



## WALL LED

LED | diffused | 8W | 3000K | 800lm | typ cri 83 |  
120V | IP 20 (indoor, dry location) | Triac wall dimming switch; Recom. dimmer: Lutron Toggler C-L, Part No. TGCL-153PH

- M3279LED structure white

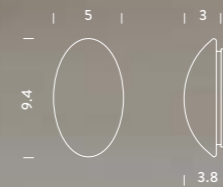



# MATRIX



Wall and ceiling lamp with diffuser in triplex opal blown glass and base in white epoxy-coated metal. Mounts to standard 4" octagonal junction box.



## 7.7" WALL/CEILING G24q-1

G24q-1 | diffused | 13W | 120V | IP 20 (indoor, dry location)

● M10295 structure white



## 8.5" WALL/CEILING G24q-3

G24q-3 | diffused | 26W | 120V | IP 20 (indoor, dry location)

● M10296 structure white



## 11" WALL/CEILING G24q-3

G24q-3 | diffused | 26W | 120V | IP 20 (indoor, dry location)

● M3874F structure white



## 7.7" WALL/CEILING GU24

GU24 | diffused | 13W | 120V | IP 20 (indoor, dry location)  
note bulb included

● M3865G structure white



## 8.5" WALL/CEILING GU24

GU24 | diffused | 2x13W | 120V | IP 20 (indoor, dry location)  
note bulb included

● M3873G structure white



## 11" WALL/CEILING GU24

GU24 | diffused | 2x13W | 120V | IP 20 (indoor, dry location)  
note bulb included

● M3874G structure white



## 7.7" WALL/CEILING E26

E26 | diffused | 75W | 120V | IP 20 (indoor, dry location) | dimmable according to bulb

● M3865 structure white



## 8.5" WALL/CEILING E26

E26 | diffused | 2x40W | 120V | IP 20 (indoor, dry location) | dimmable according to bulb

● M3873 structure white



## 11" WALL/CEILING E26

E26 | diffused | 2x60W | 120V | IP 20 (indoor, dry location) | dimmable according to bulb

● M3874 structure white



## 7.7" WALL/CEILING LED

LED | diffused | 15W | 3045K | 1260lm | typ cri 83 | 120V | IP 20 (indoor, dry location) | Triac wall dimming switch; Recom. dimmer: Lutron Toggler C-L, Part No. TGCL-153PH

● M3865LED structure white



## 8.5" WALL/CEILING LED

LED | diffused | 15W | 3045K | 1260lm | typ cri 83 | 120V | IP 20 (indoor, dry location) | Triac wall dimming switch; Recom. dimmer: Lutron Toggler C-L, Part No. TGCL-153PH

● M3873LED structure white



## 11" WALL/CEILING LED

LED | diffused | 15W | 3045K | 1260lm | typ cri 83 | 120V | IP 20 (indoor, dry location) | Triac wall dimming switch; Recom. dimmer: Lutron Toggler C-L, Part No. TGCL-153PH

● M3874LED structure white



# TANGO

Wall and ceiling lamp, widespread light. Triplex opal white matt or shiny glass with metal base. Mounts to 4" octagonal junction box.



## 10" WALL/CEILING G24q-3



G24q-3 | diffused | 13W | 120V |  
IP 20 (indoor, dry location)

- M10069 *structure white/ opal white glass*
- M10069S *structure white/ shiny opal white glass*

## 10" WALL/CEILING GU24



GU24 | diffused | 18W | 120V |  
IP 20 (indoor, dry location)  
*note bulb included*

- M3816G *structure white/opal white glass*
- M3816GS *structure white/shiny opal white glass*

## 10" WALL/CEILING E26



E26 | diffused | 75W | 120V | dimmable |  
IP 20 (indoor, dry location)

- M3816 *structure white/opal white glass*
- M3816S *structure white/shiny opal white glass*

## 10" WALL/CEILING LED



LED | diffused | 15W | 3045K | 1260lm | typ cri  
83 | 120V | IP 20 (indoor, dry location) | Triac wall  
dimming switch; Recom. dimmer: Lutron Toggler  
C-L, Part No. TGCL-153PH

- M3816LED *structure white/opal white glass*
- M3816SLED *structure white/shiny opal white glass*

## 12" WALL/CEILING G24q-3



G24q-3 | diffused | 26W | 120V |  
IP 20 (indoor, dry location)

- M10071 *structure white/ opal white glass*
- M10071S *structure white/ shiny opal white glass*

## 12" WALL/CEILING GU24



GU24 | diffused | 2x13W | 120V |  
IP 20 (indoor, dry location)  
*note bulb included*

- M3824G *structure white/opal white glass*
- M3824GS *structure white/shiny opal white glass*

## 12" WALL/CEILING E26



E26 | diffused | 2x40W | 120V | dimmable |  
IP 20 (indoor, dry location)

- M3824 *structure white/opal white glass*
- M3824S *structure white/shiny opal white glass*

## 12" WALL/CEILING LED



LED | diffused | 15W | 3045K | 1260lm | typ cri  
83 | 120V | IP 20 (indoor, dry location) | Triac wall  
dimming switch; Recom. dimmer: Lutron Toggler  
C-L, Part No. TGCL-153PH

- M3824LED *structure white/opal white glass*
- M3824SLED *structure white/shiny opal white glass*

## 15.5" WALL/CEILING LED



LED | diffused | 25W | 3045K | 2400lm | typ cri  
83 | 120V | IP 20 (indoor, dry location) | Triac wall  
dimming switch; Recom. dimmer: Lutron Toggler  
C-L, Part No. TGCL-153PH

- M3825LED *structure white/opal white glass*
- M3825SLED *structure white/shiny opal white glass*

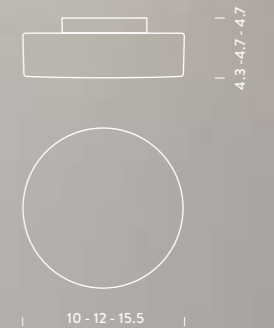



# MAGA



Pendant and wall/ceiling lamp with diffuser in opal blown glass. Spring transparent plastic fixing or chromed wall fixing.

HALO/FLUO/LED

E26 | diffused | 100W | 120V |  
IP 20 (indoor, dry and damp location) |  
dimmable according to bulb

Pendant

● MGA EWW 51 structure chrome

Wall/Ceiling

● MGA EWW 31 structure chrome

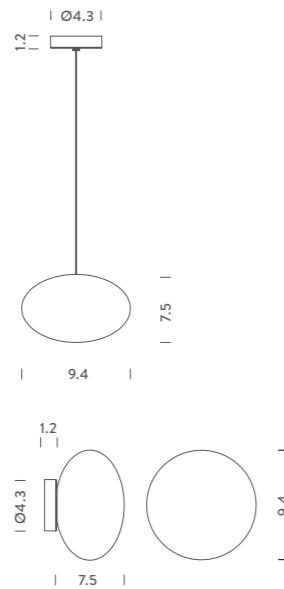

# EASTON

Pendant lamp with matt opal white triplex glass diffuser and either a white or red cord. Chrome particulars.

## PENDANT

E26 A19 | diffused | 100W / 75WLED | 120V | dimmable according to bulb | IP 20 (indoor, dry location)

- EASTON-WHT *cord white*
- EASTON-RED *cord red*

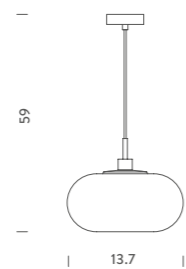



# VANA

Horizontal or vertical wall mount fixture. Opal white glass, polished chrome trim. Integrated LED line light, dimmable, driverless. Mount to standard 4" octagonal junction box.

WALL LED **ADA**

LED | diffused | 44W | 3000K | 1800lm | typ cri  
90 | dimmable | 120V | IP 20 (indoor, dry and damp  
location) | *note* horizontal or vertical mount

○● VANA2CH *structure* polished chrome

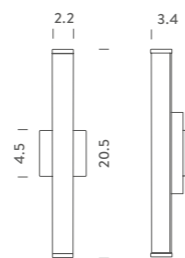

# JUNCTION BOX COVER PLATES

In The Wind Pendant	round
Tru Pendant	square
Giò Pendant	round
Spigolo Pendant	square
Flaca	square
Norma 25/65/95	square
Crown Wall	square
Applique de Marseille	square
Applique à Volet Pivotant Single/Double/Plie'	square
2 Tubes	round
Linescapes Pendant H	square
Linescapes System	square
Canna Nuda	round
Olympia Applique	round
Ghalya	round
Potence Pivotante Mini	square

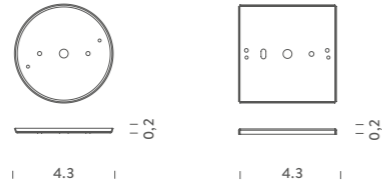

# NEMO G9 LED KIT

NEMO developed, specifically for its products, a dimmable G9 LED source of small size, with a 360° emission. The G9 LED kit has two different color temperatures (2700K or 3000K).  
Kit of 6 bulbs.

## 2700K 120V

G9 LED | diffused, 360° | 2.2W | 220lm | typ cri 81 | 83lm/W | dimmable according to dimmer specification | 120V

LED D62 71



## 3000K 120V

G9 LED | diffused, 360° | 2.2W | 220lm | typ cri 81 | 93lm/W | dimmable according to dimmer specification | 120V

LED D63 01

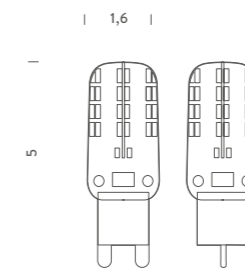



ART DIRECTION

Valentina Folli

GRAPHIC DESIGN

Studio Valentina Folli

PHOTOS

Santi Caleca

Alexander Böhle Photo Production

Cesare Chimenti

Raffaele Cipolletta

Cube Photo Production

Pascal Hermans

Francesco Merlini

Isabella Paleari

Delfino Sisto Legnani

Max Rommel

Federico Villa

Nicola Zocchi

HYSTORICAL MATERIAL

Fondation Le Corbusier

Archives Charlotte Perriand

Fondazione Franco Albini

Fondazione Vico Magistretti

Kazuhide Takahama Archives

Gabriele Basilico archives

SPECIAL THANKS

Cappellini

Cassina

Molteni

B&B Italia

Alias

Danese

Minotti

Poliform

Lema

Frette

Hotel Bellariva

Giovanni Brioschi

Anita Budd

PRINT

Stamperia Scrl

*This document supersedes and updates all previous catalogues and publications in relation to the products listed here in.*

*The author has made every effort to ensure the accuracy of the information within this catalog was correct at time of publication and invites any person or organization that might possess any right on the published material to contact Nemo.*

Dimensions are indicated in inches. Luminaires are normally supplied without light sources, except when otherwise indicated. Products with anodized finishes could show different color shades due to the industrial galvanic process. Shades have to be considered as aesthetic elements of the product. Polishing process is hand-made. Shades are therefore due to this manual process. Dimensions of products made with deformations of extrusions could be subject to changes of  $\pm 0.393701$ ". As blown glass is produced by traditional craft techniques, its thickness, color and finish are subject to variations, a feature that makes each piece unique. NEMO reserves the right to make any technical or formal alterations to its products without giving prior notice, especially for LED sources. Information concerning luminous flux/power consumption are expressed in nominal values. Effective data are indicated in the technical sheets available on the website. Warranty Conditions are indicated in a tag attached to each luminaire. When a certain lamp is supplied with the bulb, the same shall be seen as a pure service to the customer. The cost of the bulb is not included in the price of the product and therefore NEMO shall not be held responsible for any replacement in case of malfunctioning of the bulb. In case of discrepancy between the information contained in the printed materials and the website, this latter shall prevail.

**NEMO USA**

625 Jersey Avenue, Unit 7  
New Brunswick, NJ 08901 - USA  
Tel 800 734 585 8  
[usa@nemolighting.com](mailto:usa@nemolighting.com)

**[NEMOLIGHTING.COM/US/](http://NEMOLIGHTING.COM/US/)**



The history of architecture  
IS THE HISTORY OF  
STRUGGLE FOR LIGHT.

Le Corbusier<sup>®</sup>