

[SEC Info](#) [Home](#) [Search](#) [My Interests](#) [Help](#) [Sign In](#) [Please Sign In](#)

Freedom Chemical Co · 10-Q · For 9/30/97

Filed On 11/14/97 · SEC File 1-13438 · Accession Number 931075-97-7

Find in this filing. Show docs searched and every "hit".
 Help... *Wildcards: ? (any letter), * (many). Logic: for Docs: & (and), | (or); for Text: | (anywhere), "(&)" (near).*

<u>As Of</u>	<u>Filer</u>	<u>Filing</u>	<u>On/For/As</u>	<u>Docs:Pgs</u>
11/14/97	Freedom Chemical Co	10-Q	9/30/97	2:26

Quarterly Report · Form 10-Q Filing Table of Contents

<u>Document/Exhibit</u>	<u>Description</u>	<u>Pages</u>	<u>Size</u>
1: 10-Q	Quarterly Report	25	185K
2: EX-27	FDS --	1	8K

10-Q · Quarterly Report Document Table of Contents

<u>Page</u>	<u>(sequential)</u>	<u>(alphabetic)</u>	<u>Top</u>
1	1st Page	• Alternative Formats (RTF, XML, et al.)	
3	Item 1. Financial Statements	• Exhibits and Reports on Form 8-K	
9	Ftcc	• Financial Statements	
"	Hdcc	• Ftcc	
10	Kci	• Gross profit	
21	Item 2. Management's Discussion and Analysis of	• Hdcc	
"	Inventory valuation charges	• Interest and debt expense	
"	Restructuring and other charges	• Inventory valuation charges	
22	Net sales	• Kci	
"	Gross profit	• Management's Discussion and Analysis of	
23	Selling, general and administrative expense	• Net cash used in investing activities	
"	Research and development expense	• Net income (loss)	
"	Interest and debt expense	• Net sales	
"	Net income (loss)	• Other Information	
"	Net cash used in investing activities	• Research and development expense	
24	Item 5. Other Information	• Restructuring and other charges	
"	Item 6. Exhibits and Reports on Form 8-K	• Selling, general and administrative expense	

10-Q	1st Page of 25	TOC	Top	Previous	Next	Bottom	Just 1st
-------------	-----------------------	-----	-----	----------	------	--------	----------

SECURITIES AND EXCHANGE COMMISSION
WASHINGTON, D.C. 20549

FORM 10-Q

/X/ QUARTERLY REPORT PURSUANT TO SECTION 13 OR 15 (d)
OF THE SECURITIES EXCHANGE ACT OF 1934

For the quarterly period ended September 30, 1997

OR

TRANSITION REPORT PURSUANT TO SECTION 13 OR 15 (d)
OF THE SECURITIES EXCHANGE ACT OF 1934

For the transition period from _____ to _____

Commission file number 33-84778

FREEDOM CHEMICAL COMPANY

(Exact Name of Registrant as Specified in Its Charter)

Delaware

51-0340498

(State or Other Jurisdiction
of Incorporation or Organization)

(I.R.S. Employer
Identification No.)

Five Radnor Corporate Center, 100 Matsonford Road, Suite 170,

Radnor, Pennsylvania 19087

(Address of Principal Executive Offices) (Zip Code)

Registrant's Telephone Number, Including Area Code (610)964-9970

(Former Address of Principal Executive Offices, if Changed Since Last Report)

Indicate by check mark whether the registrant: (1) has filed all reports required to be filed by Section 13 or 15(d) of the Securities Exchange Act of 1934 during the preceding 12 months (or for such shorter period that the registrant was required to file such reports), and (2) has been subject to such filing requirements for the past 90 days.

Yes No

As of November 13, 1997, 156,501 shares of the registrant's Series A Common Stock and no shares of the registrant's Series B Common Stock were outstanding.

10-Q	2nd Page of 25	TOC	1st	Previous	Next	Bottom	Just 2nd
----------------------	--------------------------------	---------------------	---------------------	--------------------------	----------------------	------------------------	--------------------------

FREEDOM CHEMICAL COMPANY and SUBSIDIARIES

FORM 10-Q

TABLE OF CONTENTS· [Enlarge/Download Table](#)

	Page
PART I	
Item 1. Consolidated Balance Sheets at <u>December 31, 1996</u> and <u>September 30, 1997</u>	3
Consolidated Statements of Operations for the Three Months and Nine Months Ended <u>September 30, 1996</u> and <u>1997</u> , respectively.....	4
Consolidated Statements of Cash Flows for the Nine Months Ended <u>September 30, 1996</u> and <u>1997</u> , respectively.....	5
Notes to Consolidated Financial Statements.....	6-20
Item 2. Management's Discussion and Analysis of Financial Condition and Results of Operations.....	21-26
PART II	
Item 2. <u>Change in Securities</u>	27
Item 5. <u>Other Information</u>	27
Item 6. <u>Exhibits and Reports on Form 8-K</u>	27

10-Q	3rd Page of 25	TOC	1st	Previous	Next	Bottom	Just 3rd
------	----------------	-----	-----	----------	------	--------	----------

Part I - Financial Information

Item 1. Financial Statements

FREEDOM CHEMICAL COMPANY AND SUBSIDIARIES
 CONSOLIDATED BALANCE SHEETS (Unaudited)
 (Dollars in thousands, except share data)

· [Enlarge/Download Table](#)

	December 31, 1996	September 30, 1997
	----	----
ASSETS		
Current assets:		
Cash and cash equivalents.....	\$ 3,554	\$ 768
Accounts receivable, net of allowance for doubtful accounts of \$456 and \$858, respectively.....	44,249	45,283
Due from shareholders.....	22	68
Refundable income taxes.....	1,811	--
Inventories.....	53,019	47,843
Prepaid expenses and other current assets.....	5,251	4,489
Environmental indemnification.....	492	192
Deferred income taxes.....	7,237	6,585
	-----	-----
Total current assets.....	115,635	105,228
Property plant and equipment:		
Land.....	3,872	3,680
Buildings and improvements.....	14,600	15,442
Machinery and equipment.....	101,356	110,723
Other.....	11,137	6,440
	-----	-----
	130,965	136,285
Less accumulated depreciation.....	28,754	37,011
	-----	-----
	102,211	99,274
Intangible assets, net.....		
Environmental indemnification.....	34,040	32,695
Deferred financing costs, net.....	8	663
Investments in joint ventures.....	6,902	6,605
Other.....	541	2,280
	3,577	3,731
	-----	-----
Total assets.....	\$ 262,914	\$ 250,476
	=====	=====
LIABILITIES AND STOCKHOLDERS' DEFICIT		
Current liabilities:		
Current maturities of long-term debt.....	\$ 1,067	\$ 8
Short-term borrowings.....	936	412
Notes payable.....	1,098	987
Accounts payable.....	20,996	21,923
Accrued expenses.....	7,889	7,966
Accrued interest.....	3,033	6,387
Accrued compensation.....	5,787	5,380
Accrued restructuring and other charges.....	4,127	2,239
Environmental.....	1,700	2,812
	-----	-----
Total current liabilities.....	46,633	48,114
Long-term debt.....		
Environmental.....	153,560	150,797
	15,987	12,279

Deferred income taxes.....	12,259	11,315
Postretirement benefits.....	4,416	4,632
Other.....	3,346	1,969
Minority interest.....	3,390	3,445
Commitments and contingencies.....	—	—
Mandatory redeemable preferred stock:		
Series B, cumulative, \$1,000 par value, authorized 40,000 shares; issued and outstanding 21,322 shares and 21,519, respectively, stated at liquidation value of \$1,000 per share plus accrued and unpaid dividends of \$11,389 and \$14,429, respectively	32,711	35,948
Series C, cumulative, \$1,000 par value, authorized 15,000 shares; issued 9,137 shares, outstanding 8,916 shares, stated at liquidation value of \$1,054 per share plus accrued and unpaid dividends of \$3,453 and \$4,640, respectively.....	13,083	14,270
Less: Treasury stock, at cost (221 shares of Series C preferred)	(262)	(262)
	-----	-----
	45,532	49,956
Stockholders' deficit:		
Common stock		
Series A, \$.01 par value, authorized 200,000 shares; issued 154,872 and 156,892 shares respectively, outstanding 154,481 and 156,501 shares, respectively.....	2	2
Series B, \$.01 par value, authorized 10,000 shares; none issued or outstanding.....	--	--
Additional paid-in capital.....	10,846	7,149
Accumulated deficit.....	(30,444)	(34,742)
Cumulative translation adjustment.....	(397)	(2,224)
	-----	-----
	(19,993)	(29,815)
Less: Stockholder notes receivable.....	(2,113)	(2,113)
Treasury stock, at cost (391 shares of Series A common).....	(46)	(46)
Minimum pension liability.....	(57)	(57)
	-----	-----
Total stockholders' deficit.....	(22,209)	(32,031)
	-----	-----
Total liabilities and stockholders' deficit.....	\$ 262,914	\$ 250,476
	=====	=====

The accompanying notes are an integral part of the consolidated financial statements.

10-Q	4th Page of 25	TOC	1st	Previous	Next	Bottom	Just 4th
----------------------	--------------------------------	---------------------	---------------------	--------------------------	----------------------	------------------------	--------------------------

FREEDOM CHEMICAL COMPANY AND SUBSIDIARIES

CONSOLIDATED STATEMENTS OF OPERATIONS (Unaudited)
(Dollars in thousands)

• [Enlarge/Download Table](#)

	Three Months Ended September 30,		Nine Months Ended September 30,	
	1996	1997	1996	1997
Net sales.....	\$ 73,264	\$ 71,327	\$ 229,051	\$ 217,619
Cost of goods sold (excluding inventory valuation charges).....	57,137	56,395	173,619	168,684
Inventory valuation charges.....	4,980	--	4,980	3,155
Gross profit.....	11,147	14,932	50,452	45,780
Selling, general and administrative expense.....	11,793	10,541	35,951	31,930
Non-cash compensation expense.....	84	158	159	190
Research and development expense.....	1,085	1,045	3,584	3,317
Restructuring and other charges.....	--	112	--	2,970
Operating income (loss).....	(1,815)	3,076	10,758	7,373
Interest and debt expense.....	3,550	3,982	10,339	12,876
Other income (loss).....	281	(177)	507	298
Income (loss) before minority interest and income taxes.....	(5,084)	(1,083)	926	(5,205)
Minority interest.....	69	88	195	220
Income (loss) before income taxes.....	(5,153)	(1,171)	731	(5,425)
Provision (benefit) for income taxes.....	(508)	181	935	460
Equity in income of joint ventures.....	72	459	527	1,587
Net income (loss).....	(4,573)	(893)	323	(4,298)
Preferred dividends.....	481	1,468	2,949	4,229
Net loss applicable to common shares.....	\$ (5,054)	\$ (2,361)	\$ (2,626)	\$ (8,527)

The accompanying notes are an integral part
of the consolidated financial statements.

10-Q	5th Page of 25	TOC	1st	Previous	Next	Bottom	Just 5th
----------------------	--------------------------------	---------------------	---------------------	--------------------------	----------------------	------------------------	--------------------------

FREEDOM CHEMICAL COMPANY AND SUBSIDIARIES

CONSOLIDATED STATEMENTS OF CASH FLOWS (Unaudited)
(Dollars in thousands)

• [Enlarge/Download Table](#)

	Nine Months Ended September 30,	
	1996	1997
	-----	-----
Cash flows from operating activities:		
Net income (loss)	\$ 323	\$ (4,298)
Adjustments to reconcile net income (loss) to net cash provided by (used in) operating activities:		
Depreciation and amortization.....	10,136	10,771
Provision for doubtful accounts.....	65	290
(Gain) loss on sale of fixed assets.....	(60)	131
Minority interest.....	195	203
Non-cash compensation expense.....	159	190
Equity increase of joint ventures.....	(528)	(1,588)
Deferred income taxes.....	621	116
Inventory valuation charges.....	4,980	3,155
Restructuring and other charges (excluding inventory valuation charges), net of payments.....	(2,649)	(1,123)
Other changes that provided (used) cash:		
Accounts receivable.....	(7,940)	(3,238)
Inventories.....	(14,138)	(69)
Prepaid expenses and other current assets.....	(2,620)	2,248
Accounts payable, accrued expenses and other liabilities.....	10,581	4,963
	-----	-----
Net cash (used in) provided by operating activities.....	(875)	11,751
Cash flows from investing activities:		
Capital expenditures.....	(7,883)	(9,300)
Decrease in investments in joint ventures.....	31	--
Proceeds from sale of capital equipment.....	1,651	67
Payments for environmental liabilities.....	(1,988)	(3,744)
Proceeds from environmental indemnification.....	1,038	300
Other.....	36	184
	-----	-----
Net cash used in investing activities.....	(7,115)	(12,493)
Cash flows from financing activities:		
Issuance of common stock.....	--	223
Issuance of preferred stock.....	--	196
Revolving borrowings under Credit Agreement.....	47,000	128,011
Revolving repayments under Credit Agreement.....	(41,499)	(129,457)
Term loan repayments under Credit Agreement.....	(5,166)	--
Short-term borrowings under European Facility.....	8,329	--
Purchase of treasury stock.....	(87)	--
Payment of registration costs.....	(114)	(733)
Repayment of capital lease obligations.....	(91)	(14)
Payments for financing costs.....	(50)	(55)
Dividends paid to minority interests.....	(130)	(129)
Other.....	(40)	(14)
	-----	-----
Net cash provided by (used in) financing activities.....	8,152	(1,972)
Effect of exchange rate changes on cash.....	(68)	(72)
	-----	-----
Net increase (decrease) in cash and cash equivalents.....	94	(2,786)
Cash and cash equivalents, beginning of period.....	1,450	3,554
	-----	-----
Cash and cash equivalents, end of period.....	\$ 1,544	\$ 768
	=====	=====

The accompanying notes are an integral part
of the consolidated financial statements.

10-Q	6th Page of 25	TOC	1st	Previous	Next	Bottom	Just 6th
------	----------------	-----	-----	----------	------	--------	----------

FREEDOM CHEMICAL COMPANY AND SUBSIDIARIES

Notes to Consolidated Financial Statements (Unaudited)
(Dollars in thousands)

1. Description of Business

Freedom Chemical Company, the Registrant ("FCC"; collectively with its subsidiaries referred to as the "Company") was incorporated in Delaware on April 14, 1992 for the purpose of acquiring specialty chemical companies which manufacture and market specialty chemical products for diverse applications. The Company focuses globally on niche markets where it has strong market positions, which have relatively few competitors and where there are significant barriers to entry. In addition, the Company's products are often very important to the performance of its customers' products, but typically represent a relatively small percentage of their total costs. The Company has five core product lines: (i) Food and Personal Care Ingredients; (ii) Pharmaceutical Intermediates and Natural Additives; (iii) Specialty Organic Chemicals and Intermediates; (iv) Organic Pigments and Dyes; and (v) Textile and Paper Chemicals.

2. Accounting Policies

Principles of Consolidation

The accompanying consolidated financial statements are unaudited and have been prepared by management pursuant to the rules and regulations of the Securities and Exchange Commission. In the opinion of management, these consolidated financial statements contain all of the adjustments, consisting of normal recurring adjustments, necessary to present fairly, in summarized form, the financial position of the Company as of September 30, 1997; the results of its operations for the three and nine months ended September 30, 1996 and 1997, respectively; and changes in its cash flows for the nine months ended September 30, 1996 and 1997, respectively. The results of operations for the three and nine months periods ended September 30, 1997, respectively, are not necessarily indicative of the results that may be expected for the year ending December 31, 1997. The financial information presented herein should be read in conjunction with the consolidated financial statements included in the Registrant's Annual Report on Form 10-K for the year ended December 31, 1996.

The consolidated financial statements include the accounts of FCC and its subsidiaries which include: Freedom Textile Chemicals Co. and subsidiaries ("FTCC"), Hilton Davis Chemical Company ("HDCC"), Kalama Chemical, Inc. and subsidiaries ("KCI"), Freedom Chemical Diamalt GmbH ("Diamalt") and subsidiaries (collectively "FCD"), Freedom Europe B.V. ("BV") and Diamalt Inc. All significant intercompany accounts and transactions have been eliminated in consolidation.

Reclassifications

Beginning in 1997, certain expenses related to evaluations of lower of cost or market which were previously classified as cost of goods sold have been reclassified to inventory valuation charges as a separate component of gross profit. All financial information has been restated to conform to the current presentation.

Certain other prior year amounts have been reclassified to conform to the current year's presentation.

Forward Exchange Contracts

The Company enters into forward exchange contracts primarily as hedges relating to identifiable currency positions. These financial instruments are designed to minimize exposure and reduce risk from exchange rate fluctuations in the regular course of business. Gains and losses on forward exchange contracts that hedge exposures on firm foreign currency commitments are deferred and recognized as adjustments to the bases of those assets. Gains and losses on forward exchange contracts which hedge foreign currency assets or liabilities are recognized in income as incurred. Such amounts effectively offset gains and losses on the foreign currency assets or liabilities that are hedged. The cash flow from such contracts is classified in the same category as the transaction hedged in the statements on consolidated cash flows.

10-Q	7th Page of 25	TOC	1st	Previous	Next	Bottom	Just 7th
------	----------------	-----	-----	----------	------	--------	----------

FREEDOM CHEMICAL COMPANY AND SUBSIDIARIES

Notes to Consolidated Financial Statements (Unaudited)
(Dollars in thousands)

3. New Pronouncements

In February 1997, the Financial Accounting Standards Board ("FASB") issued Statement of Financial Accounting Standard ("SFAS") No. 129, "Disclosure of Information about Capital Structure" which becomes effective for financial statements for periods ending after December 15, 1997. SFAS No. 129 established certain required disclosures related to information about securities, liquidation preference of preferred stock and redeemable stock. The Company currently discloses the capital structure information required by SFAS 129.

In June 1997, the FASB issued SFAS No. 130, "Reporting Comprehensive Income" which becomes effective for financial statements for periods beginning after December 15, 1997. SFAS No. 130 established standards for reporting and display of comprehensive income and its components (revenues, expense, gains and losses) in a full set of general-purpose financial statements. The statement requires an enterprise to classify items of other comprehensive income by their nature in a financial statement and display the accumulated balance of other comprehensive income separately from retained earnings and additional paid-in capital in the equity section of the statement of financial position. The implementation of this standard is not expected to have a material effect on the Company's financial statements.

In June 1997, the FASB issued SFAS No. 131, "Disclosures about Segments of an Enterprise and Related Information" which becomes effective for financial statements for periods beginning after December 15, 1997. SFAS No. 131 established standards for the way that public business enterprises report information about operating segments in annual financial statements and requires that those enterprises report selected information about operating segments in interim financial reports issued to shareholders. It also established standards for related disclosures about products and services, geographical areas, and major customers. The implementation of this standard is not expected to have a material effect on the Company's financial statements.

4. Inventories

A summary of the major classifications of inventories is as follows:

	December 31, 1996	September 30, 1997
	-----	-----
Raw materials, work in process	\$ 27,265	\$ 27,627
Finished goods	31,888	21,727
	-----	-----
	59,153	49,354
Less: reserves	(6,134)	(1,511)
	-----	-----
	\$ 53,019	\$ 47,843
	=====	=====

10-Q	8th Page of 25	TOC	1st	Previous	Next	Bottom	Just 8th
----------------------	--------------------------------	---------------------	---------------------	--------------------------	----------------------	------------------------	--------------------------

FREEDOM CHEMICAL COMPANY AND SUBSIDIARIES

Notes to Consolidated Financial Statements (Unaudited)
(Dollars in thousands)

5. Inventory Valuation Charges

During the nine months ended September 30, 1997, the Company recorded inventory valuation charges of \$3,155 related to write-downs of certain products in its Pharmaceutical Intermediates and Natural Additives group. The write-downs resulted from an evaluation of lower of cost or market due primarily to industry-wide overproduction and declines in market values partially associated with recent changes in government regulation governing prescription reimbursement.

In March 1997, a charge of \$679 was recorded based on an analysis of conditions at that time. An anticipated improvement in market conditions during the three months ended June 30, 1997 did not occur. Accordingly, management reviewed the inventory balances at June 30, 1997 and recorded an additional charge of \$2,476.

In September, 1996, the Company recorded charges totaling \$4,980 as a result of inventory obsolescence principally in the Company's Organic Pigments and Dyes product line.

6. Restructuring and Other Charges

In April 1997, the Company announced a plan to close its Vernon, France facility. This closure was completed in June 1997. Manufacturing production and certain manufacturing equipment were transferred to other locations as part of the closure plan. The Company recorded restructuring and other charges of \$2,606. These charges include costs of \$1,813 for severance to employees, \$660 for the write-off of fixed assets and inventory, and \$133 for other charges, primarily for preparing the site for sale. The balance of this restructuring liability as of September 30, 1997 was \$887 and should be paid or settled during the 1997 fiscal year.

As of September 30, 1997, the Company recorded charges totaling \$444 as a result of a marketing revitalization program the Company initiated primarily for its Organic Pigments and Dyes product group. The Company expects to record approximately \$600 in 1997 for this program. These charges will be expensed as incurred throughout the remainder of the year.

7. Environmental Contingencies

Contingencies exist for the Company and certain of its subsidiaries because of legal and administrative proceedings arising out of the acquisition of businesses and the normal course of business. Such contingencies include environmental proceedings directly and indirectly against the Company or its subsidiaries as well as matters internally identified by the Company. The resolution of such matters often spans several years and frequently includes regulatory oversight and/or adjudication. Additionally, many remediation requirements are not fixed and are likely to be affected by future technological, site and regulatory developments. Consequently, the ultimate extent of liabilities with respect to such matters as well as the timing of cash disbursements cannot be determined with certainty.

In connection with the purchase of a number of the Company's facilities, contractual rights were obtained to indemnify the Company for certain types of environmental pollution relating to those facilities. As more fully described below, the Company consequently believes that a portion of the costs incurred in connection with environmental liabilities existing prior to the Company's ownership and remediation actions that may be required relating to the Company's past and present properties will be the responsibility of other parties. Accordingly, the Company believes that future liabilities over the amounts accrued, relating to environmental conditions existing prior to the Company's ownership and remediation actions, are not likely to have a material adverse effect on the financial position of the Company, although the effect on results of operations and cash flows could be material when these conditions are resolved in a future period.

10-Q	9th Page of 25	TOC	1st	Previous	Next	Bottom	Just 9th
----------------------	--------------------------------	---------------------	---------------------	--------------------------	----------------------	------------------------	--------------------------

FREEDOM CHEMICAL COMPANY AND SUBSIDIARIES

Notes to Consolidated Financial Statements (Unaudited)
(Dollars in thousands)

7. Environmental Contingencies, continued

The Company has sent wastes from its operations to various third-party waste disposal sites. From time to time the Company receives notices from representatives of governmental agencies and private parties contending that the Company is potentially liable for a portion of the investigation and remediation costs and damages at formerly owned or operated sites and third-party sites, some of which are discussed herein. The Company does not believe that its liabilities in connection with such third-party sites, either individually or in the aggregate, will have a material adverse effect on the Company's financial position, results of operations or cash flows.

FTCC

In order to consolidate its textile operations, in 1995, the Company transferred the textile assets of HDCC located in Cowpens, South Carolina, acquired as a part of the HDCC acquisition, to FTCC. In 1994, the Company reached a tentative agreement with the South Carolina Department of Health and Environmental Control on an administrative consent agreement requiring the former owner of the Cowpens facility prior to HDCC to take corrective measures and conduct additional investigation, and the Company and the State of South Carolina agreed on a work plan for assessment and remediation. As part of the FTCC Asset Purchase Agreement, the former owner of the property prior to HDCC agreed that the costs to be expended for the investigation and remediation of the existing environmental conditions would be deducted from the final purchase price payment due to them of \$350.

At the time of the acquisition, the Company recorded a liability for \$350 relating to the payment due to the former owners. In 1994, initial investigations disclosed offsite groundwater contamination. The Company hired an environmental consultant to manage this project and is developing an investigative plan. While the Company believes that any remediation costs incurred may be recovered from the prior owners, a \$1,900 charge was recorded in 1995 for estimated remediation costs since any recoveries or reimbursements from the prior owners are not currently determinable. As of September 30, 1997, FTCC has accrued approximately \$1,612 for this liability and believes the risk of loss exposure is up to \$6,500.

HDCC

In connection with the acquisition of HDCC, Sterling Winthrop, Inc. ("SWI"), a former owner of HDCC, entered into an Environmental Matters Agreement ("EMA") with HDCC, whereby SWI has taken responsibility for environmental conditions that predate 1987, with certain exceptions, as well as for remediation of the land at HDCC's Cincinnati facility pursuant to an October 1986 Consent Decree entered into between the State of Ohio and SWI and its subsidiary.

Under the EMA, HDCC has agreed to share responsibility with SWI for certain specific environmental conditions. Also, HDCC is responsible for environmental conditions that postdate 1986. In addition, PMC, Inc. ("PMC"), another prior owner of HDCC, has placed \$1,000 of the purchase price paid by the Company in an

escrow account to indemnify the Company against breaches of representations and warranties contained in the Stock Purchase Agreement between PMC and the Company, including schedules thereto, to the extent such liabilities (including certain claims not related to the environment) exceeded \$200 in the aggregate and subject to a total cap of \$1,000 (excluding certain claims not related to the environment). HDCC does not believe that it will be required to incur significant liability in connection with such environmental conditions.

10-Q	10th Page of 25	TOC	1st	Previous	Next	Bottom	Just 10th
------	-----------------	-----	-----	----------	------	--------	-----------

FREEDOM CHEMICAL COMPANY AND SUBSIDIARIES

Notes to Consolidated Financial Statements (Unaudited)
(Dollars in thousands)

7. Environmental Contingencies, continued

KCI

KCI owns three manufacturing facilities: Kalama, Washington; Garfield, New Jersey; and Beaufort, South Carolina. Operations at these three sites, including operations by subsidiaries formerly owned by KCI, have generated environmental liabilities. The Stock Purchase Agreement between the Company and BC Sugar whereby the Company acquired KCI (the "KCI Stock Purchase Agreement"), requires BC Sugar to indemnify and reimburse the Company for certain environmental liabilities, as discussed in more detail below.

The Company's Kalama, Washington facility is subject to an agreed order between KCI and the Environmental Protection Agency ("EPA") requiring KCI to remediate portions of the site and to limit potential offsite contamination, pursuant to the Resource Conservation and Recovery Act ("RCRA"). The EPA has approved one of Kalama's interim corrective measures work plans and initial RCRA facility investigation report describing proposed remediation of the site. Capital equipment has been installed in part of the facility and remediation is ongoing. The Company believes that the interim corrective measures will provide most if not all of the remediation required by the EPA. As of September 30, 1997, KCI has accrued approximately \$5,700 for this liability and believes the risk of loss exposure is up to \$18,000. The associated indemnification as of September 30, 1997 is \$435 to \$7,200 based on the risk of loss exposure.

The Company's Garfield facility is subject to an administrative consent order with the State of New Jersey requiring remediation of portions of the site and potentially requiring remediation of areas offsite, pursuant to the New Jersey Industrial Site Recovery Act ("ISRA"). The Garfield facility cleanup is also subject to a Settlement Agreement (the "Tenneco Settlement Agreement"), dated April 28, 1994, to terminate litigation between KCI and Tenneco Polymers, Inc. ("Tenneco Polymers"), the successor in interest of the prior owner of the site. The Tenneco Settlement Agreement requires Tenneco Polymers to conduct the cleanup of the facility required by the State of New Jersey and to pay for 80 percent of the cleanup costs, with KCI responsible for the remaining 20 percent of such costs. BC Sugar will remain responsible for certain of KCI's portion of the cleanup costs pursuant to the KCI Stock Purchase Agreement as described below. Tenneco Polymers is currently conducting additional site investigation and discussing with the State of New Jersey the nature and scope of the required remediation of the Garfield site. KCI has terminated manufacturing operations at this facility.

As of September 30, 1997, KCI has accrued approximately \$500 for this liability and believes the risk of loss exposure is up to \$900. The associated indemnification as of September 30, 1997 is \$200 to \$360 based on the risk of loss exposure.

The Company's Beaufort facility has been listed on the EPA's National Priorities List pursuant to the Comprehensive Environmental Response, Compensation and Liability Act ("CERCLA"). KCI's subsidiary, Kalama Specialty Chemicals, Inc. ("KSCI"), has conducted environmental studies of the site to identify the extent of contamination and to evaluate the feasibility of

remediation alternatives, pursuant to an administrative order of consent between KSCI and the EPA. The EPA and KSCI have reached agreement on a consent decree under which KSCI is to perform the remediation strategy selected by the EPA. Pilot equipment was installed and test work commenced in 1995. BC Sugar will remain responsible for certain of KCI's portion of the cleanup costs pursuant to the KCI Stock Purchase Agreement as described below. Manufacturing operations at this facility have also ceased. As of September 30, 1997, KCI has accrued approximately \$3,300 for this liability and believes the risk of loss exposure is up to \$5,300. The associated indemnification as of September 30, 1997 is \$100 to \$600 based on the risk of loss exposure.

10-Q	11th Page of 25	TOC	1st	Previous	Next	Bottom	Just 11th
------	-----------------	-----	-----	----------	------	--------	-----------

FREEDOM CHEMICAL COMPANY AND SUBSIDIARIES

Notes to Consolidated Financial Statements (Unaudited)
(Dollars in thousands)

7. Environmental Contingencies, continued

KCI and its subsidiaries have also been named as potentially responsible parties ("PRPs") pursuant to CERCLA or similar state laws at five sites not owned by KCI at which it is alleged that hazardous substances generated by KCI or its subsidiaries were disposed. These sites are being remediated or studied for remediation. KCI is cooperating with the relevant governmental agency and other PRPs in the investigation and cleanup at each of these sites. Various contingencies such as the incomplete status of investigation, the uncertainty of remediation selection and effectiveness, the search for additional PRPs, the absence of binding commitments allocating liability among PRPs and the joint and several nature of liability under CERCLA make it impossible to predict at this time KCI's total liability at these sites. KCI or one of its subsidiaries has also been named as a PRP at sites under which an indemnitor (other than BC Sugar) has agreed to undertake the defense and liability. Finally, claims of liability have been received at other sites for which KCI has denied responsibility. However, BC Sugar is responsible for certain liabilities incurred at these Superfund sites pursuant to the KCI Stock Purchase Agreement, as discussed in more detail below.

The KCI Stock Purchase Agreement provides certain indemnifications and related provisions, which address these liabilities. Pursuant to the agreement, BC Sugar remains responsible for the costs of investigation, negotiations with government agencies, and installation of the capital expenditure component of the cleanup required by the government at each of the three facilities currently owned by KCI and its subsidiaries (i.e. Kalama, Garfield and Beaufort). BC Sugar is also responsible for a total of 50 percent of the costs of operation and maintenance arising from the capital expenditure component of cleanup at these three sites until five years after the installation of the capital expenditure component of each site.

In addition, BC Sugar is responsible for all costs incurred as a result of KCI's liability at the offsite Superfund sites including the five at which KCI is a cooperating PRP, sites at which an indemnitor other than BC Sugar has agreed to accept responsibility and other identified sites at which KCI has received claims but is currently denying liability, provided that the sites were identified in the schedules to the Kalama Stock Purchase Agreement. BC Sugar's liability for these sites continues until three years after the installation of capital expenditures at all of the three currently owned facilities, but in any event no later than May 26, 2004.

In the KCI Stock Purchase Agreement, BC Sugar also agreed to remain responsible for certain liabilities arising from violations of environmental laws occurring before May 26, 1994, at sites currently or formerly owned by KCI to the extent such liabilities in the aggregate exceed \$2,000 and claims are made by the Company for such reimbursement before May 26, 1996. However, the KCI Stock Purchase Agreement also includes certain warranties and representations by BC Sugar that KCI was in compliance with environmental laws as of the closing date (May 26, 1994), except as set forth in a schedule accompanying and incorporated into the KCI Stock Purchase Agreement. BC Sugar further agreed to indemnify the Company and KCI against liabilities arising out of the breach of these representations and warranties to the extent each such liability exceeded

\$50 individually and all such liabilities exceeded \$600 in the aggregate, and provided any such claim was made by the Company or KCI before May 26, 1996. All of the indemnifications and other provisions whereby BC Sugar agreed to remain responsible for costs in the KCI Stock Purchase Agreement, including those described above, are subject to an aggregate limit of \$44,000 and including certain costs which may be directly incurred or paid by BC Sugar. The KCI Stock Purchase Agreement required BC Sugar to establish a trust fund to provide reimbursement for expenditures for environmental liabilities by KCI and the Company for which BC Sugar is liable under the agreement.

As a result of the KCI Stock Purchase Agreement and the Tenneco Settlement Agreement, the Company does not believe that additional liabilities, if any, to be incurred by KCI under environmental laws would be material to the Company's financial position, results of operations or cash flows.

10-Q	12th Page of 25	TOC	1st	Previous	Next	Bottom	Just 12th
------	-----------------	-----	-----	----------	------	--------	-----------

FREEDOM CHEMICAL COMPANY AND SUBSIDIARIES

Notes to Consolidated Financial Statements (Unaudited)
(Dollars in thousands)

7. Environmental Contingencies, continued

In May 1991, the EPA issued a compliance order to KCI alleging nine violations of the Clean Air Act, dating back to 1984, at the Kalama facility. In July 1994, KCI was informally notified by the EPA that these violations (and possibly other alleged violations of the Clean Air Act) had been referred to the Department of Justice for possible initiation of an enforcement action. In 1996, the Company signed a consent agreement with the Department of Justice, which contemplated the payment of a penalty as well as an additional payment to fund supplemental environmental projects. These amounts were included in the liabilities established by the Company in connection with the acquisition of KCI. The consent decree was finalized in early 1997 and all required payments have been made totaling approximately \$1,700. The Company has made a claim to BC Sugar for indemnification in this matter.

8. Condensed Consolidating Financial Statements

The following condensed consolidating financial data illustrates the composition of the consolidated financial statements. The Parent is FCC. The U.S. Guarantor Subsidiaries include all domestic subsidiaries of FCC including the following: FTCC and certain of its subsidiaries (Freedom Textile Chemical Company (South Carolina), Inc. and FCC Acquisition Corp.), HDCC, KCI and its subsidiaries (Kalama Specialty Chemicals, Inc. and Kalama Foreign Sales Corporation) and Diamalt Inc. The German Guarantor Subsidiary is Diamalt, excluding its subsidiaries. The Non-Guarantor Subsidiaries include the following: A-Chem (U.K.) Limited (a subsidiary of FTCC), BV, Societe Francaise Des Colloides, S.A. (a subsidiary of BV), Diamalt Pharmorganica Pvt. Limited (a subsidiary of Diamalt), Diamalt Srl (a subsidiary of Diamalt), Indiamalt Private Limited (a subsidiary of Diamalt). The U.S. and German Guarantor Subsidiaries are wholly owned by the Parent.

Investments in subsidiaries are accounted for by the Parent, the U.S. Guarantor Subsidiaries and the German Guarantor Subsidiary on an unconsolidated basis using the equity method for purposes of the consolidating presentation. Earnings of subsidiaries are therefore reflected in the Parent's, U.S. Guarantor Subsidiaries' and German Guarantor Subsidiary's investment accounts and earnings. Income tax expense (benefit) is allocated among the consolidating entities based upon taxable income (loss) by jurisdiction within each group.

The principal elimination entries eliminate investments in subsidiaries and intercompany balances and transactions. Separate financial statements of the U.S. Guarantor Subsidiaries, the German Guarantor Subsidiary, and the Non-Guarantor Subsidiaries are not presented because management has determined that such financial statements would not be material to investors.

10-Q	13th Page of 25	TOC	1st	Previous	Next	Bottom	Just 13th
------	-----------------	-----	-----	----------	------	--------	-----------

FREEDOM CHEMICAL COMPANY AND SUBSIDIARIES

Notes to Consolidated Financial Statements (Unaudited)
(Dollars in thousands)

• [Enlarge/Download Table](#)

**Condensed Consolidating Balance Sheet
As of December 31, 1996**

	Parent	U.S. Guarantor Subsidiaries	German Guarantor Subsidiary	Non Guarantor Subsidiaries	Elim- inations	Consolidated
ASSETS						
Current assets:						
Cash and cash equivalents.....	\$88	\$344	\$2,218	\$992	\$(88)	\$3,554
Accounts receivable, net.....	--	29,933	11,458	2,858	--	44,249
Due from affiliates.....	6,294	--	--	1,566	(7,860)	--
Due from shareholder.....	17	5	--	--	--	22
Refundable income taxes.....	1,811	--	10	--	(10)	1,811
Inventories.....	--	33,522	17,481	2,069	(53)	53,019
Prepaid expenses and other current assets.....	63	2,164	2,858	410	(244)	5,251
Environmental indemnification.....	--	492	--	--	--	492
Deferred income taxes.....	609	6,492	--	136	--	7,237
Total current assets.....	8,882	72,952	34,025	8,031	(8,255)	115,635
Property, plant and equipment:						
Land.....	--	2,610	438	824	--	3,872
Buildings and improvements.....	--	13,001	704	895	--	14,600
Machinery and equipment.....	--	88,186	9,047	4,123	--	101,356
Other.....	376	8,805	733	1,223	--	11,137
Less accumulated depreciation.....	142	112,602	10,922	7,065	--	130,965
	234	25,680	1,544	1,388	--	28,754
Intangible assets, net.....	335	86,922	9,378	5,677	--	102,211
Environmental indemnification.....	--	33,063	267	59	316	34,040
Deferred financing costs, net.....	--	8	--	--	--	8
Investments in joint ventures.....	--	5,946	948	8	--	6,902
Deferred income taxes.....	--	--	541	--	--	541
Other.....	3,204	--	--	--	(3,204)	--
Notes receivable, subsidiaries.....	148	3,163	220	46	--	3,577
Investment in subsidiaries.....	127,943	6,578	539	--	(135,060)	--
	25,405	2,752	3,329	--	(31,486)	--
Total assets.....	\$166,151	\$211,384	\$49,247	\$13,821	\$(177,689)	\$262,914
LIABILITIES AND STOCKHOLDERS' EQUITY (DEFICIT)						
Current liabilities:						
Current maturities of long-term debt....	\$--	\$26	\$--	\$1,041	\$--	\$1,067
Short-term borrowings.....	--	--	458	478	--	936
Notes payable.....	2	773	--	323	--	1,098
Accounts payable.....	186	15,654	4,072	1,169	(85)	20,996
Due to affiliates.....	--	479	7,161	220	(7,860)	--
Accrued expenses.....	428	6,686	730	298	(253)	7,889
Accrued interest.....	2,897	--	104	32	--	3,033
Accrued compensation.....	345	4,184	750	508	--	5,787
Accrued restructuring and other charges.	953	2,516	557	101	--	4,127
Environmental.....	--	1,700	--	--	--	1,700
Total current liabilities.....	4,811	32,018	13,832	4,170	(8,198)	46,633
Long-term debt.....	134,500	--	18,591	469	--	153,560
Environmental.....	--	15,987	--	--	--	15,987
Deferred income taxes.....	--	15,416	--	47	(3,204)	12,259
Postretirement benefits.....	--	4,416	--	--	--	4,416
Notes payable.....	--	119,676	13,425	1,959	(135,060)	--
Other.....	2,456	173	456	261	--	3,346
Minority interest.....	--	--	--	290	3,100	3,390
Commitments and contingencies.....	--	--	--	--	--	--
Mandatory redeemable preferred stock:.....	45,794	3,079	--	--	(3,079)	45,794
Less: Treasury stock.....	(262)	--	--	--	--	(262)
	45,532	3,079	--	--	(3,079)	45,532

Stockholders' equity (deficit):						
Common stock.....	2	1,200	1,291	2,333	(4,824)	2
Preferred stock.....	--	3,839	--	--	(3,839)	--
Additional paid-in capital.....	10,846	33,928	8,241	2,761	(44,930)	10,846
Retained earnings (accumulated deficit).....	(29,980)	(18,148)	(6,097)	1,648	22,133	(30,444)
Cumulative translation adjustment.....	--	--	(492)	(117)	212	(397)
Less: Stockholder note receivable.....	(1,913)	(200)	--	--	--	(2,113)
Treasury stock, at cost.....	(46)	--	--	--	--	(46)
Minimum pension liability.....	(57)	--	--	--	--	(57)
	-----	-----	-----	-----	-----	-----
Total stockholders' equity (deficit).....	(21,148)	20,619	2,943	6,625	(31,248)	(22,209)
	-----	-----	-----	-----	-----	-----
Total liabilities and stockholders' equity (deficit)...	\$166,151	\$211,384	\$49,247	\$13,821	\$ (177,689)	\$262,914
	=====	=====	=====	=====	=====	=====

10-Q	14th Page of 25	TOC	1st	Previous	Next	Bottom	Just 14th
------	-----------------	-----	-----	----------	------	--------	-----------

FREEDOM CHEMICAL COMPANY AND SUBSIDIARIES

Notes to Consolidated Financial Statements (Unaudited)
(Dollars in thousands)

• [Enlarge/Download Table](#)

Condensed Consolidating Balance Sheet
As of September 30, 1997

	Parent	U. S. Guarantor Subsidiaries	German Guarantor Subsidiary	Non Guarantor Subsidiaries	Elimin- ations	Consolidated
ASSETS						
Current assets:						
Cash and cash equivalents	\$ 424	\$ 73	\$ (224)	\$ 722	\$ (227)	\$ 768
Accounts receivable, net	--	31,574	11,376	2,326	7	45,283
Due from affiliates	6,393	(38)	722	411	(7,488)	--
Due from shareholder	68	--	--	--	--	68
Refundable income taxes	--	--	--	--	--	--
Inventories	--	34,145	12,856	964	(122)	47,843
Prepaid expenses and other current assets	380	2,225	1,660	224	--	4,489
Environmental indemnification	--	192	--	--	--	192
Deferred income taxes	609	5,939	--	37	--	6,585
Total current assets	7,874	74,110	26,390	4,684	(7,830)	105,228
Property, plant and equipment:						
Land	--	2,514	384	782	--	3,680
Buildings and improvements	--	13,209	616	1,617	--	15,442
Machinery and equipment	--	97,499	7,898	5,326	--	110,723
Other	660	4,632	994	154	--	6,440
Less accumulated depreciation	660	117,854	9,892	7,879	--	136,285
	231	33,164	1,886	1,730	--	37,011
	429	84,690	8,006	6,149	--	99,274
Intangible assets, net	266	31,739	352	338	--	32,695
Environmental indemnification	--	663	--	--	--	663
Deferred financing costs, net	428	5,418	754	5	--	6,605
Investments in joint ventures	--	--	2,280	--	--	2,280
Deferred income taxes	3,617	--	--	--	(3,617)	--
Other	159	3,534	--	38	--	3,731
Notes receivable, subsidiaries	130,207	6,578	1,006	--	(137,791)	--
Investment in subsidiaries	14,121	569	3,128	--	(17,818)	--
Total assets	\$ 157,101	\$ 207,301	\$ 41,916	\$ 11,214	\$ (167,056)	\$ 250,476
LIABILITIES AND STOCKHOLDERS' EQUITY (DEFICIT)						
Current liabilities:						
Current maturities of long-term debt	\$ --	\$ 2	\$ --	\$ 6	\$ --	\$ 8
Short-term borrowings	--	--	--	412	--	412
Notes payable	2	958	--	27	--	987
Accounts payable	109	18,818	2,261	962	(227)	21,923
Due to affiliates	--	404	6,478	606	(7,488)	--
Accrued expenses	842	5,677	1,227	220	--	7,966
Accrued interest	6,222	--	132	33	--	6,387
Accrued compensation	47	3,900	1,070	363	--	5,380
Accrued restructuring and other charges	959	393	--	887	--	2,239
Environmental	--	2,812	--	--	--	2,812
Total current liabilities	8,181	32,964	11,168	3,516	(7,715)	48,114
Long-term debt	129,750	--	19,786	1,261	--	150,797
Environmental	--	12,279	--	--	--	12,279
Deferred income taxes	--	14,863	--	69	(3,617)	11,315
Postretirement benefits	--	4,632	--	--	--	4,632
Accrued restructuring and other charges	--	--	--	--	--	--
Notes payable	--	121,732	13,425	2,634	(137,791)	--
Other	1,068	221	552	128	--	1,969
Minority interest	--	--	--	269	3,176	3,445
Commitments and contingencies	--	--	--	--	--	--
Mandatory redeemable preferred stock:	50,218	3,149	--	--	(3,149)	50,218
Less: Treasury stock	(262)	--	--	--	--	(262)
	49,956	3,149	--	--	(3,149)	49,956

Stockholders' equity (deficit):

Common stock	2	1,200	1,291	2,333	(4,824)	2
Preferred stock	--	4,147	--	--	(4,147)	--
Additional paid-in capital	7,149	33,927	8,241	2,761	(44,929)	7,149
Retained earnings (accumulated deficit)	(36,965)	(21,613)	(10,649)	(1,177)	35,662	(34,742)
Cumulative translation adjustment	(24)	--	(1,898)	(580)	278	(2,224)
Less: Stockholder note receivable	(1,913)	(200)	--	--	--	(2,113)
Treasury stock, at cost	(46)	--	--	--	--	(46)
Minimum pension liability	(57)	--	--	--	--	(57)
	-----	-----	-----	-----	-----	-----
Total stockholders' equity (deficit)	(31,854)	17,461	(3,015)	3,337	(17,960)	(32,031)
	-----	-----	-----	-----	-----	-----
Total liabilities and stockholders' equity (deficit)	\$ 157,101	\$ 207,301	\$ 41,916	\$ 11,214	\$ (167,056)	\$ 250,476
	=====	=====	=====	=====	=====	=====

10-Q	15th Page of 25	TOC	1st	Previous	Next	Bottom	Just 15th
----------------------	---------------------------------	---------------------	---------------------	--------------------------	----------------------	------------------------	---------------------------

FREEDOM CHEMICAL COMPANY AND SUBSIDIARIES

Notes to Consolidated Financial Statements (Unaudited)
(Dollars in thousands)

• [Enlarge/Download Table](#)

Condensed Consolidating Statement of Operations
For the Three Months Ended September 30, 1996

	Parent	U.S. Guarantor Subsidiaries	German Guarantor Subsidiary	Non Guarantor Subsidiary	Elimin- ations	Consolidated
Net sales.....	\$ --	\$ 52,474	\$ 18,313	\$ 3,731	\$ (1,254)	\$ 73,264
Cost of goods sold (excluding inventory valuation charges).....	--	42,897	15,415	2,398	(924)	57,137
Inventory valuation charges.....	--	4,980	--	--	--	4,980
Gross profit.....	--	7,246	2,898	1,333	(330)	11,147
Selling, general and administrative expense.....	1,700	6,587	3,012	607	(113)	11,793
Non-cash compensation expense.....	84	--	--	--	--	84
Research and development expense.....	--	777	267	41	--	1,085
Operating income (loss).....	(1,784)	(118)	(381)	685	(217)	(1,815)
Interest and debt expense (income).....	(146)	2,899	726	72	(1)	3,550
Other income (loss).....	2,854	(2,467)	125	(40)	(191)	281
Equity in income (loss) of subsidiary.....	(4,033)	(556)	420	--	4,169	--
Income (loss) before minority interest and income taxes.....	(2,817)	(6,040)	(562)	573	3,762	(5,084)
Minority interest.....	--	--	--	--	69	69
Income (loss) before income taxes.....	(2,817)	(6,040)	(562)	573	3,693	(5,153)
Provision (benefit) for income taxes.....	1,488	(2,199)	2	409	(208)	(508)
Equity in income of joint ventures.....	--	--	72	--	--	72
Net income (loss).....	(4,305)	(3,841)	(492)	164	3,901	(4,573)
Preferred dividends.....	481	(637)	--	--	637	481
Net income (loss) applicable to common shares.....	\$ (4,786)	\$ (3,204)	\$ (492)	\$ 164	\$ 3,264	\$ (5,054)

10-Q	16th Page of 25	TOC	1st	Previous	Next	Bottom	Just 16th
------	-----------------	-----	-----	----------	------	--------	-----------

FREEDOM CHEMICAL COMPANY AND SUBSIDIARIES

Notes to Consolidated Financial Statements (Unaudited)
(Dollars in thousands)

· [Enlarge/Download Table](#)

**Condensed Consolidating Statement of Operations
For the Three Months Ended September 30, 1997**

	Parent	U.S. Guarantor Subsidiaries	German Guarantor Subsidiary	Non Guarantor Subsidiaries	Elimin- ations	Consolidated
Net sales.....	\$ --	\$ 56,238	\$ 14,940	\$ 2,593	\$(2,444)	\$ 71,327
Cost of goods sold (excluding inventory valuation charges).....	--	43,818	12,846	2,173	(2,442)	56,395
Inventory valuation charges.....	--	--	--	--	--	--
Gross profit.....	--	12,420	2,094	420	(2)	14,932
Selling, general and administrative expense.....	1,007	6,691	2,576	353	(86)	10,541
Non-cash compensation expense.....	158	--	--	--	--	158
Research and development expense.....	--	821	210	14	--	1,045
Restructuring and other charges.....	--	112	--	--	--	112
Operating income (loss).....	(1,165)	4,796	(692)	53	84	3,076
Interest and debt expense	(15)	3,359	568	70	--	3,982
Other income (loss).....	2,329	(2,187)	218	(345)	(192)	(177)
Equity in income (loss) of subsidiary.....	(2,022)	(297)	(47)	--	2,366	--
Income (loss) before minority interest and income taxes.....	(843)	(1,047)	(1,089)	(362)	2,258	(1,083)
Minority interest.....	--	--	--	17	71	88
Income (loss) before income taxes.....	(843)	(1,047)	(1,089)	(379)	2,187	(1,171)
Provision (benefit) for income taxes.....	1,020	(73)	14	40	(820)	181
Equity in income of joint ventures.....	--	--	412	--	47	459
Net income (loss).....	(1,863)	(974)	(691)	(419)	3,054	(893)
Preferred dividends.....	1,468	175	--	--	(175)	1,468
Net income (loss) applicable to common shares.....	\$ (3,331)	\$ (1,149)	\$ (691)	\$ (419)	\$ 3,229	\$ (2,361)

10-Q	17th Page of 25	TOC	1st	Previous	Next	Bottom	Just 17th
------	-----------------	-----	-----	----------	------	--------	-----------

FREEDOM CHEMICAL COMPANY AND SUBSIDIARIES

Notes to Consolidated Financial Statements (Unaudited)
(Dollars in thousands)

· [Enlarge/Download Table](#)

**Condensed Consolidating Statement of Operations
For the Nine Months Ended September 30, 1996**

	Parent	U.S. Guarantor Subsidiaries	German Guarantor Subsidiary	Non Guarantor Subsidiary	Elimin- ations	Consolidated
Net sales	\$ --	\$ 164,912	\$ 57,247	\$ 11,113	\$ (4,221)	\$ 229,051
Cost of goods sold (excluding inventory valuation charges)	--	124,813	45,000	7,641	(3,835)	173,619
Inventory valuation charges	--	4,980	--	--	--	4,980
Gross profit	--	35,119	12,247	3,472	(386)	50,452
Selling, general and administrative expense	3,500	21,526	9,332	1,962	(369)	35,951
Noncash compensation expense	159	--	--	--	--	159
Research and development expense	--	2,542	901	141	--	3,584
Operating income (loss)	(3,659)	11,051	2,014	1,369	(17)	10,758
Interest and debt expense	(96)	8,318	1,897	220	--	10,339
Other income (loss)	8,884	(8,078)	533	(241)	(591)	507
Equity in income (loss) of subsidiary	(2,388)	648	630	--	1,110	--
Income (loss) before minority interest and income taxes	2,933	(4,697)	1,280	908	502	926
Minority interest	--	--	--	--	195	195
Income (loss) before income taxes	2,933	(4,697)	1,280	908	307	731
Provision (benefit) for income taxes	2,015	(1,374)	4	498	(208)	935
Equity in income of joint ventures	--	--	527	--	--	527
Net income (loss)	918	(3,323)	1,803	410	515	323
Preferred dividends	2,949	--	--	--	--	2,949
Net income (loss) applicable to common shares	\$ (2,031)	\$ (3,323)	\$ 1,803	\$ 410	\$ 515	\$ (2,626)

10-Q	18th Page of 25	TOC	1st	Previous	Next	Bottom	Just 18th
------	-----------------	-----	-----	----------	------	--------	-----------

FREEDOM CHEMICAL COMPANY AND SUBSIDIARIES

Notes to Consolidated Financial Statements (Unaudited)
(Dollars in thousands)

• [Enlarge/Download Table](#)

**Condensed Consolidating Statement of Operations
For the Nine Months Ended September 30, 1997**

	Parent	U.S. Guarantor Subsidiaries	German Guarantor Subsidiary	Non Guarantor Subsidiaries	Elimin- ations	Consolidated
Net sales	\$ --	\$ 171,663	\$ 42,513	\$ 11,363	\$ (7,920)	\$ 217,619
Cost of goods sold (excluding inventory valuation charges)	--	131,475	36,603	8,839	(8,233)	168,684
Inventory valuation charges	--	--	3,155	--	--	3,155
Gross profit	--	40,188	2,755	2,524	313	45,780
Selling, general and administrative expense	2,630	20,688	7,351	1,649	(388)	31,930
Non-cash compensation expense	190	--	--	--	--	190
Research and development expense	--	2,519	705	--	--	3,317
Restructuring and other charges	--	444	--	2,526	--	2,970
Operating income (loss)	(2,820)	16,537	(5,301)	(1,744)	701	7,373
Interest and debt expense (income)	(155)	10,381	2,476	174	--	12,876
Other income (loss)	7,356	(6,869)	1,105	(619)	(675)	298
Equity in income (loss) of subsidiary	(10,449)	(2,097)	594	--	11,952	--
Income (loss) before minority interest and income taxes	(5,758)	(2,810)	(6,078)	(2,537)	11,978	(5,205)
Minority interest	--	--	--	17	203	220
Income (loss) before income taxes	(5,758)	(2,810)	(6,078)	(2,554)	11,775	(5,425)
Provision (benefit) for income taxes	1,313	61	14	185	(1,113)	460
Equity in income of joint ventures	--	--	1,540	--	47	1,587
Net income (loss)	(7,071)	(2,871)	(4,552)	(2,739)	12,935	(4,298)
Preferred dividends	4,229	508	--	--	(508)	4,229
Net income (loss) applicable to common shares	\$ (11,300)	\$ (3,379)	\$ (4,552)	\$ (2,739)	\$ 13,443	\$ (8,527)

10-Q	19th Page of 25	TOC	1st	Previous	Next	Bottom	Just 19th
------	-----------------	-----	-----	----------	------	--------	-----------

FREEDOM CHEMICAL COMPANY AND SUBSIDIARIES

Notes to Consolidated Financial Statements (Unaudited)
(Dollars in thousands)

• [Enlarge/Download Table](#)

**Condensed Consolidating Statement of Cash Flows
For the Nine Months Ended September 30, 1996**

	Parent	U.S. Guarantor Subsidiaries	German Guarantor Subsidiary	Non Guarantor Subsidiary	Elimin- ations	Consolidated
Net cash provided by (used in) operating activities	\$ 2,853	\$ 1,521	\$ (4,910)	\$ (304)	\$ (35)	\$ (875)
Cash flows from investing activities:						
Capital expenditures	(113)	(5,856)	(890)	(1,024)	--	(7,883)
(Increase) decrease in investments in joint ventures	--	--	(20)	51	--	31
Proceeds from sale of capital equipment ...	--	1,572	79	--	--	1,651
Payments for environmental liabilities	--	(1,988)	--	--	--	(1,988)
Proceeds from environmental indemnification	--	1,038	--	--	--	1,038
Other	--	30	--	6	--	36
Net cash used in investing activities	(113)	(5,204)	(831)	(967)	--	(7,115)
Cash flows from financing activities:						
Issuance of common stock	--	--	--	--	--	--
Issuance of preferred stock	--	--	--	--	--	--
Revolving borrowings under Credit Agreement	47,000	--	--	--	--	47,000
Revolving repayments under Credit Agreement	(41,499)	--	--	--	--	(41,499)
Term loan repayments under Credit Agreement	(5,166)	--	--	--	--	(5,166)
Short-term loan borrowings under European Facility	--	--	7,906	423	--	8,329
Payment of treasury stock	(87)	--	--	--	--	(87)
Payment of registration costs	(114)	--	--	--	--	(114)
Repayment of capital lease obligations	--	(56)	--	(35)	--	(91)
Payments for financing costs	--	--	--	(50)	--	(50)
Dividends paid to minority interests	--	(130)	--	--	--	(130)
Other	--	(40)	--	--	--	(40)
Subsidiary loans	(2,870)	4,445	(2,216)	611	30	--
Net cash provided by (used in) financing activities	(2,736)	4,219	5,690	949	30	8,152
Effect of exchange rate changes on cash	--	--	112	(180)	--	(68)
Net increase (decrease) in cash and cash equivalents	4	536	61	(502)	(5)	94
Cash and cash equivalents, beginning of period	248	--	429	1,021	(248)	1,450
Cash and cash equivalents, end of period	\$ 252	\$ 536	\$ 490	\$ 519	\$ (253)	\$ 1,544

10-Q	20th Page of 25	TOC	1st	Previous	Next	Bottom	Just 20th
------	-----------------	-----	-----	----------	------	--------	-----------

FREEDOM CHEMICAL COMPANY AND SUBSIDIARIES

Notes to Consolidated Financial Statements (Unaudited)
(Dollars in thousands)

• [Enlarge/Download Table](#)

**Condensed Consolidating Statement of Cash Flows
For the Nine Months Ended September 30, 1997**

	Parent	U.S. Guarantor Subsidiaries	German Guarantor Subsidiary	Non Guarantor Subsidiary	Elimin- ations	Consolidated
Net cash provided by (used in) operating activities	\$ 7,709	\$ 7,900	\$ (4,140)	\$ 980	\$ (698)	\$ 11,751
Cash flows from investing activities:						
Capital expenditures	(295)	(6,679)	(524)	(1,802)	--	(9,300)
Increase in investments in subsidiaries ..	--	--	(581)	--	581	--
Proceeds from sale of capital equipment ...	--	--	--	67	--	67
Payments for environmental liabilities	--	(3,744)	--	--	--	(3,744)
Proceeds from environmental indemnification	--	300	--	--	--	300
Other	--	36	148	--	--	184
Net cash used in investing activities	(295)	(10,087)	(957)	(1,735)	--	(12,493)
Cash flows from financing activities:						
Issuance of common stock	223	--	--	8	(8)	223
Issuance of preferred stock	196	--	--	--	--	196
Revolving borrowings under Credit Agreement	55,000	--	71,452	1,559	--	128,011
Revolving repayments under Credit Agreement	(59,500)	--	(68,143)	(1,814)	--	(129,457)
Term loan repayments under Credit Agreement	--	--	--	--	--	--
Short-term loan borrowings under European Facility	--	--	--	--	--	--
Payment of treasury stock	--	--	--	--	--	(733)
Payment of registration costs	(733)	--	--	--	--	(14)
Repayment of capital lease obligations	--	(14)	--	--	--	(55)
Payments for financing costs	--	--	(55)	--	--	(129)
Dividends paid to minority interests	--	(129)	--	--	--	(14)
Other	--	2	--	(16)	--	--
Subsidiary loans	(2,264)	2,056	(467)	675	--	--
Net cash provided by (used in) financing activities	(7,078)	1,915	2,787	412	(8)	(1,972)
Effect of exchange rate changes on cash	--	1	(132)	(89)	148	(72)
Net increase (decrease) in cash and cash equivalents	336	(271)	(2,442)	(432)	23	(2,786)
Cash and cash equivalents, beginning of period	88	344	2,218	992	(88)	3,554
Cash and cash equivalents, end of period	\$ 424	\$ 73	\$ (224)	\$ 560	\$ (65)	\$ 768

10-Q	21st Page of 25	TOC	1st	Previous	Next	Bottom	Just 21st
------	-----------------	-----	-----	----------	------	--------	-----------

Item 2. Management's Discussion and Analysis of

Financial Condition and Results of Operations

The following should be read in conjunction with Item 1 of this report.

General

The Company is a leading global manufacturer and marketer of a broad range of specialty and fine chemical products which are sold into several market segments for use in food and beverage products, household and industrial products, cosmetics and personal care products, pharmaceuticals, pet foods, textile and paper products and many other diverse applications. The Company operates in one industry segment, with revenues derived from sales in five core product groups: (i) Food and Personal Care Ingredients; (ii) Pharmaceutical Intermediates and Natural Additives; (iii) Specialty Organic Chemicals and Intermediates; (iv) Organic Pigments and Dyes; and (v) Textile and Paper Chemicals.

Inventory Valuation Charges

During the nine months ended September 30, 1997, the Company recorded inventory valuation charges of \$3.2 million related to write-downs of certain products in its Pharmaceutical Intermediates and Natural Additives group. The write-downs resulted from an evaluation of lower of cost or market due primarily to industry-wide overproduction and declines in market values partially associated with recent changes in government regulation governing prescription reimbursement. In March 1997, a charge of \$0.7 million was recorded based on an analysis of conditions at that date. An anticipated improvement in market conditions during the three months ended June 30, 1997 did not occur. Accordingly, management reviewed the inventory balances at June 30, 1997 and recorded an additional charge of \$2.5 million. After recording this adjustment, management expects that profitability will return to historical levels for the Pharmaceutical Intermediates and Natural Additives product line.

In September, 1996, the Company recorded charges totaling \$5.0 million as a result of inventory obsolescence principally in the Company's Organic Pigments and Dyes product line.

Restructuring and Other Charges

In April 1997, the Company announced a plan to close its Vernon, France facility. This closure was completed in June 1997. Manufacturing production and certain manufacturing equipment were transferred to other locations as part of the closure. The Company recorded restructuring and other charges of \$2.6 million. These charges include costs of \$1.8 million for severance to employees, \$0.7 million for the write-off of fixed assets and inventory, and \$0.1 million for other charges, primarily for preparing the site for sale. The closing of this facility is consistent with the Company's strategic plan of improving its cost structure by having fewer manufacturing plants producing greater volume products. The Company estimates that the annual savings as a result of this plant closure will be approximately \$2.2 million most of which will begin in 1998.

During the nine months ended September 30, 1997, the Company recorded charges totaling \$0.4 million which reduced operating income as a result of a

marketing revitalization program the Company initiated primarily for its Organic Pigments and Dyes product group. The Company expects to record approximately \$0.6 million in 1997 for this program. These charges will be expensed as incurred throughout the remainder of the year.

10-Q	22nd Page of 25	TOC	1st	Previous	Next	Bottom	Just 22nd
-------------	------------------------	------------	------------	-----------------	-------------	---------------	------------------

Results of Operations

The following table sets forth certain data from the Consolidated Financial Statements (Unaudited) expressed as a percentage of net sales.

• [Enlarge/Download Table](#)

	Three Months Ended September 30,		Nine Months Ended September 30,	
	1996 ----	1997 ----	1996 ----	1997 ----
Net sales	100.0%	100.0%	100.0%	100.0%
Cost of goods sold (excluding inventory valuation charges)	78.0	79.1	75.8	77.5
Inventory valuation charges	6.8	--	2.2	1.4
Gross profit	15.2	20.9	22.0	21.0
Selling, general and administrative expense	16.1	14.8	15.7	14.7
Research and development expense	1.5	1.5	1.6	1.5
Restructuring and other charges	--	0.2	--	1.4
Operating income (loss)	(2.4)	4.3	4.7	3.4
Interest and debt expense	4.8	5.6	4.5	5.9
Net (loss) income	(6.2)	(1.3)	0.1	(2.0)
Preferred dividends	0.7	2.1	1.3	1.9
Net loss applicable to common shares	(6.9)	(3.3)	(1.1)	(3.9)

Three Months Ended September 30, 1997
Compared to Three Months Ended September 30, 1996

Net Sales. Net sales declined \$1.9 million to \$71.3 million in the quarter ended September 30, 1997 compared to the quarter ended September 30, 1996. Pharmaceuticals revenues declined \$3.7 million because of (i) industry-wide overstocking due to producer and customer expectations of comparable business strengths in 1997 versus 1996, and (ii) changes in German social legislation regarding the reimbursement for certain medications in which one of the Company's main products is used. It is expected that this development will not result in a permanent loss of business. Textile and Paper Chemicals revenues decreased \$2.9 million, primarily as a result of the discontinuation of unprofitable product lines. Organic Pigment and Dye revenues declined \$0.5 million as a result of effects of increased European competition on Color Former sales, offset partially by increased sales in Inks. Specialty Organics and Intermediates revenues increased \$4.8 million, primarily due to capacity expansion.

Gross Profit. Gross profit, excluding inventory charges of \$5.0 million in 1996, decreased \$1.2 million for the three months ended September 30, 1997 to \$14.9 million compared to \$16.1 million for the three months ended September 30, 1996. This decrease resulted primarily from the following: (i) \$1.5 million was due to lower Pharmaceutical sales and \$2.4 million in Textile and Paper Chemicals due to unfavorable yield variances. These negative impacts were offset, in part, by the following improvements: (i) \$1.8 million in Specialty Organics and Chemical Intermediates due to increased sales and \$1.1 million in Food and Personal Care Ingredients due to a favorable change in product mix and plant cost structure.

The following table displays a comparison for each of the Company's five

core product lines of pounds of product sold, average prices, net sales, gross profit dollars (excluding inventory valuation charges), and gross profit percentage for the quarters ending September 30, 1997 and 1996, respectively. (All values are in millions except for average price.)

10-Q	23rd Page of 25	TOC	1st	Previous	Next	Bottom	Just 23rd
-------------	------------------------	------------	------------	-----------------	-------------	---------------	------------------

[Enlarge/Download Table](#)

Line	September 30, 1997					September 30, 1996				
	Volume (pounds)	Average Price	Net Sales	Gross Profit	Gross Margin	Volume (pounds)	Average Price	Net Sales	Gross Profit	Gross Margin
Specialty Organics and Intermediates	33.69	\$0.50	\$16.96	\$4.76	28.10%	23.78	\$0.51	\$12.13	\$2.96	24.37%
Food and Personal Care Ingredients	15.98	\$1.17	\$18.62	\$6.17	33.14%	17.30	\$1.06	\$18.27	\$5.04	27.60%
Pharmaceutical Intermediates	0.50	\$16.79	\$8.43	\$0.56	6.64%	0.53	\$23.04	\$12.12	\$2.01	16.56%
Textile and Paper Chemicals	27.88	\$0.51	\$14.10	\$1.90	13.51%	29.65	\$0.57	\$17.03	\$4.28	25.14%
Organic Pigments and Dyes	3.10	\$4.27	\$13.22	\$1.53	11.58%	2.78	\$4.93	\$13.71	\$1.83	13.39%
Company Total	81.15	\$0.88	\$71.33	\$14.93	20.93%	74.03	\$0.99	\$73.26	\$16.12	22.01%

The Company recorded estimated costs of shutdown of \$0.7 million and \$0.4 million for the three months ended September 30, 1997 and 1996, respectively. The costs of shutdown are accrued on a pro rata basis over the period between shutdowns. Plant shutdowns are typically scheduled on a semi-annual; nine-month and annual basis at the Company's various plants for the performance of maintenance and inspection of various pieces of equipment. As of September 30, 1997, \$0.7 million was accrued related to such costs, which represented a decrease from December 31, 1996 of \$0.2 million due primarily to shutdowns at the Company's Hilton Davis and Kalama facilities in June and Freedom Textile in July and the timing of various other plant shutdowns scheduled in 1997.

Selling, General and Administrative Expense. Selling, general, and administrative expense decreased \$1.3 million to \$10.5 million in the three months ended September 30, 1997 compared to the same period of the prior year primarily due to personnel reductions and plant closings as a result of restructuring and other charges. As a percentage of sales, selling, general, and administrative expense decreased to 14.8% in the three months ended September 30, 1997 from 16.1% for the same period in 1996.

Research and Development Expense. Research and development expense remained constant at \$1.1 million compared to the same period of the prior year. As a percentage of sales, research and development also was constant at 1.5% in the three months ended September 30, 1997 compared to the same period in 1996.

Operating Income. Operating income, excluding restructuring charges of \$0.1 million in 1997 and inventory charges of \$5.0 million in 1996, remained constant at \$3.2 million for the quarter ended September 30, 1997 compared to the same quarter of 1996.

Interest and Debt Expense. Interest and debt expense increased \$0.4 million to \$4.0 million for the three months ended September 30, 1997 compared to the same period of the prior year. The weighted average interest rate of the Company's borrowings was 9.9% at September 30, 1997, as compared to 8.9% at September 30, 1996. The increase in the weighted average interest rate is attributable to the issuance of the 10 5/8% Senior Subordinated Notes due 2006 (the "Notes") that were issued in October 1996.

Net Income (Loss). Net loss decreased \$3.7 million to a loss of \$0.9 million in the three months ended September 30, 1997 as compared to the same

period of the prior year. The decreases resulted primarily from items discussed above.

Net Income (Loss) Applicable to Common Shares. The net loss applicable to common shares decreased by \$2.7 million to a loss of \$2.4 million for the three months ended September 30, 1997 as compared to the same period of the prior year. The decrease resulted from the items referred to above.

Nine months Ended September 30, 1997
Compared to Nine months Ended September 30, 1996

Net Sales. Net sales declined \$11.4 million to \$217.6 million in the nine months ended September 30, 1997 compared to the same period in 1996. Pharmaceuticals revenues declined \$15.3 million because of (i) industry-wide overstocking due to producer and customer expectations of comparable business strengths in 1997 versus 1996, and (ii) changes in German social legislation regarding the reimbursement for certain medications in which one of the Company's main products is used. It is expected that this development will not result in a permanent loss of business. Textile and Paper Chemicals revenues decreased \$4.0 million, primarily as a result of the discontinuation of unprofitable product lines. These declines were offset by the following: (i) Organic Pigment and Dye revenues increased \$0.8 million as a result of strong sales in the Inks product line, (ii) Specialty Organics and Intermediates revenues increased \$5.9 million, primarily due to capacity expansion, and (iii) Food and Personal Care Ingredients revenues increased \$1.2 million as a result of strong sales in Preservatives, Colors and Cosmetics.

Gross Profit. Gross profit, excluding the inventory valuation charges of \$3.2 million and \$5.0 million in 1997 and 1996, respectively, declined \$6.5 million for nine months ended September 30, 1997 to \$48.9 million compared to \$55.4 million for the nine months ended September 30, 1996. This decline resulted primarily from the following: (i) \$6.0 million was due to lower Pharmaceutical sales, (ii) \$1.6 million in Textile and Paper Chemicals due to unfavorable yield variances, which was offset by the favorable effects of the discontinuation of unprofitable product lines and (iii) \$0.1 million in Specialty Organics and Intermediates due primarily to lower overall prices, higher toluene and energy costs, offset by higher sales volumes. These negative impacts were offset by improvements of \$1.4 million in Food and Personal Care Ingredients due primarily to increased sales in Preservatives, Colors and Cosmetics.

The following table displays a comparison for each of the Company's five core product lines of pounds of product sold, average prices, net sales, gross profit dollars (excluding inventory valuation charges), and gross profit percentage for the nine months ended September 30, 1997 and 1996, respectively. (All values are in millions except for average price.)

[Enlarge/Download Table](#)

Line	Nine months Ended					September 30, 1996				
	September 30, 1997					September 30, 1996				
	Volume (pounds)	Average Price	Net Sales	Gross Profit	Gross Margin	Volume (pounds)	Average Price	Net Sales	Gross Profit	Gross Margin
Specialty Organics and Intermediates	94.72	\$0.51	\$48.43	\$11.83	24.42%	78.45	\$0.54	\$42.51	\$11.96	28.13%
Food and Personal Care Ingredients	50.97	\$1.07	\$54.68	\$17.15	31.36%	50.43	\$1.06	\$53.49	\$15.71	29.37%
Pharmaceutical Intermediates	1.45	\$16.44	\$23.80	\$2.79	11.72%	1.84	\$21.21	\$39.10	\$8.80	22.49%

Textile and Paper Chemicals	77.15	\$0.63	\$48.45	\$9.84	20.31%	80.62	\$0.65	\$52.46	\$11.46	21.85%
Organic Pigments and Dyes	9.76	\$4.33	\$42.26	\$7.33	17.35%	8.52	\$4.87	\$41.49	\$7.50	18.09%
Company Total	234.05	\$0.93	\$217.62	\$48.94	22.49%	219.86	\$1.04	\$229.05	\$5.43	24.20%

The Company recorded estimated costs of shutdown of \$1.6 million and \$1.1 million for the nine months ended September 30, 1997 and 1996, respectively. The costs of shutdown are accrued on a pro rata basis over the period between shutdowns. Plant shutdowns are typically scheduled on a semi-annual, nine-month and annual basis at the Company's various plants for the performance of maintenance and inspection of various pieces of equipment. As of September 30, 1997, \$0.7 million was accrued related to such costs, which represented a decrease from December 31, 1996 of \$0.2 million due primarily to shutdowns at the Company's Hilton Davis and Kalama facilities in June and Freedom Textile in July and the timing of various other plant shutdowns scheduled in 1997.

Selling, General and Administrative Expense. Selling, general, and administrative expense decreased \$4.0 million to \$31.9 million in the nine months ended September 30, 1997 compared to the same period of the prior year primarily due to personnel reductions and plant closings as a result of restructuring and other charges. As a percentage of sales, selling, general, and administrative expense decreased to 14.7% in the nine months ended September 30, 1997 from 15.7% for the same period in 1996.

Research and Development Expense. Research and development expense declined \$0.3 million to \$3.3 million compared to the same period of the prior year. As a percentage of sales, research and development declined to 1.5% in the nine months ended September 30, 1997 from 1.6% for the same period in 1996.

Operating Income. Operating income, excluding inventory valuation and restructuring charges of \$6.1 million and \$5.0 million in 1997 and 1996, respectively, declined \$2.2 million to \$13.5 million for the nine months ended September 30, 1997 compared to the same period of 1996. The decrease resulted primarily from items discussed above.

Interest and Debt Expense. Interest and debt expense increased \$2.5 million to \$12.9 million for the nine months ended September 30, 1997 compared to the same period of the prior year. The weighted average interest rate of the Company's borrowings was 9.9% at September 30, 1997, as compared to 8.9% at September 30, 1996. The increase in the weighted average interest rate is attributable to the issuance of the 10 5/8% Senior Subordinated Notes due 2006 (the "Notes") that were issued in October 1996.

Net Income (Loss). Net income decreased \$4.6 million to a loss of \$4.3 million in the nine months ended September 30, 1997 as compared to the same period of the prior year. The loss resulted primarily from items discussed above.

In addition, the Company's equity in income of joint ventures increased \$1.1 million for the nine months ended September 30, 1997 as compared to the same period of the prior year. The increase is primarily attributable to the increase in the equity in income of Srinivasa Cystine Limited which increased \$1.1 million.

Net Income (Loss) Applicable to Common Shares. The net loss applicable to common shares increased by \$5.9 million to a loss of \$8.5 million for the nine months ended September 30, 1997 as compared to the same period of the prior year. The decrease resulted from the items referred to above.

Liquidity and Capital Resources

Net Cash Provided By Operating Activities. Net cash provided by operating activities for the nine months ended September 30, 1997 was \$11.8 million, which represented a change of \$12.6 million from the \$0.9 million net cash used in operating activities in the same period of the prior year. This change was due primarily to a decrease in inventory.

Net Cash Used in Investing Activities. Net cash used in investing activities for the nine months ended September 30, 1997 was \$12.5 million, an increase of \$5.4 million compared to the same period of the prior year. Capital expenditures in the nine months ended September 30, 1997 were \$9.3 million compared to \$7.9 million in the same period of the prior year. This increase in capital expenditures in 1997 included \$2.5 million related to the expansion program at the Company's Kalama facility.

Net Cash Used in Financing Activities. Net cash used in financing activities for the nine months ended September 30, 1997 was \$2.0 million, a change of \$10.1 million from the net cash provided by financing activities of \$8.1 million over the same period of the prior year. This change includes net repayments of \$1.4 million compared to net borrowings of \$8.7 million for the same period in the prior year and cash proceeds of \$0.4 million from the issuance of common and preferred stock.

Liquidity. On October 17, 1996, the Company issued the Notes. The Notes are fully and unconditionally guaranteed, on a joint and several basis, as to payment of principal, premium, if any, and interest, by all of the Company's domestic subsidiaries and Diamalt.

Concurrently with the consummation of the offering of the Notes, the Company amended and restated its existing credit agreement (as amended and restated, the "*Amended and Restated Credit Agreement*") to, among other things, increase the amount of the revolving loan facility to \$85 million and include Diamalt as a co-borrower. The Amended and Restated Credit Agreement and the Indenture related to the Notes contain certain financial covenants that restrict, among other things, the incurrence of additional indebtedness, the sale of assets, and certain investments, acquisitions and distributions by the Company. The Amended and Restated Credit Agreement also requires the Company to maintain specified financial ratios and tests, including maximum leverage ratios and minimum interest coverage ratios. The Company was in compliance with such ratios and tests at September 30, 1997.

The Company expects that its ongoing cash requirements will consist primarily of interest payments on its outstanding indebtedness, including the Notes and any borrowings under the Amended and Restated Credit Agreement. As of September 30, 1997 the Company had \$57.1 million of working capital (current assets less current liabilities) and \$59.1 million available under the Amended and Restated Credit Agreement.

Although the Company expects that cash flows from operations and available borrowings under the Amended and Restated Credit Agreement will provide sufficient working capital to operate the Company's business, to make expected capital expenditures and to meet the Company's foreseeable liquidity requirements, there can be no assurance that sufficient sources of funds will be available.

Foreign Currency Exchange Rates

The Company's substantial foreign operations expose it to the risk of exchange rate fluctuations. If foreign currency denominated revenues are greater

than costs, the translation of foreign currency denominated costs and revenues into U.S. dollars will improve profitability when the foreign currency strengthens against the U.S. dollar and will reduce profitability when the foreign currency weakens. In addition, the remeasurement of foreign currency denominated assets and liabilities into U.S. dollars gives rise to foreign exchange gains or losses, which are included in the determination of net income.

The Company's foreign currency exposures are managed on a consolidated basis, which allows certain exposures to be offset naturally. However, forward contracts are entered into periodically to hedge specific foreign currency exposures. Under this strategy, gains or losses on hedging transactions are offset by gains or losses on the underlying exposures being hedged.

10-Q	24th Page of 25	TOC	1st	Previous	Next	Bottom	Just 24th
------	-----------------	-----	-----	----------	------	--------	-----------

PART II - OTHER INFORMATION

Item 2. Changes in Securities

Recent Sales of Unregistered Securities

In September 1997, the Company issued 445.75 shares of its Series A Common Stock and 98.292 shares of its Series B Redeemable Preferred Stock to Alexander R. Castaldi for an aggregate purchase price of \$150,000.

In April 1997, the Company issued 445.75 shares of its Series A Common Stock and 98.292 shares of its Series B Redeemable Preferred Stock to Vincent P. Langone for an aggregate purchase price of \$150,000.

The issuance of these securities was made in reliance on the exemption from registration provided by Section 4(2) of the Securities Act of 1933, as amended, for transactions not involving a public offering.

Item 5. Other Information

On March 18, 1997, the Company consummated a fully-subscribed registered exchange offer for the Notes (the "Exchange Offer") to satisfy certain of the Company's obligations under a registration rights agreement relating to the Notes. The form and terms of the Notes issued under the Exchange Offer are substantially identical in all material respects to the form and terms of the Notes issued on October 17, 1996.

Item 6. Exhibits and Reports on Form 8-K

(a) Exhibits.

Exhibit
No.

Description of Exhibit

- 3.1 Restated Certificate of Incorporation of Freedom Chemical Company and Certificate of Designation for Preferred Stock (filed as Exhibit 3.1 to the Company's Registration Statement on Form S-1 (33-84778) and incorporated herein by reference).
- 3.2 By-laws of Freedom Chemical Company (filed as Exhibit 3.2 to the Company's Registration Statement on Form S-1 (33-84778) and incorporated herein by reference).
- 27 Financial Data Schedule.

(b) Reports on Form 8-K.

No reports on Form 8-K were filed during the quarter for which this report is filed.

SIGNATURES

Pursuant to the requirements of the Securities Exchange Act of 1934, the Registrant has duly caused this report to be signed on its behalf by the undersigned hereunto duly authorized.

FREEDOM CHEMICAL COMPANY

(Registrant)

By: /s/ **BRIAN F. MCNAMARA**

Brian F. McNamara
Vice President, Secretary
and General Counsel

Date: November 13, 1997

By: /s/ **DENNIS M. MONAHAN**

Dennis M. Monahan
Vice President, Finance
and Control

10-Q	Last Page of 25	TOC	1st	Previous	Next	Bottom	Just 25th
----------------------	---------------------------------	---------------------	---------------------	--------------------------	----------------------	------------------------	---------------------------

FREEDOM CHEMICAL COMPANY

Form 10-Q Report for the Nine Months Ended
September 30, 1997

INDEX TO EXHIBITS

Exhibit

No. Description of Exhibit

- 3.1 Restated Certificate of Incorporation of Freedom Chemical Company and Certificate of Designation for Preferred Stock (filed as Exhibit 3.1 to the Company's Registration Statement on Form S-1 (33-84778) and incorporated herein by reference).
- 3.2 By-laws of Freedom Chemical Company (filed as Exhibit 3.2 to the Company's Registration Statement on Form S-1 (33-84778) and incorporated herein by reference).
- 27 Financial Data Schedule.
-

Dates Referenced Herein and Documents Incorporated By Reference

<u><i>This 10-Q Filing</i></u>	<u><i>Date</i></u>	<u><i>Referenced-On Page</i></u>		<u><i>Other Filings</i></u>
		<u><i>First</i></u>	<u><i>Last</i></u>	
	4/14/92	<u>6</u>		
	4/28/94	<u>10</u>		
	5/26/94	<u>11</u>		
	5/26/96	<u>11</u>		
	9/30/96	<u>2</u>	<u>23</u>	
	10/17/96	<u>23</u>	<u>24</u>	
	12/31/96	<u>2</u>	<u>23</u>	<u>10-K405</u>
	3/18/97	<u>24</u>		
	6/30/97	<u>8</u>	<u>21</u>	<u>10-Q</u>
For The Period Ended	9/30/97	<u>1</u>	<u>25</u>	
	11/13/97	<u>1</u>	<u>24</u>	
Filed On / Filed As Of	11/14/97			
	11/19/97			
	12/15/97	<u>7</u>		
	12/31/97	<u>6</u>		
	5/26/4	<u>11</u>		

[Top](#)[List All Filings](#)

Alternative Formats: [Rich Text / Word \(.rtf\)](#), [Text \(.txt\)](#), [EDGAR \(.sgml\)](#), [XML \(.xml\)](#),
et al.

*Copyright © 2006 Fran Finnegan & Company All Rights Reserved.
www.secinfo.com - Thu, 10 Aug 2006 19:44:28.21 GMT - Help at SEC Info*



UNITED STATES ENVIRONMENTAL PROTECTION AGENCY
REGION 2
290 BROADWAY
NEW YORK, NY 10007-1866

SEP 15 2003

**GENERAL NOTICE LETTER
CERTIFIED MAIL-RETURN RECEIPT REQUESTED**

Joseph Akers, Vice President
Bayer Corporation
100 Bayer Road
Pittsburgh, Pennsylvania 15205-9741

RE: Diamond Alkali Superfund Site
Notice of Potential Liability for
Response Actions in the Lower Passaic River, New Jersey

Dear Mr. Akers:

The United States Environmental Protection Agency ("EPA") is charged with responding to the release and/or threatened release of hazardous substances, pollutants, and contaminants into the environment and with enforcement responsibilities under the Comprehensive Environmental Response, Compensation, and Liability Act of 1980, as amended ("CERCLA"), 42 U.S.C. §9601 *et seq.*

You received a letter from EPA, dated August 6, 1996, notifying Bayer Corporation ("Bayer") of its potential liability relating to the Passaic River Study Area, which is part of the Diamond Alkali Superfund Site ("Site") located in Newark, New Jersey, pursuant to Section 107(a) of CERCLA, 42 U.S.C. §9607(a). Under CERCLA, potentially responsible parties ("PRPs") include current and past owners of a facility, as well as persons who arranged for the disposal or treatment of hazardous substances at the Site, or the transport of hazardous substances to the Site. Accordingly, EPA is seeking your cooperation in an innovative approach to environmental remediation and restoration activities for the Lower Passaic River.

EPA has documented the release or threatened release of hazardous substances, pollutants and contaminants into the six-mile stretch of the river, known as the Passaic River Study Area, which is part of the Site located in Newark, New Jersey. Based on the results of previous CERCLA remedial investigation activities and other environmental studies, including a reconnaissance study of the Passaic River conducted by the United States Army Corps of Engineers ("USACE"), EPA has further determined that contaminated sediments and other potential sources of hazardous substances exist along the entire 17-mile tidal reach of the Lower Passaic River. Thus, EPA has decided to expand the Study to include the areal extent of contamination to which hazardous substances from the six-mile stretch were transported; and those sources from which

Internet Address (URL) • <http://www.epa.gov>

Recycled/Recyclable • Printed with Vegetable Oil Based Inks on Recycled Paper (Minimum 50% Postconsumer content)

851620001

TIERRA-B-001177

hazardous substances outside the six-mile stretch have come to be located within the expanded Study Area.

In recognition of our complementary roles, EPA has formed a partnership with USACE and the New Jersey Department of Transportation-Office of Maritime Resources ("OMR") ["the governmental partnership"] to identify and to address water quality improvement, remediation, and restoration opportunities in the 17-mile Lower Passaic River. This governmental partnership is consistent with a national Memorandum of Understanding ("MOU") executed on July 2, 2002 between EPA and USACE. This MOU calls for the two agencies to cooperate, where appropriate, on environmental remediation and restoration of degraded urban rivers and related resources. In agreeing to implement the MOU, the EPA and USACE will use their existing statutory and regulatory authorities in a coordinated manner. These authorities for EPA include CERCLA, the Clean Water Act, and the Resource Conservation and Recovery Act. The USACE's authority stems from the Water Resources Development Act ("WRDA"). WRDA allows for the use of some federal funds to pay for a portion of the USACE's approved projects related to ecosystem restoration.

For the first phase of the Lower Passaic River Project, the governmental partners are proceeding with an integrated five- to seven-year study to determine an appropriate remediation and restoration plan for the river. The study will involve investigation of environmental impacts and pollution sources, as well as evaluation of alternative actions, leading to recommendations of environmental remediation and restoration activities. This study is being conducted by EPA under the authority of CERCLA and by USACE and OMR, as local sponsor, under WRDA. EPA, USACE, and OMR are coordinating with the New Jersey Department of Environmental Protection and the Federal and State Natural Resource Trustee agencies. EPA, USACE, and OMR estimate that the study will cost approximately \$20 million, with the WRDA and CERCLA shares being about \$10 million each. EPA will be seeking its share of the costs of the study from PRPs.

Based on information that EPA evaluated during the course of its investigation of the Site, EPA believes that hazardous substances were being released from the former Thomasett Colors/Sterling facility located at 120 Lister Avenue in Newark, New Jersey, into the Lower Passaic River. Hazardous substances, pollutants and contaminants released from the facility into the river present a risk to the environment and the humans who may ingest contaminated fish and shellfish. Therefore, Bayer may be potentially liable for response costs which the government may incur relating to the study of the Lower Passaic River. In addition, responsible parties may be required to pay damages for injury to, destruction of, or loss of natural resources, including the cost of assessing such damages.

Enclosed is a list of the other PRPs who have received Notice letters. This list represents EPA's findings on the identities of PRPs to date. We are continuing efforts to locate additional PRPs who have released hazardous substances, directly or indirectly, into the Passaic River. Inclusion on, or exclusion from, the list does not constitute a final determination by EPA concerning the liability of any party for the release or threat of release of hazardous substances at the Site. Be advised that notice of your potential liability at the Site is being forwarded to all parties on this

85162002

list.

We request that you consider becoming a "cooperating party" for the Lower Passaic River Project. As a cooperating party, you, along with many other such parties, will be expected to fund EPA's share of the study costs. Upon completion of the study, it is expected that CERCLA and WRDA processes will be used to identify the required remediation and restoration programs, as well as the assignment of remediation and restoration costs. At this time, the commitments of the cooperating parties will apply only to the study. For those who choose not to cooperate, EPA may apply the CERCLA enforcement process, pursuant to Sections 106 (a) and 107(a) of CERCLA, 42 U.S.C. §9606(a) and §9607(a) and other laws.

Pursuant to CERCLA Section 113(k), EPA must establish an administrative record that contains documents that form the basis of EPA's decision on the selection of a response action for a site. The administrative record files, which contain the documents related to the response action selected for this Site are located at EPA's Region 2 office (290 Broadway, New York) on the 18th floor. You may call the Records Center at (212) 637-4308 to make an appointment to view the administrative record for the Lower Passaic River Project.

EPA will be holding a meeting with all PRPs on October 29, 2003 at 10:00 AM in Conference Room 27A at the Region 2 office. At that meeting, EPA will provide information about the actions taken to date in the Lower Passaic River, as well as plans for future activities. After the presentation, PRPs will be given the opportunity to caucus, and EPA will return to answer any questions that might be generated during the private session. Please be advised that due to increased security measures, all visitors need to be registered with the security desk in the lobby in order to gain entry to the office. In order to ensure a smooth arrival, you will need to provide EPA with a list of attendees no later than October 15, 2003.

EPA recommends that the cooperating parties select a steering committee to represent the group's interest as soon as possible, since EPA expects a funding commitment for the financing of the CERCLA share of the \$20 million study by mid-November 2003. If you wish to discuss this further, please contact Ms. Alice Yeh, Remedial Project Manager, at (212) 637-4427 or Ms. Kedari Reddy, Assistant Regional Counsel, at (212) 637-3106. Please note that all communications from attorneys should be directed to Ms. Reddy.

Sincerely yours,



George Pavlou, Director
Emergency and Remedial Response Division

Enclosure

cc: Gerard Hickel, Esq.
Bayer Corporation

85162003

PRPs in Receipt of Notice Letters:

PRP	Legal Counsel
J. Roger Hirl President and Chairman of the Board Occidental Chemical Co. Occidental Tower 5005 LBJ Freeway Dallas, Texas 75244	Paul W. Herring, Esq. Andrews & Kurth L.L.P. 1717 Main Street, Suite 3700 Dallas, Texas 75201
Joseph Gabriel Vice President of Operations 360 North Pastoria Environmental Corp. 1100 Ridgeway Avenue Rochester, New York 14652-6280	Philip Sellinger, Esq. Sills Cummis Zuckerman One Riverfront Plaza Newark, NJ 07102
Robert Ball, President Alcan Aluminum Corporation 100 Erieview Plaza, 29th Floor Cleveland, Ohio 44114	Lawrence Salibra, Esq. Alcan Aluminum Corporation 6060 Parkland Blvd. Mayfield Hts., OH 44124
Mark Epstein, President Alden Leeds Inc. 55 Jacobus Ave. Kearny, New Jersey 07032	Eric Aronson, Esq. Whitman Breed Abbott & Morgan One Gateway Center Newark, NJ 07102
Alan Bendelius, President Alliance Chemical, Inc. Linden Avenue Ridgefield, New Jersey 07657	Fredi L. Pearlmutter, Esq. Cooper, Rose & English, LLP 480 Morris Avenue Summit, New Jersey 07901-1527
William Gentner, President The Andrew Jergens Co. 2535 Spring Grove Ave. Cincinnati, Ohio 45214	A. Christian Worrell III, Esq. Head & Ritchey, LLP 1900 Fifth Third Center 511 Walnut Street Cincinnati, OH 45202
Gary Cappeline, President Ashland Specialty Chemical Co. 5200 Blazer Parkway Dublin, Ohio 43017	Stephen Leermakers, Esq. Ashland Specialty Chemical Co. 5200 Blazer Parkway Dublin, OH 43017
Klaus Peter Loebbe, President BASF Corporation 3000 Continental Drive North Mount Olive, New Jersey 07828	Nan Bernardo, Esq. and Nancy Lake Martin, Esq. BASF Corporation 3000 Continental Drive North Mount Olive, NJ 07828

851620004

Joseph Akers, Vice President Bayer Corporation 100 Bayer Road Pittsburgh, Pennsylvania 15205-9741	Gerard Hickel, Esq. Bayer Corporation 100 Bayer Road Pittsburgh, PA 15205-9741
Yvan Dupay, President Benjamin Moore & Co. 51 Chestnut Ridge Road Montvale, New Jersey 07645	Arthur Schulz, Esq. Environmental Counsel 4910 Massachusetts Ave., N.W. Suite 221 Washington, DC 20016
Alberto Celleri, President Chemical Compounds Inc. 10 Baldwin Court Roseland, New Jersey 07086	Jim Giannotti Chemical Compounds Inc. 29-75 Riverside Avenue Newark, NJ 07104
President Chris-Craft Industries, Inc. 767 Fifth Avenue, 46th Floor New York, New York 10153	Brian Kelly, Esq. Chris-Craft Industries, Inc. 767 Fifth Avenue, 46th Floor New York, NY 10153
John Guffey, President Coltec Industries, Inc. 3 Coliseum Centre 2550 West Tyvola Road Charlotte, North Carolina 28217	John R. Mayo, Esq. Coltec Industries, Inc. 430 Park Avenue New York, NY 10022
Roger Marcus, President Congoleum Corporation 3705 Quakerbridge Road Mercerville, New Jersey 08619	Russell Hewit, Esq. Dughi & Hewit 340 North Avenue Cranford, NJ 07016
Martin Benante, Chairman Curtiss-Wright Corp. 4 Becker Farm Road Roseland, New Jersey 07068	James Maher, Esq. Curtiss-Wright Corp. 4 Becker Farm Road Roseland, NJ 07068
Antonio Perez, President Eastman Kodak Company 343 State Street Rochester, New York 14650	Elliot Stern, Esq. Eastman Kodak Company 343 State Street Rochester, NY 14650
Edgar Woolard, Chairman E.I. du Pont de Nemours & Co. 1007 Market Street Wilmington, Delaware 19898	Bernard J. Reilly, Esq. Corporate Counsel E.I. du Pont de Nemours & Co. 1007 Market Street Wilmington, DE 19898

851620005

David Weisman, CEO Elan Chemical Company 268 Doremus Ave. Newark, New Jersey 07105	Jeffrey Schwartz, Esq. Sarber Schlesinger Satz & Goldstein One Gateway Center Newark, NJ 07102
Al Reisch, President E M Sergeant Pulp & Chemical Co. Inc. 6 Chelsea Road Clifton, New Jersey 07102	None
Mark Tucker, Esq. Essex Chemical Corp. 2030 WMDC Midland, Michigan 48674	Kenneth Mack, Esq. Fox, Rothschild, O'Brien & Frankel Princeton Pike Corp.Center 997 Lenox Drive, Building 3 Lawrenceville, NJ 08648
Todd Walker, President Fairmount Chemical Co. Inc. 117 Blanchard St. Newark, New Jersey 07105	John Ix, Esq. Porzio Bromberg & Newman 163 Madison Ave. Morristown, NJ 07962
Bradley Buechler, President Franklin-Burlington Plastics Inc. 113 Passaic Ave. Kearny, New Jersey 07032	Robert M. Becker, Esq. Kraemer, Burns, Mytelka & Lovell, P.A. 675 Morris Ave. Springfield, NJ 07081
Henry Benz, President Hoescht Celanese Chemicals, Inc. Route 202-206 P.O.Box 2500 Somerville, New Jersey 08876	Anne Conley-Pitchell, Esq. Hoescht Celanese Corp. Route 202-206 P.O.Box 2500 Somerville, NJ 08876
Francine Rothschild, President Kearny Smelting & Refining 936 Harrison Ave #5 Kearny, New Jersey 07032	None
Henry Schact, CEO Lucent Technologies, Inc. 600 Mountain Avenue Murray Hill, New Jersey 07974	Ralph McMurry, Esq. Hill, Betts & Nash LLP 1 Riverfront Plaza, Suite 327 Newark, NJ 07102-5401
Richard Meelia, President Mallinckrodt, Inc. 675 McDonnell Blvd. Hazelwood, Missouri 63042	Patricia Duft, Esq. Mallinckrodt, Inc. 675 McDonnell Blvd. Hazelwood, MO 63042

851620006

Richard Mahoney, CEO Monsanto Company 800 N. Lindbergh Blvd. St. Louis, Missouri 63167	L. William Higley, Esq. Monsanto Company 800 N. Lindbergh Blvd. St. Louis, MO 63167
Joseph Galli, President Newell Rubbermaid, Inc. 29 E. Stephenson St. Freeport, Illinois 61032	Peter Schultz, Director Environmental Affairs Newell Co. 4000 Auburn St. Rockford, IL 61101
Jean-Pierre van Rooy, President Otis Elevator Company North American Operations 10 Farm Springs Road Farmington, Connecticut 06032	Sarah Hurley, Esq. Robinson & Cole LLP 695 East Main Street Stamford, CT 06904-2305
Richard Ablon, President Ogden Corporation Two Pennsylvania Plaza, 25 th Floor New York, New York 10121	J.L. Effinger, Esq. Ogden Corporation Two Pennsylvania Plaza, 25 th Floor New York, NY 10121
Henry McKinnell, Chairman Pfizer Inc. 235 E. 42 nd St. New York, New York 10017	Michael McThomas, Esq. Pfizer Inc. 235 E. 42 nd St. New York, NY 10017
Raymond LeBoeuf, President PPG Industries, Inc. One PPG Place Pittsburgh, Pennsylvania 15272	Joseph Karas, Esq. PPG Industries, Inc. One PPG Place Pittsburgh, PA 15272
Lawrence Codey, President PSE&G Co. P.O. Box 570 Newark, New Jersey 07101-0570	Hugh Mahoney, Esq. PSE&G Co. P.O. Box 570 Newark, NJ 07101
Phillip D. Ashkettle, President Reichhold Chemicals, Inc. P.O. Box 13582 Research Triangle Park, North Carolina 27709	Adam S. Walters, Esq. Phillips, Lytle, Hitchcock, Blaine & Huber 3400 Marine Midland Center Buffalo, NY 14203
Robert McNeeley, President Reilly Industries, Inc. 1510 Market Square Center 151 North Delaware Street Indianapolis, Indiana 46204	Paul Rivers, Director Corporate Environmental Affairs Reilly Industries, Inc. 1500 S. Tibbs Avenue Indianapolis, IN 46242

851620007

<p>Robert Finn, President RSR Corporation 2777 Stemmons Freeway, Suite 1800 Dallas, Texas 75207</p>	<p>Howard Myers, Esq. RSR Corporation 2777 Stemmons Freeway, Suite 1800 Dallas, TX 75207</p>
<p>Christopher Connor, CEO The Sherwin-Williams Company 101 Prospect Avenue, N.W. Cleveland, Ohio 44115-1075</p>	<p>Donald McConnell, Esq. The Sherwin-Williams Co. 101 Prospect Ave., N.W. Cleveland, OH 44115</p>
<p>George Barrett, President Teva Pharmaceuticals USA Inc. 1090 Horsham Road North Wales, Pennsylvania 19454</p>	<p>Kirsten E. Bauer, Esq. Teva North America 1090 Horsham Road North Wales, PA 19454</p>
<p>Robert Senior, President Three County Volkswagen 701 Riverside Ave. Lyndhurst, New Jersey 07071</p>	<p>Robert DiLascio, Esq. 30 Park Avenue, Suite 101 Lyndhurst, NJ 07071</p>
<p>Michael Jordan, President Westinghouse Electric Corp. 11 Stanwix Street Pittsburgh, Pennsylvania 15222</p>	<p>Roger Willis, Esq. Westinghouse Electric Corp. 11 Stanwix Street Pittsburgh, PA 15222</p>
<p>Isaac Weinberger, President Wiggins Plastics Inc. 547 Maitland Ave. Teaneck, New Jersey 07666</p>	<p>None</p>

851620008

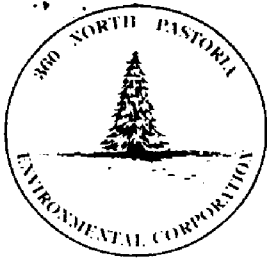

360 NORTH PASTORIA ENVIRONMENTAL CORPORATION

Rochester, New York 14652-6280

January 4, 1996

Mr. Lance R. Richman, P.G.
Emergency and Remedial Response Division
U.S. Environmental Protection Agency
290 Broadway, Floor 19
New York, New York 10007-1866

Subject: Thomasset Colors, Inc./The Hilton-Davis Chemical Company
A Division of Sterling Drug, Inc.
Request for Information Under 42 U.S.C. §9601 et seq.
Diamond Alkali Superfund Site, Passaic River Study Area

Dear Mr. Richman:

This is in response to your letter of November 14, 1995 to Sterling Winthrop Inc. (Sterling) requesting information relative to the operations of Thomasset Colors, Inc. (Thomasset) at 120 Lister Avenue in Newark, New Jersey (the Site). Note that this response is limited to Thomasset's operations at the Site, during the period that Thomasset was owned by Sterling, i.e., from March 11, 1957 to October 23, 1986.

The preliminary response set forth below is based upon our investigation to date. There are no active Sterling employees that have any direct knowledge of Thomasset's operations at the Site. As a result, this response is subject to further clarification as additional information becomes available.

Following is Sterling's response to each question in the Request for Information.

1. *How long and during what years has your company operated at the facility designated above?*

Sterling acquired Thomasset on March 11, 1957. On December 28, 1983, Sterling transferred the assets of Thomasset to its subsidiary, The Hilton-Davis Chemical Company (Hilton-Davis). On October 23, 1986, the assets of Hilton-Davis were sold to H. D. Acquisition Corporation, which later changed its name to Hilton Davis Co., a division of PMC Specialties (PMC). On September 9, 1993, PMC sold Hilton Davis Co. to Freedom Chemical Company (Freedom). Thomasset ceased operating at the facility on October 23, 1986 with the sale of Hilton-Davis to PMC, however Sterling maintained ownership of the property until Freedom purchased the property in late 1993.

844710001

Joseph G. Gabriel, Vice President of Operations Tel: (716) 588-4369 Fax: (716) 588-2161

Mr. Lance R. Richman, P.G.
U.S. Environmental Protection Agency
January 3, 1996

- 2a. *Does your company have or has it in the past had a permit or permits issued pursuant to the Resource Conservation and Recovery Act, 42 U.S.C. §6901 et seq.? If "yes", please provide the years that your company held such a permit and its EPA Identification Number.*

During Thomasset's period of operation, the facility did not have any permits issued pursuant to the Resource Conservation and Recovery Act (RCRA). The facility was a generator of hazardous waste from August 18, 1980 through October 23, 1986 and its EPA Identification Number was NJD000537274.

- 2b. *Does your company have or has it in the past had a permit or permits issued pursuant to the Federal Water Pollution Control Act, 33 U.S.C. §1251. et seq.? If "yes", please provide the years that your company held such a permit.*

The Passaic Valley Sewerage Commissioners (PVSC) issued a sewer connection permit (# 20402690) to the facility for the period May 15, 1981 through May 15, 1986. This permit was revised effective May 21, 1984 to change the required sampling frequency. The permit was renewed by PVSC effective May 27, 1986 for a period of five years.

3. *Did your company receive, utilize, manufacture, discharge, release or dispose of any materials containing the following substances:*

During Thomasset's period of operation, the facility used barium sulfate, barium chloride, naphthalene, and 1,2-dichlorobenzene in the manufacture of Food and Drug Administration (FDA) approved pigments. In addition, the facility blended and repackaged chromium oxide and chromium hydrate for resale, but did not use or produce these substances in any manufacturing operation.

- 4a. *Provide a description of the manufacturing processes for which all hazardous substances, including, but not limited to, the substances listed in response to item (3), were a product or by-product.*

Because these manufacturing processes are historic in nature, Sterling has no current knowledge regarding how these operations were conducted or varied over time. Based on the investigation to date and subject to change based on the availability of additional information, a preliminary understanding of these processes follows.

The principal products manufactured at the facility during Thomasset's period of operation were phthalocyanine pigments, transoxide pigments, and FDA certified colors for use in food and cosmetic applications, referred to as FD&C and D&C colors, respectively. Following are descriptions of the manufacturing processes for these products.

Mr. Lance R. Richman, P.G.
U.S. Environmental Protection Agency
January 3, 1996

Phthalocyanine Pigments: Two types of phthalocyanine pigments were manufactured during Thomasset's period of operation, Phthalo Blue and Phthalo Green. We have been unable to locate any details regarding the Phthalo Green manufacturing process and this product appears to have been discontinued in mid-1981.

Phthalo Blue was manufactured by blending phthalic anhydride, copper sulfate and urea in mixing tanks. The resultant mixture was then dried. The dried pigment was ground and mixed in a dilute sulfuric acid solution. The slurry (refined pigment) was then neutralized with ammonia prior to being dewatered in filter presses. The press cakes (final product) were packed into drums for shipment.

Transoxide Pigments: Soda ash, ferrous sulfate and water were mixed and agitated with air in mixing tanks. The resulting slurry then underwent a boiling process prior to being dewatered in filter presses. The filter cakes were either dried and packed into drums or further processed in an extruder. Extruded products were either baked at 550 F to produce a red pigment or steamed at 150 F to produce a yellow pigment. The final product was milled, blended with other coloring agents, and packed into drums for shipment.

D&C Colors: Several varieties of D&C colors were produced at the facility during Sterling's period of operation. The major production process for D&C colors is described here. Para-toluidine-meta-sulfonic acid and beta-oxynaphthoic acid were blended in mixing tanks and the resulting slurry was dewatered in filter presses. The filter cakes were dried, milled, blended, and packed into drums for shipment.

Other Manufacturing Operations: In addition to the manufacturing operations described above, the facility also handled some final products that were produced at other Hilton-Davis manufacturing plants. These materials were relabeled and/or re-packaged, primarily in Building 8, in preparation for shipment to customers. There are no records of any waste streams generated by these operations.

4b. *During what parts of the manufacturing processes identified in the response to items (4) (a), above, were hazardous substances, including, but not limited to, the substances listed in response to item (3), generated?*

- i) *Describe the chemical composition of these hazardous substances.*
- ii) *For each process, what amount of hazardous substances was generated per volume of finished product?*
- iii) *Were these hazardous substances combined with wastes from other processes? If so, wastes from what processes?*

Waste streams from the manufacturing processes described above consisted primarily of decant water and filter press effluent. The substances contained in these liquid waste streams, which are also listed in 40 CFR 302.4, are described below.

Mr. Lance R. Richman, P.G.
U.S. Environmental Protection Agency
January 3, 1996

Phthalocyanine Pigments: Phthalo Blue decant water and filtrates contained approximately 3 percent sulfuric acid and may have contained trace amounts of copper salts. Phthalo Green filtrates may have contained trace amounts of copper salts. Filtrates from Phthalo Blue and Phthalo Green production were discharged to the sanitary sewer as described below in the answer to Question 6. Decant water from the Phthalo Blue process was discharged to the sanitary sewer, except from the summer of 1963 through June 1971 when this stream may have been discharged to the Passaic River as described below in the answer to Question 7(b).

Transoxide Pigments: Filtrates from Transoxide manufacturing may have contained unreacted iron salts and sulfuric acid. These filtrates were discharged to the sanitary sewer as described below in the answer to Question 6.

D&C Colors: Filtrates from D&C Colors manufacturing may have contained beta oxynaphthoic acid, 1,2-dichlorobenzene, trichlorobenzene, aluminum salts, and/or bromine. These filtrates were discharged to the sanitary sewer as described below in the answer to Question 6.

5. *Describe the methods of collection, storage, treatment, and disposal of all hazardous substances, including, but not limited to, the substances listed in response to item (3) and (4). Include information on the following:*
- a) *Identify all persons who arranged for and managed the processing, treatment and disposal of hazardous substances.*
 - b) *If hazardous substances were taken off-site by a hauler or transporter, provide the names and addresses of the waste haulers and the disposal site locations.*
 - c) *Describe all storage practices employed by your company with respect to all hazardous substances from the time operations commenced until the present. Include all on-site and off-site storage activities.*
 - d) *Describe all storage locations at the facility. Include in your description whether there was a containment system around the storage area.*

The identities of the person(s) who arranged for and managed the processing, treatment and disposal of hazardous substances could not be determined from the available documentation.

Annual RCRA hazardous waste generator reports were found for 1982, 1983 and 1984. No hazardous waste was manifested in 1983 or 1984. In 1982, 3,667 gallons of No. 6 fuel oil was manifested to and disposed of at B&L Oil Corp. in Newark, New Jersey.

Mr. Lance R. Richman, P.G.
U.S. Environmental Protection Agency
January 3, 1996

Above ground tanks were used for the storage of bulk material. There were no underground tanks at the facility during the period of Thomasset's operation. The following bulk storage tanks were used for the storage of hazardous substances:

Tank No.	Contents
15	Phthalo Blue slurry (contained copper salts)
16	Phthalo Blue slurry (contained copper salts)
26-A	dilute sulfuric acid (Phthalo Blue decant)
26-B	dilute sulfuric acid (Phthalo Blue decant)
26-C	dilute sulfuric acid (Phthalo Blue decant)
41	sulfuric acid
42	sulfuric acid
44	No. 6 fuel oil
45	No. 6 fuel oil
67	anhydrous ammonia
--	caustic soda

The remaining materials used on site were stored in 55 gallon steel drums, carboys and bags, which were located in Buildings 6, 7, 8 or 9. A detailed inventory of raw materials that were present on site in November 1985 is included in Attachment A.

6a. *For process waste waters generated at the facility which contained any hazardous substances, including, but not limited to, the substances listed in response to item (3) and (4):*

- i) Did the waste stream connect to a sanitary sewer and if so, during what years?*
- ii) Were they treated before being discharged to the sanitary sewer and if so, how?*
- iii) If the waste waters were not discharged to the sanitary sewer, where were they disposed and during what years?*

Except as described in the answer to Question 7(b) below, process wastewater generated at the facility during Thomasset's period of operation was discharged to a sanitary sewer. A wastewater neutralization system was constructed in June 1971 to neutralize process wastewater prior to discharge to the sanitary sewer.

6b. *For floor drains or other disposal drains at the facility:*

- i) Did the waste stream connect to a sanitary sewer and if so, during what years?*
- ii) Was the waste stream treated before being discharged to the sanitary sewer and if so, how?*

Mr. Lance R. Richman, P.G.
U.S. Environmental Protection Agency
January 3, 1996

- iii) If the floor drains or other disposal drains at the facility were not discharged to the sanitary sewer, where did they discharge and during what years?**

Waste streams from floor drains generated at the facility during Thomasset's period of operation were discharged to a sanitary sewer. A wastewater neutralization system was constructed in June 1971 to neutralize process wastewater prior to discharge to the sanitary sewer.

6c.

- i) Did any storm sewers, catch basins or lagoons exist at any time at the facility and if so, during what years?**
- ii) If catch basins or lagoons existed, were they lined or un-lined?**
- iii) Where was the discharge from any of these structures released and during what years? Was this discharge treated before its release and if so, how and during what years?**

Stormwater catch basins and process wastewater were discharged to the City of Newark sanitary sewer in Lister Avenue through a combined 12 inch sewer line. In June 1971 a new 16 inch sewer was constructed to discharge treated process wastewater to the municipal sanitary sewer. At the same time, the existing 12 inch sewer line was converted for stormwater use only and was connected to a municipal storm sewer in Lister Avenue. In March 1972, the 12 inch sewer line was sealed off from the municipal storm sewer.

- 6d. Please supply diagrams of any waste water collection or disposal systems on the property.**

Our understanding of the manner in which the wastewater collection and treatment system was constructed in June 1971 is reflected in Attachment B.

- 7a. For each hazardous substance, including, but not limited to, the substances listed in response to item (3) or identified in the responses to item (4), above, provide the total amount generated during the operation of the facility on an annual basis.**

We do not have adequate information to accurately respond to this request.

Mr. Lance R. Richman, P.G.
U.S. Environmental Protection Agency
January 3, 1996

- 7b. *Were any hazardous substances, including, but not limited to, the substances listed in response to item (3) or identified in the responses to item (4), above, disposed of in the Passaic River or discharged to the Passaic River? If yes, estimate the amount of material discharged to or disposed of in the Passaic River and the frequency with which this discharge or disposal occurred.*

Decant water from the Phthalo Blue manufacturing process may have been discharged to the Passaic River from the summer of 1963 through June 1971. This waste stream contained, inter alia, dilute sulfuric acid and trace amounts of unreacted copper salts. We do not have sufficient information to accurately estimate the amount of decant water discharged to the Passaic River.

8. *Please identify any leaks, spills, explosions, fires, or other incidents of accidental material discharge that occurred at the facility during which or as a result of which any hazardous substances, including, but not limited to, the substances listed in response to item (3) or (4), were released on the property of the facility or discharged to the Passaic River. Provide any documents or information relating to these incidents.*

On August 19, 1971 a container of green fluorescein dye, a non-hazardous substance, was discharged to a stormwater catch basin at the Site and reached the Passaic River through the Lockwood Street storm sewer. On February 18, 1972, Thomasset received a Notice of Violation from the City of Newark for "chemical" in the storm sewer. As a result of these two incidents, the storm sewer was sealed off in March 1972 to prevent any further accidental releases to the Passaic River. Documents related to these incidents are included in Attachment C.

9. *Provide the date of any leaks, spills, explosions, fires or other incidents of accidental material discharge of any hazardous substances, including, but not limited to, the substances listed in response to item (3) and (4), on the property or into the waste water discharge system at the facility. Provide details of the ultimate disposal of any contaminated materials.*

In 1963 joints on the 12 inch combined sewer from the Thomasset site to the municipal sewer in Lister Avenue appeared to be leaking. We have not located any documentation to indicate how this problem was resolved at that time. In June 1971 a new 16 inch sewer was constructed to discharge treated process wastewater to the municipal sanitary sewer, replacing the 12 inch sewer.

On January 22, 1981, approximately 7,000 gallons of transoxide leaked from a fitting on tank No. 65. Most of the spill was contained within a depressed area of a neighboring parking lot. The spill was cleaned up and the waste was discharged into the sanitary sewer. The spill was contained on the property and did not reach the Passaic River.

Mr. Lance R. Richman, P.G.
U.S. Environmental Protection Agency
January 3, 1996

10a. *Was your facility ever subject to flooding. If so, was the flooding due to:*

- i) *overflow from sanitary or storm sewer back-up, and/or*
- ii) *flood overflow from the Passaic River?*

The facility has been subject to flooding from the Passaic River.

10b. *Please provide the date and duration of each flood event.*

Review of available documents did not reveal any specific dates or duration of flood events.

11. *Please provide a detailed description of any civil, criminal or administrative proceedings against your company for violations of any local, State or federal laws or regulations relating to water pollution or hazardous waste generation, storage, transport or disposal. Provide copies of all pleadings and depositions or other testimony given in these proceedings.*

On April 27, 1976 a \$750 fine was imposed on Thomasset for violations of the SPCC regulations under Section 311 of the Federal Water Pollution Control Act. Note that this response is limited to the Thomasset facility located at 120 Lister Avenue in Newark, New Jersey from March 11, 1957 to October 23, 1986.

12. *Provide a copy of each document which relates to the generation, purchase, use, handling, hauling, and/or disposal of all hazardous substances, including, but not limited to, the substances listed in response to item (3) or (4). If you are unable to provide a copy of any document, then identify the document by describing the nature of the document (e.g. letter, file memo, invoice, inventory form, billing record, hazardous waste manifests, etc.). Describe the relevant information contained therein. Identify the name and job title the person who prepared the document. If the document is not readily available, state where it is stored, maintained, or why it is unavailable.*

In review with legal counsel, it has been determined that this request is over broad and beyond the Agency's administrative authority.

13. *Provide all other documents pertaining to the results of any analyses of ground water, surface water, ambient air, and any other environmental media performed at the facility.*

We are not aware of any sampling or analyses of ground water, surface water, ambient air, or other environmental media performed at the facility during Thomasset's period of operation. However, significant soil and groundwater sampling has been conducted by Sterling from 1987 through 1995 in connection a New Jersey Department of Environmental Protection ECRA/ISRA investigation and cleanup.

Mr. Lance R. Richman, P.G.
U.S. Environmental Protection Agency
January 3, 1996

- 14a. *From whom did your company purchase the property and in what year? If your company subsequently sold the property, to whom did your company sell it and in what year? Please provide copies of any deeds and documents of sale.*

Sterling purchased Thomasset, the owner of the facility, on March 11, 1957. Sterling sold the property to Freedom in late 1993 (see response to question 1 above).

- 14b. *To the extent that you know, please provide the names of all parties who owned or operated the facility during the period from 1940 through the present. Describe the relationship, if any, of each of those parties with your company.*

Listed below is a chronology of parties who owned or operated the facility.

Owner/Operator	From	To
Freedom Chemical Company	September 1993	present
PMC Specialties	October 1986	September 1993
Sterling Winthrop Inc.	March 1957	October 1986
Thomasset Colors, Inc. (pre Sterling)	June 1955	March 1957
Turco Products, Inc.	July 1950	June 1955
Swan-Finch Oil Corporation	March 1930	July 1950
American Agricultural Chemical Co.	Unknown	March 1930

15. *Answer the following questions regarding your business or company. In identifying a company that no longer exists, provide all the information requested, except for the agent for service or process. If your company did business under more than one name, list each name.*

During the period from 1957 to 1986, Thomasset was affiliated as a division of Sterling and later of Hilton-Davis. Sterling Drug Inc., a Delaware Corporation, acquired all of the capital stock of Thomasset Colors, Inc., a New Jersey Corporation, on March 11, 1957. Thomasset was liquidated in a Plan of Liquidation dated April 30, 1961. Thomasset operated as "Thomasset Colors, Division of Sterling Drug Inc." until December 28, 1983, when Sterling transferred the assets of Thomasset to its subsidiary, The Hilton-Davis Chemical Company. On October 1, 1991, the name of Sterling Drug Inc. was changed to Sterling Winthrop Inc.

Mr. Lance R. Richman, P.G.
U.S. Environmental Protection Agency
January 4, 1996

16. *Provide the name, address, telephone number, title and occupation of the person(s) answering this "Request for Information" and state whether such person(s) has personal knowledge of the responses. In addition, identify each person who assisted in any way in responding to the "Request for Information" and specify the question to which each person assisted in responding.*

This response is provided by Mr. Joseph G. Gabriel, Vice-President, 360 North Pastoria Environmental Corporation (NPEC), which is located at 1100 Ridgeway Avenue, Rochester, New York 14652 (telephone: 716-588-4369). Mr. Gabriel does not have personal knowledge of the information relevant to these responses or of Thomasset's operations at the Site. This response was prepared based on documents obtained from the Sterling Corporate archives and the Hilton-Davis archives. In the course of answering this Request for Information, NPEC has relied upon the advice of counsel and its environmental consultants in researching relevant information.

If you have any questions or need additional information, please call me.

Sincerely,
360 North Pastoria Environmental Corporation

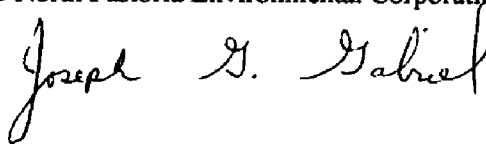

Enclosures

cc: Amelia Wagner, U.S. EPA
S. Nunley/G. Hickel, Bayer Corporation

CERTIFICATION OF ANSWERS TO REQUEST FOR INFORMATION

State of New York :

County of Monroe :

I certify under penalty of law that I have personally examined and am familiar with the information submitted in this document (response to EPA Request for Information) and all documents submitted herewith, and that based on my inquiry of those individuals immediately responsible for obtaining the information, I believe that the submitted information is true, accurate, and complete, and that all documents submitted herewith are complete and authentic unless otherwise indicated. I am aware that there are significant penalties for submitting false information, including the possibility of fine and imprisonment. I am also aware that my company is under a continuing obligation to supplement its response to EPA's Request for Information if any additional information relevant to the matters addressed in EPA's Request for Information or the company's response thereto should become known or available to the company.

Joseph G. Gabriel
NAME (print or type)

U. R. Operations N.P.E.C
TITLE (print or type)

Joseph G. Gabriel
SIGNATURE

Sworn to before me this 4th
day of January, 1996

Julie Y. Detor
Notary Public

JULIE Y. DETOR
Notary Public in the State of New York
MONROE COUNTY #01DE4980971
Commission Expires April 19, 1997

844710011

Attachment A

**Raw Material Inventory
Response to Questions 5(c) and 5(d)**

844710012

TABLE 2-1

Hilton Davis Facility Raw Material Inventory

(1) EPA TOXIC POLLUTANT
(2) EPA HAZ. SUBSTANCE

MATERIAL NAME	FORM	QUANTITY (LB)	LOCATION	STORAGE METHOD	REGULATORY STATUS
Corrosives					
Ammonia	Liquid	8437	Tank 67	Bulk	Yes, (2)
Acetic Acid 100%	Liquid	7859	Bldg. #6	Drum	Yes, (2)
Beta Oxy Napthoic Acid	Solid	2970	Bldg. #9	Drum	No
Carmines	Solid	209	Bldg. #9	Drum	No
Caustic Soda Flakes	Solid	4400	Bldg. #9	Drum	No
Lithosol Acid RBA	Solid	2000	Bldg. #9	Bag	No
Muriatic Acid	Liquid	1070	Bldg. #9	Carboy	No
Oleic Acid	Liquid	1377	Bldg. #9	Drum	No
Oxalic Acid	Solid	301	Bldg. #9	Bag	No
Para Toluidene Meta Sulfonic Acid	Solid	1876	Bldg. #9	Bag	No
Pure 4B Acid	Solid	50	Bldg. #9	Drum	No
Phosphoric Acid 75%	Liquid	1135	Bldg. #9	Drum	No
Sulfuric Acid	Liquid	28500	Bldg. #9	Tank	Yes, (2)
Pigments, Dyes, Colors					
Aerofloc	Solid	460	Bldg. #9	Bag	No
Blanc Fixe No. 333	Solid	505	Bldg. #9	Bag	No
Bon	Solid	4140	Bldg. #9	Drum	No
Black Oxide	Solid	5800	Bldg. #9	Bag	No
Celite	Solid	100	Bldg. #9	Bag	No
Crude Blue 92%	Solid	1148	Bldg. #8 & #9	Bag	No

TABLE 2-1

Hilton Davis Facility Raw Material Inventory

(1) EPA TOXIC POLLUTANT
(2) EPA HAZ. SUBSTANCE

MATERIAL NAME	FORM	QUANTITY (LB)	LOCATION	STORAGE METHOD	REGULATORY STATUS
D&C Red #21	Solid	300	Bldg. #6	Drum	No
Duponel	Solid	129	Bldg. #9	Drum	No
Dresinate X	Solid	900	Bldg. #9	Bag	No
D&C Orange #4	Solid	220	Bldg. #6	Drum	No
Hydrated Alum-Hydro #604	Solid	1046	Bldg. #9	Bag	No
Hisperse Iron Blue P3551	Solid	7250	Bldg. #9	Bag	No
Igepal 630	Solid	260	Bldg. #9	Drum	No
Iron Powder	Solid	10900	Bldg. #9	Bag	No
Krolin 378	Solid	338	Bldg. #9	Bag	No
Low Micron Talc	Solid	100	Bldg. #9	Bag	No
Mapico Red 617	Solid	28	Bldg. #9	Bag	No
Mapico Yellow 1075	Solid	295	Bldg. #9	Bag	No
Mang Violet 4	Solid	16	Bldg. #9	Bag	No
Marasperse N-22	Solid	1956	Bldg. #9	Bag	No
Mica V.F.	Solid	1711	Bldg. #8	Drum	No
Mapico Red 387	Solid	2490	Bldg. #9	Bag	No
Mapico Red R-3200	Solid	5723	Bldg. #9	Bag	No
Mapico Red 297	Solid	3050	Bldg. #9	Bag	No
Merlum Powder	Solid	75	Bldg. #9	Drum	No
Monochlor 4 Chlor, PTH	Solid	1360	Bldg. #9	Drum	No
No. 339 Talc <No. 461, 442	Solid	3229	Bldg. #9	Bag	No

TABLE 2-1

Hilton Davis Facility Raw Material Inventory

(1) EPA TOXIC POLLUTANT

(2) EPA HAZ. SUBSTANCE

MATERIAL NAME	FORM	QUANTITY (LB)	LOCATION	STORAGE METHOD	REGULATORY STATUS
Permaline Blue 6343	Solid	5544	Bldg. #9 yard	Drum	No
Red #6	Solid	100	Bldg. #9	Drum	No
Triethanolamine	Solid	363	Bldg. #9	Drum	Yes, (2)
Tech Mangan	Solid	1104	Bldg. #9	Bag	No
Ultra Pink	Solid	2200	Bldg. #9	Bag	No
Ultra Marine Violet 5C	Solid	2200	Bldg. #9	Bag	No
Ultra Blue	Solid	1500	Bldg. #9	Drum	No
Urea	Solid	8500	Bldg. #9	Bag	No
UMB EC-62	Solid	8800	Bldg. #9	Bag	No
Ultramarine Blue EC-40	Solid	13252	Bldg. #9	Bags & Drum	No
UMB EC-20	Solid	6600	Bldg. #9	Bags & Drum	No
Inorganic Salts					
Ammonium Sulfate	Solid	178	Bldg. #9	Bag	Yes, (2)
Aerosol OT	Liquid	37	Bldg. #9	Drum	No
Aluminum Chloride Solution	Liquid	900	Bldg. #9	Carboy	No
Bromine	Liquid	104	Bldg. #9	Bottle	No
Beta Naphthol	Solid	72	Bldg. #9	Drum	No
Barium Chloride	Solid	279	Bldg. #9	Bag	No
Bromine 225 gal. cont.	Liquid	1125	Bldg. #9	Drum	No
Calcium Chloride	Solid	641	Bldg. #9	Bag	No
Copper Sulfate Monohydrate	Solid	1000	Bldg. #9	Drum	Yes, (1)

TABLE 2-1

Hilton Davis Facility Raw Material Inventory

(1) EPA TOXIC POLLUTANT
(2) EPA HAZ. SUBSTANCE

MATERIAL NAME	FORM	QUANTITY (LB)	LOCATION	STORAGE METHOD	REGULATORY STATUS
Ferrous Sulfate	Solid	149045	Bldg. #9	Bag	Yes, (2)
Phthalic Anhydride	Solid	6600	Bldg. #8	Bag	Yes, (1)
Potassium Carbonate	Solid	747	Bldg. #9	Bag	No
Soda Ash	Solid	82600	Bldg. #8, #9	Bag	No
Soda Bicarb Tech	Solid	1500	Bldg. #9	Bag	No
Sodium Sulfate	Solid	351	Bldg. #9	Bag	No
Sodium Nitrate	Solid	185	Bldg. #9	Drum	Yes, (2)
Salt Granular	Solid	4720	Bldg. #9	Bag	No
Sodium Molybdate Anhyd.	Solid	1613	Bldg. #9	Drum	No
Sodium Chlorate	Solid	300	Bldg. #9 & #2	Drum	No
Sodium Hydrosulfide	Solid	606	Bldg. #9	Drum	Yes, (2)
Tri Poly Phos Soda	Solid	100	Bldg. #9	Bag	No
Tetra Sodium Pyro Phospha	Solid	1316	Bldg. #9	Bag	No
Titanium Dioxide A420	Solid	7253	Bldg. #9	Bag	No
Tetrecthloro Fluorescein	Solid	5664	Bldg. #8	Drum	No
Zirconium Oxy	Solid	3172	Bldg. #9 & #2	Drum	No

Attachment B

**Diagram of Wastewater Collection and Treatment System
Response to Question 6(d)**

844710017

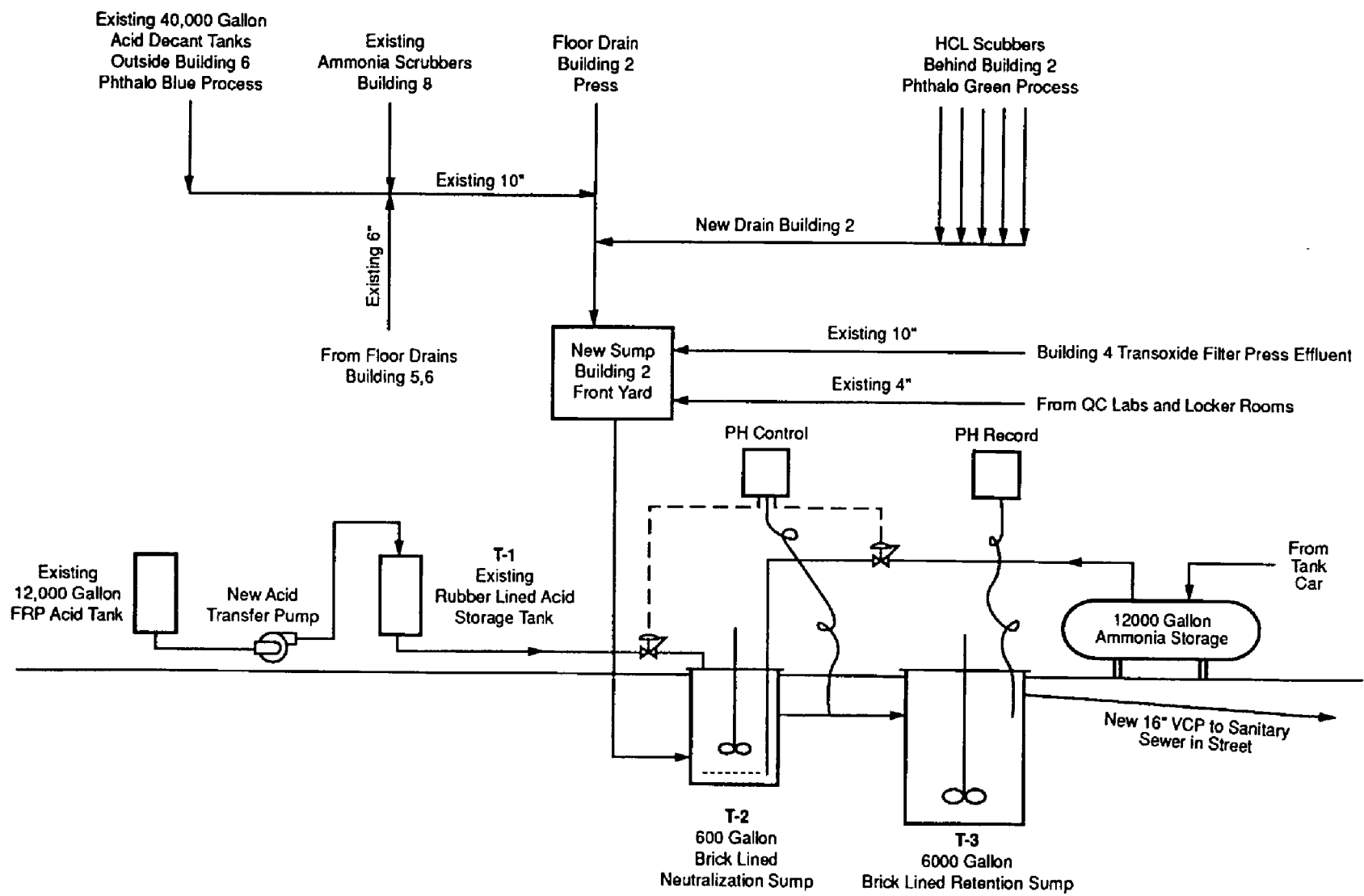

EFFLUENT NEUTRALIZATION SYSTEM - 1971
THOMASSET COLORS INC.

Attachment C

**Documents Relating to Spill Incidents
Response to Question 8**

844710019

AUG 27 1971

THOMAS LATZIO
CHAIRMAN
WALTER J. DAVIS
VICE CHAIRMAN
CARMINE T. PERRAPATO
BENJAMIN W. GORDON
LOUIS BAY, 2ND
COMMISSIONERS

PASSAIC VALLEY SEWERAGE COMMISSIONERS
790 BROAD STREET
NEWARK, N.J. 07102

SEYMOUR A. LUBETKIN
CHIEF ENGINEER
JAMES V. SEGRETO
CHIEF COUNSEL
MRS. CHARLES T. SCHAEDEL
CLERK, TREASURER

August 25, 1971

Tomasset Color Company
120 Lister Avenue
Newark, New Jersey 07102

Attn: Mr. Paul Tomasset, Vice President

Dear Sir:

This will confirm our conversation at the time of my visit to your plant on August 19, 1971.

A green material in the Passaic River, coming from the Lockwood Street Storm Sewer, was traced back to your company. Further inspection indicated that an accident occurred at your plant wherein, a container of green fluorescent dye was discharged into a catch basin within your plant area, which thence reached the Lockwood Street Storm Sewer and the Passaic River.

I pointed out to you during our inspection, that the area was extremely sloppy and pollution could occur not only by accidental spills, but during any time rain would wash the material which was lying on the ground, to the storm sewer. I informed you that the area which drains to any storm sewer must be cleared of any spillage and kept clean. I also informed you that if it was impossible to keep clean, you must repipe this sewer to the sanitary system, if allowed by the City of Newark. In any case, the polluting material could not be allowed to reach the Passaic River.

The Commissioners request a reply to this letter, in which you will inform them of what steps you will take to prevent a further pollution to the Passaic River from your plant, together with a time table indicating when these steps taken will be completed. At that time the Commissioners would desire to re-inspect your plant area to determine if all possible points of pollution have been eliminated.

Very truly yours,

PASSAIC VALLEY SEWERAGE COMMISSIONERS

S. A. Lubetkin,
Chief Engineer

SAL:mr.

Certified Mail/

C.C. TO: P.V.S.C., Chief Counsel Segreto, Messrs. Goldberg,
Fleming, Cuccinello, & De Lane.

844710020

September 9, 1971

Mr. S.A. Lubetkin
Chief Engineer
Passaic Valley Sewerage Commissioners
790 Broad Street
Newark, New Jersey

Dear Mr. Lubetkin;

The catch basin area in question has been cleaned and maintained since your visit of August 19, 1971. This area has been inspected twice by John McLaughlin during this period, and he indicated the housekeeping was satisfactory.

In addition, we are presently installing a seventy foot long six inch plastic drain to receive all scrubbing water and effluent in this area. This will be installed by the end of September.

Finally, no further production of fluorescein is anticipated this year. If we manufacture this product in the future, we will recover and bleach all dye effluent before discharging to the sanitary sewer.

Very truly yours,

Paul B. Thomasset

RT/sc
CC - Mr. Roger Rodwin ✓
Mr. Doug Eisenfelder

844710021



FEB 15 1972

CITY OF NEWARK, NEW JERSEY
KENNETH A. GIBSON, Mayor

DEPARTMENT OF HEALTH AND WELFARE
DR. ALAN S. CLARK, Director

CORNELIUS BODINE
BUSINESS ADMINISTRATOR

DIVISION OF INSPECTIONS
ARMAND E. LEMBO
DIRECTOR

February 18, 1972

Thomas Set Colors
120 Lister Avenue
Newark, New Jersey

Re: 120 Lister Avenue

Dear Sir:

A recent inspection made by the Division of Inspections discloses the following violations: Section: 13.10.1 - Plumbing Code

The Sewer Department took out a sample from the sewer line and found chemical in the line.

Have this condition checked for a defective sewer line or you are putting same chemical in the line from your tank.

Inspector: James Policastro

You are hereby notified that a reinspection will be made within 30 days. All violations must be corrected at the expiration of that time or a court complaint will be issued against you for failure to comply with the rules and regulations of this Division.

SECTION 15:2-4
ANY PERSON SERVED WITH ANY NOTICE REFERRED TO IN THIS SECTION MAY REQUEST A HEARING THEREON, PROVIDED SUCH REQUEST IS MADE IN WRITING AND FILED WITH THE DIRECTOR, DEPARTMENT OF HEALTH AND WELFARE, ROOM 210, CITY HALL, NEWARK, N. J. WITHIN FIVE DAYS AFTER THE DATE NOTICE WAS SERVED.

JG:rs

Very truly yours,

John G. Gorman
John Gorman
Chief Plumbing Inspector

844710022

Copied for H. F. Singer
& Kenneth
R. Warner

XXXXX 344-7308

February 23, 1972

Dr. Alan B. Clark, Director
Department of Health and Welfare
Room 210
City Hall
Newark, New Jersey

Dear Dr. Clark:

I have received a letter from John Geumaria that we are in violation of Section 13.10.1 - Plumbing Code - because there is chemical in our sewer line (copy enclosed).

I would appreciate clarification of this. Which sewer, storm or sanitary? Where and when was the sample taken and how was it taken? What chemicals were found?

This facility is in the business of manufacturing various organic and inorganic chemicals, our normal discharge often contains various salts and solids. To my knowledge the mere presence of chemical does not constitute a violation.

We are familiar with the Newark sewer discharge codes and do not exceed any of their specifications.

Very truly yours,

THOMASSET COLORS DIV.

Paul B. Thomasset
Vice President

PBT/rt
Enc.

cc: Mr. W. H. Johnson ✓
Mr. D. Eisenfelder

844710023

UH 18 1996

GENERAL NOTICE LETTER
URGENT LEGAL MATTER
EXPRESS MAIL - RETURN RECEIPT REQUESTED

Mr. Joseph G. Gabriel
Vice President of Operations
360 North Pastoria Environmental Corporation
1100 Ridgeway Avenue
Rochester, New York 14652-6280

Re: Diamond Alkali Superfund Site
Notice of Potential Liability of Sterling Drug for
Response actions in the Passaic River Study Area

Dear Mr. Gabriel:

The United States Environmental Protection Agency ("EPA") is charged with responding to the release and/or threatened release of hazardous substances, pollutants, and contaminants into the environment and with enforcement responsibilities under the Comprehensive Environmental Response, Compensation, and Liability Act of 1980 ("CERCLA"), as amended, 42 U.S.C. §9601 et seq.

EPA has documented the release or threatened release of hazardous substances, pollutants and contaminants into the Passaic River Study Area which is part of the Diamond Alkali Superfund Site ("Site"). By this letter, EPA has determined that Sterling Drug, Inc. ("Sterling") (now known as Sterling Winthrop, Inc.) as the owner of Thomasset Colors, Inc., may be potentially liable relating to the Site pursuant to Section 107 of CERCLA. EPA is notifying 360 North Pastoria Environmental Corporation (a wholly-owned subsidiary of Eastman Kodak Company) of Sterling's potential liability with the understanding that 360 North Pastoria Environmental Corporation is handling Sterling's environmental liabilities.

Sediment in the Passaic River contain numerous hazardous substances, pollutants and contaminants. Investigations undertaken by EPA indicated that hazardous materials were being released from the former Thomasset facility located at 120 Lister Avenue in Newark, New Jersey, into the Passaic River Study Area. Hazardous substances, pollutants and contaminants released from the facility into the Passaic River Study Area present a risk to the environment and the humans who may ingest contaminated fish

ORG. ^{WAGNER}
WAGNER
7/16/96

ERRD ^{RICHMAN}
RICHMAN
7/16

ERRD ^{DIFORTE}
DIFORTE
7/16

ERRD ^{FRISCO}
FRISCO

ERRD ^{PAVLOU}
PAVLOU

ERRD ^{CALLAHAN}
CALLAHAN

JBF 7/18/96

844650001

and shellfish. Therefore, Sterling may be potentially liable for all response costs which the government may incur relating to the Passaic River Study Area.

Under Sections 106(a) and 107(a) of CERCLA, 42 U.S.C. §9606(a) and §9607(a) and other laws, potentially responsible parties ("PRPs") may be obligated to implement response actions deemed necessary by EPA to protect public health, welfare or the environment, and may be liable for all costs incurred by the government in responding to any release or threatened release at the Site. If response actions are performed by EPA rather than by the PRPs, those PRPs may be subject to legal action pursuant to Section 107(a) of CERCLA, 42 U.S.C. §9607(a), to recover public funds expended by EPA in response to the release and threatened release of hazardous materials at the Site. Such actions and costs may include, but need not be limited to, expenditures for conducting a Remedial Investigation/Feasibility Study ("RI/FS"), a Remedial Design/Remedial Action, and other investigation, planning, response, oversight, and enforcement activities. In addition, responsible parties may be required to pay damages for injury to, destruction of, or loss of natural resources, including the cost of assessing such damages.

While EPA has the discretionary authority to invoke special notice procedures, EPA hereby notifies you that it will not utilize the special notice procedures contained in Section 122(e) of CERCLA, 42 U.S.C. §9622(e). EPA has concluded that use of the special notice procedures in Section 122(e) of CERCLA would delay the implementation of the RI/FS which is currently being performed at the Site to determine the extent of contamination and to evaluate possible actions to mitigate any adverse effects. EPA will determine at a subsequent time whether additional measures are required to mitigate releases from the Site in order to protect the public health, welfare, and the environment. The decision not to use the special notice procedures does not preclude you from entering into discussions with EPA regarding your participation in activities at the Site.

By this letter, EPA encourages you, as a PRP, to voluntarily participate in the EPA-approved activities underway at the Passaic River Study Area in conjunction with other PRPs. At the present time, an RI/FS is being performed at the Study Area under an Administrative Consent Order with the Occidental Chemical Corporation ("OCC"). The actual work is being performed by Maxus Energy Corporation ("Maxus"), pursuant to certain contractual arrangements with OCC, and should be contacted for information pertaining to the work being done. Maxus can be contacted at the addresses listed in the Attachment to this letter. Other PRPs who have received Notice letters are also listed in the Attachment. Be advised that notice of your potential liability at the Site is being forwarded to OCC by EPA.

844650002

EPA requests your cooperation in this matter. If you are interested in participating in the ongoing response action you should notify EPA of your intentions to join with OCC. Notification should be in writing and should be delivered to EPA no later than fourteen (14) days after the date that you receive this letter. Your letter should be sent to:

Lance R. Richman, P.G.
U.S. Environmental Protection Agency
Emergency and Remedial Response Division
290 Broadway, Floor 19
New York, NY 10007-1866,

with a copy to Ms. Amelia Wagner, Esq., of the Office of Regional Counsel, Floor 17 at the same street address.

If EPA does not receive a written response from you in the time specified above, EPA will assume that you voluntarily decline to participate in any of the response actions taking place at the Site. EPA reserves the right to pursue its available enforcement options with regard to the site.

If you wish to discuss this matter further, please contact Mr. Lance R. Richman, P.G., of my staff at (212) 637-4409 or Ms. Wagner at (212) 637-3141. Please note that all communications from attorneys should be directed to Ms. Wagner.

Sincerely yours,

Kathleen Callahan, Director
Emergency and Remedial Response Division

Attachments

CC: Elliott Stern, Esq.
Eastman Kodak, Legal Department

Ms. Carol Dinkins, Esq.
Vinson & Elkins, L.L.P.

Mr. Richard P. McNutt
Maxus Energy Corporation

844650003

ATTACHMENT

Contact for Maxus Energy Corporation:

Mr. Richard P. McNutt
Maxus Energy Corporation
1015 Belleville Turnpike
Kearny, New Jersey 07032

Counsel: Ms. Carol E. Dinkins, Esq.
Vinson & Elkins, L.L.P.
2300 First City Tower
1001 Fannin Street
Houston, Texas 77002-6760

PRPs in receipt of Notice Letters:

Mr. J. Roger Hirl
President and Chairman of the Board
Occidental Chemical Company
Occidental Tower
5005 LBJ Freeway
Dallas, Texas 75244

Mr. Robert L. Ball, President
Alcan Aluminum Corporation
100 Erieview Plaza, 29th Floor
Cleveland, Ohio 44114

Counsel: Lawrence A. Salibra II, Esq., Senior Counsel
Alcan Aluminum Corporation
6060 Parkland Blvd.
Mayfield, Hts., Ohio 44124

Mr. David J. D'Antoni, President
Ashland Chemical Company
P.O. Box 2219
Columbus, Ohio 43216

Counsel: Stephen W. Leermakers, Esq., Senior Litigation Counsel
Ashland Chemical Company
5200 Blazer Parkway
Dublin, Ohio 43017

844650004

Mr. Maurice C. Workman, President
Benjamin Moore & Co.
51 Chestnut Ridge Road
Montvale, New Jersey 07645

Counsel: Arthur A. Schulcz, Sr., Esq.
The Harker Firm
Suite 740
5301 Wisconsin Avenue, N.W.
Washington, D.C. 20015

Brian C. Kelly, Esq.
Chris-Craft Industries, Inc.
600 Madison Avenue
New York, New York 10022

Counsel: Peter Simshauser, Esq.
Skadden, Arps, Slate, Meagher & Flom
300 South Grand Avenue
Los Angeles, California 90071-3144

Mr. Edgar S. Woolward, Jr., Chairman
E.I. du Pont de Nemours and Company
1007 Market Street
Wilmington, Delaware 19898

Counsel: Bernard J. Reilly, Esq., Corporate Counsel
E.I. du Pont de Nemours and Company

Mr. Richard J. Mahoney, Chief Executive
Monsanto Company
800 N. Lindbergh Blvd.
St. Louis, Missouri 63167

Counsel: Peter H. Smith, Esq., Assistant Environmental Counsel
Monsanto Company

Mr. Robert D. McNeeley, President
Reilly Industries, Inc.
1510 Market Square Center
151 North Delaware Street
Indianapolis, IN 46204

Counsel: Jacqueline A. Simmons, Esq.
Reilly Industries, Inc.

844650005

Mr. John G. Breen, Chairman of the Board
The Sherwin-Williams Company
101 Prospect Avenue, N.W.
Cleveland, Ohio 44115-1075

Counsel: Donald J. McConnell, Esq., Environmental Counsel
The Sherwin-Williams Company

844650006



UNITED STATES ENVIRONMENTAL PROTECTION AGENCY
REGION 2
290 BROADWAY
NEW YORK, NY 10007-1866

SEP 15 2003

**GENERAL NOTICE LETTER
CERTIFIED MAIL-RETURN RECEIPT REQUESTED**

Joseph Gabriel
Vice President of Operations
360 North Pastoria Environmental Corp.
1100 Ridgeway Avenue
Rochester, New York 14652-6280

RE: Diamond Alkali Superfund Site
Notice of Potential Liability for
Response Actions in the Lower Passaic River, New Jersey

Dear Mr. Gabriel:

The United States Environmental Protection Agency ("EPA") is charged with responding to the release and/or threatened release of hazardous substances, pollutants, and contaminants into the environment and with enforcement responsibilities under the Comprehensive Environmental Response, Compensation, and Liability Act of 1980, as amended ("CERCLA"), 42 U.S.C. §9601 *et seq.*

You received a letter from EPA, dated July 18, 1996, notifying 360 North Pastoria Environmental Corp. ("360 North Pastoria") of its potential liability relating to the Passaic River Study Area, which is part of the Diamond Alkali Superfund Site ("Site") located in Newark, New Jersey, pursuant to Section 107(a) of CERCLA, 42 U.S.C. §9607(a). Under CERCLA, potentially responsible parties ("PRPs") include current and past owners of a facility, as well as persons who arranged for the disposal or treatment of hazardous substances at the Site, or the transport of hazardous substances to the Site. Accordingly, EPA is seeking your cooperation in an innovative approach to environmental remediation and restoration activities for the Lower Passaic River.

EPA has documented the release or threatened release of hazardous substances, pollutants and contaminants into the six-mile stretch of the river, known as the Passaic River Study Area, which is part of the Site located in Newark, New Jersey. Based on the results of previous CERCLA remedial investigation activities and other environmental studies, including a reconnaissance study of the Passaic River conducted by the United States Army Corps of Engineers ("USACE"), EPA has further determined that contaminated sediments and other potential sources of hazardous substances exist along the entire 17-mile tidal reach of the Lower Passaic River. Thus, EPA has decided to expand the Study to include the areal extent of contamination to which hazardous substances from the six-mile stretch were transported; and those sources from which

851530001

Internet Address (URL) • <http://www.epa.gov>

Recycled/Recyclable • Printed with Vegetable Oil Based Inks on Recycled Paper (Minimum 50% Postconsumer content)

TIERRA-B-001214

hazardous substances outside the six-mile stretch have come to be located within the expanded Study Area.

In recognition of our complementary roles, EPA has formed a partnership with USACE and the New Jersey Department of Transportation-Office of Maritime Resources ("OMR") ["the governmental partnership"] to identify and to address water quality improvement, remediation, and restoration opportunities in the 17-mile Lower Passaic River. This governmental partnership is consistent with a national Memorandum of Understanding ("MOU") executed on July 2, 2002 between EPA and USACE. This MOU calls for the two agencies to cooperate, where appropriate, on environmental remediation and restoration of degraded urban rivers and related resources. In agreeing to implement the MOU, the EPA and USACE will use their existing statutory and regulatory authorities in a coordinated manner. These authorities for EPA include CERCLA, the Clean Water Act, and the Resource Conservation and Recovery Act. The USACE's authority stems from the Water Resources Development Act ("WRDA"). WRDA allows for the use of some federal funds to pay for a portion of the USACE's approved projects related to ecosystem restoration.

For the first phase of the Lower Passaic River Project, the governmental partners are proceeding with an integrated five- to seven-year study to determine an appropriate remediation and restoration plan for the river. The study will involve investigation of environmental impacts and pollution sources, as well as evaluation of alternative actions, leading to recommendations of environmental remediation and restoration activities. This study is being conducted by EPA under the authority of CERCLA and by USACE and OMR, as local sponsor, under WRDA. EPA, USACE, and OMR are coordinating with the New Jersey Department of Environmental Protection and the Federal and State Natural Resource Trustee agencies. EPA, USACE, and OMR estimate that the study will cost approximately \$20 million, with the WRDA and CERCLA shares being about \$10 million each. EPA will be seeking its share of the costs of the study from PRPs.

Based on information that EPA evaluated during the course of its investigation of the Site, EPA believes that hazardous substances were being released from the former Thomasett Colors/Sterling facility located at 120 Lister Avenue in Newark, New Jersey, into the Lower Passaic River. Hazardous substances, pollutants and contaminants released from the facility into the river present a risk to the environment and the humans who may ingest contaminated fish and shellfish. Therefore, 360 North Pastoria may be potentially liable for response costs which the government may incur relating to the study of the Lower Passaic River. In addition, responsible parties may be required to pay damages for injury to, destruction of, or loss of natural resources, including the cost of assessing such damages.

Enclosed is a list of the other PRPs who have received Notice letters. This list represents EPA's findings on the identities of PRPs to date. We are continuing efforts to locate additional PRPs who have released hazardous substances, directly or indirectly, into the Passaic River. Inclusion on, or exclusion from, the list does not constitute a final determination by EPA concerning the liability of any party for the release or threat of release of hazardous substances at the Site. Be advised that notice of your potential liability at the Site is being forwarded to all parties on this

851530002

list.

We request that you consider becoming a "cooperating party" for the Lower Passaic River Project. As a cooperating party, you, along with many other such parties, will be expected to fund EPA's share of the study costs. Upon completion of the study, it is expected that CERCLA and WRDA processes will be used to identify the required remediation and restoration programs, as well as the assignment of remediation and restoration costs. At this time, the commitments of the cooperating parties will apply only to the study. For those who choose not to cooperate, EPA may apply the CERCLA enforcement process, pursuant to Sections 106 (a) and 107(a) of CERCLA, 42 U.S.C. §9606(a) and §9607(a) and other laws.

Pursuant to CERCLA Section 113(k), EPA must establish an administrative record that contains documents that form the basis of EPA's decision on the selection of a response action for a site. The administrative record files, which contain the documents related to the response action selected for this Site are located at EPA's Region 2 office (290 Broadway, New York) on the 18th floor. You may call the Records Center at (212) 637-4308 to make an appointment to view the administrative record for the Lower Passaic River Project.

EPA will be holding a meeting with all PRPs on October 29, 2003 at 10:00 AM in Conference Room 27A at the Region 2 office. At that meeting, EPA will provide information about the actions taken to date in the Lower Passaic River, as well as plans for future activities. After the presentation, PRPs will be given the opportunity to caucus, and EPA will return to answer any questions that might be generated during the private session. Please be advised that due to increased security measures, all visitors need to be registered with the security desk in the lobby in order to gain entry to the office. In order to ensure a smooth arrival, you will need to provide EPA with a list of attendees no later than October 15, 2003.

EPA recommends that the cooperating parties select a steering committee to represent the group's interest as soon as possible, since EPA expects a funding commitment for the financing of the CERCLA share of the \$20 million study by mid-November 2003. If you wish to discuss this further, please contact Ms. Alice Yeh, Remedial Project Manager, at (212) 637-4427 or Ms. Kedari Reddy, Assistant Regional Counsel, at (212) 637-3106. Please note that all communications from attorneys should be directed to Ms. Reddy.

Sincerely yours,



George Pavlou, Director
Emergency and Remedial Response Division

Enclosure

cc: Philip Sellinger, Esq.
Sills Cummis Zuckerman

851530003

PRPs in Receipt of Notice Letters:

PRP	Legal Counsel
<p>J. Roger Hirl President and Chairman of the Board Occidental Chemical Co. Occidental Tower 5005 LBJ Freeway Dallas, Texas 75244</p>	<p>Paul W. Herring, Esq. Andrews & Kurth L.L.P. 1717 Main Street, Suite 3700 Dallas, Texas 75201</p>
<p>Joseph Gabriel Vice President of Operations 360 North Pastoria Environmental Corp. 1100 Ridgeway Avenue Rochester, New York 14652-6280</p>	<p>Philip Sellinger, Esq. Sills Cummis Zuckerman One Riverfront Plaza Newark, NJ 07102</p>
<p>Robert Ball, President Alcan Aluminum Corporation 100 Erieview Plaza, 29th Floor Cleveland, Ohio 44114</p>	<p>Lawrence Salibra, Esq. Alcan Aluminum Corporation 6060 Parkland Blvd. Mayfield Hts., OH 44124</p>
<p>Mark Epstein, President Alden Leeds Inc. 55 Jacobus Ave. Kearny, New Jersey 07032</p>	<p>Eric Aronson, Esq. Whitman Breed Abbott & Morgan One Gateway Center Newark, NJ 07102</p>
<p>Alan Bendelius, President Alliance Chemical, Inc. Linden Avenue Ridgefield, New Jersey 07657</p>	<p>Fredi L. Pearlmuter, Esq. Cooper, Rose & English, LLP 480 Morris Avenue Summit, New Jersey 07901-1527</p>
<p>William Gentner, President The Andrew Jergens Co. 2535 Spring Grove Ave. Cincinnati, Ohio 45214</p>	<p>A. Christian Worrell III, Esq. Head & Ritchey, LLP 1900 Fifth Third Center 511 Walnut Street Cincinnati, OH 45202</p>
<p>Gary Cappeline, President Ashland Specialty Chemical Co. 5200 Blazer Parkway Dublin, Ohio 43017</p>	<p>Stephen Leermakers, Esq. Ashland Specialty Chemical Co. 5200 Blazer Parkway Dublin, OH 43017</p>
<p>Klaus Peter Loebbe, President BASF Corporation 3000 Continental Drive North Mount Olive, New Jersey 07828</p>	<p>Nan Bernardo, Esq. and Nancy Lake Martin, Esq. BASF Corporation 3000 Continental Drive North Mount Olive, NJ 07828</p>

851530004

Joseph Akers, Vice President Bayer Corporation 100 Bayer Road Pittsburgh, Pennsylvania 15205-9741	Gerard Hickel, Esq. Bayer Corporation 100 Bayer Road Pittsburgh, PA 15205-9741
Yvan Dupay, President Benjamin Moore & Co. 51 Chestnut Ridge Road Montvale, New Jersey 07645	Arthur Schulz, Esq. Environmental Counsel 4910 Massachusetts Ave., N.W. Suite 221 Washington, DC 20016
Alberto Celleri, President Chemical Compounds Inc. 10 Baldwin Court Roseland, New Jersey 07086	Jim Giannotti Chemical Compounds Inc. 29-75 Riverside Avenue Newark, NJ 07104
President Chris-Craft Industries, Inc. 767 Fifth Avenue, 46th Floor New York, New York 10153	Brian Kelly, Esq. Chris-Craft Industries, Inc. 767 Fifth Avenue, 46th Floor New York, NY 10153
John Guffey, President Coltec Industries, Inc. 3 Coliseum Centre 2550 West Tyvola Road Charlotte, North Carolina 28217	John R. Mayo, Esq. Coltec Industries, Inc. 430 Park Avenue New York, NY 10022
Roger Marcus, President Congoleum Corporation 3705 Quakerbridge Road Mercerville, New Jersey 08619	Russell Hewit, Esq. Dughi & Hewit 340 North Avenue Cranford, NJ 07016
Martin Benante, Chairman Curtiss-Wright Corp. 4 Becker Farm Road Roseland, New Jersey 07068	James Maher, Esq. Curtiss-Wright Corp. 4 Becker Farm Road Roseland, NJ 07068
Antonio Perez, President Eastman Kodak Company 343 State Street Rochester, New York 14650	Elliot Stern, Esq. Eastman Kodak Company 343 State Street Rochester, NY 14650
Edgar Woolard, Chairman E.I. du Pont de Nemours & Co. 1007 Market Street Wilmington, Delaware 19898	Bernard J. Reilly, Esq. Corporate Counsel E.I. du Pont de Nemours & Co. 1007 Market Street Wilmington, DE 19898

851530005

David Weisman, CEO Elan Chemical Company 268 Doremus Ave. Newark, New Jersey 07105	Jeffrey Schwartz, Esq. Sarber Schlesinger Satz & Goldstein One Gateway Center Newark, NJ 07102
Al Reisch, President E M Sergeant Pulp & Chemical Co. Inc. 6 Chelsea Road Clifton, New Jersey 07102	None
Mark Tucker, Esq. Essex Chemical Corp. 2030 WMDC Midland, Michigan 48674	Kenneth Mack, Esq. Fox, Rothschild, O'Brien & Frankel Princeton Pike Corp.Center 997 Lenox Drive, Building 3 Lawrenceville, NJ 08648
Todd Walker, President Fairmount Chemical Co. Inc. 117 Blanchard St. Newark, New Jersey 07105	John Ix, Esq. Porzio Bromberg & Newman 163 Madison Ave. Morristown, NJ 07962
Bradley Buechler, President Franklin-Burlington Plastics Inc. 113 Passaic Ave. Kearny, New Jersey 07032	Robert M. Becker, Esq. Kraemer, Burns, Mytelka & Lovell, P.A. 675 Morris Ave. Springfield, NJ 07081
Henry Benz, President Hoescht Celanese Chemicals, Inc. Route 202-206 P.O.Box 2500 Somerville, New Jersey 08876	Anne Conley-Pitchell, Esq. Hoescht Celanese Corp. Route 202-206 P.O.Box 2500 Somerville, NJ 08876
Francine Rothschild, President Kearny Smelting & Refining 936 Harrison Ave #5 Kearny, New Jersey 07032	None
Henry Schact, CEO Lucent Technologies, Inc. 600 Mountain Avenue Murray Hill, New Jersey 07974	Ralph McMurry, Esq. Hill, Betts & Nash LLP 1 Riverfront Plaza, Suite 327 Newark, NJ 07102-5401
Richard Meelia, President Mallinckrodt, Inc. 675 McDonnell Blvd. Hazelwood, Missouri 63042	Patricia Duft, Esq. Mallinckrodt, Inc. 675 McDonnell Blvd. Hazelwood, MO 63042

851530006

Richard Mahoney, CEO Monsanto Company 800 N. Lindbergh Blvd. St. Louis, Missouri 63167	L. William Higley, Esq. Monsanto Company 800 N. Lindbergh Blvd. St. Louis, MO 63167
Joseph Galli, President Newell Rubbermaid, Inc. 29 E. Stephenson St. Freeport, Illinois 61032	Peter Schultz, Director Environmental Affairs Newell Co. 4000 Auburn St. Rockford, IL 61101
Jean-Pierre van Rooy, President Otis Elevator Company North American Operations 10 Farm Springs Road Farmington, Connecticut 06032	Sarah Hurley, Esq. Robinson & Cole LLP 695 East Main Street Stamford, CT 06904-2305
Richard Ablon, President Ogden Corporation Two Pennsylvania Plaza, 25 th Floor New York, New York 10121	J.L. Effinger, Esq. Ogden Corporation Two Pennsylvania Plaza, 25 th Floor New York, NY 10121
Henry McKinnell, Chairman Pfizer Inc. 235 E. 42 nd St. New York, New York 10017	Michael McThomas, Esq. Pfizer Inc. 235 E. 42 nd St. New York, NY 10017
Raymond LeBoeuf, President PPG Industries, Inc. One PPG Place Pittsburgh, Pennsylvania 15272	Joseph Karas, Esq. PPG Industries, Inc. One PPG Place Pittsburgh, PA 15272
Lawrence Codey, President PSE&G Co. P.O. Box 570 Newark, New Jersey 07101-0570	Hugh Mahoney, Esq. PSE&G Co. P.O. Box 570 Newark, NJ 07101
Phillip D. Ashkettle, President Reichhold Chemicals, Inc. P.O. Box 13582 Research Triangle Park, North Carolina 27709	Adam S. Walters, Esq. Phillips, Lytle, Hitchcock, Blaine & Huber 3400 Marine Midland Center Buffalo, NY 14203
Robert McNeeley, President Reilly Industries, Inc. 1510 Market Square Center 151 North Delaware Street Indianapolis, Indiana 46204	Paul Rivers, Director Corporate Environmental Affairs Reilly Industries, Inc. 1500 S. Tibbs Avenue Indianapolis, IN 46242

851530007

Robert Finn, President RSR Corporation 2777 Stemmons Freeway, Suite 1800 Dallas, Texas 75207	Howard Myers, Esq. RSR Corporation 2777 Stemmons Freeway, Suite 1800 Dallas, TX 75207
Christopher Connor, CEO The Sherwin-Williams Company 101 Prospect Avenue, N.W. Cleveland, Ohio 44115-1075	Donald McConnell, Esq. The Sherwin-Williams Co. 101 Prospect Ave., N.W. Cleveland, OH 44115
George Barrett, President Teva Pharmaceuticals USA Inc. 1090 Horsham Road North Wales, Pennsylvania 19454	Kirsten E. Bauer, Esq. Teva North America 1090 Horsham Road North Wales, PA 19454
Robert Senior, President Three County Volkswagen 701 Riverside Ave. Lyndhurst, New Jersey 07071	Robert DiLascio, Esq. 30 Park Avenue, Suite 101 Lyndhurst, NJ 07071
Michael Jordan, President Westinghouse Electric Corp. 11 Stanwix Street Pittsburgh, Pennsylvania 15222	Roger Willis, Esq. Westinghouse Electric Corp. 11 Stanwix Street Pittsburgh, PA 15222
Isaac Weinberger, President Wiggins Plastics Inc. 547 Maitland Ave. Teaneck, New Jersey 07666	None

851530008

AUG 06 1996

GENERAL NOTICE LETTER
URGENT LEGAL MATTER
EXPRESS MAIL - RETURN RECEIPT REQUESTED

Mr. George M. Fisher, President
Eastman Kodak Company
343 State Street
Rochester, New York 14650

Re: Notice of Potential Liability of Sterling Winthrop for
Response actions in the Passaic River Study Area
Diamond Alkali Superfund Site, Newark, New Jersey

Dear Sir:

The United States Environmental Protection Agency ("EPA") is charged with responding to the release and/or threatened release of hazardous substances, pollutants, and contaminants into the environment and with enforcement responsibilities under the Comprehensive Environmental Response, Compensation, and Liability Act of 1980 ("CERCLA"), as amended, 42 U.S.C. §9601 et seq.

EPA has documented the release or threatened release of hazardous substances, pollutants and contaminants into the Passaic River Study Area which is part of the Diamond Alkali Superfund Site ("Site") located in Newark, New Jersey. By this letter, EPA has determined that Sterling Winthrop, Inc. ("Sterling"), as the owner of the former Thomasset Colors, Inc. located at 120 Lister Avenue, may be potentially liable relating to the Site pursuant to Section 107 of CERCLA. EPA is notifying Eastman Kodak Company of Sterling's potential liability as the owner of 360 North Pastoria Environmental Corporation (a wholly-owned subsidiary of Eastman Kodak) which handles Sterling's liabilities.

Sediment in the Passaic River contain numerous hazardous substances, pollutants and contaminants. Investigations undertaken by EPA indicated that hazardous materials were being released from the former Thomasset facility located at 120 Lister Avenue in Newark, New Jersey, into the Passaic River Study Area. Hazardous substances, pollutants and contaminants released from the facility into the Passaic River Study Area present a risk to the environment and the humans who may ingest contaminated fish and shellfish. Therefore, Sterling may be potentially liable for all response costs which the government may incur relating to the Passaic River Study Area.

G:\USER\SHARE\DOCUMENT6.1\CONCUR.WPD

847500001

SYMBOL →	S&CT	ORCSUP		SPB		D-ERRD		
SURNAME →	RICHMAN	WAGNER/HICK	Hauptman	VAUGHN	B. J. McCabe	CASPE		
DATE →	7/24	7/24/91	8/1/91	8/1/91	8/1/91	8/1/91		

Under Sections 106(a) and 107(a) of CERCLA, 42 U.S.C. §9606(a) and §9607(a) and other laws, potentially responsible parties ("PRPs") may be obligated to implement response actions deemed necessary by EPA to protect public health, welfare or the environment, and may be liable for all costs incurred by the government in responding to any release or threatened release at the Site. If response actions are performed by EPA rather than by the PRPs, those PRPs may be subject to legal action pursuant to Section 107(a) of CERCLA, 42 U.S.C. §9607(a), to recover public funds expended by EPA in response to the release and threatened release of hazardous materials at the Site. Such actions and costs may include, but need not be limited to, expenditures for conducting a Remedial Investigation/Feasibility Study ("RI/FS"), a Remedial Design/Remedial Action, and other investigation, planning, response, oversight, and enforcement activities. In addition, responsible parties may be required to pay damages for injury to, destruction of, or loss of natural resources, including the cost of assessing such damages.

While EPA has the discretionary authority to invoke special notice procedures, EPA hereby notifies you that it will not utilize the special notice procedures contained in Section 122(e) of CERCLA, 42 U.S.C. §9622(e). EPA has concluded that use of the special notice procedures in Section 122(e) of CERCLA would delay the implementation of the RI/FS which is currently being performed at the Site to determine the extent of contamination and to evaluate possible actions to mitigate any adverse effects. EPA will determine at a subsequent time whether additional measures are required to mitigate releases from the Site in order to protect the public health, welfare, and the environment. The decision not to use the special notice procedures does not preclude you from entering into discussions with EPA regarding your participation in activities at the Site.

By this letter, EPA encourages you, as a PRP, to voluntarily participate in the EPA-approved activities underway at the Passaic River Study Area in conjunction with other PRPs. At the present time, an RI/FS is being performed at the Study Area under an Administrative Consent Order with the Occidental Chemical Corporation ("OCC"). The actual work is being performed by Maxus Energy Corporation ("Maxus"), pursuant to certain contractual arrangements with OCC, and should be contacted for information pertaining to the work being done. Maxus can be contacted at the addresses listed in the Attachment to this letter. Other PRPs who have received Notice letters are also listed in the Attachment. Be advised that notice of your potential liability at the Site is being forwarded to OCC by EPA.

847500002

EPA requests your cooperation in this matter. If you are interested in participating in the ongoing response action you should notify EPA of your intentions to join with OCC. Notification should be in writing and should be delivered to EPA no later than fourteen (14) days after the date that you receive this letter. Your letter should be sent to:

Lance R. Richman, P.G.
U.S. Environmental Protection Agency
Emergency and Remedial Response Division
290 Broadway, Floor 19
New York, NY 10007-1866,

with a copy to Ms. Amelia Wagner, Esq., of the Office of Regional Counsel, Floor 17 at the same street address.

If EPA does not receive a written response from you in the time specified above, EPA will assume that you voluntarily decline to participate in any of the response actions taking place at the Site. EPA reserves the right to pursue its available enforcement options with regard to the site.

If you wish to discuss this matter further, please contact Mr. Lance R. Richman, P.G., of my staff at (212) 637-4409 or Ms. Wagner at (212) 637-3141. Please note that all communications from attorneys should be directed to Ms. Wagner.

Sincerely yours,

Richard Caspe, Director
Emergency and Remedial Response Division

Attachments

CC: Elliott Stern, Esq., Counsel
Eastman Kodak Company

Joseph G. Gabriel
360 North Pastoria Environmental Corporation

Ms. Carol Dinkins, Esq.
Vinson & Elkins, L.L.P.

Mr. Richard P. McNutt
Maxus Energy Corporation

847500003

ATTACHMENT

Contact for Maxus Energy Corporation:

Mr. Richard P. McNutt
Maxus Energy Corporation
1015 Belleville Turnpike
Kearny, New Jersey 07032

Counsel: Ms. Carol E. Dinkins, Esq.
Vinson & Elkins, L.L.P.
2300 First City Tower
1001 Fannin Street
Houston, Texas 77002-6760

PRPs in receipt of Notice Letters:

Mr. J. Roger Hirl
President and Chairman of the Board
Occidental Chemical Company
Occidental Tower
5005 LBJ Freeway
Dallas, Texas 75244

Mr. Robert L. Ball, President
Alcan Aluminum Corporation
100 Erieview Plaza, 29th Floor
Cleveland, Ohio 44114

Counsel: Lawrence A. Salibra II, Esq., Senior Counsel
Alcan Aluminum Corporation
6060 Parkland Blvd.
Mayfield, Hts., Ohio 44124

Mr. David J. D'Antoni, President
Ashland Chemical Company
P.O. Box 2219
Columbus, Ohio 43216

Counsel: Stephen W. Leermakers, Esq., Senior Litigation Counsel
Ashland Chemical Company
5200 Blazer Parkway
Dublin, Ohio 43017

President
Bayer Corporation
100 Bayer Road
Pittsburgh, Pennsylvania 15205-9741

Counsel: Gerard F. Hickel, Esq.
Counsel, Corporate Health, Environment and Safety
Bayer Corporation

Mr. Maurice C. Workman, President
Benjamin Moore & Co.
51 Chestnut Ridge Road
Montvale, New Jersey 07645

Counsel: John T. Rafferty, Esq., General Counsel
Benjamin Moore & Co.

Brian C. Kelly, Esq.
Chris-Craft Industries, Inc.
600 Madison Avenue
New York, New York 10022

Counsel: Peter Simshauser, Esq.
Skadden, Arps, Slate, Meagher & Flom
300 South Grand Avenue
Los Angeles, California 90071-3144

Mr. Edgar S. Woolward, Jr., Chairman
E.I. du Pont de Nemours and Company
1007 Market Street
Wilmington, Delaware 19898

Counsel: Bernard J. Reilly, Esq., Corporate Counsel
E.I. du Pont de Nemours and Company

Mr. George M. Fisher, President
Eastman Kodak Company
343 State Street
Rochester, New York 14650

Mr. Joseph G. Gabriel, Vice President
360 North Pastoria Environmental Corporation
(a wholly-owned subsidiary of Eastman Kodak Company)
1100 Ridgeway Avenue
Rochester, New York 14652-6280

Counsel: Elliot Stern, Esq., Counsel
Eastman Kodak Company

Mr. Richard J. Mahoney, Chief Executive
Monsanto Company
800 N. Lindbergh Blvd.
St. Louis, Missouri 63167

Counsel: Peter H. Smith, Esq., Assistant Environmental Counsel
Monsanto Company

Mr. Robert D. McNeeley, President
Reilly Industries, Inc.
1510 Market Square Center
151 North Delaware Street
Indianapolis, IN 46204

Counsel: Jacqueline A. Simmons, Esq.
Reilly Industries, Inc.

Mr. John G. Breen, Chairman of the Board
The Sherwin-Williams Company
101 Prospect Avenue, N.W.
Cleveland, Ohio 44115-1075

Counsel: Donald J. McConnell, Esq., Environmental Counsel
The Sherwin-Williams Company

Is your RETURN ADDRESS completed on the reverse side?

SENDER:

- Complete items 1 and/or 2 for additional services.
- Complete items 3, 4a, and 4b.
- Print your name and address on the reverse of this form so that we can return this card to you.
- Attach this form to the front of the mailpiece, or on the back if space does not permit.
- Write "Return Receipt Requested" on the mailpiece below the article number.
- The Return Receipt will show to whom the article was delivered and the date delivered.

I also wish to receive the following services (for an extra fee):

- 1. Addressee's Address
- 2. Restricted Delivery

Consult postmaster for fee.

3. Article Addressed to:
 Ms. Carol E. Dinkins, Esq.
 Vinson & Elkins, L.L.P.
 2300 First City Tower
 1001 Fannin Street
 Houston, Texas 77002-6760
 VINSON & ELKINS L.L.P.
 2300 First City Tower

4a. Article Number
 EG298060240US

4b. Service Type
 Registered Certified
 Express Mail Insured
 Return Receipt for Merchandise COD

7. Date of Delivery **12 AUG 1996**

5. Received By: *(Print Name)*
 Carol E. Dinkins
 Houston, TX 77002-6760

8. Addressee's Address (Only if requested and fee is paid)

6. Signature: (Addressee or Agent)
 X 

PS Form 3811, December 1984

Domestic Return Receipt

Thank you for using Return Receipt Service.

847500007

Is your RETURN ADDRESS completed on the reverse side?

SENDER:

- Complete Items 1 and/or 2 for additional services.
- Complete Items 3, and 4a & b.
- Print your name and address on the reverse of this form so that we can return this card to you.
- Attach this form to the front of the mailpiece, or on the back if space does not permit.
- Write "Return Receipt Requested" on the mailpiece below the article number.
- The Return Receipt will show to whom the article was delivered and the date delivered.

I also wish to receive the following services (for an extra fee):

- 1. Addressee's Address
- 2. Restricted Delivery

Consult postmaster for fee.

3. Article Addressed to:
George M. Fisher, President
Eastman Kodak Company
343 State Street
Rochester, New York 14650

4a. Article Number

4b. Service Type
 Registered Insured
 Certified COD
 Express Mail Return Receipt for Merchandise

7. Date of Delivery
8/9/96

5. Signature (Addressee)
Maureen S. Marowski

8. Addressee's Address (Only if requested and fee is paid)

6. Signature (Agent)

Thank you for using Return Receipt Service.

847500008

Is your RETURN ADDRESS completed on the reverse side?

SENDER:

- Complete items 1 and/or 2 for additional services.
- Complete items 3, 4a, and 4b.
- Print your name and address on the reverse of this form so that we can return this card to you.
- Attach this form to the front of the mailpiece, or on the back if space does not permit.
- Write "Return Receipt Requested" on the mailpiece below the article number.
- The Return Receipt will show to whom the article was delivered and the date delivered.

I also wish to receive the following services (for an extra fee):

1. Addressee's Address
2. Restricted Delivery

Consult postmaster for fee.

3. Article Addressed to:
 Elliot Stern, Esq., Counsel
 Eastman Kodak Company
 360 North Pastoria Envir. Corp.
 1100 Ridgeway Ave.
 Rochester, NY 14652-6280

4a. Article Number
 EG298060205US

4b. Service Type

<input type="checkbox"/> Registered	<input type="checkbox"/> Certified
<input checked="" type="checkbox"/> Express Mail	<input type="checkbox"/> Insured
<input type="checkbox"/> Return Receipt for Merchandise	<input type="checkbox"/> COD

7. Date of Delivery

5. Received By: (Print Name)

8. Addressee's Address (Only if requested and fee is paid)

6. Signature: (Addressee or Agent)
 X Sandra Lee

PS Form 3811, December 1994

Domestic Return Receipt

Thank you for using Return Receipt Service.

847500009

Is your RETURN ADDRESS completed on the reverse side?	SENDER: ■ Complete items 1 and/or 2 for additional services. ■ Complete items 3, 4a, and 4b. ■ Print your name and address on the reverse of this form so that we can return this card to you. ■ Attach this form to the front of the mailpiece, or on the back if space does not permit. ■ Write "Return Receipt Requested" on the mailpiece below the article number. ■ The Return Receipt will show to whom the article was delivered and the date delivered.		I also wish to receive the following services (for an extra fee): 1. <input type="checkbox"/> Addressee's Address 2. <input type="checkbox"/> Restricted Delivery Consult postmaster for fee.
	3. Article Addressed to: Mr. Joseph G. Gabriel, VP 360 North Pastoria Envi. Corp. (a wholly-owned subsidiary of Eastman Kodak Company) 1100 Ridgeway Ave. Rochester, NY 14652-6280	4a. Article Number EG298060222US	4b. Service Type <input type="checkbox"/> Registered <input type="checkbox"/> Certified <input checked="" type="checkbox"/> Express Mail <input type="checkbox"/> Insured <input type="checkbox"/> Return Receipt for Merchandise <input type="checkbox"/> COD
5. Received By: (Print Name) <i>NANCY K. CAREY</i>	7. Date of Delivery		
6. Signature: (Addressee or Agent) <i>X Nancy Carey</i>	8. Addressee's Address (Only if requested and fee is paid)		
PS Form 3811, December 1994		Domestic Return Receipt	

Thank you for using Return Receipt Service.

847500010

Is your RETURN ADDRESS completed on the reverse side?

SENDER: • Complete items 1 and/or 2 for additional services. • Complete items 3, 4a, and 4b. • Print your name and address on the reverse of this form so that we can return this card to you. • Attach this form to the front of the mailpiece, or on the back if space does not permit. • Write "Return Receipt Requested" on the mailpiece below the article number. • The Return Receipt will show to whom the article was delivered and the date delivered.		I also wish to receive the following services (for an extra fee): 1. <input type="checkbox"/> Addressee's Address 2. <input type="checkbox"/> Restricted Delivery Consult postmaster for fee.	
3. Article Addressed to: Mr. Rick McNutt Project Coordinator Maxus Energy Corporation 1015 Belleville Turnpike Kearny, NJ 07032		4a. Article Number EG298060284US	
		4b. Service Type <input type="checkbox"/> Registered <input type="checkbox"/> Certified <input checked="" type="checkbox"/> Express Mail <input type="checkbox"/> Insured <input type="checkbox"/> Return Receipt for Merchandise <input type="checkbox"/> COD	
		7. Date of Delivery 9 1998	
5. Received By: (Print Name) R. GARCIA		8. Addressee's Address (Only if requested and fee is paid)	
6. Signature: (Addressee or Agent) <i>[Handwritten Signature]</i>			

Thank you for using Return Receipt Service.

PS Form 3811, December 1994

Domestic Return Receipt

847500011



UNITED STATES ENVIRONMENTAL PROTECTION AGENCY
REGION 2
290 BROADWAY
NEW YORK, NY 10007-1866

SEP 15 2003

**GENERAL NOTICE LETTER
CERTIFIED MAIL-RETURN RECEIPT REQUESTED**

Antonio Perez, President
Eastman Kodak Company
343 State Street
Rochester, New York 14650

RE: Diamond Alkali Superfund Site
Notice of Potential Liability for
Response Actions in the Lower Passaic River, New Jersey

Dear Mr. Perez:

The United States Environmental Protection Agency ("EPA") is charged with responding to the release and/or threatened release of hazardous substances, pollutants, and contaminants into the environment and with enforcement responsibilities under the Comprehensive Environmental Response, Compensation, and Liability Act of 1980, as amended ("CERCLA"), 42 U.S.C. §9601 et seq.

You received a letter from EPA, dated August 6, 1996, notifying Eastman Kodak Company ("Eastman Kodak") of its potential liability relating to the Passaic River Study Area, which is part of the Diamond Alkali Superfund Site ("Site") located in Newark, New Jersey, pursuant to Section 107(a) of CERCLA, 42 U.S.C. §9607(a). Under CERCLA, potentially responsible parties ("PRPs") include current and past owners of a facility, as well as persons who arranged for the disposal or treatment of hazardous substances at the Site, or the transport of hazardous substances to the Site. Accordingly, EPA is seeking your cooperation in an innovative approach to environmental remediation and restoration activities for the Lower Passaic River.

EPA has documented the release or threatened release of hazardous substances, pollutants and contaminants into the six-mile stretch of the river, known as the Passaic River Study Area, which is part of the Site located in Newark, New Jersey. Based on the results of previous CERCLA remedial investigation activities and other environmental studies, including a reconnaissance study of the Passaic River conducted by the United States Army Corps of Engineers ("USACE"), EPA has further determined that contaminated sediments and other potential sources of hazardous substances exist along the entire 17-mile tidal reach of the Lower Passaic River. Thus, EPA has decided to expand the Study to include the areal extent of contamination to which hazardous substances from the six-mile stretch were transported; and those sources from which hazardous substances outside the six-mile stretch have come to be located within the expanded

Internet Address (URL) • <http://www.epa.gov>

Recycled/Recyclable • Printed with Vegetable Oil Based Inks on Recycled Paper (Minimum 50% Postconsumer content)

851690001

TIERRA-B-001233

Study Area.

In recognition of our complementary roles, EPA has formed a partnership with USACE and the New Jersey Department of Transportation-Office of Maritime Resources ("OMR") ["the governmental partnership"] to identify and to address water quality improvement, remediation, and restoration opportunities in the 17-mile Lower Passaic River. This governmental partnership is consistent with a national Memorandum of Understanding ("MOU") executed on July 2, 2002 between EPA and USACE. This MOU calls for the two agencies to cooperate, where appropriate, on environmental remediation and restoration of degraded urban rivers and related resources. In agreeing to implement the MOU, the EPA and USACE will use their existing statutory and regulatory authorities in a coordinated manner. These authorities for EPA include CERCLA, the Clean Water Act, and the Resource Conservation and Recovery Act. The USACE's authority stems from the Water Resources Development Act ("WRDA"). WRDA allows for the use of some federal funds to pay for a portion of the USACE's approved projects related to ecosystem restoration.

For the first phase of the Lower Passaic River Project, the governmental partners are proceeding with an integrated five- to seven-year study to determine an appropriate remediation and restoration plan for the river. The study will involve investigation of environmental impacts and pollution sources, as well as evaluation of alternative actions, leading to recommendations of environmental remediation and restoration activities. This study is being conducted by EPA under the authority of CERCLA and by USACE and OMR, as local sponsor, under WRDA. EPA, USACE, and OMR are coordinating with the New Jersey Department of Environmental Protection and the Federal and State Natural Resource Trustee agencies. EPA, USACE, and OMR estimate that the study will cost approximately \$20 million, with the WRDA and CERCLA shares being about \$10 million each. EPA will be seeking its share of the costs of the study from PRPs.

Based on information that EPA evaluated during the course of its investigation of the Site, EPA believes that hazardous substances were being released from the former Thomasett Colors/Sterling facility located at 120 Lister Avenue in Newark, New Jersey, into the Lower Passaic River. Hazardous substances, pollutants and contaminants released from the facility into the river present a risk to the environment and the humans who may ingest contaminated fish and shellfish. Therefore, Eastman Kodak may be potentially liable for response costs which the government may incur relating to the study of the Lower Passaic River. In addition, responsible parties may be required to pay damages for injury to, destruction of, or loss of natural resources, including the cost of assessing such damages.

Enclosed is a list of the other PRPs who have received Notice letters. This list represents EPA's findings on the identities of PRPs to date. We are continuing efforts to locate additional PRPs who have released hazardous substances, directly or indirectly, into the Passaic River. Inclusion on, or exclusion from, the list does not constitute a final determination by EPA concerning the liability of any party for the release or threat of release of hazardous substances at the Site. Be advised that notice of your potential liability at the Site is being forwarded to all parties on this list.

851690002

We request that you consider becoming a "cooperating party" for the Lower Passaic River Project. As a cooperating party, you, along with many other such parties, will be expected to fund EPA's share of the study costs. Upon completion of the study, it is expected that CERCLA and WRDA processes will be used to identify the required remediation and restoration programs, as well as the assignment of remediation and restoration costs. At this time, the commitments of the cooperating parties will apply only to the study. For those who choose not to cooperate, EPA may apply the CERCLA enforcement process, pursuant to Sections 106 (a) and 107(a) of CERCLA, 42 U.S.C. §9606(a) and §9607(a) and other laws.

Pursuant to CERCLA Section 113(k), EPA must establish an administrative record that contains documents that form the basis of EPA's decision on the selection of a response action for a site. The administrative record files, which contain the documents related to the response action selected for this Site are located at EPA's Region 2 office (290 Broadway, New York) on the 18th floor. You may call the Records Center at (212) 637-4308 to make an appointment to view the administrative record for the Lower Passaic River Project.

EPA will be holding a meeting with all PRPs on October 29, 2003 at 10:00 AM in Conference Room 27A at the Region 2 office. At that meeting, EPA will provide information about the actions taken to date in the Lower Passaic River, as well as plans for future activities. After the presentation, PRPs will be given the opportunity to caucus, and EPA will return to answer any questions that might be generated during the private session. Please be advised that due to increased security measures, all visitors need to be registered with the security desk in the lobby in order to gain entry to the office. In order to ensure a smooth arrival, you will need to provide EPA with a list of attendees no later than October 15, 2003.

EPA recommends that the cooperating parties select a steering committee to represent the group's interest as soon as possible, since EPA expects a funding commitment for the financing of the CERCLA share of the \$20 million study by mid-November 2003. If you wish to discuss this further, please contact Ms. Alice Yeh, Remedial Project Manager, at (212) 637-4427 or Ms. Kedari Reddy, Assistant Regional Counsel, at (212) 637-3106. Please note that all communications from attorneys should be directed to Ms. Reddy.

Sincerely yours,



George Pavlou, Director
Emergency and Remedial Response Division

Enclosure

cc: Elliot Stern, Esq.
Eastman Kodak Company

851690003

PRPs in Receipt of Notice Letters:

PRP	Legal Counsel
<p>J. Roger Hirl President and Chairman of the Board Occidental Chemical Co. Occidental Tower 5005 LBJ Freeway Dallas, Texas 75244</p>	<p>Paul W. Herring, Esq. Andrews & Kurth L.L.P. 1717 Main Street, Suite 3700 Dallas, Texas 75201</p>
<p>Joseph Gabriel Vice President of Operations 360 North Pastoria Environmental Corp. 1100 Ridgeway Avenue Rochester, New York 14652-6280</p>	<p>Philip Sellinger, Esq. Sills Cummis Zuckerman One Riverfront Plaza Newark, NJ 07102</p>
<p>Robert Ball, President Alcan Aluminum Corporation 100 Erieview Plaza, 29th Floor Cleveland, Ohio 44114</p>	<p>Lawrence Salibra, Esq. Alcan Aluminum Corporation 6060 Parkland Blvd. Mayfield Hts., OH 44124</p>
<p>Mark Epstein, President Alden Leeds Inc. 55 Jacobus Ave. Kearny, New Jersey 07032</p>	<p>Eric Aronson, Esq. Whitman Breed Abbott & Morgan One Gateway Center Newark, NJ 07102</p>
<p>Alan Bendelius, President Alliance Chemical, Inc. Linden Avenue Ridgefield, New Jersey 07657</p>	<p>Fredi L. Pearlmutter, Esq. Cooper, Rose & English, LLP 480 Morris Avenue Summit, New Jersey 07901-1527</p>
<p>William Gentner, President The Andrew Jergens Co. 2535 Spring Grove Ave. Cincinnati, Ohio 45214</p>	<p>A. Christian Worrell III, Esq. Head & Ritchey, LLP 1900 Fifth Third Center 511 Walnut Street Cincinnati, OH 45202</p>
<p>Gary Cappeline, President Ashland Specialty Chemical Co. 5200 Blazer Parkway Dublin, Ohio 43017</p>	<p>Stephen Leermakers, Esq. Ashland Specialty Chemical Co. 5200 Blazer Parkway Dublin, OH 43017</p>
<p>Klaus Peter Loebbe, President BASF Corporation 3000 Continental Drive North Mount Olive, New Jersey 07828</p>	<p>Nan Bernardo, Esq. and Nancy Lake Martin, Esq. BASF Corporation 3000 Continental Drive North Mount Olive, NJ 07828</p>

851690004

Joseph Akers, Vice President Bayer Corporation 100 Bayer Road Pittsburgh, Pennsylvania 15205-9741	Gerard Hickel, Esq. Bayer Corporation 100 Bayer Road Pittsburgh, PA 15205-9741
Yvan Dupay, President Benjamin Moore & Co. 51 Chestnut Ridge Road Montvale, New Jersey 07645	Arthur Schulz, Esq. Environmental Counsel 4910 Massachusetts Ave., N.W. Suite 221 Washington, DC 20016
Alberto Celleri, President Chemical Compounds Inc. 10 Baldwin Court Roseland, New Jersey 07086	Jim Giannotti Chemical Compounds Inc. 29-75 Riverside Avenue Newark, NJ 07104
President Chris-Craft Industries, Inc. 767 Fifth Avenue, 46th Floor New York, New York 10153	Brian Kelly, Esq. Chris-Craft Industries, Inc. 767 Fifth Avenue, 46th Floor New York, NY 10153
John Guffey, President Coltec Industries, Inc. 3 Coliseum Centre 2550 West Tyvola Road Charlotte, North Carolina 28217	John R. Mayo, Esq. Coltec Industries, Inc. 430 Park Avenue New York, NY 10022
Roger Marcus, President Congoleum Corporation 3705 Quakerbridge Road Mercerville, New Jersey 08619	Russell Hewit, Esq. Dughi & Hewit 340 North Avenue Cranford, NJ 07016
Martin Benante, Chairman Curtiss-Wright Corp. 4 Becker Farm Road Roseland, New Jersey 07068	James Maher, Esq. Curtiss-Wright Corp. 4 Becker Farm Road Roseland, NJ 07068
Antonio Perez, President Eastman Kodak Company 343 State Street Rochester, New York 14650	Elliot Stern, Esq. Eastman Kodak Company 343 State Street Rochester, NY 14650
Edgar Woolard, Chairman E.I. du Pont de Nemours & Co. 1007 Market Street Wilmington, Delaware 19898	Bernard J. Reilly, Esq. Corporate Counsel E.I. du Pont de Nemours & Co. 1007 Market Street Wilmington, DE 19898

851690005

David Weisman, CEO Elan Chemical Company 268 Doremus Ave. Newark, New Jersey 07105	Jeffrey Schwartz, Esq. Sarber Schlesinger Satz & Goldstein One Gateway Center Newark, NJ 07102
Al Reisch, President E M Sergeant Pulp & Chemical Co. Inc. 6 Chelsea Road Clifton, New Jersey 07102	None
Mark Tucker, Esq. Essex Chemical Corp. 2030 WMDC Midland, Michigan 48674	Kenneth Mack, Esq. Fox, Rothschild, O'Brien & Frankel Princeton Pike Corp.Center 997 Lenox Drive, Building 3 Lawrenceville, NJ 08648
Todd Walker, President Fairmount Chemical Co. Inc. 117 Blanchard St. Newark, New Jersey 07105	John Ix, Esq. Porzio Bromberg & Newman 163 Madison Ave. Morristown, NJ 07962
Bradley Buechler, President Franklin-Burlington Plastics Inc. 113 Passaic Ave. Kearny, New Jersey 07032	Robert M. Becker, Esq. Kraemer, Burns, Mytelka & Lovell, P.A. 675 Morris Ave. Springfield, NJ 07081
Henry Benz, President Hoescht Celanese Chemicals, Inc. Route 202-206 P.O.Box 2500 Somerville, New Jersey 08876	Anne Conley-Pitchell, Esq. Hoescht Celanese Corp. Route 202-206 P.O.Box 2500 Somerville, NJ 08876
Francine Rothschild, President Kearny Smelting & Refining 936 Harrison Ave #5 Kearny, New Jersey 07032	None
Henry Schact, CEO Lucent Technologies, Inc. 600 Mountain Avenue Murray Hill, New Jersey 07974	Ralph McMurry, Esq. Hill, Betts & Nash LLP 1 Riverfront Plaza, Suite 327 Newark, NJ 07102-5401
Richard Meelia, President Mallinckrodt, Inc. 675 McDonnell Blvd. Hazelwood, Missouri 63042	Patricia Duft, Esq. Mallinckrodt, Inc. 675 McDonnell Blvd. Hazelwood, MO 63042

851690006

Richard Mahoney, CEO Monsanto Company 800 N. Lindbergh Blvd. St. Louis, Missouri 63167	L. William Higley, Esq. Monsanto Company 800 N. Lindbergh Blvd. St. Louis, MO 63167
Joseph Galli, President Newell Rubbermaid, Inc. 29 E. Stephenson St. Freeport, Illinois 61032	Peter Schultz, Director Environmental Affairs Newell Co. 4000 Auburn St. Rockford, IL 61101
Jean-Pierre van Rooy, President Otis Elevator Company North American Operations 10 Farm Springs Road Farmington, Connecticut 06032	Sarah Hurley, Esq. Robinson & Cole LLP 695 East Main Street Stamford, CT 06904-2305
Richard Ablon, President Ogden Corporation Two Pennsylvania Plaza, 25 th Floor New York, New York 10121	J.L. Effinger, Esq. Ogden Corporation Two Pennsylvania Plaza, 25 th Floor New York, NY 10121
Henry McKinnell, Chairman Pfizer Inc. 235 E. 42 nd St. New York, New York 10017	Michael McThomas, Esq. Pfizer Inc. 235 E. 42 nd St. New York, NY 10017
Raymond LeBoeuf, President PPG Industries, Inc. One PPG Place Pittsburgh, Pennsylvania 15272	Joseph Karas, Esq. PPG Industries, Inc. One PPG Place Pittsburgh, PA 15272
Lawrence Codey, President PSE&G Co. P.O. Box 570 Newark, New Jersey 07101-0570	Hugh Mahoney, Esq. PSE&G Co. P.O. Box 570 Newark, NJ 07101
Phillip D. Ashkettle, President Reichhold Chemicals, Inc. P.O. Box 13582 Research Triangle Park, North Carolina 27709	Adam S. Walters, Esq. Phillips, Lytle, Hitchcock, Blaine & Huber 3400 Marine Midland Center Buffalo, NY 14203
Robert McNeeley, President Reilly Industries, Inc. 1510 Market Square Center 151 North Delaware Street Indianapolis, Indiana 46204	Paul Rivers, Director Corporate Environmental Affairs Reilly Industries, Inc. 1500 S. Tibbs Avenue Indianapolis, IN 46242

851690007

Robert Finn, President RSR Corporation 2777 Stemmons Freeway, Suite 1800 Dallas, Texas 75207	Howard Myers, Esq. RSR Corporation 2777 Stemmons Freeway, Suite 1800 Dallas, TX 75207
Christopher Connor, CEO The Sherwin-Williams Company 101 Prospect Avenue, N.W. Cleveland, Ohio 44115-1075	Donald McConnell, Esq. The Sherwin-Williams Co. 101 Prospect Ave., N.W. Cleveland, OH 44115
George Barrett, President Teva Pharmaceuticals USA Inc. 1090 Horsham Road North Wales, Pennsylvania 19454	Kirsten E. Bauer, Esq. Teva North America 1090 Horsham Road North Wales, PA 19454
Robert Senior, President Three County Volkswagen 701 Riverside Ave. Lyndhurst, New Jersey 07071	Robert DiLascio, Esq. 30 Park Avenue, Suite 101 Lyndhurst, NJ 07071
Michael Jordan, President Westinghouse Electric Corp. 11 Stanwix Street Pittsburgh, Pennsylvania 15222	Roger Willis, Esq. Westinghouse Electric Corp. 11 Stanwix Street Pittsburgh, PA 15222
Isaac Weinberger, President Wiggins Plastics Inc. 547 Maitland Ave. Teaneck, New Jersey 07666	None

851690008

SUMMARY OF INSPECTIONS BY INSPECTORS
Week of August 20, to August 24, 1956, Inc.

Aug. 20, Violation

Thomassett Color Chemical Company, Newark, N. J.
Seepage from floor washings which were discharged into an area on the west side of this plant, was finding its way into the Passaic River. Our inspector contacted Mr. Cohen and he promised to eliminate this violation.

Aug. 24, Elimination -

Thomassett Color Chemical Company, Newark, N. J.
Mr. Cohen had the area covered with ten yards of sand and also ten yards of crushed stone. The work took three days.
The washings from the concrete floor will from now on be diverted into the sanitary sewer.

Chief Inspector

Michael D. Andoline.

MDA:VP

Week of July 30, to August 3, 1956, Inc.

July 31, Violation -

Thompson Color Co., 120 Lister Ave., Newark.

Our inspector saw a 4" clay pipe discharging a deep blue color into the river at the rear of the above premises. This pipe is so low that it can only be seen at low tide.

Mr. Cohen, the plant manager told our inspector that the discharge is from three large wooden vats. These vats are vented out daily for one hour and then allowed to discharge into the river.

Mr. Capone told him that this was a violation and this practice must be stopped.

Mr. Cohen said he would divert the flow as soon as possible. He is writing a letter to the Newark Sewer Division to find where he can connect to the city sewer.

Aug. 3, Violation

▲
Elimination

Franklin St., Storm Sewer, Newark, N. J.

Our inspector saw sewage coming out of this storm sewer discharging into the river. He called our office and No. 12 truck was sent out to investigate.

The gate valve was stuck and this permitted the sewage to flow into the storm sewer. The valve was fixed and the violation was eliminated.

Acting Chief Inspector,

Wilbert Seals

WS:VP

ANNUAL REPORT

by

Chief Engineer
S. A. LUBETKIN

to the

PASSAIC VALLEY
SEWERAGE COMMISSIONERS

FOR THE YEAR

1971



Violation & Elimination - Tenneco Chemicals, Inc. - (Continued) -

It was the belief of Tenneco supervisors that the 15" line belonged to Belleville and went through their property without any connection to their system.

During May, this company blocked the passage way from their plant site to the 16" storm sewer collecting the surface water in the corner of their property. It is being collected in a sump pit. They purchased a pump to transfer this water to the sewer on July 28, 1971.

Under the circumstances the violation was considered eliminated and the Commissioners' personnel contacted Belleville and asked them to trace back the 15" sewer line to the intermittent source of pollution, (see Violation Town of Belleville, page 121).

Violation & Elimination - Thomasset Colors, Division of Sterling Drug, Inc., 120 Lister Avenue, Newark, N.J.
August 18 to 20, 1971 (J. McLaughlin)

Mr. Lubetkin received a call from Mr. D. Clark, of the Environmental Protection concerning a telephone call about green in the River at Newark. At Mr. Lubetkin's instruction, Mr. Goldberg investigated. He found a large amount of green fluorescein dye coming from the Lockwood Street Storm Sewer.

This was traced to the Thomasset Colors, where it was found that a drum of the dye had spilled and flowed to the storm sewer. Mr. Goldberg reported sloppy housekeeping and potential pollution through the Lockwood Street Sewer, each time the ground was washed or drained.

Mr. Lubetkin contacted the City of Newark's Sewer Department and visited the plant, together with Mr. Goldberg and Mr. Fleming of the Passaic Valley Sewerage Commissioners, and Mr. Van Riper and Mr. Altiero of the City of Newark on August 19, 1971. They met Mr. Paul Thomasset and Mr. Tyron Schulze of Thomasset Colors and pointed out the various points of sloppy housekeeping. Both the Newark representatives and Mr. Lubetkin informed Thomasset that any area which drains to a storm sewer must be kept clean. This was confirmed in a letter from Mr. Lubetkin dated August 25, 1971.

Inspector McLaughlin reported that as of August 20, no further evidence of pollution was indicated, and that the company was continuing a clean-up operation.

AUG 27 1971

THOMAS LATZIO
CHAIRMAN

WALTER J. DAVIS
VICE CHAIRMAN

CARMINE T. FERRAPATO
BENJAMIN W. GORDON
LOUIS BAY, 2ND
COMMISSIONERS

PASSAIC VALLEY SEWERAGE COMMISSIONERS

790 BROAD STREET
NEWARK, N.J. 07102

SEYMOUR A. LUBETKIN
CHIEF ENGINEER

JAMES V. SEGRETO
CHIEF COUNSEL

MRS. CHARLES T. SCHAEDEL
CLERK/TREASURER

August 25, 1971

Tomasset Color Company
120 Lister Avenue
Newark, New Jersey 07102

Attn: Mr. Paul Tomasset, Vice President

Dear Sir:

This will confirm our conversation at the time of my visit to your plant on August 19, 1971.

A green material in the Passaic River, coming from the Lockwood Street Storm Sewer, was traced back to your company. Further inspection indicated that an accident occurred at your plant wherein, a container of green fluorescent dye was discharged into a catch basin within your plant area, which thence reached the Lockwood Street Storm Sewer and the Passaic River.

I pointed out to you during our inspection, that the area was extremely sloppy and pollution could occur not only by accidental spills, but during any time rain would wash the material which was lying on the ground, to the storm sewer. I informed you that the area which drains to any storm sewer must be cleared of any spillage and kept clean. I also informed you that if it was impossible to keep clean, you must repipe this sewer to the sanitary system, if allowed by the City of Newark. In any case, the polluting material could not be allowed to reach the Passaic River.

The Commissioners request a reply to this letter, in which you will inform them of what steps you will take to prevent a further pollution to the Passaic River from your plant, together with a time table indicating when these steps taken will be completed. At that time the Commissioners would desire to re-inspect your plant area to determine if all possible points of pollution have been eliminated.

Very truly yours,

PASSAIC VALLEY SEWERAGE COMMISSIONERS

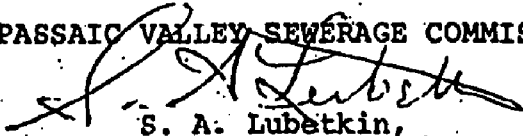
S. A. Lubetkin,
Chief Engineer

SAL:mr.

Certified Mail/

C.C. TO: P.V.S.C., Chief Counsel Segreto, Messrs. Goldberg,
Fleming, Cuccinello, & De Lane.

September 9, 1971

Mr. S.A. Lubetkin
Chief Engineer
Passaic Valley Sewerage Commissioners
790 Broad Street
Newark, New Jersey

Dear Mr. Lubetkin;

The catch basin area in question has been cleaned and maintained since your visit of August 19, 1971. This area has been inspected twice by John McLaughlin during this period, and he indicated the housekeeping was satisfactory.

In addition, we are presently installing a seventy foot long six inch plastic drain to receive all scrubbing water and effluent in this area. This will be installed by the end of September.

Finally, no further production of fluorescein is anticipated this year. If we manufacture this product in the future, we will recover and bleach all dye effluent before discharging to the sanitary sewer.

Very truly yours,

Paul B. Thomasset

BT/sc

CC - Mr. Roger Rodwin ✓
Mr. Doug Eisenfelder

FEB 15 1972



CITY OF NEWARK, NEW JERSEY
KENNETH A. GIBSON, Mayor

DEPARTMENT OF HEALTH AND WELFARE
DR. ALAN B. CLARK, Director

CORNELIUS BODINE
BUSINESS ADMINISTRATOR

DIVISION OF INSPECTIONS
ARMAND E. LEMBO
DIRECTOR

February 18, 1972

Thomas Set Colors
120 Lister Avenue
Newark, New Jersey

Re: 120 Lister Avenue

Dear Sir:

A recent inspection made by the Division of Inspections discloses the following violations: Section: U3.10.1 - Plumbing Code

The Sewer Department took out a sample from the sewer line and found chemical in the line.

Have this condition checked for a defective sewer line or you are putting same chemical in the line from your tank.

Inspector: James Policastro

You are hereby notified that a reinspection will be made within 30 days. All violations must be corrected at the expiration of that time or a court complaint will be issued against you for failure to comply with the rules and regulations of this Division.

SECTION 15:2-4
ANY PERSON SERVED WITH ANY NOTICE REFERRED TO IN THIS SECTION MAY REQUEST A HEARING THEREON, PROVIDED SUCH REQUEST IS MADE IN WRITING AND FILED WITH THE DIRECTOR, DEPARTMENT OF HEALTH AND WELFARE, ROOM 210, CITY HALL, NEWARK, N. J. WITHIN FIVE DAYS AFTER THE DATE NOTICE WAS SERVED.

JG:rs

Very truly yours,



John Gestmaria
Chief Plumbing Inspector

TIERRA-B-001247

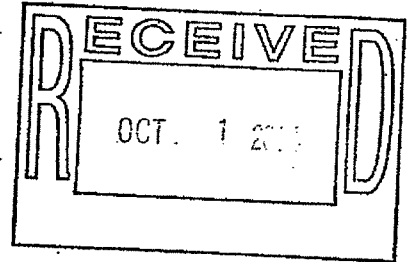

UNITED STATES ENVIRONMENTAL PROTECTION AGENCY
REGION 2
290 BROADWAY
NEW YORK, NY 10007-1866

SEP 20 2011



**GENERAL NOTICE LETTER
URGENT LEGAL MATTER
PROMPT REPLY NECESSARY
CERTIFIED MAIL-RETURN RECEIPT REQUESTED**

Ralph Foglia, President
Drum Service of Newark, Inc.
51 Stanton Street
Newark, NJ 07102

RE: Diamond Alkali Superfund Site
Notice of Potential Liability for
Response Actions in the Lower Passaic River Study Area, New Jersey

Dear Mr. Foglia:

The United States Environmental Protection Agency ("EPA") is charged with responding to the release and/or threatened release of hazardous substances, pollutants, and contaminants into the environment and with enforcement responsibilities under the Comprehensive Environmental Response, Compensation, and Liability Act of 1980, as amended ("CERCLA"), 42 U.S.C. §9601 et seq. Accordingly, EPA is seeking your cooperation in an innovative approach to environmental remediation and restoration activities for the Lower Passaic River.

EPA has documented the release or threatened release of hazardous substances, pollutants and contaminants into the six-mile stretch of the river, known as the Passaic River Study Area, which is part of the Diamond Alkali Superfund Site ("Site") located in Newark, New Jersey. Based on the results of previous CERCLA remedial investigation activities and other environmental studies, including a reconnaissance study of the Passaic River conducted by the United States Army Corps of Engineers ("USACE"), EPA has further determined that contaminated sediments and other potential sources of hazardous substances exist along the entire 17-mile tidal reach of the Lower Passaic River. Thus, EPA has decided to expand the area of study to include the entire Lower Passaic River and its tributaries from Dundee Dam to Newark Bay ("Lower Passaic River Study Area").

By this letter, EPA is notifying Drum Service of Newark, Inc. ("Drum Service") of its potential liability relating to the Site pursuant to Section 107(a) of CERCLA, 42 U.S.C. §9607(a). Under CERCLA, potentially responsible parties ("PRPs") include current and past owners of a facility, as well as persons who arranged for the disposal or treatment of hazardous substances at the Site, or the transport of hazardous substances to the Site.

Internet Address (URL) • <http://www.epa.gov>

Recycled/Recyclable • Printed with Vegetable Oil Based Inks on Recycled Paper (Minimum 50% Postconsumer content)

TIERRA-B-001248

In recognition of our complementary roles, EPA has formed a partnership with USACE and the New Jersey Department of Transportation-Office of Maritime Resources ("OMR") ["the governmental partnership"] to identify and to address water quality improvement, remediation, and restoration opportunities in the 17-mile Lower Passaic River. This governmental partnership is consistent with a national Memorandum of Understanding ("MOU") executed on July 2, 2002 between EPA and USACE. This MOU calls for the two agencies to cooperate, where appropriate, on environmental remediation and restoration of degraded urban rivers and related resources. In agreeing to implement the MOU, the EPA and USACE will use their existing statutory and regulatory authorities in a coordinated manner. These authorities for EPA include CERCLA, the Clean Water Act, and the Resource Conservation and Recovery Act. The USACE's authority stems from the Water Resources Development Act ("WRDA"). WRDA allows for the use of some federal funds to pay for a portion of the USACE's approved projects related to ecosystem restoration.

For the first phase of the Lower Passaic River Restoration Project, the governmental partners are proceeding with an integrated five- to seven-year study to determine an appropriate remediation and restoration plan for the river. The study will involve investigation of environmental impacts and pollution sources, as well as evaluation of alternative actions, leading to recommendations of environmental remediation and restoration activities. This study is being conducted by EPA under the authority of CERCLA and by USACE and OMR, as local sponsor, under WRDA. EPA, USACE, and OMR are attempting to coordinate with the New Jersey Department of Environmental Protection and the Federal and State Natural Resource Trustee agencies. EPA, USACE, and OMR estimate that the study will cost approximately \$20 million, with the WRDA and CERCLA shares being about \$10 million each. EPA is seeking its share of the costs of the study from PRPs.

Based on information that EPA evaluated during the course of its investigation of the Site, EPA believes that hazardous substances were being released from Drum Service's facility located at 120 Lister Avenue in Newark, New Jersey, into the Lower Passaic River Study Area. Hazardous substances, pollutants and contaminants released from the facility into the river present a risk to the environment and the humans who may ingest contaminated fish and shellfish. Therefore, Drum Service may be potentially liable for response costs which the government may incur relating to the study of the Lower Passaic River. In addition, responsible parties may be required to pay damages for injury to, destruction of, or loss of natural resources, including the cost of assessing such damages.

EPA is aware that the financial ability of some PRPs to contribute toward the payment of response costs at the Site may be substantially limited. If you believe, and can document, that you fall within that category, please inform Ms. Reddy and Mr. Hyatt in writing at the addresses identified in this letter. You will be asked to submit financial records including business and, possibly, personal federal income tax returns as well as audited financial statements to substantiate such a claim.

Please note that, because EPA has a potential claim against you, you must include EPA as a creditor if you file for bankruptcy. You are also requested to preserve and retain any documents now in your Company's or its agents' possession or control, that relate in any manner to your facility or the Site or to the liability of any person under CERCLA for response actions or response costs at or in connection with the facility or the Site, regardless of any corporate document retention policy to the contrary.

Enclosed is a list of the other PRPs who have received Notice letters. This list represents EPA's findings on the identities of PRPs to date. We are continuing efforts to locate additional PRPs who have released hazardous substances, directly or indirectly, into the Lower Passaic River Study Area. Exclusion from the list does not constitute a final determination by EPA concerning the liability of any party for the release or threat of release of hazardous substances at the Site. Be advised that notice of your potential liability at the Site may be forwarded to all parties on this list as well as to the Natural Resource Trustees.

We request that you become a "cooperating party" for the Lower Passaic River Restoration Project. As a cooperating party, you, along with many other such parties, will be expected to fund EPA's share of the study costs. Upon completion of the study, it is expected that CERCLA and WRDA processes will be used to identify the required remediation and restoration programs, as well as the assignment of remediation and restoration costs. At this time, the commitments of the cooperating parties will apply only to the study. For those who choose not to cooperate, EPA may apply the CERCLA enforcement process, pursuant to Sections 106(a) and 107(a) of CERCLA, 42 U.S.C. §9606(a) and §9607(a) and other laws.

You may become a cooperating party by participating in the Cooperating Parties Group ("Group") that has already formed to provide EPA's funding for the Lower Passaic River Restoration Project. This cooperative response is embodied in an Administrative Order on Consent ("AOC"), a copy of which can be obtained at the following web address: www.ourpassaic.org/home/aoc.pdf.

We strongly encourage you to review the AOC and contact the Group to discuss your participation. You may do so by contacting:

William H. Hyatt, Esq.
Common Counsel for the Lower Passaic River Study Area Cooperating Parties Group
Kirkpatrick & Lockhart LLP
One Newark Center, 10th Floor
Newark, New Jersey 07102
(973) 848-4045
whyatt@kl.com

Written notification should be provided to EPA and Mr. Hyatt documenting your intention to join the Group and settle with EPA no later than 30 calendar days from your receipt of this letter. It is EPA's intent to amend the AOC at a later date to reflect the settlement negotiations. EPA's written notification should be mailed to:

Kedari Reddy, Assistant Regional Counsel
Office of Regional Counsel
U.S. Environmental Protection Agency
290 Broadway - 17th Floor
New York, New York 10007-1866

Pursuant to CERCLA Section 113(k), EPA must establish an administrative record that contains documents that form the basis of EPA's decision on the selection of a response action for a site. The administrative record files, which contain the documents related to the response action selected for this Site are located at EPA's Region 2 office (290 Broadway, New York, NY) on the 18th floor. You may call the Records Center at (212) 637-4308 to make an appointment to view the administrative record for the Diamond Alkali Site, Passaic River.

As you may be aware, on January 11, 2002, President Bush signed into law the Superfund Small Business Liability Relief and Brownfields Revitalization Act. This Act contains several exemptions and defenses to CERCLA liability, which we suggest that all parties evaluate. You may obtain a copy of the law via the Internet at <http://www.epa.gov/swerosps/bf/sblbra.htm> and review EPA guidances regarding these exemptions at <http://www.epa.gov/compliance/resources/policies/cleanup/superfund>.

Inquiries by counsel or inquiries of a legal nature should be directed to Ms. Reddy at (212) 637-3106. Questions of a technical nature should be directed to Elizabeth Butler, Remedial Project Manager, at (212) 637-4396.

Sincerely yours,

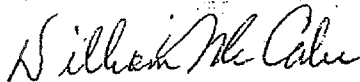

George Pavlou, Director
Emergency and Remedial Response Division

Enclosures

AUG 06 1996

GENERAL NOTICE LETTER
URGENT LEGAL MATTER
EXPRESS MAIL - RETURN RECEIPT REQUESTED

President
Bayer Corporation
100 Bayer Road
Pittsburgh, Pennsylvania 15205-9741

Re: Notice of Potential Liability of Sterling Winthrop for
Response actions in the Passaic River Study Area
Diamond Alkali Superfund Site, Newark, New Jersey

Dear Sir:

The United States Environmental Protection Agency ("EPA") is charged with responding to the release and/or threatened release of hazardous substances, pollutants, and contaminants into the environment and with enforcement responsibilities under the Comprehensive Environmental Response, Compensation, and Liability Act of 1980 ("CERCLA"), as amended, 42 U.S.C. §9601 et seq.

EPA has documented the release or threatened release of hazardous substances, pollutants and contaminants into the Passaic River Study Area which is part of the Diamond Alkali Superfund Site ("Site") located in Newark, New Jersey. By this letter, EPA has determined that Sterling Winthrop, Inc. ("Sterling"), as the owner of the former Thomasset Colors, Inc. located at 120 Lister Avenue, may be potentially liable relating to the Site pursuant to Section 107 of CERCLA. EPA is notifying Bayer Corporation of Sterling's potential liability as the current owner of Sterling.

Sediment in the Passaic River contain numerous hazardous substances, pollutants and contaminants. Investigations undertaken by EPA indicated that hazardous materials were being released from the former Thomasset facility located at 120 Lister Avenue in Newark, New Jersey, into the Passaic River Study Area. Hazardous substances, pollutants and contaminants released from the facility into the Passaic River Study Area present a risk to the environment and the humans who may ingest contaminated fish and shellfish. Therefore, Sterling may be potentially liable for all response costs which the government may incur relating to the Passaic River Study Area.

844390001

G:\USER\SHARE\DOCUMENT6.1\CONCUR.WPD

SYMBOL -->	S&CT	ORCSUP		SPB		D-ERRD		
SURNAME -->	RICHMAN	WAGNER/HICK	Hampton	VAUGHN	B. M. G. C.	CASPE		
DATE -->	7/24	7/24/96	8/1/96	8/2	8/2	8/6		

Under Sections 106(a) and 107(a) of CERCLA, 42 U.S.C. §9606(a) and §9607(a) and other laws, potentially responsible parties ("PRPs") may be obligated to implement response actions deemed necessary by EPA to protect public health, welfare or the environment, and may be liable for all costs incurred by the government in responding to any release or threatened release at the Site. If response actions are performed by EPA rather than by the PRPs, those PRPs may be subject to legal action pursuant to Section 107(a) of CERCLA, 42 U.S.C. §9607(a), to recover public funds expended by EPA in response to the release and threatened release of hazardous materials at the Site. Such actions and costs may include, but need not be limited to, expenditures for conducting a Remedial Investigation/Feasibility Study ("RI/FS"), a Remedial Design/Remedial Action, and other investigation, planning, response, oversight, and enforcement activities. In addition, responsible parties may be required to pay damages for injury to, destruction of, or loss of natural resources, including the cost of assessing such damages.

While EPA has the discretionary authority to invoke special notice procedures, EPA hereby notifies you that it will not utilize the special notice procedures contained in Section 122(e) of CERCLA, 42 U.S.C. §9622(e). EPA has concluded that use of the special notice procedures in Section 122(e) of CERCLA would delay the implementation of the RI/FS which is currently being performed at the Site to determine the extent of contamination and to evaluate possible actions to mitigate any adverse effects. EPA will determine at a subsequent time whether additional measures are required to mitigate releases from the Site in order to protect the public health, welfare, and the environment. The decision not to use the special notice procedures does not preclude you from entering into discussions with EPA regarding your participation in activities at the Site.

By this letter, EPA encourages you, as a PRP, to voluntarily participate in the EPA-approved activities underway at the Passaic River Study Area in conjunction with other PRPs. At the present time, an RI/FS is being performed at the Study Area under an Administrative Consent Order with the Occidental Chemical Corporation ("OCC"). The actual work is being performed by Maxus Energy Corporation ("Maxus"), pursuant to certain contractual arrangements with OCC, and should be contacted for information pertaining to the work being done. Maxus can be contacted at the addresses listed in the Attachment to this letter. Other PRPs who have received Notice letters are also listed in the Attachment. Be advised that notice of your potential liability at the Site is being forwarded to OCC by EPA.

844390002

EPA requests your cooperation in this matter. If you are interested in participating in the ongoing response action you should notify EPA of your intentions to join with OCC. Notification should be in writing and should be delivered to EPA no later than fourteen (14) days after the date that you receive this letter. Your letter should be sent to:

Lance R. Richman, P.G.
U.S. Environmental Protection Agency
Emergency and Remedial Response Division
290 Broadway, Floor 19
New York, NY 10007-1866,

with a copy to Ms. Amelia Wagner, Esq., of the Office of Regional Counsel, Floor 17 at the same street address.

If EPA does not receive a written response from you in the time specified above, EPA will assume that you voluntarily decline to participate in any of the response actions taking place at the Site. EPA reserves the right to pursue its available enforcement options with regard to the site.

If you wish to discuss this matter further, please contact Mr. Lance R. Richman, P.G., of my staff at (212) 637-4409 or Ms. Wagner at (212) 637-3141. Please note that all communications from attorneys should be directed to Ms. Wagner.

Sincerely yours,

Richard Caspe, Director
Emergency and Remedial Response Division

Attachments

CC: Gerard F. Hickel, Counsel
Bayer Corporation

Joseph G. Gabriel
360 North Pastoria Environmental Corporation

Ms. Carol Dinkins, Esq.
Vinson & Elkins, L.L.P.

Mr. Richard P. McNutt
Maxus Energy Corporation

844390003

ATTACHMENT

Contact for Maxus Energy Corporation:

Mr. Richard P. McNutt
Maxus Energy Corporation
1015 Belleville Turnpike
Kearny, New Jersey 07032

Counsel: Ms. Carol E. Dinkins, Esq.
Vinson & Elkins, L.L.P.
2300 First City Tower
1001 Fannin Street
Houston, Texas 77002-6760

PRPs in receipt of Notice Letters:

Mr. J. Roger Hirl
President and Chairman of the Board
Occidental Chemical Company
Occidental Tower
5005 LBJ Freeway
Dallas, Texas 75244

Mr. Robert L. Ball, President
Alcan Aluminum Corporation
100 Erieview Plaza, 29th Floor
Cleveland, Ohio 44114

Counsel: Lawrence A. Salibra II, Esq., Senior Counsel
Alcan Aluminum Corporation
6060 Parkland Blvd.
Mayfield, Hts., Ohio 44124

Mr. David J. D'Antoni, President
Ashland Chemical Company
P.O. Box 2219
Columbus, Ohio 43216

Counsel: Stephen W. Leermakers, Esq., Senior Litigation Counsel
Ashland Chemical Company
5200 Blazer Parkway
Dublin, Ohio 43017

President
Bayer Corporation
100 Bayer Road
Pittsburgh, Pennsylvania 15205-9741

Counsel: Gerard F. Hickel, Esq.
Counsel, Corporate Health, Environment and Safety
Bayer Corporation

Mr. Maurice C. Workman, President
Benjamin Moore & Co.
51 Chestnut Ridge Road
Montvale, New Jersey 07645

Counsel: John T. Rafferty, Esq., General Counsel
Benjamin Moore & Co.

Brian C. Kelly, Esq.
Chris-Craft Industries, Inc.
600 Madison Avenue
New York, New York 10022

Counsel: Peter Simshauser, Esq.
Skadden, Arps, Slate, Meagher & Flom
300 South Grand Avenue
Los Angeles, California 90071-3144

Mr. Edgar S. Woolward, Jr., Chairman
E.I. du Pont de Nemours and Company
1007 Market Street
Wilmington, Delaware 19898

Counsel: Bernard J. Reilly, Esq., Corporate Counsel
E.I. du Pont de Nemours and Company

Mr. George M. Fisher, President
Eastman Kodak Company
343 State Street
Rochester, New York 14650

Mr. Joseph G. Gabriel, Vice President
360 North Pastoria Environmental Corporation
(a wholly-owned subsidiary of Eastman Kodak Company)
1100 Ridgeway Avenue
Rochester, New York 14652-6280

Counsel: Elliot Stern, Esq., Counsel
Eastman Kodak Company

Mr. Richard J. Mahoney, Chief Executive
Monsanto Company
800 N. Lindbergh Blvd.
St. Louis, Missouri 63167

Counsel: Peter H. Smith, Esq., Assistant Environmental Counsel
Monsanto Company

Mr. Robert D. McNeeley, President
Reilly Industries, Inc.
1510 Market Square Center
151 North Delaware Street
Indianapolis, IN 46204

Counsel: Jacqueline A. Simmons, Esq.
Reilly Industries, Inc.

Mr. John G. Breen, Chairman of the Board
The Sherwin-Williams Company
101 Prospect Avenue, N.W.
Cleveland, Ohio 44115-1075

Counsel: Donald J. McConnell, Esq., Environmental Counsel
The Sherwin-Williams Company

Is your RETURN ADDRESS completed on the reverse side?

SENDER:

- Complete items 1 and/or 2 for additional services.
- Complete items 3, and 4a & b.
- Print your name and address on the reverse of this form so that we can return this card to you.
- Attach this form to the front of the mailpiece, or on the back if space does not permit.
- Write "Return Receipt Requested" on the mailpiece below the article number.
- The Return Receipt will show to whom the article was delivered and the date delivered.

I also wish to receive the following services (for an extra fee):

1. Addressee's Address
2. Restricted Delivery

Consult postmaster for fee.

3. Article Addressed to:
President
Bayer Corporation
100 Bayer Road
Pittsburgh, Pennsylvania 15205-
9741

4a. Article Number
 158 608 378

4b. Service Type

<input type="checkbox"/> Registered	<input type="checkbox"/> Insured
<input type="checkbox"/> Certified	<input type="checkbox"/> COD
<input checked="" type="checkbox"/> Express Mail	<input checked="" type="checkbox"/> Return Receipt for Merchandise

7. Date of Delivery
8/9/96

5. Signature (Addressee)
TOM HACTWICK

8. Addressee's Address (Only if requested and fee is paid)

6. Signature (Agent)

PS Form 3811, December 1991 U.S. GPO: 1993-352-714 **DOMESTIC RETURN RECEIPT**

Thank you for using Return Receipt Service.

844390007

Is your RETURN ADDRESS completed on the reverse side?

SENDER:

- Complete items 1 and/or 2 for additional services.
- Complete items 3, 4a, and 4b.
- Print your name and address on the reverse of this form so that we can return this card to you.
- Attach this form to the front of the mailpiece, or on the back if space does not permit.
- Write "Return Receipt Requested" on the mailpiece below the article number.
- The Return Receipt will show to whom the article was delivered and the date delivered.

I also wish to receive the following services (for an extra fee):

- 1. Addressee's Address
- 2. Restricted Delivery

Consult postmaster for fee.

3. Article Addressed to:
 Mr. Rick McNutt
 Project Coordinator
 Maxus Energy Corporation
 1015 Belleville Turnpike
 Kearny, NJ 07032

4a. Article Number
 EG298060267US

4b. Service Type
 Registered Certified
 Express Mail Insured
 Return Receipt for Merchandise COD

7. Date of Delivery
 AUG 19 1996

5. Received By: (Print Name)
 R. GARCIA

8. Addressee's Address (Only if requested and fee is paid)

6. Signature: (Addressee or Agent)
 X Ruth Garcia

Thank you for using Return Receipt Service.

PS Form 3811, December 1994

Domestic Return Receipt

844390008

Is your RETURN ADDRESS completed on the reverse side?

SENDER:

- Complete items 1 and/or 2 for additional services.
- Complete items 3, 4a, and 4b.
- Print your name and address on the reverse of this form so that we can return this card to you.
- Attach this form to the front of the mailpiece, or on the back if space does not permit.
- Write "Return Receipt Requested" on the mailpiece below the article number.
- The Return Receipt will show to whom the article was delivered and the date delivered.

I also wish to receive the following services (for an extra fee):

1. Addressee's Address
2. Restricted Delivery

Consult postmaster for fee.

3. Article Addressed to:
 Mr. Joseph G. Gabriel, VP
 360 North Pastoria Envi. Corp.
 (a wholly-owned subsidiary of
 Eastman Kodak Company)
 1100 Ridgeway Ave.
 Rochester, NY 14652-6280

4a. Article Number
 EG298060219US

4b. Service Type

<input type="checkbox"/> Registered	<input type="checkbox"/> Certified
<input checked="" type="checkbox"/> Express Mail	<input type="checkbox"/> Insured
<input type="checkbox"/> Return Receipt for Merchandise	<input type="checkbox"/> COD

7. Date of Delivery

5. Received By: (Print Name)
NANCY K. CAREY

6. Signature: (Addressee or Agent)
X Nancy K. Carey

8. Addressee's Address (Only if requested and fee is paid)

Domestic Return Receipt

Thank you for using Return Receipt Service.

PS Form 3811, December 1994

844390009

Is your RETURN ADDRESS completed on the reverse side?

SENDER:

- Complete items 1 and/or 2 for additional services.
- Complete items 3, 4a, and 4b.
- Print your name and address on the reverse of this form so that we can return this card to you.
- Attach this form to the front of the mailpiece, or on the back if space does not permit.
- Write "Return Receipt Requested" on the mailpiece below the article number.
- The Return Receipt will show to whom the article was delivered and the date delivered.

I also wish to receive the following services (for an extra fee):

- 1. Addressee's Address
- 2. Restricted Delivery

Consult postmaster for fee.

3. Article Addressed to:

Ms. Carol E. Dinkins, Esq.
 Vinson & Elkins, L.L.P.
 2300 First City Tower
 1001 Fannin Street
 Houston, Texas 77002-6760

VINSON & ELKINS L.L.P.

4a. Article Number

EG298060253US

4b. Service Type

- Registered Certified
- Express Mail Insured
- Return Receipt for Merchandise COD

7. Date of Delivery 2 AUG 1996

5. Received By: (Print Name)

1001 Fannin

6. Signature: (Addressee or Agent)

X 

8. Addressee's Address (Only if requested and fee is paid)

Thank you for using Return Receipt Service.

PS Form 3841, December 1994

Domestic Return Receipt

844390010