



Petroleum Liquids Transportation

Petroleum Storage & Transportation

National Petroleum Council • April 1989



Petroleum Liquids Transportation

Petroleum Storage & Transportation

National Petroleum Council • April 1989

William E. Swales, Chairman, Committee on Petroleum Storage & Transportation

NATIONAL PETROLEUM COUNCIL

Edwin L. Cox, *Chairman*
Lodwrick M. Cook, *Vice Chairman*
Marshall W. Nichols, *Executive Director*

U.S. DEPARTMENT OF ENERGY

James D. Watkins, *Secretary*

The National Petroleum Council is a federal advisory committee to the Secretary of Energy.

The sole purpose of the National Petroleum Council is to advise, inform, and make recommendations to the Secretary of Energy on any matter requested by the Secretary relating to petroleum or the petroleum industry.

All Rights Reserved
Library of Congress Catalog Card Number: 89-60761
© National Petroleum Council 1989
Printed in the United States of America

VOLUME V
PETROLEUM LIQUIDS TRANSPORTATION

TABLE OF CONTENTS

	<u>Page</u>
INTRODUCTION	1
EXECUTIVE SUMMARY	5
Overview of Pipelines	5
Crude Oil Pipeline Systems	6
Product Pipeline Systems	7
LPG Pipeline Systems	8
Waterborne Transportation	8
Tank Cars and Tank Trucks	10
Government Regulation	11
Conclusion	12
CHAPTER ONE: U.S. PETROLEUM LOGISTICS SYSTEM	13
CHAPTER TWO: PETROLEUM PIPELINE CHARACTERISTICS	15
Pipeline Basics	15
Pipeline Safety and Regulation	28
Crude Oil Pipeline Systems	35
Product Pipeline Systems	45
LPG Pipeline Systems	51
CHAPTER THREE: WATERBORNE TRANSPORTATION	59
Maritime Vessels	63
Changes Since 1979	64
Principal Constraints	68
Regulation	71
Industry Perspective	72
Summary	72
CHAPTER FOUR: TANK CARS/TANK TRUCKS	75
Tank Cars	76
Tank Trucks	78

APPENDICES

Appendix A:	Request Letter and Description of the National Petroleum Council	A-1
Appendix B:	Study Group Rosters	B-1
Appendix C:	Crude Oil Pipeline Maps and Tables	C-1
Appendix D:	Product Pipeline Maps and Tables	D-1
Appendix E:	LPG Pipeline Maps and Tables	E-1
Appendix F:	NPC 1988 Survey of U.S. Petroleum Pipeline Capacities (Crude Oil and Products)	F-1
Appendix G:	Tanker and Barge Appendices	G-1
Appendix H:	Glossary	H-1

INDEX	IN-1
-------------	------

Order Form for Profiles of Companies Participating in the
National Petroleum Council's 1988 Survey of U.S. Petroleum
Pipelines

INTRODUCTION

In February 1987, the Secretary of Energy requested the National Petroleum Council (NPC) to determine the capacities of the nation's petroleum and gas storage and transportation facilities as part of the federal government's overall review of emergency preparedness planning. The Council has conducted similar studies at the request of the federal government since 1948. The most recent reports are the 1979 report entitled Petroleum Storage and Transportation Capacities and the 1984 report entitled Petroleum Inventories and Storage Capacity. (See Appendix A for the complete text of the Secretary's request letter and a description of the National Petroleum Council.)

To respond to the Secretary's request, the NPC established the Committee on Petroleum Storage & Transportation, chaired by William E. Swales, Vice Chairman - Energy, USX Corporation. The Honorable H. A. Merklein, Administrator, Energy Information Administration, served as Government Cochairman of the Committee. A Coordinating Subcommittee and four task groups were formed to assist the Committee. The Liquids Transportation Task Group, chaired by John P. DesBarres, President, Santa Fe Pacific Pipeline, Inc., was requested to update and expand the information contained in the petroleum pipeline, waterborne, and tank car/tank truck volumes of the 1979 NPC report. Ronald W. O'Neill, Chief, Industry Analysis Branch, Petroleum Supply Division, Energy Information Administration, served as Government Cochairman of the Task Group. (Rosters of the study groups responsible for this volume are contained in Appendix B.)

The Council's overall report, Petroleum Storage & Transportation, is being issued in five volumes:

- Volume I - Executive Summary
- Volume II - System Dynamics
- Volume III - Natural Gas Transportation
- Volume IV - Petroleum Inventories and Storage
- Volume V - Petroleum Liquids Transportation.

In addition, detailed profiles of the companies that participated in the natural gas transportation and petroleum pipeline surveys are available from the NPC.

PETROLEUM PIPELINES

In this report, capacity data as of December 31, 1987, are presented for common-carrier crude oil lines, refined petroleum

product lines, and liquefied petroleum gas (LPG) lines in the form of maps and tables.

The maps include:

- Separate U.S. maps for crude oil, petroleum product, and LPG pipelines
- Regional maps for crude oil and petroleum product pipelines by Petroleum Administration for Defense District (PADD). The PAD Districts are shown in Figure 1.
- Detailed area maps for major refining and pipeline centers.

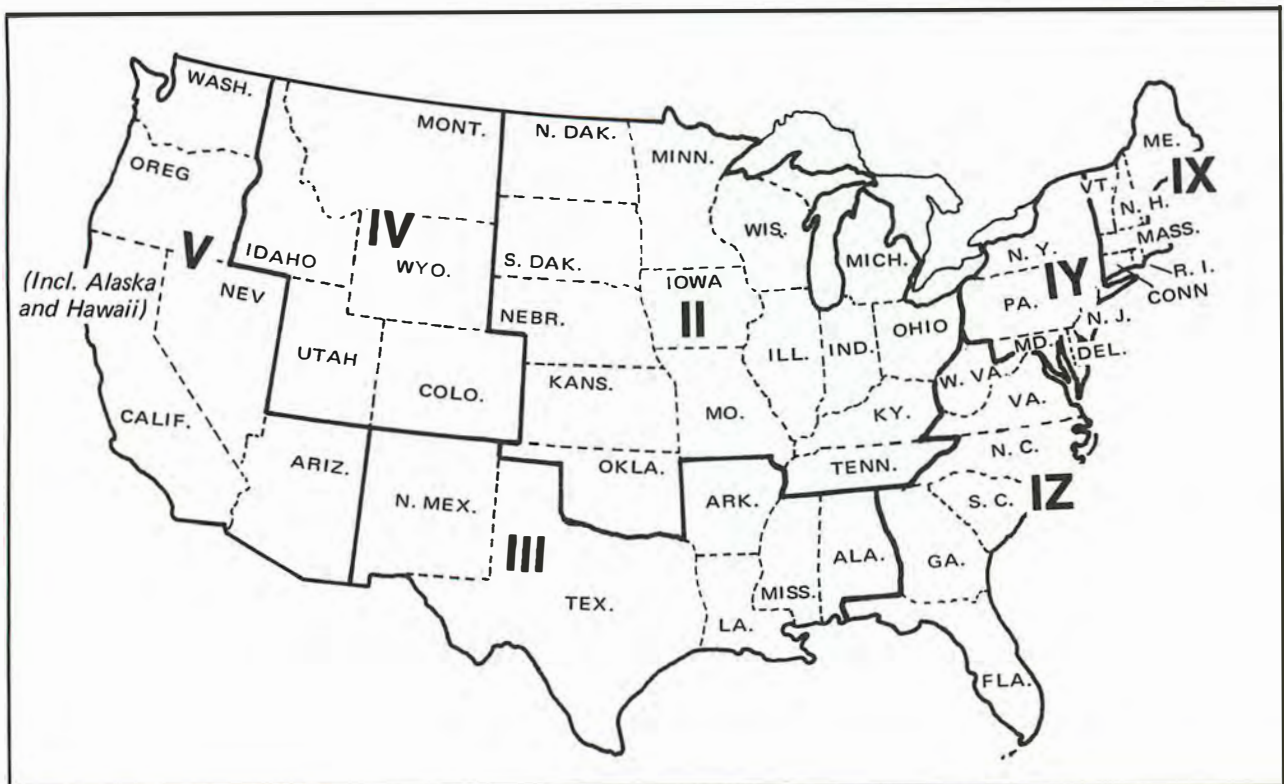

Figure 1. Petroleum Administration for Defense Districts (PADDs).

Tables presenting more detailed information as well as the above-mentioned maps are included in Appendices C, D, and E.

To develop these data, a petroleum pipeline questionnaire was distributed by the National Petroleum Council (see Appendix F). A mailing list was prepared with the assistance of the Association of Oil Pipe Lines, whose member companies transport more than 95 percent of the petroleum in the United States; the list included members as well as nonmembers of the association. Thus, all of the major transporters of petroleum in the United States were among those surveyed.

Ninety-nine companies responded to the survey, furnishing statistical data covering virtually every significant common-carrier pipeline system in the United States. Other respondents noted that their systems are either gathering lines or private lines. Some private systems are included in this report, but gathering lines are not within its scope. Detailed profiles of the pipeline systems of the companies that participated in the survey are available in a separate volume. These profiles provide a brief description, maps, and data sheets for each pipeline system. An order form is included in the back of this volume.

In an effort to enhance the usefulness of the basic information presented in this volume of the report, several items not found in the 1979 report have been included:

- Additional area maps indicating interconnections of pipelines in the vicinity of major refining and distribution centers. As with the 1979 area maps, these maps expand on the general maps by presenting details of interconnections to storage and distribution terminals, refineries, and other facilities.
- An update on the status of the principal crude oil and petroleum product expansion projects planned or under construction at the time of the 1979 report.
- A summary of pipeline projects completed between January 1, 1979 and December 31, 1987 that were not identified as principal crude oil or petroleum product expansion projects in the 1979 report.
- The integration of pipeline, waterborne, and tank car/tank truck information into one comprehensive "Liquids Transportation Volume."
- Longitude and latitude data relative to pipeline origin and delivery points. This information enhances the ability to analyze the pipeline industry and provides the basis for computer-aided drafting of the individual pipeline systems.

WATERBORNE TRANSPORTATION

The waterborne transportation portion of this study includes:

- An update of the 1979 NPC inventory of waterborne petroleum transportation equipment, noting equipment age and other significant trends
- An updated examination of navigational structures and waterways

- An examination of constraints on the waterborne transportation industry such as weather-related, facility-related, and regulatory-related impediments.

Statistical data were obtained from numerous government agencies and trade groups. Principal data sources were the U.S. Coast Guard, the U.S. Maritime Administration, and the U.S. Army Corps of Engineers.

The study presents data on waterborne transportation equipment that carried a valid certificate issued by the U.S. Coast Guard as of December 31, 1987 (see Appendix G). Also included are data on equipment under construction or under construction contract.

TANK CARS/TANK TRUCKS

The tank car/tank truck portion of the 1979 study was updated to:

- Provide an analysis of the U.S. rail tank car fleet
- Determine the number of tank vehicles that might be called upon to safely haul petroleum products (including LPG) in the event of a national emergency.

The Association of American Railroads provided the data for the analysis of the U.S. rail tank car fleet. The Association maintains a record of the U.S. railcar fleet in its Universal Machine Language Equipment Register computer file.

The tank vehicle data were obtained from recent surveys conducted for the U.S. Department of Transportation. These data were not segregated beyond PADDs, because trucks are readily mobile in the event of an emergency.

EXECUTIVE SUMMARY

This report was prepared to provide detailed information on the nation's liquid petroleum transportation system. This system is comprised of crude oil, petroleum product, and LPG pipelines; railroad tank cars and tank trucks; and marine carriers including barges and oceangoing tankers. Descriptions of the various transportation modes, petroleum movements, pertinent regulations, and significant developments since the 1979 NPC report, as well as future prospects, are summarized below.

OVERVIEW OF PIPELINES

At the end of 1986, the nation's petroleum pipeline network totaled approximately 204,000 miles. This network encompassed over 108,000 miles of crude oil pipelines carrying domestic and imported crude oil from producing fields and ports to refineries; some 72,000 miles of refined-product lines moving gasolines and other products to market; and some 23,000 miles of LPG lines transporting commodities such as propane and ethane.

During the past decade, the overall reduction in the demand for petroleum products and some shifts in supply and demand patterns have had an impact on the pipeline system. Crude oil pipeline mileage declined, while product pipeline mileage including LPG lines, increased, with total mileage remaining approximately the same. Construction of both crude oil and petroleum product pipelines totaled 23,909 miles.

Comparisons to the 1979 NPC report indicate that crude oil movements to the Mid-Continent have decreased from both PADD III and PADD IV. Crude oil movements from Alaska and imports from Canada, however, have increased. The capabilities of product pipelines were increased in PADDs I and V in response to increased demands, while pipeline systems in PADDs II and III underwent a significant restructuring necessitated by reduced crude oil production and decreased refining capacity. The total supply of LPGs has increased slightly, but there have been major shifts in supply and demand requiring modifications in the pipeline system.

For the future, there appears to be ample crude oil pipeline capacity in total, and no major logistical problems are envisioned. As in the past, the industry will continually make minor logistical adjustments to accommodate shifting supply-demand patterns. Future product pipeline activities will be primarily directed toward removing bottlenecks in certain pipeline-system flows. Further modifications of the LPG lines are anticipated to accommodate such developments as increased waterborne and Canadian imports of LPG.

CRUDE OIL PIPELINE SYSTEMS

Every day, crude oil pipelines transport millions of barrels of oil from producing fields and ports to refineries. The amount of oil processed at refineries (crude oil runs) is the ultimate determinant of crude oil movements in the United States.

Between 1979 and 1987, total refinery crude oil runs dropped from 14.6 million barrels per day (MMB/D) to 12.9 MMB/D. A low of 11.7 MMB/D was reached in 1983. However, while refinery runs in PADD II declined by as much as 24.3 percent, West Coast (PADD V) refinery runs increased by just over 3 percent.

Domestic crude oil production also has an important impact on crude oil movements. While production was declining in PADDs III and IV, total Alaskan production was steadily increasing. As overall U.S. production has declined, crude oil imports have increased since 1985.

These changes in refinery runs, domestic production, and crude oil imports caused modifications in the crude oil pipeline system. Two major lines, Seaway and Texoma, which were constructed in the mid-1970s to move foreign crude oil from the Gulf Coast to Oklahoma, were converted to natural gas service by the mid-1980s due to low volumes. Responding to a projected renewal of demand in the Mid-Continent, ARCO has reversed a pipeline to move up to 100 thousand barrels per day (MB/D) of imported oil to PADD II. Other pipelines transporting crude oil into the Upper Midwest, such as Capline and Mid-Valley, have experienced significant throughput declines. Recently, however, Capline throughput has increased and at times has reached its downsized capacity.

During the same period, the Trans-Alaska Pipeline System (TAPS) increased capacity from about 1.6 MMB/D to 2.1 MMB/D by adding more pump stations and using a drag-reduction additive. These expansions were necessary to handle volumes originating from new Alaskan North Slope (ANS) systems built to accommodate new fields coming on stream. At a point when Canadian crude oil imports were declining, Koch Industries constructed a 150-mile line to connect the Wood River Pipeline system in Illinois to the Minnesota crude oil market. The All American Pipeline, a 30-inch heated heavy-oil system originating in Santa Barbara County and extending into Texas, was constructed and brought into service in late 1987.

Off the coast of California, the Point Perdernales system originating from Platform Irene and terminating near Lompoc had throughput of 20 MB/D by year-end 1987. And in the Gulf of Mexico, the Louisiana Offshore Oil Port (LOOP) system came into operation in 1981 to handle import volumes. While LOOP was largely underutilized in its early years, recent increases in economic activity and consumption and rising crude oil imports have seen this facility operating at a substantially higher level.

Sometime in 1989, the Point Arguello Pipeline System, located off the coast of California, is expected to be brought into service to bring ashore increasing production. Longer-term exploration and development in Alaska, the Lower-48 States, and offshore may require the construction of new lines. However, with modest product-demand growth forecast through the early 1990s, the existing system -- with minor modifications -- should prove adequate to meet crude oil transportation needs.

PRODUCT PIPELINE SYSTEMS

Petroleum product pipelines play a major role in the transportation of refined products from refining centers and ports to consuming markets. More than 50 different products flow through the system including various grades of gasoline, home heating oil, and kerosine. During 1987, the total annual amount of product moved by all carriers in the 72,000 miles of pipeline network amounted to 1.6 trillion barrel-miles.

From 1979 to 1983, petroleum product demand fell 18 percent to 15.2 MMB/D from 18.7 MMB/D. Although there has been a subsequent increase in demand, consumption remains about 10 percent below 1979 levels. In this same period, refined product imports increased 7.5 percent, particularly into PADD III. And, as noted, refinery throughput declined, particularly in PADD II.

In response to these trends, over 3,732 miles of new, looped, and/or converted lines have been placed in product service, while approximately 2,072 miles of lines have been taken out of this service. Notable expansions during that decade include Colonial's capacity expansion in 1980, by looping and horsepower additions, from the Gulf Coast to the East Coast, and Explorer's horsepower expansion in 1986 to provide additional capacity from the Gulf Coast to the Chicago area. (Looping is the addition of a new line parallel to an existing line.) Sun expanded capacity between the Philadelphia area and New York Harbor in 1983.

Within each PADD, numerous projects have been completed since 1979. For example, in PADD II, 1 MMB/D of refining capacity was taken out of service, which placed increased reliance on product supply from the Gulf Coast and the Northern Tier refineries. Williams Pipeline responded by expanding and introducing reversal capability into its system.

While a continued trend of supply restructuring may be expected in the future, no significant logistical problems are anticipated. A new 20-inch Santa Fe line from Colton, California, to Phoenix, Arizona, will provide an additional 63 MB/D of new capacity in early 1989. Depending on market demand for service, this project may include a 16-inch line reversal from Phoenix to Tucson, which will allow the capacity for movement of 50 MB/D. A total of 457 miles of new lines are expected to be added, while 44 miles of looping is projected.

LPG PIPELINE SYSTEMS

In this study, the term LPG includes both liquefied petroleum gas and natural gas liquids. There are two separate systems for transporting LPGs. Gathering systems collect the product from gas processing plants, fractionators, and refineries and deliver it to storage hubs. Distribution systems move the product from storage to marketing outlets such as chemical plants, refineries, and numerous other locations of end-use.

Three types of storage are available for LPGs. The gathering system generally delivers LPGs into salt formation storage. Mined caverns and steel pressure vessels are used to store product moved out of the distribution systems. Pressurized steel storage tanks are generally found at the end-user sites, as well as at truck and rail terminals.

Since 1979, there have been significant increases in LPG production in the Overthrust Belt area. As a result, new LPG lines were constructed from Wyoming to West Texas, and from West Texas to the Houston-Mont Belvieu area.

A large decline in traditional, residential/commercial, industrial, and agricultural usage resulted in significant volume decreases on some lines. Conversely, an increase in the transportation of LPG feedstocks to chemical companies has been instrumental in the addition of distribution lines serving the Gulf Coast area.

While no new construction plans have been announced, in the future a number of projects may prove feasible. Among these could be LPG pipelines to new ethylene plants along the Gulf Coast; new connections, and possibly new lines, to handle projected increases in Canadian and waterborne imports; a new pipeline system from Mont Belvieu to serve the refinery and chemical industry in New Orleans; and an East Coast pipeline project to transport excess refinery butanes resulting from the proposed reductions in gasoline vapor pressure scheduled to go into effect in 1989. Based on Energy Information Administration (EIA) projections of LPG demand, the existing system, with minor additions and modifications, will have the capacity to handle LPG transportation volumes into the 1990s.

WATERBORNE TRANSPORTATION

Marine carriers transport more petroleum than any other commodity, domestically as well as worldwide. Waterborne petroleum commerce in the United States is comprised of foreign and domestic traffic. Foreign traffic consists primarily of imports of foreign crude oil from the Middle East, Africa, Latin America, the North Sea, and Southeast Asia, carried by oceangoing tankers. Domestic traffic is largely composed of petroleum products produced by refineries and moved inland by river barges and along the coast by oceangoing tankers and tug-barge units.

Also included in the domestic trade are substantial volumes of Alaskan crude oil carried on U.S. flag tankers. The major petroleum product imported into the United States remains residual fuel oil, which in 1987 accounted for approximately 30 percent of product imports.

Maritime Carriers

The oceangoing vessels involved in domestic trade vary from tankers of over 175,000 deadweight tons (DWT) to smaller coastal tankers and tug-barges of between 20,000 and 80,000 DWT that move petroleum along the U.S. coast. Fourteen of the larger tankers are currently transporting Alaskan crude oil.

The nation's port facilities vary in their ability to handle oceangoing tankers. Most ports have depths in the range of 35 to 40 feet and are capable of berthing tankers in the 40,000-60,000 DWT class. West Coast port facilities provide some of the deepest tanker berths -- Los Angeles and Long Beach have terminals with depths of 50 feet (100,000 DWT) and 60 feet (190,000 DWT), and the Puget Sound area offers a port facility with a 65-foot depth (260,000 DWT capability, although other restrictions limit capacity to 125,000 DWT). In 1981, the start-up of operations at LOOP made available for the first time a port facility on the Gulf Coast that could handle Ultra Large Crude Carriers (ULCCs).

Since the 1979 NPC report, the two most significant trends in the design and construction of oceangoing vessels involve the type and number of vessels built. New tanker construction in U.S. shipyards has steadily declined. From 1980 to 1987, only 39 tankers were delivered to the U.S. Flag Fleet. The only vessels currently under construction are being built for military needs. However, while the number of tankers being built in U.S. shipyards decreased, the average deadweight tonnage per vessel increased by 28 percent, from 54,000 DWT at the end of 1979 to almost 70,000 DWT at the end of 1987. Much of this increase, however, is the result of very large tankers built for ANS service.

Since crude oil and petroleum product imports are expected to increase, the relative share of U.S. flag tankers as a mode of petroleum transportation will continue to decrease. The total investment in U.S. flag tankers on the part of industry will decrease due to retirements and lack of new construction. Most future industry investment will be in marine facilities and improvements, and possibly in deepwater ports.

Inland Waterway Carriers

The inland waterway system includes more than 25,000 miles of navigable rivers flowing into the Atlantic and Pacific oceans and the Gulf of Mexico, such as the the Mississippi and its tributaries, intracoastal waterways, canals, channels, and other waterways. Nearly 25 percent of the inland waterway system is less than six feet deep and almost 80 percent is less than 14

feet deep. Thus, draft and length limits are imposed on commercial traffic.

Tank barges are the principal means of transportation on inland waterways. They are the second largest domestic transporter of petroleum products, exceeded only by pipelines. In 1986, tank barges carried 198.8 million short tons, approximately 1,377 million barrels of refined petroleum products.

In the past 10 years there has been only a 7 percent increase in the petroleum tonnage shipped on inland waterways. But technological innovation has led to improvements in productivity. These innovations include the development of swing indicators, fuel management systems, and better communications.

Marine operating systems are, however, reaching the physical limitations of the inland waterways. Principal constraints include weather, marine routes, and outmoded navigational structures such as locks, dams, and low bridges. Low-water conditions as evidenced in 1988 can have a serious effect on operations, as can flooding and ice. Obsolete locks can cause prolonged delays. Widening and deepening of waterways can significantly increase marine movements.

The start-up of operations on the Tennessee-Tombigbee Waterway in 1985 and the ongoing project to permit commercial navigation on the Red River have been the principal construction activities on the nation's inland waterway system.

In the immediate future, Upper Mississippi lockage delays will be greatly alleviated by completion of the replacement Lock and Dam 26 near Alton, Illinois. Construction of other new marine facilities will be impeded by the reduced availability of federal funds for waterway projects and the increased costs of building port facilities by the private sector.

For the long term, substantial coastal and inland waterway trade in petroleum products will continue, with tank barges being an efficient and viable means of transportation. However, to accommodate this trade, major investments will be necessary to modernize and upgrade deteriorating and outmoded navigational facilities along these waterways.

TANK CARS AND TANK TRUCKS

Tank trucks and rail tank cars are primarily involved in the delivery of finished products to redistribution terminals and to ultimate consuming locations. Truck movements from redistribution terminals to service stations and rail shipments of lubricants, asphalts, and petroleum solvents to customers are examples of this service. Some exceptions to this general rule are crude oil and condensate gathering and delivery by trucks from producing fields to pipeline storage points or refineries.

Reduction of the federal government's economic regulation of the rail industry has resulted in improved earnings, allowing a major reinvestment in equipment and facilities. As a result, the system has become safer and more efficient. Tank cars are making more trips per year, and each trip is taking less time today than in 1979. Improvements have also been made in car design, resulting in larger average car size and improved safety.

Tank trucks operate over a U.S. highway system that provides for a high degree of flexibility. The trucking industry has also seen the practical elimination of economic regulation. Although there has been substantial economic restructuring in the tank truck industry, more tank truck capacity is available today than in 1979, and the industry is far more adaptable in its ability to handle changing demands.

Both tank truck and tank car transportation will continue to have essential roles in the transportation of crude oil and petroleum products.

GOVERNMENT REGULATION

All modes of the nation's liquid petroleum transportation system experience different degrees of regulation by government in a number of areas including safety, environmental, and economic regulation. They are also subject to regulation on the state and local levels.

Since 1979, federal economic regulation of the rail tank car and truck industries has been substantially reduced, with positive benefits in improved service and productivity. The waterborne segments do not experience direct economic regulation, although U.S. flag companies operating in domestic trade are required by the Jones Act to operate U.S.-manned and U.S.-built ships at a cost two to three times that of foreign-built vessels. Through various programs, the federal government has attempted to provide guaranteed loans for U.S. flag vessels operating in domestic and foreign trade, and construction subsidies for U.S. operators in foreign trade.

The waterborne industry has had difficulties with a lack of consistent regulations among various government agencies. For example, state-imposed environmental regulations may be in direct conflict with those established at the federal level. Currently, several states are considering, and a few are developing, their own requirements to control vapor emissions. The NPC believes that rational uniform standards, applicable nationwide, would be a far preferable regulatory course.

Under the provisions of the Port and Tanker Safety Act of 1978, it is estimated that the U.S. flag tanker fleet has spent almost \$300 million for pollution and safety systems. These expenditures have been made for items such as optional clean

ballast tanks, crude oil washing equipment, and dual radar/collision avoidance features.

In the same period, oil pipelines continued to be economically regulated under the Interstate Commerce Act by the Federal Energy Regulatory Commission (FERC). By means of precedent-setting cases and legislative proposals, all branches of the federal government -- legislative, judicial, and executive -- wrestled with crafting a new, viable economic climate for the industry. More than 10 years have passed with no resolution of the fundamental regulatory issues. This "track record" has created an atmosphere of uncertainty, particularly with respect to both present and future oil pipeline investments.

On a more positive note, during the same 10-year period, the Congress enacted the comprehensive Hazardous Liquids Pipeline Safety Act. Under this statute, the U.S. Department of Transportation has promulgated a number of significant regulations. Cooperation between the petroleum industry and the federal government and their joint efforts have demonstrably contributed to ensuring that oil pipelines continue to be the safest mode of transportation.

As to the future, the question of whether oil pipelines should continue to be economically regulated will be a major issue for the petroleum industry and a matter before the Congress and the executive branch. Environmental issues will also continue to have a significant impact on waterborne carriers and pipelines. Environmentally induced changes in gasoline specifications, as well as increased regulatory requirements involving product pipelines and storage facilities, may necessitate additional investment.

CONCLUSION

Since the 1979 NPC report, all modes of transportation concerned with the movement of petroleum liquids have been affected by a reduction in demand for petroleum products and by shifts in the supply-and-demand patterns. Recently, however, major pieces of environmental and safety legislation have been enacted which affect these petroleum carriers. Technological innovations and changing investment opportunities have also had impact. In some instances, these developments have caused economic dislocations and loss of business; in other instances, new business and productivity gains have resulted.

Future pipeline investment decisions, however, will not only be dependent upon the U.S. supply-demand equation and individual PADD's needs, but also upon congressional action to alleviate the regulatory uncertainty that exists.

CHAPTER ONE

U.S. PETROLEUM LOGISTICS SYSTEM

The general transportation logistics of the petroleum industry entail the initial gathering of crude oil in producing fields -- domestic and foreign -- and the delivery of that commodity to refineries. From refineries, finished products are then moved to markets throughout the nation.

Transportation is accomplished by a variety of land and marine modes including pipelines, rail tank cars, tank trucks, barges, and oceangoing tankers. On a volume basis, pipelines and marine carriers are predominant, but trucks and rail tank cars have essential functions. Substantial tankage must also be available within this transportation network to ensure its viable operation.

Crude oil is delivered to 195 refineries in 35 states. Oceangoing tankers deliver foreign and Alaskan crude oil to marine terminals, from which point pipelines continue the movement. Sometimes this movement is only a few yards to a conveniently adjacent refinery, but often distances as long as those from the Gulf of Mexico to the Great Lakes are involved.

Most of domestically produced crude oil is delivered by large-diameter pipelines to refineries. Again, the distances involved vary, from short hauls such as East Texas to Beaumont-Port Arthur to long hauls such as California to the Gulf Coast. Trunk pipeline movements are often routed through hubs where several pipelines converge. At such points, transfers may be made into connecting pipelines for delivery to various destinations. Sufficient storage capacity must be available at these locations to provide for the segregation, batching, and inventory accumulation necessary for continuous pipeline operations.

The product distribution system from refineries to end-users is composed of pipelines, barges and tankers, and tank cars and trucks. The distances transported again vary. For example, products such as gasoline and home heating oil are moved daily by the millions of barrels through pipelines from Houston to New York and Houston to Iowa and Minnesota. Trucks deliver products directly from refineries or terminals to local markets. Rail tank cars primarily carry shipments of lubricants, waxes, and asphalt.

Substantial volumes of product are transported by barge on the inland waterways, including the Mississippi and Ohio rivers, and the Hudson and Columbia rivers. Oceangoing tankers and barges also transport products along the Pacific, Gulf, and Atlantic coasts to ports such as Boston, Charleston, Tampa,

Houston, and Seattle. Oceangoing tankers also bring products refined in other countries into many of these ports.

At all these many destination markets, and at markets along pipeline and marine routes, another infrastructure of tankage must be in place to receive the incoming product and to provide storage. From this point, delivery is made, usually by truck, to the many distributors of petroleum products such as fuel oil dealers, bulk plant operators, and service stations, and ultimately, in the case of heating oil, to individual homes.

CHAPTER TWO

PETROLEUM PIPELINE CHARACTERISTICS

PIPELINE BASICS

History

After oil was discovered in western Pennsylvania in August 1859, crude oil was carried in barrels loaded on horse-drawn wagons or on barges. In 1862, a railroad line into the western Pennsylvania oil fields was completed, and oil was moved to refineries in primitive tank cars consisting of flat cars with two large wooden drums.

The first crude oil pipelines were built during the 1860s with wood, cast iron, and wrought iron. Pipeline companies were formed and rapidly replaced barges, wagons, and railroads as the primary carrier of crude oil, because they reduced cost, congestion, and spillage. The first system designed expressly to move oil from wells to pipeline storage was completed in 1865, and pipeline companies began to provide oil storage for their customers the following year. By 1870, approximately one million barrels of storage existed in the western Pennsylvania oil region.

These early pipelines were small, having diameters of two or three inches. In 1879, a 108-mile, six-inch pipeline was completed from western to central Pennsylvania and in 1888 was extended to Bayonne, New Jersey. Early pipeline activity centered in Pennsylvania, West Virginia, Kentucky, Ohio, and Indiana, where crude oil production and the refining centers of Pittsburgh and Cleveland were located. In 1901, the first batching of refined products through a crude oil pipeline was performed. Construction of product pipelines began in earnest in the 1930s. The small-diameter lap-welded cast iron or wrought iron pipelines of the 1860s have given way to the steel corrosion-protected pipelines of today, which range in diameter up to 48 inches. Construction and operation of TAPS, an 818-mile, 48-inch crude oil pipeline, is perhaps the best and most recent example of the technological advances in pipeline materials and construction that have taken place.

Industry Overview

From a few thousand miles of gathering and small-diameter crude oil transportation lines a century ago, the oil pipeline industry has developed into a network of approximately 204,000 miles of gathering and trunk lines operating in all 50 states and owned by many diverse entities. The pipeline network in the United States in 1987 encompassed over 108,000 miles of crude oil

pipelines carrying domestic and imported crude oil from producing fields and ports to refineries, and some 95,000 miles of product pipelines carrying refined products and LPG to terminals and industrial customers.

During 1986 these pipelines carried over 578 billion ton-miles of petroleum, or about 23 percent of the nation's total intercity freight tonnage, at approximately 2.9 percent of the intercity freight cost. This tonnage generally moves at a very low transportation cost. For about 2 to 2.5¢ per gallon, gasoline can be moved from Houston to the New York area, and crude oil can be moved from the New Orleans area to Chicago for about 1.5¢ per gallon. Table 1 shows the average revenues per ton-mile of various modes of transportation.

The United States is an energy intensive country, relying on petroleum products to grow its crops, heat its homes, and fuel its factories and transportation modes. Every day, nearly 17 million barrels are consumed in all these necessary activities. To meet these needs, oil pipelines perform the service of transporting petroleum products to consumers in a safe and dependable manner.

TABLE 1
 AVERAGE REVENUE PER TON-MILE
 BY MODE OF TRANSPORTATION
 (In Cents)

	<u>Air Freight</u>	<u>Truck*</u>	<u>Rail</u>	<u>Barge</u>	<u>Ocean Tanker</u>	<u>Oil Pipeline</u> §
1985	102.23	22.90	3.04	.800	.480	.854
1986	110.60	21.63	2.92	.762	.457	.814
1987	112.70	20.67	2.73	.742	.445	.816

*LTL (less than truck load) carriers. Truck load average in 1987 was 9.78 cents.

§Excludes revenues for TAPS.

Sources: Transportation Policy Association, "Transportation in America," 6th ed., March 1988, supplement July 1988; and Transportation Center, Northwestern University, Evanston, Illinois.

Ownership

There are three basic forms of ownership of petroleum pipelines: wholly owned, joint venture, and undivided interest.

A wholly owned pipeline is owned by one company. That company may be a crude oil producer, a refiner, a product marketer, or a company that simply owns and operates the pipeline as a business venture. This pipeline can be either a common carrier or a proprietary (private) line. All interstate common-carrier pipelines must file their tariffs with FERC.

A joint venture stock company involves two or more companies or individuals that form a new company to build, own, and manage a pipeline. These owners usually have an interest in shipping their own petroleum through the pipeline when it is constructed. The legal form of the company may be stock or partnership. The stock company files its own interstate tariffs with FERC.

An undivided interest pipeline also involves a number of companies owning a single pipeline. Each undivided interest owner, however, owns a specific portion of the pipeline's capacity and files tariffs as if it were a separate pipeline. One company, often the largest single owner, serves as the operator for the entire system.

Multiple ownership of pipelines via joint venture stock companies and undivided interest pipelines have made possible the building of larger-diameter pipelines by the sharing of capital and risk. The investment required to construct a large-diameter pipeline prohibits most companies from undertaking such a project on an individual basis.

Pipeline Design

The Decision to Build a Pipeline

The decision to build a new pipeline requires a demonstrated need and must be physically, economically, and environmentally feasible. New pipelines or expansions of existing pipelines are considered where there is a need to connect one geographic region's oversupply (of crude oil, refined-product production, or marine terminal imports) with another region's undersupply (of crude oil for refinery input, refined product for consumption, or marine terminal exports) in a manner that is cost-efficient versus alternative means (other pipeline systems, barges, tank cars, tankers, and trucks). The expected financial return from a proposed pipeline must be acceptable for the level of the risk involved if the project is to be economically sound. A typical large-diameter pipeline requires at least five years for planning, design, engineering, environmental permits, and construction. Factors considered in determining the feasibility and expected life of a project are projections of:

- Product-demand growth
- Refinery construction, expansion, and shutdowns

- Changes in domestic crude oil production
- Potential crude oil and petroleum product imports
- Possible construction of competing new pipelines
- Competition from other pipelines or modes of transportation
- Economic regulatory factors
- Product prices
- Federal, state, and local government regulations.

A company's ultimate decision to build a new pipeline depends on capital availability, and the allocation of that capital among the alternative investments available to them. The obvious fact that pipelines are capital-intensive and have inflexible routes, while the forces of supply and demand and free-market competition are dynamic, creates uncertainty that translates into "risk." Pipeline investments carry varying degrees of risk, which is a critical element in the decision to build.

Determining the Size of a New Pipeline

Normally, a pipeline company or the group designing the pipeline contacts all prospective shippers, if they can be identified, to determine their interest in ownership or use of a pipeline and their long-term shipment forecasts through the line. After compilation of all shippers' forecasts, an adjustment can be made to account for prospective shippers who are as yet unidentified or who do not submit a forecast. The adjusted total of these forecasts is then compared against the estimate of market size, supply availability, competition, and projected market share to arrive at a realistic volume projection and a proper determination of the required size of the pipeline and facilities.

When pipelines are designed, they usually take into account some built-in capability for expansion, often referred to as "normal expansion capability" or "economic expansion capability." These expansions can be made by adding booster pump stations, or by adding or increasing pumping capacity at existing stations. These expansion possibilities are planned when the pipeline is designed, but whether they take place depends upon demand after it begins operating.

In the past few years, drag-reducing chemical additives have played an important role in providing additional capacity, primarily in crude oil pipeline systems. This method requires a lower capital expenditure than adding horsepower or looping, but operating expenses are normally higher. Drag reducers must be injected downstream of each pump station because the drag reducer is destroyed in passing through the pump, limiting its effectiveness.

Pipelines that have been expanded to their limits by adding booster stations and pumping equipment can be expanded further

only by line looping (i.e., construction of a new pipeline parallel to an existing pipeline) or replacing the existing line with larger-diameter pipe.

Route Selection

A major part of planning a new pipeline is route selection. The key considerations for routing are the origin, destination, and intermediate delivery points. Product pipelines typically have a number of intermediate delivery points because product demand tends to be distributed with population; crude oil pipelines normally have only a few intermediate delivery points, which are determined by refinery locations or by pipeline distribution centers.

Another consideration is topography. High terrain generally means higher construction and pumping costs; it takes more power to pump petroleum uphill than it does to pump it along flat terrain. River crossings are more expensive to construct because of burial requirements to accommodate shifting currents, flood plains, course changes, and so on. Where possible, urban areas and river crossings are avoided because of higher construction costs. The pipeline company must obtain right-of-way (i.e., permission to lay the pipe across a private piece of property) for the route, either by purchase of the land or purchase of the right-of-way from the landowners. As common carriers, pipeline companies have the authority to exercise the right of eminent domain under appropriate state law.

A concurrent step is to obtain permits from various agencies of federal, state, and local governments. The precise requirements vary, but government permits for most major projects now require one to three years to process. Objections to pipeline construction generally come from environmental groups, landowners, and developers. These objections may lead to a rerouting of the line or, if no resolution can be reached, suspension or cancellation of pipeline construction plans.

Basic Design

Petroleum pipelines normally carry either crude oil or petroleum products, although a few pipelines carry both in a segregated fashion. The function of a pipeline is to move a commodity from a source to a market.

Crude oil pipelines move crude oil from producing oil fields (often hundreds of oil wells) and marine terminals to refineries. "Gathering" lines (generally smaller-diameter pipelines) connect the various producing wells into "trunk" lines (generally larger-diameter pipelines). Petroleum product pipelines move refined products from refineries to terminals from which distributors move them to market.

Crude oil and petroleum products are pumped through pipelines in a continuous flow. Pipelines are connected to storage

facilities (tank farms and terminals) at their points of origin and destination, and are sometimes connected to "break-out" tanks at intermediate points. All petroleum entering or leaving the system is measured to account for any differences between receipts into the pipeline and deliveries out of the pipeline.

Pipeline Capacity

Petroleum pipeline capacity is difficult to define, tends to be oversimplified, and is, in general, an elusive concept. The capacity of a pipeline cannot be described with a specific, single figure. Rather, total capacity varies significantly, depending on the product shipped and operating conditions. The classic definition of capacity is the maximum volume that a pipeline can move between two points during a given time period using existing equipment, and is dependent on the following factors:

- Pipeline diameter
- Pipeline length
- Pumping equipment
- Distance between pumping stations
- Pipeline topography
- Petroleum viscosity, temperature, and gravity
- Ambient ground temperature.

Seasonal variations in viscosity, temperature, and gravity can result in capacity differences. For example, during the winter season, product pipelines must move more heating oils. These heating oils have higher viscosities than gasolines, which means that they will move through the pipeline more slowly, causing a reduction in refined-product pipeline capacity. In addition, lower ambient temperatures in the winter will increase the viscosities of both refined products and crude oil, also causing reductions in pipeline capacities.

Pipeline Technology¹

Construction

Horses were used to haul pipe and equipment during construction of the earliest petroleum pipelines, and most of the work was done manually. Land was cleared, ditches were dug, pipe lengths were screwed together and lowered into ditches, and the ditches were backfilled by hand. Steel pipe first became available in 1895 and underwent several important developments in the early 1900s. Pipeline joints were soon gas welded, and in 1928,

¹For further information regarding pipeline technology, see Introduction to the Oil Pipeline Industry, 3rd ed. (Austin: University of Texas Petroleum Extension Service, 1984).

electric arc welding and the technology to manufacture 40-foot seamless pipe sections were developed. These developments represented significant improvements over earlier, less reliable welding techniques and short lengths of pipe requiring more frequent welds. Recent improvements in pipeline construction technology have been dramatically demonstrated in the building of TAPS across the Alaskan wilderness. For example, to avoid disturbing the surrounding permafrost, portions of the pipeline were constructed on heat-shedding stanchions.

Another significant technical development has been the use of drilling equipment to bore horizontal holes under major rivers, canals, and ship channels for pipeline crossings. This method of installing crossings prevents soil erosion, eliminates silting, and permits construction with minimum interference to normal river traffic.

Today, pipelines are usually constructed by specialized pipeline contractors. First, the pipeline's right-of-way is cleared to accommodate construction equipment. Pipe sections, often 60 to 80 feet in length, are placed (or "strung") along the cleared right-of-way, and the ditch is dug with a ditching machine. Where necessary, the pipe is bent to fit the ditch, welded either manually or automatically, and lowered into the ditch. Welded joints are visually inspected and most are examined by X-ray to detect flaws. Upon completion of the pipeline, the entire system is hydrostatically tested to a minimum of 125 percent of the expected operating pressure.

Prior to 1969, liquids pipelines and facilities were constructed in accordance with standards developed and published by the organizations listed below:

- American Petroleum Institute (API)
- American Society of Mechanical Engineers (ASME)
- Manufacturers Standardization Society (MSS)
- American National Standards Institute (ANSI)
- National Fire Prevention Association (NFPA)
- American Insurance Association (AIA).

Also, state and local building and fire codes were followed in designing facilities.

In 1969, the U.S. Department of Transportation issued CFR 149, Part 195, which established standards governing pipeline construction. This code incorporated many of the standards of the organizations listed above.

The standard known as ANSI B31.4, Liquid Petroleum Transportation Piping System, is the most widely used code for pipeline design. In addition, the National Electric Code, which is one of the several NFPA codes, and state and local building and fire codes are utilized.

Materials and Equipment

In the past decade, many advances have been made in the materials used in pipelines. In turn, these new materials have led to the development of new construction equipment and techniques. For example, the tensile strength of pipe steel has risen steadily, thus permitting the use of thinner-walled pipe. Today, pipe commonly has a tensile strength of up to 70,000 pounds per square inch, an increase of 25 to 35 percent over steels used 10 to 20 years ago. At the same time, new alloys have improved the ductile characteristics and the low-temperature properties of the pipe. These developments have improved service over a wide range of conditions, resulting in significantly lower construction costs.

Welding processes have also changed. Automated pipe welding techniques are common today. New welding rods with high tensile strengths and special properties that prevent the cracking of high-yield-strength weld metal have been developed for use with new steels and alloys. New welding processes permit faster construction and higher quality welding.

New materials and processes for coating both the outside and inside of pipe have reduced corrosion-related problems and extended pipe life. The external coating was previously made of asphalt, coal tar, or enamel with layers of felt, glass, or paper. Recently, there has been increased use of plastic tape, extruded plastic, and fusion-bonded epoxy thin-film coatings to coat both the inside and outside of pipe.

Motors and pumps used on pipelines have not changed drastically in recent years, but some improvements are constantly being made. More efficient yet smaller electric motors to drive pipeline pumps result in reduced costs and in space savings. Low-speed industrial and high-speed aircraft turbines are also used to drive pipeline pumps, in addition to diesel and electric drivers. Where electrical power is inaccessible or very expensive, turbines can be fueled by gas or a small portion of the petroleum being pumped. TAPS has several small refineries along its route that take crude oil from the pipeline, refine a fuel product from it to supply the pipeline's turbines, and return the unused portion of the crude oil to the pipeline where it mixes back into the passing crude oil.

Electronic, pneumatic, and hydraulic equipment for controlling and monitoring pipelines has changed substantially. Computerized supervisory systems and solid state electronics have resulted in more efficient centralized pipeline operations. One or more pipeline systems can now be monitored from a computerized control center, requiring fewer people and providing substantially more data than previous systems. Satellite communications are increasingly used today to relay signals between the pipeline control center and each remote pump station, receipt, or delivery point.

State-of-the-art computers and remote terminal units have high reliability and provide processing power to perform complicated sequence controls, calculate complicated flow equations, and provide for digital control loops of analog processes, thus making pipeline operations even safer and more efficient. The efficiency of electronic equipment has increased significantly since 1979. These efficiencies have allowed system designers and engineers to install much more sophisticated System Control and Data Acquisition systems than ever before.

The innovative use of highly reliable communications satellites now allows pipeline master control stations to send and receive data from any location in the contiguous 48 states without telephone connections. The key element is a satellite that geosynchronously orbits the earth (fixed over a point on the earth) 22,500 miles in space. The satellite signals are received by field units called Very Small Aperture Terminals (VSAT) (see Figure 2).

Many pipeline companies are using internal inspection devices called intelligent "pigs" (Figure 3) to inspect their pipelines for metal loss and other anomalies such as dents. Pig sizes range from 8 to 48 inches in diameter. These intelligent pigs employ internally mounted computers and recorders to gather pipeline data from sensors mounted on the outer circumference of the pig. The sensors currently use an electromagnetic flux or

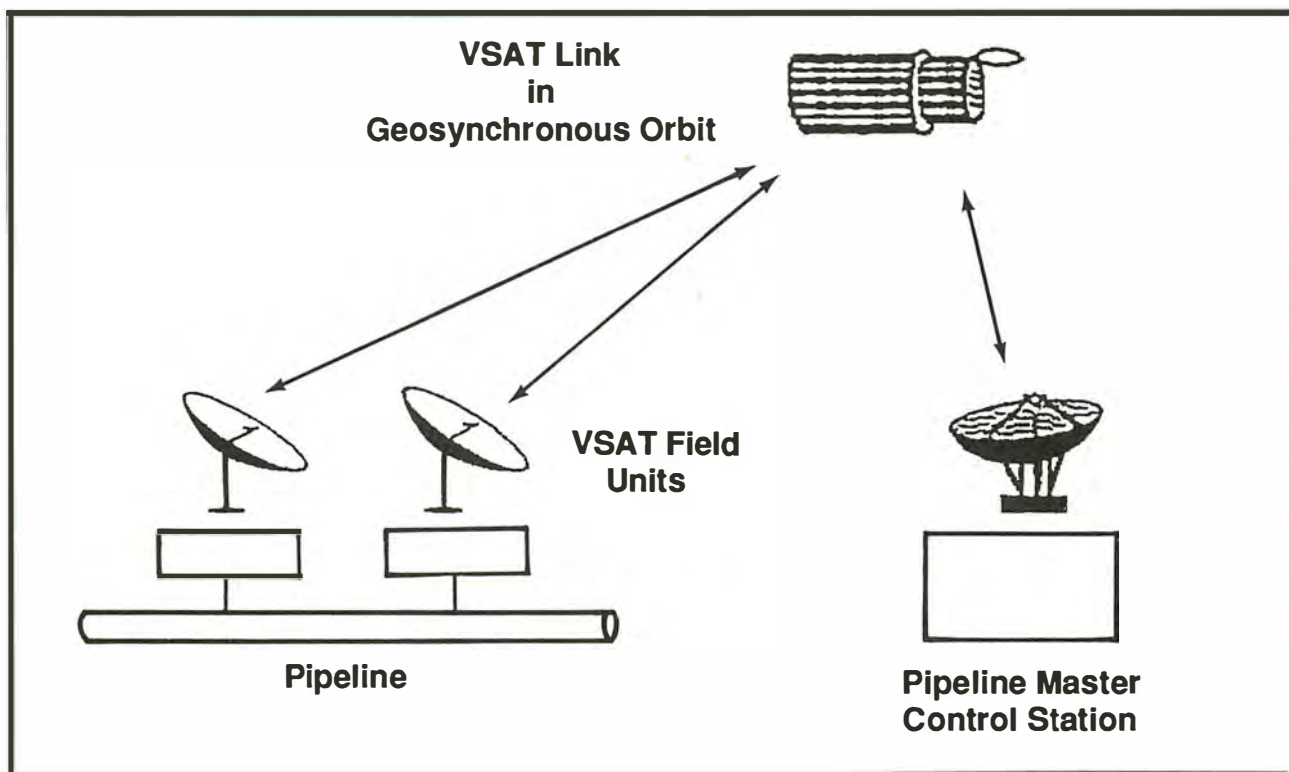

Figure 2. Schematic of a Satellite Communications Network for Pipeline Operations.

28-inch Magnetic Inspection Vehicle

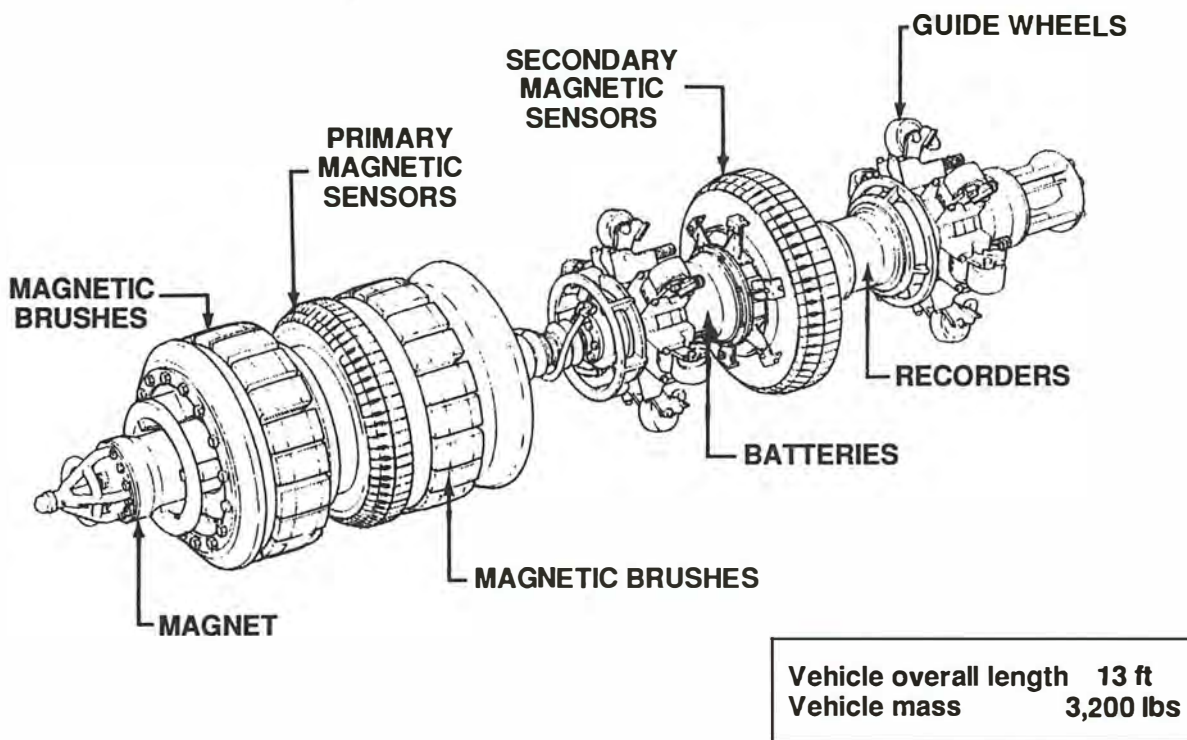

Figure 3. Diagram of an Intelligent Pig.

ultrasonic techniques to measure pipeline wall thickness. These sensors are able to detect loss of metal from the inner or outer wall. The location of pipe wall anomalies is derived from the tool's odometers, from girth-weld positions, magnetic markers, and surface-mounted markers. The number of miles of data that can be recorded in one pass through a pipeline depends on a multitude of factors such as flow rate and battery capacity.

There have been significant advances since 1979 in the area of pipeline control and leak detection systems. Pipeline companies have installed highly sophisticated computers to control pipeline operations. The techniques applied to solving pipeline control and leak detection problems include complicated hydraulic models, sophisticated net volume input-output calculations, and monitored hydraulic transients to detect leaks. This emerging technology holds great promise for the future.

Operations and Maintenance

Operations

A pipeline can be a single line of uniform-diameter pipe with liquids pumped at a uniform rate from one place to another,

or it can be a substantially more complex system. The line might have intermediate entry and exit points, differing diameters or pumping capabilities at various points, or be several separate pipelines of varying diameters running side by side -- the combinations are almost limitless. The typical pipeline will have points of origin and destination, breakout tankage, and decreasing or increasing capacity as the line approaches its terminus. All of these factors make scheduling pipeline movements and overseeing pipeline operations complex and challenging tasks.

As noted earlier, the volume of liquid a pipeline can carry depends upon the size of the pipeline, the capabilities of its pumps, and the gravity and viscosity of the liquid being pumped. Pipeline operators publish tariffs that establish prices for shipping, and state the conditions and specifications for what may be shipped through a pipeline. Specifications will normally be set on the pour point of the liquid (the temperature at which the liquid will no longer flow) and its viscosity (a measure of the resistance exhibited by the liquid), because the rate of flow in a pipeline is determined by the slowest-moving liquid in the pipeline. In addition, crude oil pipelines usually carry specifications on the sulfur content, gravity, vapor pressure, basic sediment and water, and limits on contaminants such as metals and chlorides. Product pipelines may have limited capacities for certain products, and therefore restrictions for these products will be stipulated. The reasons for establishing specifications on materials handled in crude oil and petroleum product pipelines are the need to maintain an optimum rate of flow and the desire to avoid downgrading or contaminating the crude oil or petroleum products normally shipped.

Contamination can result in costly penalties to the pipeline, the refiner, or the distributor who receives the contaminated crude oil or product. Pipelines protect crude oil and product qualities by means of careful quality-control practices. Separation of different grades of crude oil or petroleum products in a pipeline is called "batching." The mixing of different products at the interface in a pipeline is minimized by maintaining pipeline pressure, but batches are sometimes physically separated by batching devices such as reusable rubber spheres. Regardless of separation method, some mixing at the interface occurs. To minimize the effects of this mixing, shipments are batched in a continuous, orderly sequence with product grades of similar quality. Crude oil is normally batched by sequencing compatible crude oils; such qualities as specific gravity, viscosity, sulfur content, and whether the crude oil is asphaltic, paraffinic, or naphthenic based are taken into account. Products are typically shipped in groups that move from lighter to heavier gravities and then back to lighter again in cycles such as the following: gasoline-kerosine-fuel oil-kerosine-gasoline. Cycles are typically 5 to 10 days in length depending on the pipeline capacity, scheduling of refinery operations, and market demand. A 10-day cycle translates to 3 cycles per month and 36 cycles per year.

Pipelines are operated as either "segregated" or "fungible" pipelines or both. In a segregated pipeline, specific shipments are identified as the property of a shipper and are moved through the pipeline in such a way as to maintain the integrity and identity of the specific product. In a fungible products pipeline, the pipeline company sets a range of specifications for each grade of fungible (or similar) product. All volumes of that product grade are commingled into a single batch. When the fungible batch reaches the delivery point, every shipper receives its share of the volume.

In a common-stream crude oil pipeline, the crude oil the shipper receives may vary from the oil the shipper put into the pipeline. When the potential difference in quality is small (that is, the acceptable quality range defined by the pipeline for each common stream grade is narrow), then the shipper simply takes his share of that grade-type to which he contributed. When large differences exist in the quality of crude oil injected into a pipeline, a gravity-sulfur bank may be established as a means of monetarily compensating a shipper who received a poorer quality crude oil than it put in with funds assessed a shipper who received a better quality crude oil than it tendered.

Efficient pipeline operations depend on large shipments, which result in lower operating costs for the pipeline and, consequently, lower transportation costs to shippers. For efficiency and to maintain product integrity, pipelines normally establish minimum batch sizes ranging upward from 25,000 barrels. The effect of establishing minimum batch sizes is to reduce the number of interfaces and thus minimize losses due to interface contamination.

Any company wishing to ship crude oil or petroleum products on a common-carrier pipeline has the right to do so provided it meets the requirements of the pipeline's published tariffs and indicates an intention to request space for (or "nominate") shipment on the pipeline. This nomination must stipulate the products and volumes to be shipped during a specified month, and must be submitted prior to the pipeline's nominating deadline for the month. The pipeline confirms the movement and a shipment date once the shipper meets the published rules and regulations of the pipeline's tariff. If requests for shipments during a month are greater than the capacity available, the pipeline managers may have to apportion (or "prorate") available capacity among all those nominating for it.

The physical characteristics of pipeline operations require a pipeline to be full before any deliveries can be made. This line fill is normally furnished and owned by all of the shippers on a pipeline but remains in the custody of the pipeline company. It includes pipeline fill, manifolding and tank line fill, and working storage in tankage. Line fill can be as much as several million barrels depending on the length and diameter of the pipeline and associated tankage.

Scheduling shipments through a pipeline is a complex and exacting job. The pipeline companies must balance all the various nominations of different qualities of crude oil or grades of products, their entry points and destinations, and their shipment and arrival dates. Many pipeline companies use computers to prepare and adjust short- and long-range schedules and update them on a regular basis. Schedule changes often cause shipment dates to be shifted from day to day or week to week. These changes are caused by refinery shutdowns, pipeline operating problems, erratic tanker arrivals, and volume changes by shippers. In addition, pipeline schedules vary seasonally as product demand changes.

Trunk line operations are monitored around the clock from a central location by dispatching personnel, many using supervisory control equipment. Dispatchers control operations at remote, unmanned facilities; keep track of the grade, quantity, and ownership of each batch; coordinate with field operation personnel at manned facilities; and monitor flow rates, pressures, and shipments to maintain safe and efficient operations.

Although this view of pipeline operations indicates how complex the operation of a pipeline can be, only the operation of a single pipeline or pipeline system has been considered. In practice, a shipment of crude oil or petroleum product may change systems several times before it is delivered to its final destination. For example, crude oil from southeastern Utah can move sequentially through the Texas-New Mexico, Basin, Cushing to Chicago, Lakehead, and Interprovincial systems to the Buffalo, New York area for delivery to Warren, Pennsylvania; or products can move from Lake Charles, Louisiana, to product distribution terminals in Pittsburgh, Pennsylvania, through either the Colonial and Laurel systems or the Explorer, ARCO, and Buckeye systems. These shipments may be moved on pipelines with varying quality requirements or may be moved through several different storage facilities between pipelines, but they will meet the shipper's quality specifications at their destination.

Maintenance

Pipeline inspection and maintenance is continuous -- from routine maintenance of the pipeline's facilities (pump stations, equipment, and tank farms) and rights-of-way, to emergency repair and major maintenance such as line lowering, replacement, or relocation. Some pipeline companies have maintenance crews that to varying degrees handle tasks in each of these maintenance areas, while others use contract personnel. All pipeline companies use their employees to supervise and inspect the work performed by others.

Corrosion control is of great importance, in both the design and maintenance of pipelines. Corrosion can cause metal loss to a pipeline system due to external forces (soil conditions) or due to the characteristics of products moved in the pipeline (e.g., hydrogen sulfide entrained in water). External corrosion is

mitigated by coating the outside of the pipeline and by impressing and carefully controlling the flow of electric current between the soil and the pipeline (cathodic protection). Internal corrosion is controlled through use of coating systems applied to the inside of the pipe and/or through the use of chemical corrosion inhibitors injected directly into the product stream. In order to ensure the effectiveness of these corrosion control methods, numerous inspection techniques are employed. These include visual inspection of the pipe, use of internal inspection devices (intelligent pigs), and survey of pipe-to-soil electrical potentials along the pipeline.

Periodically, pipelines are cleaned internally of accumulated dirt, sediment, water, wax, and other matter by use of scrapers (or pigs), which are cylindrically shaped metal or polyurethane devices with wire brushes or a series of protrusions. They are put into and taken out of the pipeline through pipe and valve assemblies called "scraper traps." These scrapers are pushed by the oil in the pipeline at the flow rate and deposit the dirt or wax into the scraper trap where it is removed. These scraper traps also facilitate the use of intelligent pigs.

Most problems along the pipeline can be located and identified by computers at the pipeline's control center, which analyze the operating data fed back to it from the various stations along the pipeline's route. Visual inspection is usually done by aerial patrol, to check the pipeline route for abnormal conditions such as washouts and new construction on or near a pipeline. All main lines are inspected at least once every two weeks and in most cases more frequently. Aerial and ground inspection are especially important in reducing the potential for damage by leaks caused by third parties. Third parties constitute the single largest cause of damage and leaks.

When a leak is detected, the pipeline is immediately shut down and maintenance crews are dispatched to uncover the line and place a specially designed clamp around the pipe to stop the leak. After flow in the line is stopped, one of several methods may be used to repair the line: for a small leak, a full encirclement sleeve is installed; for a larger leak, the line segment is isolated and drained, the damaged section is removed, and a new section welded in place. All new welds are tested and coated to prevent corrosion. Concurrent with the repair, a clean-up operation is undertaken to protect the environment.

PIPELINE SAFETY AND REGULATION

As might be expected, industry and the government interact in many ways, on many subjects, and at many levels. Pipeline companies pay taxes, obtain rights-of-way, conduct community information programs, and engage in numerous other activities that bring them in contact with federal, state, and local authorities. This relationship has become more pervasive as statutes, government agencies, and regulations have proliferated in recent

years. Three areas of particular importance -- safety, environmental, and economic regulation -- are set forth in more detail in this section.

Pipeline Safety Legislation and Regulations

Facilities

Over many years, the oil pipeline industry has compiled an outstanding safety record. This is attributable to a number of factors, most important of which is the industry's responsible approach to the design, construction, operation, and maintenance of its facilities. Indeed, voluntary industry standards developed for pipeline construction and operation have served as the basis for federal regulations.

The industry has worked diligently to advance pipeline technology and operating practices that affect safety. The last four decades have seen great improvements in corrosion control, quality of pipe and equipment used in pipelines, and instrumentation for pressure control and leak detection.

There are many incentives for the industry to operate safely. These include responsibility to the public for potential injury, loss of life, and property damage; loss of product transported and throughput revenues; significant capital investment; and the need to attract investor, employee, and general public good will.

Federal involvement in pipeline safety has been a relatively recent development. In 1908, the Congress enacted the Transportation of Explosives Act (TOEA), which applied to pipelines only because of its general applicability to hazardous materials transportation. It did not contemplate an overall federal pipeline safety program.

In 1978 and 1979, the Congress conducted a series of hearings on proposed legislation affecting the oil and natural gas pipeline industries. While concluding that "pipelines are the safest means of transporting these commodities," the Congress found that the existing "NGPSA and the TOEA do not provide all the necessary tools for a sensible and effective Federal pipeline safety."²

Accordingly, in November of 1979, the Hazardous Liquids Pipeline Safety Act (HLPSA) was signed into law, signaling many comprehensive changes in the way petroleum pipeline safety is regulated at the federal level. The statute provided a clear preemption by the federal government of authority over the states

²Report of the Committee on Commerce, Science and Transportation, May 15, 1979. NGPSA is the Natural Gas Pipeline Safety Act enacted in 1968.

for regulation of interstate pipelines. It established federal jurisdiction over intrastate petroleum pipelines for the first time, as well as criminal penalties for violations of the law. Under the statute, a grants-in-aid program was created whereby states would establish pipeline safety programs in response to incentives from the federal government.

Under this statute, there have been a number of significant regulations promulgated by the U.S. Department of Transportation (DOT) during the last several years. These have included the requirement of hydrostatic testing of all pipelines transporting highly volatile liquids to 1.25 times their maximum operating pressure, mandatory standards for operation manuals for all petroleum pipelines, and the revision of the reporting forms for pipeline incidents in order to provide better data on their causes.

Pipeline operators now are required to report to both federal and state agencies the existence of unsafe conditions within a very short time of their discovery. Pipeline operators are also subject to strenuous audits of their operations by inspectors of DOT, which recently has made a number of improvements to standardize the inspection criteria and frequency. In order to encourage greater public participation in the pipeline safety rulemaking and policy development process, DOT has formed an advisory committee, the Hazardous Liquids Pipeline Safety Standards Committee, which gives it independent advice on an ongoing basis.

During the current Congressional session, a detailed review of the NGPSA and the HLPSA has been undertaken, and a number of amendments were proposed, some of which were enacted into law in October 1988.

The industry generally supported this legislative initiative. Certain of the provisions, such as those pertaining to one-call systems and penalties for willfully damaging or defacing pipeline markers, received wholehearted industry support. One-call systems allow anyone excavating to call one telephone number to notify participating underground facility owners of planned activity in a given geographic area. The single largest cause of accidents has been third-party-excavator damage, and the legislation directs DOT to issue minimum federal requirements for the operation of one-call systems for adoption by the individual states.

Other provisions require more frequent inspections, authorize DOT to consider the need to issue standards for testing and/or certifying individuals responsible for operation and maintenance, and require operators to provide more information relating to their facilities.

The joint efforts of industry and government in the area of safety have demonstrably contributed to ensuring that pipelines have been, are, and will be the country's safest mode of crude

oil and petroleum product transportation. Figure 4 compares the safety records of different modes of transportation.

Public and Personnel Safety

During the past several years, the pipeline industry and DOT have taken initiatives to develop and promote closer contact between petroleum pipelines and members of the public who live near pipeline facilities. DOT regulations require each operator to establish continuing public education activities to enable the public, appropriate government organizations, and parties involved in excavation to recognize a potential hazardous liquid pipeline emergency and to report it to the operator, the fire department, police, or other public safety organization.

Liquid pipeline system operators have developed programs to meet this need. Public education programs typically include distribution of informational brochures and calendars, personal contact on a periodic basis with residents and fire and police officials along the right-of-way, sponsorship of public service announcements on television and radio, and distribution of educational materials to excavators.

The industry also has supported the need for close cooperation between liquid pipeline companies and public agencies charged with responsibility for emergency response.

The industry is developing information to assist public agencies in learning how petroleum pipelines operate and how pipelines and agencies can cooperate in the event of an emergency. Companies currently provide public officials with material safety data sheets as required by the Occupational Safety and Health Administration.

Personnel training is a critical component of each company's safety program and is another area regulated by DOT. The industry sponsors a pipeline technology school with the University of Texas and holds regular conferences on new developments in technology and pipeline design and operating practices. DOT requires each company to establish and document operations, maintenance, and emergency procedures. Each company is required to ensure that its employees are familiar with these procedures.

Environmental Regulation

Petroleum pipelines enjoy several natural advantages over other modes of transportation in terms of the environment. They operate primarily underground in closed systems and cause minimum interference to the public, above-ground traffic, and air and water quality. Pipelines are usually compatible with other forms of land use.

During the last decade, as society has become more conscious of the need to protect the environment, a number of laws and regulations have been enacted that directly affect petroleum pipelines. Petroleum pipelines are subject to the requirements of

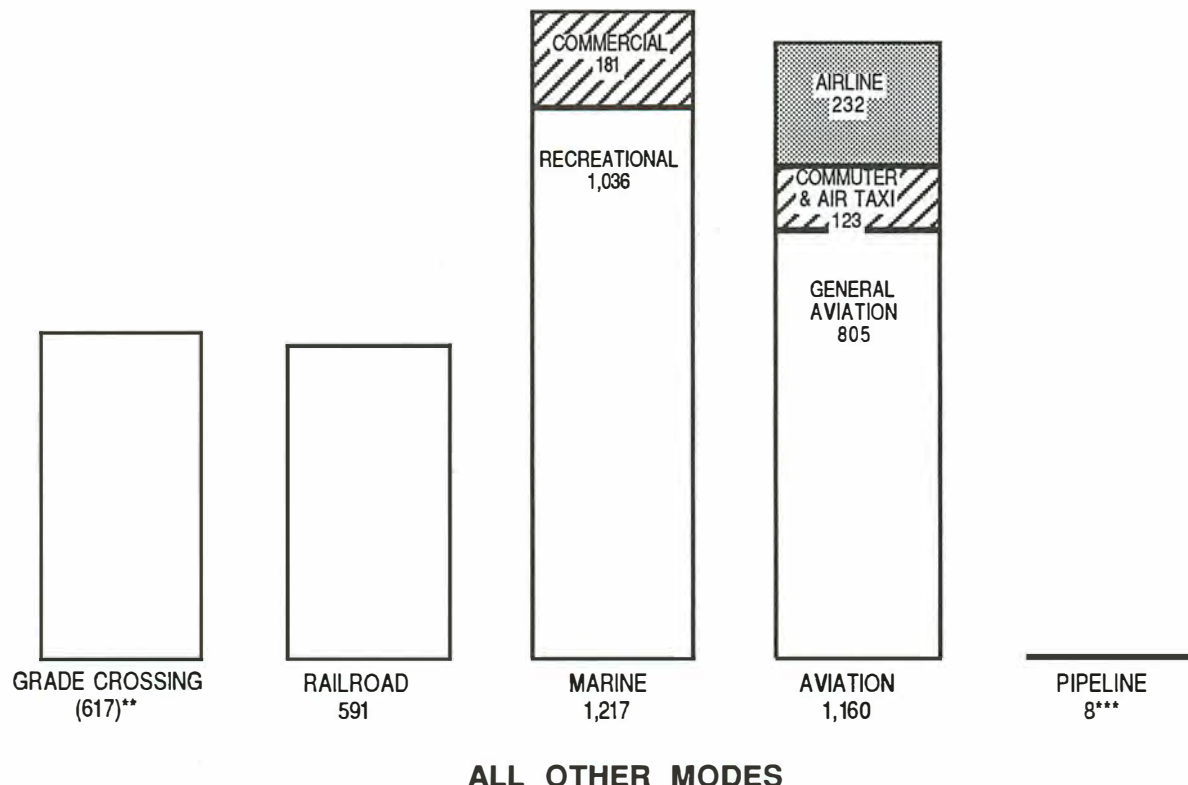
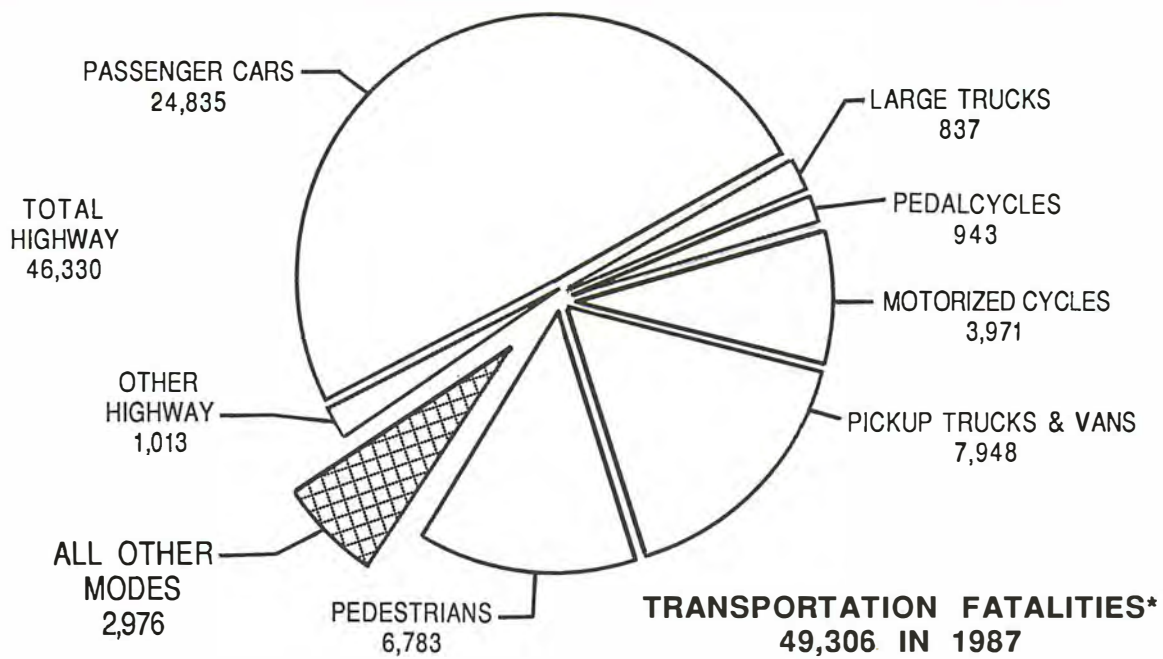

* Preliminary estimates
 ** The grade crossing fatalities are counted in the highway and rail categories.
 *** Natural Gas pipelines accounted for all 8 fatalities. Liquid pipelines had 0 fatalities.

SOURCE: National Transportation Safety Board, Washington, D.C.

Figure 4. Safety Record of Different Modes of Transportation.

many statutes for which the Environmental Protection Agency (EPA) is the primary regulatory agency. These include the Clean Water Act, the Clean Air Act, the Safe Drinking Water Act, the Resource Conservation and Recovery Act, and the Comprehensive Environmental Response Compensation and Liability Act. These laws have provided sweeping new authority to limit pollution into the environment. Examples include discharges to groundwater and the improper handling of hazardous wastes and other by-products of industrial activity. Most of these laws also provide a significant enforcement responsibility for the states.

Economic Regulation

Since 1906, oil pipelines engaged in interstate commerce have been regulated under certain provisions of the Interstate Commerce Act. The nature of this regulation has been two-fold; to ensure that the rates charged by pipelines are "just and reasonable," and that shippers have access to the lines on a non-discriminatory basis.

From 1906 until the 1970s, the Interstate Commerce Commission exercised regulatory jurisdiction over the carriers. Shipper complaints were few and the Commission adopted a "light-handed" approach, not undertaking regulatory proceedings without a complaint and establishing rate-of-return guidelines that encouraged industry investment and development.

In 1977, the Department of Energy Authorization Act transferred economic regulatory jurisdiction of oil pipelines under the Interstate Commerce Act from the Interstate Commerce Commission to FERC.

At that time, the Farmers Union case was pending before the United States Court of Appeals for the District of Columbia. This case was an inquiry into the rate-base methodology and rates of return that had been applicable to oil pipelines for 40 years, and which had recently been reaffirmed by the full Interstate Commerce Commission.

In 1978, at the request of FERC, the Court of Appeals remanded Farmers Union to FERC for further proceedings "to attempt for itself to build a viable modern precedent for use in future cases."

The case was again appealed to the Court of Appeals, and in March 1984, that Court again remanded the case to FERC for further proceedings, noting that the Commission "must carefully scrutinize the rate base and rate of return methodologies to see that they will operate together to produce a just and reasonable rate." The Court also noted that the rate of return should take account of the risks associated with the regulated enterprise.

In June 1985, without additional evidentiary hearings, FERC issued Opinion 154B. This opinion adopted the concept of a trended original-cost rate base for the industry without, however, resolving a number of fundamental questions, including the

appropriate rate(s) of return to be applied. Other fundamental issues, such as rate design, were not addressed. These matters were left to be resolved on a case-by-case basis.

The Farmers Union case was again appealed, but subsequently that appeal was vacated with the consent of all the parties on the basis of a settlement that had been entered into between those having a financial interest in the case. That development, however, did not resolve any of the fundamental issues.

Since the issuance of Opinion 154B in 1985, a number of cases have been commenced at FERC which attempt to resolve questions of rate base, rate of return, and other issues left unresolved by that Opinion. None of these cases has been decided by FERC. Further, FERC has divided one of these cases into two stages, the first being an inquiry into questions of competition and the presence or absence of market power. When any decisions can be expected is pure speculation. Ten years of administrative and judicial proceedings with no resolution of fundamental issues relating to the economic regulation of the industry has created an atmosphere of uncertainty, particularly relating to both present and future pipeline investments.

During the last several years, industry and the government have been seeking ways to resolve this regulatory and judicial morass. One promising approach was to seek legislation from the Congress that would either appropriately amend the Interstate Commerce Act or create a new and partially deregulated environment. In this effort, beginning in 1981, several bills were introduced in both the Senate and the House of Representatives, and numerous hearings were conducted on the measures. In 1982 and 1983 the Administration testified in favor of deregulating the industry.

Within the past year, as a result of numerous meetings between the Administration and interested parties, significant progress has been made in drafting legislation that addresses carrier needs for economic deregulation as well as shipper concerns for safeguards against discriminatory treatment. In the fall of 1988, comprehensive deregulation bills (S-2770 and HR-5289) were submitted to the Congress and are generally supported by the industry.

Under this bill, oil pipelines would be economically deregulated as to the setting of rates, but a shipper would have an opportunity to challenge the competitiveness of an individual market; and the U.S. Department of Energy, after an administrative proceeding, would decide whether or not that market should continue to be regulated. Further, common-carrier obligations would remain in effect to ensure nondiscriminatory treatment of shippers.

The bill, submitted in September 1988, reflects the rationalization of two bills previously introduced in the

Congress: the Administration's bill and the bill supported by the oil pipeline industry. Both legislative proposals reflect the emerging consensus that deregulation of oil pipeline rates is now both appropriate and necessary.

The importance of this common consensus cannot be over-emphasized; there is no disagreement between the industry and the executive branch of the government as to the need for regulatory reform. One of the major challenges of the 101st Congress is that action must be taken in a timely manner to remove the cloud of uncertainty which now prevails in the area of pipeline rate regulation.

CRUDE OIL PIPELINE SYSTEMS

The crude oil pipeline industry's current position is shown in Table 2 and clearly reflects shifting supply-and-demand trends that have taken place over the past decade. Crude oil barrel-mileage fell during the 1979-1987 period, reflecting lower refinery runs, shorter hauls, increasing Canadian imports, and shifting import patterns. This leaves the industry with substantial unused crude oil pipeline capacity. There do not appear to be any major logistical problems on the horizon that are beyond the industry's ability to handle.

TABLE 2
1987 PIPELINE MOVEMENTS OF CRUDE OIL BETWEEN PADDs
 (Thousands of Barrels per Day)

<u>From</u>	<u>To</u>				
	<u>PADD I</u>	<u>PADD II</u>	<u>PADD III</u>	<u>PADD IV</u>	<u>PADD V</u>
PADD I	X	0	0	0	0
PADD II	1	X	75	20	0
PADD III	0	1,418	X	0	0
PADD IV	0	198	59	X	0
PADD V	0	0	20	0	X

Overall Description of Crude Oil Movements

Refinery requirements are the ultimate determinant of crude oil movements in the United States. Refinery throughput figures reflect the significant changes that have taken place in the crude oil pipeline system between 1979 and 1987. For example, total refinery crude oil runs dropped from 14.6 MMB/D in 1979 to 12.9 MMB/D in 1987, a 12.2 percent decline. A low of 11.7 MMB/D was reached in 1983, some 20.2 percent below 1979.

In 1987, refinery runs in PADD II were down by 885 MB/D, a decline of 23.7 percent since 1979, almost twice the national average. Refinery runs on the West Coast (PADD V) were up by 78 MB/D, or 3.3 percent over 1979.

The decline in refinery runs in PADD II has caused a drastic reduction in long-haul pipeline movements from PADDs III and IV into PADD II. In most cases, the major lines from Texas, Oklahoma, and the Rocky Mountain region to the St. Louis, Chicago, and Detroit areas suffered heavy volume reductions with the impact on barrel-miles being even more pronounced. Shipments out of PADD IV were also limited because of refinery requirements in the Rocky Mountain area.

Domestic production is another key factor that provides a picture of the utilization of crude oil pipelines for crude oil movements. While domestic production climbed gradually between 1979 and 1985, the price collapse of 1986 has contributed to a 622 MB/D decline over the past two years. At the same time, total Alaskan production has increased steadily over the 1979-1987 period, averaging almost 2 MMB/D last year.

PADD I

PADD I refineries are fed primarily by waterborne foreign imports delivered into the mid-Atlantic Coast. To a significantly lesser extent, Canadian imports are received at Warren, Pennsylvania, via the Interprovincial-Kiatone pipelines. Inland waterway movements originating in Ohio serve the specialty refining areas in western Pennsylvania.

PADD II

Canadian crude oil shipped through Interprovincial Pipeline is a major supply source for the Great Lakes region. Virtually all of the 465 MB/D of Canadian crude oil processed in PADD II in 1987 entered the district via Interprovincial Pipeline. The western portion of this region, consisting primarily of refiners in the Twin Cities, receives North Dakota production and a minimal amount of foreign crude oil pipelined via the U.S. Gulf Coast into Wood River, Illinois. Rocky Mountain (PADD IV) crude oil production also arrives at Wood River.

In addition to Canadian supply through Lakehead Pipeline, the U.S. extension of Interprovincial Pipeline, crude oil supply

for the eastern Great Lakes region is provided from several other major sources including: Rocky Mountain crude oil delivered by Platte, Amoco, and connecting carriers; foreign imports transported from the Gulf of Mexico across Capline and connecting carriers; Texas production moving northeasterly over the Mid-Valley and Mobil systems; and Texas/Mid-Continent crude oil shipped across the Midwest into Chicago via the Amoco and ARCO pipelines. In addition, Texas/Mid-Continent production enters the lower Midwest through the Ozark pipeline into Wood River. The Mississippi River and connecting waterways provide still another supply line both into and within PADD II.

The PADD II refiners located in the Mid-Continent are supplied predominantly by PADD II and West Texas production transported over major pipeline systems including Amoco and Basin. The recently reversed ARCO Pipeline now provides the potential to feed foreign imports into PADD II via pipeline from the U.S. Gulf Coast.

PADD III

In addition to providing supply for the Mid-Continent and Midwest, West Texas/New Mexico crude oil is transported southeast to Texas Gulf Coast refiners. These refiners are also supplied by waterborne foreign imports and PADD V production. PADD V volumes, consisting largely of ANS and California Outer Continental Shelf (OCS) crude oils, move into the Gulf Coast region aboard tankers (through the Panama Canal or around the southern tip of South America) or across the newly constructed All American Pipeline, flowing east from the Santa Barbara area and connecting with major pipeline systems in Texas.

East Texas crude oil production is pipelined to local refineries and refineries in Louisiana and the Texas Gulf Coast. Refineries located in southern Louisiana meet supply requirements primarily with Louisiana onshore and offshore production and marine transfers of foreign imports or ANS crude oil into the area.

PADD IV

PADD IV is a net crude oil exporter to other PADDs, shipping volumes eastward into Kansas, Missouri, and Illinois over the Amoco and Platte pipelines. Imports into the region, however, are also significant, with Canadian imports moving south to refineries located in Montana, Wyoming, and Colorado across the Continental and Texaco/Butte systems.

PADD V

Domestic production in PADD V is either refined on the Western Seaboard or exported on marine vessels to refineries on the U.S. Gulf Coast and Atlantic Coast. Recently, the All American Pipeline has commenced operations, transporting PADD V crude oil east into PADD III.

Imports

The peak year for crude oil imports was 1977. Between 1979 and 1983, crude oil imports dropped from 6.5 MMB/D to 3.3 MMB/D. Recently, however, declining Lower-48 production and increasing demand combined to increase crude oil imports to almost 4.7 MMB/D in 1987. These increases are expected to continue. Crude oil imports by PADD are illustrated in Table 3.

Following a shift in Canadian crude oil export policy, imports of Canadian crude oil increased sharply between 1979 and 1987. In 1987, the United States imported 608 MB/D from Canada, representing a 124 percent increase over the 1979 level. The majority of Canadian volume goes to refining centers in the Upper Midwest (PADD II). Despite shifting patterns, the Gulf Coast continues to be the gateway for approximately 60 percent of the nation's imported crude oil.

TABLE 3

FOREIGN CRUDE OIL IMPORTS BY PADD
(Thousands of Barrels per Day)

	<u>PADD I</u>	<u>PADD II</u>	<u>PADD III</u>	<u>PADD IV</u>	<u>PADD V</u>	<u>U.S. Total*</u>
1979	1,432	1,526	2,969	65	528	6,519
1983	817	530	1,734	38	210	3,329
1987	1,111	870	2,431	65	197	4,674
% Decline 1979-1987	(22.4)	(43.0)	(18.1)	0	(62.7)	(28.3)

*Totals may not add due to independent rounding.

Changes Since 1979

Operating U.S. crude oil distillation refining capacity peaked in 1981 at almost 18.1 MMB/D and by 1988 stood at over 15.0 MMB/D. Declining consumption has contributed to the permanent closing or mothballing of the nation's least efficient and accessible refining capacity, with much of this reduction occurring in the Mid-Continent and Midwest. This meant a significant decline in pipeline movements from the Gulf Coast to the interior. The Seaway (a 500-mile, 30-inch line) and Texoma

(a 457-mile, 30-inch line) pipelines, which connected the eastern Gulf Coast of Texas with the Cushing, Oklahoma area, were built in the mid-1970s specifically to move foreign crude oils. By 1984, Seaway and Texoma were converted to natural gas service with a flow reversal to south from north. Both Capline and Mid-Valley pipeline throughput fell during the same period. In addition, the Paline Pipeline System from Beaumont to Longview in East Texas was also sold for conversion to alternative service. The conversions of Seaway and Texoma reduced capacity from PADD III to PADD II by 600 MB/D.

Following these conversions, two crude oil lines running north from the eastern Gulf Coast of Texas remained in service. Sun Pipe Line operates a 10-inch, 35 MB/D pipeline from Nederland to Longview, Texas, where it connects with Mid-Valley pipeline and ultimately the Upper Ohio Valley. ARCO operates a combination gathering-trunk line system, which collects crude oil in East Texas and joins the company's Houston-Jacksboro line at Wortham, Texas. This system was made reversible in 1987. Southbound capacity is estimated to be approximately 170 MB/D. Northbound capacity, from Jacksboro to Cushing, is 100 MB/D.

The Louisiana Offshore Oil Port (LOOP) and the connecting LOCAP pipeline system came on stream in 1981. LOOP was built to meet the need for handling a steady increase in import volumes, particularly long-haul imports transported from the Middle East by large crude oil carriers.

While LOOP was largely underutilized in its early years, supply patterns have been shifting and contributing to increased throughput. Between 1985 and 1987, increased economic activity and lower oil prices have contributed to an increase in consumption of about 1 MMB/D; at the same time, with lower oil prices, domestic production dropped by more than 600 MB/D. The result has been a return to rising crude oil import levels, with imports reaching about 5 MMB/D by early 1988. Because of a significant increase in long-haul foreign crude oil coupled with usage of smaller-sized vessels than originally contemplated, LOOP is now operating at a substantially higher level of utilization.

The five storage sites and related facilities located along the Louisiana and East Texas Gulf Coast, which make up the Strategic Petroleum Reserve (SPR), had an inventory of 560 million barrels of crude oil at year-end 1988. This compares with an SPR inventory of 91 million at the end of 1979. The SPR should reach its maximum inventory of 750 million barrels in 1994, under anticipated fill rates.

Emergency distribution of SPR inventories was originally planned through three major pipeline systems -- Seaway, Texoma, and Capline -- but the conversions of Seaway and Texoma to natural gas service eliminated much of this distribution capability. Although Seaway is no longer an option, tie-ins still exist to the Phillips system at Freeport, Texas. A new pipeline was laid to connect the SPR Bryan Mound storage facility to ARCO at Texas

City. The loss of Texoma is expected to be recouped by a pipeline connecting West Hackberry, Louisiana, with Lake Charles, Louisiana, as well as by improvements and additions to marine terminals at Lake Charles and Nederland, Texas. A direct pipeline connection to Capline is being constructed at St. James, Louisiana, and additional dock facilities are scheduled for connection to Capline. When these modifications are completed in 1992, SPR drawdown capabilities will be 4.5 MMB/D. Drawdown capabilities were tested in 1985 at a lesser capacity.

The Canadian National Energy Plan, designed to preserve Canadian resources, resulted in a reduction of Canadian exports to the United States between 1979 and 1983. Following the revision of this policy in 1985, imports of Canadian crude oil have more than doubled and the recently drafted U.S.-Canadian Free Trade Agreement is expected to continue this trend.

Four primary pipeline systems move Canadian crude oil into the United States. The Trans-Mountain Pipeline serves the Pacific Northwest; the Continental and Texaco Pipelines supply the Rocky Mountain region; and Lakehead Pipeline serves the Great Lakes area through both its south and north legs. The majority of Canadian imports move through the Lakehead system to Chicago and the Upper Ohio Valley; significant volumes are diverted to the Minnesota Pipeline at Clearbrook, Minnesota.

In response to the former policy of the Canadian government, Koch Industries, Inc., constructed 150 miles of pipeline to connect the Wood River Pipeline System near St. Louis, Missouri, to the Minnesota crude oil market. Crude oil can move to Minnesota from the Gulf Coast by either barge or Capline to the Koch Wood River System. The Wood River System is also connected to Mid-Continent sources of crude oil. A tie-in to Platte's 20-inch diameter pipeline system allows the delivery of Rocky Mountain sour crude oil into Minnesota.

Since 1979, production of Canadian sweet crude oil has been on the decline, while output of heavy oil has increased. This trend has contributed to continuing expansion of the Interprovincial/Lakehead System. It is likely that additional capacity will eventually be required to transport Canadian crude oil into PADDs II and IV.

Production from PADD V, excluding Alaska, has increased by 12.7 percent between 1979 and 1987. While pipeline activity has diminished throughout much of the country, it has accelerated in California as a result of increasing production in that state. Most of the production increase has resulted from secondary and tertiary recovery activities. In response, several major oil companies have upgraded or modernized their pipeline systems.

At year-end 1987, two new major pipeline projects were on line and a third was essentially complete. The largest of these projects is the All American Pipeline, a 30-inch heated heavy-oil system originating in Santa Barbara County, which will eventually

reach Houston, Texas. This is the first large-diameter pipeline running eastward from the West Coast. A projected excess of PADD V production, largely OCS, was a major force behind the line's construction. All American is capable of moving both OCS and inland California production, as well as ANS oil, via a connection with the Four Corner system in California's Mojave Desert. Inland California and ANS oil began moving through the system in late 1987. Celeron Gathering Company has constructed a 16-inch gathering line beginning in the Belridge area and connecting with the All American system west of Emidio, California. By blending light and heavy crude oils, the All American system was moving unheated crude oil at year-end 1987.

The second major California project was the Point Pedernales system (see Figure 5), originating from offshore Platform Irene (Block 441), and terminating at Unocal Corporation's proprietary

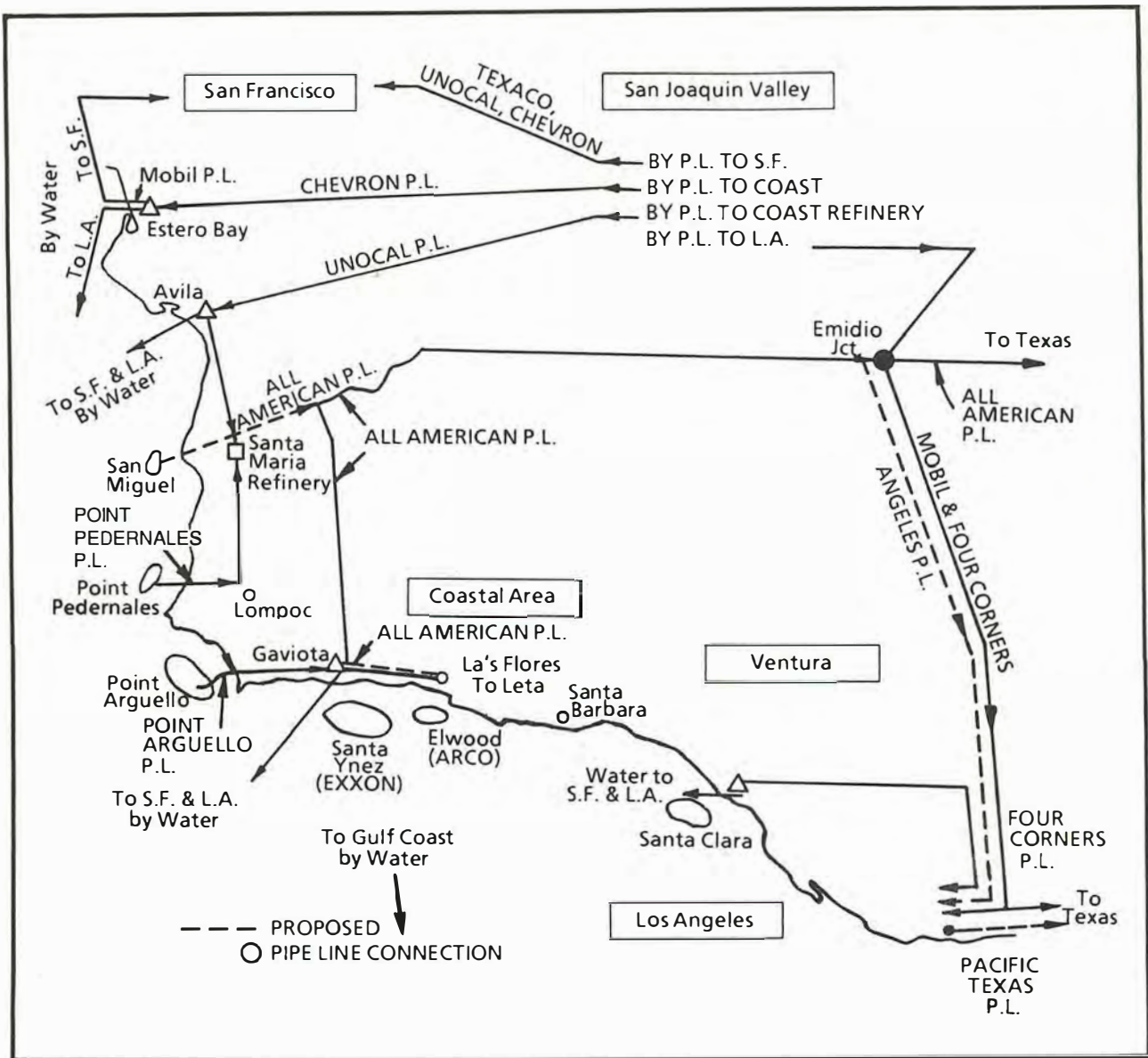

Figure 5. Southern California Crude Oil Pipeline System.

system near Lompoc. Throughput at year-end 1987 was approximately 20 MB/D.

The Point Arguello Pipeline system is awaiting start-up of production from several platforms south of Block 441. The 24-inch system will be capable of delivering as much as 100 MB/D to Gaviota, a marine-pipeline terminal west of Santa Barbara. At this time, crude oil delivered into Gaviota would have to be delivered out via ship or barge, but a construction permit for connection with the All American system has been granted by Santa Barbara County.

TAPS, which went on line in 1977, is a 48-inch pipeline stretching 800 miles from Prudhoe Bay to the Port of Valdez. TAPS started up with a capacity of 1,160 MB/D. Additional pump stations raised mechanical capacity to 1,420 MB/D in 1980. An innovative program of drag-reduction additive injection, which began in 1979, has resulted in TAPS capacity increasing to about 2,100 MB/D.

The increases in TAPS capacity have kept pace with rising Alaskan crude oil production. Prudhoe Bay currently produces 1,600 MB/D. The Kuparuk River Unit, which came on stream in December 1981, was producing 300 MB/D by the beginning of 1988. The Lisburne Unit, which started up in December 1986, currently contributes about 50 MB/D to Alaskan production. Lastly, the Duck Island Unit came on line in October 1987 at about 100 MB/D.

Besides TAPS, three common-carrier pipeline systems operate on the North Slope. Kuparuk Transportation Company operates a 28-mile, 24-inch diameter pipeline connecting the Kuparuk River Unit with TAPS Pump Station Number 1. Milne Point Pipeline Company owns a 10-mile, 14-inch diameter pipeline connected to the Kuparuk system. The Milne Point system suspended operations in January 1987 due to the collapse of oil prices and the mothballing of Milne Point production facilities, which accounted for about 30 MB/D. The Endicott Pipeline Company system, which started operations in October 1987, is a 25-mile, 16-inch diameter pipeline connecting the Duck Island Unit to TAPS Pump Station Number 1. The Duck Island Unit is to the east of Prudhoe Bay, approximately two miles offshore in the Beaufort Sea.

With the export of ANS crude oil currently prohibited by federal statute, Alaskan oil that cannot find a market on the West Coast or is not shipped east via pipeline from the Los Angeles area must move around the tip of South America or across the Isthmus of Panama. Until late 1982, movements across Panama were exclusively by Canal; this required transshipment from Very Large Crude Carriers (VLCCs -- vessels in the approximate 200,000 to 300,000 DWT capacity range) to smaller tankers capable of navigating the Canal. The Trans-Panama Pipeline System (Panapipe), an alternative to Canal movements, now unloads VLCCs at the Pacific port of Puerto Armuelles. The oil then flows 82 miles through a 40/36-inch diameter pipeline to the Atlantic port of Chiriqui Grande. The system has a capacity of 800 MB/D. This has eliminated tankers waiting to navigate the Canal, and permits

the use of optimally sized tankers to move Alaskan crude oil from Chiriqui Grande to the Gulf Coast. During the 1982-1987 period, Panapipe operated at a high throughput level.

Future Plans

At year-end 1988, the crude oil pipeline industry was actively involved in a number of expansion projects. Four of these projects had received final approval or had already progressed to the construction phase (see Table 4). In addition, two significant projects -- the Angeles and Pacific Texas pipelines -- had been proposed for the southwestern United States.

Angeles Pipeline

The Angeles Pipeline, or Southern California Pipeline System, is a proposed crude oil pipeline from Emidio, California, to Los Angeles. Currently, three companies are participating in the study phase of this pipeline: Chevron, Texaco, and Shell. An Environmental Impact Report was issued earlier this year.

The proposed Angeles Pipeline would be 140 miles long and have a 30-inch diameter. Initial design capacity is planned at 300 MB/D with a maximum capacity of 500 MB/D. The line would move local San Joaquin Valley heavy crude oil and Santa Barbara Channel crude oil via the All American Pipeline from Gaviota to Emidio. The estimated cost is \$400 million.

Connection points in the Los Angeles Basin would be the Four Corners' Hynes Tank Farm in Long Beach, the Shell Wilmington Refinery, and the Texaco Wilmington Refinery.

Pacific Texas Pipeline

The "Pacific Texas Pipeline" is a proposed crude oil pipeline from Long Beach, California, to Midland, Texas. The "Pacific Texas Pipeline Company" is in the permitting phase of this project.

The final environmental studies and reports for this project were approved in November 1985. The California Coastal Commission approved the off-loading facilities in San Pedro Bay and has extended the construction permit to May of 1989.

The proposed "Pacific Texas Pipeline" is planned as a 42-inch diameter line designed to receive and transport ANS crude oil. The line would be 1,026 miles long and would have a capacity of 900 MB/D.

The \$2 billion project would include two dredged sea islands in Los Angeles Harbor for discharging ANS from VLCCs.

Summary

Despite the dramatic shifts in domestic supply-demand patterns between 1979 and 1987, the pipeline segment of the industry

TABLE 4

PRINCIPAL CRUDE OIL PIPELINE FUTURE EXPANSION PROJECTS PLANNED OR UNDER CONSTRUCTION IN 1988

(0 may indicate that no data were provided)

<u>Pipeline Company</u>	<u>Location</u>	<u>Type of Expansion</u>	<u>Miles</u>	<u>Diameter (Inches)</u>	<u>Present Capacity (MB/D)</u>	<u>Approximate Anticipated Capacity (MB/D)</u>	<u>Completion Date</u>
All American	McCamey TX to Webster TX	New Line	512	30	0	300	
	Las Flores Canyon CA to Gaviota GA	New Line	11	24	0	300	
	Santa Maria GA to Sisquoc CA	New Line	24	24	0	150	
Arco	Houston TX to Wichita Falls TX	Reversal	58	12	41	100	01/01/88
Arco	Houston TX to Wichita Falls TX	Reversal	152	18	41	100	10/10/88
Arco	Houston TX to Wichita Falls TX	Reversal	150	20	41	100	01/01/88
Chevron	San Joaquin Valley CA to Los Angeles CA	New Line	130	30	0	330	07/90
DOE	St. James LA to West Hackberry LA to Lake Charles LA	New Line	12	36	0	800	01/31/89
Lakehead	North Cass Lake MN & Floodwood MN & Superior WI	Horsepower	0	0	0	0	11/01/88
Phillips P.L.	Bridger Lake Station UT	Unknown	27	6	12	18	09/30/88
Pt. Arguillo	Platform Merriosa CA to Gaviota CA	New Line	26	24	0	100	07/88

has been able to meet the crude oil requirements of the nation's refineries. Based on present and projected crude oil supply services, along with modest product-demand growth forecast through the early 1990s, the existing system's surplus capacity would tend to be filled, but with minor modifications, and expansions should be able to continue meeting those needs.

PRODUCT PIPELINE SYSTEMS

Overall Description of Product Movements

Similar to the crude oil pipelines network, the petroleum product pipeline industry's current position reflects significant changes in supply and demand trends in the last 10 years. In particular, the industry has adapted to structural changes in supply sources as a result of refinery closures and shifting import patterns. While a continued trend of supply restructuring may be expected in the future, there do not appear to be any significant logistical problems that would impede the petroleum product pipeline industry's ability to handle future demands.

Product pipeline configurations are the reverse of crude oil pipeline configurations. Crude oil lines generally begin from small-diameter gathering lines and increase to much larger ones as they approach the refineries. Conversely, product pipelines often start with larger-diameter lines as they originate from the refineries and/or water ports and become smaller in diameter as they arrive at storage and loading terminals or other end-user facilities. Products move through the system at a rate ranging from three to eight miles per hour, depending upon the diameter of the pipeline and the pressure, as well as the density and viscosity of the product. Accordingly, petroleum products traveling in lines from Houston, Texas, will arrive in the New York City area within 14 to 22 days.

More than 50 different grades of refined petroleum products flow through the transportation system. These include such diverse products as leaded and unleaded gasolines, home heating oil, aviation turbine fuel, kerosine, and diesel fuel. Some product pipelines also move other types of speciality products such as liquefied propane, butane, ethane, anhydrous ammonia, various feedstocks, and blending components from producing plants to market terminals. During 1987, the total annual movement of refined products by all carriers amounted to 1.9 trillion barrel-miles through the approximately 72,000 mile petroleum product pipeline network. Figure 6 generally depicts the overall flow of petroleum products within the primary pipeline distribution network. Petroleum product pipelines play a major role in the transportation of refined products from the major refining centers, such as the Gulf Coast, to the major consuming areas of the country (see Table 5).

Changes Since 1979

Escalating energy prices of the early 1980s coupled with other economic factors led to reduced economic activity and,

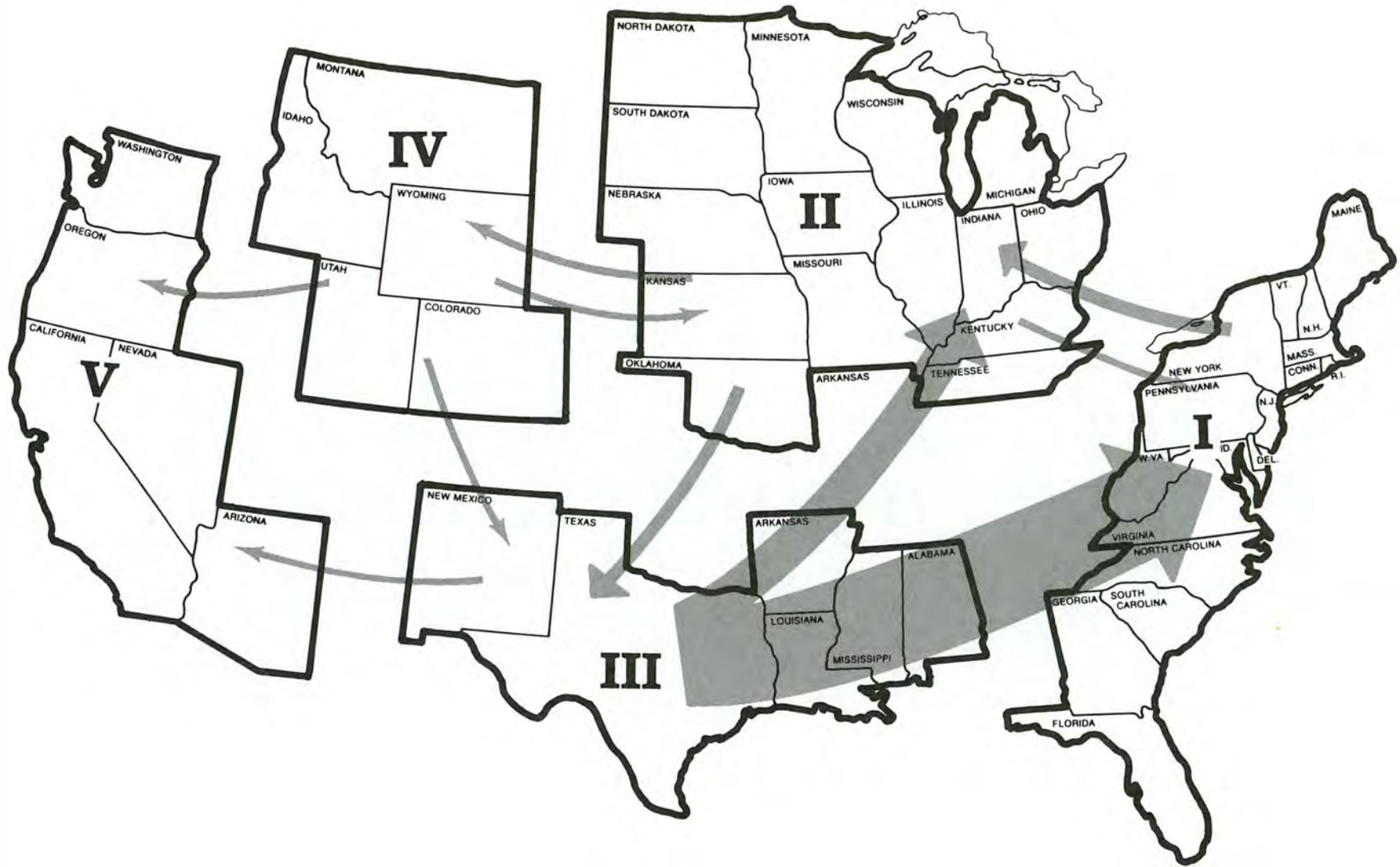

Figure 6. Pipeline Movements of Petroleum Products Between Petroleum Administration for Defense Districts (PADDs).

TABLE 5
 1987 PIPELINE MOVEMENTS
 OF PETROLEUM PRODUCTS BETWEEN PADDs
 (Thousands of Barrels per Day)

<u>From</u>	<u>To</u>				
	<u>PADD I</u>	<u>PADD II</u>	<u>PADD III</u>	<u>PADD IV</u>	<u>PADD V</u>
PADD I	X	222	0	0	0
PADD II	81	X	185	70	0
PADD III	2,070	734	X	0	56
PADD IV	0	47	33	X	41

Source: Energy Information Administration, Petroleum Supply Annual, 1987.

consequently, an overall reduction in petroleum product demand. By 1983, U.S. petroleum product demand had fallen 18 percent, from 18.5 MB/D to 15.2 MB/D. Increased energy conservation, the loss of industrial load, and end-use switching to natural gas all contributed to the overall decline in demand. Since 1979, conservation measures have played a key role. The amount of petroleum consumed per dollar of Gross National Product (GNP) can be used as a measure of the general effectiveness of conservation efforts. In terms of thousand British thermal units (BTUs) consumed per 1982 dollar of GNP, petroleum consumption declined 30 percent from 12.19 in 1979 to 8.54 in 1987.

Despite a robust economy after the 1982 recession, total U.S. petroleum product consumption remains 10 percent below 1979 levels. Likewise, while future demand is expected to increase, 1992 demand is not expected to exceed 1979 levels (see Table 6).

Despite the overall product-demand decline from 1979 to 1987, refined product imports to the United States have increased by 7.5 percent (see Table 7). Although significant increases have been witnessed in the Gulf Coast (PADD III), the change in the mix of heavy and light product imports has reduced the demand for transfers from PADD III to PADD I.

Declining product demand coupled with changing government regulations led to increased pressure to eliminate inefficient

TABLE 6

U.S. PETROLEUM PRODUCT DEMAND
(Thousands of Barrels per Day)

	<u>1979</u>	<u>1983</u>	<u>1987</u>	<u>% Change 1979-1987</u>	<u>1992</u>
Motor Gasoline	7,034	6,622	7,206	+2.4	7,310
Distillate Fuel	3,311	2,690	2,976	-10.1	3,440
Residual	2,826	1,421	1,264	-55.3	1,330
LPG	1,592	1,509	1,612	+1.3	1,780
Other	<u>3,749</u>	<u>2,989</u>	<u>3,606</u>	<u>-3.8</u>	<u>3,680</u>
Total	18,513	15,231	16,665	-10.0	17,540

Source: Energy Information Administration, Petroleum Supply Annual, 1987, and Annual Energy Outlook.

TABLE 7

REFINED PRODUCT IMPORTS BY PAD DISTRICT OF ENTRY
(Thousands of Barrels per Day)

	<u>PADD I</u>	<u>PADD II</u>	<u>PADD III</u>	<u>PADD IV</u>	<u>PADD V</u>	<u>Total U.S.</u>
<u>Year</u>						
1979	1,520	189	79	23	126	1,937
1983	1,157	181	266	21	97	1,722
1987	1,404	107	388	19	86	2,004
% Change 1979-1987	(7.6)	(43.4)	391.1	17.4	(31.7)	3.5

Source: Energy Information Administration, Petroleum Supply Annual, 1987.

refineries. The number of refineries operating in the United States decreased from 301 in 1979 to 195 by 1987, with a resulting decrease in refinery distillation capacity of approximately 3 MMB/D. This trend was most pronounced in PADD II, where refinery runs decreased by 23.7 percent since 1979.

In response to these trends, the petroleum product pipeline network adapted to accommodate changing supply in the last 10 years. Over 3,732 miles of new, looped, and converted lines have been placed in product service while approximately 2,072 miles of product lines have been taken out of service. At the time of the last NPC survey in 1979, 590 miles of new product pipelines were under construction. Further, 336 miles of pipeline looping and 54 miles of line replacement were also under construction. All of these projects have been completed.

Since 1979, numerous product pipeline projects have been undertaken. A complete listing is contained in Table 8. In PADDs I and V, the capacities of product pipelines were increased to handle increased demands while in PADDs II and III a significant change occurred in pipeline systems to accommodate supply restructuring necessitated by reduced crude oil production and refinery shutdowns. Notable projects with respect to these adjustments include: Colonial's capacity expansion from the Gulf Coast to the East Coast via new lines and increasing capacity on existing lines with horsepower expansions; Explorer's horsepower expansion and de-bottlenecking to provide additional capacity between the Gulf Coast and the Chicago area; Phillips' Borger, Texas, to Paola, Kansas, 16-inch line; Texas Eastern's 1979 looping of its existing system between the Gulf Coast and Seymour, Indiana.

Within each PADD, numerous projects have been completed since 1979 to provide additional capacity to accommodate increased demand and changing sources of supply. Within PADD II, there has been a pronounced trend toward re-orienting pipeline systems to handle shifting supply sources. Since 1979, approximately 1 MMB/D of refining capacity has been taken out of service in PADD II, resulting in increased reliance on supply from Gulf Coast refineries as well as refineries in the Northern Tier that have access to Canadian crude oil. Notable pipeline projects include Williams' expansion and reversal of its pipeline system to pump products from refineries in Minnesota and Wisconsin south to Iowa, South Dakota, and Illinois. Likewise, Koch in 1988 has commenced operation of a new line from the Twin Cities area to the Madison and Milwaukee, Wisconsin, area.

Future Plans

Based on responses received by the NPC from the recent questionnaire, product pipeline capacity is adequate for the immediate future (through 1992). Mostly, future projects reflect activities that will remove the bottlenecks in certain pipeline system flows. The majority of the projects are in PADD V, specifically in its southwestern region. A new 20-inch line from

TABLE 8

PRINCIPAL PETROLEUM PRODUCT PIPELINE FUTURE EXPANSION PROJECTS PLANNED OR UNDER CONSTRUCTION IN 1988

(0 may indicate that no data were provided)

<u>Pipeline Company</u>	<u>Project Number</u>	<u>Location</u>	<u>Type of Expansion</u>	<u>Miles</u>	<u>Diameter (Inches)</u>	<u>Present Capacity (MB/D)</u>	<u>Approximate Anticipated Capacity (MB/D)</u>	<u>Completion Date</u>
Buckeye	3	JFK NY to Inwood NY	New Line	6	12	108	0	03/31/88
Colonial	1	Knoxville TN Stubline	Loop Line	20	16	0	0	
	2	S. Albany GA to Bainbridge GA	Loop Line	51	12	31	64	
Explorer	3	Port Arthur TX to Tulsa OK	Horsepower	536	28	477	477	01/01/88
Phillips P.L.	72	Alven TX to Pasadena TX	New Line	41	12	85	100	03/31/89
Plantation	1	Bremen GA to Austell GA	Abandonment of 10" P/L	28	10	0	0	03/31/88
S. Pacific	1	Colton CA to Phoenix AZ	New Line	257	20	112	175	01/31/89
	2	Richmond CA to Concord CA	New Line	26	16	60	175	
	3	Pendleton Loop CA	Loop Line	25	16	112	138	
	4	Roseville CA to Reno NV	Replacement Line	23	10	38	46	
	5	Phoenix AZ to Tucson AZ	Reversal	112	16	0	50	
	6	Watson CA to Colton CA	New Line	62	16	0	115	
	7	Orange Loop CA	Loop Line	19	16	105	112	
	8	Walnut Station CA	New Station	0	0	290	340	
Sun Pipe Line	1	Line Between Icedale PA and Syracuse (North Line) NY	Drag Reducer	0	6	16	17.6	07/01/89
	2	Newark NJ East Line	New Line	0	0	126	160	
Union Pacific	1	Valley Well CA	Horsepower	0	0	58	65	05/01/89

Colton, California, to Phoenix, Arizona, will provide an additional 63 MB/D of new capacity to a growing market.

Table 7 represents the responses that were received by the NPC from its 1988 survey. All in all, 457 miles of new line will be added, while 44 miles of looping is projected. Additionally, 23 miles of pipeline are expected to be replaced.

Since demand for petroleum products is not expected to increase dramatically, it is not surprising that no major changes are planned by the petroleum product pipeline industry. The system has proved able to manage and respond to changing supply patterns, de-bottlenecking problem areas and compensating for disruptions.

Summary

As mentioned previously, environmental issues have had, and will continue to have, a significant impact on investment in refining capacities, terminal facilities, and product pipelines. Environmentally induced changes in gasoline specifications (e.g., lead phase-down, oxygenates, vapor pressure), as well as increased regulatory requirements involving pipeline and storage facilities, may require additional investment by the pipeline companies in order to conform to such legislation. However, it is anticipated that such initiatives can be accommodated without fundamental changes in the existing petroleum pipeline network.

Future pipeline investment decisions will not only be depending on the U.S. supply-demand equation and individual PADD's needs, but also on congressional action to alleviate the regulatory malaise that now clouds the pipeline investment process. The uncertainty inherent in the situation as it exists today and the chilling effect which this uncertainty has imposed on prospective oil pipeline investment decisions is clearly not in the public interest or the national security interest of the nation.

The executive branch of the government, the 101st Congress, and the industry must act in the near future to deregulate the highly competitive and efficient liquid pipeline transportation system and remove any uncertainties affecting future pipeline investment decisions.

LPG PIPELINE SYSTEMS

Overall Description of LPG Movements

Some product pipelines are dedicated to the transportation of LPG, while other pipelines batch LPGs with other products. LPGs include ethane, propane, normal butane, iso-butane, and mixtures of these products. Ethanes are primarily used as chemical feedstocks at ethylene plants. Propanes are supplied for residential/commercial heating, agricultural uses, and

chemical feedstock. Butanes are used by refineries for the blending of gasoline. (See Table 5 for product consumption.)

LPG pipelines are primarily owned by major, integrated petroleum companies and by independent pipeline companies. Many are jointly owned by those companies with producing and/or marketing interests.

There are two distinct systems for transporting LPGs: gathering systems (Figure 7) and distribution systems (Figure 8). Gathering systems collect product from gas processing plants, fractionators, and refineries and deliver it to storage hubs. A majority of the gathering systems are owned by producers of LPGs. Distribution systems deliver product from storage to such marketing outlets as chemical plants, refineries, and numerous other locations of end-use. A significant number of distribution systems are owned by commercial end-users such as refineries and chemical plants.

Large-capacity storage facilities are essential to both gathering and distribution systems. There are three types of storage available for LPGs: salt-formation storage, mined caverns, and pressurized steel tanks. The gathering system generally delivers LPGs into salt-dome storage (Figure 9). Mined caverns and steel tanks are used to store product moved out of the distribution system.

Mined caverns (Figure 10) are used for storage at locations needing large storage volumes where salt-dome storage is unavailable. Pressurized steel storage tanks are generally found at the end-user's site as well as at truck and rail terminals. They are the most expensive and represent smaller volumes of LPG storage on pipeline systems.

Major storage hubs were primarily developed in those areas having geologic salt domes or salt formations. Salt-dome storage is the least expensive to develop and the most abundant form of LPG storage. Salt-dome storage is created by leaching the salt dome with fresh water until the desired size of storage cavern is achieved. (Once the storage is placed in service, brine is used to move the product out. This prevents further expansion through leaching.) It is economically more feasible to utilize salt-dome storage versus mined caverns or steel tanks.

The three major salt-formation storage areas in the United States are located at Mont Belvieu, Texas; Hattiesburg, Mississippi; and Conway-Hutchinson, Kansas. The average cavern size at Mont Belvieu and Hattiesburg is 1.5 million barrels, compared to 200,000 barrels at Conway-Hutchinson. These three storage areas gather and supply the bulk of the LPGs to the appropriate distribution system for delivery.

Changes Since 1979

Although demand for crude oil and refined petroleum products has dropped, the total supply and demand for LPGs has increased

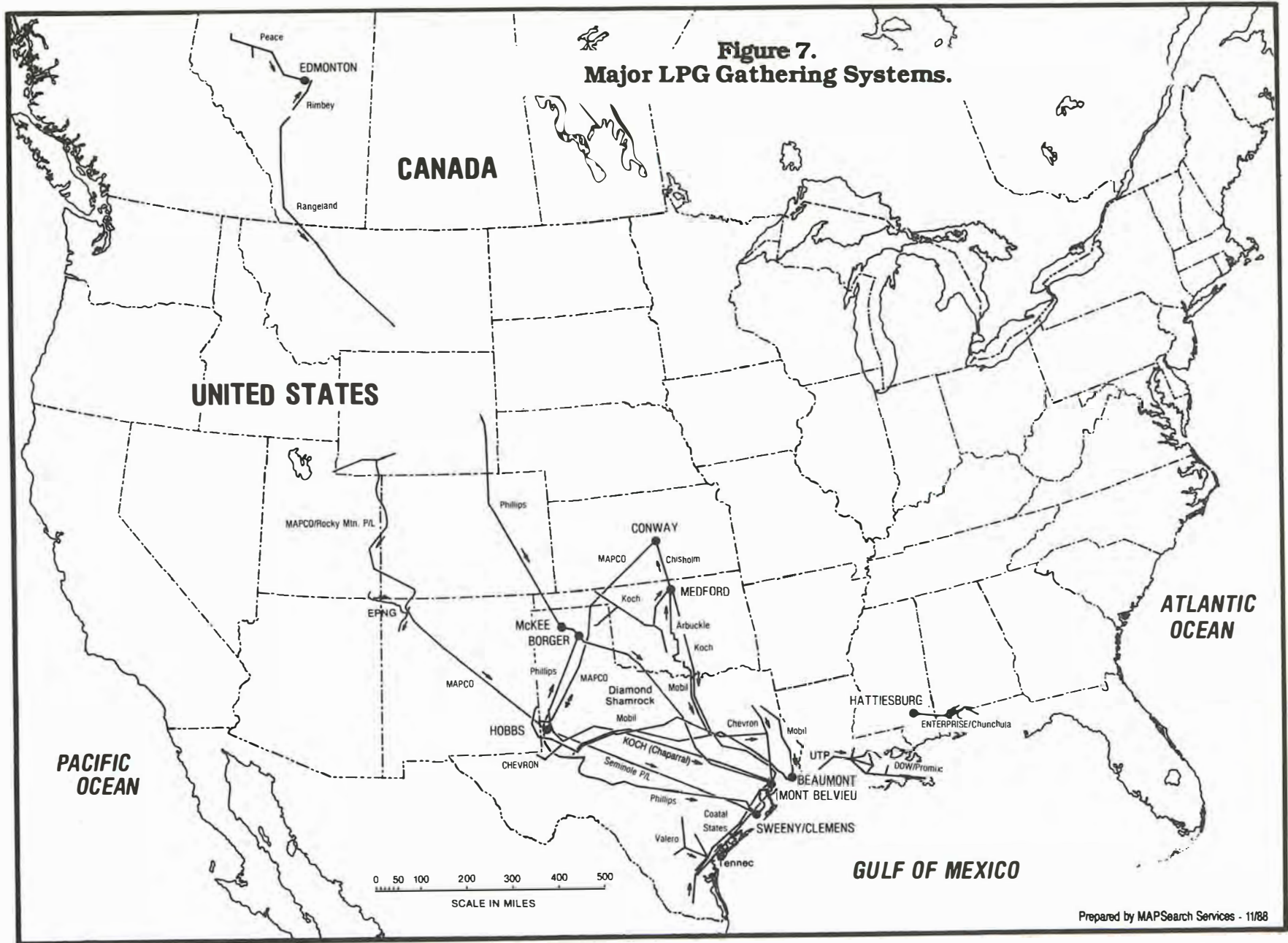

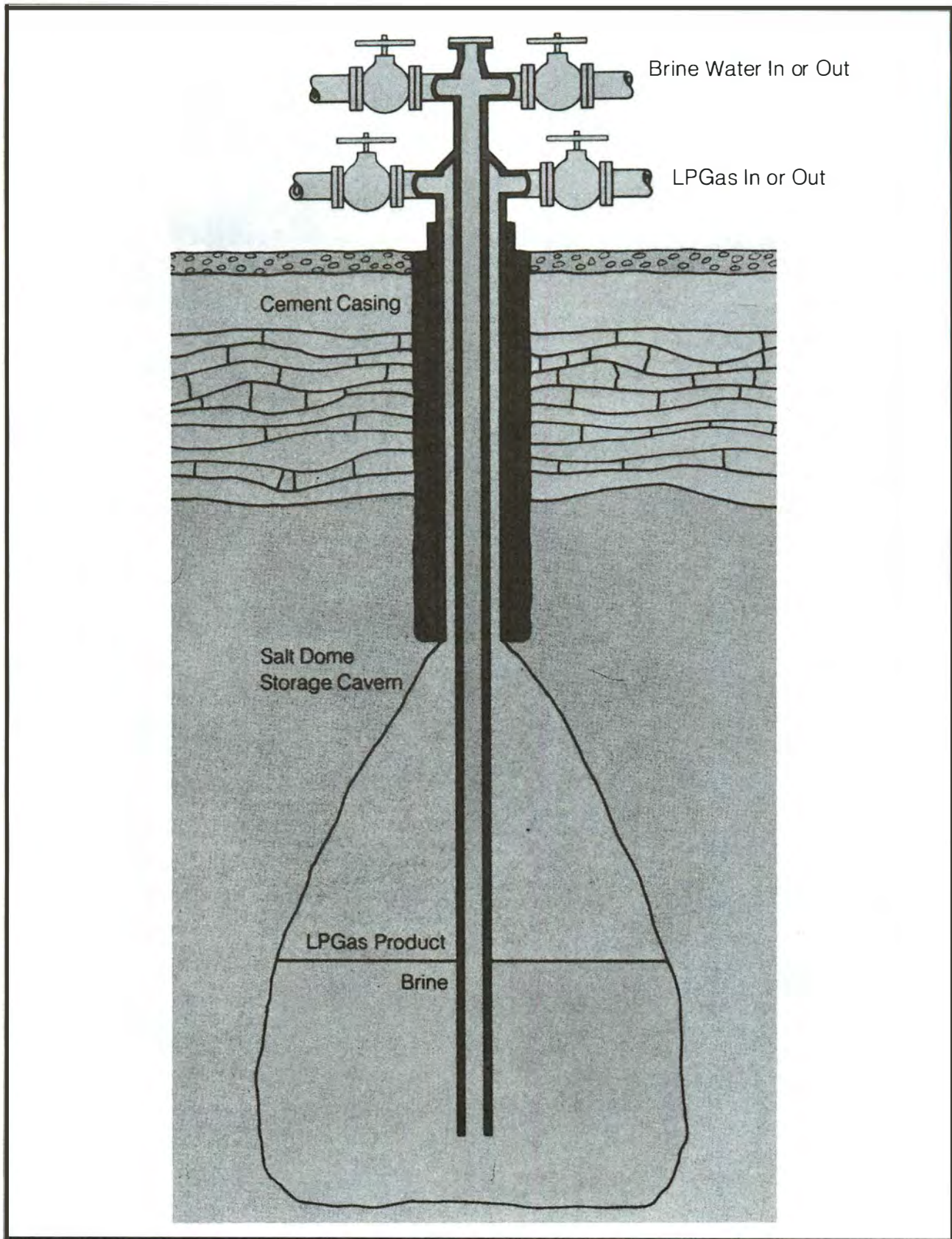

Figure 9. Cross Section of a Salt Cavern Storage System.

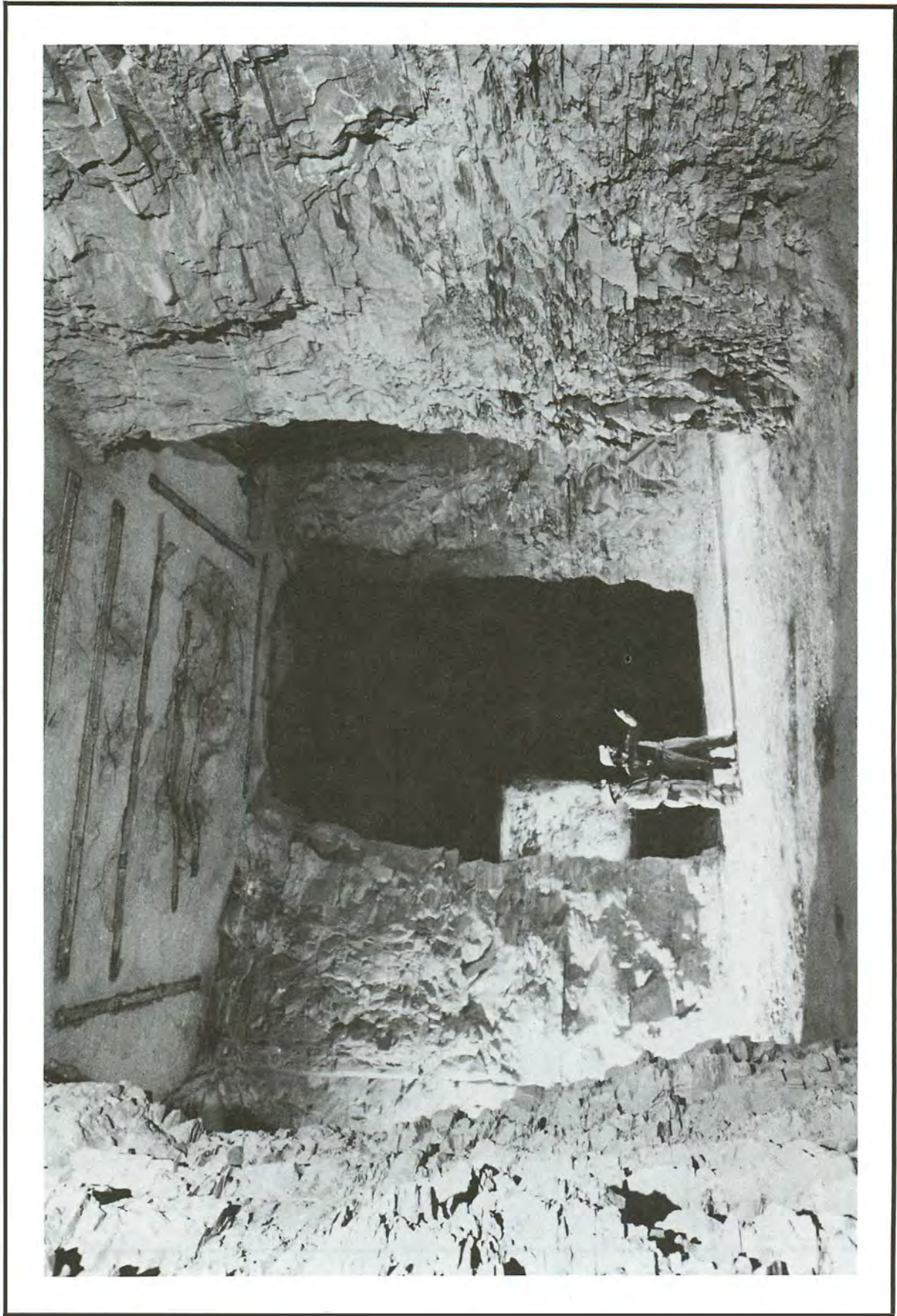

Figure 10. Mined Storage Cavern.

slightly since 1979. However, it must be noted that significant modifications in the pipeline industry have resulted from major shifts in LPG supply and demand. These include the following.

Supply side:

- Large increases in LPG production occurred in the Overthrust Belt area. The Overthrust production increase resulted in the construction of a new Mapco line from Wyoming to West Texas for distribution to the Midwest and Gulf Coast areas.
- The Seminole line was constructed to transport LPGs from Hobbs, New Mexico, and West Texas to the Houston-Mont Belvieu, Texas, area.

Demand side: The LPG demand, excluding chemical and refinery demand, has declined from 892 MB/D in 1979 to 730 MB/D in 1987. The large drop in demand has resulted in a significant loss of business to the major LPG lines that serve those markets. In spite of these reduced demands on LPG pipelines, a number of pipeline projects have taken place to address specific market niches. Examples are:

- Mapco extended their pipeline system from the Chicago area to serve the Quantum chemical plant in Tuscola, Illinois.
- Williams converted a former Mobil product pipeline -- extending from near Topeka, Kansas, to Sioux Falls, South Dakota -- to propane service.
- Enron constructed a new line from the Conway-Hutchinson, Kansas, area to Kansas City.

Conversely, the increase in chemical demand -- from 700 MB/D in 1979 to 882 MB/D in 1987 -- has been instrumental in the addition of several distribution lines to the Gulf Coast area. This is especially evident in the transportation of LPG feedstocks to chemical companies.

- Texas Eastman constructed an LPG line from Mont Belvieu, Texas, to their chemical plant in Longview, Texas.
- Koch constructed an LPG line to transport ethane-propane mix from Medford, Oklahoma, to Mont Belvieu, Texas.

Future Plans

While the industry has not announced the start-up of any major pipeline projects, it seems certain that a number of such projects may arise in response to logistics needs. These will result from:

- The projection of large increases in waterborne LPG imports along the Gulf Coast
- The expansion of ethylene capacity through debottlenecking
- The announcement that each of three newly proposed ethylene plants (Phillips at Sweeny, Dow at Chocolate Bayou, and Quantum at LaPorte) will have the flexibility to utilize between 40 and 50 MB/D of LPG each
- The projection of large increases in Canadian LPG imports, with further impact on the Midwest and Northeast.

The proposed reductions in gasoline vapor pressures will have a significant impact on the amounts of butane blended into gasoline. For example, these reductions in vapor pressure would likely result in a total U.S. butane demand reduction of 100 to 300 MB/D during the summer months. The excess butanes displaced from the gasoline pool may be used in several ways: refinery fuel, stored product for winter blending, petrochemical feedstock, or as a spur to some new demand.

Industry will be looking at the following types of projects as a result of the above trends and developments:

- New LPG connections to ethylene plants along the Gulf Coast.
- New connections, and possibly new lines, to handle the projected Canadian imports. Sarnia, Ontario, is emerging as a hub for storage and distribution.
- Construction of new lines to existing Gulf Coast import facilities. (This may involve the addition of some new import facilities, as well.)
- A new pipeline system from Mont Belvieu and/or new lines and connections from a Louisiana import terminal to serve the refinery and chemical industry in the New Orleans area
- An East Coast pipeline project to handle excess refinery butanes resulting from the proposed reduction in gasoline vapor pressure.

Summary

Since long-haul LPG pipelines have greater excess capacity today than in 1979, the existing system, with minor modifications, should be able to meet projected LPG demand into the 1990s. These modifications will include new pipelines for short distances and additional pipeline connections to meet new logistics requirements resulting from changes in supply sources and demand areas.

CHAPTER THREE

WATERBORNE TRANSPORTATION

More petroleum is transported by water than is any other commodity, domestically as well as worldwide. There are two types of waterborne petroleum commerce in the United States: foreign traffic and domestic traffic. Domestic traffic includes all commercial traffic between points in the United States including Alaska, Hawaii, Puerto Rico, the U.S. Virgin Islands, and Guam. Foreign traffic includes all movement between the United States and foreign countries. Practically all foreign movement is handled by oceangoing tankers, while domestic traffic is moved by river barges, integrated tug-barges for lake and coastal service, and coastal tankers.

Some ports are used by both deep-draft and shallow-draft vessels. Some of the port facilities have been strained since both deep and shallow-draft vessels have transported greater volumes in recent years in response to the nation's increased demand for foreign petroleum-based energy.

Foreign traffic is dominated by imports of foreign crude oil from the Middle East, West Africa, Latin America, the North Sea, and Southeast Asia. From 1985 to 1987, U.S. imports of crude oil came principally from Latin America. However, as shown in Table 9, Latin America's share declined from 37 percent in 1985 to 28 percent in 1987. During the same period, crude oil imports from the Middle East rose significantly. In 1985, Middle East crude oil represented just under 8 percent of all U.S. crude oil imports, but this share increased to over 21 percent of the total in 1987.

The largest volume of petroleum products imported into the United States is residual fuel oil. In 1987, residual petroleum imports averaged 565 MB/D, or almost 30 percent of all U.S. petroleum product imports, as shown in Table 10. The sophistication of U.S. refineries and their ability to upgrade residual fuels into gasolines and distillate accounts for the disproportionate share of residual fuel oil imports relative to consumption. However, the level of residual fuel oil imports has been declining as a percentage of total U.S. product imports. For example, the residual fuel oil share of total U.S. product imports was 92 percent in 1949, gradually declining to about 60 percent by 1977, and it is now about 30 percent. This compares with total gasolines, which comprise about 20 percent. A rapid decline in residual fuel oil imports began in 1978 and has continued. The reason for the decline is the significant reduction in the domestic use of residual fuel oil for heat, power, and for vessel fuel bunkers.

TABLE 9

U.S. IMPORTS OF CRUDE OIL
 BY MAJOR GEOGRAPHIC REGION, 1985-1987*
 (Thousands of Barrels Per Day)

<u>Region</u>	<u>1985</u>	<u>1986</u>	<u>1987</u>
Latin America	1,186	1,265	1,308
Mexico	715	621	602
Venezuela	306	416	488
Colombia	0	57	115
Trinidad & Tobago	98	93	75
Ecuador	56	64	23
Guatemala	0	5	3
Argentina	0	0	2
Peru	12	9	1
Middle East	245	792	984
Saudi Arabia	132	618	642
Iran	27	19	98
Iraq	46	81	82
Kuwait	4	28	70
U.A.E.	35	38	56
Oman	2	8	35
Africa	584	743	1,000
Nigeria	280	437	529
Angola	104	102	180
Algeria	84	78	115
Egypt	3	10	54
Cameroon	0	38	42
Gabon	51	25	35
Zaire	34	26	22
Congo	16	20	16
Tunisia	12	3	0
Benin	0	1	3
Brunei	0	4	4
Canada ^S	468	570	608
Northern Europe	309	370	374
United Kingdom	278	317	304
Norway	31	53	70
Southeast Asia			
Indonesia	292	297	262
Subtotal	3,084	4,037	4,536
Other	117	141	138
Total	3,201	4,178	4,674

* Totals may not equal sum of components due to independent rounding.

^S Movement primarily by pipeline.

Source: Energy Information Administration, Petroleum Supply Annual, 1985, 1986, and 1987.

TABLE 10

U.S. IMPORTS OF PETROLEUM PRODUCTS -- 1987
(Thousands of Barrels per Day)

<u>Product Type</u>	<u>Quantity</u>
Residual Fuel Oil	565
Distillate Fuel Oil	255
Finished Motor Gasoline	384
Unfinished Oils	299
LPG	190
Gasoline Blending Components	60
Jet Fuel	67
Subtotal	1,820
Other Products	184
Total	2,004

Source: Energy Information Administration, Petroleum Supply Annual, 1987.

Domestic waterborne traffic consists of domestic oceanborne trade and domestic inland waterway trade. In the last 10 years, the composition of U.S. domestic waterborne traffic has been formed by the various streams of petroleum products produced by U.S. refineries and the very significant introduction of the ANS crude oil production. This cargo mix has changed greatly since 1979. Crude oil is the major movement followed by residual fuel oil, motor gasoline, middle distillate fuel oils, and other refined products. Tables 11 and 12 show the waterborne movements between PADDs for crude oil and petroleum products.

More than 25,000 miles of inland waterways constitute the inland waterway system of the United States and include navigable rivers flowing into the Atlantic and Pacific oceans, the Mississippi and its tributaries, intracoastal waterways, canals, channels, and other waterways. Water depth, the width of the waterway, and the navigability of its bends, locks, and channels are important in determining its commercial usefulness. Nearly 25 percent of the total inland waterway system is less than 6 feet deep and almost 80 percent is less than 14 feet deep. Thus, draft and length limits are imposed on the commercial traffic operating on the inland waterway system.

In 1986, 150 million short tons of petroleum products were moved on the inland waterway system. This represents 26.8 percent of the total tonnage of cargo moved on these waterways.

TABLE 11
 1987 WATERBORNE MOVEMENTS OF CRUDE OIL
 BETWEEN PADDs
 (Thousands of Barrels per Day)

From	To				
	PADD I	PADD II	PADD III	PADD IV	PADD V
PADD I	X	1	0	0	0
PADD II	3	X	0	0	0
PADD III	10	*	X	0	0
PADD IV	0	0	0	X	0
PADD V	46	0	539	0	X

* Less than 500 barrels per day.

TABLE 12
 1987 WATERBORNE MOVEMENTS OF PETROLEUM PRODUCTS
 BETWEEN PADDs
 (Thousands of Barrels per Day)

From	To				
	PADD I	PADD II	PADD III	PADD IV	PADD V
PADD I	X	3	5	0	0
PADD II	61	X	11	0	0
PADD III	509	137	X	0	4
PADD IV	0	0	0	X	0
PADD V	0	0	1	0	0

The Tennessee-Tombigbee Waterway was completed and began operation in 1985, connecting the Tennessee River to the Black Warrior River, giving Mississippi and Alabama access to the Gulf Coast at Mobile, Alabama, and the Ohio River via the Tennessee River at Paducah, Kentucky. This link proved crucial to the oil industry in the summer of 1988, when drought reduced the Mississippi River water levels to nearly unnavigable lows. In addition, the U.S. Army Corps of Engineers is constructing a project on the Red River that will provide commercial navigation on the Red River to Shreveport, Louisiana, from its confluence with the Mississippi River near Baton Rouge.

MARITIME VESSELS

Among the different types of vessels and vessel configurations are oceangoing tankers, coastal tug-barge units, inland tank barges, and tugboats and towboats that provide the power to move barges. The short-haul coastal trade is serviced primarily by the use of small, shallow-draft coastal tankers, integrated tug-barge units, and conventional tug-barge units. Whereas the longer-haul trade, such as movements from the Gulf Coast to New York, is serviced by deep-draft tankers, inland trade is serviced primarily by the use of inland tank barges.

Oceangoing tankers over 175,000 DWT are employed primarily in the carriage of crude oil. According to Drewry Shipping Consultants, nearly 160 million DWT were employed in the crude oil trades worldwide in 1986, of which 82 million DWT were 175,000 DWT or above. Approximately 12 million DWT, or 15 percent, of tankers over 175,000 DWT were employed in the U.S. import and domestic trades. At present, there are 14 tankers of 170,000 DWT and above and 22 vessels of 75,000-170,000 DWT active in the U.S. domestic fleet, operating in the ANS crude oil trade to the Gulf Coast and the West Coast.

The development of a supertanker of over 170,000 DWT has helped to reduce the transportation cost component of both imported and domestic crude oil. For example, tanker voyage and operating costs on a per-cargo-ton basis are almost 50 percent lower for a 250,000 DWT tanker than for an 80,000 DWT tanker.

Although some West Coast ports could handle fully loaded tankers larger than 170,000 DWT, it was not until 1982 that a U.S. Gulf Coast port could do so. This occurred with the start-up of LOOP, which can handle VLCCs and ULCCs. The completion of LOOP, as previously stated, has helped to reduce the need to "lighter" or off-load a portion of the cargo into shallower draft vessels prior to docking. West Coast facilities provide the deepest tanker berths in the United States. Los Angeles and Long Beach have terminals with depths of 50 feet (100,000 DWT) and 60 feet (190,000 DWT). The Puget Sound area offers a facility with a 65-foot (260,000 DWT) capability although other restrictions limit the capacity to 125,000 DWT. The majority of U.S. tanker facilities fall in the range of 35 to 40 feet, capable of berthing tankers in the 20,000-80,000 DWT class.

Coastal tankers and oceangoing tug-barge units of between 25,000 and 50,000 DWT are important in the transportation of petroleum along the U.S. coast. For shorter coastal moves, a growing percentage of product is moved by tug-barge units. Most of the coastal tankers average 15.5 knots, while oceangoing barges average 8.5 knots. Tankers and barges of a smaller size (up to 35,000 DWT) can generally be loaded or unloaded in 24 hours under ideal conditions, while the large tankers require between 24 and 36 hours.

Tank barges, pushed by towboats or pulled by tugboats, are an important means of inland transportation and are the second

largest domestic means of moving petroleum, preceded only by pipelines. Barges compete with pipeline deliveries and take primary responsibility for the transportation of various products, specialty petrochemicals, and crude oil not shipped by pipeline. Towboats pushing barges are the most common vessel configuration for inland water routes. Towboats are flat bottomed and diesel powered. They are shallow-draft vessels equipped with multiple screws and rudders that afford maximum control in narrow waterways. The tugboat configuration is not generally used on inland waterways because of its lack of maneuverability. In 1986, according to data collected by the U.S. Army Corps of Engineers, tank barges carried 198.8 million short tons of petroleum products (excluding crude oil) in domestic trade. Self-propelled tankers carried 62.2 million short tons of these commodities. By comparison, in 1986 domestic pipelines carried 511.0 million short tons of petroleum products.

A tow may consist of as many as 12 tank barges normally pushed by a towboat, although the average configuration is 3 barges. The ability to push large numbers of barges permits the formation of flotillas with capacities of up to 300,000 barrels. In some cases, local restrictions dictate smaller tows, reducing the carrying capacity. Travel times of these movements are affected by the particular characteristics of the waterway and its lockage constraints, and the horsepower capability of the towing vessel in relation to the size of its tow.

CHANGES SINCE 1979

Inland Waterways

In the past 10 years, there has been only a 7 percent increase in the total petroleum tonnage shipped on the nation's inland waterways. But technological development has led to improvements in productivity. Development of fuel management systems, a cellular VHF system with data and voice transmissions, the Kort nozzle, the tunnel hull and double skin tank barges, and the swing indicator have all helped to a certain extent to keep the marine system safe and competitive. Marine operating systems are, however, currently reaching the physical limitations of the inland waterway system. Research and development activities must extend to areas other than floating equipment to maintain or improve productivity; and future efforts should focus on improved infrastructure such as terminal facilities and marine structures -- locks and dams.

Ocean Tankers

The two most significant changes in the design and construction of tank vessels (self- and non-self-propelled) since 1979 involve the type and number of vessels built. In 1979, large tankers (over 100,000 DWT) were still under construction for the ANS crude oil trade. Between 1968 and 1979, the period covered

in the last NPC report, 88 new tankers were delivered, of which 33 were over 100,000 DWT. In the last 10 years, new tanker construction in U.S. shipyards has steadily declined. The only large oceangoing vessels currently under construction are being built for military needs.

During 1980-1987, only 39 tankers were delivered to the U.S. Flag Fleet, of which 37 were built for domestic service. Nearly 75 percent of the total number were delivered during 1981-1984. Thereafter, deliveries slowed and no new orders were placed, because: (1) adequate tonnage was available in the domestic trade, (2) while demand declined, product pipeline throughput remained constant, (3) product imports to the East Coast carried by foreign flag vessels increased, and (4) declines in Alaskan crude oil movements were forecast. All these elements, laid against projected supply-demand balance for vessels, did not attract capital for "newbuildings."

The most significant event regarding petroleum receiving facilities was the development and start-up of LOOP, a deep-water port facility in the Gulf Coastal waters of the United States that is capable of handling larger tankers of crude oil, ULCCs. LOOP limits the amount of offshore lightering required and substantially reduces the amount of small tanker traffic on the lower Mississippi River. Although underutilized at first, it has significantly increased volumes in 1987 and 1988, as crude oil imports increased.

The petroleum tanker segment of the U.S. flag merchant fleet has declined in both the number of vessels and number of owners. Tankers have decreased in number from 288 in 1980 to an estimated 225 as of December 31, 1987. As a result of the large tankers built for ANS service, the average deadweight tonnage per vessel increased by 28 percent from 54,000 DWT at the end of 1979 to almost 70,000 DWT at the end of 1987. Table 13 reflects the change in the number of tankers. The greater use of coastwise barges and foreign product imports (which are imported in foreign flag vessels) have also contributed to this decline.

In the past 10 years, an oversupply of tankers has depressed foreign flag freight rates to break-even levels. This has not directly affected U.S. flag vessels, as the only "foreign" cargoes carried by U.S. flag operators are a limited few of those obtained under U.S. government preference programs. Even if a U.S. flag vessel in foreign trade is built overseas, U.S. flag operators' costs are higher than foreign competitors, due to tax laws that are not internationally competitive and due to crewing costs. At best, these higher costs are only partially offset by the maritime promotional programs of the U.S. government. In addition, some foreign governments directly or indirectly support their national fleets with benefits not usually available to U.S. flag operators.

The principal direct-subsidy programs that have been provided by the U.S. government have been construction differential

TABLE 13

NUMBER OF TANKERS AND INTEGRATED TUG-BARGE VESSELS
1980-1987

<u>Type</u>	<u>1980</u>	<u>1982</u>	<u>1984</u>	<u>1985</u>	<u>1986</u>	<u>1987</u> [*]
Freighters	263	252	233	216	209	197
Tankers	288	296	274	247	235	225
Pass. & Cargo	7	7	7	6	8	8
Bulk Carriers	<u>20</u>	<u>19</u>	<u>24</u>	<u>23</u>	<u>25</u>	<u>26</u>
Total	578	574	538	492	477	456
CDS vessels [§]	130					

* Estimate based on industry survey (12/31/87).

§CDS = construction differential subsidy.

subsidies, which were not funded after 1982; operating differential subsidies; and Title XI loan guarantees. Title XI provided the opportunity for U.S. tanker and barge companies to obtain low-cost financing for new construction through government guaranteed loans. The program was an effort to make U.S. flagged vessels competitive internationally. Title XI has been less than successful in two ways. Expanded to include domestic trade companies, the program was taken beyond its original intent. This expansion led to a large number of defaults, which have increased the cost of the program. Secondly, Title XI does not address operating costs, and thus has not made U.S. flagged vessels competitive worldwide.

To help maintain the viability of our domestic shipbuilding industry in the face of overseas competition, cabotage laws (Jones Act) require the use of U.S.-built and manned tankers in domestic service. The higher resulting cost of construction, some two to three times that of foreign-built vessels, must be recovered by domestic operators through higher fees in the protected trade markets granted them.

A related and noteworthy trend since the 1979 report is the decline of the U.S. shipbuilding and repair industry and related supplier industries. As stated in the September 30, 1987 report, The First Report of the Commission on Merchant Marine and Defense: Findings of Fact and Conclusions: "The Commission's

analysis shows that, in the industry as a whole between 1982 and the end of 1986, approximately 52,500 jobs were lost; 76 shipyards and ship repair facilities were closed; and 22 building ways, 17 floating dry-docks, 21 graving docks (all capable of accommodating ships over 400 feet in length), and numerous plant facilities were lost. In August 1987, at least 15 of the surviving firms were operating under Chapter 11 bankruptcy protection." As a result of this decline, a virtual halt in commercial ship construction in the United States has occurred because of the inability of our shipbuilding industry to compete worldwide. In 1980, there were five shipyards with active construction. By the end of 1987, there were no commercial ships under construction, even for Jones Act trade. The report also points out that the decline of the domestic ship construction and repair industry is followed by the decline of the shipyard suppliers.

Most shipyards along the Mississippi and its tributaries have stopped construction of both towboats and barges for the past several years, and 50 percent of the major yards have ceased operations. Those remaining are engaged in repair work only.

This trend does not appear to have a negative impact on the commercial side of the waterborne industry as of yet, but is worth mentioning, and it does reduce our nation's strategic military advantage.

Under the provisions of the Port and Tanker Safety Act of 1978 (PTSA), many tankers calling at U.S. ports are required to be equipped with anti-pollution systems and enhanced safety equipment. These requirements vary depending upon the size and type of tanker. Depending on vessel size and age, the PTSA requires optional clean ballast tanks; crude oil washing equipment; inert gas systems; and dual radar/collision avoidance features.

Based on an analysis of the PTSA equipment that has been installed on the current U.S. flag tanker fleet, and based on preliminary Coast Guard and industry estimates of the cost of that equipment, the U.S. Maritime Administration estimates that vessel owners spent almost \$300 million for pollution and safety systems on their ships.

Although the equipment cost represents the major financial impact of the PTSA, additional costs were incurred by tanker operators due to the diminished carrying capacity of tankers resulting from retrofit to meet PTSA regulations. For some retrofitted vessels, the ballast requirements reduce the cargo volume of the tanker, and decrease the revenue earned on each voyage. In addition, some owners decided to scrap older vessels rather than incur retrofit costs, which resulted in overall revenue reductions for those operators but may have helped increase unit revenues. This is not to say these costs are or are not justified, but that they affect the industry.

The cost of building a tanker is not directly proportional to its size. A large hull costs considerably less per DWT than a smaller one, and the cost of machinery, accommodations, and cargo handling equipment does not increase greatly with size. The cost of a large ship is only about 85 percent of the combined costs of two ships of half the size. This gives the larger ship a capital cost advantage that is generally reflected in its lower unit charges. Even though operating costs (insurance premiums, repair and maintenance, wages, provisions, and administration) rise in absolute terms as ship size increases, these costs become progressively smaller as related to capacity or unit costs. But because of limited port facilities, the largest estimated fully loaded tanker that can be handled in the U.S. East and Gulf Coast areas (excluding LOOP) is only about 100,000 DWT, with limitations of 40,000 to 50,000 DWT in most ports. Some West Coast ports are capable of accommodating fully loaded tankers of up to 150,000 DWT. The development of the supertanker of over 175,000 DWT has thus had several significant effects on the United States: it reduced the transportation component of imported oil costs; and it prompted the establishment of lightering points where cargoes could be transferred to smaller tankers that could tolerate the shallow draft of U.S. ports.

The primary competition of coastal tankers, which generally are smaller in size, is the network of petroleum product pipelines, which has changed the economics and flow pattern of products moving to the northeastern United States from Gulf Coast refineries. Substantial coastal trade in petroleum products will continue, since the pipelines do not serve all port areas and generally do not carry residual fuel oil, speciality products/lubricating oils, or other heavy products. Also, because they are common carriers, these pipelines are required, at capacity, to impose proration on their customers, shifting volume to marine movements.

Since crude oil and petroleum product imports are expected to increase, the relative share of U.S. flag tankers as a mode of petroleum transportation will decrease. The level of investment in tanker transportation on the part of the U.S. oil industry will be minimal in the future. Most investment will be in the form of marine facilities and improvements thereto, and possibly deepwater ports.

Another important trend gradually becoming apparent is improved safety by operators on the waterways. More and more contractions and mergers have been occurring since the 1979 NPC study. The remaining companies tend to be stronger financially and have invested more heavily in safety equipment and programs. Many have also emphasized improved safety results even with reduced manning requirements.

PRINCIPAL CONSTRAINTS

The waterborne transportation industry has long been recognized by shippers as an efficient, safe, dependable, and flexible

mode of transportation. However, operational constraints do exist that can and do create serious interruptions. The most serious constraints are noted in this section.

Constraints can be classified into three general areas: weather, marine routes, and navigational structures (locks and dams, bridges, ports, and harbors).

Weather considerations adversely affecting the efficient operation of the waterborne transportation industry (and in particular, the fleets operating in the upper or northern portions of the inland waterways and the Great Lakes) are beyond the effective control of the industry and the governmental agencies responsible for the maintenance of these waterways.

Generally speaking, the natural constraints of high- and low-water seasons are experienced at some time on all portions of the inland waterway system. These conditions result in slower movement of barges during high flow and light loading of barges during low flow.

Flooding on the Upper Mississippi River system, caused by snow melt and rain from tributary streams, has been a major problem in the past, and this situation is expected to continue. Mississippi River floods normally occur during the spring runoff period between April and June. During periods of high flow, operating machinery at the locks and dams is removed, rendering the locks inoperable. There are no feasible reservoir sites along the main stem of the Mississippi River because of the highly developed nature of the flood plain. Reservoirs on the large tributary streams and local flood protection projects and flood plain management practices along the main stem appear to be the best solutions to the flood problem. The record floods of April 1965 and spring 1973 caused widespread damage along the river and its tributary streams. In 1983, serious flooding on the Upper Mississippi stopped barge traffic for almost two weeks.

Low-water conditions on the inland waterways system can have as serious an effect on the efficient operation of the waterborne transportation industry as can flooding. Low-water conditions not only force barge operators to navigate with lighter loads to avoid grounding, but also cause them to cut the size of their tows, since maneuverability is impaired as water level drops. When an operator cuts the draft of the barge, additional boats and barges must be used to carry the same volume of cargo. Reducing the draft by one foot lessens the payload of a single barge 200 to 600 tons, depending upon its size. In addition, the cost of moving a lightly loaded barge is nearly the same as for a fully loaded one. Also, low-water conditions increase transit times, adding from one to two days, for example, to the normal five-day trip from St. Louis to New Orleans. As a result, freight rates must be increased seasonally to cover the additional costs.

An extreme example of this problem occurred in the summer of 1988. Low-water conditions increased freight rates by as much as

300 percent in less than a month in some areas of the Mississippi, though rates subsequently returned to more normal levels in the fall.

Another serious effect of low-water conditions (as well as of high water and flooding) is the creation of shifting channels, which require dredging, and the replacement and repositioning of many channel buoys and navigational markers. Thus, additional and more frequent dredging must be undertaken by the U.S. Army Corps of Engineers -- an activity that causes further disruptions in normal river movements. This kind of dredging, as well as scheduled dredging by the Corps of Engineers, has been limited by budgetary constraints as well as the lack of cooperation from some states with respect to supplying sites where dredging spoils can be properly placed.

Ice can be a problem from January through March in the upper inland waterway system as well as the Great Lakes. On the Great Lakes, ice formations are generally so extensive that they actually close down all water movements except for those essential to public welfare, and even these movements are made only with U.S. Coast Guard cutter escort and/or specially constructed all-weather tankers and barges.

The condition and antiquated method of operation of some of the locks and dams of the inland waterway system are a cause of great concern to the waterborne transportation industry. A leading cause of delays to barge traffic on the Ohio River is the physical constraint of obsolete locks. The replacement of Locks 52 and 53 in the lower Ohio Valley with the new locks under the Olmsted Project should correct the situation. Continued work on the Gallipolis Project is also needed. The Upper Mississippi also has lockage delays that will be vastly improved by completion of the replacement Lock and Dam 26 near Alton, Illinois. Other facilities in immediate need of replacement or improvement include the Calcasieu Lock on the Gulf Intracoastal Waterway and the Industrial Canal Lock at New Orleans.

Two other factors considered to be constraints to the waterborne transportation industry are: the escalating volume of traffic at the smaller locks, and the bridges spanning the inland waterway system with restrictive horizontal and vertical clearances, which represent another type of navigational concern.

Planned maintenance and rehabilitation of an effective inland waterway system requires an in-depth analysis and comparison of the current system's capabilities and projection of growth potential in order to determine the best use of available resources. The Gulf Intracoastal Waterway is typical of those portions of the waterway system that require additional analysis. When this waterway was authorized in the 1920s, it was anticipated that it would handle 5 million tons of cargo per year. In the early 1940s, the waterway was handling 18 million tons per year, and Congress authorized that its depth be increased from 9 feet to 12 feet and the bottom width be increased from 100 feet

to 125 feet. Currently, this waterway is handling in excess of 100 million tons of cargo annually and has almost reached its maximum capability. There are proponents of both the widening and deepening of this system and a thorough analysis of both suggestions should be made.

The U.S. Army Corps of Engineers, under legislation passed by the Congress, has the responsibility of maintaining the waterways of the United States for navigation, and the U.S. Coast Guard has the responsibility of maintaining aids to navigation, including bridges across navigable waterways. The U.S. Maritime Administration and the operators and users of the waterway system recognize the important effects that natural and physical constraints have on the productive, efficient operation of the system. These groups are working together to ensure that the waterway system operates with a minimum of natural and physical constraints.

REGULATION

As is the case with other modes of transportation, the waterborne transportation industry is regulated by various local, state, and federal government agencies in the operation of its facilities and services. The principal problem with this approach to regulation is the lack of consistency between regulations imposed upon the waterways industry by the various government agencies. As an example, several states are considering, and a few are developing, requirements to control vapor emissions from the loading and ballasting of tankships and barges carrying volatile organic compounds, mainly hydrocarbons. These requirements should be made consistent with federal standards administered by EPA.

In April 1982 and March 1987, the Maritime Administrator sent to the EPA Administrator proposed amendments to the Clean Air Act, developed jointly by the U.S. Maritime Administration and the U.S. Coast Guard, which would give the federal government exclusive jurisdiction over the regulation of air pollutants emitted by commercial vessels within the jurisdiction of the United States. This legislative proposal would, among other things, encourage the development of international standards by the International Maritime Organization. Without action such as this, the imposition by any one state of nonuniform safety and environmental requirements could require significant and unique changes in equipment and operations and could be an intrusion into federal regulation of shipping and of interstate and international commerce. The development of rational uniform standards applicable nationwide would prevent the potentially harmful economic, safety, and environmental costs of inconsistent state requirements.

In summary, institutional constraints upon the waterborne transportation industry include conflicting or nonuniform laws,

directives, and regulations of federal, state, and local governments. Such conflicts tend to restrict domestic marine commerce and generate unnecessary economic uncertainty.

INDUSTRY PERSPECTIVE

There is a significant amount of public investment in navigable waterways. Most marine equipment and port facilities are financed through the private capital market. Escalating costs are critical issues, as the cost of new construction appears to be rising faster than the resultant benefits of projects. The change in emphasis of federal goals and the reduced availability of, and increased competition for, federal funds for waterways projects also contribute to the uncertainty in financial matters.

The enactment of Public Law 99-662, establishing a toll or user tax on diesel fuel for inland waterway operators, mandated that the Inland Waterway User Board develop and make recommendations regarding new construction and rehabilitation priorities. Recommendations are made to the Assistant Secretary of the Army for Civil Works. The Board's first meeting was held in July 1987.

Comparative model studies point out that the American public benefits from all current modes of transportation by receiving the best service for a specific application. Because the waterway industry is one of the most fuel-efficient forms of transportation, measures that would reduce the use of waterborne transportation would be counterproductive.

The identification and planned development of effective, career-oriented personnel programs require analysis of the industry's current and projected resources and needs. The correlation between available personnel, existing jobs, labor force growth trends, and projected future employment opportunities figures greatly in the development of programs to attract high caliber, well-motivated people to career positions in the waterborne transportation industry. It is also important to provide properly trained vessel-operating personnel through modern training methods and adequate facilities. In addition, a need exists to foster the continued growth of the waterborne transportation industry through the recruitment and retention of efficient, highly qualified professional managers; through emphasis on the need for properly trained vessel-operating personnel; and through identification of any future manpower shortages by skill and by domestic shipping area.

SUMMARY

Since the 1979 study, the following has occurred:

- Fewer U.S. flagged vessels are in service, but the existing vessels possess higher carrying capacity and

are more efficient (a result of the construction of larger tankers of 170,000 DWT and above for ANS movements to the Lower-48 States).

- A significant reduction has taken place in the U.S. shipbuilding industry (the production of U.S.-built tankers for commercial use has come to a halt).
- Introduction of diesel-powered tankers has improved efficiency and reduced operational costs.
- Introduction of ANS crude oil production has made crude oil the largest percentage of liquid cargo moved domestically.
- A decrease in the number of product tankers has resulted from decreased demand and increased product imports.
- Fewer companies are involved in marine transportation, but they tend to be larger and financially stronger.
- The inland and shallow-draft systems are being pushed to capacity and will require large capital infusions to greatly alleviate future problems.
- Private and public entities have worked to fine-tune the system so that more volume can be effectively shipped.
- Various state and federal agencies are developing conflicting and costly laws and regulations to deal with primarily environmental issues.
- Three major facility improvements have been undertaken -- LOOP, Tennessee-Tombigbee Waterway, and the Red River Project.

In summary, a good job has been done handling growth, but there is increased concern about the future, focused on improving and expanding the inland waterway system, and on aging vessels, many of which are unlikely to be replaced unless ANS crude oil production is sustained or government intervention occurs.

CHAPTER FOUR

TANK CARS/TANK TRUCKS

In order to meet the logistical requirements of the petroleum market, distribution of raw materials and refined products takes place under two broad categories -- transportation and delivery.

Transportation is broadly defined as the movement of raw materials into refineries and the outbound movement of refined products to redistribution terminals and to other petroleum refineries or chemical plants. This "transportation" is generally performed by pipeline and marine modes. Transportation implies a stock movement from one phase of the logistics system to another, generally for manufacture or storage within the distribution chain. The economics of large-volume movement involved in these phases of distribution dictate that rail and truck modes play little part in the process.

Delivery can be defined as the movement of finished products to ultimate consuming locations. Relatively small-volume parcels are delivered to numerous destinations. Truck movements from redistribution terminals to service stations, and rail shipments of lubricants, asphalts, waxes, petroleum solvents, etc., to customers (i.e., blenders, manufacturers, distributors, retailers) are the major examples of "delivery." Delivery is generally performed by rail and truck modes. Most deliveries involve a sale rather than a stock transfer.

Trucks and rail cars are generally not used in the upstream side of the logistics chain. Some exceptions to this are crude oil and condensate gathering by truck from well to pipeline storage points, or refineries and natural gas liquid movement into refineries where pipeline construction is not feasible. Rail cars and trucks may occasionally be used to transfer feedstocks between refining locations. In some isolated cases, rail cars are used to move crude oil to refineries where pipeline construction is not feasible. While there are limited applications for rail and truck in the upstream sector, the capital investment necessary and their relative inefficiency for large-scale volume movement render them impractical for use in any major supply disruption. Since trucks and rail cars are primarily dedicated to delivery in the distribution chain, it is unlikely they could effectively be diverted to "transportation" use without major disruption to the downstream sector.

While the available data indicate a very large rail tank car capacity, the majority of these cars are dedicated to chemical, food, and vegetable oil service. In a petroleum supply emergency, it is not likely that many rail cars could be spared from

those vital industries. Most tank trucks are used for gasoline delivery to service stations or the shipment of chemicals, fertilizer, food products, and vegetable oil. There is little likelihood they could be readily shifted to petroleum transportation service without causing substantial harm to the distribution systems they serve.

TANK CARS

Tank cars move over a U.S. rail system that has been changed substantially since passage of the Transportation Act of 1980 -- commonly known as "The Staggers Act." As a result of "Staggers," the railroad carriers have been granted far more flexibility in their economic decision making and substantial freedom in their ability to abandon and dispose of unprofitable rail segments. The major railroads have restructured their physical systems since 1979, abandoning trackage and selling unprofitable branch lines to local or regional carriers. A summary of the U.S. tank car fleet is shown in Table 14.

Tank cars are tied to the existing rail system, thus limiting accessibility. This limited access has caused no major disruption to the movement of petroleum products and raw materials under normal distribution patterns. However, it has made the rail tank car less flexible as a vehicle for use in emergency situations. There are some locations no longer served by rail that once handled tank car deliveries.

Economic deregulation has improved the profitability of the U.S. rail industry. One impact of this added profitability has been greatly improved physical plants throughout the United States for all large railroads. Today's improved system has provided the petroleum industry with the ability to gain marked productivity in its rail tank car fleet. Tank cars are making more trips per year and each trip is taking less time per mile than was the case in 1979.

Improvements have also been made in car design and in construction, further improving safety and performance. As a result of design changes, we continue to see the average car size increase. The smaller, less efficient rail tank cars are being replaced by fewer but larger-capacity cars. This efficiency improvement does, however, reduce fleet flexibility. As fewer cars move more product, there are fewer spares and a higher concentration of capacity in the traditional services to which rail tank cars are dedicated.

The tank car supply side has also undergone change since 1979. The number of suppliers building tank cars has been reduced from seven to three. Capacity to build cars peaked at 11,000 per year in 1980 and is now estimated at 7,000 cars per year. This reduction in building capacity is significant but does not impair the industry's ability to meet normal, new construction demands. Since new construction requires a six-to-

TABLE 14

THE U.S. RAIL TANK CAR FLEET
AS OF FEBRUARY 16, 1988

	Under 11,499 (Gal.)	11,500- 18,499 (Gal.)	18,500- 24,499 (Gal.)	24,500- 31,499 (Gal.)	Over 31,500 (Gal.)	Total Number of Tank Cars	Total Capacity (Gal.)
Suitable Tank Cars							
Non-Pressure							
Uninsulated	4,972	5,143	29,435	9,868	231	49,649	1,040,288,552
Coiled	2,073	499	15,772	1,508	7	19,859	396,357,073
Insulated	12,690	30,662	36,524	1,767	50	81,693	1,462,488,567
Coiled	10,602	23,725	34,628	1,529	47	70,531	1,293,931,704
Subtotal	17,662	35,805	65,959	11,635	281	131,342	2,502,777,119
Pressure							
Uninsulated	71	331	801	2,661	16,127	19,991	641,231,599
Insulated	6,081	6,966	1,917	2,834	7,828	25,626	559,705,627
Subtotal	6,152	7,297	2,718	5,495	23,955	45,617	1,200,937,226
Total	23,814	43,102	68,677	17,130	24,236	176,959	3,703,714,345
Unsuitable Tank Cars							
Canadian	990	3,074	6,300	1,547	3,753	15,664	359,543,827
Mexican	443	17	1,186	0	33	1,679	29,439,917
Total	1,443	3,091	7,486	1,547	3,786	17,343	388,983,744
Aluminum/Other Cars	4,745	7,234	4,627	90	183	16,879	249,984,475
Grand Total	29,992	53,427	80,790	18,767	28,205	211,181	4,342,682,564

Source: Association of American Railroads, Universal Machine Language Equipment Register.

eight-month period, short-term needs of the petroleum industry cannot be met by new-car construction. Therefore, the impact of reduced new-car capacity is of little importance to the emergency requirements of petroleum shippers.

TANK TRUCKS

Tank trucks operate over a U.S. highway system that provides a high degree of flexibility. This flexibility has been further enhanced by the Motor Carrier Act of 1980, which has practically eliminated federal economic regulation of the carriers involved in providing tank truck service to the petroleum industry. In some cases, this federal deregulation has carried over into states that have also freed tank truck common and contract carriers from economic regulation.

While economic deregulation has created some instability in the tank truck industry, it has not resulted in any negative impact on the amount of service or equipment available to the petroleum industry. In fact, in spite of several major business failures in the tank truck industry, more tank truck capacity is available today than ever before, and the industry is far more flexible in its ability to handle change than it was in 1979. Summaries of the national tank truck inventory by PADD and DOT specification are shown in Tables 15 and 16.

TABLE 15

NATIONAL CARGO TANK TRUCK INVENTORY
BY MAJOR DOT SPECIFICATION

<u>DOT Specification*</u>	<u>Number of Units</u>	<u>Average Capacity in Gallons per Unit (estimated)</u>	<u>Total Capacity in Gallons (estimated)</u>
MC 306	57,900	8,000	463,200,000
MC 307	22,000	6,500	143,000,000
MC 312	12,600	4,500	56,700,000
MC 331§	<u>10,000</u>	10,000	<u>100,000,000</u>
Total	102,500		762,900,000

* These four specifications cover all crude oil, petroleum products (including chemicals), and LPG transporting vehicles.

§ Liquefied Petroleum Gas (LPG) Service.

TABLE 16

NATIONAL CARGO TANK TRUCK INVENTORY
BY PADD AND DOT SPECIFICATION

<u>DOT Specification*</u>	<u>PADD I</u>	<u>PADD II</u>	<u>PADD III</u>	<u>PADD IV</u>	<u>PADD V</u>	<u>Total</u>
MC 306	17,950	18,500	8,700	1,750	11,000	57,900
MC 307	6,800	7,050	3,300	660	4,190	22,000
MC 312	3,900	4,030	1,900	400	2,370	12,600
MC 331§	3,100	3,200	1,500	300	1,900	<u>10,000</u>
Total						102,500

* These four specifications cover all crude oil, petroleum products (including chemicals), and LPG transporting vehicles.

§ Liquefied Petroleum Gas (LPG) Service.

Appendices

APPENDIX A

**STUDY REQUEST LETTER AND
DESCRIPTION OF THE NATIONAL PETROLEUM COUNCIL**



The Secretary of Energy
Washington, DC 20585

February 20, 1987

Mr. Ralph E. Bailey
Chairman
National Petroleum Council
1625 K Street, N. W.
Washington, D. C. 20006

Dear Mr. Bailey:

The National Petroleum Council has prepared numerous studies in the past on the nation's petroleum inventory, storage, and transportation systems. The Council's last comprehensive study on this subject was completed in 1979. The principal objectives of that study were to analyze current inventories, estimate minimum operating inventory levels, determine the total storage capacity of the primary petroleum distribution system, and provide detailed information on the nation's transportation system for oil and natural gas. In 1984, the Council issued a report updating and expanding the inventories and storage capacity portions of the 1979 study.

These studies are the most current, comprehensive treatment of petroleum storage and transportation that are available for reference, with some data being nearly a decade old and the most recent from early 1983. Since the release of these studies, there have been major changes in the production and transportation of crude oil and natural gas, refinery operations, petroleum products distribution networks, and the markets they serve.

Accordingly, I am requesting the Council to undertake a comprehensive new study on petroleum inventory, storage, and transportation capacities updating the Council's earlier studies as necessary. Emphasis should be given to the reexamination of minimum operating inventory levels, the location of storage facilities and availability of inventories in relation to local demand, and the capabilities of distribution networks to move products from refining centers to their point of consumption particularly during periods of stress.

For the purpose of this study, I designate Dr. H. A. Merklein, Administrator, Energy Information Administration, to represent me and to provide the necessary coordination between the Department of Energy and the Council.

Yours truly,

A handwritten signature in black ink that reads "John S. Herrington".

John S. Herrington

DESCRIPTION OF THE NATIONAL PETROLEUM COUNCIL

In May 1946, the President stated that he had been impressed by the contribution made through government/industry cooperation to the success of the World War II petroleum program. He felt that this close relationship should be continued and suggested that the Secretary of the Interior establish an industry organization to provide advice on oil and gas matters. Pursuant to this request, Interior Secretary J. A. Krug established the National Petroleum Council (NPC) on June 18, 1946. In October 1977, the Department of Energy was established and the Council's functions were transferred to the new department.

The sole purpose of the NPC is to advise, inform, and make recommendations to the Secretary of Energy on any matter, requested by him, relating to petroleum or the petroleum industry. Matters that the Secretary would like to have considered by the Council are submitted as a request in the form of a letter outlining the nature and scope of the study. The Council reserves the right to decide whether it will consider any matter referred to it.

Examples of recent major studies undertaken by the NPC at the request of the Secretary include:

- Refinery Flexibility (1980)
- Unconventional Gas Sources (1980)
- Emergency Preparedness for Interruption of Petroleum Imports into the United States (1981)
- U.S. Arctic Oil & Gas (1981)
- Environmental Conservation -- The Oil & Gas Industries (1982)
- Third World Petroleum Development: A Statement of Principles (1982)
- Petroleum Inventories and Storage Capacity (1983, 1984)
- Enhanced Oil Recovery (1984)
- The Strategic Petroleum Reserve (1984)
- U.S. Petroleum Refining (1986)
- Factors Affecting U.S. Oil & Gas Outlook (1987)
- Integrating R&D Efforts (1988).

The NPC does not concern itself with trade practices, nor does it engage in any of the usual trade association activities. The Council is subject to the provisions of the Federal Advisory Committee Act of 1972.

Members of the National Petroleum Council are appointed by the Secretary of Energy and represent all segments of petroleum interests. The NPC is headed by a Chairman and a Vice Chairman, who are elected by the Council. The Council is supported entirely by voluntary contributions from its members.

NATIONAL PETROLEUM COUNCIL

MEMBERSHIP

1989

ADAMS, William L.
Chairman and
Chief Executive Officer
Union Pacific Resources Company

ALLEN, Jack M.
Chairman of the Board
Alpar Resources, Inc.

AMES, Eugene L., Jr.
President
Venus Oil Company

ANDERSON, Robert O.
President
Hondo Oil & Gas Company

ANGELO, Ernest, Jr.
Petroleum Engineer
Midland, Texas

BAILEY, Ralph E.
Chairman of the Board and
Chief Executive Officer
United Meridian Corporation

BAIRD, D. Euan
Chairman, President and
Chief Executive Officer
Schlumberger Limited

BARNES, James E.
President and
Chief Executive Officer
MAPCO Inc.

BASS, Sid R.
President
Bass Brothers Enterprises, Inc.

BLACKBURN, Charles L.
Chairman, President and
Chief Executive Officer
Maxus Energy Corporation

BOWEN, W. J.
Chairman of the Board
Transco Energy Company

BRINKLEY, Donald R.
President and
Chief Executive Officer
Colonial Pipeline Company

BURGUIERES, Philip
Chairman, President and
Chief Executive Officer
Cameron Iron Works, Inc.

BURKE, Frank M., Jr.
Chairman and
Chief Executive Officer
Burke, Mayborn Company, Ltd.

CALDER, Bruce
President
Bruce Calder, Inc.

CARL, William E.
President
Carl Oil & Gas Co.

CARVER, John A., Jr.
College of Law
University of Denver

CASH, R. D.
Chairman, President and
Chief Executive Officer
Questar Corporation

CHANDLER, Collis P., Jr.
President
Chandler & Associates, Inc.

CHENAULT, James E., Jr.
Vice Chairman of the Board
Lone Star Steel Company

CHRISMAN, Neil D.
Senior Vice President
Morgan Guaranty Trust Company
of New York

CONKLIN, Danny H.
Partner
Philcon Development Co.

COOK, Lodwick M.
Chairman of the Board and
Chief Executive Officer
Atlantic Richfield Company

COPELAND, Mark G.
Partner
Copeland, Landye, Bennett
and Wolf

COPULOS, Milton
President
National Defense Council
Foundation

COURSON, Harold D.
President
Courson Oil & Gas, Inc.

COX, Edwin L.
Chairman
Cox Oil & Gas, Inc.

CRUIKSHANK, Thomas H.
President and
Chief Executive Officer
Halliburton Company

DERR, Kenneth T.
Chairman of the Board and
Chief Executive Officer
Chevron Corporation

DIETLER, Cortlandt S.
Chairman and
Chief Executive Officer
Associated Natural Gas
Corporation

DONAHUE, Alice C.
International President
General Federation of
Women's Clubs

DORN, David F.
President
Forest Oil Corporation

EMISON, James W.
President
Western Petroleum Company

ERICKSON, Ronald A.
Chairman of the
Executive Committee
Erickson Petroleum Corporation

EVANS, Fred H.
President
Equity Oil Company

FARRELL, J. Michael
Partner
Manatt, Phelps, Rothenberg &
Evans

FISHER, William L.
Director
Bureau of Economic Geology
University of Texas at Austin

GARY, James F.
International Business and
Energy Advisor
Honolulu, Hawaii

GLANVILLE, James W.
General Partner
Lazard Freres & Co.

GLASSER, James J.
Chairman and President
GATX Corporation

GONZALEZ, Richard J.
Energy Economic Consultant
Austin, Texas

GOTTWALD, F. D., Jr.
Chairman of the Board,
Chief Executive Officer and
Chairman of the Executive
Committee
Ethyl Corporation

GUNN, Robert D.
Chairman of the Board
Gunn Oil Company

HALBOUTY, Michel T.
Chairman of the Board and
Chief Executive Officer
Michel T. Halbouty Energy Co.

HALL, John R.
Chairman and
Chief Executive Officer
Ashland Oil, Inc.

HALL, Ronald E.
President and
Chief Executive Officer
CITGO Petroleum Corporation

HAMILTON, Frederic C.
Chairman, Chief Executive Officer
and President
Hamilton Oil Corporation

HAMMER, Armand
Chairman of the Board and
Chief Executive Officer
Occidental Petroleum Corporation

HAUN, John D.
Chairman of the Board
Barlow & Haun, Inc.

HAUPTFUHRER, Robert P.
Chairman and
Chief Executive Officer
Sun Exploration and
Production Company

HEFNER, Raymond H., Jr.
Chairman and
Chief Executive Officer
Bonray Energy Corporation

HEMMINGHAUS, Roger R.
Chairman and
Chief Executive Officer
Diamond Shamrock R&M, Inc.

HENDRIX, Dennis R.
President and
Chief Executive Officer
Texas Eastern Corporation

HESS, Leon
Chairman of the Board and
Chief Executive Officer
Amerada Hess Corporation

HOBBS, Marcia Wilson
Community Leader
Los Angeles, California

HOWSON, Robert E.
Chairman of the Board and
Chief Executive Officer
McDermott International Inc.

HUFFINGTON, Roy M.
Chairman of the Board and
Chief Executive Officer
Roy M. Huffington, Inc.

HUNSUCKER, Robert D.
Chairman, President and
Chief Executive Officer
Panhandle Eastern Corporation

HUNT, Ray L.
Chairman of the Board
Hunt Oil Company

JOHNSON, A. Clark
Chairman and
Chief Executive Officer
Union Texas Petroleum
Corporation

JONES, A. V., Jr.
Partner
Jones Company

JONES, Jon Rex
Partner
Jones Company

KEPLINGER, H. F.
President and
Chairman of the Board
Keplinger Holdings, Ltd.

KETELSEN, James L.
Chairman and
Chief Executive Officer
Tenneco Inc.

KINNEAR, James W.
President and
Chief Executive Officer
Texaco Inc.

KOCH, Charles G.
Chairman and
Chief Executive Officer
Koch Industries, Inc.

KUEHN, Ronald L., Jr.
Chairman, President and
Chief Executive Officer
Sonat Inc.

LAY, Kenneth L.
Chairman of the Board and
Chief Executive Officer
Enron Corp.

LICHTBLAU, John H.
President
Petroleum Industry Research
Foundation, Inc.

LIEDTKE, J. Hugh
Chairman of the Board
Pennzoil Company

McCLEMENTS, Robert, Jr.
Chairman of the Board and
Chief Executive Officer
Sun Company, Inc.

MacDONALD, Peter
Chairman
The Navajo Tribal Council

McFARLAND, Lee C.
Chairman of the Board
McFarland Energy, Inc.

McNUTT, Jack W.
President and
Chief Executive Officer
Murphy Oil Corporation

McPHERSON, Frank A.
Chairman and
Chief Executive Officer
Kerr-McGee Corporation

MAGUIRE, Cary M.
President
Maguire Oil Company

MAYER, Frederick R.
Chairman of the Board
Caza Drilling &
Exploration Companies

MEIDINGER, Judy
Chairman of the Board
Koniag, Inc.

MILLER, C. John
Partner
Miller Energy Company

MISBRENER, Joseph M.
President
Oil, Chemical & Atomic Workers
International Union, AFL-CIO

MITCHELL, George P.
Chairman, Chief Executive Officer
and President
Mitchell Energy and
Development Corporation

MOFFETT, James R.
Chairman of the Board and
Chief Executive Officer
Freeport-McMoran Inc.

MORROW, Richard M.
Chairman of the Board
Amoco Corporation

MUNRO, John Thomas
President
Munro Petroleum &
Terminal Corporation

MURPHY, John J.
Chairman, President and
Chief Executive Officer
Dresser Industries, Inc.

MURRAY, Allen E.
Chairman of the Board, President
and Chief Executive Officer
Mobil Corporation

NICANDROS, Constantine S.
President and
Chief Executive Officer
Conoco Inc.

NOBLE, Samuel R.
Chairman of the Board
Noble Affiliates

O'CONNOR, Raymond J.
Vice President
Citibank, N.A.

PACKER, William B., Sr.
Chairman of the Board
Seaview Petroleum Company

PALMER, C. R.
Chairman of the Board, President
and Chief Executive Officer
Rowan Companies, Inc.

PARKER, Robert L.
Chairman of the Board and
Chief Executive Officer
Parker Drilling Company

PERRY, Kenneth W.
Vice Chairman of the Board
American Petrofina, Incorporated

PETTY, Travis H.
Vice Chairman
Burlington Resources Inc.

PICKENS, T. Boone, Jr.
General Partner
Mesa Limited Partnership

PITTS, L. Frank
Owner
Pitts Energy Group

PLANK, Raymond
Chairman and
Chief Executive Officer
Apache Corporation

PRUET, Chesley R.
President
Pruet Drilling Company

RAWL, Lawrence G.
Chairman of the Board and
Chief Executive Officer
Exxon Corporation

REED, Robert G. III
Chairman of the Board, President
and Chief Executive Officer
Pacific Resources, Inc.

RICHARDSON, Frank H.
President and
Chief Executive Officer
Shell Oil Company

ROSENBERG, Henry A., Jr.
Chairman of the Board and
Chief Executive Officer
Crown Central Petroleum
Corporation

ROSS, James H.
President and
Chief Executive Officer
BP America Inc.

SILAS, C. J.
Chairman of the Board and
Chief Executive Officer
Phillips Petroleum Company

SIMMONS, Donald M.
President
Simmons Royalty Company

SLAWSON, Donald C.
Chairman of the Board and
President
Slawson Companies

SMITH, Clair S., Jr.
Smith Enterprises
Shreveport, Louisiana

SMITH, Weldon H.
Chairman of the Board
Big 6 Drilling Company

SMITH, William T.
Chairman
Wolverine Exploration Company

SORENSEN, Arlo G.
President
M. H. Whittier Corporation

STEGEMEIER, Richard J.
President and
Chief Executive Officer
Unocal Corporation

STEWART, H. Leighton
Chairman, President and
Chief Executive Officer
The Louisiana Land and
Exploration Company

SWALES, William E.
Vice Chairman - Energy
USX Corporation

TRUE, H. A., Jr.
Partner
True Oil Company

VETTER, Edward O.
President
Edward O. Vetter &
Associates, Inc.

WARD, L. O.
Owner-President
Ward Petroleum Corporation

WEST, Robert V., Jr.
Chairman of the Board
Tesoro Petroleum Corporation

WILLIAMS, Joseph H.
Chairman of the Board and
Chief Executive Officer
The Williams Companies, Inc.

WISCHER, Irene S.
President and
Chief Executive Officer
Panhandle Producing Company

WOODS, Dalton J.
President
Dalwood Corporation

WOODS, James D.
President and
Chief Executive Officer
Baker Hughes Incorporated

ZARROW, Henry
President
Sooner Pipe & Supply Corporation

ZEPPA, Keating V.
Chairman
DeltaUS Corporation

APPENDIX B
STUDY GROUP ROSTERS

NATIONAL PETROLEUM COUNCIL
COMMITTEE ON
PETROLEUM STORAGE & TRANSPORTATION

CHAIRMAN

William E. Swales
Vice Chairman - Energy
USX Corporation

GOVERNMENT COCHAIRMAN

H. A. Merklein
Administrator
Energy Information Administration
U.S. Department of Energy

EX OFFICIO

Edwin L. Cox
Chairman
National Petroleum Council

EX OFFICIO

Lodwick M. Cook
Vice Chairman
National Petroleum Council

SECRETARY

Marshall W. Nichols
Executive Director
National Petroleum Council

* * *

W. J. Bowen
Chairman of the Board
Transco Energy Company

Ronald A. Erickson
Chairman of the
Executive Committee
Erickson Petroleum Corporation

John R. Hall
Chairman and
Chief Executive Officer
Ashland Oil, Inc.

Ronald E. Hall
President and
Chief Executive Officer
CITGO Petroleum Corporation

Kenneth L. Lay
Chairman of the Board and
Chief Executive Officer
Enron Corp.

John H. Lichtblau
President
Petroleum Industry Research
Foundation, Inc.

Robert McClements, Jr.
Chairman of the Board and
Chief Executive Officer
Sun Company, Inc.

Richard M. Morrow
Chairman of the Board
Amoco Corporation

COMMITTEE ON PETROLEUM STORAGE & TRANSPORTATION

Allen E. Murray
Chairman of the Board,
President and
Chief Executive Officer
Mobil Corporation

C. J. Silas
Chairman of the Board and
Chief Executive Officer
Phillips Petroleum Company

Robert G. Reed III
Chairman of the Board,
President and
Chief Executive Officer
Pacific Resources, Inc.

Richard J. Stegemeier
President and
Chief Executive Officer
Unocal Corporation

Joseph H. Williams
Chairman of the Board and
Chief Executive Officer
The Williams Companies, Inc.

NATIONAL PETROLEUM COUNCIL
COORDINATING SUBCOMMITTEE
OF THE
COMMITTEE ON
PETROLEUM STORAGE & TRANSPORTATION

CHAIRMAN

R. N. Yamine
President
Emro Marketing Company

GOVERNMENT COCHAIRMAN

Jimmie L. Petersen, Director
Office of Oil and Gas
Energy Information Administration
U.S. Department of Energy

ASSISTANT TO THE CHAIRMAN

C. M. Palmer, Manager
Crude Oil Scheduling
Marathon Petroleum Company

SECRETARY

John H. Guy, IV
Deputy Executive Director
National Petroleum Council

*

*

*

Ronald J. Bertus
Vice President
Supply and Transportation
Shell Refining and Marketing
Company

D. R. Hayward
Vice President
U.S. Supply
Marketing & Refining
Division - U.S.
Mobil Oil Corporation

Ronald J. Burns
President
Interstate Pipelines
Gas Pipeline Group
Enron Corp.

Robert B. Keifer, Jr.
Group Vice President
Supply and Transportation
Ashland Petroleum Company

Stephen L. Cropper, President
Williams Pipe Line Company

Rodger W. Murtaugh
Vice President
Operations Planning and
Transportation
Amoco Oil Company

John P. DesBarres, President
Santa Fe Pacific Pipelines, Inc.

Bruce D. Frolich
Vice President
Supply & Distribution
Chevron U.S.A. Inc.

Robert P. Neuschel
Director, Transportation Center
Northwestern University

COORDINATING SUBCOMMITTEE

William M. Oller
Executive Vice President
Texas Eastern Products
Pipeline Company

L. E. Scott
Vice President
Crude Supply and Transportation
Unocal Refining and Marketing
Division
Unocal Corporation

J. E. Shamas
President
Texaco Trading and
Transportation Inc.

Ray G. Steiner
Vice President
Supply and Transportation
Phillips 66 Company

NATIONAL PETROLEUM COUNCIL
LIQUIDS TRANSPORTATION TASK GROUP
OF THE
COMMITTEE ON
PETROLEUM STORAGE & TRANSPORTATION

CHAIRMAN

John P. DesBarres
President
Santa Fe Pacific Pipelines, Inc.

ASSISTANT TO THE CHAIRMAN

Buddy J. Currens, Director
Engineering and Compliance
Sun Pipe Line Company

GOVERNMENT COCHAIRMAN

Ronald W. O'Neill, Chief
Industry Analysis Branch
Petroleum Supply Division
Energy Information Administration
U.S. Department of Energy

SECRETARY

Benjamin A. Oliver, Jr.
Committee Coordinator
National Petroleum Council

*

*

*

Patrick H. Corcoran
Executive Director
Association of Oil Pipe Lines

Stephen L. Cropper, President
Williams Pipe Line Company

M. Cynthia Douglass
Administrator
Research and Special Programs
Administration
U.S. Department of
Transportation

Robert D. Green, Director
NGL Distribution & Inventories
Phillips 66 Company

David F. Johnson, Director
Systems Planning and Analysis
Division
Strategic Petroleum Reserve
U.S. Department of Energy

Peter E. Luitwieler
Vice President
Supply and Logistics
CITGO Petroleum Corporation

William M. Oller
Executive Vice President
Texas Eastern Products
Pipeline Company

Charles A. Rysenga
President
Marathon Pipe Line Company

W. L. Thacker, President
Unocal Pipeline Company

Larry C. Thomas, Manager
Joint Interest Pipeline
BP America Inc.

R. Scott VanDyke
President and
Chief Executive Officer
Explorer Pipeline Company

Lawrence W. Vogel
Senior Program Manager
Science Applications
International Corporation

LIQUIDS TRANSPORTATION TASK GROUP

SPECIAL ASSISTANTS

Lester C. Bedient
Senior Vice President, Retired
Crowley Maritime Corp.

C. J. Colessides
Senior Planning Analysis
The Williams Companies, Inc.

William A. Creelman
Deputy Maritime Administrator
Maritime Administration

Timothy M. Crowe
Inventory and Systems
Control Manager
International Supply and
Transportation
CITGO Petroleum Corporation

Michel E. Dabbar, Manager
Worldwide Crude Oil Supply and
Maritime Transportation
Phillips 66 Company

Michael R. Frakes
Transportation Systems Analyst
Science Applications
International Corporation

Robert L. Gray, Consultant
Marine Transportation
Ashland Petroleum Company

Howard B. Hile
Assistant Vice President -
Marketing
Maritrans Operating Partners L.P.

Mark B. Johnke
Staff Assistant
Marathon Pipe Line Company

David G. Lunceford
Inland Fleet Manager
Exxon Shipping Company

Douglas C. Nettle
Manager, Inventory & Storage
Texas Eastern Products Pipeline
Company

E. D. Olmo, Manager
Land Transportation
Shell Oil Company

John W. Shannon
Consultant

William D. Vanderbilt
Manager
Joint Venture Pipelines
BP America Inc.

APPENDIX C

CRUDE OIL PIPELINE MAPS AND TABLES

MAPS:	Pages
- National – U.S.	C-1
- Regional – PAD Districts	C-3 - C-11
- Area – Transportation and Refining Centers ...	C-13 - C-31
 TABLES:	
- Cross-PADD Capacities	C-32 - C-34
- Intra-PADD Capacities	C-35 - C-45
- Expansion Projects	
Planned or Under Construction in 1979	C-46 - C-47
- Expansion Projects	
Completed Between 1/1/79 and 12/31/87.....	C-48 - C-54

CRUDE OIL PIPELINE CAPACITIES*
AS OF DECEMBER 31, 1987
(THOUSANDS OF BARRELS DAILY)

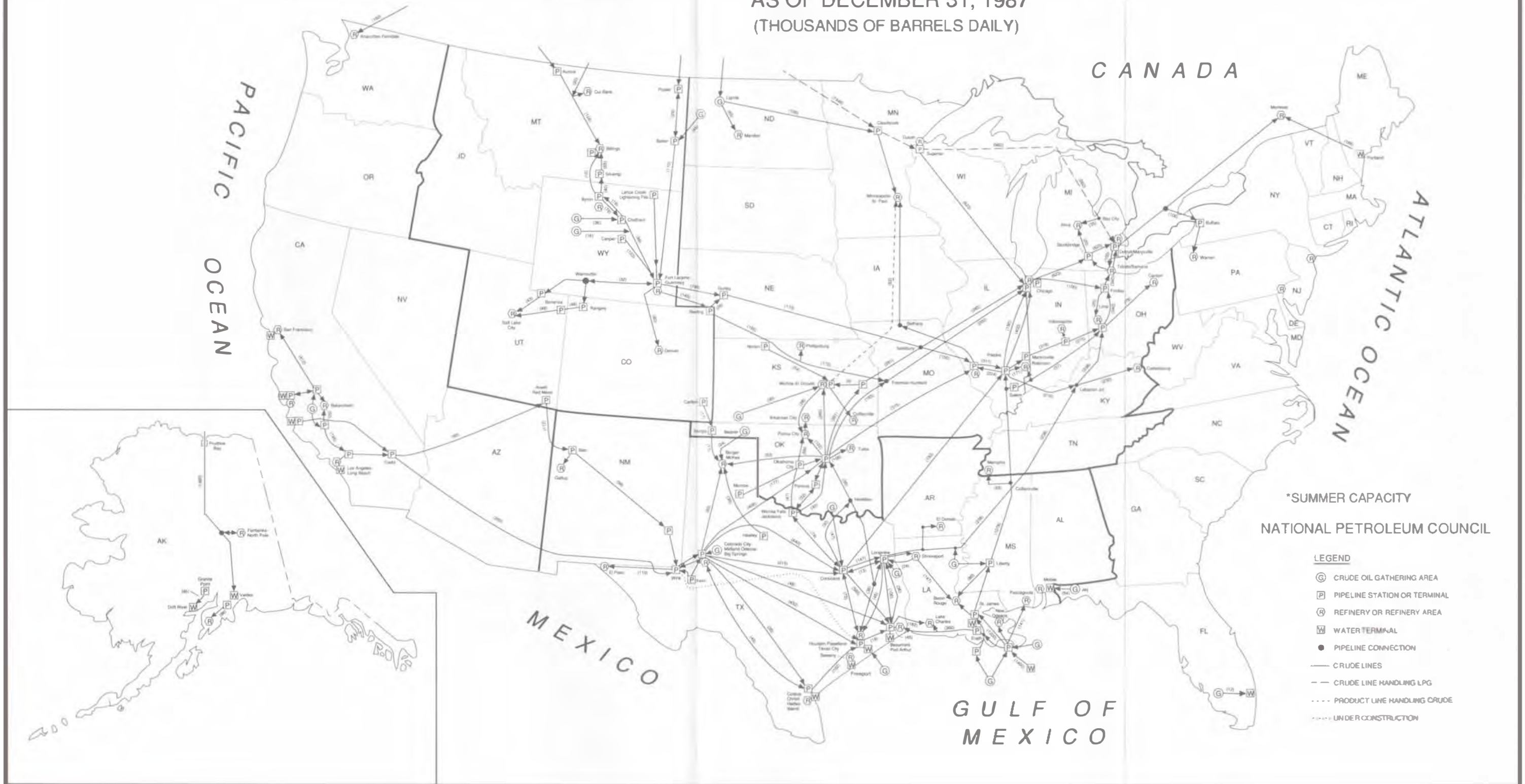

*SUMMER CAPACITY

NATIONAL PETROLEUM COUNCIL

LEGEND

- G CRUDE OIL GATHERING AREA
- P PIPELINE STATION OR TERMINAL
- R REFINERY OR REFINERY AREA
- W WATER TERMINAL
- PIPELINE CONNECTION
- CRUDE LINES
- - - CRUDE LINE HANDLING LPG
- · · · · PRODUCT LINE HANDLING CRUDE
- · · · · UNDER CONSTRUCTION

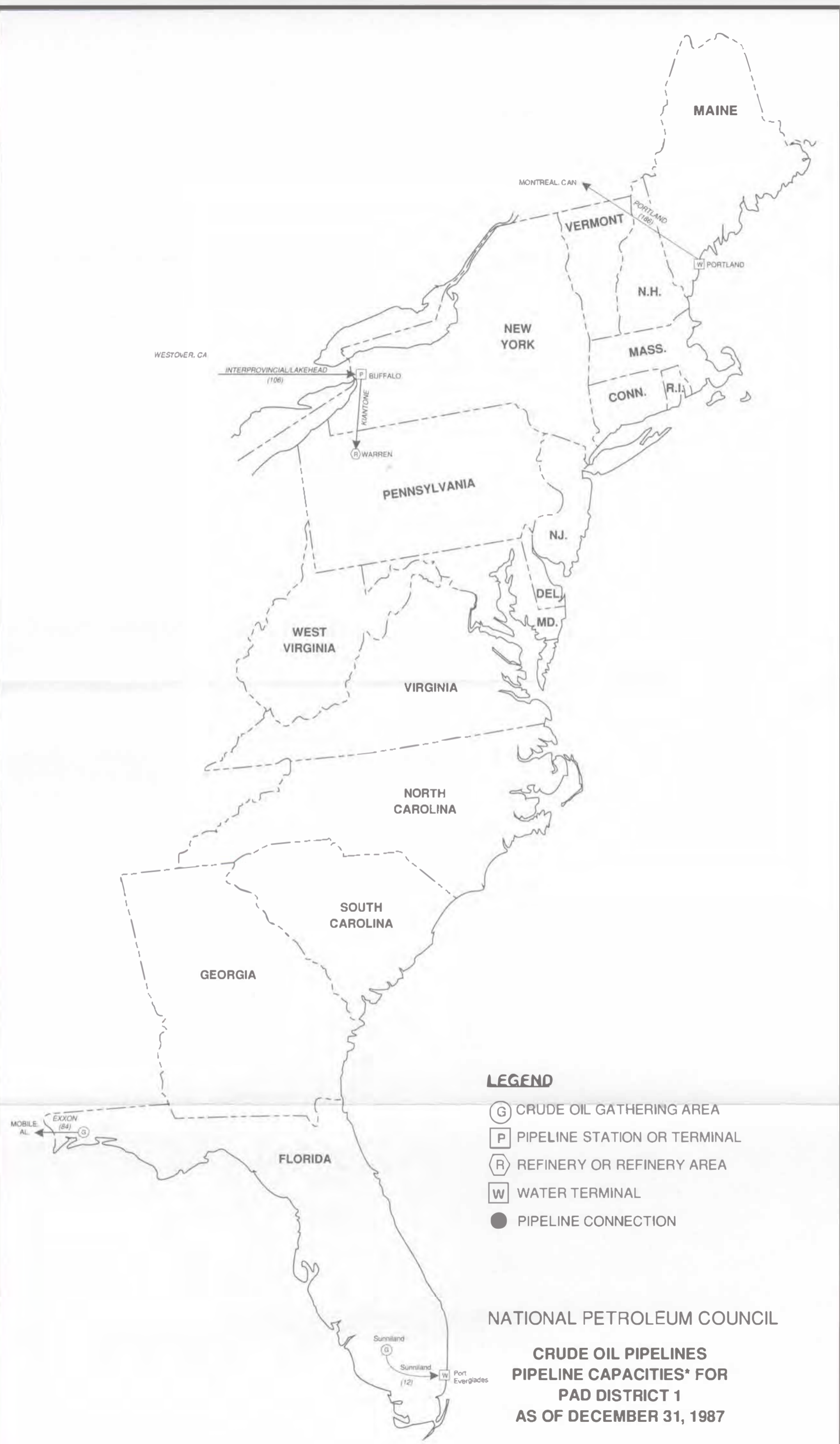

LEGEND

- (G) CRUDE OIL GATHERING AREA
- (P) PIPELINE STATION OR TERMINAL
- (R) REFINERY OR REFINERY AREA
- (W) WATER TERMINAL
- PIPELINE CONNECTION

NATIONAL PETROLEUM COUNCIL

**CRUDE OIL PIPELINES
PIPELINE CAPACITIES* FOR
PAD DISTRICT 1
AS OF DECEMBER 31, 1987**

* SUMMER CAPACITY (THOUSANDS OF BARRELS DAILY)

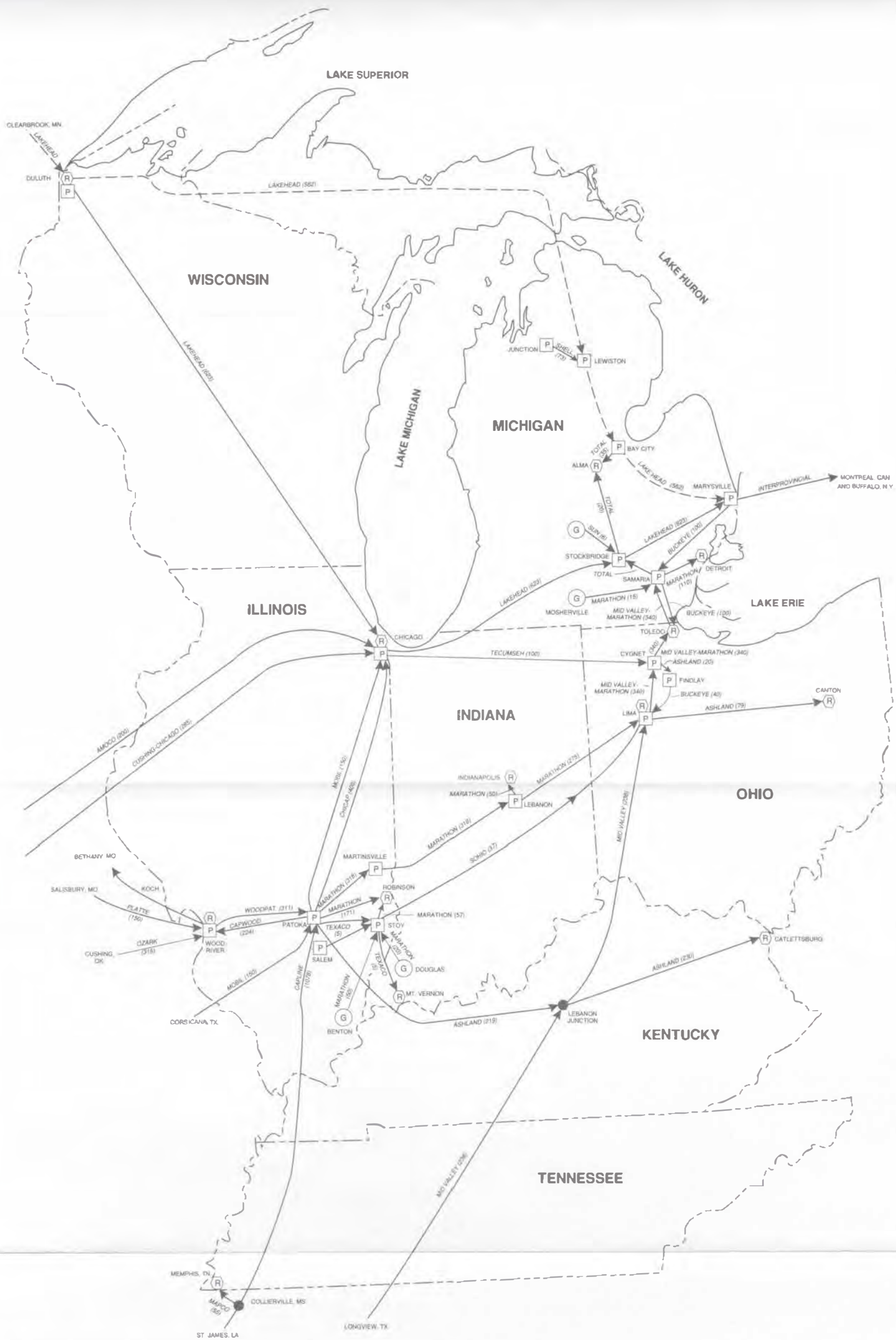

NATIONAL PETROLEUM COUNCIL

**CRUDE OIL PIPELINES
PIPELINE CAPACITIES* FOR
PAD DISTRICT 2
EAST OF THE MISSISSIPPI RIVER
AS OF DECEMBER 31, 1987**

LEGEND

- (G) CRUDE OIL GATHERING AREA
- (P) PIPELINE STATION OR TERMINAL
- (R) REFINERY OR REFINERY AREA
- PIPELINE CONNECTION
- CRUDE LINE HANDLING LPG

* SUMMER CAPACITY (THOUSANDS OF BARRELS DAILY)

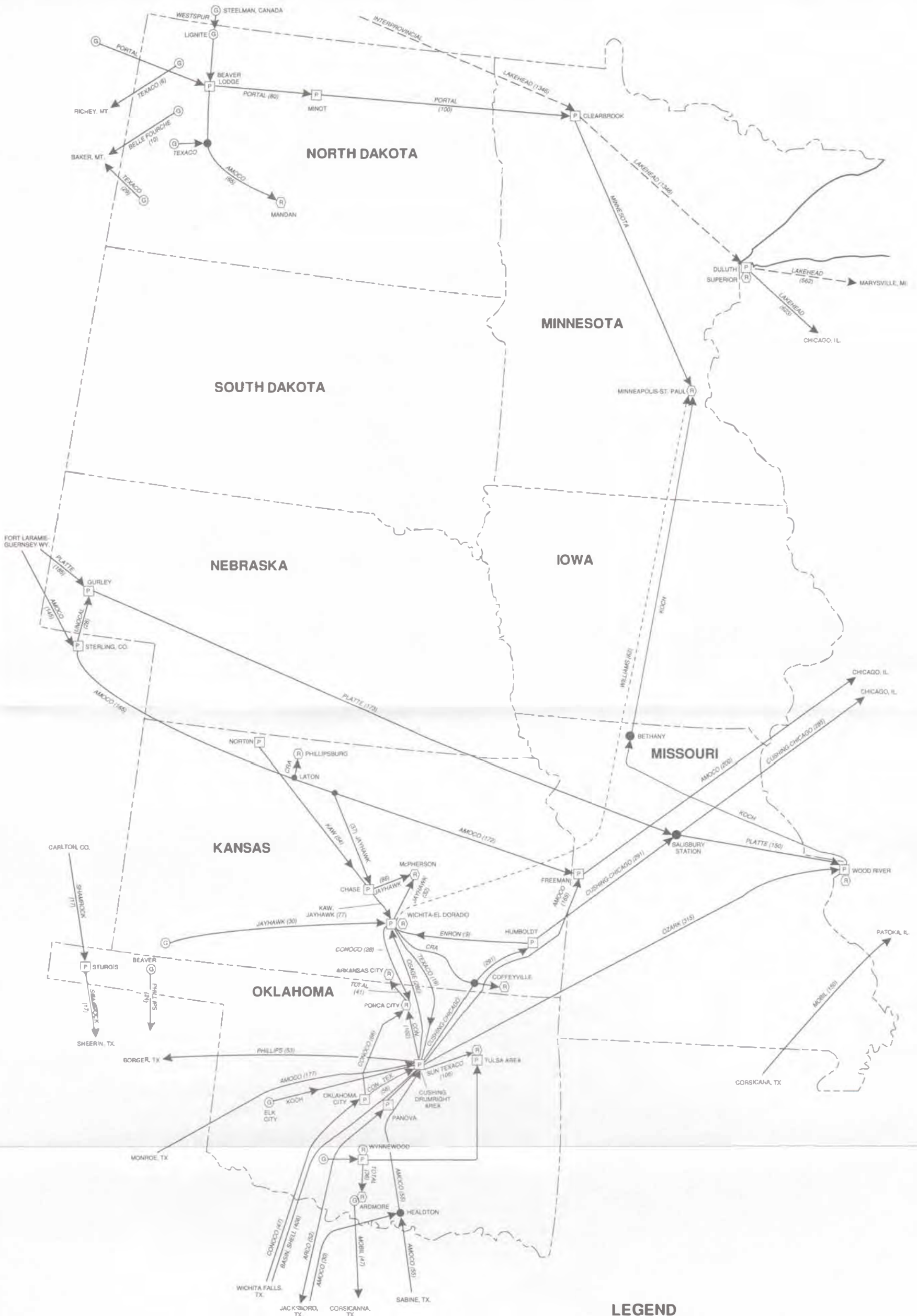

NATIONAL PETROLEUM COUNCIL
CRUDE OIL PIPELINES
PIPELINE CAPACITIES* FOR
PAD DISTRICT 2
WEST OF THE MISSISSIPPI RIVER
AS OF DECEMBER 31, 1987

* SUMMER CAPACITY (THOUSANDS OF BARRELS DAILY)

- LEGEND**
- (G) CRUDE OIL GATHERING AREA
 - (P) PIPELINE STATION OR TERMINAL
 - (R) REFINERY OR REFINERY AREA
 - PIPELINE CONNECTION
 - PRODUCT LINE HANDLING CRUDE
 - CRUDE LINE HANDLING LPG

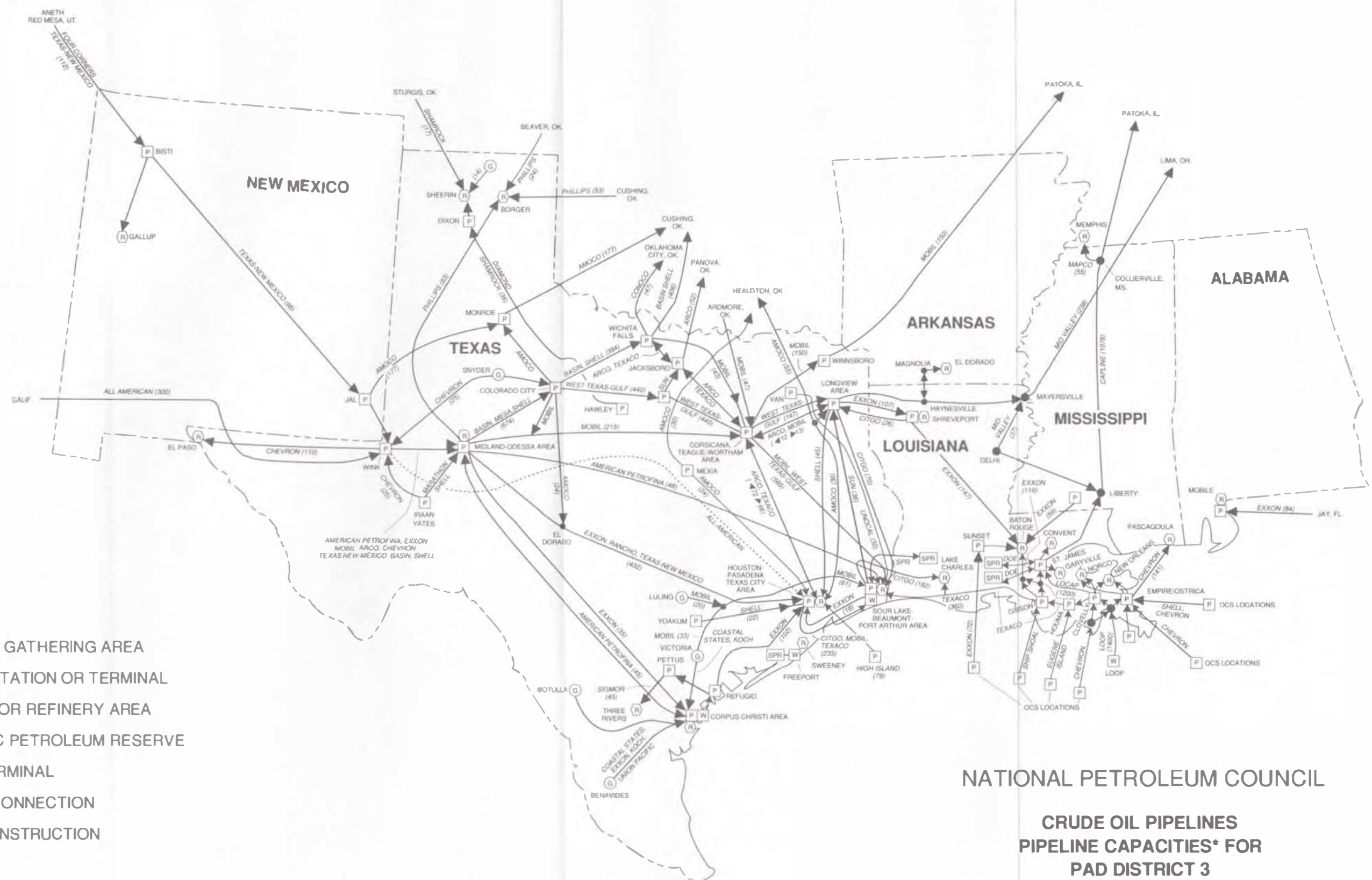

LEGEND

- G CRUDE OIL GATHERING AREA
- P PIPELINE STATION OR TERMINAL
- R REFINERY OR REFINERY AREA
- SPR STRATEGIC PETROLEUM RESERVE
- W WATER TERMINAL
- PIPELINE CONNECTION
- UNDER CONSTRUCTION

NATIONAL PETROLEUM COUNCIL

**CRUDE OIL PIPELINES
PIPELINE CAPACITIES* FOR
PAD DISTRICT 3
AS OF DECEMBER 31, 1987**

* SUMMER CAPACITY (THOUSANDS OF BARRELS DAILY)

**NATIONAL PETROLEUM COUNCIL
CRUDE OIL PIPELINES
PIPELINE CAPACITIES* FOR
PAD DISTRICTS 4 & 5
AS OF DECEMBER 31, 1987**

* SUMMER CAPACITY (THOUSANDS OF BARRELS DAILY)

LEGEND

- (G)** CRUDE OIL GATHERING AREA
- (P)** PIPELINE STATION OR TERMINAL
- (R)** REFINERY OR REFINERY AREA
- (W)** WATER TERMINAL
- PIPELINE CONNECTION



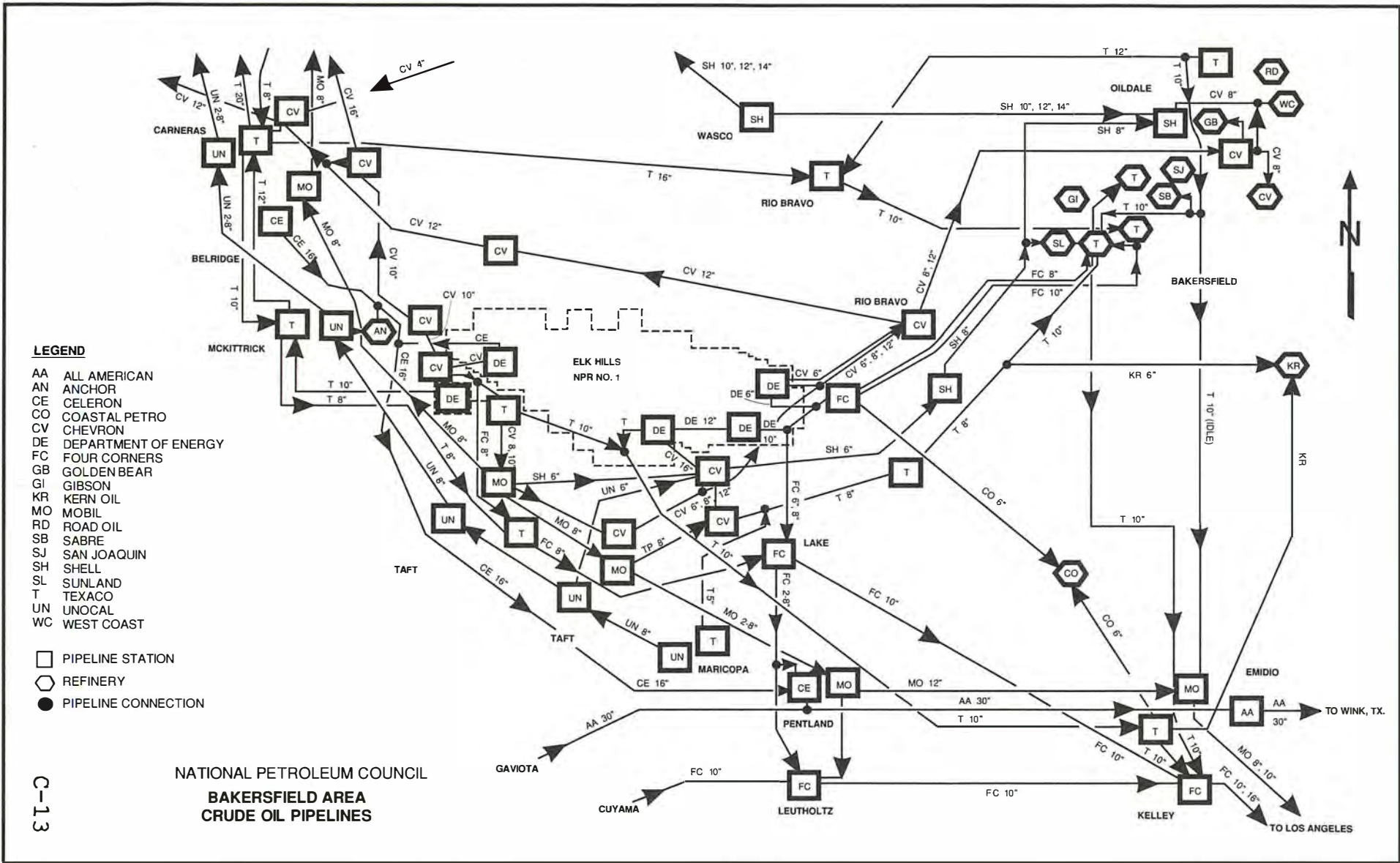

LEGEND

- AA ALL AMERICAN
- AN ANCHOR
- CE CELERON
- CO COASTAL PETRO
- CV CHEVRON
- DE DEPARTMENT OF ENERGY
- FC FOUR CORNERS
- GB GOLDEN BEAR
- GI GIBSON
- KR KERN OIL
- MO MOBIL
- RD ROAD OIL
- SB SABRE
- SJ SAN JOAQUIN
- SH SHELL
- SL SUNLAND
- T TEXACO
- UN UNOCAL
- WC WEST COAST

- PIPELINE STATION
- ⬡ REFINERY
- PIPELINE CONNECTION

NATIONAL PETROLEUM COUNCIL
**BAKERSFIELD AREA
 CRUDE OIL PIPELINES**

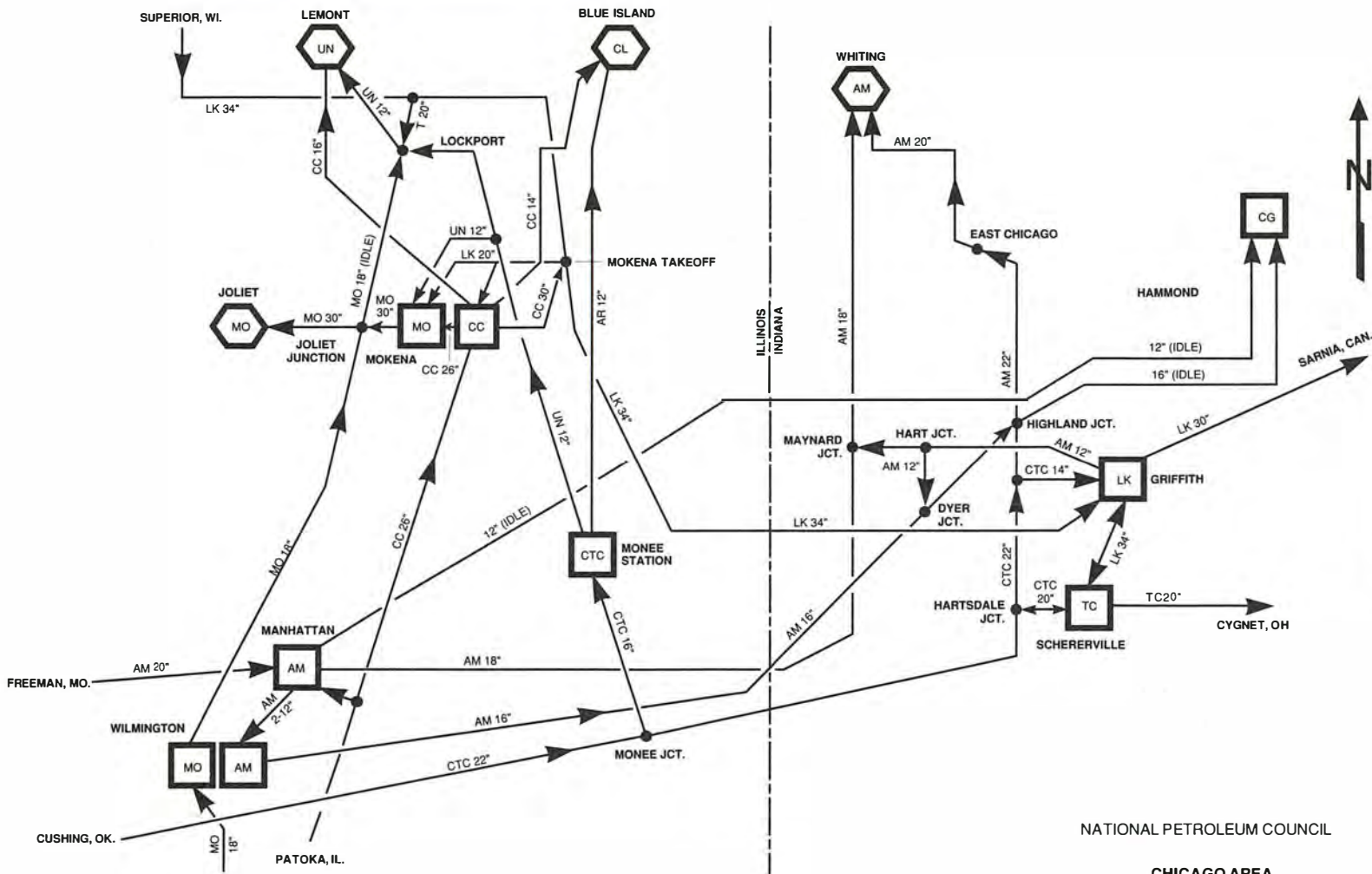

- LEGEND**
- AM AMOCO
 - AR ARCO
 - CC CHICAP
 - CG CITGO
 - CL CLARK
 - CTC CUSHING TO CHICAGO
 - LK LAKEHEAD
 - MO MOBIL
 - TC TExaco
 - T TEXACO
 - UN UNOCAL
 - PIPELINE STATION
 - REFINERY
 - PIPELINE CONNECTION

NATIONAL PETROLEUM COUNCIL
**CHICAGO AREA
 CRUDE OIL PIPELINES**

LEGEND

- AH AMERADA HESS
- AP AMERICAN PETROFINA
- CH CHAMPLIN
- CT COASTAL STATES
- EX EXXON
- KO KOCH
- MO MOBIL
- PN PERMIAN
- QH QUINTANA-HOWELL
- SG SIGMOR
- SN SOUTHWESTERN (KERR McGEE)
- SU SUN
- TR TRIFINERY
- UP UNION PACIFIC
- VR VALERO REFINING
- REFINERY
- PIPELINE STATION
- PIPELINE CONNECTION

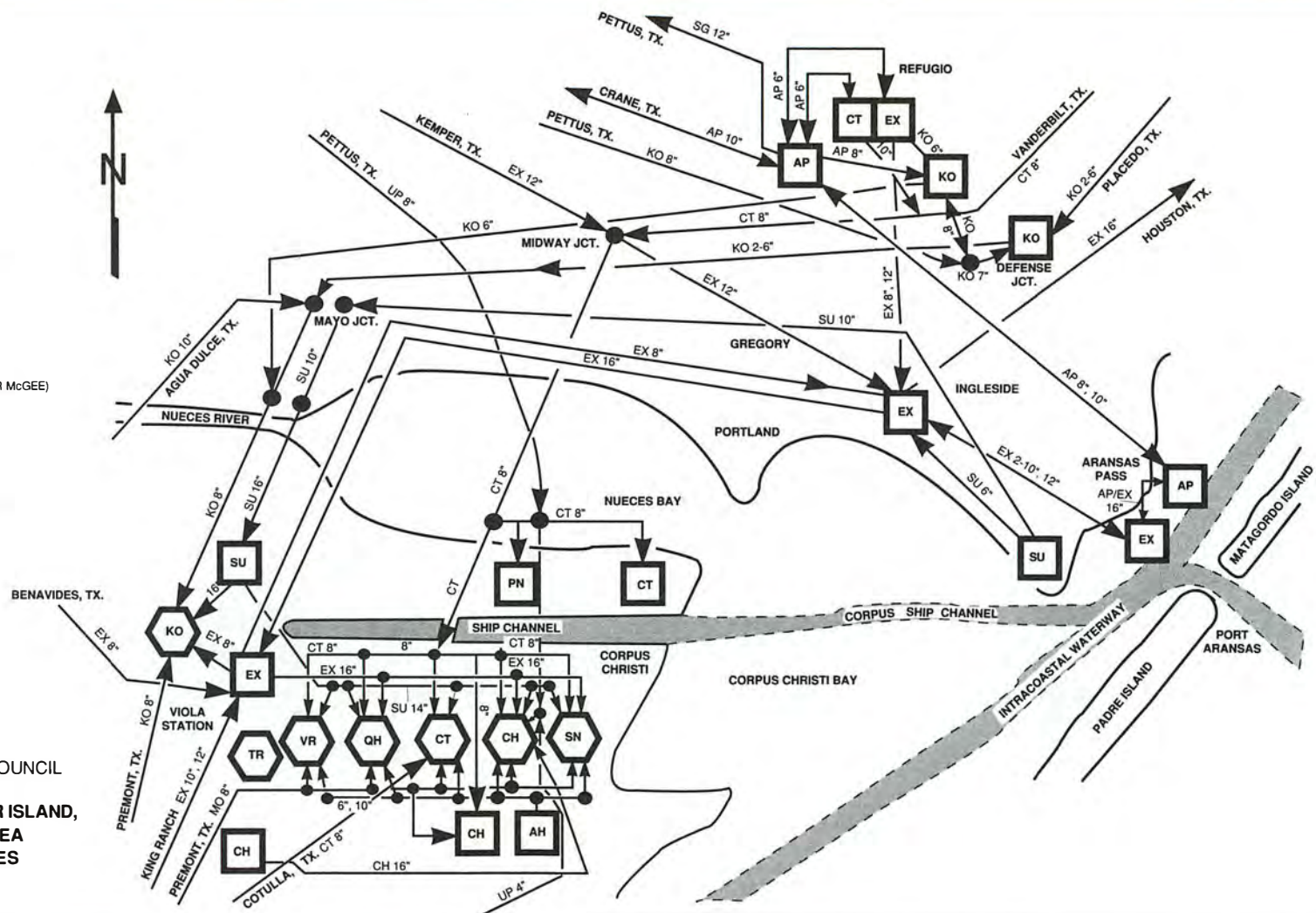

NATIONAL PETROLEUM COUNCIL
 CORPUS CHRISTI, HARBOR ISLAND,
 REFUGIO, TEXAS AREA
 CRUDE OIL PIPELINES

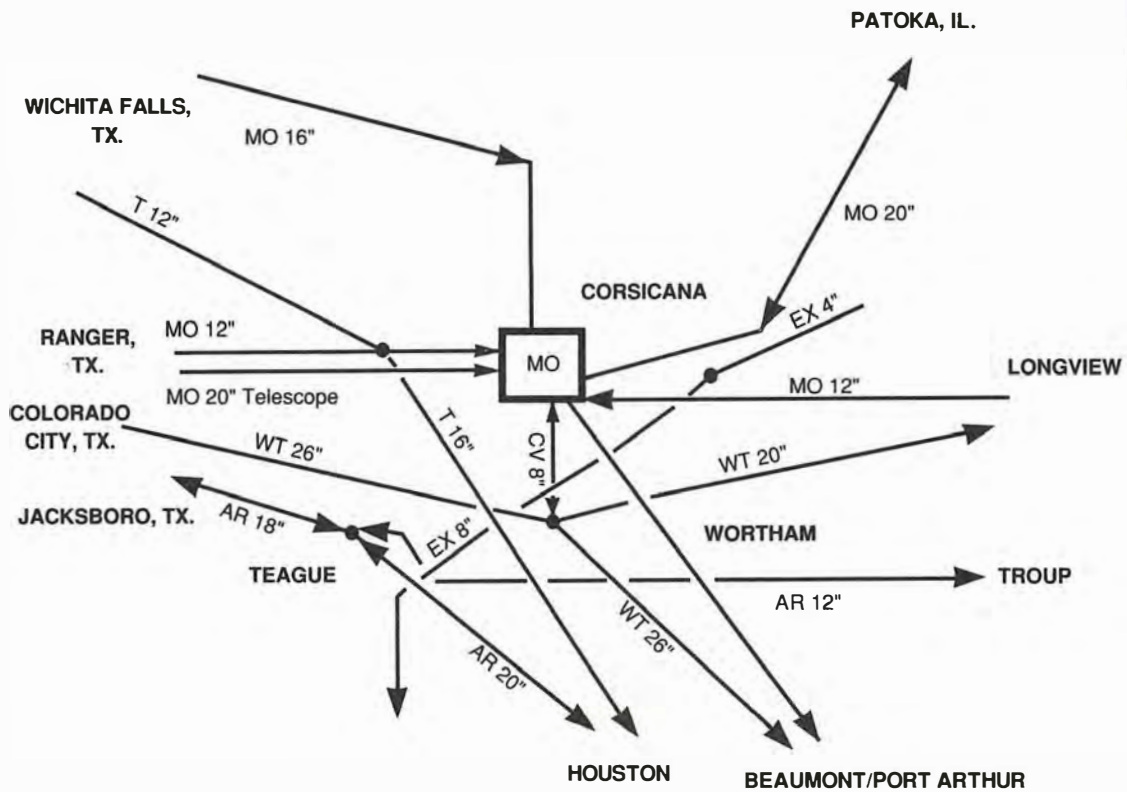

CRUDE PIPELINES

LEGEND

- AR ARCO
- CV CHEVRON
- EX EXXON
- MO MOBIL PUMPING STATION
- T TEXACO
- WT W. TEXAS GULF

□ PIPELINE STATION

● PIPELINE CONNECTION

NATIONAL PETROLEUM COUNCIL CORSICANA/WORTHAM/TEAGUE AREA

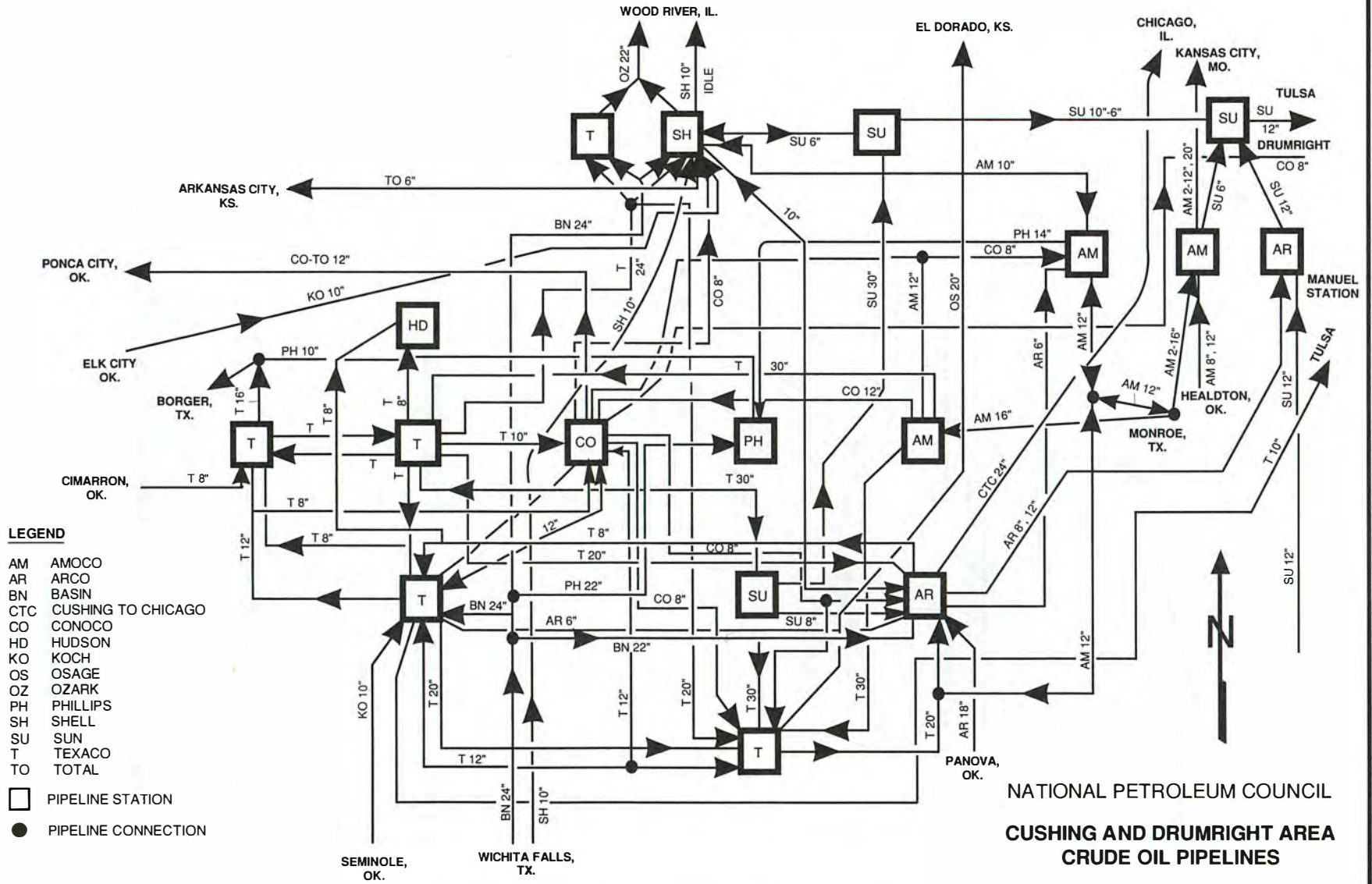

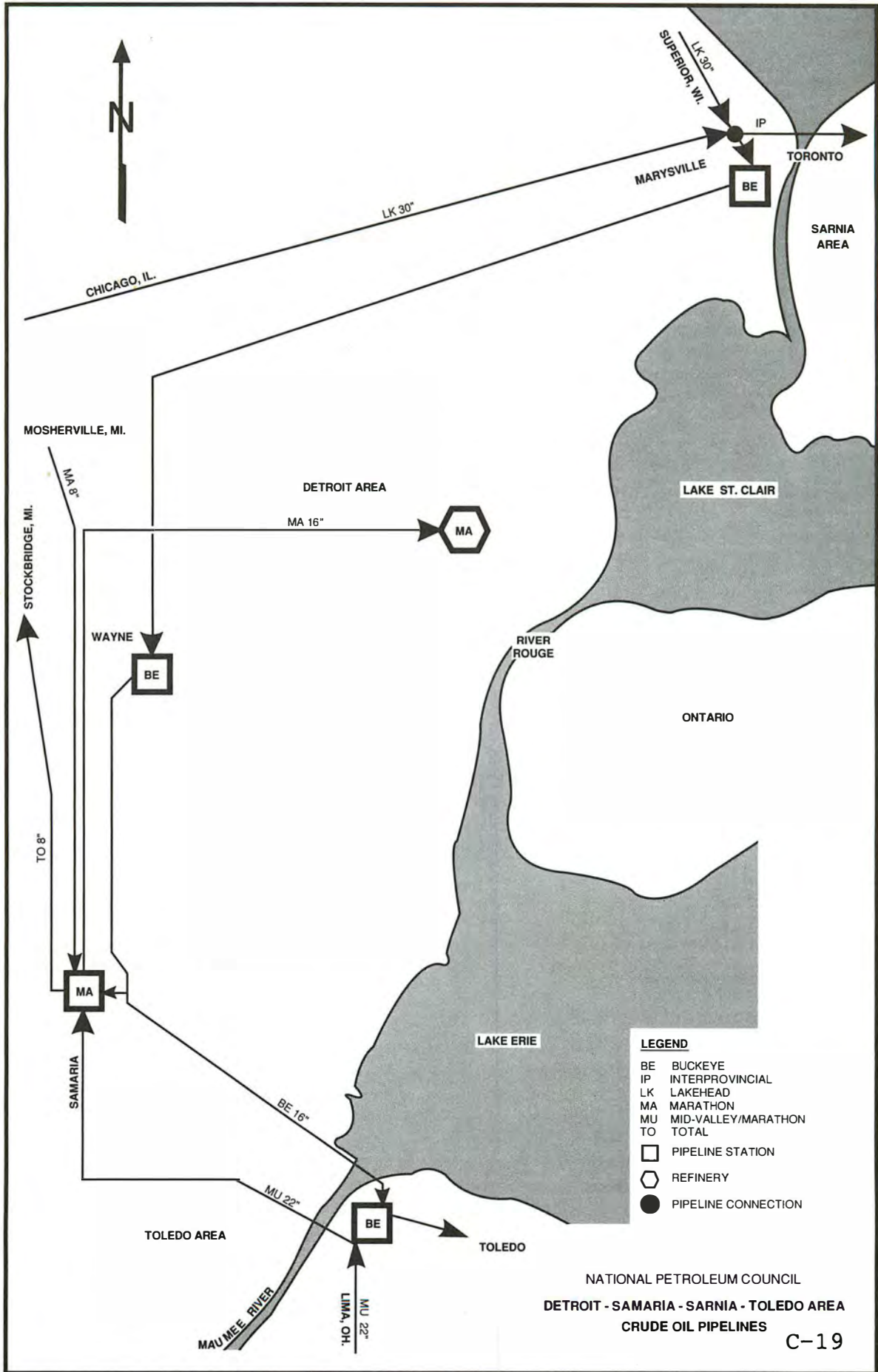

LEGEND

- BE BUCKEYE
- IP INTERPROVINCIAL
- LK LAKEHEAD
- MA MARATHON
- MU MID-VALLEY/MARATHON
- TO TOTAL
- PIPELINE STATION
- ⬡ REFINERY
- PIPELINE CONNECTION

NATIONAL PETROLEUM COUNCIL
 DETROIT - SAMARIA - SARNIA - TOLEDO AREA
 CRUDE OIL PIPELINES

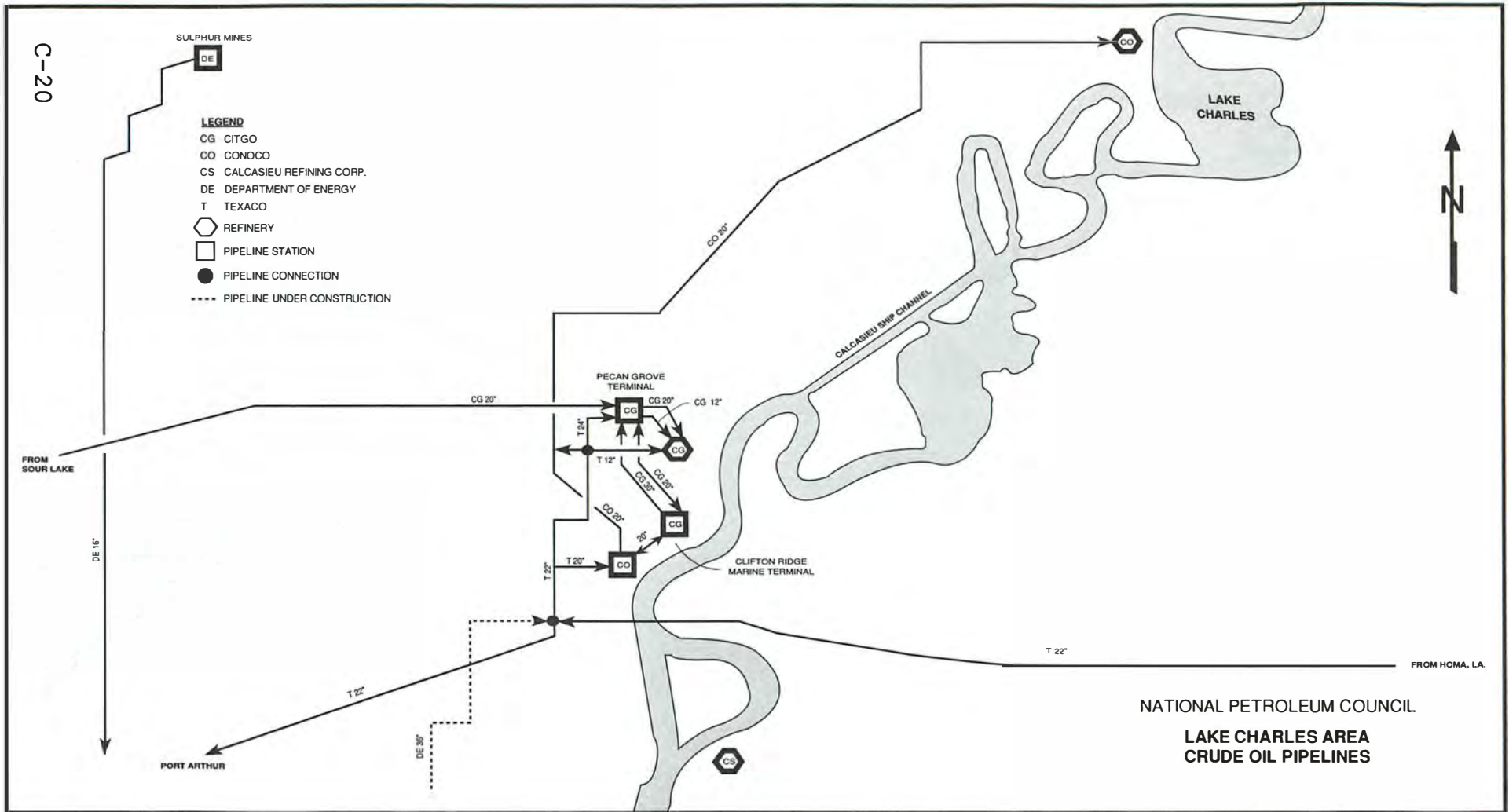

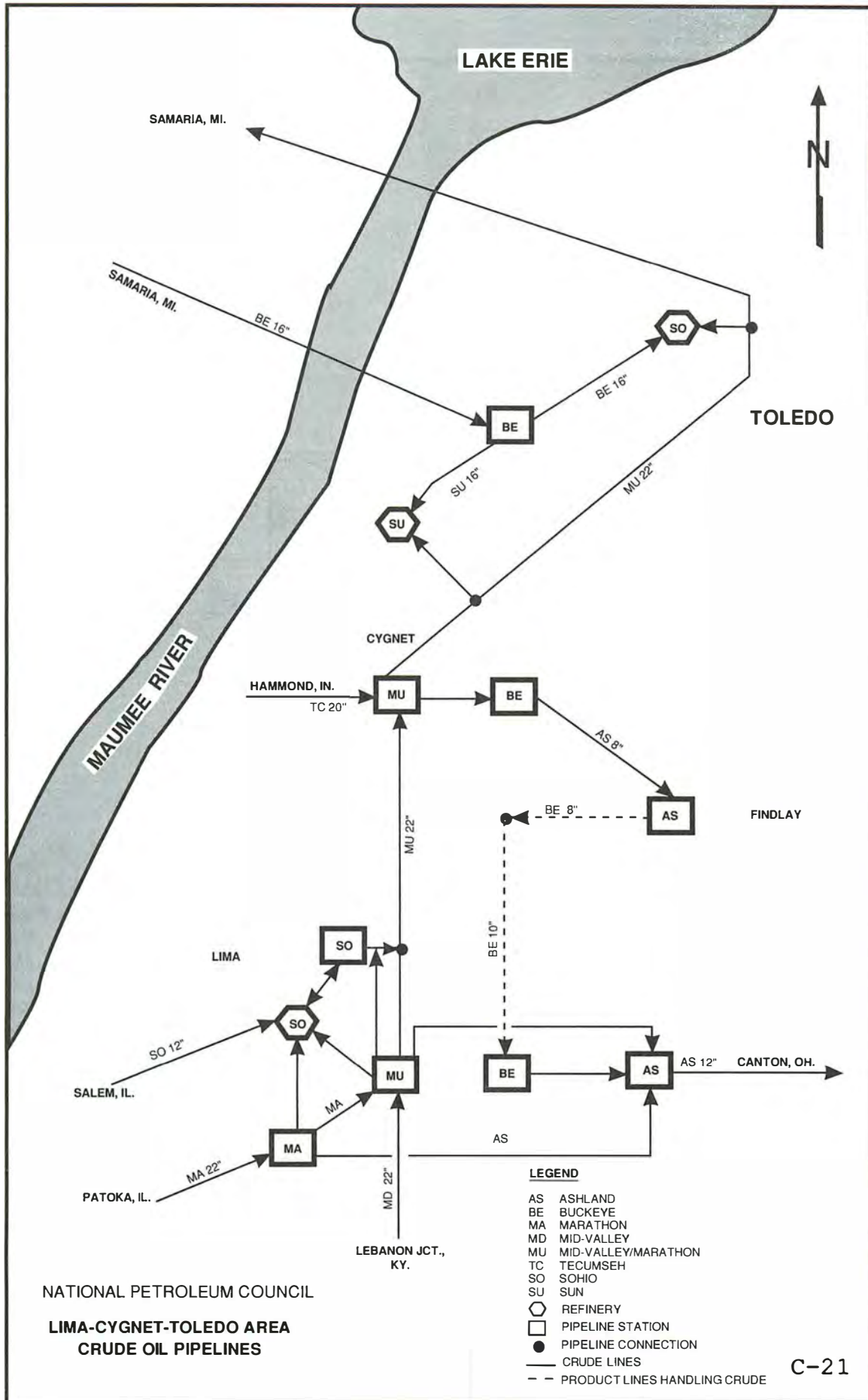

NATIONAL PETROLEUM COUNCIL

**LIMA-CYGNET-TOLEDO AREA
CRUDE OIL PIPELINES**

LEGEND

- AS ASHLAND
- BE BUCKEYE
- MA MARATHON
- MD MID-VALLEY
- MU MID-VALLEY/MARATHON
- TC TECUMSEH
- SO SOHIO
- SU SUN
- ◻ PIPELINE STATION
- ◻ PIPELINE CONNECTION
- CRUDE LINES
- - PRODUCT LINES HANDLING CRUDE

LEGEND

- AM AMOCO
- AR ARCO
- CG CITGO
- EX EXXON
- LG LA GLORIA
- MD MID VALLEY
- MO MOBIL
- PN PERMIAN
- SC SCURLOCK
- SH SHELL
- SO SOHIO
- SU SUN
- T TEXACO
- UN UNOCAL
- WT WEST TEXAS GULF
- REFINERY
- PIPELINE STATION
- PIPELINE CONNECTION

VAN ZANDT



UN 10"
NEDERLAND, TX.

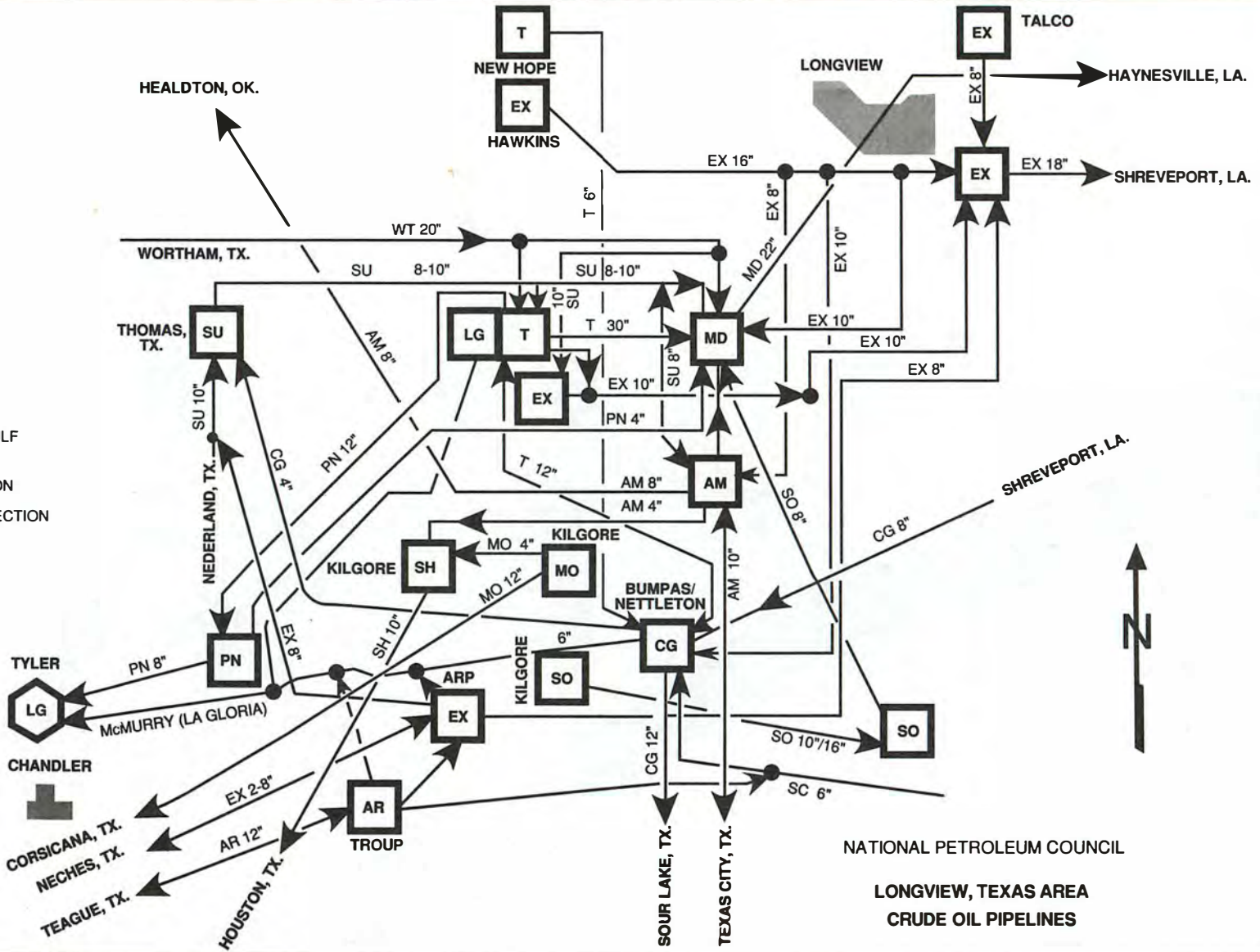

NATIONAL PETROLEUM COUNCIL
LONGVIEW, TEXAS AREA
CRUDE OIL PIPELINES

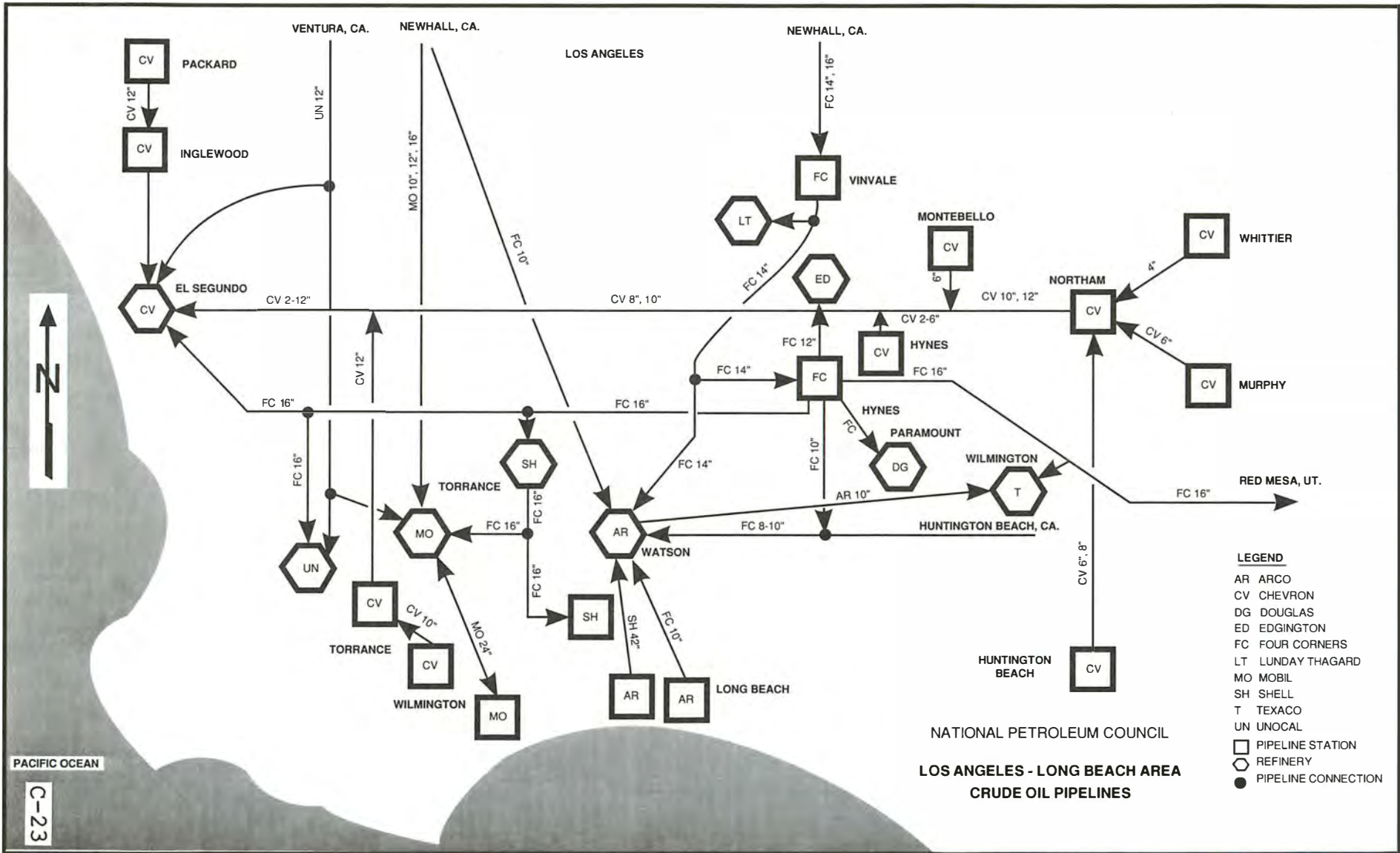

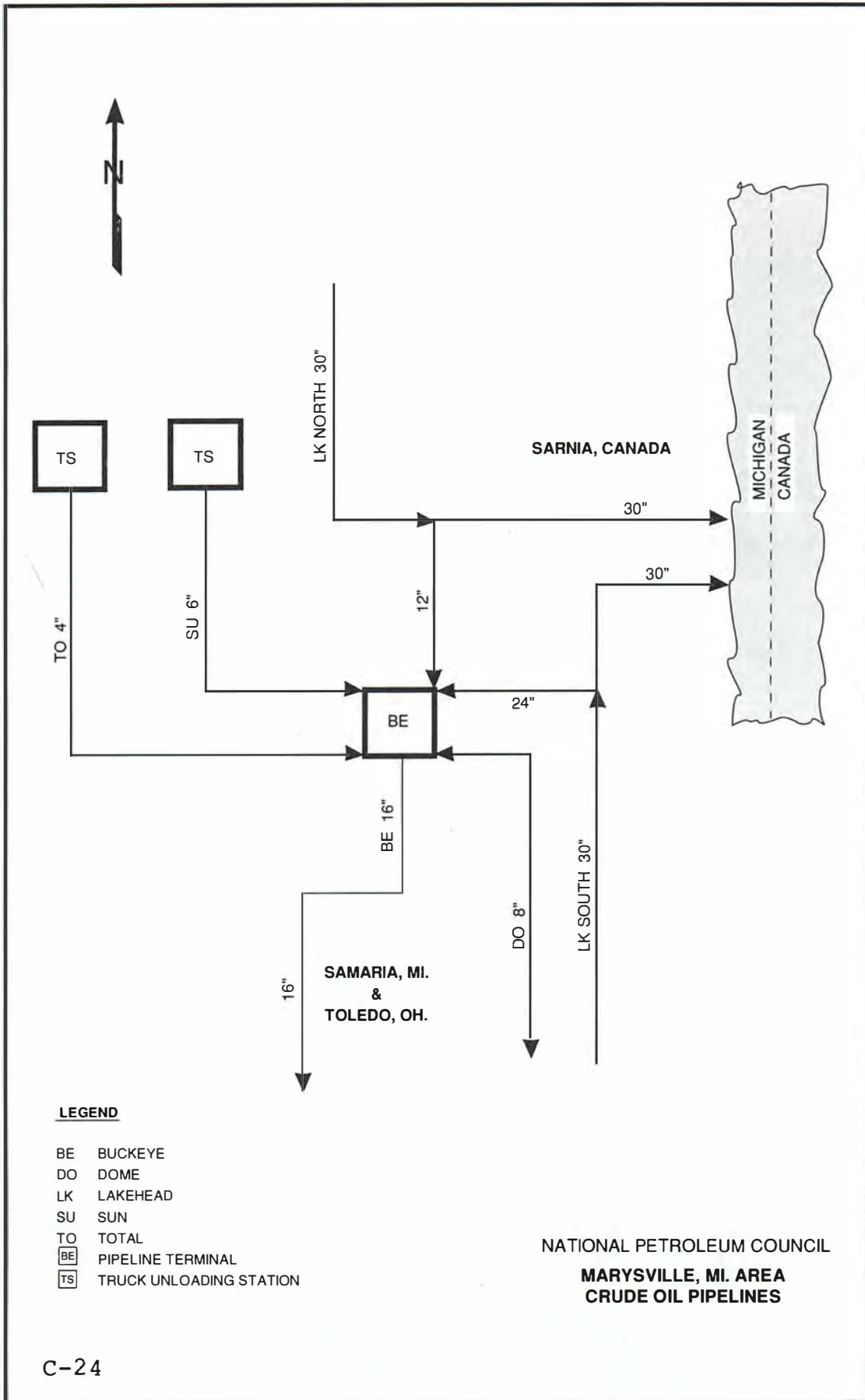

LEGEND

- BE BUCKEYE
- DO DOME
- LK LAKEHEAD
- SU SUN
- TO TOTAL
- BE PIPELINE TERMINAL
- TS TRUCK UNLOADING STATION

NATIONAL PETROLEUM COUNCIL
**MARYSVILLE, MI. AREA
 CRUDE OIL PIPELINES**

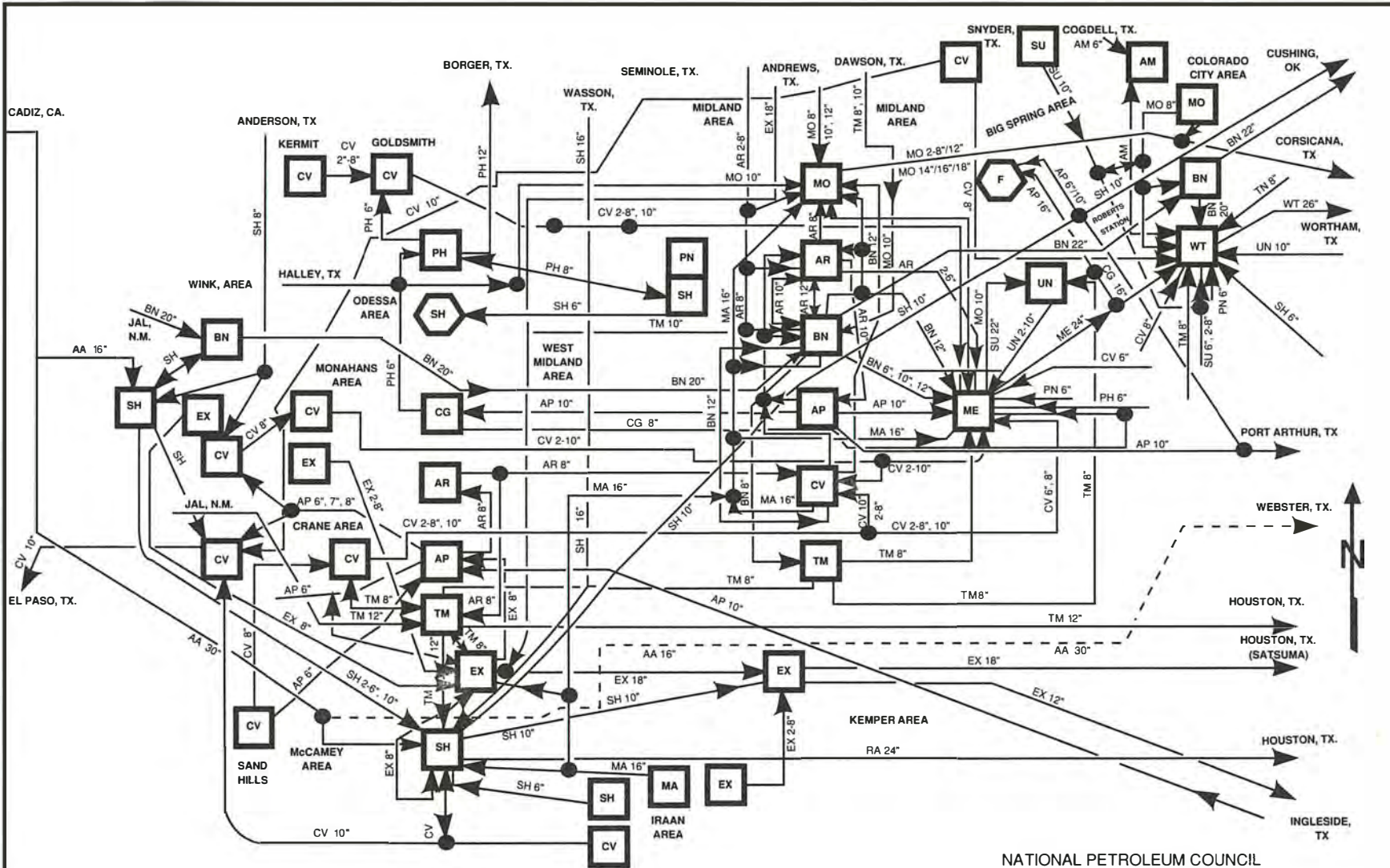

LEGEND

- AA ALL-AMERICAN
- AP AMERICAN PETROFINA
- AM AMOCO
- AR ARCO
- BN BASIN
- CG CITGO

- CV CHEVRON
- EX EXXON
- FINA FINA
- MA MARATHON
- ME MESA
- MO MOBIL
- PH PHILLIPS

- PN PERMIAN RANCHO
- RA RANCHO SHELL
- SH SHELL
- SU SUN
- TM TEXAS-NEW MEXICO
- UN UNOCAL
- WT WEST TEXAS GULF

- REFINERY
- PIPELINE STATION
- PIPELINE CONNECTION
- UNDER CONSTRUCTION

**ODESSA, CRANE, MIDLAND & COLORADO CITY, TEXAS AREA
CRUDE OIL PIPELINES**

NATIONAL PETROLEUM COUNCIL

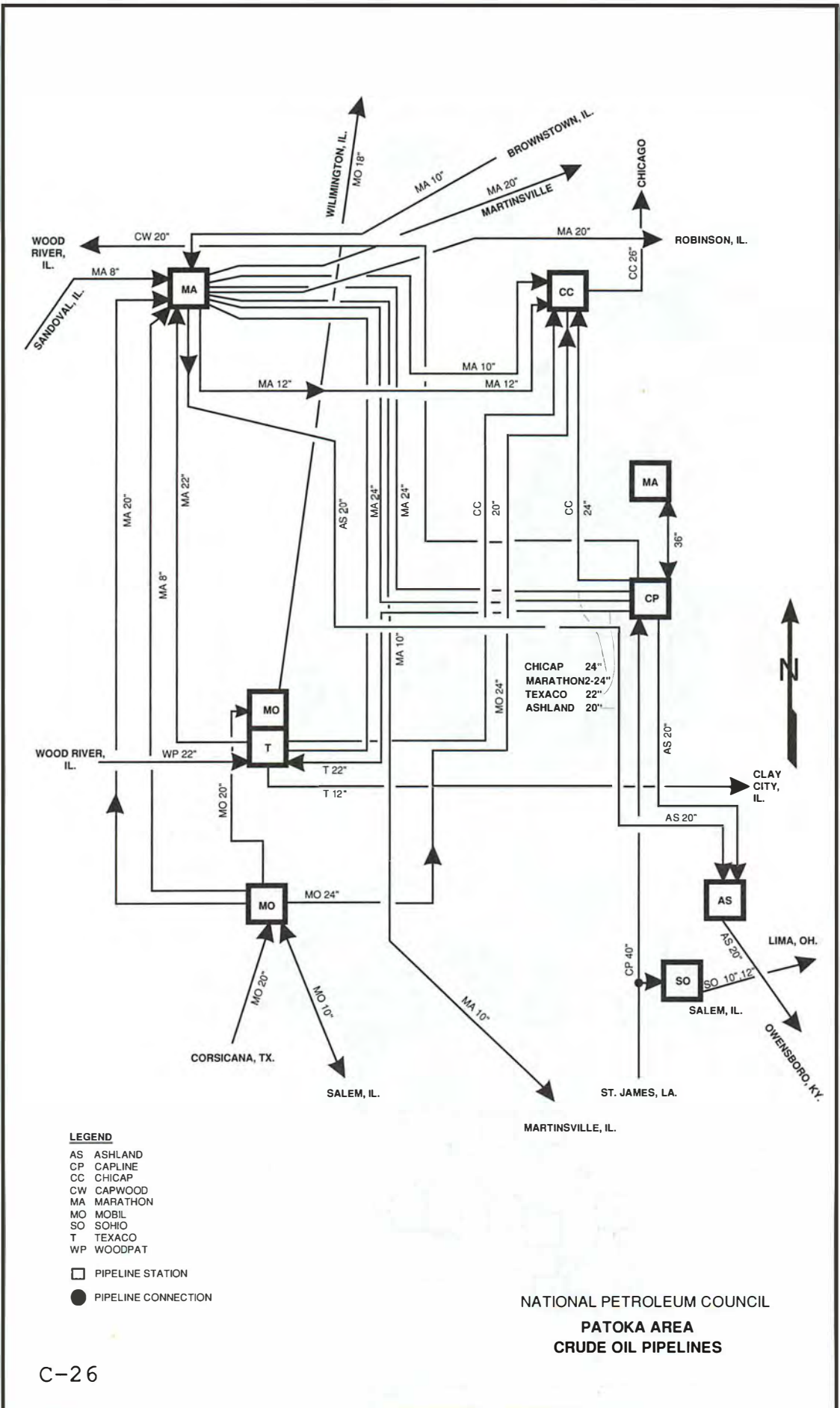

LEGEND

- AS ASHLAND
- CP CAPLINE
- CC CHICAP
- CW CAPWOOD
- MA MARATHON
- MO MOBIL
- SO SOHIO
- T TEXACO
- WP WOODPAT

- PIPELINE STATION
- PIPELINE CONNECTION

NATIONAL PETROLEUM COUNCIL
**PATOKA AREA
 CRUDE OIL PIPELINES**

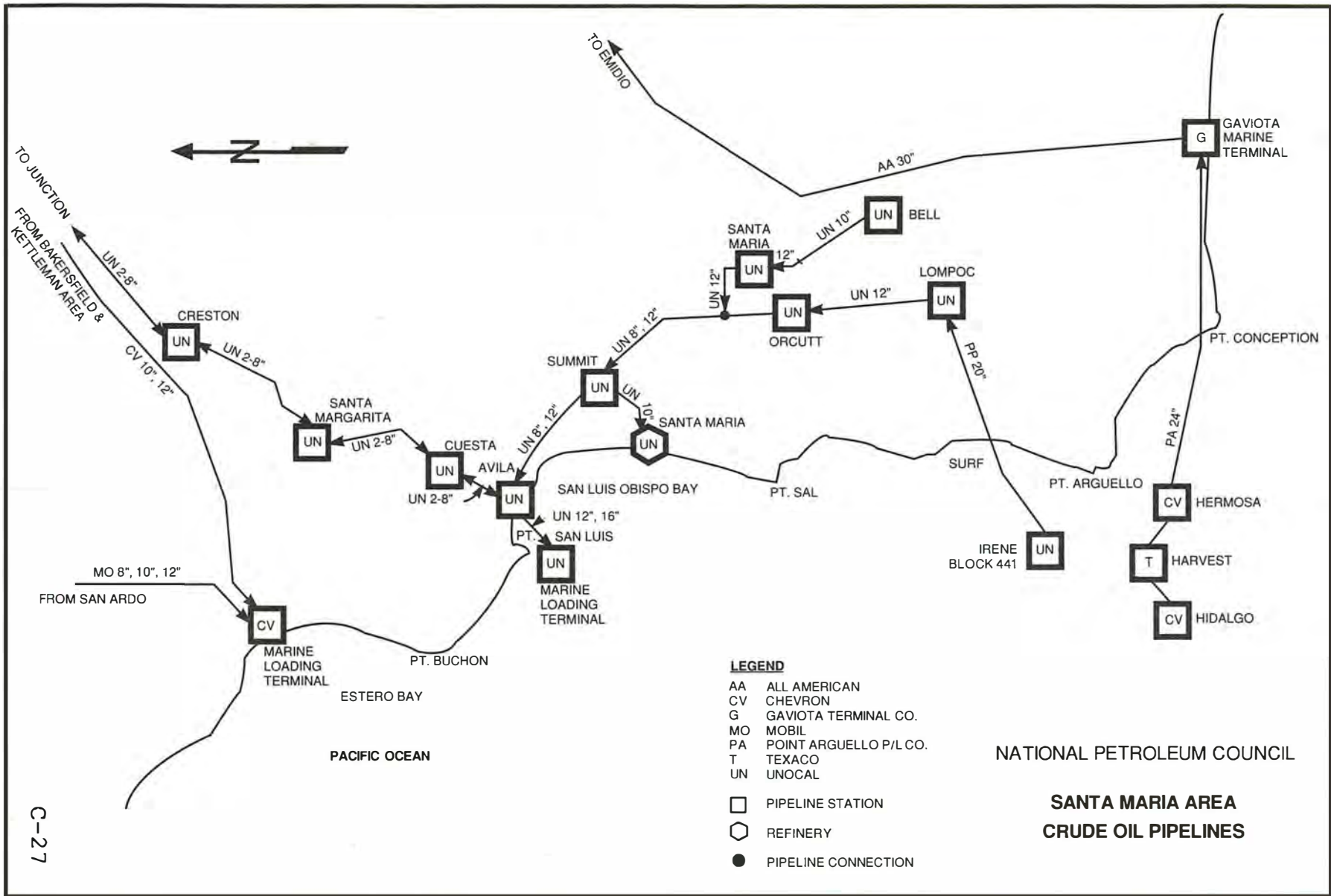

NATIONAL PETROLEUM COUNCIL

**SANTA MARIA AREA
CRUDE OIL PIPELINES**

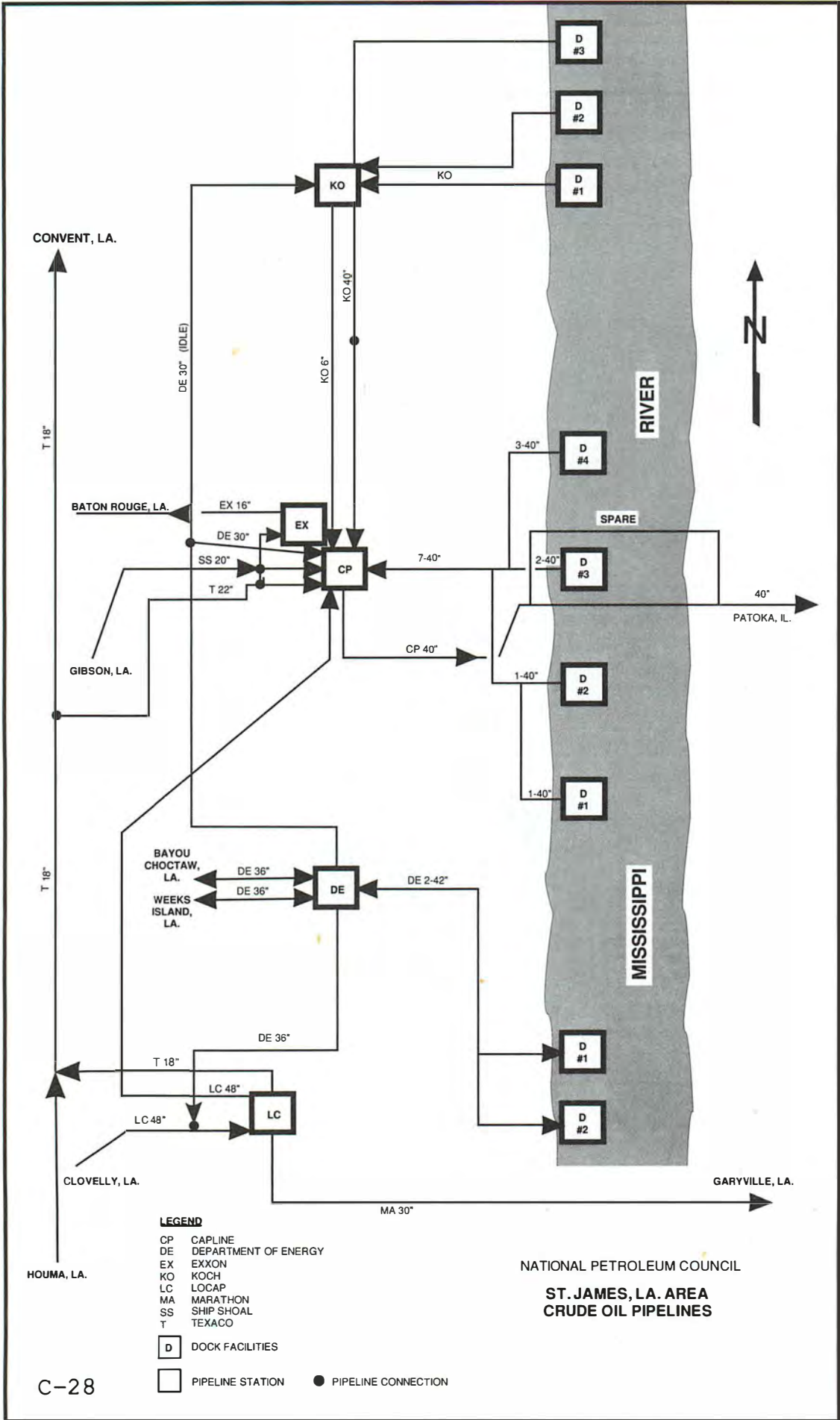

CONVENT, LA.

BATON ROUGE, LA.

GIBSON, LA.

BAYOU CHOCTAW, LA.
WEEKS ISLAND, LA.

HOUMA, LA.

CLOVELLY, LA.

GARYVILLE, LA.



- LEGEND**
- CP CAPLINE
 - DE DEPARTMENT OF ENERGY
 - EX EXXON
 - KO KOCH
 - LC LOCAP
 - MA MARATHON
 - SS SHIP SHOAL
 - T TEXACO
 - D DOCK FACILITIES
 - PIPELINE STATION
 - PIPELINE CONNECTION

NATIONAL PETROLEUM COUNCIL
**ST. JAMES, LA. AREA
CRUDE OIL PIPELINES**

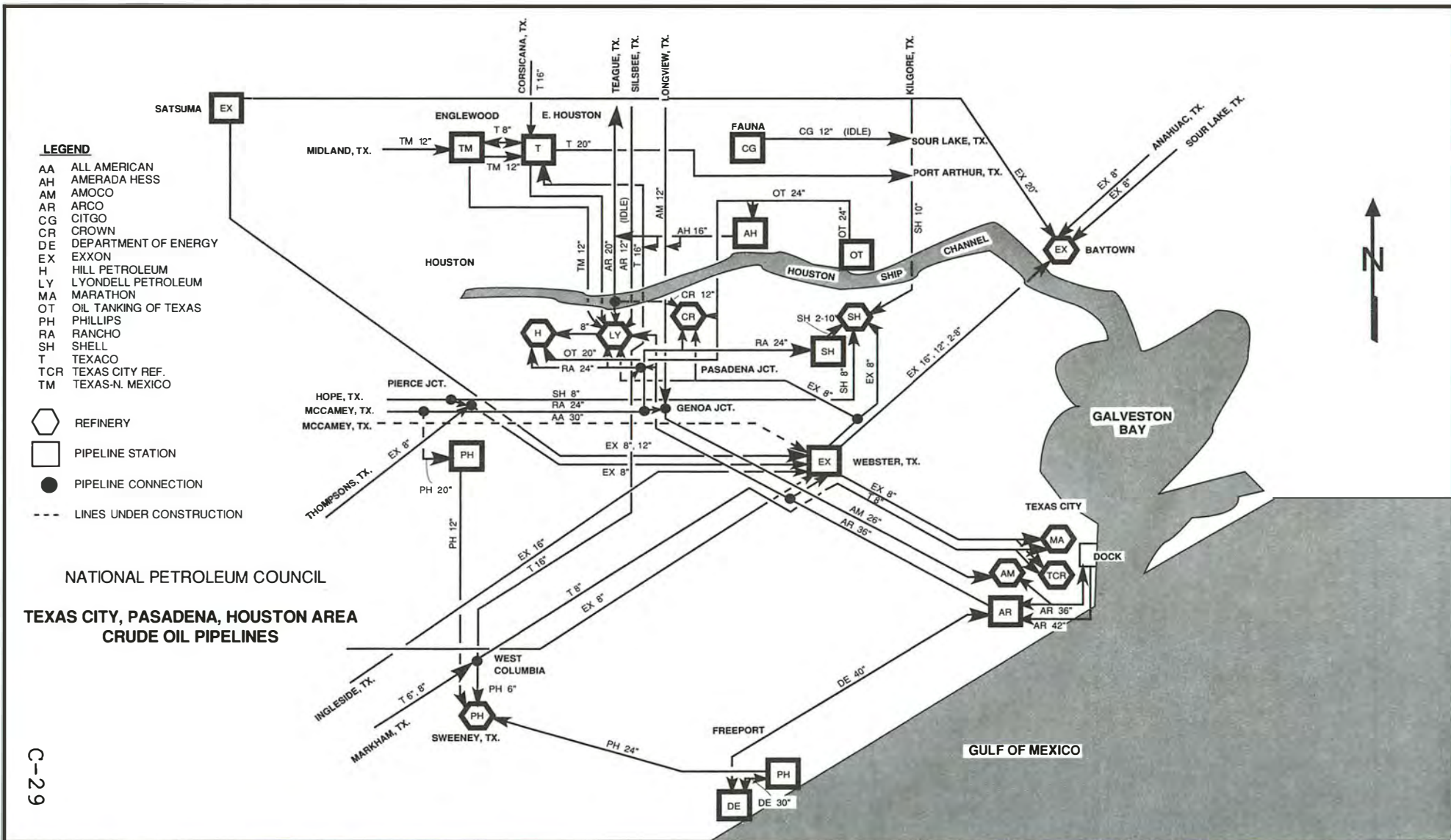

C-30

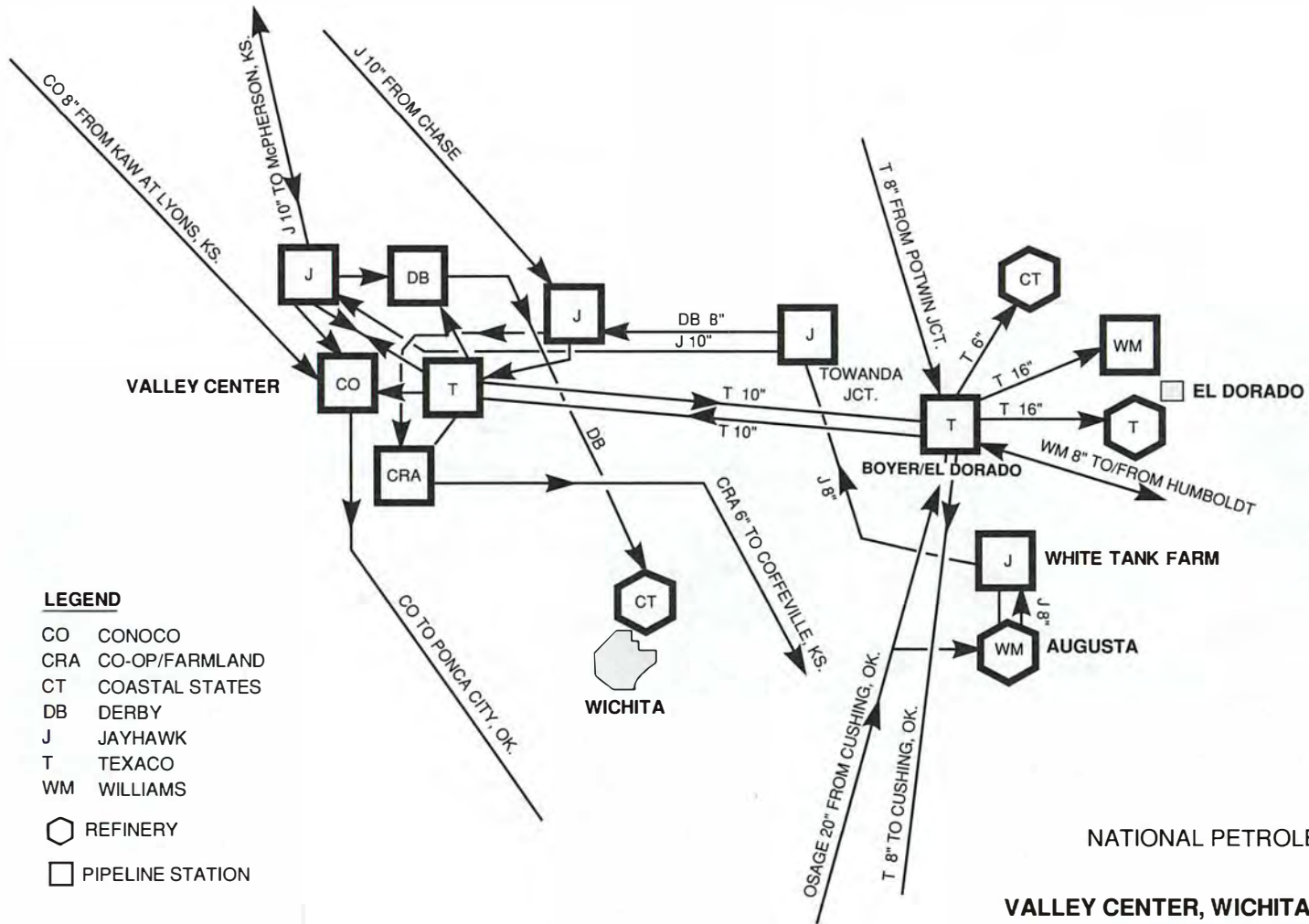

- LEGEND**
- CO CONOCO
 - CRA CO-OP/FARMLAND
 - CT COASTAL STATES
 - DB DERBY
 - J JAYHAWK
 - T TEXACO
 - WM WILLIAMS
 - ◻ PIPELINE STATION
 - ◻ REFINERY

NATIONAL PETROLEUM COUNCIL

**VALLEY CENTER, WICHITA, EL DORADO AREA
CRUDE OIL PIPELINES**



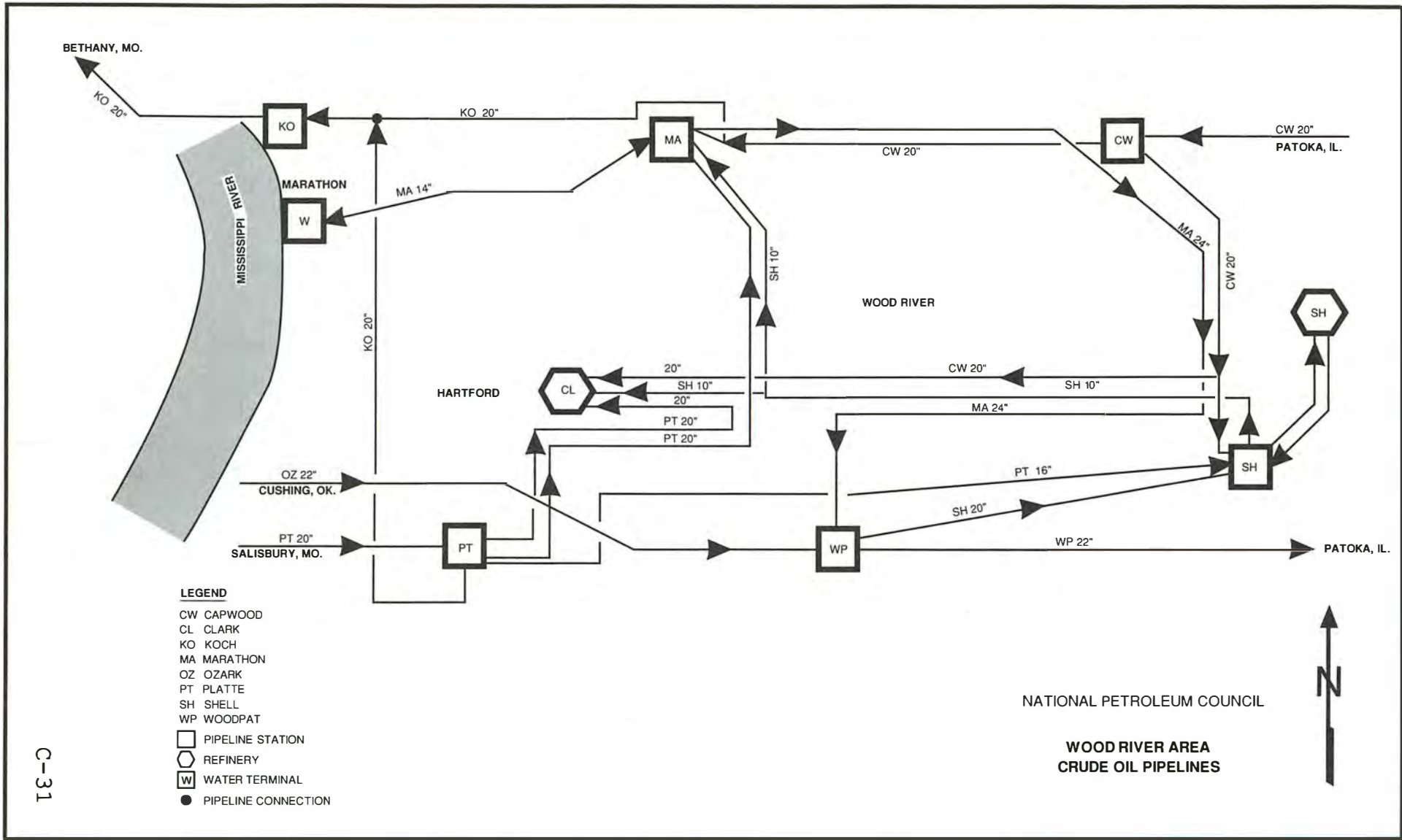

BETHANY, MO.

KO 20"



KO

W

MARATHON

KO 20"

MA 14"

KO 20"

OZ 22"
CUSHING, OK.

PT 20"
SALISBURY, MO.

HARTFORD

CL

MA

SH 10"

WOOD RIVER

CW 20"

CW

CW 20"
PATOKA, IL.

MA 24"

CW 20"

SH

20"

SH 10"

20"

PT 20"

PT 20"

CW 20"

SH 10"

MA 24"

PT 16"

SH 20"

WP

WP 22"

PATOKA, IL.

LEGEND

- CW CAPWOOD
- CL CLARK
- KO KOCH
- MA MARATHON
- OZ OZARK
- PT PLATTE
- SH SHELL
- WP WOODPAT
- PIPELINE STATION
- REFINERY
- ◻ WATER TERMINAL
- PIPELINE CONNECTION

NATIONAL PETROLEUM COUNCIL

**WOOD RIVER AREA
CRUDE OIL PIPELINES**



C-31

TABLE C-1

CROSS-PADD CRUDE OIL PIPELINE CAPACITIES AS OF DECEMBER 31, 1987
(Thousands of Barrels per Day)

<u>PAD District</u>		<u>Origin and Type*</u>	<u>Destination and Type*</u>	<u>Company</u>	<u>Average Capacity</u>	
<u>From</u>	<u>To</u>				<u>Summer</u>	<u>Winter</u>
I	Can.	Portland, ME - (W)	Montreal, Can. - (R)	Portland	186	186
II	Can.	Marysville, MI - (PL)	Sarnia, Can. - (PL)	Lakehead	562	540
					748	726
Can.	I	Westover, Can. - (PL)	Buffalo, NY - (PL,R)	Lakehead	106	101
Can.	II	Edmonton, Can. - (PL)	Clearbrook, MN - (PL)	Lakehead	1,346	1,314
Can.	IV	Oldman, Can. - (PL)	Aurora, MT - (PL)	Conoco	79	79
		Regina, Can. - (PL)	Poplar, MT - (PL)	Texaco	36	36
		Sweetgrass, MT - (PL)	Cutbank, MT - (R,PL)	Cenex	20	20
Can.	V	Sumas, Can. - (PL)	Ferndale, WA - (PL)	Transmountain	160	160
					1,747	1,710
I	III	Jay, FL - (GA)	Mobile, AL - (R,W)	Exxon	84	80
II	III	Sturgis, OK - (PL)	Sheerin, TX - (R)	Shamrock	17	15
		Cushing, OK - (PL)	Borger, TX - (R)	Phillips	53	50
		Beaver, OK - (PL)	Borger, TX - (R)	Phillips	24	23
		Ardmore, OK, Area - (GA)	Corsicana, Teague, and Wortham, TX - (PL)	Mobil	47	46
					141	134

TABLE C-1 (Continued)

<u>PAD District</u>		<u>Origin and Type*</u>	<u>Destination and Type*</u>	<u>Company</u>	<u>Average Capacity</u>	
<u>From</u>	<u>To</u>				<u>Summer</u>	<u>Winter</u>
III	II	North Texas Area - (PL)	Cushing, OK - (PL)	Amoco	55	55
		Monroe, TX - (PL)	Cushing, OK - (PL)	Amoco	177	177
		Wichita Falls and Jacksboro, TX - (PL)	Cushing, OK - (PL)	ARCO	52	49
		Colorado City, TX - (PL)	Cushing, OK - (PL)	Basin ^S	382	382
		" "	" "	Shell	<u>24</u>	<u>24</u>
					690	687
		Wichita Falls and Jacksboro, TX - (PL)	Oklahoma City, OK - (PL)	Conoco	47	47
		Corsicana, Teague, and Wortham, TX - (PL)	Patoka, IL - (PL)	Mobil	150	148
		St. James, LA - (PL,W)	Patoka, IL - (PL)	Capline ^S	<u>1,078</u>	<u>1,029</u>
					1,228	1,177
II	IV	Colliersville, MS - (PL)	Memphis, TN (R)	Mapco	55	55
		Longview, TX - (PL)	Cleves and Lima, OH - (PL)	Mid-Valley	238	230
					<u>2,258</u>	<u>2,196</u>
		Cartwright, ND - (PL)	Sidney, MT (PL)	Texaco	6	6
		Fryburg, ND - (PL)	Baker, MT (PL)	Texaco	29	29
		McKenzie Co., ND - (GA)	Baker, MT (PL)	Belle Fourche	<u>10</u>	<u>10</u>
			45	45		

TABLE C-1 (Continued)

<u>PAD District</u>		<u>Origin and Type*</u>	<u>Destination and Type*</u>	<u>Company</u>	<u>Average Capacity</u>	
<u>From</u>	<u>To</u>				<u>Summer</u>	<u>Winter</u>
IV	II	Sterling, CO (PL)	Laton, KS - (PL)	Amoco	165	165
		Fort Laramie-Guernsey, WY - (PL)	Salisbury, MO - (PL)	Platte	185	185
		Carlton, CO - (GA)	Sturgis, OK - (PL)	Shamrock	17	15
		Sterling, CO - (PL)	Gurley, NE - (PL)	Unocal	20	20
					<u>387</u>	<u>385</u>
IV	III	Aneth and Red Mesa, UT - (GA, PL)	Bisti, NM - (PL)	Texas-New Mexico	42	38
		" "	" "	Four Corners	70	65
					<u>112</u>	<u>103</u>
V	IV	Long Beach and Los Angeles, CA - (W)	Aneth and Red Mesa, UT - (PL)	Four Corners	60	57
V	III	Maricopa, CA - (PL)	Wink, TX - (PL)	All American	300	300

* Legend: (GA) - Gathering Area; (PL) - Pipeline Terminal; (R) - Refinery; (W) - Water Terminal.

§ Undivided interest pipeline systems.

TABLE C-2
INTRA-PADD CRUDE PIPELINE CAPACITIES
AS OF DECEMBER 31, 1987

	<u>DIAMETER*</u>	<u>SUMMER</u> <u>(MB/D)</u>	<u>WINTER</u> <u>(MB/D)</u>
PADD IZ			
Sunniland - Sunniland, FL to Fort Lauderdale, FL	4"/6"/8"	12	12
PADD II			
Amoco - Tioga, ND to Mandan, ND	10"/12"/16"	65	65
Drumright, OK to Freeman, MO	12"	90	90
Freeman, MO to Whiting, IN	12"/20"/22"/18"	200	190
Laton, KS to Freeman, MO	24"	172	172
Healdton, OK to Cushing, OK	12"	55	55
Arco - Ringling, OK to Panova, OK	16"	90	88
Panova, OK to Cushing, OK	18"	180	160
Cushing, OK to Caney, KS	24"	291	291
Caney, KS to Humboldt, KS	24"	265	265
Humboldt, KS to Salisbury, MO	24"	291	291
Salisbury, MO to Chicago, IL	22"	285	285
Ashland - Patoka, IL to Owensboro, KY	20"	219	206
Lima, OH to Canton, OH	12"	79	74
Cygnets, OH to Findlay, OH	8"	20	19
Buckeye - Findlay, OH to Lima, OH	10"	40	40
Marysville, MI to Samaria Jct., MI	16"	100	100
Samaria Jct., MI to Toledo, OH	16"	100	100
Chicap - Patoka, IL to Chicago, IL	26"	400	380
Conoco - Letsch, KS to Valley Center, KS	6"/8"	14	14
Valley Center, KS to Ponca City, OK	8"	29	29
Franks Creek, ND to Fryburg, ND	6"	23	23
Cushing, OK to Ponca City, OK	12"	102	102
Oklahoma City, OK to Ponca City, OK	12"	68	68
Oklahoma City, OK to Cushing, OK	8"	32	32
Tussy, OK to Oklahoma City, OK	12"	49	49
Enron - Humboldt, KS to El Dorado, KS	8"	9	3
Jayhawk - Meade, KS to Chase, KS	12"	30	28
Laton, KS to Chase, KS	10"	37	35
Chase, KS to McPherson, KS	12"	86	82
Chase, KS to Valley Center, KS	10"	37	35
Valley Center, KS to McPherson, KS	10"	32	30
Augusta, KS to Valley Center, KS	8"	32	30

TABLE C-2 (Continued)

	<u>DIAMETER</u> [*]	<u>SUMMER</u> <u>(MB/D)</u>	<u>WINTER</u> <u>(MB/D)</u>
Kaw - Bemis, KS to Sullivan, KS	8"	9	9
Bemis, KS to Sullivan, KS	12"	14	14
Sullivan, KS to Big Creek, KS	8"	5	5
Sullivan, KS to Big Creek, KS	12"	39	39
Big Creek, KS to Allen, KS	8"	15	15
Big Creek, KS to Allen, KS	8"	15	15
Big Creek, KS to Allen, KS	12"	23	23
Allen, KS to Bortz, KS	8"	24	24
Allen, KS to Bortz, KS	8"/10"	30	30
Bortz, KS to Claflin, KS	8"	14	14
Bortz, KS to Claflin, KS	10"	18	18
Bortz, KS to Claflin, KS	12"	22	22
Claflin, KS to Chase, KS	12"	54	54
Lakehead - ND/Can. Border to Superior, WI	18"	228	225
ND/Can. Border to Superior, WI	26"	412	402
ND/Can. Border to Superior, WI	34"	706	687
Superior, WI to Chicago, IL	34"	623	625
Chicago, IL to Marysville, MI	30"	623	625
Superior, WI to Lewiston, MI	30"	562	540
Lewiston, MI to Marysville, MI	30"	562	540
Marathon - Stoy, IL to Robinson, IL	10"	57	57
Patoka, IL to Robinson, IL	20"	171	171
Bridgeport, IL to Robinson, IL	10"	50	50
Bridgeport, IL to Robinson, IL	8"	32	32
Bridgeport, IL to Robinson, IL	8"	32	32
Patoka, IL to Martinsville, IL	20"	271	271
Patoka, IL to Martinsville, IL	10"	47	47
Martinsville, IL to Lebanon, IN	22"	318	318
Lebanon, IN to Indianapolis, IN	12"	50	50
Lebanon, IN to Lima, OH	22"	275	275
Samaria Jct., MI to Detroit, MI	16"	110	110
Mosherville, MI to Samaria Jct., MI	8"	15	15
Loudon, IL to Patoka, IL	6"/10"	17	17
Wood River, IL to Patoka, IL (Woodpat)	22"	311	311
Mid-Continent - Weber, OK to Enid, OK	6"	11	11
Wide Awake, OK to Enid, OK	6"	10	10
Stillwater, OK to Cushing, OK	8"	30	30
Enid, OK to Stillwater, OK	8"	24	24
Hennesey, OK to Enid, OK	6"	10	10
Oklahoma City, OK to Hearn, OK	8"	14	14
Enid, OK to Cushing, OK	8"	8	8

TABLE C-2 (Continued)

	<u>DIAMETER*</u>	<u>SUMMER</u> <u>(MB/D)</u>	<u>WINTER</u> <u>(MB/D)</u>
Mid-Valley - Hornsby, TN to Lima, OH	22"	238	230
Lima, OH to Samaria Jct., MI (Mid-Valley-Marathon)	22"	340	330
Mobil - Healdton, OK to Addington, OK	8"	27	26
Hough, OK to Hardesty, OK	8"	19	17
Patoka, IL to Chicago, IL	18"	150	148
Doniphan, MO to Patoka, IL	20"	150	148
Osage - Cushing, OK to El Dorado, KS	20"	280	280
Owensboro - Ashland - Owensboro, KY to Catlettsburg, KY	24"	230	218
Platte - Gurley, NE to Salisbury, MO	20"	173	173
Salisbury, MO to Wood River, IL	20"	150	150
Portal - Maxbrass, ND to Minot, ND	10"	12	12
Grenora, ND to Beaver Lodge, ND	10"	24	24
Trenton, ND to Beaver Lodge, ND	8"	24	24
Beaver Lodge, ND to Minot, ND	12"	80	80
Minot, ND to Clearbrook, MN	16"	100	100
Shell - Salem, IL to Patoka, IL (Capline)	40"	1078	1029
Patoka, IL to Wood River, IL (Capwood)	20"	224	224
Cushing, OK to Wood River, IL (Ozark)	22"	315	315
Sohio - Salem, IL to Stoy, IL	10"	46	44
Stoy, IL to Lima, OH	12"	39	37
Sun - Cromwell, OK to Bad Creek, OK	6"/8"	28	28
Bad Creek, OK to Beggs, OK	10"	30	30
Beggs, OK to Tulsa, OK	10"/8"	29	29
Ada, OK to Nahola, OK	6"	12	12
Nahola, OK to Wynnewood	6"	13	13
Eola, OK to Wynnewood	6"	20	20
Maysville, OK to Eola	6"	10	10
Fitts, OK to Cromwell, OK	4"/6"/8"	12	12
Duncan OK to Velma, OK	6"	4	4
Velma, OK to Seminole, OK	6"	10	10
Seminole, OK to Cromwell, OK	8"	24	24
Cushing, OK to Drumright, OK	6"	15	15
Cushing, OK to Drumright, OK	10"	34	34
Drumright, OK to Tulsa, OK	12"	64	64
Tecumseh - Chicago, IL to Cygnet, OH	20"	100	100

TABLE C-2 (Continued)

	<u>DIAMETER</u> *	<u>SUMMER</u> <u>(MB/D)</u>	<u>WINTER</u> <u>(MB/D)</u>
Texaco - El Dorado, KS to Cimarron Jct., OK	8"	19	19
Oklahoma City, OK to Cimarron Jct. OK	8"	24	24
Cimarron Jct., OK to Cushing, OK	8"	37	37
Cushing, OK to Tulsa, OK	10"	44	44
Valley Center, KS to El Dorado, KS	10"	40	40
Burns, KS to El Dorado, KS	8"	15	15
Salem, IL to Clay City, IL	8"	9	9
Patoka, IL to Clay City, IL	12"	5	5
Clay City, IL to Bridgeport, IL	10"	10	10
Clay City, IL to Mt. Vernon, IN	12"/6"	5	5
Alexander, ND to Keene, ND (Mondak)	8"	23	23
Franks Creek, ND to Fryburg, ND (Mondak)	2-6"	31	31
Cunningham, KS to Arlington Jct., KS	12"	16	16
Arlington, Jct., KS to Burrton, KS	12"	35	35
Burrton, KS to El Dorado, KS	12"	55	55
Lyons, KS to Burrton, KS	8"	15	15
Isabel Jct., KS to Cunningham, KS	8"	10	10
Larned Jct., KS to Arlington Jct., KS	8"	12	12
Total - Garber, OK to See, OK	6"	10	10
Cushing, OK to See, OK	6"	12	12
See, OK to Fishe Jct., OK	6"/8"	17	17
Fishe Jct., OK to Phelps, OK	8"	34	34
Phelps, OK to Arkansas City, OK	8"	38	38
Fishe, OK to Arkansas City, OK	10"	41	40
Fishe, OK to Fishe Jct., OK	8"	34	34
Bivens, OK to Wasson, OK	8"	20	19
Dundee, OK to Wasson, OK	8"	24	24
Wasson, OK to Ardmore, OK	8"	50	50
Ardmore, OK to Wynnewood, OK	12"	36	35
Stockbridge, MI to Crystal, MI	8"	20	20
Crystal, MI to Alma, MI	2-6"	32	32
Farewell, MI to Crystal, MI	8"	25	25
Bay City, MI to Alma, MI	10"	35	35
Williams - El Dorado, KS to Des Moines, IA	10"/12"	NR	NR
Des Moines, IA to Minneapolis, MN	12"	62	56
PADD III			
American Petrofina - Midland, TX to Port Arthur, TX	10"	48	48
Crane, TX to Corpus Christi, TX	10"	45	45
Amoco - Sabine, TX to Texas City, TX	12"/26"	36	36
Sabine, TX to Yantis, TX	8"	14	14

TABLE C-2 (Continued)

	<u>DIAMETER</u> *	<u>SUMMER</u> <u>(MB/D)</u>	<u>WINTER</u> <u>(MB/D)</u>
Mexia, TX to Texas City, TX	10"	24	24
Mexia, TX to Bowie, TX	12"	30	30
Slaughter, TX to Monroe, TX	16"	177	177
Arco - Texas City, TX to Houston, TX	36"	840	840
Houston, TX to Teague, TX	20"	72	70
Teague, TX to Troup, TX	12"	13	12
Teague, TX to Jacksboro, TX	18"	87	85
Hobbs, NM to Midland, TX	8"	23	23
Wood, TX to Midland, TX	8"	41	40
Midland, TX to Crane, TX	8"	25	24
Jacksboro, TX to Wichita Falls, TX	12"	62	60
Chevron - Empire, LA to Pascagoula, LA	20"	141	141
Fourchon, LA to Empire, LA	20"	182	182
Venice, LA to Ostrica, LA	12"	109	109
Venice, LA to Ostrica, LA	6"	18	18
Romere Pasa, LA to Empire, LA	16"	207	207
Grand Bay, LA to Ostrica, LA	10"	45	45
Black Bay, LA to Ostrica, LA	8"	25	25
Baxterville, MS to Lumberton, MS	14"	165	165
Yates, TX to Wink, TX	10"	25	25
Wink, TX to El Paso, TX	20"	110	110
Snyder, TX to Wink, TX	10"	25	25
Snyder, TX to Colorado City, TX	8"	25	25
Snyder, TX to Colorado City, TX	8"	30	30
Crane, TX to Midland, TX	10"	32	32
Crane, TX to Midland, TX	8"	15	15
Monahans, TX to Crane, TX	10"	52	52
Monahans, TX to Crane, TX	10"	44	44
Sandhills, TX to Crange, TX	8"	38	38
Wink, TX to Monahans, TX	8"	39	39
Keystone, TX to Midland, TX	2-8"	62	62
Midland TX to Colorado City, TX (Mesa)	24"	280	280
Citgo - Haynesville, LA to Longview, TX	8"	26	26
Haynesville, LA to Longview, TX	8"	26	26
Longview, TX to Sour Lake, TX	12"	70	70
Houston, TX to Sour Lake, TX	12"	67	67
Sour Lake, TX to Lake Charles, LA	20"	182	182
Coastal - Vanderbilt, TX to Corpus Christi, TX	8"	40	40
Cotulla, TX to Corpus Christi, TX	6"/8"	30	30
Conoco - Grand Isle, LA to Golden Meadow, LA	8"	21	21
Tepetate, LA to Lake Charles, LA	8"	27	27
Deer Creek, TX to Wichita Falls, TX	6"/8"	15	15

TABLE C-2 (Continued)

	<u>DIAMETER</u> *	<u>SUMMER</u> <u>(MB/D)</u>	<u>WINTER</u> <u>(MB/D)</u>
Twin Butte, TX to Wichita Falls, TX	6"	12	12
Mt. Pleasant, TX to Hawkins, TX	6"	18	18
D-S - Hawley, TX to McKee, TX	10"	36	36
Exxon - St. James, LA to Baton Rouge, LA	16"	101	96
Raceland, LA to St. James, LA	16"	95	90
Grand Isle, LA to Manilla Jct., LA	16"	95	90
Empire, LA to Manilla Jct., LA	12"	47	45
Manilla, Jct., LA to Raceland, LA	12"	95	90
Sunset, LA to Baton Rouge, LA	16"	72	69
South Bend, LA to Sunset LA	12"	72	69
Clovelly, LA to Baton Rouge, LA	16"	151	144
Liberty, MS to Baton Rouge, LA	12"	59	56
Soso, MS to Liberty, MS	10"	42	40
Finney, LA to Baton Rouge, LA	22"	147	140
Lonview, TX to Finney, LA	18"	107	102
Hawkins, TX to Longview, TX	16"	63	60
Talco, TX to Longview, TX	8"	8	7
Sour Lake, TX to Baytown, TX	8"	18	17
Ector, TX to Crane, TX	18"	137	130
Crane, TX to Kemper, TX	18"	179	179
Crane, TX to McCamey, TX	8"	65	62
Kemper, TX to Satsuma, TX	18"	130	125
Yates Pecos, TX to Kemper, TX	10"	22	21
Hearne, TX to Satsuma, TX	12"	48	46
Conroe, TX to Satsuma, TX	8"	25	24
Satsuma, TX to Webster, TX	12"	79	75
Satsuma, TX to Baytown, TX	20"	210	200
Webster, TX to Baytown, TX	8"	100	95
Webster, TX to Texas City, TX	8"	46	44
Kemper, TX to Ingleside, TX	12"	35	34
Harbor Island, TX to Ingleside, TX	12"	89	85
Ingleside, TX to Baytown, TX	16"	102	97
Locap - Clovelly, LA to St. James, LA	48"	1200	1200
Loop - Offshore Terminal to Clovelly, LA	48"	1400	1400
Marathon - St. James, LA to Garyville, LA	30"	288	288
Yates, TX to Iraan, TX	16"	45	45
Iraan, TX to Midland, TX	16"	100	100
Mid-Valley - Longview, TX to Mayersville, MS	20"	238	230
Haynesville, LA to Magnolia, AR	8"	26	24
Delhi, LA to Mayersville, MS	12"	37	35

TABLE C-2 (Continued)

	<u>DIAMETER*</u>	<u>SUMMER</u> <u>(MB/D)</u>	<u>WINTER</u> <u>(MB/D)</u>
Mobil - Vanderbilt, TX to Sealy, TX	8"/10"	33	32
Luling, TX to Sealy, TX	8"	28	27
Sealy, TX to Hull, TX	(3-8")/8"	28	28
Hull, TX to Beaumont, TX	16"	61	61
Corsicana, TX to Conway, AR	20"	150	148
Burt, TX to Ringgold, TX	8"	24	24
Ringgold, TX to Corsicana, TX	16"	43	42
Crossroads, NM to Seminole, TX	8"	18	176
Mallet, TX to Seminole, TX	8"	42	41
Seminole, TX to Andrews, TX	8"	29	28
Seminole, TX to Andrews, TX	8"	29	28
Seminole, TX to Andrews, TX	8"	29	28
Andrews, TX to Midland, TX	10"	32	31
Andrews, TX to Midland, TX	12"	53	52
Fullerton, TX to Andrews, TX	6",8",4"	31	31
Scurry, TX to Iatan, TX	8"	37	37
Halley, TX to Midland, TX	10"	29	29
Midland, TX to Corsicana, TX	(12",8")/16"	73	73
Midland, TX to Corsicana, TX	16"/20"	142	142
Kilgore, TX to Corsicana, TX	12"	12	12
Corsicana, TX to Beaumont, TX	20"	250	250
Phillips - Odessa, TX to Borger, TX	14"	83	78
Missouri City, TX to Sweeny, TX	12"	64	62
Shamrock - Perryton, TX to McKee, TX	6"	14	14
Dixon, TX to McKee, TX	14"/16"	95	92
Shell - Wasson, TX to Jal, NM	12"	100	100
Wasson, TX to Hendrick, TX	6"	20	20
Wasson, TX to McCamey, TX	16"	100	100
Odessa, TX to Midland, TX	6"	24	24
McCamey, TX to El Dorado, TX (Rancho)	24"	312	312
El Dorado, TX to Houston, TX (Rancho)	24"	388	388
Hope, TX to Houston, TX	8"	17	17
McCamey, TX to Colardo City, TX	10"	24	24
Lovington, NM to Wink, TX	10"	15	15
Wink, TX to Hendrick, TX	6"	38	38
Wheeler, TX to Hendrick, TX	10"	50	50
Hendrick, TX to McCamey, TX	10"	48	48
Hendrick, TX to McCamey, TX	6"	13	13
Hendrick, TX to McCamey, TX	6"	13	13
McCamey, TX to Kemper, TX	10"	38	38
Kilgore, TX to Houston, TX	10"	45	45
Ostrica, LA to Norco, LA	16"/20"	212	212
Gibson, LA to St. James, LA (Ship Shoal)	20"	341	341
St. James, LA to Collierville, MS (Capine)	40"	1078	1029

TABLE C-2 (Continued)

	<u>DIAMETER*</u>	<u>SUMMER</u> <u>(MB/D)</u>	<u>WINTER</u> <u>(MB/D)</u>
Sigmor - Refugio, TX to Three Rivers, TX	12"	45	45
Sohio - Clovelly, LA to Alliance, LA	24"	283	269
Alliance, LA to Mereaux, LA	24"	178	169
Ostrica, LA to Elmers Jct., LA	12"	135	128
Bay Marchand, LA to Elmers, Jct., LA	12"	150	142
Elmers, Jct., LA to Alliance, LA	18"	195	185
Sun - South Bend, TX to Colorado City, TX	6"/8"	12	12
Jameson, TX to Colorado City, TX	8"	16	16
Clairmont, TX to Colorado City, TX	8"	45	44
Sour Lake, TX to Nederland, TX	8"	7	7
Nederland, TX to Sour Lake, TX	10"	48	47
Sour Lake, TX to Grissom, TX	10"	36	35
Ingleside, TX to Corpus Christi, TX	10"	55	53
Tenneco - Empire, LA to Chalmette, LA	14"	56	56
Texaco - Markham, TX to W. Columbia, TX	8",6"	28	28
Withers, TX to W. Columbia, TX	8"	17	17
W. Columbia, TX to Texas City, TX	8"	14	14
W. Columbia, TX to E. Houston, TX	16"	33	33
Caillou, LA to Houma, LA	10"/12"	48	48
Caillou, LA to Houma, LA	16"	125	125
Golden Medow, LA to Houma, LA	12"	36	36
Clovelly, LA to Houma, LA	24"	292	292
Lafitte, LA to Houma, LA	12"	12	12
Paradise, LA to Houma, LA	8"	10	10
Houma, LA to St. James, LA	18"	205	205
St. James, LA to Convent, LA	18"	309	309
Houma, LA to Gibson, LA	22"	183	183
Gibson, LA to Erath, LA	22"	249	249
Erath, LA to Port Arthur, TX	22"	360	360
Houston, TX to Port Arthur, TX	20"	107	107
Sour Lake, TX to Port Arthur, TX	12"	27	27
Jal, NM to Midland, TX (Basin)	20"	288	288
Midland, TX to Colorado City, TX (Basin)	22"	338	338
Colorado City, TX to Wichita Falls, TX (Basin)	22"	370	370
Wichita Falls, TX to E. Houston, TX	12"/16"	66	64
South Bend, TX to Wichita Falls, TX	8"/10"	23	23
White Deer, TX to Amarillo, TX	8"	22	22
Texas-New Mexico - Bisti, NM to Lynch, NM	16"	68	66
Lynch, NM to Jal, NM	16"	98	94
Shafter Lake, NM to Jal, NM	8",6"	31	30

TABLE C-2 (Continued)

	<u>DIAMETER*</u>	<u>SUMMER</u> <u>(MB/D)</u>	<u>WINTER</u> <u>(MB/D)</u>
Vacuum Pool, NM to Jal, NM	8"/14"	38	36
Kimbrough, NM to Jal, NM	14"	50	48
Jal, NM to Crane, TX	12"	78	74
Sundown, TX to Midland, TX	10"/12"	90	90
Midland, TX to Crane, TX	8"	18	18
Crane, TX to McCamey, TX	12"	96	94
Crane, TX to Rozansky, TX	12"	48	47
Rozansky, TX to Houston, TX	12"	69	68
Jo-Mill, TX to Colorado City, TX	10"	58	56
Union Pacific - Welder Ranch, TX to Corpus Christi, TX	8"	16	16
Unocal - Van, TX to Bullard, TX	10"	45	45
Bullard, TX to Nederland, TX	10"	30	30
West Texas Gulf - Colorado City, TX to Wortham, TX	26"	440	440
Wortham, TX to Longview, TX	20"	147	147
Wortham, TX to Beaumont, TX	26"	335	335
PADD IV			
Butte - Baker, MT to Osage, WY	16"	94	94
Osage, WY to Guernsey, WY	16"	110	110
Chevron - Ranglely, WY to Salt Lake City, UT	10"	48	48
Conoco - Lance Creek, WY to Guernsey, WY	8"	19	19
Guernsey, WY to Denver, CO	(8",10")/10"	56	56
Guernsey, WY to Cheyenne, WY	8"	24	24
Aurora, MT to Cutbank, MT	8"	21	21
Aurora, MT to Cutbank, MT	12"	29	29
Aurora, MT to Cutbank, MT	12"	29	29
Cutbank, MT to Billings, MT	8"/10"	27	27
Cutbank, MT to Billings, MT	12"	54	54
Billings, MT to Laurel, MT	8"	35	35
Frannie, MT to Laurel, WY	8"	22	22
Exxon - Silver Tip, MT to Billings, MT	8"	63	60
Marathon - Elk Basin, WY to Byron, WY	6"	11	11
Byron, WY to Silvertip, MT	12"	50	50
Grass Creek, WY to Chatham, WY	(8",6")/8"	26	26
Chatham, WY to Byron, WY	8"	10	6
Montana - Cut Bank, MT to Great Falls, MT	5"	6	5
Phillips - Bridger Lake, UT to Bridger, WY	6"	12	11

TABLE C-2 (Continued)

	<u>DIAMETER*</u>	<u>SUMMER</u> <u>(MB/D)</u>	<u>WINTER</u> <u>(MB/D)</u>
Platte - Byron, WY to Chatham, WY	12"/14"	64	64
Chatham, WY to Lost Cabin, WY	16"	86	86
Lost Cabin, WY to Casper, WY	16"	96	96
Casper, WY to Guernsey, WY	20"	185	185
Texaco - Savageton, WY to Reno, WY	6"	17	17
Sidney, MT to Richey, MT (Modak)	8"/6"	19	19
MT/Can. Border to Richey, MT (Mondak)	12"	36	36
Richey, MT to Baker, MT (Mondak)	10"/12"	29	29
Union Pacific - Brady, WY to Wamsutter, WY	8"/6"	20	20
Unocal - Merino, CO to Sterling, CO	10"	25	25
Lisbon, UT to Aneth, UT	10"	17	17
Grieves, WY to Casper, WY	8"	30	30
PADD V			
All-American - Gaviota, CA to Cadiz, CA	30"	300	300
Alyeska - Prudhoe Bay, AK to Valdez, AK (TAPS)	48"	1480	1420
Celeron Gathering - Beldridge, CA to Pentland, CA	16"	100	100
Chevron - Midway, CA to Belridge, CA	10"	22	22
Rio Bravo, CA to Beldridge, CA	12"	27	27
Belridge, CA to Estero, CA	12"	60	60
Belridge, CA to Kettleman, CA	16"	72	72
Kettleman, CA to Richmond, CA	18"/2-12"	92	92
Cook Inlet - West Forelands, AK to Drift River, AK	20"	85	85
Four Corners - Elk Hills, CA to Los Angeles, CA	10", (16"/14")	160	135
Long Beach, CA to Cadiz, CA	16"	60	57
Kenai - MGS Terminal, AK to Kenai, AK	12"	70	65
Swanson, AK to Kenai, AK	8"	16	14
Kuparuk - Kuparuk, AK to Prudhoe Bay, AK	24"	330	330
Milne Point - Milne Point, AK to Kuparuk, AK	12"	36	36
Mobil - San Ardro, CA to Estero Bay, CA	12"	30	28
Rincon, CA to Ventura, CA	22"	72	72
Belridge, CA to Los Angeles, CA	12"	65	61

TABLE C-2 (Continued)

	<u>DIAMETER</u> *	<u>SUMMER</u> <u>(MB/D)</u>	<u>WINTER</u> <u>(MB/D)</u>
Shell - Ventura, CA to Los Angeles, CA	10"	53	53
Bakersfield, CA to Coalinga, CA	14"/18"	83	83
Texaco - Ventura, CA to Newhall, CA	8"	28	28
Carneras, CA to Coalinga, CA	16"	80	78
Coalinga, CA to San Francisco, CA	20"	238	233
Carneras, CA to Bakersfield, CA	16"/10"	40	39
Olig, CA to Emidio, CA	10"	40	40
Trans-Mountain - WA/Can. Border to Laurel, WA	20"	160	160
Laurel, WA to Ferndale, WA	16"	160	160
Laurel, WA to Anacortes, WA	16"	160	160
Unocal - Kern County, CA to San Francisco, CA	12"/16"	82	82
McKittrick, CA to Kern County, CA	8"	30	30
Lompoc, CA to Santa Maria, CA	8"	25	25
San Luis Obispo, CA to Kern County, CA	8"	28	28
Santa Maria, CA to Avila Beach, CA	12"	40	40
Santa Maria, CA to Avila Beach, CA	8"	38	38
Santa Maria, CA to Avila Beach, CA	8"	24	24
Brea, CA to Wilmington, CA	8"	20	20
Torrey Canyon, CA to Los Angeles, CA	12"	60	60

* The following symbolic conventions are used in this table:

- / indicates a change of diameter.
- , indicates an additional separate pipeline.
- () indicates that the reader should interpret the symbols inside the parenthesis first.
- N - X" indicates N multiple pipelines of X" diameter.

TABLE C-3

STATUS OF PRINCIPAL CRUDE OIL EXPANSION PROJECTS PLANNED OR UNDER CONSTRUCTION IN 1979
AS REPORTED IN 1979 NPC SURVEY

<u>Pipeline Company</u>	<u>Project* Number</u>	<u>Location</u>	<u>Type of Expansion</u>	<u>Miles</u>	<u>Diameter (Inches)</u>	<u>Present Capacity (MB/D)</u>	<u>Approximate Anticipated Capacity (MB/D)</u>	<u>Completed</u>
ARCO	1	Texas City TX Ship Dock	New Lines	37	36	-	500	Yes
Ashland	2	Patoka IL to Owensboro KY	New Stations	-	20	161	219	Yes
	3	Owensboro KY to Catlettsburg KY	New Stations Horsepower	- -	- 24	- 173	- 216	Yes Yes
	4	Lima OH to Canton OH	Horsepower	12	12	76	82	Yes
Capline	5	St. James LA to Patoka IL	Horsepower	-	-	1,032	1,098 ^S	Yes
Citgo	6	Fauna TX to Sour Lake TX	New Line	34	12	-	60	Yes
Exxon	7	Cloverly Dome LA to LaFourche Parish LA	New Line	7	20	-	170	Yes
	8	Racland Station LA to LaFourche Parish LA	New Line	13	20	-	120	Yes
Lakehead	9	Griffith IN to Marysville, MI	Loop Line Horsepower	35 -	30 -	- -	65 Add.	Yes Yes
Loop Inc.	10	Cloverly LA to St. James LA	New Line	52	48	-	1,350	Yes
Marathon	11	St. James LA to Garyville LA	New Line	19	30	-	300	Yes
Mid-Valley/ Marathon	12	Lima OH to Samaria MI	New Stations	-	22	278	338	Yes
Northern Pipeline	13	Wood River IL to Pine Bend MN	New Line	476	24	-	135	Yes
Shamrock	14	Borger TX to Dumas TX	New Line	44	14,16	-	40	Yes
Alyeska	15	Prudhoe Bay AK to Valdez AK	Horsepower	-	-	1,230	1,360	Yes

TABLE C-3 (Continued)

<u>Pipeline Company</u>	<u>Project* Number</u>	<u>Location</u>	<u>Type of Expansion</u>	<u>Miles</u>	<u>Diameter (Inches)</u>	<u>Present Capacity (MB/D)</u>	<u>Approximate Anticipated Capacity (MB/D)</u>	<u>Completed</u>
Williams	16	Des Moines IA to Mason City IA	New Line	-	18	-	-	Yes
SPR Projects [¶]	17	Bryan Mound TX	New Storage and Lines	8	30	-	387	Yes
	18	Bryan Mound TX	Expansion	NA	NA	387	1,054	Yes
	19	West Hackberry LA to Nederland TX	New Storage and Lines	42	42	-	402	Yes
	20	West Hackberry LA to Nederland TX	Expansion	NA	NA	402	1,400	Yes
	21	Bayou Choctaw LA to St. James LA	New Storage and Lines	37	36	-	240	Yes
	22	Bayou Choctaw LA to St. James LA	Expansion	NA	NA	240	480	Yes
	23	Sulphur Mines LA to West Hackberry LA	New Storage and Lines	16	16	-	100	Yes
	24	Weeks Island LA to St. James LA	New Storage and Lines	67	36	-	590	Yes
	25	St. James Terminal LA	Dock and Pump Station	NA	NA	-	720 ^{**}	Yes

* Corresponds to project number on Table 2 of the NPC's 1988 Survey of U.S. Petroleum Pipeline Capacities.

^S Design crude oil capacity. Annual average capacity will be higher.

[¶] Systems are government-owned and capacities are drawn-down capacity.

** Combined pumping capacity to Weeks Island and Bayou Choctaw.

TABLE C-4

OTHER PRINCIPAL CRUDE OIL EXPANSION PROJECTS COMPLETED BETWEEN 1/1/79 and 12/31/87

(0 may indicate that no data were provided)

<u>Pipeline Company</u>	<u>Location</u>	<u>Type of Expansion</u>	<u>Miles</u>	<u>Diameter (Inches)</u>	<u>Present Capacity (MB/D)</u>	<u>Approximate Anticipated Capacity (MB/D)</u>	<u>Completion Date</u>
All American	Gaviota CA to Cadiz CA	New Line	341	30	75	300	12/06/87
	Cadiz CA to McCamey TX	New Line	871	30	75	300	12/06/87
Alyeska	Alaska	New Station	0	0	0	1,960	
	Alaska	Flow Improver	0	0	0	2,100	
Amoco	Union Co. NM to Yoakum Co. TX	New Line	218	20	325	0	12/01/84
	Summit Co. UT to Natrona Co. WY	New Line	290	16	75	0	12/01/83
	Texas City TX to Pasadena TX	Conversion	33	12	100	0	12/01/84
	Offshore to Texas City TX	Conversion	91	14	0	0	01/01/83
	Texas City TX	Horsepower	0	0	0	0	07/01/87
ARCO	Carson Crude CA	Storage Tanks	0	0	0	450	10/01/87
	Shiprock NM and Oatman AZ Tonalea AZ, Danby CA, Corona CA	New Station	0	0	40	55	06/01/82
	North Slope AK	New Line	37	24	340	340	10/01/84
	North Slope AK	New Line	37	18	340	340	10/01/84
	North Slope AK	New Line	37	12	340	340	10/01/84
	Mobile Block 861 to Mobile Block 902 AL	New Line	11	12	114	0	08/85
	Southwest Pass W-2 to Dixon Bay Junction LA	Loop Line	3	10	125	0	09/82
Chevron	Dixon Bay Junction to West Bay Station LA	Loop Line	4	10	129	0	10/84
	South Tinbalier 52A to 35D LA	New Line	6	10	118	0	12/84

TABLE C-4 (Continued)

<u>Pipeline Company</u>	<u>Location</u>	<u>Type of Expansion</u>	<u>Miles</u>	<u>Diameter (Inches)</u>	<u>Present Capacity (MB/D)</u>	<u>Approximate Anticipated Capacity (MB/D)</u>	<u>Completion Date</u>
Chevron	Eugene Island Block 51 to Block 42 LA	New Line	7	4	9	0	09/84
	West Delta 109 to West Delta 53 LA	New Line	15	8	43	0	02/81
	East Cameron 23 to 28 SSTI LA	New Line	13	4	7	0	06/81
	Main Pass 299A to 299B LA	New Line	3	6	45	0	/82
	Ship Shoal 69 to South Pelto 13 LA	New Line	13	8	41	0	12/84
	Eugene Island Block 133 to South Marsh 268A LA	New Line	10	4	7	0	12/84
	Eugene Island 361 to Texas Pipeline LA	New Line	13	12	131	0	12/84
	Main Pass 69G to Main Pass 69B LA	New Line	*	4	18	0	04/86
	Southwest Pass E-2 to E-3 LA	Abandonment	4	6	0	0	01/87
	Venice to Ostrica Terminal CA	Idle	16	4	5	0	
	Venice to Ostrica Terminal CA	Idle	16	6	18	0	
	Marathon Yates LPG to Shell Tippet TX	New Line	23	4	0	0	09/84
	Midland LPG Station to M.P. 4.7 TX	Loop Line	5	8	0	0	/85
	Midland to Shell Tippet Junction TX	Loop Line	3	8	0	0	04/85
	Carpenteria to Mobil-Rincon, CA	Acquisition	6	10	24	0	/85
	MP 25.7 to MP 19.3, Bridgeport TX	Loop Line	6	6	0	0	09/85

TABLE C-4 (Continued)

<u>Pipeline Company</u>	<u>Location</u>	<u>Type of Expansion</u>	<u>Miles</u>	<u>Diameter (Inches)</u>	<u>Present Capacity (MB/D)</u>	<u>Approximate Anticipated Capacity (MB/D)</u>	<u>Completion Date</u>
Conoco	P.S. 70 miles n. of Denver CO	P.S. in Service	70	10	40	56	03/01/81
	Glenrock WY to Douglas WY	Reversal	44	6	3	4	06/01/82
	Carway MT to Roundup MT	Viscous Crude	291	12	88	59	04/01/81
	Conrad MT and Utica MT	Deactivated P.S.	276	8	25	20	07/01/82
	Judith Gap MT and Rayesford MT	Reactivated J. G.	344	12	47	54	04/01/85
	Conrad MT and Utica MT	Rebuilt P.S.	276	8	47	54	08/01/86
	Clifton Ridge Marine Terminal LA	New Line	1	20	0	240	07/15/82
	Mermentau LA to Tepetate LA	Sold	15	16	9	0	12/30/82
	Geuda Springs KS	New Station	11	8	20	20	09/01/87
	Valley Center KS to Geuda Springs KS	Reversal	50	8	13	17	07/01/82
	Valley Center KS to Geuda Springs KS	Reversal	50	8	17	14	05/02/85
	Geuda Springs P.S. KS	Remove Drag Reducer Skid	0	0	17	14	07/01/85
	Valley Center P.S. KS	Inject Drag Reducer	0	0	17	20	06/01/85
	Ponca City OK to Geuda Springs KS	Bi-Directional 1 Way	0	0	20	28	06/01/85
	Carson TX to Twin Butte TX	Increased Line Size	9	6	8	13	06/15/87
	Iowa LA to Lake Charles LA	Flow Improver System	14	8	21	27	04/10/83
	Ville Platte LA to Tepetate LA	Horsepower	30	8	22	10	04/10/83
	Tepetate LA to Iowa LA	Trimmed Pump Impeller	31	8	27	19	07/21/86

TABLE C-4 (Continued)

<u>Pipeline Company</u>	<u>Location</u>	<u>Type of Expansion</u>	<u>Miles</u>	<u>Diameter (Inches)</u>	<u>Present Capacity (MB/D)</u>	<u>Approximate Anticipated Capacity (MB/D)</u>	<u>Completion Date</u>
Conoco	Manchester LA	Downsized Pump	12	4	7	4	03/25/85
Cook Inlet	Granite Point AK	Horsepower	0	0	205	0	01/01/80
	West Forelands AK	Horsepower	0	0	205	0	01/01/84
DOE	Bryan Mound TX to Texas City TX	New Line	46	40	1,000	1,000	07/31/87
	Big Hill TX to Nederland TX	New Storage & Lines	26	36	1,000	1,000	09/30/87
Diamond Shamrock	AWP Field Gathering - Exxon TX	Sold P/L	9	4	0	0	
	AWP Field Gathering - Exxon TX	Sold P/L	9	3	0	0	10/01/85
	Refugio TX - Three Rivers TX	Acquisition	66	12	0	0	01/01/83
	Clayton Lateral TX	Acquisition	23	4	0	0	01/01/83
Farmers	Cut Bank MT Area	New Line	32	10	20	24	06/04/85
Jayhawk	Anadarko, Texas County OK	New Line	3	2	0	0	12/01/81
	Kinney Field, Stevens County KS	New Line	4	3	0	0	11/01/84
	Steinle Gathering, Russell County KS	New Line	1	3	0	0	04/01/84
	McPherson Station, McPherson County KS	Station Construction and Erection of Tank (120 MB)	0	0	0	0	10/01/85
	Chase Station, Chase KS	Horsepower, Add 800 HP Motor	0	0	0	0	05/01/84
	Churchman Bible Field, Stevens County KS	New Line	2	6	0	0	06/01/87
	Larabee Field, Stevens County KS	New Line	2	4	0	0	10/01/87
	Red Cliff East, Clark County KS	New Line	2	3	0	0	12/01/87

TABLE C-4 (Continued)

<u>Pipeline Company</u>	<u>Location</u>	<u>Type of Expansion</u>	<u>Miles</u>	<u>Diameter (Inches)</u>	<u>Present Capacity (MB/D)</u>	<u>Approximate Anticipated Capacity (MB/D)</u>	<u>Completion Date</u>
Jayhawk	Central & East KS Pipelines	Acquisition of Mobil Facilities	662	2	0	0	12/01/87
Lakehead	5 Stations-26" Line	Horsepower	0	0	0		
	Minnesota-34" Line	Loop Line	13	48	0	705	11/01/87
	Saxon Station WI	Horsepower	0	0	0	0	12/01/86
	Naubinway MI	New Station	0	0	0	562	10/01/87
	Mokena IL	New Station	0	0	0	623	12/01/87
	Clearbrook MN to Deer River MN	Conversion	0	0	0	0	06/01/81
	N. Cass Lake MN & Floodwood MN	New Station	0	0	0	0	11/01/85
LOOP Inc.	Grand Isle LA to Galliano LA	New Line	43	48	1,400	1,400	01/01/79
Marathon	Albion IL to Gaddy IL	Abandonment	23	10	0	0	04/01/81
	Gaddy IL to Bridgeport IL	Abandonment	8	8	0	0	04/01/81
	Gila IL	Abandonment	0	0	0	0	06/01/82
	Chatham WY to Kirby WY	Abandonment	4	12	0	0	08/01/81
	Cody WY to Amoco Junction WY	Purchase	17	8	3	3	02/01/84
	Whistle Creek WY to Frannie WY	Abandonment	11	6	0	0	08/01/81
	W. Bonanaza WY to Torchlight WY	Abandonment	15	8	0	0	08/01/81
	Neiber Dome South WY	Abandonment	10	4	0	0	10/01/83
	Texas City TX	Horsepower	0	12	62	162	06/11/80
	Salisbury MO	Horsepower	0	20	150	150	05/30/86
	Casper WY	Horsepower	0	16	0	0	10/16/84
	Maverick Station WY	Horsepower	0	6	5	5	11/15/83
	Pilot Butte Station WY	Horsepower	0	8	22	22	09/30/84
	Yates Station West TX	Horsepower	0	8	21	21	05/12/80

C-52

TABLE C-4 (Continued)

<u>Pipeline Company</u>	<u>Location</u>	<u>Type of Expansion</u>	<u>Miles</u>	<u>Diameter (Inches)</u>	<u>Present Capacity (MB/D)</u>	<u>Approximate Anticipated Capacity (MB/D)</u>	<u>Completion Date</u>
Marathon	Garyville LA						
	Products Station	Horsepower	0	16	180	180	07/31/80
Phillips P.L.	Borger TX to Laverne OK	Sold	110	8	0	0	01/01/82
	Cushing OK to Yale OK	Sold	10	18	0	0	01/01/83
	Burbank OK to						
	Kansas City KS	Sold	215	10	0	0	01/01/83
	Burbank OK to						
	Kansas City KS	Sold	215	8	0	0	01/01/83
	Lyons KS to Thrall KS	Sold	105	6	0	0	01/01/83
	Yale OK to Burbank OK	Sold	99	12	0	0	01/01/84
	Cushing OK to Borger TX	New Station	277	10	26	50	09/21/84
	Borger TX to McKee TX	New Line	37	12	36	45	10/31/85
	McKee TX to Borger TX						
	Place Line in Crude Serv.	Conversion	37	6	0	7	12/09/87
Portal	Williams County ND	New Line	65	8	25	25	11/01/83
Portland	Maine, New Hampshire,						
	Vermont, Quebec, Canada	Deactivation	71	12	0	0	01/11/82
	Maine, New Hampshire,						
	Vermont, Quebec, Canada	Deactivation	166	12	0	0	01/11/82
	Maine, New Hampshire						
	Vermont, Quebec, Canada	Abandonment	166	12	0	0	01/03/84
	Maine, New Hampshire,						
	Vermont, Quebec, Canada	Abandonment	71	12	0	0	01/03/84
	Maine, New Hampshire						
	Vermont, Quebec, Canada	Deactivation	165	18	0	0	01/01/86
	Maine, New Hampshire						
	Vermont, Quebec, Canada	Deactivation	70	0	0	0	01/10/86
	Maine, New Hampshire,						
	Vermont, Quebec, Canada	Lease	165	18	0	0	01/11/87
	Maine, New Hampshire,						
	Vermont, Quebec, Canada	Lease	70	18	0	0	01/11/87

TABLE C-4 (Continued)

<u>Pipeline Company</u>	<u>Location</u>	<u>Type of Expansion</u>	<u>Miles</u>	<u>Diameter (Inches)</u>	<u>Present Capacity (MB/D)</u>	<u>Approximate Anticipated Capacity (MB/D)</u>	<u>Completion Date</u>
Shell	Offshore LA	New Line	27	12	24	85	
	Offshore LA	New Line	27	12	51	52	11/20/67
Sohio Pipe and Sohio Oil Co.	Salem II to Stoy IL	Conversion Gathering	74	10	42	42	
	Stoy IL to Lima OH	New Station	238	12	37	37	01/01/81
Sohio	Longview TX to Port Arthur TX	Sale	186	10	46	0	01/01/84
	Port Arthur TX to Smiths Bluff TX	Sale	8	8	34	0	05/01/85
Sun Pipe Line	Stockbridge MI - Purchase Mobil Crude Line & Station	New Line	12	4	5	0	10/01/87
	Total Pipeline	Ponca City OK to Arkansas City KS	New Line	29	10	46	0
Ponca City OK and West Healdton OK		New Line	9	10	43	0	12/01/84
Ardmore OK		New Line	10	8	20	0	06/24/86
Lone Grove OK		New Line	4	10	50	0	10/06/87
Carter & Love Counties OK		Loop Line	4	8	50	0	04/19/84
Carter & Love Counties OK		New Line	15	6	3	0	01/17/83
Carter & Love Counties OK		New Line	1	4	3	0	10/04/73
Arkansas City KS to Geuda Springs KS		New Line	9	8	24	0	05/01/79
Union Pacific	Violet Station TX to Nueces County TX	Horsepower	0	0	6	9	05/01/86
	Williams P.L.	Sheldon MO to Wilmington IL	Crude Line	436	12	0	0

*Less than half a mile.

APPENDIX D
PRODUCT PIPELINE MAPS AND TABLES

MAPS:	Pages
- National – U.S.	D-1
- Regional – PAD Districts	D-3 - D-11
- Area – Transportation and Refining Centers ...	D-13 - D-31
 TABLES:	
- Cross-PADD Capacities	D-32 - D-34
- Intra-PADD Capacities	D-35 - D-48
- Expansion Projects	
Planned or Under Construction in 1979	D-49 - D-50
- Expansion Projects	
Completed Between 1/1/79 and 12/31/87.....	D-51 - D-58

PETROLEUM PRODUCTS PIPELINE CAPACITIES*
 AS OF DECEMBER 31, 1987
 (THOUSANDS OF BARRELS DAILY)



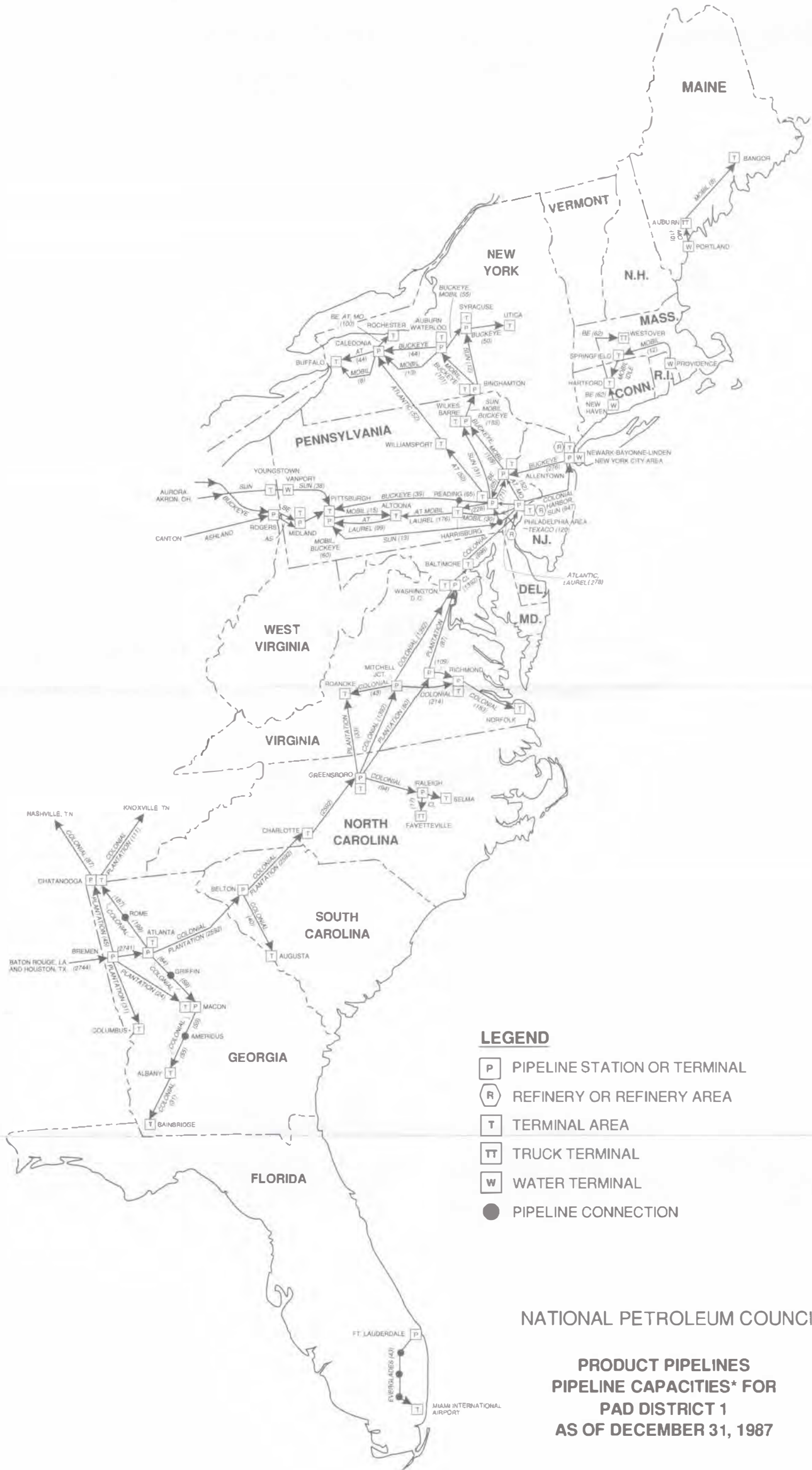

- LEGEND**
- P PIPELINE STATION OR TERMINAL
 - R REFINERY OR REFINERY AREA
 - T TERMINAL AREA
 - TT TRUCK TERMINAL
 - W WATER TERMINAL
 - PIPELINE CONNECTION

NATIONAL PETROLEUM COUNCIL
PRODUCT PIPELINES
PIPELINE CAPACITIES* FOR
PAD DISTRICT 1
AS OF DECEMBER 31, 1987

* FIGURES INDICATE WINTER CAPACITY IN THOUSANDS OF BARRELS PER CALENDAR DAY FOR PUMPING #2 FUEL OIL. IF NOT AVAILABLE, NORMAL MIX USED.

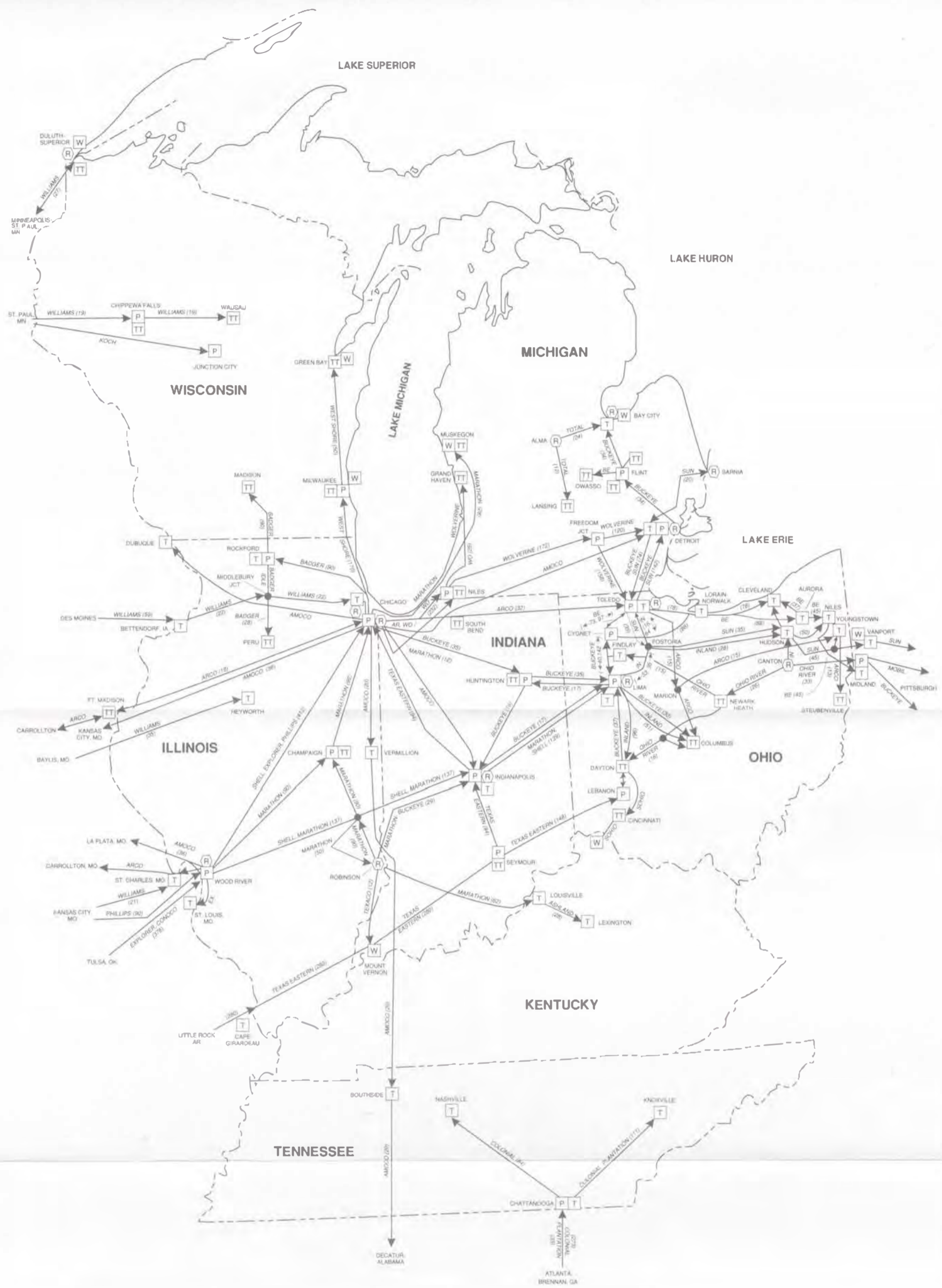

NATIONAL PETROLEUM COUNCIL

**PRODUCT PIPELINES
PIPELINE CAPACITIES* FOR
PAD DISTRICT 2
EAST OF THE MISSISSIPPI RIVER
AS OF DECEMBER 31, 1987**

* FIGURES INDICATE CAPACITY IN THOUSANDS OF BARRELS PER CALENDAR DAY FOR PUMPING #2 FUEL OIL. IF NOT AVAILABLE, NORMAL MIX USED.

LEGEND

- P PIPELINE STATION OR TERMINAL
- R REFINERY OR REFINERY AREA
- T TERMINAL AREA
- TT TRUCK TERMINAL
- W WATER TERMINAL
- PIPELINE CONNECTION

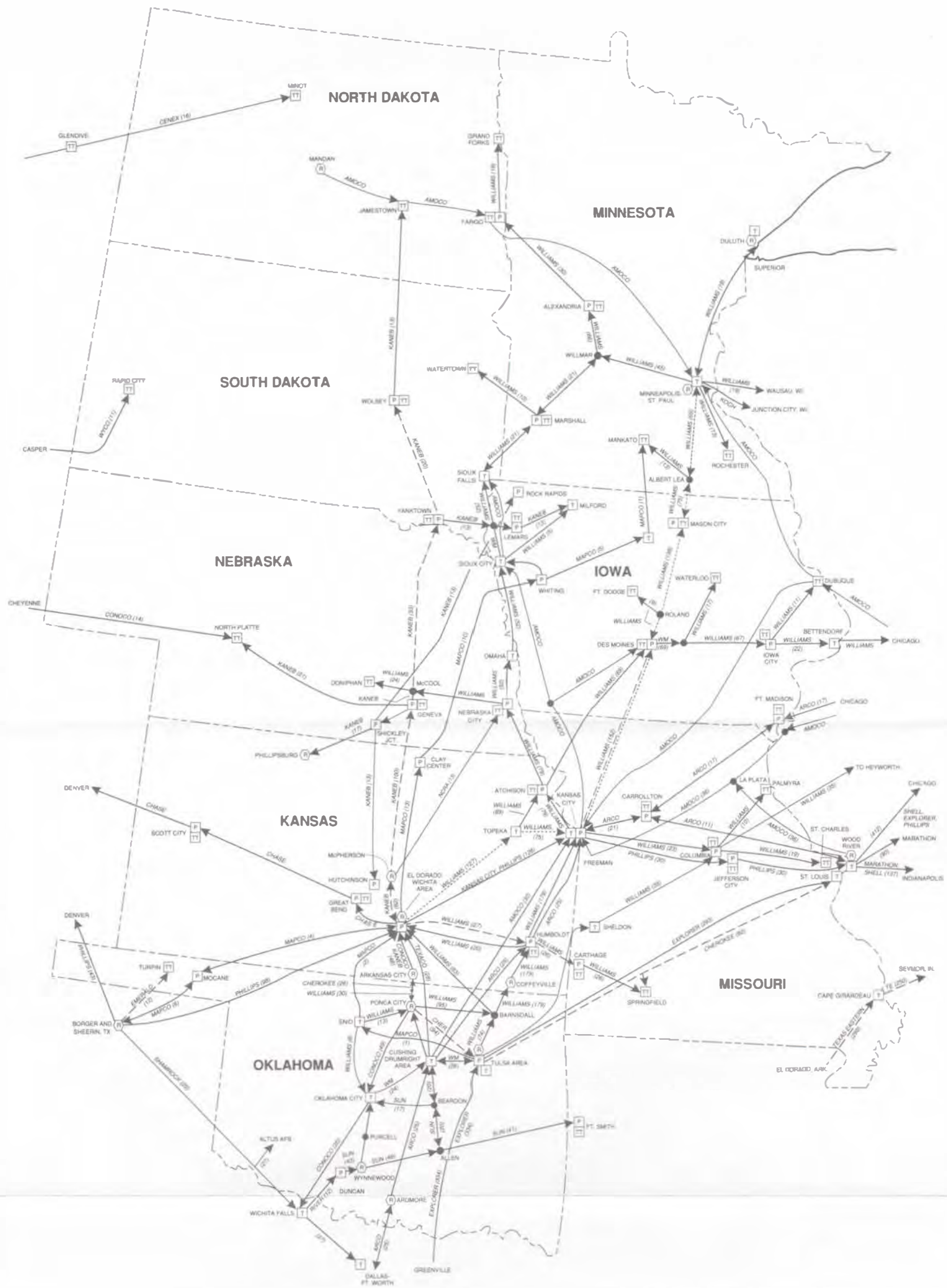

NATIONAL PETROLEUM COUNCIL

**PRODUCT PIPELINES
PIPELINE CAPACITIES* FOR
PAD DISTRICT 2
WEST OF THE MISSISSIPPI RIVER
AS OF DECEMBER 31, 1987**

LEGEND

P PIPELINE STATION OR TERMINAL

R REFINERY OR REFINERY AREA

T TERMINAL AREA

TT TRUCK TERMINAL

● PIPELINE CONNECTION

— PRODUCT LINE HANDLING CRUDE

- - - PRODUCT LINE HANDLING LPG

* FIGURES INDICATE WINTER CAPACITY IN THOUSANDS OF BARRELS PER CALENDAR DAY FOR PUMPING #2 FUEL OIL. IF NOT AVAILABLE, NORMAL MIX USED.

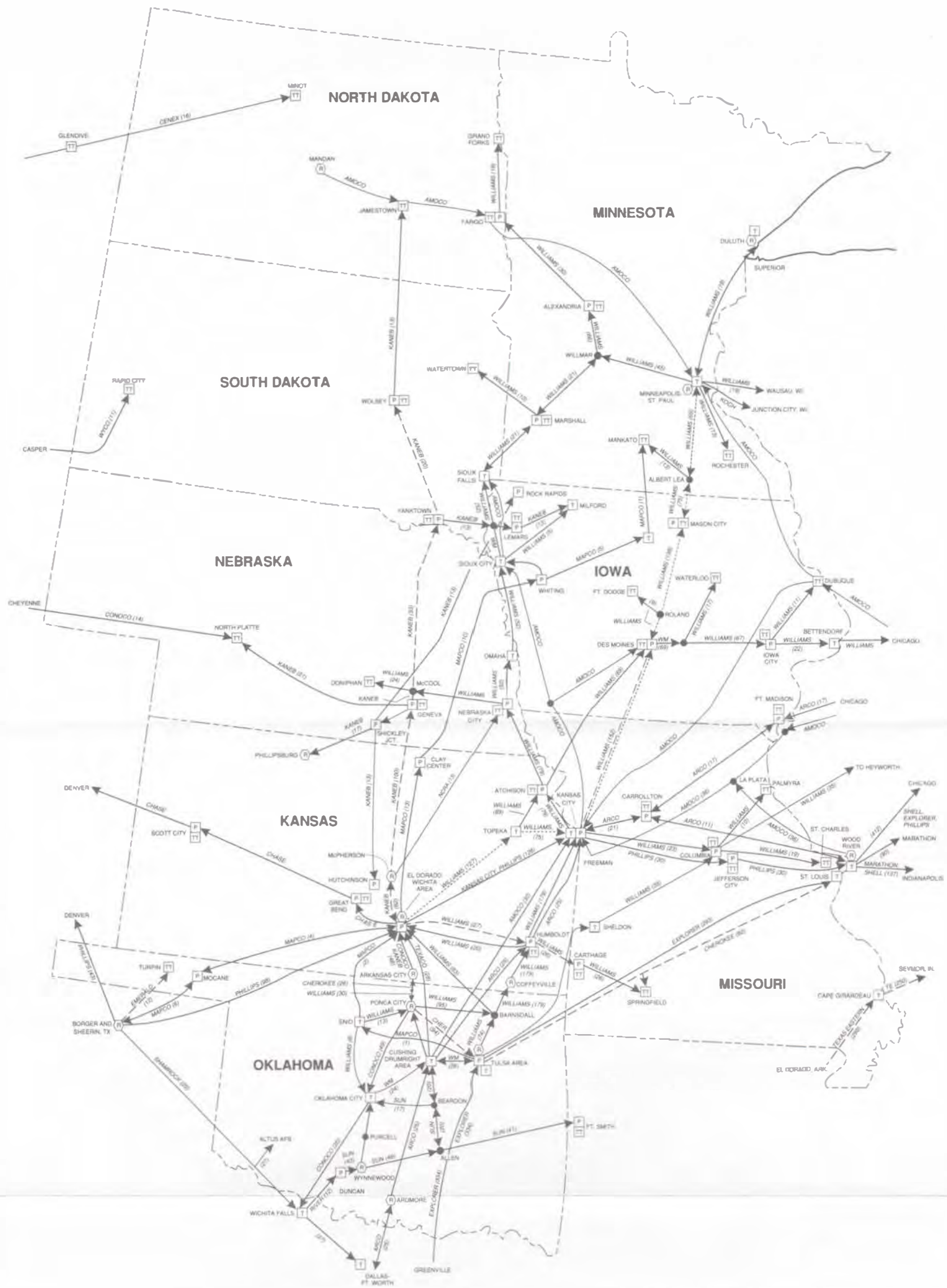

NATIONAL PETROLEUM COUNCIL

**PRODUCT PIPELINES
PIPELINE CAPACITIES* FOR
PAD DISTRICT 2
WEST OF THE MISSISSIPPI RIVER
AS OF DECEMBER 31, 1987**

LEGEND

- P** PIPELINE STATION OR TERMINAL
- R** REFINERY OR REFINERY AREA
- T** TERMINAL AREA
- TT** TRUCK TERMINAL
- PIPELINE CONNECTION
- PRODUCT LINE HANDLING CRUDE
- - - PRODUCT LINE HANDLING LPG

* FIGURES INDICATE WINTER CAPACITY IN THOUSANDS OF BARRELS PER CALENDAR DAY FOR PUMPING #2 FUEL OIL. IF NOT AVAILABLE, NORMAL MIX USED.

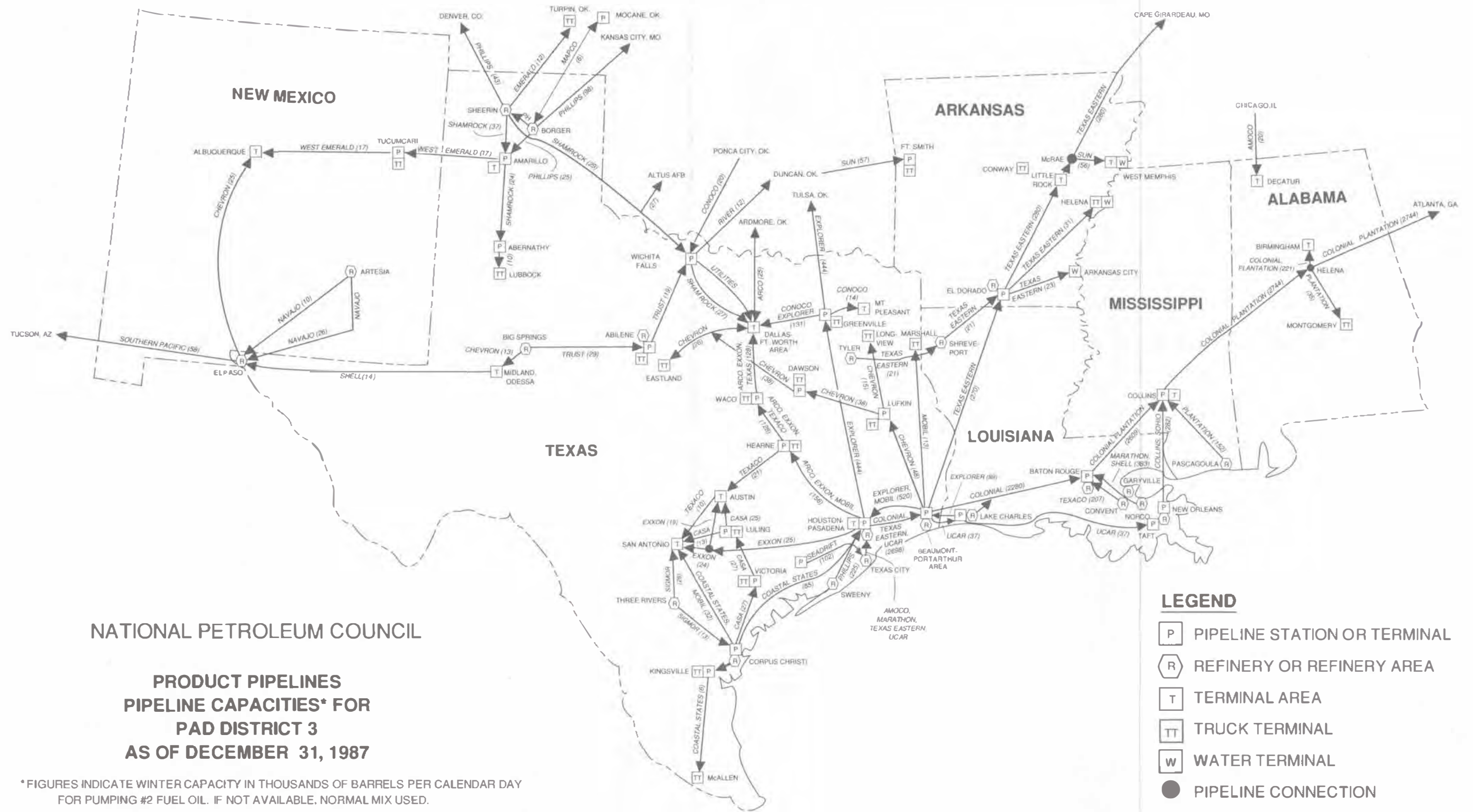



NATIONAL PETROLEUM COUNCIL

**PRODUCT PIPELINES
PIPELINE CAPACITIES* FOR
PAD DISTRICTS 4 & 5
AS OF DECEMBER 31, 1987**

LEGEND

- P PIPELINE STATION OR TERMINAL
- R REFINERY OR REFINERY AREA
- TT TRUCK TERMINAL
- T TERMINAL AREA
- W WATER TERMINAL
- PIPELINE CONNECTION

* FIGURES INDICATE WINTER CAPACITY IN THOUSANDS OF BARRELS PER CALENDAR DAY FOR PUMPING #2 FUEL OIL. IF NOT AVAILABLE, NORMAL MIX USED.

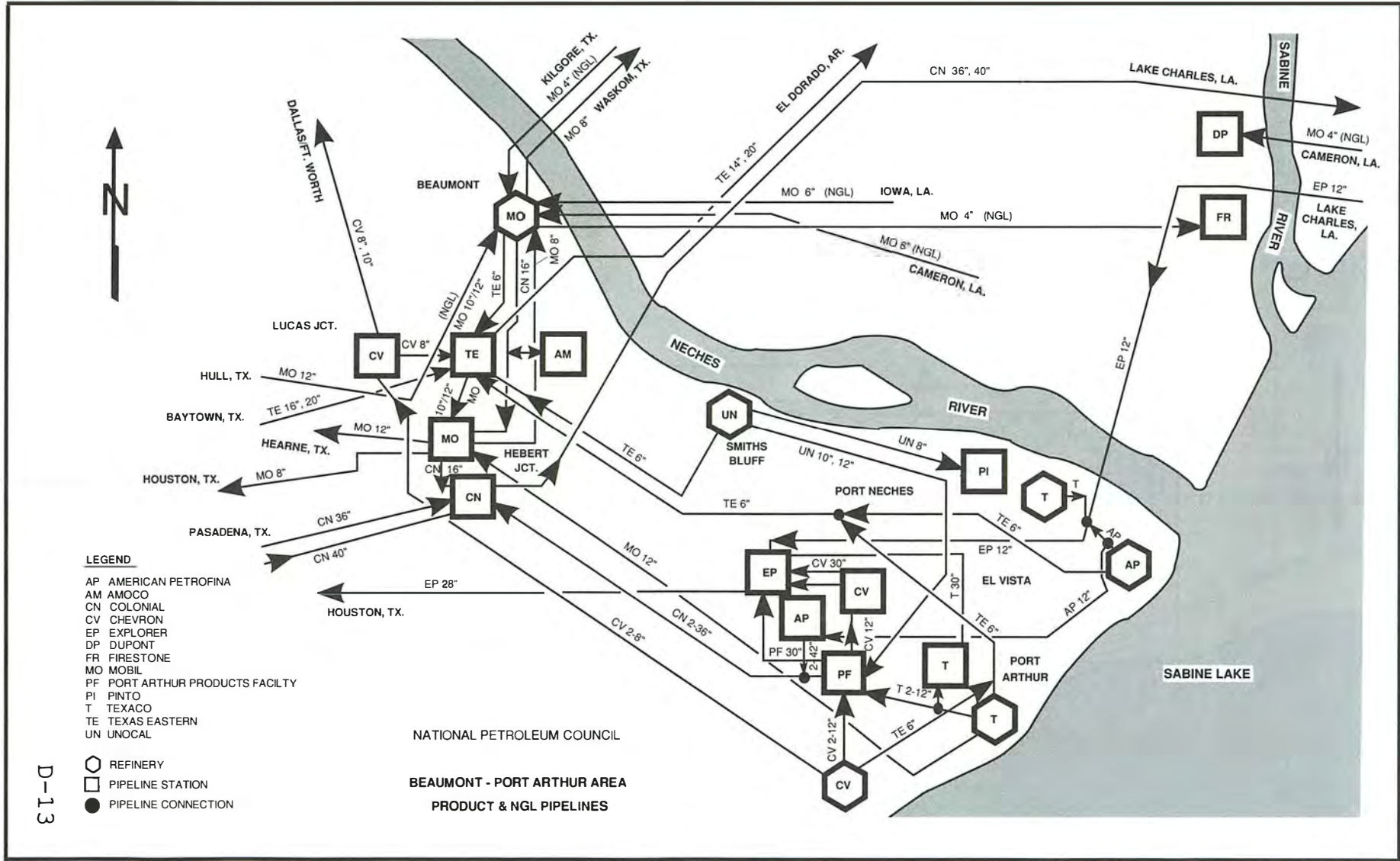

LEGEND

- AM AMOCO
 - AR ARCO
 - AX APEX
 - BA BADGER
 - BE BUCKEYE
 - BL BELL OIL
 - CG CITGO
 - CL CLARK
 - CO CONOCO
 - EC ENERGY COOP
 - EP EXPLORER
 - ER ENRON
 - GN GREAT NORTHERN
 - GX GATX
 - MA MARATHON
 - MAT MARTIN
 - M/O MARS OIL
 - MO MOBIL
 - PH PHILLIPS
 - SH SHELL
 - T TEXACO
 - TE TEXAS EASTERN
 - TR TROPICANA
 - UN UNOCAL
 - WH WEST SHORE
 - WM WILLIAMS
 - WO WOLVERINE
 - WW WHITE WATER
-
- REFINERY
 - PIPELINE STATION
 - PIPELINE CONNECTION

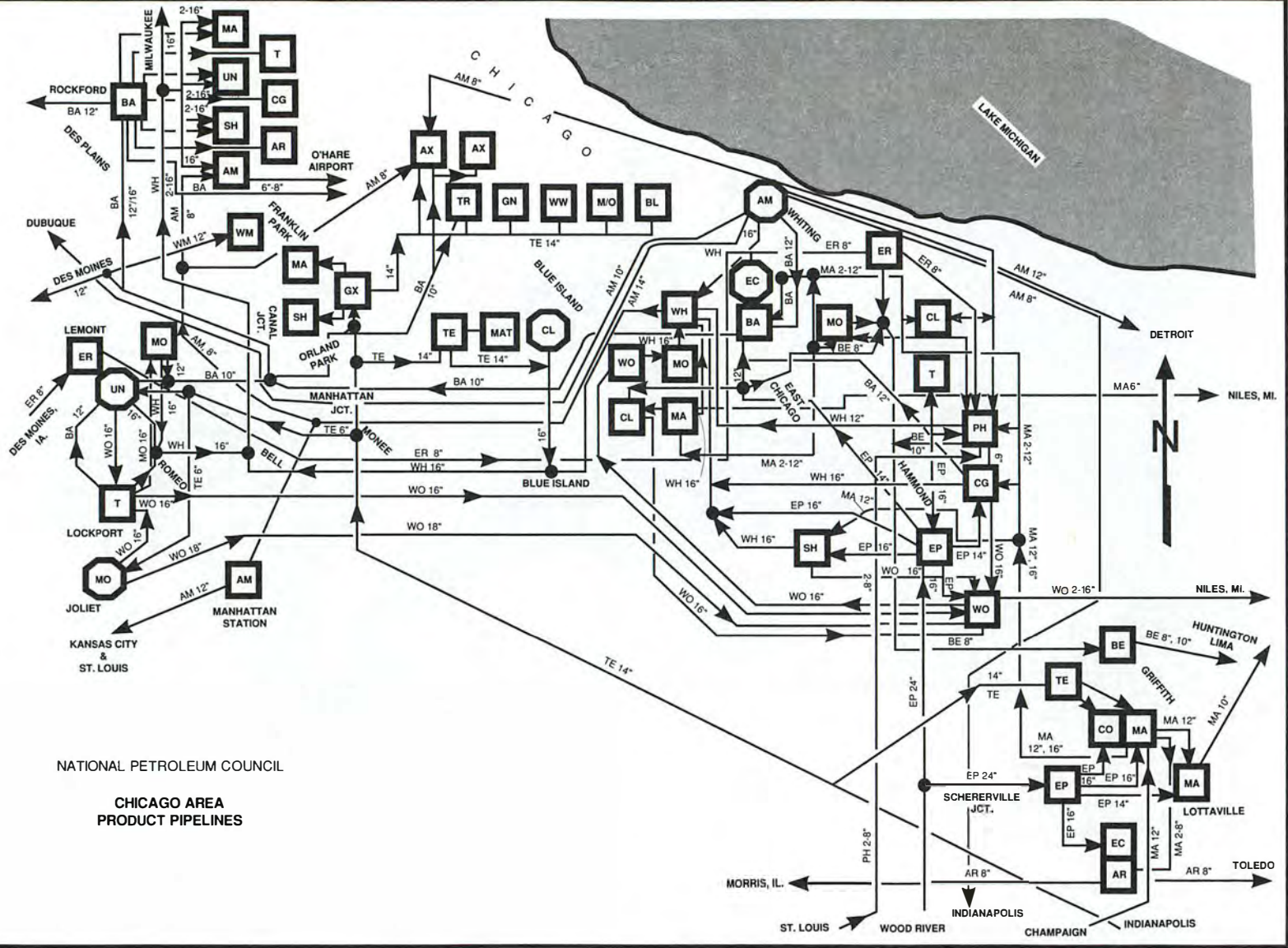

NATIONAL PETROLEUM COUNCIL

**CHICAGO AREA
PRODUCT PIPELINES**

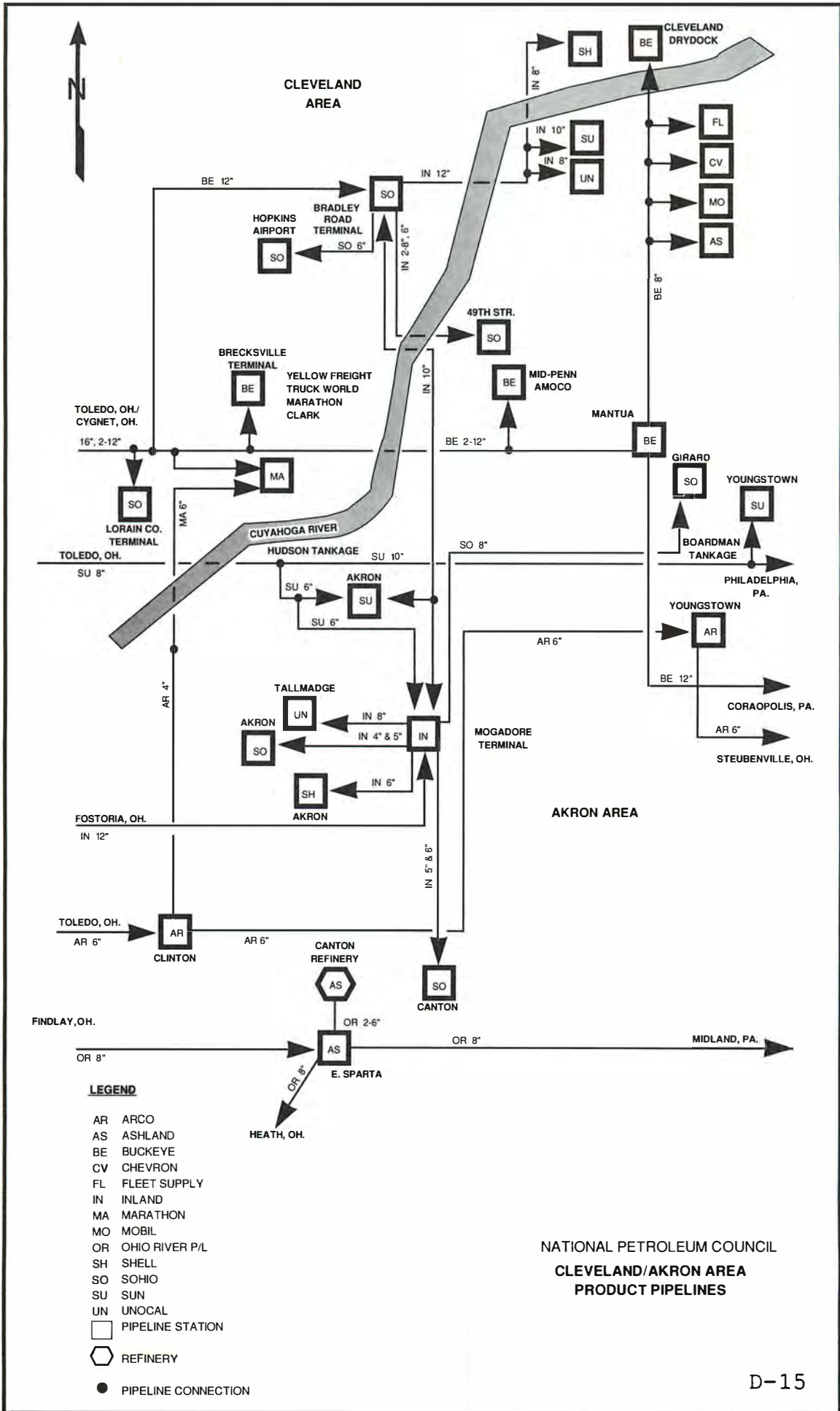

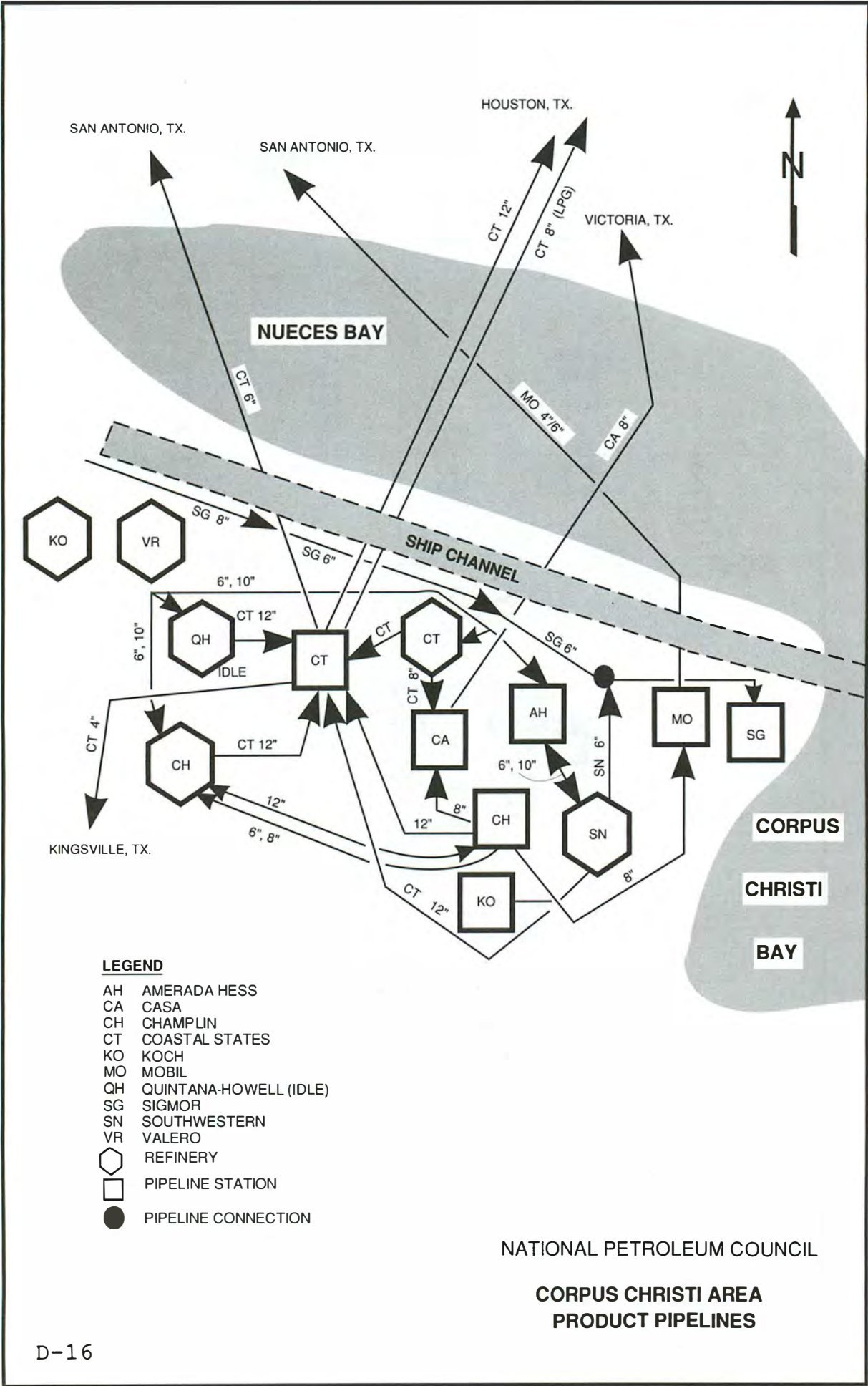

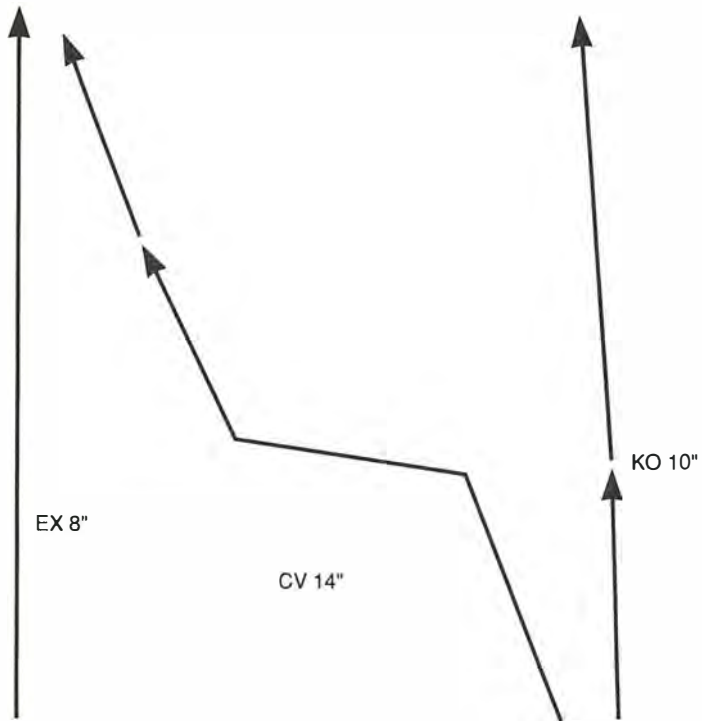

LEGEND

CV CHEVRON
EX EXXON
KO KOCH

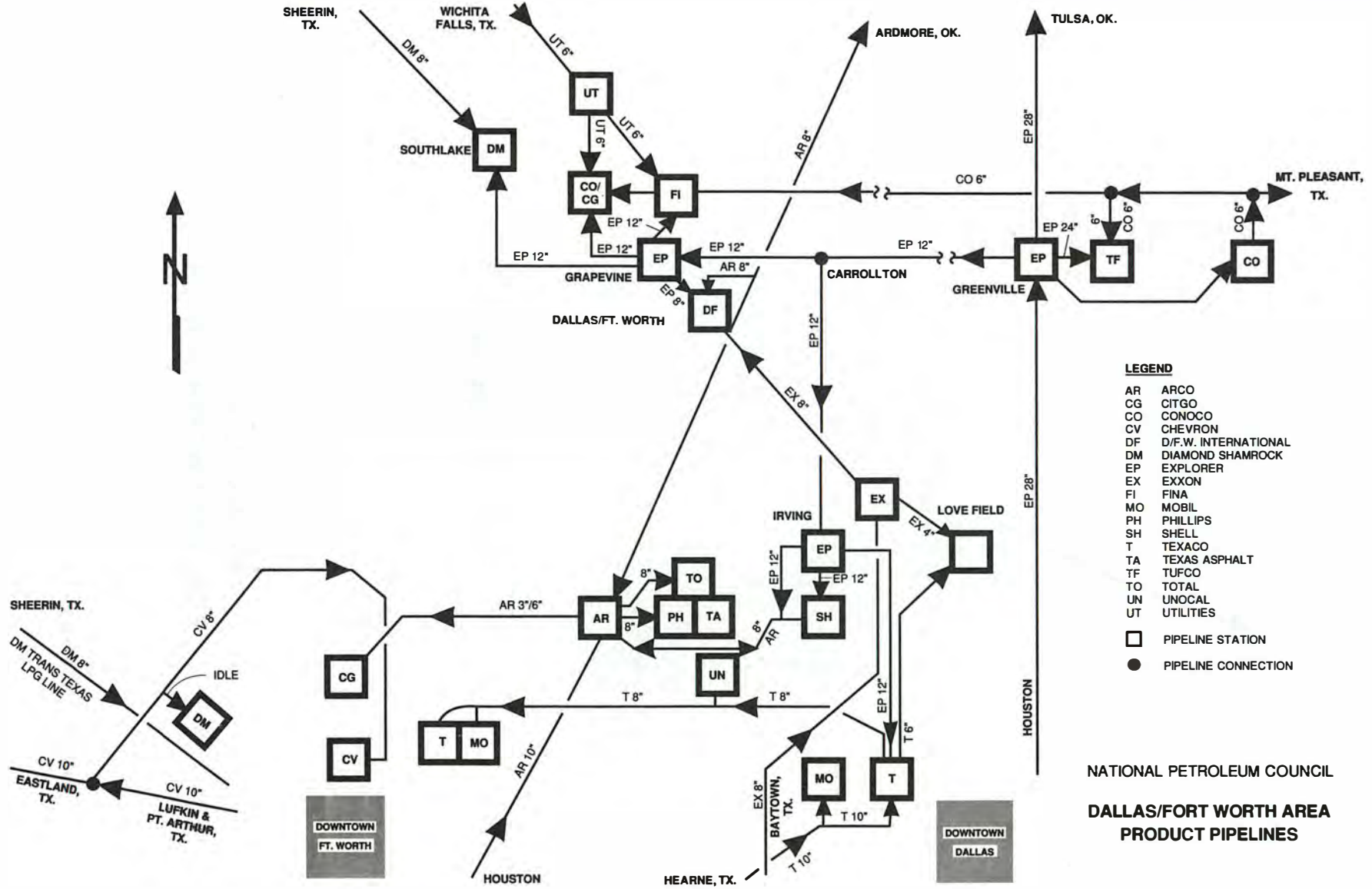

PRODUCT PIPELINES

**NATIONAL PETROLEUM COUNCIL
CORNICANA/WORTHAM/TEAGUE AREA**



LEGEND

- AR ARCO
- CG CITGO
- CO CONOCO
- CV CHEVRON
- DF D/F.W. INTERNATIONAL
- DM DIAMOND SHAMROCK
- EP EXPLORER
- EX EXXON
- FI FINA
- MO MOBIL
- PH PHILLIPS
- SH SHELL
- TA TEXAS ASPHALT
- T TEXACO
- TO TOTAL
- UN UNOCAL
- UT UTILITIES

-  PIPELINE STATION
-  PIPELINE CONNECTION

NATIONAL PETROLEUM COUNCIL
DALLAS/FORT WORTH AREA
PRODUCT PIPELINES

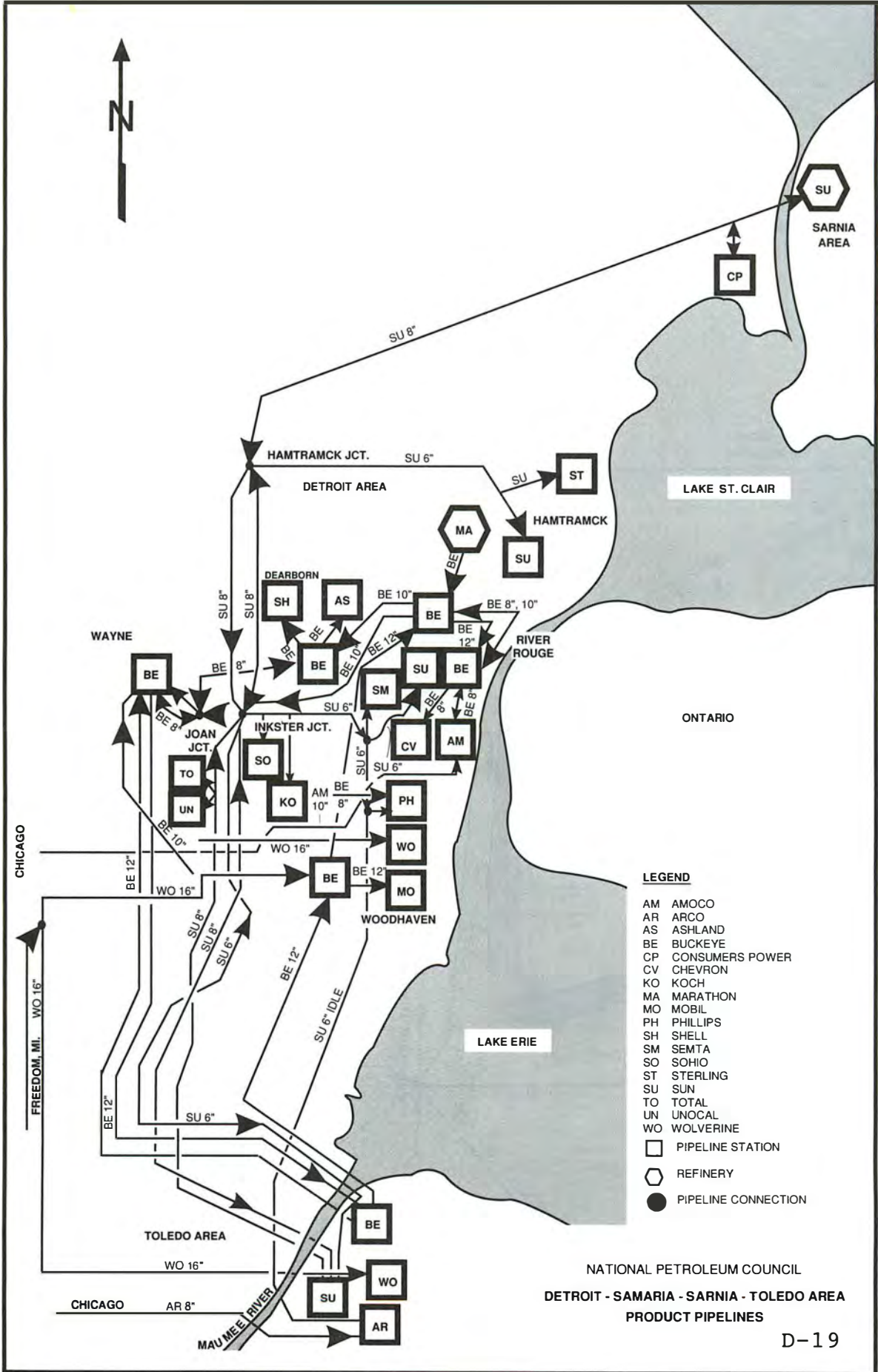

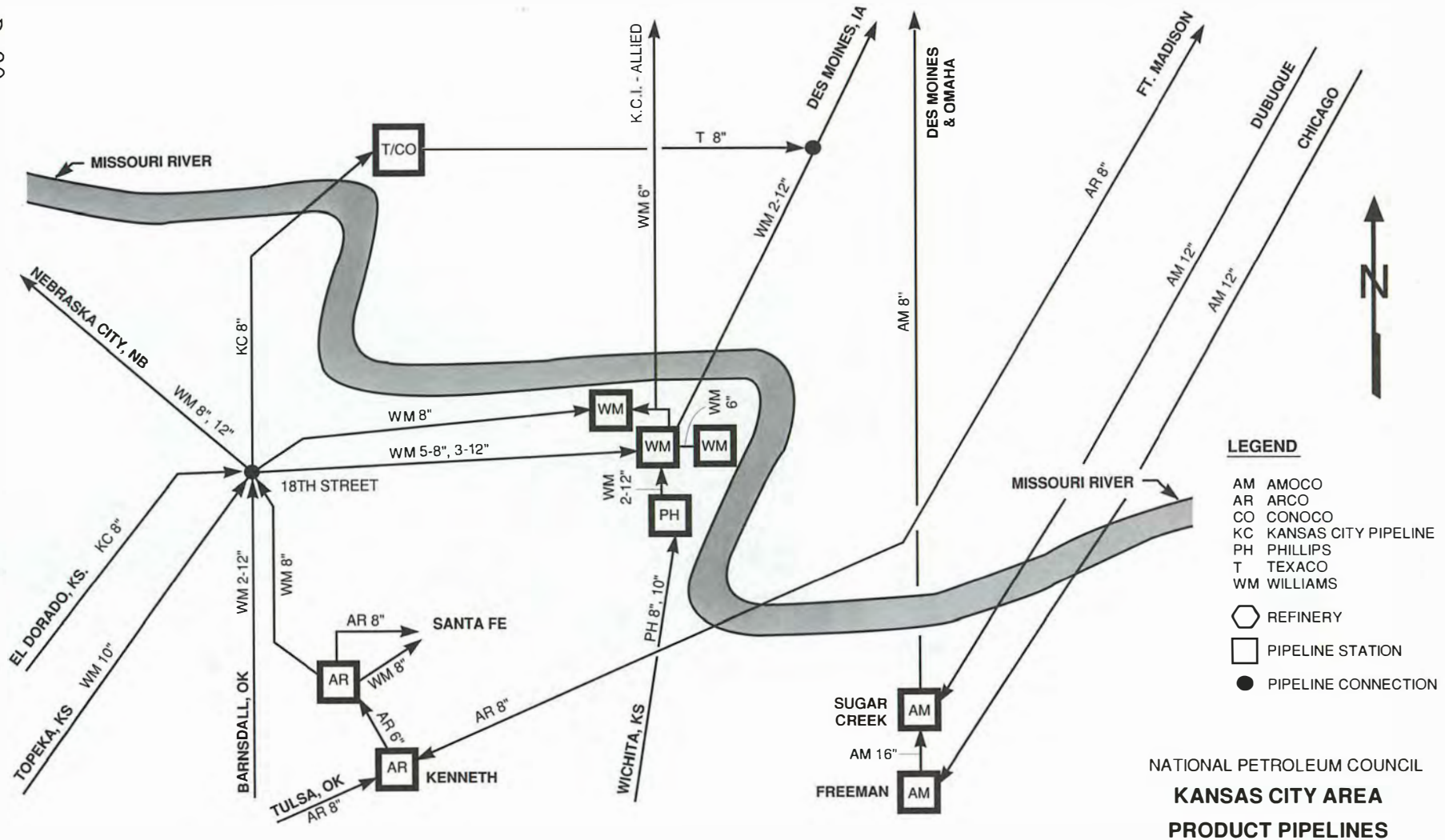

NATIONAL PETROLEUM COUNCIL
 DETROIT - SAMARIA - SARNIA - TOLEDO AREA
 PRODUCT PIPELINES



NATIONAL PETROLEUM COUNCIL
**KANSAS CITY AREA
 PRODUCT PIPELINES**

LEGEND

- CG CITGO
- CN COLONIAL PIPELINE CO.
- CO CONOCO
- CS CALCASIEU REFINING CORP.
- DX DIXIE
- EP EXPLORER PIPELINE CO.
- LC LAKE CHARLES PIPELINE COMPANY
- OX OXY NGL INC.
-  REFINERY
-  PIPELINE STATION
-  PIPELINE CONNECTION

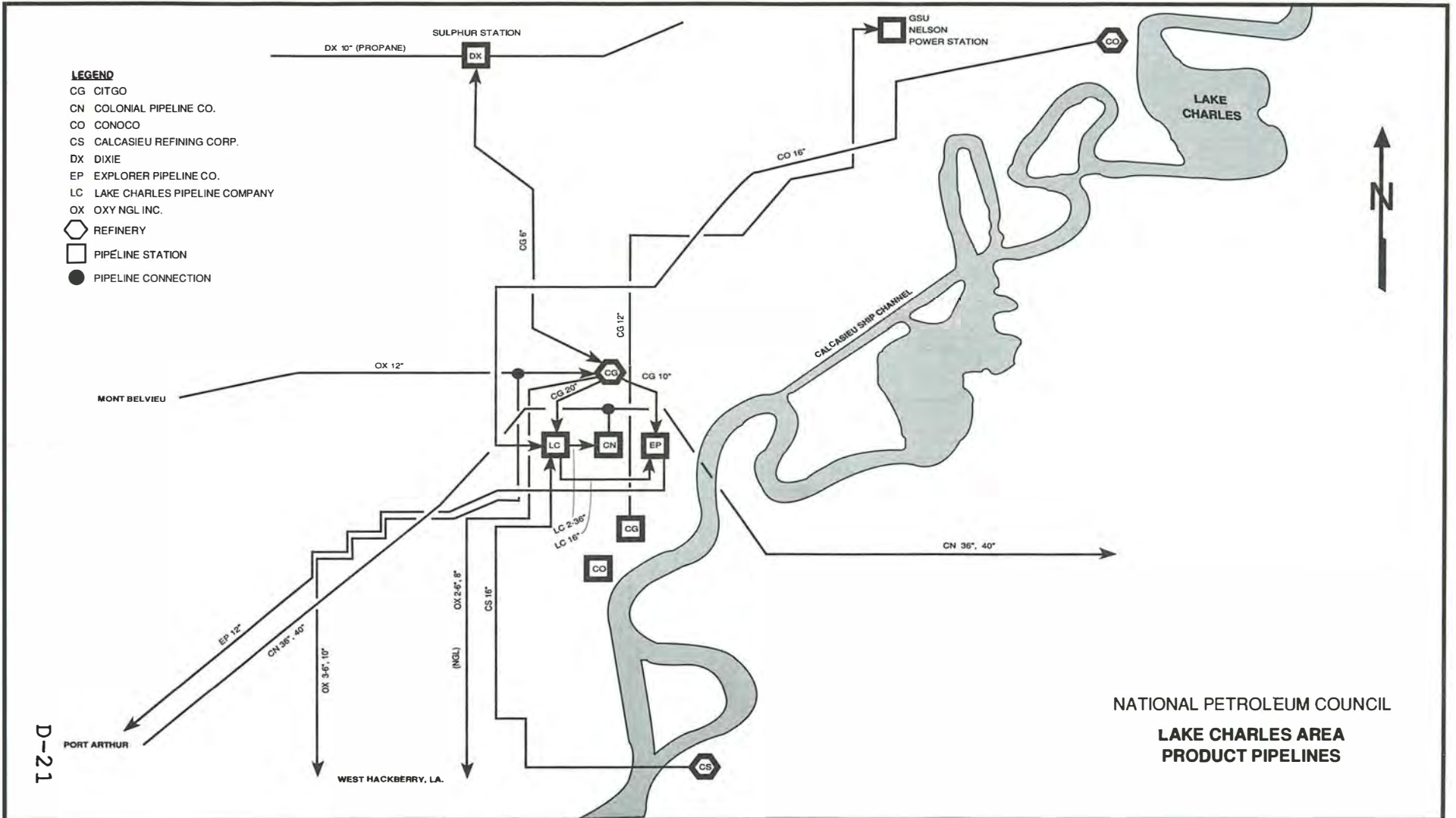

D-21

NATIONAL PETROLEUM COUNCIL
LAKE CHARLES AREA
PRODUCT PIPELINES

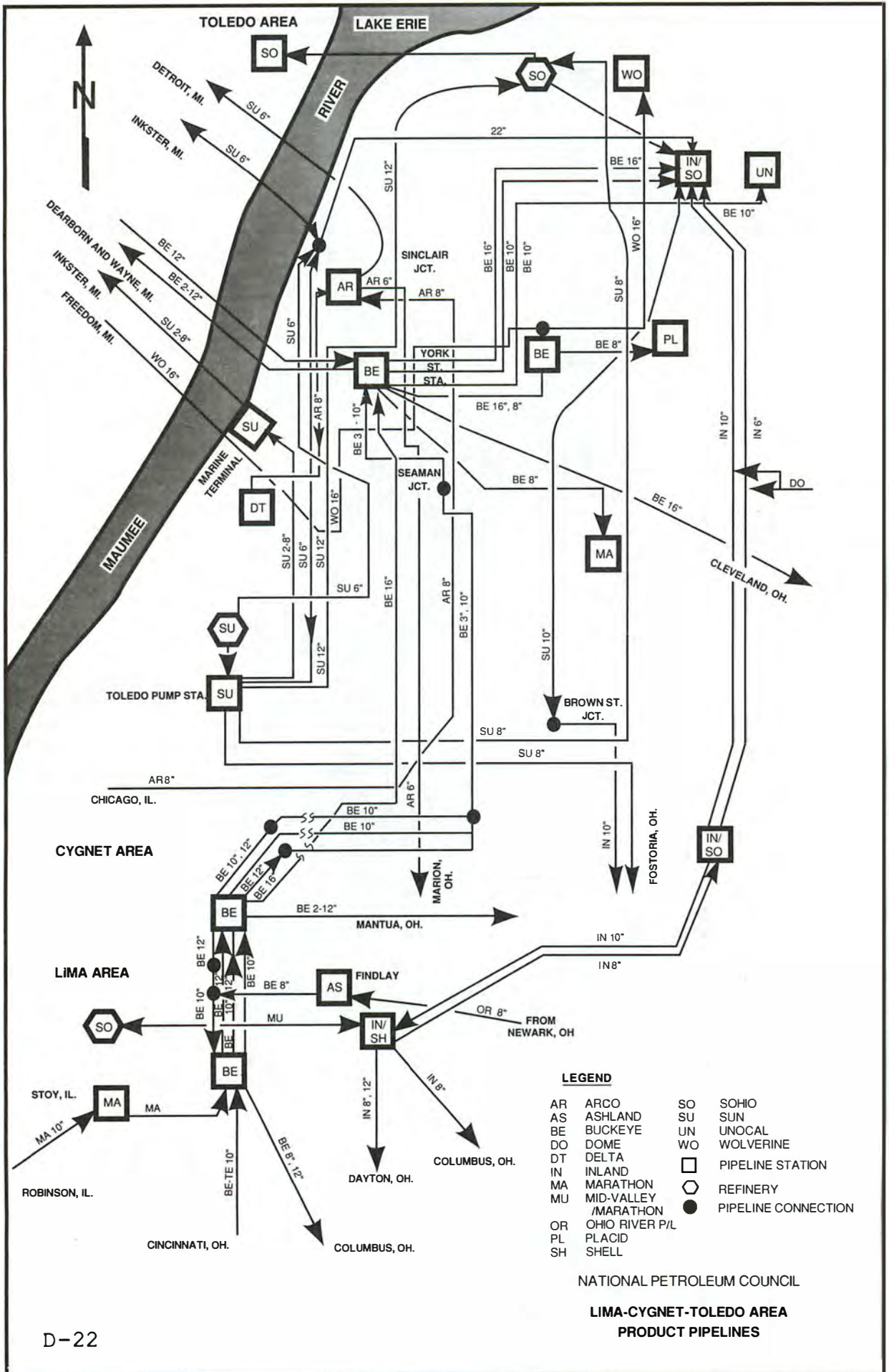

LEGEND

- | | | | |
|----|-----------------------|----|---------------------|
| AR | ARCO | SO | SOHIO |
| AS | ASHLAND | SU | SUN |
| BE | BUCKEYE | UN | UNOCAL |
| DO | DOME | WO | WOLVERINE |
| DT | DELTA | □ | PIPELINE STATION |
| IN | INLAND | ○ | REFINERY |
| MA | MARATHON | ● | PIPELINE CONNECTION |
| MU | MID-VALLEY / MARATHON | | |
| OR | OHIO RIVER P/L | | |
| PL | PLACID | | |
| SH | SHELL | | |

NATIONAL PETROLEUM COUNCIL

**LIMA-CYGNNET-TOLEDO AREA
PRODUCT PIPELINES**

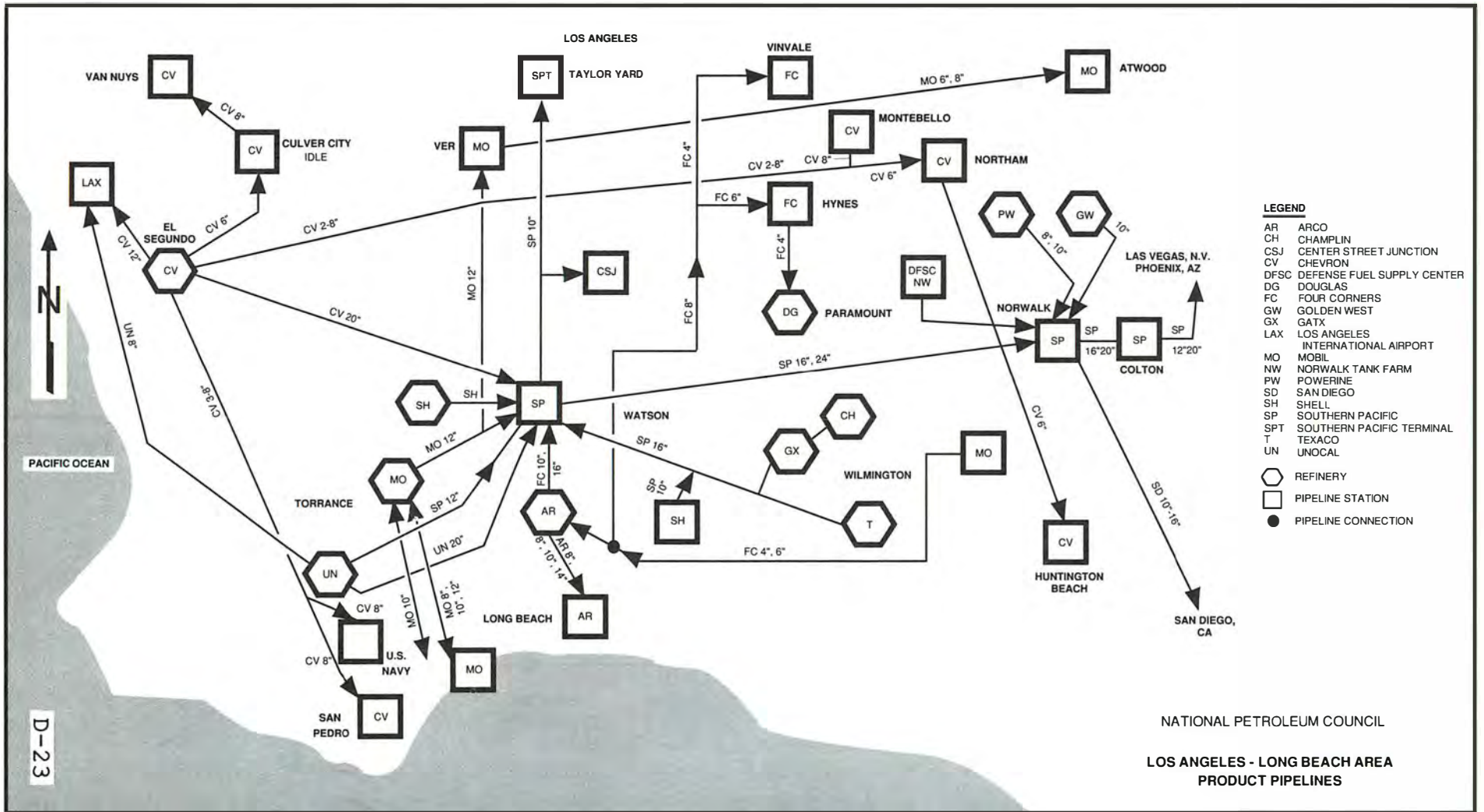

D-24

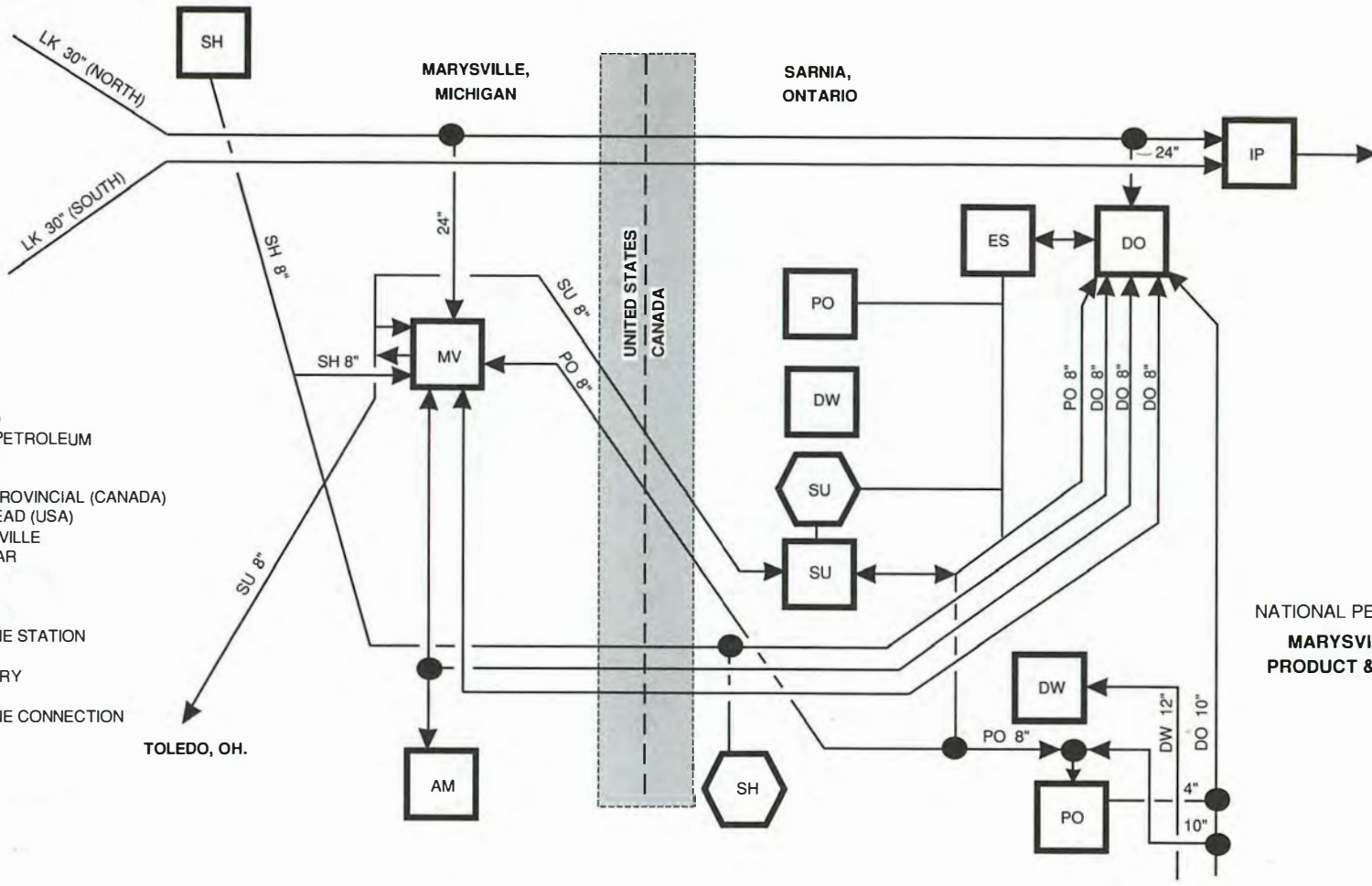

LEGEND

- AM AMOCO
- DO DOME PETROLEUM
- DW DOW
- ES ESSO
- IP INTERPROVINCIAL (CANADA)
- LK LAKEHEAD (USA)
- MV MARYSVILLE
- PO POLYSAR
- SH SHELL
- SU SUN
- PIPELINE STATION
- ⬡ REFINERY
- PIPELINE CONNECTION

NATIONAL PETROLEUM COUNCIL
**MARYSVILLE, MI. AREA
 PRODUCT & LPG PIPELINES**

TOLEDO, OH.

NATIONAL PETROLEUM COUNCIL

NEW YORK (NEWARK, BAYONNE, LINDEN) AREA
PRODUCT PIPELINES

LEGEND

- | | |
|------------------------|---------------------|
| AH AMERADA HESS | GT GETTY |
| AM AMOCO | GU GULF |
| AT ATLANTIC | GX GATX |
| BE BUCKEYE | HB HARBOR |
| BP BRITISH PETROLEUM | MET METROPOLITAN |
| BUG BROOKLYN UNION GAS | MO MOBIL |
| CCO CARBON CONCORD OIL | NIA NEWARK INT'L |
| CG CITGO | NV NORTHVILLE |
| CN COLONIAL | RO ROYAL |
| CR CROWN | SH SHELL |
| CT COASTAL STATES | SU SUN |
| CV CHEVRON | T TEXACO |
| EX EXXON | TN TENNECO |
| | WI WIZARD PETROLEUM |

- PIPELINE STATION
- REFINERY
- PIPELINE CONNECTION

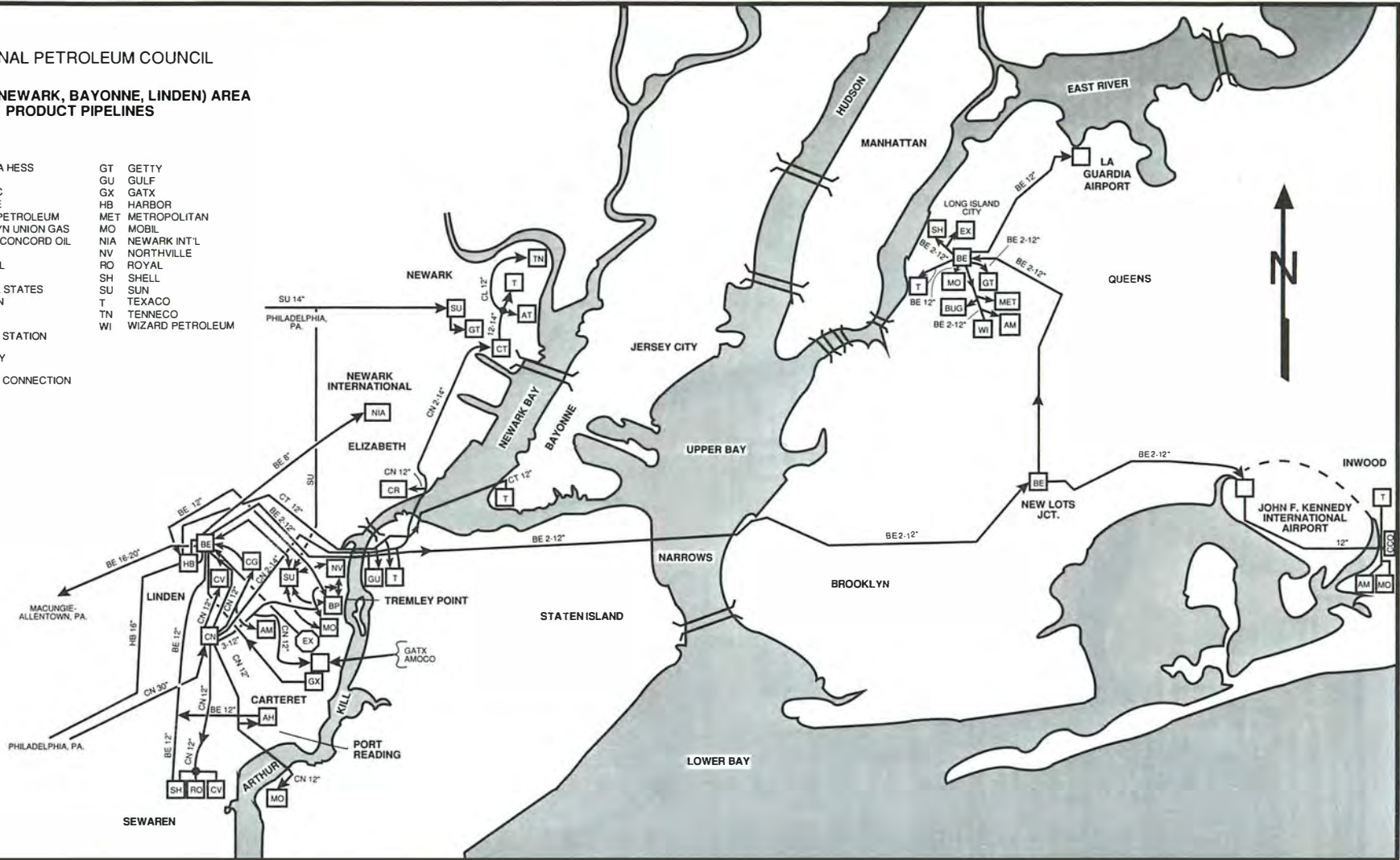



LEGEND

- AH AMERADA HESS
- AM AMOCO
- AT ATLANTIC
- BP BRITISH PETROLEUM
- CG CITGO
- CN COLONIAL
- CO CONOCO
- CT COASTAL STATES
- CV CHEVRON
- DP DELAWARE PETROLEUM
- EX EXXON
- HB HARBOR
- KO KOCH
- LR LAUREL
- MO MOBIL
- NH NATIONALHEAT
- SO SOHIO
- SU SUN
- SW SWAN
- T TEXACO
- TE TEXAS EASTERN (LPG)
- REFINERY
- PIPELINE STATION
- PIPELINE CONNECTION

NATIONAL PETROLEUM COUNCIL

PHILADELPHIA AREA
PRODUCT PIPELINES

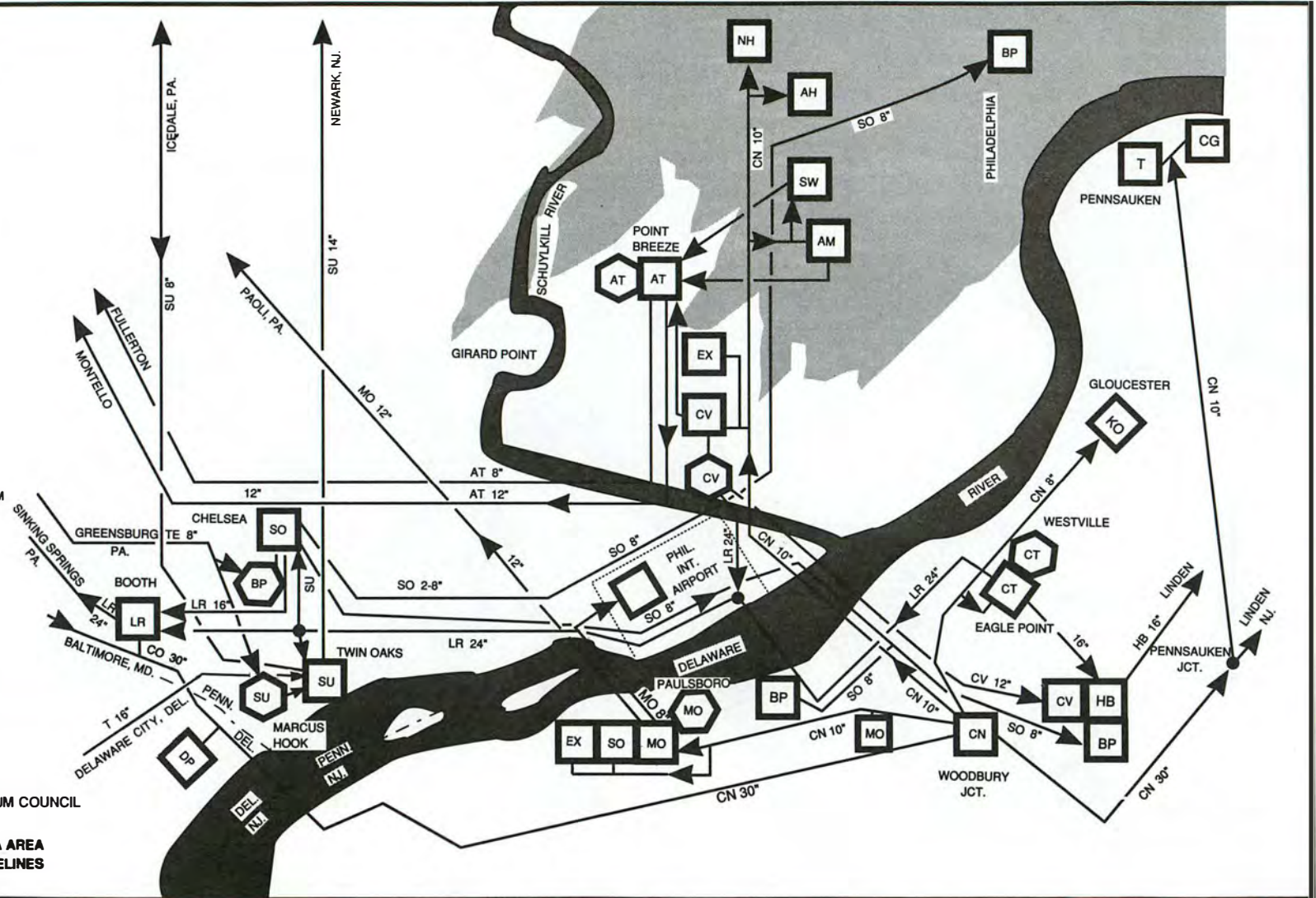

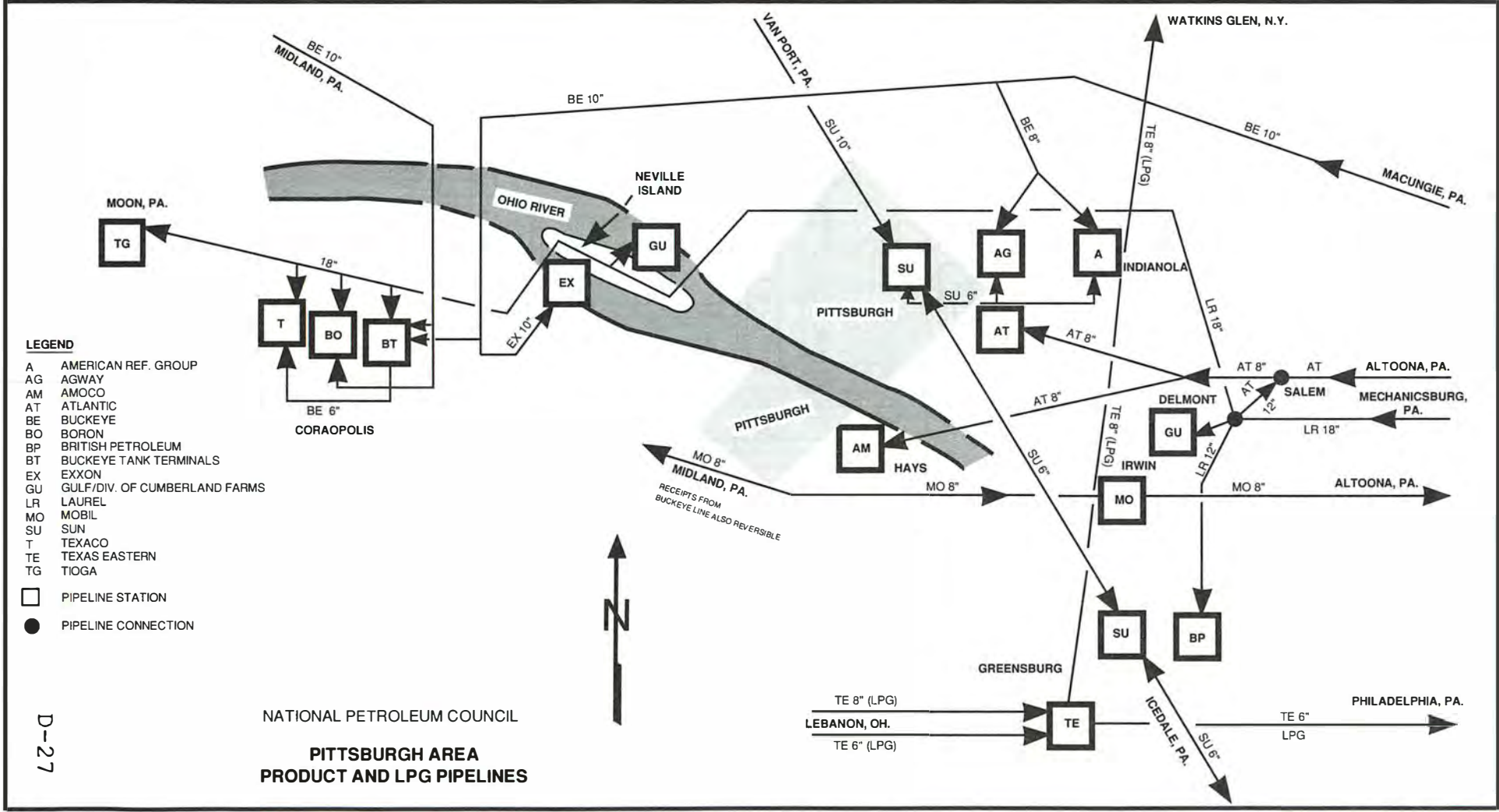

LEGEND

- A AMERICAN REF. GROUP
- AG AGWAY
- AM AMOCO
- AT ATLANTIC
- BE BUCKEYE
- BO BORON
- BP BRITISH PETROLEUM
- BT BUCKEYE TANK TERMINALS
- EX EXXON
- GU GULF/DIV. OF CUMBERLAND FARMS
- LR LAUREL
- MO MOBIL
- SU SUN
- T TEXACO
- TE TEXAS EASTERN
- TG TIOGA

- PIPELINE STATION
- PIPELINE CONNECTION

NATIONAL PETROLEUM COUNCIL
**PITTSBURGH AREA
 PRODUCT AND LPG PIPELINES**

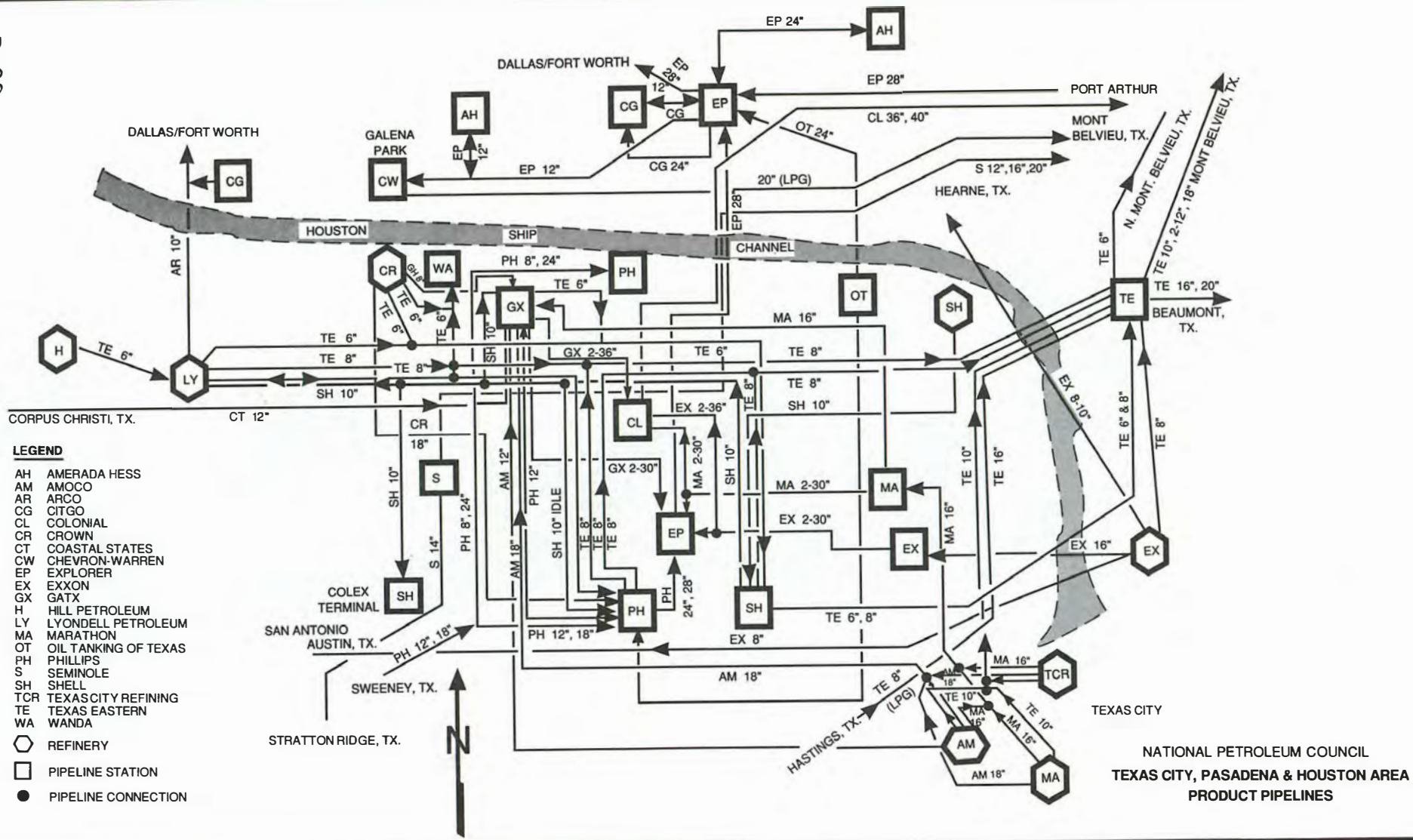

LEGEND

- AH AMERADA HESS
- AM AMOCO
- AR ARCO
- CG CITGO
- CL COLONIAL
- CR CROWN
- CT COASTAL STATES
- CW CHEVRON-WARREN
- EP EXPLORER
- EX EXXON
- GX GATX
- H HILL PETROLEUM
- LY LYONDELL PETROLEUM
- MA MARATHON
- OT OIL TANKING OF TEXAS
- PH PHILLIPS
- S SEMINOLE
- SH SHELL
- TCR TEXAS CITY REFINING
- TE TEXAS EASTERN
- WA WANDA
- REFINERY
- PIPELINE STATION
- PIPELINE CONNECTION

NATIONAL PETROLEUM COUNCIL
 TEXAS CITY, PASADENA & HOUSTON AREA
 PRODUCT PIPELINES

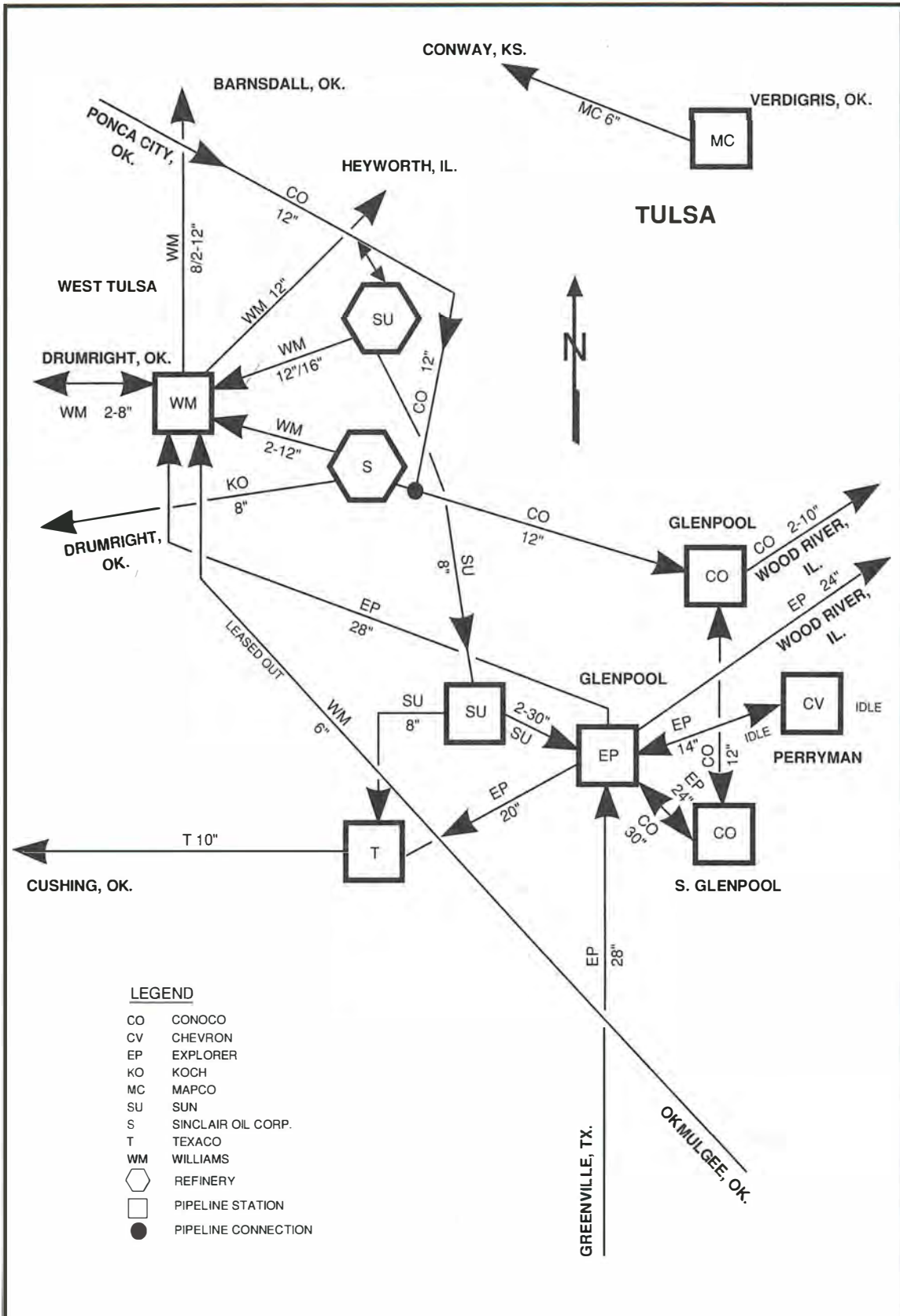



- LEGEND**
- CO CONOCO
 - CV CHEVRON
 - EP EXPLORER
 - KO KOCH
 - MC MAPCO
 - SU SUN
 - S SINCLAIR OIL CORP.
 - T TEXACO
 - WM WILLIAMS
 - REFINERY
 - PIPELINE STATION
 - PIPELINE CONNECTION

NATIONAL PETROLEUM COUNCIL

TULSA AREA
PRODUCT PIPELINES

LEGEND

- AM AMOCO
- CO CONOCO
- CS CHASE
- CT COASTAL STATES
- ER ENRON
- KC KANSAS CITY PIPELINE
- KN KANEB
- NCRA NATIONAL COOPERATIVE REFINERY ASSOCIATION
- PH PHILLIPS
- T TEXACO
- WM WILLIAMS
-  REFINERY
-  PIPELINE STATION

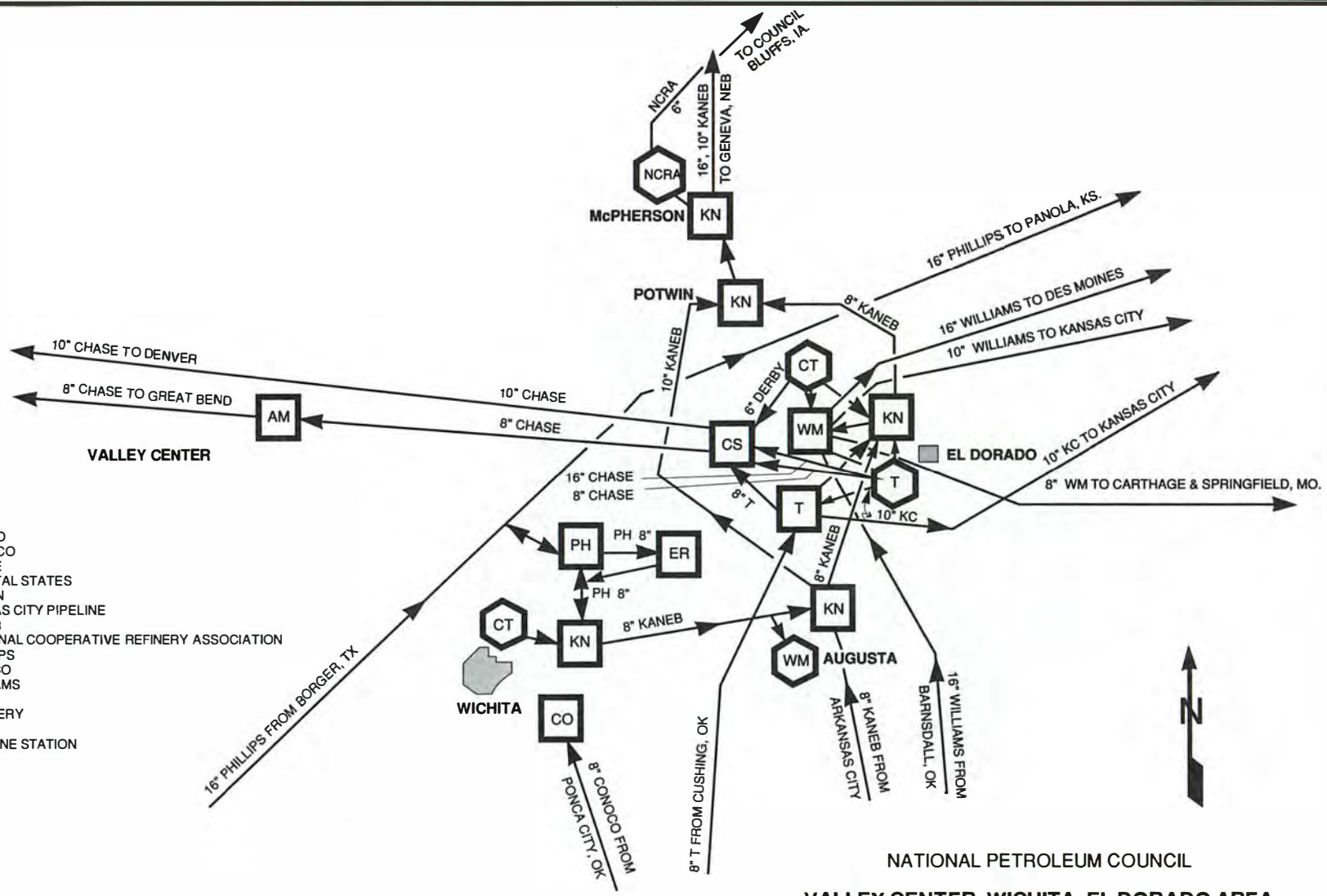

NATIONAL PETROLEUM COUNCIL
**VALLEY CENTER, WICHITA, EL DORADO AREA
 PRODUCT PIPELINES**

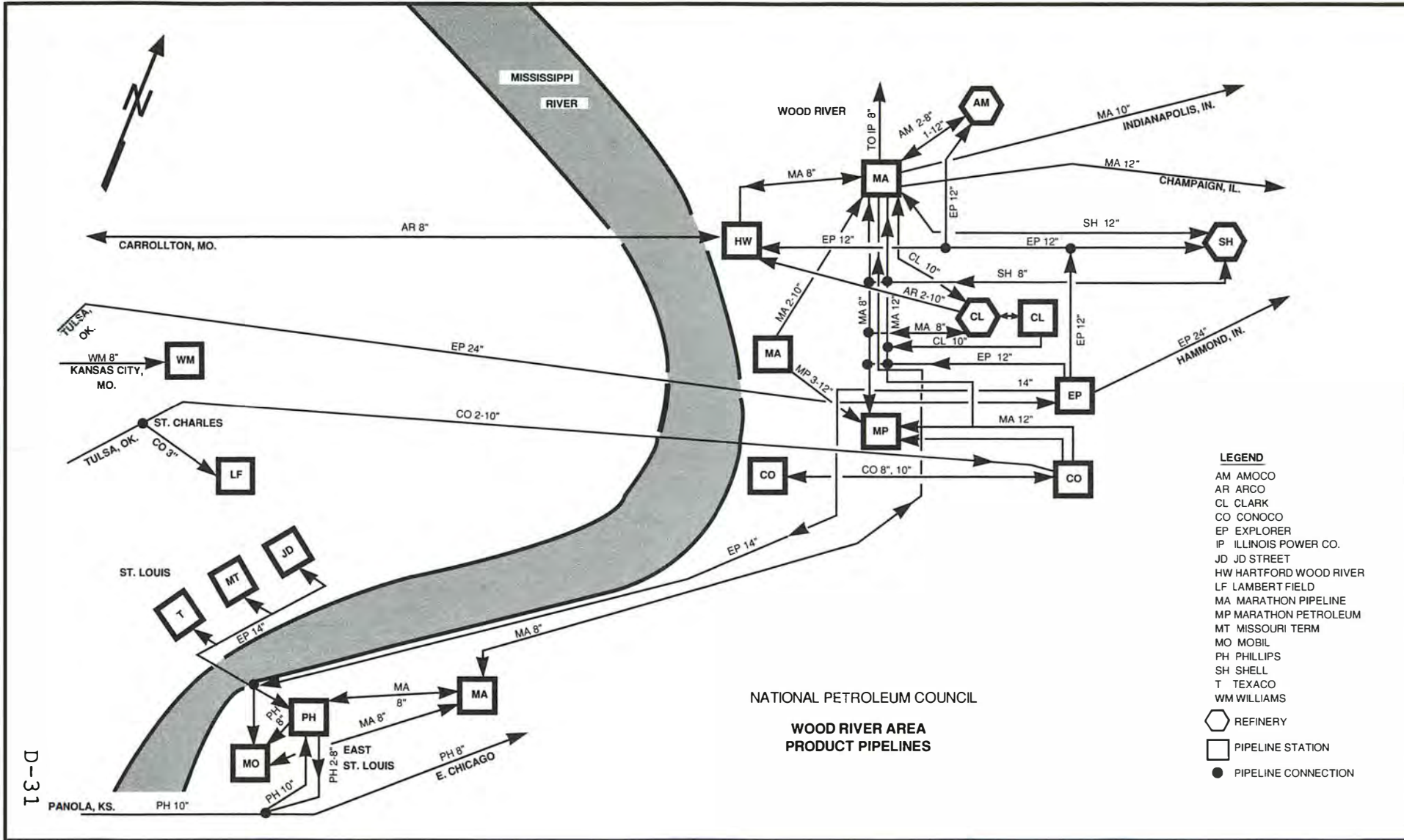

D-31

TABLE D-1

CROSS-PADD PETROLEUM PRODUCT PIPELINE CAPACITIES AS OF DECEMBER 31, 1987

	<u>Pipeline Diameter</u>	<u>Summer No. 2 (MB/D)</u>	<u>Summer Normal Mix (MB/D)</u>	<u>Winter No. 2 (MB/D)</u>	<u>Winter Normal Mix (MB/D)</u>
<u>PADD III to PADD IZ</u>					
Colonial (Helena, AL, to Bremen, GA)	36"	NA	1,224	NA	1,224
	36"	960	960	960	960
Plantation (Helena, AL, to Bremen, GA)	18"	148	164	148	164
	30"	297	<u>396</u>	297	<u>396</u>
			2,744		2,744
<u>PADD III to PADD II</u>					
Shamrock (McKee, TX, to Altus AFB, OK)	8"	NA	27	NA	NA
Explorer (Greenville, TX, to Tulsa, OK)	28"	444	360	444	360
Texas Eastern (Little Rock, AR, to Cape Girardeau, MO)	20"	186	225	186	225
	16"	94	113	94	113
ARCO (Dallas-Ft. Worth, TX, to Ardmore, OK)	8"	NA	NA	26	25
River (Wichita Falls, TX, to Duncan, OK)	6"	12	13	12	13
Phillips (Borger, TX, to Wichita, KS)	16"	97	110	99	111
Emerald (McKee, TX, to Turpin, OK)	6"	12	13	12	13
<u>PADD III to PADD IV</u>					
Phillips (Borger, TX, to Denver, CO)	8"/12"	41	45	41	45
<u>PADD III to PADD V</u>					
	12"	NA	45	NA	45
So. Pacific (El Paso, TX, to Tucson, AZ)	8"	NA	<u>13</u>	NA	<u>13</u>
			58		58

TABLE D-1 (Continued)

	<u>Pipeline Diameter</u>	<u>Summer No. 2 (MB/D)</u>	<u>Summer Normal Mix (MB/D)</u>	<u>Winter No. 2 (MB/D)</u>	<u>Winter Normal Mix (MB/D)</u>
<u>PADD IZ to PADD IY</u>					
Colonial (Chantilly, VA, to Dorsey, MD)	36"	996	1,038	996	1,026
	32"	<u>396</u>	<u>455</u>	<u>396</u>	<u>438</u>
		1,392	1,493	1,392	1,464
<u>PADD IZ to PADD II East</u>					
Colonial (Atlanta to Chatanooga)	12"	NA	88	NA	88
	8"	34	34	34	34
	10"	90	110	90	106
Plantation (Bremen to Chatanooga)	8"	34	<u>45</u>	34	<u>45</u>
			277		273
<u>PADD II East to PADD IY</u>					
Ashland (Canton, OH, to Pittsburgh Area)	8"	36	40	33	36
Buckeye (Niles, OH, to Pittsburgh Area)	10"	45	60	45	60
Sun (Youngstown, OH, to Pittsburgh Area)	10"	NA	<u>36</u>	NA	<u>36</u>
			136		132
<u>PADD II East to PADD III</u>					
Amoco (Whiting, IN to Decatur, AL)	8"	NA	20	NA	20
<u>PADD II West to PADD III</u>					
Conoco (Oklahoma City to Wichita Falls, TX)	8"	20	20	20	20
Sun (Allen, OK, to Ft. Smith, AR)	12"	<u>41</u>	<u>43</u>	<u>41</u>	<u>43</u>
		61	63	61	63

TABLE D-1 (Continued)

	<u>Pipeline Diameter</u>	<u>Summer No. 2 (MB/D)</u>	<u>Summer Normal Mix (MB/D)</u>	<u>Winter No. 2 (MB/D)</u>	<u>Winter Normal Mix (MB/D)</u>
<u>PADD IV to PADD II</u>					
Cenex (Billings, MT to Minot, ND)	8"	NA	16	NA	NA
Wyco (Casper, WY, to Rapid City, SD)	6"	11	14	11	14
Cheyenne (Cheyenne, WY, to N. Platte, NE)	6"	17	<u>17</u> 47	17	17
<u>PADD IV to PADD V</u>					
Yellowstone (Helena, MT, to Spokane, WA)	10"	56	56	56	56
Chevron (Boise, ID, to Pasco, WA)	8"	<u>17</u> 73	NA	<u>17</u> 73	NA

NA = Not available.

TABLE D-2

**INTRA-PADD PETROLEUM PRODUCT PIPELINE
CAPACITIES AS OF DECEMBER 31, 1987**

	<u>PIPELINE DIAMETER</u> *	<u>SUMMER NO. 2 (MB/D)</u>	<u>SUMMER NORMAL MIX (MB/D)</u>	<u>WINTER NO. 2 (MB/D)</u>	<u>WINTER NORMAL MIX (MB/D)</u>
PADD IX					
Buckeye - New Haven, CT to Ludlow, MA	12"	62	62	62	62
Mobil - Portland, ME to Bangor, ME	6"	10	12	10	11
Providence, RI to Springfield, MA	6"	12	16	12	16
PADD IY					
Atlantic - Pt. Breze, PA to Montello, PA	8"	NA	29	NA	29
Pt. Breze, PA to Montello, PA	12"	NA	96	NA	96
Montello, PA to Kingston, PA	6"	NA	15	NA	15
Montello, PA to Buffalo, NY	8"	NA	46	NA	46
Montello, PA to Mechanicsburg, PA	6"	NA	17	NA	17
Montello, PA to Mechanicsburg, PA	8"	NA	29	NA	29
Mechanicsburg, PA to Pittsburgh, PA	8"	NA	27	NA	27
Buckeye - Linden, NJ to Macungie, PA	20"	137	182	137	182
Linden, NJ to Macungie, PA	16"	139	139	139	139
Macungie, PA to Auburn, NY	14"	86	115	86	115
Aurburn, NY to Rochester, NY	10"	44	58	44	58
Aurburn, NY to Utica, NY	10"	50	67	50	67
Colonial - Dorsey, MD to Woodbury, NJ	30"	996	1038	996	1038
Woodbury, NY to Linden, NJ	30"	708	792	708	768
Harbor - Woodbury, NJ to Linden, NJ	16"	121	129	116	124
Laurel - Booth, PA to Mechanicsburg, PA	24"	137	182	137	182
Mechanicsburg, PA to Coraopolis, PA	18"	54	72	54	72

TABLE D-2 (Continued)

	<u>PIPELINE DIAMETER *</u>	<u>SUMMER NO. 2 (MB/D)</u>	<u>SUMMER NORMAL MIX (MB/D)</u>	<u>WINTER NO. 2 (MB/D)</u>	<u>WINTER NORMAL MIX (MB/D)</u>
Mobil - Malvern, PA to Binghampton, NY	8"	15	18	15	17
Binghampton, NY to Waterloo, NY	6"	13	17	13	16
Waterloo, NY to Syracuse, NY	6"	5	6	5	6
Waterloo, NY to Buffalo, NY	6"	8	10	8	10
Paulsboro, PA to Harrisburg, PA	10"	27	31	27	31
Harrisburg, PA to Altoona, PA	8"	2	2	2	2
Midland, PA to Altoona, PA	6"	5	6	5	6
Sun - Twin Oaks, PA to Icedale, PA	8"	NA	32	NA	30
Icedale, PA to Allegheny, PA	6"	NA	14	NA	14
Icedale, PA to Syracuse, NY	6"	NA	17	NA	16
Twin Oaks, PA to Newark, NJ	14"	NA	128	NA	126
Texaco - Delaware City, DE to Twin Oaks, PA	16"	120	150	120	150
PADD IZ					
Colonial - Atlanta, GA to Greensboro, NC	36"	888	888	888	888
Atlanta, GA to Greensboro, NC	40"	NA	1212	NA	1212
Greensboro, NC to Chantilly, VA	32"	396	455	396	438
Greensboro, NC to Chantilly, VA	36"	996	1038	996	1026
Atlanta, GA to Macon, GA	8"	59	67	59	66
Macon, GA to Bainbridge, GA	8"	25	29	25	29
Atlanta, GA to Chattanooga Station, GA	10"	34	34	34	34
Atlanta, GA to Chattanooga Station, GA	12"	NA	88	NA	88
Atlanta, GA to Chattanooga Station, GA	16"	90	110	90	107
Greensboro, NC to Selma, NC	16"	77	89	77	85
Mitchell, VA to Richmond, VA	16"	214	237	214	230
Richmond, VA to Norfolk, VA	14"	103	123	103	118
Mitchell, VA to Roanoke, VA	8"	43	52	43	49
Chantilly, VA to Fairfax, VA	22"	384	434	384	420
Everglades - Port Everglades, FL to Miami, FL	10"	43	43	43	43

TABLE D-2 (Continued)

	<u>PIPELINE DIAMETER *</u>	<u>SUMMER NO. 2 (MB/D)</u>	<u>SUMMER NORMAL MIX (MB/D)</u>	<u>WINTER NO. 2 (MB/D)</u>	<u>WINTER NORMAL MIX (MB/D)</u>
Plantation - Bremen, GA to Columbus, GA	8"	23	31	23	31
Bremen, GA to Macon, GA	8"	18	24	18	24
Bremen, GA to Atlanta, GA	10"	59	65	59	65
Bremen, GA to Atlanta, GA	14"	86	96	86	96
Bremen, GA to Atlanta, GA	26"	297	396	297	396
Atlanta, GA to Greensboro, NC	14"	86	96	86	96
Atlanta, GA to Greensboro, NC	26"	297	396	297	396
Greensboro, NC to Roanoke, VA	8"	25	33	25	33
Greensboro, NC to Richmond, VA	14"	70	80	70	80
Richmond, VA to Newington, VA	12"	70	87	70	87
PADD II					
Amoco - Manhattan, IL to LaPlata, MO	12"	38	38	36	36
Wood River, IL to La Plata, MO	12"	38	38	36	36
La Plata, MO to Kansas City, MO	12"	38	38	36	36
Ashland - Louisville, KY to Lexington, KY	8"	30	34	28	32
Badger - E. Chicago, IN to Des Plaines, IL	12"	86	98	86	98
E. Chicago, IN to Des Plaines, IL	16"	115	134	115	134
Des Plaines, IL to Rockford, IL	12"	86	98	86	98
Rockford, IL to Madison, WI	12"	80	98	80	98
Buckeye - Robinson, IL to Lawrenceville, FL	6"	10	13	10	13
Lawrenceville, IL to Lima, OH	10"/8"	17	22	17	22
Lebanon, OH to Lima, OH	10"	35	46	35	46
Lima, OH to Columbus, OH	8"	30	40	30	40
Lima, OH to Cygnet, OH	12"	41	55	41	55
Lima OH to Cygnet, OH	12"	56	75	56	75
Lima OH, to Cygnet, OH	10"	45	60	45	60
East Chicago, IN to Lima, OH	10"/8"	35	46	35	46
Hutington, IN to Clermont, IN	8"	16	21	16	21

TABLE D-2 (Continued)

	<u>PIPELINE DIAMETER *</u>	<u>SUMMER NO. 2 (MB/D)</u>	<u>SUMMER NORMAL MIX (MB/D)</u>	<u>WINTER NO. 2 (MB/D)</u>	<u>WINTER NORMAL MIX (MB/D)</u>
	Cygnets, OH to Mantua, OH	43	57	43	57
	Cygnets, OH to Mantua, OH	45	60	45	60
	Mantua, OH to Cleveland, OH	37	49	37	49
	Cygnets, OH to Toledo, OH	41	55	41	55
	Cygnets, OH to Toledo, OH	56	75	56	75
	Toledo, OH to Cleveland, OH	78	104	78	104
	Toledo, OH to Cygnets, OH	43	57	43	57
	Toledo, OH to Cygnets, OH	30	40	30	40
	Toledo, OH to Detroit, MI	51	68	51	68
	Toledo, OH to Detroit, MI	40	53	40	53
	Detroit, MI to Bay City, MI	34	45	34	45
	Flint, MI to Owosso, MI	34	45	34	45
	Wayne, MI to Toledo, OH	43	57	43	57
	Cherokee - Ponca City, OK to Tulsa, OK	94	94	94	94
	Tulsa, OK to St. Louis, MO	41	41	41	41
	Tulsa, OK to St. Louis, MO	41	41	41	41
	Colonial - Chattanooga, TN to Knoxville, TN	64	76	64	76
	Chattanooga, TN to Nashville, TN	NA	88	NA	88
	Chattanooga, TN to Nashville, TN	34	34	34	34
	Conoco - Tulsa, OK to El Dorado, KS	24	24	24	24
	Explorer - Tulsa, OK to Wood River,	293	300	293	300
	Wood River, IL to Hammond, IN	293	300	293	300
	Indiana F.B.C. - Mt. Vernon, IN to Jolietville, IN	18	20	18	20
	Jolietville, IN to Peru, IN	7	7	7	7
	Inland - Lima, OH to Columbus, OH	53	58	51	55
	Lima, OH to Dayton, OH	22	25	22	24

TABLE D-2 (Continued)

	PIPELINE DIAMETER *	SUMMER NO. 2 (MB/D)	SUMMER NORMAL MIX (MB/D)	WINTER NO. 2 (MB/D)	WINTER NORMAL MIX (MB/D)
Lima, OH to Dayton, OH	12"	77	85	74	80
Lima, OH to Fostoria, OH	8"	36	40	35	38
Lima, OH to Fostoria, OH	10"	55	61	53	60
Toledo, OH to Fostoria, OH	6"	17	19	16	18
Toledo, OH to Fostoria, OH	10"	67	74	64	61
Cleveland, OH to Magadore, OH	10"	55	61	53	58
Fostoria, OH to Magadore, OH	10"/8"/12"	30	33	28	31
Magadore, OH to Canton, OH	6"/5"	19	21	18	19
Magadore, OH to Akron, OH	5"	14	14	13	13
Kaneb - Arkansas City, KS to El Dorado, KS	8"/10"	38	41	38	41
El Dorado, KS to McPherson, KS	8"	24	27	24	28
McPherson, KS to Geneva, NE	16"	100	107	100	108
Geneva, NE to Phillipsburg, KS	6"	17	18	17	18
Geneva, NE to Yankton, SD	8"	33	38	33	38
Geneva, NE to North Platte, NE	8"	21	24	21	24
Yankton, SD to Wolsey, SD	6"	20	23	20	23
Wolsey, SD to Jamestown, ND	6"	13	15	13	15
Yankton, SD to Milford, IA	6"	13	15	13	15
Shickley, NE to Hutchinson, KS	6"	13	15	13	15
Shickley, NE to Rock Rapids, ND	6"	13	15	13	15
Mapco - Mocane, OK to Conway, KS	8"	NA	2	NA	2
El Dorado, KS to Conway, KS	6"	NA	2	NA	2
Conway, KS to Greenwood, NE	8"	NA	10	NA	10
Greenwood, NE to Whiting, IA	8"	NA	5	NA	5
Whiting, IA to Mason City, IA	6"	NA	4	NA	4
Mason City, IA to Mankato, MN	6"	NA	1	NA	1
Marathon - Robinson, IL to Louisville, KY	16"	62	66	62	66
Robinson, IL to Lima, OH	10"	48	50	48	50
Robinson, IL to Champaign, IL	12"	90	94	90	94
Wood River, IL to Indianapolis, IN	12"	90	94	90	94

TABLE D-2 (Continued)

	<u>PIPELINE DIAMETER *</u>	<u>SUMMER NO. 2 (MB/D)</u>	<u>SUMMER NORMAL MIX (MB/D)</u>	<u>WINTER NO. 2 (MB/D)</u>	<u>WINTER NORMAL MIX (MBD)</u>
Champaign, IL to Chicago, IL	12"	90	94	90	94
Wood River, IL to Indianapolis, IN	10"	48	50	48	50
Griffith, IN to Muskegan, MI	10"	30	36	30	36
Hammond, IN to Niles, MI	6"	10	12	10	12
NCRA - McPherson, KS to Irvington, NE	6"	13	16	13	16
Ohio River - Canton, OH to Heath, OH	8"	28	32	26	30
Heath, OH to Dayton, OH	6"	17	20	16	18
Heath, OH to Findlay, OH	10"/8"	18	22	15	21
Canton, OH to Rodgers, OH	8"	36	40	33	37
Phillips - Kansas City, MO to E. St. Louis, MO	12"	97	110	99	111
E. St. Louis, MO to E. Chicago, IN	8"	16	18	17	18
Plantation - Chattanooga, TN to Knoxville, TN	8"	34	45	34	45
Shell - Wood River, IL to Lima, OH	8"	NA	18	NA	18
Wood River, IL to Lima, OH	12"	NA	71	NA	71
Wood River, IL to Des Plaines, IL	14"	NA	103	NA	103
Sohio - Cleveland, OH to Magadore, OH	6"	NA	15	NA	15
Magadore, OH to Niles, OH	8"	25	27	24	26
Dayton, OH to Cincinatti, OH	8"/6"	39	43	38	40
Sun - Toledo, OH to Fostoria, OH	8"	NA	38	NA	38
Fostoria, OH to Hudson, OH	8"	NA	38	NA	38
Hudson, OH to Boardman, OH	10"	NA	38	NA	38
Toledo, OH to Inkster, MI	10"/6"	NA	14	NA	14
Toledo, OH to Inkster, MI	8"	NA	31	NA	31
Toledo, OH to Inkster, MI	8"	NA	31	NA	31
Inkster, MI to Marysville, MI	2-8"/8"	NA	20	NA	20
Texaco - Lawrenceville, IL to Mt. Vernon, IN	10"	12	13	12	13

D-40

TABLE D-2 (Continued)

	PIPELINE DIAMETER *	SUMMER NO. 2 (MB/D)	SUMMER NORMAL MIX (MB/D)	WINTER NO. 2 (MB/D)	WINTER NORMAL MIX (MB/D)
Texas Eastern - Cape Girardeau, MO to Seymour, IN	16"	94	113	94	113
Cape Girardeau, MO to Seymour, IN	20"	186	225	186	225
Seymour, IN to Chicago, IL	14"	84	94	84	94
Total - Alma, MI to Bay City, MI	6"	24	26	24	26
Alma, MI to Lansing, MI	6"	12	14	12	13
West Shore - Chicago, IL to Milwaukee, WI	16"	170	180	170	180
Milwaukee, WI to Green Bay, WI	10"	50	55	50	55
Williams - Arkansas City, KS to Ponca City, OK	8"	32	35	30	33
Ponca City, OK to Barnsdall, OK	12"	80	89	76	86
Ponca City, OK to Barnsdall, OK	8"	20	22	19	21
Tulsa, OK to Barnsdall, OK	12"	77	86	74	83
Tulsa, OK to Heyworth, IL	12"	36	38	35	37
Oklahoma City, OK to Cushing, OK	8"	26	29	24	25
Barnsdall, OK to El Dorado, KS	16"	86	96	83	93
Barnsdall, OK to Kansas City, MO	8"	29	32	27	30
Barnsdall, OK to Kansas City, MO	12"	77	86	75	82
Barnsdall, OK to Kansas City, MO	12"	79	89	77	86
Kansas City, MO to Columbia, MO	8"	24	27	23	25
Columbia, MO to Palmyra, MO	8"	11	12	10	11
Columbia, MO to St. Charles, MO	8"	20	22	19	21
Cushing, OK to Tulsa, OK	8"	28	31	26	29
Kansas City, MO to Des Moines, IA	12"	78	87	76	84
Des Moines, IA to Mason City, IA	12"	71	79	69	77
Des Moines, IA to Mason City, IA	12"	71	79	69	76
Mason City, IA to Mineapolis, MN	12"	71	79	69	77
Des Moines, IA to Iowa City, IA	12"	69	76	67	74
Grinnel Jct., IA to Waterloo, IA	8"	19	21	17	20
Iowa City, IA to Middleburg Jct., IA	8"	23	25	22	24
El Dorado, KS to Humboldt, KS	8"	26	29	24	27
Humboldt, KS to Springfield, MO	8"	31	34	30	33

TABLE D-2 (Continued)

	PIPELINE DIAMETER*	SUMMER NO. 2 (MB/D)	SUMMER NORMAL MIX (MB/D)	WINTER NO. 2 (MB/D)	WINTER NORMAL MIX (MB/D)
El Dorado, KS to Kansas City, KS	10"	41	46	38	43
El Dorado, KS to Des Moines, IA	16"	92	102	89	98
Enid, OK to Ponca City, OK	6"	14	16	13	15
Enid, OK to Oklahoma City, OK	6"	9	10	8	9
Humboldt, KS to El Dorado, KS	10"/8"	21	22	20	21
Kansas City, KS to Sioux Falls, SD	(8",12")/12"	54	60	52	58
Independence, KS to Humboldt, KS	10"	28	32	27	31
Minneapolis, MN to Duluth, MN	8"	20	22	19	21
Minneapolis, MN to Wausau, WI	8"	20	22	19	21
Sioux Falls, SD to Alexandria, MN	8"	22	24	21	22
Marshall, MN to Watertown, SD	6"	10	11	10	11
Nebraska City, NE to Doniphan, NE	8"	25	28	24	26
Willmar, MN to Alexandria, MN	12"	47	52	45	49
Rosemount, MN to Willmar, MN	12"	47	52	45	49
Rosemount, MN to Rochester, MN	8"	14	15	13	14
Roland, IA to Fort Dodge, IA	6"	10	11	9	10
Alexandria, MN to Grand Forks, ND	6"	22	22	19	21
Albert Lea, MN to Mankato, MN	6"	13	14	13	14
Wolverine - Joliet, IL to Niles, MI	16"	172	172	172	172
Joliet, IL to Niles, MI	16"	80	80	80	80
Niles, MI to Grand Haven, MI	8"	25	25	25	25
Niles, MI to Freedom Jct., MI	16"	172	172	172	172
Freedom Jct., MI to Toledo, OH	16"	52	52	52	52
Freedom Jct., MI to Detroit, MI	16"	120	120	120	120
PADD III					
American Petrofina - Big Springs, TX to Wichita Falls, TX	8"	17	19	17	19
Arco - Admore, OK to Drumright, OK	8"/12"	NA	25	NA	25
Ardmore, OK to Kenneth, KS	8"	NA	26	NA	25

TABLE D-2 (Continued)

	PIPELINE DIAMETER *	SUMMER NO. 2 (MB/D)	SUMMER NORMAL MIX (MB/D)	WINTER NO. 2 (MB/D)	WINTER NORMAL MIX (MB/D)
Kenneth, KS to Kansas City, KS	8"	NA	28	NA	27
Kenneth, KS to Carrollton, MO	8"	NA	22	NA	21
Carrollton, MO to Chicago, IL	8"	NA	18	NA	17
Carrollton, MO to Wood River, IL	8"	NA	11	NA	11
Chicago, IL to Toledo, OH	8"	NA	33	NA	32
Toledo, OH to Marion, OH	6"	NA	17	NA	16
Marion, OH to Clinton, OH	6"	NA	16	NA	15
Clinton, OH to Brecksville, OH	4"	NA	5	NA	5
Clinton, OH to Youngtown, OH	6"	NA	16	NA	15
Youngstown, OH to Steubenville, OH	6"	NA	14	NA	13
Coastal - Corpus Christi, TX to McAllen, TX	4",6"	NA	6	NA	6
Corpus Christi, TX to San Antonio, TX	6"/10"/12"	NA	28	NA	28
Corpus Christi, TX to Houston, TX	12"	85	100	85	100
Collins - Mereaux, LA to Collins, MS	16"	145	151	140	148
Colonial - Houston TX to Baton Rouge, LA	40"	NA	1320	NA	1320
Houston, TX to Baton Rouge, LA	36"	960	960	960	960
Baton Rouge, LA to Oxford, AL	36"	NA	1224	NA	1224
Baton Rouge, LA to Oxford, AL	36"	960	960	960	960
Pelham, AL to Birmingham, AL	10",8"	144	144	144	144
Conoco - Greenville, TX to Mt. Pleasant, TX	6"	14	14	14	14
Greenville, TX to Dallas, TX	6"	14	14	14	14
Explorer - Lake Charles, LA to Port Arthur, TX	12"	89	96	89	96
Port Arthur, TX to Houston, TX	28"	444	477	444	477
Houston, TX to Greenville, TX	28"	444	477	444	477
Greenville, TX to Dallas, TX	12"	110	117	110	117
Exxon - Baytown, TX to Dallas, TX	8"	37	40	35	38
Baytown, TX to Luling, TX	8"	26	28	25	27

D-43

TABLE D-2 (Continued)

	PIPELINE DIAMETER *	SUMMER NO. 2 (MB/D)	SUMMER NORMAL MIX (MB/D)	WINTER NO. 2 (MB/D)	WINTER NORMAL MIX (MBD)
Luling, TX to San Antonio, TX	6"	22	24	21	23
Luling, TX to Austin, TX	6"	18	20	17	19
Marathon - Garyville, LA to Baton Rouge, LA	20"	236	273	236	273
Texas City, TX to Pasadena, TX	16"	152	162	152	162
Mobil - Corpus Christi, TX to San Antonio, TX	4"	5	6	5	6
Beaumont, TX to Houston, TX	8"/6"	20	25	20	25
Beaumont, TX to Hearne, TX	12"	76	93	76	93
Beaumont, TX to Waskom, TX	8"	13	17	13	18
Navajo - Artesia, NM to El Paso, TX	6"	10	12	9	11
Artesia, NM to El Paso, TX	8"	26	34	26	34
Phillips - Borger, TX to Amarillo, TX	8"	22	25	23	26
Missouri City, TX to Pasadena, TX	18"	114	127	118	132
Missouri City, TX to Pasadena, TX	12"	94	94	98	98
Plantation - Baton Rouge, LA to Collins, MS	18"	143	190	143	190
Baton Rouge, LA to Collins, MS	18"	140	156	140	156
Baton Rouge, LA to Collins, MS	12"	59	79	59	79
Pascagoula, MS to Collins, MS	12"	63	84	63	84
Pascagoula, MS to Collins, MS	12"	61	68	61	68
Collins, MS to Helena, AL	18"	74	82	74	82
Collins, MS to Helena, AL	18"	74	82	74	82
Collins, MS to Helena, AL	30"	297	396	297	396
Helena, AL to Birmingham, AL	10"	39	43	39	43
Helena, AL to Birmingham, AL	8"	38	51	38	51
Helena, AL to Montgomery, AL	8"	32	35	32	35
Helena, AL to Oxford, AL	18"	148	164	148	164
Helena, AL to Oxford, AL	30"	297	396	297	396
Seadrift - Markham, TX to Seadrift, TX	4"	5	6	5	6
Beaumont, TX to Houston, TX	8"/6"	20	25	20	25

D-44

TABLE D-2 (Continued)

	<u>PIPELINE DIAMETER *</u>	<u>SUMMER NO. 2 (MB/D)</u>	<u>SUMMER NORMAL MIX (MB/D)</u>	<u>WINTER NO. 2 (MB/D)</u>	<u>WINTER NORMAL MIX (MBD)</u>
Beaumont, TX to Hearne, TX	12"	76	93	76	93
Beaumont, TX to Waskom, TX	8"	13	17	13	18
Seagull - Mt. Belvieu, TX to Port Arthur, TX	8"	NA	25	NA	25
Mt. Belvieu, TX to Port Arthur, TX	8"	NA	25	NA	25
Port Arthur, TX to Mt. Belvieu, TX	6"	NA	12	NA	12
Sour Lake, TX to Mt. Belvieu, TX	8"	NA	30	NA	30
Mt. Belvieu, TX to Houston, TX	6"	NA	12	NA	12
Mt. Belvieu, TX to Houston, TX	8"	NA	30	NA	30
Shamrock - McKee, TX to Amarillo, TX	8"	34	37	34	37
Amarillo, TX to Abernathy, TX	6"	21	24	20	22
Abernathy, TX to Lubbock, TX	6"	9	9	8	9
McKee, TX to Dallas, TX	8"	23	27	23	27
Shell - Odessa, TX to El Paso, TX	6"	NA	15	NA	14
Norco, LA to Baton Rouge, LA	12"	NA	110	NA	110
Norco, LA to Garyville, LA	24"	190	190	190	190
Norco, LA to New Orleans, LA	8"	NA	28	NA	28
Norco, LA to Sorrento, LA	6"	NA	15	NA	15
Yclosky, LA to Norco, LA	10"	NA	88	NA	88
Sigmor - Three Rivers, TX to Corpus Christi, TX	6"	13	17	13	17
Three Rivers, TX to San Antonio, TX	8"	28	36	28	36
Sohio - Alliance, LA to Collins, MS	20"	204	220	196	210
Sun - Ft. Smith, AR to Little Rock, AR	12"	48	48	48	48
McRae, AR to W. Mephis, AR	12"	48	53	48	53
Texaco - McKee, TX to Amarillo, TX	6"	16	16	16	16
Convent, LA to Baton Rouge, LA	16"	207	212	207	212
Hearne, TX to Austin, TX	8"	21	21	21	21
Austin, TX to San Antonio, TX	6"	10	10	10	10
Hearne, TX to Dallas, TX	10"	48	48	48	48

TABLE D-2 (Continued)

	<u>PIPELINE DIAMETER *</u>	<u>SUMMER NO. 2 (MB/D)</u>	<u>SUMMER NORMAL MIX (MB/D)</u>	<u>WINTER NO. 2 (MB/D)</u>	<u>WINTER NORMAL MIX (MB/D)</u>
Texas Eastern - Texas City, TX to Baytown, TX	8"	68	79	68	79
Baytown, TX to Beaumont, TX	16"	121	161	121	61
Baytown, TX to Beaumont, TX	20"	192	220	192	220
Beaumont, TX to El Dorado, AR	16"	91	110	91	110
Beaumont, TX to El Dorado, AR	20"	179	220	179	220
El Dorado, AR to McRae, AR	16"	94	113	94	113
El Dorado, AR to McRae, AR	20"	186	225	186	225
Tyler, TX to El Dorado, AR	8"	21	28	21	28
El Dorado, AR to Helena, AR	10"	31	42	31	42
El Dorado, AR to Arkansas City, AR	10"	23	28	23	28
Ucar - Texas City, TX to Taft, LA	6"/10"/8"	NA	37	NA	37
West Emerald - Amarillo, TX to Albuquerque, NM	6"	16	17	15	16
PADD IV					
Chevron - Salt Lake City, UT to Idaho, ID	2-8"	64	64	64	64
Idaho, ID to Pocatello, ID	8"	NR	NR	NR	NR
Idaho, ID to Boise, ID	2-8"	64	64	64	64
Conoco - Billings, MT to Casper, WY	8"	34	34	34	34
Farmers Union - Laurel, MT to Glendive, MT	8"	25	25	25	25
Phillips - LaJunta, CO to Denver, CO	8"	36	39	37	41
Pioneer - Casper, WY to Salt Lake City, UT	8"	34	34	34	34
Wyco - Casper, WY to Mule Creek, WY	6"/8"	11	13	11	13
Casper, WY to Denver, CO	8"/10"	42	54	42	54

TABLE D-2 (Continued)

	<u>PIPELINE DIAMETER*</u>	<u>SUMMER NO. 2 (MB/D)</u>	<u>SUMMER NORMAL MIX (MB/D)</u>	<u>WINTER NO. 2 (MB/D)</u>	<u>WINTER NORMAL MIX (MB/D)</u>
Yellowstone - Billings, MT to Bozeman, MT	10"	60	60	60	60
Bozeman, MT to Missoula, MT	10"	56	56	56	56
Helena, MT to Great Falls, MT	6"	14	14	14	14
PADD V					
Calnev - Colton, CA to Las Vegas, NV	8"	NA	19	NA	19
Colton, CA to Las Vegas, NV	12"	55	65	55	65
George AFB, CA to Edwards AFB, CA	6"	NA	12	NA	12
Chevron - Ontario, OR to Pasco, WA	8"	17	17	17	17
Pasco, WA to Spokane, WA	8"	14	14	14	14
Richmond, CA to San Jose, CA	10"/8"	16	16	16	16
Pittsburg, CA to Sacramento, CA	8"	12	12	12	12
Olympic - Ferndale, WA to Mt. Vernon, WA	16"	155	180	155	180
Mt. Vernon, WA to Tacoma, WA	14"	119	171	119	171
Tacoma, WA to Portland, OR	14"	103	131	103	131
San Diego - Watson, CA to San Diego, CA	16"	103	111	103	111
Shell - Wilmington, CA to Ventura, CA	8"/4"	NA	15	NA	15
Southern Pacific - Bakersfield, CA to Fresno, CA	8"	23	28	23	28
Concord, CA to Fresno, CA	12"	42	55	42	55
Concord, CA to San Jose, CA	10"	56	68	56	68
Concord, CA to Stockton, CA	10"	65	72	65	72
Concord, CA to Sacramento, CA	14"	122	128	122	128
Sacramento, Ca to Reno, NV	12"/10"	34	38	34	38
Stockton, CA to Atwater/Castle AFB, CA	8"	12"	15	12	15
Richmond, CA to Concord, CA	4-8"	176	220	176	220
Richmond, CA to Oakland, CA	12"	65	76	65	76

TABLE D-2 (Continued)

	<u>PIPELINE DIAMETER</u> *	<u>SUMMER NO. 2 (MB/D)</u>	<u>SUMMER NORMAL MIX (MB/D)</u>	<u>WINTER NO. 2 (MB/D)</u>	<u>WINTER NORMAL MIX (MB/D)</u>
Richmond, CA to Oakland, CA	8"	48	59	48	59
Oakland, CA to San Jose, CA	8"	31	38	31	38
Watson, CA to Colton, CA	24"	250	290	250	290
Colton, CA to Phoenix, AZ	20"	104	112	104	112
Phoenix, AZ to Tuscon, AZ	8"	3	7	3	7
Phoenix, AZ to Tuscon, AZ	6"	5	7	5	7
Tucson, AZ to Phoenix, AZ	8"	30	40	30	40
Portland, OR to Eugene, OR	8"	42	49	42	49
Yellowstone - Spokane, WA to Moses Lake, WA	6"	9	9	9	9

* The following symbolic conventions are used in this table:

- / indicates a change of diameter.
- , indicates an additional separate pipeline.
- () indicates that the reader should interpret the symbols inside the parenthesis first.
- N - X" indicates N multiple pipelines of X" diameter.

TABLE D-3

STATUS OF PRINCIPAL PETROLEUM PRODUCT EXPANSION PROJECTS PLANNED OR UNDER CONSTRUCTION IN 1979
AS REPORTED IN 1979 NPC SURVEY

<u>Pipeline Company</u>	<u>Project* Number</u>	<u>Location</u>	<u>Type of Expansion</u>	<u>Miles</u>	<u>Diameter (Inches)</u>	<u>Present Capacity (MB/D)</u>	<u>Approximate Anticipated Capacity (MB/D)</u>	<u>Completed</u>
Badger	26	System, IL and WI	Horsepower	0	-	90	120	Yes
Calnev	27	Hinkle, Umatilla County OR to Columbia River Barge Terminal OR	New Line	10	4	-	6	Yes
Collins	28	Meraux LA to Collins MS	New Stations	-	-	100	125	Yes
Colonial	29	Houston (Pasadena) TX to Hebert TX	Loop Line	80	40	1,920	2,296	Yes
	30	Port Arthur TX to Hebert TX	Loop Line	8	36	-	-	
	31	Greensboro NC to Mitchell Jct. VA	Loop Line	148	36	960	1,320	Yes
	32	Helena AL to Birmingham AL	New Line	12	16	-	127	Yes
	33	Atlanta GA to Chatanooga TN	Loop Line	92	16	238	252	Yes
	34	Mitchell Jct. VA to Roanoke VA	Replace 8"	42	12	34	51	Yes
	35	Dorsey MD to Woodbury NJ	Horsepower	-	-	768	960	Yes
	36	Mitchell Jct. VA to Richmond VA	Horsepower	-	-	125	240	Yes
	37	Belton Jct. SC to Augusta GA	Horsepower	-	-	27	45	Yes
	38	Atlanta GA to Bainbridge GA	Horsepower	-	-	60	72	Yes
Explorer	39	Port Neches TX to Port Arthur TX	Loop Line	8	14	101	190	Yes
	40	Port Arthur TX & Pasadena TX to Tulsa OK	Horsepower	-	28	380	440	Yes
Chevron	41	Mesquite Line-Lucas TX to Lufkin TX	Horsepower	-	-	55	63	
Enron	42	Bushton KS to Dearborn MO	New Line	230	10	-	35	
Laurel	43	Extension of existing El Dorado PA to Dancan- ville 12" lateral to connect new term. in PA	Lateral	1	12	-	-	Yes

TABLE D-3 (Continued)

<u>Pipeline Company</u>	<u>Project* Number</u>	<u>Location</u>	<u>Type of Expansion</u>	<u>Miles</u>	<u>Diameter (Inches)</u>	<u>Present Capacity (MB/D)</u>	<u>Approximate Anticipated Capacity (MB/D)</u>	<u>Completed</u>
Marathon	44	Garyville LA to Baton Rouge LA	Horsepower	-	-	150	280	Yes
Mid America (LPG)	45	Sanborn IA to Mankato MN	New Line	93	8	42	54	Yes
Phillips	46	Sweeney TX to Pasadena TX	New Line	60	18	-	158	Yes
Plantation	47	Austell GA to Atlanta Airport GA	Replacement	12	12	-	67	Yes
	48	Clanton AL to Helena AL to Montgomery AL	Horsepower	-	-	-	40	Yes
Shamrock	49	McKee Refinery near Borger TX to Dallas/ Ft. Worth TX area	New Line	363	8	-	15	Yes
Southern Pacific	50	Norwalk CA to Colton CA	New Line	32	20	247	300	Yes
Sun	51	Fostoria OH to Hudson OH Addition of pump sta- tions in Seneca and Media Counties OH	New Stations	-	-	30	47	Yes
Texas Eastern	52	Baytown TX to Seymour IN	Loop Line	-	16	-	360	
Transgulf	53	Baton Rouge LA to Kissimmee FL	Conversion of Gas Line and Looping	-	24	-	240	Cancelled
	54	Kissimmee FL to Port Everglades FL	Conversion of Gas Line and Looping	-	20	-	70	Cancelled
	55	24" Line to Jacksonville FL	New Line	-	20	-	130	Cancelled
Williams	56	Minneapolis MN to Wausau MN	Horsepower	-	8	26	34	Yes

* Corresponds to project number on Table 3 of the NPC's 1988 Survey of U.S. Petroleum Pipeline Capacities.

TABLE D-4

OTHER PRINCIPAL PRODUCT EXPANSION PROJECTS COMPLETED BETWEEN 1/1/79 and 12/31/87

(0 may indicate that no data were provided)

<u>Pipeline Company</u>	<u>Location</u>	<u>Type of Expansion</u>	<u>Miles</u>	<u>Diameter (Inches)</u>	<u>Present Capacity (MB/D)</u>	<u>Approximate Anticipated Capacity (MB/D)</u>	<u>Completion Date</u>
Amoco	Wood River IL to LaPlata/Freeman MO	Conversion	307	12	45	0	12/01/86
	Manhattan IL to LaPlata MO	Conversion	269	12	45	0	12/01/86
Atlantic	Atlantic PA	New Line	1	10	0	0	03/01/85
	Atlantic PA	Conversion	3	16	96	0	03/01/85
Buckeye	Lawrenceville IL to Robinson IL	New Line	22	10	38	0	07/31/80
	Findlay OH to Cygnet OH	Replacement	14	12	60	0	08/31/81
Colonial	Mitchell VA to Dorsey MD	Loop Line	142	36	0	0	12/31/80
	Pasadena TX to Greensboro NC	Horsepower	0	0	0	0	12/31/80
	Greensboro NC to Dorsey MD	Horsepower	0	0	0	0	12/31/80
	Atlanta Jct. GA	Horsepower	0	0	0	0	12/31/80
	Port Arthur TX to Hebert TX	Horsepower	0	0	0	0	12/31/80
	Atlanta GA to Bainbridge GA	Horsepower	0	0	0	0	12/31/80
	Atlanta GA to Nashville TN	Horsepower	0	0	0	0	12/31/80
	Linden NJ	Horsepower	0	0	0	0	12/31/80
	Mitchell VA to Norfolk VA	Horsepower	0	0	0	0	12/31/80
	Mitchell VA to Roanoke VA	Horsepower	0	0	0	0	12/31/80
	Dorsey MD to Curtis Bay MD	Loop Line	32	12	0	0	12/31/81
	Finksburg MD to Washington DC	New Line	8	8	0	0	12/31/81
	Krotz Springs LA	Injection Fac.	0	0	0	0	12/31/81
	Baltimore MD to BWI Airport MD	New Line	1	8	0	0	12/31/81
	Ben Hill GA to Atlanta GA	New Line	6	8	0	0	12/31/82
	Moundville Station AL	Injection Fac.	0	0	0	0	12/31/84
	Montezuma GA to Americus GA	Loop Line	28	12	0	0	12/31/85

TABLE D-4 (Continued)

<u>Pipeline Company</u>	<u>Location</u>	<u>Type of Expansion</u>	<u>Miles</u>	<u>Diameter (Inches)</u>	<u>Present Capacity (MB/D)</u>	<u>Approximate Anticipated Capacity (MB/D)</u>	<u>Completion Date</u>
Colonial	Suffolk VA to Portsmouth VA	New Line	7	12	0	0	12/31/85
	Americus GA to Albany GA	Loop Line	28	12	0	0	12/31/86
	Ben Hill GA to Americus GA	Line Sold	144	8	0	0	12/31/86
	Charlotte NC to Airport	New Line	6	8	0	0	12/31/87
	Apex NC to Raleigh-Durham NC	New Line	12	8	0	0	12/31/87
Conoco	Pilot Butte P.S. WY	Horsepower	177	8	36	37	08/03/87
	Ponca City OK to Oklahoma City OK	New Station	94	8	36	49	05/20/84
	Lake Charles Gas LA to Colonial	Horsepower	1	36	1,200	1,248	04/18/79
	Lake Charles Dist. LA to Colonial	Horsepower	0	36	1,200	1,152	04/18/79
	Lakes Charles LA	New Receipt Manifold	0	12	0	204	08/22/80
	Lake Charles Dist. LA to Colonial	Horsepower	1	36	1,248	1,392	05/09/81
	Caddo Mills TX to Mt. Pleasant TX	New Station	71	6	8	14	08/05/85
	Caddo Mills TX to Grapevine TX	New Station	58	6	8	14	02/05/86
	Amarillo TX to Abernathy TX	Horsepower	0	0	0	0	09/01/84
	Amarillo Pump Station TX	Horsepower	0	0	0	0	09/01/84
Diamond Shamrock	McKee Refinery TX to Amarillo TX	New Line	48	6	0	0	03/01/86
	Amarillo TX to Palo Duro P.S. TX	Horsepower	0	0	0	0	09/01/84
	McKee Refinery TX to Amarillo TX	New Line	48	8	0	0	03/01/86
	Trans TX P.L. Belvieu TX	Horsepower	0	0	9	0	11/01/84

TABLE D-4 (Continued)

<u>Pipeline Company</u>	<u>Location</u>	<u>Type of Expansion</u>	<u>Miles</u>	<u>Diameter (Inches)</u>	<u>Present Capacity (MB/D)</u>	<u>Approximate Anticipated Capacity (MB/D)</u>	<u>Completion Date</u>
Diamond Shamrock	Trans TX Russel P.S. OK	Horsepower	0	0	0	0	07/01/82
	Pettus P.S. TX to Coastal TX	New Line	1	8	0	0	01/01/85
	Three Rivers to Corpus Christi TX	Acquisition	3	8	0	0	01/01/83
	Three Rivers to Corpus Christi TX	Acquisition	59	6	0	0	01/01/83
	Three Rivers to San Antonio TX	Acquisition	69	8	0	0	01/01/83
	Champlin Sigmores TX P.O. Sold	Sale of P.L.	2	6	0	0	11/11/85
	Denver Stapleton Airport CO	New Line	1	8	0	0	02/01/85
	Southlake P.L. Justin Terminal TX	New Terminal	0	0	0	0	06/01/82
	Southlake P.L. Russel P.S. OK	Horsepower	0	0	0	0	07/01/82
	Southlake to Altus AFB OK	New Line	10	8	0	0	08/01/85
	NWPRT TX & Russel P.S. TX	Horsepower	0	0	0	0	10/01/85
	Tucumcari Terminal NM add - 100 HP	Horsepower	0	0	0	0	06/01/87
	Explorer Tulsa OK to Hammon IN	De-bottlenecking	403	24	300	300	01/01/87
	Explorer Dallas-Ft. Worth TX Area	New Station	74	12	117	117	01/01/86
	Marathon Velsicol Jct., Marshall IL		0	6	0	0	
Marathon Hammond IN to Niles MI	Purchase Existing Line	84	6	0	0	10/01/85	
Marathon Zachary Station LA	Horsepower	1	36	1,200	1,200	08/20/79	
Marathon Plantation Stations LA	Horsepower	0	16	192	192	10/31/82	
Marathon Pasadena Station TX	Horsepower	0	0	1,200	1,200	04/10/80	
Marathon Pasadena Station TX	Horsepower	0	16	0	0	06/08/80	
Marathon Garyville LA Products Station	Horsepower	0	16	273	273	07/31/80	

TABLE D-4 (Continued)

<u>Pipeline Company</u>	<u>Location</u>	<u>Type of Expansion</u>	<u>Miles</u>	<u>Diameter (Inches)</u>	<u>Present Capacity (MB/D)</u>	<u>Approximate Anticipated Capacity (MB/D)</u>	<u>Completion Date</u>
Mid-Continent	Shawnee OK	New Line	5	3	2	0	09/01/86
Navajo	Artesia NM	New Line	40	8	34	0	07/01/81
N. Rockies	Guernsey WY	New Line	16	6	3	3	01/10/79
	Amarillo TX	New Line	3	4	2	2	
Ohio River	East Sparta OH to Harpster	Remove from Service	203	8	0	0	06/01/85
	East Sparta OH to Heath	New Line	81	8	32	0	09/27/82
Olympic	Olympia WA and Castle Rock WA	DRA Injection	0	0	131	0	06/01/88
Phillips P.L.	Freeport TX to Cushing OK	Sold	500	30	0	0	01/01/80
	Paola KS to Kansas City KS	Sold	53	6	0	0	01/01/83
	Cushing OK to Yale OK	Sold	60	6	0	0	01/01/83
	Borger TX to Paola KS	New Line	416	16	92	98	09/01/81
Plantation	Austell GA to Atlanta GA Airport	Abandonment of 6" P.L.	0	6	0	0	06/30/79
	Clanton AL	New Station	0	0	0	0	10/31/79
	Newington VA	Horsepower	0	0	0	0	05/31/80
	Charlotte NC to Airport	New Line	4	6	0	13	09/30/83
	Salisbury NC	Shut down Delivery Term.	0	0	0	0	02/28/83
	Petal MS	New Line	5	8	0	46	08/31/83
	Cleveland TN	New Station	0	0	0	0	12/15/85
	Loudon TN	New Station	0	0	0	0	12/15/85
	Richmond VA	New Line	13	14	0	109	06/30/86
	Richmond VA	Abandonment of 8" Spur	13	8	0	0	11/30/86
	Bremen GA to Austell GA	New Line	28	12	0	65	09/25/87
Southern Pacific	Concord CA to Brentwood Junction CA	New Line	26	12	0	55	07/09/86

TABLE D-4 (Continued)

<u>Pipeline Company</u>	<u>Location</u>	<u>Type of Expansion</u>	<u>Miles</u>	<u>Diameter (Inches)</u>	<u>Present Capacity (MB/D)</u>	<u>Approximate Anticipated Capacity (MB/D)</u>	<u>Completion Date</u>	
Southern Pacific	Sacramento CA to Roseville CA	New Line	23	12	114	128	10/07/87	
	Colton CA to Phoenix AZ	Loop Line	100	20	96	112	10/06/85	
	Brentwood CA to Fresno CA	New Line	65	12	30	55	12/31/84	
	SPDC North, South, and Central Loops CA	Loop Line	63	6	103	112	12/15/85	
	Roseville CA to Reno NV	Loop Line	10	10	30	38	10/27/86	
	Norwalk CA to Nogales St. CA	New Line	17	24	290	290	04/30/86	
	Elmira Station CA	New Station	128	0	90	105	03/10/82	
	Morgan Station OR	New Station	49	0	34	49	04/23/85	
	Fargo Station OR	New Station	49	0	34	49	04/23/85	
	Feather Station CA	New Station	36	0	28	36	06/02/87	
	Sun Pipe Line	Oklahoma City OK	Conversion	0	0	0	0	12/31/86
		Tremeley Point NJ - Spur Line to Buckeye	New Line	1	12	128	0	05/01/82
		Tremeley Point NJ Mogadore, OH -	New Line	1	12	128	0	12/01/81
		Spur Line to Sohio Indianapolis - Alleghany Co. PA - Spur Line	New Line	1	6	14	0	09/30/79
Pitt Oil		New Line	2	8	21	0	03/01/80	
Lowell OH		New Station	0	0	38	0	09/01/80	
Medina OH		New Station	0	0	38	0	09/02/80	
Norwalk OH - Increased Horsepower		Horsepower	0	0	38	0	01/01/80	
Fostoria OH - Increased Horsepower		Horsepower	0	0	38	0	09/01/80	
Twin Oaks PA - Increased Horsepower		Horsepower	0	0	128	0	09/01/83	
Bucks County PA		New Station	0	0	128	0	09/01/83	

TABLE D-4 (Continued)

<u>Pipeline Company</u>	<u>Location</u>	<u>Type of Expansion</u>	<u>Miles</u>	<u>Diameter (Inches)</u>	<u>Present Capacity (MB/D)</u>	<u>Approximate Anticipated Capacity (MB/D)</u>	<u>Completion Date</u>
Sun Pipe Line	Tremley Point NJ - Spur Line to Getty	New Line	7	14	128	0	12/01/83
	Newark NJ - Doremus Ave. Spur to Getty	New Line	1	14	128	0	12/01/83
	Twin Oaks PA - Spur Line to Chelsea to Twin Oaks	New Line	2	16	128	0	12/01/80
Tenneco Oil	Meraux LA & Crossroads MS	Horsepower	0	0	125	151	09/01/85
Texas Eastern	Harris Co. TX	New Line	34	8	0	0	02/01/80
	Warren Co. OH	Sold	96	10	0	0	03/01/82
	Dubberly, Webster Parish LA	Sold	0	0	0	0	08/01/86
	Warren, Bradley Co. AR	Retired	0	0	0	0	01/01/87
	Dewitt, Arkansas Co. AR	Retired	0	0	0	0	01/01/87
	Beaumont, Orange Co. TX	New Station	0	0	0	0	09/01/84
	Beaumont Marine, Orange Co. TX	New Dock and Station	0	0	0	0	
Union Pacific	George AFB CA to Edwards AFB CA	New Line	57	6	8	0	
	Colton CA to Las Vegas NV	Reactivation	248	8	19	34	10/01/85
Williams P.L.	Pine Bend MN to Rosemount MN	New Line	8	10	53	0	
	Ponca City OK to Enid OK	Reversal	46	6	16	0	01/01/83
	Willmar MN to Sioux Falls SD	Reversal	142	8	24	0	01/01/86
	Kansas City KS to Olathe KS	Reversal	26	12	86	0	01/01/84
	Des Moines IA to Clear Lake IA	Horsepower	112	6	24	0	01/01/82
	Tulsa OK to Heyworth IL	Conversion	476	12	38	0	01/01/84
	Cushing OK to Oklahoma City OK	Conversion	60	8	29	0	01/01/83
	Enid OK to Oklahoma City OK	New line	80	6	25	0	01/01/84

TABLE D-4 (Continued)

<u>Pipeline Company</u>	<u>Location</u>	<u>Type of Expansion</u>	<u>Miles</u>	<u>Diameter (Inches)</u>	<u>Present Capacity (MB/D)</u>	<u>Approximate Anticipated Capacity (MB/D)</u>	<u>Completion Date</u>	
Williams P.L.	Barnsdall OK to Ponca City OK	Reversal	54	8	22	0		
	Rosemount MN to Alexandria MN	Horsepower	163	12	52	0	01/01/86	
	Des Moines IA to Chicago IL	Decommissioned	305	6	0	0	01/01/86	
	Okmulgee OK to Tulsa OK	Decommissioned	35	6	0	0	01/01/86	
	Nebraska City NE to Sioux Falls SD	Decommissioned	200	8	0	0	01/01/87	
	Tulsa OK to Kansas City KS	Decommissioned	429	8	0	0	01/01/86	
	Humboldt KS to Kansas City KS	Decommissioned	109	8	0	0	01/01/86	
	Tulsa OK to New Perryman OK	Decommissioned	14	8	0	0	01/01/86	
	Verdigris OK to Barnsdall Jct. OK	Decommissioned	35	6	0	0	01/01/88	
	Rosemount MN to Minneapolis MN	Decommissioned	35	6	0	0	01/01/88	
	Kansas City KS to Des Moines IA	Decommissioned	188	8	0	0	01/01/86	
	Kansas City KS to Des Moines IA	Decommissioned	188	8	0	0	01/01/86	
	Neodesha KS to Humboldt KS	Decommissioned	29	6	0	0	01/01/86	
	Clear Lake IA to Cottage Grove MN	Sold	150	18	0	0	01/01/81	
	Wolverine	Romulus and Taylor MI	New Line	1	12	12	12	12/01/87

TABLE D-4 (Continued)

<u>Pipeline Company</u>	<u>Location</u>	<u>Type of Expansion</u>	<u>Miles</u>	<u>Diameter (Inches)</u>	<u>Present Capacity (MB/D)</u>	<u>Approximate Anticipated Capacity (MB/D)</u>	<u>Completion Date</u>
<u>Product/LPG</u>							
Phillips P.L.	McKee TX to Denver CO	New Station	318	8	37	41	10/31/85
	Selected Sections Between McKee TX & Lajunta CO	New Line	55	12	41	43	09/24/87
Sun Pipe Line	Taylor MI - Spur Line to Phillips	New Line	1	6	30	0	12/01/84
Texas Eastern	Many LA	New Station	0	0	0	0	12/01/79
	Newton County TX	New Station	0	0	0	0	12/01/79
	Castor Bienville Parish LA	New Station	0	0	0	0	12/01/79
	Mokean Cook Co. IL	New Line	4	14	0	0	08/01/79
	El Dorado Union Co. AR	New Station	0	0	0	0	12/01/79
	El Dorado Union Co. AR	New Station	0	0	0	0	12/01/79
	Griffin Posey Co. IN	New Station	0	0	0	0	08/01/81
	Griffith Lake Co. IN	New Line	1	16	0	0	09/01/81
	Dexter Stoddard Co. MO	New Station	0	0	0	0	12/01/79
<u>Product/Crude</u>							
Williams P.L.	Des Moines IA to Minneapolis MN	Decommissioned	261	6	0	0	01/01/86
<u>Product/Crude/LPG</u>							
Williams P.L.	Minneapolis MN to Des Moines IA	Reversal	261	12	79	0	01/01/84

APPENDIX E
LPG PIPELINE MAPS AND TABLES

MAPS:	Pages
- National – U.S.	E-1
- Area – Transportation and Refining Centers ...	E-3 - E-8
TABLES:	
- Cross-PADD Capacities	E-9
- Intra-PADD Capacities	E-10 - E-13
- Expansion Projects	
Completed Between 1/1/79 and 12/31/87.....	E-14

LPG AND NGL PIPELINE CAPACITIES
AS OF DECEMBER 31, 1987
(THOUSANDS OF BARRELS DAILY)





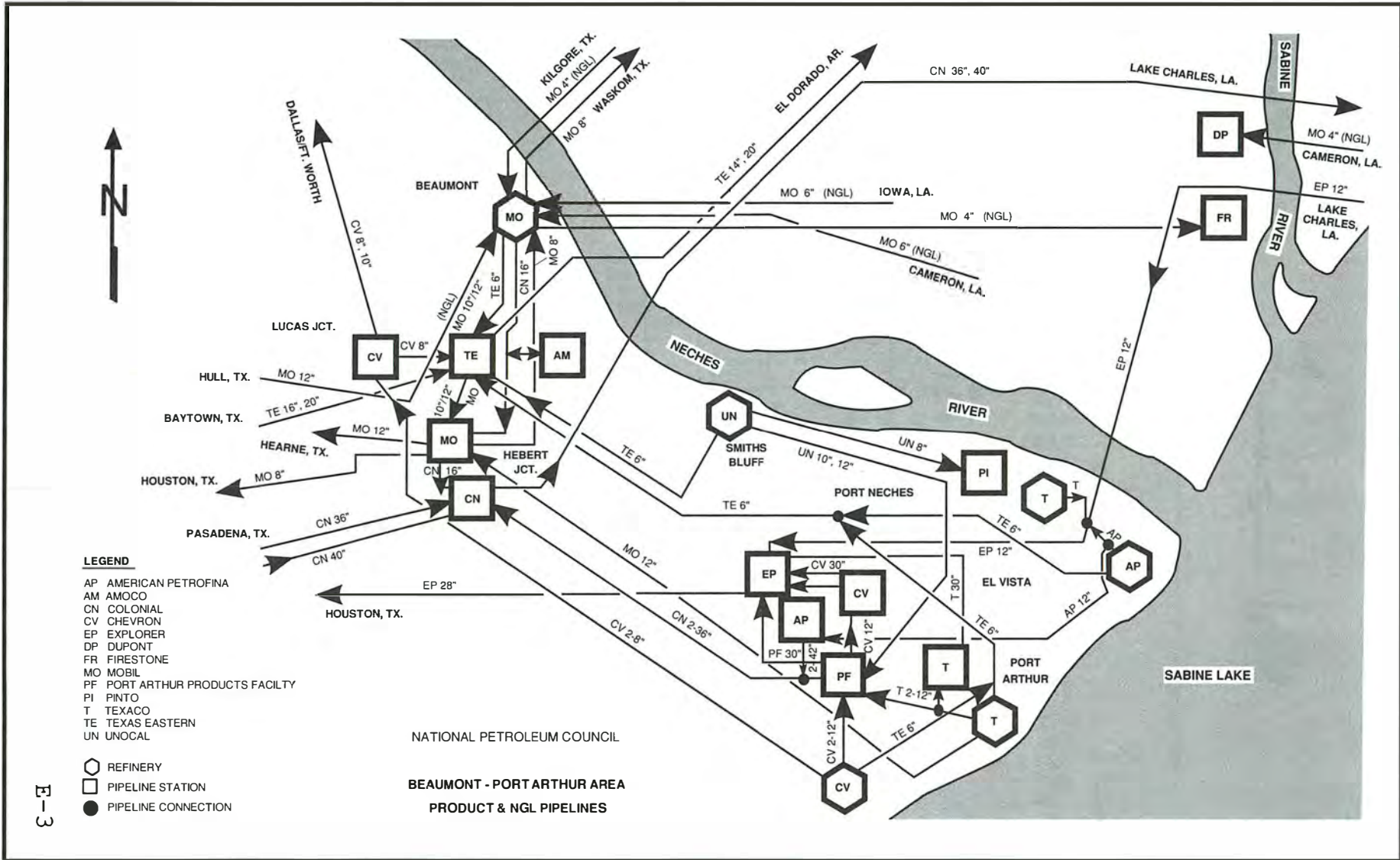

NATIONAL PETROLEUM COUNCIL

- LEGEND**
- FRACTIONATOR GAS PLANT OR REFINERY
 - ⊙ GATHERING SYSTEM
 - ⊠ TERMINAL
 - UNDERGROUND STORAGE
 - LPG & PRODUCTS
 - - - LPG & CRUDE
 - LPG



E-4

LEGEND

- AR A RCO
 - CH CHISOLM
 - CT COASTAL STATES
 - EL EL PASO
 - EM EMPIRE
 - ER ENRON
 - FA FARAL
 - KA KANEB
 - KO KOCH
 - MC MAPCO
 - MO MOBIL
 - NC NAT. COOP. REF. ASSOC.
 - OX OXY NGL INC.
 - PH PHILLIPS
 - SA SENTRY UNDERGROUND STORAGE
 - T TEXACO
 - WM WILLIAMS
 - (SD) SHUT DOWN
-
-  FRACTIONATOR
 -  PIPELINE CONNECTION
 -  PIPELINE STATION
 -  REFINERY
 -  UNDERGROUND STORAGE

NATIONAL PETROLEUM COUNCIL

CONWAY, BUSHTON, HUTCHINSON,
WICHITA, EL DORADO, KS. AREA
LPG - NGL PIPELINES

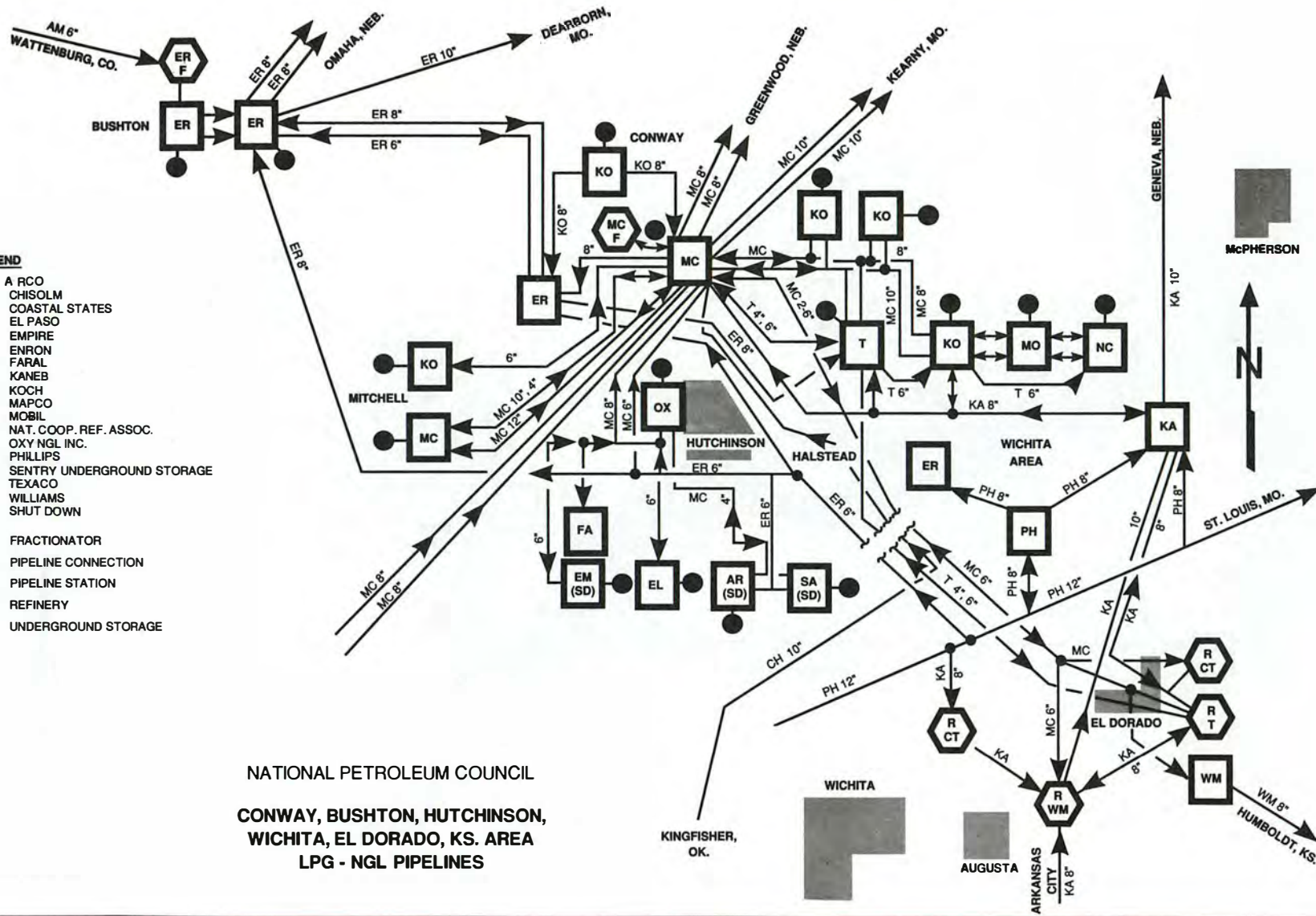

KINGFISHER,
OK.

WICHITA

AUGUSTA

ARKANSAS
CITY
KA 8"

EL DORADO

R CT

R T

WM

PH 8"

PH 8"

PH 8"

PH 8"

PH 8"

PH 8"

PH 8"

PH 8"

PH 8"

PH 8"

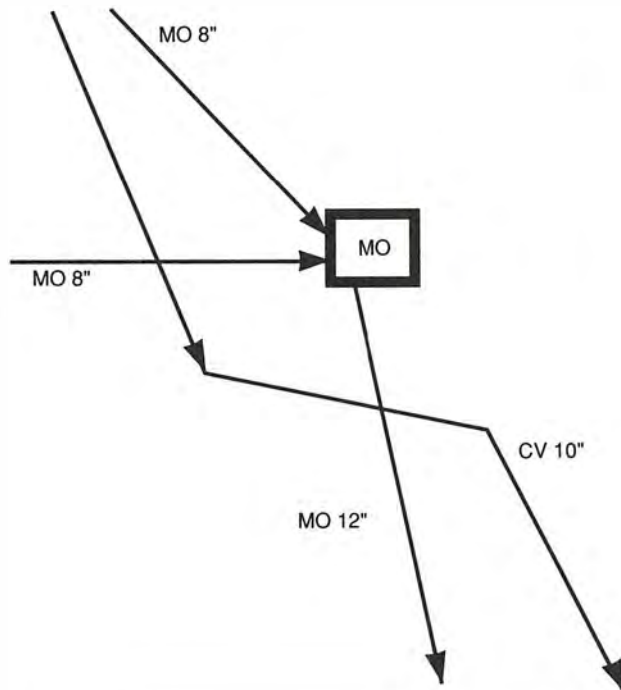

LEGEND

- CV CHEVRON
- MO MOBIL PUMPING STATION
- PIPELINE STATION

NGL PIPELINES

**NATIONAL PETROLEUM COUNCIL
CORNICANA/WORTHAM/TEAGUE AREA**

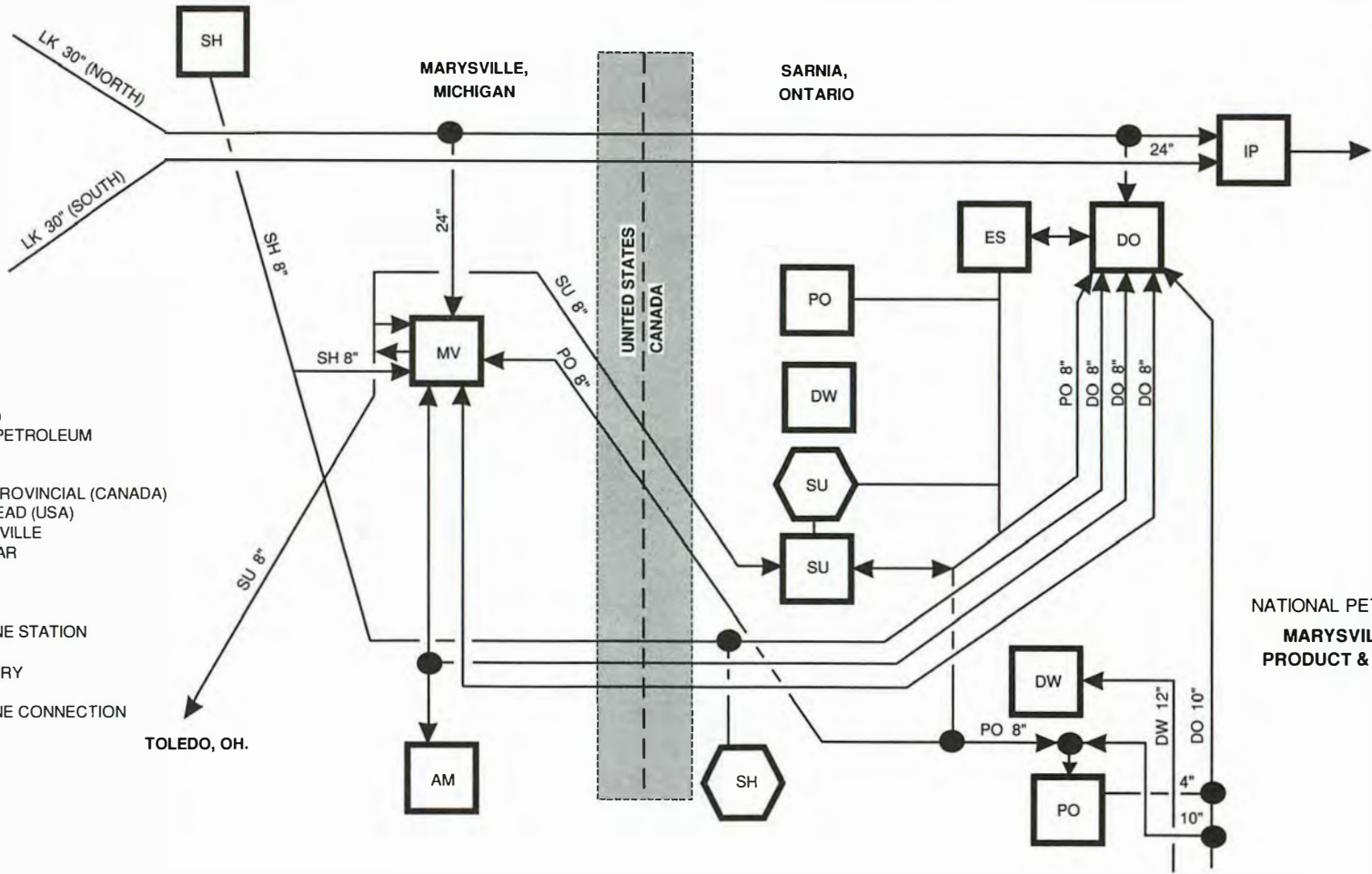

LEGEND

- AM AMOCO
- DO DOME PETROLEUM
- DW DOW
- ES ESSO
- IP INTERPROVINCIAL (CANADA)
- LK LAKEHEAD (USA)
- MV MARYSVILLE
- PO POLYSAR
- SH SHELL
- SU SUN
- PIPELINE STATION
- ⬡ REFINERY
- PIPELINE CONNECTION

NATIONAL PETROLEUM COUNCIL
**MARYSVILLE, MI. AREA
 PRODUCT & LPG PIPELINES**

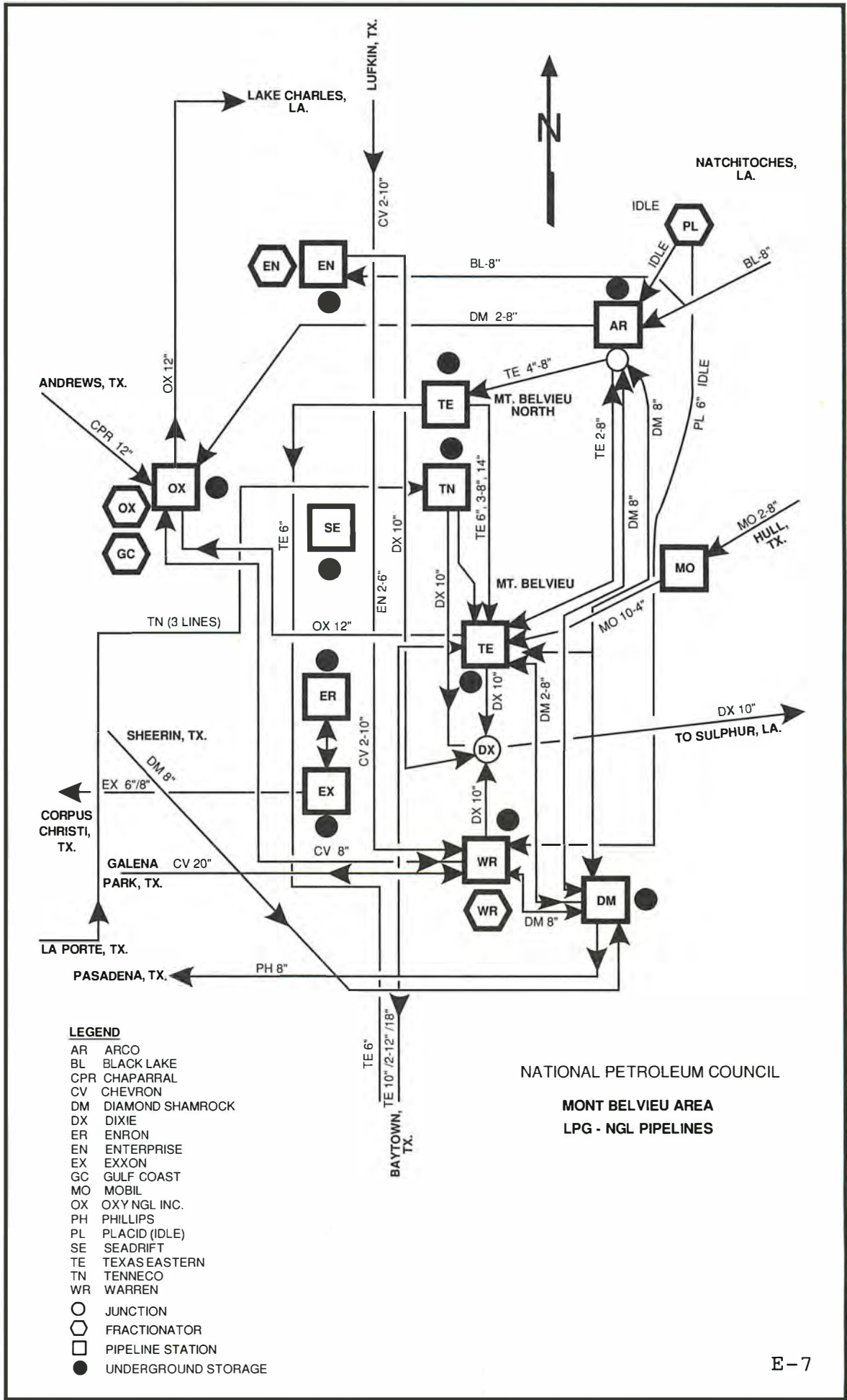

LEGEND

- AR ARCO
- BL BLACK LAKE
- CPR CHAPARRAL
- CV CHEVRON
- DM DIAMOND SHAMROCK
- DX DIXIE
- ER ENRON
- EN ENTERPRISE
- EX EXXON
- GC GULF COAST
- MO MOBIL
- OX OXY NGL INC.
- PH PHILLIPS
- PL PLACID (IDLE)
- SE SEADRIFT
- TE TEXAS EASTERN
- TN TENNECO
- WR WARREN
- JUNCTION
- ⬡ FRACTIONATOR
- PIPELINE STATION
- UNDERGROUND STORAGE

NATIONAL PETROLEUM COUNCIL

**MONT BELVIEU AREA
LPG - NGL PIPELINES**

LEGEND

- A AMERICAN REF. GROUP
- AG AGWAY
- AM AMOCO
- AT ATLANTIC
- BE BUCKEYE
- BO BORON
- BP BRITISH PETROLEUM
- BT BUCKEYE TANK TERMINALS
- EX EXXON
- GU GULF/DIV. OF CUMBERLAND FARMS
- LR LAUREL
- MO MOBIL
- SU SUN
- T TEXACO
- TE TEXAS EASTERN
- TG TIOGA

□ PIPELINE STATION

● PIPELINE CONNECTION

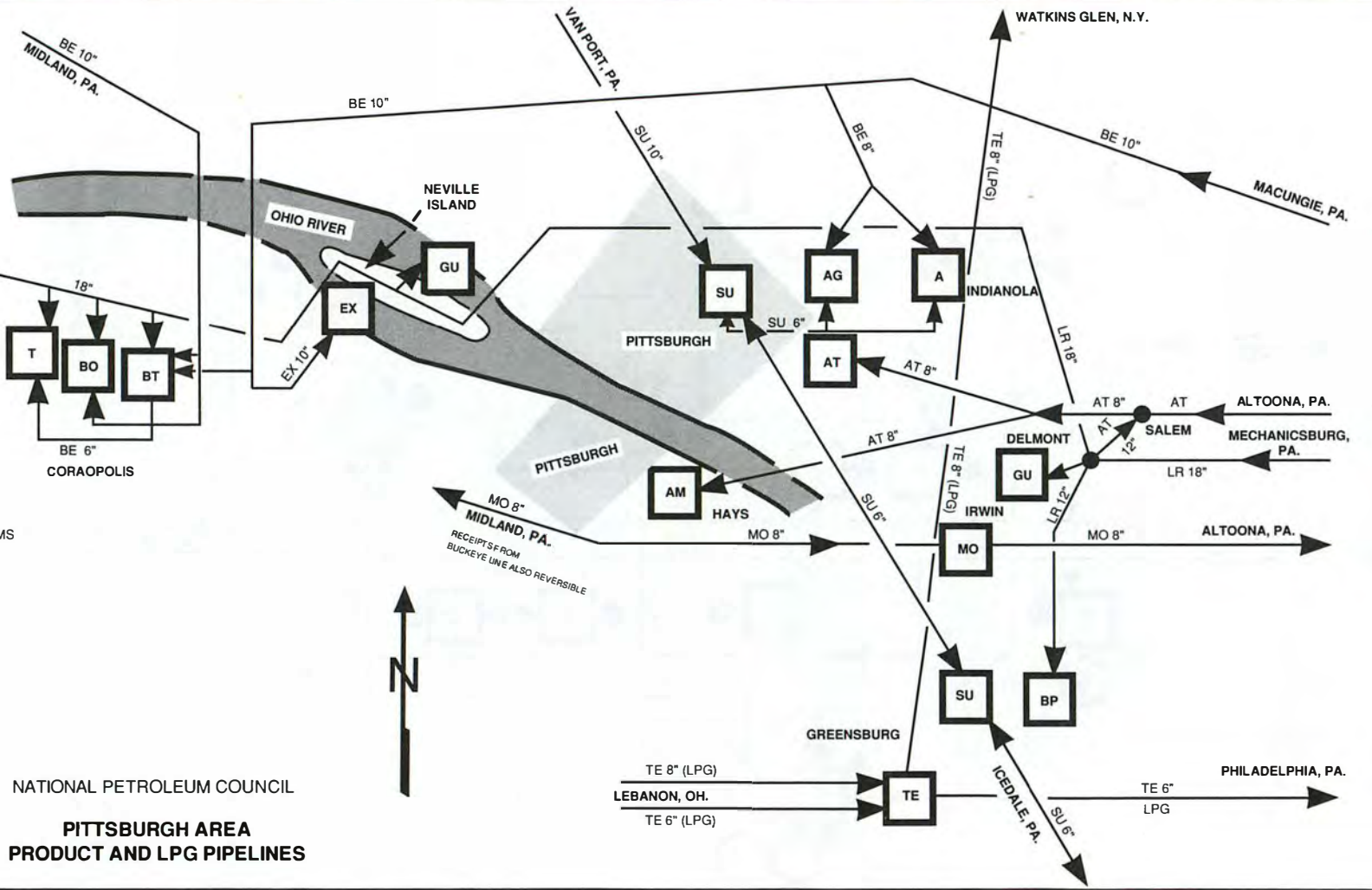

NATIONAL PETROLEUM COUNCIL

PITTSBURGH AREA PRODUCT AND LPG PIPELINES

TABLE E-1

CROSS-PADD LPG/NGL PIPELINE CAPACITIES
AS OF DECEMBER 31, 1987

	<u>MB/D</u>
<u>PADD III to PADD IZ</u>	
Dixie (Opelika, AL, to Milner, GA)	84
(Opelika, AL, to Albany, GA)	<u>25</u>
	109
<u>PADD III to PADD II</u>	
Texas Eastern (El Dorado, AR, to Cape Gerardeau, MO)	225*
Phillips (Borger, TX, to Rago, KS)	52
Emerald (Sheerin, TX, to Liberal, KS)	13*
MAPCO (Skellytown, TX, to Mocane, OK)	<u>50</u>
	340
<u>PADD III to PADD IV</u>	
Phillips (Borger, TX, to Denver, CO)	47*
<u>PADD II to PADD IY</u>	
Texas Eastern (Lebanon, OH, to Greensburg, PA)	61
<u>PADD II to PADD III</u>	
Mobil (Long Grove, OK, to Corsicana, TX)	10
<u>PADD IV to PADD II</u>	
Amoco (Wattenberg, CO, to Bushton, KS)	12
<u>Canada to PADD II</u>	
Lakehead (Edmonton, Canada, to Superior, WI)	228§
Cochin (Edmonton, Canada, to Toledo, OH)	55
Sun (Sarnia, Canada, to Toledo, OH)	20*
Dome (Sarnia, Canada, to Marysville, MI)	28
Dome (Sarnia, Canada, to St. Claire, MI)	<u>28</u>
	359

*Combined product, LPG/NGL, normal mix capacity.

§Combined crude oil, LPG/NGL, normal mix capacity.

TABLE E-2**INTRA-PADD LPG PIPELINE CAPACITIES AS OF
DECEMBER 31, 1987**

<u>PADD IY</u>		<u>Diameter</u> *	<u>Avg. Capacity</u>
Texas Eastern -	Greensburg, PA to Philadelphia, PA	6"	17
	Greensburg, PA to Selkirk, NY	8"	33
<u>PADD IZ</u>			
C&T -	Bethune, SC to Tirzah, SC	6"	12
Dixie -	Milner Terminal, GA to Apex Terminal, NC	8"	31
	Albany Terminal, GA to Alma Terminal, GA	6"	17
<u>PADD II</u>			
Amoco -	Moument, KS to Bushton, KS	6"	12
Arbuckle -	Velma, OK to Knox, Ok	8"	8
	Knox, OK to Maysville, OK	8"	10
	Maysville, OK to Goldsby, OK	8"	18
	Goldsby, OK to Moore, OK	8"	23
	Moore, OK to Kingfisher, OK	8"	26
Badger -	Middleburg Jct. IL to Rockford, IL	12"	34
Chisolm -	Medford, OK to Conway, KS	8"	40
Cochin -	ND/Canada Border to Detroit, MI	12"	55
Kaneb -	McPherson, KS to Geneva, NB	10"	50
	Geneva, NB to Yankton, SD	6"	25
Mapco -	Partridge, KS to Hutchinson, KS	8"	23
	Conway, KS to El Dorado, KS	6"	16
	"	6"	3
	Conway, KS to Kearney, MO	10"/8"	41
	"	10"	17
	Kearney, MO to Birmingham Jct., MO	10"	41
	"	8"	7
	Birmingham Jct. MO to Iowa City, IA	10"	41
	"	8"	4
	Birmingham Jct., MO to Farmington, IL	8"	4
	Iowa City, IA to Janesville, WI	6"	9
	Iowa City, IA to Clinton, IA	10"	41
	"	8"	1
	Clinton, IA to Morris, IL	10"	13
	Morris, IL to Tuscola, IL	8"	13
Hutchinson, KS to Conway, KS	8"	25	
Mocane, OK to Conway KS	12"/10"	19	
"	10"	23	

TABLE E-2 (Continued)

		<u>Diameter *</u>	<u>Avg. Capacity</u>
	Conway, KS to Beatrice, NE	8"	6
	"	8"	6
	Beatrice, NE to Whiting, IA	8"	3
	"	8"	3
	Whiting, IA to Mankato, MN	8"	4
	"	8"	4
	Mankato, MN to Minneapolis, MN	8"	15
Phillips -	E. St. Louis, MO to Chicago, IL	8"	20
Shell -	Kalkaska, MI to Marysville, MI	8"	26
Texaco -	Conway, KS to El Dorado KS	6"	24
	"	4"	7
Texas Eastern -	Todhunder, OH to Coshocton, OH	8"	44
	Dexter, MO to Todhunter, OH	20"	228
	Dexter, MO to Calvert City, KY	8"	57
	Seymour, IN to Chicago, IL	14"	93
	Chicago, IL to Joliet, IL	6"	93
Williams -	Kansas City, MO to Des Moines, IA	12"	45
	"	12"	36
	Des Moines, IA to Albert Lea, MN	6"	24
	Des Moines, IA to Chicago, IL	8"/12"	36
	El Dorado, KS to Humboldt, KS	8"	20
	Humboldt, KS to Carthage, MO	8"	25
	Hoyt, KS to Canton, SD	6"	17
<u>PADD III</u>			
Black Lake -	Black Lake, LA to Mont Belvieu, TX	8"	32
Chevron -	Galena Park, TX to Mont Belvieu, TX	20"	360
	Ranger, TX to Mont Belvieu, TX	10"/14"	160
	Coahoma, TX to Ranger, TX	2-10"	160
	Snyder, TX to Big Spring, TX	4"	3
Coastal -	Corpus Christi, TX to Houston, TX	8"/10"	32
	McAllen, TX to Corpus Christi, TX	4"/6"	12
Diamond Shamrock -	McKee, TX to Mt. Belvieu, TX	8"	45
Dixie -	Mont Belvieu, TX to Sulphur, LA	10"	58
	Sulphur, LA to Breaux Bridge, LA	10"	74
	Breaux Bridge, LA to Hattiesburg, MS	12"	120
	Hattiesburg, MS to Demopolis, AL	12"	120
	Demopolis, AL to Opelika, AL	12"	113

TABLE E-2 (Continued)

		<u>Diameter *</u>	<u>Avg. Capacity</u>
Exxon -	Conroe, TX to Clear Lake, TX	8"	6
	Mont Belvieu, TX to Kingsville, TX	8"	19
	Garden City, LA to Baton Rouge, LA	8"	21
Mapco -	Huerfano, NM to Edgewood, NM	8"	29
	"	10"/12"	56
	Edgewood, NM to Hobbs, TX	8"	29
	"	10"/12"	56
	Midkiff, TX to Hobbs, TX	8"	16
	Hobbs, TX to Skellytown, TX	10"	23
Mobil -	Cameron, LA to Beaumont, TX	2-8"	10
	Corsicana, TX to Beaumont, TX	12"	70
	Keller, TX to Corsicana, TX	8"	12
	Hull, TX to Mont Belvieu, TX	8"	15
	"	8"	45
	Kinsloe, TX to Beaumont, TX	4"/5"/6"	6
	Midland, TX to Corsicana, TX	(8"/12"/14"/8"),8"	42
Plantation -	Pascagoula, MS to Hattiesburg, MS	12"/8"	46
Seadrift -	Falfurrias, TX to Seadrift, TX	8"	26
	"	10"	42
	Mont Belvieu, TX to Texas City, TX	10"/(8",6")	46
	Texas City, TX to Seadrift, TX	6"	20
Seminole -	Hobbs, NM to Brenham Dome, TX	14"	93
	Brenham Dome, TX to Stratton Ridge, TX	14"	104
	Stratton Ridge, TX to Houston, TX	14"	73
Shell -	Mallettsville, TX to Pasadena, TX	6"	10
Sigmor -	Refugio, TX to Three Rivers, TX	8"	10
Sun -	McRae, AR to West Memphis, AR	12"	NA
Texas Eastern -	Mont Belvieu, TX to Fontaine, AR	20"	228
Ucar -	Napoleonville, LA to Taft, LA	8"	54
Union Pacific -	Driscoll, TX to Corpus Christi, TX	6"	16
	Carthage, TX to Lufkin, TX	8"	15
	Carthage, TX to Longview, TX	6"	11
Valero	San Martin, TX to Corpus Christi, TX	6"	14

TABLE E-2 (Continued)

		<u>Diameter</u> *	<u>Avg. Capacity</u>
<u>PADD IV</u>			
Amoco -	Wattenburg, CO to Seibert, CO	6"	12
Mapco -	Rock Springs, WY to Dolores, CO	12"/10"	46
<u>PADD V</u>			
Alyeska -	Prudhoe Bay, AK to Valdez, AK	48"	55

* The following symbolic conventions are used in this table:

- / indicates a change of diameter.
- , indicates an additional separate pipeline.
- () indicates that the reader should interpret the symbols inside the parenthesis first.
- N - X" indicates N multiple pipelines of X" diameter.

TABLE E-3

PRINCIPAL LPG EXPANSION PROJECTS COMPLETED BETWEEN 1/1/79 AND 12/31/87

(0 may indicate that no data were provided)

<u>Pipeline Company</u>	<u>Location</u>	<u>Type of Expansion</u>	<u>Miles</u>	<u>Diameter (Inches)</u>	<u>Present Capacity (MB/D)</u>	<u>Approximate Anticipated Capacity (MB/D)</u>	<u>Completion Date</u>
Diamond Shamrock	Refugio TX to Three Rivers TX	Conversion	38	8	0	0	
Seminole	Bryan TX	New Line	1	3	0	6	06/01/85
	Hobbs NM to Mont Belview TX	New Line	635	14	35	97	09/01/81
	Summerville TX to Cayhill TX	New Line	0	4	6	10	09/01/81
	Snook TX	New Line	3	4	81	81	09/01/81
	Bryan TX to Tunis TX	New Line	15	6	7	22	09/01/81
	Tunis TX to Lyons TX	New Line	9	4	3	22	09/01/81
	Lyons TX to Muellersville TX	New Line	26	8	14	39	09/01/81
	Iola TX to Snook TX	New Line	28	4	5	10	09/01/81
	Snook TX to Lyons TX	New Line	12	6	4	23	09/01/81
	Bryan TX	New Line	0	3	17	60	09/01/81
	Bryan TX	New Line	0	3	0	1	09/01/81
	Katy TX to East Bernard TX	New Line	19	3	24	6	09/01/81
	Orchard TX	New Line	1	2	24	24	09/01/81
	Oyster OK	New Line	3	6	8	23	09/01/81
	Liverpool TX	New Line	0	2	0	2	09/01/81
	Pasadena TX	New Line	1	14	0	132	09/01/81
	Sweeny TX to Brazoria TX	New Line	17	4	1	10	09/01/81
	Pasadena TX	New Line	0	6	0	22	09/01/81
Sun Pipe Line	Wyandotte MI - Spur Line to Phillips	New Line	1	6	28	0	04/01/82
Texas Eastern	Harford Mills NY	New Station	0	0	0	0	07/01/86
Valero	South Central TX to Corpus Christi TX	New Line	129	6	14	23	05/18/81
	South Central TX to Corpus Christi TX	New Line	129	8	14	23	05/18/81
Williams P.L.	Hoyt KS to Canton SD	Conversion	289	10	17	0	01/01/83

APPENDIX F

**NPC 1988 SURVEY OF
U.S. PETROLEUM PIPELINE CAPACITIES
(CRUDE OIL AND PRODUCTS)**

NATIONAL PETROLEUM COUNCIL
1988 SURVEY OF

**U.S. PETROLEUM PIPELINE CAPACITIES
(CRUDE OIL AND PRODUCTS)**

Reporting Company: _____

Address: _____

_____ Zip Code: _____

Person in reporting company to be contacted if questions arise:

Phone: (____) _____

Number of Pipeline Sections Described: _____

Please submit your response to this survey by May 2, 1988, to:

Mr. Benjamin A. Oliver, Jr.
National Petroleum Council
1625 K Street, N.W.
Washington, D.C. 20006

If you have any questions regarding this survey, please call Mr. Oliver,
at the National Petroleum Council office, (202) 393-6100.

GENERAL INSTRUCTIONS

In **Part I** you are asked to furnish information about your company's overall pipeline system. Requested on these pages are:

- Updates of PAD District system maps (trunk line systems) and detailed area maps supplied in this mailing.
- Update status of pipeline projects projected for completion in the 1979 NPC Pipeline Capacity report. The list of projects is included in the mailing.
- A general description of pipeline projects completed during the period from January 1, 1979 to December 31, 1987, including new pipeline construction, conversions, sales, or abandonments that were not previously identified in the 1979 NPC report.
- A general description of any planned new pipeline systems and plans for extension and expansion, conversion or abandonment of existing systems.

Please include all of your company's pipelines, whether common carrier or proprietary. If your company owns lines (common carrier or proprietary) in undivided interest, do not report these lines unless you are the operator. Joint interests, stock companies or partnerships should also be reported by the operator.

Because pipeline companies may own numerous separate systems which are not interdependent, in **Part II** you are asked to divide your various systems into suitable sections. Such sections may be from the origin to termination point or may be further divided by pipeline connection points to other pipelines, refineries or delivery points. Examples of correct procedures for breaking out sections are included. **Part II** concerns each of these sections individually. Please number the pages relating to each pipeline section consecutively.

If a question does not apply to the pipeline section being reported, please enter "NA" where appropriate.

If additional blank questionnaires are required, they may be obtained from the National Petroleum Council office, or they may be copied from these originals. Many of the questions, and information tables, are formatted on the enclosed personal computer (PC) "floppy disk". The questionnaire contained on the "floppy disk" is completely self contained and self running on your IBM-compatible computer. Operating instructions are enclosed with the disk.

PART I

SYSTEM MAPS

PADD System Maps - Please update the applicable maps included in this mailing. Annotate the maps with any changes, additions or deletions in your pipeline system. Additions should include information on locations and capacity of the various pipelines. Do not include any daily average throughput information. In addition, if you have other trunk line maps of your system, please provide them.

Detailed Area Maps - Please update the applicable area maps included in this mailing.

If your pipeline system originates, connects, or terminates at any of the locations listed below, please circle "X" before the appropriate location. A detailed area schematic is enclosed for a majority of the locations listed below. If applicable, please update it with your latest information. If no changes have been made please return the area schematic with the notation, "No Change". If an area map is not enclosed for a location in which you operate, please provide one. Circle an "M" before each location for which an updated or new map is enclosed.

List of Locations

X	M	Bakersfield Area	X	M	Marysville (Michigan)
X	M	Beaumont -- Port Arthur	X	M	Mont Belvieu
X	M	Chicago	X	M	New York (Newark, Bayonne, Linden)
X	M	Cleveland -- Akron	X	M	Odessa -- Midland
X	M	Conway -- Hutchinson (Kansas)	X	M	Patoka
X	M	Corpus Christi	X	M	Philadelphia
X	M	Corsicana	X	M	Pittsburgh
X	M	Cushing	X	M	San Francisco Bay Area
X	M	Dallas -- Fort Worth	X	M	Santa Maria Area
X	M	Detroit -- Toledo	X	M	St. James -- Clovelly -- LOOP
X	M	Kansas City	X	M	Texas City -- Houston -- Pasadena
X	M	Lake Charles	X	M	Tulsa
X	M	Lima	X	M	Valley Center -- Wichita -- El Dorado
X	M	Longview	X	M	Wood River -- St. Louis
X	M	Los Angeles -- Long Beach	X	M	Other (specify) _____

PREVIOUSLY PLANNED PROJECTS

The following tables (Tables 2 and 3 from the 1979 NPC Pipeline Capacity report) contain pipeline projects that were planned as of **December 31, 1978**. If your company has projects on this list please review them to determine if they were completed as shown, completed with modification, or not completed. Using the project number in the first column of the list as a reference, indicate the status of that project on the lines below.

For each project, enter the project number from the attached Table 2 or 3 list. Check the appropriate box to indicate **YES** - if the project that was completed as planned; **NO** - if the project was not completed; **MODIFIED** - if the project was completed but modified from previous plan.

For each project not completed or modified, please indicate the specific reason why it was not completed or the type of modification that was made. If you need additional space, please continue on another sheet of paper and attach to this page.

	<u>Project Number</u>	<u>Completion Status</u>			<u>Reason Not Completed or Modified</u>
		Yes	No	Modified	
Project	_____	<input type="checkbox"/>	<input type="checkbox"/>	<input type="checkbox"/>	_____
Project	_____	<input type="checkbox"/>	<input type="checkbox"/>	<input type="checkbox"/>	_____
Project	_____	<input type="checkbox"/>	<input type="checkbox"/>	<input type="checkbox"/>	_____
Project	_____	<input type="checkbox"/>	<input type="checkbox"/>	<input type="checkbox"/>	_____
Project	_____	<input type="checkbox"/>	<input type="checkbox"/>	<input type="checkbox"/>	_____
Project	_____	<input type="checkbox"/>	<input type="checkbox"/>	<input type="checkbox"/>	_____
Project	_____	<input type="checkbox"/>	<input type="checkbox"/>	<input type="checkbox"/>	_____
Project	_____	<input type="checkbox"/>	<input type="checkbox"/>	<input type="checkbox"/>	_____
Project	_____	<input type="checkbox"/>	<input type="checkbox"/>	<input type="checkbox"/>	_____

TABLE 2*

Principal Crude Oil Expansion Projects Planned or Under Construction - 1979

Project Number	Pipeline Company	Location	Type of Expansion	Miles	Diameter (Inches)	Present Capacity (MB/D)	Approximate Anticipated Capacity (MB/D)	Completion Date
1	Arco	Texas City Ship Dock to Arco Refinery (Pasadena)	New Lines	37 5	36 42	--	500	Mid-1980
2	Ashland	Patoka, IL, to Ownesboro, KY	New Stations	--	20	161	219	March 1979
3		Owensboro to Catlettsburg, KY	New Station Horsepower	--	24	173	216	April 1979
4		Lima to Canton, OH	Horsepower	--	12	76	82	October 1979
5	Capline	St. James, LA, to Patoka, IL	Horsepower	--	--	1,032*	1,098*	October 1980
6	Cities Service	Fauna to Sour Lake, TX	New Line	34	12	--	60	Late 1979
7	Exxon	Clovelly Dome to LaFourche Parish, LA	New Line	7	20	--	170	1980
8		Raceland Station to LaFourche Parish, LA	New Line	13	20	--	170	1980
9	Lakehead	Griffith, IN, to Marysville, MI	Loop Line Horsepower	35	30	--	65 (Additional)	Late 1979
10	LOCAP	Clovelly to St. James, LA	New Line	52	48	--	1,350	Late 1980
11	Marathon	St. James to Garyville, LA	New Line	19	30	--	300	January 1, 1980
12	Mid-Valley/Marathon	Lima, OH, to Samaria, MI	New Stations	--	22	278	338	First Quarter 1980
13	Northern Pipeline	Wood River, IL, to Pine Bend, MN	New Line	476	24	--	135	Permitting Process
14	Shamrock	Borger to Dumas, TX	New Line	44	14, 16	--	40	July 1979
15	Trans-Alaska	Prudhoe Bay to Valdez, AK	Horsepower	--	--	1,230	1,360	January 1, 1980
16	Williams	Des Moines to Mason City, IA	New Line	--	18	--	--	Permitting Process

*Table 2 from Petroleum Pipeline volume of 1979 NPC report, *Storage & Transportation Capacities*.

TABLE 2 (continued)

Project Number	Pipeline Company	Location	Type of Expansion	Miles	Diameter (Inches)	Present Capacity (MB/D)	Approximate Anticipated Capacity (MB/D)	Completion Date
17	Strategic Petroleum Reserve Projects †	Bryan Mound at Freeport, TX	New Storage and Lines	5	30	--	387	August 1979
18		Bryan Mound at Freeport, TX	Expansion	NA	NA	387	1,054	January 1980
19		West Hackberry, LA, to Nederland, TX	New Storage and Lines	42	42	--	402	September 1979
20		West Hackberry, LA to Nederland, TX	Expansion	NA	NA	402	1,400	February 1980
21		Bayou Choctaw to St. James, LA	New Storage and Lines	69	36	--	240	September 1979
22		Bayou Choctaw to St. James, LA	Expansion	NA	NA	240	480	May 1980
23		Sulphur Mines to West Hackberry, LA	New Storage and Lines	17	16	--	100	November 1979
24		Weeks Island, Iberia Parish to St. James, LA	New Storage and Lines	69	36	--	590	March 1980
25		St. James Terminal, LA	Dock and Pump Station	NA	--	--	720§	September 1979

* Design crude capacity. Annual average capacity will be higher.

† Systems are government-owned and capacities shown are drawdown capacities.

§ Combined pumping capacity to Weeks Island and Bayou Choctaw.

TABLE 3*
Principal Products Expansion Projects Planned or Under Construction - 1979

Project Number	Pipeline Company	Location	Type of Expansion	Miles	Diameter (Inches)	Present Capacity (MB/D)	Approximate Anticipated Capacity (MB/D)	Completion Date
26	Badger	System	Horsepower	--	--	90	120	December 1979
27	Calnev	Hinkle, Umatilla County, OR, to Columbia River Barge Terminal	New Line	10	4	--	6	May 1979
28	Collins	Meraux, LA, to Collins, MS	New Stations	--	--	100	125	August 1979
29	Colonial	Houston (Pasadena) to Hebert, TX	Loop Line	80	40	1,920	2,296	1979
30		Port Arthur to Hebert, TX	Loop Line	8	36			
31		Greensboro, NC, to Mitchell Junction, VA	Loop Line	148	36	960	1,320	1979
32		Helena to Birmingham, AL	New Line	12	16	--	127	December 1979
33		Atlanta, GA, to Chattanooga, TN	Loop Line	92	16	238	252	1979
34		Mitchell Junction to Roanoke, VA	Replace 8"	42	12	34	51	1979
35		Dorsey, MD, to Woodbury, NJ	Horsepower	--	--	768	960	1979
36		Mitchell Junction to Richmond, VA	Horsepower	--	--	125	240	1979
37		Belton Junction, SC, to Augusta, GA	Horsepower	--	--	27	45	1979
38		Atlanta to Bainbridge, GA	Horsepower	--	--	60	72	1979
39	Explorer	Port Neches to Port Arthur, TX	Loop Line	8	14	101	190	October 1, 1979
40		Port Arthur and Pasadena, TX, to Tulsa, OK	Horsepower	--	28	380	440	July 1, 1979
41	Gulf	Mesquite Line - Lucas to Lufkin, TX	Horsepower	--	--	55	63	January 1, 1980
42	Hydrocarbon Transportation, Inc. (LPG)	Bushton, KS, to Dearborn, MO	New Line	230	10	--	35	Late 1980

*Table 3 from Petroleum Pipeline volume of 1979 NPC report, *Storage & Transportation Capacities*.

TABLE 3 (continued)

Principal Products Expansion Projects Planned or Under Construction - 1979

Project Number	Pipeline Company	Location	Type of Expansion	Miles	Diameter (Inches)	Present Capacity (MB/D)	Approximate Anticipated Capacity (MB/D)	Completion Date
43	Laurel	Extension of existing El Dorado, PA, to Duncanville 12" lateral to connect new terminal in Pennsylvania	Lateral	1	12	--	--	3rd Quarter 1979
44	Marathon	Garyville to Baton Rouge, LA	Horsepower	--	--	150	280	January 1, 1980
45	Mid America (LPG)	Sanborn, IA, to Mankato, MN	New Line	93	8	42	54	January 1, 1980
46	Phillips	Sweeney to Pasadena, TX	New Line	60	18	--	158	April 1980
47	Plantation	Austell, GA, to Atlanta Airport	Replacement	12	12	--	67	August 1, 1979
48		Clanton to Helena to Montgomery, AL	Horsepower	--	--	--	40	December 31, 1979
49	Shamrock	McKee Refinery near Borger, TX, to Dallas - Fort Worth Area	New Line	363	8	--	15	4th Quarter 1979
50	Southern Pacific	Norwalk to Colton, CA	New Line	32	20	247	300	January 1, 1980
51	Sun	Fostoria to Hudson, OH. Addition of pump stations in Seneca and Medina Counties	New Stations	--	--	30	47	4th Quarter 1979
52	Texas Eastern	Baytown, TX, to Seymour, IN	Loop Line	--	16	--	360	December 1979
53	Transgulf	Baton Rouge, LA, to Kissimmee, FL	Conversion of Gas Line and Looping	--	24	--	240	Permitting Process
54		Kissimmee to Port Everglades, FL	Conversion of Gas Line and Looping	--	20	--	130	Permitting Process
55		24" Line to Jacksonville, FL	New Line	--	14	--	70	Permitting Process
56	Williams	Minneapolis, MN, to Wausau, WI	Horsepower	--	8	26	34	July 1979

NEW PIPELINE PROJECTS

Provide the information requested below for all pipeline projects completed during the period from **January 1, 1979 through December 31, 1987** that were not identified in Table 2 and 3 from Part I, Section II of this survey. Include new pipeline construction, conversions, flow reversals, sales or abandonments. If you have more than two projects, please reproduce copies of this page to describe the others.

Project _____							
Company Name _____	Location of Project _____						
Type of Project	<input type="checkbox"/> New Line	<input type="checkbox"/> Loop Line	<input type="checkbox"/> New Station	<input type="checkbox"/> Conversion	<input type="checkbox"/> Reversal	<input type="checkbox"/> Horsepower	<input type="checkbox"/> Other _____
Miles _____	Diameter (inches) _____			Present Capacity (MB/D) _____			
Completion Date _____				Anticipated Capacity (MB/D) _____			

Project _____							
Company Name _____	Location of Project _____						
Type of Project	<input type="checkbox"/> New Line	<input type="checkbox"/> Loop Line	<input type="checkbox"/> New Station	<input type="checkbox"/> Conversion	<input type="checkbox"/> Reversal	<input type="checkbox"/> Horsepower	<input type="checkbox"/> Other _____
Miles _____	Diameter (inches) _____			Present Capacity (MB/D) _____			
Completion Date _____				Anticipated Capacity (MB/D) _____			

FUTURE PIPELINE PLANS

Provide a general description of any planned new pipeline systems or sections thereof and plans for extension and expansion of existing systems by location, pipe size, added capacity, and status. Such expansions should be firm (announced) proposals with anticipated start-of-construction and completion schedules, but do not necessarily need to be budgeted to be included. A brief narrative describing expected impediments to expansion plans/proposals (governmental, environmental, other) will be useful. Also, include a description of any planned pipeline conversions, flow reversals, capacity cut backs or pipeline phase outs. If you have more than two projects, please reproduce copies of this page to describe the others.

Project _____							
Company Name _____	Location of Project _____						
Type of Project	<input type="checkbox"/> New Line	<input type="checkbox"/> Loop Line	<input type="checkbox"/> New Station	<input type="checkbox"/> Conversion	<input type="checkbox"/> Reversal	<input type="checkbox"/> Horsepower	<input type="checkbox"/> Other _____
Miles _____	Diameter (inches) _____			Present Capacity (MB/D) _____			
Completion Date _____				Anticipated Capacity (MB/D) _____			
Narrative _____							

Project _____							
Company Name _____	Location of Project _____						
Type of Project	<input type="checkbox"/> New Line	<input type="checkbox"/> Loop Line	<input type="checkbox"/> New Station	<input type="checkbox"/> Conversion	<input type="checkbox"/> Reversal	<input type="checkbox"/> Horsepower	<input type="checkbox"/> Other _____
Miles _____	Diameter (inches) _____			Present Capacity (MB/D) _____			
Completion Date _____				Anticipated Capacity (MB/D) _____			
Narrative _____							

PART II

Pipeline Schematic

Prepare a schematic, using the attached example on page 17, for each of your pipeline systems including crude oil, products, or LPG service. Include location of the beginning and end of the system, major origin points, other pipeline connections, refinery receipt or delivery points and pipeline diameter for each section of the system. For ease of identification, please assign a unique three position numeric code to each of the points (nodes) in the pipeline as shown in the example on page 17. Be sure the schematic includes the name of the node and its location as shown in the example.

Indicate on the schematic the longitude and latitude (measured as degrees and minutes to the nearest tenth of a minute) of each of the nodes you have identified. Use the attached example for the preferred way to show point location for each node. Longitude and latitude information can be easily obtained from USGS survey sheets. We suggest you check with your engineering department.

Pipeline Section Data

For each pipeline section between nodes identified on the pipeline schematic, provide the information requested on the attached form using the instructions that follow. Using the example on page 17, there would be seven (7) separate section data forms provided. These would include two pipeline sections from node 100 to 110, and one each from 110 to 120, 120 to 125, 120 to 130, 130 to 135, and 130 to 140. When two or more pipeline sections exist between two nodes, uniquely identify each by adding an A, B, etc., to the three position identifier. In the example on page 17 the two lines between nodes 100 and 110 would be identified as 100A to 110A and 100B to 110B. Photocopy as many copies of the form as you need.

Section Data Instructions

1. **Pipeline System Name** - Identify the name commonly used for the pipeline system.
2. **Origin:**
 - a. **Node** - The three character numeric identifier (and letter, if applicable) established by you to identify the node.
 - b. **Name** - Identify name of the starting node.
 - c. **Location** - City and State of the starting node.
 - d. **Type of Facility** - Check the box that identifies the type of facility. If you check **other**, describe the type of facility in the space below the box.
 - e. **Longitude** - Indicate the longitude of this node measured as degrees and minutes to the nearest tenth of a minute.
 - f. **Latitude** - Indicate the latitude of this node measured as degrees and minutes to the nearest tenth of a minute.

3. **Destination:** The example on page 17 illustrates the following information.
- a. **Node -** The three character numeric (and letter, if applicable) identifier established by you to identify the node.
 - b. **Name -** Identify name of the ending node.
 - c. **Location -** City and State of the ending node.
 - d. **Type of Facility -** Check the box that identifies the type of facility. If you check **other**, describe the type of facility in the space below the box.
 - e. **Longitude -** Indicate the longitude of this node measured as degrees and minutes to the nearest tenth of a minute.
 - f. **Latitude -** Indicate the latitude of this node measured as degrees and minutes to the nearest tenth of a minute.
4. **Business Organization -** Check the box that describes the ownership type.
5. **Operator -** List the company or corporate name of the operator of the pipeline section.
6. **Pipeline Service -** Check the block that identifies the commodity handled by this section. If more than one commodity is handled by the section, indicate the percentage of each in the boxes.
7. **Regulatory Status -** Check the appropriate box for private or common carrier line.
8. **Class -** Check the appropriate box to indicate the relationship of the pipeline section to the pipeline system. An **independent section** is a part of the main pipeline which is capable of independent operation. A **pipeline subsection** is a part of the main pipeline which is dependent on the prior sections operation. A **pipeline spur** is principally an exit section to deliver flow from the main pipeline.
9. **Size:**
- a. **Diameter -** Pipeline external diameter in inches.
 - b. **Length -** Pipeline section length in miles to the nearest tenth of a mile.
10. **Bi-Directional -**
- a. Check box to indicate if pipeline currently has capability to reverse flow direction.
 - b. **Reverse Capacity -** Indicate capacity in thousand barrels per day in reverse flow direction.
11. **Operating Data:**
- a. **Crude Oil Lines -**
 - 1 - 4. **Capacity -** Provide the maximum operating capacity in thousand barrels per day under each operating condition. Capacity using flow improvers should be based upon your best judgement of the maximum use of flow improvers.

5. **Gravity Range** - Range of API Gravities of crude oil normally handled ($^{\circ}$ API).
6. **Viscosity Range** - Range of viscosities of crude oil normally handled (SSU @ 100 $^{\circ}$ F).
- b. **Product Pipelines** - Provide the maximum operating capacity in thousand barrels per day under each operating condition. Capacity using flow improvers should be based upon your best judgement of the maximum use of flow improvers. For capacity under a normal mix indicate the product mix in percentages such as 70% motor gasoline, 30% distillate fuel oil.
- c. **LPG Lines** - Provide the average daily capacity in thousand barrels per day.
12. **Expansion Potential** - a. Check box to indicate if pipeline has capability to expand capacity in a 1 -3 month time frame assuming authorizations (internal and external) have been obtained.
- b. **Expansion Capacity** - Indicate capacity of pipeline after expansion in thousand barrels per day.
13. **Reversibility Potential** - a. Check box to indicate if pipeline has capability to reverse flow directions in a 1 - 3 month time frame assuming authorizations (internal and external) have been obtained.
- b. **Potential Capacity** - Indicate capacity of pipeline in thousand barrels per day when flow is reversed.

Section Data

1. Pipeline System Name _____

2. Origin

a. Node _____

b. Name _____

c. Location _____
City _____ State _____

d. Type of Facility

<input type="checkbox"/>	<input type="checkbox"/>	<input type="checkbox"/>	<input type="checkbox"/>	<input type="checkbox"/>	<input type="checkbox"/>	<input type="checkbox"/>
Marine Terminal	Pipeline Terminal	Storage Site	Injection Point	Exit Point	Refinery	Other

f. Longitude _____

g. Latitude _____

3. Destination

a. Node _____

b. Name _____

c. Location _____
City _____ State _____

d. Type of Facility

<input type="checkbox"/>	<input type="checkbox"/>	<input type="checkbox"/>	<input type="checkbox"/>	<input type="checkbox"/>	<input type="checkbox"/>	<input type="checkbox"/>
Marine Terminal	Pipeline Terminal	Storage Site	Injection Point	Exit Point	Refinery	Other

f. Longitude _____

g. Latitude _____

4. Business Organization

Single Owner

Undivided Interest

Stock Company

Partnership

Jointly Owned

5. Operator _____

<p>6. Pipeline Service:</p> <table border="0"><tr><td><input type="checkbox"/></td><td><input type="checkbox"/></td><td><input type="checkbox"/></td></tr><tr><td>Crude Oil</td><td>Refined Products</td><td>LPG/NGL</td></tr></table>	<input type="checkbox"/>	<input type="checkbox"/>	<input type="checkbox"/>	Crude Oil	Refined Products	LPG/NGL	<p>7. Regulatory Status:</p> <table border="0"><tr><td><input type="checkbox"/></td><td><input type="checkbox"/></td></tr><tr><td>Private</td><td>Common Carrier</td></tr></table>	<input type="checkbox"/>	<input type="checkbox"/>	Private	Common Carrier
<input type="checkbox"/>	<input type="checkbox"/>	<input type="checkbox"/>									
Crude Oil	Refined Products	LPG/NGL									
<input type="checkbox"/>	<input type="checkbox"/>										
Private	Common Carrier										

<p style="text-align: center;">8. Class:</p> <div style="display: flex; justify-content: space-around; align-items: center;"> <div style="text-align: center;"><input type="checkbox"/> Independent Section</div> <div style="text-align: center;"><input type="checkbox"/> Pipeline Subsection</div> <div style="text-align: center;"><input type="checkbox"/> Pipeline Spur</div> </div>	<p style="text-align: center;">9. Size:</p> <p>a. Diameter: _____ (in.)</p> <p>b. Length: _____ (mi.)</p>	<p style="text-align: center;">10. Bi-Directional:</p> <p>a. <input type="checkbox"/> <input type="checkbox"/> Yes No</p> <p>b. Capacity _____ (MB/D)</p>
---	--	--

11. Operating Data

a. Crude Oil Lines:

1. Summer capacity _____ (MB/D)
2. Summer capacity (with flow improvers) _____ (MB/D)
3. Winter capacity _____ (MB/D)
4. Winter capacity (with flow improvers) _____ (MB/D)
5. Gravity range max _____ min _____ (° API)
6. Viscosity range max _____ min _____ (SSU @ 100° F)

b. Product Pipelines:

1. Summer capacity (#2 oil) _____ (MB/D)
2. Summer capacity (normal mix) _____ (MB/D)
- Product mix _____
3. Summer capacity (with flow improvers) _____ (MB/D)
4. Winter capacity (#2 oil) _____ (MB/D)
5. Winter capacity (normal mix) _____ (MB/D)
- Product mix _____
6. Winter capacity (with flow improvers) _____ (MB/D)

c. LPG Lines:

Average capacity: _____ (MB/D)

<p style="text-align: center;">12. Expansion Potential:</p> <p>a. <input type="checkbox"/> <input type="checkbox"/> Yes No</p> <p>b. Capacity _____ (MB/D)</p>	<p style="text-align: center;">13. Reversibility Potential:</p> <p>a. <input type="checkbox"/> <input type="checkbox"/> Yes No</p> <p>b. Capacity _____ (MB/D)</p>
---	---

EXAMPLE

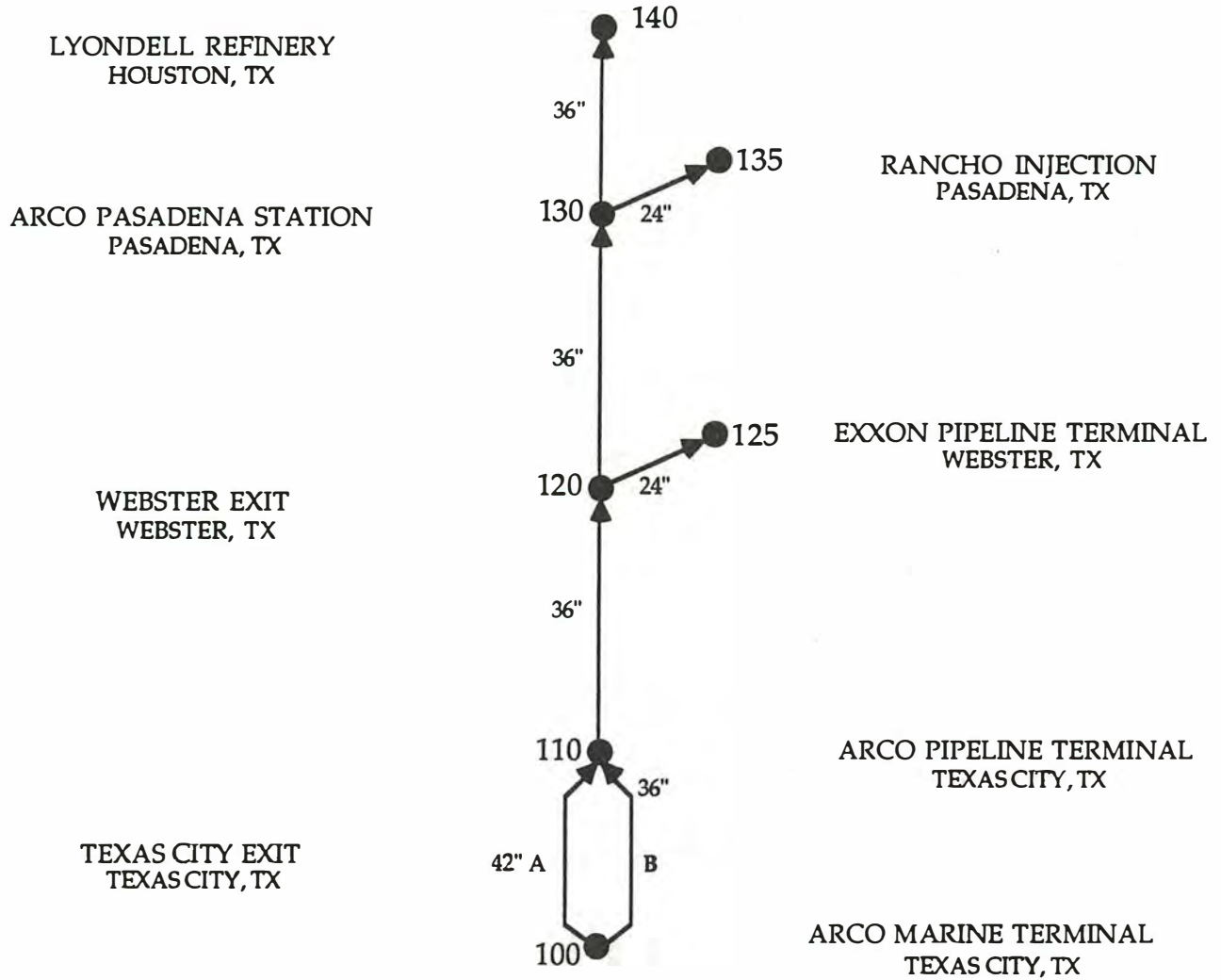

NODE	LATITUDE	LONGITUDE
100	29° 22.8'	94° 53.6'
110	29° 21.1'	94° 56.0'
120	29° 31.6'	95° 06.4'
125	29° 31.8'	95° 06.2'
130	29° 43.0'	95° 13.2'
135	29° 43.1'	95° 13.2'
140	29° 43.1'	95° 13.6'

APPENDIX G
TANKER AND BARGE APPENDICES

TABLES:	Pages
- Storage Capacity of Petroleum Terminals on U.S. Inland Waterway System.....	G-1 - G-2
- Storage Capacity of Petroleum Facilities in U.S. Coastal and Great Lake Ports.....	G-3 - G-10
- U.S. Flag Tank Ships – by Type of Use.....	G-11
- U.S. Flag Tank Barges -- by Type of Use.....	G-11
- U.S. Flag Tank Ships – by Year Built.....	G-12 - G-13
- U.S. Flag Tank Barges – by Year Built	G-14 - G-15
 DESCRIPTION OF THE PRINCIPAL U.S. INLAND WATERWAYS.....	 G-16 - G-29

TABLE G-1

STORAGE CAPACITY OF PETROLEUM TERMINALS LOCATED ON THE U.S. INLAND WATERWAY SYSTEM
(Capacities in Thousands of Barrels)

	<u>Number of Terminals</u>	<u>Refined Petroleum</u>	<u>Crude Petroleum</u>	<u>Fuel Oil</u>	<u>Asphalt</u>	<u>LPG/LNG</u>	<u>Mixed Products*</u>	<u>Total Capacity</u>
<u>Ohio River System</u>	<u>174</u>	<u>21,095</u>	<u>2,783</u>	<u>5,609</u>	<u>5,275</u>	<u>217</u>	<u>2,473</u>	<u>37,452</u>
Ohio River	111	15,430	2,358	2,519	2,904	17	2,458	25,686
Allegheny River	5	488		238	154			880
Monongahela River	17	1,176		688	340			2,204
Kanawaha River	6	565		119				684
Big Sandy River, KY	3	387	400	500	1,000			2,287
Licking River, KY	2	275		24				299
Cumberland River	11	1,255	25	437	375			2,092
Tennessee River	17	1,486		1,084	502	200		3,272
Big Spring Creek, AL	1	33						33
Emory River, TN	1						15	15
<u>Illinois Waterway System</u>	<u>43</u>	<u>18,016</u>	<u>88</u>	<u>1,700</u>	<u>464</u>		<u>5,205</u>	<u>25,473</u>
Illinois Waterway	17	1,463	88	1,027	464		185	3,227
Chicago Sanitary/Ship Canal	21	12,358		673			5,020	18,051
Calumet SAG Channel	2	1,678						1,678
Little Calumet River	1	165						165
Des Plaines River	2	2,352						2,352
<u>Upper Mississippi System</u>	<u>56</u>	<u>24,358</u>	<u>6,535</u>	<u>1,109</u>	<u>5,263</u>		<u>5,435</u>	<u>42,700</u>
Upper Mississippi River	52	23,870	6,535	966	4,930		5,435	41,736
Minnesota River	1				167			167
Black River, WI	3	488		143	166			797
<u>Missouri River System</u>	<u>5</u>	<u>1,200</u>		<u>256</u>	<u>453</u>			<u>1,909</u>
Missouri River	5	1,200		256	453			1,909

TABLE G-1 (continued)

	<u>Number of Terminals</u>	<u>Refined Petroleum</u>	<u>Crude Petroleum</u>	<u>Fuel Oil</u>	<u>Asphalt</u>	<u>LPG/LNG</u>	<u>Mixed Products*</u>	<u>Total Capacity</u>
<u>Lower Mississippi System</u>	<u>68</u>	<u>9,868</u>	<u>3,017</u>	<u>6,413</u>	<u>354</u>	<u>10,886</u>	<u>3,585</u>	<u>34,123</u>
Lower Mississippi River	52	8,331	3,017	5,320	210	10,886	2,688	30,452
Arkansas River	8	390		848			627	1,865
Verdigris River	2			120	144		270	534
Yazoo River	5	1,147						1,147
Ouachita & Black River	1			125				125
<u>Tennessee-Tombigbee Waterway System</u>	<u>18</u>	<u>364</u>	<u>886</u>	<u>452</u>	<u>245</u>			<u>1,947</u>
Tennessee-Tombigbee W/W	1				195			195
Tombigbee River	2			262				262
Black Warrior River	2	222	510					732
Locust Fork, AL	2	27			50			77
Mulberry Fork, AL	2	115	260					375
Alabama/Coosa River	7		36	150				186
Mobile River	2		80	40				120
<u>Columbia-Snake River System</u>	<u>6</u>	<u>1,552</u>		<u>40</u>				<u>1,592</u>
Columbia River	3	498		40				538
Snake River	3	1,054						1,054
Total	370	76,453	13,309	15,579	12,054	11,103	16,698	145,196

* This category provides aggregate storage data for those terminals which did not separate storage capacity by one of the five commodity classifications.

Source: U.S. Maritime Administration.

TABLE G-2

STORAGE CAPACITY OF PETROLEUM FACILITIES LOCATED IN U.S. COASTAL AND GREAT LAKES PORTS
(Capacities in Thousands of Barrels)

	<u>Number of Terminals</u>	<u>Refined Petroleum</u>	<u>Crude Petroleum</u>	<u>Fuel Oil</u>	<u>Asphalt</u>	<u>LPG/LNG</u>	<u>Mixed Products*</u>	<u>Total Capacity</u>
<u>North Atlantic Ports</u>	<u>101</u>	<u>95,019</u>	<u>3,450</u>	<u>7,547</u>	<u>775</u>	<u>2,403</u>	<u>24,763</u>	<u>133,957</u>
Bucksport, ME	2	1,250						1,250
Searsport, ME	2	3,582		342				3,924
Portland, ME	8	5,261	3,450		165			8,876
Portsmouth, NH	6	2,034		1,293	224	400		3,951
Boston, MA	14	10,627		20		974	2,758	14,379
Baintree, MA	1	1,259						1,259
Weymouth, MA	1			482				482
Quincy, MA	2	1,211						1,211
Tiverton, RI	2	2,449						2,449
Fall River, MA	4	1,904		1,764				3,668
Providence, RI	11	8,563			245	1,000		9,808
New London, CT	2	879		181				1,060
New Haven, CT	8	7,688		650	141			8,479
Bridgeport, CT	2	1,690		680				2,370
New York, NY	9	7,558		1,903		29		9,490
Jersey City, NJ	1	1,440						1,440
Sayreville, NJ	1			92				92
Sewaren, NJ	1	2,700						2,700
Perth Amboy, NJ	1						6,030	6,030
Linden, NJ	4	5,479		15			15,975	21,469
Carteret, NJ	1	695						695
Woodbridge, NJ	1			125				125
Elizabeth, NJ	1	457						457
Bayonne, NJ	4	17,333						17,333
Newark, NJ	2	1,800						1,800
Albany, NY	10	9,160						9,160

TABLE G-2 (continued)

	<u>Number of Terminals</u>	<u>Refined Petroleum</u>	<u>Crude Petroleum</u>	<u>Fuel Oil</u>	<u>Asphalt</u>	<u>LPG/LNG</u>	<u>Mixed Products*</u>	<u>Total Capacity</u>
<u>Mid-Atlantic Ports</u>	<u>66</u>	<u>43,500</u>	<u>12,923</u>	<u>6,512</u>	<u>1,782</u>	<u>2,260</u>	<u>43,482</u>	<u>110,459</u>
Deepwater, NJ	1			325				325
Crab Point, NJ	1			55				55
Paulsboro, NJ	5	1,672					12,550	14,222
Gloucester City, NJ	2	800					8,619	9,419
Camden, NJ	4	2,203		32	165			2,400
Pennsauken, NJ	1	2,300						2,300
Burlington, NJ	2	386		250				591
Duck Island, NJ	1			50				50
Delaware City, DE	1	3,000	4,975					7,975
Edgemoor, DE	1			800				800
Claymont, DE	1	835						835
Marcus Hook, PA	2		3,500			1,780	12,677	17,957
Eddystone, PA	1			381				381
Philadelphia, PA	14	7,728	4,448	1,076			2,712	15,964
Croydon, PA	1			611				611
Tullytown, PA	1	524						524
Fairless Hills, PA	1			181				181
Wilmington, DE	2	1,152						1,152
Baltimore, MD	13	16,260		2,796	1,617			20,673
Yorktown, VA	1						6,259	6,259
Newport News, VA	1	520						520
Portsmouth, VA	1	410						410
Chesapeake, VA	7	3,210				480	665	4,355
Norfolk, VA	1	2,500						2,500
<u>South Atlantic Ports</u>	<u>60</u>	<u>35,809</u>	<u>550</u>	<u>3,485</u>	<u>2,111</u>	<u>1,225</u>		<u>43,180</u>
Morehead City, NC	3	865			165			1,030
Wilmington, NC	10	5,372		513	393			6,278
Charleston, SC	8	5,425		13	600			6,038

TABLE G-2 (continued)

	<u>Number of Terminals</u>	<u>Refined Petroleum</u>	<u>Crude Petroleum</u>	<u>Fuel Oil</u>	<u>Asphalt</u>	<u>LPG/LNG</u>	<u>Mixed Products*</u>	<u>Total Capacity</u>
Savannah, GA	9	4,900	550	40	445	1,200		7,135
Brunswick, GA	1	310						310
Fernandina Beach, FL	2			55				55
Jacksonville, FL	14	6,499		2,345	285			9,129
Port Canaveral, FL	1	904			41			945
Palm Beach, FL	1	1,510		519				2,029
Port Everglades, FL	10	9,357			182	25		9,564
Miami, FL	1	667						667
<u>Gulf Ports</u>	<u>139</u>	<u>108,725</u>	<u>80,252</u>	<u>9,202</u>	<u>1,519</u>	<u>6,183</u>	<u>130,937</u>	<u>336,818</u>
Tampa, FL	10	6,770		1,470	176			8,416
Port Manatee, FL	1	2,500		1,000				3,500
Port St. Joe, FL	1		914					914
Panama City, FL	2	499		140				639
Pennsacola, FL	2	555	200		100			855
Mobile, AL	8	1,384	3,310	570	463			5,727
Pascagoula, MS	2		18,000					18,000
Pilottown, LA	1		800					800
Venice, LA	1		700					700
Ostrica, LA	3	433	1,272			20		1,725
Point A La Hache, LA	1		30					30
Alliance, LA	1					390	5,014	5,404
Braithwaite, LA	1			15				15
Mereaux, LA	1	569						569
Chalmette, LA	2	2,298	1,300					3,598
New Orleans, LA	3	3,705						3,705
Avondale, LA	1						1,000	1,000
St. Rose, LA	1						5,500	5,500
Good Hope, LA	2	5,750	3,340					9,090
Norco, LA	1						9,913	9,913
Garyville, LA	1	4,060	4,500		600			9,160

TABLE G-2 (continued)

	<u>Number of Terminals</u>	<u>Refined Petroleum</u>	<u>Crude Petroleum</u>	<u>Fuel Oil</u>	<u>Asphalt</u>	<u>LPG/LNG</u>	<u>Mixed Products*</u>	<u>Total Capacity</u>
Mt. Airy, LA	1	565	127					692
Paulina, LA	1		600	1,700				2,300
St. James, LA	4	2,420	8,315				6,630	17,365
Convent, LA	2	1,000	2,500	35				3,535
Donaldsonville, LA	1			110				110
Geismer, LA	2			143			279	422
Carville, LA	1			60				60
St. Gabriel, LA	1			2,415				2,415
Sunshine, LA	1						900	900
Baton Rouge, LA	4	15,020		57			1,757	16,834
Lake Charles, LA	9	80	1,781			4,069	10,837	16,767
Beaumont, TX	8	9,171	12,285				22,762	44,218
Houston, TX	19	24,634	4,135	1,200		1,354	29,959	61,282
Texas City, TX	10	120	1,505	107			24,547	26,279
Freeport, TX	2	1,100	5,900					7,000
Corpus Christi, TX	18	17,242	8,738	160	180	340	10,402	37,062
Port Arthur, TX	1	7,900						7,900
Port Bolivar, TX	1					10		10
Galveston, TX	3	950		20				970
Matagorda, TX	1						2	2
Brownsville, TX	3						1,435	1,435
<u>South Pacific Ports</u>	<u>54</u>	<u>20,408</u>	<u>5,560</u>	<u>17,737</u>		<u>600</u>	<u>46,055</u>	<u>90,360</u>
San Diego, CA	1			131				131
Carlsbad, CA	1			2,500				2,500
Huntington Beach, CA	1		600					600
Long Beach, CA	6	628		398			8,453	9,479
Los Angeles, CA	14	6,401	1,400	107		600	6,703	15,211
El Segundo, CA	1						2,000	2,000
Mandalay Beach, CA	1	440						400
Ventura, CA	1		280					280

TABLE G-2 (continued)

	<u>Number of Terminals</u>	<u>Refined Petroleum</u>	<u>Crude Petroleum</u>	<u>Fuel Oil</u>	<u>Asphalt</u>	<u>LPG/LNG</u>	<u>Mixed Products*</u>	<u>Total Capacity</u>
Carpinteria, CA	1						200	200
Estero Bay, CA	2	500		770				1,270
Avon, CA	1						7,700	7,700
Pittsburg, CA	1			5,404				5,404
Antioch, CA	3			2,372				2,372
Moss Landing, CA	1			6,000				6,000
Redwood City, CA	1	360						360
Alameda, CA	1	54						54
Richmond, CA	7	3,706	1,000				16,100	20,806
Mare Island, CA	1						3,860	3,860
Crockett, CA	1			55				55
Ozol, CA	1	1,000						1,000
Martinez, CA	2	5,316					1,039	6,355
Benicia, CA	2	1,848	2,280					4,128
Eureka, CA	3	155						155
<u>North Pacific Ports</u>	<u>53</u>	<u>19,169</u>	<u>11,164</u>	<u>2,632</u>	<u>166</u>	<u>357</u>	<u>1,300</u>	<u>34,788</u>
Astoria, OR	2	107						107
Wauna, OR	1			40				40
Westport, OR	1			1,350				1,350
Longview, WA	2	92		450				542
Vancouver, WA	2	715						715
Portland, OR	14	6,804	1,337	136	166		1,300	9,743
North Bend, OR	1	71						71
Coos Bay, OR	2	194						194
Umpqua, OR	1			100				100
Toledo, OR	1			45				45
Grays Harbor, WA	1	100						100
Port Angeles, WA	2	143		45				188
Port Townsend, WA	1			67				67
Tacoma, WA	5	140		185				325

TABLE G-2 (continued)

	<u>Number of Terminals</u>	<u>Refined Petroleum</u>	<u>Crude Petroleum</u>	<u>Fuel Oil</u>	<u>Asphalt</u>	<u>LPG/LNG</u>	<u>Mixed Products*</u>	<u>Total Capacity</u>
Seattle, WA	7	2,167						2,167
Point Wells, WA	1	1,926						1,926
Renton, WA	1			167				167
Everett, WA	1			38				38
Anacortes, WA	2	3,695	6,627					10,322
Bellingham, WA	1			9				9
Winslow, WA	1	6						6
Ferndale, WA	3	3,009	3,200			357		6,566
<u>Hawaiian Ports</u>	<u>16</u>	<u>6,215</u>	<u>3,668</u>	<u>420</u>	<u>70</u>	<u>49</u>		<u>10,422</u>
Hilo, HI	1	390				14		404
Kawaihae, HI	1	41						41
Kahului, HI	2	876				16		892
Kaunapau, HI	1	14						14
Kaunakakai, HI	1	27						27
Barbers Point, HI	2	2,265	3,668	420				6,353
Honolulu, HI	6	2,453			70	5		2,528
Port Allen, HI	1	87						87
Nawiliwili, HI	1	62				14		76
<u>Alaskan Ports</u>	<u>28</u>	<u>6,333</u>	<u>11,070</u>	<u>197</u>		<u>675</u>	<u>5,103</u>	<u>23,378</u>
Kenai, AK	1						4,593	4,593
Ketchikan, AK	4	310		55				365
Petersburg, AK	2	18						18
Juneau, AK	2	56						56
Sitka, AK	2	19		70				89
Haines, AK	2	434						434
Skagway, AK	1	213						213
Valdez, AK	2	180	9,180	72				9,432
Whittier, AK	1	330						330

TABLE G-2 (continued)

	<u>Number of Terminals</u>	<u>Refined Petroleum</u>	<u>Crude Petroleum</u>	<u>Fuel Oil</u>	<u>Asphalt</u>	<u>LPG/LNG</u>	<u>Mixed Products*</u>	<u>Total Capacity</u>
Seward, AK	1	20						20
Homer, AK	1	732						732
Nikishka, AK	3	171	1,890			675	510	3,246
Anchorage, AK	1	3,001						3,001
Kodiak, AK	3	428						428
Dutch Harbor, AK	1	381						381
Unalaska, AK	1	40						40
<u>Great Lakes Ports</u>	<u>63</u>	<u>35,380</u>		<u>3,158</u>	<u>1,487</u>		<u>2,189</u>	<u>42,214</u>
Oswego, NY	1	380						380
Sackets Harbor, NY	1	589						589
Toledo, OH	5	5,684						5,684
Lorain, OH	1			500				500
Cleveland, OH	8	1,271		285	133		165	1,854
Erie, PA	1			12				12
Buffalo, NY	5	2,093		622	162			2,877
Tonawanda, NY	1	200						200
Trenton, MI	1	1,365						1,365
Wyandotte, MI	1			7				7
Ecorse, MI	1	835						835
River Rouge, MI	3	2,263		238				2,501
Detroit, MI	6	699		950	1,031			2,680
Dearborn, MI	1	1,800						1,800
Essexville, MI	1	183						183
Bay City, MI	3	1,080					2,024	3,104
Ludington, MI	1			119				119
Muskegon, MI	1	466						466
East Chicago, IN	5	10,264			51			10,315
Chicago, IL	2	1,215		95				1,310
Milwaukee, WI	2	680						680
Port Washington, WI	1	191						191

TABLE G-2 (continued)

	<u>Number of Terminals</u>	<u>Refined Petroleum</u>	<u>Crude Petroleum</u>	<u>Fuel Oil</u>	<u>Asphalt</u>	<u>LPG/LNG</u>	<u>Mixed Products*</u>	<u>Total Capacity</u>
Sheboygan, WI	1	392						392
Kewaunee, WI	1	220						220
Green Bay, WI	3	1,265			110			1,375
Escanaba, MI	5	1,490		330				1,820
Superior, WI	1	755						755
<u>Puerto Rico/Virgin Islands</u>		Not Available						
Total	580	370,558	128,637	50,890	7,910	13,752	253,829	825,576

*This category provides aggregate storage data for those terminals which did not separate storage capacity by one of the five commodity classifications.

Source: U.S. Maritime Administration.

TABLE G-3

U.S. FLAG TANK SHIPS WITH CURRENT USCG CERTIFICATES
BY TYPE OF USE
AS OF DECEMBER 31, 1987

15-Apr-88
MAR 115.1

SOURCE: USCG

ROUTE		UNDER 5000 GROSS TONS		OVER 5000 GROSS TONS		TOTAL TANK SHIPS		
		NUMBER OF VESSELS	TOTAL CAPACITY (BARRELS)	NUMBER OF VESSELS	TOTAL CAPACITY (BARRELS)	NUMBER OF VESSELS	TOTAL CAPACITY (BARRELS)	CAPACITY PER VESSEL
CC	COASTWISE	20	205,573	1	88,880	21	294,453	14,022
CG	COASTWISE-GREAT LAKES	2	26,004	1	75,298	3	101,302	33,767
GG	GREAT LAKES	5	115,635			5	115,635	23,127
LC	LIMITED COASTWISE	3	14,356			3	14,356	4,785
LL	LAKES, BAYS, SOUNDS	45	181,069			45	181,069	4,024
OO	OCEANS	5	923,404	209	103,483,977	214	104,407,381	487,885
RG	RIVERS-GREAT LAKES	1	6,296			1	6,296	6,296
RR	RIVERS	4	2,395			4	2,395	599
TOTAL		85	1,474,732	211	103,648,155	296	105,122,887	355,145

TABLE G-4

U.S. FLAG TANK BARGES WITH CURRENT USCG CERTIFICATES
BY TYPE OF USE
AS OF DECEMBER 31, 1987

SOURCE: USCG

ROUTE		UNDER 5000 GROSS TONS		OVER 5000 GROSS TONS		TOTAL TANK BARGES		
		NUMBER OF VESSELS	TOTAL CAPACITY (BARRELS)	NUMBER OF VESSELS	TOTAL CAPACITY (BARRELS)	NUMBER OF VESSELS	TOTAL CAPACITY (BARRELS)	CAPACITY PER VESSEL
CC	COASTWISE	49	709,081	3	455,473	52	1,164,554	22,395
CG	COASTWISE-GREAT LAKES	21	387,134			21	387,134	18,435
GG	GREAT LAKES	12	138,486	1	67,472	13	205,958	15,843
LC	LIMITED COASTWISE	130	2,105,579			130	2,105,579	16,197
LG	LIMITED GREAT LAKES	110	1,593,433			110	1,593,433	14,486
LL	LAKES, BAYS, SOUNDS	3,141	47,405,597			3,141	47,405,597	15,093
OO	OCEANS	262	8,693,285	101	16,966,264	363	25,659,549	70,687
RG	RIVERS-GREAT LAKES							
RR	RIVERS	247	2,732,813			247	2,732,813	11,064
TOTAL		3,972	63,765,408	105	17,489,209	4,077	81,254,617	19,930

TABLE G-5

U.S. FLAG TANK SHIPS WITH CURRENT USCG CERTIFICATES
BY YEAR BUILT
AS OF DECEMBER 31, 1987

15-Apr-88
MAR 115.1

SOURCE: USCG

YEAR BUILT	UNDER 5000 GROSS TONS		OVER 5000 GROSS TONS		TOTAL VESSELS		
	NUMBER OF VESSELS	TOTAL CAPACITY (BARRELS)	NUMBER OF VESSELS	TOTAL CAPACITY (BARRELS)	NUMBER OF VESSELS	TOTAL CAPACITY (BARRELS)	CAPACITY PER VESSEL
19	1	2,372			1	2,372	2,372
20	2	13,506			2	13,506	6,753
24	2	32,701			2	32,701	16,351
26	1	1,573			1	1,573	1,573
27	1	90			1	90	90
28	1	95			1	95	95
29	1	236			1	236	236
30	2	797			2	797	399
31	1	5,000			1	5,000	5,000
33	1	1,095			1	1,095	1,095
34	1	21,000			1	21,000	21,000
38	3	33,202			3	33,202	11,067
41	1	8,500			1	8,500	8,500
42	1	15,600			1	15,600	15,600
43	1	193	1	155,349	2	155,542	77,771
44	2	22,141	4	627,292	6	649,433	108,239
45	4	839,747	3	567,567	7	1,407,314	201,045
47	1	65			1	65	65
48	1	354			1	354	354
49	2	867			2	867	434
50	1	1,227	1	233,295	2	234,522	117,261
53	2	27,016	3	875,375	5	902,391	180,478
54	3	2,402	4	1,205,193	7	1,207,595	172,514
55	1	156	1	423,437	2	423,593	211,797
56	2	14,402	4	1,184,084	6	1,198,486	199,748
57	3	76,874	7	1,746,526	10	1,823,400	182,340
58	2	28,324	7	1,817,567	9	1,845,891	205,099
59			6	1,851,678	6	1,851,678	308,613
60	1	4,330	5	1,465,486	6	1,469,816	244,969
61	1	791	4	1,506,498	5	1,507,289	301,458
62			1	274,355	1	274,355	274,355
63	2	42,274	3	599,908	5	642,182	128,436
64	1	5,700	5	1,850,422	6	1,856,122	309,354
65			2	795,237	2	795,237	397,619
66	4	6,637	2	943,361	6	949,998	158,333
68	1	38,000	4	1,196,741	5	1,234,741	246,948
69	2	30,429	8	2,864,756	10	2,895,185	289,519
70			8	3,286,400	8	3,286,400	410,800
71	1	1,020	7	3,302,118	8	3,303,138	412,892
72			6	2,965,595	6	2,965,595	494,266
73	1	6,296	6	4,963,701	7	4,969,997	710,000
74	2	48,059	10	5,575,365	12	5,623,424	468,619
75	3	657	12	5,850,065	15	5,850,722	390,048
76	3	55,308	11	9,061,332	14	9,116,640	651,189
77	2	28,837	14	11,118,316	16	11,147,153	696,697
78	2	8,187	13	8,468,410	15	8,476,597	565,106
79	5	557	10	6,809,143	15	6,809,700	453,980

TABLE G-5 (Continued)

U.S. FLAG TANK SHIPS WITH CURRENT USCG CERTIFICATES
 BY YEAR BUILT
 AS OF DECEMBER 31, 1987

YEAR BUILT	<u>UNDER 5000 GROSS TONS</u>		<u>OVER 5000 GROSS TONS</u>		<u>TOTAL VESSELS</u>		
	NUMBER OF VESSELS	TOTAL CAPACITY (BARRELS)	NUMBER OF VESSELS	TOTAL CAPACITY (BARRELS)	NUMBER OF VESSELS	TOTAL CAPACITY (BARRELS)	CAPACITY PER VESSEL
80	2	21,738	2	1,639,264	4	1,661,002	415,251
81	4	211	11	4,637,983	15	4,638,194	309,213
82	2	286	5	3,477,363	7	3,477,649	496,807
83	1	180	6	3,737,424	7	3,737,604	533,943
84			5	1,832,313	5	1,832,313	366,463
85	1	25,700	3	725,967	4	751,667	187,917
86			4	2,150,102	4	2,150,102	537,526
87			3	1,863,167	3	1,863,167	621,056
TOTAL	85	1,474,732	211	103,648,155	296	105,122,887	355,145
AVERAGE AGE (YEARS)	29.4	35.9	16.2	13.4	20.0	13.7	

TABLE G-6

U.S. FLAG TANK BARGES WITH CURRENT USCG CERTIFICATES
BY YEAR BUILT
AS OF DECEMBER 31, 1987

15-Apr-88
MAR 115.1

SOURCE: USCG

YEAR BUILT	UNDER 5000 GROSS TONS		OVER 5000 GROSS TONS		TOTAL VESSELS		
	NUMBER OF VESSELS	TOTAL CAPACITY (BARRELS)	NUMBER OF VESSELS	TOTAL CAPACITY (BARRELS)	NUMBER OF VESSELS	TOTAL CAPACITY (BARRELS)	CAPACITY PER VESSEL
13	2	7,492			2	7,492	3,746
15	1	5,984			1	5,984	5,984
21	1	6,500			1	6,500	6,500
24	1	18,797			1	18,797	18,797
26	3	14,243			3	14,243	4,748
28	3	9,680			3	9,680	3,227
29	1	1,800			1	1,800	1,800
31	2	5,485			2	5,485	2,743
32	1	2,640			1	2,640	2,640
33	4	27,156			4	27,156	6,789
34	6	57,247			6	57,247	9,541
35	6	27,500			6	27,500	4,583
36	6	31,131			6	31,131	5,189
37	15	94,902			15	94,902	6,327
38	1	1,620			1	1,620	1,620
39	5	36,305			5	36,305	7,261
40	21	121,686			21	121,686	5,795
41	25	157,141			25	157,141	6,286
42	18	164,682			18	164,682	9,149
43	23	159,129	1	140,168	24	299,297	12,471
44	9	71,195	1	130,889	10	202,084	20,208
45	21	215,614			21	215,614	10,267
46	13	82,680			13	82,680	6,360
47	25	224,520			25	224,520	8,981
48	47	573,853			47	573,853	12,210
49	49	669,846			49	669,846	13,670
50	16	179,226			16	179,226	11,202
51	47	785,513			47	785,513	16,713
52	26	434,236			26	434,236	16,701
53	13	200,488			13	200,488	15,422
54	25	266,421			25	266,421	10,657
55	46	690,580			46	690,580	15,013
56	47	479,487	1	265,609	48	745,096	15,523
57	67	887,372			67	887,372	13,244
58	57	572,739			57	572,739	10,048
59	53	714,178			53	714,178	13,475
60	79	1,062,272			79	1,062,272	13,446
61	86	896,437			86	896,437	10,424
62	77	1,044,796			77	1,044,796	13,569
63	85	1,402,439	1	229,609	86	1,632,048	18,977
64	95	1,219,500			95	1,219,500	12,837
65	105	1,476,388			105	1,476,388	14,061

TABLE G-6 (Continued)

U.S. FLAG TANK BARGES WITH CURRENT USCG CERTIFICATES
BY YEAR BUILT
AS OF DECEMBER 31, 1987

YEAR BUILT	UNDER 5000 GROSS TONS		OVER 5000 GROSS TONS		TOTAL VESSELS		
	NUMBER OF VESSELS	TOTAL CAPACITY (BARRELS)	NUMBER OF VESSELS	TOTAL CAPACITY (BARRELS)	NUMBER OF VESSELS	TOTAL CAPACITY (BARRELS)	CAPACITY PER VESSEL
66	135	2,208,138	1	53,095	136	2,261,233	16,627
67	179	2,688,404	2	191,943	181	2,880,347	15,914
68	182	3,206,041	3	244,081	185	3,450,122	18,649
69	146	2,592,383	2	227,585	148	2,819,968	19,054
70	154	2,814,145	5	786,229	159	3,600,374	22,644
71	138	2,560,412	6	865,727	144	3,426,139	23,793
72	92	1,620,313	6	763,236	98	2,383,549	24,322
73	163	3,008,710	3	477,316	166	3,486,026	21,000
74	195	3,762,574	3	613,201	198	4,375,775	22,100
75	182	3,619,407	6	844,477	188	4,463,884	23,744
76	133	2,463,603	9	1,209,225	142	3,672,828	25,865
77	127	1,970,886	2	159,809	129	2,130,695	16,517
78	154	2,482,242	3	429,206	157	2,911,448	18,544
79	137	3,019,884	7	1,145,711	144	4,165,595	28,928
80	286	4,446,163	10	1,372,085	296	5,818,248	19,656
81	208	3,469,952	16	3,190,027	224	6,659,979	29,732
82	64	1,775,521	8	1,292,656	72	3,068,177	42,614
83	33	519,149	1	1,785	34	520,934	15,322
84	8	178,943	3	842,004	11	1,020,947	92,813
85	12	141,989			12	141,989	11,832
86	6	75,270	1	8,160	7	83,430	11,919
87	5	40,379	4	2,005,376	9	2,045,755	227,306
TOTAL	3,972	63,765,408	105	17,489,209	4,077	81,254,617	19,930
AVERAGE AGE (YEARS)	18.5	16.8	10.9	9.6	18.3	15.2	

DESCRIPTION OF THE PRINCIPAL U.S. INLAND WATERWAYS

The following is an alphabetic list of 23 inland waterways of the United States including river mileages, controlling depths, name or number of each lock facility, and the size of lock chamber. The physical size of each lock may not necessarily indicate the maximum size of the tows using each waterway. For example, some of the locks are long enough to handle a 1,190 foot tow while others will require double or multiple locking. Some waterways have other restraints, such as vertical bridge clearances, approach bends, and low water conditions, which dictate the size of the tow.

Flooding affects the operation of the locks in different ways depending upon the design of each facility. For example, most of the dams on the upper Mississippi River are the movable weir type that can be lowered during high water to allow the vessels to pass over the dam without locking; however, some of the newer locks on the upper Mississippi and the newer dams on the Ohio River are fixed structures and locking conditions prevail full time, with no bypass provisions, until the water reaches a maximum operational level and locking procedures cease due to high water.

-
1. ALABAMA-COOSA RIVERS: The Alabama River project length is 305 miles from its junction with the Tombigbee River to about 10 miles above Montgomery. The Coosa River is 286 miles long from Wetumpka to Rome, Georgia.

<u>WATERWAY/LOCK NAME OR NUMBER</u>	<u>RIVER MILE</u>	<u>WIDTH (FEET)</u>	<u>LENGTH (FEET)</u>	<u>LIFT (FEET)</u>
<u>Alabama River</u>				
Claiborne	81.2	84	600	30
Millers Ferry	142.3	84	600	48
Robert F. Henry	245.4	84	600	45

2. ALLEGHENY RIVER: The Allegheny River project extends 72 miles from East Brady, Pennsylvania, to Pittsburgh.

<u>WATERWAY/LOCK NAME OR NUMBER</u>	<u>RIVER MILE</u>	<u>WIDTH (FEET)</u>	<u>LENGTH (FEET)</u>	<u>LIFT (FEET)</u>
<u>Allegheny River</u>				
L&D 2	6.7	56	360	11
L&D 3	14.5	56	360	14
L&D 4	24.2	56	360	11
L&D 5	30.4	56	360	12
L&D 6	36.3	56	360	12
L&D 7	45.7	56	360	13
L&D 8	52.6	56	360	18
L&D 9	62.2	56	360	22

3. ARKANSAS RIVER (McCLELLAN-KERR ARKANSAS RIVER NAVIGATION SYSTEM):

The McClennan-Kerr Arkansas River Navigation System extends from Catoosa, Oklahoma, on the Verdigris River to the waterway's junction with the Mississippi River (450 miles). The Arkansas system includes the lower most 10 miles of the White River. The Arkansas system has a project depth of nine feet and project widths of 250 feet on the Arkansas River, 150 feet on the Verdigris River for 50 miles, 300 feet in the White River, Arkansas Post Canal, which connects the White and Arkansas Rivers, and the short tributary San Bois Creek.

<u>WATERWAY/LOCK NAME OR NUMBER</u>	<u>RIVER MILE</u>	<u>WIDTH (FEET)</u>	<u>LENGTH (FEET)</u>	<u>LIFT (FEET)</u>
Norrell	10.3	110	600	30
Lock 2 & Mills Dam	13.3	110	600	20
L&D 3	50.2	110	600	20
L&D 4	66.0	110	600	14
L&D 5	86.3	110	600	17
David T. Terry	108.1	110	600	18
Murray	125.4	110	600	18
Toad Suck	155.9	110	600	16
Ormond	176.9	110	600	20
Dardanelle	205.5	110	600	55
Ozark	256.8	110	600	34
James W. Trimble	292.8	110	600	20
W. D. Mayo	319.6	110	600	21
Robert S. Kerr	336.2	110	600	48
Webbers Falls	366.6	110	600	30
Chouteau (Verd.R)	401.5	110	600	21
Newt Graham (Verd. R)	421.6	110	600	21

4. ATCHAFALAYA RIVER: The Atchafalaya River extends from its junction with the Mississippi River about seventy-six miles above Baton Rouge to its junction with the Gulf Intracoastal Waterway at Morgan City, Louisiana (121 miles). The Red and Atchafalaya Rivers share a six mile long common channel called the Old River immediately west of their junction with the Mississippi River. The Atchafalaya River project channel, including the six mile Old River, is twelve feet deep and 125 feet wide.

<u>WATERWAY/LOCK NAME OR NUMBER</u>	<u>RIVER MILE</u>	<u>WIDTH (FEET)</u>	<u>LENGTH (FEET)</u>	<u>LIFT (FEET)</u>
<u>Atchafalaya (Old) River</u>				
Old River	304.0	75	1200	35

5. ATLANTIC INTRACOASTAL WATERWAY: The Atlantic Intracoastal Waterway consists of the 833 mile long Atlantic Intracoastal Waterway from Norfolk to the St. Johns River, about 20 miles east of Jacksonville, Florida, and the 370 mile long Intracoastal Waterway from Jacksonville to Miami. The AIWW includes the 62 mile long Albermarle and Chesapeake Canal Route and the 65 mile long Dismal Swamp Route. The main channel, 739 miles on the AIWW and 349 miles on the IWW, accounts for about 90 percent of the total length of 1,203 miles. The project depths are 12 feet in the main channel, except for 6 feet in the Dismal Swamp Canal itself and 9 to 10 feet on the rest of the Route. The project widths are 90 feet on the AIWW main channel and 125 feet on the IWW main channel, except for 50 to 100 feet on the Dismal Swamp Canal Route and 125 to 300 in some river and open water portions of the AIWW.

<u>WATERWAY/LOCK NAME OR NUMBER</u>	<u>RIVER MILE</u>	<u>WIDTH (FEET)</u>	<u>LENGTH (FEET)</u>	<u>LIFT (FEET)</u>
<u>Albermarle and Chesapeake Canal Route</u>				
Great Bridge	11.5	75	600	3
<u>Dismal Swamp Canal Route</u>				
South Mills	33.2	52	300	12
Deep Creek	10.6	52	300	12

6. BLACK WARRIOR-MOBILE RIVERS: The Mobile-Tombigbee-Black Warrior Rivers system is 453 miles long from Mobile Bay to the head of navigation northwest of Birmingham on Locust, Mulberry, and Sipsey Forks.

<u>WATERWAY/LOCK NAME OR NUMBER</u>	<u>RIVER MILE</u>	<u>WIDTH (FEET)</u>	<u>LENGTH (FEET)</u>	<u>LIFT (FEET)</u>
<u>Black Warrior River</u>				
John Hollis Bankhead	365.7	110	600	68
Holt	347.0	110	600	64
Wm. Bacon Oliver	338.1	95	460	28
Selden (Warrior)	261.7	110	600	22

7. COLUMBIA RIVER (COLUMBIA-SNAKE RIVERS INLAND WATERWAYS): This segment includes the Columbia River from Bonneville Lock and Dam (mile 146) to the tri-cities of Pasco, Kennewick, and Richland, Washington, (mile 338), just above its junction with the Snake River; and the Snake River from its junction with the Columbia River to Johnson's Bar Landing, Idaho (mile 233), 92 miles above Lewiston, Idaho (mile 141). The Columbia River project depth is 27 feet from Bonneville Lock and Dam to the Dalles Lock and dam, 15 feet from the Dalles Lock and Dam to McNary Lock and Dam, and 14 feet to Richland. The project width on the Columbia River is 300 feet below the Dallas Lock and Dam and 250 feet above it. The project dimensions on the Snake River are 14 feet deep and 250 feet wide to Lewiston and two feet deep thereafter.

<u>WATERWAY/LOCK NAME OR NUMBER</u>	<u>RIVER MILE</u>	<u>WIDTH (FEET)</u>	<u>LENGTH (FEET)</u>	<u>LIFT (FEET)</u>
<u>Columbia-Snake Waterway</u>				
Bonneville	146.0	76	500	65
Bonneville (u. const.)	146.0	86	675	65
The Dalles	190.0	86	675	88
John Day	215.0	86	675	110
McNary	282.0	86	675	75
Ice Harbor	9.7	86	675	100
Lower Monumental	41.6	86	675	98
Little Goose	70.3	86	675	98
Lower Granite	107.5	86	675	100

8. CUMBERLAND RIVER: The Cumberland River existing project extends from Celina, Tennessee, near the Kentucky state line, 385 miles to its mouth near Smithland, Kentucky and includes the nearly two mile long Barkley Canal.

<u>WATERWAY/LOCK NAME OR NUMBER</u>	<u>RIVER MILE</u>	<u>WIDTH (FEET)</u>	<u>LENGTH (FEET)</u>	<u>LIFT (FEET)</u>
<u>Cumberland River</u>				
Barkley	30.6	110	800	57
Cheatham	148.7	110	800	25
Old Hickory	216.2	84	400	60
Cordell Hull	313.5	84	400	59

9. GREEN AND BARREN RIVERS: The Green and Barren Rivers project includes about 198 miles to its mouth near Smithland, Kentucky and includes the nearly two mile long Barkley Canal.

<u>WATERWAY/LOCK NAME OR NUMBER</u>	<u>RIVER MILE</u>	<u>WIDTH (FEET)</u>	<u>LENGTH (FEET)</u>	<u>LIFT (FEET)</u>
<u>Green/Barren Rivers</u>				
L&D 1	9.1	84	600	12
L&D 2	63.1	84	600	14
L&D 3*	108.5	36	138	17
		36	138	--
L&D 4*	149.0	--	---	--
L&D 1	15.0	56	360	--

* Not operational

10. GULF INTRACOASTAL WATERWAY: This segment consists of the Gulf Intracoastal Waterway (GIWW) from Apalachee Bay near St. Marks, Florida, to the Mexican border at Brownsville, Texas 1,113 miles, including the GIWW alternate route from Morgan City to Port Allen, Louisiana (64 miles); the Apalachicola, Chattahoochee, and Flint Rivers (297 miles); and the Pearl River (58 miles). The main channel project depth for the GIWW and the alternate route is 12 feet deep and 125 feet wide, except for 150 feet wide between the Mississippi River and Mobile Bay portion of the GIWW-East. There are about fifteen GIWW side channels and tributaries ranging from two to 35 miles long and the usual dimensions are 12 feet deep and 125 feet wide or 9 by 100 feet. The GIWW connects with nine non-fuel taxed waterways and 23 harbors along the Gulf Coast with over 250,000 tons of traffic.

<u>WATERWAY/LOCK</u> <u>NAME OR NUMBER</u>	<u>RIVER</u> <u>MILE</u>	<u>WIDTH</u> <u>(FEET)</u>	<u>LENGTH</u> <u>(FEET)</u>	<u>LIFT</u> <u>(FEET)</u>
<u>Gulf Intracoastal Waterway</u>				
Inner Harbor	92.6	75	640	17
Harvey Lock	98.2	75	425	20
Algiers Lock	88.0	75	760	18
Bayou Boeuf	93.3	75	1156	11
Leland Bowman Lock	162.7	110	1200	5
Calcasieu Lock	238.5	75	1206	4
Brazos River E. Fldgt	404.1	75	--	--
Brazos River W. Fldgt	404.1	75	--	--
Colorado River E. Lock	444.8	75	1200	5
Colorado River W. Lock	444.8	75	1200	5
<u>GIWW, Morgan City - Port Allen Route</u>				
Port Allen	227.6	84	1202	45
Bayou Sorrel	131.0	56	747	21
<u>Apalachicola, Chattahoochee, and Flint Rivers</u>				
Jim Woodruff	106.31	82	450	33
George W. Andrews	154.3	82	450	25
Walter F. George	182.8	82	450	88
<u>Pearl River</u>				
Lock 1	28.7	65	310	17
Lock 2	40.8	65	310	15
Lock 3	14.0	65	310	11

11. ILLINOIS WATERWAY (CALUMET-SAG CHANNEL): The Illinois Waterway includes four sections. The lower section is 300 feet wide and extends from the waterway's mouth at the Mississippi near Grafton (38 miles above St. Louis) to Lockport, with 273 miles on the Illinois River and 18.1 miles on the DesPlaines River. The center section on the Chicago Sanitary and Ship Canal is 160 feet wide and extends 12.4 miles from the Lockport to the junction with the Calumet-Sag Channel. From the junction, the third section follows the Chicago Sanitary and Ship Canal and South Branch of the Chicago River to Lake Street and the Chicago River for 22.1 miles with channels 160-300 feet wide. The fourth section, from the junction to O'Brien Lock and Lake Calumet via the Calumet-Sag channel and Little Calumet and Calumet Rivers, is 23.8 miles long and 225 feet wide. All four sections total 349 miles with project depths of nine feet deep. The remaining distances to Lake Michigan are via the deep draft Chicago River and Chicago Harbor from Lake Street and Lake Calumet and Calumet Harbor and River from O'Brien Lock.

<u>WATERWAY/LOCK NAME OR NUMBER</u>	<u>RIVER MILE</u>	<u>WIDTH (FEET)</u>	<u>LENGTH (FEET)</u>	<u>LIFT (FEET)</u>
<u>Illinois Waterway</u>				
LaGrange L&D	80.2	110	600	10
Peoria L&D	157.5	110	600	11
Starved Rock L&D	231.0	110	600	19
Marseilles L&D	244.6	110	600	24
Dresden Island L&D	271.5	110	600	22
Brandon Road L&D	286.0	110	600	34
Lockport Lock	291.1	110	600	40
T.J. O'Brien Lock	326.5	110	1000	5
Chicago Harbor Lock	327.2	80	600	--

12. KANAWHA RIVER: The Kanawha River project extends from Deepwater, West Virginia (mile 91) to its mouth at Point Pleasant, West Virginia.

<u>WATERWAY/LOCK NAME OR NUMBER</u>	<u>RIVER MILE</u>	<u>WIDTH (FEET)</u>	<u>LENGTH (FEET)</u>	<u>LIFT (FEET)</u>
<u>Kanawha River</u>				
Winfield	31.1	56	360	28
		56	360	28
Winfield (u. const.)	31.1	110	800	28
Marmet	67.8	56	360	24
		56	360	24

13. KENTUCKY RIVER: The Kentucky River extends about 255 miles from its formation near Beattyville, Kentucky, but only the lower 82 miles to Lock and Dam 5 are operated and maintained for commercial navigation.

<u>WATERWAY/LOCK NAME OR NUMBER</u>	<u>RIVER MILE</u>	<u>WIDTH (FEET)</u>	<u>LENGTH (FEET)</u>	<u>LIFT (FEET)</u>
<u>Kentucky River</u>				
L&D 1	4.0	38	145	8
L&D 2	31.0	38	145	14
L&D 3	42.0	38	145	13
L&D 4	65.0	38	145	13

14. LOWER MISSISSIPPI RIVER: The Lower Mississippi River extends from the mouth of the Ohio River at Cairo, Illinois, to Baton Rouge, Louisiana (725 miles). Channel size and river conditions for the Lower Mississippi River differ markedly from that of its five tributaries. It has an authorized project channel depth of twelve feet that has been constructed and maintained to nine feet and a project width of 300 feet.

15. MIDDLE MISSISSIPPI: This segment includes the Mississippi River from the mouth of the Missouri River to the mouth of the Ohio River (195 miles), the Missouri River from Sioux City, Iowa, to its mouth (735 miles), and the Kaskaskia River from Fayetteville, Illinois, to its mouth (36 miles). The project depth is 9 feet. Project channel widths on the Mississippi River are 300 feet north to St. Louis and 200 feet from St. Louis to the Missouri River. They are 225 feet on the Kaskaskia River and 300 feet on the Missouri River, except for a 250 foot limitation from Miami to the mouth.

<u>WATERWAY/LOCK NAME OR NUMBER</u>	<u>RIVER MILE</u>	<u>WIDTH (FEET)</u>	<u>LENGTH (FEET)</u>	<u>LIFT (FEET)</u>
L&D 27 Main chamber	185.1	110	1200	21
L&D 27 Aux. chamber	185.1	110	600	21
Kaskaskia	0.8	84	600	32

16. UPPER MISSISSIPPI RIVER: The Mississippi River between the Missouri River and Minneapolis has been improved for navigation by a system of 28 locks and dams. The nine foot deep channel stretches 663 miles from mile 145 to mile 858 at the head of navigation with the project width being 200 feet up to Lock and Dam 22 (mile 301.2), but none are specified for further upriver.

<u>WATERWAY/LOCK NAME OR NUMBER</u>	<u>RIVER MILE</u>	<u>WIDTH (FEET)</u>	<u>LENGTH (FEET)</u>	<u>LIFT (FEET)</u>
Upper St. Anthony Falls	853.9	56	400	49
Lower St. Anthony Falls	853.3	56	400	25
No. 1	847.6	57	400	38
No. 2	815.0	57	500	12
No. 3	769.9	110	600	12
No. 4	752.8	110	600	8
No. 5	738.1	110	600	9
No. 5a	728.5	110	600	5
No. 6	714.0	110	600	6
No. 7	702.0	110	600	8
No. 8	679.0	110	600	11
No. 9	647.0	110	600	9
No.10	615.0	110	600	8
No.11	583.0	110	600	11
No.12	556.0	110	600	9
No.13	522.0	110	600	11
No.14	493.9	80	320	11
No.15	482.9	110	600	16
No.16	457.2	110	600	9
No.17	437.1	110	600	8
No.18	410.5	110	600	10
No.19	364.2	110	1200	38
No.20	343.2	110	600	10
No.21	324.9	110	600	10
No.22	301.2	110	600	10
No.24	273.4	110	600	15
No.25	241.4	110	600	15
No.26	202.9	110	600	24
No.26 Aux Chamber	202.9	110	360	24
No.26 Main (u. constr.)	----	110	1200	24
No.26 Aux (u. constr.)	----	110	600	24

17. MONONGAHELA RIVER: The Monongahela River is formed by the junction of the Tygart and West Fork Rivers at Fairmont (mile 129), West Virginia, and flows north to Pittsburgh.

<u>WATERWAY/LOCK NAME OR NUMBER</u>	<u>RIVER MILE</u>	<u>WIDTH (FEET)</u>	<u>LENGTH (FEET)</u>	<u>LIFT (FEET)</u>
<u>Monongahela River</u>				
L&D 2	11.2	110	720	9
		56	360	9
L&D 3	23.8	56	720	8
		56	360	8
L&D 4	41.5	56	720	17
		56	360	17
Maxwell	61.2	84	720	20
		84	720	20
L&D 7	85.0	56	360	15
Grays Landing (u. const.)	82.0	84	720	15
L&D 8	90.8	56	360	19
Pt. Marion (u. const.)	90.8	84	720	19
Morgantown	102.0	84	600	17
Hildebrand	108.0	84	600	21
Opekiska	115.4	84	600	22

18. OHIO RIVER: The Ohio River is formed by the junction of the Allegheny and Monongahela Rivers at Pittsburg and flows generally southwestward for 981 miles to join the Mississippi River near Cairo, Illinois.

<u>WATERWAY/LOCK NAME OR NUMBER</u>	<u>RIVER MILE</u>	<u>WIDTH (FEET)</u>	<u>LENGTH (FEET)</u>	<u>LIFT (FEET)</u>
<u>Ohio River</u>				
Emsworth	974.8	110	600	18
		56	360	18
Dashiels	967.7	110	600	10
		56	360	10
Montgomery	949.3	110	600	18
		56	360	18
New Cumberland	926.6	110	1200	21
		110	600	21
Pike Island	896.7	110	1200	21
		110	600	21
Hannibal	854.6	110	1200	21
		110	600	21
Willow Island	819.3	110	1200	20
		110	600	20
Belleville	777.1	110	1200	22
		110	600	22
Racine	743.5	110	1200	22
		110	600	22
Gallipolis	701.8	110	600	23
		110	360	23
Gallipolis (const.)	279.2	110	1200	23
		110	600	23
Greenup	640.0	110	1200	30
		110	600	30
Meldahl	544.8	110	1200	30
		110	600	30
Markland	449.5	110	1200	35
		110	600	35
McAlpine	374.2	110	1200	37
		110	600	37
		110	360	37
Cannelton	260.3	110	1200	25
		110	600	25
Newburgh	204.9	110	1200	16
		110	600	16
Uniontown	135.0	110	1200	18
		110	600	18
Smithland	35.3	110	1200	22
		100	1200	22
L&D 52	42.1	110	1200	12
		110	600	12
L&D 53	18.4	110	1200	12
		110	600	12
Olmstead (PED)	----	110	1200	--
		110	1200	--

19. OUACHITA-BLACK RIVERS: The Ouachita and Black Rivers extend from Camden, Arkansas to the junction with the Red River in Louisiana (350 miles). The project channel is nine feet deep and 100 feet wide.

<u>WATERWAY/LOCK NAME OR NUMBER</u>	<u>RIVER MILE</u>	<u>WIDTH (FEET)</u>	<u>LENGTH (FEET)</u>	<u>LIFT (FEET)</u>
<u>Ouachita & Black Rivers</u>				
Jonesville	25.0	84	600	30
Columbia	117.2	84	600	18
Felsenthal	226.8	84	600	18
Thatcher	281.7	84	600	12

20. RED RIVER: The Red River project now under construction extends from Shreveport, Louisiana, to its junction with the Atchafalaya River (236 miles) six miles west of the Mississippi River. The Red River project is authorized for a channel nine feet deep and 200 feet wide. By the end of 1987, those dimensions will exist to Lock and Dam No. 3 (about mile 140 at Colfax).

<u>WATERWAY/LOCK NAME OR NUMBER</u>	<u>RIVER MILE</u>	<u>WIDTH (FEET)</u>	<u>LENGTH (FEET)</u>	<u>LIFT (FEET)</u>
<u>Red River</u>				
L&D 1	28.7	84	600	36
Overton	88.0	84	600	--
L&D 3 (Under Const.)	140.0	84	600	--

21. TENNESSEE RIVER: The Tennessee-Tombigbee Waterway, which extends from its junction with the Tennessee River near the intersection of the Tennessee, Alabama, and Mississippi state borders to the confluence of the Black Warrior River with the Tombigbee River, is 234 miles long. The project depth is nine feet except for twelve feet in the canal and divide sections of the Tennessee-Tombigbee Waterway. The project width is 200 feet on the rivers and 300 feet on the waterway, except for 280 feet in the divide cut.

The Tennessee River project includes 652 miles from the junction of the French Broad and Holston Rivers at Knoxville to the mouth at Paducah, Kentucky and about 61 miles on the Clinch River to Clinton, Tennessee.

<u>WATERWAY/LOCK NAME OR NUMBER</u>	<u>RIVER MILE</u>	<u>WIDTH (FEET)</u>	<u>LENGTH (FEET)</u>	<u>LIFT (FEET)</u>
<u>Tennessee-Tombigbee WW</u>				
Gainesville	49.1	110	600	36
Aliceville	89.8	110	600	27
Columbus	117.6	110	600	27
Aberdeen	140.0	110	600	27
A	154.0	110	600	30
B	159.3	110	600	25
C	174.0	110	600	25
D	181.0	110	600	30
E	189.0	110	600	30
Bay Springs	194.9	110	600	84
<u>Tennessee/Clinch Rivers</u>				
Kentucky	22.4	110	600	56
Pickwick	206.7	110	600	55
(u.const.)		110	1000	55
Wilson	259.4	60	300	94
		60	292	--
		110	600	94
Wheeler	274.9	110	600	48
		60	400	48
Guntersville	349.0	110	600	39
		60	360	39
Nickajack	424.7	110	600	39
Chickamauga	471.0	60	360	49
Watts Bar	529.9	60	360	58
Ft. Loudon	602.3	60	360	72
Melton Hill (Clnch R)	23.1	75	400	58

22. WHITE RIVER: The White River extends from Newport, Arkansas, to its junction with the Arkansas system (244 miles). The White River is maintained at a minimum width of 125 feet and depth of five feet, but eight feet when the stage reaches twelve on the Clarendon gauge, from the Arkansas system (mile 10) to Augusta (mile 199) and a minimum width of 100 feet and depth of 4.5 feet from the Augusta to Newport.

23. WILLAMETTE RIVER: The Willamette River above Portland (mile 14) to Corvallis (mile 132) and the Yamhill River to mile 7 is maintained at 8 feet to the locks at Oregon City (mile 26) and widths of 200 feet to Cedar Island (mile 23) and 150 feet from there to Oregon City. Above Oregon City, the maintained dimensions are 3.5 feet or less deep and 150 feet wide.

<u>WATERWAY/LOCK NAME OR NUMBER</u>	<u>RIVER MILE</u>	<u>WIDTH (FEET)</u>	<u>LENGTH (FEET)</u>	<u>LIFT (FEET)</u>
<u>Willamette River</u>				
Lock No. 1	26.0	40	210	20
Lock No. 2	26.0	40	210	10
Lock No. 3	26.0	40	210	10
Lock No. 4	26.0	40	210	10
Guard Lock	26.4	40	210	10

APPENDIX H

GLOSSARY

APPENDIX H

GLOSSARY

aerial patrol -- the use of an aircraft at low altitude and speed to observe the pipeline right-of-way.

American Waterways Operators -- nongovernmental organization, composed of barge and towboat owners and operators on navigable coastal and inland waterways, that provides information on safety, shipbuilding, and maintenance. It also provides committee liaison with the U.S. Coast Guard, U.S. Army Corps of Engineers, the Maritime Administration, and the Federal Communications Commission.

Army Corps of Engineers -- that portion of the U.S. Army that has the responsibility for planning, improving, and maintaining the nation's waterways including harbors.

asphaltic -- a crude oil having a predominant base of asphalt, with very little paraffin wax, but often relatively high in sulfur, oxygen, and nitrogen content. This type of crude oil is particularly suitable for making high-quality gasoline, lubricating oil, and asphalt.

backfill -- soil replaced in the ditch to cover the pipe. Also, the act of covering the pipe in the ditch.

barge -- general name given to a flat-bottomed vessel especially adapted for transporting bulk cargoes. Barges can be self-propelled, towed, or pushed.

barrel -- the standard unit of liquid volume in the petroleum industry; equals 42 U.S. gallons.

batches -- homogeneous quantities of petroleum shipped through a pipeline usually having a specified minimum acceptable size.

B/D -- liquid volumes in barrels per day (e.g., MB/D -- thousands of barrels per day).

booster pump station -- a pumping facility at an intermediate location that increases the flow rate of a pipeline.

breakout tankage -- a storage facility consisting of one or more tanks used to accommodate petroleum between pipelines or between pipeline segments with different pumping rates.

bulk carrier -- a carrier engaged in transporting commodities such as petroleum that are not packaged, canned, drummed, or otherwise packed.

bunkering -- to fill a ship's storage compartment with coal or oil.

buoy -- an anchored floating object that serves as an aid to mariners, marking the navigable limits of channels, submerged dangers, isolated rocks, etc.

cabotage (laws) -- legislation designed to specify trade routes between two points within a country or within coastal waters.

capacity -- the maximum volume that a pipeline can move between two points during a given time period using existing equipment. It depends on pipeline diameter; pipeline length; pumping equipment; intermediate locations; pipeline topography; and petroleum viscosity, temperature, and gravity.

carrier -- an individual, partnership, or corporation engaged in the business of transporting goods.

cathodic protection -- method of preventing corrosion of pipelines, tanks, and other metal objects by applying weak DC current to counteract the currents associated with ion exchange of corrosion.

Clean Air Act -- common term for the Clean Air amendments of 1970 that set in motion nationwide federal and state programs to achieve healthful air quality by establishing national standards of ambient air quality.

Clean Water Act -- commonly used term for the 1977 amendments to the Federal Water Pollution Control Act that extended U.S. national jurisdiction for control to the ocean beyond the contiguous zone where the fisheries and other natural resources of the U.S. may be adversely affected.

Coast Guard -- an agency of the U.S. Department of Transportation responsible for providing for the safety of people and property associated with the water. This encompasses such areas as navigational aid systems, communication systems, vessel traffic systems, cargo information, pollution prevention, licensing of marine personnel, inspection and certification of vessels used in the marine transportation of petroleum and hazardous cargoes, etc.

common carrier -- transportation line or system carrying persons or goods for compensation, impartially for all persons or shippers.

common-carrier pipeline -- a pipeline with the authority and responsibility (state or federal) to provide public transportation for hire.

common stream -- movement of similar types of petroleum with a common range.

contamination -- mixing of small amounts of petroleum into a larger batch, adversely affecting the quality of the larger batch.

contract carrier -- any person, partnership, or corporation, not a common carrier, that transports passengers or property for compensation under individual contracts or agreements.

corrosion -- the exchange of ions of a metal object; commonly referred to as "rusting."

crude oil -- raw, unrefined petroleum or hydrocarbon liquid.

custody -- taking possession of and responsibility for (but not title or ownership of) a petroleum shipment.

cycle -- a sequence of pipeline movements (for example, gasoline-kerosine-jet fuel-No. 2 fuel oil-kerosine-gasoline) which is repeated on a consistent basis; usually five, seven, or ten days in length.

destination (unloading point) -- place to which a shipment is consigned or delivered.

dispatchers -- pipeline personnel who control the system from a central location.

distillate -- petroleum products such as kerosine, jet fuel, diesel fuel, and No. 2 fuel oil.

ditching machine -- mechanical equipment used to dig the ditch.

draft -- the depth of a vessel below the waterline.

dry bulk tanks -- designed for transporting cement, flour, etc. and could, with modification, transport liquid commodities.

dry-docking -- a system designed to lift a vessel or barge out of water for repair or cleaning.

ductile -- characteristic of steel which refers to its bendability.

DWT (deadweight tons) -- the carrying capacity of a ship in tons of 2,240 pounds; the difference between a ship's displacement light and her displacement loaded.

Environmental Impact Statement (EIS) -- the written evaluation, required by law, of the effect on the environment of a proposed project.

Environmental Protection Agency (EPA) -- an independent federal agency in the executive branch that coordinates governmental action in regard to the environment.

feeder lines -- a pipeline delivering petroleum into a common-carrier pipeline.

fractionator -- a processing plant which separates natural gas liquids into the marketable components ethane, propane, butane, and natural gasolines.

fungible -- products or crude oils of like characteristics which can be mixed without downgrading.

gathering system -- the network of small lines used to collect crude oil and gas liquids from individual production units or facilities.

general-purpose-type tanks -- tanks used conventionally for petroleum products and noncorrosive chemicals, etc.; can be top or bottom loading, top or bottom unloading; designed for moderate or no pressure.

gravity -- the weight per unit measure of petroleum liquid, usually expressed in either degrees API or related to water as a specific gravity. API gravity is a measure of density in degrees API; specific gravity is the weight per unit of a liquid as related to water.

gravity-sulfur bank -- a system of accounting used on common-stream pipelines where a shipper is compensated or penalized for shipping crude oils of better quality (high gravity, low sulfur) or lesser quality (low gravity, high sulfur) than the quality of the common stream.

Gulf Intracoastal Waterway -- the navigable 1,800-mile waterway from Brownsville, Texas to St. Marks, Florida.

hydraulic -- the use of flowing pressurized fluid in cylinders to operate valves and other controls.

hydrostatic test -- the test of a pipeline prior to operation during which it is filled with water and pressurized to a level that will subject pipe, welds, and other components to a stress of not more than 100 percent of specified minimum yield strength (SMYS) of the pipe and not less than 90 percent of the SMYS. The system is sealed off from external pressure sources and the pressure is maintained and recorded for up to 24 hours.

inhibitors -- small amounts of special chemicals injected into the pipeline as required to eliminate internal corrosion in pipelines and storage tanks.

integrated tug barge -- a tandem vessel arrangement consisting of an oceangoing tug and an unmanned ocean barge, joined together with a rigid but quick-release connection. Rigidly connected tug barges combine the speed and maneuverability of a ship with the economics of a tug and barge.

interchange point -- location at which a shipment, in the course of transportation, is delivered by one railroad to another.

interface -- the point or area at which two dissimilar products or grades of crude oil meet in a pipeline as they are pumped, one behind the other.

interstate traffic -- traffic moving from one state to another state; between points in the same state, but passing within or through another state en route; and between points in the United States and foreign countries.

intrastate traffic -- traffic having its origin, destination, and entire transportation within the same state.

joint rate -- a tariff associated with the movement of petroleum through two or more pipelines, from an original point on one pipeline to a destination point on another delivering pipeline, where the tariff may be equal to or lower than the sum of the individual local tariffs.

joint-venture pipeline -- either: (1) a corporate joint venture in which two or more companies own stock in a pipeline company; or less frequently (2) the undivided interest system. The corporate joint venture is normally financed by use of throughput agreements and private placement loans; it contracts for construction of pipeline facilities, publishes tariffs under its corporate name; and arranges for the performance of all operations, maintenance and record-keeping. The board of directors of the company exercises full control by establishing the financing program, tariff rates, and the capital and operating budget.

Jones Act -- commonly used term for the Merchant Marine Act of 1920 that provides for the protection of the U.S. merchant fleet by excluding foreign-built, owned, or operated ships from the U.S. domestic trades. The Jones Act covers all waterborne transportation between U.S. ports, including inland waterways and the Great Lakes, and the oceanborne trade between the U.S. mainland and Alaska, Hawaii, and Puerto Rico; also designates all vessel personnel, long-shoremen, and harbor workers as "seamen" and wards of the federal court.

lighter -- to convey by a flat-bottomed barge to or from ships.

line fill -- the petroleum contained in all pipes, manifolds, pump and valve bodies, and the bottoms of tanks used by pipelines.

LNG (liquefied natural gas) -- natural gas becomes a liquid at minus 258°F and may be stored and transported in the liquid state.

loading time -- the time required for transporting equipment to be spotted, inspected, loaded, and released to move. It varies from shipper to shipper, and is contingent on shipper facilities; i.e., congestion within facilities, age of facility and equipment, etc.

local traffic -- traffic moving between points on same carrier.

lock -- a physical structure on a waterway made up of one or more chambers that allows vessels to bypass unnavigable areas by lifting or lowering the vessel in the chambers through a flooding and emptying process.

loop -- the construction of a pipeline parallel to an existing line, usually in the same right-of-way, to increase the capacity of the system.

LPG (liquefied petroleum gases) -- butane, propane, and ethane, which are separated from natural and refinery gases by fractionation and are transported in liquid form.

manifold-- an array of piping valves that connect the tanks, pumps, and pipelines.

Maritime Administration (MARAD) -- an agency of the U.S. Department of Commerce that administers programs to aid in the development, promotion, and operation of the U.S. merchant marine industry, including emergency merchant ship operations.

maximum economic capacity -- the maximum volume that a fully expanded pipeline can move economically between two points without constructing a loop.

MC specification -- 300, 301, 302, 303, 304, 305, 306, 307, 310, 311, 312, 330, and 331, designated DOT (Department of Transportation) specifications. The particular hazard classification and product characteristics are indicative of the MC specification tank to be used.

navigational aids -- the equipment (buoy markers, lighthouses, radio beams, etc.) established and maintained by the Coast Guard to increase navigational safety and to provide faster and more accurate vessel-positioning capabilities.

navigational facilities -- the locks, dams, mooring facilities, harbors, ports, etc., that are built, replaced, and maintained in order to provide an efficient waterborne transportation system.

NGL (natural gas liquids) -- high vapor pressure, hydrocarbon liquids separated from wet natural gas and moved by pipeline to a fractionation facility where the components are separated into ethanes, propanes, butanes, and natural gasoline.

nominate -- the process by which a shipper notifies a pipeline company of the amount of petroleum he wishes to ship during the next month. Notification is usually done by letter or telegram.

non-specification tanks -- these tanks are utilized for the transportation of certain petroleum products and other products not considered hazardous, i.e., asphalt, certain road oil or surfacing materials, greases, and edible products.

Occupational Safety and Health Administration (OSHA) -- a unit of the U.S. Department of Labor that develops and promulgates occupational safety and health standards, develops and issues regulations, conducts investigations and inspections to determine regulatory compliance, and issues citations and proposes penalties for noncompliance with safety and health standards and regulations.

paraffinic crude -- a crude oil having a predominant base liquid that, when separated by a distillation process, is used in the manufacture of waxes and lubricating oils.

petroleum product -- broad definition of gasolines, distillates, and heating oils--the output of a petroleum refinery.

pipeline contractor -- one who specializes in building pipeline facilities.

pneumatic -- use of high-pressure air to operate valves or other controls.

pour point -- the temperature at which a liquid will not readily flow or at which it congeals.

private carrier -- any person, partnership, or corporation other than common or contract carrier that transports its own property, and the transportation furthers of its own commercial enterprise.

private line -- a pipeline owned and operated to move only the owner company's crude oil, LPG/NGL, or products.

product distribution terminal -- a facility consisting of storage tanks, pumping equipment, meters, and loading docks where the product is pumped into trucks or tank cars for delivery to bulk plants or service stations. Terminals normally receive products from pipelines, barges, and tankers.

proration -- a method of apportioning pipeline use when nominated shippers' volumes exceed the pipeline capacity.

right-of-way markers -- signs used to physically mark pipeline crossings and routes.

route -- (a) course or direction a shipment moves; (b) designation of motor carrier or rail lines from point of origin to point of delivery.

scow -- a large flat-bottomed boat with broad square ends.

sediment -- a sludge that accumulates in pipelines and tanks and consists of wax, mill scale, dirt, and other debris. It is periodically cleaned out of the facilities.

segregated -- products or crude oil moved through a pipeline in a manner that maintains the identify and specifications of each individual batch.

semi-trailer -- a vehicle without motive power designed to be drawn or towed by another vehicle and so constructed that some part of its weight is carried by a towing vehicle.

sour crude oil -- crude oil having a sulfur content greater than 1 percent (by weight).

sulfur content -- the amount of sulfur in crude oil, expressed as a percentage by weight. This sulfur can be in the form of elemental sulfur, mercaptan sulfur, and/or hydrogen sulfide.

supervisory equipment -- computers, graphic panels, cathode ray tubes, remote telemetry units, and other components used in the remote control and monitoring of a pipeline.

sweet crude oil -- crude oil having a sulfur content of less than 0.5 percent (by weight).

swing indicator -- a navigation instrument that senses and indicates the rate of turn or swing when a tow begins to divert from set course.

tank barge (coastal) -- carries liquid cargo in bulk, stowed in cargo tanks within the vessel hull. Cargo is pumped aboard and unloaded by shore terminal equipment or the vessel's installed pumping system. Sizes range from 10,000 to 42,000 dead weight tons. Approximately 4,252 are presently in domestic coastal service.

tank barge (inland) -- a closed barge with multiple tanks or compartments for the carriage of bulk liquids.

tank car -- rail car used for transporting liquids in bulk. It is constructed in accordance with varying specifications, depending on the physical properties and characteristics of products to be transported.

tank farm -- a group of tanks manifolded together to provide origin, destination, or operational storage for pipeline movements.

tariff -- the document published by the common-carrier pipeline owner setting rates charged and rules and regulations under which services will be performed. Interstate common carriers must file tariffs with the Federal Energy Regulatory Commission.

tariff rate -- the charge in cents per barrel, set out in the published tariff, that a shipper must pay for transportation services.

tensile strength -- the measure of any material's ability to withstand tensile stress, or being pulled apart. Some pipe steels will withstand 70,000 pounds per square inch.

Title XI -- the portion of the Merchant Marine Act of 1936 as amended in 1970 that provides for federal assistance in the financing of tank vessels used solely in domestic trade. The Merchant Marine Act of 1970, which amended the 1936 Merchant Marine Act, represents changes designed to make the Maritime Administration Merchant Marine Program more attractive to private operators.

tow -- one or more barges pushed by a towboat or pulled by a tugboat.

tractor -- power vehicle designed primarily for drawing or towing other vehicles, but not constructed to carry a load other than part of the weight of the vehicle and load so drawn.

trailer -- vehicle (bulk tank) without motive power designed to be drawn by a tractor and so constructed that no part of its weight rests upon the towing vehicle. Also a second trailer; i.e., pup attached to first trailer with single tractor. Specifications vary for physical properties and characteristics of products carried.

truck -- powered vehicle with bulk tank on same chassis (capacity in excess of 3,500 gallons). Possible varying specifications due to characteristics of products carried.

trunk line -- a large-diameter pipeline that usually delivers petroleum into a refinery or production distribution terminal.

undivided interest -- a form of pipeline ownership in which the investors share in the pipeline capacity according to their percentage of ownership in the system. Each publishes a tariff and collects its own revenues. One investor is usually employed to manage, schedule, operate, and maintain the facilities.

U.S. flag fleet -- all ships registered in the United States.

Vessel Traffic Services (VTS) -- an integrated system encompassing the variety of technologies, equipment, and people employed to coordinate vessel movements in or approaching a port or waterway.

viscosity -- the internal resistance to flow of a fluid. This characteristic is usually measured in Saybolt Seconds Universal (SSU) for petroleum liquids. This is the time required for a standard quantity of a liquid to flow through a standard orifice at a set temperature.

waterway -- more than 25,000 miles of navigable rivers, canals, and channels in the United States, maintained to a depth of at least nine feet.

wax -- a component of crude oil that will generally solidify at normal ambient temperatures and tend to collect on pipe walls and on the sides and bottoms of tanks.

INDEX

INDEX

A

Alaskan North Slope oil, 6, 7, 37, 42-43
 common-carrier pipeline systems for, 42
 prohibited export of, 42
 Trans-Alaska Pipeline System, 6, 42
All American Pipeline, 6, 37, 41
Angeles Pipeline, 43

B

Batching, 25-26

C

Canada
 crude oil from, 36-38, 40
 LPG from, 5, 58
Canadian National Energy Plan, 40
Clean Air Act, 33, 71
Clean Water Act, 33
Communications satellites, for pipeline
 data, 23
Comprehensive Environmental Response
 Compensation and Liability Act, 33
Crude oil
 demand changes for, 5, 38
 import of, 36-38, 40
 movements of, 36-38
 production of, 6, 40
 waterborne transportation of, 62

Crude oil pipelines, 5-7, 35-45
 All American Pipeline, 6, 37, 41
 amount transported by, 6
 changes since 1979, 38-43
 construction of, 5, 40-41
 conversion to alternate service,
 6, 39
 factors affecting utilization of, 36
 future plans for, 43-44
 Angeles Pipeline, 43
 Pacific Texas Pipeline, 43
Louisiana Offshore Oil Port system,
 6, 9, 39, 63, 65, 73
overview of, 36-38
by PADD, 36-37
Point Arguello Pipeline system, 7, 42
Point Perdernes system, 6, 41
Trans-Alaska Pipeline System, 6, 42

D

Drag reducers, 18

E

Economic regulations, 33-35
Environmental Protection Agency (EPA),
 33, 71
Environmental regulations, 31, 33
Executive summary, 5-12

F

Farmers Union case, 33-34
 Federal Energy Regulatory Commission
 12, 33
 Opinion 154B, 33-34
*The First Report of the Commission
 on Merchant Marine and Defense*,
 66-67

G

Gulf Intracoastal Waterway, 70-71

H

Hazardous Liquids Pipeline Safety Act,
 12, 29-30

I

Imports
 of crude oil, 38, 59-61
 from Canada, 36-38, 40
 by geographic region, 60
 by PADD, 38
 of LPG, from Canada, 5, 58
 of petroleum products, 47-48, 61
 of residual fuel oil, 59
 Inland waterway system, 9-10,
 61-62
 changes since 1979, 64
 constraints on, 10, 68-71
 construction projects of, 10
 draft and length limits of, 9-10, 61
 Gulf Intracoastal Waterway, 70-71
 Inland Waterway User Board, 72
 locks and dams of, 70
 maintenance and rehabilitation of,
 70-71
 tank barges, 10
 Tennessee-Tombigbee Waterway,
 10, 62
 Intelligent "pigs", 23-24
 Interstate Commerce Act, 33
 Interstate Commerce Commission, 33

J

Jones Act, 11, 66-67

L

Liquefied petroleum gas, 1
 Canadian imports of, 5
 changes since 1979, 52, 57
 definition of, 8
 demand changes for, 5, 57
 distribution systems for, 8, 52, 54
 gathering systems for, 8, 52-53
 movements of, 51-52
 pipelines for, 5, 8, 51-58
 expansion of, 8
 future plans, 57-58
 storage of, 8, 52
 mined caverns, 52, 56
 salt-dome, 52, 55
 supply changes for, 57
 types and uses of, 51-52
 Louisiana Offshore Oil Port (LOOP),
 6, 9, 39, 63, 65, 73

M

Maritime carriers, 9, 63-64
 coastal tankers, 63
 oceangoing tankers, 63
 oceangoing tug-barge units, 63
 port facilities for, 9
 supertankers, 63
 tank barges, 63-64
 Ultra Large Crude Carriers, 9
 U.S. flag tankers, 9
 vessel construction, 9
 Motor Carrier Act of 1980, 78

N

National Petroleum Council reports
 *Petroleum Inventories and Storage
 Capacity*, 1

Petroleum Storage & Transportation, 1
Petroleum Storage and Transportation Capacities, 1
Natural Gas Pipeline Safety Act, 29-30

P

Pacific Texas Pipeline, 43
Petroleum Administration for Defense Districts (PADDs), 2
 crude oil movements by, 36-37
 petroleum product movements by, 46-47
Petroleum products. *See also* Product pipelines
 demand changes for, 5, 7, 47-48
 import of, 61
 types of, 7, 45
Petroleum transportation system. *See also* specific components
 definition of, 75
 pipelines, 15-58
 tank cars/tank trucks, 4, 10-11, 75-79
 waterborne transportation, 3-4, 8-10, 59-73
Pipelines, 15-58. *See also* Crude oil pipelines; Product pipelines
 capacity of
 drag reducers and, 18
 factors affecting, 20
 survey of, 1-3
 connection to break-out tanks, 20
 construction of, 20-24
 history of, 20-21
 materials and methods for, 22-24
 planned expansion projects, 3, 18-19
 recently completed projects, 3
 regulation of, 21
 technological developments and, 21
 cost of tonnage moved by, 16
 decision to build, 17-18
 design of, 17-20
 determining size of, 18-19
 forms of ownership of, 17
 future investments in, 12

 gathering vs. trunk lines, 19
 history of, 15
 interconnections of, 3
 looping of, 19
 maintenance of, 27-28
 cleaning, 28
 computer analysis, 28
 corrosion control, 27-28
 leaks, 28
 normal expansion capability of, 18
 operation of, 24-27
 line fill, 26
 materials specifications, 25
 product batching, 25-26
 scheduling, 27
 shipment nominations, 26
 origin and delivery points of, 3
 overview of, 5, 15-16
 regulation of, 11-12, 21, 28-35. *See also* Regulations
 route selection for, 19
 segregated vs. fungible, 25
 size of system, 5, 15-16
Point Arguello Pipeline System, 7, 42
Point Perdernales system, 6, 41
Port and Tanker Safety Act, 11, 67
Product pipelines, 5, 7, 45-51
 changes since 1979, 45-49
 configuration of, 45
 construction of, 5, 7, 49-50
 demand reductions and, 47
 effects of environmental issues on, 51
 future plans for, 49-51
 investment in, 51
 looping of, 7
 overview of, 45
 by PADD, 46-47
 products carried by, 7, 45

R

Red River project, 62, 73
Regulations, 11-12
 economic, 33-35
 environmental, 31, 33

Federal Energy Regulatory
Commission, 12, 33-34
Hazardous Liquids Pipeline Safety Act,
12, 29-30
Jones Act, 11, 66-67
Natural Gas Pipeline Safety
Act, 29-30
need for reform in, 35
for pipelines, 11-12, 21, 28-35
Port and Tanker Safety Act, 11, 67
reduction of, 11, 34-35
for tank car/tank truck industries, 11,
76, 78
Transportation of Explosives Act, 29
for waterborne transportation, 11,
71-72
Resource Conservation and Recovery
Act, 33

S

Safe Drinking Water Act, 33
Safety
of public and personnel, 31
regulations on, 28-31. *See also*
Regulations
of various transportation modes, 32
of waterborne transportation, 67-68
Scheduling, of pipeline shipments, 27
Scraper traps, 28
"Staggers Act", 76
Strategic Petroleum Reserve, 39

T

Tank cars/tank trucks, 4, 10-11, 75-79
effects of deregulation on, 11, 76, 78
rail cars, 75-78
accessibility of, 76
capacity of, 75-76
design changes in, 76
"Staggers Act", 76
supply of, 76-78
services of, 10, 75

trucks, 78-79
inventory of, 78-79
Motor Carrier Act of 1980, 78
Tennessee-Tombigbee Waterway, 10, 62
Trans-Alaska Pipeline System (TAPS), 6, 42
Trans-Panama Pipeline System
(Panapipe), 42
Transportation Act of 1980, 76
Transportation of Explosives Act, 29

U

Ultra Large Crude Carriers (ULCC), 9, 63

V

Very Large Crude Carriers (VLCC), 42, 63

W

Waterborne transportation, 3-4, 8-10,
59-73
cargo mix of, 61
changes since 1979, 64-68, 72-73
constraints on, 10, 68-71
of crude oil, 62
domestic, 8-9, 59, 61
foreign, 8, 59
high- and low-water conditions and,
69-70
industry perspective, 72
inland waterway system, 9-10, 61-62
changes since 1979, 64
construction projects of, 10
draft and length limits of, 9-10, 61
Gulf Intracoastal Waterway, 70-71
Inland Waterway User Board, 72
locks and dams of, 70
maintenance and rehabilitation of,
70-71
tank barges, 10
Tennessee-Tombigbee Waterway, 10, 62
Louisiana Offshore Oil Port, 6, 9, 39,
63, 65, 73

maritime carriers, 9, 63-64
 changes since 1979, 64-68
 coastal tankers, 63
 oceangoing tankers, 63
 oceangoing tug-barge units, 63
 port facilities for, 9
 supertankers, 63, 65
 tank barges, 63-64
 Ultra Large Crude Carriers, 9
 U.S. flag tankers, 9
 vessel construction, 9
personnel for, 72

port facilities for, 59
regulation of, 11, 71-72
vessels for, 65-68
 cabotage laws, 66
 construction of, 9, 65
 cost of, 68
 effect of Port and Tanker Safety
 Act, 67
 numbers of, 65-66
 shipbuilding and repair industries,
 66-67
 subsidies for, 65-66

ORDER FORM

**Profiles of Crude Oil and
Petroleum Product Pipeline Systems
of Companies Participating in the
National Petroleum Council's
1988 Survey of U.S. Petroleum Pipelines**

Appendices C, D, and E of Volume V, *Petroleum Liquids Transportation*, of the National Petroleum Council's 1989 report, *Petroleum Storage & Transportation*, present data and maps based on NPC pipeline survey data. This information is presented on a national, regional, and major refining and pipeline center area basis. Additional detailed information on the pipeline companies that participated in the survey was not included in Volume V but is available from the NPC. Company profiles were compiled from survey responses, providing a brief description, maps, and data sheets for each participating pipeline system.

A complete set of company profiles (approximately 600 pages) covering 98 crude oil and petroleum product pipeline systems in the United States is available at \$75.00.

Order Form

Publications Department
National Petroleum Council
1625 K Street, N.W.
Washington, D.C. 20006

A check in the amount of
\$_____ is enclosed for _____
sets of the petroleum pipe-
line profiles.

Name_____

Organization_____

Street_____

City_____

State_____

Zip Code_____

Telephone Number_____

Profiles are shipped via United Parcel Service. A street address is required.

**Profiles of Crude Oil and
Petroleum Product Pipeline Systems
of Companies Participating in the
National Petroleum Council's
1988 Survey of U.S. Petroleum Pipelines**

Appendices C, D, and E of Volume V, *Petroleum Liquids Transportation*, of the National Petroleum Council's 1989 report, *Petroleum Storage & Transportation*, present data and maps based on NPC pipeline survey data. This information is presented on a national, regional, and major refining and pipeline center area basis. Additional detailed information on the pipeline companies that participated in the survey was not included in Volume V but is available from the NPC. Company profiles were compiled from survey responses, providing a brief description, maps, and data sheets for each participating pipeline system.

A complete set of company profiles (approximately 600 pages) covering 98 crude oil and petroleum product pipeline systems in the United States is available at \$75.00.

Order Form

Publications Department
National Petroleum Council
1625 K Street, N.W.
Washington, D.C. 20006

A check in the amount of
\$_____ is enclosed for _____
sets of the petroleum pipe-
line profiles.

Name _____
Organization _____
Street _____
City _____
State _____
Zip Code _____
Telephone Number _____

Profiles are shipped via United Parcel Service. A street address is required.

