

Rev. 0

**WOLF CREEK
UPDATED SAFETY ANALYSIS REPORT**

Figure 2.1-1
Location of Site within the State
of Kansas

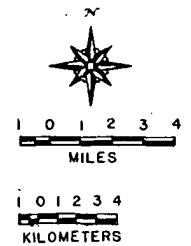

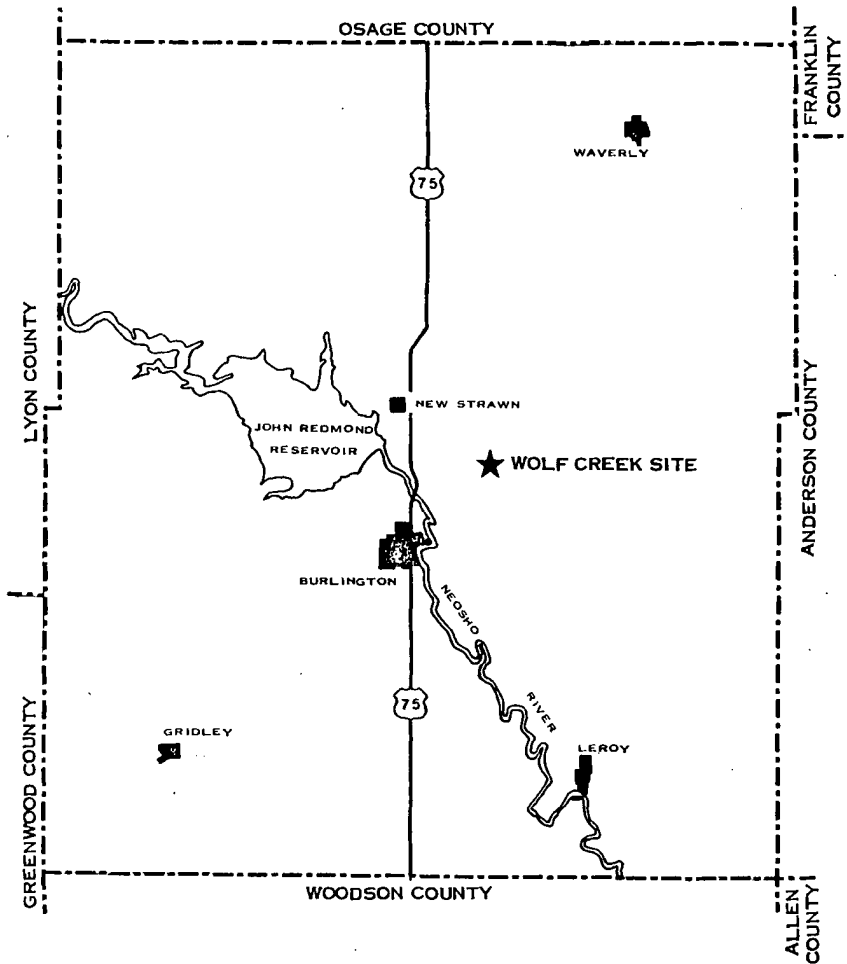

Rev. 0

**WOLF CREEK
UPDATED SAFETY ANALYSIS REPORT**

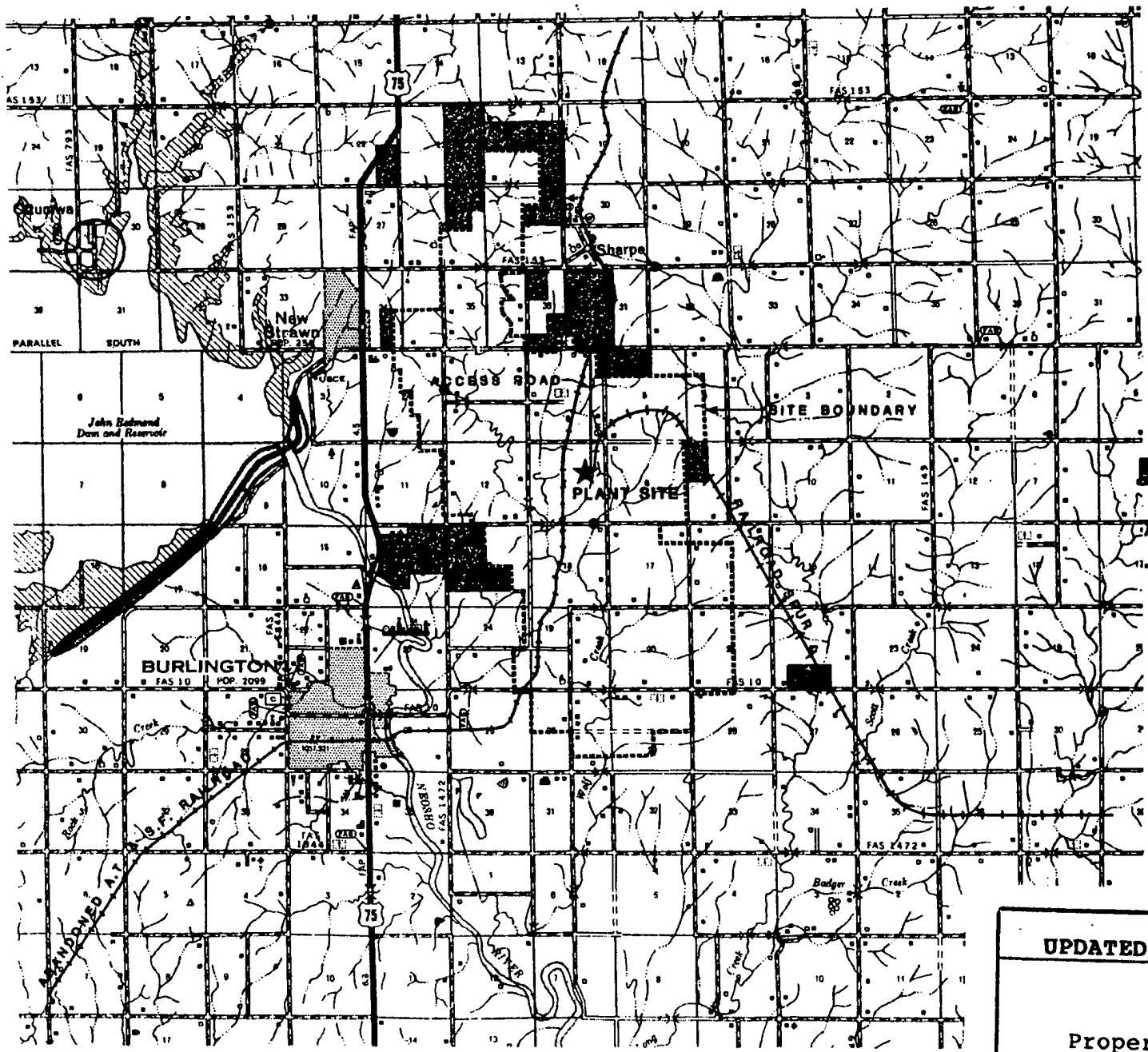
Figure 2.1-2
Location of Site within Coffey
County



LEGEND

-  AREA OUTSIDE SITE BOUNDARY OWNED BY APPLICANTS
-  PLANT LOCATION
-  SITE BOUNDARY

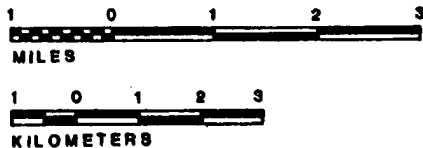

Rev. 0

**WOLF CREEK
 UPDATED SAFETY ANALYSIS REPORT**

Figure 2.1-3

Property Owned By Applicant

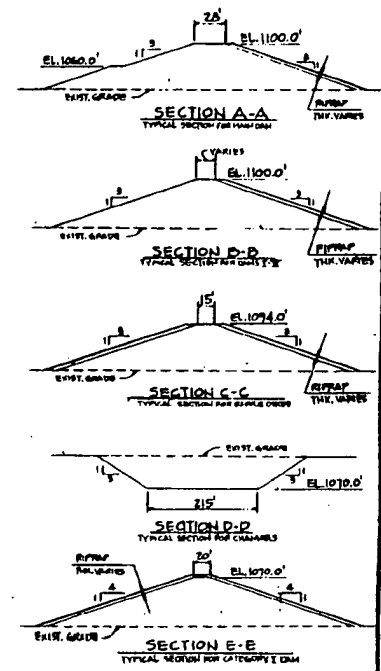
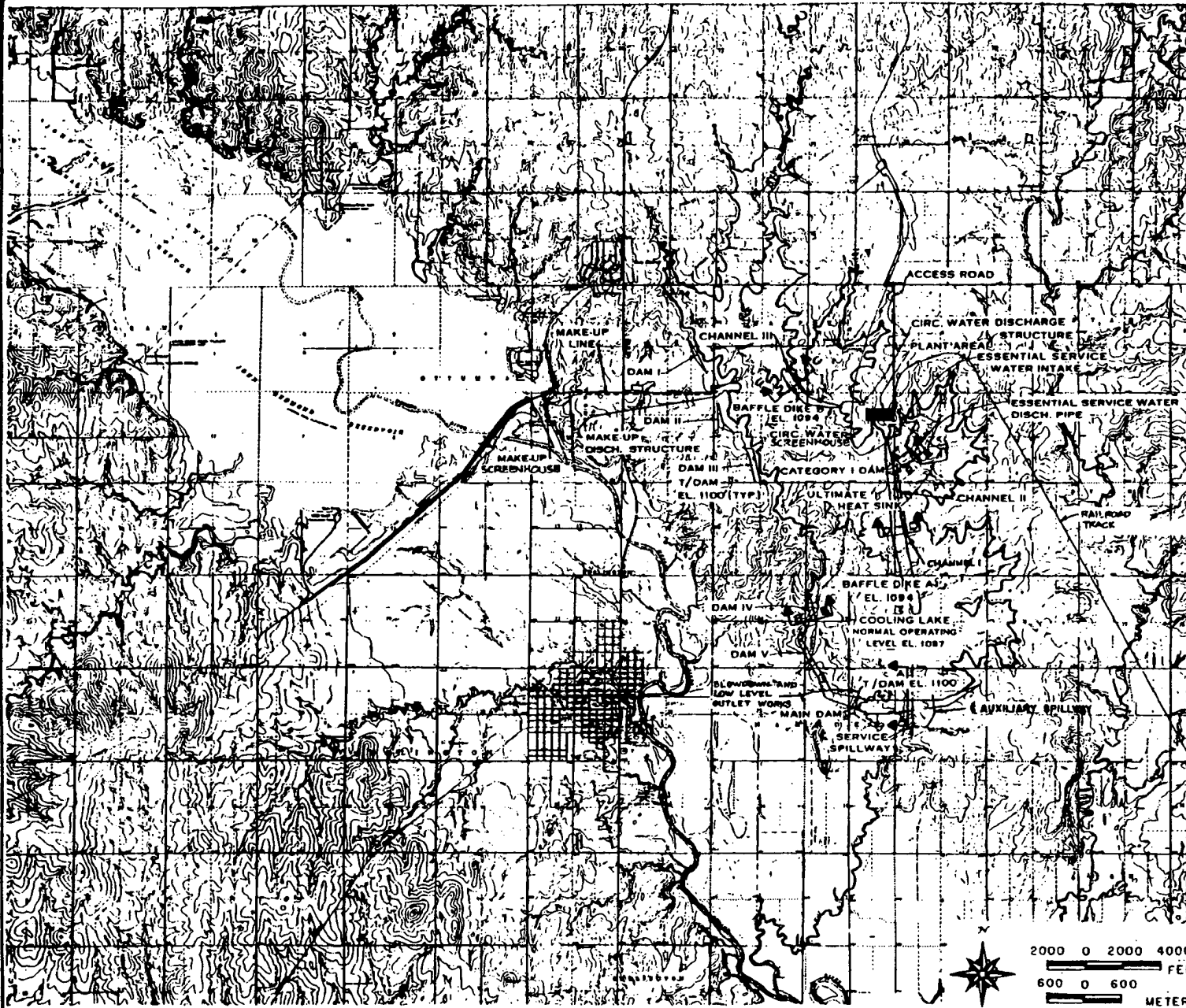

ITEM	APPROX LENGTH	WIDTH	SIDE SLOPE
MAIN DAM	12260'	26'	3:1
DAM I	1740'	12'	3:1
DAM II	3020'	12'	3:1
DAM III	2450'	12'	3:1
DAM IV	2470'	20'	3:1
DAM V	445'	12'	3:1
BAFFLE DIKE 'A'	10410'	15'	3:1
BAFFLE DIKE 'B'	4570'	15'	3:1
CHANNEL #1	4800'	215'	3:1
CHANNEL #2	3230'	215'	3:1
CHANNEL #3	4700'	215'	3:1
CATEGORY I DAM	1500'	20'	4:1

Rev. 0

**WOLF CREEK
UPDATED SAFETY ANALYSIS REPORT**

Figure 2.1-5

Layout of Dams, Dikes, Spillways,
and Outlet Work

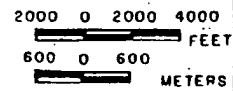

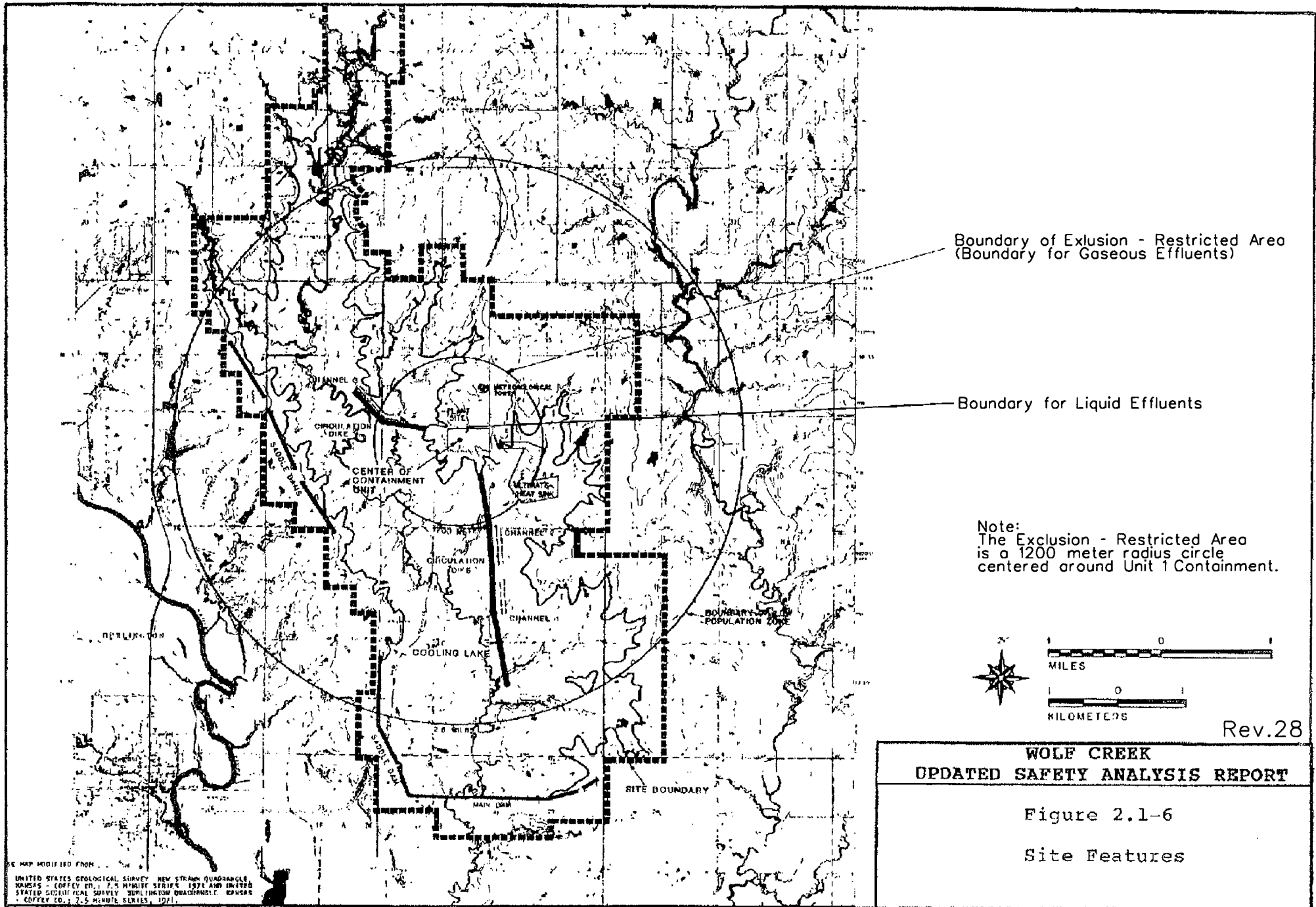

Boundary of Exclusion - Restricted Area
(Boundary for Gaseous Effluents)

Boundary for Liquid Effluents

Note:
The Exclusion - Restricted Area
is a 1200 meter radius circle
centered around Unit 1 Containment.

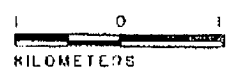
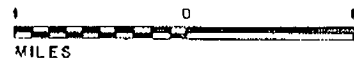

Rev.28

**WOLF CREEK
UPDATED SAFETY ANALYSIS REPORT**

Figure 2.1-6
Site Features

MAP MODIFIED FROM
UNITED STATES GEOLOGICAL SURVEY NEW STRAIN QUADRANGLE
SPANSAS - COPPER CO., 7.5 MINUTE SERIES, 1970 AND UNITED
STATES GEOLOGICAL SURVEY WASHINGTON QUADRANGLE SPANSAS
- COPPER CO., 7.5 MINUTE SERIES, 1971.

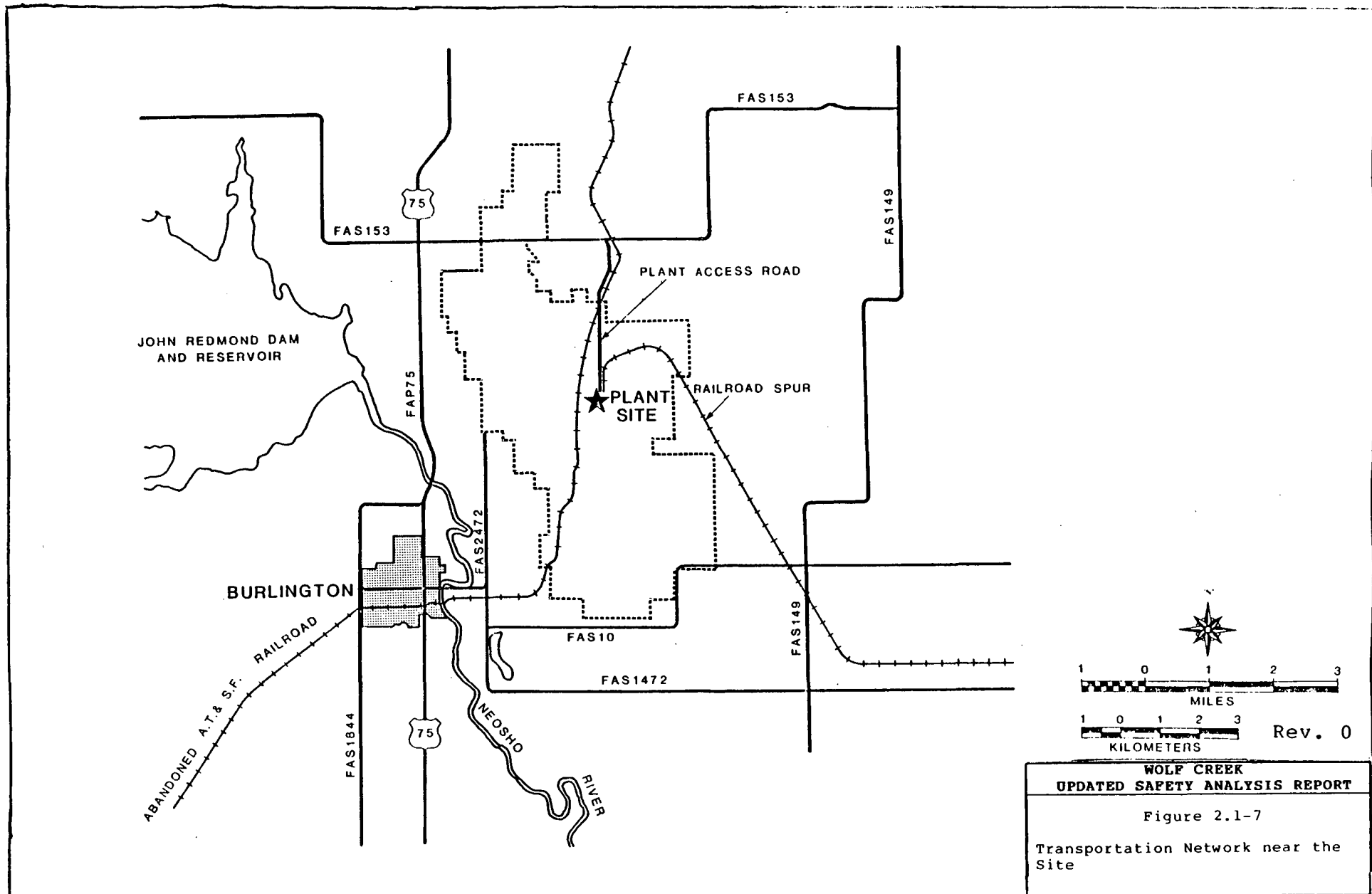

WOLF CREEK
UPDATED SAFETY ANALYSIS REPORT
 Figure 2.1-7
 Transportation Network near the Site

Rev. 0

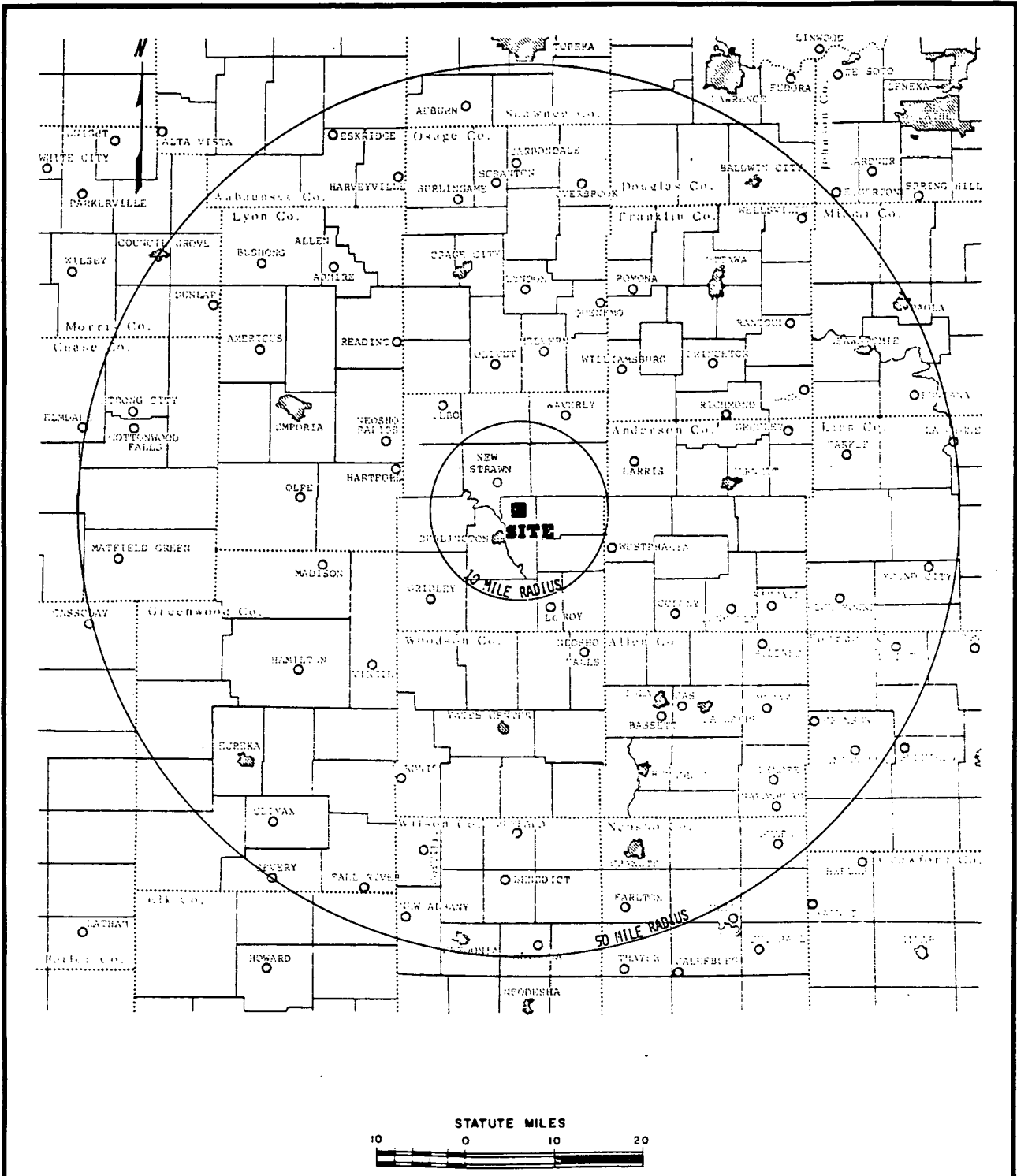

Rev. 0

**WOLF CREEK
UPDATED SAFETY ANALYSIS REPORT**

Figure 2.1-8
Cities and Towns within 50 Miles
of the Site

REFERENCE:
BUREAU OF CENSUS, CIVIL DIVISION
MAP OF KANSAS, 1970

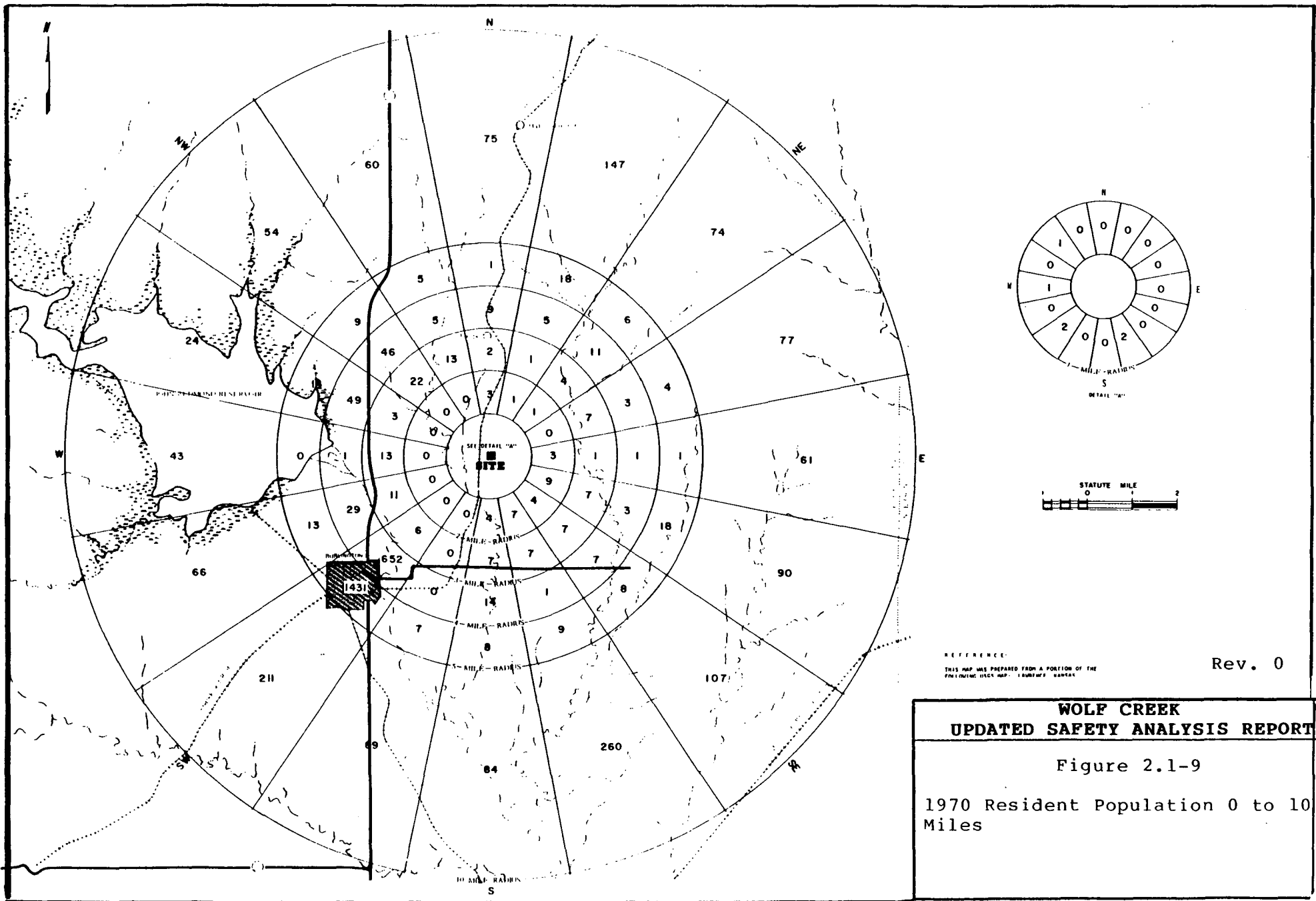

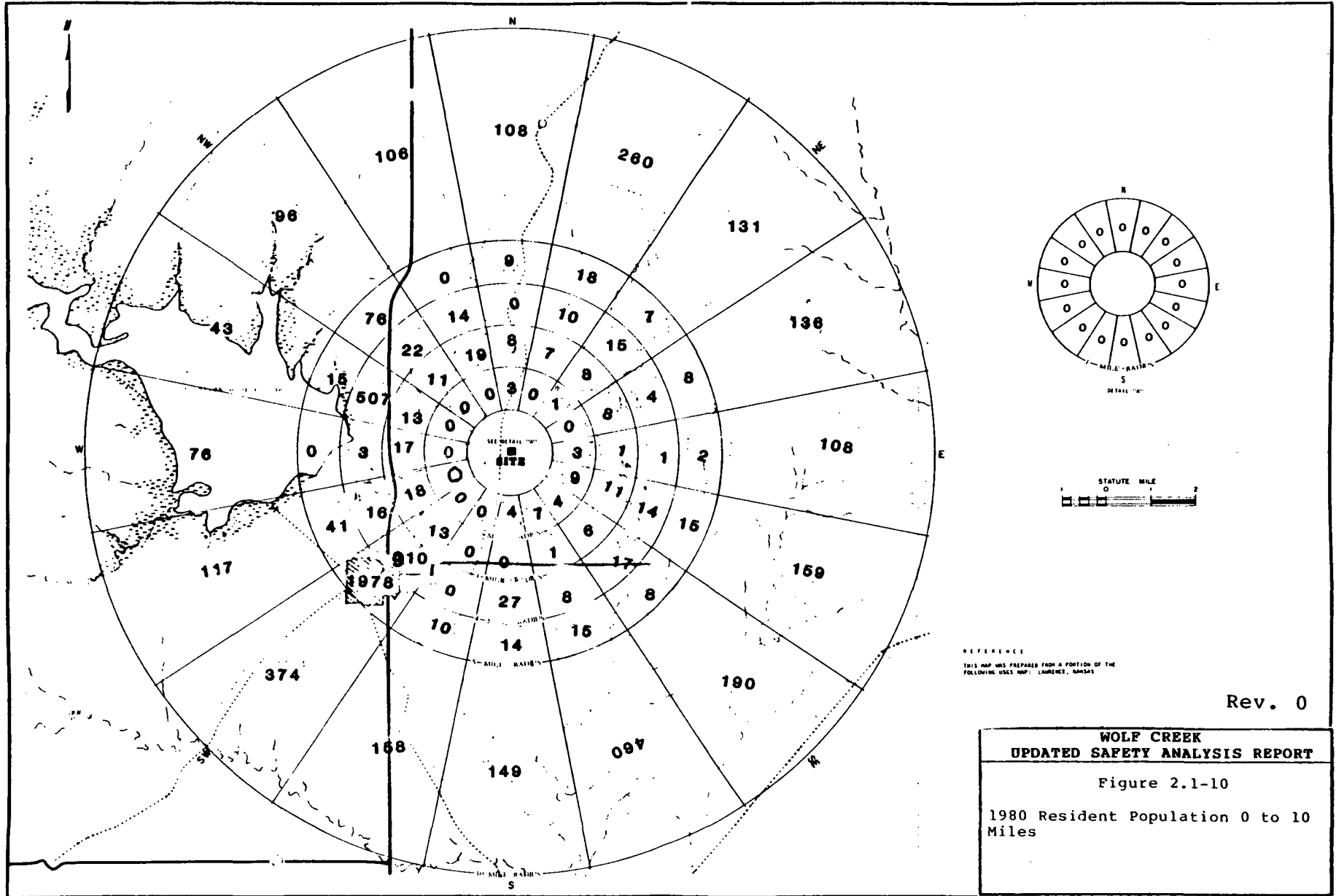

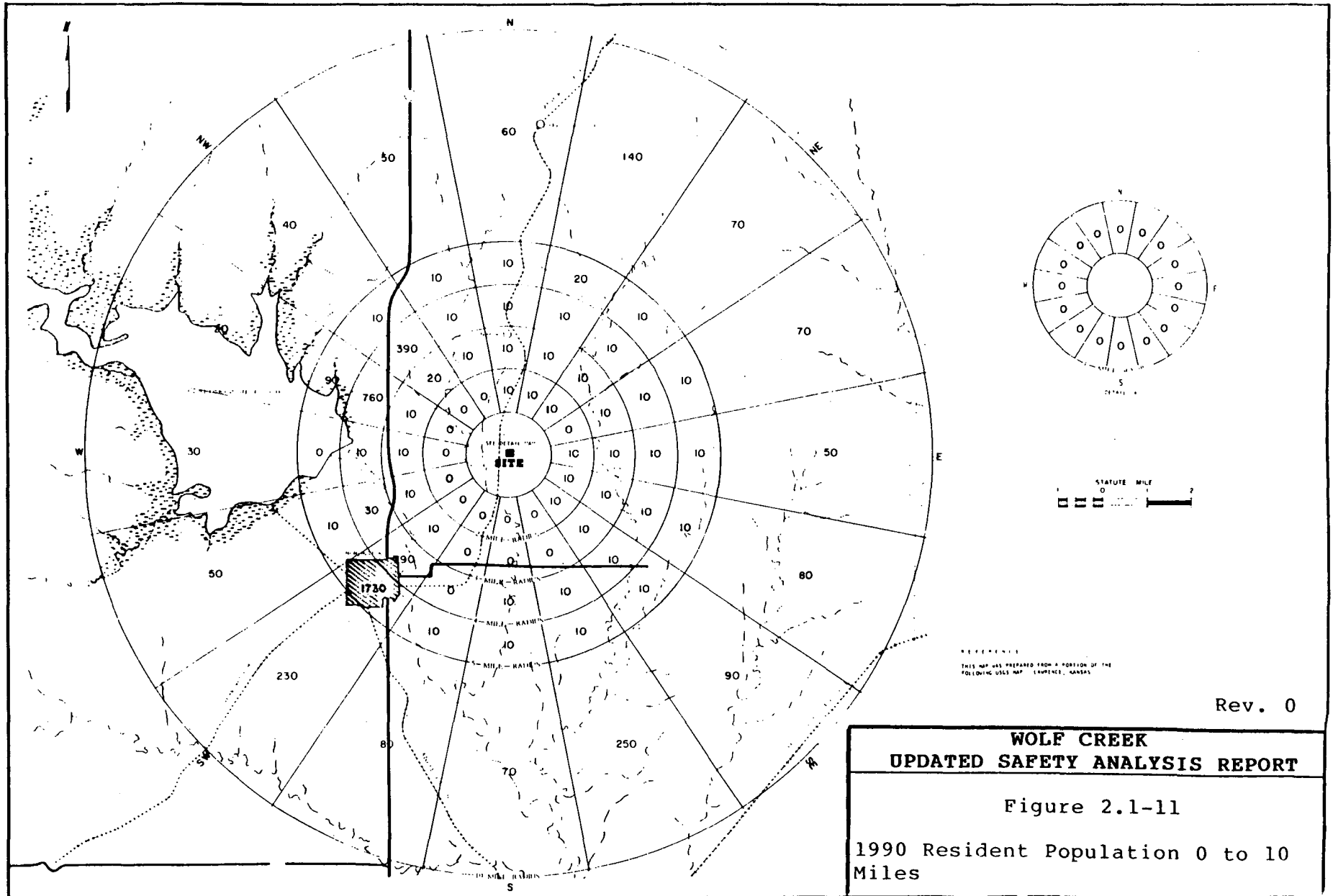

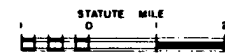
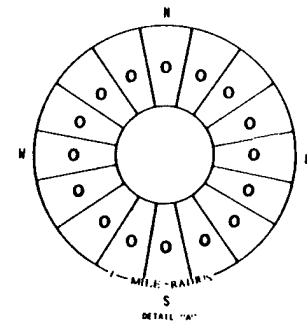
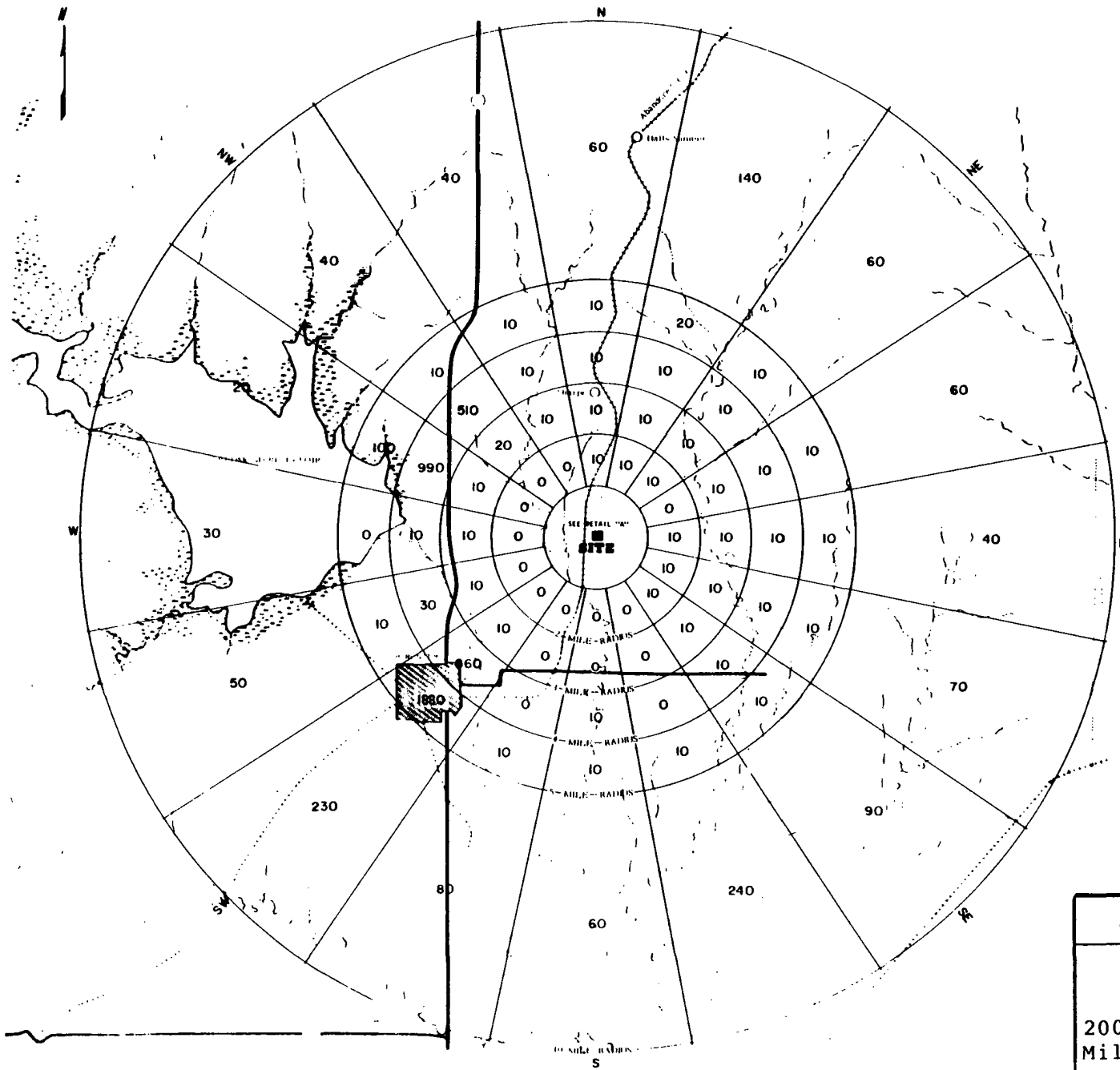

REFERENCE:
THIS MAP WAS PREPARED FROM A PORTION OF THE
FOLLOWING USGS MAP: LAWRENCE, KANSAS

Rev. 0

**WOLF CREEK
UPDATED SAFETY ANALYSIS REPORT**

Figure 2.1-12
2000 Resident Population 0 to 10
Miles

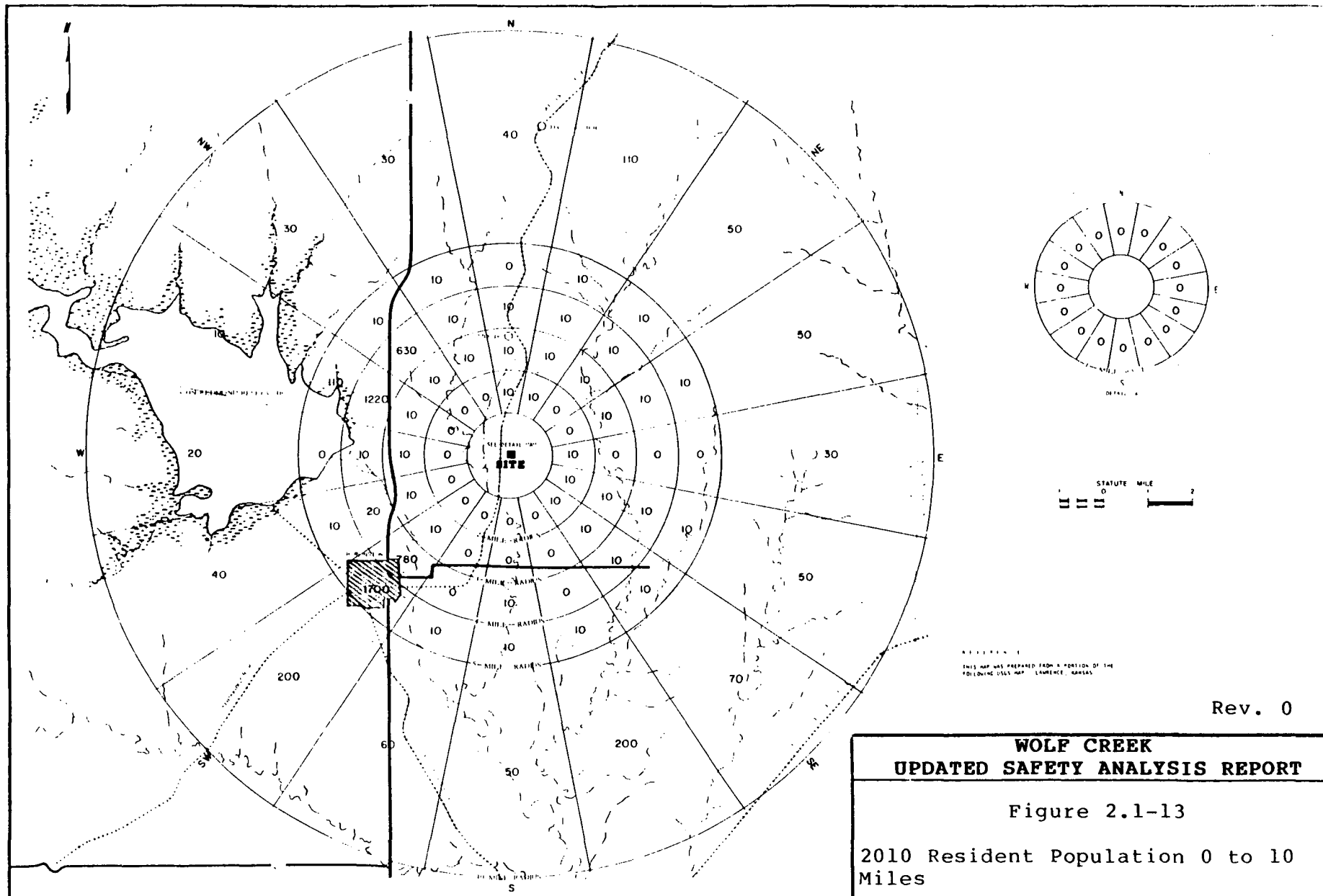

Rev. 0

**WOLF CREEK
UPDATED SAFETY ANALYSIS REPORT**

Figure 2.1-13

2010 Resident Population 0 to 10 Miles

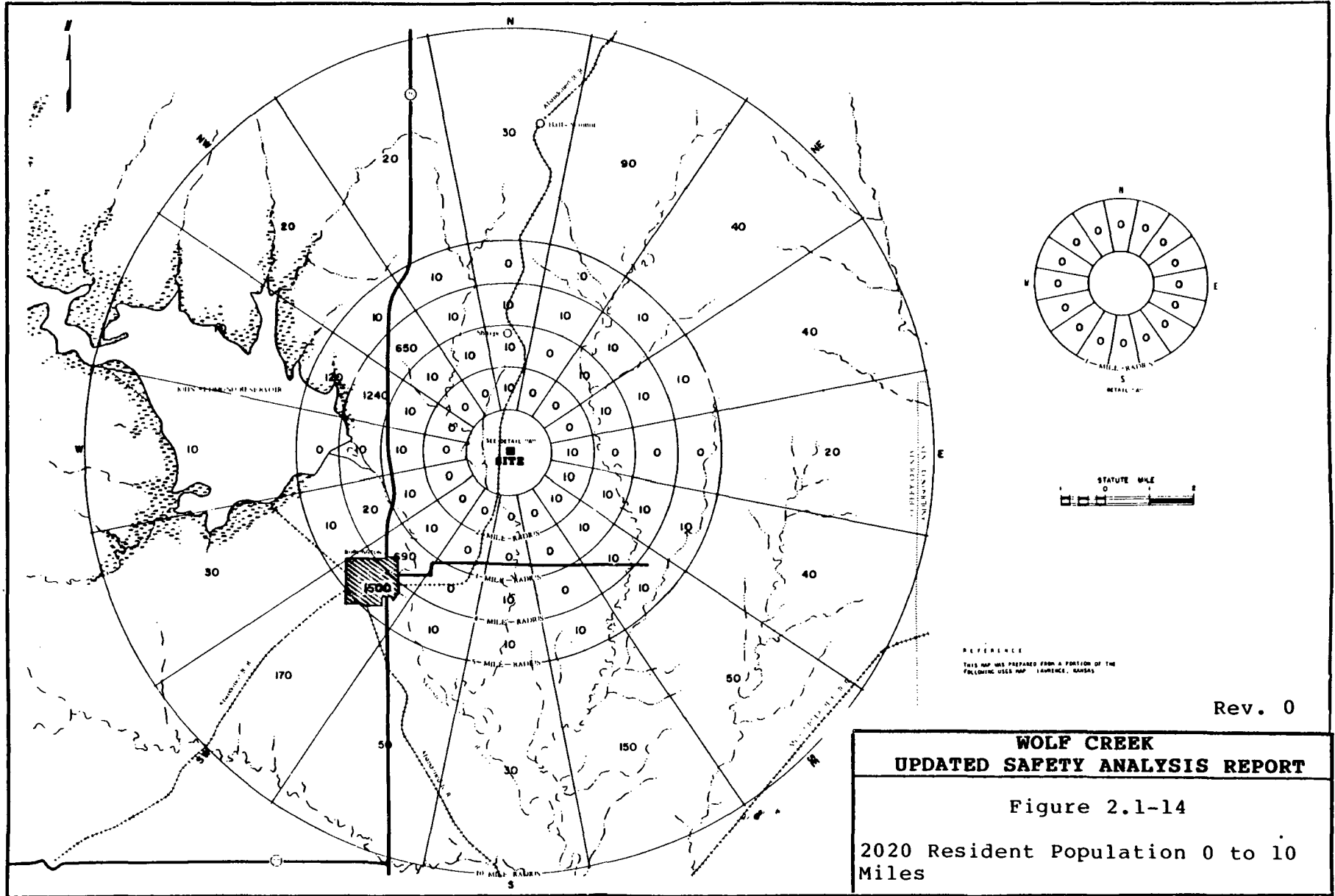

**WOLF CREEK
UPDATED SAFETY ANALYSIS REPORT**

Figure 2.1-14
2020 Resident Population 0 to 10
Miles

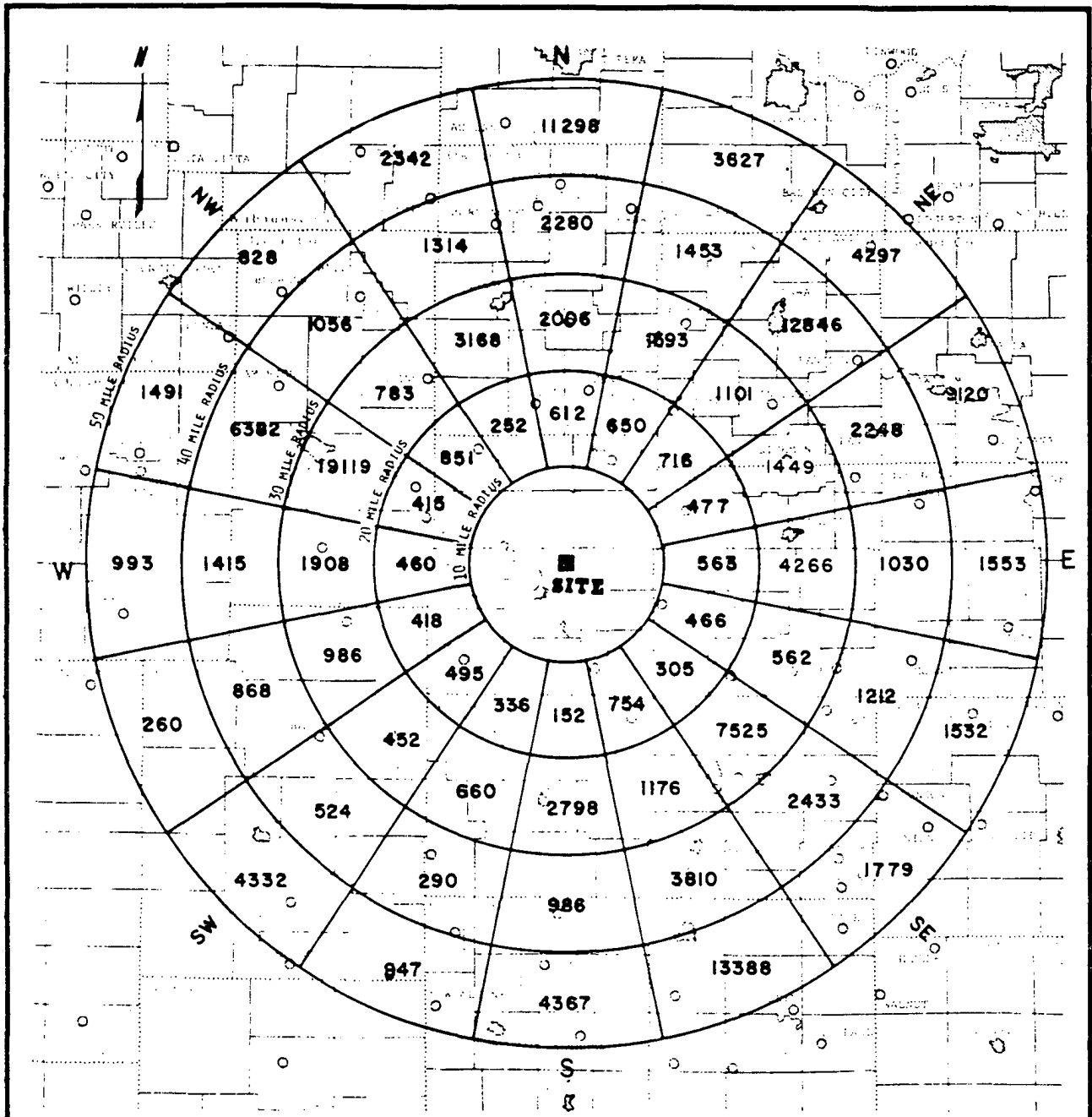

Rev. 0

**WOLF CREEK
UPDATED SAFETY ANALYSIS REPORT**

Figure 2.1-15

1970 Resident Population 10 to 50 Miles

REFERENCE:
BUREAU OF CENSUS, CIVIL DIVISION
MAP OF KANSAS, 1970

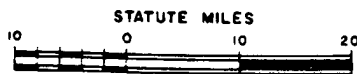
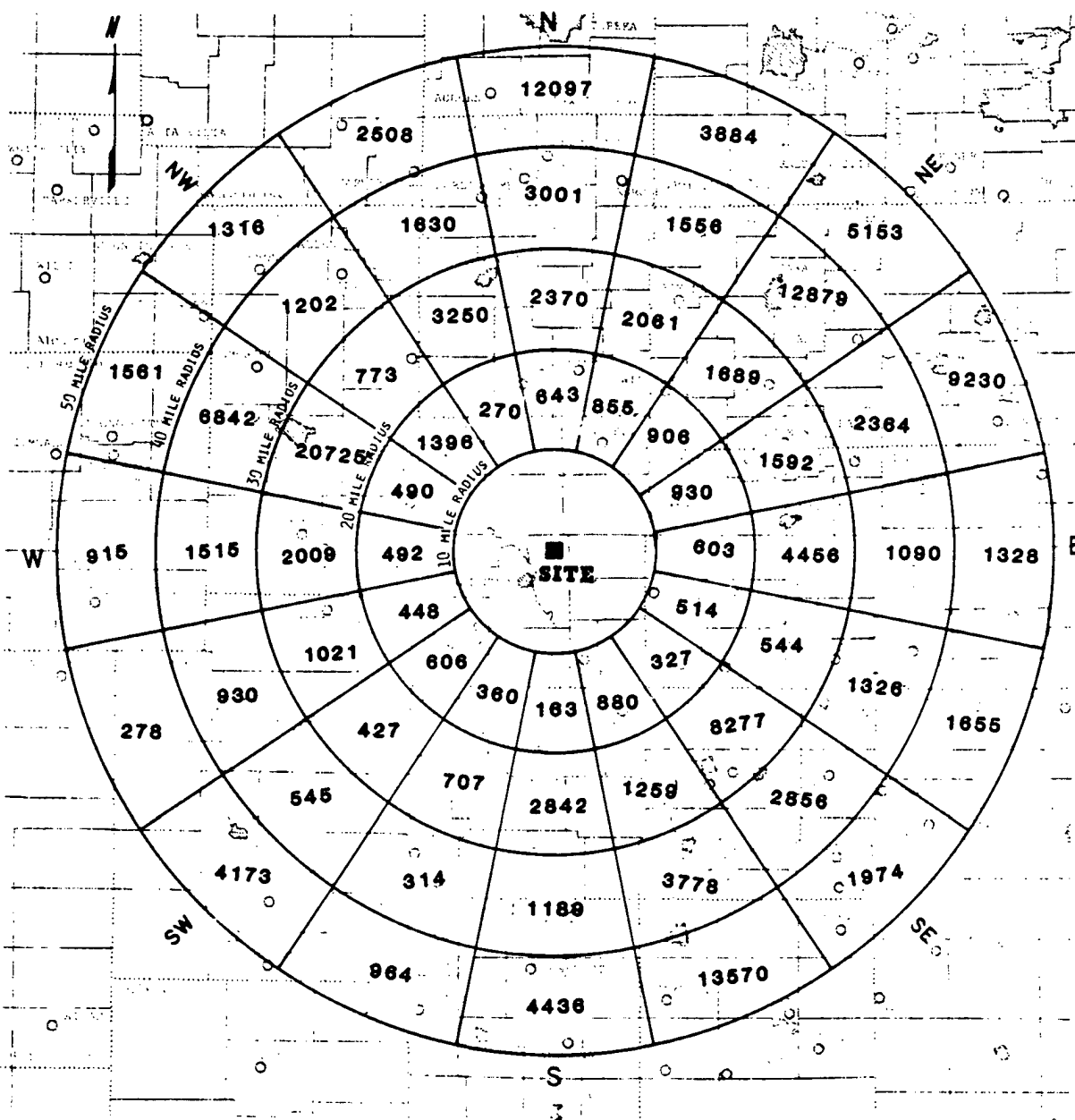

Rev. 0

**WOLF CREEK
UPDATED SAFETY ANALYSIS REPORT**

Figure 2.1-16

1980 Resident Population 10 to 50 Miles

REFERENCE:
BUREAU OF CENSUS, CIVIL DIVISION
MAP OF KANSAS, 1970

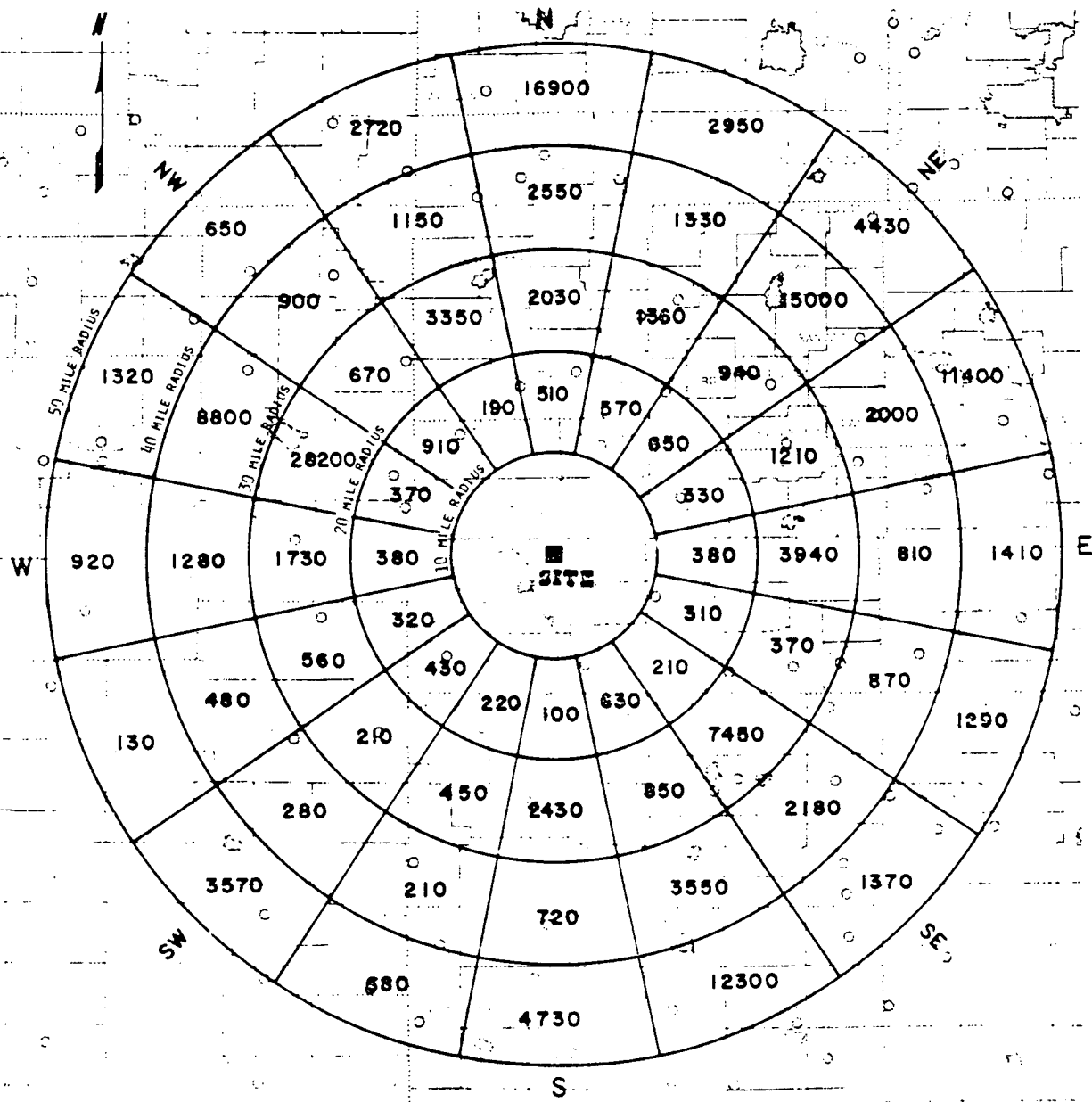
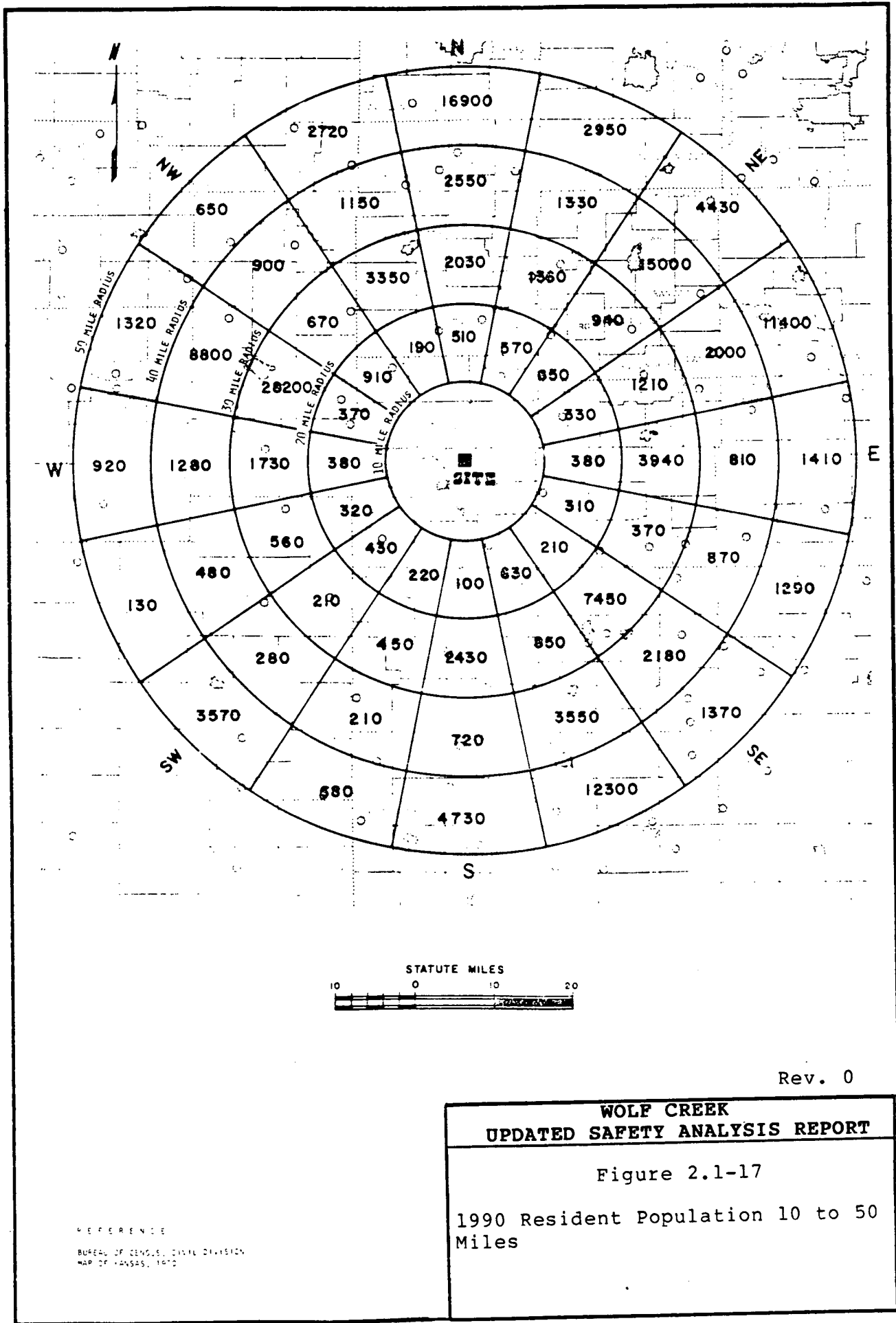

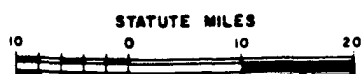
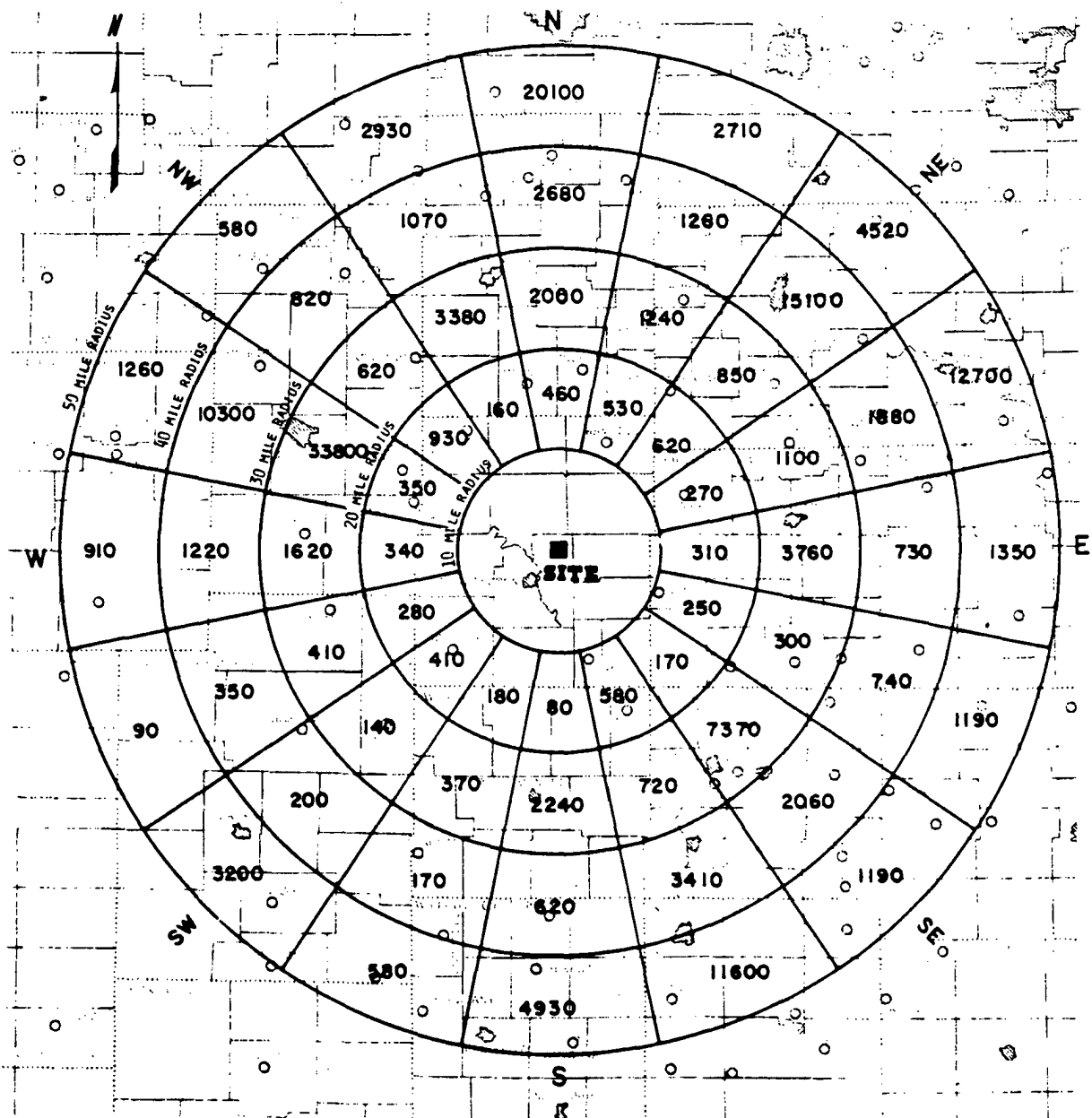

Rev. 0

**WOLF CREEK
UPDATED SAFETY ANALYSIS REPORT**

Figure 2.1-18
2000 Resident Population 10 to 50 Miles

REFERENCE:
BUREAU OF CENSUS, CIVIL DIVISION
MAP OF KANSAS, 1970

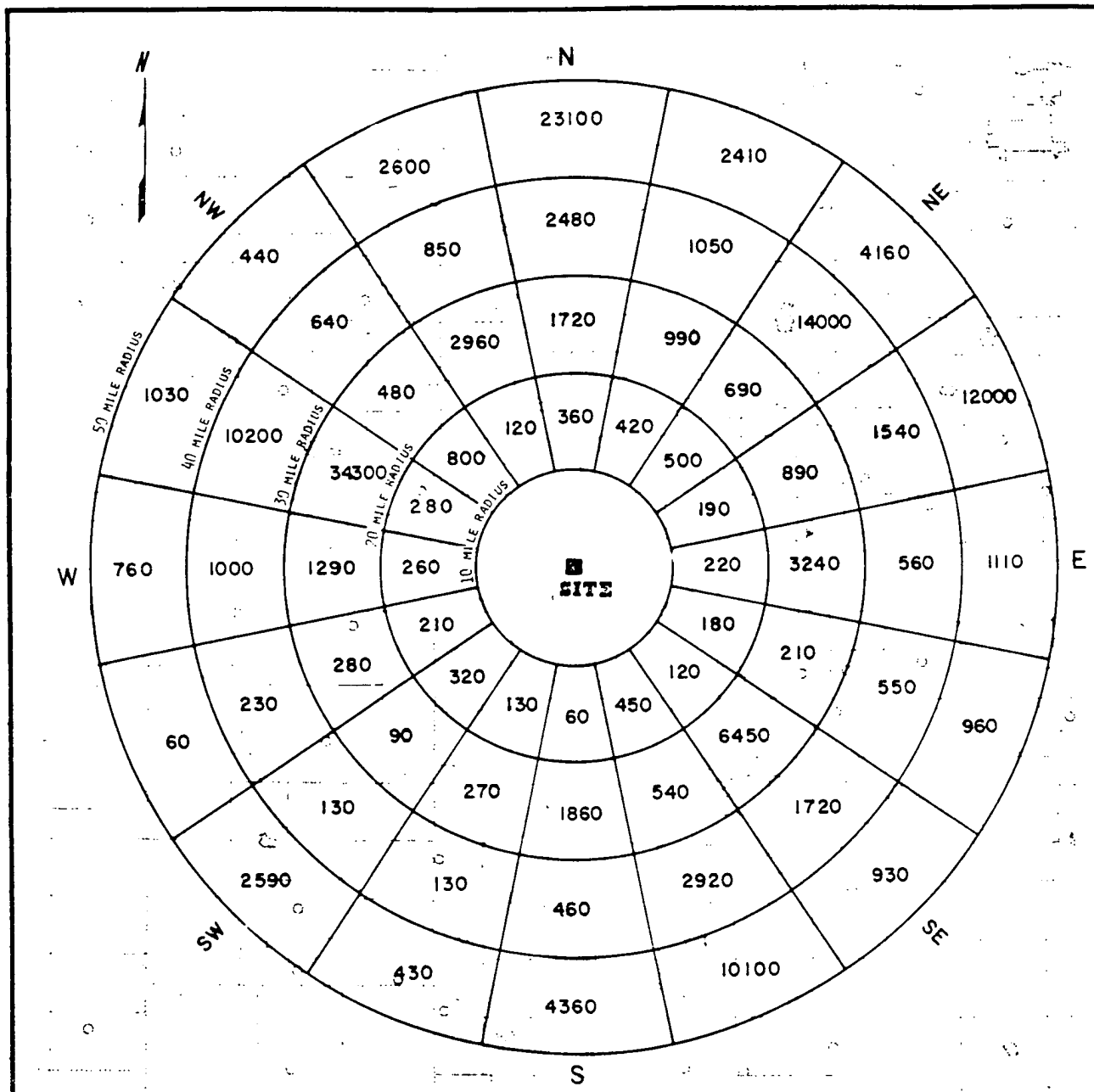

Rev. 0

**WOLF CREEK
UPDATED SAFETY ANALYSIS REPORT**

Figure 2.1-19
2010 Resident Population 10 to 50 Miles

REFERENCE
BUREAU OF CENSUS, CIVIL DIVISION
MAP OF KANSAS, 1970

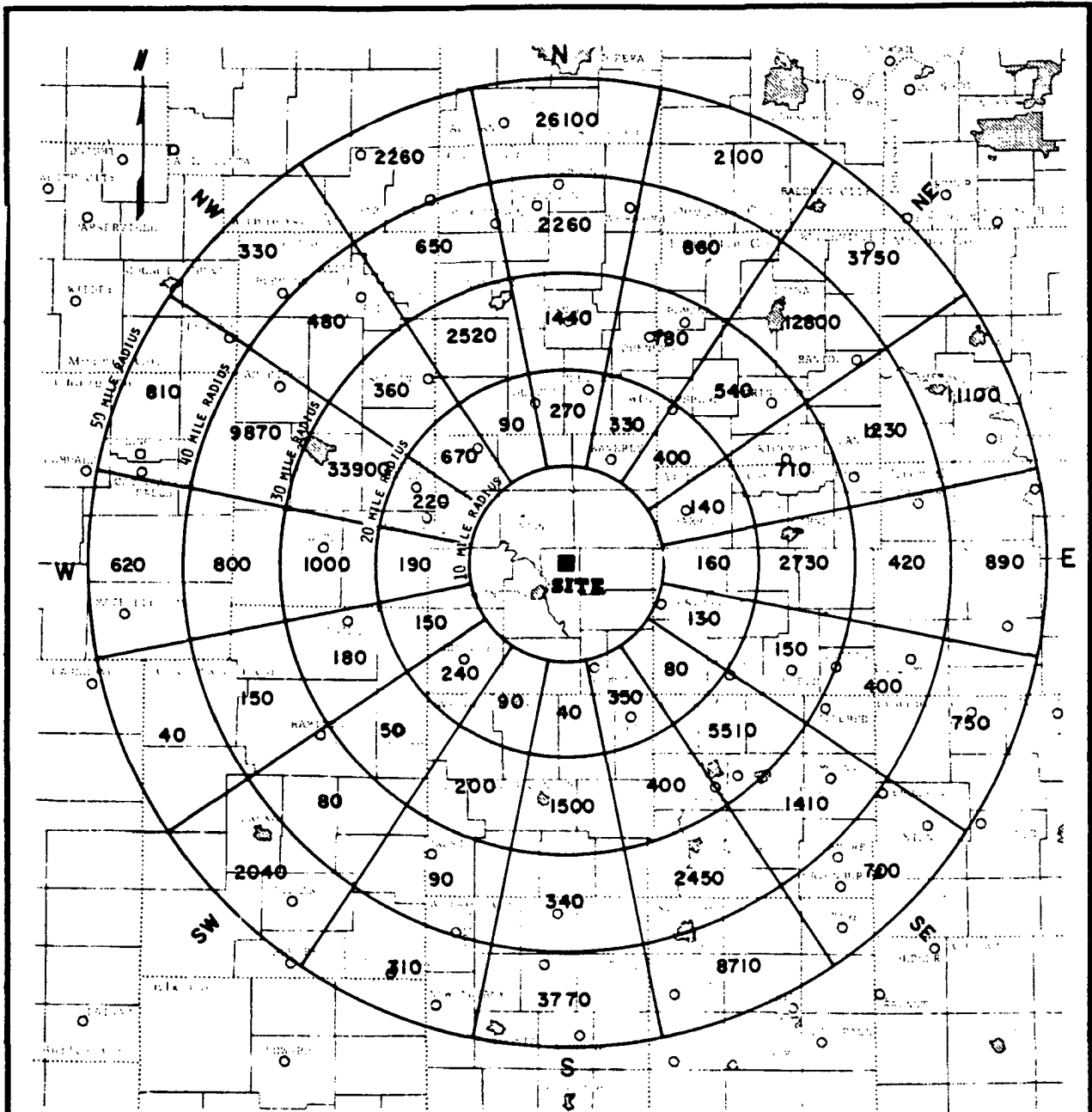

Rev. 0

**WOLF CREEK
UPDATED SAFETY ANALYSIS REPORT**

Figure 2.1-20

2020 Resident Population 10 to 50 Miles

REFERENCE:
BUREAU OF CENSUS, CIVIL DIVISION
MAP OF KANSAS, 1970

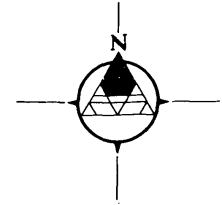
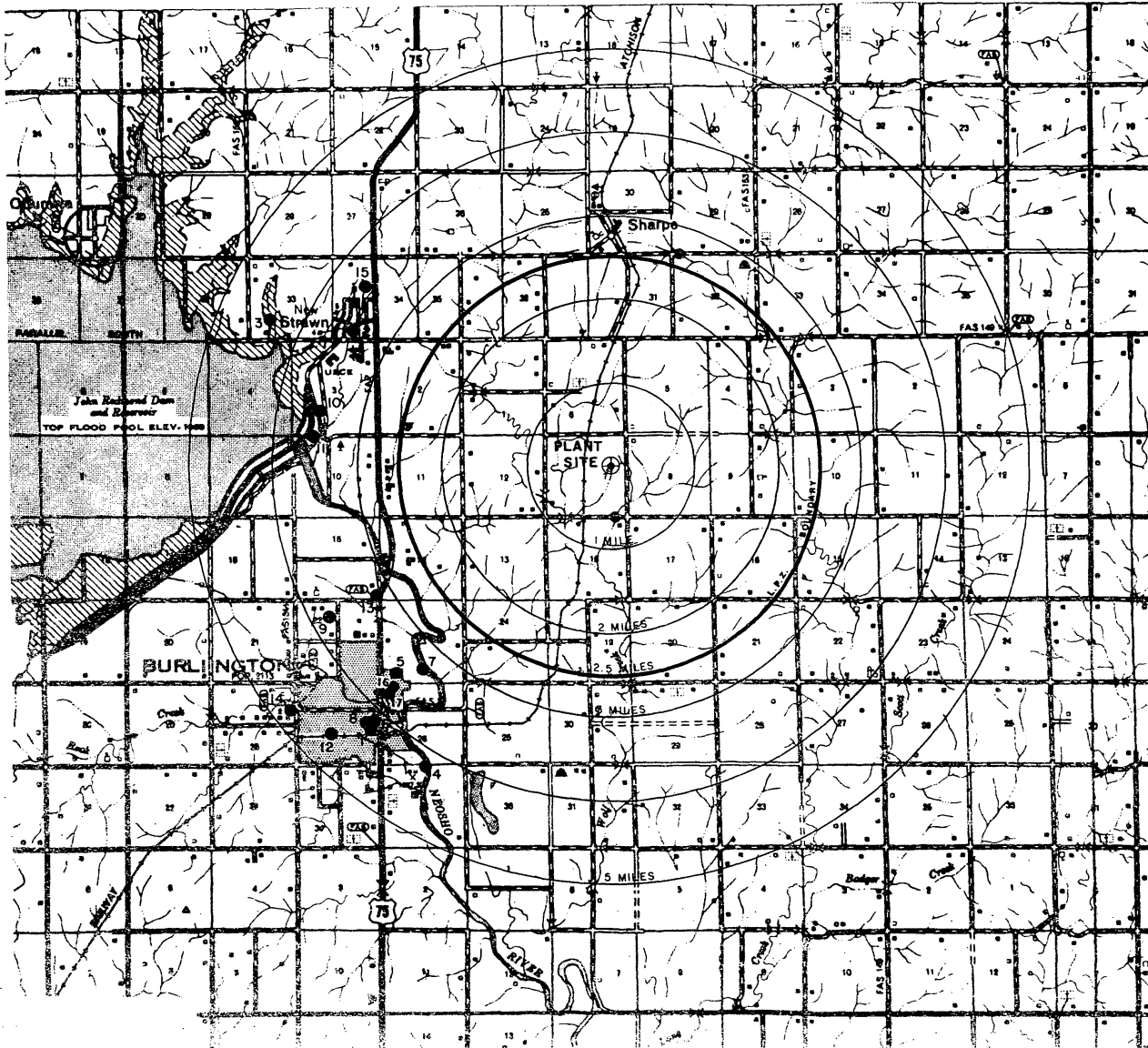

EXPLANATION

- LOCATION OF FACILITY
- NAME OF FACILITY
- 1. UNIFIED SCHOOL DISTRICT 244 (BURLINGTON)
- 2. SPECIAL SCHOOL (PROJECTED)
- 3. OUTDOOR LABORATORY FOR ENVIRONMENTAL EDUCATION
- 4. COFFEY COUNTY FAIR GROUNDS
- 5. COFFEY COUNTY HOSPITAL
- 6. COFFEY COUNTY JAIL
- 7. ORAKE PARK
- 8. FLORAL PARK
- 9. GOLDEN AGE LODGE
- 10. HONEY TREE PRESCHOOL
- 11. JOHN REDMOND RESERVOIR
- 12. KATY PARK
- 13. PLEASANT VALLEY TOURIST FARM
- 14. ROCK CREEK COUNTRY CLUB
- 15. ARROWHEAD HILLS COUNTRY CLUB
- 16. ALLELUIA ACADEMY
- 17. IMMANUEL BAPTIST ACADEMY

NOTE:
 THERE ARE NO PUBLIC FACILITIES LOCATED BETWEEN 5 AND 10 MILES OF THE SITE EXCEPT FOR THE FLINT HILLS NATIONAL WILDLIFE REFUGE. IT IS LOCATED ALONG THE PERIMETER OF JOHN REDMOND RESERVOIR, 6.8 MILES TO 20.8 MILES WEST TO NORTHWEST OF THE SITE.

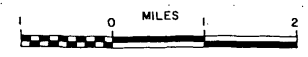

**WOLF CREEK
 UPDATED SAFETY ANALYSIS REPORT**

FIGURE 2.1-21

PUBLIC FACILITIES AND INSTITUTIONS
 WITHIN 5 MILES OF THE SITE

Rev. 0

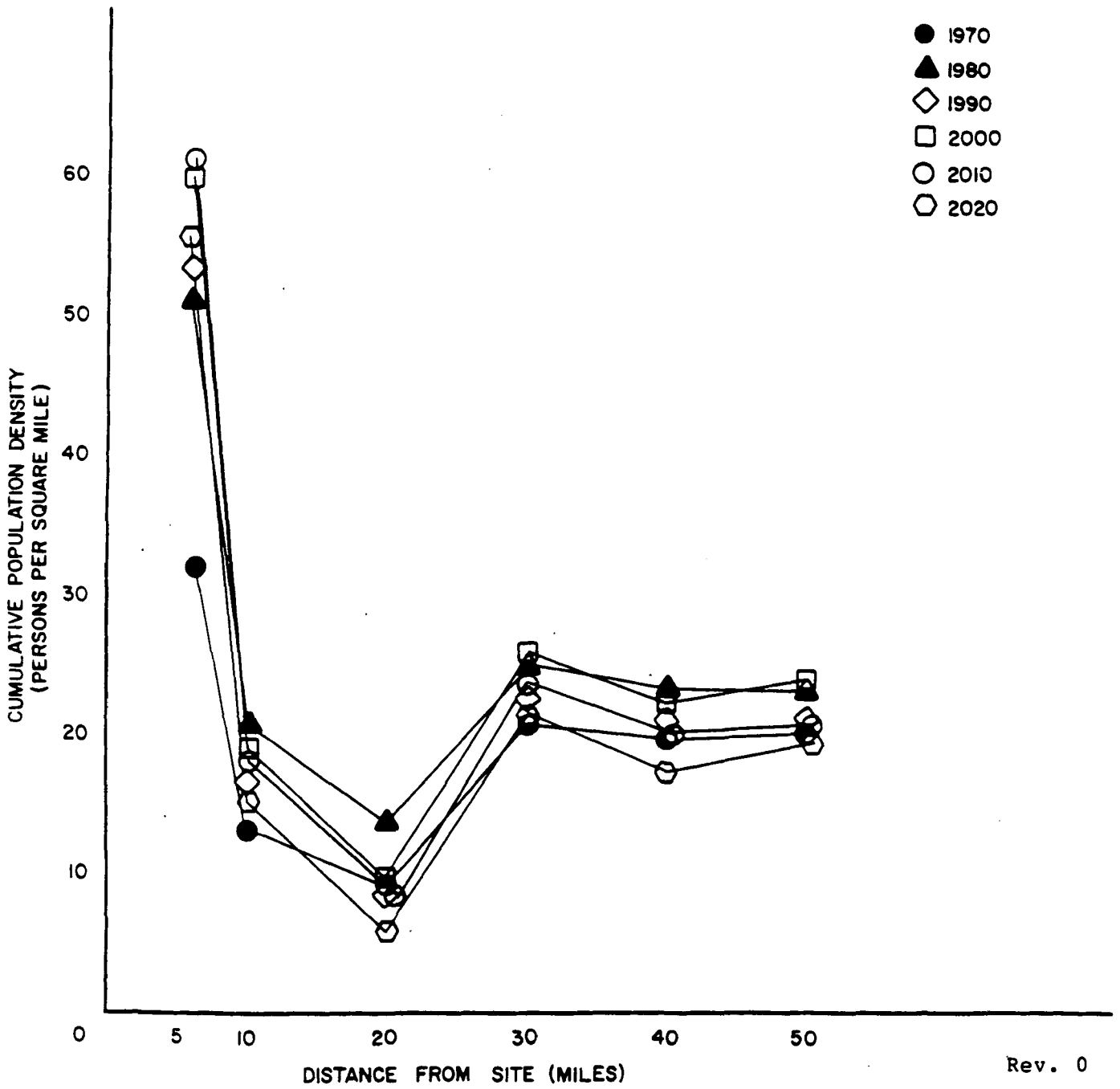

Rev. 0

**WOLF CREEK
UPDATED SAFETY ANALYSIS REPORT**

Figure 2.1-22
Cumulative Population Density,
1970 to 2020 within 50 Miles of
the Site

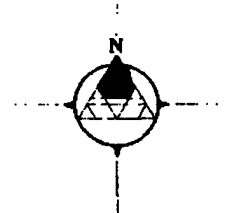

LEGEND:
 ● LOCATION OF FACILITY

▬▬▬ PIPELINES

NAME OF FACILITY

- 1 BOLTON OIL CO. - BULK STORAGE
- 2 BURLINGTON ELEVATOR CO.
- 3 BURLINGTON MUNICIPAL AIRPORT
- 4 BURLINGTON MUNICIPAL LIGHT PLANT
- 5 FINA OIL CO. - BULK STORAGE
- 6 ICON BOAT WORKS, INC.
- 7 KANSAS ARMY NATIONAL GUARD
- 8 KATY ELEVATOR & CO.
- 9 MOBIL OIL CO. - BULK STORAGE
- 10 MCCURRY FEED AND SUPPLY
- 11 NELSON QUARRY, INC.
- 12 PHILLIPS PIPELINE CO. - SHARPE STATION
- 13 PHILLIPS PIPELINE CO. - CRUDE OIL AND NATURAL GAS LINES
- 14 PHILLIPS PIPELINE CO. - PRODUCTS LINES
- 15 STANDARD OIL CO. - BULK STORAGE
- 16 UNION GAS - PROPANE STORAGE
- 17 UNION GAS - NATURAL GAS PIPELINE
- 18 WINGERT OIL CO. - BULK STORAGE
- 19 CLARKSON CONSTRUCTION COMPANY
- 20. **KEPCo Generation Facility**

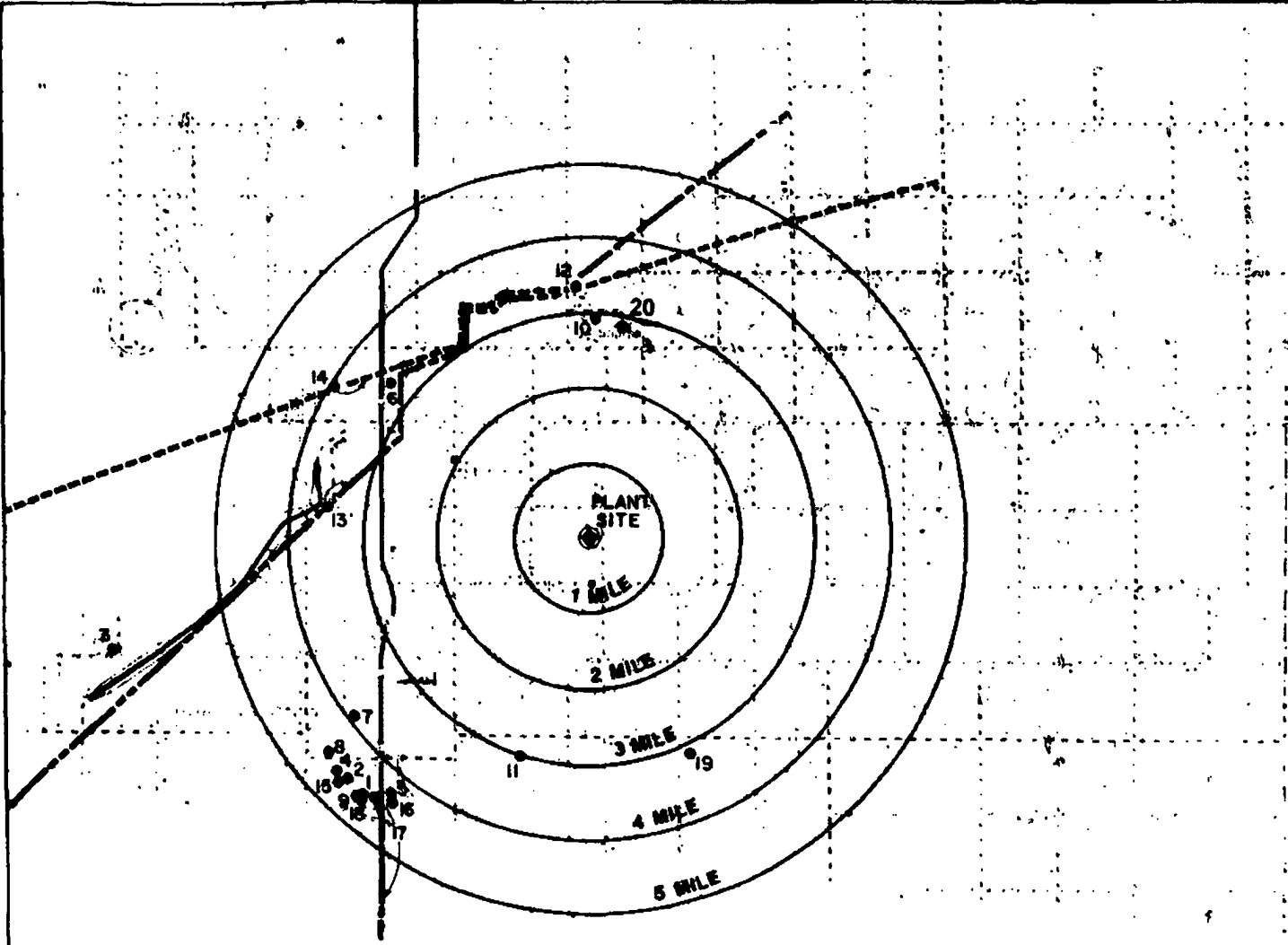

BASE MAP REFERENCE:
 BASE MAP MODIFIED FROM GENERAL HIGHWAY
 MAP, COFFEY COUNTY, KANSAS, STATE HIGHWAY
 COMMISSION OF KANSAS, 1974.

Rev. 16

**WOLF CREEK GENERATING STATION
 UNIT NO. 1
 FINAL SAFETY ANALYSIS REPORT**

**FIGURE 2.2-1
 INDUSTRIAL, TRANSPORTATION,
 AND MILITARY FACILITIES,
 0 TO 5 MILES**

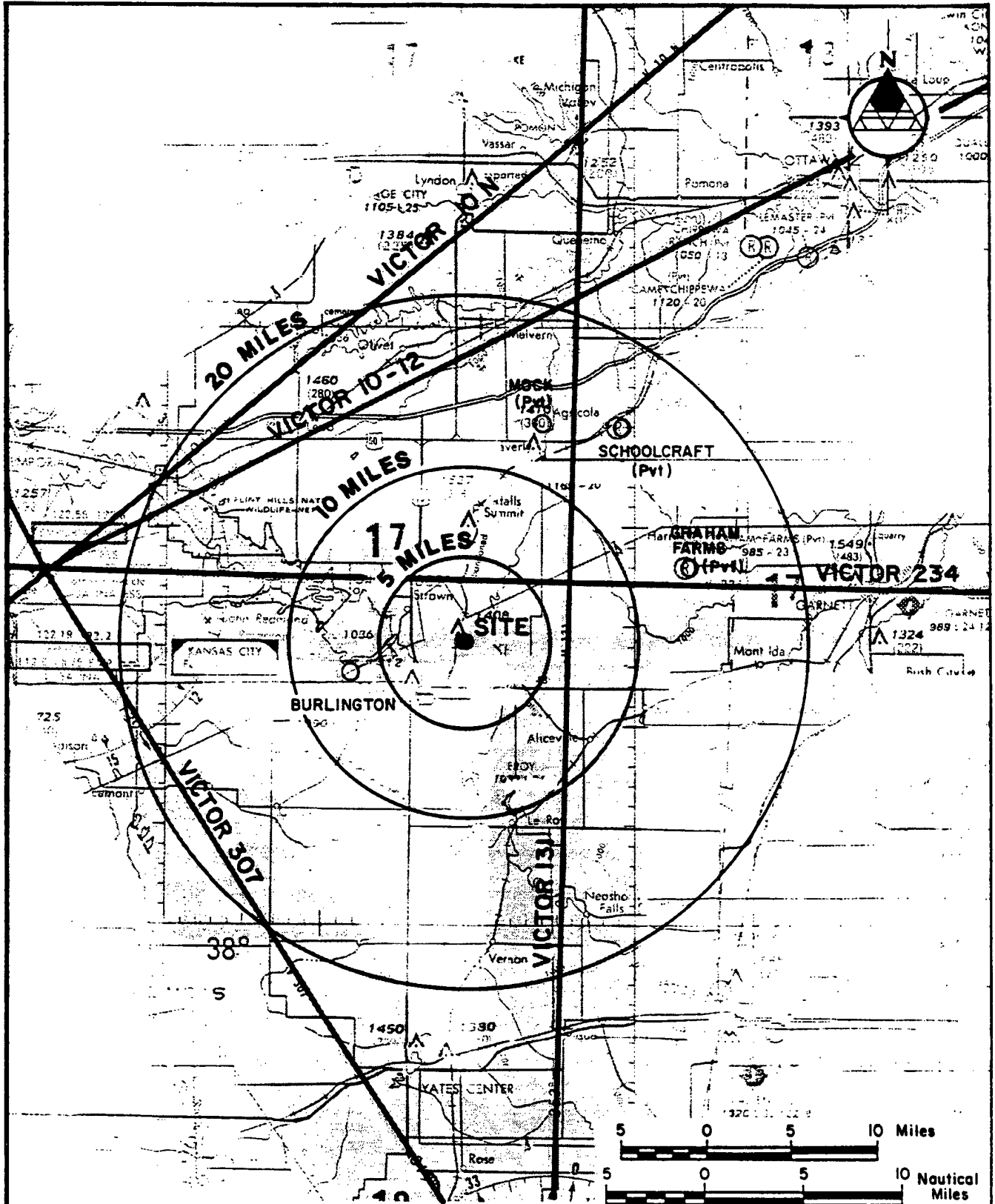

KEY:
 ○ AIRPORTS
 — AIR ROUTE

NOTE:
 LOCATION OF MOCK AIRPORT PROVIDED BY
 R. MOCK (1979).
 AIR INFORMATION SOURCE AND BASE MAP REFERENCE:
 NATIONAL OCEANIC AND ATMOSPHERIC ADMINISTRATION,
 1978, KANSAS CITY SECTIONAL AERONAUTICAL CHART,
 SCALE 1:500,000, 21st EDITION (DECEMBER 28)
 WASHINGTON, D.C.

Rev. 0

**WOLF CREEK
 UPDATED SAFETY ANALYSIS REPORT**

Figure 2.2-2
 Low Altitude Air Routes and
 Airports within 20 Miles

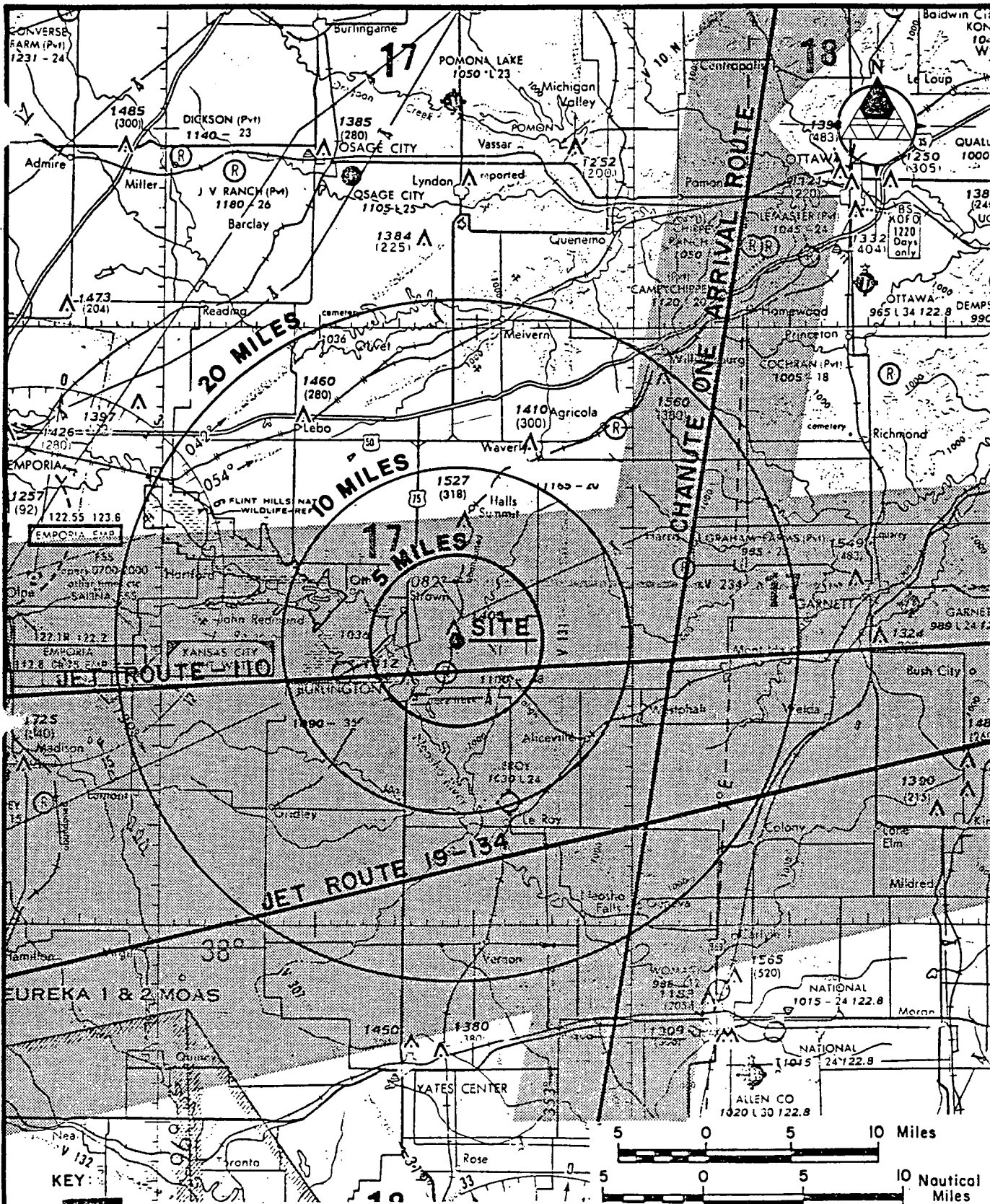

AIR INFORMATION SOURCE:

McQUEEN, R.W., 1979, CHIEF, KANSAS CITY AIR ROUTE TRAFFIC CONTROL CENTER, FEDERAL AVIATION ADMINISTRATION, OLATHE, KANSAS, WRITTEN COMMUNICATION (SEPT. 19, 1979).

NATIONAL OCEANIC AND ATMOSPHERIC ADMINISTRATION, 1979, NORTHEAST, ENROUTE HIGH ALTITUDE-U.S. MAP, JUNE 14th EDITION, WASHINGTON, D.C..

BASE MAP REFERENCE:

NATIONAL OCEANIC AND ATMOSPHERIC ADMINISTRATION, 1978, KANSAS CITY SECTIONAL AERONAUTICAL CHART, SCALE 1:500,000, 21st EDITION (DECEMBER 28) WASHINGTON, D.C..

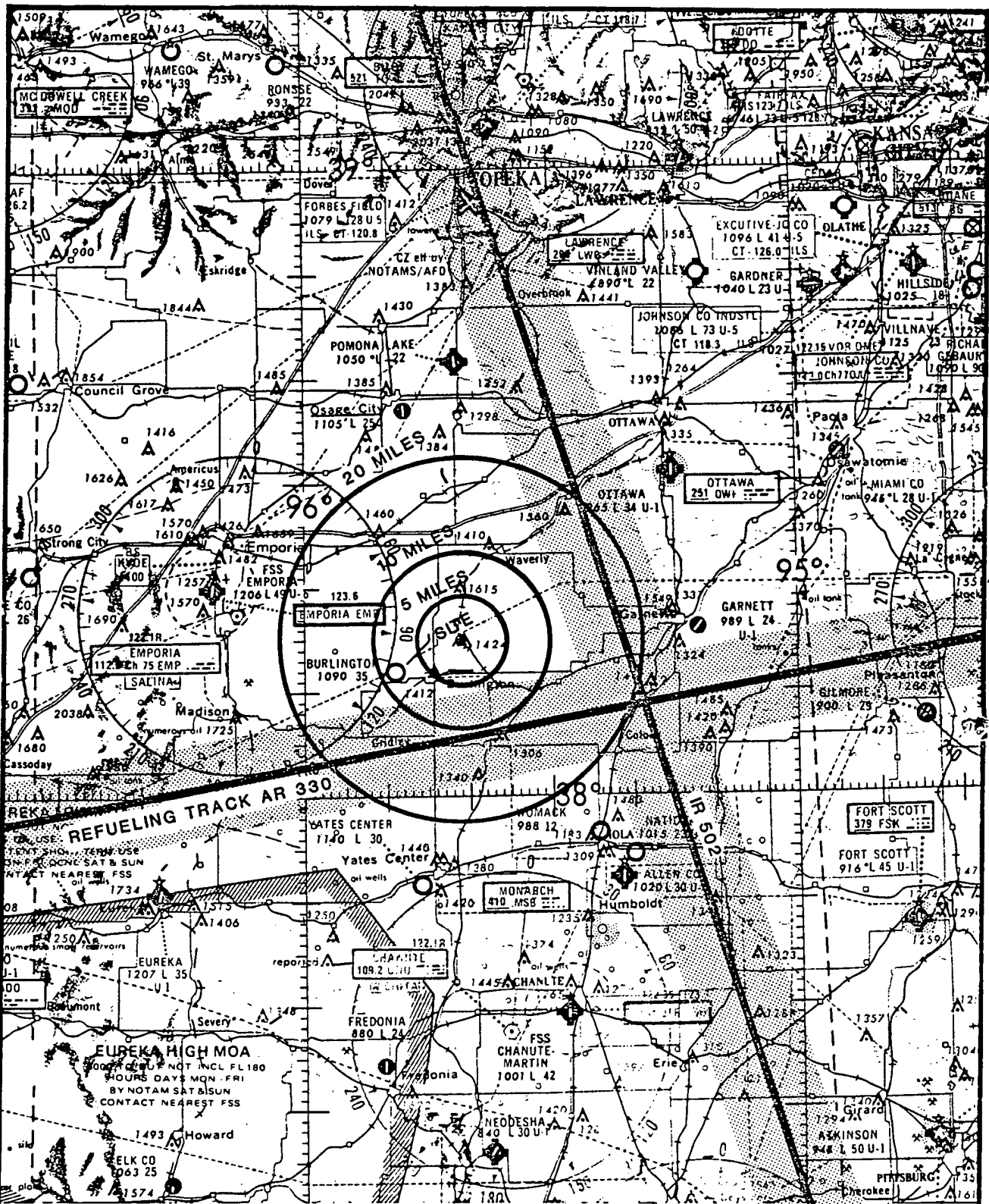

KEY: AIR ROUTE

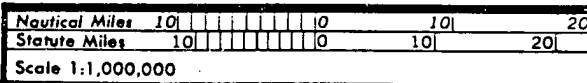

BASE MAP REFERENCE:
KANSAS AERONAUTICAL CHART
JUNE 1, 1984

WOLF CREEK
UPDATED SAFETY ANALYSIS REPORT

Figure 2.2-4

Military Air Routes within 20 Miles

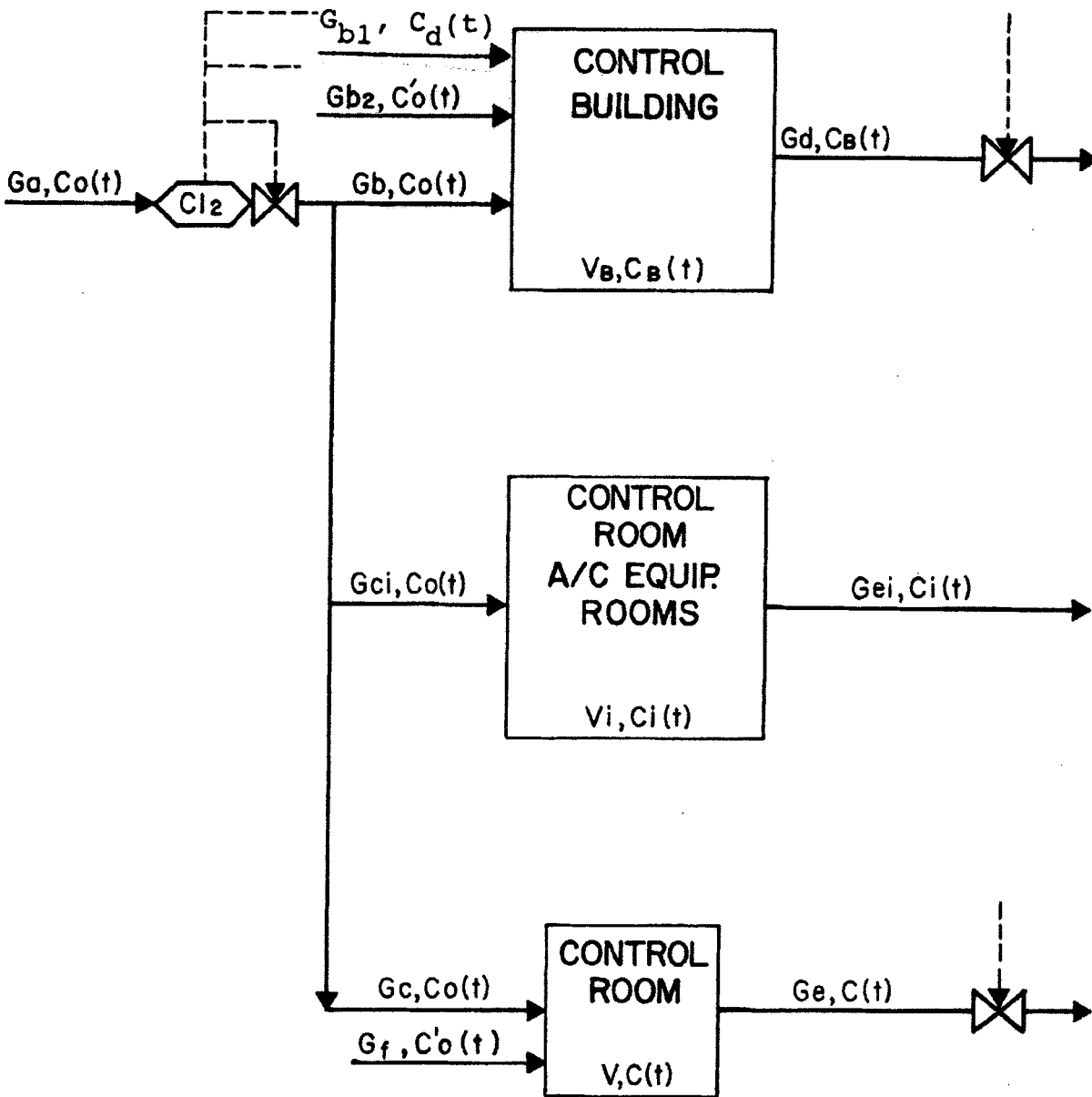

REV. 2

WOLF CREEK UPDATED SAFETY ANALYSIS REPORT
Figure 2.2-6 (sheet 1 of 2) Mathematical Model for the Control Room Chlorine Analysis Pre-Isolation Mode

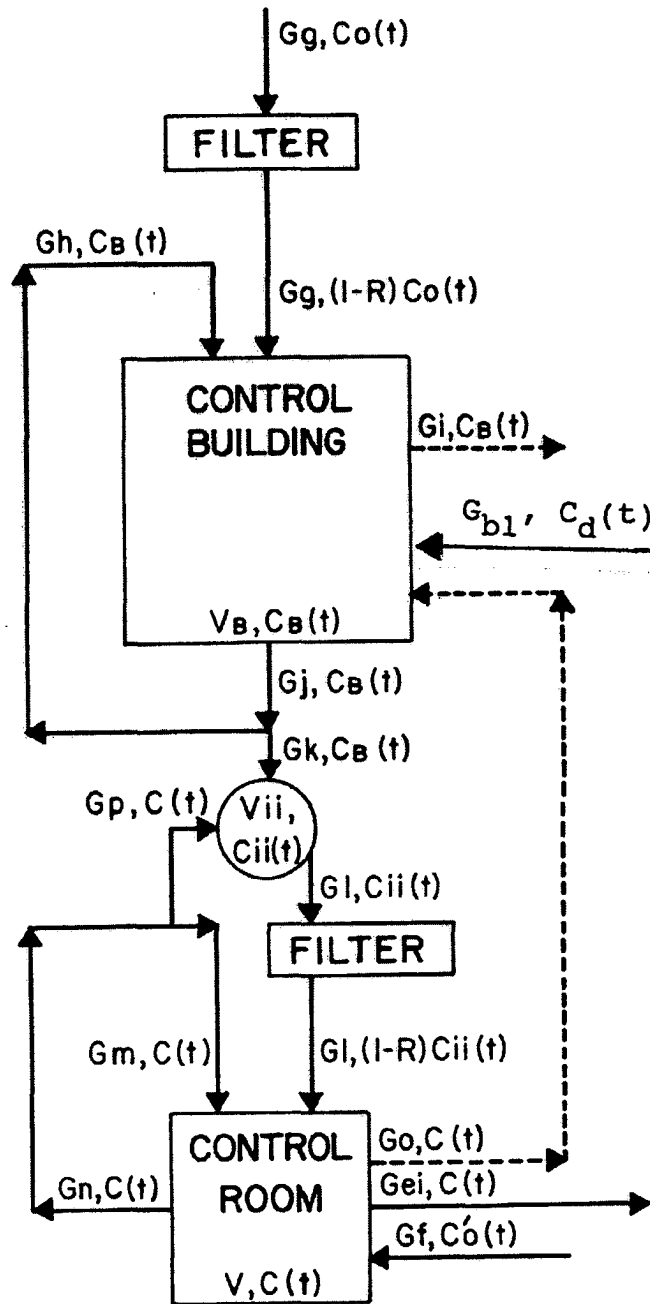

REV. 2

WOLF CREEK UPDATED SAFETY ANALYSIS REPORT
Figure 2.2-6 (sheet 2 of 2) Mathematical Model for the Control Room Chlorine Analysis Post-isolation Mode

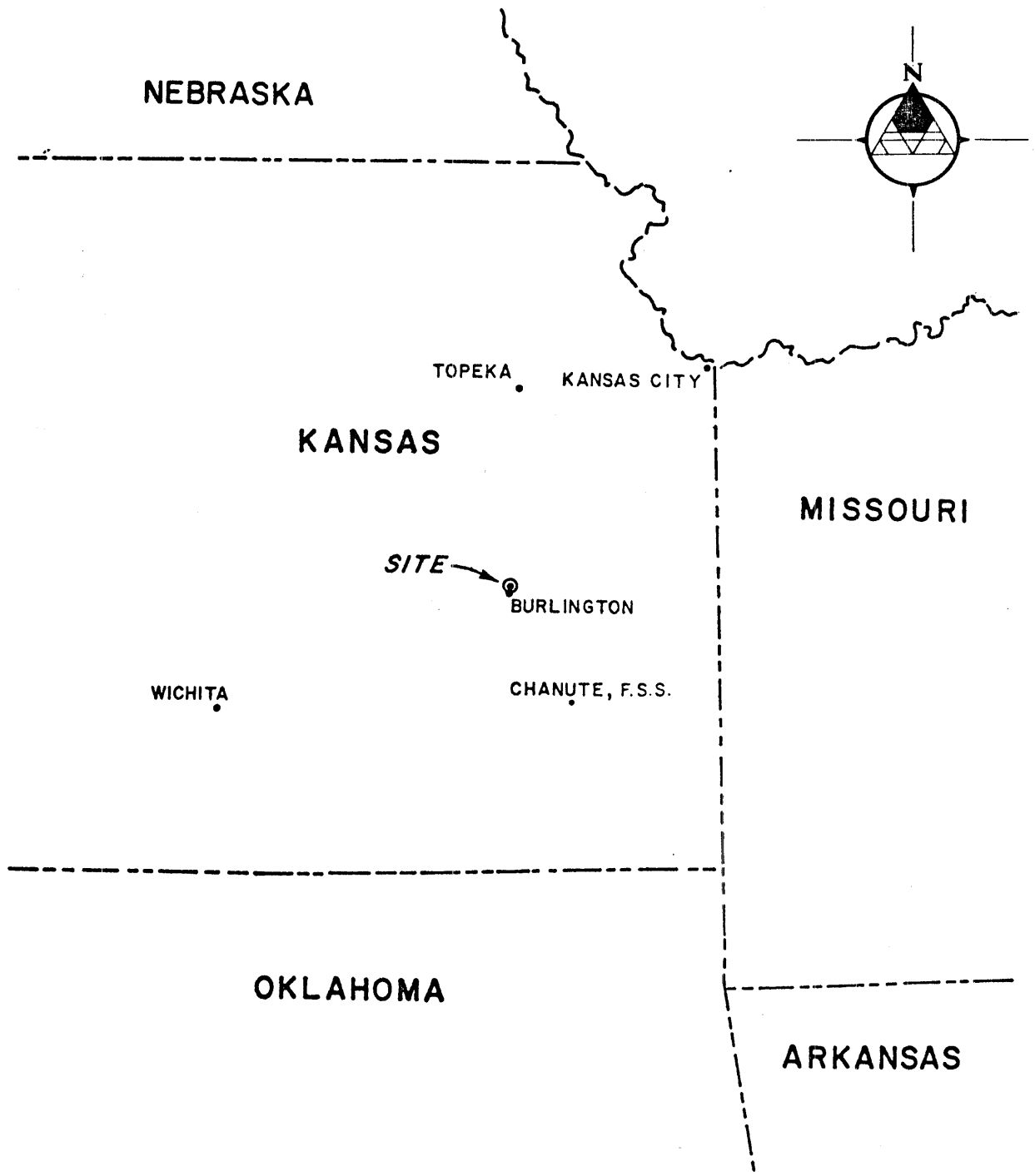

Rev. 0

<p>WOLF CREEK UPDATED SAFETY ANALYSIS REPORT</p>
<p>Figure 2.3-1 Regional Climatological Stations</p>

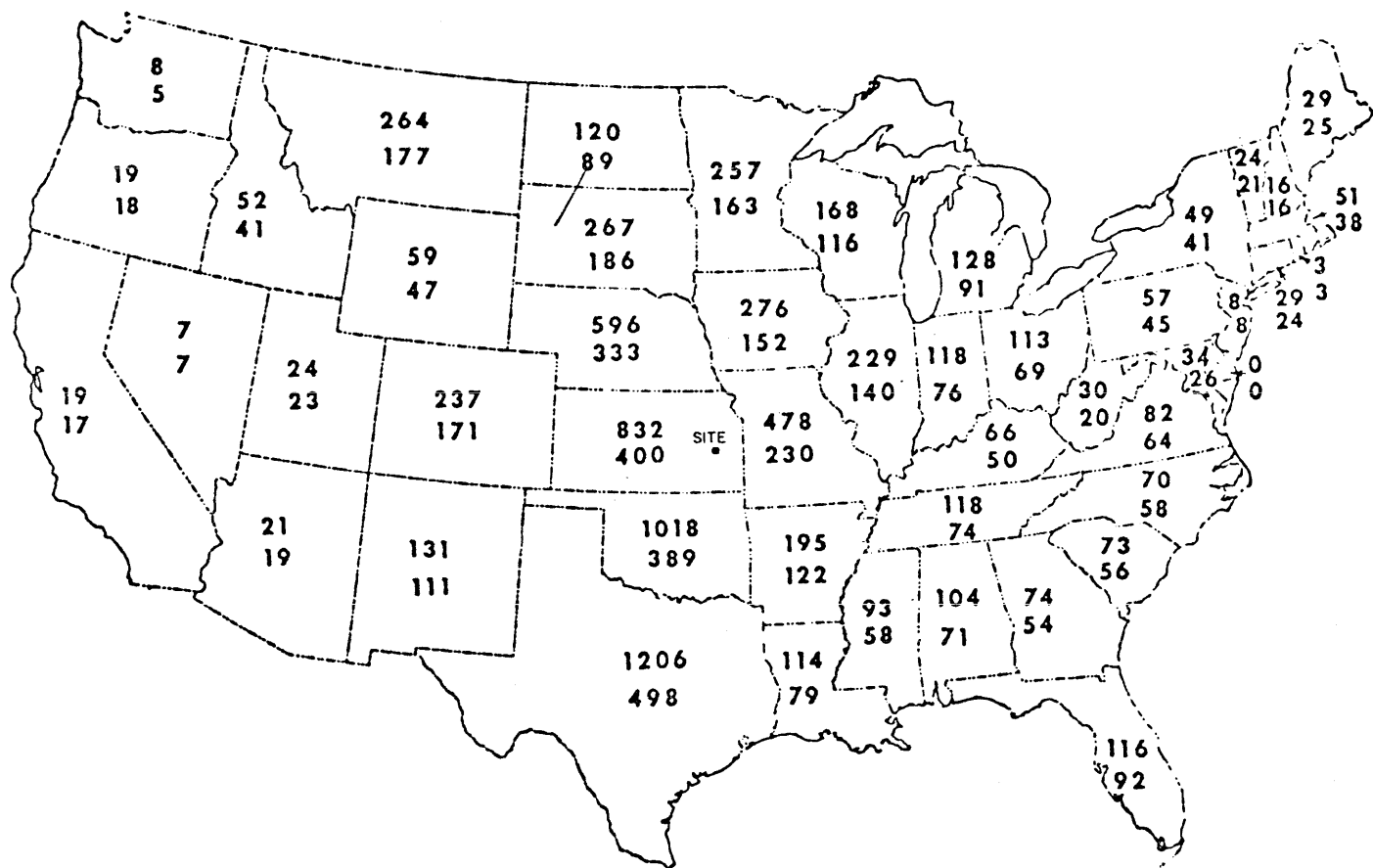

Rev. 0

**WOLF CREEK
UPDATED SAFETY ANALYSIS REPORT**

Figure 2.3-2

Hail Reports, 1955-1967

REFERENCE:
PAUTZ, M.E., 1969; SEVERE LOCAL STORM
OCCURRENCES 1955-1967. ESSA TECH. MEMO
WBTH FCST 12, OFFICES OF METEOROLOGICAL
OPERATIONS, SILVER SPRING, MD.



NOTES

Upper figure is number of hail reports 0.75 inch and greater; lower figure, total days this size reported, 1955-1967.

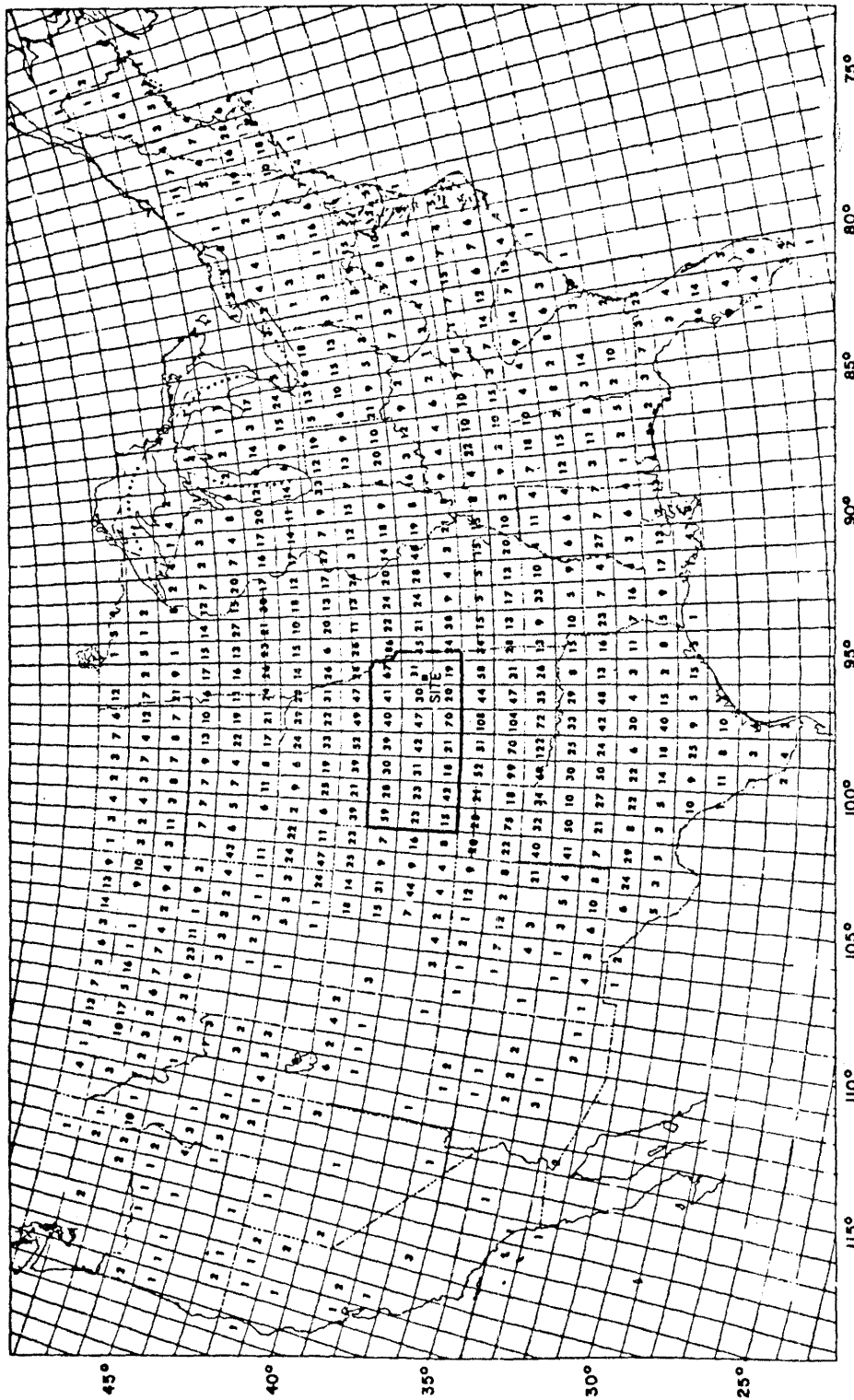

NOTE: DATA SHOWS TOTAL NUMBER OF REPORTS OF HAIL 3/4 INCH IN DIAMETER OR GREATER FROM 1955 TO 1967.

REFERENCE: PAUTZ, M.E., 1969: SEVERE LOCAL STORM OCCURRENCES 1955-1967. ESSA TECH. MEMO WBTM FCST 12, OFFICE OF METEOROLOGICAL OPERATIONS, SILVER SPRING, MD.



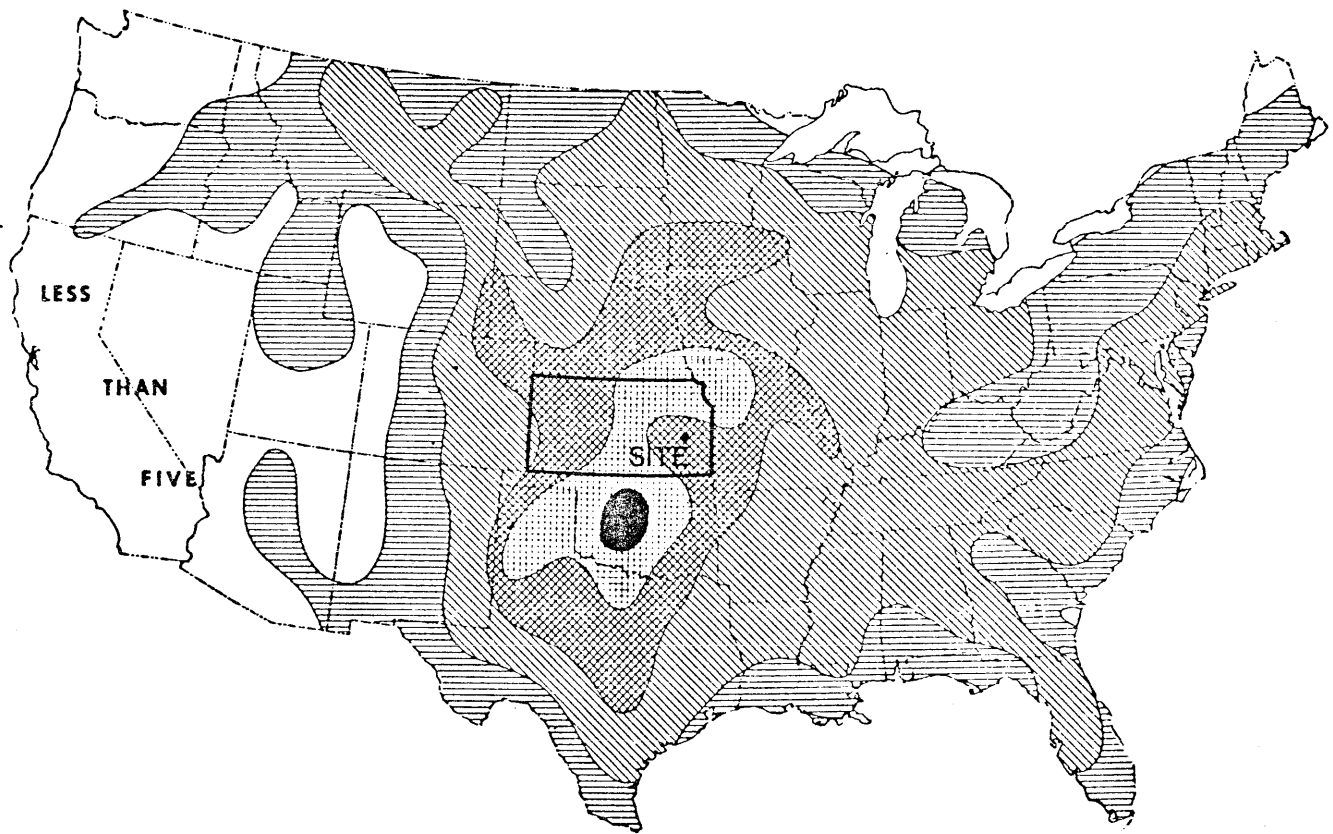

Rev. 0

**WOLF CREEK
UPDATED SAFETY ANALYSIS REPORT**

Figure 2.3-3
Hail Reports by One-Degree Squares, 1955-1967



EXPLANATION

-  300 +
-  150 - 300
-  75 - 150
-  25 - 75
-  5 - 25



NOTE: MAP ZONATION SHOWS TOTAL NUMBER OF REPORTS OF HAIL 3/4 INCH IN DIAMETER OR GREATER FROM 1955 TO 1967. DATA FOR 2-DEGREE LATITUDE AND LONGITUDE SQUARES.

REFERENCE:
 PAUTZ, M. E., 1969: SEVERE LOCAL STORM OCCURRENCES, 1955-1967. ESSA TECH. MEMO WBTM FCST 12, OFFICE OF METEOROLOGICAL OPERATIONS, SILVER SPRING, MD.

Rev. 0

**WOLF CREEK
 UPDATED SAFETY ANALYSIS REPORT**

Figure 2.3-4

Hail Reports by Two-Degree Squares, 1955-1967

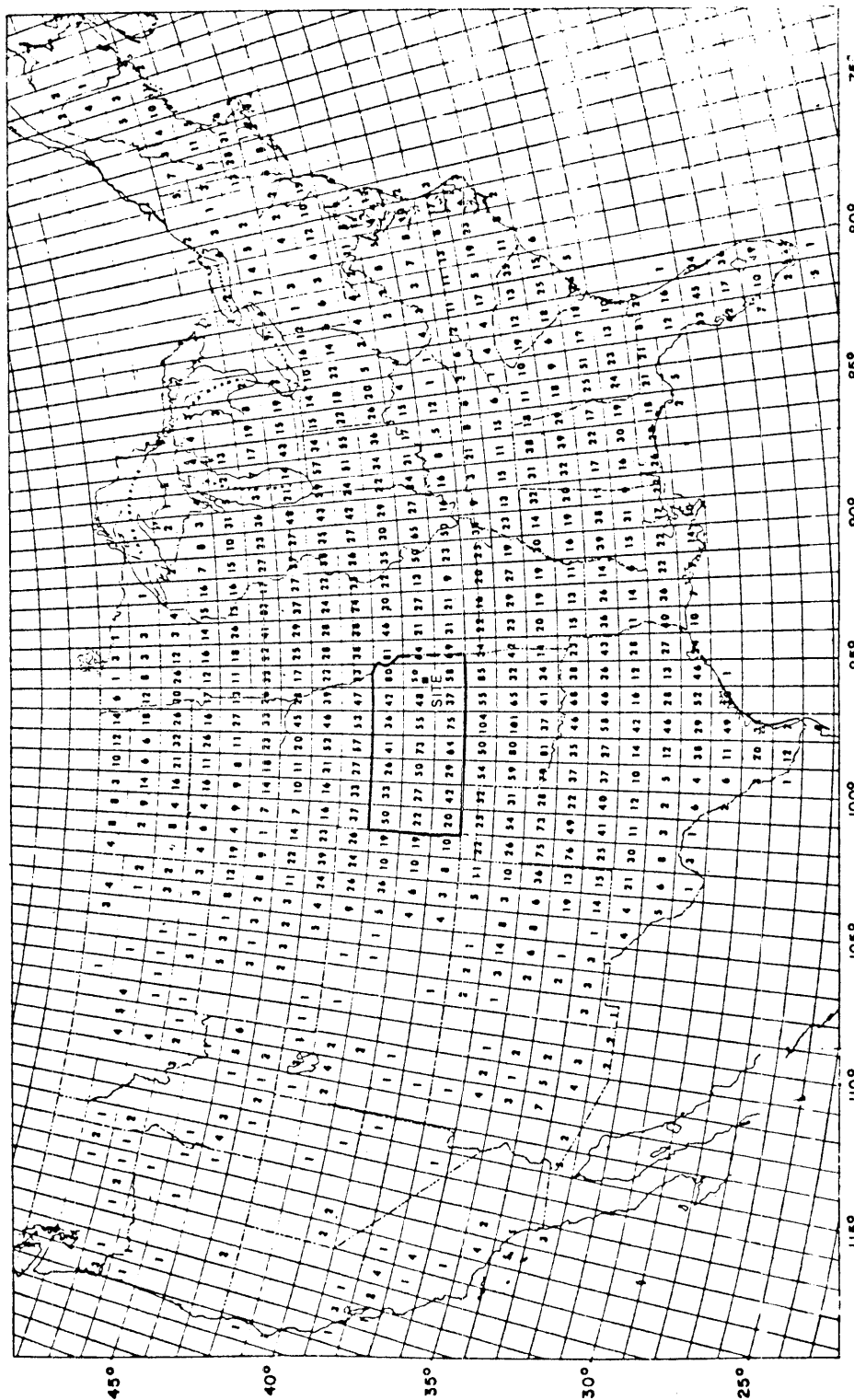

NOTE: DATA SHOWS TOTAL NUMBER OF TORNADO REPORTS FROM 1955 TO 1967.

REFERENCE: PAUTZ, M.E., 1969: SEVERE LOCAL STORM OCCURRENCES 1955-1967. ESSA TECH. MEMO WBTM FCST 12, OFFICE OF METEOROLOGICAL OPERATIONS, SILVER SPRING, MD.

**WOLF CREEK
UPDATED SAFETY ANALYSIS REPORT**

Figure 2.3-5

Tornado Reports by One-Degree Squares, 1955-1967

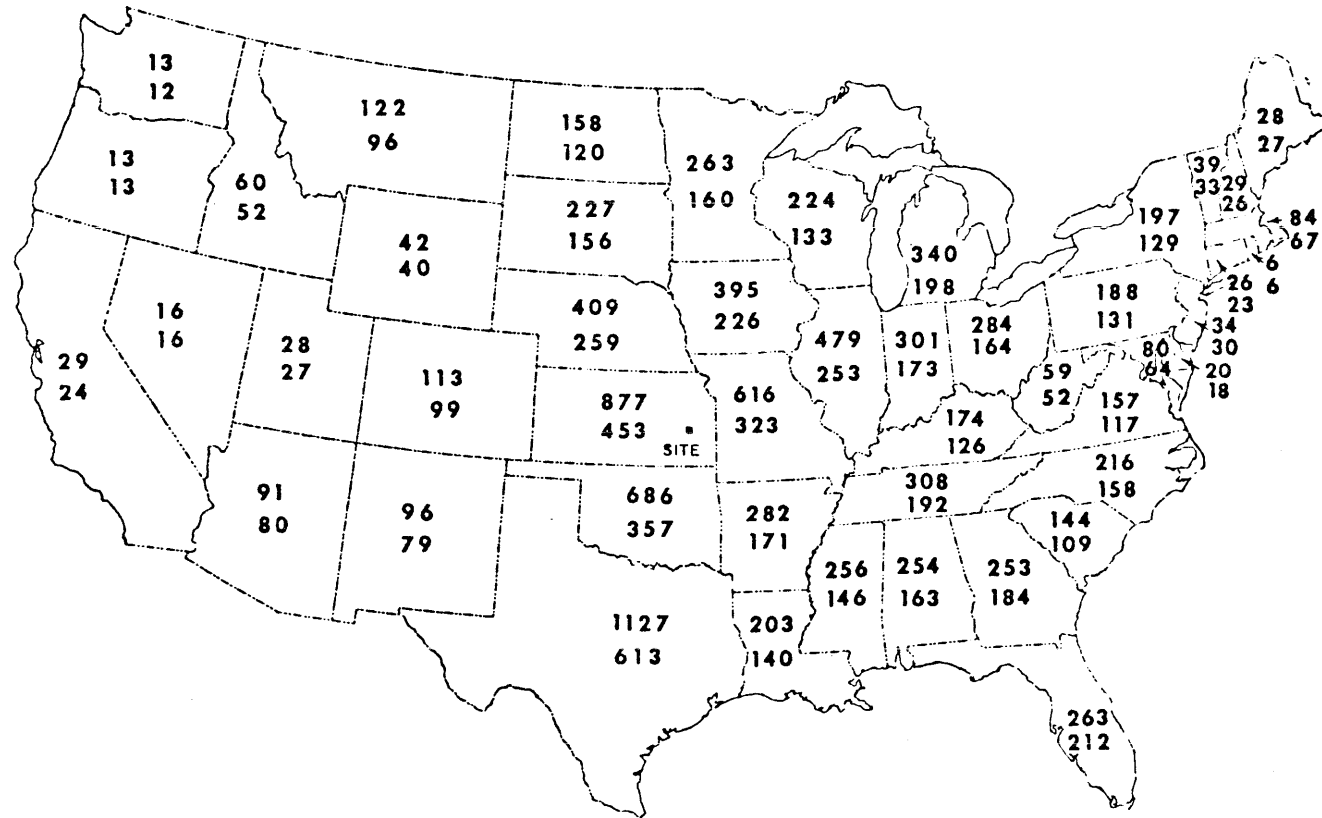

NOTES

Upper figure is number of wind gusts 50 knots and greater; lower figure, total days on which wind gusts occurred, 1955-1967.

REFERENCE:
 PAUTZ, M.E., 1969: SEVERE LOCAL STORM OCCURRENCES 1955-1967. ESSA TECH. MEMO WBTH FCST 12, OFFICE OF METEOROLOGICAL OPERATIONS, SILVER SPRING, MD.

Rev. 0

**WOLF CREEK
 UPDATED SAFETY ANALYSIS REPORT**

Figure 2.3-6

Wind Gusts, 1955-1967

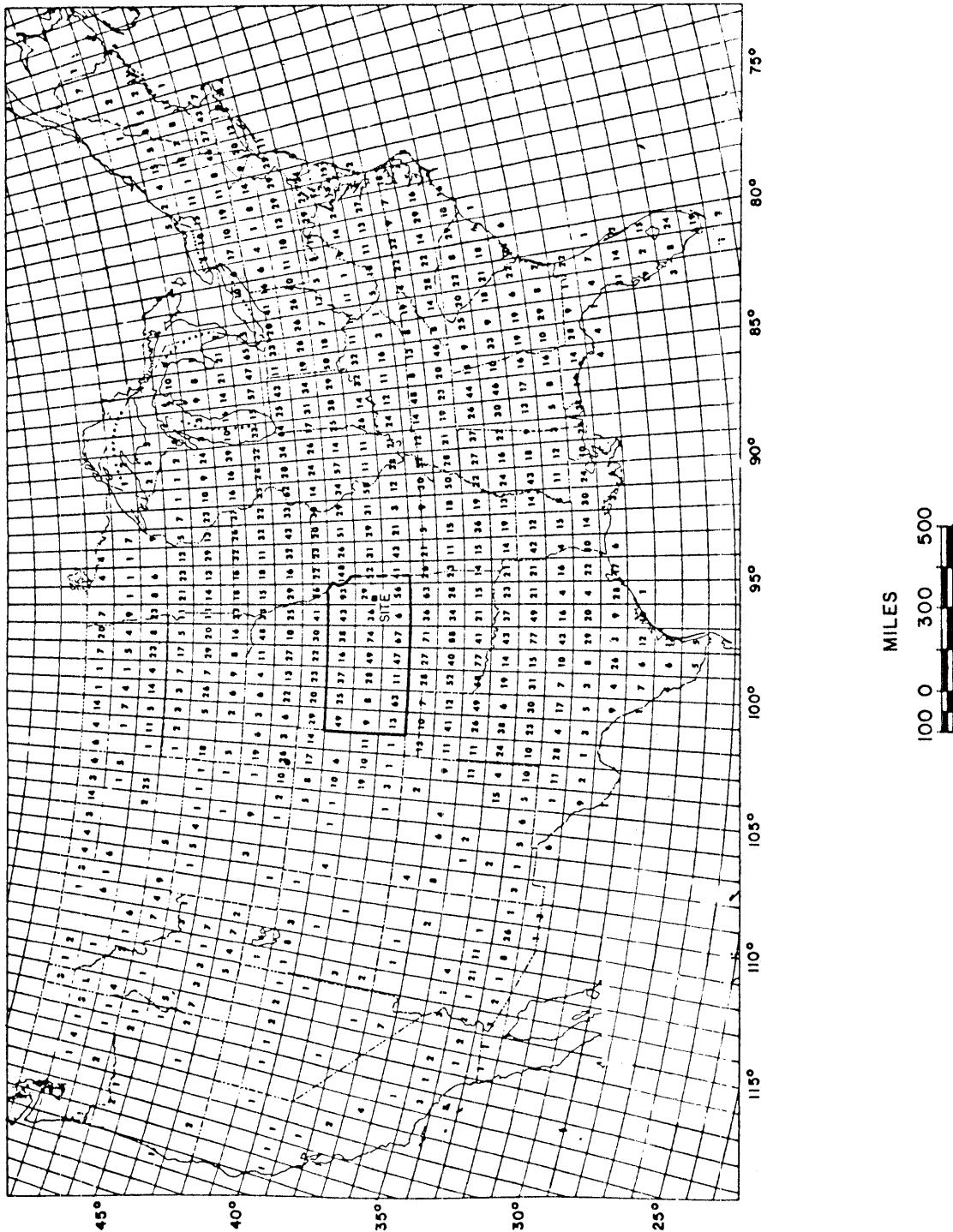

NOTE: DATA SHOWS TOTAL NUMBER OF REPORTS OF WIND GUSTS 50 KNOTS OR GREATER FROM 1955 TO 1967.

REFERENCE: PAULZ, R. E., 1969: SEVERE LOCAL STORM OCCURRENCES 1955-1967. ESSA TECH. MEMO 88TH FCST 12, OFFICE OF METEOROLOGICAL OPERATIONS, SILVER SPRING, MD.

Rev. 0

**WOLF CREEK
UPDATED SAFETY ANALYSIS REPORT**

Figure 2.3-7
Wind Storms by One-Degree Squares, 1955-1967

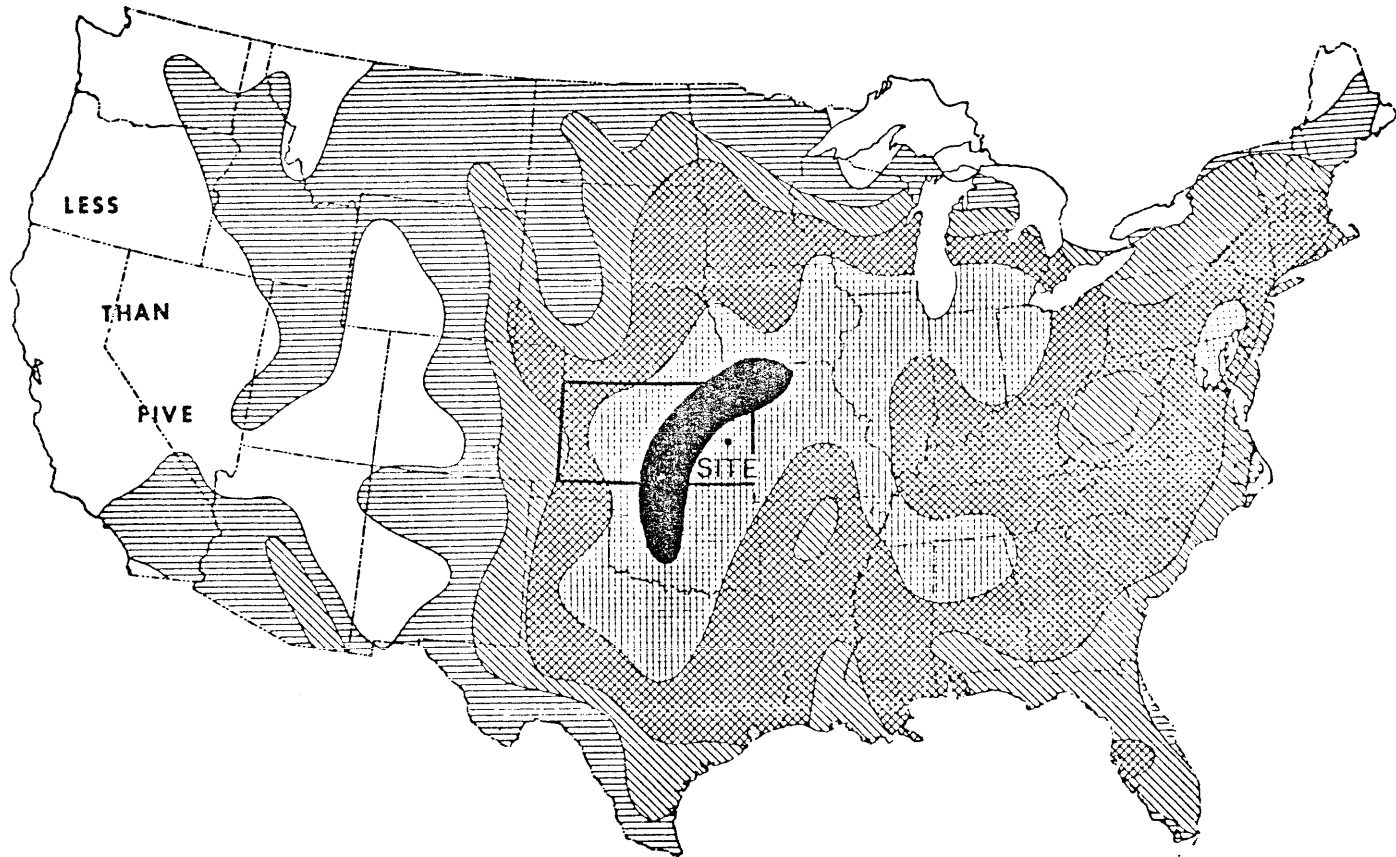

Wind Storms by Two-Degree Squares, 1955-1967

Figure 2.3-8

**WOLF CREEK
UPDATED SAFETY ANALYSIS REPORT**

Rev. 0

NOTE: MAP ZONATION SHOWS TOTAL NUMBER OF WIND STORMS WITH 50 KNOT GUSTS OR GREATER FROM 1955 TO 1967. DATA FOR 2-DEGREE LATITUDE AND LONGITUDE SQUARES.

REFERENCE:
PAUTZ, M.E., 1969: SEVERE LOCAL STORM OCCURRENCES, 1955-1967. ESSA TECH. MEMO WBTH FCST 12, OFFICE OF METEOROLOGICAL OPERATIONS, SILVER SPRING, MD.



EXPLANATION

- 200 +
- ▣ 100 - 200
- ▤ 50 - 100
- ▥ 25 - 50
- ▦ 5 - 25

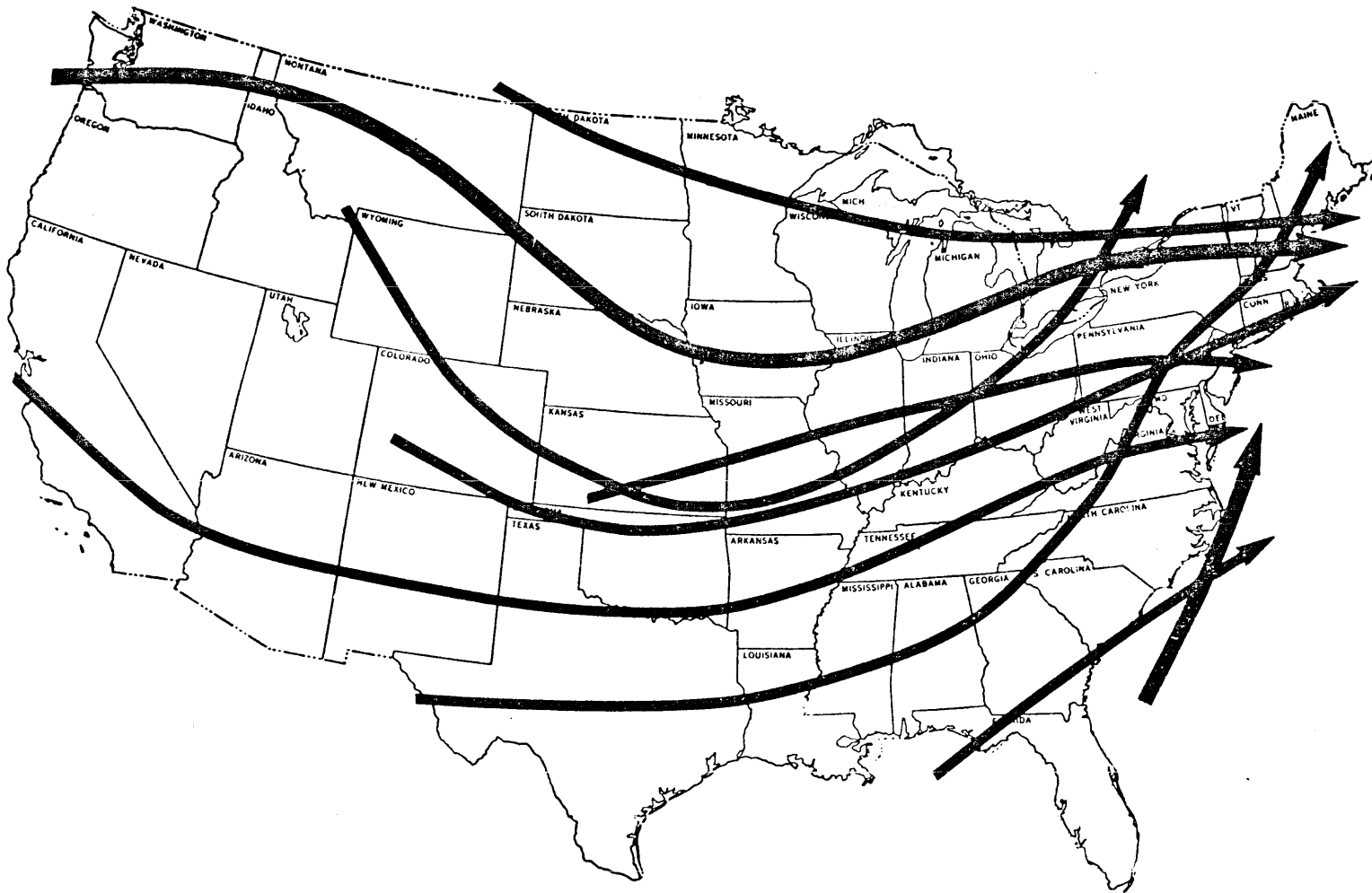

**WOLF CREEK
UPDATED SAFETY ANALYSIS REPORT**

Figure 2.3-9

Average Tracks by Cyclones

Rev. 0

REFERENCE:

KLEIN, W.H., 1957: PRINCIPAL TRACKS AND MEAN FREQUENCIES OF CYCLONES AND ANTICYCLONES IN THE NORTHERN HEMISPHERE. U.S. WEATHER BUREAU RES. PAPER, NO. 40.

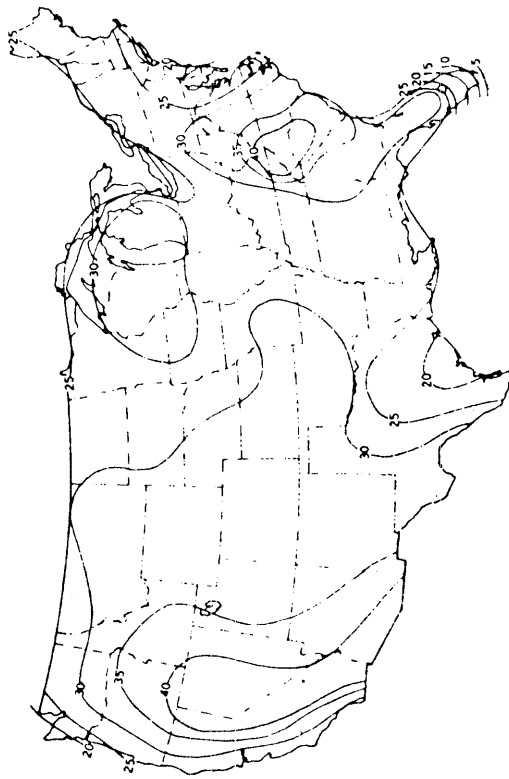

SPRING

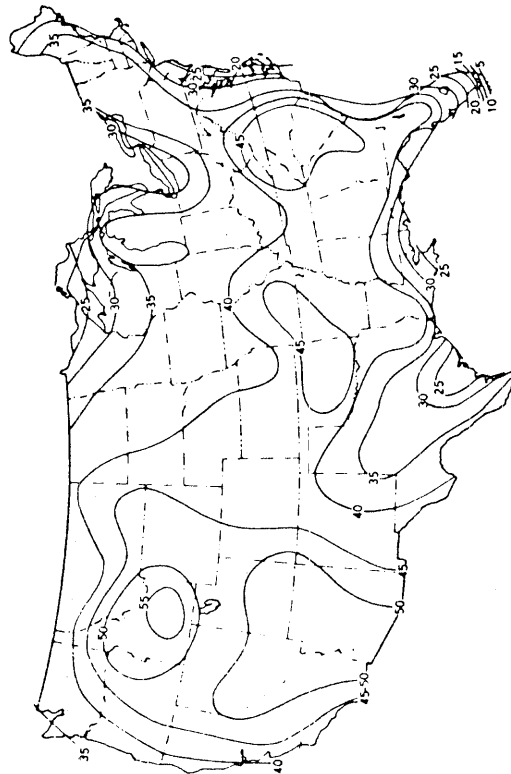

FALL

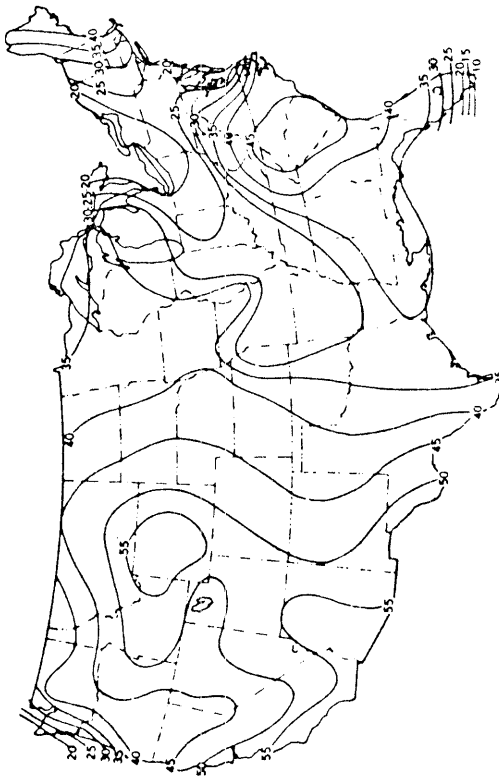

WINTER

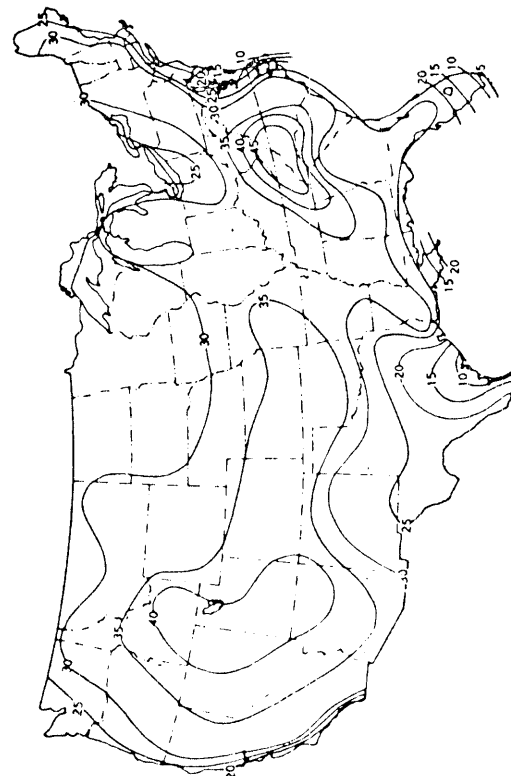

SUMMER

Rev. 0

**WOLF CREEK
UPDATED SAFETY ANALYSIS REPORT**

Figure 2.3-10

Seasonal Inversions and Isothermal Maps

NOTE: CONTOURS REPRESENT PERCENT FREQUENCY OF INVERSIONS AND ISOTHERMAL CONDITIONS.

REFERENCE:
HOSLER, C.R., 1961: LOW LEVEL INVERSION FREQUENCY IN THE CONTIGUOUS UNITED STATES. MON. WEA. REV., 89, 379-339.

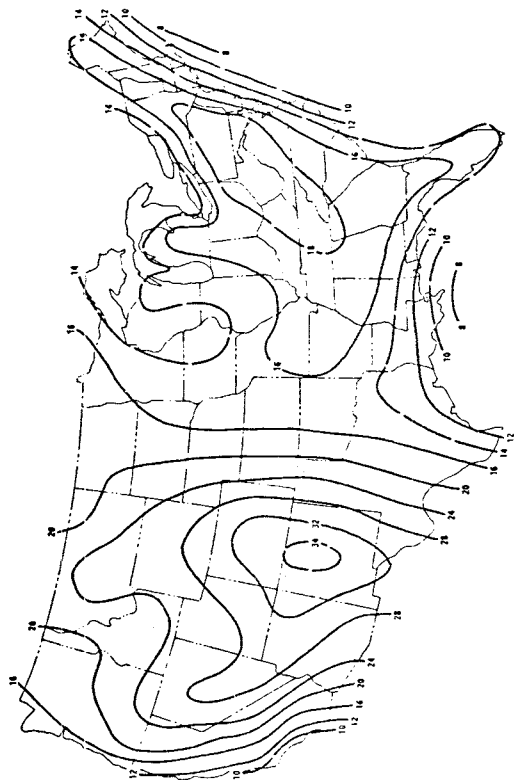

SPRING

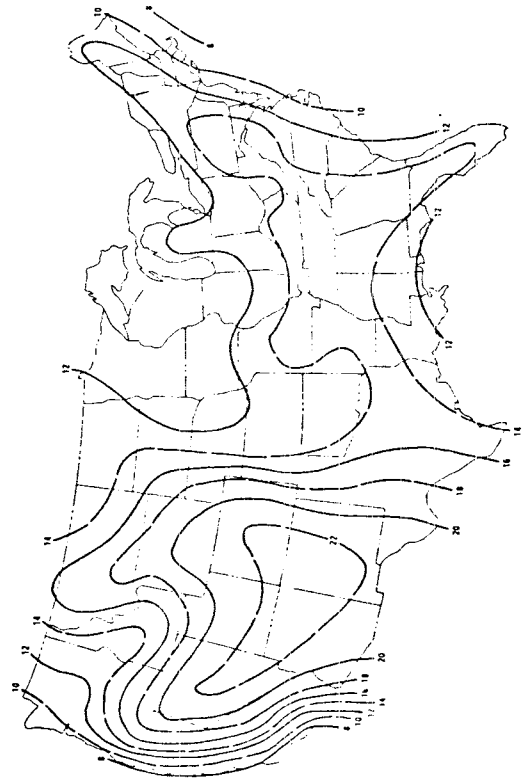

FALL

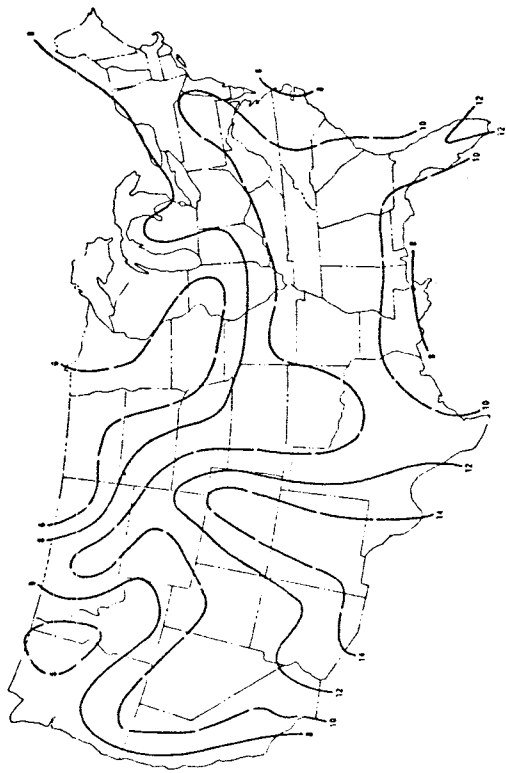

WINTER

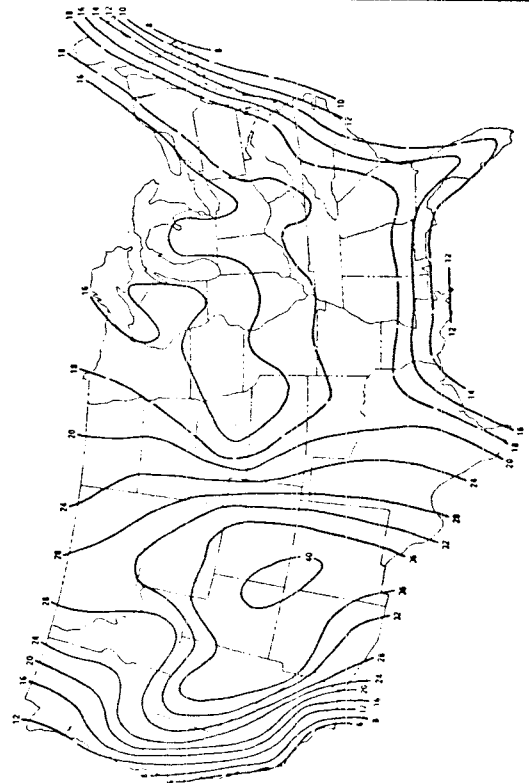

SUMMER

Rev. 0

NOTE:
ISOPLETH LINES DESIGNATE DEPTHS
IN HUNDREDS OF METERS.

REFERENCE:
HOLZWORTH, G.C., 1972: MIXING HEIGHTS,
WIND SPEEDS, AND POTENTIAL FOR URBAN
AIR POLLUTION THROUGHOUT THE CONTIGUOUS
UNITED STATES, U.S. ENVIRONMENTAL PRO-
TECTION AGENCY NO. AP-101, p. 32-35.

**WOLF CREEK
UPDATED SAFETY ANALYSIS REPORT**

Figure 2.3-11

Isopleths of Seasonal Mean
Afternoon Mixing Depths

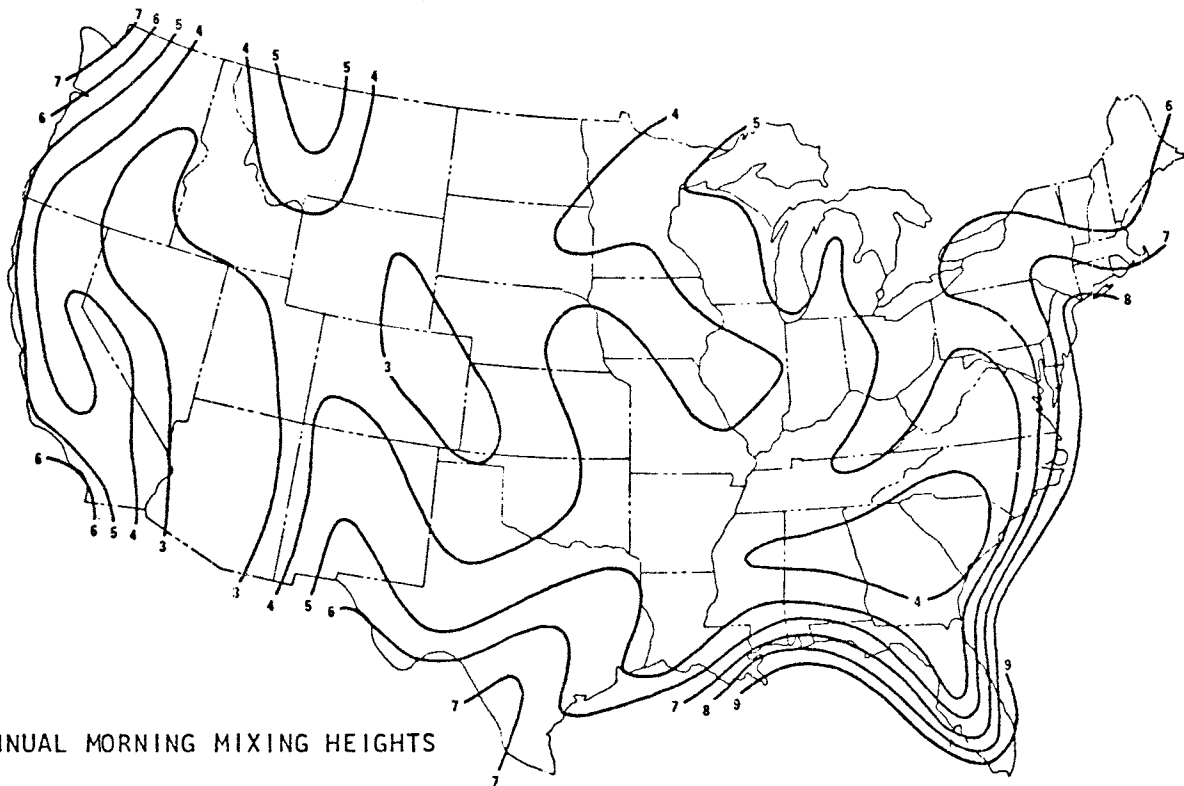

ANNUAL MORNING MIXING HEIGHTS

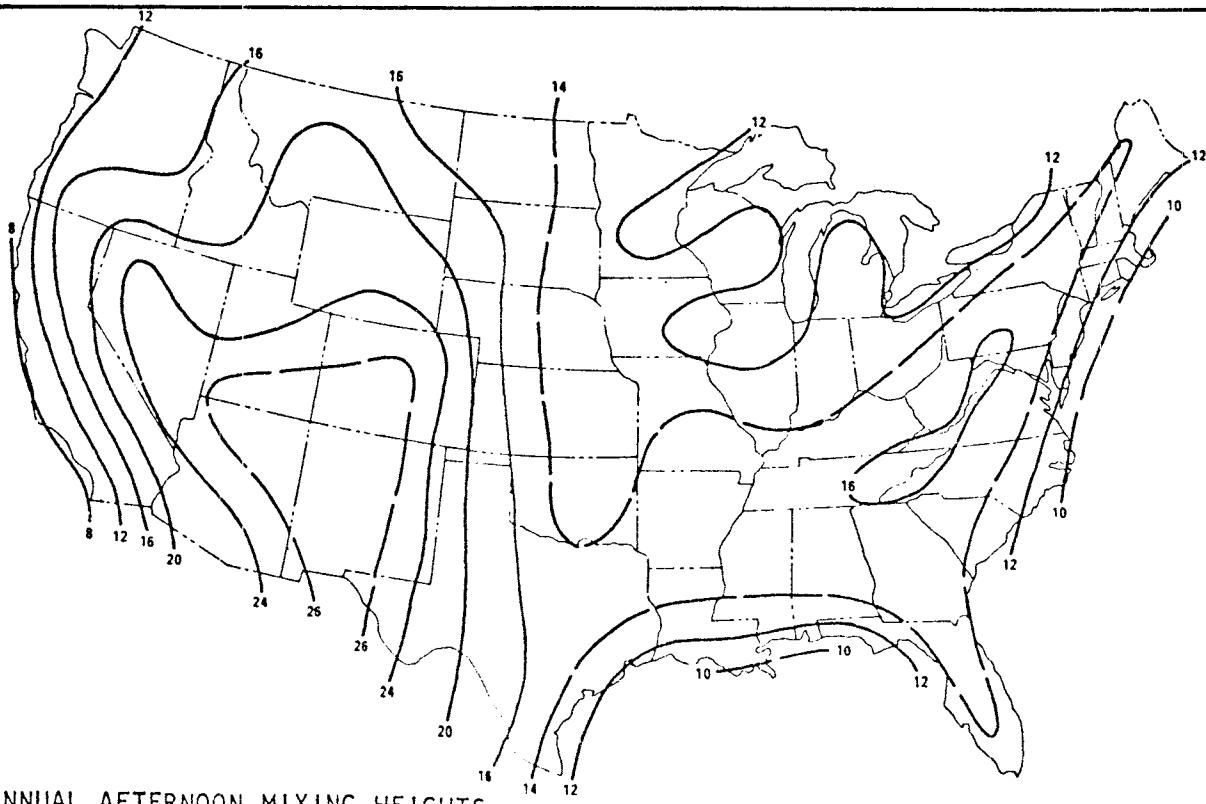

ANNUAL AFTERNOON MIXING HEIGHTS

Rev. 0

**WOLF CREEK
UPDATED SAFETY ANALYSIS REPORT**

Figure 2.3-12

Isopleths of Annual Mean Mixing
Depths

NOTE: ISOPLETH LINES DESIGNATE DEPTHS IN HUNDREDS OF METERS.

REFERENCE:
HOLZWORTH, G.C., 1972: MIXING HEIGHTS, WIND SPEEDS, AND POTENTIAL FOR URBAN AIR POLLUTION THROUGHOUT THE CONTIGUOUS UNITED STATES. U.S. ENVIRONMENTAL PROTECTION AGENCY. NO. AP-101, p. 26 AND 31.

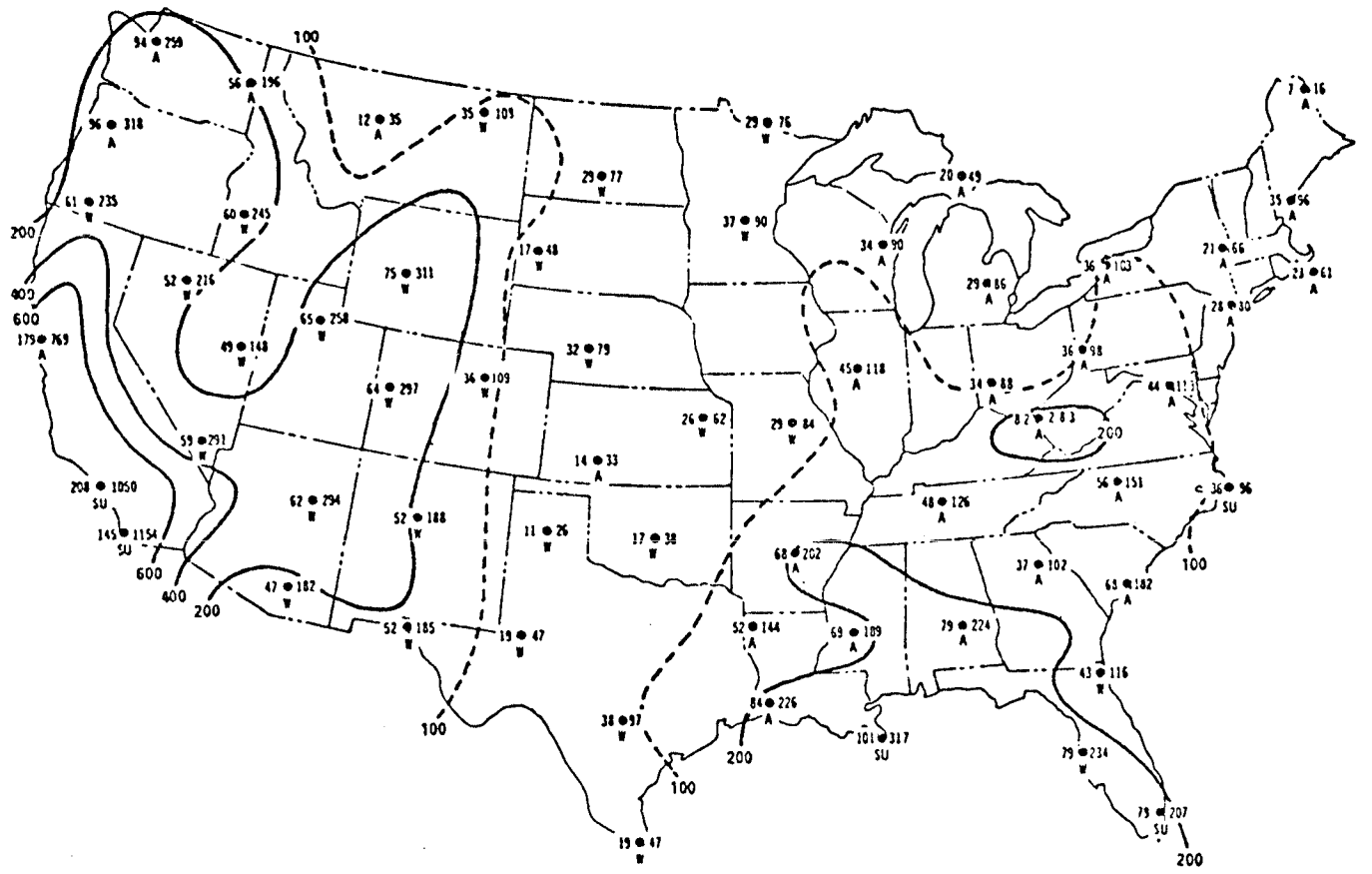

EXPLANATION

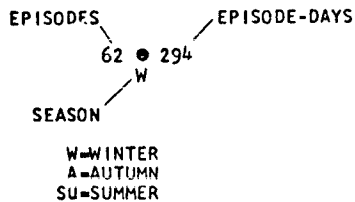

NOTES:
ISOPLETH LINES DESIGNATE TOTAL NUMBER OF EPISODE DAYS IN 5 YEARS WITH MIXING DEPTHS 1500 METERS OR LESS AND WIND SPEEDS ≤ 6.0 MPS. ISOPLETHS FOR DATA AT SAN DIEGO AND SANTA MONICA, CALIFORNIA WERE LEFT INCOMPLETE FOR CLARITY.

REFERENCE:
HOLZWORTH, G.C., 1972: MIXING HEIGHTS, WIND SPEEDS, AND POTENTIAL FOR URBAN AIR POLLUTION THROUGHOUT THE CONTIGUOUS UNITED STATES. U.S. ENVIRONMENTAL PROTECTION AGENCY. NO. AP-101, p 84.

WOLF CREEK
UPDATED SAFETY ANALYSIS REPORT
 Figure 2.3-13
 Mixing Depth Episode Days

Rev. 0

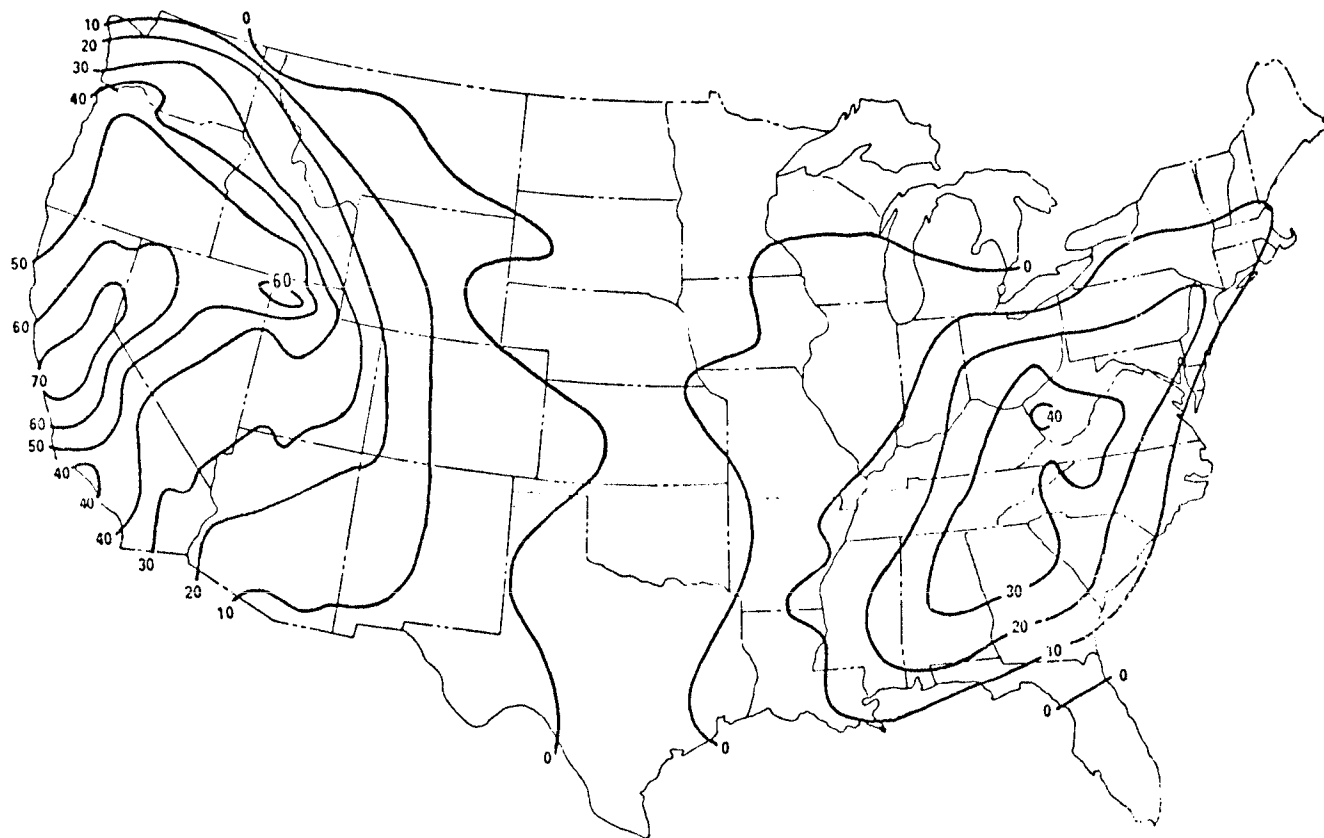

NOTE: ISOPLETH LINES DESIGNATE TOTAL NUMBER OF FORECAST DAYS OF HIGH AIR POLLUTION POTENTIAL. DATA IS BASED ON FORECASTS ISSUED FROM AUGUST 1, 1960 AND OCTOBER 1, 1963 FOR EASTERN AND WESTERN PARTS OF THE UNITED STATES, RESPECTIVELY, THROUGH APRIL 3, 1970.

REFERENCE:
 HOLZWORTH, G.C., 1972: MIXING HEIGHTS, WIND SPEEDS, AND POTENTIAL FOR URBAN AIR POLLUTION THROUGHOUT THE CONTIGUOUS UNITED STATES. U.S. ENVIRONMENTAL PROTECTION AGENCY. NO. AP-101 p. 96.

Rev. 0

**WOLF CREEK
 UPDATED SAFETY ANALYSIS REPORT**

Figure 2.3-14

Forecast Days of High Air
 Pollution Potential

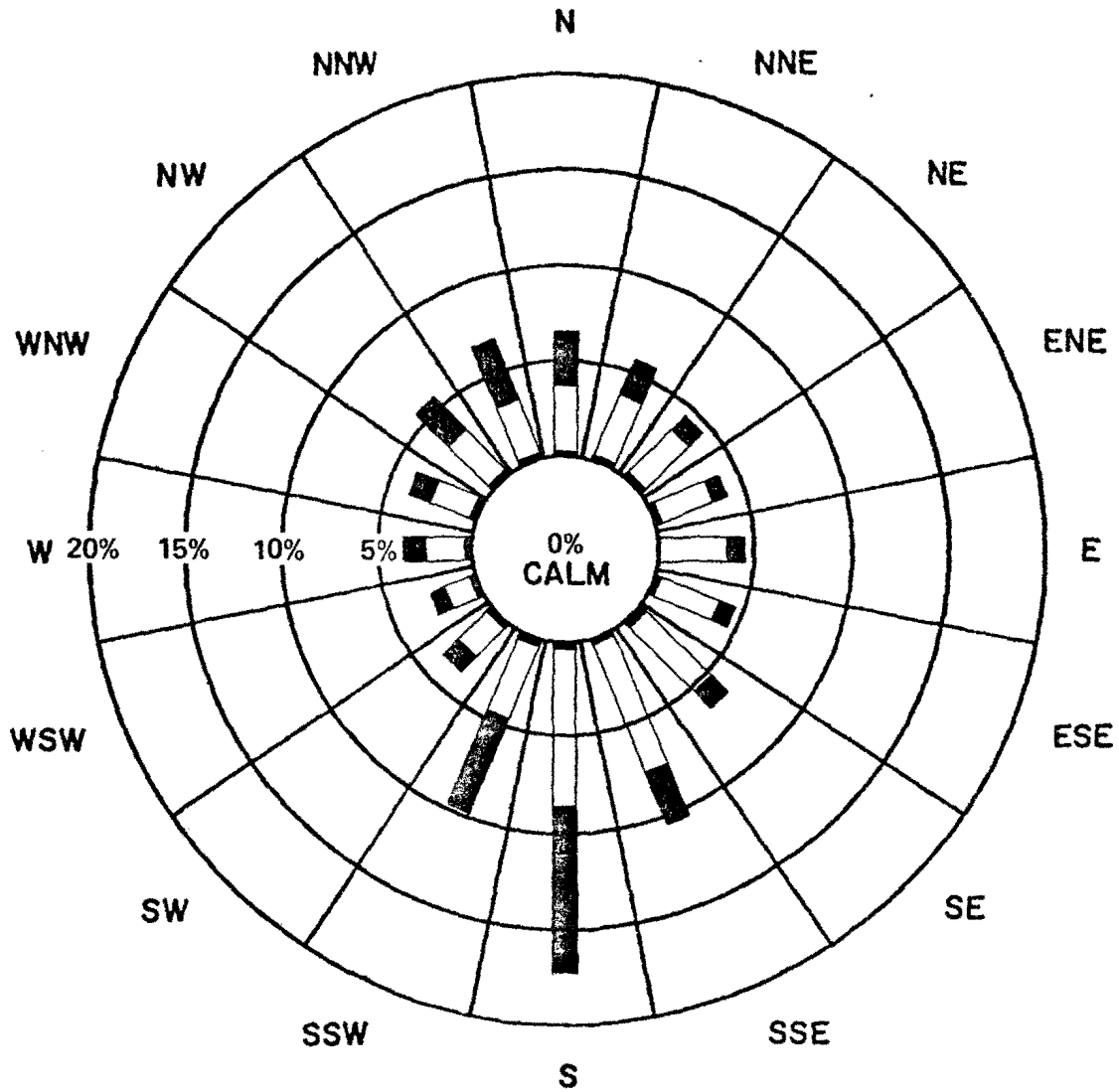

Rev. 0

**WOLF CREEK
UPDATED SAFETY ANALYSIS REPORT**

Figure 2.3-15

Wind Frequency Distribution in
Percent - 3 Years Combined

LEGEND:

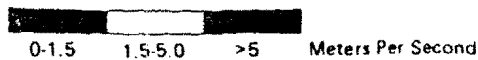

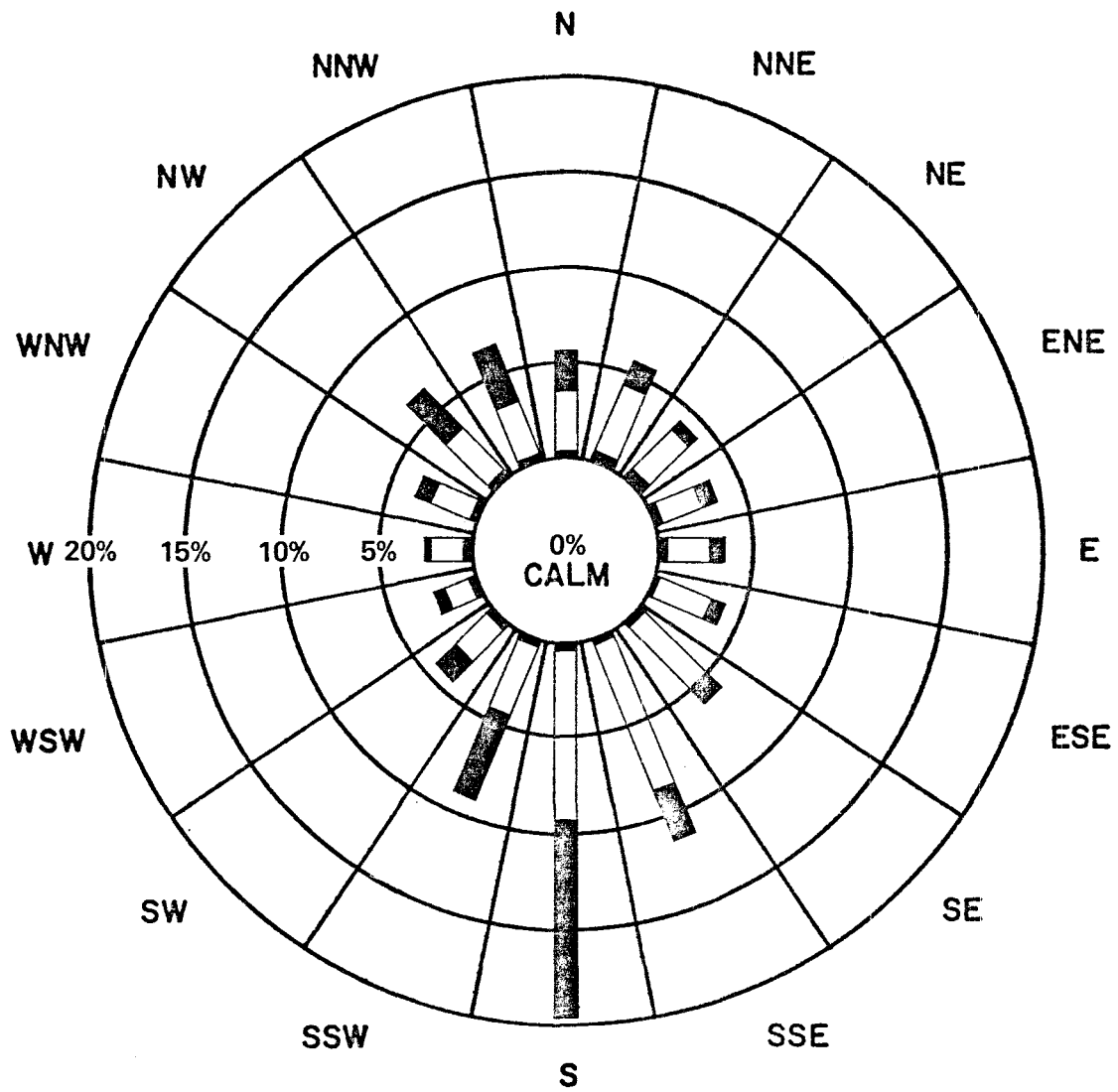

Rev. 0

**WOLF CREEK
UPDATED SAFETY ANALYSIS REPORT**

Figure 2.3-16

Wind Frequency Distribution in
Percent - 6/1/73 - 5/31/74

LEGEND:

0-1.5 1.5-5.0 >5 Meters Per Second

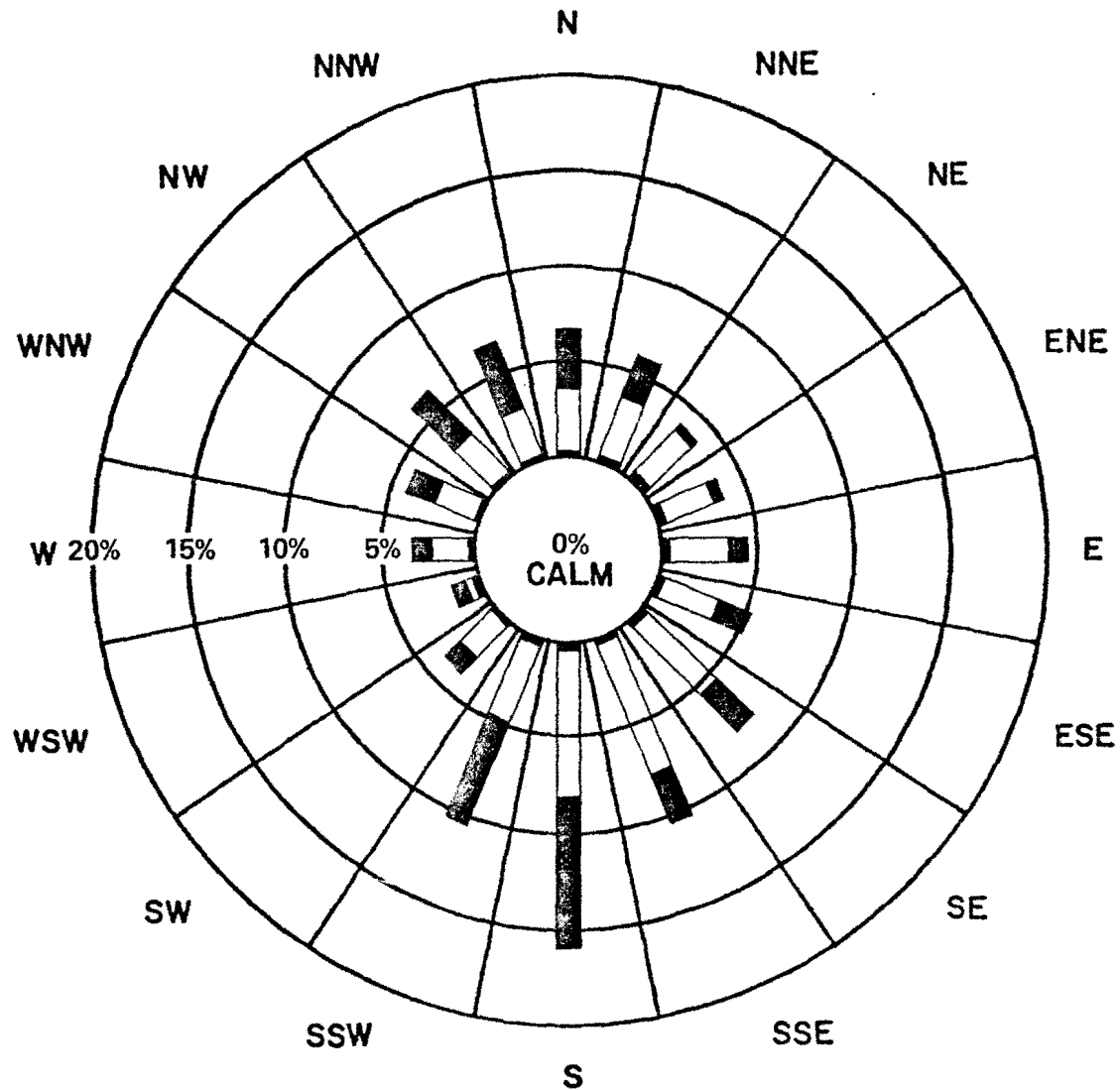

Rev. 0

**WOLF CREEK
UPDATED SAFETY ANALYSIS REPORT**

Figure 2.3-17

Wind Frequency Distribution in
Percent - 6/1/74 - 5/31/75

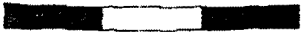
LEGEND:

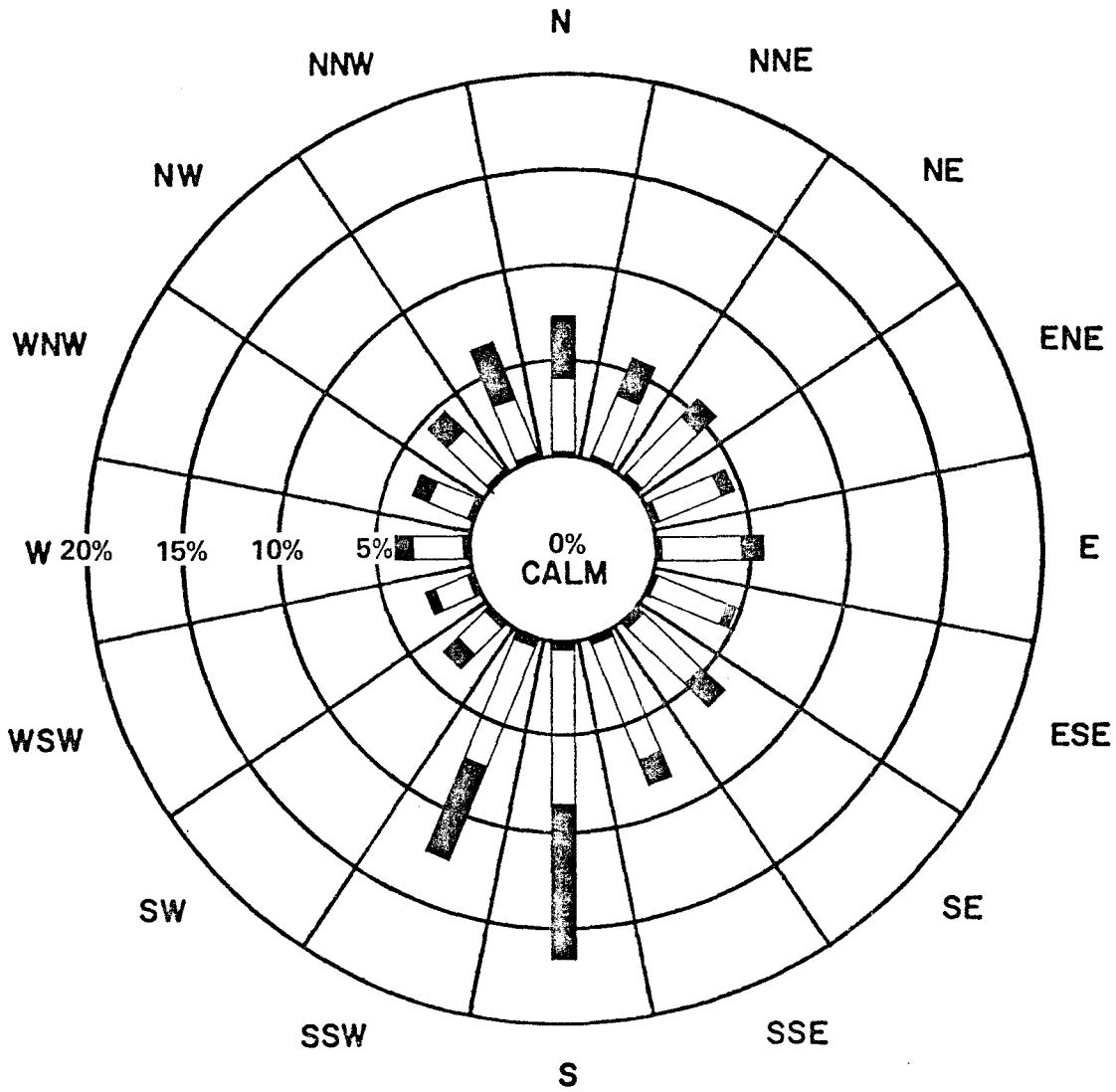
 0-1.5 1.5-5.0 >5 Meters Per Second



Rev. 0

**WOLF CREEK
UPDATED SAFETY ANALYSIS REPORT**

Figure 2.3-18

Wind Frequency Distribution in
Percent - 3/5/79 - 3/4/80

LEGEND:

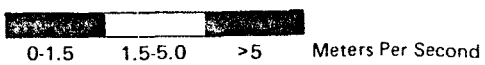

REFERENCE: USGS 7 1/2" Quadrangles of New Straawn, Kansas, 1971 and Burlington, Kansas, 1971

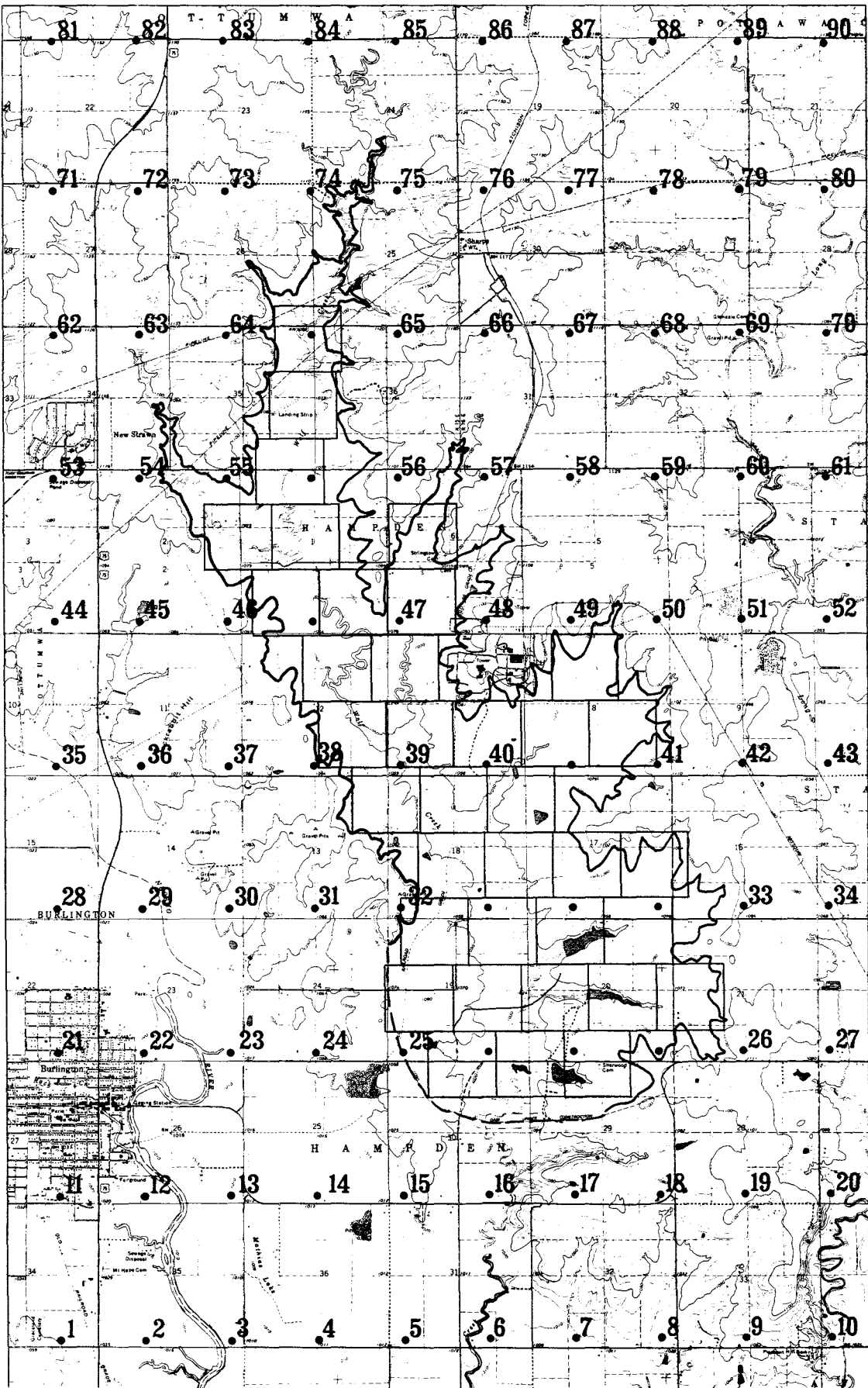
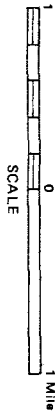

Rev. 0

**WOLF CREEK
UPDATED SAFETY ANALYSIS REPORT**

Figure 2.3-19
Fogging and Icing Analysis Grid

BUILDING KEY

- ① AUXILIARY/HOT SHOPS
- ② REACTOR
- ③ CONTROL/COMM. COR.
- ④ TURBINE
- ⑤ DIESEL
- ⑥ FUEL
- ⑦ ESW VERTICAL LOOP CHASE

29

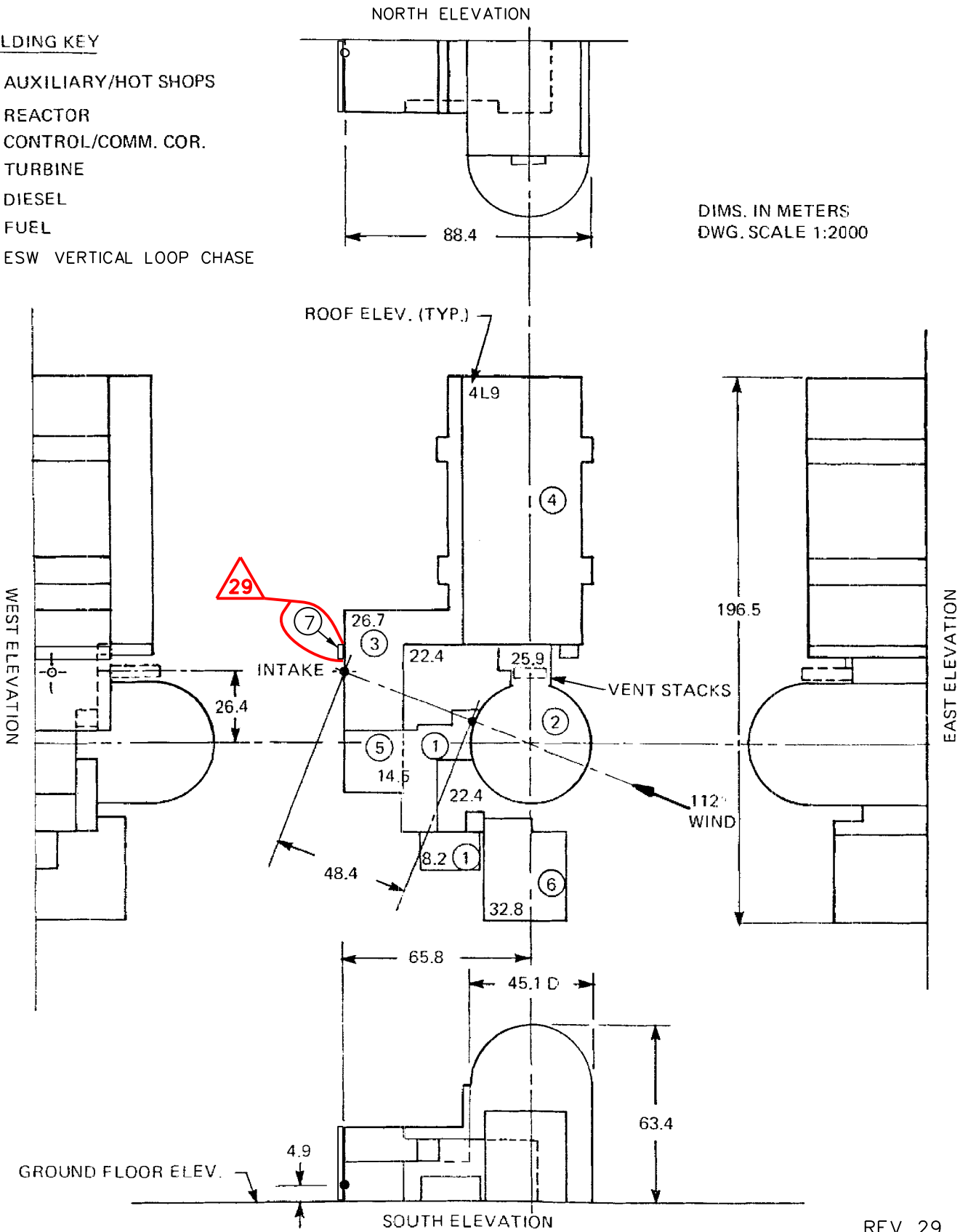

DIMS. IN METERS
DWG. SCALE 1:2000

REV. 29

**WOLF CREEK
UPDATED SAFETY ANALYSIS REPORT**

Figure 2.3-20
Contiguous Building Arrangement
One-Unit Plant

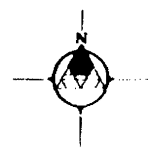
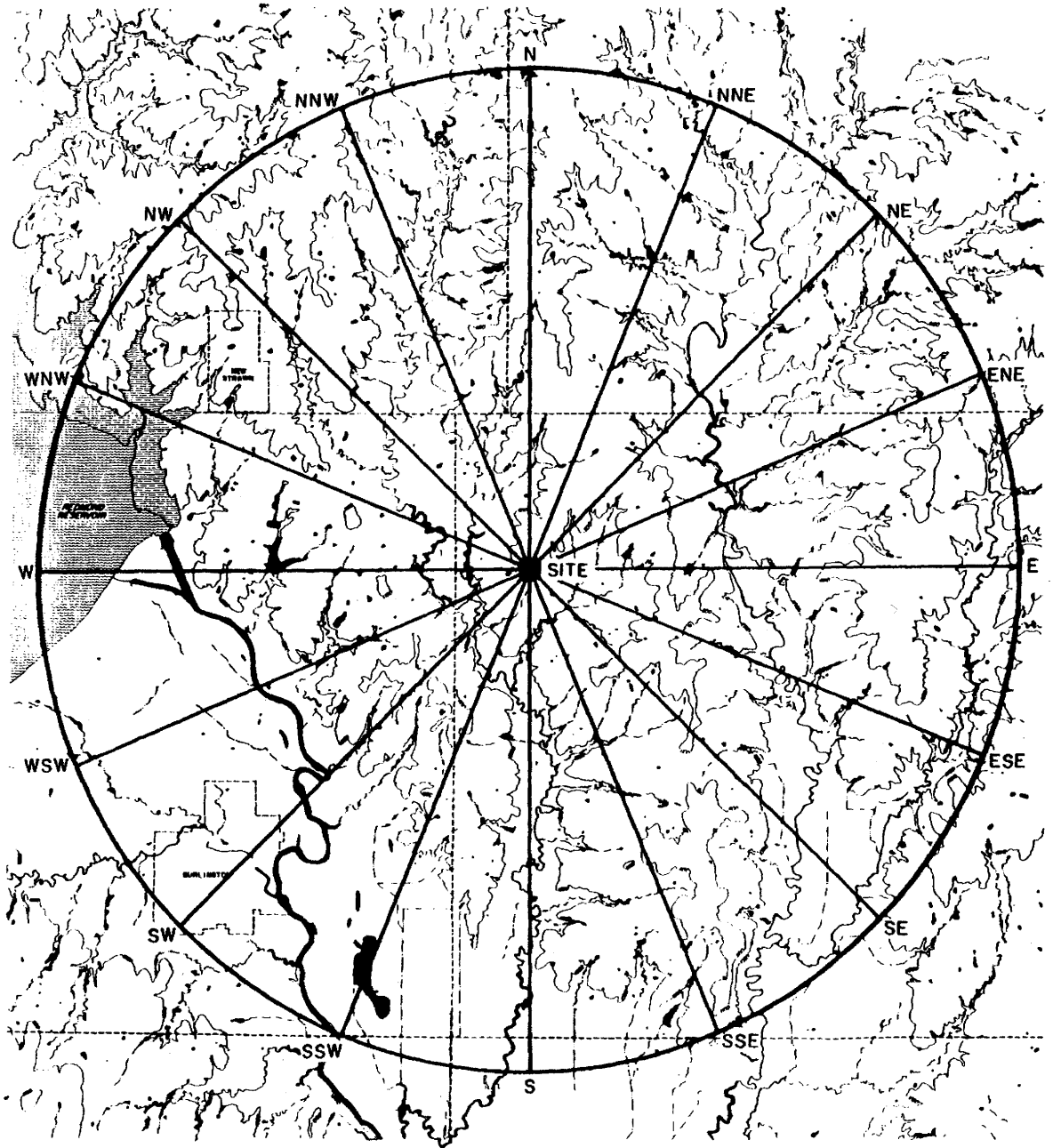

REFERENCE:
 FIFTY-FOOT TOPOGRAPHIC CONTOURS FROM
 U.S. GEOLOGICAL SURVEY QUADRANGLES FOR
 NEW STRAWN (1971), OTTURMA (1970),
 WAVERLY SE (1971), ALICEVILLE (1971),
 AND JOHN REDMOND DAM (1966); 7.5 MINUTE
 SERIES.

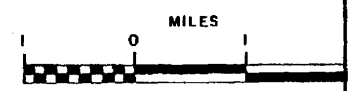

CONTOUR INTERVAL 50 FEET
 DATUM IS MEAN SEA LEVEL

Rev. 0

**WOLF CREEK
 UPDATED SAFETY ANALYSIS REPORT**

Figure 2.3-21
 Topographic Features within 5
 Miles of the Plant Site

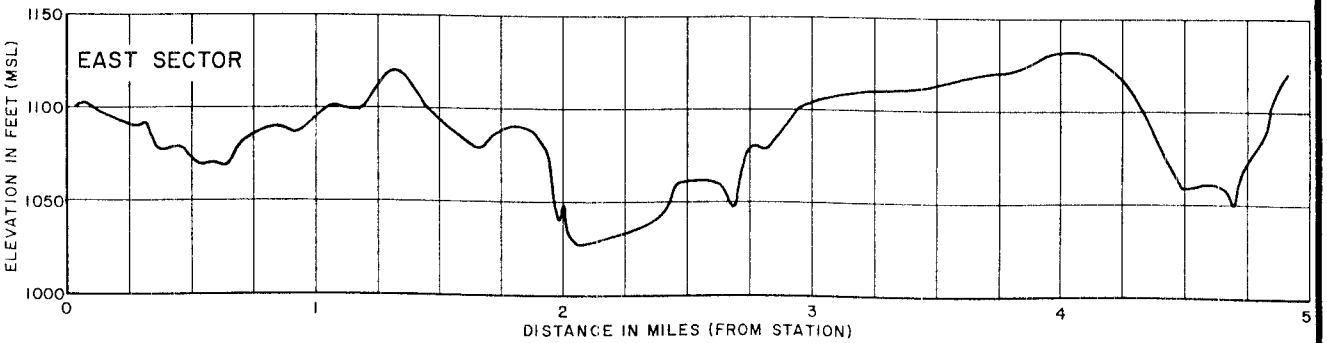
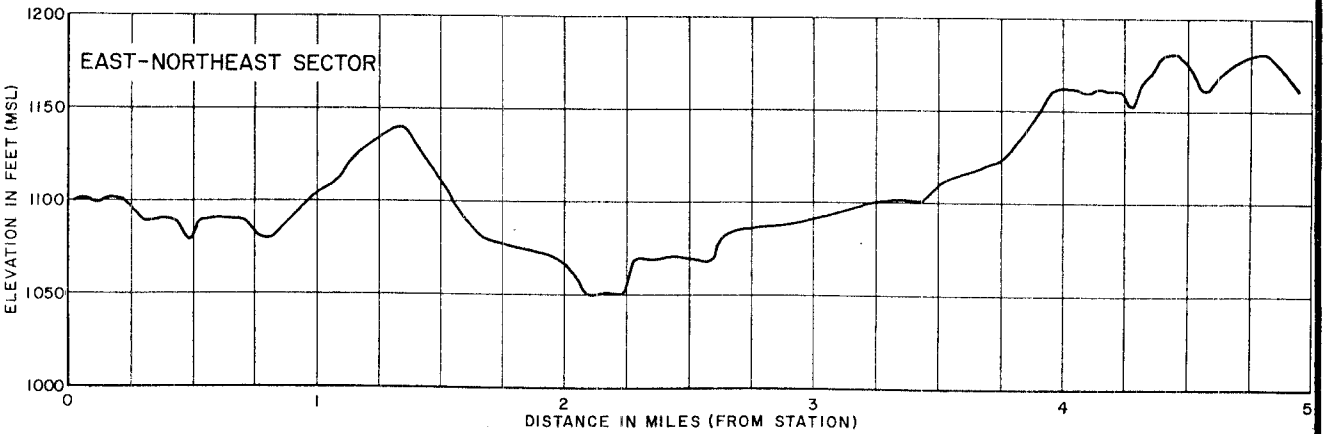
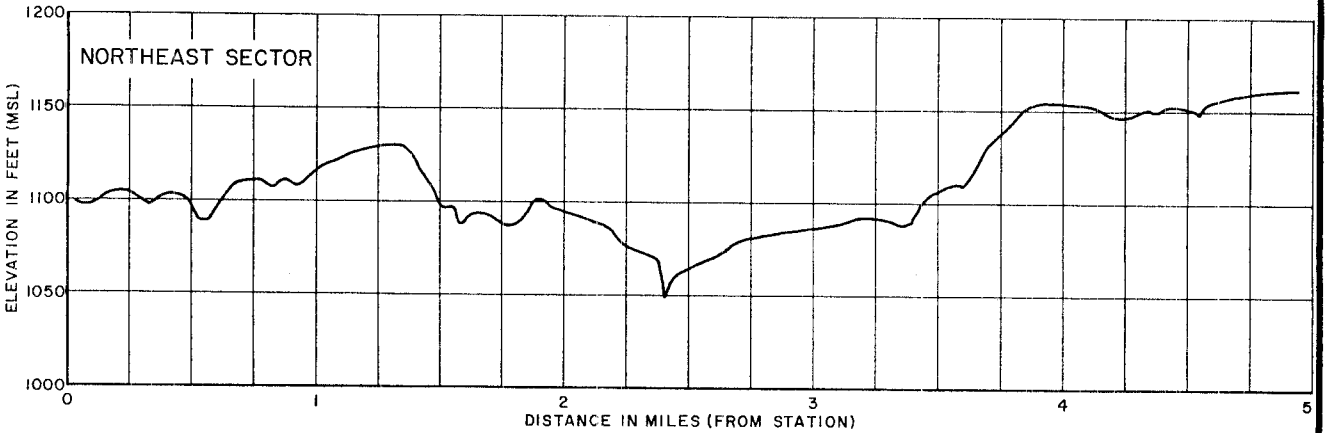
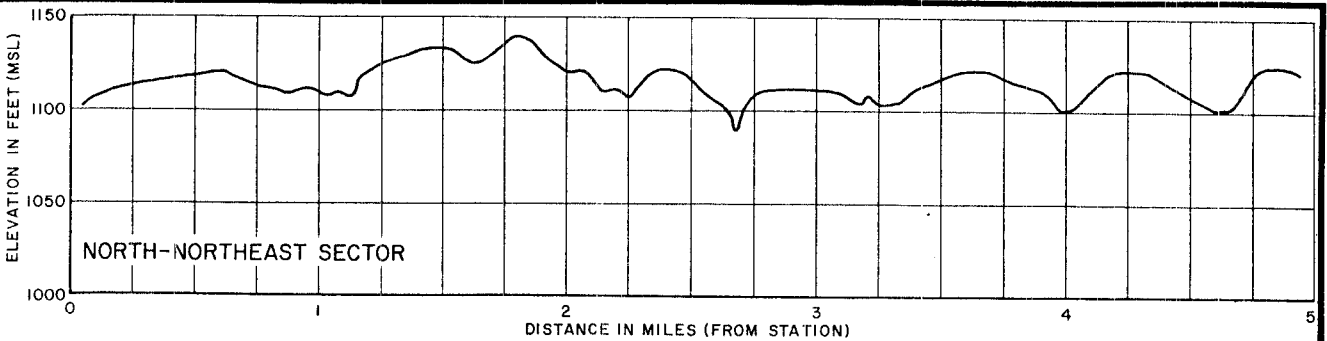

Rev. 0

**WOLF CREEK
UPDATED SAFETY ANALYSIS REPORT**

Figure 2.3-22 (Sheet 1 of 4)

Topographic Cross-Sections within
5 Mile Radius of the Site

NOTES: CROSS SECTIONS CORRESPOND TO RADIALS SHOWN
IN FIGURE 2.3-21. VERTICAL EXAGGERATION
EQUALS 40.

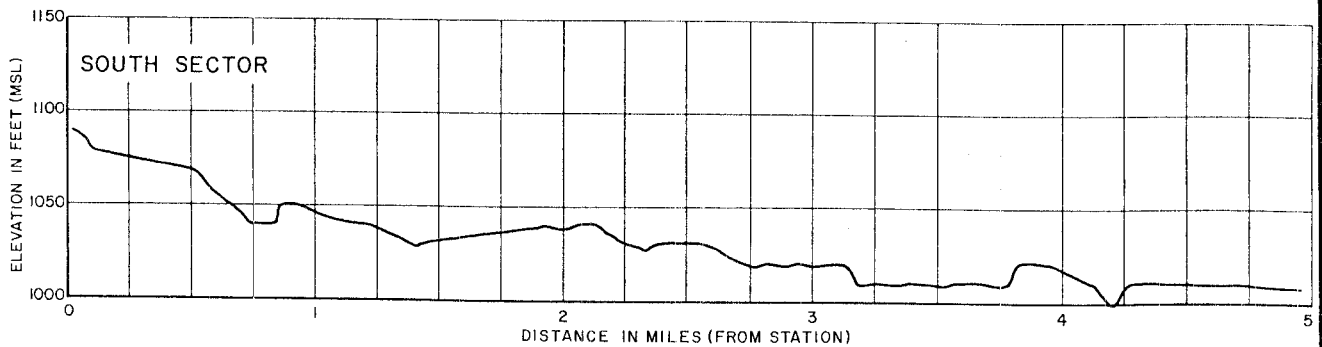
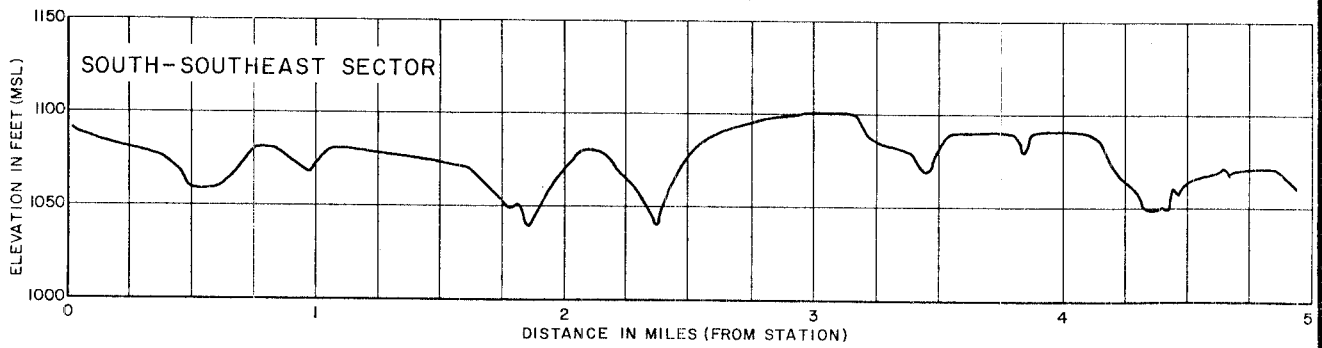
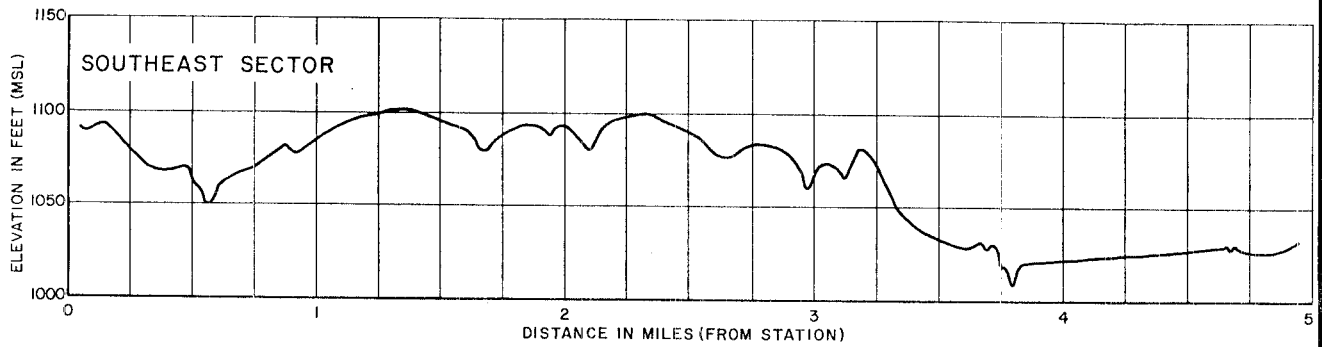
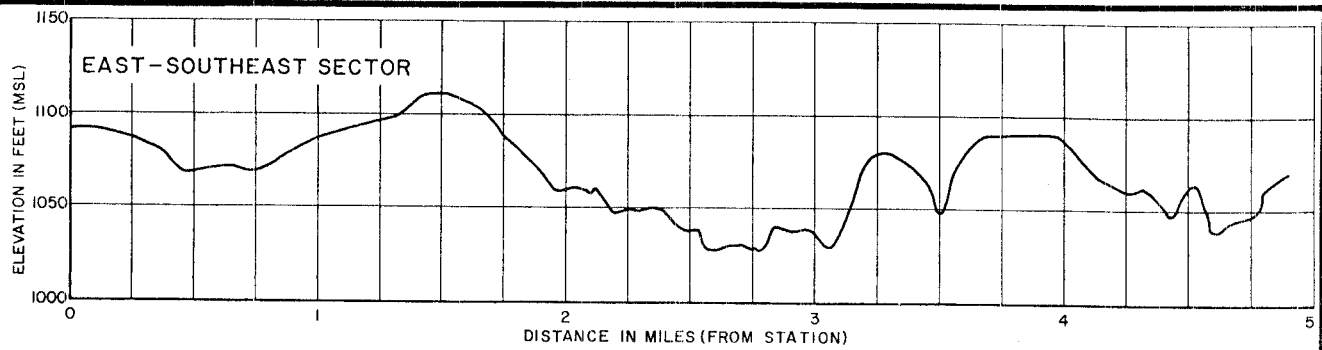

Rev. 0

**WOLF CREEK
UPDATED SAFETY ANALYSIS REPORT**

Figure 2.3-22 (Sheet 2 of 4)

Topographic Cross-Sections within
5 Mile Radius of the Site

NOTES: CROSS SECTIONS CORRESPOND TO RADIALS SHOWN
IN FIGURE 2.3-21. VERTICAL EXAGGERATION
EQUALS 40.

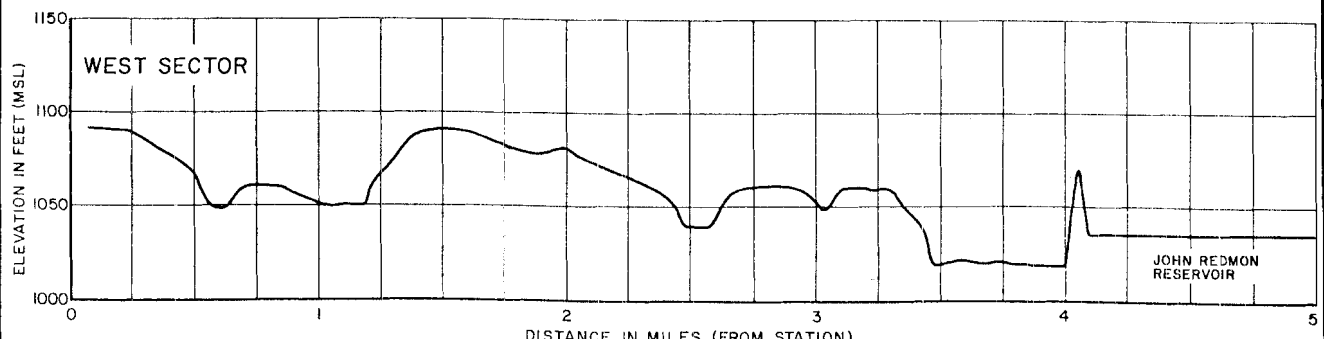
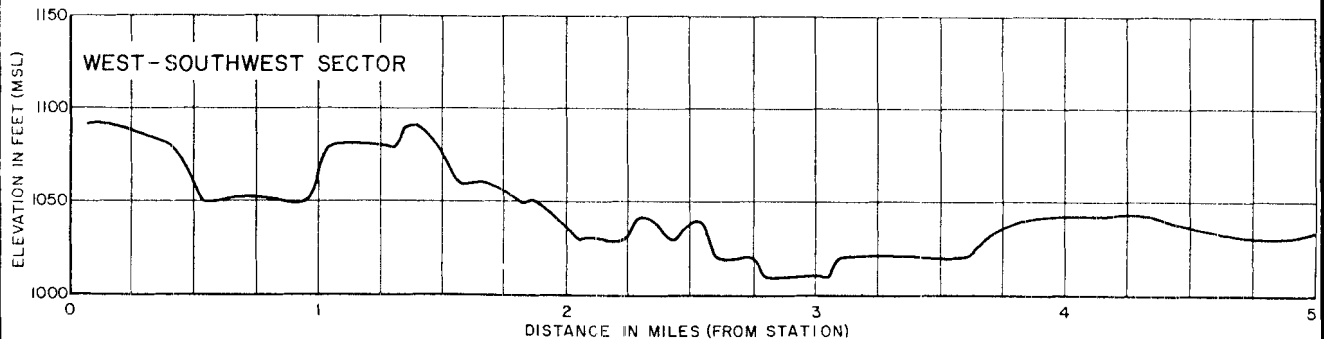
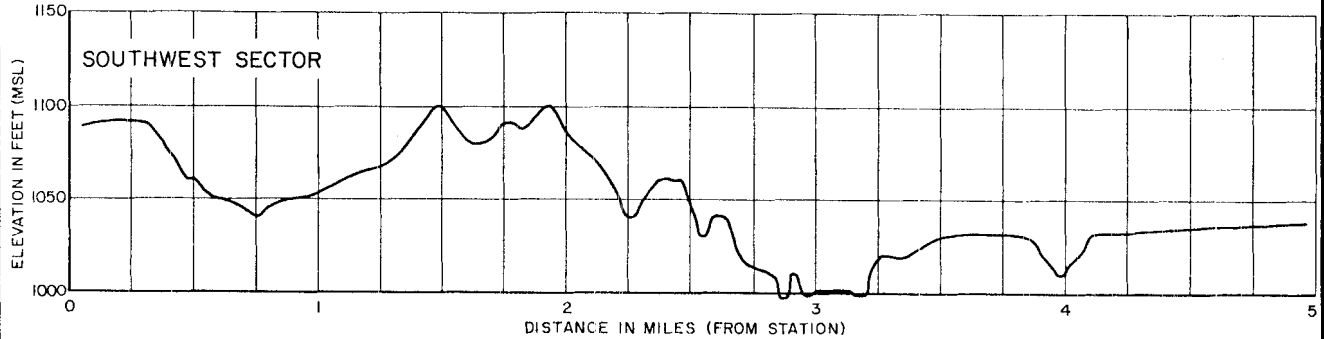
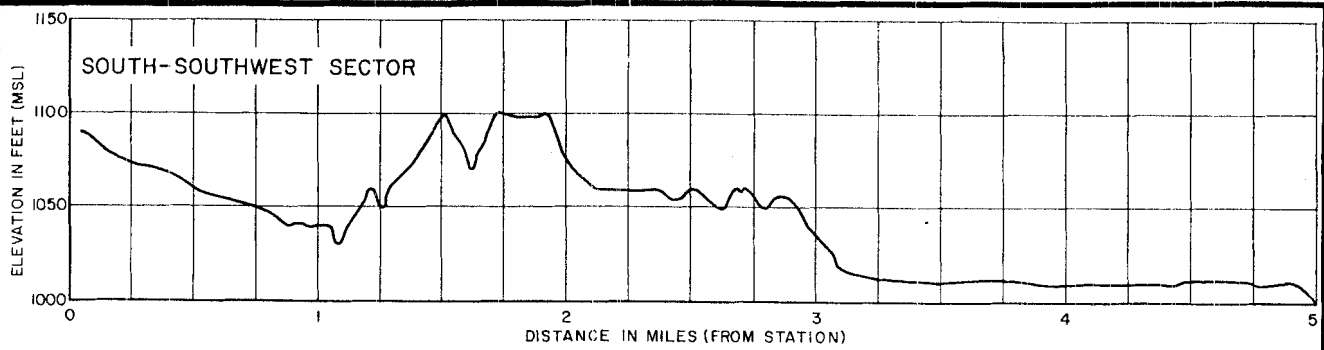

Rev. 0

**WOLF CREEK
UPDATED SAFETY ANALYSIS REPORT**

Figure 2.3-22 (Sheet 3 of 4)

Topographic Cross-Sections within
5 Mile Radius of the Site

NOTES: CROSS SECTIONS CORRESPOND TO RADIALS SHOWN
IN FIGURE 2.3-21. VERTICAL EXAGGERATION
EQUALS 40.

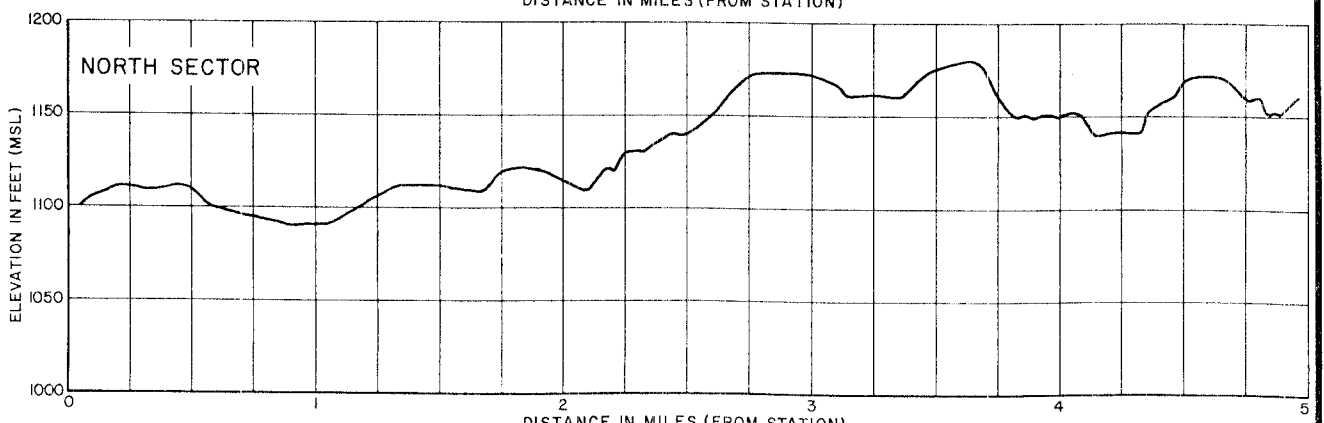
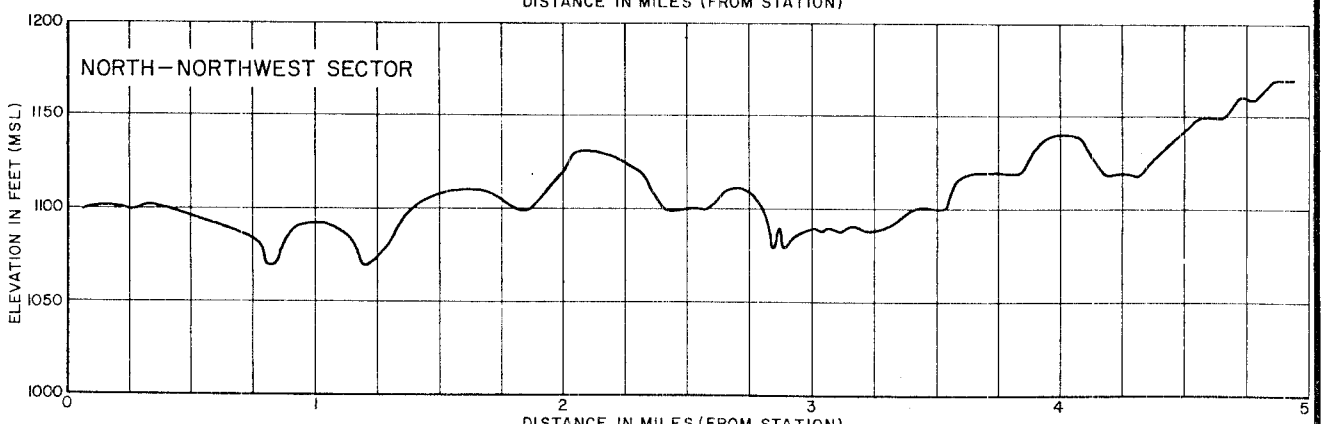
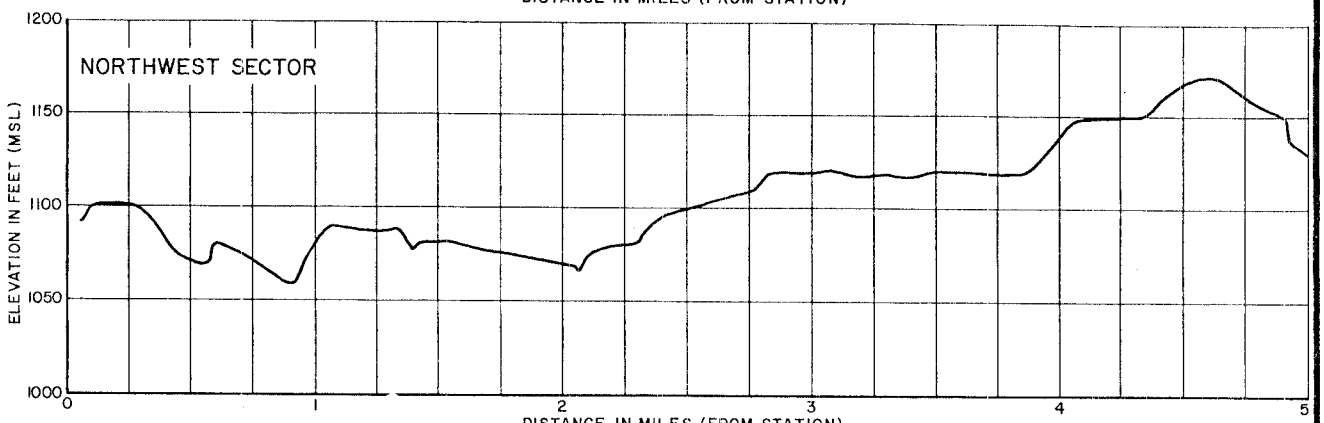
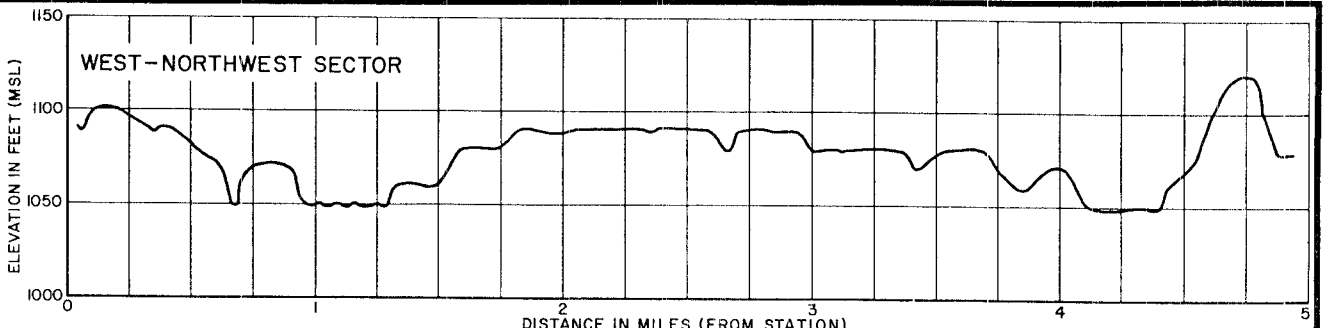

Rev. 0

**WOLF CREEK
UPDATED SAFETY ANALYSIS REPORT**

Figure 2.3-22 (Sheet 4 of 4)

Topographic Cross-Sections within
5 Mile Radius of the Site

NOTES: CROSS SECTIONS CORRESPOND TO RADIALS SHOWN
IN FIGURE 2.3-21. VERTICAL EXAGGERATION
EQUALS 40.

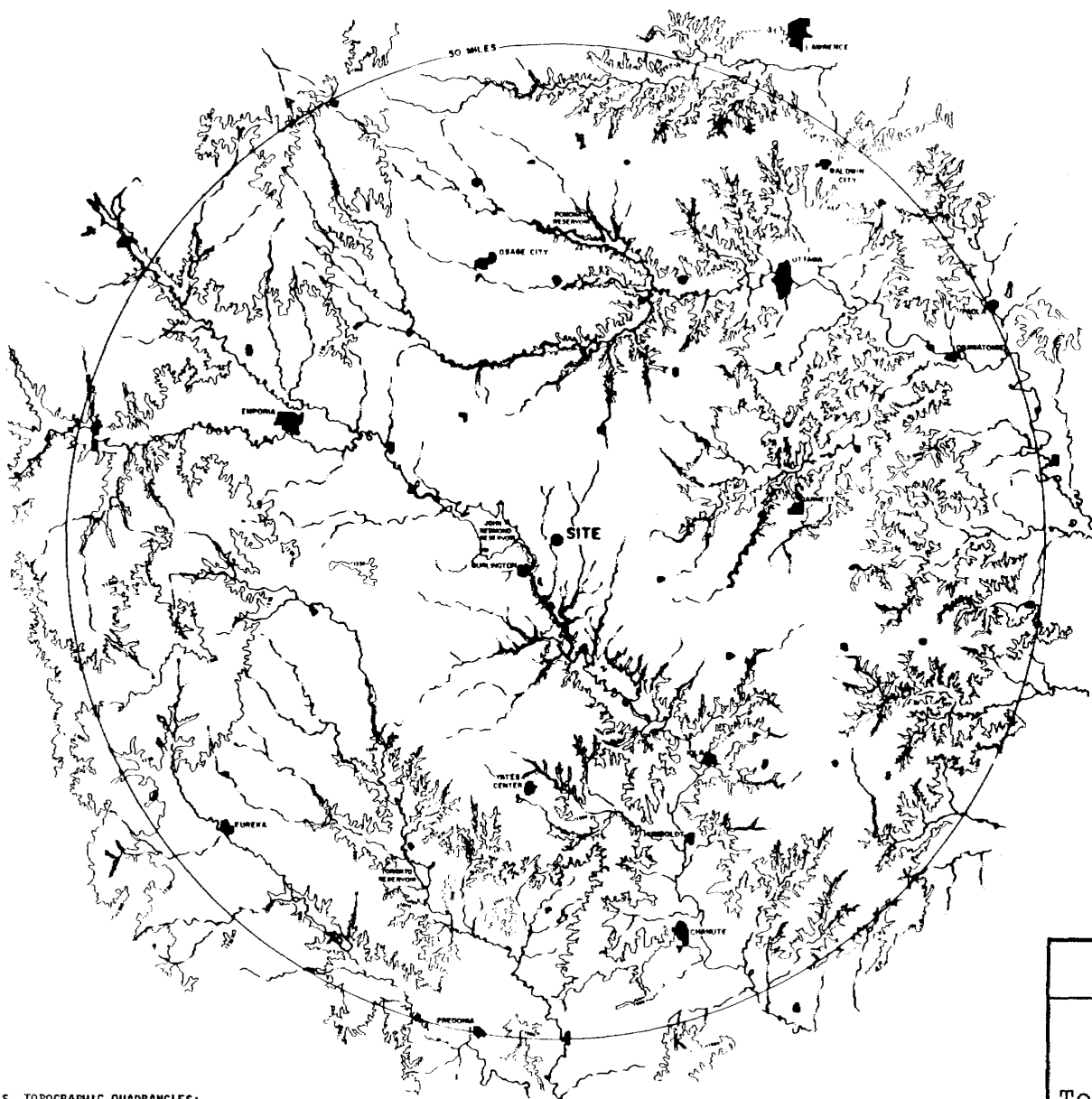

REFERENCE:

BASED ON U.S.G.S. TOPOGRAPHIC QUADRANGLES;
 HUTCHINSON, KANSAS - 1955
 JOPLIN, MISSOURI; KANSAS - 1954
 LAWRENCE, KANSAS; MISSOURI - 1956
 WICHITA, KANSAS - 1955

Rev. 0

**WOLF CREEK
 UPDATED SAFETY ANALYSIS REPORT**

Figure 2.3-23

Topographic Features within 50
 Miles of the Plant Site

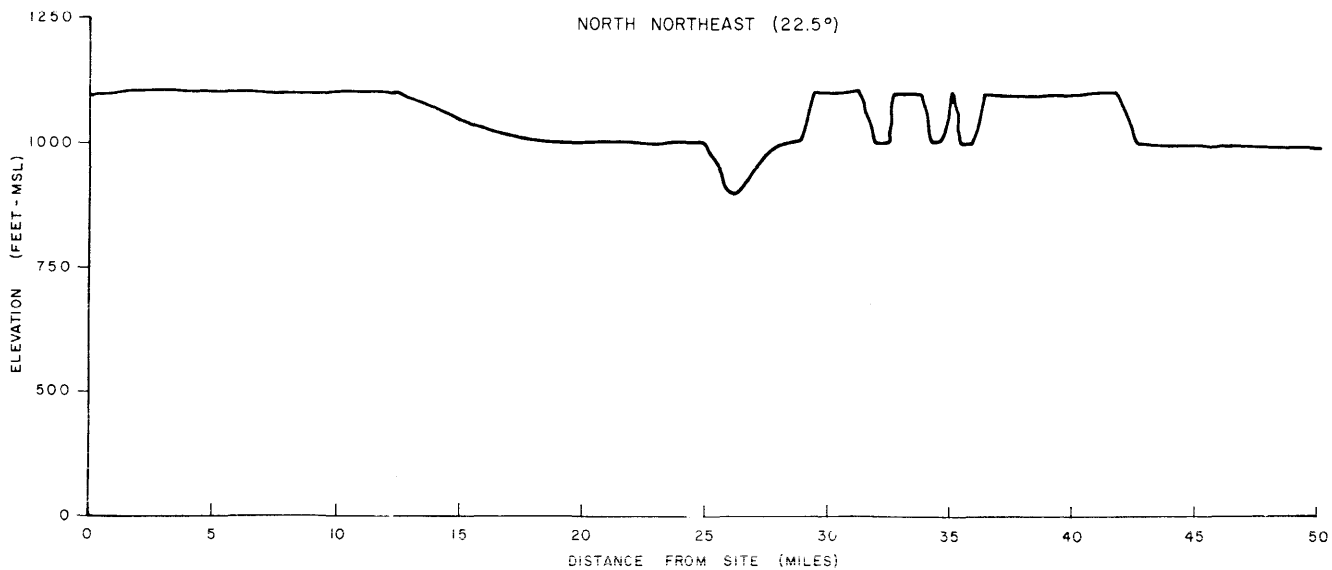
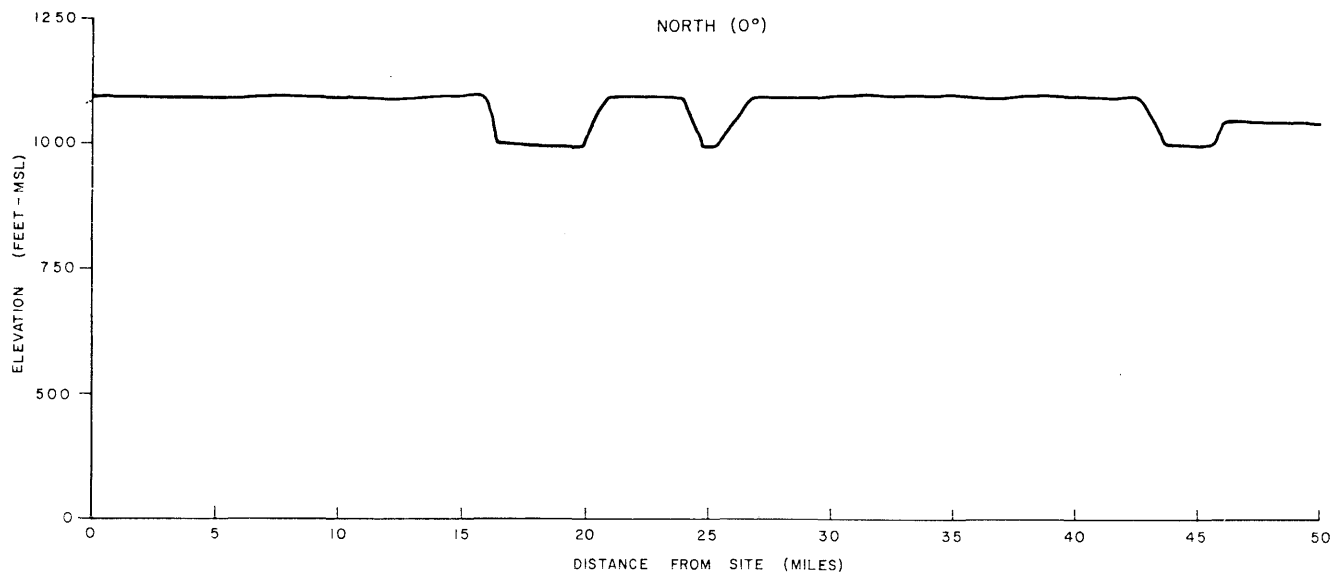

Rev. 0

**WOLF CREEK
UPDATED SAFETY ANALYSIS REPORT**

Figure 2.3-24 (Sheet 1 of 8)

Topographic Cross-Sections within
a 50 Mile Radius of the Site

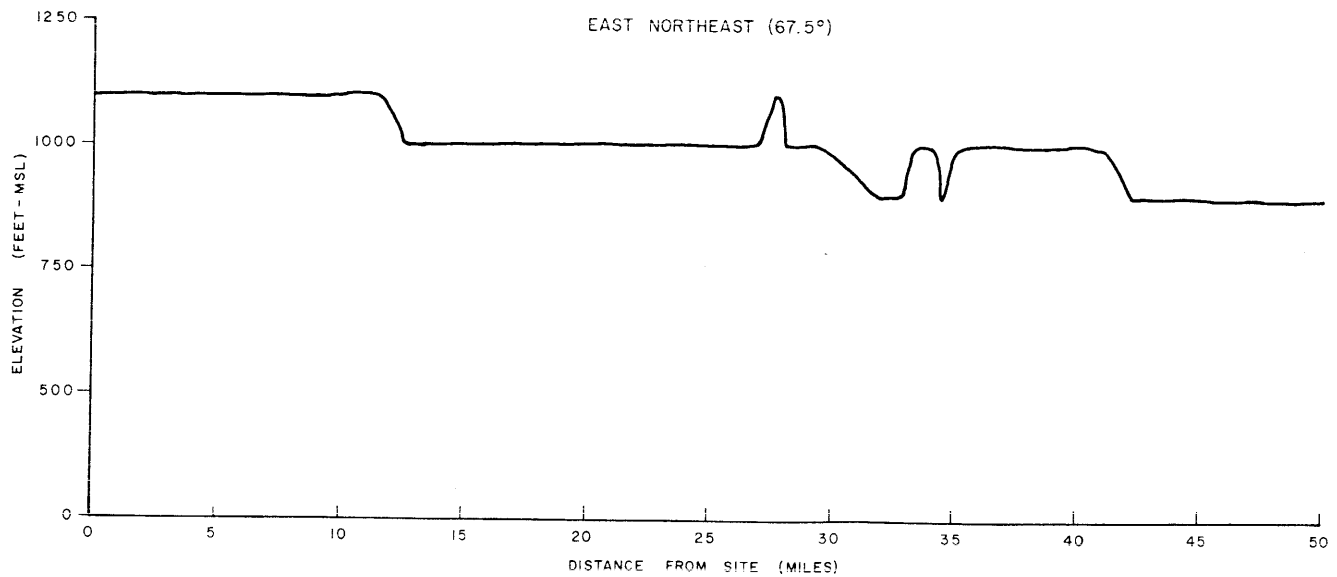
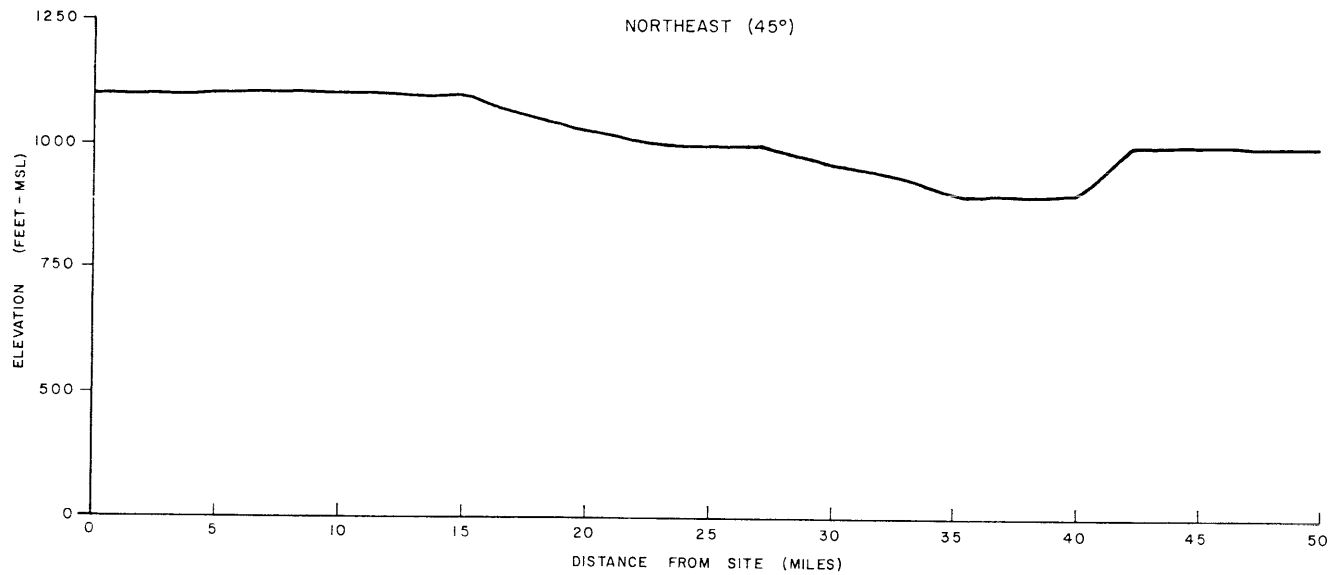

Rev. 0

**WOLF CREEK
UPDATED SAFETY ANALYSIS REPORT**

Figure 2.3-24 (Sheet 2 of 8)

Topographic Cross-Sections within
a 50 Mile Radius of the Site

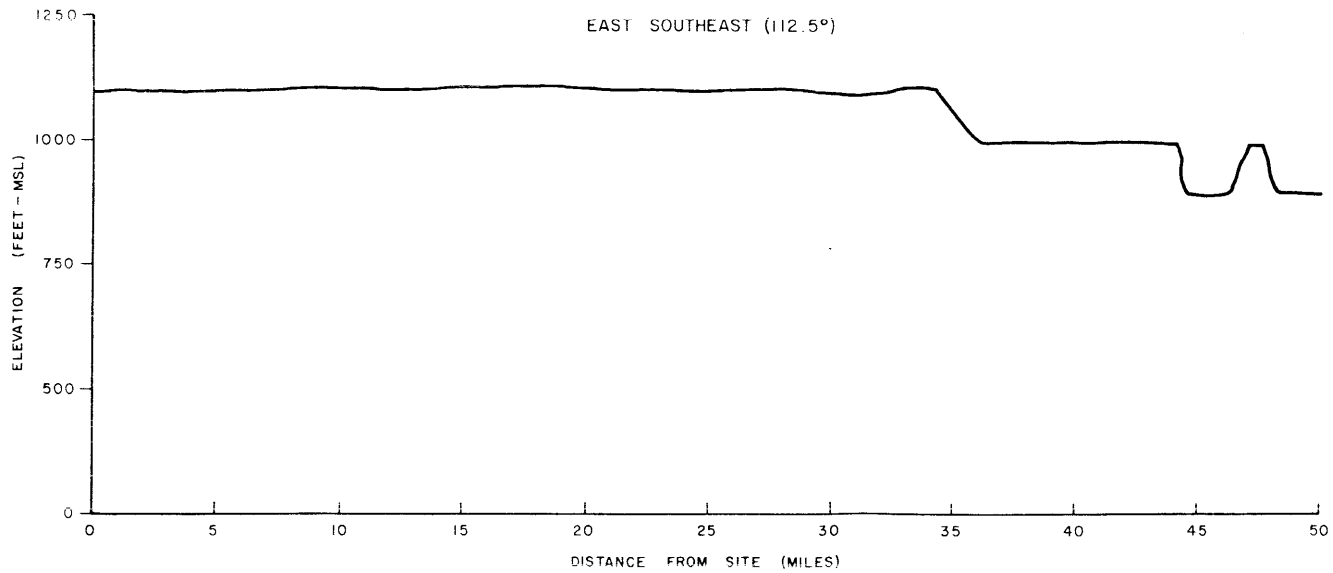
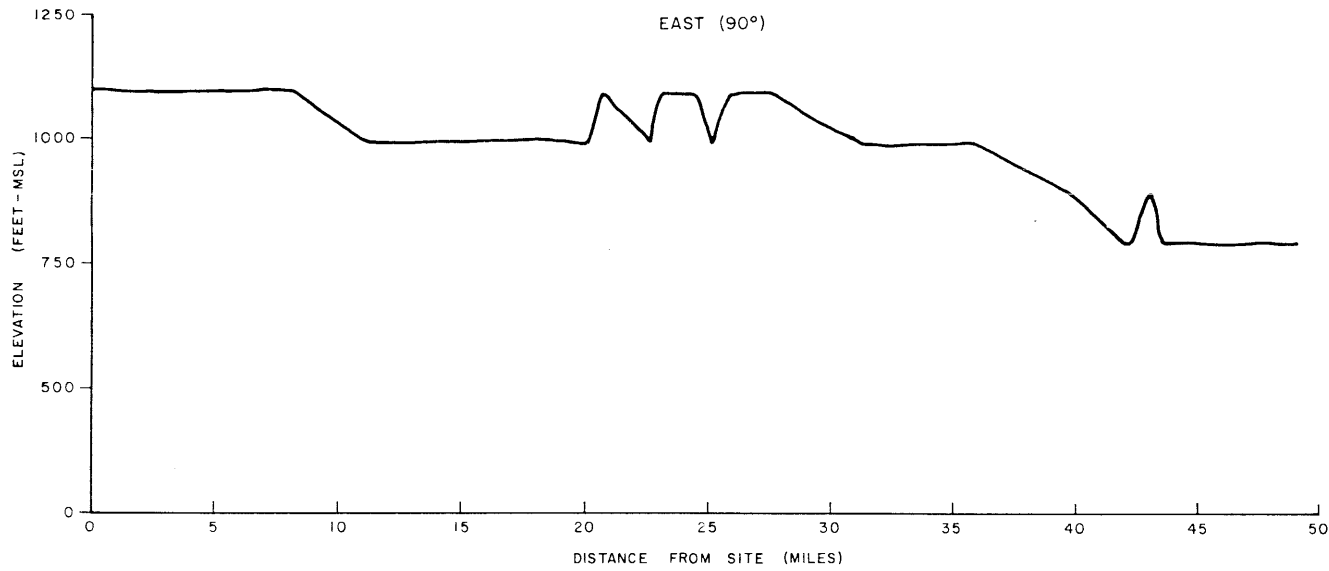

Rev. 0

**WOLF CREEK
UPDATED SAFETY ANALYSIS REPORT**

Figure 2.3-24 (Sheet 3 of 8)

Topographic Cross-Sections within
a 50 Mile Radius of the Site

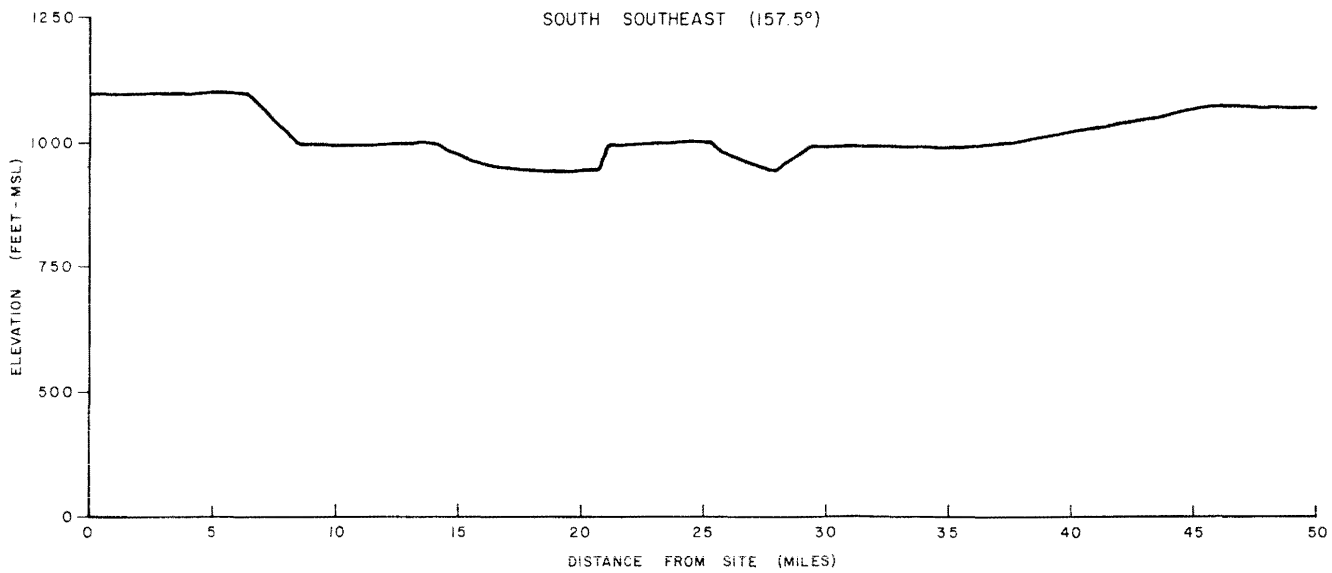
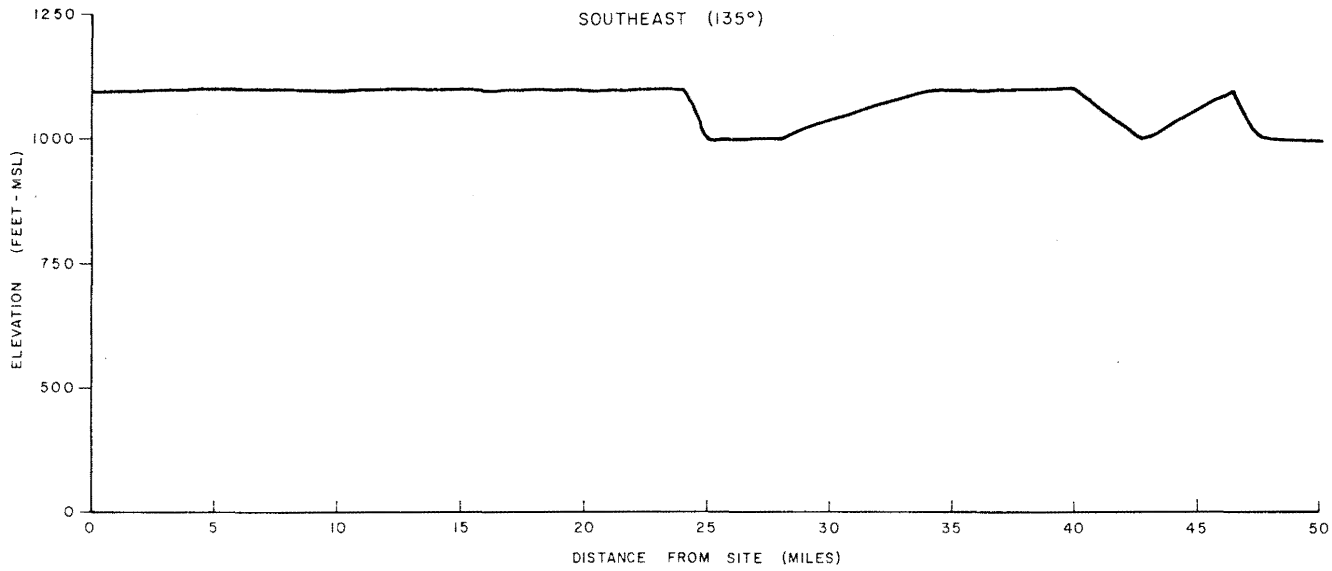

Rev. 0

**WOLF CREEK
UPDATED SAFETY ANALYSIS REPORT**

Figure 2.3-24 (Sheet 4 of 8)

Topographic Cross-Sections within
a 50 Mile Radius of the Site

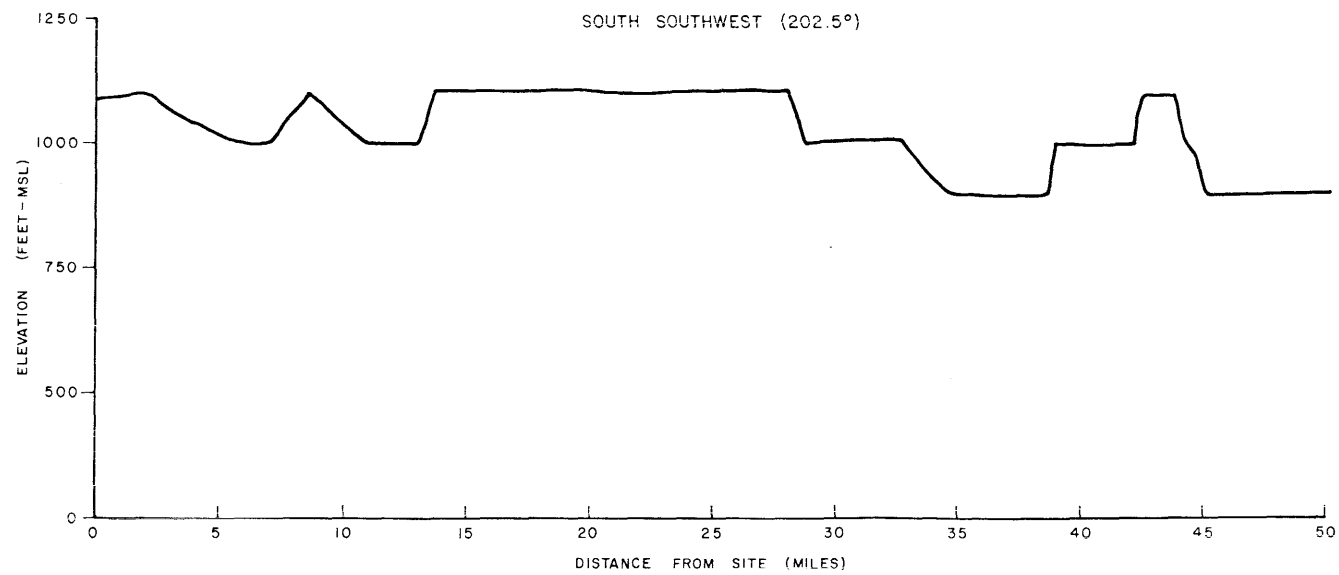
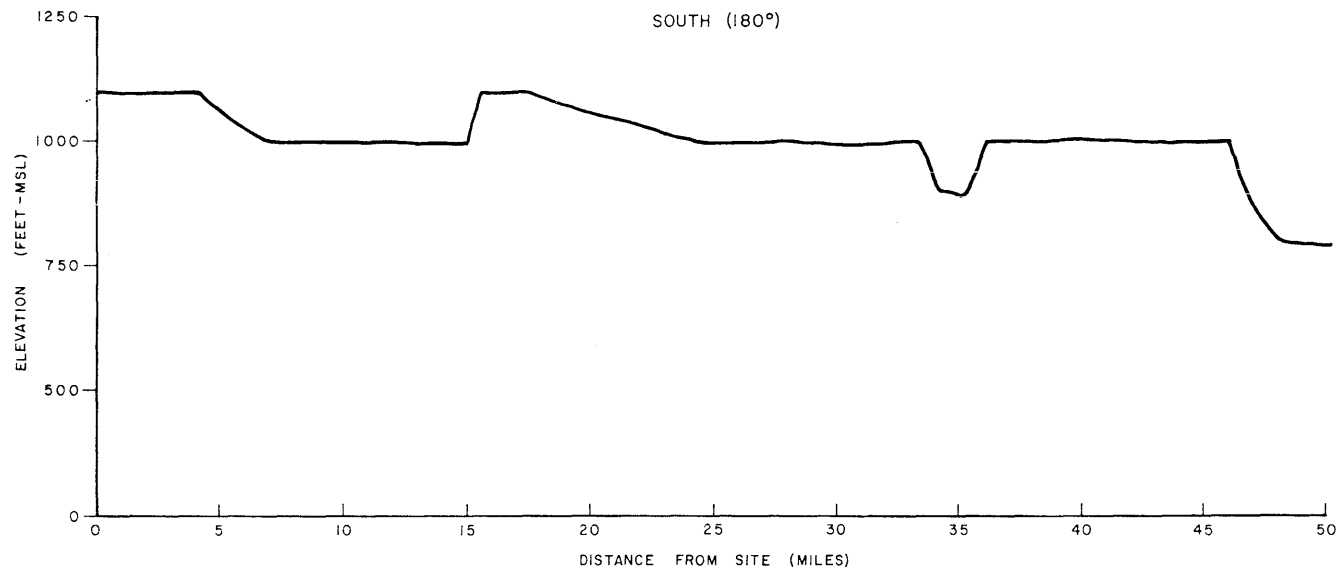

Rev. 0

WOLF CREEK UPDATED SAFETY ANALYSIS REPORT
Figure 2.3-24 (Sheet 5 of 8)
Topographic Cross-Sections within a 50 Mile Radius of the Site

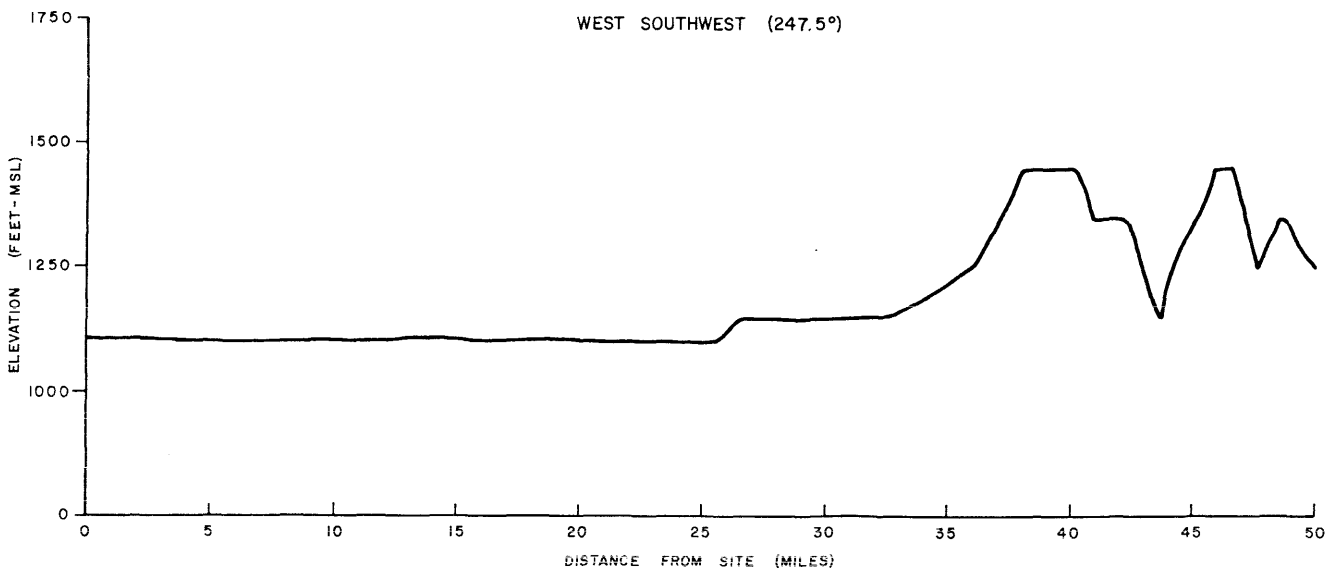
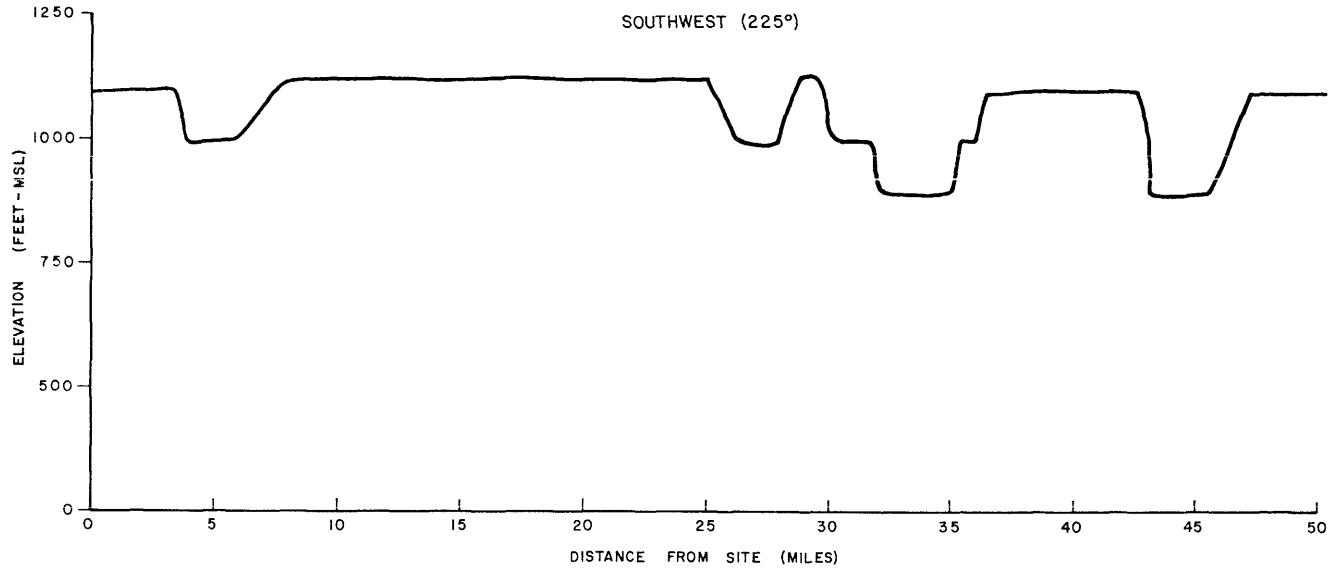

Rev. 0

WOLF CREEK
 UPDATED SAFETY ANALYSIS REPORT

Figure 2.3-24 (Sheet 6 of 8)

Topographic Cross-Sections within
 a 50 Mile Radius of the Site

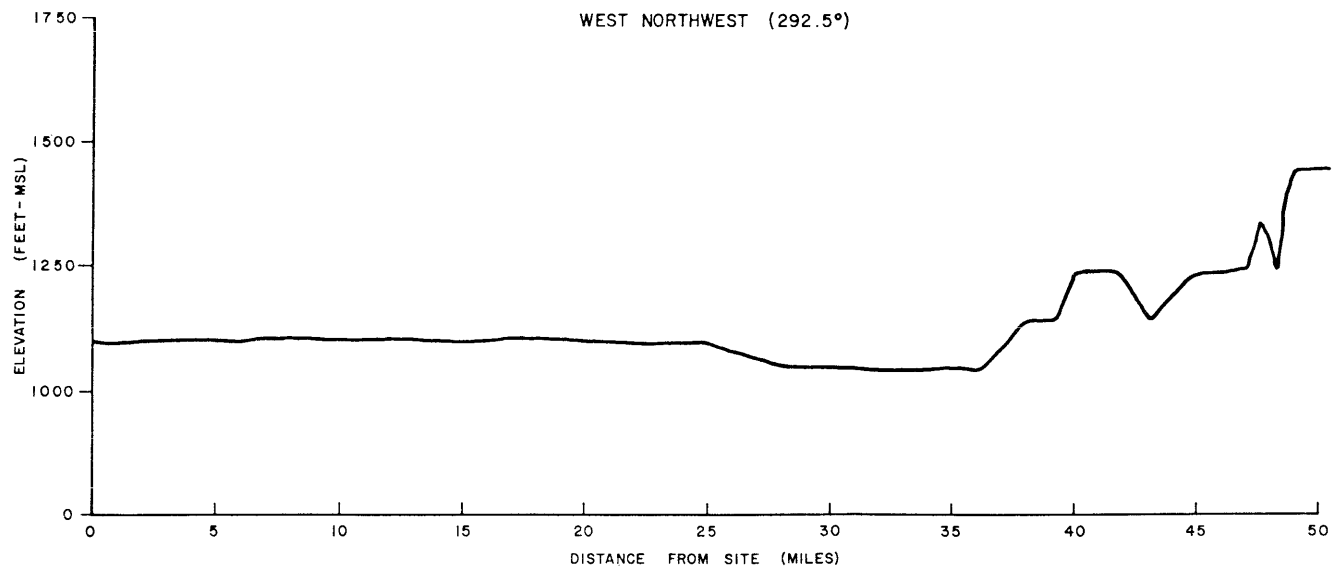
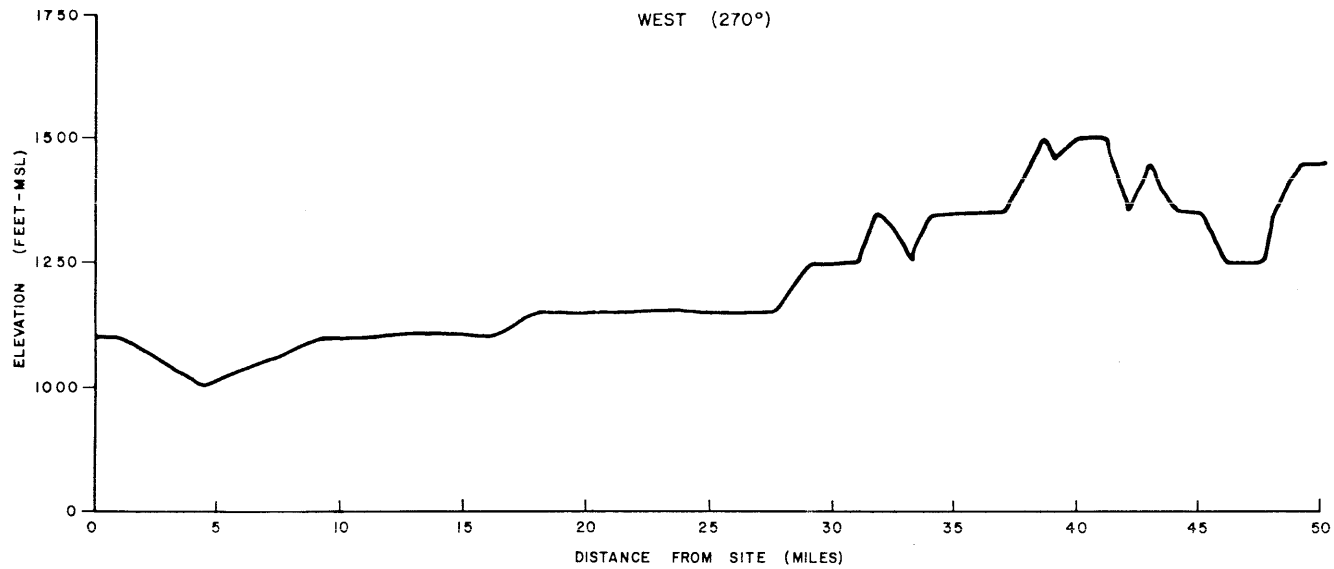

Rev. 0

**WOLF CREEK
UPDATED SAFETY ANALYSIS REPORT**

Figure 2.3-24 (Sheet 7 of 8)

Topographic Cross-Sections within
a 50 Mile Radius of the Site

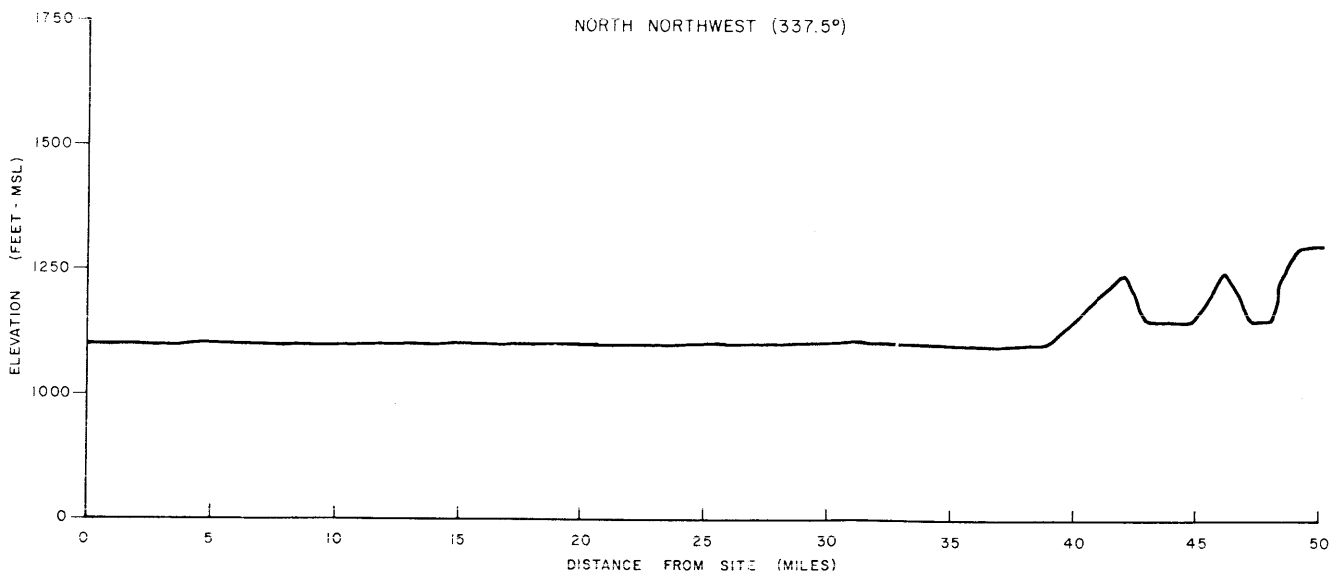
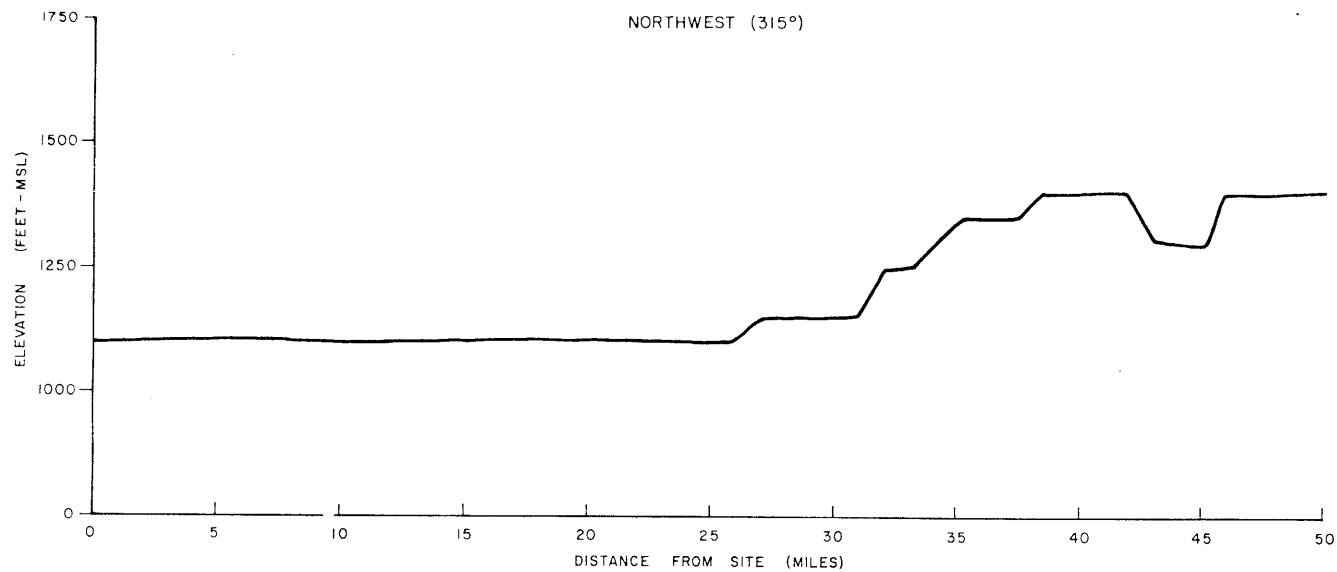

Rev. 0

**WOLF CREEK
UPDATED SAFETY ANALYSIS REPORT**

Figure 2.3-24 (Sheet 8 of 8)

Topographic Cross-Sections within
a 50 Mile Radius of the Site

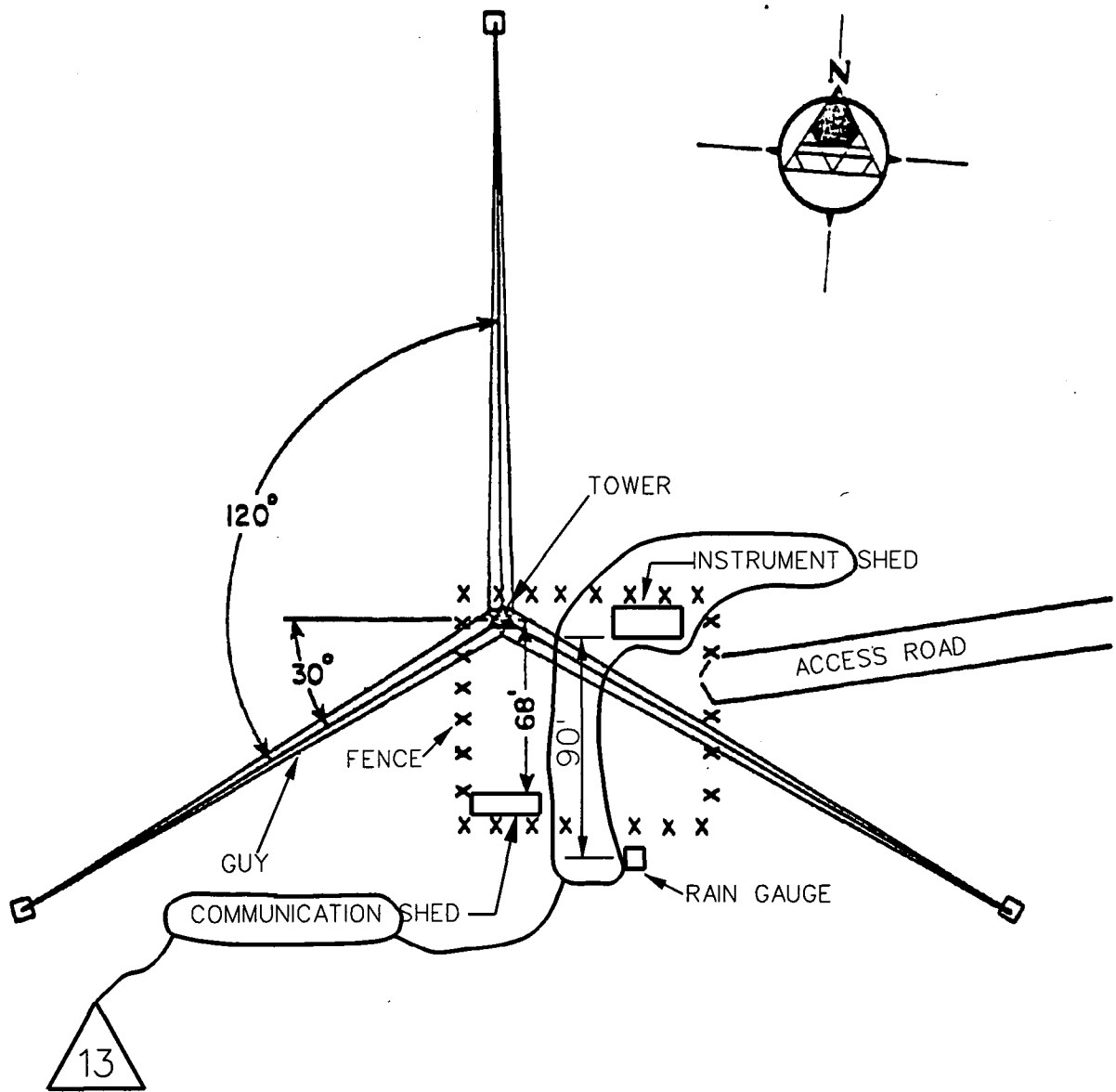

**WOLF CREEK
UPDATED SAFETY ANALYSIS REPORT**

Figure 2.3-25, REV. 13

Meteorological Tower Plot Plan

NOTE:

FIGURE 2.1-6 SHOWS THE RELATIONSHIP OF THE METEOROLOGICAL TOWER TO PLANT STRUCTURES AND FEATURES.

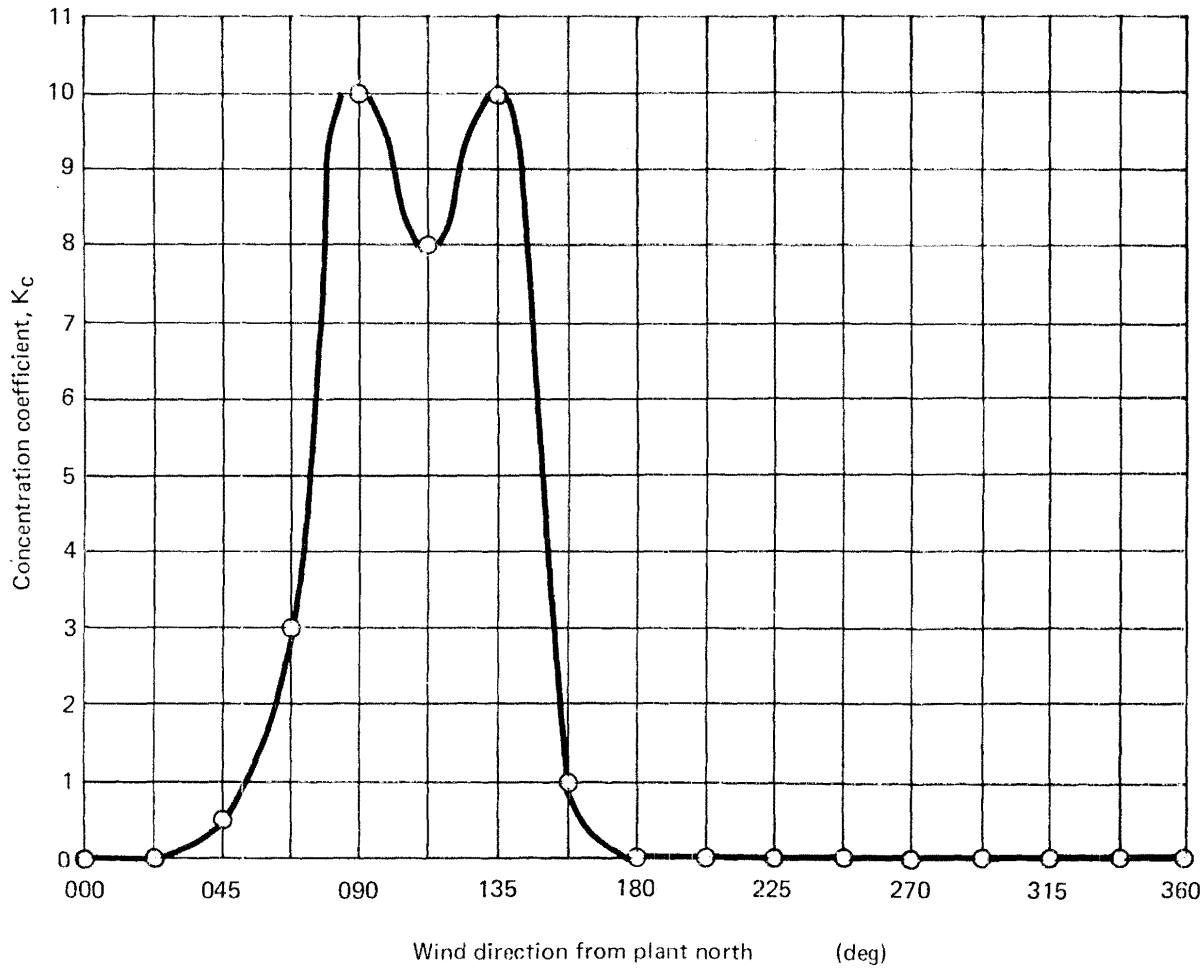

Rev. 0

**WOLF CREEK
UPDATED SAFETY ANALYSIS REPORT**

Figure 2.3-26

Variation of Intake K_c with Wind Direction

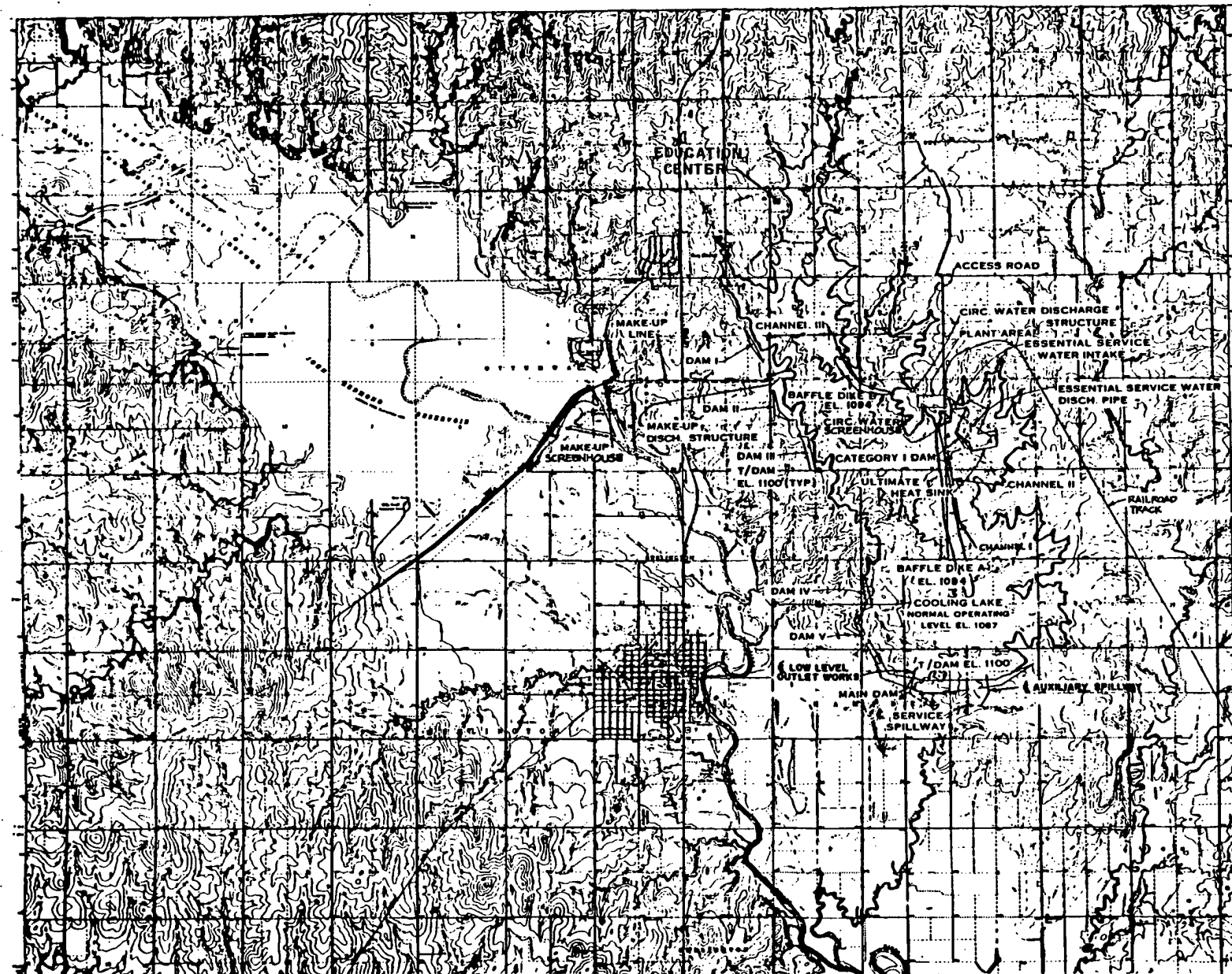

Rev. 0

**WOLF CREEK
UPDATED SAFETY ANALYSIS REPORT**

Figure 2.4-1
General Arrangement

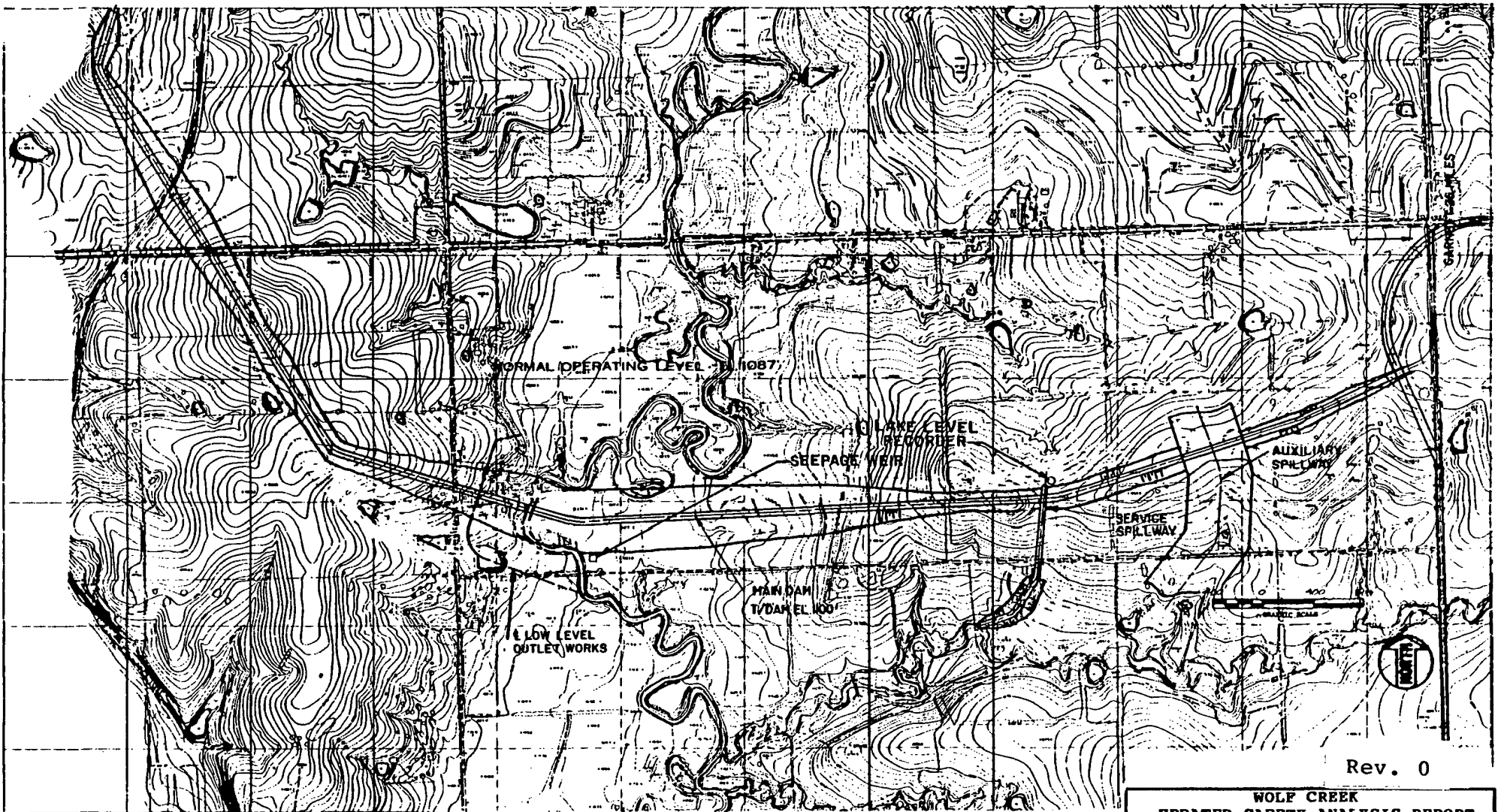

Rev. 0

**WOLF CREEK
UPDATED SAFETY ANALYSIS REPORT**

Figure 2.4-2

Main Dam and Appurtenant
Structures

THIS PAGE INTENTIONALLY LEFT BLANK

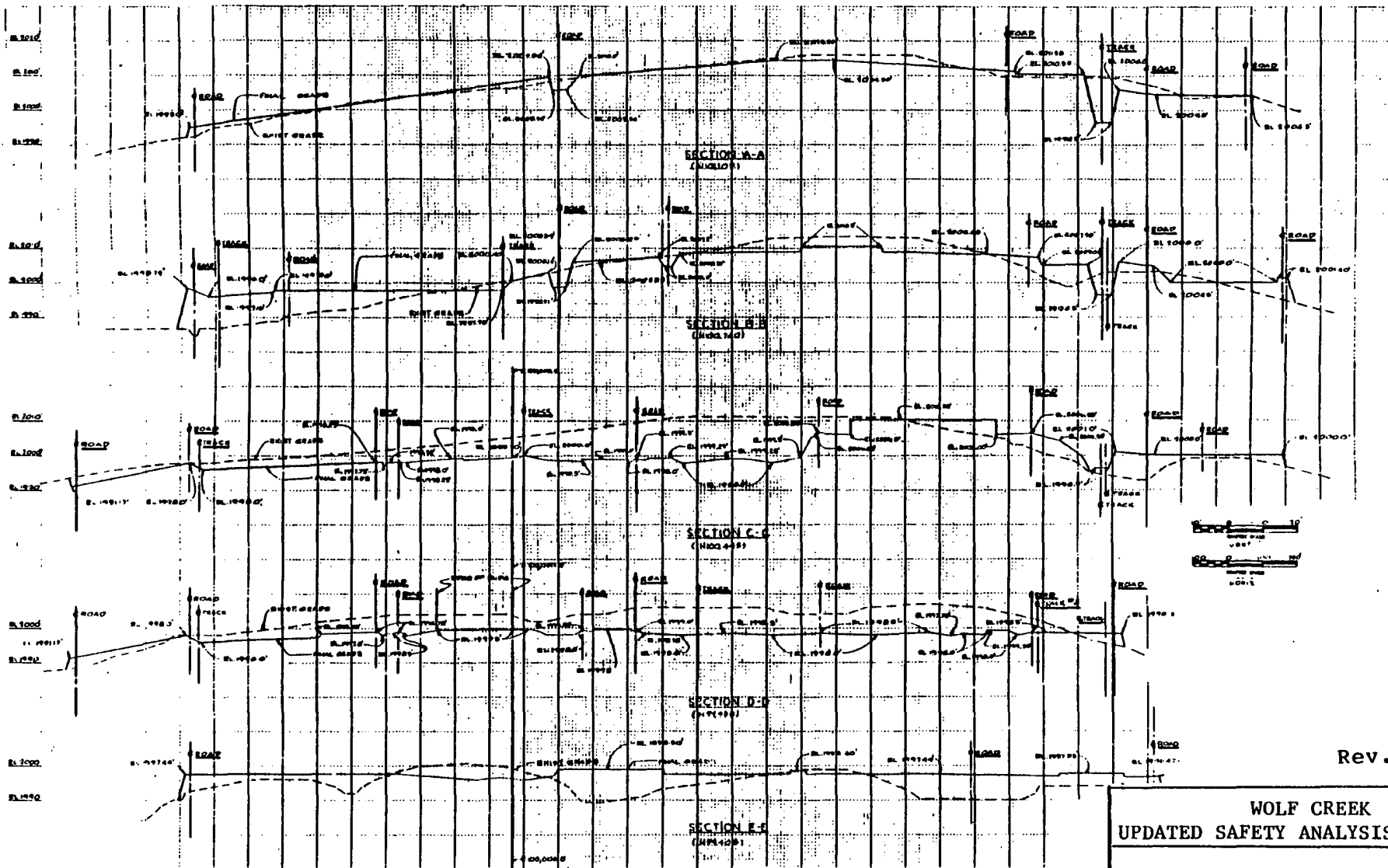

Rev. 0

WOLF CREEK
 UPDATED SAFETY ANALYSIS REPORT

FIGURE 2.4-4
 GRADING AND DRAINAGE SECTIONS

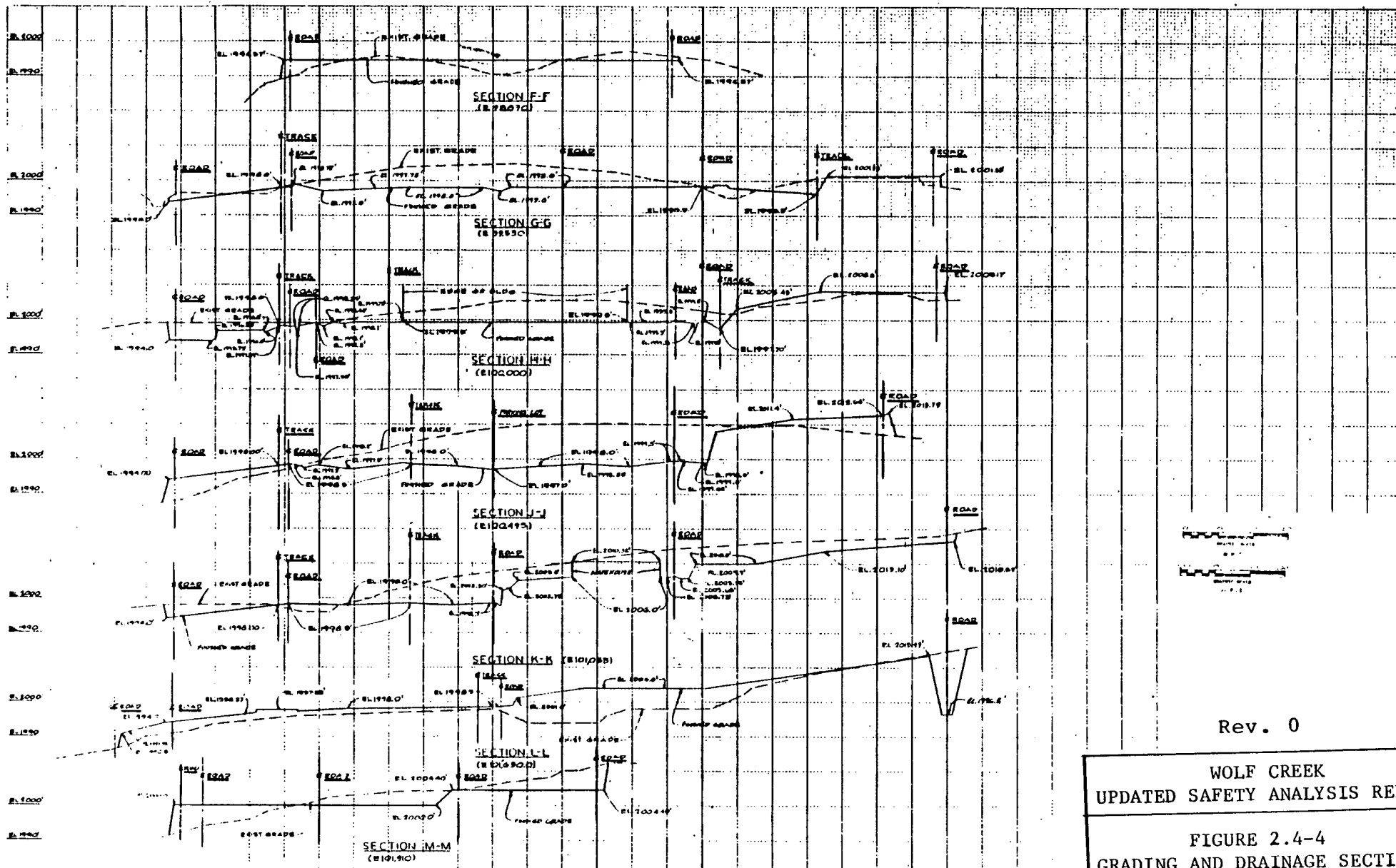

Rev. 0

WOLF CREEK
 UPDATED SAFETY ANALYSIS REPORT

FIGURE 2.4-4
 GRADING AND DRAINAGE SECTIONS

(SHEET 2 OF 3)

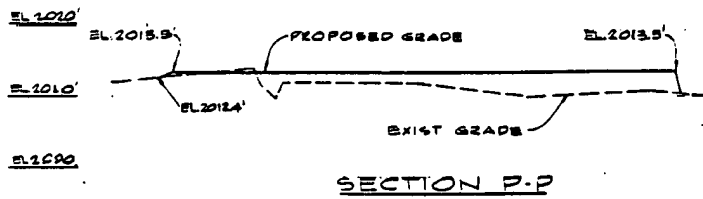
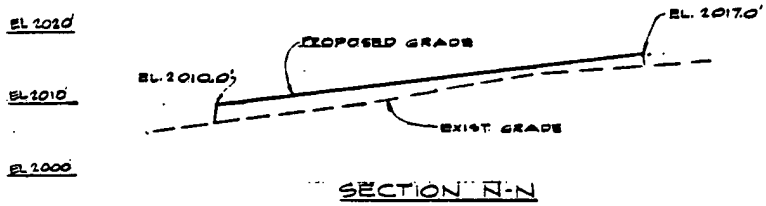

Rev. 0

**WOLF CREEK
UPDATED SAFETY ANALYSIS REPORT**

Figure 2.4-4 (Sheet 3 of 3)

Grading and Drainage Sections

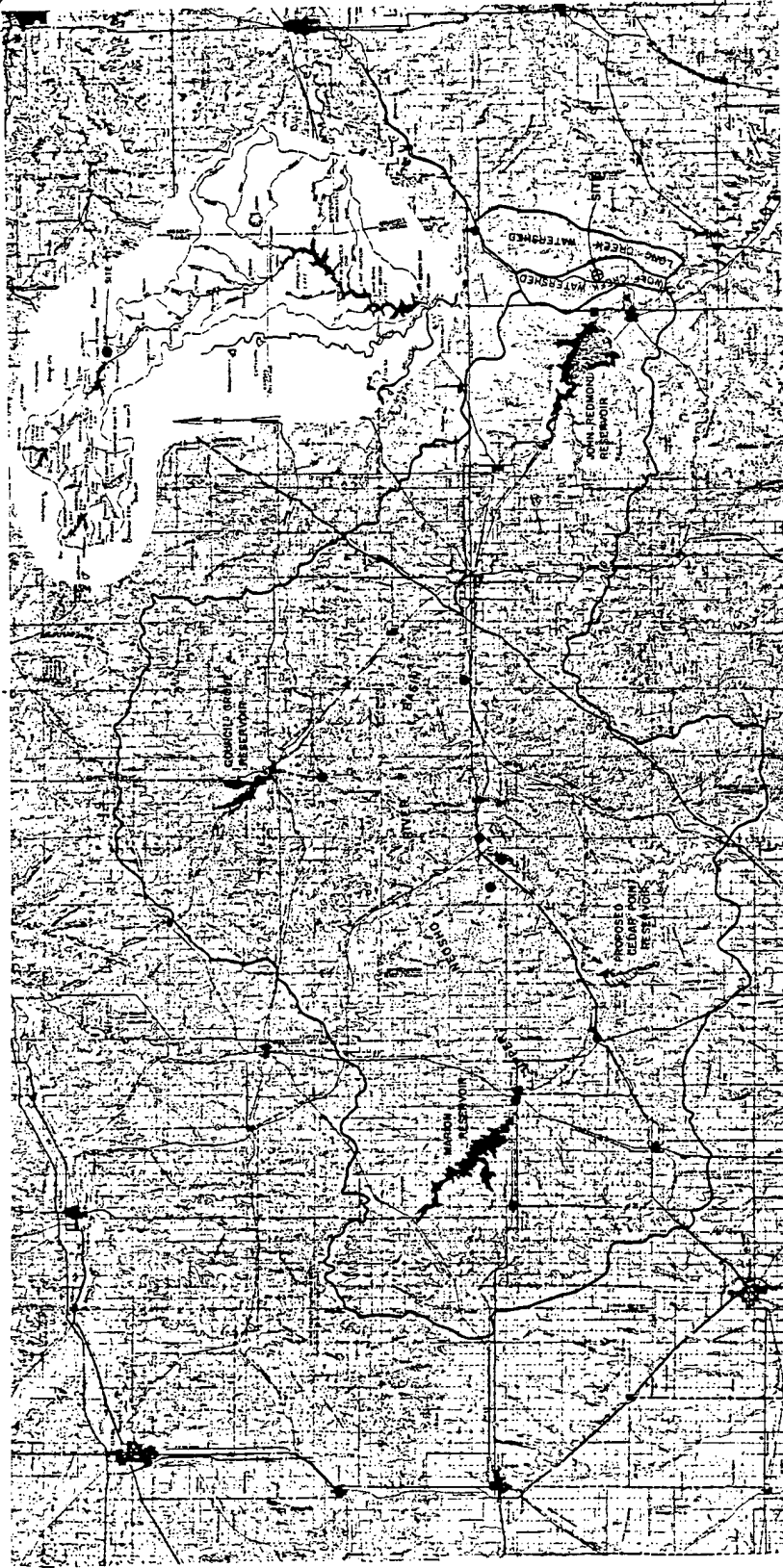

Rev. 0

WOLF CREEK UPDATED SAFETY ANALYSIS REPORT
Figure 2.4-5 Neosho River Basin in Kansas

- LEGEND**
- ▲ EXISTING U.S.G.S. STREAM-GAGING STATIONS
 - DISCONTINUED U.S.G.S. STREAM-GAGING STATIONS
 - U.S.G.S. RESERVOIR WATER-STAGE RECORDERS

REFERENCE:
 MAPS OF U.S.A., 1967,
 "WOLF CREEK WATERSHED", 1:250,000

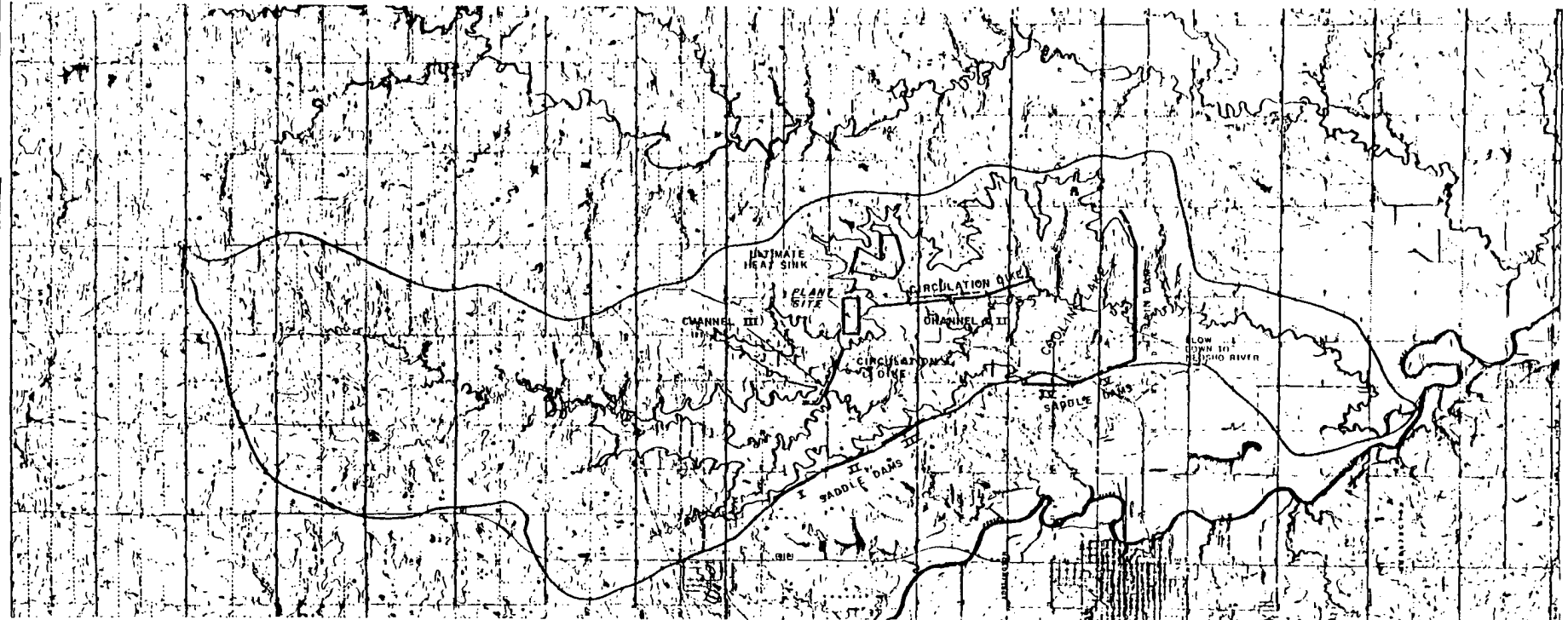

MAP REFERENCE
 THIS MAP TAKEN FROM U.S.G.S. QUADRANGLES
 BURLINGTON, KANSAS AND NE W. STRAWN,
 KANSAS DATED 1971

**WOLF CREEK
 UPDATED SAFETY ANALYSIS REPORT**

Figure 2.4-6

Wolf Creek Watershed



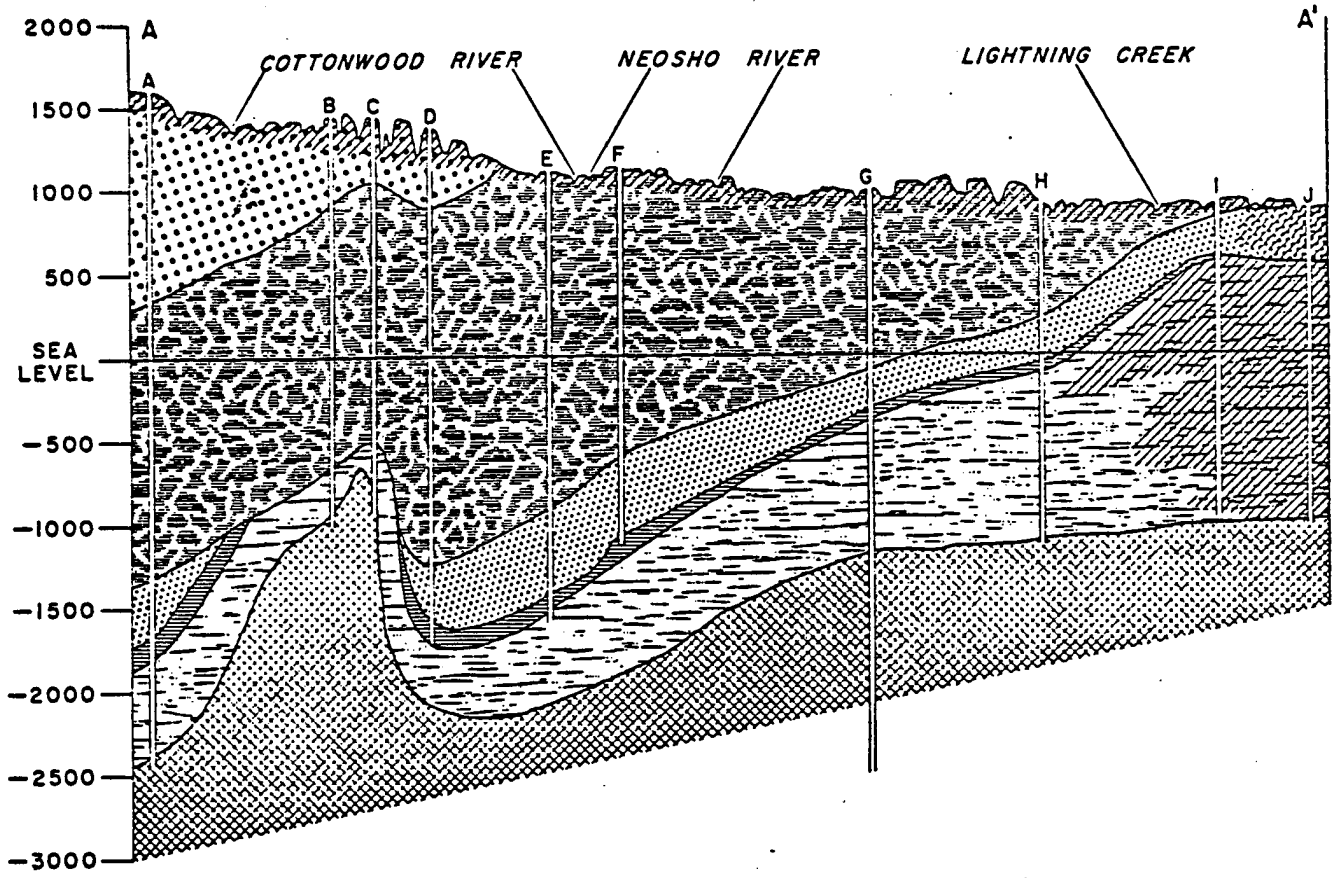

Rev. 0

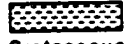
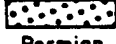
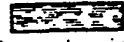

Area from which fresh to brackish water is obtained ———— H

Test holes ————

SYSTEMS

- | | |
|---|---|
|  Cretaceous |  Permian |
|  Pennsylvanian |  Mississippian |
|  Mississippian or Devonian |  Cambrian and Ordovician |
|  Precambrian | |

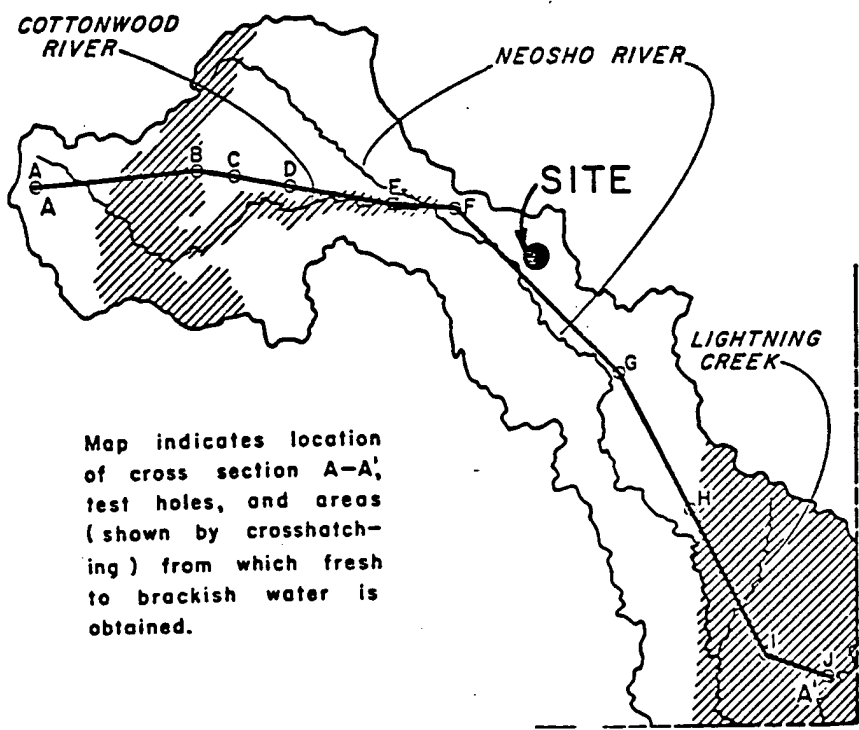

Map indicates location of cross section A-A', test holes, and areas (shown by crosshatching) from which fresh to brackish water is obtained.

**WOLF CREEK
UPDATED SAFETY ANALYSIS REPORT**

Figure 2.4-7

Generalized Geologic Cross-Section, Neosho River Basin in Kansas

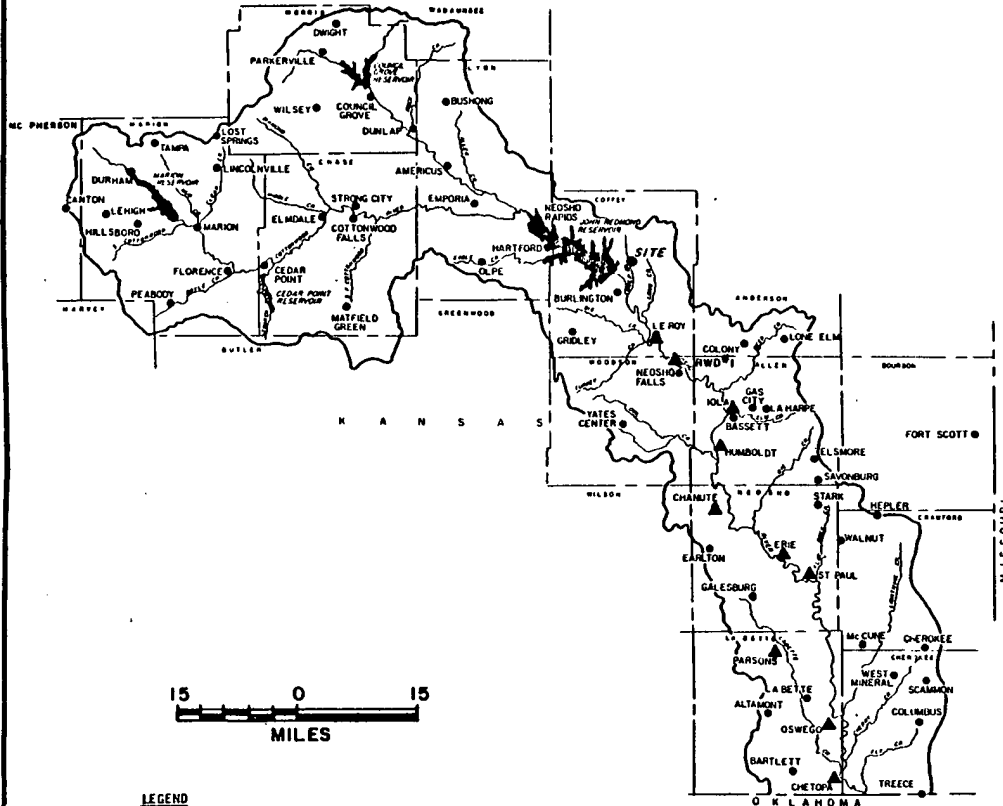

LEGEND

- ▲ MUNICIPALITIES AND RURAL WATER DISTRICTS UTILIZING THE NEOSHO RIVER DOWN-STREAM OF THE SITE. REFER TO TABLE 2.4-5 FOR USAGE INFORMATION.
- 10 ● COFFEY COUNTY WATER USER; SYMBOL INDICATES POINT OF INTAKE OR POINT OF DIVERSION. REFER TO TABLE 2.4-4 FOR OWNER, SOURCE AND USAGE INFORMATION.

REFERENCE:

KANSAS BOARD OF AGRICULTURE, 1979: OPEN FILE MATERIAL:
 DIVISION OF WATER RESOURCES, TOPEKA, KANSAS (MARCH)
 FLICKENGER, G., 1979, ASSOCIATE ENGINEER, WATER RESOURCES BOARD, TOPEKA, KANSAS WRITTEN COMMUNICATION (MARCH 9)

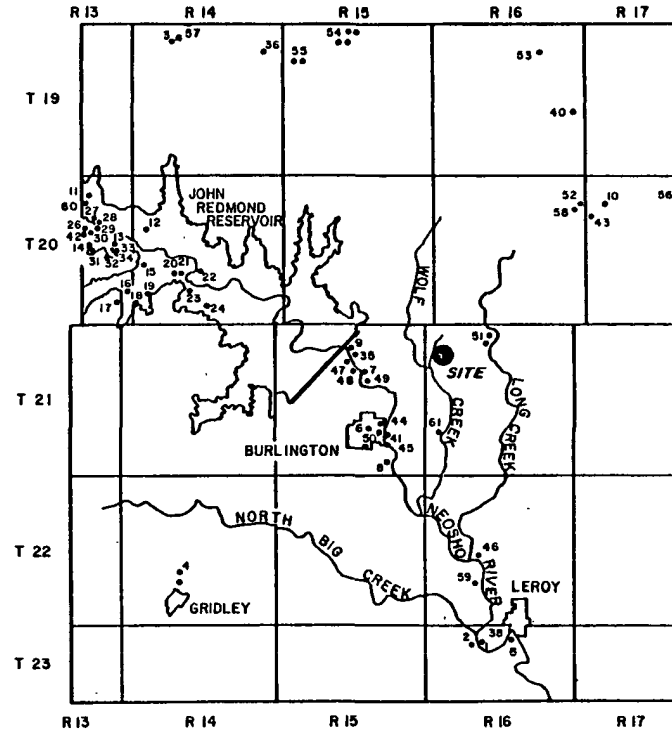

ENLARGEMENT OF COFFEY COUNTY, KANSAS



Rev. 0

**WOLF CREEK
 UPDATED SAFETY ANALYSIS REPORT**

Figure 2.4-8

**Water Users in Coffey County and
 Municipal Users Downstream of
 Site**

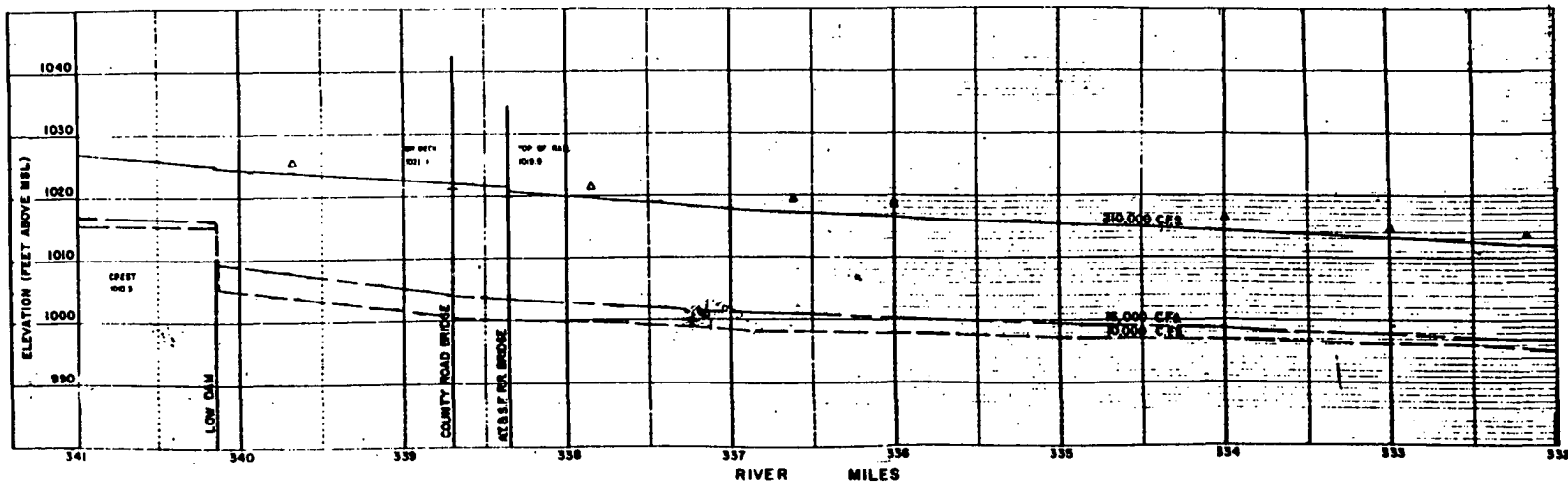

LEGEND
 ▲ ▲ HIGH WATER EXPERIENCED
 IN JULY 1951
 FLOODS MODIFIED BY COUNCIL GROVE, MARION
 CEDAR POINT AND JOHN DECAHO RESERVOIRS
 ——— JULY 1951 FLOOD
 - - - JULY 1948 FLOOD
 ····· MAY 1957 FLOOD

REFERENCE:
 REPRODUCED FROM U.S. ARMY CORPS
 OF ENGINEERS, 1965. PLATE A-16.

4000 0 4000
 FEET

Rev. 0

**WOLF CREEK
 UPDATED SAFETY ANALYSIS REPORT**

Figure 2.4-9

Flood Areas and Profiles, Neosho
 River Mile 332 to Mile 341.

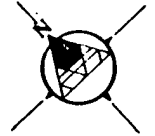
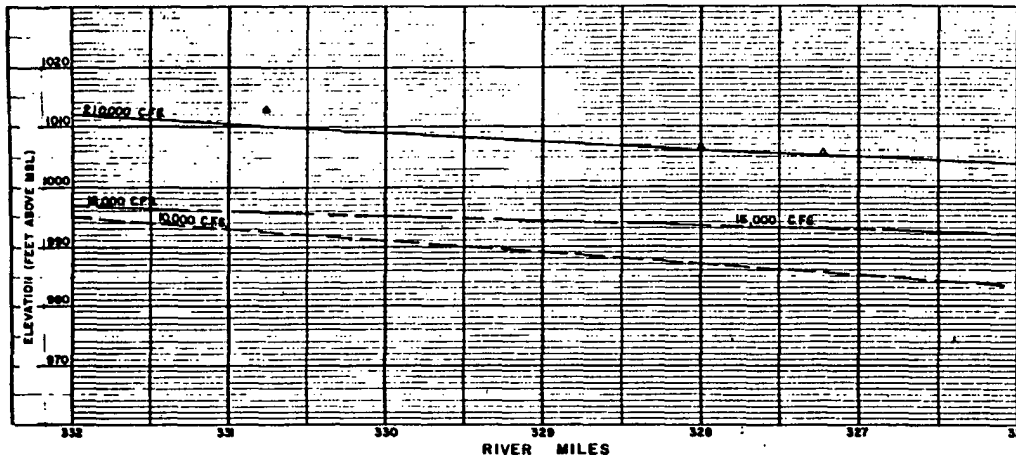

LEGEND

- ▲ ▲ HIGH WATER EXPERIENCED IN JULY 1951
- FLOODS MODIFIED BY COLUMBIA GROVE, MARION CEDAR POINT AND JOHN REDMOND RESERVOIRS
- JULY 1956 FLOOD
- JULY 1948 FLOOD
- MAY 1957 FLOOD

4000 0 4000
FEET

Rev. 0

**WOLF CREEK
UPDATED SAFETY ANALYSIS REPORT**

Figure 2.4-10

Flood Areas and Profiles, Neosho
River Mile 326 to Mile 332

REFERENCE:
REPRODUCED FROM U. S. ARMY CORPS
OF ENGINEERS, 1965, PLATE A-15.

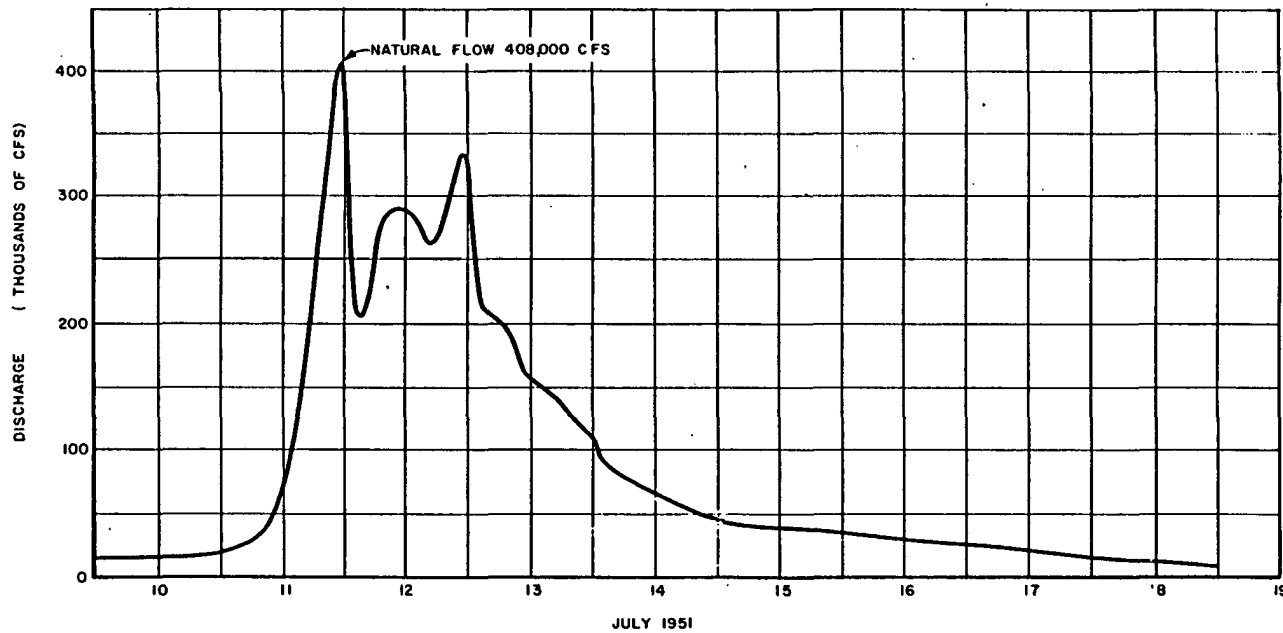

Rev. 0

**WOLF CREEK
UPDATED SAFETY ANALYSIS REPORT**

Figure 2.4-11

July 1951 Flood Hydrograph, John
Redmond Dam

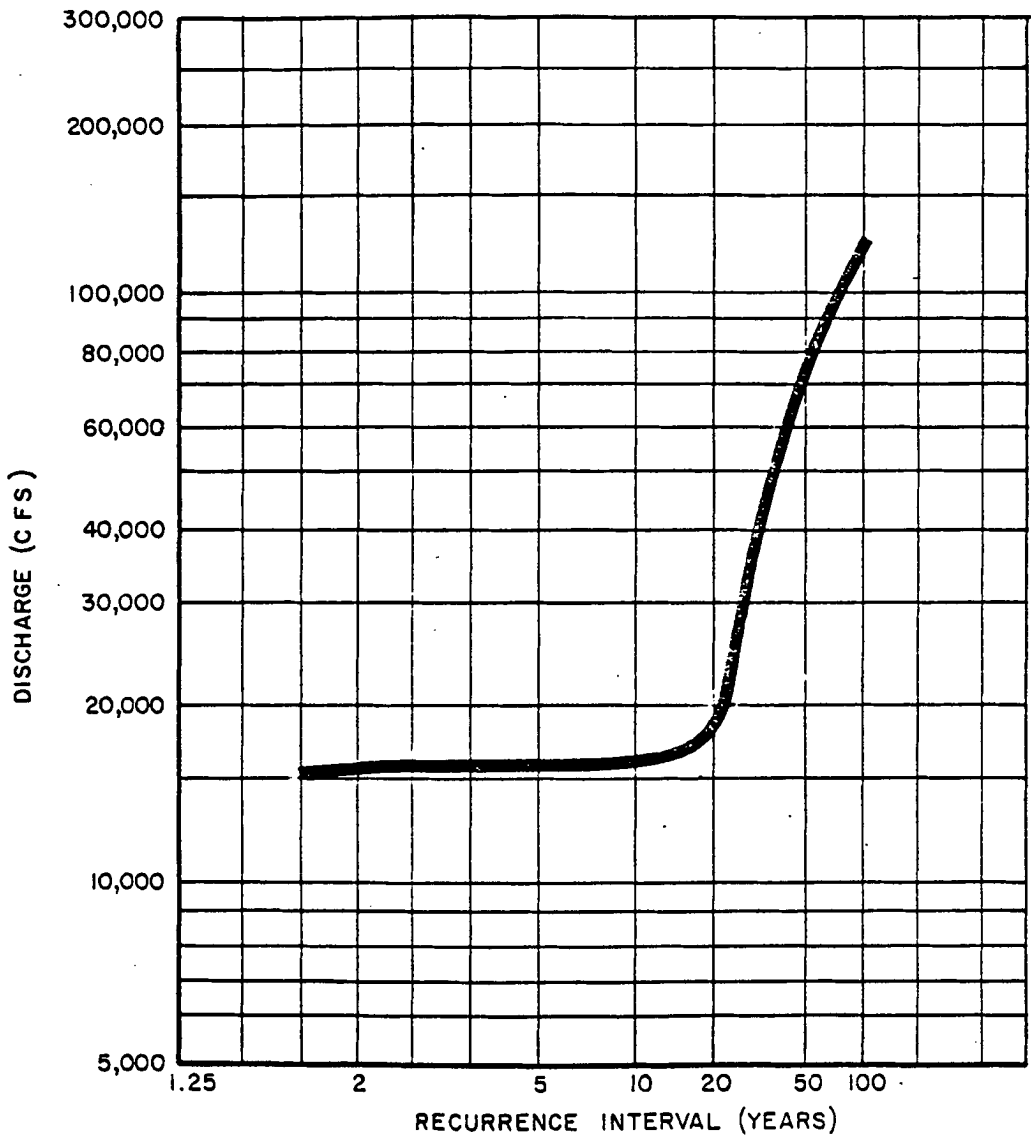

NOTE: THE CURVE INCLUDES THE REGULATING EFFECTS OF COUNCIL GROVE, MARION, CEDAR POINT AND JOHN REDMOND RESERVOIRS.

Rev. 0

WOLF CREEK UPDATED SAFETY ANALYSIS REPORT
Figure 2.4-12
Discharge Frequency Curve for John Redmond Dam

REFERENCE:
REPRODUCED FROM U.S. ARMY CORPS
OF ENGINEERS, 1965, PLATE A-47.

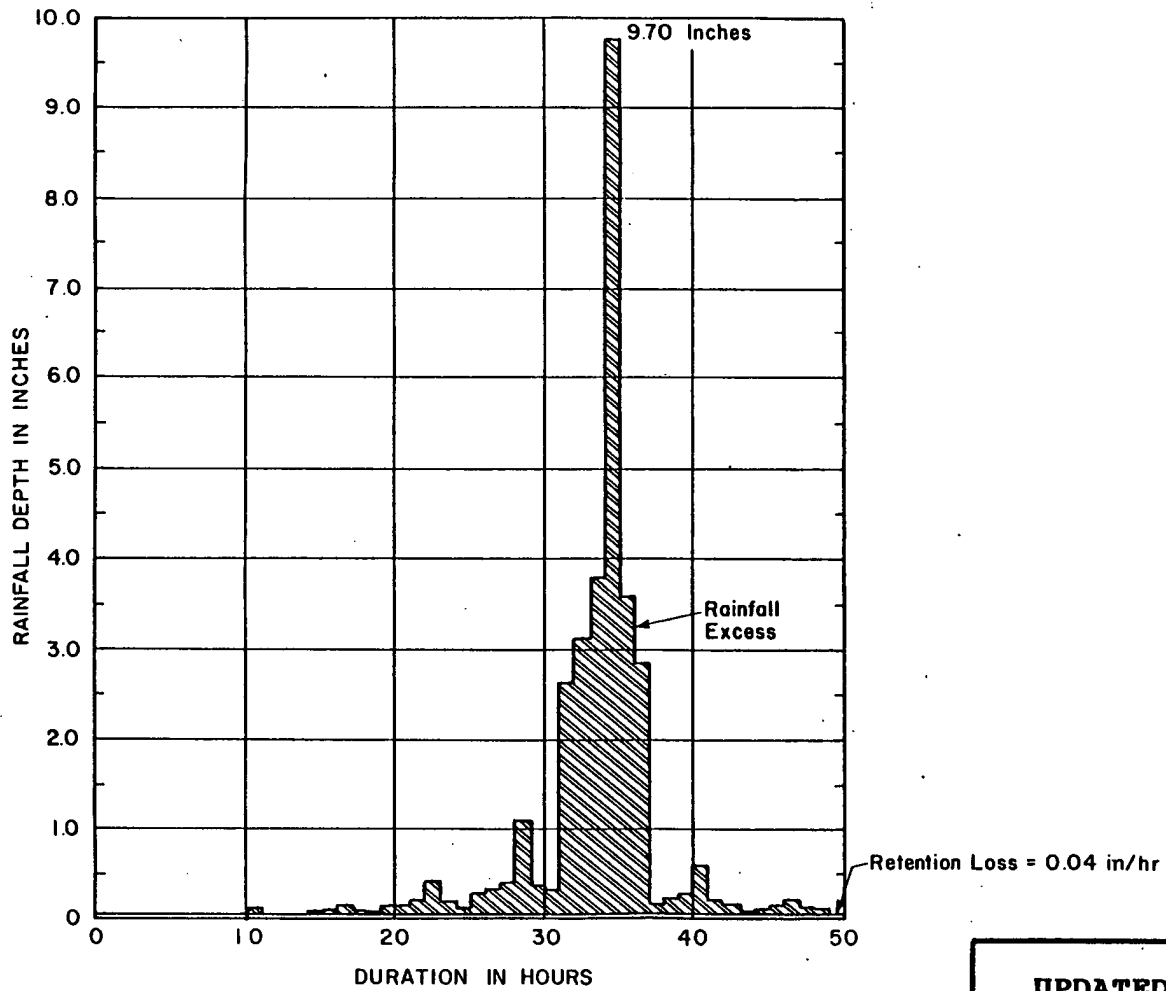

Rev. 0

**WOLF CREEK
UPDATED SAFETY ANALYSIS REPORT**

Figure 2.4-13
PMP Storm Distribution

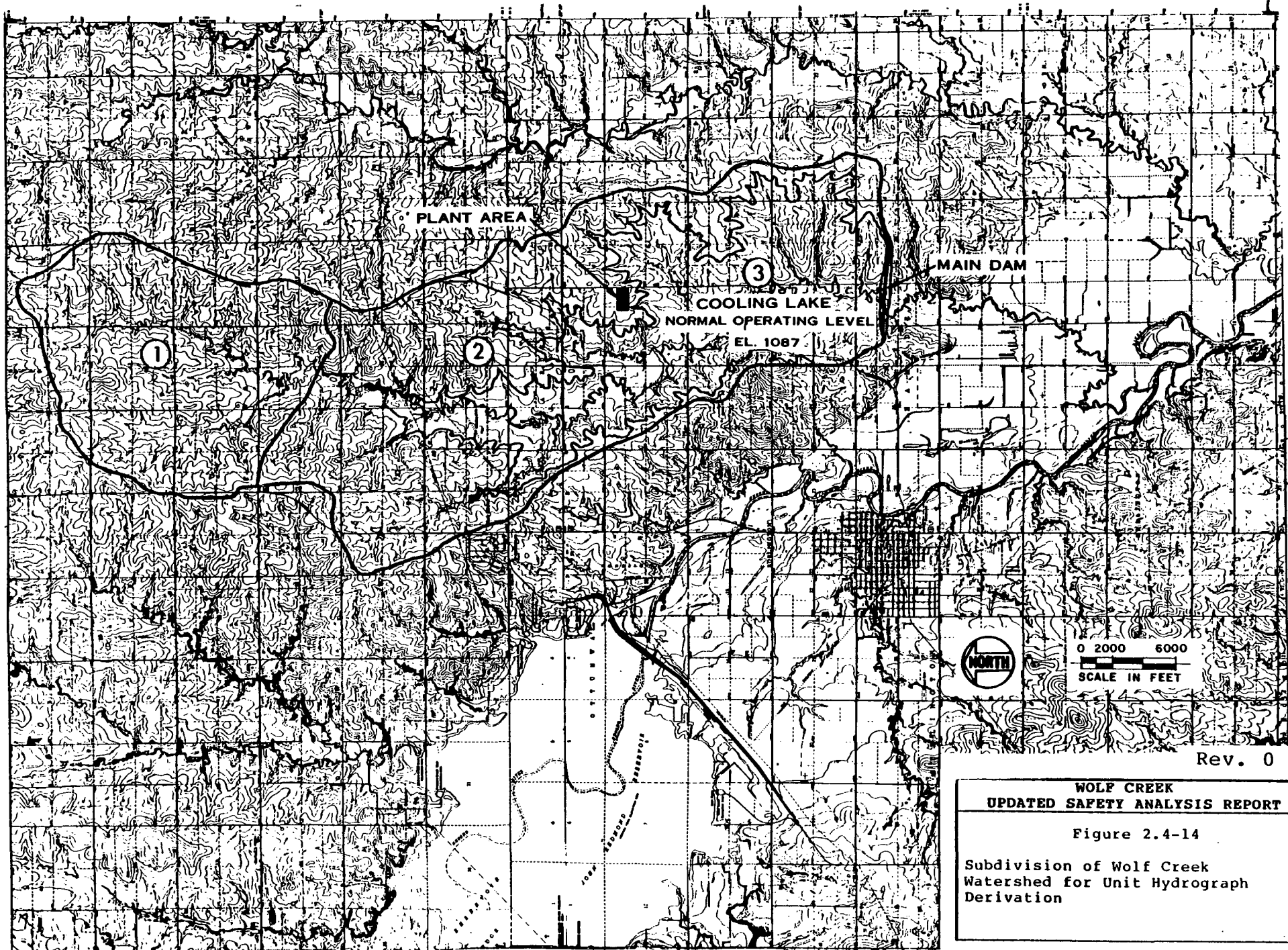

Rev. 0

**WOLF CREEK
UPDATED SAFETY ANALYSIS REPORT**

Figure 2.4-14

Subdivision of Wolf Creek
Watershed for Unit Hydrograph
Derivation

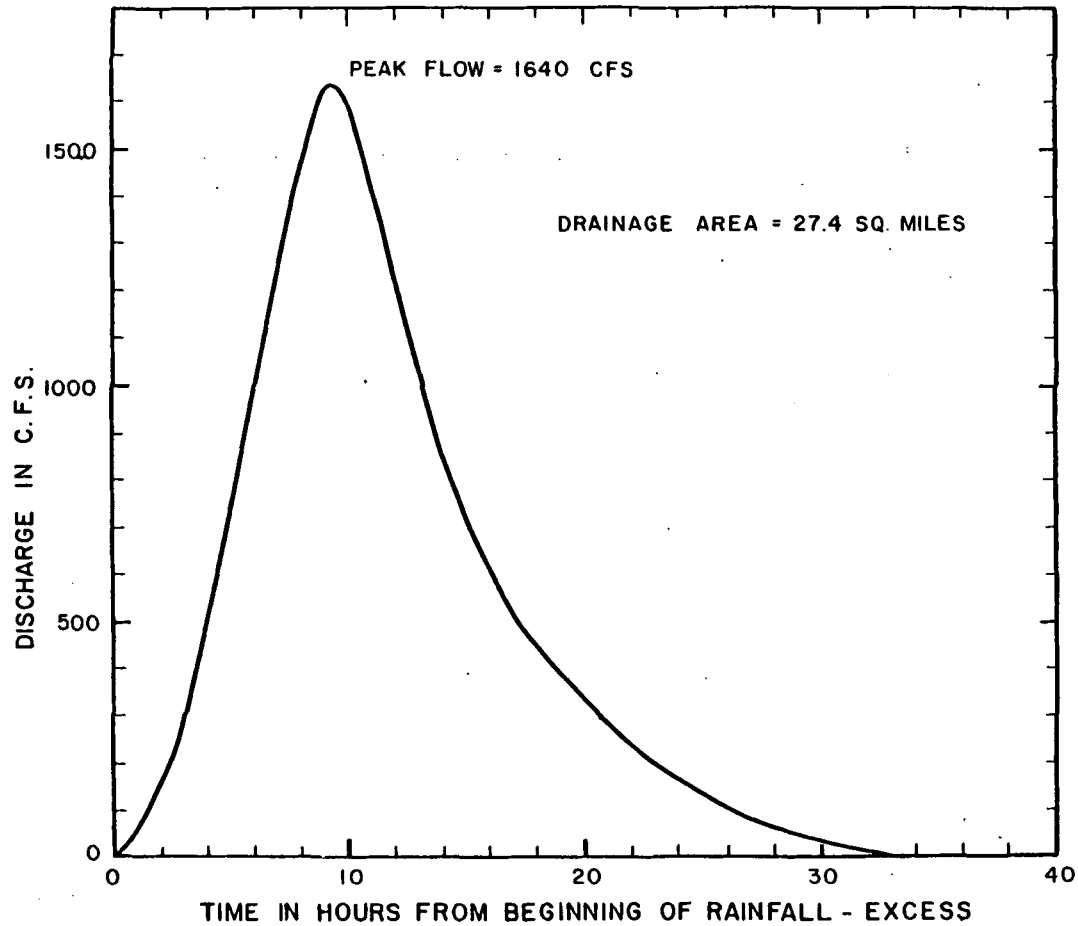

Rev. 0

**WOLF CREEK
UPDATED SAFETY ANALYSIS REPORT**

Figure 2.4-15

1-Hour Unit Hydrograph Under
Natural Conditions

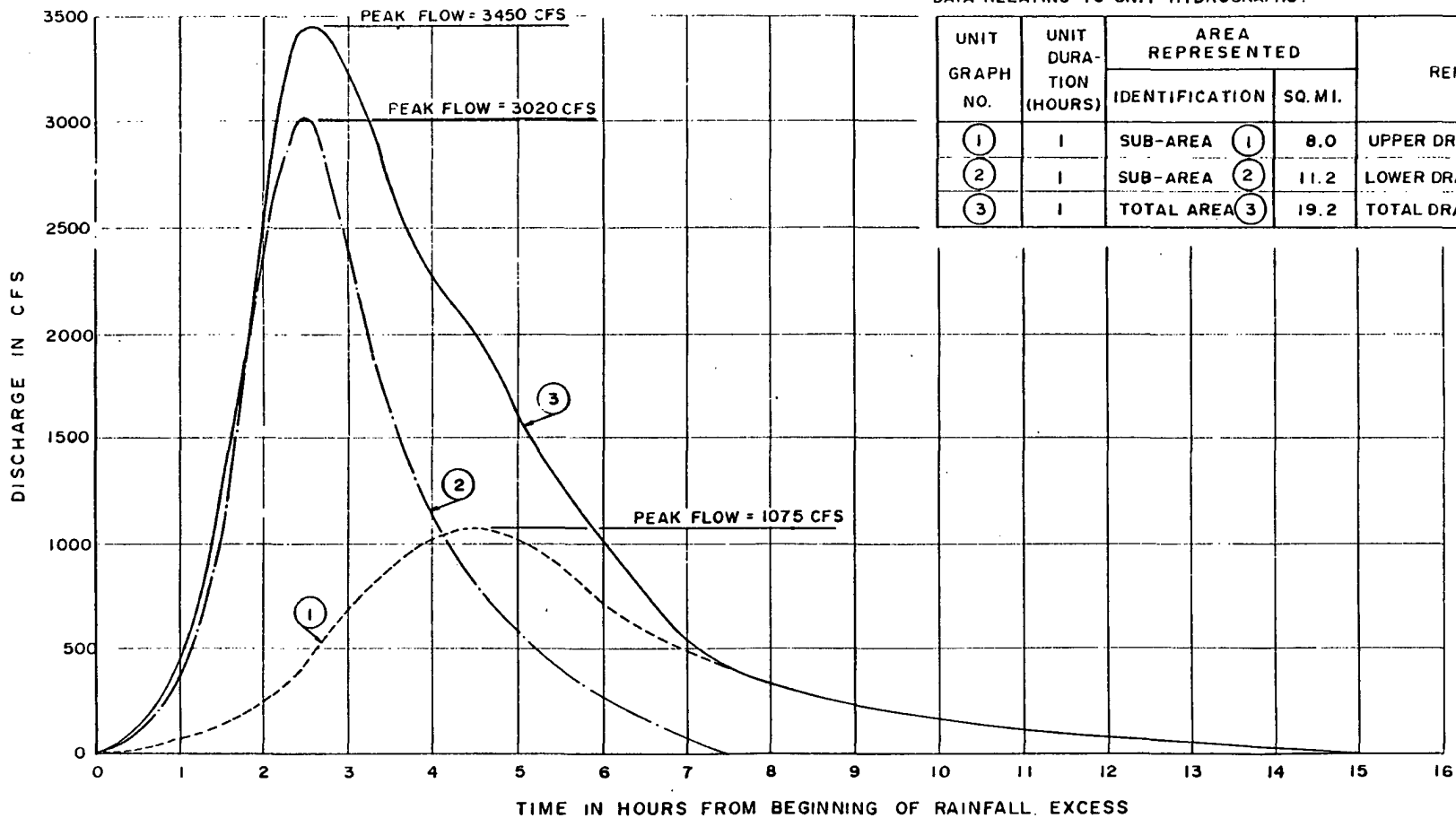

Rev. 0

**WOLF CREEK
UPDATED SAFETY ANALYSIS REPORT**

Figure 2.4-16

1-Hour Unit Hydrograph for Sub-Basin Drainage Areas

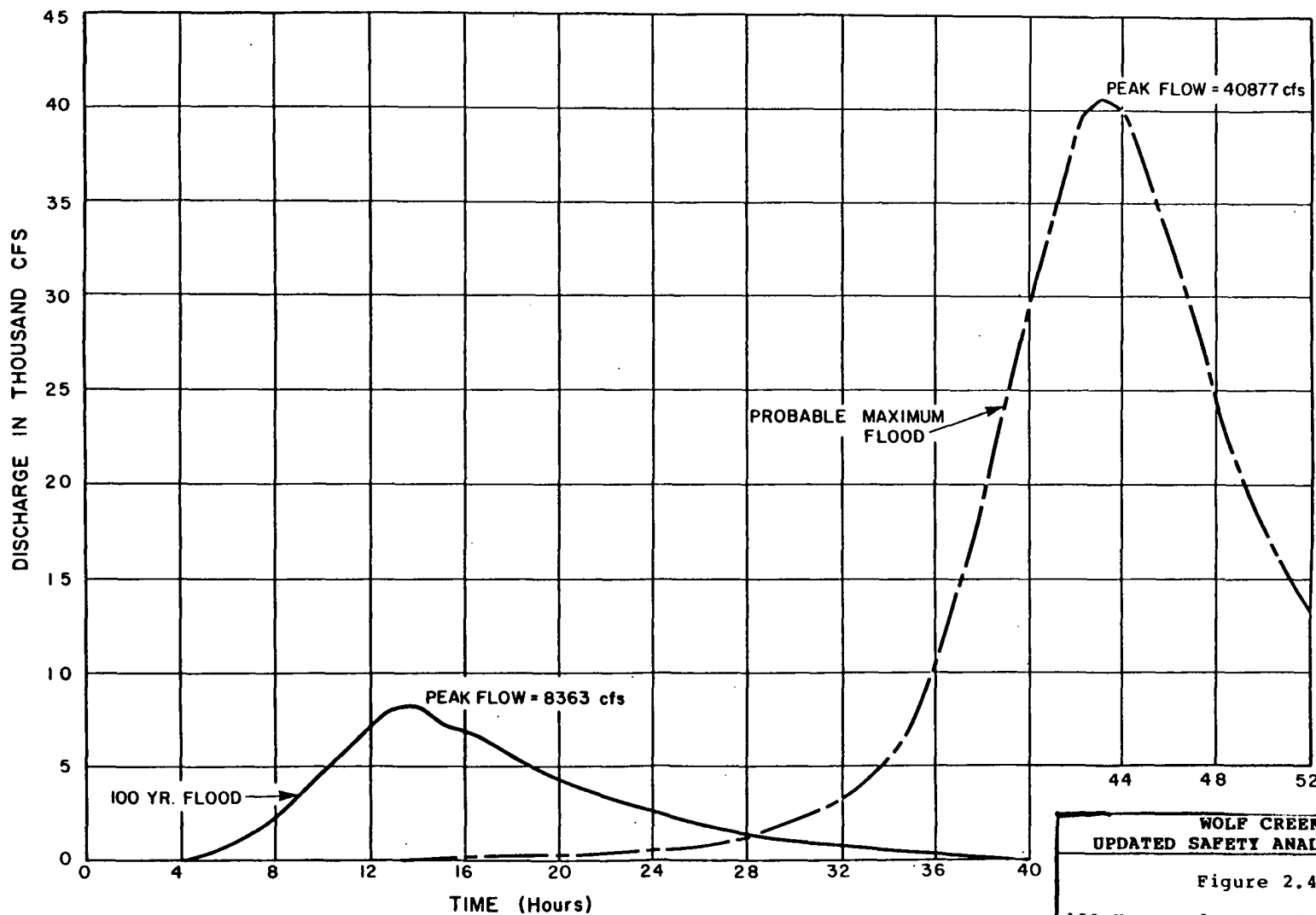

Rev. 0

**WOLF CREEK
UPDATED SAFETY ANALYSIS REPORT**

Figure 2.4-17

100-Year and PMF Hydrograph Under
Natural Conditions

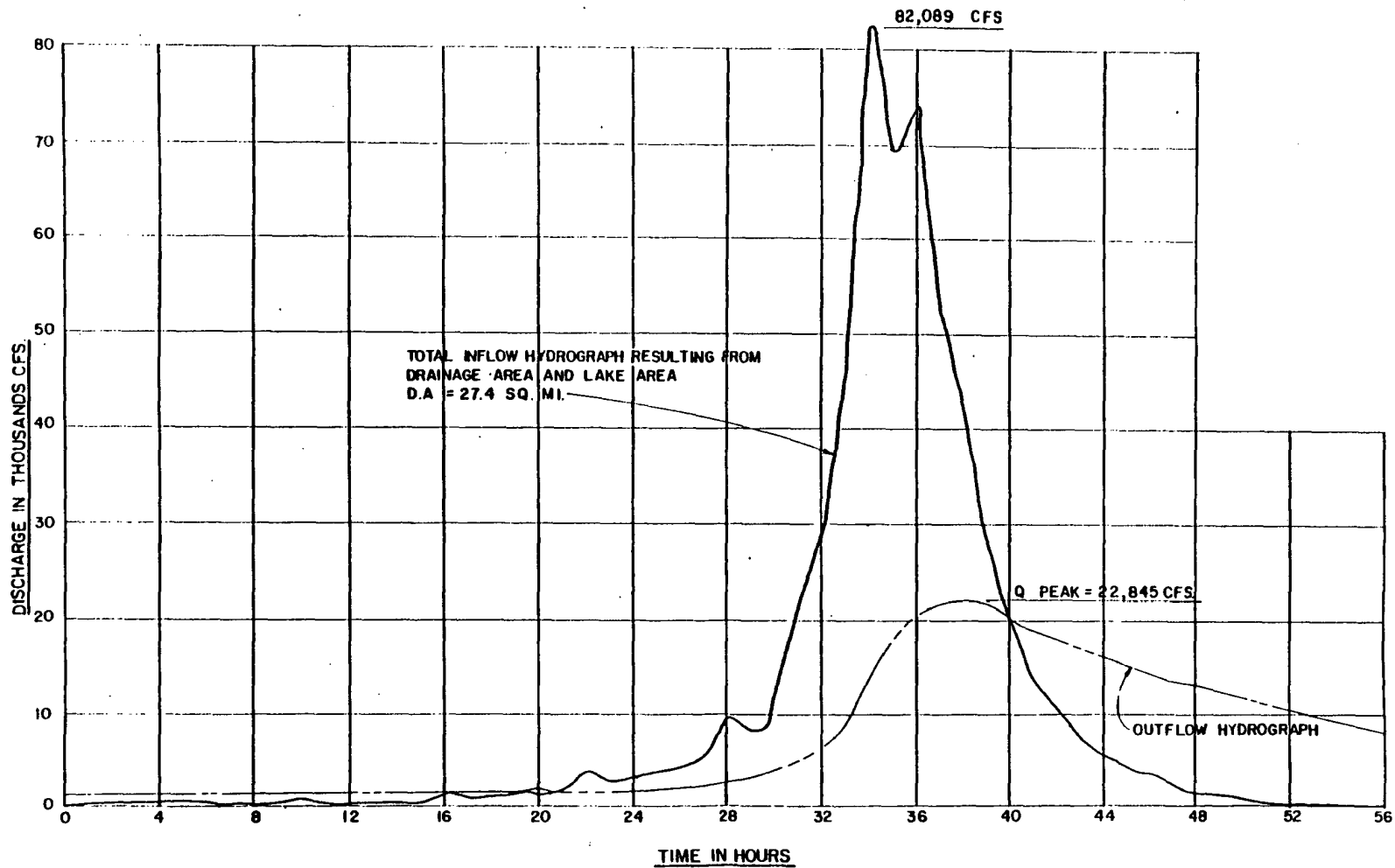

Rev. 0

**WOLF CREEK
UPDATED SAFETY ANALYSIS REPORT**

Figure 2.4-18

PMF Hydrographs (Modified
Conditions)

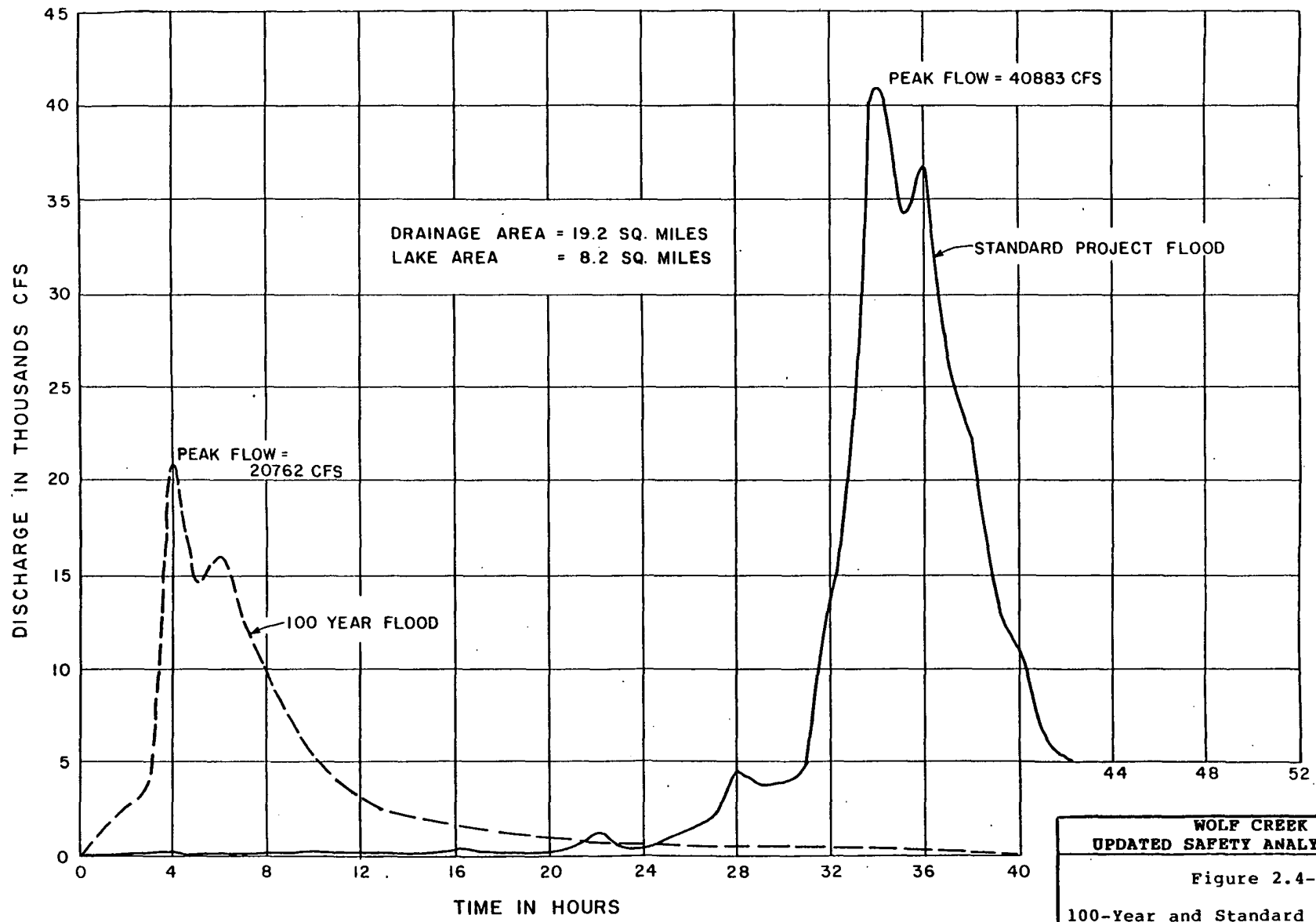

Rev. 0

**WOLF CREEK
UPDATED SAFETY ANALYSIS REPORT**

Figure 2.4-19

100-Year and Standard Flood
Hydrographs (Modified Conditions)

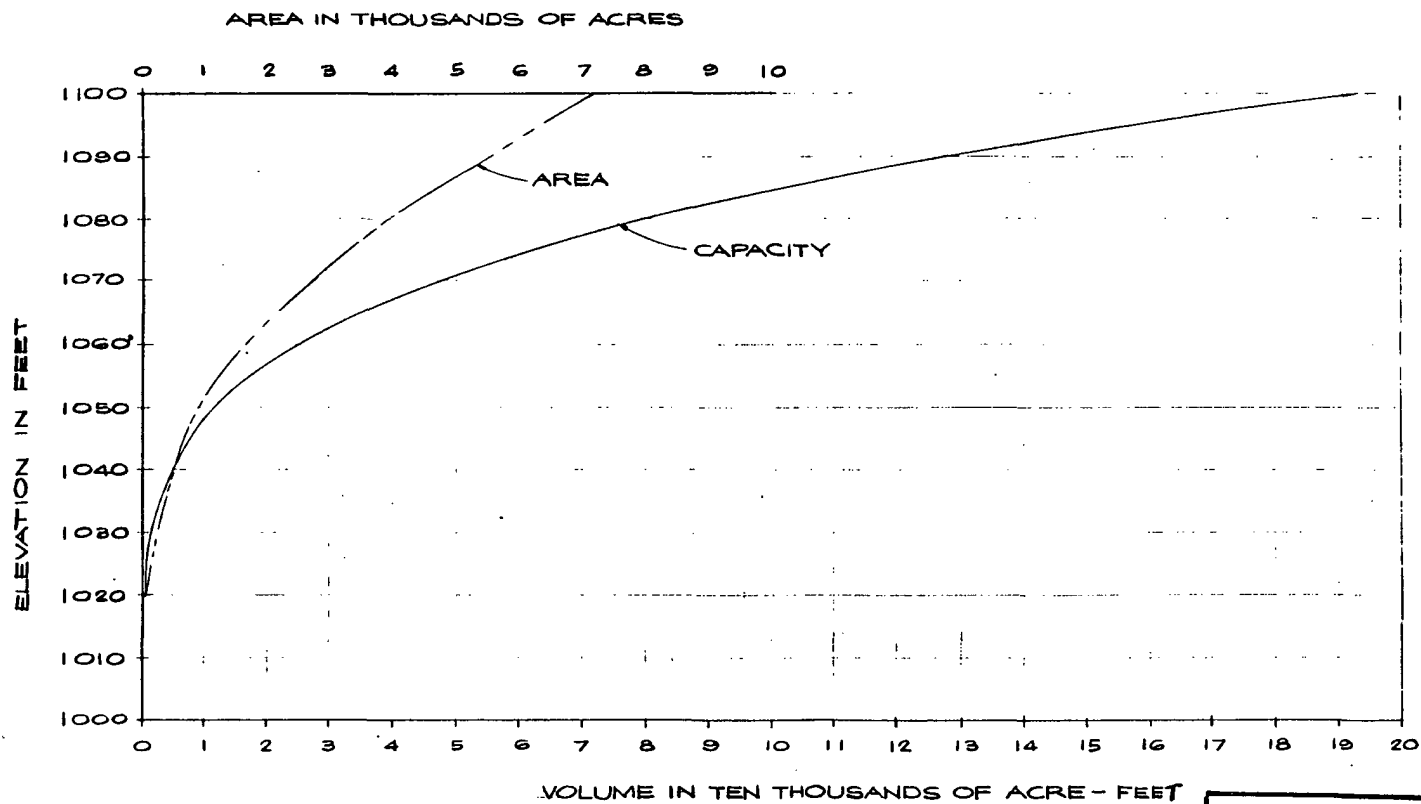

ELEVATION IN FEET	AREA IN ACRES	CAPACITY IN ACRE- FEET
1020.0	31	118
1030.0	245	1205
1040.0	507	4797
1050.0	891	11720
1060.0	1623	25181
1070.0	2643	46520
1080.0	3981	79300
1088.0	5247	116370
1090.0	5510	127120
1100.0	7155	190633

Rev. 0

**WOLF CREEK
UPDATED SAFETY ANALYSIS REPORT**

Figure 2.4-20

Cooling Lake Area - Capacity
Curves

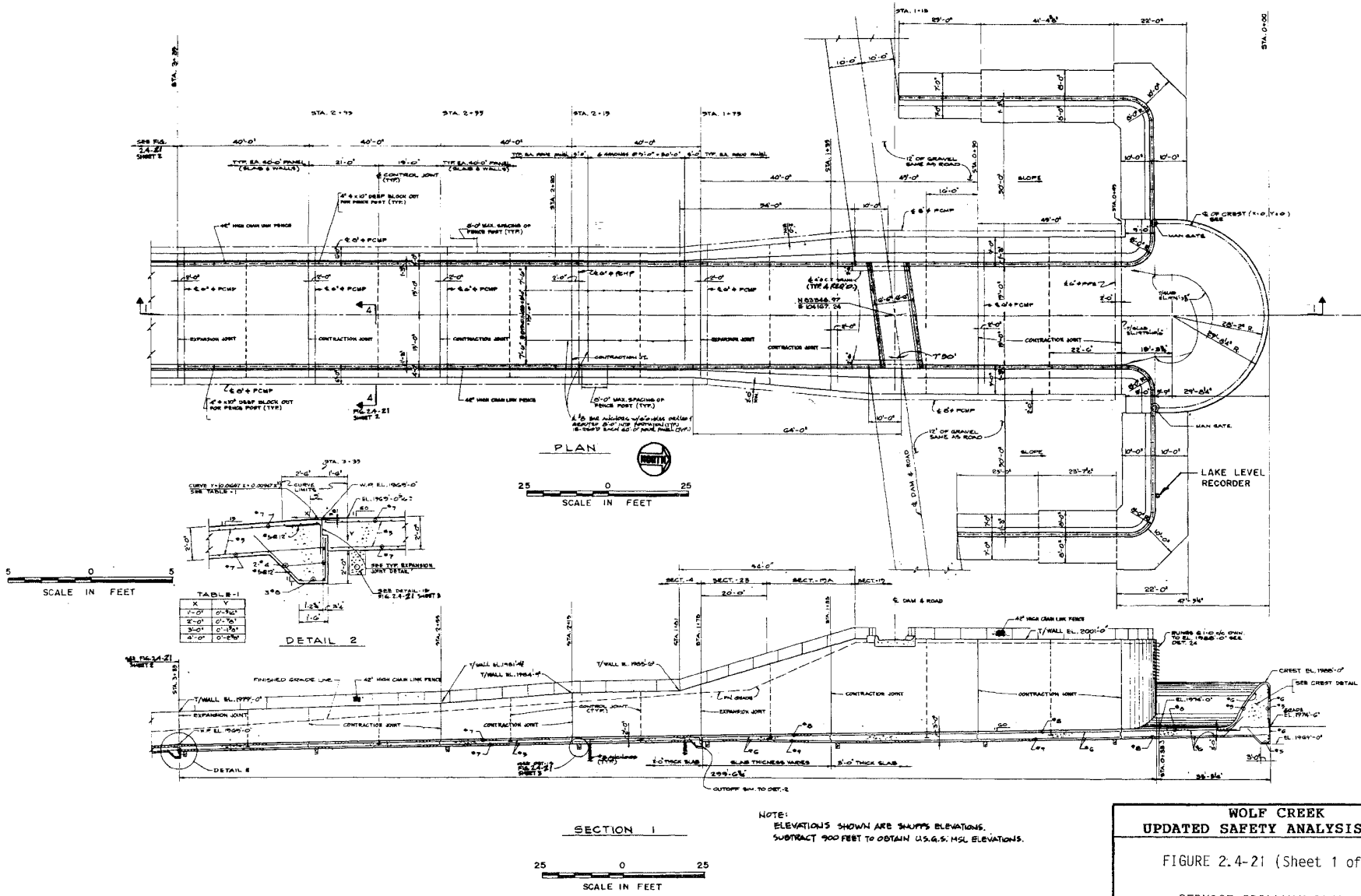

Rev. 0

**WOLF CREEK
UPDATED SAFETY ANALYSIS REPORT**

FIGURE 2.4-21 (Sheet 1 of 3)

SERVICE SPILLWAY PLANS

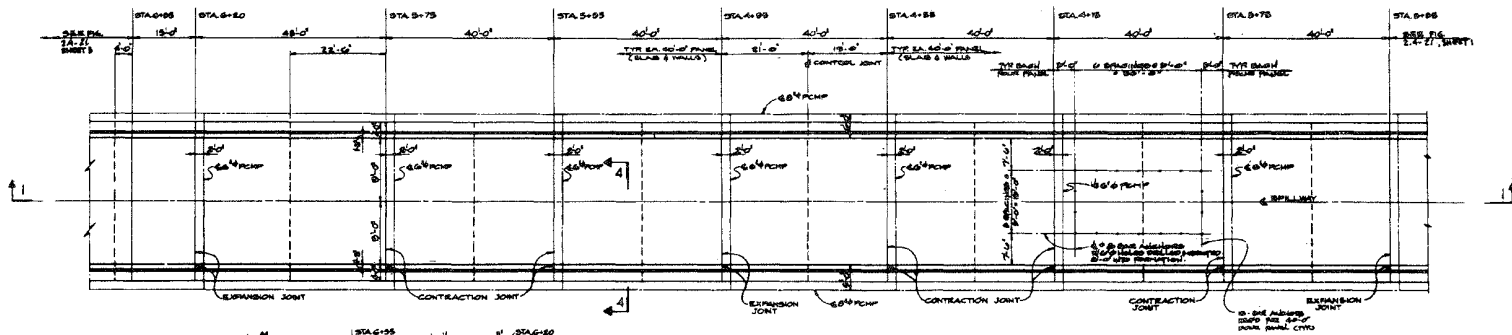
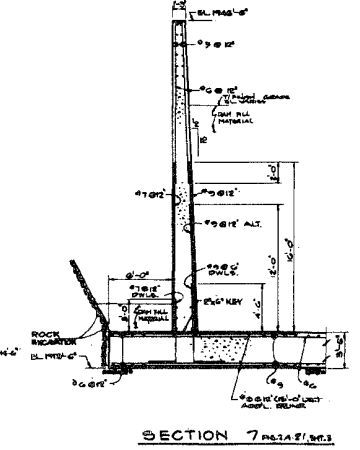
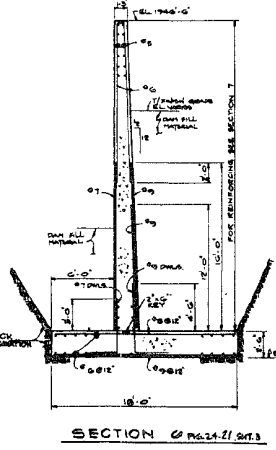
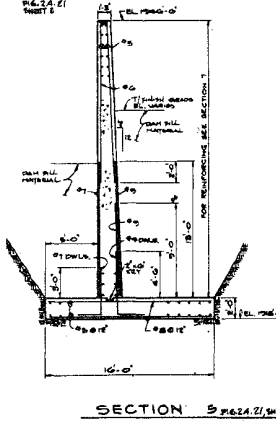
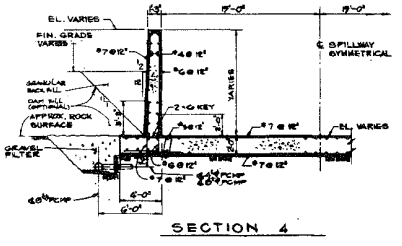
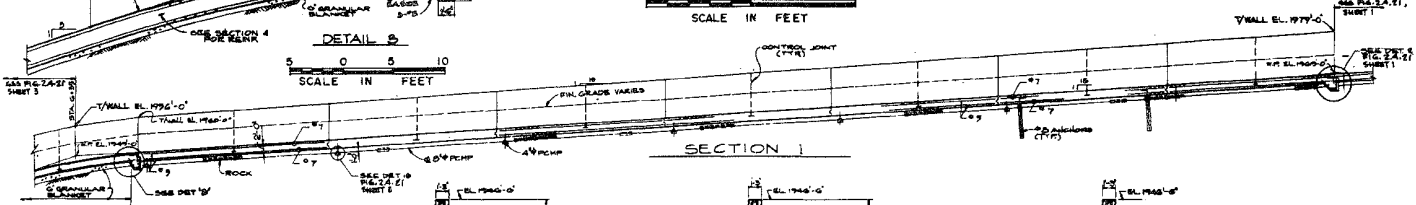
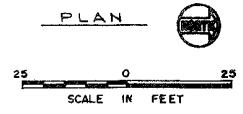
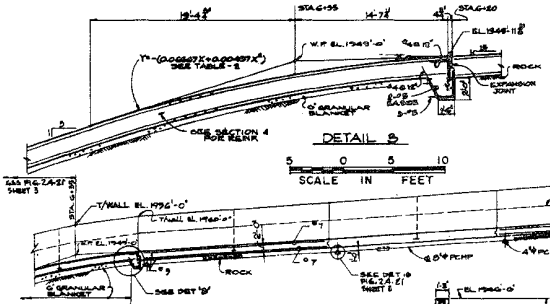

TABLE 2

X	
2'-0"	0.17%
4'-0"	0.42%
6'-0"	0.93%
8'-0"	1.71%
10'-0"	3.00%
12'-0"	4.80%
14'-0"	7.14%
16'-0"	10.00%
18'-0"	13.33%
20'-0"	17.14%
22'-0"	21.43%
24'-0"	26.19%
26'-0"	31.43%
28'-0"	37.14%
30'-0"	43.33%
32'-0"	50.00%



Rev. 0

WOLF CREEK
UPDATED SAFETY ANALYSIS REPORT
 FIGURE 2.4-21 (Sheet 2 of 3)
 SERVICE SPILLWAY PLANS

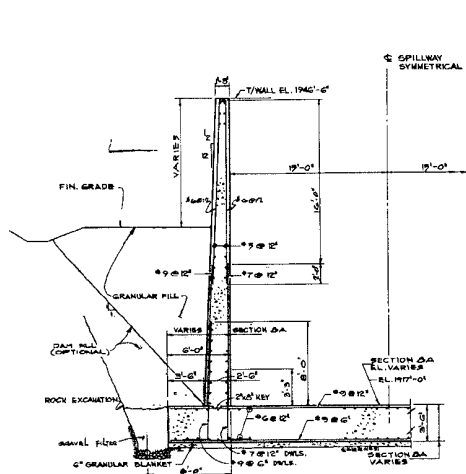

SECTION 6
SECTION 6A (AS NOTED)

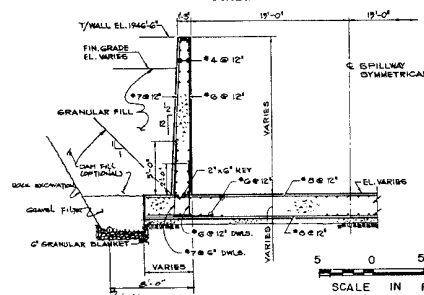

SECTION 7

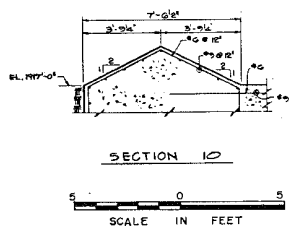

SECTION 10

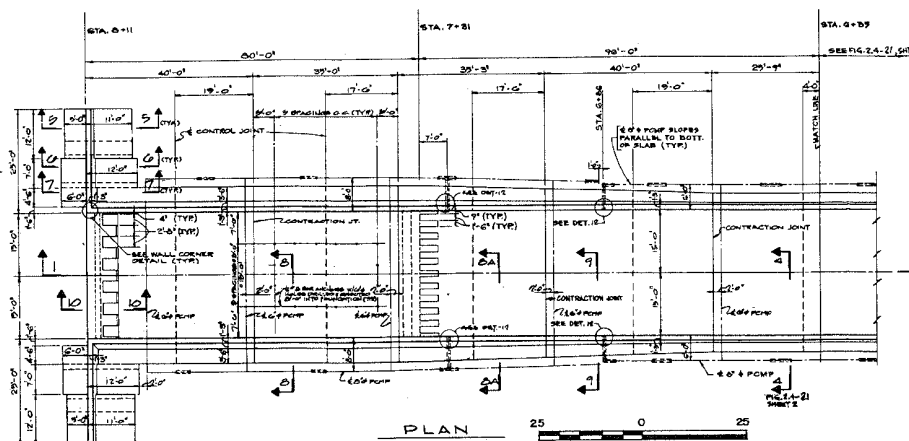

PLAN
SCALE IN FEET

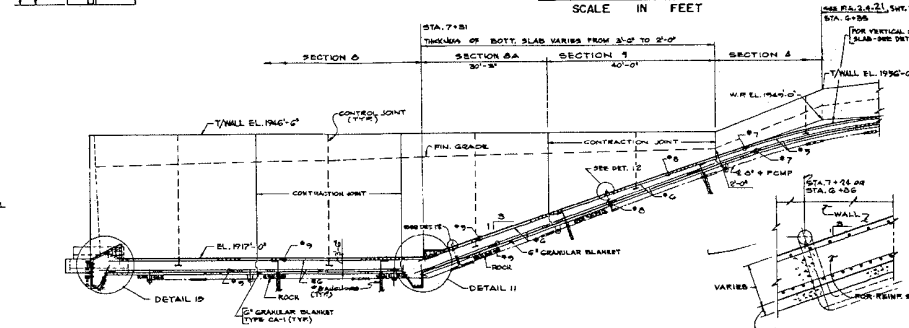

SECTION 1

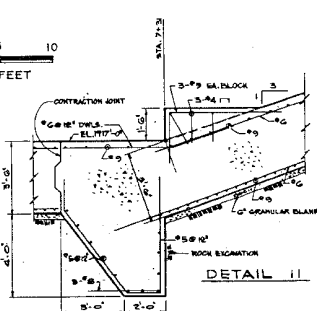

DETAIL 11

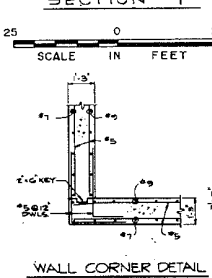

WALL CORNER DETAIL

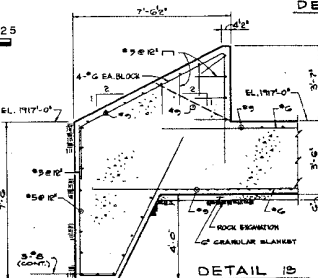

DETAIL 12

BAR #	LAP LENGTH		ANCHOR LENGTH	
	TOP BARS	BOTTOM BARS	TOP BARS	BOTTOM BARS
#4	18"	18"	14"	18"
#5	24"	18"	17"	18"
#6	27"	20"	21"	18"
#7	33"	20"	27"	18"
#8	42"	20"	34"	24"
#9	50"	20"	42"	31"
#10	71"	31"	50"	34"
#11	87"	37"	67"	40"

NOTES

- LAP REINFORCEMENT SHALL BE USED ONLY WHEN IT IS NOT POSSIBLE TO USE CONTIGUOUS BARS.
- LAP AND ANCHORAGE LENGTHS ARE NOT TO BE EQUALLED FROM DIMENSIONS.
- WHENEVER BARS OF DIFFERENTIAL GRADES ARE APPLIED, THE LAP LENGTHS LENGTH OF THE SMALLER BAR SHALL BE.
- LAP REINFORCEMENT SHALL BE LOCATED ON OPPOSITE SIDES UNLESS THE CONTRACTOR HAS A OTHER ARRANGEMENT. LENGTH WITH APPROVAL OF THE CONTRACTOR'S SUPERVISOR.
- TOP REINFORCEMENT OF ANCHORAGE SHALL BE PLACED THAT MORE THAN 1" OF CONCRETE IS COME IN THE REINFORCEMENT BELOW THE BAR. REINFORCEMENT SHALL BE CONTINUED AS THE BARS.
- ALL HORIZONTAL REINFORCEMENT IN WALLS.
- TOP BARS IN PARTIALS AND WALLS.
- LAP REINFORCEMENT SHALL BE USED FOR REINFORCEMENT APPLIED (LAPS = TYP.) FOR ALL REINFORCED SURFACES USE CLASS-C TYPE REINFORCEMENT (SEE ANCHOR LENGTHS).

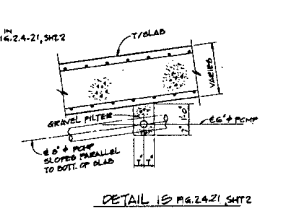

DETAIL 13

Rev. 0

**WOLF CREEK
UPDATED SAFETY ANALYSIS REPORT**

FIGURE 2.4-21 (Sheet 3 of 3)

SERVICE SPILLWAY PLANS

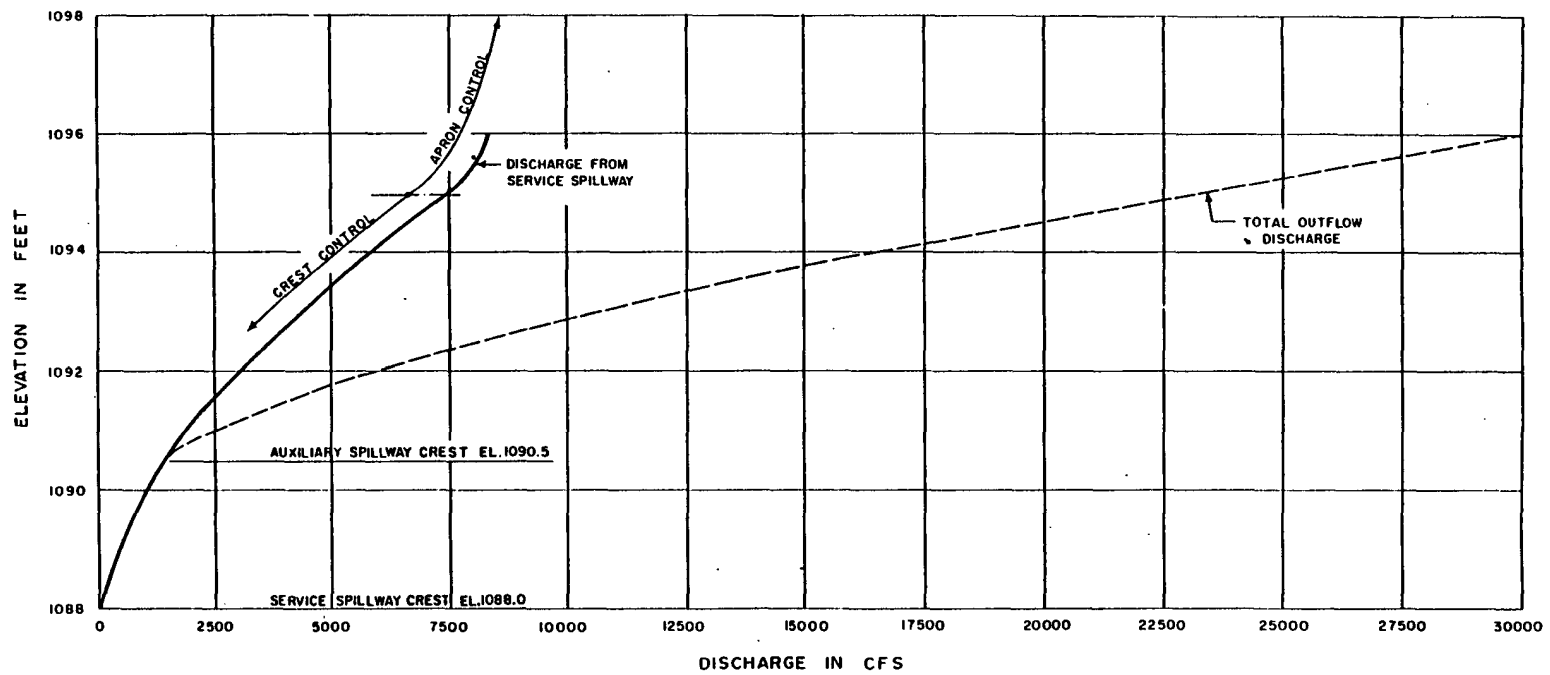

Rev. 0

**WOLF CREEK
UPDATED SAFETY ANALYSIS REPORT**

Figure 2.4-22

Spillway Rating Curve

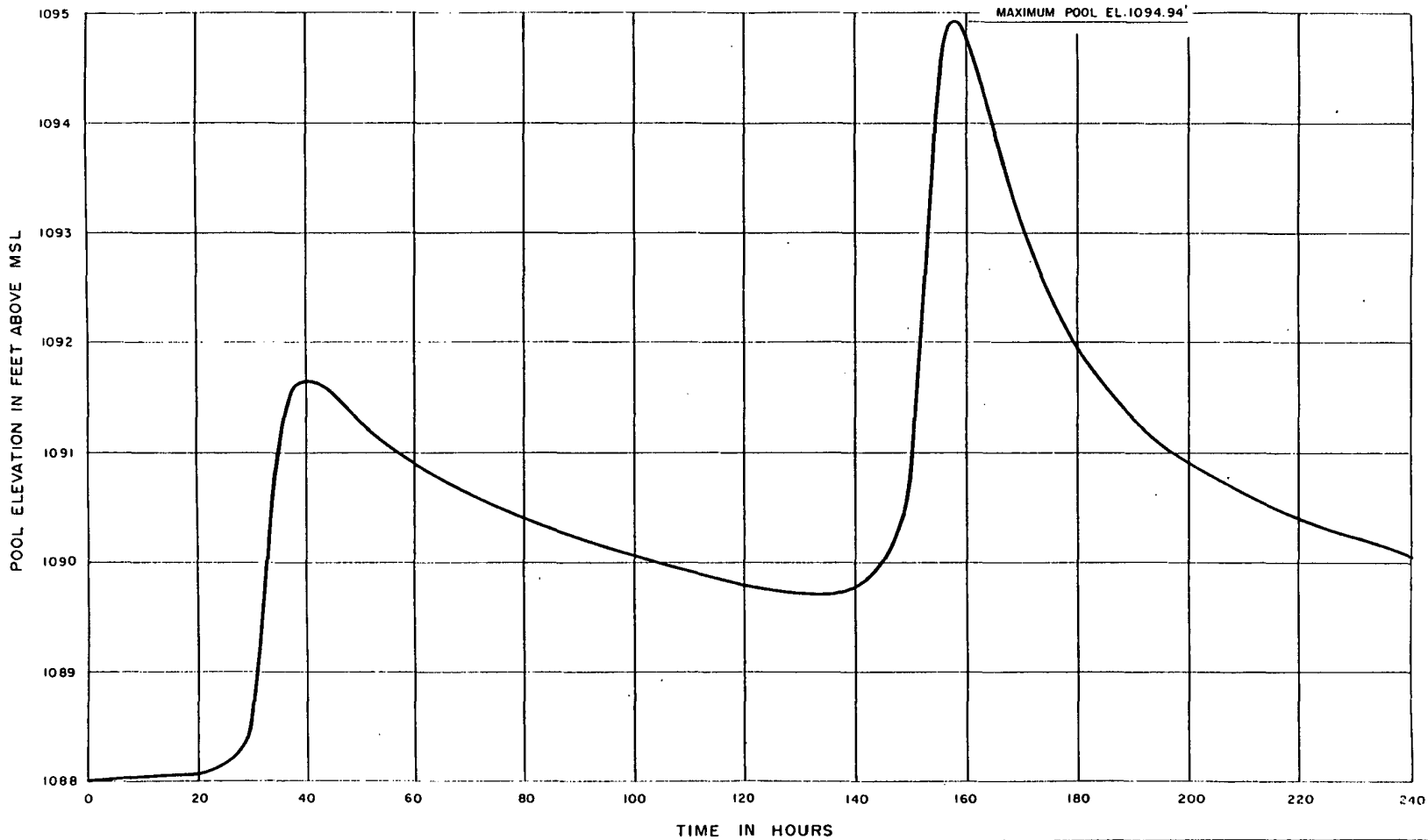

Rev. 0

**WOLF CREEK
UPDATED SAFETY ANALYSIS REPORT**

Figure 2.4-23

Lake Water Level Variation with
Time from Flood Routing Analysis

α	$COS \alpha$	X_1	X_2	$X_1 \cdot X_2$
42	.743	4,700	9,500	
36	.809	5,460	4,410	
30	.866	6,500	7,350	
24	.914	13,200	12,350	
18	.951	14,900	19,600	
12	.978	14,900	14,600	
6	.995	15,250	15,200	
0	1.000	15,800	15,800	
6	.995	15,200	15,200	
12	.978	14,200	14,000	
18	.951	14,650	15,906	
24	.914	4,700	4,500	
30	.866	4,260	5,710	
36	.809	4,260	5,520	
42	.743	4,200	5,200	
TOTAL	15,512			144,650

$$Fetch = \frac{\sum X_1 \cdot COS \alpha}{\sum COS \alpha}$$

$$= \frac{144,650}{15,512}$$

= 10,700 FT.

= 2.05 MILES

WIND DIRECTION

Rev. 0

WOLF CREEK
 UPDATED SAFETY ANALYSIS REPORT
 Figure 2.4-24
 Effective Fetch at Plant Location

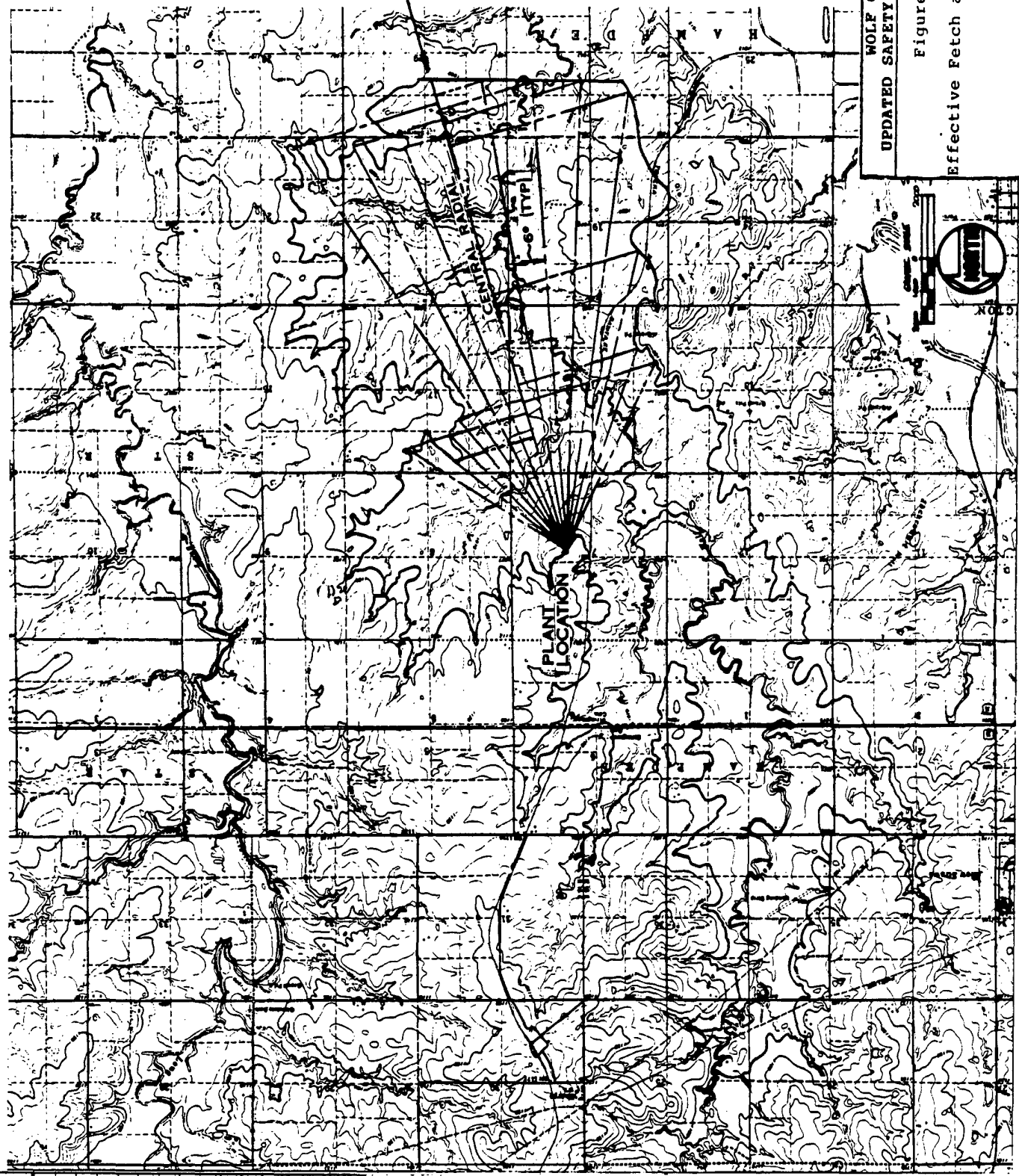

α	$\cos \alpha$	X_1	$X_1 \cos \alpha$
42	.743	7,600	5,650
36	.809	8,250	6,670
30	.846	9,190	7,970
24	.914	15,600	14,440
18	.951	15,500	14,740
12	.978	14,550	14,200
6	.995	21,250	21,100
0	1.000	31,850	31,850
6	.995	24,450	24,300
12	.978	7,950	7,700
18	.951	5,600	5,320
24	.914	5,550	5,070
30	.866	5,300	4,570
36	.809	4,900	3,960
42	.743	3,250	2,420
TOTAL	15.512		172,000

$$F_{eff} = \frac{\sum X_1 \cos \alpha}{\sum \cos \alpha}$$

$$= \frac{172,000}{13.512}$$

$$= 12,700 \text{ FT.}$$

$$= 2.40 \text{ MILES}$$

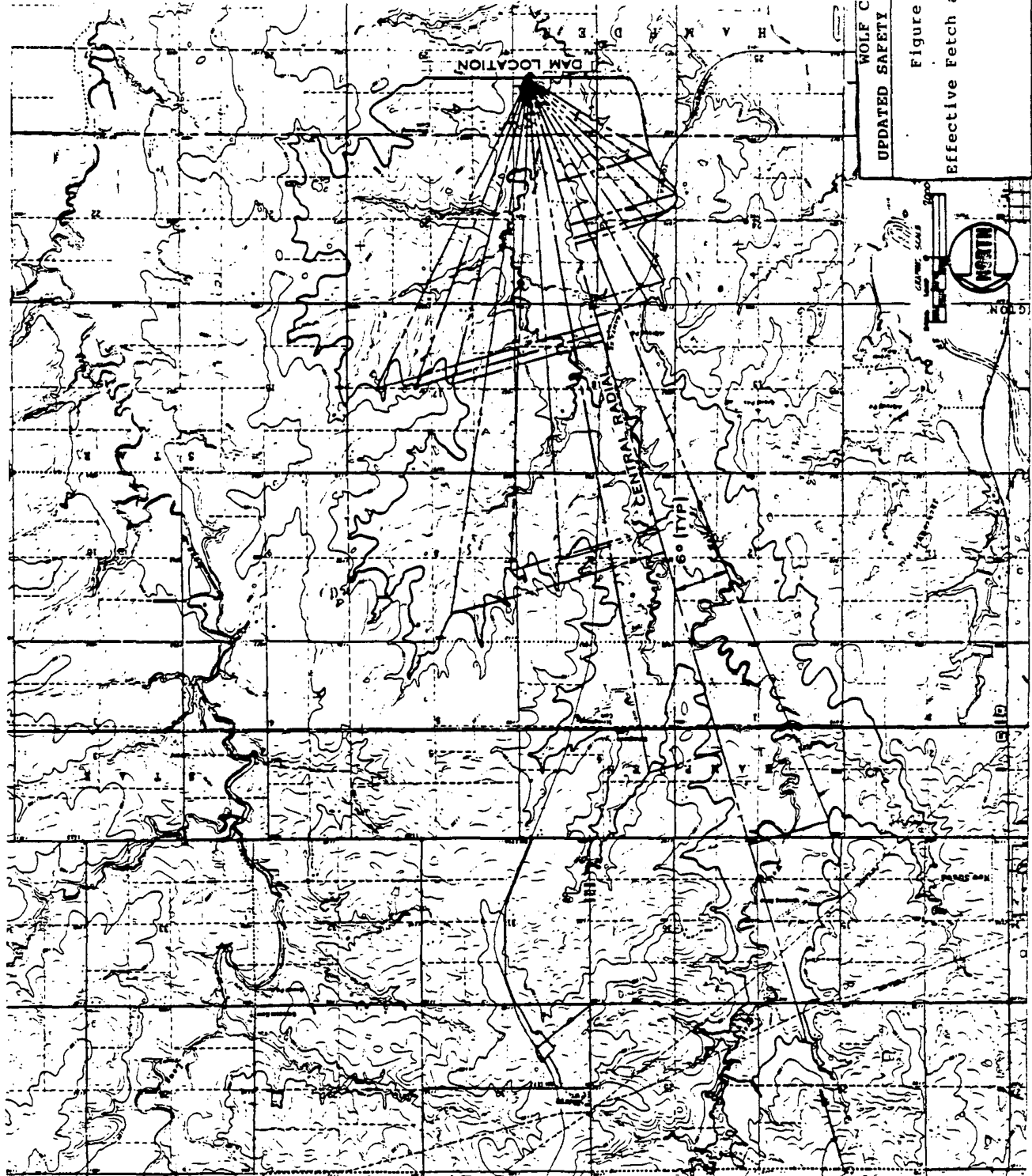

WIND DIRECTION

Rev. 0

WOLF CREEK
 UPDATED SAFETY ANALYSIS REPORT
 Figure 2.4-25
 Effective Fetch at Dam Location

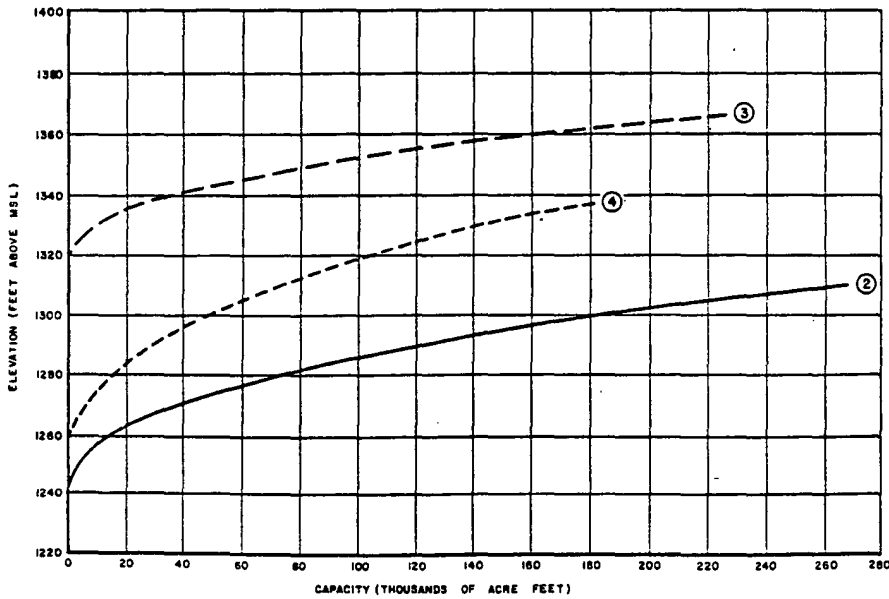
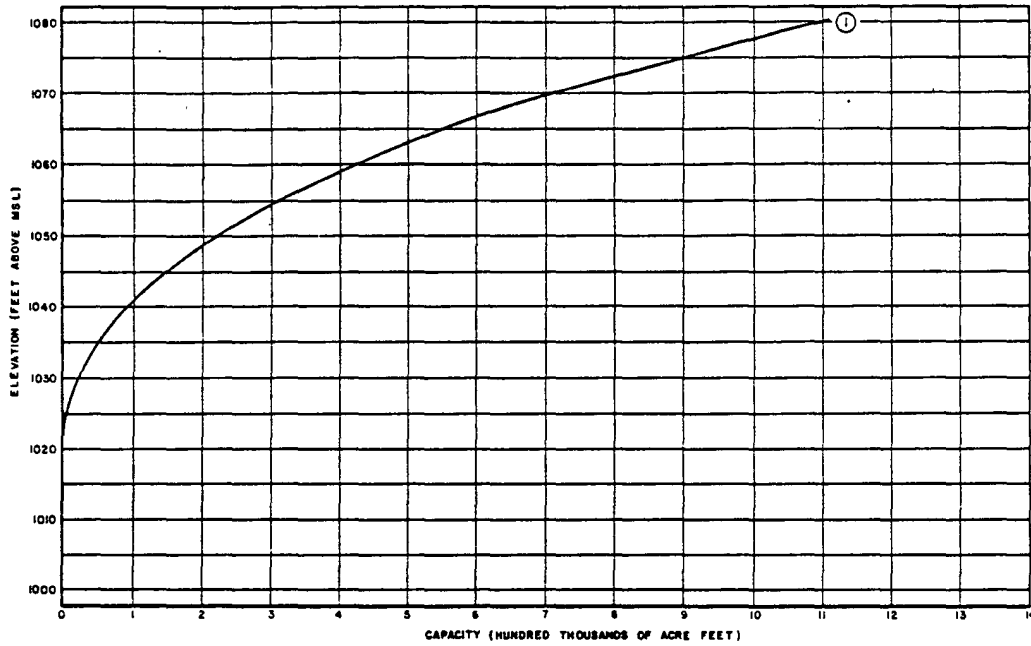

Rev. 0

NOTE:

- ① JOHN REDMOND RESERVOIR
- ② COUNCIL GROVE RESERVOIR
- ③ MARION RESERVOIR
- ④ PROPOSED CEDAR POINT RESERVOIR

REFERENCES:
 U.S. ARMY CORPS OF ENGINEERS,
 1958; 1959; 1961; 1973.

**WOLF CREEK
 UPDATED SAFETY ANALYSIS REPORT**

Figure 2.4-26

Reservoir Capacity Curves in Upper
 Neosho River Basin

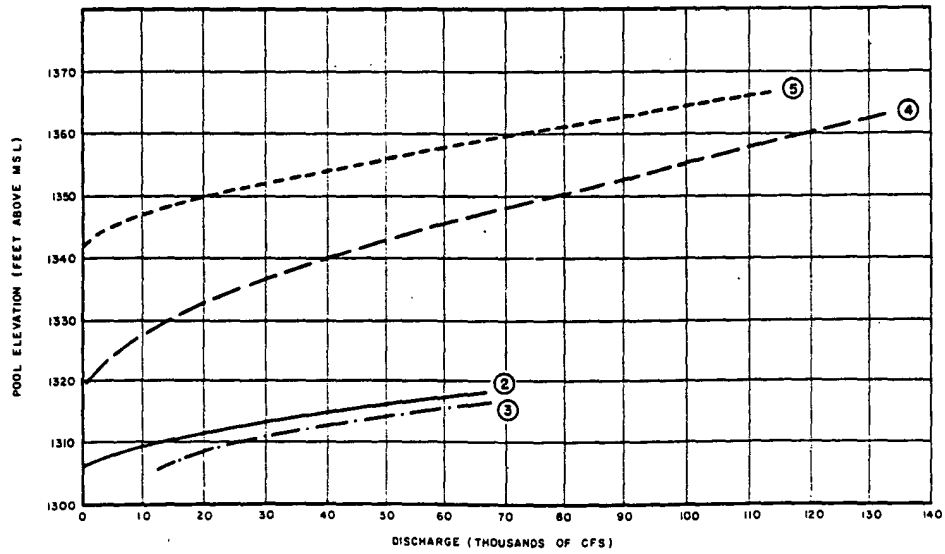
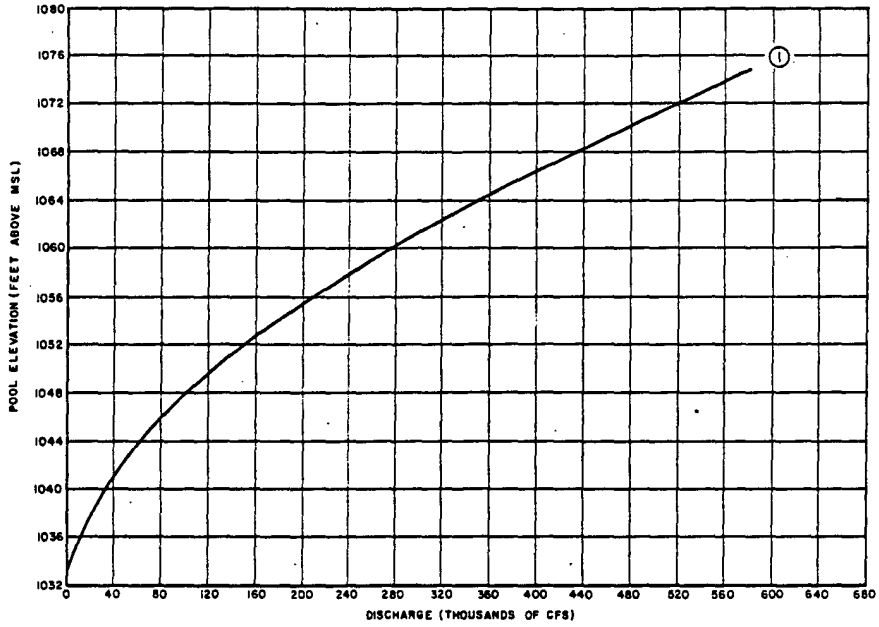

Rev. 0

- 1 JOHN REDMOND RESERVOIR
- 2 COUNCIL GROVE RESERVOIR, WITH 500' UNCONTROLLED SPILLWAY
- 3 COUNCIL GROVE RESERVOIR, 1-17' CONDUIT AND 500' UNCONTROLLED SPILLWAY
- 4 MARION RESERVOIR
- 5 PROPOSED CEDAR POINT RESERVOIR

**WOLF CREEK
UPDATED SAFETY ANALYSIS REPORT**

Figure 2.4-27

Spillway Rating Curves in Upper
Neosho River Basin

REFERENCES:
U.S. ARMY CORPS OF ENGINEERS,
1962; 1967; 1968; 1973.

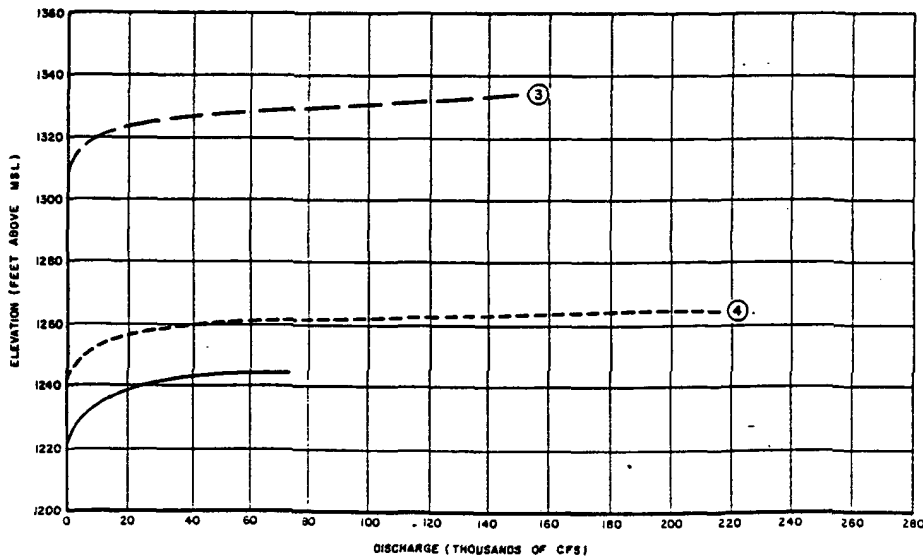
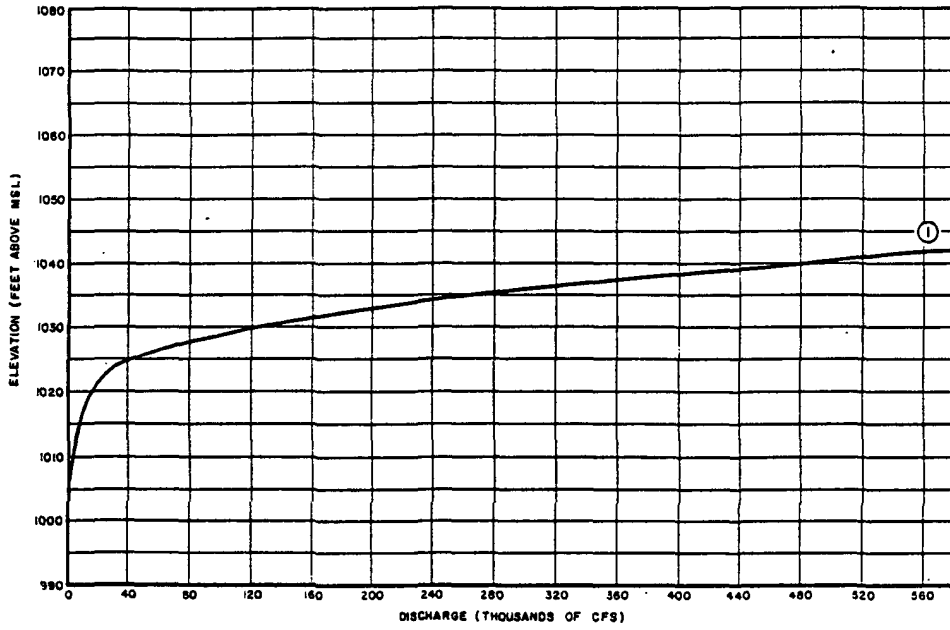

NOTE:

- 1 JOHN REDMOND RESERVOIR
- 2 COUNCIL GROVE RESERVOIR
- 3 MARION RESERVOIR
- 4 PROPOSED CEDAR POINT RESERVOIR

REFERENCES:
 U.S. ARMY CORPS OF ENGINEERS,
 1962; 1967; 1973.

Rev. 0

**WOLF CREEK
 UPDATED SAFETY ANALYSIS REPORT**

Figure 2.4-28

Tailwater Rating Curves in Upper
 Neosho River Basin

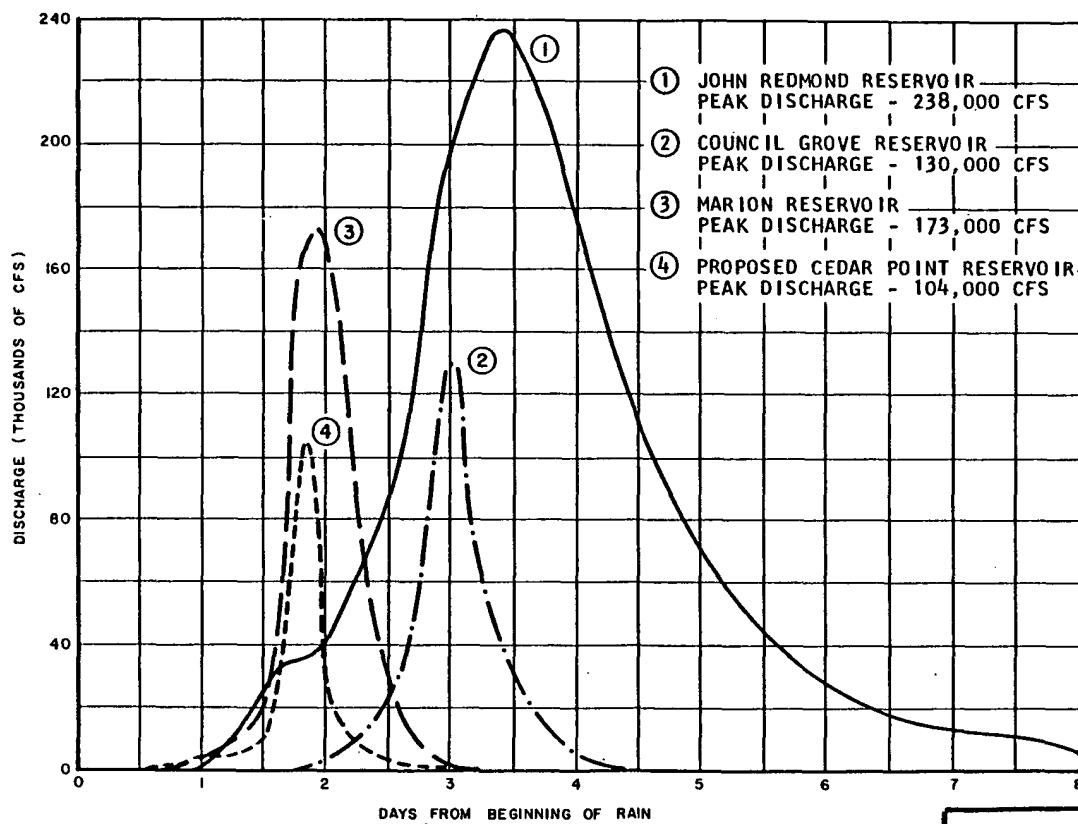

Rev. 0

**WOLF CREEK
UPDATED SAFETY ANALYSIS REPORT**

Figure 2.4-29

Standard Project Flood
Hydrographs

REFERENCES:
U.S. ARMY CORPS OF ENGINEERS,
1958; 1959; 1961; 1971.

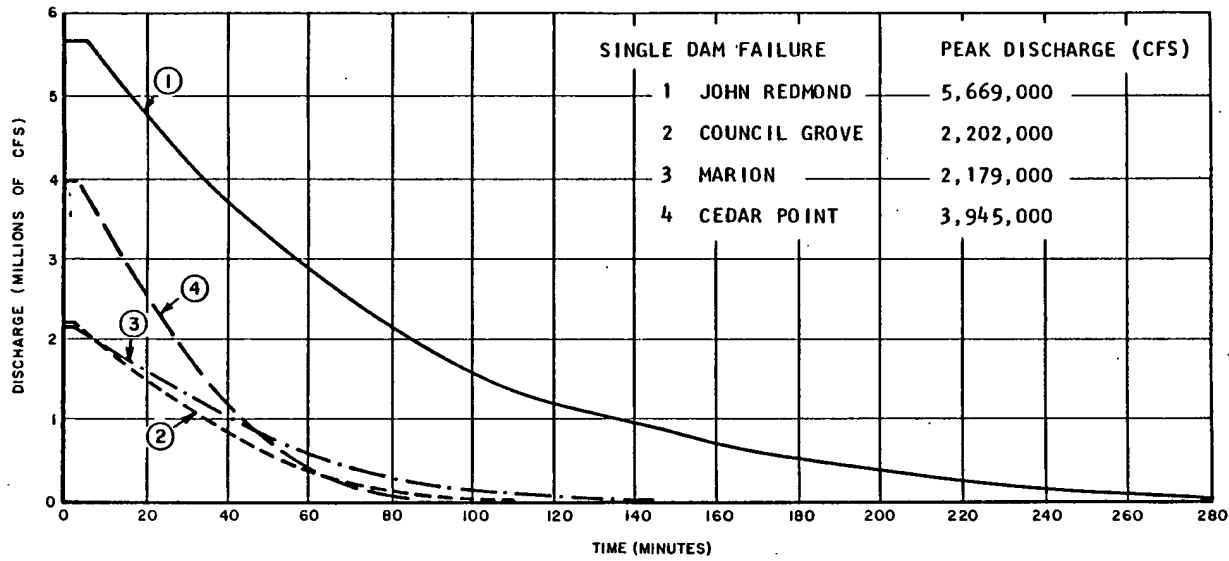

Rev. 0

**WOLF CREEK
UPDATED SAFETY ANALYSIS REPORT**

Figure 2.4-30

Computed Dambreak Water Release Rates

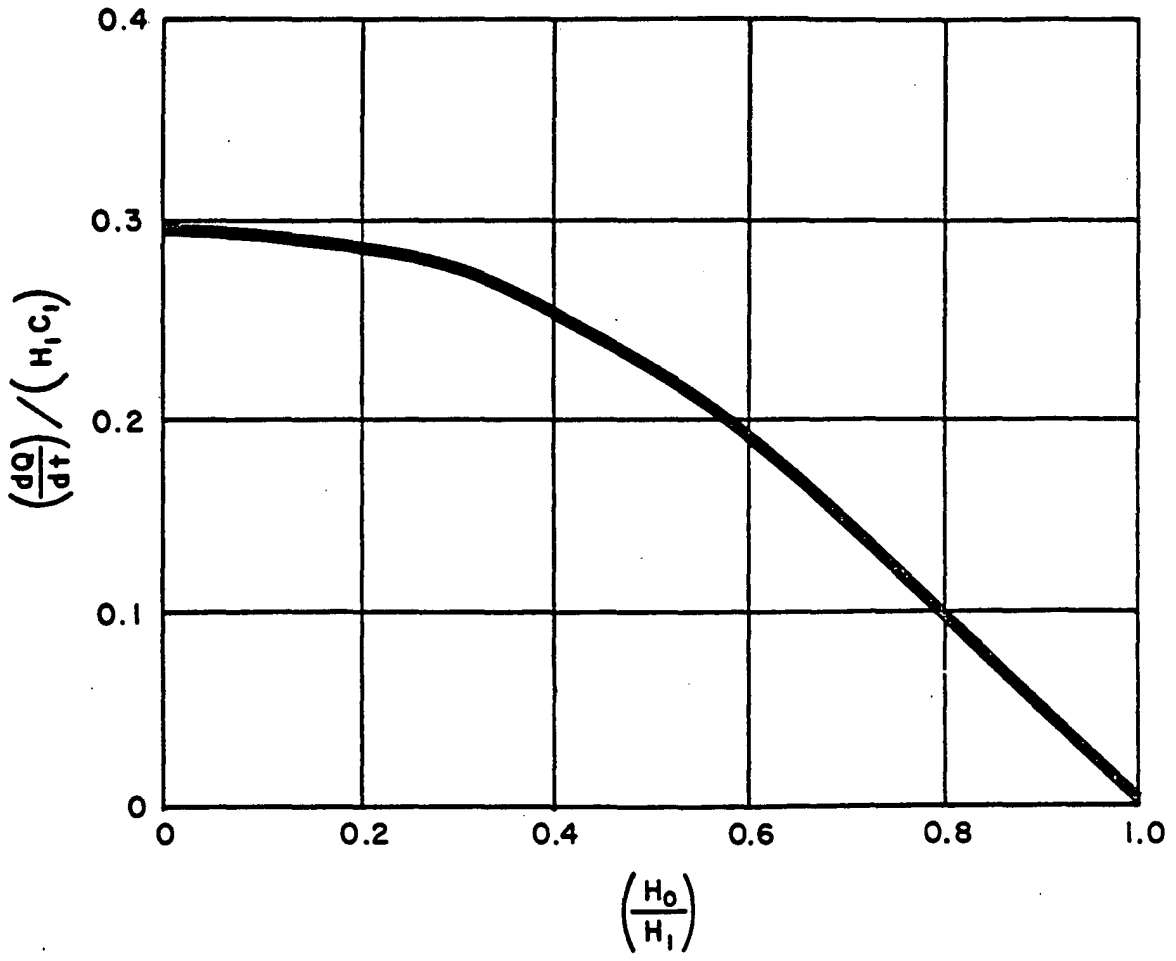

Rev. 0

**WOLF CREEK
UPDATED SAFETY ANALYSIS REPORT**

Figure 2.4-31
Discharge Rate at the Damsite

REFERENCE:
REPRODUCED FROM STOKER, 1957,
P. 339, FIG. 10.8-4.

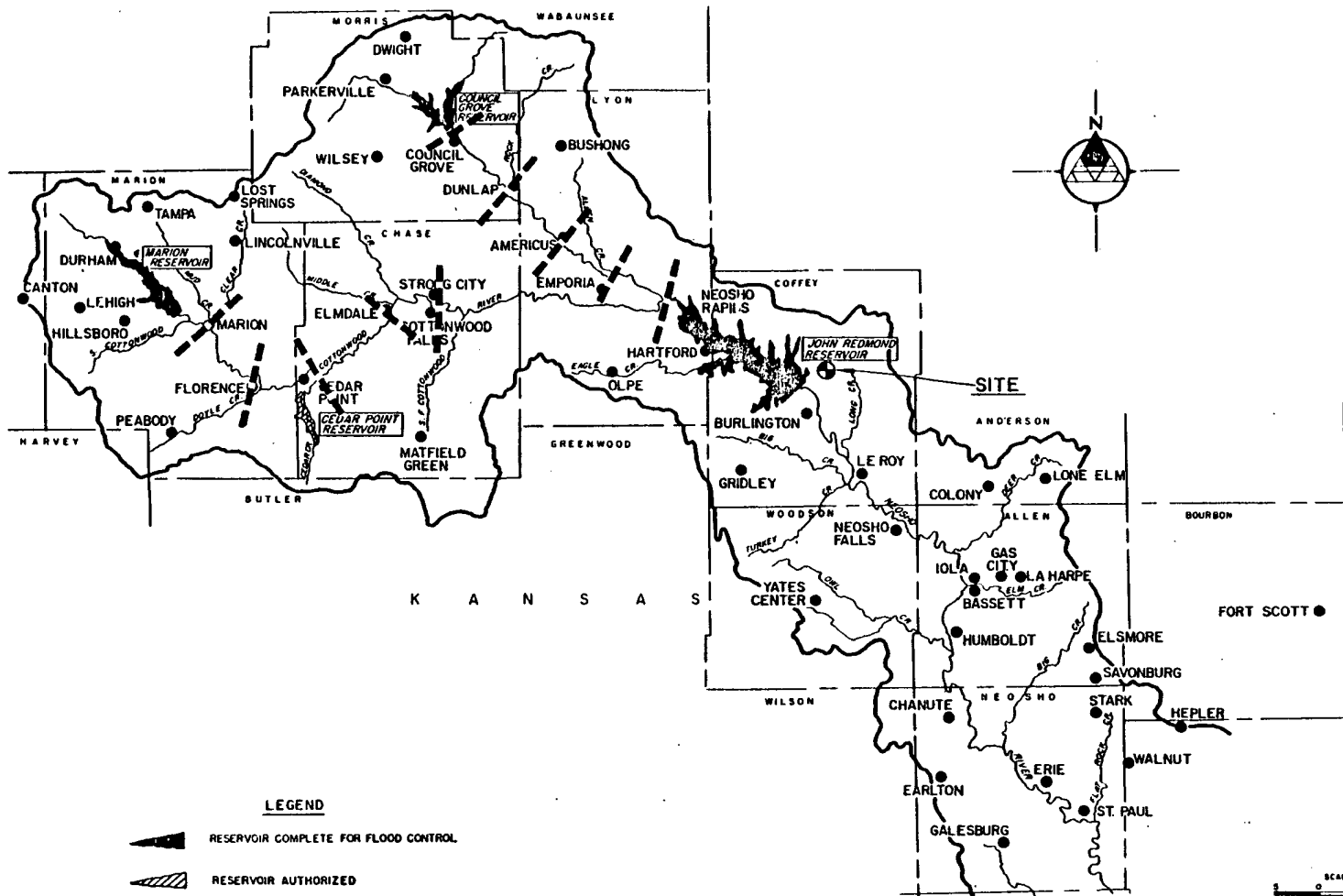

Rev. 0

**WOLF CREEK
UPDATED SAFETY ANALYSIS REPORT**

Figure 2.4-32

Control Stations along the Neosho
and Cottonwood Rivers

REFERENCE:
REPRODUCED FROM U.S. ARMY CORPS
OF ENGINEERS, 1965, PLATE 1.

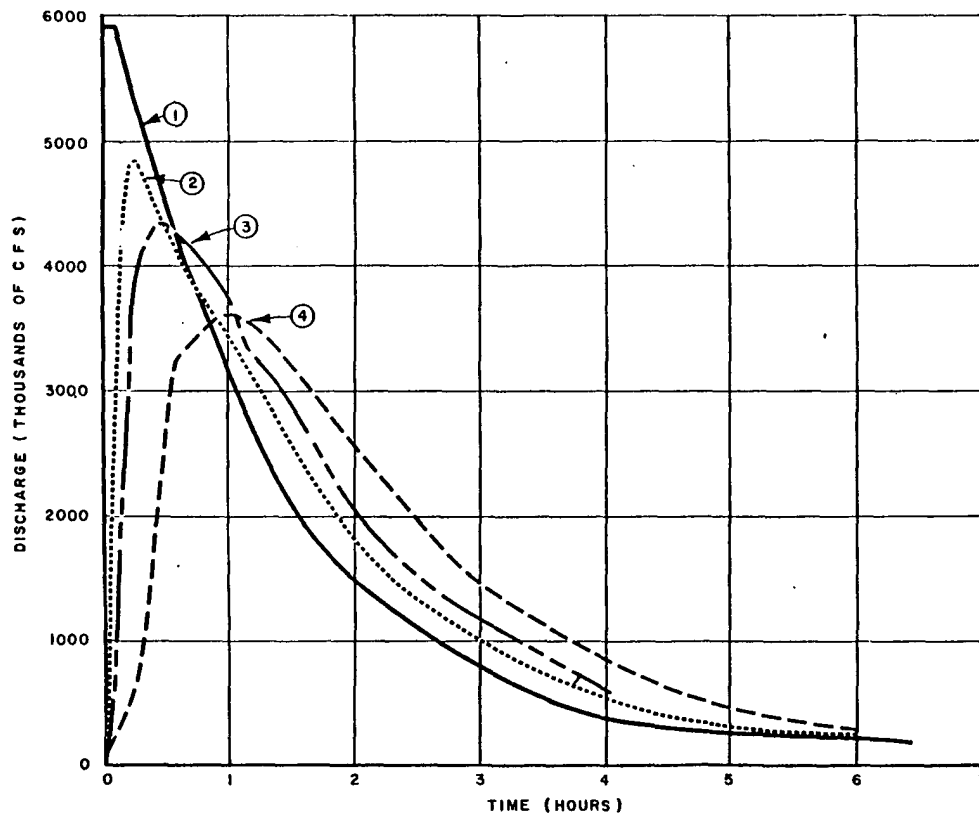

STANDARD PROJECT FLOOD AND DAM FAILURE
AT JOHN REDMOND

- 1 JOHN REDMOND DAMSITE
- 2 TWO MILES DOWNSTREAM FROM DAMSITE
- 3 THREE MILES DOWNSTREAM FROM DAMSITE
- 4 SIX MILES DOWNSTREAM FROM DAMSITE

NOTE: PLANT SITE GRADE FAR ABOVE MAXIMUM
FLOOD STAGES ON NEOSHO RIVER.

Rev. 0

**WOLF CREEK
UPDATED SAFETY ANALYSIS REPORT**

Figure 2.4-33

John Redmond Dam Failure Flood
Translation

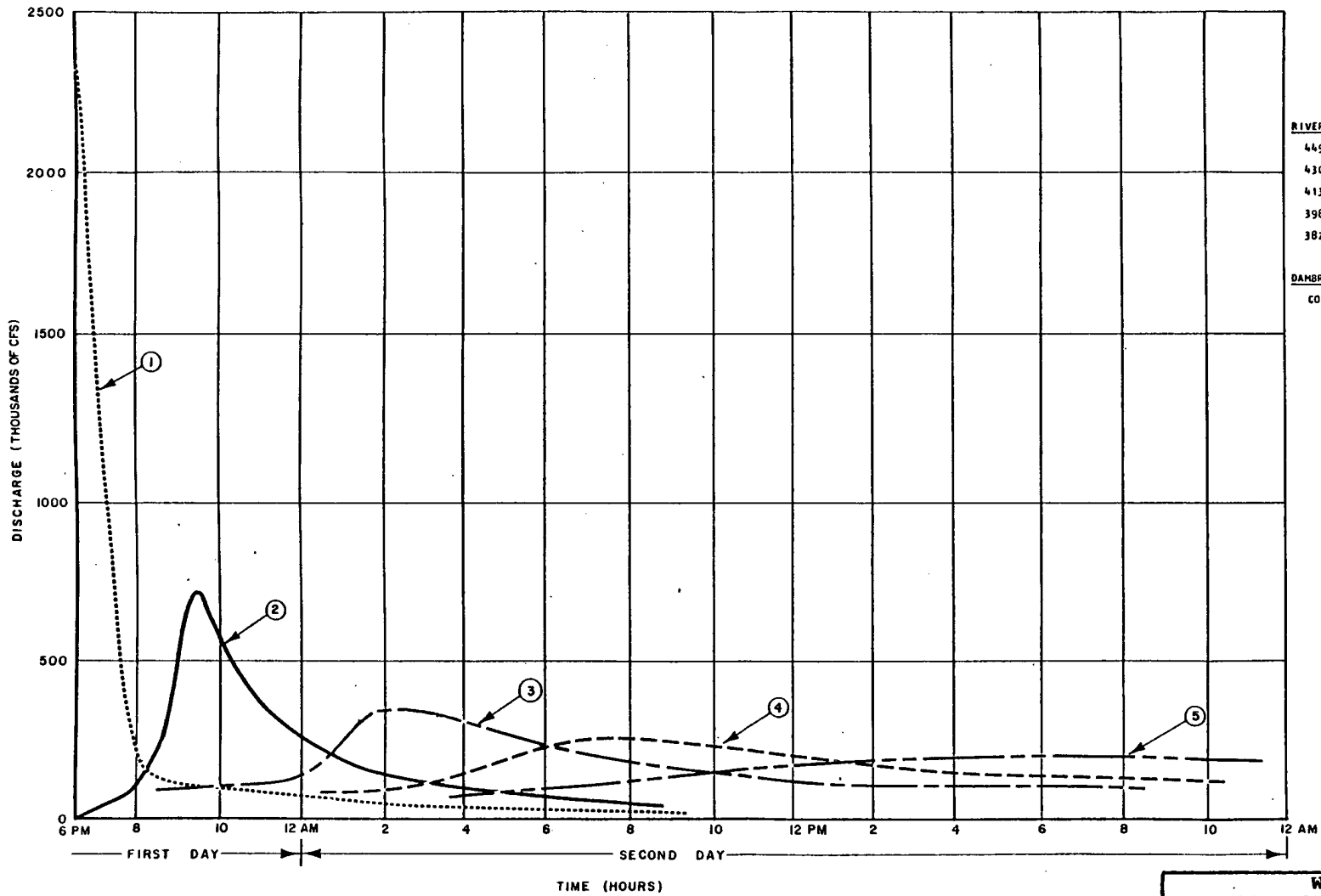

RIVER MILE		
449.9	1	COUNCIL GROVE DAM SITE
430.5	2	DUNLAP
413.0	3	AMERICUS
398.1	4	EMFORIA
382.8	5	JUNCTION OF NEOSHO RIVER AND COTTONWOOD RIVER

DAMBREAK TIME
 COUNCIL GROVE DAM: 6:25 PM, FIRST DAY

Rev. 0

**WOLF CREEK
 UPDATED SAFETY ANALYSIS REPORT**

Figure 2.4-34
 Council Grove Dam Failure Flood
 Translation

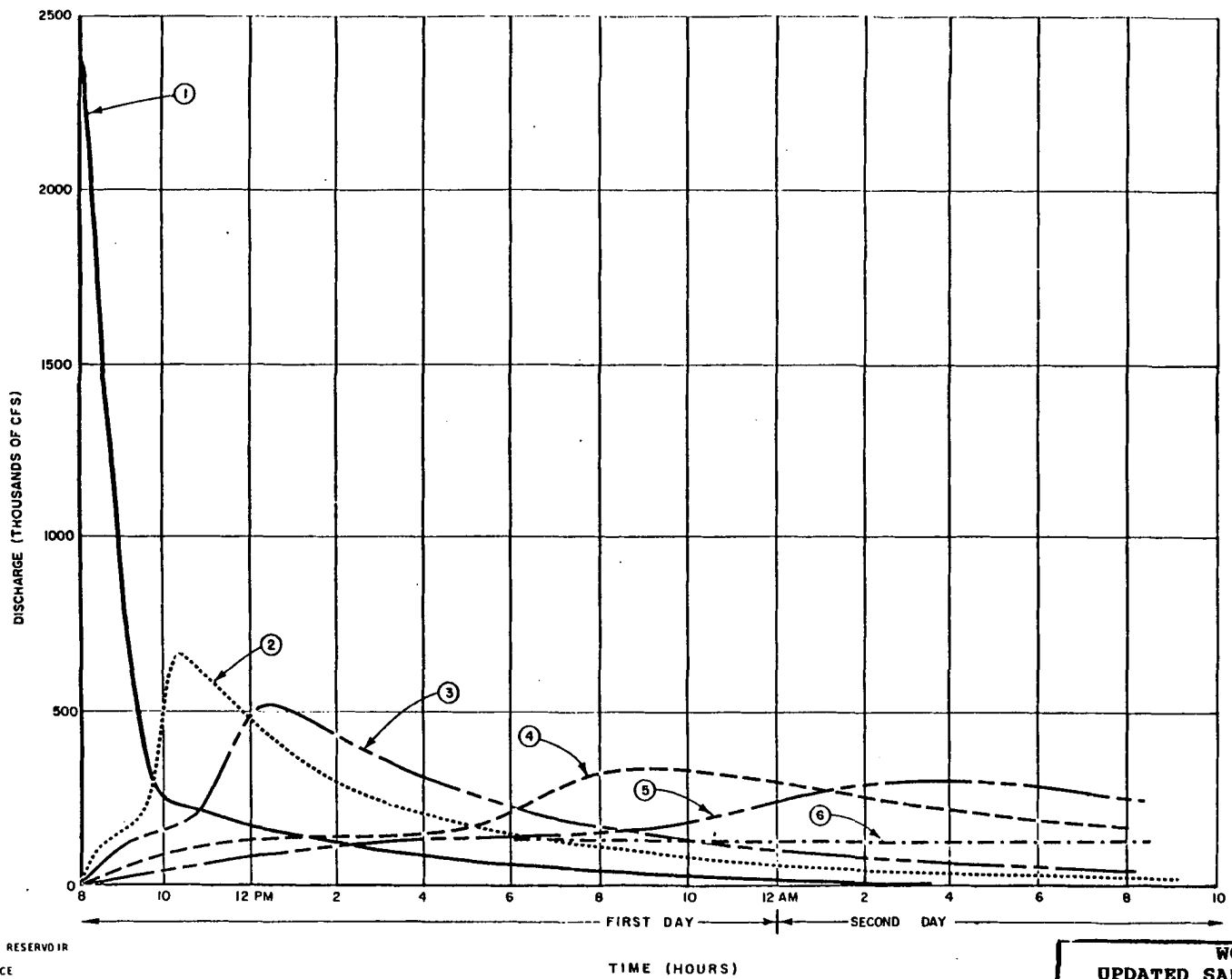

RIVER MILE	Location
126.7	1 MARION RESERVOIR
108.2	2 FLORENCE
98.1	3 CEDAR POINT
70.9	4 ELMDALE
55.0	5 STRONG CITY
0	6 JUNCTION OF HEDSHO RIVER AND COTTONWOOD RIVER

DAMBREAK TIME
 MARION DAM: 8:17 AM, FIRST DAY

Rev. 0

**WOLF CREEK
 UPDATED SAFETY ANALYSIS REPORT**

Figure 2.4-35
 Marion Dam Failure Flood
 Translation

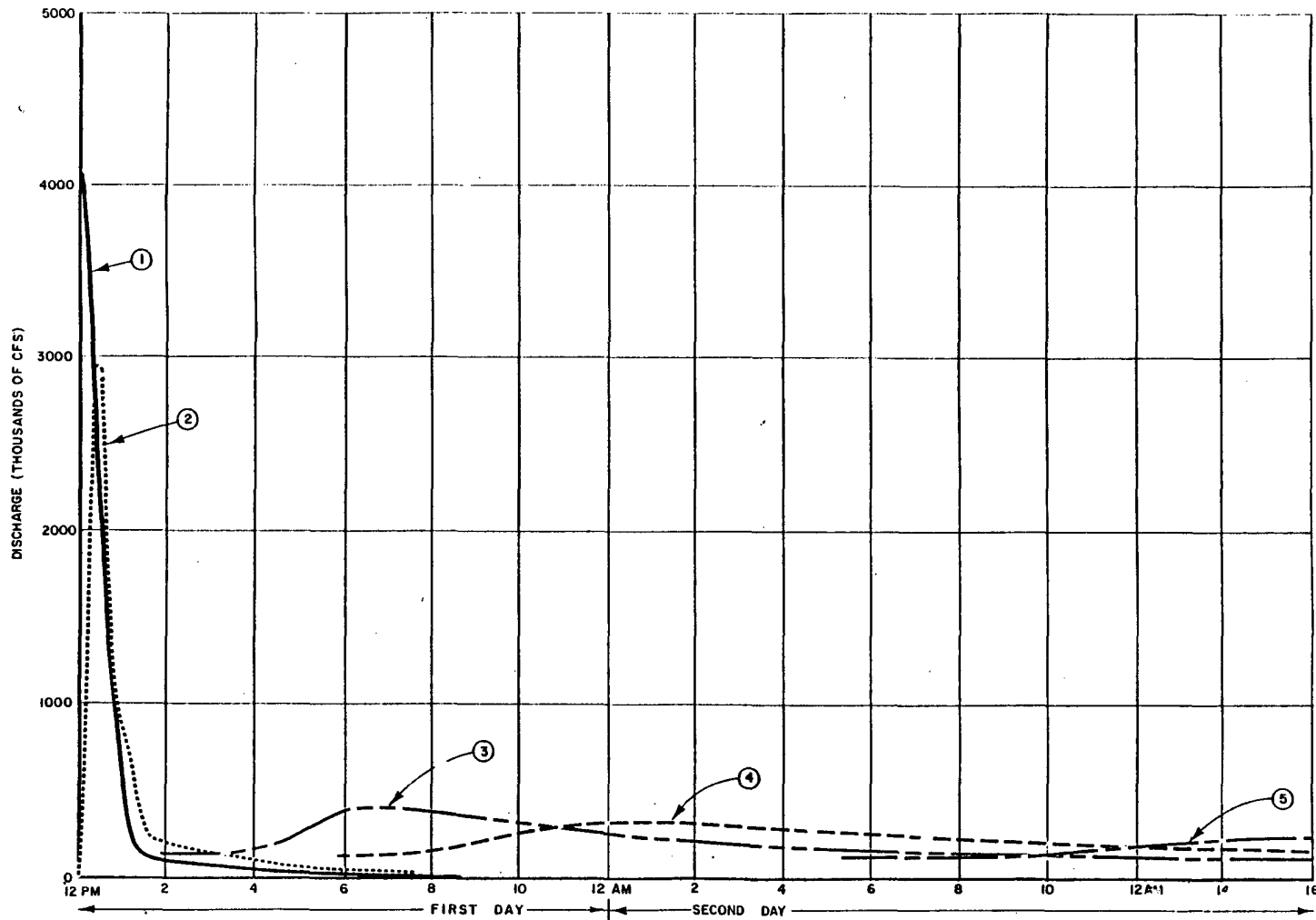

Rev. 0

RIVER MILE	
102.3	1 CEDAR POINT DAMSITE
98.1	2 CEDAR POINT
70.9	3 ELMDALE
55.0	4 STRONG CITY
0	5 JUNCTION OF NEOSHO AND COTTONWOOD RIVERS

DAMBREAK TIME
CEDAR POINT DAM: 12:00 PM, FIRST DAY

**WOLF CREEK
UPDATED SAFETY ANALYSIS REPORT**

Figure 2.4-36
Cedar Point Dam Failure Flood
Translation

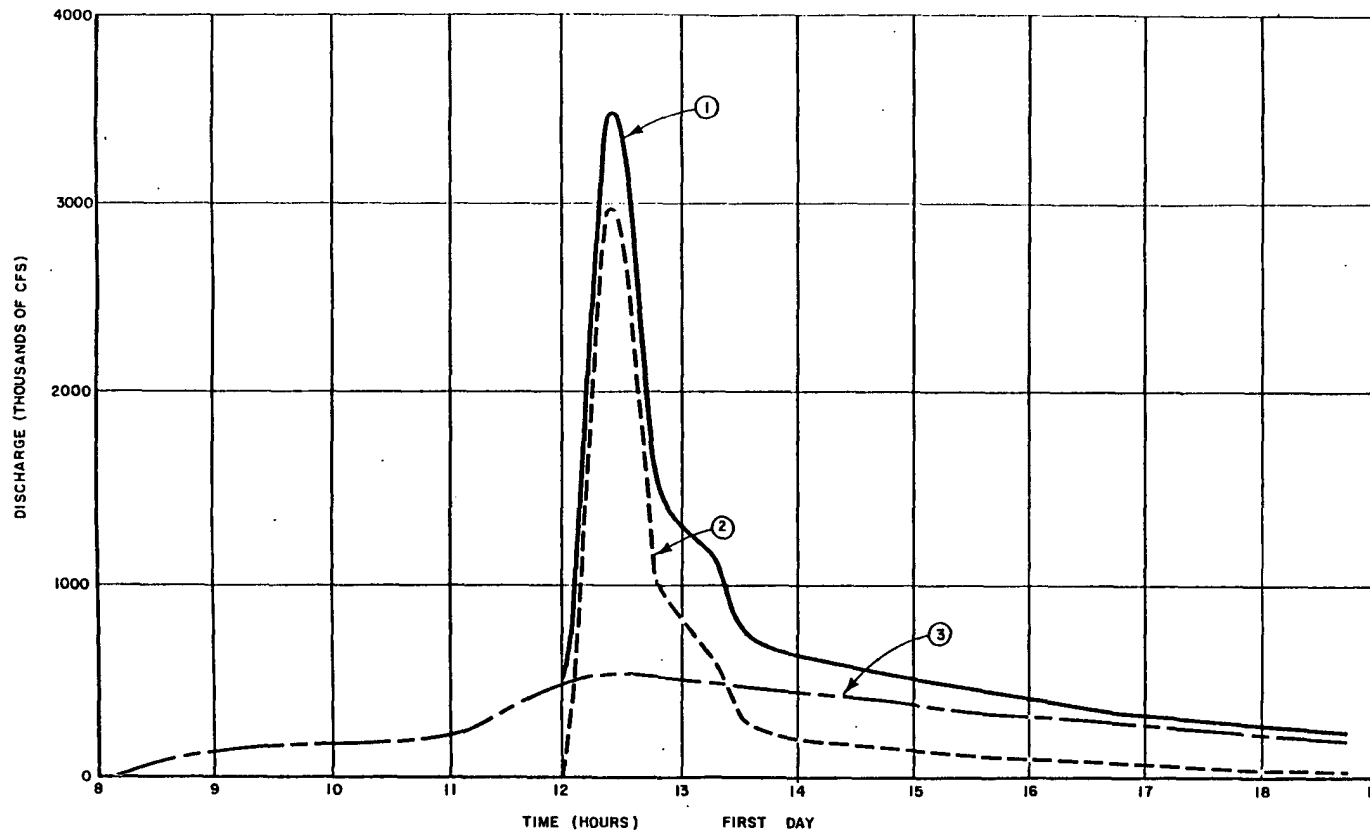

Rev. 0

- 1 FLOOD AT JUNCTION OF CEDAR CREEK AND COTTONWOOD RIVER
- 2 CEDAR POINT DAM FAILURE FLOOD
- 3 MARION DAM FAILURE FLOOD

DAMBREAK TIME

MARION RESERVOIR: 8:17 AM
 CEDAR POINT RESERVOIR: 12:00 PM

**WOLF CREEK
 UPDATED SAFETY ANALYSIS REPORT**

Figure 2.4-37

Flood at Junction of Cedar Creek and Cottonwood River

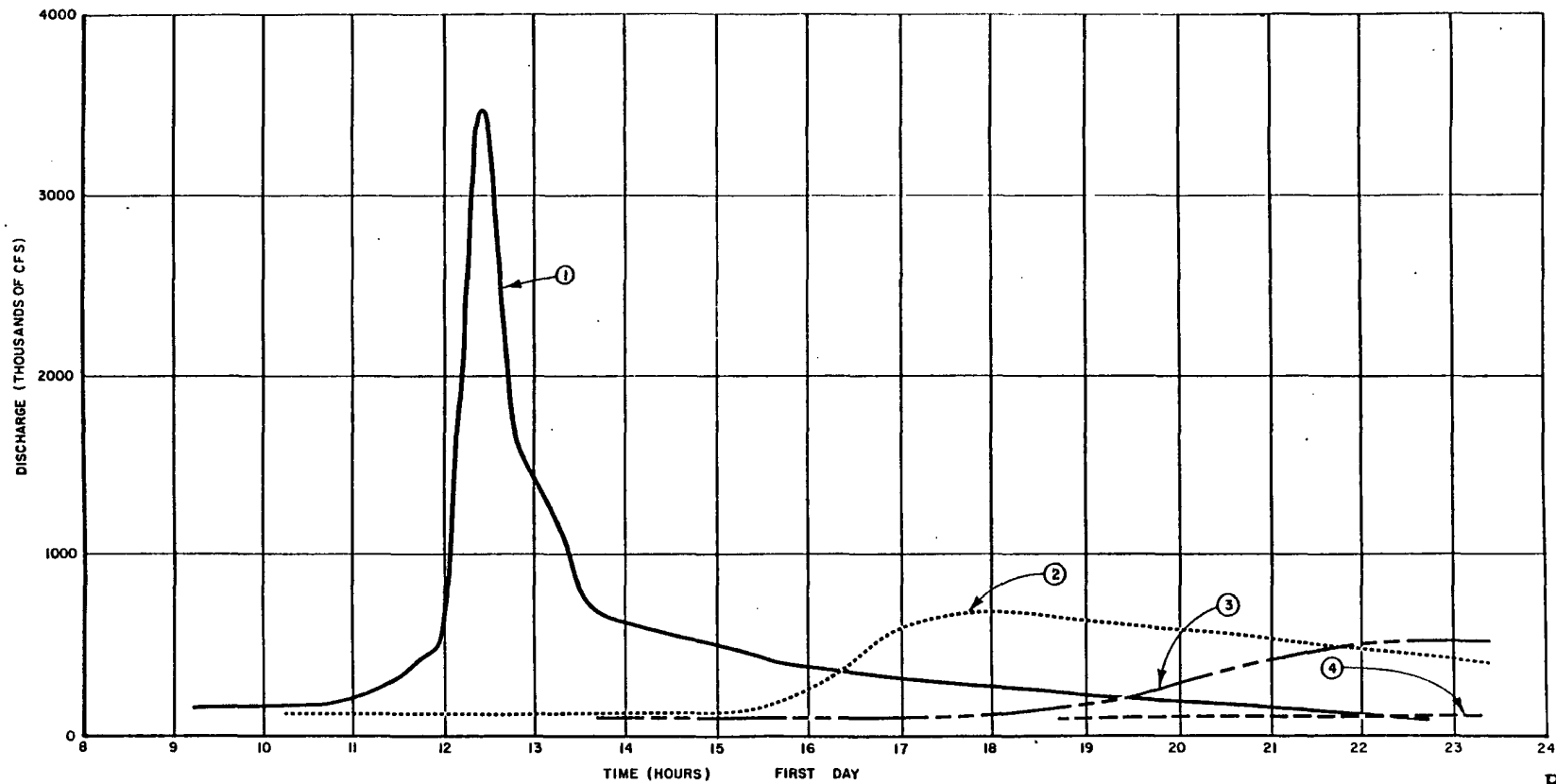

Rev. 0

RIVER MILE

98.1	1	CEDAR POINT
70.9	2	ELMOALE
55.0	3	STRONG CITY
0	4	JUNCTION OF NEOSHO RIVER AND COTTONWOOD RIVER

DAMBREAK TIME

MARION DAM: 8:17 AM
 CEDAR POINT DAM: 12:00 PM

**WOLF CREEK
 UPDATED SAFETY ANALYSIS REPORT**

Figure 2.4-38

Combination of Marion and Cedar Point Dams Failures Flood Translation

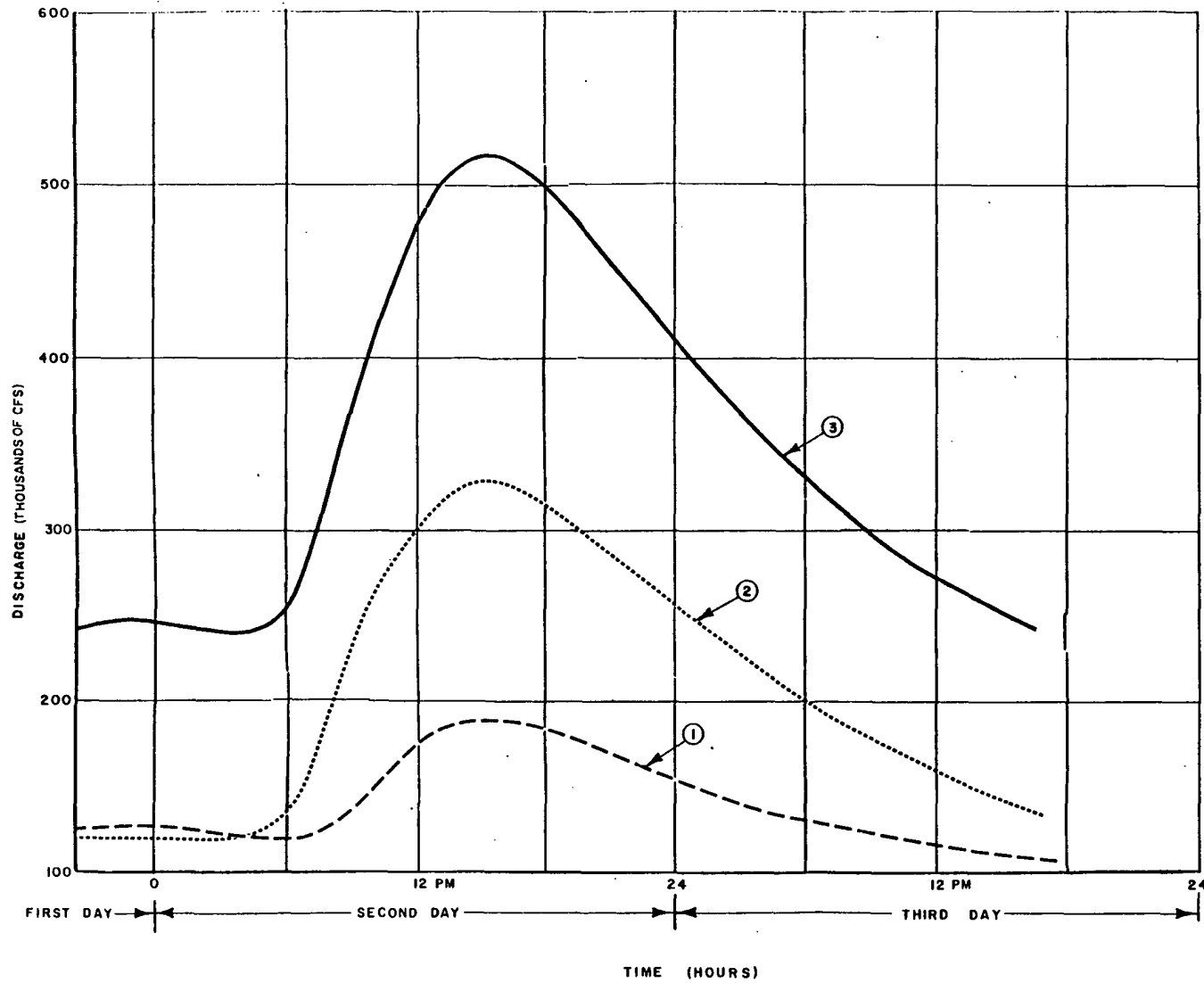

- 1 FLOOD FROM COUNCIL GROVE DAM FAILURE
 - 2 FLOOD FROM MARION AND CEDAR POINT DAM FAILURE
 - 3 FLOOD AT JUNCTION OF NEOSHO RIVER AND COTTONWOOD RIVER
- DAMBREAK TIME
 MARION DAM: 8:17 AM, FIRST DAY
 CEDAR POINT DAM: 12:00 PM, FIRST DAY
 COUNCIL GROVE DAM: 6:25 PM, FIRST DAY

Rev. 0

**WOLF CREEK
 UPDATED SAFETY ANALYSIS REPORT**

Figure 2.4-39

Flood at Junction of Neosho and
 Cottonwood Rivers

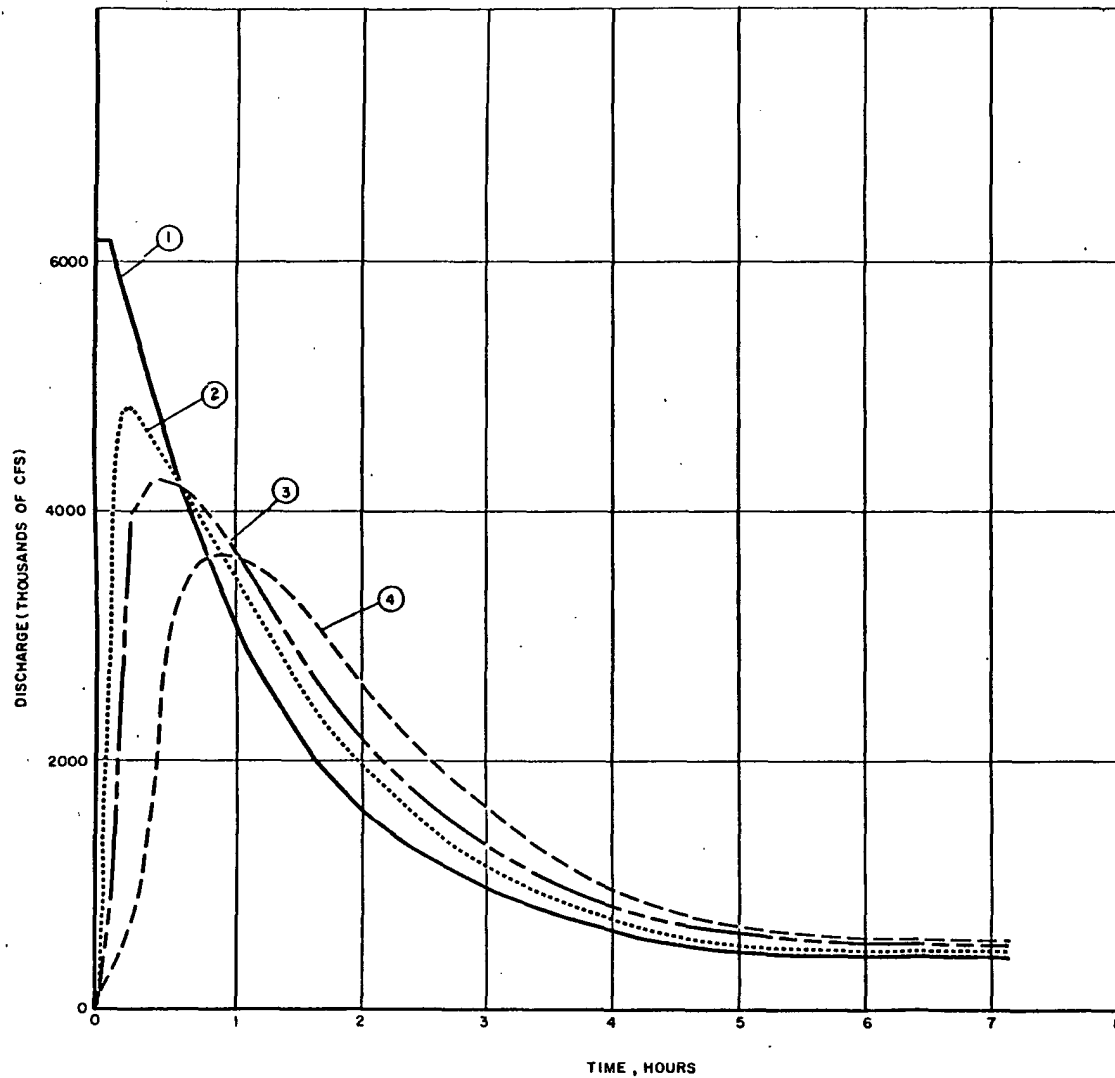

DAM FAILURES AT JOHN REDMOND, COUNCIL GROVE, MARION AND CEDAR POINT DAM

STANDARD PROJECT FLOODS WERE INCLUDED AT COUNCIL GROVE, MARION AND CEDAR POINT.

- 1 JOHN REDMOND DAM
- 2 TWO MILES DOWNSTREAM FROM DAMSITE
- 3 THREE MILES DOWN STREAM FROM DAMSITE
- 4 SIX MILES DOWNSTREAM FROM DAMSITE

NOTE: PLANT SITE GRADE FAR ABOVE MAXIMUM FLOOD STAGES ON NEOSHO RIVER.

Rev. 0

**WOLF CREEK
UPDATED SAFETY ANALYSIS REPORT**

Figure 2.4-40

Multiple Dam Failures Flood Translation

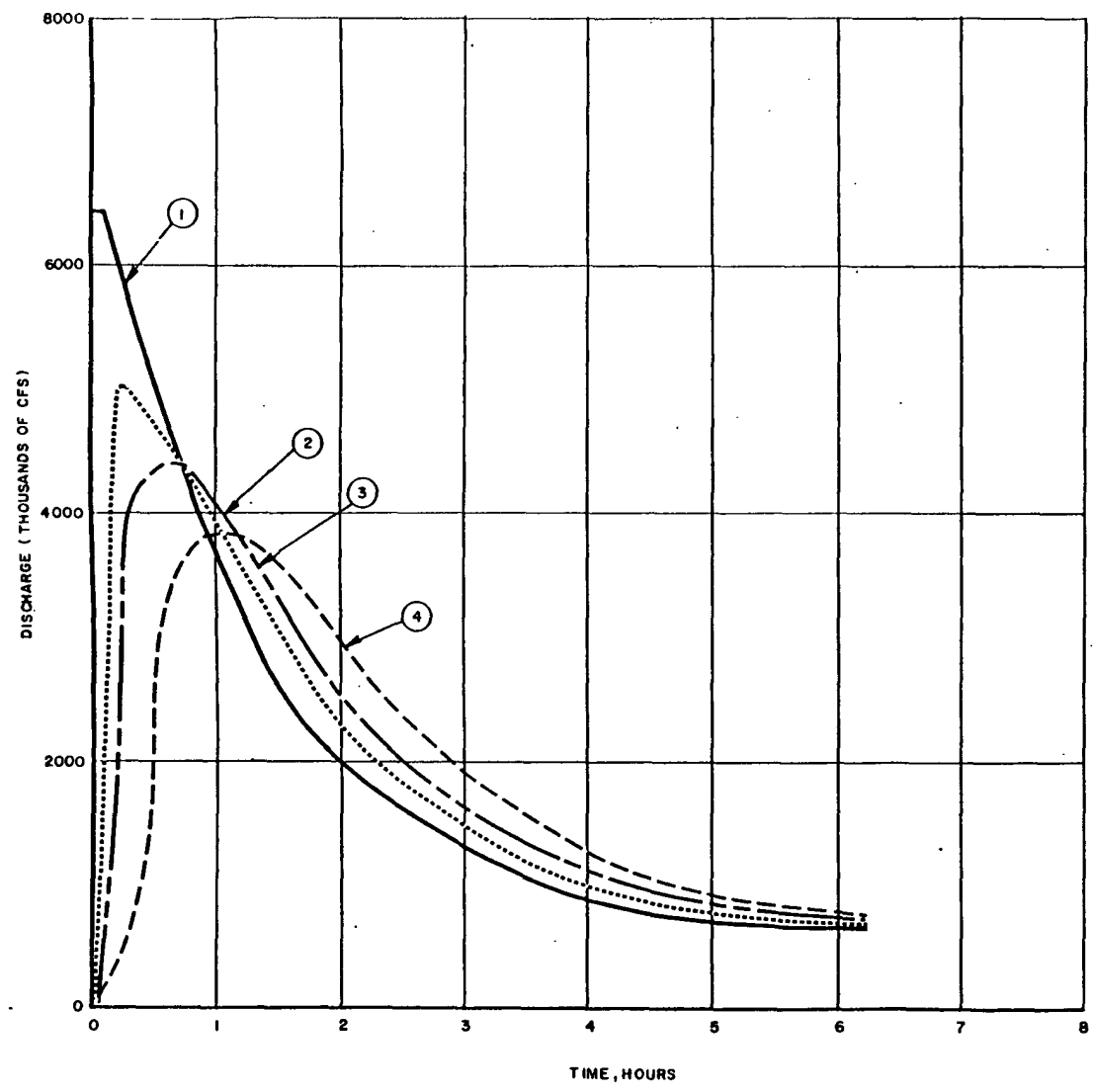

STANDARD PROJECT FLOOD AND DAM FAILURE AT JOHN REDMOND DAM, COUNCIL GROVE, MARION, AND CEDAR POINT DAMS.

- 1 JOHN REDMOND DAMSITE
- 2 TWO MILES DOWNSTREAM FROM DAMSITE
- 3 THREE MILES DOWNSTREAM FROM DAMSITE
- 4 SIX MILES DOWNSTREAM FROM DAMSITE

NOTE: PLANT SITE GRADE FAR ABOVE MAXIMUM FLOOD STAGES ON NEOSHO RIVER.

Rev. 0

**WOLF CREEK
UPDATED SAFETY ANALYSIS REPORT**

Figure 2.4-41

Multiple Dam Failures with
Standard Project Flood
Translation

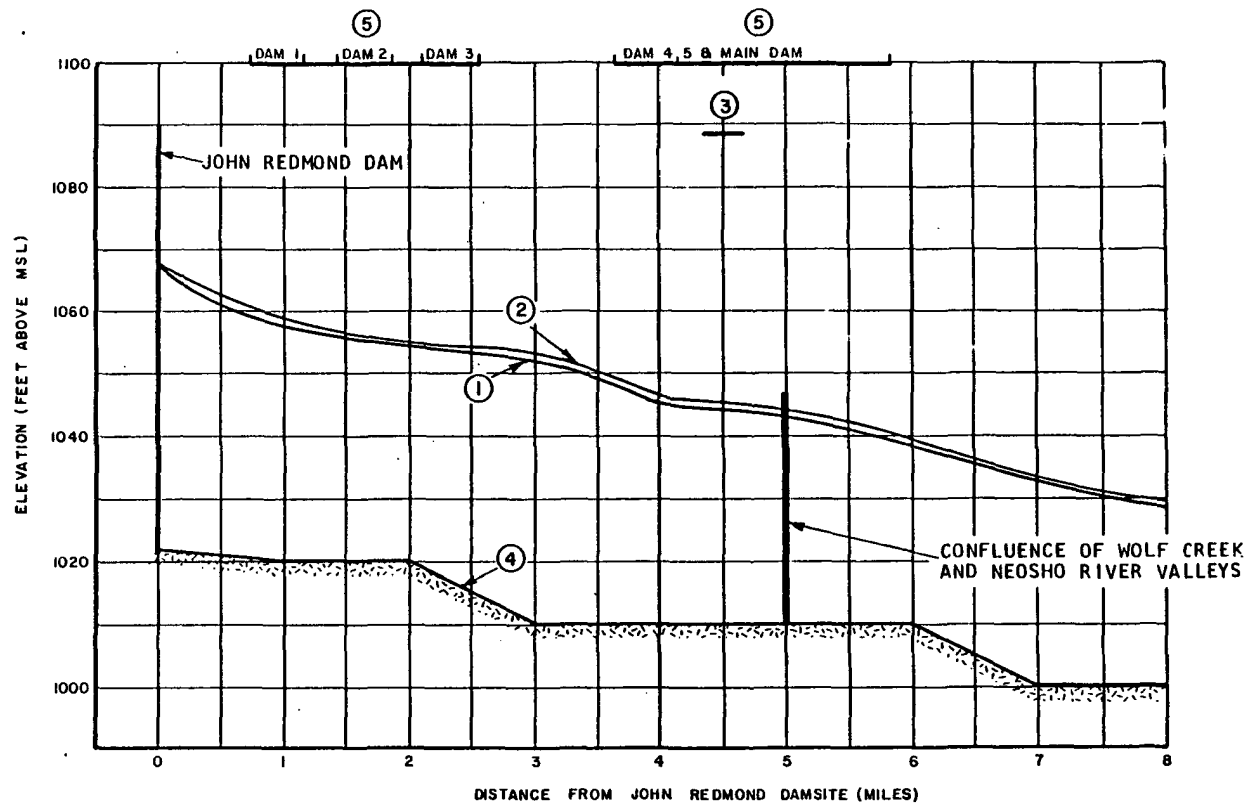

- 1 RESULTED FROM DAM FAILURE OF JOHN REDMOND DAM RESERVOIR COINCIDENT WITH THE SPF.
- 2 RESULTED FROM DAM FAILURES OF JOHN REDMOND, COUNCIL GROVE, MARION AND CEDAR POINT RESERVOIRS COINCIDENT WITH THE SPF.
- 3 WOLF CREEK DAM SPILLWAY CREST = 1088 FEET
- 4 NEOSHO RIVER DAM
- 5 ELEVATIONS AND LOCATIONS FOR WOLF CREEK COOLING LAKE DAMS; ALSO SEE FIGURE 2.4-1.

Rev. 0

**WOLF CREEK
UPDATED SAFETY ANALYSIS REPORT**

Figure 2.4-42

Maximum Flood Stages of Neosho
River near the Wolf Creek Dam

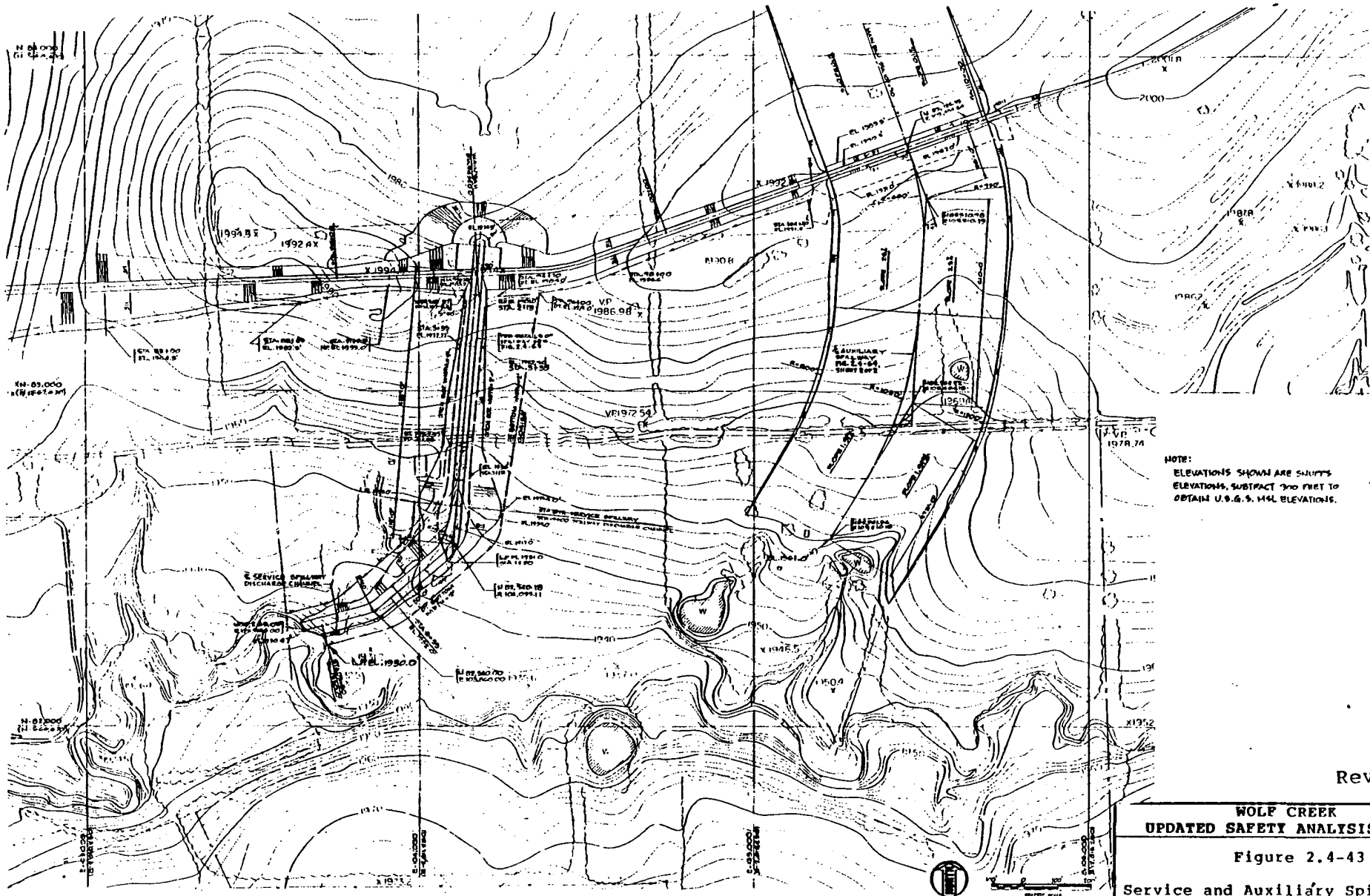

NOTE:
ELEVATIONS SHOWN ARE SHIFTS
ELEVATIONS, SUBTRACT 700 FEET TO
OBTAIN U.S.G.S. MSL ELEVATIONS.

Rev. 0

**WOLF CREEK
UPDATED SAFETY ANALYSIS REPORT**

Figure 2.4-43

Service and Auxiliary Spillways
Location

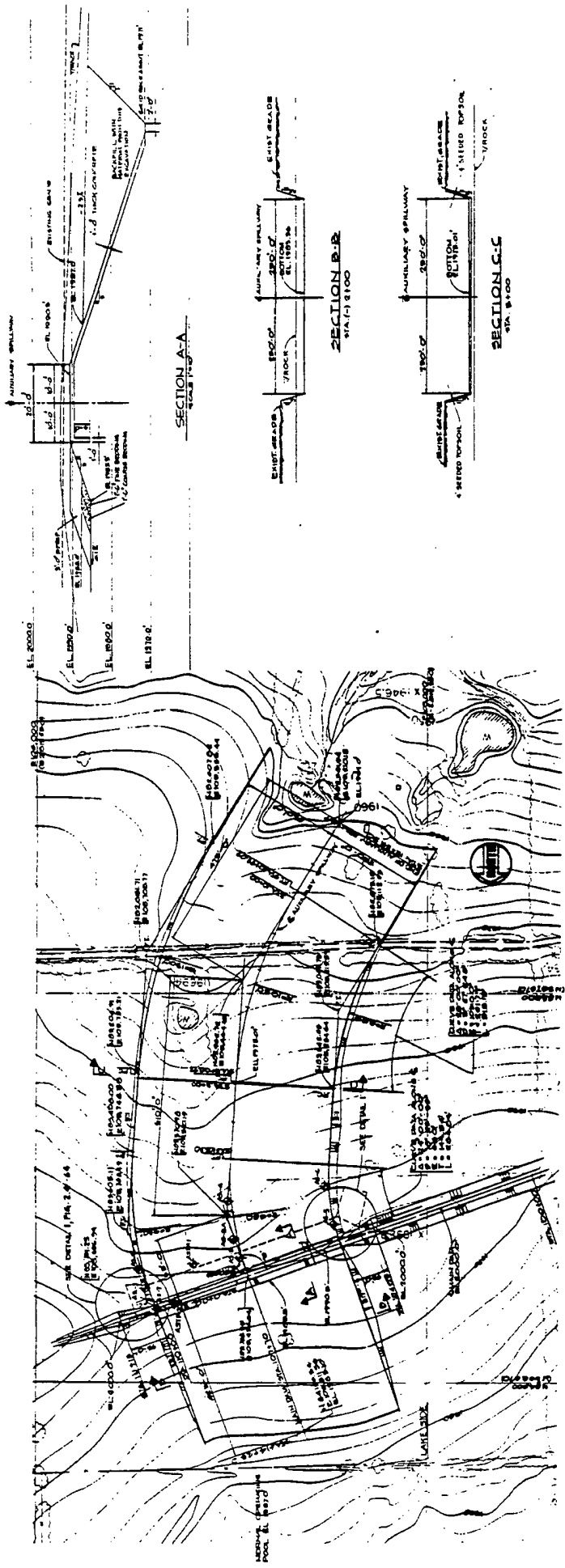

PLAN

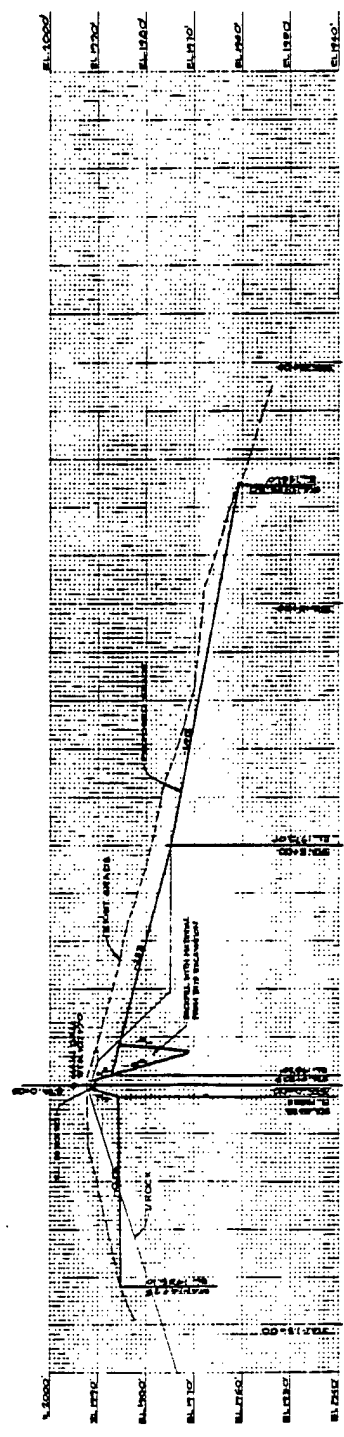

LONGITUDINAL PROFILE ALONG A-A

NOTE:
 ELEVATIONS SHOWN ARE MOUNTAIN ELEVATIONS.
 SUBTRACT 900 FEET TO OBTAIN U.S.A.S. MSL ELEVATIONS.

Rev. 0

WOLF CREEK
 UPDATED SAFETY ANALYSIS REPORT
 Figure 2.4-44 (Sheet 1 of 2)
 Auxiliary Spillway Plans



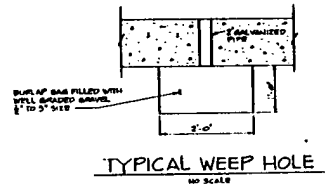
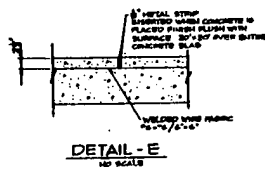
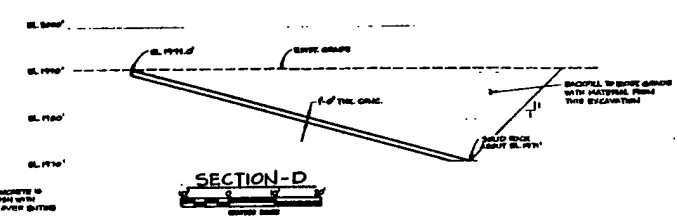
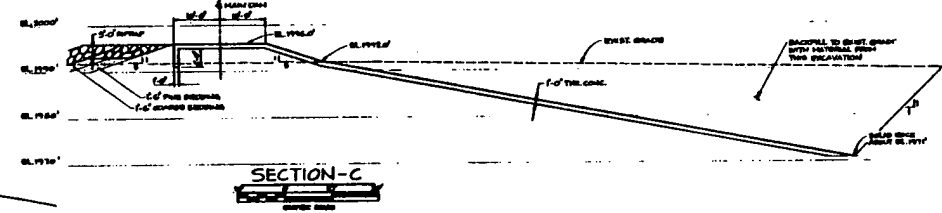
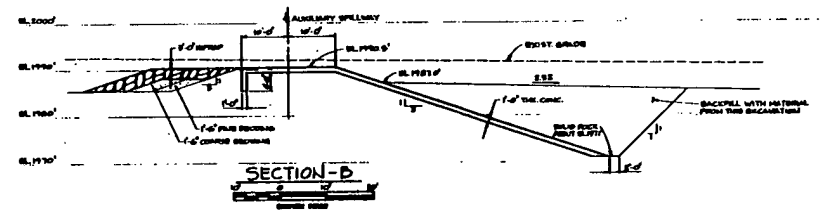
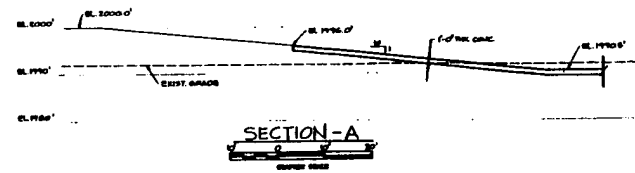
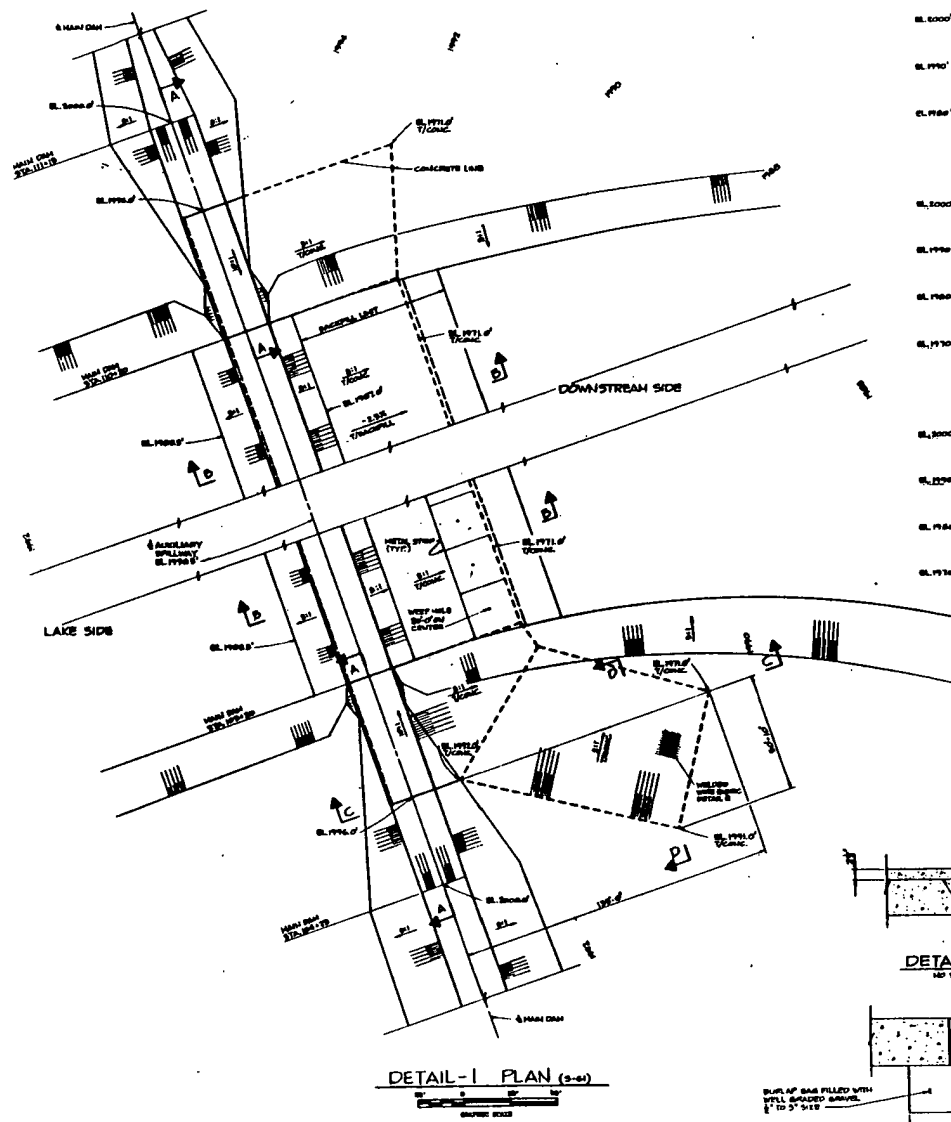

Rev. 0

**WOLF CREEK
UPDATED SAFETY ANALYSIS REPORT**

Figure 2.4-44 (Sheet 2 of 2)
Auxiliary Spillway Plans

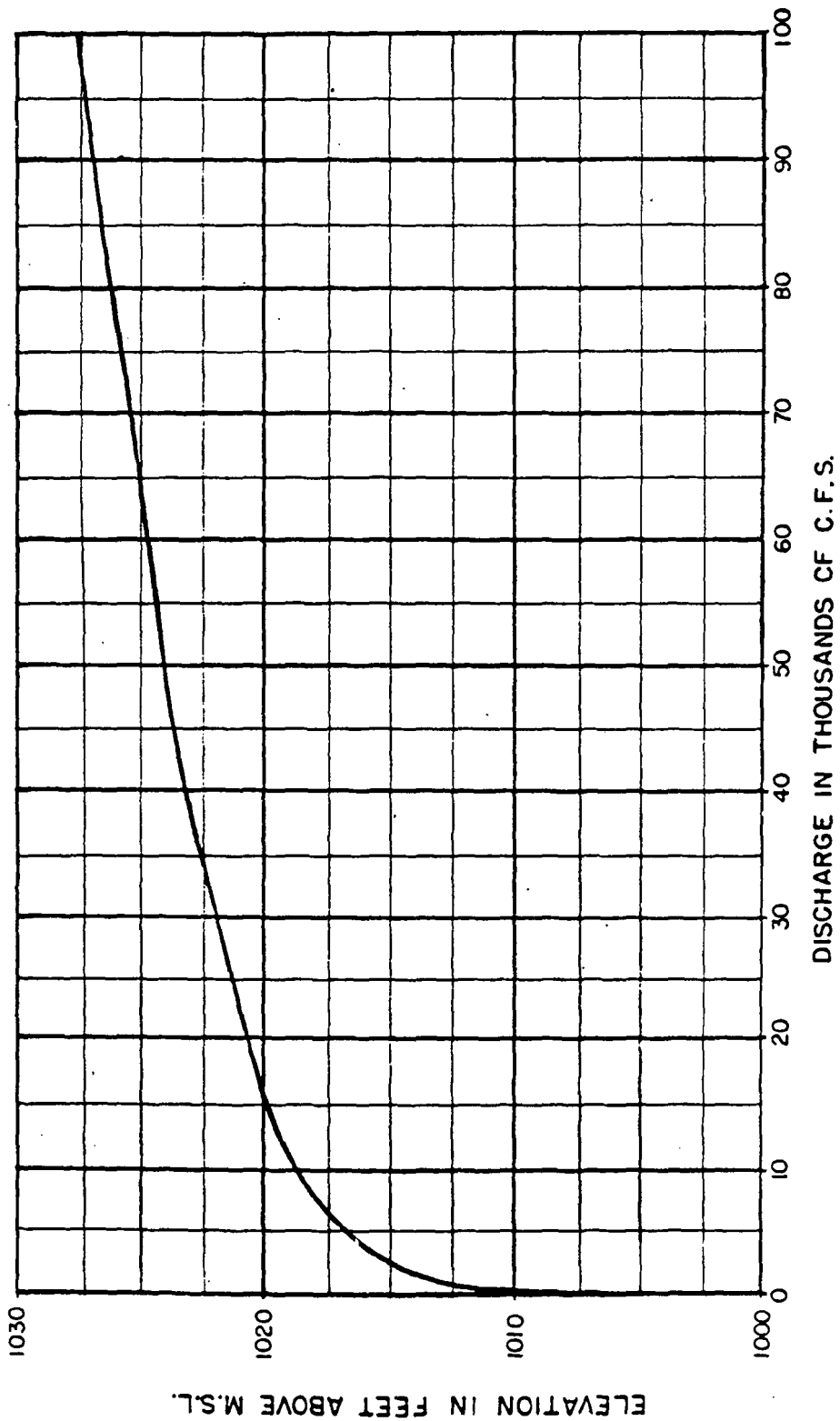

Rev. 0

**WOLF CREEK
UPDATED SAFETY ANALYSIS REPORT**

Figure 2.4-45

Tailwater Rating Curve, Wolf
Creek Dam

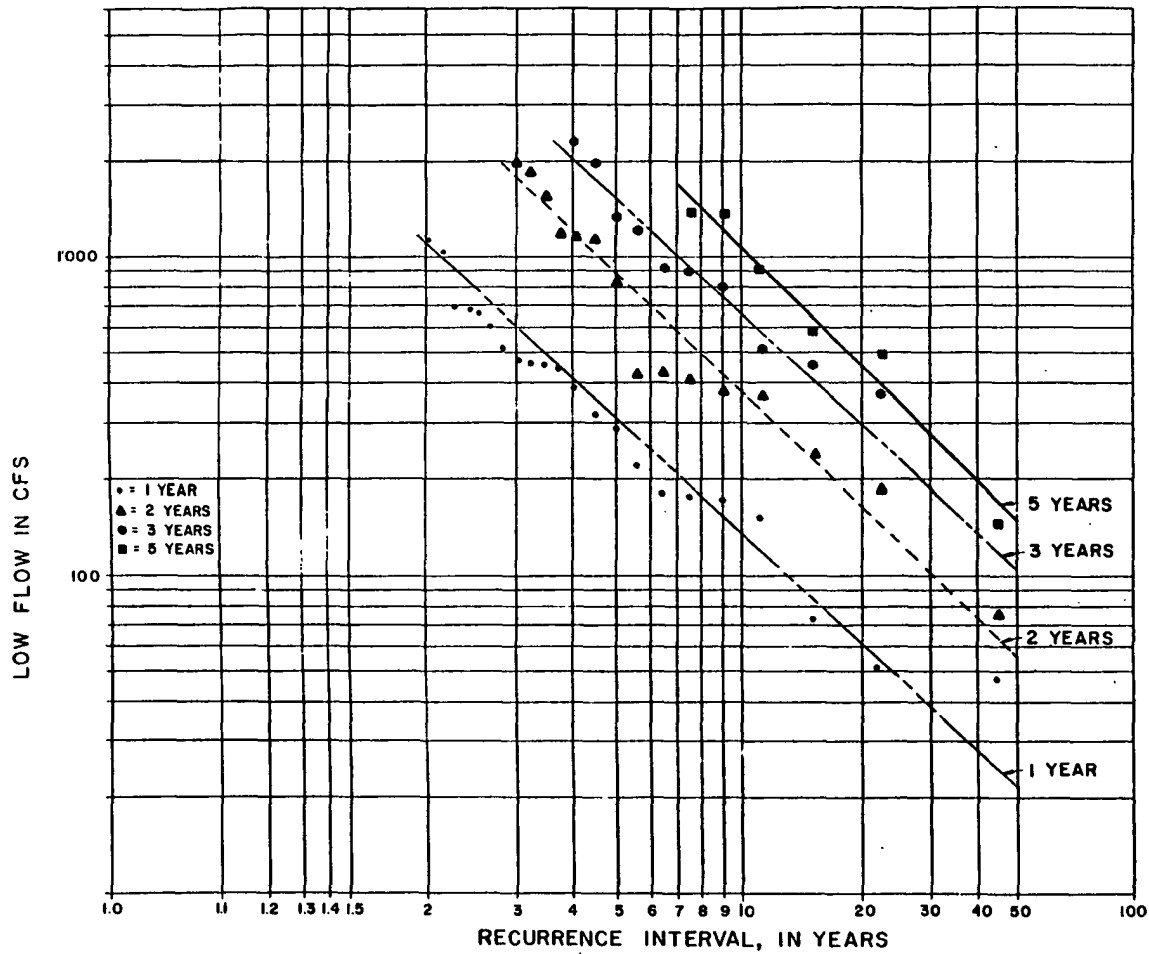

Rev. 0

**WOLF CREEK
UPDATED SAFETY ANALYSIS REPORT**

Figure 2.4-46

Low Flow Frequency Duration
Curves for Neosho River at John
Redmond Damsite

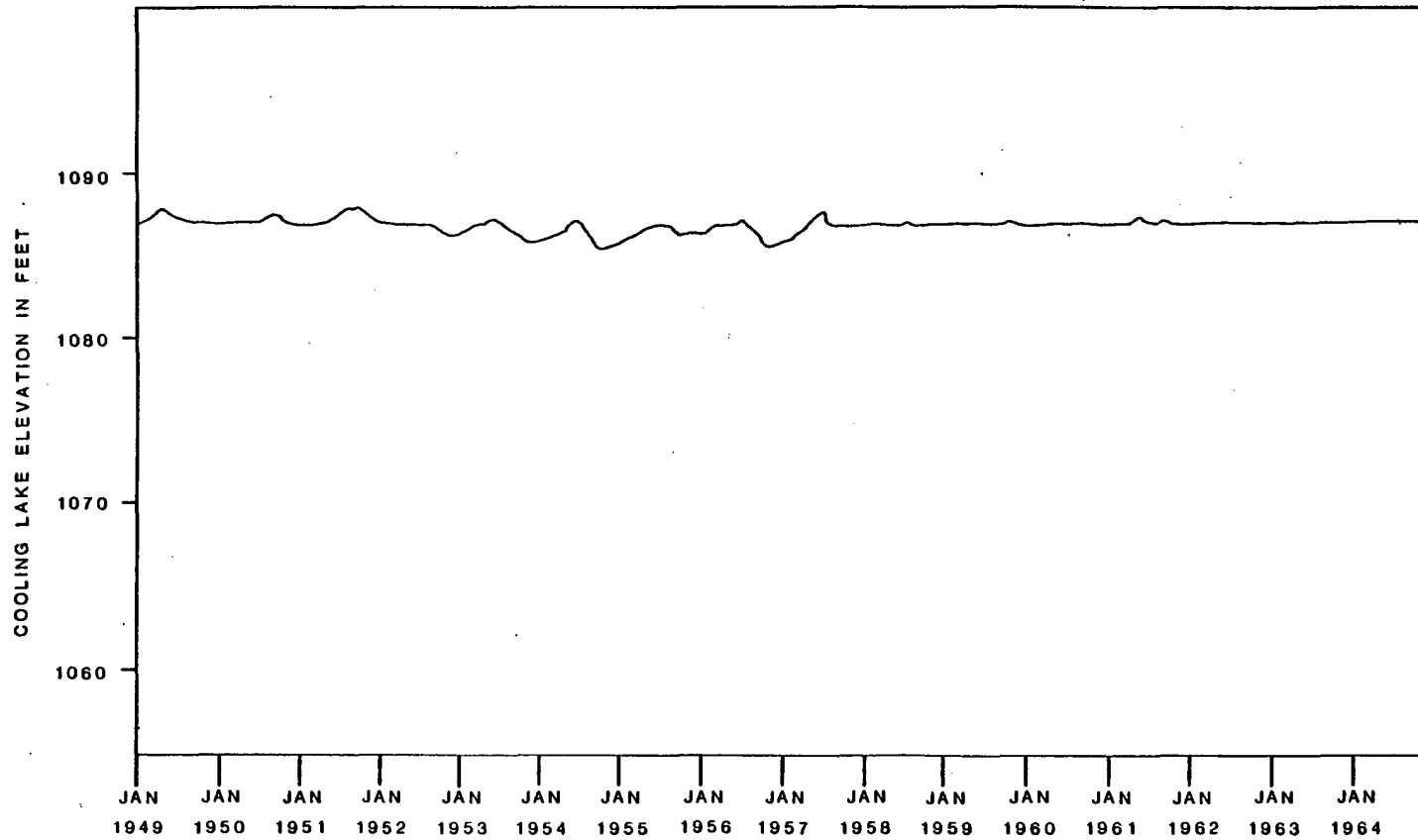

NOTE: ONE UNIT AT 100% AVERAGE ANNUAL LOAD FACTOR.

Rev. 0

<p>WOLF CREEK UPDATED SAFETY ANALYSIS REPORT</p>
<p>Figure 2.4-47 Simulated Cooling Lake Drawdown Analysis - 1951-1959</p>

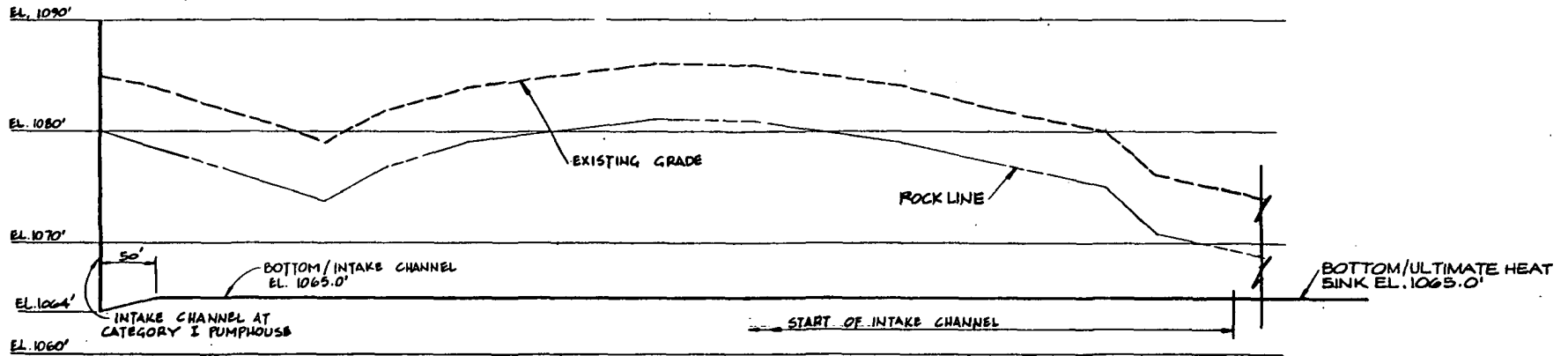

LONGITUDINAL SECTION

SCALE: HORIZONTAL 1"=100'-0"
VERTICAL 1"=10'-0"

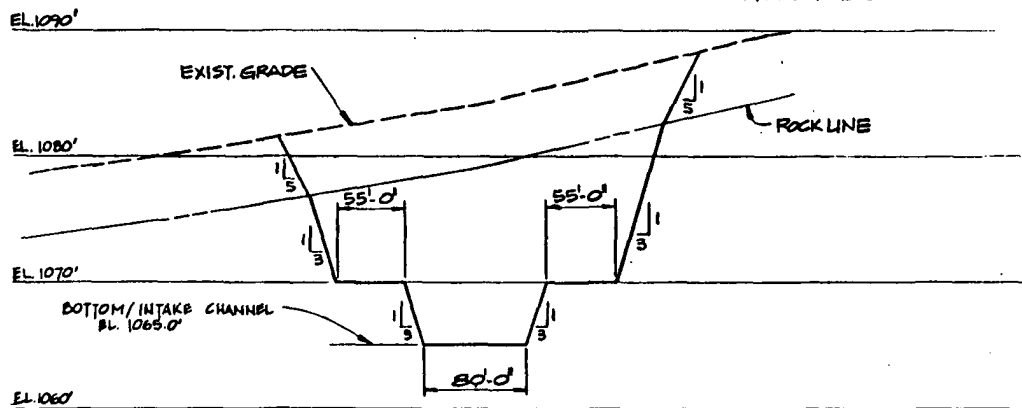

TRANSVERSE SECTION

SCALE: HORIZONTAL 1"=100'-0"
VERTICAL 1"=10'-0"

Rev. 0

WOLF CREEK
UPDATED SAFETY ANALYSIS REPORT

Figure 2.4-48

Ultimate Heat Sink, Intake
Channel Sections

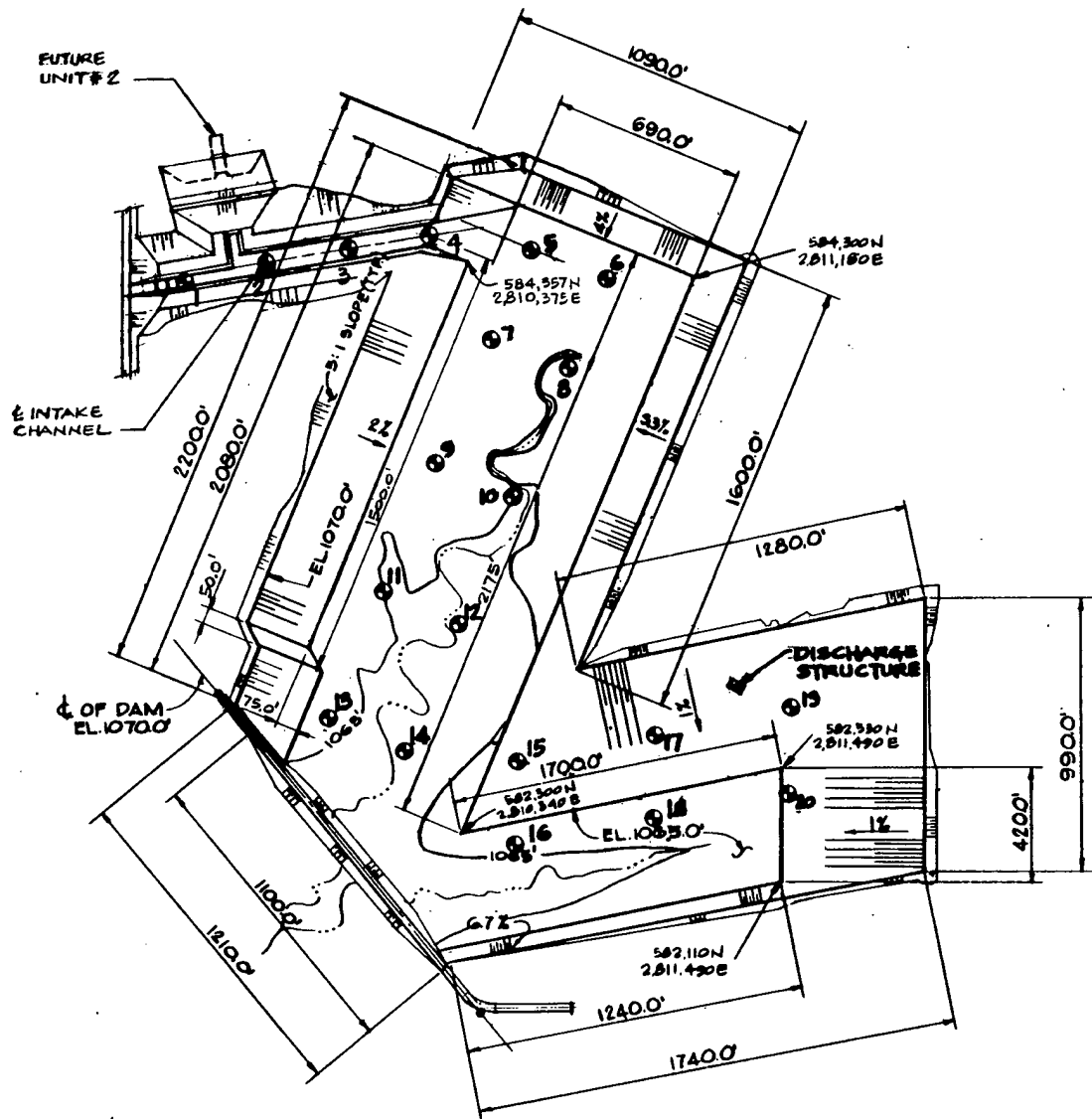

STA- TION	LOCATION	
	NORTH	EAST
1	584,298	2,809,338
2	584,361	2,809,632
3	584,405	2,809,929
4	584,448	2,810,226
5	584,415	2,810,580
6	584,300	2,810,860
7	584,060	2,810,430
8	583,950	2,810,695
9	583,610	2,810,230
10	583,490	2,810,510
11	583,150	2,810,045
12	583,030	2,810,320
13	582,655	2,809,850
14	582,565	2,810,120
15	582,530	2,810,530
16	582,225	2,810,520
17	582,630	2,811,017
18	582,520	2,811,015
19	582,730	2,811,510
20	582,420	2,811,500

⊙ - SOUNDING STATION



Rev. 0

**WOLF CREEK
UPDATED SAFETY ANALYSIS REPORT**

Figure 2.4-49

Location of Sounding Stations in
Ultimate Heat Sink

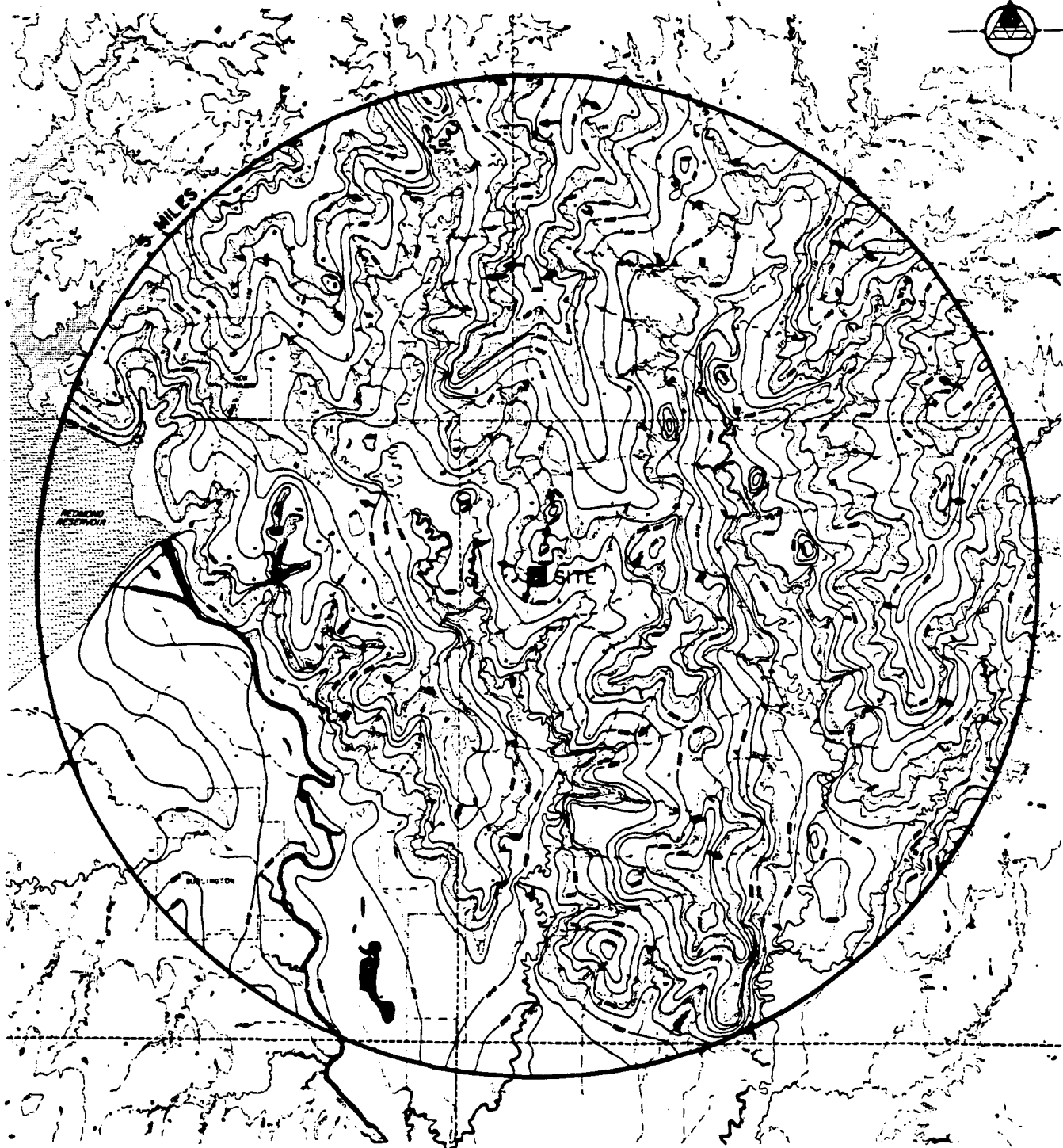
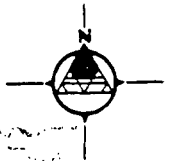

LEGEND:

- 1100- TOPOGRAPHIC CONTOURS (50 FOOT INTERVALS)
- 1000- WATER TABLE ELEVATION CONTOURS (10 FOOT INTERVAL FROM DATA GATHERED DURING WELL INVENTORY. (SEE TABLE 2.4-29).
- ↓ ARROWS SHOW DIRECTION OF GROUND-WATER FLOW.

REFERENCE:

FIFTY-FOOT TOPOGRAPHIC CONTOURS FROM U.S. GEOLOGICAL SURVEY QUADRANGLES FOR NEW STRAWN (1971); OTTUMWA (1970), WAVERLY SE (1971), ALICEVILLE (1971), BURLINGTON (1971) AND JOHN REDMOND DAM (1966); 7.5 MINUTE SERIES.

Rev. 0

**WOLF CREEK
UPDATED SAFETY ANALYSIS REPORT**

Figure 2.4-50

Water Table Contour Map within 5
Miles of the Site

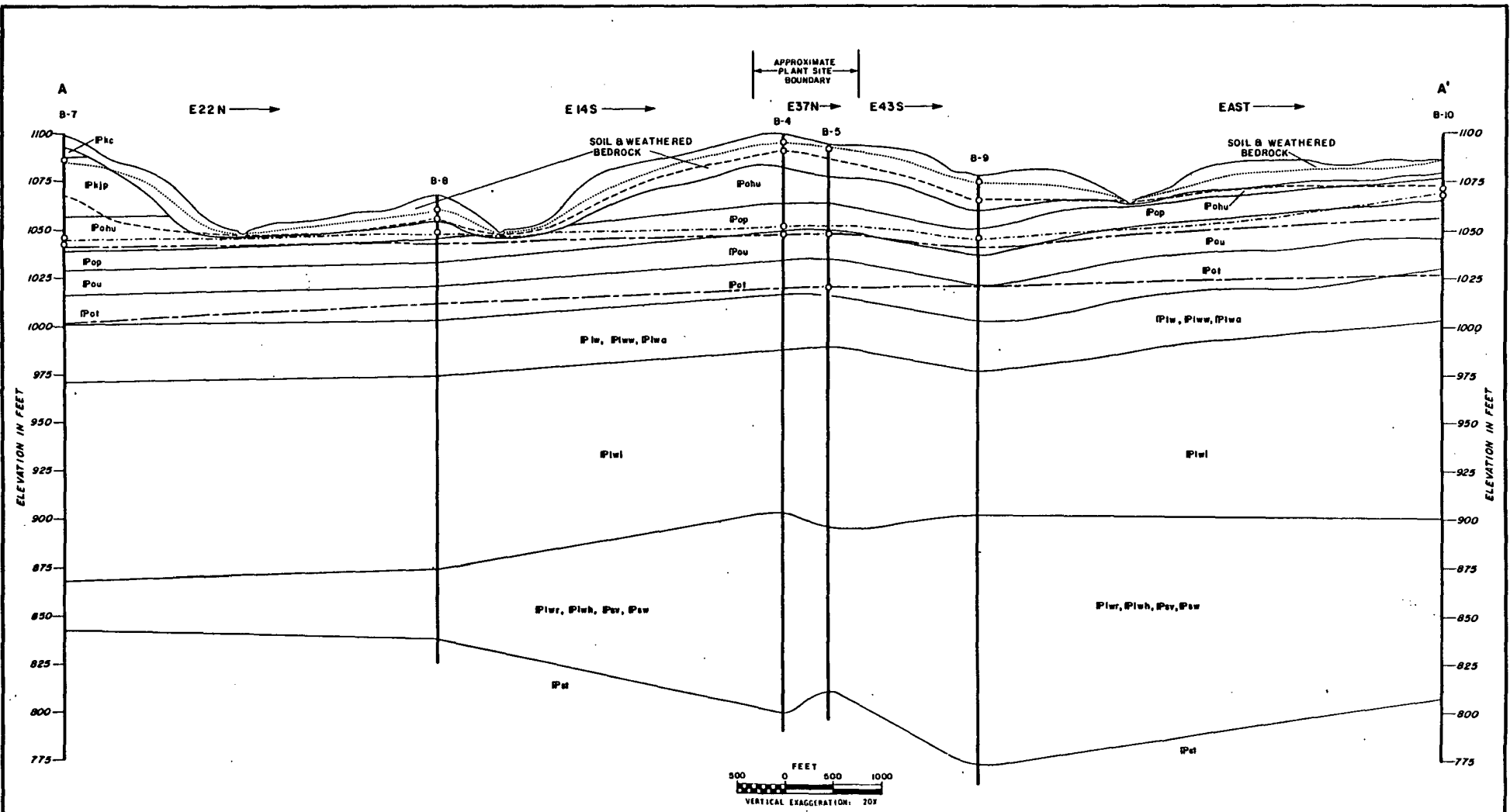

Rev. 0

- NOTES:**
- FIGURE 2.4-54 SHOWS LOCATION OF CROSS-SECTION A-A'
 - FIGURE 2.5-41 SHOWS DETAILED SITE STRATIGRAPHIC COLUMN.
 - TABLE 2.4-32 LISTS PIEZOMETER WATER LEVEL READINGS.
 - ELEVATIONS REFER TO USGS DATUM.
 - THE CROSS-SECTION AND WATER LEVELS SHOWN REPRESENT OUR EVALUATION OF THE MOST PROBABLE CONDITIONS BASED UPON INTERPRETATION OF PRESENTLY AVAILABLE DATA AND REVIEW OF INFORMATION PRESENTED IN FIGURES 2.4-52, 2.4-58, 2.4-59, 2.5-16a, 2.5-16b, 2.5-22, AND 2.5-23. HOWEVER, SOME VARIATION OF SUBSURFACE CONDITIONS BETWEEN BOREHOLES MUST BE EXPECTED.

- EXPLANATION:**
- O AVERAGE WATER LEVEL ELEVATION IN FEET (ALL AVERAGES FOR JUNE, 1974, EXCEPT B-7 AVERAGED FOR OCTOBER, 1973. B-7 NOT MONITORED AFTER OCTOBER, 1973.)
 - WATER TABLE
 - PLATTSMOUTH POTENTIOMETRIC SURFACE
 - TORONTO POTENTIOMETRIC SURFACE
 - IRELAND POTENTIOMETRIC SURFACE
 - TONGANOXIE POTENTIOMETRIC SURFACE

STRATIGRAPHIC COLUMN:

SYMBOL	STRATIGRAPHIC MEMBER	SYMBOL	STRATIGRAPHIC MEMBER
Pkc	CLAY CREEK LIMESTONE MEMBER	Plw	WILLIAMSBURG COAL BED
Pkjp	JACKSON PARK SHALE MEMBER	Plwa	ANAZONIA LIMESTONE MEMBER
Pahu	HELMADER SHALE MEMBER	Plvl	IRELAND SANDSTONE MEMBER
Pop	PLATTSMOUTH LIMESTONE MEMBER	Plvr	ROBBINS SHALE MEMBER
Pou	UNDIFFERENTIATED HEEBNER SHALE LEAVERMOUTH LIMESTONE AND SHADDEVILLE SHALE MEMBERS	Plvh	HASKELL LIMESTONE MEMBER
Pot	TORONTO LIMESTONE MEMBER	Psv	VINLAND SHALE MEMBER
Plw	UNNAMED LAWRENCE SHALE MEMBER	Plw	WESTPHALIA LIMESTONE MEMBER
		Pst	TONGANOXIE SANDSTONE MEMBER

**WOLF CREEK
UPDATED SAFETY ANALYSIS REPORT**

Figure 2.4-51

Generalized East-West Cross-Section through Plant Site
Showing Potentiometric Water Levels

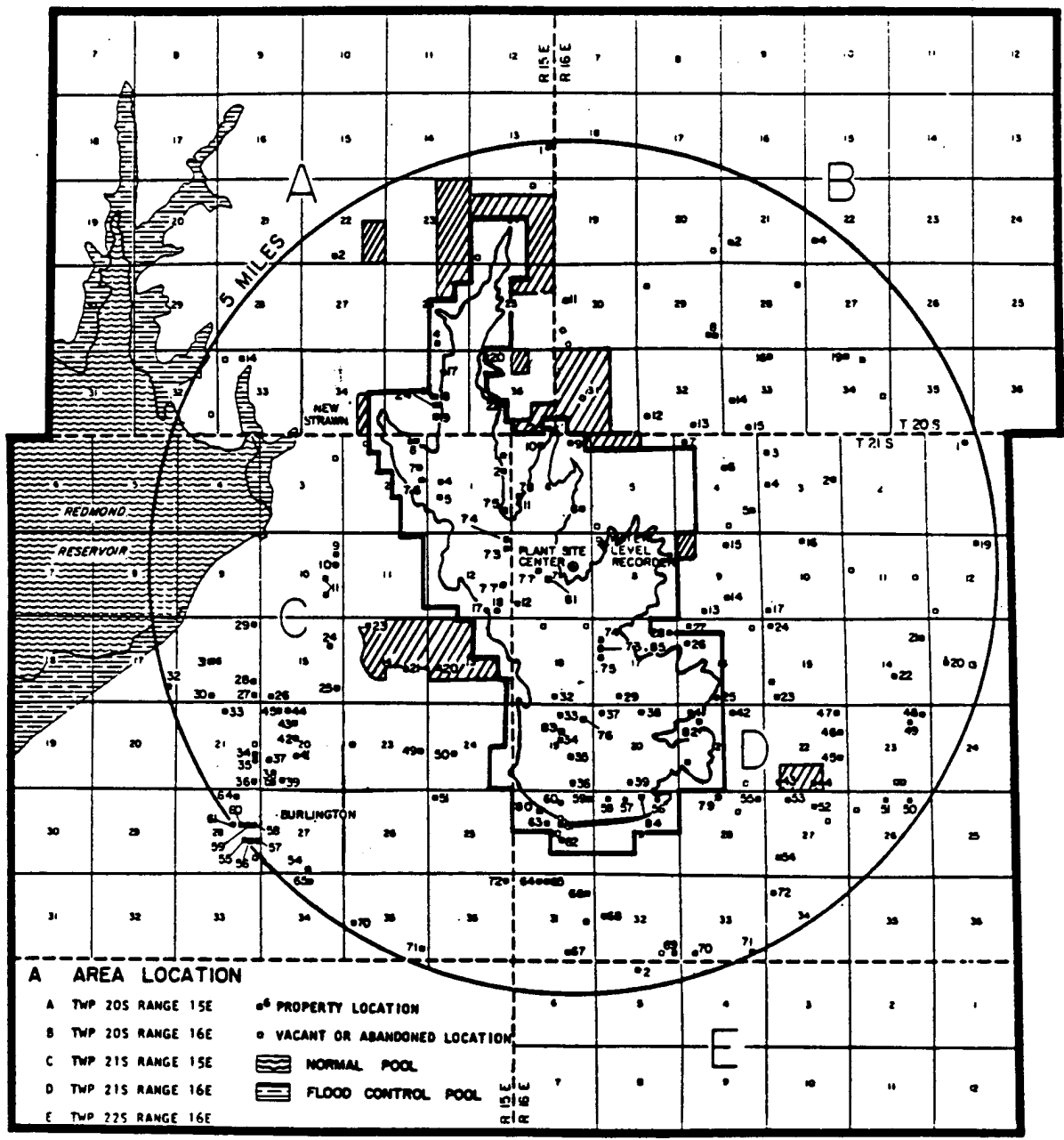

A AREA LOCATION

- | | |
|---------------------|--------------------------------|
| A TWP 20S RANGE 15E | ○ PROPERTY LOCATION |
| B TWP 20S RANGE 16E | ○ VACANT OR ABANDONED LOCATION |
| C TWP 21S RANGE 15E | ▨ NORMAL POOL |
| D TWP 21S RANGE 16E | ▨ FLOOD CONTROL POOL |
| E TWP 22S RANGE 16E | |



LEGEND:

- SITE BOUNDARY
- COOLING LAKE AT NORMAL OPERATING LEVEL (1087 FEET)
- AREA OUTSIDE SITE BOUNDARY OWNED BY APPLICANTS

Rev. 0

**WOLF CREEK
UPDATED SAFETY ANALYSIS REPORT**

Figure 2.4-52

Well Inventory within 5 Miles
Relative to Cooling Lake and
Property Boundary

REFERENCE:

GENERAL HIGHWAY MAP OF COFFEY COUNTY,
KANSAS; PREPARED BY THE KANSAS STATE
HIGHWAY DEPARTMENT.
FIGURES 2.1-3, 2.4-52, 2.5-2 (FSAR).

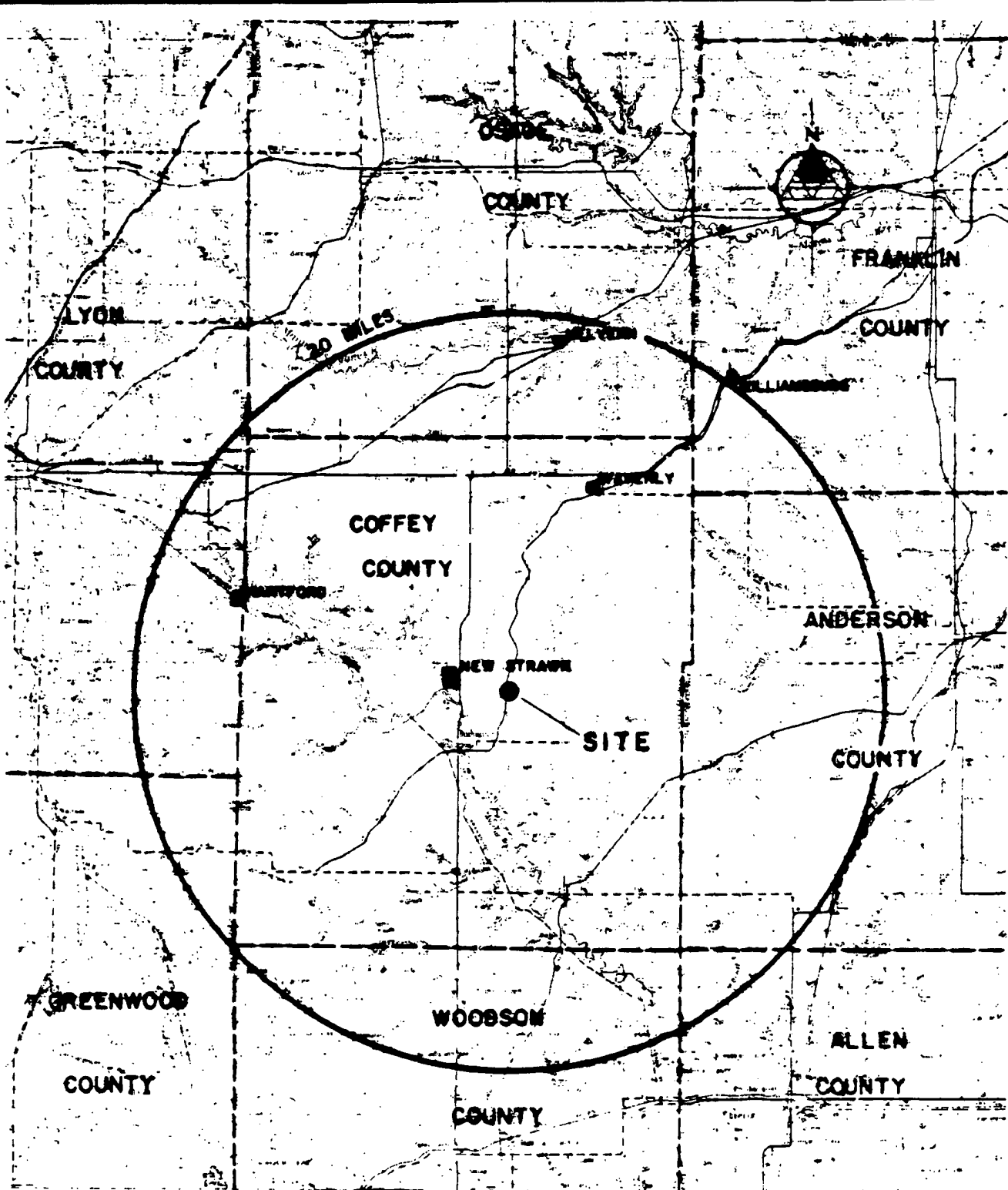

**WOLF CREEK
UPDATED SAFETY ANALYSIS REPORT**

Figure 2.4-53

Municipal Ground-Water Supplies
within 20 Miles of the Site

Rev. 0

REFERENCE:
 BASED ON U. S. G. S. TOPOGRAPHIC QUADRANGLES;
 HUTCHINSON, KANSAS - 1955
 JOPLIN, MISSOURI: KANSAS - 1954
 LAWRENCE, KANSAS: MISSOURI - 1956
 WICHITA, KANSAS - 1955

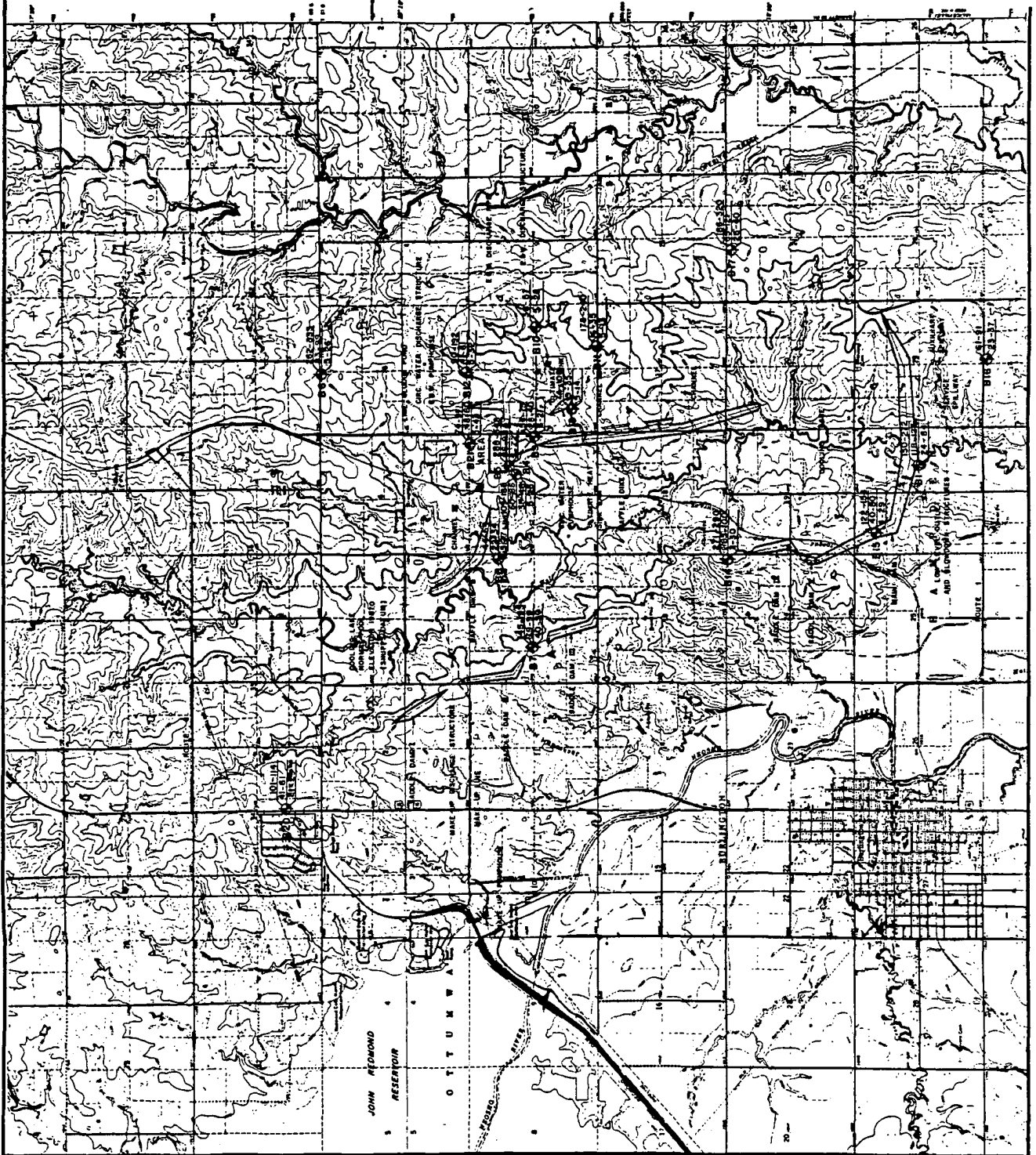

WOLF CREEK
 UPDATED SAFETY ANALYSIS REPORT
 Figure 2.4-54
 Location of Piezometers, B-Series
 Borings
 Rev. 0

GENERAL MANAGEMENT, WOLF CREEK GENERATING STATION UNIT 1
 SARASOTA GAS AND ELECTRIC COMPANY AND SARASOTA CITY POWER AND LIGHT COMPANY
 SARASOTA, FLORIDA
 DATE: 12/17/78
 MAP BASE PREPARED FROM U.S.G.S. TOPOGRAPHIC QUADRANGLES, 7.5' SERIES, WASHINGTON,
 DISTRICT OF COLUMBIA, 1961, JOHN REDMOND DAM, SARASOTA, 1964; NEW STATION, SARASOTA, 1971; OTTUMWA,
 SARASOTA, 1974.

EXPLANATION:
 B-ID ————
 ———— DEPTH TO TOP OF EFFECTIVE INTERVAL
 ———— DEPTH TO BOTTOM OF EFFECTIVE INTERVAL
 NOTE:
 CROSS-SECTION A-A' SHOWN ON FIGURE 2.4-51.

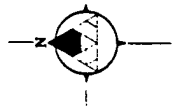

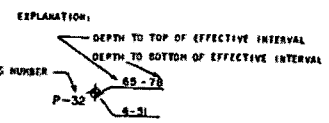
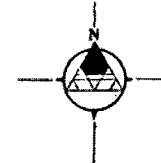
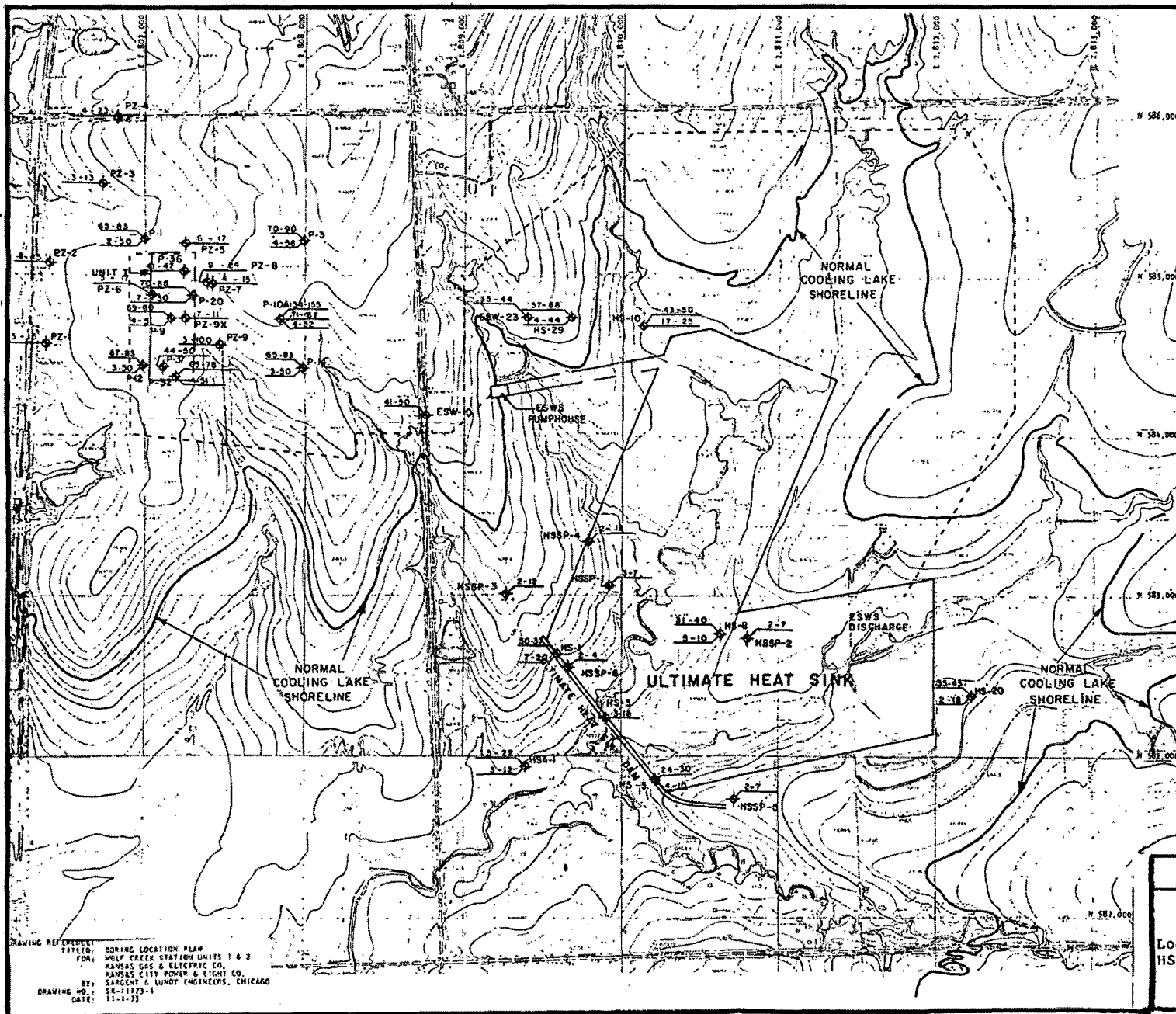

- NOTES:**
1. INTERVAL DEPTHS FOR ESW-, HS-, AND P SERIES PIEZOMETERS GIVEN TO NEAREST FOOT.
 2. INTERVAL SHOWN FOR P2 AND HSSP BORINGS SPECIFY DEPTHS TESTED BY FIELD PIEZOMETER TESTS BORING OR SUBSEQUENT TO INSTALLING. NO PIEZOMETER CURRENTLY ARE AT THESE LOCATIONS.
 3. FIGURE 2.5-98 SHIT. 2 SHOWS THE LOCATION OF B-100-SERIES BORING DRILLED FOR THE REPLACEMENT ESWS PIPING.

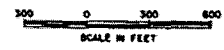

Rev. 28

**WOLF CREEK
 UPDATED SAFETY ANALYSIS REPORT**

Figure 2.4-55

Location of Piezometers, ESW-,
 HS-, and P-Series Borings

DRAWING REFERENCES:

TITLED: BORING LOCATION PLAN
 FOR: WOLF CREEK STATION UNITS 1 & 2
 KANSAS GAS & ELECTRIC CO.
 KANSAS CITY POWER & LIGHT CO.
 BY: SARGENT & LUNDY ENGINEERS, CHICAGO
 DRAWING NO.: SK-1173-1
 DATE: 11-1-73

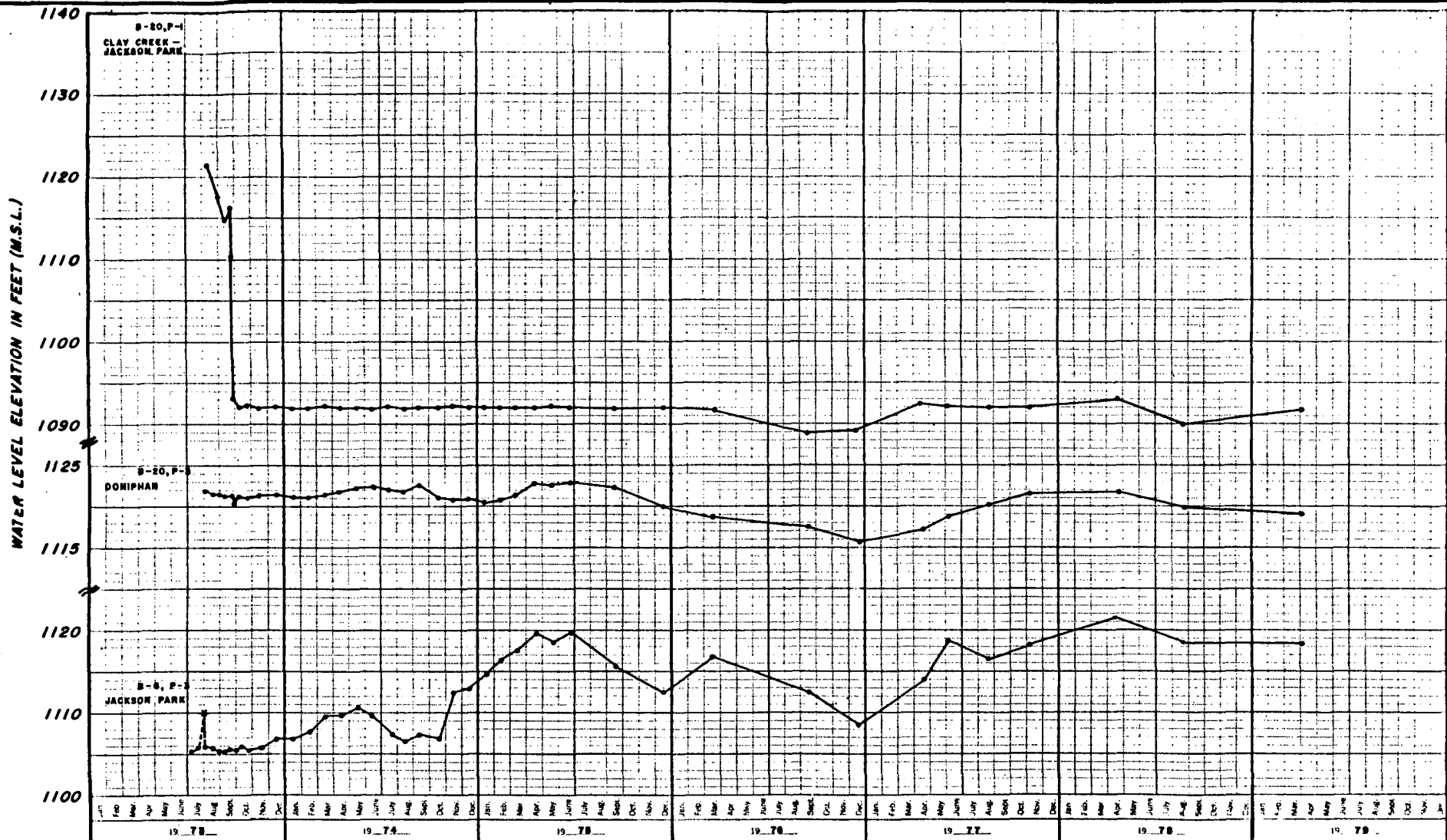

* THIS PORTION OF HYDROGRAPH NOT SHOWN.
SEE TABLES 2.4-32 AND 2.4-33.

**WOLF CREEK
UPDATED SAFETY ANALYSIS REPORT**
Figure 2.4-56 (Sheet 1 of 18)
Variations of Water Levels in
Piezometers
Rev. 0

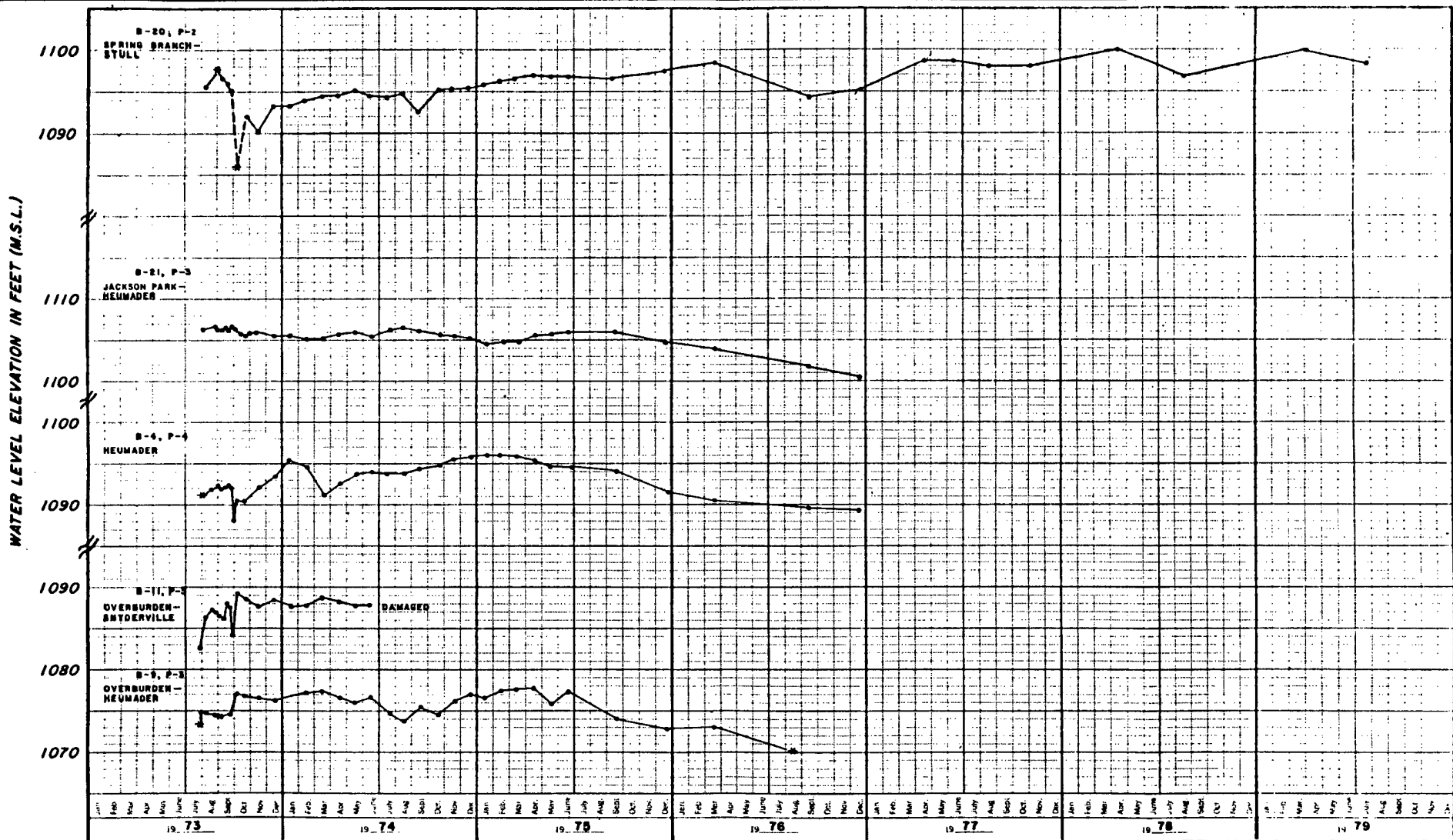

**WOLF CREEK
UPDATED SAFETY ANALYSIS REPORT**

Figure 2.4-56 (Sheet 2 of 18)

Variations of Water Levels in
Piezometers

Rev. 0

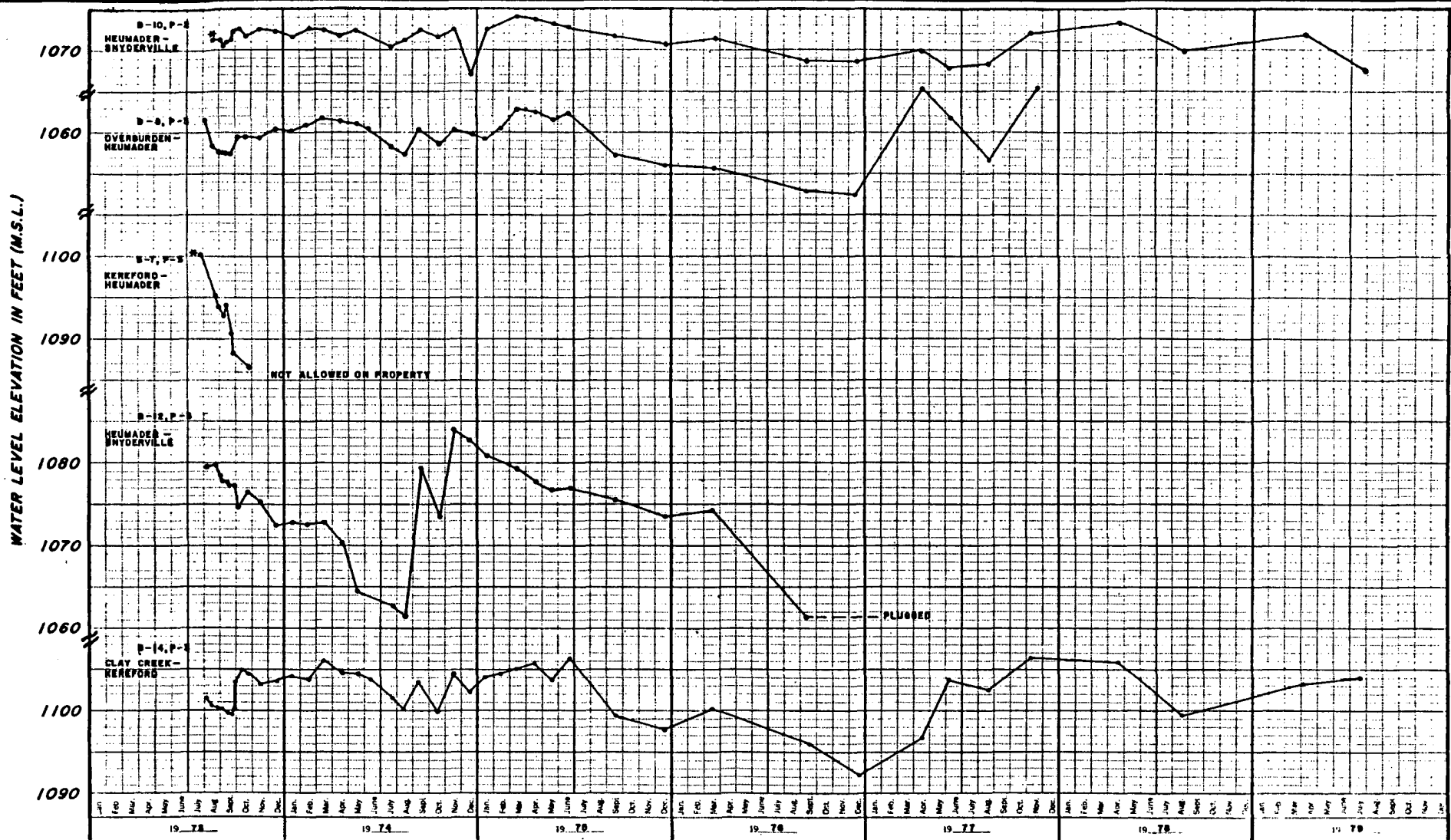

**WOLF CREEK
UPDATED SAFETY ANALYSIS REPORT**

Figure 2.4-56 (Sheet 3 of 18)

Variations of Water Levels in
Piezometers

Rev. 0

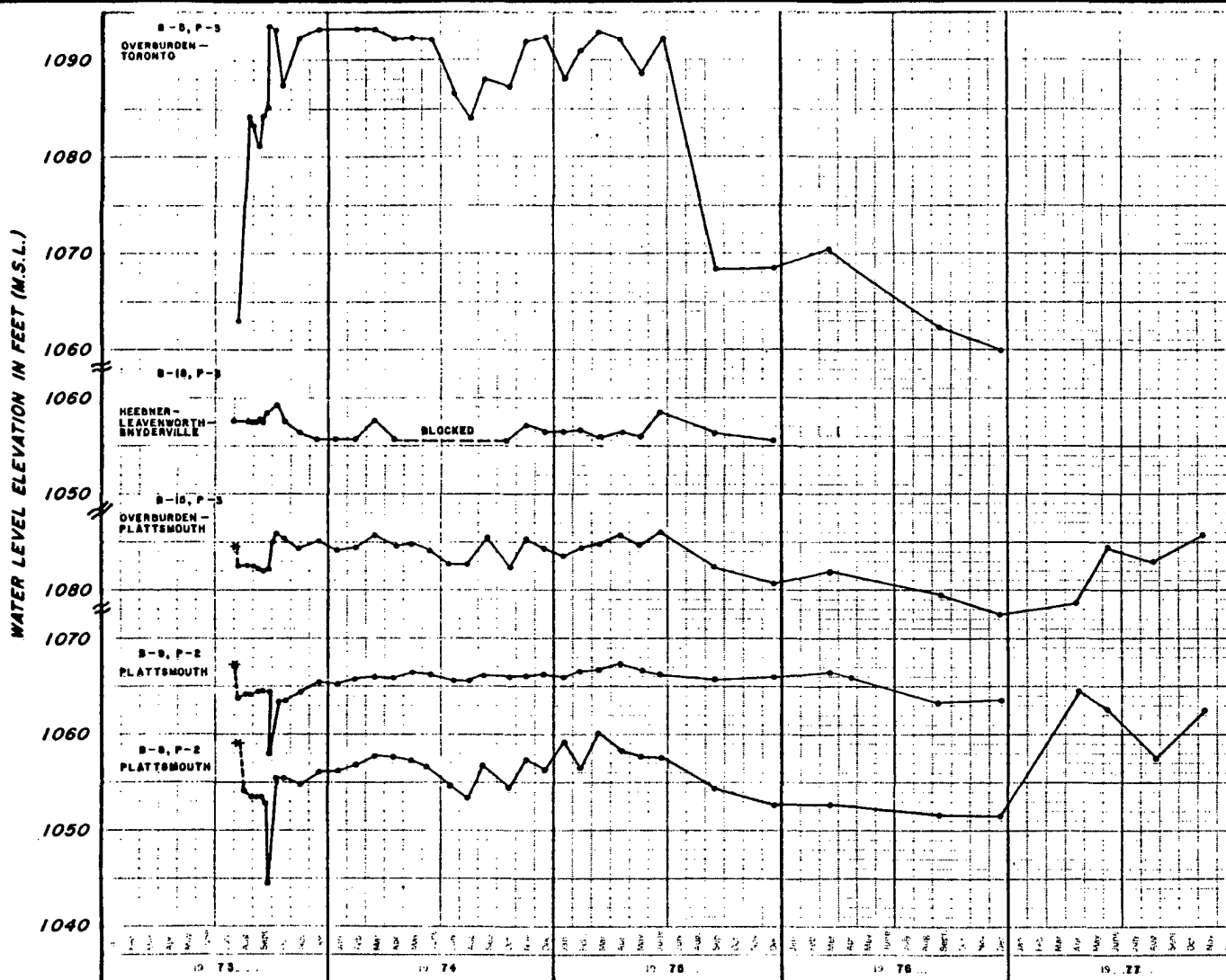

Rev. 0

WOLF CREEK
UPDATED SAFETY ANALYSIS REPORT

Figure 2.4-56 (Sheet 4 of 18)

Variations of Water Levels in
Piezometers

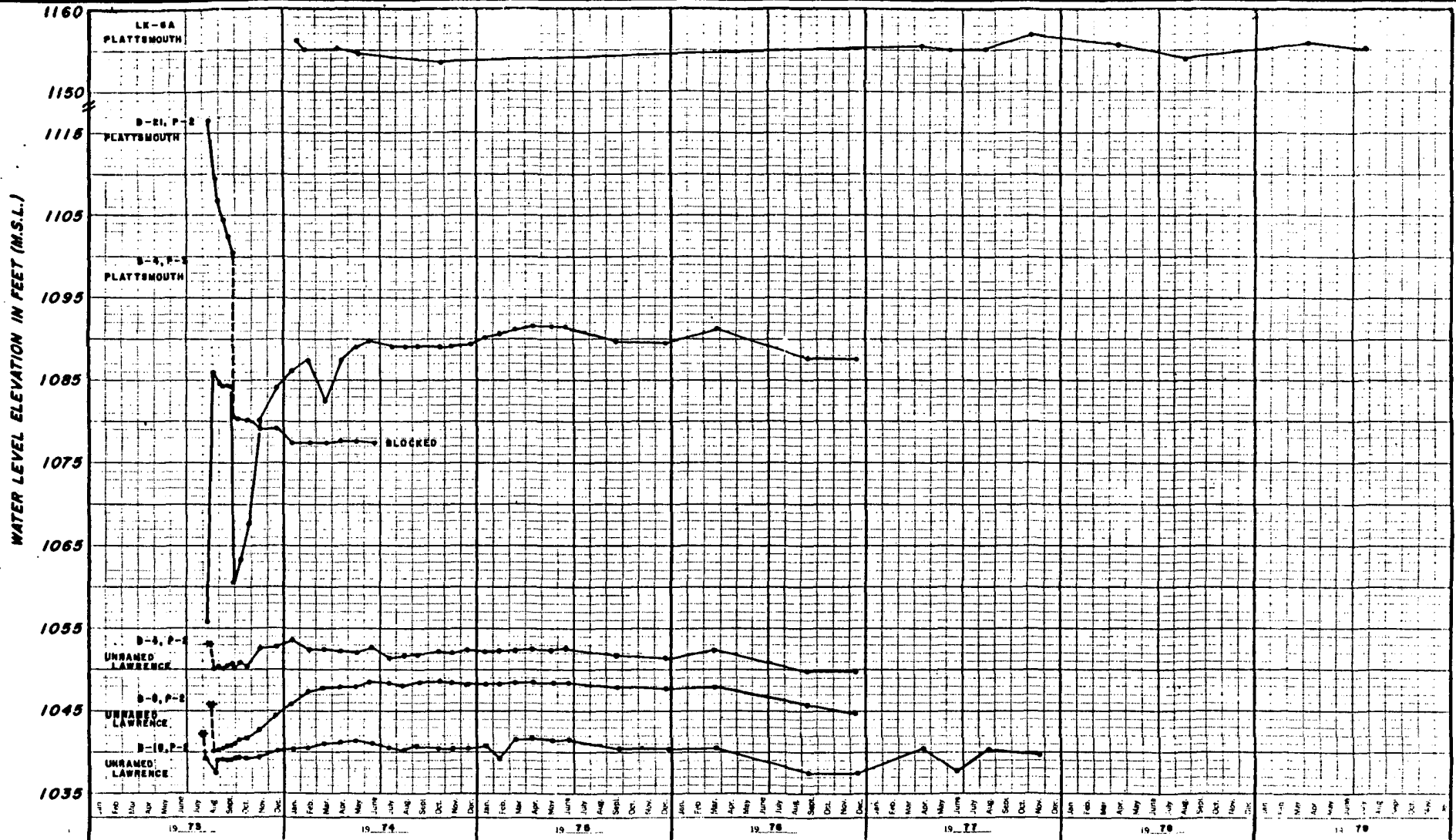

WOLF CREEK
 UPDATED SAFETY ANALYSIS REPORT
 Figure 2.4-56 (Sheet 5 of 18)
 Variations of Water Levels in
 Piezometers
 Rev. 0

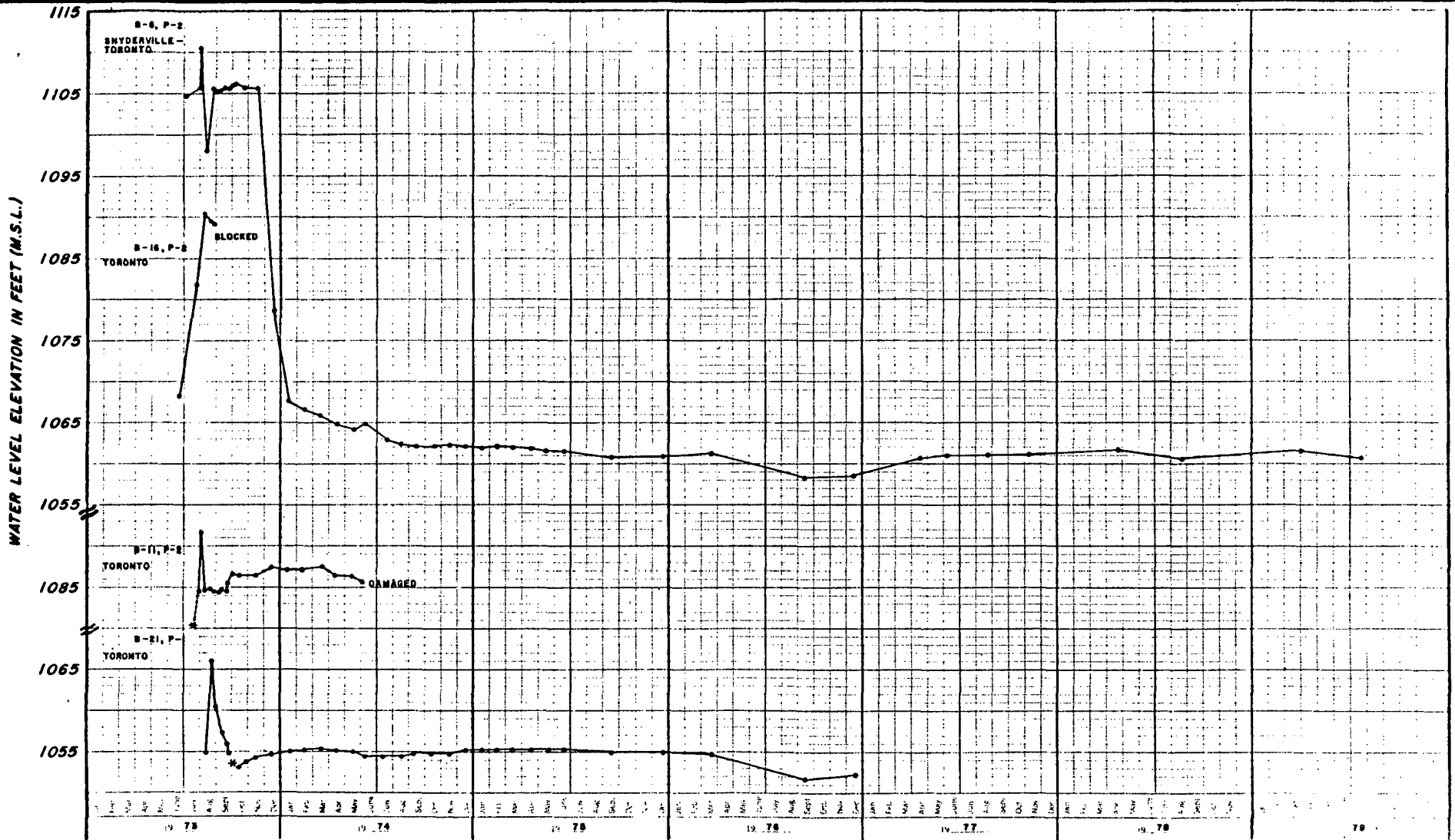

**WOLF CREEK
UPDATED SAFETY ANALYSIS REPORT**

Figure 2.4-56 (Sheet 6 of 18)

Variations of Water Levels in
Piezometers

Rev. 0

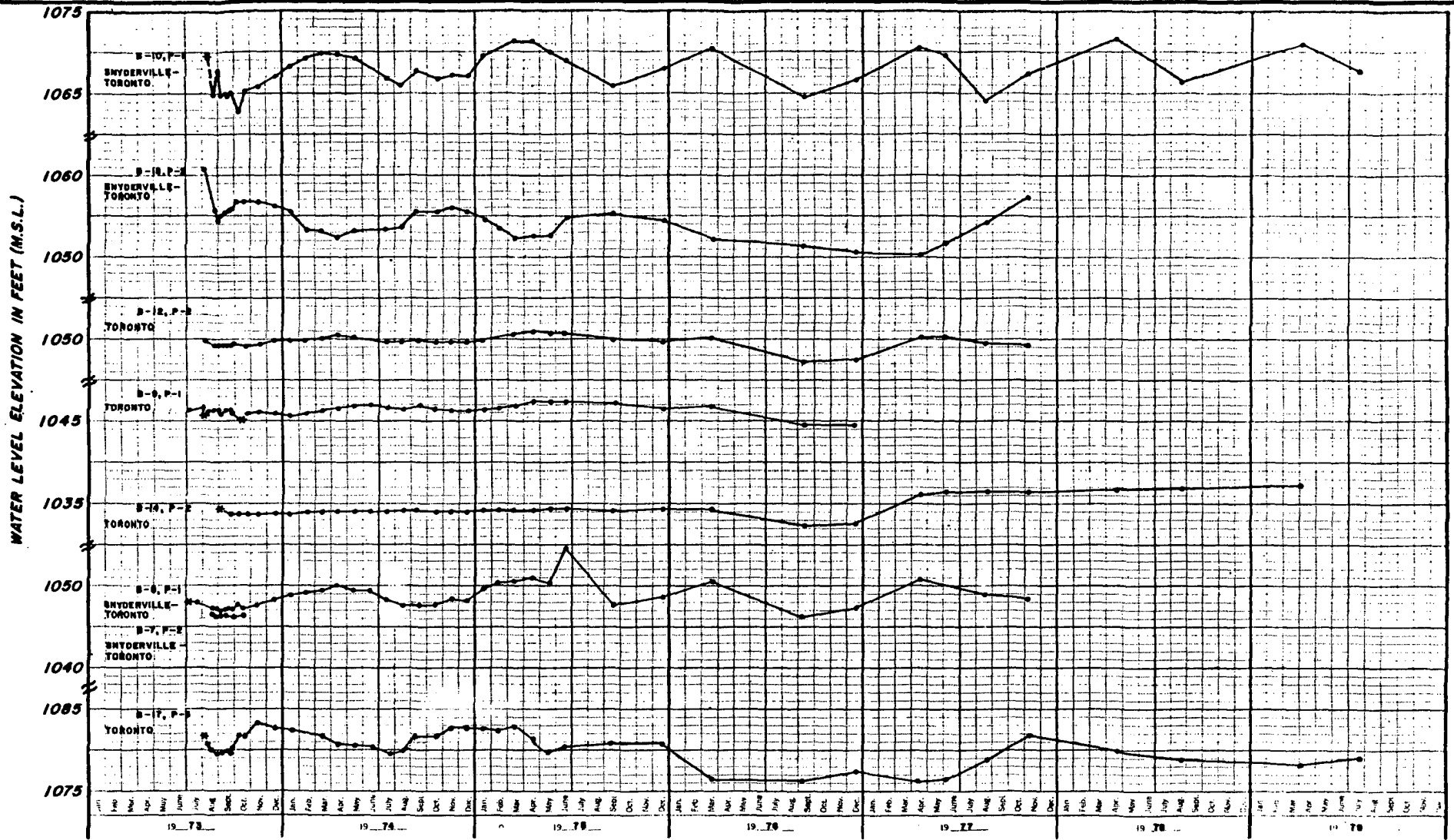

**WOLF CREEK
UPDATED SAFETY ANALYSIS REPORT**

Figure 2.4-56 (Sheet 7 of 18)

Variations of Water Levels in
Piezometers

Rev. 0

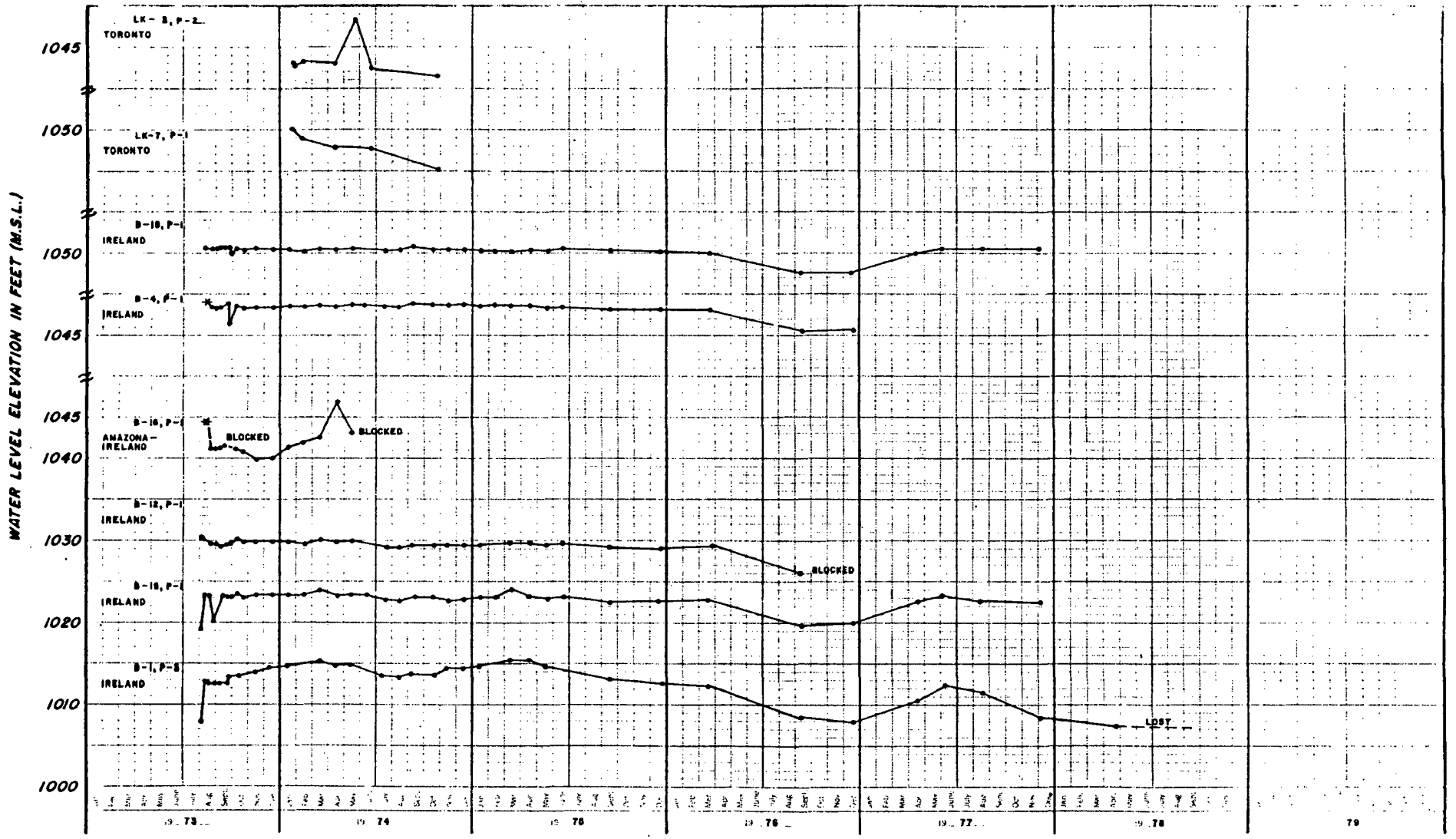

WOLF CREEK
 UPDATED SAFETY ANALYSIS REPORT
 Figure 2.4-56 (Sheet 8 of 18)
 Variations of Water Levels in
 Piezometers
 Rev. 0



**WOLF CREEK
UPDATED SAFETY ANALYSIS REPORT**

Figure 2.4-56 (Sheet 9 of 18)

Variations of Water Levels in
Piezometers

Rev. 0



**WOLF CREEK
UPDATED SAFETY ANALYSIS REPORT**

Figure 2.4-56 (Sheet 10 of 18)

Variations of Water Levels in
Piezometers

Rev. 0

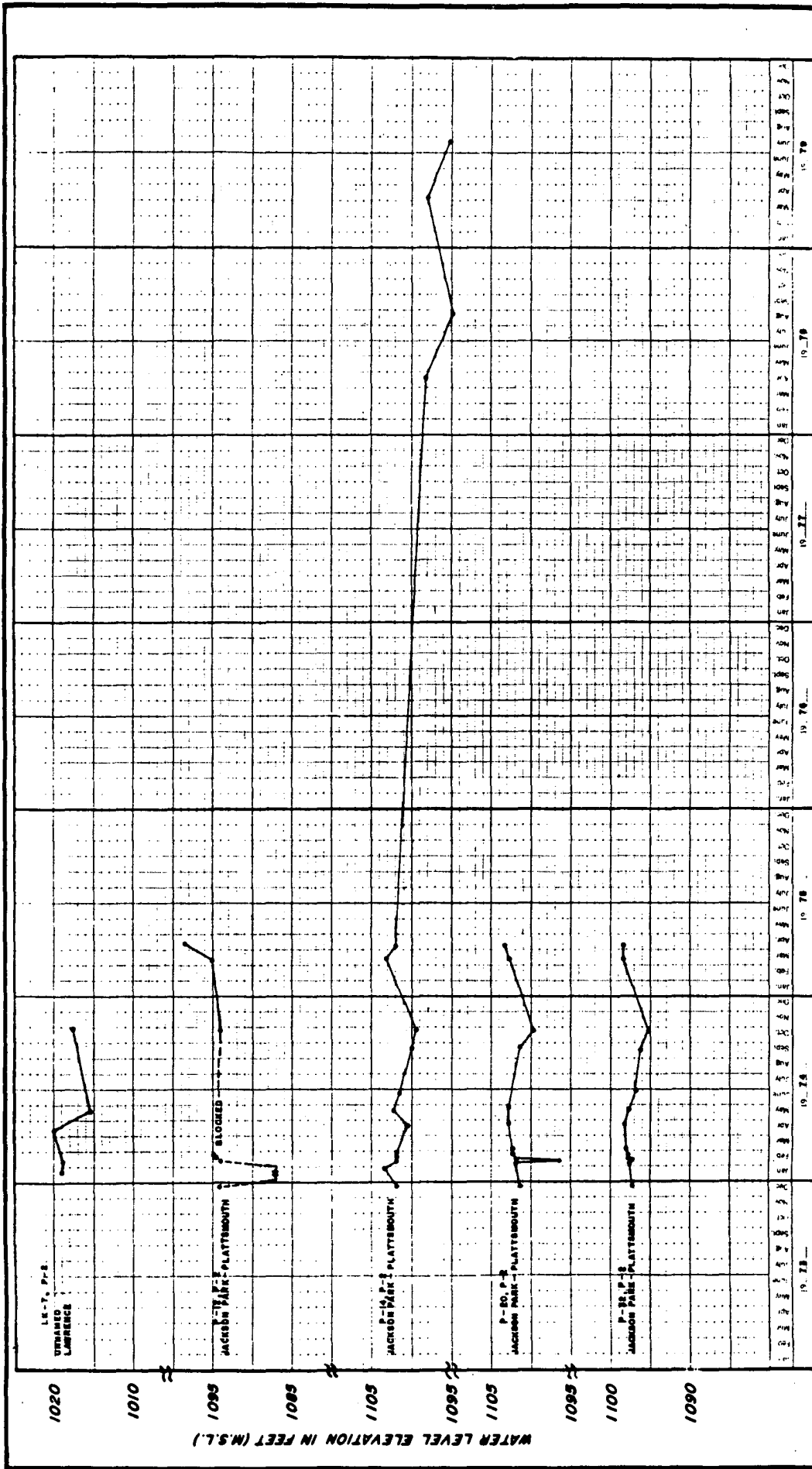

WOLF CREEK
UPDATED SAFETY ANALYSIS REPORT
 Figure 2.4-56 (Sheet 11 of 18)
 Variations of Water Levels in
 Piezometers
 Rev. 0

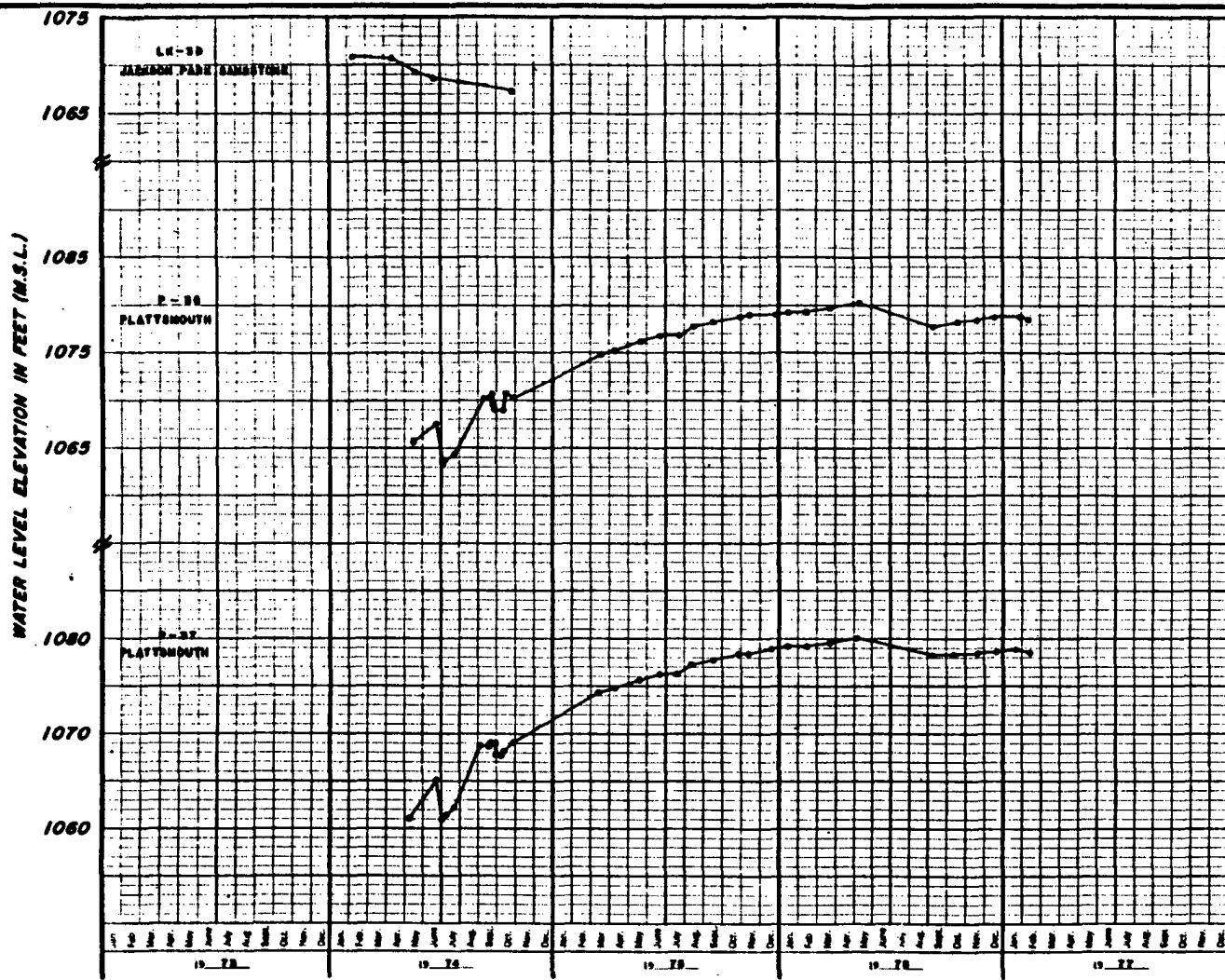

**WOLF CREEK
UPDATED SAFETY ANALYSIS REPORT**

Figure 2.4-56 (Sheet 12 of 18)

Variations of Water Levels in
Piezometers

Rev. 0

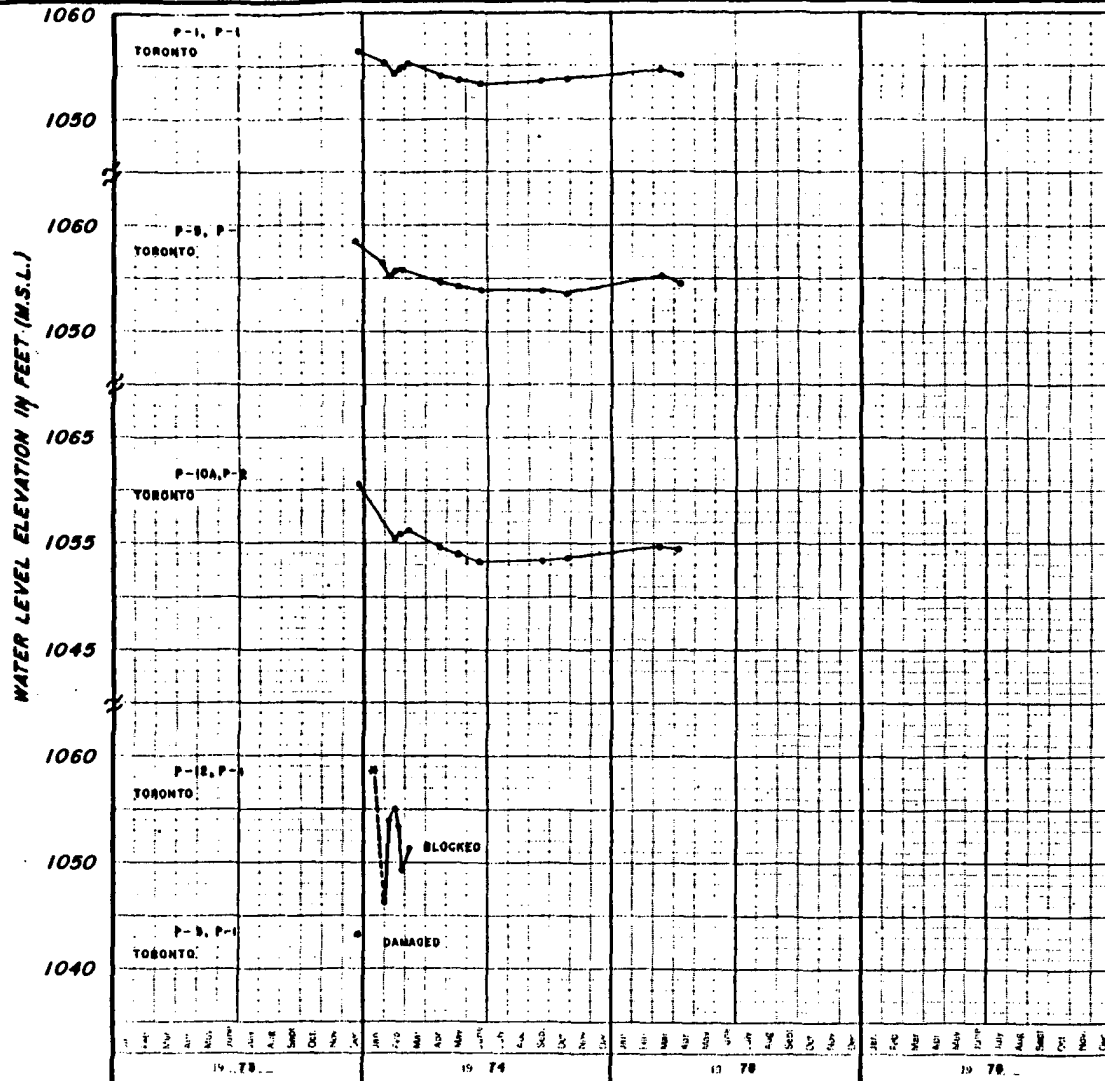

**WOLF CREEK
UPDATED SAFETY ANALYSIS REPORT**

Figure 2.4-56 (Sheet 13 of 18)

Variations of Water Levels in
Piezometers

Rev. 0

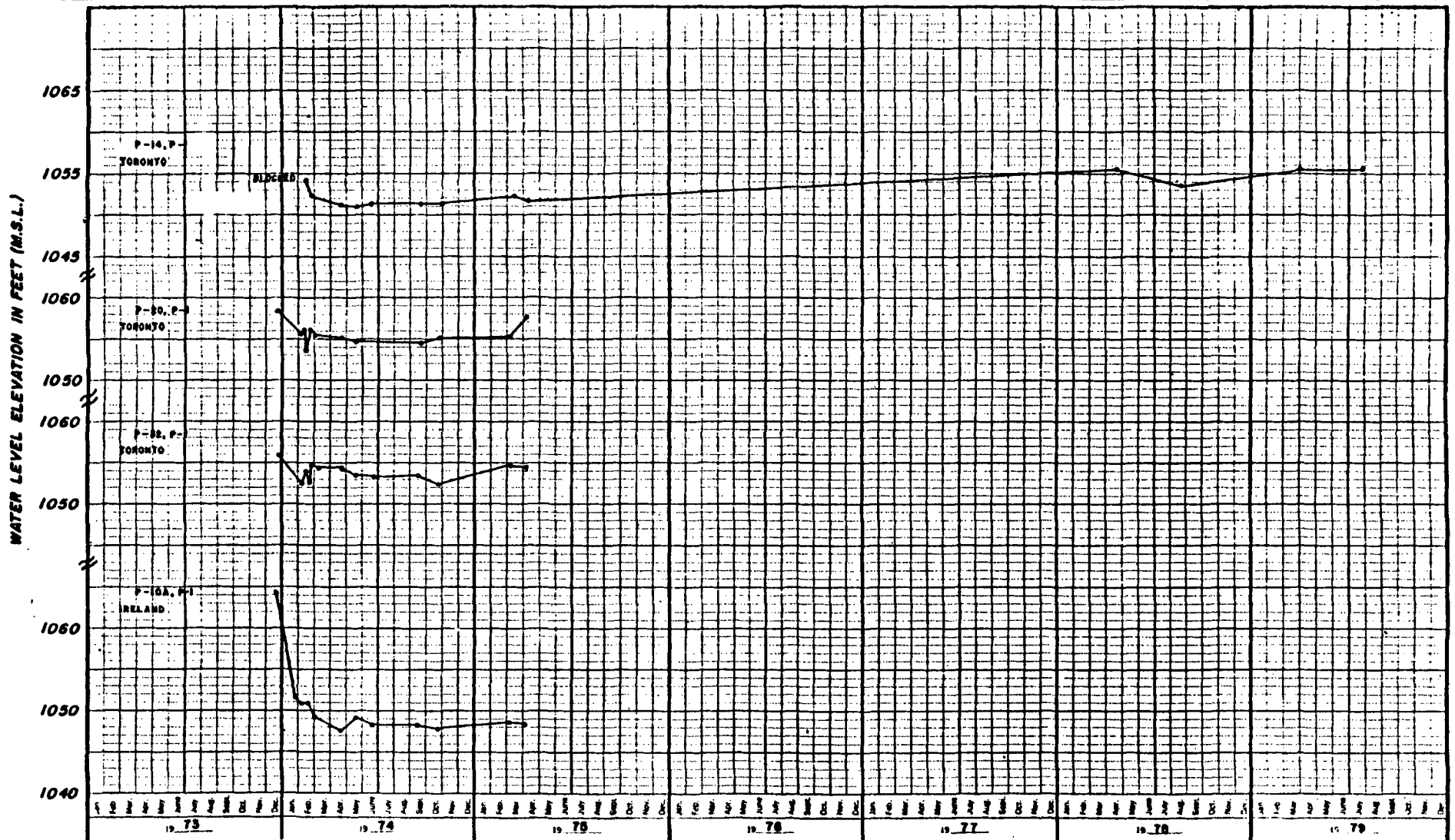

**WOLF CREEK
UPDATED SAFETY ANALYSIS REPORT**

Figure 2.4-56 (Sheet 14 of 18)

Variations of Water Levels in
Piezometers

Rev. 0

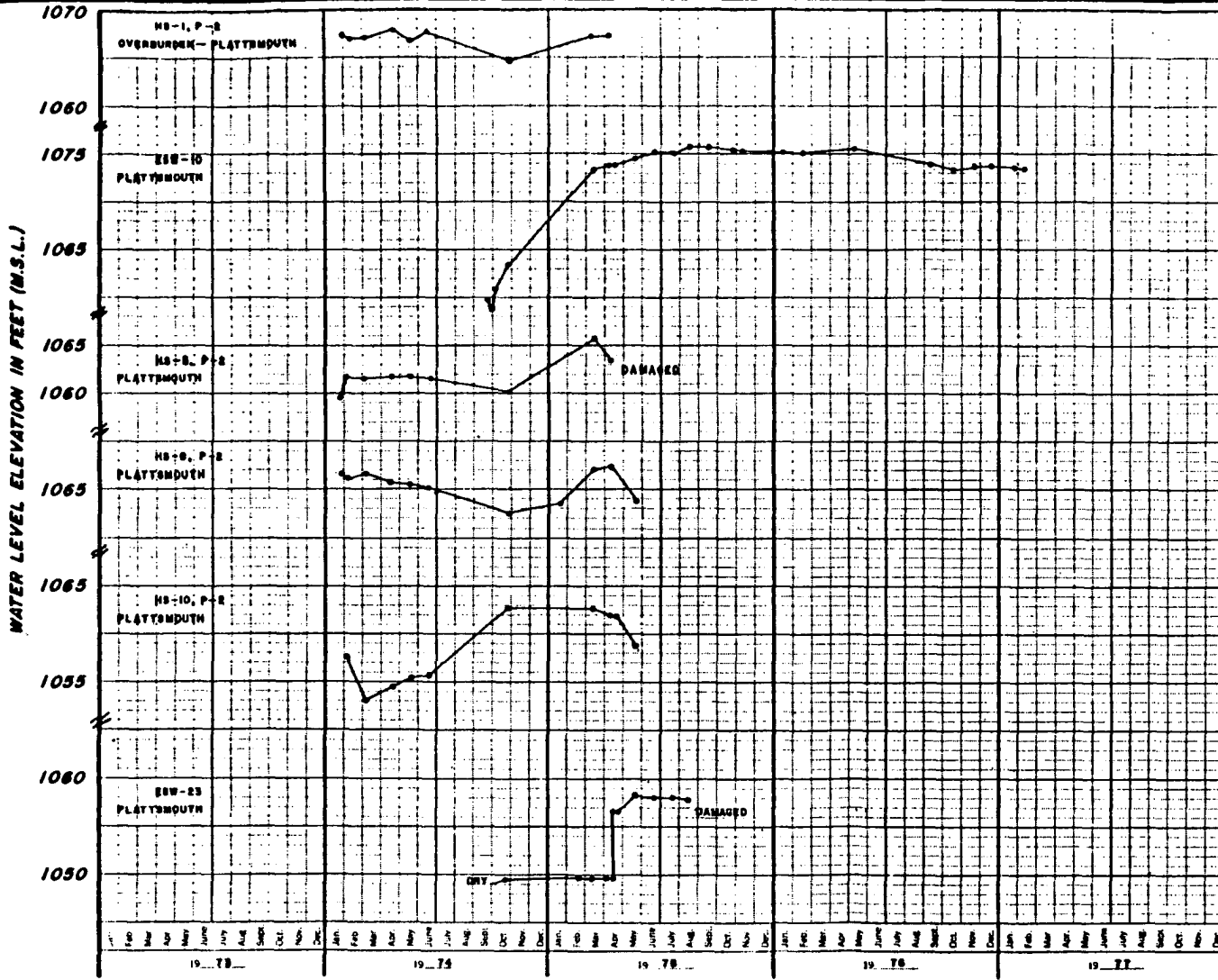

Rev. 0

WOLF CREEK
 UPDATED SAFETY ANALYSIS REPORT
 Figure 2.4-56 (Sheet 15 of 18)
 Variations of Water Levels in
 Piezometers

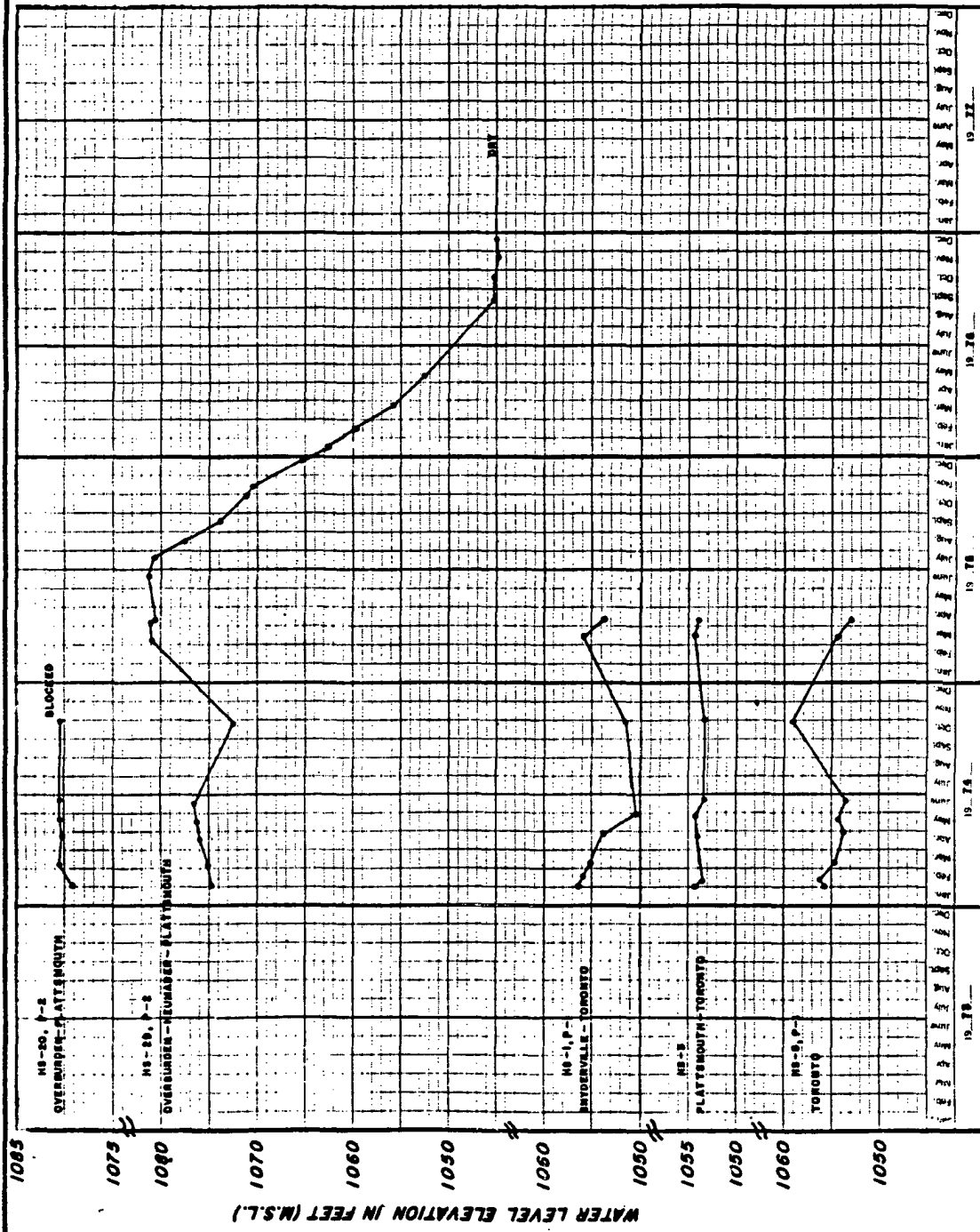

Rev. 0

WOLF CREEK
UPDATED SAFETY ANALYSIS REPORT
 Figure 2.4-56 (Sheet 16 of 18)
 Variations of Water Levels in
 Piezometers

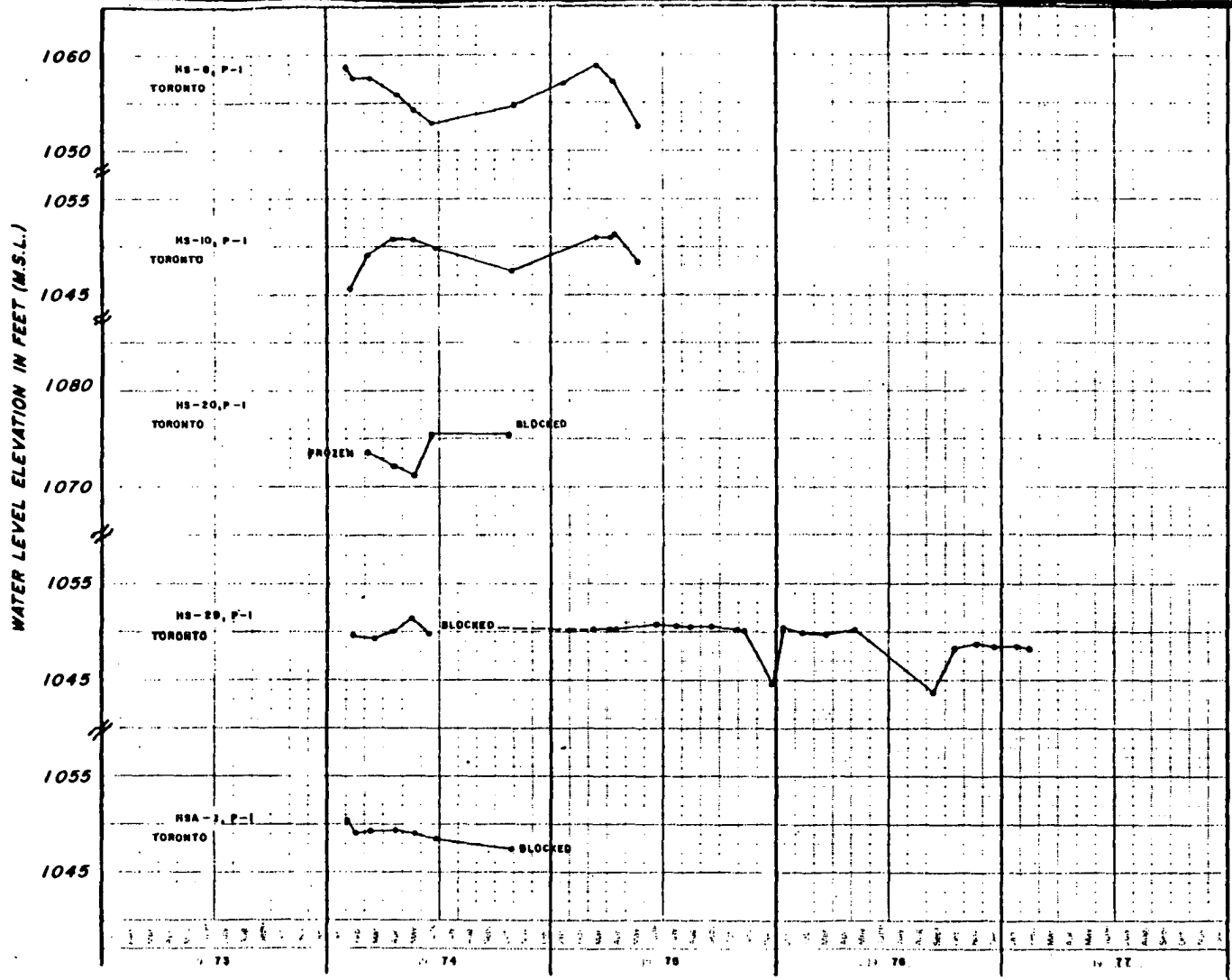

Rev. 0

**WOLF CREEK
UPDATED SAFETY ANALYSIS REPORT**

Figure 2.4-56 (Sheet 17 of 18)

Variations of Water Levels in
Piezometers

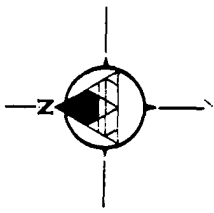

LEGEND:
 B-Piezometer Number and Location
 Average Water Level Elevation in Feet
 Fall Averages for June, 1974, except
 1056.0 - Average for October, 1974
 1054.0 - Average for October, 1974
 1054.0 - Readings averaged for October, 1974
 ---1080--- Potentiometric Contours
 ---1080--- Interpolated Potentiometric Contours
 Elevations Refer to USGS Datum

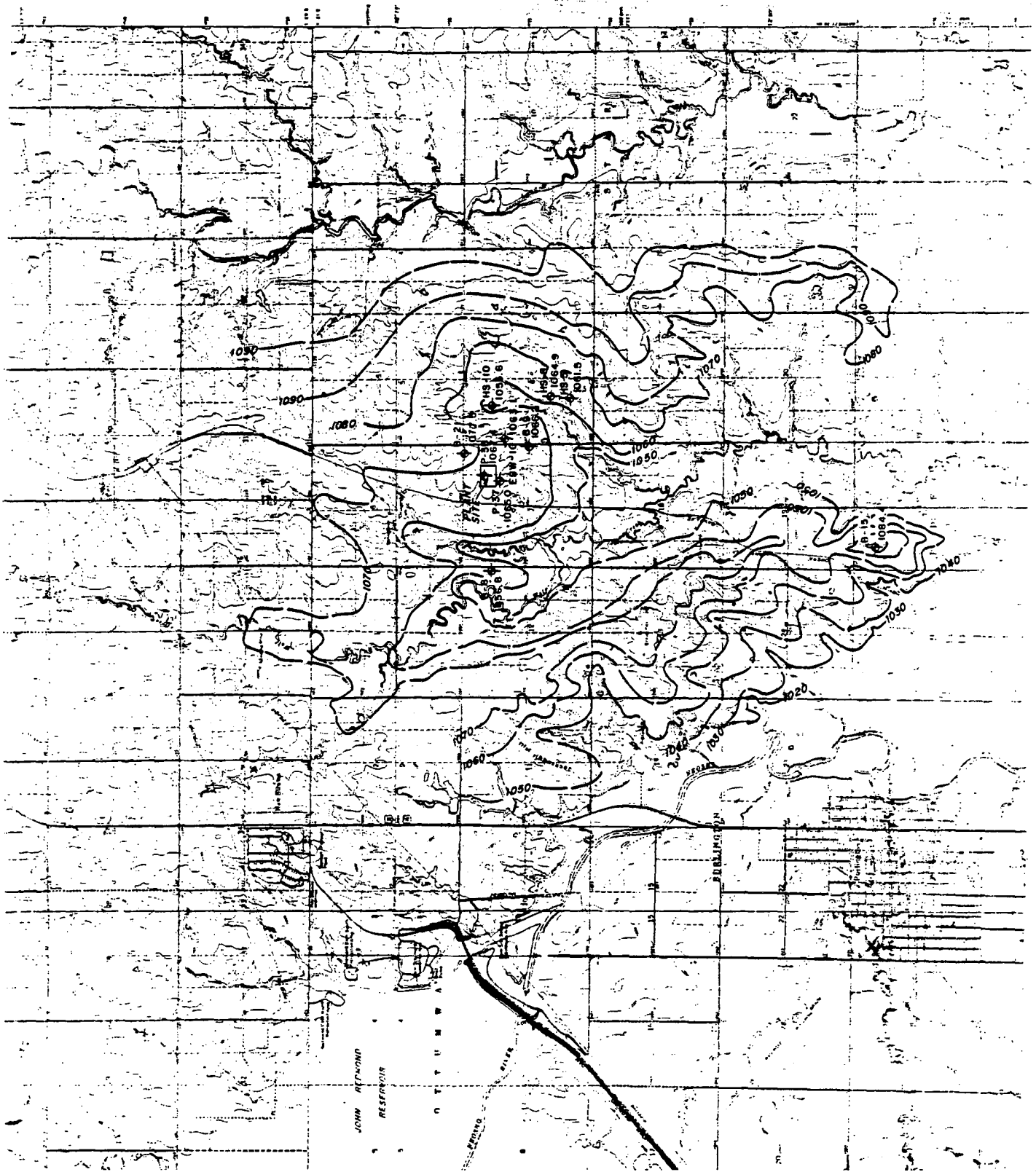

ISSUING OFFICE: CHICAGO DISTRICT OFFICE, U.S. GEOLOGICAL SURVEY
 TITLE: WOLF CREEK DAM, ILLINOIS, AND CREEK DRAINAGE SYSTEM (MILL)
 FOR: UNITED STATES AND ELECTRIC COMPANY AND ILLINOIS CITY POWER AND LIGHT COMPANY
 BY: SARGENT AND LUNDY ENGINEERS, CHICAGO
 DRAWING NO. 1-1, Rev. 0
 DATE: 12/17/74
 MAP BASE PREPARED FROM U.S.G.S. TOPOGRAPHIC QUADRANGLES, 7.5' SERIES; WASHINGTON
 COUNTY, ILLINOIS; JOHN ATWOOD DAM, ILLINOIS, 1946; NEW STAMM, ILLINOIS, 1971; OGDON
 DAM, ILLINOIS, 1971.



Rev. 0

WOLF CREEK
UPDATED SAFETY ANALYSIS REPORT

Figure 2.4-57
 Generalized Potentiometric
 Surface Contours of Plattsburgh
 Member

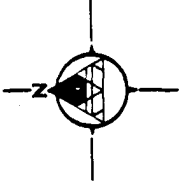

LEGEND:
B-17 PNEUMETER NUMBER AND LOCATION
10300 AVERAGE GAGES LEVEL ELEVATION IN FEET
10300 GAGE MEASUREMENTS FOR MAY TO JUNE, 1951
EXCEPT B-7 ARRANGED FOR OCTOBER, 1951
B-7 NOT MONITORED SINCE OCTOBER, 1951
-1050 POTENTIOMETRIC CONTOURS
-1050 INTERPOLATED POTENTIOMETRIC CONTOURS
ELEVATIONS REFER TO SEAS DATUM

ENGINEER: RICHARD W. BELL
TITLE: GENERAL INVESTIGATION, WOLF CREEK GENERATING STATION UNIT 1
BY: RICHARD W. BELL, CIVIL ENGINEER AND DRAINAGE CITY ENGINEER AND LIGHT COMPANY
DATE: JANUARY 1952
PROJECT NO. 1-1, REV. 0
DRAWING NO. 102/1776
THIS MAP PREPARED FROM U.S.G.S. TOPOGRAPHIC QUADRANGLES, T. 21, N. 41, W. 10, WASHINGTON,
D.C.; 25000 SCALE, 1941; NEW BRUNSWICK, N.J.; 25000 SCALE, 1941; NEW BRUNSWICK,
N.J.; 25000 SCALE, 1941.



Rev. 0

UPDATED SAFETY ANALYSIS REPORT

Figure 2.4-59

Generalized Potentiometric
Surface Contours of Ireland
Member

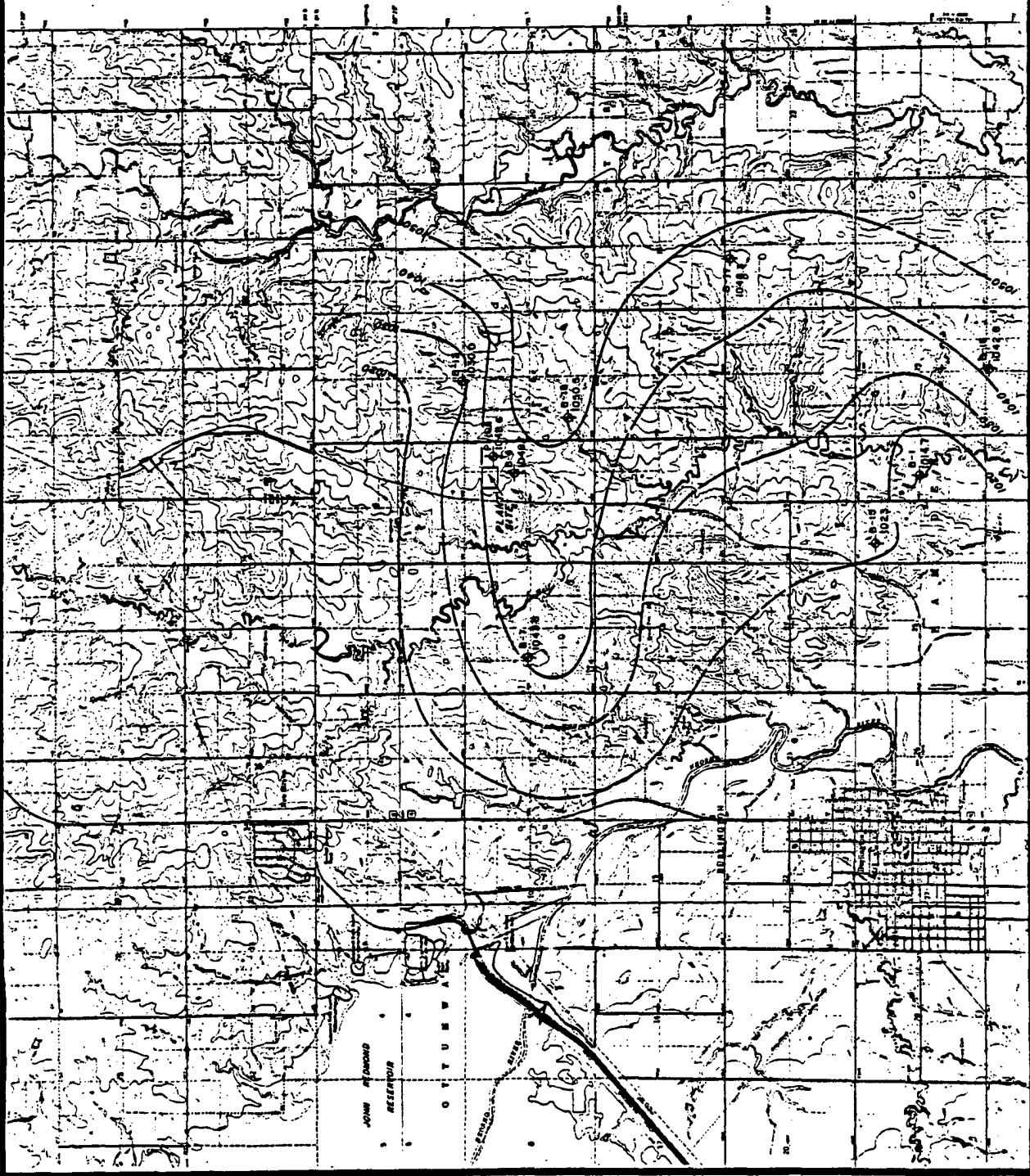

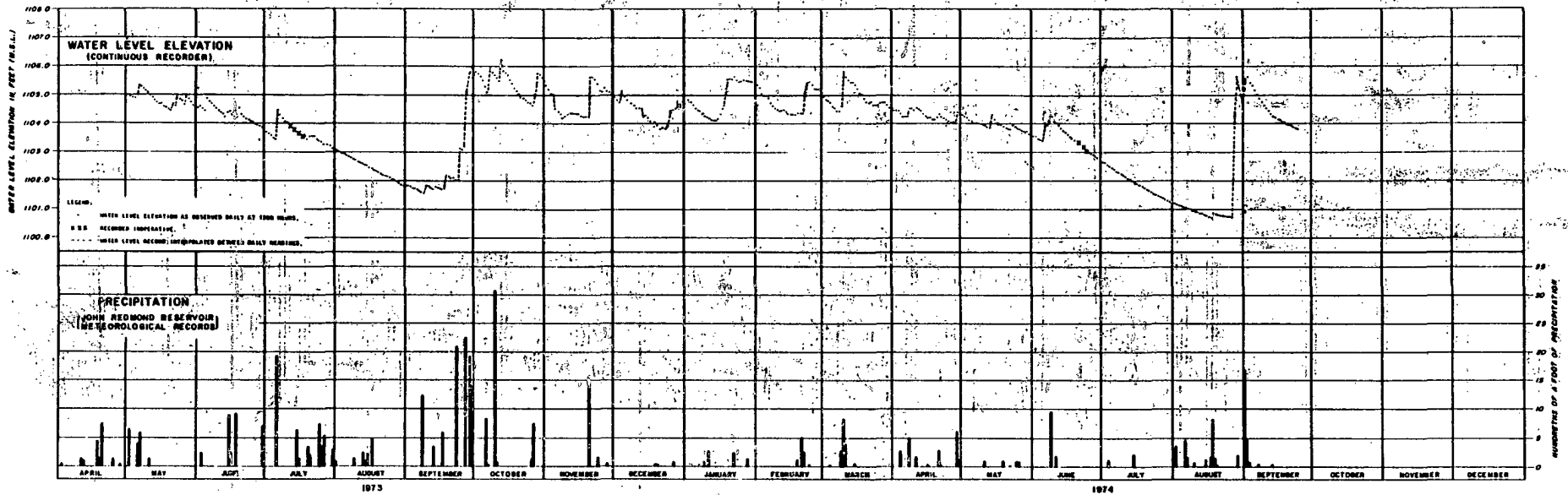

Rev. 0

**WOLF CREEK
 UPDATED SAFETY ANALYSIS REPORT**

Figure 2.4-60

Water Level Recorder Chart and
 Precipitation Record at Site



EXPLANATION

1. 1/2 AND CW SERIES BORING
LOCATIONS AND THE
SEALING OF FOLLOW-UP
PIEZOMETER TO FILLING OF
COILING CASE



NOTES:

1. TOPOGRAPHIC CONTOUR INTERVAL IS 10 FEET
WITH SUPPLEMENTARY CONTOURS AT 5 FEET

SOURCE MATERIALS:
USGS, TERRAIN MAPS, WOLF CREEK SECTION, SECTION 10T, 10R, 10S, 10T, 10U, 10V, 10W, 10X, 10Y, 10Z, 11T, 11R, 11S, 11U, 11V, 11W, 11X, 11Y, 11Z, 12T, 12R, 12S, 12U, 12V, 12W, 12X, 12Y, 12Z, 13T, 13R, 13S, 13U, 13V, 13W, 13X, 13Y, 13Z, 14T, 14R, 14S, 14U, 14V, 14W, 14X, 14Y, 14Z, 15T, 15R, 15S, 15U, 15V, 15W, 15X, 15Y, 15Z, 16T, 16R, 16S, 16U, 16V, 16W, 16X, 16Y, 16Z, 17T, 17R, 17S, 17U, 17V, 17W, 17X, 17Y, 17Z, 18T, 18R, 18S, 18U, 18V, 18W, 18X, 18Y, 18Z, 19T, 19R, 19S, 19U, 19V, 19W, 19X, 19Y, 19Z, 20T, 20R, 20S, 20U, 20V, 20W, 20X, 20Y, 20Z, 21T, 21R, 21S, 21U, 21V, 21W, 21X, 21Y, 21Z, 22T, 22R, 22S, 22U, 22V, 22W, 22X, 22Y, 22Z, 23T, 23R, 23S, 23U, 23V, 23W, 23X, 23Y, 23Z, 24T, 24R, 24S, 24U, 24V, 24W, 24X, 24Y, 24Z, 25T, 25R, 25S, 25U, 25V, 25W, 25X, 25Y, 25Z, 26T, 26R, 26S, 26U, 26V, 26W, 26X, 26Y, 26Z, 27T, 27R, 27S, 27U, 27V, 27W, 27X, 27Y, 27Z, 28T, 28R, 28S, 28U, 28V, 28W, 28X, 28Y, 28Z, 29T, 29R, 29S, 29U, 29V, 29W, 29X, 29Y, 29Z, 30T, 30R, 30S, 30U, 30V, 30W, 30X, 30Y, 30Z, 31T, 31R, 31S, 31U, 31V, 31W, 31X, 31Y, 31Z, 32T, 32R, 32S, 32U, 32V, 32W, 32X, 32Y, 32Z, 33T, 33R, 33S, 33U, 33V, 33W, 33X, 33Y, 33Z, 34T, 34R, 34S, 34U, 34V, 34W, 34X, 34Y, 34Z, 35T, 35R, 35S, 35U, 35V, 35W, 35X, 35Y, 35Z, 36T, 36R, 36S, 36U, 36V, 36W, 36X, 36Y, 36Z, 37T, 37R, 37S, 37U, 37V, 37W, 37X, 37Y, 37Z, 38T, 38R, 38S, 38U, 38V, 38W, 38X, 38Y, 38Z, 39T, 39R, 39S, 39U, 39V, 39W, 39X, 39Y, 39Z, 40T, 40R, 40S, 40U, 40V, 40W, 40X, 40Y, 40Z, 41T, 41R, 41S, 41U, 41V, 41W, 41X, 41Y, 41Z, 42T, 42R, 42S, 42U, 42V, 42W, 42X, 42Y, 42Z, 43T, 43R, 43S, 43U, 43V, 43W, 43X, 43Y, 43Z, 44T, 44R, 44S, 44U, 44V, 44W, 44X, 44Y, 44Z, 45T, 45R, 45S, 45U, 45V, 45W, 45X, 45Y, 45Z, 46T, 46R, 46S, 46U, 46V, 46W, 46X, 46Y, 46Z, 47T, 47R, 47S, 47U, 47V, 47W, 47X, 47Y, 47Z, 48T, 48R, 48S, 48U, 48V, 48W, 48X, 48Y, 48Z, 49T, 49R, 49S, 49U, 49V, 49W, 49X, 49Y, 49Z, 50T, 50R, 50S, 50U, 50V, 50W, 50X, 50Y, 50Z, 51T, 51R, 51S, 51U, 51V, 51W, 51X, 51Y, 51Z, 52T, 52R, 52S, 52U, 52V, 52W, 52X, 52Y, 52Z, 53T, 53R, 53S, 53U, 53V, 53W, 53X, 53Y, 53Z, 54T, 54R, 54S, 54U, 54V, 54W, 54X, 54Y, 54Z, 55T, 55R, 55S, 55U, 55V, 55W, 55X, 55Y, 55Z, 56T, 56R, 56S, 56U, 56V, 56W, 56X, 56Y, 56Z, 57T, 57R, 57S, 57U, 57V, 57W, 57X, 57Y, 57Z, 58T, 58R, 58S, 58U, 58V, 58W, 58X, 58Y, 58Z, 59T, 59R, 59S, 59U, 59V, 59W, 59X, 59Y, 59Z, 60T, 60R, 60S, 60U, 60V, 60W, 60X, 60Y, 60Z, 61T, 61R, 61S, 61U, 61V, 61W, 61X, 61Y, 61Z, 62T, 62R, 62S, 62U, 62V, 62W, 62X, 62Y, 62Z, 63T, 63R, 63S, 63U, 63V, 63W, 63X, 63Y, 63Z, 64T, 64R, 64S, 64U, 64V, 64W, 64X, 64Y, 64Z, 65T, 65R, 65S, 65U, 65V, 65W, 65X, 65Y, 65Z, 66T, 66R, 66S, 66U, 66V, 66W, 66X, 66Y, 66Z, 67T, 67R, 67S, 67U, 67V, 67W, 67X, 67Y, 67Z, 68T, 68R, 68S, 68U, 68V, 68W, 68X, 68Y, 68Z, 69T, 69R, 69S, 69U, 69V, 69W, 69X, 69Y, 69Z, 70T, 70R, 70S, 70U, 70V, 70W, 70X, 70Y, 70Z, 71T, 71R, 71S, 71U, 71V, 71W, 71X, 71Y, 71Z, 72T, 72R, 72S, 72U, 72V, 72W, 72X, 72Y, 72Z, 73T, 73R, 73S, 73U, 73V, 73W, 73X, 73Y, 73Z, 74T, 74R, 74S, 74U, 74V, 74W, 74X, 74Y, 74Z, 75T, 75R, 75S, 75U, 75V, 75W, 75X, 75Y, 75Z, 76T, 76R, 76S, 76U, 76V, 76W, 76X, 76Y, 76Z, 77T, 77R, 77S, 77U, 77V, 77W, 77X, 77Y, 77Z, 78T, 78R, 78S, 78U, 78V, 78W, 78X, 78Y, 78Z, 79T, 79R, 79S, 79U, 79V, 79W, 79X, 79Y, 79Z, 80T, 80R, 80S, 80U, 80V, 80W, 80X, 80Y, 80Z, 81T, 81R, 81S, 81U, 81V, 81W, 81X, 81Y, 81Z, 82T, 82R, 82S, 82U, 82V, 82W, 82X, 82Y, 82Z, 83T, 83R, 83S, 83U, 83V, 83W, 83X, 83Y, 83Z, 84T, 84R, 84S, 84U, 84V, 84W, 84X, 84Y, 84Z, 85T, 85R, 85S, 85U, 85V, 85W, 85X, 85Y, 85Z, 86T, 86R, 86S, 86U, 86V, 86W, 86X, 86Y, 86Z, 87T, 87R, 87S, 87U, 87V, 87W, 87X, 87Y, 87Z, 88T, 88R, 88S, 88U, 88V, 88W, 88X, 88Y, 88Z, 89T, 89R, 89S, 89U, 89V, 89W, 89X, 89Y, 89Z, 90T, 90R, 90S, 90U, 90V, 90W, 90X, 90Y, 90Z, 91T, 91R, 91S, 91U, 91V, 91W, 91X, 91Y, 91Z, 92T, 92R, 92S, 92U, 92V, 92W, 92X, 92Y, 92Z, 93T, 93R, 93S, 93U, 93V, 93W, 93X, 93Y, 93Z, 94T, 94R, 94S, 94U, 94V, 94W, 94X, 94Y, 94Z, 95T, 95R, 95S, 95U, 95V, 95W, 95X, 95Y, 95Z, 96T, 96R, 96S, 96U, 96V, 96W, 96X, 96Y, 96Z, 97T, 97R, 97S, 97U, 97V, 97W, 97X, 97Y, 97Z, 98T, 98R, 98S, 98U, 98V, 98W, 98X, 98Y, 98Z, 99T, 99R, 99S, 99U, 99V, 99W, 99X, 99Y, 99Z, 100T, 100R, 100S, 100U, 100V, 100W, 100X, 100Y, 100Z

FEET
0 2000 4000 6000

WOLF CREEK
UPDATED SAFETY ANALYSIS REPORT
 Figure 2.4-61
 Location of Piezometers Requiring
 Sealing, LK and CW Borings
 Member
 Rev. 0

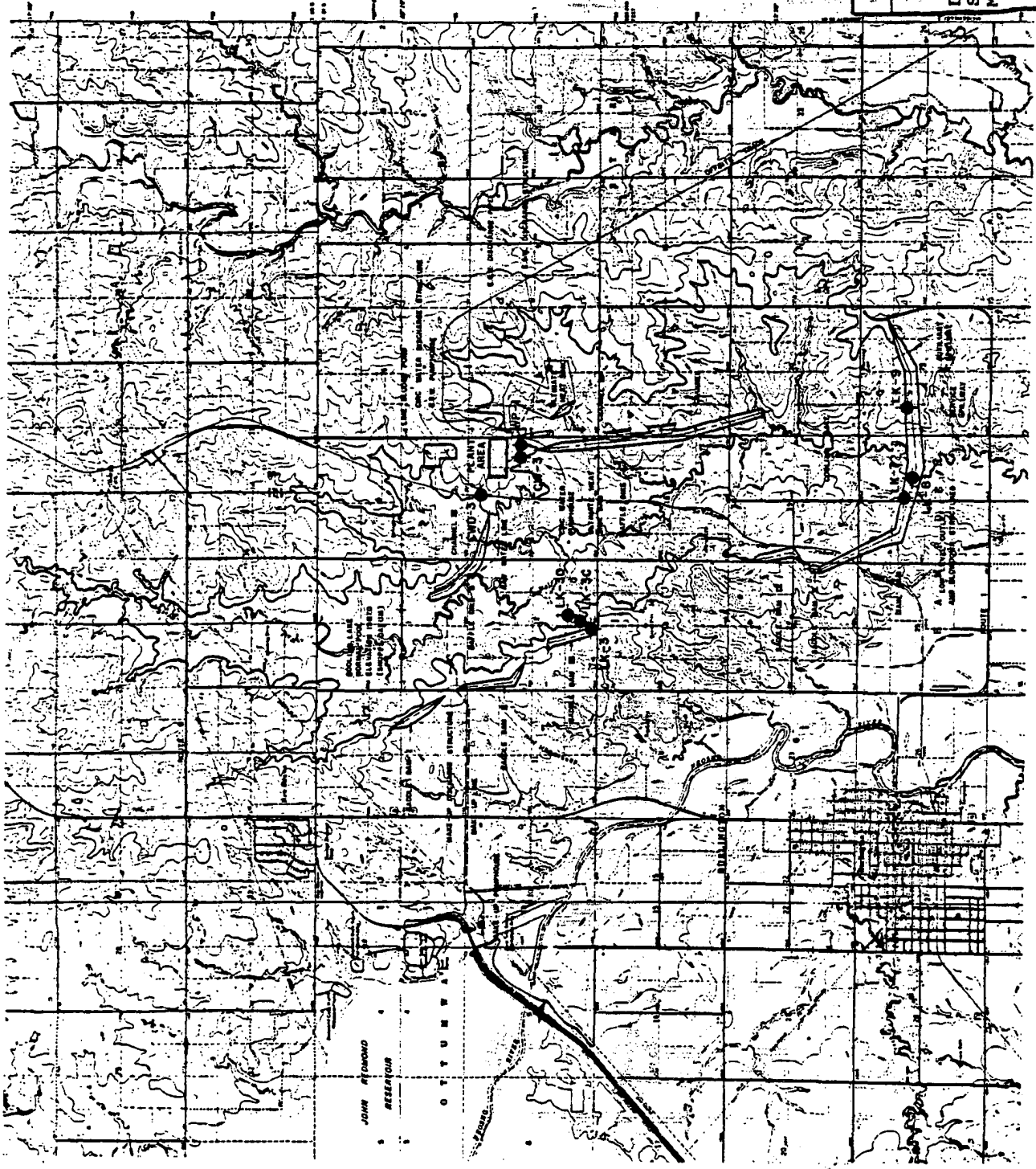

ROOF GEOMETRY

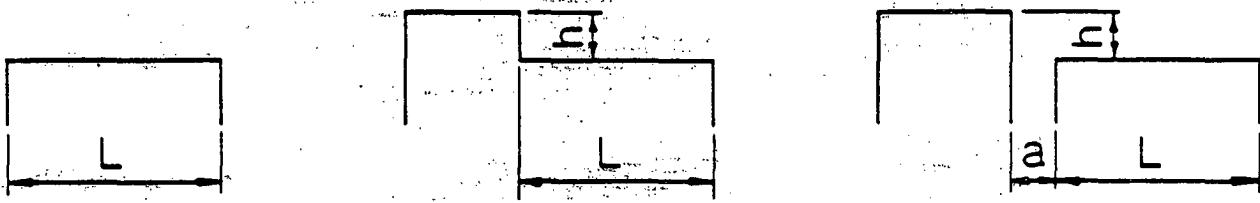

FLAT EXPOSED ROOF,
UPPER LEVEL OF
MULTI-LEVEL ROOFS,
AND DOMES.

LOWER LEVEL OF MULTI-LEVEL ROOFS
WHEN UPPER ROOF IS PART OF THE
SAME BUILDING OR AN ADJACENT
BUILDING NOT MORE THAN 15FT. AWAY.

DISTRIBUTION COEFFICIENTS

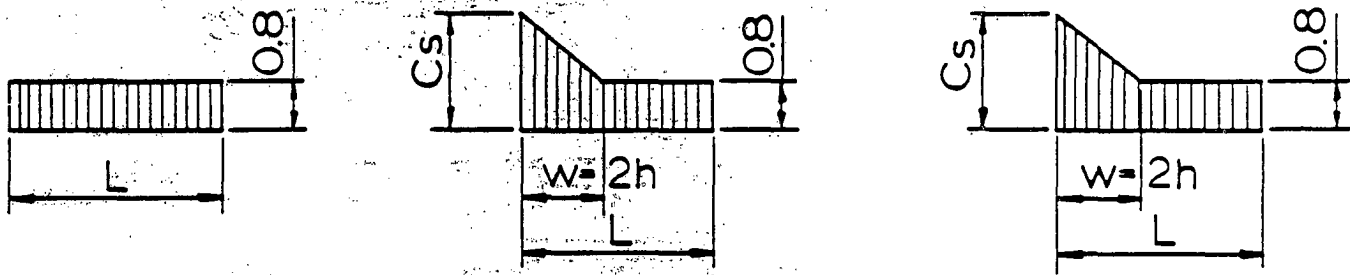

$C_s = 0.8$ FOR ALL EXPOSED
UNSHELTERED ROOFS.

$C_s = 15 \frac{h}{g}$
WHEN $15 \frac{h}{g} < 0.8$ USE $C_s = 0.8$
WHEN $15 \frac{h}{g} > 3.0$ USE $C_s = 3.0$

IN ADDITION
FOR SPHERICAL
DOMES:

$w = 2h$
WHEN $h < 5$ FT. USE $w = 10$ FT.
WHEN $h > 15$ FT. USE $w = 30$ FT.

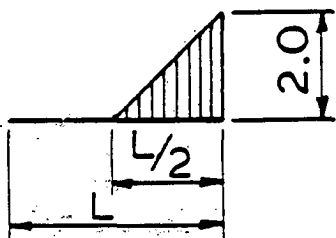

WHERE

h = DIFFERENCE IN ROOF HT. IN FT.
 g = GROUND SNOW LOAD IN PSF
 w = WIDTH OF DRIFT IN FT.
 a = DISTANCE BETWEEN
BUILDINGS < 15 FT.

REFERENCE: AMERICAN
NATIONAL STANDARD A58.1-
1972, SECTION 7.1, FIGURES
5 AND 6.

Rev. 0

<p>WOLF CREEK UPDATED SAFETY ANALYSIS REPORT</p> <p>Figure 2.4-62</p> <p>Snowload Distributions and Coefficients</p>
--

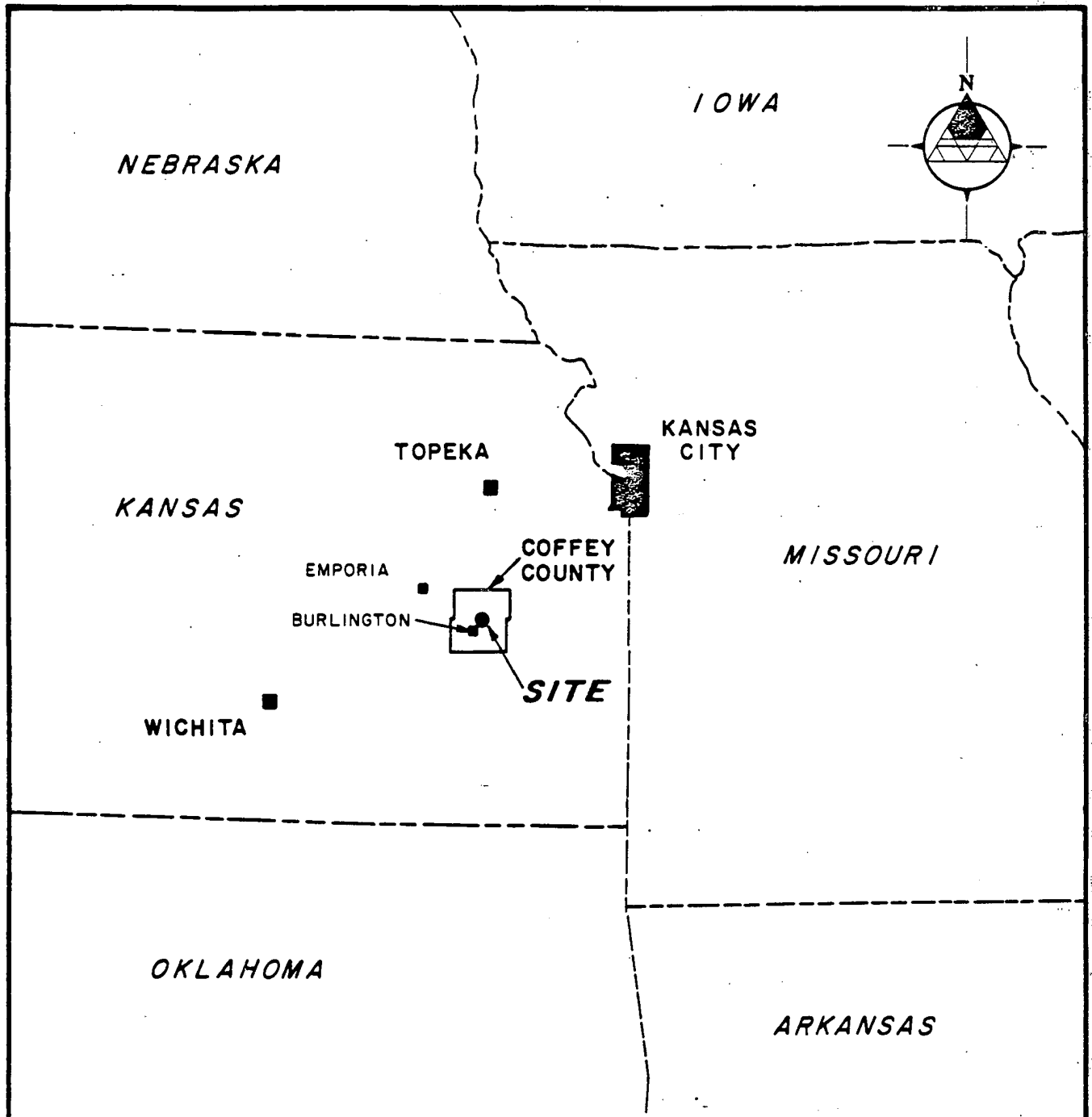

Rev. 0

**WOLF CREEK
UPDATED SAFETY ANALYSIS REPORT**

Figure 2.5-1
Site Location Map

REFERENCE:

BASE MAP COMPILED FROM UNITED STATES GEOLOGICAL SURVEY, UNITED STATES, WASHINGTON, D.C.: 1961.



DRAWING REFERENCE:
 TITLE: WOLF CREEK GENERATING STATION, PROPERTY & FACILITIES SITE PLAN
 FOR: KANSAS GAS & ELECTRIC COMPANY AND KANSAS CITY POWER & LIGHT COMPANY
 BY: KANSAS GAS & ELECTRIC COMPANY
 DRAWING NO.: 8025-G-K01201, REV. 0
 DATE: 8/30/82
 MAP BASE PREPARED FROM U.S.G.S. TOPOGRAPHIC QUADRANGLES, 7.5' SERIES; SURLINGTON, KANSAS, 1971; JOHN REDMOND DAM, KANSAS, 1966; NEW STRAWN, KANSAS, 1971; OTTUMWA, KANSAS, 1970

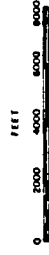

Rev. 0

WOLF CREEK
 UPDATED SAFETY ANALYSIS REPORT

Figure 2.5-2
 Site Plot Plan

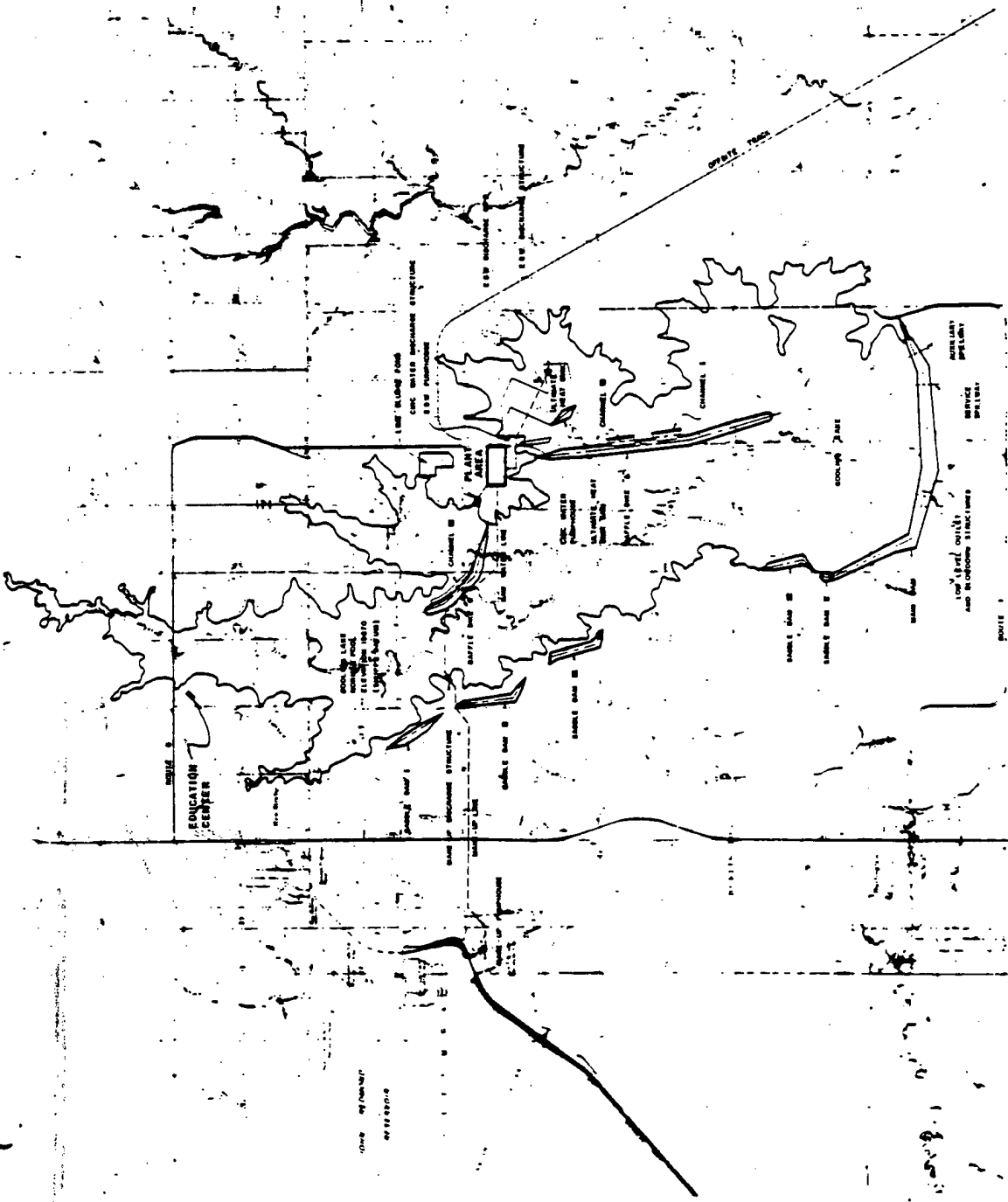

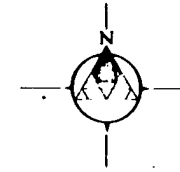
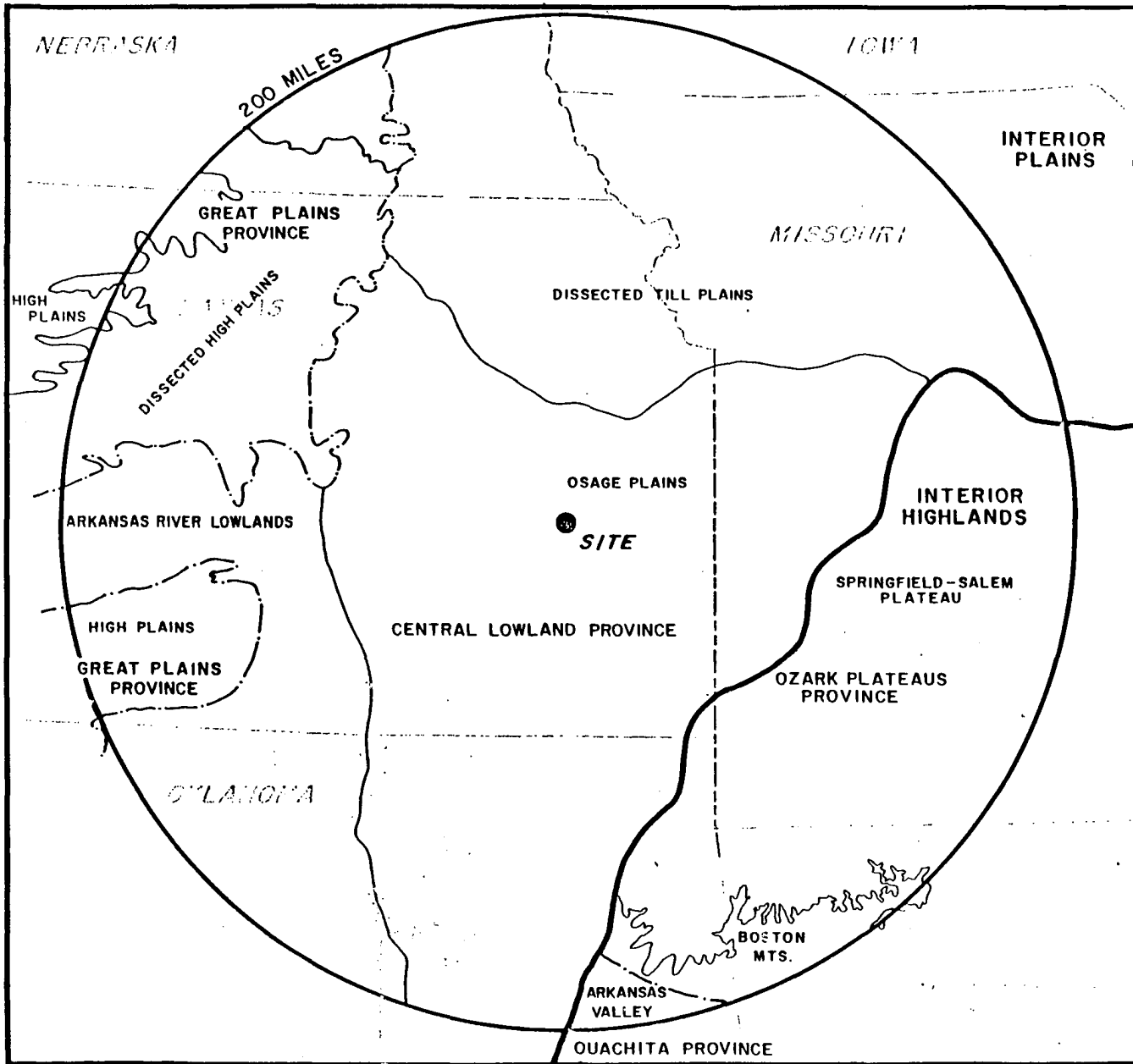

- EXPLANATION:
- MAJOR PHYSIOGRAPHIC PROVINCE
 - - - - PROVINCE BOUNDARY
 - SECTION BOUNDARY
 - - - - STATE BOUNDARY

NOTE:

1. BASE MAP MODIFIED FROM UNITED STATES GEOLOGICAL SURVEY, UNITED STATES, WASHINGTON, D.C., 1963

- REFERENCES:
- MODIFIED FROM:
1. CROMETS, C., 1930, GEOLOGY OF ARKANSAS PALEOZOIC AREA, ARKANSAS GEOLOGICAL SURVEY BULL. 3, PL. III.
 2. CURTIS, JR., N.M., AND HAH, W.E., 1972, GEOMORPHIC PROVINCES OF OKLAHOMA, GEOLOGY AND EARTH RESOURCES OF OKLAHOMA, OKLAHOMA GEOLOGICAL SURVEY, EDUCATION PUBLICATION 1, P. 3.
 3. EIDER, J.A., 1969, SOILS OF NEBRASKA, NEBRASKA GEOLOGICAL SURVEY, RESOURCE REPORT NO. 2, P. 7.
 4. FERRELL, N.M., 1957, PHYSICAL DIVISION OF THE UNITED STATES, EDITION OF 1954, WASHINGTON D.C., UNITED STATES GEOLOGICAL SURVEY.
 5. FRYE, J.C., AND SWENFORD, A., 1959, THE PLAINS BORDER, PHYSIOGRAPHIC SECTION, TRANSACTION OF THE KANSAS ACADEMY OF SCIENCE, VOLUME 52, NO. 1, PP. 21-50.
 6. SCHMELT, W.H., 1949, THE GEOGRAPHY OF KANSAS, PART II, PHYSICAL GEOGRAPHY, TRANSACTION OF THE KANSAS ACADEMY OF SCIENCE, VOLUME 52, NO. 3, PP. 275-277.



Rev. 0

**WOLF CREEK
UPDATED SAFETY ANALYSIS REPORT**

Figure 2.5-3
Regional Physiographic Map

NO. 14 0000

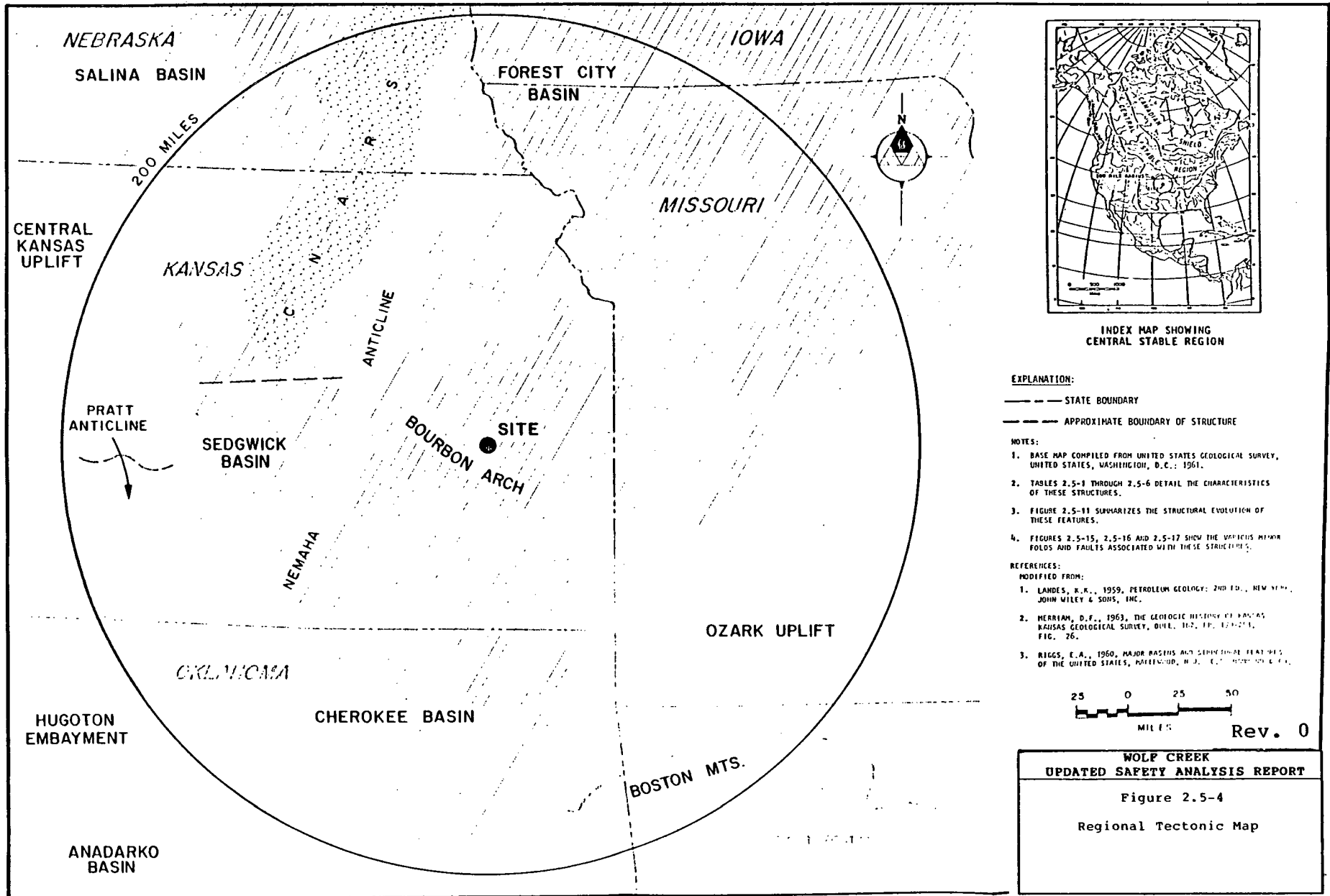

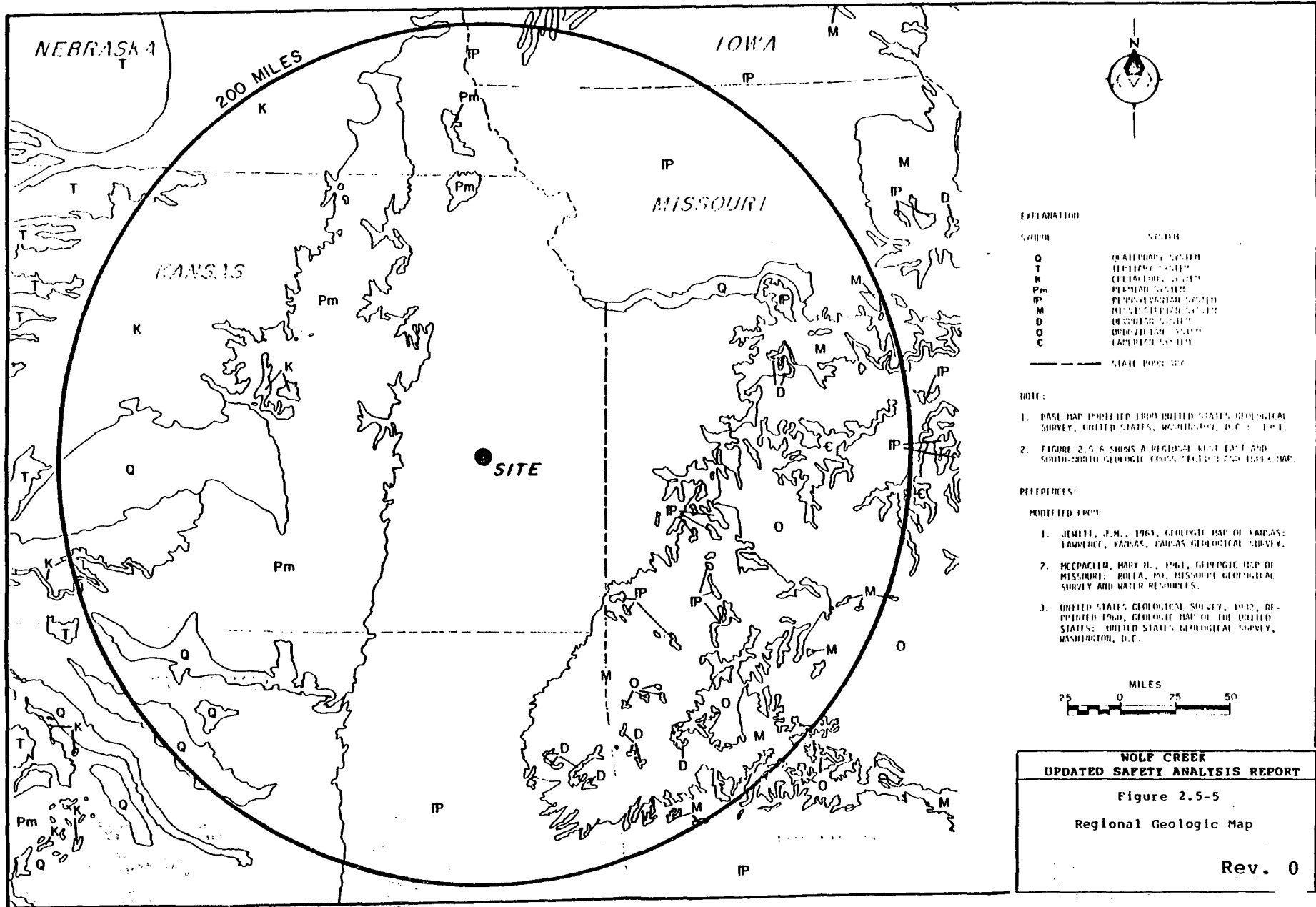

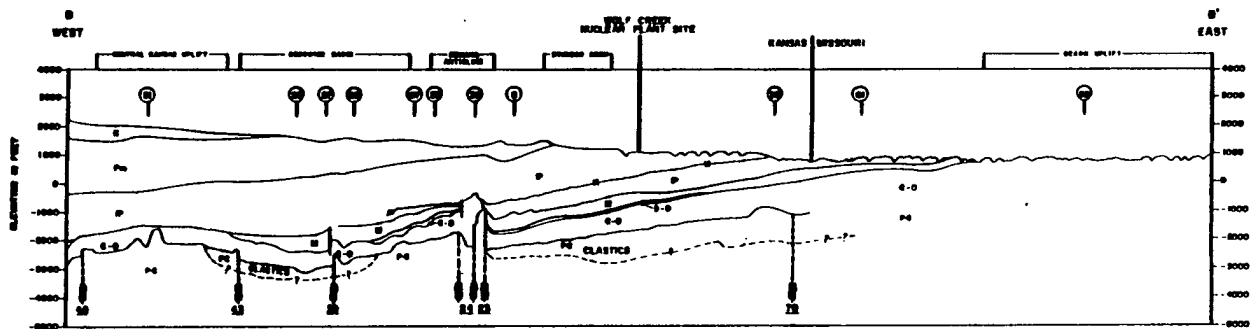
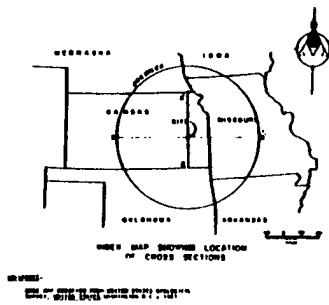
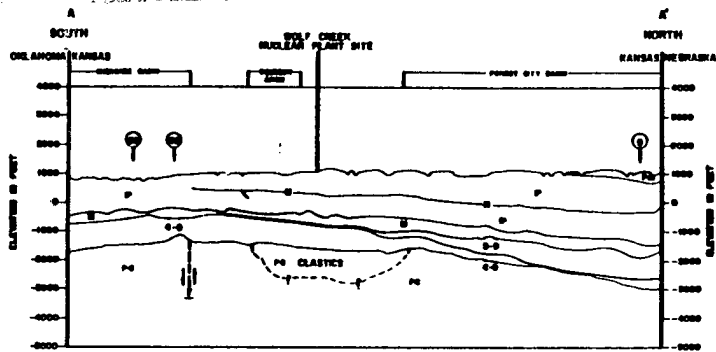

EXPLANATION

O - ORDOVICIAN
 Pm - PENNSYLVANIAN
 M - MISSISSIPPIAN
 S - SILURIAN AND DEVONIAN
 C-O - CARBONIAN AND ORDOVICIAN
 P - PRECAMBRIAN

EXPLANATION:

NUMBER CORRESPONDS TO FOLD NUMBERS ON FIGURES 2.5-15 AND TABLE 2.5-1 THROUGH 2.5-6.
 FAULT NUMBER CORRESPONDS TO FAULT NUMBERS ON FIGURES 2.5-16 AND TABLE 2.5-8 THROUGH 2.5-13.

WELL NO. 101 OF THE KANSAS CITY CAMP BEYOND LIMITS SHOWN HAS NOT BEEN PRESENTED IN REFERENCE 17.

- REFERENCES**
- MODIFIED FROM:
1. DANFORTH, CARL C., AND OTHERS, 1965, GEOLGIC AND OIL AND GAS RESOURCES OF GREAT CANYON, 800 NORTH, MISSOURI GEOLOGICAL SURVEY, BULLETIN 94, PP. 47, 48, 51.
 2. COLE, EUGENE S., 1974, CORRELATION OF THE TOP OF PRECAMBRIAN ROCKS IN KANSAS: KANSAS GEOLOGICAL SURVEY, MAP N. 7, SCALE 1:500,000.
 3. KANSAS, 1976, SURFACE GEOLOGICAL CAMPING NOTES IN KANSAS: KANSAS GEOLOGICAL SURVEY, UNPUBLISHED GEOLOGY SERIES 7, 10P.
 4. FANDEL, R.J., 1967, STRUCTURAL GEOLOGY OF NORTH AMERICA, HARPER AND ROW, 746 P., PP. 51, 77.
 5. JEWETT, J.H., 1960, GEOLOGIC MAP OF KANSAS: KANSAS GEOLOGICAL SURVEY, MAP N. 1, SCALE 1:500,000.
 6. KANSAS GEOLOGICAL SOCIETY, 1964, NORTH-SOUTH ELECTRIC LOG CROSS SECTION FROM MISSOURI TO OREGON AND SIBIRI PRINCIPAL MEMBERS: KANSAS GEOLOGICAL SOCIETY, PLATE.
 7. KANSAS GEOLOGICAL SOCIETY, 1964, EAST-WEST-SOUTH ELECTRIC LOG CROSS SECTION FROM TENNESSEE TO CALIFORNIA: KANSAS GEOLOGICAL SOCIETY, PLATE.
 8. LEE, WILBERT, 1966, STRUCTURAL DEVELOPMENT OF THE KANSAS CITY BASIN OF MISSOURI, KANSAS, IOWA, AND NEBRASKA, OIL AND GAS INVESTIGATION: KANSAS GEOLOGICAL SURVEY, PRELIMINARY MAP NO. SHEET 9, 6.
 9. LEE, WILBERT, 1964, TENSILE AND STRUCTURAL DEVELOPMENT OF THE KANSAS BASIN AREA: KANSAS GEOLOGICAL SURVEY, SHEET 17A.
 10. HICKMAN, HARRY H., 1961, GEOLOGIC MAP OF MISSOURI, MISSOURI GEOLOGICAL SURVEY AND WATER RESOURCES.
 11. REPORT OF INVESTIGATION, 1973, STRUCTURAL FEATURES OF MISSOURI, AND WATER RESOURCES, PL. 1.
 12. HERRIN, DANIEL F., WISEWELL, RICHARD J., AND ATKINSON, W.H., 1960, PRELIMINARY REGIONAL STRUCTURAL CORRELATION MAP ON TOP OF MISSISSIPPIAN ROCKS IN KANSAS, OIL AND GAS INVESTIGATION: KANSAS GEOLOGICAL SURVEY, NO. 19, MAP.
 13. HERRIN, DANIEL F., 1960, PRELIMINARY REGIONAL STRUCTURAL CORRELATION MAP ON TOP OF MISSISSIPPIAN ROCKS IN KANSAS, OIL AND GAS INVESTIGATION: KANSAS GEOLOGICAL SURVEY, NO. 27, MAP.
 14. AND STELL, J.S., 1960, PRELIMINARY REGIONAL STRUCTURAL CORRELATION MAP ON TOP OF "MURKIN" (ILLINOIS MEMPHIAN) ROCKS IN KANSAS, OIL AND GAS INVESTIGATION: KANSAS GEOLOGICAL SURVEY, NO. 25, MAP.
 15. AND SMITH, PERRY, 1961, PRELIMINARY REGIONAL STRUCTURAL CORRELATION MAP TO TOP OF ARKANSAS ROCKS (CAMBRIAN-ORDOVICIAN) IN KANSAS, OIL AND GAS INVESTIGATION: KANSAS GEOLOGICAL SURVEY, NO. 25, MAP.
 16. SAUER, FRANK B., 1960, GEOLOGIC HISTORY OF MID-CONTINENTAL UNITED STATES TO AND INCLUDING W.H. MEADY COLLECTION, UNIVERSITY OF MISSOURI PRESS, SERIES 3, NO. 3, P. 75.
 17. HAYES, W., 1960, 1970, STRUCTURAL CORRELATION MAP BASED ON KANSAS CITY GROUP (LOWER PENNSYLVANIAN) - EASTERN KANSAS: KANSAS GEOLOGICAL SURVEY, MAP N. 10.
 18. ZIEGLER, OWEN S., (ED.), 1960, THE STRATIGRAPHIC SUCCESSION IN KANSAS: KANSAS GEOLOGICAL SURVEY, BULLETIN 100, PL. 1.

Rev. 0

**WOLF CREEK
UPDATED SAFETY ANALYSIS REPORT**

**FIGURE 2.5-6
REGIONAL GEOLOGIC CROSS SECTION**

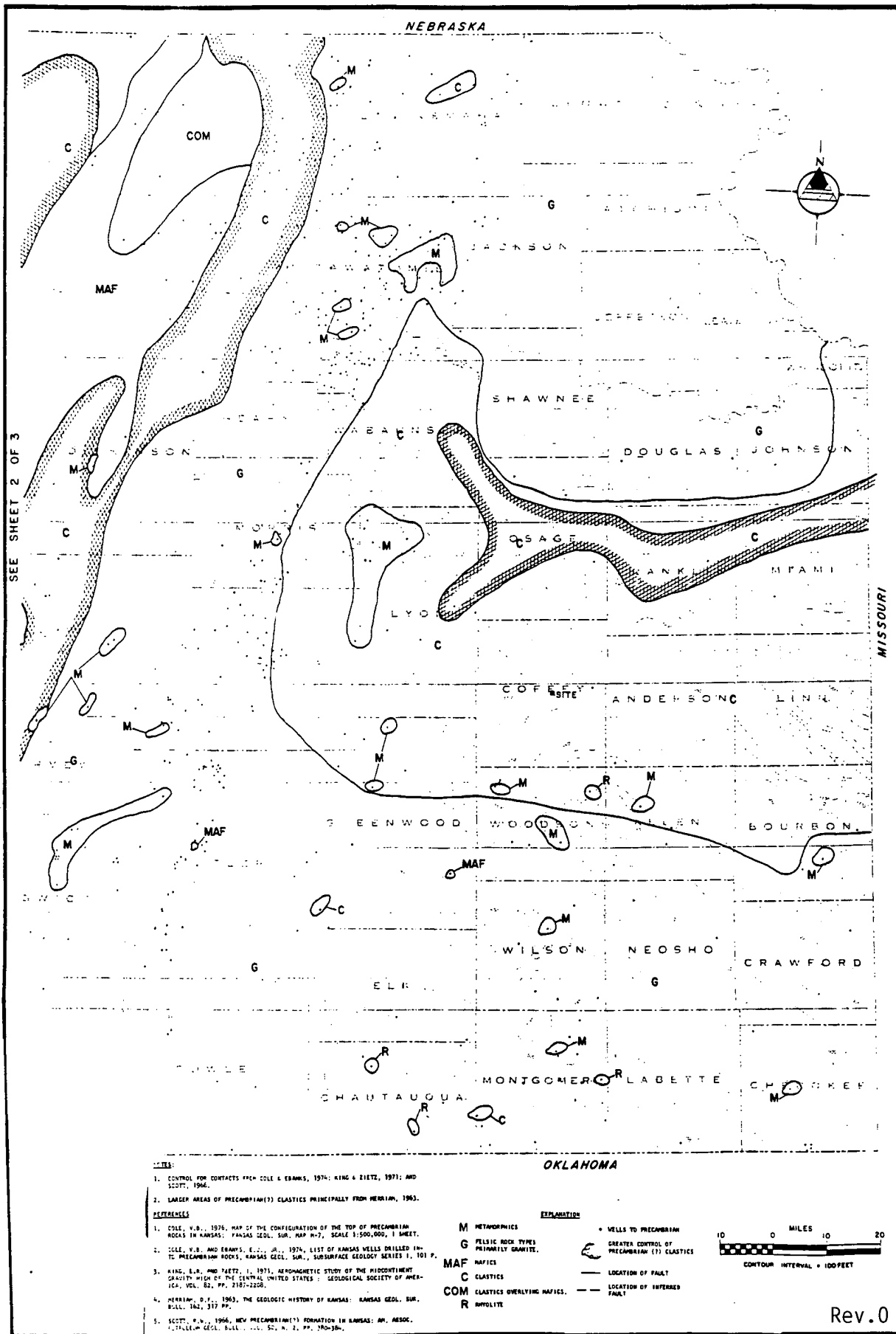

- CITIS:**
1. CONTROL FOR CONTACTS FROM COLE & EBANES, 1974; KING & EIZETZ, 1971; AND SCOTT, 1964.
 2. LARGER AREAS OF PRECAMBRIAN(?) CLASTICS PRINCIPALLY FROM MERRIAM, 1963.
- REFERENCES:**
1. COLE, V.B., 1976, MAP OF THE CONFIGURATION OF THE TOP OF PRECAMBRIAN ROCKS IN KANSAS, KANSAS GEOL. SUR., MAP 87, SCALE 1:500,000, 1 SHEET.
 2. COLE, V.B. AND EBANES, E.C., JR., 1974, LIST OF KANSAS WELLS DRILLED INTO PRECAMBRIAN ROCKS, KANSAS GEOL. SUR., SURFACE GEOLOGY SERIES 1, 101 P.
 3. KING, E.R. AND PAETZ, I., 1971, AEROMAGNETIC STUDY OF THE MIDCONTINENT GRAVITY HIGH OF THE CENTRAL UNITED STATES, GEOLOGICAL SOCIETY OF AMERICA, VOL. 62, PP. 2187-2228.
 4. MERRIAM, D.F., 1963, THE GEOLOGIC HISTORY OF KANSAS, KANSAS GEOL. SUR., BULL. 184, 317 PP.
 5. SCOTT, G.H., 1966, NEW PRECAMBRIAN(?) FORMATION IN KANSAS, AM. ASSOC. PETROLEUM GEOL. BULL., VOL. 52, NO. 2, PP. 390-394.

OKLAHOMA

EXPLANATION

- M METAMORPHICS
- G FELSIC ROCK TYPES, PRIMARILY GRANITE.
- MAF MAFICS
- C CLASTICS
- COM CLASTICS OVERLYING MAFICS.
- R AMPHOLITE
- WELLS TO PRECAMBRIAN
- GREATER CONTROL OF PRECAMBRIAN (?) CLASTICS
- LOCATION OF FAULT
- - - LOCATION OF INFERRED FAULT

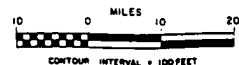

Rev.0

**WOLF CREEK
UPDATED SAFETY ANALYSIS REPORT**

Figure 2.5-7 (Sheet 1 of 3)

Structure Contour and Lithologic Map of Precambrian Surface in Kansas

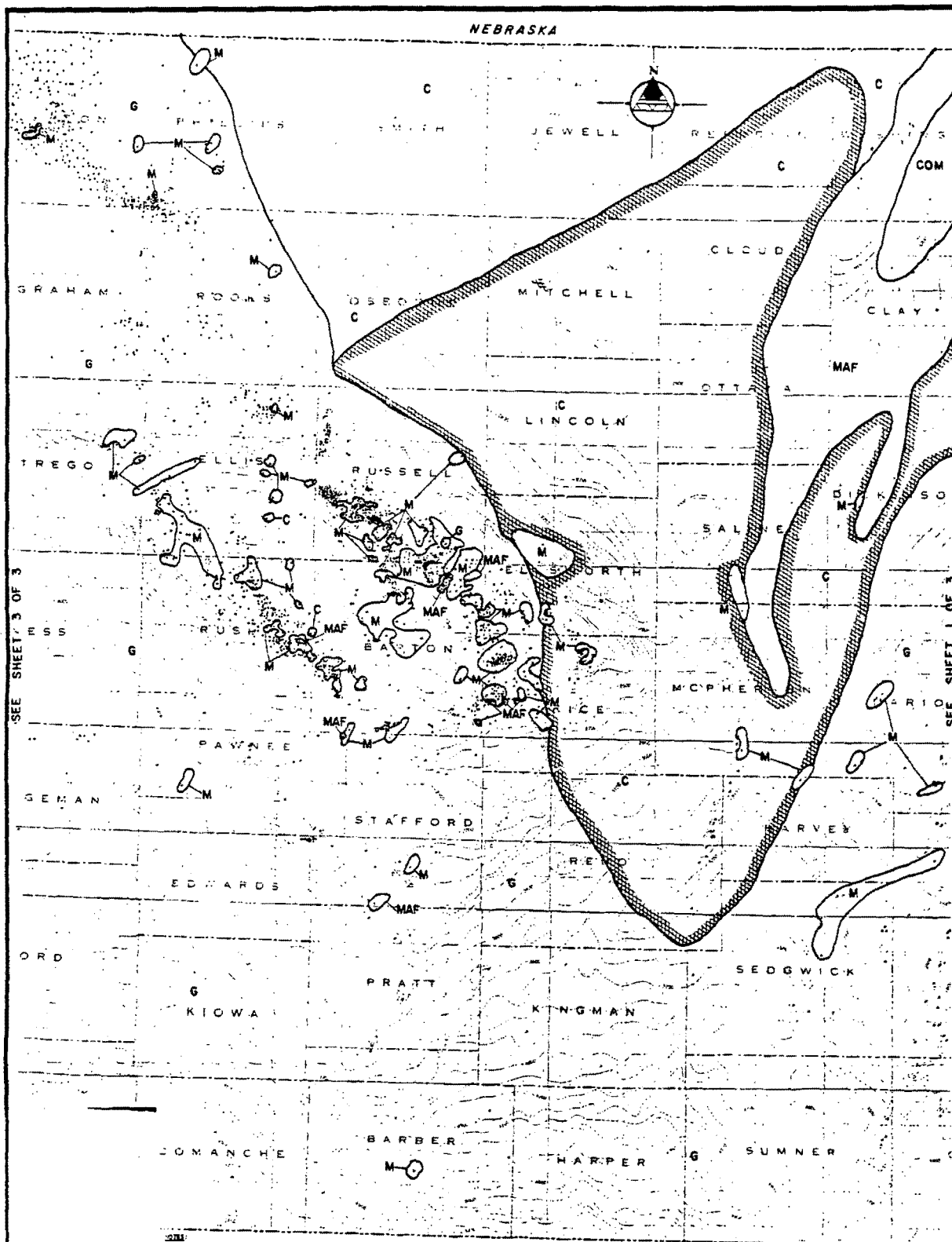

SEE SHEET 3 OF 3

SEE SHEET 1 OF 3

- CITE:**
1. CONTROL FOR CONTACTS FROM COLE & EDWARDS, 1974; KING & STEETS, 1971; AND SCOTT, 1966.
 2. LARGER AREAS OF PRECAMBRIAN(?) CLASTICS PRINCIPALLY FROM HENNING, 1963.
- LITERATURE:**
1. COLE, V.S., 1976, MAP OF THE EMPLACEMENT OF THE TOP OF PRECAMBRIAN ROCKS IN KANSAS; KANSAS GEOL. SUR. PAP. NO. 7, SCALE 1:500,000, 1 SHEET.
 2. COLE, V.S. AND EDWARDS, E.J., JR., 1974, LIST OF KANSAS WELLS DRILLED INTO PRECAMBRIAN ROCKS; KANSAS GEOL. SUR., SURFACE GEOLOGY SERIES 1, 101 P.
 3. KING, E.R. AND STEETS, J., 1971, MAGNETIC STUDY OF THE ALTOUSHUBERT GRAVITY HIGH OF THE CENTRAL UNITED STATES; GEOLOGICAL SOCIETY OF AMERICA, VOL. 81, PP. 2187-2208.
 4. HENNING, B.J., 1963, THE GEOLOGIC HISTORY OF KANSAS; KANSAS GEOL. SUR. BULL. 162, 317 PP.
 5. SCOTT, R.W., 1966, NEW PRECAMBRIAN(?) FORMATION IN KANSAS; AM. ASSOC. PETROLEUM GEOL., BULL., VOL. 50, P. 1, PP. 380-386.

EXPLANATION:

M	METAMORPHICS	—	WELLS TO PRECAMBRIAN
G	GLAUCOUS SHALES PRINCIPALLY QUARTZITE	○	GREATER CONTROL OF PRECAMBRIAN (?) CLASTICS
MAF	MAFIC	—	LOCATION OF FAULT
C	CLASTIC	—	LOCATION OF EMPERSED FAULT
COM	CLASTICS OVERLYING PAPPEL		
R	RHYOLITE		

0 10 20 MILES
 0 100 FEET
 CONTOUR INTERVAL = 100 FEET

**WOLF CREEK
 UPDATED SAFETY ANALYSIS REPORT**

Figure 2.5-7 (Sheet 2 of 3)

Structure Contour and Lithologic Map of Precambrian Surface in Kansas

Rev. 0

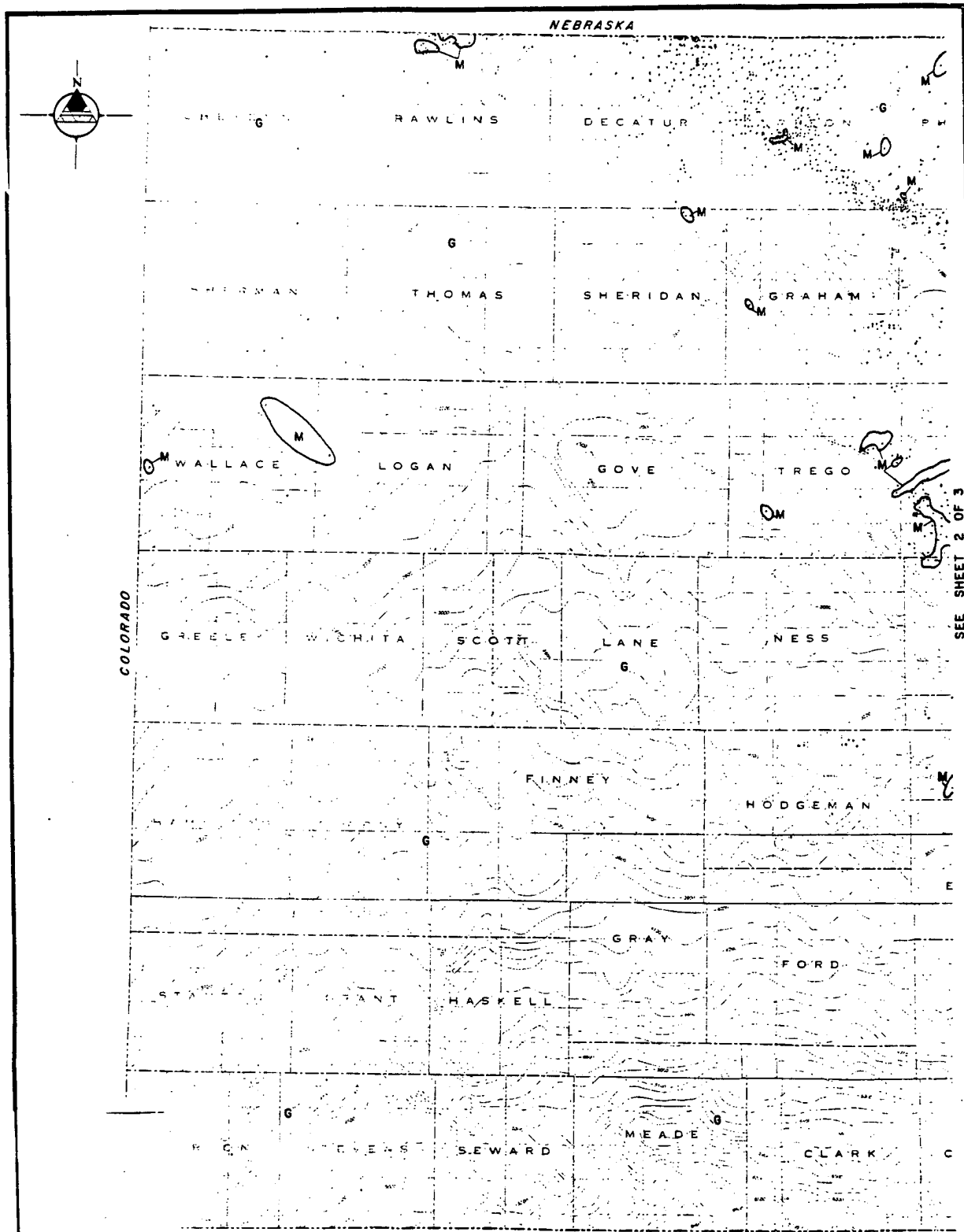

SEE SHEET 2 OF 3

COLORADO

NEBRASKA

OKLAHOMA

- NOTE:**
- CONTROL FOR CONTACTS FROM COLE & ERANKS, 1974; KING & ZIETZ, 1971; AND SCOTT, 1966.
 - LARGER AREAS OF PRECAMBRIAN(?) CLASTICS PRINCIPALLY FROM HERRIN, 1963.
- REFERENCES:**
- COLE, V.B., 1976, MAP OF THE CONFIGURATION OF THE TOP OF PRECAMBRIAN ROCKS IN KANSAS: KANSAS GEOL. SUR. MAP #17, SCALE 1:500,000, 1 SHEET.
 - COLE, V.B. AND ERANKS, E.C., JR., 1970, LIST OF KANSAS WELLS DRILLED INTO PRECAMBRIAN ROCKS, KANSAS GEOL. SUR., SURFACE GEOLOGY SERIES 1, 101 P.
 - KING, E.A. AND ZIETZ, J., 1971, AEROMAGNETIC STUDY OF THE MIDCONTINENT GRAVITY HIGH OF THE CENTRAL UNITED STATES: GEOLOGICAL SOCIETY OF AMERICA, VOL. 82, PP. 2187-2308.
 - HERRIN, B.F., 1963, THE NEOLITHIC HISTORY OF KANSAS: KANSAS GEOL. SUR. BULL. 162, 317 PP.
 - SCOTT, B.M., 1966, NEW PRECAMBRIAN(?) FORMATION IN KANSAS: AM. ASSOC. PETROLEUM GEOL., BULL., VOL. 50, NO. 2, PP. 380-384.

- EXPLANATION**
- M NETWORKS
 - G BELSIC ROCK TYPES PRIMARILY GRANITE
 - MAF MAPICS
 - C CLASTICS
 - COM CLASTICS OVERLYING MAPICS
 - R BIVOLITE
 - WELLS TO PRECAMBRIAN
 - ◻ GREATER CONTROL OF PRECAMBRIAN (?) CLASTICS
 - LOCATION OF FAULT
 - LOCATION OF INFERRED FAULT

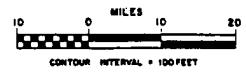

**WOLF CREEK
UPDATED SAFETY ANALYSIS REPORT**

Figure 2.5-7 (Sheet 3 of 3)

Structure Contour and Lithologic
Map of Precambrian Surface in
Kansas

Rev. 0

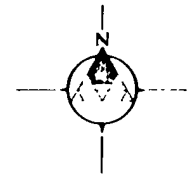
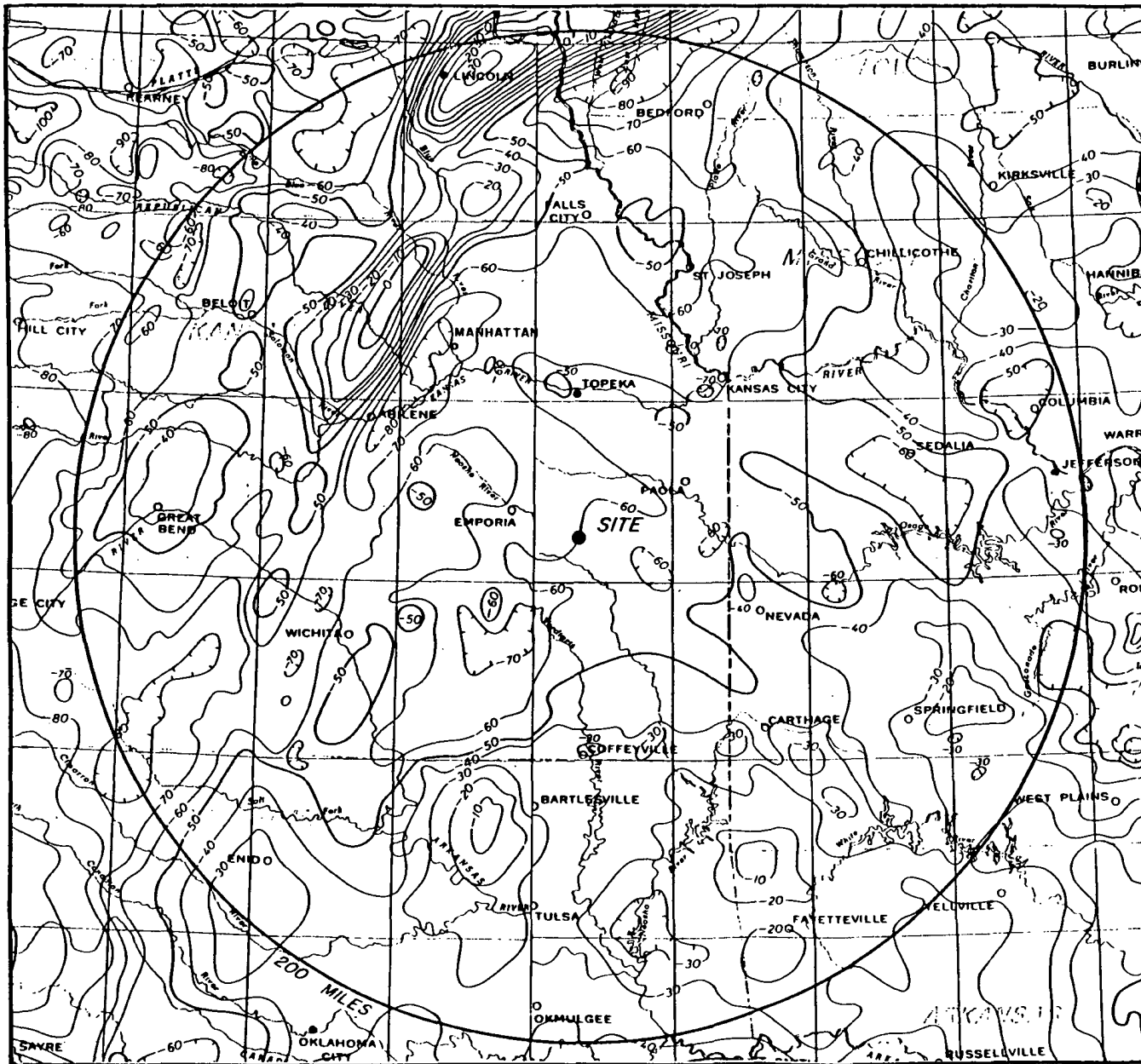

EXPLANATION

--- STATE BOUNDARY

REFERENCE:

AMERICAN GEOPHYSICAL UNION AND UNITED STATES GEOLOGICAL SURVEY, 1964, BOUGUER GRAVITY ANOMALY MAP OF THE UNITED STATES.

CONTOUR INTERVAL 10 HILLIGALS

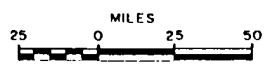

**WOLF CREEK
UPDATED SAFETY ANALYSIS REPORT**

Figure 2.5-8

Regional Bouguer Gravity Anomaly
Map

Rev. 0

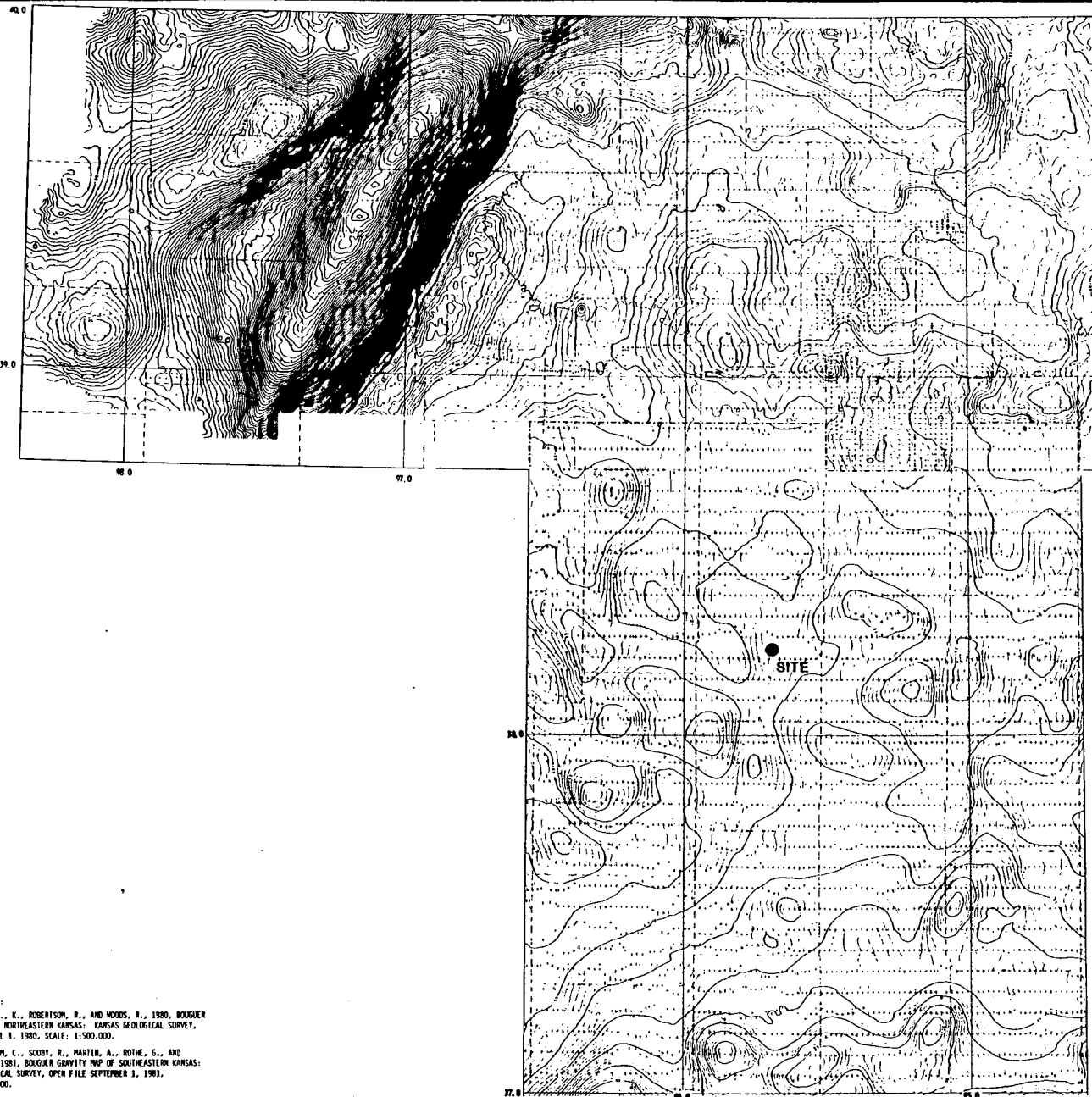

KEY:
 - - - - - INDICATES THE BOUNDARY BETWEEN THE BOUGUER GRAVITY MAP OF NORTHEASTERN KANSAS AND BOUGUER GRAVITY MAP OF SOUTHEASTERN KANSAS.



PINKNEY GRAVITY FIELD OF THE EARTH IN MILLIGALS
 CONTOUR INTERVAL 1 MILLIGAL

Rev. 0

MAP REFERENCES:
 YARGER, H., HIGGINS, K., ROBERTSON, B., AND MOODS, B., 1980, BOUGUER GRAVITY MAP OF NORTHEASTERN KANSAS; KANSAS GEOLOGICAL SURVEY, OPEN FILE APRIL 1, 1980, SCALE: 1:500,000.
 YARGER, H., LAM, C., SOOBY, R., MARTIN, A., ROHE, G., AND STEEPLES, D., 1981, BOUGUER GRAVITY MAP OF SOUTHEASTERN KANSAS; KANSAS GEOLOGICAL SURVEY, OPEN FILE SEPTEMBER 1, 1981, SCALE: 1:500,000.

WOLF CREEK
UPDATED SAFETY ANALYSIS REPORT

Figure 2.5-8a

Bouguer Gravity Map of Eastern Kansas

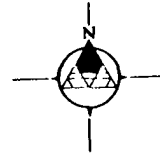
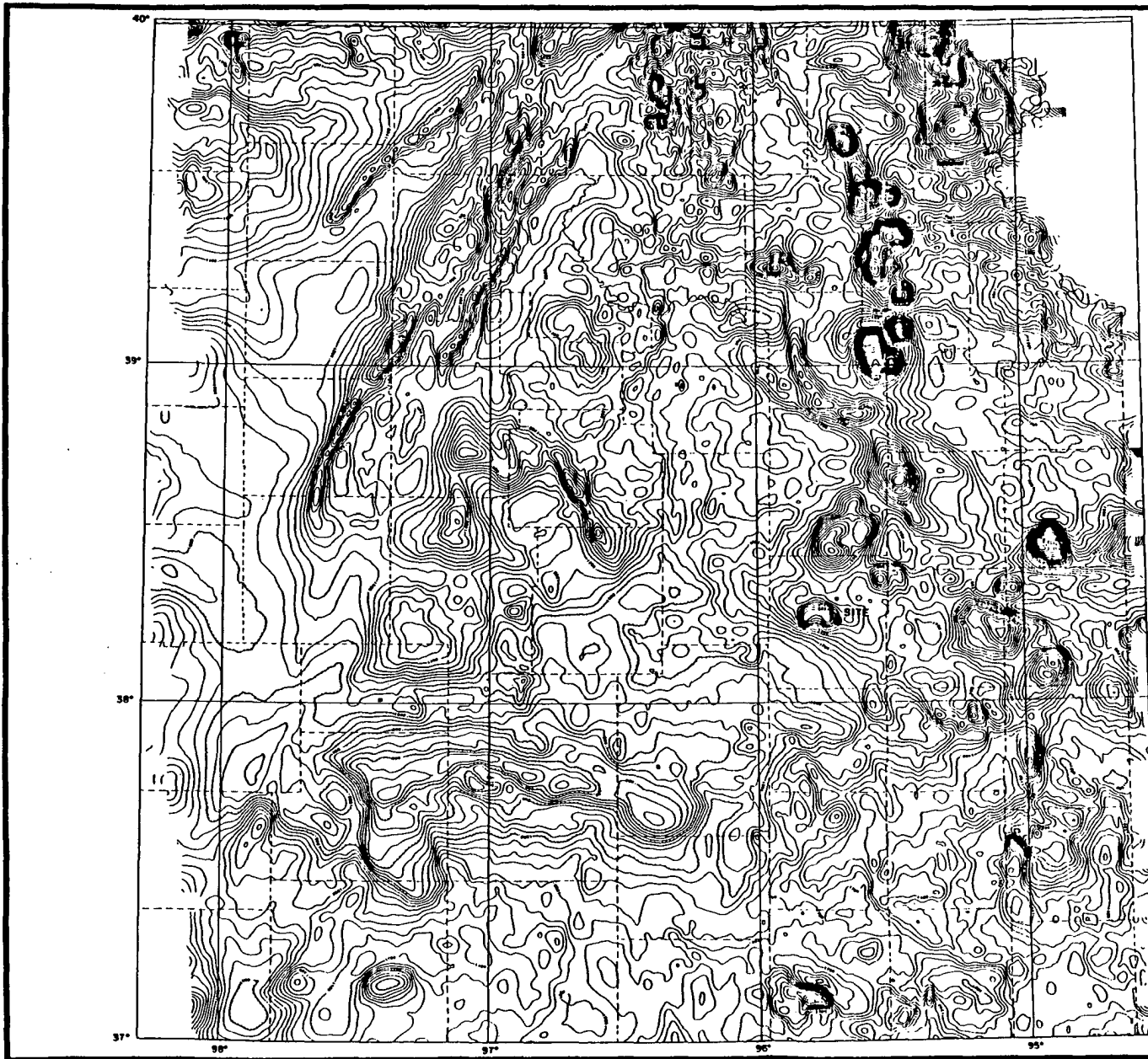

SOURCE:
 UNITED STATES GEOLOGICAL SURVEY, WASHINGTON, D.C.
 1:50,000 SCALE, 1960 EDITION, 1:50,000 SCALE, 1960 EDITION, 1:50,000 SCALE, 1960 EDITION, 1:50,000 SCALE, 1960 EDITION.

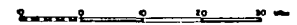

**WOLF CREEK
 UPDATED SAFETY ANALYSIS REPORT**

Figure 2.5-9



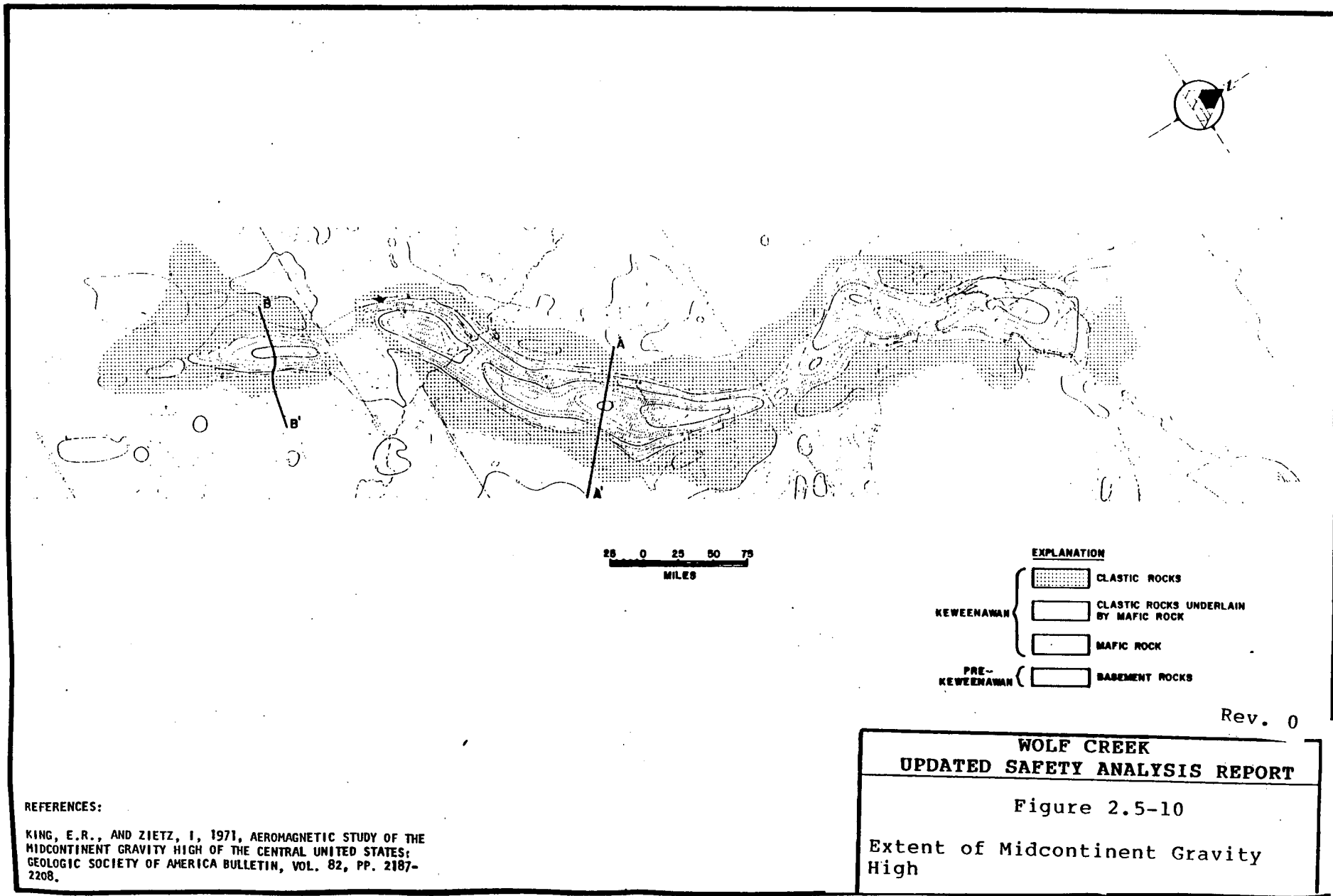

Regional Aeromagnetic Anomaly Map

Rev. 0



25 0 25 50 75
MILES

EXPLANATION

		CLASTIC ROCKS
KEWEENAW		CLASTIC ROCKS UNDERLAIN BY MAFIC ROCK
		MAFIC ROCK
PRE-KEWEENAW		BASINEMENT ROCKS

Rev. 0

**WOLF CREEK
UPDATED SAFETY ANALYSIS REPORT**

Figure 2.5-10
Extent of Midcontinent Gravity High

REFERENCES:

KING, E.R., AND ZIETZ, I, 1971, AEROMAGNETIC STUDY OF THE MIDCONTINENT GRAVITY HIGH OF THE CENTRAL UNITED STATES; GEOLOGIC SOCIETY OF AMERICA BULLETIN, VOL. 82, PP. 2187-2208.

OZARK UPLIFT
 FOREST CITY BASIN,
 CHEROKEE BASIN,
 BOURBON ARCH
 NEMAHA ANTICLINE
 HUGOTON BASIN
 ANADARKO BASIN
 SEDGWICK ARCH
 CHAUTAUQUA AREA
 SALINA BASIN AREA
 NORTH KANSAS
 BASIN AREA
 PRATT ANTICLINE
 CENTRAL KANSAS
 UPLIFT

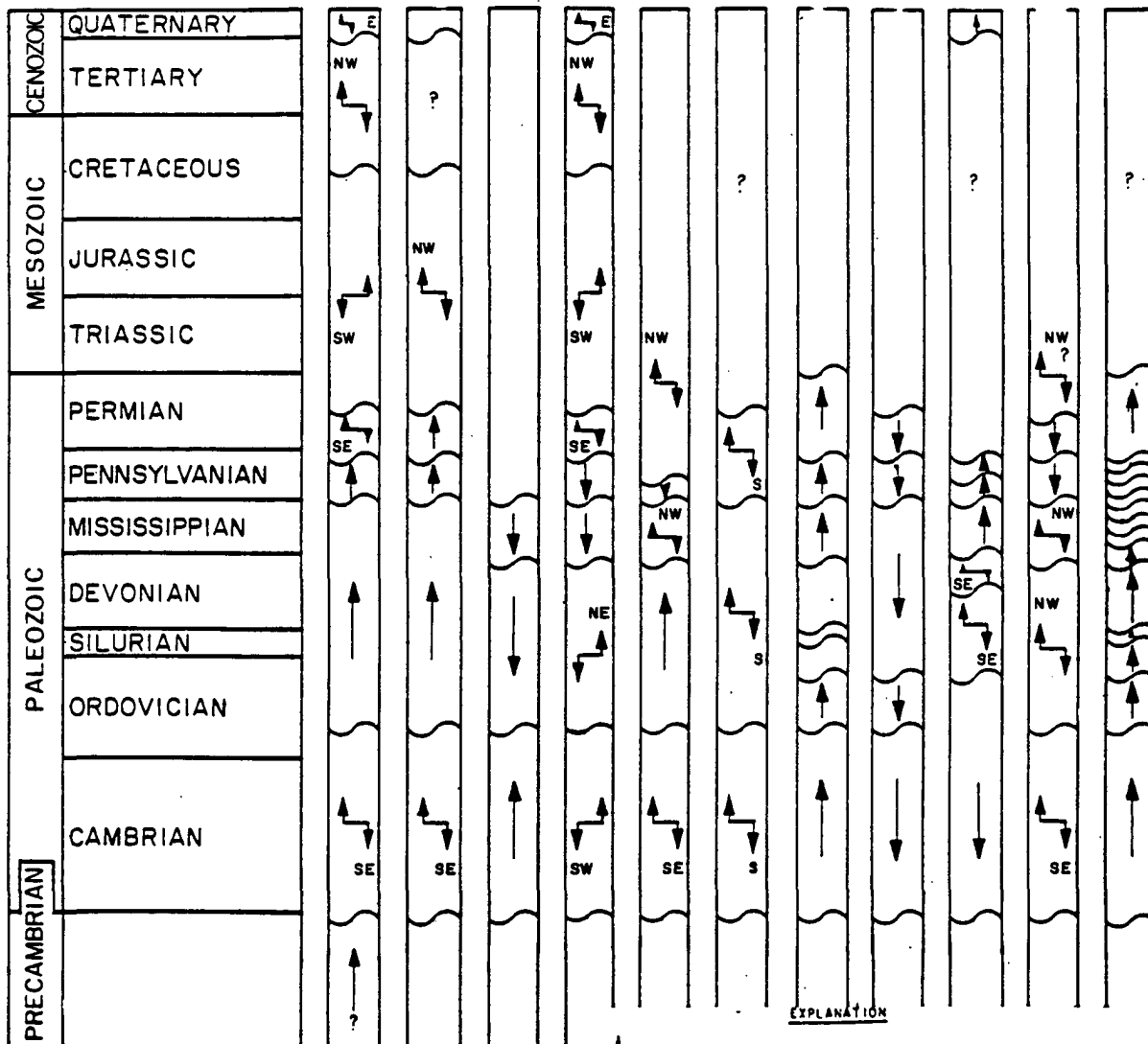

NOTES:

1. LOCATIONS OF THE VARIOUS STRUCTURES ARE SHOWN ON FIGURE 2.5-4.
2. TABLES 2.5-1 THROUGH 2.5-6 DETAIL THE CHARACTERISTICS OF THESE STRUCTURES.
3. FIGURES 2.5-15, 2.5-16 AND 2.5-17 SHOW THE VARIOUS MINOR FOLDS AND FAULTS ASSOCIATED WITH THESE STRUCTURES.

- EXPLANATION**
- ↑ UPWARD MOVEMENT
 - ↓ DOWNWARD MOVEMENT
 - ↙↘ TILTING WITH DIRECTIONAL NOTATION
 - 〰 UNCONFORMITIES

* FOR A SHORT PERIOD OF TIME DURING THE MISSISSIPPIAN-PENNSYLVANIAN, THE BOURBON ARCH MOVED UPWARD RELATIVE TO THE FOREST CITY AND CHEROKEE BASINS. (SECTION 2.5 I.1.5.1.11).

Rev. 0

REFERENCES:

MODIFIED FROM:

1. ARBENZ, J.K., 1956, TECTONIC MAP OF OKLAHOMA SHOWING SURFACE STRUCTURAL FEATURES: OKLAHOMA GEOLOGICAL SURVEY, MAP.
2. McCRACKEN, M.H., 1971, STRUCTURAL FEATURES OF MISSOURI: MISSOURI GEOL. SURVEY AND WATER RESOURCES, R.I. NO. 49, PP. 8-67, PL. 1.
3. MERRIAM, D.F., 1963, THE GEOLOGIC HISTORY OF KANSAS: KANSAS GEOL. SURVEY, BULL. 162, PP. 179-253, FIG. 124.

**WOLF CREEK
UPDATED SAFETY ANALYSIS REPORT**

Figure 2.5-11

Structural Evolution of Regional
Tectonic Features

TIME-STRATIGRAPHIC		ROCK-STRATIGRAPHIC		LITHO-LOGIC SYMBOL	THICKNESS IN FEET	DESCRIPTION
PENNSYLVANIAN SYSTEM	UPPER PENNSYLVANIAN SERIES	VIRGINIAN STAGE	SHAWNEE GROUP	O	0 to 88	Silty clay and clay with locally sandy, silty clay gravel.
					8 to 88	Shale and sandstone.
PENNSYLVANIAN SYSTEM	UPPER PENNSYLVANIAN SERIES	VIRGINIAN STAGE	DOUGLAS GROUP	LAWRENCE FORMATION	40+	Limestone and shale.
					60	Shale, sandy shale, sandstone and siltstone.
					80	Limestone and shale.
					80 (13)	Shale with sandstone and limestone.
					180 (104)	Siltstone, sandstone and silty, clayey shale.
					180 (104)	Siltstone, sandstone and silty, clayey shale.
					180 (104)	Siltstone, sandstone and silty, clayey shale.
					180 (104)	Siltstone, sandstone and silty, clayey shale.
					180 (104)	Siltstone, sandstone and silty, clayey shale.
					180 (104)	Siltstone, sandstone and silty, clayey shale.
					180 (104)	Siltstone, sandstone and silty, clayey shale.
PENNSYLVANIAN SYSTEM	UPPER PENNSYLVANIAN SERIES	MISSOURIAN STAGE	KANSAS CITY GROUP	STANTON LIMESTONE	78 (423)	Limestone and shale.
					78 (423)	Limestone and shale.
					78 (423)	Limestone and shale.
					78 (423)	Limestone and shale.
					78 (423)	Limestone and shale.
					78 (423)	Limestone and shale.
					78 (423)	Limestone and shale.
					78 (423)	Limestone and shale.
					78 (423)	Limestone and shale.
					78 (423)	Limestone and shale.
					78 (423)	Limestone and shale.
PENNSYLVANIAN SYSTEM	UPPER PENNSYLVANIAN SERIES	MISSOURIAN STAGE	KANSAS CITY GROUP	WYANDOTT LIMESTONE	848 (475)	Limestone and shale.
					848 (475)	Limestone and shale.
					848 (475)	Limestone and shale.
					848 (475)	Limestone and shale.
					848 (475)	Limestone and shale.
					848 (475)	Limestone and shale.
					848 (475)	Limestone and shale.
					848 (475)	Limestone and shale.
					848 (475)	Limestone and shale.
					848 (475)	Limestone and shale.
					848 (475)	Limestone and shale.

PENNSYLVANIAN SYSTEM		UPPER PENNSYLVANIAN SERIES		MISSOURIAN STAGE		KANSAS CITY GROUP	
PENNSYLVANIAN SYSTEM	UPPER PENNSYLVANIAN SERIES	MISSOURIAN STAGE	KANSAS CITY GROUP	ORISKANY LIMESTONE	Limestone and shale.	ORISKANY LIMESTONE	Limestone and shale.
				CHEERYVALE SHALE	Shale and limestone.	CHEERYVALE SHALE	Shale and limestone.
PENNSYLVANIAN SYSTEM	UPPER PENNSYLVANIAN SERIES	MISSOURIAN STAGE	KANSAS CITY GROUP	DEWINS LIMESTONE	Limestone and shale.	DEWINS LIMESTONE	Limestone and shale.
				GALZBURG SHALE	Shale with coal and sandstone.	GALZBURG SHALE	Shale with coal and sandstone.
PENNSYLVANIAN SYSTEM	UPPER PENNSYLVANIAN SERIES	MISSOURIAN STAGE	KANSAS CITY GROUP	WISSE LIMESTONE	Limestone and shale.	WISSE LIMESTONE	Limestone and shale.
				LADORE LIMESTONE	Shale with coal.	LADORE LIMESTONE	Shale with coal.
PENNSYLVANIAN SYSTEM	UPPER PENNSYLVANIAN SERIES	MISSOURIAN STAGE	KANSAS CITY GROUP	NESTOR LIMESTONE	Limestone and shale.	NESTOR LIMESTONE	Limestone and shale.
				TACKET SHALE	Shale with sandstone and limestone.	TACKET SHALE	Shale with sandstone and limestone.
PENNSYLVANIAN SYSTEM	UPPER PENNSYLVANIAN SERIES	MISSOURIAN STAGE	KANSAS CITY GROUP	CHECKERBOARD LIMESTONE	Limestone.	CHECKERBOARD LIMESTONE	Limestone.
				BEARD LIMESTONE	Shale with coal, sandstone at base.	BEARD LIMESTONE	Shale with coal, sandstone at base.
PENNSYLVANIAN SYSTEM	UPPER PENNSYLVANIAN SERIES	MISSOURIAN STAGE	KANSAS CITY GROUP	HOLDENVILLE SHALE	Clay shale.	HOLDENVILLE SHALE	Clay shale.
				LENAPE LIMESTONE	Limestone and shale.	LENAPE LIMESTONE	Limestone and shale.
PENNSYLVANIAN SYSTEM	UPPER PENNSYLVANIAN SERIES	MISSOURIAN STAGE	KANSAS CITY GROUP	ROBERTS SHALE	Shale and sandstone.	ROBERTS SHALE	Shale and sandstone.
				SLAYBORN LIMESTONE	Limestone and shale.	SLAYBORN LIMESTONE	Limestone and shale.
PENNSYLVANIAN SYSTEM	UPPER PENNSYLVANIAN SERIES	MISSOURIAN STAGE	KANSAS CITY GROUP	BANDERA SHALE	Limestone and sandstone.	BANDERA SHALE	Limestone and sandstone.
				PRINCE LIMESTONE	Limestone and shale with limestone lenses.	PRINCE LIMESTONE	Limestone and shale with limestone lenses.
PENNSYLVANIAN SYSTEM	UPPER PENNSYLVANIAN SERIES	MISSOURIAN STAGE	KANSAS CITY GROUP	LABETTE SHALE	Shale with sandstone, coal and limestone.	LABETTE SHALE	Shale with sandstone, coal and limestone.
				FORT SCOTT LIMESTONE	Limestone and shale.	FORT SCOTT LIMESTONE	Limestone and shale.
PENNSYLVANIAN SYSTEM	UPPER PENNSYLVANIAN SERIES	MISSOURIAN STAGE	KANSAS CITY GROUP	CARBON FORMATION	Limestone.	CARBON FORMATION	Limestone.
				CARBON FORMATION	Limestone.	CARBON FORMATION	Limestone.
PENNSYLVANIAN SYSTEM	UPPER PENNSYLVANIAN SERIES	MISSOURIAN STAGE	KANSAS CITY GROUP	KREBS FORMATION	Shale, limestone, sandstone and under of clay with coal.	KREBS FORMATION	Shale, limestone, sandstone and under of clay with coal.
				KREBS FORMATION	Shale, limestone, sandstone and under of clay with coal.	KREBS FORMATION	Shale, limestone, sandstone and under of clay with coal.

PENNSYLVANIAN SYSTEM		UPPER PENNSYLVANIAN SERIES		MISSOURIAN STAGE		KANSAS CITY GROUP	
PENNSYLVANIAN SYSTEM	UPPER PENNSYLVANIAN SERIES	MISSOURIAN STAGE	KANSAS CITY GROUP	ORISKANY LIMESTONE	Limestone and shale.	ORISKANY LIMESTONE	Limestone and shale.
				CHEERYVALE SHALE	Shale and limestone.	CHEERYVALE SHALE	Shale and limestone.
PENNSYLVANIAN SYSTEM	UPPER PENNSYLVANIAN SERIES	MISSOURIAN STAGE	KANSAS CITY GROUP	DEWINS LIMESTONE	Limestone and shale.	DEWINS LIMESTONE	Limestone and shale.
				GALZBURG SHALE	Shale with coal and sandstone.	GALZBURG SHALE	Shale with coal and sandstone.
PENNSYLVANIAN SYSTEM	UPPER PENNSYLVANIAN SERIES	MISSOURIAN STAGE	KANSAS CITY GROUP	WISSE LIMESTONE	Limestone and shale.	WISSE LIMESTONE	Limestone and shale.
				LADORE LIMESTONE	Shale with coal.	LADORE LIMESTONE	Shale with coal.
PENNSYLVANIAN SYSTEM	UPPER PENNSYLVANIAN SERIES	MISSOURIAN STAGE	KANSAS CITY GROUP	NESTOR LIMESTONE	Limestone and shale.	NESTOR LIMESTONE	Limestone and shale.
				TACKET SHALE	Shale with sandstone and limestone.	TACKET SHALE	Shale with sandstone and limestone.
PENNSYLVANIAN SYSTEM	UPPER PENNSYLVANIAN SERIES	MISSOURIAN STAGE	KANSAS CITY GROUP	CHECKERBOARD LIMESTONE	Limestone.	CHECKERBOARD LIMESTONE	Limestone.
				BEARD LIMESTONE	Shale with coal, sandstone at base.	BEARD LIMESTONE	Shale with coal, sandstone at base.
PENNSYLVANIAN SYSTEM	UPPER PENNSYLVANIAN SERIES	MISSOURIAN STAGE	KANSAS CITY GROUP	HOLDENVILLE SHALE	Clay shale.	HOLDENVILLE SHALE	Clay shale.
				LENAPE LIMESTONE	Limestone and shale.	LENAPE LIMESTONE	Limestone and shale.
PENNSYLVANIAN SYSTEM	UPPER PENNSYLVANIAN SERIES	MISSOURIAN STAGE	KANSAS CITY GROUP	ROBERTS SHALE	Shale and sandstone.	ROBERTS SHALE	Shale and sandstone.
				SLAYBORN LIMESTONE	Limestone and shale.	SLAYBORN LIMESTONE	Limestone and shale.
PENNSYLVANIAN SYSTEM	UPPER PENNSYLVANIAN SERIES	MISSOURIAN STAGE	KANSAS CITY GROUP	BANDERA SHALE	Limestone and sandstone.	BANDERA SHALE	Limestone and sandstone.
				PRINCE LIMESTONE	Limestone and shale with limestone lenses.	PRINCE LIMESTONE	Limestone and shale with limestone lenses.
PENNSYLVANIAN SYSTEM	UPPER PENNSYLVANIAN SERIES	MISSOURIAN STAGE	KANSAS CITY GROUP	LABETTE SHALE	Shale with sandstone, coal and limestone.	LABETTE SHALE	Shale with sandstone, coal and limestone.
				FORT SCOTT LIMESTONE	Limestone and shale.	FORT SCOTT LIMESTONE	Limestone and shale.
PENNSYLVANIAN SYSTEM	UPPER PENNSYLVANIAN SERIES	MISSOURIAN STAGE	KANSAS CITY GROUP	CARBON FORMATION	Limestone.	CARBON FORMATION	Limestone.
				CARBON FORMATION	Limestone.	CARBON FORMATION	Limestone.
PENNSYLVANIAN SYSTEM	UPPER PENNSYLVANIAN SERIES	MISSOURIAN STAGE	KANSAS CITY GROUP	KREBS FORMATION	Shale, limestone, sandstone and under of clay with coal.	KREBS FORMATION	Shale, limestone, sandstone and under of clay with coal.
				KREBS FORMATION	Shale, limestone, sandstone and under of clay with coal.	KREBS FORMATION	Shale, limestone, sandstone and under of clay with coal.

PENNSYLVANIAN SYSTEM		UPPER PENNSYLVANIAN SERIES		MISSOURIAN STAGE		KANSAS CITY GROUP	
PENNSYLVANIAN SYSTEM	UPPER PENNSYLVANIAN SERIES	MISSOURIAN STAGE	KANSAS CITY GROUP	ORISKANY LIMESTONE	Limestone and shale.	ORISKANY LIMESTONE	Limestone and shale.
				CHEERYVALE SHALE	Shale and limestone.	CHEERYVALE SHALE	Shale and limestone.
PENNSYLVANIAN SYSTEM	UPPER PENNSYLVANIAN SERIES	MISSOURIAN STAGE	KANSAS CITY GROUP	DEWINS LIMESTONE	Limestone and shale.	DEWINS LIMESTONE	Limestone and shale.
				GALZBURG SHALE	Shale with coal and sandstone.	GALZBURG SHALE	Shale with coal and sandstone.
PENNSYLVANIAN SYSTEM	UPPER PENNSYLVANIAN SERIES	MISSOURIAN STAGE	KANSAS CITY GROUP	WISSE LIMESTONE	Limestone and shale.	WISSE LIMESTONE	Limestone and shale.
				LADORE LIMESTONE	Shale with coal.	LADORE LIMESTONE	Shale with coal.
PENNSYLVANIAN SYSTEM	UPPER PENNSYLVANIAN SERIES	MISSOURIAN STAGE	KANSAS CITY GROUP	NESTOR LIMESTONE	Limestone and shale.	NESTOR LIMESTONE	Limestone and shale.
				TACKET SHALE	Shale with sandstone and limestone.	TACKET SHALE	Shale with sandstone and limestone.
PENNSYLVANIAN SYSTEM	UPPER PENNSYLVANIAN SERIES	MISSOURIAN STAGE	KANSAS CITY GROUP	CHECKERBOARD LIMESTONE	Limestone.	CHECKERBOARD LIMESTONE	Limestone.
				BEARD LIMESTONE	Shale with coal, sandstone at base.	BEARD LIMESTONE	Shale with coal, sandstone at base.
PENNSYLVANIAN SYSTEM	UPPER PENNSYLVANIAN SERIES	MISSOURIAN STAGE	KANSAS CITY GROUP	HOLDENVILLE SHALE	Clay shale.	HOLDENVILLE SHALE	Clay shale.
				LENAPE LIMESTONE	Limestone and shale.	LENAPE LIMESTONE	Limestone and shale.
PENNSYLVANIAN SYSTEM	UPPER PENNSYLVANIAN SERIES	MISSOURIAN STAGE	KANSAS CITY GROUP	ROBERTS SHALE	Shale and sandstone.	ROBERTS SHALE	Shale and sandstone.
				SLAYBORN LIMESTONE	Limestone and shale.	SLAYBORN LIMESTONE	Limestone and shale.
PENNSYLVANIAN SYSTEM	UPPER PENNSYLVANIAN SERIES	MISSOURIAN STAGE	KANSAS CITY GROUP	BANDERA SHALE	Limestone and sandstone.	BANDERA SHALE	Limestone and sandstone.
				PRINCE LIMESTONE	Limestone and shale with limestone lenses.	PRINCE LIMESTONE	Limestone and shale with limestone lenses.
PENNSYLVANIAN SYSTEM	UPPER PENNSYLVANIAN SERIES	MISSOURIAN STAGE	KANSAS CITY GROUP	LABETTE SHALE	Shale with sandstone, coal and limestone.	LABETTE SHALE	Shale with sandstone, coal and limestone.
				FORT SCOTT LIMESTONE	Limestone and shale.	FORT SCOTT LIMESTONE	Limestone and shale.
PENNSYLVANIAN SYSTEM	UPPER PENNSYLVANIAN SERIES	MISSOURIAN STAGE	KANSAS CITY GROUP	CARBON FORMATION	Limestone.	CARBON FORMATION	Limestone.
				CARBON FORMATION	Limestone.	CARBON FORMATION	Limestone.
PENNSYLVANIAN SYSTEM	UPPER PENNSYLVANIAN SERIES	MISSOURIAN STAGE	KANSAS CITY GROUP	KREBS FORMATION	Shale, limestone, sandstone and under of clay with coal.	KREBS FORMATION	Shale, limestone, sandstone and under of clay with coal.
				KREBS FORMATION	Shale, limestone, sandstone and under of clay with coal.	KREBS FORMATION	Shale, limestone, sandstone and under of clay with coal.

REFERENCES:

- MODIFIED FROM:
1. COLE, V.P., 1976, CORRECTION OF THE TOP OF PRECAMBRIAN ROCKS IN KANSAS: KANSAS GEOLOGICAL SURVEY, MAP NO. 7, SCALE 1:500,000.
 2. _____, 1973, PRIVATE COMMUNICATION.
 3. JEWETT, J.M., 1963, OIL AND GAS IN EASTERN KANSAS: KANSAS GEOLOGICAL SURVEY, BULL. 104, PP. 80-190.
 4. MERRIAM, W.F., 1963, THE GEOLOGIC HISTORY OF KANSAS: KANSAS GEOLOGICAL SURVEY, BULL. 167, PP. 80-190.
 5. THOMPSON, T.L. AND COBBLE, E.D., 1968, CONTOURS AND STRATIGRAPHY OF THE MISSOURIAN STAGE (UPPER MISSISSIPPIAN) IN KANSAS: KANSAS GEOLOGICAL SURVEY, BULL. 192, PP. 4-7.
 6. WATNEY, E.L., 1970, STRUCTURAL CONTOUR MAP: BASE OF KANSAS CITY GROUP (UPPER PENNSYLVANIAN)-EASTERN KANSAS: KANSAS GEOLOGICAL SURVEY, MAP NO. 10, SCALE 1:500,000.
 7. STALLER, D.W., (ED.), 1969, THE STRATIGRAPHIC SUCCESSION IN KANSAS: KANSAS GEOLOGICAL SURVEY, BULL. 109, 81PP., 2 PL.

EXPLANATION

-  GRANITE
-  SHALE
-  SANDSTONE
-  METAMORPHICS
-  LIMESTONE
-  DOLOMITE
-  OPEN
-  COAL
-  CALCAREOUS SHALE

NOTES

1. PLEISTOCENE MATERIALS MAY OR MAY NOT BE PRESENT AT ANY ONE AREA OF THE SITE AND MAY OVERLIE OR UNDERLIE DOWN TO THE INELAND SANDSTONE MEMBER.
2. PLEISTOCENE MATERIALS OCCUR AS HIGH LEVEL TERRACE DEPOSITS AND MAY OR MAY NOT BE PRESENT AT ANY ONE AREA OF THE SITE. THEY MAY OVERLIE OR UNDERLIE DOWN TO THE TORONTO LIMESTONE MEMBER.
3. THICKNESSES OF THE FORMATIONS DOWN THROUGH THE STANGER FORMATION AS FROM BOREHOLES IN THE SITE AREA. ALL OTHER THICKNESSES ARE ESTIMATES.
4. BOREHOLE IN PARTNERSHIP REPORTS ESTIMATED DEPTHS TO THE TOP OF THE FORMATIONS BEARING THE PROPOSED PLANT SITE.
5. A DETAILED STRATIGRAPHIC COLUMN OF THE BOULDER AND SHAWNEE GROUPS IS PRESENTED ON FIGURE 2.5-12.

Rev. 0

WOLF CREEK
UPDATED SAFETY ANALYSIS REPORT

Figure 2.5-12

Generalized Site - Stratigraphic
Column

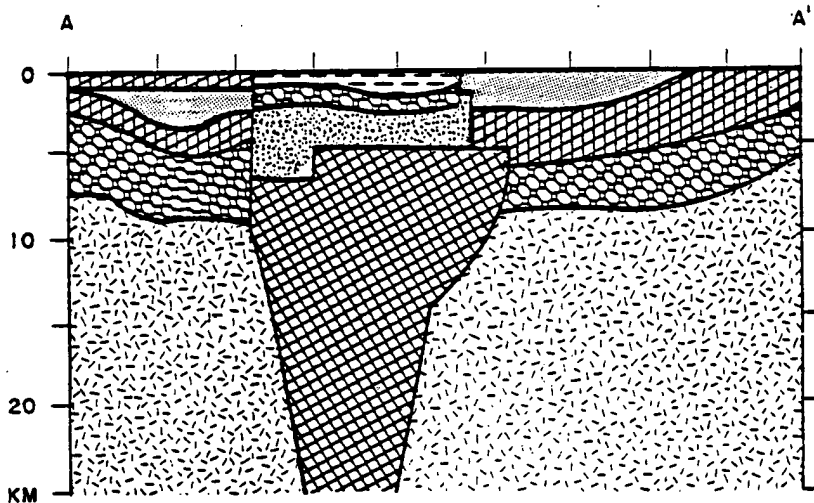
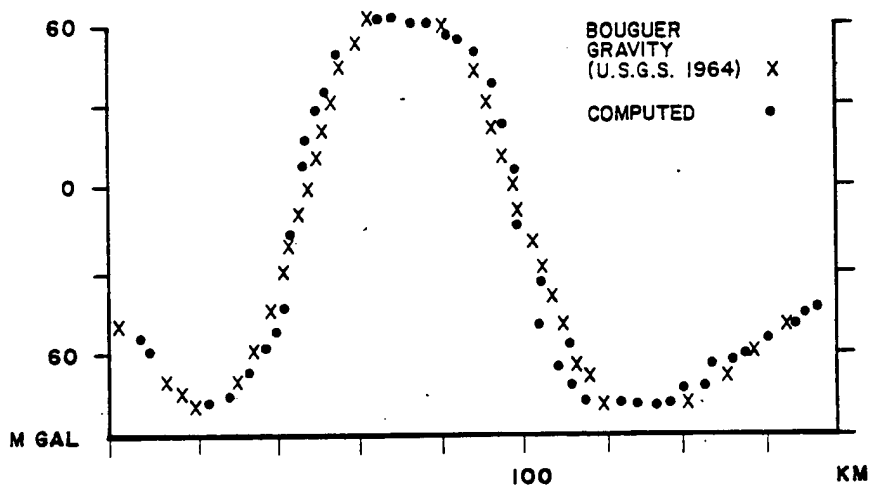

VELOCITY
KM/SEC
(DENSITY
GM/CC)

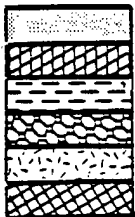

3.5 (2.42)
4.7 (2.60)
5.3 (2.72)
5.6 (2.82)
6.4 (2.94)
6.9 (3.08)



Rev. 0

REFERENCE:

OCOLA, L.C., AND MEYER, R.P., 1973,
CENTRAL NORTH AMERICAN RIFT SYSTEM,
STRUCTURE AT THE AXIAL ZONE FROM
SEISMIC AND GRAVIMETRIC DATA: JOUR.
OF GEOPHYSICAL RESEARCH, VOL. 78, NO.
23, PP. 5173-5194, FIG. 10.

NOTE:

LOCATION OF PROFILE IS SHOWN ON
FIGURE 2.5-10.

**WOLF CREEK
UPDATED SAFETY ANALYSIS REPORT**

Figure 2.5-13

Model of Iowa-Nebraska Segment of
Midcontinent Gravity High

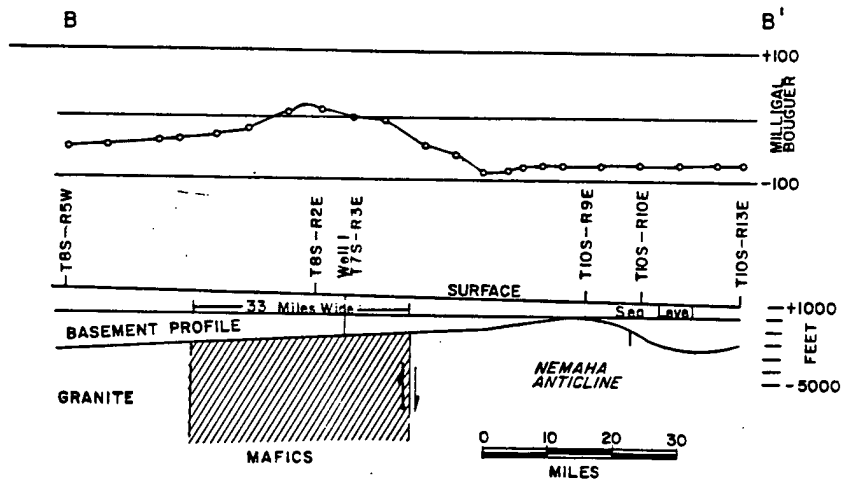

Rev. 0

NOTES:

1. DRAWING MODIFIED FROM LYONS, P.L., 1959, THE GREENLEAF ANOMALY, A SIGNIFICANT GRAVITY FEATURE, IN HAMBLETON, W.W., (ED.), SYMPOSIUM ON GEOPHYSICS IN KANSAS: KANSAS GEOL. SUR., BULL. 137, PP. 105-120, FIG. 5. DIRECTION OF RELATIVE MOVEMENT ALONG FAULT IS AS INTERPRETED BY LYONS.
2. LOCATION OF PROFILE IS SHOWN ON FIGURE 2.5-10.

**WOLF CREEK
UPDATED SAFETY ANALYSIS REPORT**

Figure 2.5-14

Model of Kansas Segment of
Midcontinent Gravity High

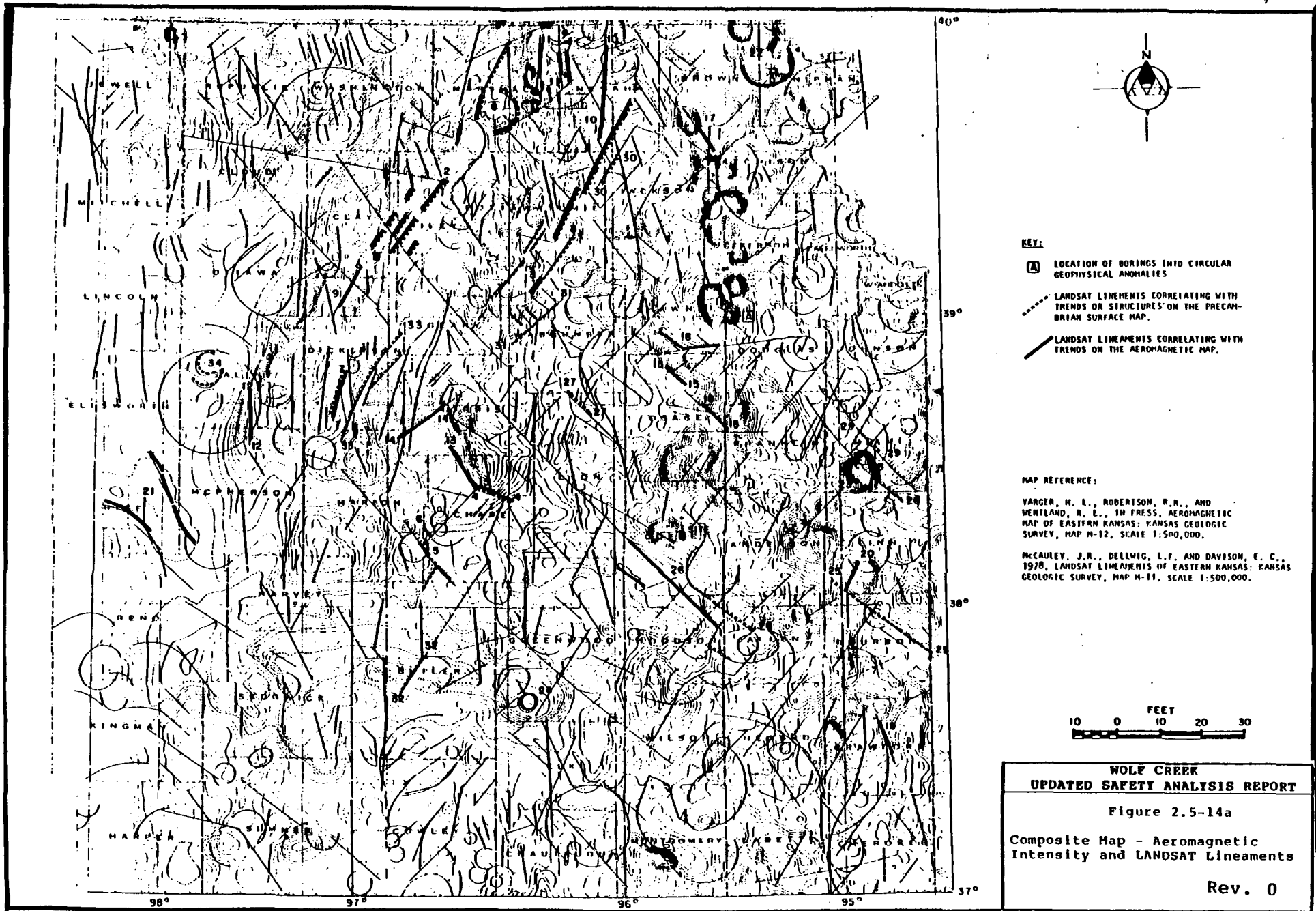

KEY:

- (A) LOCATION OF BORINGS INTO CIRCULAR GEOPHYSICAL ANOMALIES
- LANDSAT LINEMENTS CORRELATING WITH TRENDS OR STRUCTURES ON THE PRECAMBRIAN SURFACE MAP.
- LANDSAT LINEMENTS CORRELATING WITH TRENDS ON THE AEROMAGNETIC MAP.

MAP REFERENCE:

YARGER, H. L., ROBERTSON, R. R., AND WENTLAND, R. L., IN PRESS, AEROMAGNETIC MAP OF EASTERN KANSAS: KANSAS GEOLOGIC SURVEY, MAP H-12, SCALE 1:500,000.

MCCAULEY, J. R., DELLWIG, L. F. AND DAVIDSON, E. C., 1978, LANDSAT LINEMENTS OF EASTERN KANSAS: KANSAS GEOLOGIC SURVEY, MAP H-11, SCALE 1:500,000.



**WOLF CREEK
UPDATED SAFETY ANALYSIS REPORT**

Figure 2.5-14a

Composite Map - Aeromagnetic
Intensity and LANDSAT Lineaments

Rev. 0

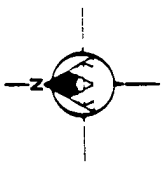
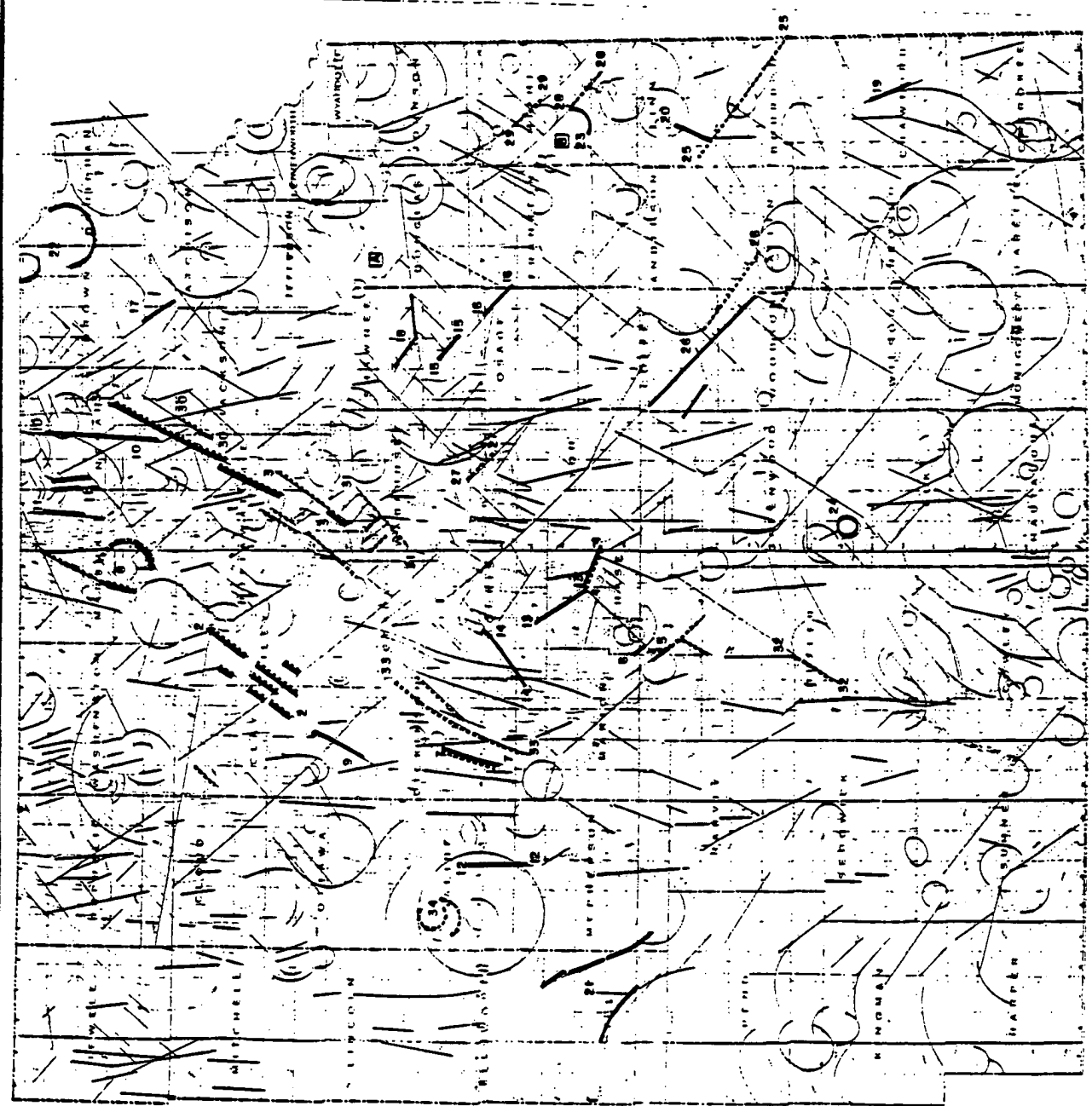

REF:

- (A) LOCATION OF BORINGS INTO CIRCULAR GEOPHYSICAL ANOMALIES
- LANDSAT LINEMENTS CORRELATING WITH TRENDS OR STRUCTURES ON THE PRECAMBRIAN SURFACE MAP.
- LANDSAT LINEMENTS CORRELATING WITH TRENDS ON THE MENOMONIE MAP.

MAP REFERENCE:

COTE, W. R., 1976, CORRELATION OF THE TOP OF PRECAMBRIAN UNITS IN EASTERN KANSAS GEOLOGIC SURVEY, MAP M-1, SCALE 1:500,000.

MCNEELY, J. R., HELBIG, T. F., AND DAVISON, E. C., 1978, LANDSAT LINEMENTS OF EASTERN KANSAS: KANSAS GEOLOGICAL SURVEY, MAP M-11, SCALE 1:500,000.



REV. 4. 7/81

UPDATED SAFETY ANALYSIS REPORT

WOLF CREEK



Figure 2.5-14b

Composite Map - Precambrian Surface and LANDSAT Lineaments

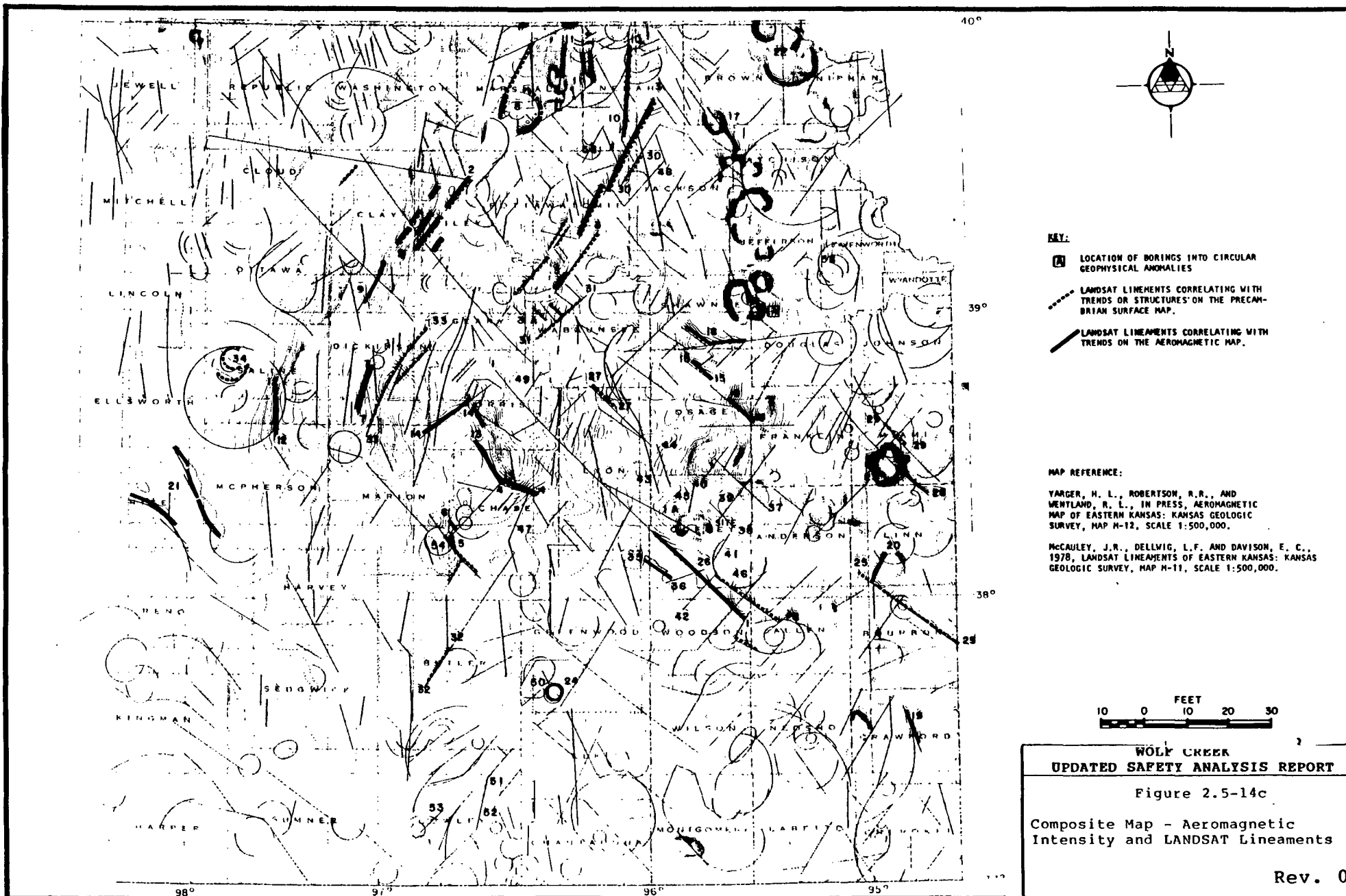
Rev. 0



KEY:

-  LOCATION OF BORINGS INTO CIRCULAR GEOPHYSICAL ANOMALIES
-  LANDSAT LINEMENTS CORRELATING WITH TRENDS OR STRUCTURES ON THE PRECAMBRIAN SURFACE MAP.
-  LANDSAT LINEMENTS CORRELATING WITH TRENDS ON THE AEROMAGNETIC MAP.

MAP REFERENCE:

YARGER, H. L., ROBERTSON, R. R., AND WENTLAND, R. L., IN PRESS, AEROMAGNETIC MAP OF EASTERN KANSAS: KANSAS GEOLOGIC SURVEY, MAP M-12, SCALE 1:500,000.

MCCAULEY, J. R., DELLWIG, L. F. AND DAVISON, E. C., 1978, LANDSAT LINEMENTS OF EASTERN KANSAS: KANSAS GEOLOGIC SURVEY, MAP M-11, SCALE 1:500,000.



**WOLF CREEK
UPDATED SAFETY ANALYSIS REPORT**

Figure 2.5-14c

Composite Map - Aeromagnetic Intensity and LANDSAT Lineaments

Rev. 0

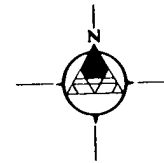
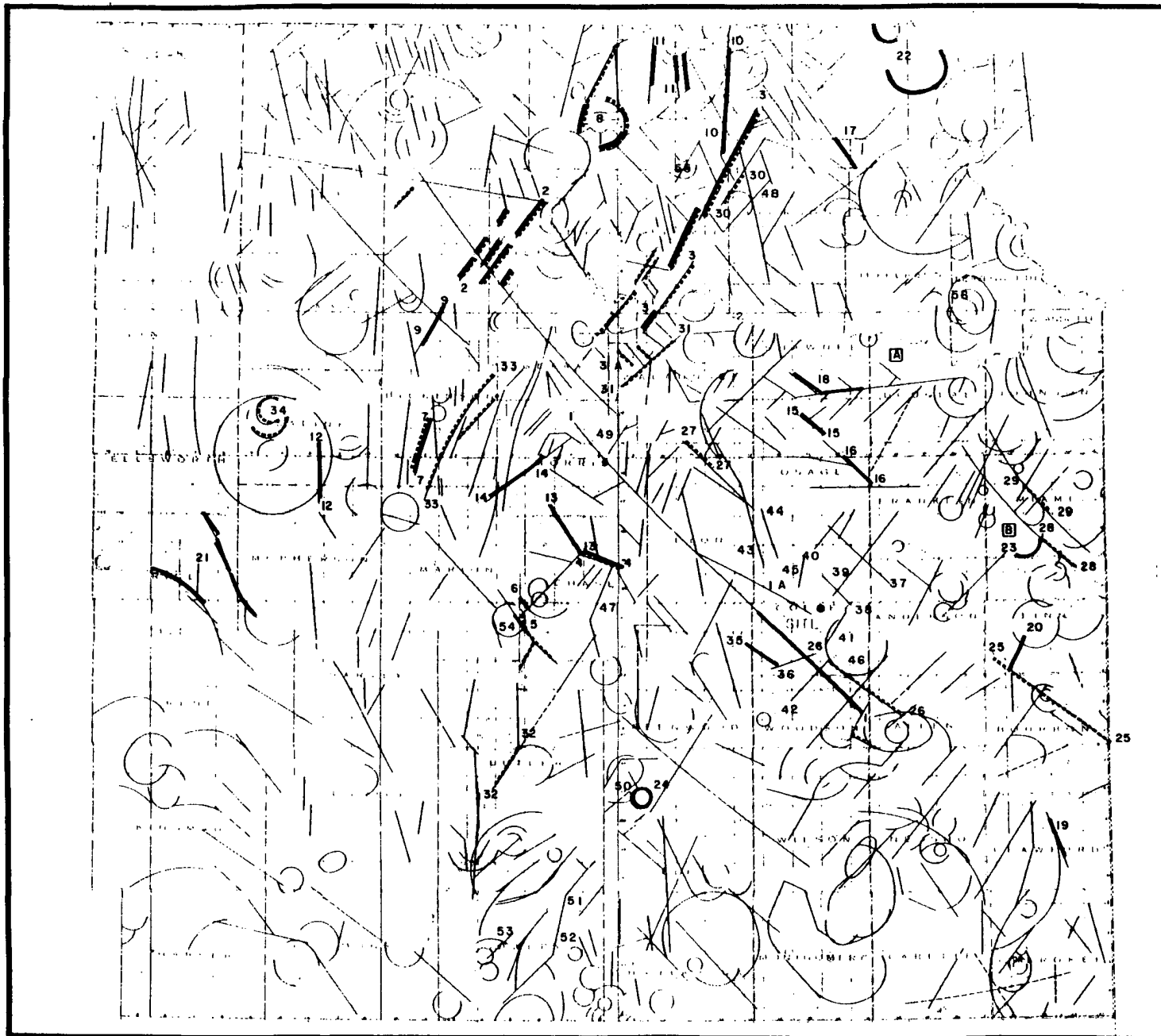

KEY:

- (A)** LOCATION OF BORINGS INTO CIRCULAR GEOPHYSICAL ANOMALIES
- LANDSAT LINEMENTS CORRELATING WITH TRENDS OR STRUCTURES ON THE PRECAMBRIAN SURFACE MAP.
- LANDSAT LINEMENTS CORRELATING WITH TRENDS ON THE AEROMAGNETIC MAP.

MAP REFERENCE:

COLE, V. B., 1976, CONFIGURATION ON THE TOP OF PRECAMBRIAN ROCKS IN KANSAS: KANSAS GEOLOGIC SURVEY, MAP M-7, SCALE 1:500,000.

MCCAULEY, J.R., DELLWIG, L. F., AND DAVISON, E. C., 1978, LANDSAT LINEMENTS OF EASTERN KANSAS: KANSAS GEOLOGICAL SURVEY, MAP M-11, SCALE: 1:500,000.



**WOLF CREEK
UPDATED SAFETY ANALYSIS REPORT**

Figure 2.5-14d

Composite Map - Precambrian
Surface and LANDSAT Lineaments

Rev. 0

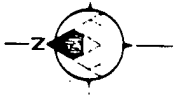
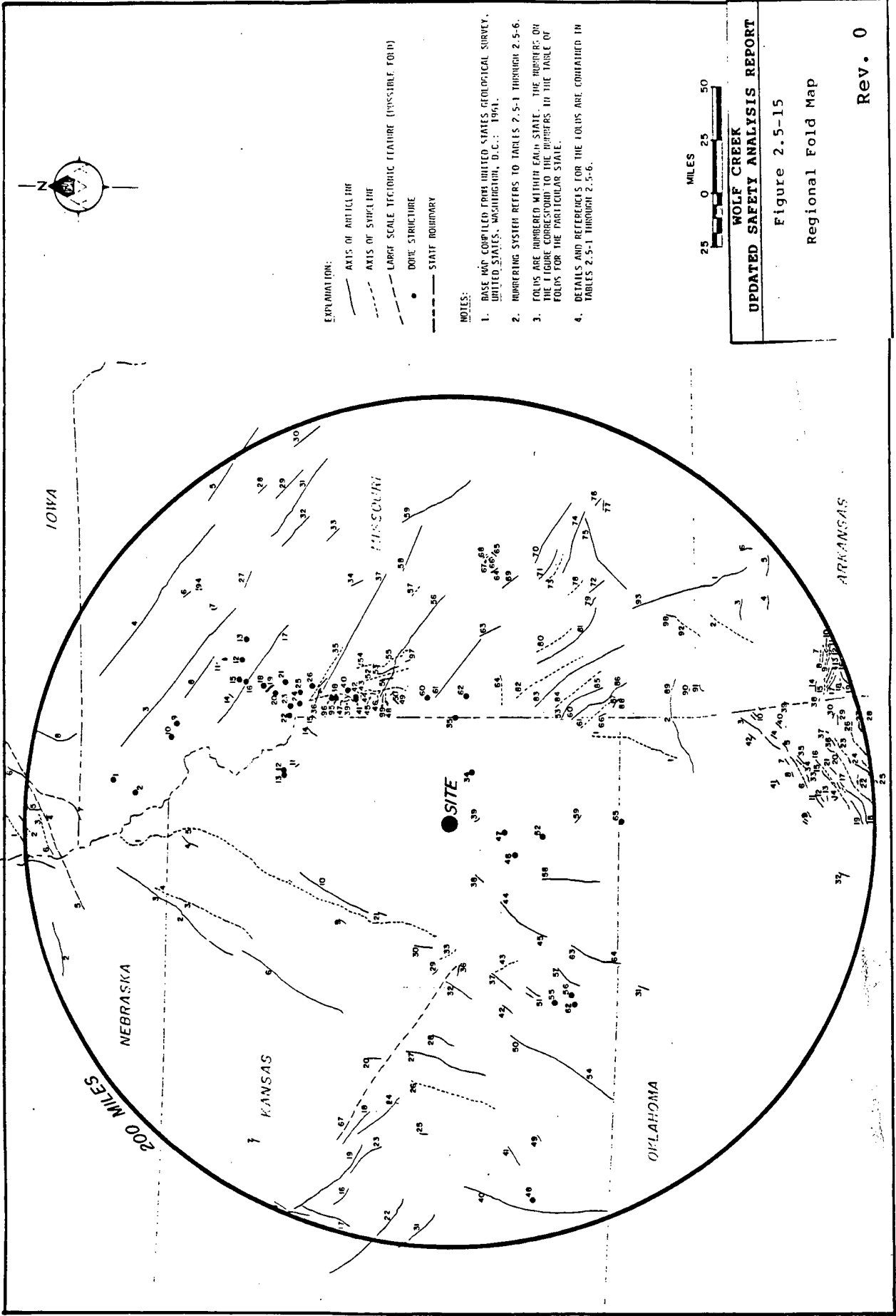

- EXPLANATION:**
- AXIS OF ANTICLINE
 - - - - - AXIS OF SYNCLINE
 - - - - - LARGE SCALE TECTONIC FEATURE (POSSIBLE FOLD)
 - DOME STRUCTURE
 - - - - - STATE BOUNDARY

NOTES:

1. BASE MAP COMPILED FROM UNITED STATES GEOLOGICAL SURVEY, UNITED STATES, WASHINGTON, D.C.: 1991.
2. NUMBERING SYSTEM REFERS TO TABLES 2.5-1 THROUGH 2.5-6.
3. FOLIOS ARE NUMBERED WITHIN EACH STATE. THE NUMBERS ON THE FIGURE CORRESPOND TO THE NUMBERS IN THE TABLE OF FOLIOS FOR THE PARTICULAR STATE.
4. DETAILS AND REFERENCES FOR THE FOLIOS ARE CONTAINED IN TABLES 2.5-1 THROUGH 2.5-6.

**WOLF CREEK
UPDATED SAFETY ANALYSIS REPORT**

Figure 2.5-15
Regional Fold Map

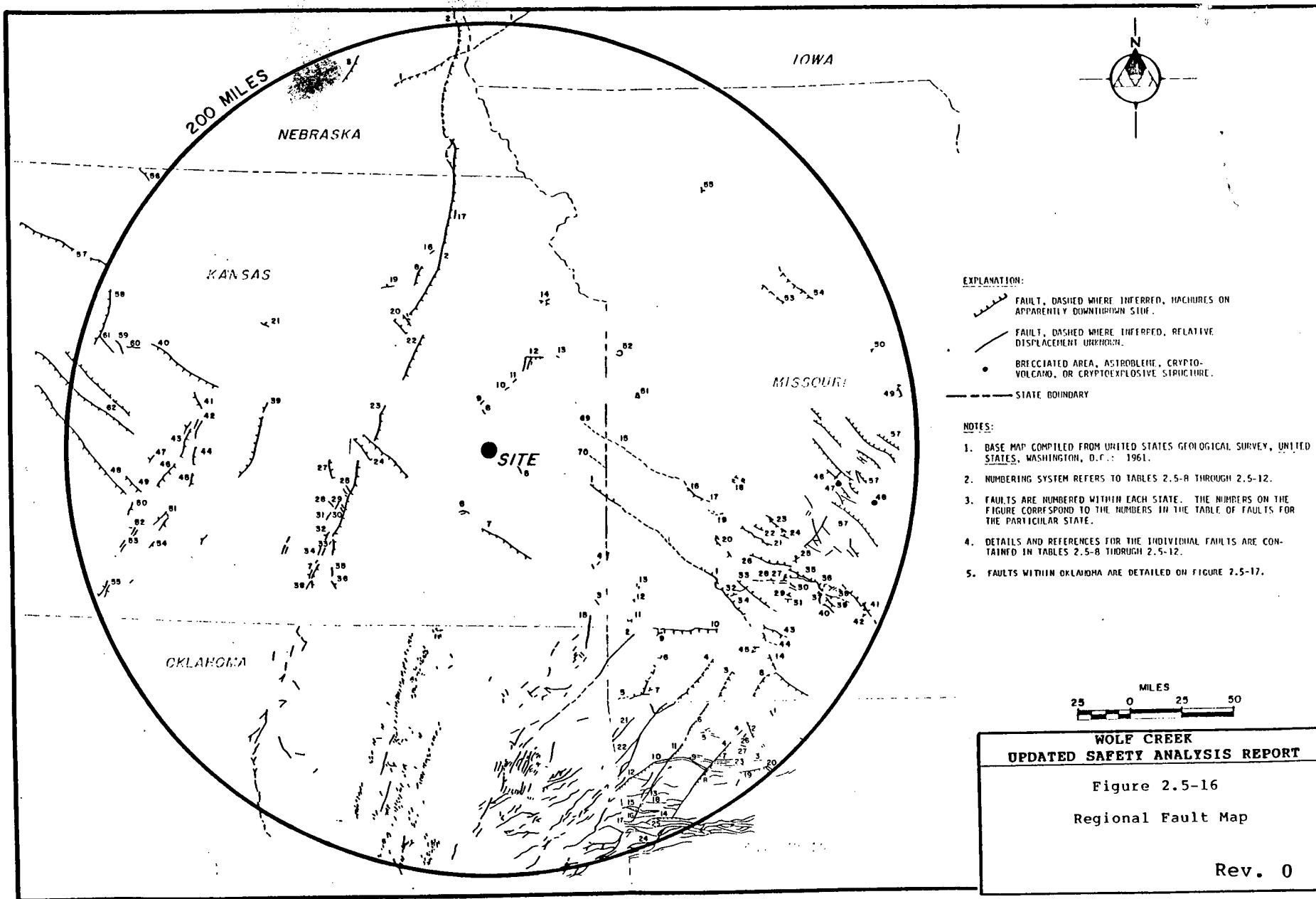

EXPLANATION:

- FAULT, DASHED WHERE INFERRED, INDICATES ON APPARENTLY DOWNTHROW SIDE.
- FAULT, DASHED WHERE INFERRED, RELATIVE DISPLACEMENT UNKNOWN.
- BRECCIATED AREA, ASTROBLEME, CRYPTO-VOLCANO, OR CRYPTOEXPLOSIVE STRUCTURE.
- STATE BOUNDARY

NOTES:

1. BASE MAP COMPILED FROM UNITED STATES GEOLOGICAL SURVEY, UNITED STATES, WASHINGTON, D.C.: 1961.
2. NUMBERING SYSTEM REFERS TO TABLES 2.5-A THROUGH 2.5-12.
3. FAULTS ARE NUMBERED WITHIN EACH STATE. THE NUMBERS ON THE FIGURE CORRESPOND TO THE NUMBERS IN THE TABLE OF FAULTS FOR THE PARTICULAR STATE.
4. DETAILS AND REFERENCES FOR THE INDIVIDUAL FAULTS ARE CONTAINED IN TABLES 2.5-8 THROUGH 2.5-12.
5. FAULTS WITHIN OKLAHOMA ARE DETAILED ON FIGURE 2.5-17.

WOLF CREEK
UPDATED SAFETY ANALYSIS REPORT
 Figure 2.5-16
 Regional Fault Map
 Rev. 0



KANSAS

OKLAHOMA

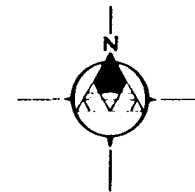
MISSOURI



EXPLANATION:

-  FAULT, HACHURES ON APPARENTLY DOWNTHROWN SIDE
-  FAULT, RELATIVE DISPLACEMENT UNKNOWN
-  INFERRED FAULT

NOTES:

1. BASED MAP MODIFIED FROM UNITED STATES GEOLOGICAL SURVEY, UNITED STATES, WASHINGTON D. C.; 1961.
2. THE NUMBERS ON THE FIGURE CORRESPOND TO THE NUMBERS IN TABLE 2.5-13.
3. DETAIL AND REFERENCES FOR THE INDIVIDUAL FAULTS ARE CONTAINED IN TABLE 2.5-13.

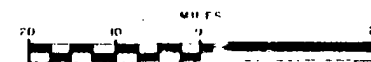

WOLF CREEK
UPDATED SAFETY ANALYSIS REPORT

Figure 2.5-17
Oklahoma Fault Map

Rev. 0

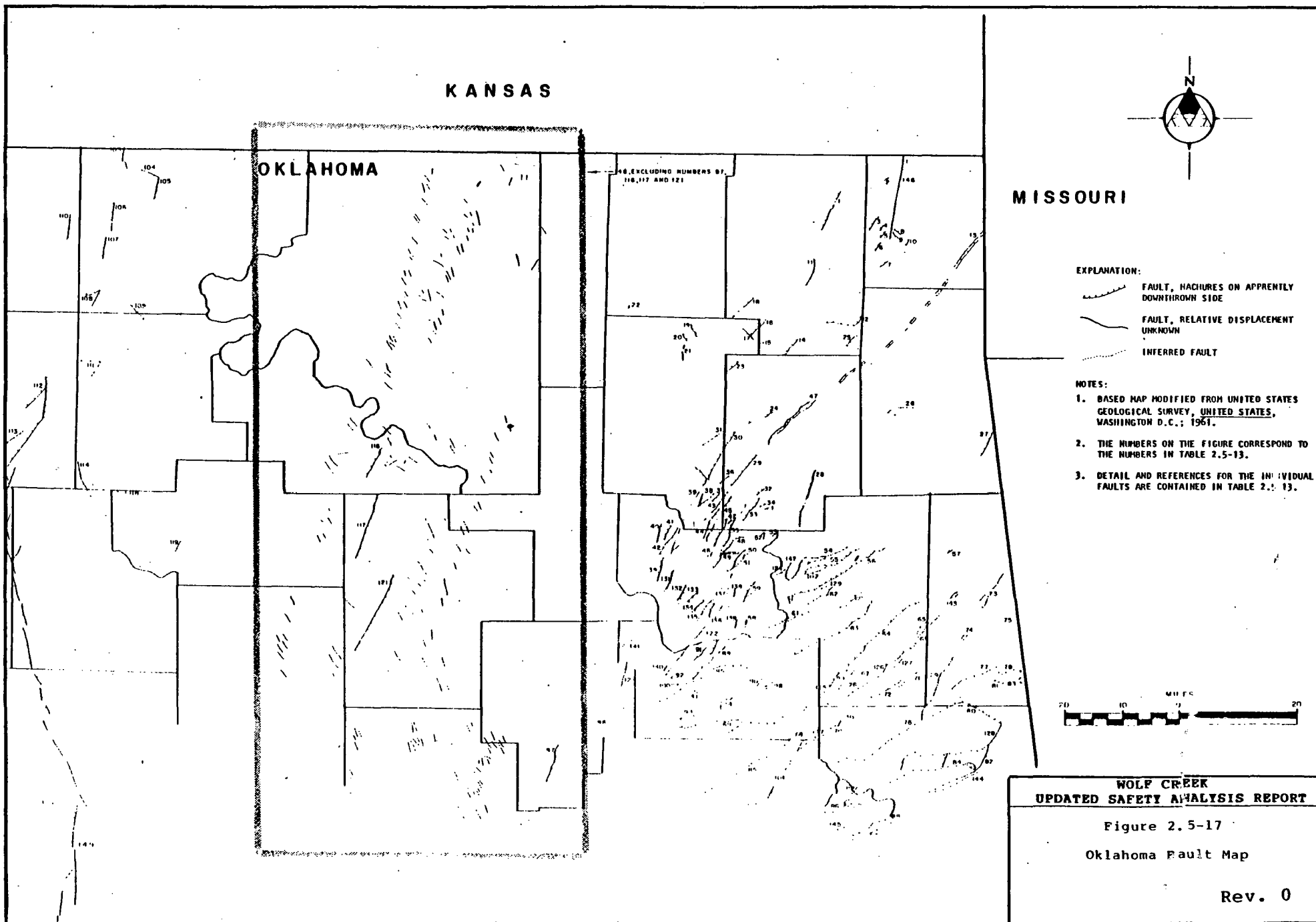

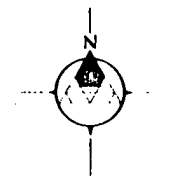
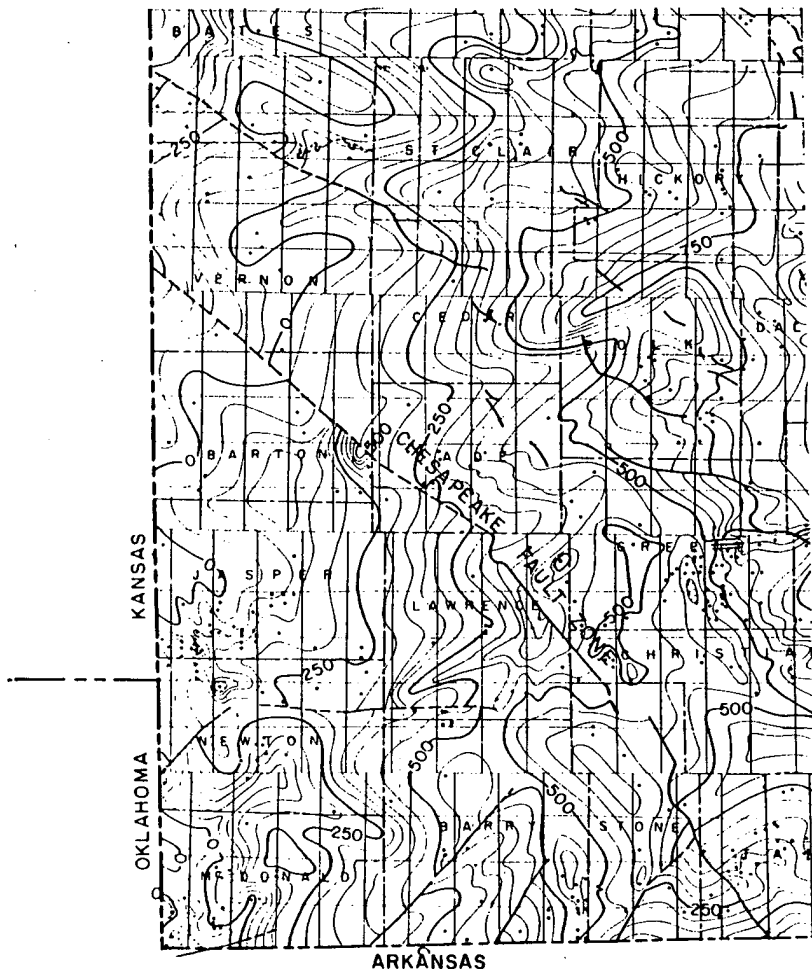

EXPLANATION:

- CONTROL POINT
- MAPPED FAULT
- PROBABLE FAULT
- - - STATE BOUNDARY
- - - COUNTY BOUNDARY

NOTES:

1. MODIFIED FROM McCracken AND McCracken, 1965
2. MAP IS CONTOURED ON BASE OF ROUBIDOUX FORMATION.



**WOLF CREEK
UPDATED SAFETY ANALYSIS REPORT**

Figure 2.5-18

Location of Control Points for
Chesapeake Fault Zone for
Missouri

Rev. 0

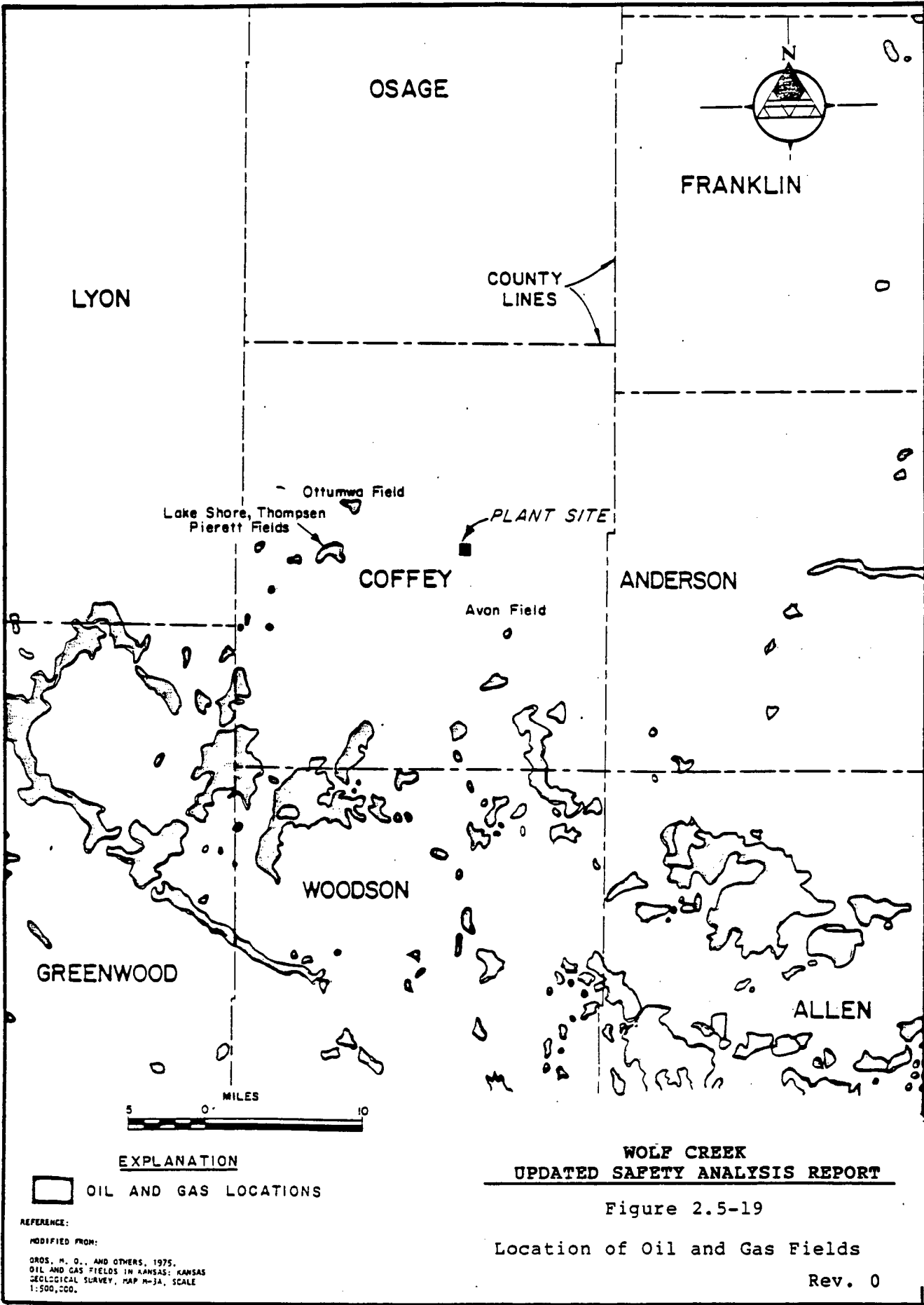

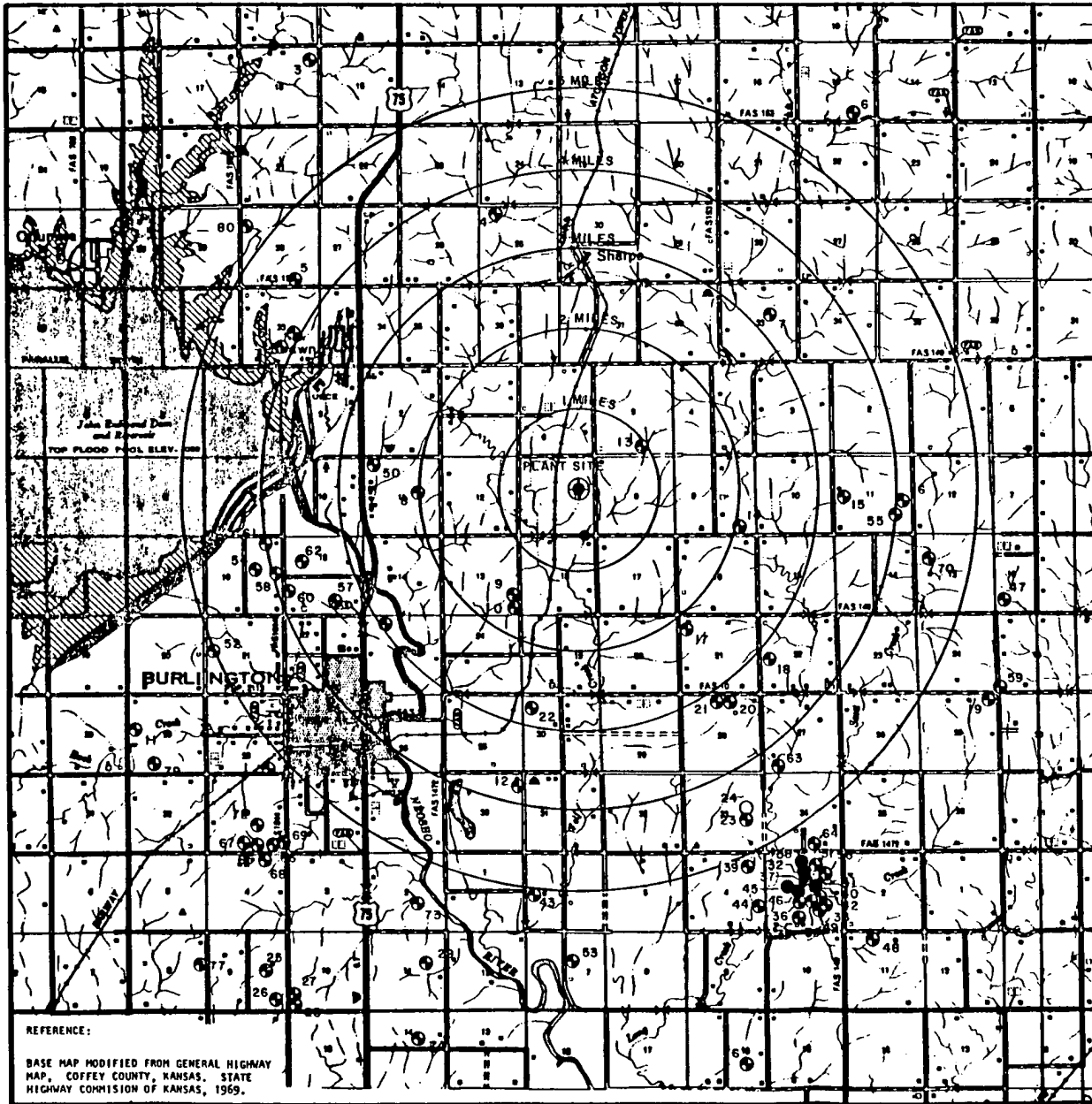

EXPLANATION:

- DRY HOLE
- PRODUCING WELL
- ABANDONED LOCATION

NOTES:

1. INFORMATION COMPLETE THROUGH MAY 11, 1981
2. NUMBERING SYSTEM REFERS TO TABLE 2.5-16.



Rev. 0

**WOLF CREEK
UPDATED SAFETY ANALYSIS REPORT**

Figure 2.5-20
Location of Oil Wells

REFERENCE:

BASE MAP MODIFIED FROM GENERAL HIGHWAY
MAP, COFFEY COUNTY, KANSAS, STATE
HIGHWAY COMMISSION OF KANSAS, 1969.

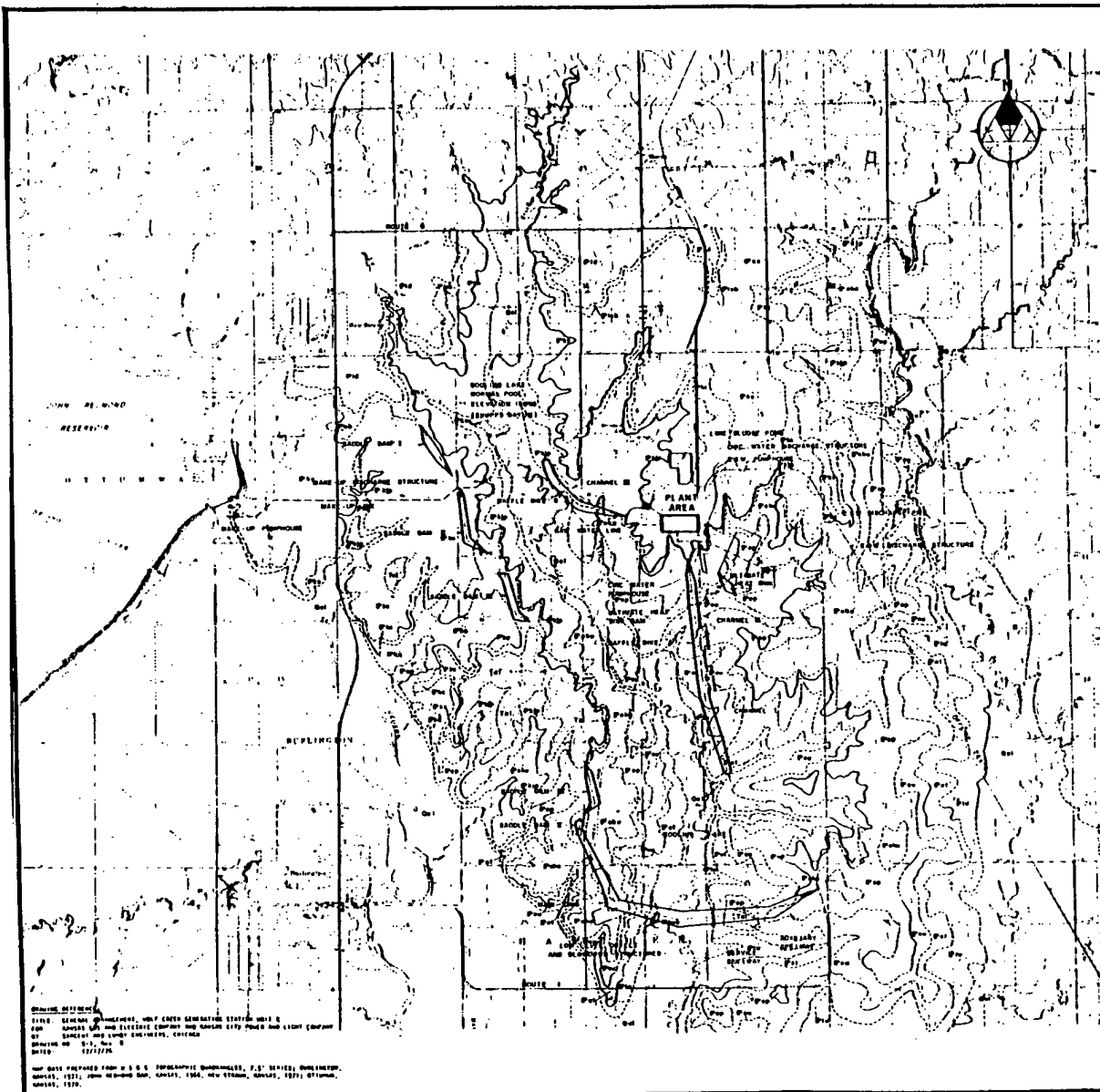

EXPLANATION

— CONTACT VERIFIED BY FIELD OBSERVATION
 - - - CONTACT FROM AERIAL PHOTOGRAPHIC INTERPRETATION OR INFERRED

STRATIGRAPHIC SYMBOLS

SYMBOL	STRATIGRAPHIC NOMENCLATURE
Qol	QUATERNARY ALLUVIUM
Tal	TERTIARY GRAVELS
	LECONTON FORMATION
Dpid	DOWNSHAW SHALE MEMBER
Dpiab	SPRING BRANCH LIMESTONE MEMBER
	KAWAKA FORMATION
Dpih	STILL SHALE MEMBER
Dpic	CLAY CREEK LIMESTONE MEMBER
Dpip	JACKSON PARK SHALE MEMBER
	DREAD FORMATION
Dpoh	HEMLOCK SHALE MEMBER
Dpka	UNDIFFERENTIATED JACKSON PARK SHALE, KERRFORD LIMESTONE AND HEMLOCK SHALE MEMBERS
Dpop	PLATYSOUTH LIMESTONE MEMBER
Dpoh	HEBNER SHALE MEMBER
Dpol	LEAVERTH LIMESTONE MEMBER
Dpou	SHYDERVILLE SHALE MEMBER
Dpou	UNDIFFERENTIATED HEBNER SHALE, LEAVERTH LIMESTONE AND SHYDERVILLE SHALE MEMBERS
Dpot	TORONTO LIMESTONE MEMBER
Dpiw	LAWRENCE FORMATION

NOTE:
 FIGURE 2.5-41 IS A DETAILED STRATIGRAPHIC SECTION OF THE UNITS ENCOUNTERED AT THE SURFACE AND IN THE BORING PROGRAM IN THE SITE AREA.

TOPOGRAPHIC CONTOUR INTERVAL IS 10 FEET WITH SUPPLEMENTARY CONTOURS AT 5 FEET



**WOLF CREEK
 UPDATED SAFETY ANALYSIS REPORT**

Figure 2.5-21
 Surficial Geologic Map - Site
 Rev. 0

WORKING DRAFT
 TITLE: KANSAS BRIDGEPORT WOLF CREEK SAMPLING STATION NO. 2
 FOR: KANSAS GAS AND ELECTRIC COMPANY AND KANSAS CITY POWER AND LIGHT COMPANY
 BY: SANDRIS AND COMPANY ENGINEERS, CHICAGO
 DRAWING NO. 21, REV. 0
 DATE: 12/17/76

MAP DATA PREPARED FROM U.S.G. TOPOGRAPHIC QUADRANGLES, 7.5' SERIES: DUNDELMAN, MISSOURI, 1971; JOHN WARDEN DAM, MISSOURI, 1966; NEW STRAIN, MISSOURI, 1971; OTTAWA, MISSOURI, 1970.

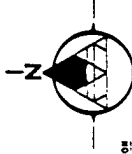

EXPLANATION
 CONTACTS DEFINED BY FIELD OBSERVATION
 CONTACTS FROM AERIAL PHOTOGRAMMETRIC
 INTERPRETATION OF TERRAIN

STRATIGRAPHIC SYMBOLS

STRATIGRAPHIC ABBREVIATIONS

LEONOWORTH FORMATION

P14 Devonian Shale Member
 P16 Spring Branch Limestone Member

SEAWARD FORMATION

P18 Tuff Shale Member
 P19 Clay Creek Limestone Member
 P20 Jackson Park Shale Member

ORISKANY FORMATION

P21 Brander Shale Member
 P22 Undifferentiated Jackson Park Shale, Bedford Limestone and Brander Shale Members
 P23 Flat-topped Limestone Member
 P24 Heather Shale Member
 P25 Leonoworth Limestone Member
 P26 Snyderville Shale Member
 P27 Undifferentiated Heather Shale, Leonoworth Limestone and Snyderville Shale Members
 P28 Toronto Limestone Member

LAMINGE FORMATION

- NOTES**
- FIGURE 2.5-21 IS A DETAILED STRATIGRAPHIC COLUMN OF THE UNITS PRESENT AT THE SURFACE IN THE SITE AREA.
 - FIGURE 2.5-22 SHOWS THE SURFICIAL GEOLOGY OF THE SITE AREA.
 - FIGURE 2.5-23 SHOWS DETAILS OF GEOTECHNICAL DATA FOR THE CONTACT AREA.

UNSATURATED CONTACT INTERVALS ARE TO FEET WITH
 SUPPLEMENTARY CONTACTS AT 5 FEET

SCALE
 0 1000 2000 3000 4000 5000 6000
 FEET

REVISIONS

DATE: 10/17/78
 BY: J. J. WILSON
 FOR THE FEDERAL BUREAU OF SURVEY, U.S. GEOLOGICAL SURVEY, WASHINGTON, D.C. 20540
 PROJECT: WOLF CREEK DAM, MISSOURI, 1961, AND WOLF CREEK DAM, MISSOURI, 1978

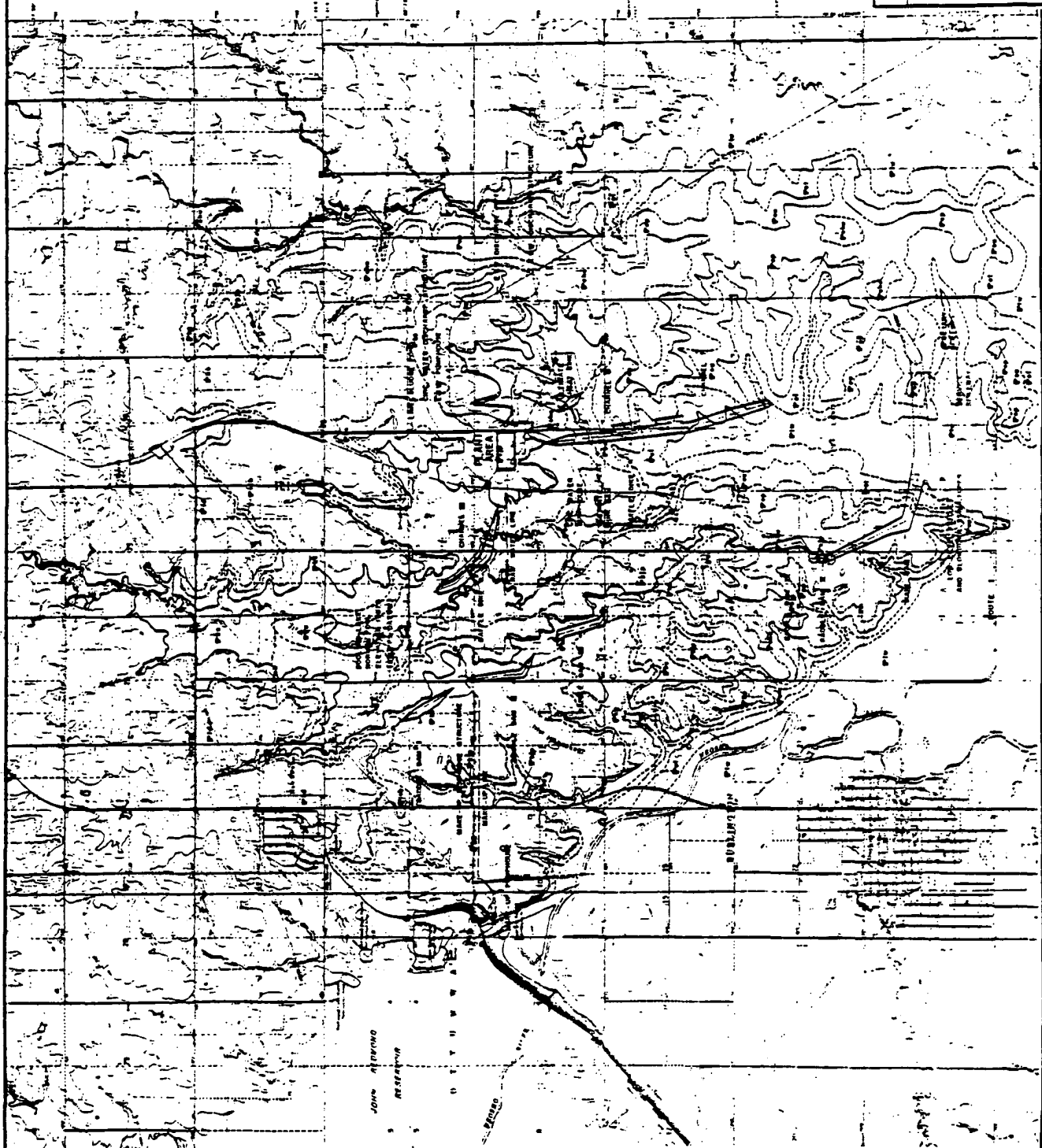

**WOLF CREEK
 UPDATED SAFETY ANALYSIS REPORT**

Figure 2.5-22
 Bedrock Geologic Map - Site

Rev. 0

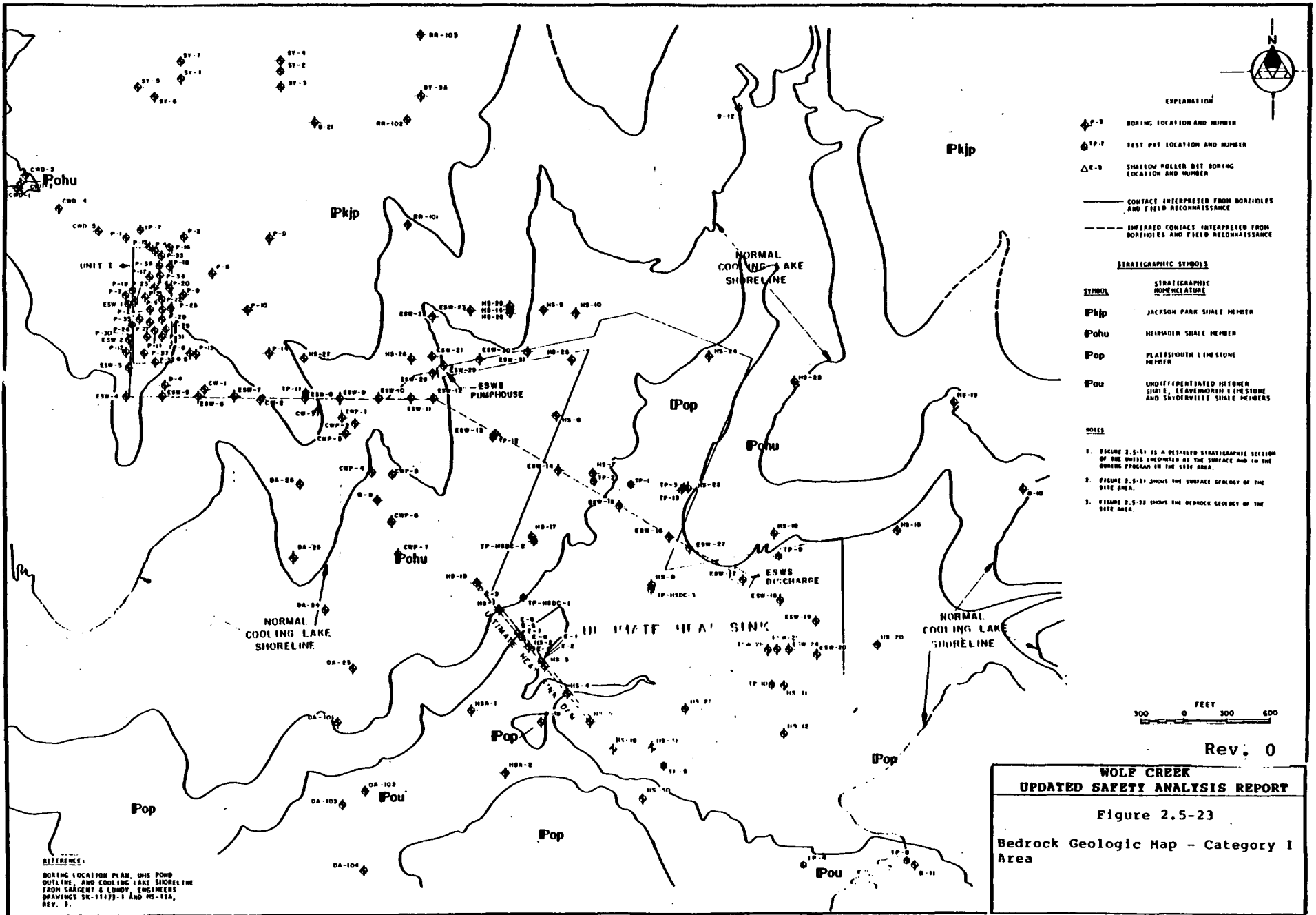

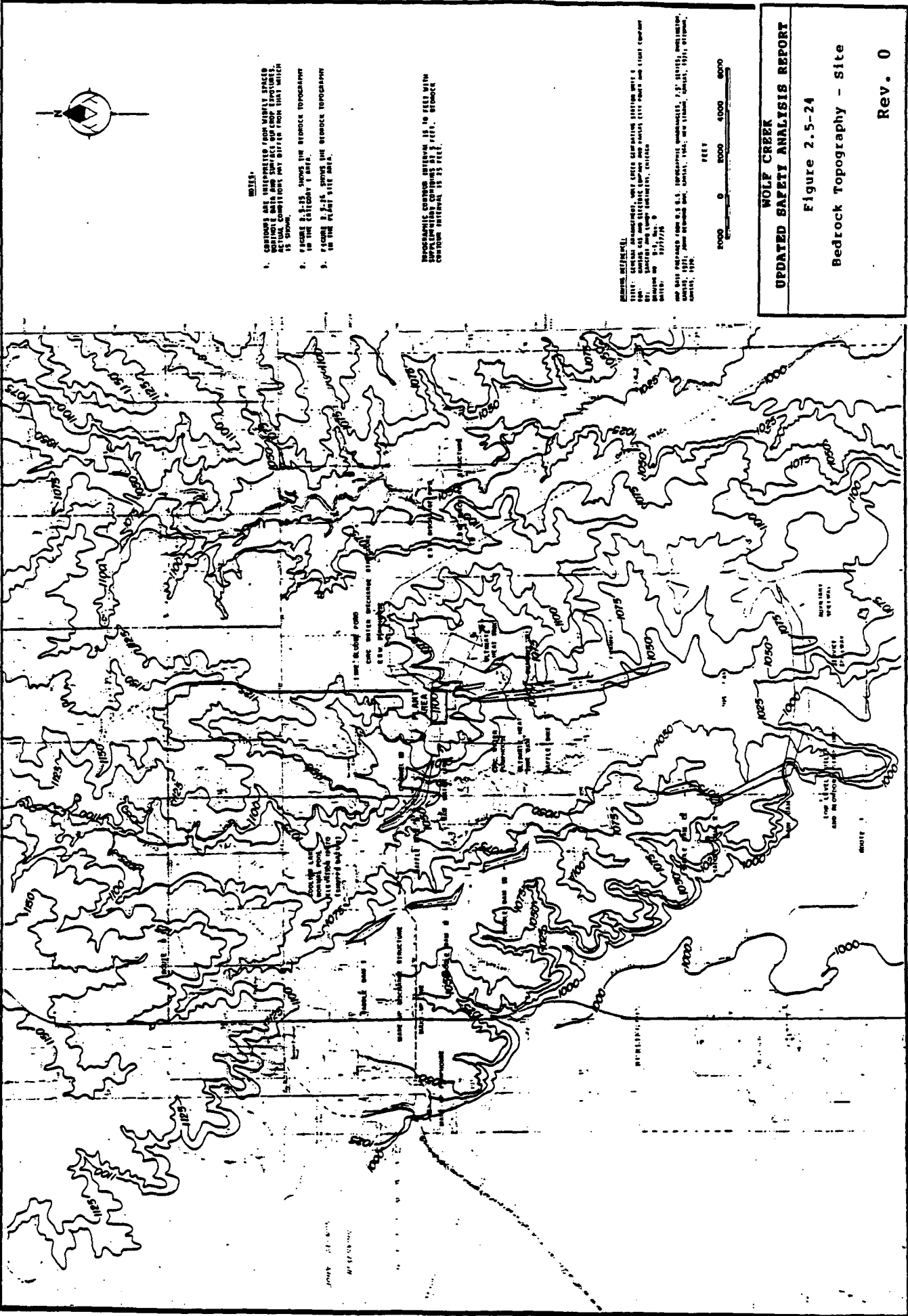

- NOTES:**
1. CONTOUR AND WATERWAYS FROM SOURCE TO SOURCE. ACTUAL COMPLETION MAY DIFFER FROM THAT WHICH IS SHOWN.
 2. SCALE 1:25,000. SHOWS THE BEDROCK TOPOGRAPHY IN THE CANYON AREA.
 3. SCALE 1:25,000. SHOWS THE BEDROCK TOPOGRAPHY IN THE PLATEAU AREA.

NECESSARY CONTOUR INTERVAL IS IN FEET WITH SUPPLEMENTARY CONTOURS AT 2 FEET. ELEVATION CONTOUR INTERVAL IS 25 FEET.

GENERAL INFORMATION:
 THIS MAP WAS PREPARED BY THE U.S. GEOLOGICAL SURVEY, WASHINGTON, D.C. UNDER CONTRACT NO. D-111-77-0010. THE MAP WAS PREPARED BY THE U.S. GEOLOGICAL SURVEY, WASHINGTON, D.C. UNDER CONTRACT NO. D-111-77-0010. THE MAP WAS PREPARED BY THE U.S. GEOLOGICAL SURVEY, WASHINGTON, D.C. UNDER CONTRACT NO. D-111-77-0010.

WOLF CREEK
UPDATED SAFETY ANALYSIS REPORT
 Figure 2.5-24
 Bedrock Topography - Site
 Rev. 0

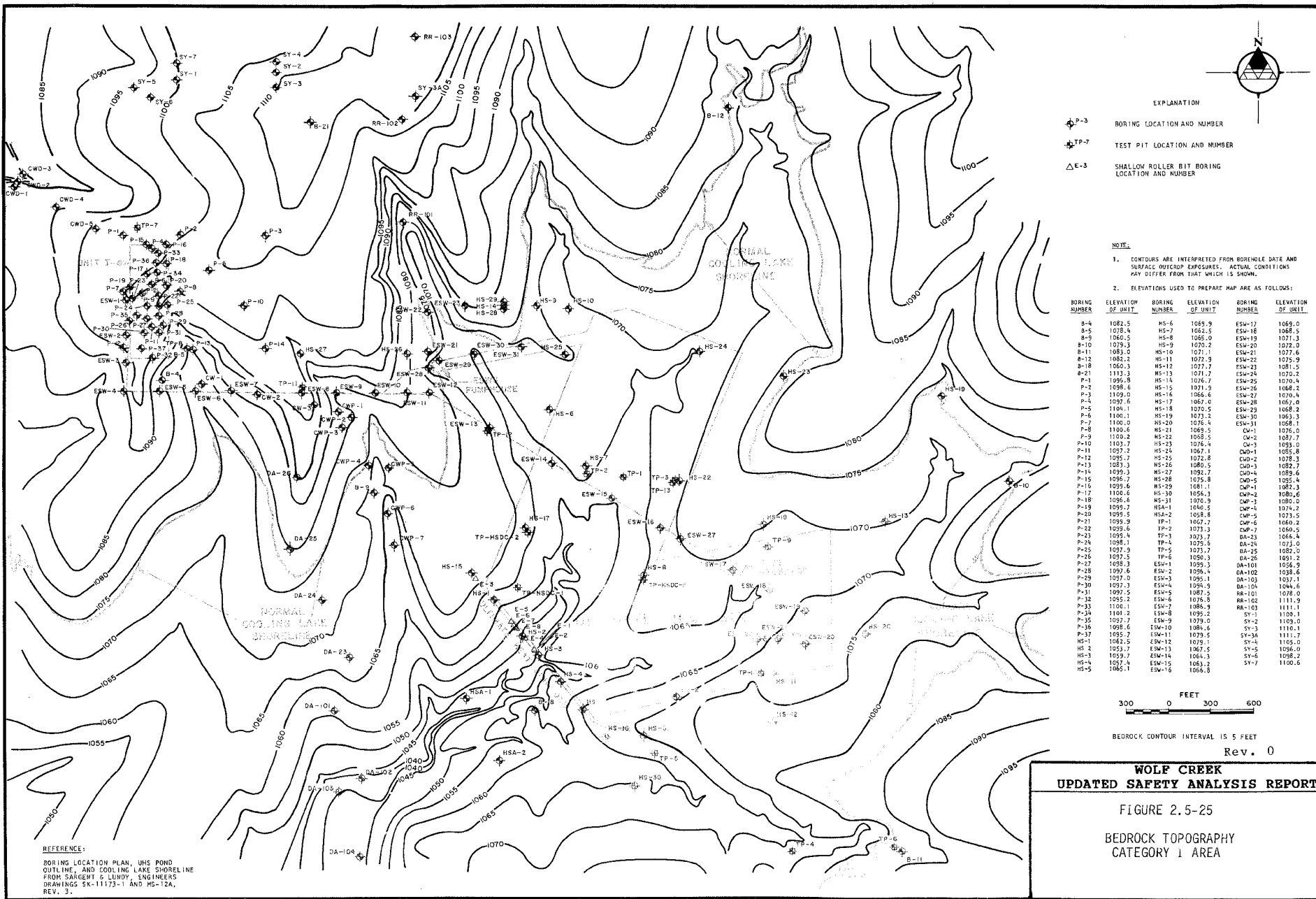

- EXPLANATION**
- ⊕ P-3 BORING LOCATION AND NUMBER
 - ⊕ TP-7 TEST PIT LOCATION AND NUMBER
 - △ E-3 SHALLOW ROLLER BIT BORING LOCATION AND NUMBER

- NOTE:**
1. CONTOURS ARE INTERPRETED FROM BOREHOLE DATE AND SURFACE OUTCROP EXPOSURES. ACTUAL CONDITIONS MAY DIFFER FROM THAT WHICH IS SHOWN.
 2. ELEVATIONS USED TO PREPARE MAP ARE AS FOLLOWS:

BORING NUMBER	ELEVATION OF UNIT	BORING NUMBER	ELEVATION OF UNIT	BORING NUMBER	ELEVATION OF UNIT
B-4	1082.5	HS-6	1089.9	ESW-17	1069.0
B-5	1076.4	HS-7	1062.5	ESW-18	1068.5
B-9	1065.5	HS-8	1065.0	ESW-19	1071.3
B-10	1079.3	HS-9	1070.2	ESW-20	1072.0
B-11	1083.0	HS-10	1071.1	ESW-21	1077.6
B-12	1082.2	HS-11	1072.3	ESW-22	1075.9
B-18	1060.3	HS-12	1077.7	ESW-23	1081.5
B-21	1113.3	HS-13	1071.7	ESW-24	1073.0
P-1	1095.8	HS-14	1076.7	ESW-25	1070.4
P-2	1098.6	HS-15	1071.9	ESW-26	1068.2
P-3	1109.0	HS-16	1066.6	ESW-27	1070.4
P-4	1097.6	HS-17	1067.0	ESW-28	1067.0
P-5	1106.1	HS-18	1070.5	ESW-29	1069.2
P-6	1100.1	HS-19	1073.2	ESW-30	1061.3
P-7	1100.0	HS-20	1076.4	ESW-31	1058.1
P-8	1100.6	HS-21	1083.5	CA-1	1076.0
P-9	1103.2	HS-22	1085.2	CA-2	1087.7
P-10	1103.7	HS-23	1076.4	CA-3	1093.0
P-11	1097.2	HS-24	1067.1	CA-4	1055.8
P-12	1095.7	HS-25	1072.8	CWD-2	1078.3
P-13	1087.3	HS-26	1080.5	CWD-3	1082.7
P-14	1099.3	HS-27	1093.3	CWD-4	1059.6
P-15	1096.7	HS-28	1075.8	CWD-5	1051.4
P-16	1099.6	HS-29	1081.1	CWP-1	1087.3
P-17	1102.6	HS-30	1096.3	CWP-2	1080.6
P-18	1096.6	HS-31	1070.9	CWP-3	1080.0
P-19	1099.7	HSA-1	1046.5	CWP-4	1074.2
P-20	1095.5	HSA-2	1058.8	CWP-5	1073.5
P-21	1099.9	TP-1	1067.7	CWP-6	1060.2
P-22	1099.6	TP-2	1073.3	CWP-7	1060.5
P-23	1099.4	TP-3	1073.7	DA-23	1044.4
P-24	1088.1	TP-4	1075.6	DA-24	1072.0
P-25	1097.9	TP-5	1071.7	DA-25	1085.0
P-26	1097.5	TP-6	1080.3	DA-26	1091.2
P-27	1095.3	ESW-1	1099.3	DA-101	1056.9
P-28	1099.6	ESW-2	1099.4	DA-102	1038.6
P-29	1097.0	ESW-3	1095.1	DA-103	1037.1
P-30	1097.3	ESW-4	1094.9	DA-104	1044.6
P-31	1099.5	ESW-5	1087.5	RR-101	1078.0
P-32	1095.2	ESW-6	1076.8	RR-102	1111.9
P-33	1100.1	ESW-7	1086.9	RR-103	1111.1
P-34	1101.2	ESW-8	1095.2	SY-1	1100.1
P-35	1097.7	ESW-9	1079.0	SY-2	1103.0
P-36	1098.6	ESW-10	1081.6	SY-3	1110.1
P-37	1095.7	ESW-11	1079.5	SY-3A	1111.7
HS-1	1082.5	ESW-12	1075.1	SY-4	1105.0
HS-2	1057.7	ESW-13	1067.5	SY-5	1096.0
HS-3	1059.7	ESW-14	1064.3	SY-6	1098.2
HS-4	1057.4	ESW-15	1061.2	SY-7	1100.6
HS-5	1065.1	ESW-16	1066.8		



BEDROCK CONTOUR INTERVAL IS 5 FEET
Rev. 0

**WOLF CREEK
UPDATED SAFETY ANALYSIS REPORT**

FIGURE 2.5-25

BEDROCK TOPOGRAPHY
CATEGORY 1 AREA

REFERENCE:
BORING LOCATION PLAN, UHS POND
OUTLINE, AND COOLING LAKE SHORELINE
FROM SARCENT & LINDY, ENGINEERS
DRAWINGS SK-11173-1 AND HS-12A,
REV. 3.

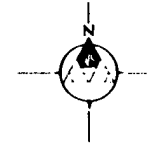
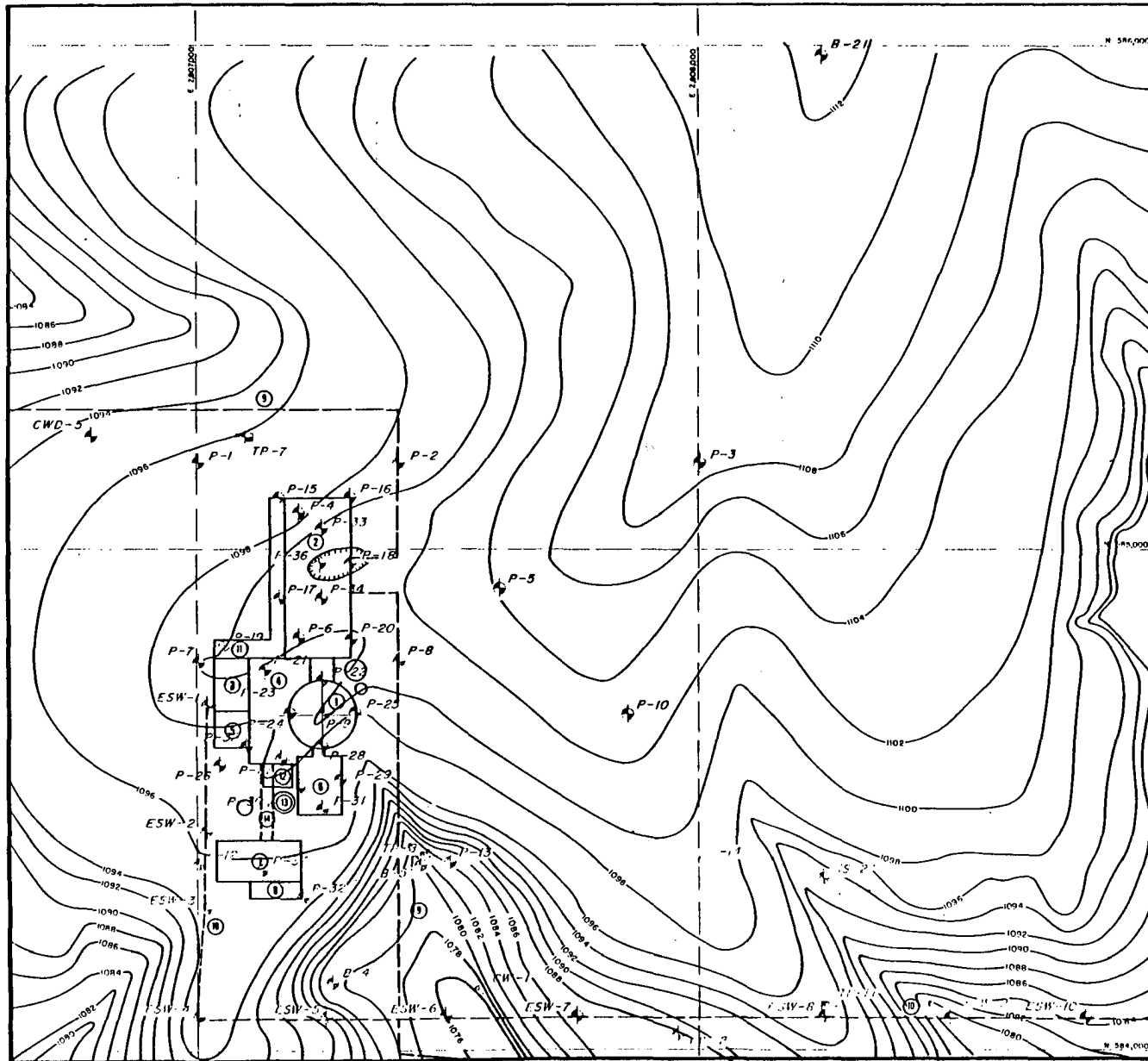

- EXPLANATION:**
- ① CONTAINMENT
 - ② SURFING POND
 - ③ FILLING POND
 - ④ ASPHALT POND
 - ⑤ EMER. STORAGE CAN. POND
 - ⑥ FRESH WATER POND
 - ⑦ DRAINAGE POND
 - ⑧ FRESH STORAGE (COILED WASTE)
 - ⑨ FRESH WATER PIPELINE
 - ⑩ FRESH WATER TANK
 - ⑪ FRESH WATER STORAGE TANK
 - ⑫ FRESH WATER STORAGE TANK
 - ⑬ FRESH WATER STORAGE TANK
 - ⑭ FRESH WATER STORAGE TANK

①-3 SPRING LOCATION AND NUMBER

①-7 TEST PIT LOCATION AND NUMBER

- NOTES:
- CONTOUR MAP INTERPRETED FROM BATHYMETRIC DATA AND SURFACE ELEVATION MEASUREMENTS. ALL DATA FROM DESIGN AND DATA FROM THIS PROJECT IS CORRECT.
 - FIGURE 2.5-26 SHOWS BEDROCK TOPOGRAPHY IN THE AREA.
 - FIGURE 2.5-25 SHOWS BEDROCK TOPOGRAPHY IN THE CATEGORIES AREA.
 - ELEVATION USED TO PREPARE MAP ARE AS FOLLOWS:

SPRING NUMBER	ELEVATION OF TIE	SPRING NUMBER	ELEVATION OF TIE
P-1	1082.5	P-26	1092.5
P-2	1078.4	P-27	1098.1
P-3	1055.3	P-28	1094.6
P-4	1096.8	P-29	1095.0
P-5	1098.6	P-30	1092.1
P-6	1105.0	P-31	1092.5
P-7	1092.4	P-32	1095.2
P-8	1100.1	P-33	1109.1
P-9	1100.2	P-34	1101.2
P-10	1101.2	P-35	1092.2
P-11	1092.2	P-36	1102.3
P-12	1095.2	P-37	1098.1
P-13	1082.3	P-38	1094.3
P-14	1095.3	P-39	1094.4
P-15	1096.7	P-40	1094.1
P-16	1095.8	P-41	1094.9
P-17	1100.6	P-42	1092.5
P-18	1095.6	P-43	1092.9
P-19	1095.2	P-44	1094.9
P-20	1098.5	P-45	1094.2
P-21	1098.9	P-46	1092.0
P-22	1095.8	P-47	1094.6
P-23	1095.4	P-48	1094.0
P-24	1098.1	P-49	1092.2
P-25	1092.4	P-50	1102.4

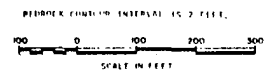



**WOLF CREEK
UPDATED SAFETY ANALYSIS REPORT**

Figure 2.5-26
Bedrock Topography - Plant Site

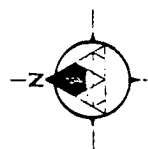
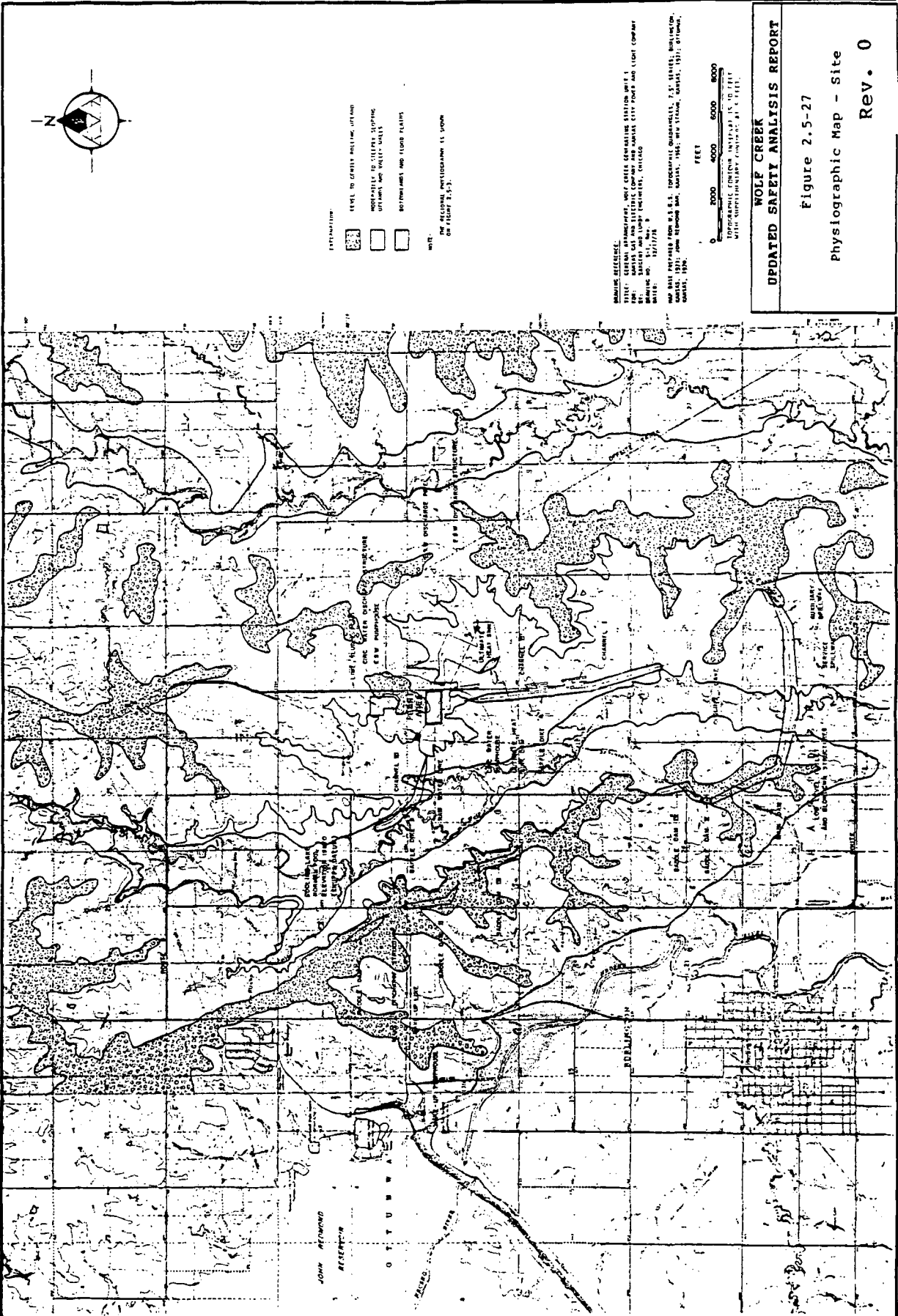
Rev. 0



- ESTIMATION
-  LEVEL TO GROUND (HILLING, UPLAND)
 -  IMPROVABLE TO STEEPLY SLOPING UPLAND AND VALLEY WALLS
 -  BOTTOMLANDS AND FLOOD PLAINS

NOTE:
THE REGIONAL TOPOGRAPHY IS SHOWN ON FIGURE 2.5-1.

MAJOR REFERENCE:
 U.S. GEOLOGICAL SURVEY, 1961, *TOPOGRAPHIC MAP OF THE CHICAGO AREA*, 1:25,000, SERIES 1, SHEET 10,000, U.S. GEOLOGICAL SURVEY, WASHINGTON, D.C.
 U.S. GEOLOGICAL SURVEY, 1961, *TOPOGRAPHIC MAP OF THE CHICAGO AREA*, 1:25,000, SERIES 1, SHEET 10,000, U.S. GEOLOGICAL SURVEY, WASHINGTON, D.C.
 U.S. GEOLOGICAL SURVEY, 1961, *TOPOGRAPHIC MAP OF THE CHICAGO AREA*, 1:25,000, SERIES 1, SHEET 10,000, U.S. GEOLOGICAL SURVEY, WASHINGTON, D.C.

0 2000 4000 6000 8000
 FEET
 TOPOGRAPHIC CONTOUR INTERVAL IS 20 FEET
 WITH SUPPLEMENTARY INTERVALS AT 5 FEET

**WOLF CREEK
 UPDATED SAFETY ANALYSIS REPORT**

Figure 2.5-27

Physiographic Map - Site

Rev. 0

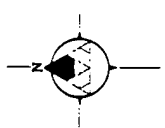
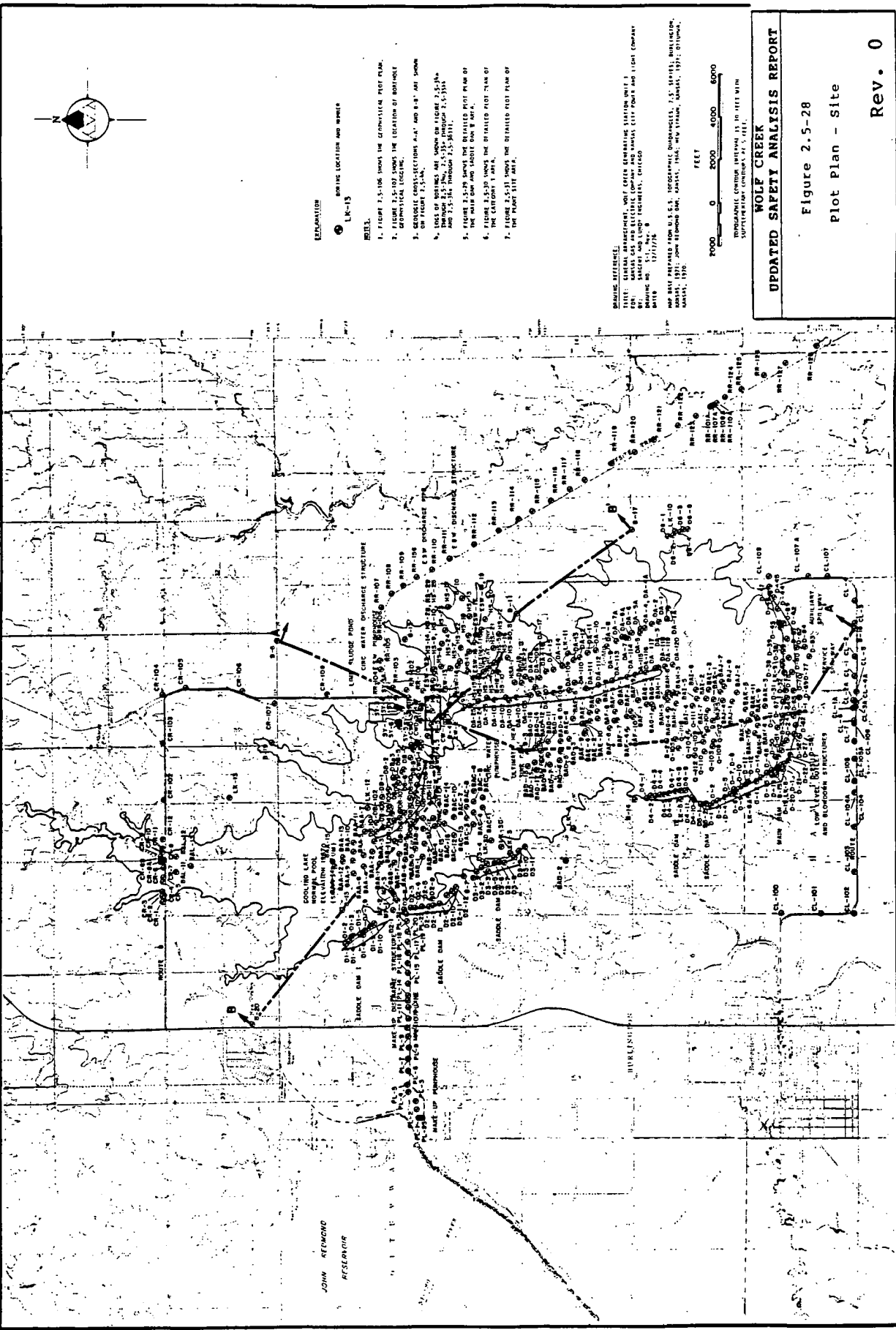

EXPLANATION

① SEE THE LOCATION AND NUMBER

② LR-13

- NOTES:**
- FIGURE 2.5-106 SHOWS THE COMPLETION PLOT PLAN.
 - FIGURE 2.5-107 SHOWS THE LOCATION OF BOTTLENECK OPERATIONAL FACILITIES.
 - GENERAL CONTRACTOR'S P.L. AND S.P. ARE SHOWN.
 - LOCUS OF BOTTLENECK ARE SHOWN ON FIGURES 2.5-106 THROUGH 2.5-109. 2.5-106 THROUGH 2.5-108 THROUGH 2.5-109.
 - FIGURE 2.5-109 SHOWS THE DETAILED PLOT PLAN OF THE MAIN DAM AND SHOOT DAM #100.
 - FIGURE 2.5-110 SHOWS THE DETAILED PLOT PLAN OF THE MAIN DAM.
 - FIGURE 2.5-111 SHOWS THE DETAILED PLOT PLAN OF THE MAIN DAM.

SHADING REFERENCE:

① CONCRETE STRUCTURES, ONLY (SEE EXPLANATION, FIGURE 2.5-106)

② SHOOT DAMS AND ELECTRIC CONTROL AND TRANSFORMER HOUSES AND LIGHT HOUSES

③ SHOOT DAMS AND LIGHT HOUSES, CHECKED

④ SHOOT DAMS, CHECKED

⑤ SHOOT DAMS, CHECKED

⑥ SHOOT DAMS, CHECKED

⑦ SHOOT DAMS, CHECKED

⑧ SHOOT DAMS, CHECKED

⑨ SHOOT DAMS, CHECKED

⑩ SHOOT DAMS, CHECKED

⑪ SHOOT DAMS, CHECKED

⑫ SHOOT DAMS, CHECKED

⑬ SHOOT DAMS, CHECKED

⑭ SHOOT DAMS, CHECKED

⑮ SHOOT DAMS, CHECKED

⑯ SHOOT DAMS, CHECKED

⑰ SHOOT DAMS, CHECKED

⑱ SHOOT DAMS, CHECKED

⑲ SHOOT DAMS, CHECKED

⑳ SHOOT DAMS, CHECKED

㉑ SHOOT DAMS, CHECKED

㉒ SHOOT DAMS, CHECKED

㉓ SHOOT DAMS, CHECKED

㉔ SHOOT DAMS, CHECKED

㉕ SHOOT DAMS, CHECKED

㉖ SHOOT DAMS, CHECKED

㉗ SHOOT DAMS, CHECKED

㉘ SHOOT DAMS, CHECKED

㉙ SHOOT DAMS, CHECKED

㉚ SHOOT DAMS, CHECKED

㉛ SHOOT DAMS, CHECKED

㉜ SHOOT DAMS, CHECKED

㉝ SHOOT DAMS, CHECKED

㉞ SHOOT DAMS, CHECKED

㉟ SHOOT DAMS, CHECKED

㊱ SHOOT DAMS, CHECKED

㊲ SHOOT DAMS, CHECKED

㊳ SHOOT DAMS, CHECKED

㊴ SHOOT DAMS, CHECKED

㊵ SHOOT DAMS, CHECKED

㊶ SHOOT DAMS, CHECKED

㊷ SHOOT DAMS, CHECKED

㊸ SHOOT DAMS, CHECKED

㊹ SHOOT DAMS, CHECKED

㊺ SHOOT DAMS, CHECKED

㊻ SHOOT DAMS, CHECKED

㊼ SHOOT DAMS, CHECKED

㊽ SHOOT DAMS, CHECKED

㊾ SHOOT DAMS, CHECKED

㊿ SHOOT DAMS, CHECKED

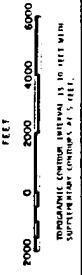

WOLF CREEK

UPDATED SAFETY ANALYSIS REPORT

Figure 2.5-28

Plot Plan - Site

Rev. 0

JOHN REYNOLD
RESEARCH

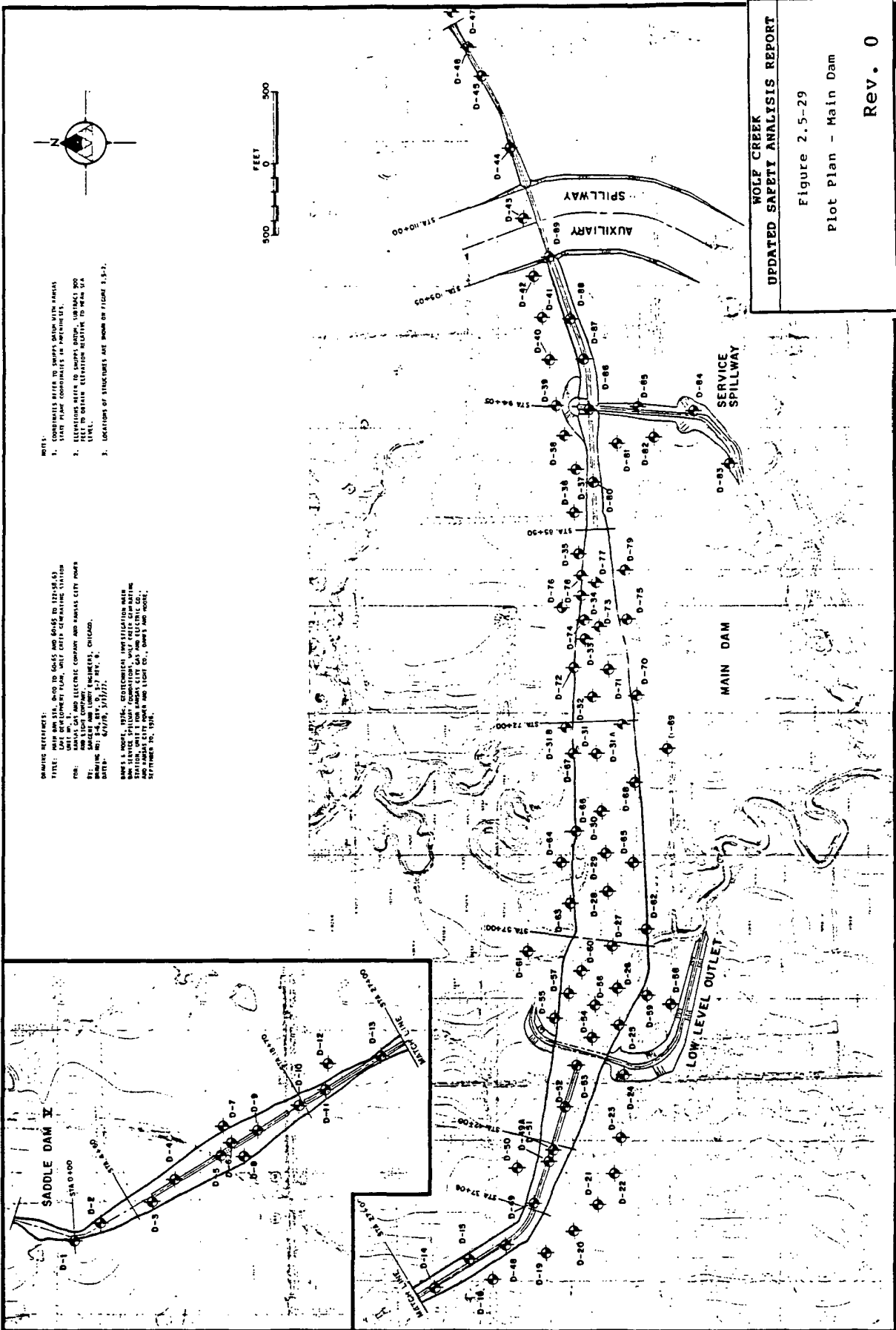

- NOTES:**
1. CONCRETE BUILT TO SWIFT DATA WITH AREAS STATE PLANS CORRECTED AS APPLICABLE.
 2. ELEVATIONS REFER TO SWIFT DATUM, UNLESS OTHERWISE NOTED TO BE TO OTHER ELEVATION RELATIVE TO MEAN SEA LEVEL.
 3. LOCATIONS OF STRUCTURES ARE SHOWN ON FIGURE 1.5-1.

GENERAL REFERENCES:

TITLE: MAIN DAM STA. 3740 TO GAGES AND GAGE NO. 1214-05-63
 DATE: DEVELOPMENT PLAN, JET CRIP OPERATING SYSTEM
 FOR: SANSU, CO. AND ELECTRIC COMPANY AND SANSU CITY POWER
 CO.
 BY: SANSU CITY POWER AND ELECTRIC ENGINEERS, CHICAGO.
 DRAWING NO: 2-4, REV. 0, 37, REV. 0,
 DATE: 6/17/73, 3/17/77.

DAVE L. MOORE, 1976, GEOTECHNICAL INVESTIGATION MADE
 FOR THE SANSU CITY POWER AND ELECTRIC COMPANY AND
 SANSU CITY POWER AND ELECTRIC COMPANY AND SANSU CITY
 AND SANSU CITY POWER AND ELECTRIC CO., SANSU AND MOORE,
 SPRINGFIELD, ILL., 1974.

**WOLF CREEK
 UPDATED SAFETY ANALYSIS REPORT**

Figure 2.5-29
 Plot Plan - Main Dam

Rev. 0

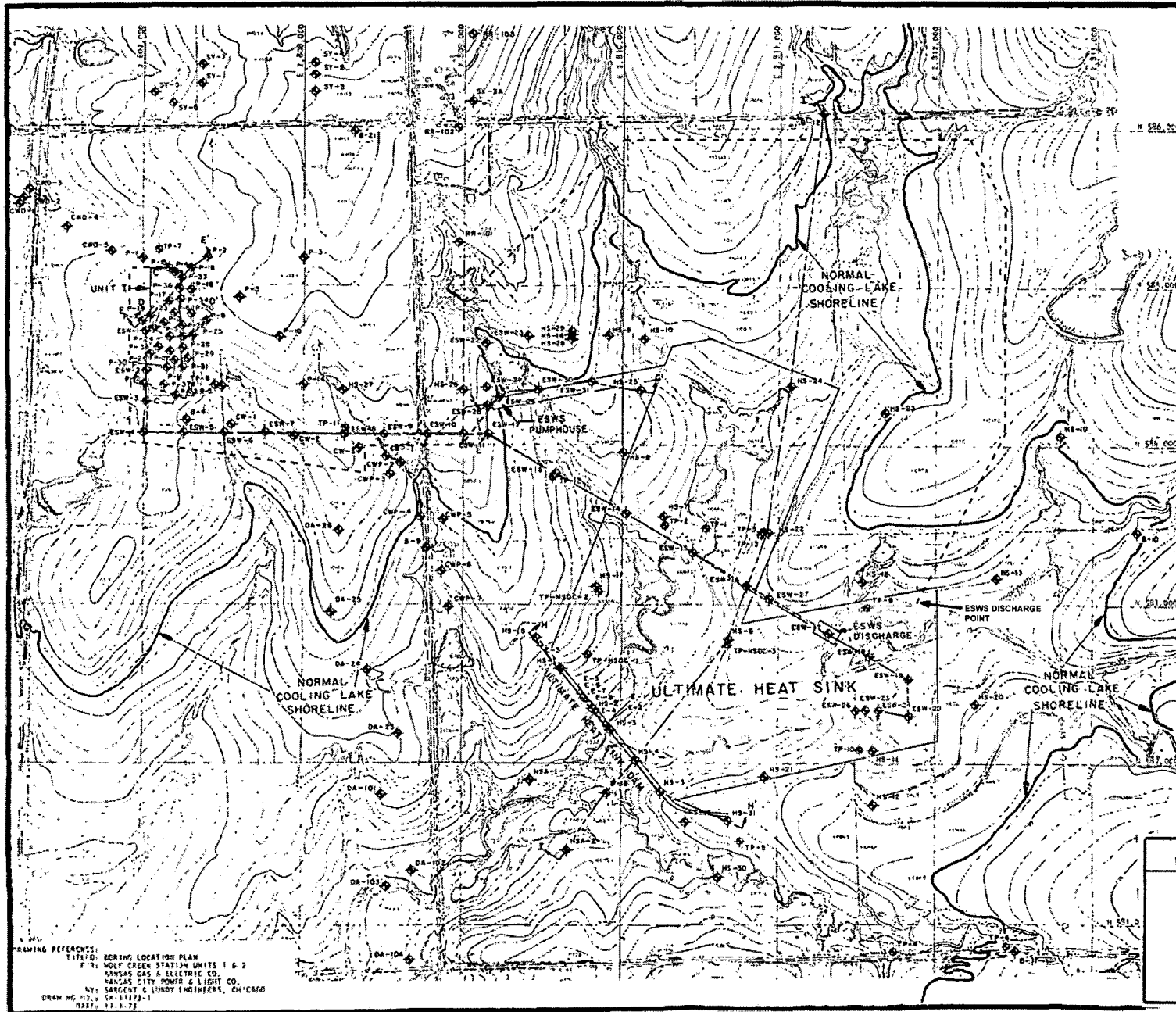

N

EXPLANATION

- ◆ P-3 BORING LOCATION AND NUMBER
- ◆ TP-2 TEST PIT LOCATION AND NUMBER
- △ E-3 SHALLOW ROLLER BIT BORING LOCATION AND NUMBER
- CROSS-SECTION LINE
- - - - LOCATION OF PIPELINE

NOTES:

1. FIGURE 2.5-58 SHOWS THE GEOPHYSICAL PLOT PLAN.
2. FIGURE 2.5-59 SHOWS THE LOCATION OF BOREHOLE GEOPHYSICAL LOGGING.
3. GEOLOGIC CROSS-SECTIONS ARE SHOWN ON FIGURES 2.5-45 THROUGH 2.5-51.
4. LOGS OF BORING ARE SHOWN ON FIGURES 2.5-34a THROUGH 2.5-34c, 2.5-35a THROUGH 2.5-35c, AND 2.5-36a THROUGH 2.5-36c. LOGS OF TEST PITS ARE SHOWN ON FIGURES 2.5-37a THROUGH 2.5-37c.
5. FIGURE 2.5-18 SHOWS THE PLOT PLAN OF THE SITE.
6. FIGURE 2.5-31 SHOWS THE PLOT PLAN OF THE PLANT SITE.
7. FIGURE 2.5-98 SHEET 2 SHOWS THE NEW BORINGS DRILLED FOR THE REPLACEMENT ESWS PIPING.

TOPOGRAPHIC CONTOUR INTERVAL IS 2 FEET.

COORDINATES REFER TO STATE PLANE COORDINATE SYSTEM.

0 300 600
FEET

**WOLF CREEK
UPDATED SAFETY ANALYSIS REPORT**

Figure 2.5-30

Plot Plan - Category I Area

Rev. 28

DRAWING REFERENCES:

117170: BORING LOCATION PLAN

117171: WOLF CREEK STATION UNITS 1 & 2

117172: KANSAS GAS & ELECTRIC CO.

117173: KANSAS CITY POWER & LIGHT CO.

117174: SARGENT & LUNDY ENGINEERS, CHICAGO

DRW. NO. 117173-1

DATE: 11-7-53

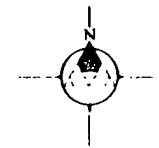
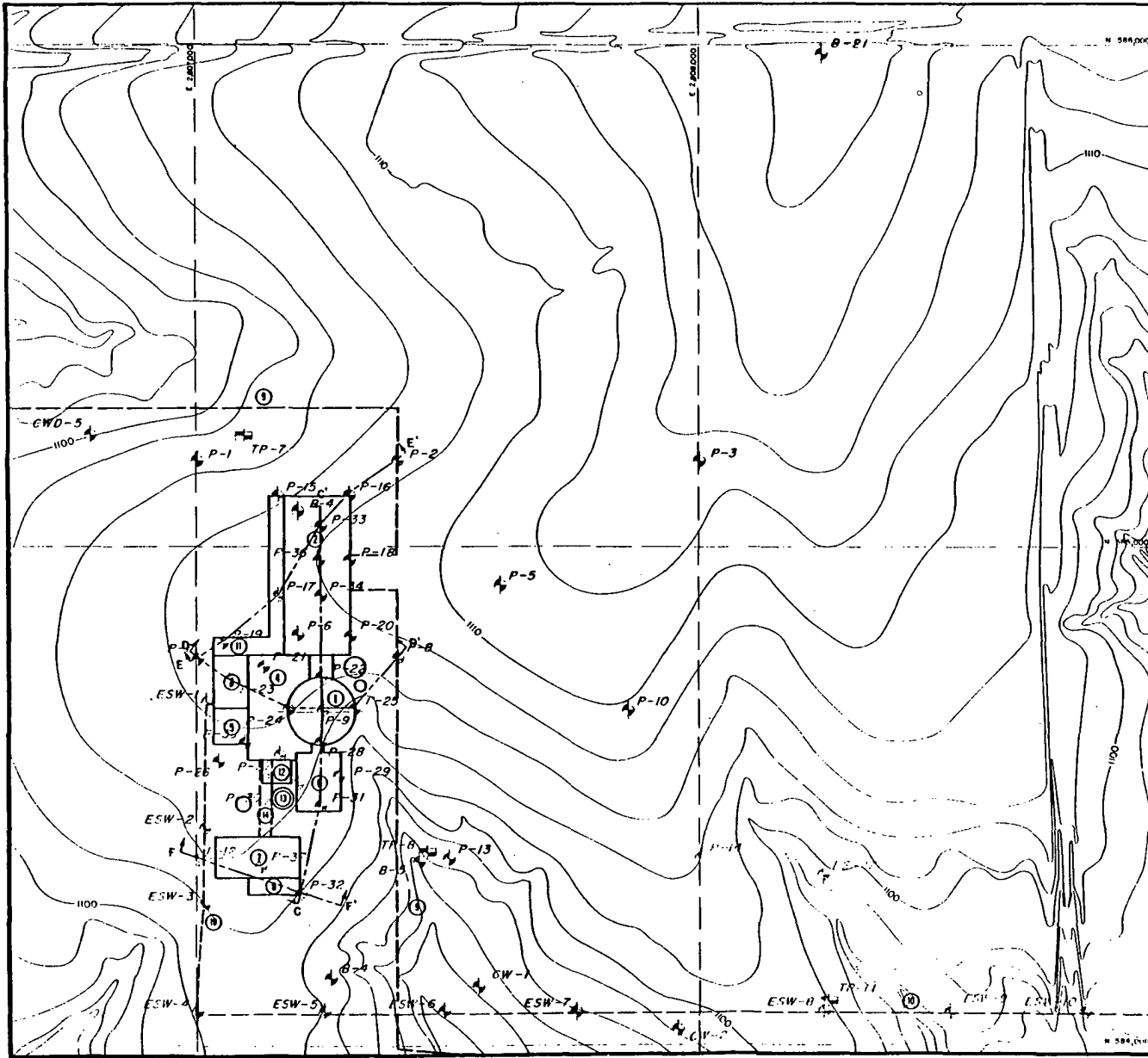

EXPLANATION:

- | | |
|---------------------------|---|
| ① CENTERLINE* | Ⓜ DRUMS TO BE FILLED (PILE WASTE) |
| ② SURFACE BLDG. | Ⓝ CONTAINING WATER PIPES LINES |
| ③ FOUNDATION BLDG. | Ⓣ FOUNDATION* |
| ④ FIBER LAMP BLDG. | Ⓤ FIBER LAMP BLDG. (CONTAINING WATER PIPES LINES) |
| ⑤ OTHER OFFICE GEN. BLDG. | Ⓥ DIRT MOUND (PILE) |
| ⑥ FIBER PAPER BLDG. | Ⓦ BREAKING WATER* (PILE WASTE) |
| ⑦ RAWWATER BLDG. | Ⓧ PILE TO BE FILLED (PILE WASTE) |
- * CATEGORY 2

- Ⓜ P-3 BOREHOLE LOCATION AND NUMBER
- Ⓜ TP-7 TEST PIT LOCATION AND NUMBER
- LOCATION OF PERMIT LINE
- - - - - LOCATION OF CROSS-SECTION LINES

NOTES:

- FIGURE 2.5-9B SHOWS THE GEOPHYSICAL TEST PLAN.
- FIGURE 2.5-9C SHOWS THE LOCATION OF PIPELINE GEOPHYSICAL LOGGING.
- GEOPHYSICAL CROSS-SECTIONS ARE SHOWN ON FIGURES 2.5-10A THROUGH 2.5-10D.
- LOGS OF BOREHOLES ARE SHOWN ON FIGURES 2.5-11A THROUGH 2.5-11D, 2.5-12A THROUGH 2.5-12C, AND LOGS OF TEST PITS ARE SHOWN ON FIGURES 2.5-13A THROUGH 2.5-13C.
- FIGURE 2.5-18 SHOWS THE PLOT PLAN OF THE SITE.
- FIGURE 2.5-20 SHOWS THE PLOT PLAN OF THE CATEGORY 2 AREA.

TOPOGRAPHIC CONTOUR INTERVAL IS 2 FEET

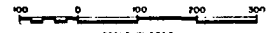

**WOLF CREEK
UPDATED SAFETY ANALYSIS REPORT**

Figure 2.5-31
Plot Plan - Plant Site

Rev. 0

EXPLANATION OF TEST DATA SYMBOLS

LL LIQUID LIMIT
 PL PLASTIC LIMIT
 PI PLASTICITY INDEX
 D DRY DENSITY (POUNDS PER CUBIC FOOT)
 Dm MAXIMUM DRY DENSITY (POUNDS PER CUBIC FOOT)
 W MOISTURE CONTENT (PERCENT)
 W_o OPTIMUM MOISTURE CONTENT (PERCENT)
 S SHEAR STRENGTH (POUNDS PER SQUARE FOOT)
 S_p PEAK SHEAR STRENGTH (POUNDS PER SQUARE FOOT)
 S_y YIELD SHEAR STRENGTH (POUNDS PER SQUARE FOOT)
 P CONFINING PRESSURE (POUNDS PER SQUARE INCH)
 Q UNCONFINED COMPRESSIVE STRENGTH (POUNDS PER SQUARE FOOT)
 E MODULUS OF ELASTICITY (POUNDS PER SQUARE INCH)
 I_d SLAKE DURABILITY INDEX (TWO CYCLE TEST)
 Kr RECOMPACTED PERMEABILITY (CENTIMETERS PER SECOND)
 Ku PERMEABILITY OBTAINED FROM UNDISTURBED SAMPLE (CENTIMETERS PER SECOND)

- 1* RESULTS OF PARTICLE SIZE ANALYSES ARE SHOWN ON FIGURE 2.5-90
- 2* CONSOLIDATION CURVES ARE SHOWN ON FIGURES 2.5-88_a THROUGH 2.5-88_j.
- 3* CLAY MINERALOGY IS SHOWN IN TABLE 2.5-43
- 4* SWELLING POTENTIALS ARE AVAILABLE IN TABLE 2.5-44
- 5* RESULTS OF RESONANT COLUMN TESTS ARE PRESENTED IN TABLES 2.5-40.
- 6* RESULTS OF DYNAMIC TRIAXIAL TESTS ARE PRESENTED IN TABLE 2.5-42 AND ON FIGURE 2.5-92.

PERMEABILITY
cm/ann

97 × 10⁻⁷

PERMEABILITY OBTAINED FROM BOREHOLE PRESSURE TESTS.
 HORIZONTAL SOLID LINES SEPARATE TESTED INTERVAL.
 ZERO (0) VALUES INDICATE NO WATER WAS LOST DURING PRESSURE TESTING.

- 90% PERCENT RECOVERED INDICATES TOTAL AMOUNT OF CORE RECOVERED FOR EACH RUN, EXPRESSED AS A PERCENTAGE OF THE TOTAL LENGTH OF THE CORE RUN.
- RQD ROCK QUALITY DESIGNATION
 A MODIFIED CORE RECOVERY PERCENTAGE IN WHICH ALL THE PIECES OF SOUND CORE OVER 4 INCHES LONG ARE COUNTED AS RECOVERY. THE MODIFIED SUM OF CORE RECOVERED IS THEN EXPRESSED AS A PERCENTAGE OF THE TOTAL LENGTH OF THE CORE RUN.

EXPLANATION OF SYMBOLS FOR SAMPLES

- INDICATES THE NUMBER OF BLOWS REQUIRED TO DRIVE A STANDARD PENETRATION TEST SAMPLER 1 FOOT WITH A 140 POUND HAMMER FALLING 30 INCHES
- 13 ■ INDICATES DEPTH OF STANDARD PENETRATION TEST (2" O.D. SPLIT SPOON SAMPLER)
- INDICATES THE NUMBER OF BLOWS REQUIRED TO DRIVE A DAMES & MOORE TYPE U SAMPLER 1 FOOT WITH A 340 POUND HAMMER FALLING 24 INCHES
- 13 ■ INDICATES DEPTH OF SAMPLE OBTAINED WITH DAMES & MOORE TYPE U SAMPLER (3.25" O.D. 2.42" I.D. SPLIT SPOON SAMPLER)
- P INDICATES SAMPLER PUSHED TO OBTAIN SAMPLE
- INDICATES DEPTH OF SAMPLING ATTEMPT WITH NO RECOVERY
- INDICATES DISTURBED SAMPLE; OH TEST PIT LOGS INDICATES ZONE OF GRAB SAMPLE
- C □ INDICATES SAMPLE OBTAINED BY CORING WITH A 2-3/8 INCH INSIDE DIAMETER DENNISON SAMPLER
- P □ INDICATES SAMPLE OBTAINED BY PUSHING A 3 INCH INSIDE DIAMETER SHELBY TUBE

Rev. 0

**WOLF CREEK
 UPDATED SAFETY ANALYSIS REPORT**

Figure 2.5-32 (Sheet 1 of 2)

Explanation and General Notes for
 Boring and Test Pit Logs

NOTES

ELEVATIONS REFER TO U.S.G.S. DATUM.

- 5% VUGS INDICATES THE ESTIMATED RATIO OF VUGGED CORE SURFACE AREA TO TOTAL CORE SURFACE AREA.
- SANDSTONE 70% INDICATES THE VISUALLY ESTIMATED PERCENTAGE OF SANDSTONE BY VOLUME TO THE TOTAL VOLUME OF THE CORE OVER THE INTERVAL INDICATED.
- 60° REPRESENTS 60 DEGREES MEASURED FROM A PLANE PERPENDICULAR TO THE LONGITUDINAL AXIS OF THE CORE.
- OCCASIONAL REPRESENTS 0 TO 10 PERCENT BY VOLUME
- NUMEROUS REPRESENTS 10 TO 50 PERCENT BY VOLUME
- CLAYEY REFERS TO SHALES WHICH HAVE BEEN ALTERED BY WEATHERING OR GROUNDWATER ACTION, USUALLY ALONG THIN, HORIZONTAL BEDDING PLANES. THE ALTERATION HAS DEGRADED THE SHALE INTO CLAY PARTICLES, THEREBY SIGNIFICANTLY REDUCING THE STRENGTH IN THE CLAYEY AREAS.

BEDDING TERMINOLOGY

- THINLY LAMINATED - LESS THAN 0.001 FOOT
LAMINATED - 0.001 FOOT TO 0.01 FOOT
THIN BEDDED - 0.01 FOOT TO 0.1 FOOT
MEDIUM BEDDED - 0.1 FOOT TO 1.0 FOOT
THICK BEDDED - GREATER THAN 1.0 FOOT

WEATHERING TERMINOLOGY

- SLIGHTLY WEATHERED ROCK IS SLIGHTLY DISCOLORED WITH A SLIGHTLY LOWER STRENGTH THAN UNWEATHERED ROCK.
- MODERATELY WEATHERED ROCK IS CONSIDERABLY DISCOLORED WITH A SIGNIFICANTLY LOWER STRENGTH THAN UNWEATHERED ROCK.
- HIGHLY WEATHERED ROCK IS DISCOLORED AND WEAKENED SO INTENSELY THAT 2-INCH DIAMETER ROCK CORES CAN BE BROKEN READILY BY HAND. WET STRENGTH IS USUALLY MUCH LOWER THAN DRY STRENGTH.

Rev. 0

**WOLF CREEK
UPDATED SAFETY ANALYSIS REPORT**

Figure 2.5-32 (Sheet 2 of 2)

Explanation and General Notes for
Boring and Test Pit Logs

MAJOR DIVISIONS		GRAPH SYMBOL	LETTER SYMBOL	TYPICAL DESCRIPTIONS	
COARSE GRAINED SOILS	GRAVEL AND GRAVELLY SOILS	CLEAN GRAVELS (LITTLE OR NO FINES)		GW	WELL-GRADED GRAVELS, GRAVEL-SAND MIXTURES, LITTLE OR NO FINES
		GRAVELS WITH FINES (APPRECIABLE AMOUNT OF FINES)		GP	POORLY-GRADED GRAVELS, GRAVEL-SAND MIXTURES, LITTLE OR NO FINES
		GRAVELS WITH FINES (APPRECIABLE AMOUNT OF FINES)		GM	SILTY GRAVELS, GRAVEL-SAND-SILT MIXTURES
		GRAVELS WITH FINES (APPRECIABLE AMOUNT OF FINES)		GC	CLAYEY GRAVELS, GRAVEL-SAND-CLAY MIXTURES
	SAND AND SANDY SOILS	CLEAN SAND (LITTLE OR NO FINES)		SW	WELL-GRADED SANDS, GRAVELLY SANDS, LITTLE OR NO FINES
				SP	POORLY-GRADED SANDS, GRAVELLY SANDS, LITTLE OR NO FINES
		SANDS WITH FINES (APPRECIABLE AMOUNT OF FINES)		SM	SILTY SANDS, SAND-SILT MIXTURES
				SC	CLAYEY SANDS, SAND-CLAY MIXTURES
FINE GRAINED SOILS	SILTS AND CLAYS	LICUID LIMIT LESS THAN 50		ML	INORGANIC SILTS AND VERY FINE SANDS, ROCK FLOUR, SILTY OR CLAYEY FINE SANDS OR CLAYEY SILTS WITH SLIGHT PLASTICITY
		LICUID LIMIT LESS THAN 50		CL	INORGANIC CLAYS OF LOW TO MEDIUM PLASTICITY, GRAVELLY CLAYS, SANDY CLAYS, SILTY CLAYS, LEAN CLAYS
		LICUID LIMIT LESS THAN 50		OL	ORGANIC SILTS AND ORGANIC SILTY CLAYS OF LOW PLASTICITY
	SILTS AND CLAYS	LICUID LIMIT GREATER THAN 50		MH	INORGANIC SILTS, MICACULOUS OR DIATOMACEOUS FINE SAND OR SILTY SOILS
		LICUID LIMIT GREATER THAN 50		CH	INORGANIC CLAYS OF HIGH PLASTICITY, FAT CLAYS
		LICUID LIMIT GREATER THAN 50		OH	ORGANIC CLAYS OF MEDIUM TO HIGH PLASTICITY, ORGANIC SILTS
HIGHLY ORGANIC SOILS			PT	PEAT, MUCKS, SWAMP SOILS WITH HIGH ORGANIC CONTENTS	

NOTE: DUAL SYMBOLS ARE USED TO INDICATE BORDERLINE SOIL CLASSIFICATIONS.

SOIL CLASSIFICATION CHART

Rev. 0

**WOLF CREEK
UPDATED SAFETY ANALYSIS REPORT**

Figure 2.5-33

Unified Soil Classification System

BORING B-1

SURFACE ELEVATION 1019.8
 COORDINATES: N 567445.8 E 2808152.3

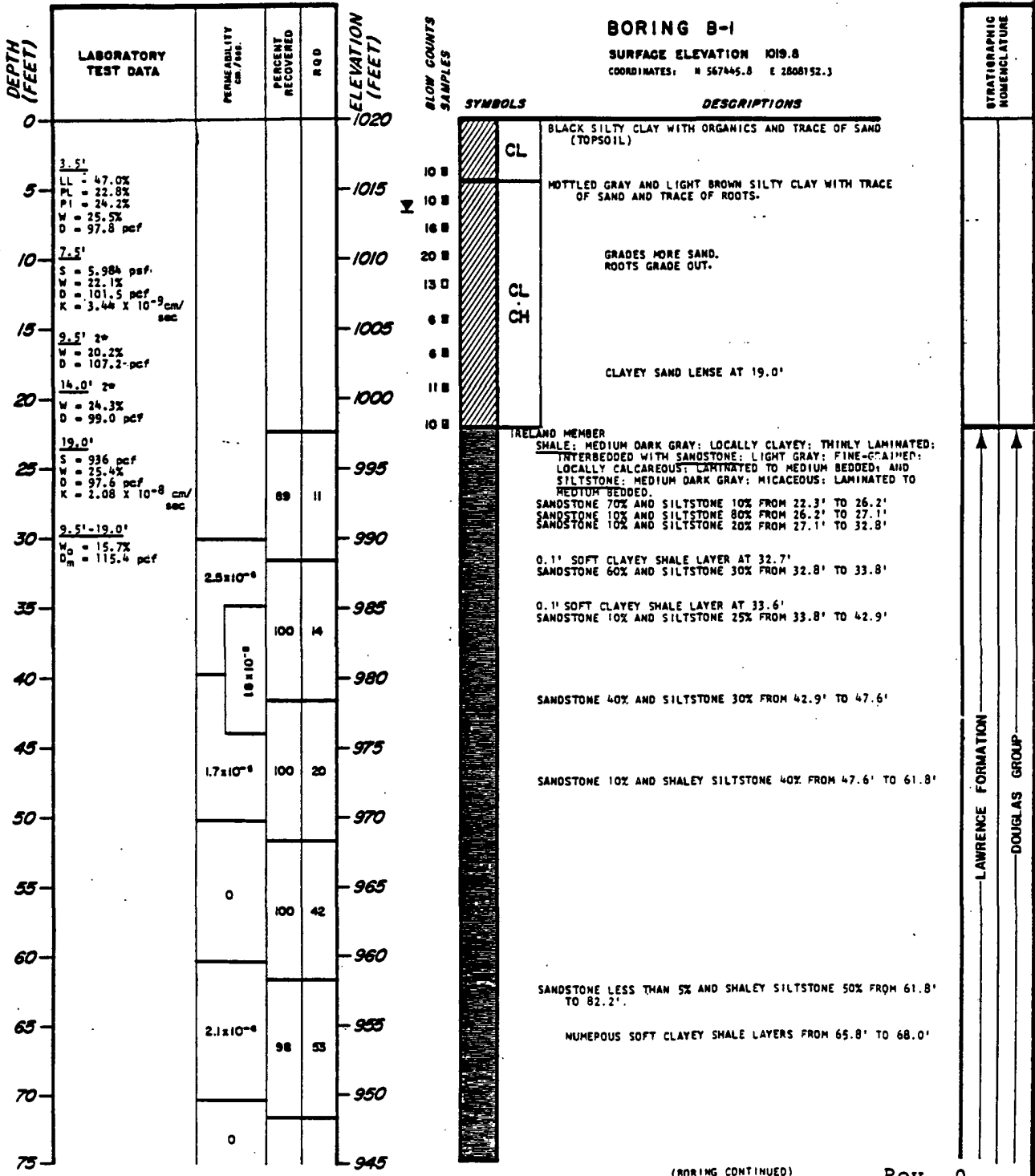

(BORING CONTINUED)

Rev. 0

**WOLF CREEK
 UPDATED SAFETY ANALYSIS REPORT**

Figure 2.5-34a (Sheet 1 of 4)

Log of Boring B-1

BORING B-1 CONT.

DEPTH (FEET)	LABORATORY TEST DATA	PERMEABILITY cm. / sec.	PERCENT RECOVERED	ROD	ELEVATION (FEET)
75					945
		0	96	53	
80					940
		0	93	57	
85					935
					930
		0	100	49	
95					925
					920
		0	96	90	
105					915
					910
		1.9×10^{-7}	100	76	
115					905
					900
		1.1×10^{-7}	100	59	
125					895
					890
		3.9×10^{-8}	100	40	
135					885
					880
			100	30	
145		1.0×10^{-8}			875
150					870

SYMBOLS



DESCRIPTIONS

NUMEROUS SOFT CLAYEY SHALE LAMINAE FROM 76.4' TO 79.0'

NUMEROUS SOFT CLAYEY SHALE LAMINAE FROM 80.5' TO 83.9'

ROBBINS MEMBER
 SHALE: MEDIUM DARK GRAY; THINLY LAMINATED.

OCCASIONAL SOFT CLAYEY SHALE LAMINAE FROM 93.1' TO 96.9'

OCCASIONAL 0.05' TO 0.15' PALE YELLOWISH-BROWN DOLOMITIC CONCRETIONS GRADE IN AT 103.9'

BROKEN ZONE FROM 106.7' TO 107.1'

LIMESTONE: OLIVE GRAY; VERY SHALEY; FOSSILIFEROUS; THIN TO MEDIUM BEDDED.

SHALE: DARK GRAY; SLIGHTLY CARBONACEOUS; THINLY LAMINATED; OCCASIONAL 0.05' TO 0.15' PALE YELLOWISH-BROWN DOLOMITIC CONCRETIONS.

HASKELL MEMBER
 LIMESTONE: MEDIUM LIGHT GRAY; FINE-GRAINED; FOSSILIFEROUS; THIN TO THICK BEDDED; SHALEY IN BASAL 0.3'

VINLAND MEMBER
 SHALE: DARK GREENISH-GRAY; CLAYEY; VERY CALCAREOUS; LAMINATED TO THIN BEDDED; FOSSILIFEROUS IN UPPER 0.8'; OCCASIONAL 30' SLICKENSIDED FRACTURES FROM 119.7' TO 121.7'

WESTPHALIA MEMBER
 LIMESTONE: LIGHT OLIVE GRAY; 70% FUSULINID FOSSILS; 10% GREENISH-GRAY SHALE PARTINGS; THIN TO THICK BEDDED.

TONGANOXIE MEMBER
 SANDSTONE: LIGHT GRAY; FINE-GRAINED; CROSS-BEDDED; LOCALLY CALCAREOUS; LAMINATED TO MEDIUM BEDDED; INTERBEDDED WITH SHALE; GREENISH-GRAY; LOCALLY CLAYEY; THINLY LAMINATED; AND SILTSTONE; MEDIUM GRAY; MICACEOUS; LAMINATED TO MEDIUM BEDDED.
 SHALE 30% AND SILTSTONE 40% FROM 130.7' TO 136.3'; OCCASIONAL SOFT CLAYEY SHALE LAYERS FROM 132.8' TO 135.7'
 SHALE 10% AND SILTSTONE 10% FROM 136.3' TO 151.9'

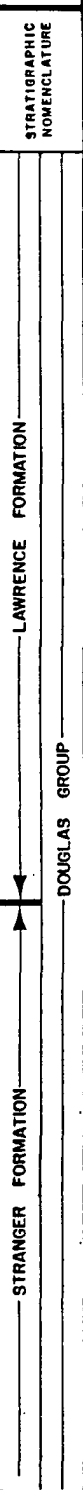

(BORING CONTINUED)

Rev. 0

WOLF CREEK
UPDATED SAFETY ANALYSIS REPORT

Figure 2.5-34a (Sheet 2 of 4)
 Log of Boring B-1

BORING B-1 CONT.

DEPTH (FEET)	LABORATORY TEST DATA	PERMEABILITY CM./SEC.	PERCENT RECOVERED	RQD	ELEVATION (FEET)
150					870
155		3.9×10^{-6}	99	39	865
160					860
165		8.3×10^{-6}	100	48	855
170					850
175			100	70	845
180					840
185		0	100	88	835
190					830
195			100	92	825
200					820
205			100	72	815
210					810
215			100	100	805
220					800
225		0	100	100	795

SYMBOLS

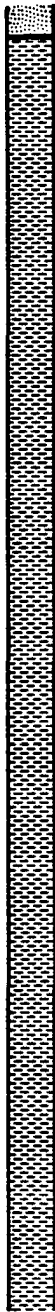

DESCRIPTIONS

SILTSTONE: MEDIUM GRAY; MICACEOUS; LAMINATED TO THICK BEDDED; INTERBEDDED WITH LENSES OF SANDSTONE. LIGHT GRAY; FINE-GRAINED; LOCALLY CALCAREOUS; LAMINATED TO THIN BEDDED.

SANDSTONE 10% FROM 151.9' TO 155.8'
 SANDSTONE 80% FROM 155.8' TO 156.8'
 SANDSTONE 25% FROM 156.8' TO 160.2'

SILTSTONE 100% FROM 160.2' TO 164.3'

DISTORTED SANDSTONE 50% FROM 164.3' TO 165.2'

SANDSTONE 10% FROM 165.2' TO 167.9'

SANDSTONE 75% FROM 167.9' TO 169.4'

SANDSTONE 15% FROM 169.4' TO 178.8'

DISTORTED SANDSTONE 50% FROM 178.8' TO 179.4'
 SANDSTONE 15% FROM 179.4' TO 183.5'

CLAYEY BROKEN ZONE FROM 181.0' TO 181.3'

CLAYEY BROKEN ZONE FROM 183.0' TO 183.5'
 SANDSTONE 60% FROM 183.5' TO 184.1'
 SANDSTONE 15% FROM 184.1' TO 188.8'

SILTSTONE 100% FROM 188.8' TO 196.3'

SANDSTONE 15% FROM 196.3 TO 198.1'

SILTSTONE 100% FROM 198.1' TO 205.2'

60° FRACTURES AT 200.4' AND 200.8'

DISTORTED SANDSTONE 60% FROM 205.2' TO 205.9'

SILTSTONE 100% FROM 205.9' TO 240.2'

STRATIGRAPHIC NOMENCLATURE

STRANGER FORMATION

DOUGLAS GROUP

(BORING CONTINUED)

Rev. 0

WOLF CREEK
 UPDATED SAFETY ANALYSIS REPORT

Figure 2.5-34a (Sheet 3 of 4)

Log of Boring B-1

BORING B-1 CONT.

DEPTH (FEET)	LABORATORY TEST DATA	PERMEABILITY cm./sec.	PERCENT RECOVERED	RQD	ELEVATION (FEET)
225					795
230		0			790
235			100	95	785
240			100	66	780
245			89	84	775
250					770
255			98	48	765
260					760
265			88	11	755
270					750
275					745

SYMBOLS

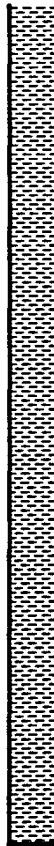

DESCRIPTIONS

70° FRACTURE AT 230.9'

SANDSTONE 25% FROM 240.2' TO 241.0'
SILTSTONE 100% FROM 241.0' TO 248.3'

30° FRACTURE AT 243.0'

SILTSTONE AND SANDSTONE BECOME INTERBEDDED WITH SHALE;
MEDIUM DARK GRAY; THINLY LAMINATED
SANDSTONE 10% AND SHALE 10% FROM 248.3' TO 270.0'

0.06' CLAYEY BROKEN LAYERS AT 251.0' AND 251.9'

60° SLICKENSIDED FRACTURE AT 252.4'

30° SLICKENSIDED FRACTURE AT 252.9'

60° FRACTURE AT 255.2'

NUMEROUS 20° TO 45° SLICKENSIDED FRACTURES FROM 256.0' TO 260.2'

30° FRACTURE AT 261.4'

60° FRACTURES AT 261.6' AND 262.0'

NUMEROUS SOFT CLAYEY SHALE LAYERS FROM 263.3' TO 272.3'

SHALEY SILTSTONE 50% AND SHALE 50% FROM 270.0' TO 272.3'

BORING COMPLETED AT 272.3 FEET ON 7-4-73.
CASING USED TO A DEPTH OF 22.3 FEET.
GROUNDWATER LEVEL RECORDED AT 7.0 FEET ON 7-5-73.
THIRD PIEZOMETER INSTALLED AT AN INTERVAL FROM 24.0 FEET TO 84.0 FEET ON 7-18-73.
SECOND PIEZOMETER INSTALLED AT AN INTERVAL FROM 118.0 FEET TO 125.0 FEET ON 7-18-73.
FIRST PIEZOMETER INSTALLED AT AN INTERVAL FROM 130.0 FEET TO 272.0 FEET ON 7-18-73.
PIEZOMETER READINGS ARE PRESENTED ON TABLE 2.4-29.

STRATIGRAPHIC NOMENCLATURE

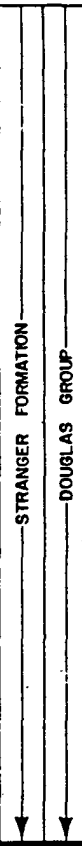

Rev. 0

**WOLF CREEK
UPDATED SAFETY ANALYSIS REPORT**

Figure 2.5-34a (Sheet 4 of 4)

Log of Boring B-1

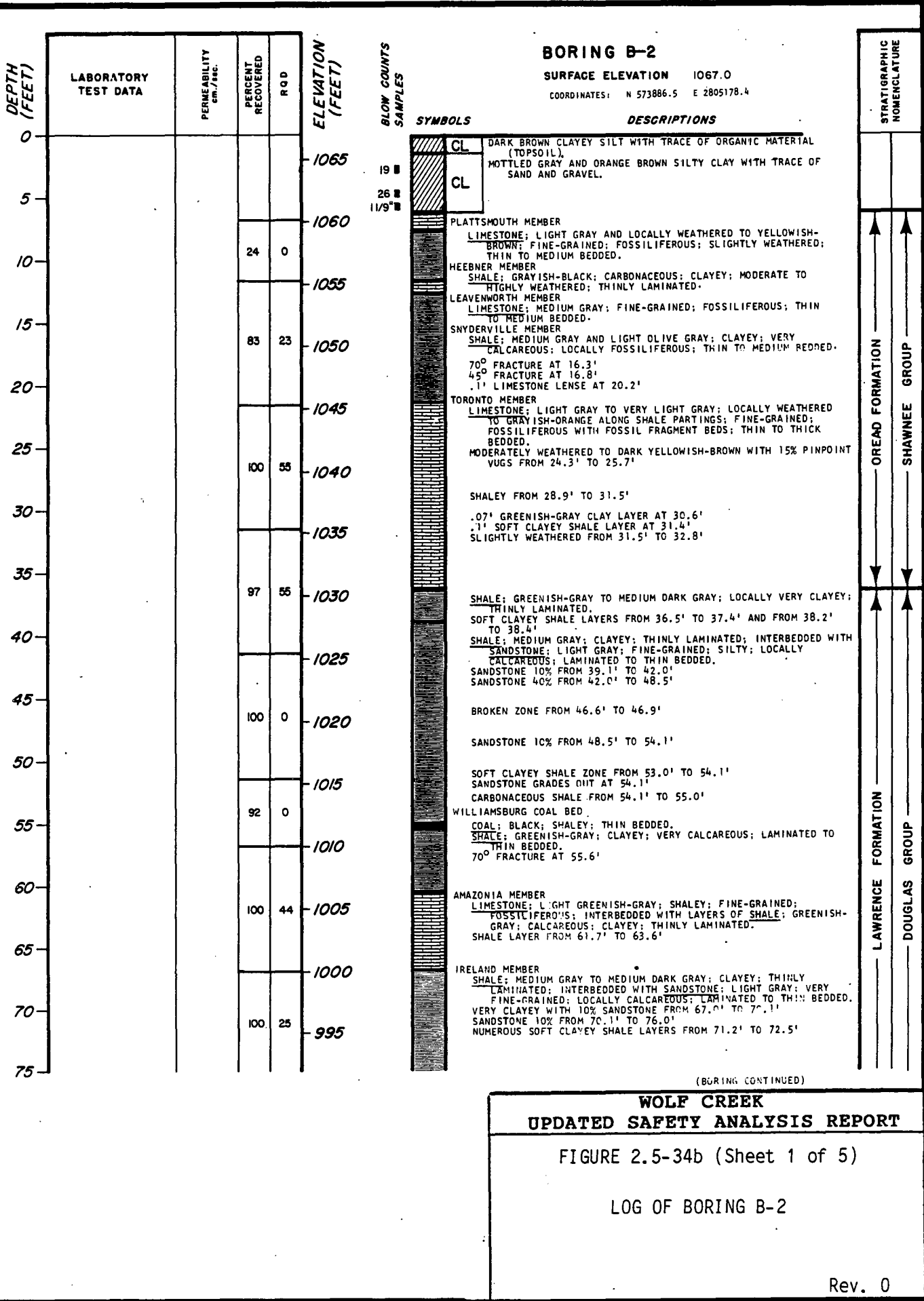

BORING B-2 CONT'D

DEPTH (FEET)	LABORATORY TEST DATA	PERMEABILITY cm./SEC.	PERCENT RECOVERED	RQD	ELEVATION (FEET)
75					990
80			100	34	985
85					980
90			97	24	975
95					970
100			99	17	965
105					960
110			100	27	955
115					950
120			100	22	945
125					940
130			99	34	935
135					930
140			100	5	925
145					920
150					

SYMBOLS



DESCRIPTIONS

SANDSTONE 30% FROM 76.0' TO 79.2'

SANDSTONE 10% FROM 79.2' TO 80.3'

COAL; BLACK; SHALEY; LAMINATED TO THIN BEDDED. SHALE; MEDIUM GRAY TO MEDIUM DARK GRAY; THINLY LAMINATED; INTERBEDDED WITH SANDSTONE; LIGHT GRAY; FINE-GRAINED; LAMINATED TO MEDIUM BEDDED; AND SILTSTONE; MEDIUM GRAY; MICACEOUS; LAMINATED TO MEDIUM BEDDED.

SHALE 100% FROM 81.0' TO 82.4'

SANDSTONE 85% AND SILTSTONE 10% FROM 82.4' TO 89.2'

SANDSTONE 30% AND SILTSTONE 65% FROM 89.2' TO 91.3'

SANDSTONE 10% AND SILTSTONE 40% FROM 91.3' TO 98.7'

NUMEROUS SOFT CLAYEY SHALE LAYERS FROM 89.2' TO 94.6'

NUMEROUS SOFT CLAYEY SHALE LAYERS FROM 96.8' TO 98.3'

SANDSTONE 20% AND SILTSTONE 75% FROM 98.7' TO 99.2'

SANDSTONE 90% AND SILTSTONE 5% FROM 99.2' TO 99.6'

SANDSTONE 10% AND SILTY SHALE 85% FROM 99.6' TO 99.9'

SANDSTONE 10% AND SILTSTONE 85% FROM 99.9' TO 112.7'

NUMEROUS SOFT SILTY CLAYEY SHALE LAYERS FROM 102.5' TO 104.3'

70° FRACTURE AT 104.2'

BROKEN ZONE FROM 105.5' TO 105.7'

40° FRACTURE AT 105.7'

NUMEROUS SOFT SILTY CLAYEY SHALE LAYERS FROM 106.5' TO 107.0'

CLAYEY ZONE FROM 108.5' TO 109.7'

SANDSTONE 60% AND SILTSTONE 35% FROM 112.7' TO 112.9'

SANDSTONE 10% AND SILTSTONE 85% FROM 112.9' TO 113.1'

SANDSTONE 95% FROM 113.1' TO 113.8'

50° SLICKENSIDED FRACTURE AT 113.5'

SANDSTONE 10% AND SILTSTONE 85% FROM 113.8' TO 117.7'

60° SLICKENSIDED CLAY FILLED FRACTURE AT 115.2'

1.2' CALCAREOUS SANDSTONE LAYER WITH INTERBEDDED, DISTORTED NON-CALCAREOUS, CARBONACEOUS, SHALEY SILTSTONE AT 117.7'

SANDSTONE 10% AND SILTSTONE 85% FROM 118.9' TO 128.0'

NUMEROUS SOFT CLAYEY LAYERS FROM 118.9' TO 120.1'

0.4' CROSSBEDDED SANDSTONE LAYER WITH INTERBEDDED CARBONACEOUS SILTSTONE PARTINGS AT 121.7'

BROKEN ZONE WITH IRREGULAR VERTICAL FRACTURE FROM 121.9' TO 122.2'

NUMEROUS SOFT CLAYEY LAYERS FROM 124.2' TO 124.5'

0.5' SOFT CLAYEY LAYER AT 126.0'

SANDSTONE 30% AND SILTSTONE 65% FROM 128.0' TO 133.4'

SANDSTONE 60% AND SILTSTONE 35% FROM 133.4' TO 148.2'

OCCASIONAL SOFT CLAYEY LAYERS FROM 139.0' TO 140.0'

0.35' CALCAREOUS SANDSTONE LAYER AT 141.7'

NUMEROUS SOFT CLAYEY LAYERS FROM 142.1' TO 148.3'

SANDSTONE 50% AND SILTY SHALE 50% FROM 148.2' TO 149.7'

SANDSTONE 20% AND SILTY SHALE 75% FROM 149.7' TO 156.5'

STRATIGRAPHIC NOMENCLATURE

LAWRENCE FORMATION

DOUGLAS GROUP

(BORING CONTINUED)

WOLF CREEK
UPDATED SAFETY ANALYSIS REPORT

FIGURE 2.5-34b (Sheet 2 of 5)

LOG OF BORING B-2

Rev. 0

BORING B-2 CONT'D

DEPTH (FEET)	LABORATORY TEST DATA	PERMEABILITY cm./SEC.	PERCENT RECOVERED	ROD	ELEVATION (FEET)	SYMBOLS	DESCRIPTIONS	STRATIGRAPHIC NOMENCLATURE
150					915			
155			100	4	910		ROBBINS MEMBER SHALE; MEDIUM DARK GRAY; MICACEOUS; THINLY LAMINATED; SLIGHTLY CALCAREOUS AND SLIGHTLY CARBONACEOUS BELOW 179.4'.	
160			96	74	905			
165					900			
170			100	100	895			
175					890			
180			100	37	885		LIMESTONE; LIGHT OLIVE GRAY; VERY SHALEY; FOSSILIFEROUS; MEDIUM BEDDED. SHALE; MEDIUM GRAY; CARBONACEOUS; PLANT FOSSILIFEROUS; SLIGHTLY CALCAREOUS; THINLY LAMINATED; OCCASIONAL PALE YELLOWISH-BROWN CONCRETIONS. 0.6' BROKEN ZONE WITH IRREGULAR VERTICAL FRACTURE AT 181.5'	
185					880		HASKELL MEMBER LIMESTONE; LIGHT GRAY; FINE-GRAINED; FOSSILIFEROUS; MEDIUM BEDDED.	
190			100	84	875		VINLAND MEMBER SHALE; MEDIUM DARK GRAY; VERY CALCAREOUS; MICACEOUS; PLANT FOSSILIFEROUS; THINLY LAMINATED; INTERBEDDED WITH SANDSTONE; LIGHT GRAY; FINE TO VERY FINE GRAINED; LOCALLY SLIGHTLY CALCAREOUS; MICACEOUS; SLIGHTLY CARBONACEOUS; LAMINATED TO THINLY LAMINATED. 0.2' SOFT CLAYEY BROKEN ZONE AT 189.5'	
195					870		SANDSTONE 10% AND SILTY SHALE 90% FROM 190.0' TO 191.1' SHALE 100% FROM 191.1' TO 192.4' 0.1' PALE YELLOWISH-BROKEN CONCRETION AT 193.1'	
200			99	57	865		SANDSTONE 10% AND SHALE 90% FROM 192.4' TO 195.8' SANDSTONE; LIGHT GRAY; FINE-GRAINED; SLIGHTLY CALCAREOUS; MICACEOUS; SLIGHTLY CARBONACEOUS; LAMINATED; INTERBEDDED WITH SHALE; MEDIUM DARK GRAY; SLIGHTLY CALCAREOUS; MICACEOUS; SLIGHTLY CARBONACEOUS; THINLY LAMINATED. SANDSTONE 75% AND SHALE 25% FROM 195.8' TO 201.7'	
205					860		LIMESTONE; MEDIUM LIGHT GRAY; 60% FUSULINID FOSSILS; SHALEY; THIN BEDDED. TONGANOXIE MEMBER SANDSTONE; LIGHT GRAY TO LIGHT OLIVE GRAY; FINE-GRAINED; MICACEOUS; LOCALLY SLIGHTLY CALCAREOUS; CROSS-BEDDED; LAMINATED; INTERBEDDED WITH SHALE; MEDIUM DARK GRAY; CARBONACEOUS; THINLY LAMINATED; AND SILTSTONE; MEDIUM DARK GRAY; MICACEOUS; CARBONACEOUS; MEDIUM BEDDED TO THINLY LAMINATED.	
210					855		0.3' SOFT GREENISH-GRAY CLAYEY ZONE AT 202.1' SANDSTONE 5% AND SHALE 95% FROM 202.4' TO 204.9' NUMEROUS SOFT CLAYEY LAMINAE FROM 202.4' TO 204.7' 0.15' GRAYISH-ORANGE CALCAREOUS ZONE AT 203.0'	
215					850		SANDSTONE 30% AND SILTSTONE 20% FROM 204.9' TO 208.9' SANDSTONE 85% AND SILTSTONE 10% FROM 208.9' TO 210.4' SANDSTONE 45% AND SILTSTONE 45% FROM 210.4' TO 214.8' SANDSTONE 80% AND SILTY SHALE 20% FROM 214.8' TO 216.8'	
220			100	0	845		NUMEROUS SOFT SANDY CLAYEY LAYERS FROM 215.5' TO 216.8' 0.15' MEDIUM GRAY CONCRETION AT 216.8' SANDSTONE 20% (LOCALLY GRADES TO 40%); SILTSTONE 70% AND SHALE 10% FROM 216.8' TO 228.4' 0.5' SOFT SANDY CLAYEY BROKEN ZONE AT 219.4'	
225							NUMEROUS SOFT CLAYEY LAYERS FROM 222.1' TO 225.7'	

STRANGER FORMATION
 LAWRENCE FORMATION
 DOUGLAS GROUP

(BORING CONTINUED)

**WOLF CREEK
 UPDATED SAFETY ANALYSIS REPORT**

FIGURE 2.5-34b (Sheet 3 of 5)

LOG OF BORING B-2

Rev. 0

BORING B-2 CONT'D

DEPTH (FEET)	LABORATORY TEST DATA	PERMEABILITY cm./sec.	PERCENT RECOVERED	R.O.D.	ELEVATION (FEET)	SYMBOLS	DESCRIPTIONS	STRATIGRAPHIC NOMENCLATURE	
								STRANGER FORMATION	DOUGLAS GROUP
225					840				
230			100	29	835		SANDSTONE 5% AND SILTSTONE 90% FROM 228.4' TO 284.9'		
235					830		0.1' BROKEN SOFT CLAYEY ZONE AT 231.2'		
240			100	66	825		0.7' CONVOLUTED SANDSTONE BEDDING AT 235.7'		
245					820		70° SLICKENSIDED FRACTURE AT 240.4'		
250			100	68	815		0.3' BROKEN ZONE WITH 70° SLICKENSIDED FRACTURED AT 240.5'		
255					810		0.6' CONVOLUTED SANDSTONE BEDDING AT 240.9'		
260					805		OCCASIONAL SOFT CLAYEY LAMINAE FROM 245.7' TO 247.7'		
265			96	71	800		OPEN VERTICAL FRACTURE FROM 248.4' TO 249.1'		
270			100	97	795		0.1' BROKEN ZONE AT 151.1'		
275					790		OCCASIONAL 60° SLICKENSIDED FRACTURES ALONG CROSS-BEDDING PLANES FROM 259.6' TO 262.1'		
280			99	24	785		NUMEROUS SOFT CLAYEY LAMINAE FROM 270.1' TO 276.3'		
285					780		0.1' BROKEN SOFT CLAYEY ZONE AT 278.0'		
290			96	60	775		OCCASIONAL SOFT CLAYEY LAYERS FROM 279.0' TO 280.2'		
295			93	39	770		SANDSTONE 20% AND SILTSTONE 70% FROM 281.0' TO 286.7'		
300							0.1' BROKEN ZONE AT 281.8'		
							OCCASIONAL SOFT CLAYEY LAMINAE FROM 283.3' TO 284.7'		
							SANDSTONE 5% AND SILTSTONE 85% FROM 286.7' TO 292.0'		
							NUMEROUS SOFT CLAYEY LAYERS FROM 287.3' TO 288.1'		
							SANDSTONE 10% AND SILTSTONE 70% FROM 292.0' TO 296.3'		
							NUMEROUS SOFT CLAYEY LAMINAE FROM 293.1' TO 295.3'		
							SANDSTONE 10% AND SILTSTONE 50% FROM 296.3' TO 309.0'		
							OCCASIONAL SOFT CLAYEY LAMINAE FROM 299.0' TO 302.7'		

(BORING CONTINUED)

WOLF CREEK
UPDATED SAFETY ANALYSIS REPORT
 FIGURE 2.5-34b (Sheet 4 of 5)
 LOG OF BORING B-2

BORING B-2 CONT'D

DEPTH (FEET)	LABORATORY TEST DATA	PERMEABILITY cm./sec.	PERCENT RECOVERED	R Q D	ELEVATION (FEET)
300					765
305			100	28	760
310					755
315			96	88	750
320					745
325			97	4	740
330					735
335					

SYMBOLS



DESCRIPTIONS

NUMEROUS SOFT CLAYEY LAYERS FROM 302.7' TO 305.3'

OCCASIONAL SOFT CLAYEY LAYERS FROM 305.3' TO 307.4'

NUMEROUS SOFT CLAYEY LAYERS FROM 307.4' TO 308.4'

SANDSTONE 5% AND SILTSTONE 90% FROM 309.0' TO 322.9'

NUMEROUS SOFT CLAYEY LAMINAE FROM 309.9' TO 310.6'

NUMEROUS SOFT CLAYEY LAYERS FROM 311.6' TO 312.7'

0.2' BROKEN ZONE WITH IRREGULAR VERTICAL FRACTURE AT 314.1'

NUMEROUS SMALL DISPLACEMENT (0.005' TO 0.03') FRACTURES AND SLICKENSIDED FRACTURES FROM 320.0' TO 327.8'

NUMEROUS SOFT CLAYEY LAYERS FROM 324.2' TO 332.9'

SILTSTONE 60% AND SHALE 40% FROM 322.9' TO 332.9'

BORING COMPLETED AT 332.9' FEET ON 6-20-73.
 CASING USED TO A DEPTH OF 6.8 FEET.
 GROUNDWATER LEVEL RECORDED AT 173.4 FEET
 ON 6-28-73.

STRATIGRAPHIC NOMENCLATURE	
FORMATION	GROUP
STRANGER	DOUGLAS

**WOLF CREEK
 UPDATED SAFETY ANALYSIS REPORT**

FIGURE 2.5-34b (Sheet 5 of 5)

LOG OF BORING B-2

Rev. 0

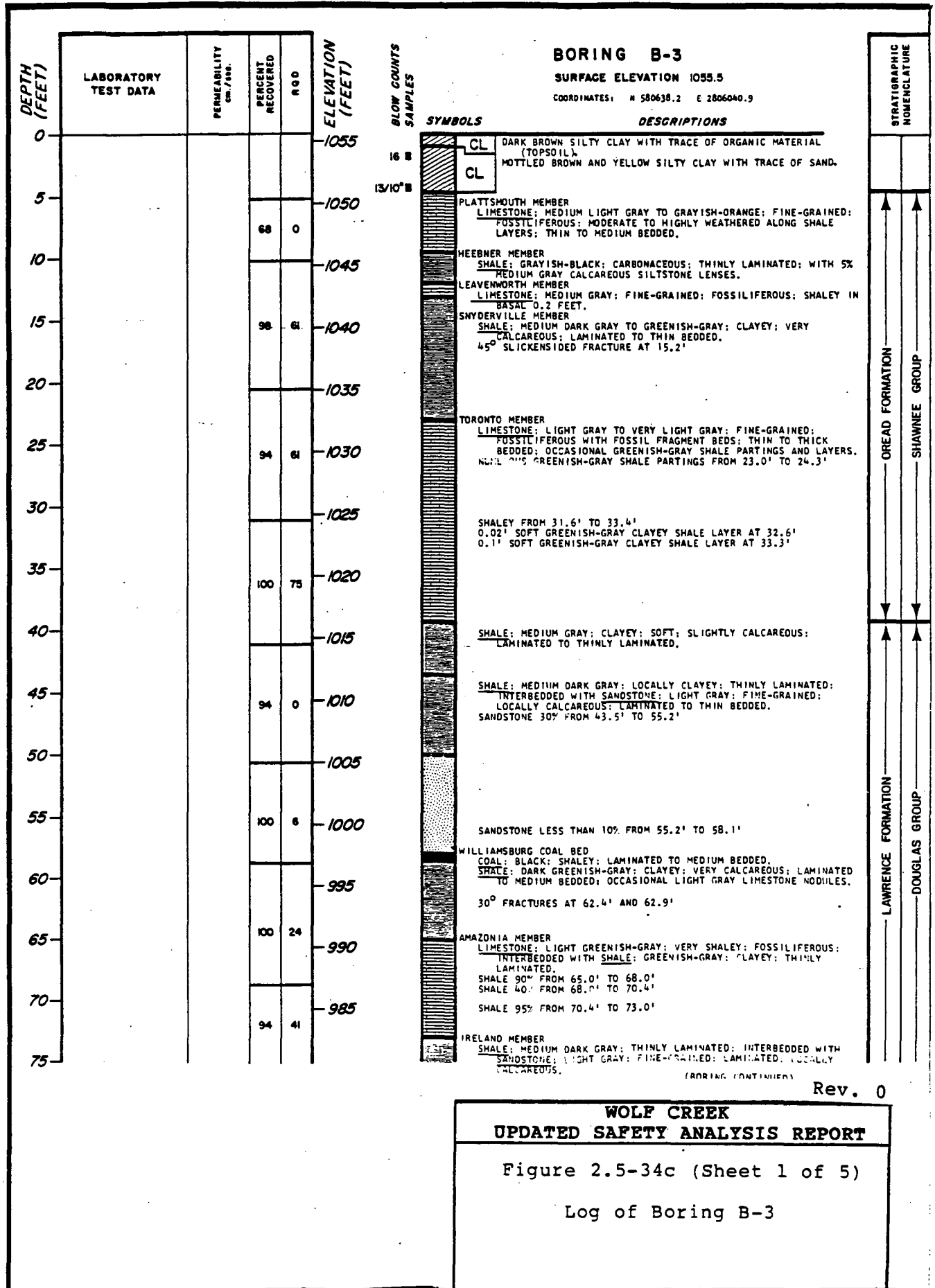

BORING B-3 CONT'D

DEPTH (FEET)	LABORATORY TEST DATA	PERMEABILITY cm./sec.	PERCENT RECOVERED		ELEVATION (FEET)	SYMBOLS	DESCRIPTIONS	STRATIGRAPHIC NOMENCLATURE
				R & D				
75					980		SANDSTONE 10% FROM 73.0' TO 83.6'	
80					975		NUMEROUS SOFT CLAYEY SHALE LAMINAE FROM 79.0' TO 80.4'	
85			98	43	970		SANDSTONE LESS THAN 5% FROM 83.6' TO 90.6' SHALE LOCALLY BECOMES CARBONACEOUS FROM 83.7' TO 90.6'	
90					965		COAL: BLACK; SHALEY: LAMINATED TO THIN BEDDED. SHALE: MEDIUM DARK GRAY; SOFT; CLAYEY: LAMINATED TO THIN BEDDED.	
95			100	28	960		NUMEROUS SOFT CLAYEY SHALE LAYERS FROM 94.1' TO 96.4' SHALE: MEDIUM DARK GRAY; LOCALLY CLAYEY; THINLY LAMINATED; INTERBEDDED WITH SANDSTONE; LIGHT GRAY; FINE-GRAINED; LOCALLY CALCAREOUS; LAMINATED TO THIN BEDDED; AND SILTSTONE; MEDIUM GRAY; MICACEOUS; LAMINATED TO MEDIUM BEDDED.	
100					955		SANDSTONE 15% AND SILTSTONE 10% FROM 94.3' TO 101.8' 60% SOFT CLAYEY SHALE FROM 97.2' TO 98.5'	
105			90	18	950		SANDSTONE 40% AND SILTSTONE 30% FROM 101.8' TO 105.8'	
110					945		SANDSTONE 100% FROM 105.8' TO 106.5' SANDSTONE 60% AND SILTSTONE 10% FROM 106.5' TO 110.6'	
115			94	0	940		NUMEROUS SOFT CLAYEY SHALE LAMINAE FROM 110.0' TO 121.3' SANDSTONE 30% AND SILTSTONE 30% FROM 110.6' TO 113.5' SANDSTONE 15% AND SILTSTONE 25% FROM 113.5' TO 126.7'	
120					935		OCCASIONAL SOFT CLAYEY SHALE LAYERS AND LAMINAE FROM 122.2' TO 126.7'	
125			100	0	930		SANDSTONE 10% AND SILTSTONE 70% FROM 126.7' TO 128.7' SHALEY SILTSTONE 100% FROM 128.7' TO 131.8'	
130					925		SANDSTONE 5% AND SHALEY SILTSTONE 90% FROM 131.8' TO 140.0' OCCASIONAL SOFT CLAYEY SHALE LAMINAE FROM 132.5' TO 135.3'	
135			100	30	920			
140					915		SANDSTONE GRADES OUT AT 140.0' SHALEY SILTSTONE 100% FROM 140.0' TO 144.4'	
145			100	86	910		SHALEY SILTSTONE 50% AND SHALE 50% FROM 144.4' TO 180.8'	
150							NUMEROUS SOFT CLAYEY SHALE LAMINAE FROM 149.4' TO 151.5'	

LAWRENCE FORMATION
DOUGLAS GROUP

(BORING CONTINUED) Rev. 0

**WOLF CREEK
UPDATED SAFETY ANALYSIS REPORT**

Figure 2.5-34c (Sheet 2 of 5)

Log of Boring B-3

BORING B-3 CONT'D

DEPTH (FEET)	LABORATORY TEST DATA	PERMEABILITY cm/sec	PERCENT RECOVERED	RQD	ELEVATION (FEET)
150					905
155			96	30	900
160					895
165			100	48	890
170					885
175			100	47	880
180					875
185			90	33	870
190					865
195			100	82	860
200					855
205			77	41	850
210					845
215			80	57	840
220					835
225			100	52	

SYMBOLS



DESCRIPTIONS

NUMEROUS SOFT CLAYEY SHALE LAMINAE FROM 152.3' TO 154.0'

OCCASIONAL SOFT CLAYEY SHALE LAMINAE FROM 157.0' TO 162.8'

OCCASIONAL SOFT CLAYEY SHALE LAMINAE FROM 168.8' TO 171.9'

OCCASIONAL 0.05' CLAYEY BROKEN ZONES FROM 179.0' TO 185.6'

ROBBINS MEMBER
SHALE; MEDIUM DARK GRAY; THINLY LAMINATED.

LIMESTONE; MEDIUM GRAY TO LIGHT OLIVE GRAY; FOSSILIFEROUS;
SHALEY IN BASAL 0.3'; THIN TO MEDIUM BEDDED.
SHALE; DARK GRAY; SLIGHTLY CARBONACEOUS; THINLY LAMINATED;
OCCASIONAL 0.05' TO 0.1' PALE YELLOWISH-BROWN DOLOMITIC
CONCRETIONS.

STRATIGRAPHIC NOMENCLATURE

LAWRENCE FORMATION

DOUGLAS GROUP

(BORING CONTINUED) Rev. 0

WOLF CREEK
UPDATED SAFETY ANALYSIS REPORT

Figure 2.5-34c (Sheet 3 of 5)
Log of Boring B-3

BORING B-3 CONT'D

DEPTH (FEET)	LABORATORY TEST DATA	PERMEABILITY cm./100.	PERCENT RECOVERED	ROD	ELEVATION (FEET)	SYMBOLS	DESCRIPTIONS	STRATIGRAPHIC NOMENCLATURE	
								LAWRENCE FORMATION	DOUGLAS GROUP
225					830		SHALE; MEDIUM DARK GRAY; VERY CALCAREOUS; FOSSILIFEROUS; THIN BEDED. SHALE; GRAYISH-BLACK; CARBONACEOUS; SLIGHTLY CALCAREOUS; THINLY LAMINATED.		
230			100	65	825				
235					820		HASKELL MEMBER LIMESTONE; MEDIUM LIGHT GRAY; FINE-GRAINED; FOSSILIFEROUS; THIN TO MEDIUM BEDED; SHALEY IN UPPER AND BASAL 0.15'. VINLAND MEMBER SHALE; MEDIUM GRAY; VERY CALCAREOUS; FOSSILIFEROUS; LAMINATED TO THIN BEDED. COAL; BLACK; SHALEY; LAMINATED TO THIN BEDED. SILTSTONE; LIGHT GREENISH-GRAY; SHALEY; SANDY; LAMINATED TO THIN BEDED; INTERBEDDED WITH SANDSTONE; LIGHT GRAY; FINE-GRAINED; SILTY; CALCAREOUS; LAMINATED TO THIN BEDED; AND SHALE; DARK GREENISH-GRAY; THINLY LAMINATED.		
240			100	57	815		SHALE 80% AND SILTSTONE 20% FROM 236.6' TO 238.6' SILTSTONE 60% AND SHALE 10% FROM 238.6' TO 243.2' SILTSTONE 50% AND SANDSTONE 50% FROM 243.2' TO 245.0'		
245					810		SILTSTONE 50% AND SHALE 40% FROM 245.0' TO 249.7' NUMEROUS CLAYEY SHALE LAYERS FROM 245.1' TO 246.8'		
250			89	58	805		SILTSTONE 40% AND SANDSTONE 50% FROM 249.7' TO 257.5'		
255					800				
260			100	77	795		SILTY SANDSTONE 90% AND SILTSTONE 10% FROM 257.5' TO 266.0'		
265					790		0.15' SILTY FUSULINID LIMESTONE LAYER AT 265.3'		
270			98	78	785		LIMESTONE; LIGHT OLIVE GRAY; 60% FUSULINID FOSSILS; 10% ROUNDED LIMESTONE PEBBLES; SHALEY; THIN TO THICK BEDED. TONGANOXIE MEMBER SHALE; MEDIUM DARK GRAY; THINLY LAMINATED; INTERBEDDED WITH SANDSTONE; LIGHT GRAY; FINE-GRAINED; LOCALLY CALCAREOUS; LAMINATED TO THIN BEDED; AND SILTSTONE; MEDIUM GRAY; MICACEOUS; LAMINATED TO MEDIUM BEDED. SANDSTONE 25% AND SILTSTONE 35% FROM 269.3' TO 279.5'		
275					780				
280			100	39	775		SANDSTONE 10% AND SILTSTONE 20% FROM 279.5' TO 291.4'		
285					770		NEAR VERTICAL FRACTURE FROM 285.4' TO 285.7'		
290			99	89	765		SANDSTONE 30% AND SILTSTONE 30% FROM 291.4' TO 295.0'		
295					760		SANDSTONE LESS THAN 5% AND SHALEY SILTSTONE 50% FROM 295.0' TO 316.0'		
300									

(BORING CONTINUED) Rev. 0

**WOLF CREEK
UPDATED SAFETY ANALYSIS REPORT**

Figure 2.5-34c (Sheet 4 of 5)

Log of Boring B-3

BORING B-3 CONT'D

DEPTH (FEET)	LABORATORY TEST DATA	PERMEABILITY cm./sec.	PERCENT RECOVERED	R Q D	ELEVATION (FEET)
300					755
305			94	25	750
310			100	96	745
315			78	29	740
320			100	36	735
325					

SYMBOLS



DESCRIPTIONS

CARBONACEOUS SHALE LAYER FROM 300.0' TO 300.3'

CARBONACEOUS SHALE LAYER FROM 305.9' TO 306.4'

WESTON MEMBER
 SHALE: MEMBER DARK GRAY; THINLY LAMINATED.

BORING COMPLETED AT 322.9 FEET ON 6-28-73.
 CASING USED TO A DEPTH OF 5.2 FEET.
 GROUNDWATER LEVEL RECORDED AT 114.1 FEET
 ON 6-28-73.

STRATIGRAPHIC NOMENCLATURE

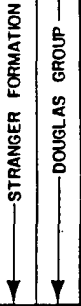

Rev. 0

**WOLF CREEK
 UPDATED SAFETY ANALYSIS REPORT**

Figure 2.5-34c (Sheet 5 of 5)

Log of Boring B-3

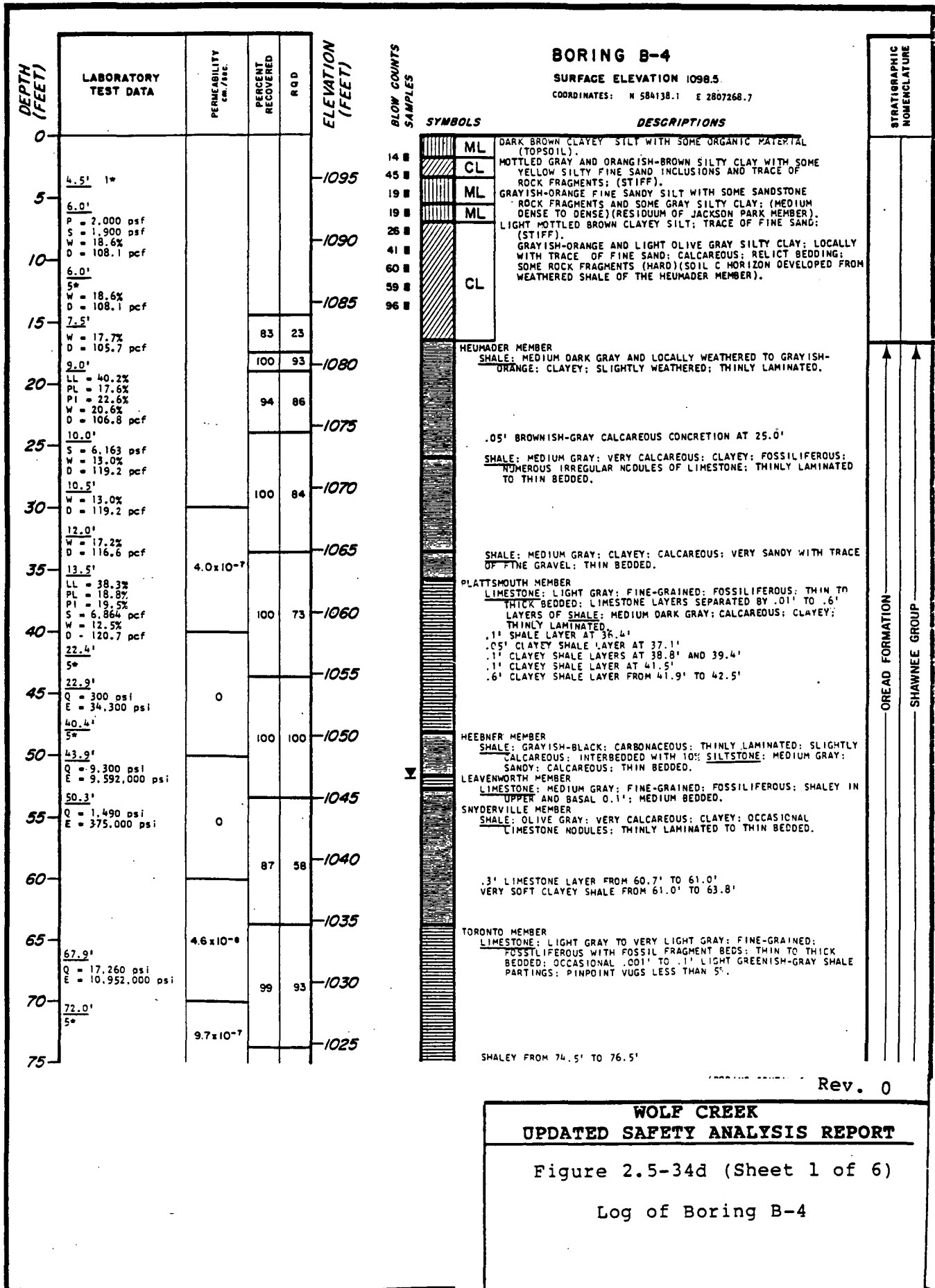

BORING B-4 CONT.

DEPTH (FEET)	LABORATORY TEST DATA	PERMEABILITY cm/sec	PERCENT RECOVERED	ROD	ELEVATION (FEET)	SYMBOLS	DESCRIPTIONS	STRATIGRAPHIC NOMENCLATURE
75								
80		9.7 x 10 ⁻⁷	97	79	1020			
85		2.9 x 10 ⁻⁷			1015		SHALE: GREENISH-GRAY; CALCAREOUS; CLAYEY; LOCALLY FOSSILIFEROUS; THINLY LAMINATED. SHALE: MEDIUM DARK GRAY; SLIGHTLY CARBONACEOUS; CLAYEY; THINLY LAMINATED; INTERBEDDED WITH SANDSTONE; LIGHT GRAY; VERY FINE-GRAINED; LAMINATED TO THIN BEDDED. SANDSTONE 20% TO 40% FROM 82.9' TO 95.4'	
90			97	71	1010			
95		1.1 x 10 ⁻⁷			1005		NUMEROUS SOFT CLAYEY SHALE LAYERS FROM 91.5' TO 99.3'	
100			94	30	1000		SANDSTONE LESS THAN 10% FROM 95.4' TO 99.8'	
105		0			995		WILLIAMSBURG COAL BED COAL: BLACK; THIN TO MEDIUM BEDDED; SHALEY AT BASE. SHALE: DARK GREENISH-GRAY; CARBONACEOUS; THIN BEDDED. AMAZONTA MEMBER	
110			98	85	990		SHALE: GREENISH-GRAY; VERY CALCAREOUS; CLAYEY; THINLY LAMINATED TO THIN BEDDED; INTERBEDDED WITH .05' TO .1' LENSES OF GREENISH-GRAY LIMESTONE. NUMEROUS SOFT CLAYEY SHALE LAYERS FROM 104.1' TO 104.9'	
115		0			985		LIMESTONE: GREENISH-GRAY; SHALEY; LOCALLY FOSSILIFEROUS; THIN BEDDED. SOFT GREENISH-GRAY CLAYEY SHALE LAYER FROM 109.2' TO 109.8'	
120			100	66	980		IRELAND MEMBER SHALE: GREENISH-GRAY; SLIGHTLY CALCAREOUS; CLAYEY; THINLY LAMINATED.	
125					975		SHALE: MEDIUM DARK GRAY; LOCALLY CLAYEY; THINLY LAMINATED; INTERBEDDED WITH LENSES OF SANDSTONE; LIGHT GRAY; VERY FINE-GRAINED; LAMINATED TO THIN BEDDED. SANDSTONE LESS THAN 5% FROM 114.8' TO 127.5'	
130			94	56	970		SHALE GRADES MORE COMPETENT AND LESS CLAYEY BELOW 123.4'	
135		4.6 x 10 ⁻⁸			965		COAL: BLACK; SHALEY; THIN TO MEDIUM BEDDED. SHALE: MEDIUM DARK GRAY; SLIGHTLY CARBONACEOUS; CLAYEY WITH NUMEROUS SOFT CLAYEY ZONES; THINLY LAMINATED TO THIN BEDDED. .1' SHALEY COAL LAYER AT 128.6'	
140			99	42	960		SHALE: MEDIUM DARK GRAY; SLIGHTLY CARBONACEOUS; LOCALLY CLAYEY; THINLY LAMINATED; INTERBEDDED WITH LENSES OF SANDSTONE; LIGHT GRAY; FINE-GRAINED; LOCALLY CALCAREOUS AND CROSS-BEDDED; LAMINATED TO MEDIUM BEDDED; AND SILTSTONE; MEDIUM GRAY; MICACEOUS; THIN TO MEDIUM BEDDED. SANDSTONE 20% AND SHALE 80% FROM 134.2' TO 135.8' SANDSTONE 50% AND SHALE 50% FROM 135.8' TO 141.7'	
145		1.3 x 10 ⁻⁷			955		SANDSTONE 20% AND SHALE 80% FROM 141.7' TO 143.1' SANDSTONE 90% AND SHALE 10% FROM 143.1' TO 144.0' SILTSTONE 80% AND SANDSTONE 20% FROM 144.0' TO 144.8' SILTSTONE 20% AND SANDSTONE 80% FROM 144.8' TO 148.8'	
150			100	47	950		SILTSTONE 30% AND SANDSTONE 70% FROM 148.8' TO 150.0'	

LAWRENCE FORMATION
DOUGLAS GROUP

Rev. 0

**WOLF CREEK
UPDATED SAFETY ANALYSIS REPORT**

Figure 2.5-34d (Sheet 2 of 6)
Log of Boring B-4

BORING B-4 CONT.

DEPTH (FEET)	LABORATORY TEST DATA	PERMEABILITY cm./sec.	PERCENT RECOVERED	ROD	ELEVATION (FEET)
150					945
155		3.9 x 10 ⁻⁶			940
160			100	63	935
165		2.9 x 10 ⁻⁷			930
170			100	72	925
175					920
180			100	78	915
185	184.5' Q = 1,580 psi E = 438,000 psi 185.0' 5*		100	100	910
190					905
195					900
200			100	83	895
205					890
210			100	100	885
215					880
220			99	93	875
225					

SYMBOLS

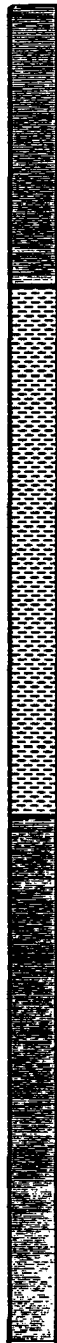

DESCRIPTIONS

SANDSTONE 20% AND SHALE 80% FROM 150.0' TO 157.7'

.15' SOFT CLAYEY SHALE LAYER AT 154.3'

SILTSTONE 50% AND CALCAREOUS SANDSTONE 40% FROM 157.7' TO 158.5'

SILTSTONE 10% AND SANDSTONE 10% FROM 158.5' TO 165.6'

SILTSTONE: MEDIUM DARK GRAY; VERY SHALEY; SLIGHTLY MICACEOUS; OCCASIONAL LAMINAE OF LIGHT GRAY VERY FINE-GRAINED SANDSTONE: THINLY LAMINATED.

NUMEROUS SOFT CLAYEY SHALE ZONES FROM 169.1' TO 173.5'

.05' SOFT CLAYEY SHALE BROKEN ZONES AT 176.1', 176.5', 176.9' AND 177.2'

.1' SOFT CLAYEY SHALE BROKEN ZONE AT 183.4'

ROBBINS MEMBER
SHALE: MEDIUM DARK GRAY; THINLY LAMINATED.
SOFT CLAYEY SHALE BROKEN ZONE FROM 196.1' TO 196.5'

4.5° FRACTURE AT 201.1'

.1' CLAYEY SHALE LAYER AT 215.0'

STRATIGRAPHIC NOMENCLATURE

LAWRENCE FORMATION
DOUGLAS GROUP

Rev. 0

**WOLF CREEK
UPDATED SAFETY ANALYSIS REPORT**

Figure 2.5-34d (Sheet 3 of 6)
Log of Boring B-4

BORING B-4 CONT.

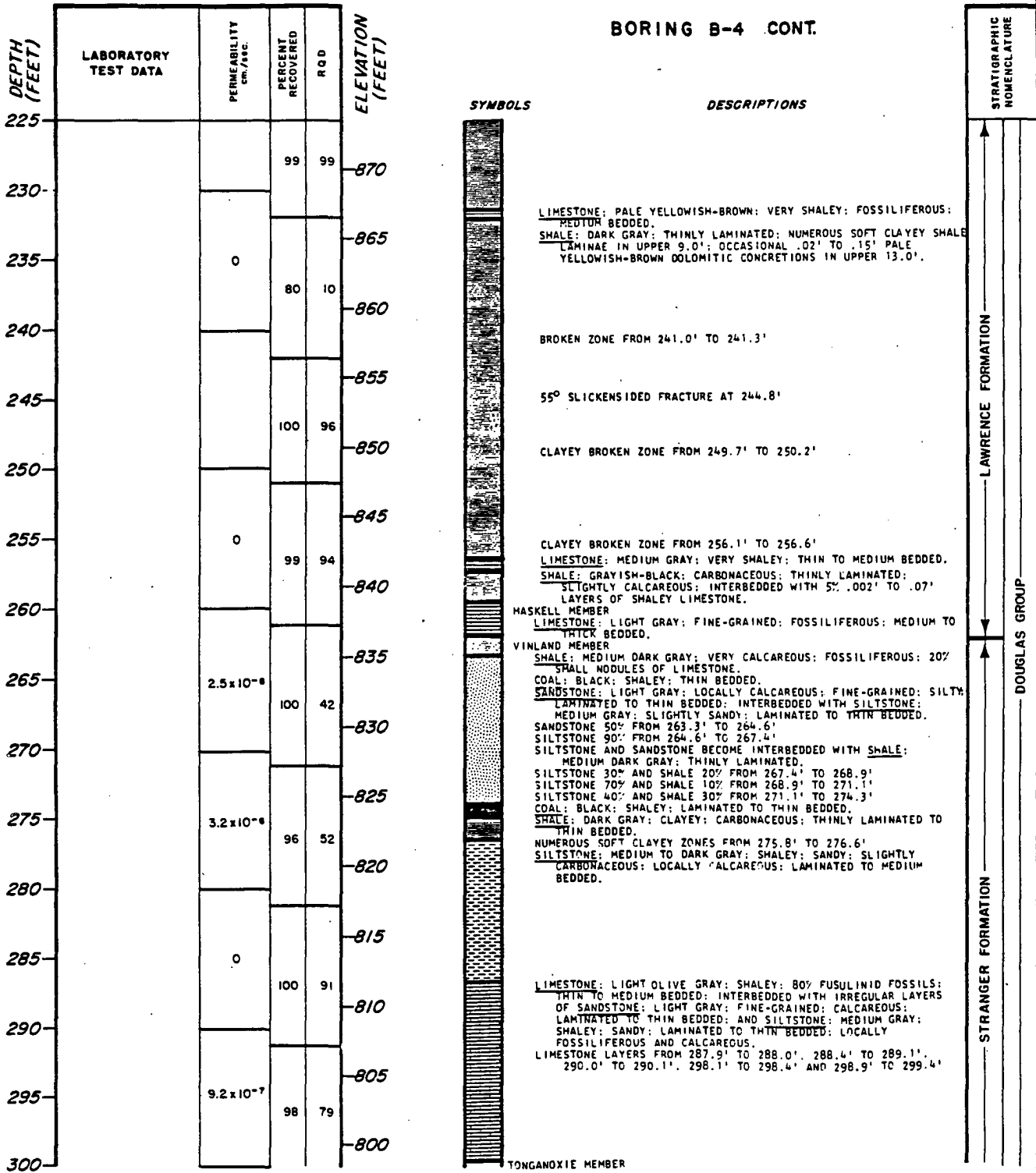

TONGANOXIE MEMBER

Rev. 0

**WOLF CREEK
UPDATED SAFETY ANALYSIS REPORT**

Figure 2.5-34d (Sheet 4 of 6)

Log of Boring B-4

BORING B-4 CONT.

DEPTH (FEET)	LABORATORY TEST DATA	PERMEABILITY cm./SEC.	PERCENT RECOVERED	ROD	ELEVATION (FEET)
300					
305		5.0x10 ⁻⁶	100	79	-795
310					-790
315			96	82	-785
320					-780
325			100	100	-775
330			100	85	-770
335					-765
338.2' 5*			76	73	-760
340					-755
345					-750
350			100	82	-745
355					-740
360			100	46	-735
365					-730
368.8' 5*			100	100	-725
370					
369.3'					
375			100	100	

Q = 1,250 psi
E = 555,000 psi

SYMBOLS



DESCRIPTIONS

SHALE: MEDIUM DARK GRAY; THINLY LAMINATED; INTERBEDDED WITH SANDSTONE; LIGHT GRAY; FINE-GRAINED; LAMINATED TO THIN BEDED.

SANDSTONE 20% FROM 299.4' TO 301.2'

NUMEROUS SOFT CLAYEY SHALE BROKEN ZONES FROM 299.5' TO 301.2'

SANDSTONE 40% FROM 301.2' TO 302.9'

SANDSTONE 70% FROM 302.9' TO 311.2'

SANDSTONE 20% FROM 311.2' TO 316.9'

SANDSTONE LESS THAN 5% FROM 316.9' TO 326.9'

VERTICAL FRACTURE FROM 325.6' TO 326.2'

SANDSTONE 10% FROM 326.9' TO 330.7'

SANDSTONE LESS THAN 5% FROM 330.7' TO 361.2'

.07' SOFT CLAYEY SHALE LAYER AT 332.4'

CLAYEY BROKEN ZONE FROM 334.8' TO 335.1'

CLAYEY BROKEN ZONE FROM 338.9' TO 339.4'

CLAYEY BROKEN ZONE FROM 340.0' TO 340.8'

.05' CLAYEY BROKEN ZONE AT 344.8'

.05' CLAYEY BROKEN ZONE AT 349.6'

GRAYISH-BLACK CARBONACEOUS SHALE LAYER FROM 350.6' TO 351.1'

GRAYISH-BLACK CARBONACEOUS SHALE LAYER FROM 354.2' TO 354.3'

WESTON MEMBER
SHALE: DARK GRAY; SLIGHTLY CARBONACEOUS; THINLY LAMINATED.

STRATIGRAPHIC NOMENCLATURE

STRANGER FORMATION

DOUGLAS GROUP

Rev. 0

WOLF CREEK
UPDATED SAFETY ANALYSIS REPORT

Figure 2.5-34d (Sheet 5 of 6)

Log of Boring B-4

BORING B-4 CONT.

DEPTH (FEET)	LABORATORY TEST DATA	PERMEABILITY cm./sec.	PERCENT RECOVERED	R O D	ELEVATION (FEET)
375					720
380					
385			99	95	715
390			100	73	710
395					705
400			100	94	700
405					695

SYMBOLS



DESCRIPTIONS

CLAYEY BROKEN ZONE FROM 384.8' TO 385.0'

GRADES PLANT FOSSILIFEROUS WITH PYRITE REPLACED SHELLS BELOW 389.8'
 .1' DOLOMITIC CONCRETION AT 390.7'
 VERTICAL FRACTURE FROM 391.3' TO 391.7'
 BROKEN ZONE FROM 391.7' TO 392.3'

SOUTH BEND MEMBER

LIMESTONE: LIGHT GRAY; FINE-GRAINED; FOSSILIFEROUS; THIN TO THICK BEDDED; SANDY IN BASAL 1.0'.
 VERTICAL OPEN FRACTURE FROM 394.4' TO 397.2'
 SHALEY FROM 395.5' TO 395.7'

ROCK LAKE MEMBER

SHALE: DARK GRAY; CALCAREOUS; THINLY LAMINATED; INTERBEDDED WITH LIMESTONE; LIGHT GRAY; SANDY; LAMINATED TO THIN BEDDED.
 SHALE 60% FROM 397.0' TO 400.9'
 70% OPEN FRACTURE FROM 400.4' TO 400.7'
 SHALE 30% FROM 400.9' TO 402.4'

BORING COMPLETED AT 402.4 FEET ON 5-31-73.
 CASING USED TO A DEPTH OF 19.0 FEET.
 GROUNDWATER LEVEL RECORDED AT 51.9 FEET ON 6-1-73.
 FOURTH PIEZOMETER INSTALLED AT AN INTERVAL FROM 5.0 FEET TO 26.0 FEET ON 7-30-73.
 THIRD PIEZOMETER INSTALLED AT AN INTERVAL FROM 35.0 FEET TO 48.0 FEET ON 7-30-73.
 SECOND PIEZOMETER INSTALLED AT AN INTERVAL FROM 60.0 FEET TO 86.0 FEET ON 7-30-73.
 FIRST PIEZOMETER INSTALLED AT AN INTERVAL FROM 109.0 FEET TO 188.0 FEET ON 7-30-73.
 PIEZOMETER READINGS ARE PRESENTED ON TABLE 2.4-29.

STRATIGRAPHIC NOMENCLATURE	
STRANGER FORMATION	DOUGLAS GROUP
STANTON FORMATION	LANSING GROUP

Rev. 0

**WOLF CREEK
 UPDATED SAFETY ANALYSIS REPORT**

Figure 2.5-34d (Sheet 6 of 6)

Log of Boring B-4

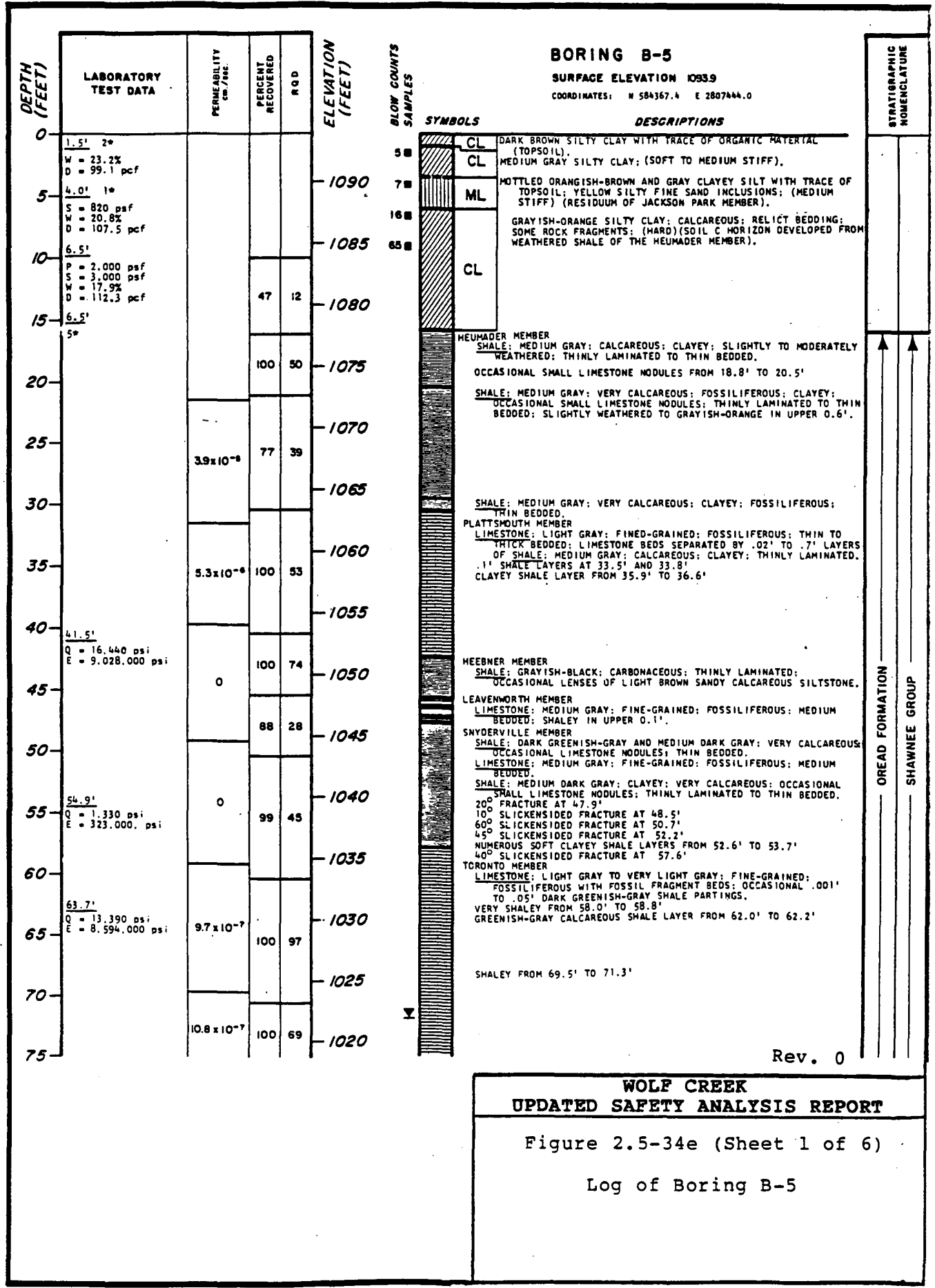

WOLF CREEK
UPDATED SAFETY ANALYSIS REPORT

Figure 2.5-34e (Sheet 1 of 6)

Log of Boring B-5

BORING B-5 CONT.

DEPTH (FEET)	LABORATORY TEST DATA	PERMEABILITY cm. Darcy	PERCENT RECOVERED	ROD	ELEVATION (FEET)
75		10.8×10^{-7}			1015
80					1010
85		1.2×10^{-7}	95	40	1005
89.2' $I_d = 87\%$					1000
90					995
95		0	100	49	990
100					985
108.5' $I_d = 81\%$					980
109.7' 5*					975
110					970
115					965
120					960
125					955
130					950
135		9.7×10^{-7}	58	10	945
140					
145		8.3×10^{-8}	100	54	
150					

SYMBOLS



DESCRIPTIONS

SHALE; MEDIUM DARK GRAY; THINLY LAMINATED; INTERBEDDED WITH LENSES OF SANDSTONE; LIGHT GRAY; FINE-GRAINED; LOCALLY CALCAREOUS; LAMINATED TO THIN BEDDED; AND SILTSTONE; MEDIUM DARK GRAY; MICACEOUS; LAMINATED TO THIN BEDDED. SILTSTONE AND SANDSTONE LESS THAN 10% FROM 76.8' TO 79.0' SANDSTONE 25% AND SILTSTONE 25% FROM 79.0' TO 82.0' SOFT CLAYEY SHALE BROKEN ZONE FROM 80.0' TO 80.4' SANDSTONE 40% AND SILTSTONE 10% FROM 82.0' TO 90.7'

NUMEROUS LAMINAE OF SOFT CLAYEY SHALE FROM 84.9' TO 86.6'

NUMEROUS SOFT CLAYEY SHALE LAYERS FROM 87.9' TO 88.6'

SANDSTONE 25% AND SILTSTONE 10% FROM 90.7' TO 92.8'

SANDSTONE AND SILTSTONE LESS THAN 10% FROM 92.8' TO 97.2'

SHALE GRADES CARBONACEOUS BELOW 95.0'

WILLIAMSURG COAL BED
COAL; BLACK; SHALEY; LAMINATED TO MEDIUM BEDDED.

SHALE; MEDIUM DARK GRAY; CLAYEY; CALCAREOUS; SLIGHTLY CARBONACEOUS; THIN BEDDED.
15' FRACTURE AT 99.4'

AMAZONIA MEMBER
SHALE; GREENISH-GRAY; VERY CALCAREOUS; THINLY LAMINATED; WITH LENSES AND NODULES OF SHALEY LIMESTONE.
LIMESTONE LAYER FROM 101.8' TO 102.0'

LIMESTONE; LIGHT GRAY; FINE-GRAINED; THIN TO MEDIUM BEDDED;
OCCASIONAL .001' MEDIUM GRAY SHALE PARTINGS.

IRELAND MEMBER
SHALE; GREENISH-GRAY IN UPPER 1.0' GRADING TO MEDIUM DARK GRAY BELOW; LOCALLY CLAYEY; THINLY LAMINATED; INTERBEDDED WITH LENSES OF SANDSTONE; LIGHT GRAY; FINE-GRAINED; LOCALLY CALCAREOUS; LAMINATED TO THIN BEDDED.
NUMEROUS SOFT CLAYEY SHALE LAYERS FROM 103.4' TO 108.4'
SANDSTONE LESS THAN 10% FROM 103.4' TO 112.7'

SANDSTONE LESS THAN 1% FROM 112.7' TO 120.2'
30' SLICKENSIDED FRACTURE AT 114.1'
10' SLICKENSIDED FRACTURE AT 114.5'

SHALE GRADES CARBONACEOUS BELOW 116.2'

COAL; BLACK; SHALEY; THIN BEDDED.
SHALE; MEDIUM DARK GRAY; THINLY LAMINATED.
CLAYEY BROKEN ZONE FROM 120.7' TO 121.8'
SOFT CLAYEY SHALE BROKEN ZONE FROM 122.2' TO 122.5'
BROKEN ZONE FROM 124.4' TO 124.9'

SHALE; MEDIUM DARK GRAY; THINLY LAMINATED; INTERBEDDED WITH LENSES OF SANDSTONE; LIGHT GRAY; FINE-GRAINED; LOCALLY CALCAREOUS; LAMINATED TO THIN BEDDED.
SANDSTONE 40% FROM 125.0' TO 129.7'

SANDSTONE 70% FROM 129.7' TO 132.0'

SANDSTONE 50% FROM 132.0' TO 133.5'
SANDSTONE 70% FROM 133.5' TO 136.0'
.05' CLAYEY SHALE BROKEN ZONE AT 134.4'

SANDSTONE AND SHALE BECOME INTERBEDDED WITH SILTSTONE; MEDIUM DARK GRAY; MICACEOUS; LAMINATED TO THIN BEDDED.
SANDSTONE 40% AND SILTSTONE 20% FROM 136.0' TO 142.0'

SANDSTONE 20% AND SILTSTONE 20% FROM 142.0' TO 154.6'
SOFT CLAYEY SHALE BROKEN ZONE FROM 143.1' TO 143.4'

CALCAREOUS SANDSTONE LAYER FROM 149.5' TO 149.8'

STRATIGRAPHIC NOMENCLATURE

LAWRENCE FORMATION

DOUGLAS GROUP

Rev. 0

WOLF CREEK
UPDATED SAFETY ANALYSIS REPORT

Figure 2.5-34e (Sheet 2 of 6)

Log of Boring B-5

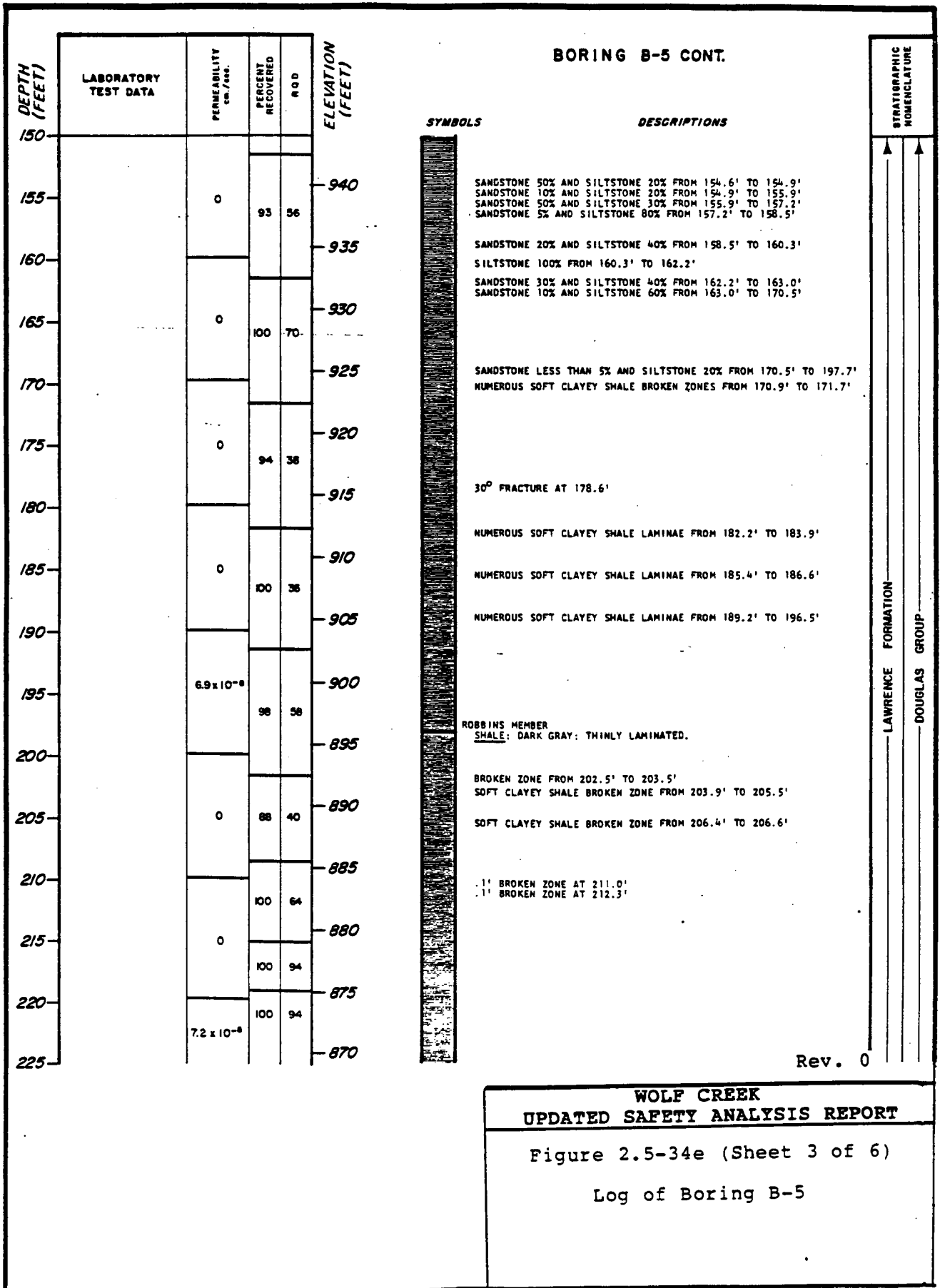

BORING B-5 CONT.

DEPTH (FEET)	LABORATORY TEST DATA	PERMEABILITY cm./SEC.	PERCENT RECOVERED	R Q D	ELEVATION (FEET)	SYMBOLS	DESCRIPTIONS	STRATIGRAPHIC NOMENCLATURE
225		7.2 x 10 ⁻⁸			865		LIMESTONE: PALE YELLOWISH-BROWN; VERY SHALEY; FOSSILIFEROUS; LAMINATED TO MEDIUM BEDDED. SHALE: DARK GRAY; SLIGHTLY CARBONACEOUS; THINLY LAMINATED; OCCASIONAL .05' TO .1' PALE YELLOWISH-BROWN DOLOMITIC CONCRETIONS.	
230					860			
235		0	100	94	860			
240					855		BROKEN ZONE FROM 238.5' TO 243.5'	
245		3.6 x 10 ⁻⁷			850		.1' BROKEN ZONE AT 244.8' .1' BROKEN ZONE AT 245.8'	
250			100	73	845			
255		3.9 x 10 ⁻⁷			840		BROKEN ZONE FROM 252.2' TO 253.0' SHALE: MEDIUM GRAY; VERY CALCAREOUS; FOSSILIFEROUS; THIN BEDDED. SHALE: GRAYISH-BLACK; CARBONACEOUS; CALCAREOUS; THINLY LAMINATED; OCCASIONAL .002' TO .02' LAYERS OF SHALEY LIMESTONE.	
260			100	70	835		HASKELL MEMBER LIMESTONE: LIGHT GRAY; FINE-GRAINED; FOSSILIFEROUS; THIN TO THICK BEDDED. VINLAND MEMBER SHALE: MEDIUM GRAY; VERY CALCAREOUS; FOSSILIFEROUS; 20% LIMESTONE NODULES AND FOSSILS.	
265		7.2 x 10 ⁻⁷			830		SANDSTONE: MEDIUM LIGHT GRAY; VERY FINE-GRAINED; SILTY; LAMINATED TO THIN BEDDED; INTERBEDDED WITH 50% SILTSTONE; MEDIUM GRAY TO GRAYISH-BLACK; LOCALLY CARBONACEOUS; LAMINATED TO THIN BEDDED. CLAYEY CARBONACEOUS SHALE LAYER FROM 259.9' TO 260.2'	
270			100	5	825			
275		1.8 x 10 ⁻⁷			820		COAL: BLACK; SHALEY; THIN BEDDED. SHALE: MEDIUM DARK GRAY; SILTY; CALCAREOUS; LOCALLY CARBONACEOUS; THINLY LAMINATED TO THIN BEDDED. SOFT CLAYEY SHALE LAYER FROM 269.7' TO 269.9' BROKEN ZONE FROM 271.8' TO 273.5' GRADES TO 50% SHALEY SILTSTONE AT 274.0'	
280			92	90	815			
285		1.5 x 10 ⁻⁷			810		SHALE: DARK GRAY; VERY CALCAREOUS; SLIGHTLY CARBONACEOUS; 5% FUSULINID FOSSILS; LAMINATED TO MEDIUM BEDDED. TONGANOXIE MEMBER SHALE: DARK GREENISH-GRAY; SLIGHTLY CARBONACEOUS; OCCASIONAL FOSSILIFEROUS LIMESTONE NODULES; LAMINATED TO MEDIUM BEDDED.	
290			96	28	805		SHALE: MEDIUM DARK GRAY; THINLY LAMINATED; NUMEROUS LOW ANGLE SLICKENSIDED FRACTURES AND SOFT CLAYEY SHALE LAYERS.	
295		4.2 x 10 ⁻⁷			800		.1' PALE YELLOWISH-BROWN CONCRETIONS AT 290.4' AND 292.5'	
300			97	15	795		SHALE: MEDIUM DARK GRAY; THINLY LAMINATED; INTERBEDDED WITH SANDSTONE: LIGHT GRAY; FINE-GRAINED; LAMINATED TO THIN BEDDED. NUMEROUS LOW ANGLE SLICKENSIDED FRACTURES AND SOFT, CLAYEY SHALE LAYERS FROM 292.6' TO 293.7' SANDSTONE 40% FROM 292.6' TO 298.8' NUMEROUS CLAYEY SHALE LAMINAE FROM 293.7' TO 297.3' SANDSTONE 75% FROM 298.8' TO 307.1'	STRANGER FORMATION

WOLF CREEK
UPDATED SAFETY ANALYSIS REPORT

Figure 2.5-34e (Sheet 4 of 6)
Log of Boring B-5

Rev. 0

BORING B-5 CONT.

DEPTH (FEET)	LABORATORY TEST DATA	PERMEABILITY cm / sec.	PERCENT RECOVERED	RQD	ELEVATION (FEET)
300					790
305		3.0×10^{-7}	98	15	785
310					780
315		3.3×10^{-8}	98	92	775
320					770
325		3.0×10^{-8}	100	55	765
330					760
335		5.8×10^{-8}	100	100	755
340					750
345		4.4×10^{-8}	99	94	745
350					740
355		3.9×10^{-8}	96	85	735
360					730
365		1.4×10^{-8}	100	38	725
370					720
375		5.3×10^{-8}			

SYMBOLS

DESCRIPTIONS



SANDSTONE 10% FROM 307.1' TO 319.5'

.1' CLAYEY BROKEN ZONE AT 313.7'

SANDSTONE LESS THAN 5% FROM 319.5' TO 333.6'

BROKEN ZONE FROM 320.0' TO 320.5'

BROKEN ZONE FROM 322.3' TO 322.6'

BROKEN ZONE FROM 325.0' TO 325.4'
 BROKEN ZONE FROM 325.8' TO 326.0'
 VERTICAL FRACTURE FROM 326.0' TO 326.5'
 BROKEN ZONE FROM 326.8' TO 327.0'

BROKEN ZONE FROM 332.0' TO 332.5'

BROKEN ZONE FROM 342.0' TO 342.5'

.06' CARBONACEOUS SHALE LAYER AT 346.6'
 CARBONACEOUS SHALE LAYER FROM 349.2' TO 349.6'

WESTON MEMBER
 SHALE: MEDIUM DARK GRAY; SLIGHTLY CARBONACEOUS; THINLY LAMINATED.

OCCASIONAL CLAYEY SHALE LAMINAE FROM 363.0' TO 365.8'

CLAYEY BROKEN ZONE FROM 366.9' TO 367.7'

.1' SOFT CLAYEY SHALE LAYER AT 374.8'

STRATIGRAPHIC NOMENCLATURE

STRANGER FORMATION

DOUGLAS GROUP

WOLF CREEK
 UPDATED SAFETY ANALYSIS REPORT

Figure 2.5-34e (Sheet 5 of 6)

Log of Boring B-5

BORING B-5 CONT.

DEPTH (FEET)	LABORATORY TEST DATA	PERMEABILITY cm./sec.	PERCENT RECOVERED	R O D	ELEVATION (FEET)
375					
380		5.3 x 10 ⁻⁸	100	80	715
385		3.9 x 10 ⁻⁸			710
390			94	75	705
395		3.9 x 10 ⁻⁸			700
400			100	76	695
405			100	58	690
410					685

SYMBOLS



DESCRIPTIONS

.05' SOFT CLAYEY SHALE LAYER AT 377.1'

BROKEN ZONE FROM 384.6' TO 385.1'

SOUTH BEND MEMBER
 LIMESTONE: MEDIUM LIGHT GRAY; FINE-GRAINED; FOSSILIFEROUS;
 UCCASTONAL BROWNISH-GRAY SHALE PARTINGS; THIN TO THICK
 BEDDED; SANDY IN BASAL 1.2 FEET.

ROCK LAKE MEMBER
 SHALE: MEDIUM DARK GRAY; CALCAREOUS; THINLY LAMINATED;
 INTERBEDDED WITH IRREGULAR LAYERS AND LENSES OF LIMESTONE;
 MEDIUM LIGHT GRAY; FINE-GRAINED; LOCALLY VERY SANDY;
 LAMINATED TO MEDIUM BEDDED.
 SHALE 60% FROM 391.0' TO 395.1'
 SHALE 20% FROM 395.1' TO 396.6'
 10% SHALE AND 90% SANDY LIMESTONE FROM 396.6' TO 398.1'

**SANDSTONE: LIGHT OLIVE GRAY; FINE- TO MEDIUM-GRAINED; SLIGHTLY
 CALCAREOUS; OCCASIONAL MEDIUM DARK GRAY SHALE PARTINGS;
 THIN TO THICK BEDDED.**
 VERTICAL OPEN FRACTURE FROM 400.3' TO 401.5'
 VERTICAL OPEN FRACTURE FROM 404.2' TO 405.8', CALCITE-LINED
 FROM 405.1' TO 405.8'

BORING COMPLETED AT 405.8 FEET ON 6-5-73.
 CASING USED TO A DEPTH OF 16.2 FEET.
 GROUNDWATER LEVEL RECORDED AT 71.8 FEET ON 6-7-73.
 THIRD PIEZOMETER INSTALLED AT AN INTERVAL FROM 5.0
 FEET TO 72.0 FEET ON 8-7-73.
 SECOND PIEZOMETER INSTALLED AT AN INTERVAL FROM
 86.0 FEET TO 98.0 FEET ON 8-7-73.
 FIRST PIEZOMETER INSTALLED AT AN INTERVAL FROM
 288.0 FEET TO 348.0 FEET ON 8-7-73.
 PIEZOMETER READINGS ARE PRESENTED ON TABLE 2.4-29.

STRATIGRAPHIC NOMENCLATURE
STANTON FORMATION
LANSING GROUP

Rev. 0

**WOLF CREEK
 UPDATED SAFETY ANALYSIS REPORT**

Figure 2.5-34e (Sheet 6 of 6)

Log of Boring B-5

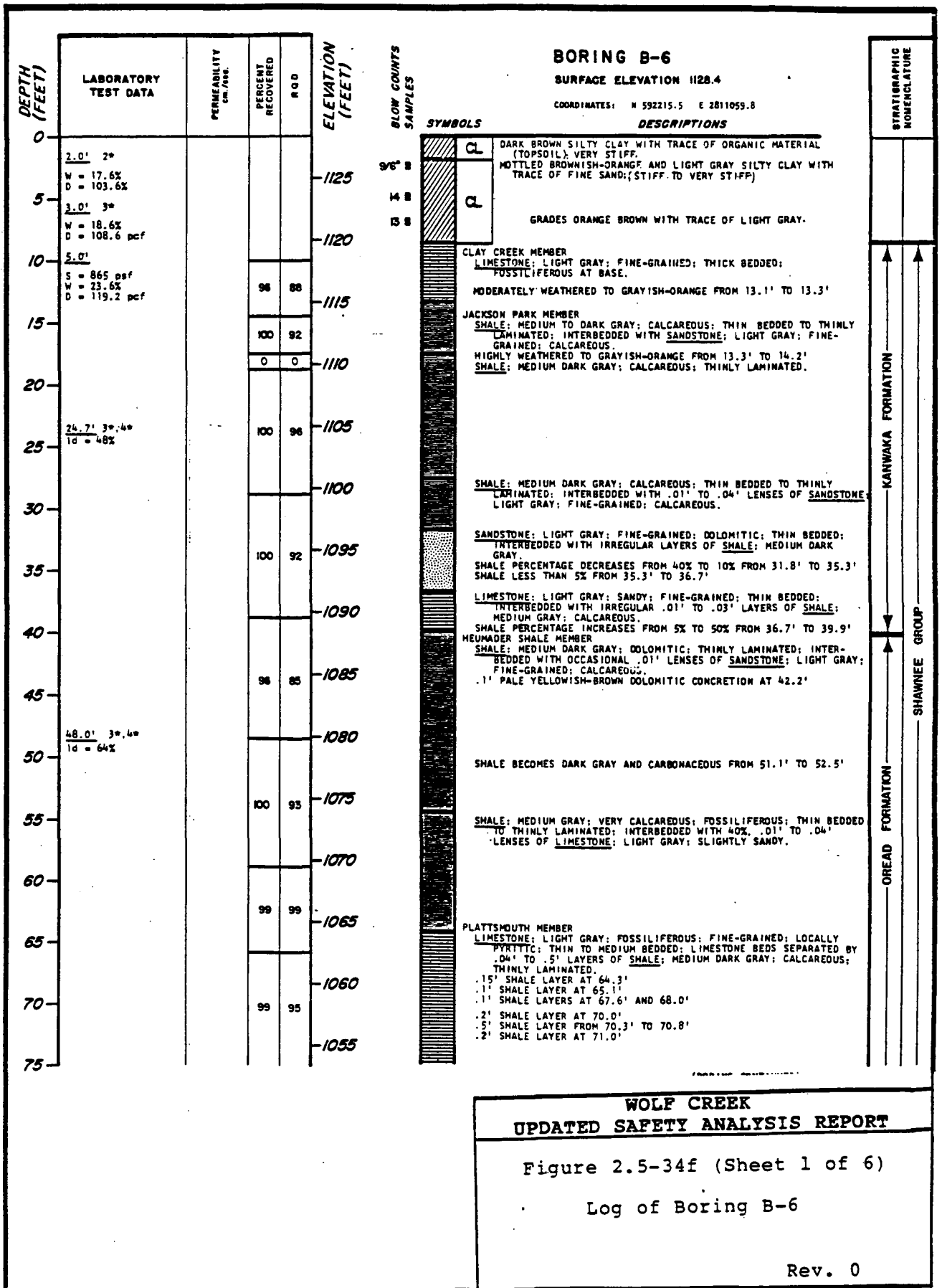

BORING B-6 CONT.

DEPTH (FEET)	LABORATORY TEST DATA	PERMEABILITY cm./sec.	PERCENT RECOVERED	R.O.D.	ELEVATION (FEET)	SYMBOLS	DESCRIPTIONS	STRATIGRAPHIC NOMENCLATURE
75								
78.4'	3*, 4* I _d = 97%		100	100	1050		HEEBNER MEMBER SHALE: DARK GRAY TO GRAYISH-BLACK; CARBONACEOUS; THINLY LAMINATED; FISSILE; INTERBEDDED WITH .01' TO .03' LAYERS OF LIMESTONE; LIGHT GRAY; SILTY.	
80	81.8' 3*, 4* I _d = 3%						LEAVENWORTH MEMBER LIMESTONE: LIGHT BLUISH-GRAY; FINE-GRAINED; FOSSILIFEROUS; MEDIUM BEDDED; SHALEY AT TOP. SNYDERVILLE MEMBER SHALE: MEDIUM GRAY; VERY CALCAREOUS; THIN TO MEDIUM BEDDED; CLAYEY IN ZONES. 45' OPEN FRACTURE AT 81.6' .15' CLAYEY ZONE AT 85.0'	
85			98	61	1045		TORONTO MEMBER LIMESTONE: VERY LIGHT GRAY; FINE-GRAINED; FOSSILIFEROUS WITH FOSSIL FRAGMENT BEDS; THIN TO THICK BEDDED; OCCASIONAL .01' TO .02' GREENISH-GRAY SHALE PARTINGS. FRACTURED AND BROKEN WITH 50% GREENISH-GRAY SHALE FROM 86.0' TO 87.0' 40% GREENISH-GRAY SHALE PARTINGS FROM 87.0' TO 90.4'	
90					1040			
95			100	68	1035		.1' BROKEN CLAYEY ZONE AT 94.1'	
100					1030		.05' GREENISH-GRAY CLAYEY SHALE LAYER AT 97.7'	
105			78	49	1025		SHALE: MEDIUM DARK GRAY; THIN BEDDED TO THINLY LAMINATED; INTERBEDDED WITH .01' TO .06' LENSES OF SANDSTONE; LIGHT GRAY; FINE-GRAINED; CALCAREOUS. NUMEROUS SOFT HORIZONTAL CLAYEY SHALE LAYERS FROM 101.8' TO 105.7' .15' SOFT CLAYEY SHALE LAYER AT 105.5' SANDSTONE 40% TO 50% FROM 105.8' TO 115.8'	
110			100	72	1020		.04' SOFT CLAYEY SHALE LAYER AT 112.7'	
115					1015		SANDSTONE LESS THAN 10% FROM 115.8' TO 120.6'	
120			90	30	1010		SHALE BECOMES GRAYISH-BLACK FROM 120.2' TO 120.6'	
125			90	30	1005		WILLIAMSBURG COAL BED COAL: BLACK; MEDIUM BEDDED. SHALE: GREENISH-GRAY; CLAYEY; CALCAREOUS; THINLY LAMINATED TO MEDIUM BEDDED. FRACTURED AND SOFT FROM 121.9' TO 123.4'	
130					1000		NUMEROUS SOFT CLAYEY ZONES FROM 126.1' TO 127.4'	
135			96	20	995		AMAZONIA MEMBER LIMESTONE: GREENISH-GRAY; SHALEY; FINE-GRAINED; LOCALLY VERY SHALEY AND SOFT IN UPPER PORTION; THIN TO THICK BEDDED. .1' SOFT CLAYEY LAYER AT 127.9' VERY SOFT CLAYEY ZONE FROM 128.9' TO 129.2' DENSE SHALEY FOSSILIFEROUS LIMESTONE FROM 130.2' TO 131.9'	
140					990		IRELAND MEMBER SHALE: DARK GRAY; SLIGHTLY CALCAREOUS; THINLY LAMINATED TO THIN BEDDED; OCCASIONAL .01' TO .02' LENSES OF SANDSTONE; LIGHT GRAY; FINE-GRAINED; CALCAREOUS. NUMEROUS LAYERS OF SOFT CLAYEY SHALE FROM 131.9' TO 135.5'	
145			92	33	985		SHALE BECOMES CARBONACEOUS FROM 138.1' TO 145.5'	
150	149.1' Q = 290 psi E = 30,300 psi				980		.05' SOFT CLAYEY LAYER AT 145.3' COAL: BLACK; THIN TO MEDIUM BEDDED; SHALEY. SHALE: DARK GRAY; THINLY LAMINATED TO THIN BEDDED; INTERBEDDED WITH IRREGULAR .01' TO .1' LENSES OF CROSS-BEDDED, RIPPLE-MARKED SANDSTONE; LIGHT GRAY; FINE-GRAINED. .4' SOFT CLAYEY SHALE LAYER FROM 146.3' TO 146.7'	



WOLF CREEK
UPDATED SAFETY ANALYSIS REPORT

Figure 2.5-34f (Sheet 2 of 6)

Log of Boring B-6

Rev. 0

BORING B-6 CONT

DEPTH (FEET)	LABORATORY TEST DATA	PERMEABILITY cm./sec.	PERCENT RECOVERED	R.O.D.	ELEVATION (FEET)
150			96	.83	975
155			70	20	970
160					965
165			100	42	960
170					955
175			78	41	950
180					945
185			79	38	940
190			100	47	935
195			84	74	930
200					925
205			100	86	920
210					915
215			90	82	910
220					905
225			100	87	

SYMBOLS



DESCRIPTIONS

SANDSTONE LESS THAN 10% FROM 146.7' TO 149.6'
 SANDSTONE 30% TO 50% FROM 149.6' TO 160.3'

SANDSTONE LESS THAN 10% FROM 160.3' TO 175.5'
 .1' BROKEN ZONE AT 161.4'
 BROKEN ZONE FROM 162.8' TO 163.1'

.2' SANDSTONE LAYER AT 167.3'
 .05' SOFT CLAYEY SHALE LAYER AT 167.8'
 .1' BROKEN ZONES AT 169.2' AND 169.5'
 .2' CLAYEY BROKEN ZONE AT 170.8'

ROBBINS MEMBER
 SHALE: DARK GRAY; SLIGHTLY CARBONACEOUS; THINLY LAMINATED.

.1' SOFT CLAYEY SHALE ZONES AT 182.5' AND 182.8'

NUMEROUS .04' TO .15' LAYERS OF SOFT CLAYEY SHALE FROM 191.7' TO 196.7'

70° FRACTURE FROM 195.1' TO 195.4'

VERTICAL FRACTURE FROM 207.2' TO 207.6'
 .1' SOFT CLAYEY SHALE LAYER AT 207.7'
 45° CLAY-LINED FRACTURE AT 208.5'
 60° OPEN FRACTURE AT 209.8'

.1' SOFT CLAYEY SHALE LAYER AT 220.2'

STRATIGRAPHIC NOMENCLATURE

LAWRENCE FORMATION

DOUGLAS GROUP

**WOLF CREEK
 UPDATED SAFETY ANALYSIS REPORT**

Figure 2.5-34f (Sheet 3 of 6)
 Log of Boring B-6

Rev. 0

BORING B-6 CONT.

DEPTH (FEET)	LABORATORY TEST DATA	PERMEABILITY cm./100.	PERCENT RECOVERED		ROD	ELEVATION (FEET)	SYMBOLS	DESCRIPTIONS	STRATIGRAPHIC NOMENCLATURE
225	226.0' 3", 4" ld = 76%								
230			87	9		900		SHALE BECOMES DARK GRAY AND SLIGHTLY CARBONACEOUS FROM 232.8' TO 236.3'	
			100	100					
235			100	99		895			
						890		SHALE: DARK GRAY; VERY CALCAREOUS; FOSSILIFEROUS; MEDIUM BEDDED. SHALE: DARK GRAY; SLIGHTLY CARBONACEOUS; THINLY LAMINATED; OCCASIONAL .05' TO .15' PALE YELLOWISH-BROWN IRONSTONE CONCRETIONS. VERTICAL CLAY-LINED FRACTURE ZONE FROM 238.4' TO 238.9' VERTICAL OPEN FRACTURE FROM 232.2' TO 232.8'	
240									
			100	88		885		HASKELL MEMBER LIMESTONE: LIGHT GRAY; FINE-GRAINED; 10% FUSULINID FOSSILS; MEDIUM TO THICK BEDDED. VINLAND MEMBER LIMESTONE: LIGHT GRAY; FOSSILIFEROUS; SANDY; THIN BEDDED; INTERBEDDED WITH 40% DARK GRAY SHALE.	
245								SANDSTONE: LIGHT GRAY; FINE-GRAINED; MICACEOUS; SLIGHTLY CALCAREOUS; THIN TO THICK BEDDED; OCCASIONAL .01' DARK GRAY SHALE PARTINGS.	
250						880			
			99	88		875		SHALE: GREENISH-GRAY; SLIGHTLY CALCAREOUS; THIN TO MEDIUM BEDDED; NUMEROUS 20" TO 40" SLICKENSIDED FRACTURES. SHALE BECOMES LIGHT GREENISH-GRAY AND VERY DOLOMITIC FROM 254.1' TO 254.7'	
255								WESTPHALIA MEMBER LIMESTONE: LIGHT GRAY; FINE-GRAINED; 60% FUSULINID FOSSILS; THIN TO THICK BEDDED; INTERBEDDED WITH GREENISH-GRAY SHALE. SHALE LESS THAN 5% FROM 254.7' TO 256.4' SHALE 10% FROM 256.4' TO 260.4'	
260			100	99		870		SHALE INCREASES FROM 20% TO 80% FROM 260.4' TO 261.5'	
						865		TONGANXIE MEMBER SANDSTONE: GREENISH-GRAY; VERY FINE-GRAINED; SILTY; MEDIUM BEDDED. SILTSTONE: LIGHT TO MEDIUM GRAY; SLIGHTLY SANDY; MICACEOUS; THIN TO THICK BEDDED; INTERBEDDED WITH SHALE; DARK GRAY; THINLY LAMINATED; AND SANDSTONE: LIGHT GRAY; VERY FINE-GRAINED; THIN BEDDED.	
265			95	72		860		SANDSTONE 10% AND SHALE 5% FROM 262.6' TO 267.4' VERTICAL CLAY-LINED FRACTURE FROM 263.5' TO 264.5' SILTSTONE 100% FROM 267.4' TO 275.6'	
270								CURVING NEAR VERTICAL SLICKENSIDED FRACTURE AT 270.8' 45° SLICKENSIDED FRACTURES AT 271.1' AND 271.2'	
			100	88		855			
275								SANDSTONE 30% AND SHALE 10% FROM 275.6' TO 286.2'	
						850			
280								HIGHLY FRACTURED ZONE FROM 280.8' TO 281.3' NEAR VERTICAL FRACTURE FROM 281.4' TO 281.9'	
			100	89		845			
285								SANDSTONE 5% AND SHALE 25% FROM 286.2' TO 312.1'	
						840			
290									
			100	90		835			
295									
						830			

**WOLF CREEK
UPDATED SAFETY ANALYSIS REPORT**

Figure 2.5-34f (Sheet 4 of 6)

Log of Boring B-6

Rev. 0

BORING B-6 CONT.

DEPTH (FEET)	LABORATORY TEST DATA	PERMEABILITY cm./100g.	PERCENT RECOVERED	ROD	ELEVATION (FEET)
300					
305			100	83	825
310					820
315			100	100	815
320					810
325			95	95	805
330					800
335			100	98	795
340					790
345					785
350			100	81	780
355			87	74	775
360			79	68	770
365			98	27	765
370			98	0	760
375			100	68	755



SYMBOLS

DESCRIPTIONS

.1' CALCAREOUS SANDSTONE LAYER AT 300.6'
 .05' SOFT CLAYEY SHALE LAYER AT 301.1'
 HIGHLY FRACTURED BROKEN ZONE FROM 301.4' TO 302.0'

SANDSTONE LESS THAN 5% AND SHALE 60% FROM 312.1' TO 333.6'

SANDSTONE LAYERS BECOME CALCAREOUS FROM 322.8' TO 329.7'

SHALE: DARK GRAY; SLIGHTLY SILTY; SLIGHTLY CARBONACEOUS BELOW 361.0'; THINLY LAMINATED.

VERTICAL FRACTURE FROM 349.6' TO 351.0'

HIGHLY FRACTURED ZONE WITH SOME CLAY-LINED FRACTURES FROM 367.8' TO 372.2'

STRATIGRAPHIC NOMENCLATURE
STRANGER FORMATION
DOUGLAS GROUP

**WOLF CREEK
 UPDATED SAFETY ANALYSIS REPORT**

Figure 2.5-34f (Sheet 5 of 6)
 Log of Boring B-6

Rev. 0

BORING B-6 CONT.

DEPTH (FEET)	LABORATORY TEST DATA	PERMEABILITY cm./sec.	PERCENT RECOVERED	RQD	ELEVATION (FEET)	SYMBOLS	DESCRIPTIONS	STRATIGRAPHIC NOMENCLATURE
375					750		SHALE: DARK GRAY; SLIGHTLY CARBONACEOUS; THINLY LAMINATED; INTERBEDDED WITH 5% TO 10% SANDSTONE; LIGHT GRAY; VERY FINE-GRAINED; SLIGHTLY CALCAREOUS; THINLY LAMINATED TO THIN BEDDED; MAXIMUM LAYER THICKNESS .03'.	STRANGER FORMATION DOUGLAS GROUP
380			100	100	745			
385			100	100	740			
390					735			
395			100	100	730			
400					725		SANDSTONE LESS THAN 5% FROM 400.0' TO 405.5'	
405			100	100	720		WESTON MEMBER SHALE: DARK GRAY; SLIGHTLY CARBONACEOUS; THINLY LAMINATED.	
410					715		FRACTURED ZONE WITH SOFT CLAYEY SHALE LAYERS FROM 409.9' TO 410.7' SOFT CLAYEY SHALE FRACTURED ZONE FROM 411.8' TO 412.2'	
415			100	74	710			
420					705			
425			100	100	700			
430			100	100	695			
435					690		.05' PALE YELLOWISH-BROWN DOLOMITIC CONCRETIONS AT 431.4' AND 434.0' SHALE BECOMES MEDIUM GRAY, CALCAREOUS, AND FOSSILIFEROUS FROM 334.7' TO 334.9'	STANTON FORMATION LANISING GROUP
440			100	100	685		SOUTH BEND MEMBER LIMESTONE: LIGHT GRAY; FINE-GRAINED; FOSSILIFEROUS; THICK BEDDED. LIMESTONE: LIGHT GRAY; SANDY; FINE-GRAINED; MEDIUM BEDDED. ROCK LAKE MEMBER SHALE: DARK GRAY; THINLY LAMINATED; INTERBEDDED WITH SANDSTONE; MEDIUM LIGHT GRAY; FINE- TO MEDIUM-GRAINED; CALCAREOUS; THIN BEDDED. SANDSTONE 30% FROM 439.2' TO 441.6' SANDSTONE 70% FROM 441.6' TO 442.8' LIGHT BLUISH-GRAY FOSSILIFEROUS LIMESTONE CONGLOMERATE FROM 442.8' TO 443.3'	
445					680		STONER MEMBER LIMESTONE: MOTTLED VERY LIGHT GRAY AND PALE BLUISH-GRAY; FINE-GRAINED; THIN TO THICK BEDDED; OCCASIONAL .001' TO .04' DARK GREENISH-GRAY SHALE PARTINGS; NUMEROUS STYLOLITES.	
450			100	100	675			

THIRD PIEZOMETER INSTALLED AT AN INTERVAL OF 5.0 FEET TO 26.0 FEET ON 7-3-73.
SECOND PIEZOMETER INSTALLED AT AN INTERVAL FROM 83.0 FEET TO 89.0 FEET ON 7-3-73.
FIRST PIEZOMETER INSTALLED AT AN INTERVAL FROM 262.0 FEET TO 333.0 FEET ON 7-3-73.
PIEZOMETER READINGS ARE PRESENTED ON TABLE 2.4-29.

**WOLF CREEK
UPDATED SAFETY ANALYSIS REPORT**

Figure 2.5-34f (Sheet 6 of 6)

Log of Boring B-6

Rev. 0

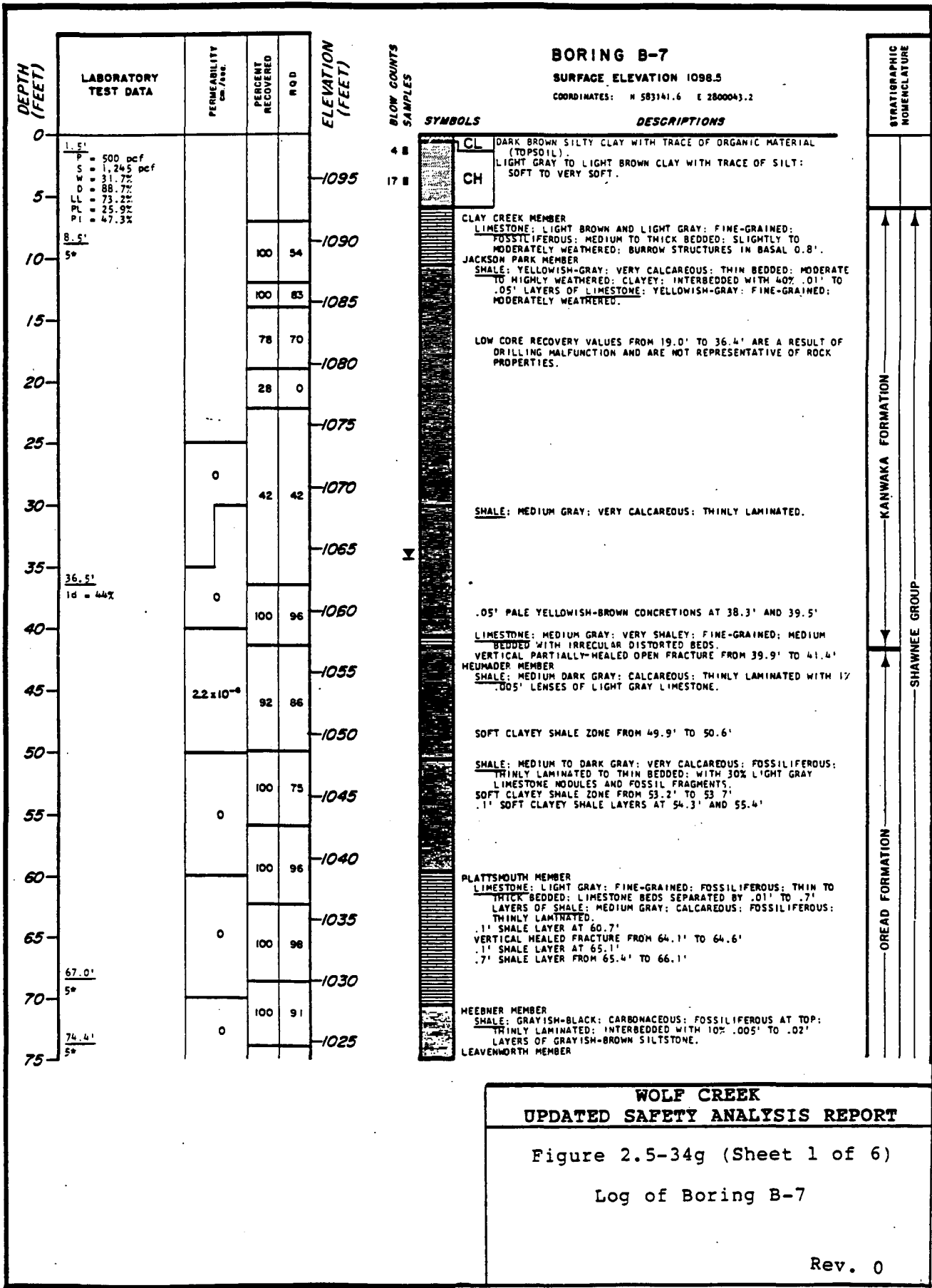

WOLF CREEK
UPDATED SAFETY ANALYSIS REPORT

Figure 2.5-34g (Sheet 1 of 6)
Log of Boring B-7

Rev. 0

BORING B-7 CONT.

DEPTH (FEET)	LABORATORY TEST DATA	PERMEABILITY cm./sec.	PERCENT RECOVERED	ROD	ELEVATION (FEET)
75					
80		0	100	88	1020
85		1.3 x 10 ⁻⁶	96	92	1015
90					1010
95	95.5' 5*	10 x 10 ⁻⁶	100	96	1005
100	99.2' Q = 1,780 psi E = 1,167,000 psi				1000
105		0	99	78	995
110					990
115		0	98	81	985
120					980
125		0	93	88	975
130					970
135			100	74	965
140					960
145			100	87	955
150					950

SYMBOLS



DESCRIPTIONS

LIMESTONE: LIGHT BLuish-GRAY; FINE-GRAINED; FOSSILIFEROUS; MEDIUM BEDDED.
 SNYDERVILLE MEMBER
 SHALE: DARK GREENISH-GRAY; VERY CALCAREOUS; CLAYEY; LOCALLY FOSSILIFEROUS; THINLY LAMINATED TO THIN BEDDED.

TORONTO MEMBER
 LIMESTONE: LIGHT GRAY TO VERY LIGHT GRAY; FINE-GRAINED; FOSSILIFEROUS WITH FOSSIL FRAGMENT BEDS; THIN TO THICK BEDDED; OCCASIONAL .005' TO .1' GREENISH-GRAY SHALE PARTINGS; PINPOINT VUGS LESS THAN 5%.
 40% LIGHT GREENISH-GRAY SHALE FROM 81.5' TO 82.1'
 IRREGULAR NEAR VERTICAL LIGHT GREENISH-GRAY CLAY LAYER .02' TO .07' WIDE FROM 82.6' TO 83.1'

.1' GREENISH-GRAY SHALE LAYER AT 93.4'

SHALE: MEDIUM DARK GRAY; CLAYEY; THINLY LAMINATED.
 TWO PARALLEL 45° SLICKENSIDED FRACTURES AT 98.3'

SHALE: MEDIUM TO DARK GRAY; THINLY LAMINATED; INTERBEDDED WITH LENSES OF SANDSTONE; LIGHT GRAY; VERY FINE-GRAINED; LOCALLY CALCAREOUS; THINLY LAMINATED TO THIN BEDDED.
 SANDSTONE 50% FROM 100.1' TO 103.9'
 VERTICAL FRACTURE FROM 103.2' TO 103.8'
 SANDSTONE 10% TO 20% FROM 103.9' TO 110.9'
 VERTICAL FRACTURE FROM 104.2' TO 104.8'

80° FRACTURE FROM 110.4' TO 110.8'
 BROKEN ZONE FROM 110.9' TO 111.1'
 SANDSTONE LESS THAN 5% FROM 110.9' TO 114.7'

WILLIAMSBURG COAL BED
 COAL: BLACK; MEDIUM BEDDED.
 GRAYISH-BLACK CARBONACEOUS SHALE FROM 114.9' TO 115.1'
 45° SLICKENSIDED FRACTURE AT 115.0'
 SHALE: GREENISH-GRAY; VERY CALCAREOUS; THINLY LAMINATED; 20° SLICKENSIDED FRACTURES SPACED .3' TO 1.0' APART.

AMAZONIA MEMBER
 SHALE: DARK GREENISH-GRAY; VERY CALCAREOUS; THINLY LAMINATED; INTERBEDDED WITH 5% TO 50% .01' TO .1' NODULES OF LIMESTONE; LIGHT GRAY; FINE-GRAINED; PYRITIC.
 20° SLICKENSIDED FRACTURES AT 120.5' AND 120.8'
 LIMESTONE: LIGHT GRAY; FINE-GRAINED; FOSSILIFEROUS; THIN TO MEDIUM BEDDED; INTERBEDDED WITH 40% GREENISH-GRAY SHALE IN UPPER 1.3'
 SANDY AND SHALEY FROM 126.4' TO 126.7'

IRELAND MEMBER
 SHALE: MEDIUM DARK GRAY; THINLY LAMINATED; INTERBEDDED WITH .002' TO .01' LAYERS OF SANDSTONE; LIGHT GRAY; FINE-GRAINED.
 SANDSTONE 10% FROM 126.9' TO 131.9'
 SANDSTONE LESS THAN 5% FROM 131.9' TO 140.6'
 FRACTURED BROKEN ZONE FROM 132.0' TO 132.9'

COAL: BLACK; THIN TO MEDIUM BEDDED.
 SOFT GREENISH-GRAY CLAYEY SHALE FROM 141.2' TO 142.8'

SHALE: MEDIUM GRAY; THINLY LAMINATED; INTERBEDDED WITH .002' TO .02' LAYERS OF SANDSTONE; LIGHT GRAY; FINE-GRAINED.
 SANDSTONE 5% TO 30% FROM 142.8' TO 148.8'

SANDSTONE: LIGHT GRAY; FINE-GRAINED; IRREGULARLY BEDDED WITH

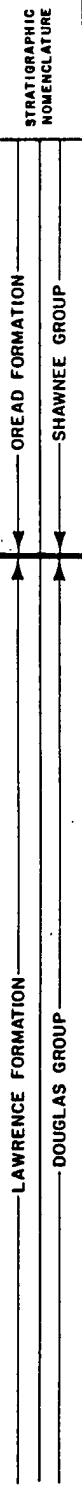

WOLF CREEK
UPDATED SAFETY ANALYSIS REPORT

Figure 2.5-34g (Sheet 2 of 6)
 Log of Boring B-7

Rev. 0

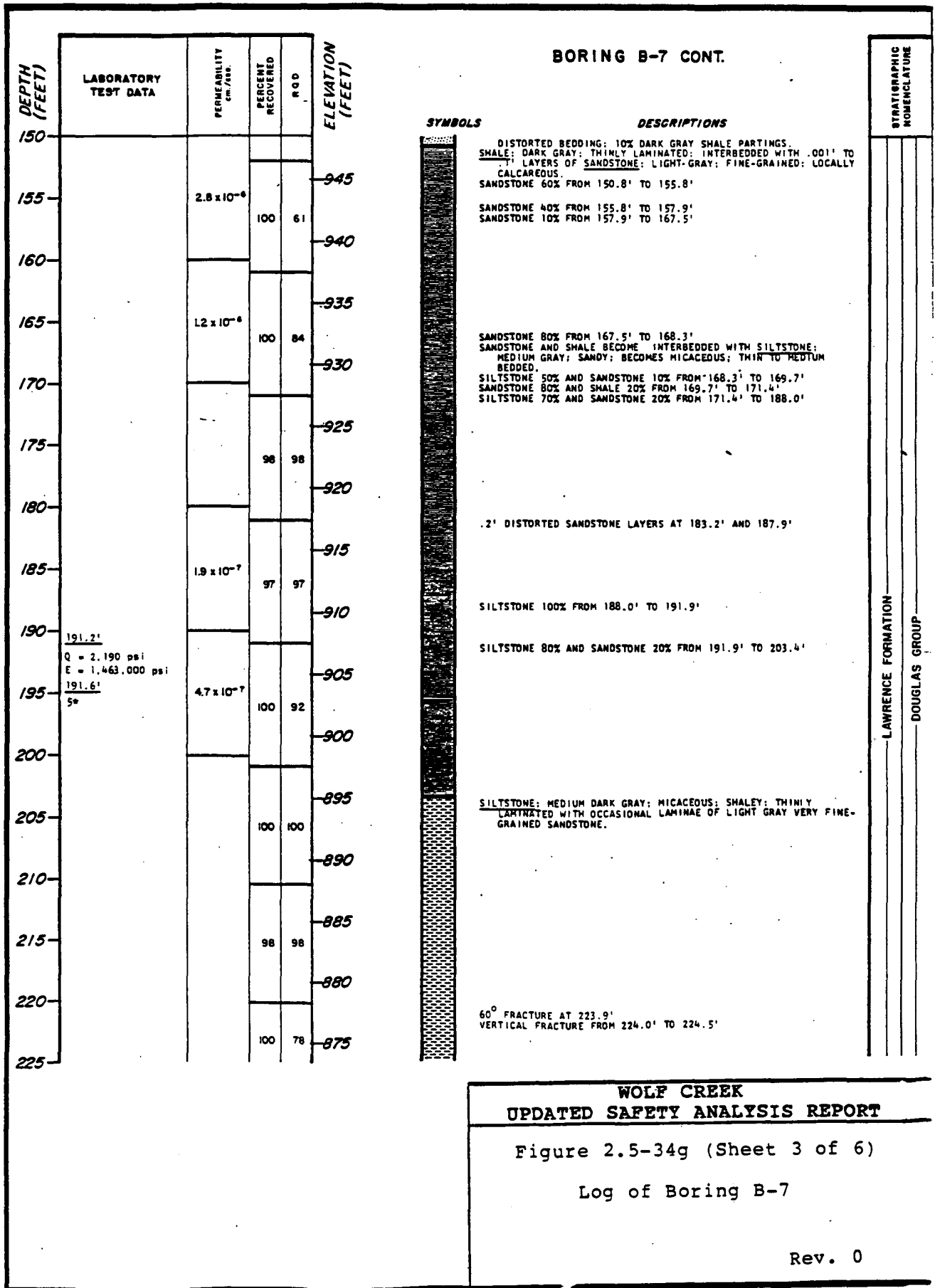

BORING B-7 CONT.

DEPTH (FEET)	LABORATORY TEST DATA	PERMEABILITY CM./FOOT	PERCENT RECOVERED	R.O.D.	ELEVATION (FEET)
225			100	78	870
230					865
235		1.0 x 10 ⁻⁷	100	100	860
240					855
245		4.2 x 10 ⁻⁷	100	97	850
250					845
255		1.6 x 10 ⁻⁷	100	100	840
260			100	90	835
265		1.8 x 10 ⁻⁶	100	100	830
270					825
275		3.3 x 10 ⁻⁶	100	98	820
280			100	100	815
285			100	100	810
290					805
295			100	100	800
300					

SYMBOLS

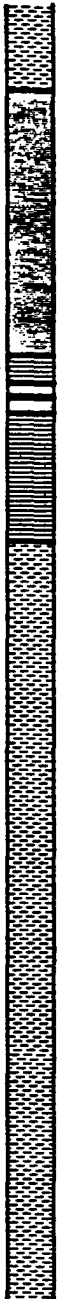

DESCRIPTIONS

VERTICAL FRACTURE FROM 227.4' TO 227.8'

ROBBINS MEMBER
SHALE; MEDIUM DARK GRAY; SLIGHTLY CARBONACEOUS; THINLY LAMINATED.

MEDIUM DARK GRAY CALCAREOUS, FOSSILIFEROUS SHALE FROM 243.0' TO 243.2'
VERTICAL FRACTURE FROM 243.5' TO 243.8'

MASKELL MEMBER
LIMESTONE; LIGHT GRAY; FINE-GRAINED; FOSSILIFEROUS; THIN TO MEDIUM BEDDED; OCCASIONAL .001" DARK GRAY SHALE PARTINGS.

VINLAND MEMBER
SHALE; MEDIUM DARK GRAY; VERY CALCAREOUS; FOSSILIFEROUS; SLIGHTLY SANDY; THINLY LAMINATED TO THIN BEDDED.

WESTPHALIA MEMBER
LIMESTONE; LIGHT GRAY; SHALEY; 70% FUSULINID FOSSILS; THIN TO THICK BEDDED; VERY SHALEY IN UPPER 0.4'.

TONGANOXIE MEMBER
SILTSTONE; MEDIUM GRAY; MICACEOUS; SLIGHTLY SANDY; THIN TO THICK BEDDED; INTERBEDDED WITH SHALE; MEDIUM DARK GRAY; THINLY LAMINATED; AND SANDSTONE; LIGHT GRAY; FINE-GRAINED; SILTY; THIN TO THICK BEDDED WITH DISTORTED BEDDING.
SILTSTONE 70% AND SANDSTONE 30% FROM 356.0' TO 358.2'
SILTSTONE 60% AND SANDSTONE 20% FROM 258.2' TO 259.6'
SANDY SILTSTONE 100% FROM 259.6' TO 264.0'

SILTSTONE 50% AND SANDSTONE 30% FROM 264.0' TO 265.9'
SILTSTONE 70% AND SANDSTONE 20% FROM 265.9' TO 271.1'

SILTSTONE 40% AND SANDSTONE 20% FROM 271.1' TO 282.5'

SILTSTONE 20% AND SANDSTONE 20% FROM 282.5' TO 305.9'

STATIONARY NOMENCLATURE

↑ LAWRENCE FORMATION

↓ DOUGLAS GROUP

↑ STRANGER FORMATION

**WOLF CREEK
UPDATED SAFETY ANALYSIS REPORT**

Figure 2.5-34g (Sheet 4 of 6)
Log of Boring B-7

Rev. 0

BORING B-7 CONT.

DEPTH (FEET)	LABORATORY TEST DATA	PERMEABILITY cm./sec.	PERCENT RECOVERED	R Q D	ELEVATION (FEET)
300					
305			100	96	795
310					790
315			99	99	785
320			100	0	780
325			100	100	775
330					770
335			95	95	765
340					760
345			100	100	755
350					750
355			88	78	745
360			100	100	740
365					735
370			100	99	730
375					725

SYMBOLS



DESCRIPTIONS

SILTSTONE AND SANDSTONE LESS THAN 5% FROM 305.9' TO 313.6'

SHALE: MEDIUM DARK GRAY: THINLY LAMINATED.

SHALE: MEDIUM DARK GRAY: THINLY LAMINATED: INTERBEDDED WITH SANDSTONE: LIGHT GRAY: VERY FINE-GRAINED: LOCALLY CALCAREOUS: LAMINATED TO THIN BEDDED.

SANDSTONE LESS THAN 5% FROM 328.4' TO 333.4'
SANDSTONE 20% TO 40% FROM 333.4' TO 355.3'

SANDSTONE LESS THAN 5% FROM 355.3' TO 389.2'

STRATIGRAPHIC NOMENCLATURE

STRANGER FORMATION
DOUGLAS GROUP

WOLF CREEK
UPDATED SAFETY ANALYSIS REPORT

Figure 2.5-34g (Sheet 5 of 6)
Log of Boring B-7

BORING B-7 CONT.

DEPTH (FEET)	LABORATORY TEST DATA	PERMEABILITY cm./sec.	PERCENT RECOVERED	R Q D	ELEVATION (FEET)
375					
380			95	95	720
385					715
390			100	100	710
395					705
400			100	98	700
405					695
410			100	100	690
415			94	94	685
420			100	100	680
425					675
430			100	100	670
435			100	100	665
440					660

SYMBOLS



DESCRIPTIONS

WESTON MEMBER
SHALE; MEDIUM DARK GRAY; SLIGHTLY CARBONACEOUS; THINLY LAMINATED.

GRAYISH-BLACK CARBONACEOUS SHALE LAYER FROM 395.1' TO 395.3'

.05' PALE YELLOWISH-BROWN CONCRETION AT 419.5'
SHALE BECOMES PLANT FOSSILIFEROUS BELOW 420.0'
.02' PYRITE NODULE AT 422.8'

SOUTH BEND MEMBER
LIMESTONE; LIGHT GRAY; FINE-GRAINED; FOSSILIFEROUS; THIN TO THICK BEDDED; OCCASIONAL .001' BROWNISH-GRAY SHALE PARTINGS; SANDY IN BASAL 2.1'

ROCK LAKE MEMBER
SHALE; MEDIUM DARK GRAY; SLIGHTLY CALCAREOUS; INTERBEDDED WITH LIMESTONE; LIGHT GRAY; FINE-GRAINED; SANDY; LOCALLY FOSSILIFEROUS; LAMINATED TO THIN BEDDED.

SHALE 50% FROM 428.0' TO 429.8'
SHALE 95% FROM 429.8' TO 430.1'
SHALE 40% FROM 430.1' TO 431.5'
SHALE 90% FROM 431.5' TO 432.2'

STONER MEMBER
LIMESTONE; VERY LIGHT GRAY TO MEDIUM GRAY; FINE-GRAINED; THIN TO THICK BEDDED.
SHALEY FROM 435.3' TO 436.2'

BORING COMPLETED AT 437.4 FEET ON 5-25-73.
CASING USED TO A DEPTH OF 22.0 FEET.
GROUNDWATER LEVEL RECORDED AT 34.4 FEET ON 5-29-73.

THIRD PIEZOMETER INSTALLED AT AN INTERVAL FROM 40.0 FEET TO 50.0 FEET ON 8-2-73.
SECOND PIEZOMETER INSTALLED AT AN INTERVAL FROM 75.0 FEET TO 95.0 FEET ON 8-2-73.
FIRST PIEZOMETER INSTALLED AT AN INTERVAL FROM 145.0 FEET TO 195.0 FEET ON 8-2-73.
PIEZOMETER READINGS ARE PRESENTED ON TABLE 2.4-29.

STRATIGRAPHIC NOMENCLATURE

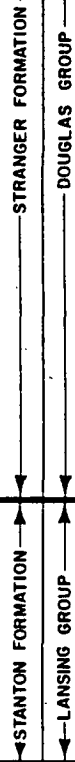

**WOLF CREEK
UPDATED SAFETY ANALYSIS REPORT**

Figure 2.5-34g (Sheet 6 of 6)

Log of Boring B-7

Rev. 0

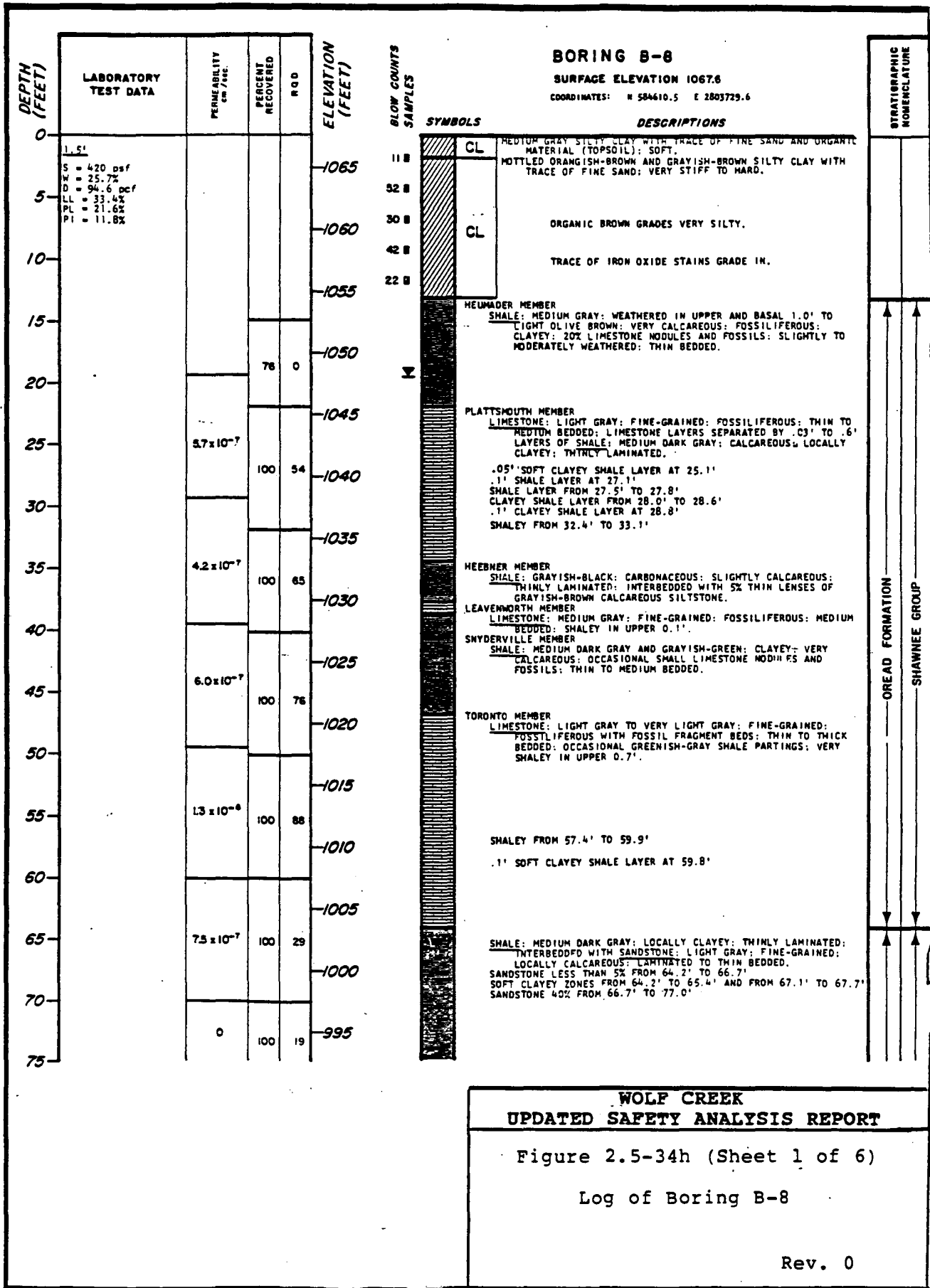

BORING B-8 CONT.

DEPTH (FEET)	LABORATORY TEST DATA	PERMEABILITY (cm./sec.)	PERCENT RECOVERED	ROD	ELEVATION (FEET)
75		0			990
80			93	47	985
85		0			980
90			85	19	975
95		0			970
100			100	75	965
105		0			960
110			100	31	955
115		6.5×10^{-7}			950
120			88	4	945
125					940
130			98	47	935
135		9.9×10^{-8}			930
140			99	21	925
145					920
150			100	47	

SYMBOLS

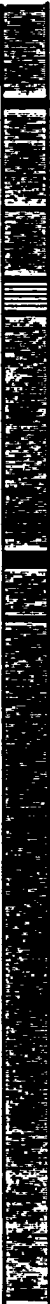

DESCRIPTIONS

SANDSTONE LESS THAN 10% FROM 77.0' TO 80.6'

WILLIAMSBURG COAL BED
 COAL: BLACK; SHALEY; THIN-BEDDED.
 SHALE: GREENISH-GRAY; VERY CALCAREOUS; CLAYEY; LAMINATED TO THIN BEDDED.

AMAZONIA MEMBER
 SHALE: GREENISH-GRAY; CALCAREOUS; THINLY LAMINATED; INTER-BEDDED WITH LENSES AND NODULES OF LIGHT GRAY LIMESTONE.
 LIMESTONE 70% FROM 86.9' TO 87.6'
 LIMESTONE 10% FROM 87.6' TO 90.9'
 LIMESTONE: LIGHT GRAY; FINE-GRAINED; FOSSILIFEROUS; LOCALLY SHALEY; THIN TO MEDIUM BEDDED.

IRELAND MEMBER
 SHALE: MEDIUM DARK GRAY; SILTY; LOCALLY CARBONACEOUS; THINLY LAMINATED; INTERBEDDED WITH SANDSTONE; LIGHT GRAY; VERY FINE-GRAINED; SILTY; LAMINATED.
 SANDSTONE LESS THAN 10% FROM 93.0' TO 114.7'
 SOFT CLAYEY LAYER FROM 94.2' TO 98.8'
 NUMEROUS SOFT CLAYEY SHALE LAMINAE FROM 94.2' TO 94.8'
 SANDSTONE LESS THAN 5% FROM 98.8' TO 107.0'
 SHALE BECOMES MICACEOUS AND PLANT FOSSILIFEROUS BELOW 101.0'

NUMEROUS SOFT CLAYEY SHALE LAYERS FROM 104.4' TO 106.7'

COAL: BLACK; SHALEY; THIN BEDDED.
 SHALE: DARK GRAY AND CARBONACEOUS AT TOP GRADING TO GREENISH-GRAY AT BASE; CLAYEY; LAMINATED TO THIN BEDDED.

SHALE: MEDIUM DARK GRAY; SILTY; LOCALLY CLAYEY; THINLY LAMINATED; INTERBEDDED WITH SANDSTONE; LIGHT GRAY; FINE-GRAINED; LAMINATED TO THIN BEDDED; AND SILTSTONE: MEDIUM GRAY; MICACEOUS; LAMINATED TO MEDIUM BEDDED.
 SANDSTONE 15% AND SILTSTONE 60% FROM 110.5' TO 113.5'
 SANDSTONE 50% AND SILTSTONE 10% FROM 113.5' TO 122.8'
 NUMEROUS SOFT CLAYEY SHALE LAMINAE FROM 113.5' TO 121.7'

SANDSTONE 20% AND SILTSTONE 70% FROM 122.8' TO 135.4'

SANDSTONE 10% AND SILTSTONE 50% FROM 135.4' TO 154.0'

NUMEROUS SOFT CLAYEY SHALE LAMINAE FROM 137.6' TO 143.5'

STRATIGRAPHIC NOMENCLATURE
LAWRENCE FORMATION
DOUGLAS GROUP

**WOLF CREEK
 UPDATED SAFETY ANALYSIS REPORT**

Figure 2.5-34h (Sheet 2 of 6)
 Log of Boring B-8

Rev. 0

BORING B-8 CONT.

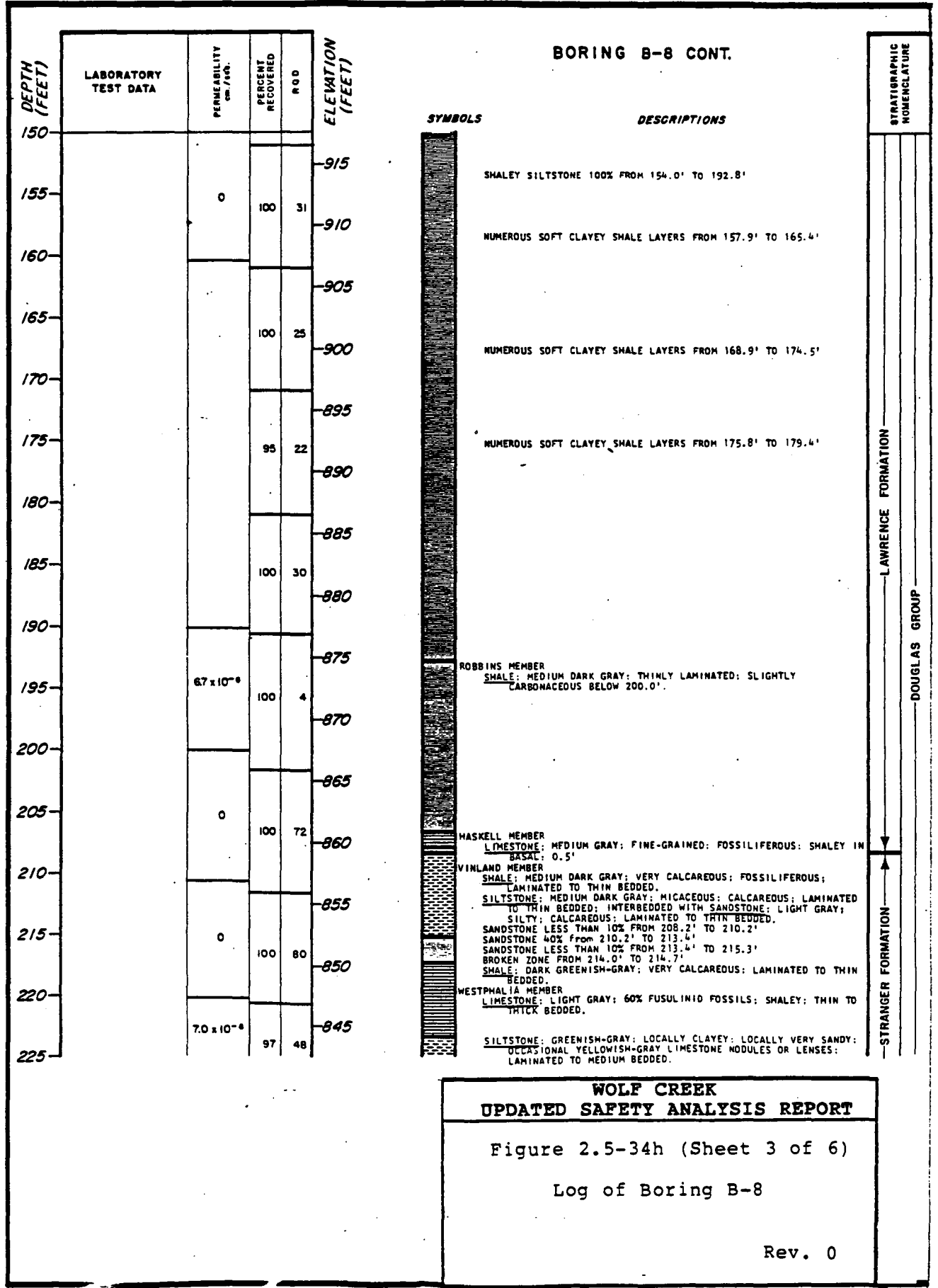

WOLF CREEK
UPDATED SAFETY ANALYSIS REPORT

Figure 2.5-34h (Sheet 3 of 6)
 Log of Boring B-8

Rev. 0

BORING B-8 CONT.

DEPTH (FEET)	LABORATORY TEST DATA	PERMEABILITY cm./sec.	PERCENT RECOVERED	R.O.D.	ELEVATION (FEET)	SYMBOLS	DESCRIPTIONS	STRATIGRAPHIC NOMENCLATURE
225		7.0 x 10 ⁻⁸	97	48	840			
230					835			
235			99	17	830			
240					825			
245			92	0	820			
250					815			
255			100	15	810			
260					805			
265			85	85	800			
270					795			
275					790			
280			100	44	785			
285					780			
290					775			
295					770			
300								

TONGANOXIE MEMBER
 SHALE: GREENISH-GRAY AT TOP GRADING TO MEDIUM DARK GRAY BELOW 234.0'; LOCALLY VERY CLAYEY; THINLY LAMINATED TO THIN BEDDED; INTERBEDDED WITH SANDSTONE; LIGHT GRAY; FINE-GRAINED; LOCALLY CALCAREOUS; LAMINATED TO THIN BEDDED; AND SILTSTONE; MEDIUM DARK GRAY; MICACEOUS; LAMINATED TO THIN BEDDED.
 SANDSTONE 10% AND SILTSTONE 30% FROM 229.2' TO 261.5'
 NUMEROUS SOFT CLAYEY SHALE LAYERS FROM 233.5' TO 261.0'
 .1' BROWNISH-GRAY DOLOMITIC CONCRETION AT 235.4'

SANDSTONE 20% AND SILTSTONE 40% FROM 261.5' TO 264.4'

SANDSTONE 5% AND SILTSTONE 20% FROM 264.4' TO 299.5'

NUMEROUS SOFT CLAYEY SHALE LAYERS FROM 272.1' TO 276.7'

NUMEROUS SOFT CLAYEY SHALE LAYERS FROM 277.8' TO 282.5'

NUMEROUS SOFT CLAYEY SHALE LAYERS FROM 287.6' TO 393.1'

CALCAREOUS SANDSTONE 20% AND SILTSTONE 10% FROM 299.5' TO 313.4'

STRANGER FORMATION
 DOUGLAS GROUP

**WOLF CREEK
 UPDATED SAFETY ANALYSIS REPORT**

Figure 2.5-34h (Sheet 4 of 6)

Log of Boring B-8

Rev. 0

BORING B-8 CONT.

DEPTH (FEET)	LABORATORY TEST DATA	PERMEABILITY cm./SEC.	PERCENT RECOVERED	RQD	ELEVATION (FEET)
300					
305		0	100	0	765
310					760
315		0	96	0	755
320					750
325			96	0	745
330					740
335			97	0	735
340					730
345			98	0	725
350					720
355			97	0	715
360					710
365		1.7 x 10 ⁻⁷	94	3	705
370					700
375		0	97	0	695

SYMBOLS



DESCRIPTIONS

SANDSTONE AND SILTSTONE LESS THAN 10% FROM 313.4' TO 315.8'
 SANDSTONE 50% AND SILTSTONE 10% FROM 315.8' TO 318.9'
 SANDSTONE AND SILTSTONE LESS THAN 10% FROM 318.9' TO 354.0'

VERTICAL CLAY-FILLED FRACTURE FROM 326.0' TO 327.0'

WESTON MEMBER
 SHALE; MEDIUM DARK GRAY; SLIGHTLY CARBONACEOUS; THINLY LAMINATED.

VERTICAL FRACTURE FROM 356.8' TO 357.2'
 .1' CARBONACEOUS SHALE LAYER AT 358.8'
 .25' CARBONACEOUS SHALE LAYER AT 361.2'

STRATIGRAPHIC NOMENCLATURE
 STRANGER FORMATION
 DOUGLAS GROUP

(BORING CONTINUED)

**WOLF CREEK
 UPDATED SAFETY ANALYSIS REPORT**

Figure 2.5-34h (Sheet 5 of 6)
 Log of Boring B-8

Rev. 0

BORING B-8 CONT.

DEPTH (FEET)	LABORATORY TEST DATA	PERMEABILITY <small>CM./SEC.</small>	PERCENT RECOVERED	R.O.D.	ELEVATION (FEET)
375					690
380		0			685
385			97	6	680
390					675
395			91	43	670
400					665
405			100	61	660
410					

SYMBOLS



DESCRIPTIONS

.15' BROKEN ZONE AT 376.5'
.2' BROKEN ZONE AT 377.6'

BROKEN AND CLAYEY FROM 389.5' TO 393.1'

SOUTH BEND MEMBER

LIMESTONE: LIGHT GRAY; FINE-GRAINED; FOSSILIFEROUS; THIN TO THICK BEDDED; SANDY IN BASAL 1.4'.
VERTICAL CALCITE-HEALED FRACTURES FROM 393.5' TO 394.7' AND FROM 395.2' TO 396.8'

ROCK LAKE MEMBER

SHALE: MEDIUM DARK GRAY; CALCAREOUS; THINLY LAMINATED; INTERBEDDED WITH LIMESTONE: LIGHT GRAY; FINE-GRAINED; LOCALLY VERY SANDY; LAMINATED TO MEDIUM BEDDED.
SHALE 70% FROM 397.9' TO 401.5'

LIMESTONE 70% FROM 401.5' TO 403.1'
VERY SANDY FROM 402.3' TO 403.1'

STONER MEMBER

LIMESTONE: LIGHT GRAY TO VERY LIGHT GRAY; FINE-GRAINED; OCCASIONAL GREENISH-GRAY SHALE PARTINGS; THIN TO THICK BEDDED.

BORING COMPLETED AT 405.1 FEET ON 6-11-73.
CASING USED TO A DEPTH OF 15.0 FEET.
GROUNDWATER LEVEL RECORDED AT 20.0 FEET ON 6-25-73.

THIRD PIEZOMETER INSTALLED AT AN INTERVAL FROM 5.0 FEET TO 17.0 FEET ON 7-31-73.
SECOND PIEZOMETER INSTALLED AT AN INTERVAL FROM 22.0 FEET TO 34.0 FEET ON 7-31-73.
FIRST PIEZOMETER INSTALLED AT AN INTERVAL FROM 44.0 FEET TO 64.0 FEET ON 7-31-73.
PIEZOMETER READINGS ARE PRESENTED ON TABLE 2.4-29.

STRATIGRAPHIC NOMENCLATURE	
STRANGER FORMATION	DOUGLAS GROUP
STANTON FORMATION	LANSING GROUP

Rev. 0

**WOLF CREEK
UPDATED SAFETY ANALYSIS REPORT**

Figure 2.5-34h (Sheet 6 of 6)

Log of Boring B-8

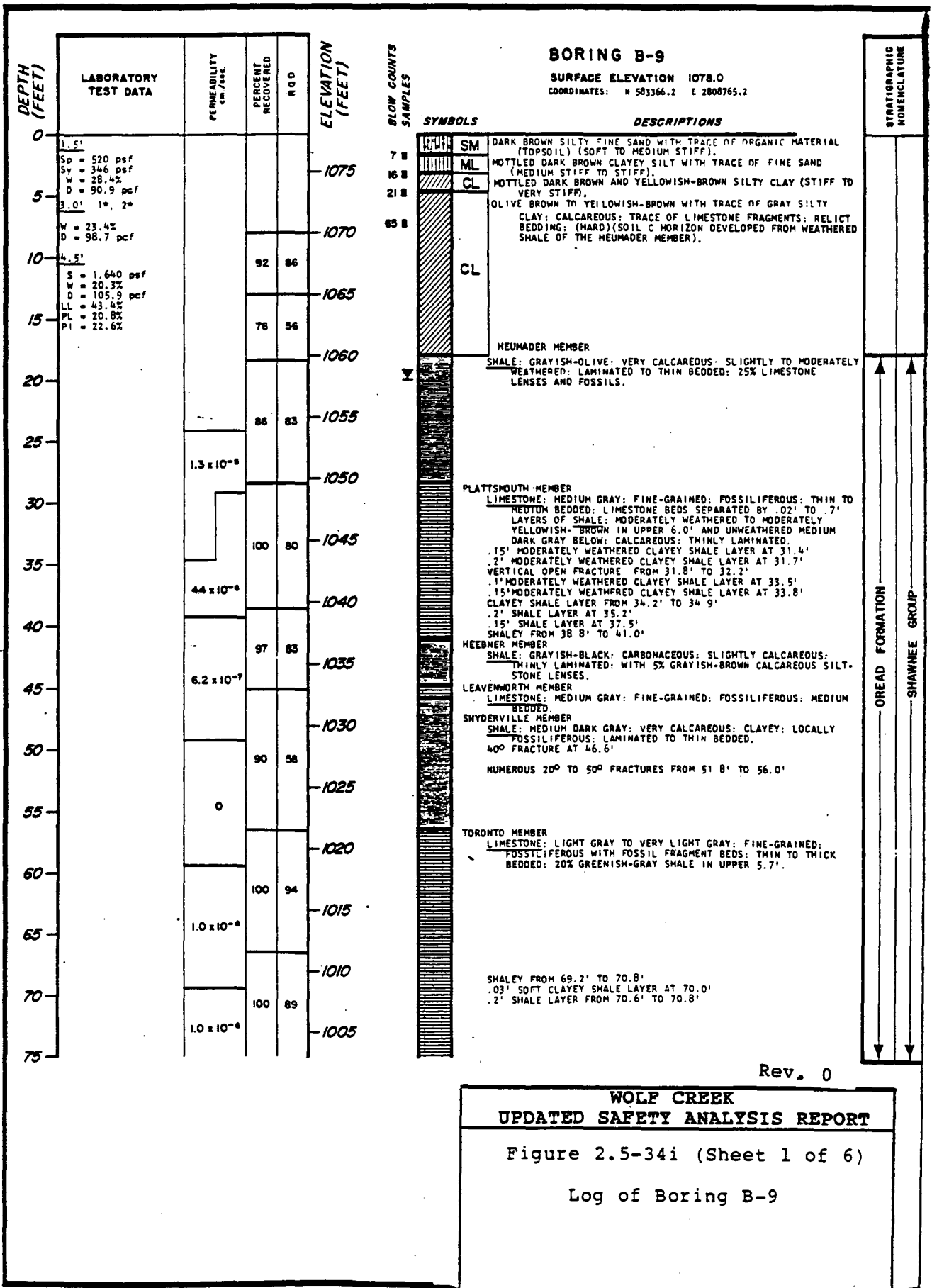

BORING B-9 CONT.

DEPTH (FEET)	LABORATORY TEST DATA	PERMEABILITY cm./100 ft.	PERCENT RECOVERED	RQD	ELEVATION (FEET)
75					1000
80		1.0×10^{-6}	100	66	995
85		0			990
90			100	68	985
95		0			980
100			100	79	975
105		0			970
110			100	78	965
115		0			960
120			96	68	955
125		2.5×10^{-7}			950
130			100	44	945
135		1.2×10^{-6}			940
140			100	69	935
145					930
150			99	89	

SYMBOLS



DESCRIPTIONS

SHALE: MEDIUM TO DARK GRAY; LOCALLY SOFT AND CLAYEY; THINLY LAMINATED; INTERBEDDED WITH SANDSTONE; LIGHT GRAY; FINE-GRAINED; LOCALLY CALCAREOUS; LAMINATED TO THIN BEDDED.
 100% SOFT CLAYEY SHALE FROM 75.6' TO 79.0'
 SANDSTONE 20% TO 40% FROM 79.0' TO 94.1'
 NUMEROUS SOFT CLAYEY SHALE LAYERS FROM 80.4' TO 85.9'

BROKEN ZONE FROM 86.5' TO 86.7'

SANDSTONE LESS THAN 10% FROM 94.1' TO 96.3'

WILLIAMSBURG COAL BED
 COAL: BLACK; SHALEY; THINLY LAMINATED TO THIN BEDDED.
 SHALE: GREENISH-GRAY; CLAYEY; CALCAREOUS; LAMINATED TO THIN BEDDED; NUMEROUS LOW ANGLE FRACTURES.
 AMAZONIA MEMBER
 LIMESTONE: GREENISH-GRAY; VERY SHALEY; FOSSILIFEROUS; THIN BEDDED.
 IRELAND MEMBER
 SHALE: GREENISH-GRAY; CLAYEY; OCCASIONAL LIMESTONE NODULES; CALCAREOUS IN UPPER 1.0'; THINLY LAMINATED TO THIN BEDDED.
 SHALE: MEDIUM DARK GRAY; LOCALLY CLAYEY; THINLY LAMINATED; INTERBEDDED WITH SANDSTONE; LIGHT GRAY; FINE-GRAINED; LOCALLY CALCAREOUS; LAMINATED TO THIN BEDDED; AND SILTSTONE; MEDIUM GRAY; MICACEOUS; LAMINATED TO THIN BEDDED.
 NUMEROUS SOFT CLAYEY SHALE LAYERS FROM 104.2' TO 106.2'
 SANDSTONE 5% AND SILTSTONE 20% FROM 104.2' TO 107.7'
 SANDSTONE 40% AND SILTSTONE 30% FROM 107.7' TO 109.0'
 FRACTURED CLAYEY ZONE FROM 108.0' TO 108.4'
 SANDSTONE 10% AND SILTSTONE 30% FROM 109.0' TO 121.0'
 CLAYEY BROKEN ZONE FROM 109.0' TO 109.4'

SOFT CLAYEY ZONE FROM 114.9' TO 115.5'

COAL: BLACK; SHALEY; LAMINATED TO MEDIUM BEDDED.
 SHALE: MEDIUM GRAY; CLAYEY; THINLY LAMINATED; CARBONACEOUS IN UPPER 0.3'
 CLAYEY BROKEN ZONE FROM 122.2' TO 122.6'

SHALE: MEDIUM DARK GRAY; THINLY LAMINATED; INTERBEDDED WITH SANDSTONE; LIGHT GRAY; FINE-GRAINED; LAMINATED TO MEDIUM BEDDED; AND SILTSTONE; MEDIUM GRAY; MICACEOUS; LAMINATED TO MEDIUM BEDDED.
 SANDSTONE 20% AND SILTSTONE 40% FROM 125.2' TO 128.2'
 SANDSTONE 75% AND SILTSTONE 15% FROM 128.2' TO 132.6'

BROKEN ZONE FROM 131.5' TO 131.8'

VERTICAL FRACTURE FROM 132.2' TO 132.4'
 SANDSTONE 50% AND SILTSTONE 30% FROM 132.6' TO 142.2'

60° FRACTURE AT 132.7'
 45° FRACTURE AT 135.0'

SANDSTONE 20% AND SILTSTONE 50% FROM 142.2' TO 146.4'

SANDSTONE 10% AND SILTSTONE 30% FROM 146.4' TO 157.8'
 .05' CARBONACEOUS SHALE LAYER AT 147.9'

STRATIGRAPHIC NOMENCLATURE

LAWRENCE FORMATION

DOUGLAS GROUP

WOLF CREEK
UPDATED SAFETY ANALYSIS REPORT

Figure 2.5-34i (Sheet 2 of 6)

Log of Boring B-9

Rev. 0

BORING B-9 CONT.

DEPTH (FEET)	LABORATORY TEST DATA	PERMEABILITY cm./sec.	PERCENT RECOVERED	R Q D	ELEVATION (FEET)
150					925
155					920
160			100	77	915
165					910
170			100	100	905
175		0			900
180			99	79	895
185					890
190			100	100	885
195					880
200			91	37	875
205			100	93	870
210					865
215			98	44	860
220					855
225		0	100	75	

SYMBOLS



DESCRIPTIONS

10% SANDSTONE AND 90% SILTSTONE FROM 157.8' TO 160.0'

SANDSTONE 10% AND SILTSTONE 30% FROM 160.0' TO 167.9'
 45° FRACTURE AT 160.4'
 INTERSECTING 60° CLAY-LINED FRACTURES AT 160.7'
 70° FRACTURE AT 162.0'

CLAYEY BROKEN ZONE FROM 164.5' TO 165.0'

SILTSTONE 100% FROM 167.9' TO 171.8'

SANDSTONE 10% AND SILTSTONE 30% FROM 171.8' TO 175.8'

ROBBINS MEMBER
 SHALE; MEDIUM DARK GRAY; SLIGHTLY CARBONACEOUS; THINLY LAMINATED.
 60° FRACTURE AT 177.0'
 10° FRACTURE AT 178.5'
 .05' SOFT CLAYEY SHALE LAYER AT 180.0'
 20° FRACTURE AT 180.3'
 NUMEROUS SOFT CLAYEY SHALE LAYERS FROM 181.6' TO 185.2'

60° FRACTURE AT 192.3'

BROKEN ZONES FROM 198.1' TO 198.8' AND FROM 199.6' TO 200.2'

VERTICAL FRACTURE FROM 209.1' TO 209.6'

BROKEN ZONE FROM 211.6' TO 213.1'

BROKEN ZONE FROM 214.1' TO 214.6'
 VERTICAL FRACTURE FROM 214.9' TO 215.1'

VERTICAL FRACTURE FROM 216.1' TO 216.8'
 45° FRACTURE AT 218.1'

60° FRACTURE AT 220.4'

STRATIGRAPHIC NOMENCLATURE

LAWRENCE FORMATION

DOUGLAS GROUP

**WOLF CREEK
 UPDATED SAFETY ANALYSIS REPORT**

Figure 2.5-34i (Sheet 3 of 6)
 Log of Boring B-9

Rev. 0

BORING B-9 CONT.

DEPTH (FEET)	LABORATORY TEST DATA	PERMEABILITY cm./sec.	PERCENT RECOVERED	RQD	ELEVATION (FEET)
225		0			850
230			100	100	845
235			100	89	840
240			94	94	835
245			100	96	830
250					825
255			100	100	820
260					815
265		0	97	88	810
270					805
275		0	100	73	800
280					795
285		7.5×10^{-8}	97	86	790
290	291.8' 5"				785
295	292.3' Q = 2,980 psi E = 1,017,000 psi	1.1×10^{-7}	100	75	780
300					

SYMBOLS



DESCRIPTIONS

LIMESTONE: LIGHT OLIVE GRAY; VERY SHALEY; FOSSILIFEROUS; MEDIUM BEDDED.
 SHALE: MEDIUM DARK GRAY; SLIGHTLY CARBONACEOUS; OCCASIONAL PALE YELLOWISH-BROWN DOLOMITIC CONCRETIONS; THINLY LAMINATED.

SHALE: MEDIUM DARK GRAY; VERY CALCAREOUS; FOSSILIFEROUS; THIN TO MEDIUM BEDDED.
 SHALE: GRAYISH-BLACK; CARBONACEOUS; THINLY LAMINATED; OCCASIONAL MEDIUM GRAY CALCAREOUS SILTSTONE LENSE IN UPPER 1.2 FEET.

HASKELL MEMBER
 LIMESTONE: MEDIUM LIGHT GRAY; FINE-GRAINED; FOSSILIFEROUS; THIN TO THICK BEDDED.

VINLAND MEMBER
 SHALE: MEDIUM DARK GRAY; VERY CALCAREOUS; FOSSILIFEROUS; THIN TO MEDIUM BEDDED; 30% LIMESTONE FOSSILS.
 COAL: BLACK; SHALEY; LAMINATED TO THIN BEDDED.
 SHALE: MEDIUM GRAY TO DARK GRAY; LOCALLY CLAYEY; LOCALLY CARBONACEOUS; LOCALLY CALCAREOUS; LAMINATED TO THIN BEDDED.
 FRACTURED CLAYEY ZONE FROM 271.2' TO 271.6'
 SHALE BECOMES INTERBEDDED WITH 10% LAMINAE OF VERY FINE-GRAINED SANDSTONE FROM 273.0' TO 275.8'
 BROKEN CLAYEY LAYERS AT 276.0', 276.9', 277.6', 278.5' AND 279.1'

BROKEN ZONE FROM 280.0' TO 280.7'
 SILTSTONE: GREENISH-GRAY; SANDY; CALCAREOUS; LAMINATED TO THICK BEDDED; INTERBEDDED WITH SHALE; GREENISH-GRAY; SILTY THINLY LAMINATED; AND SANDSTONE; MEDIUM GRAY; FINE- TO MEDIUM-GRAINED WITH 50% LIMESTONE FOSSIL FRAGMENTS; SILTY; LAMINATED TO MEDIUM BEDDED.
 SILTSTONE 90% AND SANDSTONE 10% FROM 281.2' TO 283.9'
 SILTSTONE 50% AND SHALE 50% FROM 283.9' TO 285.2'
 SANDY SILTSTONE 100% FROM 285.2' TO 287.0'
 SILTSTONE 50% AND SANDSTONE 50% FROM 287.0' TO 291.3'
 SILTSTONE 90% AND SANDSTONE 10% FROM 291.3' TO 294.3'

LIMESTONE: MEDIUM GRAY; 80% FUSULINID FOSSILS; SHALEY; THIN TO THICK BEDDED; LIMESTONE BEDS SEPARATED BY .02' TO .6' LAYERS OF SILTSTONE; MEDIUM GRAY; SHALEY; SANDY; CARBONACEOUS; CALCAREOUS; LAMINATED TO MEDIUM BEDDED.
 SILTSTONE 50% FROM 294.3' TO 296.2'
 SANDY SILTSTONE LAYER FROM 296.9' TO 297.5'
 .15' COAL LAYER AT 297.8'
 .2' SANDY SILTSTONE LAYER AT 299.4'

STRATIGRAPHIC NOMENCLATURE

LAWRENCE FORMATION

DOUGLAS GROUP

STRANGER FORMATION

WOLF CREEK
 UPDATED SAFETY ANALYSIS REPORT

Figure 2.5-34i (Sheet 4 of 6)

Log of Boring B-9

Rev. 0

BORING B-9 CONT.

DEPTH (FEET)	LABORATORY TEST DATA	PERMEABILITY cm ² /sec.	PERCENT RECOVERED	R.O.D.	ELEVATION (FEET)
300					775
305		L2 x 10"	100	67	770
310					765
315	312.4' Q = 1,670 psi E = 368,000 psi		100	46	760
320					755
325		0	100	65	750
330					745
335	338.2' 5*		100	100	740
340					735
345			100	100	730
350					725
355			99	91	720
360					715
365			100	100	710
370			100	70	705
375					

SYMBOLS



DESCRIPTIONS

.2' SANDY SILTSTONE LAYER AT 300.2'

.1' SILTSTONE LAYER AT 304.5'

TONGANOXIE MEMBER
 SHALE: MEDIUM DARK GRAY; THINLY LAMINATED; INTERBEDDED WITH SANDSTONE; LIGHT GRAY; VERY FINE-GRAINED; LAMINATED TO THIN BEDDED; AND SILTSTONE; MEDIUM GRAY; MICACEOUS; LAMINATED TO THICK BEDDED.
 SANDSTONE 50% AND SILTSTONE 10% FROM 304.6' TO 305.4'
 SANDSTONE 20% AND SILTSTONE 20% FROM 305.4' TO 309.6'
 SANDSTONE 10% AND SILTSTONE 10% FROM 309.6' TO 328.9'

BROKEN ZONE WITH NUMEROUS HIGH ANGLE FRACTURES FROM 312.9' TO 314.4'
 70° FRACTURE AT 314.9'

BROKEN ZONE WITH NUMEROUS HIGH ANGLE FRACTURES FROM 318.0' TO 319.5'

SANDSTONE AND SILTSTONE LESS THAN 10% FROM 328.9' TO 362.5'

WESTON MEMBER
 SHALE: MEDIUM DARK GRAY; SLIGHTLY CARBONACEOUS; THINLY LAMINATED.

BROKEN ZONE FROM 368.2' TO 368.4'

30° FRACTURE AT 371.8'
 CLAYEY BROKEN ZONE FROM 373.1' TO 373.3'

BROKEN ZONE FROM 374.0' TO 375.0'

STRATIGRAPHIC NOMENCLATURE

STRANGER FORMATION

DOUGLAS GROUP

**WOLF CREEK
 UPDATED SAFETY ANALYSIS REPORT**

Figure 2.5-34i (Sheet 5 of 6)

Log of Boring B-9

Rev. 0

BORING B-9 CONT.

DEPTH (FEET)	LABORATORY TEST DATA	PERMEABILITY cm./sec.	PERCENT RECOVERED	ROD	ELEVATION (FEET)
375					700
380			100	0	695
385		0			690
390			99	92	685
395					680
400			100	96	675
405					

SYMBOLS



DESCRIPTIONS

NUMEROUS SOFT CLAYEY SHALE LAMINAE FROM 375.7' TO 385.3'

SOUTH BEND MEMBER

LIMESTONE; MEDIUM LIGHT GRAY; FINE-GRAINED; FOSSILIFEROUS; MEDIUM TO THICK BEDDED; SANDY IN BASAL 1.0'. SHALEY FROM 398.6' TO 399.0'

ROCK LAKE MEMBER

SHALE; MEDIUM DARK GRAY; CALCAREOUS; THINLY LAMINATED; INTERBEDDED WITH 30% LIMESTONE; LIGHT GRAY; LOCALLY SANDY; LAMINATED TO THIN BEDDED.

BORING COMPLETED AT 402.2 FEET ON 6-18-73. CASING USED TO A DEPTH OF 8.0 FEET. GROUNDWATER LEVEL RECORDED AT 20.0 FEET ON 6-27-73.

THIRD PIEZOMETER INSTALLED AT AN INTERVAL FROM 6.0 FEET TO 21.0 FEET ON 7-5-73. SECOND PIEZOMETER INSTALLED AT AN INTERVAL FROM 28.0 FEET TO 40.0 FEET ON 7-5-73. FIRST PIEZOMETER INSTALLED AT AN INTERVAL FROM 56.0 FEET TO 75.0 FEET ON 7-5-73. PIEZOMETER READINGS ARE PRESENTED ON TABLE 2.4-29.

STRATIGRAPHIC NOMENCLATURE	
STRANGER FORMATION	DOUGLAS GROUP
STANTON FORMATION	LANSING GROUP

Rev. 0

**WOLF CREEK
UPDATED SAFETY ANALYSIS REPORT**

Figure 2.5-34i (Sheet 6 of 6)

Log of Boring B-9

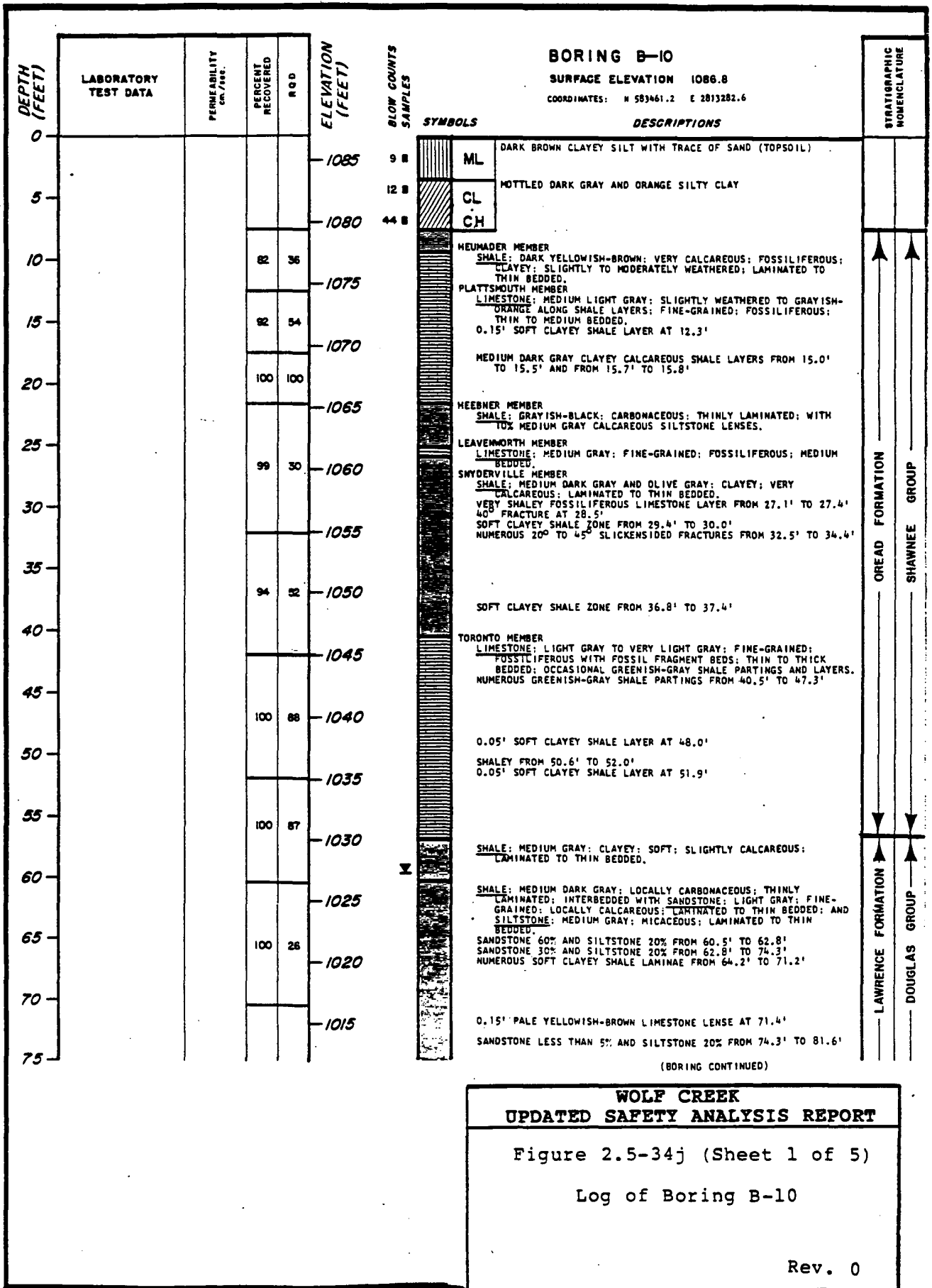

BORING B-10 CONT'D

DEPTH (FEET)	LABORATORY TEST DATA	PERMEABILITY (ML/INCH)	PERCENT RECOVERED	R.O.D.	ELEVATION (FEET)
75			100	86	1010
80					1005
85			100	88	1000
90					995
95			100	75	990
100					985
105			100	45	980
110					975
115			97	12	970
120					965
125			100	86	960
130					955
135			99	99	950
140					945
145			95	51	940
150					

SYMBOLS



DESCRIPTIONS

WILLIAMSURG COAL BED
 COAL: BLACK; SHALEY; LAMINATED TO THIN BEDDED.
 SHALE: GRAYISH-BLACK; CARBONACEOUS; CLAYEY; LAMINATED.

AMAZONTA MEMBER
 SHALE: GREENISH-GRAY; CLAYEY; VERY CALCAREOUS; FOSSILIFEROUS;
 LAMINATED TO THIN BEDDED; OCCASIONAL SMALL LIMESTONE
 NODULES.

IRELAND MEMBER
 SHALE: GREENISH-GRAY GRADING TO MEDIUM DARK GRAY BELOW 86.5';
 LOCALLY CARBONACEOUS; THINLY LAMINATED; INTERBEDDED WITH
 SANDSTONE: LIGHT GRAY; FINE-GRAINED; LOCALLY CALCAREOUS;
 LAMINATED; AND SILTSTONE: MEDIUM GRAY; MICACEOUS;
 LAMINATED TO THIN BEDDED.

SANDSTONE 30% AND SILTSTONE 20% FROM 84.5' TO 90.9'
 CLAYEY BROKEN ZONE FROM 89.1' TO 89.6'
 SANDSTONE 10% AND SILTSTONE 40% FROM 90.9' TO 97.4'
 OCCASIONAL SOFT CLAYEY SHALE LAMINAE FROM 91.2' TO 92.6'
 NUMEROUS SOFT CLAYEY SHALE LAYERS FROM 95.2' TO 96.4'

SANDSTONE 30% AND SILTSTONE 30% FROM 97.4' TO 99.3'
 40° FRACTURE AT 97.7'
 SANDSTONE 5% AND SILTSTONE 40% FROM 99.3' TO 101.4'
 20° SLICKENSIDED FRACTURE AT 100.4'
 FOSSILIFEROUS CALCAREOUS SHALE FROM 101.3' TO 101.4'
 CLAYEY BROKEN ZONE FROM 101.3' TO 101.4'

COAL: BLACK; SHALEY; LAMINATED TO MEDIUM BEDDED.
 SHALE: MEDIUM DARK GRAY; THINLY LAMINATED; INTERBEDDED WITH
 SANDSTONE: LIGHT GRAY; FINE-GRAINED; LOCALLY CALCAREOUS;
 LAMINATED TO THIN BEDDED; AND SILTSTONE: MEDIUM GRAY;
 MICACEOUS; LAMINATED TO MEDIUM BEDDED.

SANDSTONE 10% AND SILTSTONE 50% FROM 102.2' TO 107.0'
 BROKEN ZONE FROM 104.2' TO 104.5'
 60° FRACTURE AT 104.8'
 VERTICAL FRACTURE FROM 104.9' TO 105.4'
 BROKEN ZONE ALONG VERTICAL FRACTURE FROM 105.7' TO 106.3'
 SANDSTONE 60% AND SILTSTONE 20% FROM 107.0' TO 110.8'
 OCCASIONAL SOFT CLAYEY SHALE LAMINAE FROM 110.9' TO 120.0'
 SANDSTONE 30% AND SILTSTONE 20% FROM 110.8' TO 114.2'

SANDSTONE 50% AND SILTSTONE 20% FROM 114.2' TO 115.7'
 SANDSTONE 30% AND SILTSTONE 40% FROM 115.7' TO 117.4'

SANDSTONE 30% AND SILTSTONE 20% FROM 117.4' TO 125.0'

DISTORTED SANDSTONE 30% AND SILTSTONE 70% FROM 125.0' TO
 126.9'
 SANDSTONE 25% AND SHALEY SILTSTONE 60% FROM 126.9' TO 139.0'

SANDSTONE LESS THAN 5% AND SHALEY SILTSTONE 90% FROM 139.0'
 TO 155.0'

SANDSTONE GRADES OUT AT 146.0'

STRATIGRAPHIC NOMENCLATURE

LAWRENCE FORMATION
 DOUGLAS GROUP

(BORING CONTINUED)

WOLF CREEK
 UPDATED SAFETY ANALYSIS REPORT

Figure 2.5-34j (Sheet 2 of 5)

Log of Boring B-10

Rev. 0

BORING B-10 CONT'D

DEPTH (FEET)	LABORATORY TEST DATA	PERMEABILITY CM./SEC.	PERCENT RECOVERED	R Q D	ELEVATION (FEET)
150					935
155			90	76	930
160					925
165			95	86	920
170			78	43	915
175					910
180			100	47	905
185					900
190			100	0	895
195			100	77	890
200					885
205			70	57	880
210					875
215			97	81	870
220					865
225			94	12	

SYMBOLS

DESCRIPTIONS



30° FRACTURE AT 151.4'

SHALEY SILTSTONE 50% AND SHALE 50% FROM 155.0' TO 186.6'

OCCASIONAL SOFT CLAYEY SHALE LAYERS FROM 166.5' TO 171.6'

0.15' BROKEN ZONE AT 177.1'

0.2' CLAYEY BROKEN ZONE AT 179.4'

VERTICAL FRACTURES FROM 182.4' TO 182.9' AND FROM 183.5' TO 184.3'

OCCASIONAL SOFT CLAYEY SHALE LAMINAE FROM 184.7' TO 195.6'

ROBBINS MEMBER
SHALE; DARK GRAY; SLIGHTLY CARBONACEOUS; THINLY LAMINATED.

LIMESTONE; LIGHT OLIVE GRAY; VERY SHALEY; FOSSILIFEROUS; LAMINATED TO MEDIUM BEDDED.
SHALE; DARK GRAY; SLIGHTLY CARBONACEOUS; THINLY LAMINATED; OCCASIONAL 0.05' TO 0.1' PALE YELLOWISH-BROWN DOLOMITIC CONCRETIONS.

VERTICAL FRACTURE FROM 206.8' TO 208.9'

NUMEROUS SOFT CLAYEY SHALE LAMINAE FROM 217.5' TO 218.8'

NUMEROUS SOFT CLAYEY SHALE LAMINAE FROM 220.0' TO 227.2'

STRATIGRAPHIC NOMENCLATURE

LAWRENCE FORMATION

DOUGLAS GROUP

Rev. 0

WOLF CREEK
UPDATED SAFETY ANALYSIS REPORT

Figure 2.5-34j (Sheet 3 of 5)

Log of Boring B-10

BORING B-10 CONT'D

DEPTH (FEET)	LABORATORY TEST DATA	PERMEABILITY cm./sec.	PERCENT RECOVERED	ROD	ELEVATION (FEET)
225					860
230					855
235			99	68	850
240					845
245			97	22	840
250					835
255					830
260					825
265					820
270					815
275			100	62	810
280					805
285					800
290					795
295			100	100	790
300					790

SYMBOLS

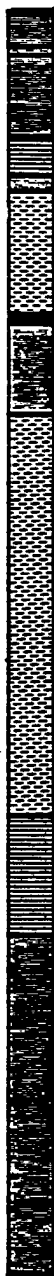

DESCRIPTIONS

SHALE: MEDIUM DARK GRAY; VERY CALCAREOUS; FOSSILIFEROUS; THIN BEDED.
 SHALE: GRAYISH-BLACK; CARBONACEOUS; SLIGHTLY CALCAREOUS; THINLY LAMINATED.

HASKELL MEMBER
 LIMESTONE: MEDIUM LIGHT GRAY; FINE-GRAINED; FOSSILIFEROUS; THIN TO MEDIUM BEDED.

VINLAND MEMBER
 SHALE: MEDIUM DARK GRAY; VERY CALCAREOUS; FOSSILIFEROUS; THIN BEDED.
 COAL: BLACK; SHALEY; THIN BEDED.
 SILTSTONE: MEDIUM DARK GRAY; THIN BEDED; INTERBEDDED WITH SANDSTONE; LIGHT GRAY; FINE-GRAINED; LOCALLY CALCAREOUS; CONTRASTED TO THIN BEDED.
 SANDSTONE 30% FROM 235.6' TO 239.0'
 SANDSTONE 60% FROM 239.0' TO 243.0'

COAL: BLACK; SHALEY; LAMINATED TO THIN BEDED.
 SHALE: MEDIUM DARK GRAY; LOCALLY CARBONACEOUS; CLAYEY; SILTY; LAMINATED TO THIN BEDED; OCCASIONAL YELLOWISH-GRAY DOLOMITIC CONCRETIONS.

SILTSTONE: MEDIUM GRAY; SILTY; SHALEY; LAMINATED TO MEDIUM BEDED; INTERBEDDED WITH SANDSTONE; LIGHT OLIVE GRAY; FINE-GRAINED; CALCAREOUS; SILTY; LAMINATED TO MEDIUM BEDED.
 30% SOFT CLAYEY SHALE LAYERS FROM 249.0' TO 255.0'
 SANDSTONE 10% FROM 249.0' TO 255.0'

SILTY SANDSTONE 60% FROM 255.0' TO 272.7'

NUMEROUS FOSSIL FRAGMENTS BECOME MIXED WITH SANDSTONE BELOW 268.0'

LIMESTONE: LIGHT OLIVE GRAY; 60% FUSILINID FOSSILS; 10% ROUNDED LIMESTONE PEBBLES; SHALEY; THIN TO THICK BEDED; INTERBEDDED WITH BEDS OF INTERLAYERED SANDSTONE AND SILTSTONE AS DESCRIBED ABOVE.
 LIMESTONE BEDS FROM 272.7' TO 273.2', 274.0' TO 275.2', 275.7' TO 278.2' AND FROM 278.7' TO 279.4'
 0.05' COAL LAYER AT 276.8'

TONGANOXIE MEMBER
 SHALE: MEDIUM DARK GRAY; THINLY LAMINATED; INTERBEDDED WITH SANDSTONE; LIGHT GRAY; FINE-GRAINED; LOCALLY CALCAREOUS; AND SILTSTONE; MEDIUM GRAY; MICACEOUS; LAMINATED TO MEDIUM BEDED.
 SANDSTONE 30% AND SILTSTONE 30% FROM 279.4' TO 291.0'
 OCCASIONAL SOFT CLAYEY SHALE LAMINAE FROM 283.7' TO 285.6'

SANDSTONE 10% AND SILTSTONE 25% FROM 291.0' TO 308.8'

STRATIGRAPHIC NOMENCLATURE
LAWRENCE FORMATION
DOUGLAS GROUP
STRANGER FORMATION

Rev. 0

WOLF CREEK
UPDATED SAFETY ANALYSIS REPORT

Figure 2.5-34j (Sheet 4 of 5)

Log of Boring B-10

BORING B-10 CONT'D

DEPTH (FEET)	LABORATORY TEST DATA	PERMEABILITY cm./sec.	PERCENT RECOVERED	ROD	ELEVATION (FEET)
300					785
305			100	100	780
310			97	61	775
315					770
320			93	0	765
325					760
330					

SYMBOLS

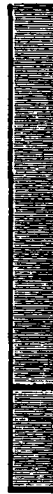

DESCRIPTIONS

0.15' CLAYEY BROKEN ZONE AT 302.3'

SANDSTONE 5% AND SILTSTONE 15% FROM 308.8' TO 321.3'

VERTICAL FRACTURE FROM 314.0' TO 315.0'

CARBONACEOUS SHALE LAYER FROM 316.5' TO 316.8'

NUMEROUS SOFT CLAYEY SHALE LAMINAE. FROM 317.9' TO 326.9'

WESTON MEMBER
SHALE; MEDIUM DARK GRAY; THINLY LAMINATED.

STRATIGRAPHIC NOMENCLATURE
STRANGER FORMATION
DOUGLAS GROUP

BORING COMPLETED AT 326.9 FEET ON 7-3-73.
CASING USED TO A DEPTH OF 10.0 FEET.
GROUNDWATER LEVEL RECORDED AT 59.6 FEET ON 6-27-73.
SECOND PIEZOMETER INSTALLED AT AN INTERVAL FROM 5.0 FEET TO 28.0 FEET ON 7-26-73.
FIRST PIEZOMETER INSTALLED AT AN INTERVAL FROM 38.0 FEET TO 57.0 FEET ON 7-26-73.
PIEZOMETER READINGS ARE PRESENTED ON TABLE 2.4-29.

Rev. 0

**WOLF CREEK
UPDATED SAFETY ANALYSIS REPORT**

Figure 2.5-34j (Sheet 5 of 5)

Log of Boring B-10

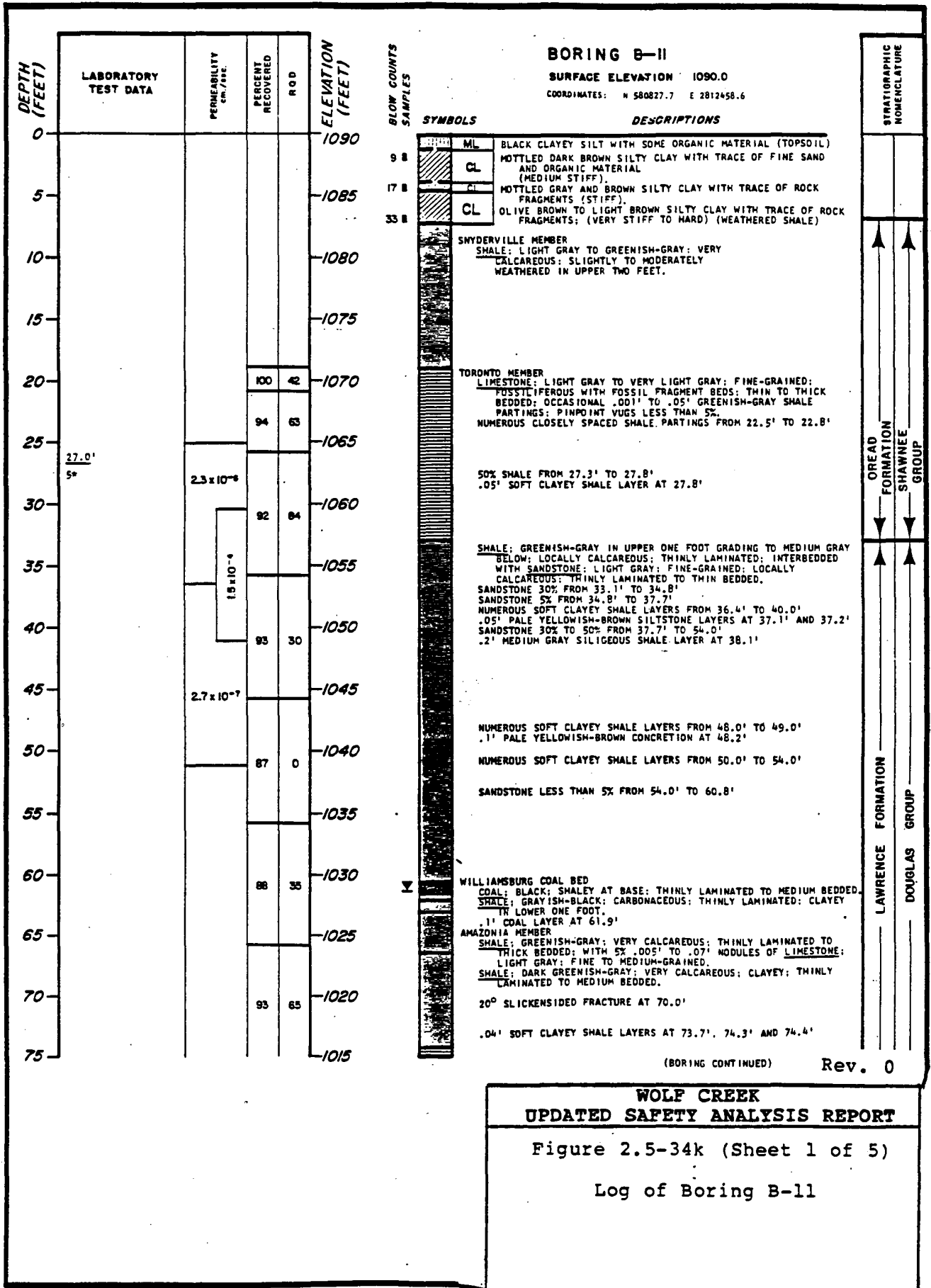

BORING B-II CONT'D

DEPTH (FEET)	LABORATORY TEST DATA	PERMEABILITY $cm/100g$	PERCENT RECOVERED	RQD	ELEVATION (FEET)
75					1015
80			98	70	1010
85					1005
90			97	37	1000
95		9.2×10^{-6}			995
100			100	54	990
105					985
110			100	30	980
115					975
120			100	16	970
125					965
130			42	42	960
135			42	8	955
140			98	68	950
145			95	30	945
150					940

140.4'
 Q = 1,950 psi
 E = 1,310,000 psi
 141.2'
 5"

SYMBOLS



DESCRIPTIONS

MEDIUM GRAY CONGLOMERATIC LIMESTONE FROM 74.4' TO 74.8'
 IRELAND MEMBER
 SHALE: MEDIUM GRAY; CLAYEY; THINLY LAMINATED TO THIN BEDDED WITH NUMEROUS SOFT CLAYEY SHALE LAYERS.

SHALE: MEDIUM GRAY; THINLY LAMINATED; INTERBEDDED WITH .001' TO .6' LAYERS OF SANDSTONE; LIGHT GRAY: FINE-GRAINED; IRREGULARLY BEDDED WITH DISTORTED BEDDING; LOCALLY CALCAREOUS.
 SANDSTONE 5% TO 20% FROM 80.9' TO 95.4'
 .2' SANDSTONE LAYER AT 84.8'
 .15' SANDSTONE LAYER AT 85.2'

SANDSTONE AND SHALE BECOMES INTERBEDDED WITH SILTSTONE: MEDIUM GRAY; SANDY; MICACEOUS; THIN TO THICK BEDDED. SILTSTONE 80% AND SANDSTONE 20% FROM 95.4' TO 98.1'
 SILTSTONE 20% AND SANDSTONE 20% FROM 98.1' TO 104.1'

SILTSTONE 60% AND SANDSTONE 20% FROM 104.1' TO 109.4'

.6' CALCAREOUS SANDSTONE LAYER FROM 108.0' TO 108.6'
 SILTSTONE 20% AND SANDSTONE 20% FROM 109.4' TO 118.2'

NUMEROUS SOFT CLAYEY SHALE LAYERS SPACED .01' TO .1' APART FROM 116.6' TO 124.1'

SILTSTONE 10% AND SANDSTONE LESS THAN 5% FROM 118.2' TO 126.0'

ROBBINS MEMBER
 SHALE: MEDIUM GRAY TO DARK GRAY; SLIGHTLY CARBONACEOUS; THINLY LAMINATED.

.1' SOFT CLAYEY SHALE LAYER AT 144.6'

STRATIGRAPHIC NOMENCLATURE

LAWRENCE FORMATION
 DOUGLAS GROUP

Rev. 0

WOLF CREEK
 UPDATED SAFETY ANALYSIS REPORT

Figure 2.5-34k (Sheet 2 of 5)

Log of Boring B-11

BORING B-II CONT'D

DEPTH (FEET)	LABORATORY TEST DATA	PERMEABILITY cm./SEC.	PERCENT RECOVERED	ROD	ELEVATION (FEET)
150					940
155			80	59	935
160			100	100	930
165			90	90	925
170			82	25	920
175			87	18	915
180			99	80	910
185		13×10^{-7}	100	25	905
190			100	40	800
195		13×10^{-6}	92	38	895
200					890
205		8.6×10^{-4}			885
210			18	2	880
215		8.6×10^{-4}			875
220					870
225		4.6×10^{-4}			865

SYMBOLS



DESCRIPTIONS

VERTICAL FRACTURE FROM 150.2' TO 151.0'

.2' SOFT CLAYEY SHALE LAYER AT 153.7'

SOFT CLAYEY BROKEN ZONE FROM 167.5' TO 168.0'

SHALE; LIGHT OLIVE GRAY; VERY CALCAREOUS; FOSSILIFEROUS; MEDIUM BEDDED.

SHALE; MEDIUM TO DARK GRAY; SLIGHTLY CARBONACEOUS; THINLY LAMINATED; OCCASIONAL .03' TO .06' OLIVE GRAY DOLOMITIC CONCRETIONS.

HASKELL MEMBER
LIMESTONE; LIGHT GRAY; FINE-GRAINED; FOSSILIFEROUS; THIN TO MEDIUM BEDDED; SHALEY AT BASE.

VINLAND MEMBER
SHALE; MEDIUM GRAY; SLIGHTLY CALCAREOUS; THINLY LAMINATED; MICACEOUS; FOSSILIFEROUS IN UPPER 0.3'; INTERBEDDED WITH SANDSTONE; LIGHT GRAY; FINE-GRAINED; CALCAREOUS; THINLY LAMINATED TO THIN BEDDED.

SANDSTONE 5% FROM 182.8' TO 184.0'

SANDSTONE 40% FROM 184.0' TO 185.5'

SANDSTONE 5% FROM 185.5' TO 188.3'

SANDSTONE 60% TO 80% FROM 188.3' TO 193.7'

VERTICAL FRACTURE FROM 189.0' TO 189.4'

DARK GRAY SHALE LAYER FROM 190.2' TO 190.7'

CLAYEY BROKEN ZONE FROM 193.4' TO 193.7'

SANDSTONE; MEDIUM LIGHT GRAY; FINE-GRAINED; SLIGHTLY CALCAREOUS; MICACEOUS; THIN TO THICK BEDDED; OCCASIONAL DARK GRAY SHALE PARTINGS.

LOW CORE RECOVERY VALUES FROM 199.5' TO 231.0' ARE A RESULT OF DRILLING MALFUNCTION AND ARE NOT REPRESENTATIVE OF ROCK PROPERTIES

SHALE LAYER FROM 205.0' TO 207.0' INTERPRETED FROM GAMMA RAY-NEUTRON LOG



Rev. 0

WOLF CREEK
UPDATED SAFETY ANALYSIS REPORT

Figure 2.5-34k (Sheet 3 of 5)
 Log of Boring B-11

BORING B-II CONT'D

DEPTH (FEET)	LABORATORY TEST DATA	PERMEABILITY cm./sec.	PERCENT RECOVERED	ROD	ELEVATION (FEET)
225		4.6 x 10 ⁻⁶			865
230			100	100	860
235			100	96	855
240					850
245			100	100	845
250					840
255			100	33	835
260					830
265			100	86	825
270					820
275			96	67	815
280					810
285			100	91	805
290					800
295			89	32	795
300					790

SYMBOLS



DESCRIPTIONS

CONTACT INTERPRETED FROM GAMMA RAY-NEUTRON LOG

SHALE; MEDIUM TO DARK GRAY; SLIGHTLY CARBONACEOUS; LOCALLY CALCAREOUS; THINLY LAMINATED; INTERBEDDED WITH SANDSTONE; LIGHT GRAY; VERY FINE-GRAINED; SILTY; MICACEOUS; CALCAREOUS; CROSS-BEDDED; LAMINATED TO THIN BEDDED.

SANDSTONE 5% FROM 231.0' TO 234.0'
SANDSTONE 50% FROM 234.0' TO 236.1'

SANDSTONE LESS THAN 5% FROM 236.1' TO 238.0'

SANDSTONE 70% FROM 238.0' TO 241.5'

SANDSTONE LESS THAN 5% FROM 241.5' TO 243.2'

SANDSTONE; LIGHT GRAY TO LIGHT OLIVE GRAY; VERY FINE-GRAINED; CALCAREOUS WITH FOSSIL FRAGMENTS; VERY SILTY; LAMINATED TO THIN BEDDED.

LIMESTONE; LIGHT OLIVE GRAY; 90% FUSULINID FOSSILS; THIN TO THICK BEDDED; INTERBEDDED WITH .05' TO .5' BEDS OF SILTSTONE; GREENISH-GRAY; SANDY; SHALEY; CALCAREOUS; LAMINATED TO THINLY LAMINATED.

SILTSTONE BEDS FROM 247.5' TO 247.6', 247.8' TO 248.1', 248.2' TO 248.6', 249.0' TO 249.1', 249.2' TO 249.7', 251.0' TO 251.2', AND FROM 251.5' TO 252.0'

TONGANOXIE MEMBER

SHALE; MEDIUM DARK GRAY; THINLY LAMINATED; INTERBEDDED WITH SANDSTONE; LIGHT GRAY; VERY FINE-GRAINED; LAMINATED TO THIN BEDDED.

SANDSTONE LESS THAN 5% FROM 253.8' TO 262.5'
NUMEROUS 20° TO 45° FRACTURES WITH OCCASIONAL SLICKENSIDES FROM 254.5' TO 259.5'

.1' PALE YELLOWISH-BROWN CONCRETION AT 261.5'
VERTICAL FRACTURE FROM 261.7' TO 262.4'
SANDSTONE 10% TO 40% FROM 262.5' TO 267.7'

SANDSTONE LESS THAN 10% FROM 267.7' TO 279.0'

.1' BROKEN ZONES AT 274.2' AND 274.8'

SANDSTONE 40% FROM 279.0' TO 280.2'
SANDSTONE LESS THAN 10% FROM 280.2' TO 283.0'
SANDSTONE 20% TO 40% FROM 283.0' TO 287.0'

SANDSTONE LESS THAN 5% FROM 287.0' TO 301.3'

40° SLICKENSIDED FRACTURE AT 294.7'
VERTICAL FRACTURE FROM 295.0' TO 295.7'

NUMEROUS 30° TO 60° FRACTURES FROM 299.5' TO 300.6'

STRATIGRAPHIC NOMENCLATURE

STRANGER FORMATION
DOUGLAS GROUP

Rev. 0

WOLF CREEK
UPDATED SAFETY ANALYSIS REPORT

Figure 2.5-34k (Sheet 4 of 5)

Log of Boring B-11

BORING B-II CONT'D

DEPTH (FEET)	LABORATORY TEST DATA	PERMEABILITY cm./SEC.	PERCENT RECOVERED	R Q D	ELEVATION (FEET)
300					790
			98	47	
305					785
			96	50	
310					780
			90	63	
315					775
			94	87	
320					770
			100	91	
325					765
			79	20	
330					760
			96	39	
335					755
			92	86	
340					750
			100	100	
345					745
					740
350					735
					730
355					725
					720

SYMBOLS



DESCRIPTIONS

.1' CLAYEY BROKEN ZONE AT 301.0'
 SHALE; GRAYISH-BLACK; CARBONACEOUS; THINLY LAMINATED.
 SHALE; MEDIUM GRAY; SILTY; THINLY LAMINATED; WITH LESS THAN 5% THIN SANDSTONE LENSES.

SOFT CLAYEY SHALE BROKEN ZONE FROM 305.8' TO 306.3'

BROKEN ZONE FROM 311.1' TO 311.5'
 BROKEN ZONE ALONG VERTICAL FRACTURE FROM 312.5' TO 314.0'

WESTON MEMBER
 SHALE; MEDIUM GRAY; SLIGHTLY CARBONACEOUS; THINLY LAMINATED.

.2' BROKEN ZONE AT 318.6'
 .1' BROKEN ZONE AT 319.0'

SOFT CLAYEY SHALE, BROKEN AND BRECCIATED ZONE FROM 320.0' TO 321.5'

60° CLAYEY FRACTURE ZONE AT 336.3'

.1' BROKEN ZONE AT 338.6'

SOFT CLAYEY SHALE BROKEN ZONE FROM 341.2' TO 342.1'
 BROKEN ZONE FROM 342.5' TO 342.8'

SOUTH BEND MEMBER
 LIMESTONE; LIGHT GRAY; FINE-GRAINED; FOSSILIFEROUS; THIN TO THICK BEDDED; OCCASIONAL MEDIUM GRAY SHALE PARTINGS; SANDY IN BASAL 0.6'.

ROCK LAKE MEMBER
 SHALE; MEDIUM DARK GRAY; CALCAREOUS; THINLY LAMINATED; INTERBEDDED WITH LIMESTONE; LIGHT GRAY; FINE-GRAINED; LOCALLY SANDY; LAMINATED TO THIN BEDDED.

STONER MEMBER
 LIMESTONE; VERY LIGHT GRAY WITH LOCAL PALE BLUISH-GRAY MOTTLING; FINE TO MEDIUM GRAINED; THIN TO THICK BEDDED; OCCASIONAL DARK GREENISH-GRAY SHALE PARTINGS.

BORING COMPLETED AT 369.0 FEET ON 5-17-73.
 CASING USED TO A DEPTH OF 19.0 FEET.
 GROUNDWATER LEVEL RECORDED AT 61.1 FEET ON 6-19-73.
 THIRD PIEZOMETER INSTALLED AT AN INTERVAL FROM 5.0 FEET TO 13.0 FEET ON 6-26-73.
 SECOND PIEZOMETER INSTALLED AT AN INTERVAL FROM 16.0 FEET TO 35.0 FEET ON 6-26-73.
 FIRST PIEZOMETER INSTALLED AT AN INTERVAL FROM 178.0 FEET TO 240.0 FEET ON 6-26-73.
 PIEZOMETER READINGS ARE PRESENTED ON

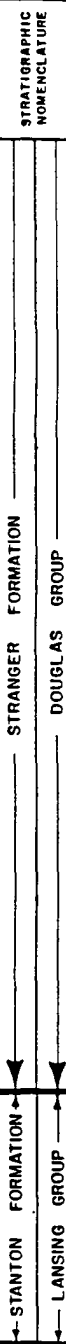

Rev. 0

**WOLF CREEK
 UPDATED SAFETY ANALYSIS REPORT**

Figure 2.5-34k (Sheet 5 of 5)

Log of Boring B-11

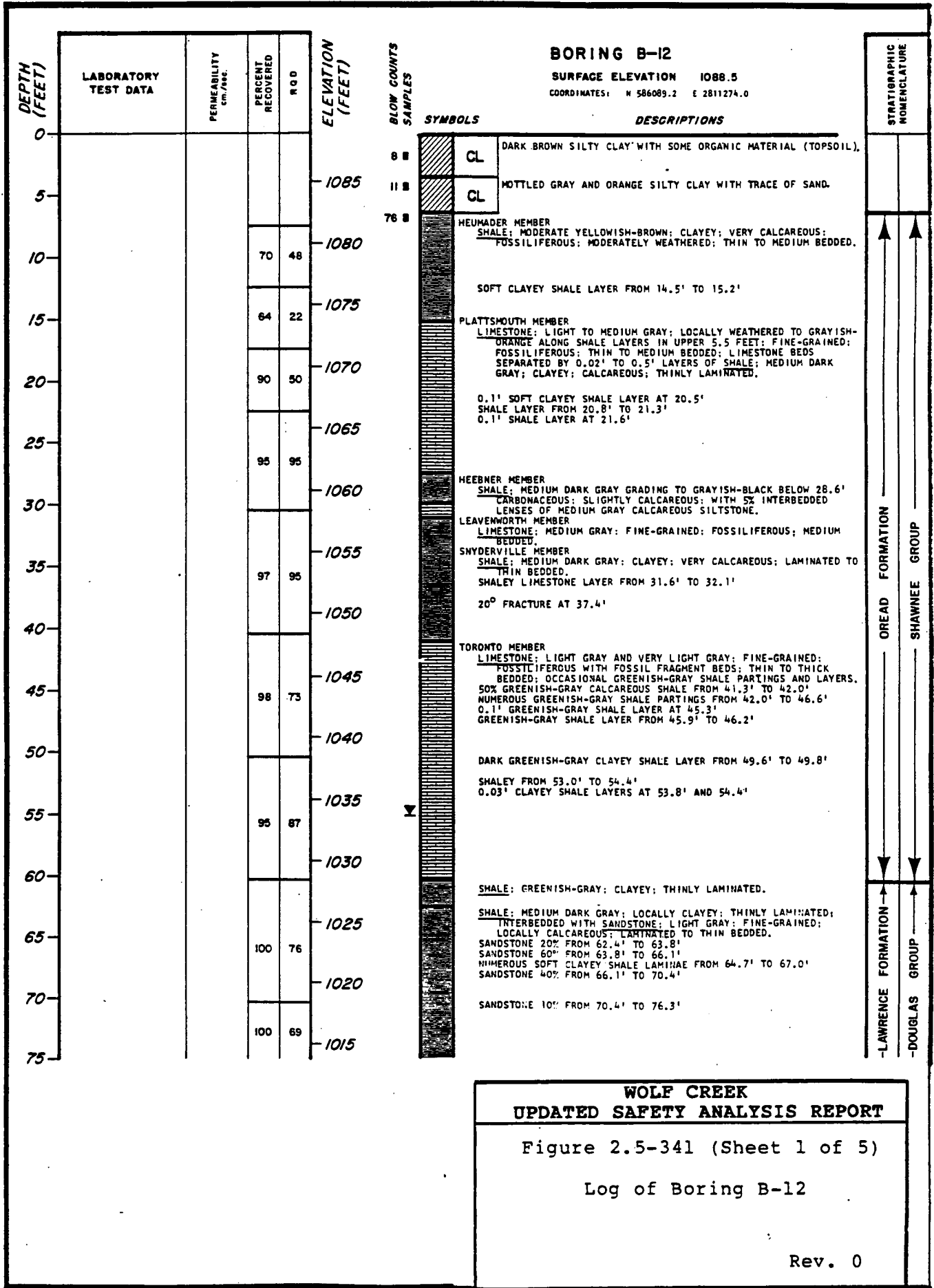

WOLF CREEK
UPDATED SAFETY ANALYSIS REPORT

Figure 2.5-341 (Sheet 1 of 5)
Log of Boring B-12

Rev. 0

BORING B-12 CONT'D

DEPTH (FEET)	LABORATORY TEST DATA	PERMEABILITY cm./sec.	PERCENT RECOVERED	R Q D	ELEVATION (FEET)	SYMBOLS		DESCRIPTIONS	STRATIGRAPHIC NOMENCLATURE	
									LAWRENCE FORMATION	DOUGLAS GROUP
75					1010			WILLIAMSBURG COAL BED COAL: BLACK; SHALEY: THIN BEDDED. SHALE: DARK GREENISH-GRAY; CLAYEY; VERY CALCAREOUS; THIN TO MEDIUM BEDDED.		
80					1005			40° SLICKENSIDED FRACTURE AT 76.6' 15° SLICKENSIDED FRACTURE AT 77.3' 30° SLICKENSIDED FRACTURE AT 77.9' 45° PARALLEL SLICKENSIDED FRACTURES AT 78.3', 78.5', 78.8' AND 79.3'		
85			99	68	1000			25° SLICKENSIDED FRACTURE AT 79.9' 60° SLICKENSIDED FRACTURES AT 80.3' AND 80.6' 45° SLICKENSIDED FRACTURES AT 82.0', 82.4', 82.5', 82.8' AND 83.0'		
90					995			AMAZONIA MEMBER LIMESTONE, LIGHT GREENISH-GRAY; SHALEY: FINE-GRAINED; THIN TO MEDIUM BEDDED; INTERBEDDED WITH SHALE; GREENISH-GRAY; CALCAREOUS; CLAYEY; THINLY LAMINATED. SHALE 50% FROM 83.0' TO 86.0' LIMESTONE 100% FROM 86.0' TO 88.1' SHALE AND VERY CALCAREOUS SHALE 100% FROM 88.1' TO 89.4'		
95			100	68	990			IRELAND MEMBER SHALE: GREENISH-GRAY GRADING TO MEDIUM DARK GRAY BELOW 94.4'; LOCALLY CLAYEY; THINLY LAMINATED; INTERBEDDED WITH SANDSTONE; LIGHT GRAY; FINE-GRAINED; LAMINATED. SANDSTONE 10% TO 20% FROM 89.4' TO 95.2' 0.1' BROWNISH-GRAY LIMESTONE CONCRETION AT 91.4' BROWNISH-GRAY LIMESTONE LAYER FROM 91.6' TO 91.9' 30° SLICKENSIDED FRACTURE AT 94.7' 0.1' SOFT CLAYEY SHALE LAYER AT 95.1' SANDSTONE 10% FROM 95.2' TO 100.2' 30° FRACTURE AT 98.4'		
100					985			30° SLICKENSIDED FRACTURES AT 99.1' AND 99.4' SANDSTONE LESS THAN 5% FROM 100.2' TO 105.8' SHALE GRADES SLIGHTLY CARBONACEOUS AT 102.5'		
105			99	83	980			COAL: BLACK; SHALEY: THIN TO MEDIUM BEDDED. SHALE: MEDIUM GRAY TO MEDIUM DARK GRAY; THINLY LAMINATED; INTERBEDDED WITH SANDSTONE; LIGHT GRAY; FINE-GRAINED; LAMINATED TO MEDIUM BEDDED; AND SILTSTONE; MEDIUM GRAY; MICACEOUS; LAMINATED TO MEDIUM BEDDED. SANDSTONE 5% AND SILTSTONE 10% FROM 106.5' TO 109.4' SOFT CLAYEY SHALE FROM 107.2' TO 108.1' BROKEN ZONE FROM 108.1' TO 108.5'		
110					975			SANDSTONE 20% AND SILTSTONE 20% FROM 109.4' TO 110.9' SANDSTONE 40% AND SILTSTONE 40% FROM 110.9' TO 115.9' SANDSTONE 80% AND SILTSTONE 10% FROM 115.9' TO 118.5'		
115			100	40	970			SANDSTONE 50% AND SILTSTONE 20% FROM 118.5' TO 126.2'		
120					965			SANDSTONE 20% AND SILTSTONE 20% FROM 126.2' TO 132.1'		
125			100	80	960			SANDSTONE 50% AND SILTSTONE 20% FROM 132.1' TO 132.9' SANDSTONE 20% AND SILTSTONE 50% FROM 132.9' TO 137.3'		
130					955			DISTORTED SANDSTONE 50% AND SILTSTONE 50% FROM 137.3' TO 140.2'		
135			100	79	950			SANDSTONE 15% AND SILTSTONE 75% FROM 140.2' TO 145.4'		
140					945			SHALEY SILTSTONE 100% FROM 145.4' TO 189.3' NUMEROUS SOFT CLAYEY SHALE LAMINAE FROM 146.9' TO 149.1' 20° FRACTURE AT 145.6'		
145			99	41	940			NUMEROUS SOFT CLAYEY SHALE LAMINAE FROM 150.1' TO 152.1'		
150										

**WOLF CREEK
UPDATED SAFETY ANALYSIS REPORT**

Figure 2.5-341 (Sheet 2 of 5)

Log of Boring B-12

Rev. 0

BORING B-12 CONT'D

DEPTH (FEET)	LABORATORY TEST DATA	PERMEABILITY cm./sec.	PERCENT RECOVERED	R Q D	ELEVATION (FEET)	SYMBOLS	DESCRIPTIONS	STRATIGRAPHIC NOMENCLATURE
150								
155			100	70	935			
160					930		OCCASIONAL SOFT CLAYEY SHALE LAMINAE FROM 159.8' TO 169.8'	
165			98	45	925			
170					920			
175			92	21	915		NUMEROUS SOFT CLAYEY SHALE LAMINAE FROM 169.8' TO 171.4' AND FROM 173.4' TO 177.0'	
180					910			
185			100	100	905			
190					900		SHALEY SILTSTONE 50% AND SHALE 50% FROM 189.3' TO 193.3'	
195			99	47	895		ROBBINS MEMBER SHALE: MEDIUM DARK GRAY; THINLY LAMINATED. NUMEROUS SOFT CLAYEY SHALE LAYERS FROM 194.0' TO 204.4'	
200					890			
205			97	46	885		LIMESTONE: LIGHT OLIVE GRAY; VERY SHALEY; FOSSILIFEROUS; THIN TO MEDIUM BEDDED. SHALE: MEDIUM DARK GRAY; SLIGHTLY CARBONACEOUS; THINLY LAMINATED; OCCASIONAL 0.05' TO 0.1' PALE YELLOWISH-BROWN DOLOMITIC CONCRETIONS.	
210					880			
215			95	24	875		NUMEROUS SOFT CLAYEY SHALE LAYERS FROM 211.0' TO 218.3'	
220					870			
225			99	24	865		NUMEROUS SOFT CLAYEY SHALE LAYERS FROM 223.7' TO 226.0'	

LAWRENCE FORMATION
DOUGLAS GROUP

Rev. 0

WOLF CREEK
UPDATED SAFETY ANALYSIS REPORT

Figure 2.5-341 (Sheet 3 of 5)
Log of Boring B-12

BORING B-12 CONT'D

DEPTH (FEET)	LABORATORY TEST DATA	PERMEABILITY cm./SEC.	PERCENT RECOVERED	R Q D	ELEVATION (FEET)
225					
230			100	76	860
235					855
240			100	55	850
245					845
250			100	91	840
255					835
260			98	1	830
265					825
270			100	100	820
275					815
280			100	97	810
285					805
290			100	54	800
295					795
300			100	100	790

SYMBOLS



DESCRIPTIONS

BROKEN ZONE FROM 227.1' TO 228.0'
 VERTICAL FRACTURE FROM 228.0' TO 228.7'
 SOFT CLAYEY BROKEN ZONE FROM 230.5' TO 230.7'

SHALE: GRAYISH-BLACK; CARBONACEOUS; SLIGHTLY CALCAREOUS; THINLY LAMINATED.
 HASKELL MEMBER
 LIMESTONE: MEDIUM LIGHT GRAY; FINE-GRAINED; FOSSILIFEROUS; THIN TO THICK BEDDED; SHALEY IN BASAL 0.6'

VINLAND MEMBER
 SHALE: MEDIUM DARK GRAY; FOSSILIFEROUS; SLIGHTLY SANDY; CALCAREOUS; THINLY LAMINATED TO THIN BEDDED.
 SANDSTONE: LIGHT BROWNISH-GRAY; FINE TO MEDIUM GRAINED; CROSS-BEDDED; VERY CALCAREOUS IN UPPER 1.5' OTHERWISE CALCAREOUS THROUGHOUT; THIN TO MEDIUM BEDDED.
 VERTICAL FRACTURE FROM 236.3' TO 236.9'
 70° FRACTURE AT 241.1'

WESTPHALIA MEMBER
 LIMESTONE: LIGHT GRAY AND LIGHT OLIVE GRAY; 70% FUSULINID FOSSILS; OCCASIONAL LIMESTONE PEBBLES; SHALEY; LOCALLY SLIGHTLY SANDY; THIN TO THICK BEDDED.

TONGANOXIE MEMBER
 SHALE: MEDIUM DARK GRAY; THINLY LAMINATED; INTERBEDDED WITH SANDSTONE; LIGHT GRAY; FINE-GRAINED; LOCALLY CALCAREOUS; LAMINATED TO THIN BEDDED; AND SILTSTONE; MEDIUM GRAY; MICACEOUS; LAMINATED TO THIN BEDDED.
 SANDSTONE 10% AND SILTSTONE 10% FROM 249.7' TO 256.0'

SHALEY SILTSTONE 15% FROM 256.0' TO 275.7'
 NUMEROUS 20° SLICKENSIDED FRACTURES FROM 256.4' TO 257.9'
 NUMEROUS SOFT CLAYEY SHALE LAMINAE FROM 258.8' TO 266.1'

SANDSTONE 5% AND SILTSTONE 5% FROM 275.7' TO 280.7'

SANDSTONE 15% AND SILTSTONE 10% FROM 280.7' TO 285.7'

SANDSTONE 30% AND SILTSTONE 10% FROM 285.7' TO 290.2'

SANDSTONE 60% AND SILTSTONE 10% FROM 290.2' TO 298.2'

SANDSTONE 40% AND SILTSTONE 20% FROM 298.2' TO 304.8'

STRATIGRAPHIC NOMENCLATURE
LAWRENCE FORMATION
STRANGER FORMATION
DOUGLAS GROUP

Rev. 0

WOLF CREEK
 UPDATED SAFETY ANALYSIS REPORT

Figure 2.5-341 (Sheet 4 of 5)
 Log of Boring B-12

BORING B-12 CONT'D

DEPTH (FEET)	LABORATORY TEST DATA	PERMEABILITY cm./100c.	PERCENT RECOVERED	R Q D	ELEVATION (FEET)
300					785
305					780
310			100	100	775
315					770
320			100	79	765
325					760
330			100	100	755
335					

SYMBOLS



DESCRIPTIONS

SANDSTONE 20% AND SILTSTONE 20% FROM 304.8' TO 309.7'

SANDSTONE 30% AND SILTSTONE 20% FROM 309.7' TO 314.6'

SANDSTONE LESS THAN 5% AND SHALEY SILTSTONE 5% FROM 314.6' TO 334.6'

STRATIGRAPHIC NOMENCLATURE	
FORMATION	GROUP
STRANGER	DOUGLAS

BORING COMPLETED AT 334.6 FEET ON 6-25-73. CASING USED TO A DEPTH OF 16.0 FEET. GROUNDWATER LEVEL RECORDED AT 55.0 FEET ON 7-12-73.

THIRD PIEZOMETER INSTALLED AT AN INTERVAL FROM 5.0 FEET TO 32.0 FEET ON 7-17-73.

SECOND PIEZOMETER INSTALLED AT AN INTERVAL FROM 41.0 FEET TO 61.0 FEET ON 7-17-73.

FIRST PIEZOMETER INSTALLED AT AN INTERVAL FROM 90.0 FEET TO 192.0 FEET ON 7-17-73. PIEZOMETER READINGS ARE PRESENTED ON TABLE 2.4-29.

Rev. 0

<p>WOLF CREEK UPDATED SAFETY ANALYSIS REPORT</p>
<p>Figure 2.5-341 (Sheet 5 of 5)</p> <p>Log of Boring B-12</p>

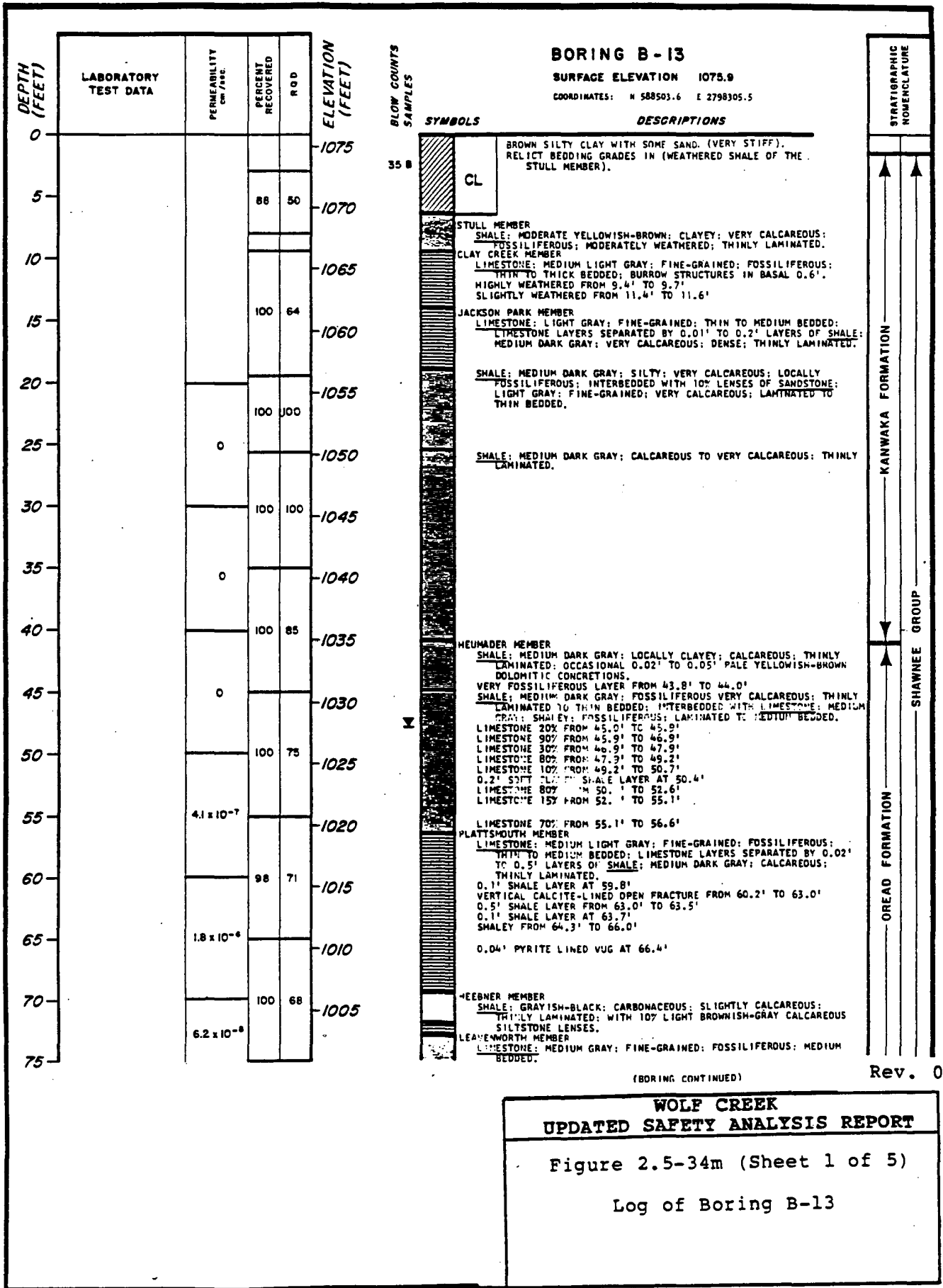

WOLF CREEK
UPDATED SAFETY ANALYSIS REPORT

Figure 2.5-34m (Sheet 1 of 5)

Log of Boring B-13

(BORING CONTINUED)

BORING B-13 CONT'D

DEPTH (FEET)	LABORATORY TEST DATA	PERMEABILITY cm./sec.	PERCENT RECOVERED	R Q D	ELEVATION (FEET)
75					1000
80			100	75	995
85		0			990
90			100	68	985
95		0			980
100			100	62	975
105					970
110			92	63	965
115					960
120			92	33	955
125					950
130			96	89	945
135					940
140			100	91	935
145					930
150			100	44	

SYMBOLS



DESCRIPTIONS

SNYDERVILLE MEMBER
 SHALE; OLIVE GRAY; VERY CALCAREOUS; CLAYEY; LOCALLY FOSSILIFEROUS; LAMINATED TO THIN BEDDED; OCCASIONAL LIGHT GRAY LIMESTONE NODULES.
 45° PARALLEL FRACTURES AT 77.9' AND 78.1'
 0.1' SOFT CLAYEY SHALE LAYER AT 78.9'

TORONTO MEMBER
 LIMESTONE; LIGHT GRAY TO VERY LIGHT GRAY; FINE-GRAINED; FOSSILIFEROUS WITH FOSSIL FRAGMENT BEDS; THIN TO THICK BEDDED; OCCASIONAL GREENISH-GRAY SHALE PARTINGS AND LAYERS.

SHALEY FROM 89.9' TO 91.6'
 0.1' GREENISH-GRAY SHALE LAYER AT 90.4'

SHALE; MEDIUM DARK GRAY; LOCALLY CLAYEY; THINLY LAMINATED; INTERBEDDED WITH LENSES OF SANDSTONE; LIGHT GRAY; FINE-GRAINED; LOCALLY CALCAREOUS; LAMINATED TO THIN BEDDED.
 CLAYEY SHALE 100% FROM 96.1' TO 97.6'
 SANDSTONE 5% FROM 97.6' TO 100.0'
 SANDSTONE 20% FROM 100.0' TO 101.5'
 SANDSTONE 50% FROM 101.5' TO 105.4'

SANDSTONE 80% FROM 105.4' TO 106.4'
 SANDSTONE 20% FROM 106.4' TO 112.8'

SANDSTONE 5% FROM 112.8' TO 115.4'

WILLIAMSBURG COAL BED
 COAL; BLACK; SHALEY; THIN BEDDED.
 SHALE; LIGHT OLIVE GRAY; CLAYEY; VERY CALCAREOUS; OCCASIONAL 20° TO 60° SLICKENSIDED FRACTURES; LAMINATED TO THIN BEDDED.

AMAZONIA MEMBER
 SHALE; GREENISH-GRAY; CLAYEY; CALCAREOUS; THINLY LAMINATED; INTERBEDDED WITH LIMESTONE; LIGHT GREENISH-GRAY; SHALEY; FOSSILIFEROUS; THIN TO MEDIUM BEDDED.
 LIMESTONE 20% FROM 121.3' TO 124.5'
 LIMESTONE 100% FROM 124.5' TO 125.7'
 LIMESTONE 70% FROM 125.7' TO 127.0'

IRELAND
 SHALE; MEDIUM DARK GRAY; THINLY LAMINATED; INTERBEDDED WITH SANDSTONE; LIGHT GRAY; FINE-GRAINED; LOCALLY CALCAREOUS; LAMINATED TO THIN BEDDED; AND SILTSTONE; MEDIUM GRAY; MICACEOUS; LAMINATED TO MEDIUM BEDDED.
 SANDSTONE 15% AND SILTSTONE 25% FROM 127.0' TO 131.0'
 SANDSTONE 35% AND SILTSTONE 25% FROM 131.0' TO 132.6'
 SANDSTONE 5% AND SHALEY SILTSTONE 45% FROM 132.6' TO 142.5'

COAL; BLACK; SHALEY; THIN BEDDED.
 SILTSTONE; MEDIUM GRAY; MICACEOUS; LAMINATED TO THICK BEDDED.
 INTERBEDDED WITH SANDSTONE; LIGHT GRAY; FINE-GRAINED; LAMINATED TO THIN BEDDED; AND SHALE; MEDIUM DARK GRAY; THINLY LAMINATED.
 CLAYEY SHALE 100% FROM 143.1' TO 144.0'
 SANDSTONE 5% AND SHALE 80% FROM 144.0' TO 148.1'
 SANDSTONE 25% AND SILTSTONE 40% FROM 148.1' TO 152.0'

STRATIGRAPHIC NOMENCLATURE

OREAD FORMATION
 ↓
 SHAWNEE GROUP
 ↑
 LAWRENCE FORMATION
 ↓
 DOUGLAS GROUP

Rev. 0

WOLF CREEK UPDATED SAFETY ANALYSIS REPORT

Figure 2.5-34m (Sheet 2 of 5)

Log of Boring B-13

BORING B-13 CONT'D

DEPTH (FEET)	LABORATORY TEST DATA	PERMEABILITY cm./sec.	PERCENT RECOVERED	R.O.D.	ELEVATION (FEET)
150					925
155					920
160			100	71	915
165					910
170			100	72	905
175					900
180			100	59	895
185					890
190			100	79	885
195					880
200			96	69	875
205					870
210			100	66	865
215					860
220			100	70	855
225					

SYMBOLS

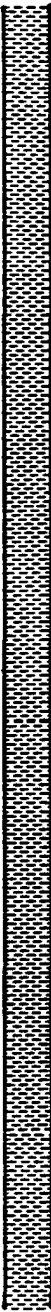

DESCRIPTIONS

SANDSTONE 40% AND SILTSTONE 40% FROM 152.0' TO 159.6'

SANDSTONE 10% AND SHALEY SILTSTONE 90% FROM 159.6' TO 181.3'

NUMEROUS SOFT CLAYEY LAMINAE FROM 171.0' TO 172.5'

SANDSTONE 20% AND SHALEY SILTSTONE 70% FROM 181.3' TO 183.1'

VERTICAL FRACTURE FROM 183.0' TO 183.5'

SANDSTONE 10% AND SHALEY SILTSTONE 80% FROM 183.5' TO 186.5'

NUMEROUS SOFT CLAYEY LAMINAE FROM 184.8' TO 186.5'

SANDSTONE 20% AND SHALEY SILTSTONE 70% FROM 186.5' TO 194.0'

SANDSTONE 10% AND SHALEY SILTSTONE 90% FROM 194.0' TO 196.1'

SANDSTONE 5% OR LESS AND SHALEY SILTSTONE 95% FROM 196.1' TO 228.4'

NUMEROUS SOFT CLAYEY LAMINAE FROM 196.2' TO 197.7'

OCCASIONAL SOFT CLAYEY LAMINAE FROM 202.8' TO 203.7'

STRATIGRAPHIC NOMENCLATURE

LAWRENCE FORMATION
DOUGLAS GROUP

Rev. 0

**WOLF CREEK
UPDATED SAFETY ANALYSIS REPORT**

Figure 2.5-34m (Sheet 3 of 5)
Log of Boring B-13

BORING B-13 CONT'D

DEPTH (FEET)	LABORATORY TEST DATA	PERMEABILITY cm./sec.	PERCENT RECOVERED	ROD	ELEVATION (FEET)
225					850
230			100	76	845
235					840
240			100	93	835
245					830
250			100	87	825
255					820
260			100	29	815
265			58	0	810
270					805
275			100	96	800
280					795
285			100	87	790
290					785
295			98	50	780
300					

SYMBOLS

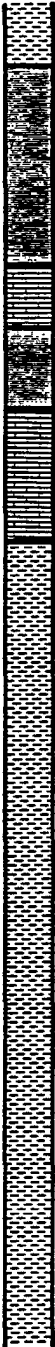

DESCRIPTIONS

ROBBINS MEMBER
 SHALE; MEDIUM GRAY; THINLY LAMINATED.

HASKELL MEMBER
 LIMESTONE; LIGHT OLIVE GRAY; SHALEY; FOSSILIFEROUS; MEDIUM BEDDED.
 0.02' SHALEY, CARBONACEOUS ZONE AT 241.4'
 GRADES VERY SHALEY AT 242.3'

VINLAND MEMBER
 SHALE; GREENISH-GRAY; CALCAREOUS; LAMINATED; WITH OCCASIONAL LIMESTONE CLASTS 0.001' TO 0.01'.
 NUMEROUS 20° SLICKENSIDED FRACTURES FROM 243.8' TO 245.6'
 VERTICAL FRACTURE WITH LOCALIZED BROKEN ZONES FROM 246.3' TO 247.3'

WESTPHALIA MEMBER
 LIMESTONE; VERY LIGHT GRAY TO LIGHT OLIVE GRAY; 70° FUSULINID FOSSILS; SHALEY; THIN TO MEDIUM BEDDED; WITH INTERBEDDED GREENISH-GRAY SHALES.

TONGANOXIE MEMBER
 SILTSTONE; MEDIUM LIGHT GRAY; MICACEOUS; CARBONACEOUS; LAMINATED TO THICK BEDDED; WITH INTERBEDDED SANDSTONE; LIGHT GRAY; FINE-GRAINED; LOCALLY CALCAREOUS; LAMINATED TO MEDIUM DISTORTED BEDDING AND SHALE; MEDIUM DARK GRAY; THINLY LAMINATED.
 SANDSTONE 10% AND SILTSTONE 90% FROM 254.9' TO 258.1'
 SANDSTONE 20% AND SILTSTONE 80% FROM 258.1' TO 266.0'
 NUMEROUS SOFT CLAYEY LAMINAE FROM 257.2' TO 268.3'

SANDSTONE 10% AND SILTSTONE 90% FROM 266.0' TO 277.5'

DISTORTED SANDSTONE LENSE FROM 277.5' TO 278.3'
 SILTSTONE 90% AND SHALE 10% FROM 278.3' TO 280.9'

DISTORTED SANDSTONE LENSE FROM 280.9' TO 281.7'
 SILTSTONE 80% AND SHALE 20% FROM 281.7' TO 286.9'

SANDSTONE 10% AND SILTSTONE 90% FROM 286.9' TO 336.1'
 NUMEROUS SOFT CLAYEY LAMINAE FROM 288.7' TO 293.0'

VERTICAL FRACTURE FROM 297.1' TO 297.3'
 NUMEROUS SOFT CLAYEY LAMINAE FROM 298.6' TO 299.2'
 OCCASIONAL SOFT CLAYEY LAMINAE FROM 292.2' TO 307.3'

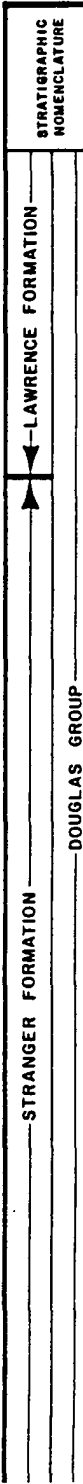

**WOLF CREEK
 UPDATED SAFETY ANALYSIS REPORT**

Figure 2.5-34m (Sheet 4 of 5)
 Log of Boring B-13

Rev. 0

BORING B-13 CONT'D

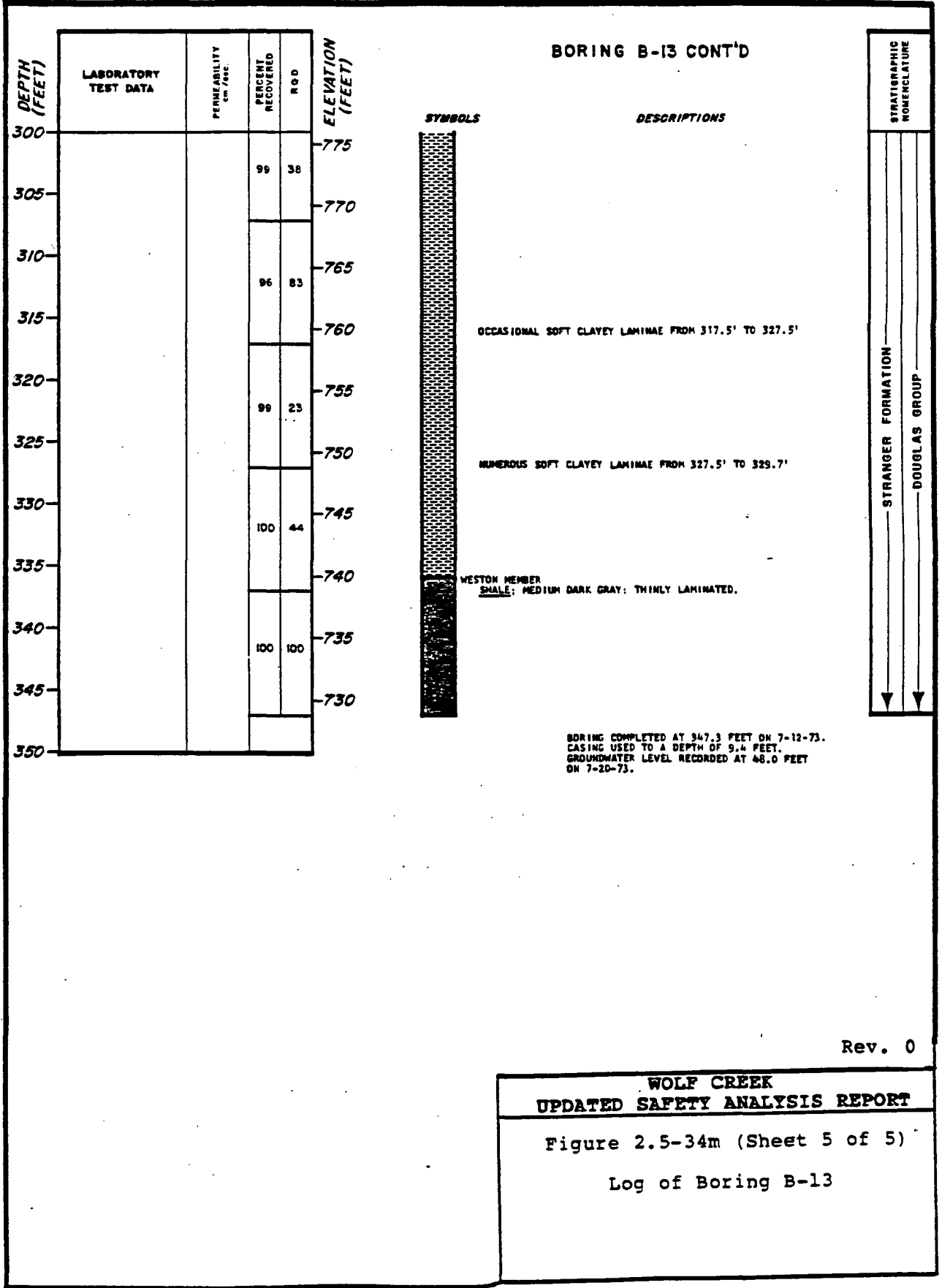

BORING COMPLETED AT 347.3 FEET ON 7-12-73.
CASING USED TO A DEPTH OF 9.4 FEET.
GROUNDWATER LEVEL RECORDED AT 48.0 FEET
ON 7-20-73.

Rev. 0

WOLF CREEK
UPDATED SAFETY ANALYSIS REPORT

Figure 2.5-34m (Sheet 5 of 5)
Log of Boring B-13

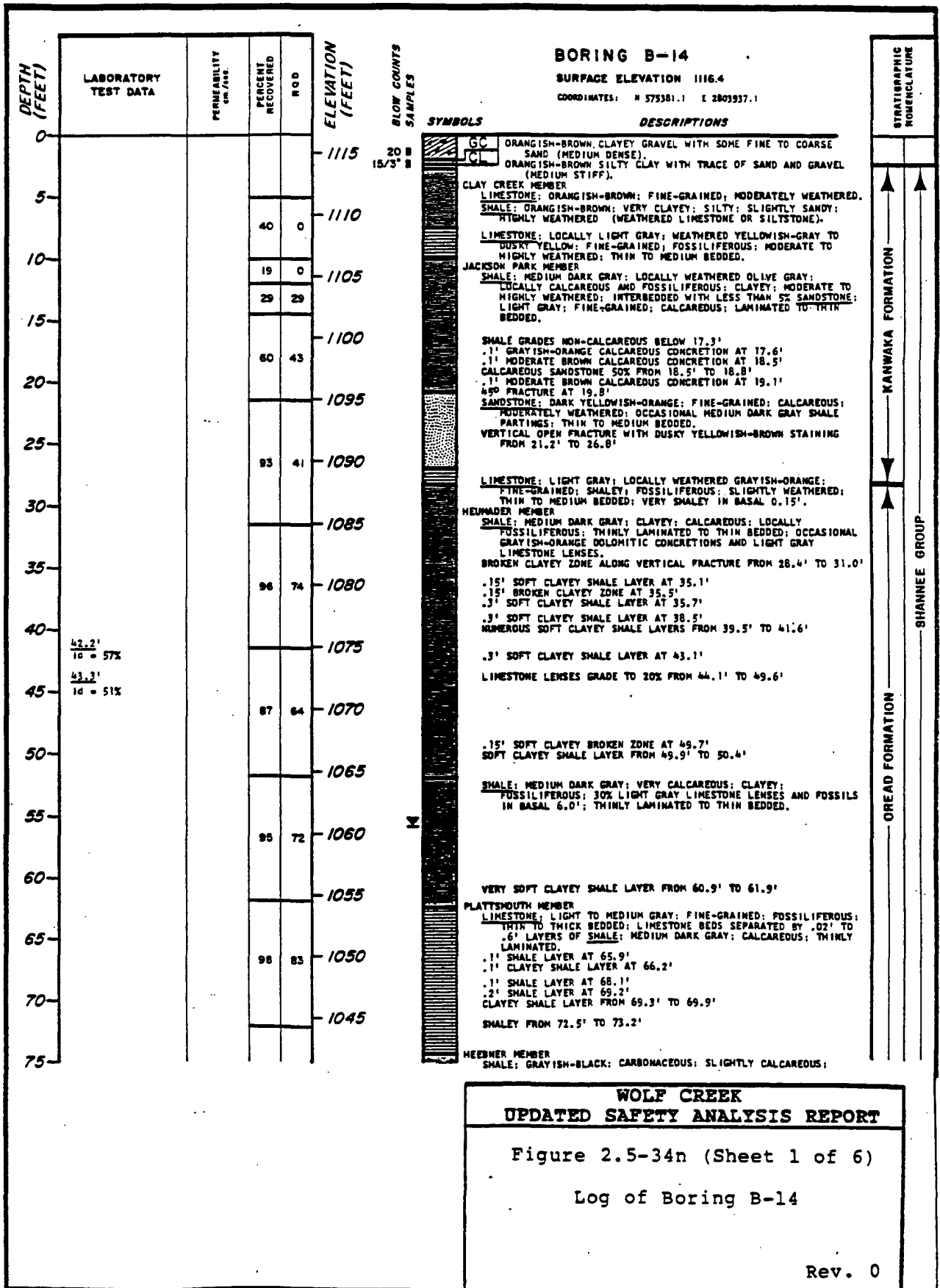

**WOLF CREEK
UPDATED SAFETY ANALYSIS REPORT**

Figure 2.5-34n (Sheet 1 of 6)
Log of Boring B-14

Rev. 0

BORING B-14 CONT'D

DEPTH (FEET)	LABORATORY TEST DATA	PERMEABILITY cm / sec	PERCENT RECOVERED	R Q D	ELEVATION (FEET)
75					1040
80			95	71	1035
85					1030
90			97	73	1025
95					1020
100			100	90	1015
105					1010
110					1005
115			99	79	1000
120					995
125			100	60	990
130					985
135			100	98	980
140					975
145			97	42	970
150					

SYMBOLS



DESCRIPTIONS

THINLY LAMINATED; WITH 5% LIGHT BROWNISH-GRAY CALCAREOUS SILTSTONE LAYERS.
 VERTICAL OPEN FRACTURE FROM 78.1' TO 79.6'
 LEAVENWORTH MEMBER
 LIMESTONE; MEDIUM LIGHT GRAY; FINE-GRAINED; FOSSILIFEROUS; TRICK BEDDED.
 SNYDERVILLE MEMBER
 SHALE; GREENISH-GRAY AND MEDIUM DARK GRAY; VERY CALCAREOUS; CLAYEY; FOSSILIFEROUS; LAMINATED TO THIN BEDDED; OCCASIONAL LAYERS AND NODULES OF LIGHT GRAY FOSSILIFEROUS LIMESTONE.
 FUSILINID LIMESTONE LAYER FROM 80.3' TO 80.8'
 45° SLICKENSIDED FRACTURE AT 83.1'
 45° SLICKENSIDED FRACTURE AT 84.6'
 TORONTO MEMBER
 LIMESTONE; LIGHT GRAY AND VERY LIGHT GRAY; FINE-GRAINED; FOSSILIFEROUS WITH FOSSIL FRAGMENT BEDS; THIN TO THICK BEDDED; OCCASIONAL DARK GREENISH-GRAY SHALE PARTINGS.
 SHALEY FROM 92.7' TO 93.7'
 .15' GREENISH-GRAY SHALE LAYER AT 94.0'
 SHALE; MEDIUM DARK GRAY; THINLY LAMINATED; INTERBEDDED WITH LENSES OF SANDSTONE; LIGHT GRAY; FINE-GRAINED; LOCALLY CALCAREOUS; LAMINATED TO THIN BEDDED.
 SOFT CLAYEY SHALE LAYER FROM 99.7' TO 100.3'
 SANDSTONE LESS THAN 10% FROM 100.3' TO 103.5'
 .2' MEDIUM GRAY LIMESTONE LAYER AT 102.5'
 SANDSTONE 70% FROM 103.5' TO 104.0'
 SANDSTONE LESS THAN 10% FROM 104.0' TO 108.5'
 NUMEROUS SOFT CLAYEY BROKEN ZONES WITH 70° FRACTURES FROM 105.2' TO 110.5'
 SANDSTONE 60% FROM 108.5' TO 111.1'
 SANDSTONE 40% FROM 111.1' TO 112.3'
 SANDSTONE 25% FROM 112.3' TO 117.9'
 SHALE; BLACK; CARBONACEOUS; FOSSILIFEROUS; THINLY LAMINATED.
 WILLTAPSBURG COAL BED
 COAL; BLACK; SHALEY; MEDIUM BEDDED.
 SHALE; MEDIUM DARK GRAY; CLAYEY; VERY CALCAREOUS; THIN TO MEDIUM BEDDED.
 45° SLICKENSIDED FRACTURE AT 119.3'
 25° SLICKENSIDED FRACTURE AT 121.3'
 20° SLICKENSIDED FRACTURES AT 121.9' AND 122.7'
 AMAZONIA MEMBER
 SHALE; GREENISH-GRAY; VERY CALCAREOUS; CLAYEY; THINLY LAMINATED TO THIN BEDDED; OCCASIONAL .05' TO .1' LIGHT GRAY LIMESTONE NODULES.
 SOFT CLAYEY SHALE ZONE FROM 125.9' TO 127.0'
 LIMESTONE; LIGHT GREENISH-GRAY; FINE-GRAINED; SHALEY; THIN BEDDED.
 GREENISH-GRAY CALCAREOUS SHALE LAYER FROM 129.4' TO 130.0'
 IRELAND MEMBER
 SHALE; MEDIUM DARK GRAY; LOCALLY CLAYEY; THINLY LAMINATED; INTERBEDDED WITH LENSES OF SANDSTONE; LIGHT GRAY; FINE-GRAINED; LOCALLY CALCAREOUS; LAMINATED TO THIN BEDDED.
 SANDSTONE 10% FROM 130.5' TO 138.4'
 .15' PALE YELLOWISH-BROWN AND MEDIUM GRAY LIMESTONE CONCRETION AT 132.5'
 45° SLICKENSIDED FRACTURE AT 138.4'
 SANDSTONE LESS THAN 5% FROM 138.4' TO 143.5'
 NUMEROUS 20° TO 60° SLICKENSIDED FRACTURES FROM 139.6' TO 143.5'
 COAL; BLACK; SHALEY; MEDIUM BEDDED.
 SHALE; GREENISH-GRAY; CLAYEY; LAMINATED TO THIN BEDDED; CARBONACEOUS IN UPPER 0.5'.
 70° SLICKENSIDED FRACTURE AT 145.4'
 SHALE; MEDIUM DARK GRAY; THINLY LAMINATED; INTERBEDDED WITH SANDSTONE; LIGHT GRAY; FINE-GRAINED; SLIGHTLY CALCAREOUS; LAMINATED TO MEDIUM BEDDED; AND SANDSTONE; MEDIUM DARK GRAY; MICACEOUS; LAMINATED TO THIN BEDDED.



WOLF CREEK
UPDATED SAFETY ANALYSIS REPORT

Figure 2.5-34n (Sheet 2 of 6)
 Log of Boring B-14

Rev. 0

BORING B-14 CONT'D

DEPTH (FEET)	LABORATORY TEST DATA	PERMEABILITY cm / sec.	PERCENT RECOVERED	R Q D	ELEVATION (FEET)	SYMBOLS	DESCRIPTIONS	STRATIGRAPHIC NOMENCLATURE
150					965		SANDSTONE 30% AND SILTSTONE 30% FROM 146.9' TO 150.0' SANDSTONE 40% AND SILTSTONE 10% FROM 150.0' TO 153.4' SANDSTONE 70% AND SILTSTONE 5% FROM 153.4' TO 155.6'	
155			100	89	960		SANDSTONE 90% AND SILTSTONE 5% FROM 155.6' TO 158.6'	
160					955		SANDSTONE 30% AND SILTSTONE 10% FROM 158.6' TO 161.6'	
165			100	81	950		SANDSTONE 50% AND SILTSTONE 50% FROM 161.6' TO 162.5' SANDSTONE 20% AND SILTSTONE 10% FROM 162.5' TO 168.5'	
170					945		SANDSTONE 50% AND SILTSTONE 40% FROM 168.5' TO 170.1'	
175			100	84	940		SANDSTONE 20% AND SILTSTONE 20% FROM 170.1' TO 172.5' SANDSTONE 20% AND SILTSTONE 80% FROM 172.5' TO 177.1' BROKEN ZONE ALONG VERTICAL FRACTURE FROM 173.9' TO 174.8'	
180					935		SANDSTONE 30% AND SILTSTONE 60% FROM 177.1' TO 179.3' SANDSTONE 10% AND SILTSTONE 90% FROM 179.3' TO 192.7'	
185			100	100	930			
190					925		SANDSTONE 40% AND SILTSTONE 50% FROM 192.7' TO 193.4' SANDSTONE 5% AND SILTSTONE 95% FROM 193.4' TO 195.8' 45° FRACTURES AT 193.6' AND 193.8' 60° FRACTURE AT 194.2'	
195			100	87	920		DISTORTED CALCAREOUS SANDSTONE 50% AND SILTSTONE 50% FROM 195.8' TO 196.9' SHALEY SILTSTONE 100% FROM 196.9' TO 214.7' .1' BROKEN ZONE AT 196.9' .1' BROKEN ZONE AT 198.0'	
200					915		60° FRACTURE AT 203.3'	
205			100	77	910		30° FRACTURE AT 205.2'	
210					905		VERTICAL FRACTURE FROM 210.0' TO 210.7'	
215					900			
220			100	100	895		SANDSTONE 5% AND SHALEY SILTSTONE 60% FROM 214.7' TO 233.8'	
225								

(BORING CONTINUED)

Rev. 0

WOLF CREEK
UPDATED SAFETY ANALYSIS REPORT

Figure 2.5-34n (Sheet 3 of 6)

Log of Boring B-14

BORING B-14 CONT'D

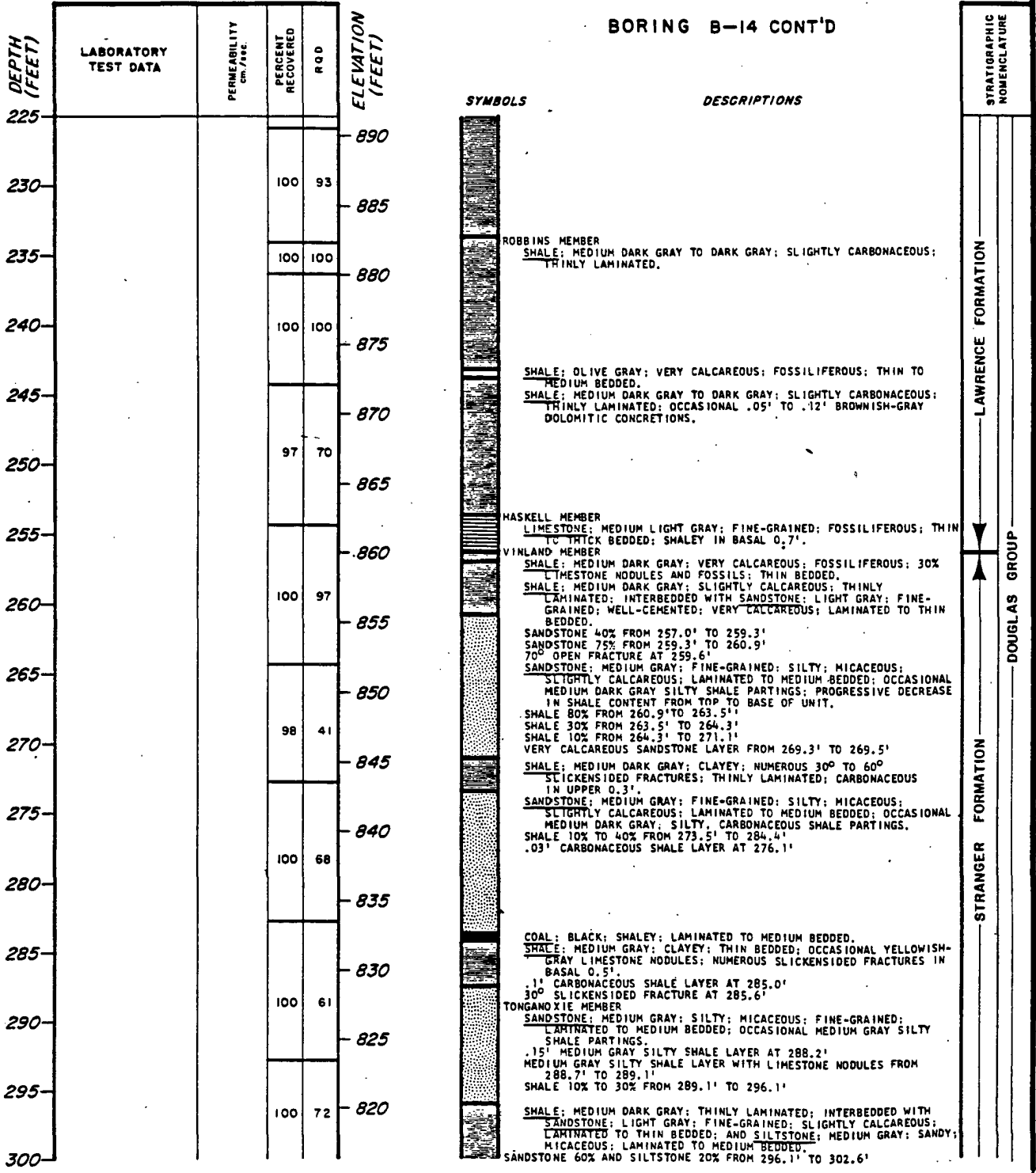

WOLF CREEK
UPDATED SAFETY ANALYSIS REPORT

Figure 2.5-34n (Sheet 4 of 6)

Log of Boring B-14

BORING B-14 CONT'D

DEPTH (FEET)	LABORATORY TEST DATA	PERMEABILITY cm./sec.	PERCENT RECOVERED	RQD	ELEVATION (FEET)
300					815
305			100	49	810
310					805
315					800
320			100	67	795
325					790
330			100	63	785
335					780
340			100	78	775
345					770
350			100	100	765
355					760
360			100	98	755
365					750
370			100	78	745
375					

SYMBOLS



DESCRIPTIONS

SANDSTONE 30% AND SILTSTONE 20% FROM 302.6' TO 303.6'
 SANDSTONE 90% AND SILTSTONE 5% FROM 303.6' TO 305.5'

SANDSTONE 30% AND SILTSTONE 40% FROM 305.5' TO 314.3'

FRACTURED BROKEN ZONE FROM 309.7' TO 310.7'

SANDSTONE 25% AND SILTSTONE 10% FROM 314.3' TO 323.5'

SANDSTONE 10% AND SILTSTONE 30% FROM 323.5' TO 330.4'
 BROKEN ZONES FROM 323.7' TO 323.9' AND FROM 325.4' TO 325.6'

.1' SOFT CLAYEY SHALE LAYER AT 330.1'
 SANDSTONE 30% AND SILTSTONE 40% FROM 330.4' TO 335.4'
 60° CLAY LINED FRACTURE AT 331.9'

SANDSTONE 40% AND SILTSTONE 10% FROM 335.4' TO 337.1'
 SANDSTONE 5% AND SILTSTONE 95% FROM 337.1' TO 338.4'
 SANDSTONE 35% AND SILTSTONE 30% FROM 338.4' TO 344.4'

SANDSTONE 10% AND SILTSTONE 70% FROM 344.4' TO 363.5'

20° SLICKENSIDED FRACTURE AT 359.1'
 THREE PARALLEL 60° SLICKENSIDED FRACTURES FROM 359.9' TO 360.3'
 GRAYISH-BLACK CARBONACEOUS SILTSTONE FROM 360.3' TO 361.8'
 60° FRACTURE AT 363.2'
 SANDSTONE LESS THAN 5% AND SILTSTONE 20% FROM 363.5' TO 379.0'

BROKEN ZONE FROM 363.6' TO 364.1'
 CLAYEY BROKEN ZONE FROM 364.5' TO 365.1'
 30° FRACTURE AT 365.9'
 60° FRACTURE AT 368.1'
 45° FRACTURE AT 369.0'

60° FRACTURE AT 371.4'
 20° FRACTURE AT 371.7'
 INTERSECTING 45° SLICKENSIDED FRACTURES AT 372.0'

(BORING CONTINUED)

**STRATIGRAPHIC
NOMENCLATURE**

STRANGER FORMATION

DOUGLAS GROUP

Rev. 0

<p>WOLF CREEK UPDATED SAFETY ANALYSIS REPORT</p>
<p>Figure 2.5-34n (Sheet 5 of 6) Log of Boring B-14</p>

BORING B-14 CONT'D

DEPTH (FEET)	LABORATORY TEST DATA	PERMEABILITY cm/sec	PERCENT RECOVERED	ROD	ELEVATION (FEET)
375					740
380			98	98	735
385					730
390			100	91	725
395					720
400			100	25	715
405					710
410					705
415			87	50	700
420					695
425			100	100	690
430					685
435			100	86	680
440			100	96	675
445					670
450					

SYMBOLS



DESCRIPTIONS

SANDSTONE 5% AND SILTSTONE 80% FROM 379.0' TO 382.5'
 60° SLICKENSIDED FRACTURE AT 380.4'
 20° FRACTURE AT 381.4'
 60° FRACTURE AT 381.9'
 SANDSTONE 5% AND SILTSTONE 50% FROM 382.4' TO 391.5'
 35° FRACTURE AT 382.4'
 45° FRACTURE AT 383.1'
 45° FRACTURE AT 388.2'
 25° SLICKENSIDED FRACTURE AT 389.1'
 NUMEROUS HIGH AND LOW ANGLE SLICKENSIDED FRACTURES FROM 390.0' TO 391.9'
 SANDSTONE GRADES OUT AT 391.5'
 SILTSTONE 40% FROM 391.5' TO 396.0'
 FRACTURED BROKEN ZONE FROM 394.6' TO 396.0'
 WESTON MEMBER
 SHALE: MEDIUM DARK GRAY; SLIGHTLY CARBONACEOUS; THINLY LAMINATED.
 45° FRACTURE AT 397.0'
 BROKEN ZONE ALONG VERTICAL FRACTURE FROM 414.5' TO 417.2'
 NEAR VERTICAL OPEN FRACTURE FROM 419.1' TO 421.0'
 NEAR VERTICAL OPEN FRACTURE FROM 424.5' TO 426.5'
 NEAR VERTICAL OPEN FRACTURE FROM 427.5' TO 429.1'
 70° FRACTURE AT 430.1'
 .1' PALE YELLOWISH-BROWN DOLOMITIC CONCRETIONS AT 433.0' AND 434.3'
 .05' SOFT CLAYEY SHALE LAYER AT 433.1'
 80° FRACTURE FROM 433.6' TO 434.1'
 SOUTH BEND MEMBER
 LIMESTONE: MEDIUM LIGHT GRAY; FINE-GRAINED; FOSSILIFEROUS; THIN TO THICK BEDDED; SANDY IN BASAL 0.7'.
 ROCK LAKE MEMBER
 SHALE: MEDIUM DARK GRAY; CALCAREOUS; THINLY LAMINATED; INTERBEDDED WITH LIMESTONE: LIGHT GRAY; LOCALLY VERY SANDY; LAMINATED TO THIN BEDDED.
 SHALE 50% FROM 439.1' TO 439.8'
 SHALE 75% FROM 439.8' TO 442.6'
 VERTICAL FRACTURE FROM 440.3' TO 440.7'
 SHALE 10% FROM 442.6' TO 443.4'
 SHALE 70% FROM 443.4' TO 444.6'
 SANDY LIMESTONE 100% FROM 444.6' TO 445.5'
 INTERSECTING 30° OPEN FRACTURES AT 445.1'

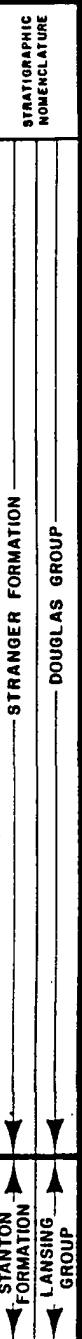

THIRD PIEZOMETER INSTALLED AT AN INTERVAL FROM 7.0 FEET TO 20.0 FEET ON 9-5-73.
 SECOND PIEZOMETER INSTALLED AT AN INTERVAL FROM 85.0 FEET TO 100.0 FEET ON 8-5-73.
 FIRST PIEZOMETER INSTALLED AT AN INTERVAL FROM 271.0 FEET TO 290.0 FEET.
 PIEZOMETER READINGS ARE PRESENTED ON TABLE 2.4-29.

BORING COMPLETED AT 445.5 FEET ON 6-11-73
 CASING USED TO A DEPTH OF 16.0 FEET.
 GROUNDWATER LEVEL DEPTHER AT 55.7 FEET

WOLF CREEK
UPDATED SAFETY ANALYSIS REPORT

Figure 2.5-34n (Sheet 6 of 6)
 Log of Boring B-14

Rev. 0

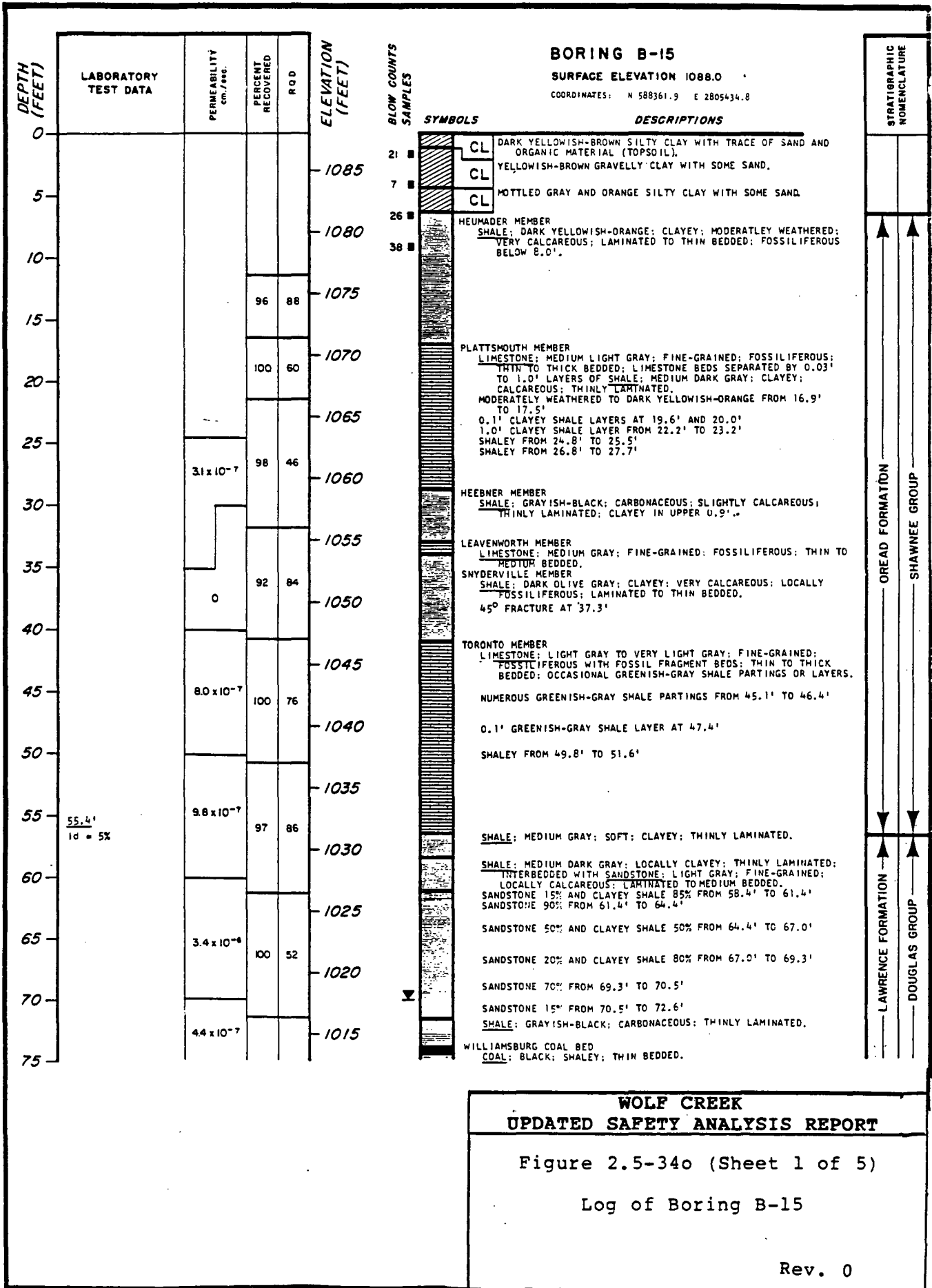

BORING B-15 CONT'D

DEPTH (FEET)	LABORATORY TEST DATA	PERMEABILITY cm/sec.	PERCENT RECOVERED	RQD	ELEVATION (FEET)
75			100	49	1010
80					1005
85		0	100	82	1000
90					995
95		0	100	77	990
100					985
105		1.3×10^{-8}	99	64	980
110					975
115		0	99	45	970
120					965
125			100	74	960
130					955
135		4.8×10^{-8}	100	71	950
140					945
145		4.9×10^{-8}	94	46	940

SYMBOLS



DESCRIPTIONS

70° FRACTURE WITH 0.1' OFFSET OF COAL BED AT 74.3'
 SHALE; DARK GREENISH-GRAY; VERY CALCAREOUS; CLAYEY;
 LAMINATED TO THIN BEDDED.
 20° FRACTURES AT 75.1' AND 75.4'
 20° FRACTURES AT 78.2', 78.6', 79.0', AND 79.2'

AMAZONIA MEMBER
 LIMESTONE; LIGHT GREENISH-GRAY; FINE-GRAINED; SHALEY; LOCALLY
 FOSSTILIFEROUS; THIN TO MEDIUM BEDDED; INTERBEDDED WITH
 SHALE; GREENISH-GRAY; CLAYEY; CALCAREOUS; THINLY LAMINATED.
 SHALE 60% AND LIMESTONE LENSES 40% FROM 80.5' TO 82.0'
 SHALE 90% FROM 82.0' TO 84.5'
 SHALEY LIMESTONE 90% FROM 84.5' TO 86.1'
 SHALE 100% FROM 86.1' TO 87.1'

IRELAND MEMBER
 SHALE; GREENISH-GRAY GRADING TO MEDIUM DARK GRAY BELOW 91.1';
 LOCALLY CLAYEY; THINLY LAMINATED; INTERBEDDED WITH
 SANDSTONE; LIGHT GRAY; FINE-GRAINED; THIN BEDDED.
 SANDSTONE 10% FROM 87.1' TO 91.1'
 60° FRACTURE AT 89.4'
 SANDSTONE 50% FROM 91.1' TO 92.0'
 SANDSTONE 15% FROM 92.0' TO 99.6'

COAL; BLACK; SHALEY; LAMINATED TO THIN BEDDED.

SHALE; MEDIUM DARK GRAY; THINLY LAMINATED; INTERBEDDED WITH
 SANDSTONE; LIGHT GRAY; FINE-GRAINED; LOCALLY CALCAREOUS;
 LAMINATED TO THICK BEDDED; AND SILTSTONE; MEDIUM GRAY;
 MICACEOUS; LAMINATED TO MEDIUM BEDDED.
 SHALE 100% FROM 100.4' TO 101.5'
 SANDSTONE 25% AND SHALE 30% FROM 101.5' TO 103.1'
 SANDSTONE 100% FROM 103.1' TO 105.4'
 SANDSTONE 70% AND SILTSTONE 30% FROM 105.4' TO 107.0'.
 60° FRACTURE AT 106.7'
 SANDSTONE 50% AND SILTSTONE 20% FROM 107.0' TO 108.7'
 SANDSTONE 10% AND SILTSTONE 40% FROM 108.7' TO 118.8'

NUMEROUS SOFT CLAYEY SHALE LAMINAE FROM 117.2' TO 118.8'

SILTSTONE 100% FROM 118.8' TO 122.9'
 BROKEN ZONES FROM 119.0' TO 119.3' AND FROM 120.0' TO 120.1'

SANDSTONE 15% AND SILTSTONE 80% FROM 122.9' TO 131.8'

NEAR VERTICAL FRACTURE FROM 130.8' TO 131.4'
 SANDSTONE 30% AND SHALEY SILTSTONE 30% FROM 131.8' TO 133.5'
 SANDSTONE 70% AND SHALEY SILTSTONE 30% FROM 133.5' TO 135.7'

SANDSTONE 40% AND SHALEY SILTSTONE 60% FROM 135.7' TO 137.0'

SANDSTONE 80% AND SILTSTONE 20% FROM 137.0' TO 139.7'
 SANDSTONE 20% AND SILTSTONE 80% FROM 139.7' TO 140.6'

SANDSTONE 80% AND SILTSTONE 20% FROM 140.6' TO 141.4'
 SANDSTONE 20% AND SILTSTONE 80% FROM 141.4' TO 142.9'
 SANDSTONE 60% AND SILTSTONE 40% FROM 142.9' TO 148.1'

SANDSTONE 10% AND SHALEY SILTSTONE 60% FROM 148.1' TO 171.8'

STRATIGRAPHIC NOMENCLATURE

LAWRENCE FORMATION

DOUGLAS GROUP

Rev. 0

WOLF CREEK
UPDATED SAFETY ANALYSIS REPORT

Figure 2.5-34c (Sheet 2 of 5)

Log of Boring B-15

BORING B-15 CONT'D

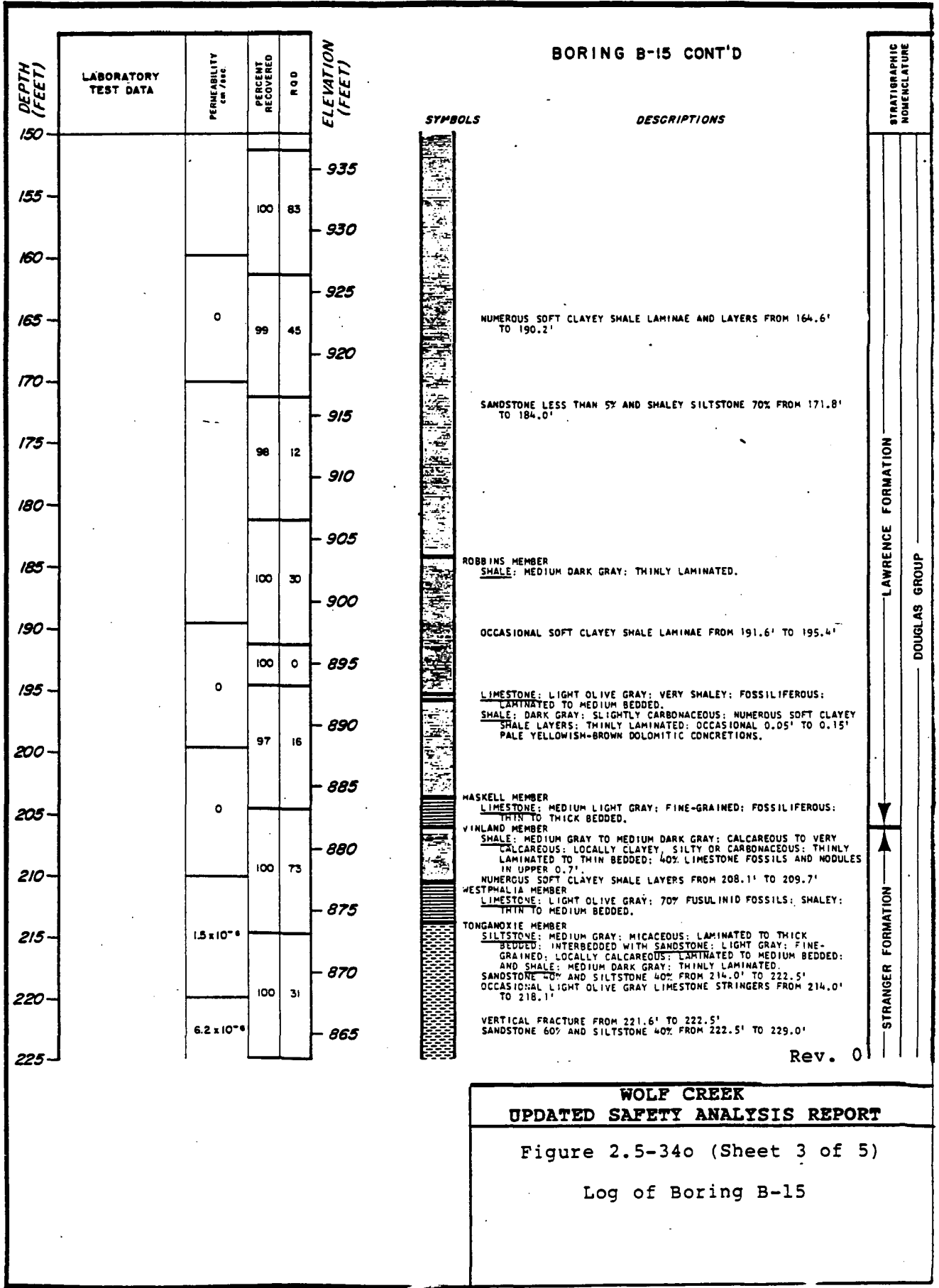

STRANGER FORMATION
LAWRENCE FORMATION
DOUGLAS GROUP

Rev. 0

WOLF CREEK
UPDATED SAFETY ANALYSIS REPORT

Figure 2.5-34o (Sheet 3 of 5)
Log of Boring B-15

BORING B-15 CONT'D

DEPTH (FEET)	LABORATORY TEST DATA	PERMEABILITY cm/sec.	PERCENT RECOVERED	R.O.D.	ELEVATION (FEET)
225		6.2 x 10 ⁻⁸	100	43	860
230					855
235		6.2 x 10 ⁻⁸			850
240			99	68	845
245		6.2 x 10 ⁻⁸			840
250			100	84	835
255					830
260			100	92	825
265					820
270			100	92	815
275		0			810
280			100	100	805
285					800
290			100	100	795
295		0			790
300					

SYMBOLS

DESCRIPTIONS

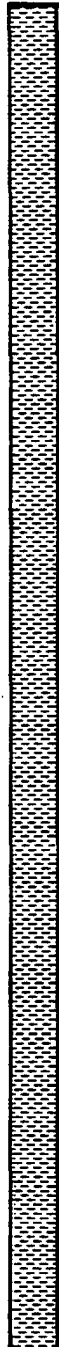

SANDSTONE 80% AND SILTSTONE 15% FROM 229.0' TO 233.4'

BROKEN ZONE FROM 230.8' TO 231.2'

SHALE GRADES OUT AT 233.4'
SANDSTONE 50% FROM 233.4' TO 243.0'
BROKEN ZONE FROM 234.4' TO 234.6'
BROKEN ZONE FROM 235.7' TO 236.1'

SANDSTONE 20% FROM 243.0' TO 248.8'

SANDSTONE 40% FROM 248.8' TO 251.8'

SANDSTONE 50% AND CARBONACEOUS, VERY MICACEOUS SILTSTONE 50% FROM 251.8' TO 252.8'
SANDSTONE 10% FROM 252.8' TO 259.6'
60° FRACTURE AT 254.4'

SANDSTONE 30% FROM 259.6' TO 264.8'

SANDSTONE 15% FROM 264.8' TO 268.3'
VERTICAL FRACTURE FROM 265.7' TO 266.0'

SANDSTONE 60% FROM 268.3' TO 270.7'

DISTORTED SANDSTONE 10% FROM 270.7' TO 282.4'
DISTORTED SANDSTONE ZONE FROM 273.6' TO 274.0'

DISTORTED SANDSTONE 25% FROM 282.4' TO 285.2'

SANDSTONE 10% FROM 285.2' TO 286.3'
SANDSTONE 90% FROM 286.3' TO 288.0'

SANDSTONE 10% FROM 288.0' TO 298.1'

SHALEY SILTSTONE 100% FROM 298.1' TO 312.1'
50° SLICKENSIDED FRACTURE AT 299.1'

STRATIGRAPHIC NOMENCLATURE

STRANGER FORMATION

DOUGLAS GROUP

Rev. 0

WOLF CREEK
UPDATED SAFETY ANALYSIS REPORT

Figure 2.5-34o (Sheet 4 of 5)

Log of Boring B-15

BORING B-15 CONT'D

DEPTH (FEET)	LABORATORY TEST DATA	PERMEABILITY cm./sec.	PERCENT RECOVERED	R Q D	ELEVATION (FEET)
300		0	100	97	785
305			73	73	780
310					775
315					

SYMBOLS

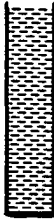

DESCRIPTIONS

BROKEN ZONE FROM 301.6' TO 301.8'

BORING COMPLETED AT 312.1 FEET ON 7-6-73.
 CASING USED TO A DEPTH OF 14.5 FEET.
 GROUND WATER LEVEL RECORDED AT 70.4 FEET
 FEET ON 7-9-73.
 THIRD PIEZOMETER INSTALLED AT AN INTERVAL
 FROM 5.0 FEET TO 29.0 FEET ON 7-13-73.
 SECOND PIEZOMETER INSTALLED AT AN INTERVAL
 FROM 40.0 FEET TO 80.0 FEET ON 7-13-73.
 FIRST PIEZOMETER INSTALLED AT AN INTERVAL
 FROM 122.0 FEET TO 154.0 FEET ON 7-13-73.
 PIEZOMETER READINGS ARE PRESENTED
 ON TABLE 2.4-29.

STRATIGRAPHIC NOMENCLATURE	
STRANGER	FORMATION
DOUGLAS	GROUP

Rev. 0

**WOLF CREEK
 UPDATED SAFETY ANALYSIS REPORT**

Figure 2.5-34o (Sheet 5 of 5)

Log of Boring B-15

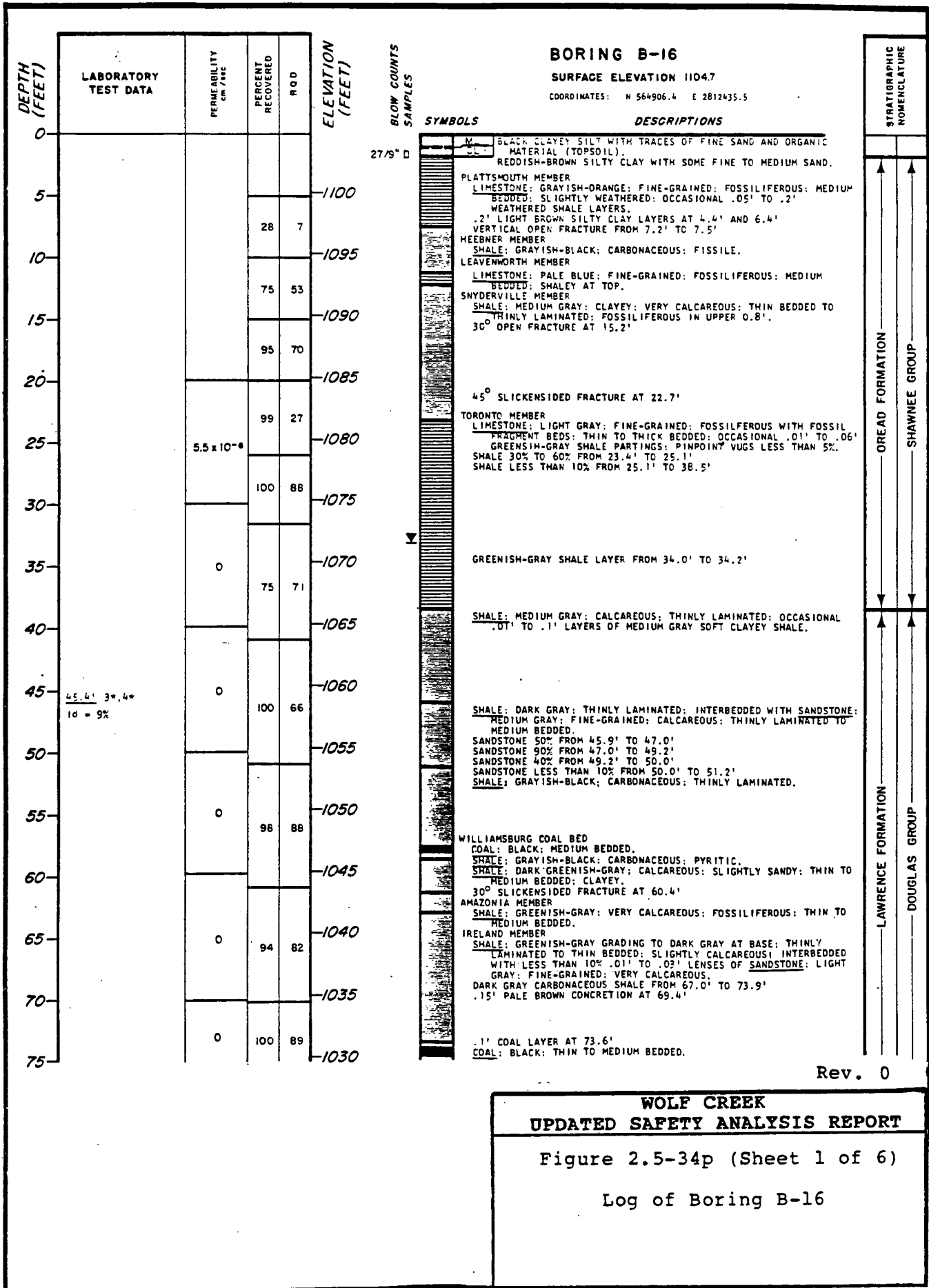

WOLF CREEK
UPDATED SAFETY ANALYSIS REPORT

Figure 2.5-34p (Sheet 1 of 6)
 Log of Boring B-16

BORING B-16 CONT.

DEPTH (FEET)	LABORATORY TEST DATA	PERMEABILITY cm/sec.	PERCENT RECOVERED	R.O.D.	ELEVATION (FEET)
75		0	100	89	
80					1025
85		0	99	79	1020
90					1015
95		1.9×10^{-7}	98	66	1010
100	99.5' lg = 70%				1005
105		0	100	89	1000
110			100	100	995
115		0	100	100	990
120					985
125			100	100	980
130			100	100	975
135			100	74	970
140					965
145			100	48	960
150					955

SYMBOLS



DESCRIPTIONS

SHALE: DARK GRAY GRADING TO GREENISH-GRAY AT BASE: SOFT; CLAYEY: THINLY LAMINATED TO MEDIUM BEDDED.
 SHALE: DARK GRAY: THINLY LAMINATED: INTERBEDDED WITH .01' TO .03' LAYERS OF SANDSTONE; LIGHT GRAY: FINE- TO MEDIUM-GRAINED; CALCAREOUS; IRREGULARLY BEDDED.
 SANDSTONE 5% TO 40% FROM 76.4' TO 95.0'

.3' SANDSTONE LAYER FROM 86.7' TO 87.0'
 .2' SANDSTONE LAYERS FROM 87.7' TO 87.9' AND FROM 90.2' TO 90.4'

.6' SANDSTONE LAYER FROM 92.7' TO 93.3'

SANDSTONE LESS THAN 5% FROM 95.0' TO 102.5'

BROKEN SOFT CLAYEY SHALE ZONE FROM 98.1' TO 99.3'

ROBBINS MEMBER

SHALE: DARK GRAY: SLIGHTLY CARBONACEOUS: THINLY LAMINATED.

OCCASIONAL .01' TO .02' LIGHT GRAY FINE-GRAINED CALCAREOUS SANDSTONE LENSES FROM 110.0' TO 114.3'

NUMEROUS SOFT MEDIUM GRAY CLAYEY SHALE LAYERS FROM 138.4' TO 144.3'

STRATIGRAPHIC NOMENCLATURE

LAWRENCE FORMATION

DOUGLAS GROUP

Rev. 0

WOLF CREEK
 UPDATED SAFETY ANALYSIS REPORT

Figure 2.5-34p (Sheet 2 of 6)

Log of Boring B-16

BORING B-16 CONT.

DEPTH (FEET)	LABORATORY TEST DATA	PERMEABILITY cm./sec.	PERCENT RECOVERED	R.O.D.	ELEVATION (FEET)
150			100	100	
155			37	0	950
			68	26	945
160					
165		0	92	63	940
170					935
			100	94	
175		1.5×10^{-7}	100	83	930
180					925
185		7.5×10^{-6}	100	48	920
190					915
195			100	45	910
200					905
205		2.6×10^{-7}	100	47	900
210					895
215		1.2×10^{-7}	100	61	890
220					885
225			100	84	880

SYMBOLS



DESCRIPTIONS

NUMEROUS SOFT MEDIUM GRAY CLAYEY SHALE LAYERS FROM 154.3' TO 156.1'

SHALE: GREENISH-GRAY; VERY CALCAREOUS; FOSSILIFEROUS; MEDIUM BEDDED.

SHALE: DARK GRAY; SLIGHTLY CARBONACEOUS; THINLY LAMINATED. .1' TO .2' PALE YELLOWISH-BROWN IRONSTONE CONCRETIONS AT 158.6', 160.1', 161.9' and 162.3'

HASKELL MEMBER

LIMESTONE: LIGHT GRAY; FINELY CRYSTALLINE; 10% FUSULINID FOSSILS; THIN TO THICK BEDDED.

VINLAND MEMBER

SHALE: DARK GRAY; VERY CALCAREOUS; CLAYEY; SLIGHTLY CARBONACEOUS; THIN TO MEDIUM BEDDED; FOSSILIFEROUS AT TOP.

SHALE: GRAYISH-OLIVE GREEN; CALCAREOUS; THIN TO MEDIUM BEDDED. 30% SLICKENSIDED FRACTURES AT 171.2' AND 171.4' 45° SLICKENSIDED FRACTURE AT 173.6'

WESTPHALIA MEMBER

LIMESTONE: LIGHT GRAY; FINE-GRAINED; 50% FUSULINID FOSSILS; GRADING FROM 70% OLIVE GREEN SHALE AT TOP TO 30% SHALE AT BASE; THIN TO MEDIUM BEDDED.

TONGANOXIE MEMBER

SANDSTONE: LIGHT OLIVE GRAY; FINE-GRAINED; SLIGHTLY CALCAREOUS; THIN TO THICK BEDDED; CROSS-BEDDED; COMMONLY EXHIBITS DISTORTED BEDS; INTERBEDDED WITH SHALE; MEDIUM GRAY; SILTY; AND SILTSTONE: MEDIUM GRAY; MICACEOUS; CROSS-BEDDED. .1' YELLOWISH-GRAY LIMESTONE NODULES AT 181.5' AND 181.8' .07' SOFT CLAYEY SHALE LAYER AT 181.9' SANDSTONE 50% FROM 179.3' TO 182.0' SANDSTONE 90% FROM 182.0' TO 190.6'

SANDSTONE 20% AND SILTSTONE 70% FROM 190.6' TO 204.1' .1' SOFT CLAYEY SHALE LAYER AT 192.2'

NUMEROUS SOFT CLAYEY SILTSTONE LAYERS FROM 194.5' TO 197.4'

.03' SOFT CLAYEY SHALE LAYER AT 202.4'

SANDSTONE 40% AND SILTSTONE 50% FROM 204.1' TO 213.7' .03' SOFT CLAYEY SHALE LAYER AT 205.3'

SANDSTONE 15% AND SILTSTONE 85% FROM 213.7' TO 223.2'

SANDSTONE 70% AND SILTSTONE 30% FROM 223.2' TO 225.0'

STRATIGRAPHIC NOMENCLATURE

LAWRENCE FORMATION

STRANGER FORMATION

DOUGLAS GROUP

Rev. 0

WOLF CREEK
UPDATED SAFETY ANALYSIS REPORT

Figure 2.5-34p (Sheet 3 of 6)

Log of Boring B-16

BORING B-16 CONT.

DEPTH (FEET)	LABORATORY TEST DATA	PERMEABILITY cm./sec.	PERCENT RECOVERED	R.O.D.	ELEVATION (FEET)
225			100	84	
230					875
235			100	92	870
240					865
245			100	80	860
250					855
255			96	96	850
260			100	84	845
265		8.3×10^{-9}	100	100	840
270					835
275		5.5×10^{-9}	100	100	830
280					825
285			100	92	820
290					815
295			91	70	810
300			100	100	805

SYMBOLS

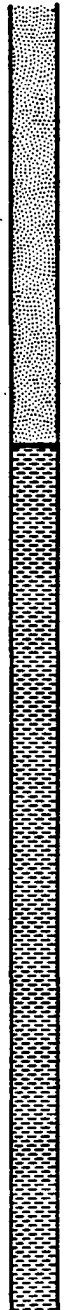

DESCRIPTIONS

SANDSTONE 20% AND SILTSTONE 80% FROM 225.0' TO 250.2'

VERTICAL OPEN FRACTURE FROM 235.2' TO 235.5'

.2' BROKEN ZONE AT 247.9'

SILTSTONE; MEDIUM TO DARK GRAY; MICACEOUS; SLIGHTLY SANDY; CROSS-BEDDED; COMMONLY EXHIBITS DISTORTED BEDS; THIN TO THICK BEDDED.

45° SLICKENSIDED FRACTURE AT 265.7'

30° SLICKENSIDED FRACTURE AT 267.3'

INTERBEDDED WITH 10% THINLY LAMINATED VERY FINE-GRAINED CALCAREOUS SANDSTONE FROM 268.4' TO 270.1'

60° OPEN FRACTURE AT 275.0'

20° SLICKENSIDED FRACTURE AT 285.6'

.02' TO .08' SOFT CLAYEY SILTSTONE LAYERS AT 285.7', 286.7', 287.0' AND 287.7'

50° SLICKENSIDED FRACTURE AT 291.9'

NUMEROUS PARALLEL 60° OPEN FRACTURES FROM 293.5' TO 294.3'

TWO 60° PARALLEL OPEN FRACTURES AT 295.5'

STRATIGRAPHIC NOMENCLATURE

STRANGER FORMATION
DOUGLAS GROUP

Rev. 0

WOLF CREEK
UPDATED SAFETY ANALYSIS REPORT

Figure 2.5-34p (Sheet 4 of 6)

Log of Boring B-16

BORING B-16 CONT.

DEPTH (FEET)	LABORATORY TEST DATA	PERMEABILITY cm./sec.	PERCENT RECOVERED	RQD	ELEVATION (FEET)
300					
305			100	68	800
310					795
315			100	75	790
320					785
325			96	74	780
330			100	95	775
335			100	87	770
340			100	52	765
345			89	0	760
350			100	0	755
355			63	58	750
360		0	100	49	745
365			100	87	740
370					735

SYMBOLS

DESCRIPTIONS

SILTSTONE GRADES MORE SHALEY BELOW 300.0'
 20° SLICKENSIDED FRACTURE AT 300.5'
 60° OPEN FRACTURE AT 301.1'
 70° SLICKENSIDED FRACTURE AT 302.7'

NUMEROUS 60° OPEN FRACTURES FROM 305.0' TO 307.4'

20° SLICKENSIDED FRACTURE AT 307.6'

.05' SOFT SHALEY SILTSTONE LAYER AT 310.1'
 1' SOFT SHALEY SILTSTONE LAYER AT 310.4'
 TWO 70° PARALLEL FRACTURES AT 311.6'

WESTON MEMBER
 SHALE; DARK GRAY; SLIGHTLY CARBONACEOUS; THINLY LAMINATED;
 INTERBEDDED IN UPPER 6 FEET WITH SILTSTONE; MEDIUM DARK
 GRAY; THINLY LAMINATED; MICACEOUS.
 TWO PARALLEL 60° FRACTURES AT 314.5'
 NUMEROUS LOW ANGLE FRACTURES FROM 315.5' TO 316.0'
 .05' BROKEN ZONE ALONG 40° FRACTURE AT 316.8'
 BROKEN ZONE FROM 317.1' TO 317.3'
 20° SLICKENSIDED FRACTURE AT 319.9'
 .2' SOFT CLAYEY SHALE LAYER AT 321.2'
 .05' SOFT CLAYEY SHALE LAYERS AT 323.0' AND 323.5'

.03' SOFT CLAYEY SHALE LAYER AT 341.2'
 .05' SOFT CLAYEY SHALE LAYER AT 341.8'
 SOFT BROKEN ZONE ALONG VERTICAL FRACTURE FROM 342.9' TO 343.4'

.1' SOFT CLAYEY SHALE LAYER AT 349.4'
 .1' SOFT CLAYEY SHALE LAYER AT 352.1'

.1' BROKEN ZONE AT 363.2'

.2' SOFT CLAYEY SHALE LAYER AT 365.5'
 .05' PALE YELLOWISH-BROWN DOLOMITIC CONCRETION AT 366.0'

.1' PALE YELLOWISH-BROWN DOLOMITIC CONCRETIONS AT 368.7'
 AND 369.7'
 THREE LOW ANGLE SLICKENSIDED FRACTURES FROM 369.8' TO 370.2'

STRATIGRAPHIC NOMENCLATURE

STRANGER FORMATION

DOUGLAS GROUP

Rev. 0

WOLF CREEK
UPDATED SAFETY ANALYSIS REPORT

Figure 2.5-34p (Sheet 5 of 6)

Log of Boring B-16

BORING B-16 CONT.

DEPTH (FEET)	LABORATORY TEST DATA	PERMEABILITY cm / sec	PERCENT RECOVERED	R O D	ELEVATION (FEET)
370			100	91	730
375					
380			97	92	725
385					720

SYMBOLS



DESCRIPTIONS

SOUTH BEND MEMBER
 LIMESTONE: LIGHT GRAY; FINE-GRAINED; FOSSILIFEROUS; THIN TO THICK BEDDED; OCCASIONAL DARK GRAY SHALE PARTINGS BELOW 374.4'.
 LIMESTONE: LIGHT GRAY; SANDY; THIN TO MEDIUM BEDDED; INTERBEDDED WITH 10% SHALE; DARK GRAY; SANDY.
 ROCK LAKE MEMBER
 SHALE: DARK GRAY; CALCAREOUS; SANDY; THINLY LAMINATED; INTERBEDDED WITH 40% LIMESTONE; LIGHT GRAY; SLIGHTLY SANDY; THIN BEDDED.
 STONER MEMBER
 LIMESTONE: VERY LIGHT GRAY; FINE-GRAINED; OCCASIONAL FUSULINID FOSSILS; THICK BEDDED.

BORING COMPLETED ON 5-4-73 AT 393.0 FEET.
 CASING USED TO A DEPTH OF 5.0 FEET.
 GROUNDWATER LEVEL RECORDED AT 32.9 FEET ON 5-7-73.
 SECOND PIEZOMETER INSTALLED AT AN INTERVAL FROM 23.0 FEET TO 37.0 FEET ON 7-27-73.
 FIRST PIEZOMETER INSTALLED AT AN INTERVAL FROM 61.0 FEET TO 91.0 FEET ON 7-27-73.
 PIEZOMETER READINGS PRE PRESENTED ON TABLE 2.4-29.

STRATIGRAPHIC NOMENCLATURE	
STANTON FORMATION	LANSING GROUP

Rev. 0

<p>WOLF CREEK UPDATED SAFETY ANALYSIS REPORT</p>
<p>Figure 2.5-34p (Sheet 6 of 6) Log of Boring B-16</p>

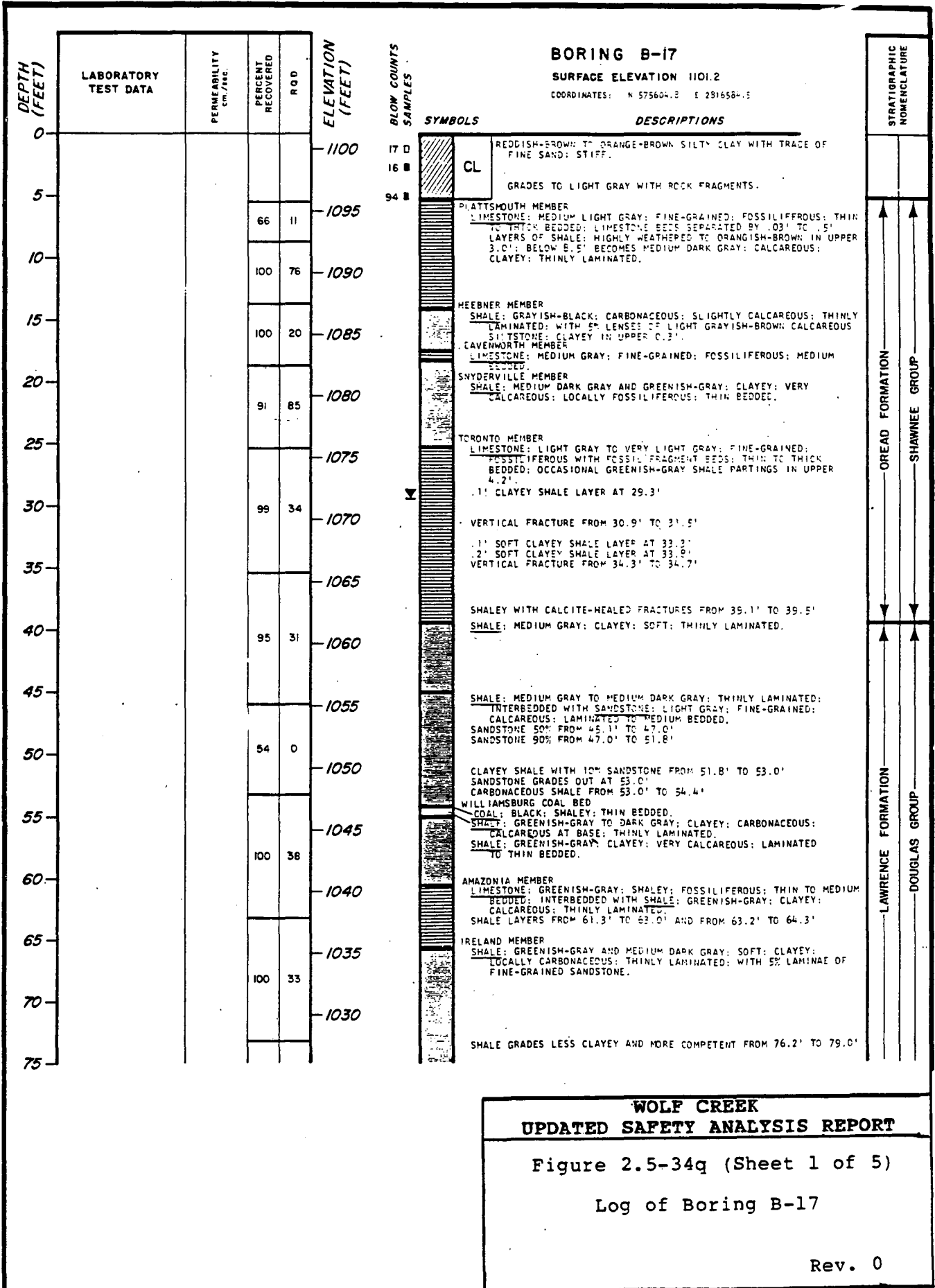

BORING B-17 CONT.

DEPTH (FEET)	LABORATORY TEST DATA	PERMEABILITY cm / sec	PERCENT RECOVERED	R.O.D	ELEVATION (FEET)
75					1025
80			97	74	1020
85					1015
90			98	0	1010
95					1005
100			97	13	1000
105					995
110			100	0	990
115					985
120			100	23	980
125					975
130			100	30	970
135					965
140			100	0	960
145					955
150			100	32	

131.4'
 Q = 1,190 psi
 P = 345,000 psi

SYMBOLS



DESCRIPTIONS

COAL: BLACK; SHALEY; LAMINATED TO MEDIUM BEDDED.
 SHALE: GREENISH-GRAY; LOCALLY CLAYEY; SLIGHTLY CALCAREOUS; THINLY LAMINATED TO THIN BEDDED.

SHALE: MEDIUM GRAY; LOCALLY CLAYEY; THINLY LAMINATED; INTERBEDDED WITH SANDSTONE: LIGHT GRAY; FINE-GRAINED; LAMINATED TO MEDIUM BEDDED; AND SILTSTONE: MEDIUM GRAY; MICACEOUS; LAMINATED TO MEDIUM BEDDED.

SANDSTONE 10% AND SILTSTONE 30% FROM 82.7' TO 85.5'
 SANDSTONE 40% AND SILTSTONE 30% FROM 85.5' TO 90.7'

SOFT CLAYEY SHALE ZONE WITH 20% SANDSTONE AND SILTSTONE FROM 90.7' TO 93.0'
 SANDSTONE 10% AND SILTSTONE 30% FROM 93.0' TO 94.3'
 SANDSTONE 50% AND SILTSTONE 30% FROM 94.3' TO 96.4'

SANDSTONE 10% AND SHALEY SILTSTONE 70% FROM 96.4' TO 103.9'

SANDSTONE 50% AND SILTSTONE 40% FROM 103.9' TO 106.5'

SANDSTONE 10% AND SHALEY SILTSTONE 60 FROM 106.5' TO 114.0'

NUMEROUS SOFT CLAYEY SHALE LAYERS FROM 108.0' TO 110.2'

BROKEN ZONE FROM 110.9' TO 111.3'

1' CLAYEY BROKEN ZONE AT 113.1'

NUMEROUS SOFT CLAYEY SHALE LAMINAE FROM 113.7' TO 119.0'
 SANDSTONE LESS THAN 10% AND SHALEY SILTSTONE 30% FROM 114.0' TO 121.0'

ROBBINS MEMBER
 SHALE: MEDIUM DARK GRAY; THINLY LAMINATED.
 NUMEROUS SOFT CLAYEY SHALE LAMINAE FROM 121.7' TO 127.4'

NUMEROUS SOFT CLAYEY SHALE LAMINAE FROM 129.4' TO 129.9'

NUMEROUS SOFT CLAYEY SHALE LAMINAE FROM 133.4' TO 150.3'

STRATIGRAPHIC NOMENCLATURE

LAWRENCE FORMATION
 DOUGLAS GROUP

Rev. 0

WOLF CREEK
 UPDATED SAFETY ANALYSIS REPORT

Figure 2.5-34q (Sheet 2 of 5)

Log of Boring B-17

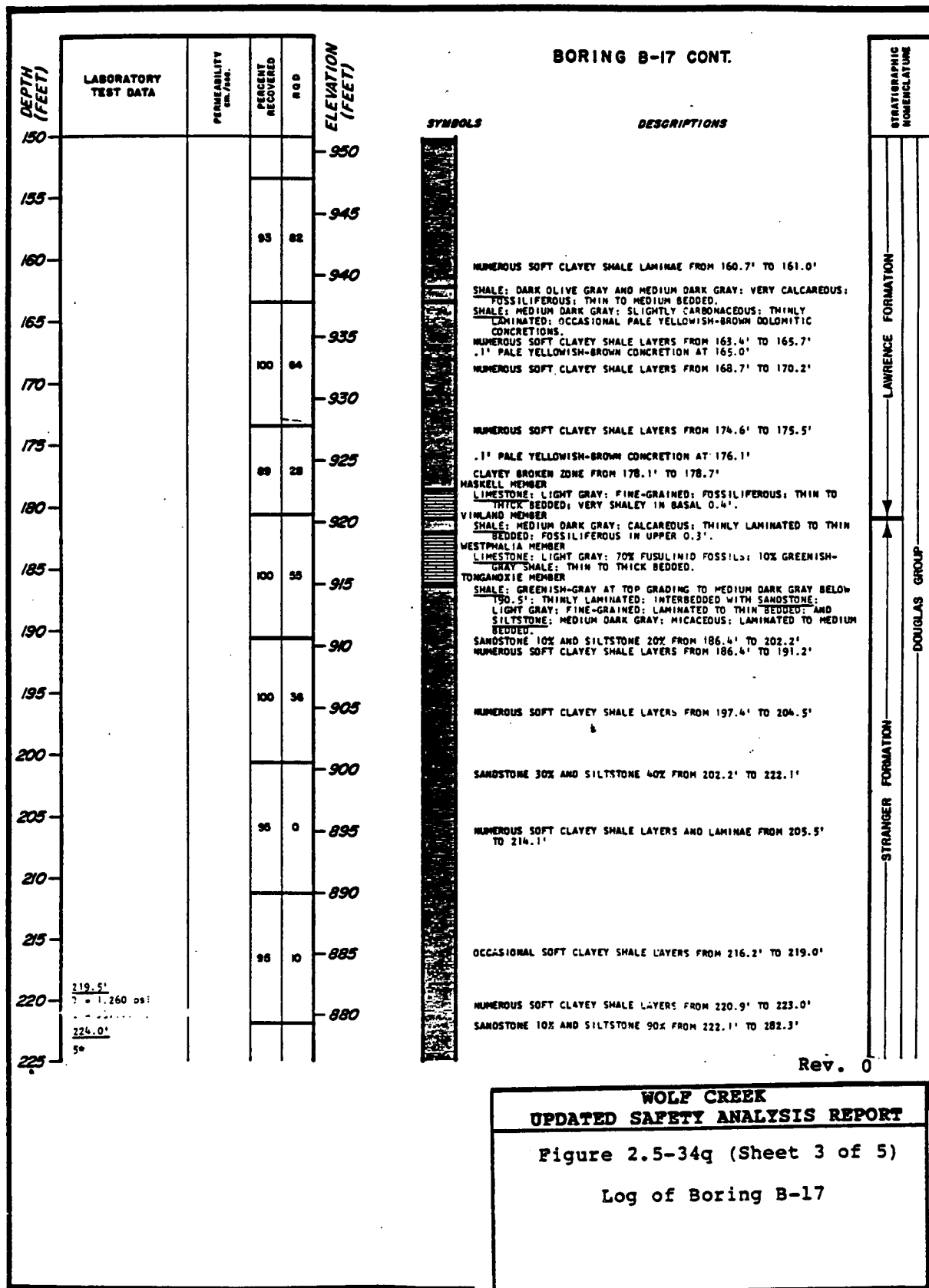

BORING B-17 CONT.

DEPTH (FEET)	LABORATORY TEST DATA	PERMEABILITY cm./sec.	PERCENT RECOVERED	R Q D	ELEVATION (FEET)
225					873
230			98	57	870
235					865
240			98	51	860
245					855
250			100	85	850
255					845
260	261.3' Q = 2.790 psi E = 957,000 psi		100	44	840
265					835
270			100	40	830
275					825
280			100	21	820
285					815
290			100	78	810
295					805
300			100	23	805

SYMBOLS



DESCRIPTIONS

.1' CLAYEY BROKEN ZONE AT 237.4'

OCCASIONAL SOFT CLAYEY SHALE LAMINAE FROM 253.9' TO 254.3'

CLAYEY BROKEN ZONE FROM 256.0' TO 256.4'

OCCASIONAL SOFT CLAYEY SHALE LAYERS FROM 259.9' TO 260.3'

NUMEROUS SOFT CLAYEY SHALE LAYERS FROM 262.4' TO 264.3'

.1' BROKEN ZONE AT 264.3'

OCCASIONAL SOFT CLAYEY SHALE LAYERS FROM 265.9' TO 278.9'

40° FRACTURE AT 270.5'

VERTICAL FRACTURE FROM 277.9' TO 278.9'

SANDSTONE 20" AND SILTSTONE 50" FROM 292.3' TO 312.1'

OCCASIONAL SOFT CLAYEY SHALE LAYERS FROM 291.3' TO 307.3'

STRATIGRAPHIC NOMENCLATURE
STRANGER FORMATION
DOUGLAS GROUP

Rev. 0

WOLF CREEK
UPDATED SAFETY ANALYSIS REPORT

Figure 2.5-34q (Sheet 4 of 5)

Log of Boring B-17

BORING B-17 CONT.

DEPTH (FEET)	LABORATORY TEST DATA	PERMEABILITY cm/sec.	PERCENT RECOVERED	R Q D	ELEVATION (FEET)
300	301.3' Q = 3,130 psi E = 968,000 psi				800
305			100	23	795
310					790
315			98	8	785
320					780
325			98	13	775
330					

SYMBOLS



DESCRIPTIONS

VERTICAL FRACTURE FROM 307.9' TO 308.3'

SANDSTONE 5% AND SILTSTONE 20% FROM 312.1' TO 320.6'
NUMEROUS SOFT CLAYEY SHALE LAMINAE FROM 313.9' TO 329.2'

WESTON MEMBER
SHALES: MEDIUM DARK GRAY; THINLY LAMINATED.

STRATIGRAPHIC NOMENCLATURE
STRANGER FORMATION
DOUGLAS GROUP

BORING COMPLETED AT 329.2 FEET ON 6-15-73.
CASING USED TO A DEPTH OF 6.5 FEET.
GROUNDWATER LEVEL RECORDED AT 29.6 FEET ON 8-6-73.

THIRD PIEZOMETER INSTALLED AT AN INTERVAL FROM 25.0 FEET TO 40.0 FEET ON 7-20-73.
SECOND PIEZOMETER INSTALLED AT AN INTERVAL FROM 65.0 FEET TO 121.0 FEET ON 7-20-73.
FIRST PIEZOMETER INSTALLED AT AN INTERVAL FROM 186.0 FEET TO 320.0 FEET ON 7-20-73.
PIEZOMETER READINGS ARE PRESENTED ON TABLE 2.4-29.

Rev. 0

**WOLF CREEK
UPDATED SAFETY ANALYSIS REPORT**

Figure 2.5-34q (Sheet 5 of 5)

Log of Boring B-17

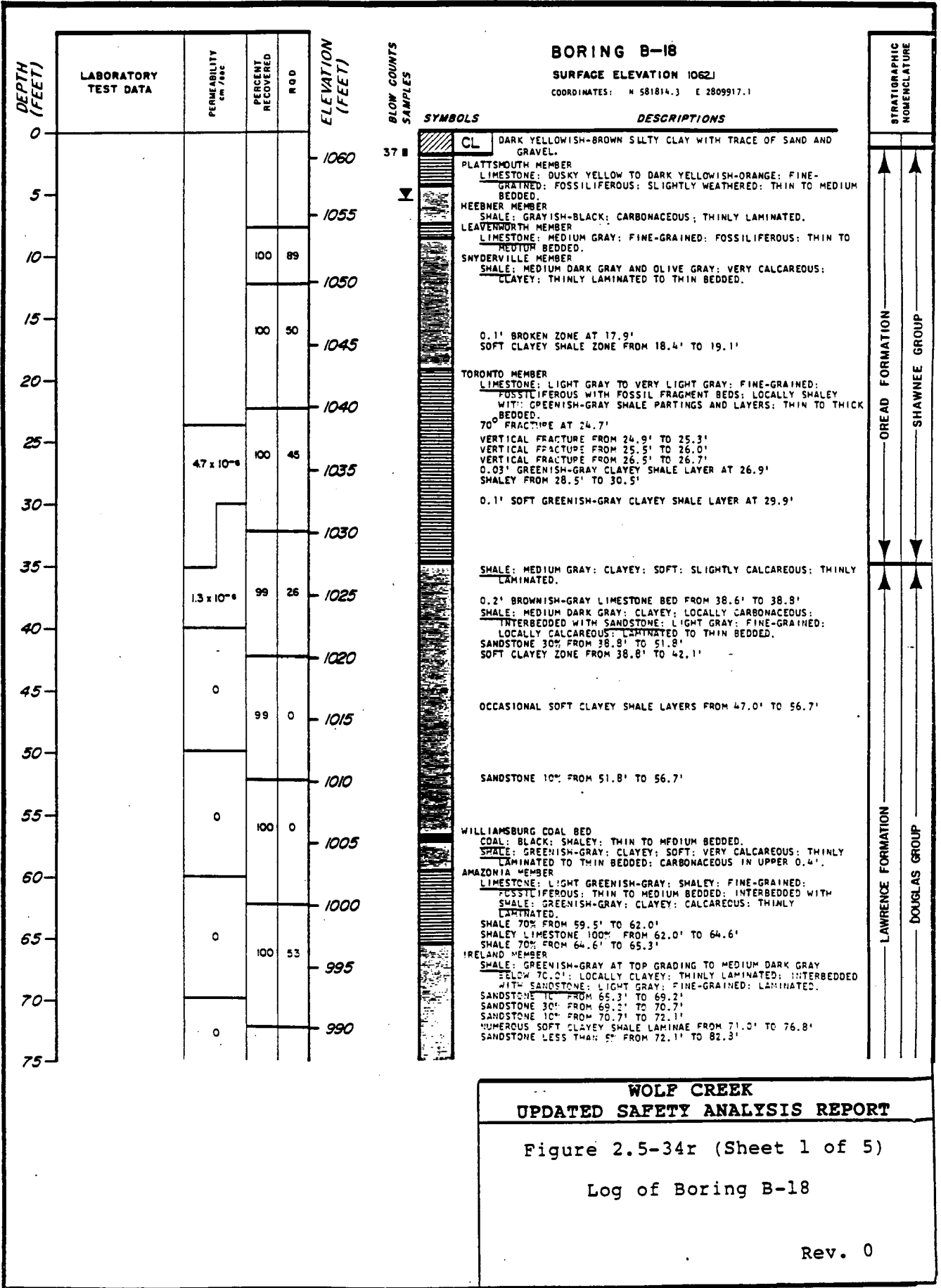

BORING B-18 CONT'D
SURFACE ELEVATION 1062.1

DEPTH (FEET)	LABORATORY TEST DATA	PERMEABILITY cm/sec	PERCENT RECOVERED	R Q D	ELEVATION (FEET)	SYMBOLS	DESCRIPTIONS	STRATIGRAPHIC NOMENCLATURE	
								LAWRENCE FORMATION	DOUGLAS GROUP
75		0	100	16	985		BROKEN ZONE FROM 78.6' TO 79.1'		
80		4.1 x 10 ⁻⁷	100	24	980		COAL: BLACK; SHALEY; LAMINATED TO 1/4" BEDDED. SHALE: MEDIUM DARK GRAY; LOCALLY CLAYEY; THINLY LAMINATED; INTERBEDDED WITH SANDSTONE; LIGHT GRAY; FINE-GRAINED; LOCALLY CALCAREOUS; LAMINATED TO THIN BEDDED; AND SILTSTONE: MEDIUM GRAY; MICACEOUS; LAMINATED TO MEDIUM BEDDED. 100% CLAYEY SHALE FROM 82.4' TO 84.5' SANDSTONE 30% AND SILTSTONE 40% FROM 84.5' TO 87.2' SANDSTONE 80% AND SILTSTONE 15% FROM 87.2' TO 92.3'		
85	975								
90		9.1 x 10 ⁻⁷	85	25	970		SANDSTONE 30% AND SILTSTONE 40% FROM 92.3' TO 102.7' NUMEROUS SOFT CLAYEY SHALE LAMINAE FROM 92.4' TO 105.4'		
95	965								
100		0	100	58	960		0.5' SILTSTONE LAYER WITH 15% DISTORTED CALCAREOUS SANDSTONE FROM 100.7' TO 101.2' SANDSTONE 25% AND SILTSTONE 20% FROM 102.7' TO 108.0'		
105	955								
110		0	100	18	950		SANDSTONE 10% AND SILTSTONE 10% FROM 109.0' TO 114.0' NUMEROUS SOFT CLAYEY SHALE LAMINAE FROM 113.4' TO 119.5' SANDSTONE 5% AND SHALEY SILTSTONE 40% FROM 114.0' TO 129.7'		
115	945								
120		0	100	20	940		NUMEROUS SOFT CLAYEY SHALE LAMINAE FROM 123.5' TO 127.2' SANDSTONE LESS THAN 5' AND SHALEY SILTSTONE 40% FROM 129.7' TO 134.8'		
125	935								
130		85	40	79	930		SANDSTONE GRADES OUT AT 134.8' SHALEY SILTSTONE 50% FROM 134.8' TO 154.8'		
135	925								
140		99	79	28	920		NUMEROUS SOFT CLAYEY SHALE LAMINAE FROM 144.4' TO 151.1'		
145	915								
150		100	28						

Rev. 0

**WOLF CREEK
UPDATED SAFETY ANALYSIS REPORT**

Figure 2.5-34r (Sheet 2 of 5)

Log of Boring B-18

BORING B-18 CONT'D

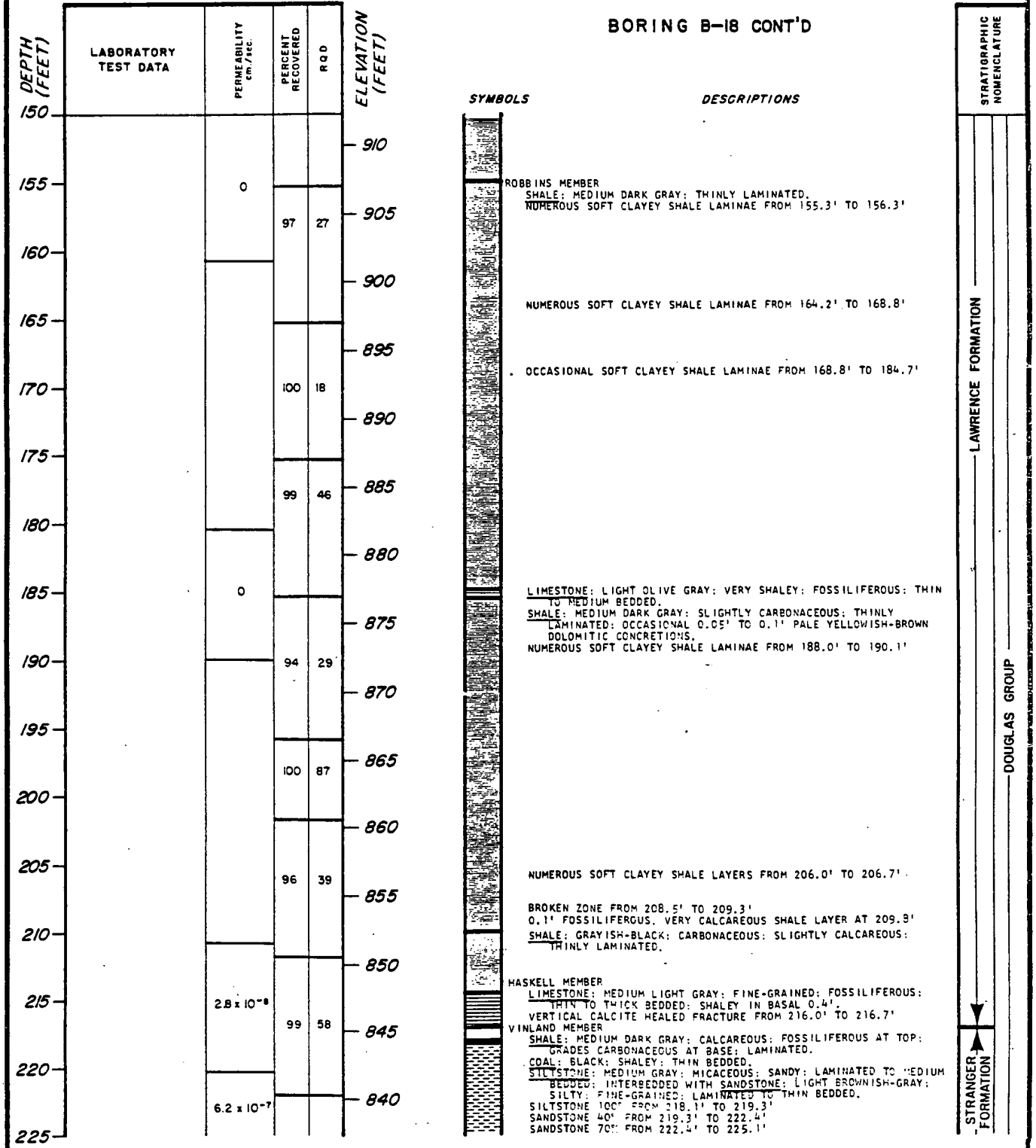

WOLF CREEK
UPDATED SAFETY ANALYSIS REPORT

Figure 2.5-34r (Sheet 3 of 5)

Log of Boring B-18

BORING B-18 CONT'D

DEPTH (FEET)	LABORATORY TEST DATA	PERMEABILITY cm./sec.	PERCENT RECOVERED	ROD	ELEVATION (FEET)	SYMBOLS	DESCRIPTIONS	STRATIGRAPHIC NOMENCLATURE	
								STRANGER FORMATION	DOUGLAS GROUP
225			83	11	835		SANDSTONE 20' FROM 225.1' TO 226.5'		
230					830		CCAL: BLACK; SHALEY: LAMINATED TO THIN BEDDED.		
235		0			825		SILTSTONE: MEDIUM GRAY; SHALEY: SANDY; LAMINATED TO MEDIUM BEDDED; INTERBEDDED WITH SANDSTONE: LIGHT BROWNISH-GRAY; FINE-GRAINED; SILTY; CALCAREOUS; LAMINATED TO THIN BEDDED; AND SHALE: MEDIUM GRAY; LOCALLY SLIGHTLY CARBONACEOUS; CLAYEY; THINLY LAMINATED TO THIN BEDDED.		
240			100	9	820		SILTSTONE 75' AND SHALE 25' FROM 226.9' TO 231.0'		
245		3.1 x 10 ⁻⁸			815		SANDSTONE 10' AND SHALE 30' FROM 231.0' TO 240.0'		
250					810		NUMEROUS SOFT CLAYEY SHALE LAMINAE FROM 231.5' TO 240.0'		
255		4.4 x 10 ⁻⁸	93	77	805		SHALE GRADES OUT AT 240.0'		
260					800		SANDSTONE 50' AND SANDY SILTSTONE 40' FROM 240.0' TO 257.5'		
265		2.0 x 10 ⁻⁸	99	92	795				
270					790		60° SLICKENSIDED FRACTURE AT 257.0'		
275					785		LIMESTONE: LIGHT OLIVE GRAY; 70' FUSULINID FR. SILEX; OCCASIONAL ROUNDED LIMESTONE PEBBLES; SHALEY; THIN TO MEDIUM BEDDED; INTERBEDDED WITH SILTSTONE: MEDIUM DARK GRAY; SHALEY; SANDY; CALCAREOUS; LAMINATED TO THIN BEDDED. LIMESTONE LAYERS FROM 257.3' TO 257.7'; FROM 258.0' TO 258.2'; AND FROM 258.8' TO 259.1'		
280					780		TONGANXIE MEMBER		
285			99	91	775		SHALE: MEDIUM DARK GRAY; THINLY LAMINATED; INTERBEDDED WITH SANDSTONE: LIGHT GRAY; FINE-GRAINED; LOCALLY CALCAREOUS; LAMINATED TO THIN BEDDED; AND SILTSTONE: MEDIUM GRAY; MICACEOUS; LAMINATED TO MEDIUM BEDDED.		
290					770		SANDSTONE 10' AND SILTSTONE 20' FROM 259.1' TO 271.9'		
295		0	99	99	765		208 FRACTURE AT 260.5'		
300							30 FRACTURE AT 261.7'		
							20 FRACTURE AT 262.6'		
							40° SLICKENSIDED FRACTURE AT 263.2'		
							0.1' BROKEN ZONE AT 263.4'		
							SANDSTONE 10' AND SILTSTONE 20' FROM 271.8' TO 282.9'		
							OCCASIONAL SOFT CLAYEY SHALE LAMINAE FROM 275.2' TO 281.0'		
							0.05' BROKEN ZONE AT 282.6'		
							SANDSTONE 25' AND SILTSTONE 20' FROM 282.9' TO 290.4'		
							VERTICAL FRACTURE FROM 288.4' TO 288.7'		
							SANDSTONE 10' AND SILTSTONE 10' FROM 290.4' TO 296.6'		
							SANDSTONE LESS THAN 5' AND SHALE/SILTSTONE 10' FROM 296.6' TO 303.6'		

Rev. 0

WOLF CREEK
UPDATED SAFETY ANALYSIS REPORT

Figure 2.5-34r (Sheet 4 of 5)

Log of Boring B-18

BORING B-18 CONT'D

DEPTH (FEET)	LABORATORY TEST DATA	PERMEABILITY cm./sec.	PERCENT RECOVERED	R.O.D.	ELEVATION (FEET)
300					760
305			100	84	755
310					750
315					

SYMBOLS



DESCRIPTIONS

CARBONACEOUS SHALE LAYER FROM 301.7' TO 302.0'

WESTON MEMBER
SHALE: MEDIUM DARK GRAY; SLIGHTLY CARBONACEOUS; THINLY LAMINATED.

STRANGER	FORMATION	DOUGLAS	GROUP
----------	-----------	---------	-------

BORING COMPLETED AT 310.5 FEET ON 6-25-73.
CASING USED TO A DEPTH OF 7.7 FEET.
GROUNDWATER LEVEL RECORDED AT 5.7 FEET ON 6-29-73.
THIRD PIEZOMETER INSTALLED AT AN INTERVAL FROM 5.0 FEET TO 10.0 FEET ON 7/19/74.
SECOND PIEZOMETER INSTALLED AT AN INTERVAL FROM 19.0 FEET TO 35.0 FEET ON 7/19/74.
FIRST PIEZOMETER INSTALLED AT AN INTERVAL FROM 74.0 FEET TO 105.0 FEET ON 7/19/74.
PIEZOMETER READINGS ARE PRESENTED ON TABLE 2.4-29.

Rev. 0

<p>WOLF CREEK UPDATED SAFETY ANALYSIS REPORT</p>
<p>Figure 2.5-34r (Sheet 5 of 5) Log of Boring B-18</p>

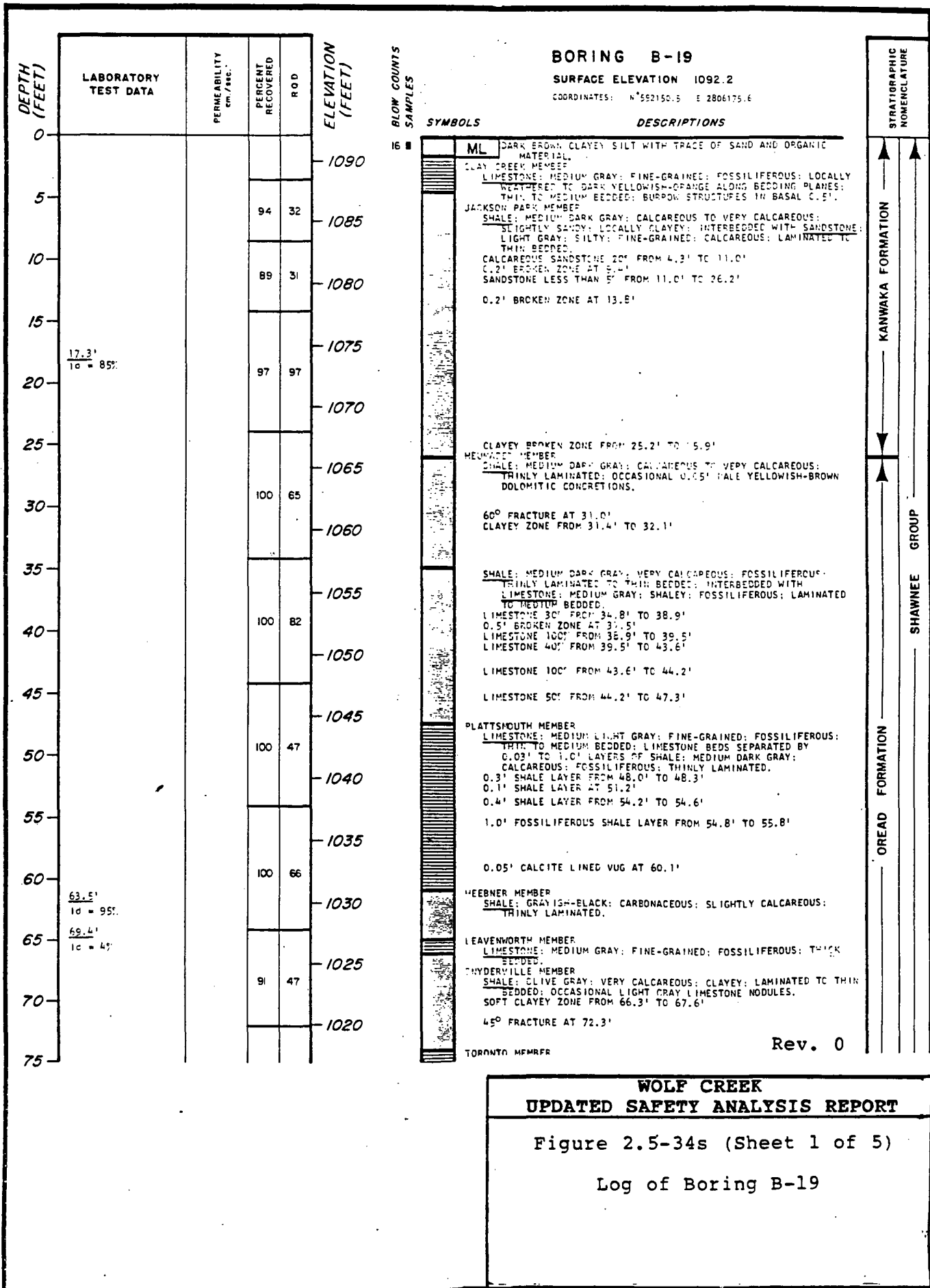

BORING B-19 CONT'D

DEPTH (FEET)	LABORATORY TEST DATA	PERMEABILITY cm./sec.	PERCENT RECOVERED	R.O.D.	ELEVATION (FEET)	SYMBOLS	DESCRIPTIONS	STRATIGRAPHIC NOMENCLATURE	
								OREAD FORMATION	SHAWNEE GROUP
75					1015		LIMESTONE: LIGHT GRAY TO VERY LIGHT GRAY; FINE-GRAINED; FOSSILIFEROUS WITH FOSSIL FRAGMENT BEDS; THIN TO THICK BEDDED; OCCASIONAL GREENISH-GRAY SHALE PARTINGS OR LAYERS. NUMEROUS GREENISH-GRAY SHALE PARTINGS FROM 74.2' TO 76.8' NUMEROUS GREENISH-GRAY SHALE PARTINGS FROM 79.0' TO 80.7'		
80			100	56	1010				
85			100	73	1005		SHALEY FROM 84.7' TO 85.5' 0.1' GREENISH-GRAY SHALE LAYER AT 85.4'		
90					1000		NUMEROUS SOFT CLAYEY SHALE LAYERS FROM 92.3' TO 96.2'		
95			99	56	995		SHALE: MEDIUM DARK GRAY; THINLY LAMINATED; INTERBEDDED WITH LENSES OF SANDSTONE: LIGHT GRAY; FINE-GRAINED; LOCALLY CALCAREOUS; LAMINATED TO THIN BEDDED. SANDSTONE 20% FROM 93.0' TO 97.1'		
100					990		SANDSTONE 50% FROM 97.1' TO 99.0'		
103.3' Id = 87%					990		SANDSTONE 10% FROM 99.0' TO 100.0' SANDSTONE 40% FROM 100.0' TO 100.8' SANDSTONE 15% FROM 100.8' TO 102.5' SANDSTONE LESS THAN 2% FROM 102.5' TO 107.3'		
105			95	82	985		WILLIAMSBURG COAL BED COAL: BLACK; SHALEY; THIN BEDDED. SHALE: GREENISH-GRAY; CLAYEY; VERY CALCAREOUS; LAMINATED TO THIN BEDDED. 20° SLICKENSIDED FRACTURE AT 108.5'		
110					980		30° SLICKENSIDED FRACTURE AT 111.2' NUMEROUS LOW ANGLE SLICKENSIDED FRACTURES FROM 112.5' TO 113.2' BROKEN CLAYEY ZONE FROM 113.5' TO 115.3'		
115			96	38	975		AMAZONIA MEMBER SHALE: GREENISH-GRAY; CLAYEY; CALCAREOUS; THINLY LAMINATED; INTERBEDDED WITH LIMESTONE: LIGHT GREENISH-GRAY; SHALEY; FINE-GRAINED; LAMINATED TO MEDIUM BEDDED. SHALE 90' FROM 114.6' TO 117.1' SHALEY LIMESTONE 160' FROM 117.1' TO 119.3' SHALE 100' FROM 119.3' TO 120.0'		
120					970		IRELAND MEMBER SHALE: MEDIUM DARK GRAY; THINLY LAMINATED; INTERBEDDED WITH SANDSTONE: LIGHT GRAY; FINE-GRAINED; LOCALLY CALCAREOUS; LAMINATED TO THIN BEDDED. SANDSTONE 10% FROM 120.0' TO 124.6' NUMEROUS SOFT CLAYEY SHALE LAYERS FROM 120.1' TO 121.7' SHALE LESS THAN 5% FROM 124.6' TO 131.1'		
125			100	65	965				
130	130.0' Id = 81%				960		COAL: BLACK; SHALEY; THIN BEDDED. SILTSTONE: MEDIUM GRAY; MICACEOUS; LAMINATED TO THICK BEDDED; INTERBEDDED WITH SANDSTONE: LIGHT GRAY; FINE-GRAINED; LOCALLY CALCAREOUS; LAMINATED TO THIN BEDDED; AND SHALE: MEDIUM DARK GRAY; LOCALLY CLAYEY; THINLY LAMINATED. SOFT CLAYEY SHALE 100' FROM 102.0' TO 102.7' SILTSTONE 50' AND SANDSTONE 50% FROM 102.7' TO 136.9' SANDSTONE 30' AND SILTSTONE 70% FROM 136.9' TO 140.7'		
135			91	63	955				
140					950		SANDSTONE 50' AND SILTSTONE 50% FROM 140.7' TO 141.9' SANDSTONE 70' AND SHALE 10% FROM 141.9' TO 148.1'		
145			95	58	945				
150					945		SANDSTONE 200' AND SHALEY SILTSTONE 50' FROM 148.1' TO 160.3' OCCASIONAL SOFT CLAYEY SHALE LAMINAE FROM 148.5' TO 150.5'		

WOLF CREEK
UPDATED SAFETY ANALYSIS REPORT

Figure 2.5-34s (Sheet 2 of 5)

Log of Boring B-19

BORING B-19 CONT'D

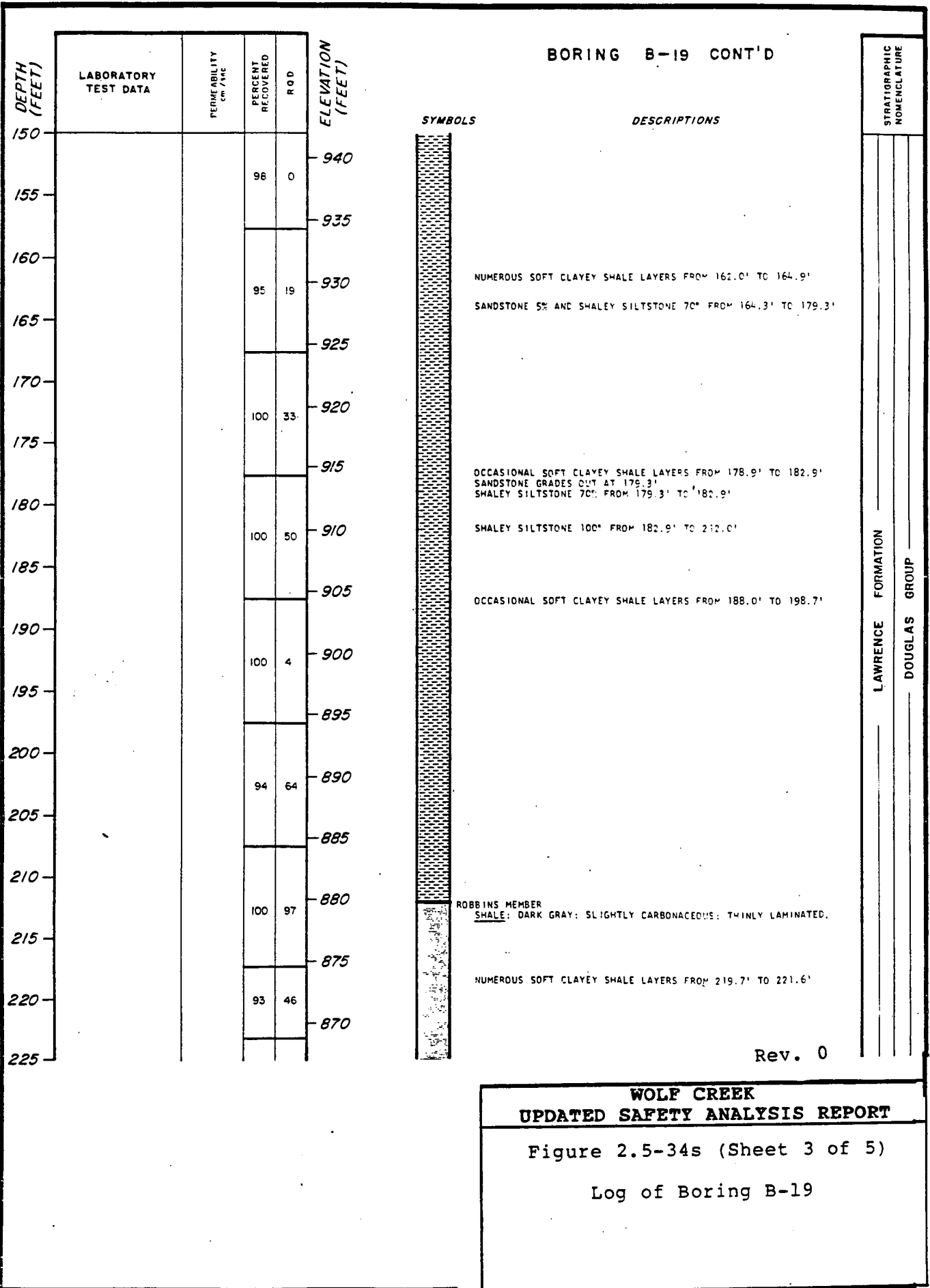

Rev. 0

WOLF CREEK
UPDATED SAFETY ANALYSIS REPORT

Figure 2.5-34s (Sheet 3 of 5)
 Log of Boring B-19

BORING B-19 CONT'D

DEPTH (FEET)	LABORATORY TEST DATA	PERMEABILITY cm/sec.	PERCENT RECOVERED	RQD	ELEVATION (FEET)
225			100	57	865
230					860
235			97	80	855
240					850
245			100	89	845
250					840
255			99	70	835
260					830
265			97	40	825
270					820
275			100	41	815
280					810
285			100	10	805
290					800
295			100	23	795
300					

SYMBOLS

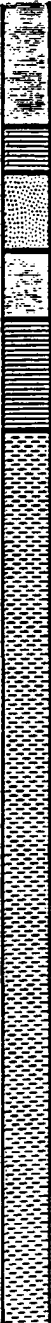

DESCRIPTIONS

0.1' PALE YELLOWISH-BROWN DOLOMITIC CONCRETION AT 229.4'

HASKELL MEMBER
LIMESTONE; MEDIUM LIGHT GRAY; FINE-GRAINED; FOSSILIFEROUS; THIN TO MEDIUM BEDDED; SHALEY IN BASAL 0.3'

VINLAND MEMBER
SANDSTONE; LIGHT GRAY; FINE-GRAINED; MASSIVE; SLIGHTLY CALCAREOUS; LOCALLY CARBONACEOUS; THICK BEDDED; SHALEY AND FOSSILIFEROUS IN UPPER 0.3'

SHALE; GREENISH-GRAY; CLAYEY; CALCAREOUS; THINLY LAMINATED; FOSSILIFEROUS IN BASAL 0.7'
25° SLICKENSIDED FRACTURE AT 239.0'
15° SLICKENSIDED FRACTURE AT 241.2'

WESTPHALIA MEMBER
LIMESTONE; LIGHT OLIVE GRAY; 60% FUSULINID FOSSILS; SHALEY WITH FREQUENT GREENISH-GRAY SHALE PARTINGS OR LAYERS; THIN TO MEDIUM BEDDED.

TONGANOXIE MEMBER
SILTSTONE; LIGHT GREENISH-GRAY GRADING TO MEDIUM GRAY BELOW; CALCAREOUS; LAMINATED TO THICK BEDDED; INTERBEDDED WITH SANDSTONE; LIGHT GRAY; FINE-GRAINED; LOCALLY CALCAREOUS; LAMINATED TO THIN BEDDED; AND SHALE; MEDIUM DARK GRAY; THINLY LAMINATED.
SANDSTONE 20" AND SHALE 5" FROM 249.2' TO 272.4'

VERTICAL FRACTURE FROM 259.2' TO 259.6'

0.4' PALE YELLOWISH-BROWN DOLOMITIC CONCRETION FROM 262.5' TO 263.3'
CLAYEY SPOKEN ZONE FROM 263.3' TO 264.0'

OCCASIONAL SOFT CLAYEY SHALE LAYER FROM 267.0' TO 271.5'

SANDSTONE 10" AND SHALE 10" FROM 272.4' TO 304.3'

OCCASIONAL SOFT CLAYEY SHALE LAMINAE FROM 277.5' TO 280.2'
60° FRACTURE AT 280.2'

OCCASIONAL SOFT CLAYEY SHALE LAYERS FROM 286.1' TO 290.1'

STRATIGRAPHIC NOMENCLATURE
LAWRENCE FORMATION
STRANGER FORMATION
DOUGLAS GROUP

Rev. 0

**WOLF CREEK
UPDATED SAFETY ANALYSIS REPORT**

Figure 2.5-34s (Sheet 4 of 5)

Log of Boring B-19

BORING B-19 CONT'D

DEPTH (FEET)	LABORATORY TEST DATA	PERMEABILITY cm / sec	PERCENT RECOVERED	R O D	ELEVATION (FEET)
300					790
305			100	90	785
310					780
315			100	80	775
320			100	55	770
325					765
330			50	40	760
335					

SYMBOLS

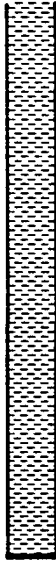

DESCRIPTIONS

45° FRACTURE AT 302.0'

SANDSTONE LESS THAN 5' AND SHALEY SILTSTONE 20' FROM 304.3' TO 330.7'

VERTICAL FRACTURE FROM 313.5' TO 314.9'

0.1' CLAYEY SPICKEZ ZONE AT 316.6'

0.1' BROKEN ZONES AT 316.9' AND 317.3'

0.2' BROKEN ZONE AT 317.9'

BORING COMPLETED AT 330.7 FEET ON 7-10-73.
 CASING USED TO A DEPTH OF 314 FEET.
 GROUNDWATER LEVEL NOT RECORDED.

STRATIGRAPHIC NOMENCLATURE

STRANGER FORMATION
 DOUGLAS GROUP

Rev. 0

WOLF CREEK
 UPDATED SAFETY ANALYSIS REPORT

Figure 2.5-34s (Sheet 5 of 5)

Log of Boring B-19

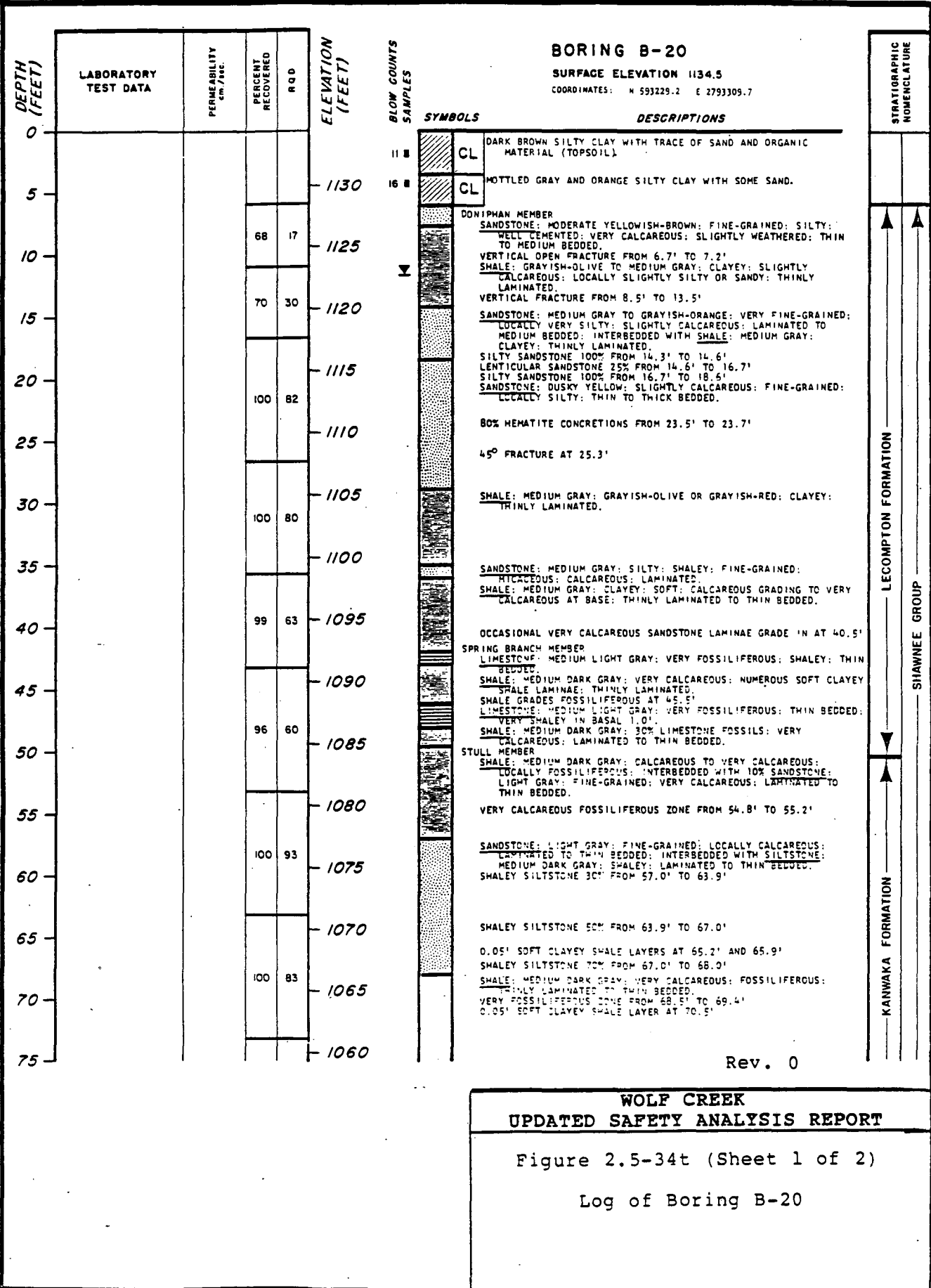

WOLF CREEK
UPDATED SAFETY ANALYSIS REPORT

Figure 2.5-34t (Sheet 1 of 2)

Log of Boring B-20

BORING B-20 CONT.

DEPTH (FEET)	LABORATORY TEST DATA	PERMEABILITY cm/sec	PERCENT RECOVERED	RQD	ELEVATION (FEET)
75					
80			100	96	1055
85					1050
90			98	66	1045
95					1040
100			100	79	1035
105					1030
110			100	90	1025
115					1020
120			99	99	1015
125					1010
130			100	95	1005
135			100	100	1000

SYMBOLS



DESCRIPTIONS

VERY FOSSILIFEROUS ZONE FROM 78.0' TO 78.8'
GRADES SANDY AND SLIGHTLY CALCAREOUS FROM 79.8' TO 79.5'

COAL: BLACK; SHALEY: LAMINATED TO THIN BEDDED.
SHALE: MEDIUM DARK GRAY; PLANT FOSSILIFEROUS; THINLY LAMINATED; INTERBEDDED WITH SANDSTONE; LIGHT GRAY; FINE-GRAINED; LOCALLY CALCAREOUS; LAMINATED TO THIN BEDDED; AND SILTSTONE; MEDIUM GRAY; PLANT FOSSILIFEROUS; LAMINATED TO MEDIUM BEDDED.
SHALE 100% FROM 79.7' TO 80.2'
SANDSTONE 40% AND SILTSTONE 60% FROM 80.2' TO 82.4'
SANDSTONE 80% AND SILTSTONE 20% FROM 82.4' TO 84.4'
SHALE 100% FROM 84.4' TO 85.3'
0.1' CARBONACEOUS SHALE LAYER AT 84.8'
MEDIUM GRAY VERY SHALEY SILTSTONE 100% FROM 85.3' TO 89.2'
0.1' PALE YELLOWISH-BROWN DOLOMITIC CONCRETION AT 87.3'
SANDSTONE 50% AND SHALEY SILTSTONE 40% FROM 89.2' TO 93.0'

SHALE 90% AND SHALEY SILTSTONE 10% FROM 93.0' TO 97.1'
NUMEROUS SOFT CLAYEY SHALE LAMINAE FROM 93.4' TO 95.0'

SHALE; MEDIUM DARK GRAY; CALCAREOUS TO VERY CALCAREOUS; LOCALLY FOSSILIFEROUS; THINLY LAMINATED.
VERY FOSSILIFEROUS LAYER FROM 97.1' TO 97.3'

CLAY CREEK MEMBER
LIMESTONE: MEDIUM LIGHT GRAY; FINE-GRAINED; FOSSILIFEROUS; THIN TO MEDIUM BEDDED; VERY SHALEY IN UPPER 0.8'; OCCASIONAL MEDIUM DARK GRAY SHALE PARTINGS.
HORIZONTAL CALCITE-LINED OPEN FRACTURE AT 102.9'
70° OPEN FRACTURE FROM 102.9' TO 103.2'
VERTICAL CALCITE-HEALED FRACTURE FROM 103.5' TO 104.8'

JACKSON PARK MEMBER
LIMESTONE: LIGHT GRAY; FINE-GRAINED; THIN TO MEDIUM BEDDED; LIMESTONE LAYERS SEPARATED BY 0.02' TO 0.4' IRREGULAR LAYERS OF SHALE; MEDIUM GRAY; VERY CALCAREOUS; DENSE; THINLY LAMINATED.

LIMESTONE: MEDIUM LIGHT GRAY; FINE-GRAINED; FOSSILIFEROUS; MEDIUM BEDDED.
SHALE: MEDIUM DARK GRAY; SILTY; SANDY; VERY CALCAREOUS; FOSSILIFEROUS; THINLY LAMINATED.

HEUMADER MEMBER
SHALE; MEDIUM DARK GRAY; CALCAREOUS; FOSSILIFEROUS; THINLY LAMINATED.

SHALE; MEDIUM DARK GRAY; 40% LIMESTONE FOSSILS; VERY CALCAREOUS; THIN BEDDED.

PLATTSMOUTH MEMBER
LIMESTONE: MEDIUM LIGHT GRAY; FINE-GRAINED; FOSSILIFEROUS; SHALEY; THIN TO MEDIUM BEDDED; INTERBEDDED WITH SHALE; MEDIUM DARK GRAY; VERY CALCAREOUS; FOSSILIFEROUS; THINLY LAMINATED.
SHALE LAYER FROM 133.9' TO 135.1'
0.1' SHALE LAYERS AT 135.7', 136.0' AND 136.2'

STRATIGRAPHIC NOMENCLATURE



BORING COMPLETED AT 137.6 FEET ON 7-10-73.
CASING USED TO A DEPTH OF 7.0 FEET.
GROUNDWATER LEVEL RECORDED AT 11.6 FEET ON 8-11-73.
THIRD PIEZOMETER INSTALLED AT AN INTERVAL FROM 21.0 FEET TO 28.0 FEET ON 7-26-73.
SECOND PIEZOMETER INSTALLED AT AN INTERVAL FROM 41.0 FEET TO 81.0 FEET ON 7-26-73.
FIRST PIEZOMETER INSTALLED AT AN INTERVAL FROM 101.0 FEET TO 114.0 FEET ON 7-26-73.
PIEZOMETER READINGS ARE PRESENTED ON TABLE 2.4-79.

Rev. 0

**WOLF CREEK
UPDATED SAFETY ANALYSIS REPORT**

Figure 2.5-34t (Sheet 2 of 2)
Log of Boring B-20

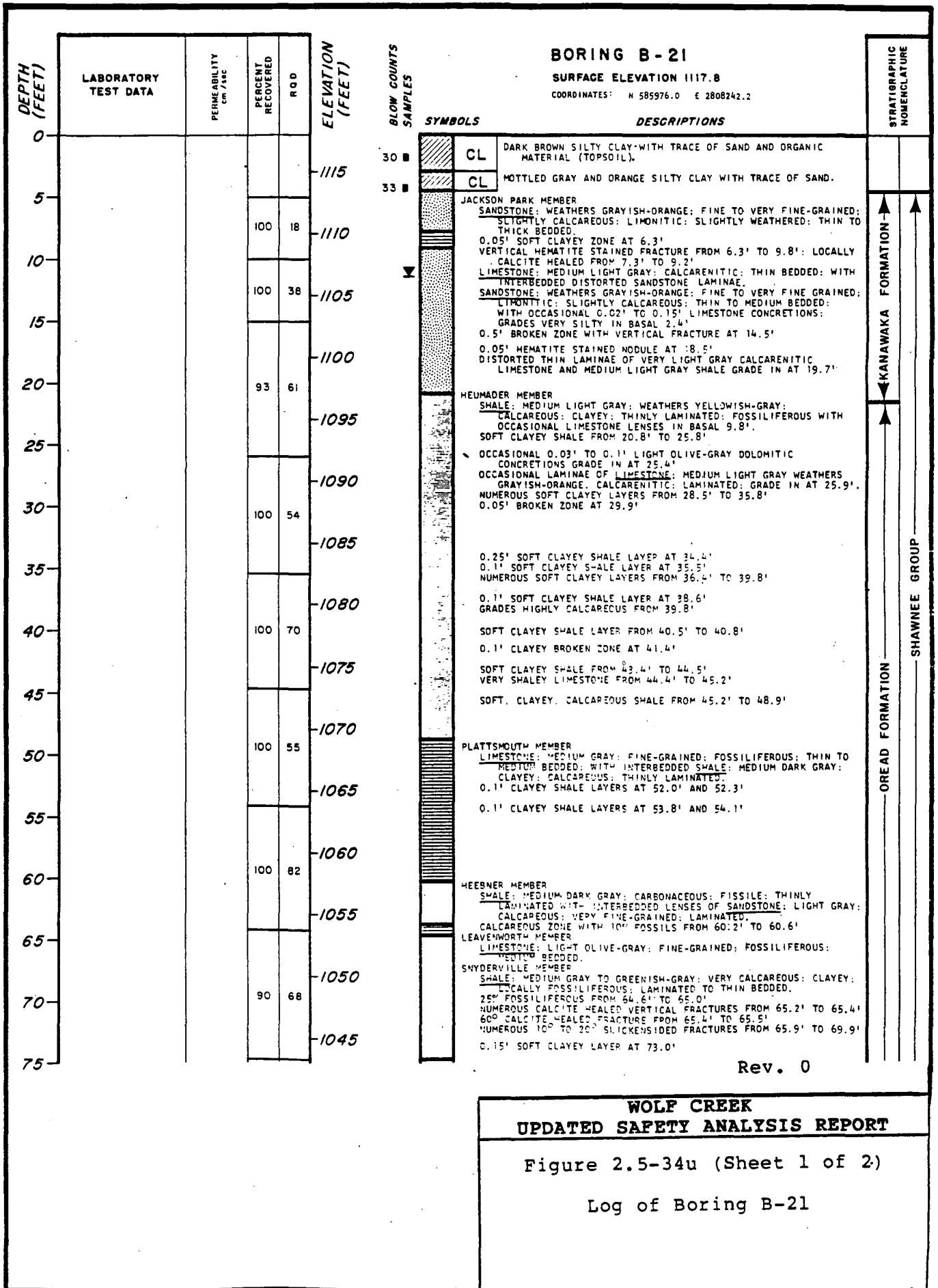

BORING B-21 CONT'D

DEPTH (FEET)	LABORATORY TEST DATA	PERMEABILITY cm./sec.	PERCENT RECOVERED	R.O.D.	ELEVATION (FEET)
75					1040
80			100	89	1035
85					1030
90			96	62	1025
95					1020
100			100	27	1015
105					1010
110			99	90	1005
115					1000
120			99	71	995
125					

SYMBOLS



DESCRIPTIONS

TORONTO MEMBER
 LIMESTONE: LIGHT GRAY TO VERY LIGHT GRAY; FINE-GRAINED; FOSSILIFEROUS; LOCALLY VERY SHALEY; MEDIUM TO THICK BEDDED; WITH INTERBEDDED GREENISH-GRAY TO LIGHT OLIVE GRAY SHALE LAMINAE.
 30% SHALE FROM 74.6' TO 75.0'
 BROKEN ZONE WITH VERTICAL FRACTURE FROM 75.8' TO 76.2'
 VERTICAL FRACTURE FROM 77.1' TO 77.7'
 60° FRACTURE FROM 78.0' TO 78.2'
 FOSSIL FRAGMENT BED WITH 90° FOSSILS FROM 78.8' TO 79.3'

0.1' SOFT CLAYEY SHALE LAYER AT 86.1'

SHALE: MEDIUM GRAY TO DARK GRAY; MICACEOUS; CARBONACEOUS; LAMINATED; WITH INTERBEDDED SANDSTONE; LIGHT GRAY; FINE TO VERY FINE-GRAINED; MICACEOUS; LOCALLY CALCAREOUS; LAMINATED.
 100% SOFT CLAYEY SHALE FROM 90.8' TO 92.4'
 10% SANDSTONE FROM 92.4' TO 93.1'
 40% SANDSTONE FROM 93.1' TO 96.5'
 20% SANDSTONE FROM 96.5' TO 104.4'

NUMEROUS SOFT CLAYEY LAYERS FROM 101.2' TO 104.4'

10% SANDSTONE FROM 104.4' TO 106.4'

WILLIAMSBURG COAL BED
 COAL: BLACK; CALCAREOUS; THINLY LAMINATED TO THIN BEDDED.
 SHALE: GREENISH-GRAY; VERY CALCAREOUS; LAMINATED TO THIN BEDDED.
 NUMEROUS LOW ANGLE SLICKENSIDED FRACTURES FROM 107.8' TO 115.1'

NUMEROUS SOFT CLAYEY LAYERS FROM 115.4' TO 118.3'

AMAZONIA MEMBER
 SHALE: GREENISH-GRAY; VERY CALCAREOUS; CLAYEY; LAMINATED; WITH LENSES AND NODULES OF SHALEY LIMESTONE.

LIMESTONE: GREENISH-GRAY; FINE-GRAINED; SHALEY; FOSSILIFEROUS; THIN TO MEDIUM BEDDED; WITH INTERBEDDED SHALE; GREENISH-GRAY; CALCAREOUS; THINLY LAMINATED.

IRELAND MEMBER
 SHALE: MEDIUM GRAY; MICACEOUS; SLIGHTLY CARBONACEOUS; THINLY LAMINATED; WITH INTERBEDDED SANDSTONE; LIGHT GRAY; FINE-GRAINED; DISTORTED LAMINATIONS.
 SANDSTONE 90% FROM 121.6' TO 123.0'
 SANDSTONE 15% FROM 123.0' TO 124.8'

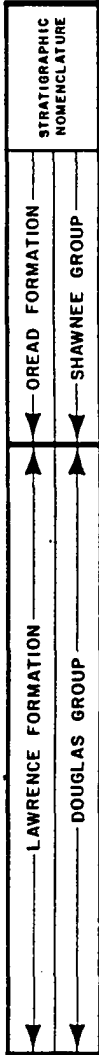

BORING COMPLETED AT 124.8 FEET ON 7-12-73.
 CASING USED TO A DEPTH OF 15.0 FEET.
 GROUNDWATER LEVEL RECORDED AT 11.4 FEET ON 8-10-73.
 THIRD PIEZOMETER INSTALLED AT AN INTERVAL FROM 5.0 FEET TO 43.0 FEET ON 7-30-73.
 SECOND PIEZOMETER INSTALLED AT AN INTERVAL FROM 48.0 FEET TO 60.0 FEET ON 7-30-73.
 FIRST PIEZOMETER INSTALLED AT AN INTERVAL FROM 74.0 FEET TO 91.0 FEET ON 7-30-73.
 PIEZOMETER READINGS ARE PRESENTED ON TABLE 2.4-29.

Rev. 0

WOLF CREEK
UPDATED SAFETY ANALYSIS REPORT

Figure 2.5-34u (Sheet 2 of 2)

Log of Boring B-21

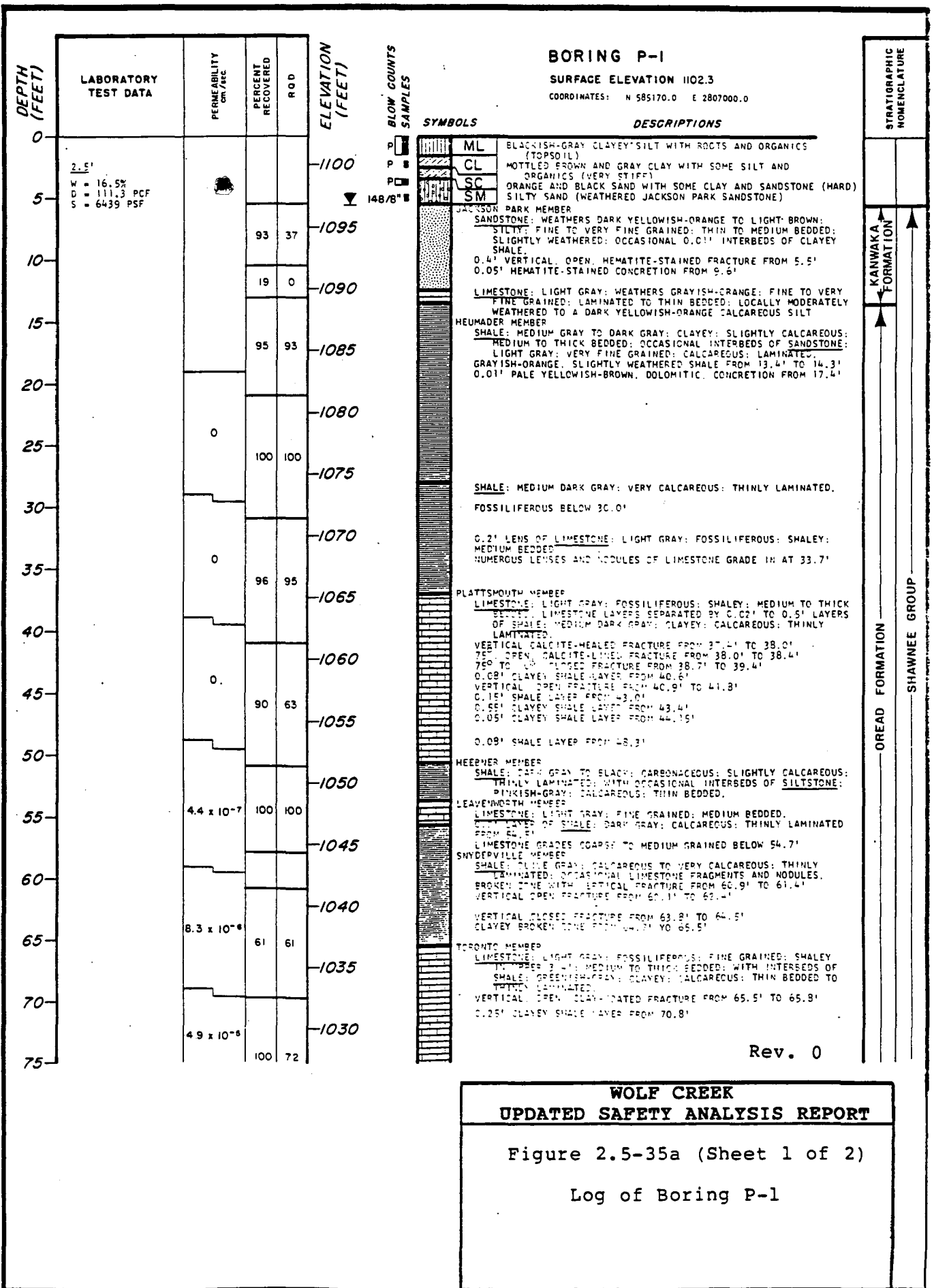

BORING P-1 CONT'D.

DEPTH (FEET)	LABORATORY TEST DATA	PERMEABILITY cm/sec	PERCENT RECOVERED	ROD	ELEVATION (FEET)
75					1025
80					1020
85		7.0 x 10 ⁻⁸	97	97	1015
90					1010
95		5.2 x 10 ⁻⁸	100	100	1005
100					1000
105			100	100	995
110					

SYMBOLS



DESCRIPTIONS

0.05' CLAYEY SHALE LAYER FROM 76.5'
 0.1' CLAYEY SHALE LAYER FROM 77.0'
 0.01' CLAYEY SHALE LAYER FROM 79.9'

SHALE: GREENISH-GRAY GRADING TO MEDIUM GRAY BELOW 84.1';
 CLAYEY; SLIGHTLY CALCAREOUS; THINLY LAMINATED; WITH
 INTERBEDS OF SANDSTONE; LIGHT GRAY; CALCAREOUS; SLIGHTLY
 CARBONACEOUS; FINE TO VERY FINE GRAINED; LAMINATED.
 SANDSTONE LESS THAN 10% FROM 82.5' TO 85.6'
 SANDSTONE 30% FROM 85.6' TO 87.2'
 SANDSTONE 50% FROM 87.2' TO 88.2'
 SANDSTONE 30% FROM 88.2' TO 89.9'

SOFT CLAYEY ZONE FROM 90.9' TO 92.3'
 SANDSTONE 10% FROM 89.9' TO 92.3'
 SANDSTONE 30% FROM 92.3' TO 97.5'

SANDSTONE 10% FROM 97.5' TO 101.1'

SHALE 100% FROM 101.1' TO 102.1'
 WILLIAMSBURG COAL BED
 COAL: BLACK; SHALEY; MEDIUM BEDDED.
 SHALE: DARK GRAY GRADING TO GREENISH-GRAY; CARBONACEOUS;
 CLAYEY; CALCAREOUS; THIN BEDDED.
 AMAZONIA MEMBER
 SHALE: GREENISH-GRAY; CALCAREOUS TO VERY CALCAREOUS; CLAYEY;
 THINLY LAMINATED TO THIN BEDDED; WITH OCCASIONAL LIGHT
 GRAY LIMESTONE NODULES.
 LIMESTONE: LIGHT GRAY; SHALEY; FINE GRAINED; LOCALLY
 FOSILIFEROUS; MEDIUM BEDDED; WITH INTERBEDS OF SHALE;
 GREENISH-GRAY; CALCAREOUS; THINLY LAMINATED.
 IRELAND MEMBER
 SHALE: GREENISH-GRAY; CALCAREOUS; THINLY LAMINATED.

STRATIGRAPHIC NOMENCLATURE

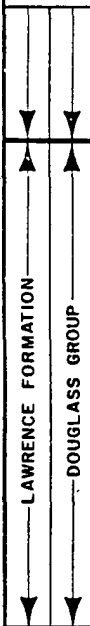

BORING COMPLETED AT 109.9 FEET ON 10-24-73.
 CASING USED TO A DEPTH OF 10.5 FEET.
 GROUNDWATER LEVEL RECORDED AT 5.5 FEET ON 10-29-73.
 SECOND PIEZOMETER INSTALLED AT AN INTERVAL FROM
 2.0 FEET TO 50.0 FEET ON 11-13-73.
 FIRST PIEZOMETER INSTALLED AT AN INTERVAL FROM
 64.5 FEET TO 93.0 FEET ON 11-13-73.
 PIEZOMETER READINGS ARE PRESENTED ON TABLE 2.4-3i.

Rev. 0

WOLF CREEK
UPDATED SAFETY ANALYSIS REPORT

Figure 2.5-35a (Sheet 2 of 2)

Log of Boring P-1

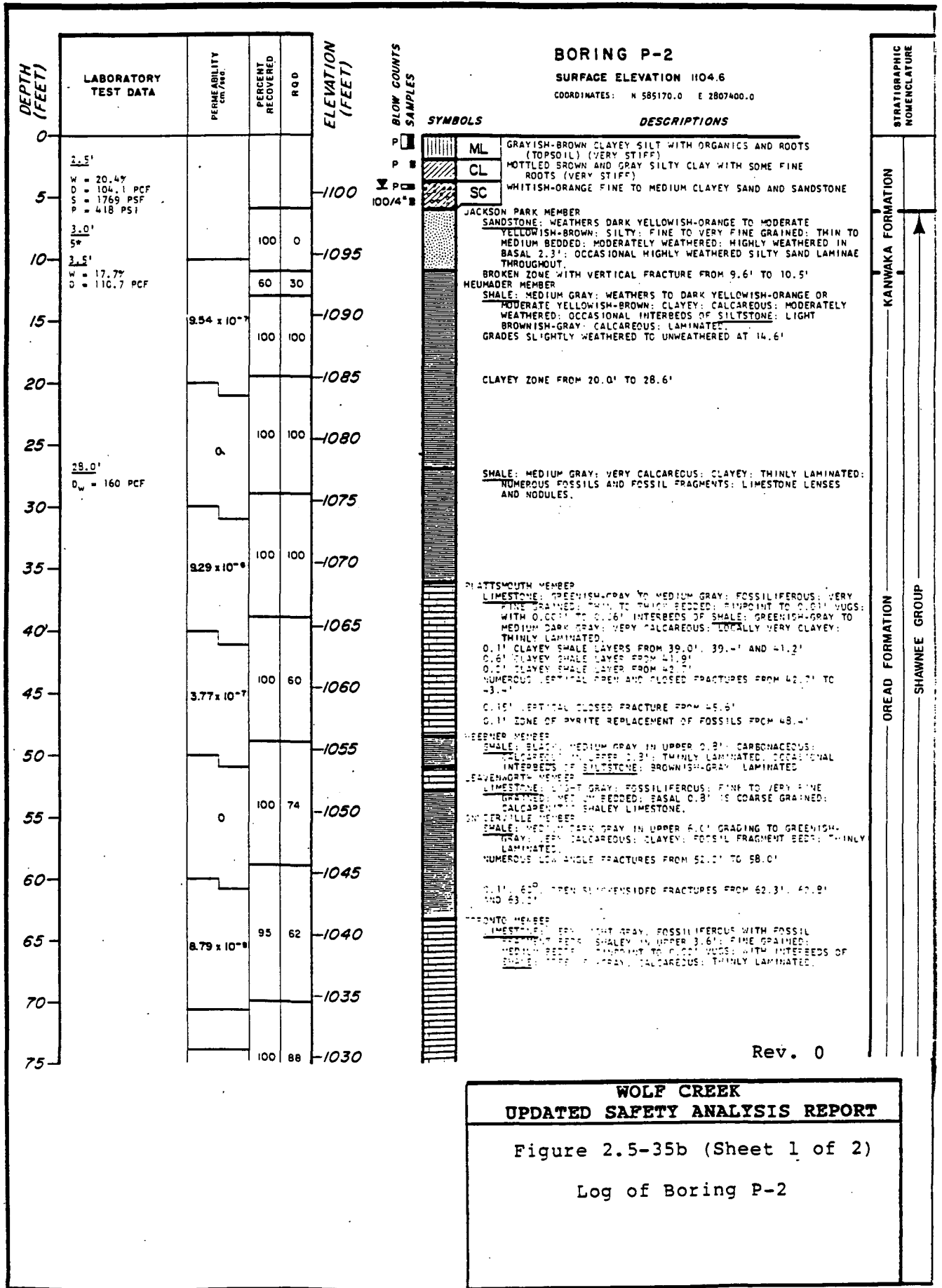

WOLF CREEK
UPDATED SAFETY ANALYSIS REPORT

Figure 2.5-35b (Sheet 1 of 2)
 Log of Boring P-2

BORING P-2 CONT'D.

DEPTH (FEET)	LABORATORY TEST DATA	PERMEABILITY cm/sec	PERCENT RECOVERED	RQD	ELEVATION (FEET)
75					
80		2.03 x 10 ⁻⁹			1025
85			100	100	1020
90		1.61 x 10 ⁻⁷			1015
95			99	99	1010
100		0			1005
105			100	100	1000
110					995
115					

SYMBOLS



DESCRIPTIONS

0.05' CLAYEY SHALE LAYER AT 78.0'
0.08' CLAYEY SHALE LAYER AT 78.6'

SHALE: GREENISH-GRAY IN UPPER 2.0' GRADING TO MEDIUM DARK GRAY; LOCALLY CALCAREOUS; CLAYEY; SLIGHTLY CARBONACEOUS; THINLY LAMINATED; WITH INTERBEDDED SANDSTONE; LIGHT GRAY; CALCAREOUS; SILTY; MICACEOUS; SLIGHTLY CARBONACEOUS; FINE-GRAINED; LAMINATED WITH DISTORTED STRUCTURE; AND SILTSTONE; MEDIUM DARK GRAY; SHALEY; SLIGHTLY CARBONACEOUS; MICACEOUS; LAMINATED TO THIN BEDDED.
80" CALCAREOUS SANDSTONE AND 20" SHALE FROM 82.4' TO 83.9'
100" SHALE FROM 83.9' TO 85.4'
C.1' 45° OPEN FRACTURE FROM 84.9'
SANDSTONE 40" AND SILTSTONE 40" FROM 85.4' TO 97.5'

SANDSTONE 10" AND SILTSTONE 50" FROM 97.5' TO 100.5'

SHALE 100" FROM 100.5' TO 103.5'
SHALE GRADES VERY CARBONACEOUS FROM 102.0'
C.1' COAL SEAM FROM 103.0'

WILLIAMSBURG COAL BED
COAL: BLACK; VERY SHALEY; LAMINATED.
SHALE: DARK GRAY GRADING TO GREENISH-GRAY; CLAYEY; CARBONACEOUS; IN UPPER 0.6'; VERY CALCAREOUS; THINLY LAMINATED.

AMAZONIA MEMBER
SHALE: GREENISH-GRAY; VERY CALCAREOUS; THINLY LAMINATED; LENTES AND NODULES OF LIMESTONE.

LIMESTONE: GREENISH-GRAY; VERY SHALEY; FOSSILIFEROUS; FINE GRAINED; MEDIUM BEDDED.
0.3' VERTICAL OPEN FRACTURE FROM 109.0'

BORING COMPLETED AT 110.5 FEET ON 10-29-73.
CASING USED TO A DEPTH OF 6.0 FEET.
GROUNDWATER LEVEL RECORDED AT 4.4 FEET ON 11-4-73.

STRATIGRAPHIC NOMENCLATURE

LAWRENCE FORMATION
DOUGLASS GROUP

Rev. 0

WOLF CREEK
UPDATED SAFETY ANALYSIS REPORT

Figure 2.5-35b (Sheet 2 of 2)

Log of Boring P-2

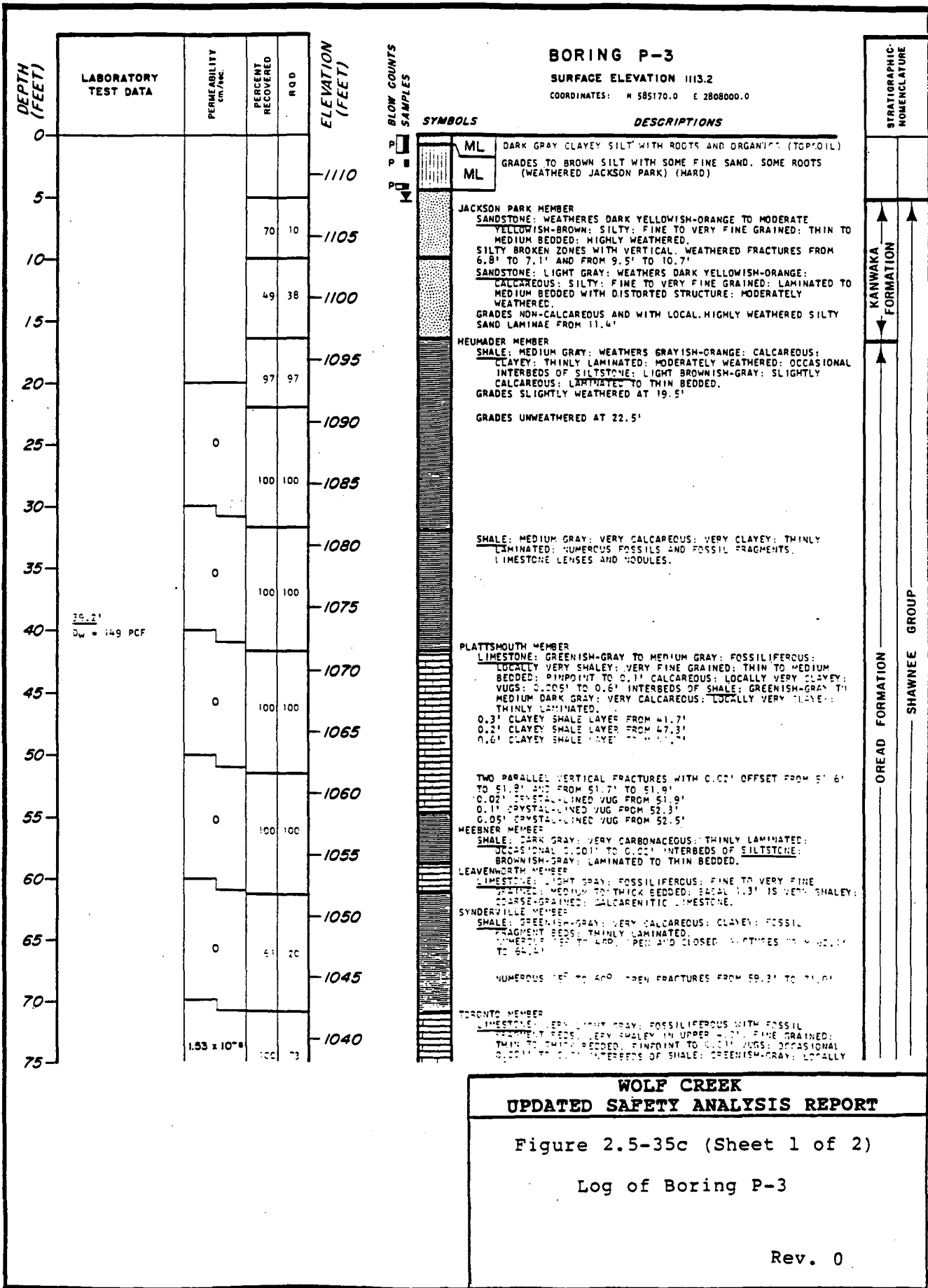

BORING P-3 CONT'D

DEPTH (FEET)	LABORATORY TEST DATA	PERMEABILITY cm/sec	PERCENT RECOVERED	ROD	ELEVATION (FEET)
75					1035
80					1030
85		105 x 10 ⁻⁸	96	80	1025
90					1020
95		2.33 x 10 ⁻⁷	100	100	1015
100					1010
105					1005
110			100	100	1000
115			100	100	
120					

SYMBOLS



DESCRIPTIONS

0.7' CLAYEY SHALE LAYER FROM 71.5'
 VERTICAL: CLAY-HEALED FRACTURE FROM 72.6' TO 73.3'

VERTICAL OPEN FRACTURE FROM 78.1' TO 79.2'

0.05' CLAYEY SHALE LAYER FROM 82.1'
 0.15' CLAYEY SHALE LAYER FROM 82.7'

0.2' VERTICAL HEALED FRACTURE FROM 87.4'

SHALE: GREENISH-GRAY IN UPPER 2.4' GRADING TO MEDIUM DARK GRAY; LOCALLY CALCAREOUS; CLAYEY SLIGHTLY CARBONACEOUS; THINLY LAMINATED; WITH INTERBEDDED SANDSTONE; LIGHT GRAY; CALCAREOUS; SILTY; MICACEOUS; SLIGHTLY CARBONACEOUS; FINE GRAINED; LAMINATED TO THIN BEDDED WITH DISTORTED STRUCTURE; AND SILTSTONE; MEDIUM DARK GRAY; SHALEY; SLIGHTLY CARBONACEOUS; MICACEOUS; LAMINATED TO THIN BEDDED. SHALE 100% FROM 88.5' TO 90.6'
 SANDSTONE 10% AND SILTSTONE 50% FROM 90.6' TO 91.9'
 SANDSTONE 40% AND SILTSTONE 40% FROM 91.9' TO 101.8'
 NUMEROUS CLAYEY SHALE LAMINAE AND THIN BEDS FROM 94.9' TO 104.0'

SANDSTONE 10% GRADING TO LESS THAN 5% AND SILTSTONE 40% FROM 101.8' TO 105.3'

GRADES CARBONACEOUS FROM 105.1'
 WILLIAMSURG COAL BED
 COAL: BLACK; SHALEY; THIN BEDDED.
 SHALE: MEDIUM DARK GRAY IN UPPER 0.2' GRADING TO GREENISH-GRAY; CALCAREOUS TO VERY CALCAREOUS; THINLY LAMINATED. 45° OPEN SLICKENSIDED FRACTURES FROM 107.6' AND 107.7'
 AMAZONIA MEMBER
 SHALE: GREENISH-GRAY; VERY CALCAREOUS; THINLY LAMINATED; NODULES AND LENSES OF LIMESTONE.

GRADES WITH INTERBEDDED LIGHT GRAY LIMESTONE FROM 114.7'

LIMESTONE: LIGHT GRAY; OCCASIONAL FOSSIL FRAGMENTS; SHALEY; FINE GRAINED; THIN TO MEDIUM BEDDED; WITH INTERBEDDED SHALE; GREENISH-GRAY; CLAYEY; CALCAREOUS; LAMINATED TO THIN BEDDED.

BORING COMPLETED AT 117.5' FEET ON 11-2-73.
 CASING USED TO A DEPTH OF 5.0 FEET.
 GROUNDWATER LEVEL RECORDED AT 5.5 FEET ON 11-4-73.
 SECOND PIEZOMETER INSTALLED AT AN INTERVAL FROM 4.0 FEET TO 56.0 FEET ON 11-14-73.
 FIRST PIEZOMETER INSTALLED AT AN INTERVAL FROM 70.0 FEET TO 90.0 FEET ON 11-14-73.
 PIEZOMETER READINGS ARE PRESENTED ON TABLE 2.4-31.



Rev. 0

WOLF CREEK
UPDATED SAFETY ANALYSIS REPORT

Figure 2.5-35c (Sheet 2 of 2)

Log of Boring P-3

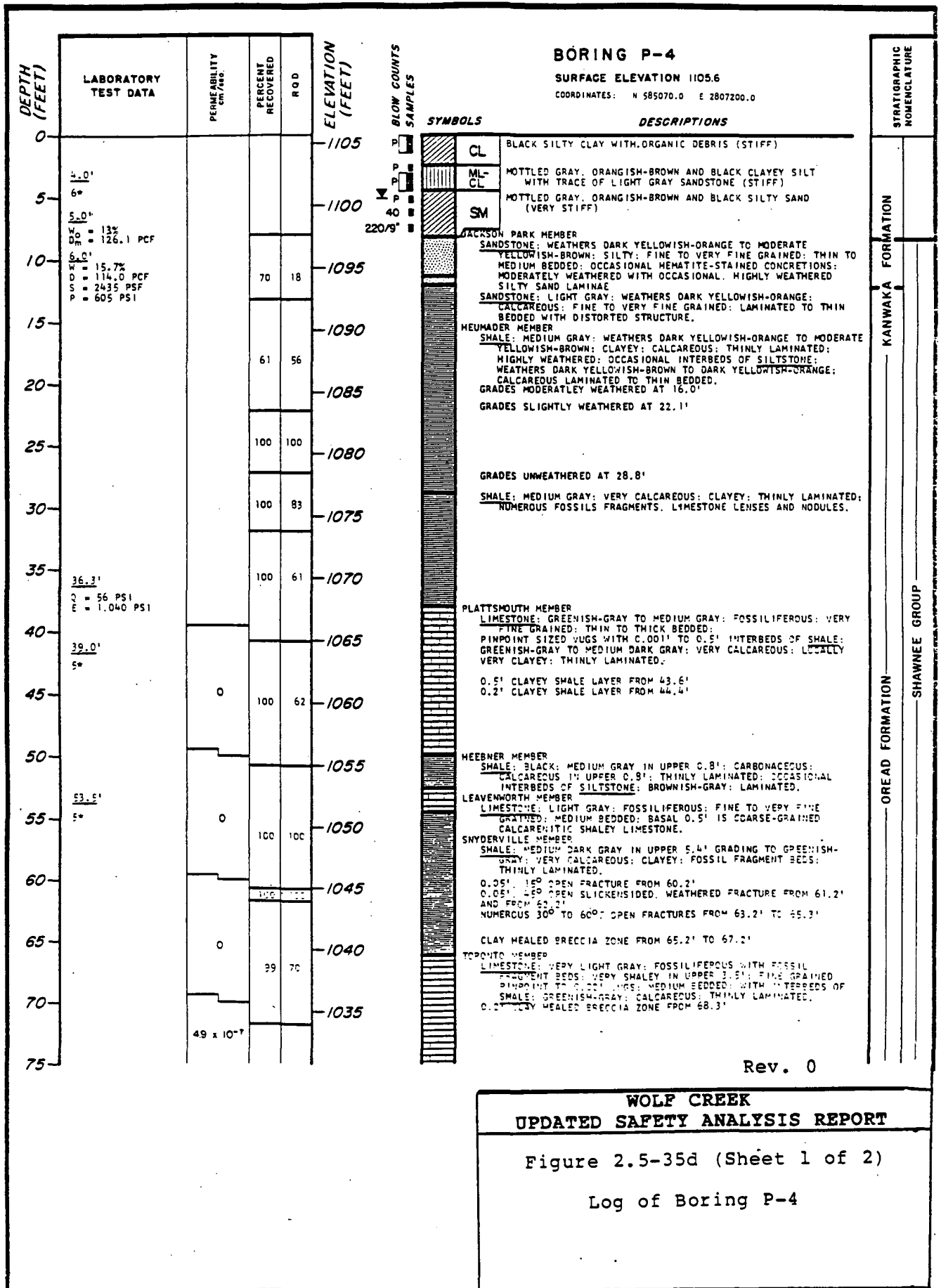

BORING P-4 CONT'D

DEPTH (FEET)	LABORATORY TEST DATA	PERMEABILITY (Darcy)	PERCENT RECOVERED	ROD	ELEVATION (FEET)
75	75.4' 5*				1030
80			100	67	1025
85		3.6×10^{-7}	100	73	1020
90					1015
95		0	100	50	1010
100					1005
105		0	100	53	1000
110					995
115			100	40	990
120					

SYMBOLS



DESCRIPTIONS

0.05' CLAYEY SHALE LAYER FROM 77.2'
0.25' CLAYEY SHALE LAYER FROM 78.3'

SHALE: GREENISH-GRAY GRADING TO MEDIUM DARK GRAY; LOCALLY CALCAREOUS; CLAYEY; MICACEOUS; SLIGHTLY CARBONACEOUS; THINLY LAMINATED; WITH INTERBEDDED SANDSTONE; LIGHT GRAY; CALCAREOUS; SILTY; MICACEOUS; SLIGHTLY CARBONACEOUS; FINE GRAINED; LAMINATED WITH DISTORTED STRUCTURE.

CALCAREOUS SANDSTONE 70' FROM 83.4' TO 83.9'
SHALE 100' FROM 83.9' TO 86.3'
SANDSTONE 40' AND 40' SILTSTONE; MEDIUM DARK GRAY; SLIGHTLY CARBONACEOUS; SHALEY; MICACEOUS; LAMINATED TO THIN BEDDED; FROM 86.3' TO 95.2'
NUMEROUS CLAYEY ZONES FROM 91.0' TO 98.7'
SANDSTONE 10' AND SILTSTONE 40' FROM 95.3' TO 101.7'

OCCASIONAL 0.05' TO 0.3' VERTICAL OPEN FRACTURES FROM 96.6' TO 99.0'

WILLIAMSBURG COAL BED
COAL: BLACK; SHALEY; PYRITIFEROUS; LAMINATED TO THIN BEDDED; WITH INTERBEDDED SHALE; GREENISH-GRAY; VERY CLAYEY; THINLY LAMINATED.
SHALE: GREENISH-GRAY; VERY CALCAREOUS; CARBONACEOUS IN UPPER 0.4'; THINLY LAMINATED.
AMAZONIA MEMBER
SHALE: GREENISH-GRAY; VERY CALCAREOUS; THINLY LAMINATED; OCCASIONAL NODULES AND LAYERS OF LIMESTONE.
LIMESTONE: LIGHT GRAY; LOCALLY FOSSILIFEROUS; FINE GRAINED; MEDIUM BEDDED; WITH INTERBEDDED SHALE; GREENISH-GRAY; VERY CALCAREOUS; THINLY LAMINATED.
C.2' VERTICAL OPEN FRACTURE FROM 100.7'
SHALE: GREENISH-GRAY IN UPPER 1.0' GRADING TO MEDIUM DARK GRAY; SLIGHTLY CALCAREOUS; THINLY LAMINATED; WITH INTERBEDDED SANDSTONE; LIGHT GRAY; CALCAREOUS; FINE GRAINED; LAMINATED.

BORING COMPLETED AT 117.2 FEET ON 10-30-73.
CASING USED TO A DEPTH OF 8.0 FEET.
GROUNDWATER LEVEL RECORDED AT 5.1 FEET ON 11-4-73.



Rev. 0

WOLF CREEK
UPDATED SAFETY ANALYSIS REPORT

Figure 2.5-35d (Sheet 2 of 2)

Log of Boring P-4

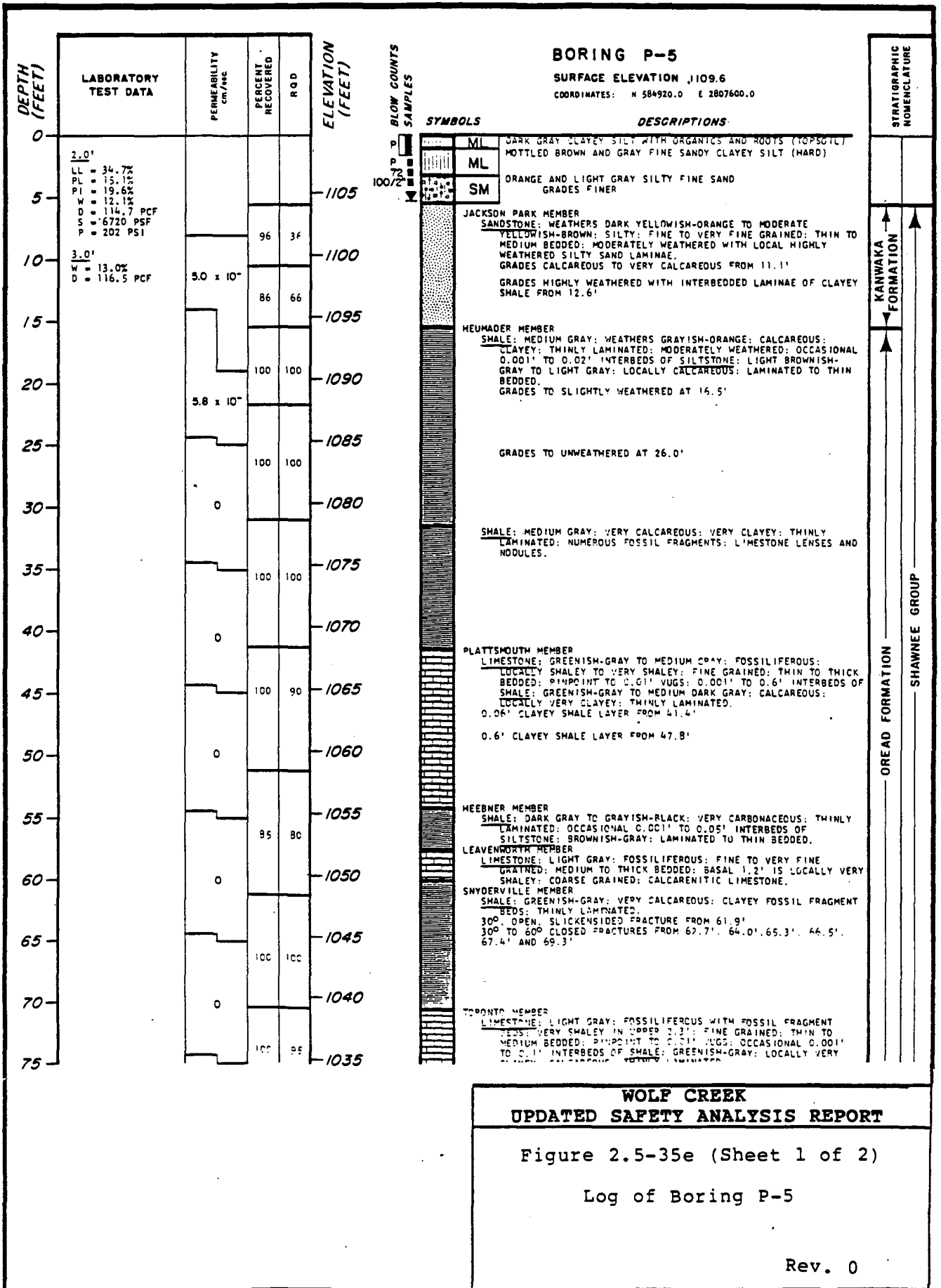

BORING P-5 CONT'D

DEPTH (FEET)	LABORATORY TEST DATA	PERMEABILITY cm/sec	PERCENT RECOVERED	ROD	ELEVATION (FEET)
75					
80		1.0 x 10 ⁻⁶			1030
85			100	85	1025
90		3.0 x 10 ⁻⁷			1020
95			100	100	1015
100		3.3 x 10 ⁻⁸			1010
105			100	100	1005
110					1000
115			100	100	995
120					990

SYMBOLS



DESCRIPTIONS

C.1' CLAYEY SHALE LAYER FROM 82.4'

SHALE: GREENISH-GRAY IN UPPER 0.9'; GRADING TO MEDIUM DARK GRAY; LOCALLY CALCAREOUS; CLAYEY; SLIGHTLY CARBONACEOUS; THINLY LAMINATED; WITH INTERBEDDED SANDSTONE; LIGHT GRAY; CALCAREOUS; SILTY; MICACEOUS; SLIGHTLY CARBONACEOUS; FINE GRAINED; LAMINATED TO THIN BEDDED WITH DISTORTED STRUCTURE; AND SILTSTONE; MEDIUM DARK GRAY; SHALEY; SLIGHTLY CARBONACEOUS; MICACEOUS; LAMINATED TO THIN BEDDED.
SHALE 100' FROM 87.5' TO 89.4'
SANDSTONE 10' GRADING TO 40' AND SILTSTONE 40' FROM 89.4' TO 101.9'
NUMEROUS CLAYEY SHALE LAMINAE AND THIN BEDS FROM 91.7' TO 98.5'

45° CLOSED FRACTURE FROM 98.5'

SANDSTONE 10' GRADING TO LESS THAN 10' AND SILTSTONE 50' FROM 101.9' TO 107.2'

GRADES CARBONACEOUS FROM 106.4'
WILLIAMSBURG COAL BED
COAL: BLACK; SHALEY; THINLY LAMINATED.
SHALE: MEDIUM DARK GRAY IN UPPER 0.2' GRADING TO GREENISH-GRAY; CALCAREOUS; CLAYEY; CARBONACEOUS IN UPPER 0.2'; THINLY LAMINATED.
40° CLOSED FRACTURE FROM 110.3'
AMAZONIA MEMBER
SHALE: GREENISH-GRAY; VERY CALCAREOUS; CLAYEY; THINLY LAMINATED; NUMEROUS LIMESTONE LENSES AND NODULES.
LIMESTONE: LIGHT GRAY; OCCASIONAL FOSSIL FRAGMENTS; SHALEY; FINE GRAINED; THIN TO MEDIUM BEDDED; WITH INTERBEDDED SHALE;
GREENISH-GRAY; CLAYEY; CALCAREOUS; THINLY LAMINATED.
IRELAND MEMBER
SHALE: GREENISH-GRAY; CLAYEY; THINLY LAMINATED.

BORING COMPLETED AT 119.1 FEET ON 11-5-73.
CASING USED TO A DEPTH OF 5.5 FEET
GROUNDWATER LEVEL RECORDED AT 5.5 FEET ON 11-12-73



Rev. 0

WOLF CREEK
UPDATED SAFETY ANALYSIS REPORT

Figure 2.5-35e (Sheet 2 of 2)

Log of Boring P-5

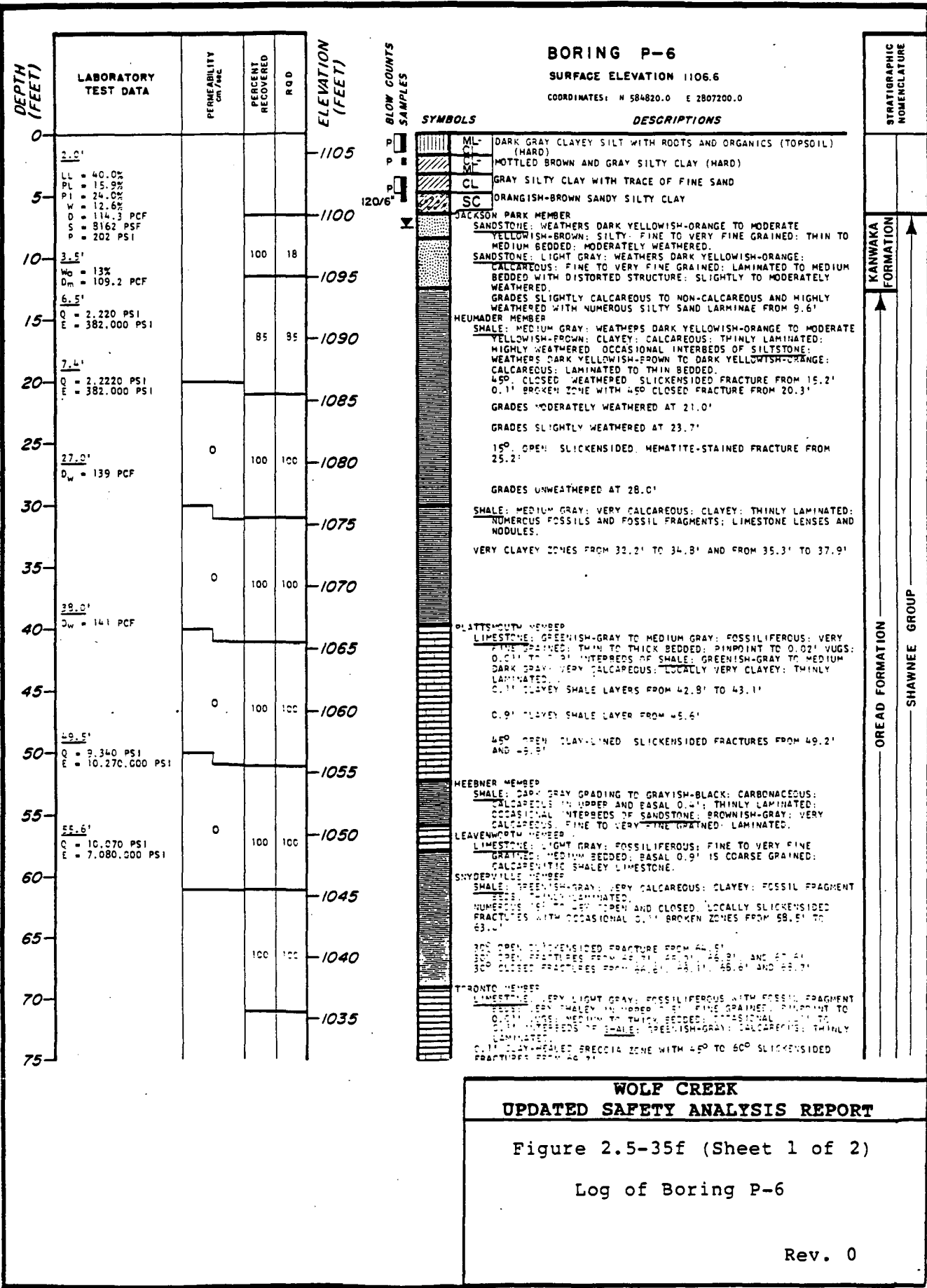

WOLF CREEK
UPDATED SAFETY ANALYSIS REPORT

Figure 2.5-35f (Sheet 1 of 2)

Log of Boring P-6

Rev. 0

BORING P-6 CONT'D

DEPTH (FEET)	LABORATORY TEST DATA	PERMEABILITY cm/sec.	PERCENT RECOVERED	ROD	ELEVATION (FEET)
75	75.2' Q = 9120 PSI E = 6,318,000 PSI		100	100	1030
80					1025
85			99	99	1020
90					1015
95			100	100	1010
100					1005
105			100	100	1000
110					
115					

SYMBOLS



DESCRIPTIONS

0.1' CLAYEY SHALE LAYER FROM 80.7'

0.01' TO 0.02' CALCITE-LINED VUGS FROM 84.8'
GRADES VERY SHALEY FROM 85.5'

SHALE: GREENISH-GRAY GRADING TO MEDIUM DARK GRAY; LOCALLY CALCAREOUS; CLAYEY; SLIGHTLY CARBONACEOUS; THINLY LAMINATED; WITH INTERBEDDED SANDSTONE; LIGHT GRAY; CALCAREOUS; SILTY; MICACEOUS; SLIGHTLY CARBONACEOUS; FINE GRAINED; LAMINATED WITH DISTORTED STRUCTURE; AND SILTSTONE; MEDIUM DARK GRAY; SHALEY; SLIGHTLY CARBONACEOUS; MICACEOUS; LAMINATED TO THIN BEDDED.

SHALE 100' FROM 95.7' TO 87.5'

SANDSTONE 10' AND SILTSTONE 50' FROM 87.5' TO 89.9'

SANDSTONE 40' AND SILTSTONE 50' FROM 89.9' TO 91.0'

NUMEROUS CLAYEY SHALE LAMINAE AND LAYERS FROM 91.0' TO 98.6'

SANDSTONE 10' AND SILTSTONE 50' FROM 91.0' TO 95.4'

SANDSTONE 50' AND SILTSTONE 30' FROM 95.4' TO 96.7'

SANDSTONE 10' AND SILTSTONE 50' FROM 96.7' TO 104.0'

GRADES VERY CARBONACEOUS FROM 103.9'

WILLIAMSBURG COAL BED

COAL: BLACK; SHALEY; THINLY LAMINATED; GRADES VERY SHALEY AND CALCAREOUS IN BASAL 0.2'

SHALE: GREENISH-GRAY; VERY CALCAREOUS; THINLY LAMINATED; NUMEROUS 45° OPEN AND CLOSED, LOCALLY DIAGONAL FRACTURES FROM 104.9' TO 109.6'

AMAZONIA MEMBER

SHALE: GREENISH-GRAY; VERY CALCAREOUS; THINLY LAMINATED; LENSES AND NODULES OF LIMESTONE.

LIMESTONE: GREENISH GRAY; VERY SHALEY; FINE GRAINED.



BORING COMPLETED AT 111.0 FEET ON 10-30-73.
CASING USED TO A DEPTH OF 6.5 FEET.
GROUNDWATER LEVEL RECORDED AT 7.8 FEET ON 11-4-73.

Rev. 0

<p>WOLF CREEK UPDATED SAFETY ANALYSIS REPORT</p>
<p>Figure 2.5-35f (Sheet 2 of 2)</p>
<p>Log of Boring P-6</p>

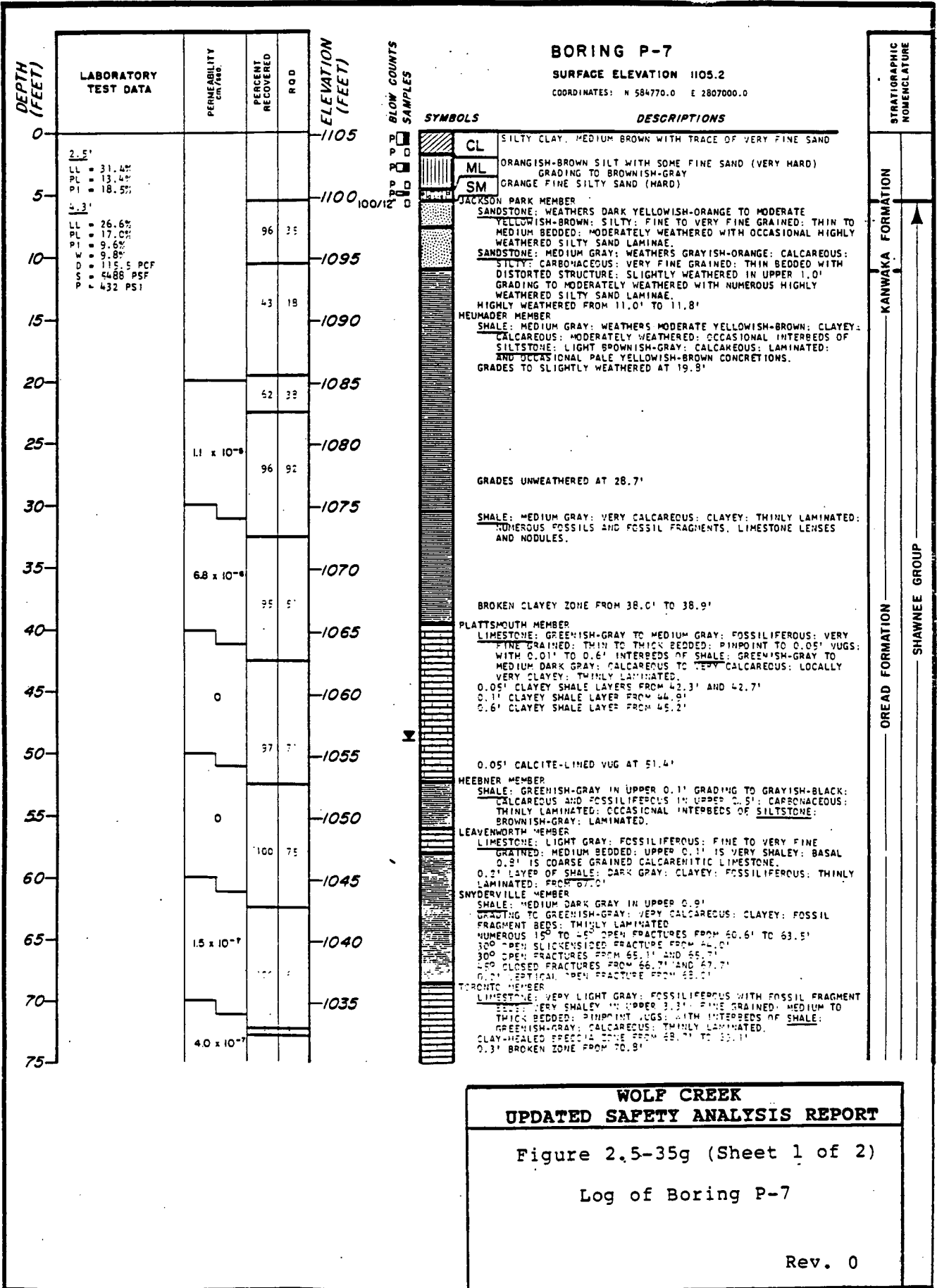

BORING P-7 CONT'D.

DEPTH (FEET)	LABORATORY TEST DATA	PERMEABILITY cm/sec	PERCENT RECOVERED	R.O.D.	ELEVATION (FEET)
75					1030
80			100	93	1025
85		6.3 x 10 ⁻⁸			1020
90			100	70	1015
95		0			1010
100			100	2	1005
105					1000
110			100	54	995
115					

SYMBOLS



DESCRIPTIONS

0.15' CLAYEY SHALE LAYER FROM 76.0'

GRADES VERY SHALEY FROM 86.0'

SHALE: GREENISH-GRAY WITH UPPER 1.4' GRADING TO MEDIUM DARK GRAY; LOCALLY CALCAREOUS; CLAYEY; SLIGHTLY CARBONACEOUS; THINLY LAMINATED WITH INTERBEDDED SANDSTONE; LIGHT GRAY; CALCAREOUS; SILTY; MICACEOUS; SLIGHTLY CARBONACEOUS; FINE GRAINED; LAMINATED WITH DISTORTED STRUCTURE; AND SILTSTONE; MEDIUM DARK GRAY; SHALEY; SLIGHTLY CARBONACEOUS; MICACEOUS; LAMINATED TO THIN BEDDED.

SHALE 100" FROM 86.3' TO 87.7'

SANDSTONE 10" AND SILTSTONE 50" FROM 87.7' TO 88.5'

SANDSTONE 40" AND SILTSTONE 40" FROM 88.5' TO 89.3'

NUMEROUS CLAYEY LAMINAE AND THIN BEDS FROM 92.4' TO 103.6'

SANDSTONE 10" AND SILTSTONE 50" FROM 99.3' TO 104.0'

0.4' BROKEN ZONE WITH 45° TO VERTICAL FRACTURES FROM 101.9'

GRADES VERY CARBONACEOUS AT 103.9'

WILLIAMSBURG COAL BED

COAL: BLACK; SHALEY; LAMINATED.

SHALE: DARK GRAY GRADING TO GREENISH-GRAY; VERY CALCAREOUS; THINLY LAMINATED.

OCCASIONAL 30° TO 60° OPEN FRACTURES FROM 104.5' TO 108.0'

AMAZONIA MEMBER

SHALE: GREENISH-GRAY; VERY CALCAREOUS; THINLY LAMINATED; OCCASIONAL NODULES AND LAYERS OF LIMESTONE.

LIMESTONE: LIGHT GRAY; FINE GRAINED; MEDIUM BEDDED.

BORING COMPLETED AT 112.3 FEET ON 10-31-73.

CASING USED TO A DEPTH OF 5.5 FEET.

GROUNDWATER LEVEL RECORDED AT -9.0 FEET ON 11-4-73.

STRATIGRAPHIC NOMENCLATURE



Rev. 0

**WOLF CREEK
UPDATED SAFETY ANALYSIS REPORT**

Figure 2.5-35g (Sheet 2 of 2)

Log of Boring P-7

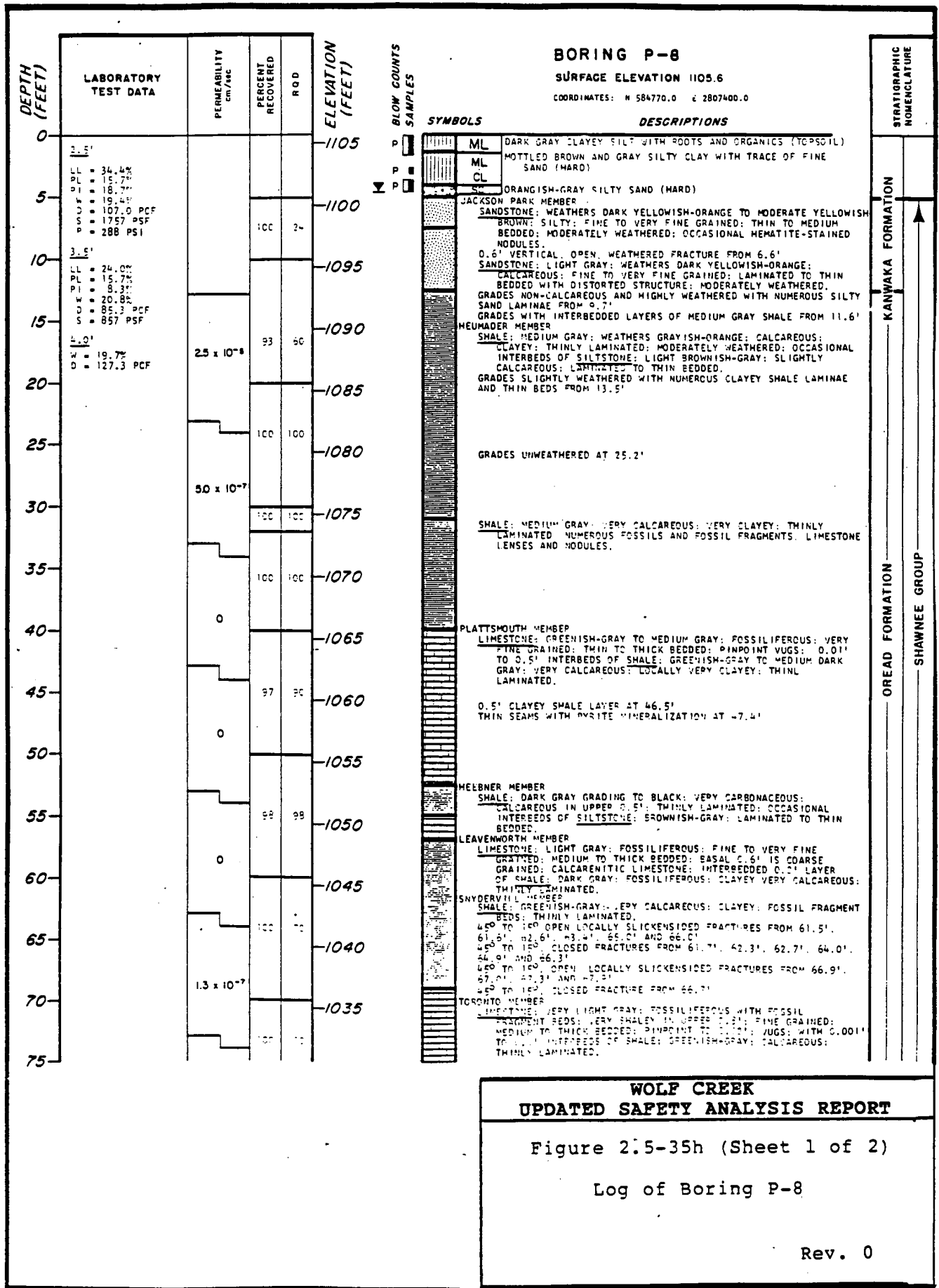

**WOLF CREEK
UPDATED SAFETY ANALYSIS REPORT**

Figure 2.5-35h (Sheet 1 of 2)

Log of Boring P-8

BORING P-8 CONT'D.

DEPTH (FEET)	LABORATORY TEST DATA	PERMEABILITY cm/sec	PERCENT RECOVERED	RQD	ELEVATION (FEET)
75					1030
80		3.1 x 10 ⁻⁷			1025
85			100	100	1020
90		8.8 x 10 ⁻⁷			1015
95			100	100	1010
100		0			1005
105			100	100	1000
110					995
115			100	100	990

SYMBOLS



DESCRIPTIONS

C. 1' CLAYEY SHALE LAYER FROM 80.7'

GRADES VERY SHALEY FROM 85.6'

SHALE: GREENISH-GRAY IN UPPER 1.3' GRADING TO MEDIUM GRAY AND MEDIUM DARK GRAY; LOCALLY CALCAREOUS; CLAYEY; SLIGHTLY CARBONACEOUS; THINLY LAMINATED; WITH INTERBEDDED SANDSTONE; LIGHT GRAY; CALCAREOUS; SILTY; MICACEOUS; SLIGHTLY CARBONACEOUS; FINE GRAINED; LAMINATED TO THIN BEDDED WITH DISTORTED STRUCTURE; AND SILTSTONE; MEDIUM DARK GRAY; SHALEY; SLIGHTLY CARBONACEOUS; MICACEOUS; LAMINATED TO THIN BEDDED.

SHALE 100% FROM 85.8' TO 87.9'

SANDSTONE 10% GRADING TO 40% AND SILTSTONE 40% FROM 87.9' TO 100.5'

40° CLOSED FRACTURE FROM 89.6'

NUMEROUS CLAYEY LAMINAE AND THIN BEDS FROM 90.0' TO 96.2'

VERTICAL OPEN AND CLOSED FRACTURE FROM 98.5' TO 100.2'

SANDSTONE 10% AND SILTSTONE 40% FROM 100.5' TO 106.1'

GRADES VERY CARBONACEOUS FROM 105.0'

WILLIAMSBURG COAL BED

COAL: BLACK; SHALEY; THINLY LAMINATED.

SHALE: MEDIUM DARK GRAY; CALCAREOUS; THINLY LAMINATED.

40° OPEN, SLICKENSIDED FRACTURES FROM 108.2', 108.5', 109.3' AND 109.8'

AMAZONIA MEMBER

SHALE: GREENISH-GRAY; CALCAREOUS TO VERY CALCAREOUS; THINLY LAMINATED; NUMEROUS NODULES AND LAYERS OF LIMESTONE.

LIMESTONE: LIGHT GRAY; OCCASIONAL FOSSIL FRAGMENTS; FINE GRAINED; THIN TO THICK BEDDED; WITH INTERBEDDED SHALE; GREENISH-GRAY; CLAYEY; CALCAREOUS; THIN BEDDED.

IRELAND MEMBER

SHALE: GREENISH-GRAY GRADING TO MEDIUM GRAY; SANDY IN UPPER 0.6'; GRADES SILTY BELOW 116.3'; MICACEOUS; THINLY LAMINATED TO THIN BEDDED.

BORING COMPLETED AT 116.5 FEET ON 10-31-73.
CASING USED TO A DEPTH OF 5.0 FEET.
GROUNDWATER LEVEL RECORDED AT 4.7 FEET ON 11-4-73.

STRATIGRAPHIC NOMENCLATURE
LAWRENCE FORMATION
DOUGLASS GROUP

Rev. 0

WOLF CREEK
UPDATED SAFETY ANALYSIS REPORT

Figure 2.5-35h (Sheet 2 of 2)

Log of Boring P-8

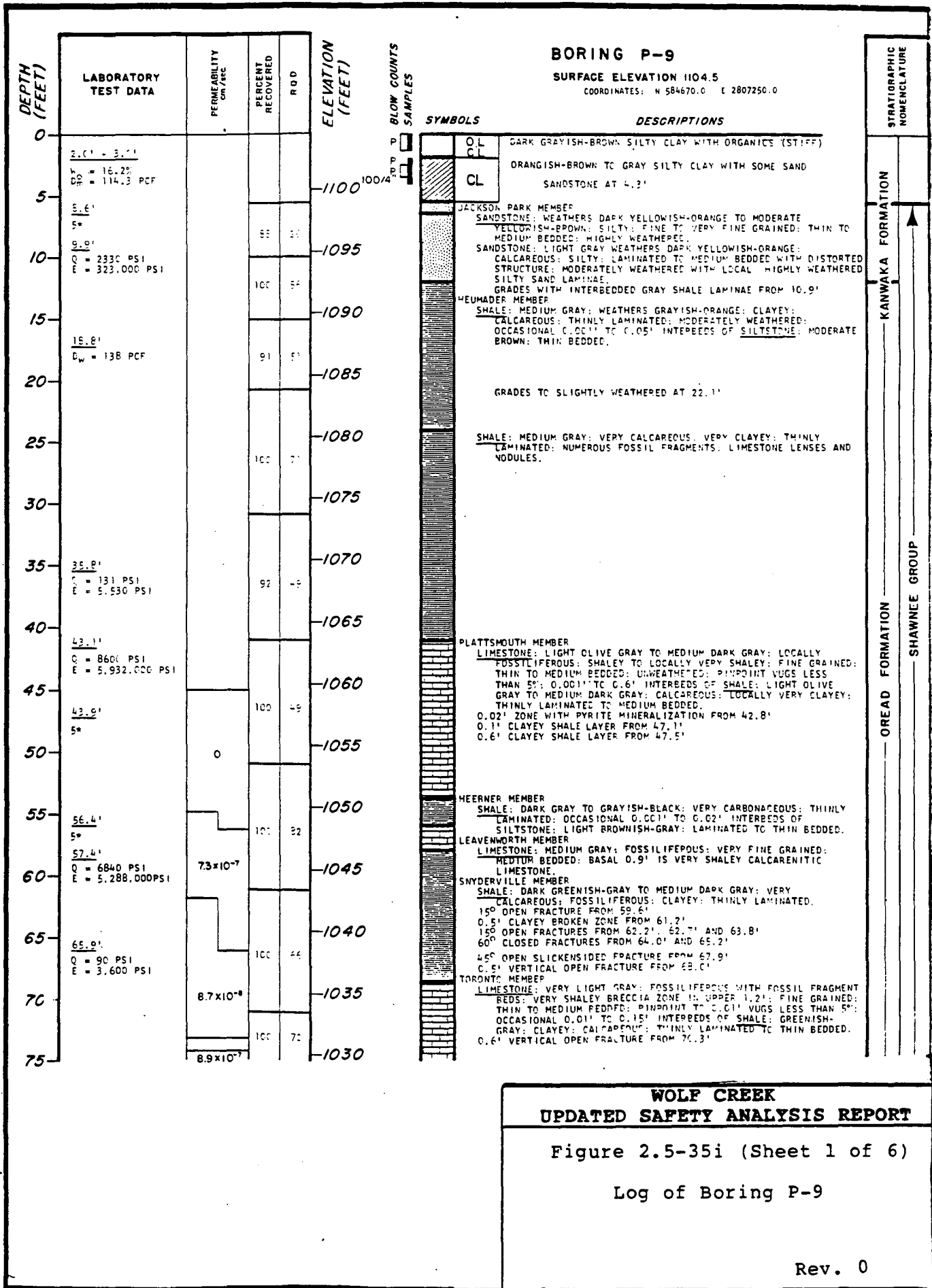

BORING P-9 CONT'D.

DEPTH (FEET)	LABORATORY TEST DATA	PERMEABILITY cm/seg	PERCENT RECOVERED	RQD	ELEVATION (FEET)	SYMBOLS	DESCRIPTIONS	STRATIGRAPHIC NOMENCLATURE
75	78.1'							
80	5*	8.9x10 ⁻⁷			1025			OREAD FORMATION
85	86.2' Q = 5580 PSI E = 3,729,000 PSI		95	53	1020		SHALE: GREENISH-GRAY; VERY CLAYEY; CALCAREOUS; THINLY LAMINATED.	SHAWNEE FORMATION
90		0			1015			
95	94.2' D _w = 156 PCF		100	78	1010		SHALE: MEDIUM DARK GRAY; CLAYEY TO LOCALLY VERY CLAYEY; SLIGHTLY CARBONACEOUS; THINLY LAMINATED WITH INTERBEDDED SANDSTONE; LIGHT GRAY; SILTY; MICACEOUS; SLIGHTLY CARBONACEOUS; LAMINATED TO THIN BEDDED WITH DISTORTED STRUCTURE; AND SILTSTONE; MEDIUM DARK GRAY; SHALEY; SLIGHTLY CARBONACEOUS; MICACEOUS; LAMINATED TO THIN BEDDED SANDSTONE 40" AND SILTSTONE 40" FROM 91.5' TO 99.8'	
100		4.4x10 ⁻⁷			1005		SANDSTONE 10" GRADING TO LESS THAN 10" AND SILTSTONE 40" FROM 99.8' TO 108.8' VERY CLAYEY FROM 101.7' TO 106.8'	
105			97	60	1000		GRADES VERY CARBONACEOUS FROM 106.9'	
110	109.9' Q = 147 PSI E = 8,670 PSI				995		WILLIAMSBURG COAL BED COAL: BLACK; SHALEY; THINLY LAMINATED TO THIN BEDDED. SHALE: MEDIUM DARK GRAY; CALCAREOUS; CLAYEY; THINLY LAMINATED. GRADES TO GREENISH-GRAY FROM 112.2'	
115	114.9' Q = 4410 PSI E = 3,153,000 PSI		100	75	990		AMAZONIA MEMBER SHALE: GREENISH-GRAY; VERY CALCAREOUS; THINLY LAMINATED; NUMEROUS LIMESTONE LENSES. LIMESTONE: GREENISH-GRAY; OCCASIONAL FOSSIL FRAGMENTS; VERY SHALEY; FINE GRAINED; THIN TO MEDIUM BEDDED; WITH INTERBEDDED SHALE; GREENISH-GRAY; CLAYEY; CALCAREOUS; THINLY LAMINATED.	LAWRENCE FORMATION
120					985		IRELAND MEMBER SHALE: GREENISH-GRAY; CALCAREOUS; THINLY LAMINATED; OCCASIONAL LIMESTONE NODULES AND THIN LIGHT GRAY SANDSTONE LAMINAE. SHALE GRADES TO MEDIUM GRAY AT 100.0'. NUMEROUS CLAYEY SHALE LAMINAE AND THIN BEDS FROM 121.4' TO 123.0'	DOUGLASS GROUP
125			80	36	980			
130					975			
135			100	90	970		COAL: BLACK; SHALEY; THINLY LAMINATED. SHALE: MEDIUM TO DARK GRAY; SLIGHTLY CARBONACEOUS; THINLY LAMINATED; WITH INTERBEDDED SANDSTONE; LIGHT GRAY; SLIGHTLY CARBONACEOUS; MICACEOUS; FINE GRAINED; THIN LAMINATED TO THIN BEDDED WITH DISTORTED STRUCTURE; AND SILTSTONE; MEDIUM GRAY; SLIGHTLY CARBONACEOUS; MICACEOUS; LAMINATED TO MEDIUM BEDDED. SANDSTONE 10" OR LESS AND SILTSTONE 50" TO 60" FROM 134.4' TO 140.4'. OCCASIONAL CLAYEY SHALE LAMINAE AND THIN BEDS FROM 134.4' TO 137.2'. SANDSTONE 20" AND SILTSTONE 50" FROM 140.4' TO 146.5'. NUMEROUS CLAYEY SHALE LAMINAE AND THIN BEDS TO 145.0'	
140	141.8' Q = 178 PSI E = 6,230 PSI		100	33	965			
145		3.7x10 ⁻⁷	91	22	960			
150					955			

(REVISIONS) Rev. 0

WOLF CREEK
UPDATED SAFETY ANALYSIS REPORT

Figure 2.5-35i (Sheet 2 of 6)

Log of Boring P-9

BORING P-9 CONT'D.

DEPTH (FEET)	LABORATORY TEST DATA	PERMEABILITY cm./sec.	PERCENT RECOVERED	RQD	ELEVATION (FEET)
150	152.5' D _w = 155 PCF	3.7 x 10 ⁻⁷			
155			98	44	950
160					945
165			100	16	940
170		2.3 x 10 ⁻⁷			935
175			100	34	930
180					925
185			100	66	920
190	197.8' D _w = 156 PCF				915
195			95	50	910
200					905
205			100	63	900
210					895
215			100	78	890
220		1.5 x 10 ⁻⁷			885
225			0	0	880

SYMBOLS



DESCRIPTIONS

SANDSTONE 10% GRADING LOCALLY TO 30% AND SILTSTONE 60% TO 70% FROM 153.6' TO 164.4'
OCCASIONAL CLAYEY SHALE LAMINAE FROM 154.2' TO 159.7'

NUMEROUS CLAYEY SHALE LAMINAE FROM 162.1' TO 166.8'
0.35' SANDSTONE LAYER FROM 162.9'

0.55' SANDSTONE LAYER FROM 164.4'
SANDSTONE 10% AND SILTSTONE 75% FROM 165.0' TO 179.1'
NUMEROUS CLAYEY SHALE LAMINAE AND THIN BEDS FROM 166.8' TO 173.8'

SANDSTONE LESS THAN 5% AND SILTSTONE 30% FROM 179.1' TO 197.7'

NUMEROUS CLAYEY SHALE LAMINAE FROM 191.5' TO 193.9'

ROBBINS MEMBER
SHALE; DARK GRAY; SILTY; MICACEOUS; SLIGHTLY CARBONACEOUS;
TRINILY LAMINATED.

0.2' CLAYEY SHALE LAYER FROM 202.9'

0.45' VERTICAL OPEN FRACTURE FROM 211.5'

1.6' VERTICAL OPEN FRACTURE WITH LOCALIZED BROKEN ZONES FROM 213.1'

0.8' 30° OPEN FRACTURE WITH BROKEN ZONE FROM 219.4'

STRATIGRAPHIC NOMENCLATURE

LAWRENCE FORMATION

DOUGLAS GROUP

Rev. 0

WOLF CREEK
UPDATED SAFETY ANALYSIS REPORT

Figure 2.5-35i (Sheet 3 of 6)

Log of Boring P-9

BORING P-9 CONT'D.

DEPTH (FEET)	LABORATORY TEST DATA	PERMEABILITY cm./sec.	PERCENT RECOVERED	RQD	ELEVATION (FEET)
225					
230			100	35	875
235	235.8' Q = 407 PSI E = 22,500 PSI		100	36	870
240					865
245		0	100	0	860
250					855
255	256.0' D _w = 154 PCF		100	65	850
260	261.6' Q = 12430 PSI E = 12,987,000 PSI				845
265	262.1' 5*		100	60	840
270					835
275			97	4	830
280					825
285	287.2' Q = 2170 PSI E = 428,000 PSI		100	70	820
290					815
295			94	35	810
300					805

SYMBOLS



DESCRIPTIONS

PYRITE REPLACEMENT OF OCCASIONAL FOSSILS GRADES IN FROM 237.0'. OCCASIONAL 0.3' TO 0.05' PALE YELLOWISH-BROWN CONCRETIONS GRADE IN FROM 237.9'

SHALE: DARK GRAY; SLIGHTLY CALCAREOUS; VERY CARBONACEOUS; THINLY LAMINATED.
HASKELL MEMBER
LIMESTONE: LIGHT OLIVE GRAY; FOSSILIFEROUS; FINE GRAINED; THIN TO MEDIUM BEDDED; OCCASIONAL MEDIUM GRAY SHALE PARTINGS.

VINLAND MEMBER
SHALE: MEDIUM GRAY; VERY CALCAREOUS; VERY CLAYEY; FOSSILIFEROUS; THINLY LAMINATED; OCCASIONAL 0.001' TO 0.01' INTERBEDS OF LIGHT GRAY SANDSTONE.
0.9' LAYER OF SANDSTONE; MEDIUM LIGHT GRAY; VERY CALCAREOUS; SHALEY; FOSSILIFEROUS; COARSE GRAINED; MEDIUM BEDDED; FROM 266.5'
0.12' BED OF COAL; BLACK; THINLY LAMINATED; FRACTURED; FROM 271.4'
SANDSTONE: LIGHT GRAY; SLIGHTLY CALCAREOUS; CARBONACEOUS WITH LOCAL VERY CARBONACEOUS THIN LAMINAE; MICACEOUS; FINE GRAINED; LAMINATED TO THINLY LAMINATED AND CROSS-LAMINATED WITH DISTORTED STRUCTURE; INTERBEDDED WITH SILTSTONE; MEDIUM GRAY TO GRAYISH-BLACK; LOCALLY CARBONACEOUS; LAMINATED.
0.2' CLAYEY SHALE LAYER FROM 278.6'
0.1' BED OF COAL; BLACK; PYRITIFEROUS; THINLY LAMINATED; FROM 279.7'
SANDSTONE: MEDIUM GRAY; SILTY; CALCAREOUS; SLIGHTLY CARBONACEOUS; MICACEOUS; VERY FINE GRAINED; THINLY LAMINATED WITH DISTORTED STRUCTURE; INTERBEDDED WITH SILTSTONE; MEDIUM DARK GRAY; SLIGHTLY CARBONACEOUS; LAMINATED TO THINLY LAMINATED.
0.3' ZONE WITH 75' FUSULINID FOSSILS FROM 281.4'
0.3' VERTICAL OPEN FRACTURE FROM 284.0'
BROKEN ZONE WITH 0.1' VERTICAL OPEN FRACTURE AND 45° OPEN FRACTURE FROM 286.0'
0.7' VERTICAL OPEN FRACTURE FROM 288.8'

SHALE: GREENISH-GRAY; CLAYEY; CALCAREOUS; THINLY LAMINATED; BASAL 0.2' GRADES WITH 50' FUSULINID FOSSILS
TONGANXIE MEMBER
SHALE: GREENISH-GRAY GRADING TO MEDIUM DARK GRAY AT 301.1'; SLIGHTLY CARBONACEOUS; SILTY; CLAYEY; LAMINATED TO THINLY LAMINATED; WITH INFREQUENT 0.001' INTERBEDS OF LIGHT GRAY SANDSTONE; AND NUMEROUS CLAYEY LAMINAE THROUGHOUT.
0.1' TO 0.05' YELLOWISH-BROWN CONCRETIONS GRADE IN AT 297.7'

STRATIGRAPHIC NOMENCLATURE

LAWRENCE FORMATION

DOUGLAS GROUP

STRANGER FORMATION

WOLF CREEK
UPDATED SAFETY ANALYSIS REPORT

Figure 2.5-35i (Sheet 4 of 6)

Log of Boring P-9

BORING P-9 CONT'D.

DEPTH (FEET)	LABORATORY TEST DATA	PERMEABILITY cm/sec	PERCENT RECOVERED		ROD	ELEVATION (FEET)	SYMBOLS	DESCRIPTIONS	STRATIGRAPHIC NOMENCLATURE
300									
305			100	0		800			
310						795			
315			90	23		790			
320						785			
325			100	19		780			
330						775			
335			100	22		770			
340	343.2' D _w = 156 PCF		98	72		765			
345						760			
350						755			
355			99	91		750			
360			100	100		745			
365			77	77		740			
370						735			
375						730			

SHALE: MEDIUM DARK GRAY; SLIGHTLY CARBONACEOUS; THINLY LAMINATED; INTERBEDDED WITH SANDSTONE: LIGHT GRAY; SLIGHTLY CARBONACEOUS; MICACEOUS; FINE GRAINED; THIN BEDDED TO THINLY LAMINATED WITH DISTORTED STRUCTURE.
 SANDSTONE 10% GRADING LOCALLY TO 25% FROM 305.6' TO 316.6'
 NUMEROUS CLAYEY SHALE LAMINAE AND THIN BEDS FROM 305.6' TO 320.5'

SANDSTONE 50% FROM 316.6' TO 318.7'
 SANDSTONE 20% FROM 318.7' TO 327.7'

SANDSTONE 10% FROM 327.7' TO 343.1'
 OCCASIONAL CLAYEY SHALE LAMINAE AND THIN BEDS FROM 328.6' TO 329.8'
 0.25' BROKEN ZONE WITH VERTICAL FRACTURE FROM 329.8'

NUMEROUS CLAYEY LAMINAE AND THIN BEDS FROM 332.9' TO 341.7'

SANDSTONE LESS THAN 10% FROM 343.1' TO 369.6'

0.4' VERY CARBONACEOUS ZONE FROM 368.7'
 WESTON MEMBER
 SHALE: DARK GRAY; SLIGHTLY CARBONACEOUS; THINLY LAMINATED.
 NUMEROUS CLAYEY SHALE LAMINAE AND THIN BEDS FROM 374.2' TO 378.5'

STRANGER FORMATION
 DOUGLAS GROUP

**WOLF CREEK ,
 UPDATED SAFETY ANALYSIS REPORT**

Figure 2.5-35i (Sheet 5 of 6)

Log of Boring P-9

Rev. 0

BORING P-9 CONT'D.

DEPTH (FEET)	LABORATORY TEST DATA	PERMEABILITY cm/DSEC	PERCENT RECOVERED	RQD	ELEVATION (FEET)
375					
380			97	36	725
385			48	11	720
390	392.8' D _w = 163 PCF				715
395			87	87	710
400					705
405			100	43	700
410					695
415			100	54	690

SYMBOLS



DESCRIPTIONS

1.4' BROKEN ZONE, LOCALLY CLAY-HEALED WITH VERTICAL AND 60° OPEN AND CLAY-HEALED FRACTURES FROM 378.5'

NUMEROUS CLAYEY SHALE LAMINAE FROM 381.3' TO 382.2'

INTERVAL FROM 389.0' TO 390.8' NOT CORED DUE TO EQUIPMENT MALFUNCTION

NUMEROUS DARK GRAY TO MEDIUM GRAY CLAYEY SHALE LAMINAE AND THIN BEDS FROM 397.5' TO 403.0'

SOUTH BEND MEMBER

LIMESTONE: LIGHT GRAY; SANDY; SHALEY; LOCALLY FOSSILIFEROUS; FINE GRAINED; THIN TO MEDIUM BEDDED; OCCASIONAL DARK GRAY SHALE PARTINGS.

ROCK LAKE MEMBER

SHALE: MEDIUM GRAY; SILTY; CALCAREOUS; VERY CLAYEY; THINLY LAMINATED; INTERBEDDED WITH SANDSTONE; LIGHT GRAY; CALCAREOUS; SILTY; FINE TO MEDIUM GRAINED; LAMINATED TO THIN BEDDED WITH DISTORTED STRUCTURE. GRADES COARSE GRAINED FROM 312.7'

BASAL 0.2' CONTAINS 0.05' ANGULAR NODULES OF LIMESTONE

STONER MEMBER

LIMESTONE: LIGHT GRAY; SHALEY; SANDY; VERY FINE GRAINED; MEDIUM BEDDED. GRADES LESS SANDY FROM 314.6' 0.4' VERTICAL OPEN FRACTURE FROM 316.5'

BORING COMPLETED AT 416.9 FEET ON 11-13-73.
CASING USED TO A DEPTH OF 19.0 FEET.
GROUNDWATER LEVEL RECORDED AT 25.0 FEET ON 11-16-73.
SECOND PIEZOMETER INSTALLED AT AN INTERVAL FROM 3.5 FEET TO 50.8 FEET ON 12-13-73.
FIRST PIEZOMETER INSTALLED AT AN INTERVAL FROM 69.0 FEET TO 80.4 FEET ON 12-11-73.
PIEZOMETER READINGS ARE PRESENTED ON TABLE 2.4-31.

STRATIGRAPHIC NOMENCLATURE

STRANGER FORMATION
DOUGLAS GROUP

STANTON FORMATION
LANSING GROUP

Rev. 0

WOLF CREEK
UPDATED SAFETY ANALYSIS REPORT

Figure 2.5-35i (Sheet 6 of 6)

Log of Boring P-9

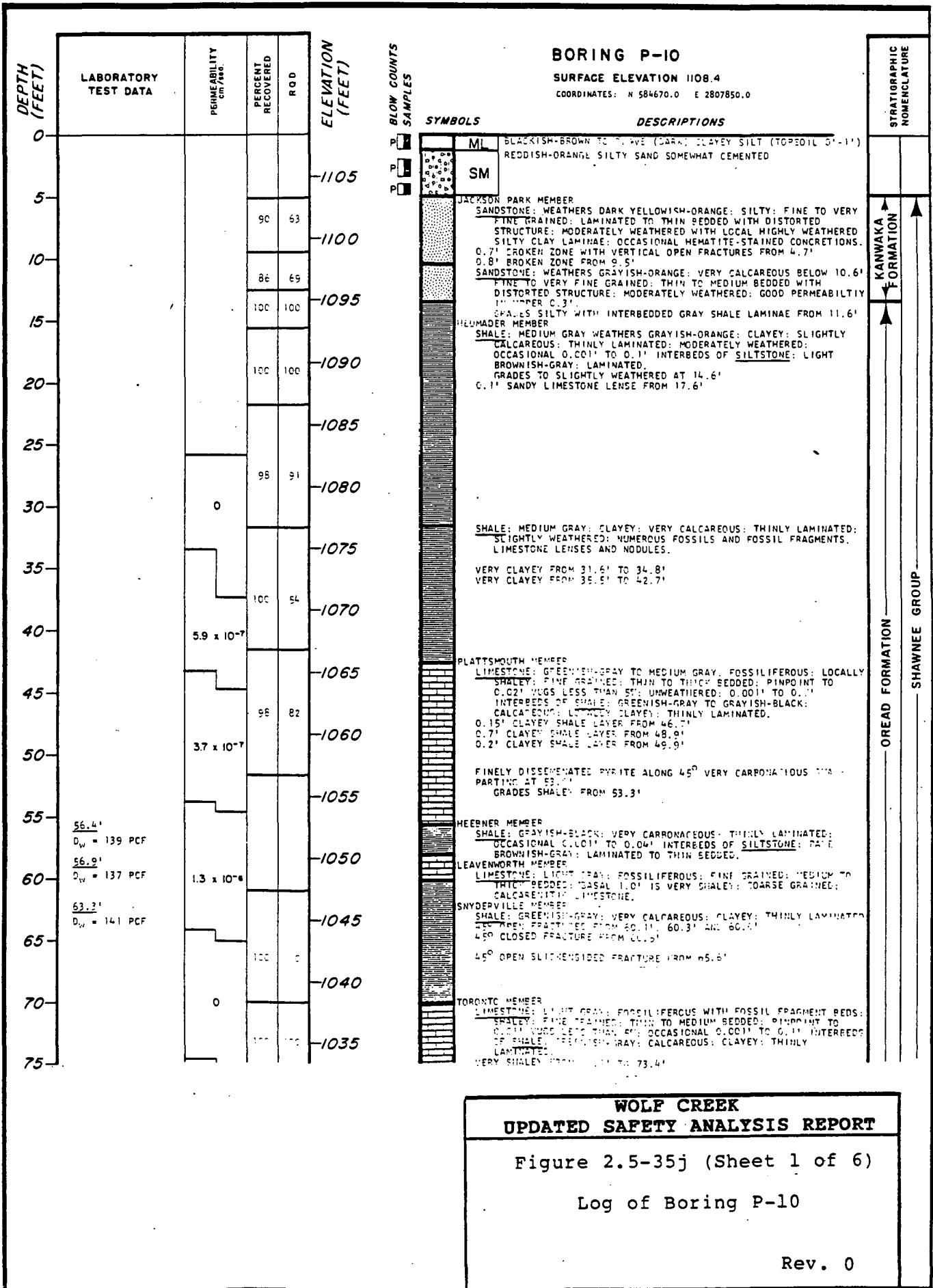

WOLF CREEK
UPDATED SAFETY ANALYSIS REPORT

Figure 2.5-35j (Sheet 1 of 6)

Log of Boring P-10

Rev. 0

BORING P-10 CONT'D.

DEPTH (FEET)	LABORATORY TEST DATA	PERMEABILITY cm/sec	PERCENT RECOVERED	RQD	ELEVATION (FEET)
75					1030
80		1.2×10^{-6}	100	100	1025
85			99	99	1020
90	91.2' $D_w = 144$ PCF	5.4×10^{-7}			1015
95			100	0	1010
100		1.0×10^{-7}			1005
105			100	0	1000
110		0			995
115			100	70	990
120	121.4' $D_w = 146$ PCF				985
125			100	0	980
130		0			975
135			100	30	970
140	140.3' $D_w = 153$ PCF	1.2×10^{-6}			965
145			80	20	960
150					

SYMBOLS

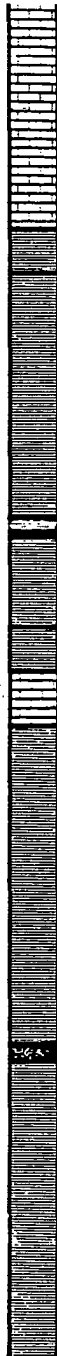

DESCRIPTIONS

TWO 0.4' INTERSECTING VERTICAL FRACTURES FROM 70.5'

0.7' 80° OPEN FRACTURE FROM 78.4' AND 0.5' VERTICAL OPEN FRACTURE FROM 75.7'

GRADES TO VERY SHALEY FROM 80.5' TO 82.2'

0.6' VERTICAL CLOSED FRACTURE FROM 80.6'

0.1' CLAYEY SHALE LAYER FROM 82.1'

SHALE: GREENISH-GRAY; CLAYEY; SLIGHTLY CALCAREOUS; THINLY LAMINATED.

SHALE: MEDIUM DARK GRAY; CLAYEY TO LOCALLY VERY CLAYEY; SLIGHTLY CARBONACEOUS; THINLY LAMINATED WITH INTERBEDDED SANDSTONE; LIGHT GRAY; SILTY; MICACEOUS; SLIGHTLY CARBONACEOUS; LAMINATED TO THIN BEDDED; AND SILTSTONE; MEDIUM DARK GRAY; SHALEY; SLIGHTLY CARBONACEOUS; MICACEOUS; LAMINATED TO THIN BEDDED.

SANDSTONE 10% AND SILTSTONE 80% FROM 90.0' TO 91.8'

SANDSTONE 40% AND SILTSTONE 50% FROM 91.8' TO 101.9'

NUMEROUS CLAYEY SHALE LAMINAE AND THIN BEDS FROM 92.9' TO 101.3'

SANDSTONE 10% GRADING TO LESS THAN 5% AND SILTSTONE 40% FROM 101.9' TO 103.6'

SHALE: GRAYISH-BLACK; VERY CLAYEY; CALCAREOUS; VERY CARBONACEOUS; THIN BEDDED.

COAL: BLACK; SHALEY; THINLY LAMINATED.

SHALE: DARK GREENISH-GRAY; VERY CALCAREOUS; CLAYEY; THINLY LAMINATED.

300 OPEN SLICKENSIDED FRACTURES FROM 106.0', 106.5' AND 107.9'

300 OPEN SLICKENSIDED FRACTURE FROM 108.4'

500 OPEN SLICKENSIDED FRACTURE FROM 108.5'

AMAZONIA MEMBER

SHALE: GREENISH-GRAY; CLAYEY; VERY CALCAREOUS; THINLY LAMINATED; OCCASIONAL LIMESTONE LENSES AND NODULES.

50 OPEN SLICKENSIDED FRACTURE FROM 108.5'

LIMESTONE: GREENISH-GRAY; VERY SHALEY; FINE GRAINED; THIN TO THICK BEDDED.

0.15' CLAYEY SHALE LAYER FROM 113.5'

GRADES WITH LESS SHALE FROM 113.7'

IRELAND MEMBER

SHALE: GREENISH-GRAY; VERY CLAYEY; SLIGHTLY CALCAREOUS TO CALCAREOUS; THINLY LAMINATED; WITH OCCASIONAL LAMINAE OF SANDSTONE.

GRADES WITH MEDIUM GRAY MOTTLING FROM 120.9'

0.001' TO 0.01' VERY CARBONACEOUS INTERLAMINATIONS GRADE IN FROM 123.6'

CLAYEY FACTION GRADES OUT AT 132.2'

COAL: BLACK WITH MODERATE BROWN INTERLAMINATIONS; THINLY LAMINATED.

NUMEROUS 0.02' TO 0.1' VERTICAL CLOSED CALCITE-LINED FRACTURES FROM 132.6' TO 133.3'

SHALE: MEDIUM GRAY TO DARK GRAY WITH GREENISH-GRAY MOTTLING; VERY CLAYEY; LOCALLY CALCAREOUS; THINLY LAMINATED WITH INTERBEDDED SANDSTONE; LIGHT GRAY; SLIGHTLY CALCAREOUS; SLIGHTLY CARBONACEOUS; MICACEOUS; VERY FINE GRAINED; THINLY LAMINATED WITH DISTORTED STRUCTURE; AND SILTSTONE; MEDIUM GRAY; SLIGHTLY CARBONACEOUS; MICACEOUS; THINLY LAMINATED.

VERY CLAYEY FROM 133.3' TO 142.2'

SANDSTONE 10% AND SILTSTONE 30% FROM 133.3' TO 140.2'

GREENISH-GRAY MOTTLING GRADES OUT AT 140.0'

0.3' SANDSTONE LAYER FROM 140.2'

SANDSTONE 50% AND SILTY SHALE 50% FROM 140.5' TO 150.5'

1.0' SANDSTONE LAYER WITH DISTORTED STRUCTURE FROM 145.2'

1.1' CALCAREOUS SANDSTONE LAYER WITH DISTORTED STRUCTURE FROM 149.0'

STRAATIGRAPHIC NOMENCLATURE

LOREAD FORMATION

SHAWNEE GROUP

LAWRENCE FORMATION

DOUGLAS GROUP

Rev. 0

WOLF CREEK
UPDATED SAFETY ANALYSIS REPORT

Figure 2.5-35j (Sheet 2 of 6)

Log of Boring P-10

BORING P-10 CONT'D.

DEPTH (FEET)	LABORATORY TEST DATA	PERMEABILITY cm/sec	PERCENT RECOVERED	RQD	ELEVATION (FEET)
150					
155			29	0	955
160			55	55	950
165					945
170		5.1 x 10 ⁻⁷	100	100	940
175					935
180			95	95	930
185					925
190			100	80	920
195					915
200			96	20	910
205			92	0	905
210					900
215			100	0	895
220	321.9' D ₁₀₀ = 147 PCF		10	0	890
225			100	15	885

SYMBOLS



DESCRIPTIONS

SANDSTONE 10% AND SHALEY SILTSTONE 90% FROM 150.5' TO 163.0'

NUMEROUS CLAYEY SHALE LAMINAE FROM 155.7' TO 159.1'

0.7' ZONE OF NUMEROUS HIGHLY DISTORTED SANDSTONE LAMINAE AND THIN BEDS FROM 159.6'

SHALEY SILTSTONE 100% WITH OCCASIONAL CALCAREOUS SANDSTONE LENSES FROM 163.0' TO 165.6'

SANDSTONE 30% AND SHALEY SILTSTONE 70% FROM 165.6' TO 175.3'

INTERSECTING 0.4' VERTICAL OPEN FRACTURE; 0.2', 80° OPEN FRACTURE AND 45° OPEN SLICKENSIDED FRACTURE FROM 175.5' SANDSTONE 10% GRADING LOCALLY TO 50% AND SHALEY SILTSTONE 90% FROM 175.3' TO 183.0'

1.5' VERTICAL OPEN FRACTURE FROM 176.6'

0.3' VERTICAL OPEN FRACTURE FROM 181.2'

0.6' VERTICAL OPEN FRACTURE FROM 182.8'

SHALEY SILTSTONE 100% FROM 183.0' TO 183.3'

0.7' CLAYEY ZONE FROM 183.7'

45° OPEN FRACTURES FROM 185.2' AND 185.4'

NUMEROUS 45° OPEN AND CLOSED FRACTURES FROM 187.7' TO 188.1'

45° OPEN FRACTURES AT 190.0' AND 191.0'

NUMEROUS CLAYEY SHALE LAMINAE FROM 194.2' TO 201.1'

0.5" FROKEN ZONE FROM 200.5'

NUMEROUS CLAYEY SHALE LAMINAE FROM 213.3' TO 219.4'

GRADES VERY CLAYEY FROM 221.0'

STRATIGRAPHIC NOMENCLATURE

LAWRENCE FORMATION

- DOUGLAS GROUP

(BORING CONTINUED)

Rev. 0

**WOLF CREEK
UPDATED SAFETY ANALYSIS REPORT**

Figure 2.5-35j (Sheet 3 of 6)

Log of Boring P-10

BORING P-10 CONT'D.

DEPTH (FEET)	LABORATORY TEST DATA	PERMEABILITY cm/sec	PERCENT RECOVERED	ROD	ELEVATION (FEET)
225					
230	232.9' D _w = 157 PCF	1.7 x 10 ⁻⁷			880
235			100	73	875
240					870
245			91	24	865
250					860
255			93	60	855
260					850
265	267.9' D _w = 138 PCF	4.9 x 10 ⁻⁷	94	8	845
270					840
275		7.0 x 10 ⁻⁷	100	4	835
280					830
285	284.5' D _w = 153 PCF		81	10	825
290					820
295	291.0' D _w = 151 PCF	1.1 x 10 ⁻⁷	100	67	815
300					810

SYMBOLS



DESCRIPTIONS

GRADES LESS CLAYEY AT 226.5'

0.8' BROKEN ZONE WITH VERTICAL FRACTURE FROM 231.2'

ROBBINS MEMBER
SHALE; MEDIUM DARK GRAY; SLIGHTLY CARBONACEOUS; LOCALLY CLAYEY; THINLY LAMINATED.

0.3' GRAYISH-ORANGE PINK LIMESTONE BED FROM 239.9'

0.35' VERTICAL OPEN FRACTURE FROM 240.3'

OCCASIONAL 0.05' TO 0.1' PALE BROWN CONCRETIONS GRADE IN AT 241.1'

NUMEROUS CLAYEY SHALE LAMINAE FROM 242.9' TO 246.3'

OCCASIONAL 0.05' TO 0.1' BROWNISH-GRAY CONCRETIONS GRADE IN AT 254.3'

OCCASIONAL CLAYEY SHALE LAMINAE FROM 260.2' TO 264.9'

NUMEROUS CLAYEY SHALE LAMINAE FROM 264.9' TO 266.9'

0.5' FOSSILIFEROUS, CALCAREOUS ZONE FROM 266.4'

SHALE; GRAYISH-BLACK; VERY CARBONACEOUS; SLIGHTLY CALCAREOUS; THINLY LAMINATED.

0.5' VERTICAL OPEN, CALCITE-LINED FRACTURE FROM 269.1'

ASKELL MEMBER
LIMESTONE; PINKISH-GRAY TO LIGHT GRAY; FOSSILIFEROUS; SHALEY; FINE GRAINED; MEDIUM BEDDED.
GRADES TO VERY SHALEY FROM 273.0'

VINLAND MEMBER
SHALE; MEDIUM GRAY; FOSSILIFEROUS; VERY CALCAREOUS; LAMINATED TO THIN BEDDED.
SANDSTONE; MEDIUM LIGHT GRAY; SILTY; LOCALLY CALCAREOUS; MEDIUM GRAINED; LAMINATED TO THIN BEDDED AND CROSS-BEDDED WITH DISTORTED STRUCTURE; INTERBEDDED WITH SILTSTONE; MEDIUM GRAY TO GRAYISH-BLACK; CARBONACEOUS TO LOCALLY VERY CARBONACEOUS; LAMINATED.

0.7' BROKEN ZONE WITH VERTICAL OPEN FRACTURE FROM 279.1'

0.9' ZONE WITH HIGHLY CONVOLUTED, DISTORTED STRUCTURE FROM 281.5'

LOCAL; BLACK; SHALEY; THINLY LAMINATED.

SHALE; DARK GRAY TO GRAYISH-BLACK; VERY CARBONACEOUS; THINLY LAMINATED.

SHALE GRADES LESS CARBONACEOUS AND GREENISH-GRAY IN COLOR FROM 286.0'

GRADES WITH INCREASING SILT CONTENT FROM 286.9'

SILTSTONE; MEDIUM LIGHT GRAY TO GREENISH-GRAY; SLIGHTLY CARBONACEOUS; SHALEY; MEDIUM GRAINED; LAMINATED TO THIN BEDDED WITH NUMEROUS VERY CARBONACEOUS LAMINAE AND DISTORTED STRUCTURE.
GRADES WITH INCREASING VERY FINE GRAINED SAND CONTENT FROM 291.9'

SANDSTONE; MEDIUM LIGHT GRAY; SLIGHTLY CALCAREOUS; MEDIUM GRAINED; SILTY; THINLY LAMINATED TO THIN BEDDED AND CROSS-BEDDED WITH DISTORTED STRUCTURE; NUMEROUS INTERBEDDED CARBONACEOUS LAMINAE.

SANDSTONE GRADES CALCAREOUS WITH 0.01' TO 0.04' MEDIUM GRAINED SANDSTONE FRAGMENTS
GRADES TO MEDIUM GRAINED SANDSTONE FROM 300.0'

STRATIGRAPHIC NOMENCLATURE

LAWRENCE FORMATION

DOUGLAS GROUP

STRANGER FORMATION

WOLF CREEK
UPDATED SAFETY ANALYSIS REPORT

Figure 2.5-35j (Sheet 4 of 6)

Log of Boring P-10

Rev. 0

BORING P-10 CONT'D

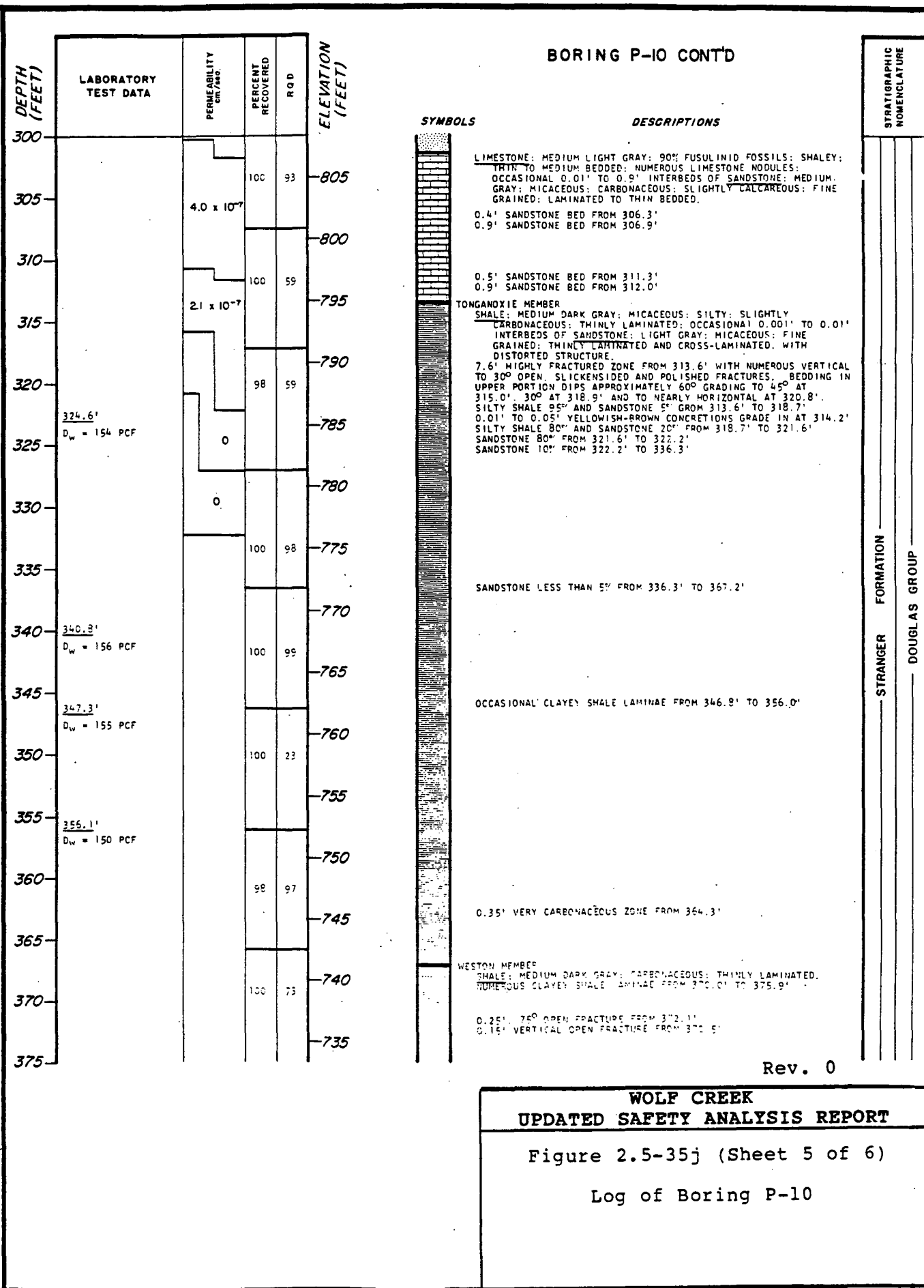

Rev. 0

**WOLF CREEK
UPDATED SAFETY ANALYSIS REPORT**

Figure 2.5-35j (Sheet 5 of 6)
Log of Boring P-10

STRANGER FORMATION
DOUGLAS GROUP

BORING P-10 CONT'D

DEPTH (FEET)	LABORATORY TEST DATA	PERMEABILITY cm./sec.	PERCENT RECOVERED	ROD	ELEVATION (FEET)
375					
380			100	99	730
385					725
390			100	100	720
395					715
400			100	97	710
405					705
410			100	95	700
415					695
420					

SYMBOLS



DESCRIPTIONS

GRADES MORE CARBONACEOUS FROM 390.0'

SOUTH BEND MEMBER

LIMESTONE: LIGHT GRAY; SANDY; SHALEY; FINE GRAINED; THIN TO THICK BEDDED; OCCASIONAL DARK GRAY SHALE PARTINGS.

ROCK LAKE MEMBER

SHALE; MEDIUM GRAY; SILTY; SLIGHTLY CALCAREOUS; CLAYEY; THINLY LAMINATED; WITH INTERBEDDED SANDSTONE; LIGHT GRAY VERY CALCAREOUS; SILTY; FINE TO MEDIUM GRAINED; LAMINATED TO THIN BEDDED WITH DISTORTED STRUCTURE.

LIMESTONE: LIGHT GRAY; SANDY; VERY FINE GRAINED; THIN TO MEDIUM BEDDED

SANDSTONE: LIGHT GRAY TO MEDIUM GRAY; MICACEOUS; SHALEY; MEDIUM GRAINED; THIN TO MEDIUM BEDDED. GRADES VERY CALCAREOUS AND FOSSILIFEROUS FROM 414.5'

STRATIGRAPHIC NOMENCLATURE

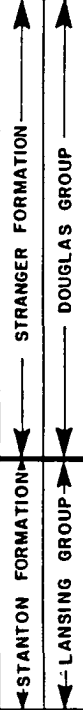

BORING COMPLETED AT 415.2 FEET ON 11-17-73.
 CASING USED TO A DEPTH OF 20.0 FEET.
 GROUNDWATER LEVEL RECORDED AT 33.5 FEET ON 11-18-73.
 THIRD PIEZOMETER INSTALLED AT AN INTERVAL FROM 134.0 FEET TO 155.0 FEET ON 12-11-73.
 SECOND PIEZOMETER INSTALLED AT AN INTERVAL FROM 70.8 FEET TO 86.6 FEET ON 12-11-73.
 FIRST PIEZOMETER INSTALLED AT AN INTERVAL FROM 4.0 FEET TO 52.0 FEET ON 12-10-73.
 PIEZOMETER READINGS ARE PRESENTED ON TABLE 2.4-31.

Rev. 0

WOLF CREEK
 UPDATED SAFETY ANALYSIS REPORT

Figure 2.5-35j (Sheet 6 of 6)

Log of Boring P-10

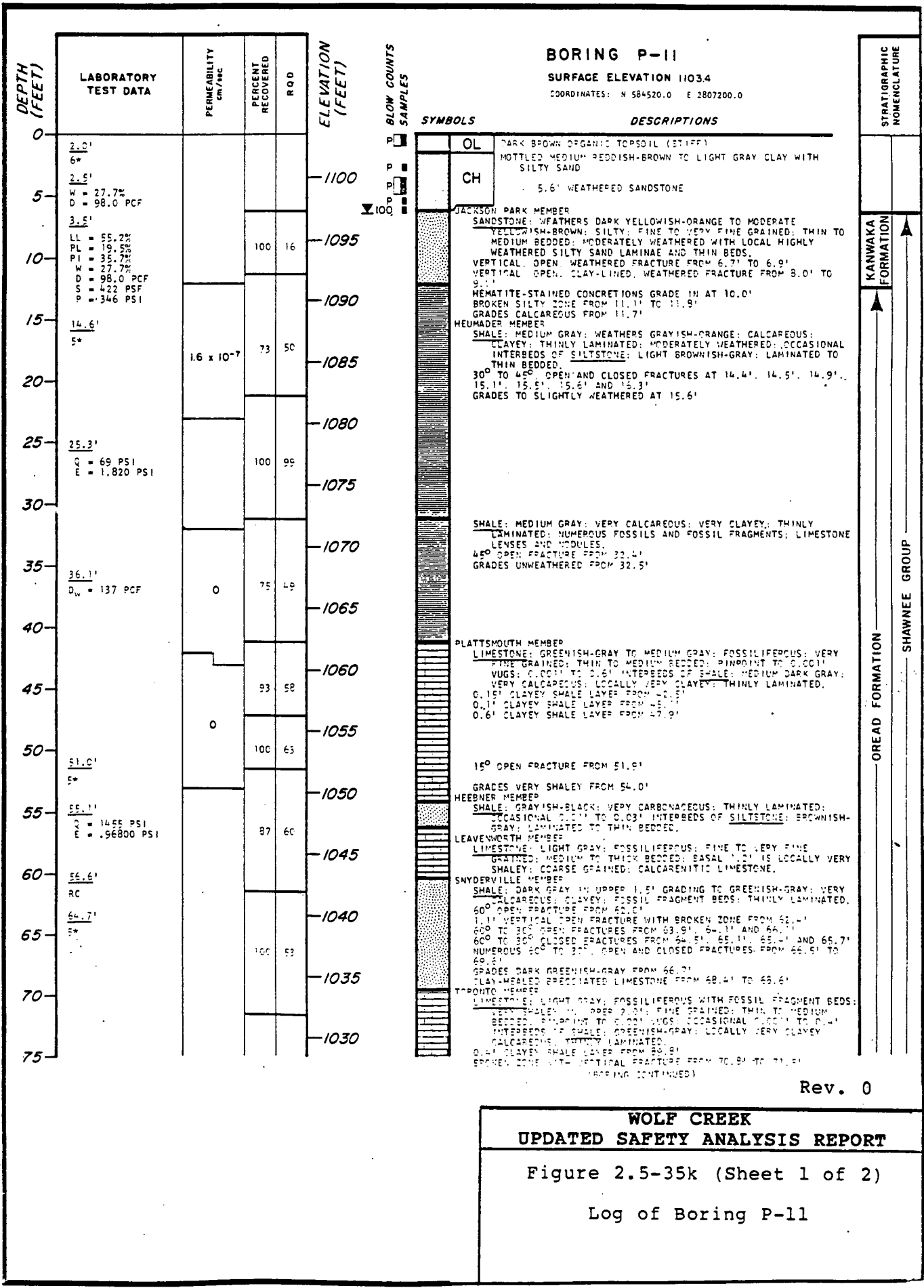

Rev. 0

WOLF CREEK
UPDATED SAFETY ANALYSIS REPORT

Figure 2.5-35k (Sheet 1 of 2)

Log of Boring P-11

BORING P-11 CONT'D

DEPTH (FEET)	LABORATORY TEST DATA	PERMEABILITY cm/sec	PERCENT RECOVERED	RQD	ELEVATION (FEET)
75			100	68	1025
80					
85		88×10^{-8}	100	57	1020
90					1015
95					1010
100		0	100	49	1005
105					1000
110					995
115			92	54	990
120					985

SYMBOLS



DESCRIPTIONS

0.1' CLAYEY SHALE LAYER FROM 82.1'

2.5' VERTICAL OPEN FRACTURE FROM 84.8'

SHALE: GREENISH-GRAY GRADING TO MEDIUM DARK GRAY; LOCALLY CALCAREOUS; CLAYEY; SLIGHTLY CARBONACEOUS; THINLY LAMINATED; WITH INTERBEDDED SANDSTONE; LIGHT GRAY CALCAREOUS; SILTY; MICACEOUS; SLIGHTLY CARBONACEOUS; FINE GRAINED; LAMINATED TO THIN BEDDED WITH DISTORTED STRUCTURE; AND SILTSTONE; MEDIUM DARK GRAY; SHALEY; SLIGHTLY CARBONACEOUS; MICACEOUS; LAMINATED TO THIN BEDDED. SHALE 100% FROM 87.5' TO 90.5' SANDSTONE 10% GRADING TO 40% AND SILTSTONE 40% FROM 90.5' TO 101.2' NUMEROUS CLAYEY SHALE LAMINAE AND THIN BEDS FROM 90.8' TO 95.2'

OCCASIONAL CLAYEY SHALE LAMINAE AND THIN BEDS FROM 99.8' TO 101.5' SANDSTONE 10% GRADING TO LESS THAN 10% AND SILTSTONE 40% FROM 101.2' TO 107.3'

WILLIAMSBURG COAL BED

COAL: BLACK; SHALEY; THIN BEDDED. SHALE: MEDIUM DARK GRAY GRADING TO GREENISH-GRAY IN BASAL 1.1'; CALCAREOUS; CARBONACEOUS; CLAYEY; THINLY LAMINATED. 30' OPEN SLICKENSIDED FRACTURES AT 109.6' AND 109.8'

AMAZONIA MEMBER

LIMESTONE: LIGHT GRAY; OCCASIONAL FOSSIL FRAGMENTS; SHALEY; FINE GRAINED; THIN TO MEDIUM BEDDED; WITH INTERBEDDED

SHALE: GREENISH-GRAY; CLAYEY; CALCAREOUS; THINLY LAMINATED.

IRELAND MEMBER

SHALE: GREENISH-GRAY; CLAYEY; SILTY; THINLY LAMINATED.

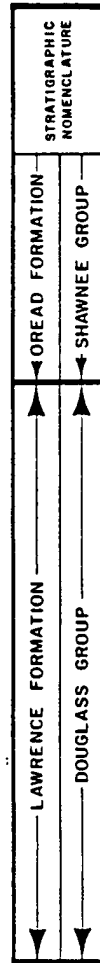

BORING COMPLETED AT 119.5 FEET ON 11-2-73.
CASING USED TO A DEPTH OF 7.1 FEET.
GROUNDWATER LEVEL RECORDED AT 6.5 FEET ON 11-4-73.

Rev. 0

WOLF CREEK
UPDATED SAFETY ANALYSIS REPORT

Figure 2.5-35k (Sheet 2 of 2)

Log of Boring P-11

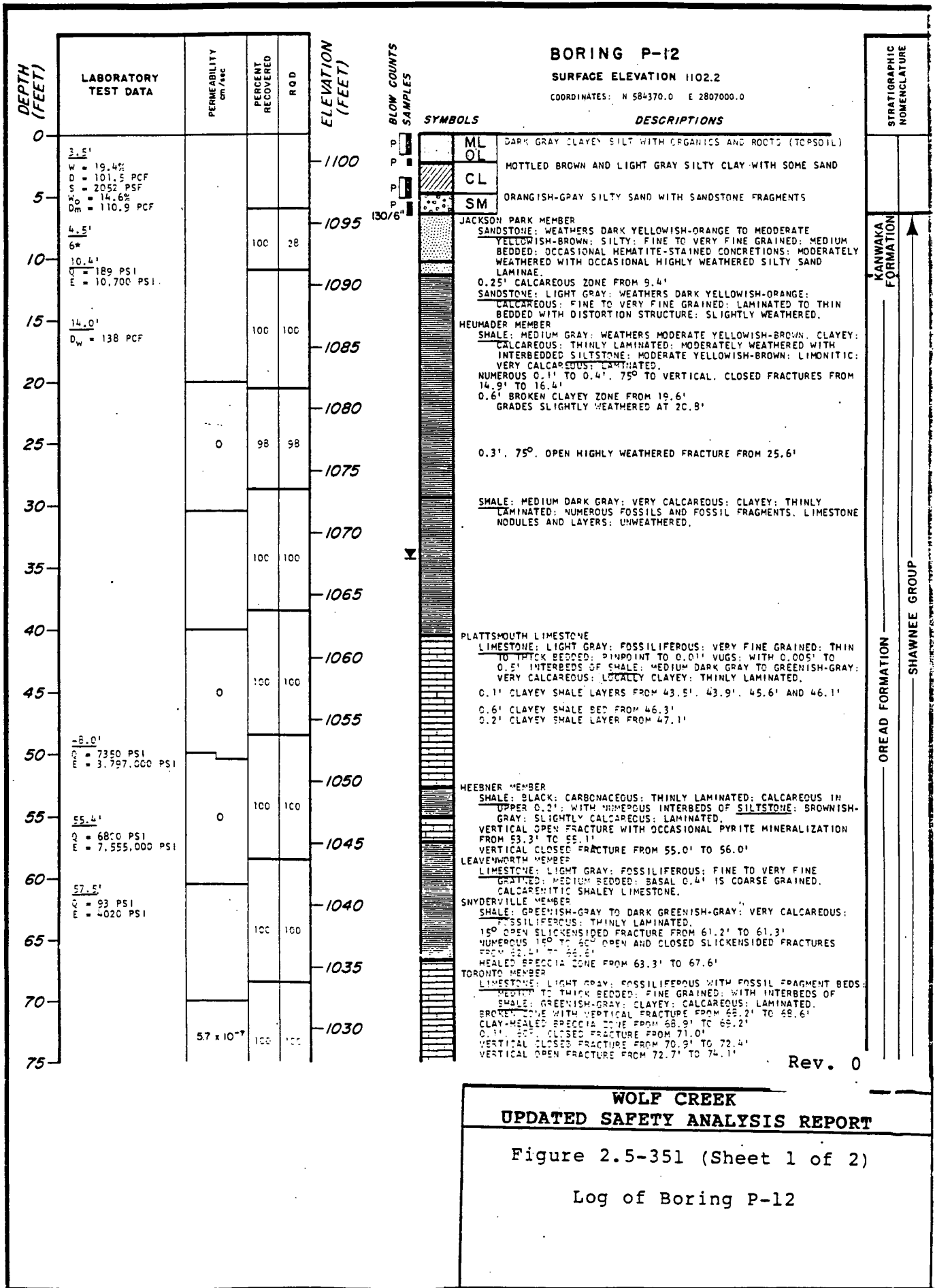

BORING P-12 CONT'D

DEPTH (FEET)	LABORATORY TEST DATA	PERMEABILITY cm/sec	PERCENT RECOVERED	R.O.D.	ELEVATION (FEET)
75	77.8' 2430 PSI 526,000 PSI 32 490,000 PSI				1025
80	1K				1020
85		3.1 x 10 ⁻⁷	100	100	1015
90					1010
95		0	100	100	1005
100					1000
105		0	100	100	995
110					990
115			100	100	985
120					

SYMBOLS



DESCRIPTIONS

SHALE: MEDIUM GRAY TO DARK GRAY; LOCALLY SLIGHTLY CALCAREOUS; CLAYEY; MICACEOUS SLIGHTLY CARBONACEOUS; THINLY LAMINATED; WITH INTERBEDDED SANDSTONE; LIGHT GRAY; CALCAREOUS; MICACEOUS; SLIGHTLY CARBONACEOUS; FINE GRAINED; LAMINATED WITH DISTORTED STRUCTURE.
 SHALE 100% FROM 84.6' TO 86.4'
 SANDSTONE 10% FROM 86.4' TO 87.8'
 SANDSTONE 40% - 50% FROM 87.8' TO 98.5'
 SANDSTONE 10% FROM 98.5' TO 101.3'
 OCCASIONAL CLAYEY SHALE LAYERS FROM 98.5' TO 103.6'
 SHALE 100% FROM 101.3' TO 103.6'

WILLIAMSBURG COAL BED
 COAL: BLACK; SHALEY; LAMINATED TO THIN BEDDED; WITH INTERBEDDED SHALE; GREENISH-GRAY TO MEDIUM GRAY; CALCAREOUS; THINLY LAMINATED.
 SHALE: GREENISH-GRAY; CALCAREOUS; CARBONACEOUS IN UPPER 0.1'; THINLY LAMINATED
 OCCASIONAL 45° OPEN FRACTURES FROM 104.8' TO 106.7'

AMAZONIA MEMBER
 SHALE: GREENISH-GRAY; VERY CALCAREOUS; THINLY LAMINATED; OCCASIONAL NODULES AND LAYERS OF LIMESTONE.
 LIMESTONE: LIGHT GRAY; LOCALLY FOSSILIFEROUS; MEDIUM BEDDED; WITH INTERBEDDED SHALE; GREENISH-GRAY; VERY CALCAREOUS; THINLY LAMINATED.

IRELAND MEMBER
 SHALE: GREENISH-GRAY IN UPPER 5.0' GRADING TO MEDIUM DARK GRAY; LOCALLY CALCAREOUS; THINLY LAMINATED; WITH INTERBEDDED SANDSTONE; LIGHT GRAY; CALCAREOUS; FINE GRAINED; LAMINATED.

BORING COMPLETED AT 118.5 FEET ON 10-25-73.
 CASING USED TO A DEPTH OF 6.5 FEET.
 GROUNDWATER RECORDED AT 34.5 FEET ON 10-29-73.
 SECOND PIEZOMETER INSTALLED AT AN INTERVAL FROM 3.0 FEET TO 50.4 FEET ON 12-3-73.
 FIRST PIEZOMETER INSTALLED AT AN INTERVAL FROM 67.0 FEET TO 83.3 FEET ON 12-3-73.
 PIEZOMETER READINGS ARE PRESENTED ON TABLE 2.4-31.



Rev. 0

WOLF CREEK
UPDATED SAFETY ANALYSIS REPORT

Figure 2.5-351 (Sheet 2 of 2)
 Log of Boring P-12

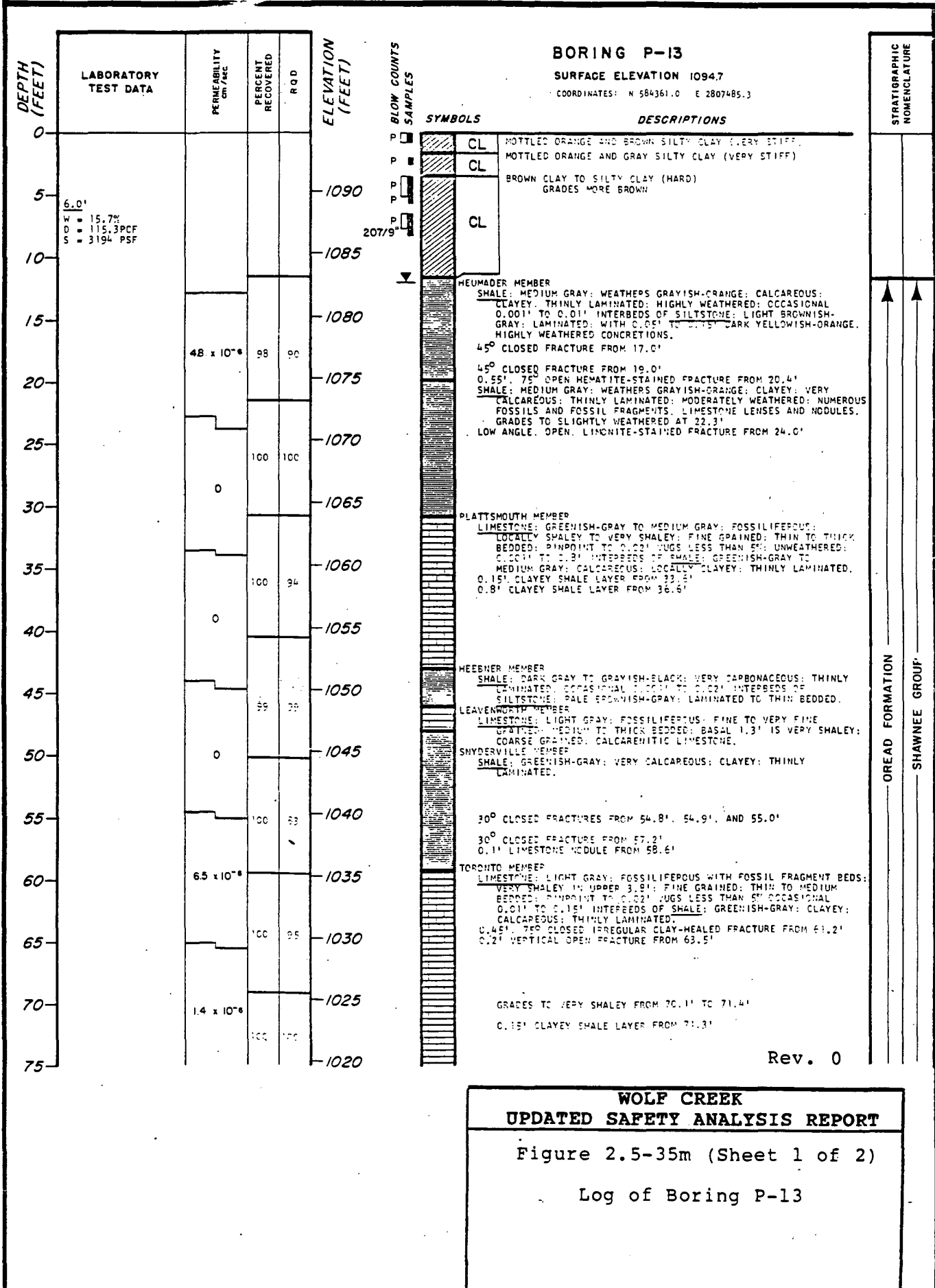

BORING P-13 CONT'D

DEPTH (FEET)	LABORATORY TEST DATA	PERMEABILITY cm/sec	PERCENT RECOVERED	R Q D	ELEVATION (FEET)
75					
80		4.5 x 10 ⁻⁷			1015
85			100	100	1010
90		3.5 x 10 ⁻⁸			1005
95			100	96	1000
100					995
105			100	91	990
110					

SYMBOLS



DESCRIPTIONS

SHALE: GREENISH-GRAY AND MOTTLED MEDIUM GRAY; SILTY; MICACEOUS; THINLY LAMINATED.
 0.5' BROKEN ZONE WITH 30° TO 45° OPEN SLICKENSIDED FRACTURES FROM 79.0'

SHALE: MEDIUM GRAY; SLIGHTLY CARBONACEOUS; THINLY LAMINATED; INTERBEDDED WITH SANDSTONE: LIGHT GRAY; SILTY; MICACEOUS; SLIGHTLY CARBONACEOUS; FINE GRAINED; LAMINATED TO THIN BEDDED WITH DISTORTED STRUCTURE; AND SILTSTONE: MEDIUM DARK GRAY; SLIGHTLY CARBONACEOUS; MICACEOUS; LAMINATED TO THIN BEDDED.
 SANDSTONE 10" AND SILTSTONE 70" FROM 79.2' TO 81.0'
 SANDSTONE 40" AND SILTSTONE 40" FROM 81.0' TO 91.9'

0.5' VERTICAL FRACTURE FROM 89.9'

SANDSTONE LESS THAN 10% AND SILTSTONE 30% FROM 91.9' TO 97.4'

GRADES VERY CARBONACEOUS FROM 96.6'

WILLIAMSBURG COAL BED
 COAL: BLACK; SHALEY; THINLY LAMINATED.
 SHALE: MEDIUM DARK GRAY; CARBONACEOUS; CLAYEY; CALCAREOUS; THINLY LAMINATED.
 BROKEN ZONE WITH 30° OPEN SLICKENSIDED FRACTURES FROM 99.0' TO 99.2'

AMAZONIA MEMBER
 LIMESTONE: LIGHT GRAY; OCCASIONAL FOSSIL FRAGMENTS; SHALEY TO VERY SHALEY; FINE GRAINED; THIN TO MEDIUM REDDED WITH INTERBEDDED SHALE: GREENISH-GRAY; CALCAREOUS; THINLY LAMINATED.
 GRADES TO VERY SHALEY AT 104.0'

IRELAND MEMBER
 SHALE: GREENISH-GRAY; CALCAREOUS; CLAYEY; THINLY LAMINATED.

BORING COMPLETED AT 107.5 FEET ON 11-6-73.
 CASING USED TO A DEPTH OF 10.0 FEET.
 GROUNDWATER LEVEL RECORDED AT 12.0 FEET ON 11-16-73.



Rev. 0

**WOLF CREEK
 UPDATED SAFETY ANALYSIS REPORT**

Figure 2.5-35m (Sheet 2 of 2)

Log of Boring P-13

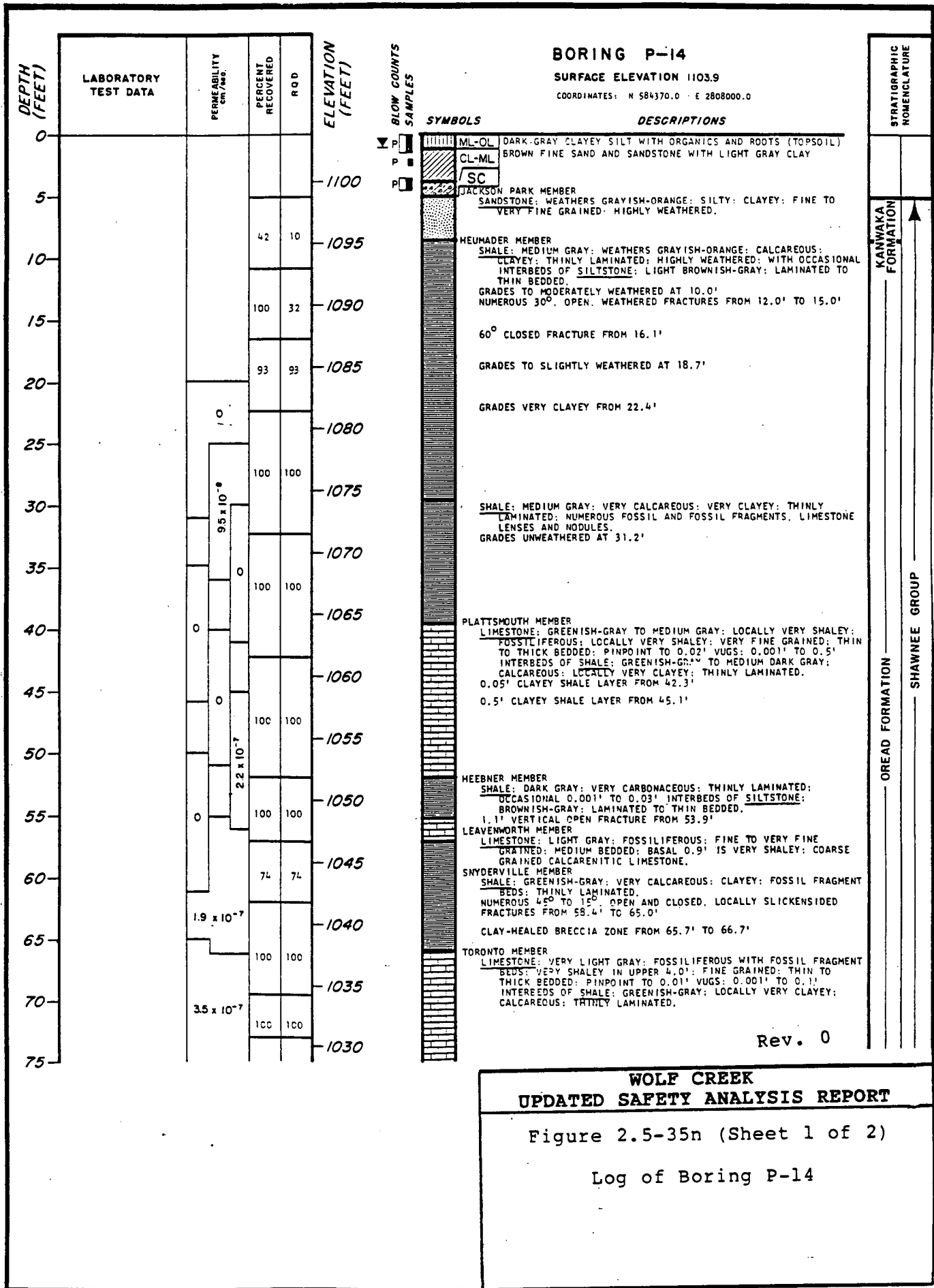

BORING P-14 CONT'D

DEPTH (FEET)	LABORATORY TEST DATA	PERMEABILITY (CM/SEC.)	PERCENT RECOVERED	ROD	ELEVATION (FEET)
75					
80		1.4 x 10 ⁻⁸	100	100	1025
85					1020
90		6.5 x 10 ⁻⁸	100	100	1015
95					1010
100		4.5 x 10 ⁻⁸	100	100	1005
105					1000
110			100	88	995
115					

SYMBOLS



DESCRIPTIONS

SHALE; GREENISH-GRAY IN UPPER 2.4' GRADING TO MEDIUM DARK GRAY; LOCALLY CALCAREOUS; CLAYEY; SLIGHTLY CARBONACEOUS; THINLY LAMINATED; WITH INTERBEDDED SANDSTONE; LIGHT GRAY; CALCAREOUS; SILTY; MICACEOUS; SLIGHTLY CARBONACEOUS; FINE GRAINED; LAMINATED TO THIN BEDDED WITH DISTORTED STRUCTURE; AND SILTSTONE; MEDIUM DARK GRAY; SHALEY; SLIGHTLY CARBONACEOUS; MICACEOUS; LAMINATED TO THIN BEDDED.
 SHALE 100% FROM 83.7' TO 86.0'
 SANDSTONE 10% GRADING TO 40% AND SILTSTONE 40% FROM 86.0' TO 97.1'

SANDSTONE 10% GRADING TO LESS THAN 10% FROM 97.1' TO 102.1'
 GRADES LOCALLY VERY CARBONACEOUS FROM 99.5'

WILLIAMSBURG COAL BED
 COAL; BLACK; SHALEY; THIN BEDDED.
 SHALE; GREENISH-GRAY; CLAYEY; THINLY LAMINATED
 0.1" CLAYEY SHALE LAYER FROM 102.3'
 GRADES VERY CALCAREOUS FROM 102.4'
 45° TO 30° OPEN AND CLOSED. LOCALLY SLICKENSIDED FRACTURES AT 103.2', 103.4', 104.0', 104.1', 104.2', 104.4', 104.8' AND 105.3'

AMAZONIA MEMBER
 SHALE; GREENISH-GRAY; CLAYEY; VERY CALCAREOUS; THINLY LAMINATED; LENSES AND NODULES OF LIMESTONE.
 LIMESTONE; LIGHT GRAY; SHALEY; FINE GRAINED; THIN TO MEDIUM BEDDED; WITH INTERBEDDED SHALE; GREENISH-GRAY; CLAYEY; CALCAREOUS; LAMINATED.

BORING COMPLETED AT 111.8 FEET ON 11-1-73.
 CASING USED TO A DEPTH OF 5.0 FEET.
 GROUNDWATER LEVEL RECORDED AT 1.0 FEET ON 11-4-73.
 SECOND PIEZOMETER INSTALLED AT AN INTERVAL FROM 3.0 FEET TO 50.4 FEET ON 11-13-73.
 FIRST PIEZOMETER INSTALLED AT AN INTERVAL FROM 65.2 FEET TO 83.2 FEET ON 11-13-73.
 PIEZOMETER READINGS ARE PRESENTED ON TABLE 2.4-31.

STRATIGRAPHIC NOMENCLATURE
OREAD FORMATION SHAWNEE GROUP
LAWRENCE FORMATION DOUGLASS GROUP

Rev. 0

WOLF CREEK
 UPDATED SAFETY ANALYSIS REPORT

Figure 2.5-35n (Sheet 2 of 2)

Log of Boring P-14

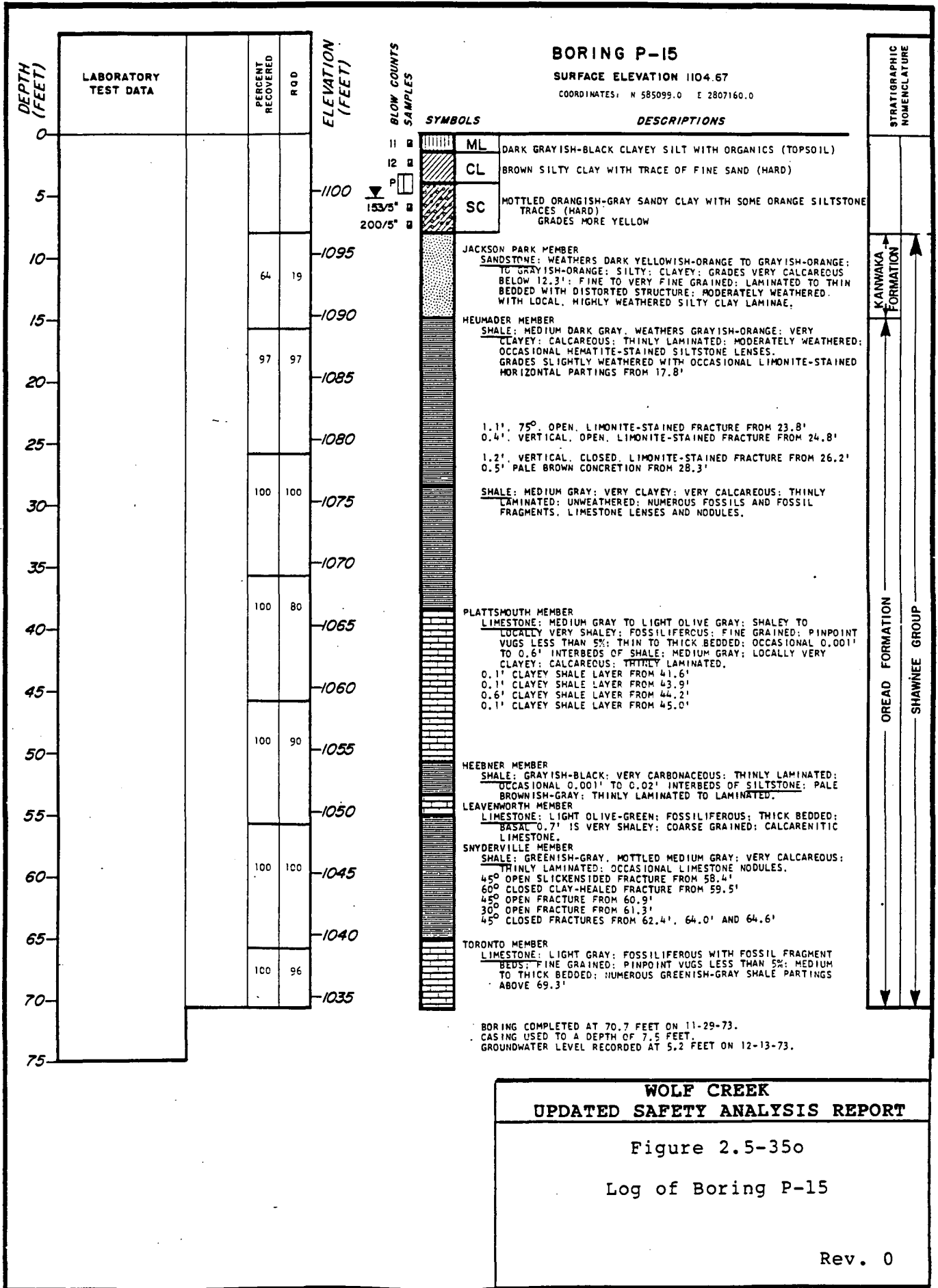

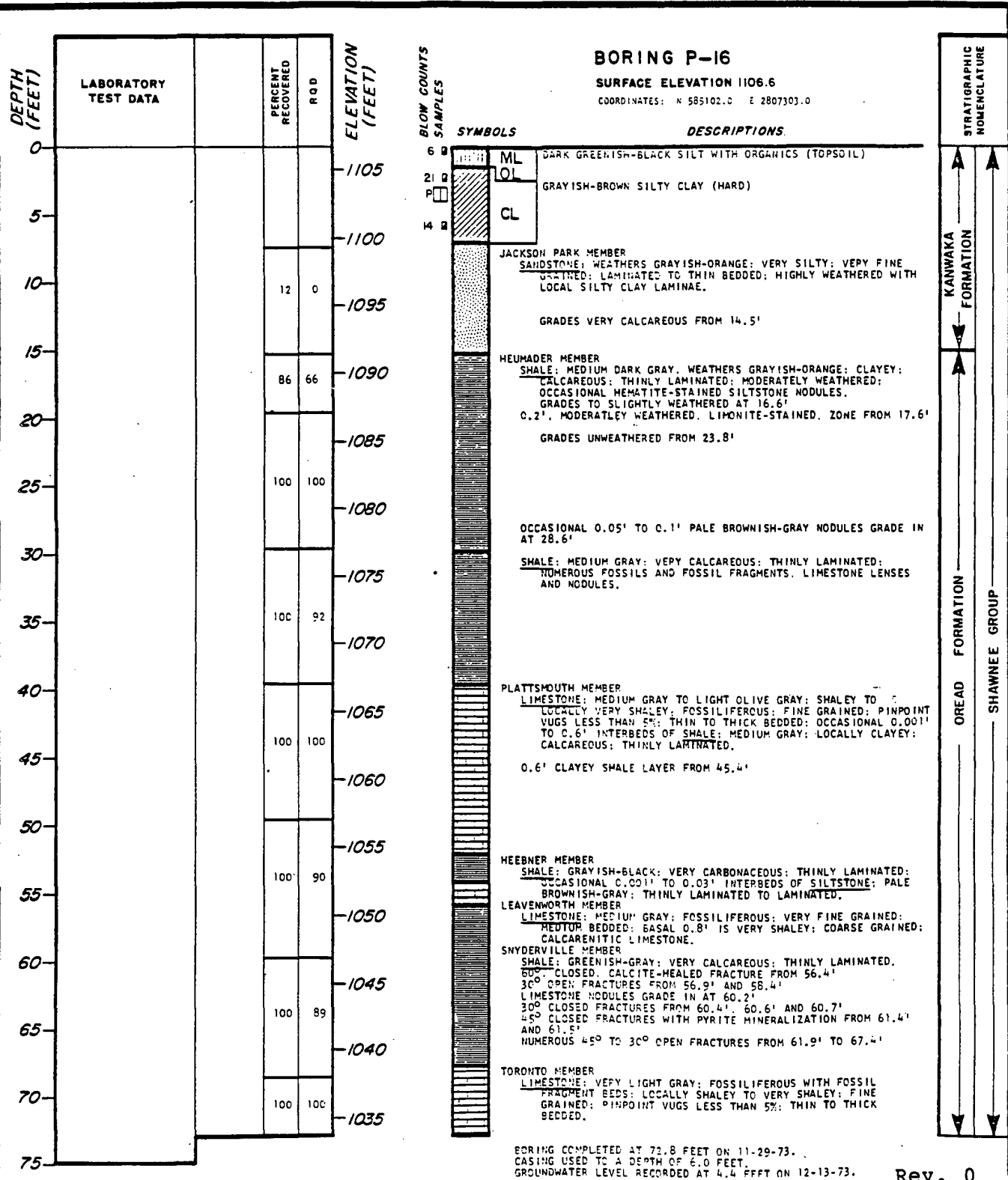

BORING COMPLETED AT 72.8 FEET ON 11-29-73.
CASING USED TO A DEPTH OF 6.0 FEET.
GROUNDWATER LEVEL RECORDED AT 4.4 FEET ON 12-13-73.

Rev. 0

WOLF CREEK
UPDATED SAFETY ANALYSIS REPORT

Figure 2.5-35p

Log of Boring P-16

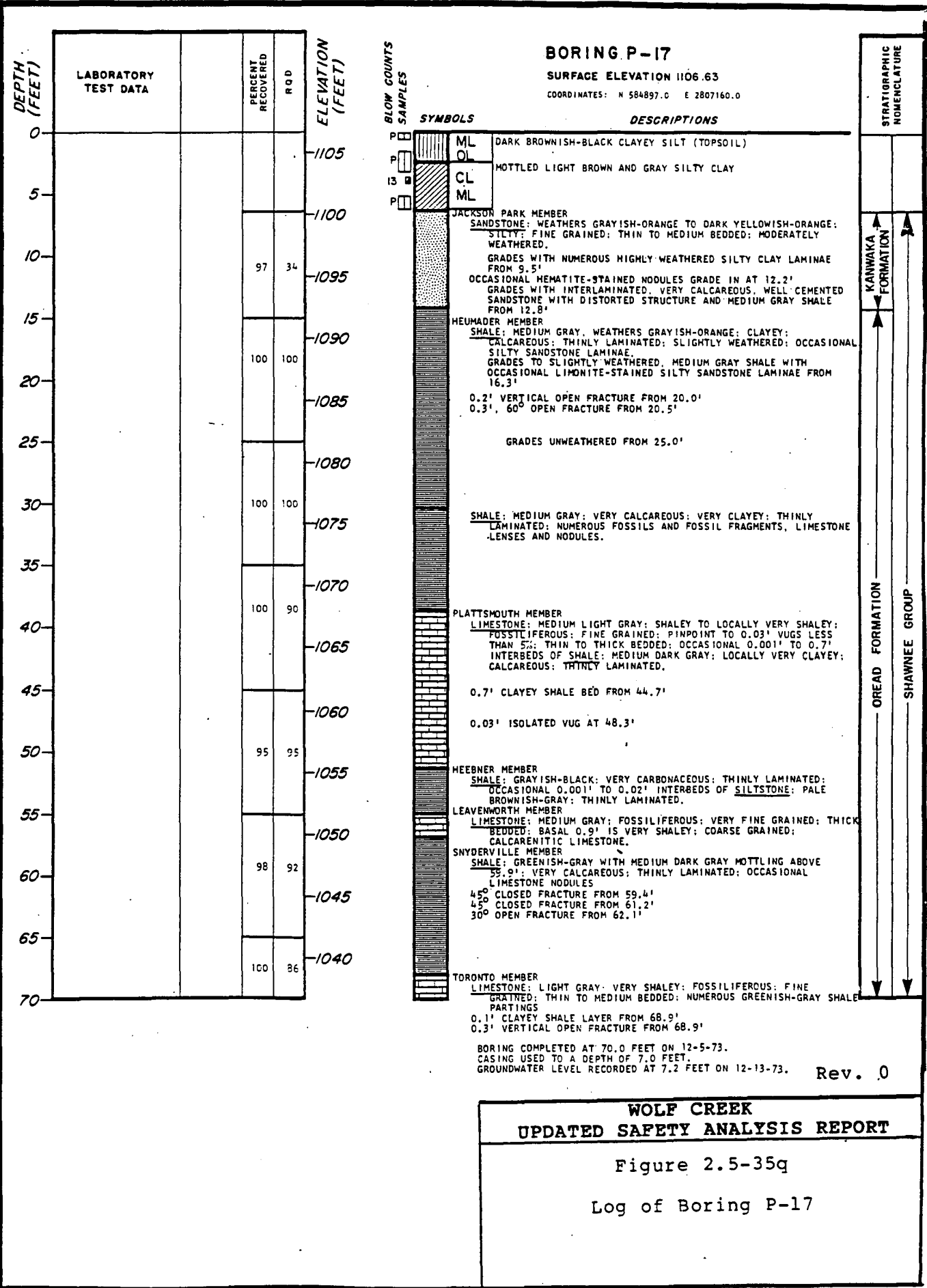

BORING P-18

SURFACE ELEVATION 1107.6

COORDINATES: N 584970.0 E 2807304.0

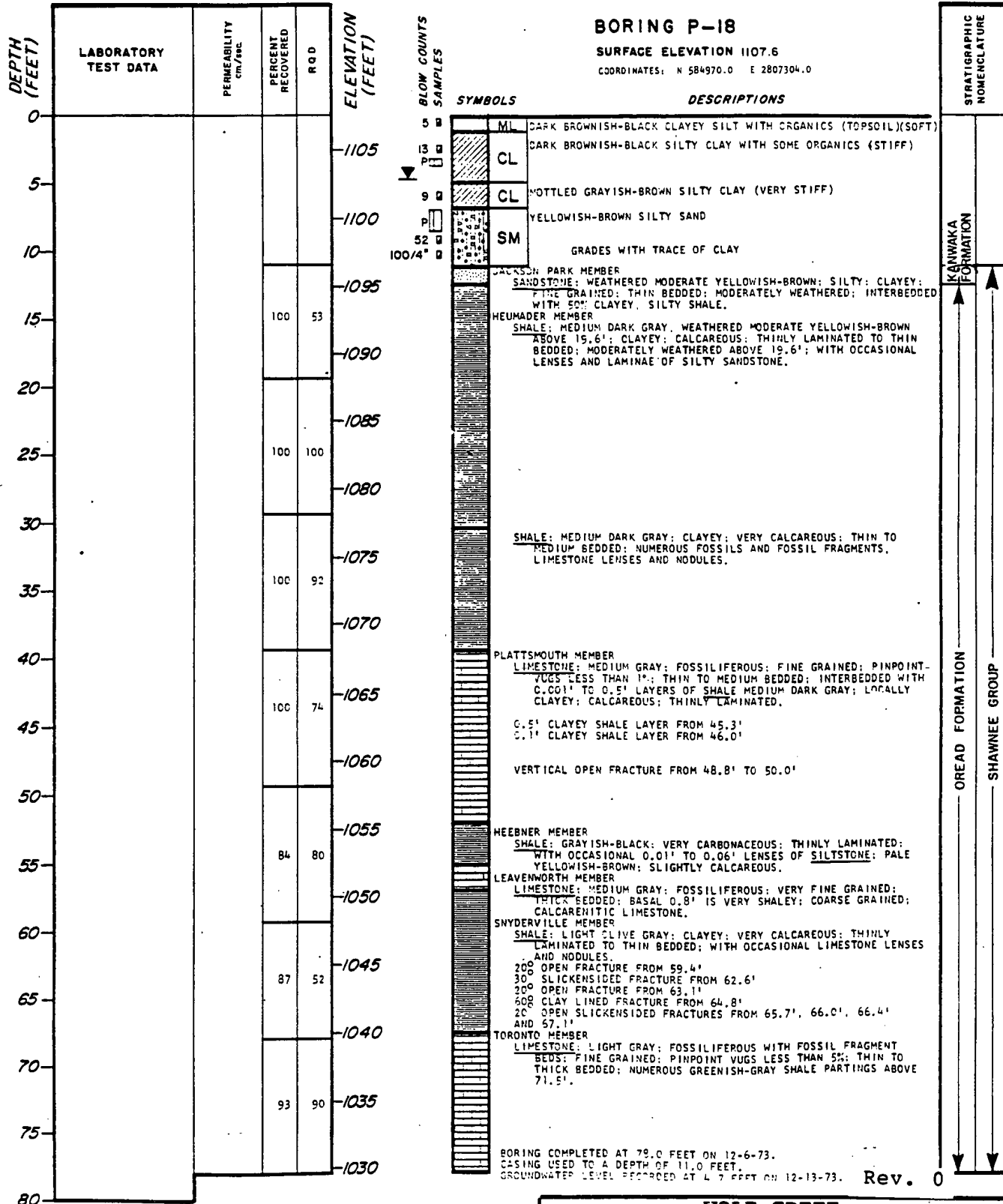

BORING COMPLETED AT 79.0 FEET ON 12-6-73.
CASING USED TO A DEPTH OF 11.0 FEET.
GROUNDWATER LEVEL RECORDED AT 4.7 FEET ON 12-13-73. Rev. 0

WOLF CREEK
UPDATED SAFETY ANALYSIS REPORT

Figure 2.5-35r
Log of Boring P-18

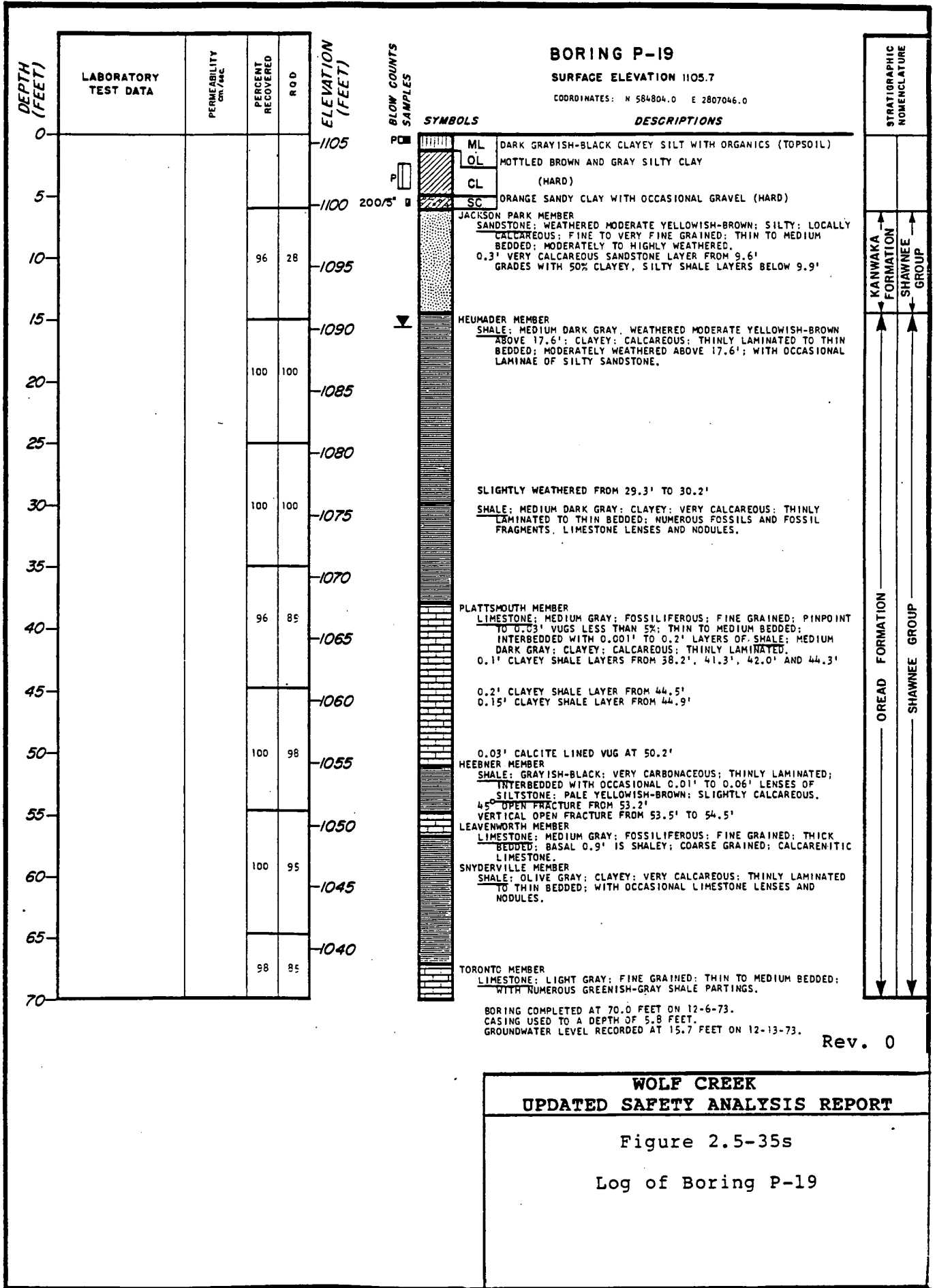

**WOLF CREEK
UPDATED SAFETY ANALYSIS REPORT**

Figure 2.5-35s
Log of Boring P-19

BORING P-20

SURFACE ELEVATION 1106.53

COORDINATES: N 584816.0 E 2807303.0

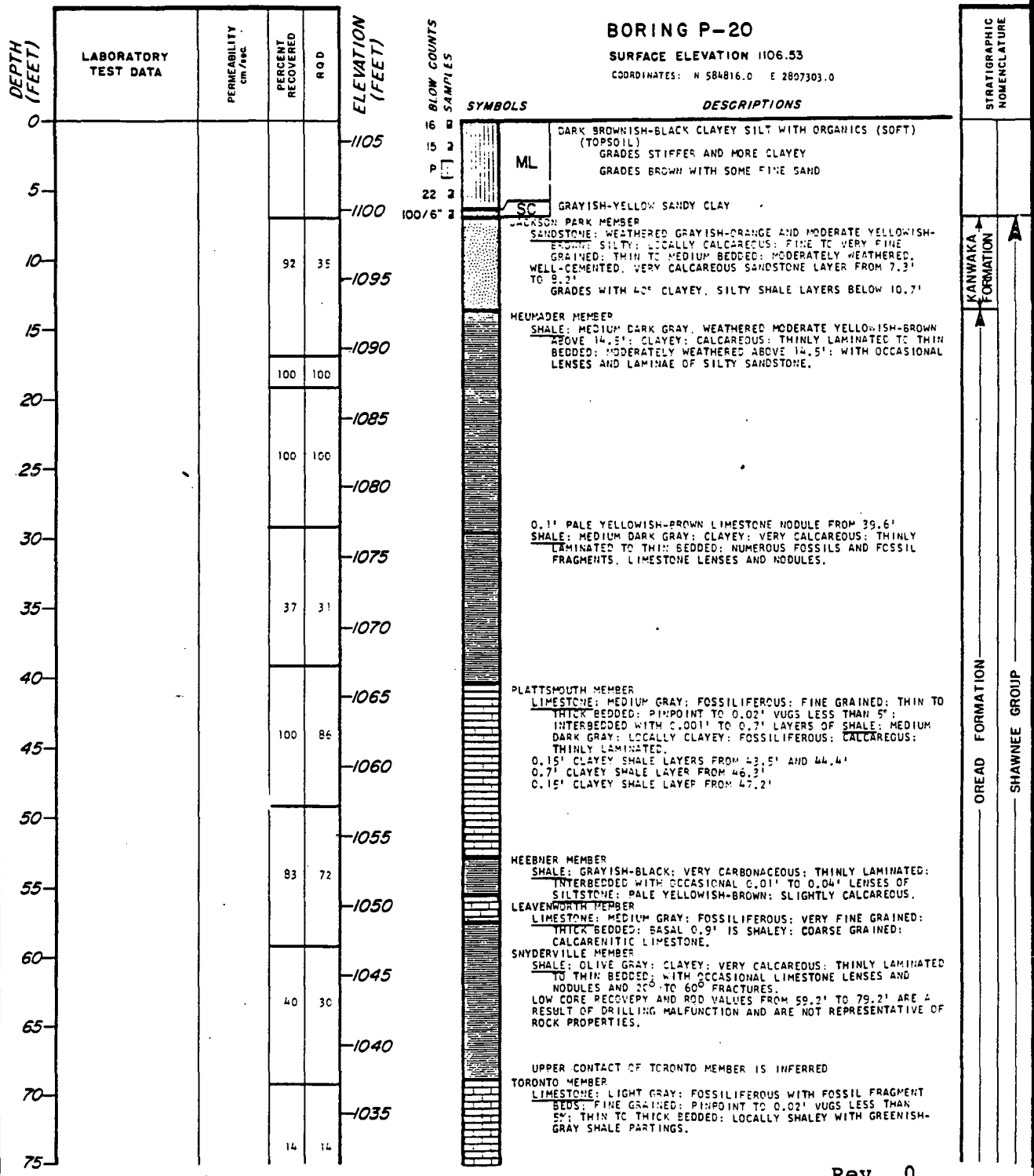

Rev. 0

**WOLF CREEK
UPDATED SAFETY ANALYSIS REPORT**

Figure 2.5-35t (Sheet 1 of 2)

Log of Boring P-20

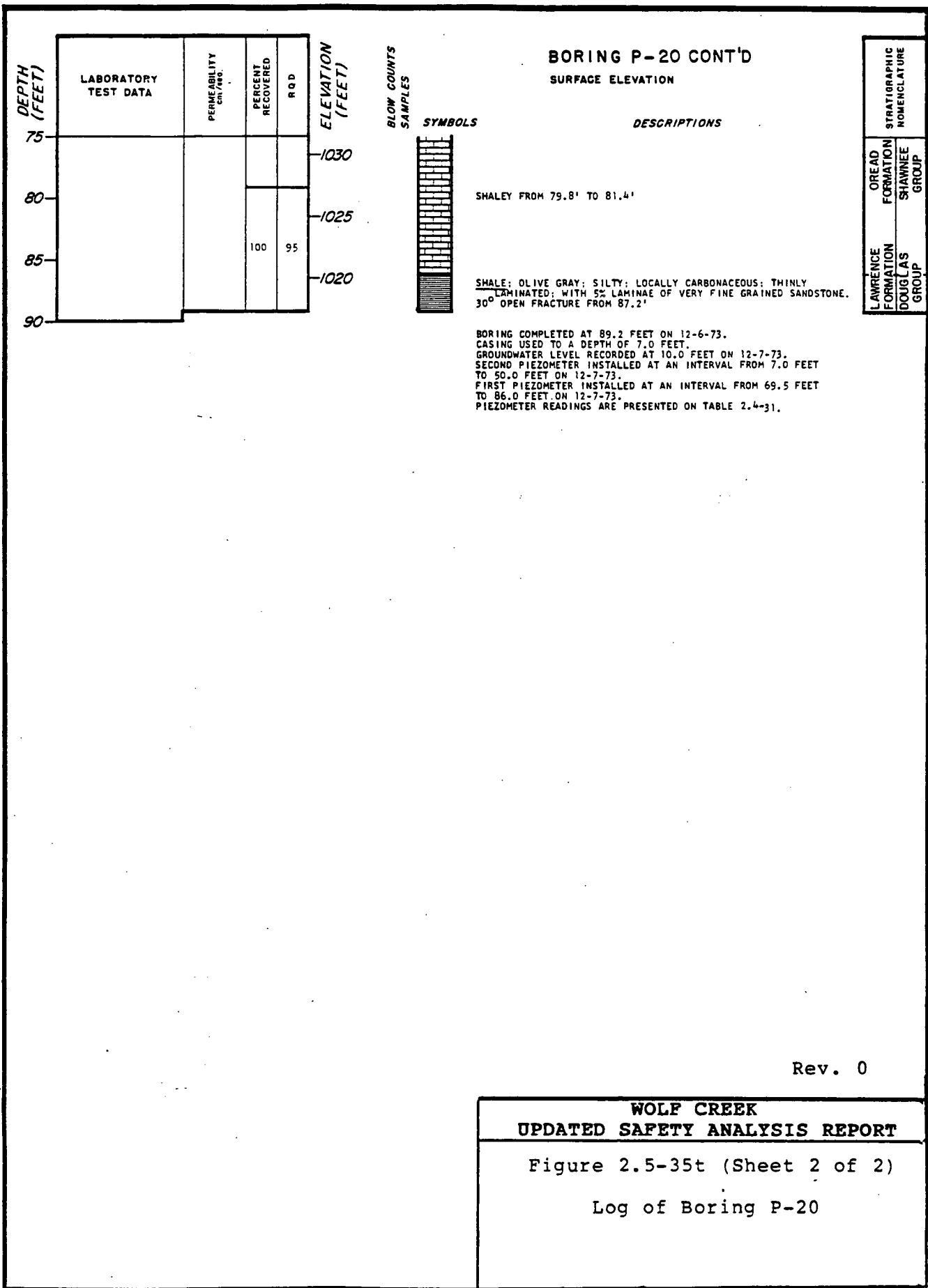

BORING P-20 CONT'D
SURFACE ELEVATION

DEPTH (FEET)	LABORATORY TEST DATA	PERMEABILITY (cm/sec)	PERCENT RECOVERED	R Q D	ELEVATION (FEET)
75					1030
80					1025
85			100	95	1020
90					

BLOW COUNTS SAMPLES



DESCRIPTIONS

SHALEY FROM 79.8' TO 81.4'

SHALE: OLIVE GRAY; SILTY; LOCALLY CARBONACEOUS; THINLY LAMINATED; WITH 5% LAMINAE OF VERY FINE GRAINED SANDSTONE. 30° OPEN FRACTURE FROM 87.2'

BORING COMPLETED AT 89.2 FEET ON 12-6-73.
CASING USED TO A DEPTH OF 7.0 FEET.
GROUNDWATER LEVEL RECORDED AT 10.0 FEET ON 12-7-73.
SECOND PIEZOMETER INSTALLED AT AN INTERVAL FROM 7.0 FEET TO 50.0 FEET ON 12-7-73.
FIRST PIEZOMETER INSTALLED AT AN INTERVAL FROM 69.5 FEET TO 86.0 FEET ON 12-7-73.
PIEZOMETER READINGS ARE PRESENTED ON TABLE 2.4-31.

STRATIGRAPHIC NOMENCLATURE
OREAD FORMATION SHAWNEE GROUP
LAWRENCE FORMATION DOUGLAS GROUP

Rev. 0

WOLF CREEK
UPDATED SAFETY ANALYSIS REPORT

Figure 2.5-35t (Sheet 2 of 2)

Log of Boring P-20

BORING P-21

SURFACE ELEVATION 1105.89

COORDINATES: N 584755.0 E 2807132.0

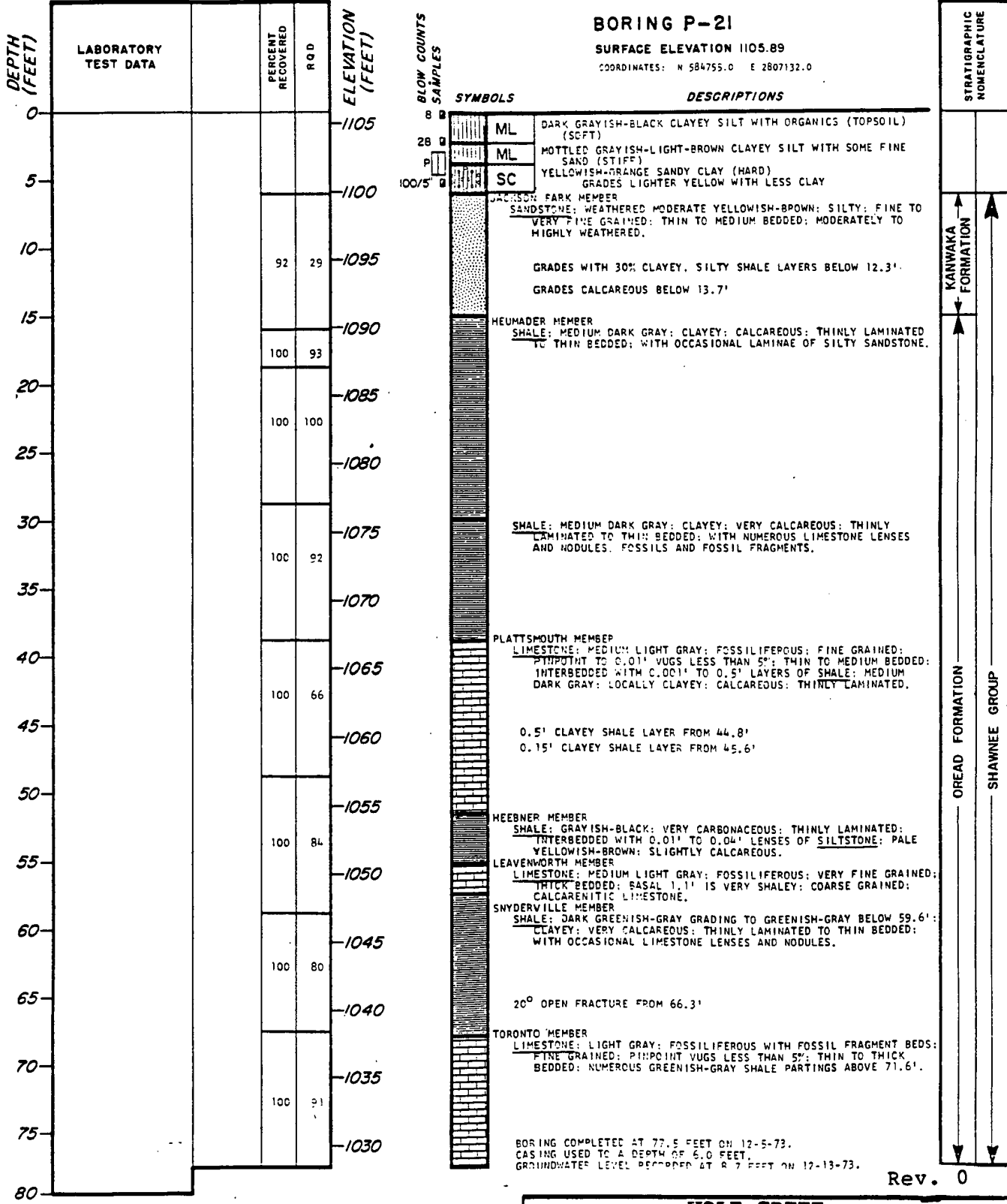

BORING COMPLETED AT 77.5 FEET ON 12-5-73.
CASING USED TO A DEPTH OF 6.0 FEET.
GROUNDWATER LEVEL RECORDED AT A 7 FEET ON 12-13-73.

Rev. 0

WOLF CREEK
UPDATED SAFETY ANALYSIS REPORT

Figure 2.5-35u

Log of Boring P-21

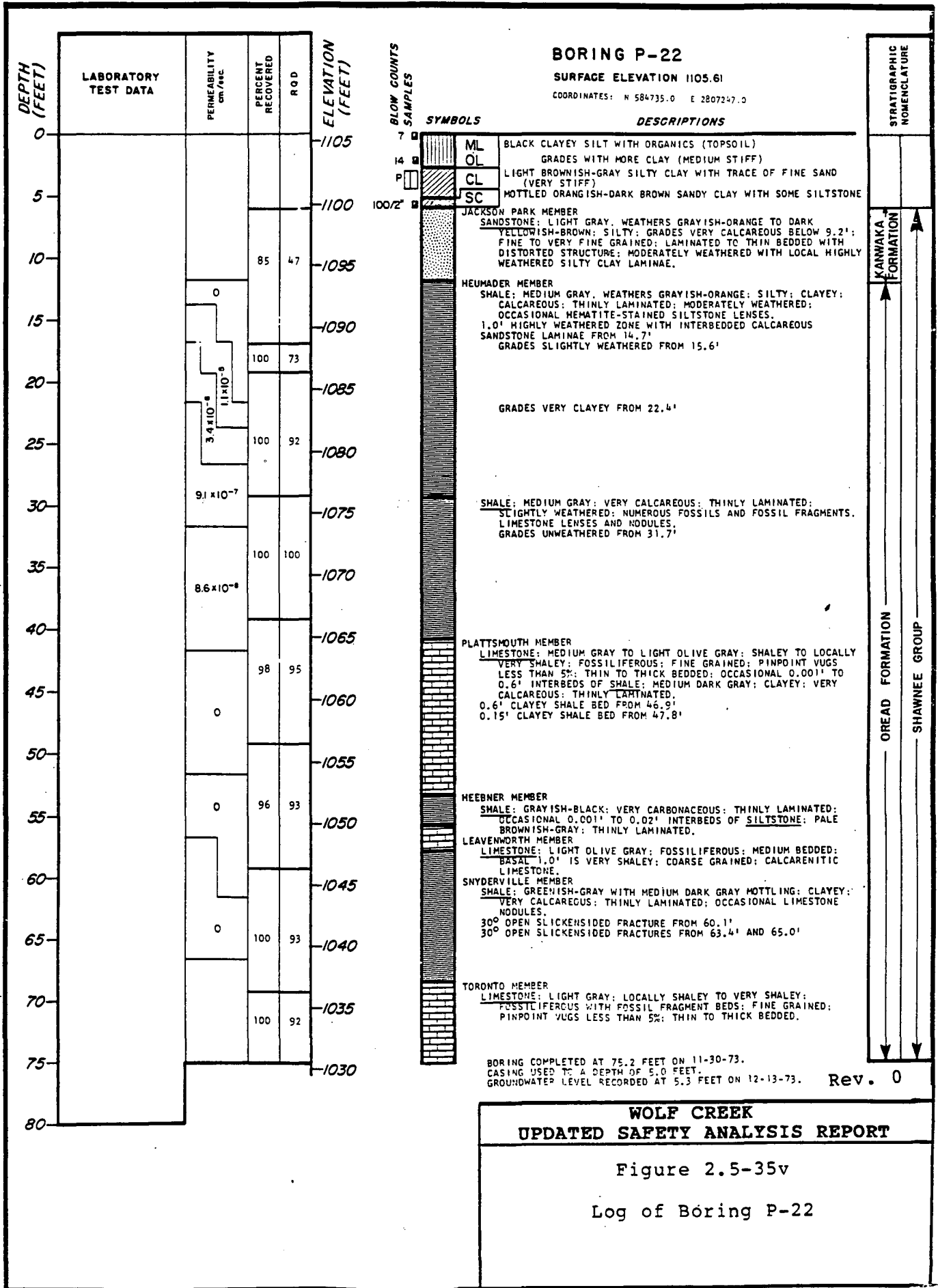

DEPTH (FEET)	LABORATORY TEST DATA	PERCENT RECOVERED	RQD	ELEVATION (FEET)
0				1105
5				1100
10		100	45	1095
15				1090
20		100	100	1085
25				1080
30		100	100	1075
35				1070
40		100	0	1065
45		100	86	1060
50		97	97	1055
55				1050
60		100	100	1045
65				1040
70		100	77	

BLOW COUNTS
SAMPLES



BORING P-23
SURFACE ELEVATION 1105.35
COORDINATES: N 584686.0 E 280707.0

SYMBOLS	DESCRIPTIONS
ML	BLACK CLAYEY SILT WITH ORGANICS (TOPSOIL);
OL	LIGHT BROWN CLAYEY SILT WITH FINE SAND (HARD)
ML	ORANGISH-BROWN FINE SAND WITH SILTSTONE FRAGMENTS
SP	
	JACKSON PARK MEMBER SANDSTONE: WEATHERS MODERATE YELLOWISH-BROWN; SILTY; LOCALLY CALCAREOUS; THIN TO MEDIUM BEDDED; MODERATELY TO HIGHLY WEATHERED.
	WELL-CEMENTED, VERY CALCAREOUS SANDSTONE LAYER FROM 10.7' TO 11.3' GRADES WITH 50% CLAYEY, SILTY SHALE LAYERS BELOW 11.3'
	HEUMADER MEMBER SHALE: MEDIUM DARK GRAY, WEATHERED MODERATE YELLOWISH-BROWN IN UPPER 2.0'; CLAYEY; CALCAREOUS; THINLY LAMINATED TO THIN BEDDED; SLIGHTLY TO MODERATELY WEATHERED; INTERBEDDED WITH OCCASIONAL LAMINAE OF SILTY SANDSTONE.
	60° CLAY LINED FRACTURE FROM 30.5'
	SHALE: MEDIUM DARK GRAY; CLAYEY; VERY CALCAREOUS; THINLY LAMINATED TO THIN BEDDED; WITH NUMEROUS FOSSILS AND FOSSIL FRAGMENTS, LIMESTONE LENSES AND NODULES.
	PLATTSMOUTH MEMBER LIMESTONE: MEDIUM LIGHT GRAY; FOSSILIFEROUS; FINE GRAINED; PINPOINT BUGS LESS THAN 1%; THIN TO MEDIUM BEDDED; INTERBEDDED WITH 0.01' TO 0.6' LAYERS OF SHALE; MEDIUM DARK GRAY; CALCAREOUS; LOCALLY CLAYEY; FOSSILIFEROUS; THINLY LAMINATED. 0.1' CLAYEY SHALE LAYER FROM 42.5' 0.6' CLAYEY SHALE LAYER FROM 45.0' 0.2' CLAYEY SHALE LAYER FROM 45.9'
	HEEBNER MEMBER SHALE: GRAYISH-BLACK; VERY CARBONACEOUS; THINLY LAMINATED; WITH 0.01' TO 0.05' LAYERS OF SILTSTONE; PALE YELLOWISH-BROWN; SLIGHTLY CALCAREOUS.
	LEAVENWORTH MEMBER LIMESTONE: MEDIUM LIGHT GRAY; FOSSILIFEROUS; VERY FINE GRAINED; THICK BEDDED; BASAL 0.8' IS VERY SHALEY; COARSE GRAINED; CALCARENITIC LIMESTONE.
	SNYDERVILLE MEMBER SHALE: GREENISH-GRAY; CLAYEY; VERY CALCAREOUS; THINLY LAMINATED TO THIN BEDDED; WITH OCCASIONAL LIMESTONE LENSES AND NODULES. 30° OPEN FRACTURE FROM 60.5'
	TORONTO MEMBER LIMESTONE: LIGHT GRAY; FINE GRAINED; THIN BEDDED; WITH NUMEROUS GREENISH-GRAY SHALE PARTINGS.

STRATIGRAPHIC NOMENCLATURE

KAWAKA FORMATION

OREAD FORMATION

SHAWNEE GROUP

BORING COMPLETED AT 70.0 FEET ON 12-3-73.
CASING USED TO A DEPTH OF 5.5 FEET.
GROUNDWATER LEVEL RECORDED 10.2 FEET ON 12-13-73.

Rev. 0

WOLF CREEK
UPDATED SAFETY ANALYSIS REPORT

Figure 2.5-35w

Log of Boring P-23

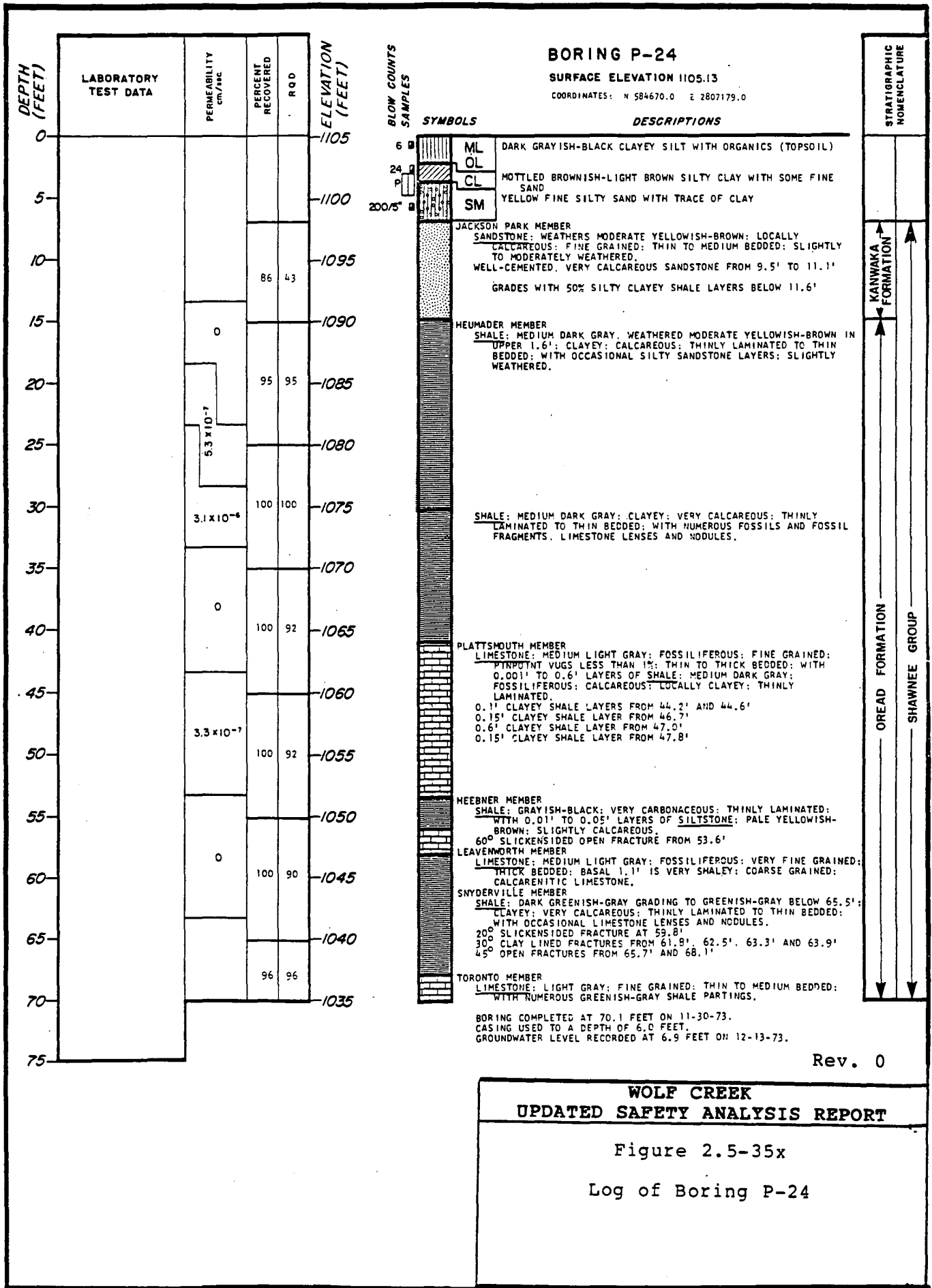

BORING P-25

SURFACE ELEVATION 1102.91

COORDINATES: N 584670.0 E 2807313.0

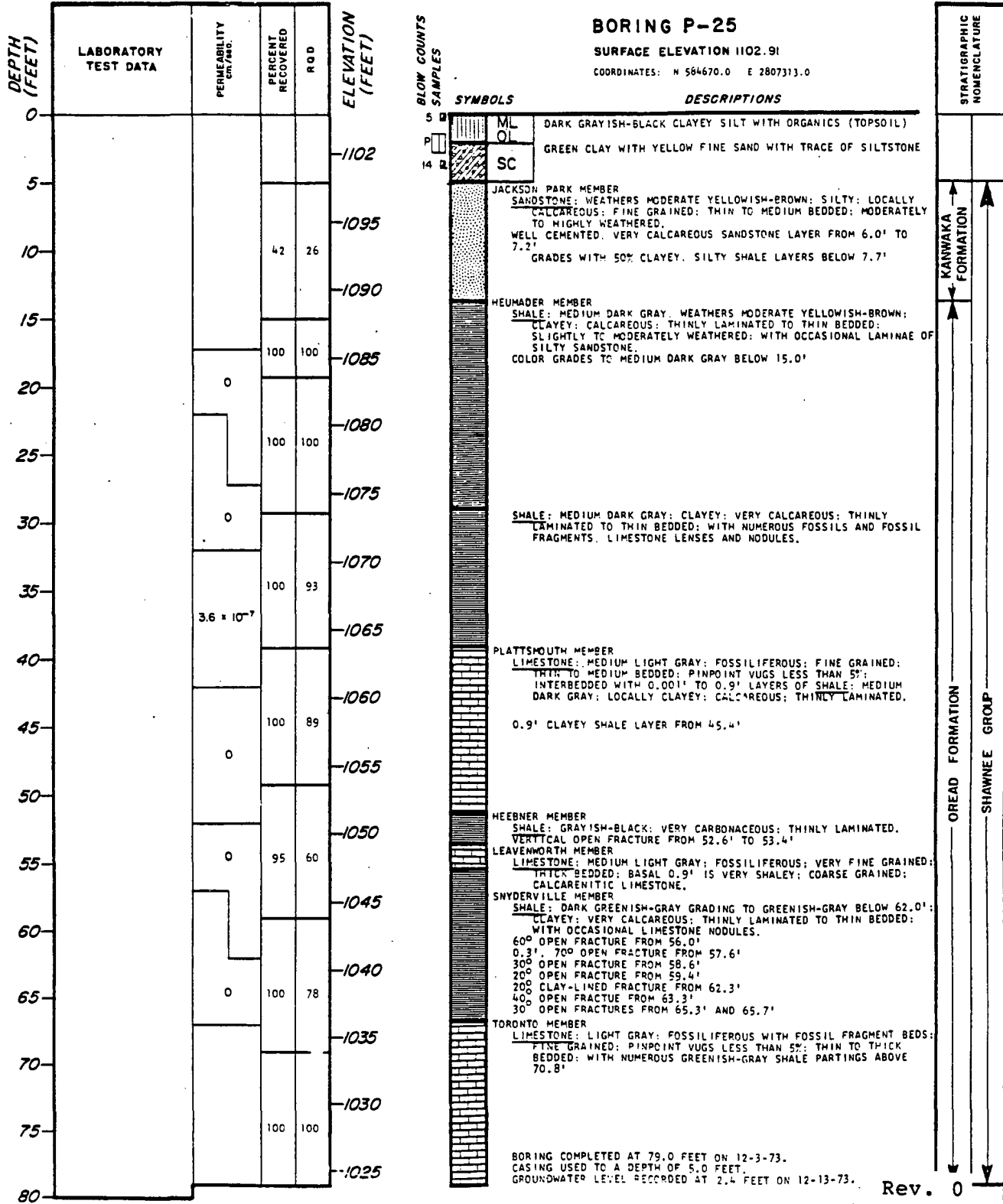

BORING COMPLETED AT 79.0 FEET ON 12-3-73.
CASING USED TO A DEPTH OF 5.0 FEET.
GROUNDWATER LEVEL RECORDED AT 2.4 FEET ON 12-13-73.

Rev. 0

WOLF CREEK UPDATED SAFETY ANALYSIS REPORT

Figure 2.5-35y
Log of Boring P-25

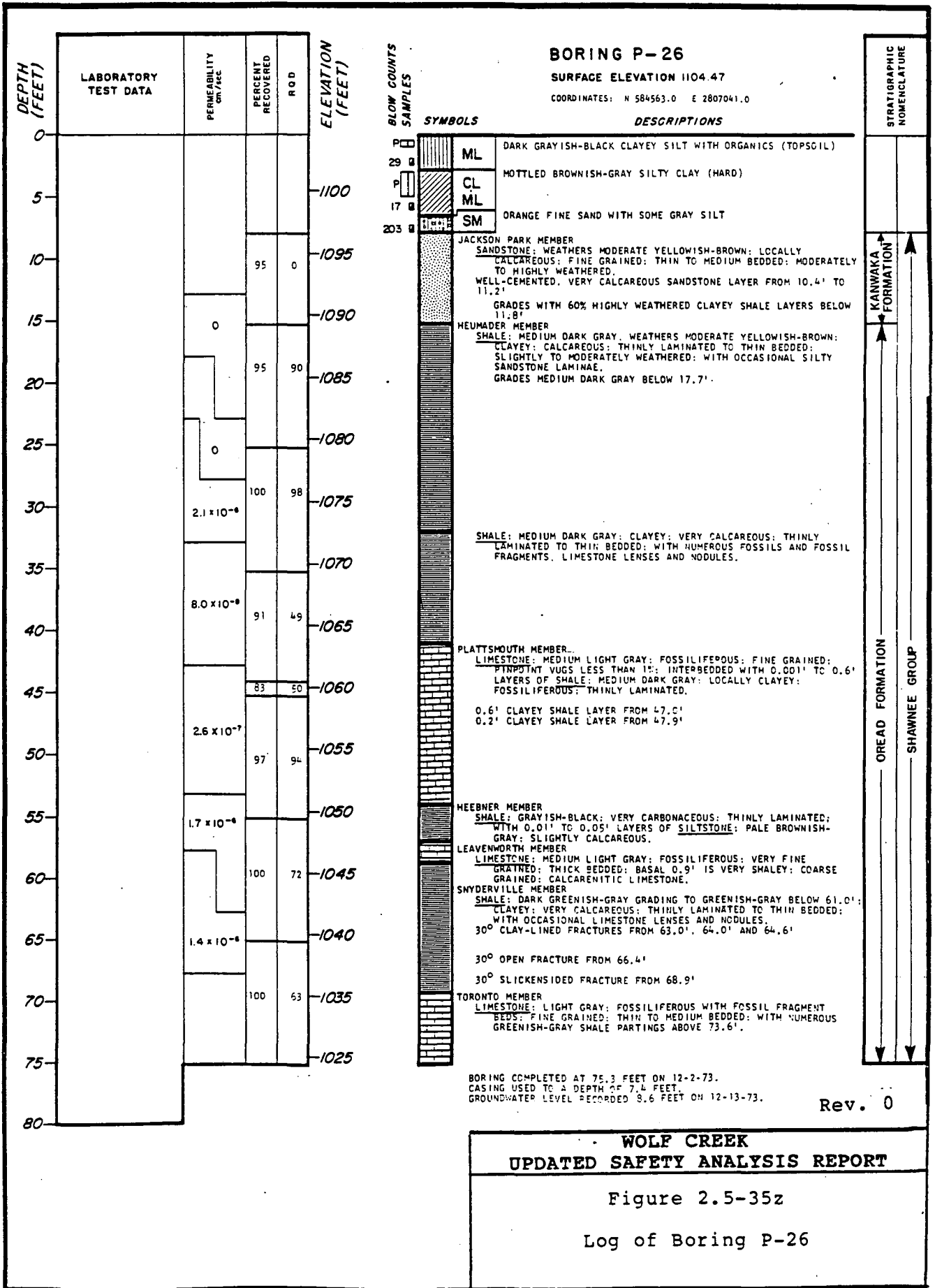

BORING P-27

SURFACE ELEVATION 1104.32

COORDINATES: N 584578.0 E 2807165.0

DEPTH (FEET)	LABORATORY TEST DATA	WATER LOSS (LUBEONS)	PERCENT RECOVERED	RQD	ELEVATION (FEET)
0		0 1 2 3			
5					1100
10			80	31	1095
15					1090
20			96	74	1085
25					1080
30	31.0' 5*		100	94	1075
35					1070
40			96	63	1065
45			97	89	1060
50			99	79	1055
55					1050
60			92	76	1045
65					1040
70			100	73	1035
75					1030

BLOW COUNTS
SAMPLES

SYMBOLS

P 0
34 0
P 1
237 0

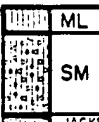

DESCRIPTIONS

DARK GRAYISH-BLACK CLAYEY SILT WITH ORGANICS (TOPSOIL)
LIGHT BROWNISH-GRAY SANDY SILT WITH TRACE OF CLAY (HARD)

GRADES YELLOW WITH LESS CLAY

JACKSON PARK MEMBER
SANDSTONE; WEATHERS MODERATE YELLOWISH-BROWN FINE GRAINED;
LOCALLY CALCAREOUS; THIN TO MEDIUM BEDDED; MODERATELY TO HIGHLY WEATHERED.
GRADES SILTY WITH 50% INTERBEDDED CLAYEY SHALE LAYERS BELOW 10.5'

HEUMADER MEMBER
SHALE; MEDIUM DARK GRAY; WEATHERS MODERATE YELLOWISH-BROWN;
CLAYEY; CALCAREOUS; THINLY LAMINATED; SLIGHTLY TO MODERATELY WEATHERED; WITH OCCASIONAL SILTY SANDSTONE LAMINAE.

0.2' 70° OPEN, LIMONITE-STAINED FRACTURE FROM 25.2'
0.6' VERTICAL, OPEN, LIMONITE-STAINED FRACTURE FROM 26.0'

GRADES UNWEATHERED BELOW 30.8'
SHALE; MEDIUM DARK GRAY; VERY CALCAREOUS; CLAYEY; THINLY LAMINATED TO THIN BEDDED; NUMEROUS FOSSILS AND FOSSIL FRAGMENTS, LIMESTONE LENSES AND NODULES.

PLATTSMOUTH MEMBER
LIMESTONE; MEDIUM LIGHT GRAY; FOSSILIFEROUS; FINE GRAINED;
PITTYHUNT VUGS LESS THAN 1%; THIN TO THICK BEDDED;
INTERBEDDED WITH 0.001' TO 0.6' LAYERS OF SHALE; MEDIUM DARK GRAY; CALCAREOUS; FOSSILIFEROUS; THINLY LAMINATED.
0.2' SHALE LAYER FROM 44.6'
0.6' SHALE LAYER FROM 47.1'
0.2' SHALE LAYER FROM 47.9'

HEEBNER MEMBER
SHALE; GRAYISH-BLACK; VERY CARBONACEOUS; THINLY LAMINATED;
WITH 0.01' TO 0.05' LAYERS OF SILTSTONE; PALE BROWNISH-GRAY; SLIGHTLY CALCAREOUS.

LEAVENWORTH MEMBER
LIMESTONE; MEDIUM LIGHT GRAY; FOSSILIFEROUS; VERY FINE GRAINED; THICK BEDDED; BASAL 1.2' IS VERY SHALEY; COARSE GRAINED; CALCARENITIC LIMESTONE.

SNYDERVILLE MEMBER
SHALE; DARK GREENISH-GRAY GRADING TO GREENISH-GRAY BELOW 64.8'; CLAYEY; VERY CALCAREOUS; THINLY LAMINATED TO THIN BEDDED.
30° CLOSED FRACTURE FROM 63.8'
45° SLICKENSIDED FRACTURE FROM 64.2'
20° CLOSED FRACTURE FROM 66.7'

TORONTO MEMBER
LIMESTONE; LIGHT GRAY; FOSSILIFEROUS WITH FOSSIL FRAGMENT
SEPS; FINE GRAINED; THIN TO THICK BEDDED; WITH NUMEROUS GREENISH-GRAY SHALE PARTINGS ABOVE 63.0'



BORING COMPLETED AT 75.0 FEET ON 12-2-73.
CASING USED TO A DEPTH OF 6.0 FEET.
GROUNDWATER LEVEL RECORDED AT 6.3 FEET ON 12-13-73.

Rev. 0

**WOLF CREEK
UPDATED SAFETY ANALYSIS REPORT**

Figure 2.5-35aa
Log of Boring P-27

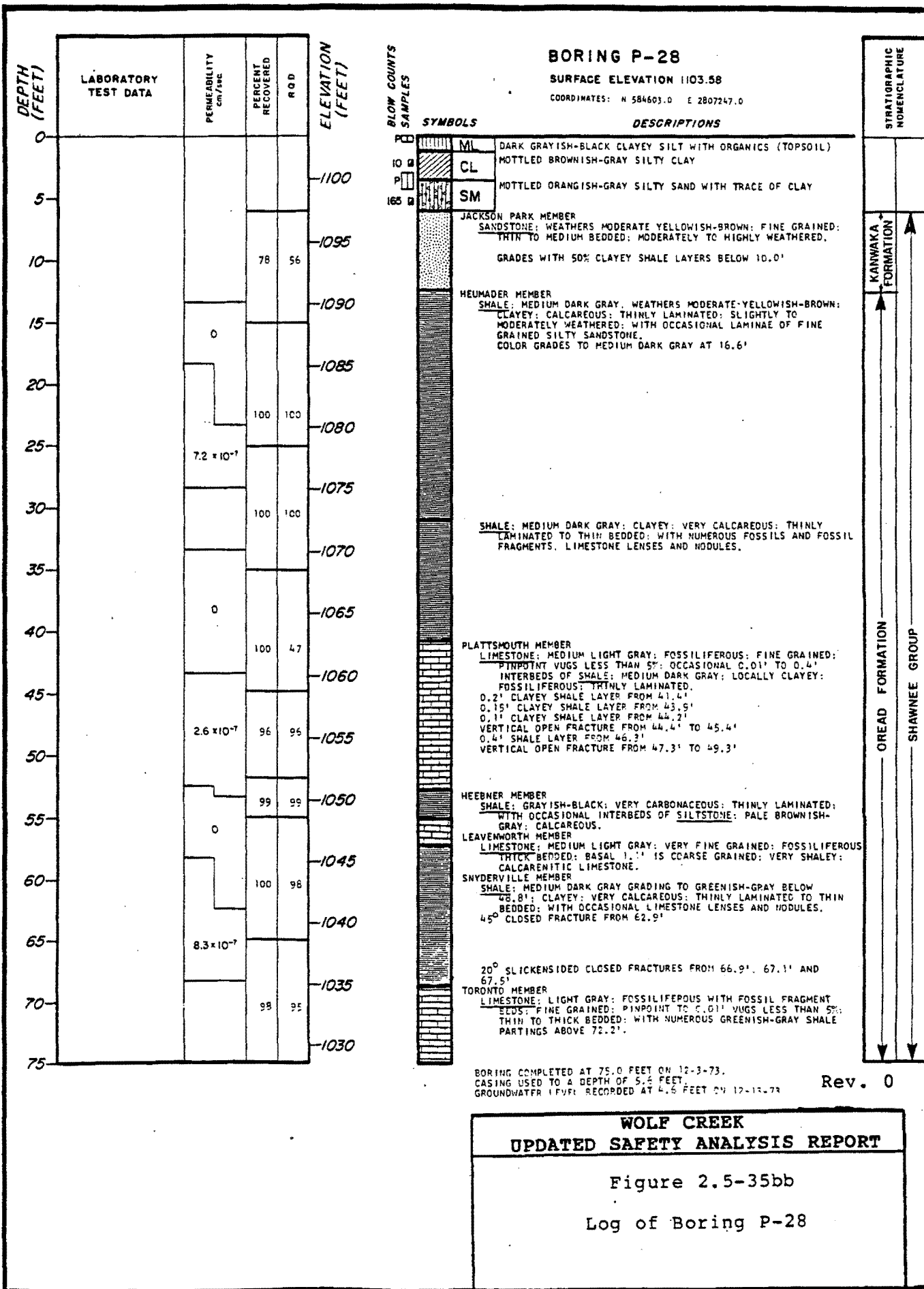

WOLF CREEK
UPDATED SAFETY ANALYSIS REPORT

Figure 2.5-35bb
 Log of Boring P-28

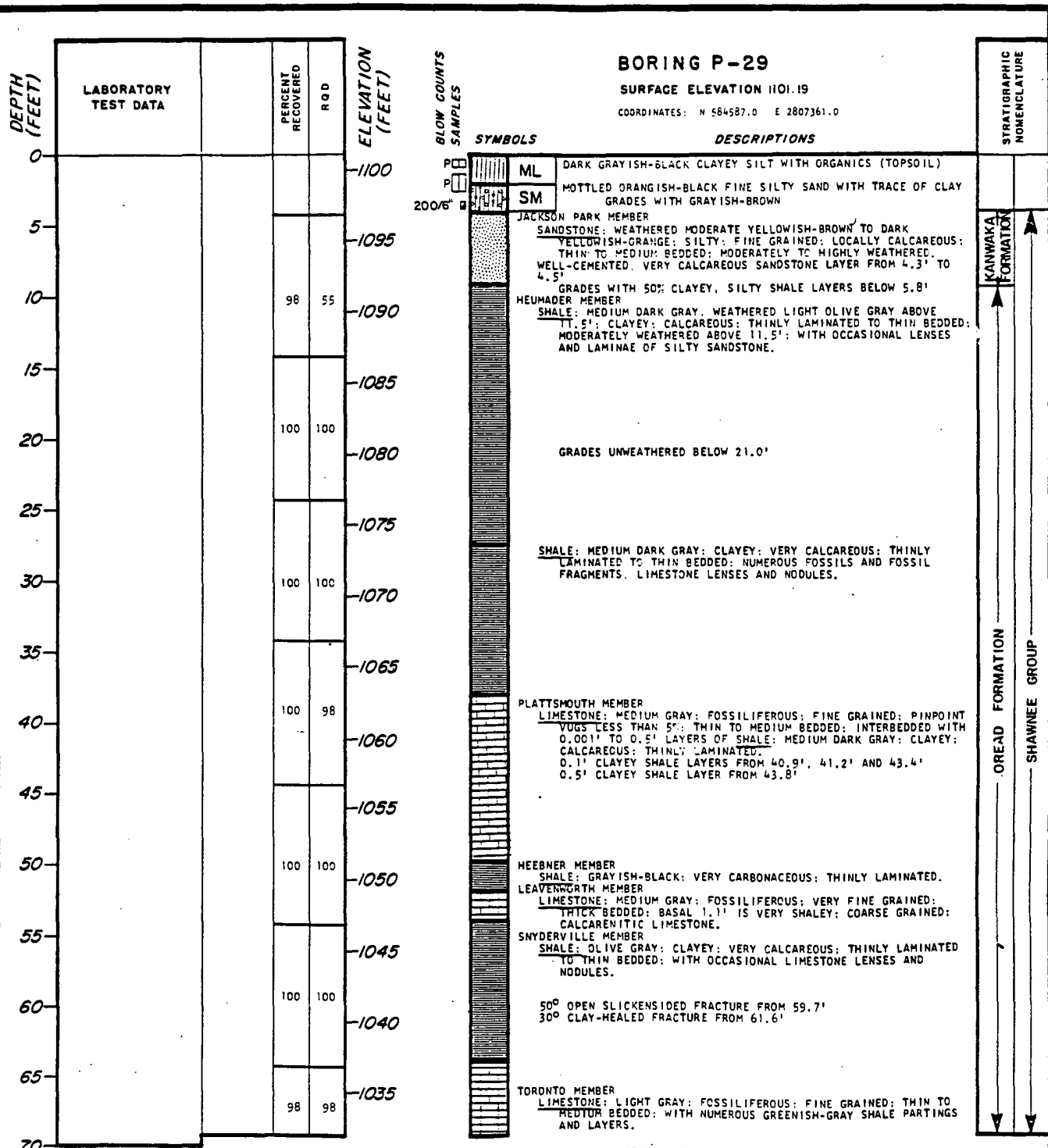

Rev. 0

WOLF CREEK
UPDATED SAFETY ANALYSIS REPORT

Figure 2.5-35cc

Log of Boring P-29

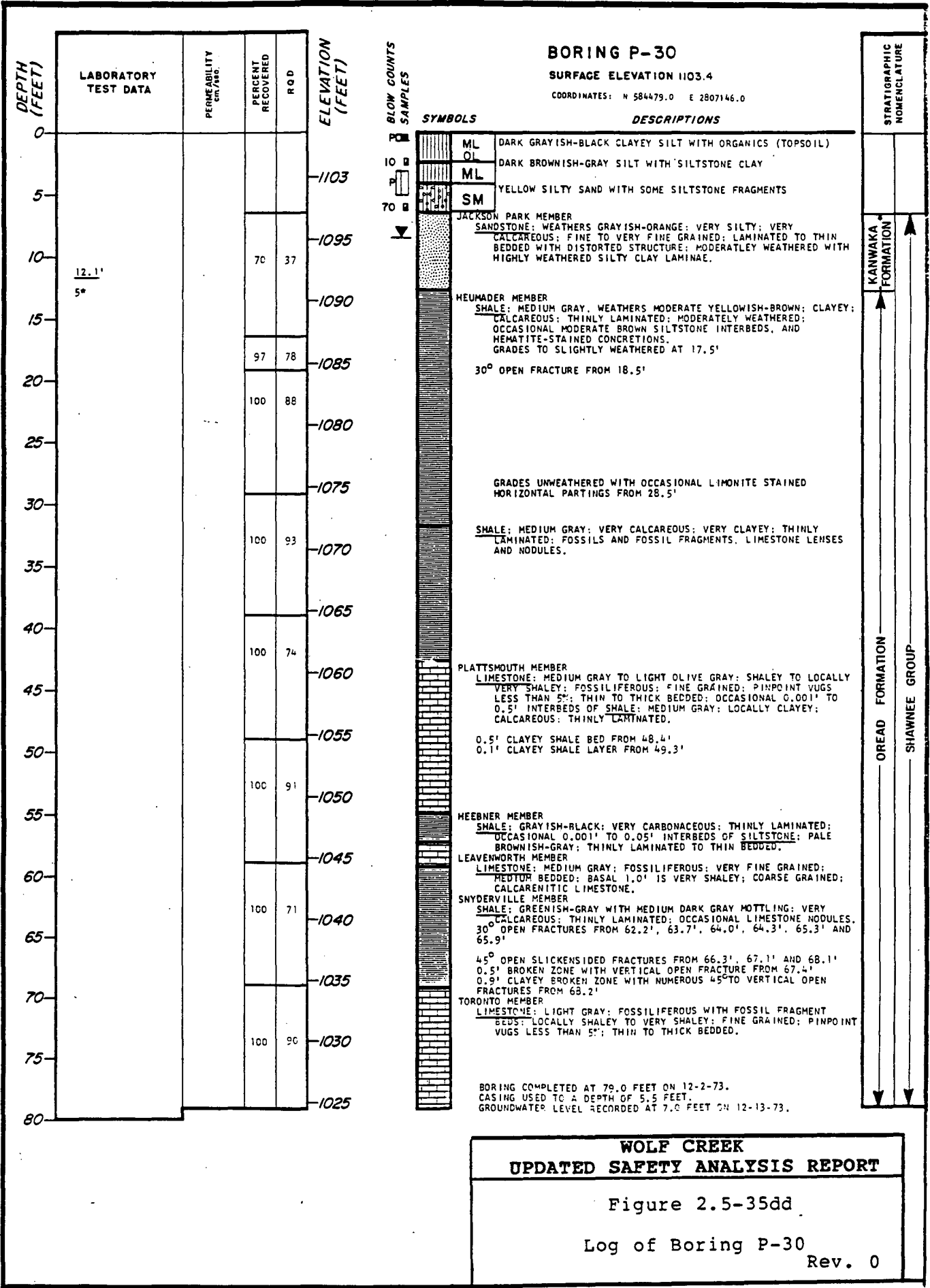

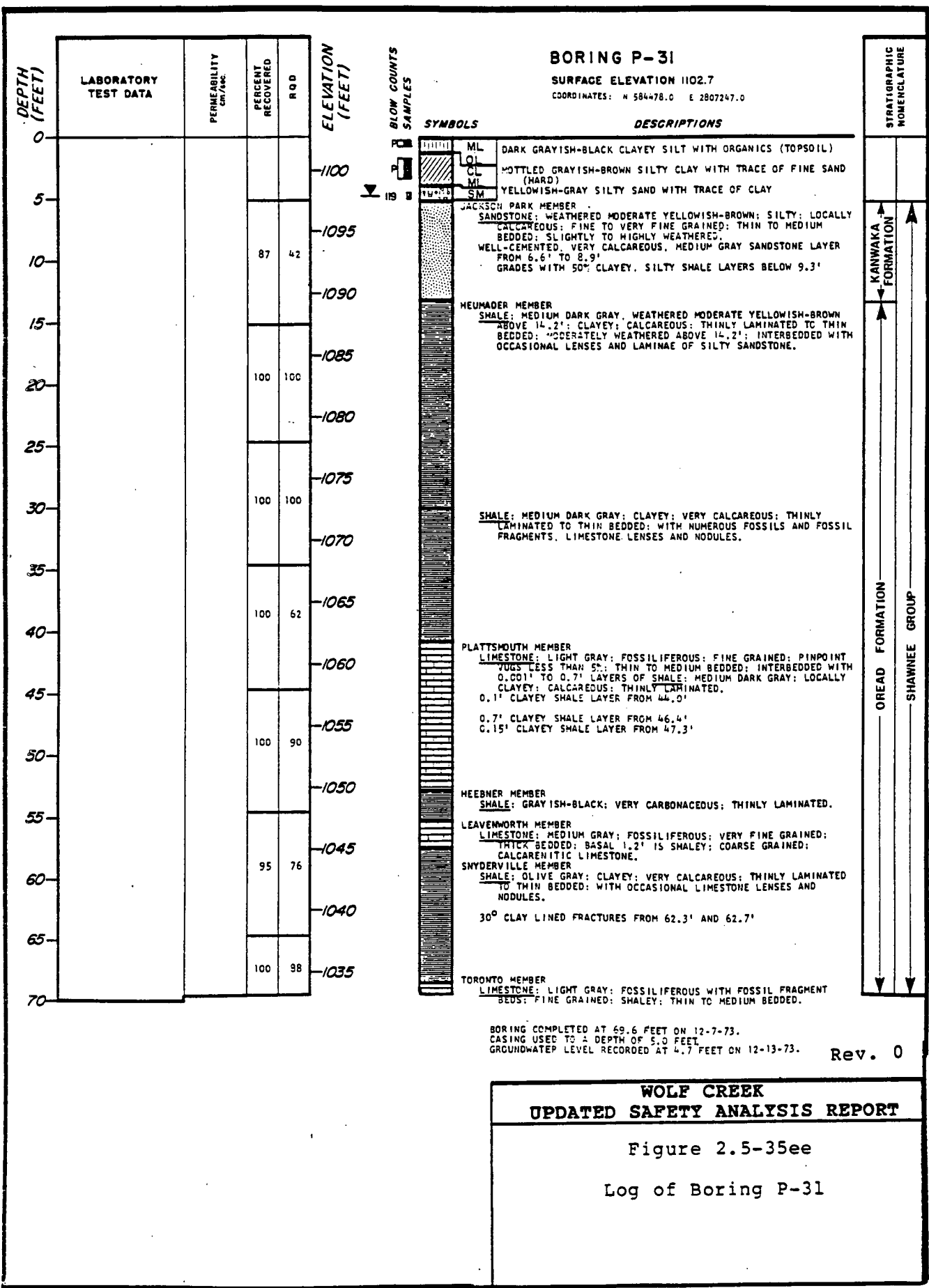

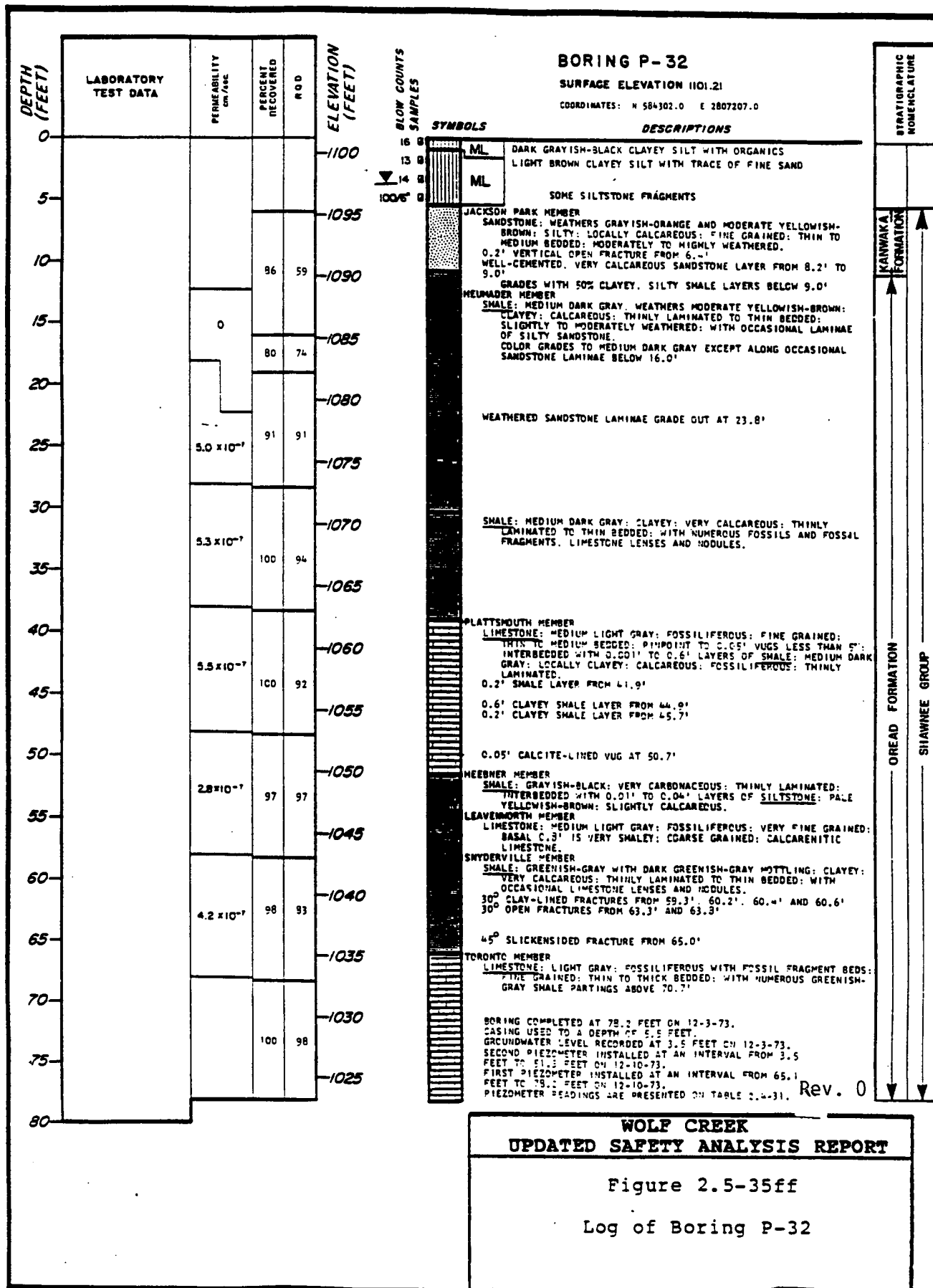

DEPTH (FEET)

DEPTH (FEET)	LABORATORY TEST DATA	PERMEABILITY cm/sec	PERCENT RECOVERED	R Q D	ELEVATION (FEET)
0					1105
5					1100
10			75	26	1095
15					1090
20			75	75	1085
25					1080
30			100	100	1075
35			100	100	1070
40			100	73	1065
45					1060
50			100	100	1055
55					1050
60			100	85	1045
65					1040
70			100	81	

BLOW COUNTS SAMPLES



BORING P-33

SURFACE ELEVATION 1106.6

COORDINATES: N 585040.0 E 2807243.0

SYMBOLS

DESCRIPTIONS

ML DARK GRAYISH-BLACK CLAYEY SILT WITH ORGANICS (TOPSOIL)
CL-ML MOTTLED BROWNISH-GRAY SILTY CLAY WITH SOME FINE SAND
SC ORANGE FINE SANDY CLAY
JACKSON PARK MEMBER
 SANDSTONE: WEATHERED MODERATE YELLOWISH-BROWN; VERY SILTY; LOCALLY WELL-CEMENTED AND CALCAREOUS; FINE TO VERY FINE GRAINED; THIN TO MEDIUM BEDDED; MODERATELY TO HIGHLY WEATHERED; INTERBEDDED WITH 50% CLAYEY, SILTY SHALE LAYERS.
MEUNADER MEMBER
 SHALE: MEDIUM DARK GRAY; WEATHERED MODERATE YELLOWISH-BROWN ABOVE 25.0'; CLAYEY; CALCAREOUS; THINLY LAMINATED TO THIN BEDDED; INTERBEDDED WITH OCCASIONAL LENSES AND LAMINAE OF SILTY SANDSTONE.
 45° OPEN, LIMONITE-STAINED, FRACTURE FROM 24.9'
 SHALE: MEDIUM DARK GRAY; LOCALLY CLAYEY; VERY CALCAREOUS; THINLY LAMINATED TO THIN BEDDED; WITH NUMEROUS FOSSILS AND FOSSIL FRAGMENTS, LIMESTONE LENSES AND NODULES.
PLATTSMOUTH MEMBER
 LIMESTONE: MEDIUM GRAY; FOSSILIFEROUS; FINE GRAINED; PINPOINT VUGS LESS THAN 1%; THIN TO THICK BEDDED; INTERBEDDED WITH 0.001' TO 0.5' LAYERS OF SHALE; MEDIUM DARK GRAY; LOCALLY CLAYEY; CALCAREOUS; THINLY LAMINATED. 0.15' CLAYEY SHALE LAYERS FROM 41.7' AND 42.2'. 0.5' CLAYEY SHALE LAYER FROM 44.7'. 0.1' CLAYEY SHALE LAYER FROM 45.5'.
HEEBNER MEMBER
 SHALE: GRAYISH-BLACK; VERY CARBONACEOUS; THINLY LAMINATED.
LEAVENWORTH MEMBER
 LIMESTONE: MEDIUM GRAY; FOSSILIFEROUS; THICK BEDDED; BASAL 0.3' IS SHALEY; COARSE GRAINED; CALCARENITIC LIMESTONE.
SNYDERVILLE MEMBER
 SHALE: OLIVE GRAY; CLAYEY; VERY CALCAREOUS; THINLY LAMINATED TO THIN BEDDED; WITH OCCASIONAL LIMESTONE LENSES AND NODULES.
 20° CLAY LINED FRACTURES FROM 61.2', 62.7' AND 63.3'
 60° OPEN FRACTURE FROM 63.5'
TORONTO MEMBER
 LIMESTONE: LIGHT GRAY; FINE GRAINED; THIN TO MEDIUM BEDDED; WITH NUMEROUS GREENISH-GRAY SHALE PARTINGS AND LAYERS.



BORING COMPLETED AT 69.0 FEET ON 12-8-73.
 CASING USED TO A DEPTH OF 6.0 FEET.
 GROUNDWATER LEVEL RECORDED AT 4.8 FEET ON 12-13-73.

Rev. 0

WOLF CREEK
UPDATED SAFETY ANALYSIS REPORT

Figure 2.5-35gg
 Log of Boring P-33

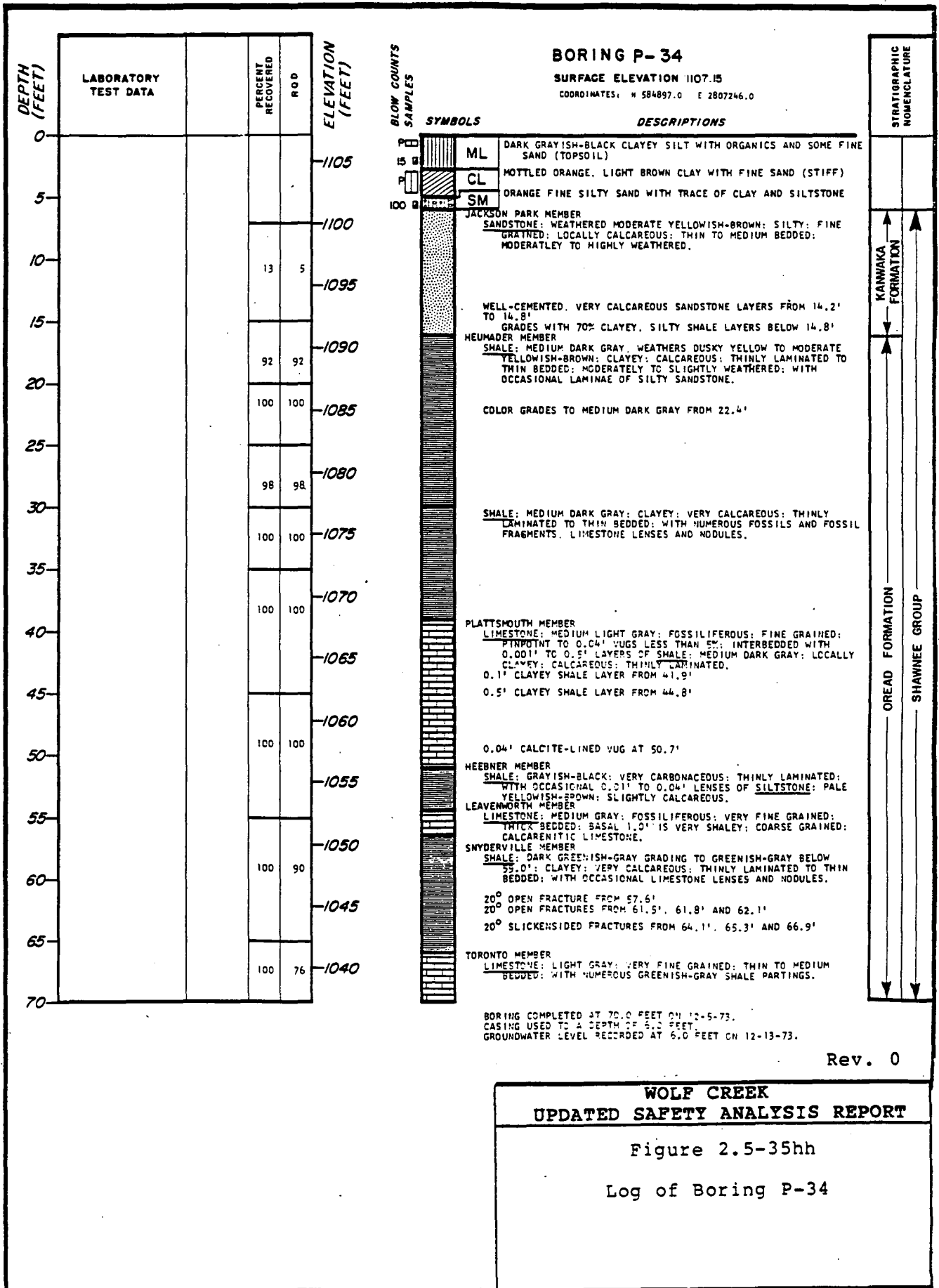

DEPTH (FEET)	LABORATORY TEST DATA	PERMEABILITY cm/sec	PERCENT RECOVERED	RQD	ELEVATION (FEET)
0					1100
5					1095
10			82	45	1090
15					1085
20			100	100	1080
25			100	100	1075
30			100	100	1070
35			100	100	1065
40			100	100	1060
45					1055
50			100	95	1050
55					1045
60			100	90	1040
65			96	93	1035
70					

BLOW COUNTS
SAMPLES

150

SYMBOLS

	ML
	CL
	SC

DESCRIPTIONS

DARK GRAYISH-BLACK CLAYEY SILT WITH ORGANICS (TOPSOIL)
 MOTTLED BROWNISH-GRAY SILTY CLAY (HARD)
 ORANGE FINE SANDY CLAY AND SOME SILTSTONE FRAGMENTS

JACKSON PARK MEMBER

SANDSTONE: WEATHERED MODERATE YELLOWISH-BROWN; SILTY; FINE GRATED; LOCALLY CALCAREOUS; THIN TO MEDIUM BEDDED; MODERATELY WEATHERED; THIN TO MEDIUM BEDDED. GRADES WITH 60% CLAYEY, SILTY SHALE LAYERS BELOW 8.1'

HEUMADER MEMBER

SHALE: MEDIUM DARK GRAY. WEATHERS MODERATE YELLOWISH-BROWN ABOVE 22.7'; CLAYEY; CALCAREOUS; THINLY LAMINATED TO THIN BEDDED; MODERATELY WEATHERED ABOVE 22.7'; INTERBEDDED WITH OCCASIONAL LENSES AND LAMINAE OF SILTY SANDSTONE AND LIMESTONE.

SHALE: MEDIUM DARK GRAY; CLAYEY; VERY CALCAREOUS; THINLY LAMINATED TO THIN BEDDED; WITH NUMEROUS FOSSILS AND FOSSIL FRAGMENTS, LIMESTONE LENSES AND NODULES.

PLATTSMOUTH MEMBER

LIMESTONE: MEDIUM GRAY; FOSSILIFEROUS; FINE GRAINED; PINPOINT VUGS LESS THAN 1"; THIN TO THICK BEDDED; INTERBEDDED WITH 0.001' TO 0.5' LAYERS OF SHALE; MEDIUM DARK GRAY; LOCALLY CLAYEY; CALCAREOUS; THINLY LAMINATED. 0.1' CLAYEY SHALE LAYERS FROM 44.1', 44.5' AND 46.3'

0.5' CLAYEY SHALE LAYER FROM 47.1'
 0.1' CLAYEY SHALE LAYER FROM 48.0'

HEEBNER MEMBER

SHALE: GRAYISH-BLACK; VERY CARBONACEOUS; THINLY LAMINATED.

LEAVENWORTH MEMBER

LIMESTONE: MEDIUM GRAY; FOSSILIFEROUS; VERY FINE GRAINED; THICK BEDDED; BASAL 1.0' IS VERY SHALEY; COARSE GRAINED; CALCARENITIC LIMESTONE.

SNYDERVILLE MEMBER

SHALE: OLIVE GRAY TO LIGHT OLIVE GRAY; CLAYEY; VERY CALCAREOUS; THINLY LAMINATED TO THIN BEDDED; WITH OCCASIONAL LIMESTONE LENSES AND NODULES.

VERTICAL OPEN FRACTURE FROM 63.5' TO 63.8'
 30° CLAY LINED FRACTURES FROM 64.0', 64.3', 64.5', 64.8', 65.1' AND 66.0'

45° OPEN SLICKENSIDED FRACTURE FROM 66.7'

TORONTO MEMBER

LIMESTONE: LIGHT GRAY; FINE GRAINED; SHALEY.

BORING COMPLETED AT 70.0 FEET ON 12-7-73.
 CASING USED TO A DEPTH OF 5.0 FEET.
 GROUNDWATER LEVEL RECORDED AT 5.0 FEET ON 12-13-73.



Rev. 0

**WOLF CREEK
 UPDATED SAFETY ANALYSIS REPORT**

Figure 2.5-35ii
 Log of Boring P-35

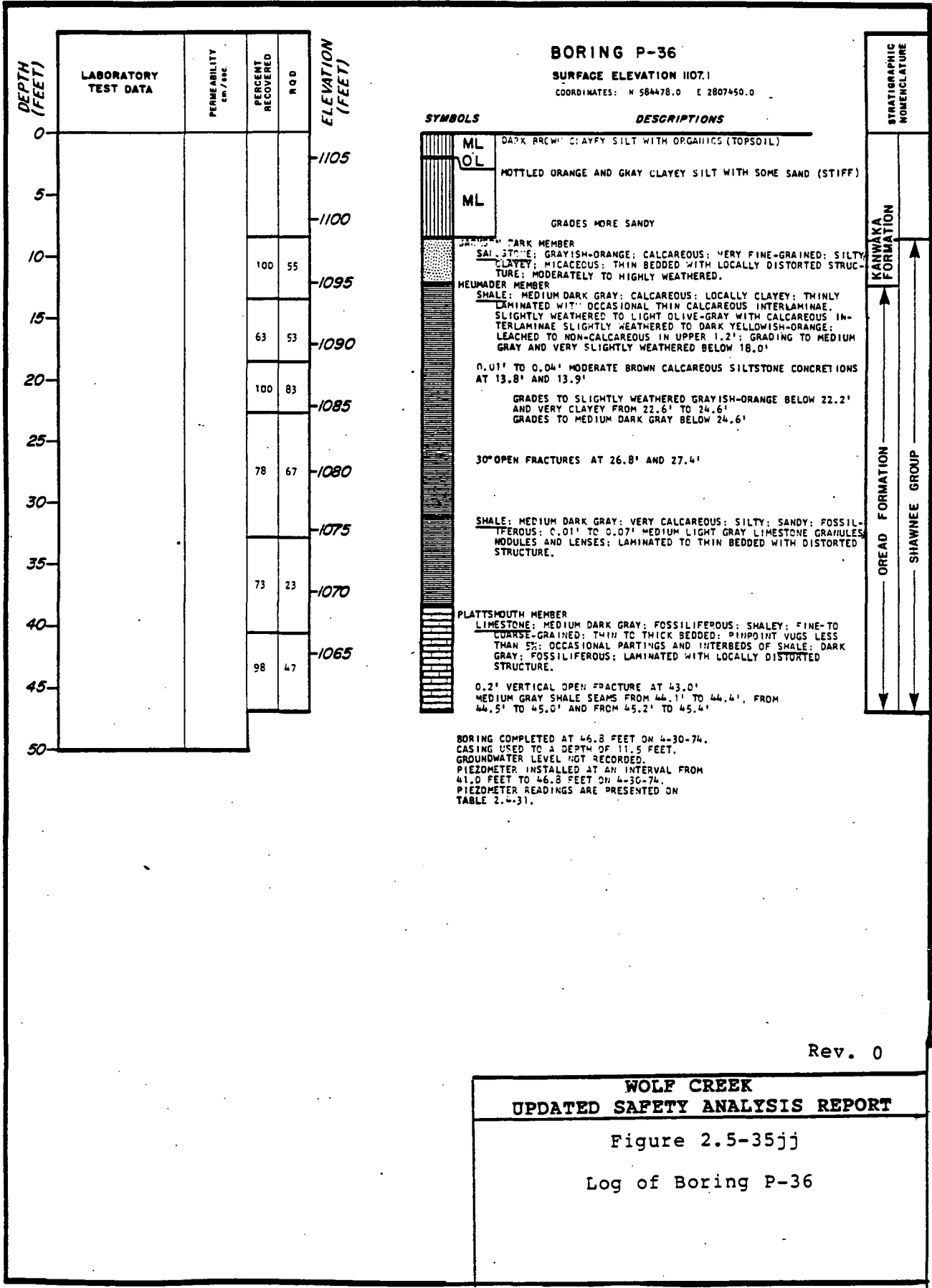

Rev. 0

WOLF CREEK
UPDATED SAFETY ANALYSIS REPORT

Figure 2.5-35jj

Log of Boring P-36

BORING P-37

SURFACE ELEVATION 1102.5

COORDINATES: N 594362.9 E 2807124.8

DEPTH (FEET)	LABORATORY TEST DATA	PERMEABILITY cm./sec.	PERCENT RECOVERED	R.O.D.	ELEVATION (FEET)
0					1100
5					
10			90	22	1095
15			50	31	1090
20			73	47	1085
25					1080
30			66	56	1075
35			97	80	1070
40			60	35	1065
45			94	47	1060
50			100	56	1055

SYMBOLS

DESCRIPTIONS

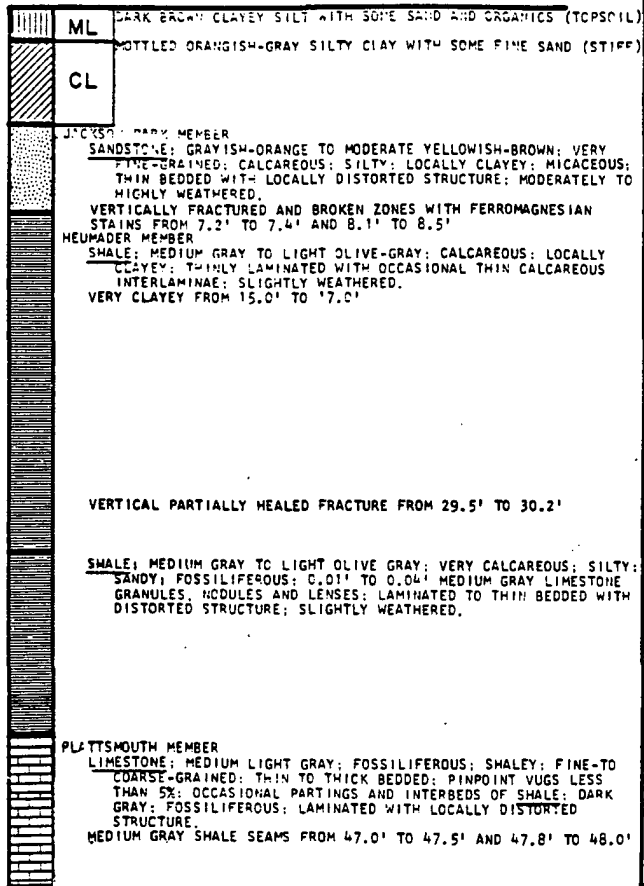

BORING COMPLETED AT 49.7 FEET ON 5-1-74.
 CASING USED TO A DEPTH OF 15.0 FEET.
 GROUNDWATER LEVEL NOT RECORDED
 PIEZOMETER INSTALLED AT AN INTERVAL FROM 44.0 FEET TO 49.7 FEET ON 5-1-74.
 PIEZOMETER READINGS ARE PRESENTED ON TABLE 2.4-31.

Rev. 0

**WOLF CREEK
 UPDATED SAFETY ANALYSIS REPORT**

Figure 2.5-35kk
 Log of Boring P-37

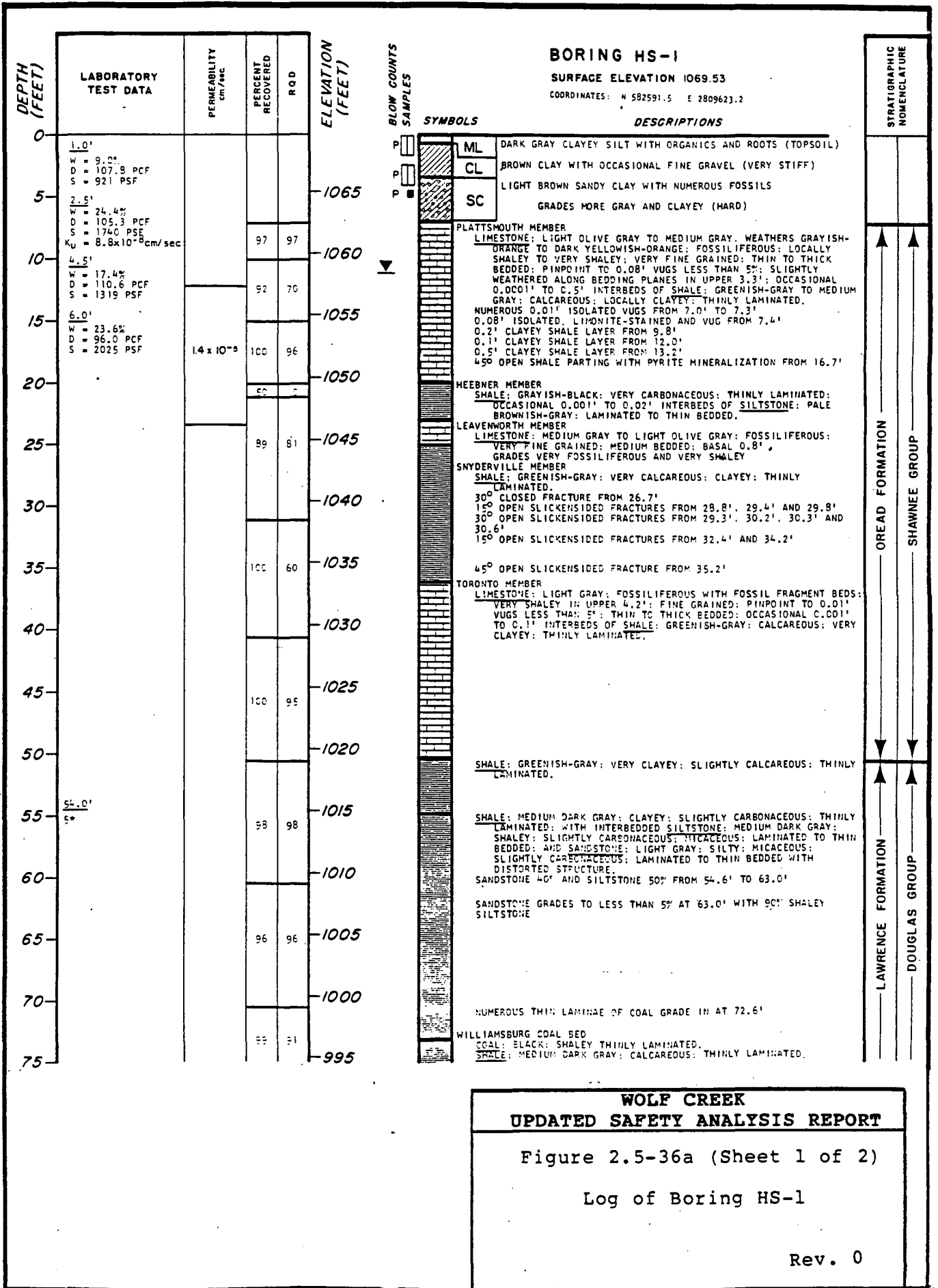

BORING HS-1 CONT'D.

DEPTH (FEET)	LABORATORY TEST DATA	PERMEABILITY cm/sec	PERCENT RECOVERED	ROD	ELEVATION (FEET)	BLOW COUNTS SAMPLES	SYMBOLS	DESCRIPTIONS	STRATIGRAPHIC NOMENCLATURE
75								15° OPEN SLICKENSIDED FRACTURES FROM 73.8', 74.2' AND 74.5' 30° CLOSED FRACTURES FROM 74.7', 75.0', 75.2' AND 75.6' 45° OPEN SLICKENSIDED FRACTURE FROM 75.7'	
80	81.9' 5"				990			AMAZONIA MEMBER SHALE: GREENISH-GRAY; VERY CALCAREOUS; LOCALLY CLAYEY; THINLY LAMINATED WITH OCCASIONAL LIMESTONE LENSES AND NODULES. NUMEROUS 30° TO 45° OPEN AND CLOSED FRACTURES FROM 79.2' TO 80.5' LIMESTONE: GREENISH-GRAY; SILTY; SHALEY; FINE GRAINED; THIN TO MEDIUM BEDDED.	
85			99	99	985			IRELAND MEMBER SHALE: GREENISH-GRAY; CALCAREOUS; THINLY LAMINATED WITH OCCASIONAL LIMESTONE NODULES AND THIN LIGHT GRAY SANDSTONE LAMINAE.	
90					980			60° OPEN FRACTURE FROM 84.2' SHALE GRADES TO MEDIUM GRAY AT 84.5' 0.1' VERTICAL OPEN FRACTURE FROM 86.0' PALE BROWN CONCRETIONS GRADE IN AT 87.1' SANDSTONE GRADES TO 20" FROM 87.3' WITH 80" SILTY SHALE SANDSTONE 10" AND SILTY SHALE 90" FROM 90.0' TO 95.7' 30° OPEN FRACTURE FROM 93.9'	
95			100	100	975			30° OPEN FRACTURES FROM 95.2', 95.3' AND 96.0' NUMEROUS HIGH-ANGLE OPEN FRACTURES FROM 96.0' TO 97.9' SANDSTONE LESS THAN 5" AND SILTY SHALE 95" FROM 95.7' TO 101.0'	
100					970			0.5' VERTICAL OPEN FRACTURE FROM 98.4' 0.5' BROKEN ZONE WITH 30° TO 60° OPEN FRACTURES FROM 99.5'	
105			100	90	965			COAL: BLACK WITH MODERATE BROWN INTERLAMINATIONS; SHALEY; THINLY LAMINATED. 0.01' TO 0.05' VERTICAL CALCITE-HEALED FRACTURE FROM 101.0' TO 101.2' SHALE: MEDIUM GRAY TO DARK GRAY; SLIGHTLY CARBONACEOUS; THINLY LAMINATED; WITH INTERBEDDED SANDSTONE; LIGHT GRAY; SILTY; SLIGHTLY CARBONACEOUS; MICACEOUS; FINE GRAINED; THINLY LAMINATED TO THIN BEDDED WITH DISTORTED STRUCTURE; AND SILTSTONE; MEDIUM GRAY; SLIGHTLY CARBONACEOUS; MICACEOUS; LAMINATED TO MEDIUM BEDDED. NUMEROUS THIN LAMINAE OF COAL FROM 101.4' TO 102.1' SHALE 100" FROM 101.4' TO 103.7' 0.5' GREENISH-GRAY BROKEN ZONE FROM 102.1' SANDSTONE 10" AND SHALEY SILTSTONE 90" FROM 103.7' TO 105.7' SANDSTONE GRADES TO 70" AND SHALEY SILTSTONE 30" FROM 105.7'	
110					960				

BORING COMPLETED AT 110.0 FEET ON 11-17-73.
CASING USED TO A DEPTH OF 7.0 FEET.
GROUNDWATER LEVEL RECORDED AT 11.2 FEET ON 12-13-73.
SECOND PIEZOMETER INSTALLED AT AN INTERVAL FROM 7.0 FEET TO 20.0 FEET ON 12-21-73.
FIRST PIEZOMETER INSTALLED AT AN INTERVAL FROM 30.0 FEET TO 37.0 FEET ON 12-21-73.
PIEZOMETER READINGS ARE PRESENTED ON TABLE 2.4-31.

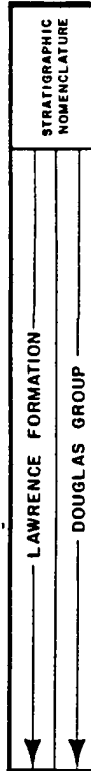

Rev. 0

WOLF CREEK
UPDATED SAFETY ANALYSIS REPORT

Figure 2.5-36a (Sheet 2 of 2)

Log of Boring HS-1

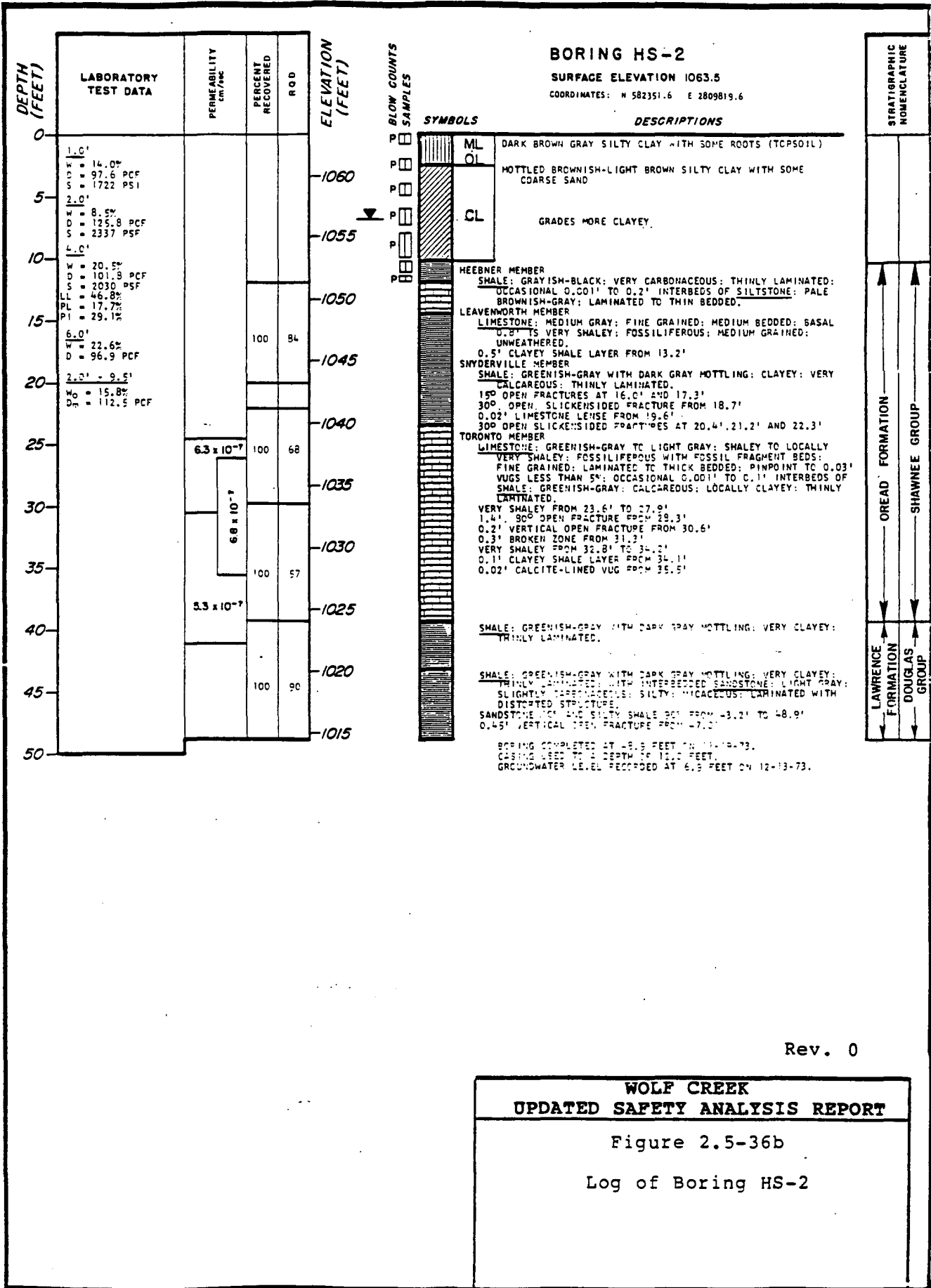

Rev. 0

WOLF CREEK
UPDATED SAFETY ANALYSIS REPORT

Figure 2.5-36b

Log of Boring HS-2

BORING HS-3

SURFACE ELEVATION 1060.7

COORDINATES: N 582204.6 E 2809940.0

DEPTH (FEET)	LABORATORY TEST DATA	PERMEABILITY cm/sec.	PERCENT RECOVERED	R Q D	ELEVATION (FEET)
0	1.0'	$K_v = 1.1 \times 10^{-7}$ cm/sec	67	2	1060
5			96	96	1055
10		3.6×10^{-8}	29	0	1050
15		1.1×10^{-6}	95	85	1045
20		2.3×10^{-9}			1040

BLOW COUNTS
SAMPLES

SYMBOLS



DESCRIPTIONS

CL BROWNISH-DARK GRAY SILTY CLAY WITH ORGANICS AND ROOTS
PLATTSMOUTH MEMBER (TOPSOIL)
LIMESTONE: LIGHT OLIVE GRAY. WEATHERS GRAYISH-ORANGE;
FOSSILIFEROUS: FINE GRAINED; THIN BEDDED; PINPOINT VUGS
10"; MODERATELY WEATHERED TO HIGHLY WEATHERED ALONG
HORIZONTAL PARTINGS.
HEEBNER MEMBER
SHALE: GRAYISH-BLACK. WEATHERS LIGHT BROWN TO PALE YELLOWISH-
BROWN; VERY CARBONACEOUS; THINLY LAMINATED; HIGHLY
WEATHERED TO CLAYEY SHALE IN UPPER 0.2' GRADING TO SLIGHTLY
WEATHERED AT 5.4'; OCCASIONAL 0.001' TO 0.02' INTERBEDS OF
SILTSTONE; PALE BROWNISH-GRAY; LAMINATED.
45° OPEN, SLIGHTLY WEATHERED FRACTURE FROM 3.5'
LEAVENWORTH MEMBER
LIMESTONE: LIGHT OLIVE GRAY; FOSSILIFEROUS: FINE GRAINED;
THIN TO MEDIUM BEDDED; UNWEATHERED; BASAL 1.1' GRADES VERY
SHALEY AND MORE FOSSILIFEROUS.
SNYDERVILLE MEMBER
SHALE: GREENISH-GRAY; VERY CALCAREOUS; CLAYEY; THINLY
LAMINATED.
OCCASIONAL 45° OPEN AND CLOSED FRACTURES FROM 15.0' TO 17.0'
LIMESTONE NODULES GRADE IN AT 16.3'
TORONTO MEMBER
LIMESTONE: GREENISH-GRAY; VERY SHALEY; FINE GRAINED; THIN
BEDDED.

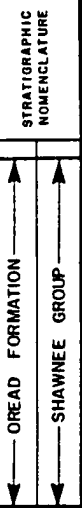

BORING COMPLETED AT 20.5 FEET ON 11-20-73.
CASING USED TO A DEPTH OF 2.8 FEET.
GROUNDWATER LEVEL RECORDED AT 6.6 FEET ON 12-13-73.
PIEZOMETER INSTALLED AT AN INTERVAL FROM 2.8 FEET TO
17.9 FEET ON 12-17-73.
PIEZOMETER READINGS ARE PRESENTED ON TABLE 2.4-31.

Rev. 0

**WOLF CREEK
UPDATED SAFETY ANALYSIS REPORT**

Figure 2.5-36c
Log of Boring HS-3

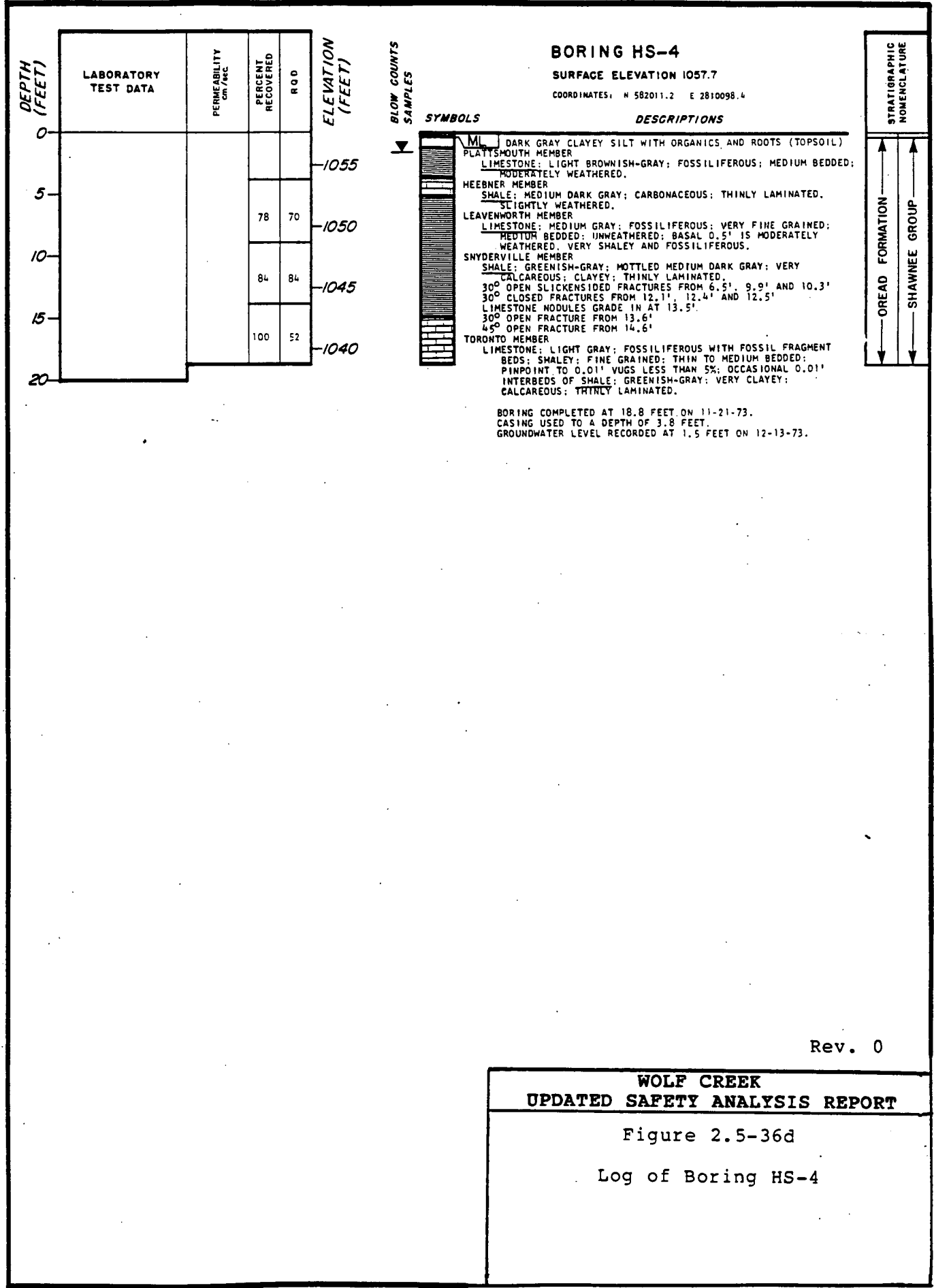

Rev. 0

WOLF CREEK
UPDATED SAFETY ANALYSIS REPORT

Figure 2.5-36d
 Log of Boring HS-4

BORING HS-5

SURFACE ELEVATION 1069.1

COORDINATES: N 581817.7 E 2212256.7

DEPTH (FEET)	LABORATORY TEST DATA	PERMEABILITY cm./ANN.	PERCENT RECOVERED	ROD	ELEVATION (FEET)
0					
2.0'	W = 35.4% D = 86.4 PCF				
5	2.5' W = 36.7% D = 83.9 PCF S = 16-5 PSI	1.1×10^{-4}	90	58	1065
10		1.2×10^{-4}			1060
15		1.1×10^{-4}	66	51	1055
20					1050
25			100	100	1045
30					

BLOW COUNTS
P SAMPLES

SYMBOLS



DESCRIPTIONS

ML DARK GRAY CLAYEY SILT WITH ORGANICS AND ROOTS (TOPSOIL)
CH BROWN CLAY WITH CHERT GRAVEL (VERY STIFF)
 ORANGISH-BROWN CLAY WITH CHUNKS (1") OF WEATHERED LIMESTONE
PLATTSMOUTH MEMBER
LIMESTONE: LIGHT CLIVE GRAY TO MEDIUM GRAY. WEATHERS GRAYISH-ORANGE TO DARK YELLOWISH-ORANGE. FOSSILIFEROUS; LOCALLY SHALEY; FINE GRAINED; THIN TO THICK BEDDED; PINPOINT TO 0.02" VUGS LESS THAN 5"; UNWEATHERED TO SLIGHTLY WEATHERED EXCEPT ALONG BEDDING PLANES WHERE IT IS MODERATELY WEATHERED.
 0.1' HIGHLY WEATHERED ZONE FROM 4.5'
 4.5' OPEN. LIMONITE-STAINED. CLAY-LINED FRACTURE FROM 5.0' WEATHERED. LIMONITE-STAINED ZONE ALONG HORIZONTAL PLANES AT 5.3', 5.5' AND 5.9'
 0.5' CALCITE LINED VUG FROM 6.9'
HEEBNER MEMBER
SHALE: GRAYISH-BLACK; VERY CARBONACEOUS; THINLY LAMINATED; HIGHLY WEATHERED TO LIGHT BROWN CLAYEY SHALE IN UPPER 0.5' GRADING TO SLIGHTLY WEATHERED; OCCASIONAL SILTSTONE INTERBEDS.
 GRADES UNWEATHERED AT 9.1'
LEAVENWORTH MEMBER
LIMESTONE: MEDIUM GRAY; FOSSILIFEROUS; VERY FINE GRAINED; THICK BEDDED.
SNYDERVILLE MEMBER
SHALE: GREENISH-GRAY WITH MEDIUM DARK GRAY MOTTLING; CLAYEY; VERY CALCAREOUS; THINLY LAMINATED.
 300' OPEN FRACTURES FROM 13.9', 14.9' AND 15.3'
 30" CLOSED FRACTURES FROM 18.7' AND 18.8'
 LIMESTONE NODULES GRADE IN AT 22.3'
TORONIC MEMBER
LIMESTONE: LIGHT GRAY; FOSSILIFEROUS WITH FOSSIL FRAGMENT BEDS; VERY SHALEY; FINE GRAINED; THIN TO MEDIUM BEDDED; PINPOINT TO 0.02" VUGS LESS THAN 5"; NUMEROUS 0.001" TO 0.01" INTERBEDS OF GREENISH-GRAY; CLAYEY SHALE.

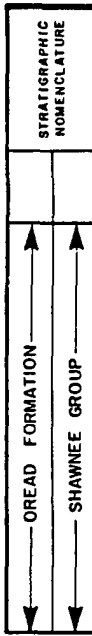

BORING COMPLETED AT 27.1 FEET ON 11-21-73.
 CASING USED TO A DEPTH OF 4.0 FEET.
 GROUNDWATER LEVEL RECORDED AT 5.8 FEET ON 12-13-73.
 SECOND PIEZOMETER INSTALLED AT AN INTERVAL FROM 4.0 FEET TO 9.6 FEET ON 12-14-73.
 FIRST PIEZOMETER INSTALLED AT AN INTERVAL FROM 23.5 FEET TO 30.5 FEET ON 12-14-73.
 PIEZOMETER READINGS ARE FOUND ON TABLE 2.4-31.

Rev. 0

**WOLF CREEK
 UPDATED SAFETY ANALYSIS REPORT**

Figure 2.5-36e
 Log of Boring HS-5

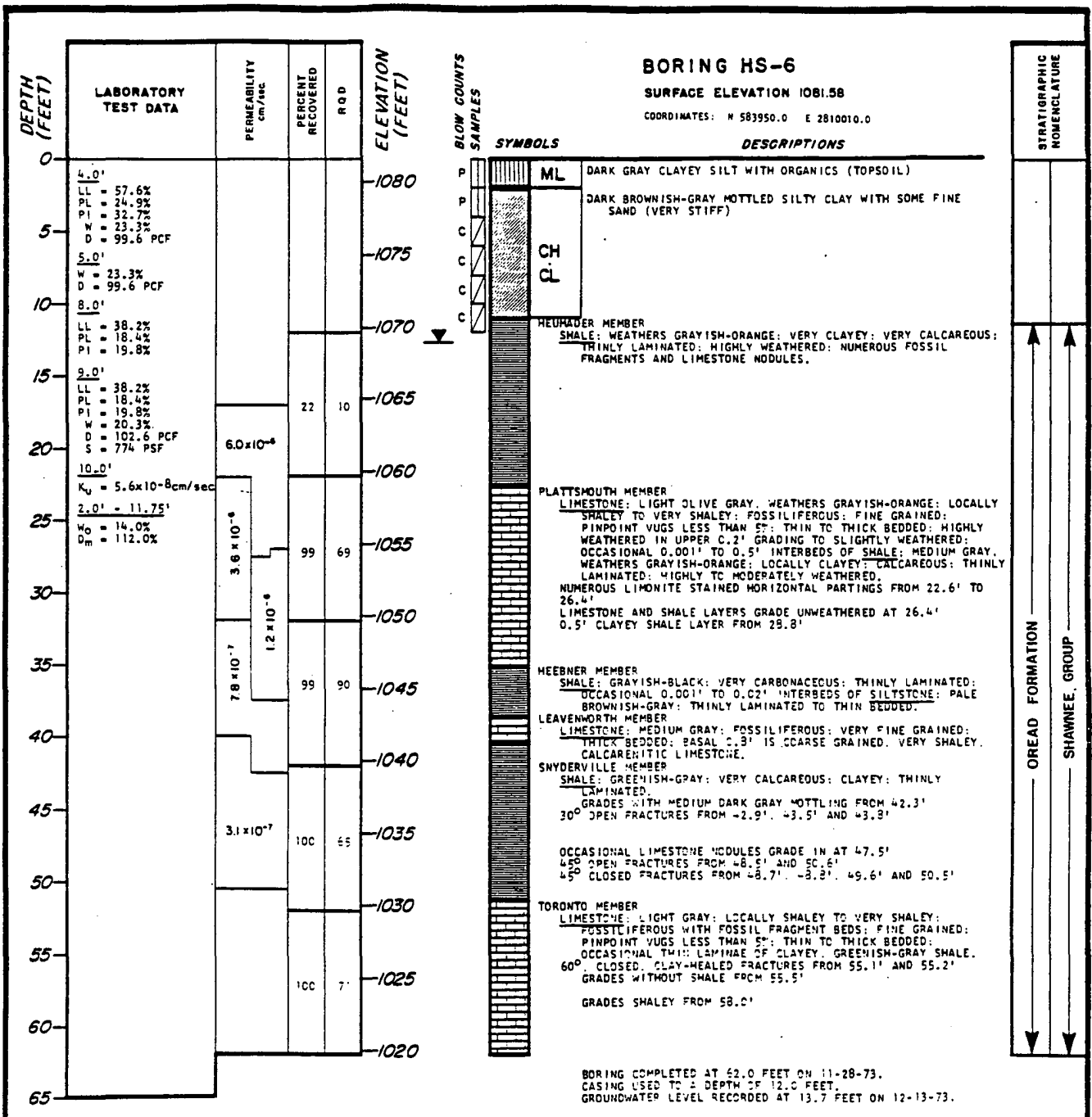

Rev. 0

WOLF CREEK
UPDATED SAFETY ANALYSIS REPORT

Figure 2.5-36f
 Log of Boring HS-6

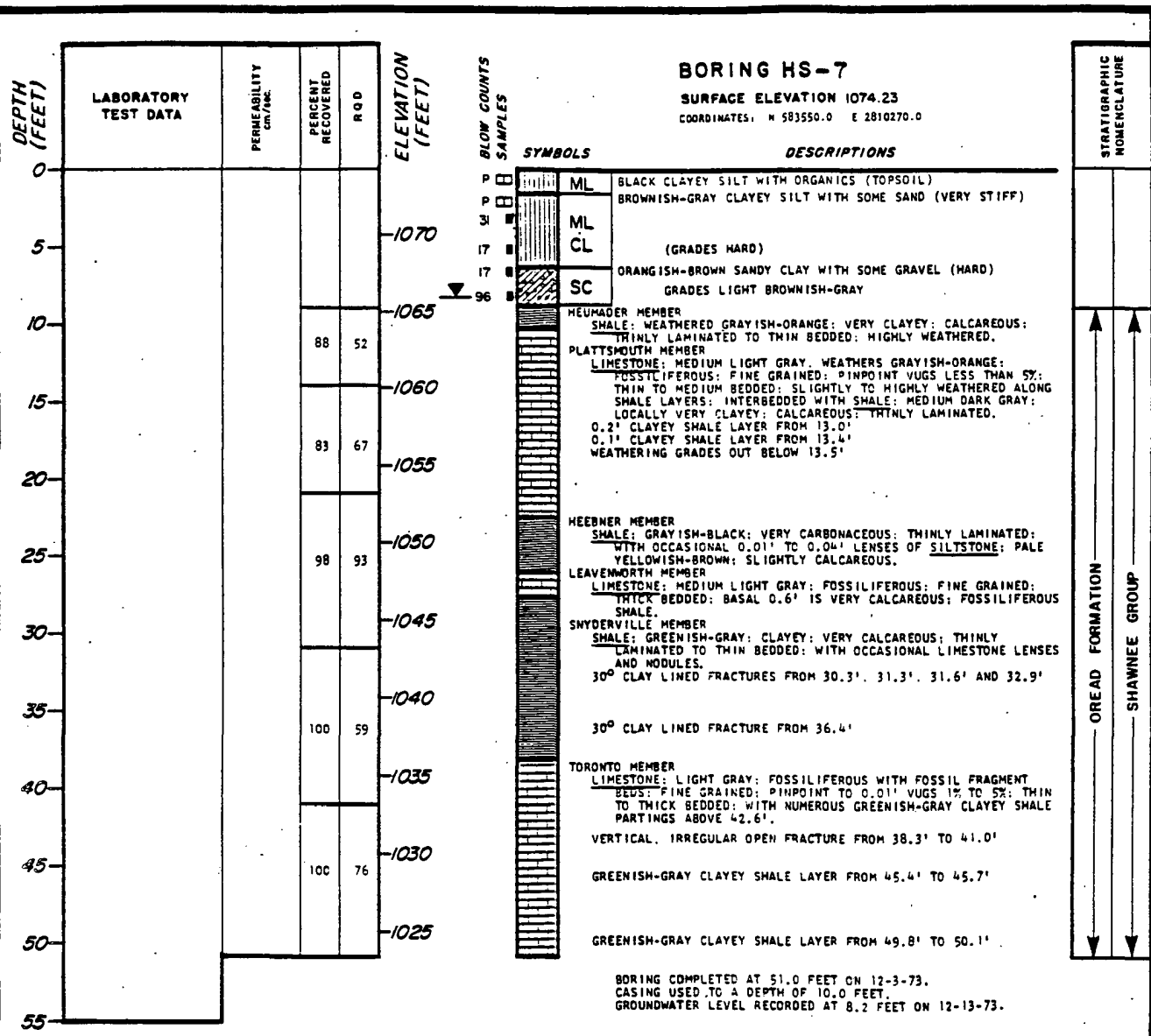

Rev. 0

WOLF CREEK
UPDATED SAFETY ANALYSIS REPORT

Figure 2.5-36g

Log of Boring HS-7

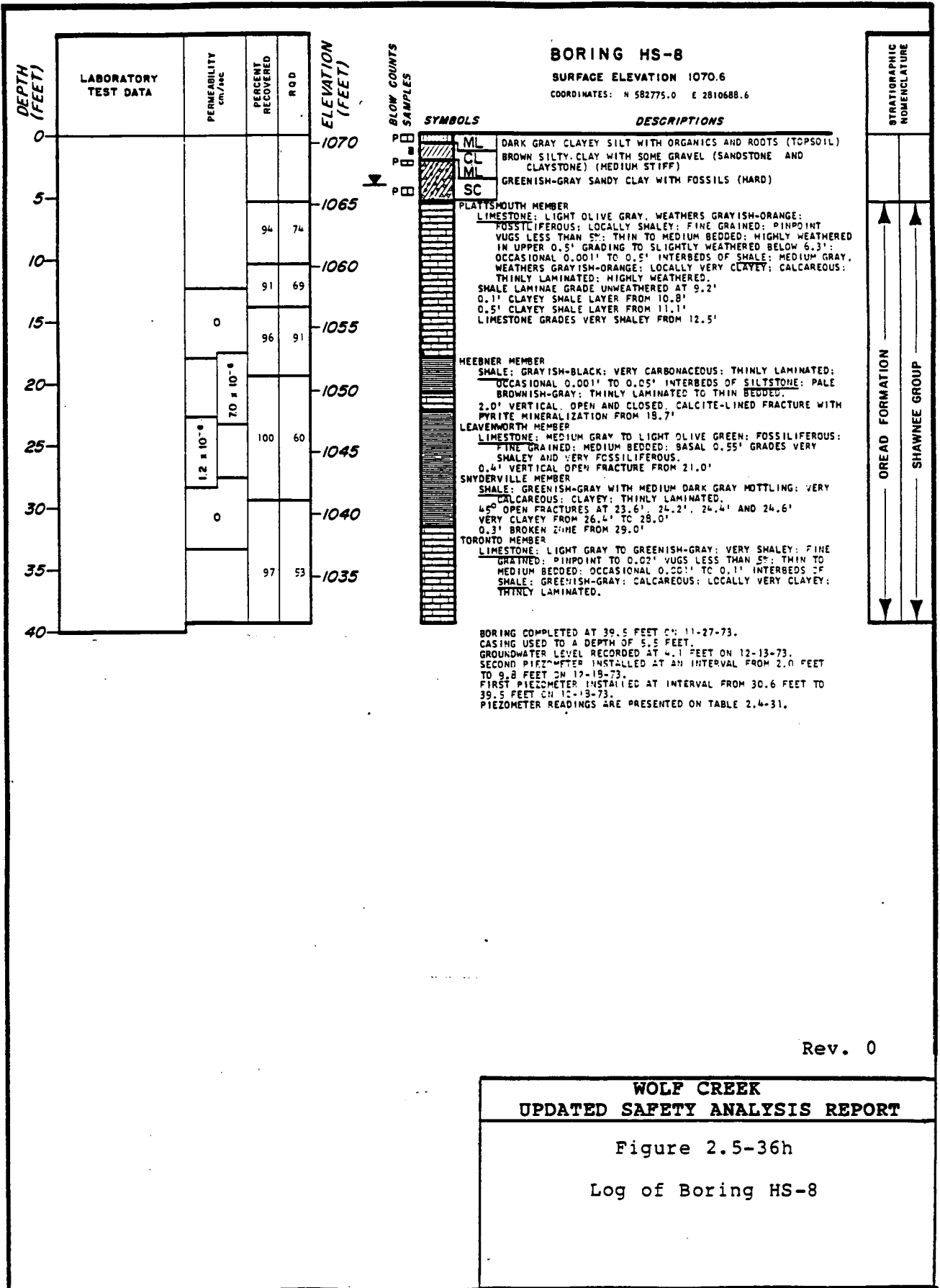

Rev. 0

**WOLF CREEK
UPDATED SAFETY ANALYSIS REPORT**

Figure 2.5-36h

Log of Boring HS-8

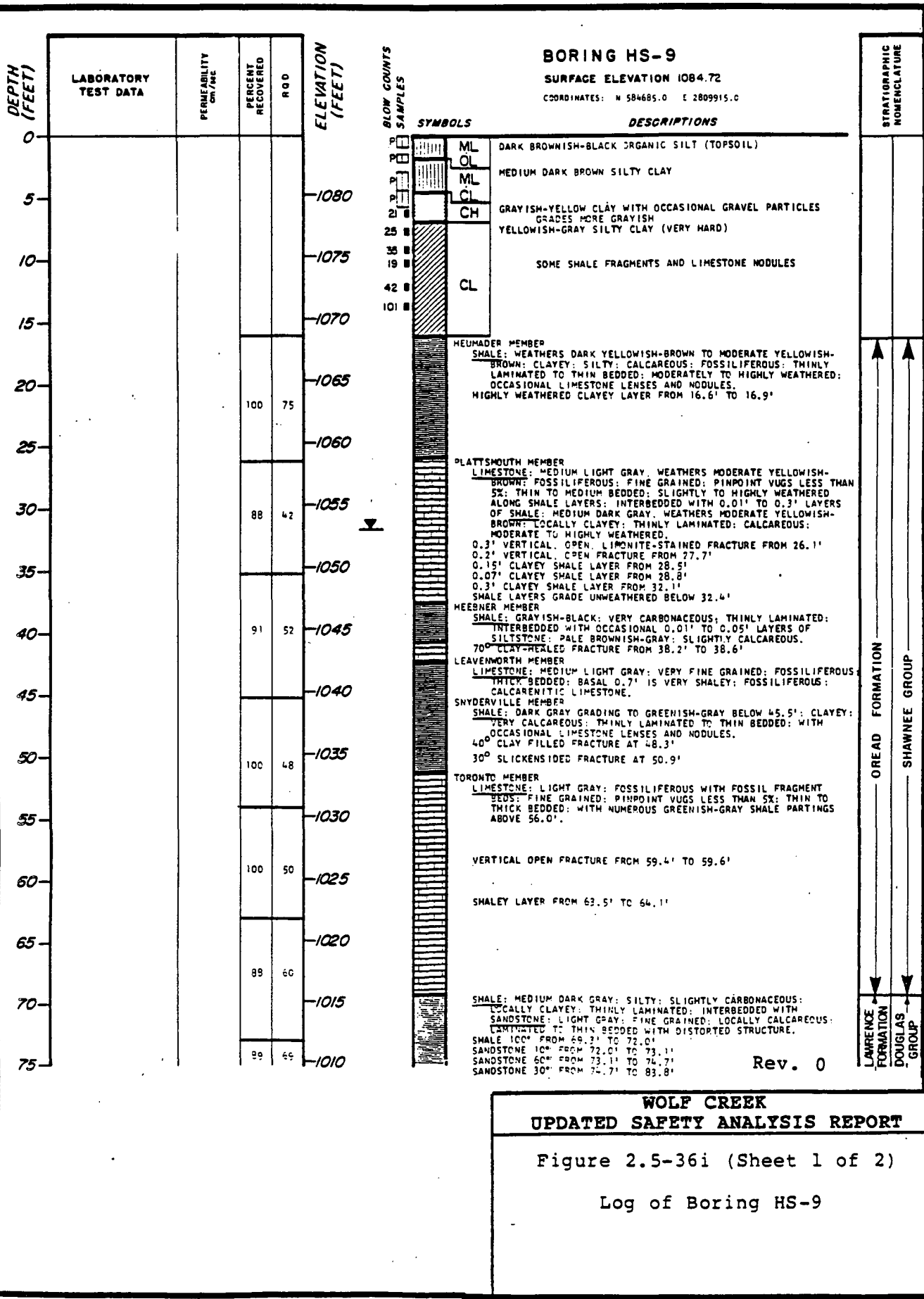

WOLF CREEK
UPDATED SAFETY ANALYSIS REPORT

Figure 2.5-36i (Sheet 1 of 2)

Log of Boring HS-9

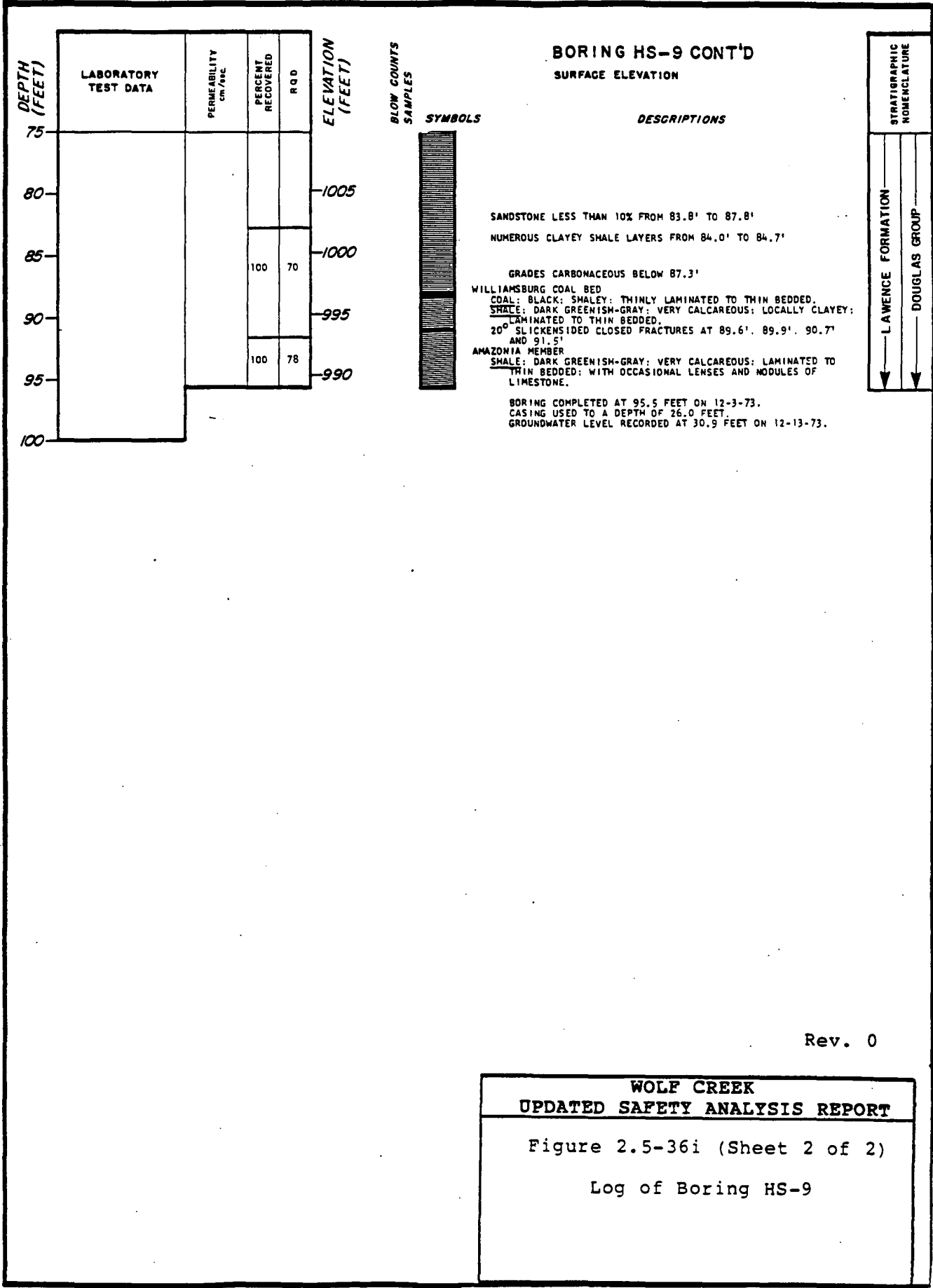

Rev. 0

WOLF CREEK
UPDATED SAFETY ANALYSIS REPORT

Figure 2.5-36i (Sheet 2 of 2)

Log of Boring HS-9

BORING HS-10

SURFACE ELEVATION 1077.6

COORDINATES: N 594670.0 E 2810140.0

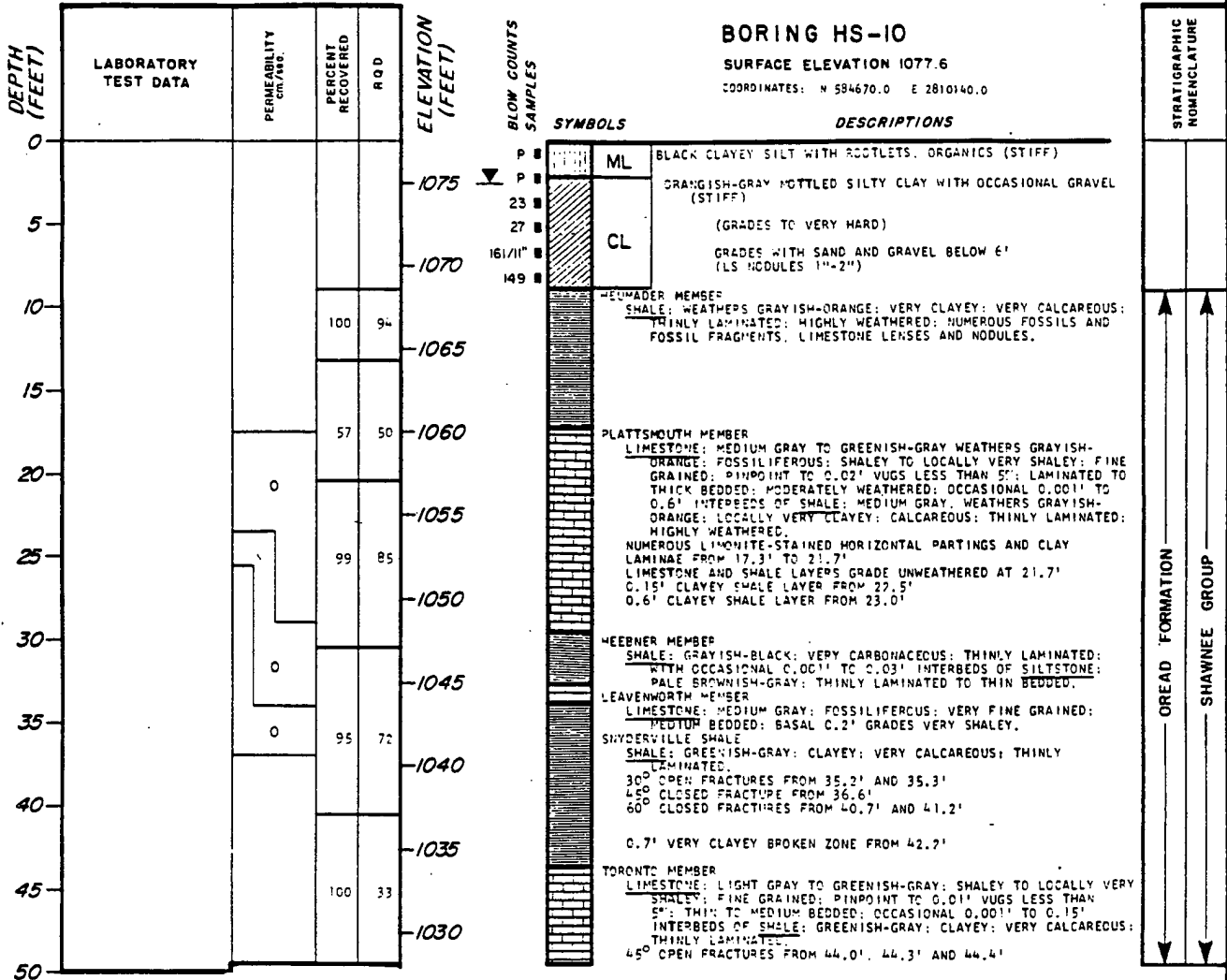

BORING COMPLETED AT 49.5 FEET ON 11-30-73.
CASING USED TO A DEPTH OF 13.3 FEET.
GROUNDWATER LEVEL RECORDED AT 2.0 FEET ON 12-13-73.
SECOND PIEZOMETER INSTALLED AT AN INTERVAL FROM 17.2 FEET TO
24.9 FEET ON 1-25-74.
FIRST PIEZOMETER INSTALLED AT AN INTERVAL FROM 42.5 FEET TO
49.5 FEET ON 1-25-74.
PIEZOMETER READINGS ARE PRESENTED ON TABLE 2.4-31.

Rev. 0

**WOLF CREEK
UPDATED SAFETY ANALYSIS REPORT**

Figure 2.5-36j
Log of Boring HS-10

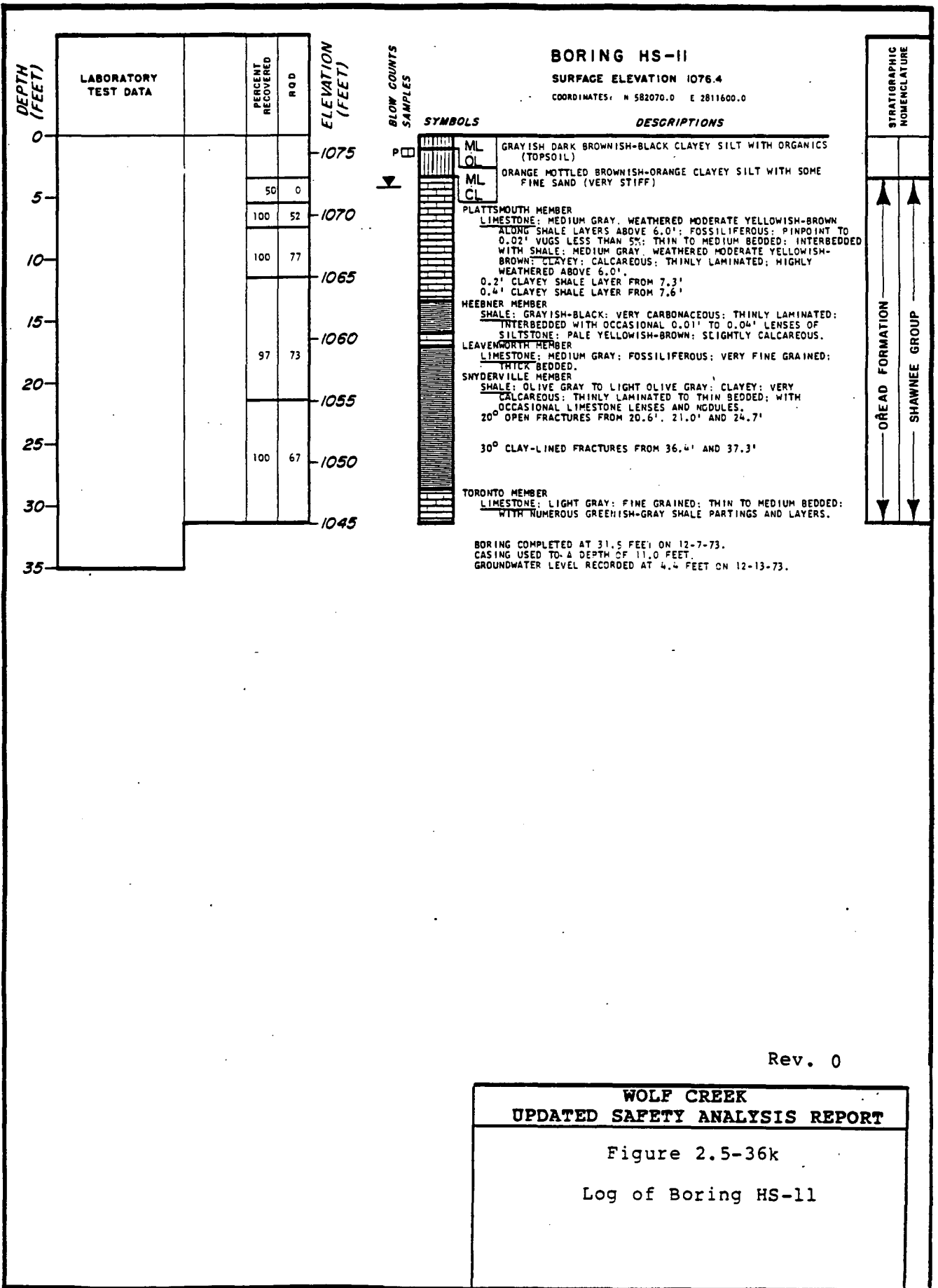

Rev. 0

**WOLF CREEK
UPDATED SAFETY ANALYSIS REPORT**

Figure 2.5-36k
Log of Boring HS-11

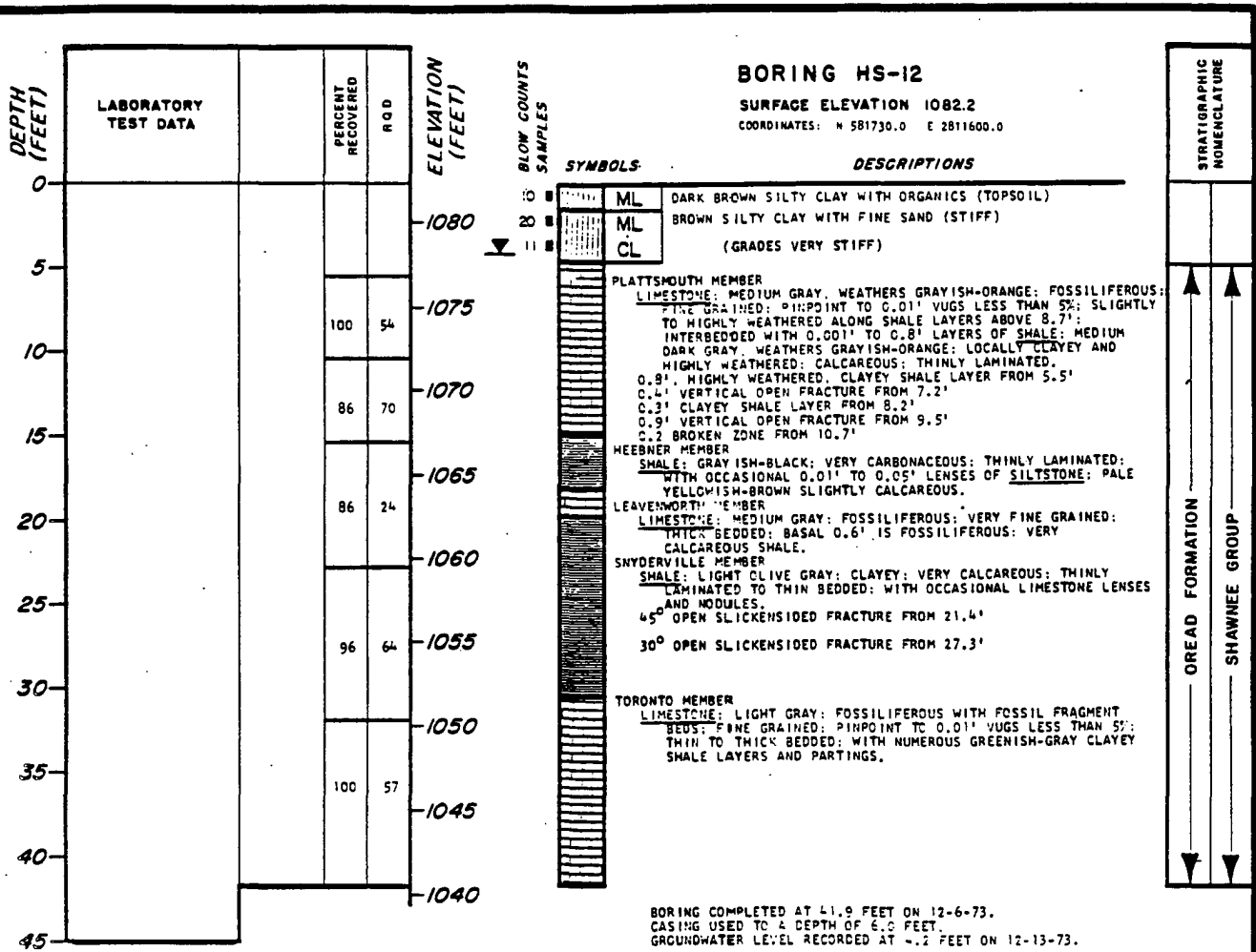

Rev. 0

WOLF CREEK
UPDATED SAFETY ANALYSIS REPORT

Figure 2.5-361
 Log of Boring HS-12

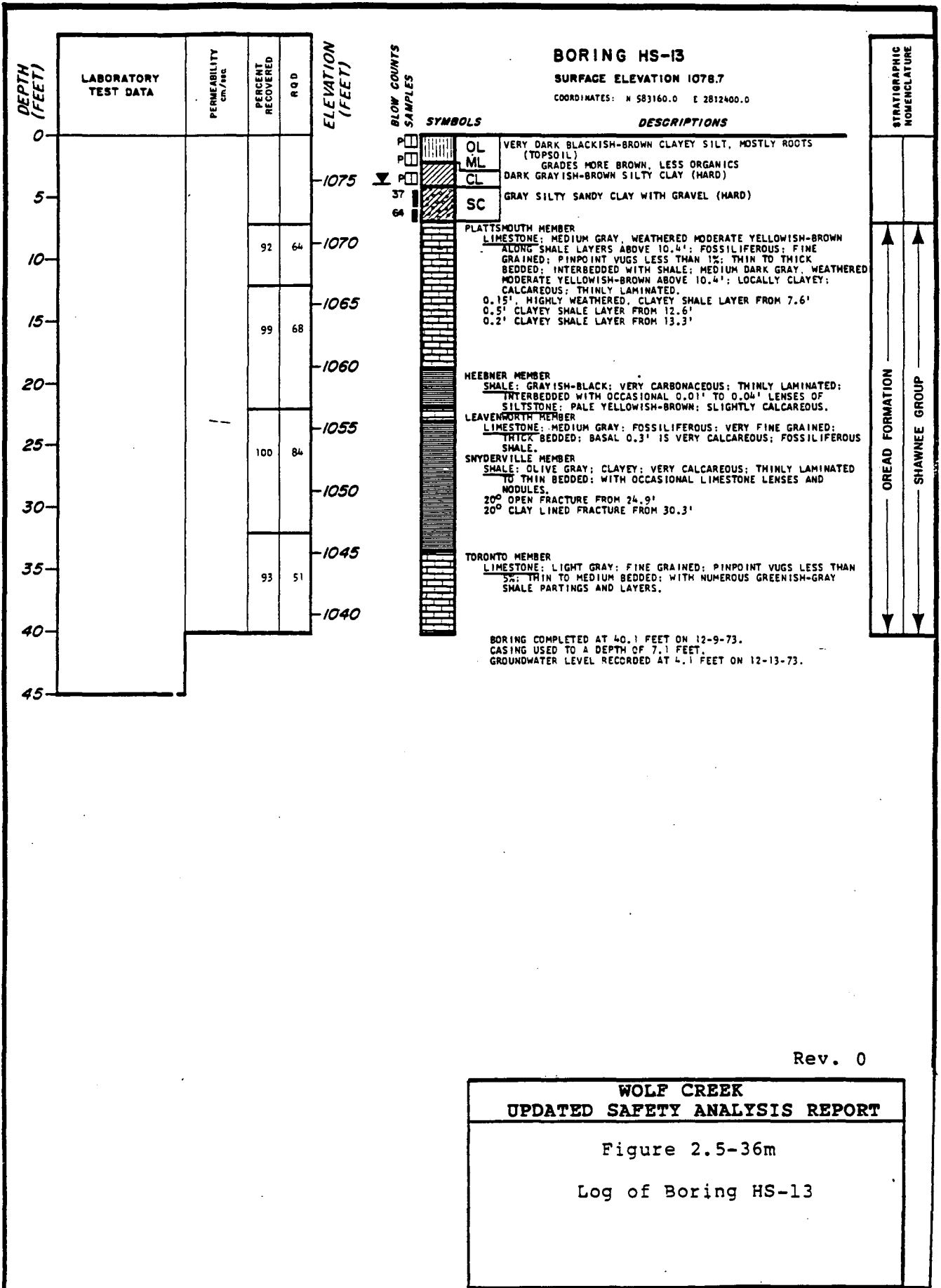

Rev. 0

WOLF CREEK
UPDATED SAFETY ANALYSIS REPORT

Figure 2.5-36m

Log of Boring HS-13

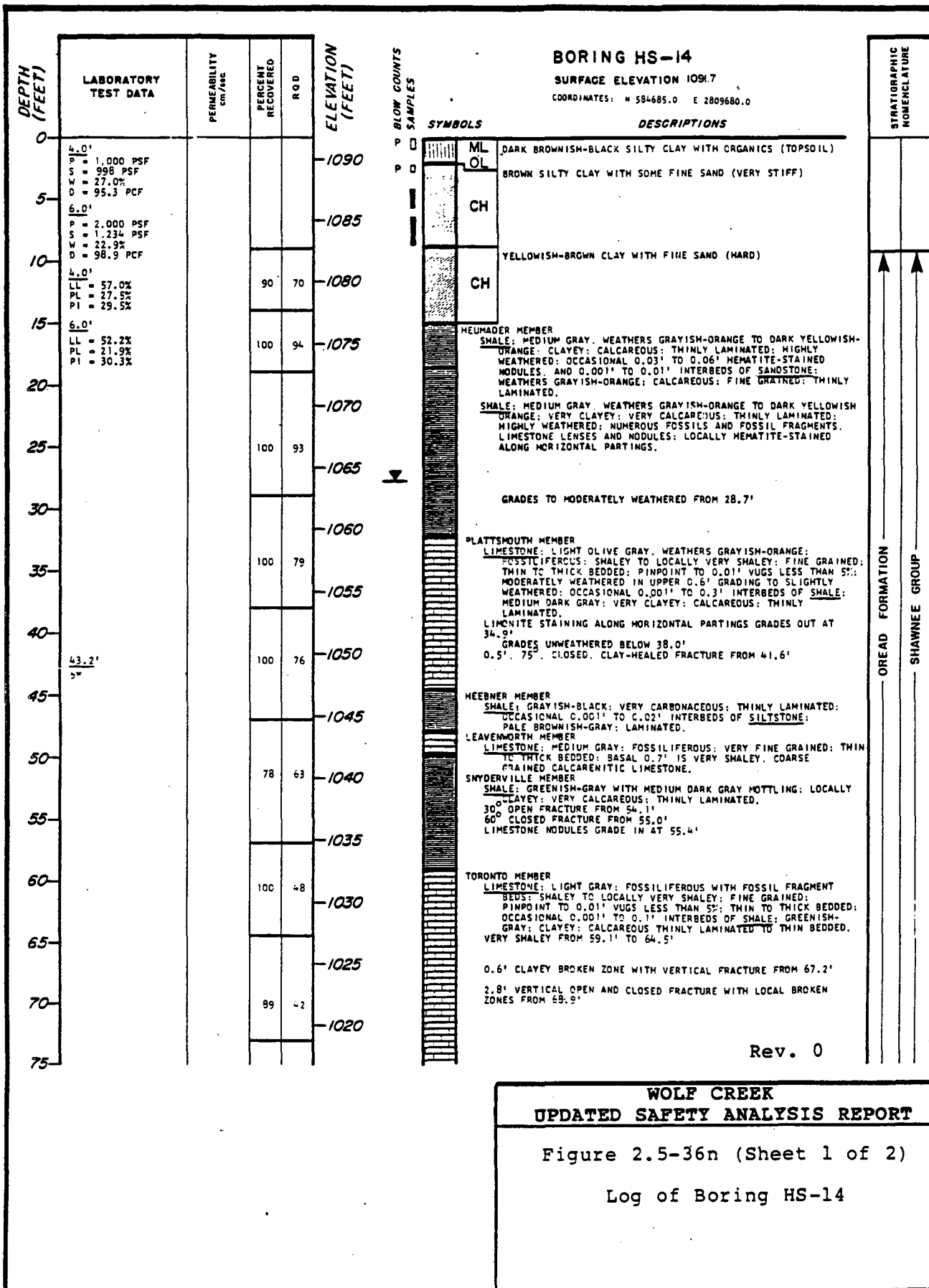

WOLF CREEK
UPDATED SAFETY ANALYSIS REPORT

Figure 2.5-36n (Sheet 1 of 2)

Log of Boring HS-14

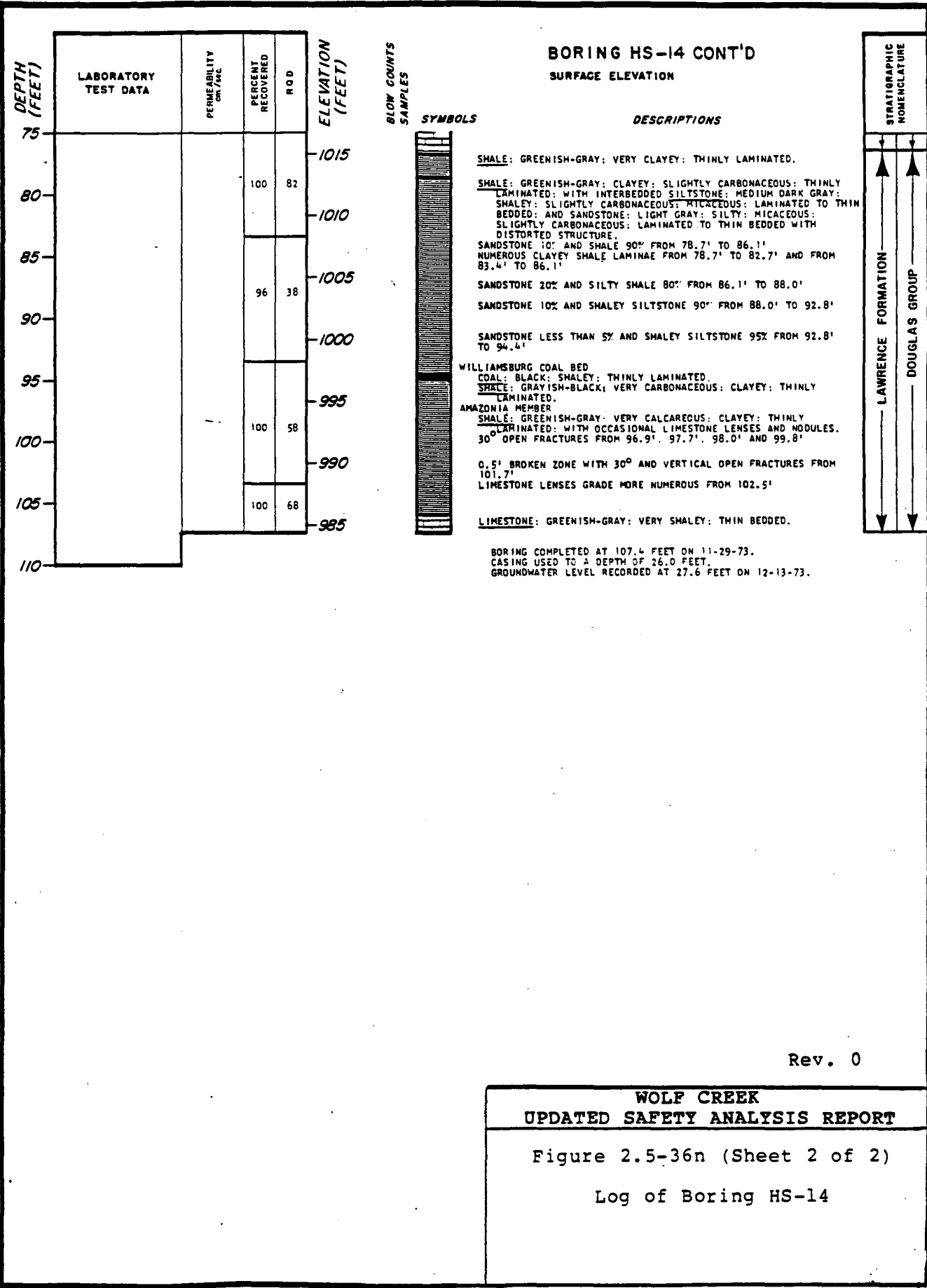

Rev. 0

WOLF CREEK
UPDATED SAFETY ANALYSIS REPORT

Figure 2.5-36n (Sheet 2 of 2)

Log of Boring HS-14

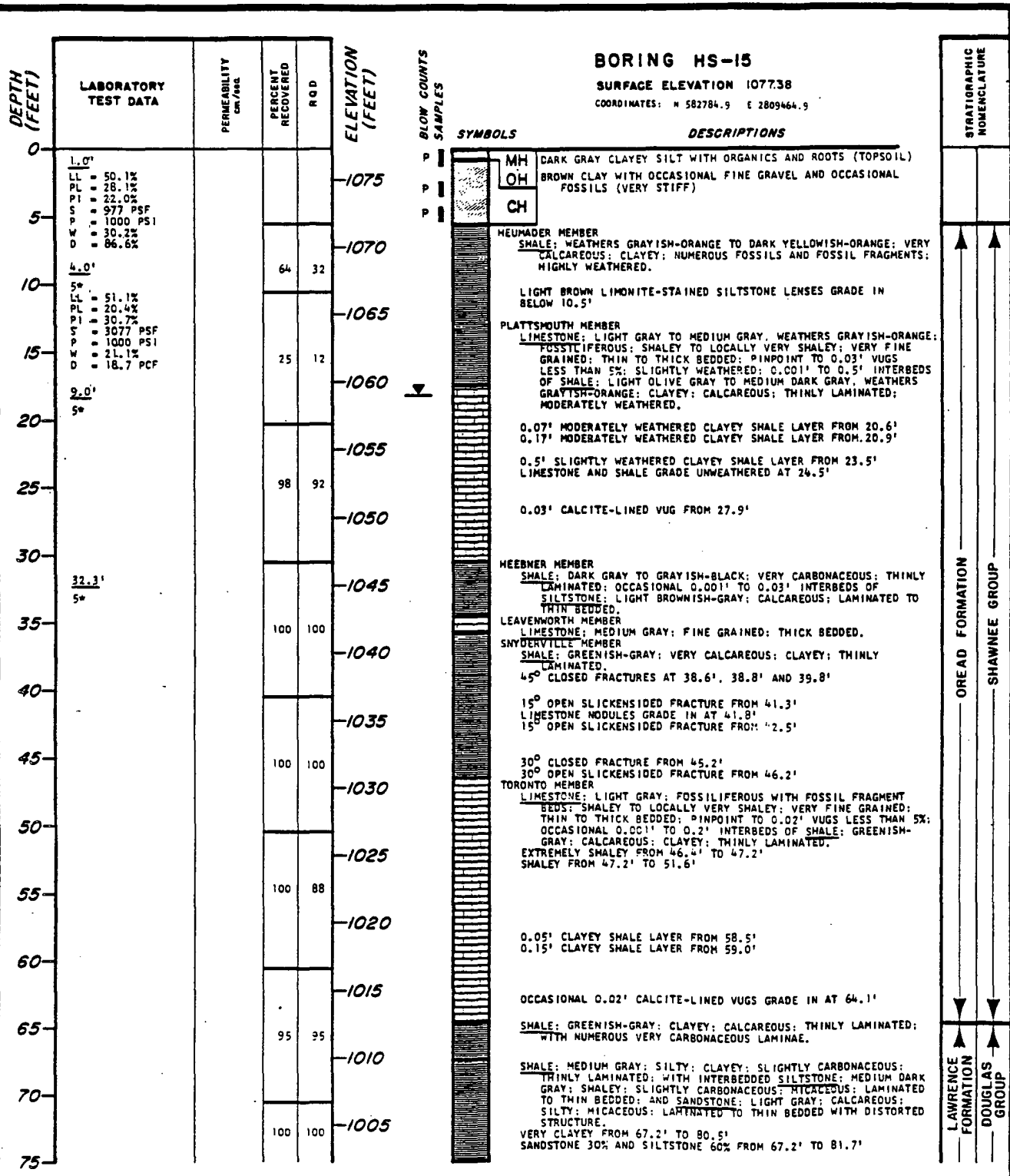

WOLF CREEK
UPDATED SAFETY ANALYSIS REPORT

Figure 2.5-36o (Sheet 1 of 2)

Log of Boring HS-15

Rev. 0

BORING HS -15 CONT'D.

DEPTH (FEET)	LABORATORY TEST DATA	PERMEABILITY cm./sec.	PERCENT RECOVERED	R Q D	ELEVATION (FEET)
75					1000
80			100	100	995
85			100	95	990
87.9' 5*					985
90					980
95			98	98	970
100					965
105			76	76	960
110			100	100	955
115			100	80	

BLOW COUNTS SAMPLES



SYMBOLS

DESCRIPTIONS

SANDSTONE LESS THAN 5% AND SHALEY SILTSTONE 95% FROM 81.7' TO 84.5'
GRADES VERY CARBONACEOUS FROM 83.5'

WILLIAMSBURG COAL BED
COAL; BLACK; SHALEY; THINLY LAMINATED.
SHALE; MEDIUM GRAY; VERY CALCAREOUS; CLAYEY; THINLY LAMINATED.
15° OPEN FRACTURE FROM 85.9'
30° OPEN SLICKENSIDED FRACTURES FROM 86.5', 86.6' AND 87.0'
0.4' BROKEN ZONE WITH 15° TO 45° OPEN SLICKENSIDED FRACTURES FROM 87.3'

AMAZONIA MEMBER
SHALE; GREENISH-GRAY; CALCAREOUS; THINLY LAMINATED; WITH NUMEROUS LIMESTONE NODULES.
LIMESTONE; GREENISH-GRAY; VERY SHALEY; VERY FINE GRAINED; MEDIUM TO THICK BEDDED.

IRELAND MEMBER
SHALE; GREENISH-GRAY; SLIGHTLY CALCAREOUS; MICACEOUS; SILTY; THINLY LAMINATED.
GRADES FROM 94.4' WITH INTERBEDDED SANDSTONE; LIGHT GRAY; MICACEOUS; FINE GRAINED; THINLY LAMINATED TO THIN BEDDED WITH DISTORTED STRUCTURE
SANDSTONE 10% FROM 94.4' TO 102.0'
SHALE GRADES TO MEDIUM GRAY AT 96.5'

SANDSTONE LESS THAN 5% FROM 102.0' TO 111.3'

VERY CARBONACEOUS LAMINAE GRADE IN AT 107.8'

2.1' CLAYEY BROKEN ZONE FROM 109.5'

COAL; BLACK; SHALEY; THINLY LAMINATED.
SHALE; MEDIUM GRAY; SILTY; CLAYEY; THINLY LAMINATED; WITH INTERBEDDED SANDSTONE; LIGHT GRAY; LOCALLY CALCAREOUS; MICACEOUS; FINE GRAINED; THINLY LAMINATED TO THIN BEDDED WITH DISTORTED STRUCTURE.
SILTY SHALE 100% FROM 112.5' TO 114.1'
SANDSTONE 30% AND SILTY SHALE 70% FROM 114.1' TO 117.5'

BORING COMPLETED AT 117.5 FEET ON 11-19-73.
CASING USED TO A DEPTH OF 5.5 FEET.
GROUNDWATER LEVEL RECORDED AT 17.8 FEET ON 12-13-73.

STRATIGRAPHIC NOMENCLATURE

LAWRENCE FORMATION
DOUGLAS GROUP

Rev. 12

**WOLF CREEK
UPDATED SAFETY ANALYSIS REPORT**

Figure 2.5-36o (Sheet 2 of 2)

Log of Boring HS-15

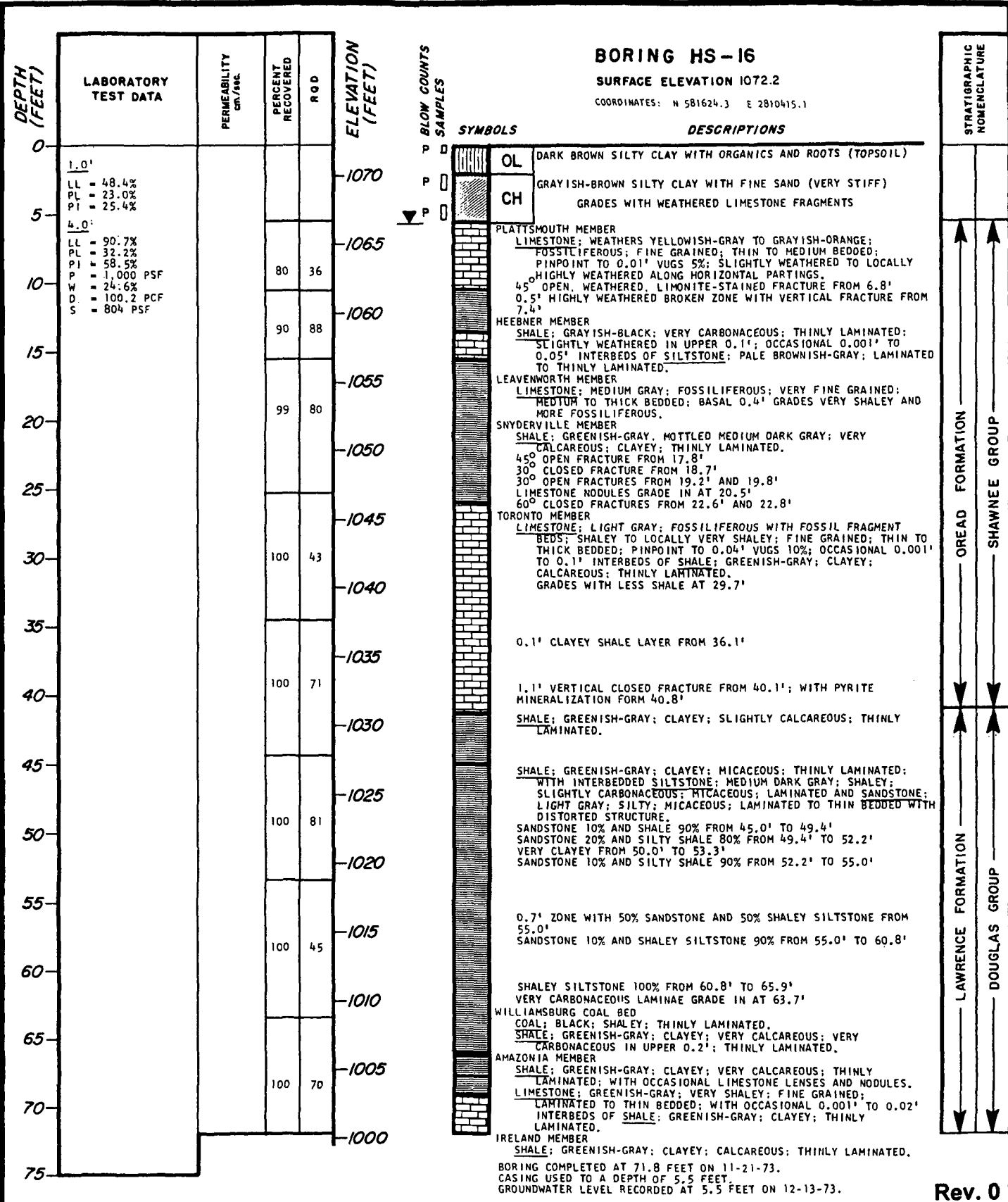

Rev. 0

WOLF CREEK

UPDATED SAFETY ANALYSIS REPORT

Figure 2.5-36p

Log of Boring HS-16

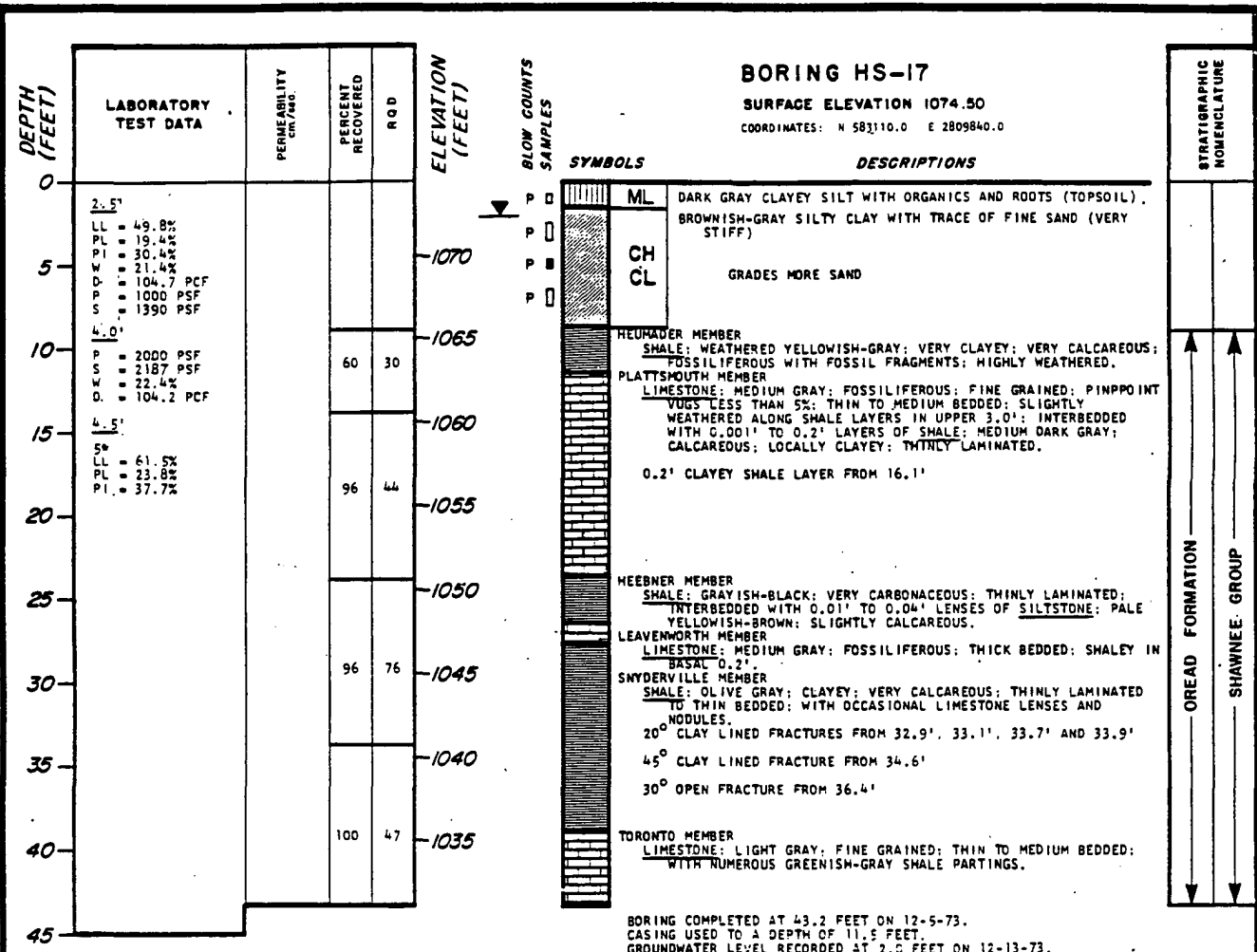

Rev. 0

WOLF CREEK
UPDATED SAFETY ANALYSIS REPORT

Figure 2.5-36q
 Log of Boring HS-17

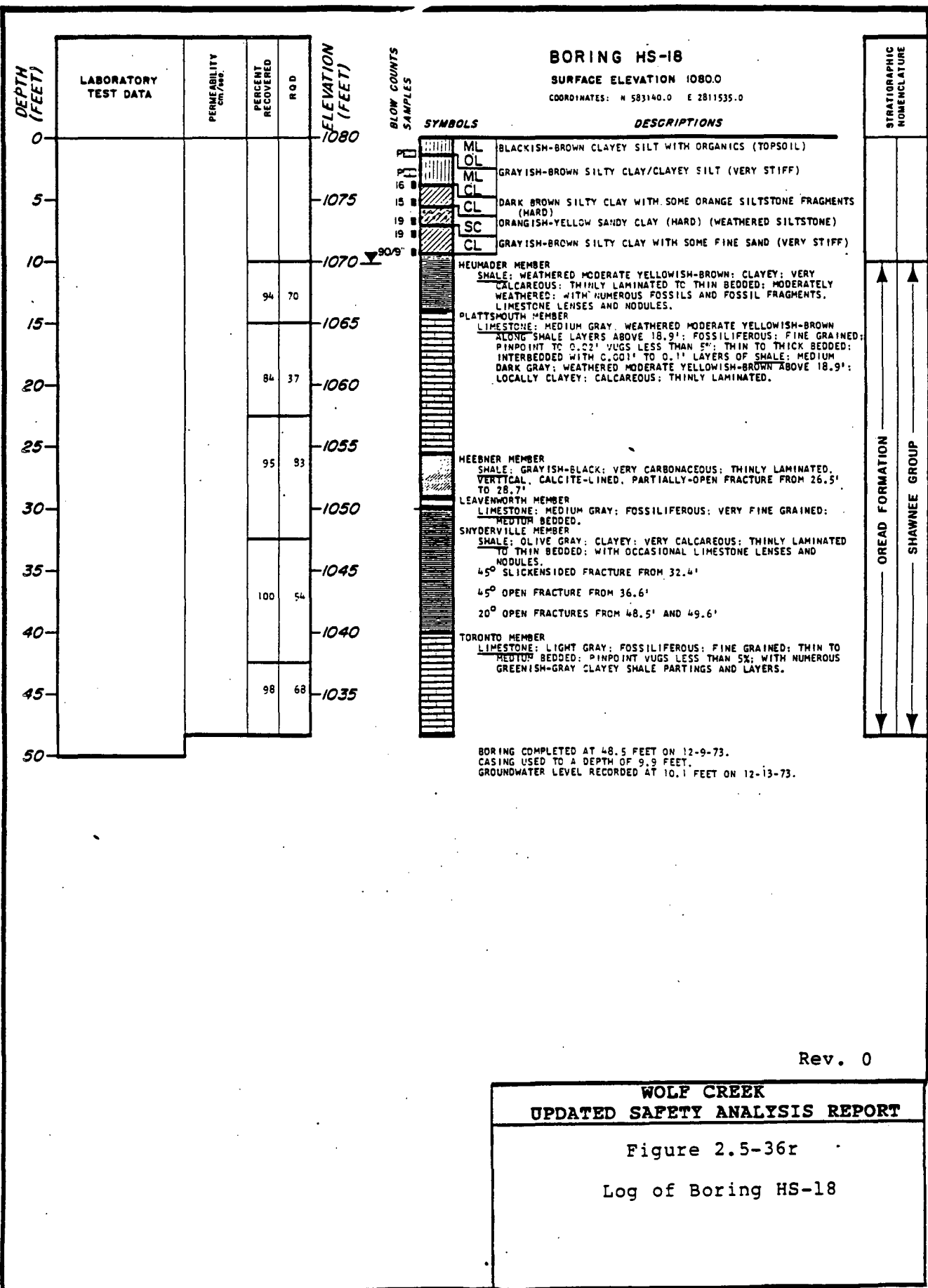

Rev. 0

WOLF CREEK
UPDATED SAFETY ANALYSIS REPORT

Figure 2.5-36r

Log of Boring HS-18

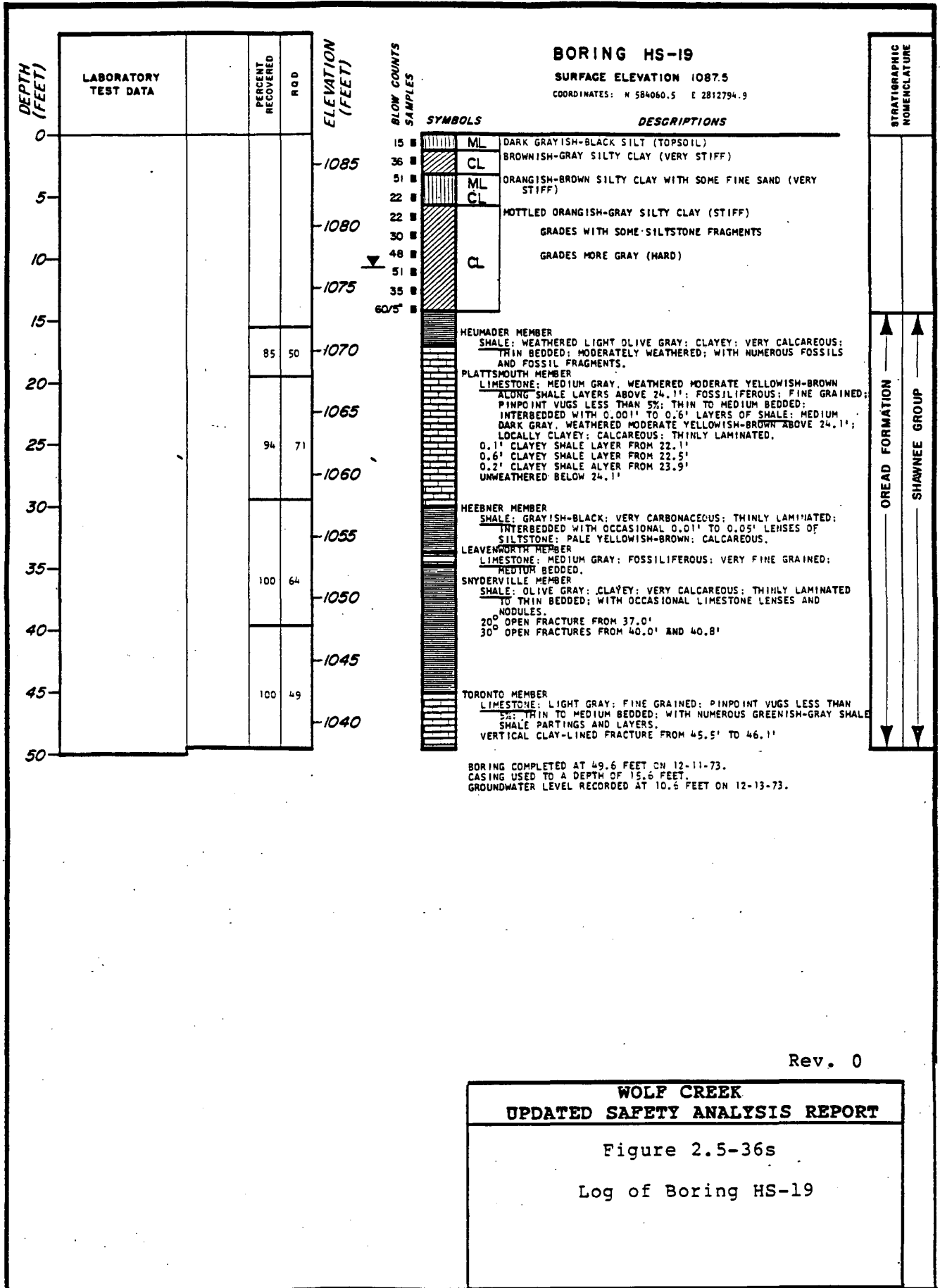

Rev. 0

WOLF CREEK
UPDATED SAFETY ANALYSIS REPORT

Figure 2.5-36s
 Log of Boring HS-19

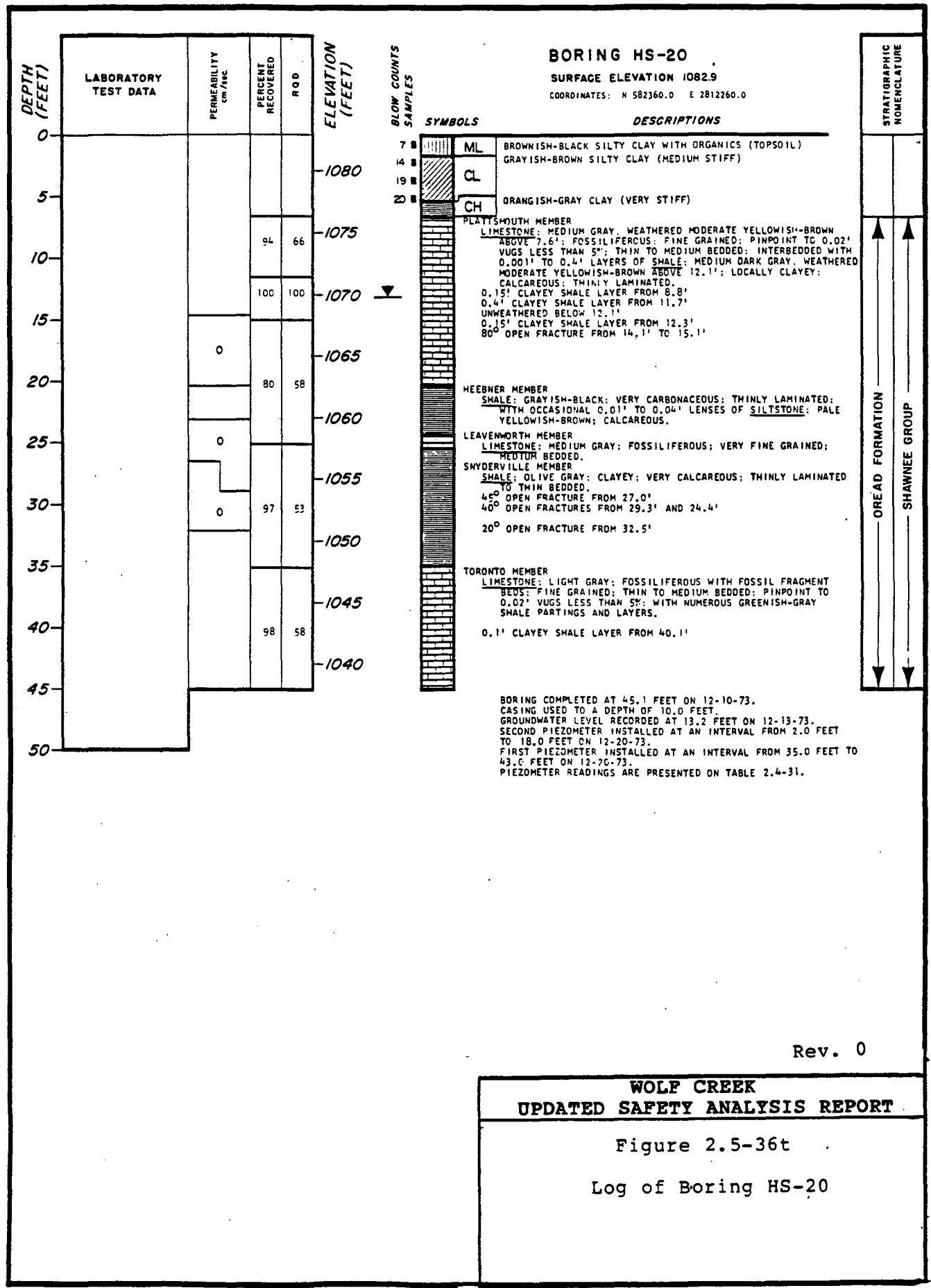

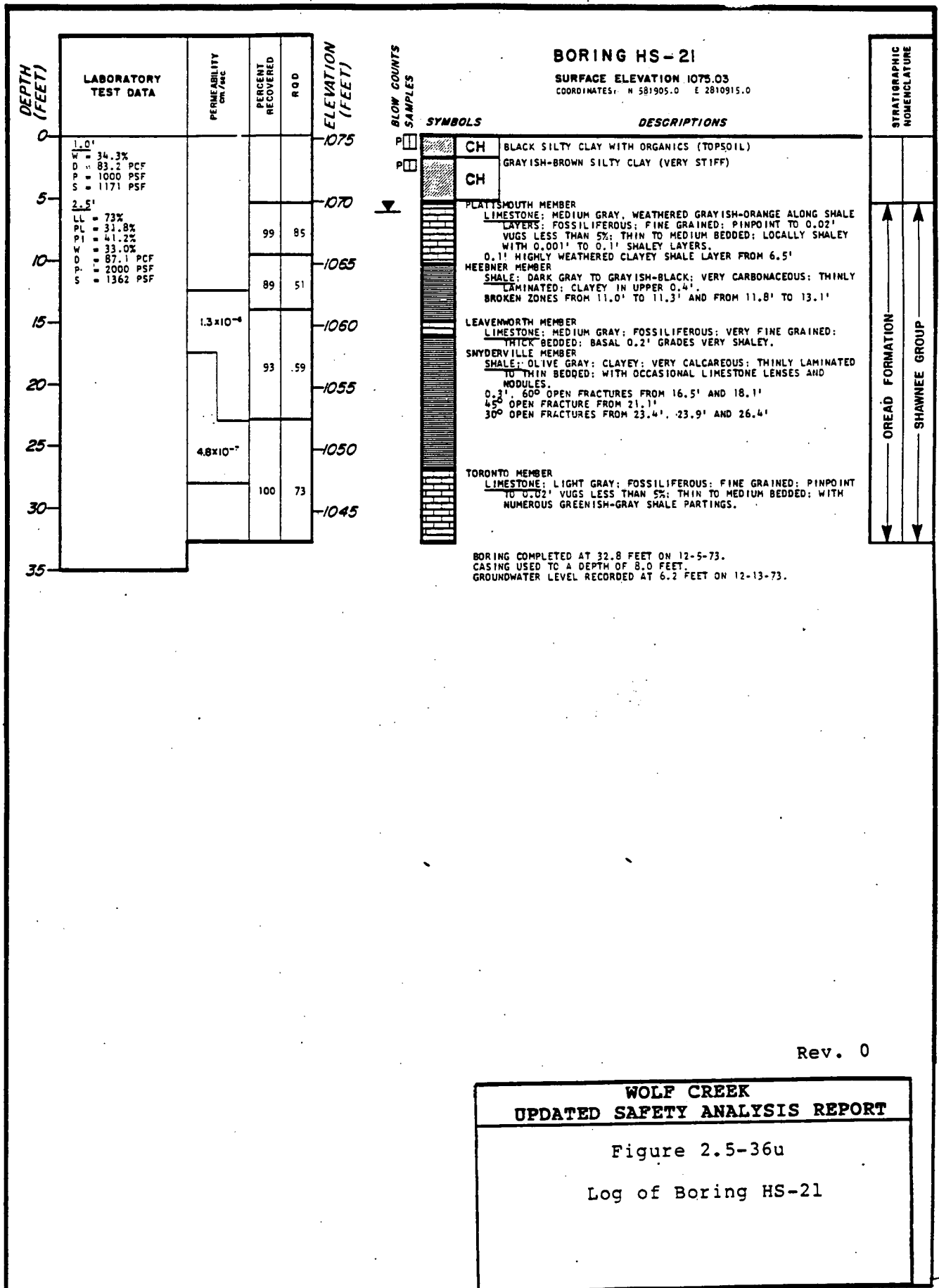

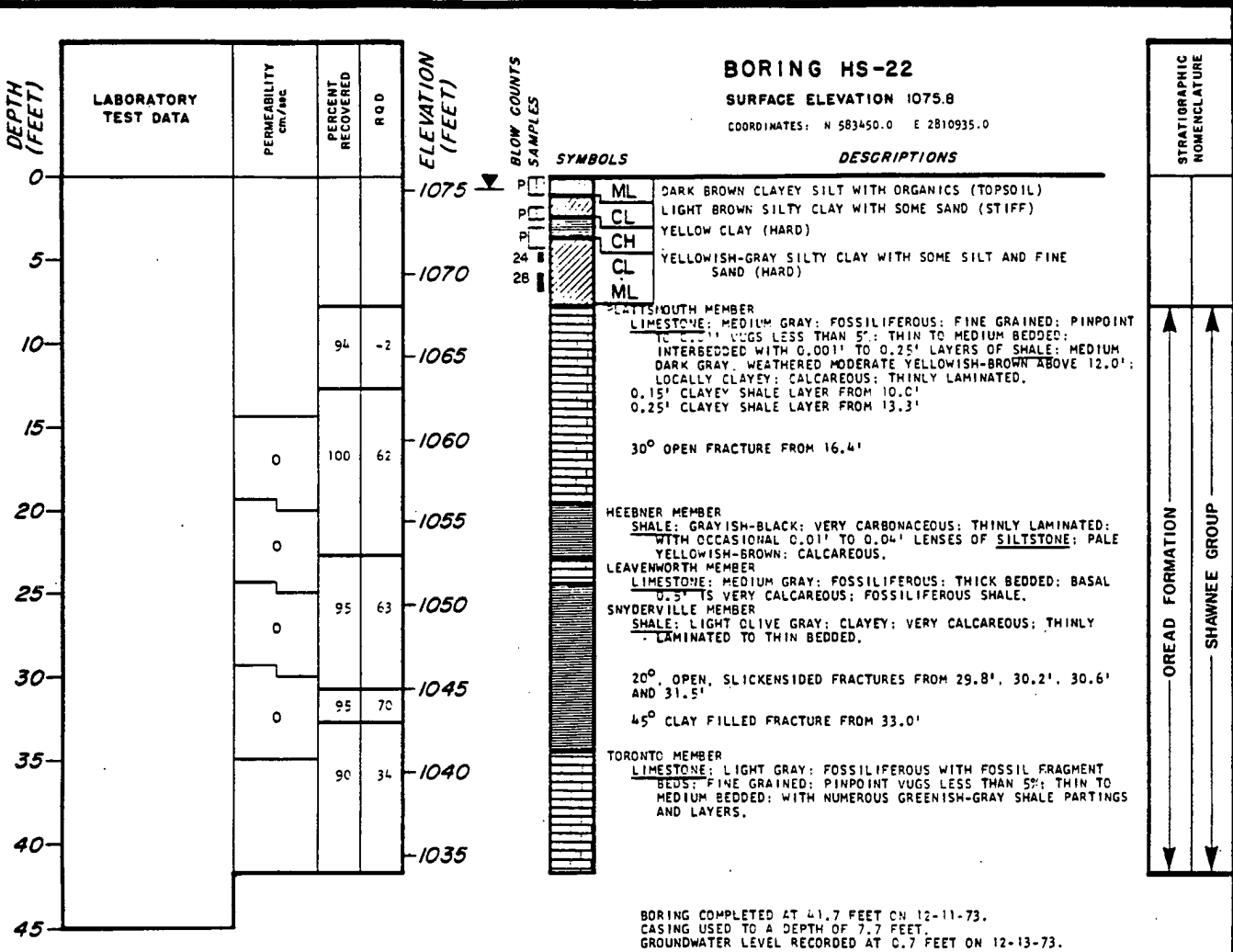

Rev. 0

WOLF CREEK
UPDATED SAFETY ANALYSIS REPORT

Figure 2.5-36v
 Log of Boring HS-22

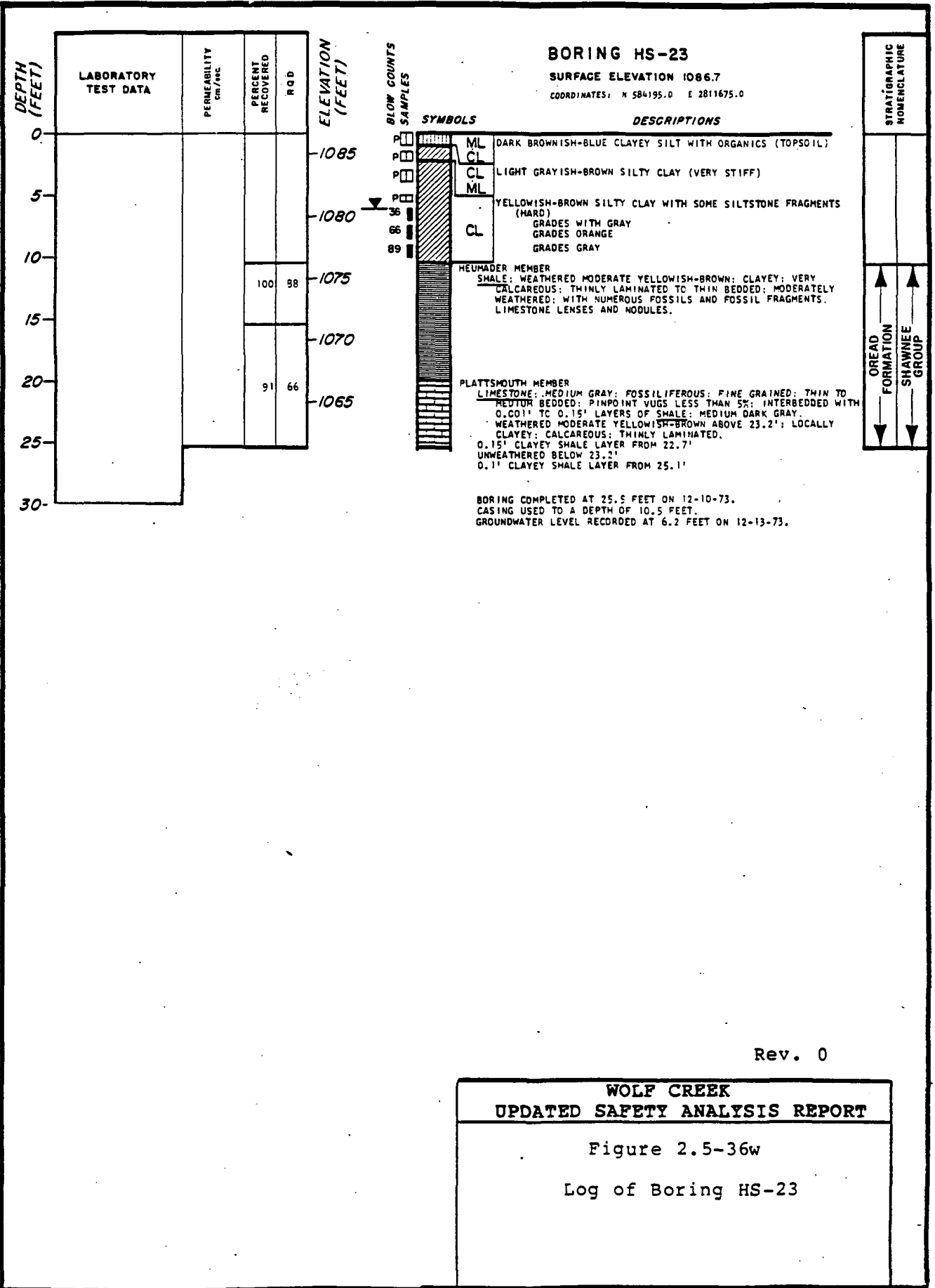

Rev. 0

**WOLF CREEK
 UPDATED SAFETY ANALYSIS REPORT**

Figure 2.5-36w
 Log of Boring HS-23

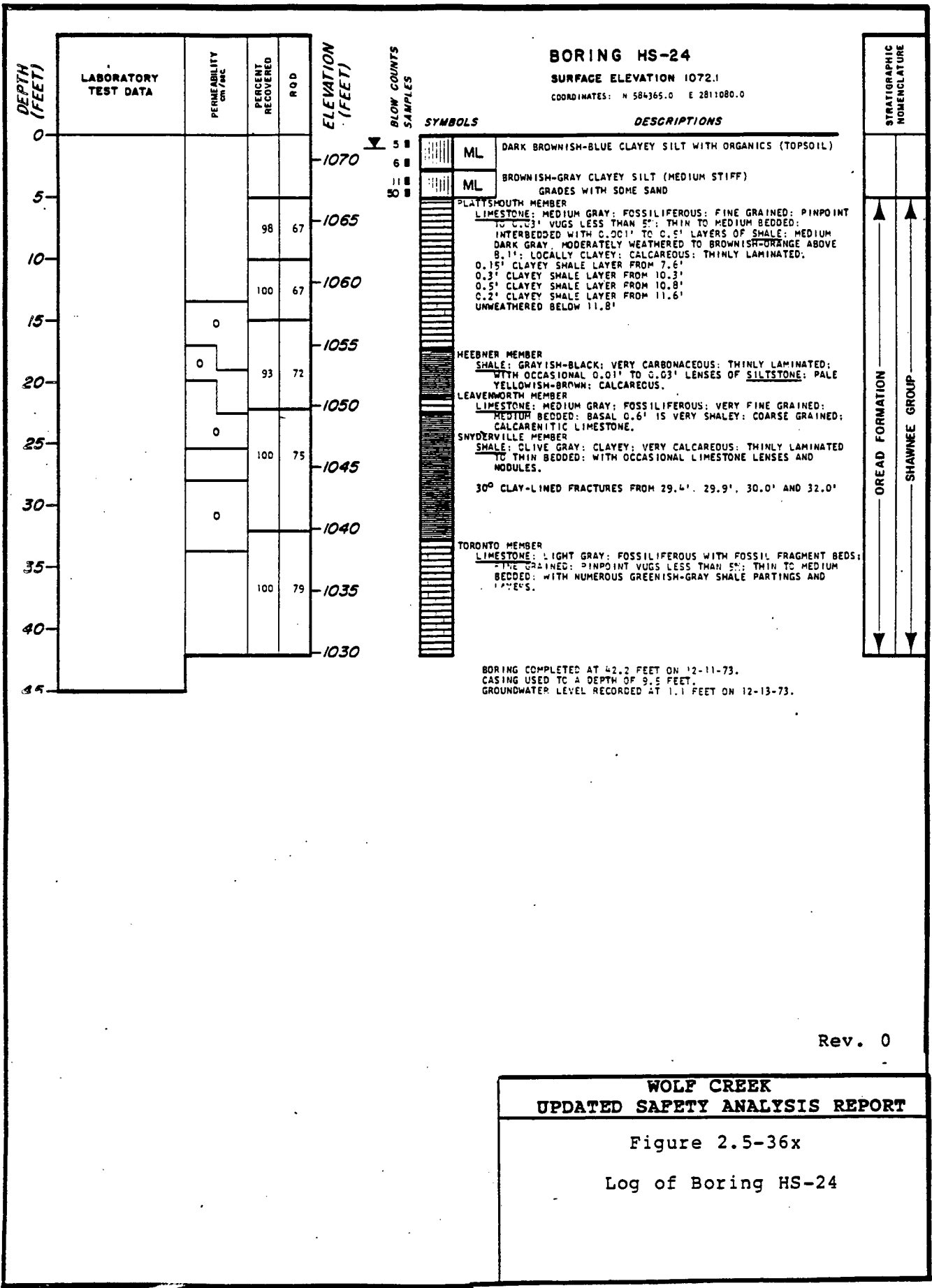

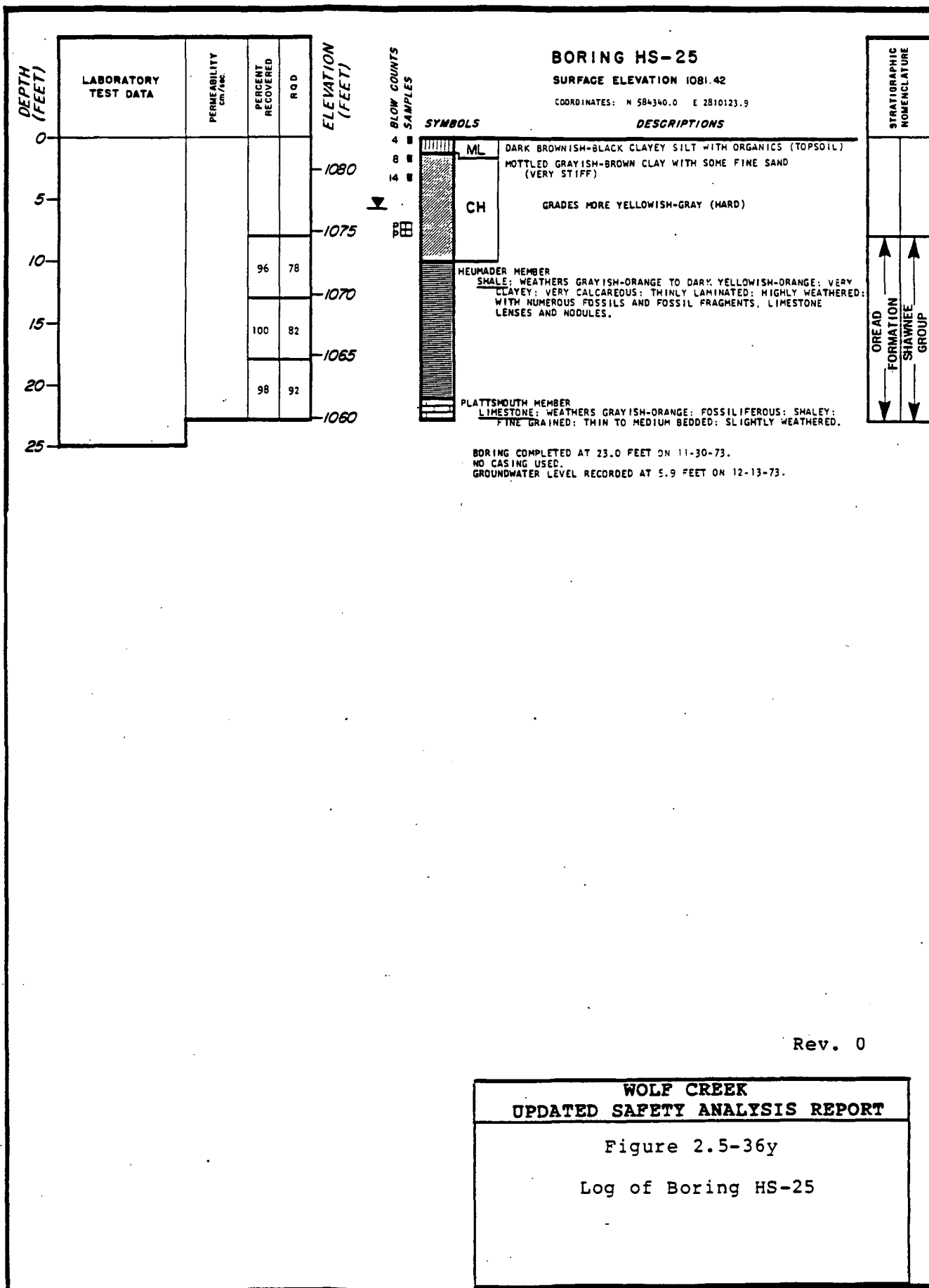

Rev. 0

WOLF CREEK
UPDATED SAFETY ANALYSIS REPORT
 Figure 2.5-36y
 Log of Boring HS-25

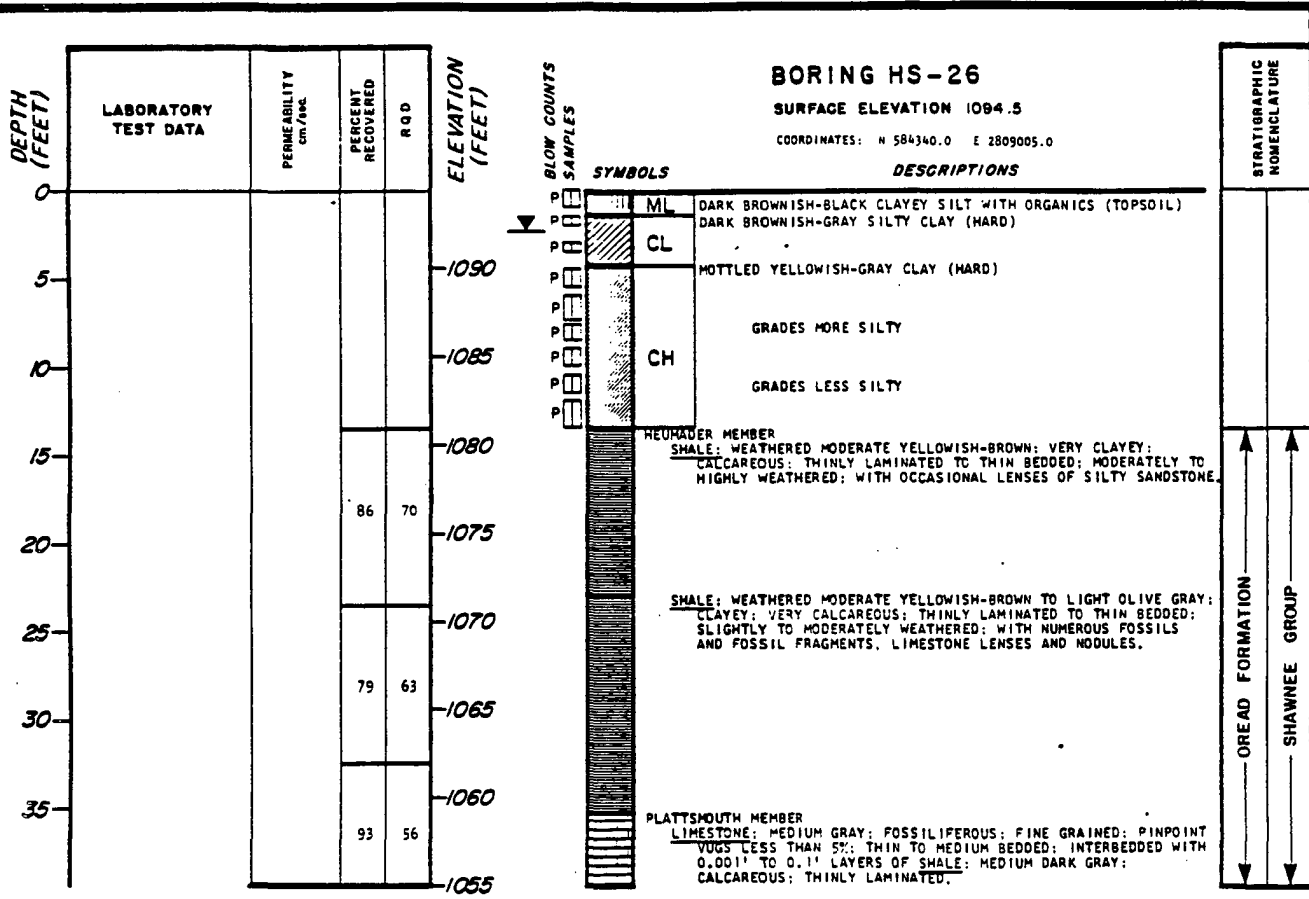

BORING COMPLETED AT 39.5 FEET ON 12-6-73.
 CASING USED TO A DEPTH OF 13.5 FEET.
 GROUNDWATER LEVEL RECORDED AT 2.3 FEET ON 12-13-73.

Rev. 0

**WOLF CREEK
 UPDATED SAFETY ANALYSIS REPORT**

Figure 2.5-36z
 Log of Boring HS-26

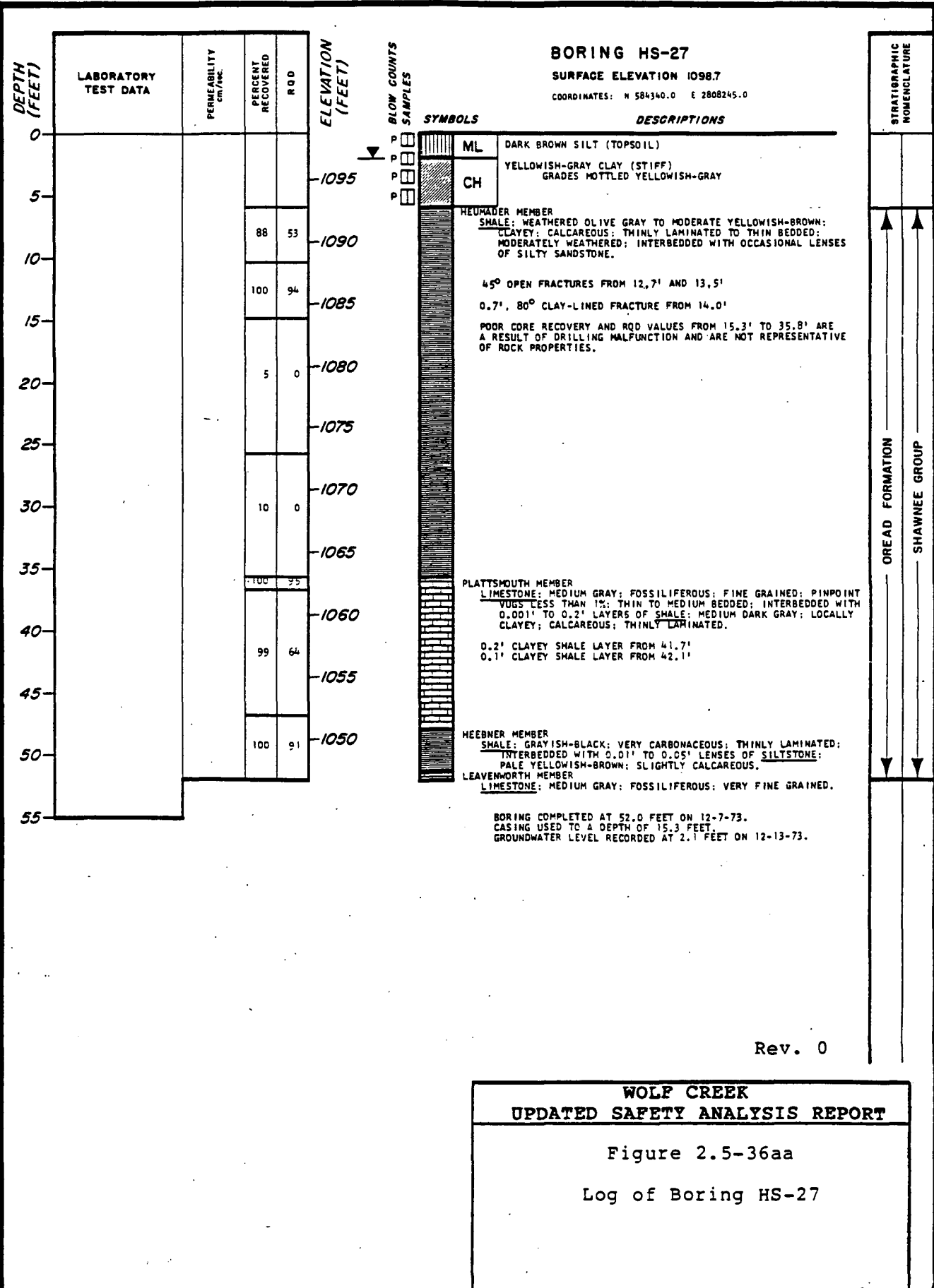

WOLF CREEK
UPDATED SAFETY ANALYSIS REPORT

Figure 2.5-36aa
Log of Boring HS-27

DEPTH (FEET)	LABORATORY TEST DATA	PERCENT RECOVERED	RQD	ELEVATION (FEET)
0				1090
5				1085
10				1080
15				1075
20		100	100	1070
25				1065
30		100	93	1060
33.0'	Q = 6.690 PSI E = 9.260,000 PSI			1055
35				1050
40		99	99	1045
42.8'	Q = 1.455 PSI E = 4.753,000 PSI			1040
45				1035
45.5'	Q = 1.110 PSI E = 110,000 PSI			1030
47.9'	Q = 10.910 PSI E = 14,000 PSI	99	96	
50				
55				
56.3'	Q = 151 PSI E = 14,000 PSI	100	8-	
60				
63.8'	Q = 6.760 PSI E = 3.853,000 PSI			
65				

BORING HS-28

SURFACE ELEVATION 1091.9

COORDINATES: N 584711.7 E 2809675.7

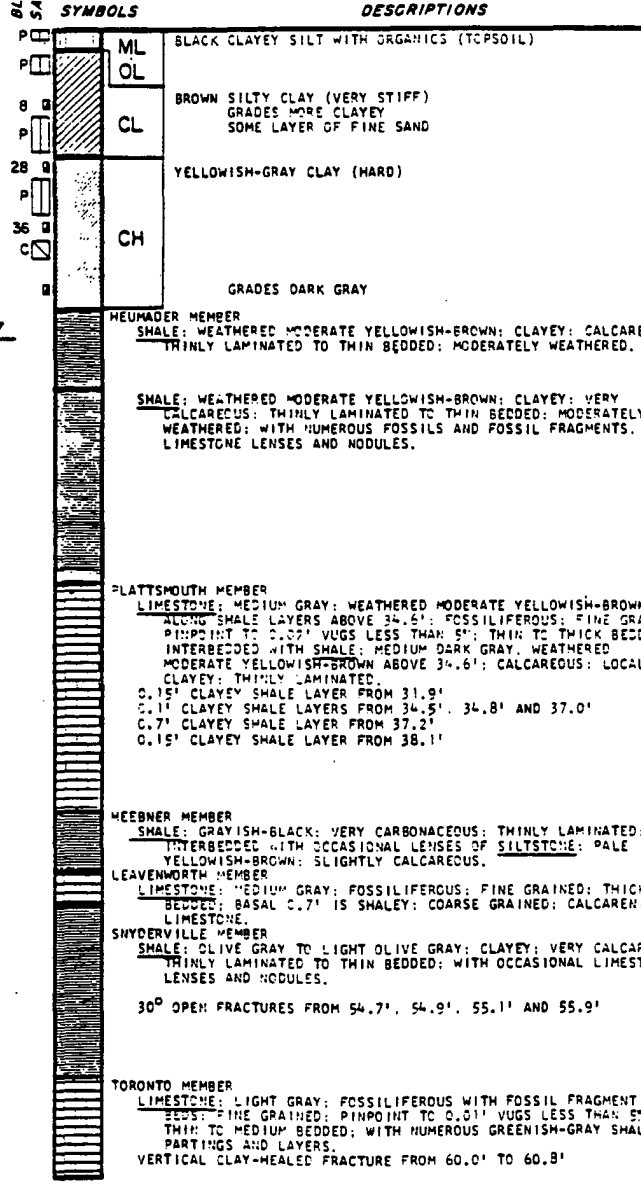

STRAATIGRAPHIC NOMENCLATURE

OREAD FORMATION

SHAWNEE GROUP

BORING COMPLETED AT 65.0 FEET ON 12-8-73.
CASING USED TO A DEPTH OF 5.5 FEET.
GROUNDWATER LEVEL RECORDED AT 17.4 FEET ON 12-13-73.

Rev. 0

**WOLF CREEK
UPDATED SAFETY ANALYSIS REPORT**

Figure 2.5-36bb

Log of Boring HS-28

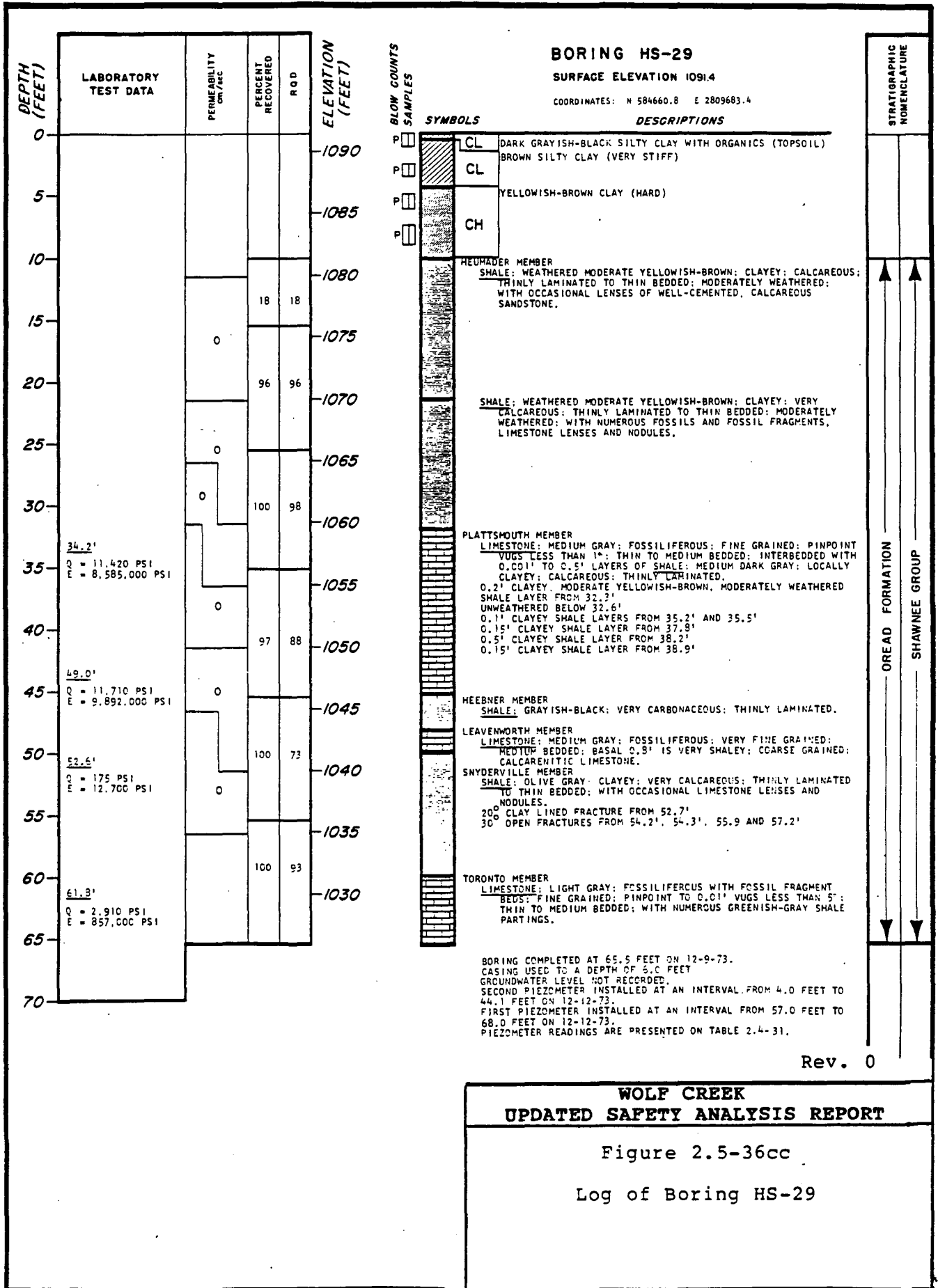

BORING HSA-1

SURFACE ELEVATION 1054.0

COORDINATES: N 581900.0 E 2809430.0

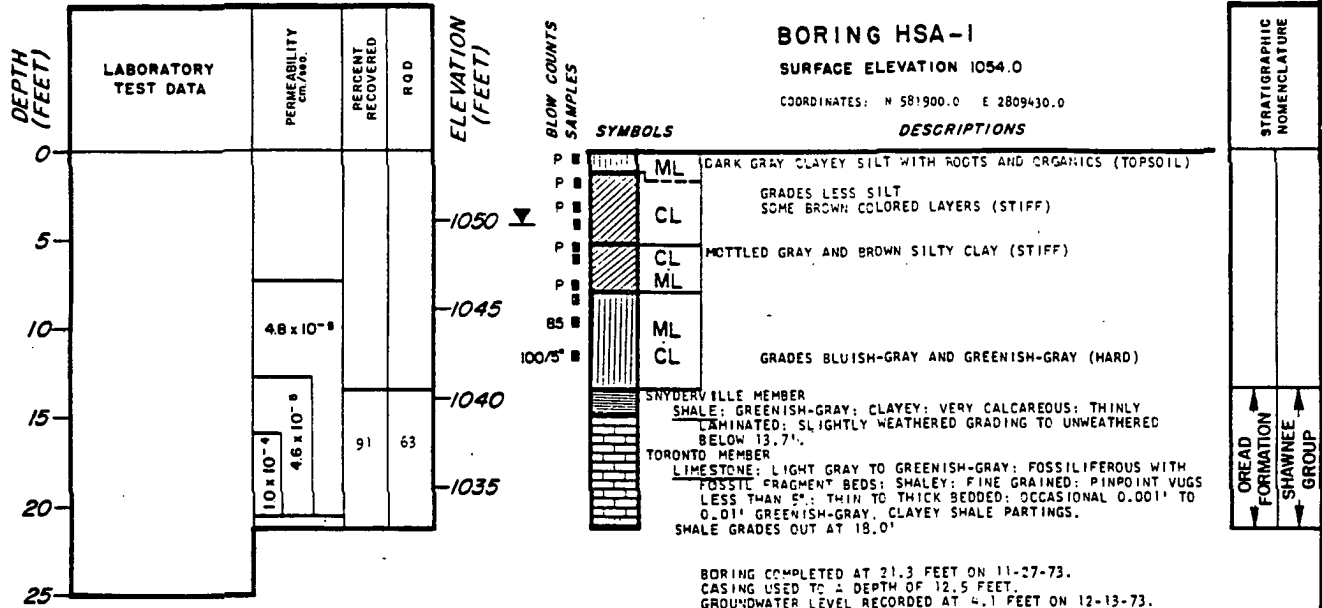

BORING COMPLETED AT 21.3 FEET ON 11-27-73.
CASING USED TO ± DEPTH OF 12.5 FEET.
GROUNDWATER LEVEL RECORDED AT 4.1 FEET ON 12-13-73.
SECOND PIEZOMETER INSTALLED AT AN INTERVAL FROM 2.7 FEET TO 11.5 FEET ON 12-18-73.
FIRST PIEZOMETER INSTALLED AT AN INTERVAL FROM 15.0 FEET TO 22.0 FEET ON 12-18-73.
PIEZOMETER READINGS ARE PRESENTED ON TABLE 2.4-31.

Rev. 0

**WOLF CREEK
UPDATED SAFETY ANALYSIS REPORT**

Figure 2.5-36dd
Log of Boring HSA-1

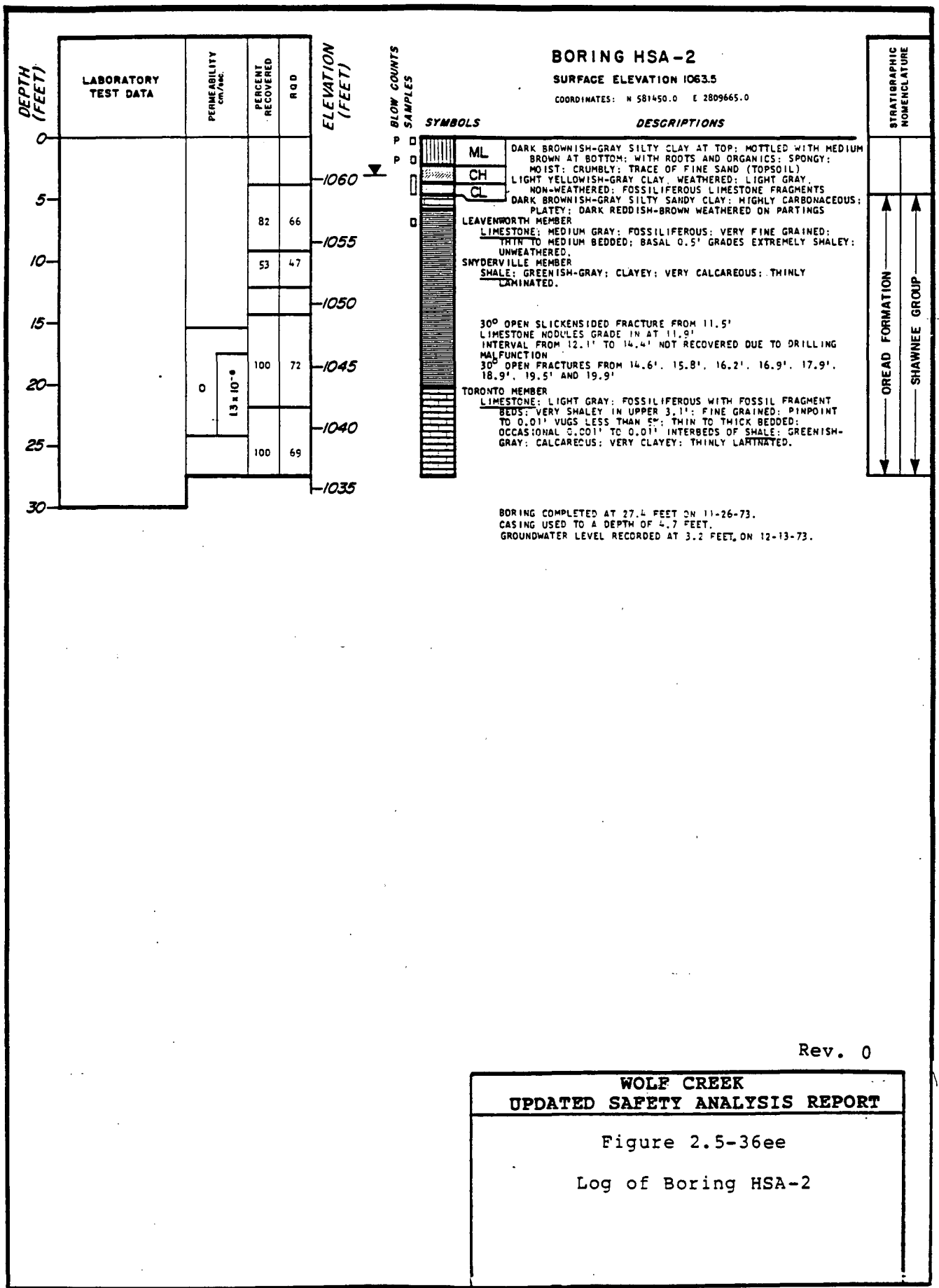

Rev. 0

WOLF CREEK
UPDATED SAFETY ANALYSIS REPORT

Figure 2.5-36ee
 Log of Boring HSA-2

BORING HS-30

SURFACE ELEVATION 1071.6

COORDINATES: N 581287.6 E 2810622.4

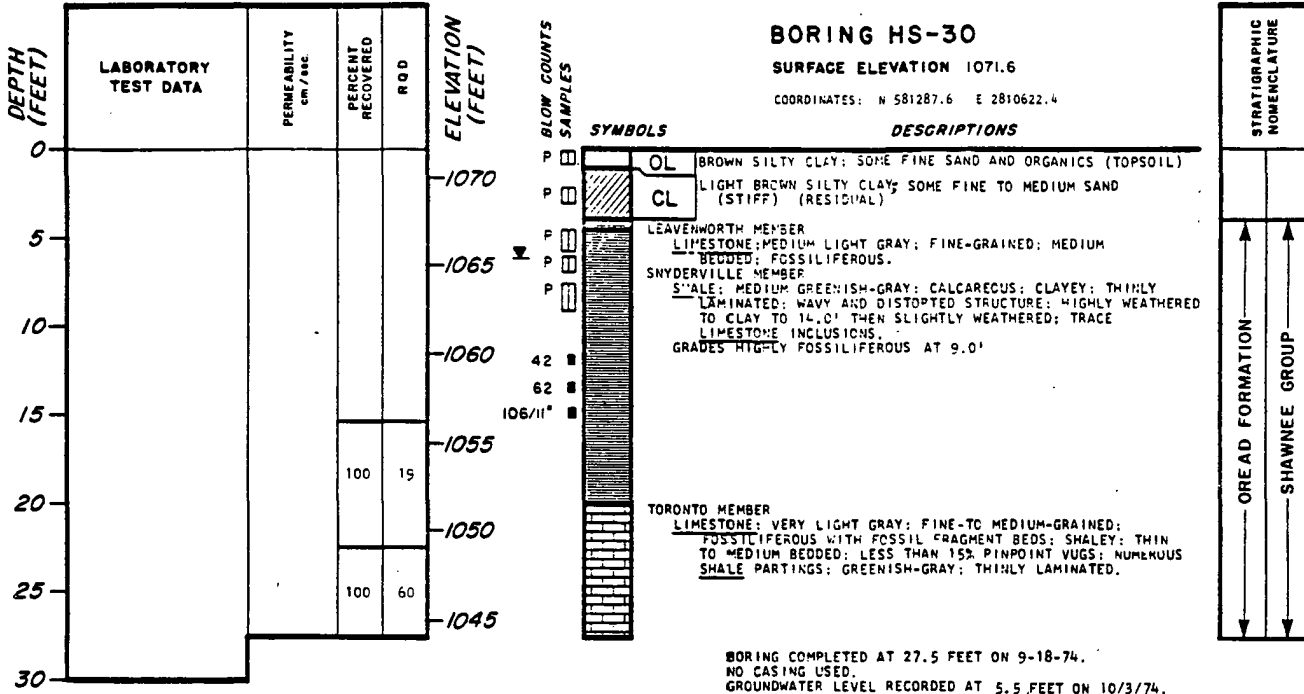

BORING COMPLETED AT 27.5 FEET ON 9-18-74.
NO CASING USED.
GROUNDWATER LEVEL RECORDED AT 5.5 FEET ON 10/3/74.

Rev. 0

**WOLF CREEK
UPDATED SAFETY ANALYSIS REPORT**

Figure 2.5-36ff
Log of Boring HS-30

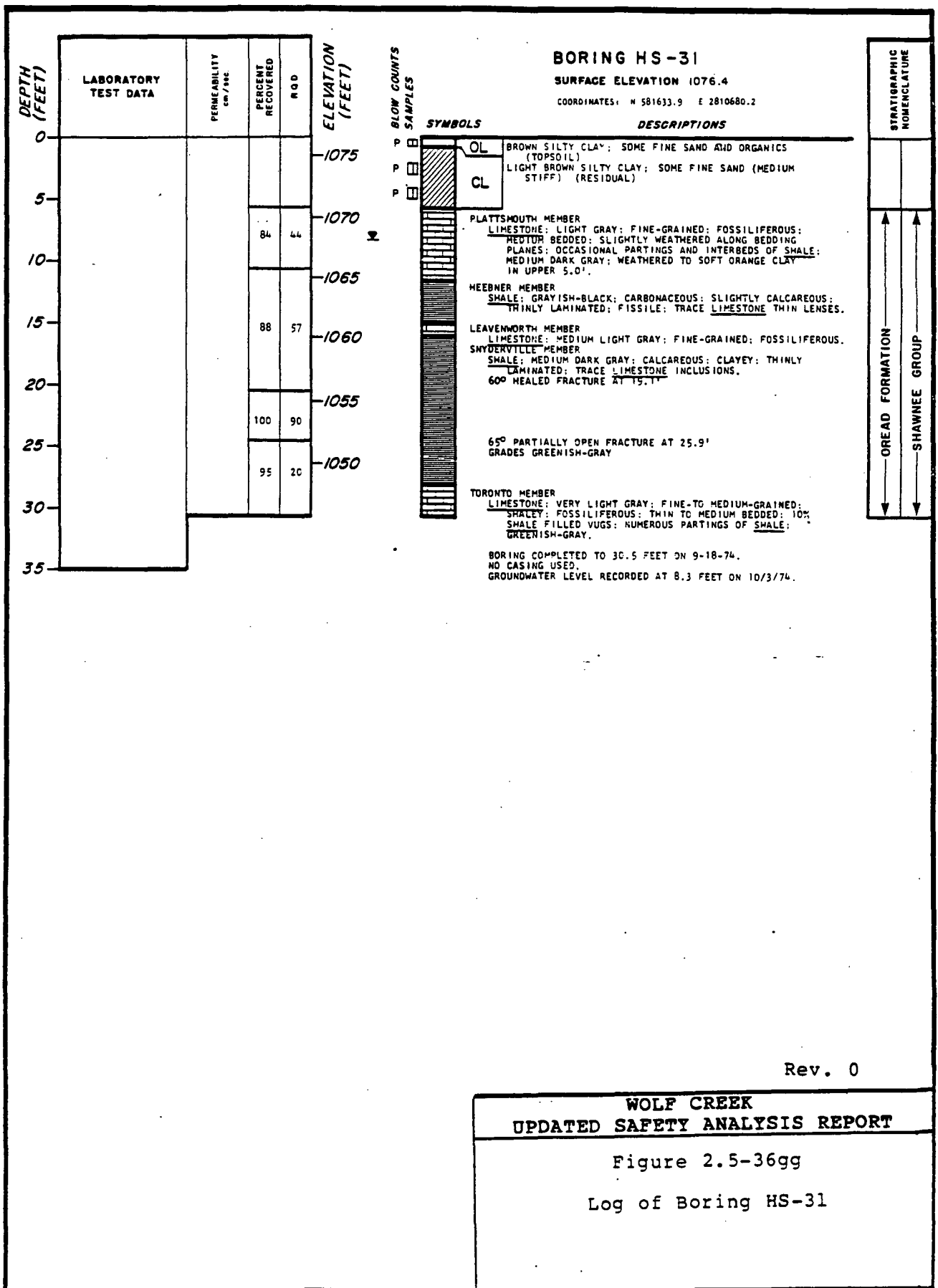

Rev. 0

WOLF CREEK
UPDATED SAFETY ANALYSIS REPORT

Figure 2.5-36gg
 Log of Boring HS-31

BORING ESW-1

SURFACE ELEVATION 1105.4

COORDINATES: N 584705.8 E 2807016.6

DEPTH (FEET)	LABORATORY TEST DATA	PERMEABILITY cm/sec	PERCENT RECOVERED	RQD	ELEVATION (FEET)
0					1105
5	W=14.1% D=114.2 PCF				1100
10			88	8	1095
15			83	45	1090
20			87	87	1085
25					1080
30			90	48	1075
35					1070
40			97	22	1065
45			80	3	1060
			90	40	
50					1055
			101	29	
55					1050
			100	71	
60					1045
			100	50	
65					

BLOW COUNTS
SAMPLES

SYMBOLS



DESCRIPTIONS

GRAYISH-BROWN SILTY CLAY, TRACE FINE SAND AND ORGANICS (TOPSOIL) 17"
MOTTLED BROWN AND GRAY SILTY CLAY WITH SOME FINE SAND; HARD (RESIDUAL)

GRADES CALCAREOUS

JACKSON PARK MEMBER
SILTSTONE: LIGHT GRAY; WEATHERS TO DARK YELLOWISH-ORANGE WITH
SOME MODERATE REDDISH-BROWN; FINE-GRAINED; MEDIUM BEDDED
CALCAREOUS; MODERATELY WEATHERED TO 9.4' THEN SLIGHTLY
WEATHERED; SOME SHALE PARTINGS
0.7' VERY LIGHT GRAY SANDY LIMESTONE FROM 9.5' TO 10.2'
VERY CALCAREOUS BELOW 12.9'

HEUMADER MEMBER
SHALE: MEDIUM DARK GRAY WEATHERING TO MODERATE YELLOWISH-
BROWN; THINLY LAMINATED; VERY CLAYEY; MODERATELY WEATHERED
TRACE SILTSTONE LENSES.
GRADES TO MEDIUM DARK GRAY CLAYEY SHALE; BELOW 16.7';
SLIGHTLY WEATHERED

SHALE: MEDIUM DARK GRAY; THINLY LAMINATED; VERY CALCAREOUS;
CLAYEY, FOSSILIFEROUS; NUMEROUS LIMESTONE FRAGMENTS.

PLATTSMOUTH MEMBER
LIMESTONE: LIGHT GRAY; FINE-GRAINED; MEDIUM BEDDED; SHALEY;
FOSSILIFEROUS, FRESH, INTERBEDDED WITH SHALE; MEDIUM DARK
GRAY; CALCAREOUS; THINLY LAMINATED PARTINGS TO MEDIUM BEDS;
BEDS DISTORTED;
0.2' CLAY SEAM AT 39.4'
0.7' CLAYEY SHALE LAYER FROM 45.0' TO 45.7'
0.3' CLAY SEAM FROM 45.9 TO 46.2'

60° CLOSED FRACTURE 0.2' LONG AT 49.8'
ISOLATED VUG 0.04' DIAMETER AT 50.6'

HEEBNER MEMBER
SHALE: GRAYISH-BLACK; THINLY LAMINATED; SLIGHTLY CALCAREOUS;
CARBOACEOUS; INTERBEDDED WITH TRACE OF MEDIUM DARK GRAY
LIMESTONE STRINGERS.
LENSES LESS THAN 0.02' THICK BELOW 54.2'

LEAVENWORTH MEMBER
LIMESTONE: MEDIUM GRAY; FINE-GRAINED; MEDIUM BEDDED.

SNYDERVILLE MEMBER
SHALE: MEDIUM DARK GRAY; THIN WAVY LAMINATIONS;
CALCAREOUS.
0.5' LIGHT GRAY SHALEY LIMESTONE LAYER WITH 0.01' DIAMETER
VUGS FROM 57.4' TO 57.9'
0.06' LIGHT GRAY SHALEY LIMESTONE WITH 0.01' VUGS AT 60.5'



BORING COMPLETED AT 62.5 FEET ON 8/21/74.
1 1/2" CASING USED
GROUNDWATER LEVEL RECORDED AT 8.7 FEET ON 9/29/74.

Rev. 0

**WOLF CREEK
UPDATED SAFETY ANALYSIS REPORT**

Figure 2.5-36hh
Log of Boring ESW-1

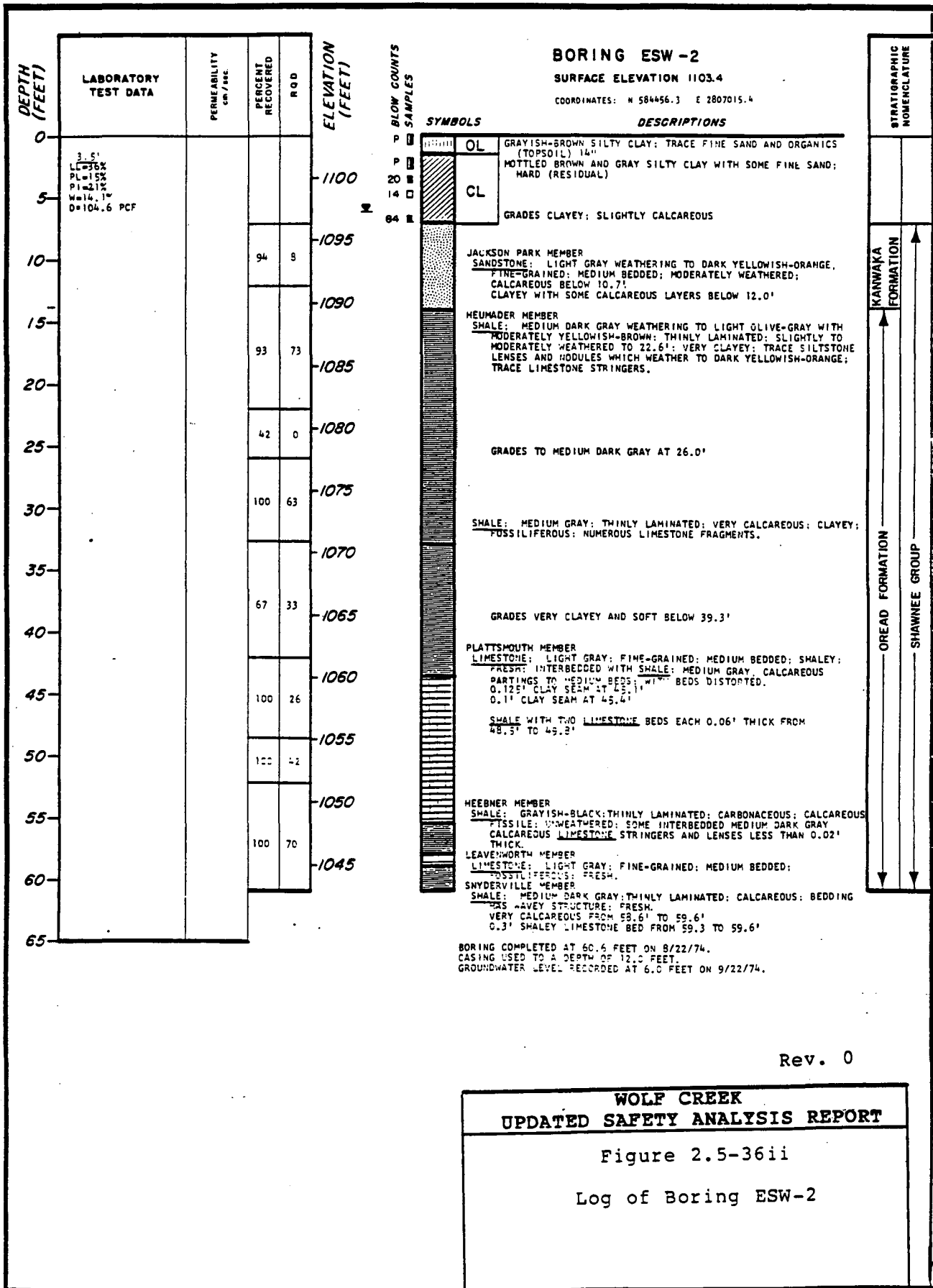

Rev. 0

**WOLF CREEK
UPDATED SAFETY ANALYSIS REPORT**

Figure 2.5-36ii

Log of Boring ESW-2

BORING ESW-3

SURFACE ELEVATION 1101.0

COORDINATES: N 584266.8 E 2807014.8

DEPTH (FEET)	LABORATORY TEST DATA	PERMEABILITY cm/sec	PERCENT RECOVERED	RQD	ELEVATION (FEET)
0					1100
5					1095
10			82	0	1090
15			100	85	1085
20					1080
25			100	91	1075
30					1070
35			100	80	1065
40					1060
45			96	32	1055
50			99	30	1050
55					1045
60			100	80	1045
65					

BLOW COUNTS
SAMPLES

SYMBOLS	DESCRIPTIONS
OL	DARK BROWN SILTY CLAY WITH SOME FINE SAND AND ORGANICS; (TOPSOIL) 13"
CL	MOTTLED GRAY AND BROWN SILTY CLAY WITH SOME FINE SAND; STIFF (RESIDUAL)

JACKSON PARK MEMBER
SANDSTONE: LIGHT GRAY WEATHERING TO DARK YELLOWISH-ORANGE; FINE-GRAINED; MEDIUM BEDDED; SLIGHTLY TO MODERATELY WEATHERED; VERY CALCAREOUS BELOW 10.5'

HEUMADER MEMBER
SHALE: MEDIUM DARK GRAY WEATHERING TO LIGHT OLIVE-GRAY AND MODERATE YELLOWISH-BROWN; THINLY LAMINATED; VERY CLAYEY; MODERATELY TO SLIGHTLY WEATHERED; TRACE LIMESTONE STRINGERS LESS THAN 0.03' THICK; TRACE SILTSTONE LENSES AND NODULES WHICH WEATHER TO MODERATE REDDISH-BROWN AND DARK YELLOWISH-ORANGE. GRADES LIGHT OLIVE-GRAY BELOW 16.2' SLIGHTLY WEATHERED BELOW 17.2'

SHALE: MEDIUM DARK GRAY; THINLY LAMINATED; VERY CALCAREOUS; FOSSILIFEROUS; NUMEROUS LIMESTONE FRAGMENTS; TRACE LIMESTONE LENSES.

PLATTSMOUTH MEMBER
LIMESTONE: LIGHT GRAY; FINE-GRAINED; MEDIUM BEDDED; SHALEY; FOSSILIFEROUS; FRESH; INTERBEDDED WITH SHALE; MEDIUM DARK GRAY; CALCAREOUS; PARTINGS TO MEDIUM BEDS; WITH SHALE BEDS DISTORTED.
0.1' CLAY SEAM AT 44.3'
0.1' CLAY SEAM AT 44.5'
0.15' CLAY SEAM AT 46.9'
0.5' SHALE FROM 47.2' TO 47.7'
0.2' CLAY SEAM AT 47.9'

45° FRACTURE ALONG CLAY PARTING AT 51.2'

HEEBNER MEMBER
SHALE: GRAYISH-BLACK; THINLY LAMINATED; CARBONACEOUS; CALCAREOUS; FISSILE; WITH SOME MEDIUM DARK GRAY LIMESTONE STRINGERS AND LENSES LESS THAN 0.02' THICK BELOW 56.0'

LEAVENWORTH MEMBER
LIMESTONE: LIGHT GRAY; FINE-GRAINED; MEDIUM BEDDED; FOSSILIFEROUS; FRESH.

SNYDERVILLE MEMBER
SHALE: MEDIUM GRAY; THINLY LAMINATED; VERY CALCAREOUS; WAVY LAMINATIONS.
.15' MEDIUM DARK GRAY LIMESTONE AT 58.7'; CALCAREOUS BELOW 58.8'

STRATIGRAPHIC NOMENCLATURE

KANWAKA FORMATION

OREAD FORMATION

SHAWNEE GROUP

BORING COMPLETED AT 60.9' FEET ON 8/23/74.
NO CASING USED.
GROUNDWATER LEVEL RECORDED AT 6.0 FEET ON 10/3/74.

Rev. 0

WOLF CREEK
UPDATED SAFETY ANALYSIS REPORT

Figure 2.5-36jj
Log of Boring ESW-3

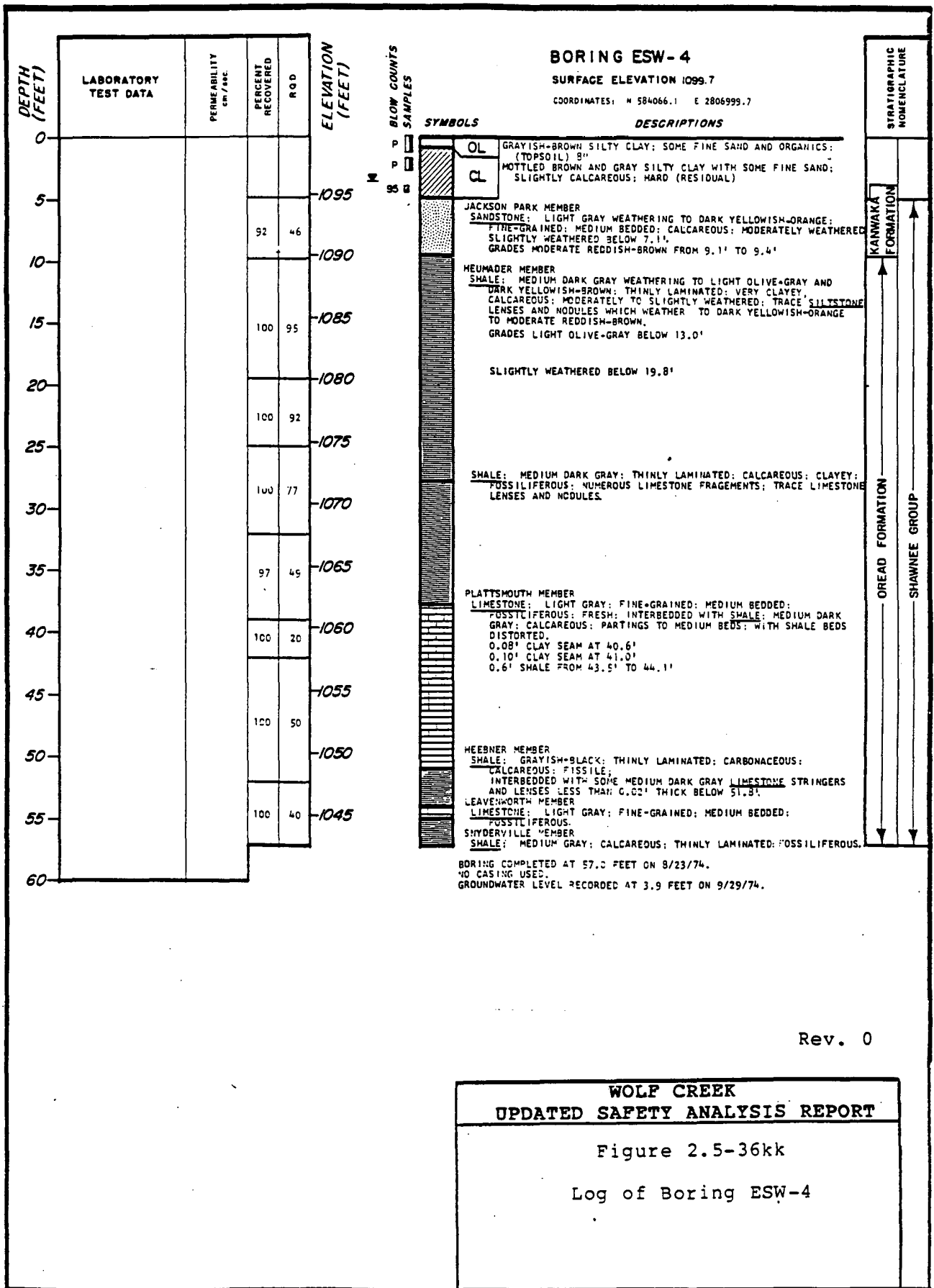

Rev. 0

WOLF CREEK
UPDATED SAFETY ANALYSIS REPORT

Figure 2.5-36kk

Log of Boring ESW-4

BORING ESW-5

SURFACE ELEVATION 1099.4

COORDINATES: N 59°065.4 E 2807249.7

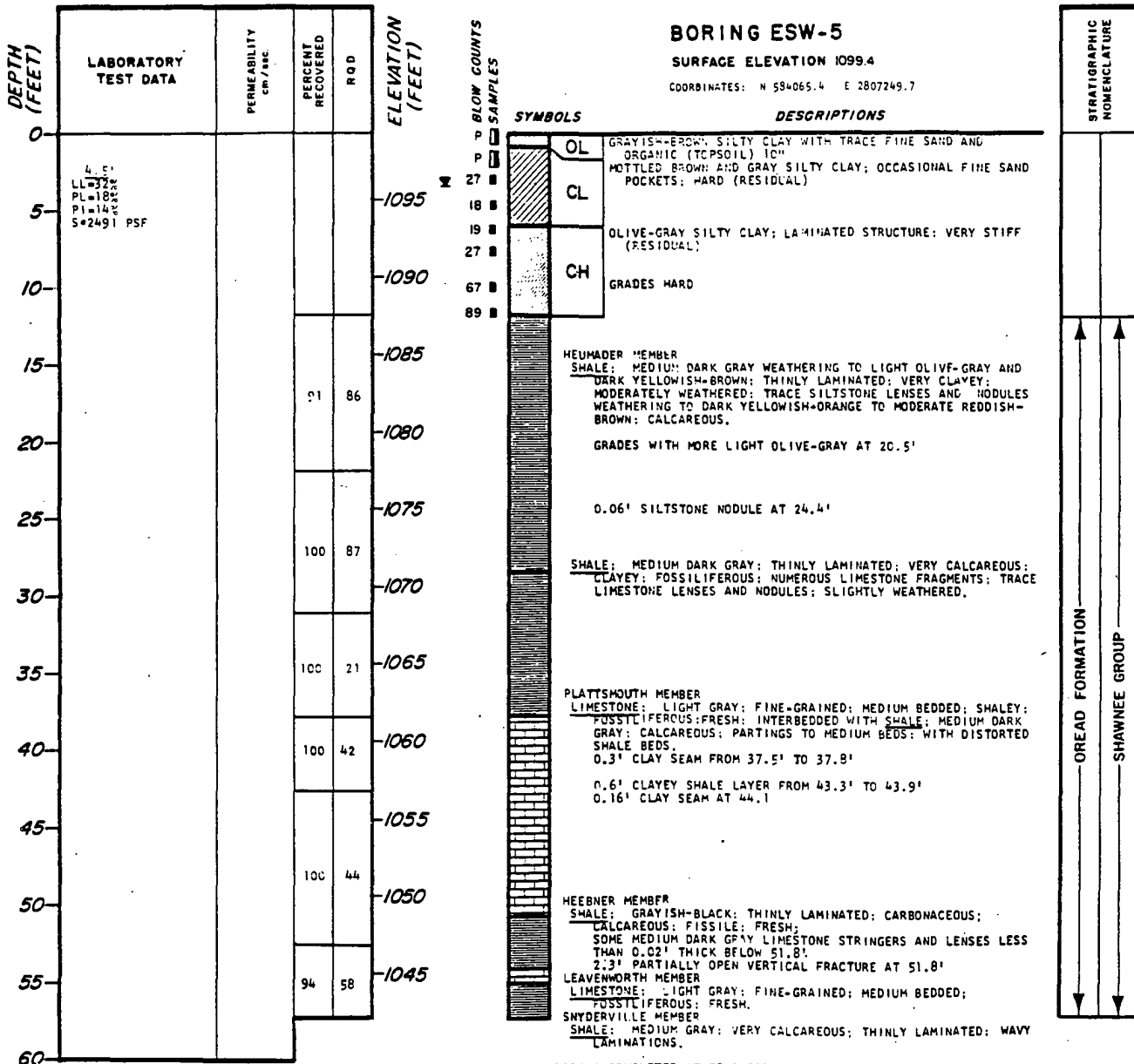

BORING COMPLETED AT 57.2 FEET ON 8/26/74.
NO CASING USED.
GROUNDWATER LEVEL RECORDED AT 3.7 FEET ON 9/29/74.

Rev. 0

WOLF CREEK UPDATED SAFETY ANALYSIS REPORT

Figure 2.5-3611

Log of Boring ESW-5

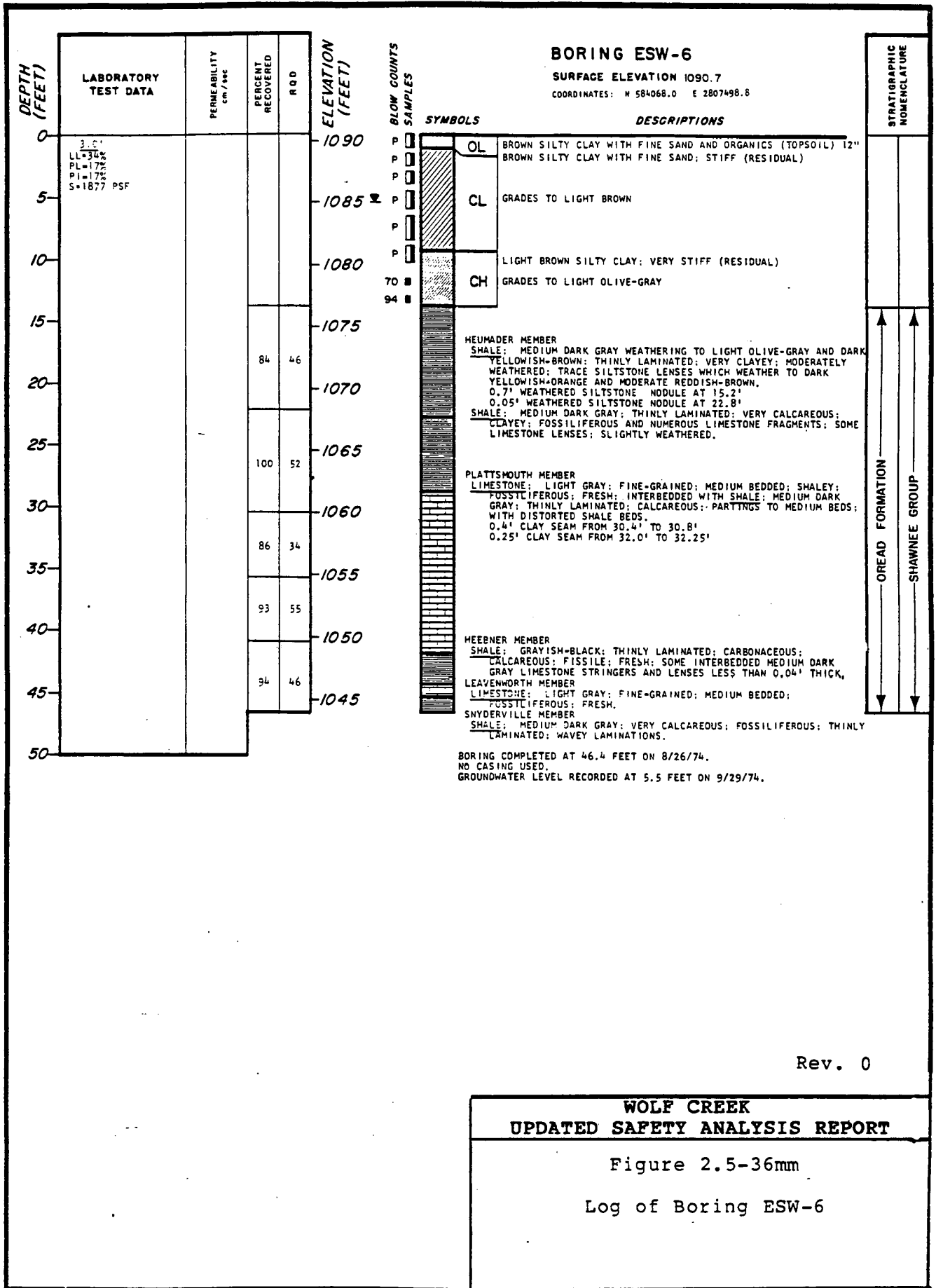

BORING ESW-7

SURFACE ELEVATION 1095.5

COORDINATES: N 584066.3 E 2807751.7

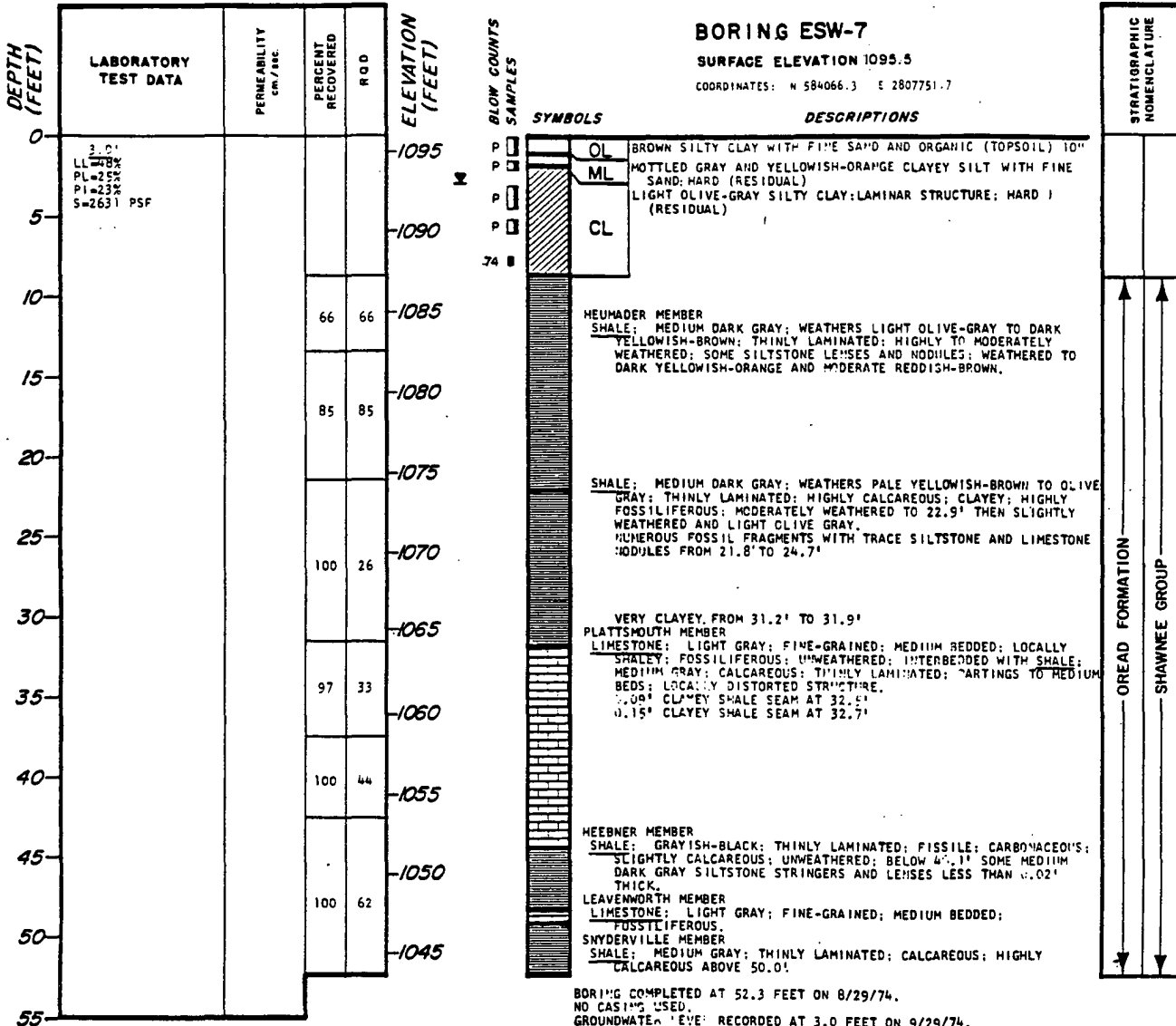

BORING COMPLETED AT 52.3 FEET ON 8/29/74.
NO CASING USED.
GROUNDWATER LEVEL RECORDED AT 3.0 FEET ON 9/29/74.

Rev. 0

WOLF CREEK
UPDATED SAFETY ANALYSIS REPORT

Figure 2.5-36nn
Log of Boring ESW-7

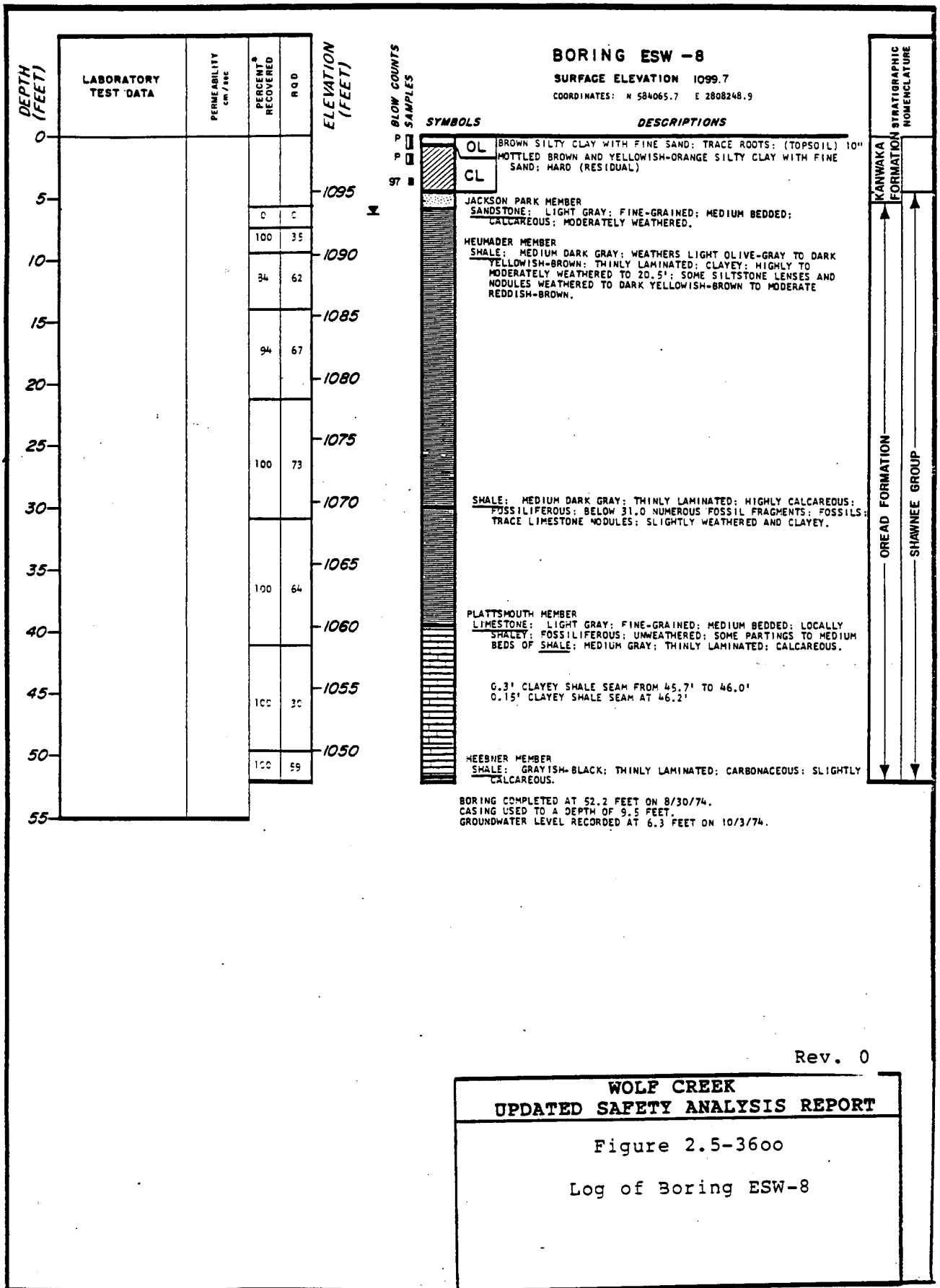

Rev. 0

WOLF CREEK
UPDATED SAFETY ANALYSIS REPORT

Figure 2.5-3600
 Log of Boring ESW-8

DEPTH (FEET)	LABORATORY TEST DATA	PERMEABILITY cm/sec	PERCENT RECOVERED	RQD	ELEVATION (FEET)
0					1090
5	6.6 S=27/14 PSF				1085
10					1080
15					1075
20			92	70	1070
25					1065
30			100	78	1060
35					1055
40			100	49	1050
45					1045
50			100	57	

BORING ESW-9
 SURFACE ELEVATION 1093.0
 COORDINATES: N 584065.9 E 2808499.2

BLOW COUNTS
 P 0
 P 0
 P 0
 42
 20
 54
 47
 119

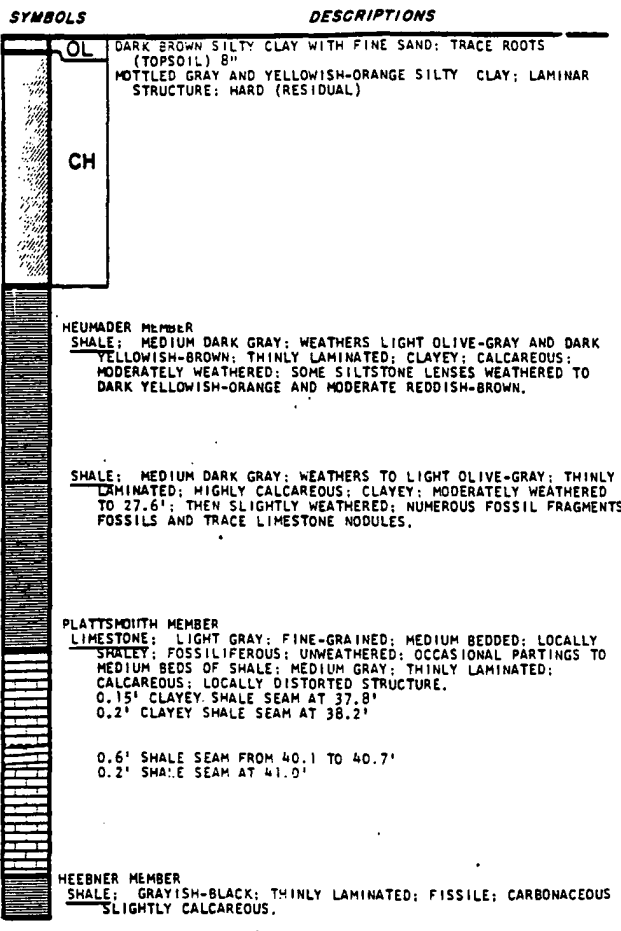

STRATIGRAPHIC NOMENCLATURE

OREAD FORMATION

SHAWNEE GROUP

BORING COMPLETED AT 49.6 FEET ON 8/30/74.
 NO CASING USED.
 GROUNDWATER LEVEL WAS RECORDED AT 5.6 FEET ON 9/29/74.

Rev. 0

WOLF CREEK
UPDATED SAFETY ANALYSIS REPORT

Figure 2.5-36pp
 Log of Boring ESW-9

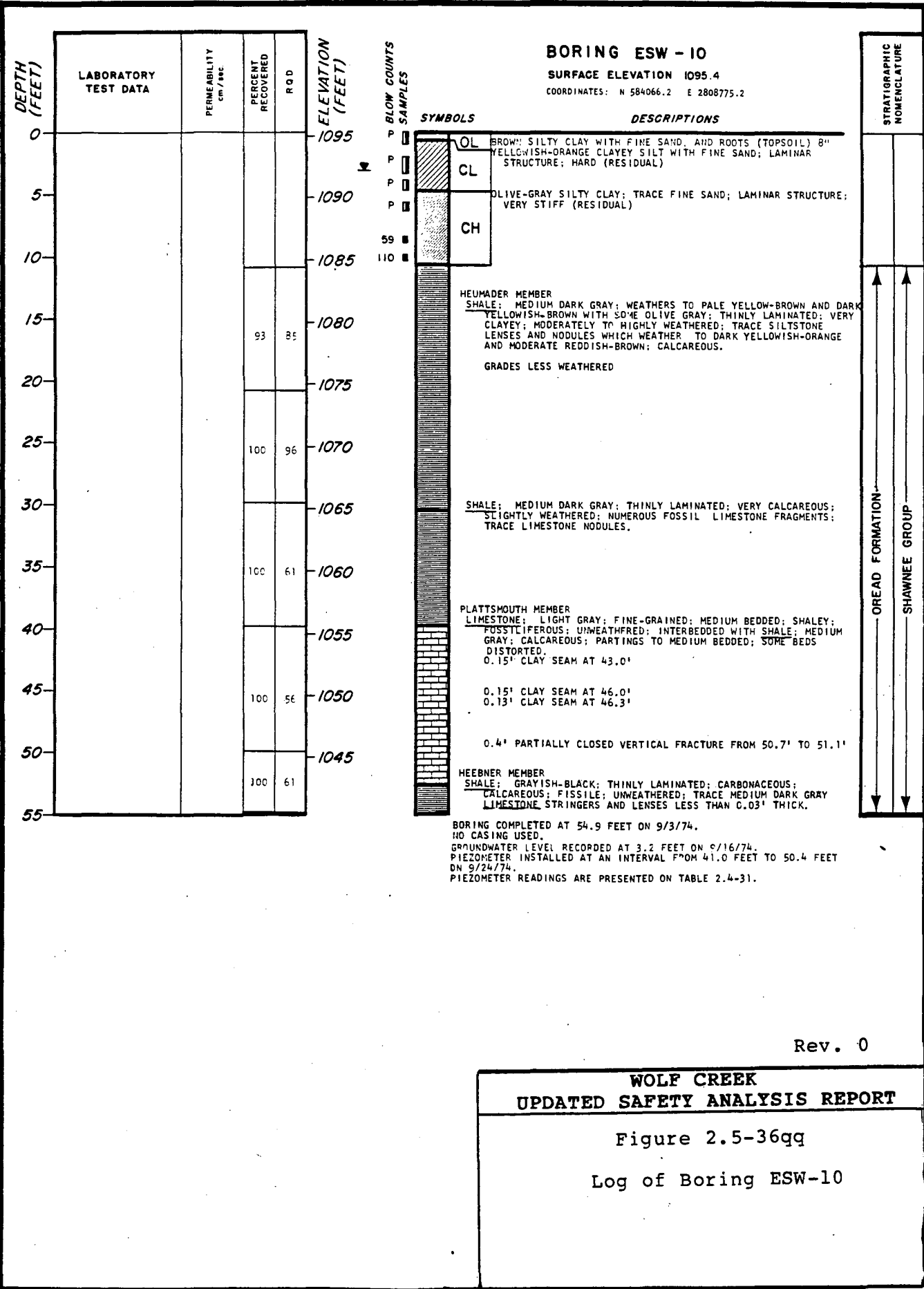

Rev. 0

WOLF CREEK
UPDATED SAFETY ANALYSIS REPORT

Figure 2.5-36qq

Log of Boring ESW-10

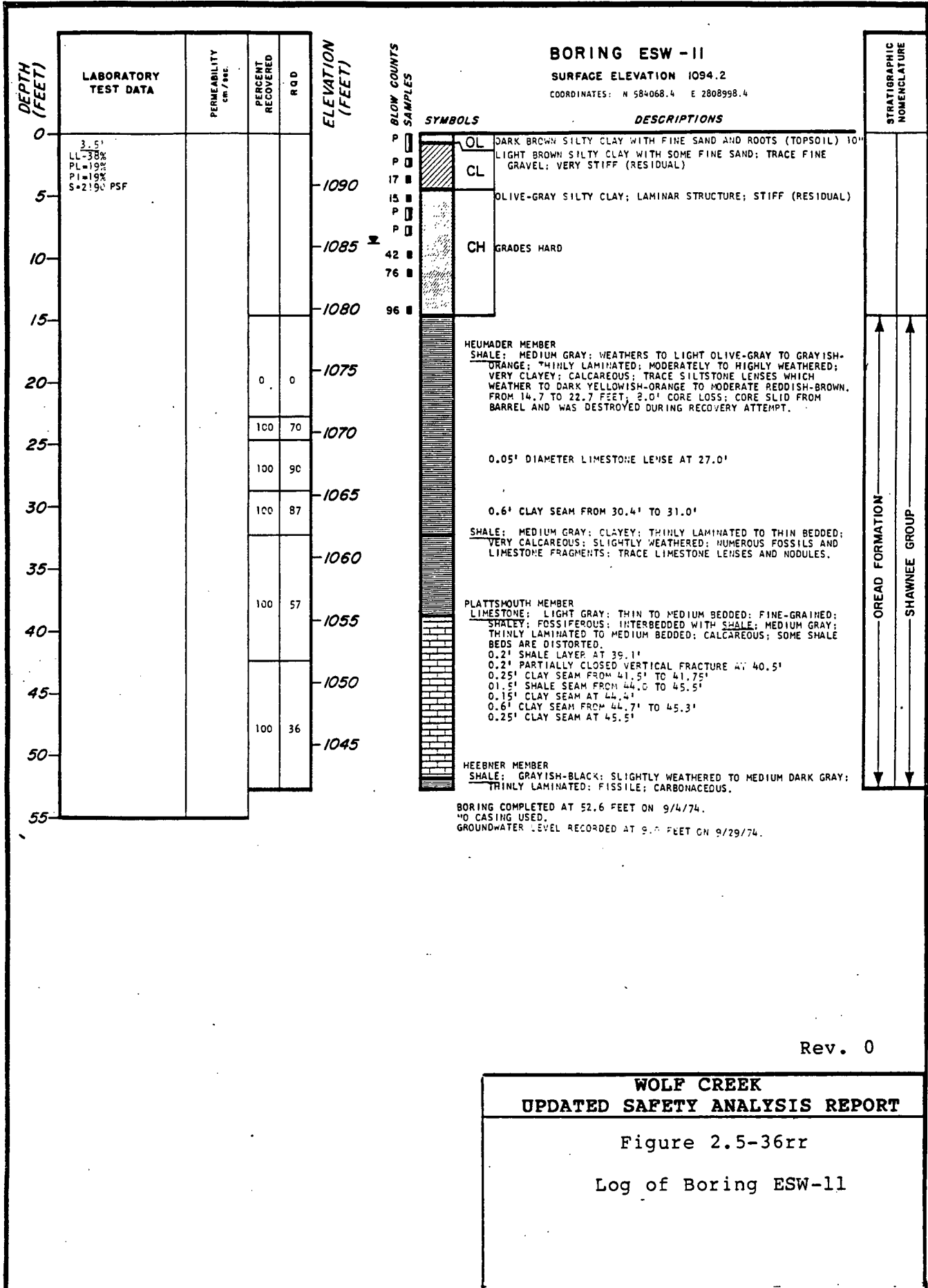

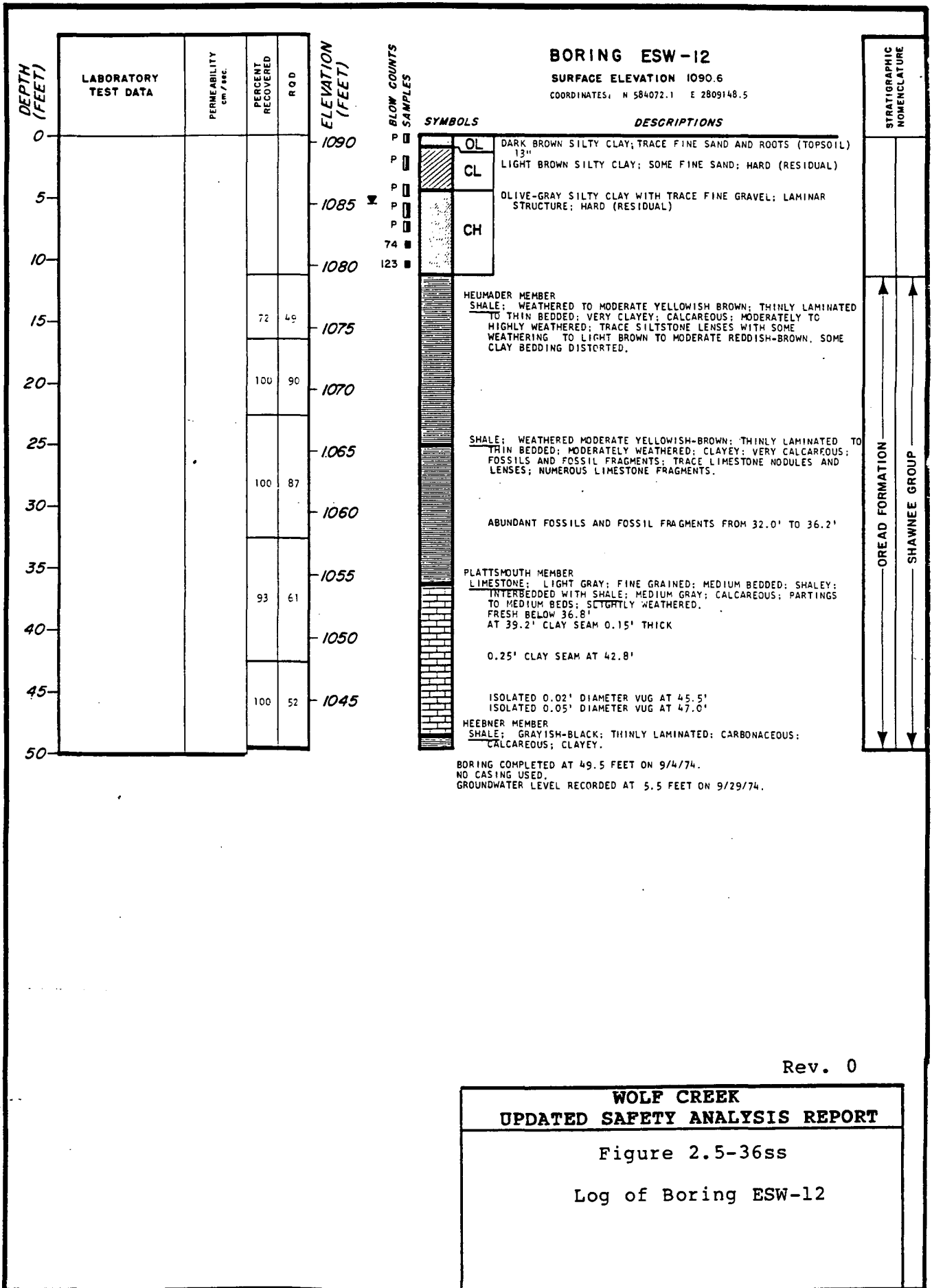

BORING ESW-12

SURFACE ELEVATION 1090.6

COORDINATES: N 584072.1 E 2809148.5

DEPTH (FEET)	LABORATORY TEST DATA	PERMEABILITY cm/sec.	PERCENT RECOVERED	ROD	ELEVATION (FEET)
0					1090
5					1085
10					1080
15			72	49	1075
20			100	90	1070
25					1065
30			100	87	1060
35					1055
40			93	61	1050
45			100	52	1045
50					

BLOW COUNTS
SAMPLES

P 13"
P
P
P
74
123

SYMBOLS

OL	DARK BROWN SILTY CLAY; TRACE FINE SAND AND ROOTS (TOPSOIL)
CL	LIGHT BROWN SILTY CLAY; SOME FINE SAND; HARD (RESIDUAL)
CH	OLIVE-GRAY SILTY CLAY WITH TRACE FINE GRAVEL; LAMINAR STRUCTURE; HARD (RESIDUAL)

DESCRIPTIONS

HEUMADER MEMBER
SHALE; WEATHERED TO MODERATE YELLOWISH BROWN; THINLY LAMINATED TO THIN BEDDED; VERY CLAYEY; CALCAREOUS; MODERATELY TO HIGHLY WEATHERED; TRACE SILTSTONE LENSES WITH SOME WEATHERING TO LIGHT BROWN TO MODERATE REDDISH-BROWN. SOME CLAY BEDDING DISTORTED.

SHALE; WEATHERED MODERATE YELLOWISH-BROWN; THINLY LAMINATED TO THIN BEDDED; MODERATELY WEATHERED; CLAYEY; VERY CALCAREOUS; FOSSILS AND FOSSIL FRAGMENTS; TRACE LIMESTONE NODULES AND LENSES; NUMEROUS LIMESTONE FRAGMENTS.

ABUNDANT FOSSILS AND FOSSIL FRAGMENTS FROM 32.0' TO 36.2'

PLATTSMOUTH MEMBER
LIMESTONE; LIGHT GRAY; FINE GRAINED; MEDIUM BEDDED; SHALEY; INTERBEDDED WITH SHALE; MEDIUM GRAY; CALCAREOUS; PARTINGS TO MEDIUM BEDS; SLIGHTLY WEATHERED.
FRESH BELOW 36.8'
AT 39.2' CLAY SEAM 0.15' THICK

0.25' CLAY SEAM AT 42.8'

ISOLATED 0.02' DIAMETER VUG AT 45.5'
ISOLATED 0.05' DIAMETER VUG AT 47.0'

HEEBNER MEMBER
SHALE; GRAYISH-BLACK; THINLY LAMINATED; CARBONACEOUS; CALCAREOUS; CLAYEY.

STRATIGRAPHIC NOMENCLATURE

OREAD FORMATION

SHAWNEE GROUP

BORING COMPLETED AT 49.5 FEET ON 9/4/74.
NO CASING USED.
GROUNDWATER LEVEL RECORDED AT 5.5 FEET ON 9/29/74.

Rev. 0

WOLF CREEK
UPDATED SAFETY ANALYSIS REPORT

Figure 2.5-36ss

Log of Boring ESW-12

BORING ESW-13

SURFACE ELEVATION 1078.8

COORDINATES: N 583819.1 E 2809583.9

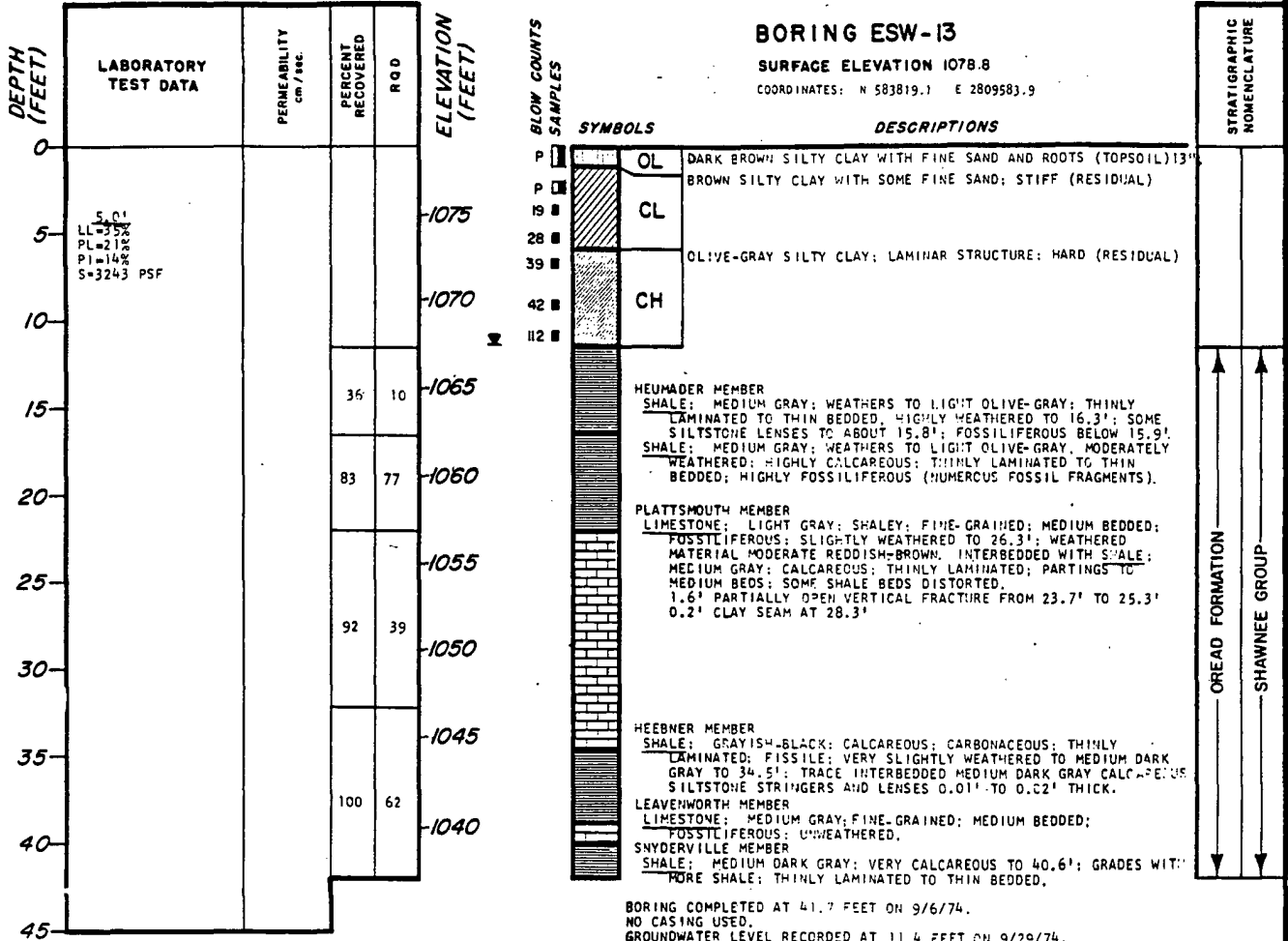

BORING COMPLETED AT 41.7 FEET ON 9/6/74.
NO CASING USED.
GROUNDWATER LEVEL RECORDED AT 11.4 FEET ON 9/29/74.

Rev. 0

**WOLF CREEK
UPDATED SAFETY ANALYSIS REPORT**

Figure 2.5-36tt

Log of Boring ESW-13

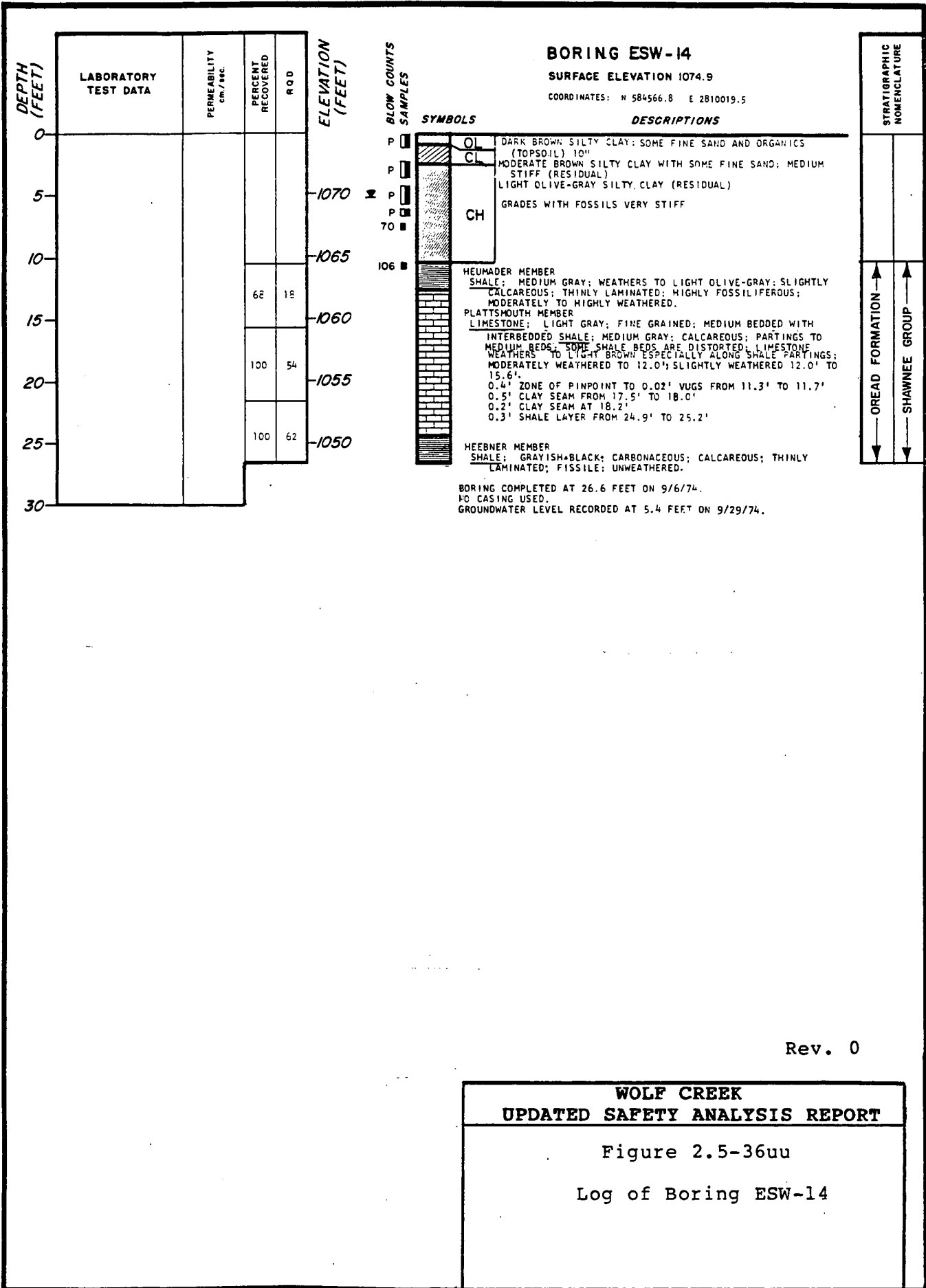

Rev. 0

WOLF CREEK
UPDATED SAFETY ANALYSIS REPORT

Figure 2.5-36uu
 Log of Boring ESW-14

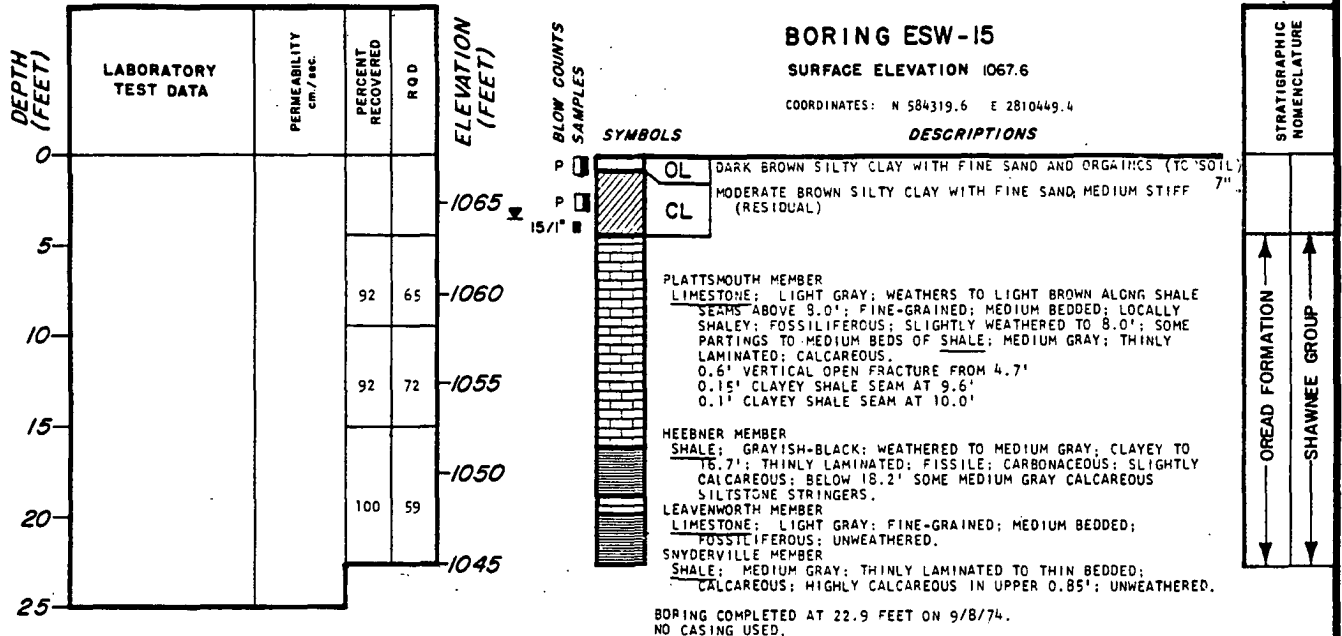

Rev. 0

WOLF CREEK
UPDATED SAFETY ANALYSIS REPORT

Figure 2.5-36vv
 Log of Boring ESW-15

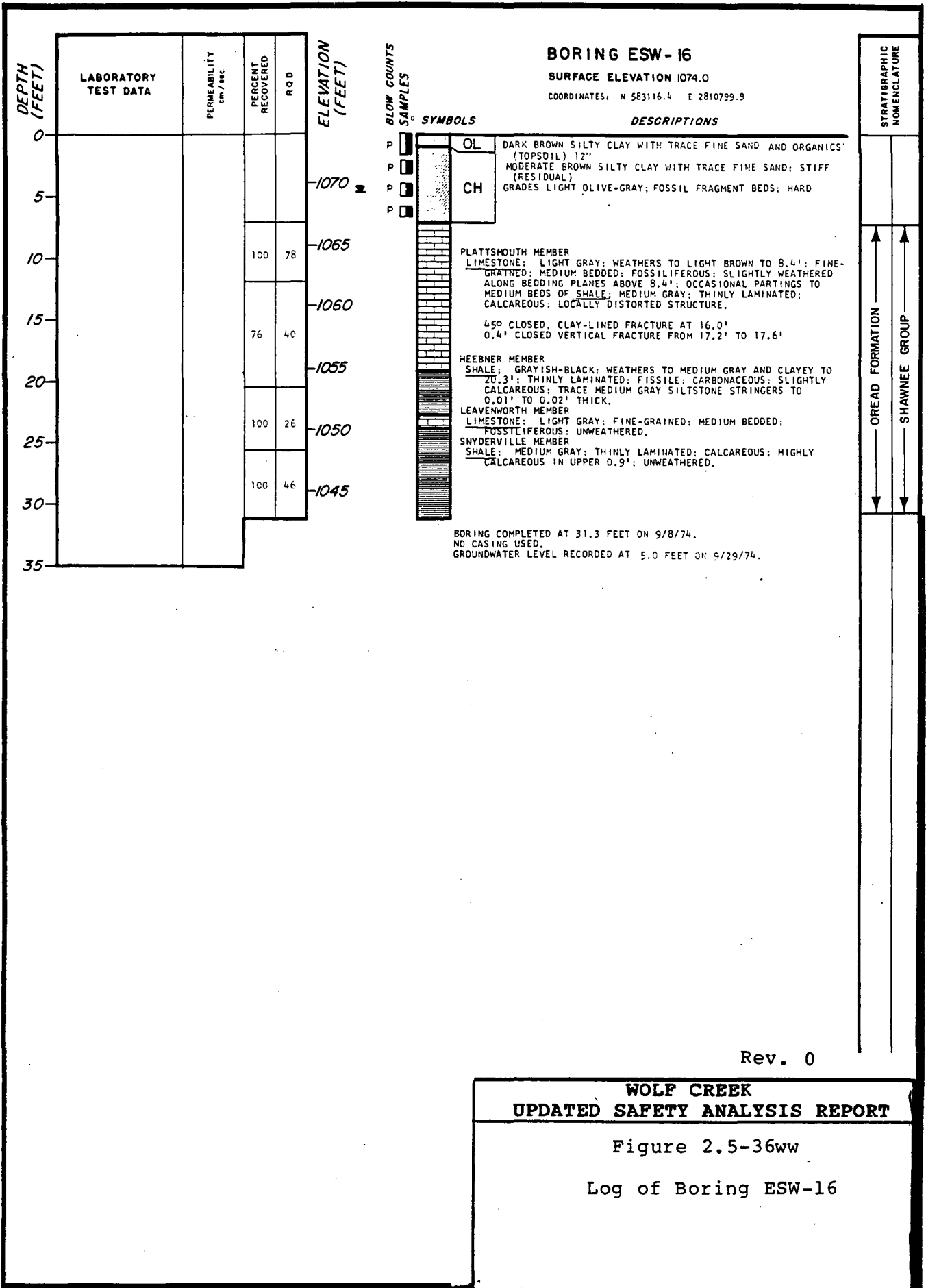

Rev. 0

WOLF CREEK
UPDATED SAFETY ANALYSIS REPORT

Figure 2.5-36ww
 Log of Boring ESW-16

DEPTH (FEET)	LABORATORY TEST DATA	PERMEABILITY cm./sec.	PERCENT RECOVERED	RQD	ELEVATION (FEET)
0	2.0' LL=60% PL=13% PI=4% S=3249 PSF				-1075
5					-1070
10			98	44	-1065
15			100	53	-1060
20					-1055
25			100	66	-1050
30					-1045
35			100	39	-1040
40					

BORING ESW-17
 SURFACE ELEVATION 1076.4
 COORDINATES: N 582816.9 E 2811304.2

BLOW COUNTS
 SAMPLES

SYMBOLS	DESCRIPTIONS
OL	DARK BROWN SILTY CLAY WITH TRACE FINE SAND AND ORGANICS (TOPSOIL) 19"
CH	MODERATE BROWN SILTY CLAY WITH SOME COARSE SAND; STIFF (RESIDUAL) GRADES TO DARK YELLOWISH-ORANGE
	PLATTSMOUTH MEMBER LIMESTONE: LIGHT GRAY; FINE-GRAINED; MEDIUM BEDDED; LOCALLY SILTY; FOSSILIFEROUS; SLIGHTLY WEATHERED TO 8.0'; OCCASIONAL PARTINGS TO MEDIUM BEDS OF SHALE; MEDIUM GRAY; CALCAREOUS; LOCALLY DISTORTED STRUCTURE. 0.12' CLAYEY SHALE LAYER FROM 9.5' 0.15' CLAYEY SHALE LAYER FROM 9.8' 4.50' CLOSED SHALE LINED FRACTURE AT 16.2'
	HEEBNER MEMBER SHALE: GRAYISH-BLACK; THINLY LAMINATED; FISSILE; WEATHERS MEDIUM GRAY; CLAYEY TO 20.2'; CARBONACEOUS; SLIGHTLY CALCAREOUS; TRACE MEDIUM GRAY SILTSTONE STRUCTURES AND LENSES 0.01' TO 0.03' THICK BELOW 21.4'.
	LEAVENWORTH MEMBER LIMESTONE: LIGHT GRAY; FINE-GRAINED; MEDIUM BEDDED; FOSSILIFEROUS; UNWEATHERED.
	SNYDERVILLE MEMBER SHALE: MEDIUM DARK GRAY; THINLY LAMINATED; CALCAREOUS. GRADES MEDIUM BLUISH-GRAY BELOW 26.1'
	GRADES VERY CLAYEY; GREENISH-GRAY, MOTTLED WITH VERY LIGHT GRAY FROM 33.8' TO 34.8'
	TORONTO MEMBER LIMESTONE: VERY LIGHT GRAY; FINE-GRAINED; MEDIUM BEDDED; FOSSILIFEROUS; SOME GREENISH-GRAY SHALE PARTINGS. GRADES HIGHLY FOSSILIFEROUS WITH 20% PINPOINT TO 0.01' VUGS BELOW 39.2'

STRATIGRAPHIC NOMENCLATURE

↑ OREAD FORMATION
 ↓ SHAWNEE GROUP

BORING COMPLETED AT 39.9 FEET ON 9/9/74.
 NO CASING USED.
 GROUNDWATER LEVEL RECORDED AT 22.7 FEET ON 9/29/74.

Rev. 0

WOLF CREEK
UPDATED SAFETY ANALYSIS REPORT

Figure 2.5-36xx
 Log of Boring ESW-17

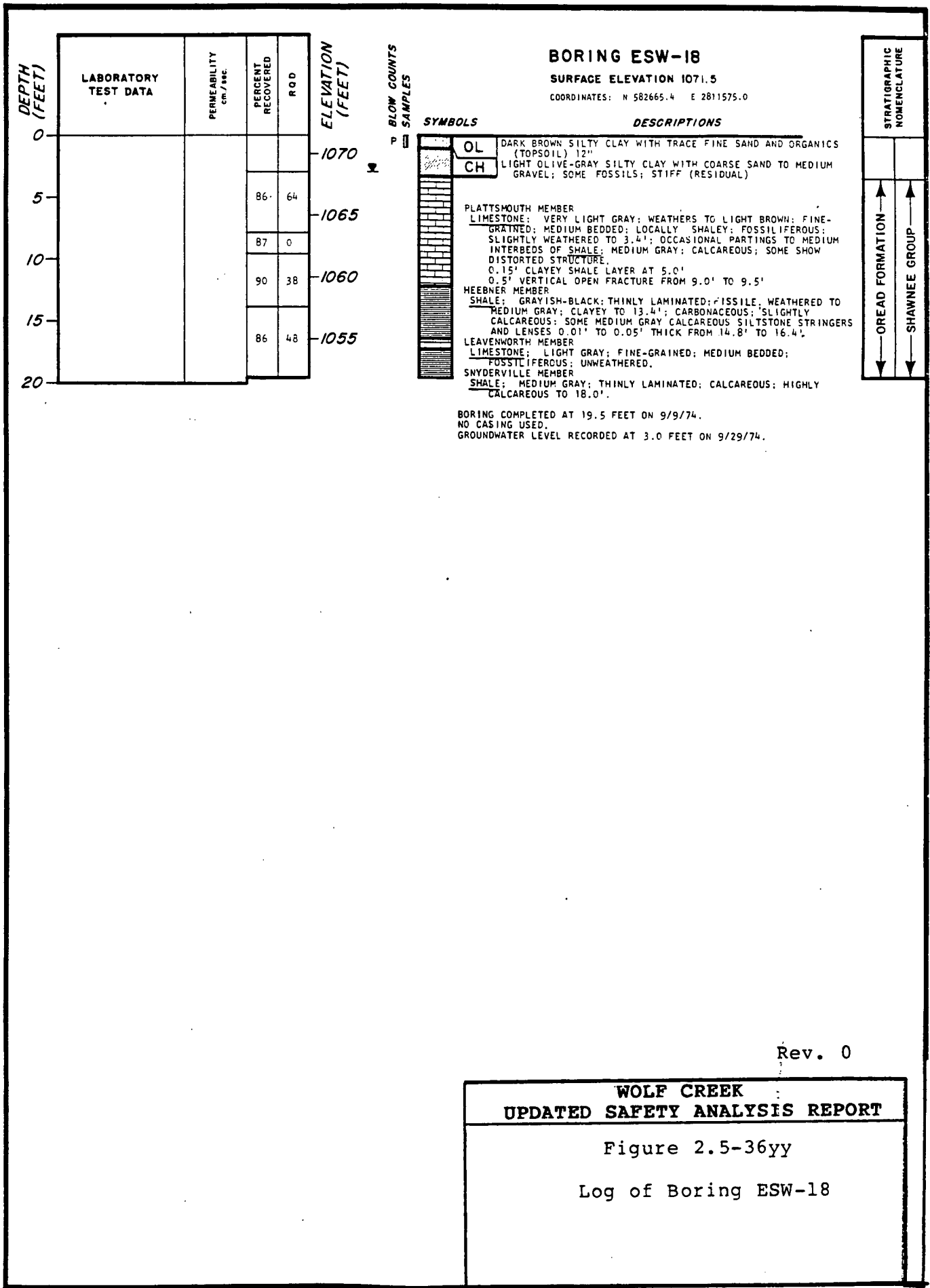

Rev. 0

WOLF CREEK
UPDATED SAFETY ANALYSIS REPORT

Figure 2.5-36yy

Log of Boring ESW-18

BORING ESW-19

SURFACE ELEVATION 1077.7

COORDINATES: N 582519.9 E 2811829.9

DEPTH (FEET)	LABORATORY TEST DATA	PERMEABILITY cm./SEC.	PERCENT RECOVERED	RQD	ELEVATION (FEET)
0					1075
5					1070
10			90	33	1065
15			98	82	1060
20			98	60	1055
25			88	62	1050
30			94	52	1045
35			92	50	
40					

BLOW COUNTS
 39 8
 27

SYMBOLS



DESCRIPTIONS

OL BROWN SILTY CLAY WITH FINE TO MEDIUM SAND AND ORGANICS (TOPSOIL) 13"
CH DARK YELLOW SILTY CLAY WITH TRACE FINE SAND; (RESIDUAL)
 GRADES WITH FOSSILS AT 2.8'
 GRADES TO LIGHT OLIVE-GRAY AT 5.5'

PLATTSBURGH MEMBER
 LIMESTONE: LIGHT GRAY; FINE-GRAINED; LOCALLY SHALEY; FOSSILIFEROUS; THIN TO MEDIUM BEDDED; SLIGHTLY WEATHERED ALONG SHALE SEAMS IN UPPER 5.0'; OCCASIONAL 0.005' TO 0.7' INTERBEDS OF SHALE; MEDIUM DARK GRAY; FOSSILIFEROUS; CALCAREOUS; THINLY LAMINATED; MODERATELY WEATHERED TO ORANGISH-BROWN CLAY IN UPPER 5.0'.
 UNWEATHERED BELOW 11.4'
 0.2' CLAYEY SHALE LAYER AT 11.7'
 0.7' CLAYEY SHALE LAYER FROM 12.1 TO 12.8'

HEEBNER MEMBER
 SHALE: GRAYISH-BLACK; CARBONACEOUS; CLAYEY AND CALCAREOUS IN UPPER 0.6'; THINLY LAMINATED; FISSILE; OCCASIONAL THIN LENSES OF LIMESTONE; MEDIUM DARK GRAY; FINE-GRAINED.

LEAVENWORTH MEMBER
 LIMESTONE: MEDIUM LIGHT GRAY; FINE-GRAINED; FOSSILIFEROUS; MEDIUM BEDDED.

SNYDERVILLE MEMBER
 SHALE: MEDIUM DARK GRAY; CALCAREOUS; THINLY LAMINATED; LOCALLY DISTORTED STRUCTURE.
 60° HEALED FRACTURE FROM 25.0'

GRADES LIGHT GREENISH-GRAY; WITH LIMESTONE GRANULES AND NODULES BELOW 32.2'

TORONTO MEMBER
 LIMESTONE: LIGHT GRAY; FINE TO MEDIUM-GRAINED; SHALEY; THIN TO MEDIUM BEDDED; 5% PINPOINT VUGS; NUMEROUS SHALE PARTINGS GREENISH-GRAY; CLAYEY; DISTORTED STRUCTURE.

STRATIGRAPHIC NOMENCLATURE

OREAD FORMATION

SHAWNEE GROUP

BORING COMPLETED AT 36.8 FEET ON 9/10/74.
 NO CASING USED.
 GROUNDWATER LEVEL RECORDED AT 0.0 FEET ON 9/29/74.

Rev. 0

WOLF CREEK
UPDATED SAFETY ANALYSIS REPORT

Figure 2.5-36zz
 Log of Boring ESW-19

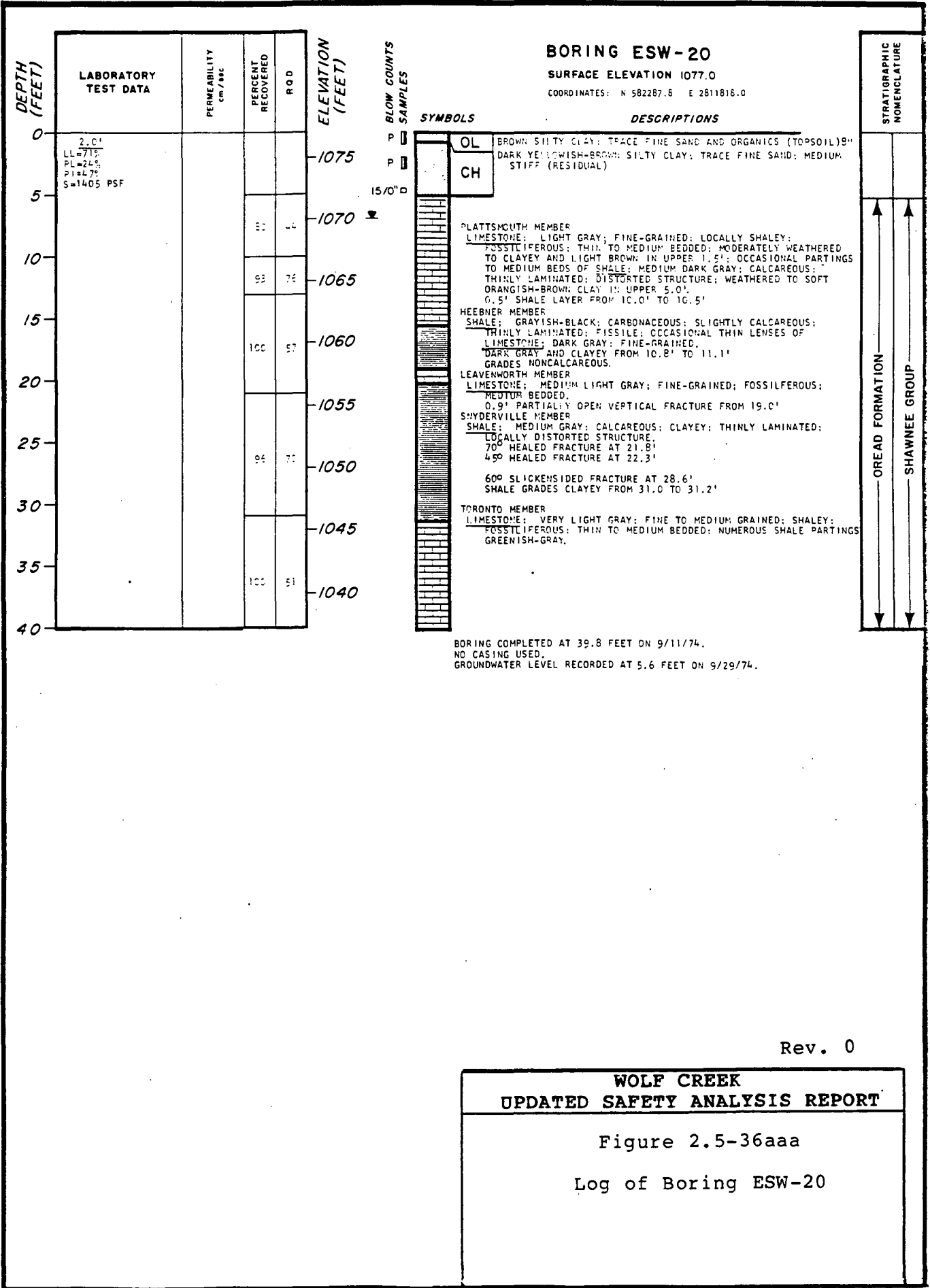

Rev. 0

WOLF CREEK
UPDATED SAFETY ANALYSIS REPORT

Figure 2.5-36aaa
 Log of Boring ESW-20

BORING ESW-21

SURFACE ELEVATION 1089.8

COORDINATES: N 584353.1 E 2809148.7

DEPTH (FEET)	LABORATORY TEST DATA	PERMEABILITY cm./sec.	PERCENT RECOVERED	R Q D	ELEVATION (FEET)
0					
5					-1085
10					-1080
15			83	74	-1075
20					-1070
25					-1065
30			71	69	-1060
35			100	39	-1055
40			100	57	-1050
45			98	86	-1045
50					

BLOW COUNTS
SAMPLES

SYMBOLS

DESCRIPTIONS

P
P
P
P
64
88

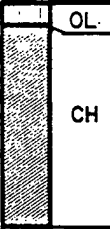

OL DARK BROWN SILTY CLAY WITH FINE SAND AND ORGANICS (TOPSOIL) 10"
LIGHT BROWN SILTY CLAY WITH TRACE FINE SAND; STIFF (RESIDUAL)

CH GRADES TO LIGHT OLIVE-GRAY VERY STIFF

HEUMADER MEMBER

SHALE; MEDIUM GRAY; WEATHERS TO MEDIUM YELLOWISH-BROWN; CLAYEY; THINLY LAMINATED; CALCAREOUS; MODERATELY WEATHERED; TRACE ORANGE SILTSTONE LENSES. GRADES SLIGHTLY WEATHERED

SHALE; MEDIUM GRAY; SLIGHTLY WEATHERED TO MEDIUM YELLOWISH-BROWN; HIGHLY CALCAREOUS; FOSSILIFEROUS; THINLY LAMINATED; SOME LIMESTONE GRANULES AND NODULES.

GRADES WITH FOSSILS AND LIMESTONE GRANULES AND NODULES

PLATTSMOUTH MEMBER

LIMESTONE; LIGHT GRAY; FINE-GRAINED; LOCALLY SHALEY; FOSSILIFEROUS; THIN TO MEDIUM BEDDED; SLIGHTLY WEATHERED ALONG SHALE LAYERS IN UPPER 3.0'; OCCASIONAL PARTINGS TO MEDIUM BEDS OF SHALE; MEDIUM DARK GRAY; CALCAREOUS; THINLY LAMINATED; MODERATELY WEATHERED TO SOFT ORANGE CLAY IN UPPER 3.0'; LOCALLY DISTORTED STRUCTURE. 0.2' SHALE LAYER AT 35.9' 0.2' SHALE LAYER AT 36.4'

0.03' CALCITE LINED SOLUTION CHANNEL AT 41.5'

HEEBNER MEMBER

SHALE; GRAYISH-BLACK; DARK GRAY AND CLAYEY IN UPPER 1.0'; SLIGHTLY CALCAREOUS IN UPPER PART; CARBONACEOUS; THINLY LAMINATED; FISSILE; SOME THIN LENSES AND INTERBEDS OF LIMESTONE; DARK GRAY; FINE-GRAINED.

LEAVENWORTH MEMBER

LIMESTONE; MEDIUM LIGHT GRAY; FINE-GRAINED; FOSSILIFEROUS; MEDIUM BEDDED.

BORING COMPLETED AT 46.4 FEET ON 9/17/74.
NO CASING USED.
GROUNDWATER LEVEL RECORDED AT 5.4 FEET ON 10/3/74.

STRATIGRAPHIC
NOMENCLATURE



Rev. 0

**WOLF CREEK
UPDATED SAFETY ANALYSIS REPORT**

Figure 2.5-36bbb

Log of Boring ESW-21

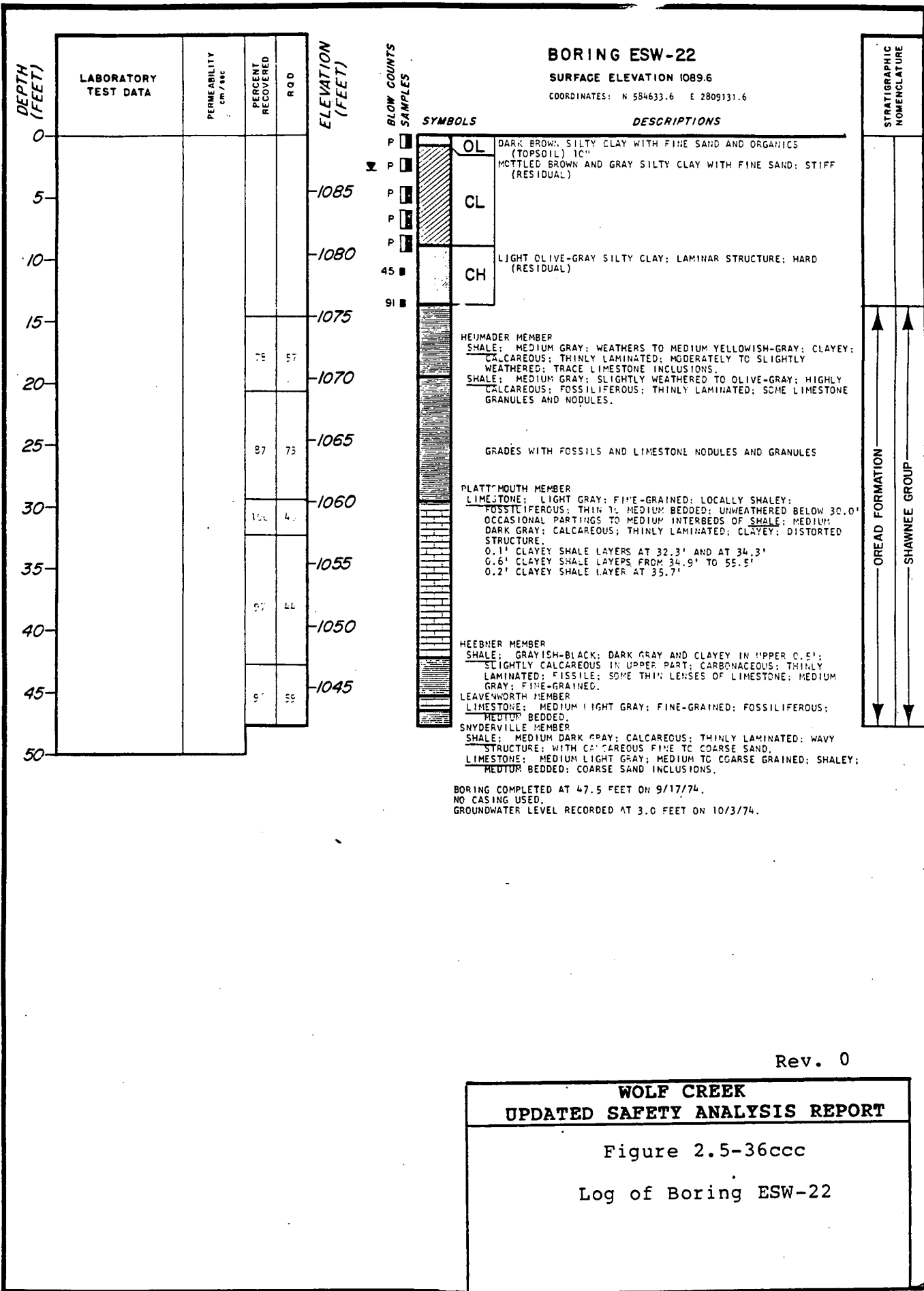

Rev. 0

WOLF CREEK
UPDATED SAFETY ANALYSIS REPORT

Figure 2.5-36ccc
 Log of Boring ESW-22

BORING ESW-23

SURFACE ELEVATION 1092.8

COORDINATES: N 584676.1 E 2809409.5

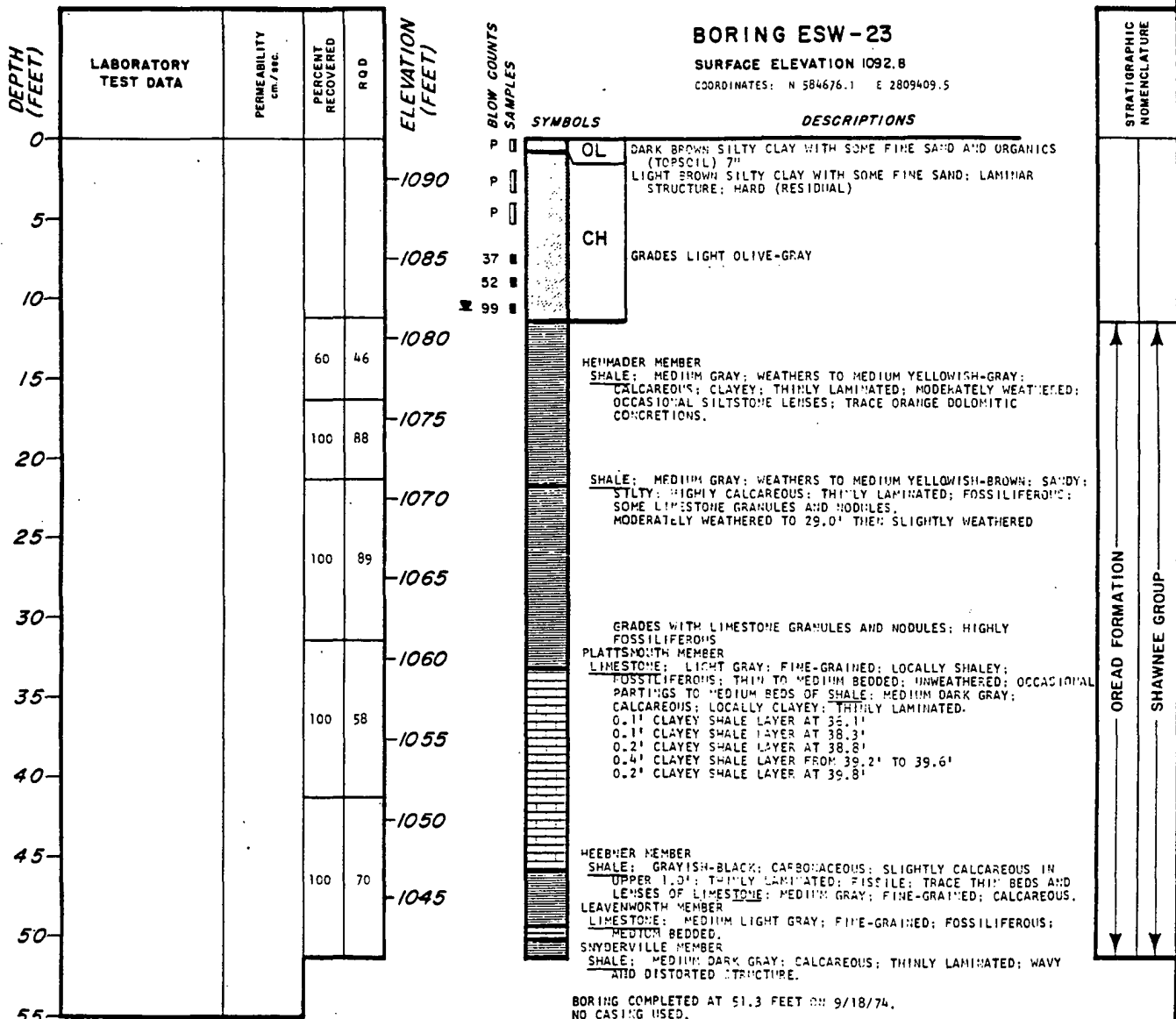

BORING COMPLETED AT 51.3 FEET ON 9/18/74.
NO CASING USED.
GROUNDWATER LEVEL RECORDED AT 10.3 FEET ON 9/22/74.
PIEZOMETER INSTALLED AT AN INTERVAL FROM 35.3 FEET TO 44.1 FEET ON 9/25/74.
PIEZOMETER READINGS ARE PRESENTED ON TABLE 2.4-31.

OREAD FORMATION
SHAWNEE GROUP

Rev. 0

**WOLF CREEK
UPDATED SAFETY ANALYSIS REPORT**

Figure 2.5-36ddd
Log of Boring ESW-23

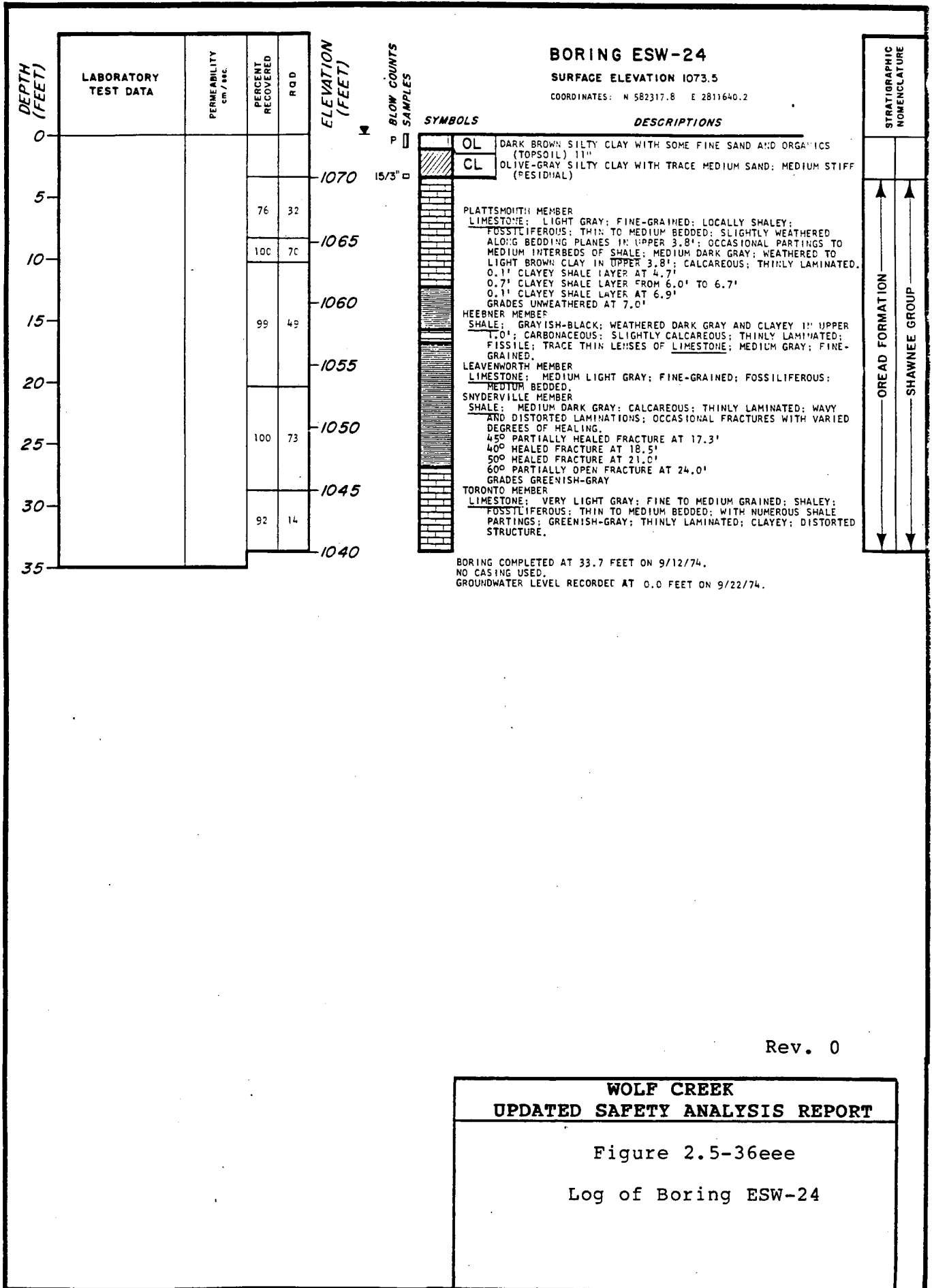

Rev. 0

WOLF CREEK
UPDATED SAFETY ANALYSIS REPORT

Figure 2.5-36eee
Log of Boring ESW-24

BORING ESW-25

SURFACE ELEVATION 1072.0

COORDINATES: N 582325.8 E 2811556.2

DEPTH (FEET)	LABORATORY TEST DATA	PERMEABILITY cm / sec	PERCENT RECOVERED	ROD	ELEVATION (FEET)
0					1070
5			90	38	1065
10			55	30	1060
15					1055
20			100	90	1050
25					1045
30			100	63	1040
35			100	20	1035
40			100	57	1030
45					1025
50			100	48	1020
55					1015
60			100	20	1010
65					1005
70			100	55	1005

SYMBOLS



DESCRIPTIONS

OL DARK BROWN SILTY CLAY WITH SOME FINE SAND AND ORGANICS (TOPSOIL) 19"

PLATTSMOUTH MEMBER
LIMESTONE: LIGHT GRAY; FINE-GRAINED; LOCALLY SHALEY; FOSSILIFEROUS; THIN TO MEDIUM BEDDED; SLIGHTLY WEATHERED ALONG BEDDING PLANES; OCCASIONAL PARTINGS OF SHALE; MEDIUM GRAY; THINLY LAMINATED; DISTORTED STRUCTURE.

HEEBER MEMBER
SHALE: GRAYISH-BLACK; WEATHERED TO DARK GRAY AND CLAYEY IN UPPER 1.8'; SLIGHTLY CALCAREOUS IN UPPER PART; CARBONACEOUS; THINLY LAMINATED; FISSILE; MODERATELY WEATHERED TO 12.0'; THEN UNWEATHERED; TRACE THIN LENSES OF LIMESTONE; MEDIUM GRAY; FINE-GRAINED.

LEAVENWORTH MEMBER
LIMESTONE: MEDIUM LIGHT GRAY; FINE-GRAINED; FOSSILIFEROUS; MEDIUM BEDDED; UNWEATHERED.

SHYDERSVILLE MEMBER
SHALE: MEDIUM GRAY; CALCAREOUS; THINLY LAMINATED; WAVY; DISTORTED LAMINATIONS; OCCASIONAL SHEAR PLANES VARIABLY HEALED.
300' HEALED FRACTURE AT 16.5'
600' HEALED FRACTURE AT 18.7'
400' PARTIALLY OPEN FRACTURE AT 21.7'
500' PARTIALLY OPEN, SLICKENSIDED FRACTURE AT 21.9'
GRADES OLIVE-GRAY

TORONTO MEMBER
LIMESTONE: VERY LIGHT GRAY; FINE TO MEDIUM GRAINED; SHALEY; FOSSILIFEROUS; THIN TO MEDIUM BEDDED; LESS THAN 5" PINPOINT WIGS; NUMEROUS SHALE PARTINGS AND THIN BEDS; GREENISH-GRAY THINLY LAMINATED.
GRADES TRACE SHALE PARTINGS

SHALEY AND HIGHLY FOSSILIFEROUS FROM 34.6' TO 35.6'
SHALE GRADES OUT

SHALE: MEDIUM OLIVE-GRAY; CLAYEY; LOCALLY CALCAREOUS; THINLY LAMINATED; SLIGHTLY FISSILE; TRACE SILT AND FINE SAND; TRACE MICACEOUS; TRACE INTERBEDS OF SILTSTONE; LIGHT GRAY; SANDY; CALCAREOUS; MICACEOUS.
GRADES MEDIUM GRAY
SILTSTONE 47' AND SHALE 60' FROM 45.6' TO 47.6'

SHALE 77' AND SILTSTONE 30' FROM 52.1' TO 53.6'

WILKINSBURG COAL BED
COAL: BLACK; SHALEY; THINLY LAMINATED.
SHALE: MEDIUM GRAY; CALCAREOUS; SILTY; THINLY LAMINATED.

AMAZONIA MEMBER
SHALE: MEDIUM GREENISH-GRAY; HIGHLY CALCAREOUS; THINLY LAMINATED; INTERBEDDED WITH LIMESTONE; LIGHT GRAY; FINE-GRAINED; SHALEY; THIN TO MEDIUM BEDS.

STRATIGRAPHIC NOMENCLATURE



(SEEPPING CONTINUED)

Rev. 0

WOLF CREEK
UPDATED SAFETY ANALYSIS REPORT

Figure 2.5-36fff (Sheet 1 of 2)

Log of Boring ESW-25

BORING ESW-25 CONT'D

DEPTH (FEET)	LABORATORY TEST DATA	PERMEABILITY cm/sec	PERCENT RECOVERED	ROD	ELEVATION (FEET)
70					1000
75			93	53	995
80					
85					

SYMBOLS



0.6' LIMESTONE FROM 71.7' TO 72.3'

IRELAND MEMBER
 SHALE: MEDIUM DARK GRAY; SLIGHTLY CALCAREOUS; THINLY LAMINATED;
 SILTY; SOME SILTSTONE THIN LENSES; MEDIUM GRAY; CALCAREOUS.

DESCRIPTIONS

BORING COMPLETED AT 81.8 FEET ON 6/16/74.
 CASING USED TO A DEPTH OF 4.6 FEET.
 GROUNDWATER LEVEL RECORDED AT 1.6 FEET ON 9/22/74.

STRATIGRAPHIC NOMENCLATURE

↑ LAWRENCE FORMATION ↑
 ↓ DOUGLAS GROUP ↓

Rev. 0

**WOLF CREEK
 UPDATED SAFETY ANALYSIS REPORT**

Figure 2.5-36fff (Sheet 2 of 2)

Log of Boring ESW-25

BORING ESW-26

SURFACE ELEVATION 1072.6

COORDINATES: N 582319.8 E 2811488.4

DEPTH (FEET)	LABORATORY TEST DATA	PERMEABILITY (cm/sec)	PERCENT RECOVERED		ELEVATION (FEET)
			PERCENT RECOVERED	R.O.D.	
0					1070
5			100	70	1065
10			100	90	1060
15			100	37	1055
20			100	68	1050
25					1045
30			100	45	
35					

BLOW COUNTS
SAMPLES

SYMBOLS



DESCRIPTIONS

DARK BROWN SILTY CLAY WITH SOME FINE SAND AND ORGANICS (TOPSOIL) 13"
 LIGHT OLIVE-GRAY SILTY CLAY WITH SOME FINE SAND; STIFF (RESIDUAL)

PLATTSBORO MEMBER
 LIMESTONE: LIGHT GRAY; FINE-GRAINED; LOCALLY SHALEY; FOSSILIFEROUS; THIN TO MEDIUM BEDDED; SLIGHTLY WEATHERED IN UPPER 3.7'; OCCASIONAL SHALE PARTINGS; MEDIUM DARK GRAY; DISTORTED STRUCTURE.

LESTER MEMBER
 SHALE: GRAYISH-BLACK; DARK GRAY AND CLAYEY IN UPPER 0.7'; CARBONACEOUS; SLIGHTLY CALCAREOUS; THINLY LAMINATED; FISSILE; TRACE THIN LENSES OF LIMESTONE; MEDIUM GRAY; FINE-GRAINED.

HEBBER MEMBER
 LIMESTONE: MEDIUM LIGHT GRAY; FINE-GRAINED; FOSSILIFEROUS; MEDIUM BEDDED.

LEAVESWORTH MEMBER
 SHALE: MEDIUM GRAY; CALCAREOUS; THINLY LAMINATED; DISTORTED AND WAVY STRUCTURE; OCCASIONAL FRACTURES.
 45° HEALED FRACTURE AT 16.5'
 90° HEALED FRACTURE AT 18.1'
 40° PARTIALLY HEALED FRACTURE AT 21.8'

SNYDERVILLE MEMBER
 GRADES MEDIUM GREENISH-GRAY

TORONTO MEMBER
 LIMESTONE: VERY LIGHT GRAY; FINE-TO MEDIUM-GRAINED; SHALEY; FOSSILIFEROUS; THIN TO MEDIUM BEDDED; 15% SHALE FILLED VUGS; HUMEROUS SHALE PARTINGS; GREENISH-GRAY; THINLY LAMINATED.

STRATIGRAPHIC NOMENCLATURE

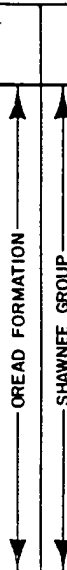

BORING COMPLETED AT 31.2 FEET ON 9/16/74.
 NO CASING USED.
 GROUNDWATER LEVEL RECORDED AT 3.9 FEET ON 9/22/74.

Rev. 0

WOLF CREEK
UPDATED SAFETY ANALYSIS REPORT

Figure 2.5-36ggg
 Log of Boring ESW-26

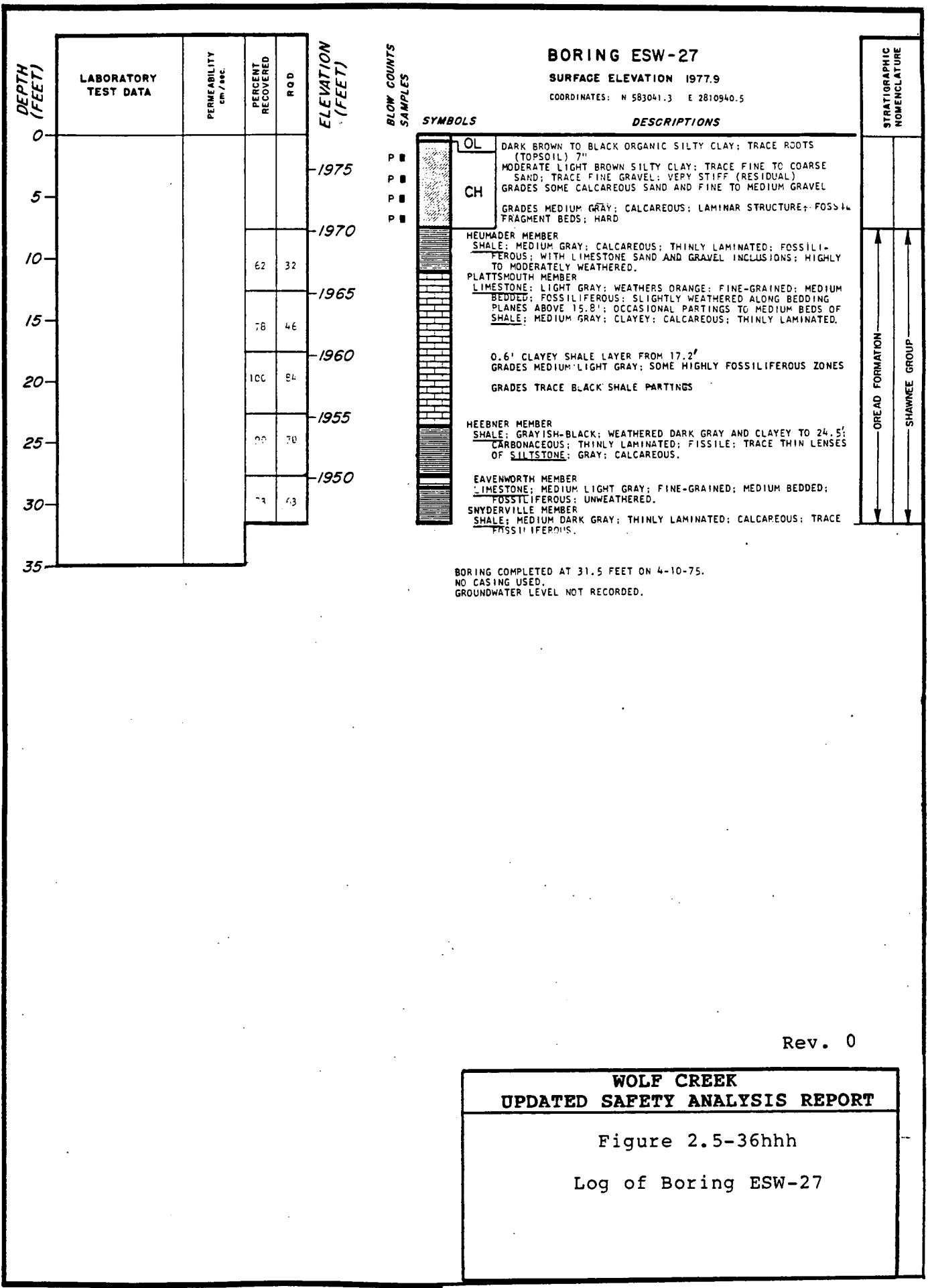

Rev. 0

WOLF CREEK
UPDATED SAFETY ANALYSIS REPORT

Figure 2.5-36hhh

Log of Boring ESW-27

BORING ESW-28

SURFACE ELEVATION 1990.2

COORDINATES: N 584250.0 E 2809150.0

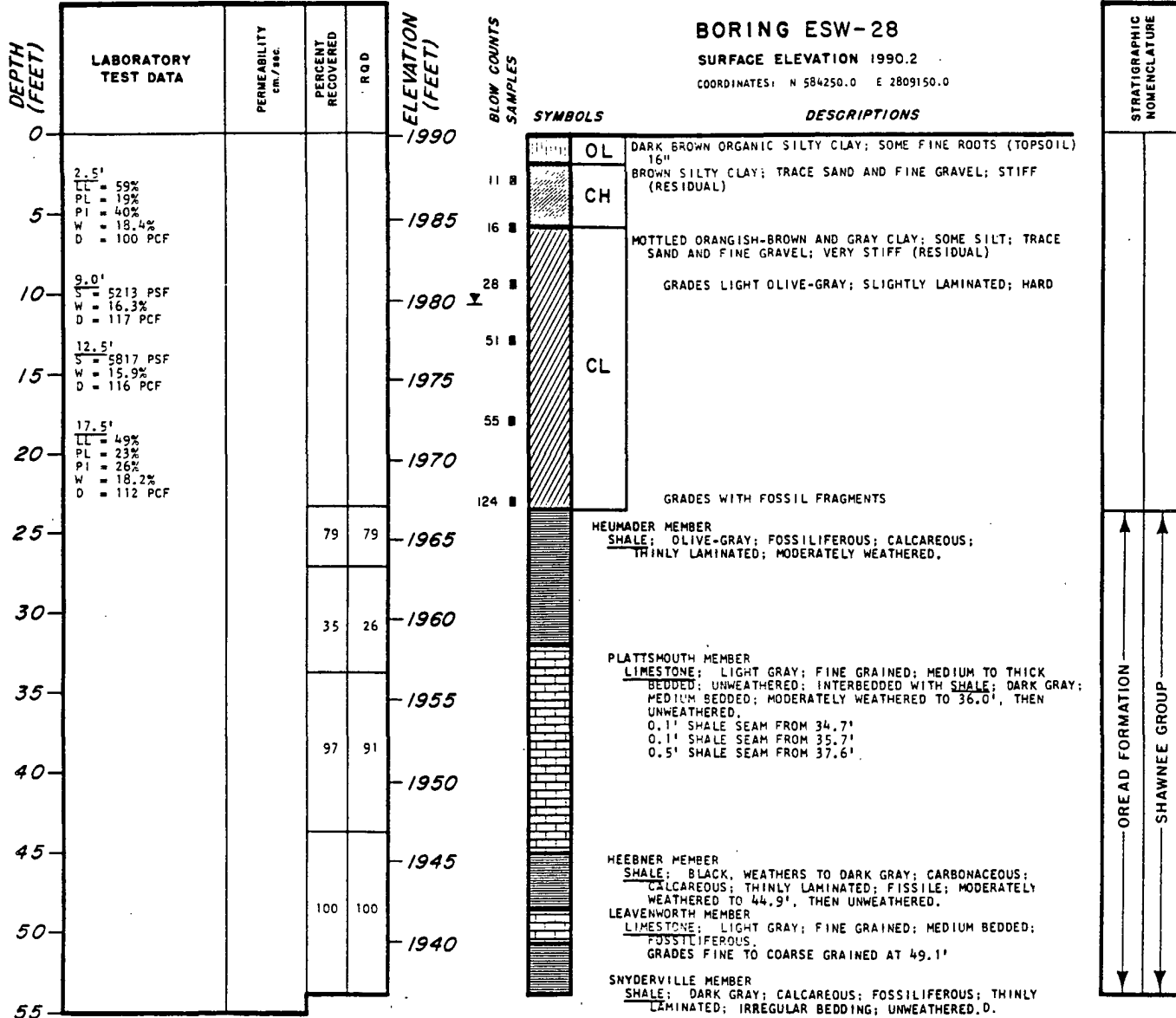

BORING COMPLETED AT 53.5 FEET ON 1/18/77.
CASING USED TO A DEPTH OF 8.0 FEET.
GROUNDWATER LEVEL RECORDED AT 10.8 FEET ON 1/20/77.

Rev. 0

WOLF CREEK
UPDATED SAFETY ANALYSIS REPORT

Figure 2.5-36iii
Log of Boring ESW-28

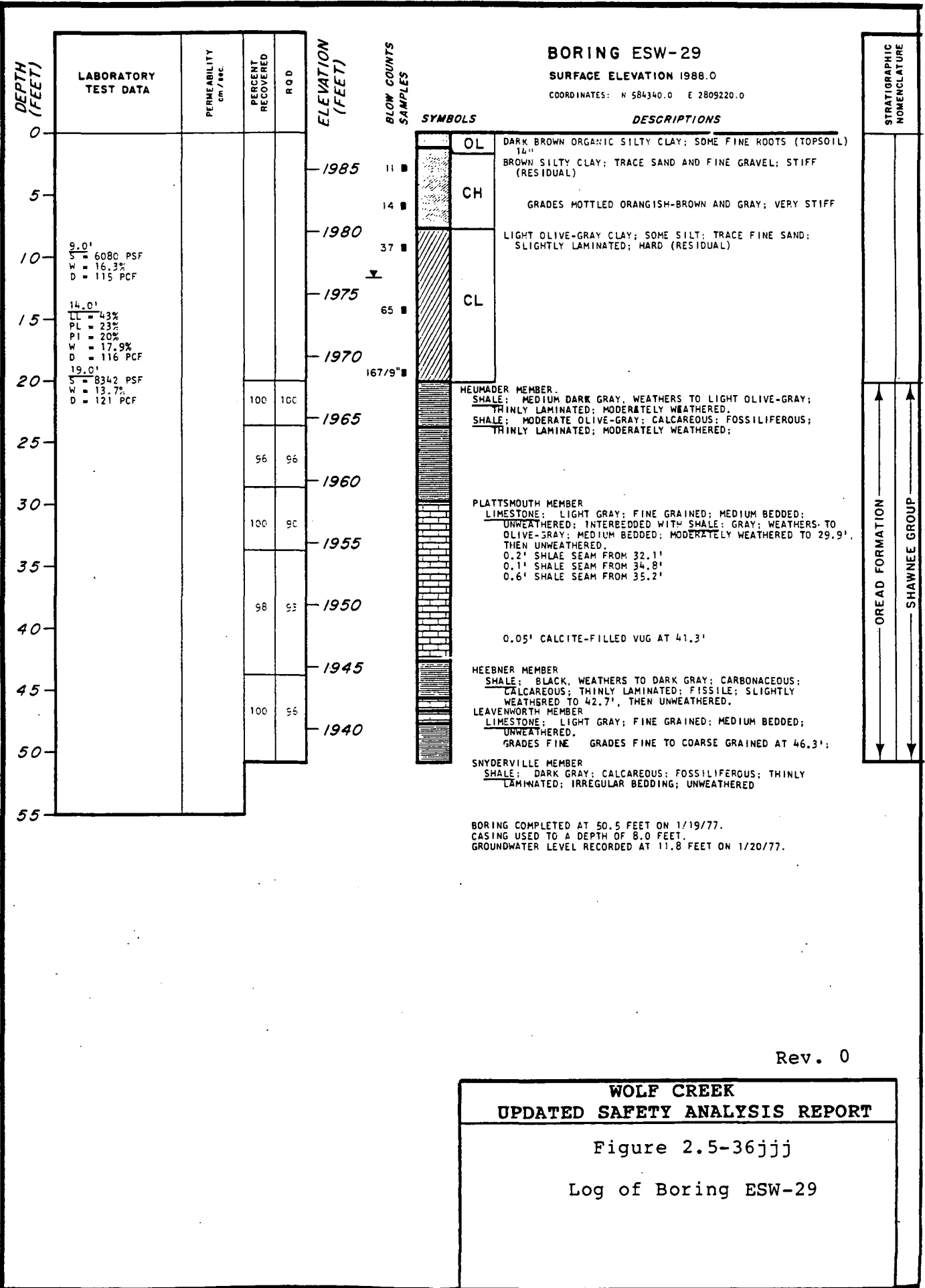

BORING ESW-30

SURFACE ELEVATION 1982.8

COORDINATES: N 584340.0 E 2809470.0

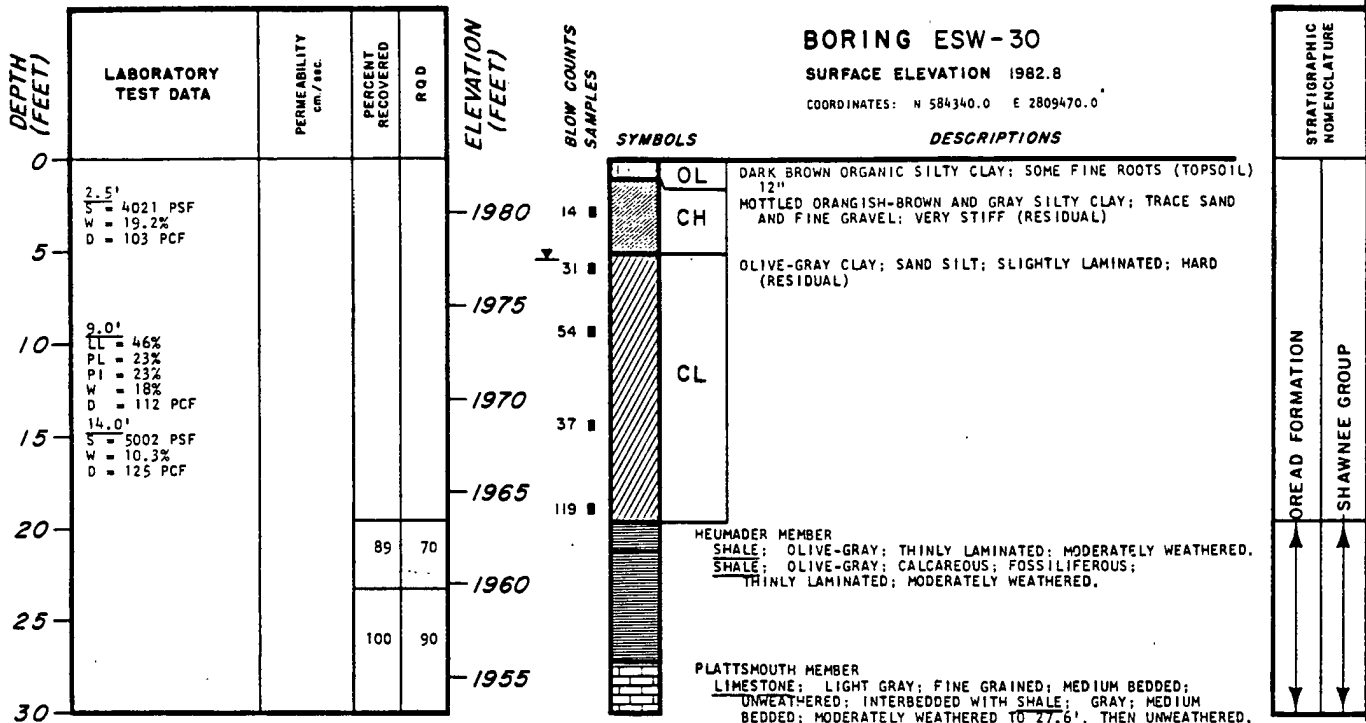

BORING COMPLETED AT 30.0 FEET ON 1/19/77.
NO CASING USED.
GROUNDWATER LEVEL RECORDED AT 5.7 FEET ON 1/20/77.

Rev. 0

WOLF CREEK
UPDATED SAFETY ANALYSIS REPORT

Figure 2.5-36kkk

Log of Boring ESW-30

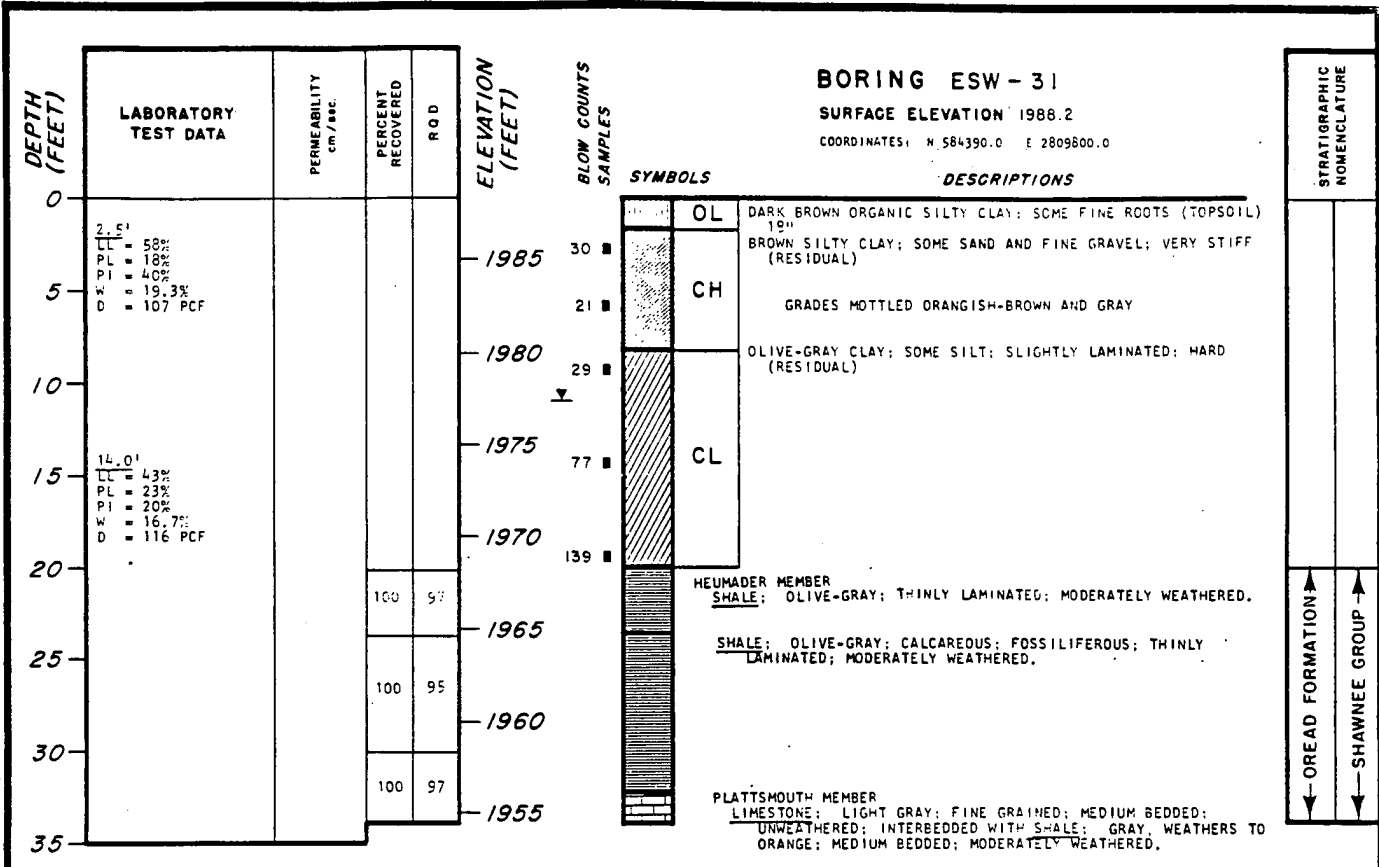

BORING COMPLETED AT 33.5 FEET ON 1/20/77.
 NO CASING USED.
 GROUNDWATER LEVEL RECORDED AT 11.0 FEET UPON COMPLETION.

Rev. 0

WOLF CREEK
UPDATED SAFETY ANALYSIS REPORT

Figure 2.5-36111

Log of Boring ESW-31

Surface Level (ft): **1998.672** Easting (ft): **99542.819017**
 Total Drill Depth (ft): **19** Northing (ft): **100004.940569**
 Inclination/Bearing: **90** Datum: **Wolf Creek Plant Datum**

Hole Id:

B-101

Sheet: 1 of 2

Depth, feet	Water Level	Drill Rate (mins)	Graphic Log	Sample Type	Sample Number	Recovery	RQD	SPT Blows per 6-inches	STRATUM DESCRIPTION	Estimated Strength (ksf)	Stratum Elev. (feet)	CLASSIFICATION					
												Total Unit Wt., pcf	Passing No. 200 Sieve, %	Water Content, %	Liquid Limit	Plastic Limit	Plasticity Index (PI)
0 - 2					SPT-1	0.7 1.5		20 10 6	SILT, with sand and clay (ML); dark reddish brown (5YR 2.5/2); dry; medium stiff to stiff; trace roots (FILL). SILT, gravelly with sand and clay (ML); dark reddish brown (5YR 2.5/2); dry; medium stiff to stiff; trace roots; large amounts of concrete and construction debris (FILL).		1998.2						
2 - 4					SPT-2	1 0.9		21 50/5.5	SAND, silty (SM); strong brown (7.5YR 5/6), mottled black (7.5 YR 2.5/1) and light gray (7.5YR 7/1), grading to light yellowish brown (10 YR 6/4); dry; hard to very stiff; 65-75% very fine grained sand; 25%-35% silt; well cemented zones; little weathered sandstone clasts; no HCl reaction.		1995.7		41	12			
4 - 6					SPT-3	0.9 0.9		22 50/4	SANDSTONE; very pale brown (10YR 7/3); dry; extremely weak (R0) to very weak (R1); moderately weathered; strong reaction to HCl; with limestone interbeds, weathered to gravel and friable.		1994.2						
6 - 8				Hard sandstone nodules in auger cuttings between 5.0 and 6.5 ft. SHALE; sandy, extremely weak to very weak (R1), moderately weathered, weak HCl reaction.									71	9			
8 - 10					SPT-4			50/5	SANDSTONE; very pale brown (10YR 7/3); dry; extremely weak (R0) to very weak (R1); moderately weathered; strong reaction to HCl; with limestone interbeds, weathered to gravel and friable.		1989.7						
10 - 14				SPT refusal criteria met. Bechtel requests augering additional 10 feet with no sampling.													
14 - 19									SHALE; dark bluish gray (5PB 4/1); dry; extremely weak (R0); completely weathered; friable; strong HCl reaction.		1984.7						

Notes:

- Terms and symbols defined on Plate 1.
- As-Built coordinates and elevation surveyed by Kaw Valley Engineering (KS-licensed).
- The SPT blow count is defined as the number of blows required for a 140 lb. auto trip safety hammer falling 30 inches to drive the split-barrel sampler 6 inches in a possible 18 inch sample interval.
- Shelby tubes used for cohesive soil sampling of dimensions 36 inches long, 3 inch outside diameter.
- HQ3 carbide Diamond bit used for rock coring.

**WOLF CREEK
 UPDATED SAFETY ANALYSIS REPORT**

Figure 2.5-36mm Rev. 28
 Log of Boring B-101
 Sheet 1 of 2

Surface Level (ft): **1998.672** Easting (ft): **99542.819017**
 Total Drill Depth (ft): **19** Northing (ft): **100004.940569**
 Inclination/Bearing: **90** Datum: **Wolf Creek Plant Datum**

Hole Id:

B-101

Sheet: 2 of 2

Depth, feet	Water Level	Drill Rate (mins)	Graphic Log	Sample Type	Sample Number	Recovery	RQD	SPT Blows per 6-inches	STRATUM DESCRIPTION	Estimated Strength (ksf)	Stratum Elev. (feet)	CLASSIFICATION					
												Total Unit Wt., pcf	Passing No. 200 Sieve, %	Water Content, %	Liquid Limit	Plastic Limit	Plasticity Index (PI)
16									SHALE; dark bluish gray (5PB 4/1); dry; extremely weak (R0); completely weathered; friable; strong HCl reaction. Grab samples from auger	500 1000 1500 2000							
18									Easy augering - Hard digging								
20											1979.7						
22																	
24																	
26																	
28																	

Notes:

- Terms and symbols defined on Plate 1.
- As-Built coordinates and elevation surveyed by Kaw Valley Engineering (KS-licensed).
- The SPT blow count is defined as the number of blows required for a 140 lb. auto trip safety hammer falling 30 inches to drive the split-barrel sampler 6 inches in a possible 18 inch sample interval.
- Shelby tubes used for cohesive soil sampling of dimensions 36 inches long, 3 inch outside diameter.
- HQ3 carbide Diamond bit used for rock coring.

**WOLF CREEK
 UPDATED SAFETY ANALYSIS REPORT**

Figure 2.5-36mm Rev. 28
 Log of Boring B-101
 Sheet 2 of 2

Surface Level (ft): **1998.63** Easting (ft): **99578.98**
 Total Drill Depth (ft): **29.5** Northing (ft): **99633.86**
 Inclination/Bearing: **90** Datum: **Wolf Creek Plant Datum**

Hole Id:

B-102

Sheet: 1 of 2

Depth, feet	Water Level	Drill Rate (mins)	Graphic Log	Sample Type	Sample Number	Recovery	RQD	SPT Blows per 6-inches	STRATUM DESCRIPTION	Estimated Strength (ksf)	Stratum Elev. (feet)	CLASSIFICATION				
												Total Unit Wt., pcf	Passing No. 200 Sieve, %	Water Content, %	Liquid Limit	Plastic Limit
0 - 2					SPT-1	1.4 1.5		5 13 16	SILT with clay and sand (ML); dark reddish brown (10R 3/2); dry; stiff to very stiff; some roots. SILT (ML); very pale brown (10YR 7/3) to light brownish gray (10YR 6/2); dry; very stiff; very fine grained, no HCl reaction.	500 1000 1500 2000	1998.1					
2 - 6					SPT-2	0.9 0.9		41 50/4	SANDSTONE; very pale brown (10YR 7/3); dry; very fine grained; extremely weak (R0); moderately weathered; sand is well-rounded; few cemented nodules but generally easily friable; no HCl reaction. Bechtel representative recommends one sample at 8.5 ft, then at 15 ft based on B-101 log.		1994.1		12			
6 - 10					SPT-3	1.4 1.5		50 50/4	SHALE, sandy; dark bluish gray (5B 5/1), very fine grained; extremely weak (R0); highly weathered; weak HCl reaction; weak bedrock structure, indistinct fine horizontal to subhorizontal laminae, very friable.		1991.6		83	11		
10 - 14					SPT-4	1.5 1.5		9 16 25	Downforce 500 lb. Auger speed 12 to 13 ft is 55 sec. Change in cuttings at 13.0 ft Auger speed 13 to 14 ft is 60 sec. Auger speed 14 to 15 ft is 60 sec.				84	12		

Notes:

- Terms and symbols defined on Plate 1.
- As-Built coordinates and elevation surveyed by Kaw Valley Engineering (KS-licensed).
- The SPT blow count is defined as the number of blows required for a 140 lb. auto trip safety hammer falling 30 inches to drive the split-barrel sampler 6 inches in a possible 18 inch sample interval.
- Shelby tubes used for cohesive soil sampling of dimensions 36 inches long, 3 inch outside diameter.
- HQ3 carbide Diamond bit used for rock coring.

**WOLF CREEK
 UPDATED SAFETY ANALYSIS REPORT**

Figure 2.5-36nnn Rev. 28
 Log of Boring B-102
 Sheet 1 of 2

Surface Level (ft): **1998.63** Easting (ft): **99578.98**
 Total Drill Depth (ft): **29.5** Northing (ft): **99633.86**
 Inclination/Bearing: **90** Datum: **Wolf Creek Plant Datum**

Hole Id:

B-102

Sheet: 2 of 2

Depth, feet	Water Level	Drill Rate (mins)	Graphic Log	Sample Type	Sample Number	Recovery	RQD	SPT Blows per 6-inches	STRATUM DESCRIPTION	Estimated Strength (ksf)	Stratum Elev. (feet)	CLASSIFICATION							
												Total Unit Wt., pcf	Passing No. 200 Sieve, %	Water Content, %	Liquid Limit	Plastic Limit	Plasticity Index (PI)		
16									SHALE, sandy; dark bluish gray (5B 5/1), very fine grained; extremely weak (R0); highly weathered; weak HCl reaction; weak bedrock structure, indistinct fine horizontal to subhorizontal laminae, very friable. Attempt shelly tube at 15 ft; refusal at 15.7 ft, discard tube. Begin wet rotary at 15.7 ft										
18					SPT-5	1.2 1.5		29 50 21/3	SPT refusal (100 total blows)										
20		0:35							MB, 25° at 20.2' MB, 0° at 20.5'										
22		1:00			CR-1	4.9 5			MB, 0° at 20.9' MB, 25° at 21.3' MB, 0°, additional breaks while transferring to core box between 21.9' and 23.5' Downpressure 250 psi										
24		0:32							MB, 0°, shoe between 24.4' and 24.7'										
26		0:35							Very weak (R1), increasingly clay sized, becoming harder										
26		0:54			SC-1					31	163		11						
28		0:36			CR-2	5 5		0.9 5	MB, 0° at 26.7' Sample B-102-SC-2-27.9-28.9 broken before wrapping MB, 0° at 27.4' MB, 0° at 27.5' MB, 0° at 27.8'										
29		0:42							SHALE; medium bluish gray (5B 5/1), very fine grained; very weak (R1); slightly to moderately weathered; strong HCl reaction. MB, 0° at 29.0'		1969.9								
		0:38									1969.1								

Notes:

- Terms and symbols defined on Plate 1.
- As-Built coordinates and elevation surveyed by Kaw Valley Engineering (KS-licensed).
- The SPT blow count is defined as the number of blows required for a 140 lb. auto trip safety hammer falling 30 inches to drive the split-barrel sampler 6 inches in a possible 18 inch sample interval.
- Shelby tubes used for cohesive soil sampling of dimensions 36 inches long, 3 inch outside diameter.
- HQ3 carbide Diamond bit used for rock coring.

**WOLF CREEK
 UPDATED SAFETY ANALYSIS REPORT**

Figure 2.5-36nnn Rev. 28
 Log of Boring B-102
 Sheet 2 of 2

Surface Level (ft): **1995.031** Easting (ft): **99592.732388**
 Total Drill Depth (ft): **29.4** Northing (ft): **99170.217696**
 Inclination/Bearing: **90** Datum: **Wolf Creek Plant Datum**

Hole Id:

B-103

Sheet: 1 of 2

Depth, feet	Water Level	Drill Rate (mins)	Graphic Log	Sample Type	Sample Number	Recovery	RQD	SPT Blows per 6-inches	STRATUM DESCRIPTION	Estimated Strength (ksf)	Stratum Elev. (feet)	CLASSIFICATION								
												Total Unit Wt., pct	Passing No. 200 Sieve, %	Water Content, %	Liquid Limit	Plastic Limit	Plasticity Index (PI)			
0																				
0.5					SPT-1	1.1 1.5		5 5	SAND, silty (SM-ML); very dark gray (5YR 3/1); dry; loose; fine grained; with grass and roots; fill. SILT, with clay (ML); gray (7.5YR 6/1) to brown (7.5YR 5/2); dry; medium stiff; very fine; weak HCl reaction		1994.6									
4					SPT-2	1.5 1.5		5 8 16	SILT, sandy (ML); light yellowish brown (10YR 6/4) to yellowish brown (10YR 5/6) and trace brown (7.5YR 4/2); dry; stiff; very fine grained; trace very fine sand; sand content decreasing with depth; no to weak HCl reaction.		1991.2		83	13						
8					SPT-3	1.3 1.5		5 5 8	CLAY, with silt (CL); light olive brown (2.5Y 5/3) to light yellowish brown (2.5Y 6/4) and trace red (10R 4/6); dry; medium stiff; plastic; no HCl reaction.		1988.5			12						
8.5					ST-1	2.1 2				2.66		127	95	18	47	18	29			
12					SPT-4	1.5 1.5		8 14 20	Increasing strength to very stiff; red absent, weak HCl reaction; trace FeO staining on weathered zones.											
14					SPT-5	1.5 1.5														

Notes:

- Terms and symbols defined on Plate 1.
- As-Built coordinates and elevation surveyed by Kaw Valley Engineering (KS-licensed).
- The SPT blow count is defined as the number of blows required for a 140 lb. auto trip safety hammer falling 30 inches to drive the split-barrel sampler 6 inches in a possible 18 inch sample interval.
- Shelby tubes used for cohesive soil sampling of dimensions 36 inches long, 3 inch outside diameter.
- HQ3 carbide Diamond bit used for rock coring.

**WOLF CREEK
 UPDATED SAFETY ANALYSIS REPORT**

Figure 2.5-36000 Rev. 28
 Log of Boring B-103
 Sheet 1 of 2

Surface Level (ft): **1995.031** Easting (ft): **99592.732388**
 Total Drill Depth (ft): **29.4** Northing (ft): **99170.217696**
 Inclination/Bearing: **90** Datum: **Wolf Creek Plant Datum**

Hole Id:

B-103

Sheet: 2 of 2

Depth, feet	Water Level	Drill Rate (mins)	Graphic Log	Sample Type	Sample Number	Recovery	RQD	SPT Blows per 6-inches	STRATUM DESCRIPTION	Estimated Strength (ksf)	Stratum Elev. (feet)	CLASSIFICATION				
												Total Unit Wt., pcf	Passing No. 200 Sieve, %	Water Content, %	Liquid Limit	Plastic Limit
16								9 13	Wet at 15 ft CLAY, with silt (CL); brown (10YR 4/3) to dark yellowish brown (10YR 4/4) and yellowish brown (10YR 5/6); moist; standing water in SPT sampler; weak HCl reaction.	500 1000 1500 2000	1979.8					
18					SPT-6	1.4 1.5		5 30 48	SHALE, silty; dark grayish brown (10YR 4/2) to sparse yellowish brown (10YR 5/6) and grayish brown (10YR 5/2); moist; extremely weak (R0); friable; no HCl reaction on gray, weak HCl reaction on yellowish brown.		1978.0					
24					SPT-7	1.4 1.5		17 22 24	SHALE; dark grayish brown (10YR 4/2) to sparse yellowish brown (10YR 5/6) and grayish brown (10YR 5/2); dry; extremely weak (R0); moderately to highly weathered (MW-HW); FeO staining in weathered zones; indistinct horizontal to sub-horizontal laminae; few hard cemented nodules similar to limestone but weak HCl reaction; breaks in angular fragments; no grains visible; weak HCl reaction.		1971.4					
28					SPT-8			27 50/3	Dry, friable, easy to break with hands. SPT-8, completed 28.6-29.4							
									No water in hole before grouting		1965.6					

Notes:

- Terms and symbols defined on Plate 1.
- As-Built coordinates and elevation surveyed by Kaw Valley Engineering (KS-licensed).
- The SPT blow count is defined as the number of blows required for a 140 lb. auto trip safety hammer falling 30 inches to drive the split-barrel sampler 6 inches in a possible 18 inch sample interval.
- Shelby tubes used for cohesive soil sampling of dimensions 36 inches long, 3 inch outside diameter.
- HQ3 carbide Diamond bit used for rock coring.

WOLF CREEK
 UPDATED SAFETY ANALYSIS REPORT

Figure 2.5-36000 Rev. 28
 Log of Boring B-103
 Sheet 2 of 2

Surface Level (ft): **1995.51** Easting (ft): **100852.08**
 Total Drill Depth (ft): **38.9** Northing (ft): **99195.74**
 Inclination/Bearing: **90** Datum: **Wolf Creek Plant Datum**

Hole Id:

B-104

Sheet: 1 of 3

Depth, feet	Water Level	Drill Rate (mins)	Graphic Log	Sample Type	Sample Number	Recovery	RQD	SPT Blows per 6-inches	STRATUM DESCRIPTION	Estimated Strength (ksf)	Stratum Elev. (feet)	CLASSIFICATION					
												Total Unit Wt., pcf	Passing No. 200 Sieve, %	Water Content, %	Liquid Limit	Plastic Limit	Plasticity Index (PI)
					SPT-1	1 1.5		7 16 11	SAND, clayey (SC); with construction gravel and roots; fill.								
2									SILT with clay and gravel (ML); very pale brown (10YR 7/4) to yellowish brown (10YR 5/6); dry; very stiff; difficult to break with hands; compacted soil/fill.		1994.2						
4					SPT-2	0.9 1.5		5 8 8	SILT with clay (ML); light yellowish brown (10YR 6/4) to yellowish brown (10YR 6/4); dry; stiff; trace very fine sand; no HCl reaction.		1991.8						
6																	
8					SPT-3	1.3 1.5		8 13 14	CLAY, silty (CL); brown (10YR 5/3) to yellowish brown (10YR 5/6); dry; stiff to very stiff; high dry strength; weak HCl reaction, little sand.		1988.9		86	15	49	18	31
					ST-1				Drilling wet rotary at 7.7 ft because cuttings are not returning on augers.								
10																	
12					SPT-4	1.5 1.5		13 19 28	SILT with clay (ML); light yellowish brown (10YR 6/4) to yellowish brown (10YR 5/4); dry; very stiff; trace fine sand; sample breaks on indistinct horizontal partings; strong HCl reaction.		1983.1		93				
14					SPT-5			13 22 27	Driller notes color change to gray at 13 ft				99				

Notes:

- Terms and symbols defined on Plate 1.
- As-Built coordinates and elevation surveyed by Kaw Valley Engineering (KS-licensed).
- The SPT blow count is defined as the number of blows required for a 140 lb. auto trip safety hammer falling 30 inches to drive the split-barrel sampler 6 inches in a possible 18 inch sample interval.
- Shelby tubes used for cohesive soil sampling of dimensions 36 inches long, 3 inch outside diameter.
- HQ3 carbide Diamond bit used for rock coring.

**WOLF CREEK
 UPDATED SAFETY ANALYSIS REPORT**

Figure 2.5-36ppp Rev. 28
 Log of Boring B-104
 Sheet 1 of 3

Surface Level (ft): **1995.51** Easting (ft): **100852.08**
 Total Drill Depth (ft): **38.9** Northing (ft): **99195.74**
 Inclination/Bearing: **90** Datum: **Wolf Creek Plant Datum**

Hole Id:

B-104

Sheet: 2 of 3

Depth, feet	Water Level	Drill Rate (mins)	Graphic Log Sample Type	Sample Number	Recovery	RQD	SPT Blows per 6-inches	STRATUM DESCRIPTION	Estimated Strength (ksf)	Stratum Elev. (feet)	CLASSIFICATION					
											Total Unit Wt., pcf	Passing No. 200 Sieve, %	Water Content, %	Liquid Limit	Plastic Limit	Plasticity Index (Pf)
16								SHALE; mottled light yellowish brown (10YR 6/4) to brown (10YR 4/3); extremely weak (R0); highly weathered (HW); high dry strength; few indistinct horizontal to sub-horizontal laminae, increasing with depth; trace FeO staining on horizontal partings; no to weak HCl reaction.		1980.5						
18				SPT-6	1.5 1.5		15 25 39	Mottled dark gray (7.5YR 4/1).					17	50	19	31
20																
22																
24				SPT-7			13 13 20	SHALE; gray (10YR 5/1) to dark gray (10YR 4/1) with trace light yellowish brown (10YR 4/3); moist; extremely weak (R0); trace FeO staining on thin partings; moisture likely introduced during drilling.		1972.0						
26																
28				SPT-8	0.5 0.5		50/5	SHALE; dark gray (2.5YR 4/1) with trace zones of white (10YR 8/1); dry; extremely weak (R0); friable; abundant horizontal to sub-horizontal laminae with common breaks on very thin lenses along laminae; strong HCl reaction. Downpressure 175 lb. No loss of water.		1967.5 1966.6						

Notes:

- Terms and symbols defined on Plate 1.
- As-Built coordinates and elevation surveyed by Kaw Valley Engineering (KS-licensed).
- The SPT blow count is defined as the number of blows required for a 140 lb. auto trip safety hammer falling 30 inches to drive the split-barrel sampler 6 inches in a possible 18 inch sample interval.
- Shelby tubes used for cohesive soil sampling of dimensions 36 inches long, 3 inch outside diameter.
- HQ3 carbide Diamond bit used for rock coring.

**WOLF CREEK
 UPDATED SAFETY ANALYSIS REPORT**

Figure 2.5-36ppp Rev. 28
 Log of Boring B-104
 Sheet 2 of 3

Surface Level (ft): **1995.51** Easting (ft): **100852.08**
 Total Drill Depth (ft): **38.9** Northing (ft): **99195.74**
 Inclination/Bearing: **90** Datum: **Wolf Creek Plant Datum**

Hole Id:

B-104

Sheet: 3 of 3

Depth, feet	Water Level	Drill Rate (mins)	Graphic Log	Sample Type	Sample Number	Recovery	RQD	SPT Blows per 6-inches	STRATUM DESCRIPTION	Estimated Strength (ksf)	Stratum Elev. (feet)	CLASSIFICATION						
												Total Unit Wt., pcf	Passing No. 200 Sieve, %	Water Content, %	Liquid Limit	Plastic Limit	Plasticity Index (PI)	
32		0:39	NM		CR-1	5/15	5/15		SHALE; argillaceous; medium gray (N5) to medium dark gray (N4) and white (N9); very weak to weak (R1-R2); fresh to slightly weathered; trace indistinct thin laminae but much less common than in other boreholes; sparse bivalve and oyster shells; trace white calcium carbonate nodules; strong HCl reaction. MB, 0° at 30.7' Soft sediment deformation with higher energy, increased sand, shell hash and calcium carbonate. MB, 0° at 33.7'									
34		0:35	NM						Shale is very muddy, argillaceous with common shell hash and clay balls; generally horizontal to sub-horizontal bedding; rough core surface.		1960.2							
36		1:35			CR-2	5/15	5/15		LIMESTONE; light olive gray (5Y 6/1) to light gray (N7); weak (R2); fresh; slightly muddy but generally cleaner with depth; few shale partings, horizontal to sub-horizontal; strong HCl reaction. MB, 0° at 35.67' Trace shell fragments below 36 ft									
38		2:00			SC-1				MB, 0° at 36.1' MB, 0° at 36.8'	•1214		167	1					
40		3:45									1956.6							
42		4:02																
44																		

Notes:

- Terms and symbols defined on Plate 1.
- As-Built coordinates and elevation surveyed by Kaw Valley Engineering (KS-licensed).
- The SPT blow count is defined as the number of blows required for a 140 lb. auto trip safety hammer falling 30 inches to drive the split-barrel sampler 6 inches in a possible 18 inch sample interval.
- Shelby tubes used for cohesive soil sampling of dimensions 36 inches long, 3 inch outside diameter.
- HQ3 carbide Diamond bit used for rock coring.

WOLF CREEK
 UPDATED SAFETY ANALYSIS REPORT

Figure 2.5-36ppp Rev. 28
 Log of Boring B-104
 Sheet 3 of 3

Surface Level (ft): **1996.74** Easting (ft): **101374.029934**
 Total Drill Depth (ft): **35.1** Northing (ft): **99305.885193**
 Inclination/Bearing: **90** Datum: **Wolf Creek Plant Datum**

Hole Id:

B-105

Sheet: 1 of 3

Depth, feet	Water Level	Drill Rate (mins)	Graphic Log	Sample Type	Sample Number	Recovery	RQD	SPT Blows per 6-inches	STRATUM DESCRIPTION	Estimated Strength (ksf)	Stratum Elev. (feet)	CLASSIFICATION						
												Total Unit Wt., pcf	Passing No. 200 Sieve, %	Water Content, %	Liquid Limit	Plastic Limit	Plasticity Index (PI)	
					GRAB-1				CLAY, silty with sand (CL-ML); light olive brown (2.5Y 5/3) to dark gray (2.5Y 4/1); moist; stiff; well-graded; little small gravel; gravel and sand are sub-angular, up to 0.5 in in diameter (Fill).		1996.2							
					SPT-1	0.9 1.5		19 14 7	GRAVEL (GP); construction gravel, (fill). Shelby tube at surface - refusal at 0.6 ft. Grab sample at 0 to 0.5 ft; dry fill.		1995.5							
2									CLAY, silty (CL-ML); olive brown (2.5Y 4/4) to black (2.5Y 2.5/1); dry to moist; stiff; very fine grained; no HCl reaction (fill).		1993.7							
					GRAB-2				GRAVEL (GP); sandstone, limey concrete; stiff to very stiff (fill). - Grab sample at 3 to 4.5 ft., dry fill. From 3.0 ft, rig grinding on rock.									
					SPT-2	1.1 1.5		4 10 18						14				
4																		
					SPT-3	1.3 1.5		3 3 4	CLAY (CH); olive gray (5Y 4/2) to dark gray (5Y 4/1); moist; soft; trace sand (less than 5%); moderately plastic; no HCl reaction.						23			
6																		
					ST-1	1.9 2				2.72			130	93	23	52	16	36
8																		
					SPT-4	1.4 1.5		8 12 18	SHALE; olive gray (5Y 5/2) and olive gray (5Y 5/3); extremely weak (R0); completely weathered; indistinct horizontal to sub-horizontal laminations; slightly to moderately silty; weak HCl reaction.			1983.9						
10																		
12																		
14																		

Notes:

- Terms and symbols defined on Plate 1.
- As-Built coordinates and elevation surveyed by Kaw Valley Engineering (KS-licensed).
- The SPT blow count is defined as the number of blows required for a 140 lb. auto trip safety hammer falling 30 inches to drive the split-barrel sampler 6 inches in a possible 18 inch sample interval.
- Shelby tubes used for cohesive soil sampling of dimensions 36 inches long, 3 inch outside diameter.
- HQ3 carbide Diamond bit used for rock coring.

**WOLF CREEK
 UPDATED SAFETY ANALYSIS REPORT**

Figure 2.5-36qqq Rev. 28
 Log of Boring B-105
 Sheet 1 of 3

Surface Level (ft): **1996.74** Easting (ft): **101374.029934**
 Total Drill Depth (ft): **35.1** Northing (ft): **99305.885193**
 Inclination/Bearing: **90** Datum: **Wolf Creek Plant Datum**

Hole Id:

B-105

Sheet: 2 of 3

Depth, feet	Water Level	Drill Rate (mins)	Graphic Log	Sample Type	Sample Number	Recovery	RQD	SPT Blows per 6-inches	STRATUM DESCRIPTION	Estimated Strength (ksf)	Stratum Elev. (feet)	CLASSIFICATION				
												Total Unit Wt., pcf	Passing No. 200 Sieve, %	Water Content, %	Liquid Limit	Plastic Limit
16									SHALE; olive gray (5Y 5/2) and olive gray (5Y 5/3); extremely weak (R0); highly to completely weathered; indistinct horizontal to sub-horizontal laminations; slightly to moderately silty; weak HCl reaction.	500 1000 1500 2000	1981.7					
18									With occasional brownish yellow (10YR 6/6) discoloration between laminae.							
20					SPT-5	1.5 1.5		13 24 37	Color change to dark gray (5Y 4/1) with occasional brownish yellow (10YR 6/6) discoloration between laminae; less silty.							
22																
24					SPT-6	1.5 1.5		16 24 42								
26																
28					SPT-7	1.5 1.5			Moderately weathered; very silty; trace very fine sand with grayish brown (10YR 5/2); strong HCl reaction.							

Notes:

- Terms and symbols defined on Plate 1.
- As-Built coordinates and elevation surveyed by Kaw Valley Engineering (KS-licensed).
- The SPT blow count is defined as the number of blows required for a 140 lb. auto trip safety hammer falling 30 inches to drive the split-barrel sampler 6 inches in a possible 18 inch sample interval.
- Shelby tubes used for cohesive soil sampling of dimensions 36 inches long, 3 inch outside diameter.
- HQ3 carbide Diamond bit used for rock coring.

WOLF CREEK
 UPDATED SAFETY ANALYSIS REPORT

Figure 2.5-36qqq Rev. 28
 Log of Boring B-105
 Sheet 2 of 3

Surface Level (ft): **1996.74** Easting (ft): **101374.029934**
 Total Drill Depth (ft): **35.1** Northing (ft): **99305.885193**
 Inclination/Bearing: **90** Datum: **Wolf Creek Plant Datum**

Hole Id:

B-105

Sheet: 3 of 3

Depth, feet	Water Level	Drill Rate (mins)	Graphic Log	Sample Type	Sample Number	Recovery	RQD	SPT Blows per 6-inches	STRATUM DESCRIPTION	Estimated Strength (ksf)	Stratum Elev. (feet)	CLASSIFICATION				
												Total Unit Wt., pcf	Passing No. 200 Sieve, %	Water Content, %	Liquid Limit	Plastic Limit
32								19 29 48	SHALE; dark gray (5Y 4/1) and grayish brown (10YR 5/2); extremely weak (R0); moderately weathered; indistinct horizontal to sub-horizontal laminae; moderately to very silty; strong HCl reaction.	500 1000 1500 2000	1966.7					
34					SPT-8	1.4 1.4		19 39 50/3	No sand, less silt; occasional calcite coating between laminae and in small crystals.		1961.6					
36																
38																
40																
42																
44																

Notes:

- Terms and symbols defined on Plate 1.
- As-Built coordinates and elevation surveyed by Kaw Valley Engineering (KS-licensed).
- The SPT blow count is defined as the number of blows required for a 140 lb. auto trip safety hammer falling 30 inches to drive the split-barrel sampler 6 inches in a possible 18 inch sample interval.
- Shelby tubes used for cohesive soil sampling of dimensions 36 inches long, 3 inch outside diameter.
- HQ3 carbide Diamond bit used for rock coring.

**WOLF CREEK
 UPDATED SAFETY ANALYSIS REPORT**

Figure 2.5-36qqq Rev. 28
 Log of Boring B-105
 Sheet 3 of 3

Surface Level (ft): **1995.458** Easting (ft): **101791.596732**
 Total Drill Depth (ft): **35.2** Northing (ft): **99276.55072**
 Inclination/Bearing: **90** Datum: **Wolf Creek Plant Datum**

Hole Id:

B-106

Sheet: 1 of 3

Depth, feet	Water Level	Drill Rate (mins)	Graphic Log	Sample Type	Sample Number	Recovery	RQD	SPT Blows per 6-inches	STRATUM DESCRIPTION	Estimated Strength (ksf)	Stratum Elev. (feet)	CLASSIFICATION				
												Total Unit Wt., pcf	Passing No. 200 Sieve, %	Water Content, %	Liquid Limit	Plastic Limit
2					SPT-1	6 1.5		10 11 12	SILT, clayey (ML); very dark grayish brown (10YR 3/2); dry; stiff; 90% silt and clay; trace roots and organics; no odor; no HCl reaction.		1994.5					
4					SPT-2	1.2 1.5		3 5 5	Lens of SAND (SP); olive (5Y 5/4); damp; fine grained; poorly graded. CLAY, sandy (CL); very dark gray (2.5Y 3/1); moist; medium stiff; moderately plastic; trace silt; no HCl reaction.		1991.4	67	15			
6					ST-1	1.85 2			CLAY (CL); light olive brown (2.5Y 5/3) to very pale brown (10YR 7/4); dry; very fine grained, trace silt and fine mica; stiff to medium stiff; moderately plastic, includes indistinct horizontal to sub-horizontal laminae (<1/32"); grading to a completely weathered shale.	1.58	1989.5	126	23	42	14	28
10					SPT-3	1.4 1.5		3 4 6								
12					SPT-4	1.5 1.5		5 12 18	SHALE; dark yellowish orange (10YR 6/6) to grayish orange (10YR 7/4); fine grained; extremely weak (RO); indistinct very thin horizontal to sub-horizontal laminae; strong HCl reaction.		1983.5					
14					SPT-5			11 15 27								13 49 16 33

Notes:

- Terms and symbols defined on Plate 1.
- As-Built coordinates and elevation surveyed by Kaw Valley Engineering (KS-licensed).
- The SPT blow count is defined as the number of blows required for a 140 lb. auto trip safety hammer falling 30 inches to drive the split-barrel sampler 6 inches in a possible 18 inch sample interval.
- Shelby tubes used for cohesive soil sampling of dimensions 36 inches long, 3 inch outside diameter.
- HQ3 carbide Diamond bit used for rock coring.

**WOLF CREEK
 UPDATED SAFETY ANALYSIS REPORT**

Figure 2.5-36rrr Rev. 28
 Log of Boring B-106
 Sheet 1 of 3

Surface Level (ft): **1995.458** Easting (ft): **101791.596732**
 Total Drill Depth (ft): **35.2** Northing (ft): **99276.55072**
 Inclination/Bearing: **90** Datum: **Wolf Creek Plant Datum**

Hole Id:

B-106

Sheet: 2 of 3

Depth, feet	Water Level	Drill Rate (mins)	Graphic Log	Sample Type	Sample Number	Recovery	RQD	SPT Blows per 6-inches	STRATUM DESCRIPTION	Estimated Strength (ksf)	Stratum Elev. (feet)	CLASSIFICATION					
												Total Unit Wt., pcf	Passing No. 200 Sieve, %	Water Content, %	Liquid Limit	Plastic Limit	Plasticity Index (PI)
16									SHALE; dark yellowish orange (10YR 6/6) to grayish orange (10YR 7/4); fine grained; extremely weak (RO); indistinct very thin horizontal to sub-horizontal laminae; strong HCl reaction. SPT Intervals: 2 per 5 ft; 0-15 ft then 1 per 5 ft 15-refusal								
20					SPT-6	1.5 1.5		12 19 31	Moisture on spoon at SPT-6								
24					SPT-7	1.3 1.5		9 14 19	Moisture absent at SPT-7 and below								
28					SPT-8	1.4 1.5											

Notes:

- Terms and symbols defined on Plate 1.
- As-Built coordinates and elevation surveyed by Kaw Valley Engineering (KS-licensed).
- The SPT blow count is defined as the number of blows required for a 140 lb. auto trip safety hammer falling 30 inches to drive the split-barrel sampler 6 inches in a possible 18 inch sample interval.
- Shelby tubes used for cohesive soil sampling of dimensions 36 inches long, 3 inch outside diameter.
- HQ3 carbide Diamond bit used for rock coring.

**WOLF CREEK
 UPDATED SAFETY ANALYSIS REPORT**

Figure 2.5-36rrr Rev. 28
 Log of Boring B-106
 Sheet 2 of 3

Surface Level (ft): **1995.458** Easting (ft): **101791.596732**
 Total Drill Depth (ft): **35.2** Northing (ft): **99276.55072**
 Inclination/Bearing: **90** Datum: **Wolf Creek Plant Datum**

Hole Id:

B-106

Sheet: 3 of 3

Depth, feet	Water Level	Drill Rate (mins)	Graphic Log	Sample Type	Sample Number	Recovery	RQD	SPT Blows per 6-inches	STRATUM DESCRIPTION	Estimated Strength (ksf)	Stratum Elev. (feet)	CLASSIFICATION				
												Total Unit Wt., pcf	Passing No. 200 Sieve, %	Water Content, %	Liquid Limit	Plastic Limit
32								12 18 33	SHALE; dark yellowish orange (10YR 6/6) to grayish orange (10YR 7/4) and trace yellowish gray (5Y 8/1); very fine grained; extremely weak (RO); very thin horizontal to sub-horizontal laminae; yellowish gray is sandy, in <1/8" sparse cemented vertical band Driller reports change at 32 ft based on return of cuttings	500 1000 1500 2000	1965.2					
34					SPT-9			19 31 50/5			1960.3					
36																
38																
40																
42																
44																

Notes:

- Terms and symbols defined on Plate 1.
- As-Built coordinates and elevation surveyed by Kaw Valley Engineering (KS-licensed).
- The SPT blow count is defined as the number of blows required for a 140 lb. auto trip safety hammer falling 30 inches to drive the split-barrel sampler 6 inches in a possible 18 inch sample interval.
- Shelby tubes used for cohesive soil sampling of dimensions 36 inches long, 3 inch outside diameter.
- HQ3 carbide Diamond bit used for rock coring.

**WOLF CREEK
 UPDATED SAFETY ANALYSIS REPORT**

Figure 2.5-36rrr Rev. 28
 Log of Boring B-106
 Sheet 3 of 3

Surface Level (ft): **1996.49**

Easting (ft): **101786.81**

Hole Id:

Total Drill Depth (ft): **44.8**

Northing (ft): **99452.04**

B-107

Inclination/Bearing: **90**

Datum: **Wolf Creek Plant Datum**

Sheet: 1 of 3

Depth, feet	Water Level	Drill Rate (mins)	Graphic Log	Sample Type	Sample Number	Recovery	RQD	SPT Blows per 6-inches	STRATUM DESCRIPTION	Estimated Strength (ksf)	Stratum Elev. (feet)	CLASSIFICATION					
												Total Unit Wt., pcf	Passing No. 200 Sieve, %	Water Content, %	Liquid Limit	Plastic Limit	Plasticity Index (PI)
0									SILT with sand; brown (7.5YR 4/3); dry; common roots; topsoil; fill? - 6" flight augers 0 to 12 ft		1996.3						
2					SPT-1	0.8 1.5		4 4 7	SILT; brownish yellow (10YR 6/6) to yellowish brown (10YR 5/6); dry; medium stiff; traces fine sand and clay; friable; fill.								
4					SPT-2	1.3 1.5		3 5 5	Sample SPT-2 jabs; SPT-2A 3.5 to 4.0 ft; SPT-2B 4.0 to 5.0 ft SAND (SP); pink (7.5YR 7/3); dry; loose; fine to medium grained; sub-angular to sub-rounded; fill. CLAY (CL); black (10YR 2/1) to dark reddish brown (5YR 3/3); dry to slightly moist; medium stiff; trace silt; no HCl reaction.		1992.8 1992.5		6				
6					ST-1				CLAY, silty (CL); dark grayish brown (10YR 4/2); very soft; moist; plastic; easy to mold with fingers; no HCl reaction.	3.46		129	90	21	39	14	25
8					SPT-3	1.4 1.5		3 5 7	CLAY, sandy (CH); mottled light yellowish brown (10YR 6/4) to very dark grayish brown (10YR 3/2) and yellowish brown (10YR 5/6); dry to slightly moist; medium stiff; medium plasticity; trace silt; no HCl reaction.		1988.5						
10					ST-2					2.52		130	77	21	53	19	34
12									At 12 ft, switch to mud drilling; install casing.								
14					SPT-4	1.4 1.5		8 13 16	Very dark grayish brown is absent								

Notes:

- Terms and symbols defined on Plate 1.
- As-Built coordinates and elevation surveyed by Kaw Valley Engineering (KS-licensed).
- The SPT blow count is defined as the number of blows required for a 140 lb. auto trip safety hammer falling 30 inches to drive the split-barrel sampler 6 inches in a possible 18 inch sample interval.
- Shelby tubes used for cohesive soil sampling of dimensions 36 inches long, 3 inch outside diameter.
- HQ3 carbide Diamond bit used for rock coring.

**WOLF CREEK
UPDATED SAFETY ANALYSIS REPORT**

Figure 2.5-36sss Rev. 28
Log of Boring B-107
Sheet 1 of 3

Surface Level (ft): **1996.49** Easting (ft): **101786.81**
 Total Drill Depth (ft): **44.8** Northing (ft): **99452.04**
 Inclination/Bearing: **90** Datum: **Wolf Creek Plant Datum**

Hole Id:

B-107

Sheet: 2 of 3

Depth, feet	Water Level	Drill Rate (mins)	Graphic Log	Sample Type	Sample Number	Recovery	RQD	SPT Blows per 6-inches	STRATUM DESCRIPTION	Estimated Strength (ksf)	Stratum Elev. (feet)	CLASSIFICATION				
												Total Unit Wt., pcf	Passing No. 200 Sieve, %	Water Content, %	Liquid Limit	Plastic Limit
16									CLAY, sandy (CH); mottled light yellowish brown (10YR 6/4) to very dark grayish brown (10YR 3/2) and yellowish brown (10YR 5/6); dry to slightly moist; medium stiff; medium plasticity; trace silt; no HCl reaction.	500 1000 1500 2000						
18					SPT-5	1.2 1.5		8 11 12	CLAY (CL); mottled yellowish brown (10YR 5/6 to 10YR 5/4) and dark gray (10YR 4/1); dry to slightly moist; very stiff; medium dry strength, low plasticity; trace very thin horizontal laminae but generally massive; weak HCl reaction.		1979.5					
20																
22																
24					SPT-6	1.3 1.5		12 18 28	Grading to dark gray (10YR 4/1); increasing very thin horizontal laminae; grading to highly weathered shale.							
26																
28					SPT-7	1.4 1.5		19 30 40	SHALE; brown (10YR 5/3) to yellowish brown (10YR 5/6) and grayish brown (10YR 5/1); extremely weak (R0); completely weathered; common indistinct horizontal to sub-horizontal thin laminae; weak HCl reaction.		1968.5					

Notes:

- Terms and symbols defined on Plate 1.
- As-Built coordinates and elevation surveyed by Kaw Valley Engineering (KS-licensed).
- The SPT blow count is defined as the number of blows required for a 140 lb. auto trip safety hammer falling 30 inches to drive the split-barrel sampler 6 inches in a possible 18 inch sample interval.
- Shelby tubes used for cohesive soil sampling of dimensions 36 inches long, 3 inch outside diameter.
- HQ3 carbide Diamond bit used for rock coring.

WOLF CREEK
 UPDATED SAFETY ANALYSIS REPORT

Figure 2.5-36sss Rev. 28
 Log of Boring B-107
 Sheet 2 of 3

Surface Level (ft): **1996.49** Easting (ft): **101786.81**
 Total Drill Depth (ft): **44.8** Northing (ft): **99452.04**
 Inclination/Bearing: **90** Datum: **Wolf Creek Plant Datum**

Hole Id:

B-107

Sheet: 3 of 3

Depth, feet	Water Level	Drill Rate (mins)	Graphic Log Sample Type	Sample Number	Recovery	RQD	SPT Blows per 6-inches	STRATUM DESCRIPTION	Estimated Strength (ksf)	Stratum Elev. (feet)	CLASSIFICATION						
											Total Unit Wt., pcf	Passing No. 200 Sieve, %	Water Content, %	Liquid Limit	Plastic Limit	Plasticity Index (PI)	
32								SHALE; brown (10YR 5/3) to yellowish brown (10YR 5/6) and grayish brown (10YR 5/1); extremely weak (R0); completely weathered; common indistinct horizontal to sub-horizontal thin laminae; weak HCl reaction.									
34				SPT-8	1.3 1.3		40 34 26/3	SHALE; dark gray (2.5Y 4/1) and trace (yellowish brown (10YR 5/6); dry to slightly moist; extremely weak (R0); completely weathered; sparse thin, horizontal laminae; trace calcium carbonate grains; strong HCl reaction. - SPT-8; Refusal, 100 blows total. Sample last interval 3" so 33.5 to 34.8 ft.		1963.0							
36		3:24						SHALE; argillaceous; mottled light olive gray (5Y 6/1) and medium gray (N5) to yellowish gray (5Y 8/1); extremely weak (R0) to very weak (R1); highly weathered to completely weathered; muddy; abundant shell fragments, calcium carbonate nodules and rip-up - At 34.8 ft, coring HQ3 Downpressure 300 psi MB, 0° at 35.0' MB, 0° at 35.85' Too soft to preserve a special care sample. MB, 0° at 37.3'		1961.7							
38		3:56		CR-1	4.9 5	4.9 5		MB, 0° at 39.8'									
40		2:23						LIMESTONE; argillaceous; light olive gray (5Y 6/1) to medium light gray (N6) and brownish gray (5YR 4/1) to dark gray (N3); very weak (R1) to extremely weak (R0) at partings; fresh (F) to slightly weathered (SW); common calcium carbonate grains and shell MB, 0° at 40.7' MB, 0°, incipient at 41.4' 1/2" vug with black crystals and several well-formed calcite crystals can be seen with hand lens. MB, 0°, spin zone at 43.0' MB, 0° at 43.4'		1956.4							
42		2:39		CR-2	4.8 5	4.8 5		MB, 0° at 44.8'									
44		3:00								1951.7							

Notes:

- Terms and symbols defined on Plate 1.
- As-Built coordinates and elevation surveyed by Kaw Valley Engineering (KS-licensed).
- The SPT blow count is defined as the number of blows required for a 140 lb. auto trip safety hammer falling 30 inches to drive the split-barrel sampler 6 inches in a possible 18 inch sample interval.
- Shelby tubes used for cohesive soil sampling of dimensions 36 inches long, 3 inch outside diameter.
- HQ3 carbide Diamond bit used for rock coring.

**WOLF CREEK
 UPDATED SAFETY ANALYSIS REPORT**

Figure 2.5-36sss Rev. 28
 Log of Boring B-107
 Sheet 3 of 3

Surface Level (ft): **1996.67** Easting (ft): **100130.72**
 Total Drill Depth (ft): **36.95** Northing (ft): **99274.436**
 Inclination/Bearing: **90** Datum: **Wolf Creek Plant Datum**

Hole Id:

B-108

Sheet: 1 of 3

Depth, feet	Water Level	Drill Rate (mins)	Graphic Log	Sample Type	Sample Number	Recovery	RQD	SPT Blows per 6-inches	STRATUM DESCRIPTION	Estimated Strength (ksf)	Stratum Elev. (feet)	CLASSIFICATION					
												Total Unit Wt., pct	Passing No. 200 Sieve, %	Water Content, %	Liquid Limit	Plastic Limit	Plasticity Index (PI)
									GRAVEL (GP), silty; fine to coarse gravel, up to 1.5" diameter; poorly graded; loose to medium dense (FILL).								
2					SPT-1	0.9 1.5		8 15 10	SILT (ML), with gravel; brownish yellow (10YR 6/8); stiff to medium stiff; damp; non-plastic; high dry strength; gravel is fine-grained sandstone and other non-natives, fine, subangular to subangular; clay and fine-grained sand increasing with depth; well graded (FILL).		1995.0						
4					SPT-2	1.3 1.5		3 8 12	CLAY (CL), with silt, sand and gravel; light olive brown (2.5Y 5/3); stiff; highly plastic matrix; pea gravel, yellowish brown (10YR 5/4); well graded (FILL).		1993.5						
6					ST-3	1/2			CLAY (CL), sandy with silt and gravel; brownish yellow (10YR 6/8); stiff; damp; low to non plastic; high dry strength; subangular pea gravel of non natives; well graded (FILL).								
8									More silty, becoming CL-ML, less sand content; damp to moist; moderate dilatancy								
10					SPT-4	1.3 1.5		13 22 35	CLAY (CL), with gravel; light olive brown (2.5Y 5/3); hard to very stiff; damp; high dry strength; fine gravel of sandstone and other non-natives; poorly graded; well consolidated; breaks along subhorizontal partings (FILL).		1988.4						
12					SPT-5	1.5 1.5		11 25 42									
14					SPT-6				Locally more silty in places.								

Notes:

WOLF CREEK
 UPDATED SAFETY ANALYSIS REPORT

Figure 2.5-36ttt Rev. 28
 Log of Boring B-108
 Sheet 1 of 3

Surface Level (ft): **1996.67** Easting (ft): **100130.72**
 Total Drill Depth (ft): **36.95** Northing (ft): **99274.436**
 Inclination/Bearing: **90** Datum: **Wolf Creek Plant Datum**

Hole Id:

B-108

Sheet: 2 of 3

Depth, feet	Water Level	Drill Rate (mins)	Graphic Log	Sample Type	Sample Number	Recovery	RQD	SPT Blows per 6-inches	STRATUM DESCRIPTION	Estimated Strength (ksf)	Stratum Elev. (feet)	CLASSIFICATION						
												Total Unit Wt., pcf	Passing No. 200 Sieve, %	Water Content, %	Liquid Limit	Plastic Limit	Plasticity Index (PI)	
16					SPT-7	1.5 1.5		14 31 44	Large reddish brown clast. CLAY (CL), with gravel; light olive brown (2.5Y 5/3); hard to very stiff; damp; high dry strength; fine gravel of sandstone and other non-natives; poorly graded; well consolidated; breaks along subhorizontal partings (FILL).									
18					SPT-8	1.5 1.5		14 25 43	Mottled gray clay stringers (GLE1 6N); minor iron oxide staining; flecks of manganese.									
20					SPT-9	1.5 1.5		12 24 35	Large orangish brown claystone clast									
22					SPT-10	1.4 1.4		13 21 34	CLAY (CL), with sand and gravel; light olive brown (2.5Y 5/3); mottled reddish brown (5YR 4/4) and yellowish brown (10YR 5/6); hard; damp; well compacted; fine gravel, subangular, non-native composition; fine to coarse grained sand; well graded (FILL).		1973.2							
24					SPT-11	0.9 0.9		17 20 50/5.0*	SHALE; light gray (N7); extremely weak (R0); slightly weathered; indistinct laminations; undulating, subhorizontal laminae; argillaceous; CaCO3 nodules. (Heumader Shale) Carbide drill bit. Down pressure 200 psi.		1970.8							
26									MB, 0° at 28.1'		1967.9							
28					CR-1													

Notes:

**WOLF CREEK
 UPDATED SAFETY ANALYSIS REPORT**

Figure 2.5-36ttt Rev. 28
 Log of Boring B-108
 Sheet 2 of 3

Surface Level (ft): **1996.67** Easting (ft): **100130.72**
 Total Drill Depth (ft): **36.95** Northing (ft): **99274.436**
 Inclination/Bearing: **90** Datum: **Wolf Creek Plant Datum**

Hole Id:

B-108

Sheet: 3 of 3

Depth, feet	Water Level	Drill Rate (mins)	Graphic Log	Sample Type	Sample Number	Recovery	RQD	SPT Blows per 6-inches	STRATUM DESCRIPTION	Estimated Strength (ksf)	Stratum Elev. (feet)	CLASSIFICATION						
												Total Unit Wt., pct	Passing No. 200 Sieve, %	Water Content, %	Liquid Limit	Plastic Limit	Plasticity Index (PI)	
32		0:59				515			SHALE; medium gray (N5); very weak (R1); fresh to slightly weathered; distinct laminations; rough core surface; undulating, subhorizontal laminae; gravel embedded in in shale, high energy deposition; argillaceous; CaCO3 nodules; soft soil deformation, clay balls. (Heumader Shale)									
34		1:39			CR-2	2.8 3	2.4 3		Bedding joint, clay bed (R0), slightly washed out in drilling. Bit plugging up, down pressure 50 psi. Harder drilling, down pressure 350 psi. Fracture zone, infilled with gravel and coarser material; fresh		1962.5							
36		2:05							LIMESTONE; light gray (N7); weak (R2); fresh; slightly dipping bedding with some thin shale interbeds; clear, sharp upper contact with Heumader Shale; slightly muddy with soft sediment deformation (Plattsmouth Limestone). Bedding joint at contact, fresh, subhorizontal Hard drilling, down pressure 500 psi. Shale interbed, 0.1 ft thickness. Fine grained angular clast at 15 degree inclination		1961.3							
38		7:57																
40		21:24																
42																		
44																		

Notes:

**WOLF CREEK
 UPDATED SAFETY ANALYSIS REPORT**

Figure 2.5-36ttt Rev. 28
 Log of Boring B-108
 Sheet 3 of 3

Surface Level (ft): **1996.8** Easting (ft): **100145.05**
 Total Drill Depth (ft): **36.95** Northing (ft): **99272.93**
 Inclination/Bearing: **90** Datum: **Wolf Creek Plant Datum**

Hole Id:

B-109

Sheet: 1 of 3

Depth, feet	Water Level	Drill Rate (mins)	Graphic Log	Sample Number	Recovery	RQD	SPT Blows per 6-inches	STRATUM DESCRIPTION	Estimated Strength (ksf)	Stratum Elev. (feet)	CLASSIFICATION					
											Total Unit Wt., pcf	Passing No. 200 Sieve, %	Water % Content	Liquid Limit	Plastic Limit	Plasticity Index (PI)
0 - 2				SPT-1	1.5 1.5		15 13 13	GRAVEL (GP), silty; fine to coarse gravel, up to 1.5" diameter; poorly graded; loose to medium dense (FILL). CLAY (CL), with silt and gravel; light olive brown (2.5Y 5/3); stiff; dry to damp; high dry strength; fine gravel, subangular, non-native (FILL). SILT (ML), sandy, with gravel; brownish yellow (10YR 6/8); stiff to medium stiff; damp; non-plastic; high dry strength; fine grained sand increasing with depth; fine-grained sandstone gravel, up to 0.6" diameter; well graded (FILL).	500 1000 1500 2000	1995.1 1994.4						
2 - 4				ST-2	2											
4 - 8				ST-3	1.2 2											
8 - 10				ST-4	1.3 1.3			CLAY (CL), with gravel; light olive brown (2.5Y 5/3); hard to very stiff; damp; high dry strength; fine gravel of sandstone and other non-natives, subangular, up to 0.5 inch diameter, with weathering rhinds; poorly graded; well consolidated; breaks along subhorizontal partings.								
10 - 12								Intermittent reddish brown claystone clasts, with large weathering rhinds around clasts.								
12 - 14				SPT-5	1.5 1.5		16 27 38	Intermittent thin clay seams at random inclinations.								

Notes:

WOLF CREEK
 UPDATED SAFETY ANALYSIS REPORT

Figure 2.5-36uuu Rev. 28
 Log of Boring B-109
 Sheet 1 of 3

Surface Level (ft): **1996.8** Easting (ft): **100145.05**
 Total Drill Depth (ft): **36.95** Northing (ft): **99272.93**
 Inclination/Bearing: **90** Datum: **Wolf Creek Plant Datum**

Hole Id:

B-109

Sheet: 2 of 3

Depth, feet	Water Level	Drill Rate (mins)	Graphic Log	Sample Type	Sample Number	Recovery	RQD	SPT Blows per 6-inches	STRATUM DESCRIPTION	Estimated Strength (ksf)	Stratum Elev. (feet)	CLASSIFICATION				
												Total Unit Wt., pcf	Passing No. 200 Sieve, %	Water Content, %	Liquid Limit	Plastic Limit
16					SPT-6	1.3 1.5		14 28 42	CLAY (CL), with gravel; light olive brown (2.5Y 5/3); hard to very stiff; damp; high dry strength; fine gravel of sandstone and other non-natives, subangular, up to 0.5 inch diameter, with weathering rhinds; poorly graded; well consolidated; breaks along subhorizontal partings.							
18					SPT-7	1.5 1.5		18 27 38								
20					SPT-8	1.5 1.5		11 16 25								
22					SPT-9	1.5 1.5		14 21 38								
24					SPT-10	1 1		18 50/5.5*								
26					SPT-11	0.5 0.5		50/5.5*		SHALE; medium gray (N5) to light gray (N7); extremely weak (R0) to very weak (R1); slightly weathered to fresh; indistinct laminations; undulating, subhorizontal laminae; argillaceous; CaCO3 nodules. (Heumader Shale) Diamond drill bit. Down pressure 200 psi.		1970.4				
28		5:07			CR-1	4.9 5	4.9 5		Higher energy deposition with soft sediment deformation and pervasive clay balls.							

Notes:

**WOLF CREEK
 UPDATED SAFETY ANALYSIS REPORT**

Figure 2.5-36uuu Rev. 28
 Log of Boring B-109
 Sheet 2 of 3

Surface Level (ft): **1996.8** Easting (ft): **100145.05**
 Total Drill Depth (ft): **36.95** Northing (ft): **99272.93**
 Inclination/Bearing: **90** Datum: **Wolf Creek Plant Datum**

Hole Id:

B-109

Sheet: 3 of 3

Depth, feet	Water Level	Drill Rate (mins)	Graphic Log	Sample Type	Sample Number	Recovery	RQD	SPT Blows per 6-inches	STRATUM DESCRIPTION	Estimated Strength (ksf)	Stratum Elev. (feet)	CLASSIFICATION				
												Total Unit Wt., pcf	Passing No. 200 Sieve, %	Water Content, %	Liquid Limit	Plastic Limit
32		5:04			CR-2	5/5	4.7/5		SHALE; medium gray (N5) to light gray (N7); extremely weak (R0) to very weak (R1); slightly weathered to fresh; indistinct laminations; undulating, subhorizontal laminae; argillaceous; CaCO3 nodules. (Heumader Shale)		1963.5					
		5:21							Becoming harder (R1-R2)							
34		5:21							LIMESTONE; light gray (N7); weak (R2); fresh to slightly weathered; undulatory bedding appears 5 to 10 degree inclination; slightly muddy with soft sediment deformation; high energy transitional upper contact with Heumader Shale, interbedded over upper 0.4 ft. Subhorizontal shale interbed at 33.6', 0.4 inch thickness. Joint pair (5°), closed, FeO staining Bedding joint along shale interbed Pervasive thin shale interbeds, subhorizontal and undulatory bedding, 0.2 to 0.5 inch thickness. Interbeds at 35.0, 35.3, 35.5, 35.9, 36.2, 36.5, 36.7, 36.8, 34.0, 34.2 ft.							
36		4:11									1959.9					
38		3:27														
40		3:20														
42		4:27														
44																

Notes:

WOLF CREEK
 UPDATED SAFETY ANALYSIS REPORT

Figure 2.5-36uuu Rev. 28
 Log of Boring B-109
 Sheet 3 of 3

Surface Level (ft): **1996.23** Easting (ft): **100130.72**
 Total Drill Depth (ft): **33.4** Northing (ft): **99238.741**
 Inclination/Bearing: **90** Datum: **Wolf Creek Plant Datum**

Hole Id:

B-110

Sheet: 1 of 3

Depth, feet	Water Level	Drill Rate (mins)	Graphic Log	Sample Type	Sample Number	Recovery	RQD	SPT Blows per 6-inches	STRATUM DESCRIPTION	Estimated Strength (ksf)	Stratum Elev. (feet)	CLASSIFICATION				
												Total Unit Wt., pcf	Passing No. 200 Sieve, %	Water Content, %	Liquid Limit	Plastic Limit
									GRAVEL (GP), silty; fine to coarse gravel, up to 1.5" diameter; poorly graded; loose to medium dense (FILL).							
2					SPT-1	0.7 1.5		7 9 11	CLAY (CL), sandy to SAND, clayey; strong brown (7.5YR 5/8) and light olive brown (2.5Y 5/3); medium stiff; damp; non plastic; high dry strength; fine grained sand; intermixed in discrete chunks of clayey sand and sandy clay; trace fine gravel; well graded (FILL).		1994.8					
4					ST-2	1.9 2										
6																
8					ST-3	0.4 2			CLAY (CL), sandy; strong brown (7.5YR 5/8); very soft to soft; wet; crumbles; slow dilatancy; low dry strength (FILL).		1989.5					
10					ST-4	1 2			GRAVEL (GP), clayey; wet; loose; subangular, fine gravel, non-natives, range in size from 0.5" diameter down to pea size, predominantly 0.5" size (FILL). Hard to recover sample, stuck in middle of tube. Possibly lost bottom 0.3'		1986.4					
12																
14					SPT-5	1.2 1.5		4 9 10								
					SPT-6											

Notes:

**WOLF CREEK
 UPDATED SAFETY ANALYSIS REPORT**

Figure 2.5-36vvv Rev. 28
 Log of Boring B-110
 Sheet 1 of 3

Surface Level (ft): **1996.23** Easting (ft): **100130.72**
 Total Drill Depth (ft): **33.4** Northing (ft): **99238.741**
 Inclination/Bearing: **90** Datum: **Wolf Creek Plant Datum**

Hole Id:

B-110

Sheet: 2 of 3

Depth, feet	Water Level	Drill Rate (mins)	Graphic Log	Sample Type	Sample Number	Recovery	RQD	SPT Blows per 6-inches	STRATUM DESCRIPTION	Estimated Strength (ksf)	Stratum Elev. (feet)	CLASSIFICATION				
												Total Unit Wt., pcf	Passing No. 200 Sieve, %	Water Content, %	Liquid Limit	Plastic Limit
16						1.5 1.5		5 6 18	CLAY (CL), with gravel; light olive brown (2.5Y 5/3); very stiff; damp; little fine gravel of non-natives; poorly graded; well compacted (FILL).	500 1000 1500 2000						
18					SPT-7	1.5 1.5		17 24 34								
20					SPT-8	1.4 1.5		12 15 22	CLAY (CL); grayish brown (10Y 5/2) to light olive brown (2.5Y 5/3), mottled orangish brown in places; hard to very stiff; poorly graded; low plasticity; no dilatancy (FILL).		1976.2					
22					SPT-9	1.5 1.5		11 22 40								
24					SPT-10	1.4 1.4		21 50/5.0*	CLAY (CL), gravelly, with silt; brown (10YR 5/3); hard to very stiff; damp to moist; clay matrix is moderate to low plasticity; fine gravel of non-natives; well graded (FILL).		1972.6					
26					SPT-11	0.9 0.9		20 50/5.0*	CLAY (CL); grayish brown (10Y 5/2) to light olive brown (2.5Y 5/3), mottled orangish brown in places; hard to very stiff; poorly graded; low plasticity; no dilatancy (FILL).		1970.6					
28									SHALE; light gray (N7); extremely weak (R0) to very weak (R1); slightly weathered to fresh; distinct laminations, broken in sample along subhorizontal laminations; undulating, subhorizontal laminae; argillaceous; CaCO3 nodules; upper few inches at contact is softer; rough core surface; high energy deposition with some soft sediment deformation (Heumader Shale) MB, 0° at 28.1' Diamond drill bit. Down pressure 200 psi.		1969.7					

Notes:

WOLF CREEK
 UPDATED SAFETY ANALYSIS REPORT

Figure 2.5-36vv Rev. 28
 Log of Boring B-110
 Sheet 2 of 3

Surface Level (ft): **1996.23** Easting (ft): **100130.72**
 Total Drill Depth (ft): **33.4** Northing (ft): **99238.741**
 Inclination/Bearing: **90** Datum: **Wolf Creek Plant Datum**

Hole Id:

B-110

Sheet: 3 of 3

Depth, feet	Water Level	Drill Rate (mins)	Graphic Log	Sample Type	Sample Number	Recovery	RQD	SPT Blows per 6-inches	STRATUM DESCRIPTION	Estimated Strength (ksf)	Stratum Elev. (feet)	CLASSIFICATION				
												Total Unit Wt., pcf	Passing No. 200 Sieve, %	Water Content, %	Liquid Limit	Plastic Limit
32		5:02			CR-1	515	515		SHALE; light gray (N7); extremely weak (R0) to very weak (R1); slightly weathered to fresh; distinct laminations, broken in sample along subhorizontal laminations; undulating, subhorizontal laminae; argillaceous; CaCO3 nodules; upper few inches at contact is softer; rough core surface; high energy deposition with some soft sediment deformation (Heumader Shale)	500 1000 1500 2000	1963.4					
34		5:27							Becomes softer to extremely weak (R0), lower energy, less clay balls, rough core surface, no shells Becoming harder to very weak (R1), more shells and clay balls Bedding joint (0°), clay bed (R0), slightly washed out in drilling.		1962.8					
36									LIMESTONE; light gray (N7); weak (R2); fresh to slightly weathered; subhorizontal bedding with some thin shale interbeds; clear, abrupt upper contact with Heumader Shale; slightly muddy with soft sediment deformation, bivalve shells (Plattsmouth Limestone).							
38									Fracture zone (10°), infilled with gravel and coarser material; fresh Bedding joint (0°) at contact, fresh, subhorizontal							
40																
42																
44																

Notes:

**WOLF CREEK
 UPDATED SAFETY ANALYSIS REPORT**

Figure 2.5-36vv Rev. 28
 Log of Boring B-110
 Sheet 3 of 3

Surface Level (ft): **1996.43** Easting (ft): **100145.05**
 Total Drill Depth (ft): **36** Northing (ft): **99237.235**
 Inclination/Bearing: **90** Datum: **Wolf Creek Plant Datum**

Hole Id:

B-111

Sheet: 1 of 3

Depth, feet	Water Level	Drill Rate (mins)	Graphic Log	Sample Type	Sample Number	Recovery	RQD	SPT Blows per 6-inches	STRATUM DESCRIPTION	Estimated Strength (ksf)	Stratum Elev. (feet)	CLASSIFICATION						
												Total Unit Wt., pcf	Passing No. 200 Sieve, %	Water Content, %	Liquid Limit	Plastic Limit	Plasticity Index (PI)	
									GRAVEL (GP), silty; fine to coarse gravel, up to 1.5 diameter; poorly graded; loose to medium dense (Parking lot road base).									
2					SPT-1	1.3 1.5		7 9 16	CLAY (CL), with gravel and sand; light olive brown (2.5Y 5/3); high dry strength; fine gravel, subangular, non-native; well graded and well compacted (FILL).		1995.5							
4					SPT-2	0.6 1.5		7 7 7	CLAY (CL), sandy to SAND, clayey with gravel; strong brown (7.5YR 5/8) and light olive brown (2.5Y 5/3); medium stiff; damp; intermixed in discrete chunks of CL and SW; sandstone clasts, subangular; non plastic; fine grained sand; well graded; medium dry strength (FILL).		1994.4							
6					SPT-3	1.5 1.5		4 5 6	CLAY (CL), with gravel; grayish brown (10Y 5/2) to light olive brown (2.5Y 5/3), mottled orangish brown in places; very stiff to hard; damp; trace fine gravel of sandstone and reddish brown claystone, subangular; poorly graded; well compacted (FILL).		1990.6							
8					ST-4	1.3 1.3												
10					SPT-5	1.5 1.5		10 20 28										
12					SPT-6	1.5 1.5		11 23 37										

Notes:
 1. Borehole dry at sampling time.

WOLF CREEK
 UPDATED SAFETY ANALYSIS REPORT

Figure 2.5-36www Rev. 28
 Log of Boring B-111
 Sheet 1 of 3

Surface Level (ft): **1996.43** Easting (ft): **100145.05**
 Total Drill Depth (ft): **36** Northing (ft): **99237.235**
 Inclination/Bearing: **90** Datum: **Wolf Creek Plant Datum**

Hole Id:

B-111

Sheet: 2 of 3

Depth, feet	Water Level	Drill Rate (mins)	Graphic Log	Sample Number	Recovery	RQD	SPT Blows per 6-inches	STRATUM DESCRIPTION	Estimated Strength (ksf)	Stratum Elev. (feet)	CLASSIFICATION					
											Total Unit Wt., pcf	Passing No. 200 Sieve, %	Water Content, %	Liquid Limit	Plastic Limit	Plasticity Index (PI)
16				SPT-7	1.5 1.5		14 24 36	CLAY (CL), with gravel; grayish brown (10Y 5/2) to light olive brown (2.5Y 5/3), mottled orangish brown in places; very stiff to hard; damp; trace fine gravel of sandstone and reddish brown claystone, subangular; poorly graded; well compacted (FILL).	500 1000 1500 2000							
18			SPT-8	1.5 1.5		18 30 38										
20			SPT-9	1.1 1.5		15 20 36										
22			SPT-10	1.5 1.5		14 26 41										
24			SPT-11	0.5 0.5		50/5.9*										
26	4:12						SHALE; medium gray (N5); extremely weak (R0) to very weak (R1); slightly weathered to fresh; distinct laminations, transitions over 1ft intervals from medium gray (N5) to moderately yellowish brown (10YR 5/4) with no composition change (Heumader Shale) Refusal at 6" mark, shale in very tip of SPT sample B111-S11 Diamond drill bit. Down pressure 150 psi.		1970.5							
28	4:55			CR-1	5 5	4.6 5				1967.7						

Notes:
 1. Borehole dry at sampling time.

**WOLF CREEK
 UPDATED SAFETY ANALYSIS REPORT**

Figure 2.5-36www Rev. 28
 Log of Boring B-111
 Sheet 2 of 3

Surface Level (ft): **1996.43** Easting (ft): **100145.05**
 Total Drill Depth (ft): **36** Northing (ft): **99237.235**
 Inclination/Bearing: **90** Datum: **Wolf Creek Plant Datum**

Hole Id:

B-111

Sheet: 3 of 3

Depth, feet	Water Level	Drill Rate (mins)	Graphic Log	Sample Type	Sample Number	Recovery	RQD	SPT Blows per 6-inches	STRATUM DESCRIPTION	Estimated Strength (ksf)	Stratum Elev. (feet)	CLASSIFICATION				
												Total Unit Wt., pcf	Passing No. 200 Sieve, %	Water Content, %	Liquid Limit	Plastic Limit
32		5:39			CR-2	510	510		SHALE; medium gray (N5); very weak (R1); fresh to slightly weathered; high energy deposition, soft sediment deformation, pervasive clay balls; upper contact is gradual over 0.3 ft; abundant bivalves and oyster shells, shell hash layers throughout; non fractured (Heumader Shale) Random fracture, open, soft infill, fresh, 10 and 15 degree dip at acute angles MB, 0° at 30.8' Bedding joint (0°), subhorizontal, soft infill, clay to coarse grained, fresh MB, 0° at 34.0' along shale interbed	500 1000 1500 2000	1960.4					
34		4:29														
36		4:19														
38		6:05														
40		3:35														
42		4:11														
44																

Notes:
1. Borehole dry at sampling time.

**WOLF CREEK
 UPDATED SAFETY ANALYSIS REPORT**

Figure 2.5-36www Rev. 28
 Log of Boring B-111
 Sheet 3 of 3

Surface Level (ft): **1963.49** Easting (ft): **103172.87**
 Total Drill Depth (ft): **12.7** Northing (ft): **98371.84**
 Inclination/Bearing: **90** Datum: **Wolf Creek Plant Datum**

Hole Id:

B-112

Sheet: 1 of 1

Depth, feet	Water Level	Drill Rate (mins)	Graphic Log	Sample Type	Sample Number	Recovery	RQD	SPT Blows per 6-inches	STRATUM DESCRIPTION	Estimated Strength (ksf)	Stratum Elev. (feet)	CLASSIFICATION						
												Total Unit Wt., pcf	Passing No. 200 Sieve, %	Water Content, %	Liquid Limit	Plastic Limit	Plasticity Index (PI)	
0 - 2.2					SPT-1	1.2 1.5		1 2 4	CLAY, sandy (CL); olive black (5Y 2/1); moist to wet; medium stiff; very clayey; 2" of well graded, fine-coarse sand in bottom of spoon (did not bag). - 26.2 ft to mud line from deck NWJ rod check to be 10 ft, 5 ft, 2 ft. Spoon dropped to 26.5 ft when lowered to mud line.				80	24	39	14	25	
2.2 - 3.3		3:31			SPT-2	0 0.1		2 50/1	LIMESTONE; pale blue (5PB 7/2); weak (R2); moderately weathered (MW); medium bedded; heavy staining and some clay fill in sub-horizontal discs to 4.8 ft; fossiliferous; very close- to closely spaced, wavy laminations; strong HCl reaction. BJ, MB - Vertical, 0° between 2.8' and 3.0' BJ, 0° at 3.3' MB, FZ, 0° between 3.5' and 3.7' 4.2 ft to water from deck MB, FZ, 0° between 4.6' and 4.8' Fresh (F) Circulation water is light gray BJ, 10° at 5.7' HW casing with drive shoe = 10.5 ft		1961.0							
3.3 - 3.5		3:31			CR-1	1 2	2 0											
3.5 - 5.7		3:23			SC-1													
5.7 - 7.5		3:02			CR-2	5 5	4.6 5		Casing alone 10.0 ft, 5.0 ft, 2.0 ft, 1.0 ft BJ, 0° at 7.5' Bedding joints are rough and undulating Bottom of lake relatively flat BJ, 0° at 8.6' BJ, 0° at 9.3'				161	2				
7.5 - 11.1		2:27																
11.1 - 11.3		3:26																
11.3 - 11.5		3:02																
11.5 - 12.0		3:26																
12.0 - 12.6		2:44			CR-3	3.3 3.2	2.4 3.2		MB, FZ, 0° between 11.1' and 11.3' SHALE; grayish black (5YR N2); very weak (R0); moderately weathered (MW); very thin to thin bedded; clayey; slight HCl reaction. Circulation water color change to dark gray at 11.5 ft BJ at 12.0' BJ at 12.6'									
12.6 - 12.7		2:44																
12.7		3:30																
		3:48																

Notes:

- Terms and symbols defined on Plate 1.
- As-Built coordinates and elevation surveyed by Kaw Valley Engineering (KS-licensed).
- The SPT blow count is defined as the number of blows required for a 140 lb. auto trip safety hammer falling 30 inches to drive the split-barrel sampler 6 inches in a possible 18 inch sample interval.
- Shelby tubes used for cohesive soil sampling of dimensions 36 inches long, 3 inch outside diameter.
- HQ3 carbide Diamond bit used for rock coring.

**WOLF CREEK
 UPDATED SAFETY ANALYSIS REPORT**

Figure 2.5-36xxx Rev. 28
 Log of Boring B-112
 Sheet 1 of 1

Surface Level (ft): **1996.59** Easting (ft): **100837.75**
 Total Drill Depth (ft): **43.05** Northing (ft): **99262.758**
 Inclination/Bearing: **90** Datum: **Wolf Creek Plant Datum**

Hole Id:

B-112L

Sheet: 1 of 3

Depth, feet	Water Level	Drill Rate (mins)	Graphic Log	Sample Type	Sample Number	Recovery	RQD	SPT Blows per 6-inches	STRATUM DESCRIPTION	Estimated Strength (ksf)	Stratum Elev. (feet)	CLASSIFICATION					
												Total Unit Wt., pcf	Passing No. 200 Sieve, %	Water Content, %	Liquid Limit	Plastic Limit	Plasticity Index (PI)
0 - 2					ST-1	$\frac{1.9}{2}$			CLAY (CL), silty, with gravel; yellowish brown; medium stiff to stiff; damp; gravel is angular to subangular, pea size; well graded (FILL).	500 1000 1500 2000							
2 - 4					ST-2	$\frac{2}{2}$											
4 - 6					ST-3	$\frac{1.8}{2}$			CLAY (CL), with silt; dark gray (10YR 4/1); medium stiff; damp; medium to high plasticity; poorly graded; medium dry strength (FILL).		1992.0			43	16	27	
6 - 8					SPT-4	$\frac{0.3}{1.5}$		5 10 7									
8 - 10					SPT-5	$\frac{0.5}{1.5}$		2 2 4	CLAY (CL), with silt; dark gray (10YR 4/1), mottled yellowish brown (10YR 5/6); soft to medium stiff; moist to damp; high to medium plasticity; poorly graded; high dry strength; fragments of intact shale with faint laminae; trace FeO staining (FILL). Gravel trailings in auger cuttings		1987.2				46	17	29
10 - 14					ST-6								87		46	17	29

Notes:

**WOLF CREEK
 UPDATED SAFETY ANALYSIS REPORT**

Figure 2.5-36yyy Rev. 28
 Log of Boring B-112L
 Sheet 1 of 3

Surface Level (ft): **1996.59** Easting (ft): **100837.75**
 Total Drill Depth (ft): **43.05** Northing (ft): **99262.758**
 Inclination/Bearing: **90** Datum: **Wolf Creek Plant Datum**

Hole Id:
B-112L

Sheet: 2 of 3

Depth, feet	Water Level	Drill Rate (mins)	Graphic Log	Sample Type	Sample Number	Recovery	RQD	SPT Blows per 6-inches	STRATUM DESCRIPTION	Estimated Strength (ksf)	Stratum Elev. (feet)	CLASSIFICATION				
												Total Unit Wt., pcf	Passing No. 200 Sieve, %	Water Content, %	Liquid Limit	Plastic Limit
16					ST-7	0.8 2			CLAY (CL), with silt; dark gray (10YR 4/1), mottled yellowish brown (10YR 5/6); soft to medium stiff; moist to damp; high to medium plasticity; poorly graded; high dry strength; fragments of intact shale with faint laminae; trace FeO staining (FILL).				89	47	18	29
18					SPT-8	0.8 1.5		2 2 7					79			
20					ST-9	0 0.5			GRAVEL, with sand (GP); loose to medium dense; wet; poorly graded; 5-10% fines content; subangular clasts up to 0.6" diameter; poorly graded (FILL) Dented tube in B112-9, no recovery		1977.6					
22																
24																
26					SPT-10	1.5 0.3		4 2 2								
28									SHALE; medium dark gray (N4); extremely weak (R0); fresh to slightly weathered; trace CaCO3 nodules; trace indistinct laminations (Heumader Shale) Driller reports harder drilling		1970.4					

Notes:

**WOLF CREEK
 UPDATED SAFETY ANALYSIS REPORT**

Figure 2.5-36yyy Rev. 28
 Log of Boring B-112L
 Sheet 2 of 3

Surface Level (ft): **1996.59** Easting (ft): **100837.75**
 Total Drill Depth (ft): **43.05** Northing (ft): **99262.758**
 Inclination/Bearing: **90** Datum: **Wolf Creek Plant Datum**

Hole Id:

B-112L

Sheet: 3 of 3

Depth, feet	Water Level	Drill Rate (mins)	Graphic Log	Sample Type	Sample Number	Recovery	RQD	SPT Blows per 6-inches	STRATUM DESCRIPTION	Estimated Strength (ksf)	Stratum Elev. (feet)	CLASSIFICATION								
												Total Unit Wt., pcf	Passing No. 200 Sieve, %	Water Content, %	Liquid Limit	Plastic Limit	Plasticity Index (PI)			
32					SPT-11	0.8 0.8		15 50/4.0*	SHALE; medium dark gray (N4); extremely weak (R0); fresh to slightly weathered; trace CaCO3 nodules; trace indistinct laminations (Heumader Shale) Driller reports harder drilling											
36					SPT-12	0.3 1.5		3 16 23												
38					SPT-13	0 0.1		50/1.0*	Refusal with auger, confirmed with SPT refusal		1958.5									
40		4:29			CR-1	5 5	4.6 5		LIMESTONE; very light gray (N8) to light gray (N7); weak (R2); fresh to slightly weathered; slightly fractured along bedding breaks; bedding is subhorizontal and undulating up to 0.8 inch amplitude; argillaceous with random coarser clasts up to 0.5" diameter; pervasive bivalves and oyster shells; generally low energy deposition, with intermittent high energy zones up to 1.2 inch thickness; bedding material is dark gray (N8), argillaceous, very weak (Plattsmouth Limestone) Bedding joint (0°), subhorizontal, open, fresh Bedding joint (0°), subhorizontal, open within soft material Bedding (10°), closed, undulatory Bedding (5°), closed, undulatory Bedding (2°), closed, undulatory, subhorizontal Bedding (0°), closed, softer material MB, 0° at 42.7'	1471.7										
42		4:03									1953.5									
44		4:50																		

Notes:

WOLF CREEK
 UPDATED SAFETY ANALYSIS REPORT

Figure 2.5-36yyy Rev. 28
 Log of Boring B-112L
 Sheet 3 of 3

Surface Level (ft): **1967.02** Easting (ft): **103470.77**
 Total Drill Depth (ft): **2.35** Northing (ft): **98152.29**
 Inclination/Bearing: **90** Datum: **Wolf Creek Plant Datum**

Hole Id:

B-113

Sheet: 1 of 1

Depth, feet	Water Level	Drill Rate (mins)	Graphic Log	Sample Type	Sample Number	Recovery	RQD	SPT Blows per 6-inches	STRATUM DESCRIPTION	Estimated Strength (ksf)	Stratum Elev. (feet)	CLASSIFICATION				
												Total Unit Wt., pcf	Passing No. 200 Sieve, %	Water Content, %	Liquid Limit	Plastic Limit
0									CLAY (CL); pale yellowish brown (10YR 6/2); moist to wet; very soft; contains limestone fragments, or residuum; Organic debris and detritus, 0 to 0.2 ft.	500 1000 1500 2000						
2					SPT-1	0.8 1.5		0 0 0	Depth to Mudline is 24.8 ft.							
2.35					SPT-2	0 0.15		21 50/2			1964.7					

Notes:

- Terms and symbols defined on Plate 1.
- As-Built coordinates and elevation surveyed by Kaw Valley Engineering (KS-licensed).
- The SPT blow count is defined as the number of blows required for a 140 lb. auto trip safety hammer falling 30 inches to drive the split-barrel sampler 6 inches in a possible 18 inch sample interval.
- Shelby tubes used for cohesive soil sampling of dimensions 36 inches long, 3 inch outside diameter.
- HQ3 carbide Diamond bit used for rock coring.

**WOLF CREEK
 UPDATED SAFETY ANALYSIS REPORT**

Figure 2.5-36zzz Rev. 28
 Log of Boring B-113
 Sheet 1 of 1

Surface Level (ft): **1996.54** Easting (ft): **100873.25**
 Total Drill Depth (ft): **40.8** Northing (ft): **99259.028**
 Inclination/Bearing: **90** Datum: **Wolf Creek Plant Datum**

Hole Id:

B-113L

Sheet: 1 of 3

Depth, feet	Water Level	Drill Rate (mins)	Graphic Log	Sample Type	Sample Number	Recovery	RQD	SPT Blows per 6-inches	STRATUM DESCRIPTION	Estimated Strength (ksf)	Stratum Elev. (feet)	CLASSIFICATION				
												Total Unit Wt., pcf	Passing No. 200 Sieve, %	Water Content, %	Liquid Limit	Plastic Limit
0 - 2					ST-1	1.2 2			CLAY, silty, with sand and trace gravel (CL); dark grey (10YR 4/1) with sand and sandstone of brownish yellow (10YR 6/6); medium stiff to stiff; damp; clay matrix is low to moderate plasticity; subangular, sandstone clasts of fine grained sand; well graded (FILL).	500 1000 1500 2000						
2 - 4					SPT-2	1 1.5		5 8 9								
4 - 6					ST-3	1.9 2			CLAY, with gravel and silt (CL); very dark gray (10YR 3/1); medium stiff; damp; clay matrix is high to moderately plastic; shale clasts, yellowish brown fine grained sandstone (R0) and reddish siltstone clasts (R0-R1); well graded; high dry strength (FILL).		1990.9			48	18	30
6 - 8					SPT-4	0.9 1.5		3 3 4								
8 - 10					ST-5	1.2 1.5					6.14			47	17	30
10 - 12																
12 - 14					SPT-6	1.5 1.5		3 3 5	CLAY, silty (CL); very dark gray (10YR 3/1), mottled yellowish brown (10YR 5/4) and dark brown (7.5 YR 3/3); little fine gravel and sand; soft to medium stiff; high to moderately plastic; moderately well graded (FILL).		1984.3		86	45	15	30

Notes:

**WOLF CREEK
 UPDATED SAFETY ANALYSIS REPORT**

Figure 2.5-36aaaa Rev. 28
 Log of Boring B-113L
 Sheet 1 of 3

Surface Level (ft): **1996.54** Easting (ft): **100873.25**
 Total Drill Depth (ft): **40.8** Northing (ft): **99259.028**
 Inclination/Bearing: **90** Datum: **Wolf Creek Plant Datum**

Hole Id:

B-113L

Sheet: 2 of 3

Depth, feet	Water Level	Drill Rate (mins)	Graphic Log	Sample Type	Sample Number	Recovery	RQD	SPT Blows per 6-inches	STRATUM DESCRIPTION	Estimated Strength (ksf)	Stratum Elev. (feet)	CLASSIFICATION						
												Total Unit Wt., pcf	Passing No. 200 Sieve, %	Water Content, %	Liquid Limit	Plastic Limit	Plasticity Index (PI)	
16					ST-7	1.3 2			CLAY, silty (CL); very dark gray (10YR 3/1), mottled yellowish brown (10YR 5/4) and dark brown (7.5 YR 3/3); little fine gravel and sand; soft to medium stiff; high to moderately plastic; moderately well graded (FILL).									
18					SPT-8	1.3 1.5		2 3 5	Large clast of siltstone, up to 2" diameter, possibly limestone up to 20% fine gravel content, generally non-native, increasing matrix plasticity to high to moderate. Hydrostatic pressure up to 15 ft depth minimum.				85					
20					SPT-9	0.9 1.5		8 8 9	GRAVEL, with sand (GP); loose to medium dense; wet; poorly graded; 5-10% fines content; subangular clasts up to 0.6" diameter; poorly graded (FILL)		1977.0		7					
22					SPT-10	0.8 1.5		6 9 10	Increasing fines content to 15%.									
24					SPT-11	1.1 1.5		6 11 14	SHALE; dark gray (N3); extremely weak (R0) to very weak (R1); fresh to slightly weathered; indistinct, subhorizontal laminations (Heumader Shale)		1970.3							
26																		
28																		

Notes:

**WOLF CREEK
 UPDATED SAFETY ANALYSIS REPORT**

Figure 2.5-36aaaa Rev. 28
 Log of Boring B-113L
 Sheet 2 of 3

Surface Level (ft): **1996.54** Easting (ft): **100873.25**
 Total Drill Depth (ft): **40.8** Northing (ft): **99259.028**
 Inclination/Bearing: **90** Datum: **Wolf Creek Plant Datum**

Hole Id:

B-113L

Sheet: 3 of 3

Depth, feet	Water Level	Drill Rate (mins)	Graphic Log	Sample Type	Sample Number	Recovery	RQD	SPT Blows per 6-inches	STRATUM DESCRIPTION	Estimated Strength (ksf)	Stratum Elev. (feet)	CLASSIFICATION				
												Total Unit Wt., pcf	Passing No. 200 Sieve, %	Water Content, %	Liquid Limit	Plastic Limit
32		4:45			SPT-12	0.8 0.8		17 50/4.0	SHALE; dark gray (N3); extremely weak (R0) to very weak (R1); fresh to slightly weathered; indistinct, subhorizontal laminations (Heumader Shale) Diamond bit. Down pressure 200 psi Bedding breaks (0°), subhorizontal, undulatory Bedding breaks (0°), subhorizontal, undulatory		1964.1					
34		5:11			CR-1	5/5	4.6 5		SHALE; medium dark gray to light gray (N4-N3); very weak (R1); fresh to slightly weathered; high energy deposition with soft sediment deformation; light gray clay balls; CaCO3 nodules; rough core surface; argillaceous (Heumader Shale) Soft gravel zones at 32.8-33.0, 33.5-33.7 ft. Extremely weak, clay-like, high plasticity. Down pressure 350 psi	69.7						
38		5:01			CR-2	5/5	5/5		Increasing strength towards limestone contact to R1-R2 Bedding breaks (0°), subhorizontal, undulatory LIMESTONE; very light gray (N8) to light gray (N7); weak (R2); fresh to slightly weathered; argillaceous with very thin shale interbeds; contact is clear and sharp with shale; minor incipient fractures; bedding is subhorizontal and undulating up to 0.4 inch amplitude (Plattsmouth Limestone) SHALE interbed, 0.1 ft thickness, R1-R2; clear contacts along undulatory bed, 0.4" amplitude.		1958.8					
40		3:35									1955.7					

Notes:

WOLF CREEK
 UPDATED SAFETY ANALYSIS REPORT

Figure 2.5-36aaaa Rev. 28
 Log of Boring B-113L
 Sheet 3 of 3

Surface Level (ft): **1996.32** Easting (ft): **100837.75**
 Total Drill Depth (ft): **36.3** Northing (ft): **99242.648**
 Inclination/Bearing: **90** Datum: **Wolf Creek Plant Datum**

Hole Id:

B-114L

Sheet: 1 of 3

Depth, feet	Water Level	Drill Rate (mins)	Graphic Log	Sample Type	Sample Number	Recovery	RQD	SPT Blows per 6-inches	STRATUM DESCRIPTION	Estimated Strength (ksf)	Stratum Elev. (feet)	CLASSIFICATION				
												Total Unit Wt., pcf	Passing No. 200 Sieve, %	Water Content, %	Liquid Limit	Plastic Limit
					ST-1				CLAY (CL); dark grey (10 YR 3/1); damp; soft to medium strong; high plasticity (FILL)		1995.6					
									GRAVEL, with sand (GP); loose; fine to coarse gravel, subangular to angular, with medium grained sand; well graded (FILL)		1994.7					
2									CLAY, silty, with sand (CL); dark gray (10YR 4/1); medium stiff; damp; medium grained sand, brownish yellow (10YR 4/1); high dry strength; low plasticity; trace clasts, angular, broken in sampler; well graded (FILL).							
					SPT-2	$\frac{1}{1.5}$		5 7 7								
					ST-3	$\frac{1.9}{2}$										
					SPT-4	$\frac{0.4}{1.5}$		2 5 6	CLAY, with gravel and silt (CL); dark gray (10YR 4/1); medium stiff; damp; high dry strength; moderate plasticity; gravel is fine, mostly shale composition (FILL).		1988.9			44	17	27
					ST-5	$\frac{1.4}{2}$										
					SPT-6	$\frac{1.2}{1.5}$		2 3 4								

Notes:

**WOLF CREEK
 UPDATED SAFETY ANALYSIS REPORT**

Figure 2.5-36bbbbb Rev. 28
 Log of Boring B-114L
 Sheet 1 of 3

Surface Level (ft): **1996.32** Easting (ft): **100837.75**
 Total Drill Depth (ft): **36.3** Northing (ft): **99242.648**
 Inclination/Bearing: **90** Datum: **Wolf Creek Plant Datum**

Hole Id:

B-114L

Sheet: 2 of 3

Depth, feet	Water Level	Drill Rate (mins)	Graphic Log	Sample Type	Sample Number	Recovery	RQD	SPT Blows per 6-inches	STRATUM DESCRIPTION	Estimated Strength (ksf)	Stratum Elev. (feet)	CLASSIFICATION				
												Total Unit Wt., pcf	Passing No. 200 Sieve, %	Water Content, %	Liquid Limit	Plastic Limit
16					ST-7	1.4 2			CLAY, with silt (CL); dark gray (10YR 4/1); stiff; damp; high dry strength; moderate plasticity; some fine gravel, mostly shale composition; poorly graded (FILL).	3.59	1981.1			44	17	27
20					SPT-8	0.9 1.5		6 9 12	GRAVEL, sandy (GP); medium dense to dense; moderately sorted; poorly graded; gravel is fine with some coarse gravel; subrounded to subangular; sand is coarse grained (FILL). Hydrostatic pressure up to 15 ft depth minimum. Cuttings don't appear to reflect gravel unit		1976.5		10			
26					SPT-9	1 1.5		4 22 43	SHALE; dark gray (N3-N4); extremely weak (R0) to very weak (R1); fresh to slightly weathered; distinct, subhorizontal laminations (Heumader Shale)		1970.8					

Notes:

**WOLF CREEK
 UPDATED SAFETY ANALYSIS REPORT**

Figure 2.5-36bbbb Rev. 28
 Log of Boring B-114L
 Sheet 2 of 3

Surface Level (ft): **1996.32** Easting (ft): **100837.75**
 Total Drill Depth (ft): **36.3** Northing (ft): **99242.648**
 Inclination/Bearing: **90** Datum: **Wolf Creek Plant Datum**

Hole Id:

B-114L

Sheet: 3 of 3

Depth, feet	Water Level	Drill Rate (mins)	Graphic Log	Sample Type	Sample Number	Recovery	RQD	SPT Blows per 6-inches	STRATUM DESCRIPTION	Estimated Strength (ksf)	Stratum Elev. (feet)	CLASSIFICATION				
												Total Unit Wt., pcf	Passing No. 200 Sieve, %	Water Content, %	Liquid Limit	Plastic Limit
32		3:34			SPT-10	1.3 1.5		3 30 50/4"	SHALE; dark gray (N3-N4); extremely weak (R0) to very weak (R1); fresh to slightly weathered; distinct, subhorizontal laminations (Heumader Shale) Diamond bit. Down pressure 160 psi	500 1000 1500 2000	1963.5					
34		5:44			CR-1	4.4 5	4.4 5		SHALE; medium gray (N5); very weak (R1) to weak (R2); fresh to slightly weathered; distinct laminations; high energy deposition with soft sediment deformation with shell hash in places; subhorizontal, undulating bedding; sparse bivalve shells; CaCO3 nodules (Heumader Shale) Bedding breaks (0°), subhorizontal, undulatory Diamond bit cutting poorly in shale	•178.4	1960.0					
36		5:50							MB, 0° at 35.9'							
38																
40																
42																
44																

Notes:

**WOLF CREEK
 UPDATED SAFETY ANALYSIS REPORT**

Figure 2.5-36bbbb Rev. 28
 Log of Boring B-114L
 Sheet 3 of 3

Surface Level (ft): **1965.47** Easting (ft): **104039.14**
 Total Drill Depth (ft): **11.1** Northing (ft): **97706.88**
 Inclination/Bearing: **90** Datum: **Wolf Creek Plant Datum**

Hole Id:

B-115

Sheet: 1 of 1

Depth, feet	Water Level	Drill Rate (mins)	Graphic Log	Sample Type	Sample Number	Recovery	RQD	SPT Blows per 6-inches	STRATUM DESCRIPTION	Estimated Strength (ksf)	Stratum Elev. (feet)	CLASSIFICATION					
												Total Unit Wt., pcf	Passing No. 200 Sieve, %	Water Content, %	Liquid Limit	Plastic Limit	Plasticity Index (PI)
					SPT-1	0.8 0.9		0 38 50/1	SILT (ML); dark gray (N3) and black (N1); wet; very soft; with clay and organics. Depth to Mudline is 26.5 ft.								
2		1:49							LIMESTONE; pale blue (5PB 7/2); medium strong (R3); moderately weathered (MW) to 2 ft, fresh (F) below 2 ft; thin to medium bedded; heavy staining to 2 ft; fossiliferous; moderately argillaceous with shale partings; strong HCl reaction. FZ, 0° between 1.1' and 2.0' BJ, 0°, rough, undulating at 2.8'		1964.6						
4		2:45			SC-1 CR-1	5/5	3.5 5		BJ, 0°, rough, undulating at 3.9'	●1800		163		1			
6		3:10							SHALE; grayish black (5YR N/2); very weak (R1); moderately weathered (MW) to highly weathered (HW); very thin to thinly bedded; clayey in HW zone, 4.5 to 5.0 ft; no reaction to HCl. - FZ, 0°, due to weathering between 4.5' and 5.1' BJ, 0° at 5.9' Light olive gray (5Y 6/1) nodules and very thin bands; very close to closely spaced, horizontal bedding joints. - BJ, 0°, very close to closely spaced between 6.1' and 8.4'		1961.0						
8		3:35															
10		2:33			CR-2	5/5	2.8 5		LIMESTONE; pale blue (5B/J/6); medium strong (R3); fresh (F); medium bedded; strong HCl reaction. BJ, 0° at 8.7' BJ, 0° at 8.8' BJ, 0° at 8.9'		1957.1						
12		6:12							SHALE; dark gray (N3); extremely weak (R0); highly weathered (HW); thin bedded; fossiliferous; moderate HCl reaction. BJ, 0° at 10.4' BJ, 0° at 10.6' BJ, 0° at 10.8'		1955.9						
14		5:58										1954.4					

Notes:

- Terms and symbols defined on Plate 1.
- As-Built coordinates and elevation surveyed by Kaw Valley Engineering (KS-licensed).
- The SPT blow count is defined as the number of blows required for a 140 lb. auto trip safety hammer falling 30 inches to drive the split-barrel sampler 6 inches in a possible 18 inch sample interval.
- Shelby tubes used for cohesive soil sampling of dimensions 36 inches long, 3 inch outside diameter.
- HQ3 carbide Diamond bit used for rock coring.

**WOLF CREEK
 UPDATED SAFETY ANALYSIS REPORT**

Figure 2.5-36cccc Rev. 28
 Log of Boring B-115
 Sheet 1 of 1

Surface Level (ft): **1996.31** Easting (ft): **100873.25**
 Total Drill Depth (ft): **37.8** Northing (ft): **99238.918**
 Inclination/Bearing: **90** Datum: **Wolf Creek Plant Datum**

Hole Id:

B-115L

Sheet: 1 of 3

Depth, feet	Water Level	Drill Rate (mins)	Graphic Log	Sample Number	Recovery	RQD	SPT Blows per 6-inches	STRATUM DESCRIPTION	Estimated Strength (ksf)	Stratum Elev. (feet)	CLASSIFICATION				
											Total Unit Wt., pcf	Passing No. 200 Sieve, %	Water Content, %	Liquid Limit	Plastic Limit
0 - 2				ST-1	$\frac{1.2}{2}$			CLAY, sandy with silt, trace gravel (CL); very dark gray (10YR 3/1) with sand nodules and sandstone of brownish yellow (10YR 6/6); medium stiff to stiff; damp; low to moderate plasticity; trace fine grained sandstone clasts, subangular; nodules of fine grained sand; well graded (FILL).	500 1000 1500 2000						
2 - 4				SPT-2	$\frac{0.9}{1.5}$		4 7 5								
4 - 6				ST-3	$\frac{1.4}{2}$			CLAY, silty (CL); brown (10YR 4/3); stiff; damp; loss of sand and gravel; low dry strength; low to moderate plasticity; higher dilatancy; poorly graded (FILL).		1990.8					
6 - 8				SPT-4	$\frac{0.6}{1.5}$		2 3 4	CLAY, with gravel and silt (CL); dark gray (10YR 4/1); medium stiff; damp; moderate plasticity; poorly graded (FILL).		1989.1					
8 - 12				ST-5	$\frac{1}{2}$			CLAY, silty (CL); brown (10YR 4/3), mottled dark gray (10YR4/1); medium stiff; moderate to high plasticity; poorly graded; trace fine gravel; trace fine grained sand; high dry strength (FILL)		1986.1					
12 - 14				SPT-6	$\frac{0.5}{1.5}$		2 3 3								

Notes:

**WOLF CREEK
 UPDATED SAFETY ANALYSIS REPORT**

Figure 2.5-36dddd Rev. 28
 Log of Boring B-115L
 Sheet 1 of 3

Surface Level (ft): **1996.31** Easting (ft): **100873.25**
 Total Drill Depth (ft): **37.8** Northing (ft): **99238.918**
 Inclination/Bearing: **90** Datum: **Wolf Creek Plant Datum**

Hole Id:

B-115L

Sheet: 2 of 3

Depth, feet	Water Level	Drill Rate (mins)	Graphic Log	Sample Type	Sample Number	Recovery	RQD	SPT Blows per 6-inches	STRATUM DESCRIPTION	Estimated Strength (ksf)	Stratum Elev. (feet)	CLASSIFICATION				
												Total Unit Wt., pcf	Passing No. 200 Sieve, %	Water Content, %	Liquid Limit	Plastic Limit
16					ST-7	1.1 2			CLAY, silty (CL); brown (10YR 4/3), mottled dark gray (10YR4/1); medium stiff; moderate to high plasticity; poorly graded; trace fine gravel; trace fine grained sand; high dry strength (FILL)	3.2		92	44	16	28	
18											1977.8					
20					SPT-8	0.9 1.5		6	GRAVEL, sandy (GP); medium dense ; wet; well sorted; poorly graded; gravel is fine, subangular; sand is coarse grained (FILL).			5				
22																
24					SPT-9	0.9 1.5		5 10 32	SHALE; dark gray (N3), mottled yellow brown (10YR 6/6) in places; extremely weak (R0) to very weak (R1); fresh to slightly weathered; intermixed little fine to coarse grained sand and angular, coarse quartz sand (Heumader Shale)		1972.3					
26																
28					SPT-10	0.7 0.7		33 50/2"	Becoming stronger							
		2:20									1966.6					

Notes:

**WOLF CREEK
 UPDATED SAFETY ANALYSIS REPORT**

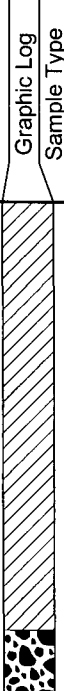

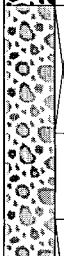

Figure 2.5-36dddd Rev. 28
 Log of Boring B-115L
 Sheet 2 of 3

Surface Level (ft): **1998.97** Easting (ft): **99761.47**
 Total Drill Depth (ft): **34** Northing (ft): **100077**
 Inclination/Bearing: **90** Datum: **Wolf Creek Plant Datum**

Hole Id:

B-118

Sheet: 1 of 3

Depth, feet	Water Level	Drill Rate (mins)	Graphic Log	Sample Type	Sample Number	Recovery, feet	RQD	SPT Blows per 6-inches	STRATUM DESCRIPTION	Estimated Strength (ksf)	Stratum Elev. (feet)	CLASSIFICATION						
												Total Unit Wt., pcf	Passing No. 200 Sieve, %	Water Content, %	Liquid Limit	Plastic Limit	Plasticity Index (PI)	
0 - 5.5									CLAY, sandy (CL) - Fill									
5.5 - 10.0									GRAVEL (GP - Fill)		1994.0							
10.0 - 12.0					SPT-1			9 13 11	GRAVEL, sandy (GP); damp; light gray (10YR 7/1); medium dense to loose; gravel is subangular, fine, average 0.5 inch diameter, up to coarse 0.8 inch diameter, generally limestone composition with non-natives; very fine to medium grained sand; no cohesion; poorly graded (FILL).		1989.0							
12.0 - 14.1					SPT-2	1.3 1.5		11 14 12	Becomes wet in sample Groundwater measured at 14.1 ft morning 5/11. Hollow stem auger in place to bedrock depth left overnight.									

Notes:

**WOLF CREEK
 UPDATED SAFETY ANALYSIS REPORT**

Figure 2.5-36e Rev. 28
 Log of Boring B-118
 Sheet 1 of 3

Surface Level (ft): **1998.97** Easting (ft): **99761.47**
 Total Drill Depth (ft): **34** Northing (ft): **100077**
 Inclination/Bearing: **90** Datum: **Wolf Creek Plant Datum**

Hole Id:

B-118

Sheet: 2 of 3

Depth, feet	Water Level	Drill Rate (mins)	Graphic Log	Sample Number	Recovery, feet	RQD	SPT Blows per 6-inches	STRATUM DESCRIPTION	Estimated Strength (ksf)	Stratum Elev. (feet)	CLASSIFICATION				
											Total Unit Wt., pcf	Passing No. 200 Sieve, %	Water Content, %	Liquid Limit	Plastic Limit
16				SPT-3	0.8 1.5		9 10 12	GRAVEL, sandy (GP); damp; light gray (10YR 7/1); medium dense to loose; gravel is subangular, fine, average 0.5 inch diameter, up to coarse 0.8 inch diameter, generally limestone composition with non-natives; very fine to medium grained sand; no cohesion; poorly graded (FILL).							
18				SPT-4	0.8 1.5		10 12 15	GRAVEL, with sand and clay (GP-GC); wet; light gray (10YR 7/1); medium dense to loose; gravel is subangular, fine, average 0.5 inch diameter, up to coarse 0.8 inch diameter, generally limestone composition with non-natives; very fine to medium grained sand; 10-15% clay; little cohesion; poorly graded (FILL).		1980.5					
20				SPT-5	0.9 1.5		10 13 14	CLAY (Residual Soil); damp; very dark gray (GLEY 1 3N); stiff to very stiff; indistinct to faint laminations; minor FeO staining along lamination breaks; very weak bedrock fabric; nonplastic moldable with strong finger pressure; poorly graded (Weathered Heumader Shale)		1977.8					
22				SPT-6	1.2 1.3		21 37 50/3	SHALE; dark gray (N3); extremely weak (R0); slightly weathered; indistinct to faint laminations; undulating, subhorizontal laminae; slightly fractured; intermittent fine gravel; lower energy deposition; rough core surface (Heumader Shale)		1975.2					
24		4:06						Surface diamond bit. Downpressure 200 psi Subhorizontal bedding, 0°, washed out, soft interbed at 24.6'							
26		4:57		CR-1	4.9 5	4.8 5		Pebble layer at 24.8 ft, 2.5 inch thickness BJ, 0°, bedding infill, soft clay at 25.7' Increasing strength, extremely weak (R0) to very weak (R1)							
28		4:01						SHALE; light gray (N7) to medium gray (N5); very weak (R1); slightly weathered to fresh; CaCO3 nodules; pervasive clay balls; high energy deposition; intermittent thin soft clay beds along bedding; distinct laminations; bivalve shells up to 0.3 inch diame BJ, 0°, bedding infill, soft clay and fine gravel at 27.6'		1971.4					
		5:12													

Notes:

WOLF CREEK
 UPDATED SAFETY ANALYSIS REPORT

Figure 2.5-36eeee Rev. 28
 Log of Boring B-118
 Sheet 2 of 3

Surface Level (ft): **1998.97** Easting (ft): **99761.47**
 Total Drill Depth (ft): **34** Northing (ft): **100077**
 Inclination/Bearing: **90** Datum: **Wolf Creek Plant Datum**

Hole Id:

B-118

Sheet: 3 of 3

Depth, feet	Water Level	Drill Rate (mins)	Graphic Log	Sample Type	Sample Number	Recovery, feet	RQD	SPT Blows per 6-inches	STRATUM DESCRIPTION	Estimated Strength (ksf)	Stratum Elev. (feet)	CLASSIFICATION					
												Total Unit Wt., pcf	Passing No. 200 Sieve, %	Water Content, %	Liquid Limit	Plastic Limit	Plasticity Index (PI)
32		6:25			CR-2	51.5	4.8	5.8	BJ, 0°, bedding infill, soft clay at 28.4' MB, 0°, along bedding at 28.8' MB, 0° at 29.1' MB, 0° at 29.3' SHALE; light gray (N7) to medium gray (N5); very weak (R1); slightly weathered to fresh; CaCO3 nodules; pervasive clay balls; high energy deposition; intermittent thin soft clay beds along bedding; distinct laminations; bivalve shells up to 0.3 inch diame BJ, 0°, bedding infill, soft clay and fine gravel at 31.4' Limestone bed, 0.8 inch thickness Soft clay bed, 0.7 inch thickness LIMESTONE; very light gray (N8); weak (R2); fresh to slightly weathered; subhorizontal bedding with some thin shaley interbeds; clear upper contact with Heumader Shale; slightly fractured with minor incipient fracturing; argillaceous with thin soft shale (R1-R0) interbeds; bivalve shells (Plattsmouth Limestone). BJ, 0°, bedding infill, soft clay and fine gravel at 32.1' BJ, 15°, undulatory argillaceous dark gray bed at 33.4' End of boring at 34 ft below ground surface	500 1000 1500 2000	1966.9						
34		3:26									1965.0						
36																	
38																	
40																	
42																	
44																	

Notes:

**WOLF CREEK
 UPDATED SAFETY ANALYSIS REPORT**

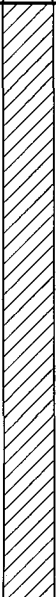



Figure 2.5-36eeee Rev. 28
 Log of Boring B-118
 Sheet 3 of 3

Surface Level (ft): **1999.1** Easting (ft): **99768.24**
 Total Drill Depth (ft): **34** Northing (ft): **100027.41**
 Inclination/Bearing: **90** Datum: **Wolf Creek Plant Datum**

Hole Id:

B-119

Sheet: 1 of 3

Depth, feet	Water Level	Drill Rate (mins)	Graphic Log Sample Type	Sample Number	Recovery, feet	RQD	SPT Blows per 6-inches	STRATUM DESCRIPTION	Estimated Strength (ksf)	Stratum Elev. (feet)	CLASSIFICATION						
											Total Unit Wt., pcf	Passing No. 200 Sieve, %	Water Content, %	Liquid Limit	Plastic Limit	Plasticity Index (PI)	
0 - 7.5								CLAY, sandy (CL) - Fill									
7.5 - 10.0								GRAVEL (GP) - Fill		1992.1							
10.0 - 12.5				SPT-1	0.83 1.5		12 16 16	GRAVEL, sandy (GP); damp; light gray (10YR 7/1); medium dense to loose; gravel is subangular, fine, average 0.5 inch diameter, up to coarse 0.8 inch diameter, generally limestone composition with non-natives; very fine to medium grained sand; no cohesion; poorly graded (FILL).		1989.1							
12.5 - 14.0				SPT-2	0.75 1.5		8 7 9	Becomes moist to wet in sample									

Notes:

**WOLF CREEK
 UPDATED SAFETY ANALYSIS REPORT**

Figure 2.5-36ffff Rev. 28
 Log of Boring B-119
 Sheet 1 of 3

Surface Level (ft): **1999.1**
 Total Drill Depth (ft): **34**
 Inclination/Bearing: **90**

Easting (ft): **99768.24**
 Northing (ft): **100027.41**
 Datum: **Wolf Creek Plant Datum**

Hole Id:

B-119

Sheet: 2 of 3

Depth, feet	Water Level	Drill Rate (mins)	Graphic Log	Sample Type	Sample Number	Recovery, feet	RQD	SPT Blows per 6-inches	STRATUM DESCRIPTION	Estimated Strength (ksf)	Stratum Elev. (feet)	CLASSIFICATION						
												Total Unit Wt., pcf	Passing No. 200 Sieve, %	Water Content, %	Liquid Limit	Plastic Limit	Plasticity Index (PI)	
16					SPT-3	0.83 1.5		10 9 7	Groundwater measured at 14.4 ft morning 5/11. Hole completed and casing left in hole overnight. GRAVEL, sandy (GP); damp; light gray (10YR 7/1); medium dense to loose; gravel is subangular, fine, average 0.5 inch diameter, up to coarse 0.8 inch diameter, generally limestone composition with non-natives; very fine to medium grained sand; no cohesion; poorly graded (FILL).									
18					SPT-4	0.83 1.5		13 13 11	Well sorted, medium to fine grained sand top of sample, called slough. Brought into sample from water table hydrostatic pressure. GRAVEL, with sand and clay (GP-GC); wet; light gray (10YR 7/1); medium dense to loose; gravel is subangular, fine, average 0.5 inch diameter, up to coarse 0.8 inch diameter, generally limestone composition with non-natives; very fine to medium grained sand; 10-15% clay; some cohesion; moderately graded (FILL).		1980.6							
20					SPT-5	0.83 1.5		6 10 10										
22					SPT-6	1 1.3		8 46 50/3	CLAY (Residual Soil); damp; very dark gray (GLEY 1 3N); stiff to very stiff; indistinct to faint laminations; minor FeO staining along lamination breaks; very weak bedrock fabric; nonplastic moldable with strong finger pressure; poorly graded; contact to Shale is gradual over 1 foot (Weathered Heumader Shale)		1977.3							
24									SHALE; dark gray (N3) to medium dark gray (N4); extremely weak (R0); slightly weathered; faint, subhorizontal laminations; argillaceous; minor FeO staining; slightly fractured; rough core surface (Heumader Shale)		1975.6							
26					CR-1	4.9 5	4.6 5		Surface diamond bit. Downpressure 300 psi BJ, 0°, bedding infill, soft clay, subhorizontal, undulatory at 25.0' BJ, 0°, bedding infill, soft clay, subhorizontal, undulatory at 26.4' BJ, 0°, bedding infill, soft clay, subhorizontal, undulatory at 27.3'									
28									SHALE; light gray (N7) to medium gray (N5); very weak (R1); slightly weathered to fresh; CaCO3 nodules; pervasive clay balls; high energy deposition; intermittent thin soft clay beds along bedding; distinct laminations; bivalve shells up to 0.3 inch diameter (Heumader Shale)		1971.3							

Notes:

**WOLF CREEK
 UPDATED SAFETY ANALYSIS REPORT**

Figure 2.5-36ffff Ref. 28
 Log of Boring B-119
 Sheet 2 of 3

Surface Level (ft): **1999.1** Easting (ft): **99768.24**
 Total Drill Depth (ft): **34** Northing (ft): **100027.41**
 Inclination/Bearing: **90** Datum: **Wolf Creek Plant Datum**

Hole Id:

B-119

Sheet: 3 of 3

Depth, feet	Water Level	Drill Rate (mins)	Graphic Log	Sample Type	Sample Number	Recovery, feet	RQD	SPT Blows per 6-inches	STRATUM DESCRIPTION	Estimated Strength (ksf)	Stratum Elev. (feet)	CLASSIFICATION					
												Total Unit Wt., pcf	Passing No. 200 Sieve, %	Water Content, %	Liquid Limit	Plastic Limit	Plasticity Index (PI)
		3:32			CR-2				RF, 20°, across bedding at 27.8' BJ, 0°, bedding infill, soft clay, subhorizontal, undulatory at 30.1'		1968.9						
32		3:49							SHALE; medium gray (N5); very weak (R1) to extremely weak (R0); slightly weathered to fresh; CaCO3 nodules; fine gravel clasts average 0.3 inch diameter, up to 0.7 inch diameter; swelling clay beds in core (Heumader Shale)		1967.4						
34		5:11							MB, 0°, along bedding at 30.4'								
36		3:38							LIMESTONE; very light gray (N8) to light gray (N7); weak (R2); fresh; argillaceous with very thin soft shale (R1-R0) interbeds; bivalve shells; slightly fractured, minor incipient fracturing; subhorizontal, undulatory bedding, 0.2 inch amplitude; clear, sharp upper contact with shale; subhorizontal bedding with some thin shaley interbeds; clear upper contact with Heumader Shale; upper 7 inches is more argillaceous and shaley at contact; (Plattsmouth Limestone).		1965.1						
38									BJ, 0°, bedding infill, soft clay at contact at 31.7'								
40									End of boring at 34 ft below ground surface								

Notes:

**WOLF CREEK
 UPDATED SAFETY ANALYSIS REPORT**

Figure 2.5-36ffff Rev. 28
 Log of Boring B-119
 Sheet 3 of 3

Mudline Level (ft): **1975.03** Easting (ft): **101964.08**
 Total Drill Depth (ft): **37.8** Northing (ft): **99646.05**
 Inclination/Bearing: **90** Datum: **Wolf Creek Plant Datum**

Hole Id:

B-120

Sheet: 1 of 3

Depth, feet	Water Level	Drill Rate (mins)	Graphic Log	Sample Type	Sample Number	Recovery, feet	RQD	SPT Blows per 6-inches	STRATUM DESCRIPTION	Estimated Strength (ksf)	Stratum Elev. (feet)	CLASSIFICATION					
												Total Unit Wt., pcf	Passing No, 200 Sieve, %	Water Content, %	Liquid Limit	Plastic Limit	Plasticity Index (PI)
2									Depth to Mudline below platform deck surface is 16.2 ft.	500							
4										1000							
6										1500							
8										2000							
10																	
12																	
14																	

Notes:

**WOLF CREEK
 UPDATED SAFETY ANALYSIS REPORT**

Figure 2.5-36gggg Rev. 28
 Log of Boring B-120
 Sheet 1 of 3

Mudline Level (ft): **1975.03** Easting (ft): **101964.08**
 Total Drill Depth (ft): **37.8** Northing (ft): **99646.05**
 Inclination/Bearing: **90** Datum: **Wolf Creek Plant Datum**

Hole Id:

B-120

Sheet: 2 of 3

Depth, feet	Water Level	Drill Rate (mins)	Graphic Log	Sample Type	Sample Number	Recovery, feet	RQD	SPT Blows per 6-inches	STRATUM DESCRIPTION	Estimated Strength (ksf) 500 1000 1500 2000	Stratum Elev. (feet)	CLASSIFICATION				
												Total Unit Wt., pcf	Passing No. 200 Sieve, %	Water Content, %	Liquid Limit	Plastic Limit
16									Depth to Mudline below platform deck surface is 16.2 ft.		1975.0					
18									Limestone Riprap - Fill							
20																
22					SPT-1	0.6 1.5		0 0 0	CLAY (CL), with gravel; olive (5Y 4/4); very soft; matrix moderate plasticity; gravel is 10-20%, fine up to 0.3 inch diameter; moist to damp; moderate dry strength; poorly graded (FILL) SPT = Weight of Hammer at 21.0'		1970.2					
24					ST-2	1.5 2			Increasing gravel content and diameter up to 0.7 inches							
26					ST-3	1 2			PP = 3.1 tsf							
28					ST-4	1.3 2			PP = 1.7 tsf			127	23			
											1962.2					

Notes:

**WOLF CREEK
 UPDATED SAFETY ANALYSIS REPORT**

Figure 2.5-36 gggg Rev. 28
 Log of Boring B-120
 Sheet 2 of 3

Mudline Level (ft): **1975.03** Easting (ft): **101964.08**
 Total Drill Depth (ft): **37.8** Northing (ft): **99646.05**
 Inclination/Bearing: **90** Datum: **Wolf Creek Plant Datum**

Hole Id:

B-120

Sheet: 3 of 3

Depth, feet	Water Level	Drill Rate (mins)	Graphic Log	Sample Type	Sample Number	Recovery, feet	RQD	SPT Blows per 6-inches	STRATUM DESCRIPTION	Estimated Strength (ksf)	Stratum Elev. (feet)	CLASSIFICATION				
												Total Unit Wt., pcf	Passing No. 200 Sieve, %	Water Content, %	Liquid Limit	Plastic Limit
32		2:07			SPT-5	1.2 1.5		6 15	CLAY (CL), with gravel and sand (Residual Soil); damp to moist; olive gray (5Y 4/2); stiff; CaCO ₃ nodules; very weak bedrock fabric; indistinct laminations; medium grained sand; fine, angular to subangular gravel, limestone composition, up to 0.2 inch diameter; minor FeO staining along lamination breaks; moderately graded (Weathered Heumader Shale) PP = 1.5 tsf Unable to advance past 32.75' w/casing advancer, switch to coring		1958.4					
34		2:14			CR-1	5/5	4.5 5/5		LIMESTONE; light gray (N7); weak (R2); fresh; dark gray shaley interbeds (R1-R2), undulatory bedding with 0.5 inch amplitude argillaceous with very thin soft shale (R1-R0) interbeds; pervasive bivalve and mollusk shells; moderately to slightly fractured, minor incipient fracturing at subvertical inclination; bedding is subhorizontal and undulatory; soft interbeds of brown shale in upper 2.8 ft and dark gray shale in lower 2.2 ft; generally low energy deposition with intermittent high energy zones; argillaceous with random fine clasts (Plattsmouth Limestone). Surface diamond Downpressure 300 psi BJ, soft brown shale (R0) interbed, between 33.1' to 33.3' RF, 10°, stepped, open at 33.7' BJ, 0°, open, fresh, subhorizontal at 33.9' BJ, BJ, in shaley (R1) interbed BJ, soft brown shale (R0) interbed, between 35.4' and 35.5' BJ, soft dark gray shale (R0) interbed, between 35.8' and 36.0' BJ, soft dark gray shale (R0) interbed, between 36.3' and 36.4' BJ, 0°, in shaley (R1) interbed, subhorizontal at 36.8' End of boring at 37.8 ft below deck surface and 21.6 ft below mudline		1953.4					
36		2:22														
38		2:48														
40		3:15														
42																
44																

Notes:

**WOLF CREEK
 UPDATED SAFETY ANALYSIS REPORT**

Figure 2.5-36gggg Rev. 28
 Log of Boring B-120
 Sheet 3 of 3

Mudline Level (ft): **1975.1** Easting (ft): **101973.43**
 Total Drill Depth (ft): **39** Northing (ft): **99672.5**
 Inclination/Bearing: **90** Datum: **Wolf Creek Plant Datum**

Hole Id:

B-121

Sheet: 1 of 3

Depth, feet	Water Level	Drill Rate (mins)	Graphic Log	Sample Type	Sample Number	Recovery, feet	RQD	SPT Blows per 6-inches	STRATUM DESCRIPTION	Estimated Strength (ksf)	Stratum Elev. (feet)	CLASSIFICATION				
												Total Unit Wt., pcf	Passing No. 200 Sieve, %	Water Content, %	Liquid Limit	Plastic Limit
2									Depth to Mudline below platform deck surface is 16.2 ft.	500 1000 1500 2000						
4																
6																
8																
10																
12																
14																

Notes:

**WOLF CREEK
 UPDATED SAFETY ANALYSIS REPORT**

Figure 2.5-36hhhh Rev. 28
 Log of Boring B-121
 Sheet 1 of 3

Mudline Level (ft): **1975.1** Easting (ft): **101973.43**
 Total Drill Depth (ft): **39** Northing (ft): **99672.5**
 Inclination/Bearing: **90** Datum: **Wolf Creek Plant Datum**

Hole Id:

B-121

Sheet: 2 of 3

Depth, feet	Water Level	Drill Rate (mins)	Graphic Log	Sample Number	Recovery, feet	RQD	SPT Blows per 6-inches	STRATUM DESCRIPTION	Estimated Strength (ksf)	Stratum Elev. (feet)	CLASSIFICATION					
											Total Unit Wt., pcf	Passing No. 200 Sieve, %	Water Content, %	Liquid Limit	Plastic Limit	Plasticity Index (PI)
16								Depth to Mudline below platform deck surface is 16.2 ft.		1975.1						
18								Limestone Riprap - Fill								
20																
22				SPT-1	0.9 1.5		3 12 14	CLAY (CL), with sand; damp; olive (5Y 4/3), mottled gray (Gley 1 6N); stiff to very stiff; faint undulating laminations; sand is very fine grained; moderate plasticity; poorly graded (Lacustrine Clay) PP > 4.5 tsf		1970.3						
24				SPT-2	1.2 1.5		8 11 12	Intermittent gravel clast, up to 0.6 diameter 3-inch interbed of dark yellowish brown (10YR 4/4) CLAY, medium stiff to stiff								
26				SPT-3	1.3 1.5		7 15 19	Interbeds of medium stiff CLAY and stiff CLAY								
28				SPT-4	1.3 1.3			PP > 4.5 tsf		1962.7						

Notes:

**WOLF CREEK
 UPDATED SAFETY ANALYSIS REPORT**

Figure 2.5-36hhhh Rev. 28
 Log of Boring B-121
 Sheet 2 of 3

Mudline Level (ft): **1975.1**

Easting (ft): **101973.43**

Total Drill Depth (ft): **39**

Northing (ft): **99672.5**

Inclination/Bearing: **90**

Datum: **Wolf Creek Plant Datum**

Hole Id:

B-121

Sheet: 3 of 3

Depth, feet	Water Level	Drill Rate (mins)	Graphic Log	Sample Type	Sample Number	Recovery, feet	RQD	SPT Blows per 6-inches	STRATUM DESCRIPTION	Estimated Strength (ksf)	Stratum Elev. (feet)	CLASSIFICATION						
												Total Unit Wt., pcf	Passing No. 200 Sieve, %	Water Content, %	Liquid Limit	Plastic Limit	Plasticity Index (PI)	
32					SPT-5	1.3 1.5		16 47 50/4	CLAY (CL), sandy (Residual Soil); damp; olive gray (5Y 5/2); very stiff to hard; CaCO3 nodules; very weak bedrock fabric; indistinct to faint laminations; fine grained sand; fine, 5-10% fine gravel; matrix is low to moderate plasticity with strong finger pressure (Weathered Heumader Shale)									
34					SPT-6	0 0.2		16 16 18	Comparable composition with increased gravel content up to 20%, mostly fine with few angular gravel up to 0.7 inch diameter; becoming stiff to very stiff									
36		2:32						50/2	Driller reports hard drilling at 33.3'									
38		2:48			CR-1	4.7 5	4.3 5		LIMESTONE; very light gray (N8) to light gray (N7); weak (R2); slightly weathered to fresh; bivalve and mollusk shells throughout with discrete beds of increased content; slightly fractured, minor incipient fracturing; bedding is subhorizontal and undulatory; soft interbeds of brown shale in upper 1 ft and dark gray shale in lower 4 ft; generally low energy deposition with intermittent thin high energy zones; intermittent 0.2-0.5 inch dark gray shaley interbeds (R1-R2) imply subhorizontal to 15 degree undulating bedding; argillaceous (Plattsmouth Limestone).		1957.3							
40		2:27							Surface diamond bit, downpressure 300 psi MB, 0° at 34.6' BJ, 10°, soft brown shale (R0) interbed at 34.8' BJ, 0°, open, fresh, top of shale interbed at 37.1' BJ, 0°, soft dark gray shale (R0) interbed at 37.2' BJ, 0°, soft dark gray shale (R0) interbed at 37.8' BJ, 0°, base of dark gray shaley interbed (R1) at 38.4'		1952.3							
42		3:09							End of boring at 39 ft below deck surface and 22.8 ft below mudline									
44		3:01																

Notes:

**WOLF CREEK
UPDATED SAFETY ANALYSIS REPORT**

Figure 2.5-36hhhh Rev. 28
Log of Boring B-121
Sheet 3 of 3

Mudline Level (ft): **1981.76** Easting (ft): **101968.77**
 Total Drill Depth (ft): **38.3** Northing (ft): **99642.7**
 Inclination/Bearing: **90** Datum: **Wolf Creek Plant Datum**

Hole Id:

B-122

Sheet: 1 of 3

Depth, feet	Water Level	Drill Rate (mins)	Graphic Log	Sample Type	Sample Number	Recovery, feet	RQD	SPT Blows per 6-inches	STRATUM DESCRIPTION	Estimated Strength (ksf)	Stratum Elev. (feet)	CLASSIFICATION								
												Total Unit Wt., pcf	Passing No. 200 Sieve, %	Water Content, %	Liquid Limit	Plastic Limit	Plasticity Index (PI)			
									Depth to Mudline below platform deck surface is 17.0 ft.	500										
2																				
4																				
6																				
8																				
10																				
12																				
14																				

Notes:

**WOLF CREEK
 UPDATED SAFETY ANALYSIS REPORT**

Figure 2.5-36iii Rev. 28
 Log of Boring B-122
 Sheet 1 of 3

Mudline Level (ft): **1981.76** Easting (ft): **101968.77**
 Total Drill Depth (ft): **38.3** Northing (ft): **99642.7**
 Inclination/Bearing: **90** Datum: **Wolf Creek Plant Datum**

Hole Id:

B-122

Sheet: 2 of 3

Depth, feet	Water Level	Drill Rate (mins)	Graphic Log	Sample Type	Sample Number	Recovery, feet	RQD	SPT Blows per 6-inches	STRATUM DESCRIPTION	Estimated Strength (ksf)	Stratum Elev. (feet)	CLASSIFICATION						
												Total Unit Wt., pcf	Passing No. 200 Sieve, %	Water Content, %	Liquid Limit	Plastic Limit	Plasticity Index (PI)	
16									Depth to Mudline below platform deck surface is 17.0 ft.									
18									Limestone Riprap - Fill		1981.8							
20									Advancing thru rip rap. Casing advanced with roller bit									
22					SPT-1	0.5 1.5		4 5 1	Driller able to push casing without rotation about 6 inches. Sounding from deck is 20.6'		1978.2							
24					SPT-2	0.3 1.5		0 1 2	SAND, gravelly; loose; moist; graded medium grained sand to fine gravel from top to bottom of sampler; subangular grains; limestone and non-natives composition; poorly consolidated; no fines; nonplastic; gravel is angular to subangular, mostly limestone; well graded (FILL)		1976.9							
26					ST-3	1.3 2			2" gravel lodged in SPT shoe. Possibly blocked more recovery									
28					ST-4	2.0			CLAY (CL); damp; olive (5Y 4/4), mottled grey (GLEYS 1 5N); very soft to soft; moderately plastic; 5-10% fine gravel of non-natives; 5-10% sand; poorly graded; high dry strength (FILL)									
									SPT sample recovered with weight of hammer at 23'									
									No sample collected in S3 Shelby. 2 ft penetration. 4" collected by pushing SPT sampler									
									Refusal with Shelby at 11 inches									
									PP = 3.25 tsf		1969.2							

Notes:

WOLF CREEK
 UPDATED SAFETY ANALYSIS REPORT

Figure 2.5-36iii Rev. 28
 Log of Boring B-122
 Sheet 2 of 3

Mudline Level (ft): **1981.76** Easting (ft): **101968.77**
 Total Drill Depth (ft): **38.3** Northing (ft): **99642.7**
 Inclination/Bearing: **90** Datum: **Wolf Creek Plant Datum**

Hole Id:

B-122

Sheet: 3 of 3

Depth, feet	Water Level	Drill Rate (mins)	Graphic Log	Sample Type	Sample Number	Recovery, feet	RQD	SPT Blows per 6-inches	STRATUM DESCRIPTION	Estimated Strength (ksf)	Stratum Elev. (feet)	CLASSIFICATION				
												Total Unit Wt., pcf	Passing No. 200 Sieve, %	Water Content, %	Liquid Limit	Plastic Limit
32		2:09			SPT-5	0.6 1.5		23/3	CLAY (CL), with gravel (Residual Soil); damp to moist; olive gray (5Y 4/2); stiff; CaCO ₃ nodules; very weak bedrock fabric; indistinct to faint laminations; fine, subangular to angular gravel of limestone composition; trace medium grained sand; some FeO staining (Weathered Heumader Shale) Comparable composition with increased gravel content up to 20%, mostly fine with few angular gravel up to 0.7 inch diameter; becoming stiff to very stiff	500 1000 1500 2000						
34		2:15			SPT-6	0.3 0.3		50/3	Very slow advance thru clay w/ roller bit. Driller reports much harder at 32.5' No penetration, high ping w/ SPT, jumping. Switch to coring. Surface diamond bit. Downpressure 300 psi. Milky white water return		1965.5					
36		2:02			CR-1	4.7 5	4.2 5		LIMESTONE; light gray (N7); weak (R2); slightly weathered to fresh; pervasive bivalve and mollusk shells; intermittent 0.2-0.5 inch dark gray shaley interbeds (R1-R2), dark gray undulatory, subhorizontal to up to 20 degree inclination; slightly to moderately fractured, minor incipient fracturing; bedding is subhorizontal and undulatory with up to 0.3 inch amplitude; soft interbeds of dark gray shale (R0) up to 1.5 inch thick; argillaceous with random fine clasts; generally low energy deposition with intermittent thin high energy zones and soft sediment deformation (Plattsmouth Limestone). RF, closed at 33.7' RF, 15°, stepped, partial bedding, F at 33.8' RF, 0°, stepped, partially along bedding at 34.4' BJ, open, F at 34.6' BJ, open, F, along shaly interbed at 34.7' Shale interbed R0, between 35.6' and 35.8' Shale interbed R0, between 36.2' and 36.3' BJ, undulating, shaley interbed (R1 - R2) at 37.2' BJ, open, F, undulatory at 37.7' MB, at 38.2' End of boring at 38.3 ft below deck surface and 21.3 ft below mudline		1960.5					
38		4:30														
40																
42																
44																

Notes:

WOLF CREEK
 UPDATED SAFETY ANALYSIS REPORT

Figure 2.5-36iii Rev. 28
 Log of Boring B-122
 Sheet 3 of 3

Mudline Level (ft): **1972.67** Easting (ft): **101976.24**
 Total Drill Depth (ft): **38.2** Northing (ft): **99648.7**
 Inclination/Bearing: **90** Datum: **Wolf Creek Plant Datum**

Hole Id:

B-123

Sheet: 1 of 3

Depth, feet	Water Level	Drill Rate (mins)	Graphic Log	Sample Type	Sample Number	Recovery, feet	RQD	SPT Blows per 6-inches	STRATUM DESCRIPTION	Estimated Strength (ksf)	Stratum Elev. (feet)	CLASSIFICATION				
												Total Unit Wt., pcf	Passing No. 200 Sieve, %	Water Content, %	Liquid Limit	Plastic Limit
2									Depth to Mudline below platform deck surface is 18.8 ft.	500 1000 1500 2000						
4																
6																
8																
10																
12																
14																

Notes:

**WOLF CREEK
 UPDATED SAFETY ANALYSIS REPORT**

Figure 2.5-36jjjj Rev. 28
 Log of Boring B-123
 Sheet 1 of 3

Mudline Level (ft): **1972.67** Easting (ft): **101976.24**
 Total Drill Depth (ft): **38.2** Northing (ft): **99648.7**
 Inclination/Bearing: **90** Datum: **Wolf Creek Plant Datum**

Hole Id:
B-123

Sheet: 2 of 3

Depth, feet	Water Level	Drill Rate (mins)	Graphic Log	Sample Type	Sample Number	Recovery, feet	RQD	SPT Blows per 6-inches	STRATUM DESCRIPTION	Estimated Strength (ksf)	Stratum Elev. (feet)	CLASSIFICATION						
												Total Unit Wt., pcf	Passing No. 200 Sieve, %	Water Content, %	Liquid Limit	Plastic Limit	Plasticity Index (PI)	
16									Depth to Mudline below platform deck surface is 18.8 ft.									
18									Advancing thru rip rap. Casing advanced with roller bit		1972.7							
20									Limestone Riprap - Fill									
22					SPT-1	0.6 1.5		4 7 4	Driller able to push casing without rotation about 6 inches. Sounding from deck is 20.6'		1971.0							
24					SPT-2	0.3 1.5		0 0 0	GRAVEL (GP); sandy, clayey; light yellowish brown (10YR 6/4), mottled gray (GLEYS 1 5N) and strong brown (7.5 YR 5/6); loose; moist to wet; gravel is subrounded to subangular, up to 2 diameter in sampler, predominantly limestone composition, mostly fine, approx. 0.5 diameter; sand is very fine to fine grained; matrix is low plasticity; well graded (FILL)		1968.9							
26					ST-3	0.3 1.5			2" gravel lodged in SPT shoe. Possibly blocked more recovery									
28					ST-4	0.9 0.9			CLAY (CL); lt olive gray (5Y 6/2); mottled dark gray (GLEYS 1 4N); strong brown (7.5YR 5/6); very soft; moderate plasticity; low dilatancy; 5-10% fine gravel, subrounded; moist; poorly graded (FILL)									
									SPT sample recovered with weight of hammer No sample collected in S3 Shelby. 2 ft penetration. 4" collected by pushing SPT sampler									
									Increasing consistency to stiff		1963.3							
									Refusal with Shelby at 11 inches									
									PP = 3.25 tsf									

Notes:

**WOLF CREEK
 UPDATED SAFETY ANALYSIS REPORT**

Figure 2.5-36jjjj Rev. 28
 Log of Boring B-123
 Sheet 2 of 3

Mudline Level (ft): **1972.67** Easting (ft): **101976.24**
 Total Drill Depth (ft): **38.2** Northing (ft): **99648.7**
 Inclination/Bearing: **90** Datum: **Wolf Creek Plant Datum**

Hole Id:

B-123

Sheet: 3 of 3

Depth, feet	Water Level	Drill Rate (mins)	Graphic Log	Sample Type	Sample Number	Recovery, feet	RQD	SPT Blows per 6-inches	STRATUM DESCRIPTION	Estimated Strength (ksf)	Stratum Elev. (feet)	CLASSIFICATION							
												Total Unit Wt., pcf	Passing No. 200 Sieve, %	Water Content, %	Liquid Limit	Plastic Limit	Plasticity Index (PI)		
32					SPT-5	1.5 1.5		14 19 29	CLAY (CL) with gravel (Residual Soil); lt olive gray (5Y 6/2); damp to moist; very stiff to stiff; low dilatancy; moderate plasticity; 15-20% fine gravel; subangular, up to 0.3 ft diameter; poorly graded; faint laminations in clay (Weathered Heumader Shale)										
34		3:17			SPT-6	0 0.1		50/1	Very slow advance thru clay w/ roller bit. Driller reports much harder at 32.5' No penetration, high ping w/ SPT, jumping. Switch to coring.		1958.3								
36		2:24			CR-1	4.9 5	4.5 5		LIMESTONE; lt gray (N7); weak (R2); sl weathered to fresh; sl fractured; pervasive bivalves and mollusk shells; intermittent shaly R1 - R2 interbeds, subhorizontal to 20 degree inclination; soft interbeds of brown shale in upper 1 ft and dk gray shale in lower 4 ft; argillaceous w/ fine clasts; bedding is subhorizontal and undulatory with 1.0-inch peak to peak amplitude; generally low energy deposition w/ few thin high energy beds (Plattsmouth Limestone)	•881.5									
38		3:30							Surface diamond bit. Downpressure 300 psi. Milky white water return BJ, open, washed out at 33.3' Bed of claystone, between 33.5' and 33.6' BJ, open, fresh, w/in shaly interbed at 35.2' Shale interbed, BJ at top, between 36.2' and 36.3' Shale interbed, between 36.5' and 36.6'		1953.3								
40		3:10							End of boring at 38.2 ft below deck surface and 19.4 ft below mudline										

Notes:

WOLF CREEK
 UPDATED SAFETY ANALYSIS REPORT

Figure 2.5-36jjjj Rev. 28
 Log of Boring B-123
 Sheet 3 of 3

Mudline Level (ft): **1975**
 Total Drill Depth (ft): **38.7**
 Inclination/Bearing: **90**

Easting (ft): **101976.67**
 Northing (ft): **99582.73**
 Datum: **Wolf Creek Plant Datum**

Hole Id:

B-124

Sheet: 1 of 3

Depth, feet	Water Level	Drill Rate (mins)	Graphic Log	Sample Type	Sample Number	Recovery, feet	RQD	SPT Blows per 6-inches	STRATUM DESCRIPTION	Estimated Strength (ksf)	Stratum Elev. (feet)	CLASSIFICATION				
												Total Unit Wt., pcf	Passing No. 200 Sieve, %	Water Content, %	Liquid Limit	Plastic Limit
									Depth to Mudline below platform deck surface is 16.1 ft.	500 1000 1500 2000						
2																
4																
6																
8																
10																
12																
14																

Notes:

**WOLF CREEK
 UPDATED SAFETY ANALYSIS REPORT**

Figure 2.5-36kkkk Rev. 28
 Log of Boring B-124
 Sheet 1 of 3

Mudline Level (ft): **1975**
 Total Drill Depth (ft): **38.7**
 Inclination/Bearing: **90**

Easting (ft): **101976.67**
 Northing (ft): **99582.73**
 Datum: **Wolf Creek Plant Datum**

Hole Id:

B-124

Sheet: 2 of 3

Depth, feet	Water Level	Drill Rate (mins)	Graphic Log	Sample Type	Sample Number	Recovery, feet	RQD	SPT Blows per 6-inches	STRATUM DESCRIPTION	Estimated Strength (ksf)	Stratum Elev. (feet)	CLASSIFICATION				
												Total Unit Wt., pcf	Passing No; 200 Sieve, %	Water Content, %	Liquid Limit	Plastic Limit
16									Depth to Mudline below platform deck surface is 16.1 ft.		1975.0					
									Limestone Riprap - Fill							
22					SPT-1	0 1.5		3 2 3	SAND; loose; poorly consolidated; poorly graded (FILL) Trace sand grains coating SPT sampler		1970.1					
24					SPT-2	0.6 1.5		0 0 2	CLAY (CL); damp to moist; very soft to soft; olive (5Y 5/3); mottled dark gray (GLE Y 1 4N); moderate to high plasticity; 10-15% fine gravel, subangular to subrounded; sandstone and other non natives composition, up to 0.7 diameter, mostly 0.3; poorly graded moderate to high dry strength; trace sand (FILL)		1968.6					
26					SPT-3	0.4 1.5		2 2 3								
28					ST-4	1.5 2										

Notes:

**WOLF CREEK
 UPDATED SAFETY ANALYSIS REPORT**

Figure 2.5-36kkkk Rev. 28
 Log of Boring B-124
 Sheet 2 of 3

Mudline Level (ft): 1975
 Total Drill Depth (ft): 38.7
 Inclination/Bearing: 90

Easting (ft): 101976.67
 Northing (ft): 99582.73
 Datum: Wolf Creek Plant Datum

Hole Id:

B-124

Sheet: 3 of 3

Depth, feet	Water Level	Drill Rate (mins)	Graphic Log	Sample Type	Sample Number	Recovery, feet	RQD	SPT Blows per 6-inches	STRATUM DESCRIPTION	Estimated Strength (ksf)	Stratum Elev. (feet)	CLASSIFICATION				
												Total Unit Wt., pcf	Passing No. 200 Sieve, %	Water Content, %	Liquid Limit	Plastic Limit
32		1:50			SPT-5	0.8 1.5		3 4	CLAY (CL); damp to moist; very soft to soft; olive (5Y 5/3); mottled dark gray (GLEY 1 4N); moderate to high plasticity; 10-15% fine gravel, subangular to subrounded; sandstone and other non natives composition, up to 0.7 diameter, mostly 0.3; poorly graded moderate to high dry strength; trace sand (FILL) PP = 3.2 tsf Increasing gravel content to CLAY with w/ gravel, fine, subangular to subrounded; sandstone, red claystone, other non-natives composition		1958.4					
34		1:50			SPT-6	0.3 0.3		50/3	CLAY (CL) (Residual Soil); olive gray; limestone gravel, fine, subrounded to subangular; CaCO3 nodules; hard soil to extremely weak (R0) rock (Weathered Heumader Shale)		1957.4					
36		2:27			CR-1	4.9 5	2.5 5		LIMESTONE; lt gray (N7); weak (R2); SW-F; moderately fractured; interbeds of brown shale in upper 3 ft, dark gray shale in lower 2 ft, up to 2 thickness; pervasive bivalve and mollusk shells; intermittent dark shaley R2 - R1 interbeds, generally subhorizontal, few up to 25 degree dip; argillaceous; generally low energy deposition with intermittent thin high energy beds; minor random clasts up to 0.6 (Plattsouth Limestone) Core start. Depth sound at 33.7' Shale, brown 2", R0, between 34.0' and 34.2' JT, 65°, F at 34.5' BJ, undulatory, subhorizontal at 34.6' JT, 70°-75°, clear mineralization, F at 35.2' BJ, 0°, subhorizontal at 35.6' BJ, thin brown SHALE at 36.7' Gray brown SHALE, R0, subhorizontal laminations, between 36.8' and 37.0' SHALE, dark gray, faint laminations, subhorizontal, between 37.2' and 37.4' BJ, in dark shaly ls bed at 38.0' BJ, 0°, undulatory, subhorizontal at 38.4' End of boring at 38.7 ft below deck surface and 22.6 ft below mudline		1952.4					

Notes:

WOLF CREEK
 UPDATED SAFETY ANALYSIS REPORT

Figure 2.5-36kkkk Rev. 28
 Log of Boring B-124
 Sheet 3 of 3

Mudline Level (ft): **1973.65** Easting (ft): **101983.16**
 Total Drill Depth (ft): **39.5** Northing (ft): **99583.29**
 Inclination/Bearing: **90** Datum: **Wolf Creek Plant Datum**

Hole Id:

B-125

Sheet: 1 of 3

Depth, feet	Water Level	Drill Rate (mins)	Graphic Log	Sample Type	Sample Number	Recovery, feet	RQD	SPT Blows per 6-inches	STRATUM DESCRIPTION	Estimated Strength (ksf)	Stratum Elev. (feet)	CLASSIFICATION				
												Total Unit Wt., pcf	Passing No. 200 Sieve, %	Water Content, %	Liquid Limit	Plastic Limit
2									Depth to Mudline below platform deck surface is 17.5 ft.	500						
										1000						
										1500						
										2000						
4																
6																
8																
10																
12																
14																

Notes:

**WOLF CREEK
 UPDATED SAFETY ANALYSIS REPORT**

Figure 2.5-36III Rev. 28
 Log of Boring B-125
 Sheet 1 of 3

Mudline Level (ft): **1973.65** Easting (ft): **101983.16**
 Total Drill Depth (ft): **39.5** Northing (ft): **99583.29**
 Inclination/Bearing: **90** Datum: **Wolf Creek Plant Datum**

Hole Id:

B-125

Sheet: 2 of 3

Depth, feet	Water Level	Drill Rate (mins)	Graphic Log Sample Type	Sample Number	Recovery, feet	RQD	SPT Blows per 6-inches	STRATUM DESCRIPTION	Estimated Strength (ksf)	Stratum Elev. (feet)	CLASSIFICATION						
											Total Unit Wt., pcf	Passing No. 200 Sieve, %	Water Content, %	Liquid Limit	Plastic Limit	Plasticity Index (PI)	
16								Depth to Mudline below platform deck surface is 17.5 ft.									
18								Limestone Riprap - Fill		1973.7							
22				SPT-1	0 1.5		6 4 1	CLAY (CL); damp to moist; olive (5Y 4/3) mottled dark gray (GLEYS 1 4N); soft to v. soft; highly plastic; 5-15% fine gravel, subangular, limestone composition; poorly graded; trace sand, fine grained; no structure; moderate dry strength (FILL)		1969.7							
24				SPT-2	0.5 1.5		0 0 1										
28				ST-3	1.3 2			CLAY (CL); damp to moist; light yellowish brown (2.5Y 6/4) mottled gray (GLEYS 4N); medium stiff; moderately plastic; 5-15% silt; 5-15% fine gravel, subangular, limestone composition (FILL) PP = 3.2 tsf		1963.9							

Notes:

**WOLF CREEK
 UPDATED SAFETY ANALYSIS REPORT**

Figure 2.5-36III Rev. 28
 Log of Boring B-125
 Sheet 2 of 3

Mudline Level (ft): **1973.65** Easting (ft): **101983.16**
 Total Drill Depth (ft): **39.5** Northing (ft): **99583.29**
 Inclination/Bearing: **90** Datum: **Wolf Creek Plant Datum**

Hole Id:

B-125

Sheet: 3 of 3

Depth, feet	Water Level	Drill Rate (mins)	Graphic Log Sample Type	Sample Number	Recovery, feet	RQD	SPT Blows per 6-inches	STRATUM DESCRIPTION	Estimated Strength (ksf)	Stratum Elev. (feet)	CLASSIFICATION				
											Total Unit Wt., pcf	Passing No. 200 Sieve, %	Water Content, %	Liquid Limit	Plastic Limit
32				ST-4	1.7 2			CLAY (CL); damp to moist; light yellowish brown (2.5Y 6/4) mottled gray (GLEYS 4N); medium stiff; moderately plastic; 5-15% silt; 5-15% fine gravel, subangular, limestone composition (FILL) PP = 3.1 tsf							
34				SPT-5			1 9 15	CLAY (CL) (Residual Soil); damp; olive gray (5Y 5/2); stiff to v. stiff; faint bedrock fabric; CaCO ₃ stringers; little FeO staining; non plastic; high dry strength; barely moldable w/ strong finger pressure; trace fine gravel, up to 0.5 diameter, angular (Weathered Heumader Shale) PP > 4.5 tsf		1959.2					
36				SPT-6	0.4 0.4		50/5	LIMESTONE; light gray (N7); weak (R2); sl weathered to fresh; sl fractured; pervasive bivalves and mollusk shells; intermittent shaly interbeds, R1 - R2, subhorizontal to 20 degree inclination; soft interbeds of brown shale in upper 2 ft, dark gray in lower 2 ft, up to 2 thickness; bedding is subhorizontal and undulatory/ up to 1.1 peak to peak amplitude, argillaceous; gradual to clear upper contact; random clasts up to 0.5; generally low energy deposition with intermittent thin high energy beds (Plattsmouth Limestone)		1956.7					
38				CR-1	4.8 5	4 5		SHALE, brown, 1" bed, R0, between 35.2' and 35.3' BJ, incipient, closed, shaly at 36.2' SHALE, dark gray, faint laminations, subhorizontal at 38.0'		1734.6					
40								End of boring at 39.5 ft below deck surface and 22.0 ft below mudline		1951.7					

Notes:

WOLF CREEK
 UPDATED SAFETY ANALYSIS REPORT

Figure 2.5-36III Rev. 28
 Log of Boring B-125
 Sheet 3 of 3

Mudline Level (ft): **1975** Easting (ft): **101977.42**
 Total Drill Depth (ft): **40.9** Northing (ft): **99569.19**
 Inclination/Bearing: **90** Datum: **Wolf Creek Plant Datum**

Hole Id:
B-126

Sheet: 1 of 4

Depth, feet	Water Level	Drill Rate (mins)	Graphic Log	Sample Type	Sample Number	Recovery, feet	RQD	SPT Blows per 6-inches	STRATUM DESCRIPTION	Estimated Strength (ksf)	Stratum Elev. (feet)	CLASSIFICATION					
												Total Unit Wt., pcf	Passing No. 200 Sieve, %	Water Content, %	Liquid Limit	Plastic Limit	Plasticity Index (PI)
									Depth to Mudline below platform deck surface is 16.6 ft.								
2																	
4																	
6																	
8																	
10																	
12																	
14																	

Notes:

**WOLF CREEK
 UPDATED SAFETY ANALYSIS REPORT**

Figure 2.5-36mmmm Rev. 28
 Log of Boring B-126
 Sheet 1 of 4

Mudline Level (ft): **1975**
 Total Drill Depth (ft): **40.9**
 Inclination/Bearing: **90**

Easting (ft): **101977.42**
 Northing (ft): **99569.19**
 Datum: **Wolf Creek Plant Datum**

Hole Id:

B-126

Sheet: 2 of 4

Depth, feet	Water Level	Drill Rate (mins)	Graphic Log	Sample Type	Sample Number	Recovery, feet	RQD	SPT Blows per 6-inches	STRATUM DESCRIPTION	Estimated Strength (ksf)	Stratum Elev. (feet)	CLASSIFICATION					
												Total Unit Wt., pcf	Passing No. 200 Sieve, %	Water Content, %	Liquid Limit	Plastic Limit	Plasticity Index (PI)
16									Depth to Mudline below platform deck surface is 16.6 ft.								
18									Limestone Riprap - Fill		1975.0						
22					SPT-1	0.6 1.5		36 39 36	GRAVEL; (GP) sandy; brownish yellow (10YR 6/6); dense; moist to wet; subangular gravel, fine up to 0.8 diameter; coarse grained sand; FeO staining; moderately graded (FILL)		1970.6						
24					SPT-2	0.6 1.5		6 14 16	CLAY (CL) (Residual Soil); hard soil to extremely weak (R0) rock; yellowish brown (10YR 5/6) to olive gray (5Y 4/2), mottled dark gray; faint laminations; FeO staining along subhorizontal partings; 5-15% limestone gravel, fine, subangular; discrete interbeds of (1) yellowish brown with fine gravel and little fine grained sand and (2) olive gray, more distinct laminations; CaCO3, FeO staining, harder consistency to R0 (Weathered Heumader Shale)		1968.8						
26					SPT-3	1.3 1.5		13 19 27	PP > 4.5 tsf								
28					SPT-4	1.5 1.5		12 18 28	PP > 4.5 tsf								

Notes:

WOLF CREEK
 UPDATED SAFETY ANALYSIS REPORT

Figure 2.5-36mmmm Rev. 28
 Log of Boring B-126
 Sheet 2 of 4

Mudline Level (ft): **1975** Easting (ft): **101977.42**
 Total Drill Depth (ft): **40.9** Northing (ft): **99569.19**
 Inclination/Bearing: **90** Datum: **Wolf Creek Plant Datum**

Hole Id:

B-126

Sheet: 3 of 4

Depth, feet	Water Level	Drill Rate (mins)	Graphic Log	Sample Type	Sample Number	Recovery, feet	RQD	SPT Blows per 6-inches	STRATUM DESCRIPTION	Estimated Strength (ksf)	Stratum Elev. (feet)	CLASSIFICATION				
												Total Unit Wt., pcf	Passing No. 200 Sieve, %	Water Content, %	Liquid Limit	Plastic Limit
32		2:20			CR-1	4.9/5	4.6/5		SHALE; light olive gray (5Y 5/2); extremely weak to very weak (R0 - R1); slightly weathered; pervasive bivalve shells; faint to indistinct laminations; rough core surface; 10-15% limestone gravel; (Heumader Shale) Advance casing to 30.9 and begin coring BJ, 0°, infilled with clay and fine gravel MW, subhorizontal at 31.9' BJ, 0°, infilled with clay MW subhorizontal at 32.2'	2.84	1960.7					
34		2:42							SHALE; pale olive (10Y 6/2) to dusky yellow (5Y 6/4); very weak (R1); sl. weathered; faint laminations; few gravel, subangular (Heumader Shale)		1957.9					
36		3:32							LIMESTONE; light gray (N7); weak (R2); sl. weathered to fresh; sl. to moderately fractured; intermittent dark shaley R1 - R2 interbeds, subhorizontal to 20 degree incline with 1 peak to peak amplitude; bivalves and mollusk shells are pervasive; upper contact with shale is clear with soft brown shale interbeds in upper 1.5 ft, and dark gray shale interbeds in lower 4 ft; argillaceous; poc marked w/ incipient fractures; bedding is subhorizontal and undulatory; random fine clasts; generally low energy deposition with intermittent high energy beds (Plattsmouth Limestone)		1956.8					
38		3:05							BJ, 0°, undulatory 0.2" wavelength, subhorizontal at 34.9'							
40		1:54			CR-2	4.9/5	4.9/5		SHALE, brown, 1", R0, between 35.1' and 35.2' Mineralized vug at 35.7', 0.4 cm wide, 0.3 cm deep BJ, 20°, stepped, in high energy bed at 36.3' BJ, 20°, undulatory to stepped in shaley R1 bed at 36.9' dark gray SHALE, 2", R0, between 37.6' and 37.8' dark gray SHALE, 1", R0, between 38.1' and 38.2' dark gray SHALE, 1", R1, between 40.2' and 40.3' FZ, clay infilled 3" zone top of SHALE contact, between 40.3' and 40.5'	1588.4	1951.1					
42		2:22							SHALE, brown, 1", R0, between 35.1' and 35.2' Mineralized vug at 35.7', 0.4 cm wide, 0.3 cm deep BJ, 20°, stepped, in high energy bed at 36.3' BJ, 20°, undulatory to stepped in shaley R1 bed at 36.9' dark gray SHALE, 2", R0, between 37.6' and 37.8' dark gray SHALE, 1", R0, between 38.1' and 38.2' dark gray SHALE, 1", R1, between 40.2' and 40.3' FZ, clay infilled 3" zone top of SHALE contact, between 40.3' and 40.5'		1950.7					
44		2:54							SHALE; medium dark to dark gray (3N to 4N); extremely weak to weak; faint laminations; fresh; unfractured; minor gravel fine (Heebner Shale)							

Notes:

**WOLF CREEK
 UPDATED SAFETY ANALYSIS REPORT**

Figure 2.5-36mmmm Rev. 28
 Log of Boring B-126
 Sheet 3 of 4

Mudline Level (ft): **1975**
 Total Drill Depth (ft): **40.9**
 Inclination/Bearing: **90**

Easting (ft): **101977.42**
 Northing (ft): **99569.19**
 Datum: **Wolf Creek Plant Datum**

Hole Id:

B-126

Sheet: 4 of 4

Depth, feet	Water Level	Drill Rate (mins)	Graphic Log	Sample Type	Sample Number	Recovery, feet	RQD	SPT Blows per 6-inches	STRATUM DESCRIPTION	Estimated Strength (ksf)	Stratum Elev. (feet)	CLASSIFICATION					
												Total Unit Wt., pcf	Passing No. 200 Sieve, %	Water Content, %	Liquid Limit	Plastic Limit	Plasticity Index (PI)
46									End of boring at 40.9 ft below deck surface and 24.3 ft below mudline								
48																	
50																	
52																	
54																	
56																	
58																	

Notes:

**WOLF CREEK
 UPDATED SAFETY ANALYSIS REPORT**

Figure 2.5-36mmmm Rev. 28
 Log of Boring B-126
 Sheet 4 of 4

Mudline Level (ft): **1973.05** Easting (ft): **101984**
 Total Drill Depth (ft): **38.4** Northing (ft): **99580**
 Inclination/Bearing: **90** Datum: **Wolf Creek Plant Datum**

Hole Id:

B-127

Sheet: 1 of 3

Depth, feet	Water Level	Drill Rate (mins)	Graphic Log	Sample Type	Sample Number	Recovery, feet	RQD	SPT Blows per 6-inches	STRATUM DESCRIPTION	Estimated Strength (ksf)	Stratum Elev. (feet)	CLASSIFICATION						
												Total Unit Wt., pcf	Passing No. 200 Sieve, %	Water Content, %	Liquid Limit	Plastic Limit	Plasticity Index (PI)	
2									Depth to Mudline below platform deck surface is 18.2 ft.	500								
4										1000								
6										1500								
8										2000								
10																		
12																		
14																		

Notes:

**WOLF CREEK
 UPDATED SAFETY ANALYSIS REPORT**

Figure 2.5-36nnnn Rev.28
 Log of Boring B-127
 Sheet 1 of 3

Mudline Level (ft): **1973.05** Easting (ft): **101984**
 Total Drill Depth (ft): **38.4** Northing (ft): **99580**
 Inclination/Bearing: **90** Datum: **Wolf Creek Plant Datum**

Hole Id:

B-127

Sheet: 2 of 3

Depth, feet	Water Level	Drill Rate (mins)	Graphic Log Sample Type	Sample Number	Recovery, feet	RQD	SPT Blows per 6-inches	STRATUM DESCRIPTION	Estimated Strength (ksf)	Stratum Elev. (feet)	CLASSIFICATION								
											Total Unit Wt., pcf	Passing No., 200 Sieve, %	Water Content, %	Liquid Limit	Plastic Limit	Plasticity Index (PI)			
16								Depth to Mudline below platform deck surface is 18.2 ft.											
18								Limestone Riprap - Fill		1973.1									
20																			
22																			
24				SPT-1	0.4 1.5		0 0 0	CLAY (CL); damp to moist; olive (5Y 5/4); highly plastic; mottled dark gray (GLEY 1 4N) very soft to soft; no structure; moderate dry strength; trace sand; 5-10% gravel, subangular, limestone composition; poorly graded (FILL)		1967.7									
26				SPT-2	0.6 1.5		0 2 3	Intermittent beds with increased consistency											
28				SPT-3	0.5 1.5		2 2 7	CLAY (CL); damp to moist; olive (5Y 5/4) to light yellowish brown (10YR 6/4), mottled dark gray (GLEY 1 4N); medium stiff; 5-10% silt; 10-15% fine gravel; moderately plastic; poorly graded (FILL)		1963.6									

Notes:

**WOLF CREEK
 UPDATED SAFETY ANALYSIS REPORT**

Figure 2.5-36nnnn Rev. 28
 Log of Boring B-127
 Sheet 2 of 3

Mudline Level (ft): **1973.05** Easting (ft): **101984**
 Total Drill Depth (ft): **38.4** Northing (ft): **99580**
 Inclination/Bearing: **90** Datum: **Wolf Creek Plant Datum**

Hole Id:
B-127

Sheet: 3 of 3

Depth, feet	Water Level	Drill Rate (mins)	Graphic Log	Sample Type	Sample Number	Recovery, feet	RQD	SPT Blows per 6-inches	STRATUM DESCRIPTION	Estimated Strength (ksf)	Stratum Elev. (feet)	CLASSIFICATION				
												Total Unit Wt., pcf	Passing No. 200 Sieve, %	Water Content, %	Liquid Limit	Plastic Limit
32					SPT-4	1.3 1.5		18 22 26	CLAY (CL) (Residual Soil); olive gray (5Y 5/2); very stiff; faint bedrock fabric; CaCO3 stringers; minor FeO staining along faint laminations; barely moldable w/ strong finger pressure; damp to moist; (Weathered Heumader Shale)		1960.4					
34		2:40			SPT-5	0 0.1		50/1	LIMESTONE; light gray (N7); weak (R2); slightly weathered; slightly fractured; argillaceous; pervasive bivalves and oyster shells; random subangular clasts up to 0.5; generally low energy deposition with few thin high energy beds; intermittent shaley interbeds (R1 - R2), up to 1.3 thickness, subhorizontal to 15 degrees inclination; soft interbeds of brown shale in upper 3 ft, dark gray in lower 2 ft, up to 2 thickness, extremely weak (R0); bedding is subhorizontal and undulatory w/ up to 1 peak to peak amplitude (Plattsmouth Limestone)		1957.9					
36		2:41			CR-1	5 5	4.5 5		Shale, brown, 1" bed, R0, between 33.7' and 33.8' 2 cm wide 4 cm deep vug at 34.0, coated in FeO BJ open, F at 34.0' BJ, base of brown shale bed, undulatory, tight, R1 at 35.9' BJ, top of shale bed at 36.2' SHALE, dark gray, R0, 1.5", between 36.2' and 36.3' BJ, top of shale bed, open, F at 36.7' SHALE, dark gray, R0 - R1 at 36.7' BJ, shaley LS, undulatory over 0.3" at 37.3' End of boring at 38.4 ft below deck surface and 20.2 ft below mudline		2298.5					
38		2:17									1952.9					
40		3:05														
42																
44																

Notes:

WOLF CREEK
UPDATED SAFETY ANALYSIS REPORT
 Figure 2.5-36nnnn Rev. 28
 Log of Boring B-127
 Sheet 3' of 3

Surface Level (ft): **1968.99** Easting (ft): **104340.83**
 Total Drill Depth (ft): **11.1** Northing (ft): **98295.47**
 Inclination/Bearing: **90** Datum: **Wolf Creek Plant Datum**

Hole Id:

B-130

Sheet: 1 of 1

Depth, feet	Water Level	Drill Rate (mins)	Graphic Log	Sample Type	Sample Number	Recovery	RQD	SPT Blows per 6-inches	STRATUM DESCRIPTION	Estimated Strength (ksf)	Stratum Elev. (feet)	CLASSIFICATION					
												Total Unit Wt., pcf	Passing No. 200 Sieve, %	Water Content, %	Liquid Limit	Plastic Limit	Plasticity Index (PI)
		3:40			SPT-1	0.1 0.1		50/1	LIMESTONE; light gray (N7); medium strong (R3); slightly weathered (SW); medium bedded; moderately argillaceous; fossiliferous; undulating dark gray (N3), close to medium spaced laminations (limey shale); strong HCl reaction.								
2		4:01			SC-1				BH, 0°, stained, rough, sub-horizontal at 0.2' MB, 90° between 0.4' and 0.5'		2100	167		1			
		3:39			CR-1	5 5		3.9 5	BJ, 0°, stained, rough, sub-horizontal at 0.5' Fresh (F) at 0.7 ft								
4		3:18							BJ, 0°, rough, sub-horizontal at 2.6' Moderate yellowish brown shale seam at 2.7 to 2.75 ft								
		3:29							BJ, 0°, rough, sub-horizontal at 2.8' Medium dark gray (N4), clayey shale seams at 3.0-3.1 ft, 3.2-3.3 ft.								
6		3:01							BJ, 0°, rough, sub-horizontal at 4.0'								
		4:17							BJ, 0 at 5.3'								
8		3:28			CR-2	5 5		4.1 5	Medium dark gray (N4) clayey shale seams at 8.15-8.25 ft, 8.6-9.3 ft, and 9.55-9.70 ft.								
		2:41							- Weak (R2) at 8.15 ft Clayey shale seams have no HCl reaction.								
10		2:15							BJ, 0°, rough, sub-horizontal at 9.4'								
									BJ, 0°, rough, sub-horizontal at 9.8'		1958.9						
									BJ, 0°, rough, sub-horizontal at 9.9'								
									BJ, 0°, rough, sub-horizontal at 10.0'								

Notes:

- Terms and symbols defined on Plate 1.
- As-Built coordinates and elevation surveyed by Kaw Valley Engineering (KS-licensed).
- The SPT blow count is defined as the number of blows required for a 140 lb. auto trip safety hammer falling 30 inches to drive the split-barrel sampler 6 inches in a possible 18 inch sample interval.
- Shelby tubes used for cohesive soil sampling of dimensions 36 inches long, 3 inch outside diameter.
- HQ3 carbide Diamond bit used for rock coring.

WOLF CREEK
 UPDATED SAFETY ANALYSIS REPORT

Figure 2.5-360000 Rev. 28
 Log of Boring B-130
 Sheet 1 of 1

Surface Level (ft): **1981.31** Easting (ft): **104551.59**
 Total Drill Depth (ft): **24.8** Northing (ft): **98559.49**
 Inclination/Bearing: **90** Datum: **Wolf Creek Plant Datum**

Hole Id:

B-131

Sheet: 1 of 2

Depth, feet	Water Level	Drill Rate (mins)	Graphic Log	Sample Type	Sample Number	Recovery	RQD	SPT Blows per 6-inches	STRATUM DESCRIPTION	Estimated Strength (ksf)	Stratum Elev. (feet)	CLASSIFICATION						
												Total Unit Wt., pcf	Passing No; 200 Sieve, %	Water Content, %	Liquid Limit	Plastic Limit	Plasticity Index (PI)	
0					SPT-1	0.8 1.5		0 1 1	CLAY (CH); dark olive brown (2.5Y 3/3); wet; soft; some silt, decreasing with depth; highly plastic - 9.7 ft to mud line; 4.4 ft to water from deck									
2					ST-1	1.3 2			CLAY (CH); brownish yellow (10YR 6/6); moist; soft; trace sand.		1979.2							
4										0.61		116	33	69	21	48		
6					SPT-2	1.3 1.5		1 2 2	CLAY, with sand (CH); brownish yellow (10YR 6/6); moist to wet; soft; some silt; trace to little subrounded gravel; mottled light grey (10YR 7/1) and dark grey (10YR 4/1).		1976.5			30	69	19	50	
8					SPT-3	1.5 1.5		6 8 11	more silty, stiff					81	19	53	18	35
10					SPT-4	1.2 1.5		14 19 31	CLAY, silty (CL); light brownish grey (2.5Y 6/2); moist to wet; very stiff; some sand and gravel; moderately plastic.		1971.7		77	14				
12																		
14					SPT-5	1.1 1.5		10 9 10	trace gravel, stiff				77	19	70	53	17	
											1966.5							

Notes:

- Terms and symbols defined on Plate 1.
- As-Built coordinates and elevation surveyed by Kaw Valley Engineering (KS-licensed).
- The SPT blow count is defined as the number of blows required for a 140 lb. auto trip safety hammer falling 30 inches to drive the split-barrel sampler 6 inches in a possible 18 inch sample interval.
- Shelby tubes used for cohesive soil sampling of dimensions 36 inches long, 3 inch outside diameter.
- HQ3 carbide Diamond bit used for rock coring.

**WOLF CREEK
 UPDATED SAFETY ANALYSIS REPORT**

Figure 2.5-36pppp Rev. 28
 Log of Boring B-131
 Sheet 1 of 2

Surface Level (ft): **1981.31** Easting (ft): **104551.59**
 Total Drill Depth (ft): **24.8** Northing (ft): **98559.49**
 Inclination/Bearing: **90** Datum: **Wolf Creek Plant Datum**

Hole Id:

B-131

Sheet: 2 of 2

Depth, feet	Water Level	Drill Rate (mins)	Graphic Log	Sample Type	Sample Number	Recovery	RQD	SPT Blows per 6-inches	STRATUM DESCRIPTION	Estimated Strength (ksf)	Stratum Elev. (feet)	CLASSIFICATION					
												Total Unit Wt., pcf	Passing No. 200 Sieve, %	Water Content, %	Liquid Limit	Plastic Limit	Plasticity Index (PI)
16		3:07			SC-1 CR-1	2.9 3.1	3.2		LIMESTONE; light gray (N7); medium strong (R3); slightly weathered, moderately stained to 19.6'; medium bedded; thin to medium spaced wavy laminations of dark gray (N3) limy shale interbeds; fossiliferous; moderately argillaceous; fossiliferous; strong HCl reaction. - 10 blows for no penetration (refusal). Begin coring HW casing set to 20.0 ft from deck with 0.5 ft stick up above deck Clay seam between discontinuities up to 0.25 ft thick at 15.1, 17.1, 17.5, 19.6 and 19.85 ft BJ, 0°, rough at 15.2' Special care sample 15.3-16.9 ft BJ, 0°, rough at 15.4' BJ, 0°, rough at 16.8' Down feed pressure is 400 psi BJ, 0°, rough at 17.4' BJ, 0°, rough at 17.5' BJ, 0°, rough at 17.6' Core spun off between 17.8 and 18.0 ft. Sideways in box BJ, 0°, rough at 18.7' BJ, 0°, rough at 18.8' BJ, 0°, rough at 19.9' medium grey (N5) clayey shale interbed up to 0.8 ft thick at 20.4 and 21.2 ft thinly spaced, subhorizontal, dark grey (N3), shaly limestone laminations between 21.7 and 22.7 ft MB, 0° at 22.8' MB, 0° at 22.9' Core separates at shale and clay seam in run 2 when placing in box. BJ, 15°, rough, FeO stained between 23.1' and 23.2' BJ, 25°, rough, FeO stained between 24.0' and 24.2' BJ, 0°, rough, slightly open at 24.4'	500 1000 1500 2000	2530	168	1				
24		2:11			CR-3	2.2	1.8 2				1956.5						

Notes:

- Terms and symbols defined on Plate 1.
- As-Built coordinates and elevation surveyed by Kaw Valley Engineering (KS-licensed).
- The SPT blow count is defined as the number of blows required for a 140 lb. auto trip safety hammer falling 30 inches to drive the split-barrel sampler 6 inches in a possible 18 inch sample interval.
- Shelby tubes used for cohesive soil sampling of dimensions 36 inches long, 3 inch outside diameter.
- HQ3 carbide Diamond bit used for rock coring.

**WOLF CREEK
 UPDATED SAFETY ANALYSIS REPORT**

Figure 2.5-36pppp Rev. 28
 Log of Boring B-131
 Sheet 2 of 2

Surface Level (ft): **1998.211** Easting (ft): **101788.076122**
 Total Drill Depth (ft): **29.9** Northing (ft): **99819.136255**
 Inclination/Bearing: **90** Datum: **Wolf Creek Plant Datum**

Hole Id:

B-140

Sheet: 1 of 2

Depth, feet	Water Level	Drill Rate (mins)	Graphic Log	Sample Type	Sample Number	Recovery	RQD	SPT Blows per 6-inches	STRATUM DESCRIPTION	Estimated Strength (ksf)	Stratum Elev. (feet)	CLASSIFICATION							
												Total Unit Wt., pcf	Passing No. 200 Sieve, %	Water Content, %	Liquid Limit	Plastic Limit	Plasticity Index (PI)		
0 - 2					SPT-1	1.3 1.5		6 23 20	SILT, gravelly (ML); very stiff; dark grayish brown (10YR 4/2) and light gray (10YR 7/2); dry; with cement and roots (fill). 4 in casing drilled with mud (temporary); hole cleaned out with flight augers to sample.										
2 - 4					SPT-2	0.9 0.9		6 50/5	Fill, CLAY and concrete mix; hard; roots absent at 3.5 ft. SPT-2 interval is 3.6 to 4.5 ft. Rig grinding from 4.5 to 5 ft; concrete. Drilling with mud		1994.7								
4 - 6					SPT-3	1.3 1.5		3 3 6	CLAY (CH); very dark brown (10YR 2/2) to black (10YR 2/1); dry to moist; soft to medium stiff; trace fine to coarse sand; no HCl reaction.		1992.2			18	69	20	49		
6 - 8					ST-1	0 2			ST-1 and ST-2, no recovery; rig pulled forward to drill B-140a in order to re-attempt ST sample collection.										
8 - 10					ST-2	0 2			Push 50 psi										
10 - 14					SPT-4	1.4 1.5		5 7 11	CLAY (CL); brown (10YR 5/3) to yellowish brown (10YR 5/6); dry to slightly moist; medium stiff to stiff; trace silt; no to weak HCL reaction.		1984.7								

Notes:

- Terms and symbols defined on Plate 1.
- As-Built coordinates and elevation surveyed by Kaw Valley Engineering (KS-licensed).
- The SPT blow count is defined as the number of blows required for a 140 lb. auto trip safety hammer falling 30 inches to drive the split-barrel sampler 6 inches in a possible 18 inch sample interval.
- Shelby tubes used for cohesive soil sampling of dimensions 36 inches long, 3 inch outside diameter.
- HQ3 carbide Diamond bit used for rock coring.

WOLF CREEK
 UPDATED SAFETY ANALYSIS REPORT

Figure 2.5-36qqqq Rev. 28
 Log of Boring B-140
 Sheet 1 of 2

Surface Level (ft): **1998.211** Easting (ft): **101788.076122**
 Total Drill Depth (ft): **29.9** Northing (ft): **99819.136255**
 Inclination/Bearing: **90** Datum: **Wolf Creek Plant Datum**

Hole Id:

B-140

Sheet: 2 of 2

Depth, feet	Water Level	Drill Rate (mins)	Graphic Log	Sample Type	Sample Number	Recovery	RQD	SPT Blows per 6-inches	STRATUM DESCRIPTION	Estimated Strength (ksf)	Stratum Elev. (feet)	CLASSIFICATION					
												Total Unit Wt., pcf	Passing No; 200 Sieve, %	Water Content, %	Liquid Limit	Plastic Limit	Plasticity Index (PI)
16									CLAY (CL); brown (10YR 5/3) to yellowish brown (10YR 5/6); dry to slightly moist; medium stiff to stiff; trace silt; no to weak HCL reaction.								
18																	
20					SPT-5	1.4 1.5		12 16 31	CLAY (CL); brownish yellow (10YR 6/6) to grayish yellow (10YR 5/2); moist; very stiff to hard; trace silt; medium to low plasticity; strong HCl reaction.		1979.7			17	46	15	31
22																	
24					SPT-6	1.3 1.5		15 26 37	Weak HCl reaction; massive below 23.0								
26																	
28					SPT-7	1.4 1.4		19 30 50/5.5	CLAY (CL); brownish yellow (10YR 6/6) to brown (10YR 5/3); moist; hard; trace calcium carbonate grains, medium sized, sub-rounded to rounded; single small crinoid stem; massive texture; strong HCl reaction.		1969.7						
											1968.3						

Notes:

- Terms and symbols defined on Plate 1.
- As-Built coordinates and elevation surveyed by Kaw Valley Engineering (KS-licensed).
- The SPT blow count is defined as the number of blows required for a 140 lb. auto trip safety hammer falling 30 inches to drive the split-barrel sampler 6 inches in a possible 18 inch sample interval.
- Shelby tubes used for cohesive soil sampling of dimensions 36 inches long, 3 inch outside diameter.
- HQ3 carbide Diamond bit used for rock coring.

**WOLF CREEK
 UPDATED SAFETY ANALYSIS REPORT**

Figure 2.5-36qqqq Rev. 28
 Log of Boring B-140
 Sheet 2 of 2

Surface Level (ft): **1998.211** Easting (ft): **101788.076122**
 Total Drill Depth (ft): **14.1** Northing (ft): **99819.136255**
 Inclination/Bearing: **90** Datum: **Wolf Creek Plant Datum**

Hole Id:

B-140a

Sheet: 1 of 1

Depth, feet	Water Level	Drill Rate (mins)	Graphic Log Sample Type	Sample Number	Recovery	RQD	SPT Blows per 6-inches	STRATUM DESCRIPTION	Estimated Strength (ksf)	Stratum Elev. (feet)	CLASSIFICATION							
											Total Unit Wt., pcf	Passing No. 200 Sieve, %	Water Content, %	Liquid Limit	Plastic Limit	Plasticity Index (PI)		
2								No recovery in attempted shelly tubes in B-140; rig pulled forward to drill B-140a in order to re-attempt ST sample collection.										
4								Lithology of B-140a logged only for ST-2 where sample was recovered. See B-140 for soil description above ST-1										
10				ST-1	2.0													
12				ST-2	1.6 2			CLAY (CL); brown (10YR 5/3) to yellowish brown (10YR 5/6); dry to slightly moist; medium stiff; sparse silt; no to weak HCL reaction.		2010.3								
14										2012.3								

Notes:

WOLF CREEK
 UPDATED SAFETY ANALYSIS REPORT

Figure 2.5-36rrrr Rev. 28
 Log of Boring B-140a
 Sheet 1 of 1

Surface Level (ft): **2005.578** Easting (ft): **101787.031361**
 Total Drill Depth (ft): **19.7** Northing (ft): **100779.997862**
 Inclination/Bearing: **90** Datum: **Wolf Creek Plant Datum**

Hole Id:

B-141

Sheet: 1 of 2

Depth, feet	Water Level	Drill Rate (mins)	Graphic Log	Sample Type	Sample Number	Recovery	RQD	SPT Blows per 6-inches	STRATUM DESCRIPTION	Estimated Strength (ksf)	Stratum Elev. (feet)	CLASSIFICATION				
												Total Unit Wt., pct	Passing No. 200 Sieve, %	Water Content, %	Liquid Limit	Plastic Limit
0									SAND (SP); construction concrete; roots (fill). SILT (ML); mottled yellow (10YR 7/6) to brown (10YR 5/3); dry; medium stiff; difficult to break with hands; sparse fine sand; trace roots; fill.		2005.3					
2					SPT-1	1.3 1.5		6 23 20								
4					SPT-2	1.2 1.5		6 50/5	SAND, silty (SM); brownish yellow (10YR 6/6) to yellowish brown (10YR 5/6); dry; stiff to very stiff; very fine grained; grains rounded; partially consolidated; mostly hard but friable; some zones well-cemented; porous; no HCl reaction.		2001.7					
6					SPT-3	1.3 1.5		3 3 6	CLAY (CL); brownish yellow (10YR 6/6) and very pale brown (10YR 8/2); dry to slightly moist; stiff to very stiff; little very fine grained sand; unconsolidated.		2000.2		90	13		
8					SPT-4	1.4 1.5		5 7 11	CLAY (CL); brownish yellow (10YR 6/6) to yellowish brown (10YR 5/6) and grayish brown (10YR 3/2); dry to slightly moist; stiff to very stiff; trace very fine sand laminae; trace grayish brown magnesium oxide staining; no HCl reaction. Set 6 ft casing; begin drilling wet rotary below SPT-3.		1998.4					
10					ST-1	0 2			CLAY (CL); light olive brown (2.5Y 5/3) to dark grayish brown (2.5Y 4/2); dry to slightly moist; stiff to very stiff; weak HCl reaction. - Attempt ST-1, pushed 1.5 ft but shelly tube lost in hole; will pull up and start second hole.		1995.6					
12					SPT-5	1.4 1.5		12 16 31	Attempt ST-2, only 7 in pushed until refusal; no recovery.							
14					ST-2	0 2						1992.1				
					SPT-6	1.3 1.5		15 26 37								

Notes:

- Terms and symbols defined on Plate 1.
- As-Built coordinates and elevation surveyed by Kaw Valley Engineering (KS-licensed).
- The SPT blow count is defined as the number of blows required for a 140 lb. auto trip safety hammer falling 30 inches to drive the split-barrel sampler 6 inches in a possible 18 inch sample interval.
- Shelby tubes used for cohesive soil sampling of dimensions 36 inches long, 3 inch outside diameter.
- HQ3 carbide Diamond bit used for rock coring.

**WOLF CREEK
 UPDATED SAFETY ANALYSIS REPORT**

Figure 2.5-36ssss Rev. 28
 Log of Boring B-141
 Sheet 1 of 2

Surface Level (ft): **2005.578** Easting (ft): **101787.031361**
 Total Drill Depth (ft): **19.7** Northing (ft): **100779.997862**
 Inclination/Bearing: **90** Datum: **Wolf Creek Plant Datum**

Hole Id:

B-141

Sheet: 2 of 2

Depth, feet	Water Level	Drill Rate (mins)	Graphic Log	Sample Type	Sample Number	Recovery	RQD	SPT Blows per 6-inches	STRATUM DESCRIPTION	Estimated Strength (ksf)	Stratum Elev. (feet)	CLASSIFICATION						
												Total Unit Wt., pcf	Passing No. 200 Sieve, %	Water Content, %	Liquid Limit	Plastic Limit	Plasticity Index (PI)	
16									CLAY (CL); gray (7.5YR 5/1) and gray (7.5YR 6/1); very stiff; difficult to break; grading to highly weathered shale; breaks along indistinct horizontal laminae, very thin; trace to sparse iron oxide staining; strong HCl reaction.									
18																		
19					SPT-7	1.4		19	CLAY (CH); dark gray (7.5YR 4/1); dry to slightly moist; hard; highly plastic at 18.5 ft, becoming less plastic; grading to shale; massive; horizontal laminae not present; weak HCl reaction.		1987.1							
20						1.4		30	SHALE; dark gray (7.5YR 4/1); dry; very weak (R1); some solid zones; trace horizontal laminae; strong HCl reaction.		1986.1							
20								50/5.5			1985.9							
22																		
24																		
26																		
28																		

Notes:

- Terms and symbols defined on Plate 1.
- As-Built coordinates and elevation surveyed by Kaw Valley Engineering (KS-licensed).
- The SPT blow count is defined as the number of blows required for a 140 lb. auto trip safety hammer falling 30 inches to drive the split-barrel sampler 6 inches in a possible 18 inch sample interval.
- Shelby tubes used for cohesive soil sampling of dimensions 36 inches long, 3 inch outside diameter.
- HQ3 carbide Diamond bit used for rock coring.

**WOLF CREEK
 UPDATED SAFETY ANALYSIS REPORT**

Figure 2.5-36ssss Rev. 28
 Log of Boring B-141
 Sheet 2 of 2

Surface Level (ft): **2005.967** Easting (ft): **101913.543012**
 Total Drill Depth (ft): **29.8** Northing (ft): **101287.495955**
 Inclination/Bearing: **90** Datum: **Wolf Creek Plant Datum**

Hole Id:

B-142

Sheet: 1 of 3

Depth, feet	Water Level	Drill Rate (mins)	Graphic Log	Sample Type	Sample Number	Recovery	RQD	SPT Blows per 6-inches	STRATUM DESCRIPTION	Estimated Strength (ksf)	Stratum Elev. (feet)	CLASSIFICATION				
												Total Unit Wt., pcf	Passing No. 200 Sieve, %	Water Content, %	Liquid Limit	Plastic Limit
					SPT-1	1.5 1.5		6 17 28	SILT, sandy (ML); dark brown (10YR 3/3); dry; very stiff; with roots (fill).		2005.3					
									SAND, silty (SM); very pale brown (10YR 7/4); dry; very stiff; partially cemented; trace magnesium oxide staining; fill.		2004.5					
2									SILT (ML); mottled brownish yellow (10YR 6/6) to dark yellowish brown (10YR 4/4); dry; stiff; few thin, horizontal laminae; sparse fine sand; trace magnesium oxide staining; no HCl reaction.							
4					SPT-2	1.5 1.5		6 6 6 6								
6					ST-1	1.6 1.6			CLAY (CL); mottled brownish yellow (10YR 6/6) to dark yellowish brown (10YR 4/4); dry to slightly moist; stiff; breaks on horizontal lines but texture generally massive; sandy at top of ST sample.	6.5	2001.1	134	19	46	16	30
8																
10					SPT-3	1.5 1.5		8 13 14	CLAY (CL); mottled light yellowish brown (2.5Y 6/4) to olive brown (2.5YR 4/3) and white (2.5Y 8/1); slightly moist; stiff; sparse iron oxide staining; trace white calcium carbonate grains; strong HCl reaction.		1997.5					
12					SPT-4			8 14 20	CLAY (CL); grayish brown (2.5Y 5/2) to dark grayish brown (2.5Y 4/2) and brownish yellow (10YR 6/6); moist; stiff to very stiff; difficult to break with hands; slightly silty with silt content decreasing with depth; brownish yellow decreasing with depth.		1996.0					
14					SPT-5			14 22 27	Grading to completely weathered shale with few indistinct horizontal to sub-horizontal laminae.							

Notes:

- Terms and symbols defined on Plate 1.
- As-Built coordinates and elevation surveyed by Kaw Valley Engineering (KS-licensed).
- The SPT blow count is defined as the number of blows required for a 140 lb. auto trip safety hammer falling 30 inches to drive the split-barrel sampler 6 inches in a possible 18 inch sample interval.
- Shelby tubes used for cohesive soil sampling of dimensions 36 inches long, 3 inch outside diameter.
- HQ3 carbide Diamond bit used for rock coring.

**WOLF CREEK
 UPDATED SAFETY ANALYSIS REPORT**

Figure 2.5-36tttt Rev. 28
 Log of Boring B-142
 Sheet 1 of 3

Surface Level (ft): **2005.967** Easting (ft): **101913.543012**
 Total Drill Depth (ft): **29.8** Northing (ft): **101287.495955**
 Inclination/Bearing: **90** Datum: **Wolf Creek Plant Datum**

Hole Id:

B-142

Sheet: 2 of 3

Depth, feet	Water Level	Drill Rate (mins)	Graphic Log	Sample Number	Recovery	RQD	SPT Blows per 6-inches	STRATUM DESCRIPTION	Estimated Strength (ksf)	Stratum Elev. (feet)	CLASSIFICATION					
											Total Unit Wt., pcf	Passing No. 200 Sieve, %	Water Content, %	Liquid Limit	Plastic Limit	Plasticity Index (PI)
16								CLAY (CL); grayish brown (2.5Y 5/2) to dark grayish brown (2.5Y 4/2) and brownish yellow (10YR 6/6); moist; stiff to very stiff; difficult to break with hands; slightly silty with silt content decreasing with depth; brownish yellow decreasing with depth.								
18																
20				SPT-6	1.3 1.3		20 49 42/4	SHALE; dark gray (2.5Y 4/1); dry; extremely weak (R0); moderately to highly weathered; common clay at 18.5 ft decreasing with depth; abundant indistinct horizontal to subhorizontal laminae; weak HCl reaction.		1987.5			14	44	18	26
22				CR-1	4.9 5	4.7 5		SHALE; medium dark gray (N4); very weak (R1) to extremely weak (R0); fresh (F) to slightly weathered (SW); very thin horizontal laminae throughout; trace iron oxide staining; trace calcium carbonate grains; strong HCl reaction. extremely weak (R0), with common thin zones of completely weathered, no HCL reaction. - MB, 0° at 20.3' MB, 0° at 20.7' MB, 0° at 22.6' MB, 0° at 23.0'								
24								Return to very weak (R1) to extremely weak (R0) below 23.8 MB, 0° at 24.6'								
26				CR-2	5 5	4.6 5		Extremely weak (R0); medium dark gray (N4); no rock structure; no HCl reaction below 25.0. - MB, 0° at 25.0' MB, 0° at 25.1' MB, 0° at 25.2' MB, 0° at 25.3' MB, 0° at 25.4'		1979.4						
28				SC-1				Returns to very weak (R1) to extremely weak (R0); thin horizontal distinct laminae; trace siltstone lenses; no to weak HCl reaction below 25.7. - MB, 0° at 25.7' MB, 0° at 25.9' MB, 0° at 26.0' MB, 0° at 26.1'	●295		159	3				
										1976.2						

Notes:

- Terms and symbols defined on Plate 1.
- As-Built coordinates and elevation surveyed by Kaw Valley Engineering (KS-licensed).
- The SPT blow count is defined as the number of blows required for a 140 lb. auto trip safety hammer falling 30 inches to drive the split-barrel sampler 6 inches in a possible 18 inch sample interval.
- Shelby tubes used for cohesive soil sampling of dimensions 36 inches long, 3 inch outside diameter.
- HQ3 carbide Diamond bit used for rock coring.

WOLF CREEK
 UPDATED SAFETY ANALYSIS REPORT

Figure 2.5-36tttt Rev. 28
 Log of Boring B-142
 Sheet 2 of 3

Surface Level (ft): **2005.967** Easting (ft): **101913.543012**
 Total Drill Depth (ft): **29.8** Northing (ft): **101287.495955**
 Inclination/Bearing: **90** Datum: **Wolf Creek Plant Datum**

Hole Id:

B-142

Sheet: 3 of 3

Depth, feet	Water Level	Drill Rate (mins)	Graphic Log	Sample Type	Sample Number	Recovery	RQD	SPT Blows per 6-inches	STRATUM DESCRIPTION	Estimated Strength (ksf)	Stratum Elev. (feet)	CLASSIFICATION				
												Total Unit Wt., pcf	Passing No. 200 Sieve, %	Water Content, %	Liquid Limit	Plastic Limit
32									SHALE; medium dark gray (N4); very weak (R1) to weak (R2); fresh (F); muddy; argillaceous with common calcium carbonate lenses and shell fragments; generally horizontal to sub-horizontal with soft sediment deformation; strong HCl reaction. MB, 0° at 26.8'	500 1000 1500 2000						
34																
36																
38																
40																
42																
44																

Notes:

- Terms and symbols defined on Plate 1.
- As-Built coordinates and elevation surveyed by Kaw Valley Engineering (KS-licensed).
- The SPT blow count is defined as the number of blows required for a 140 lb. auto trip safety hammer falling 30 inches to drive the split-barrel sampler 6 inches in a possible 18 inch sample interval.
- Shelby tubes used for cohesive soil sampling of dimensions 36 inches long, 3 inch outside diameter.
- HQ3 carbide Diamond bit used for rock coring.

**WOLF CREEK
 UPDATED SAFETY ANALYSIS REPORT**

Figure 2.5-36ttt Rev. 28
 Log of Boring B-142
 Sheet 3 of 3

Surface Level (ft): **1992.349** Easting (ft): **102521.512769**
 Total Drill Depth (ft): **25.8** Northing (ft): **101317.409776**
 Inclination/Bearing: **90** Datum: **Wolf Creek Plant Datum**

Hole Id:

B-143

Sheet: 1 of 2

Depth, feet	Water Level	Drill Rate (mins)	Graphic Log	Sample Type	Sample Number	Recovery	RQD	SPT Blows per 6-inches	STRATUM DESCRIPTION	Estimated Strength (ksf)	Stratum Elev. (feet)	CLASSIFICATION					
												Total Unit Wt., pcf	Passing No. 200 Sieve, %	Water Content, %	Liquid Limit	Plastic Limit	Plasticity Index (PI)
0 - 3.5					SPT-1	1.5 1.5		12 16 12	CLAY, sandy (CL); with construction concrete; dry (Fill)								
3.5 - 4.5					SPT-2	1.4 1.5		3 3 4	CLAY, silty (CL); dark gray (2.5Y 4/1); moist; soft to medium stiff; moderately plastic; trace fine sand; no HCl reaction.		1988.7			23	60	15	45
4.5 - 5.5					ST-1	1.85 1.85			CLAY, with silt (CH); light olive brown (2.5Y 5/4), grayish brown (2.5Y 5/2) and dark yellowish brown (10YR 4/6); moist; medium stiff; plastic; no HCl reaction.	2.5	1987.8	129		22			
5.5 - 9.5					SPT-3	1.5 1.5		3 5 7	CLAY, silty (CL); grayish brown (10YR 5/2) to yellowish brown (10YR 5/6); medium stiff; plastic; strong HCl reaction.		1983.8						
9.5 - 11.5					SPT-4	1.3 1.5		5 8 10									
11.5 - 14.5					SPT-5	1.4 1.5		7 14 17	CLAY, silty (CL); olive gray (5Y 5/2) to brown (7.5YR 5/3); dry to slightly moist; stiff to very stiff; trace sand partings with iron oxide staining; strong HCl reaction.		1979.3			13			

Notes:

- Terms and symbols defined on Plate 1.
- As-Built coordinates and elevation surveyed by Kaw Valley Engineering (KS-licensed).
- The SPT blow count is defined as the number of blows required for a 140 lb. auto trip safety hammer falling 30 inches to drive the split-barrel sampler 6 inches in a possible 18 inch sample interval.
- Shelby tubes used for cohesive soil sampling of dimensions 36 inches long, 3 inch outside diameter.
- HQ3 carbide Diamond bit used for rock coring.

**WOLF CREEK
 UPDATED SAFETY ANALYSIS REPORT**

Figure 2.5-36uuuu Rev. 28
 Log of Boring B-143
 Sheet 1 of 2

Surface Level (ft): **1992.349** Easting (ft): **102521.512769**
 Total Drill Depth (ft): **25.8** Northing (ft): **101317.409776**
 Inclination/Bearing: **90** Datum: **Wolf Creek Plant Datum**

Hole Id:

B-143

Sheet: 2 of 2

Depth, feet	Water Level	Drill Rate (mins)	Graphic Log Sample Type	Sample Number	Recovery	RQD	SPT Blows per 6-inches	STRATUM DESCRIPTION	Estimated Strength (ksf) 500 1000 1500 2000	Stratum Elev. (feet)	CLASSIFICATION					
											Total Unit Wt., pcf	Passing No. 200 Sieve, %	Water Content, %	Liquid Limit	Plastic Limit	Plasticity Index (PI)
16								CLAY, silty (CL); olive gray (5Y 5/2) to brown (7.5YR 5/3); dry to slightly moist; stiff to very stiff; trace sand partings with iron oxide staining; strong HCl reaction.								
18																
20				SPT-6	1.4 1.5		18 20 27	CLAY (CL); olive gray (5Y 5/2) to brown (7.5YR 5/4); dry; very stiff; grading to completely weathered shale; high dry strength; trace fine to medium grained sand; trace rounded sandstone nodules; trace indistinct horizontal to sub-horizontal laminae but generally massive texture; strong HCl reaction.		1973.9						
22																
24				SPT-7	1.4 1.5		21 24 40	Well cemented sand lens, cemented with CaCO ₃ ; strong HCl reaction. CLAY, silty (CL); grayish brown (10YR 5/2) to dark grayish brown (10YR 4/2); dry; very stiff to hard; grading to completely weathered shale; little sand; sparse horizontal to sub-horizontal laminae; sparse calcium carbonate grains; strong HCL reaction.		1968.6						
26				SPT-8	0 0		10/0	Auger refused at 26 ft; verify with SPT-8.		1966.5						
28																

Notes:

- Terms and symbols defined on Plate 1.
- As-Built coordinates and elevation surveyed by Kaw Valley Engineering (KS-licensed).
- The SPT blow count is defined as the number of blows required for a 140 lb. auto trip safety hammer falling 30 inches to drive the split-barrel sampler 6 inches in a possible 18 inch sample interval.
- Shelby tubes used for cohesive soil sampling of dimensions 36 inches long, 3 inch outside diameter.
- HQ3 carbide Diamond bit used for rock coring.

**WOLF CREEK
 UPDATED SAFETY ANALYSIS REPORT**

Figure 2.5-36uuuu Rev. 28
 Log of Boring B-143
 Sheet 2 of 2

Surface Level (ft): **1992.29** Easting (ft): **103840.302382**
 Total Drill Depth (ft): **25** Northing (ft): **101353.519769**
 Inclination/Bearing: **90** Datum: **Wolf Creek Plant Datum**

Hole Id:

B-144

Sheet: 1 of 2

Depth, feet	Water Level	Drill Rate (mins)	Graphic Log	Sample Type	Sample Number	Recovery	RQD	SPT Blows per 6-inches	STRATUM DESCRIPTION	Estimated Strength (ksf)	Stratum Elev. (feet)	CLASSIFICATION					
												Total Unit Wt., pcf	Passing No; 200 Sieve, %	Water Content, %	Liquid Limit	Plastic Limit	Plasticity Index (PI)
0 - 2					SPT-1	1.5 1.5		4 4 5	SILT, with clay (ML); dark gray (7.5YR 4/1); medium stiff; dry; grass at surface; trace fine sand; with roots.								
2 - 4					SPT-2	1.4 1.5		5 5 4	SILT (ML); very dark gray (7.5YR 3/2) and mottled strong brown (7.5YR 5/6) and pinkish gray (7.5YR 7/2); dry; stiff; trace sandy; blocky texture with few angular cemented sand and siltstone clasts; few clay zones; common iron and magnesium oxide staining; no HCl reaction.		1988.9		92	21			
4 - 6					SPT-3	1.2 1.5		5 5 8							17		
6 - 8					ST-1	0 0.5			ST-1 push until refusal; tube bent, no sample. Drilling mud rotary below 8 ft.								
8 - 10					SPT-4	1.4 1.5		11 14 11	CLAY, silty (CL); olive gray (5Y 5/2); dry; very stiff; trace indistinct horizontal laminae; weak HCl reaction. CLAY, silty, gravelly (CL); olive gray (5Y 5/2); dry; very stiff; gravel comprises angular sandstone; trace indistinct horizontal laminae; weak HCl reaction in clay; strong HCl reaction in limestone gravel.		1983.8 1983.1 1982.8						
10 - 12					SPT-5	1.4 1.5		9 16 28	CLAY, with silt (CL); brown (10YR 5/3) to grayish brown (10YR 5/2); dry; very stiff; trace indistinct horizontal laminae; weak HCl reaction. CLAY, with silt (CL); grayish brown (2.5Y 5/2) and light brown (7.5YR 6/4); hard; few sandy zones and CaCO3 nodules with strong HCl reaction; clay shows weak HCl reaction;		1981.5						
12 - 14					SPT-6	1.5 1.5		19 36 46	SPT-6 refusal at 15 ft on 100 blows								

Notes:

- Terms and symbols defined on Plate 1.
- As-Built coordinates and elevation surveyed by Kaw Valley Engineering (KS-licensed).
- The SPT blow count is defined as the number of blows required for a 140 lb. auto trip safety hammer falling 30 inches to drive the split-barrel sampler 6 inches in a possible 18 inch sample interval.
- Shelby tubes used for cohesive soil sampling of dimensions 36 inches long, 3 inch outside diameter.
- HQ3 carbide Diamond bit used for rock coring.

WOLF CREEK
 UPDATED SAFETY ANALYSIS REPORT

Figure 2.5-36vvv Rev. 28
 Log of Boring B-144
 Sheet 1 of 2

Surface Level (ft): **1992.29** Easting (ft): **103840.302382**
 Total Drill Depth (ft): **25** Northing (ft): **101353.519769**
 Inclination/Bearing: **90** Datum: **Wolf Creek Plant Datum**

Hole Id:

B-144

Sheet: 2 of 2

Depth, feet	Water Level	Drill Rate (mins)	Graphic Log	Sample Type	Sample Number	Recovery	RQD	SPT Blows per 6-inches	STRATUM DESCRIPTION	Estimated Strength (ksf)	Stratum Elev. (feet)	CLASSIFICATION				
												Total Unit Wt., pcf	Passing No. 200 Sieve, %	Water Content, %	Liquid Limit	Plastic Limit
16		0:36			CR-1	5/5	5/5		Grading to dark gray (5Y 4/1) completely weathered shale. SHALE; olive gray (5Y 4/1), light olive gray (5Y 6/1) and light brown (5YR 5/6); extremely weak (R0) to very weak (R1); moderately to highly weathered; includes calcium carbonate inclusions and fine to medium sand; stronger shale zones have distinct horizontal laminae with weak HCl reaction; weaker argillaceous zones have rough core surface with strong HCl reaction. Too soft to collect special care sample		1977.3					
18		0:31														
20		0:30							MB, 0° at 20.2'							
22		0:17							Shale becoming more argillaceous with depth.							
24		0:16			CR-2	5/5	4.9/5		MB, 0° at 23.1' LIMESTONE; pale brown (5YR 5/2); weak (R2); fresh (F); generally massive but with few shaly sub-horizontal partings; trace shell fragments and crinoid stem inclusions; strong HCl reaction. - Change in drilling rate at 23.2 ft; 350 psi. Limestone broken - no special care sample collected. Completely weathered shale interbed at 23.6 to 23.7 ft - MB, 0° at 23.6' MB, 0° at 23.7' Trace pyrite 24.4 to 24.7 ft - MB, 0° at 24.4'		1969.1					
26		0:23														
28		0:22														

Notes:

- Terms and symbols defined on Plate 1.
- As-Built coordinates and elevation surveyed by Kaw Valley Engineering (KS-licensed).
- The SPT blow count is defined as the number of blows required for a 140 lb. auto trip safety hammer falling 30 inches to drive the split-barrel sampler 6 inches in a possible 18 inch sample interval.
- Shelby tubes used for cohesive soil sampling of dimensions 36 inches long, 3 inch outside diameter.
- HQ3 carbide Diamond bit used for rock coring.

**WOLF CREEK
 UPDATED SAFETY ANALYSIS REPORT**

Figure 2.5-36vvv Rev. 28
 Log of Boring B-144
 Sheet 2 of 2

Surface Level (ft): **1992.48** Easting (ft): **104940.96**
 Total Drill Depth (ft): **29.9** Northing (ft): **101320.18**
 Inclination/Bearing: **90** Datum: **Wolf Creek Plant Datum**

Hole Id:

B-145

Sheet: 1 of 3

Depth, feet	Water Level	Drill Rate (mins)	Graphic Log	Sample Type	Sample Number	Recovery	RQD	SPT Blows per 6-inches	STRATUM DESCRIPTION	Estimated Strength (ksf)	Stratum Elev. (feet)	CLASSIFICATION				
												Total Unit Wt., pcf	Passing No. 200 Sieve, %	Water Content, %	Liquid Limit	Plastic Limit
					SPT-1	1.2 1.5		4 5	TILL ZONE; SILT (ML); brown (7.5YR 4/2), medium stiff, dry, with common roots and fine sand, grass at surface.							
									CLAY (CL); silty, brown (7.5YR 4/2), common roots, dry, difficult to break with hands.		1991.3					
2									CLAY, with sand (CL); light gray (7.5YR 6/1), light brown (7.5YR 6/4), and light grey (7.5YR 8/1) with common FeO-staining, dry, stiff, few cemented silt lenses, cemented with CaCO3 stained FeO, strong HCl reaction.		1990.5					
4					SPT-2	1.3 1.4		6 6 7	Cemented silt absent 4.5 - 8 ft.							
6					ST-1	1.7 2.0				1.35						
8									Common cemented silt lenses, hard, strong brown (7.5YR 4/4), grading to gray (5Y 5/1), dry, cemented silt lenses shows no to weak HCl reaction, clay shows strong reaction.							
10					SPT-3	1.5 1.5		7 12 18	Begin wash rotary at 10 ft bgs.							
12									CLAY (CL); gray (5Y 5/1) with strong brown (7.5YR 4/4) FeO staining, dry, very stiff, sparse silt, trace fine sand, strong HCl reaction.		1980.7					
14					SPT-4	1.5 1.5		8 9 14								
									CLAY, silty (CL); light yellowish brown (10YR 6/4) to yellowish brown (10YR 5/4), very stiff, high dry strength, strong HCl reaction.		1979.1					
					SPT-5	1.5 1.5		6 10 17	SHALE; dark gray (10YR 4/1), extremely weak (R0), highly weathered to residual soil		1978.2					

Notes:

- Terms and symbols defined on Plate 1.
- As-Built coordinates and elevation surveyed by Kaw Valley Engineering (KS-licensed).
- The SPT blow count is defined as the number of blows required for a 140 lb. auto trip safety hammer falling 30 inches to drive the split-barrel sampler 6 inches in a possible 18 inch sample interval.
- Shelby tubes used for cohesive soil sampling of dimensions 36 inches long, 3 inch outside diameter.
- HQ3 carbide Diamond bit used for rock coring.

**WOLF CREEK
 UPDATED SAFETY ANALYSIS REPORT**

Figure 2.5-36www Rev. 28
 Log of Boring B-145
 Sheet 1 of 3

Surface Level (ft): **1992.48** Easting (ft): **104940.96**
 Total Drill Depth (ft): **29.9** Northing (ft): **101320.18**
 Inclination/Bearing: **90** Datum: **Wolf Creek Plant Datum**

Hole Id:
B-145

Sheet: 2 of 3

Depth, feet	Water Level	Drill Rate (mins)	Graphic Log Sample Type	Sample Number	Recovery	RQD	SPT Blows per 6-inches	STRATUM DESCRIPTION	Estimated Strength (ksf)	Stratum Elev. (feet)	CLASSIFICATION				
											Total Unit Wt., pcf	Passing No. 200 Sieve, %	Water Content, %	Liquid Limit	Plastic Limit
16								SHALE; dark gray (10YR 4/1), extremely weak (R0), highly weathered to residual soil, few indistinct horizontal to subhorizontal laminae but generally massive texture, dry, weak HCl reaction.	500 1000 1500 2000						
18				SPT-6	1.3 1.3		20 50 30/2	SHALE: dark grayish brown (10YR 4/2) to yellowish brown (10YR 5/4), muddy, extremely weak (R0), common quartz granules and shell fragments, strong HCl reaction.		1974.5					
20		2:03						Refusal on 100 total blows at 19.7 ft.		1972.6					
22		1:46		CR-1	4.9 5	4.8 5		SHALE: light olive gray (5Y 5/2) to olive gray (5Y 3/2), extremely weak (R0), moderately weathered, common shell fragments and crinoid stems, trace limestone rip-up clasts, outer edge of core has rough texture, easily breakable, some horizontal laminae, strong HCl reaction. HQ3 drilling with diamond bit starting at 19.9 ft.							
24		2:09						MB, 0° at 20.7' Downpressure 300 psi, 20.9-27 ft.		1969.7					
26		2:15						LIMESTONE: medium light gray (N6) to medium dark gray (N4), with few shale interbeds, very weak (R1) to weak (R2), fresh, trace calcareous inclusions, especially in shaly zones, trace pyrite, strong HCl reaction.							
28		2:25		SC-1				Lens of extremely weak (R0), completely weathered, dark yellowish orange (10YR 6/6) coarser material, 0.1 ft thick.							
		2:19		CR-2	5.1 5	3.8 5		- MB, 0° at 23.2' MB, 0° at 23.3' MB, 0° at 25.7' MB, 0° at 25.8' MB, 0° at 26.0' Downpressure 400 psi 27-29.9 ft. No water gain or loss for hole.		1970	166		1		
		2:17						Driller reports significantly harder drilling east of lake than within Wolf Creek proper.							
		2:41						MB, 0° at 28.4'							
		2:18								1962.6					

Notes:

- Terms and symbols defined on Plate 1.
- As-Built coordinates and elevation surveyed by Kaw Valley Engineering (KS-licensed).
- The SPT blow count is defined as the number of blows required for a 140 lb. auto trip safety hammer falling 30 inches to drive the split-barrel sampler 6 inches in a possible 18 inch sample interval.
- Shelby tubes used for cohesive soil sampling of dimensions 36 inches long, 3 inch outside diameter.
- HQ3 carbide Diamond bit used for rock coring.

WOLF CREEK
 UPDATED SAFETY ANALYSIS REPORT

Figure 2.5-36www Rev. 28
 Log of Boring B-145
 Sheet 2 of 3

Surface Level (ft): **1992.48** Easting (ft): **104940.96**
 Total Drill Depth (ft): **29.9** Northing (ft): **101320.18**
 Inclination/Bearing: **90** Datum: **Wolf Creek Plant Datum**

Hole Id:

B-145

Sheet: 3 of 3

Depth, feet	Water Level	Drill Rate (mins)	Graphic Log	Sample Type	Sample Number	Recovery	RQD	SPT Blows per 6-inches	STRATUM DESCRIPTION	Estimated Strength (ksf)	Stratum Elev. (feet)	CLASSIFICATION				
												Total Unit Wt., pct	Passing No. 200 Sieve, %	Water Content, %	Liquid Limit	Plastic Limit
32									0.7 ft interbed of SHALE between 28.6 and 29.3 ft, dark gray (N3), extremely weak (R0), develops strong horizontal fractures on laminae when dry, fresh, strong reaction to HCl, Shale bands increasing with depth and show soft sediment deformation. - MB, 0° at 28.6' MB, 0° at 29.5' MB, 0° at 29.6'	500 1000 1500 2000						
34																
36																
38																
40																
42																
44																

Notes:

- Terms and symbols defined on Plate 1.
- As-Built coordinates and elevation surveyed by Kaw Valley Engineering (KS-licensed).
- The SPT blow count is defined as the number of blows required for a 140 lb. auto trip safety hammer falling 30 inches to drive the split-barrel sampler 6 inches in a possible 18 inch sample interval.
- Shelby tubes used for cohesive soil sampling of dimensions 36 inches long, 3 inch outside diameter.
- HQ3 carbide Diamond bit used for rock coring.

**WOLF CREEK
 UPDATED SAFETY ANALYSIS REPORT**

Figure 2.5-36www Rev. 28
 Log of Boring B-145
 Sheet 3 of 3

Surface Level (ft): **1992.91** Easting (ft): **104922.86**
 Total Drill Depth (ft): **25** Northing (ft): **100148.99**
 Inclination/Bearing: **90** Datum: **Wolf Creek Plant Datum**

Hole Id:

B-146

Sheet: 1 of 2

Depth, feet	Water Level	Drill Rate (mins)	Graphic Log	Sample Type	Sample Number	Recovery	RQD	SPT Blows per 6-inches	STRATUM DESCRIPTION	Estimated Strength (ksf)	Stratum Elev. (feet)	CLASSIFICATION				
												Total Unit Wt., pcf	Passing No. 200 Sieve, %	Water Content, %	Liquid Limit	Plastic Limit
					SPT-1	1.5 1.5		3 3	TILL ZONE; SILT (ML); brown (7.5YR 4/2), loose, dry, with common roots, sparse sand, grass at surface.		1991.9					
2									CLAY, silty (CL); brown (7.5YR 4/2), dry, high dry strength, no HCl reaction.							
4					SPT-2	1.5 1.5		6 7 8	CLAY, with silt (CL); gray (5YR 5/1) to yellowish red (5YR 5/6), stiff, high dry strength, no HCl reaction.					22		
8					ST-1	1.9 1.9				3.04		136	98	18		
10											1982.4					
12					SPT-3	1.4 1.5		8 14 16	CLAY (CL); gray (5YR 6/1) to light olive gray (5Y 6/2), very stiff, dry, with FeO-stained, cemented silt lenses, weak HCl reaction throughout, FeO staining is yellowish brown (10YR 5/6).							
14					SPT-4	1.4 1.5		14 17 28	Cemented silt lenses decreasing with depth.							
											1978.1					

Notes:

- Terms and symbols defined on Plate 1.
- As-Built coordinates and elevation surveyed by Kaw Valley Engineering (KS-licensed).
- The SPT blow count is defined as the number of blows required for a 140 lb. auto trip safety hammer falling 30 inches to drive the split-barrel sampler 6 inches in a possible 18 inch sample interval.
- Shelby tubes used for cohesive soil sampling of dimensions 36 inches long, 3 inch outside diameter.
- HQ3 carbide Diamond bit used for rock coring.

**WOLF CREEK
 UPDATED SAFETY ANALYSIS REPORT**

Figure 2.5-36xxxx Rev. 28
 Log of Boring B-146
 Sheet 1 of 2

Surface Level (ft): **1992.91** Easting (ft): **104922.86**
 Total Drill Depth (ft): **25** Northing (ft): **100148.99**
 Inclination/Bearing: **90** Datum: **Wolf Creek Plant Datum**

Hole Id:

B-146

Sheet: 2 of 2

Depth, feet	Water Level	Drill Rate (mins)	Graphic Log	Sample Type	Sample Number	Recovery	RQD	SPT Blows per 6-inches	STRATUM DESCRIPTION	Estimated Strength (ksf)	Stratum Elev. (feet)	CLASSIFICATION				
												Total Unit Wt., pcf	Passing No. 200 Sieve, %	Water Content, %	Liquid Limit	Plastic Limit
16									SAND, with silt (SP); dry, gray (10YR 6/1) to grayish brown (10YR 5/2) and light gray (10YR 7/2), well cemented, calcareous, hard, strong HCl reaction, quartz grains fine to medium, subrounded.	500 1000 1500 2000						
18					SPT-5	1.4 1.5		11 29 34	CLAY (CL), grading to completely weathered shale; gray (5Y 6/1) to light olive gray (5Y 6/2), hard, high dry strength, absence of cemented sand and FeO staining, indistinct horizontal to subhorizontal laminae, weak HCl reaction.		1975.9					
20									Start at 20.0 ft on 10/26/11. No water in hole at start of drilling.							
22									SHALE; gray (5Y 5/1) to olive gray (5Y 5/2), very dark gray (5Y 3/1) in places, extremely weak (R0), dry, with common shell fragments and CaCO3 nodules, highly weathered, indistinct horizontal to subhorizontal laminae, strong HCl reaction.		1970.9					
24					SPT-6	1.5 1.5		13 50/5								
26											1967.9					
28																

Notes:

- Terms and symbols defined on Plate 1.
- As-Built coordinates and elevation surveyed by Kaw Valley Engineering (KS-licensed).
- The SPT blow count is defined as the number of blows required for a 140 lb. auto trip safety hammer falling 30 inches to drive the split-barrel sampler 6 inches in a possible 18 inch sample interval.
- Shelby tubes used for cohesive soil sampling of dimensions 36 inches long, 3 inch outside diameter.
- HQ3 carbide Diamond bit used for rock coring.

WOLF CREEK
 UPDATED SAFETY ANALYSIS REPORT

Figure 2.5-36xxxx Rev. 28
 Log of Boring B-146
 Sheet 2 of 2

Surface Level (ft): **1993.62** Easting (ft): **104924.57**
 Total Drill Depth (ft): **19.8** Northing (ft): **99302.88**
 Inclination/Bearing: **90** Datum: **Wolf Creek Plant Datum**

Hole Id:

B-147

Sheet: 1 of 2

Depth, feet	Water Level	Drill Rate (mins)	Graphic Log Sample Type	Sample Number	Recovery	RQD	SPT Blows per 6-inches	STRATUM DESCRIPTION	Estimated Strength (ksf)	Stratum Elev. (feet)	CLASSIFICATION				
											Total Unit Wt., pcf	Passing No. 200 Sieve, %	Water Content, %	Liquid Limit	Plastic Limit
0				SPT-1	1.5 1.5		3 4 4	TILL ZONE; SILT (ML); brown (7.5YR 4/2), loose, dry, with common roots and clay, sparse sand, grass at surface. SILT (ML); very dark grayish brown (10YR 3/2), dry, stiff, with fine sand, trace clay, and roots, no HCl reaction.	500 1000 1500 2000	1993.0					
2				SPT-2	1.1 1.5		4 4 5	CLAY (CL); silty, mottled yellowish brown (10YR 5/3) to dark grayish brown (10YR 4/2), with brownish yellow (10YR 6/6), stiff, trace fine sand and roots, MnO staining, weak HCl reaction.		1990.6		28			
4				SPT-3	1.2 1.5		5 6 8	SILT (ML); with clay, brownish yellow (10YR 6/6) to pale brown (10YR 6/3), with very pale brown (10YR 8/2), CaCO3 nodules, stiff, trace fine sand lenses and cemented silt lenses, silt is FeO stained with high dry strength, strong HCl reaction except no reaction on siltstone zones.		1987.2		16			
6				SPT-4	1.5 1.5		11 13 16	CLAY (CL); silty, mottled gray (5Y 5/1), olive gray (5Y 5/2), and light yellowish brown (10YR 6/4), hard, dry, with common silt lenses, some lenses are cemented with gray (5Y 6/1) CaCO3, with some strong brown (7.5YR 4/6) FeO staining; HCl reaction is strong on CaCO3 cemented zones and weak on clay, none on FeO cemented zones.		1985.8					
8				SPT-5	1.4 1.5		9 19 25	Below 10.6 ft, common very fine sand, cemented zones decreasing with depth, dry, few horizontal laminae, grading to completely weathered shale.							
10				SPT-6	1.5 1.5		16 23 32					94	12		

Notes:

- Terms and symbols defined on Plate 1.
- As-Built coordinates and elevation surveyed by Kaw Valley Engineering (KS-licensed).
- The SPT blow count is defined as the number of blows required for a 140 lb. auto trip safety hammer falling 30 inches to drive the split-barrel sampler 6 inches in a possible 18 inch sample interval.
- Shelby tubes used for cohesive soil sampling of dimensions 36 inches long, 3 inch outside diameter.
- HQ3 carbide Diamond bit used for rock coring.

**WOLF CREEK
 UPDATED SAFETY ANALYSIS REPORT**

Figure 2.5-36yyyy Rev. 28
 Log of Boring B-147
 Sheet 1 of 2

Surface Level (ft): **1993.62** Easting (ft): **104924.57**
 Total Drill Depth (ft): **19.8** Northing (ft): **99302.88**
 Inclination/Bearing: **90** Datum: **Wolf Creek Plant Datum**

Hole Id:

B-147

Sheet: 2 of 2

Depth, feet	Water Level	Drill Rate (mins)	Graphic Log Sample Type	Sample Number	Recovery	RQD	SPT Blows per 6-inches	STRATUM DESCRIPTION	Estimated Strength (ksf)	Stratum Elev. (feet)	CLASSIFICATION				
											Total Unit Wt., pcf	Passing No. 200 Sieve, %	Water Content, %	Liquid Limit	Plastic Limit
16								CLAY (CL); silty, mottled gray (5Y 5/1), olive gray (5Y 5/2), and light yellowish brown (10YR 6/4), hard, dry, with common silt lenses, some lenses are cemented with gray (5Y 6/1) CaCO ₃ , with some strong brown (7.5YR 4/6) FeO staining; HCl reaction is strong on CaCO ₃ cemented zones and weak on clay, none on FeO cemented zones.		1977.6					
18								SHALE; mottled grayish brown (2.5Y 5/2), dark gra (2.5Y 4/1) and light brown (7.5YR6/4), dry, hard, abundant shell fragments, highly weathered, indistinct horizontal laminae, strong HCl reaction, few FeO-stained zones, generally horizontal bedding.							
20				SPT-7	1.5 1.5		26 50/4				1973.8				
22															
24															
26															
28															

Notes:

- Terms and symbols defined on Plate 1.
- As-Built coordinates and elevation surveyed by Kaw Valley Engineering (KS-licensed).
- The SPT blow count is defined as the number of blows required for a 140 lb. auto trip safety hammer falling 30 inches to drive the split-barrel sampler 6 inches in a possible 18 inch sample interval.
- Shelby tubes used for cohesive soil sampling of dimensions 36 inches long, 3 inch outside diameter.
- HQ3 carbide Diamond bit used for rock coring.

**WOLF CREEK
 UPDATED SAFETY ANALYSIS REPORT**

Figure 2.5-36yyyy Rev. 28
 Log of Boring B-147
 Sheet 2 of 2

Surface Level (ft): **1988.31**
 Total Drill Depth (ft): **32.3**
 Inclination/Bearing: **90**

Easting (ft): **104706.94**
 Northing (ft): **98880.82**
 Datum: **Wolf Creek Plant Datum**

Hole Id:

B-148

Sheet: 1 of 3

Depth, feet	Water Level	Drill Rate (mins)	Graphic Log Sample Type	Sample Number	Recovery	RQD	SPT Blows per 6-inches	STRATUM DESCRIPTION	Estimated Strength (ksf)	Stratum Elev. (feet)	CLASSIFICATION				
											Total Unit Wt., pcf	Passing No. 200 Sieve, %	Water Content, %	Liquid Limit	Plastic Limit
0 - 2				SPT-1	1.2 1.5		2 3	TILL ZONE; SILT (ML); brown (7.5YR 4/2), loose, dry, with common roots and clay, sparse sand, grass at surface. SILT, with clay (ML); black (7.5YR 2.5/1), dry, high dry strength, no HCl reaction.		1987.7					
2 - 4				SPT-2	1.3 1.5		4 5	CLAY (CL); silty, medium stiff, mottled dark grayish brown (10YR 4/2), dark yellowish brown (10YR 4/4), and very dark brown (10YR 2/2), dry to slightly moist, trace roots, no HCl reaction, blocky texture, moderately plastic.		1985.8		20	49	14	35
4 - 6				ST-1	2 2						126	24			
6 - 10				SPT-3	1.5 1.5		4 6 9	CLAY, silty (CL); medium stiff, yellowish brown (10YR 5/6) to brownish yellow (10YR 6/6), dry to slightly moist, with common cemented silt layers, FeO staining, no HCl reaction, blocky texture absent.		1979.8					
10 - 12				SPT-4	1.5 1.5		9 15 15	Below 11.5, includes quartz sand, fine to medium grained, CaCO3 nodules and common crinoid stems and shell fragments, strong HCl reaction.							
12 - 14				SPT-5	1.5 1.5		13 17 24	CLAY, with silt (CL); yellowish brown (10YR 5/4) to dark yellowish brown (10YR 4/6) and very pale brown (10YR 7/3), dry, few horizontal FeO stained zones, shell fragments common, trace cemented sand, strong HCl reaction.		1975.3					

Notes:

- Terms and symbols defined on Plate 1.
- As-Built coordinates and elevation surveyed by Kaw Valley Engineering (KS-licensed).
- The SPT blow count is defined as the number of blows required for a 140 lb. auto trip safety hammer falling 30 inches to drive the split-barrel sampler 6 inches in a possible 18 inch sample interval.
- Shelby tubes used for cohesive soil sampling of dimensions 36 inches long, 3 inch outside diameter.
- HQ3 carbide Diamond bit used for rock coring.

WOLF CREEK
 UPDATED SAFETY ANALYSIS REPORT

Figure 2.5-36zzzz Rev. 28
 Log of Boring B-148
 Sheet 1 of 3

Surface Level (ft): **1988.31** Easting (ft): **104706.94**
 Total Drill Depth (ft): **32.3** Northing (ft): **98880.82**
 Inclination/Bearing: **90** Datum: **Wolf Creek Plant Datum**

Hole Id:

B-148

Sheet: 2 of 3

Depth, feet	Water Level	Drill Rate (mins)	Graphic Log	Sample Type	Sample Number	Recovery	RQD	SPT Blows per 6-inches	STRATUM DESCRIPTION	Estimated Strength (ksf)	Stratum Elev. (feet)	CLASSIFICATION				
												Total Unit Wt., pcf	Passing No. 200 Sieve, %	Water Content, %	Liquid Limit	Plastic Limit
16									CLAY, with silt (CL); yellowish brown (10YR 5/4) to dark yellowish brown (10YR 4/6) and very pale brown (10YR 7/3), dry, few horizontal FeO stained zones, shell fragments common, trace cemented sand, strong HCl reaction.		1972.3					
18									SHALE; highly to completely weathered, yellowish brown (10YR 5/6) to gray (10YR 5/1), extremely weak (R0) to very weak (R1), dry, high dry strength, common shell fragments and crinoid stems, horizontal laminae not evident on fresh sample. - Rig chattering.							
20					SPT-6	1.5 1.5		18 31 36								
22									Start drilling at 20 ft, 10/27/11, no fluid in hole at start of drilling. Driller reports hard drilling at 21.2 ft. Switch from auger to wash rotary.							
24		1:56							LIMESTONE; medium gray (N5) to light olive gray (5Y 5/2), very weak to (R1) to weak (R2), fresh to slightly weathered, trace shell fragments and pyrite, with common shale lenses; shale is light gray (N7) to medium dark gray (N4), subhorizontal, showing soft sediment deformation, strong HCl reaction throughout.		1966.0					
26		2:17			CR-1	4.9 5	3.7 5		- SPT refusal at 22.3 ft bgs. Begin HQ3 coring at 22.3 ft bgs. Coring with diamond bit. Zones of extremely weak, completely weathered dark yellowish orange (10YR 6/6) material, with no rock structure or HCl reaction, up to 0.4 ft thick, at 22.6-22.8, 23.4, 23.8, 24.4, 24.8-25.2, 25.8, 27.3, and 27.6-27.8 ft.							
28		2:11							MB, 0° at 22.7' MB, 0° at 22.8' MB, 0° at 23.4' MB, 0° at 23.8' Limestone soft and broken. Mechanical breaks do not allow collection of special care sample on Run 1. MB, 0° at 24.4' MB Zone, 0° between 24.8' and 25.2'		1960.5					
		2:10			CR-2											

Notes:

- Terms and symbols defined on Plate 1.
- As-Built coordinates and elevation surveyed by Kaw Valley Engineering (KS-licensed).
- The SPT blow count is defined as the number of blows required for a 140 lb. auto trip safety hammer falling 30 inches to drive the split-barrel sampler 6 inches in a possible 18 inch sample interval.
- Shelby tubes used for cohesive soil sampling of dimensions 36 inches long, 3 inch outside diameter.
- HQ3 carbide Diamond bit used for rock coring.

**WOLF CREEK
 UPDATED SAFETY ANALYSIS REPORT**

Figure 2.5-36zzzz Rev. 28
 Log of Boring B-148
 Sheet 2 of 3

Surface Level (ft): **1988.31** Easting (ft): **104706.94**
 Total Drill Depth (ft): **32.3** Northing (ft): **98880.82**
 Inclination/Bearing: **90** Datum: **Wolf Creek Plant Datum**

Hole Id:

B-148

Sheet: 3 of 3

Depth, feet	Water Level	Drill Rate (mins)	Graphic Log	Sample Type	Sample Number	Recovery	RQD	SPT Blows per 6-inches	STRATUM DESCRIPTION	Estimated Strength (ksf)	Stratum Elev. (feet)	CLASSIFICATION					
												Total Unit Wt., pcf	Passing No. 200 Sieve, %	Water Content, %	Liquid Limit	Plastic Limit	Plasticity Index (PI)
32		2:09			SC-1	5/1.7 5/1.7	3.7/5		MB Zone, 0° between 25.4' and 25.7' MB, 0° at 26.3' No water loss or gain. Downpressure 400 psi. MB Zone, 0° between 27.6' and 27.7' MB, 0° at 27.9' LIMESTONE, medium gray (N5), weak (R2), fresh, clay zones absent, increased occurrence of soft sediment deformation, with abundant shell fragments and calcareous nodules, strong HCl reaction throughout, shale lenses at 28.0-28.6 and 28.9-29.0 ft. - MB, 0° at 27.8' MB, 0° at 32.0' MB, 0° at 32.8' MB, 0° at 32.9'		1956.0	165		2			

Notes:

- Terms and symbols defined on Plate 1.
- As-Built coordinates and elevation surveyed by Kaw Valley Engineering (KS-licensed).
- The SPT blow count is defined as the number of blows required for a 140 lb. auto trip safety hammer falling 30 inches to drive the split-barrel sampler 6 inches in a possible 18 inch sample interval.
- Shelby tubes used for cohesive soil sampling of dimensions 36 inches long, 3 inch outside diameter.
- HQ3 carbide Diamond bit used for rock coring.

**WOLF CREEK
 UPDATED SAFETY ANALYSIS REPORT**

Figure 2.5-36zzzz Rev. 28
 Log of Boring B-148
 Sheet 3 of 3

DEPTH (FEET)	LABORATORY TEST DATA	PERCENT RECOVERED	RQD	ELEVATION (FEET)
0	SAMPLE DEPTH 1'-3' LL = 41% PL = 19% PI = 22% W _o = 15% D _m = 108.2 PCF			
5	1* 6*			

BLOW COUNTS
SAMPLES

TEST PIT 1
SURFACE ELEVATION 1067.72
COORDINATES: N 583480.0 E 2810538.6

SYMBOLS		DESCRIPTIONS
	ML	DARK GRAY CLAYEY SILT WITH OCCASIONAL FINE GRAVEL (TOPSOIL)
	CL	NUMEROUS ROOTS MOTTLED BROWN AND GRAY SILTY CLAY WITH SOME FINE SAND, ROUNDED (VERY STIFF)
	SM	FINE ROOTS OCCASIONAL LENSES OF LIGHT BROWN SILT WITH FINE SAND
	CL	VERY DARK GRAYISH-BROWN SILTY FINE TO COARSE SAND WITH SOME GRAVEL OCCASIONAL FOSSILS MEDIUM DARK GRAY CLAY PLATTSMOUTH MEMBER LIMESTONE; LIGHT GRAY

TEST PIT COMPLETED AT 4.6 FEET ON 11-7-73.
WALLS STOOD VERTICAL.
NO SLUMPING.
WATER ENTER INTO PIT FROM DEPTH OF 3.0 FEET TO 6.0 FEET.
BULK SAMPLE TAKEN FROM 1.0 FEET TO 3.0 FEET.

DEPTH (FEET)	LABORATORY TEST DATA	PERCENT RECOVERED	RQD	ELEVATION (FEET)
0	SAMPLE DEPTH 1'-2' LL = 67% PL = 28% PI = 39% 1* 2'-4' LL = 66% PL = 25% PI = 41% 1* 1'-4' W _o = 20.3% 6* D _m = 103.0 PCF			
5				

BLOW COUNTS
SAMPLES

TEST PIT 2
SURFACE ELEVATION 1073.31
COORDINATES: N 583490.0 E 2810271.1

SYMBOLS		DESCRIPTIONS
	ML	DARK GRAY CLAYEY SILT WITH ROOTS AND ORGANICS (TOPSOIL)
	GM	OCCASIONAL FINE TO COARSE GRAVEL ORANGISH-BROWN FINE TO COARSE GRAVEL WITH DARK BROWN SILT
	CH	DARK GRAY AND BROWN SILTY CLAY WITH SOME SAND AND GRAVEL (VERY STIFF)
	CH	YELLOWISH-BROWN SILTY CLAY WITH OCCASIONAL SAND AND GRAVEL (VERY STIFF)
	CH	CALCAREOUS
	CH	LIGHT BLuish-GRAY SILTY CLAY WITH SOME SAND (VERY STIFF)
	CH	CALCAREOUS
	CH	LIGHT GRAY CLAY WITH HIGHLY WEATHERED NODULES (VERY STIFF)
		GRADES CRANGE PLATTSMOUTH MEMBER LIMESTONE; LIGHT GRAY

TEST PIT COMPLETED AT 4.9 FEET ON 11-7-73.
WALLS STOOD VERTICAL.
SMALL AMOUNT OF WATER SEEPAGE FROM JUST ABOVE LIMESTONE.
BULK SAMPLE TAKEN FROM 1.0 FEET TO 2.0 FEET AND FROM 2.0 FEET TO 4.0 FEET.

DEPTH (FEET)	LABORATORY TEST DATA	PERCENT RECOVERED	RQD	ELEVATION (FEET)
0	SAMPLE DEPTH 1'-3' LL = 64% PL = 22% PI = 42% 1* 3'-5' LL = 62% PL = 21% PI = 41% 1* 1'-5' W _o = 17.5% 6* D _m = 91.9PCF			
5				

BLOW COUNTS
SAMPLES

TEST PIT 3
SURFACE ELEVATION 1073.67
COORDINATES: N 583451.8 E 2810902.6

SYMBOLS		DESCRIPTIONS
	CL-MI	DARK GRAY SILTY CLAY WITH ROOTS AND ORGANICS (TOPSOIL)
	CH	GRAYISH-BROWN SILTY CLAY WITH ROOTS AND OCCASIONAL ORANGISH-BROWN GRAVEL (MEDIUM STIFF)
	CH	BROWN SILTY CLAY WITH TRACE OF SAND AND GRAVEL (°DD) (VERY STIFF)
	CH	TRACE ROOTS SOME VERTICAL JOINTING FILLED WITH DARK GRAY SILTY CLAY
	CH	MOTTLED GRAY CLAY AND ORANGISH-BROWN SILTY CLAY INTERMIXED WITH TRACE OF SAND AND GRAVEL OCCASIONAL FINE PIECES OF SANDSTONE (1/8" TO 1/4")
	GC	ORANGISH-BROWN AND LIGHT GRAY SILTY CLAY INTERMIXED WITH FINE TO COARSE GRAVEL
	CH	MOTTLED LIGHT GRAYISH-WHITE ORANGISH-BROWN AND DARK GRAY CLAY WITH TRACE OF SILT AND SOME FOSSILS PLATTSMOUTH MEMBER LIMESTONE; LIGHT GRAY

TEST PIT COMPLETED AT 6.2 FEET ON 11-7-73.
NO WATER IN PIT.
WALLS STANDING VERTICAL.
BULK SAMPLE TAKEN FROM 1.0 FEET TO 3.0 FEET AND FROM 3.0 FEET TO 5.0 FEET.

**WOLF CREEK
UPDATED SAFETY ANALYSIS REPORT**

Figure 2.5-37a

Log of Test Pits TP-1, TP-2 & TP-3

Rev. 0

DEPTH (FEET)	LABORATORY TEST DATA	PERCENT RECOVERED	RQD	ELEVATION (FEET)
0	SAMPLE DEPTH 2'-4' LL = 63% PL = 23% PI = 40% 1* *** Wo = 16.3% Dm = 92.3 PCF 6*			
5				

*** RESULT OF MIXTURE OF SAMPLE FROM 2.0 FEET TO 4.0 FEET IN TP 4 AND FROM 1.5 FEET TO 4.5 FEET IN TP 6.

DEPTH (FEET)	LABORATORY TEST DATA	PERCENT RECOVERED	RQD	ELEVATION (FEET)
0	SAMPLE DEPTH 1.5'-3.0' LL = 77% PL = 26% PI = 51% Wo = 23.1% Dm = 863 PCF 1* 6*			
5				

DEPTH (FEET)	LABORATORY TEST DATA	PERCENT RECOVERED	RQD	ELEVATION (FEET)
0	SAMPLE DEPTH *** Wo = 16.3% Dm = 92.3 PCF 6* 1.5'-4.5' LL = 69% PL = 26% PI = 43% 1* 5'-6' LL = 48% PL = 24% PI = 24% Wo = 21.9% Dm = 92.2 PCF 1* 6*			
5				

*** RESULT OF MIXTURE OF SAMPLE FROM 2.0 FEET TO 4.0 FEET IN TP 4 AND 1.5 FEET TO 4.5 FEET IN TP 6.

TEST PIT 4

SURFACE ELEVATION 1079.55
COORDINATES: N 580827.8 E 2811731.7

BLOW COUNTS	SYMBOLS	DESCRIPTIONS
	ML-CL	BLACK CLAYEY SILT WITH ROOTS AND ORGANICS (TOPSOIL)
	CH	DARK GRAYISH-BROWN CLAY WITH SOME SILT (VERY STIFF)
	CH	OCCASIONAL SMALL NODULES OF HIGHLY WEATHERED LIGHT GRAY LIMESTONE
	CH	MOTTLED GRAY, BROWN AND ORANGE SILTY CLAY (VERY STIFF)
	CH	SOME FINE ROOTS AND TRACE OF SAND
	CH	OCCASIONAL SMALL HIGHLY WEATHERED LIMESTONE NODULES
	CH	LIGHT BROWNISH-GRAY CLAY WITH INTERMIXED HIGHLY WEATHERED LIGHT GRAY LIMESTONE NODULES (VERY STIFF)
	CH	NUMEROUS GYPSUM CRYSTALS IN CLAY
	CL	SOME FINE ROOTS
	CL	MOTTLED GRAY, BROWN AND ORANGE CLAY (VERY STIFF)
	CL	NUMEROUS GYPSUM CRYSTALS
	CL	GRADES BROWN WITH TRACE OF FINE SAND
	CL	HEEBNER MEMBER
	CL	SHALE; BLACK; THINLY LAMINATED; CARBONACEOUS; FISSILE (HARD)

TEST PIT COMPLETED AT 6.4 FEET ON 11-7-73.
HOLE REFILLED.
TOPSOIL PLACED AT SURFACE.
WALLS STOOD VERTICAL.
SOME VERY SLOW WATER SEEPAGE FROM 4.9 FEET TO BASE OF PIT.
BULK SAMPLE TAKEN FROM 2.0 FEET TO 4.0 FEET AND FROM 5.0 FEET TO 6.4 FEET.

TEST PIT 5

SURFACE ELEVATION 1073.72
COORDINATES: N 581516.6 E 2810765.1

BLOW COUNTS	SYMBOLS	DESCRIPTIONS
	ML-CL	BROWNISH-BLACK SILTY CLAY WITH ROOTS AND ORGANICS (TOPSOIL)
	CH	GRAYISH-BROWN CLAY WITH TRACE OF SILT (VERY STIFF)
	CH	SOME ROOTS
	CH	OCCASIONAL SAND, ROUNDED
	CH	MOTTLED GRAYISH-BROWN AND GRAYISH-BLACK SILTY CLAY WITH OCCASIONAL SAND
	CH	ORANGE CLAY WITH TRACE OF SAND (VERY STIFF)
	CH	OCCASIONAL BLACK MANGANESE STAINING
	CH	LARGE 4" - 12" CHUNKS OF MODERATELY WEATHERED LIMESTONE (3.6')
	CH	PLATTSMOUTH MEMBER
	CH	LIMESTONE; LIGHT GRAY; SLIGHT TO MODERATE WEATHERED; VERTICAL JOINTING WITH CLAY FILL

TEST PIT COMPLETED AT 4.5 FEET ON 11-8-73.
REFILLED - TOPSOIL ON TOP.
WALL STOOD VERTICAL.
NO WATER SEEPAGE
PULK SAMPLE TAKEN FROM 1.5 FEET TO 3.0 FEET.

TEST PIT 6

SURFACE ELEVATION 1090.27
COORDINATES: N 580846.7 E 2812458.4

BLOW COUNTS	SYMBOLS	DESCRIPTIONS
	ML-CL	BLACK SILT WITH SOME CLAY, ROOTS AND ORGANICS (TOPSOIL)
	CL	BLACK SILTY CLAY WITH SOME FINE ROOTS (VERY STIFF)
	CH	VERY DARK GRAYISH-BROWN CLAY (VERY STIFF)
	CH	FINE VERTICAL ANGULAR JOINTS FILLED WITH BLACK SILTY CLAY FILL
	CH	MOTTLED GRAYISH-BROWN, YELLOWISH-BROWN AND DARK GRAY CLAY WITH SOME SILT AND TRACE OF SAND
	CH	OCCASIONAL FINE ROUNDED GRAVEL
	CH	SOME FINE ROOTS
	CH	SOME VERTICAL JOINTING
	CL	ORANGE SILTY CLAY
	CL	GRADING TO DARK GRAY CLAY
	CL	OCCASIONAL VERY LIGHT GRAY STREAKS OF HIGHLY WEATHERED LIMESTONE
	CL	SOME BouldERS OF SLIGHT TO MODERATE WEATHERED LIMESTONE
	CL	VERTICAL JOINTS IN GRAY CLAY WITH BLACK CLAY FILL CONTAINING NUMEROUS FINE ROOTS
	CL	LIGHT OLIVE GRAY SILTY CLAY WITH TRACE OF SAND (HARD) (WEATHERED SNYDERVILLE MEMBER)

TEST PIT COMPLETED AT 7.5 FEET ON 11-8-73.
WALLS STOOD VERTICAL.
WATER SLOWLY RISING FROM SEEPAGE FROM 5.0 FEET TO 6.0 FEET.
BULK SAMPLE FROM 1.5 FEET TO 4.5 FEET AND FROM 5.0 TO 6.0 FEET.

WOLF CREEK
UPDATED SAFETY ANALYSIS REPORT

Figure 2.5-37b

Log of Test Pits TP-4, TP-5 & TP-6

Rev. 0

DEPTH (FEET)	LABORATORY TEST DATA	PERCENT RECOVERED	R Q D	ELEVATION (FEET)

TEST PIT 7
 SURFACE ELEVATION 1102.3
 COORDINATES: N 585220.6 E 2807093.5

BLOW COUNTS
 SAMPLES

SYMBOLS

▨	ML
▨	CL
▨	CL
▨	SC

DESCRIPTIONS

DARK BROWN CLAYEY SILT WITH ORGANICS AND ROOTS (TOPSOIL)
 GRAYISH-BLACK SILTY CLAY WITH FINE ROOTS (HARD)
 DARK BROWN SILTY CLAY (VERY STIFF)
 GRADES MORE BROWN
 MOTTLED ORANGISH-GRAY SAND AND SANDSTONE HIGHLY WEATHERED:
 CLAY SEAMS

TEST PIT COMPLETED AT 4.5 FEET ON 12-4-73.
 WALLS STOOD VERTICAL.
 NO WATER SEEPAGE.
 BULK SAMPLE TAKEN FROM 3.0 FEET TO 4.5 FEET.

DEPTH (FEET)	LABORATORY TEST DATA	PERCENT RECOVERED	R Q D	ELEVATION (FEET)

TEST PIT 8
 SURFACE ELEVATION 1096.15
 COORDINATES: N 584382.3 E 2807456.0

BLOW COUNTS
 SAMPLES

SYMBOLS

▨	ML
▨	CL
▨	CL ML
▨	CL

DESCRIPTIONS

DARK BROWN CLAYEY SILT WITH ORGANICS AND FINE ROOTS
 (TOPSOIL)
 YELLOWISH-BROWN SILTY CLAY WITH OCCASIONAL GRAVEL
 OCCASIONAL LIMESTONE CONCRETIONS
 MOTTLED YELLOWISH-BROWN SILTY CLAY WITH FINE SAND
 PIECES OF HIGHLY WEATHERED SANDSTONE
 (VERY STIFF)
 MOTTLED YELLOWISH-BROWN CLAY WITH BLACK MANGANESE
 STAINING (STIFF)

TEST PIT COMPLETED AT 6.0 FEET ON 12-2-73.
 WALL STOOD VERTICAL.
 NO WATER SEEPAGE
 BULK SAMPLE TAKEN FROM 5.0 TO 6.0 FEET.

Rev. 0

WOLF CREEK UPDATED SAFETY ANALYSIS REPORT
Figure 2.5-37c Log of Test Pits TP-7 & TP-8

DEPTH (FEET)	LABORATORY TEST DATA	PERCENT RECOVERED	ROD	ELEVATION (FEET)
0				
1*	2-24 PL=27.7% PL=26.5% PL=28.1% W=23.5% (ave.) 2-25 PL=28.1% PL=27.7% PL=28.1% W=23.5% (ave.) 2-26 PL=28.1% PL=27.7% PL=28.1% W=23.5% (ave.) 2-27 PL=28.1% PL=27.7% PL=28.1% W=23.5% (ave.) 2-28 PL=28.1% PL=27.7% PL=28.1% W=23.5% (ave.) 2-29 PL=28.1% PL=27.7% PL=28.1% W=23.5% (ave.) 2-30 PL=28.1% PL=27.7% PL=28.1% W=23.5% (ave.)			
5				

TEST PIT 9
 SURFACE ELEVATION 1076.3
 COORDINATES: N 582977.1 E 2811555.1

BLOW COUNTS	SYMBOLS	DESCRIPTIONS
8	OL	MEDIUM BROWN CLAYEY SILT; ORGANIC; TRACE OF ROOTS (TOPSOIL)
8 8 8 8 8 8 8 8	CH	MOTTLED BROWN AND DARK YELLOW SILTY CLAY; TRACE OF FINE GRAVEL; HARD (RESIDUAL) GRADES SOME GRAY MOTTLING
		GRADES MOTTLED LIGHT GRAY AND YELLOW; VERY STIFF
		GRADES CALCAREOUS; FOSSILIFEROUS; WITH LIMESTONE GRANULES AND NODULES
		PLATTSMOUTH MEMBER LIMESTONE: MEDIUM LIGHT GRAY; FINE-GRAINED

TEST PIT COMPLETED AT 7.5 FEET ON 7-13-74.
 NO WATER SEEPAGE.
 WALLS STOOD VERTICAL.
 BULK SAMPLES TAKEN FROM 2.0 FEET TO 4.0 FEET, 5.0 FEET TO 6.0 FEET, AND FROM 6.0 FEET TO 7.5 FEET.

DEPTH (FEET)	LABORATORY TEST DATA	PERCENT RECOVERED	ROD	ELEVATION (FEET)
0				
1*	2-31 PL=52.8% PL=52.8% PL=52.8% W=23.6% (ave.) 2-32 PL=52.8% PL=52.8% PL=52.8% W=23.6% (ave.) 2-33 PL=52.8% PL=52.8% PL=52.8% W=23.6% (ave.) 2-34 PL=52.8% PL=52.8% PL=52.8% W=23.6% (ave.) 2-35 PL=52.8% PL=52.8% PL=52.8% W=23.6% (ave.) 2-36 PL=52.8% PL=52.8% PL=52.8% W=23.6% (ave.) 2-37 PL=52.8% PL=52.8% PL=52.8% W=23.6% (ave.) 2-38 PL=52.8% PL=52.8% PL=52.8% W=23.6% (ave.) 2-39 PL=52.8% PL=52.8% PL=52.8% W=23.6% (ave.) 2-40 PL=52.8% PL=52.8% PL=52.8% W=23.6% (ave.)			
5				

TEST PIT 10
 SURFACE ELEVATION 1076.9
 COORDINATES: N 582079.4 E 2811503.2

BLOW COUNTS	SYMBOLS	DESCRIPTIONS
8	OL	MEDIUM BROWN CLAYEY SILT; ORGANIC; TRACE OF ROOTS (TOPSOIL)
8 8 8 8 8 8 8 8	CH	MOTTLED LIGHT BROWN AND DARK YELLOW SILTY CLAY; TRACE OF LIMESTONE GRAVEL; FOSSILIFEROUS; STIFF (RESIDUAL)
		GRADES CALCAREOUS; FOSSILIFEROUS; WITH LIMESTONE GRANULES AND NODULES
		PLATTSMOUTH MEMBER LIMESTONE: MEDIUM LIGHT GRAY; FINE-GRAINED

TEST PIT COMPLETED AT 4.2 FEET ON 7-13-74.
 SLIGHT WATER SEEPAGE FROM TOP OF LIMESTONE.
 WALLS STOOD VERTICAL.
 BULK SAMPLE TAKEN FROM 2.0 TO 3.0 FEET.

Rev. 0

WOLF CREEK UPDATED SAFETY ANALYSIS REPORT
<p>Figure 2.5-37d Log Of Test Pits TP-9 & TP-10</p>

DEPTH (FEET)	LABORATORY TEST DATA	PERCENT RECOVERED	R.O.D.
0			
2.2'	LL=37% PL=18% PI=14%		
3.0'	LL=26% PL=19% PI=7%		
5.0'	LL=20% PL=20% PI=20%		
8.5'	LL=17% PL=21% PI=20%		
10			

ELEVATION (FEET)

BLOW COUNTS SAMPLES

TEST PIT 11

SURFACE ELEVATION 1099.6
COORDINATES: N 584080.7 E 2808248.9

SYMBOLS

DESCRIPTIONS

SYMBOLS	DESCRIPTIONS
OL	DARK BROWN CLAYEY SILT; WITH FINE SAND; TRACE ROOTS (MEDIUM STIFF) (TOPSOIL)
CL	LIGHT BROWN CLAYEY SILT; TRACE ROOTS; SOME RED SANDSTONE LENSES (VERY STIFF TO HARD) (RESIDUAL) ROOTS GRADE OUT AT 1.4'
CL	GRADES TO DARK YELLOWISH-ORANGE; HARD AT 2.7' SOME MODERATE RED SILTSTONE LENSES 0.1' TO 0.2' THICK FROM 3.1'
CL	LIGHT OLIVE-GRAY SILTY CLAY; WITH FINE SAND; LAMINAR STRUCTURE; TRACE RED SILTSTONE LENSES (VERY STIFF) (RESIDUAL) FINE SAND GRADES OUT FROM 6.1'
CL	LIGHT BROWN SILTSTONE LENSES
CH	LIGHT OLIVE-GRAY CLAY; LAMINAR STRUCTURE (VERY STIFF) (RESIDUAL)

TEST PIT COMPLETED AT 9.2 FEET ON 10/1/74.
VERY SLIGHT GROUNDWATER SEEPAGE.
WALLS STOOD VERTICAL, NO SLUMPING.

DEPTH (FEET)	LABORATORY TEST DATA	PERCENT RECOVERED	R.O.D.
0			
2.4'	LL=51% PL=22% PI=39%		
5.0'	LL=38% PL=23% PI=15%		
10			

ELEVATION (FEET)

BLOW COUNTS SAMPLES

TEST PIT 12

SURFACE ELEVATION 1078.8
COORDINATES: N 583807.1 E 2803571.9

SYMBOLS

DESCRIPTIONS

SYMBOLS	DESCRIPTIONS
OL	DARK BROWN SILTY CLAY; SOME FINE SAND; TRACE ROOTS (MEDIUM STIFF) (TOPSOIL)
CH	BROWN SILTY CLAY TRACE FINE SAND AND MEDIUM ROUNDED GRAVEL; TRACE ROOTS; (VERY STIFF) (RESIDUAL) ROOTS GRADE OUT AT 3.4'
CH	LIGHT BROWN SILTSTONE "HOODLES"; ELONGATED, ROUNDED, DISCONTINUOUS AT 3.8'
CH	LIGHT OLIVE-GRAY SILTY CLAY; SOME SILTSTONE LENSES; SOME SILTY ZONES; LAMINAR STRUCTURE; (VERY STIFF) (RESIDUAL) GRADES SOME FOSSILS FROM 6.0' TO 8.8'
CH	LIGHT BROWN SILTSTONE "HOODLES, DISCONTINUOUS

TEST PIT COMPLETED AT 12.6 FEET ON 10/1/74.
WALLS STOOD VERTICAL, NO SLUMPING.
NO APPARENT SEEPAGE.

Rev. 0

WOLF CREEK UPDATED SAFETY ANALYSIS REPORT

Figure 2.5-37e

Log Of Test Pits TP-11 & TP-12

DEPTH (FEET)	LABORATORY TEST DATA	PERCENT RECOVERED	RQD
0			
3.0'-3.5'	LL = 55% PL = 21% PI = 34% W _p = 21% D _m = 101.0 PCF 1*		
6.0'-6.5'	LL = 42% PL = 20% PI = 22% W _p = 19.5% D _m = 106.0 PCF 1*		

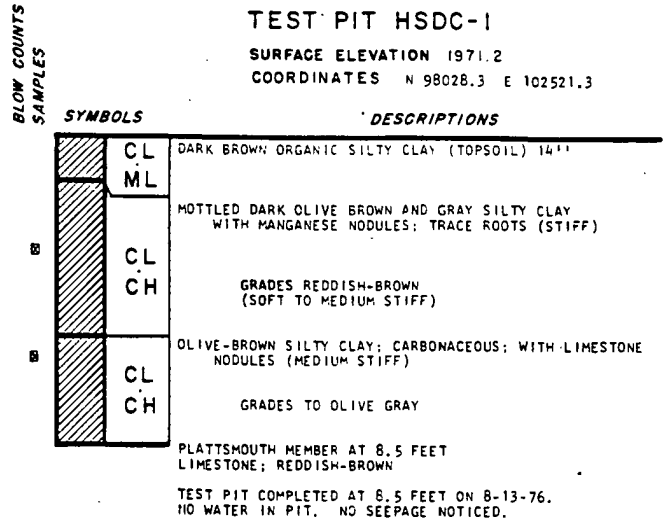

DEPTH (FEET)	LABORATORY TEST DATA	PERCENT RECOVERED	RQD
0			
3.0'-4.0'	LL = 48% PL = 20% PI = 28% W _p = 21% D _m = 102.0 PCF 1*		
5.6'-6.0'	LL = 51% PL = 20% PI = 31% W _p = 23.5% D _m = 101.0 PCF 1*		
10			

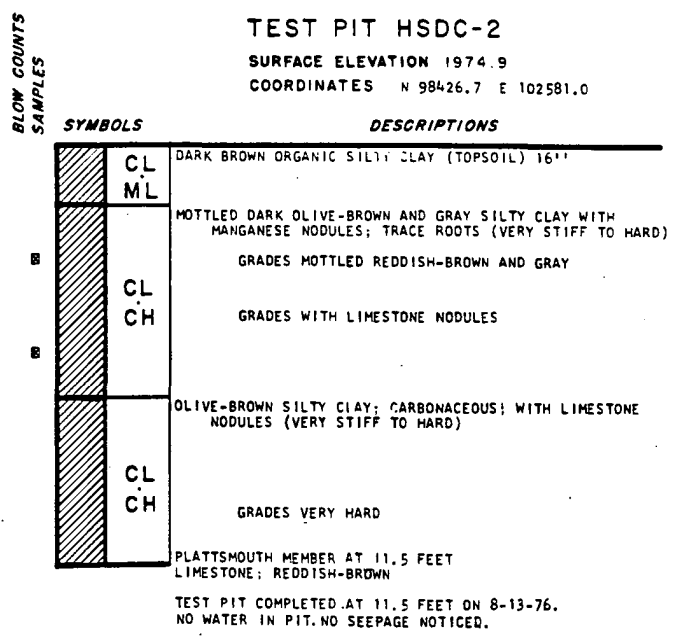

Rev. 0

**WOLF CREEK
 UPDATED SAFETY ANALYSIS REPORT**

Figure 2.5-37f

Log Of Test Pits HSDC-1 & HSDC-2

DEPTH
(FEET)

LABORATORY TEST DATA	PERCENT RECOVERED	RQD
SAMPLE DEPTH 2.5'-3.0' LL = 64% PL = 22% PI = 42% W _o = 24.1% D _m = 95.2 PCF, 1* 4.5'-5.0' LL = 77% PL = 29% PI = 48% W _o = 27.5% D _m = 93.7 PCF, 1*		

TEST PIT HSDC-3

SURFACE ELEVATION 1970.7
 COORDINATES N 98088.0 E 103425.8

BLOW COUNTS
 SAMPLES

SYMBOLS

DESCRIPTIONS

0	CL ML	DARK BROWN SILTY CLAY WITH ORGANIC AND FINE ROOTS (TOPSOIL) 16"
2	CL CH	MOTTLED DARK OLIVE-BROWN AND GRAY SILTY CLAY; WITH MANGANESE NODULES AND LIMESTONE NODULES (STIFF)
4	CH	OLIVE-BROWN SILTY CLAY; CARBONACEOUS; WITH LIMESTONE NODULES (MEDIUM STIFF)
6	CH	REDDISH-BROWN SILTY CLAY WITH LIMESTONE FRAGMENTS AND 2" - 3" LIMESTONE SLABS (MEDIUM STIFF) PLATTSMOUTH MEMBER AT 6.0 FEET LIMESTONE; REDDISH-BROWN

TEST PIT COMPLETED AT 6.0 FEET ON 8-13-76.
 NO WATER IN PIT. NO SEEPAGE NOTICED.

Rev. 0

WOLF CREEK
 UPDATED SAFETY ANALYSIS REPORT

Figure 2.5-37g

Log Of Test Pit HSDC-3

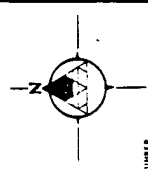

- EXPLANATION
- ⊕ P-3 BORING LOCATION AND NUMBER
 - ⊕ TP-7 TEST PIT LOCATION AND NUMBER
 - △ E-3 SHALLOW PULLER BIT BORING LOCATION AND NUMBER

NOTES

1. SOIL THICKNESS CONDITIONS ARE INTERPRETED FROM BORING DATA. ACTUAL CONDITIONS IN OTHER AREAS MAY DIFFER FROM THAT SHOWN ON THIS MAP.
2. SOIL THICKNESS MAP OF THIS SITE IS SHOWN ON FIGURE 2.5-38.
3. THICKNESS DATA IN PARENTS THAT ARE AS FOLLOWS:

BORING NUMBER	THICKNESS (FEET)	SOIL TYPE	INTERPRETATION
MS-1	15.0	MS-1	MS-1
MS-2	15.0	MS-2	MS-2
MS-3	15.0	MS-3	MS-3
MS-4	15.0	MS-4	MS-4
MS-5	15.0	MS-5	MS-5
MS-6	15.0	MS-6	MS-6
MS-7	15.0	MS-7	MS-7
MS-8	15.0	MS-8	MS-8
MS-9	15.0	MS-9	MS-9
MS-10	15.0	MS-10	MS-10
MS-11	15.0	MS-11	MS-11
MS-12	15.0	MS-12	MS-12
MS-13	15.0	MS-13	MS-13
MS-14	15.0	MS-14	MS-14
MS-15	15.0	MS-15	MS-15
MS-16	15.0	MS-16	MS-16
MS-17	15.0	MS-17	MS-17
MS-18	15.0	MS-18	MS-18
MS-19	15.0	MS-19	MS-19
MS-20	15.0	MS-20	MS-20
MS-21	15.0	MS-21	MS-21
MS-22	15.0	MS-22	MS-22
MS-23	15.0	MS-23	MS-23
MS-24	15.0	MS-24	MS-24
MS-25	15.0	MS-25	MS-25
MS-26	15.0	MS-26	MS-26
MS-27	15.0	MS-27	MS-27
MS-28	15.0	MS-28	MS-28
MS-29	15.0	MS-29	MS-29
MS-30	15.0	MS-30	MS-30
MS-31	15.0	MS-31	MS-31
MS-32	15.0	MS-32	MS-32
MS-33	15.0	MS-33	MS-33
MS-34	15.0	MS-34	MS-34
MS-35	15.0	MS-35	MS-35
MS-36	15.0	MS-36	MS-36
MS-37	15.0	MS-37	MS-37
MS-38	15.0	MS-38	MS-38
MS-39	15.0	MS-39	MS-39
MS-40	15.0	MS-40	MS-40
MS-41	15.0	MS-41	MS-41
MS-42	15.0	MS-42	MS-42
MS-43	15.0	MS-43	MS-43
MS-44	15.0	MS-44	MS-44
MS-45	15.0	MS-45	MS-45
MS-46	15.0	MS-46	MS-46
MS-47	15.0	MS-47	MS-47
MS-48	15.0	MS-48	MS-48
MS-49	15.0	MS-49	MS-49
MS-50	15.0	MS-50	MS-50
MS-51	15.0	MS-51	MS-51
MS-52	15.0	MS-52	MS-52
MS-53	15.0	MS-53	MS-53
MS-54	15.0	MS-54	MS-54



UPDATED SAFETY ANALYSIS REPORT
 WOLF CREEK
 Figure 2.5-38
 Soil Thickness Map - Category I
 Area
 Rev. 0

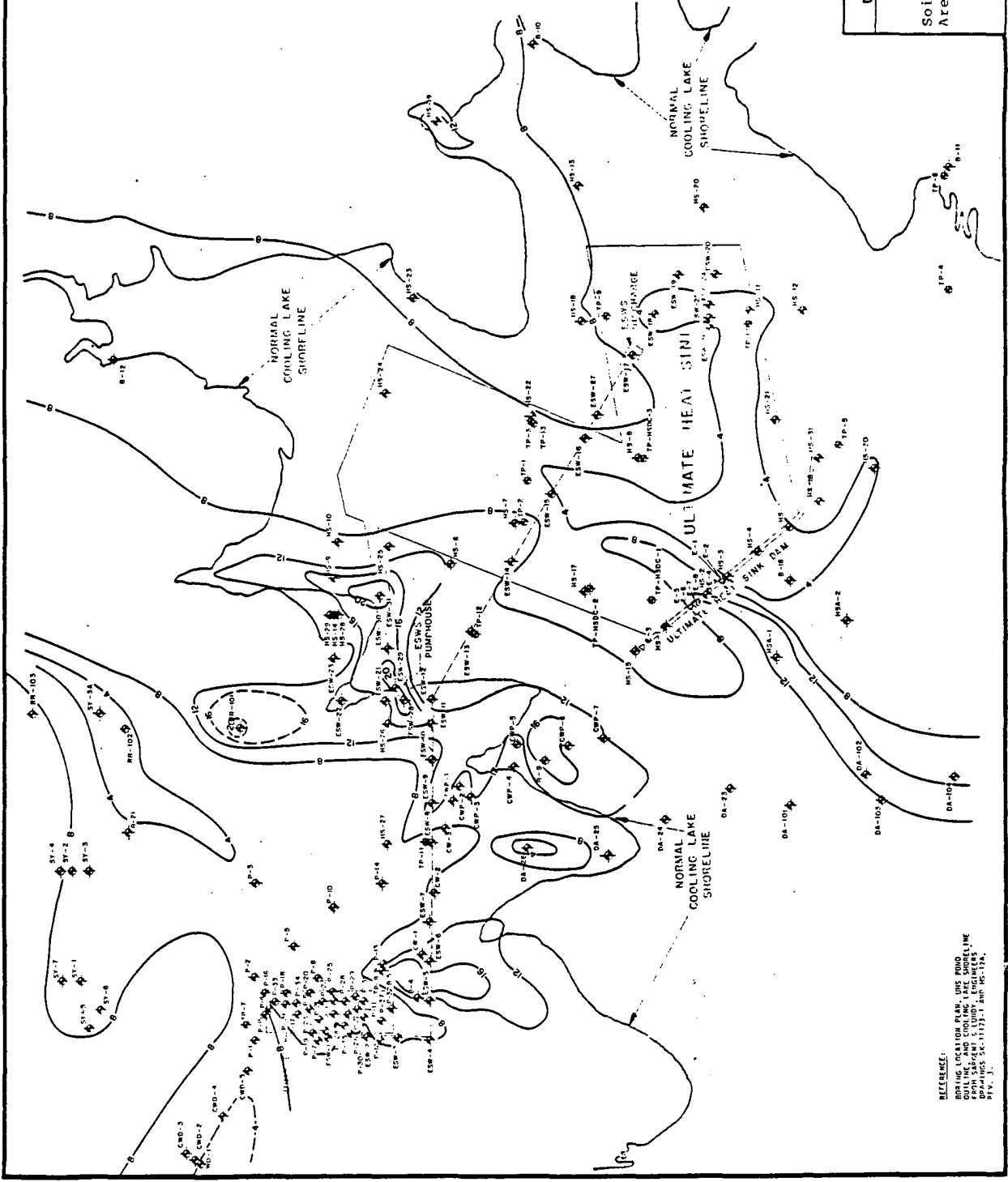

REFERENCE:
 BORING LOCATION PLAN, USE FOUNDATION
 FROM SAFETY & LIQUID ENGINEERS,
 BR-4105, 55-11173-1, AND MS-12A,
 P. 11.

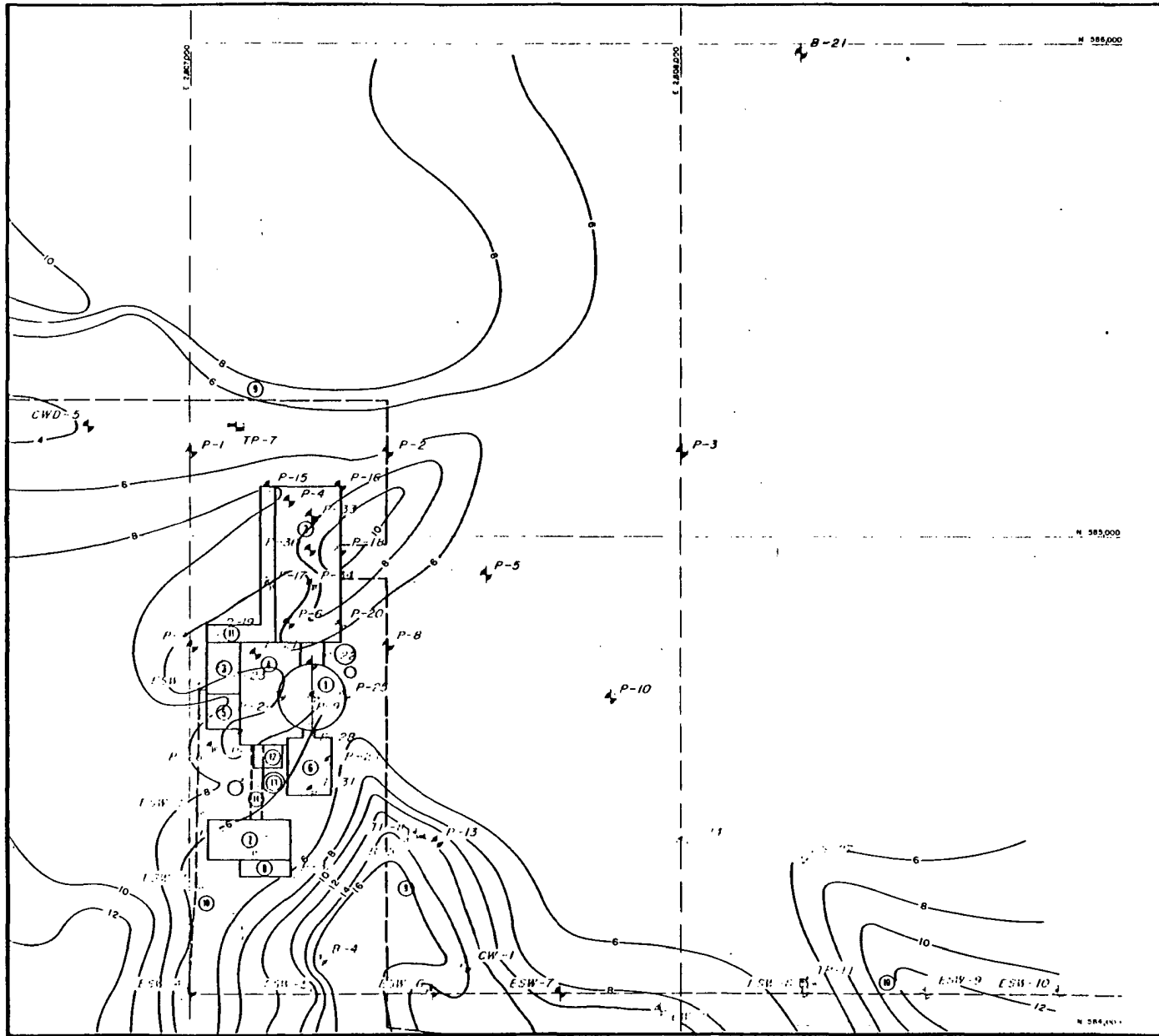

- EXPLANATION:**
- ① CONTAINER*
 - ② TURBINE BLDG.
 - ③ CONTROL BLDG.*
 - ④ AUXILIARY BLDG.*
 - ⑤ EMER. DIESEL GEN. BLDG.*
 - ⑥ FUEL PUMP BLDG.*
 - ⑦ RAWWASTE BLDG.
 - ⑧ LUMP STORAGE (SOLID WASTE)
 - ⑨ COOLING WATER PIPELINES
 - ⑩ ESWs PIPELINES*
 - ⑪ COOLING BLDG., COMMUNICATION, COMPRESSOR
 - ⑫ FINE MATERIAL TANK
 - ⑬ REFUELING WATER STORAGE TANK
 - ⑭ RAWWASTE PIPE TUNNEL*
- * CATEGORY 1

- ⊙ P-3 BORING LOCATION AND NUMBER
- ⊞ TP-7 TEST PIT LOCATION AND NUMBER

- NOTES:**
- SOIL THICKNESS CONTOURS ARE INTERPRETED FROM BORING DATA. ACTUAL CONDITIONS BETWEEN BORINGS MAY DIFFER FROM THAT WHICH IS SHOWN.
 - SOIL THICKNESS MAP FOR CATEGORY 1 AREA IS SHOWN IN FIGURE 2.5-3B.
 - THICKNESSES USED TO PREPARE THIS MAP ARE AS FOLLOWS:

BORING NUMBER	THICKNESS UP SOIL	BORING NUMBER	THICKNESS OF SOIL
B-4	16.0	P-24	7.0
B-5	15.5	P-25	5.0
B-21	4.5	P-26	7.0
P-1	5.5	P-27	6.0
P-2	6.0	P-28	6.0
P-3	4.2	P-29	4.7
P-4	8.0	P-30	6.1
P-5	5.5	P-31	5.2
P-6	6.5	P-32	6.0
P-7	5.2	P-33	6.5
P-8	5.0	P-34	6.0
P-9	4.3	P-35	6.0
P-10	4.7	P-36	8.5
P-11	6.2	P-37	6.8
P-12	6.5	ESW-17	6.0
P-13	11.5	ESW-1	5.4
P-14	4.5	ESW-2	7.0
P-15	8.0	ESW-3	5.9
P-16	7.0	ESW-4	4.8
P-17	6.0	ESW-5	13.9
P-18	11.0	ESW-6	13.4
P-19	6.0	ESW-7	8.6
P-20	7.0	ESW-8	4.5
P-21	6.1	ESW-9	14.1
P-22	6.0	ESW-10	14.9
		ESW-1	15.7
		ESW-2	10.1
		ESW-3	4.9

SOIL THICKNESS CONTOUR INTERVAL IS 2 FEET.

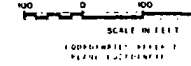

Rev. 0

**WOLF CREEK
UPDATED SAFETY ANALYSIS REPORT**

Figure 2.5-39

Soil Thickness Map - Plant Site

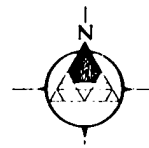
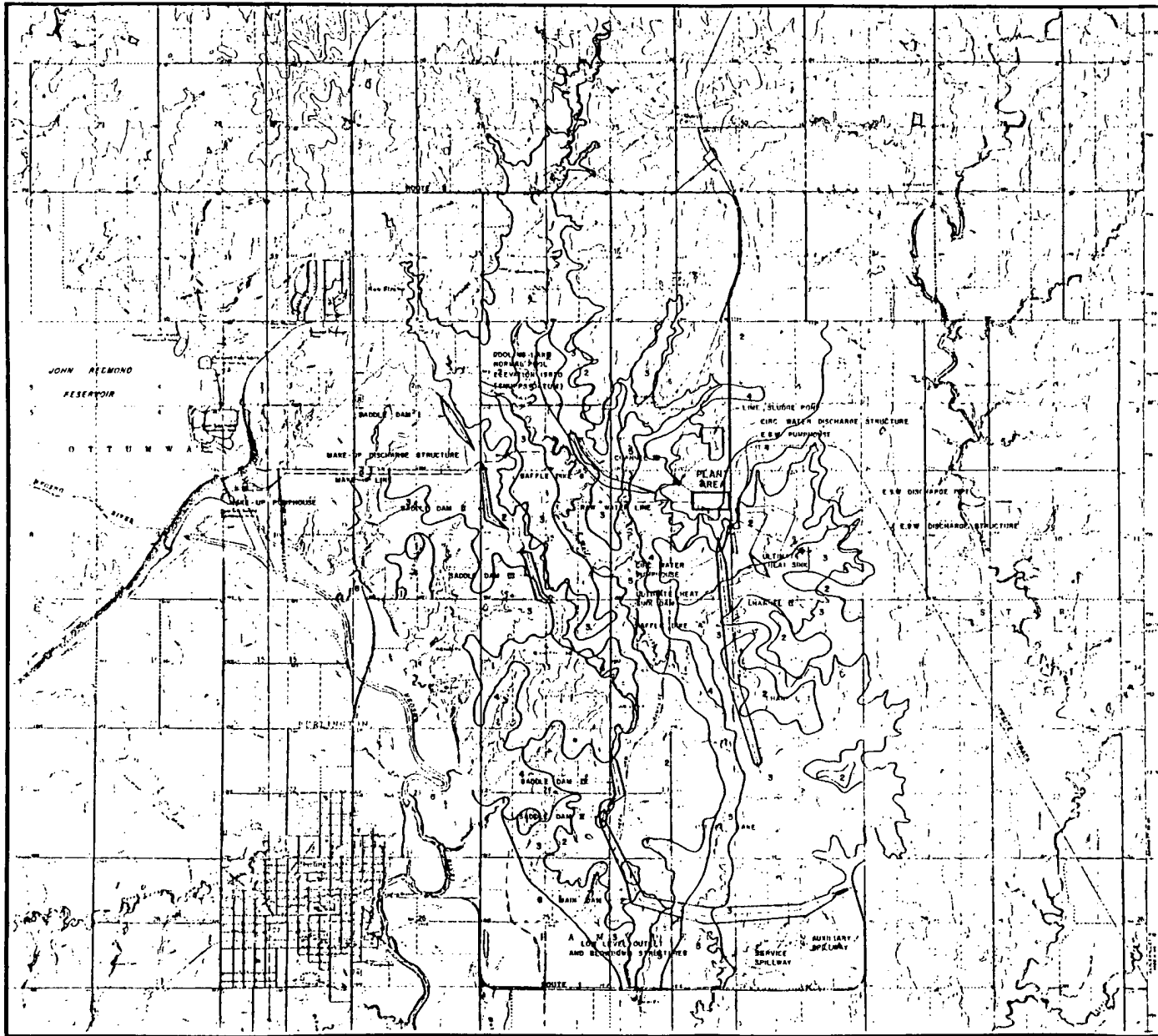

EXPLANATION

MAP NO.	ASSOCIATION NAME	COMPONENT SOIL SERIES
1	RENIMA-DIPE	400 RENIMA SERIES SOILS 300 DIPE SERIES SOILS 700 IMPROBABLY DEVELOPING DENTON AND EPAM SERIES SOILS
2	RENIMA-MIDGTON	500 RENIMA SERIES SOILS 600 MIDGTON SERIES SOILS 100 DENNIS AND SIMMIE SERIES SOILS
3	SIMMIE-ERAN	600 SIMMIE SERIES SOILS 300 ERAN SERIES SOILS 100 LULA SERIES SOILS 200 CLAYEY SOILS DEVELOPED ON LIMESTONE
4	DENNIS-RATES-ERAN	300 DENNIS SERIES SOILS 100 RATES SERIES SOILS 200 ERAN SERIES SOILS 100 PENNIA AND COLLINGSVILLE SERIES SOILS
5	HAGON-ORAWHON	500 HAGON SERIES SOILS 400 ORAWHON SERIES SOILS 100 VERDIGNIS SERIES SOILS
6	OSAGE-VERDIGNIS	500 OSAGE SERIES SOILS 400 VERDIGNIS SERIES SOILS 100 HAGON SERIES SOILS

NOTES:
SUBSECTION 7.5.1.2.3.1.A CONTAINS A BRIEF
DESCRIPTION OF THE PROPERTIES OF THESE
SOIL SERIES.

REFERENCE:
HAGER, ROBERT, 3 AUGUST 1973 PRIVATE COMMUNICATION.

DRAWING REFERENCE:
TITLE: GENERAL ARRANGMENT, WOLF CREEK GENERATING STATION UNIT 1
FOR: KANSAS GAS AND ELECTRIC COMPANY AND KANSAS CITY POWER AND LIGHT COMPANY
BY: SACRANT AND LUNDY ENGINEERS, CHICAGO
DRAWING NO. 1-1, Rev. B
DATE: 12/17/76

MAP BASE PREPARED FROM U.S.G.S. TOPOGRAPHIC QUADRANGLES, 7.5' SERIES: BURLINGTON,
KANSAS, 1971; JOHN REDMOND DAM, KANSAS, 1946; NEW STRAUB, KANSAS, 1971; OTTUMWA,
KANSAS, 1970.



WOLF CREEK
UPDATED SAFETY ANALYSIS REPORT

Figure 2.5-40

Soil Conservation Service Soils
Map - Site

Rev. 0

TIME - STRATIGRAPHIC			ROCK - STRATIGRAPHIC	LITHO-LOGIC SYMBOL	THICKNESS IN FEET	DESCRIPTION
PERMIAN	TRIASSIC	CRETACEOUS				
PENNSYLVANIAN SYSTEM			UPPER PENNSYLVANIAN SERIES	VIRGILIAN STAGE		
UPPER PENNSYLVANIAN SERIES						
VIRGILIAN STAGE						
THAMES GROUP						
CLARK SHALE						
DORSPAN SHALE MEMBER						
SPRING BRANCH LIMESTONE MEMBER						
STAR L SHALE MEMBER						
CLAY CREEK LIMESTONE MEMBER						
JACKSON PARK SHALE MEMBER						
HELMER SHALE MEMBER						
PLATON LIMESTONE MEMBER						
LEWIS LIMESTONE MEMBER						
DIXON SHALE MEMBER						
TORONTO LIMESTONE MEMBER						
UNRAINED LAWRENCE						
DOUGLAS LAWRENCE FORMATION						

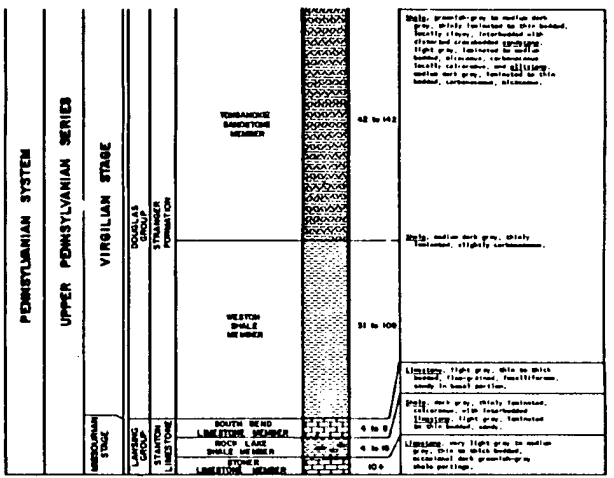
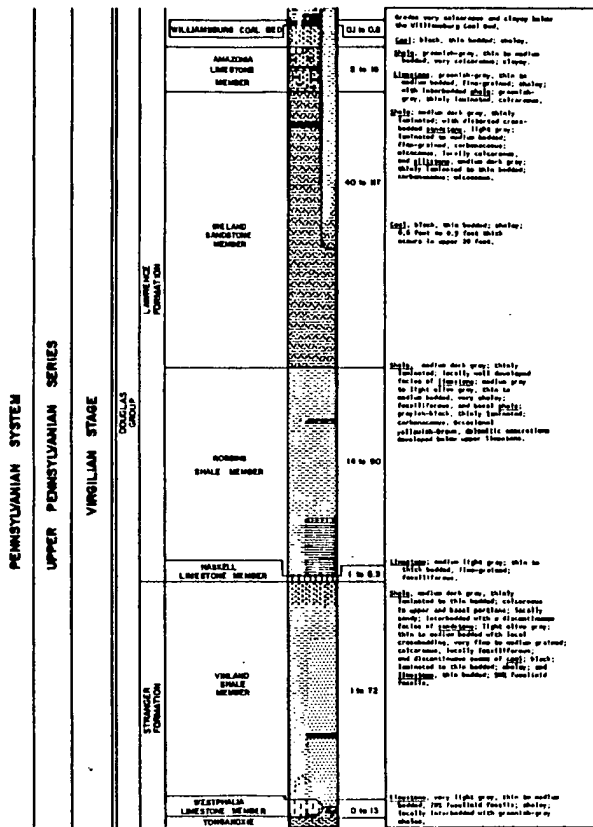

EXPLANATION

	Chert gravel		Sandy shale
	Sandstone		Carbonaceous shale
	Carbonaceous sandstone		Coal
	Shaly sandstone		Limestone
	Siltstone		Shaly limestone
	Shale		Sandy limestone
	Calcareous shale		

- NOTES:**
- PLEISTOCENE MATERIALS MAY OR MAY NOT BE PRESENT AT ANY ONE AREA OF THE SITE AND MAY OVERLIE ANY MEMBER DOWN TO THE IRELAND SANDSTONE MEMBER.
 - PLIOCENE MATERIALS OCCUR AS HIGH LEVEL TERRACE DEPOSITS AND MAY OR MAY NOT BE PRESENT AT ANY ONE AREA OF THE SITE. THEY MAY OVERLIE ANY MEMBER DOWN TO THE TORONTO LIMESTONE MEMBER.
 - THICKNESS OF STRATIGRAPHIC UNITS ARE FROM BOREHOLES IN THE PROJECT AREA.
 - FIGURES 2.5-21 AND 2.5-22 SHOW THE OUTCROP PATTERNS OF THE VARIOUS UNITS.
 - FIGURE 2.5-12 SHOWS THE GENERALIZED STRATIGRAPHIC SECTION DOWN TO THE PRECAMBRIAN BASEMENT COMPLEX.
 - BORING LOGS WITH DETAILED ROCK DESCRIPTIONS ARE PRESENTED ON FIGURES 2.5-34a THROUGH 2.5-34c, 2.5-35a THROUGH 2.5-35b, AND 2.5-36a THROUGH 2.5-36111.

Rev. 0

**WOLF CREEK
 UPDATED SAFETY ANALYSIS REPORT**

Figure 2.5-41

Detailed Site Stratigraphic Column

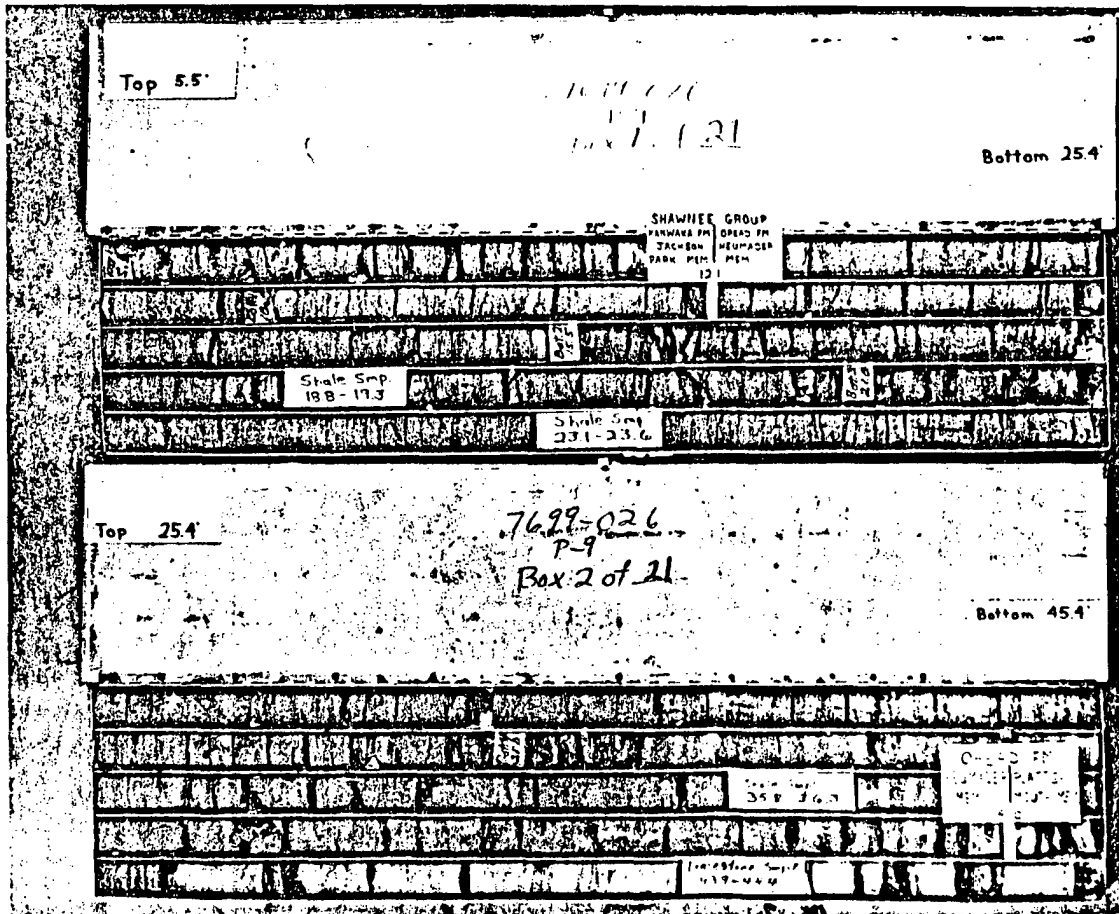

NOTE:
 LOG OF BORING P-9 IS SHOWN ON FIGURE 2.5-351.

Rev. 0

WOLF CREEK
 UPDATED SAFETY ANALYSIS REPORT

Figure 2.5-42a

Photographs of Rock Core 5.5 -
 45.4 ft.

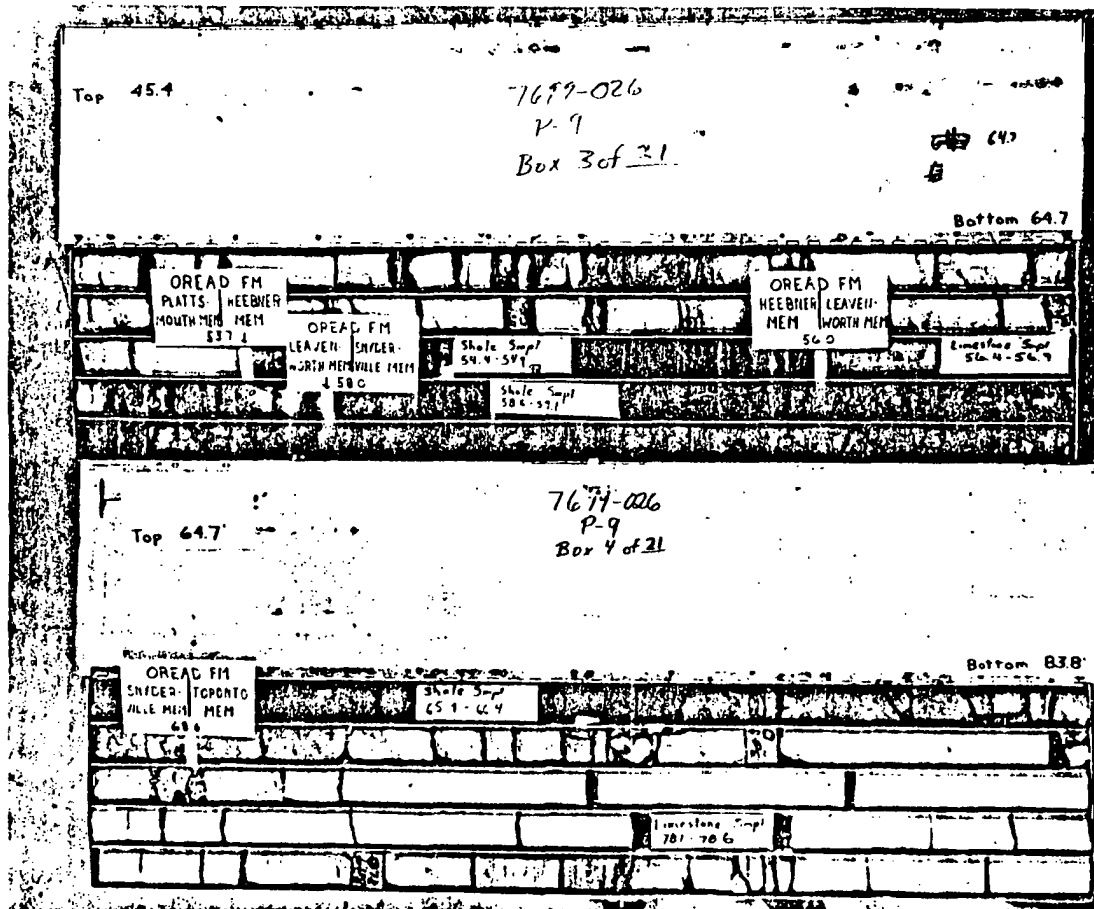

NOTE:
LOG OF BORING P-9 IS SHOWN ON FIGURE 2.5-351.

Rev. 0

WOLF CREEK
UPDATED SAFETY ANALYSIS REPORT

Figure 2.5-42b

Photographs Of Rock Core
45.4-83.8 Feet

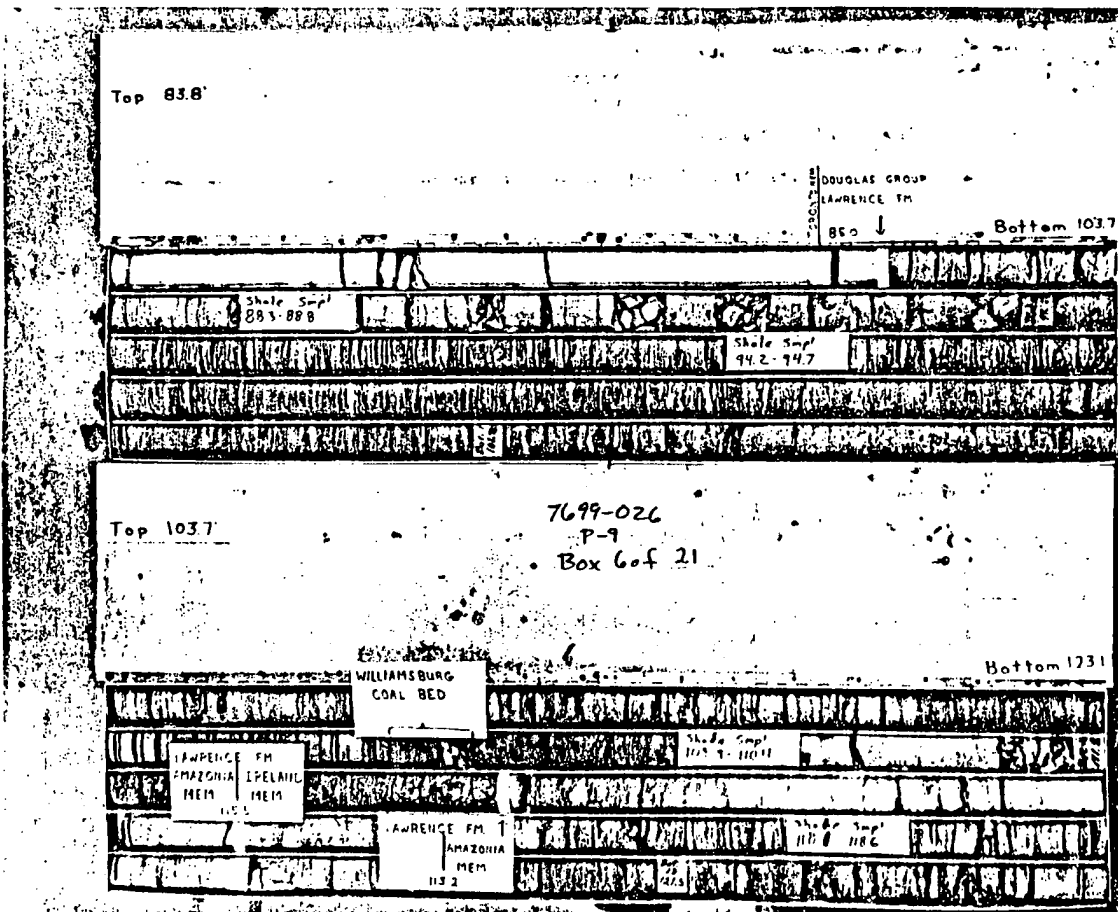

NOTE:
LOG OF BORING P-9 IS SHOWN ON FIGURE 2.5-351.

Rev. 0

**WOLF CREEK
UPDATED SAFETY ANALYSIS REPORT**

Figure 2.5-42c

Photographs Of Rock Core
83.8-123.1 Feet

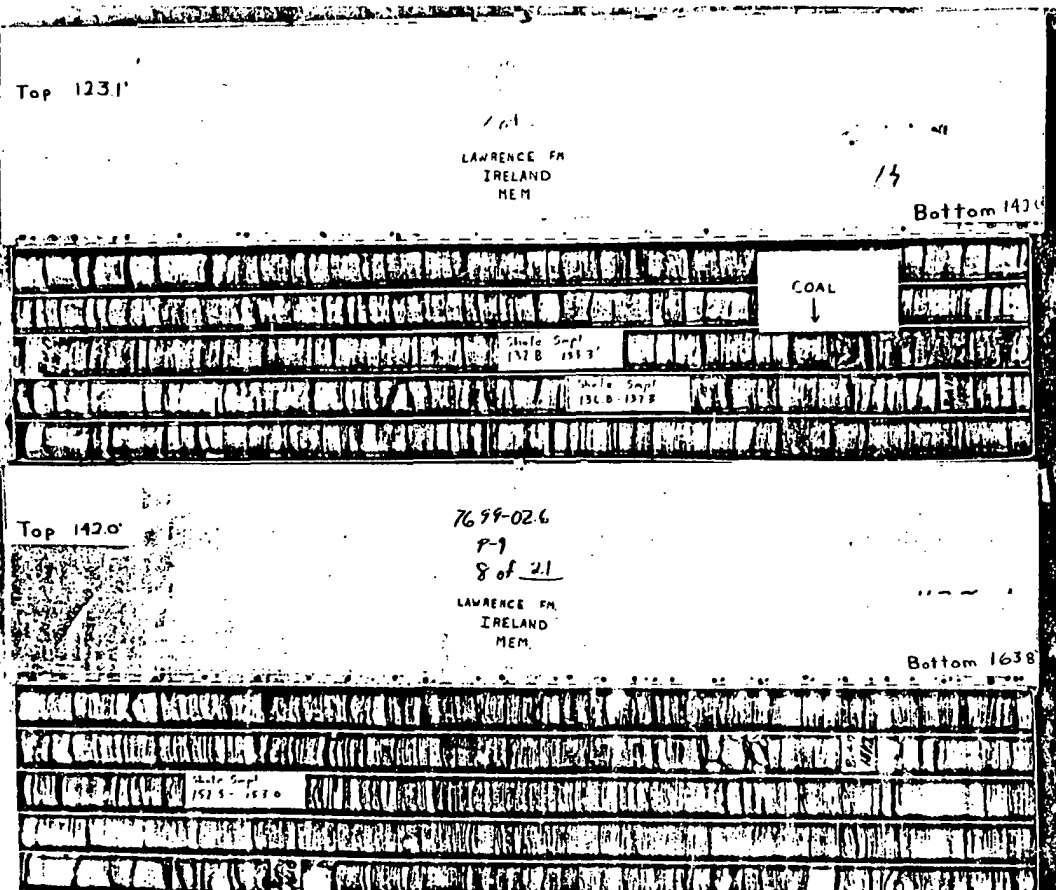

NOTE:
LOG OF BORING P-9 IS SHOWN ON FIGURE 2.5-351.

Rev. 0

WOLF CREEK
UPDATED SAFETY ANALYSIS REPORT

Figure 2.5-42d
Photographs of Rock Core
123.1-163.8 Feet

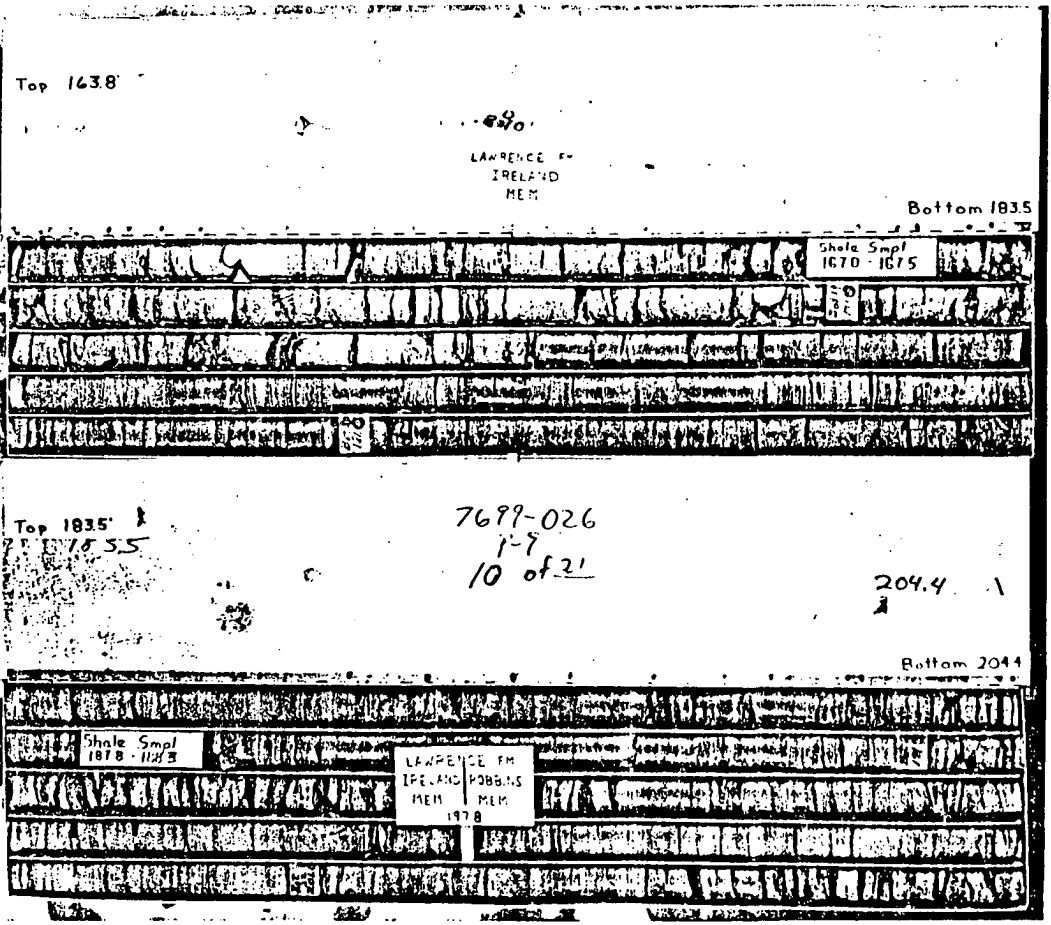

NOTE:
LOG OF BORING P-9 IS SHOWN ON FIGURE 2.5-351.

Rev. 0

WOLF CREEK
UPDATED SAFETY ANALYSIS REPORT

Figure 2.5-42e
Photographs of Rock Core
163.8-204.4 Feet

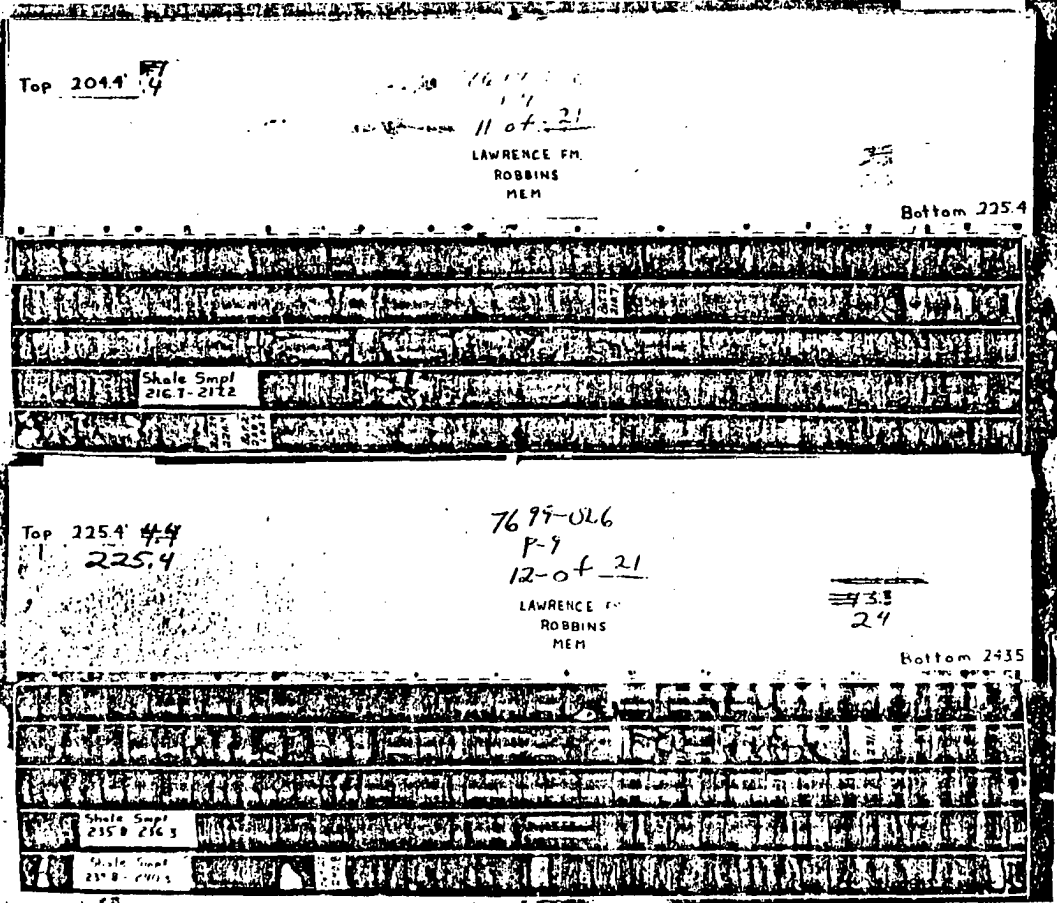

NOTE:
LOG OF BORING P-9 IS SHOWN ON FIGURE 2.5-35f.

Rev. 0

**WOLF CREEK
UPDATED SAFETY ANALYSIS REPORT**

Figure 2.5-42f
Photographs Of Rock Core
204.4-243.5 Feet

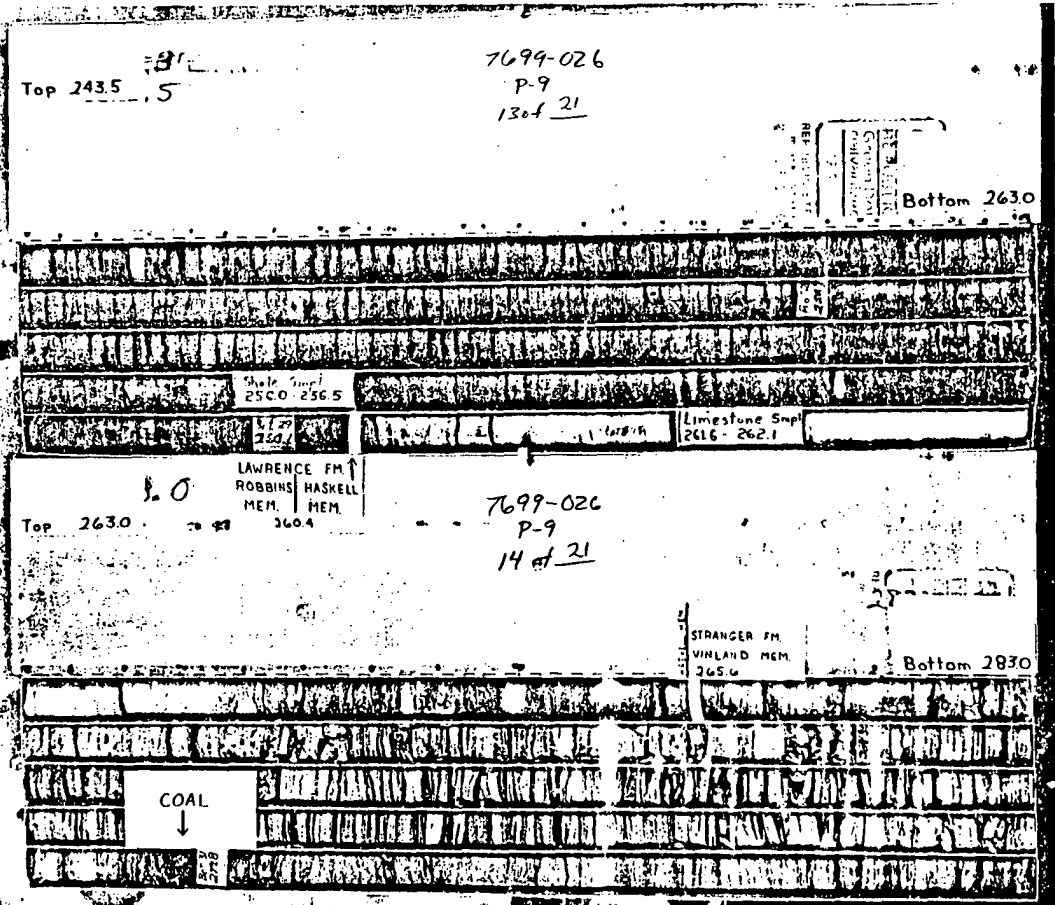

NOTE:
LOG OF BORING P-9 IS SHOWN ON FIGURE 2.5-351.

Rev. 0

**WOLF CREEK
UPDATED SAFETY ANALYSIS REPORT**

Figure 2.5-42g
Photographs of Rock Core
243.5-283.0 feet

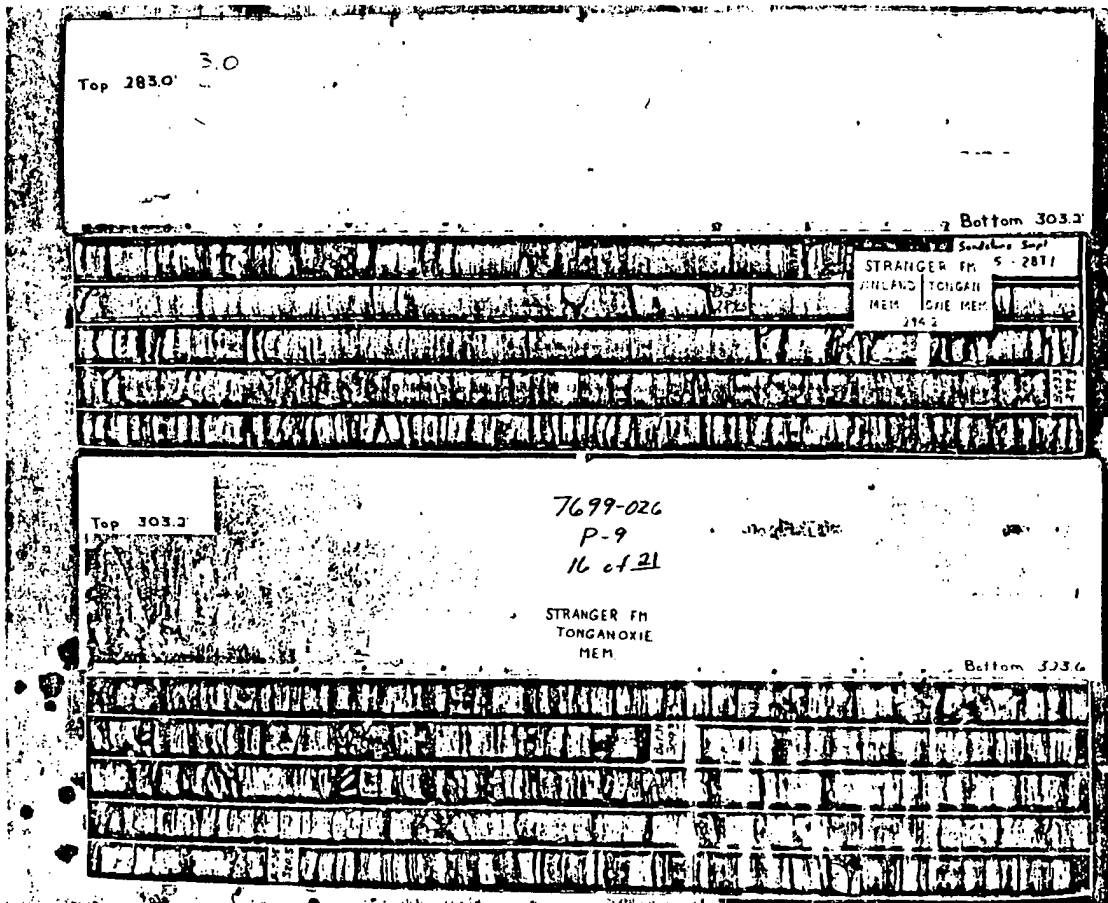

NOTE:
LOG OF BORING P-9 IS SHOWN ON FIGURE 2.5-351.

Rev. 0

WOLF CREEK
UPDATED SAFETY ANALYSIS REPORT

Figure 2.5-42h

Photographs of Rock Core
283.0-323.6 Feet

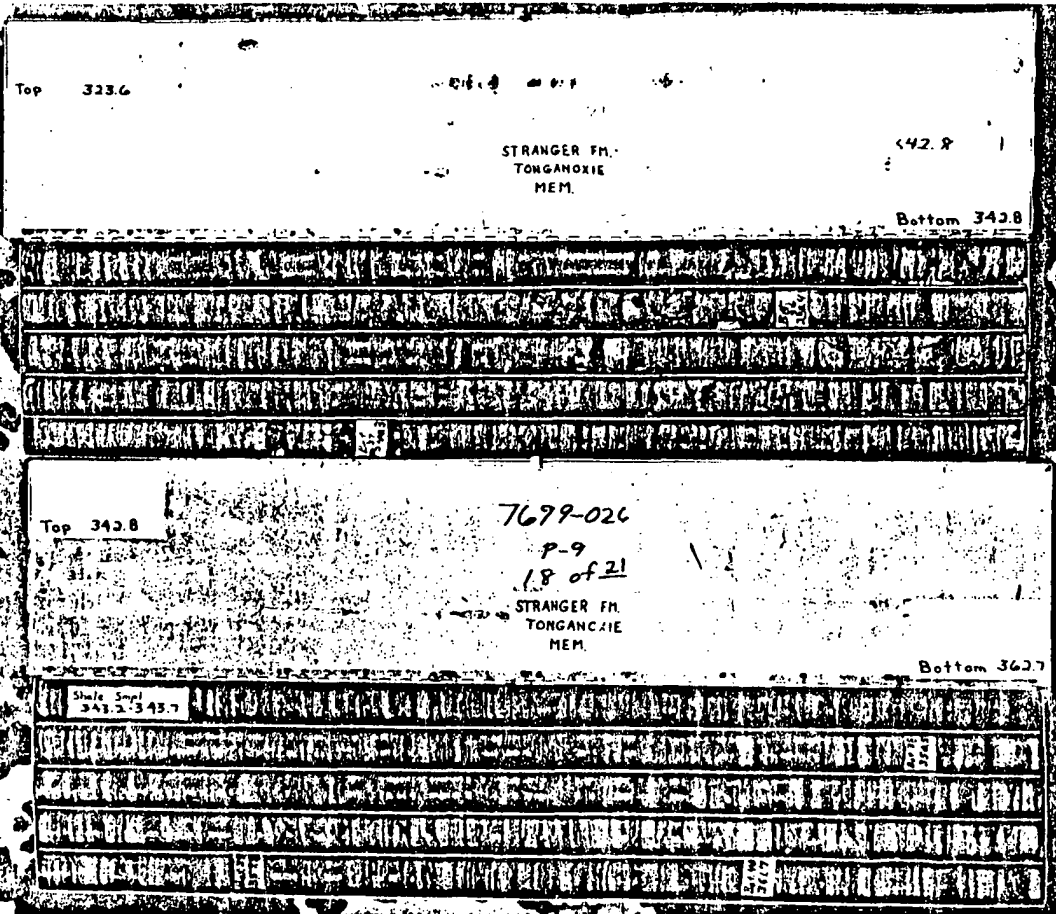

NOTE:
LOG OF BORING P-9 IS SHOWN ON FIGURE 2.5-351.

Rev. 0

WOLF CREEK
UPDATED SAFETY ANALYSIS REPORT

Figure 2.5-421

Photographs Of Rock Core
323.6-362.7 Feet

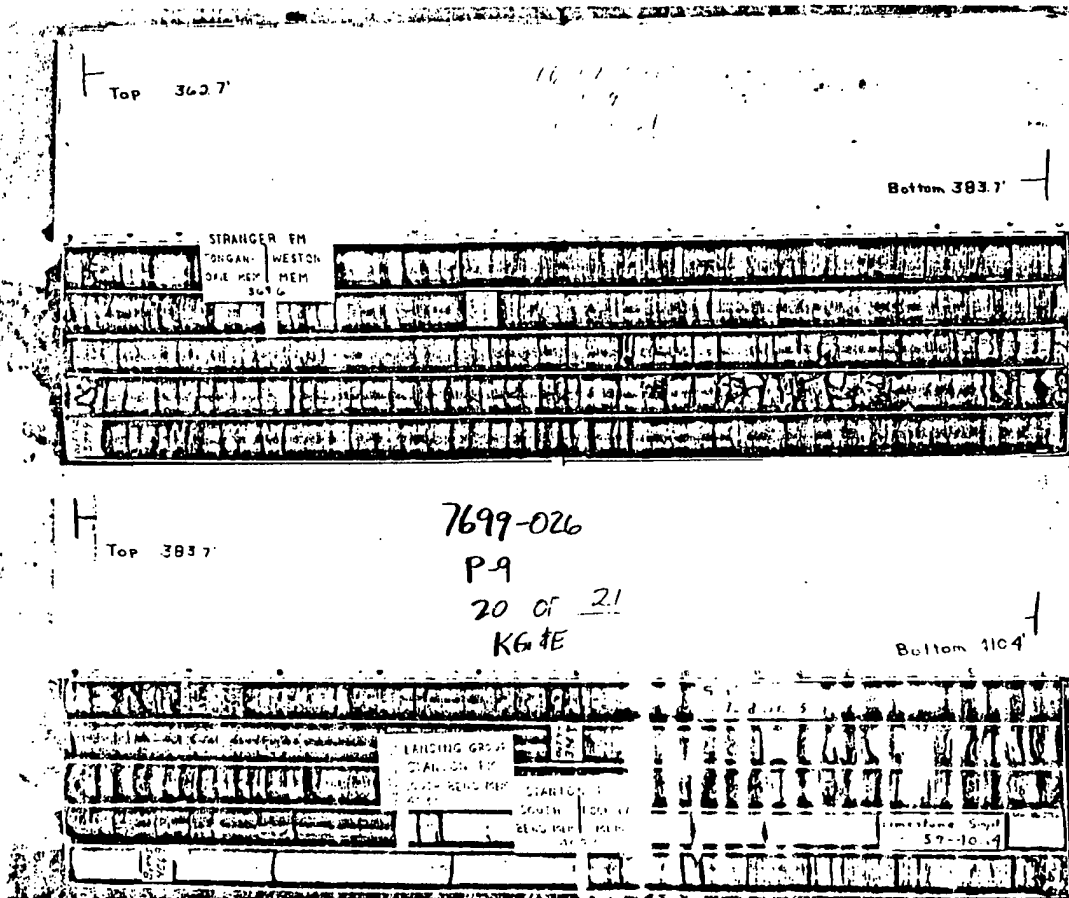

NOTE:
LOG OF BORING P-9 IS SHOWN ON FIGURE 2.5-351.

Rev. 0

**WOLF CREEK
UPDATED SAFETY ANALYSIS REPORT**

Figure 2.5-42j

Photographs Of Rock Core
362.7-410.4 Feet

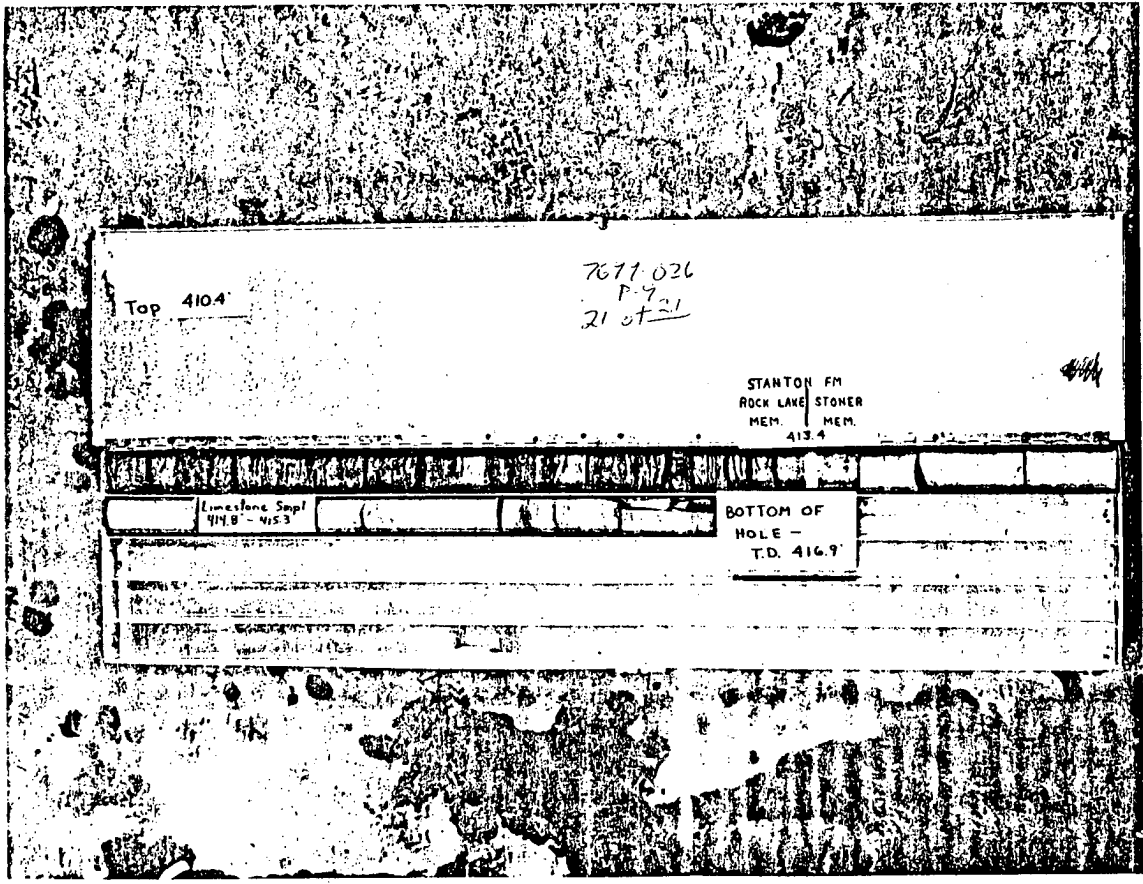

NOTE:
LOG OF BORING P-9 IS SHOWN ON FIGURE 2.5-351.

Rev. 0

**WOLF CREEK
UPDATED SAFETY ANALYSIS REPORT**

Figure 2.5 42k

Photographs Of Rock Core
410.4-416.9 Feet

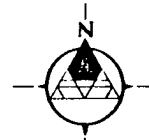
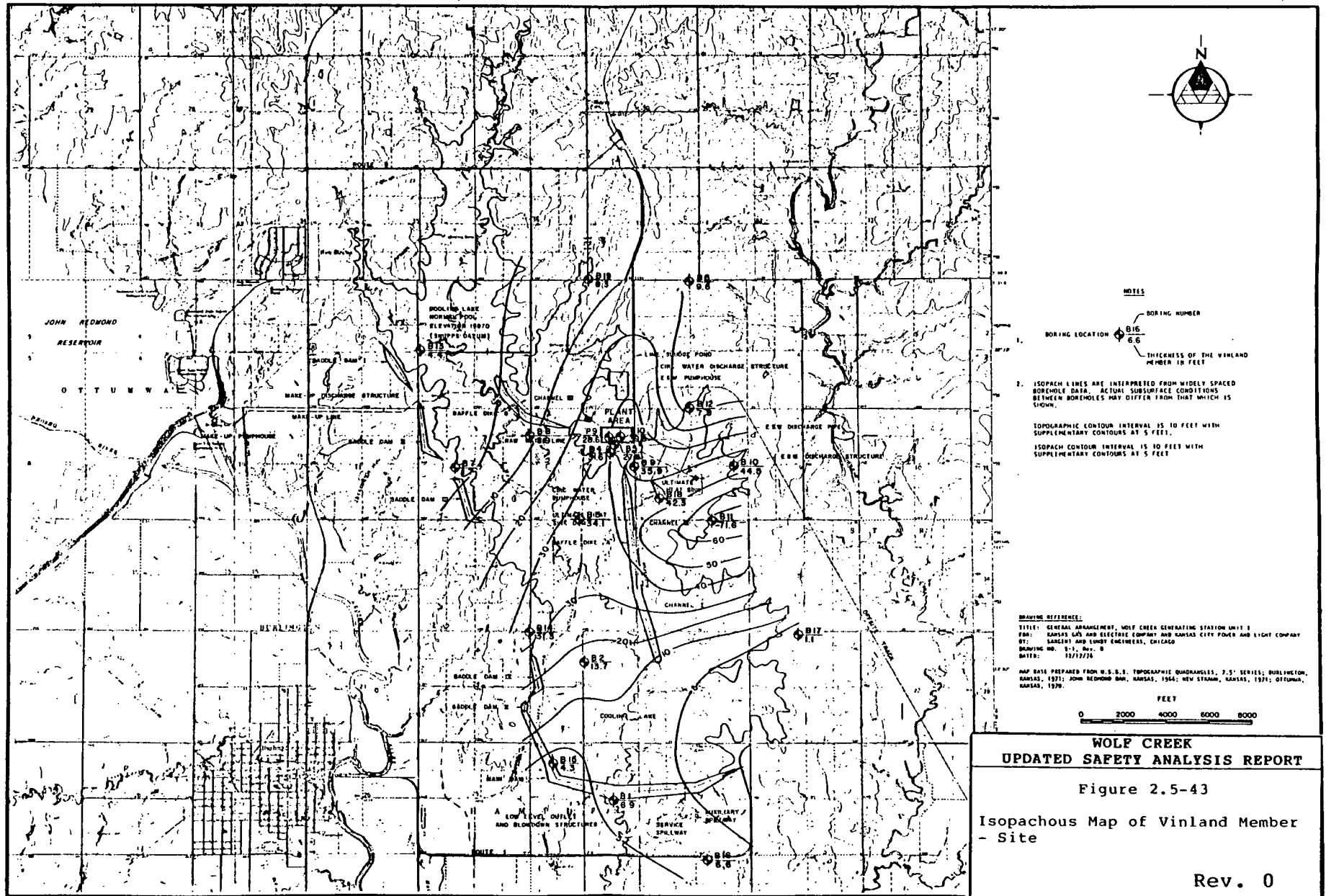

NOTES

1. BORING LOCATION BORING NUMBER
 THICKNESS OF THE VINLAND MEMBER IN FEET

2. ISOPACH LINES ARE INTERPRETED FROM WIDELY SPACED BOREHOLE DATA. ACTUAL SUBSURFACE CONDITIONS BETWEEN BOREHOLES MAY DIFFER FROM THAT WHICH IS SHOWN.

TOPOGRAPHIC CONTOUR INTERVAL IS 10 FEET WITH SUPPLEMENTARY CONTOURS AT 5 FEET.
 ISOPACH CONTOUR INTERVAL IS 10 FEET WITH SUPPLEMENTARY CONTOURS AT 5 FEET.

DRAWING REFERENCE:

TITLE: GENERAL ARRANGEMENT, WOLF CREEK GENERATING STATION UNIT 1
 FOR: KANSAS GAS AND ELECTRIC COMPANY AND KANSAS CITY POWER AND LIGHT COMPANY
 BY: SARGENT AND LUNDY ENGINEERS, CHICAGO
 DRAWING NO. S-1, Rev. 0
 DATE: 12/17/76

MAP BASE PREPARED FROM U.S.G.S. TOPOGRAPHIC QUADRANGLES, 7.5' SERIES; BURLINGTON, KANSAS, 1971; JOHN REDMOND DAM, KANSAS, 1964; NEW STRAW, KANSAS, 1971; OTTUMWA, KANSAS, 1970.



**WOLF CREEK
 UPDATED SAFETY ANALYSIS REPORT**

Figure 2.5-43

Isopachous Map of Vinland Member
 - Site

Rev. 0

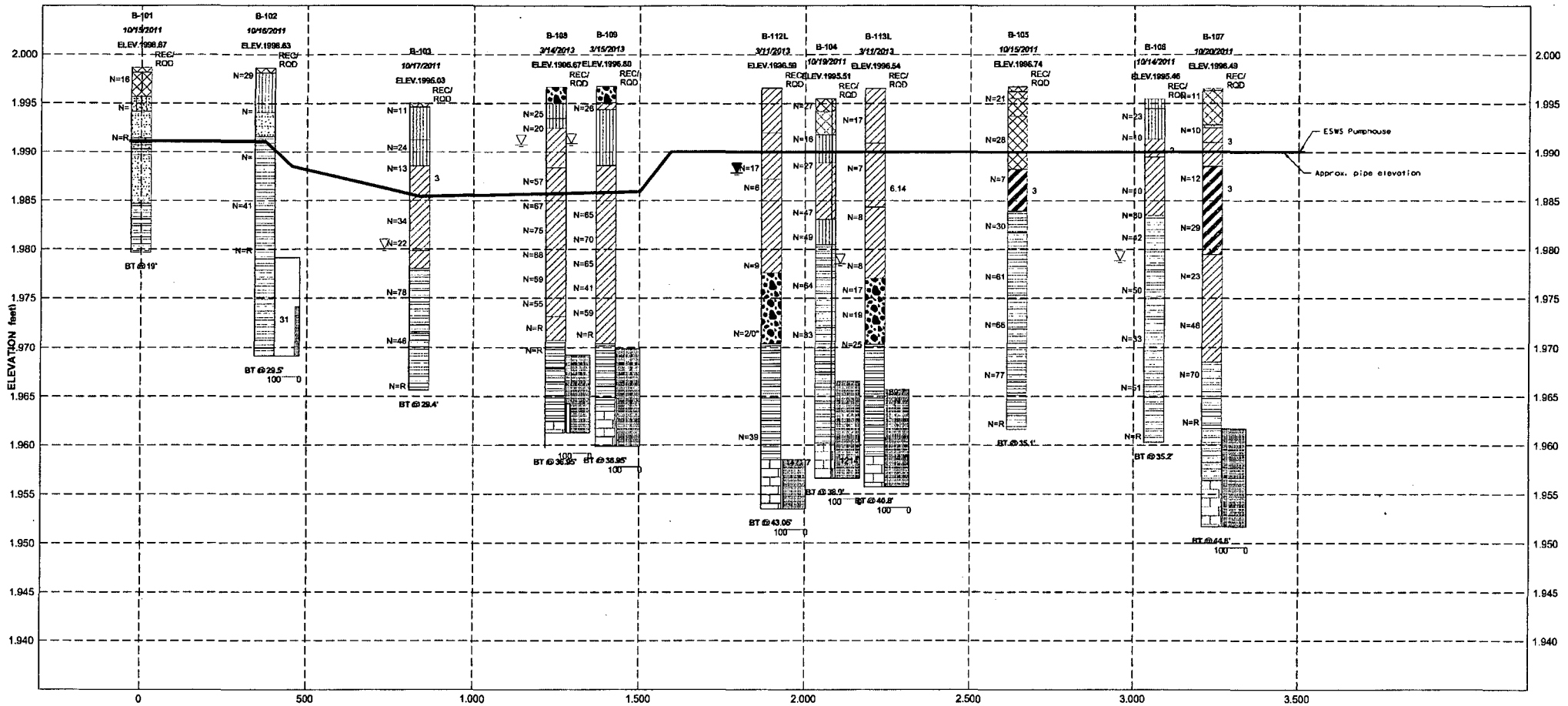

LITHOLOGY GRAPHICS

- | | | | | |
|--|--|--|--|--|
| | | | | |
| | | | | |
| | | | | |

REFERENCE:

25707-000-V14-CY05-00015-003

**WOLF CREEK
UPDATED SAFETY ANALYSIS REPORT**

Figure 2.5-47 Rev. 28
Geologic Cross Section
ESWS Pipeline - Powerblock to Pumphouse
Sheet 1 of 1

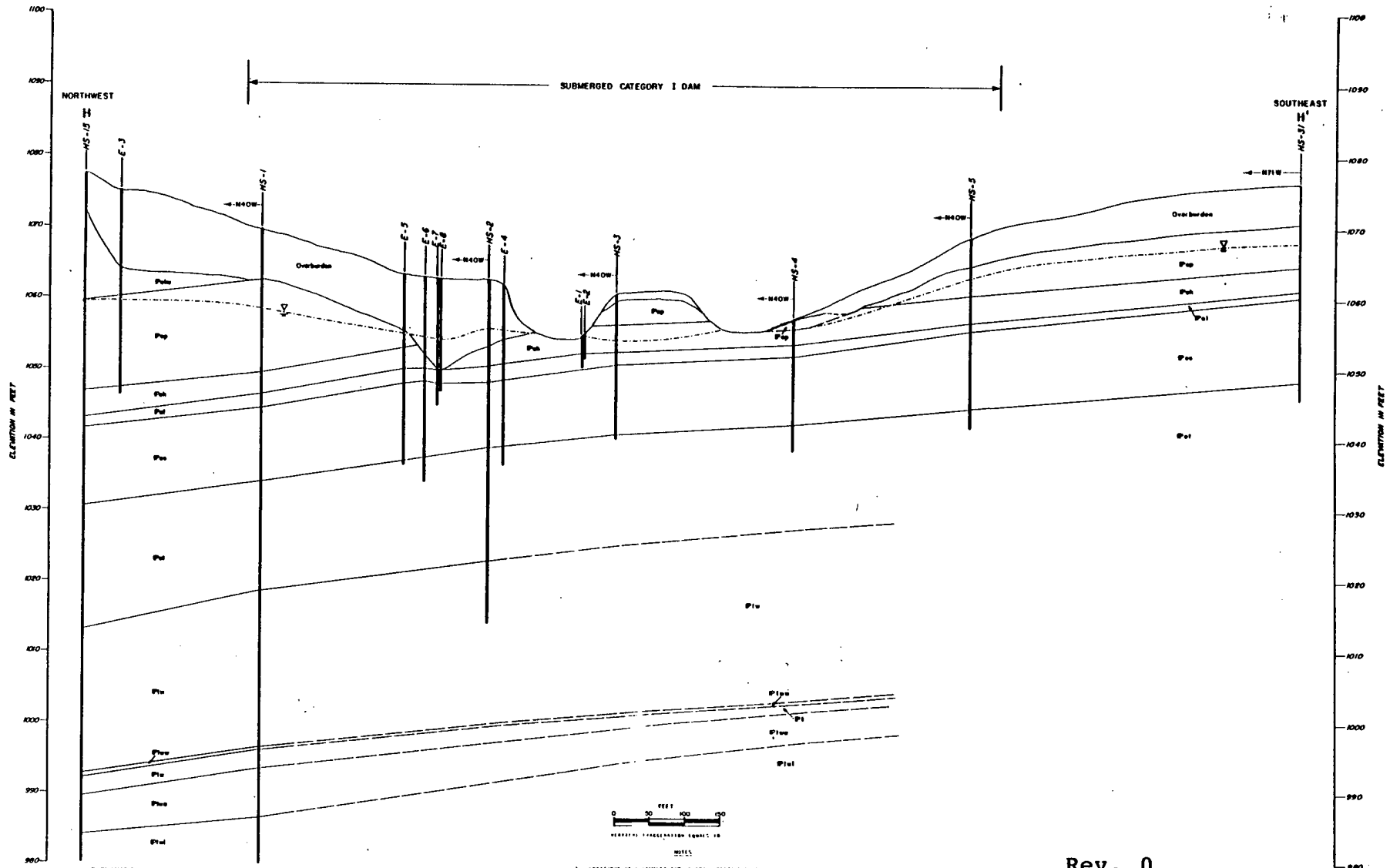

- EXPLANATION**
- | | |
|--------------------------------------|------------------------------------|
| P10 - INDIAN PARK LIMSTONE MEMBER | P10 - TORONTO LIMSTONE MEMBER |
| P9a - HONNERS SHALE MEMBER | P9a - SHARON LIMSTONE SHALE MEMBER |
| P9b - WESTMONTGOMERY LIMSTONE MEMBER | P9b - WESTMONTGOMERY COAL BED |
| P8a - INDIANA LIMSTONE MEMBER | P8a - BRIMLEY LIMSTONE MEMBER |
| P8b - LEAVENWORTH LIMSTONE MEMBER | P8b - INDIANA LIMSTONE MEMBER |
| P7 - SANDVILLE SHALE MEMBER | |
- CONTACT BETWEEN UNITS
 - - - UNCONFORM CONTACT BETWEEN UNITS
 - - - - - UNCONFORM CONTACT BETWEEN UNITS
 - - - - - UNCONFORM CONTACT BETWEEN UNITS
 - - - - - UNCONFORM CONTACT BETWEEN UNITS

1. LOCATION OF SECTION AND SECTION LINE ARE SHOWN ON PLATE 2, P. 28
2. ELEVATIONS GIVEN TO NEAREST FEET.
3. SECTIONS ARE INTERPRETED FROM SURFACE DATA AND FROM SUBSURFACE CORRELATIONS BETWEEN MEMBERS NOT SHOWN WITHIN THIS SECTION.
4. A DETAILED GEOLOGIC CORRELATION SECTION IS SHOWN ON PLATE 3, P. 28.
5. MEMBERS OF THE P SERIES ARE SHOWN EXCEPT WHERE SHOWN OTHERWISE.

Rev. 0

**WOLF CREEK
 UPDATED SAFETY ANALYSIS REPORT**

Figure 2.5-48

Geologic Cross-Section H-H' -
 Ultimate Heat Sink

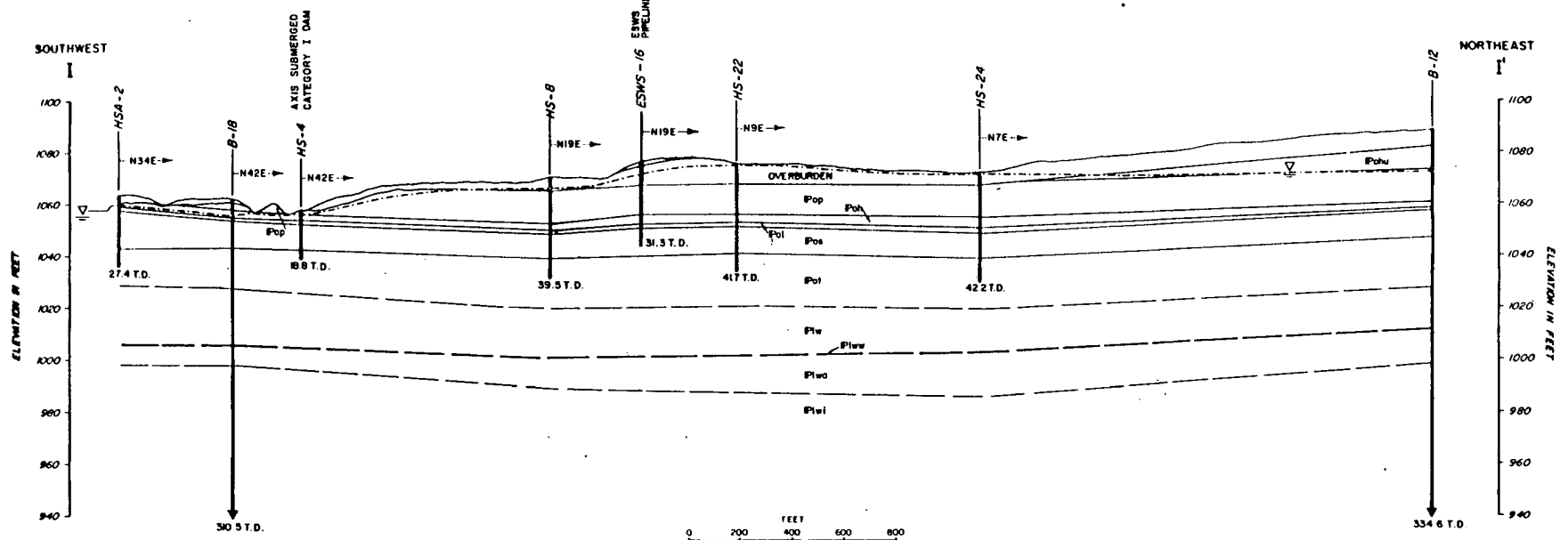

EXPLANATION

- | | |
|------------------------------------|-------------------------------------|
| Popu - HERKIMER SHALE MEMBER | Pot - TOPONO Limestone MEMBER |
| Pop - PLATTSMITH Limestone MEMBER | Plw - UNKINNED LANSING SHALE MEMBER |
| Pol - HEEREN SHALE MEMBER | Plwu - WILLIAMSBURG COAL BED |
| Pos - LEAVENWORTH Limestone MEMBER | Plwa - ARIZONA Limestone MEMBER |
| Pos - SANDERVILLE SHALE MEMBER | Plwi - IRELAND SANDSTONE MEMBER |
- - - CONTACT BETWEEN UNITS
 - - - - - IMPLIED CONTACT BETWEEN UNITS
 N19E -> AZIMUTH OF CROSS-SECTION

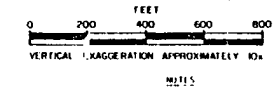

1. LOCATION OF BOREHOLES AND OF CROSS-SECTION LINE ARE SHOWN ON FIGURE 2.5-30.
2. ELEVATIONS REFER TO MEAN SEA LEVEL.
3. - - - LINES ARE INFERRED FROM BOREHOLE DATA, AND SURFACE FOUNDATIONS BETWEEN BOREHOLES ARE DRAWN FROM THE WHICH IS SHOWN.
4. A DETAILED STRATIGRAPHIC SECTION IS SHOWN IN FIGURE 2.5-44.
5. ESWS-ESSENTIAL SERVICE WATER SYSTEM.

Rev. 0

WOLF CREEK UPDATED SAFETY ANALYSIS REPORT
Figure 2.5-49
Geologic Cross-Section I-I' - Ultimate Heat Sink

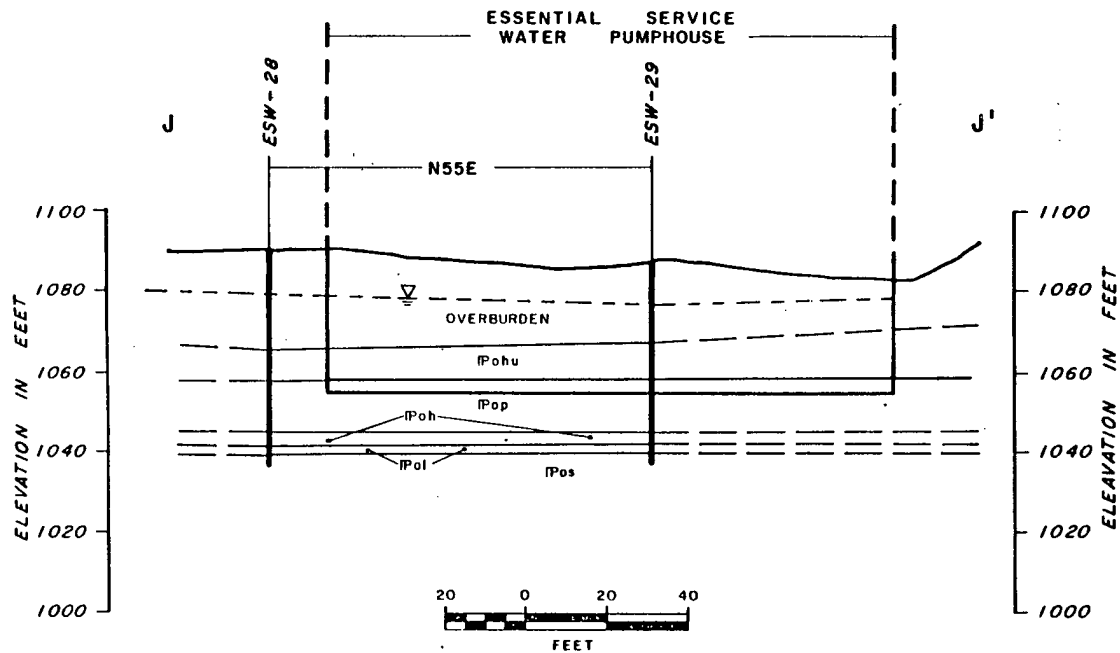

- NOTES:
1. LOCATIONS OF BOREHOLES AND OF CROSS-SECTION LINE ARE SHOWN ON FIGURE 2.5-30.
 2. ELEVATIONS REFER TO MEAN SEA LEVEL.
 3. SECTIONS ARE INTERPRETED FROM BOREHOLE DATA. ACTUAL SUBSURFACE CONDITIONS BETWEEN BOREHOLES MAY DIFFER FROM THAT WHICH IS SHOWN.
 4. A DETAILED SITE STRATIGRAPHIC SECTION IS SHOWN ON FIGURE 2.5-41.
 5. ESWS-ESSENTIAL SERVICE WATER SYSTEM.

EXPLANATION

- | | | | |
|-------|--------------------------------|--------|----------------------------------|
| IPop | - JACKSON PARK SHALE MEMBER | IPos | - SHYNDERVILLE SHALE MEMBER |
| IPohu | - HOHADER SHALE MEMBER | IPol | - TOFONTO LIMESTONE MEMBER |
| IPop | - PLATTSMOUTH LIMESTONE | --- | - CONTACT BETWEEN UNITS |
| IPoh | - HEEBNER SHALE MEMBER | - - - | - INTERRED CONTACT BETWEEN UNITS |
| IPol | - LEAVENWORTH LIMESTONE MEMBER | -N55E- | - AZIMUTH OF CROSS-SECTION |
| ∇ | - PIEZOMETRIC SURFACE | | |

Rev. 0

WOLF CREEK
UPDATED SAFETY ANALYSIS REPORT

Figure 2.5-50

Geologic Cross-Section J-J' -
ESWS Pumphouse

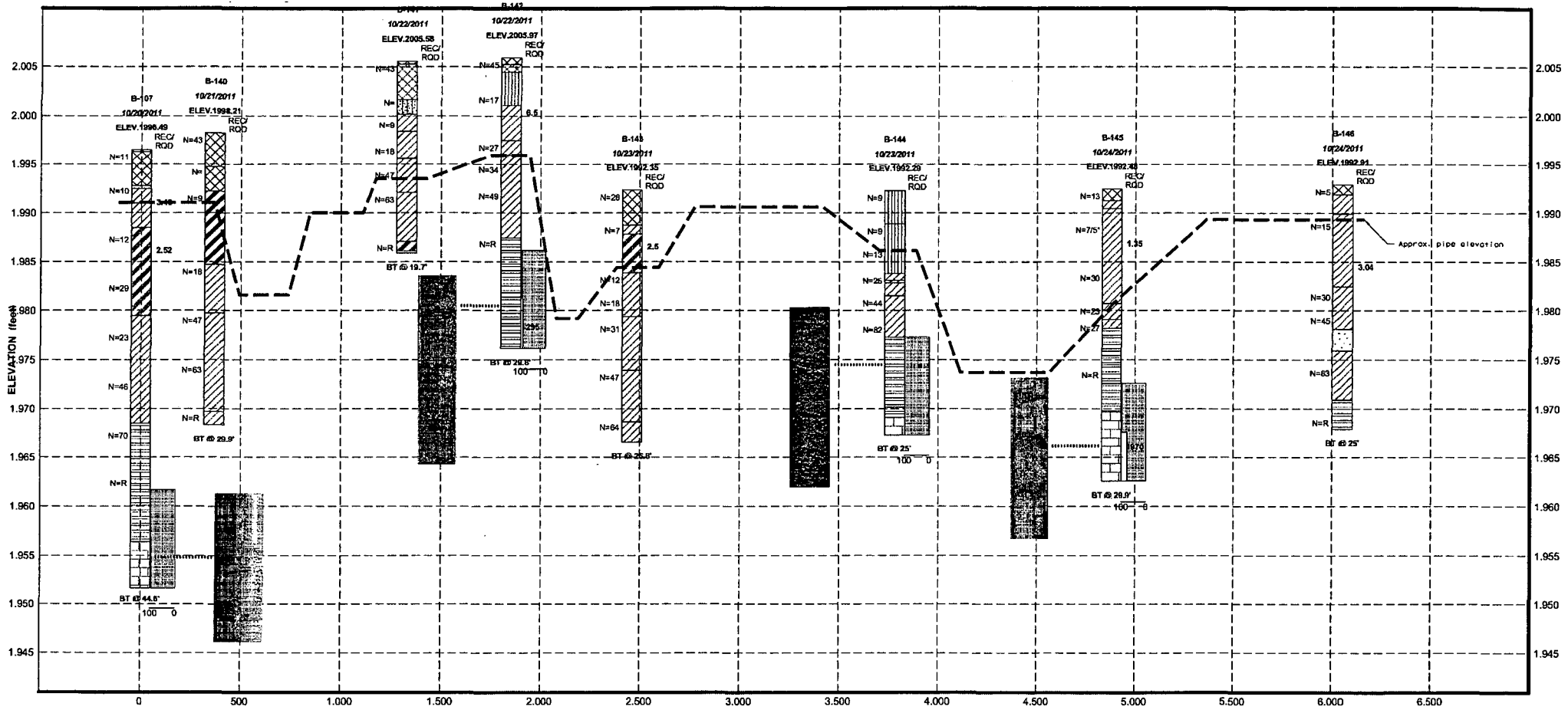

LITHOLOGY GRAPHICS

- | | | | |
|---------------------------------|---------------------------------------|--------------------|------------|
| Fat clay, high plasticity | Lean clay, low to moderate plasticity | Fill (made ground) | Limestone |
| Low to moderate plasticity silt | Shale | Silty Clay | Silty Sand |
| Clean sand, poorly graded | Sandstone | | |

- | |
|--|
| % Recovery (Unshaded) & % ROD (Shaded) per run |
| N=70 SPT N-value |
| N=R SPT Refusal |
| 3.46 UCS Failure Stress (ksf) |
| --- ESWS Discharge Piping Invert |

REFERENCE:
25707-000-V14-CY05-00015-003

**WOLF CREEK
UPDATED SAFETY ANALYSIS REPORT**

Figure 2.5-51 Rev. 28
Geologic Cross-Section
ESWS Pipeline
Sheet 1 of 2

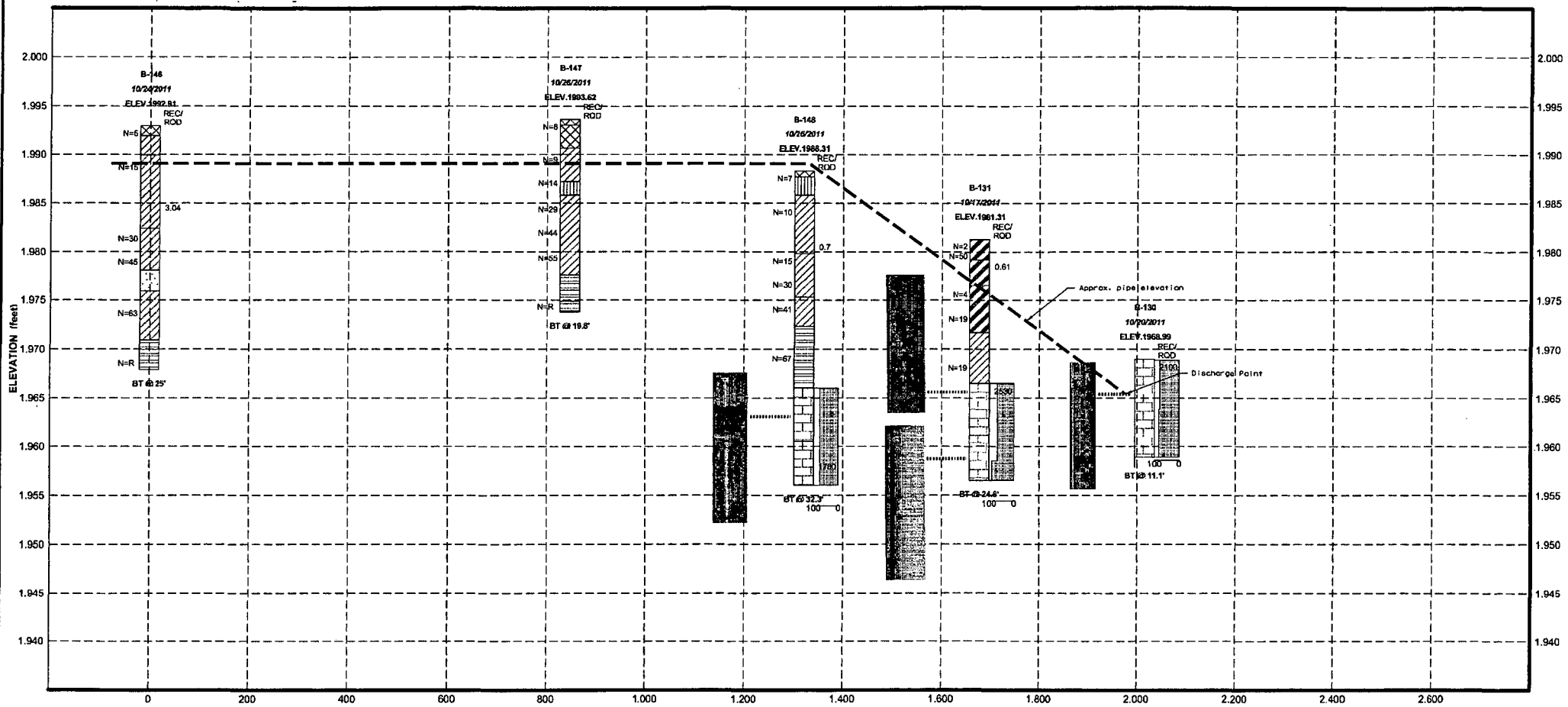

LITHOLOGY GRAPHICS

- | | | | |
|--|--|--|--|
| | | | |
| | | | |
| | | | |

- | | |
|------|--|
| | % Recovery (Unshaded) & % RQD (Shaded) per run |
| N=70 | SPT N-value |
| N=R | SPT Refusal |
| 3.46 | UCS Failure Stress (ksf) |
| | ESWS Discharge Piping Invert |

REFERENCE:

25707-000-V14-CY05-00015-003

**WOLF CREEK
UPDATED SAFETY ANALYSIS REPORT**

Figure 2.5-51 Rev. 28
Geologic Cross-Section
ESWS Discharge Piping
Sheet 2 of 2

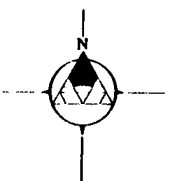
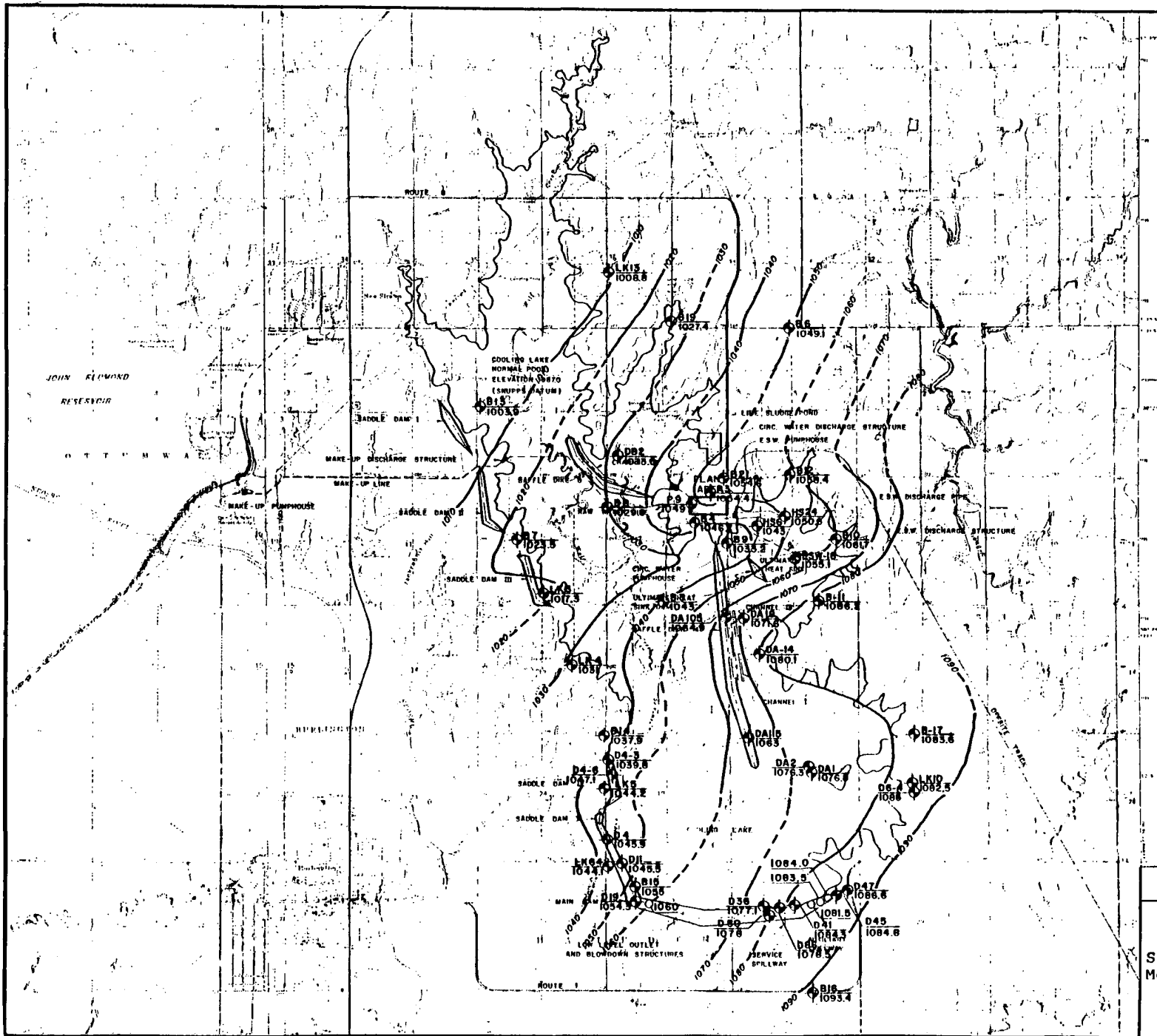

- NOTES:
1. BORING LOCATION B-10 TOP ELEVATION OF LEAVENWORTH LIMESTONE MEMBER
 2. 1084.0 ELEVATION FROM GEOLOGICAL EXCAVATION MAPPING
 3. STRUCTURAL CONTOUR LINES INTERPRETTED FROM WIDELY SPACED BOREHOLE DATA. ACTUAL SUBSURFACE CONDITIONS BETWEEN BOREHOLES MAY DIFFER FROM THAT SHOWN.
 4. CONTOURS DASHED WHERE LOCATION IS APPROPRIATE.
 5. DETAILED STRUCTURE CONTOUR MAP OF LEAVENWORTH LIMESTONE IN THE CATEGORY I AREA IS SHOWN ON FIGURE 2.5-50.

TOPOGRAPHIC CONTOUR INTERVAL IS 10 FEET WITH SUPPLEMENTARY CONTOURS AT 5 FEET.
 STRUCTURAL CONTOUR INTERVAL IS 10 FEET.

DRAWING REFERENCE:
 TITLE: GENERAL ARRANGEMENT, WOLF CREEK GENERATING STATION UNIT I
 FOR: KANSAS GAS AND ELECTRIC COMPANY AND KANSAS CITY POWER AND LIGHT COMPANY
 BY: SARGENT AND LUNDY ENGINEERS, CHICAGO
 DRAWING NO. S-1, Rev. 0
 DATED: 12/17/76

MAP BASE PREPARED FROM U.S.G.S. TOPOGRAPHIC QUADRANGLES, 7.5' SERIES; BURLINGTON, KANSAS, 1971; JOHN REDMOND DAM, KANSAS, 1966; HEW STRAW, KANSAS, 1971; OTTUMWA, KANSAS, 1970.



**WOLF CREEK
 UPDATED SAFETY ANALYSIS REPORT**

Figure 2.5-54
 Structure Contours of Leavenworth
 Member - Site

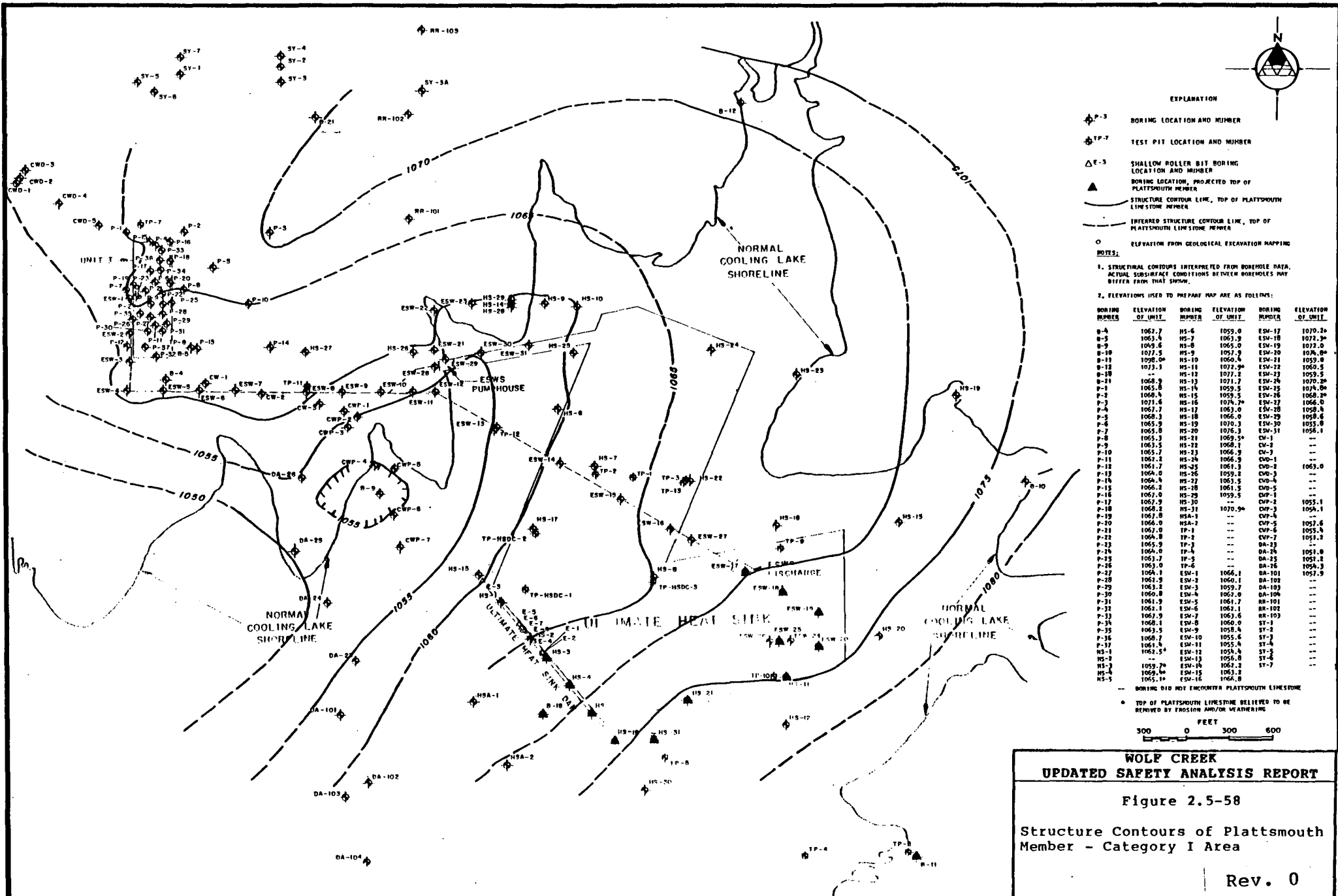

- EXPLANATION**
- ◆ P-3 BORING LOCATION AND NUMBER
 - ◆ TP-7 TEST PIT LOCATION AND NUMBER
 - △ E-3 SHALLOW ROLLER BIT BORING LOCATION AND NUMBER
 - ▲ BORING LOCATION, PROJECTED TOP OF PLATTSMOUTH MEMBER
 - STRUCTURE CONTOUR LINE, TOP OF PLATTSMOUTH LIMESTONE MEMBER
 - - - INFERRED STRUCTURE CONTOUR LINE, TOP OF PLATTSMOUTH LIMESTONE MEMBER
 - ELEVATION FROM GEOLOGICAL EXCAVATION MAPPING

NOTES:

1. STRUCTURAL CONTOURS INTERPRETED FROM BOREHOLE DATA. ACTUAL SUBSURFACE CONDITIONS BETWEEN BOREHOLES MAY DIFFER FROM THAT SHOWN.

2. ELEVATIONS USED TO PREPARE MAP ARE AS FOLLOWS:

BORING NUMBER	ELEVATION OF UNIT	BORING NUMBER	ELEVATION OF UNIT	BORING NUMBER	ELEVATION OF UNIT
B-4	1062.7	HS-6	1059.0	ESW-17	1070.2a
B-5	1063.4	HS-7	1063.9	ESW-18	1072.3a
B-9	1049.6	HS-8	1065.0	ESW-19	1072.0
B-10	1077.5	HS-9	1057.1	ESW-20	1074.0a
B-11	1028.0a	HS-10	1060.6	ESW-21	1059.8
B-12	1073.3	HS-11	1072.9a	ESW-22	1065.5
B-18	---	HS-12	1071.7	ESW-23	1055.5
B-21	1068.9	HS-13	1071.7	ESW-24	1070.2a
B-2	1065.8	HS-14	1059.5	ESW-25	1074.0a
B-3	1060.8	HS-15	1055.5	ESW-26	1060.2a
B-7	1071.6	HS-16	1074.3a	ESW-27	1066.0
B-4	1067.7	HS-17	1063.0	ESW-28	1058.4
B-10	1060.3	HS-18	1066.0	ESW-29	1058.6
B-6	1065.9	HS-19	1070.3	ESW-30	1055.8
B-7	1065.8	HS-20	1076.3	ESW-31	1056.1
B-8	1065.3	HS-21	1069.4	CV-1	---
B-9	1063.5	HS-22	1068.1	CV-2	---
B-10	1065.7	HS-23	1066.9	CV-3	---
B-11	1061.2	HS-24	1066.9	CV-4	---
B-12	1061.7	HS-25	1063.2	CV-2	1063.0
B-13	1064.0	HS-26	1059.2	CV-3	---
B-14	1064.4	HS-27	1063.5	CV-4	---
B-15	1066.2	HS-28	1061.5	CV-5	---
B-16	1067.0	HS-29	1059.5	CV-1	---
B-17	1067.9	HS-30	---	CV-2	1055.1
B-18	1068.2	HS-31	1070.9a	CV-3	1054.1
B-19	1067.8	HSA-1	---	CV-4	---
B-20	1066.0	HSA-2	---	CV-5	1057.4
B-21	1062.0	TP-1	---	CV-6	1055.4
B-22	1064.8	TP-2	---	CV-7	1051.2
B-23	1065.9	TP-3	---	DA-23	---
B-24	1064.0	TP-4	---	DA-24	1051.8
B-25	1063.7	TP-5	---	DA-25	1051.1
B-26	1063.0	TP-6	---	DA-26	1054.3
B-27	1064.1	ESW-1	1066.1	DA-101	1057.9
B-28	1061.9	ESW-2	1060.1	DA-102	---
B-29	1063.2	ESW-3	1059.7	DA-103	---
B-30	1060.8	ESW-4	1062.0	RR-100	---
B-31	1061.9	ESW-5	1061.7	RR-101	---
B-32	1062.1	ESW-6	1062.1	RR-102	---
B-33	1062.9	ESW-7	1063.0	RR-103	---
B-34	1061.8	ESW-8	1060.0	SY-1	---
B-35	1063.5	ESW-9	1058.8	SY-2	---
B-36	1068.7	ESW-10	1055.6	SY-3	---
B-37	1061.8	ESW-11	1062.0	SY-4	---
HS-1	1062.5a	ESW-12	1054.8	SY-5	---
HS-2	---	ESW-13	1056.0	SY-6	---
HS-3	1059.7a	ESW-14	1062.2	SY-7	---
HS-4	1069.8a	ESW-15	1063.2	---	---
HS-5	1065.1a	ESW-16	1064.8	---	---

- BORING DID NOT ENCOUNTER PLATTSMOUTH LIMESTONE
- TOP OF PLATTSMOUTH LIMESTONE BELIEVED TO BE REMOVED BY EROSION AND/OR WEATHERING

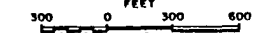

**WOLF CREEK
UPDATED SAFETY ANALYSIS REPORT**

Figure 2.5-58

Structure Contours of Plattsmouth Member - Category I Area

Rev. 0

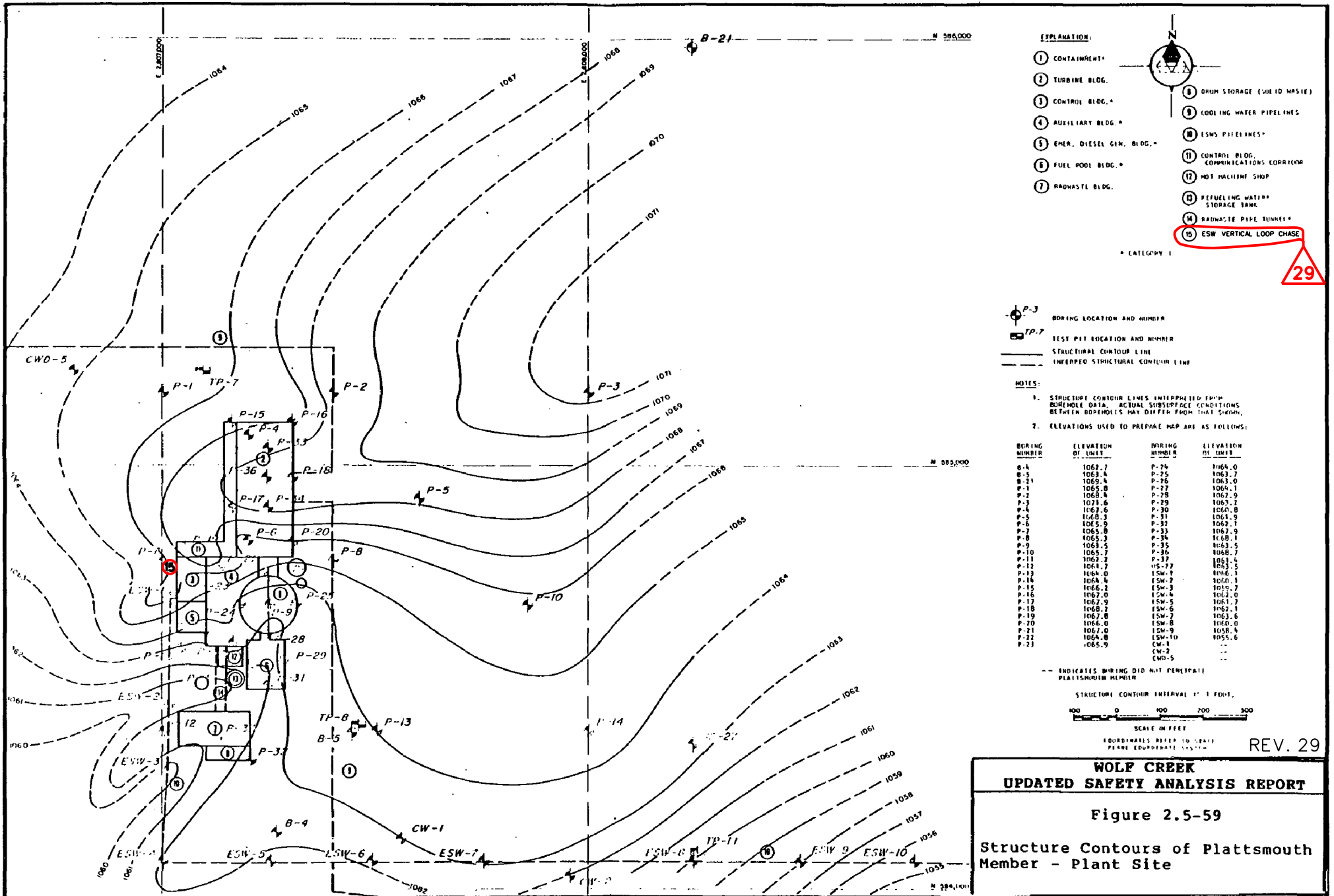

EXPLANATION:

- ① CONTAINMENT*
- ② TURBINE BLDG.
- ③ CONTROL BLDG.*
- ④ AUXILIARY BLDG.*
- ⑤ EMER. DIESEL GEN. BLDG.*
- ⑥ FUEL POOL BLDG.*
- ⑦ RADWASTE BLDG.
- ⑧ DRUM STORAGE (SHR TO WASTE)
- ⑨ COOLING WATER PIPELINES
- ⑩ ESW PIPELINES*
- ⑪ CONTROL BLDG. COMMUNICATIONS CORRIDOR
- ⑫ HOT HALOGEN SHIP
- ⑬ FUELING WATER STORAGE TANK
- ⑭ RADWASTE PIPE TUNNEL*
- ⑮ ESW VERTICAL LOOP CHASE

* CATEGORY 1

- ⊕ P-3 BORING LOCATION AND NUMBER
- ⊕ TP-7 TEST PIT LOCATION AND NUMBER
- STRUCTURAL CONTOUR LINE
- - - INTERFERED STRUCTURAL CONTOUR LINE

NOTES:

1. STRUCTURE CONTOUR LINES INTERFERED FROM BOREHOLE DATA. ACTUAL SUBSURFACE CONDITIONS BETWEEN BOREHOLES MAY DIFFER FROM THAT SHOWN.
2. ELEVATIONS USED TO PREPARE MAP ARE AS FOLLOWS:

BORING NUMBER	ELEVATION OF LOG 1	BORING NUMBER	ELEVATION OF LOG 2
B-4	1062.7	P-24	1064.0
B-5	1063.4	P-25	1063.7
B-21	1069.4	P-26	1065.0
P-1	1065.0	P-27	1064.1
P-2	1068.4	P-28	1062.9
P-3	1071.6	P-29	1065.2
P-4	1067.6	P-30	1064.0
P-5	1068.3	P-31	1064.9
P-6	1065.9	P-32	1064.1
P-7	1065.0	P-33	1062.9
P-8	1065.3	P-34	1068.1
P-9	1061.5	P-35	1062.5
P-10	1065.7	P-36	1068.7
P-11	1062.2	P-37	1063.4
P-12	1064.7	IS-77	1062.5
P-13	1064.0	ISW-7	1066.1
P-14	1064.4	ISW-7	1070.1
P-15	1066.2	ISW-5	1065.2
P-16	1067.0	ISW-4	1062.0
P-17	1067.9	ISW-5	1061.2
P-18	1068.2	ISW-6	1062.1
P-19	1067.0	ISW-7	1063.6
P-20	1066.0	ISW-8	1068.0
P-21	1067.0	ISW-9	1068.4
P-22	1064.0	ISW-10	1055.6
P-23	1065.9	CW-1	---
		CW-2	---
		CWD-5	---

-- INDICATES BORING DID NOT PENETRATE PLATTSMOUTH MEMBER

STRUCTURE CONTOUR INTERVAL = 1 FOOT.

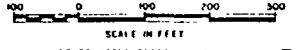

SCALE IN FEET

COORDINATES REFER TO STATE PLATTsmouth COORDINATE SYSTEM

REV. 29

**WOLF CREEK
UPDATED SAFETY ANALYSIS REPORT**

Figure 2.5-59

Structure Contours of Plattsmouth Member - Plant Site

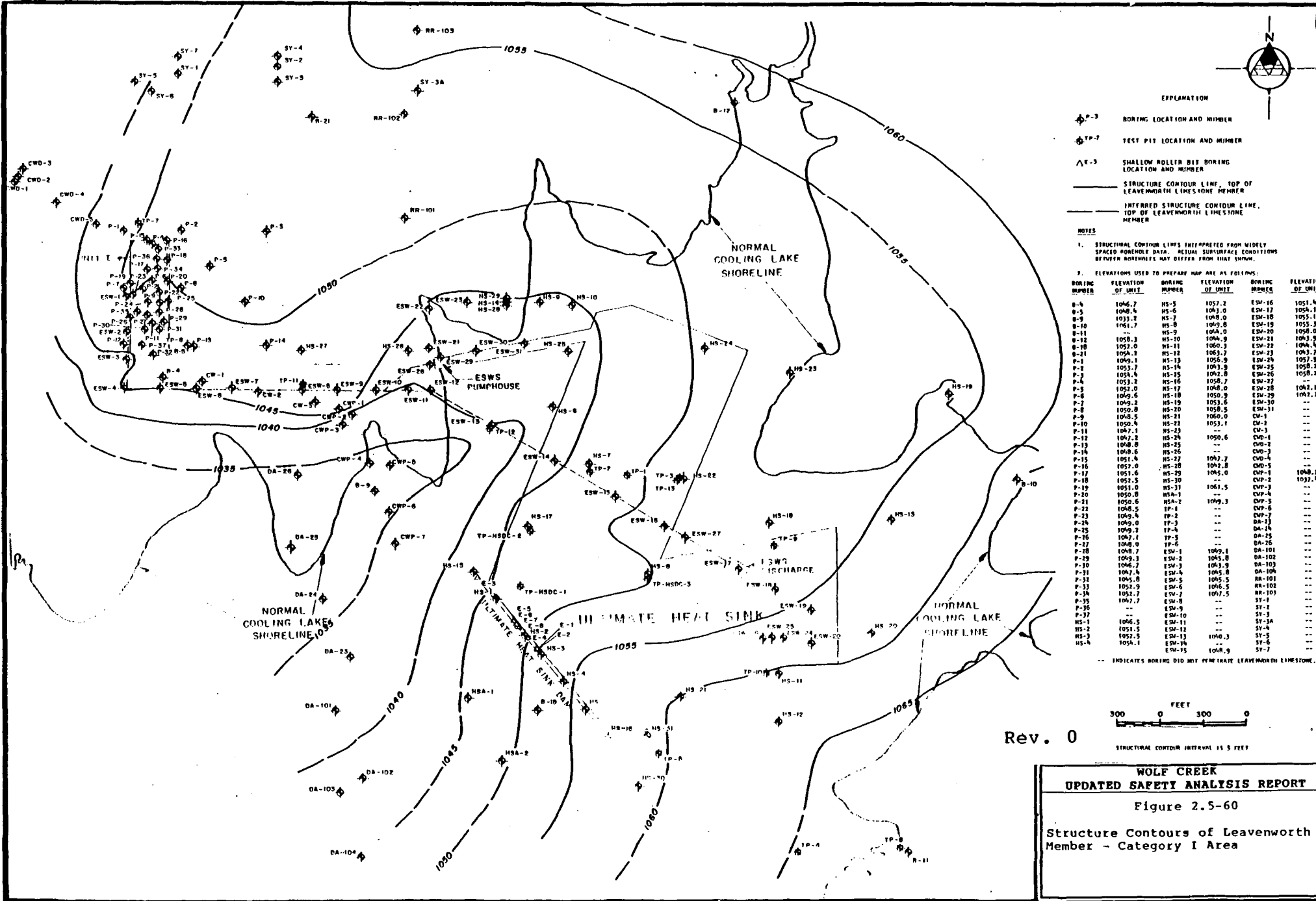

- EXPLANATION**
- ◆ P-3 BOREHOLE LOCATION AND NUMBER
 - ◆ TP-7 TEST PIT LOCATION AND NUMBER
 - △ E-3 SHALLOW ROLLER BIT BOREHOLE LOCATION AND NUMBER
 - STRUCTURE CONTOUR LINE, TOP OF LEAVENWORTH LIMESTONE MEMBER
 - - - INFERRED STRUCTURE CONTOUR LINE, TOP OF LEAVENWORTH LIMESTONE MEMBER
- NOTES**
- STRUCTURAL CONTOUR LINES INTERPRETTED FROM SPACED BOREHOLE DATA. ACTUAL SURFACE CONDITIONS BETWEEN BOREHOLES MAY DIFFER FROM THAT SHOWN.
 - ELEVATIONS USED TO PREPARE MAP ARE AS FOLLOWS:

BOREHOLE NUMBER	ELEVATION OF UNIT	BOREHOLE NUMBER	ELEVATION OF UNIT	BOREHOLE NUMBER	ELEVATION OF UNIT
B-4	1046.7	HS-5	1057.2	ESW-16	1051.4
B-9	1048.4	HS-6	1041.0	ESW-17	1054.1
B-10	1033.2	HS-7	1048.0	ESW-18	1055.1
B-11	1041.7	HS-8	1045.0	ESW-19	1055.3
B-12	1058.3	HS-9	1044.0	ESW-20	1058.0
B-13	1052.0	HS-10	1044.9	ESW-21	1043.9
B-14	1054.9	HS-11	1060.3	ESW-22	1044.4
B-15	1049.1	HS-12	1063.7	ESW-23	1043.7
B-16	1053.7	HS-13	1055.9	ESW-24	1057.9
B-17	1053.4	HS-14	1041.3	ESW-25	1058.2
B-18	1053.2	HS-15	1042.8	ESW-26	1058.3
B-19	1052.0	HS-16	1058.7	ESW-27	---
B-20	1045.6	HS-17	1046.0	ESW-28	1042.3
B-21	1049.2	HS-18	1050.9	ESW-29	1042.7
B-22	1050.0	HS-19	1053.6	ESW-30	---
B-23	1048.5	HS-20	1058.5	ESW-31	---
B-24	1050.4	HS-21	1060.0	EW-1	---
B-25	1047.1	HS-22	1053.1	EW-2	---
B-26	1047.2	HS-23	---	EW-3	---
B-27	1048.8	HS-24	1050.6	EW-4	---
B-28	1048.8	HS-25	---	EW-5	---
B-29	1048.6	HS-26	---	EW-6	---
B-30	1051.4	HS-27	1047.7	EW-7	---
B-31	1052.0	HS-28	1042.8	EW-8	---
B-32	1051.6	HS-29	1045.0	EW-9	1048.2
B-33	1052.5	HS-30	---	EW-10	1033.4
B-34	1051.0	HS-31	1061.5	EW-11	---
B-35	1050.0	HS-32	---	EW-12	---
B-36	1050.6	HS-33	---	EW-13	---
B-37	1048.5	HS-34	1049.3	EW-14	---
B-38	1049.4	TP-1	---	EW-15	---
B-39	1049.0	TP-2	---	EW-16	---
B-40	1049.2	TP-3	---	EW-17	---
B-41	1047.1	TP-4	---	EW-18	---
B-42	1048.0	TP-5	---	EW-19	---
B-43	1048.7	TP-6	---	EW-20	---
B-44	1049.3	TP-7	---	EW-21	---
B-45	1047.1	TP-8	---	EW-22	---
B-46	1049.0	TP-9	---	EW-23	---
B-47	1048.7	TP-10	---	EW-24	---
B-48	1049.3	TP-11	---	EW-25	---
B-49	1047.1	TP-12	---	EW-26	---
B-50	1048.0	TP-13	---	EW-27	---
B-51	1048.7	TP-14	---	EW-28	---
B-52	1049.3	TP-15	---	EW-29	---
B-53	1047.1	TP-16	---	EW-30	---
B-54	1048.0	TP-17	---	EW-31	---
B-55	1048.7	TP-18	---	EW-32	---
B-56	1049.3	TP-19	---	EW-33	---
B-57	1047.1	TP-20	---	EW-34	---
B-58	1048.0	TP-21	---	EW-35	---
B-59	1048.7	TP-22	---	EW-36	---
B-60	1049.3	TP-23	---	EW-37	---
B-61	1047.1	TP-24	---	EW-38	---
B-62	1048.0	TP-25	---	EW-39	---
B-63	1048.7	TP-26	---	EW-40	---
B-64	1049.3	TP-27	---	EW-41	---
B-65	1047.1	TP-28	---	EW-42	---
B-66	1048.0	TP-29	---	EW-43	---
B-67	1048.7	TP-30	---	EW-44	---
B-68	1049.3	TP-31	---	EW-45	---
B-69	1047.1	TP-32	---	EW-46	---
B-70	1048.0	TP-33	---	EW-47	---
B-71	1048.7	TP-34	---	EW-48	---
B-72	1049.3	TP-35	---	EW-49	---
B-73	1047.1	TP-36	---	EW-50	---
B-74	1048.0	TP-37	---	EW-51	---
B-75	1048.7	TP-38	---	EW-52	---
B-76	1049.3	TP-39	---	EW-53	---
B-77	1047.1	TP-40	---	EW-54	---
B-78	1048.0	TP-41	---	EW-55	---
B-79	1048.7	TP-42	---	EW-56	---
B-80	1049.3	TP-43	---	EW-57	---
B-81	1047.1	TP-44	---	EW-58	---
B-82	1048.0	TP-45	---	EW-59	---
B-83	1048.7	TP-46	---	EW-60	---
B-84	1049.3	TP-47	---	EW-61	---
B-85	1047.1	TP-48	---	EW-62	---
B-86	1048.0	TP-49	---	EW-63	---
B-87	1048.7	TP-50	---	EW-64	---
B-88	1049.3	TP-51	---	EW-65	---
B-89	1047.1	TP-52	---	EW-66	---
B-90	1048.0	TP-53	---	EW-67	---
B-91	1048.7	TP-54	---	EW-68	---
B-92	1049.3	TP-55	---	EW-69	---
B-93	1047.1	TP-56	---	EW-70	---
B-94	1048.0	TP-57	---	EW-71	---
B-95	1048.7	TP-58	---	EW-72	---
B-96	1049.3	TP-59	---	EW-73	---
B-97	1047.1	TP-60	---	EW-74	---
B-98	1048.0	TP-61	---	EW-75	---
B-99	1048.7	TP-62	---	EW-76	---
B-100	1049.3	TP-63	---	EW-77	---
B-101	1047.1	TP-64	---	EW-78	---
B-102	1048.0	TP-65	---	EW-79	---
B-103	1048.7	TP-66	---	EW-80	---
B-104	1049.3	TP-67	---	EW-81	---
B-105	1047.1	TP-68	---	EW-82	---
B-106	1048.0	TP-69	---	EW-83	---
B-107	1048.7	TP-70	---	EW-84	---
B-108	1049.3	TP-71	---	EW-85	---
B-109	1047.1	TP-72	---	EW-86	---
B-110	1048.0	TP-73	---	EW-87	---
B-111	1048.7	TP-74	---	EW-88	---
B-112	1049.3	TP-75	---	EW-89	---
B-113	1047.1	TP-76	---	EW-90	---
B-114	1048.0	TP-77	---	EW-91	---
B-115	1048.7	TP-78	---	EW-92	---
B-116	1049.3	TP-79	---	EW-93	---
B-117	1047.1	TP-80	---	EW-94	---
B-118	1048.0	TP-81	---	EW-95	---
B-119	1048.7	TP-82	---	EW-96	---
B-120	1049.3	TP-83	---	EW-97	---
B-121	1047.1	TP-84	---	EW-98	---
B-122	1048.0	TP-85	---	EW-99	---
B-123	1048.7	TP-86	---	EW-100	---

--- INDICATES BOREHOLE DID NOT PENETRATE LEAVENWORTH LIMESTONE.



Rev. 0

**WOLF CREEK
UPDATED SAFETY ANALYSIS REPORT**

Figure 2.5-60

Structure Contours of Leavenworth Member - Category I Area

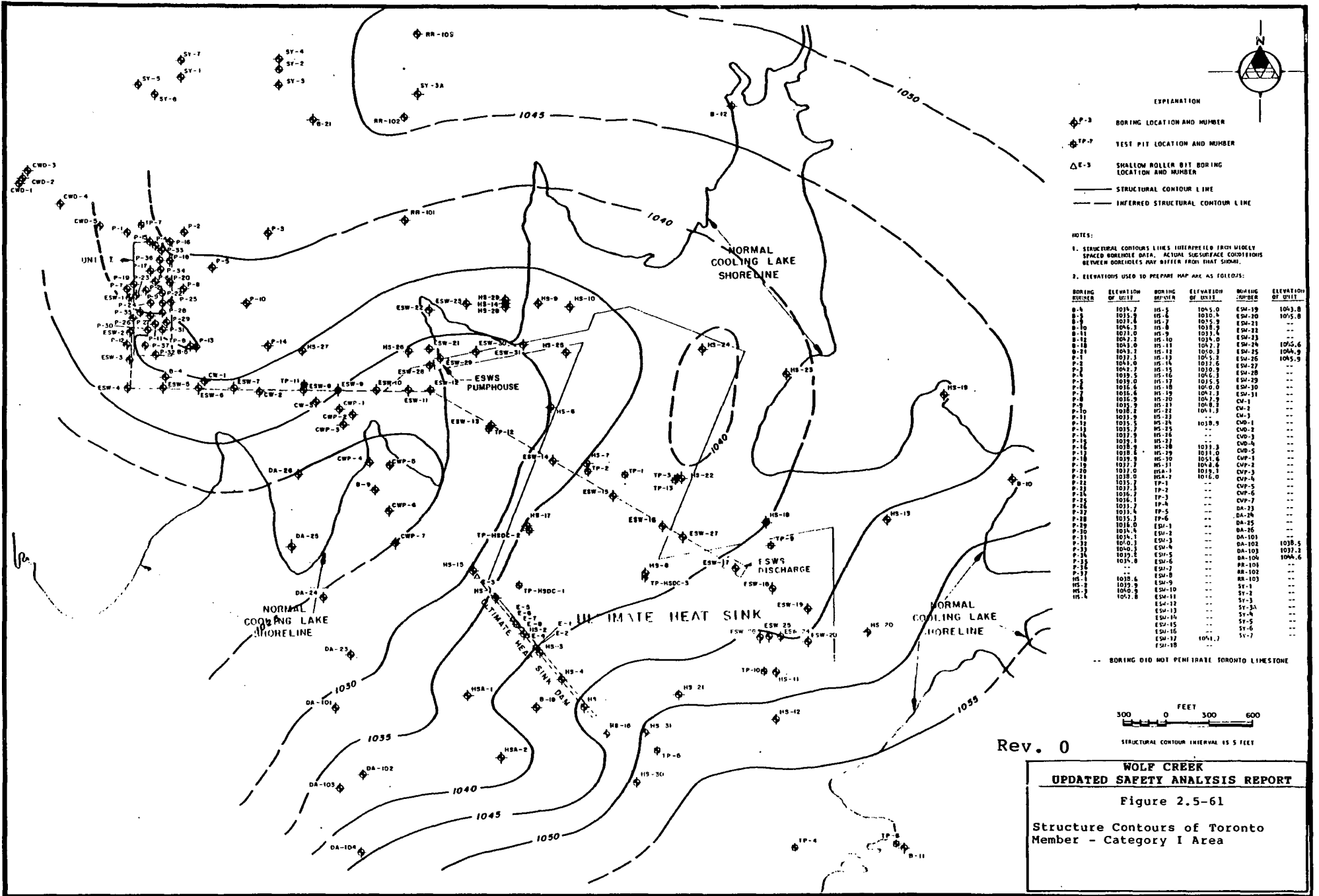

EXPLANATION

- ◆ P-3 BORING LOCATION AND NUMBER
- ◆ TP-7 TEST PIT LOCATION AND NUMBER
- △ E-3 SHALLOW ROLLER BIT BORING LOCATION AND NUMBER
- STRUCTURAL CONTOUR LINE
- - - INFERRED STRUCTURAL CONTOUR LINE

- NOTES:
- STRUCTURAL CONTOUR LINES INTERPRETED FROM FREELY SPACED BOREHOLE DATA. ACTUAL SURFACE CONDITIONS BETWEEN BOREHOLES MAY DIFFER FROM THAT SHOWN.
 - ELEVATIONS USED TO PREPARE MAP ARE AS FOLLOWS:

BORING NUMBER	ELEVATION OF SURFACE	BORING NUMBER	ELEVATION OF SURFACE	BORING NUMBER	ELEVATION OF SURFACE
B-4	1018.7	HS-2	1019.0	ESW-19	1043.8
B-5	1015.7	HS-2	1019.4	ESW-20	1043.8
B-9	1021.8	HS-7	1015.9	ESW-21	--
B-10	1019.1	HS-6	1018.2	ESW-22	--
B-11	1021.0	HS-9	1033.4	ESW-23	--
B-12	1017.2	HS-10	1029.0	ESW-24	1045.6
B-18	1043.0	HS-11	1042.7	ESW-25	1044.9
B-21	1014.2	HS-11	1010.3	ESW-26	1045.0
P-1	1017.1	HS-12	1045.2	ESW-27	--
P-2	1044.0	HS-14	1012.6	ESW-28	--
P-3	1042.7	HS-15	1010.9	ESW-29	--
P-4	1039.5	HS-16	1046.3	ESW-30	--
P-5	1015.0	HS-15	1015.2	ESW-31	--
P-6	1016.6	HS-18	1040.0	ESW-32	--
P-7	1016.6	HS-20	1042.9	CW-1	--
P-8	1015.9	HS-20	1042.9	CW-2	--
P-9	1018.9	HS-21	1041.3	CW-3	--
P-11	1015.9	HS-23	1041.3	CW-4	--
P-12	1015.7	HS-25	--	CW-5	--
P-13	1019.9	HS-26	1019.9	CW-6	--
P-14	1019.1	HS-27	--	CW-7	--
P-15	1018.1	HS-27	--	CW-8	--
P-16	1018.1	HS-29	1011.0	CW-9	--
P-17	1018.9	HS-30	1041.6	CW-10	--
P-18	1017.7	HS-31	1044.4	CW-11	--
P-19	1017.0	HSA-1	1016.0	CW-12	--
P-20	1037.0	HSA-2	1016.0	CW-13	--
P-21	1016.0	TP-1	--	CW-14	--
P-22	1015.7	TP-1	--	CW-15	--
P-23	1015.7	TP-1	--	CW-16	--
P-24	1016.7	TP-2	--	CW-17	--
P-25	1018.1	TP-3	--	CW-18	--
P-26	1017.7	TP-4	--	CW-19	--
P-27	1017.7	TP-4	--	CW-20	--
P-28	1017.7	TP-4	--	CW-21	--
P-29	1017.7	TP-5	--	CW-22	--
P-30	1018.1	TP-6	--	CW-23	--
P-31	1018.1	TP-6	--	CW-24	--
P-32	1018.1	TP-6	--	CW-25	--
P-33	1018.1	TP-6	--	CW-26	--
P-34	1018.1	TP-6	--	CW-27	--
P-35	1018.1	TP-6	--	CW-28	--
P-36	1018.1	TP-6	--	CW-29	--
P-37	1018.1	TP-6	--	CW-30	--
P-38	1018.1	TP-6	--	CW-31	--
P-39	1018.1	TP-6	--	CW-32	--
P-40	1018.1	TP-6	--	CW-33	--
P-41	1018.1	TP-6	--	CW-34	--
P-42	1018.1	TP-6	--	CW-35	--
P-43	1018.1	TP-6	--	CW-36	--
P-44	1018.1	TP-6	--	CW-37	--
P-45	1018.1	TP-6	--	CW-38	--
P-46	1018.1	TP-6	--	CW-39	--
P-47	1018.1	TP-6	--	CW-40	--
P-48	1018.1	TP-6	--	CW-41	--
P-49	1018.1	TP-6	--	CW-42	--
P-50	1018.1	TP-6	--	CW-43	--
P-51	1018.1	TP-6	--	CW-44	--
P-52	1018.1	TP-6	--	CW-45	--
P-53	1018.1	TP-6	--	CW-46	--
P-54	1018.1	TP-6	--	CW-47	--
P-55	1018.1	TP-6	--	CW-48	--
P-56	1018.1	TP-6	--	CW-49	--
P-57	1018.1	TP-6	--	CW-50	--
P-58	1018.1	TP-6	--	CW-51	--
P-59	1018.1	TP-6	--	CW-52	--
P-60	1018.1	TP-6	--	CW-53	--
P-61	1018.1	TP-6	--	CW-54	--
P-62	1018.1	TP-6	--	CW-55	--
P-63	1018.1	TP-6	--	CW-56	--
P-64	1018.1	TP-6	--	CW-57	--
P-65	1018.1	TP-6	--	CW-58	--
P-66	1018.1	TP-6	--	CW-59	--
P-67	1018.1	TP-6	--	CW-60	--
P-68	1018.1	TP-6	--	CW-61	--
P-69	1018.1	TP-6	--	CW-62	--
P-70	1018.1	TP-6	--	CW-63	--
P-71	1018.1	TP-6	--	CW-64	--
P-72	1018.1	TP-6	--	CW-65	--
P-73	1018.1	TP-6	--	CW-66	--
P-74	1018.1	TP-6	--	CW-67	--
P-75	1018.1	TP-6	--	CW-68	--
P-76	1018.1	TP-6	--	CW-69	--
P-77	1018.1	TP-6	--	CW-70	--
P-78	1018.1	TP-6	--	CW-71	--
P-79	1018.1	TP-6	--	CW-72	--
P-80	1018.1	TP-6	--	CW-73	--
P-81	1018.1	TP-6	--	CW-74	--
P-82	1018.1	TP-6	--	CW-75	--
P-83	1018.1	TP-6	--	CW-76	--
P-84	1018.1	TP-6	--	CW-77	--
P-85	1018.1	TP-6	--	CW-78	--
P-86	1018.1	TP-6	--	CW-79	--
P-87	1018.1	TP-6	--	CW-80	--
P-88	1018.1	TP-6	--	CW-81	--
P-89	1018.1	TP-6	--	CW-82	--
P-90	1018.1	TP-6	--	CW-83	--
P-91	1018.1	TP-6	--	CW-84	--
P-92	1018.1	TP-6	--	CW-85	--
P-93	1018.1	TP-6	--	CW-86	--
P-94	1018.1	TP-6	--	CW-87	--
P-95	1018.1	TP-6	--	CW-88	--
P-96	1018.1	TP-6	--	CW-89	--
P-97	1018.1	TP-6	--	CW-90	--
P-98	1018.1	TP-6	--	CW-91	--
P-99	1018.1	TP-6	--	CW-92	--
P-100	1018.1	TP-6	--	CW-93	--
P-101	1018.1	TP-6	--	CW-94	--
P-102	1018.1	TP-6	--	CW-95	--
P-103	1018.1	TP-6	--	CW-96	--
P-104	1018.1	TP-6	--	CW-97	--
P-105	1018.1	TP-6	--	CW-98	--
P-106	1018.1	TP-6	--	CW-99	--
P-107	1018.1	TP-6	--	CW-100	--
P-108	1018.1	TP-6	--	CW-101	--
P-109	1018.1	TP-6	--	CW-102	--
P-110	1018.1	TP-6	--	CW-103	--
P-111	1018.1	TP-6	--	CW-104	--
P-112	1018.1	TP-6	--	CW-105	--
P-113	1018.1	TP-6	--	CW-106	--
P-114	1018.1	TP-6	--	CW-107	--
P-115	1018.1	TP-6	--	CW-108	--
P-116	1018.1	TP-6	--	CW-109	--
P-117	1018.1	TP-6	--	CW-110	--
P-118	1018.1	TP-6	--	CW-111	--
P-119	1018.1	TP-6	--	CW-112	--
P-120	1018.1	TP-6	--	CW-113	--
P-121	1018.1	TP-6	--	CW-114	--
P-122	1018.1	TP-6	--	CW-115	--
P-123	1018.1	TP-6	--	CW-116	--
P-124	1018.1	TP-6	--	CW-117	--
P-125	1018.1	TP-6	--	CW-118	--
P-126	1018.1	TP-6	--	CW-119	--
P-127	1018.1	TP-6	--	CW-120	--
P-128	1018.1	TP-6	--	CW-121	--
P-129	1018.1	TP-6	--	CW-122	--
P-130	1018.1	TP-6	--	CW-123	--
P-131	1018.1	TP-6	--	CW-124	--
P-132	1018.1	TP-6	--	CW-125	--
P-133	1018.1	TP-6	--	CW-126	--
P-134	1018.1	TP-6	--	CW-127	--
P-135	1018.1	TP-6	--	CW-128	--
P-136	1018.1	TP-6	--	CW-129	--
P-137	1018.1	TP-6	--	CW-130	--
P-138	1018.1	TP-6	--	CW-131	--
P-139	1018.1	TP-6	--	CW-132	--
P-140	1018.1	TP-6	--	CW-133	--
P-141	1018.1	TP-6	--	CW-134	--
P-142	1018.1	TP-6	--	CW-135	--
P-143	1018.1	TP-6	--	CW-136	--
P-144	1018.1	TP-6	--	CW-137	--
P-145	1018.1	TP-6	--	CW-138	--
P-146	1018.1	TP-6	--	CW-139	--
P-147	1018.1	TP-6	--	CW-140	--
P-148	1018.1	TP-6	--	CW-141	--
P-149	1018.1	TP-6	--	CW-142	--
P-150	1018.1	TP-6	--	CW-143	--
P-151	1018.1	TP-6	--	CW-144	--
P-152	1018.1	TP-6	--	CW-145	--
P-153	1018.1	TP-6	--	CW-146	--
P-154	1018.1	TP-6	--	CW-147	--
P-155	1018.1	TP-6	--	CW-148	--
P-156	1018.1	TP-6	--	CW-149	--
P-157	1018.1	TP-6	--	CW-150	--
P-158	1018.1	TP-6	--	CW-151	--
P-159	1018.1	TP-6	--	CW-152	--
P-160	1018.1	TP-6	--	CW-153	--
P-161	1018.1	TP-6	--	CW-154	--
P-162	1018.1	TP-6	--	CW-155	--
P-163	1018.1	TP-6	--	CW-156	--
P-164	1018.1	TP-6	--	CW-157	--
P-165	1018.1	TP-6	--	CW-158	--
P-166	1018.1	TP-6	--	CW-159	--
P-167	1018.1	TP-6	--	CW-160	--
P-168	1018.1	TP-6	--	CW-161	--
P-169	1018.1	TP-6	--	CW-162	--
P-170	1018.1	TP-6	--	CW-163	--
P-171	1018.1	TP-6	--	CW-164	--
P-172	1018.1	TP-6	--	CW-165	--
P-173	1018.1	TP-6	--	CW-166	--
P-174	1018.1	TP-6	--	CW-167	--
P-175	1018.1	TP-6	--	CW-168	--
P-176	1018.1	TP-6	--	CW-169	--
P-177	1018.1	TP-6	--	CW-170	--
P-178	1018.1	TP-6	--	CW-171	--
P-179	1018.1	TP-6	--	CW-172	--
P-180	1018.1	TP-6	--	CW-173	--
P-181	1018.1	TP-6	--	CW-174	--
P-182	1018.1	TP-6	--	CW-175	--
P-183	1018.1	TP-6	--	CW-176	--
P-184	1018.1	TP-6	--	CW-177	--
P-185	1018.1	TP-6	--	CW-178	--
P-186	1018.1	TP-6	--	CW-179	--
P-187	1018.1	TP-6	--	CW-180	--
P-188	1018.1	TP-6	--	CW-181	--
P-189	1018.1	TP-6	--	CW-182	--
P-190	1018.1	TP-6	--	CW-183	--
P-191	1018.1	TP-6	--	CW-184	--
P-192	1018.1	TP-6	--	CW-185	--
P-193	1018.1	TP-6	--	CW-186	--
P-194	1018.1	TP-6	--	CW-187	--
P-195	1018.1	TP-6	--	CW-188	--
P-196	1018.1	TP-6	--	CW-189	--
P-197	1018.1	TP-6	--	CW-190	--
P-198	1018.1	TP-6	--	CW-191	--
P-199	1018.1	TP-6	--	CW-192	--
P-200	1018.1	TP-6	--	CW-193	--
P-201	1018.1	TP-6	--	CW-194	--
P-202	1018.1	TP-6	--	CW-195	--
P-203	1018.1	TP-6	--	CW-196	--
P-204	1018.1	TP-6	--	CW-197	--
P-205	1018.1	TP-6	--	CW-198	--
P-206	1018.1	TP-6	--	CW-199	--
P-207	1018.1	TP-6	--	CW-200	--
P-208	1018.1	TP-6	--	CW-201	--
P-209	1018.1	TP-6	--	CW-202	--
P-210	1018.1	TP-6	--	CW-203	--
P-211	1018.1	TP-6	--	CW-204	--
P-212	1018.1	TP-6	--	CW-205	--
P-213	1018.1	TP-6	--	CW-206	--
P-214	1018.1	TP-6	--	CW-207	--
P-215	1018.1	TP-6	--	CW-208	--
P-216	1018.1	TP-6	--	CW-209	--
P-217					

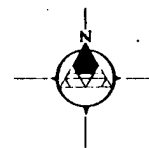
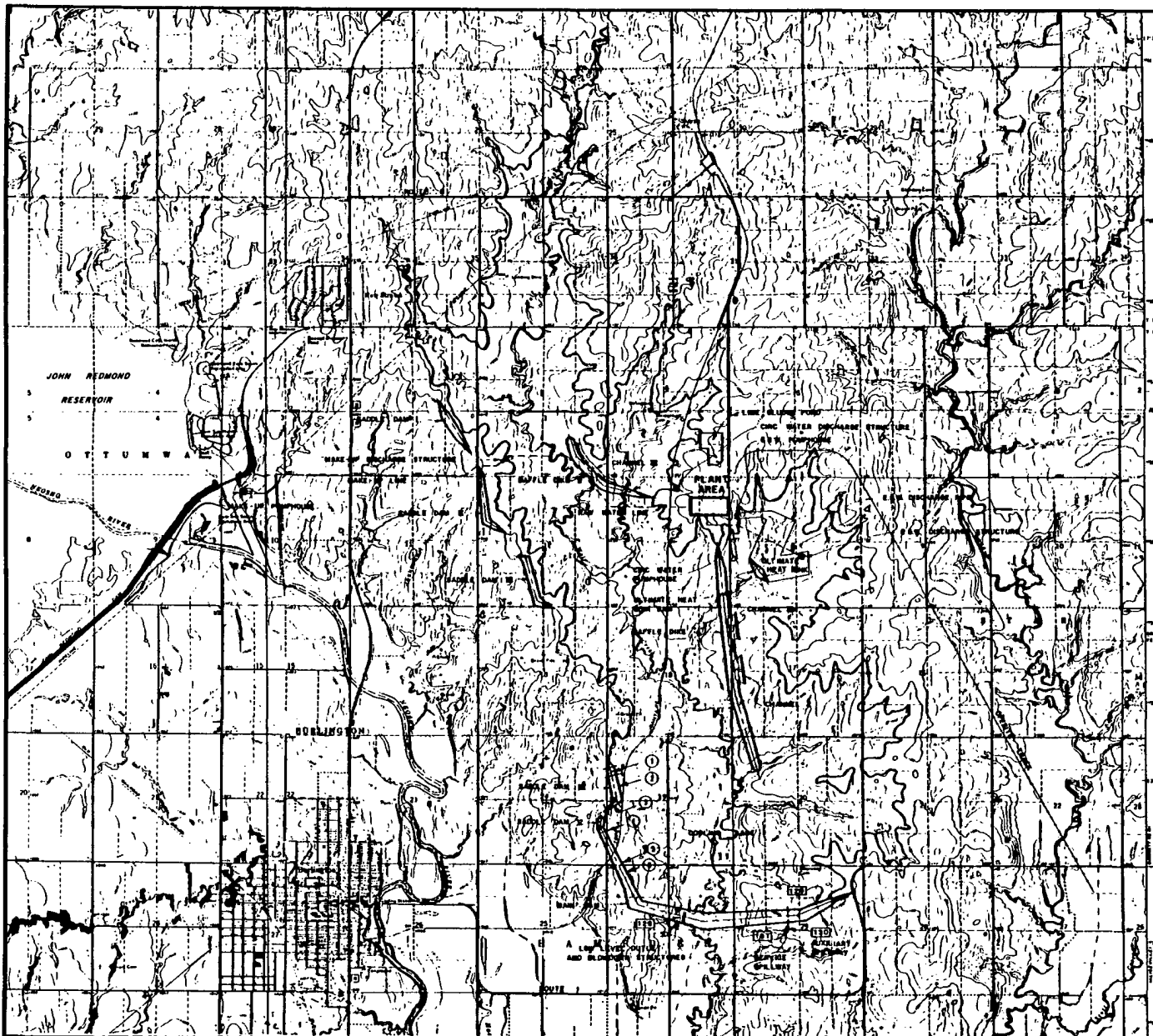

EXPLANATION:

- LOCATION OF ONE OR MORE DEFORMATION ZONES WITHIN HEMLOCK SHALE MEMBER. FEATURE NUMBER CORRESPONDING TO TABLE 231.1-1.
- ① LOCATION OF ONE OR MORE DEFORMATION ZONES IN GEOCLINAL UNITS OTHER THAN HEMLOCK SHALE MEMBER. FEATURE NUMBER CORRESPONDING TO TABLE 231.1-1.

NOTES:

1. SEE TABLE 231.3-1 AND 231.3-2 FOR THE TYPE OR TYPES OF DEFORMATION AT EACH LOCATION INDICATED.
2. SEE FIGURES 231.1-3 THROUGH 231.3-4 FOR THE LOCATIONS OF DEFORMATION ZONES IN THE PLANT AREA.

DRAWING REFERENCE:

TITLE: GENERAL ARRANGEMENT, WOLF CREEK GENERATING STATION UNIT 1
 FOR: KANSAS GAS AND ELECTRIC COMPANY AND KANSAS CITY POWER AND LIGHT COMPANY
 BY: SARGENT AND LUNDY ENGINEERS, CHICAGO
 DRAWING NO. 5-1, Rev. 0
 DATED: 12/17/76

MAP BASE PREPARED FROM U.S.G.S. TOPOGRAPHIC QUADRANGLES, 7.5' SERIES: BURLINGTON, KANSAS, 1975; JOHN REDMOND DAM, KANSAS, 1964; NEW STRAIN, KANSAS, 1971; OTTUMWA, KANSAS, 1979.

Rev. 0



**WOLF CREEK
 UPDATED SAFETY ANALYSIS REPORT**

Figure 2.5-62a

Location of Deformation Zones
 Beyond Plant Areas

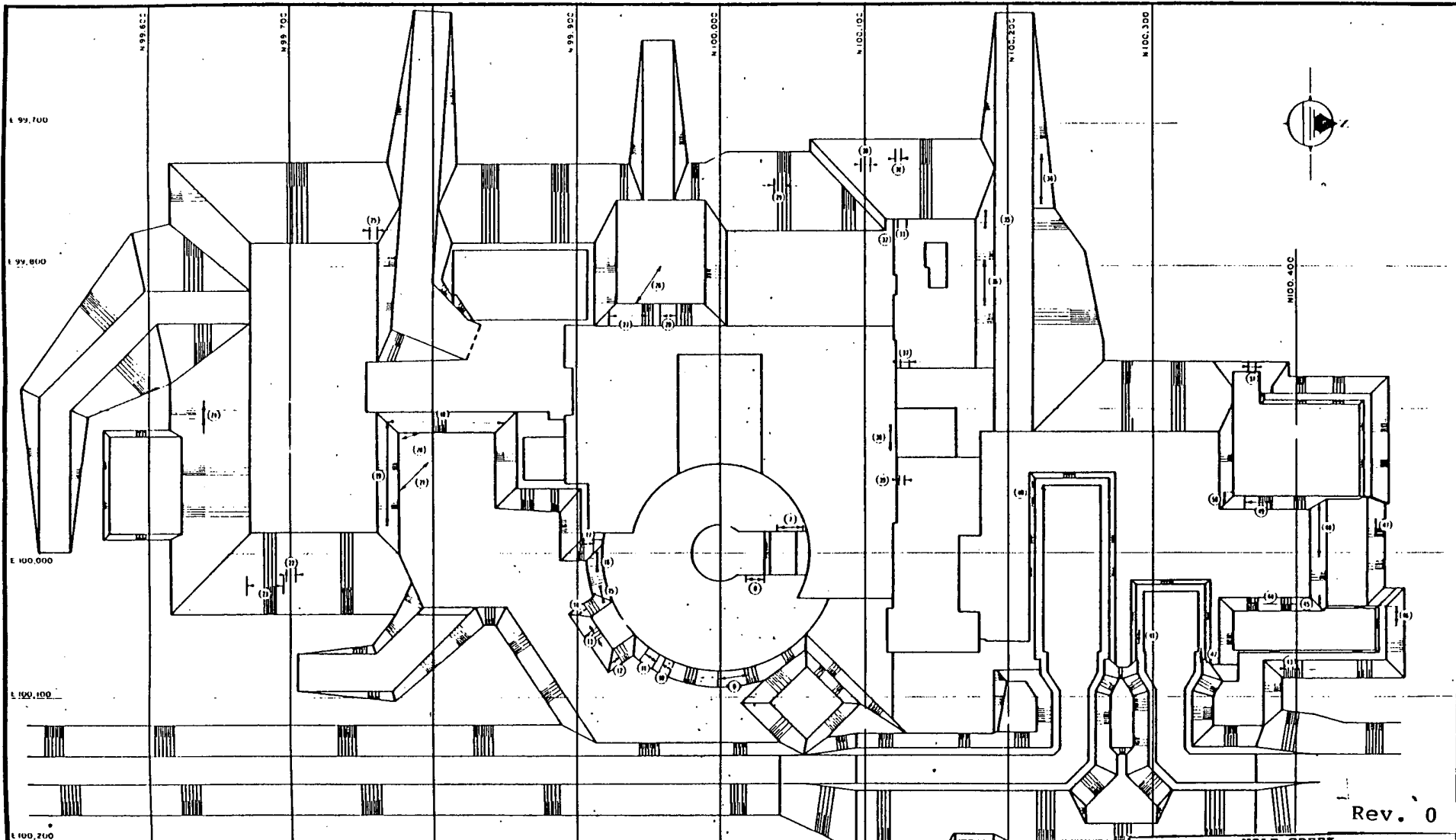

NOT REVISIONS
 REVISIONS FROM TECHNICAL STAFF
 ENGINEERING - DESIGN GROUP 2
 FRANCIS, INC. 385-1700 LANSING, MI 48206
 FRANCIS, INC. 385-1700 LANSING, MI 48206
 BY: FRANCIS, INC. 385-1700 LANSING, MI 48206
 CHECKED: FRANCIS, INC. 385-1700 LANSING, MI 48206
 DRAWING NO. 385-1700-6
 DATE 4-15-77

- NOTES
1. SEE TABLE 2.5.5-1 FOR THE TYPE AND SIZE OF DEFORMATION ZONES AS SHOWN IN THIS DRAWING.
 2. SEE TABLE 2.5.5-1 FOR THE TYPE AND SIZE OF DEFORMATION ZONES IN THE SAME AREA.
 3. DIMENSIONS REFER TO CENTER GRADE.

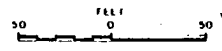

- EXPLANATION
- DEFORMATION ZONE OR LINE ON TYPE DEFORMATION ZONE, SEE TABLE 2.5.5-1 FOR SIZE AND TYPE.
 - (Z) FEATURE BORDER CORRESPONDING TO TABLE 2.5.5-1.
 - TTTTT LOCATION OF DEFORMATION ZONE.

Rev. 0

WOLF CREEK
 UPDATED SAFETY ANALYSIS REPORT
 Figure 2.5-62b
 Location of Deformation Zones -
 Power Block - Heumader Shale
 Member

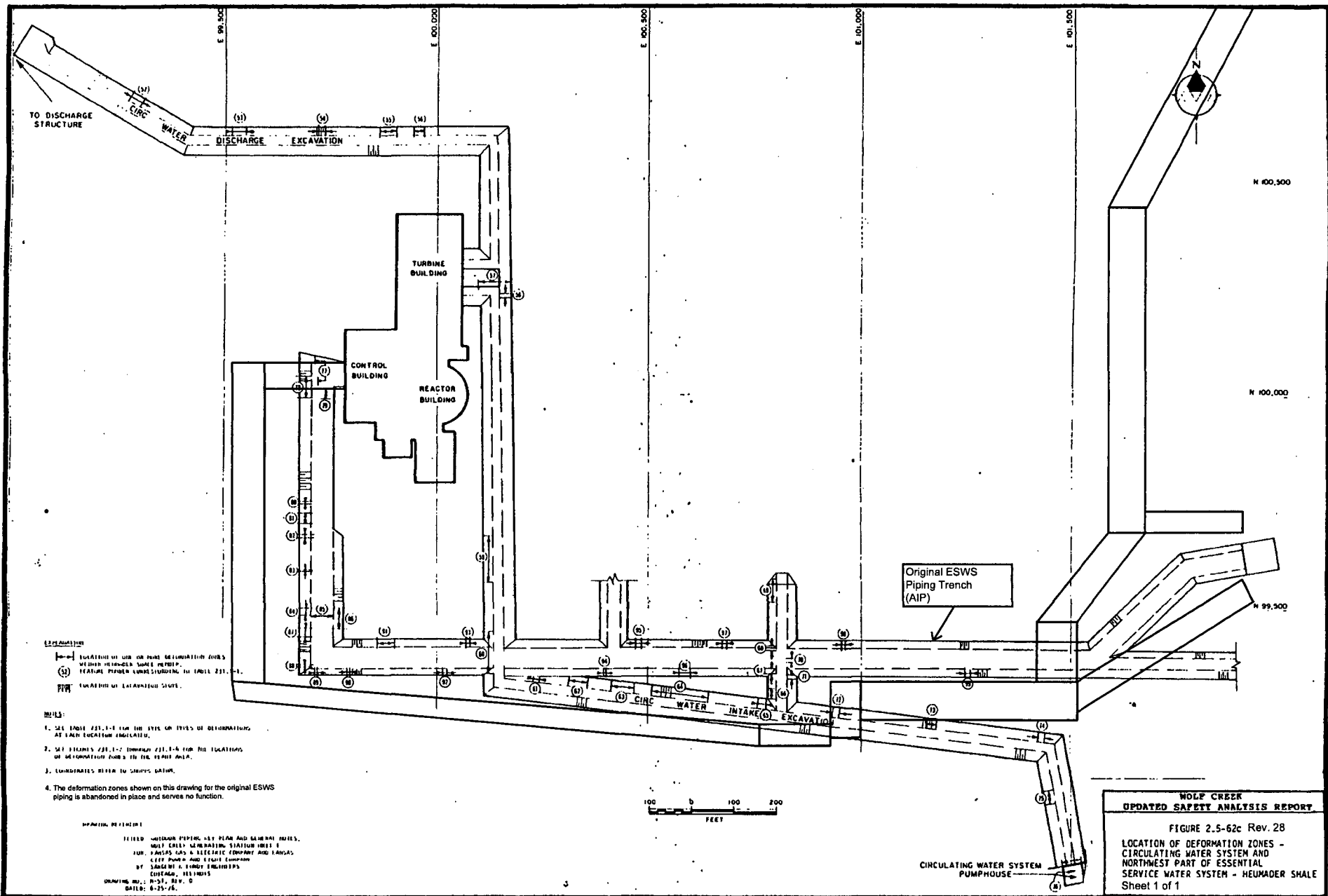

EXPLANATION

--- DEFORMATION ZONE OR POINT DEFORMATION ZONE
 --- WELDED HEAD-ON-CLASH POINTS
 --- FEATURE FROM PREVIOUS DRAWING IN FIGURE 2.5-1
 --- UNDESIRABLE EXCAVATION ZONE

- NOTES:**
1. SEE FIGURE 2.5-1 FOR THE TYPE OF DEFORMATION ZONE AT EACH LOCATION INDICATED.
 2. SEE FIGURES 2.5-1-5 THROUGH 2.5-1-9 FOR THE LOCATIONS OF DEFORMATION ZONES TO THE NORTH AREA.
 3. UNDESIRABLE ZONE IS SHOWN IN DASHES.
 4. The deformation zones shown on this drawing for the original ESWS piping is abandoned in place and serves no function.

REVISIONS:

REVISION NO. 1
 DATE: 6-25-76
 BY: [Name]
 CHECKED: [Name]
 DRAWING NO.: [Number]
 SHEET NO.: [Number]

**WOLF CREEK
 UPDATED SAFETY ANALYSIS REPORT**

FIGURE 2.5-62c Rev. 28

**LOCATION OF DEFORMATION ZONES -
 CIRCULATING WATER SYSTEM AND
 NORTHWEST PART OF ESSENTIAL
 SERVICE WATER SYSTEM - HEUMADER SHALE**

Sheet 1 of 1

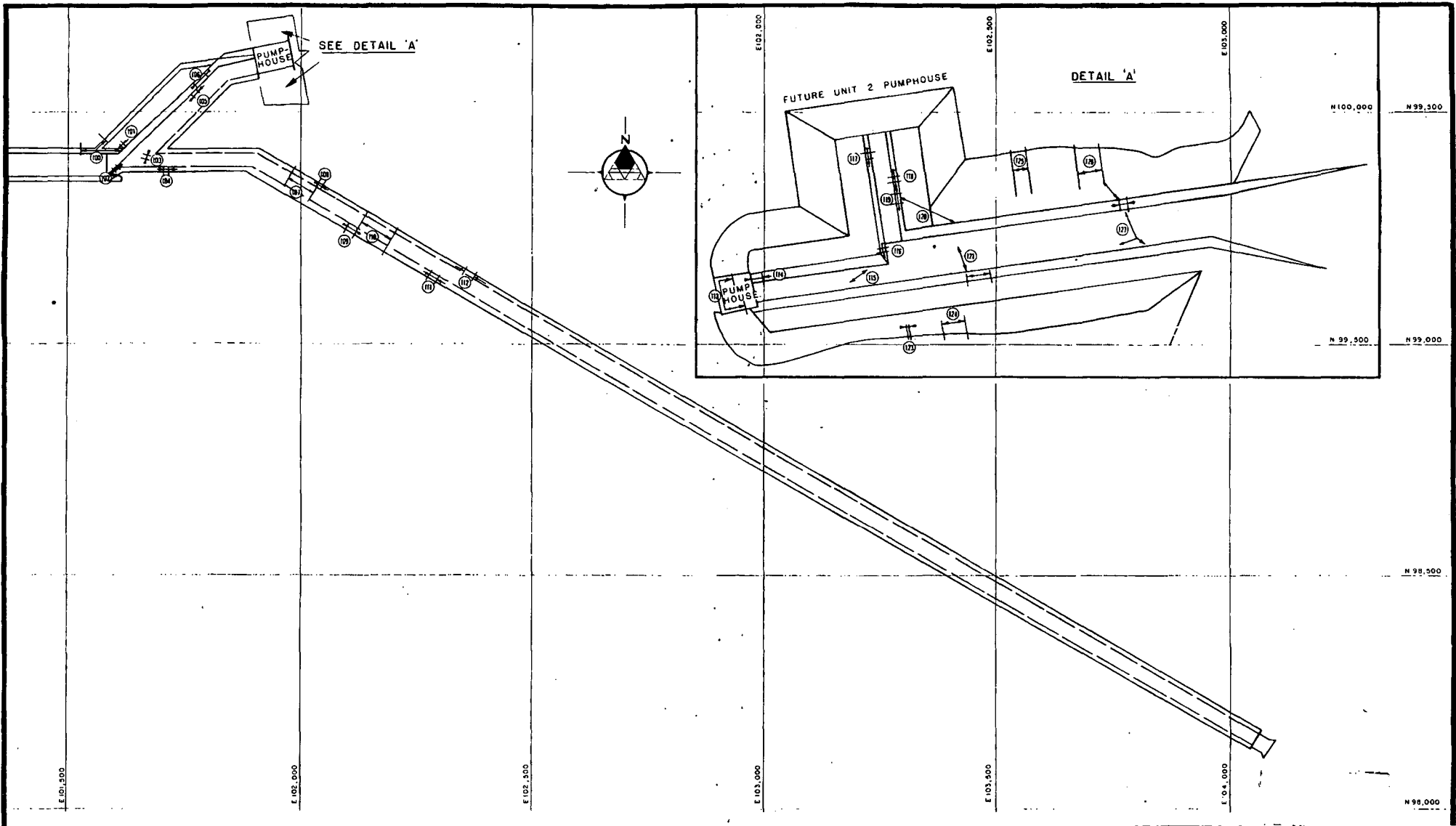

- NOTES:**
- SEE TABLE 231.1-1 FOR THE TYPE OR TYPES OF DEFORMATIONS AT EACH LOCATION INDICATED.
 - SEE FIGURES 231.1-2 THROUGH 231.1-4 FOR THE LOCATIONS OF DEFORMATION ZONES IN THE PLANT AREA.
 - COORDINATES REFER TO SHIPPS DATUM.
- The deformation zone shown on this data is the old ESWS pipeline which is abandoned in place and serves no function.



- EXPLANATION:**
- LOCATION OF ONE OR MORE DEFORMATION ZONES WITHIN HEADRiser SHALE MEMBER
 - FEATURE NUMBER CORRESPONDING TO TABLE 231.1-1.

DRAWING REFERENCE:

TITLE: YARD PIPELINES & ELECTRIC DUCT BANKS
 PLAN, SECTIONS & SCHEDULES, SHEET 2

FOR: K.G.L.E./K.C.P.C.L.
 BY: BECHTEL - SHIPPS

DRAWING NO.: S-81, REV. F
 DATED: 1-28-81

**WOLF CREEK
 UPDATED SAFETY ANALYSIS REPORT**

Figure 2.5-62d Rev. 28

Location of Deformation Zones -
 Southeast Part of Essential
 Service Water System - Heumader
 Shale Member

Sheet 1 of 1

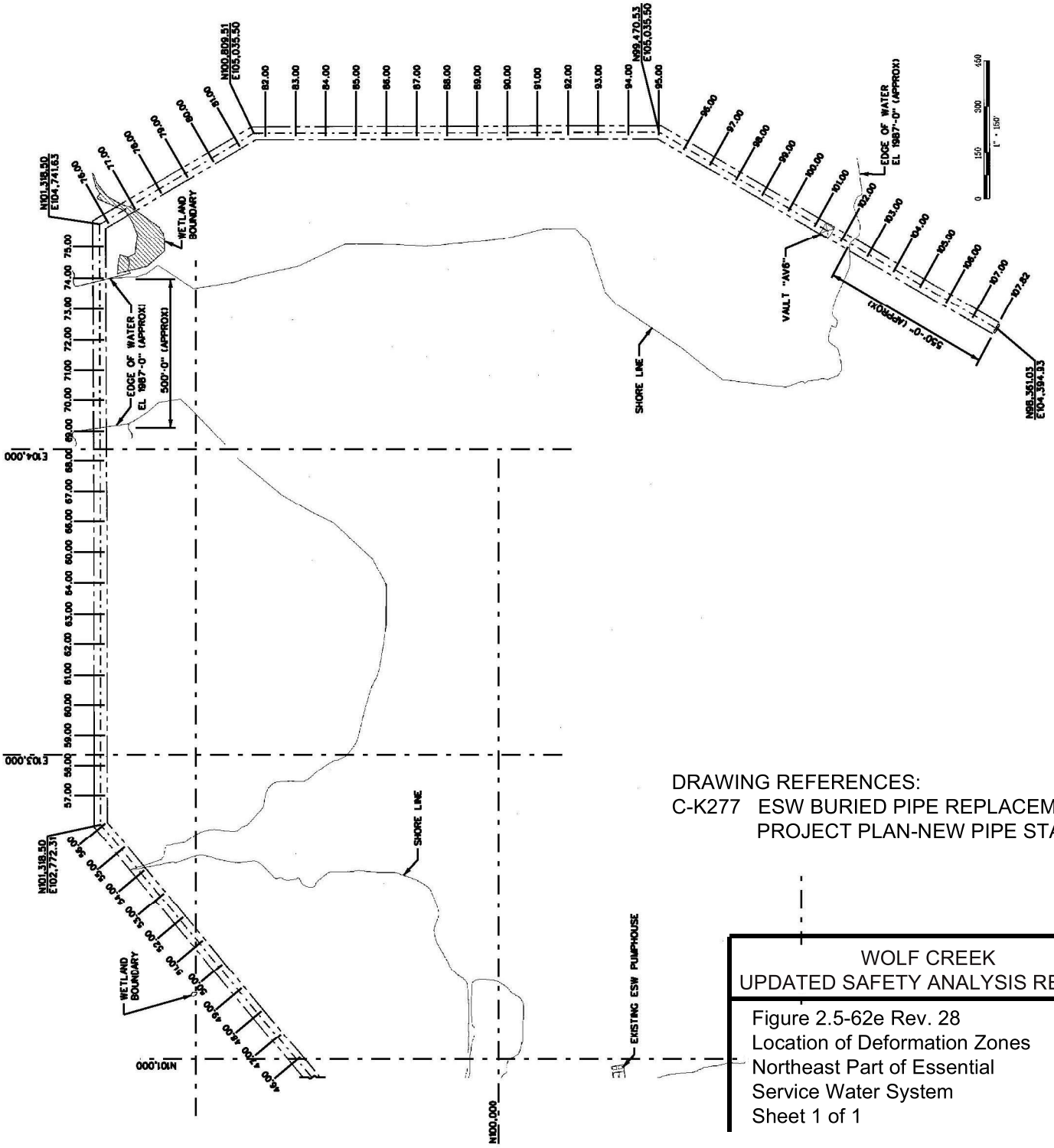

DRAWING REFERENCES:
 C-K277 ESW BURIED PIPE REPLACEMENT
 PROJECT PLAN-NEW PIPE STATION

WOLF CREEK
 UPDATED SAFETY ANALYSIS REPORT
 Figure 2.5-62e Rev. 28
 Location of Deformation Zones
 Northeast Part of Essential
 Service Water System
 Sheet 1 of 1

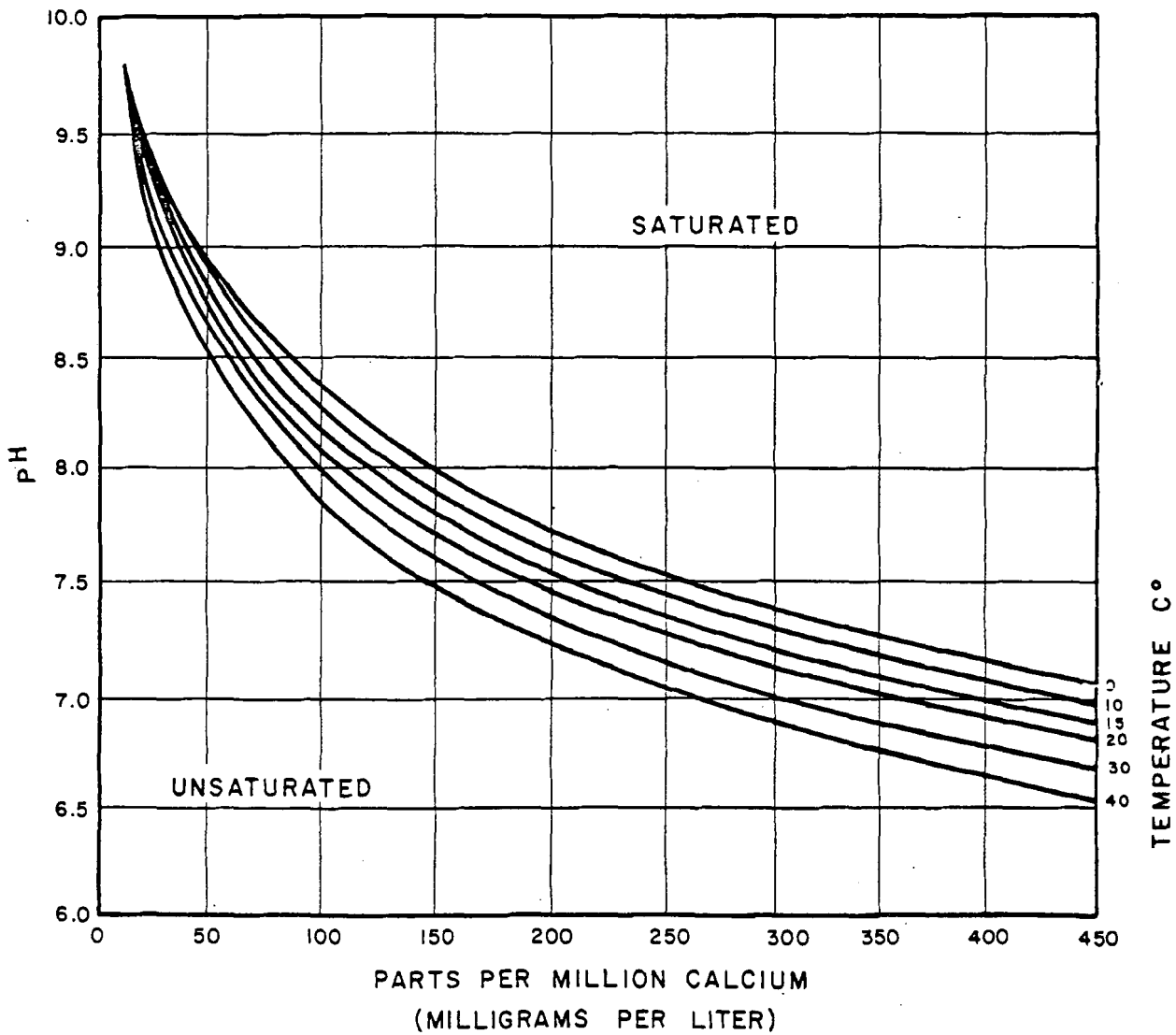

Rev. 0

**WOLF CREEK
UPDATED SAFETY ANALYSIS REPORT**

Figure 2.5-63

Calcium Solubility Curves

REFERENCE:

MODIFIED FROM SWEETING, M.M., 1966, "THE WEATHERING OF LIMESTONE, WITH PARTICULAR REFERENCE TO THE CARBONIFEROUS LIMESTONES OF NORTHERN ENGLAND IN DURY, G.H., ED., ESSAYS IN GEOMORPHOLOGY: AMERICAN ELSEVIER CO. INC., NEW YORK, P. 177-209.

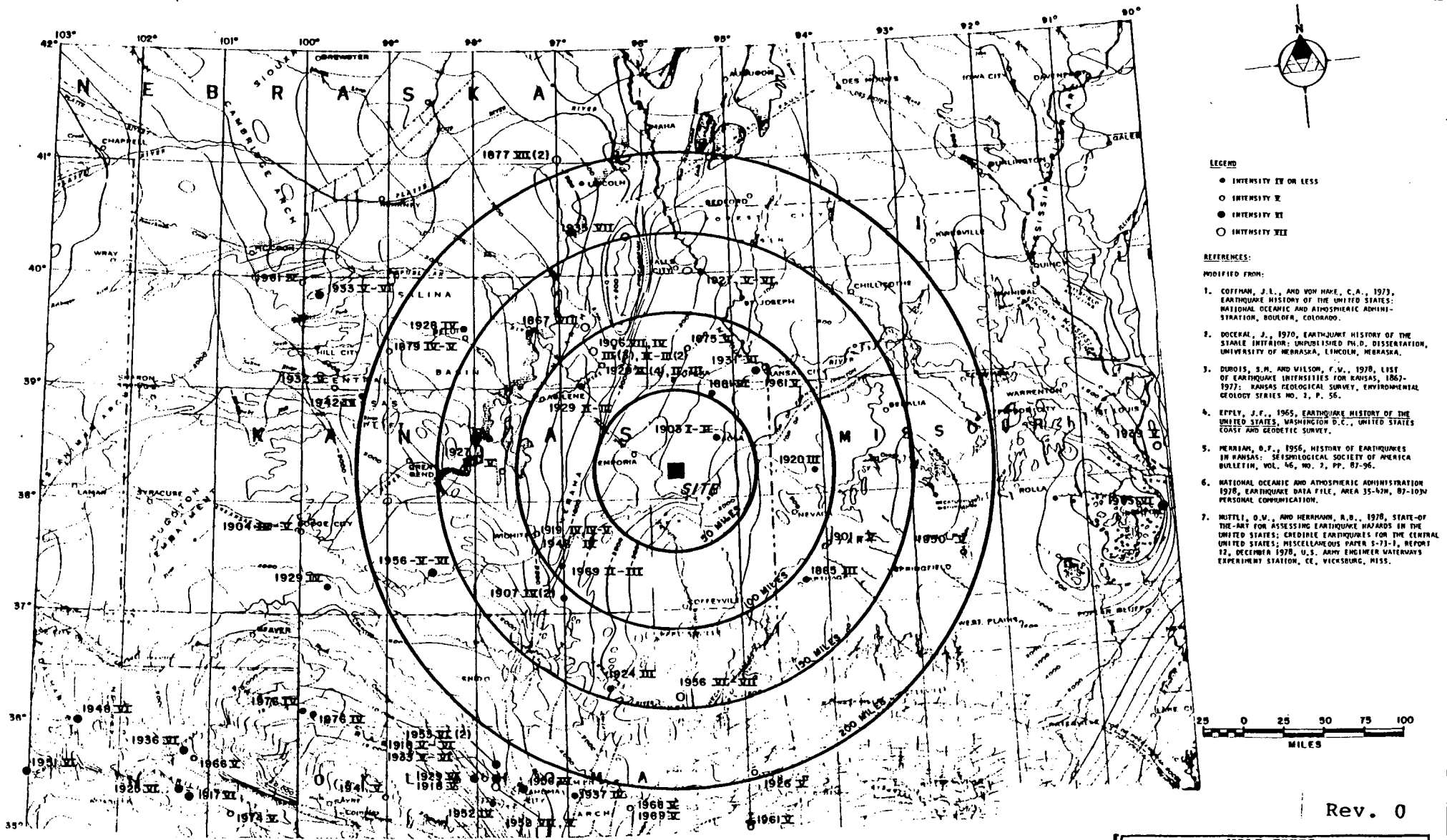

- LEGEND**
- INTENSITY IX OR LESS
 - INTENSITY X
 - INTENSITY XI
 - INTENSITY XII
- REFERENCES:**
- MODIFIED FROM:**
1. COFFMAN, J.L., AND VON HAKE, C.A., 1973, EARTHQUAKE HISTORY OF THE UNITED STATES: NATIONAL OCEANIC AND ATMOSPHERIC ADMINISTRATION, BOULDER, COLORADO.
 2. DOCKERT, J., 1970, EARTHQUAKE HISTORY OF THE STABLE INTERIOR: UNPUBLISHED Ph.D. DISSERTATION, UNIVERSITY OF NEBRASKA, LINCOLN, NEBRASKA.
 3. DUROIS, S.M. AND WILSON, F.V., 1978, LIST OF EARTHQUAKE INTENSITIES FOR KANSAS, 1862-1977: KANSAS GEOLOGICAL SURVEY, ENVIRONMENTAL GEOLOGY SERIES NO. 2, P. 56.
 4. EPPLEY, J.F., 1965, EARTHQUAKE HISTORY OF THE UNITED STATES, WASHINGTON D.C., UNITED STATES COAST AND GEODETIC SURVEY.
 5. MERRIAM, O.F., 1956, HISTORY OF EARTHQUAKES IN KANSAS: SEISMOLOGICAL SOCIETY OF AMERICA BULLETIN, VOL. 46, NO. 2, PP. 87-96.
 6. NATIONAL OCEANIC AND ATMOSPHERIC ADMINISTRATION 1978, EARTHQUAKE DATA FILE, AREA 35-42N, 87-103W PERSONAL COMMUNICATION.
 7. NUTTLI, O.V., AND HERRMANN, R.B., 1978, STATE-OF-THE-ART FOR ASSESSING EARTHQUAKE HAZARDS IN THE UNITED STATES: CADRELINE EARTHQUAKES FOR THE CENTRAL UNITED STATES; MISCELLANEOUS PAPER 5-73-1, REPORT 12, DECEMBER 1978, U.S. ARMY ENGINEER WATERWAYS EXPERIMENT STATION, CE, VICKSBURG, MISS.

Rev. 0

**WOLF CREEK
UPDATED SAFETY ANALYSIS REPORT**

Figure 2.5-64

Earthquake Intensity and
Epicenter Map

REFERENCE:
TECTONIC MAP OF THE UNITED STATES,
USGS AND AAPG, 1962.

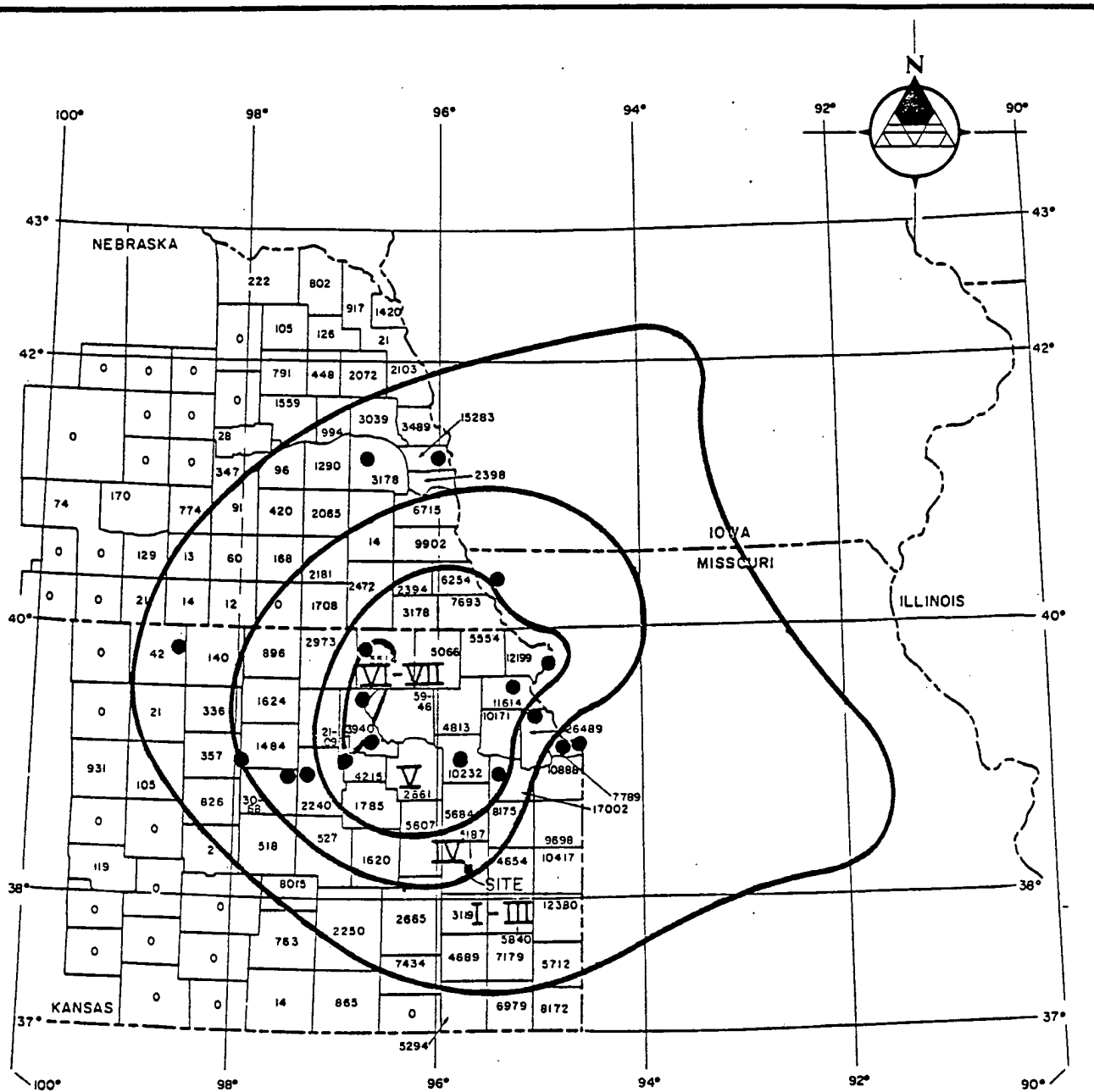

EXPLANATION:
 ● DATA POINT

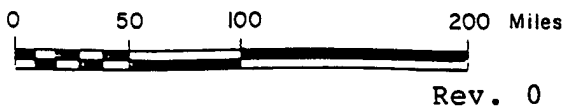

- NOTES:
1. MODIFIED MERICALLI INTENSITIES ASSIGNED BY J. DOCEKAL.
 2. SOURCE OF COUNTY POPULATION DATA-U.S. CENSUS OF 1860 AND 1870.

**WOLF CREEK
 UPDATED SAFETY ANALYSIS REPORT**

Figure 2.5-65

Docekal Isoseismal Map for 1867
 Manhattan, Kansas Earthquake

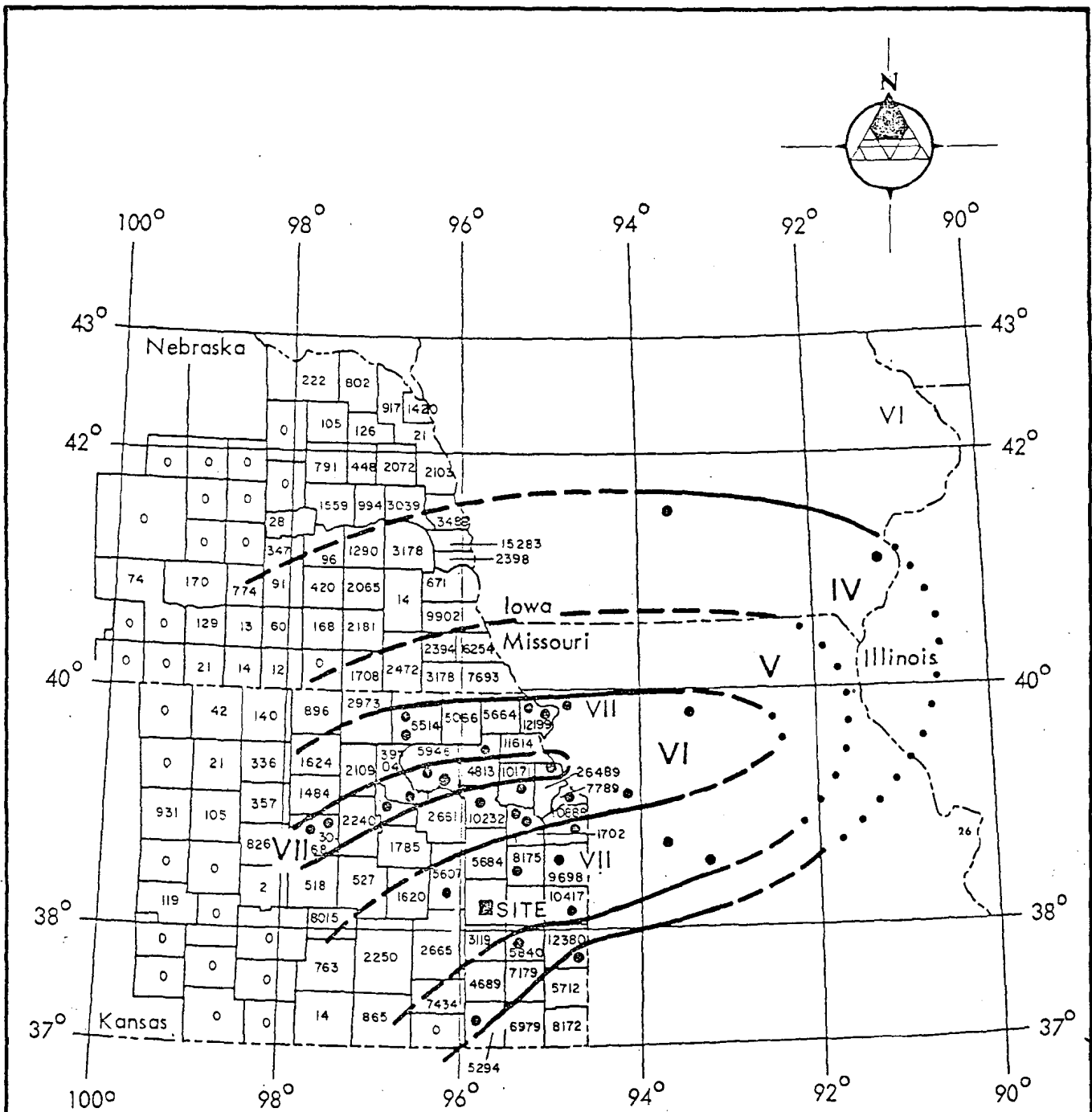

EXPLANATION
 ● DATA POINT

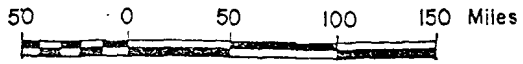

**WOLF CREEK
 UPDATED SAFETY ANALYSIS REPORT**

Figure 2.5-66

Dubois & Wilson Ioseismal Map
 for 1867 Manhattan (Wamego),
 Kansas Earthquake

Rev. 0

- NOTES:
1. MODIFIED MERCALLI INTENSITY ASSIGNED BY DUBOIS & WILSON; 1978.
 2. SOURCE OF COUNTY POPULATION DATA - US CENSUS OF 1860 AND 1870.

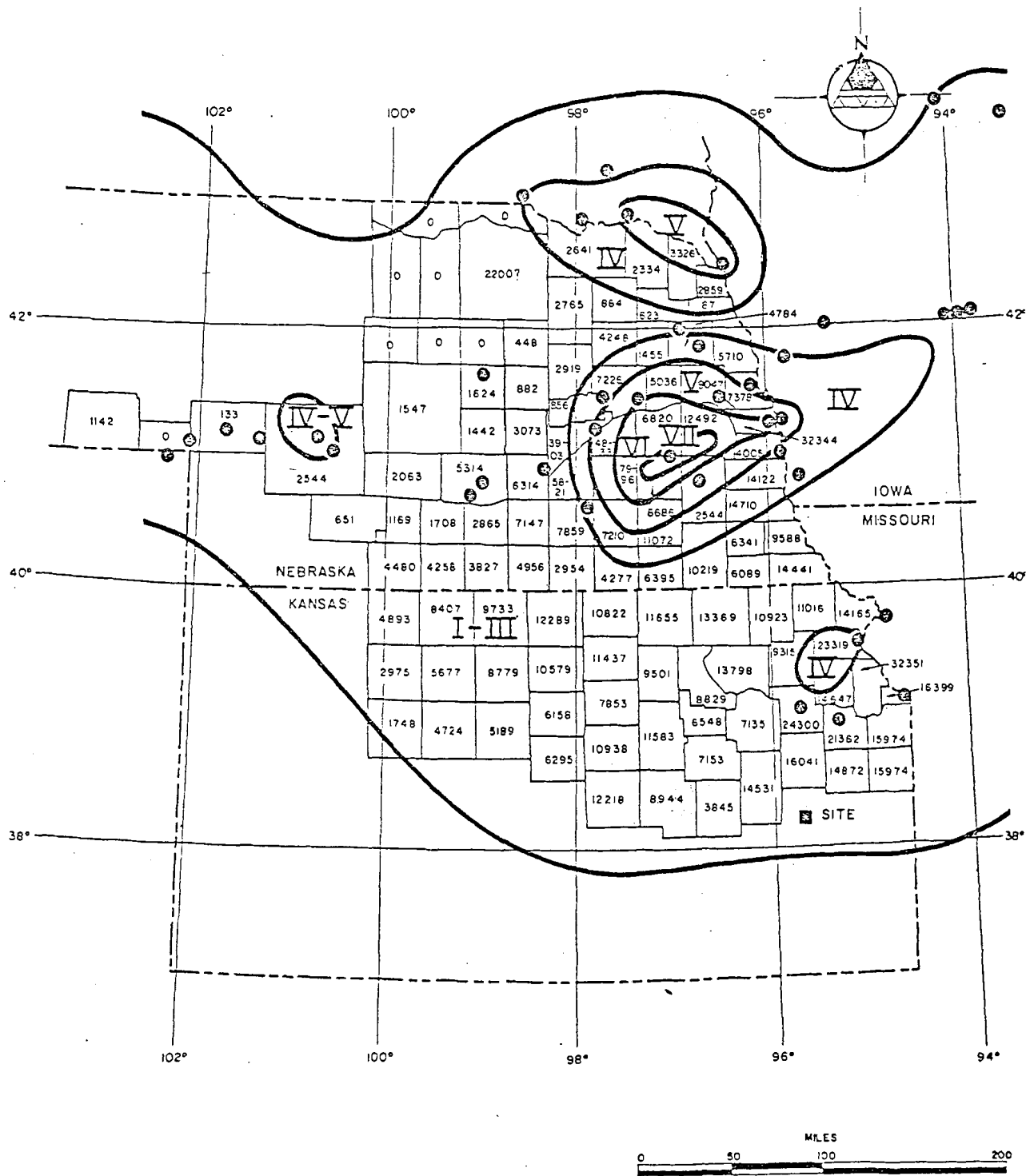

Rev. 0

**WOLF CREEK
UPDATED SAFETY ANALYSIS REPORT**

Figure 2.5-68

Isoseismal Map for 1877 Eastern
Nebraska Earthquake

EXPLANATION:

⊙ DATA POINT

NOTES:

1. MODIFIED MERICALLI INTENSITIES ASSIGNED BY J. DOCEKAL.
2. SOURCE OF COUNTY POPULATION DATA-U.S. CENSUS OF 1870 AND 1880.

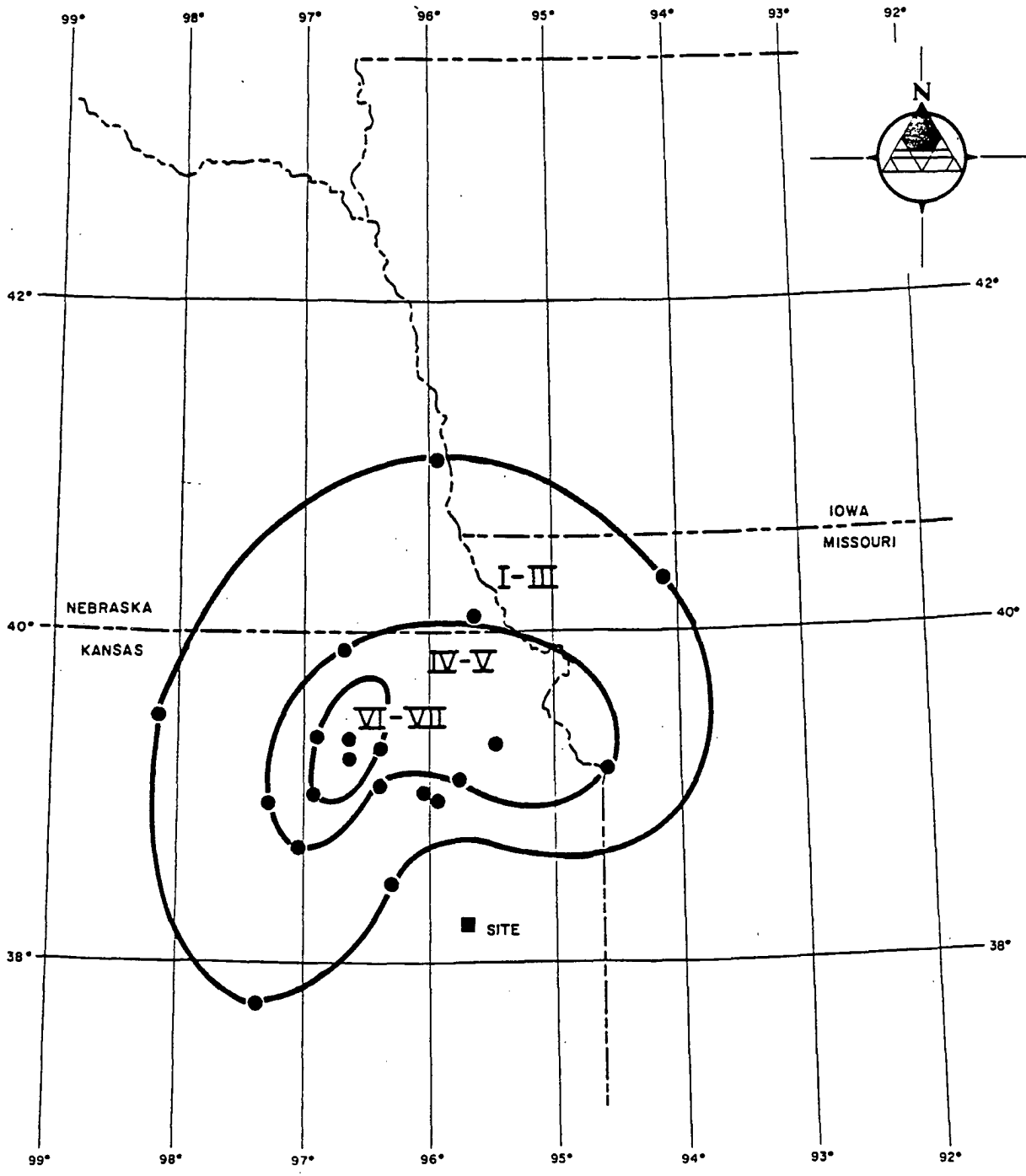

EXPLANATION
 ● DATA POINT

20 0 20 40 60 80 Miles
 Rev. 0

**WOLF CREEK
 UPDATED SAFETY ANALYSIS REPORT**

Figure 2.5-69

Docekal Iseismal Map for 1906
 Manhattan, Kansas Earthquake

NOTES:
 1. MODIFIED MERCALLI INTENSITY ASSIGNED
 BY J. DOCEKAL.

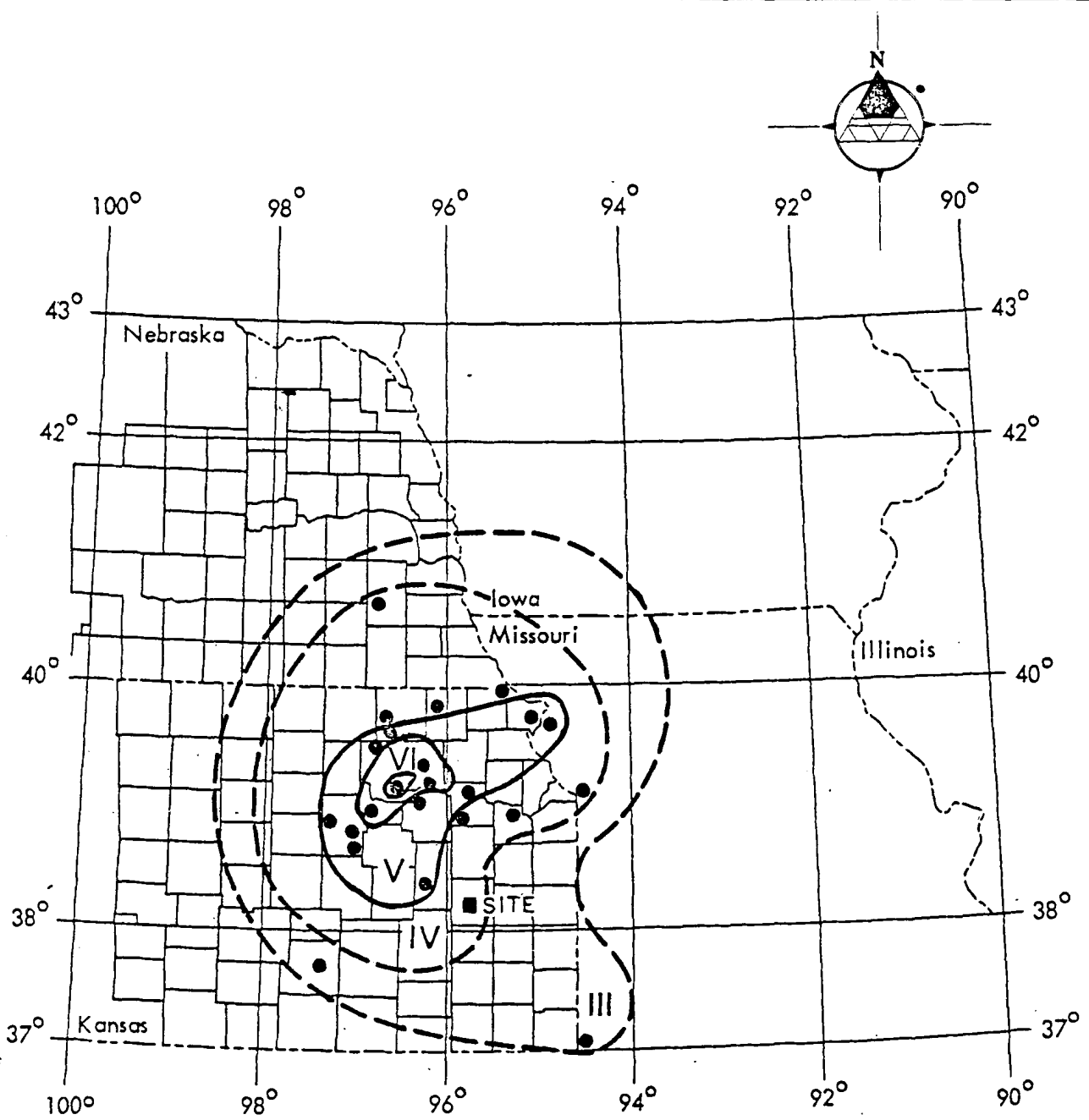

EXPLANATION
 ● DATA POINT

50 0 50 100 150 Miles

Rev. 0

**WOLF CREEK
 UPDATED SAFETY ANALYSIS REPORT**

Figure 2.5-70

Dubois & Wilson Ioseismal Map
 for 1906 Manhattan, Kansas
 Earthquake

NOTES:
 1. MODIFIED MERCALLI INTENSITY ASSIGNED
 BY DUBOIS & WILSON; 1978.

Wolf Creek

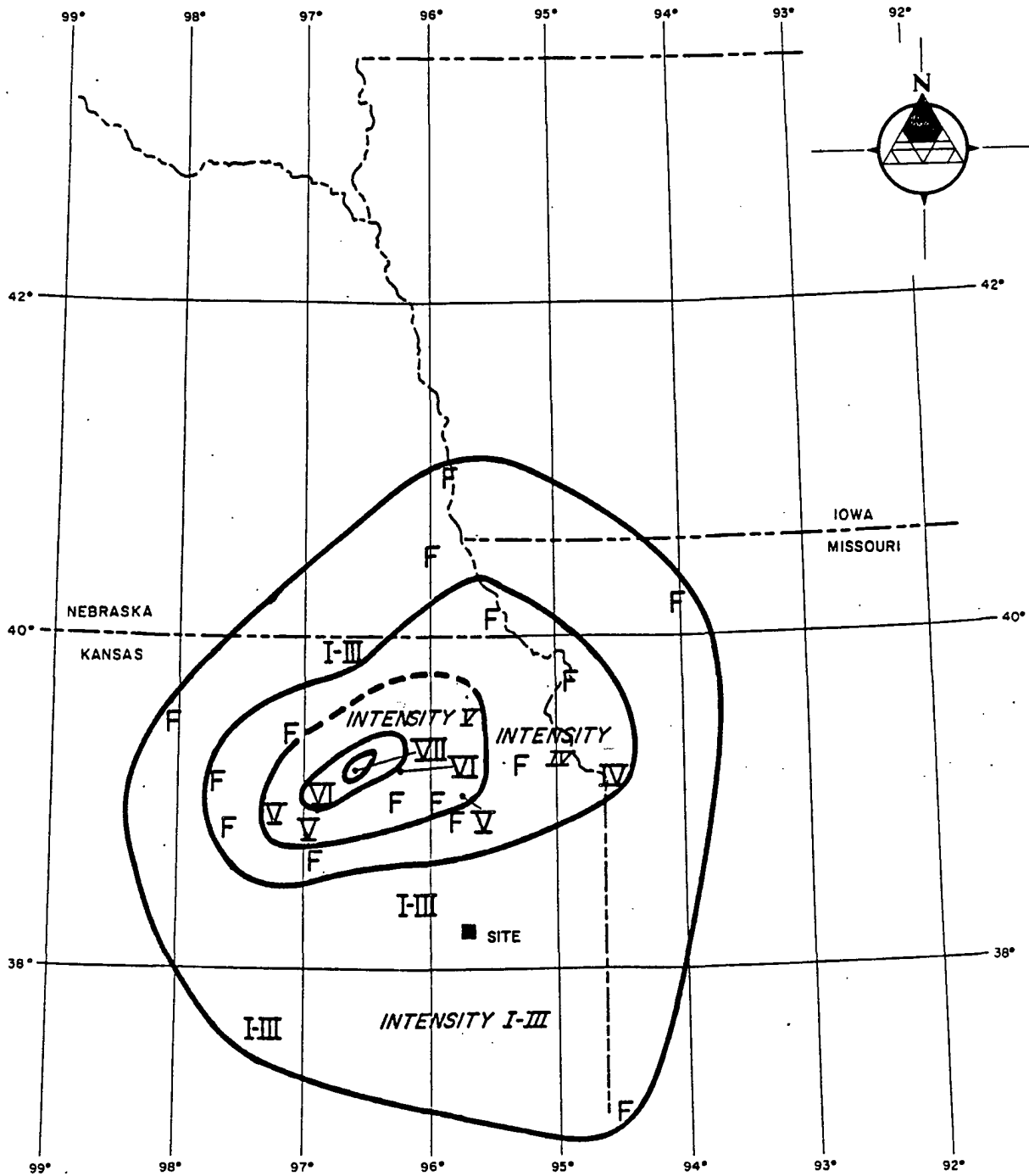

EXPLANATION:

F EARTHQUAKE FELT-INTENSITY UNKNOWN

NOTES:

1. MODIFIED MERCALLI INTENSITIES ASSIGNED BY DAMES AND MOORE.
2. DATA LISTED IN TABLE 2.5-23.

**WOLF CREEK
UPDATED SAFETY ANALYSIS REPORT**

FIGURE 2.5-71

DAMES & MOORE ISOSEISMAL MAP FOR
1906 MANHATTAN, KANSAS EARTHQUAKE

Rev. 0

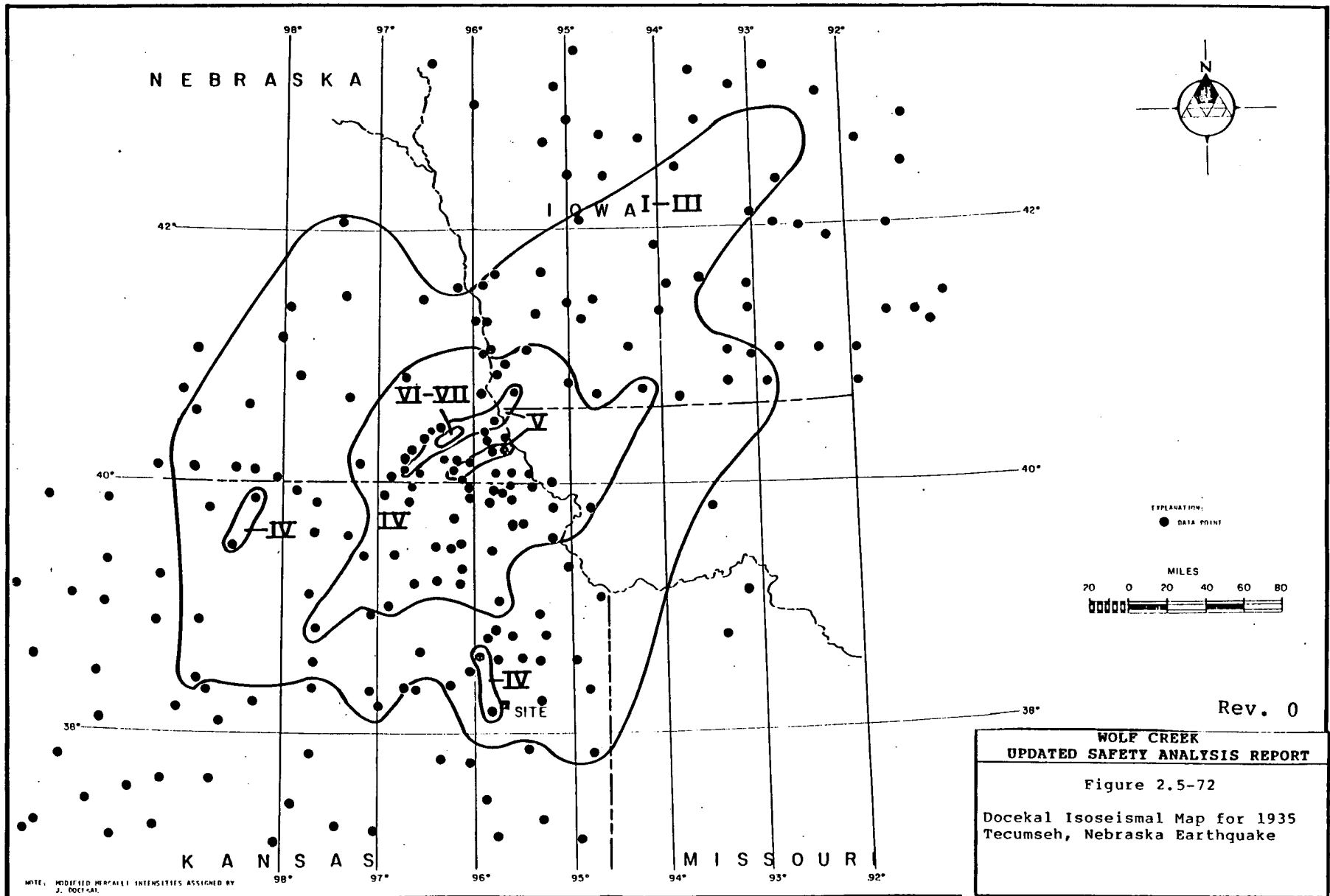

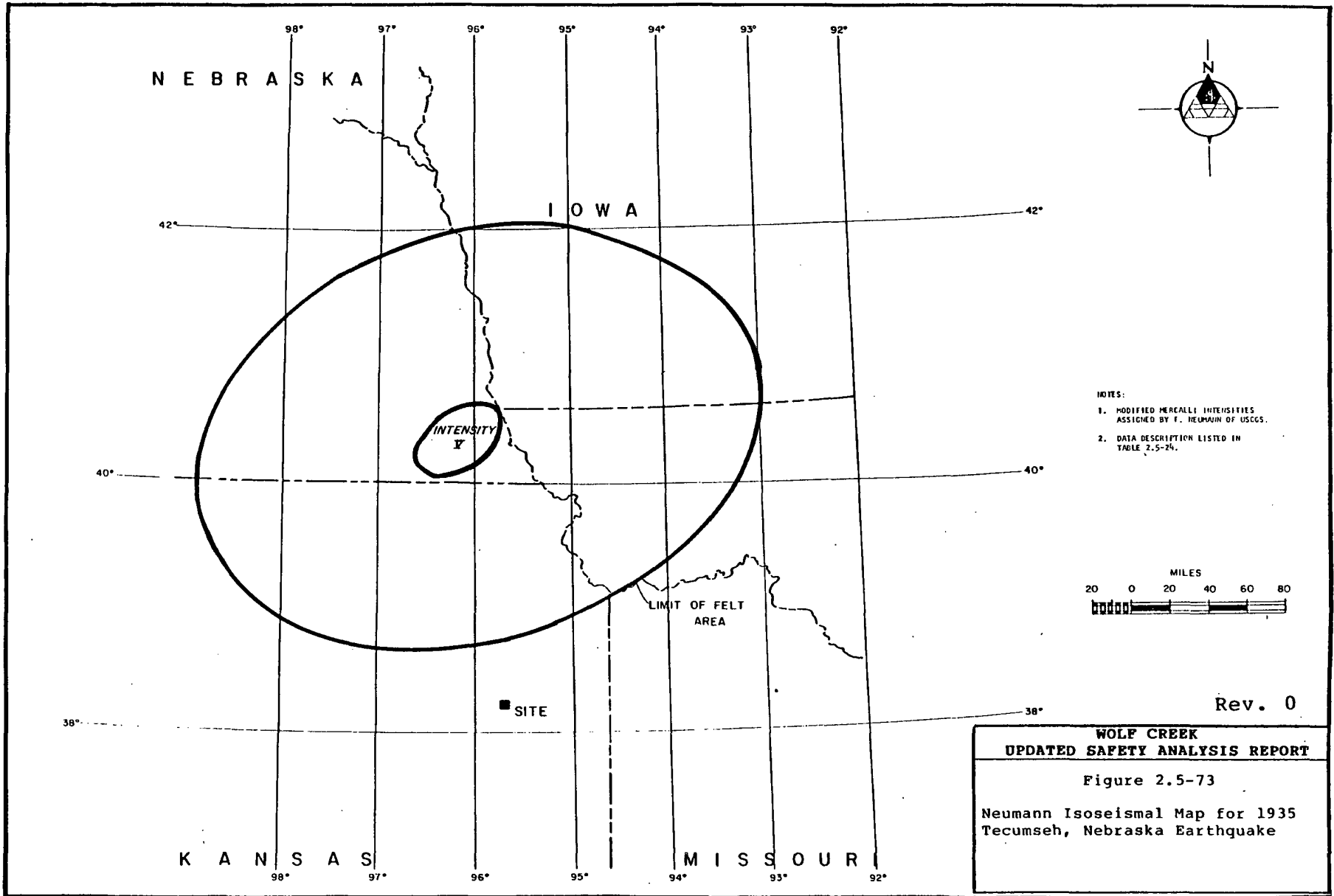

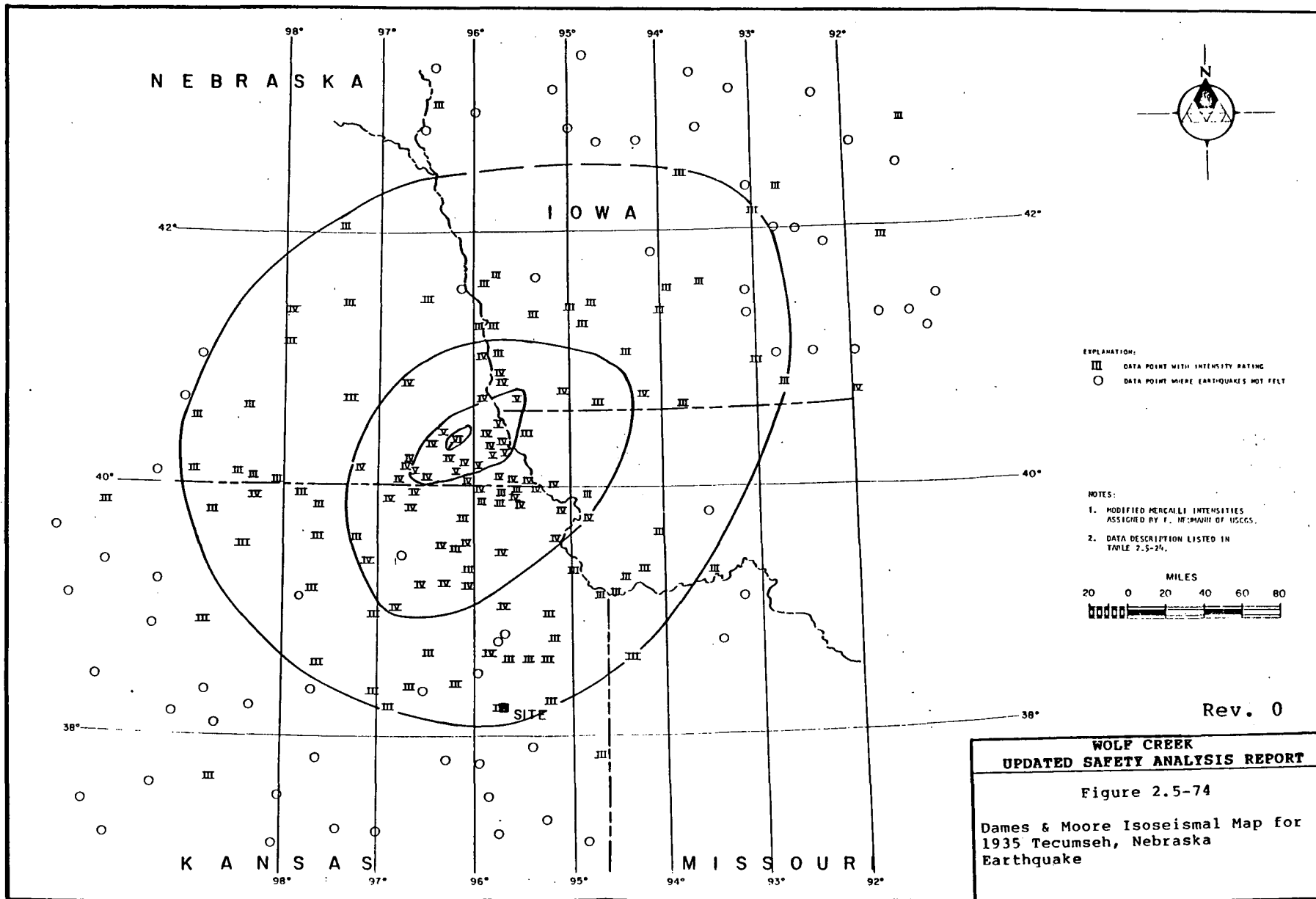

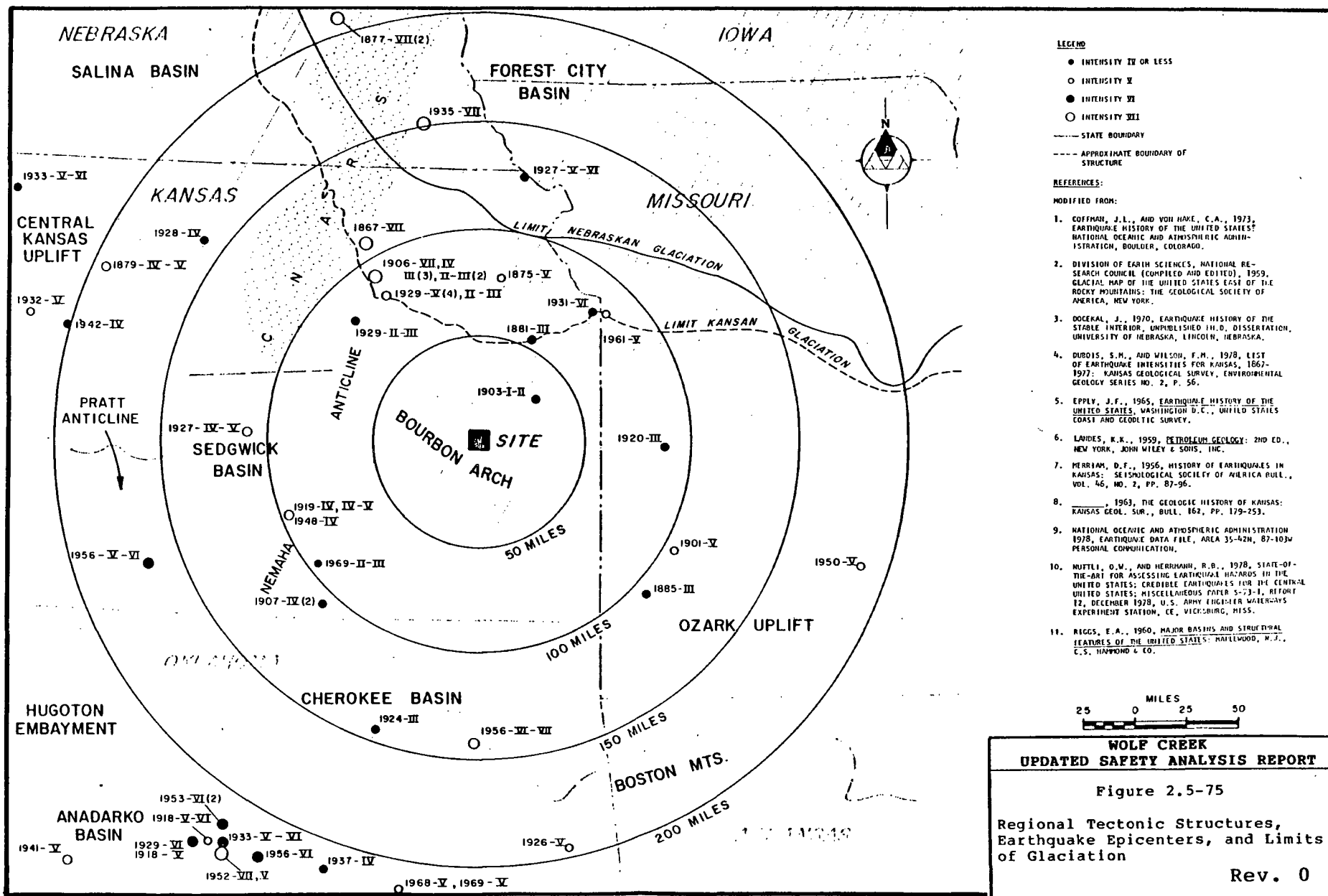

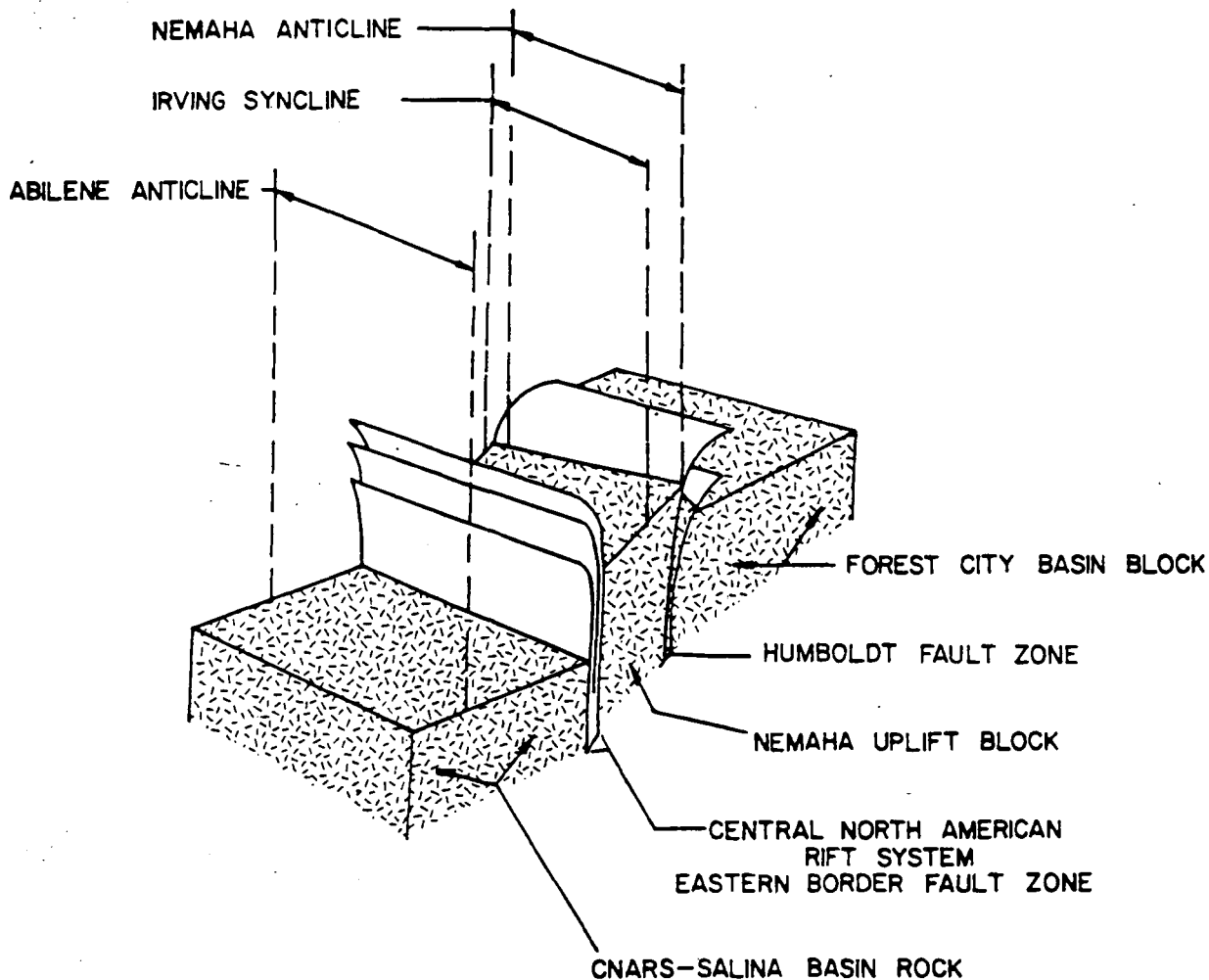

NOTE:
 THE NEMAHA AND ABILENE ANTICLINES AND THE IRVING SYNCLINE ARE EXPRESSED ON THE CONFIGURATION OF THE PRECAMBRIAN SURFACE AND IN THE OVERLYING SEDIMENTS (SECTION 2.5.1.1.5.1.15)

Rev. 0

MODIFIED FROM:

SYLVESTER, A.G., AND SMITH, R.R., 1976, TECTONIC TRANSPRESSION AND BASEMENT-CONTROLLED DEFORMATION IN SAN ANDREAS FAULT ZONE, SALTON TROUGH, CALIF.: AMERICAN ASSOC. PETROLEUM GEOL. BULL., VOL. 60, NO. 12, PP. 2081-2102, FIG. 6.

**WOLF CREEK
 UPDATED SAFETY ANALYSIS REPORT**

Figure 2.5-76

Idealized Block Diagram of
 Basement and Principal Faults in
 Central Kansas

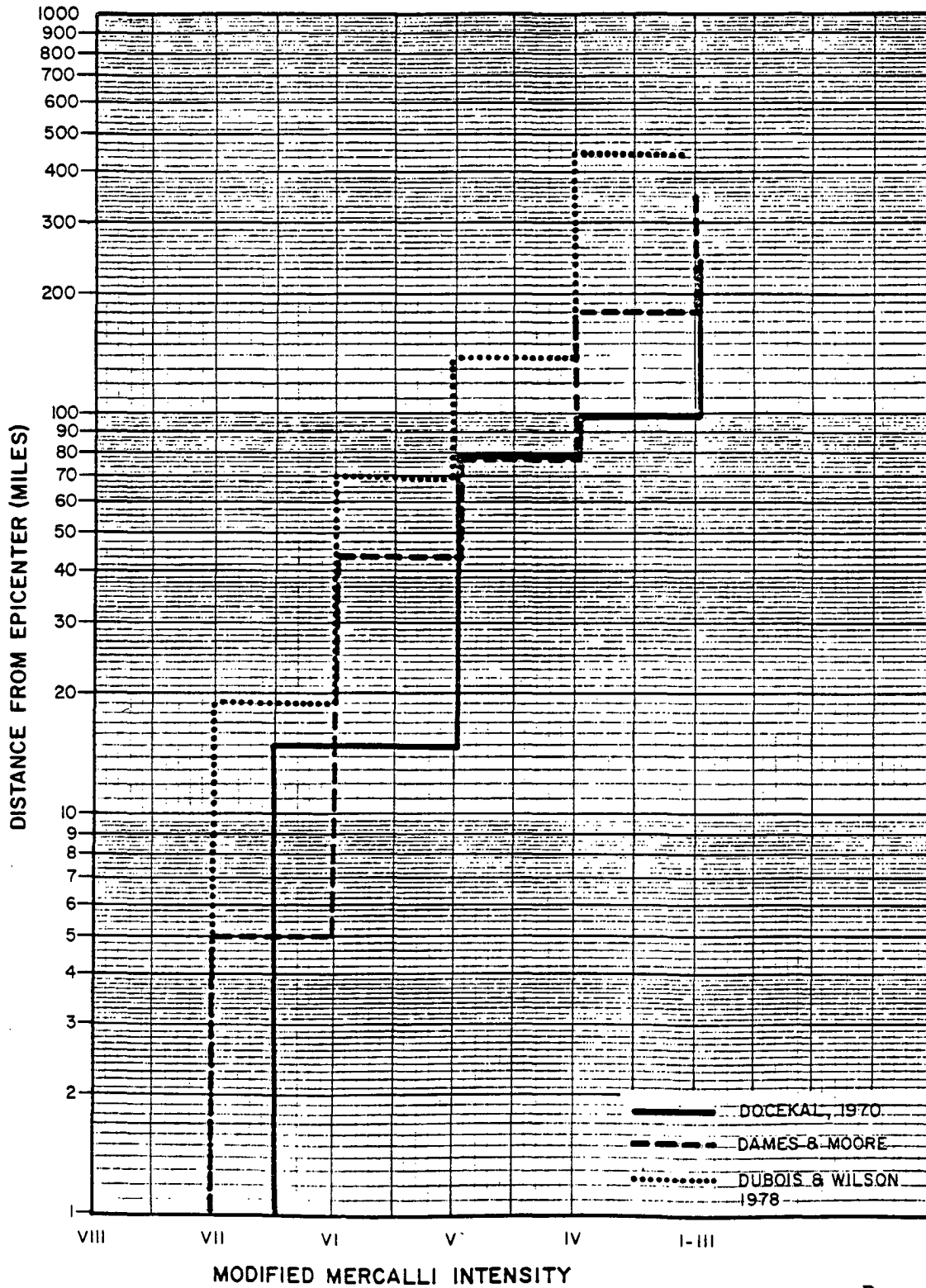

Rev. 0

**WOLF CREEK
UPDATED SAFETY ANALYSIS REPORT**

Figure 2.5-77

Attenuation Curves for 1867
Manhattan, Kansas Earthquake

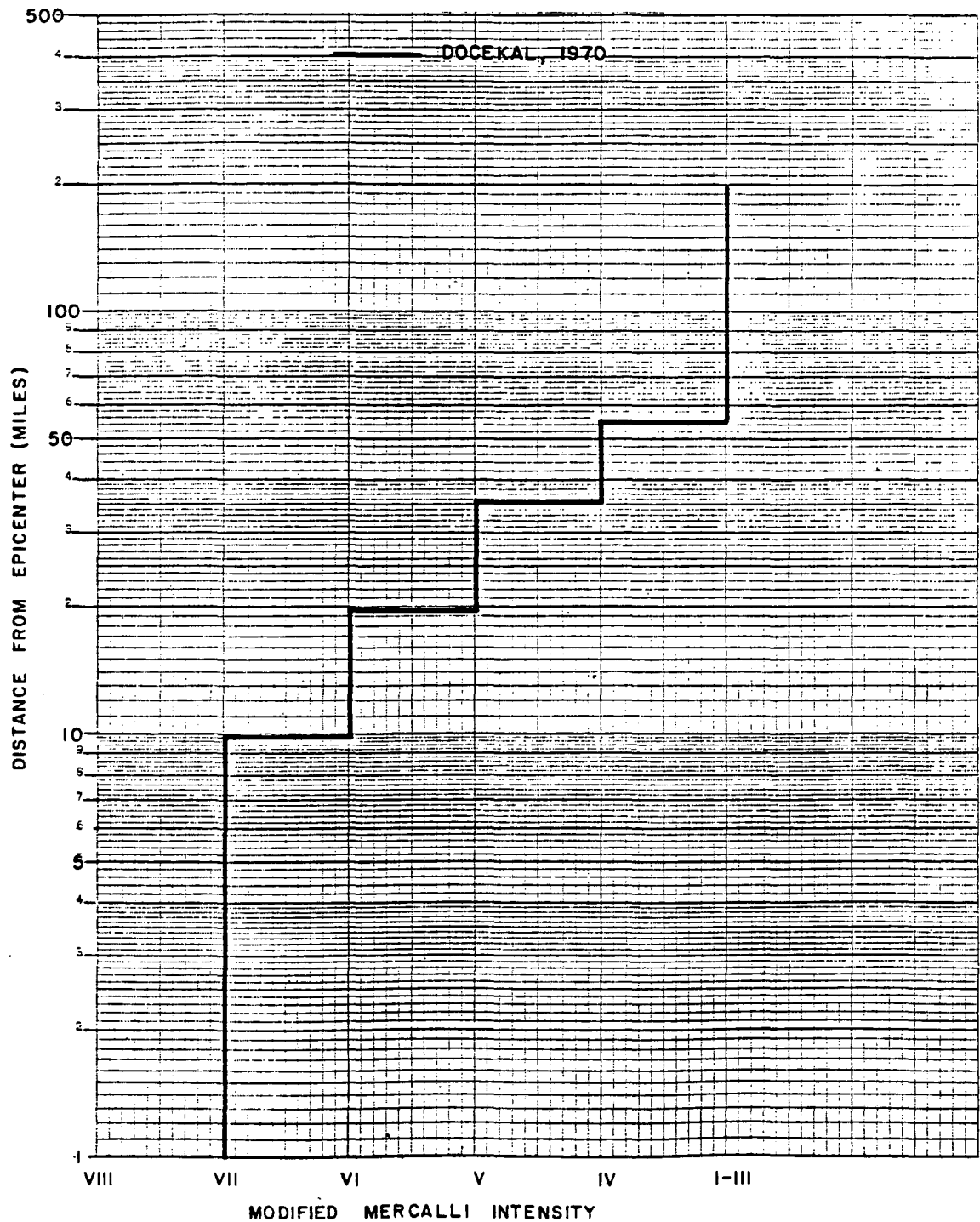

Rev. 0

**WOLF CREEK
 UPDATED SAFETY ANALYSIS REPORT**

Figure 2.5-78

Attenuation Curve for 1877
 Eastern Nebraska Earthquake

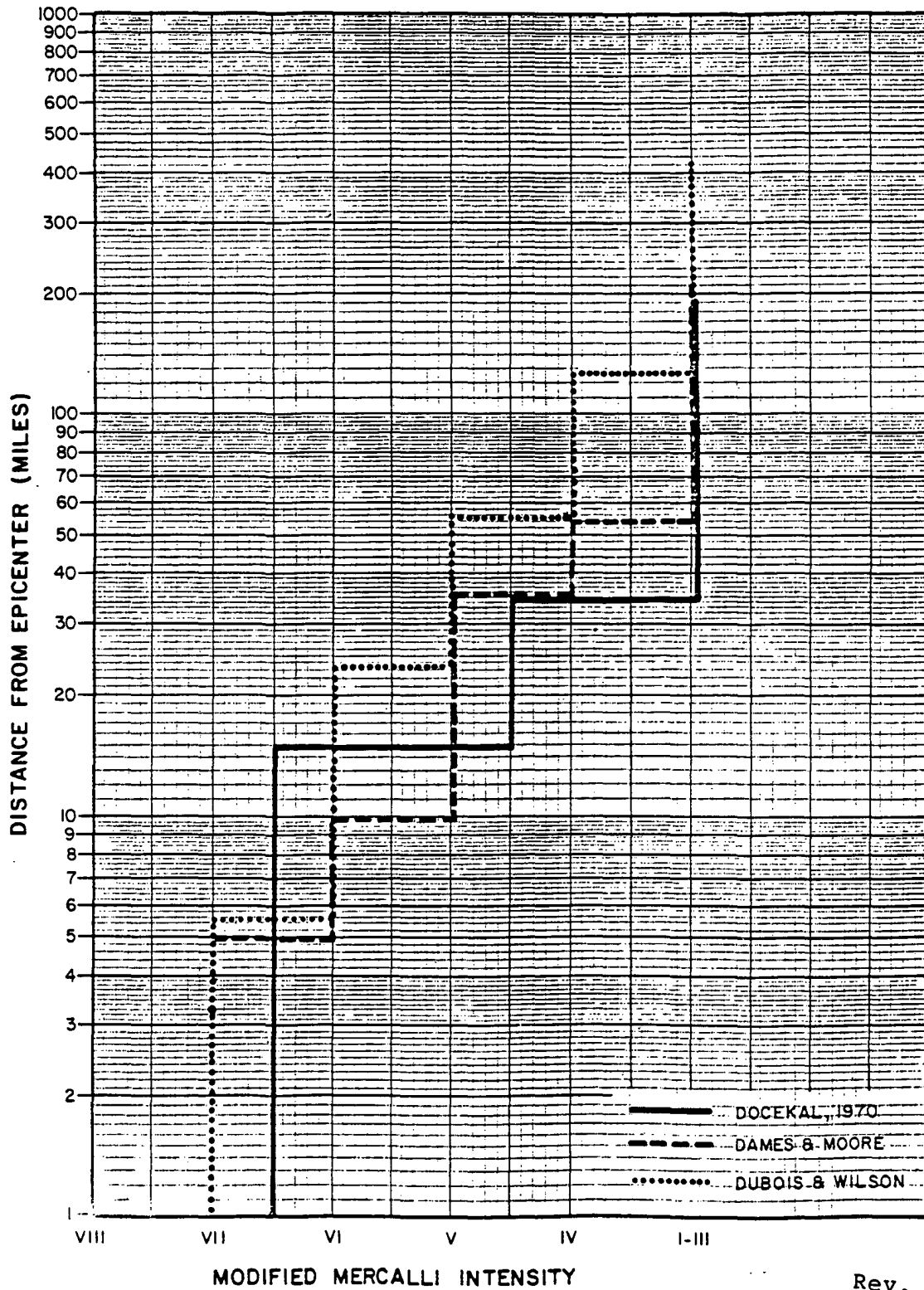

Rev. 0

**WOLF CREEK
UPDATED SAFETY ANALYSIS REPORT**

Figure 2.5-79

Attenuation Curves for 1906
Manhattan, Kansas Earthquake

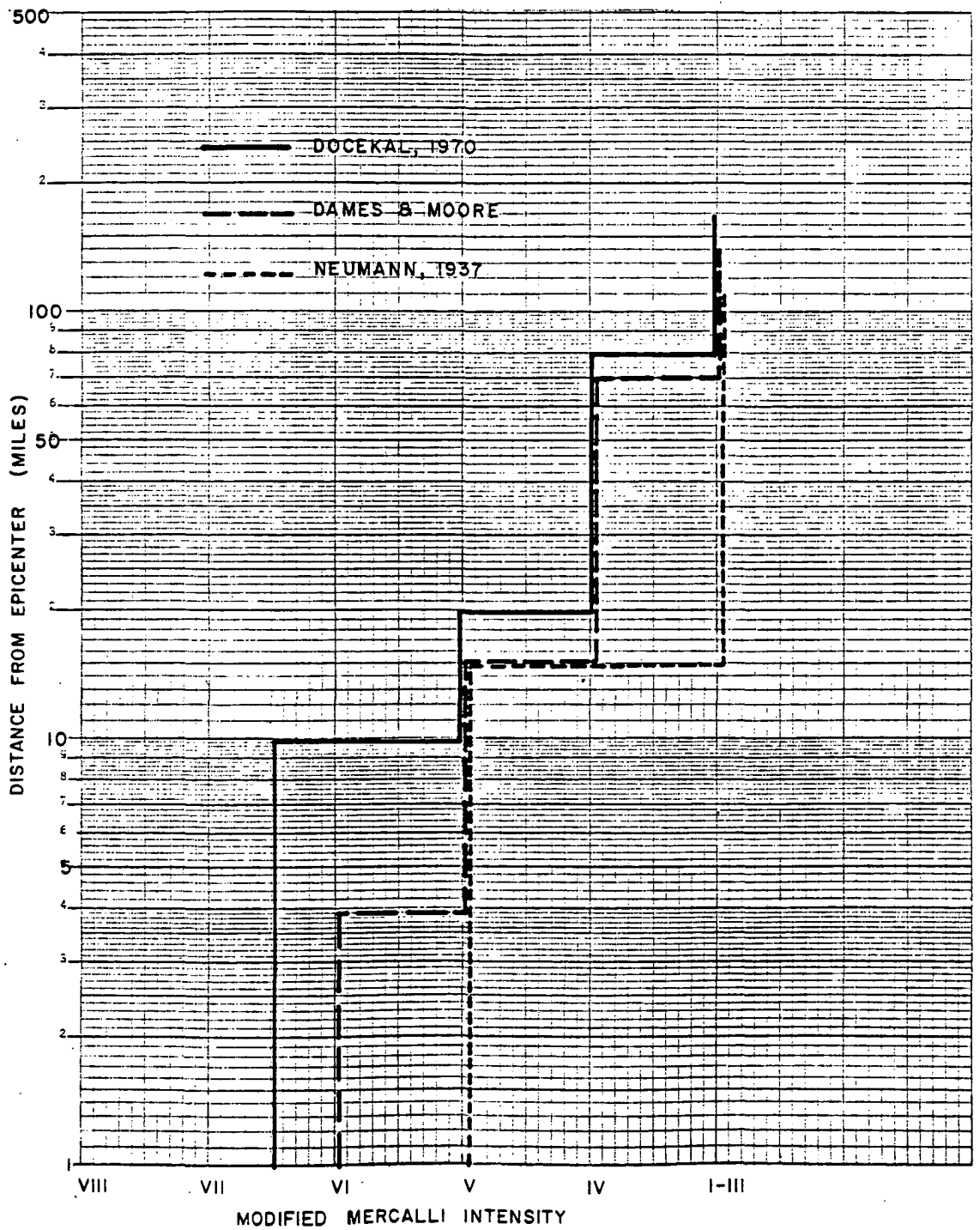

Rev. 0

**WOLF CREEK
UPDATED SAFETY ANALYSIS REPORT**

Figure 2.5-80

Attenuation Curves for 1935
Tecumseh, Nebraska Earthquake

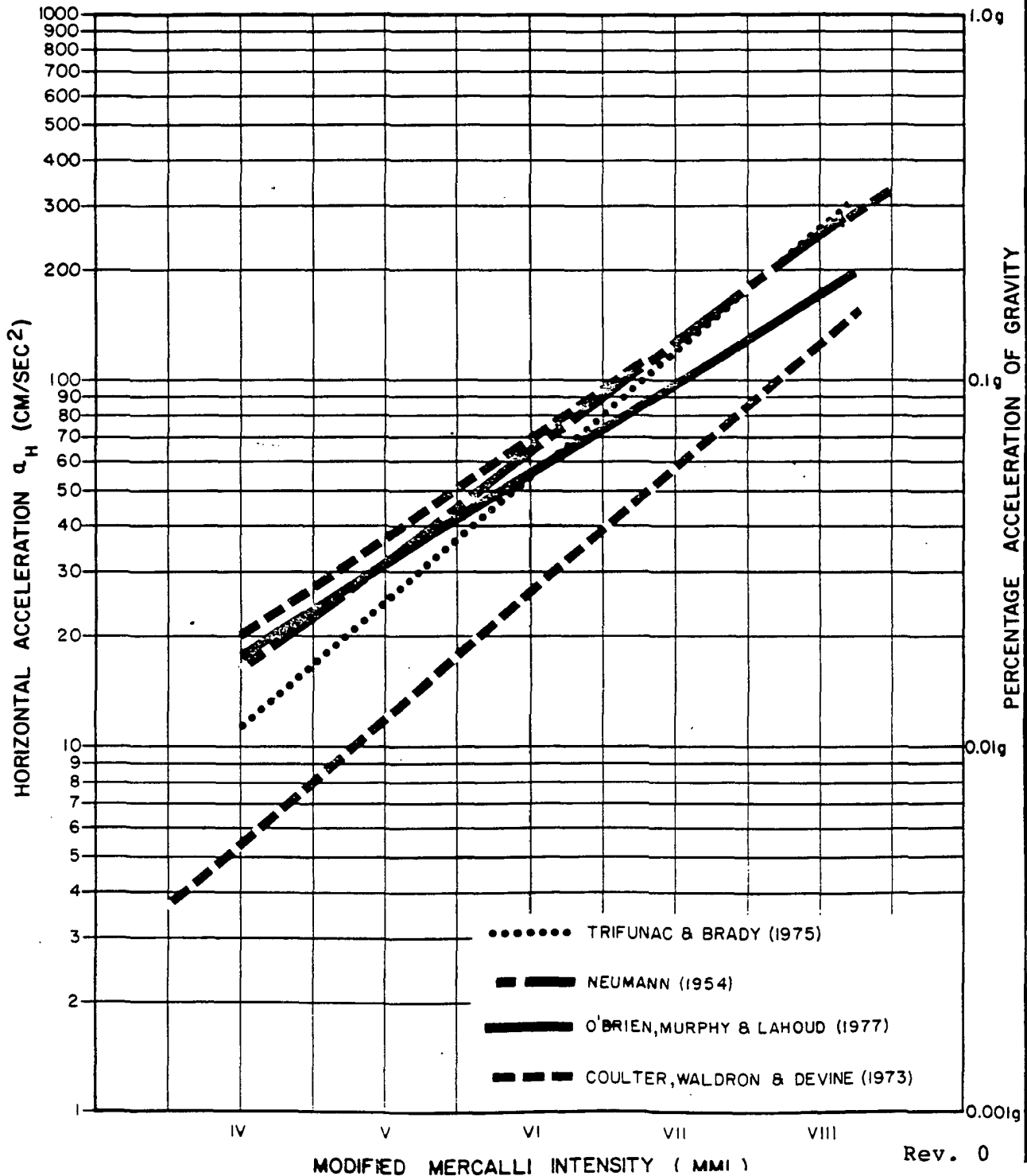

REFERENCES:

Coulter, H.W. Waldron, H.H. and Devine, J.F., 1973, Seismic and design considerations for nuclear facilities in Proceedings of the fifth world conference on earthquake engineering: Rome, Italy, Paper no. 302.

Neumann, F., 1954, Earthquake intensity and related ground motion: University of Washington Press, Seattle, Washington.

O'Brien L.J., Murphy, J.R. and Lahoud, J.A., 1977, The correlation of peak ground acceleration amplitude with seismic intensity and other physical parameters, Computer Sciences Corporation, Falls Church, Virginia.

Trifunac, M.A. and Brady, A.G., 1975, On the correlation of seismic intensity scales with peaks of recorded strong ground motion: Bulletin of the Seismological Society of America, Vol. 66, p. 139-162.

**WOLF CREEK
UPDATED SAFETY ANALYSIS REPORT**

Figure 2.5-81

Epical Earthquake Intensity
vs Horizontal Acceleration

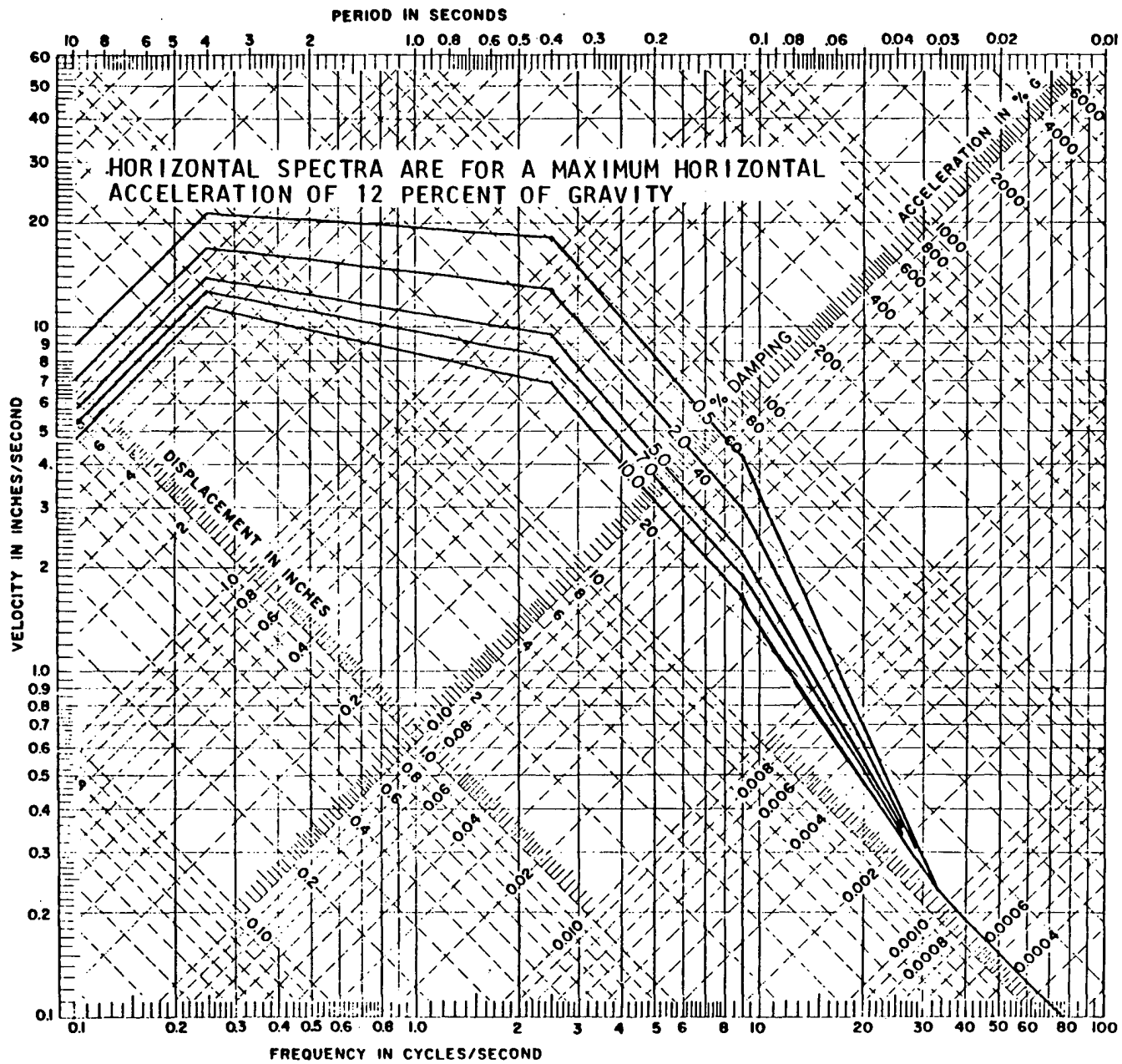

Horizontal Response Spectra Safe
Shutdown Earthquake

Figure 2.5-82

WOLF CREEK
UPDATED SAFETY ANALYSIS REPORT

Rev. 0

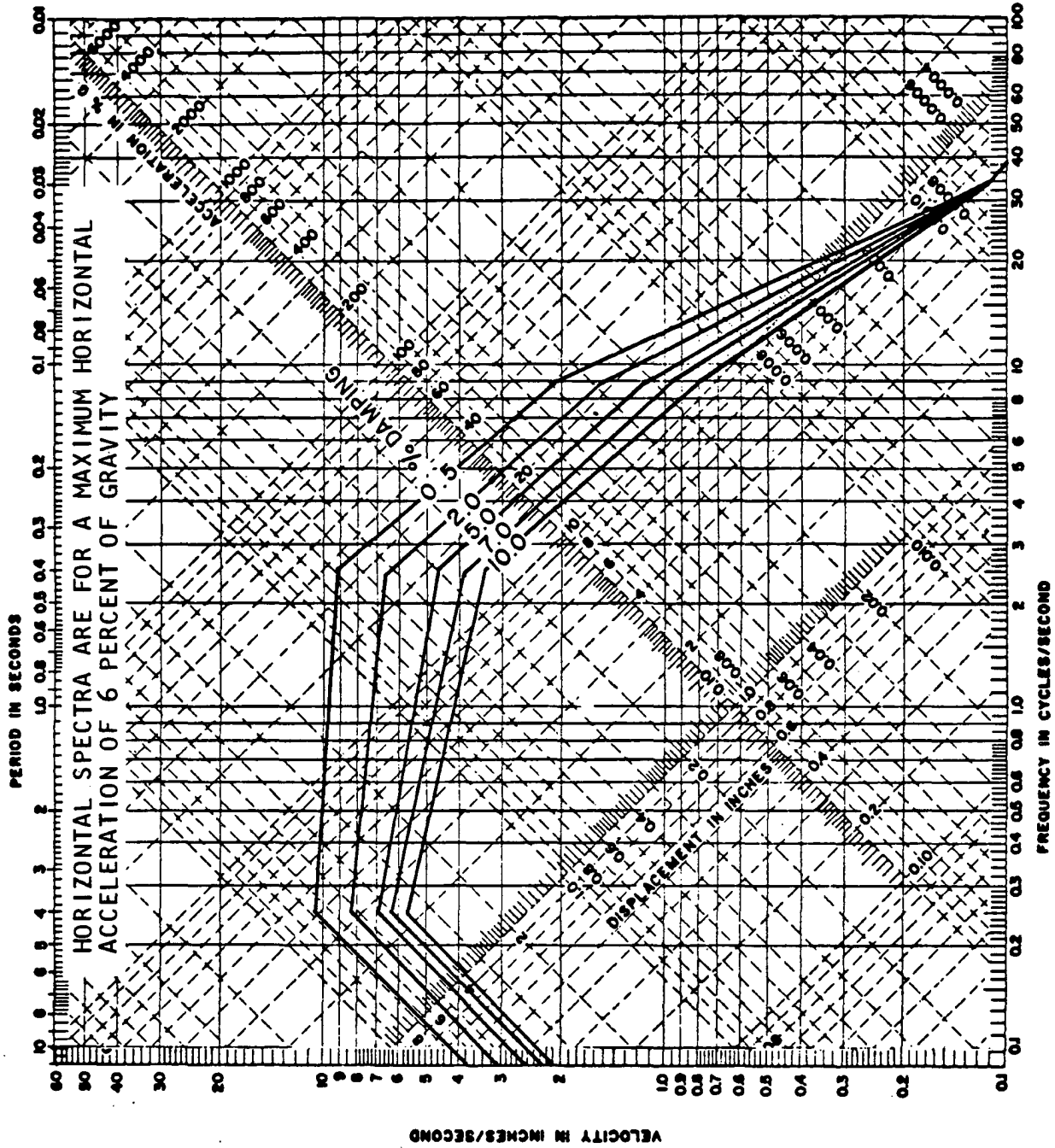

Rev. 0

**WOLF CREEK
UPDATED SAFETY ANALYSIS REPORT**

Figure 2.5-83
Horizontal Response Spectra
Operating Basis Earthquake

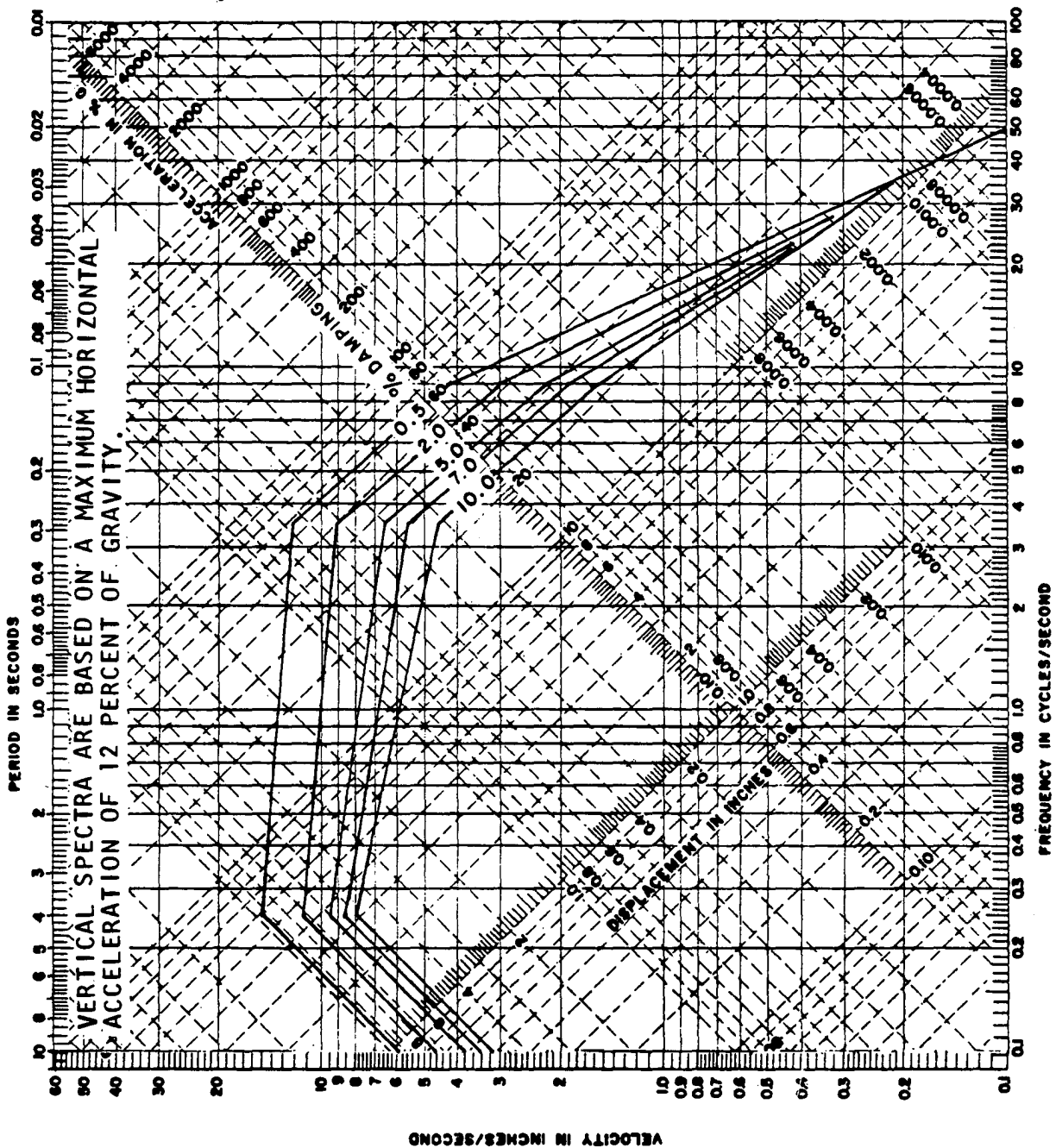

Rev. 0

**WOLF CREEK
UPDATED SAFETY ANALYSIS REPORT**

Figure 2.5-84

Vertical Response Spectra, Safe Shutdown Earthquake

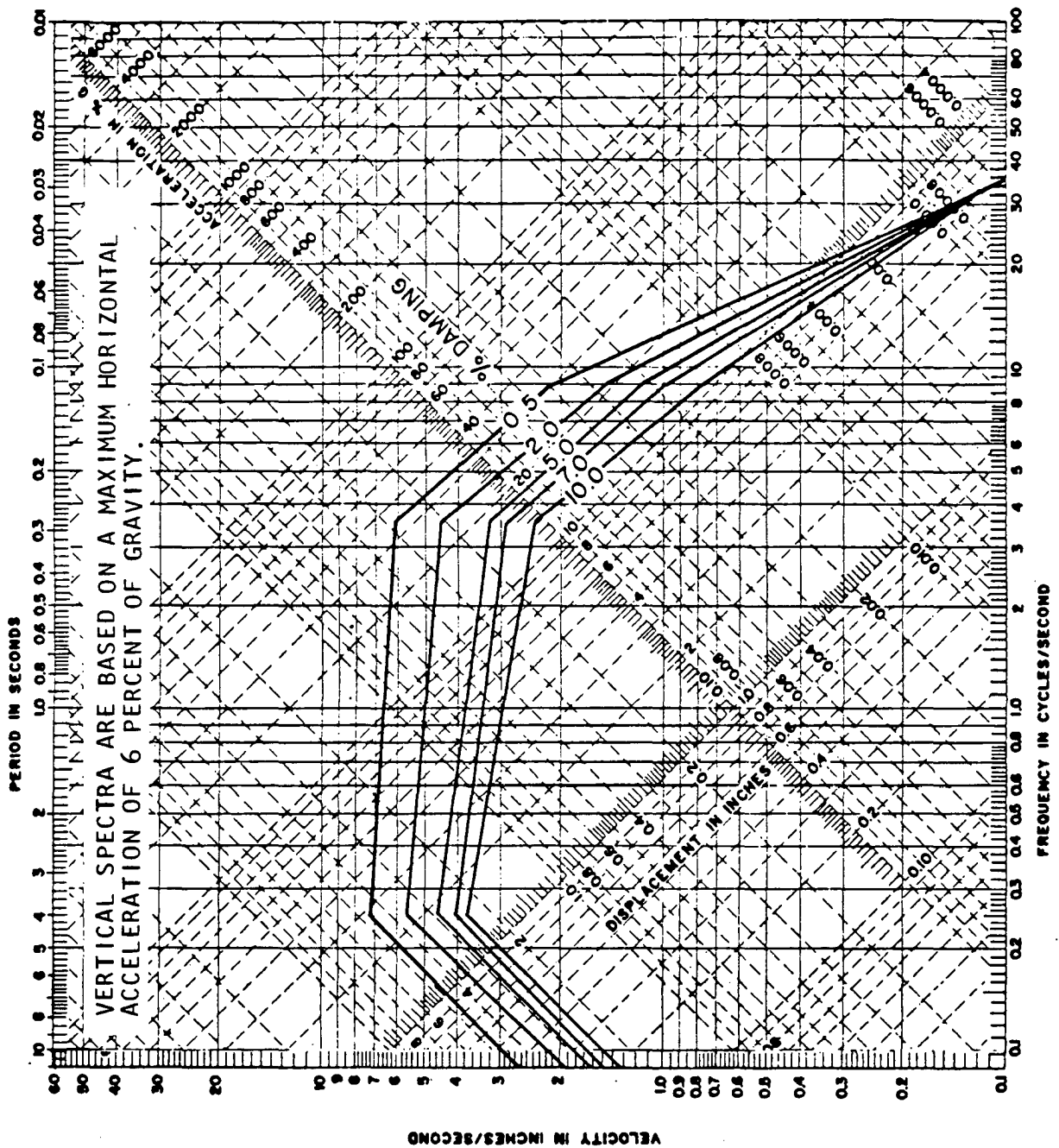

Rev. 0

**WOLF CREEK
UPDATED SAFETY ANALYSIS REPORT**

Figure 2.5-85

Vertical Response Spectra,
Operating Basis Earthquake

WESTERN WASHINGTON EARTHQUAKE
 OF APRIL 13, 1949 (SEATTLE DIST.
 ENGINEERS OFFICE RECORD) 5%
 RESPONSE SPECTRA ENVELOPE
 SCALED TO PGA OF 0.045g

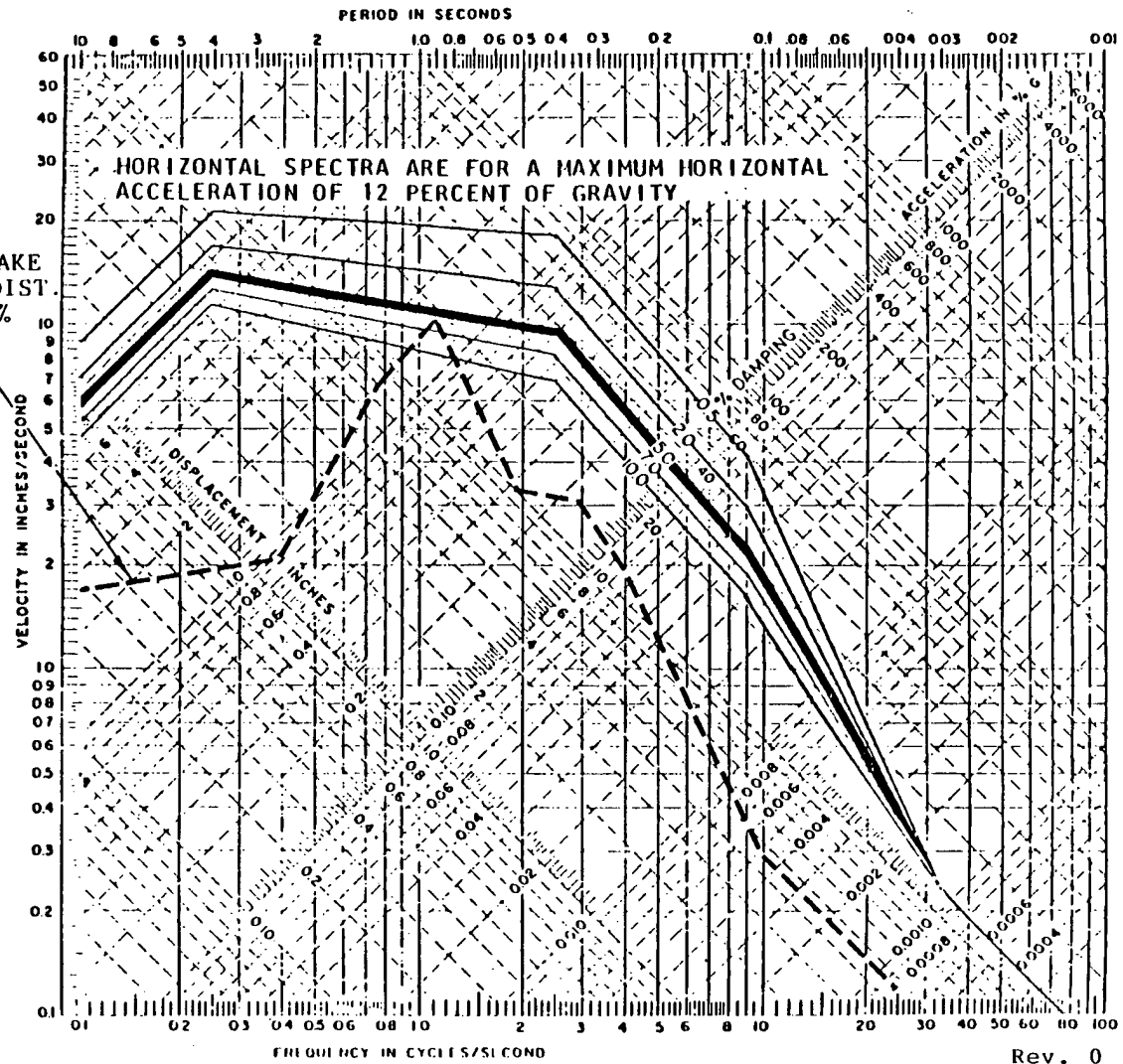

Rev. 0

WOLF CREEK
 UPDATED SAFETY ANALYSIS REPORT

Figure 2.5-85a

Horizontal Response Spectra, Safe Shutdown Earthquake, Compared with the Western Washington Earthquake Response Spectra

TOKACHI - oki MAY 16, 1968
 HACHINOHE HARBOR 5% RESPONSE
 SPECTRA ENVELOPE SCALED TO
 PEAK GROUND ACCELERATION OF
 0.045g

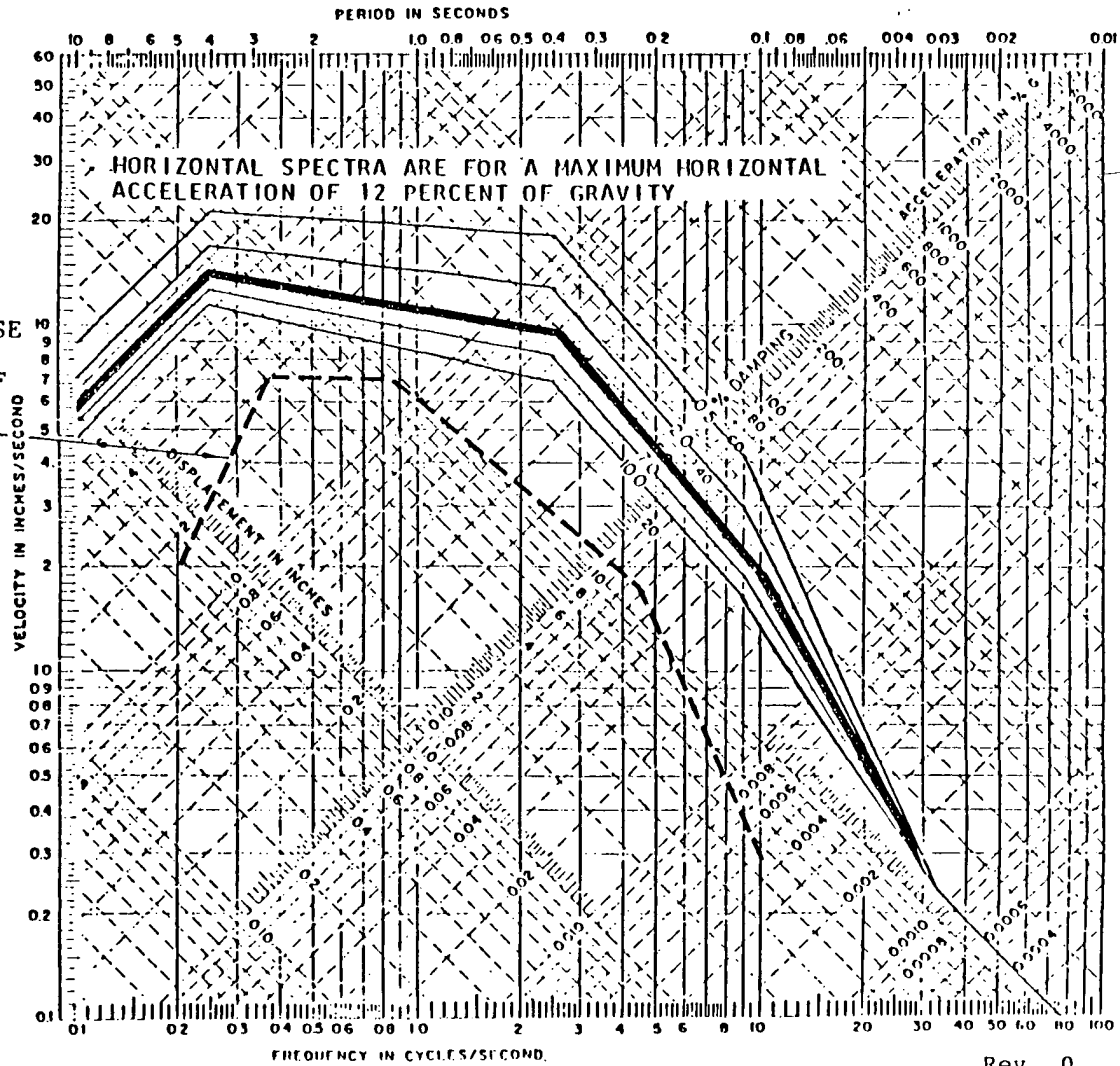

Rev. 0

WOLF CREEK
 UPDATED SAFETY ANALYSIS REPORT
 Figure 2.5-85b
 Horizontal Response Spectra, Safe
 Shutdown Earthquake, Compared
 with the Tokachi-Oki Earthquake
 Response Spectra

NUTTLI (1973b) REGION 1
 AT EPICENTRAL DISTANCE
 OF 300 MILES

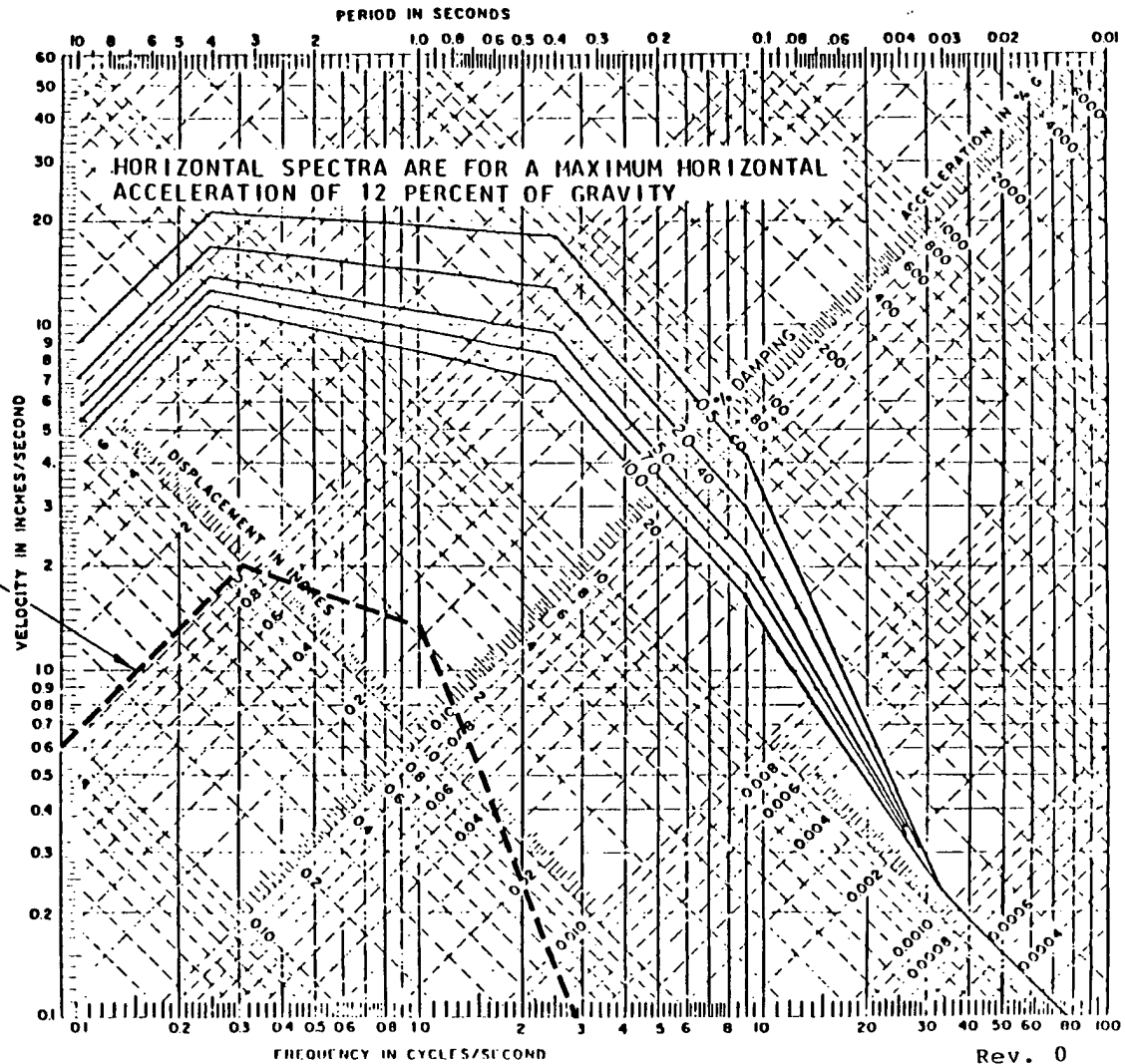

WOLF CREEK
 UPDATED SAFETY ANALYSIS REPORT
 Figure 2.5-85c
 Horizontal Response Spectra, Safe
 Shutdown Earthquake, Compared
 with Nuttli's (1973b) Proposed
 Spectra

COMPARISON OF SCALED TIME HISTORIES AT MAG = 5.3
 (SCALED TO PGA = 0.10g)

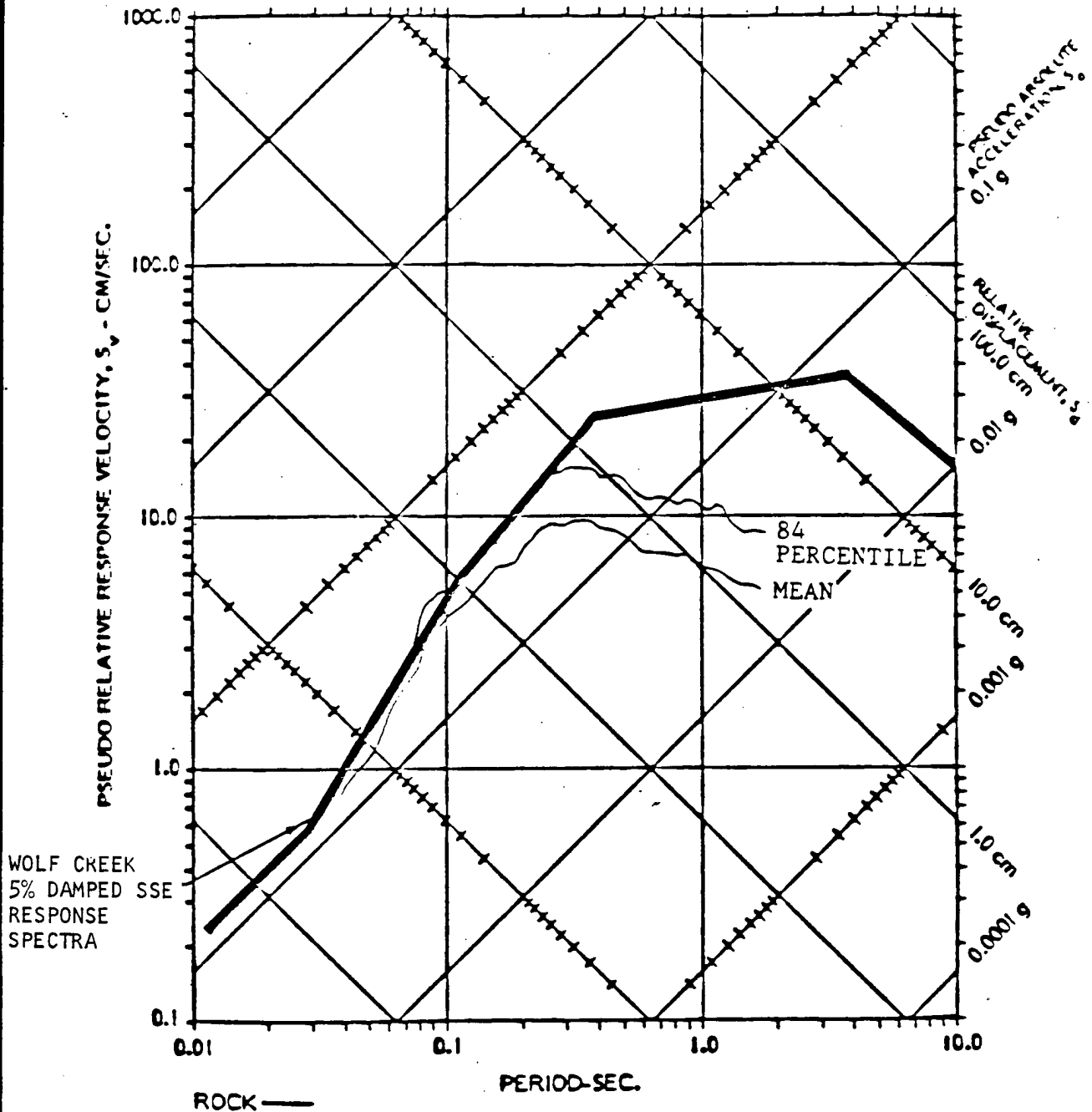

Rev. 0

**WOLF CREEK
 UPDATED SAFETY ANALYSIS REPORT**

Figure 2.5-85d

Maximum Random Event Spectra
 Scaled to 0.10g, Compared with
 Wolf Creek 5% Damped SSE Spectra

COMPARISON OF SCALED TIME HISTORIES AT MAG = 5.8
 (SCALED TO PGA = 0.05g)

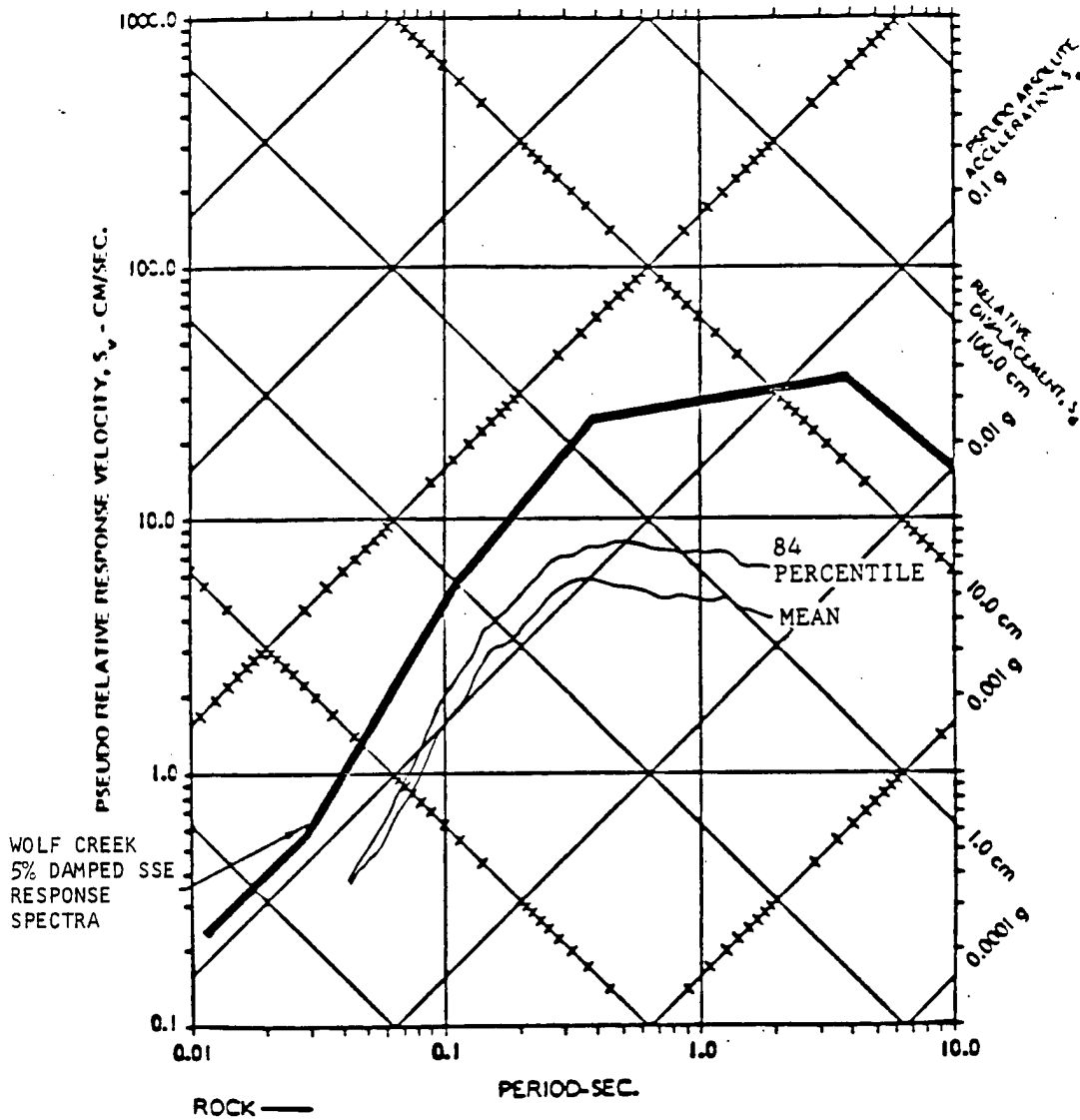

Rev. 0

WOLF CREEK
 UPDATED SAFETY ANALYSIS REPORT

Figure 2.5-85e

Maximum Nemaha Event Spectra,
 Scaled to 0.05g, Compared with
 Wolf Creek 5% Damped SSE Spectra

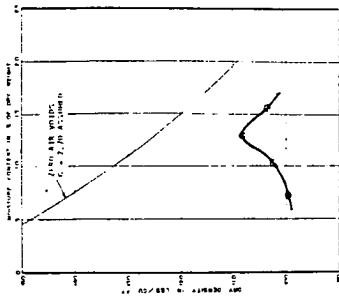

BORING 6-11 AT A DEPTH OF 3.5 FEET
 9.5 TO 15.0 FEET - MOTTLED GRAY AND LIGHT
 BROWN SILTY CLAY (CL-CH)
 OPTIMUM MOISTURE = 15.3%
 LIQUID LIMIT = 45.5%
 PLASTICITY INDEX = 15.5
 METHOD - HANDED PREPARATION
 25 TAMPERS PER LAYER
 40 POUND STRIKE

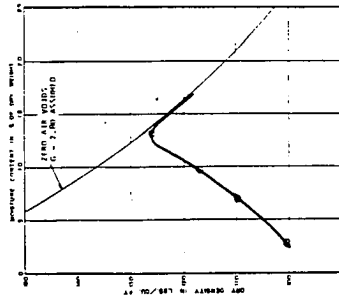

BORING 6-13 AT A DEPTH OF 5.0 FEET
 5.0 TO 10.0 FEET - UNDESIGNATED SAND
 OPTIMUM MOISTURE = 13.3%
 LIQUID LIMIT = 41.0%
 PLASTICITY INDEX = 11.0
 METHOD - HANDED PREPARATION
 25 TAMPERS PER LAYER
 40 POUND STRIKE

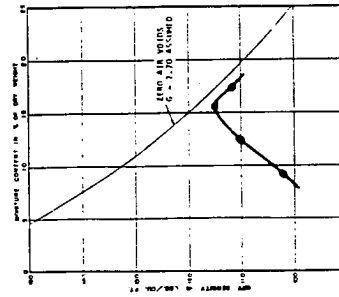

BORING 6-15 AT A DEPTH OF 3.0 FEET
 3.0 TO 15.0 FEET - MOTTLED GRAY AND LIGHT
 BROWN SILTY CLAY (CL-CH)
 OPTIMUM MOISTURE = 15.3%
 LIQUID LIMIT = 45.5%
 PLASTICITY INDEX = 15.5
 METHOD - HANDED PREPARATION
 25 TAMPERS PER LAYER
 40 POUND STRIKE

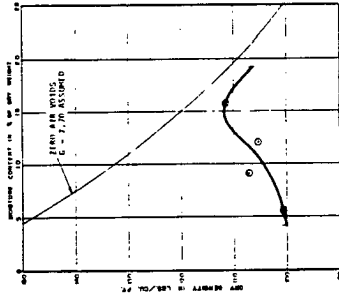

BORING 6-17 AT A DEPTH OF 3.0 FEET TO 3.5 FEET
 3.5 TO 10.0 FEET - UNDESIGNATED SAND
 OPTIMUM MOISTURE = 13.3%
 LIQUID LIMIT = 41.0%
 PLASTICITY INDEX = 11.0
 METHOD - HANDED PREPARATION
 25 TAMPERS PER LAYER
 40 POUND STRIKE

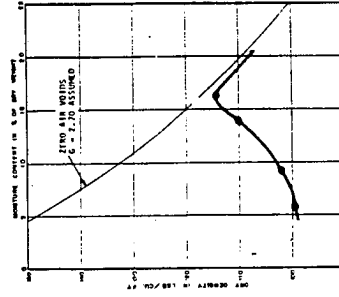

BORING 6-19 AT A DEPTH OF 3.0 FEET
 3.0 TO 15.0 FEET - MOTTLED GRAY AND LIGHT
 BROWN SILTY CLAY (CL-CH)
 OPTIMUM MOISTURE = 15.3%
 LIQUID LIMIT = 45.5%
 PLASTICITY INDEX = 15.5
 METHOD - HANDED PREPARATION
 25 TAMPERS PER LAYER
 40 POUND STRIKE

NOTES:
 1. GRAPHING OF BORING 6-11 IS BASED ON TESTS 2-5, 6, 7.
 2. GRAPHING OF BORING 6-12, 6-13, 6-14, 6-15, 6-16, 6-17, 6-18, 6-19, 6-20 IS BASED ON TESTS 1-10, 11, 12, 13, 14, 15, 16, 17, 18, 19, 20.

Rev. 0

WOLF CREEK
 UPDATED SAFETY ANALYSIS REPORT
 Figure 2.5-86
 Results of Compaction Tests for
 Borings

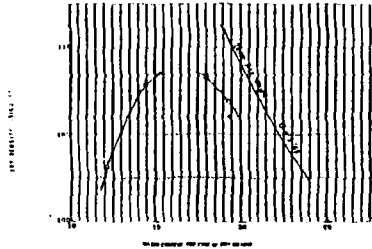

TEST PIT 1 AT A DEPTH OF 1.0 FEET TO 1.5 FEET
 MOTTLED BROWN AND GRAY SILTY CLAY WITH SOME SAND (S)
 OPTIMUM MOISTURE = 16.4%
 MAXIMUM DRY DENSITY = 108.0 LB/CU FT.
 METHOD - STANDARD PROCTOR

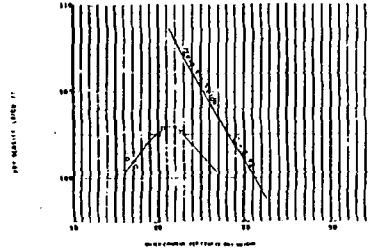

TEST PIT 2 AT A DEPTH FROM 1.0 FEET TO 4.0 FEET
 DARK GRAY AND BROWN SILTY CLAY WITH SOME SAND AND GRAVEL TO LIGHT GRAY CLAY (C)
 OPTIMUM MOISTURE = 20.7%
 MAXIMUM DRY DENSITY = 97.2 LB/CU FT.

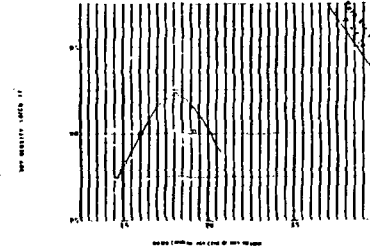

TEST PIT 3 AT A DEPTH FROM 1.0 FEET TO 5.0 FEET
 GRAYISH BROWN SILTY CLAY, BROWN SILTY CLAY AND MOTTLED GRAY CLAY AND GRAYISH-BROWN SILTY CLAY WITH TRACE OF SAND AND GRAVEL (C)
 OPTIMUM MOISTURE = 18.1%
 MAXIMUM DRY DENSITY = 92.2 LB/CU FT.
 METHOD - STANDARD PROCTOR

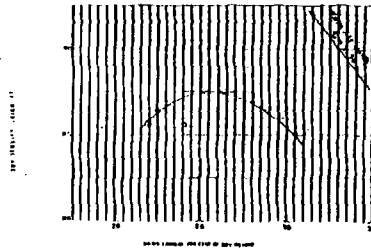

TEST PIT 4 AT A DEPTH OF 1.5 FEET TO 2.0 FEET
 MOTTLED GRAYISH-BROWN AND GRAYISH-BROWN SILTY CLAY WITH OCCASIONAL SAND AND DRAB CLAY WITH TRACE OF SAND (C)
 OPTIMUM MOISTURE = 25.7%
 MAXIMUM DRY DENSITY = 97.4 LB/CU FT.
 METHOD - STANDARD PROCTOR

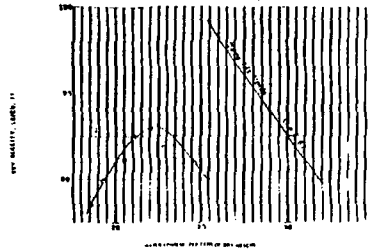

TEST PIT 5 AT A DEPTH OF 1.0 FEET TO 2.0 FEET
 LIGHT TO MEDIUM GRAY SILTY CLAY (C)
 OPTIMUM MOISTURE = 21.1%
 MAXIMUM DRY DENSITY = 91.1 LB/CU FT.
 METHOD - STANDARD PROCTOR

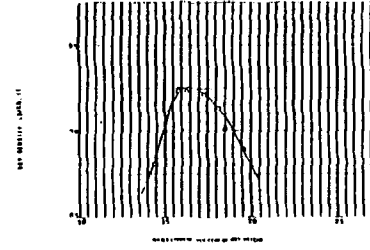

COMMENTS:
 TEST PIT 6 AT A DEPTH FROM 2.0 FEET TO 4.0 FEET
 DARK GRAYISH-BROWN CLAY WITH SOME SILT TO LIGHT BROWNISH GRAY CLAY (C) WITH
 TEST PIT 6 FROM 1.5 FEET TO 4.5 FEET
 VERY DARK GRAYISH-BROWN CLAY AND MOTTLED GRAYISH BROWN, BROWNISH BROWN AND DARK GRAY CLAY WITH SOME SILT AND TRACE OF SAND (C)
 OPTIMUM MOISTURE = 16.7%
 MAXIMUM DRY DENSITY = 107.6 LB/CU FT.
 METHOD - STANDARD PROCTOR

NOTE: COORDINATES OF THE TEST PITS ARE SHOWN ON FIGURE 2.5-79.

Rev. 0

WOLF CREEK
UPDATED SAFETY ANALYSIS REPORT

Figure 2.5-87 (Sheet 1 of 3)
 Results of Compaction Tests for
 Test Pits

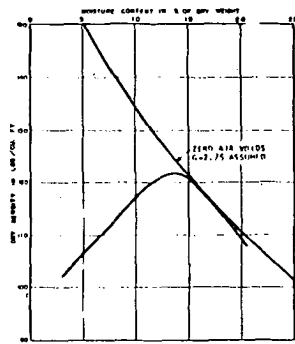

TEST PIT 8 AT A DEPTH OF 5 FEET
 MOISTURE (LIGHT GRAY AND YELLOW SILTY CLAY;
 TRACE OF FINE SAND (CM)
 OPTIMUM MOISTURE = 15%
 MAXIMUM DRY DENSITY = 122 PCF
 METHOD = ASTM D1557-70 METHOD A

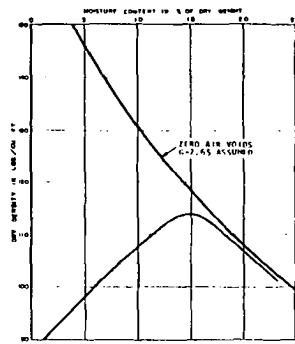

TEST PIT 9 AT A DEPTH FROM 5 TO 7 FEET
 MOISTURE (LIGHT GRAY AND YELLOW SILTY CLAY;
 TRACE FINE SAND (CM)
 OPTIMUM MOISTURE = 15%
 MAXIMUM DRY DENSITY = 122 PCF
 METHOD = STANDARD PROCTON

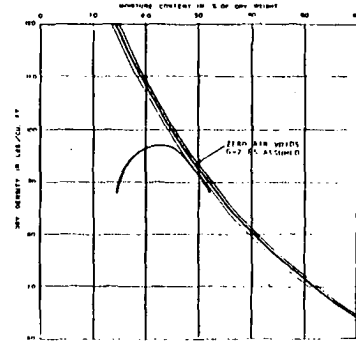

TEST PIT 10 AT A DEPTH FROM 2 TO 3 FEET
 MOISTURE (BROWN SILTY CLAY (CM)
 OPTIMUM MOISTURE = 15%
 MAXIMUM DRY DENSITY = 122 PCF
 METHOD = STANDARD PROCTON

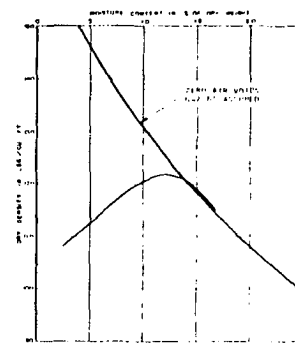

TEST PIT 11 AT A DEPTH OF 3 FEET
 MOISTURE (BROWN GRAY SILTY AND MED SAND (CM)
 OPTIMUM MOISTURE = 15%
 MAXIMUM DRY DENSITY = 122 PCF
 METHOD = ASTM D1557-70 METHOD A

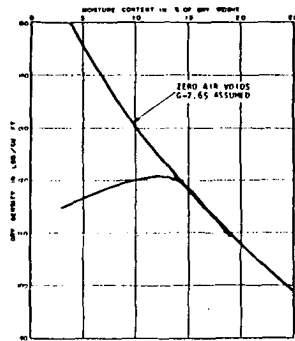

TEST PIT 11 AT A DEPTH FROM 5 TO 8.5 FEET
 MOISTURE (DARK YELLOW-ORANGE SILTY CLAY; SOME RED
 SANDSTONE LEVELS (CM)
 OPTIMUM MOISTURE = 15%
 MAXIMUM DRY DENSITY = 122.5 PCF
 METHOD = ASTM D1557-70 METHOD A

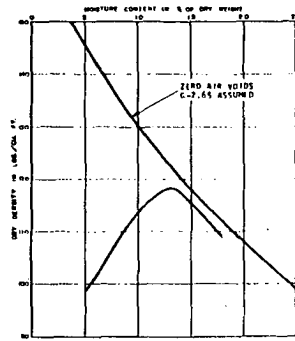

TEST PIT 12 AT A DEPTH OF 2.4 FEET
 MOISTURE (BROWN SILTY CLAY; TRACE FINE SAND AND MEDIUM
 ROUNDED GRAVEL (CM)
 OPTIMUM MOISTURE = 15.5%
 MAXIMUM DRY DENSITY = 118.5 PCF
 METHOD = ASTM D1557-70 METHOD A

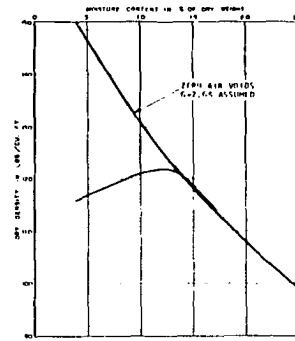

TEST PIT 12 AT A DEPTH OF 5 FEET
 MOISTURE (BROWN SILTY CLAY; TRACE FINE SAND AND
 MEDIUM ROUNDED GRAVEL
 OPTIMUM MOISTURE = 15%
 MAXIMUM DRY DENSITY = 122 PCF
 METHOD = ASTM D1557-70 METHOD A

NOTE: LOCATIONS OF THE TEST PITS ARE SHOWN
 IN FIGURE 2.5-10

Rev. 0

WOLF CREEK
 UPDATED SAFETY ANALYSIS REPORT

Figure 2.5-87 (Sheet 2 of 3)

Results of Compaction Tests for
 Test Pits

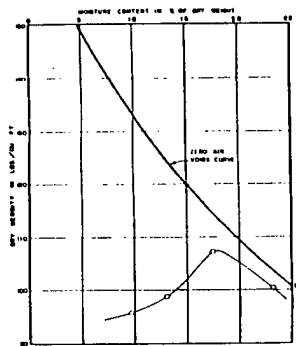

A.S.T.M. D 698 (STANDARD PROCTOR)
 TPL-18 AT 5.0-10.0 FEET
 MOTTLED GRAY AND BROWN SILTY CLAY
 OPTIMUM MOISTURE 12.0%
 MAXIMUM DRY DENSITY 107 lb/ft³
 LIQUID LIMIT 37
 PLASTICITY INDEX 27

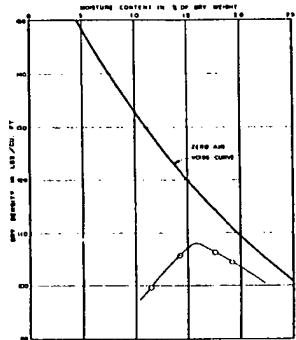

A.S.T.M. D 698 (STANDARD PROCTOR)
 TPL-18 AT 8.0-10.0 FEET
 MOTTLED GRAY AND BROWN SILTY CLAY
 OPTIMUM MOISTURE 16.0%
 MAXIMUM DRY DENSITY 107 lb/ft³
 LIQUID LIMIT 41
 PLASTICITY INDEX 21

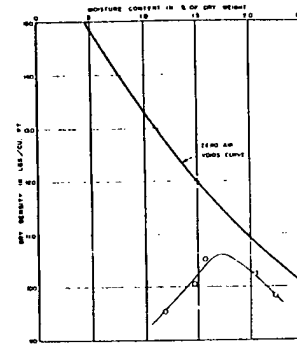

A.S.T.M. D 698 (STANDARD PROCTOR)
 TPL-18 AT 11.0-12.0 FEET
 MOTTLED GRAY AND YELLOWISH-BROWN
 SILTY CLAY
 OPTIMUM MOISTURE 17.5%
 MAXIMUM DRY DENSITY 106 lb/ft³
 LIQUID LIMIT 36
 PLASTICITY INDEX 19

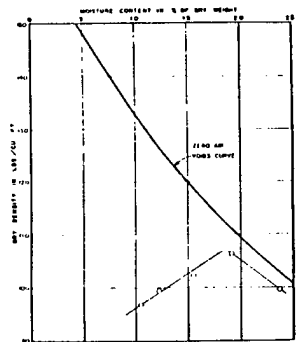

A.S.T.M. D 698 (STANDARD PROCTOR)
 TPL-18 AT 10.0-11.5 FEET
 GRAY AND BROWN SILTY CLAY
 OPTIMUM MOISTURE 18.0%
 MAXIMUM DRY DENSITY 106 lb/ft³
 LIQUID LIMIT 32
 PLASTICITY INDEX 23

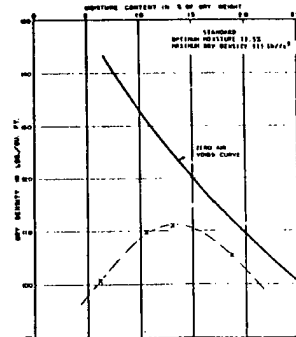

A.S.T.M. D 698 (STANDARD PROCTOR) SHOW
 PL. W. BELOW LINE.
 A SUMMARY LISTING OF
 TESTS IS ON THE NEXT
 PAGE.

TEST NO.	DEPTH	PLASTICITY
TPL-18	5	27
TPL-18	8	21
TPL-18	11	19
TPL-18	10	23

Rev. 0

**WOLF CREEK
 UPDATED SAFETY ANALYSIS REPORT**

Figure 2.5-87 (Sheet 3 of 3)

Results of Compaction Tests for
 Test Pits

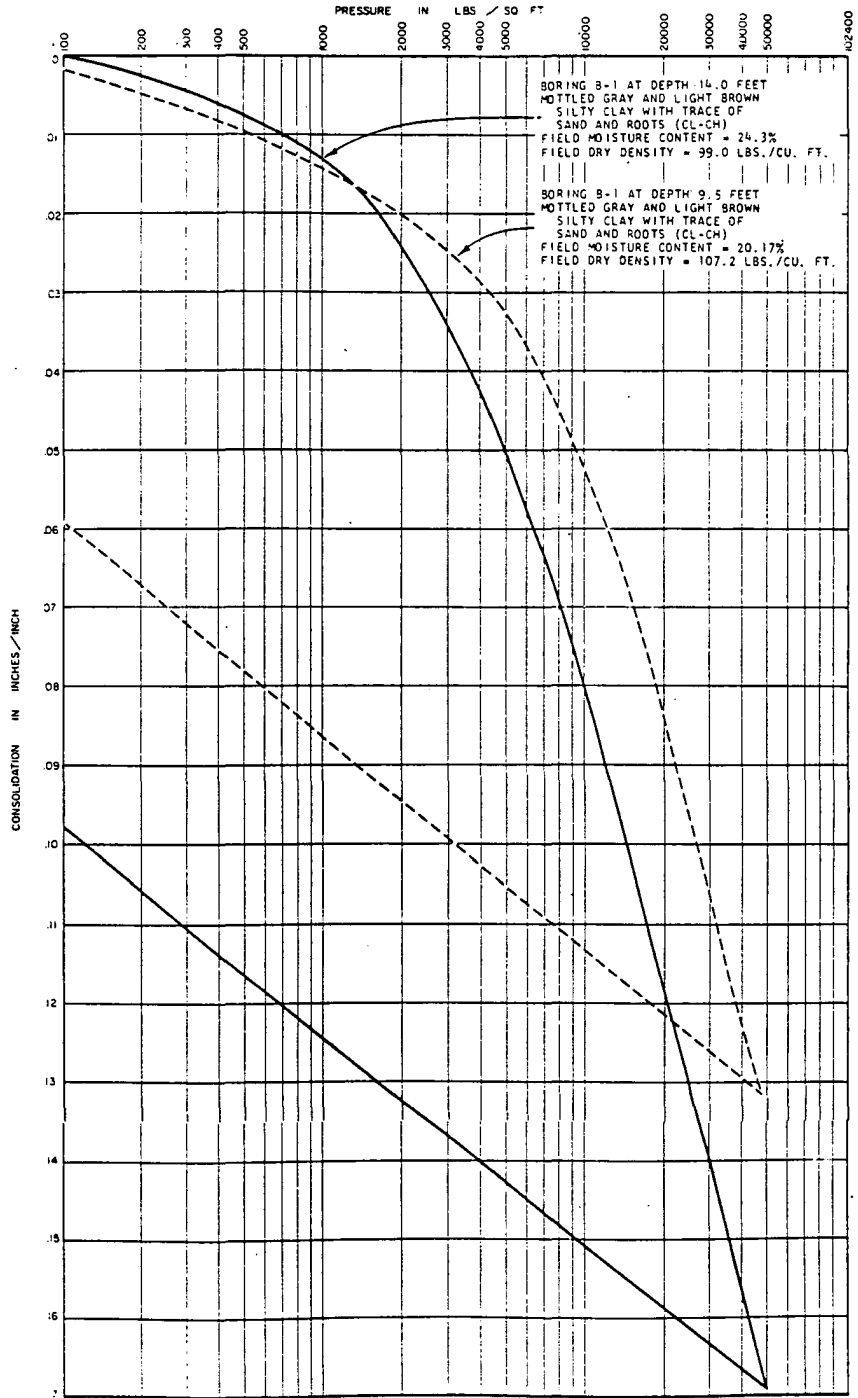

Rev. 0

**WOLF CREEK
 UPDATED SAFETY ANALYSIS REPORT**

Figure 2.5-88a

Results of Consolidation Tests -
 Boring B-1

NOTE:
 LOCATION OF BORING B-1 IS SHOWN
 ON FIGURE 2.5-22.

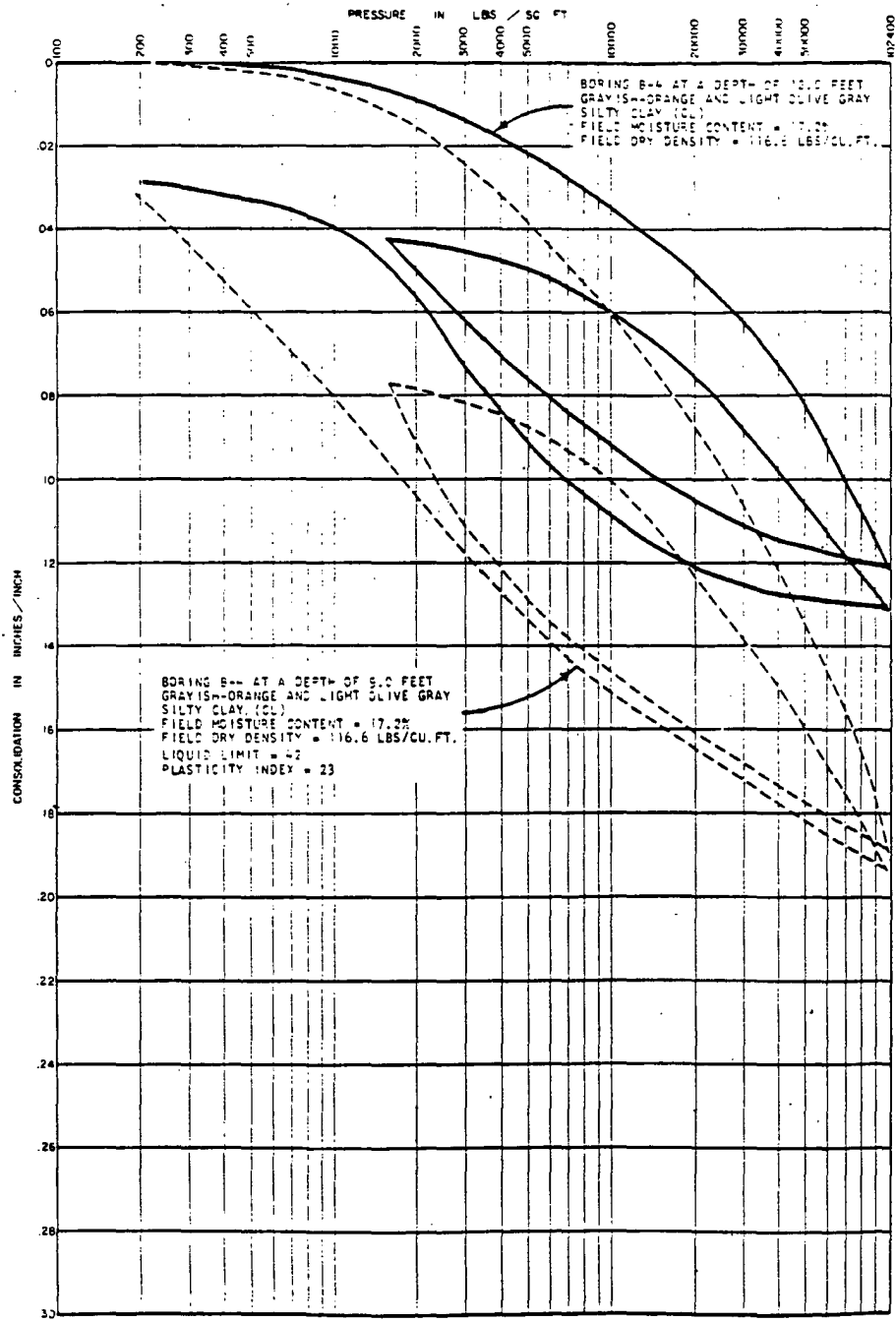

Rev. 0

NOTE:
 LOCATION OF BORING B-4 IS SHOWN ON
 FIGURES 2.5-28, 2.5-30 AND 2.5-31.

**WOLF CREEK
 UPDATED SAFETY ANALYSIS REPORT**

Figure 2.5-88b
 Results of Consolidation Tests -
 Boring B-4

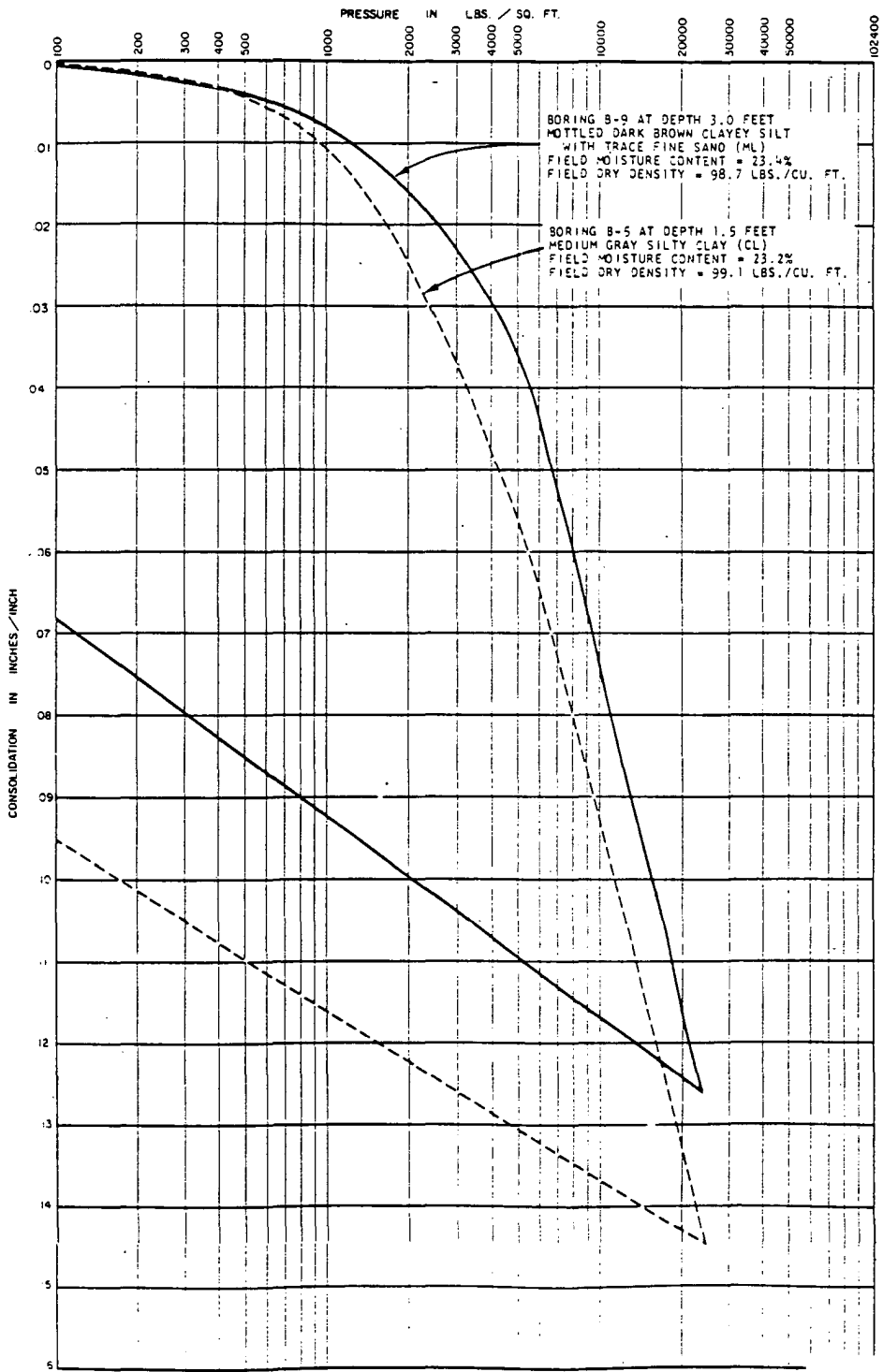

Rev. 0

WOLF CREEK
 UPDATED SAFETY ANALYSIS REPORT

Figure 2.5-88c

Results of Consolidation Tests -
 Borings B-5 and B-9

NOTE:
 LOCATION OF BORINGS B-5 AND B-9
 ARE SHOWN ON FIGURE 2.5-28.

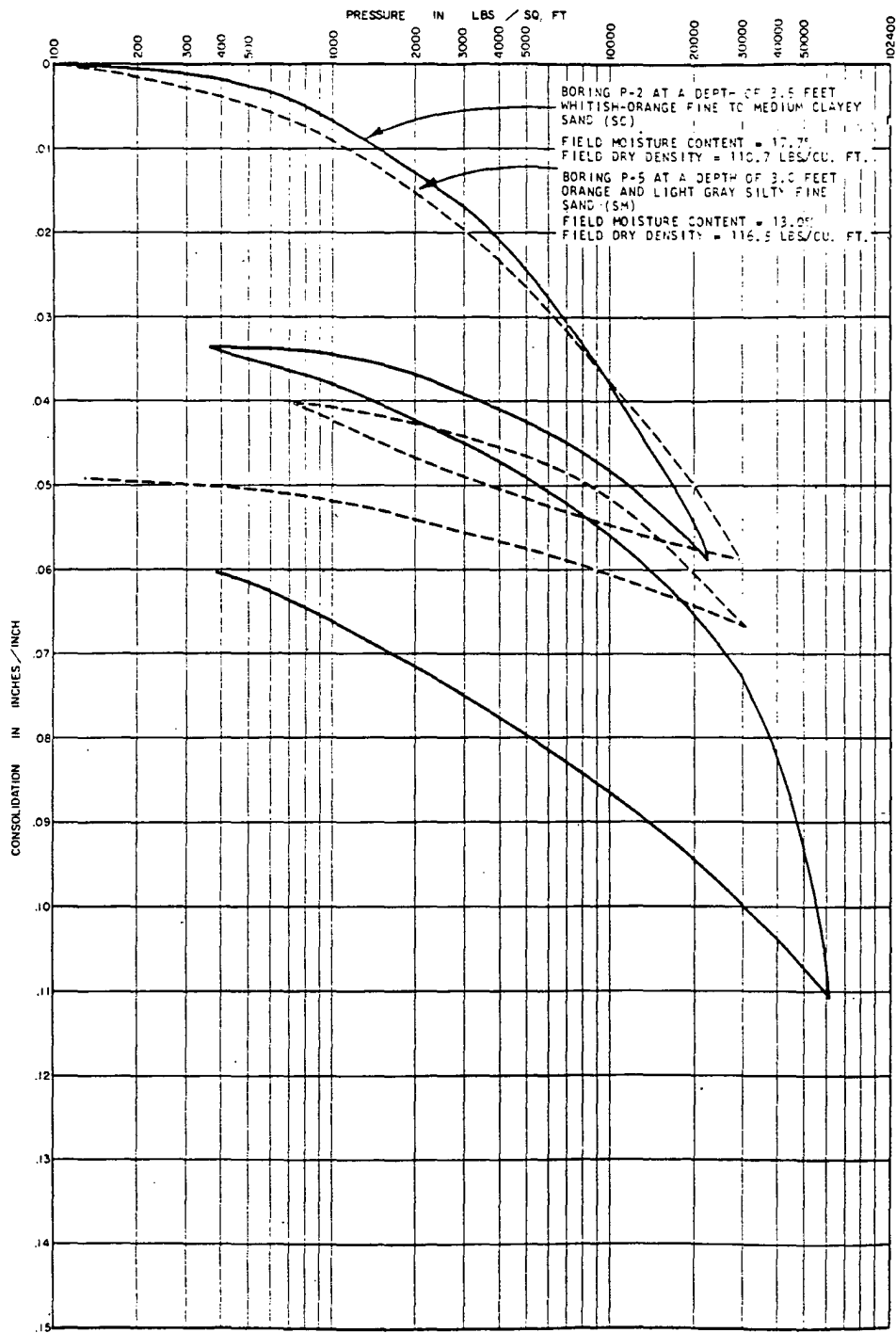

Rev. 0

NOTE:

LOCATION OF BORINGS P-2 AND P-5
 ARE SHOWN ON FIGURE 2.5-31.

**WOLF CREEK
 UPDATED SAFETY ANALYSIS REPORT**

Figure 2.5-88d

Results of Consolidation Tests -
 Borings P-2 and P-5

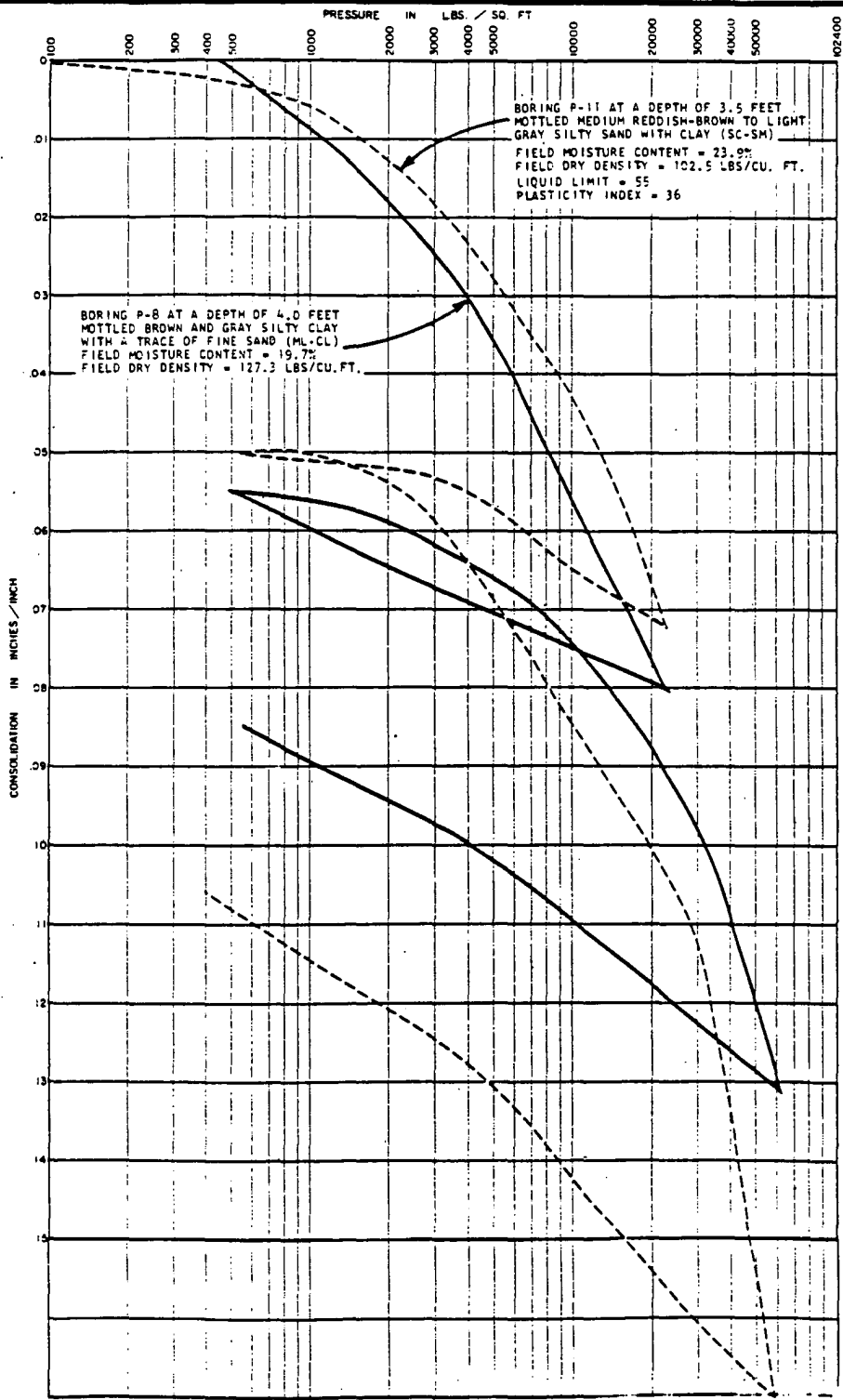

Rev. 0

**WOLF CREEK
 UPDATED SAFETY ANALYSIS REPORT**

Figure 2.5-88e

Results of Consolidation Tests -
 Borings P-8 and P-11

NOTES:
 LOCATION OF BORINGS P-8 AND P-11
 ARE SHOWN ON FIGURE 2.5-31.

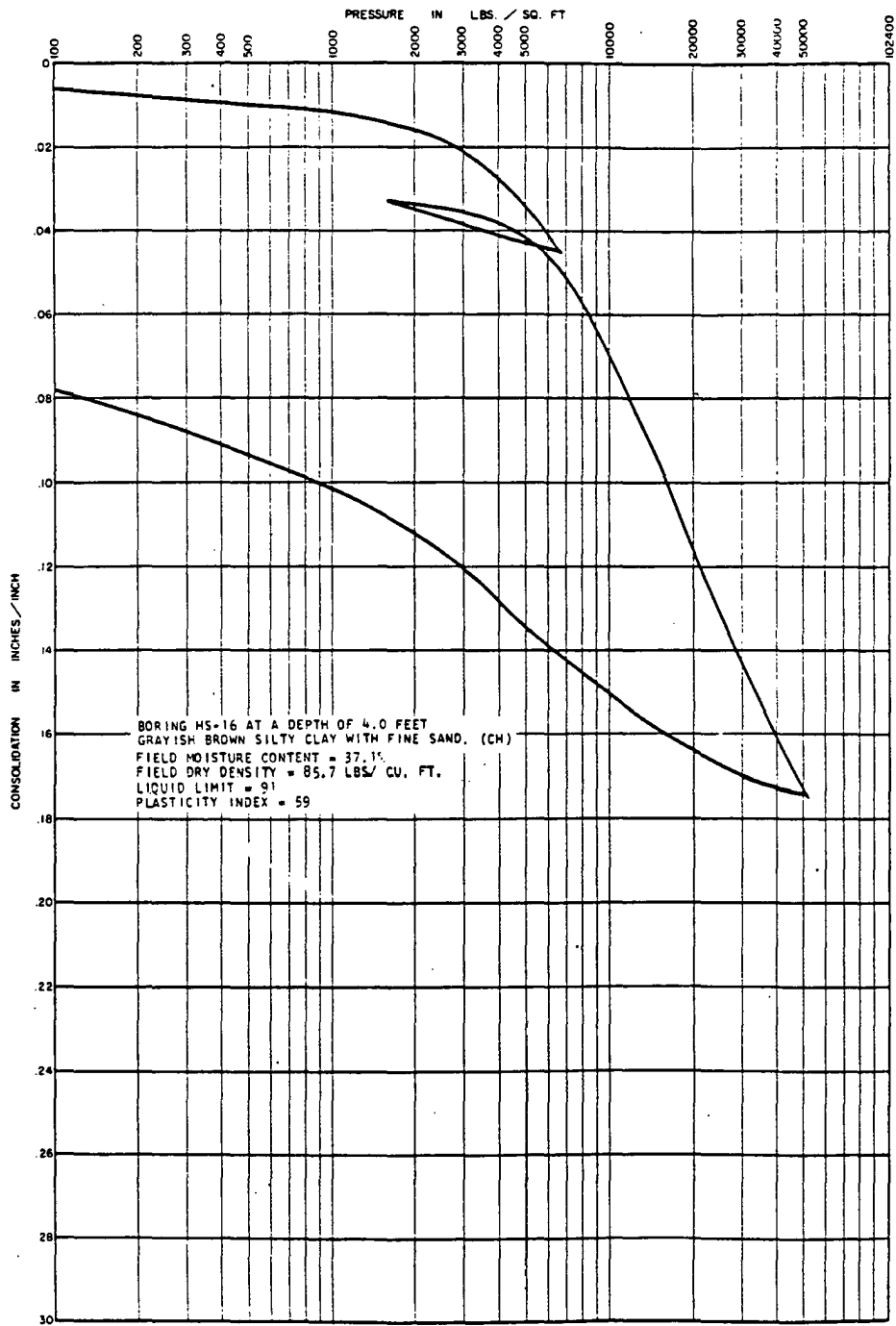

Rev. 0

NOTE:

LOCATION OF BORING HS-16 IS SHOWN
ON FIGURE 2.5-30.

**WOLF CREEK
UPDATED SAFETY ANALYSIS REPORT**

- Figure 2.5-88f

Results of Consolidation Tests -
Boring HS-16

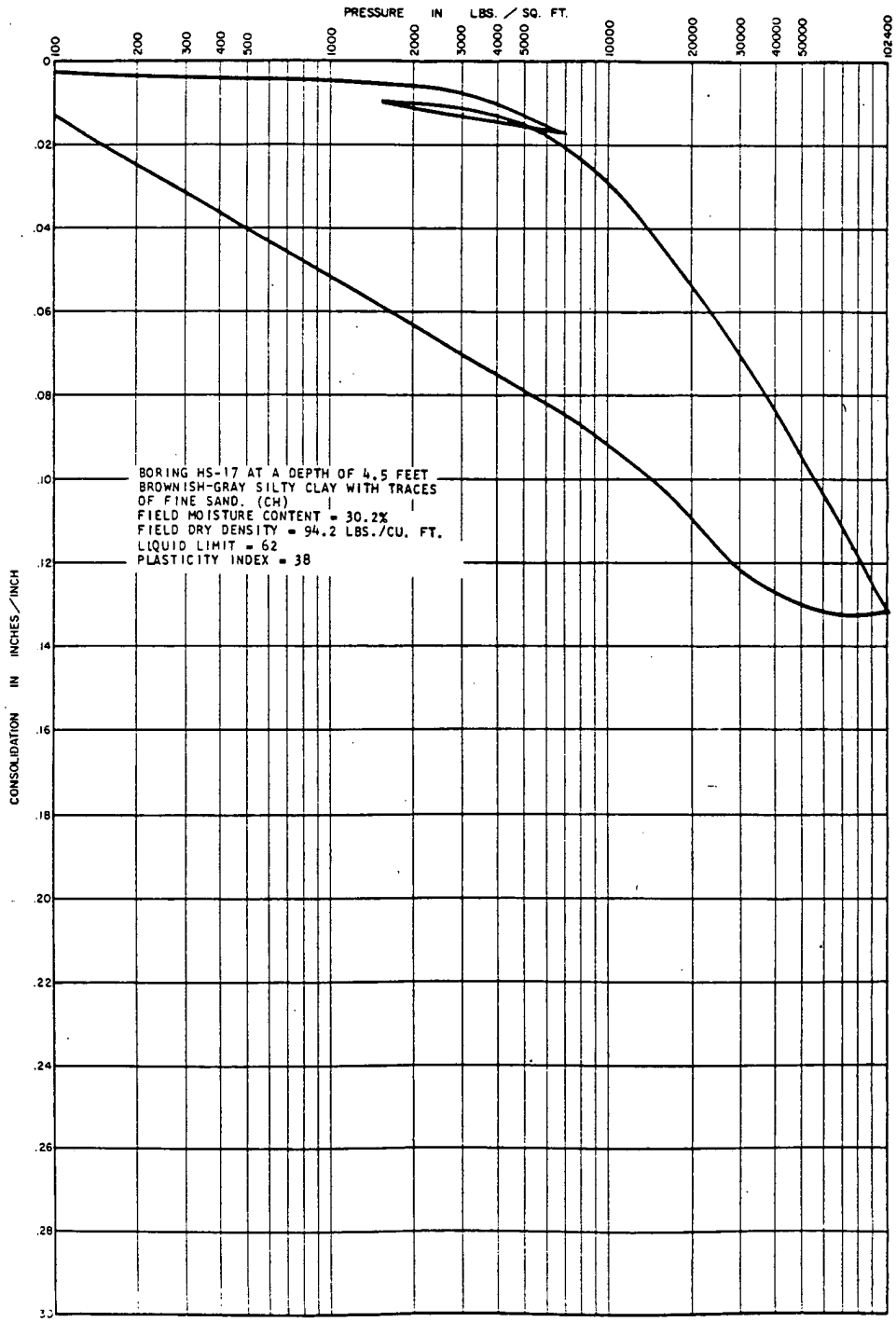

Rev. 0

NOTE:
 LOCATION OF BORING HS-17 IS SHOWN
 ON FIGURE 2.5-30.

**WOLF CREEK
 UPDATED SAFETY ANALYSIS REPORT**

Figure 2.5-88g

Results of Consolidation Tests -
 Boring HS-17

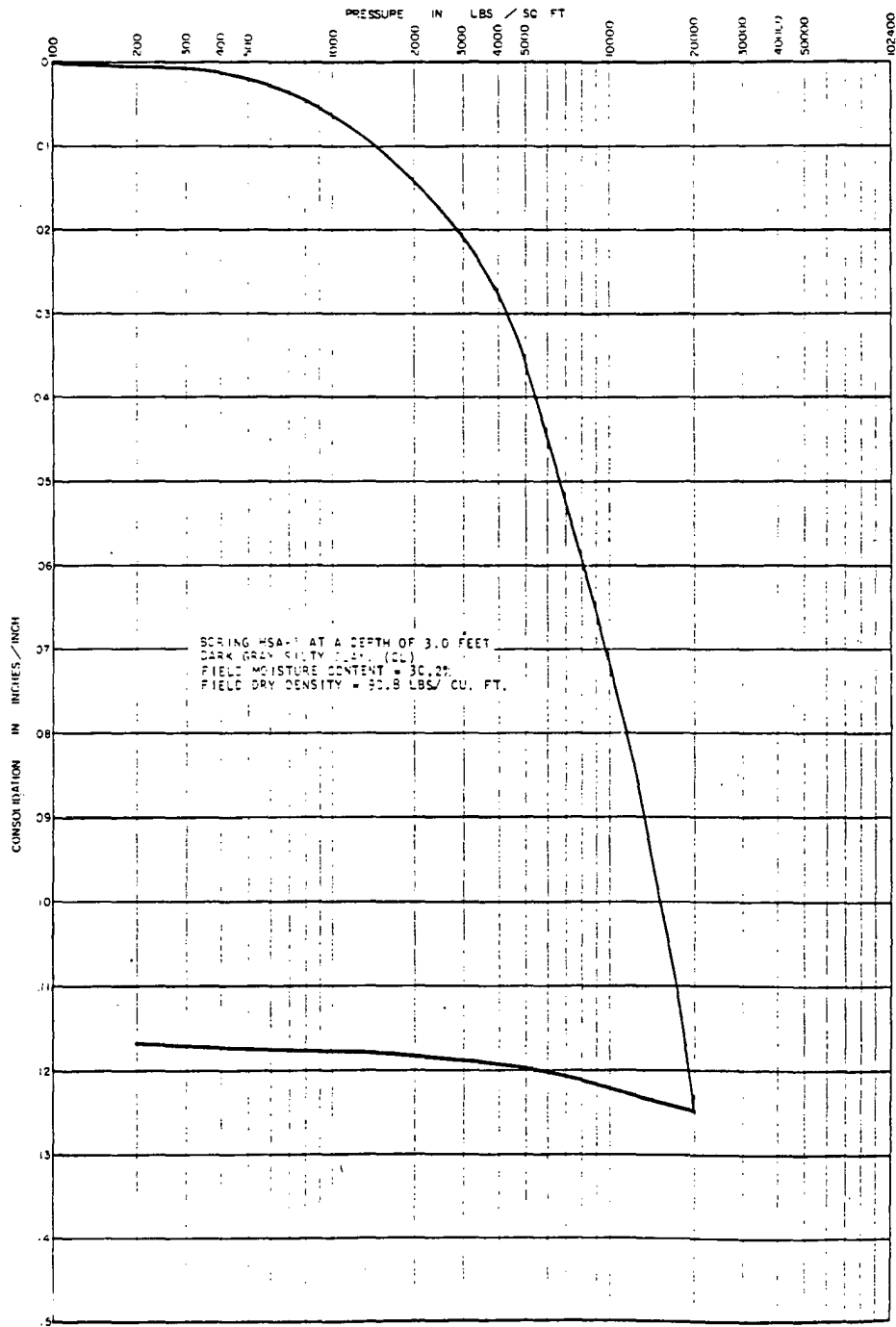

Rev. 0

NOTE:
 LOCATION OF BORING HSA-1 IS SHOWN
 IN FIGURE 2.5-3...

WOLF CREEK
UPDATED SAFETY ANALYSIS REPORT

Figure 2.5-88h

Results of Consolidation Tests -
 Boring HSA-1

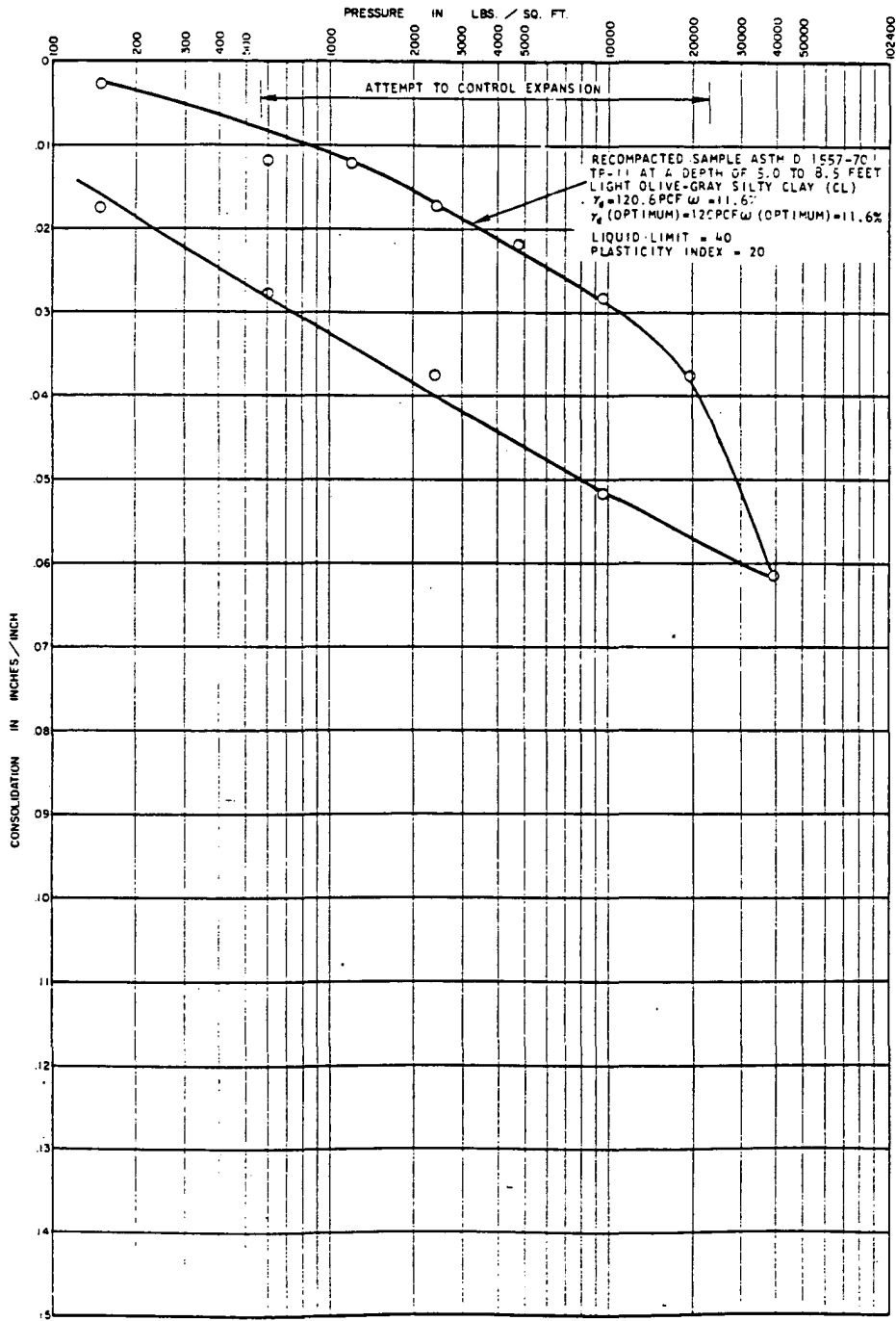

Rev. 0

**WOLF CREEK
 UPDATED SAFETY ANALYSIS REPORT**

Figure 2.5-88i

Results of Consolidation Tests -
 Test Pit-11

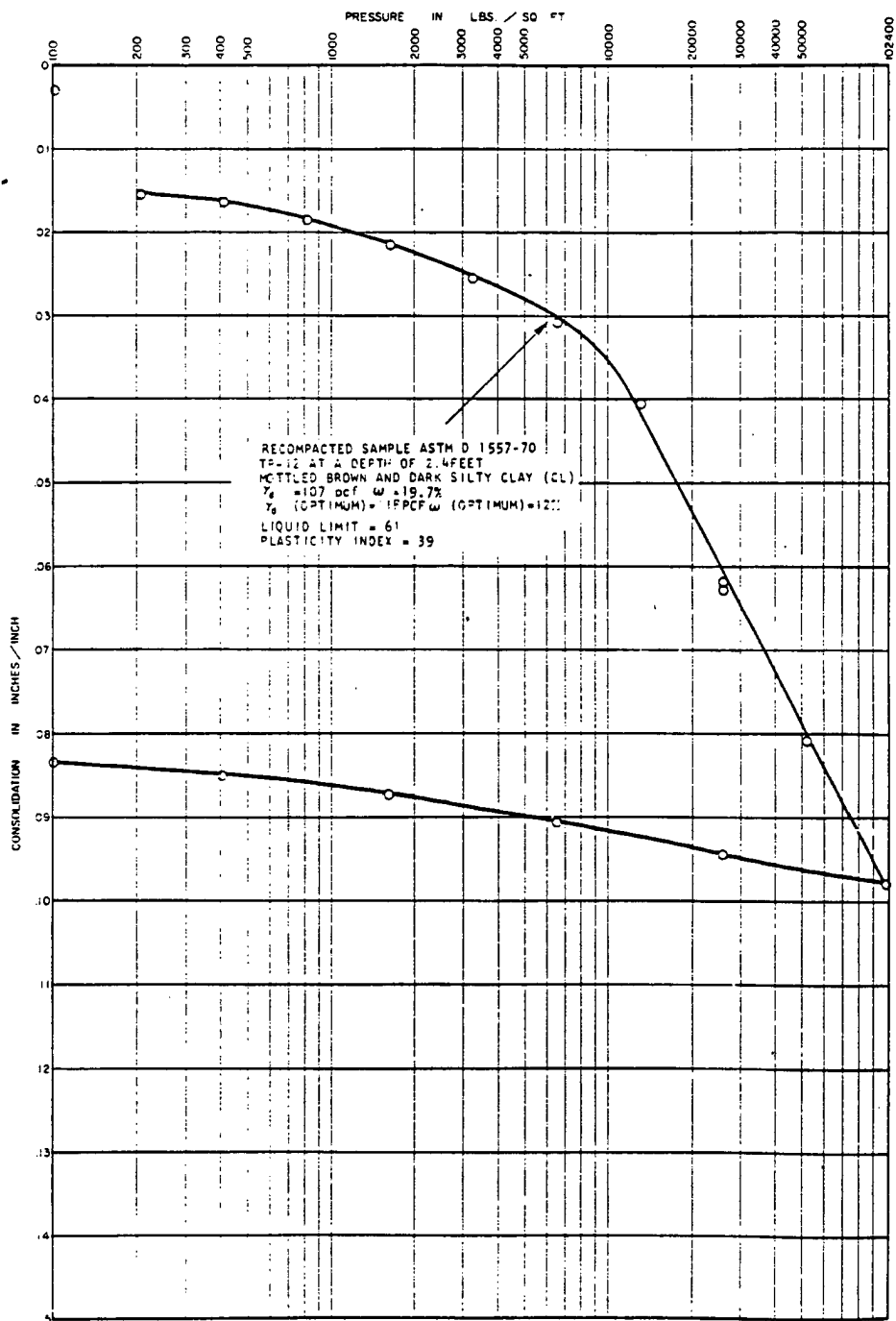

Rev. 0

**WOLF CREEK
 UPDATED SAFETY ANALYSIS REPORT**

Figure 2.5-88j

Results of Consolidation Tests -
 Test Pit-12

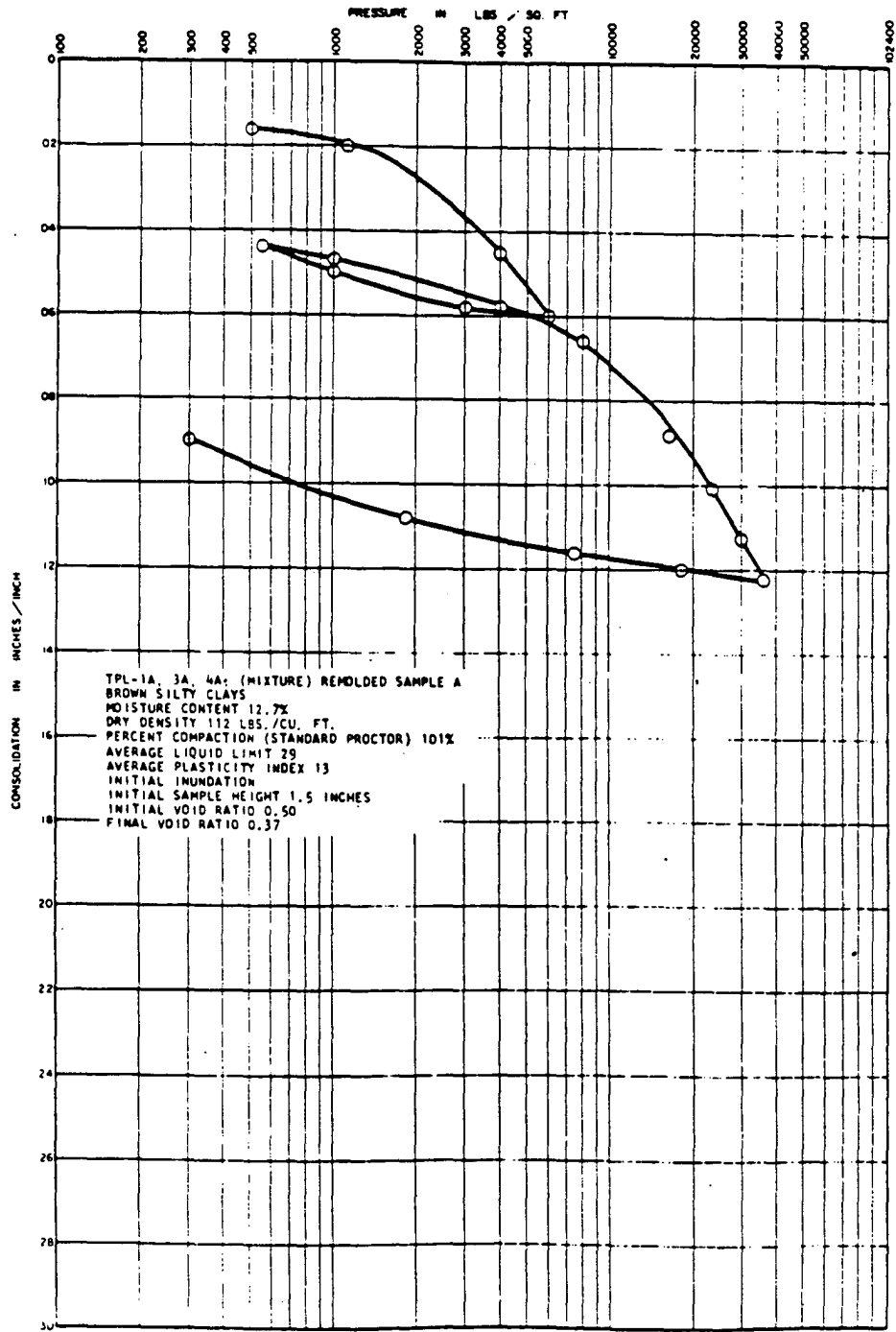

Rev. 0

**WOLF CREEK
UPDATED SAFETY ANALYSIS REPORT**

Figure 2.5-89 (Sheet 1 of 4)

Consolidation Test Data

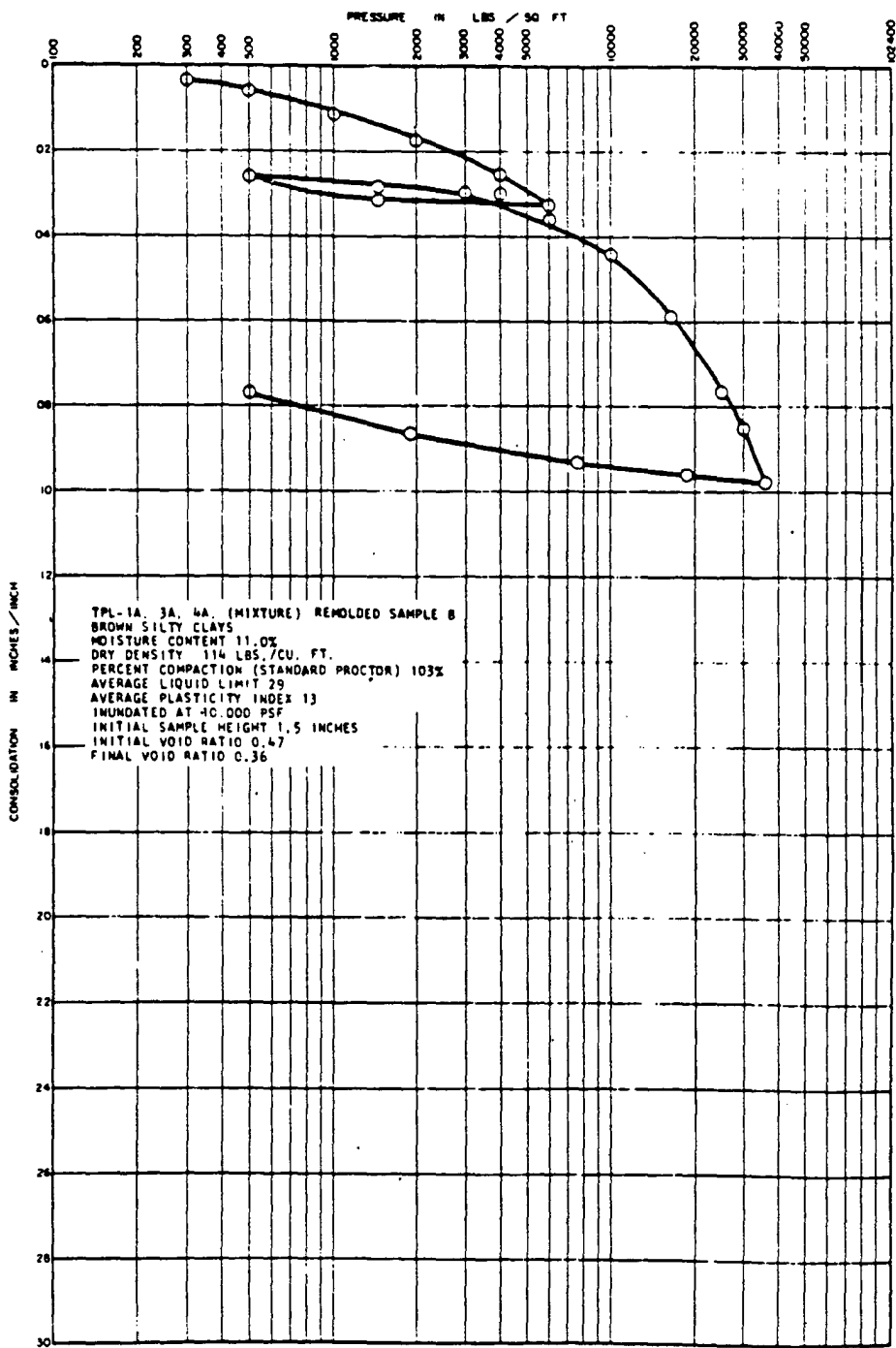

Rev. 0

WOLF CREEK
UPDATED SAFETY ANALYSIS REPORT
 Figure 2.5-89 (Sheet 2 of 4)
 Consolidation Test Data

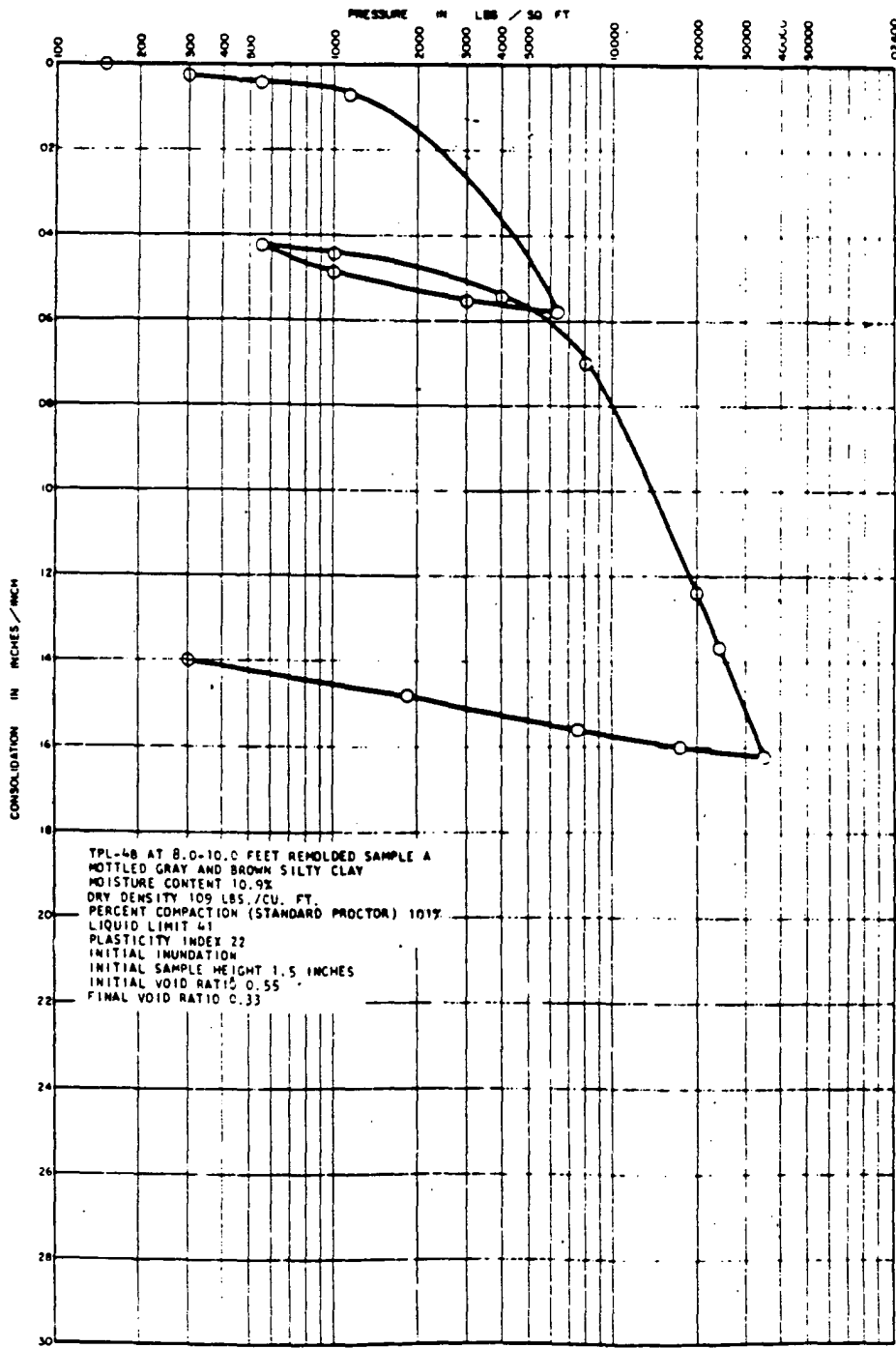

Rev. 0

**WOLF CREEK
UPDATED SAFETY ANALYSIS REPORT**

Figure 2.5-89 (Sheet 3 of 4)

Consolidation Test Data

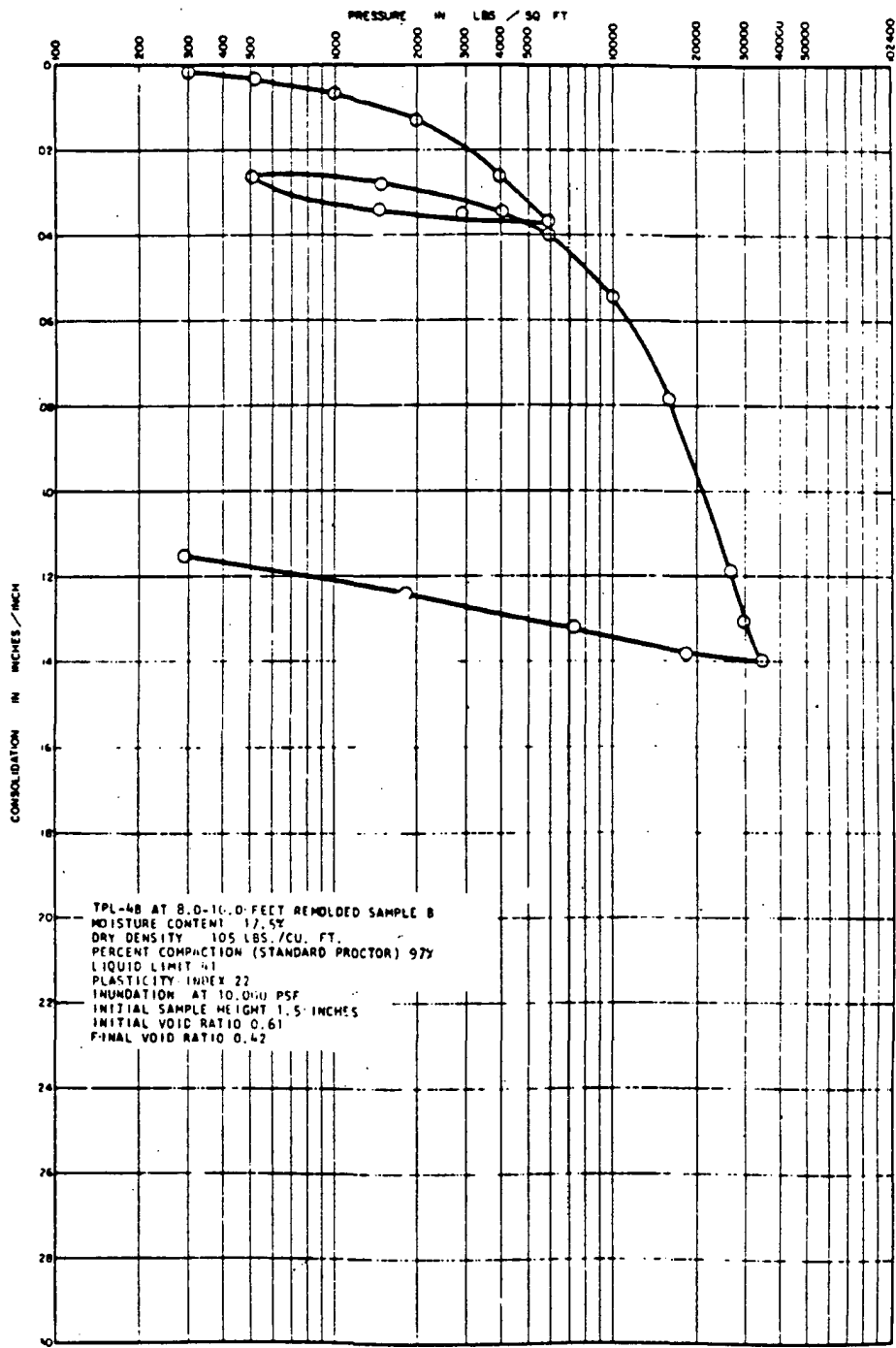

Rev. 0

**WOLF CREEK
 UPDATED SAFETY ANALYSIS REPORT**

Figure 2.5-89 (Sheet 4 of 4)

Consolidation Test Data

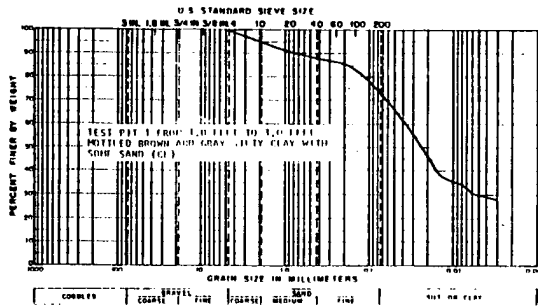
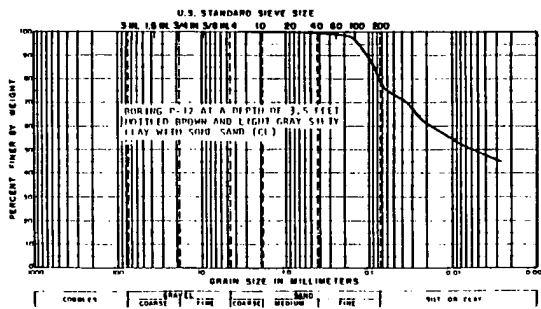
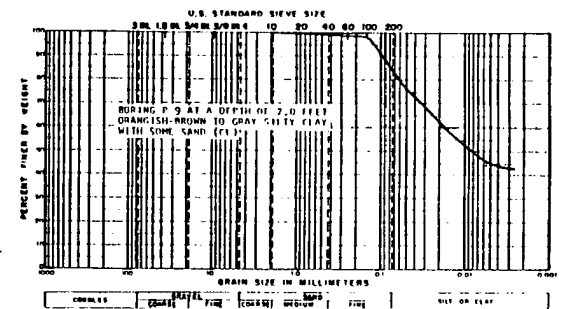
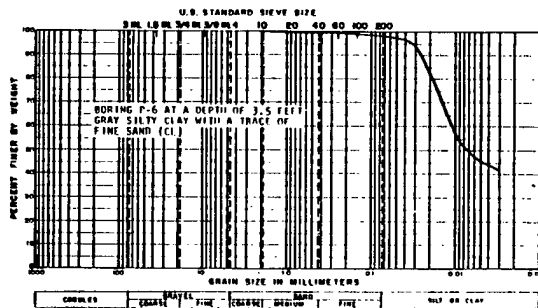
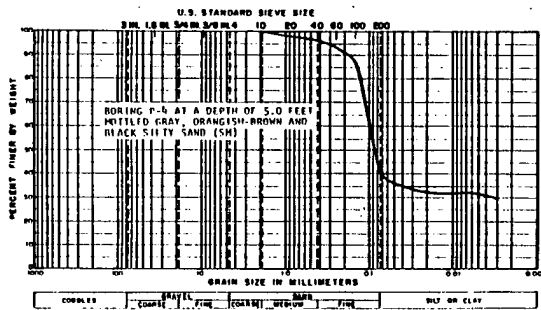
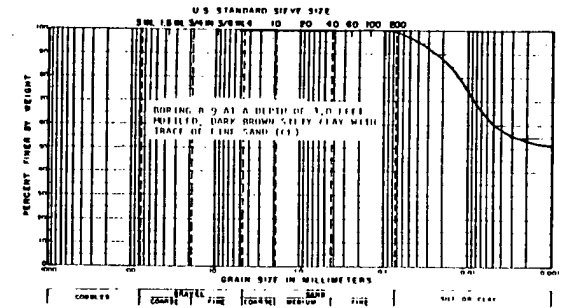
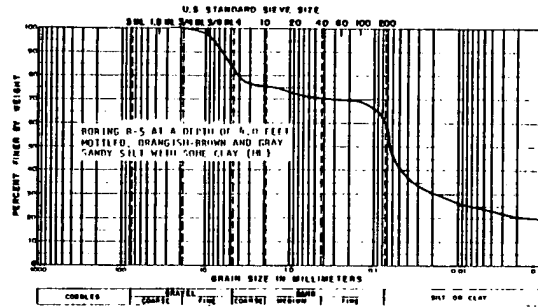
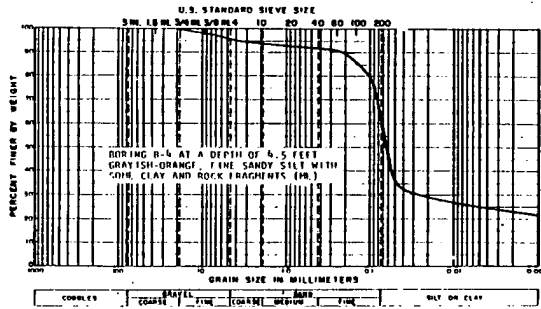

Rev. 0

WOLF CREEK
UPDATED SAFETY ANALYSIS REPORT

Figure 2.5-90 (Sheet 1 of 7)

Results of Particle-Size Analyses

NOTE:

THE LOCATIONS OF THE BORINGS ARE
SHOWN ON FIGURES 2.5-28, 2.5-29,
AND 2.5-31.

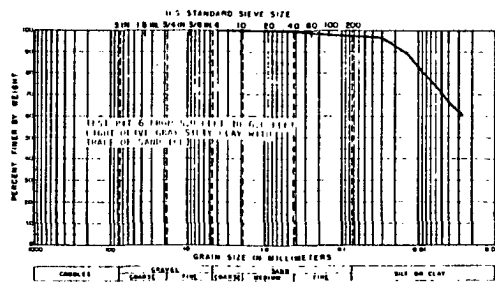
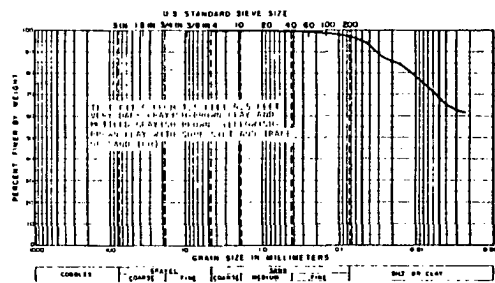
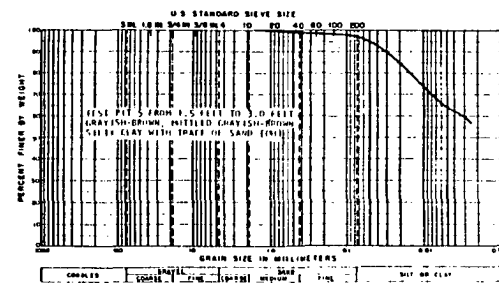
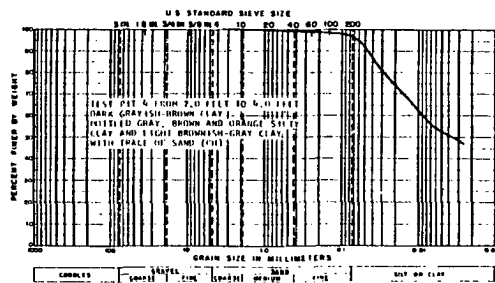
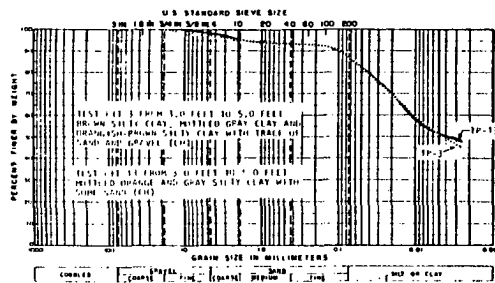
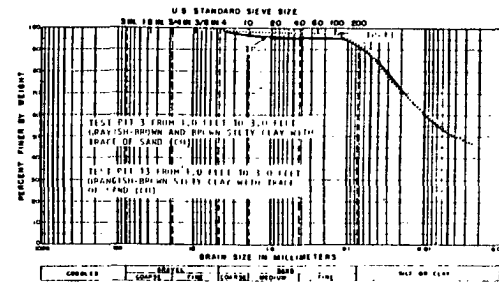
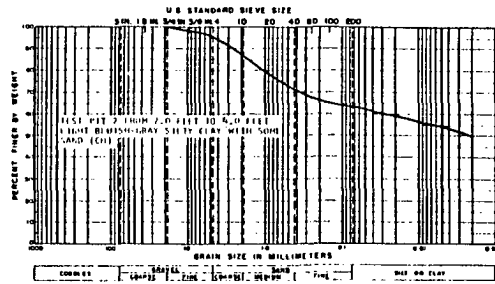
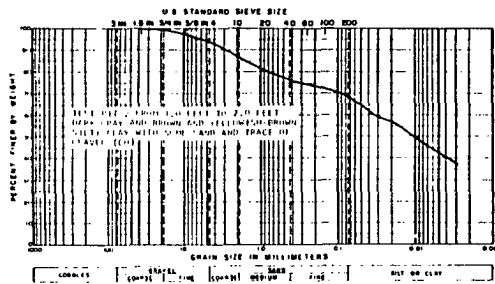

NOTE:
THE LOCATIONS OF THE TEST
PITS ARE SHOWN ON FIGURE 2.5-30

Rev. 0

WOLF CREEK
UPDATED SAFETY ANALYSIS REPORT

Figure 2.5-90 (Sheet 2 of 7)

Results of Particle-Size Analyses

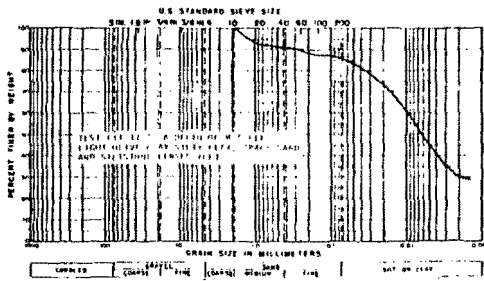
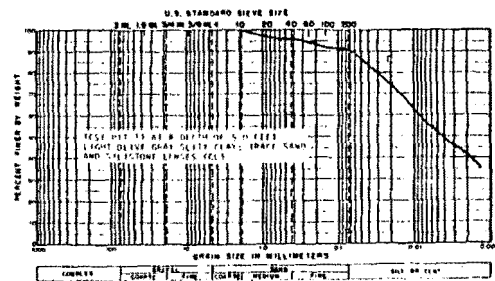
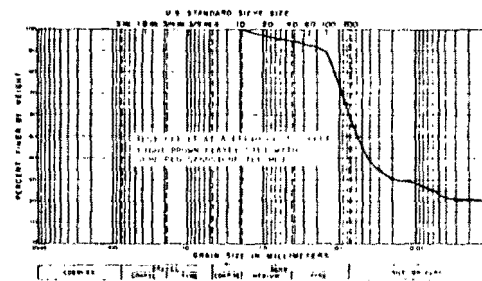
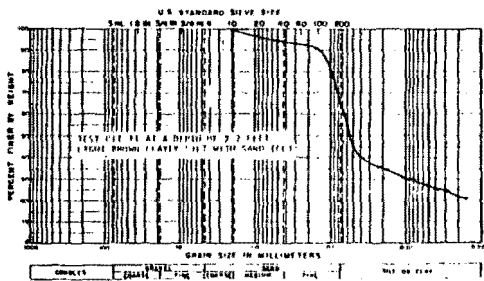
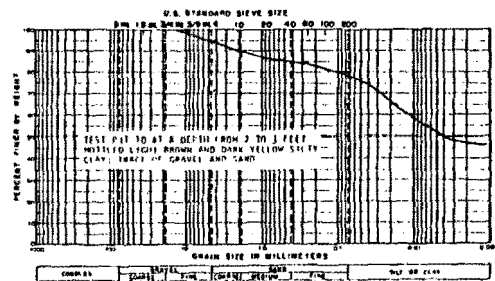
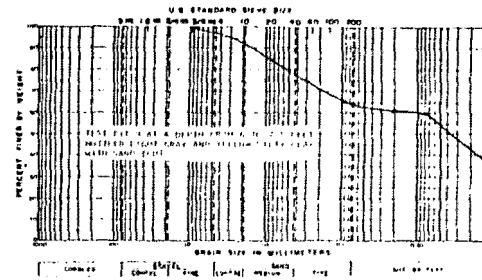
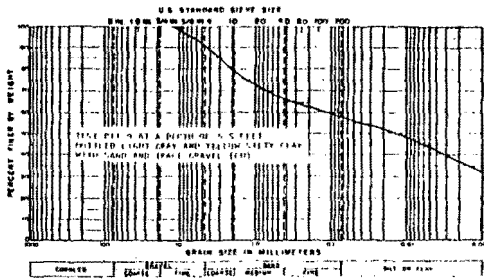
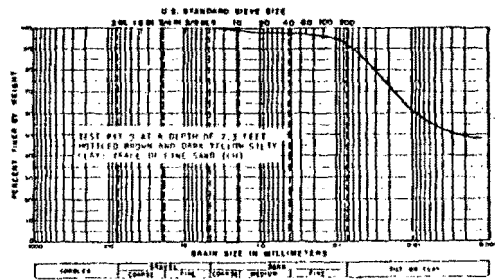

Rev. 0

WOLF CREEK
 UPDATED SAFETY ANALYSIS REPORT
 Figure 2.5-90 (Sheet 3 of 7)
 Results of Particle-Size Analyses

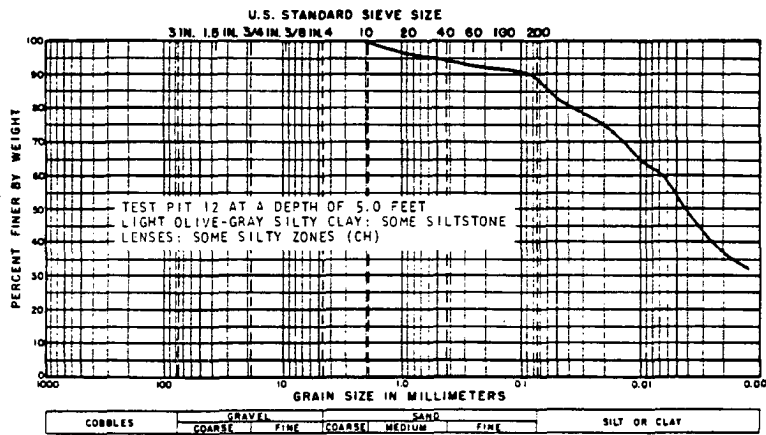
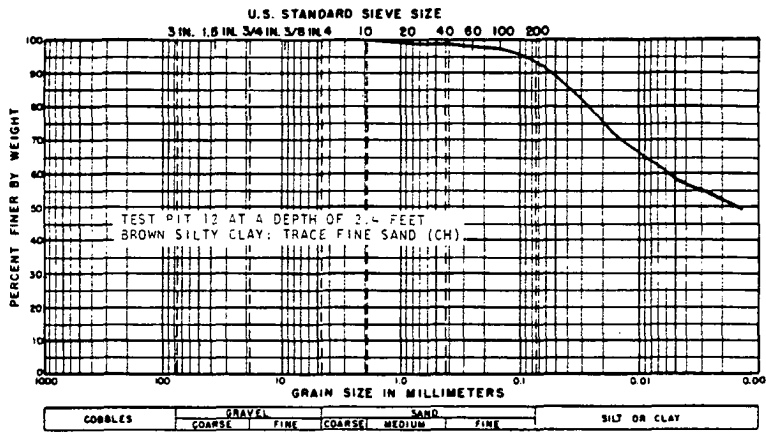

Rev. 0

**WOLF CREEK
UPDATED SAFETY ANALYSIS REPORT**

Figure 2.5-90 (Sheet 4 of 7)
Results of Particle-Size Analyses

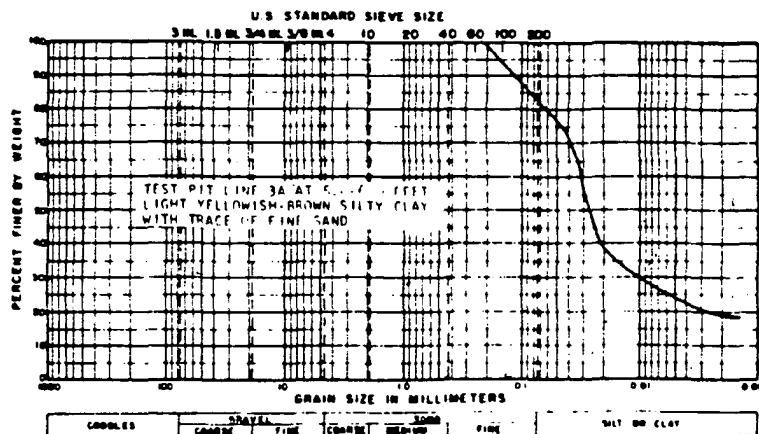
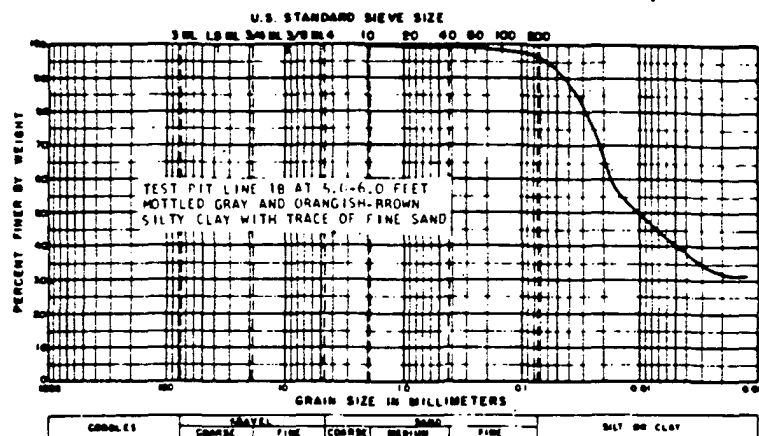
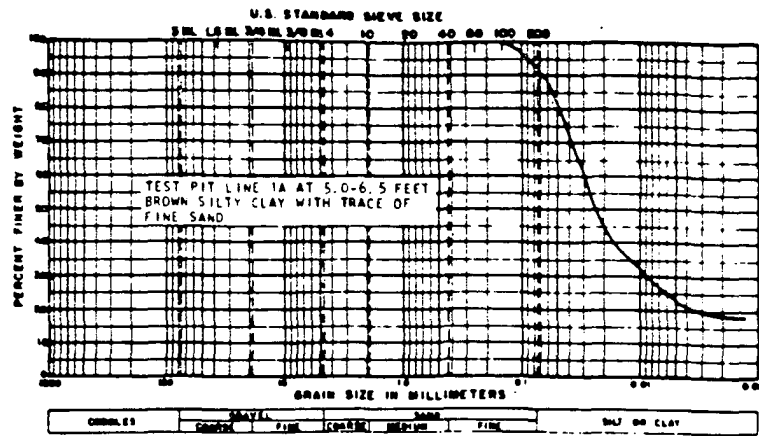

Rev. 0

**WOLF CREEK
UPDATED SAFETY ANALYSIS REPORT**

Figure 2.5-90 (Sheet 5 of 7)
Results of Particle-Size Analyses

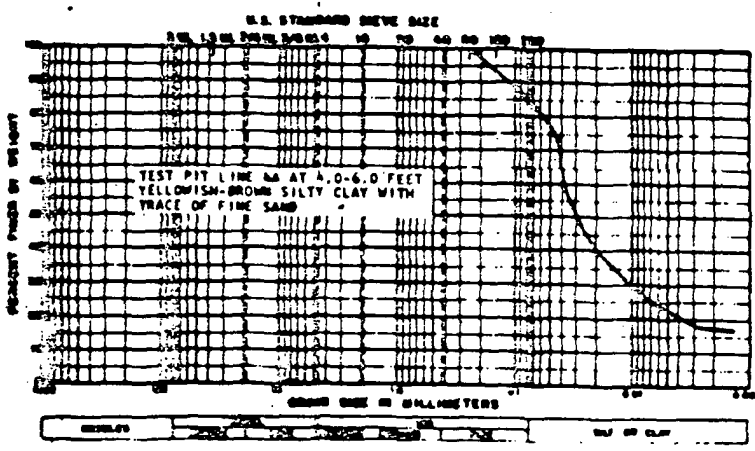
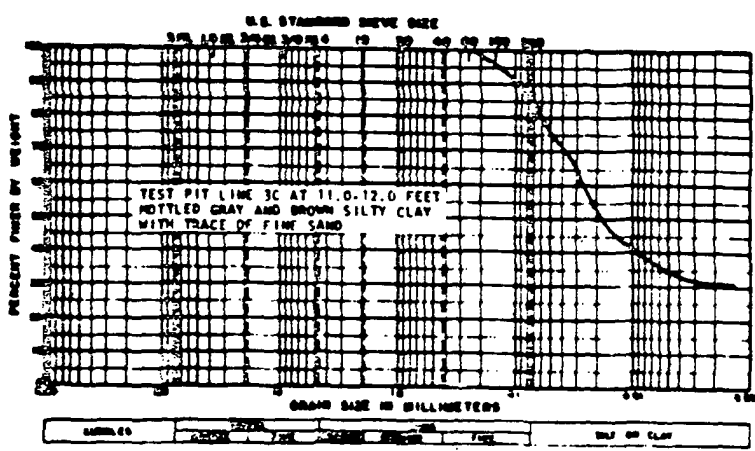
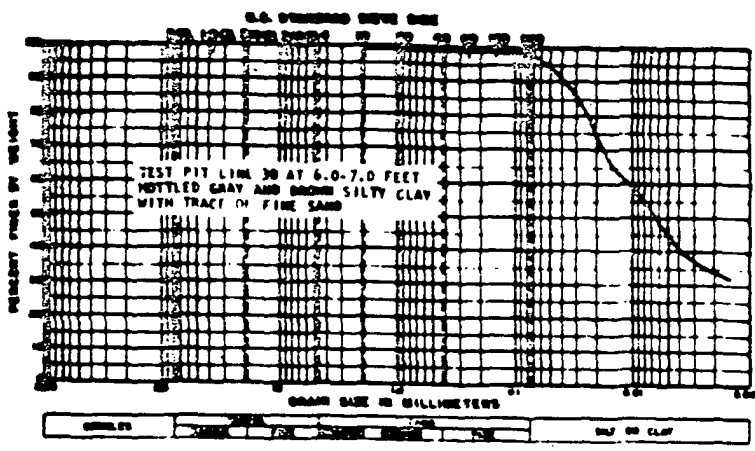

Rev. 0

WOLF CREEK
UPDATED SAFETY ANALYSIS REPORT

Figure 2.5-90 (Sheet 6 of 7)
Results of Particle-Size Analyses

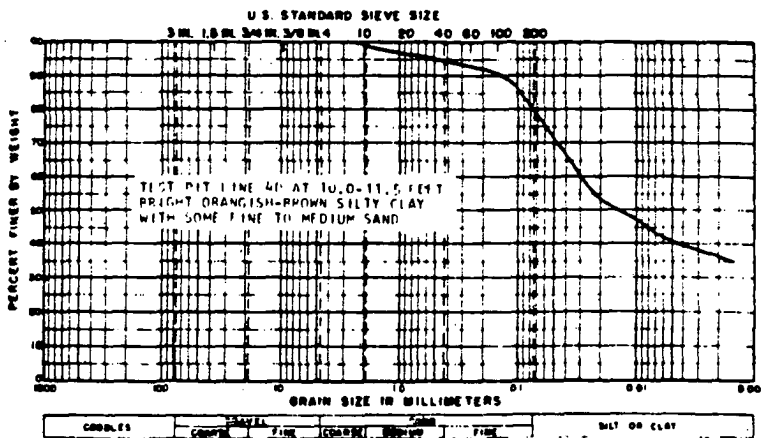
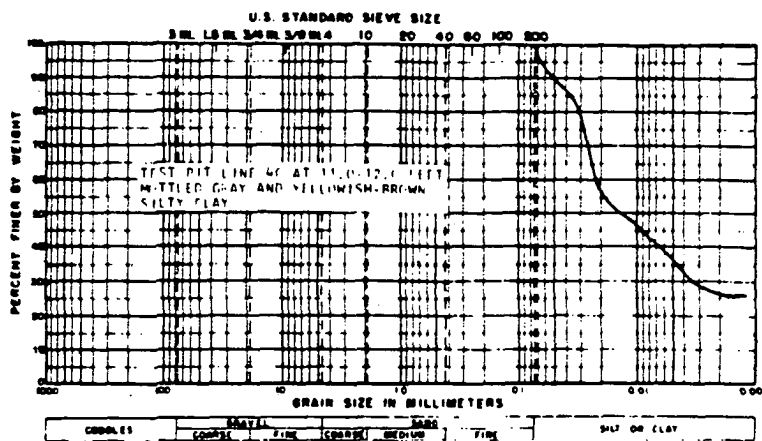
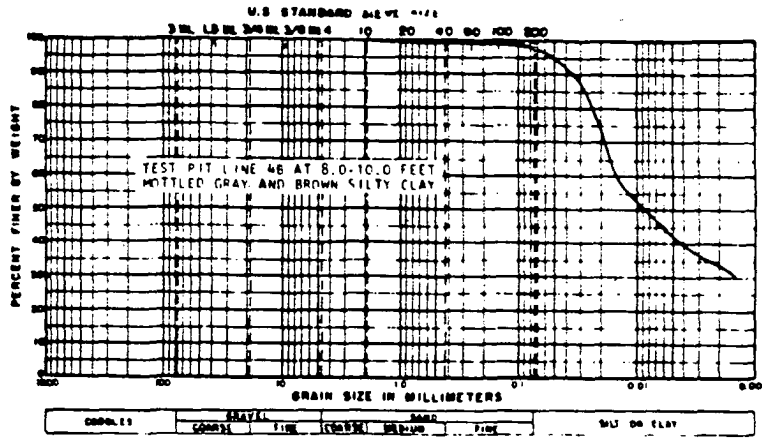

Rev. 0

**WOLF CREEK
UPDATED SAFETY ANALYSIS REPORT**

Figure 2.5-90 (Sheet 7 of 7)
Results of Particle-Size Analyses

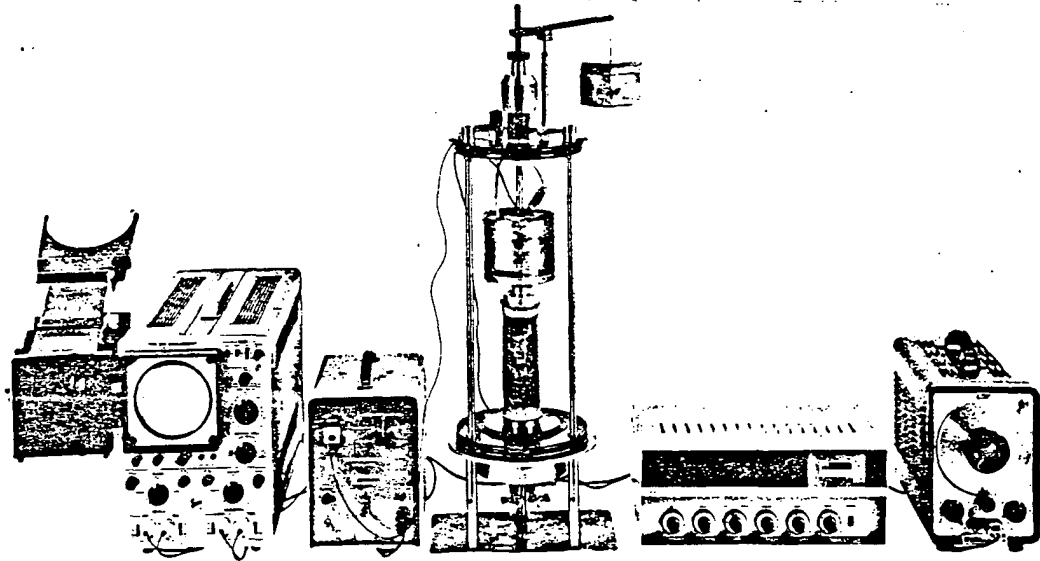

RESONANT COLUMN TESTS ARE PERFORMED TO EVALUATE THE DYNAMIC PROPERTIES OF THE SOIL OR ROCK SAMPLES. UTILIZING THE RESONANT COLUMN APPARATUS, A CYLINDRICAL COLUMN OF SOIL OR ROCK IS SUBJECTED TO A STEADY STATE SINUSOIDAL FORCING FUNCTION, WHICH STRESSES THE SAMPLE IN TORSION. THE FREQUENCY OF THE APPLIED FORCE IS VARIED UNTIL THE RESONANT FREQUENCY OF THE SOIL APPARATUS SYSTEM IS OBTAINED. THE RESONANT FREQUENCY IS THAT WHICH PRODUCES THE MAXIMUM AMPLITUDE OF OUTPUT RECORDED. THE RESONANT FREQUENCY THIS OBTAINED IS RELATED TO THE TORSIONAL SHEAR MODULUS OF THE MATERIAL TESTED.

RESONANT COLUMN TESTS ARE PERFORMED ON UNDISTURBED OR RECONSTITUTED CYLINDRICAL SAMPLES OF SOIL APPROXIMATELY 6 INCHES IN LENGTH AND $2\frac{1}{2}$ INCHES IN DIAMETER. THE SAMPLES ARE ENCASED IN A RUBBER MEMBRANE AND PLACED IN A TEST CHAMBER. THE TESTS MAY BE PERFORMED CONFINED OR UNCONFINED ON SOILS AT FIELD MOISTURE OR ON ARTIFICIALLY SATURATED SAMPLES. THE APPARATUS EMPLOYS A VIBRATION EXCITATION DEVICE, POWERED BY A VARIABLE FREQUENCY SINE WAVE GENERATOR WHICH APPLIES A FORCING TORQUE TO THE FREE END OF THE SPECIMEN. THE RESULTING VIBRATIONS ARE MEASURED BY AN ACCELEROMETER WHICH PRODUCES A CALIBRATED OUTPUT THAT IS A MEASURE OF THE ANGULAR ACCELERATION OF THE FREE END OF THE SPECIMEN. THE SINUSOIDAL VOLTAGE USED TO PRODUCE THE FORCING TORQUE AND THE OUTPUT OF THE ACCELEROMETER ARE DISPLAYED ON THE X-Y AXES OF THE OSCILLOSCOPE RESULTING IN ELLIPTICAL CONFIGURATIONS FOR ASSOCIATED FREQUENCIES. THESE ELLIPTICAL LOOPS ARE PHOTOGRAPHED AND EVALUATED TO DETERMINE THE DAMPING CHARACTERISTICS OF THE SAMPLES TESTED.

**WOLF CREEK
UPDATED SAFETY ANALYSIS REPORT**

Figure 2.5-91

Method of Performing Resonant
Column Tests

Rev. 0

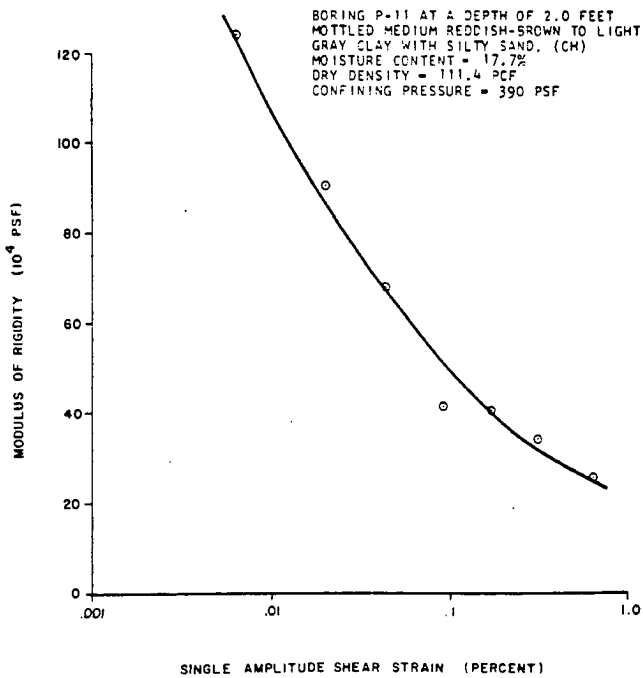
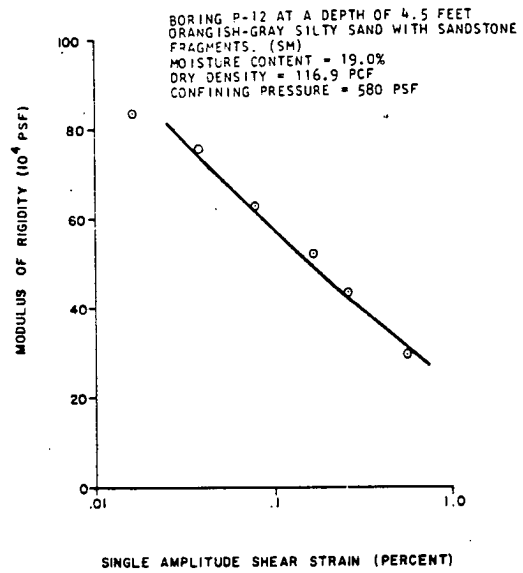
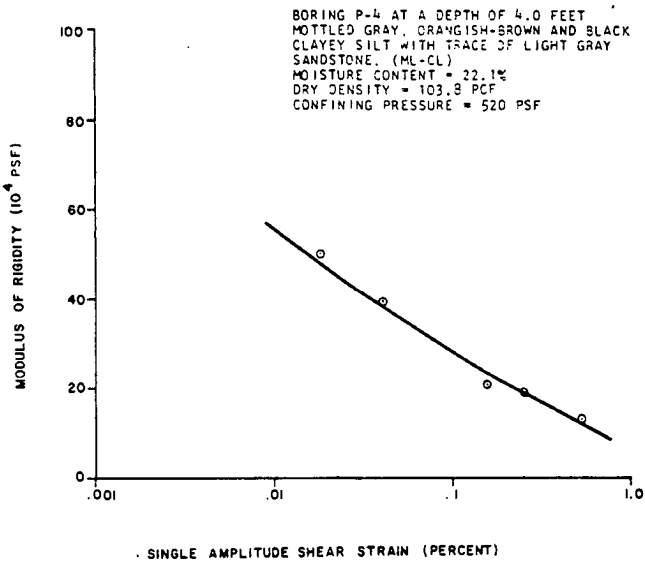

Rev. 0

**WOLF CREEK
UPDATED SAFETY ANALYSIS REPORT**

Figure 2.5-92

Results of Dynamic Triaxial
Testing

NOTE: 1. THE LOCATION OF BORINGS P-4, P-11
AND P-12 IS SHOWN ON FIGURE 2.5-31.
2. DYNAMIC TRIAXIAL TEST RESULTS ARE
PRESENTED IN TABLE 2.5-31

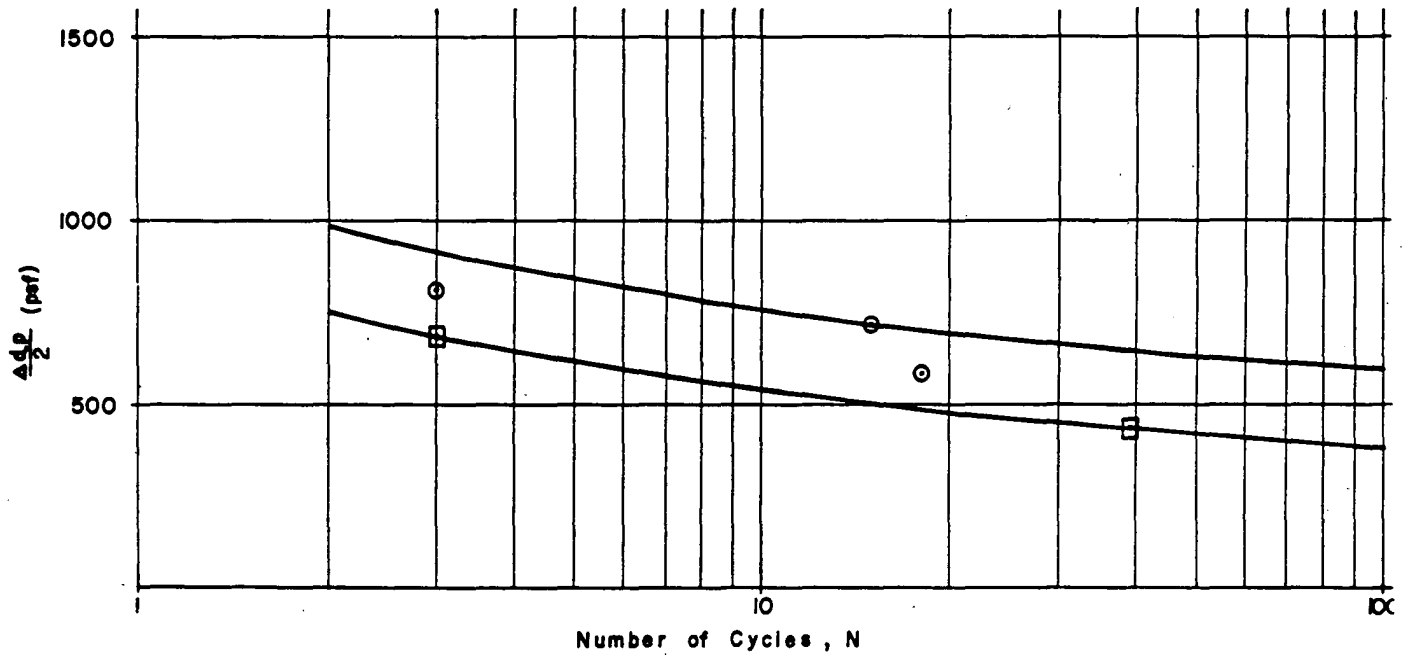

LEGEND (TP-13)

	σ_{3c} (tsf)	K_c
○	0.6	1.75
◻	0.2	1.75

Rev. 0

**WOLF CREEK
UPDATED SAFETY ANALYSIS REPORT**

Figure 2.5-93 (Sheet 1 of 2)

Results of Stress-Controlled
Cyclic Triaxial Tests for Five
Percent Strain

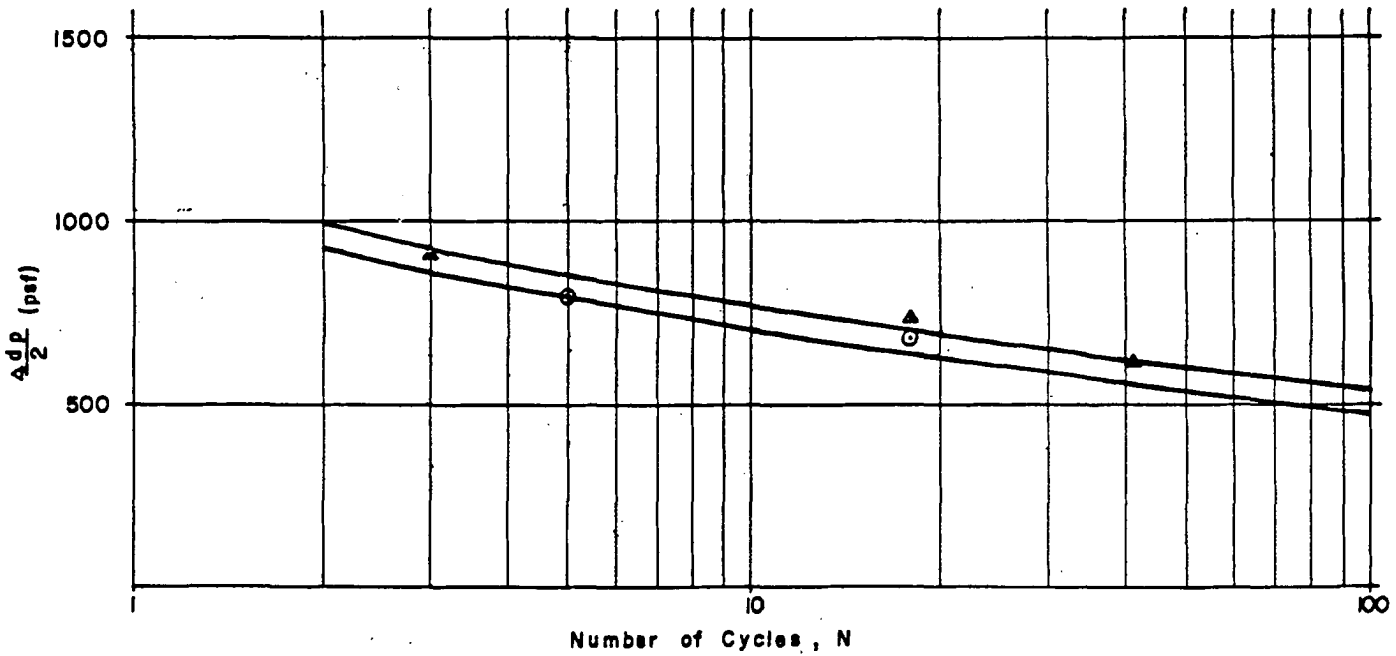

LEGEND (TP-3)

	σ_{sc} (tsf)	K_c
▲	0.9	1.25
⊙	0.6	1.25

Rev. 0

**WOLF CREEK
UPDATED SAFETY ANALYSIS REPORT**

Figure 2.5-93 (Sheet 2 of 2)

Results of Stress-Controlled
Cyclic Triaxial Tests for Five
Percent Strain

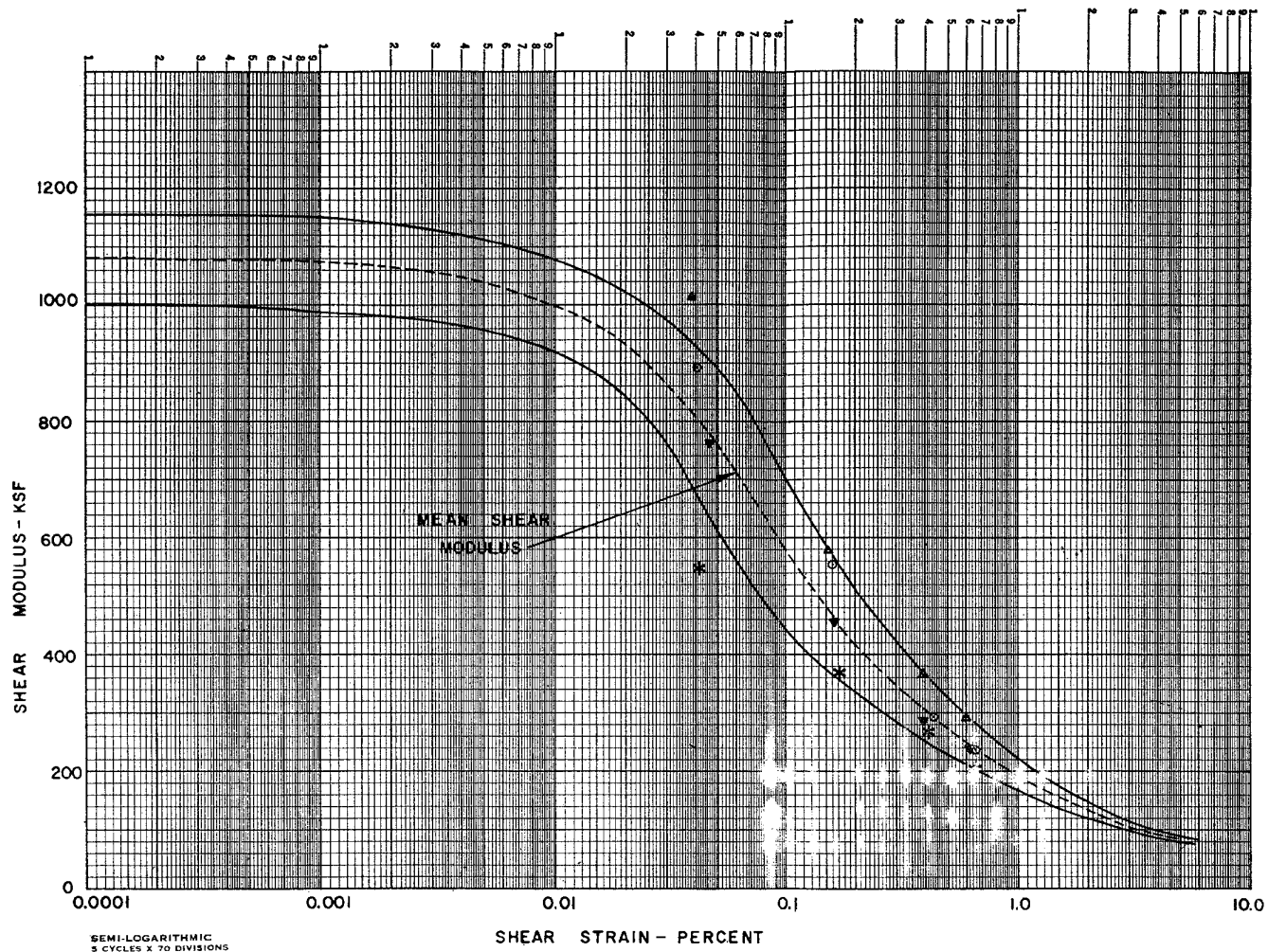

- TP-1 (7 Series)
- ▲ TP-1 (8 Series)
- * TP-3 (9 Series)
- ▼ TP-3 (10 Series)

Rev. 0

WOLF CREEK
 UPDATED SAFETY ANALYSIS REPORT

FIGURE 2.5-94

LABORATORY DATA - SHEAR MODULI FOR CLAY

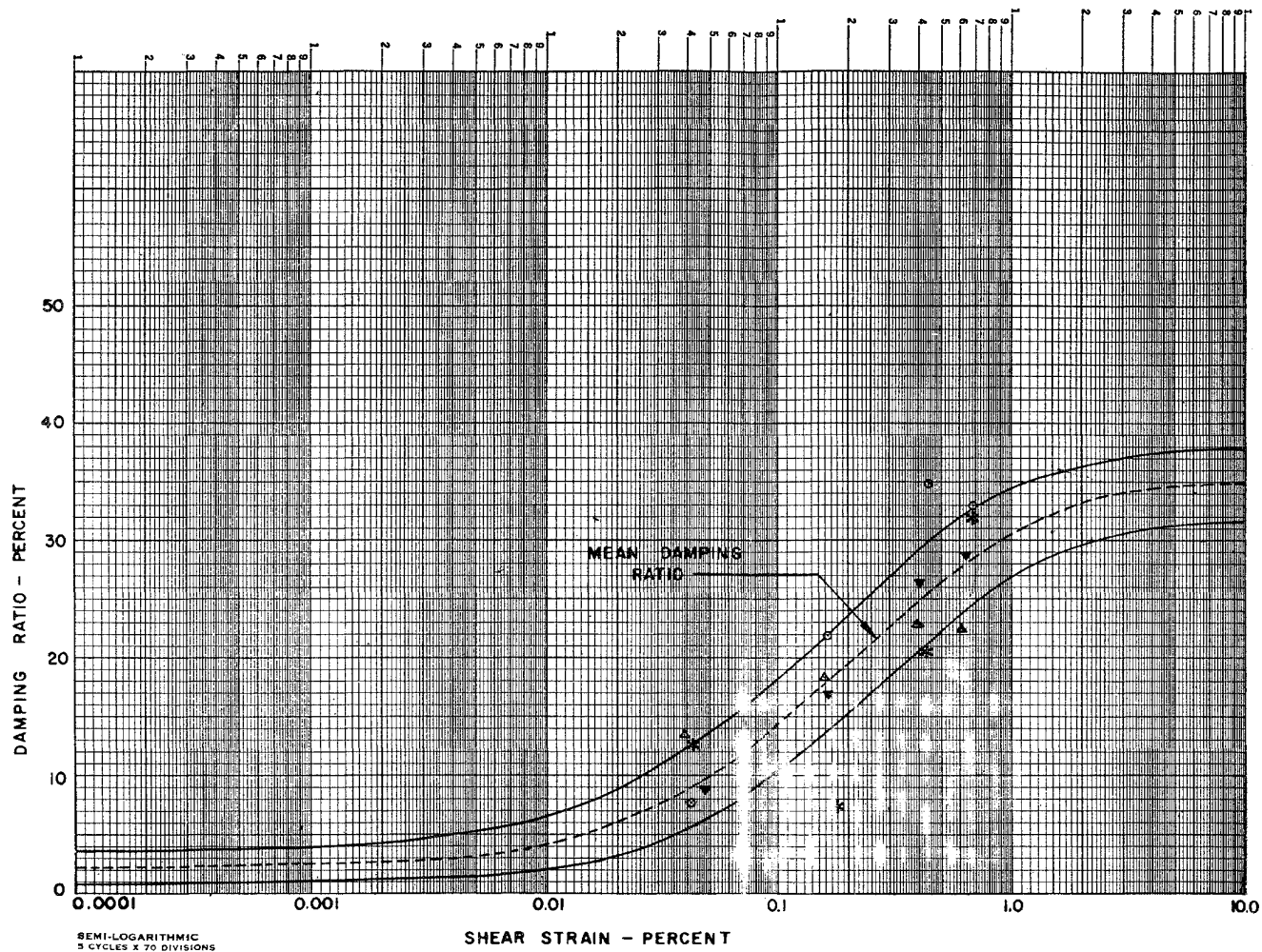

- TP-1 (7 Series)
- ▲ TP-1 (8 Series)
- * TP-3 (9 Series)
- ▼ TP-3 (10 Series)

Rev. 0

WOLF CREEK
UPDATED SAFETY ANALYSIS REPORT

FIGURE 2.5-95

LABORATORY DATA - DAMPING RATIOS FOR CLAY

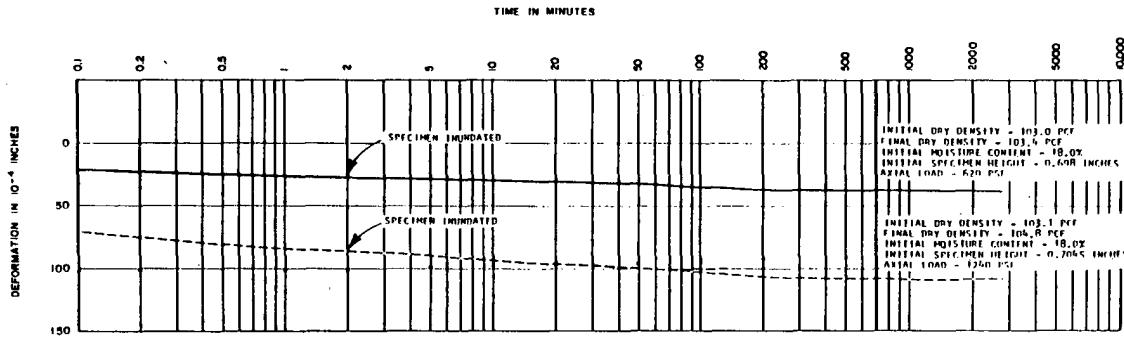

TEST PIT 1 AT A DEPTH OF 1.0 FEET TO 3.0 FEET
FRIEDED BROWN AND GRAY SILTY CLAY WITH SAND
(C1)

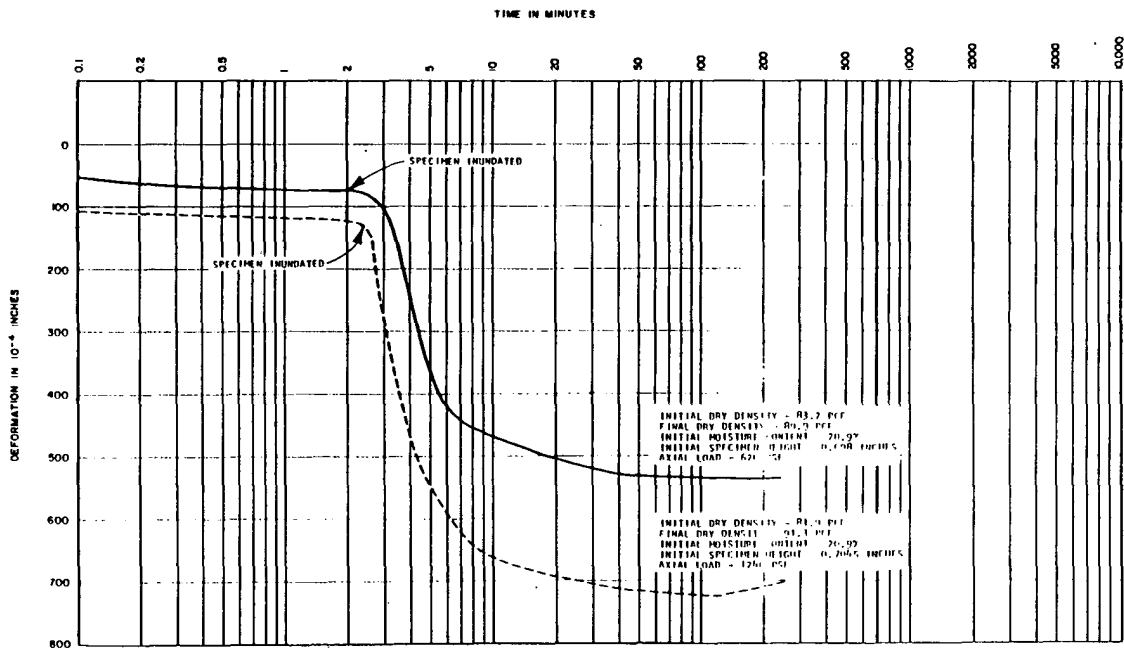

TEST PIT 3 AT A DEPTH OF 1.0 FEET TO 5.0 FEET
FRIEDED BROWN AND GRAY SILTY CLAY WITH TRACES OF
LOAM AND GRAVEL FRAGS

Rev. 0

WOLF CREEK
UPDATED SAFETY ANALYSIS REPORT

Figure 2.5-96a

Results of Swell Load Testing -
Test Pits 1 and 3

- NOTES: 1. THE LOCATIONS OF THESE PITS 1 AND 3 ARE
SHOWN ON FIGURE 2.5-30.
2. SHAFT SAMPLES EMPLOYED TO 95 PERCENT
ASTM D 608-70.

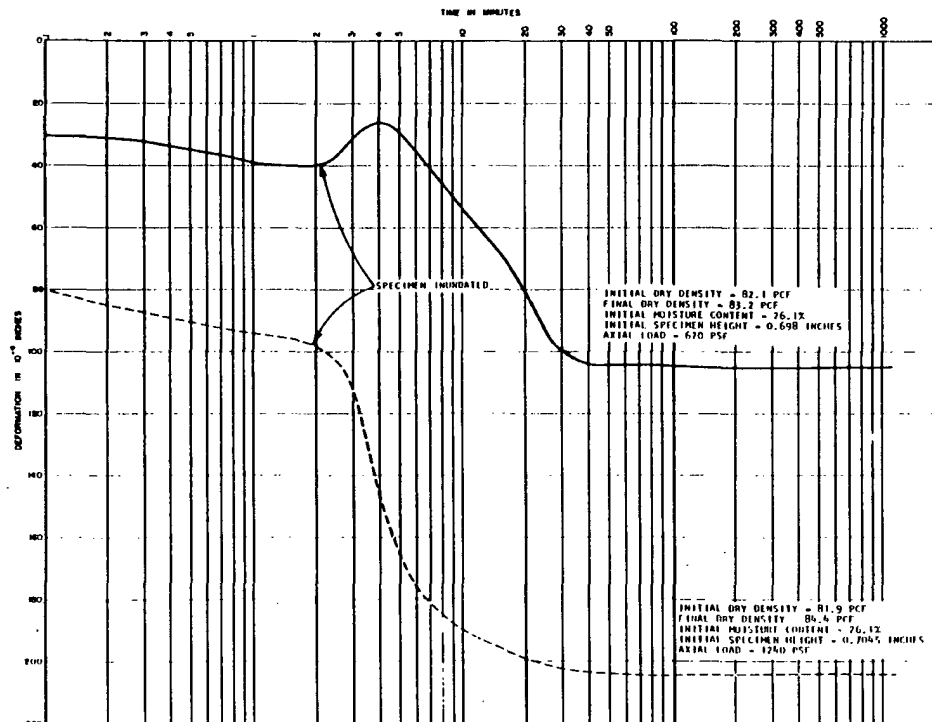

TEST PIT 5 AT A DEPTH OF 1.5 FEET TO
3.0 FEET
FILLED GRAYISH-BROWN AND GRAYISH-BLACK
SILTY CLAY WITH OCCASIONAL SAND AND
ORANGE CLAY WITH TRACE OF SAND (H)

Rev. 0

WOLF CREEK
UPDATED SAFETY ANALYSIS REPORT

Figure 2.5-96b

Results of Swell Load Testing -
Test Pit 5

NOTE: 1. THE LOCATION OF TEST PIT 5 IS
SHOWN ON FIGURE 2.5-10.
2. SAMPLES COMPARED TO 95 PERCENT
ASTM D 698-70.

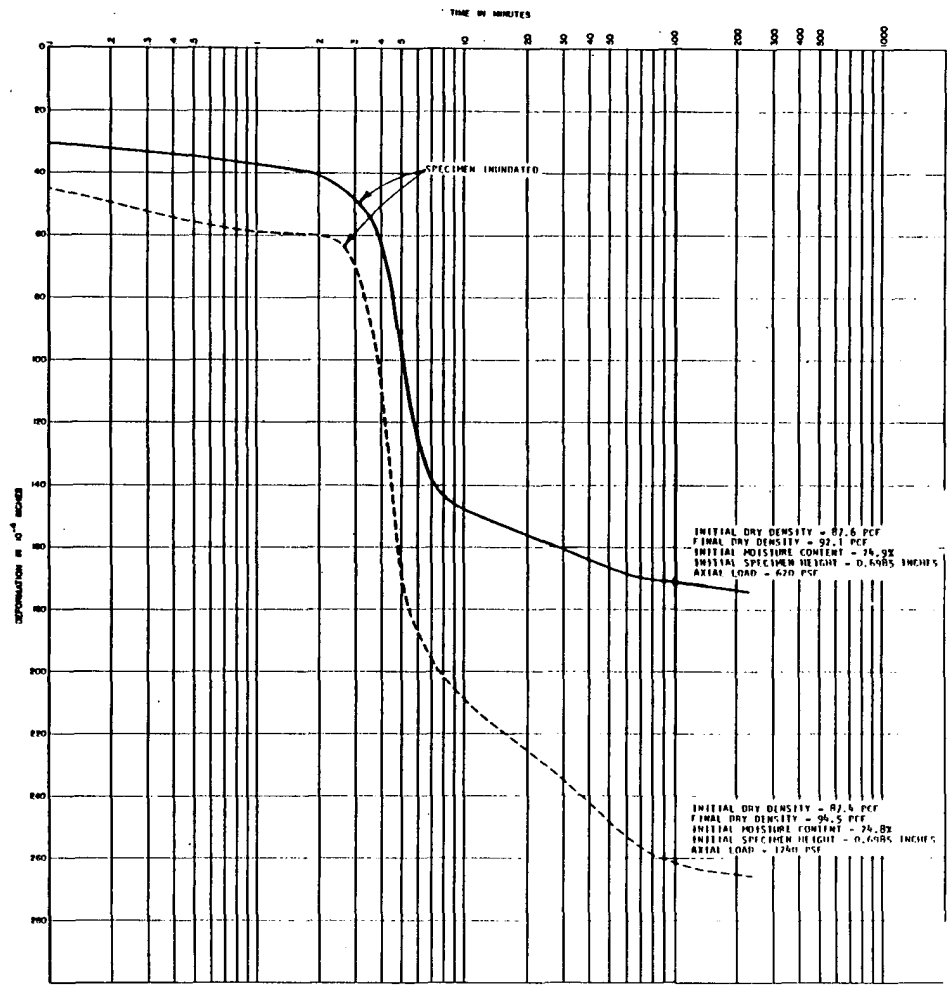

TEST PIT 6 AT A DEPTH OF 5.0 FEET TO
 6.0 FEET
 (RIGHT OF THE GRAY SILTY CLAY (CL))

Rev. 0

WOLF CREEK
 UPDATED SAFETY ANALYSIS REPORT

Figure 2.5-96c
 Results of Swell Load Testing -
 Test Pit 6

NOTE: 1. THE LOCATION OF TEST PIT 6
 IS SHOWN IN FIGURE 2.5-10.
 2. SAMPLES COMPACTED TO 95 PERCENT
 ASTM D 698-70

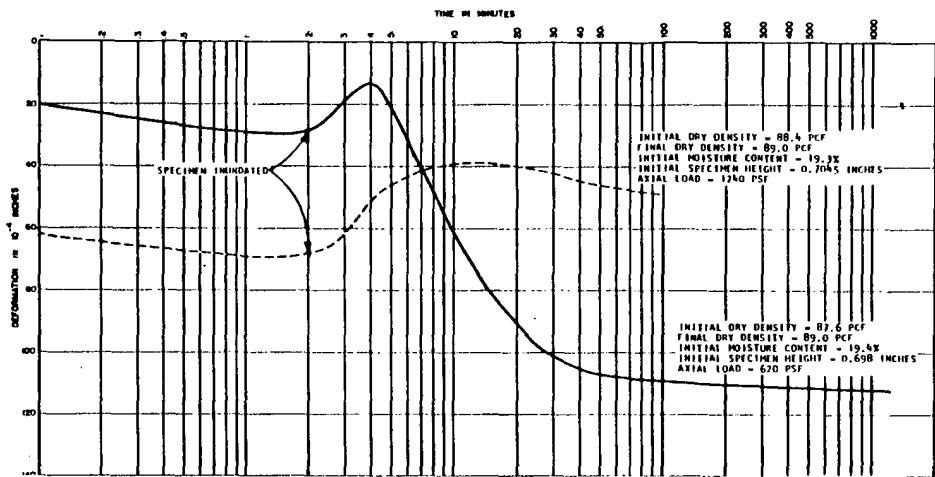

TEST PIT 4 AT A DEPTH OF 2.0 FEET TO 4.0 FEET
DARK GRAYISH-BROWN CLAY WITH SOME SILT TO LIGHT BROWNISH-GRAY CLAY (CH) WITH TEST PIT 6 AT A DEPTH OF 1.5 FEET TO 4.5 FEET
VERY DARK GRAYISH-BROWN CLAY AND MOTTLED GRAYISH-BROWN, YELLOWISH-BROWN AND DARK GRAY CLAY WITH SOME SILT AND TRACE OF SAND (CH)

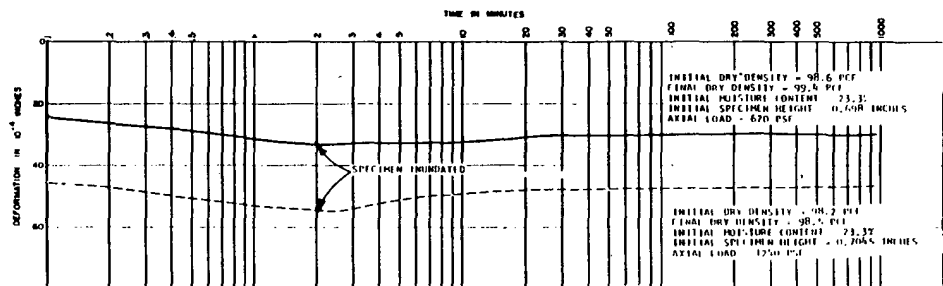

TEST PIT 2 AT A DEPTH OF 1.0 FEET TO 4.0 FEET
DARK GRAY AND BROWN SILTY CLAY WITH SOME SAND AND GRAVEL TO LIGHT GRAY CLAY (CH)

Rev. (

**WOLF CREEK
UPDATED SAFETY ANALYSIS REPORT**

Figure 2.5-96d

Results of Swell Load Testing -
Test Pit 2 and Combination Test
Pits 4 and 6

NOTE: 1. THE LOCATION OF TEST PITS 4 AND 6 IS SHOWN IN FIGURE 2.5-30
2. SAMPLES COMPACTED TO 95 PERCENT ASTM D 698-70.

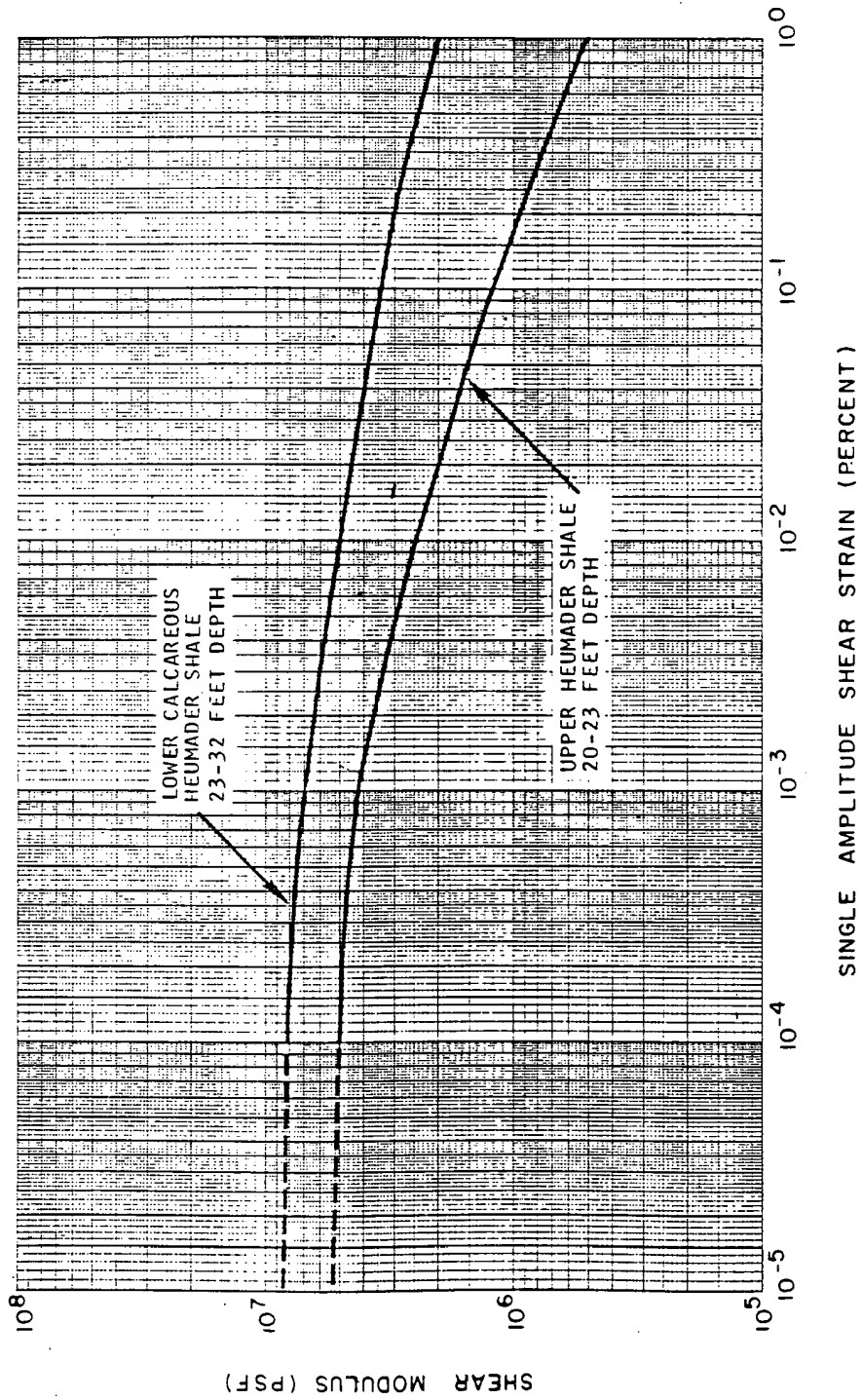

Rev. 0

**WOLF CREEK
UPDATED SAFETY ANALYSIS REPORT**

Figure 2.5-97a

Recommended Design Shear Modulus
Versus Shear Strain Curves for
the Heumader Shale Member at the
ESWS Pumphouse

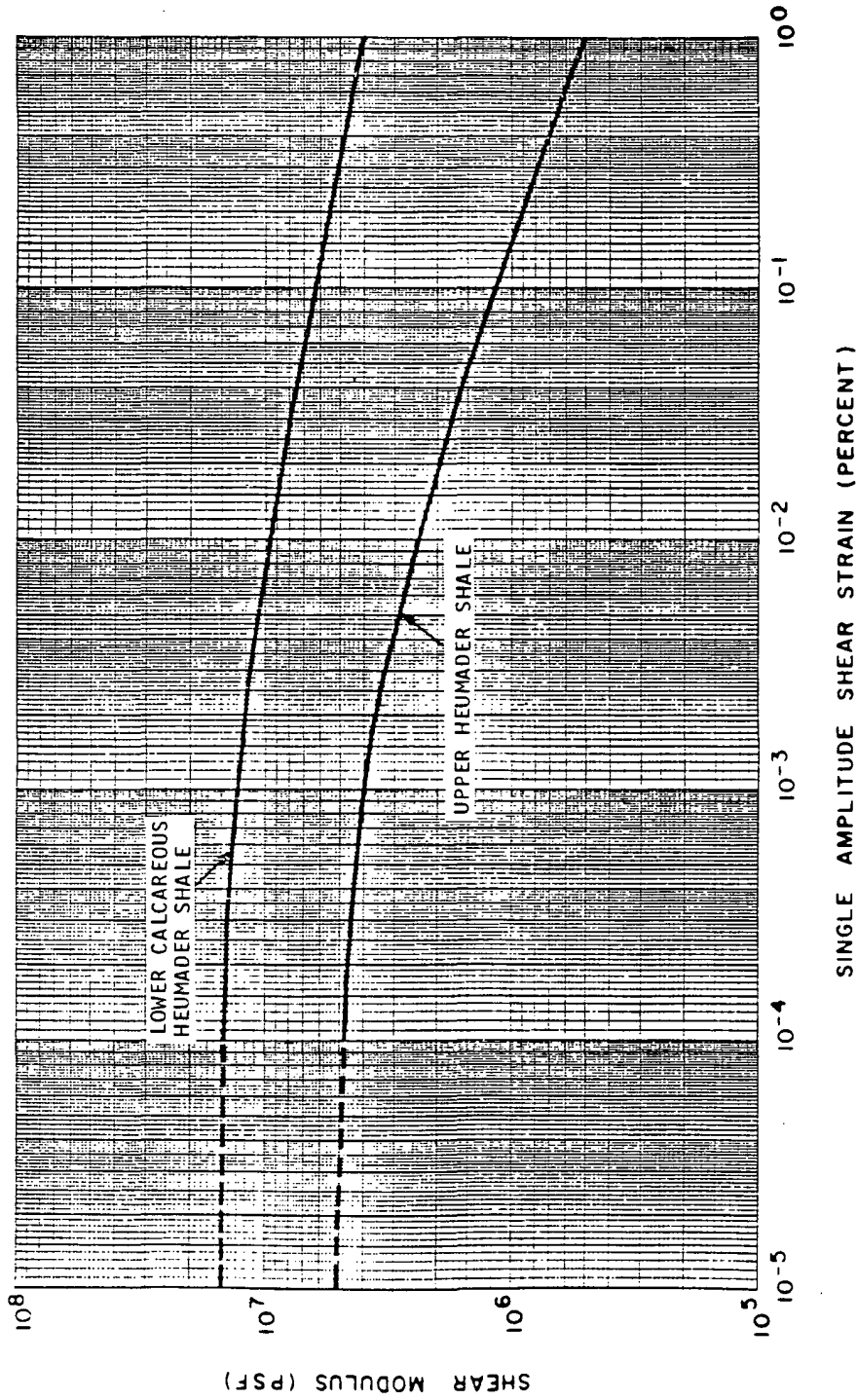

Rev. 0

**WOLF CREEK
UPDATED SAFETY ANALYSIS REPORT**

Figure 2.5-97b

Recommended Design Shear Modulus
Versus Shear Strain Curves for
the Heumader Shale Member at the
Plant Site

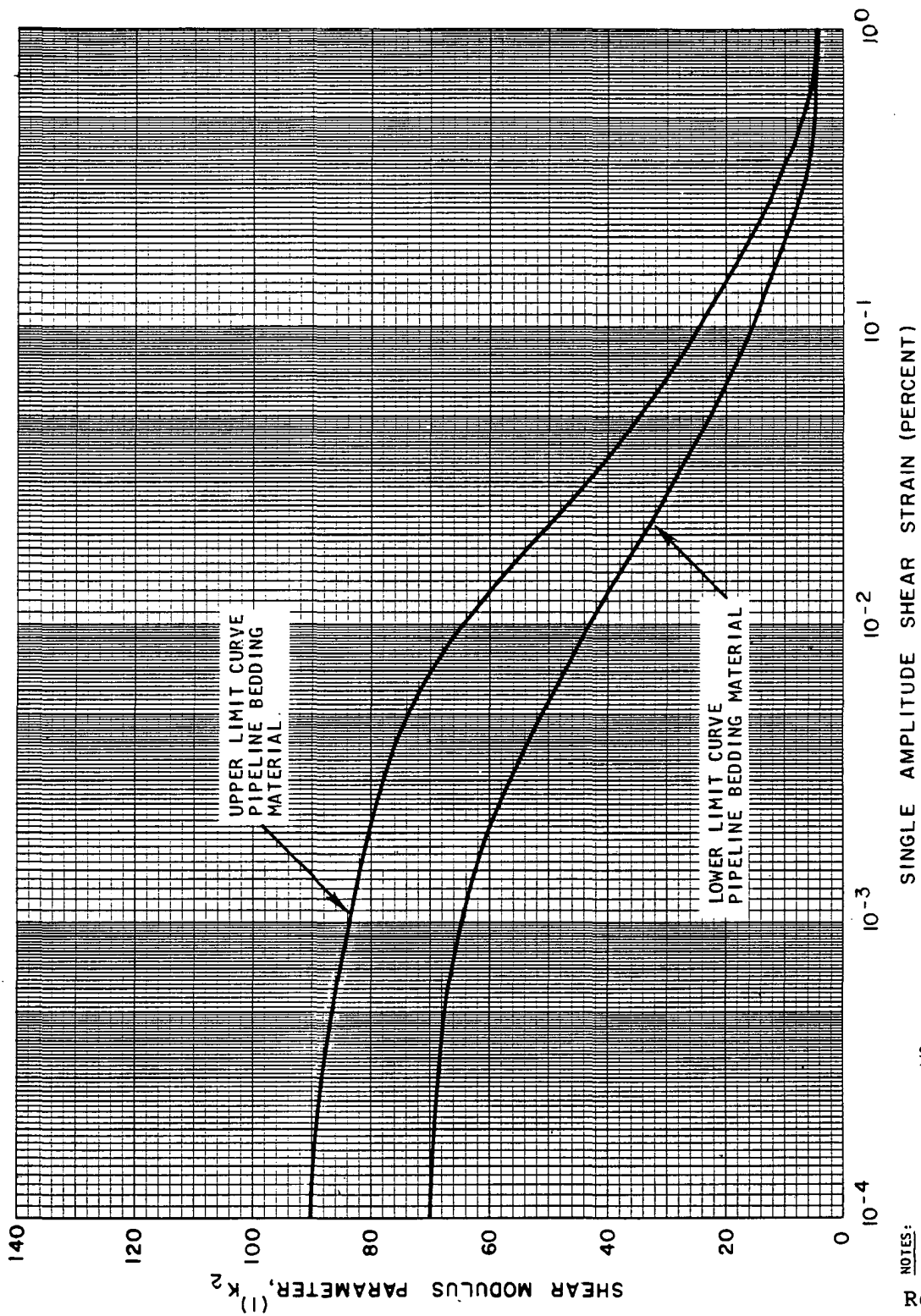

NOTES:

1. $G = 1000K^2 (\delta_m)^{1/2}$
 WHERE G IN PSF IS THE SHEAR MODULUS,
 K^2 IS A CONSTANT AND δ_m IS THE MEAN
 EFFECTIVE STRESS, ALSO IN PSF.
2. GRADATIONS PER SARGENT & LUNDY
 ENGINEERS SPEC. NO. A-3852 SECTION
 301.5C

Rev. 0

**WOLF CREEK
 UPDATED SAFETY ANALYSIS REPORT**

Figure 2.5-97c

Recommended Shear Modulus Versus
 Shear Strain Curve for Crushed
 Rock Pipeline Bedding Material

Recommended Shear Modulus Versus
 Strain Curve for Crushed Rock
 Structural Fill

Figure 2.5-97d

WOLF CREEK
UPDATED SAFETY ANALYSIS REPORT

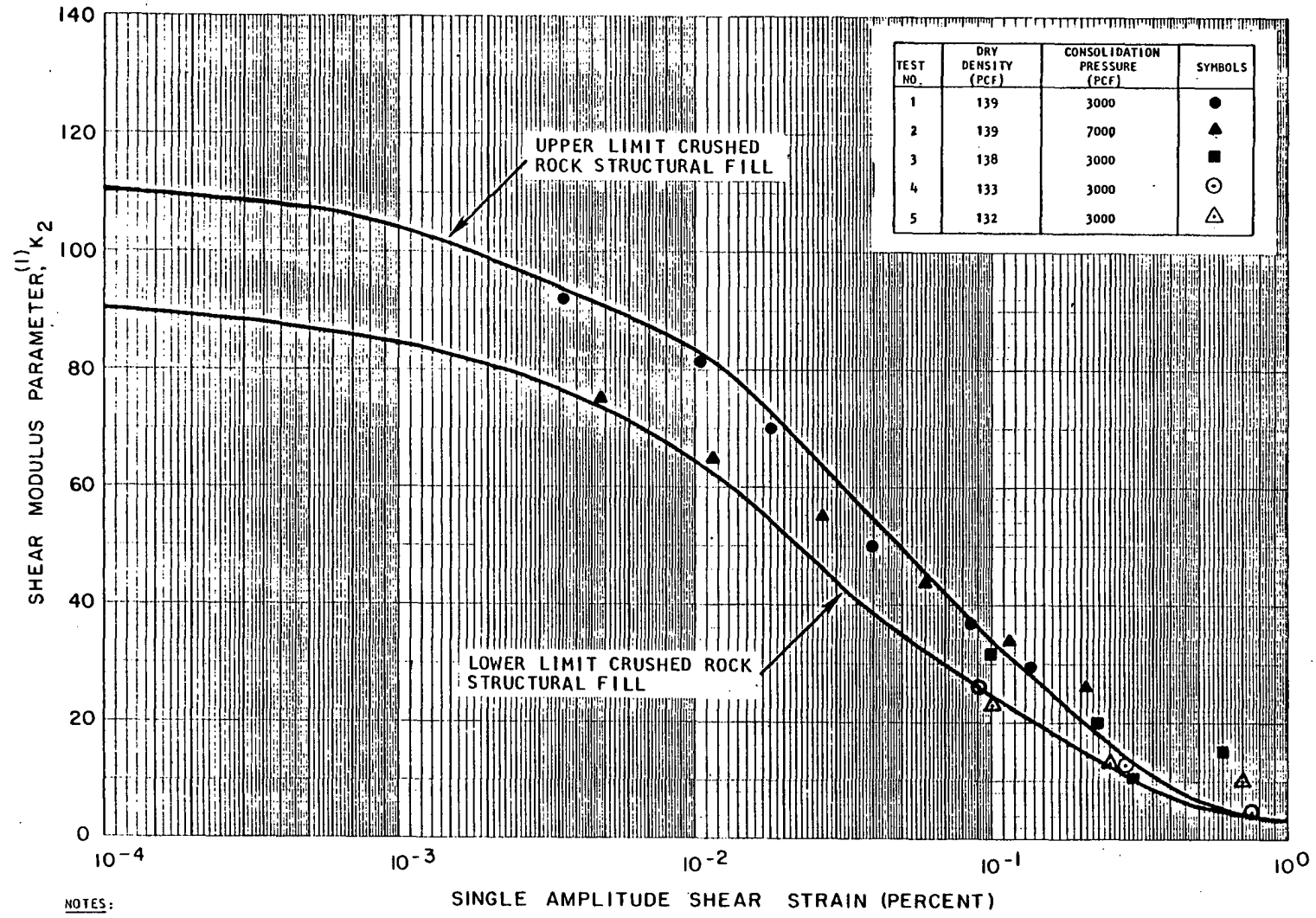

NOTES:
 1. $G = 1000K_2 (\sigma_m')^{1/2}$
 WHERE G IN PSF IS THE SHEAR MODULUS,
 K_2 IS A CONSTANT, AND σ_m' IS THE MEAN
 EFFECTIVE STRESS, ALSO IN PSF.
 2. GRADATIONS PER DMLK-419, JULY 6,
 1977.

Rev. 0

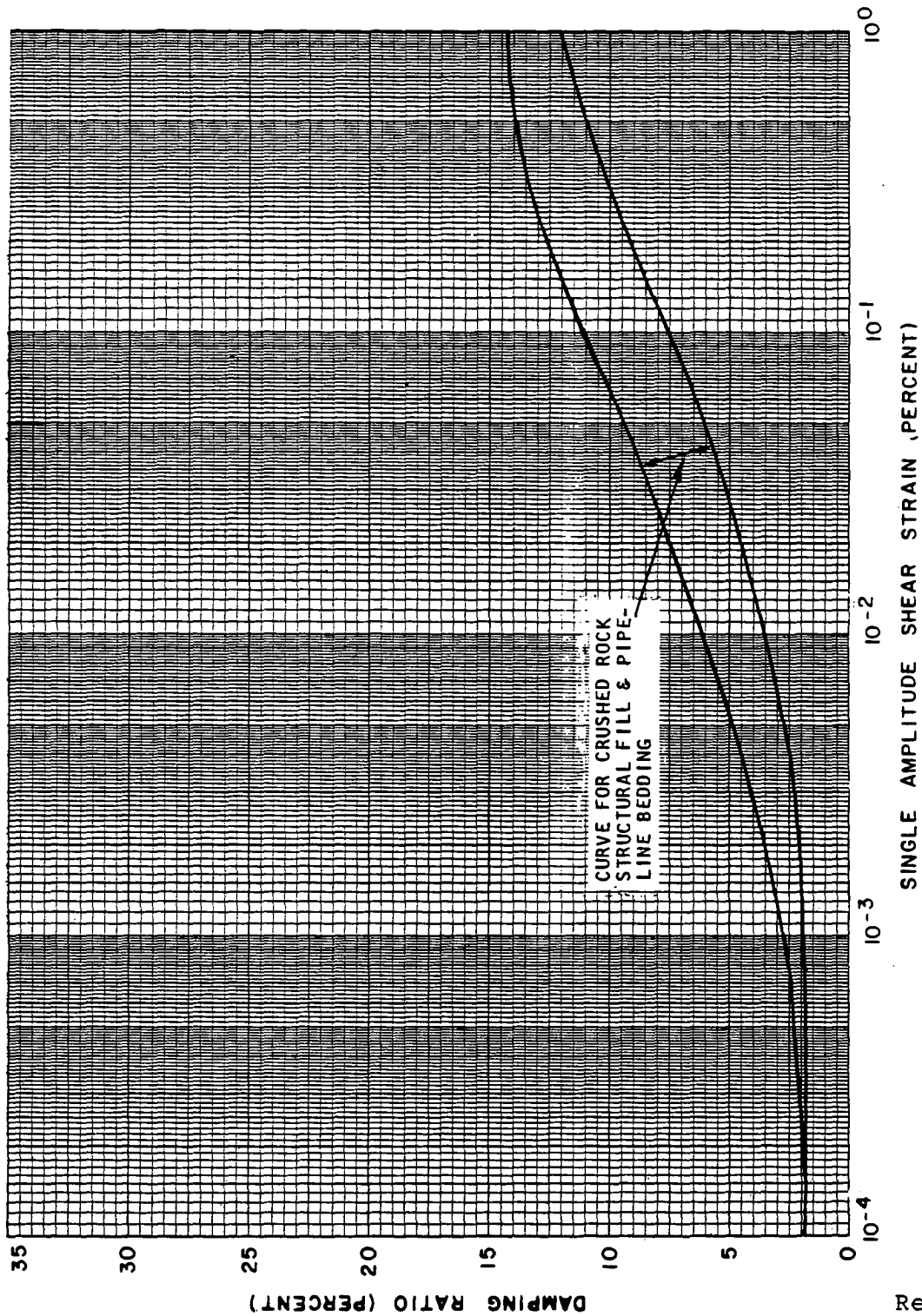

NOTES:

1. GRADATION PER DHLK-419, JULY 6, 1977 AND SARGENT & LUNDY ENGINEERS SPEC. NO. A-3852 SECTION 301.5C.

Rev. 0

**WOLF CREEK
UPDATED SAFETY ANALYSIS REPORT**

Figure 2.5-97e

Recommended Damping Ratio Versus Shear Strain Curve for Crushed Rock Backfill

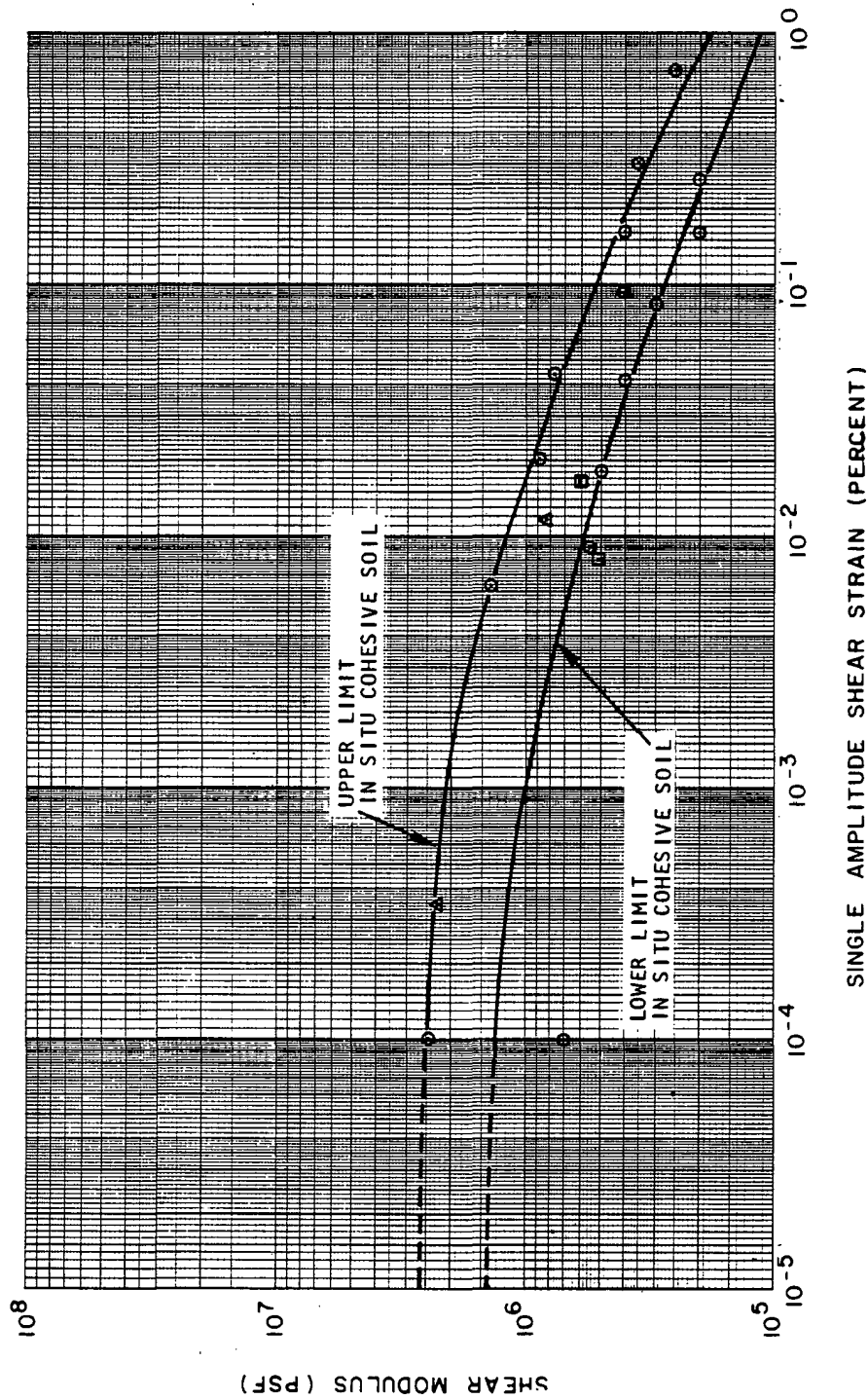

NOTE:

- 1. UPPER LIMIT CURVE IS MORE REPRESENTATIVE OF SOILS BELOW 6 FEET AND THE LOWER LIMIT CURVE IS MORE REPRESENTATIVE OF SOILS BETWEEN 0-6 FEET.

Rev. 0

**WOLF CREEK
UPDATED SAFETY ANALYSIS REPORT**

Figure 2.5-97f

Recommended Design Shear Modulus
Versus Shear Strain Curves for in
Situ Cohesive Soils at the ESWS
Pumphouse

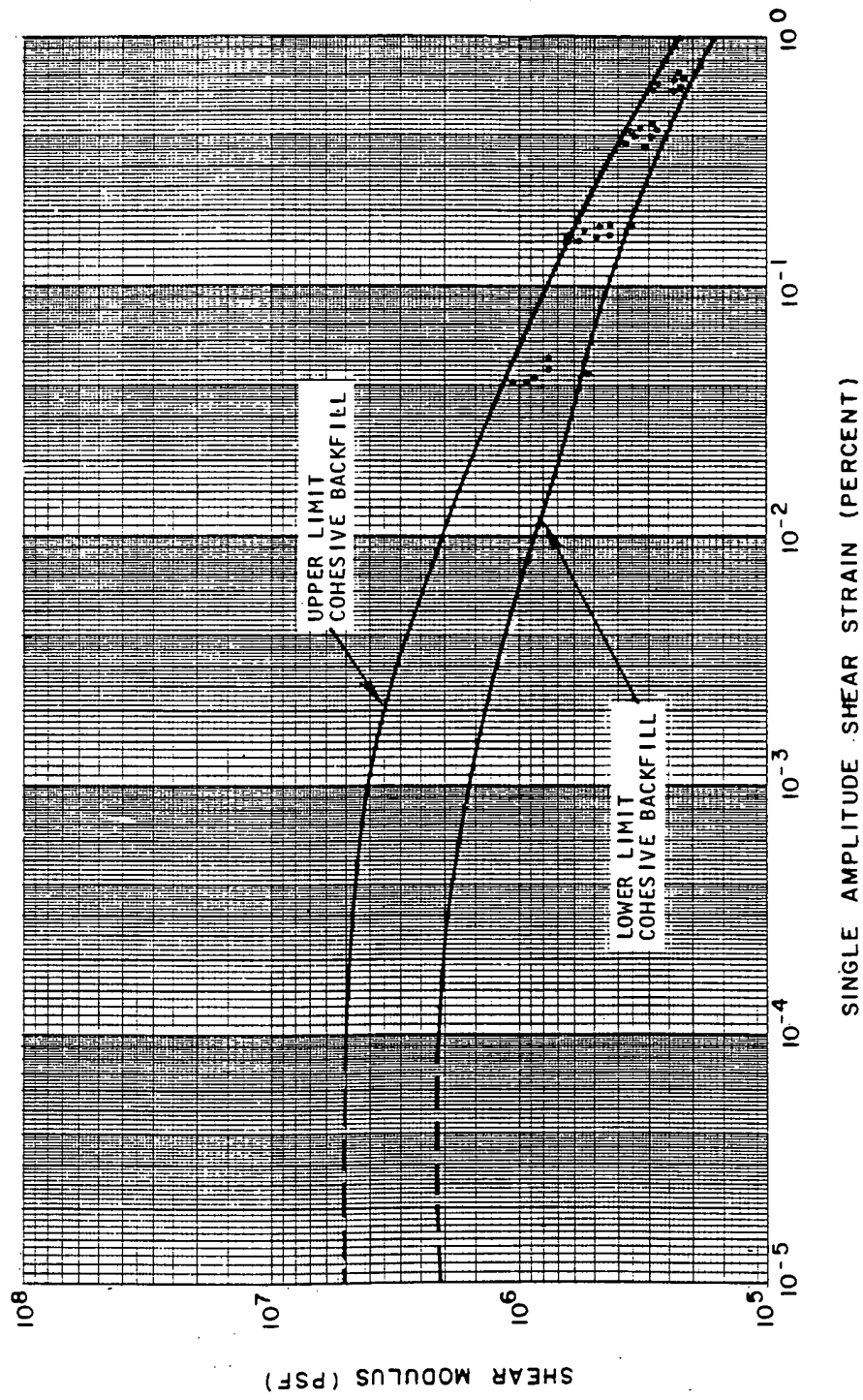

NOTE:

1. COHESIVE BACKFILL ASSUMED TO BE PLASTIC CLAY SOILS (CL OR CH) COMPACTED TO 90% γ_d (MAX) PER ASTM D1557.

Rev. 0

**WOLF CREEK
UPDATED SAFETY ANALYSIS REPORT**

Figure 2.5-97g

Recommended Design Shear Modulus
Versus Shear Strain Curves for
Cohesive Backfill at the ESWS
Pumphouse

SHEAR MODULUS (PSF)

SINGLE AMPLITUDE SHEAR STRAIN (PERCENT)

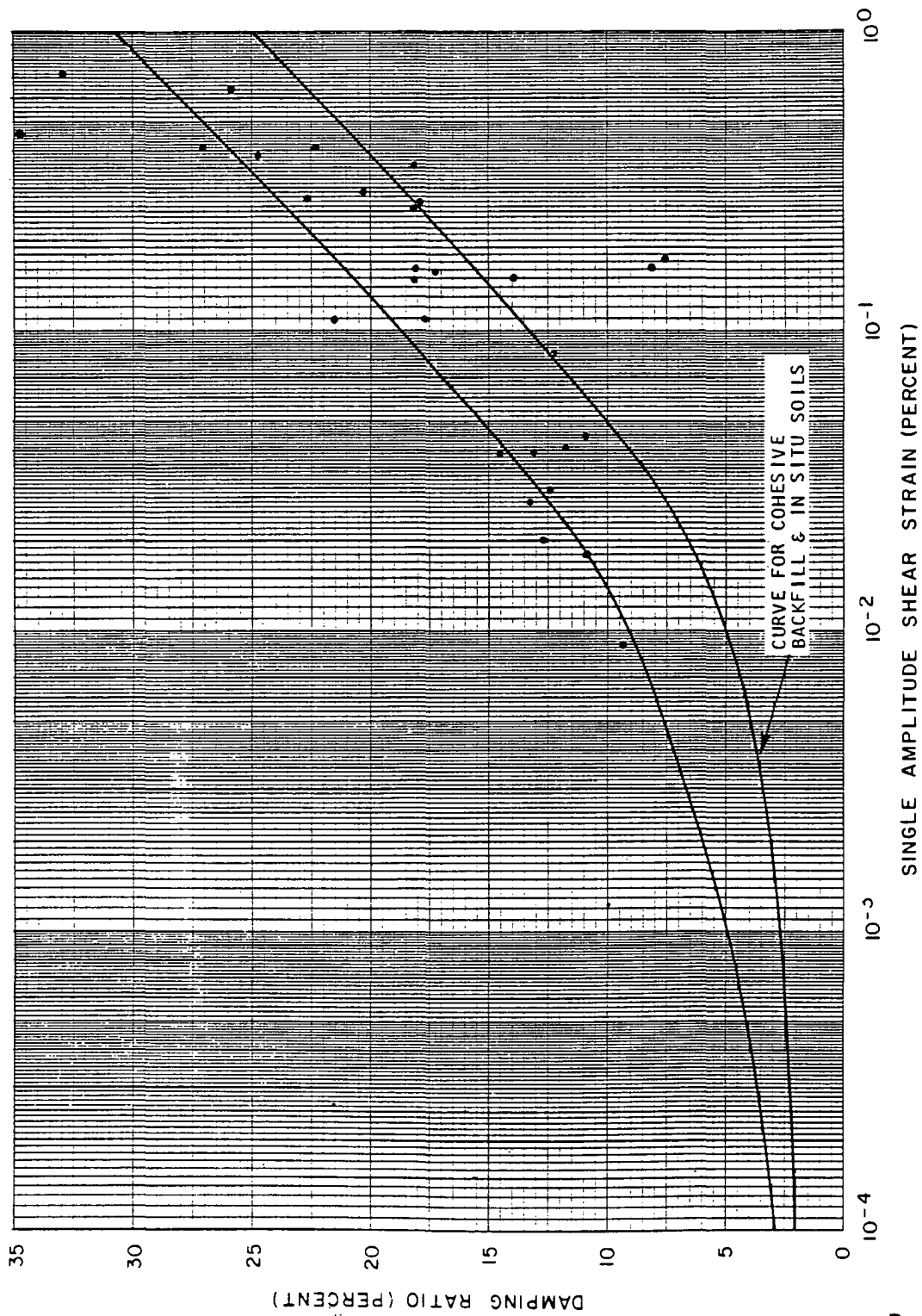

Rev. 0

**WOLF CREEK
UPDATED SAFETY ANALYSIS REPORT**

Figure 2.5-97h

Recommended Damping Ratio Versus Shear Strain Curve for Cohesive Backfill and in Situ Soils at the EWS Pumphouse

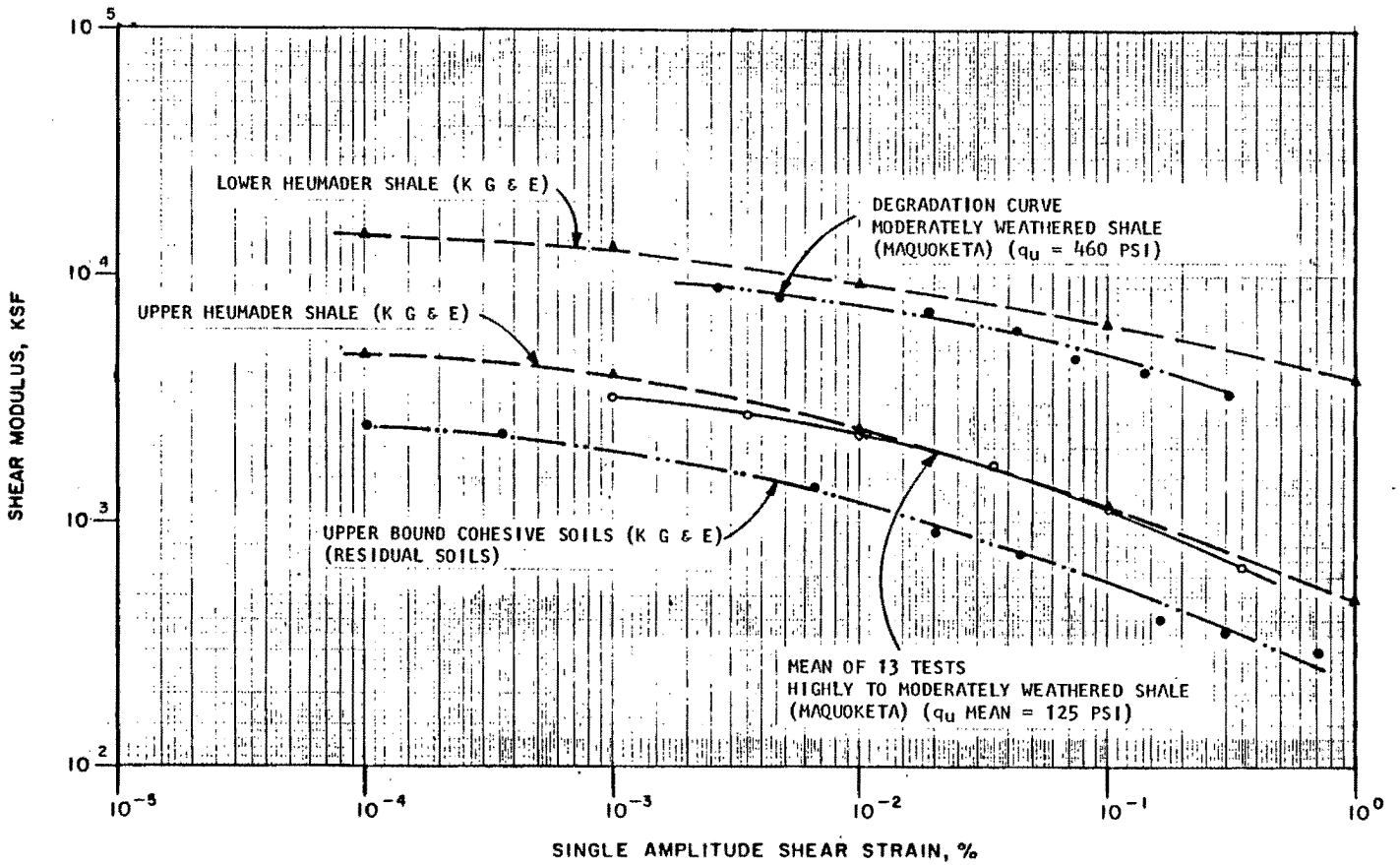

Strain Degradation Curves for
Heumader Shale and Maquoketa
Shale

Figure 2.5-97i

WOLF CREEK
UPDATED SAFETY ANALYSIS REPORT

Rev. 0

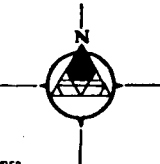

EXPLANATION

- ◆ P-3 BORING LOCATION AND NUMBER
- ⊕ TP-7 TEST PIT LOCATION AND NUMBER
- △ E-3 SHALLOW ROLLER BIT BORING LOCATION AND NUMBER
- SEISMIC REFRACTION SURVEY LINE AND STATION NUMBERS
- CROSSHOLE SURVEY STATION NUMBERS
- SURFACE WAVELINE AND STATION NUMBERS
- AMBIENT STATION

NOTES:

1. TIME DISTANCE PLOTS FOR SEISMIC PROFILES ARE SHOWN ON FIGURES 2.5-101a THROUGH 2.5-101g.
2. TABLE 2.5-46 PRESENTS A SUMMARY OF GEOPHYSICAL PROPERTIES OF SUBSURFACE MATERIALS AT THE PLANT SITE.
3. TABLE 2.5-51 PRESENTS A SUMMARY OF GEOPHYSICAL PROPERTIES AT THE ULTIMATE HEAT SINK.
4. TABLE 2.5-49 PRESENTS THE RESULTS OF SURFACE WAVE SURVEYS.
5. TABLE 2.5-50 PRESENTS THE RESULTS OF AMBIENT GROUND MOTION MEASUREMENTS.
6. FIGURES 2.5-102a THROUGH 2.5-102c PRESENTS THE RESULTS OF THE UPHOLE COMPRESSIONAL WAVE VELOCITY SURVEYS.



**WOLF CREEK
UPDATED SAFETY ANALYSIS REPORT**

Figure 2.5-98 Rev.28

Geophysical Plot Plan -
Category I Area
Sheet 1 of 2

REFERENCE:
BORING LOCATION PLAN, UNS POND
OUTLINE, AND COOLING LAKE SHORELINE
FROM SARGENT & LUNDY, ENGINEERS
DRAWINGS SK-11173-1 AND HS-12A,
REV. 3.

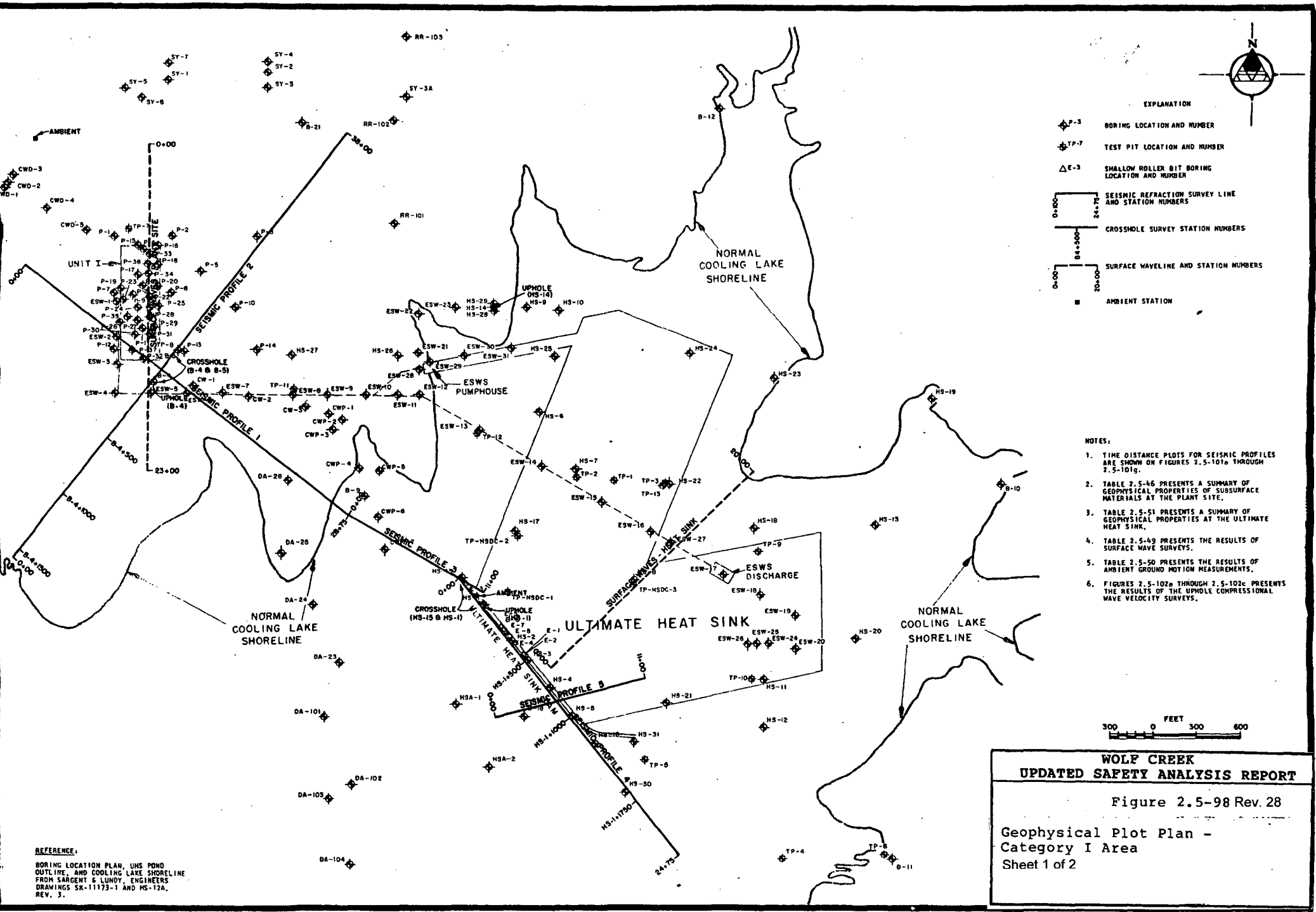

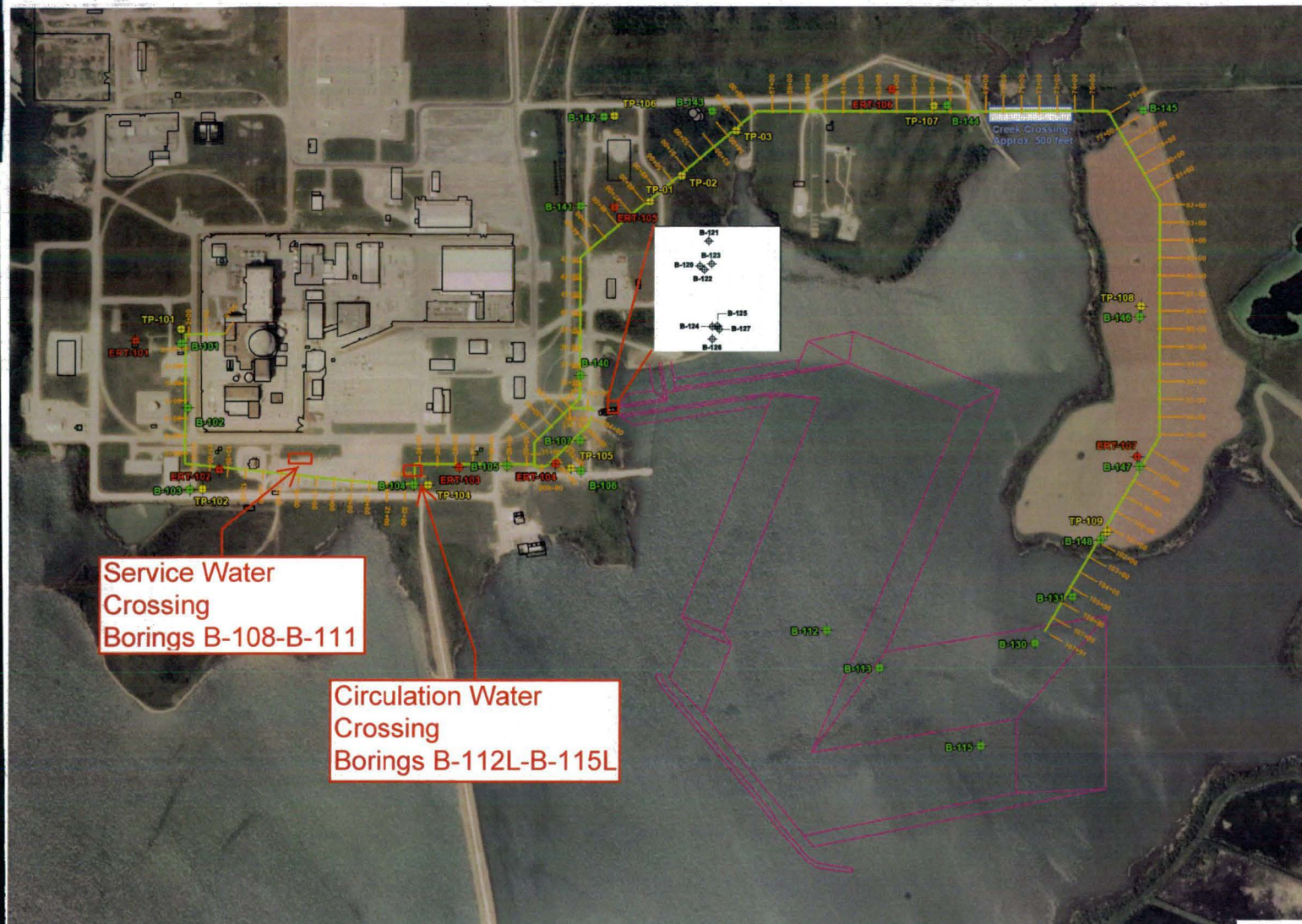

Service Water Crossing
Borings B-108-B-111

Circulation Water Crossing
Borings B-112L-B-115L

Notes:
Borings B-108-B-111 and B-112L-B-115L were drilled in the vicinity of the areas shown.

Drawing Reference:
Drawing comes from Attachment 2 of Bechtel calculation 25707-000-30R-K01G-00002 Rev. 02

WOLF CREEK
UPDATED SAFETY ANALYSIS REPORT

Figure 2.5-98 Rev. 28
Geophysical Plot Plan -
Category I Area
Sheet 2 of 2

BORING B - 4

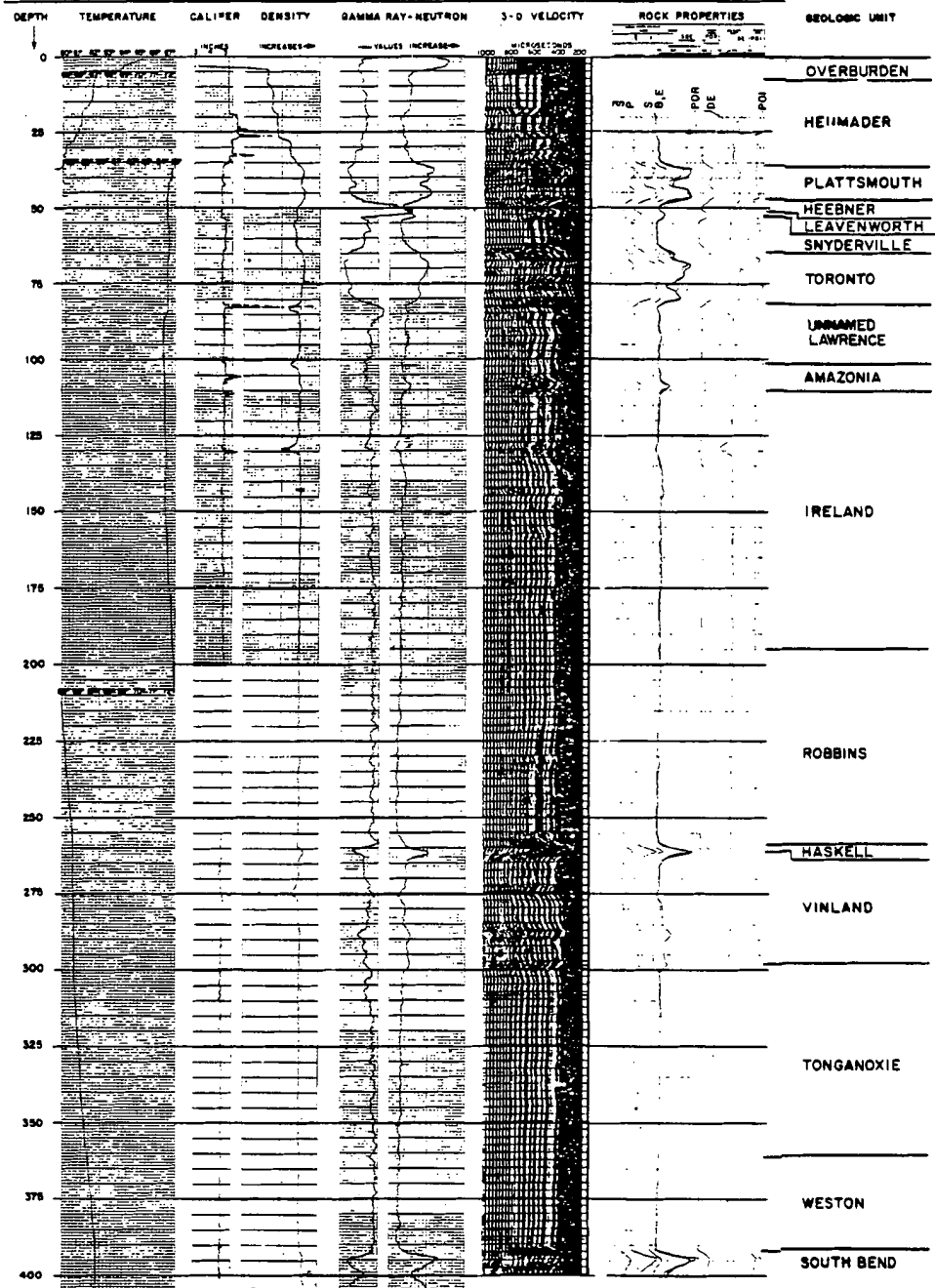

EXPLANATION OF SYMBOLS FOR ROCK PROPERTIES

S SHEAR WAVE TIME	S SHEAR MODULUS	POH POROSITY
P PRESSURE WAVE TIME	B BULK MODULUS	DE DENSITY
	E YOUNG'S MODULUS	POI POISSON'S RATIO

NOTES:

1. GEOPHYSICAL BOREHOLE LOGGING WAS PERFORMED BY THE BIRDWELL DIVISION OF THE SEISMOGRAPH SERVICE CORPORATION.
2. LOCATION OF BOREHOLE LOGGING IS SHOWN ON FIGURE 2.5-99.

WOLF CREEK
 UPDATED SAFETY ANALYSIS REPORT
 Figure 2.5-100a
 Birdwell Geophysical Logging -
 Boring B-4

Rev. 0

BORING B-5

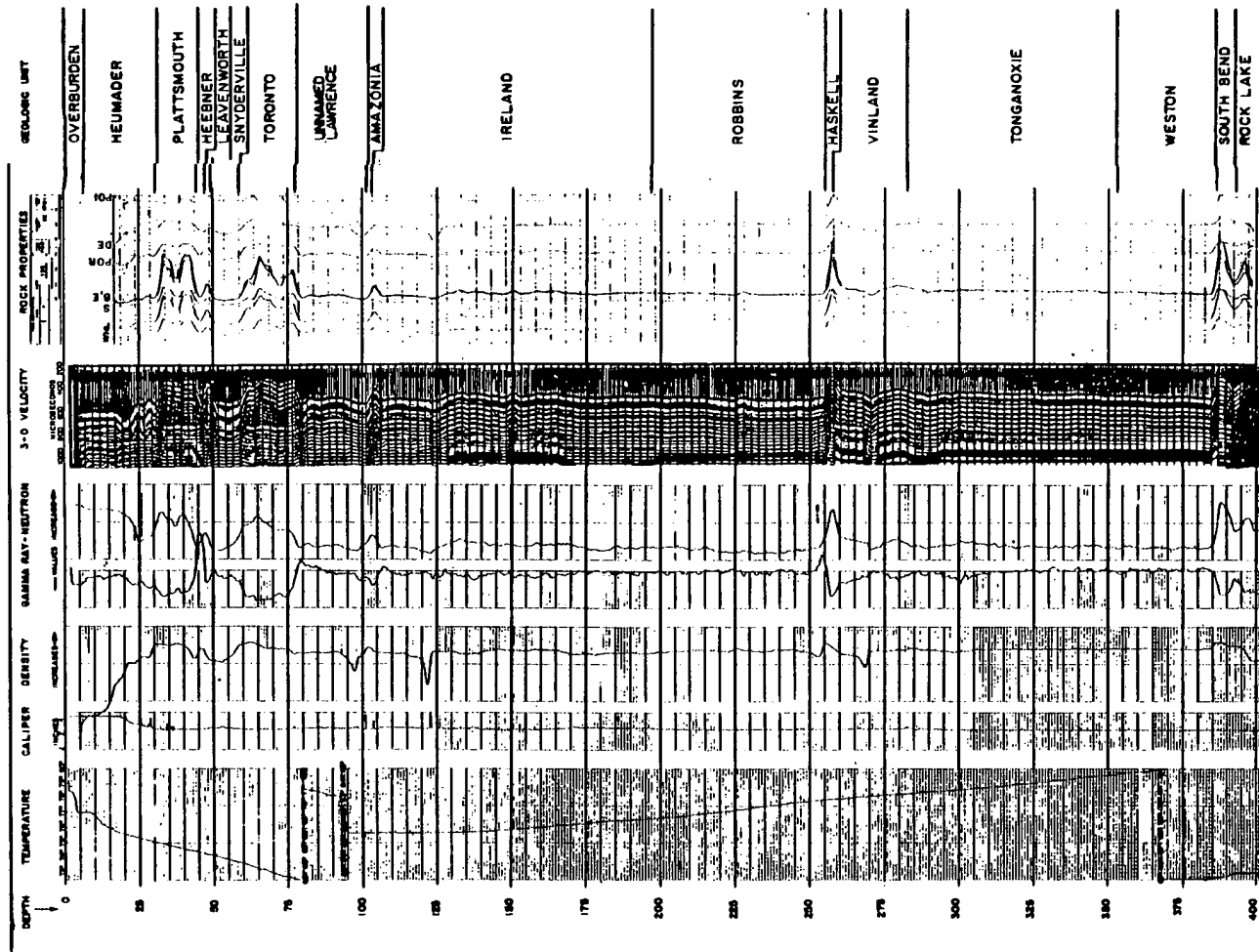

EXPLANATION OF SYMBOLS FOR ROCK PROPERTIES

- S SHEAR WAVE TIME S SHEAR MODULUS FOR POROSITY
- P PRESSURE WAVE TIME B BULK MODULUS OR DENSITY
- Y YOUNG'S MODULUS C YOUNG'S MODULUS FOR POROSITY RATIO

NOTES:

1. GEOPHYSICAL BOREHOLE LOGGING WAS PERFORMED BY THE BIRDWELL DIVISION OF THE BIRDWELL SERVICE CORPORATION.
2. LOCATION OF BOREHOLE LOGGING IS SHOWN ON FIGURE 2.5-99.

Rev. 0

WOLF CREEK
 UPDATED SAFETY ANALYSIS REPORT

Figure 2.5-100b

Birdwell Geophysical Logging -
 Boring B-5

BORING B-6

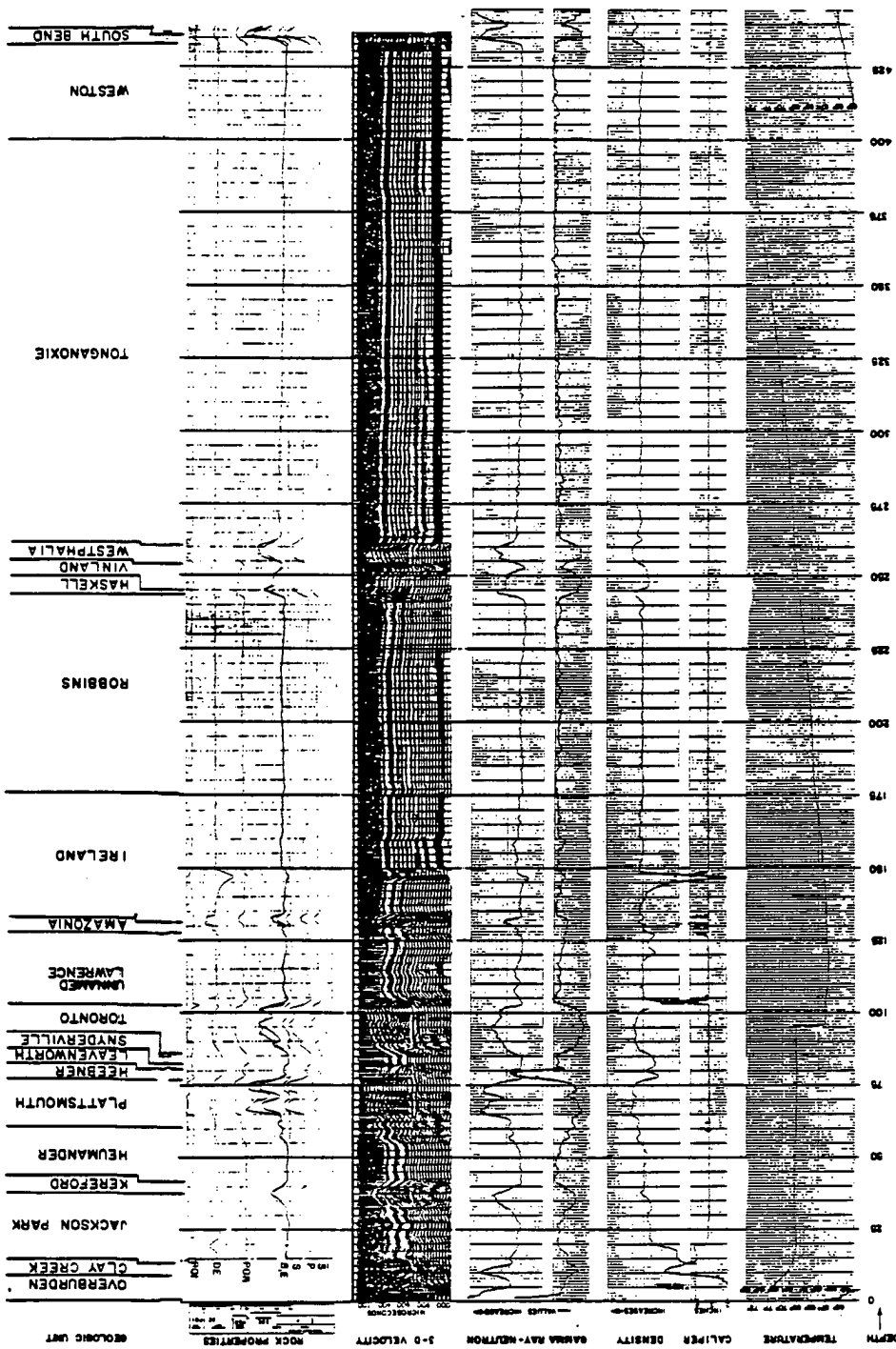

EXPLANATION OF SYMBOLS FOR ROCK PROPERTIES

- 1 SHEAR WAVE TIME
- 2 PRESSURE WAVE TIME
- 3 BULK MODULUS
- 4 TENSILE MODULUS
- 5 POISSON'S RATIO
- 6 MODULUS
- 7 MODULUS

NOTES:

1. GEOPHYSICAL BOREHOLE LOGGING WAS PERFORMED BY THE BIRDWELL DIVISION OF THE SEISMOGRAPH SERVICE CORPORATION.
2. LOCATION OF BOREHOLE LOGGING IS SHOWN ON FIGURE 2.5-99.

Rev. 0

WOLF CREEK
UPDATED SAFETY ANALYSIS REPORT
 Figure 2.5-100c
 Birdwell Geophysical Logging -
 Boring B-6

BORING B-7

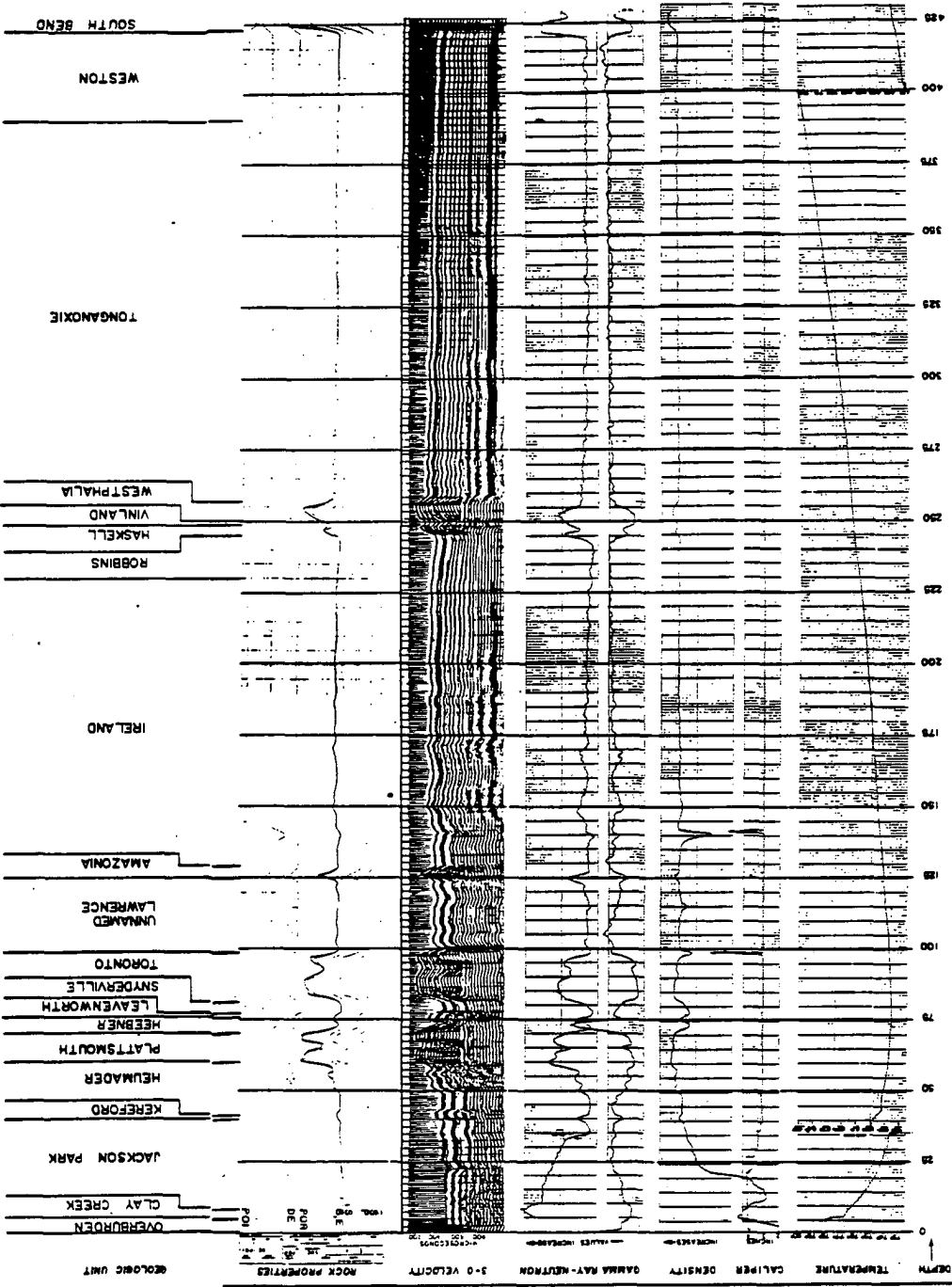

EXPLANATION OF SYMBOLS FOR ROCK PROPERTIES

- 1 SHEAR WAVE TIME
- 2 PRESSURE WAVE TIME
- 3 SUELL MODULUS
- 4 SUELL MODULUS
- 5 YOUNG'S MODULUS
- 6 DENSITY
- 7 POROSITY RATIO

NOTES:

1. GEOPHYSICAL BOREHOLE LOGGING WAS PERFORMED BY THE BIRDELL DIVISION OF THE SEISMOGRAPH SERVICE CORPORATION.
2. LOCATION OF BOREHOLE LOGGING IS SHOWN ON FIGURE 2.5-99.

Rev. 0

**WOLF CREEK
UPDATED SAFETY ANALYSIS REPORT**

Figure 2.5-100d

Birdwell Geophysical Logging -
Boring B-7

Rev. 0

- NOTES:
1. GEOPHYSICAL BOREHOLE LOGGING WAS PERFORMED BY THE BIRDWELL DIVISION OF THE SEISMOGRAPH SERVICE CORPORATION.
 2. LOCATION OF BOREHOLE LOGGING IS SHOWN ON FIGURE 2.5-99.

EXPLANATION OF SYMBOLS FOR
 ROCK PROPERTIES

- 1 SHEAR WAVE TIME
- 2 PRESSURE WAVE TIME
- 3 SILENT MODULUS
- 4 TORSION MODULUS
- 5 POISSON'S RATIO
- 6 ROCK DENSITY
- 7 GAMMA RAY
- 8 NEUTRON
- 9 CALIPER
- 10 TEMPERATURE
- 11 VELOCITY

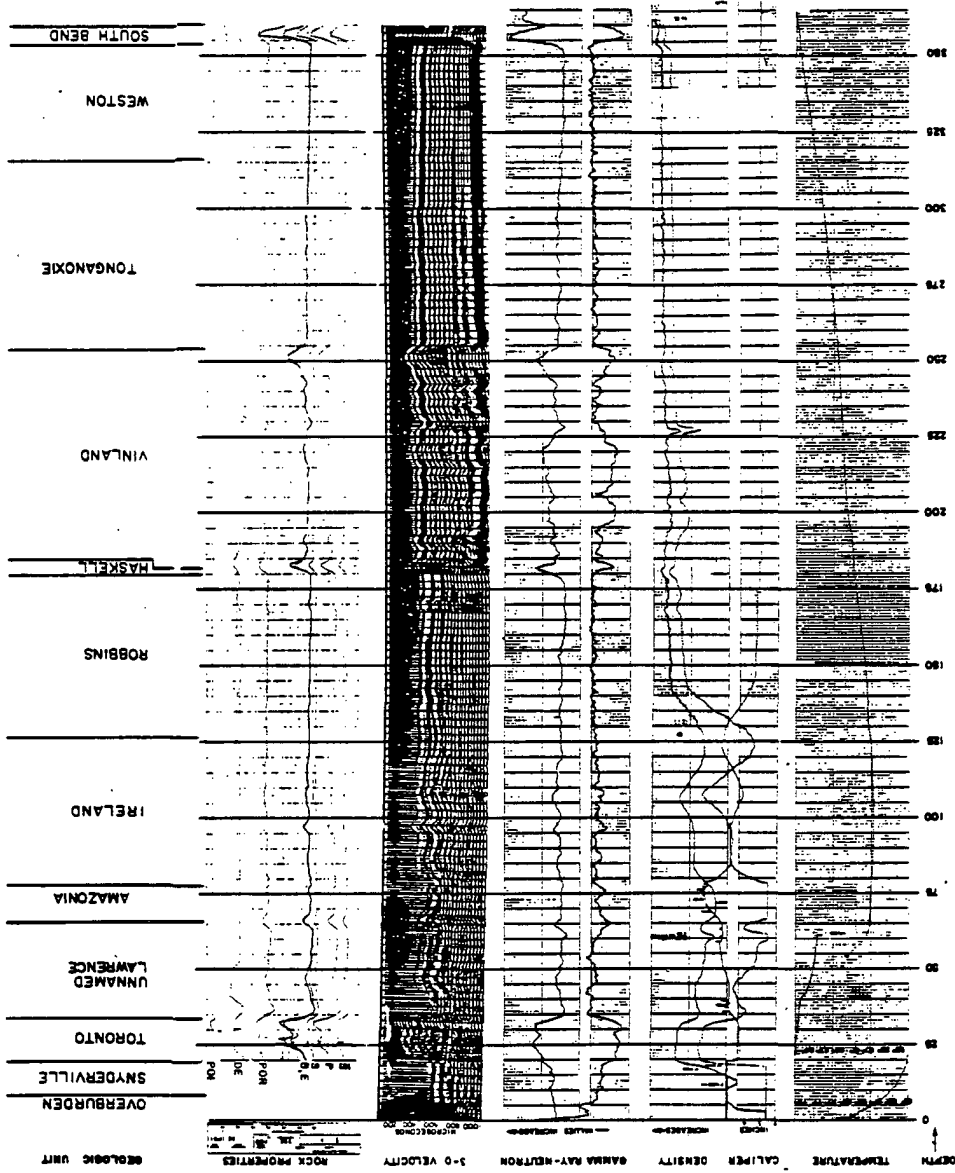

BORING B - 11

BORING B-16

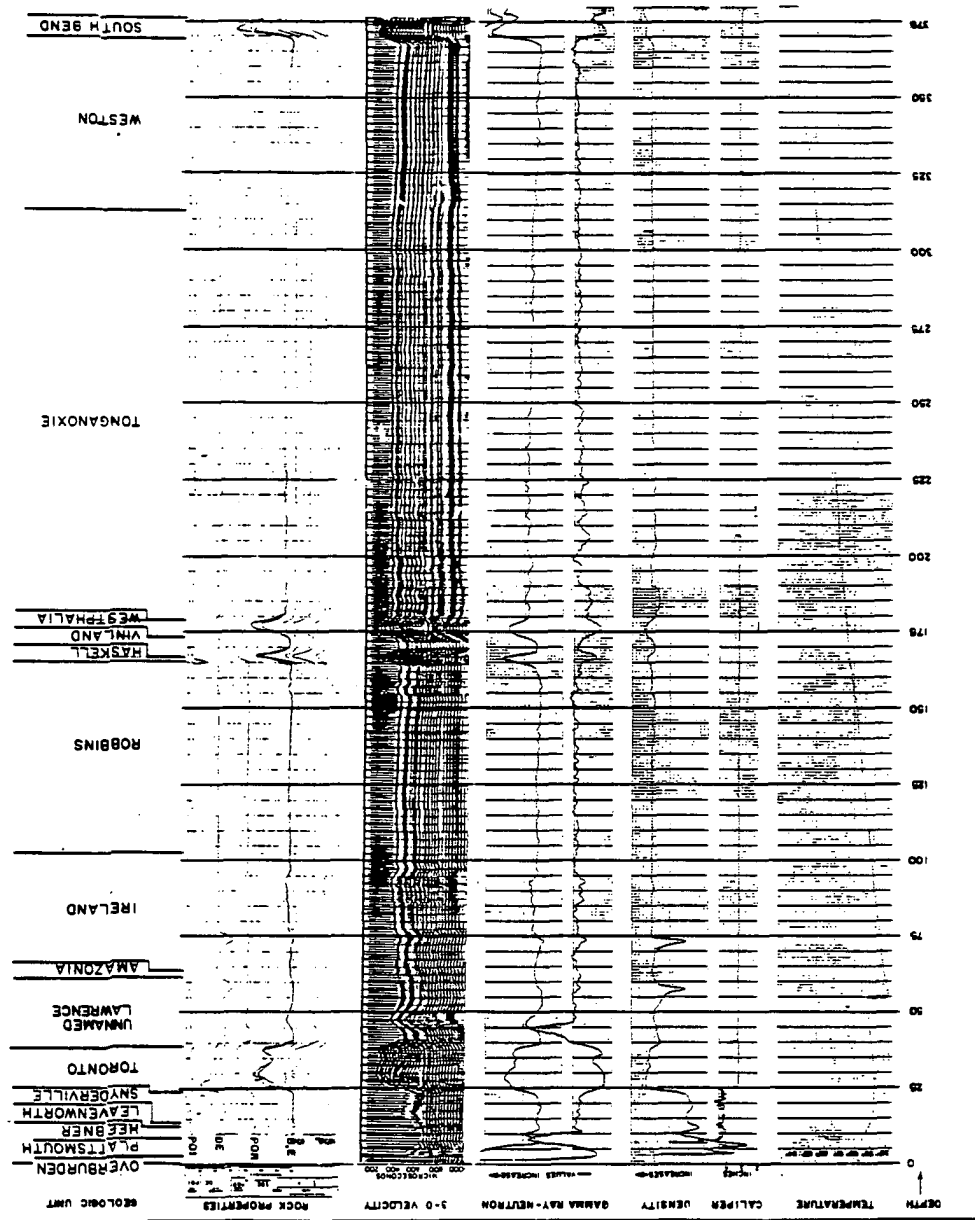

EXPLANATION OF SYMBOLS FOR ROCK PROPERTIES

P PRESSURE WAVE TIME
 S SHEAR WAVE TIME
 E YOUNG'S MODULUS
 B BULK MODULUS
 D DENSITY
 P POISSON'S RATIO

NOTES:

1. GEOPHYSICAL BOREHOLE LOGGING WAS PERFORMED BY THE BIRDWELL DIVISION OF THE SEISMOGRAPH SERVICE CORPORATION.
2. LOCATION OF BOREHOLE LOGGING IS SHOWN ON FIGURE 2.5-99.

Rev. 0

WOLF CREEK
 UPDATED SAFETY ANALYSIS REPORT

Figure 2.5-100f

Birdwell Geophysical Logging -
 Boring B-16

TIME-DISTANCE PROFILE--SEISMIC PROFILE 1
 APPARENT VELOCITY VELOCITIES (M/S) ON LEFT Y-AXIS

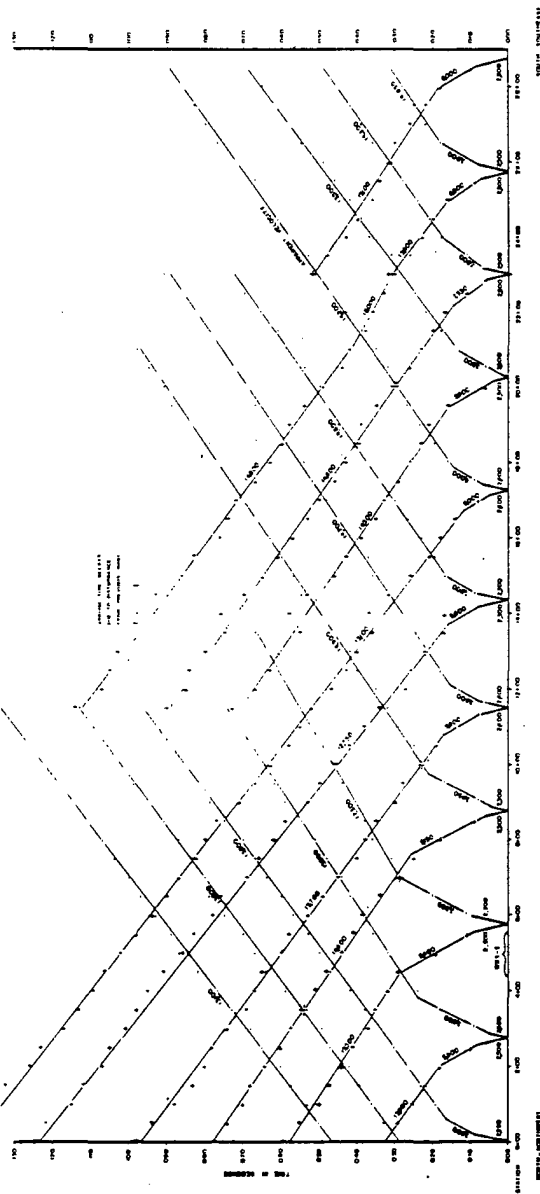

SEISMIC PROFILE 1
 VELOCITY (M/S) ON LEFT Y-AXIS

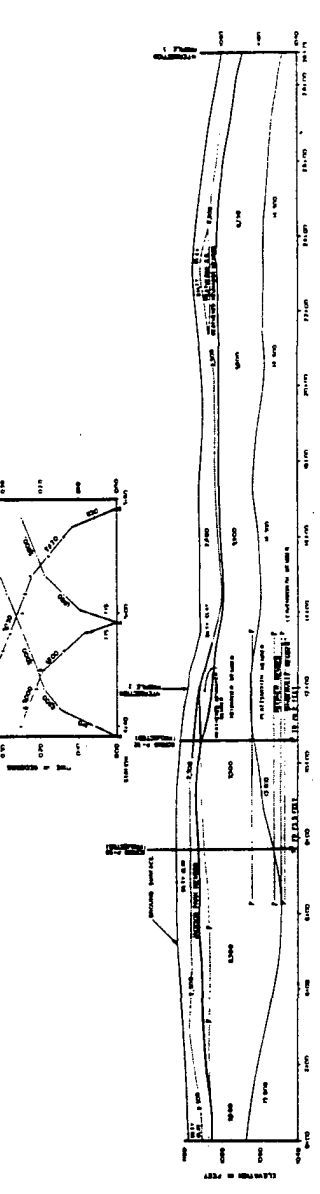

NOTE: THIS PROFILE IS A REPRESENTATIVE EXAMPLE OF THE TYPE OF PROFILE THAT CAN BE OBTAINED FROM SEISMIC DATA. THE VELOCITIES SHOWN ARE APPARENT VELOCITIES AND NOT TRUE VELOCITIES. THE VELOCITIES SHOWN ARE BASED ON THE ASSUMPTION THAT THE SEISMIC WAVES ARE TRAVELING IN A HOMOGENEOUS MEDIUM. THE VELOCITIES SHOWN ARE BASED ON THE ASSUMPTION THAT THE SEISMIC WAVES ARE TRAVELING IN A HOMOGENEOUS MEDIUM. THE VELOCITIES SHOWN ARE BASED ON THE ASSUMPTION THAT THE SEISMIC WAVES ARE TRAVELING IN A HOMOGENEOUS MEDIUM.

Rev. 0

**WOLF CREEK
 UPDATED SAFETY ANALYSIS REPORT**
 Figure 2.5-101a
 Seismic Refraction Profile 1

LONG-DURATION PILE - SEISMIC PROFILE 2
 PRESENTS SEISMIC REFRACTION DATA IN EAST-WEST SECTION

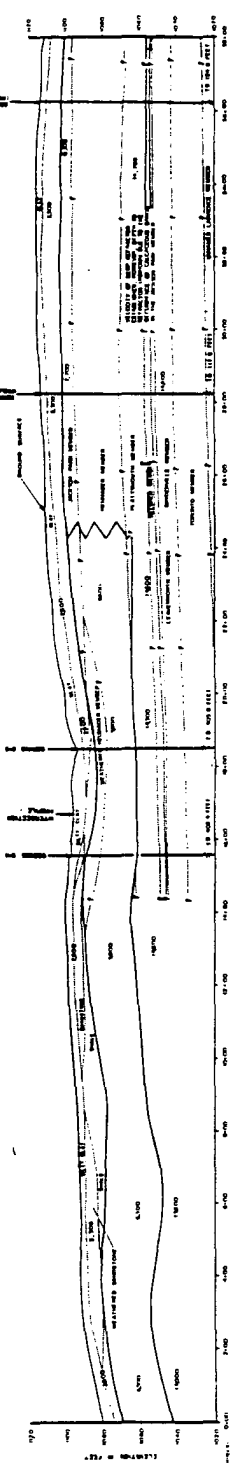
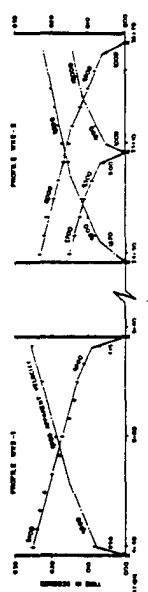
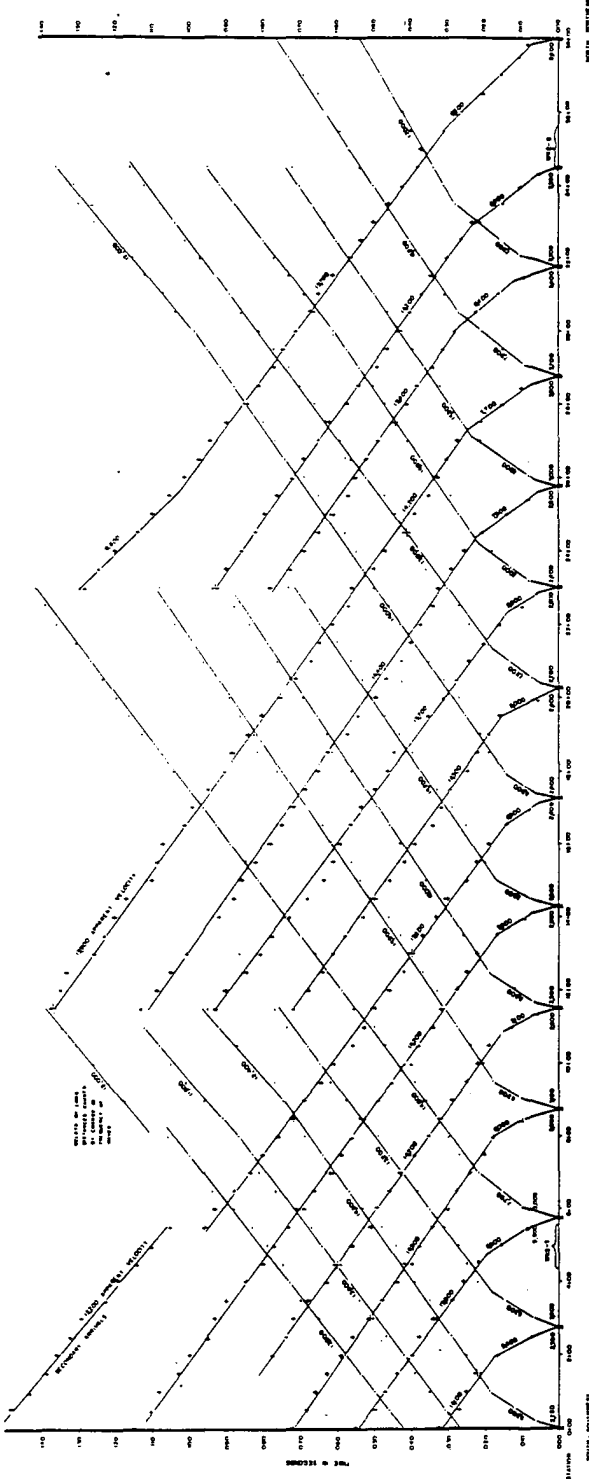

Rev. 0

**WOLF CREEK
 UPDATED SAFETY ANALYSIS REPORT**
 Figure 2.5-101b
 Seismic Refraction Profile 2

ENGINEER: [unreadable]
 CONTRACT: [unreadable]

THIS REPORT IS THE PROPERTY OF THE ENGINEERING COMPANY AND IS NOT TO BE REPRODUCED OR TRANSMITTED IN ANY FORM OR BY ANY MEANS, ELECTRONIC OR MECHANICAL, INCLUDING PHOTOCOPYING, RECORDING, OR BY ANY INFORMATION STORAGE AND RETRIEVAL SYSTEM, WITHOUT THE WRITTEN PERMISSION OF THE ENGINEERING COMPANY.

TIME-DISTANCE PLOT—SEISMIC PROFILE 3

APPARENT SEISMIC VELOCITIES GIVEN IN FEET PER SECOND

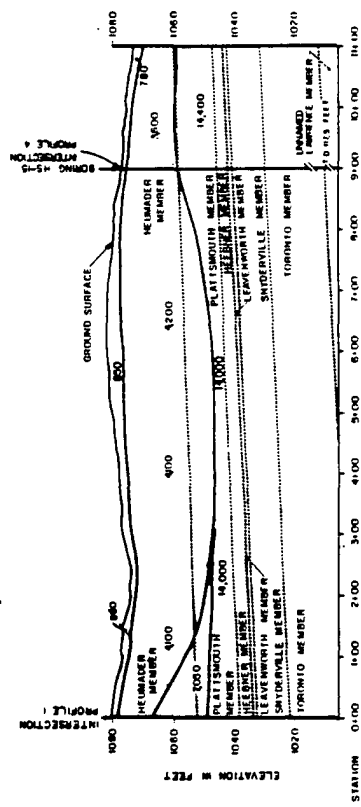
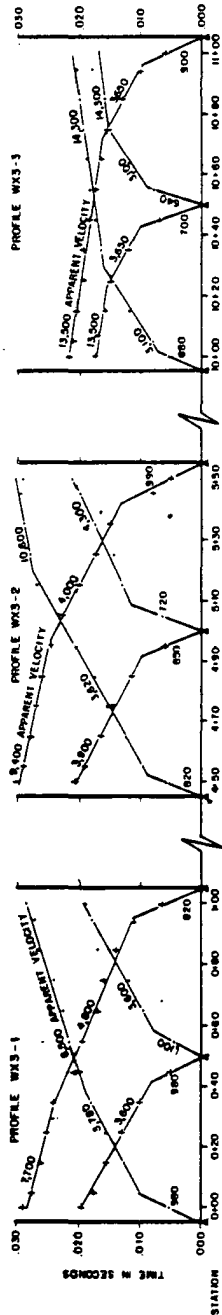
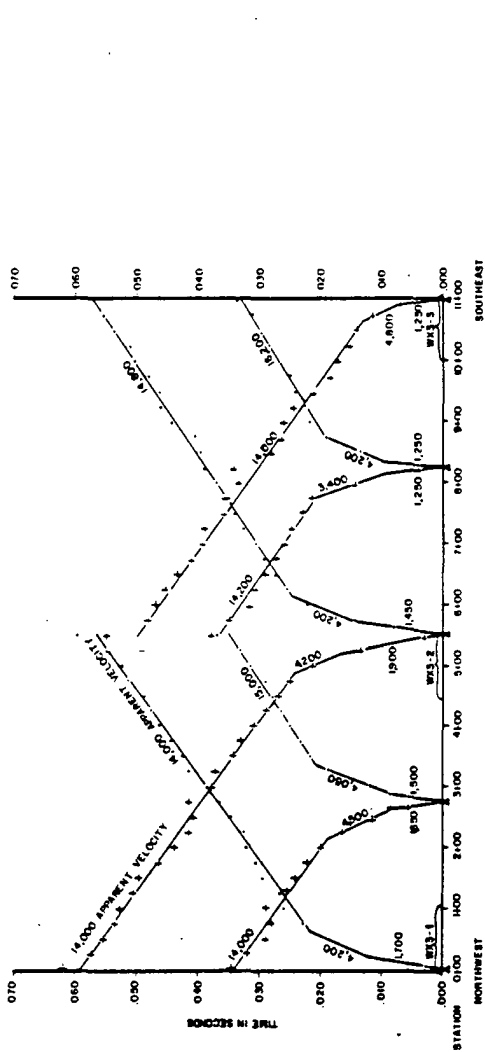

NOTES:

1. SHEET POINT LOCATION: THESE REFLECT INFORMATION COLLECTED FROM SHOT POINTS LOCATED AT VARIOUS LOCATIONS ALONG A SEISMIC LINE. FOR CLARIFICATION, THE FOLLOWING POINT NUMBERS HAVE BEEN USED:
2. SHEET POINT LOCATION: FROM THE LEFT, (WEST) TO THE RIGHT, (EAST) OF THE SHEET FROM THE LEFT.
3. THE SUBSURFACE SECTION SHOWN REPRESENTS THE EVALUATION OF THE BEST AVAILABLE DATA BASED UPON INTERPRETATIONS OF PRESENTLY AVAILABLE DATA. SOME VARIATIONS FROM THESE DATA MAY OCCUR IN THE FIELD.
4. ALL OF THE DATA ARE APPARENT VELOCITIES. THESE VELOCITIES HAVE BEEN DETERMINED DIRECTLY FROM THE PLACES. WITH THE APPROPRIATE CORRECTIONS FOR ANOMALOUS REFRACTION AND COMPLESSORAL WAVE VELOCITY RESULTS, AS SHOWN IN THE SUBSURFACE CROSS SECTION, THE VELOCITIES SHOWN IN THIS SECTION WOULD BE MORE ACCURATE.
5. THE GEODETIC DRAWING OF THE SUBSURFACE CROSS SECTION HAS BEEN MADE FROM THE DATA AND INFORMATION AVAILABLE AT THE TIME OF THE REPORT. SOME VARIATIONS FROM THESE CONDITIONS MUST BE EXPECTED.

VERTICAL EXAGGERATION X3

EXPLANATION

CONTACT FROM REPORT DATA ONLY
CONTACT FROM SEISMIC REFRACTION DATA

Rev. 0

WOLF CREEK
UPDATED SAFETY ANALYSIS REPORT

Figure 2.5-101c

Seismic Refraction Profile 3

TIME-DISTANCE PLOT - SEISMIC PROFILE 5

APPARENT SEISMIC VELOCITIES GIVEN IN FEET PER SECOND

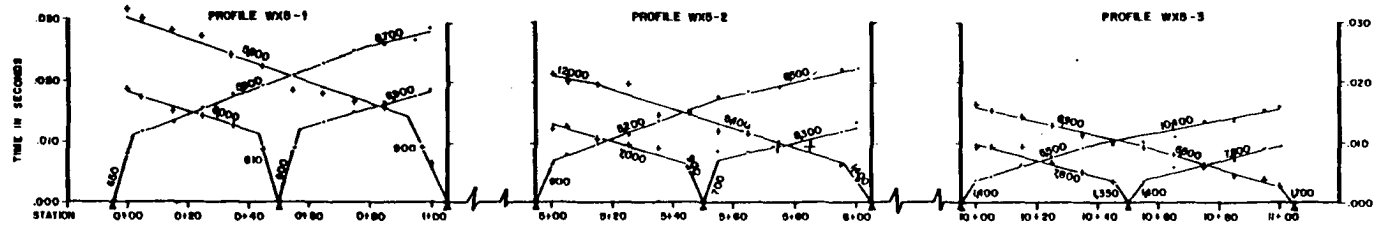
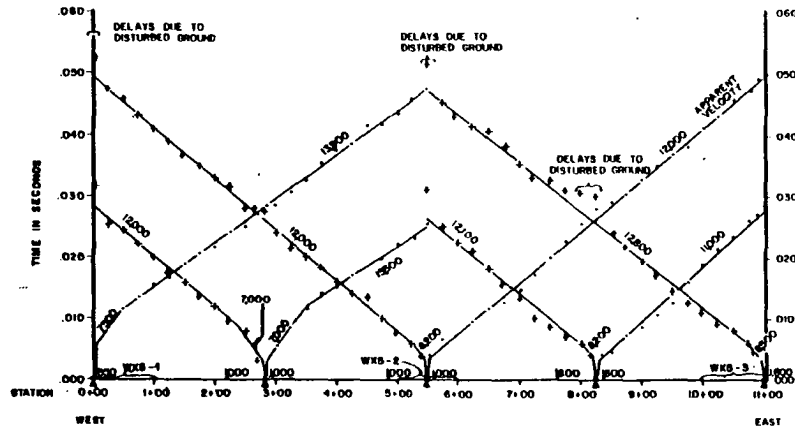

NOTES:

TIME-DISTANCE PLOTS REFLECT INFORMATION COLLECTED FROM SHOT POINTS ESTABLISHED AT SEVERAL LOCATIONS ALONG A SEISMIC LINE. FOR CLARIFICATION, THE FOLLOWING PLOT SYMBOLS HAVE BEEN USED:

- ▲ SHOT POINT LOCATION.
- ORIGIN OF THE SHOCK FROM THE LEFT.
- ORIGIN OF THE SHOCK FROM THE RIGHT.

THE SUBSURFACE SECTION SHOWN REPRESENTS OUR EVALUATION OF THE MOST PROBABLE CONDITIONS BASED UPON INTERPRETATIONS OF PRESENTLY AVAILABLE DATA. SOME VARIATIONS FROM THESE CONDITIONS MUST BE EXPECTED.

ALL OF THE COMPRESSIONAL WAVE VELOCITIES SHOWN ON THE TIME-DISTANCE PLOTS ARE APPARENT VELOCITIES. THESE VELOCITIES HAVE BEEN DETERMINED DIRECTLY FROM THE PLOTS. WHEN THE APPARENT COMPRESSIONAL WAVE VELOCITIES HAVE BEEN CORRECTED FOR SURFACE TOPOGRAPHY AND SUBSURFACE VARIATIONS, THE TRUE COMPRESSIONAL WAVE VELOCITY RESULTS, AS SHOWN IN THE SUBSURFACE CROSS-SECTIONS.

THE GEOLOGY SHOWN ON THE SUBSURFACE CROSS-SECTION HAS BEEN INTERPRETED FROM GEOLOGIC WRITING AND SHOT HOLE DRILLING INFORMATION. SOME VARIATIONS FROM THESE CONDITIONS MUST BE EXPECTED.

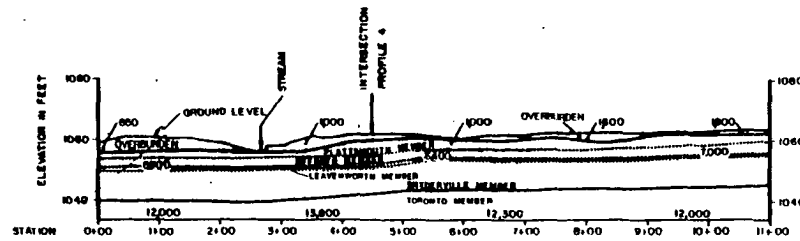

VERTICAL EXAGGERATION X5

EXPLANATION

- CONTACT FROM BOREHOLE DATA ONLY
- CONTACT FROM SEISMIC REFRACTION DATA

Rev. 0

WOLF CREEK
UPDATED SAFETY ANALYSIS REPORT

Figure 2.5-10le
Seismic Refraction Profile 5

TIME-DISTANCE PLOT - SEISMIC PROFILE 4 - DETAIL - STATIONS 4+95 TO 12+05
 APPARENT SEISMIC VELOCITIES GIVEN IN FEET PER SECOND

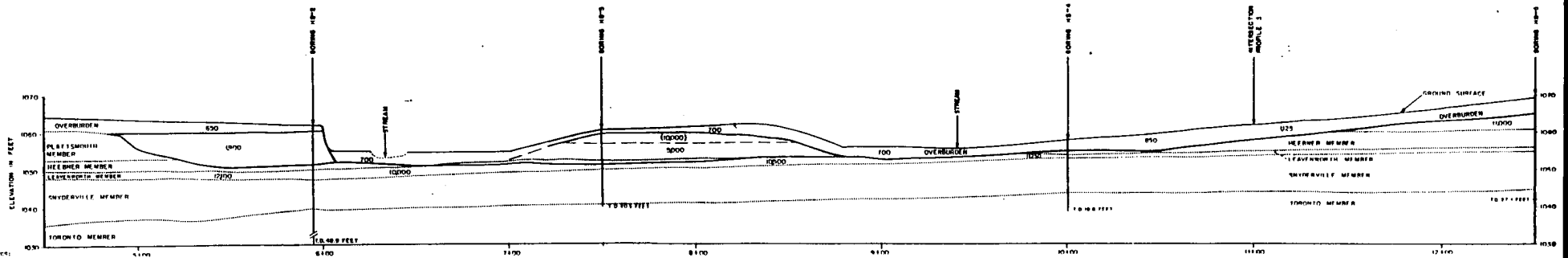
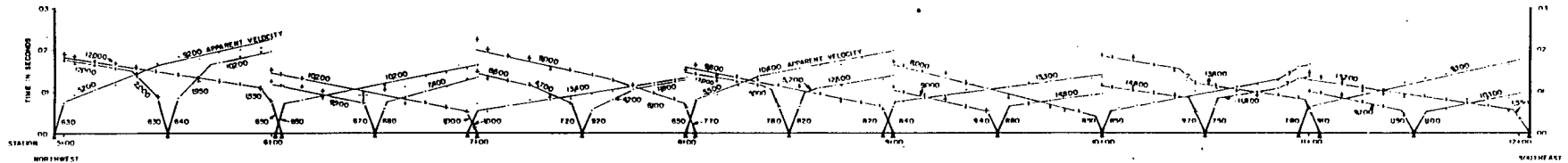

NOTE: TIME-DISTANCE DATA REFLECT INFORMATION COLLECTED FROM THIS PROJECT ESTABLISHED AT SEVERAL LOCATIONS ALONG A GENERAL LINE. FOR CLARIFICATION, THE FORECASTER'S PLANS SHOULD HAVE BEEN USED.

ALL OF THE COMPRESSIONAL WAVE VELOCITIES SHOWN ON THE TIME-DISTANCE PLOTS ARE APPARENT VELOCITIES. TRUE VELOCITIES HAVE BEEN DETERMINED DIRECTLY FROM THE PLOTS. WHEN THE APPARENT COMPRESSIONAL WAVE VELOCITIES HAVE BEEN CORRECTED FOR SURFACE TOPOGRAPHY AND CRUSTAL VARIATIONS, THE TRUE COMPRESSIONAL WAVE VELOCITY RESULTS, AS SHOWN ON THE SURFACE TOPOGRAPHY.

THE GEOLOGY SHOWN ON THE CROSSSECTION - WHICH DEPENDS UPON THE INFORMATION FROM GEOPHYSICAL AND OTHER DATA - IS ONLY AN INDICATION OF THE INFORMATION. THE VARIATIONS FROM THESE CONDITIONS MUST BE EXPECTED.

VERTICAL EXAGGERATION 32

EXPLANATION
 CONTACT FROM ROUGHNESS DATA ONLY
 ———— CONTACT FROM SEISMIC REFRACTION DATA

Rev. 0

WOLF CREEK
 UPDATED SAFETY ANALYSIS REPORT
 Figure 2.5-101f
 Seismic Refraction Profile 4 -
 Stations 4+95 to 12+05

TIME-DISTANCE PLOT—SEISMIC PROFILE 4 — DETAIL — STATIONS 14+95 TO 18+55

APPARENT SEISMIC VELOCITIES GIVEN IN FEET PER SECOND

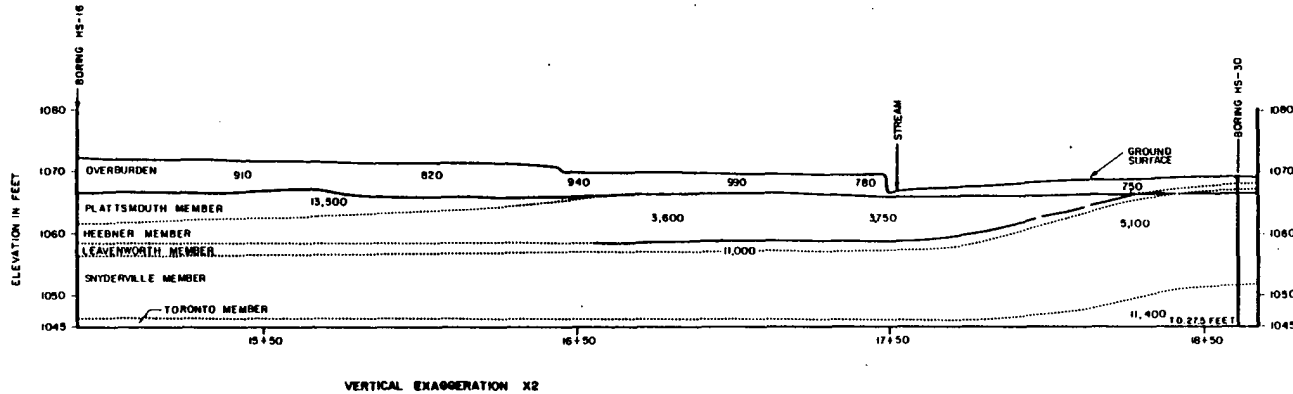
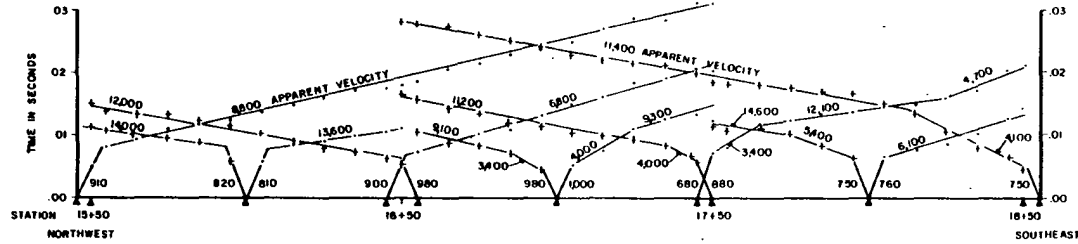

NOTES:

TIME-DISTANCE PLOTS REFLECT INFORMATION COLLECTED FROM SHOT POINTS ESTABLISHED AT SEVERAL LOCATIONS ALONG A SEISMIC LINE. FOR CLARIFICATION, THE FOLLOWING PLOT SYMBOLS HAVE BEEN USED:

- ▲ SHOT POINT LOCATION.
- ORIGIN OF THE SHOCK FROM THE LEFT.
- ORIGIN OF THE SHOCK FROM THE RIGHT.

THE SUBSURFACE SECTION SHOWN REPRESENTS OUR EVALUATION OF THE MOST PROBABLE CONDITIONS BASED UPON INTERPRETATIONS OF PREVIOUSLY AVAILABLE DATA. SOME VARIATIONS FROM THESE CONDITIONS MUST BE EXPECTED.

ALL OF THE COMPRESSIONAL WAVE VELOCITIES SHOWN ON THE TIME-DISTANCE PLOTS ARE APPARENT VELOCITIES. THESE VELOCITIES HAVE BEEN IDENTIFIED DIRECTLY FROM THE PLOTS. WHEN THE APPARENT COMPRESSIONAL WAVE VELOCITIES HAVE BEEN CORRECTED FOR GROUND TRANSMISSION AND SUBSURFACE VARIATIONS, THE TRUE COMPRESSIONAL WAVE VELOCITY RESULTS, AS SHOWN IN THE SUBSURFACE CROSS-SECTION.

THE GEOLGY SHOWN ON THE SUBSURFACE CROSS-SECTION HAS BEEN INTERPRETED FROM GEOLOGIC BORING AND SHOT HOLE DRILLING INFORMATION. SOME VARIATIONS FROM THESE CONDITIONS MUST BE EXPECTED.

EXPLANATION

- CONTACT FROM BOREHOLE DATA ONLY
- CONTACT FROM SEISMIC REFRACTION DATA

Rev. 0

WOLF CREEK
UPDATED SAFETY ANALYSIS REPORT

Figure 2.5-101g

Seismic Refraction Profile 4 -
Stations 14+95 to 18+55

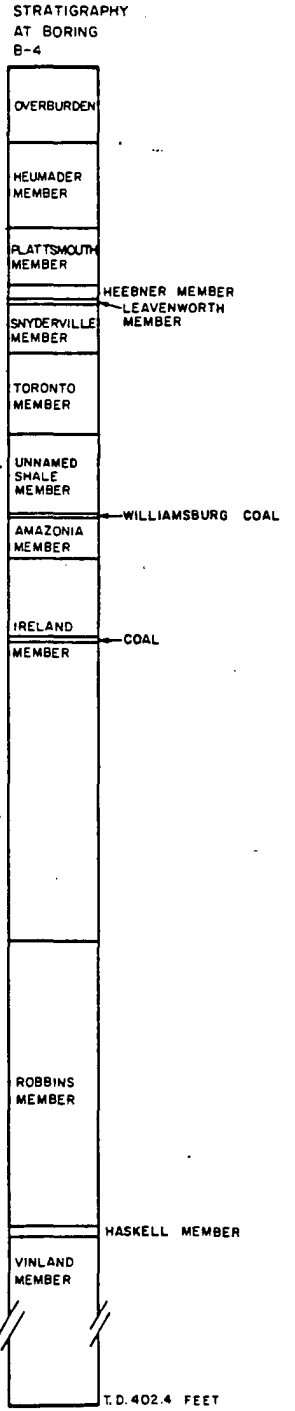
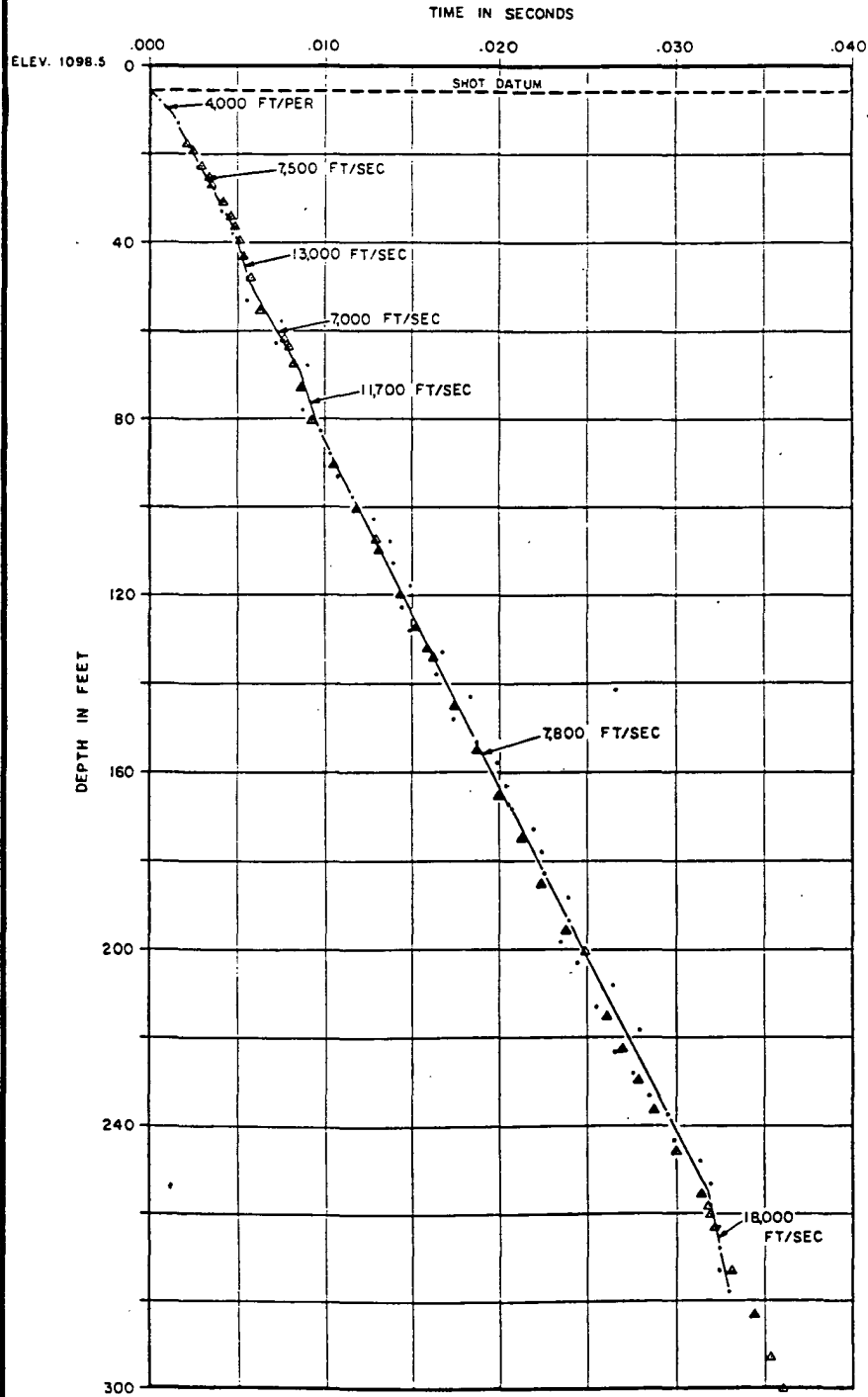

Rev. 0

NOTES:

LOCATION OF GEOPHYSICAL WORK IS SHOWN ON FIGURE 2.5-98.

FOR CLARIFICATION, THE FOLLOWING PLOT SYMBOLS HAVE BEEN USED:

- TRAVEL TIME FROM UPHOLE SURVEY
- ▲ INTEGRATED TRAVEL TIME FROM BIRDWELL LOG.

THE COMPRESSIONAL WAVE VELOCITIES SHOWN HAVE BEEN CORRELATED WITH, AND ADJUSTED TO FIT, THE LITHOLOGIES FROM THE BORING LOG AND THE MEASURED VELOCITIES FROM OTHER GEOPHYSICAL STUDIES AT THE SITE.

**WOLF CREEK
UPDATED SAFETY ANALYSIS REPORT**

Figure 2.5-102a

Uphole Compressional Wave
Velocity Survey - Boring B-4

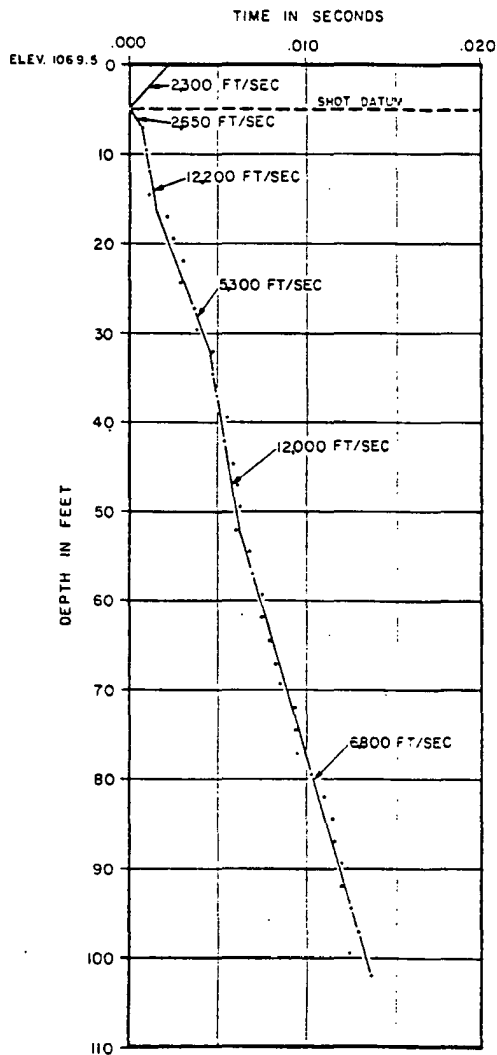

STRATIGRAPHY
AT BORING
HS-1

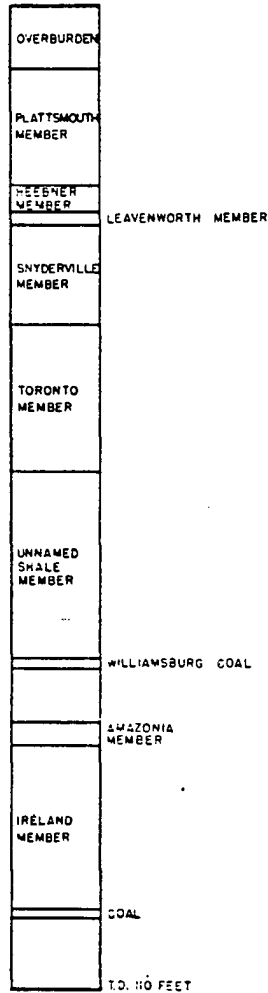

Rev. 0

**WOLF CREEK
UPDATED SAFETY ANALYSIS REPORT**

Figure 2.5-102b

Uphole Compressional Wave
Velocity Survey - Boring HS-1

NOTES:

LOCATION OF GEOPHYSICAL WORK IS SHOWN
ON FIGURE 2.5-98.

THE COMPRESSIONAL WAVE VELOCITIES SHOWN
HAVE BEEN CORRELATED WITH, AND ADJUSTED TO
FIT, THE LITHOLOGIES FROM THE BORING LOG
AND THE MEASURED VELOCITIES FROM OTHER
GEOPHYSICAL STUDIES AT THE SITE.

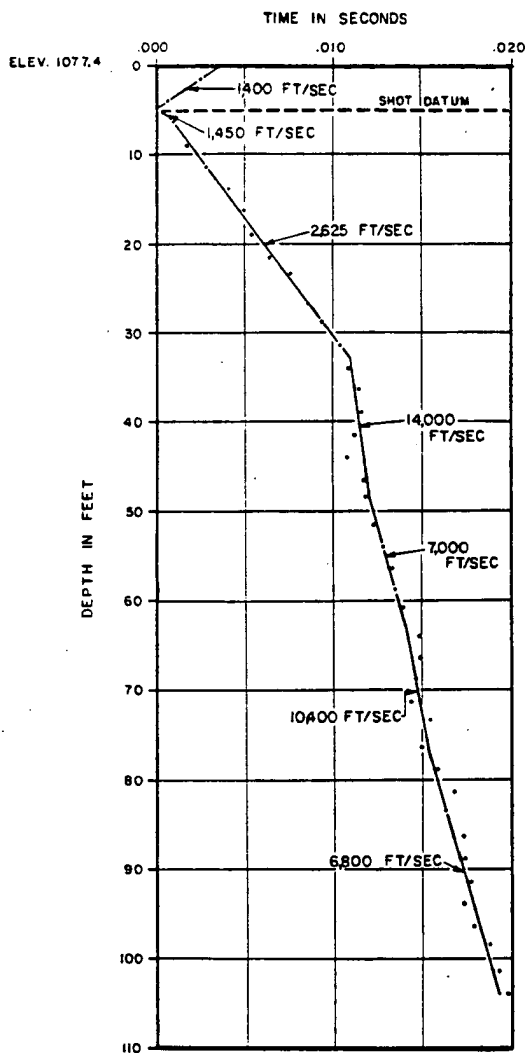

STRATIGRAPHY
AT BORING
HS-14

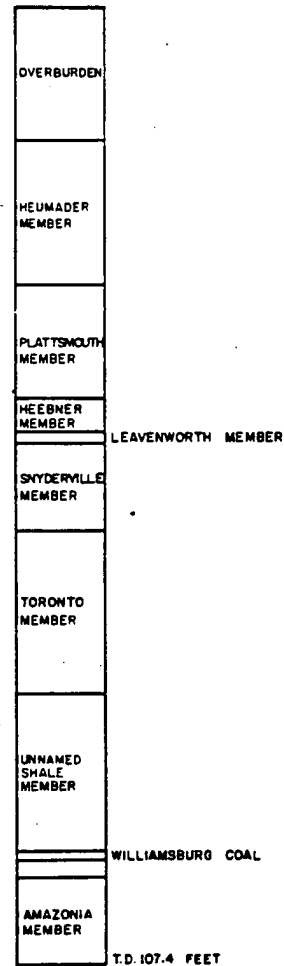

Rev. 0

**WOLF CREEK
UPDATED SAFETY ANALYSIS REPORT**

Figure 2.5-102c

Uphole Compressional Wave
Velocity Survey - Boring HS-14

NOTES:

LOCATION OF GEOPHYSICAL WORK IS SHOWN
ON FIGURE 2.5-98.

THE COMPRESSIONAL WAVE VELOCITIES SHOWN
HAVE BEEN CORRELATED WITH, AND ADJUSTED TO
FIT, THE LITHOLOGIES FROM THE BORING LOG
AND THE MEASURED VELOCITIES FROM OTHER
GEOPHYSICAL STUDIES AT THE SITE.

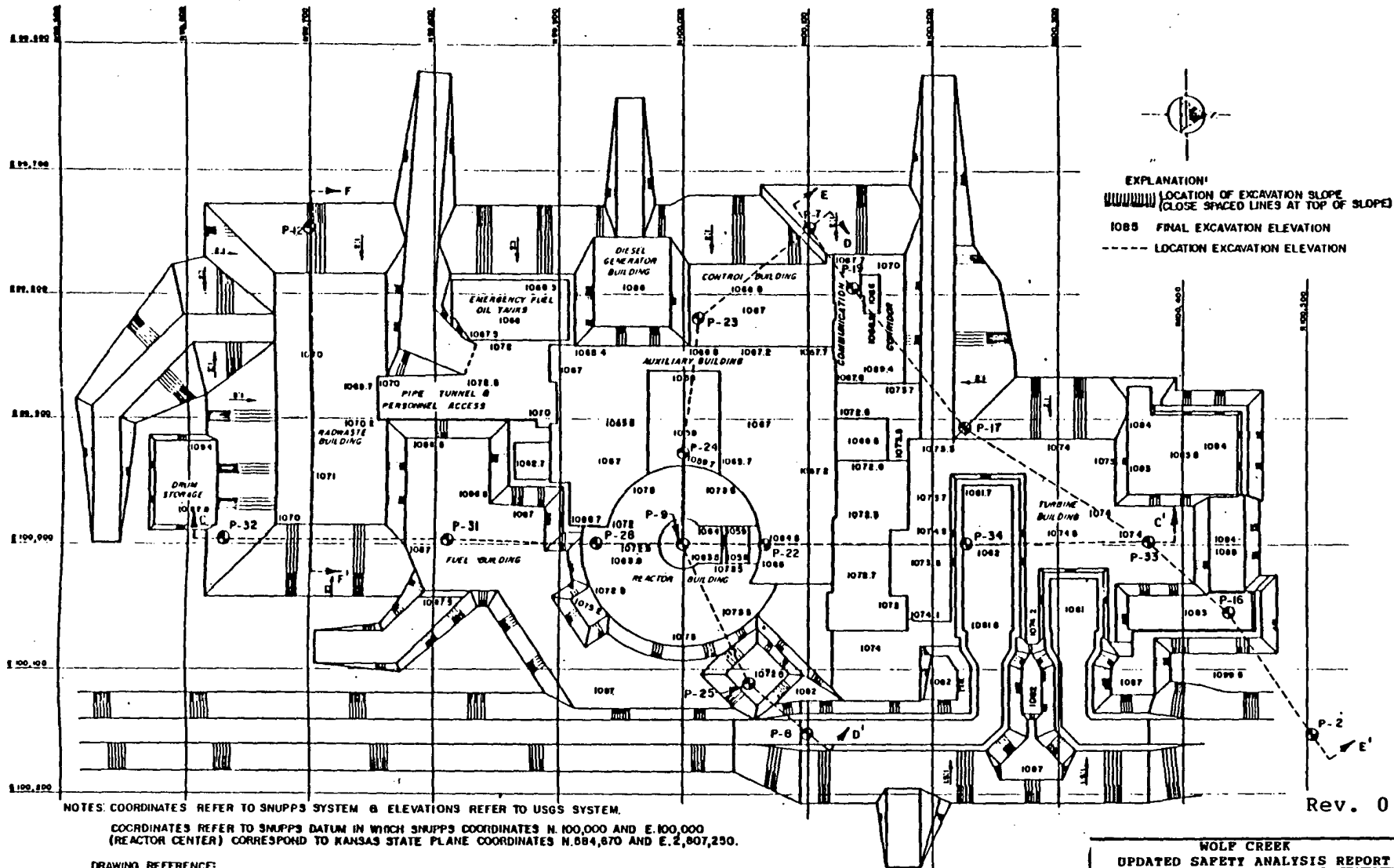

EXPLANATION:
 LOCATION OF EXCAVATION SLOPE
 (CLOSE SPACED LINES AT TOP OF SLOPE)
 1085 FINAL EXCAVATION ELEVATION
 --- LOCATION EXCAVATION ELEVATION

NOTES: COORDINATES REFER TO SHUPPS SYSTEM & ELEVATIONS REFER TO USGS SYSTEM.
 COORDINATES REFER TO SHUPPS DATUM IN WHICH SHUPPS COORDINATES N. 100,000 AND E. 100,000
 (REACTOR CENTER) CORRESPOND TO KANSAS STATE PLANE COORDINATES N. 884,870 AND E. 2,807,250.

DRAWING REFERENCE:
 TITLE: EXCAVATION PLAN, PLANT AREA, WOLF CREEK GENERATING STATION UNIT 1
 FOR: KANSAS GAS & ELECTRIC COMPANY AND KANSAS CITY POWER & LIGHT COMPANY
 BY: SARGENT & LUNDY ENGINEERS, CHICAGO
 DRAWING NO.: 8-181 REV. 0
 DATE: 4/15/77

WOLF CREEK
 UPDATED SAFETY ANALYSIS REPORT
 Figure 2.5-103
 Excavation Plan

Rev. 0

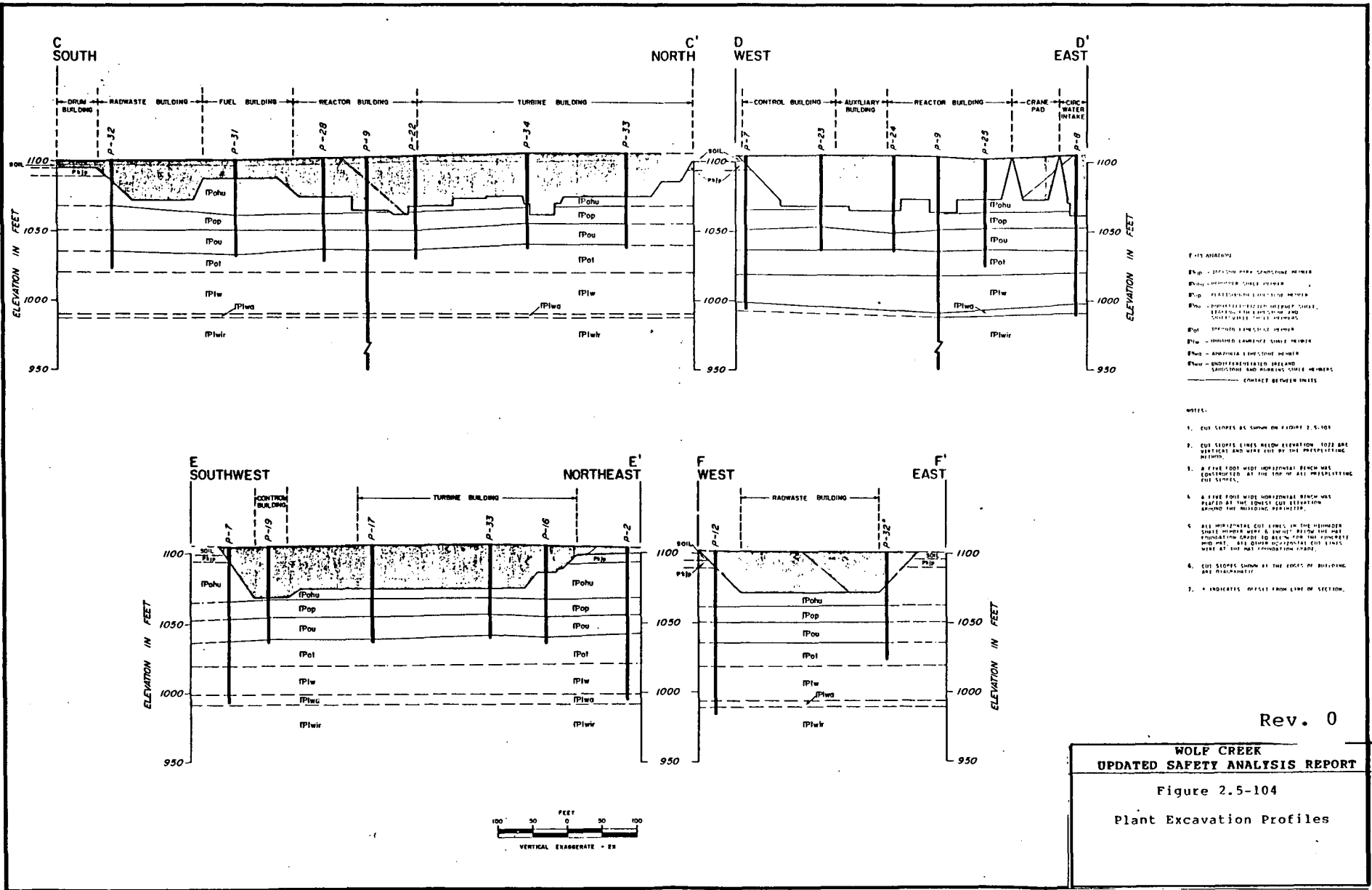

Rev. 0

WOLF CREEK
UPDATED SAFETY ANALYSIS REPORT

Figure 2.5-104

Plant Excavation Profiles

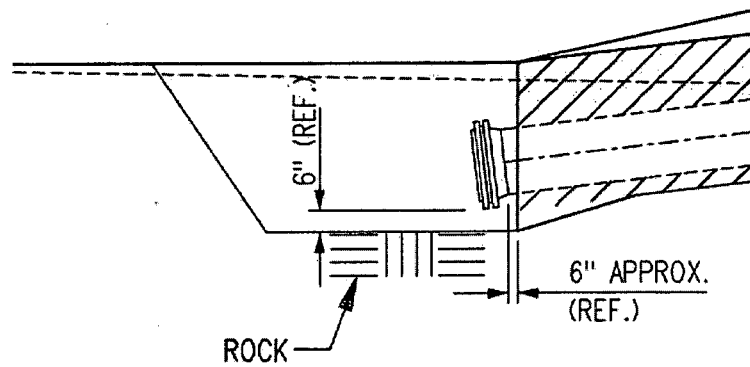
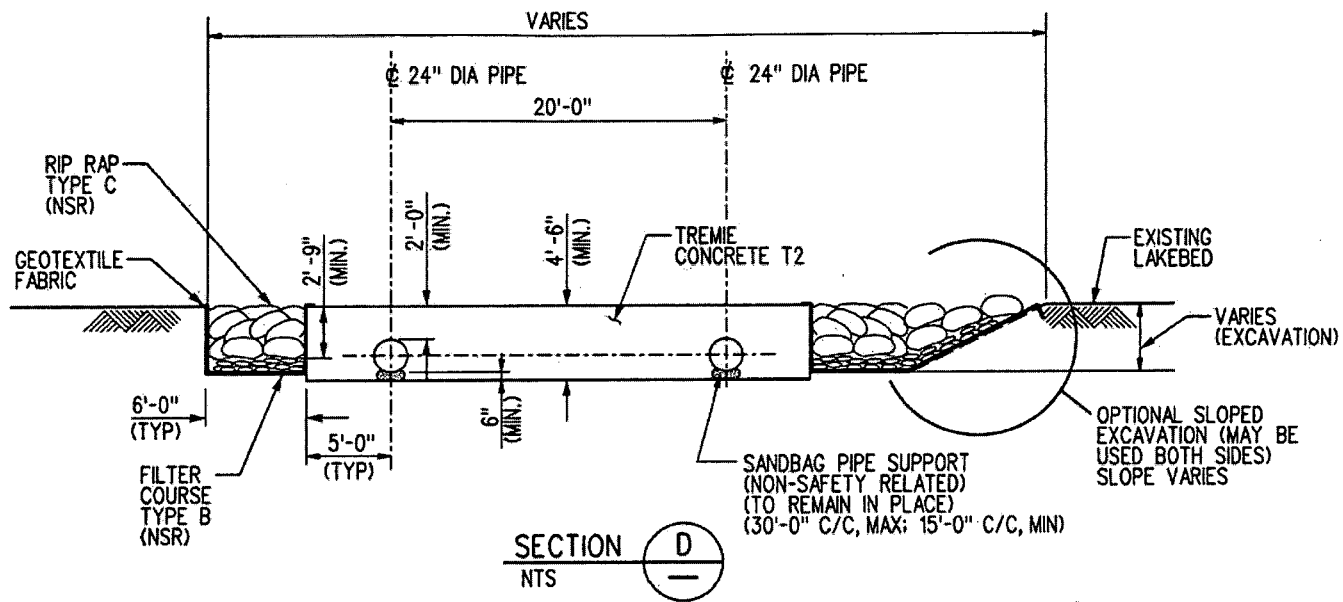

Drawing Number:
C-K276 Rev. 03
By: Bechtel Engineers

WOLF CREEK
UPDATED SAFETY ANALYSIS REPORT

Figure 2.5-105 Rev. 28
ESWS Discharge Pipe Encasement
and Discharge Point Sections
Sheet 1 of 1

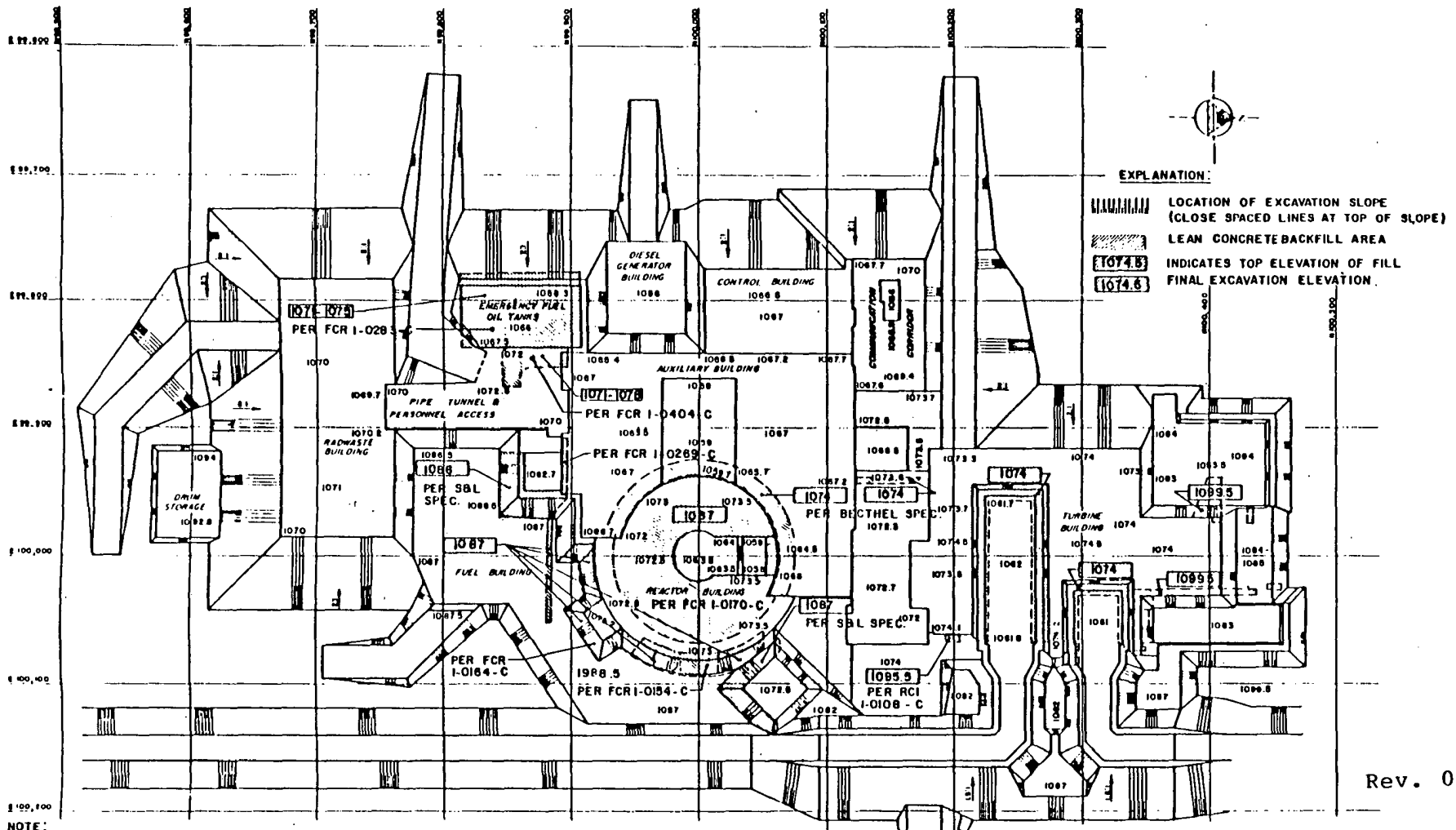

EXPLANATION:

- LOCATION OF EXCAVATION SLOPE (CLOSE SPACED LINES AT TOP OF SLOPE)
- LEAN CONCRETE BACKFILL AREA
- INDICATES TOP ELEVATION OF FILL
- FINAL EXCAVATION ELEVATION.

Rev. 0

NOTE:
 ELEVATIONS REFER TO USGS SYSTEM & COORDINATES REFER TO SNUPPS SYSTEM.
 DRAWING REFERENCE:

TITLE: EXCAVATION PLAN, PLANT AREA, WOLF CREEK GENERATING STATION UNIT 1
 FOR: KANSAS GAS & ELECTRIC COMPANY AND KANSAS CITY POWER & LIGHT COMPANY
 BY: SARGENT & LUNDY ENGINEERS, CHICAGO, ILL.
 DRAWING NO: S-181 REV. 0
 DATE: 4/15/84

WOLF CREEK
 UPDATED SAFETY ANALYSIS REPORT

Figure 2.5-105a
 Lean Concrete Status

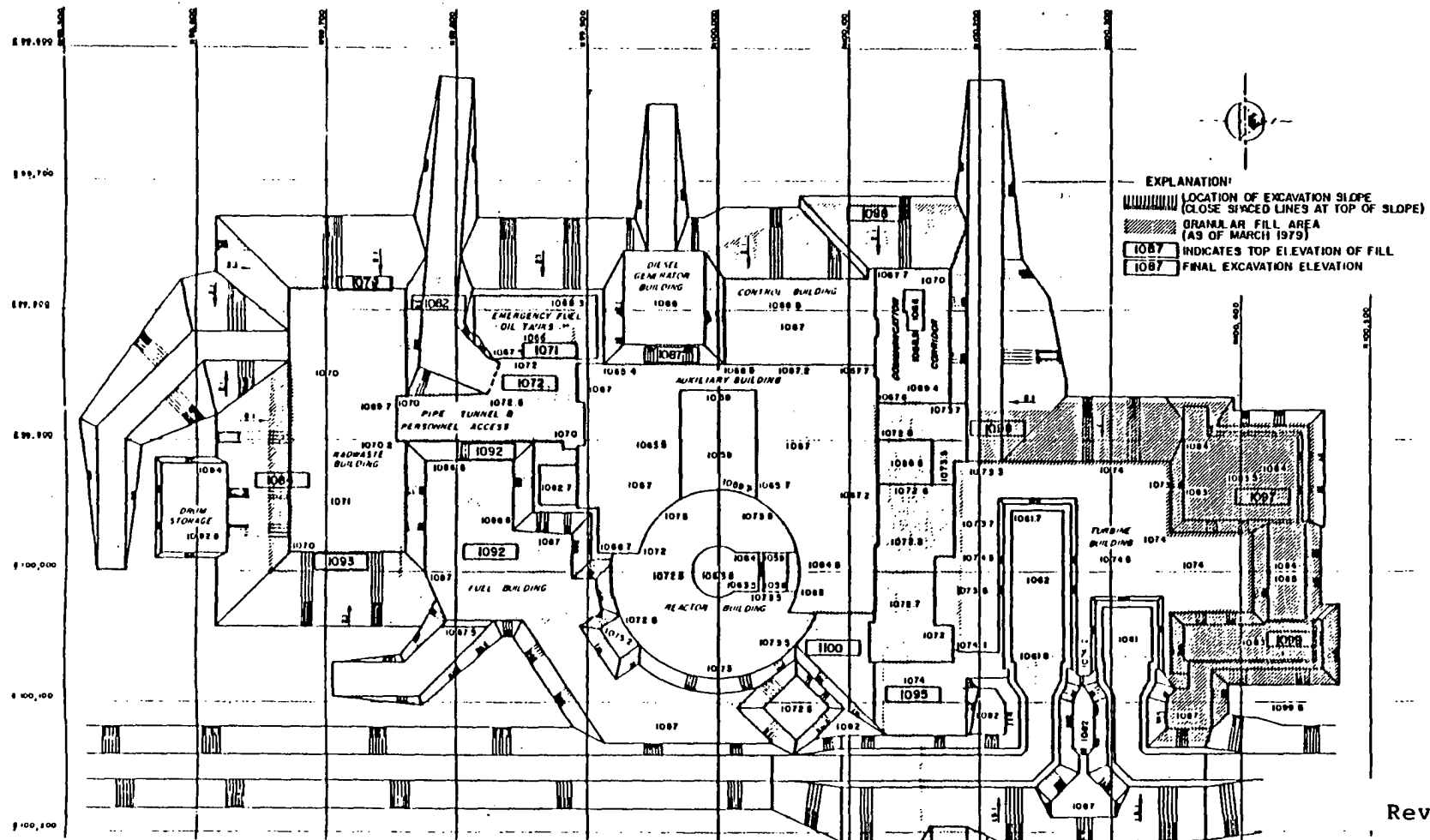

Rev. 0

NOTE: COORDINATES REFER TO SHUPPS SYSTEM & ELEVATIONS REFER TO USGS SYSTEM.
 COORDINATES REFER TO SHUPPS DATUM IN WHICH SHUPPS COORDINATES N. 100,000 AND E. 100,000
 (REACTOR CENTER) CORRESPOND TO KANSAS STATE PLANE COORDINATES N. 584,670 AND E. 2,807,250.

DRAWING REFERENCE:
 TITLE: EXCAVATION PLAN, PLANT AREA, WOLF CREEK GENERATING STATION UNIT 1
 FOR: KANSAS GAS & ELECTRIC COMPANY AND KANSAS CITY POWER & LIGHT COMPANY
 BY: SARGENT & LUNDY ENGINEERS, CHICAGO
 DRAWING NO.: S-181 REV. 0
 DATE: 4/15/77

WOLF CREEK
 UPDATED SAFETY ANALYSIS REPORT
 Figure 2.5-105b (Sheet 1 of 2)
 Granular Fill Status

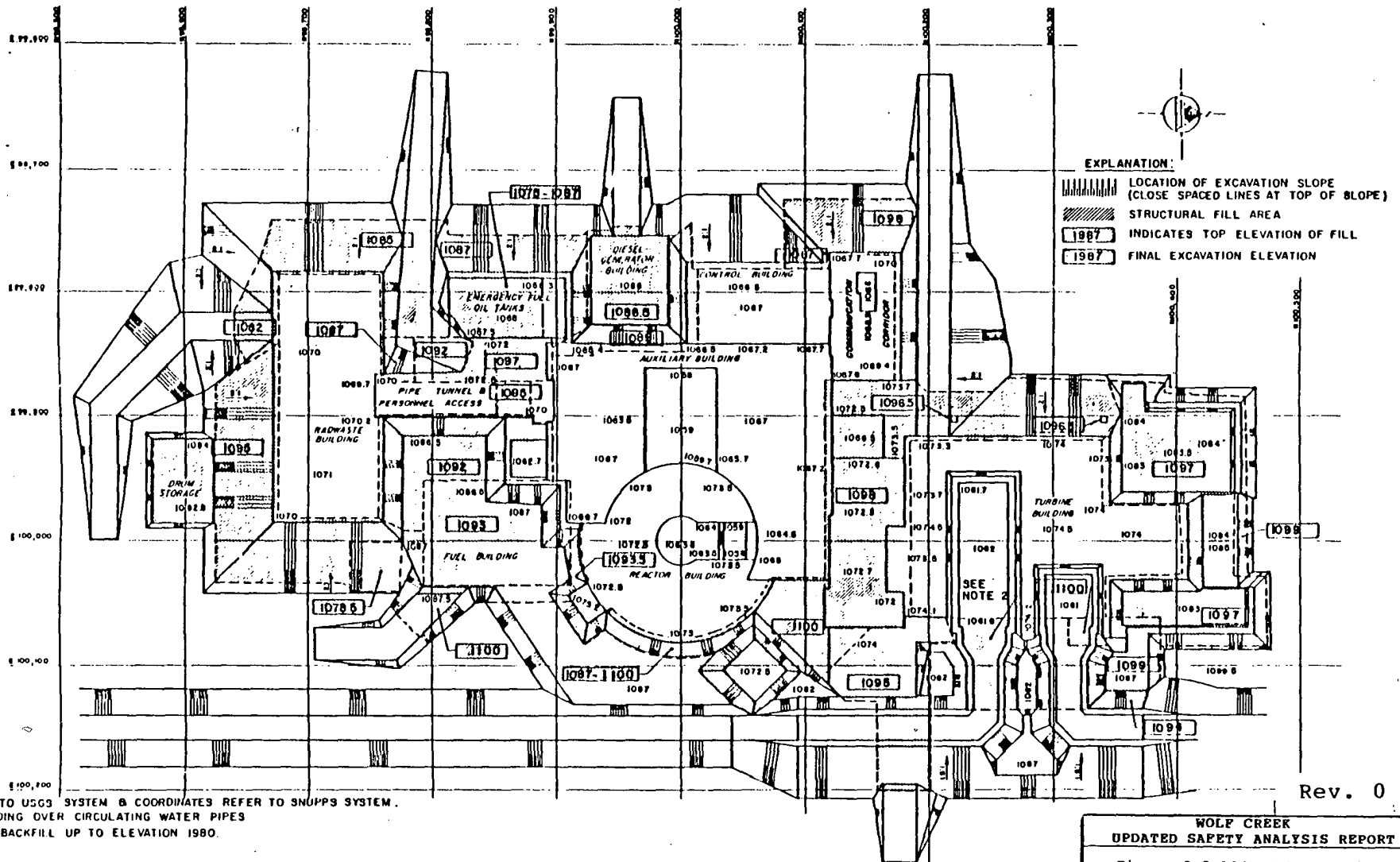

EXPLANATION:

- LOCATION OF EXCAVATION SLOPE (CLOSE SPACED LINES AT TOP OF SLOPE)
- STRUCTURAL FILL AREA
- INDICATES TOP ELEVATION OF FILL
- FINAL EXCAVATION ELEVATION

NOTES:
 ELEVATIONS REFER TO USGS SYSTEM & COORDINATES REFER TO SNUPPS SYSTEM.
 1 FOOT OF PIPE BEDDING OVER CIRCULATING WATER PIPES
 THEN STRUCTURAL BACKFILL UP TO ELEVATION 1980.

DRAWING REFERENCE:
 TITLE: EXCAVATION PLAN, PLANT AREA, WOLF CREEK GENERATING STATION UNIT 1
 FOR: KANSAS GAS & ELECTRIC COMPANY AND KANSAS CITY POWER & LIGHT COMPANY
 BY: SARGENT & LUNDY ENGINEERS, CHICAGO, ILL.
 DRAWING NO: S-181 REV 0
 DATE: 4/18/77

Rev. 0

**WOLF CREEK
 UPDATED SAFETY ANALYSIS REPORT**
 Figure 2.5-105b (Sheet 2 of 2)
 Granular Fill Status

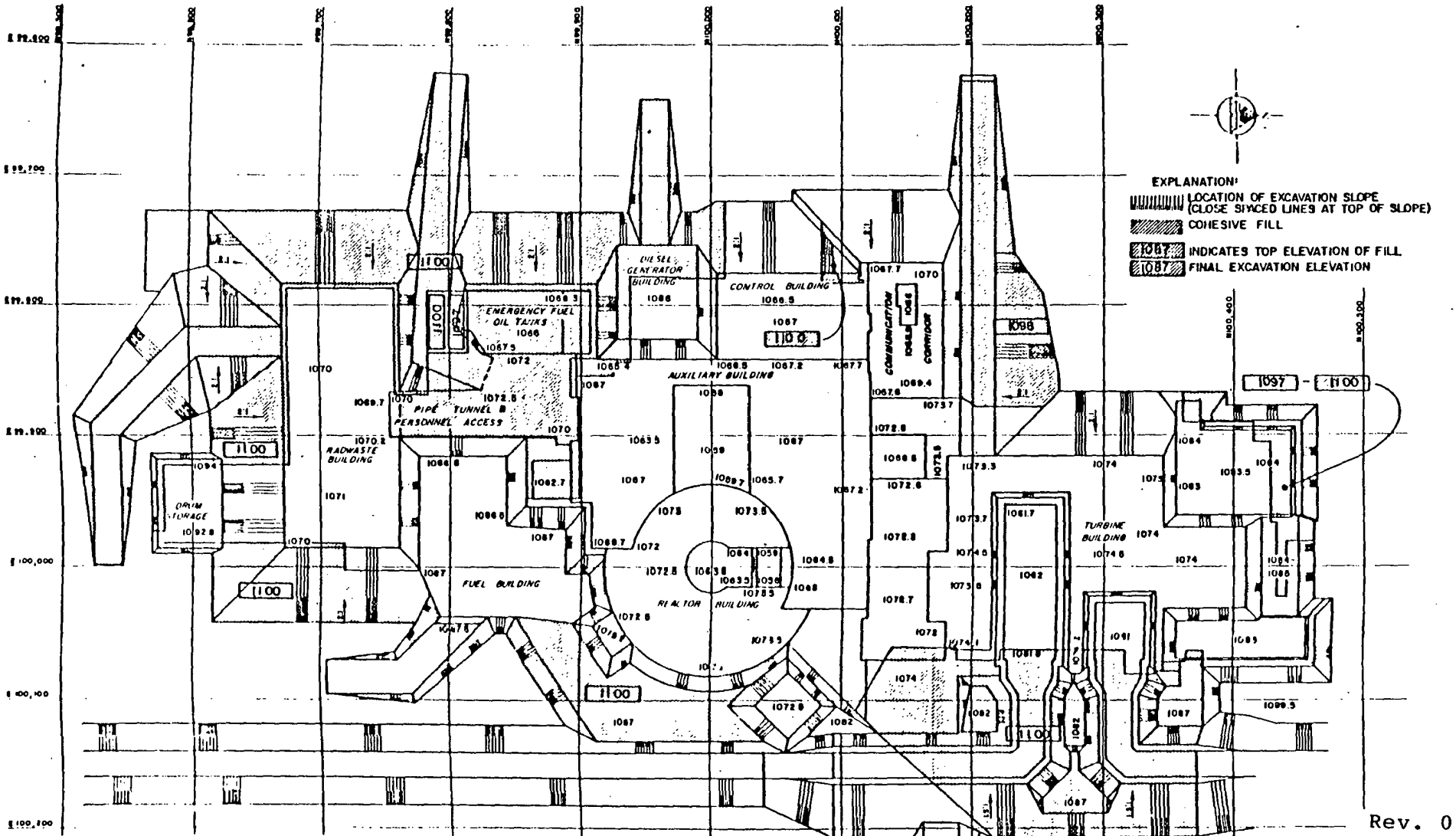

NOTES: COORDINATES REFER TO SHIPP'S SYSTEM & ELEVATIONS REFER TO USGS SYSTEM.
 COORDINATES REFER TO SHIPP'S DATUM IN WHICH SHIPP'S COORDINATES N. 100,000 AND E. 100,000
 (REACTOR CENTER) CORRESPOND TO KANSAS STATE PLANE COORDINATES N. 684,670 AND E. 2,807,250.

DRAWING REFERENCE:
 TITLE: EXCAVATION PLAN, PLANT AREA, WOLF CREEK GENERATING STATION UNIT 1
 FOR: KANSAS GAS & ELECTRIC COMPANY AND KANSAS CITY POWER & LIGHT COMPANY
 BY: SARGENT & LUNDY ENGINEERS, CHICAGO
 DRAWING NO.: S-181 REV. 0
 DATE: 4/15/77

WOLF CREEK
 UPDATED SAFETY ANALYSIS REPORT
 Figure 2.5-105c (Sheet 1 of 3)
 Cohesive Backfill Status

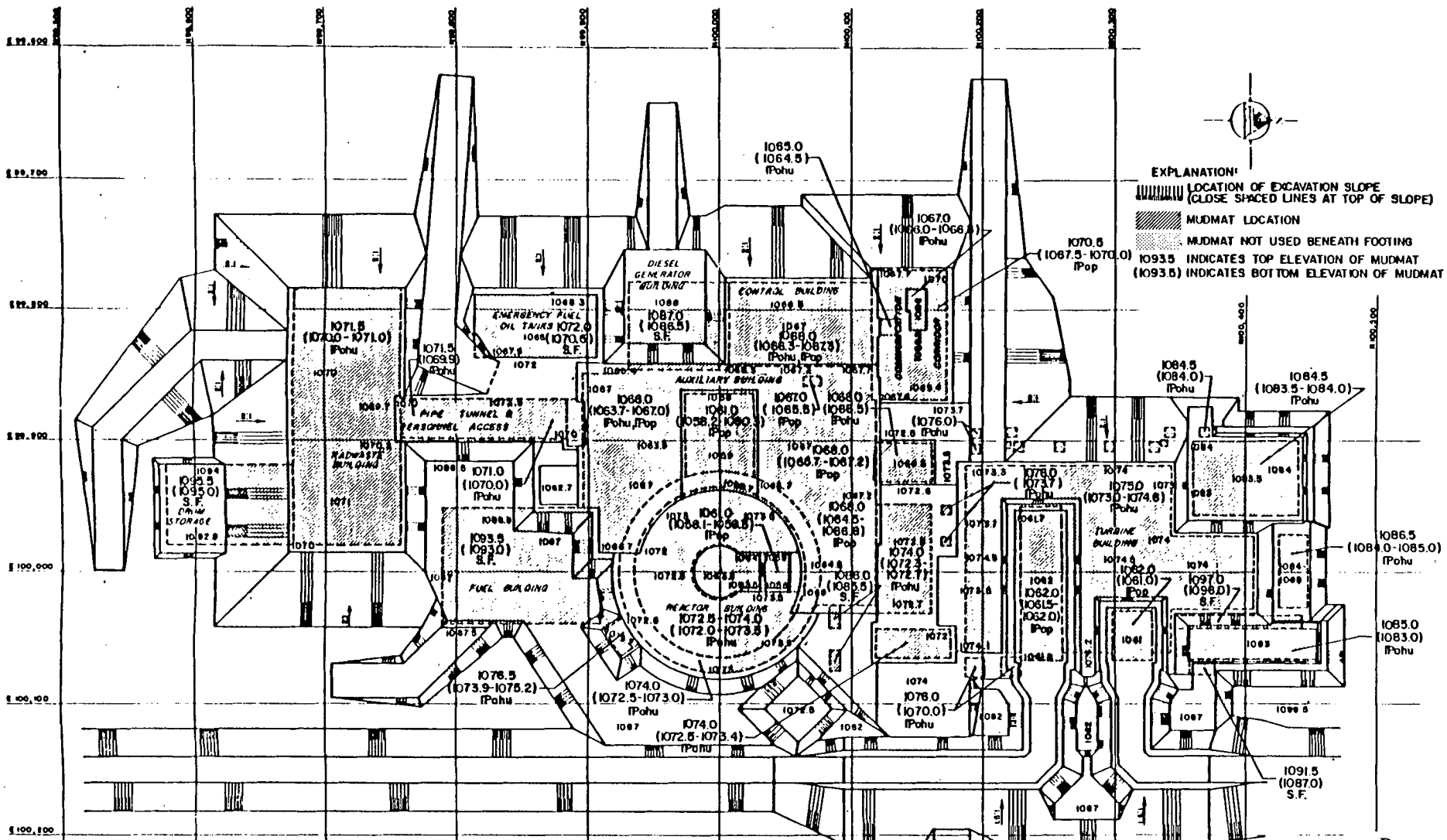

EXPLANATION:

- LOCATION OF EXCAVATION SLOPE (CLOSE SPACED LINES AT TOP OF SLOPE)
- MUDMAT LOCATION
- MUDMAT NOT USED BENEATH FOOTING
- 1093.5** INDICATES TOP ELEVATION OF MUDMAT
- (1093.5)** INDICATES BOTTOM ELEVATION OF MUDMAT

NOTES: COORDINATES REFER TO SNUPPS SYSTEM & ELEVATIONS REFER TO USGS SYSTEM.

COORDINATES REFER TO SNUPPS DATUM IN WHICH SNUPPS COORDINATES N. 100,000 AND E. 100,000 (REACTOR CENTER) CORRESPOND TO KANSAS STATE PLANE COORDINATES N. 884,670 AND E. 2,807,250.

DRAWING REFERENCE:
TITLE: EXCAVATION PLAN, PLANT AREA WOLF CREEK GENERATING STATION UNIT 1
FOR: KANSAS GAS & ELECTRIC COMPANY AND KANSAS CITY POWER & LIGHT COMPANY
BY: SARGENT & LUNDY ENGINEERS, CHICAGO
DRAWING NO.: S-181 REV. 0
DATE: 4/15/77

SUB-BASE MATERIALS:
 S.F. STRUCTURAL FILL
 IPohu HEUMADER SHALE MEMBER
 IPop PLATTSMOUTH LIMESTONE MEMBER

Rev. 0

WOLF CREEK
UPDATED SAFETY ANALYSIS REPORT
 Figure 2.5-105c (Sheet 2 of 3)
 Cohesive Backfill Status

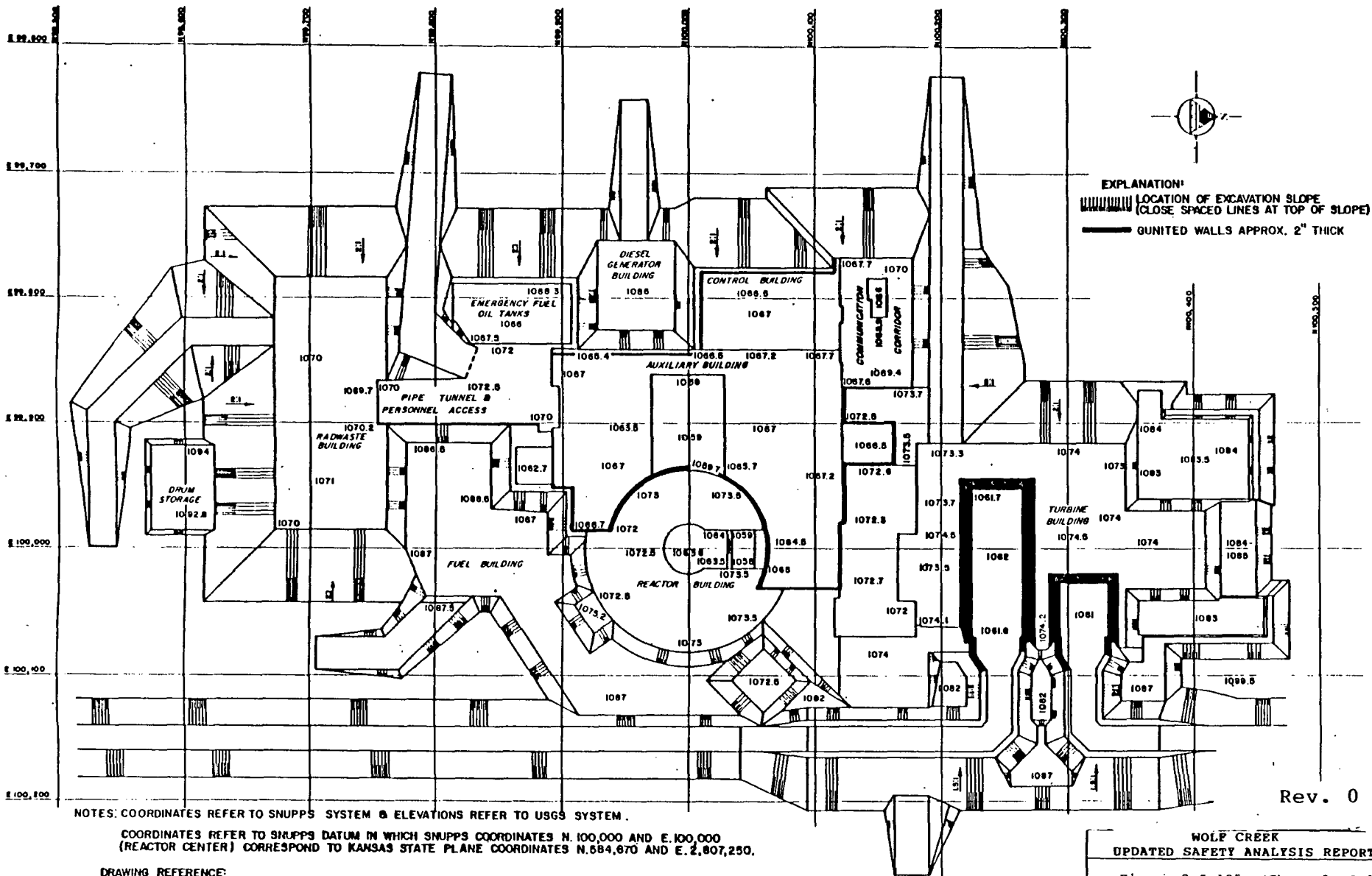

NOTES: COORDINATES REFER TO SNUPPS SYSTEM & ELEVATIONS REFER TO USGS SYSTEM.

COORDINATES REFER TO SNUPPS DATUM IN WHICH SNUPPS COORDINATES N. 100,000 AND E. 100,000 (REACTOR CENTER) CORRESPOND TO KANSAS STATE PLANE COORDINATES N. 584,670 AND E. 2,807,250.

DRAWING REFERENCE:

TITLE: EXCAVATION PLAN, PLANT AREA WOLF CREEK GENERATING STATION UNIT 1
 FOR: KANSAS GAS & ELECTRIC COMPANY AND KANSAS CITY POWER & LIGHT COMPANY
 BY: SARGENT & LUNDY ENGINEERS, CHICAGO
 DRAWING NO.: 8-181 REV. 0
 DATE: 4/18/77

Rev. 0

WOLF CREEK
 UPDATED SAFETY ANALYSIS REPORT
 Figure 2.5-105c (Sheet 3 of 3)
 Cohesive Backfill Status

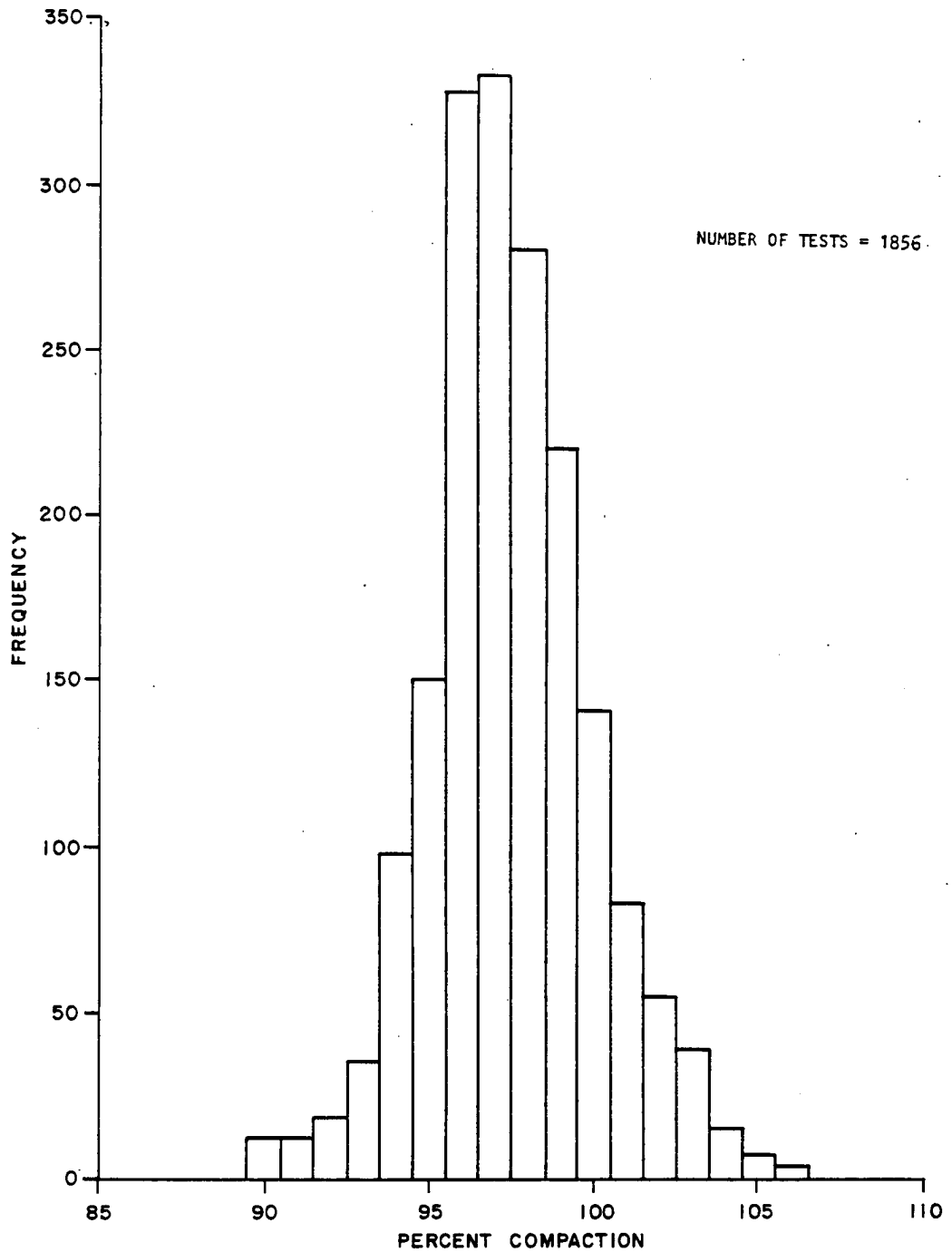

NOTES:

1. RETESTS ON AREAS WHERE TESTS DID NOT MEET COMPACTION CRITERIA ARE INCLUDED IN THIS PLOT.
2. MINIMUM COMPACTION IS 95% ASTM D-15

Rev. 0

7699-064-07

**WOLF CREEK
UPDATED SAFETY ANALYSIS REPORT**

Figure 2.5-105d

Power Block - Structural Fill
Statistical Distribution Plot

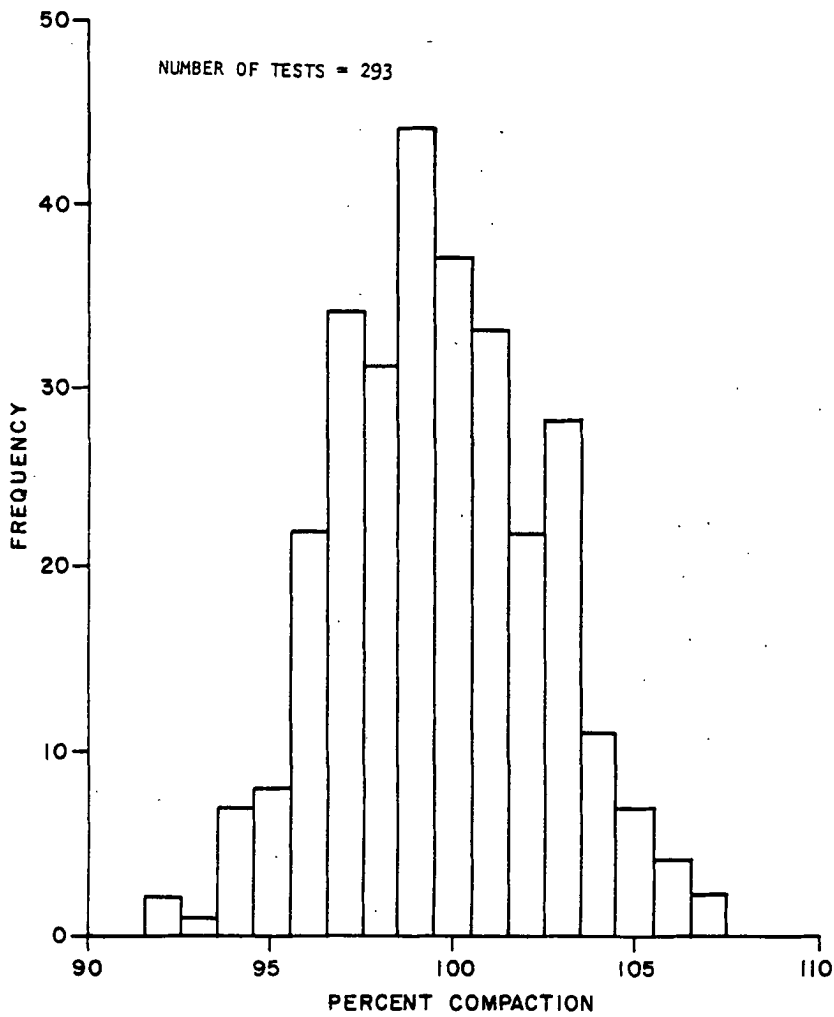

NOTES:

1. RETESTS ON AREAS WHERE TESTS DID NOT MEET COMPACTION CRITERIA ARE INCLUDED IN THIS PLOT.
2. MINIMUM COMPACTION IS 95% ASTM D-698.

Rev. 0

**WOLF CREEK
UPDATED SAFETY ANALYSIS REPORT**

Figure 2.5-105e

Power Block - Cohesive Fill
Statistical Distribution Plot

7699-064-07

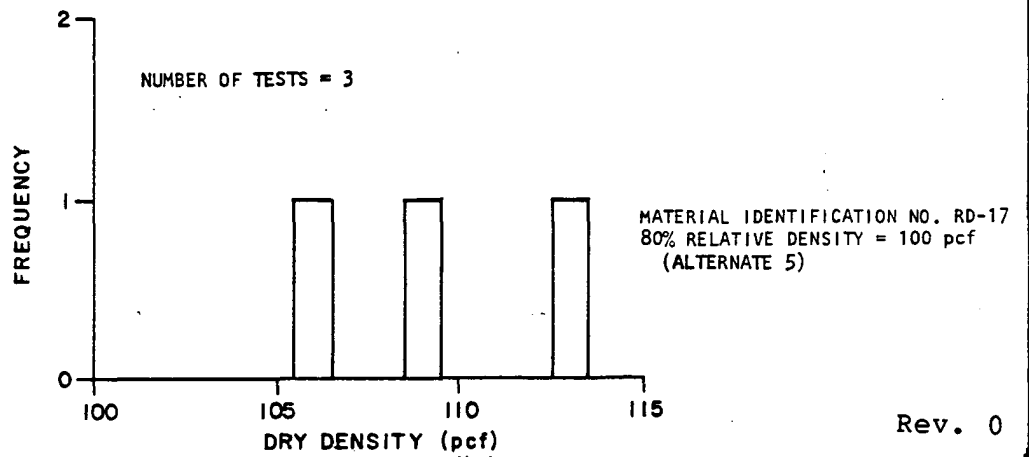
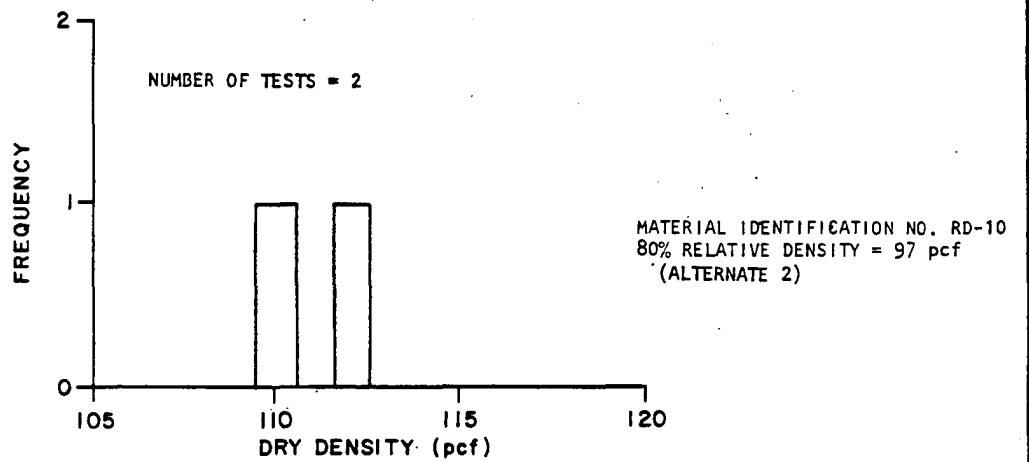
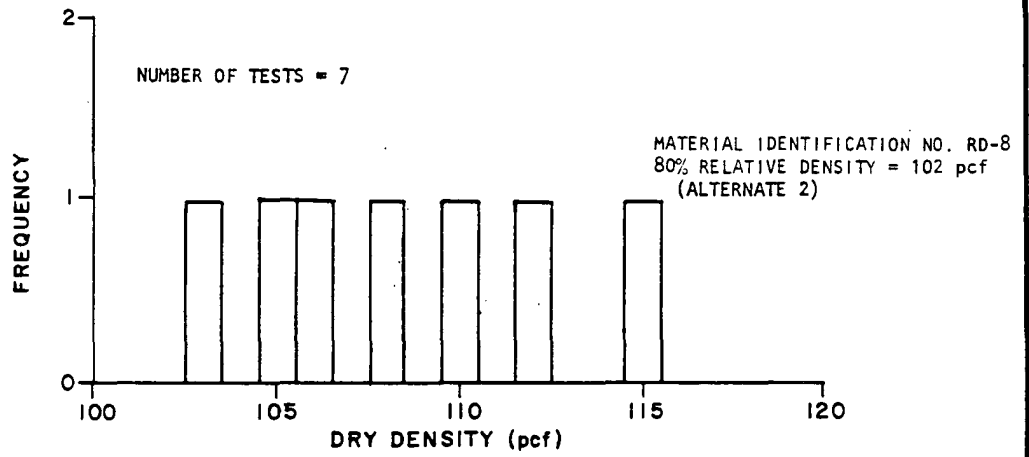

Rev. 0

**WOLF CREEK
UPDATED SAFETY ANALYSIS REPORT**

Figure 2.5-105f

Power Block - Pipe Bedding
Material Statistical Distribution
Plot

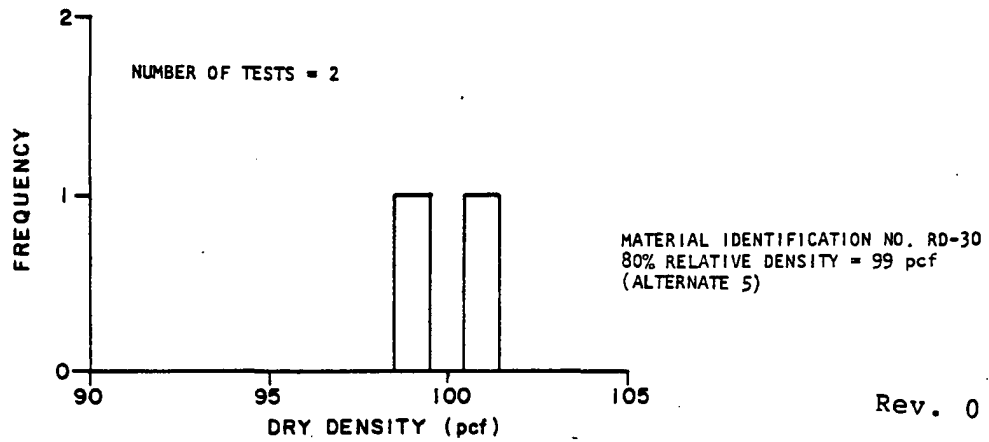
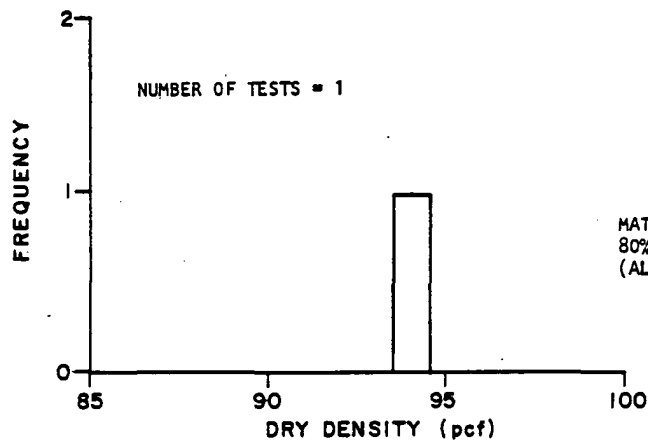
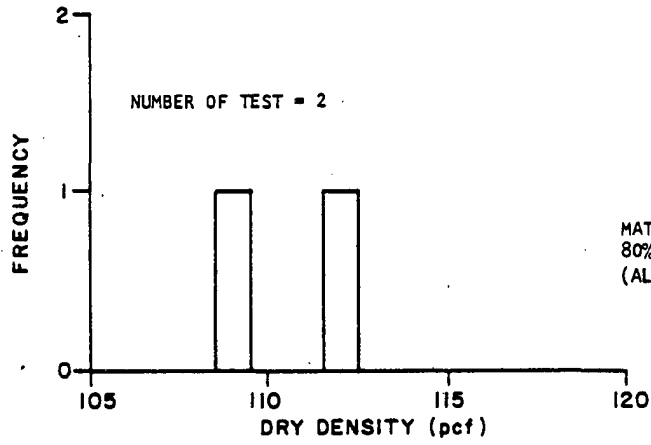

Rev. 0

**WOLF CREEK
UPDATED SAFETY ANALYSIS REPORT**

Figure 2.5-105g

Power Block - Pipe Bedding
Material Statistical Distribution
Plot

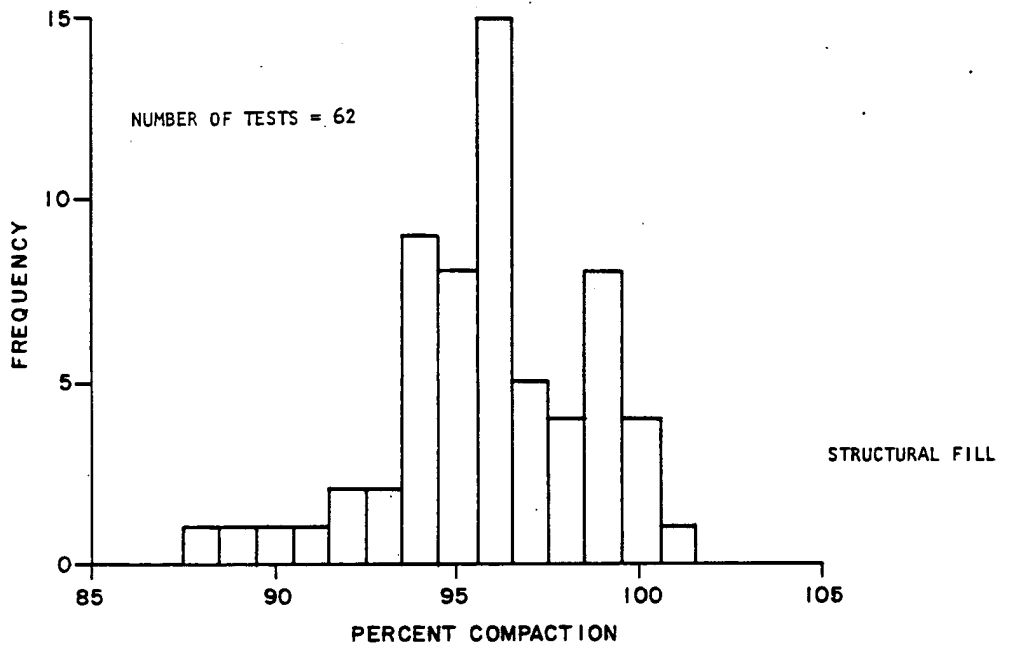
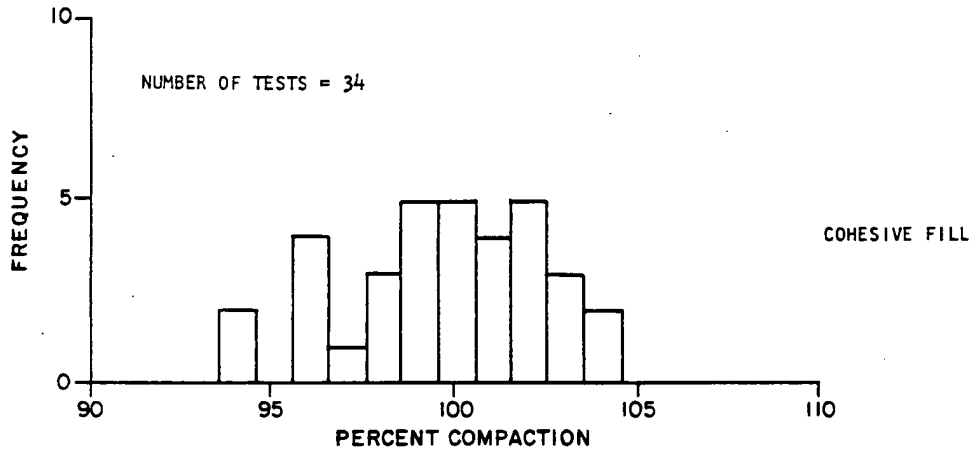

NOTES:

1. RETESTS ON AREAS WHERE TESTS DID NOT MEET COMPACTION CRITERIA ARE INCLUDED IN THESE PLOTS.
2. MINIMUM COMPACTION IS 95% ASTM D-698 FOR COHESIVE FILL, 95% ASTM D-1557 FOR STRUCTURAL FILL.

Rev. 0

7699-064-07

WOLF CREEK UPDATED SAFETY ANALYSIS REPORT
Figure 2.5-105h ESW Structures - Statistical Distribution Plot

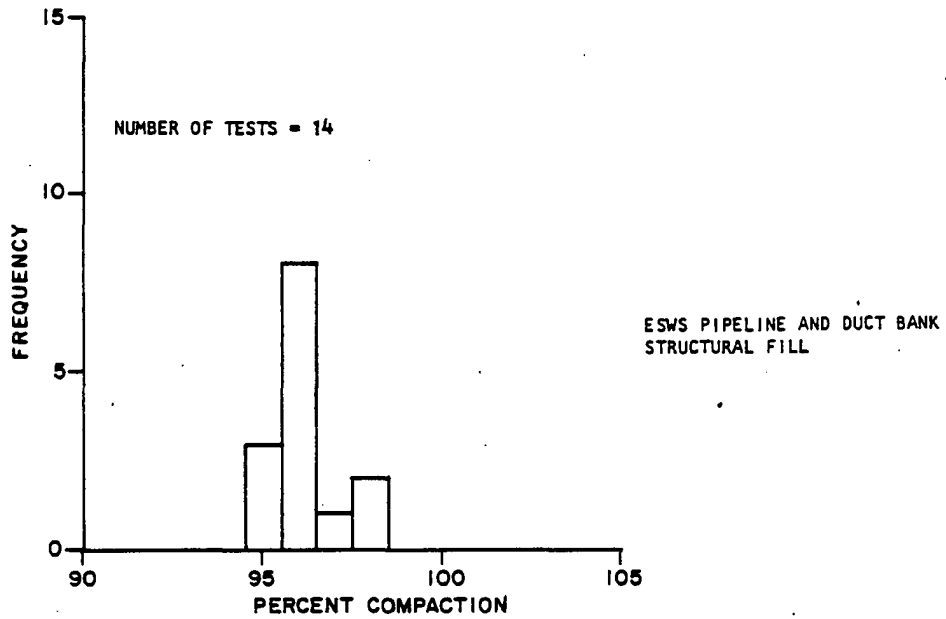
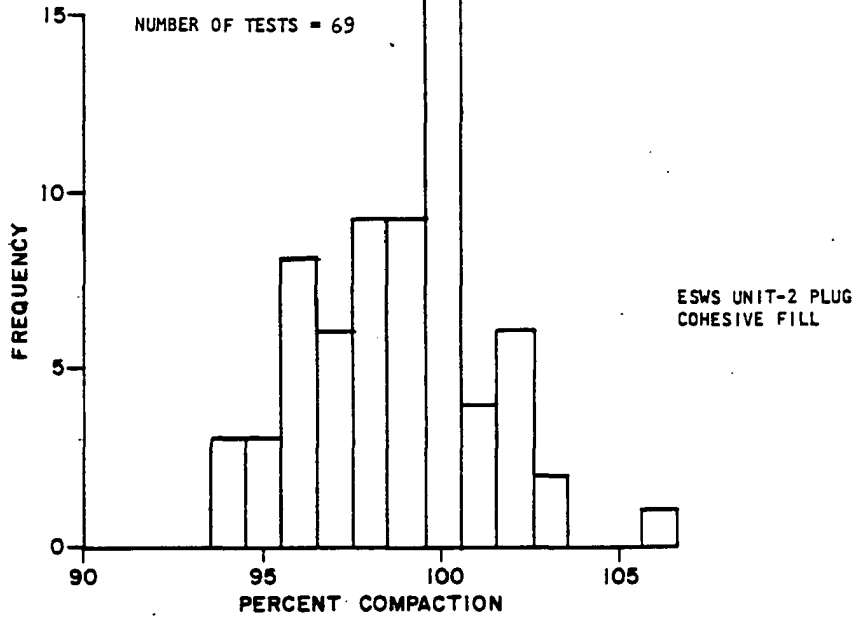

NOTES:

1. RETESTS ON AREAS WHERE TESTS DID NOT MEET COMPACTION CRITERIA ARE INCLUDED IN THESE PLOTS.
2. MINIMUM COMPACTION IS 95% ASTM D-698 FOR COHESIVE FILL, 95% ASTM D-1557 FOR STRUCTURAL FILL.

Rev. 0

**WOLF CREEK
UPDATED SAFETY ANALYSIS REPORT**

Figure 2.5-105i

ESWS - Statistical Distribution
Plot

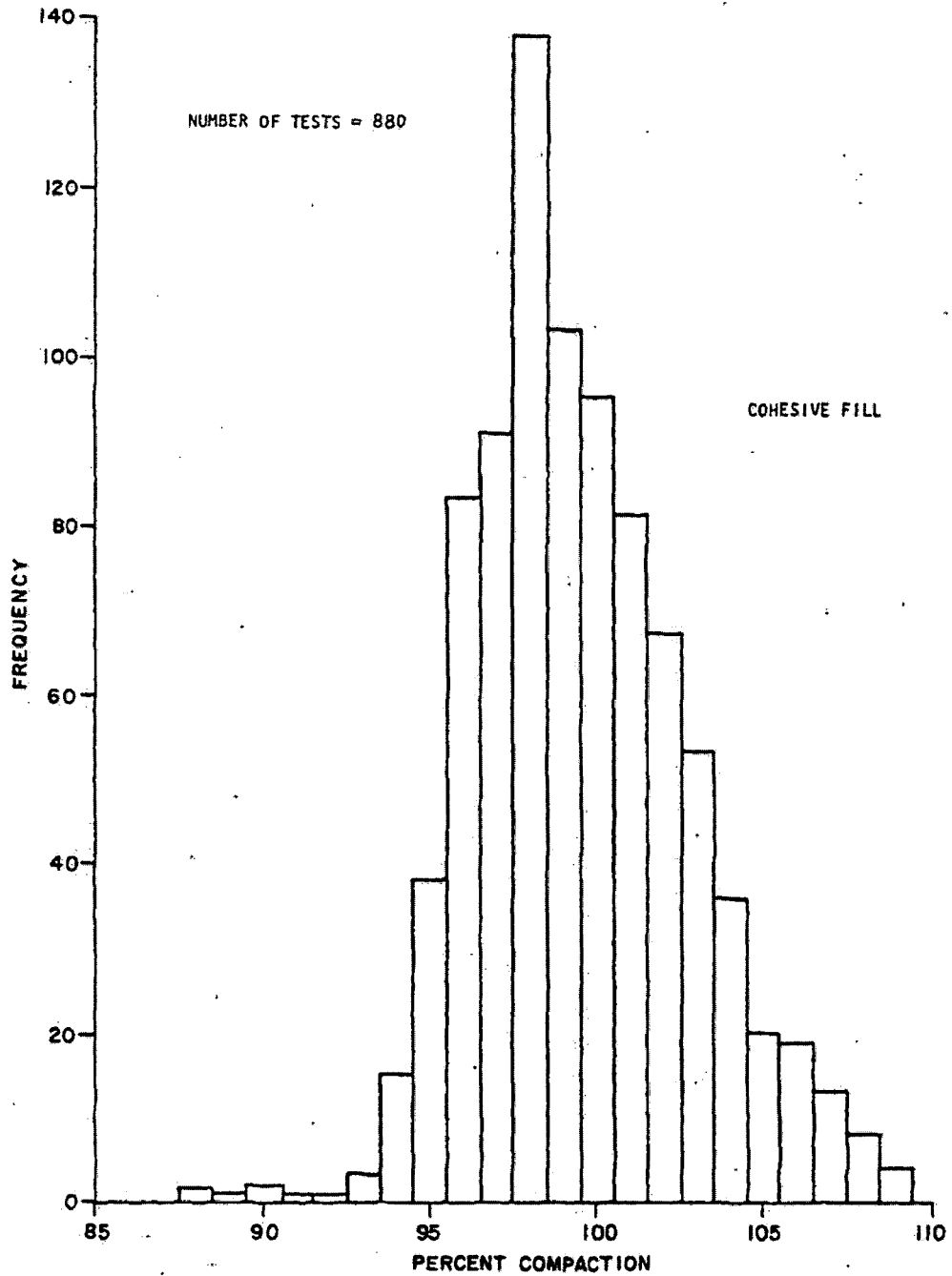

NOTES:

1. RETESTS ON AREAS WHERE TESTS DID NOT MEET COMPACTION CRITERIA ARE INCLUDED IN THIS PLOT.
2. MINIMUM COMPACTION IS ASTM D-1557.
3. 12 additional tests were performed for the ESW pipe replacement with similar distribution to that shown.

**WOLF CREEK
UPDATED SAFETY ANALYSIS REPORT**

Figure 2.5-105j Rev. 28
 ESWS Pipeline and Duct Bank -
 Statistical Distribution Plot
 Sheet 1 of 1

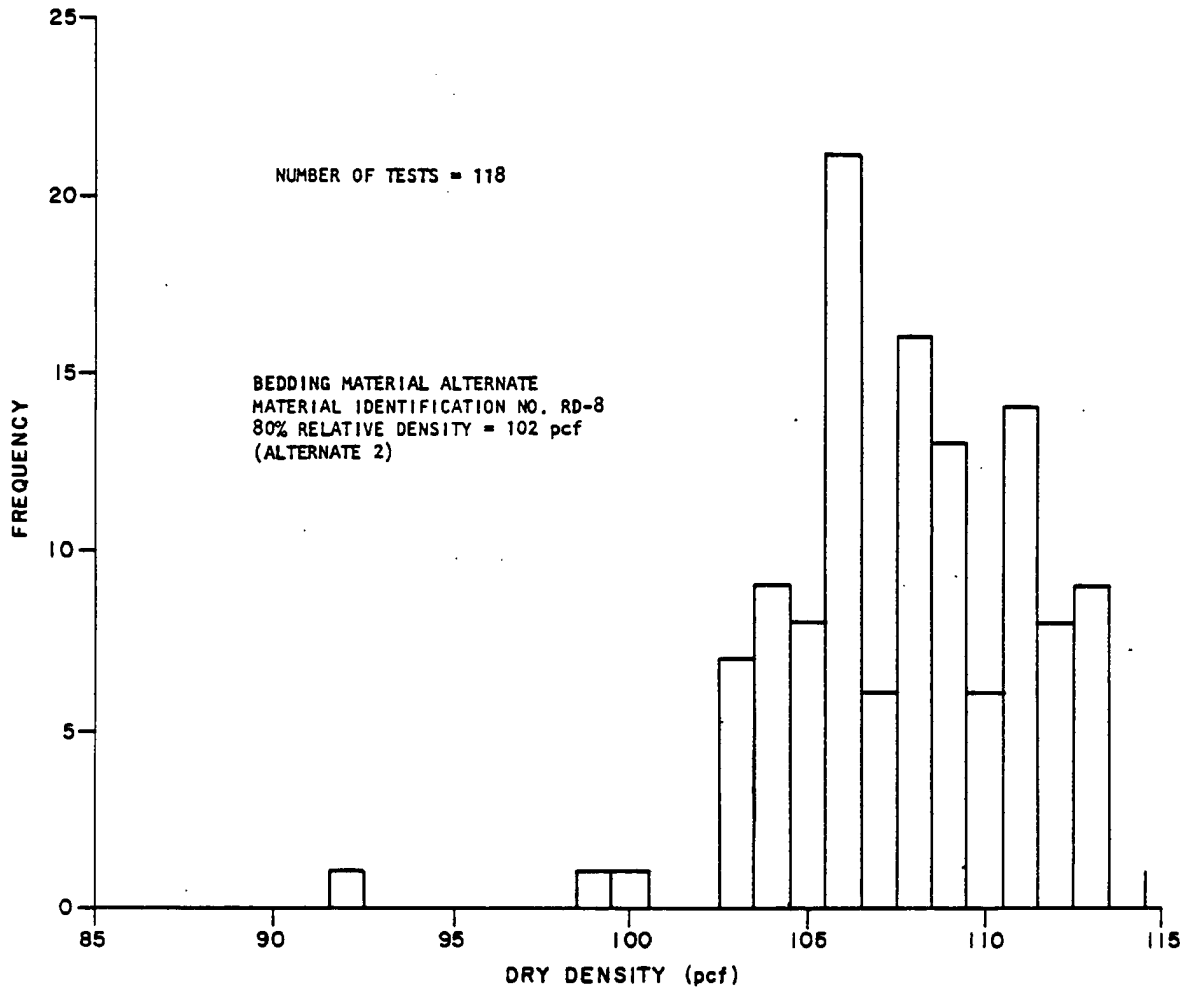

NOTES:

1. RETESTS ON AREAS WHERE TESTS DID NOT MEET COMPACTION CRITERIA ARE INCLUDED IN THIS PLOT.

Rev. 0

7699-064-07

**WOLF CREEK
UPDATED SAFETY ANALYSIS REPORT**

Figure 2.5-105k

ESWS Pipeline and Duct Bank -
Statistical Distribution Plot

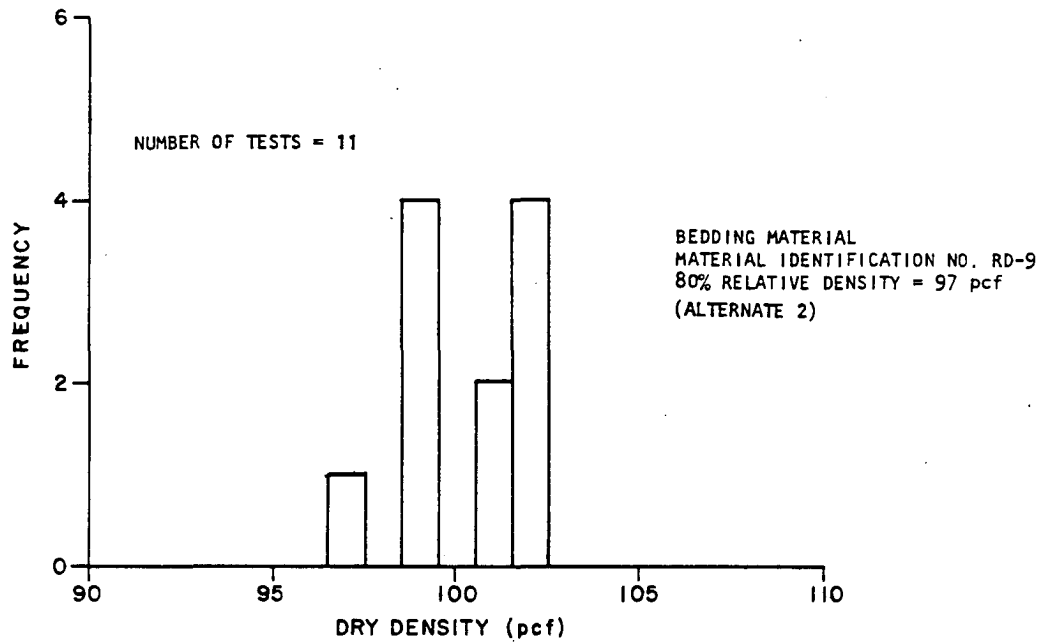

NOTES:

1. RETESTS ON AREAS WHERE TESTS DID NOT MEET COMPACTION CRITERIA ARE INCLUDED IN THIS PLOT.

7699-064-07

Rev. 0

**WOLF CREEK
UPDATED SAFETY ANALYSIS REPORT**

Figure 2.5-1051

ESWS Pipeline and Duct Bank -
Statistical Distribution Plot

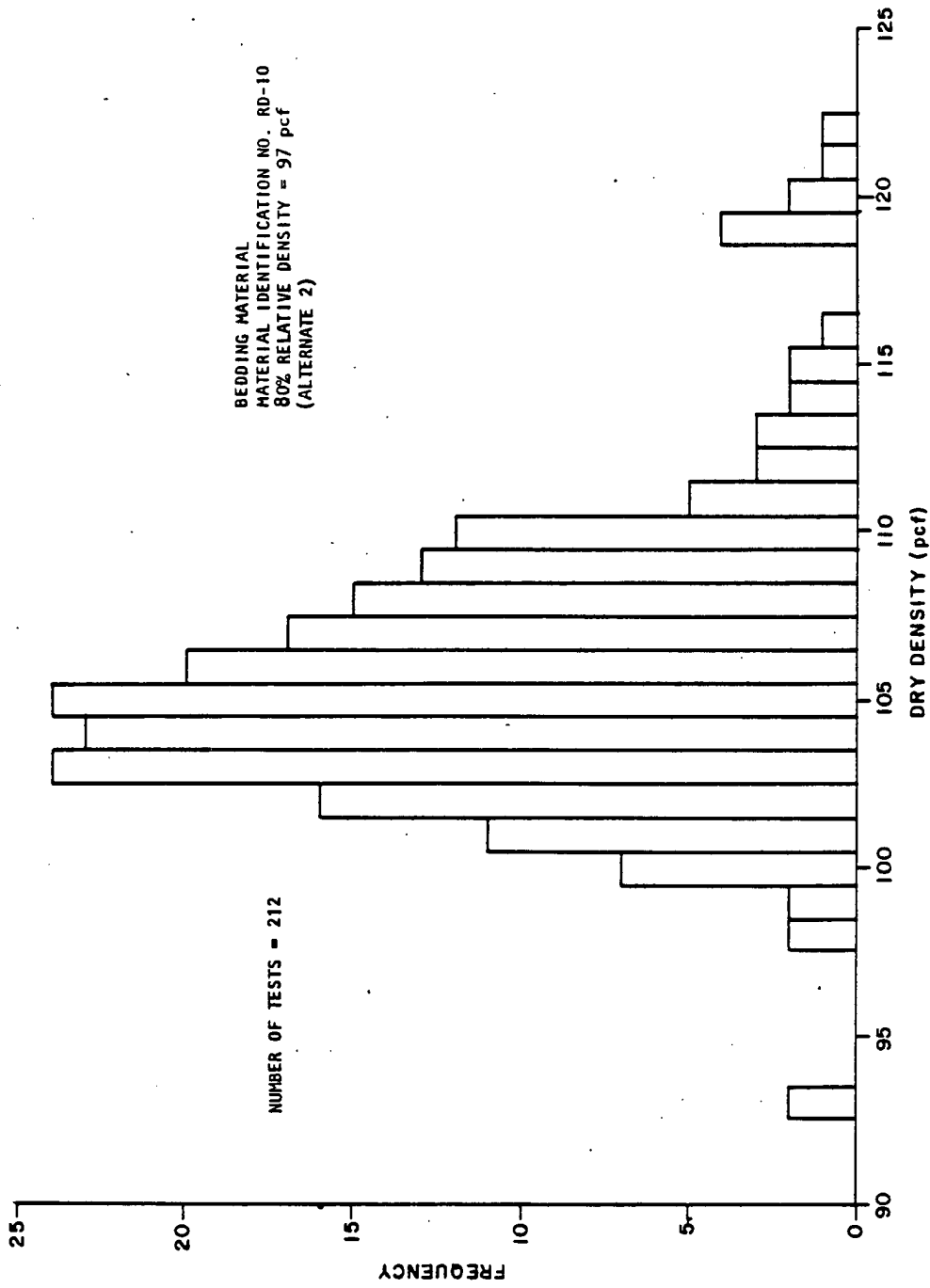

Rev. 0

**WOLF CREEK
UPDATED SAFETY ANALYSIS REPORT**

Figure 2.5-105m

ESWS Pipeline and Duct Bank -
Statistical Distribution Plot

7699-064-07

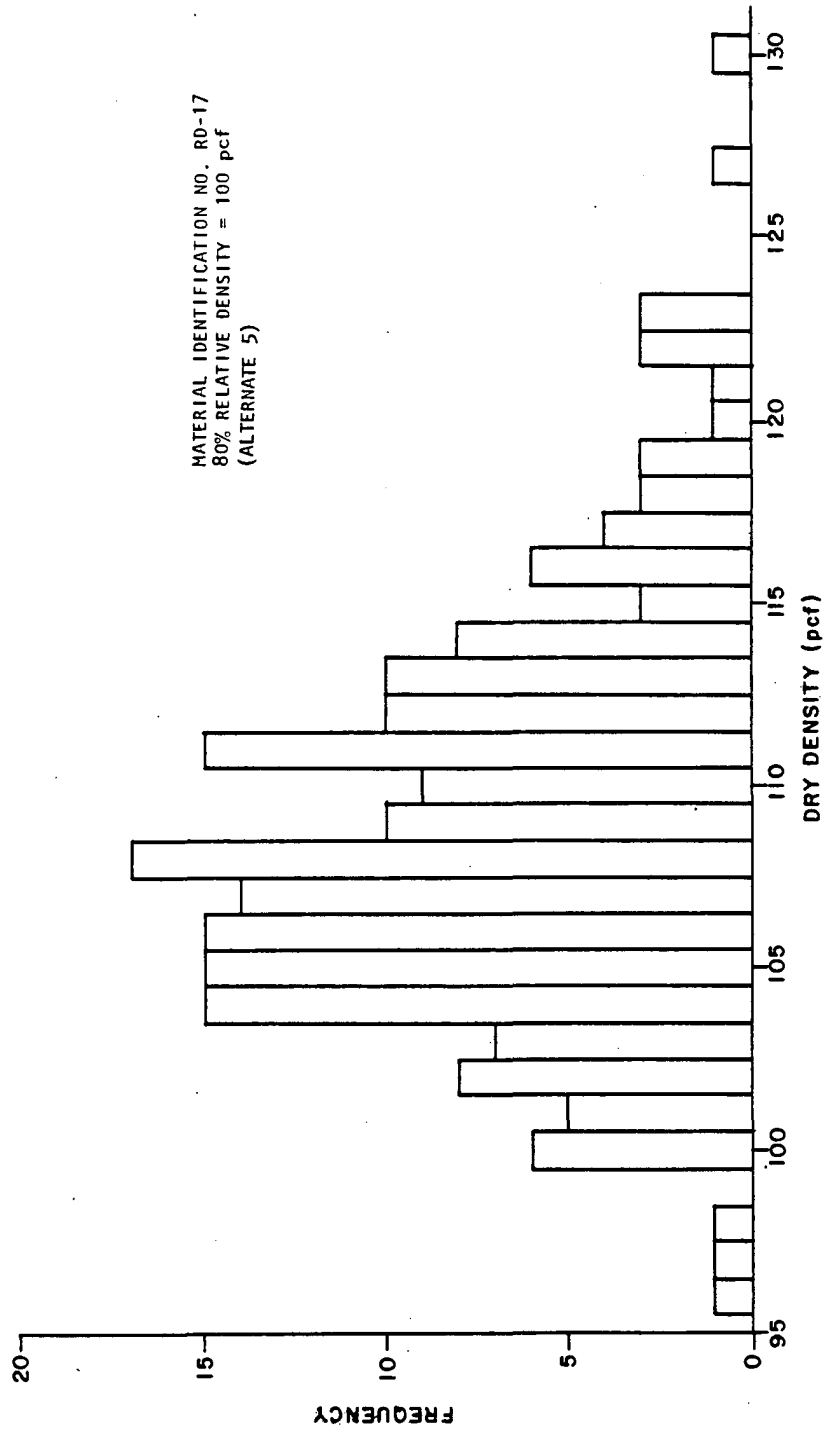

NOTES:

1. RETESTS ON AREAS WHERE TESTS DID NOT MEET COMPACTION CRITERIA ARE INCLUDED IN THIS PLOT.

Rev. 0

**WOLF CREEK
UPDATED SAFETY ANALYSIS REPORT**

Figure 2.5-105n

ESWS Pipeline - Bedding Material
Statistical Distribution Plot

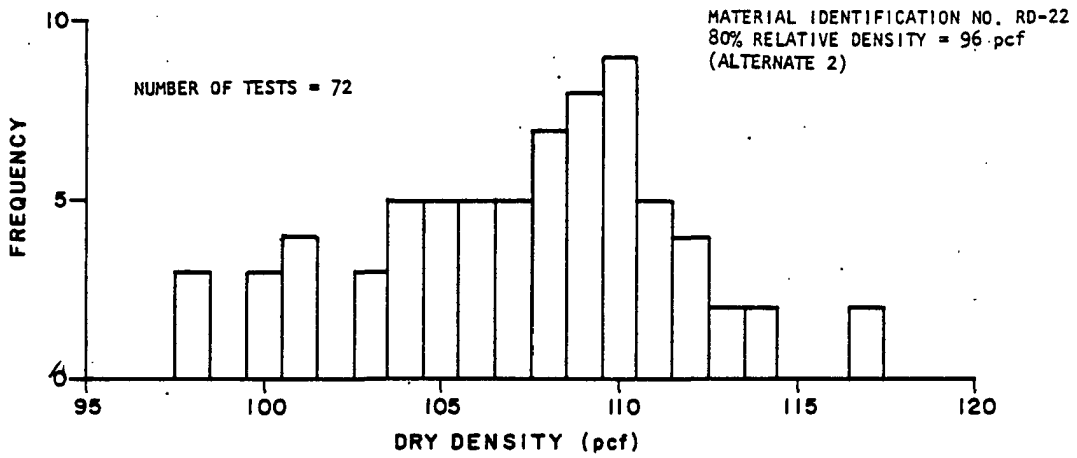

Rev. 0

**WOLF CREEK
UPDATED SAFETY ANALYSIS REPORT**

Figure 2.5-105o

ESWS Pipeline and Duct Bank -
Bedding Material Statistical
Distribution Plot

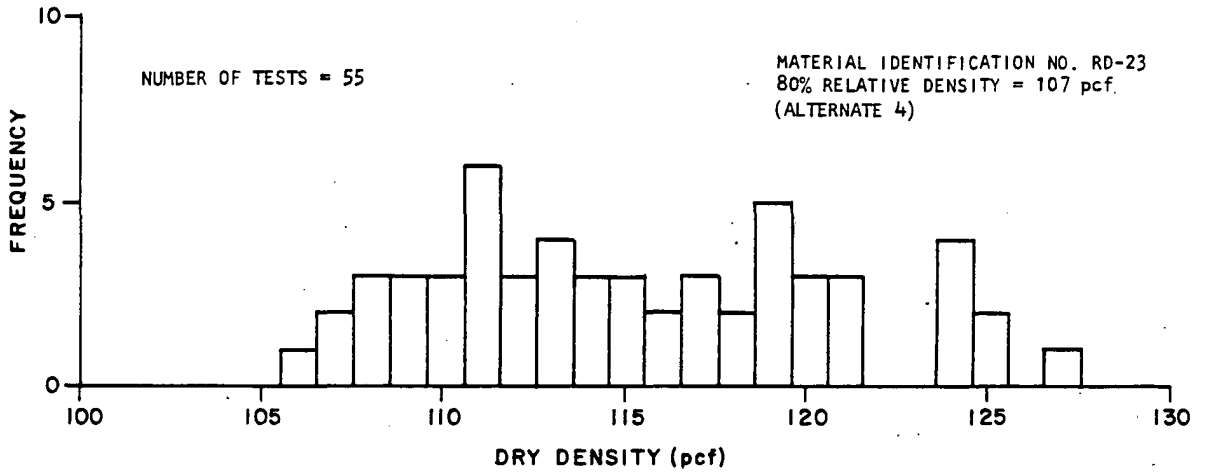

NOTES:

1. RETESTS ON AREAS WHERE TESTS DID NOT MEET COMPACTION CRITERIA ARE INCLUDED IN THIS PLOT.

Rev. 0

7699-064-07

**WOLF CREEK
UPDATED SAFETY ANALYSIS REPORT**

Figure 2.5-105p

ESWS Pipeline and Duct Bank -
Bedding Material Statistical
Distribution Plot

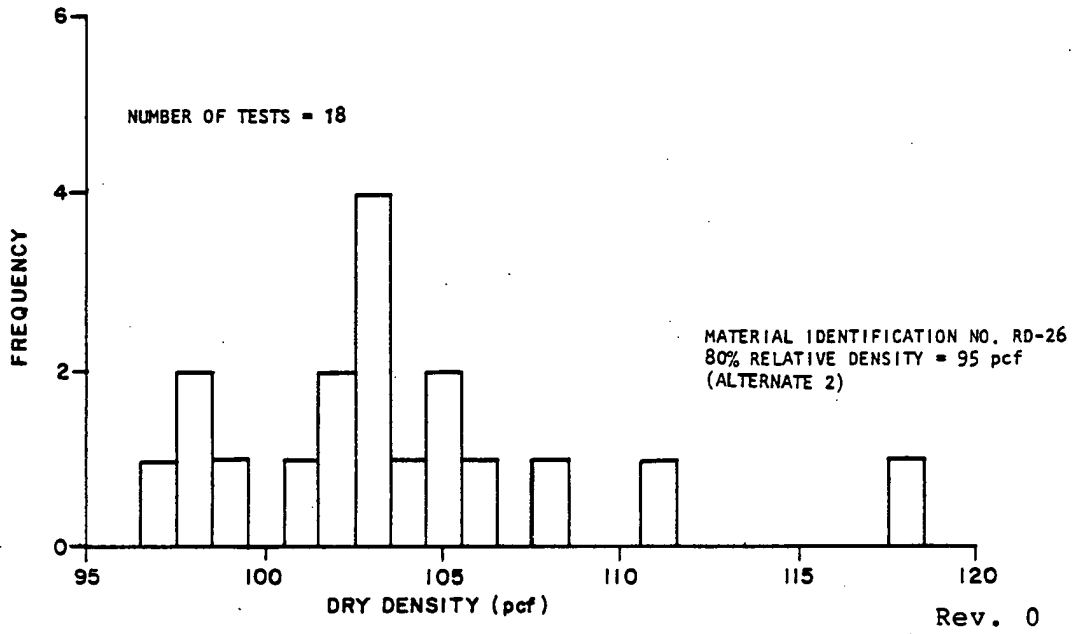
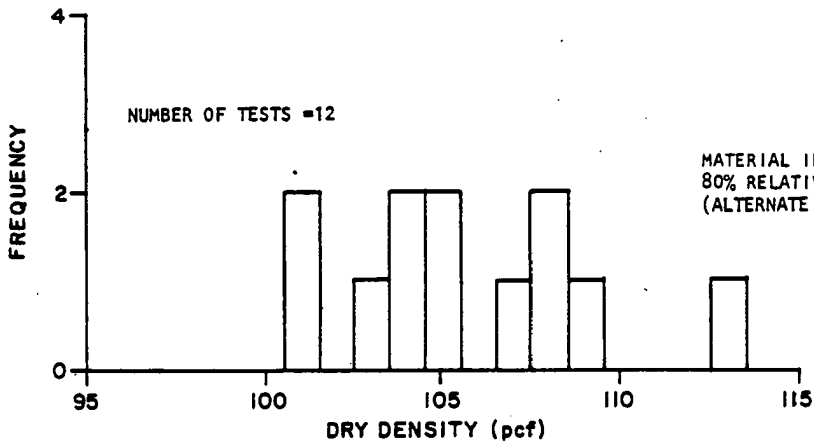

Rev. 0

**WOLF CREEK
UPDATED SAFETY ANALYSIS REPORT**

Figure 2.5-105q

ESWS Pipeline and Duct Bank -
Bedding Material Statistical
Distribution Plot

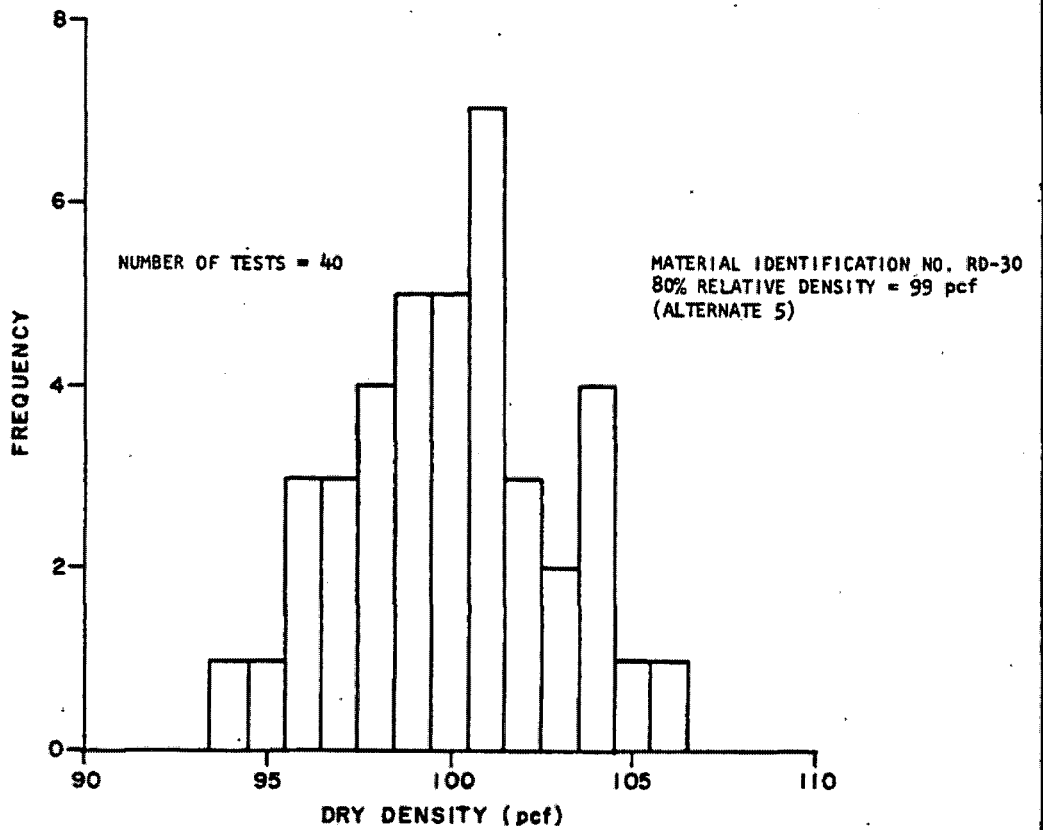
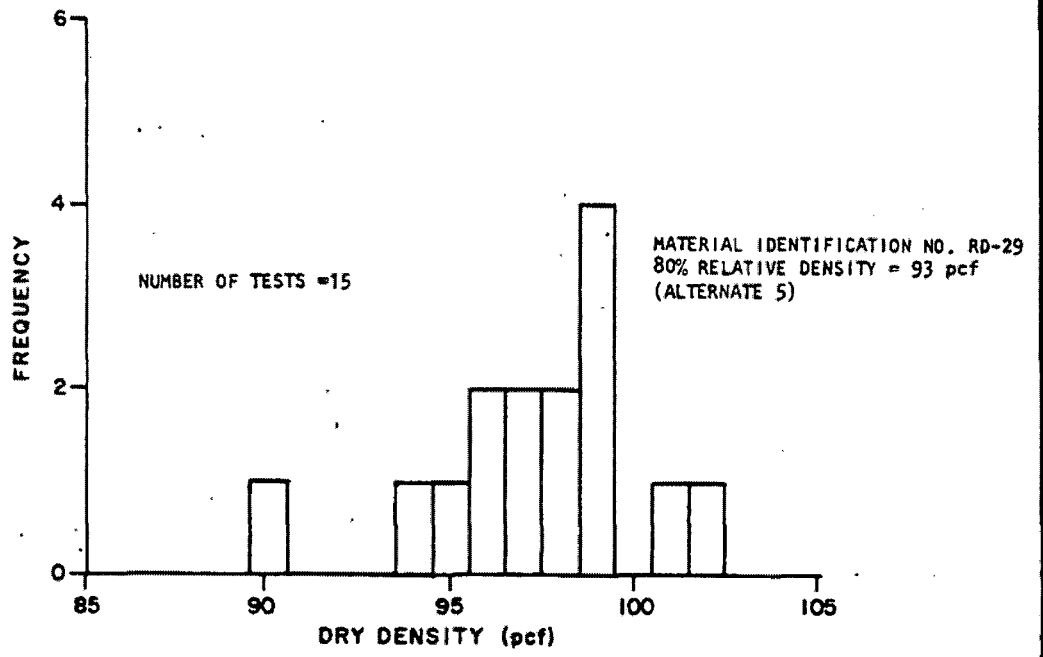

NOTES:

1. RETESTS ON AREAS WHERE TESTS DID NOT MEET COMPACTION CRITERIA ARE INCLUDED IN THESE PLOTS.

**WOLF CREEK
UPDATED SAFETY ANALYSIS REPORT**

Figure 2.5-105r Rev. 28

ESWS Pipeline and Duct Bank -
Bedding Material Statistical
Distribution Plot

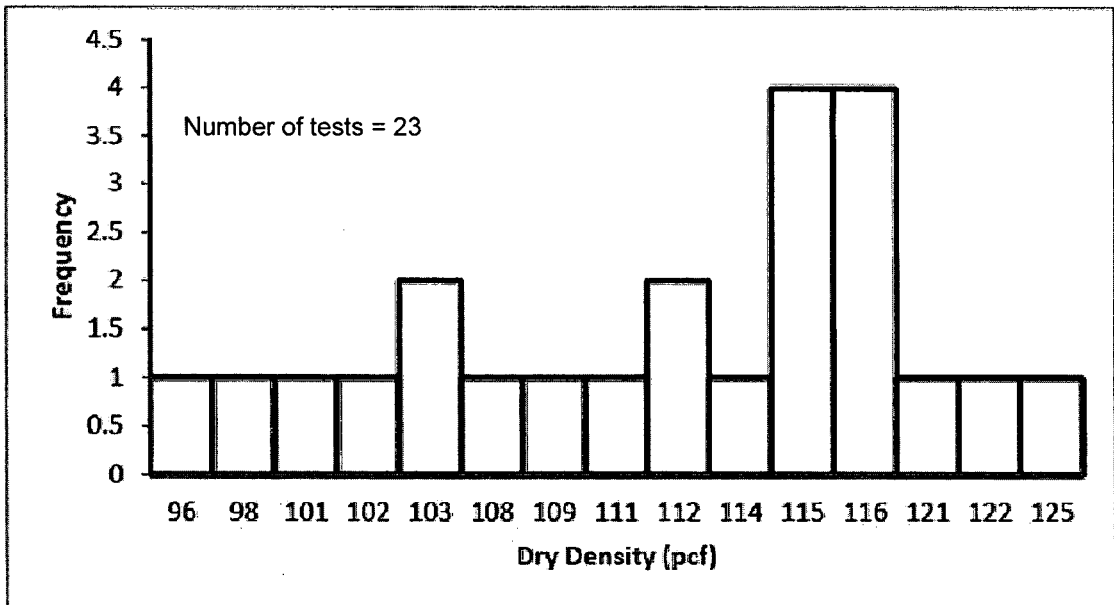

NOTES:

1. Bedding material for the ESW replacement is plotted above.

**WOLF CREEK
UPDATED SAFETY ANALYSIS REPORT**

Figure 2.5-105r Rev. 28

ESWS Pipeline and Duct Bank -
Bedding Material Statistical
Distribution Plot

Sheet 2 of 2

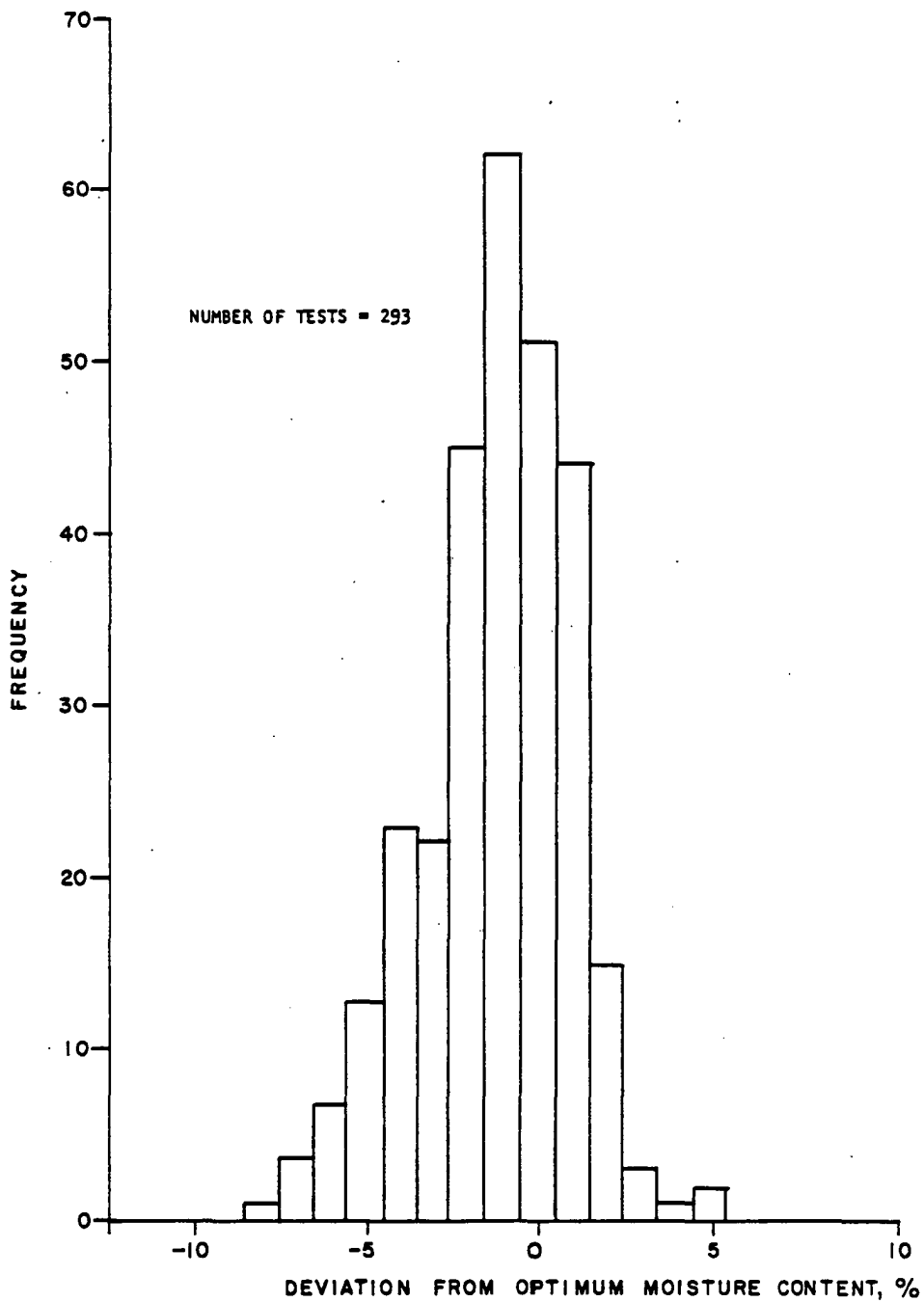

Rev. 0

NOTES:

1. RETESTS ON AREAS WHERE TESTS DID NOT MEET COMPACTION CRITERIA ARE INCLUDED IN THIS PLOT.
2. ACCEPTANCE CRITERIA IS $\pm 2\%$ OF OPTIMUM MOISTURE CONTENT, HOWEVER FAILING TESTS ON THE DRY SIDE WERE GENERALLY ACCEPTED IF THE DENSITY REQUIREMENTS WERE MET.

**WOLF CREEK
UPDATED SAFETY ANALYSIS REPORT**

Figure 2.5-105s

Power Block - Cohesive Fill
Statistical Distribution Plot

7699-064-07

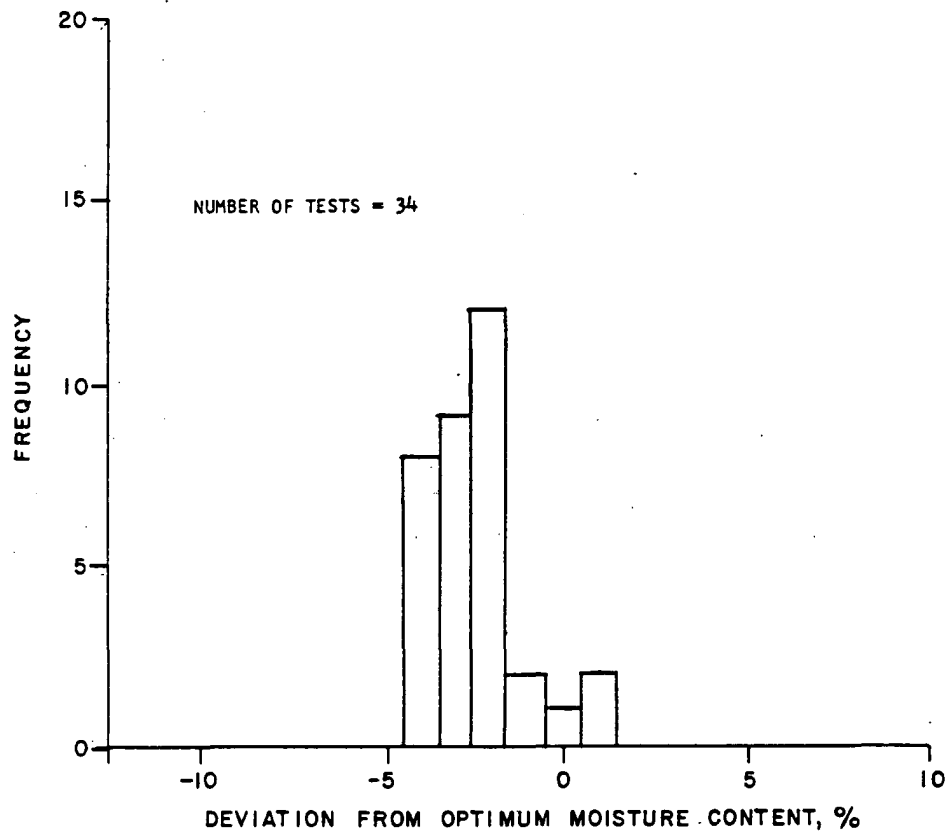

7699-064-07

Rev. 0

NOTES:

1. RETESTS ON AREAS WHERE TESTS DID NOT MEET COMPACTION CRITERIA ARE INCLUDED IN THIS PLOT.
2. ACCEPTANCE CRITERIA IS $\pm 2\%$ OF OPTIMUM MOISTURE CONTENT, HOWEVER FAILING TESTS ON THE DRY SIDE WERE GENERALLY ACCEPTED IF THE DENSITY REQUIREMENTS WERE MET.

**WOLF CREEK
UPDATED SAFETY ANALYSIS REPORT**

Figure 2.5-105t

ESWS Structures - Cohesive Fill
Statistical Distribution Plot

7699-064-07

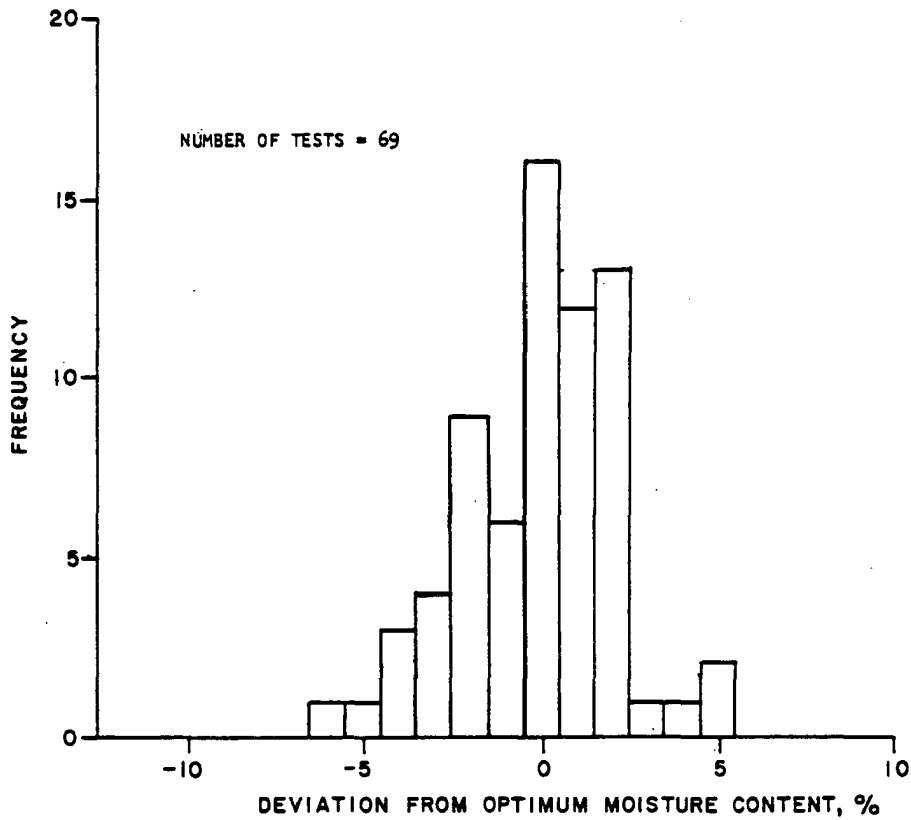

Rev. 0

NOTES:

1. RETESTS ON AREAS WHERE TESTS DID NOT MEET COMPACTION CRITERIA ARE INCLUDED IN THIS PLOT.
2. ACCEPTANCE CRITERIA IS $\pm 2\%$ OF OPTIMUM MOISTURE CONTENT, HOWEVER FAILING TESTS ON THE DRY SIDE WERE GENERALLY ACCEPTED IF THE DENSITY REQUIREMENTS WERE MET.

WOLF CREEK
UPDATED SAFETY ANALYSIS REPORT

Figure 2.5-105u

ESWS Unit 2 Plug - Cohesive Fill
Statistical Distribution Plot

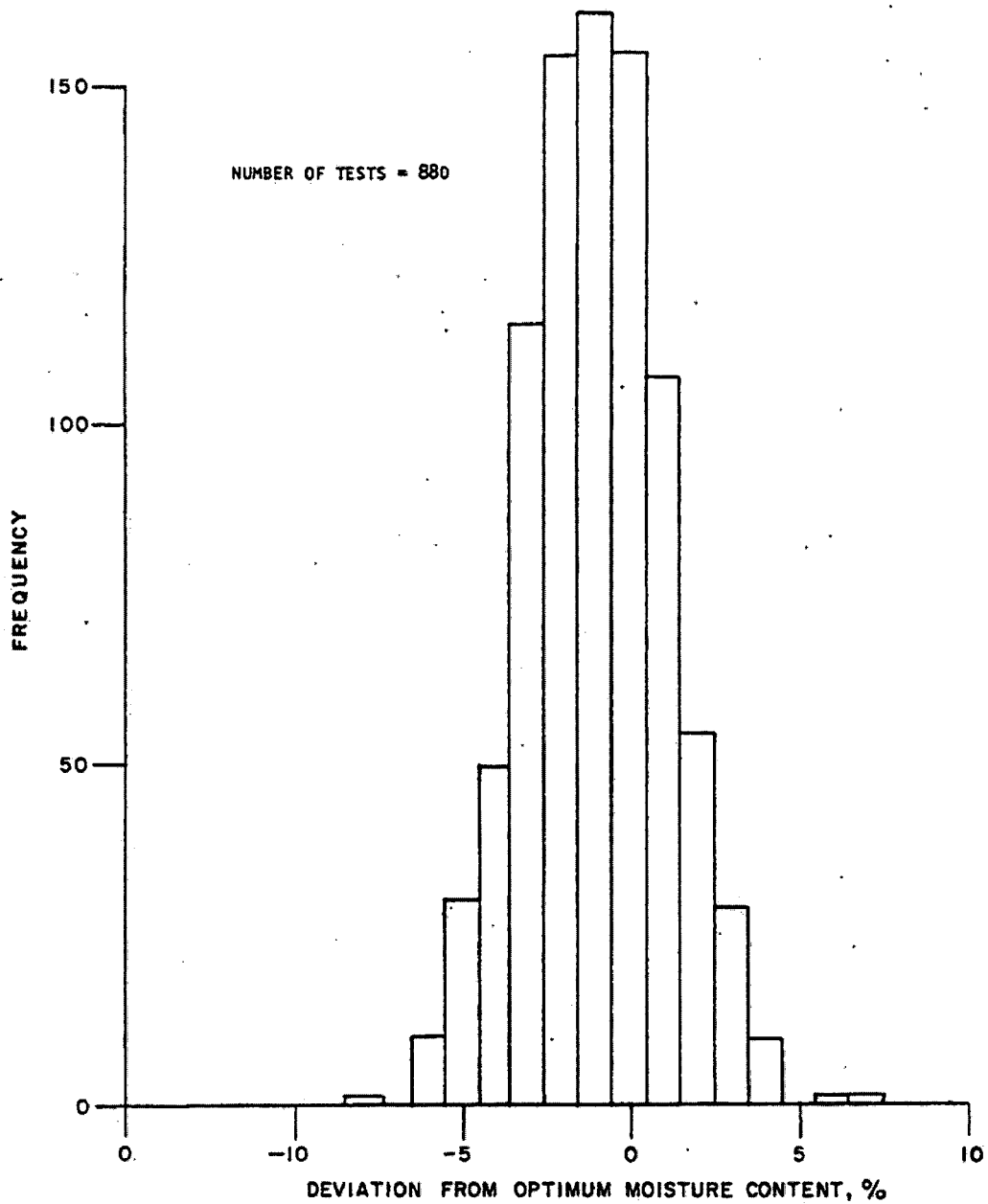

NOTES:

1. RETESTS ON AREAS WHERE TESTS DID NOT MEET COMPACTION CRITERIA ARE INCLUDED IN THIS PLOT.
2. ACCEPTANCE CRITERIA IS +/- 2% OF OPTIMUM MOISTURE CONTENT. HOWEVER FAILING TESTS ON THE DRY SIDE WERE GENERALLY ACCEPTED IF THE
3. 12 NEW TESTS POINTS TAKEN FOR ESW REPLACEMENT PROJECT. HOWEVER DUE TO DROUGHT CONDITIONS MOST DATA POINTS ARE OUTSIDE OF CHART AREA. DENSITY REQUIREMENTS WERE MET.

REV. 28

**WOLF CREEK
UPDATED SAFETY ANALYSIS REPORT**

Figure 2.5-105v

**ESWS Pipeline - Cohesive Backfill
Statistical Distribution Plot**

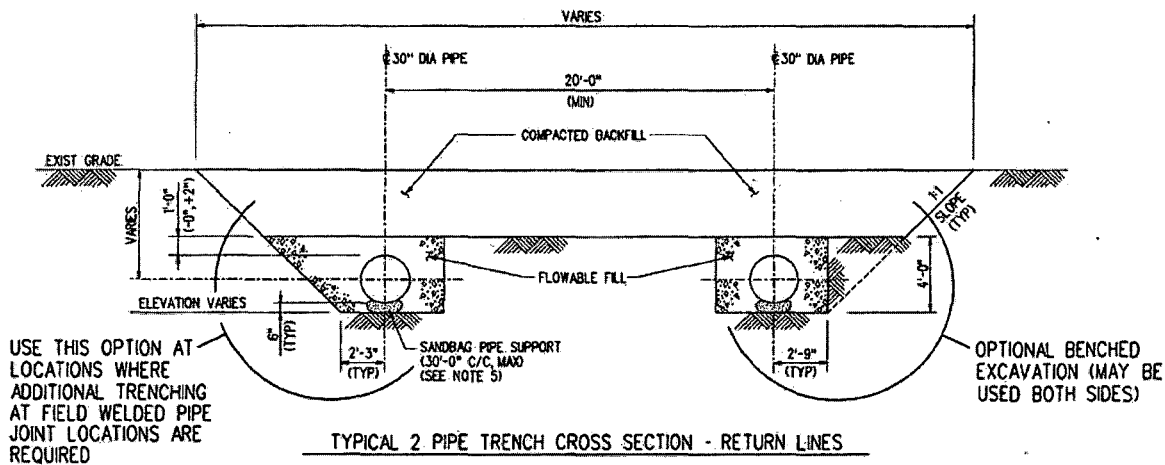
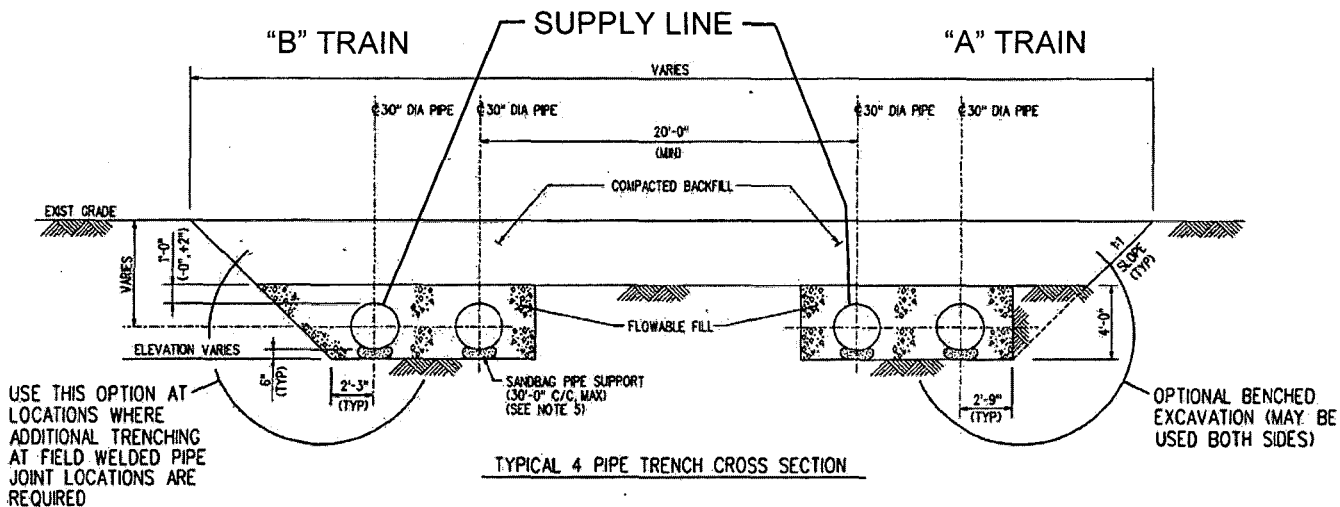

REV. 28

<p>WOLF CREEK UPDATED SAFETY ANALYSIS REPORT</p>
<p>Figure 2.5-105w</p>
<p>TYPICAL ESWs TRANSVERSE CROSS-SECTION</p>

DRAWING REFERENCE
 DRAWING NO.: C-K236 REV. 01
 BY BECHTEL ENGINEERS

**WOLF CREEK
UPDATED SAFETY ANALYSIS REPORT**

FIGURE 2.5-105x Rev. 28

CROSS-SECTIONS NEAR THE INTERFACE
BETWEEN THE ESW/S PIPES AND THE
CONTROL BUILDING
Sheet 1 of 1

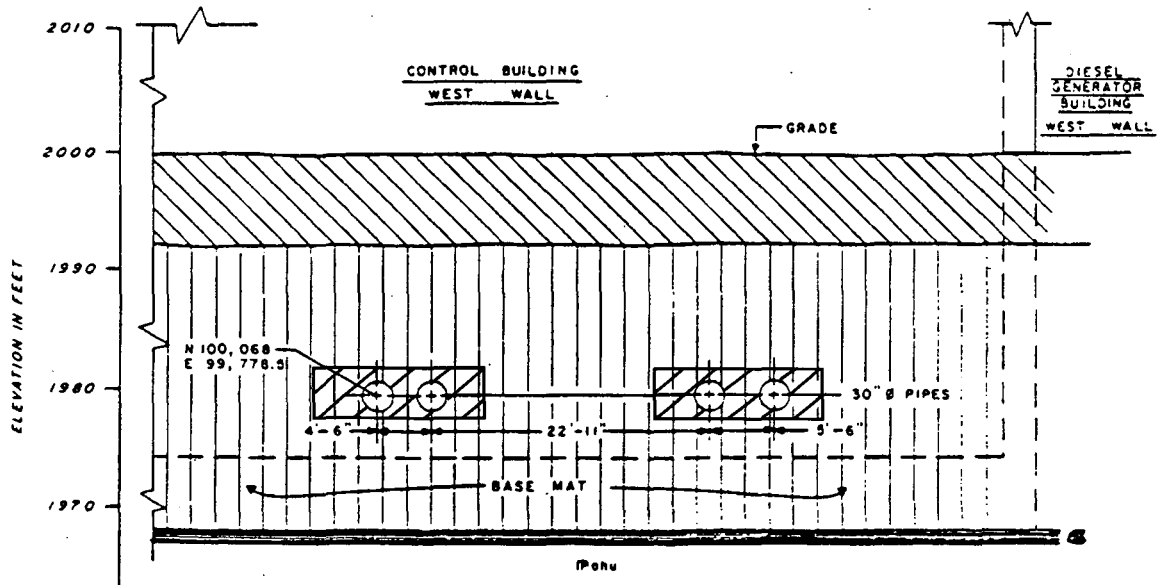
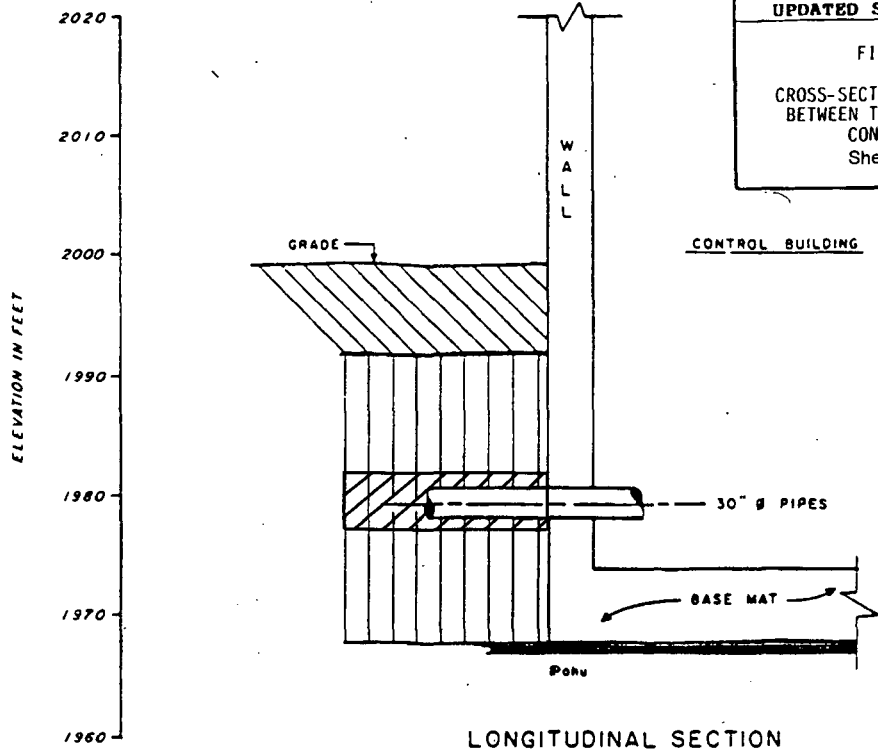

KEY:

	COHESIVE FILL
	PIPE BEDDING
	MUD MAT
	ESM
SYMBOL	STRATIGRAPHIC MEMBER
IPohu	HEUMADER SHALE MEMBER

NOTE:
ELEVATIONS AND COORDINATES REFER TO
SNUPPS SYSTEM.
N100,000 SNUPPS = N584,670
STATE PLANE COORDINATE SYSTEM
E100,000 SNUPPS = E2,807,250
STATE PLANE COORDINATE SYSTEM
ELEVATION 2,000' SNUPPS = 1,100'
U.S.G.S. DATUM.

DRAWING REFERENCE
DRAWING NOS. C-OC 3312, REV. 1;
C-OC 3902, REV. 14;
C-OR 3901, REV. 9;
BY: BECHTEL ENGINEERS

Wolf Creek

WOLF CREEK UPDATED SAFETY ANALYSIS REPORT



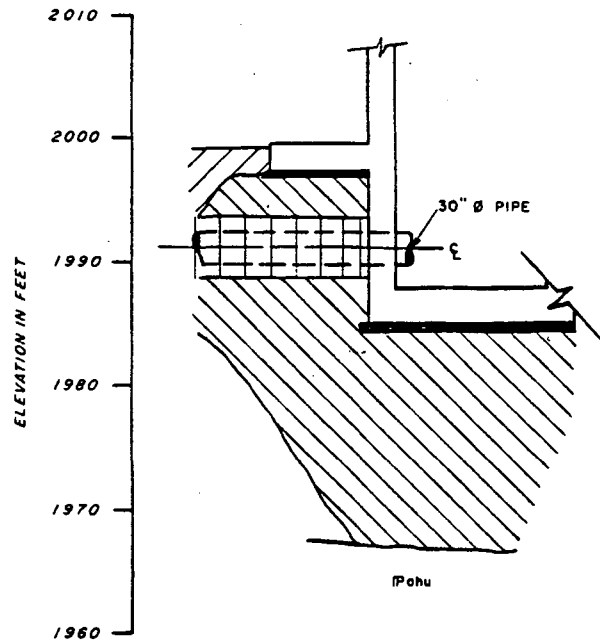

FIGURE 2.5-105y Rev. 28

CROSS SECTIONS NEAR THE
INTERFACE BETWEEN THE ESWS
PIPES AND THE PUMPHOUSE
Sheet 1 of 1



LONGITUDINAL SECTION

KEY:

-  COHESIVE FILL
-  PIPE BEDDING
-  STRUCTURAL FILL
-  MUD MAT

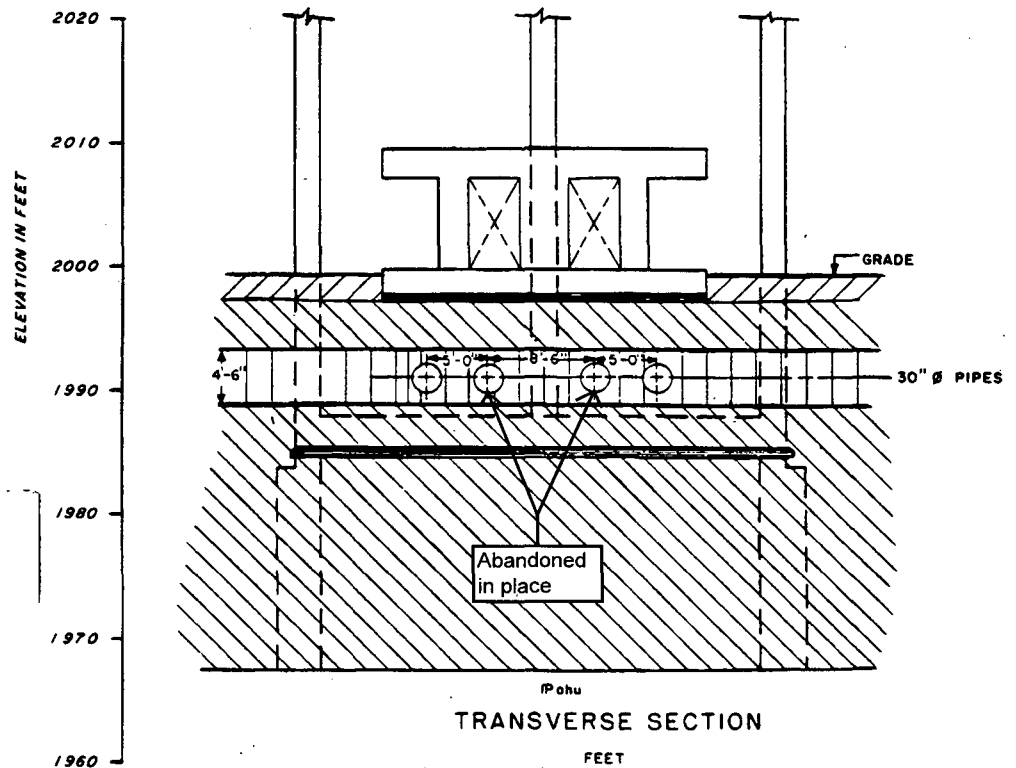

TRANSVERSE SECTION



DRAWING REFERENCE:

DRAWING NOS.: C-KC 301, REV. 4:
C-KC 302, REV. 3:
C-KC 303, REV. 3:
C-KC 305, REV. 4:
C-KC 306, REV. 4:
BY: BECHTEL ENGINEERS

NOTE:

ELEVATIONS REFER TO SHUPPS SYSTEM.
ELEVATION 2,000' SHUPPS = 1,100'
U.S.G.S. DATUM.

EXPLANATION

SYMBOL	STRATIGRAPHIC MEMBER
Pohu	HELMADER SHALE MEMBER

Wolf Creek

WOLF CREEK UPDATED SAFETY ANALYSIS REPORT

FIGURE 2.5-105Z

CROSS-SECTIONS NEAR THE
INTERFACE
BETWEEN THE ESWs WARMING LINES
AND THE PUMPHOUSE

REV. 28

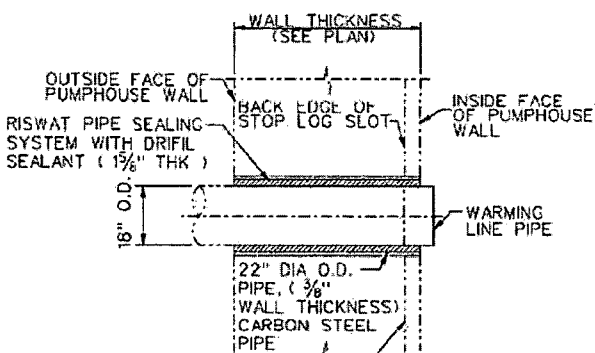

BACK EDGE OF STOP LOG SLOT

WARMING LINE PENETRATION DETAIL

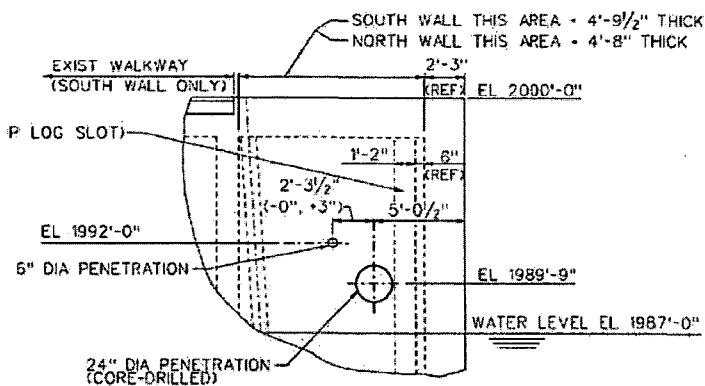

DRAWING REFERENCE:
C-KC303 R18
C-K316 R0
BY BECHTEL ENGINEERS

SECTION A
1/2" x 1/2"

SECTION B (OPP)
1/2" x 1/2"

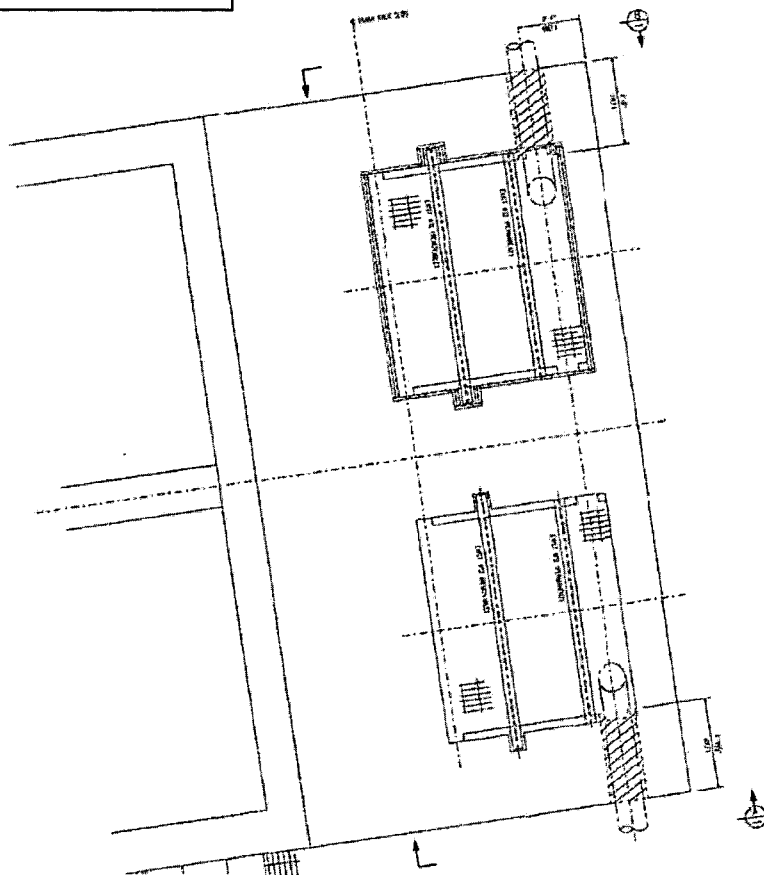

ESWS PUMPHOUSE PLAN

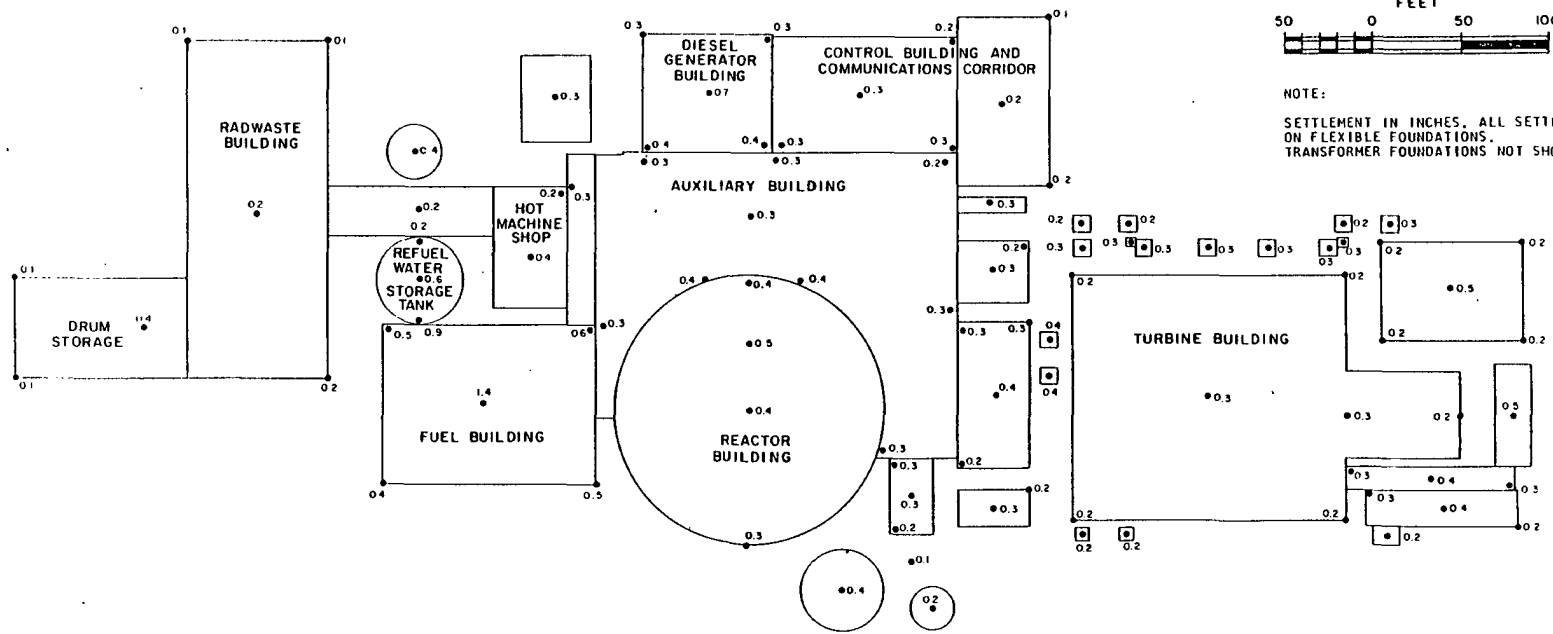

Rev. 0

**WOLF CREEK
UPDATED SAFETY ANALYSIS REPORT**

Figure 2.5-106
Computed Settlement

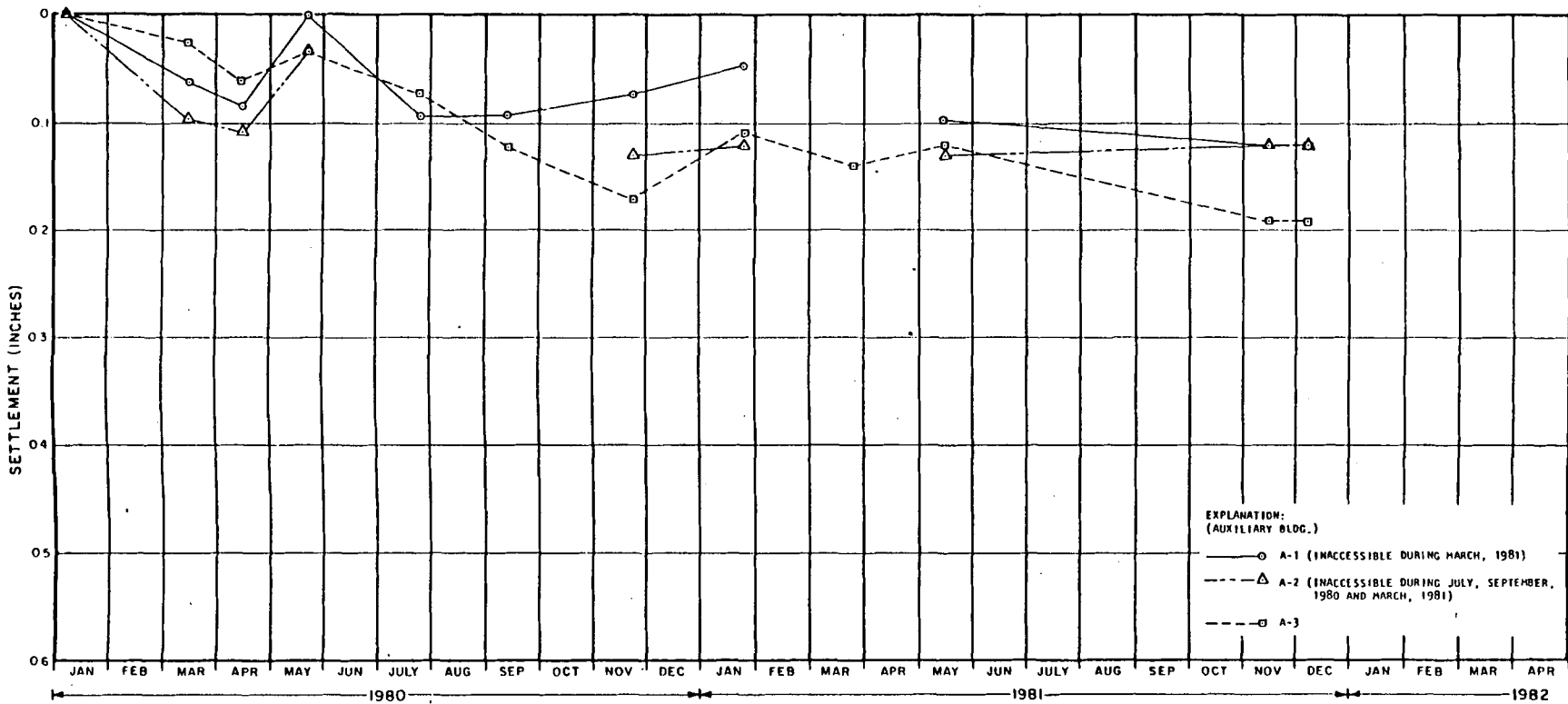

EXPLANATION:
 (AUXILIARY BLDG.)
 —○— A-1 (INACCESSIBLE DURING MARCH, 1981)
 - - -△- - - A-2 (INACCESSIBLE DURING JULY, SEPTEMBER, 1980 AND MARCH, 1981)
 - · - · -□- · - · A-3

7699-064-07

**WOLF CREEK
 UPDATED SAFETY ANALYSIS REPORT**

Figure 2.5-106a (Sheet 1 of 2)
 Measured Settlement, Auxiliary
 Building

Rev. 0

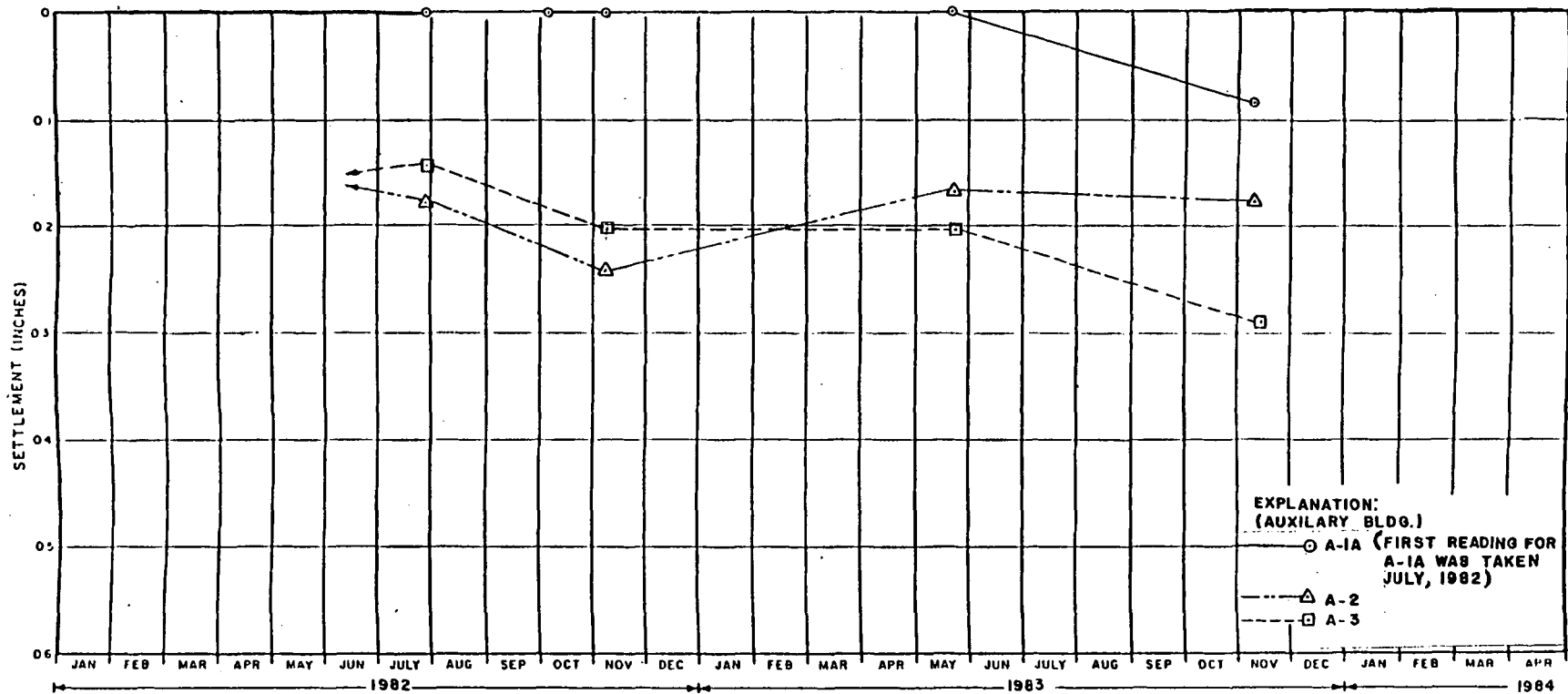

7599-054-07

**WOLF CREEK
 UPDATED SAFETY ANALYSIS REPORT**

Figure 2.5-106a (Sheet 2 of 2)

Measured Settlement, Auxiliary Building

Rev. 0

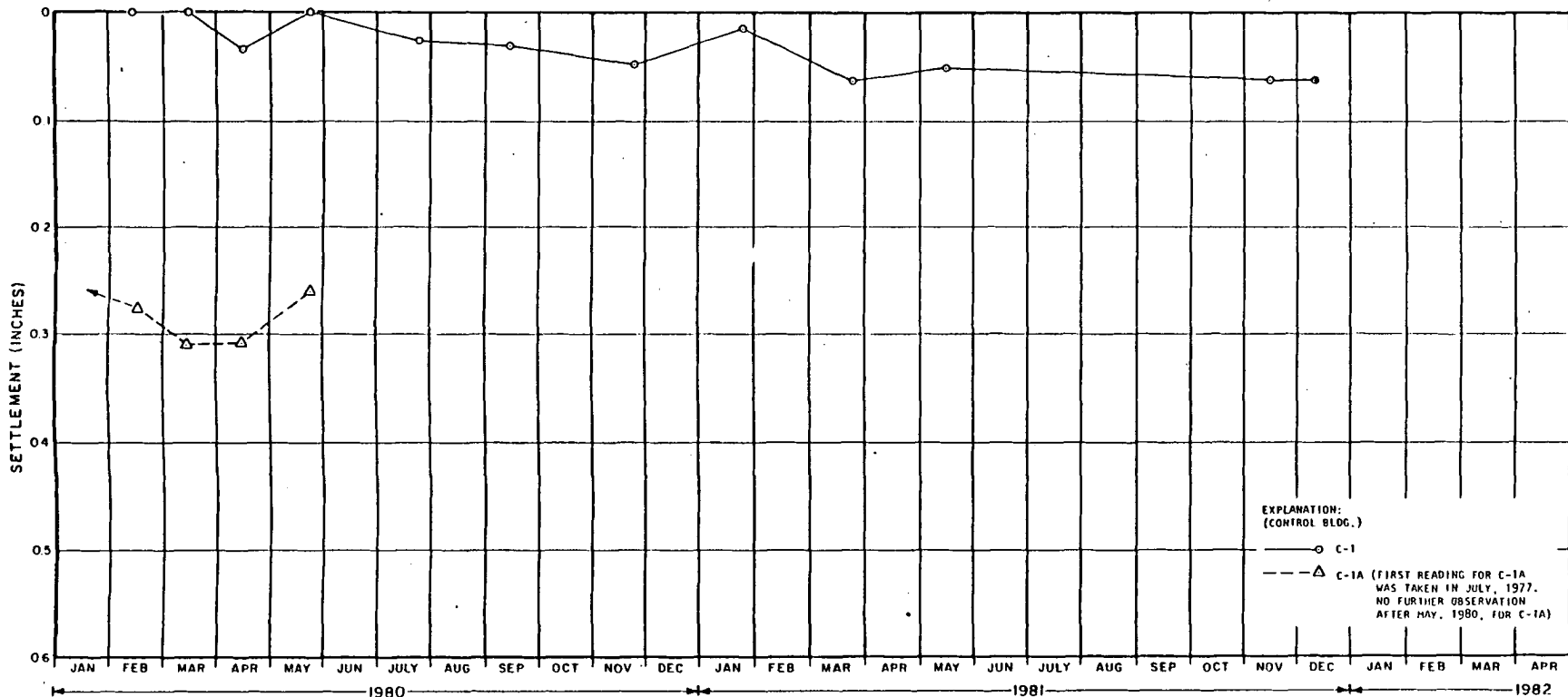

EXPLANATION:
 (CONTROL BLDG.)
 ○ C-1
 ---△ C-1A (FIRST READING FOR C-1A WAS TAKEN IN JULY, 1977. NO FURTHER OBSERVATION AFTER MAY, 1980, FOR C-1A)

7699-064-07

**WOLF CREEK
 UPDATED SAFETY ANALYSIS REPORT**

Figure 2.5-106b (Sheet 1 of 2)
 Measured Settlement, Control Building

Rev. 0

7699-054-07

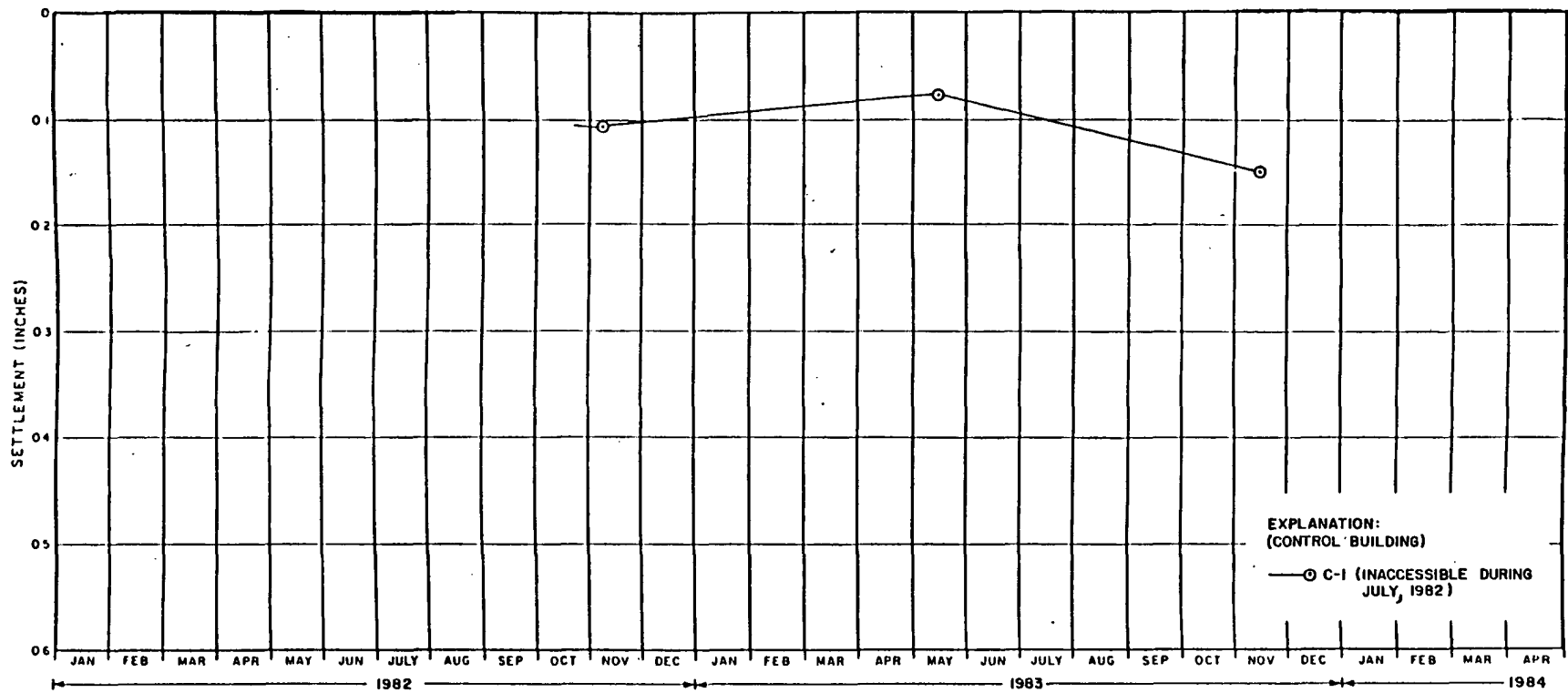

**WOLF CREEK
UPDATED SAFETY ANALYSIS REPORT**

Figure 2.5-106b (Sheet 2 of 2)

Measured Settlement, Control
Building

Rev. 0

7699-064-07

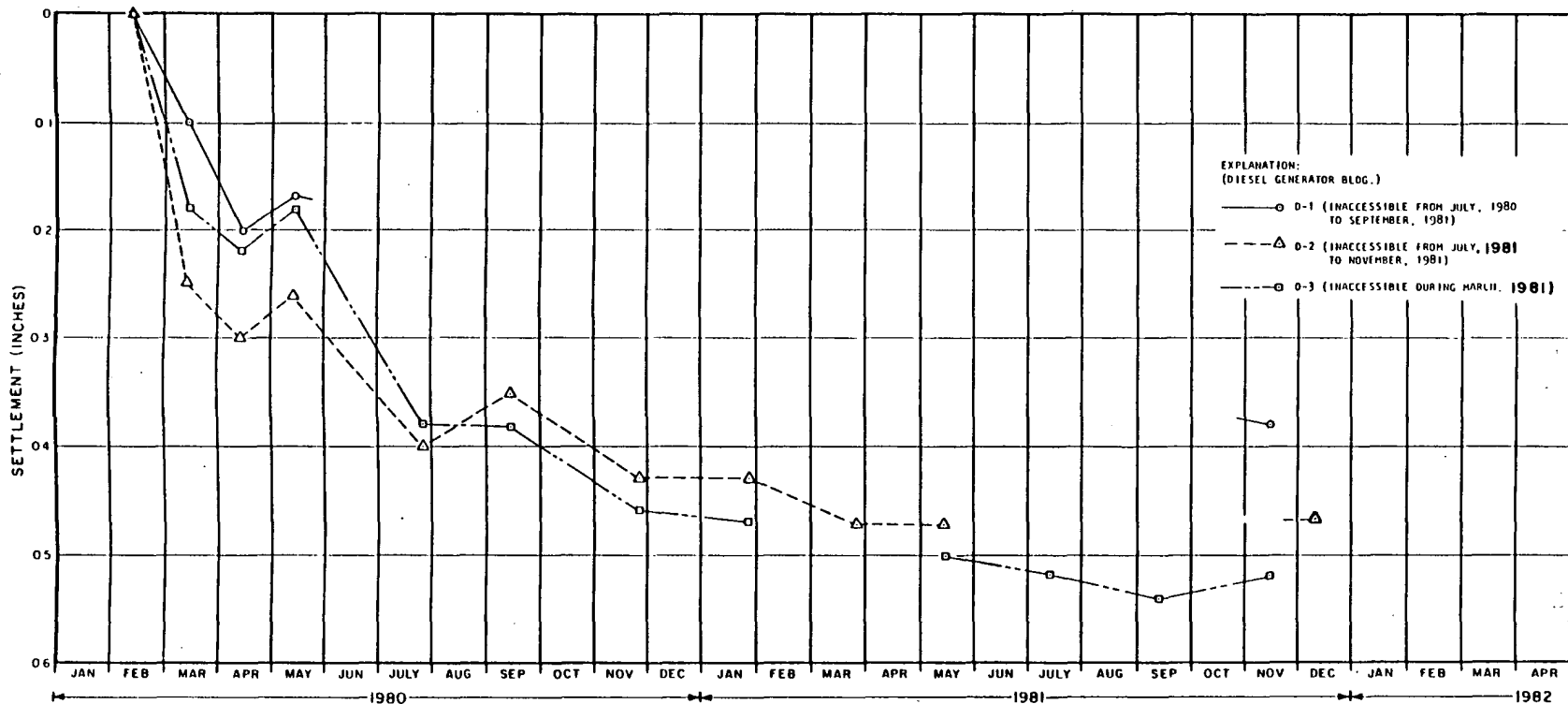

**WOLF CREEK
UPDATED SAFETY ANALYSIS REPORT**

Figure 2.5-106c (Sheet 1 of 2)

Measured Settlement, Diesel
Generator Building

Rev. 0

7599-064-07

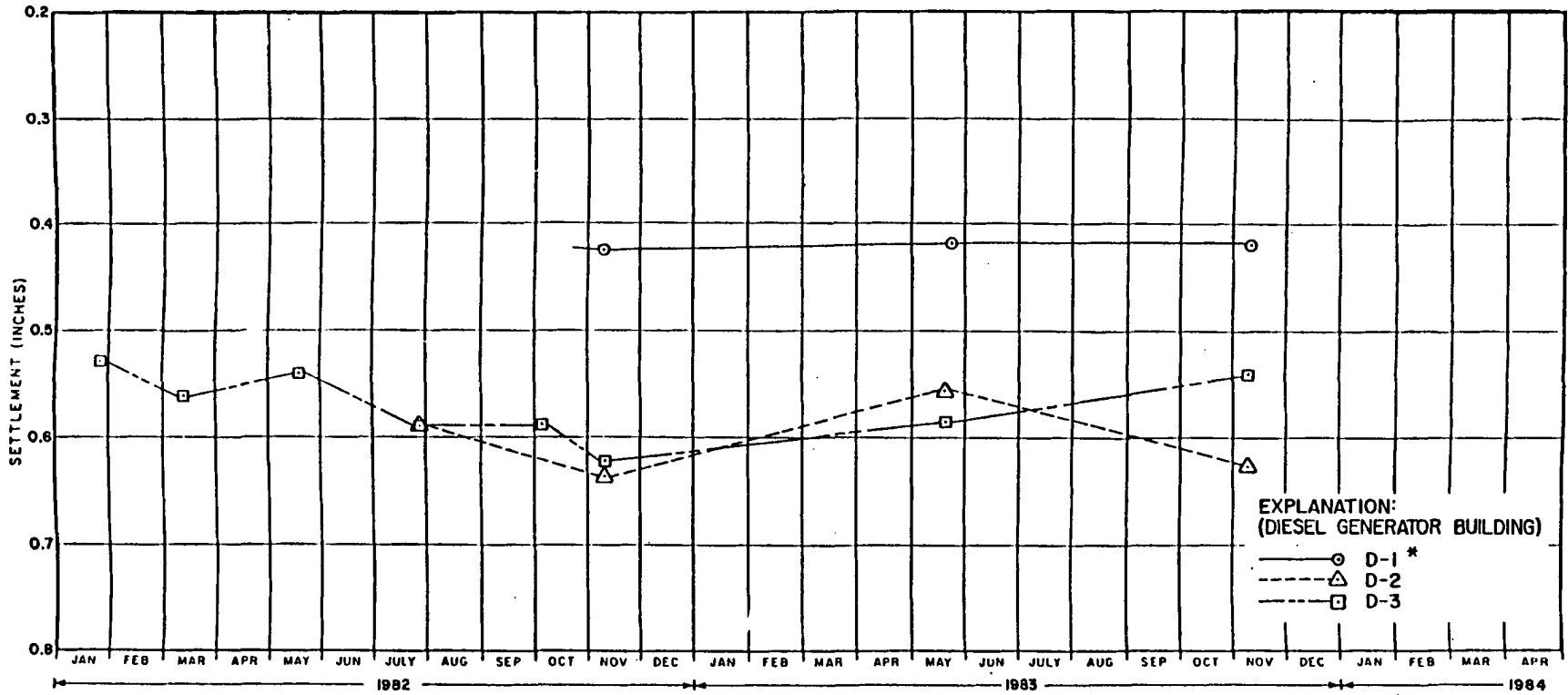

* (INACCESSIBLE DURING JULY, 1982)

**WOLF CREEK
UPDATED SAFETY ANALYSIS REPORT**

Figure 2.5-106c (Sheet 2 of 2)

Measured Settlement, Diesel
Generator Building

Rev. 0

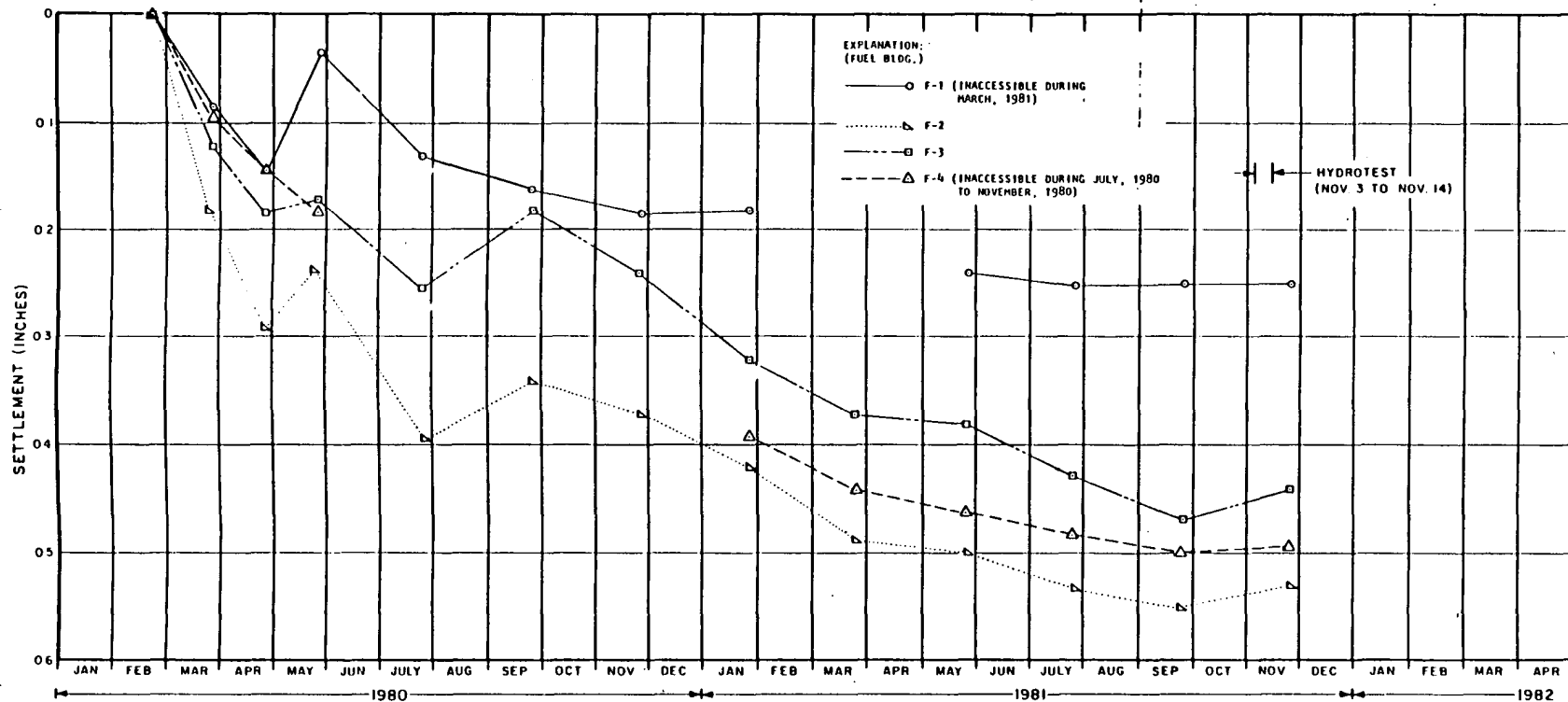

**WOLF CREEK
UPDATED SAFETY ANALYSIS REPORT**

Figure 2.5-106d (Sheet 1 of 2)

Measured Settlement, Fuel
Building

Rev. 0

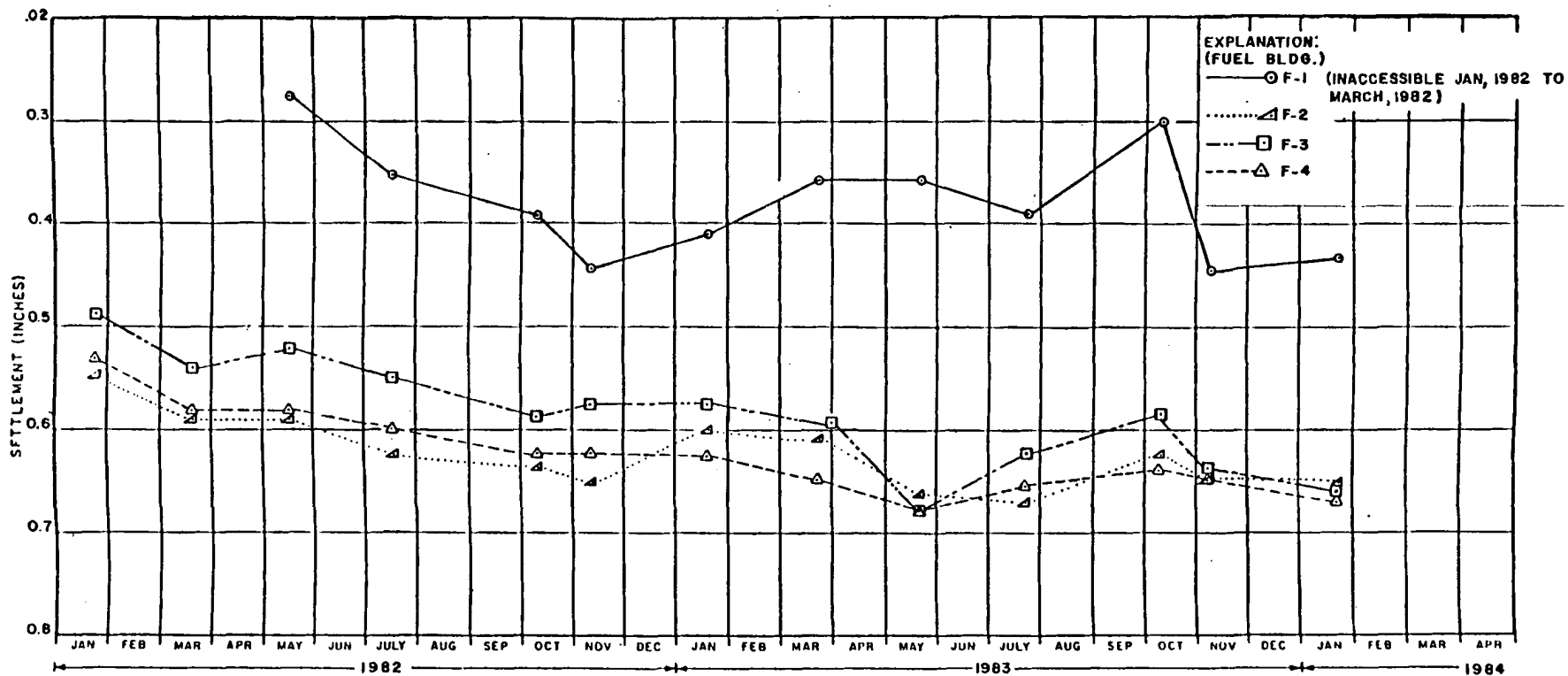

7699-054-07

**WOLF CREEK
 UPDATED SAFETY ANALYSIS REPORT**

Figure 2.5-106d (Sheet 2 of 2)

Measured Settlement, Fuel Building

Rev. 0

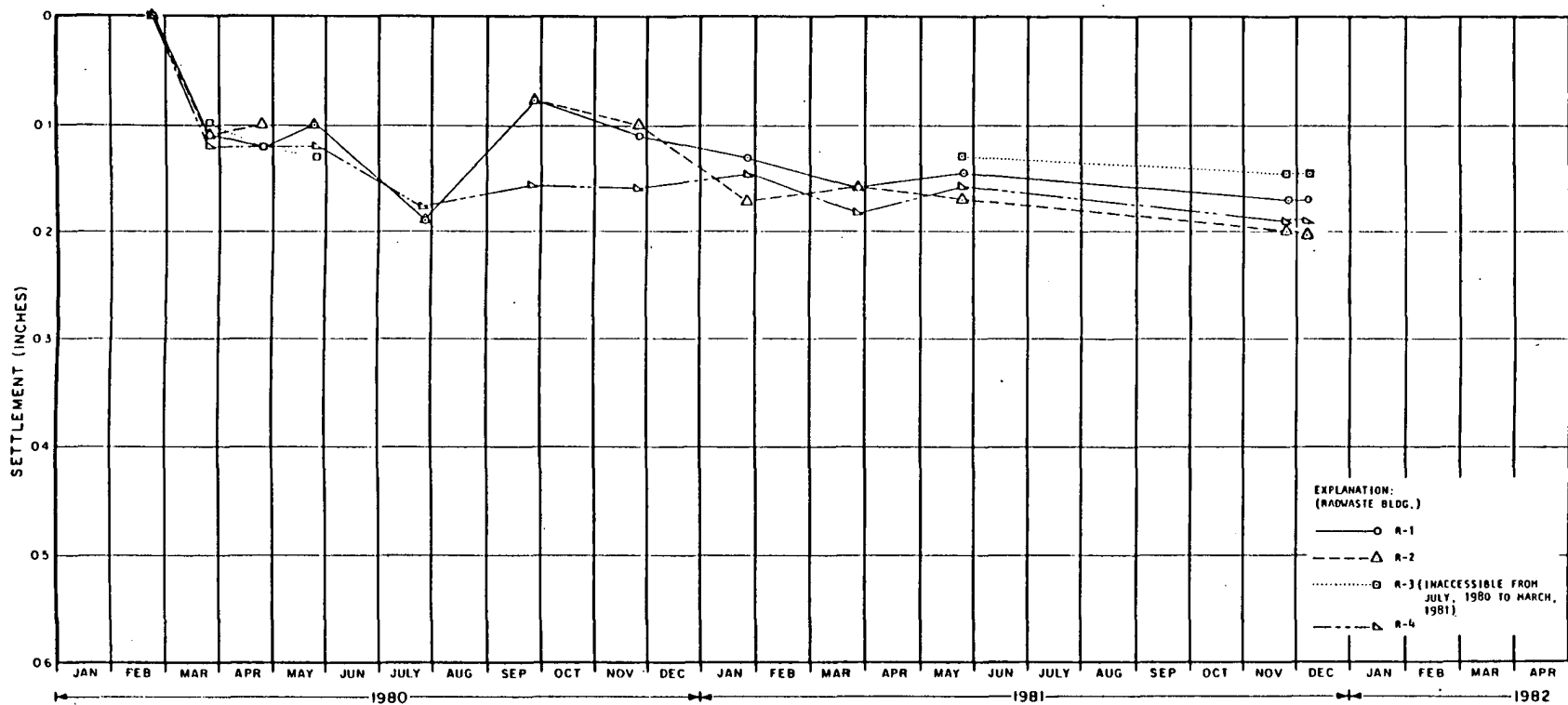

**WOLF CREEK
UPDATED SAFETY ANALYSIS REPORT**

Figure 2.5-106e (Sheet 1 of 2)

Measured Settlement, Radwaste
Building

Rev. 0

7699-064-07

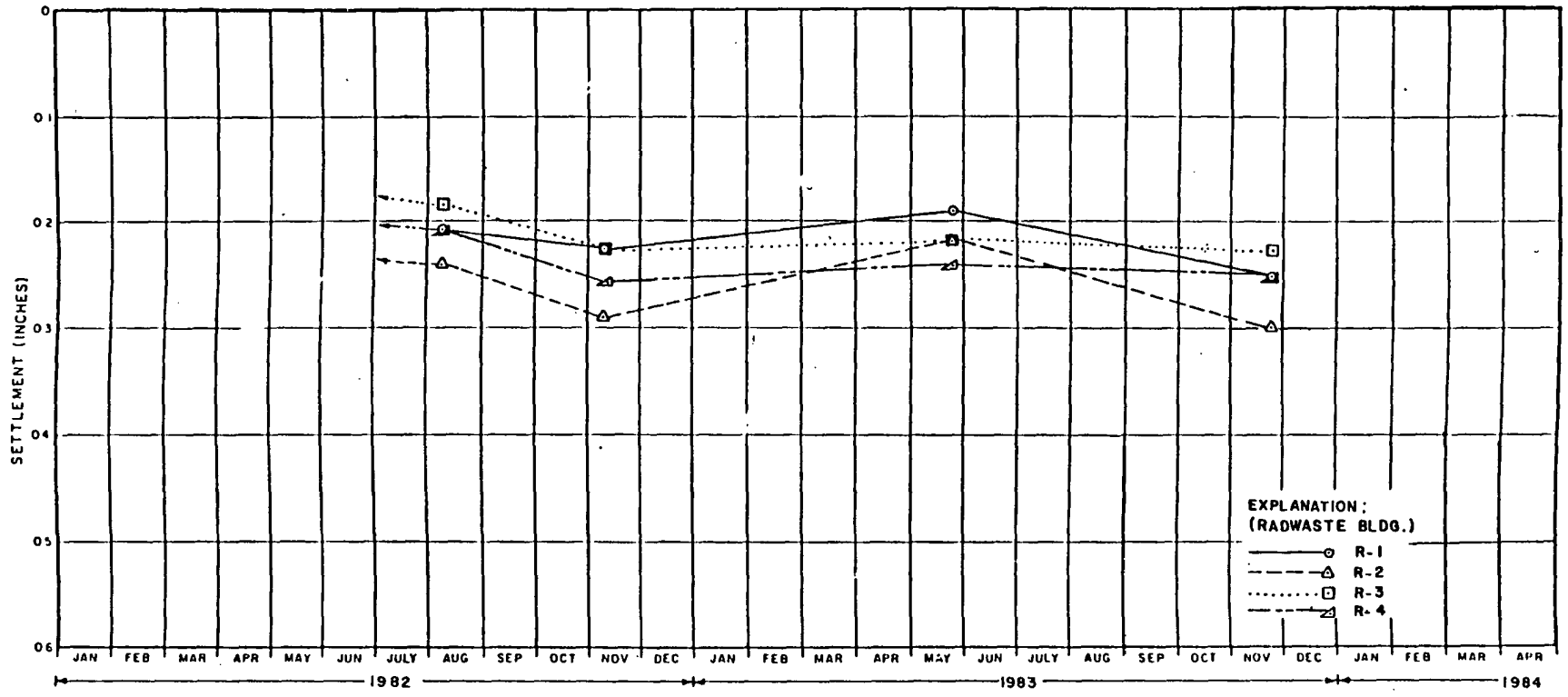

EXPLANATION:
 (RADWASTE BLDG.)

- R-1
- △ R-2
- R-3
- △ R-4

**WOLF CREEK
 UPDATED SAFETY ANALYSIS REPORT**

Figure 2.5-106e (Sheet 2 of 2)
 Measured Settlement, Radwaste
 Building

Rev. 0

7699-054-07

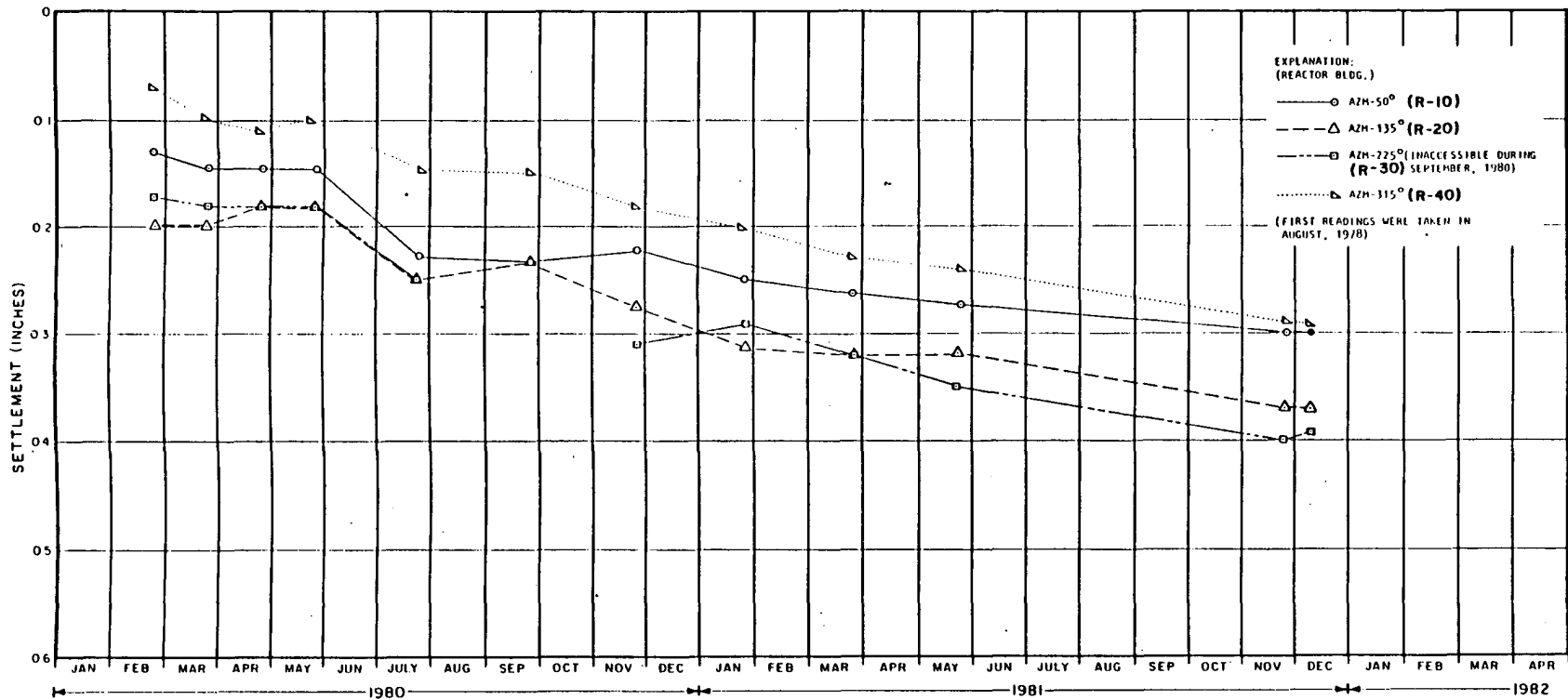

**WOLF CREEK
UPDATED SAFETY ANALYSIS REPORT**

Figure 2.5-106f (Sheet 1 of 2)

Measured Settlement, Reactor
Building

Rev. 0

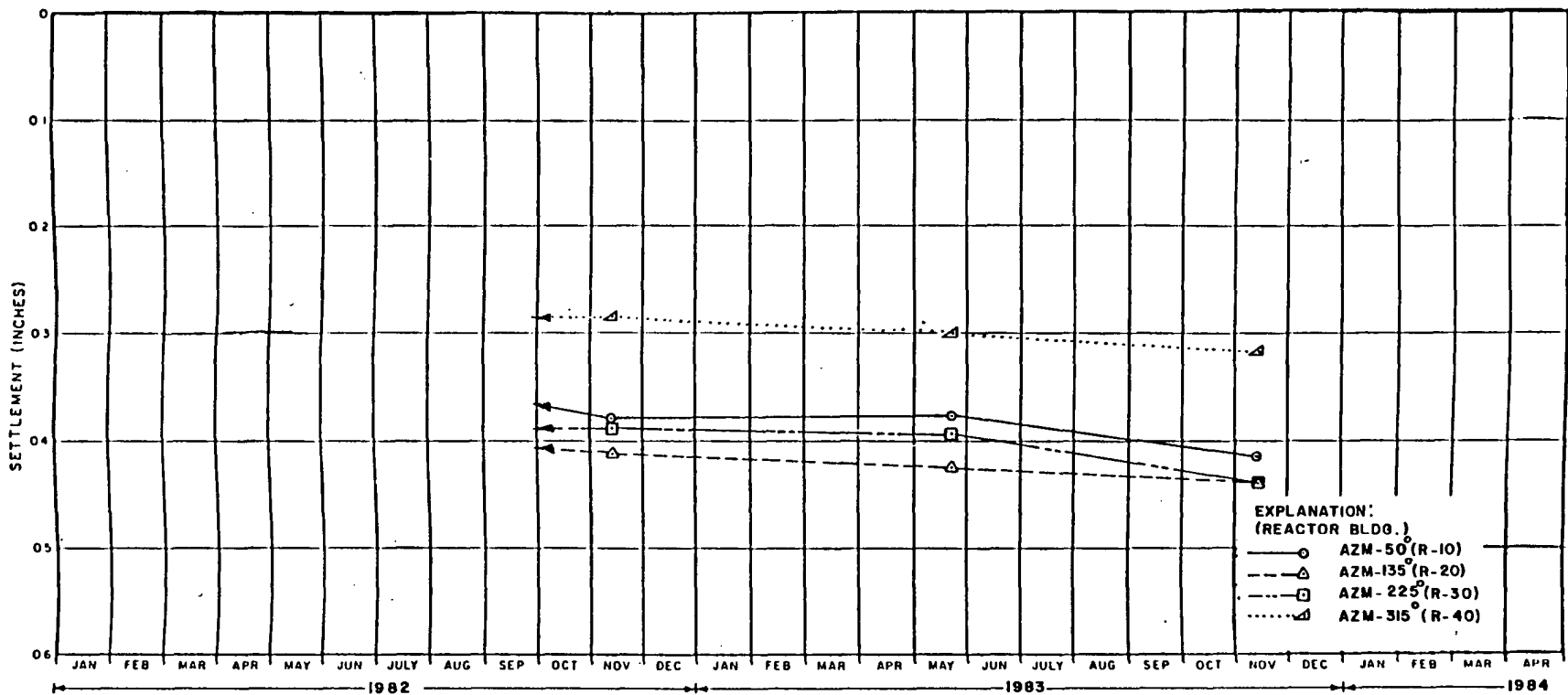

**WOLF CREEK
UPDATED SAFETY ANALYSIS REPORT**

Figure 2.5-106f (Sheet 2 of 2)
Measured Settlement, Reactor
Building

Rev. 0

7699-064-07

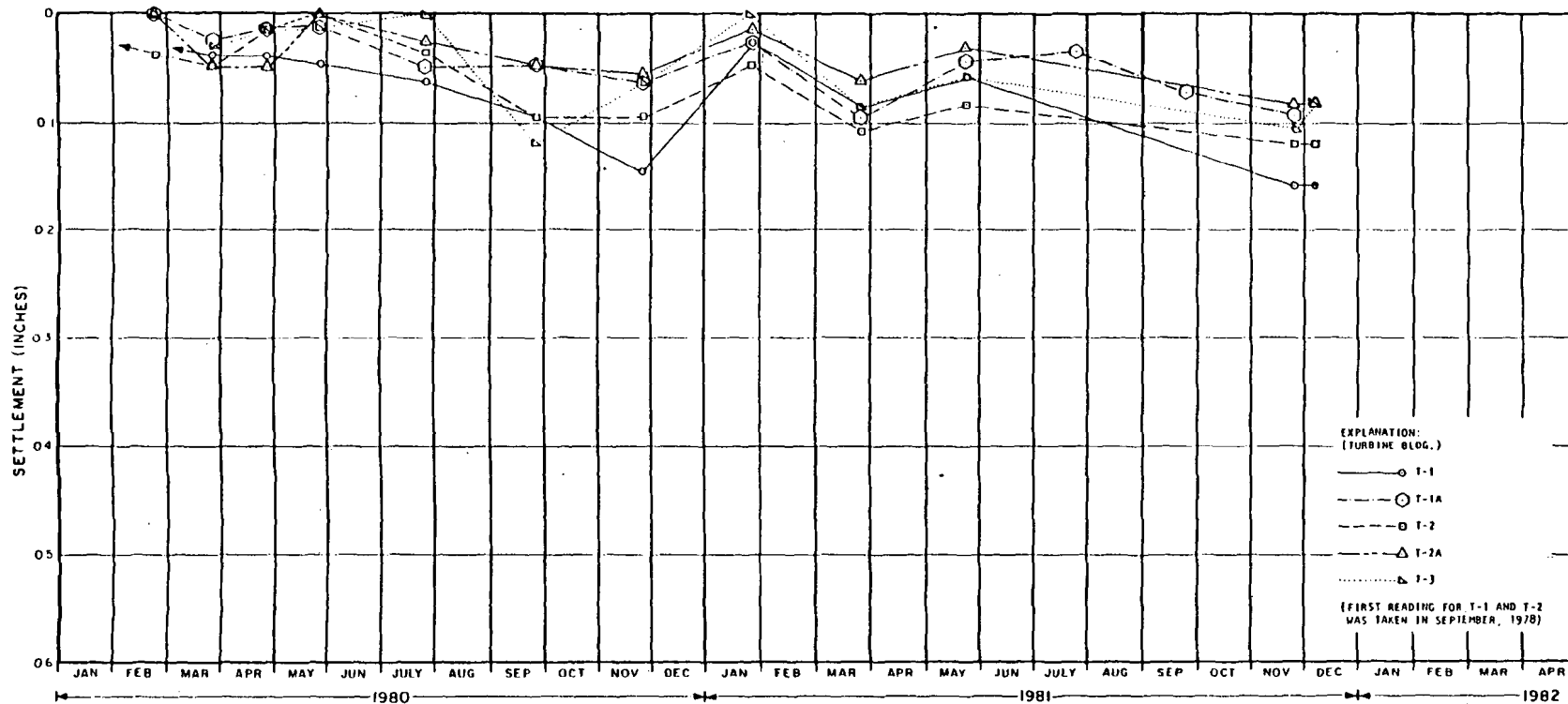

**WOLF CREEK
UPDATED SAFETY ANALYSIS REPORT**

Figure 2.5-106g (Sheet 1 of 4)
Measured Settlement, Turbine
Building

Rev. 0

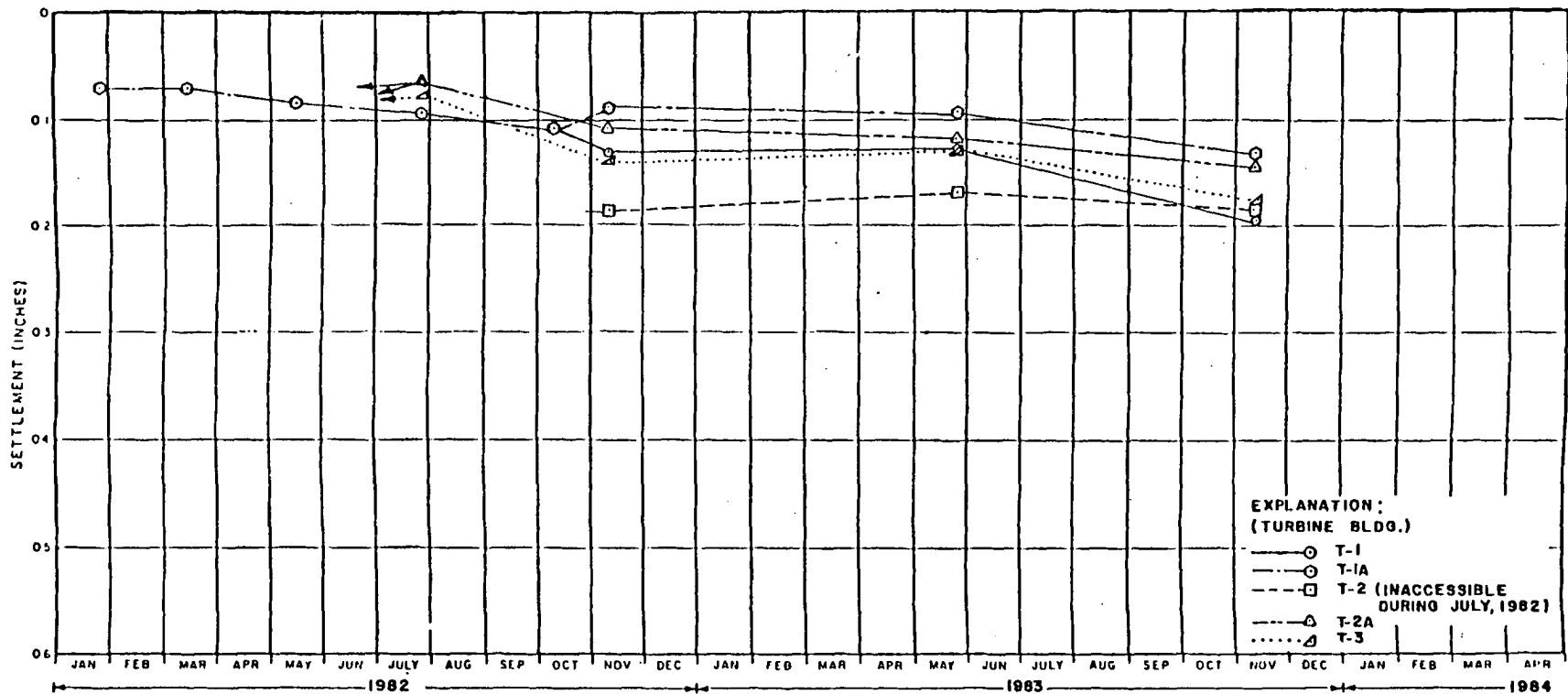

EXPLANATION:
 (TURBINE BLDG.)
 —○— T-1
 - - -○- T-1A
 - - -□- T-2 (INACCESSIBLE DURING JULY, 1982)
 - - -△- T-2A
△ T-3

**WOLF CREEK
 UPDATED SAFETY ANALYSIS REPORT**

Figure 2.5-106g (Sheet 2 of 4)
 Measured Settlement, Turbine Building

Rev. 0

7699-C-4-07

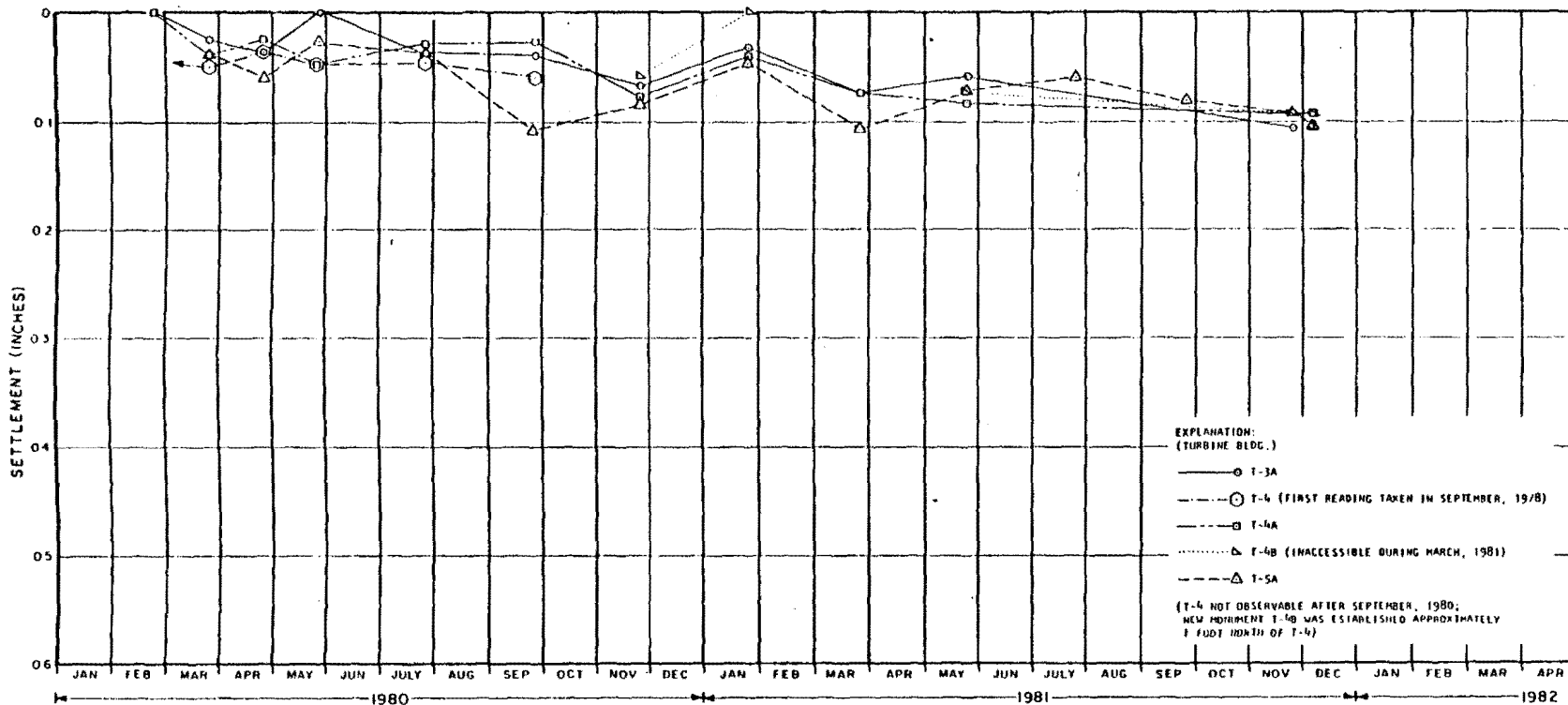

7699-064-07

**WOLF CREEK
 UPDATED SAFETY ANALYSIS REPORT**

Figure 2.5-106g (Sheet 3 of 4)

Measured Settlement, Turbine
 Building

Rev. 0

7695-C54-07

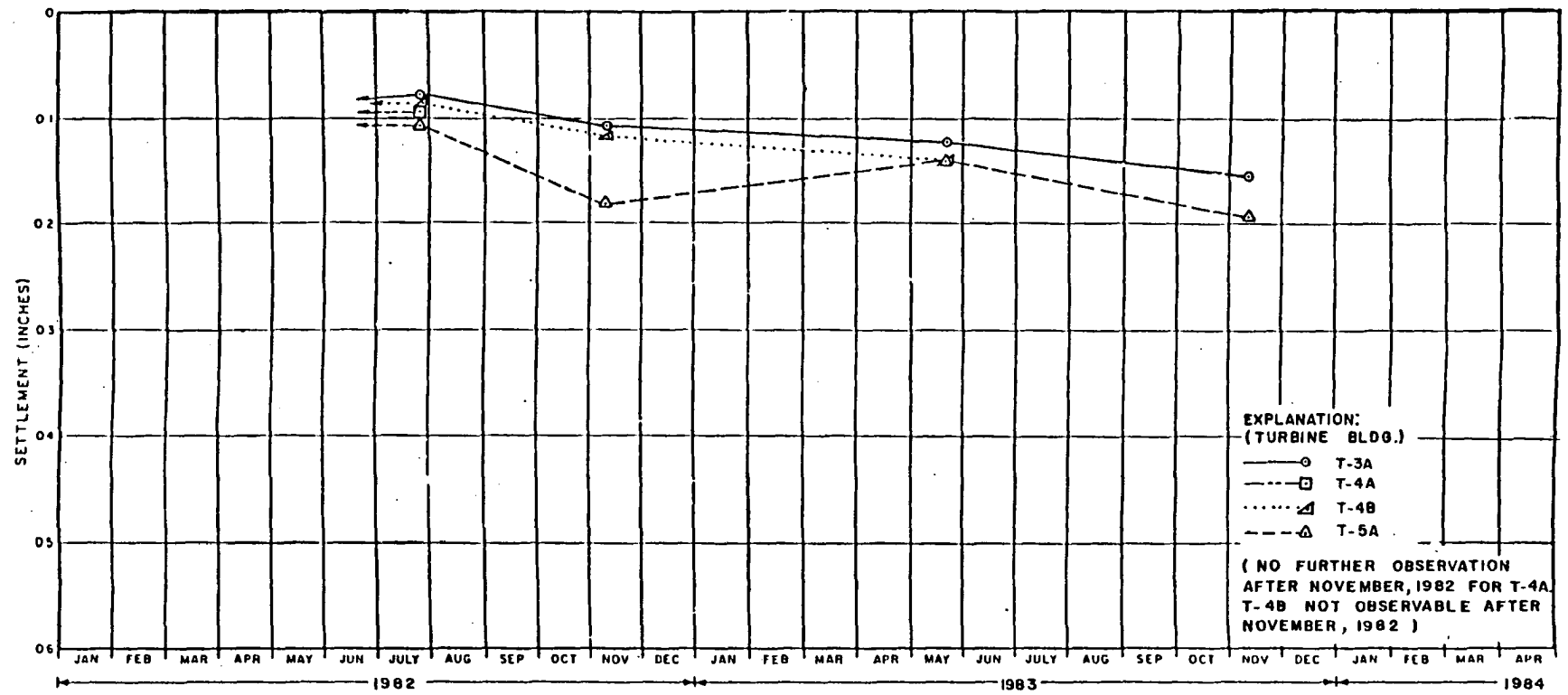

**WOLF CREEK
UPDATED SAFETY ANALYSIS REPORT**

Figure 2.5-106g (Sheet 4 of 4)
Measured Settlement, Turbine
Building

Rev. 0

Wolf Creek

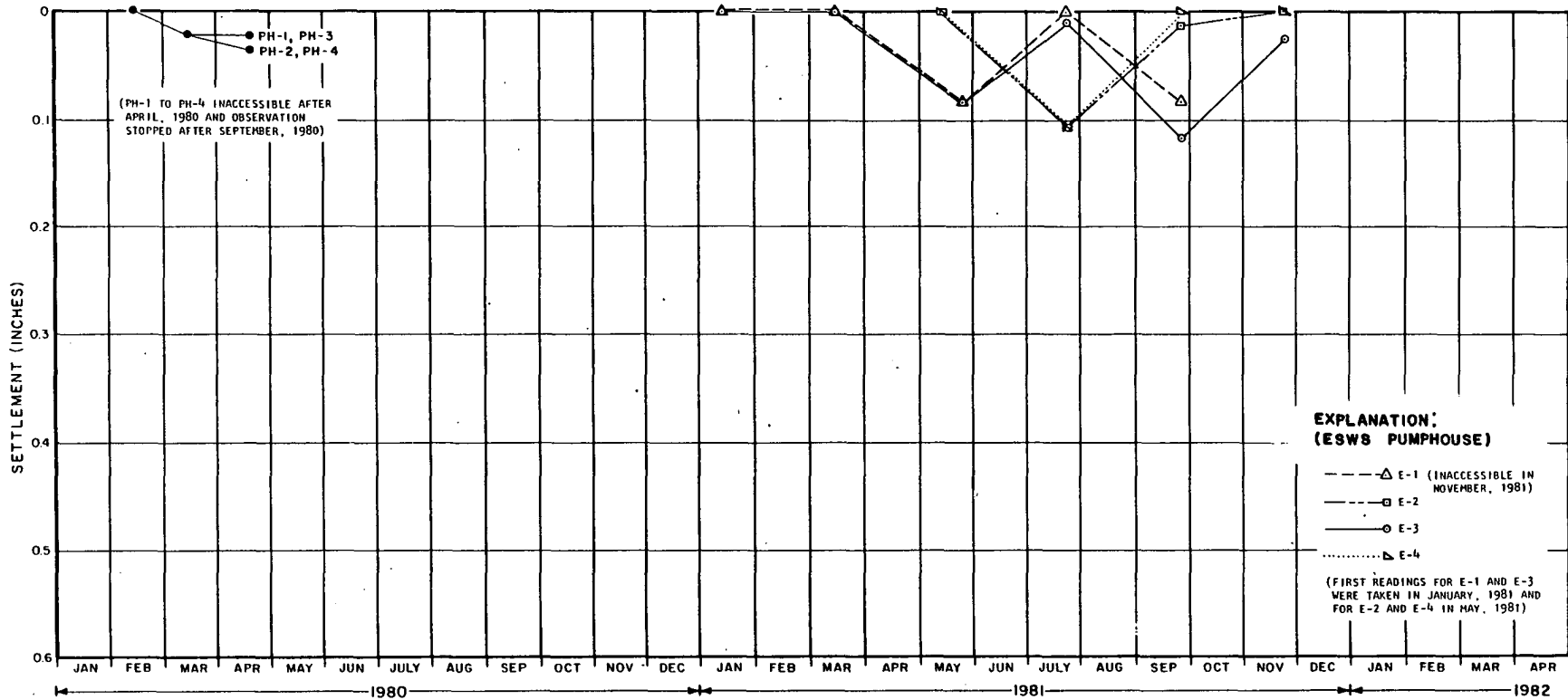

WOLF CREEK UPDATED SAFETY ANALYSIS REPORT

FIGURE 2.5-106h (Sheet 1 of 2)

MEASURED SETTLEMENT,
EWS PUMPHOUSE

Rev. 0

Wolf Creek

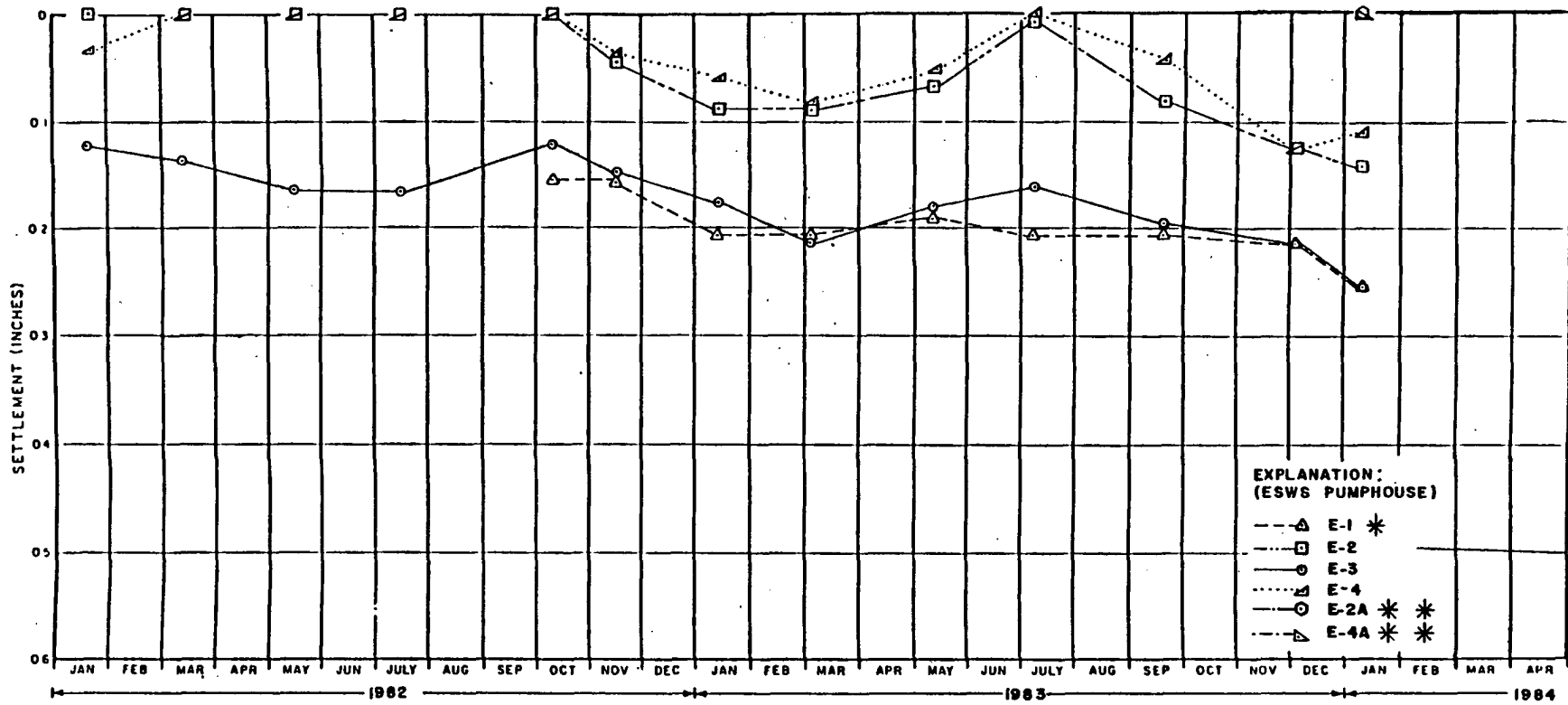

EXPLANATION:
(ESWS PUMPHOUSE)

- △ E-1 *
- E-2
- E-3
- △ E-4
- E-2A * *
- △ E-4A * *

*INACCESSIBLE FROM JAN.1982 TO JULY,1982

**FIRST READING FOR E-2A & E-4A WERE TAKEN JAN.,1984

Rev. 0

**WOLF CREEK
UPDATED SAFETY ANALYSIS REPORT**

FIGURE 2.5-106h
MEASURED SETTLEMENT,
ESWS PUMPHOUSE

(Sheet 2 of 2)

7699-064-07

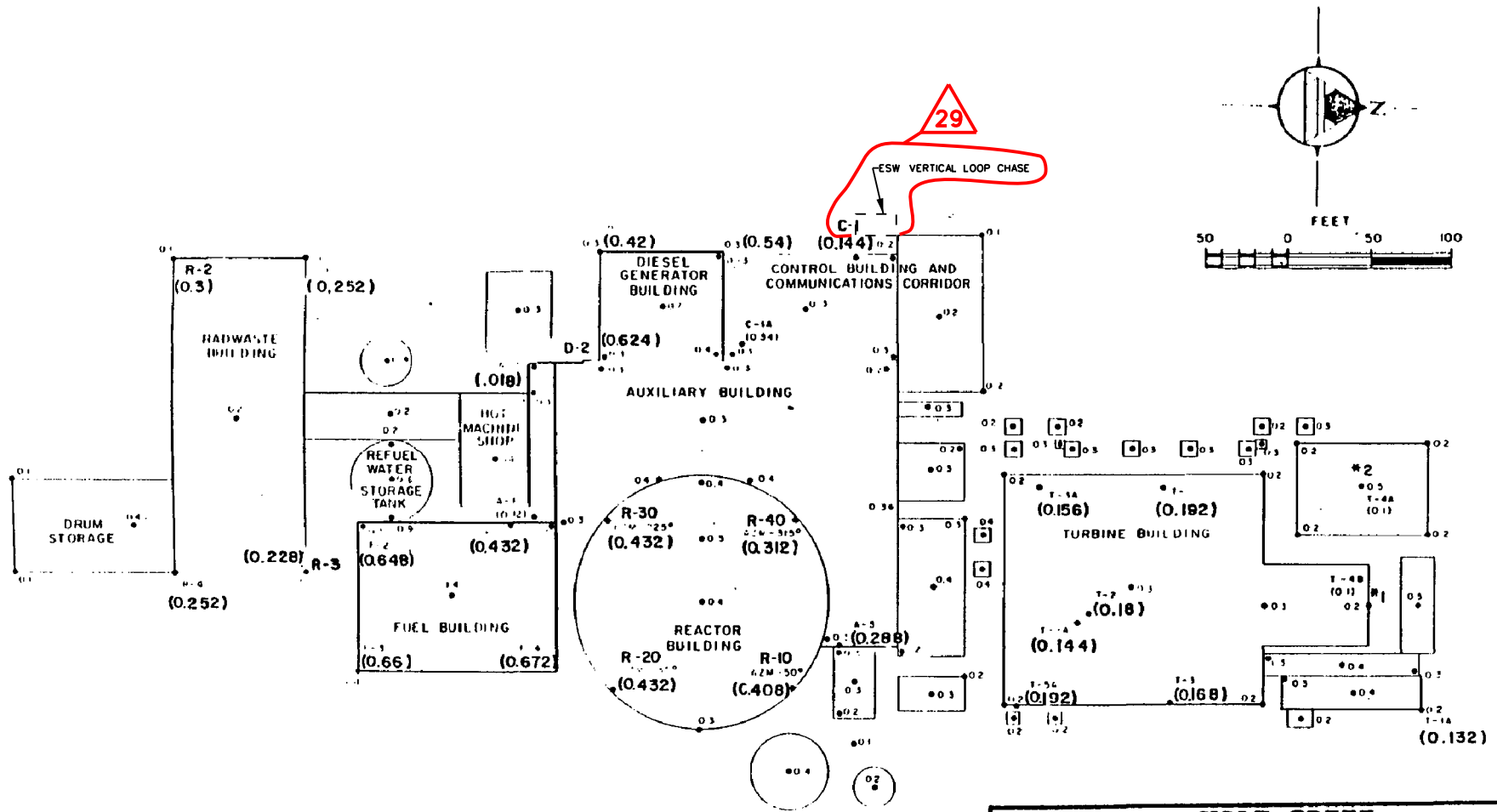

REV. 29

NOTES:

SETTLEMENT IN INCHES. ALL COMPUTED SETTLEMENTS ARE BASED ON FLEXIBLE FOUNDATIONS. TRANSFORMER FOUNDATIONS NOT SHOWN.

0 2 INDICATES COMPUTED SETTLEMENT.

(0.13) INDICATES MEASURED SETTLEMENT.

*-3 INDICATES NUMBER AND LOCATION OF SETTLEMENT MOMENT.

*1. T-4B DESTROYED (11/09/83)
 *2. T-4A NOT ACCESSIBLE FROM 7/82

**WOLF CREEK
 UPDATED SAFETY ANALYSIS REPORT**

Figure 2.5-106i

Computed and Measured Settlement,
 Power Block

Wolf Creek

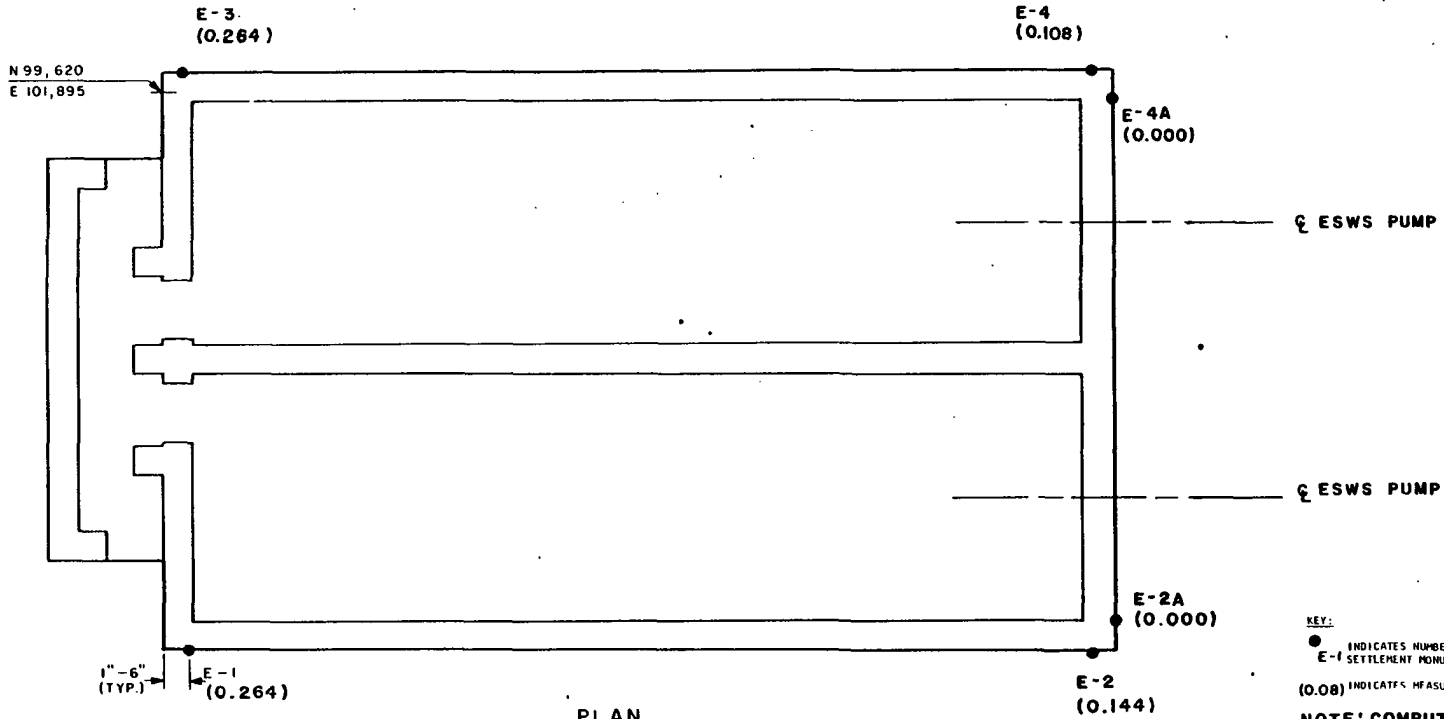
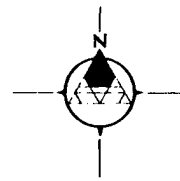

KEY:
 ● INDICATES NUMBER AND LOCATION OF
 E-I SETTLEMENT POINT.
 (0.08) INDICATES MEASURED SETTLEMENT IN INCHES.
 NOTE: COMPUTED SETTLEMENT IS
 SLIGHTLY MORE THAN $\frac{1}{4}$ INCH

PLAN
 WALLS ABOVE EL. 2000'-0"



<p>WOLF CREEK UPDATED SAFETY ANALYSIS REPORT</p>
<p>FIGURE 2.5-106j</p> <p>MEASURED SETTLEMENT, ESWS PUMPHOUSE</p>

Rev. 0

'q' VARIES (MIN SURCHARGE = 250 PSF)

PLANT GRADE, EL. 1099.5 FT. M.S.L. (SNUPPS EL. 1999.5 M.S.L.)

GROUNDWATER SURFACE AT GRADE

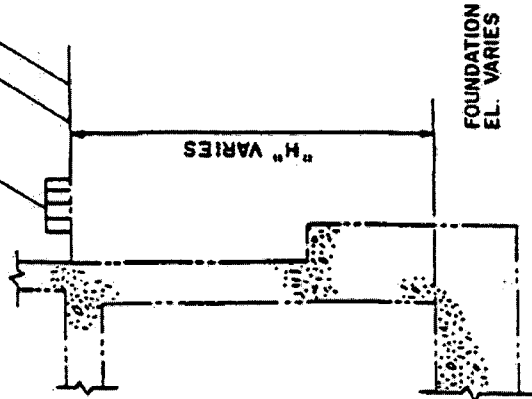

CASES	STATIC LOADS		DYNAMIC LOADS	
	AT REST	SURCHG.	AT REST	SURCHG.
1 SAFE SHUTDOWN EARTHQUAKE (SSE) (0.15G)				
2 OPERATING BASIS EARTHQUAKE (OBE) (0.06G)				

NOTES:

1. K_0 TAKEN AS 0.45
2. UNIT WEIGHT OF SOIL
SATURATED 150 PCF
BUOYANT 88 PCF
3. CLSM CAN BE CREATED WITH SIMILAR PROPERTIES AS BACKFILL AND GENERATES A SMALLER LOAD AGAINST A STRUCTURE.

NOTE:
WALL CONFIGURATION IS FOR
PICTORIAL PURPOSE ONLY

REV. 28

**WOLF CREEK
UPDATED SAFETY ANALYSIS REPORT**

FIGURE 2.5-107a

**DESIGN CRITERIA FOR LATERAL EARTH
PRESSURES - WOLF CREEK SITE
(GRANULAR BACKFILL)**

'q' VARIES (MIN SURCHARGE = 250 PSF)
 PLANT GRADE, EL. 1099.5 FT. M.S.L. (SNUPPS EL. 1999.5 M.S.L.)
 GROUNDWATER SURFACE AT GRADE

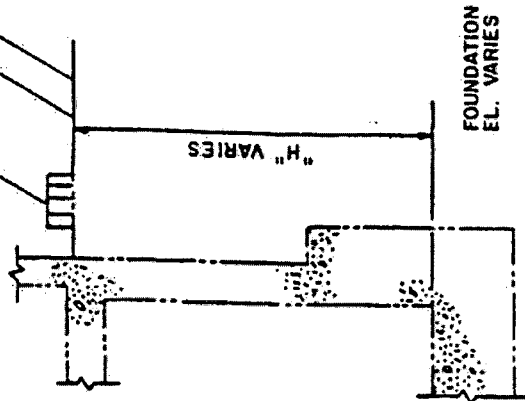

CASES	STATIC LOADS		DYNAMIC LOADS	
	AT REST	SURCHG.	AT REST	SURCHG.
1 SAFE SHUTDOWN EARTHQUAKE (SSE) (0.15G)				
2 OPERATING BASIS EARTHQUAKE (OBE) (0.06G)				

NOTES:

1. K_0 TAKEN AS 0.65
2. UNIT WEIGHT OF SOIL
SATURATED 130 PCF
BUOYANT 68 PCF
3. CLSM CAN BE CREATED WITH SIMILAR PROPERTIES
AS BACKFILL AND GENERATES A SMALLER LOAD
AGAINST A STRUCTURE.

NOTE:
WALL CONFIGURATION IS FOR
PICTORIAL PURPOSE ONLY

REV. 28

**WOLF CREEK
 UPDATED SAFETY ANALYSIS REPORT**

FIGURE 2.5-107b

DESIGN CRITERIA FOR LATERAL EARTH
 PRESSURES - WOLF CREEK SITE
 (COHESIVE FILL)

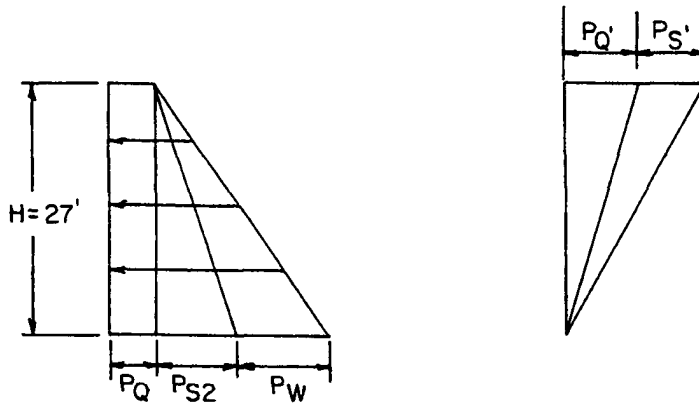

STATIC X 1.7 (KSF)			DYN X 1.9 (KSF)		TOTAL WITH LOAD FACTORS	
P_Q	P_{S2}	P_W	$P_{Q'}$	$P_{S'}$	EARTH PRESS @ EL. 2000'	EARTH PRESS @ EL. 1973'
0.32	2.43	2.85	0.10	0.53	0.95 KSF	5.6 KSF

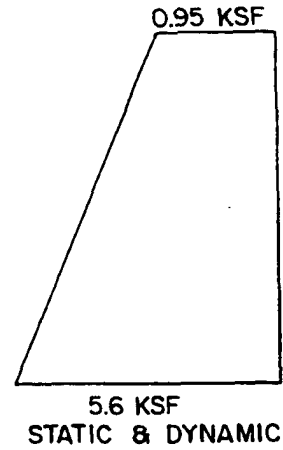
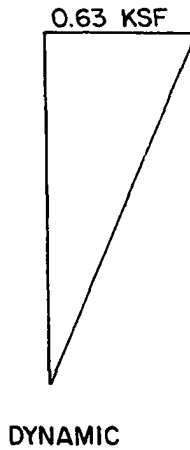
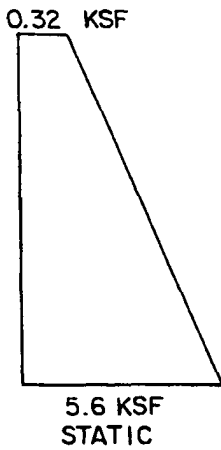

P_Q , which is the static pressure due to surcharge loading, varied according to the imposed load due to the building adjacent to the exterior wall of the auxiliary building.

NOTES:

1. The watertable is assumed to be at grade level.
2. Values shown are derived from lateral earth pressures based on an SSE = 0.25g. The licensing basis for lateral earth pressure is however based on an SSE = 0.2g as shown on Figure 2.5-152.

Rev. 14

WOLF CREEK UPDATED SAFETY ANALYSIS REPORT
FIGURE 2.5-107c
Auxiliary Building Exterior Wall Design

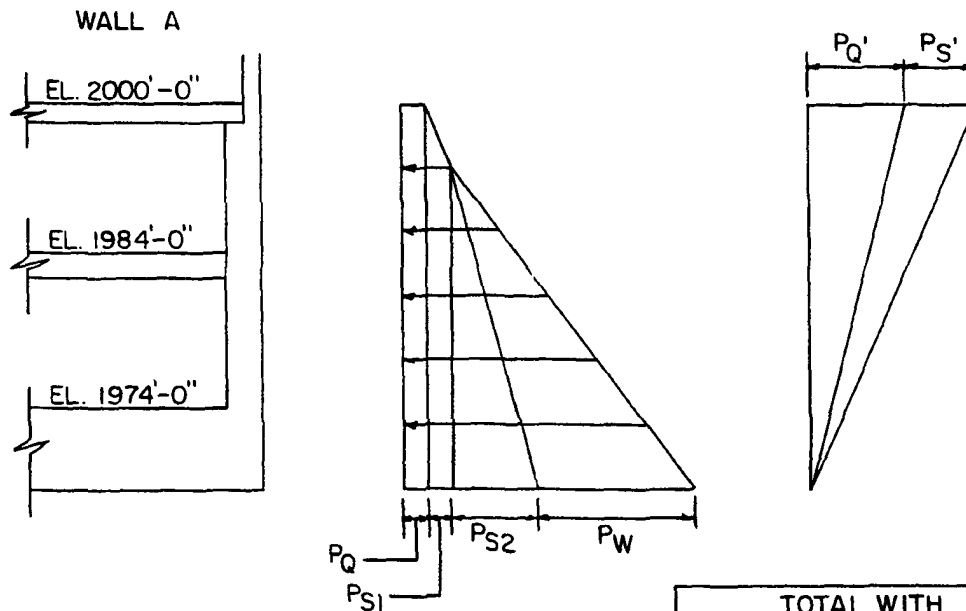

				TOTAL WITH LOAD FACTORS			
STATIC X 1.7 (KSF)				DYN X 1.9 (KSF)		EARTH PRESS	EARTH PRESS
P_Q	P_{S1}	P_{S2}	P_W	$P_{Q'}$	$P_{S'}$	@ EL. 2000'	@ EL. 1974'
3.825	1.198	1.651	1.95	2.622	1.423	7.870	8.624

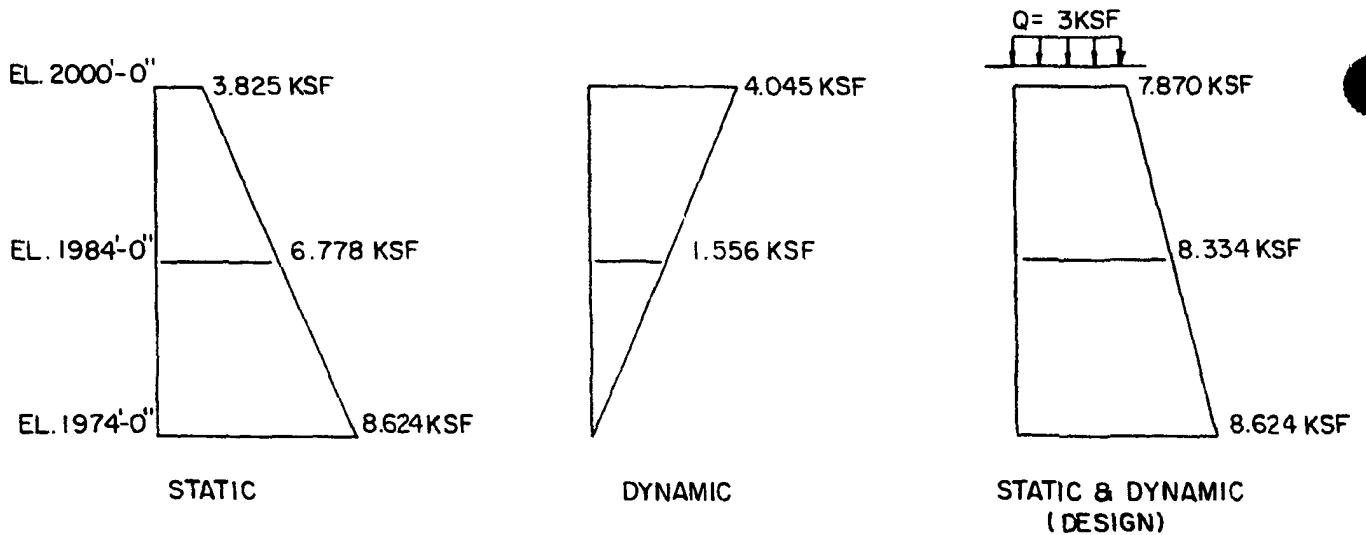

Rev. 14

NOTES:

1. The watertable is assumed to be at grade level.
2. Values shown are derived from lateral earth pressures based on an SSE = 0.25g. The licensing basis for lateral earth pressure is however based on an SSE = 0.2g as shown on Figure 2.5-152.

WOLF CREEK UPDATED SAFETY ANALYSIS REPORT
FIGURE 2.5-107d
Control Building Exterior Wall Design

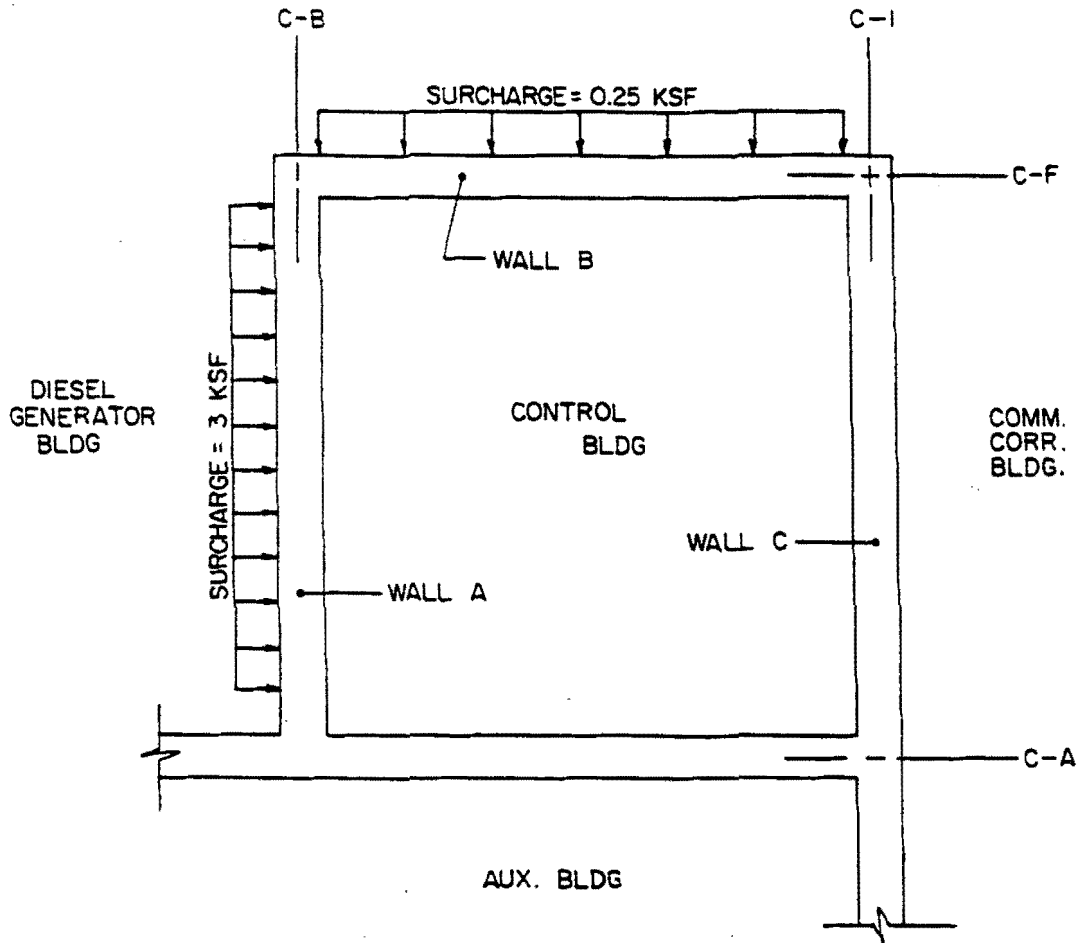

PLAN VIEW

Rev. 03

WOLF CREEK UPDATED SAFETY ANALYSIS REPORT
Figure 2.5-107e Control Building Exterior Wall Design

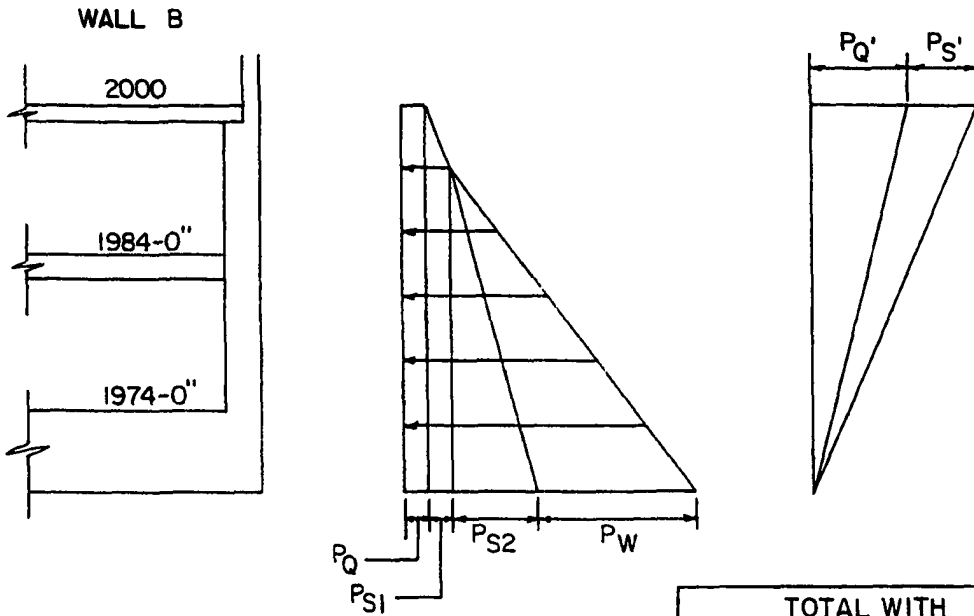

STATIC X 1.7 (KSF)				DYN X 1.9 (KSF)		TOTAL WITH LOAD FACTORS	
P_Q	P_{S1}	P_{S2}	P_W	$P_{Q'}$	$P_{S'}$	EARTH PRESS @ EL. 2000'	EARTH PRESS @ EL. 1974'
0.319	1.198	1.651	1.75	0.219	1.423	1.961	5.118

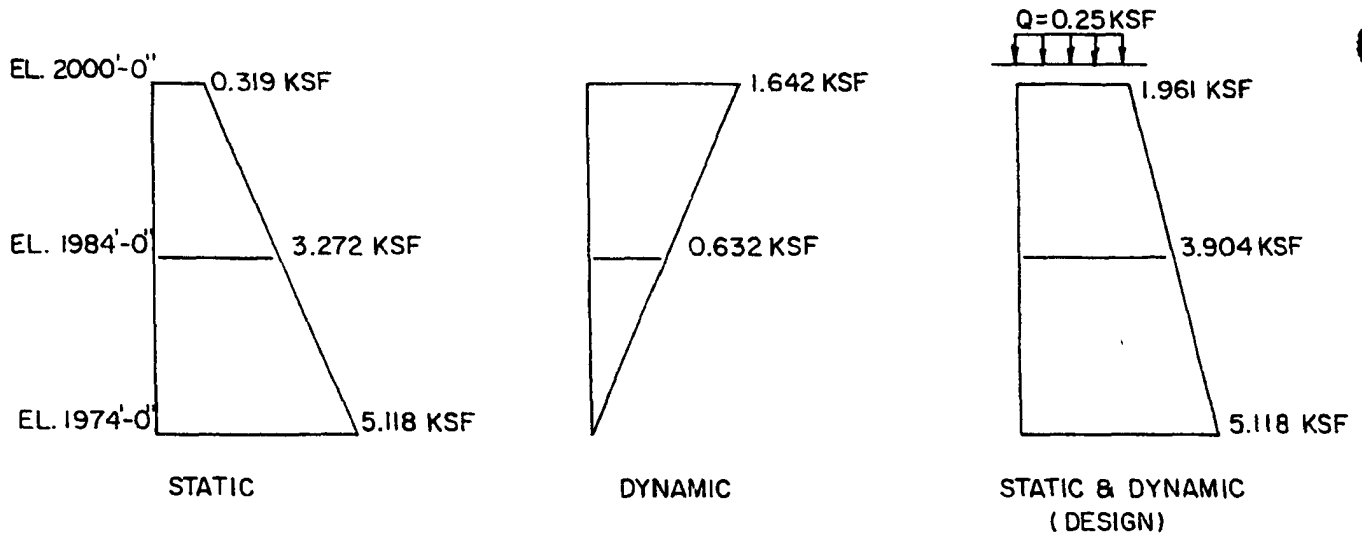

Rev. 14

NOTES:

1. The watertable is assumed to be at grade level.
2. Values shown are derived from lateral earth pressures based on an SSE = 0.25g. The licensing basis for lateral earth pressure is however based on an SSE = 0.2g as shown on Figure 2.5-152.

WOLF CREEK UPDATED SAFETY ANALYSIS REPORT
FIGURE 2.5-107f Control Building Exterior Wall Design

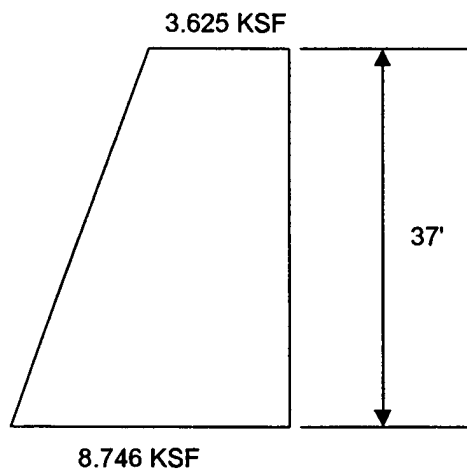
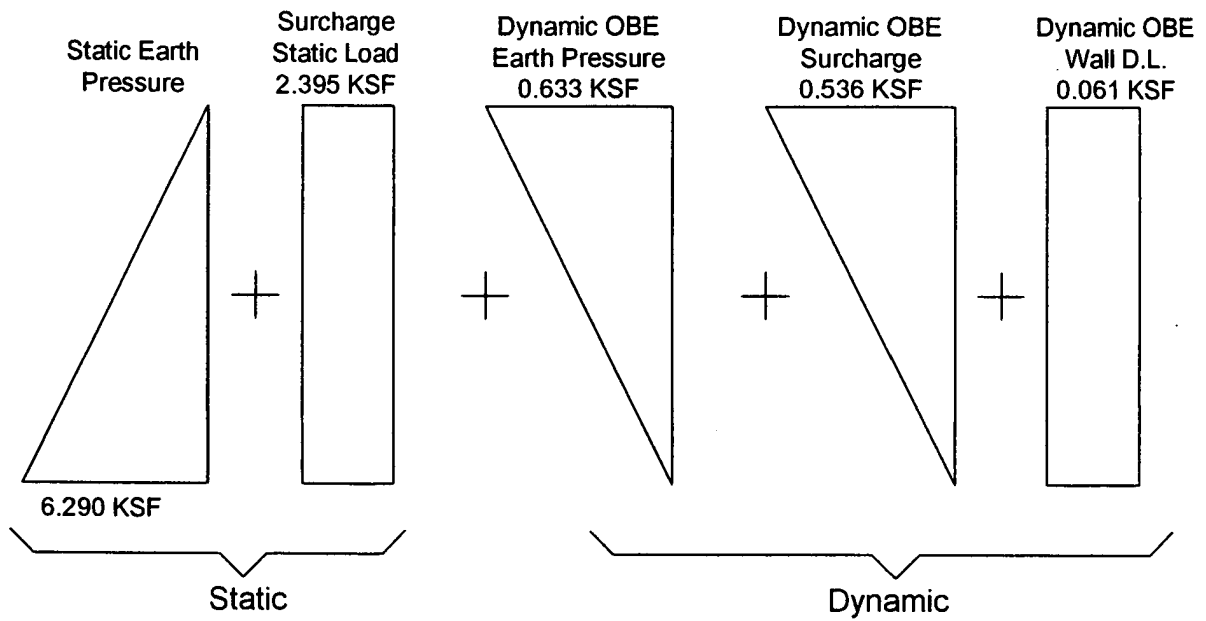

Static & Dynamic

Rev. 14

Note: Pressures are Ultimate Loads

<p>WOLF CREEK UPDATED SAFETY ANALYSIS REPORT</p>
<p>Figure 2.5-107g ESWS Pumphouse Exterior Wall Design</p>

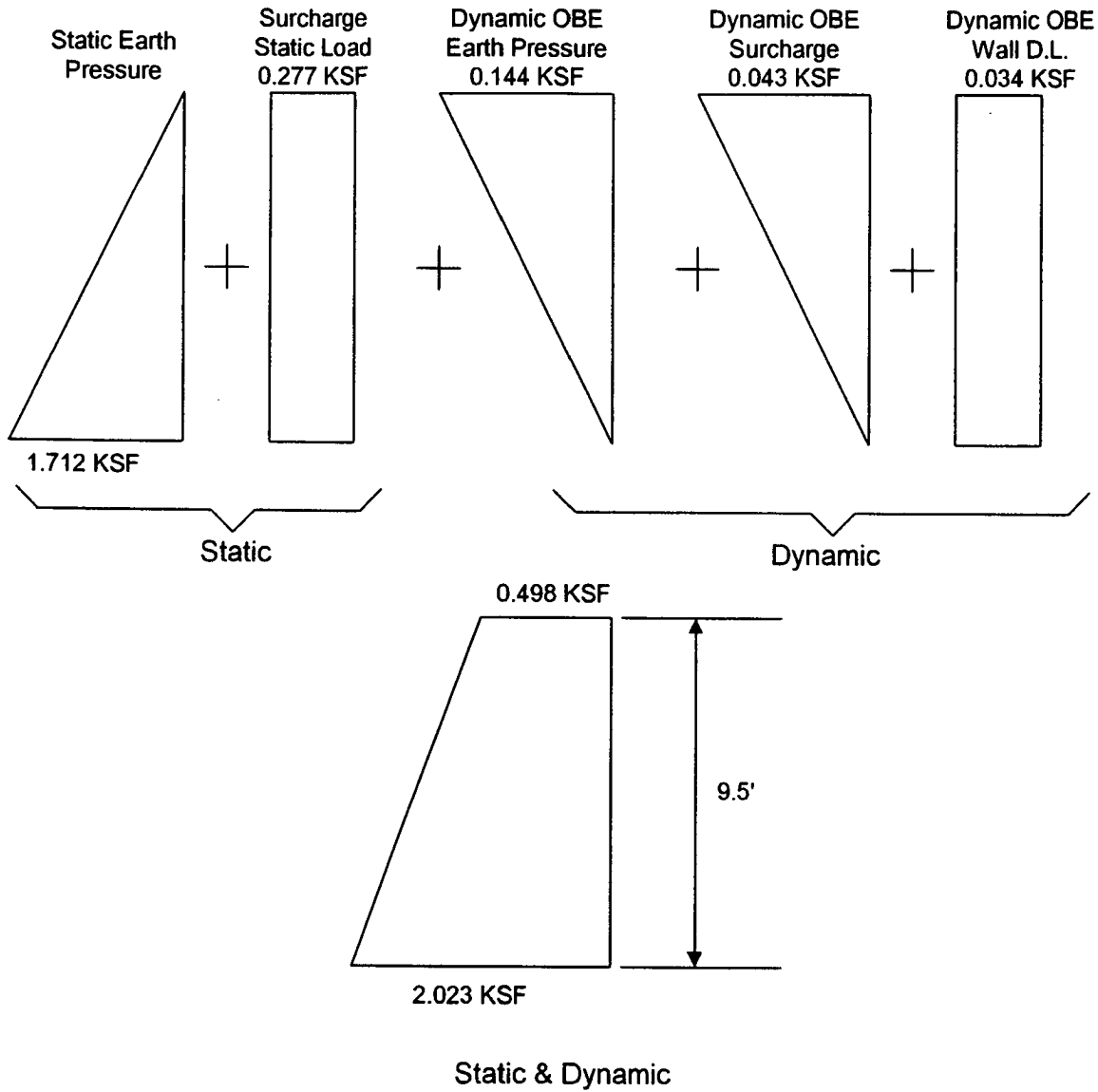

Note: Pressures are Ultimate Loads

Rev. 14

<p>WOLF CREEK UPDATED SAFETY ANALYSIS REPORT</p>
<p>Figure 2.5-107h ESWS Discharge Structure Exterior Wall Design</p>

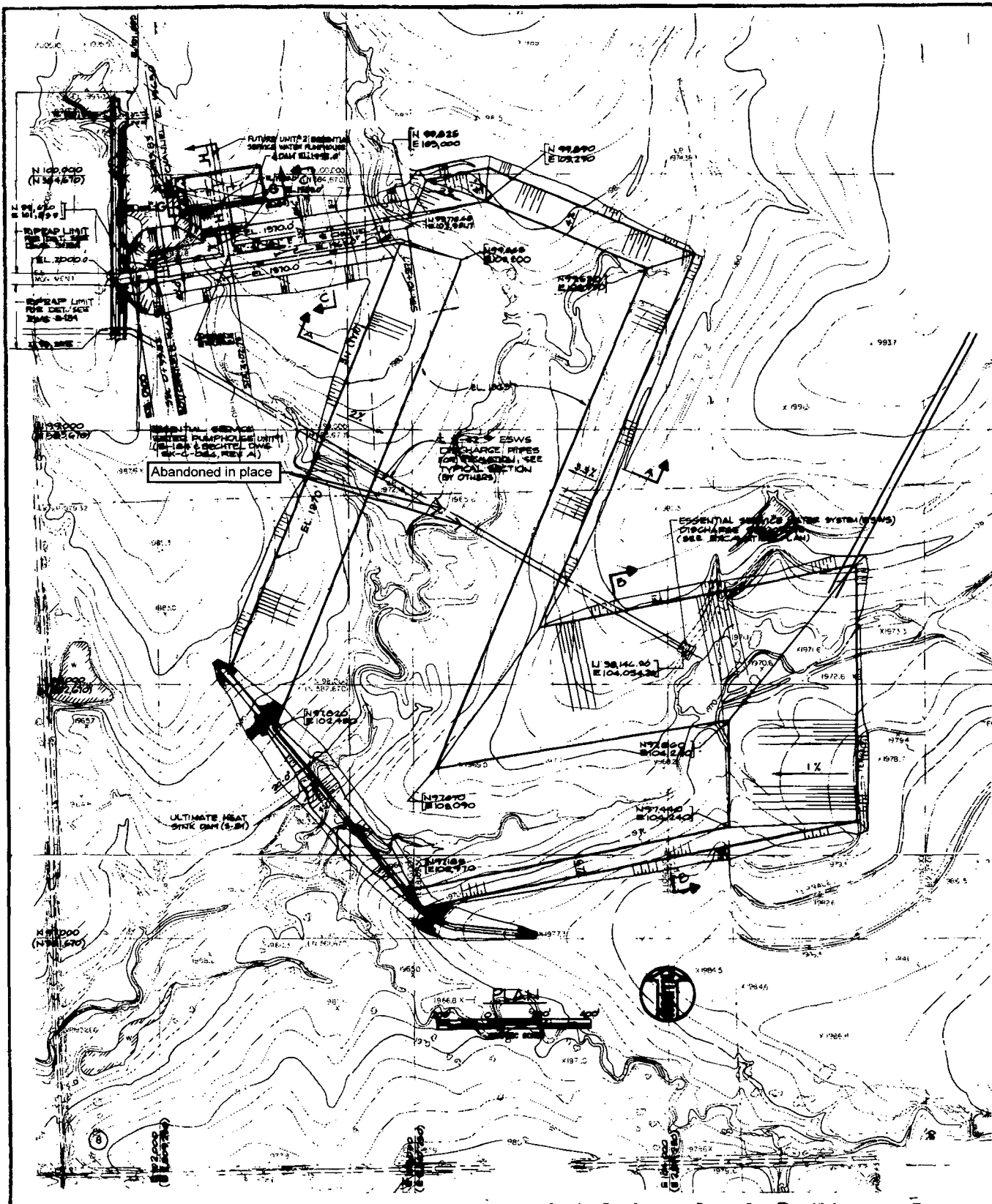

**WOLF CREEK
UPDATED SAFETY ANALYSIS REPORT**

Figure 2.5-108 Rev.28

Ultimate Heat Sink
Sheet 1 of 1

ELEVATION IN FEET
1990
1980
1970
1960

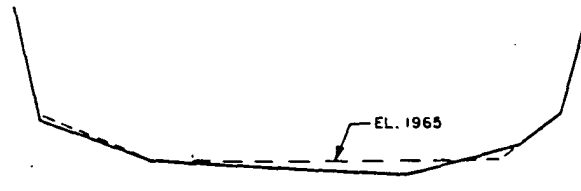

ELEVATION IN FEET
1990
1980
1970
1960

ELEVATION IN FEET
1980
1970
1960



ELEVATION IN FEET
1980
1970
1960

EXPLANATION:

- - - - INDICATES DESIGN GRADE
- INDICATES AS-BUILT GRADE



NOTES:

- ELEVATIONS REFER TO SHUPPS DATUM
ELEV. 2500' SHUPPS = 1100' USGS DATUM.

Rev. 0

DRAWING REFERENCE:

TITLED: ULTIMATE HEAT SINK PLAN & SECTIONS

FOR: WOLF CREEK GENERATION STATION UNIT 1
KANSAS GAS & ELECTRIC CO.
KANSAS CITY POWER & LIGHT CO.

BY: SARGENT & LUNDY ENGINEERS
CHICAGO, ILL.

DRAWING NO: S-80, REV. J

DATE: 8-25-80

**WOLF CREEK
UPDATED SAFETY ANALYSIS REPORT**

Figure 2.5-109

Ultimate Heat Sink - Typical Man-Made Slopes

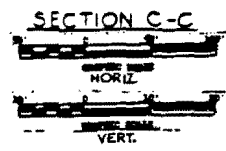
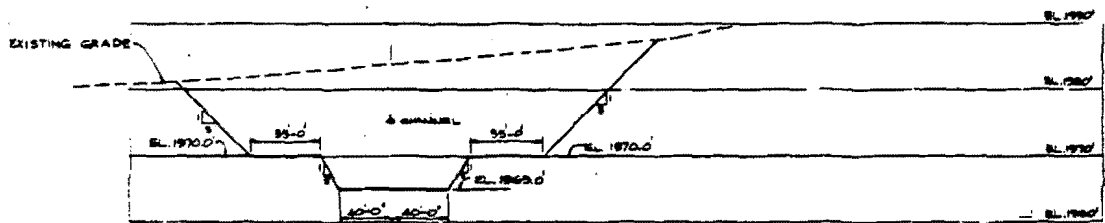

NOTE:

CROSS-SECTION LOCATION SHOWN
IN FIGURE 2.5-108 "ULTIMATE
HEAT SINK".

Rev. 0

<p>WOLF CREEK UPDATED SAFETY ANALYSIS REPORT</p>
<p>Figure 2.5-110</p>
<p>Ultimate Heat Sink - Intake Channel Section</p>

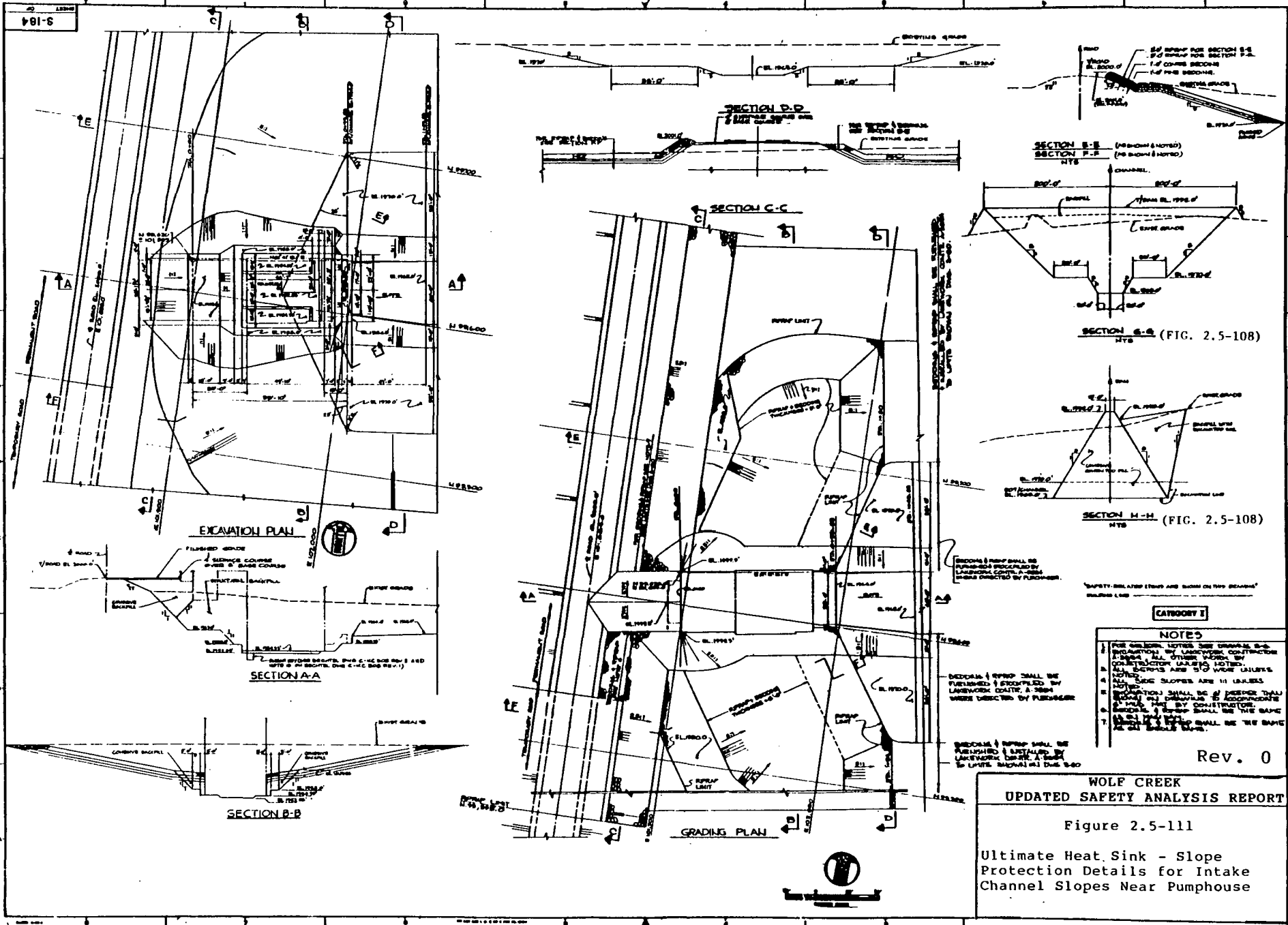

SECTION E-E (FIG. 2.5-108)

SECTION H-H (FIG. 2.5-108)

CATEGORY I

NOTES

1. FOR OTHER NOTES SEE DRAWING 2.5-108.
2. PROVISIONS BY UNDERWRITER CONTRACTOR TO BE MAINTAINED BY CONTRACTOR.
3. ALL SECTIONS ARE TO BE MAINTAINED UNLESS NOTED OTHERWISE.
4. ALL SIDE SLOPES ARE 1H UNLESS NOTED OTHERWISE.
5. PROVISIONS SHALL BE ACCORDING TO THE REQUIREMENTS OF THE CONTRACTOR.
6. ALL SECTIONS SHALL BE THE SAME UNLESS NOTED OTHERWISE.
7. ALL SECTIONS SHALL BE THE SAME UNLESS NOTED OTHERWISE.

Rev. 0

WOLF CREEK
UPDATED SAFETY ANALYSIS REPORT

Figure 2.5-111

Ultimate Heat Sink - Slope
Protection Details for Intake
Channel Slopes Near Pumphouse

CONDITION	SOIL PARAMETERS	MINIMUM FACTOR OF SAFETY
End of Construction	$\gamma=124\text{pcf}$ $\phi_{cu}=10^\circ$ $c_{cu}=585\text{ psf}$	7.8
Steady State	$\gamma=124\text{pcf}$ $\phi' =20^\circ$ $c' =400\text{psf}$	5.3
Steady State Plus SSE (0.12g)	$\gamma=124\text{pcf}$ $\phi' =20^\circ$ $c' =400\text{psf}$	3.5

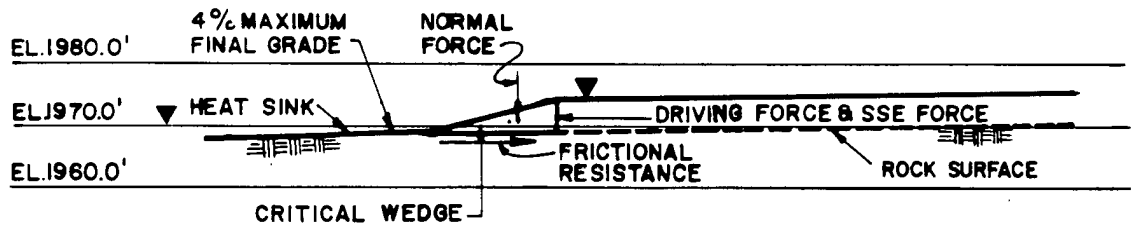

Rev. 0

WOLF CREEK UPDATED SAFETY ANALYSIS REPORT
Figure 2.5-112 Ultimate Heat Sink - Wedge Analysis of Excavated Sites

MODIFIED BISHOP METHOD
SLOPE STABILITY ANALYSIS

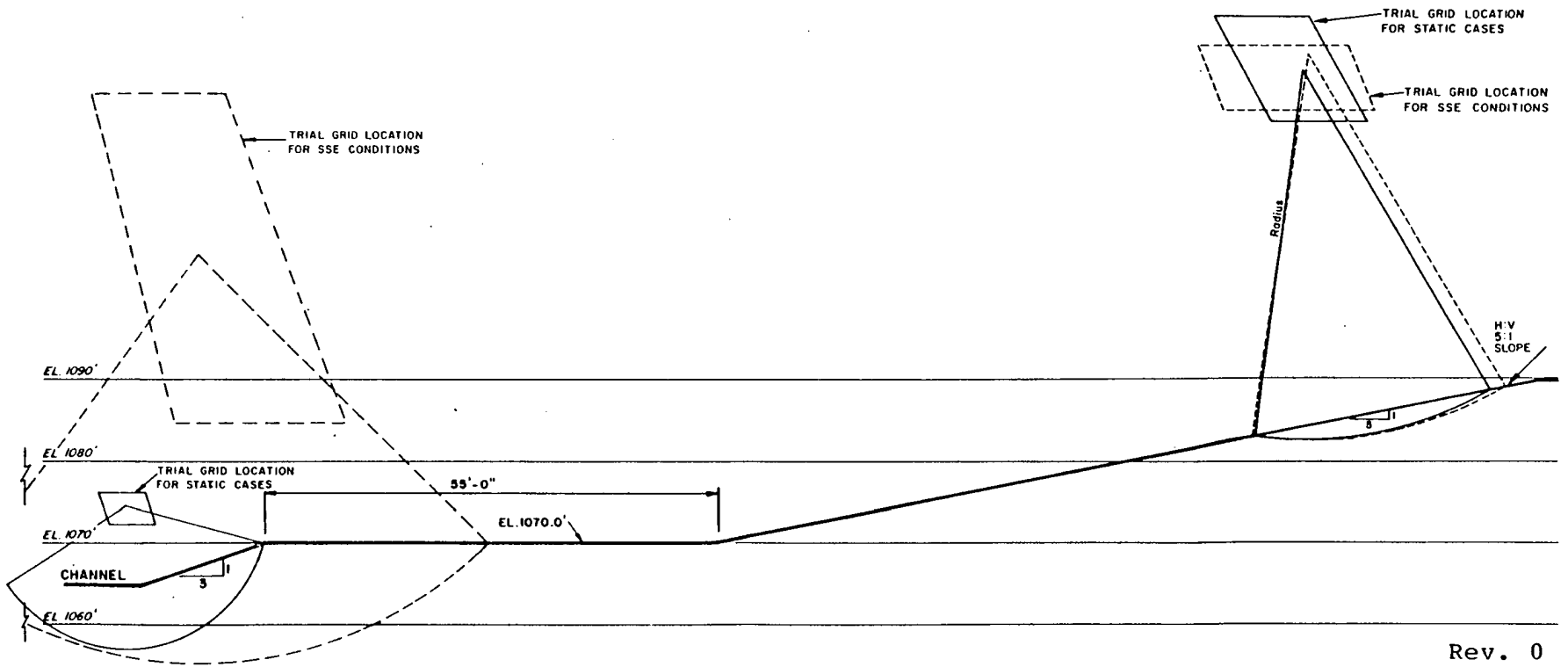

Rev. 0

<p>WOLF CREEK UPDATED SAFETY ANALYSIS REPORT</p>
<p>Figure 2.5-113</p> <p>Ultimate Heat Sink - Intake Channel Slope Stability Analysis (Modified Bishop Method)</p>

SOIL	SOIL DESCRIPTION	SOIL PARAMETERS		
		UNIT WT. γ PCF	COHESION C PSF	FRICTION ANGLE ϕ DEGREE
1	DUMMY LAYER	0	0	0
2	WATER	62.4	0	0
3	RESIDUAL	124	400	20
4	ROCK	150	5000	35

MINIMUM SAFETY FACTOR = 7.13

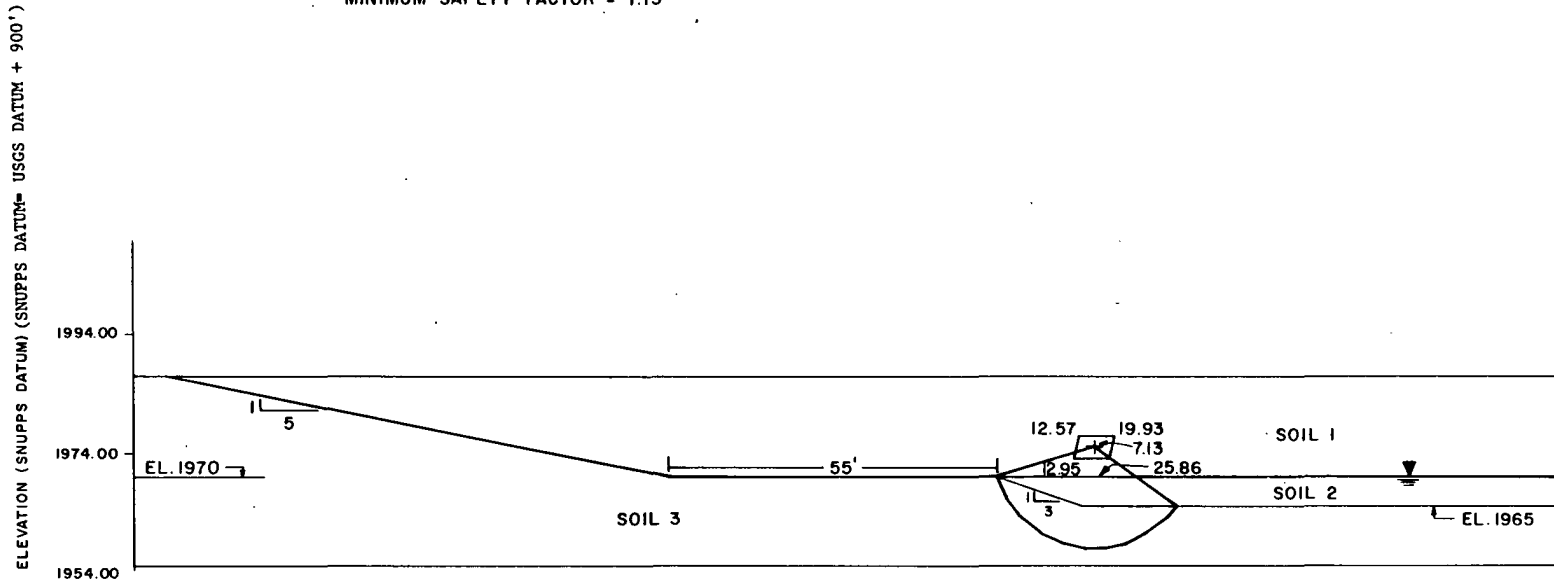

Rev. 0

**WOLF CREEK
UPDATED SAFETY ANALYSIS REPORT**

Figure 2.5-113a

ESWS Intake Channel Slope
Stability Analysis, 3:1 Slope
Submerged Condition

SOIL	SOIL DESCRIPTION	SOIL PARAMETERS		
		UNIT WT. γ_T PCF	COHESION C PSF	FRICTION ANGLE ϕ DEGREE
1	DUMMY LAYER	0	0	0
2	WATER	62.4	0	0
3	RESIDUAL	124	400	20
4	ROCK	150	5000	35

MINIMUM SAFETY FACTOR = 3.37

ELEVATION (SNUPPS DATUM) (SNUPPS DATUM = USGS DATUM + 900')

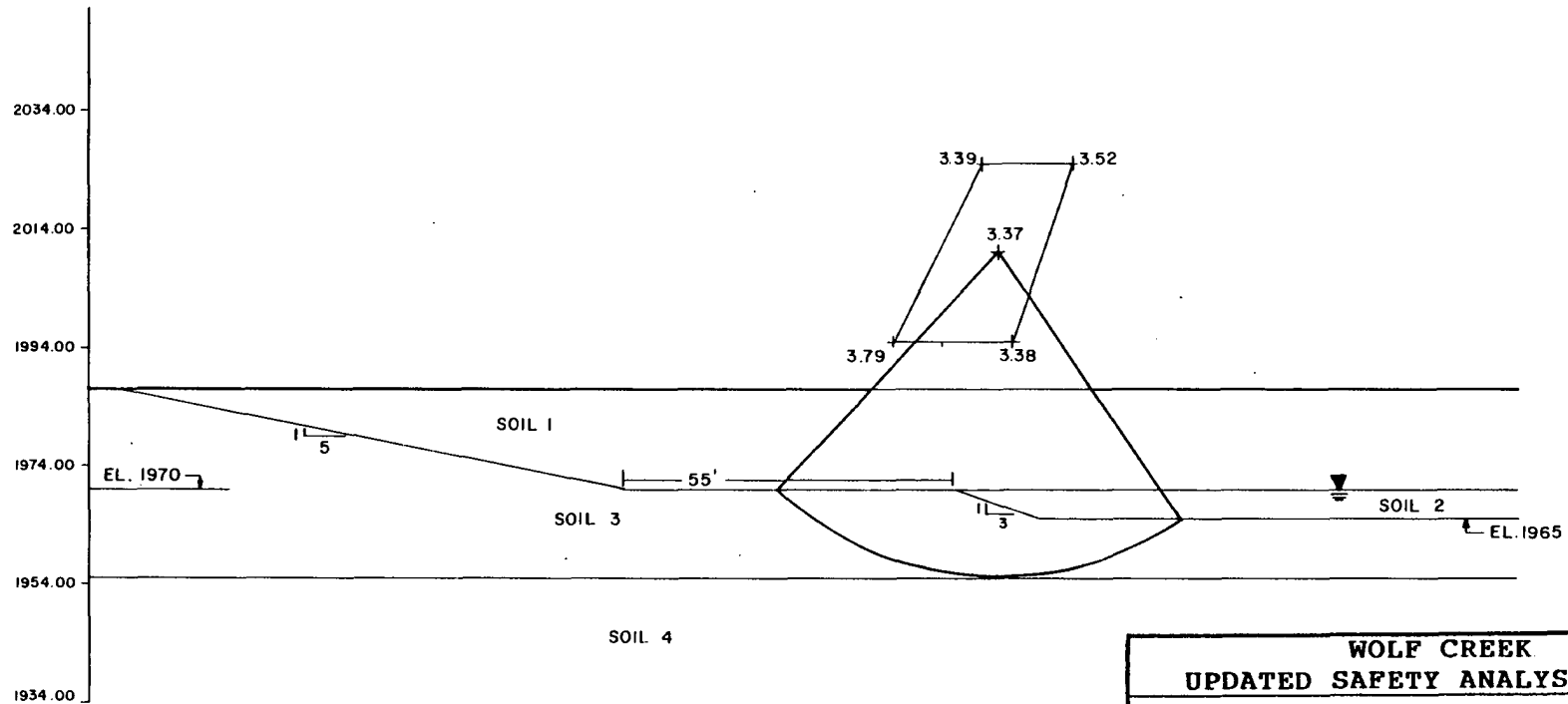

Rev. 0

**WOLF CREEK
UPDATED SAFETY ANALYSIS REPORT**

Figure 2.5-113b

ESWS Intake Channel Slope
Stability Analysis, 3:1 Slope
Submerged with SSE - Effective
Stress Parameters

SOIL	SOIL DESCRIPTION	SOIL PARAMETERS		
		UNIT WT. γ _T PCF	COHESION C PSF	FRICTION ANGLE φ DEGREE
1	DUMMY LAYER	0	0	0
2	WATER	62.4	0	0
3	RESIDUAL	124	585	10
4	ROCK	150	5000	35

MINIMUM SAFETY FACTOR = 3.88

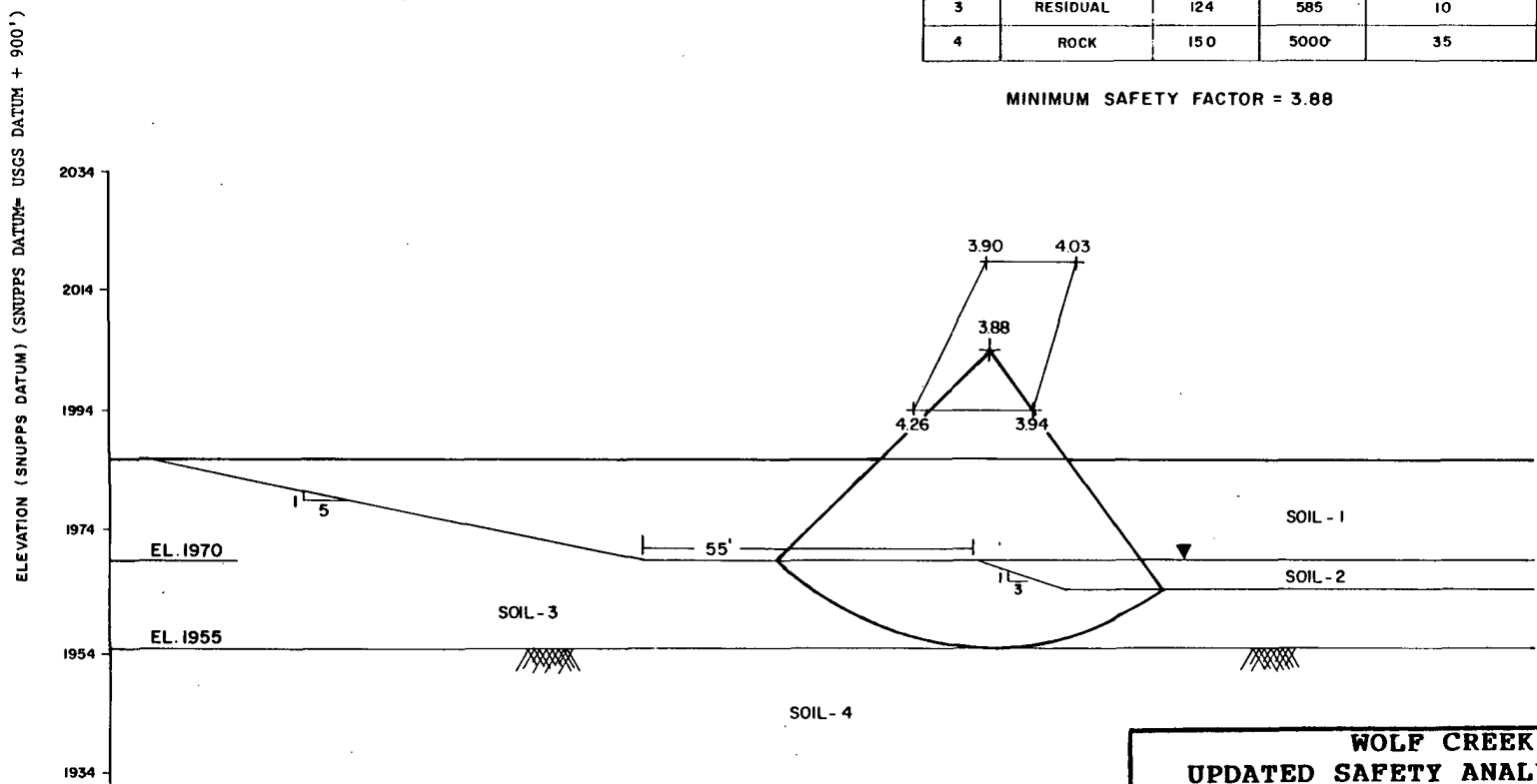

Rev. 0

**WOLF CREEK
UPDATED SAFETY ANALYSIS REPORT**

Figure 2.5-113c

ESWS Intake Channel Slope
Stability Analysis, 3:1 Slope
Submerged with SSE - Total Stress
Parameters

SOIL	SOIL DESCRIPTION	SOIL PARAMETERS		
		DENSITY γ_T PCF	COHESION C PSF	FRICTION ANGLE ϕ DEGREE
1	DUMMY LAYER	0	0	0
2	RESIDUAL	124	585	10
3	ROCK	150	5000	35

MINIMUM SAFETY FACTOR = 5.69

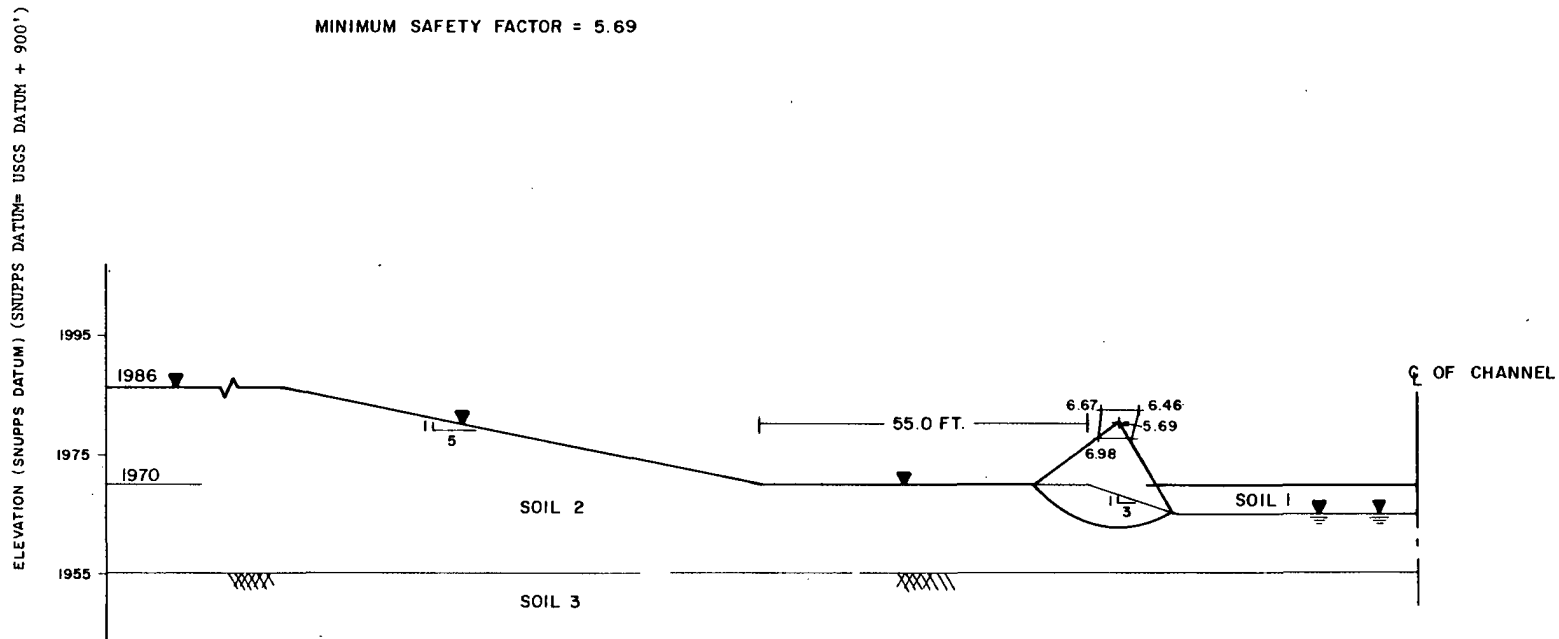

Rev. 0

**WOLF CREEK
UPDATED SAFETY ANALYSIS REPORT**

Figure 2.5-113d

ESWS Intake Channel Slope
Stability Analysis, 3:1 Slope
End of Construction - Short Term

SOIL	SOIL DESCRIPTION	SOIL PARAMETERS		
		DENSITY γ_t PCF	COHESION C PSF	FRICTION ANGLE ϕ DEGREE
1	DUMMY LAYER	0	0	0
2	RESIDUAL	124	585	10
3	ROCK	150	5000	35

MINIMUM SAFETY FACTOR 5.97

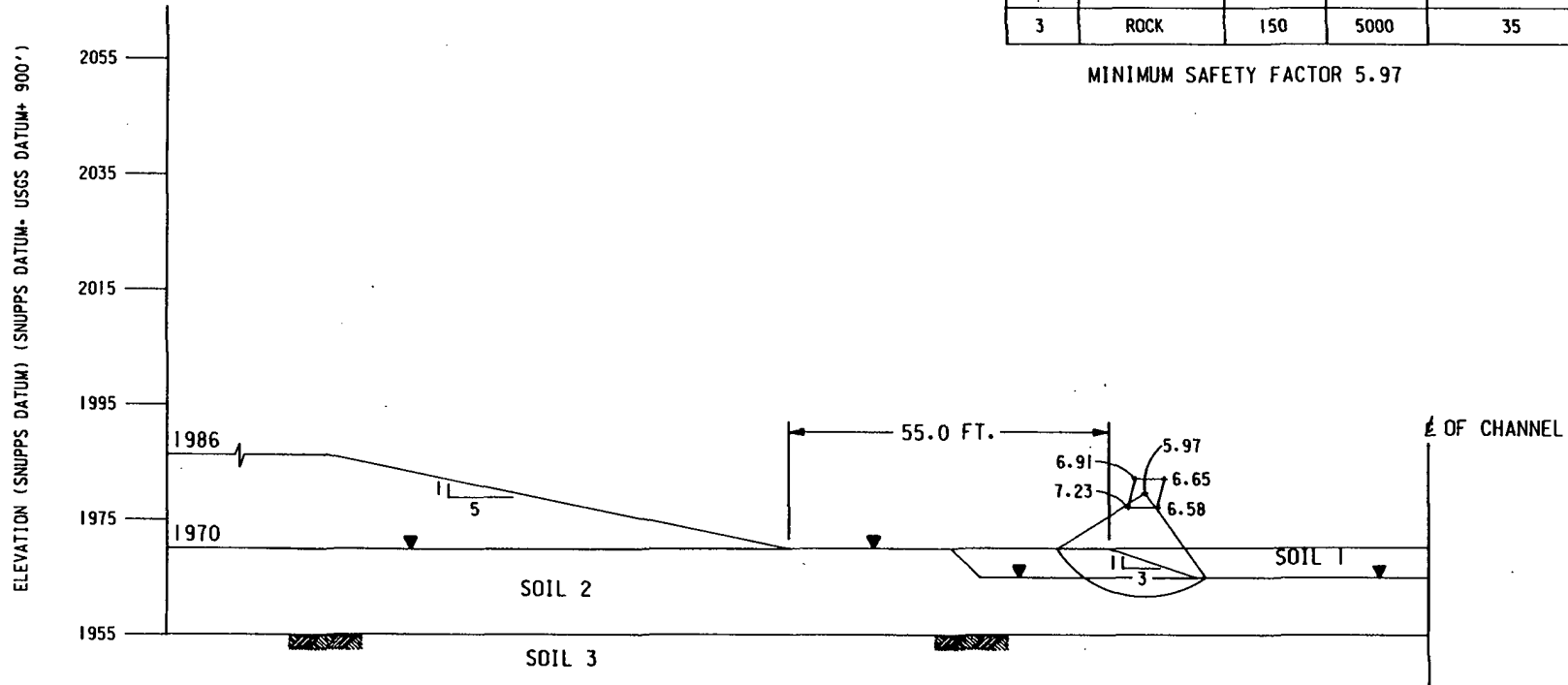

Rev. 0

**WOLF CREEK
UPDATED SAFETY ANALYSIS REPORT**

Figure 2.5-113f

ESWS Intake Channel Slope
Stability Analysis, 3:1 Slope
End of Construction - Total
Stress Parameters

SOIL	SOIL DESCRIPTION	SOIL PARAMETERS		
		DENSITY γ_t PCF	COHESION C PSF	FRICTION ANGLE ϕ DEGREE
1	WATER	62.4	0	0
2	RESIDUAL	124	400	20
3	ROCK	150	5000	35

MINIMUM SAFETY FACTOR 5.91

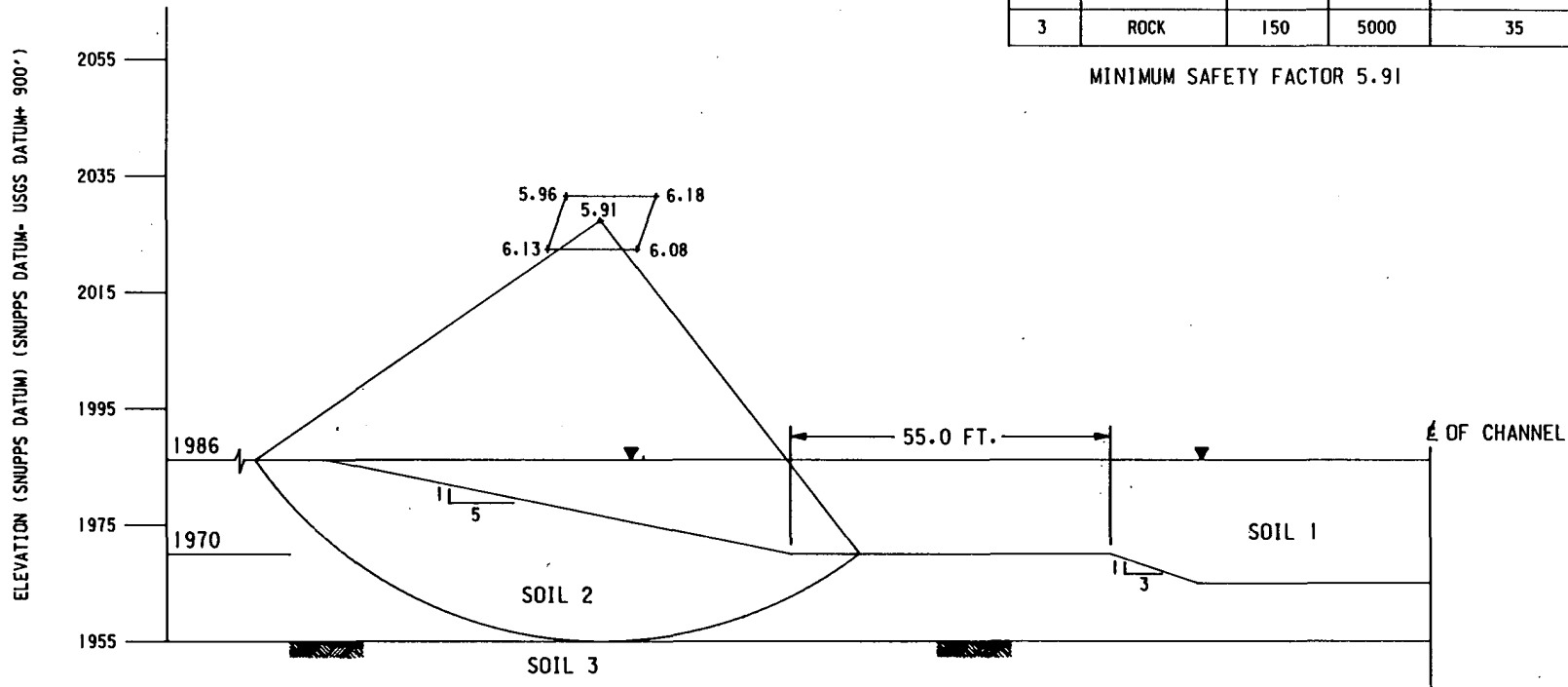

Rev. 0

**WOLF CREEK
UPDATED SAFETY ANALYSIS REPORT**

Figure 2.5-113g

ESWS Intake Channel Slope
Stability Analysis, 5:1 Slope
Submerged Conditions

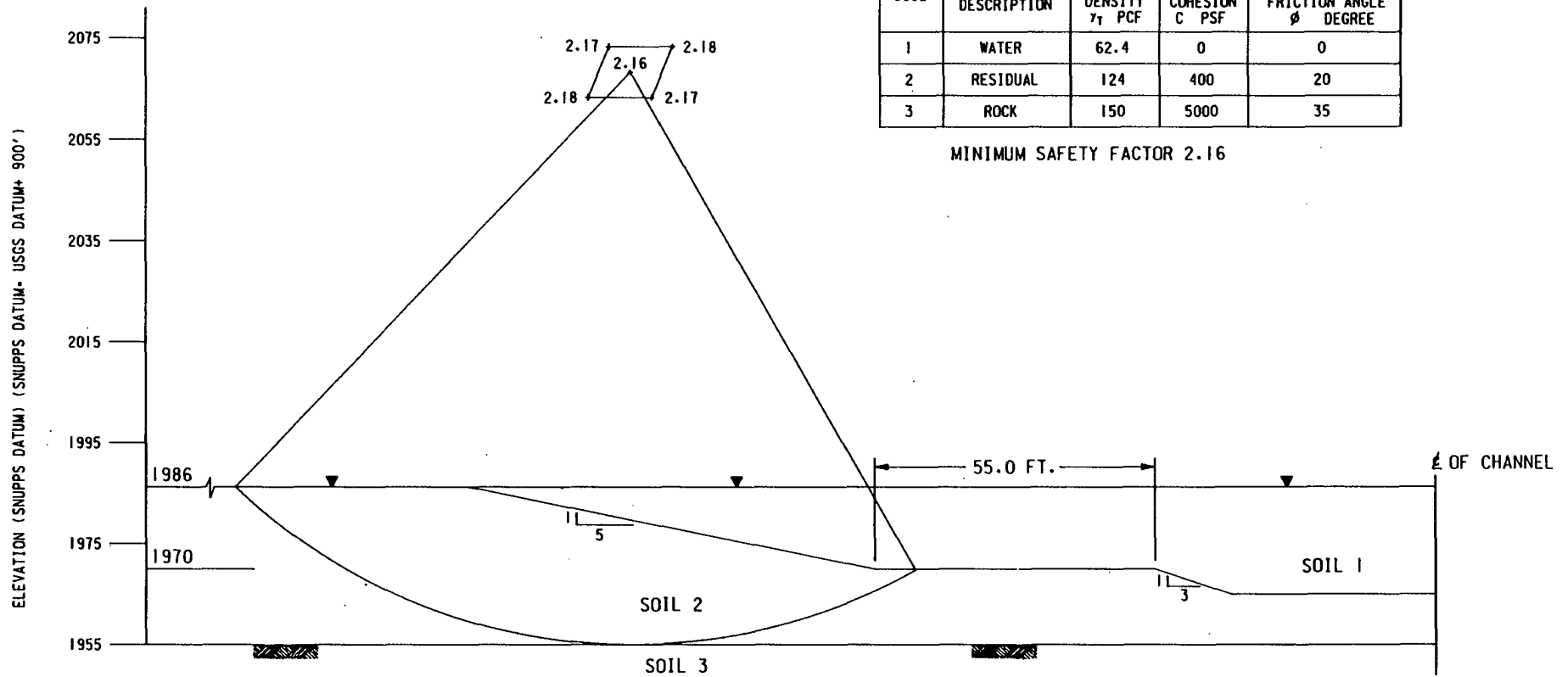

SOIL	SOIL DESCRIPTION	SOIL PARAMETERS		
		DENSITY γ_t PCF	COHESION C PSF	FRICTION ANGLE ϕ DEGREE
1	WATER	62.4	0	0
2	RESIDUAL	124	400	20
3	ROCK	150	5000	35

MINIMUM SAFETY FACTOR 2.16

Rev. 0

**WOLF CREEK
UPDATED SAFETY ANALYSIS REPORT**

Figure 2.5-113h

ESWS Intake Channel Slope
Stability Analysis, 5:1 Slope
Submerged with SSE

SOIL	SOIL DESCRIPTION	SOIL PARAMETERS		
		DENSITY γ_t PCF	COHESION C PSF	FRICTION ANGLE ϕ DEGREE
1	WATER	62.4	0	0
2	RESIDUAL	124	400	20
3	ROCK	150	5000	35

MINIMUM SAFETY FACTOR 2.82

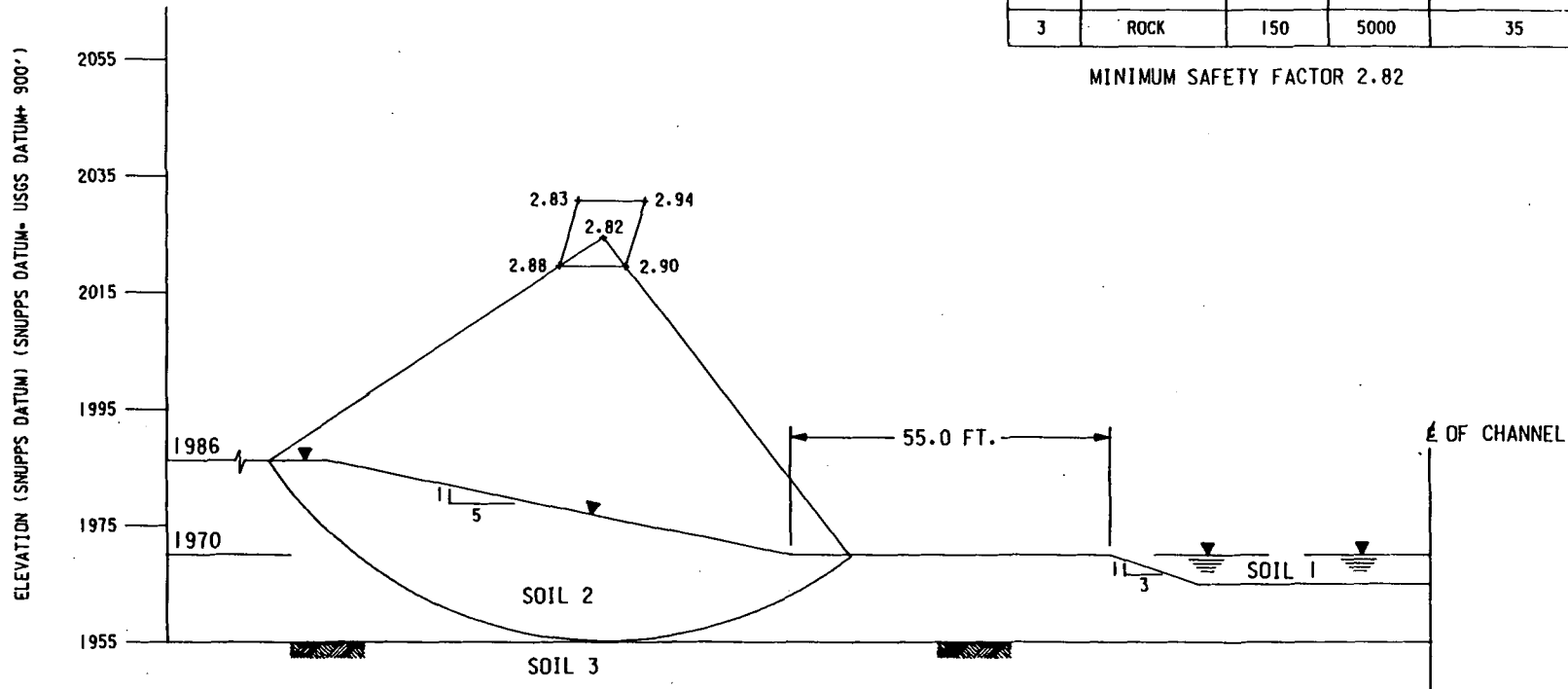

Rev. 0

**WOLF CREEK
UPDATED SAFETY ANALYSIS REPORT**

Figure 2.5-113i

ESWS Intake Channel Slope
Stability Analysis, 5:1 Slope
Rapid Drawdown

SOIL	SOIL DESCRIPTION	SOIL PARAMETERS		
		DENSITY γ_t PCF	COHESION C PSF	FRICTION ANGLE ϕ DEGREE
1	DUMMY LAYER	0	0	0
2	RESIDUAL	124	585	10
3	ROCK	150	5000	35

MINIMUM SAFETY FACTOR 2.86

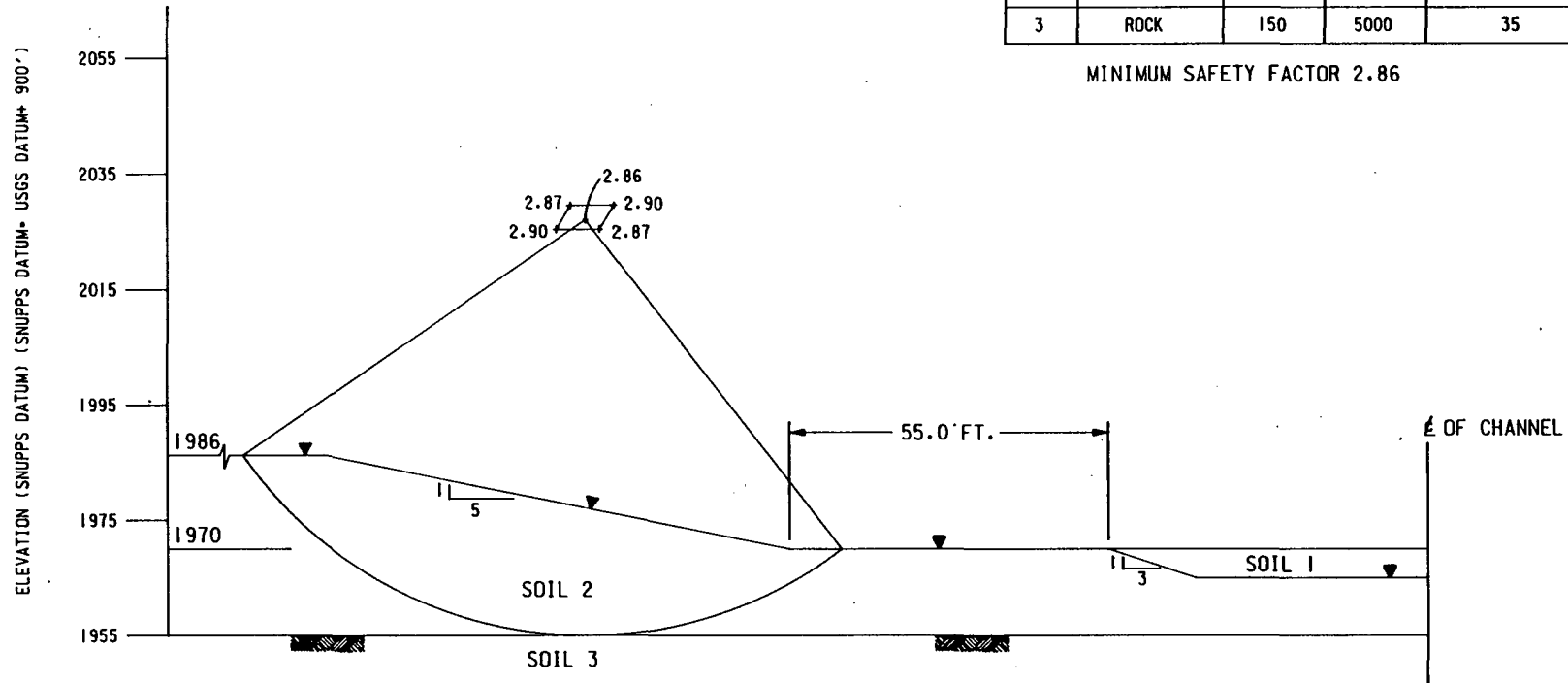

Rev. 0

**WOLF CREEK
UPDATED SAFETY ANALYSIS REPORT**

Figure 2.5-113j

ESWS Intake Channel Slope
Stability Analysis, 5:1 Slope
End of Construction - Short Term

ELEVATION (SNUPPS DATUM) (SNUPPS DATUM = USGS DATUM + 900')

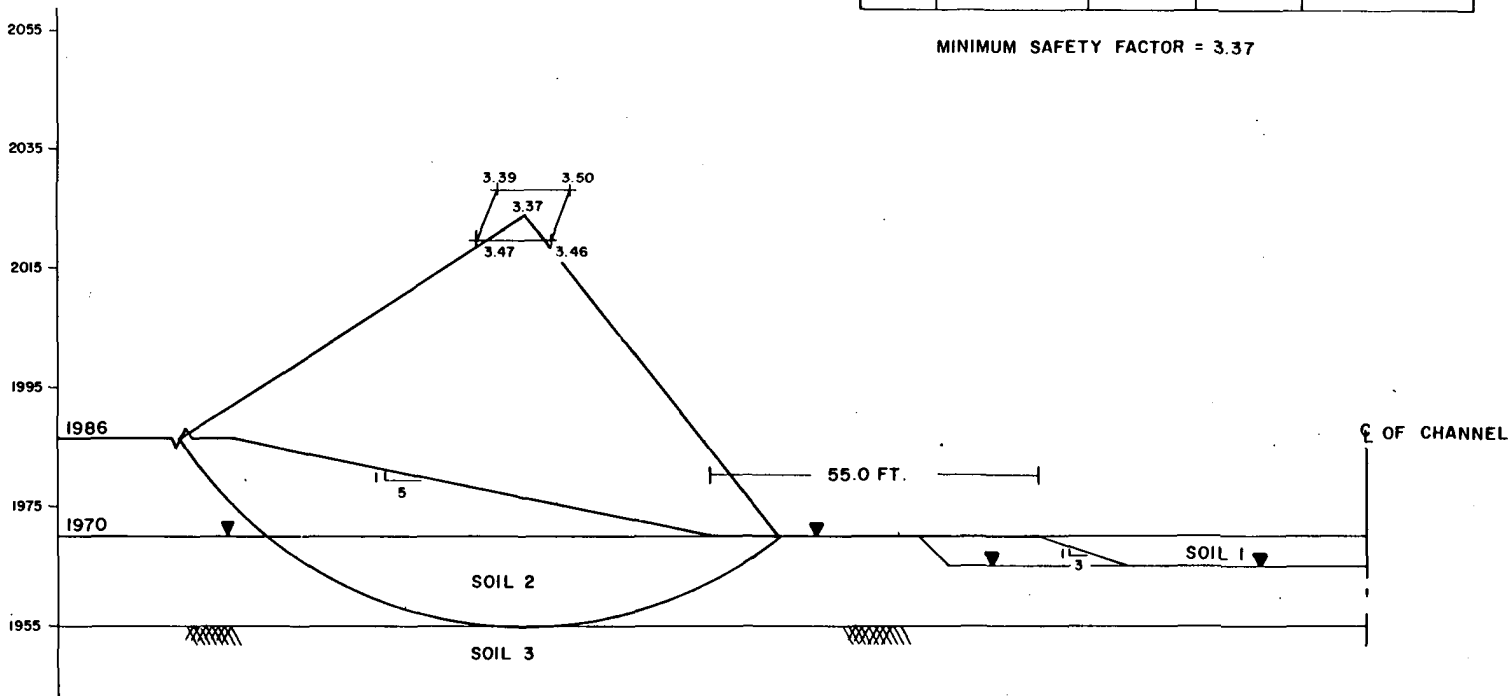

SOIL	SOIL DESCRIPTION	SOIL PARAMETERS		
		DENSITY γ_T PCF	COHESION C PSF	FRICTION ANGLE ϕ DEGREE
1	DUMMY LAYER	0	0	0
2	RESIDUAL	124	400	20
3	ROCK	150	5000	35

MINIMUM SAFETY FACTOR = 3.37

Rev. 0

**WOLF CREEK
UPDATED SAFETY ANALYSIS REPORT**

Figure 2.5-113k

ESWS Intake Channel Slope
Stability Analysis, 5:1 Slope
End of Construction - Effective
Stress Parameters

ELEVATION (SNUPPS DATUM) (SNUPPS DATUM = USGS DATUM + 900')

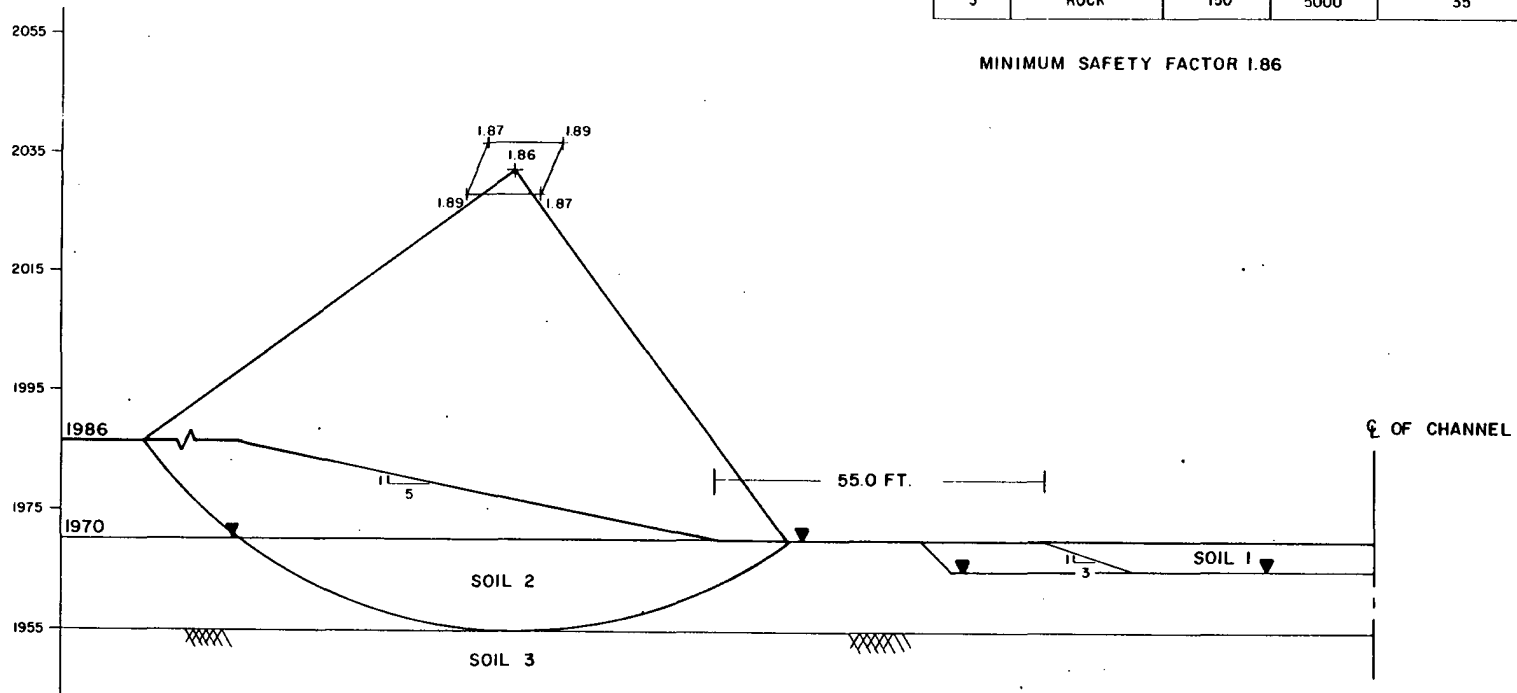

SOIL	SOIL DESCRIPTION	SOIL PARAMETERS		
		DENSITY γ_T PCF	COHESION C PSF	FRICTION ANGLE ϕ DEGREE
1	DUMMY LAYER	0	0	0
2	RESIDUAL	124	400	20
3	ROCK	150	5000	35

MINIMUM SAFETY FACTOR 1.86

Rev. 0

**WOLF CREEK
UPDATED SAFETY ANALYSIS REPORT**

Figure 2.5-1131

ESWS Intake Channel Slope
Stability Analysis, 5:1 Slope
End of Construction with SSE -
Effective Stress Parameters

SOIL	SOIL DESCRIPTION	SOIL PARAMETERS		
		DENSITY γ_T PCF	COHESION C PSF	FRICTION ANGLE ϕ DEGREE
1	DUMMY LAYER	0	0	0
2	RESIDUAL	124	585	10
3	ROCK	150	5000	35

MINIMUM SAFETY FACTOR = 3.14

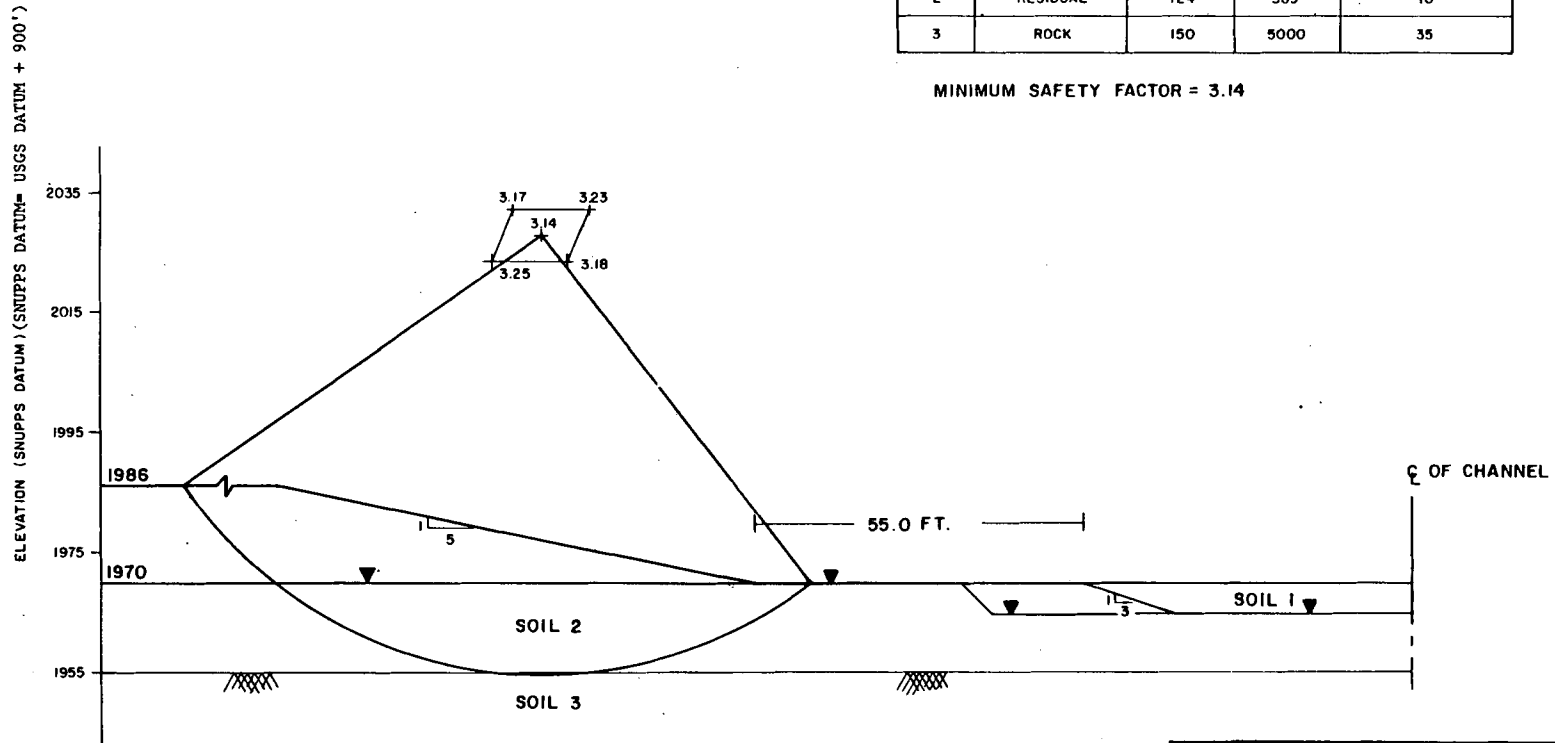

Rev. 0

**WOLF CREEK
UPDATED SAFETY ANALYSIS REPORT**

Figure 2.5-113m

ESWS Intake Channel Slope
Stability Analysis, 5:1 Slope
End of Construction - Total
Stress Parameters

SOIL	SOIL DESCRIPTION	SOIL PARAMETERS		
		DENSITY PCF	COHESION C PSF	FRICTION ANGLE ϕ DEGREE
1	DUMMY LAYER	0	0	0
2	RESIDUAL	124	585	10
3	ROCK	150	5000	35

MINIMUM SAFETY FACTOR = 1.74

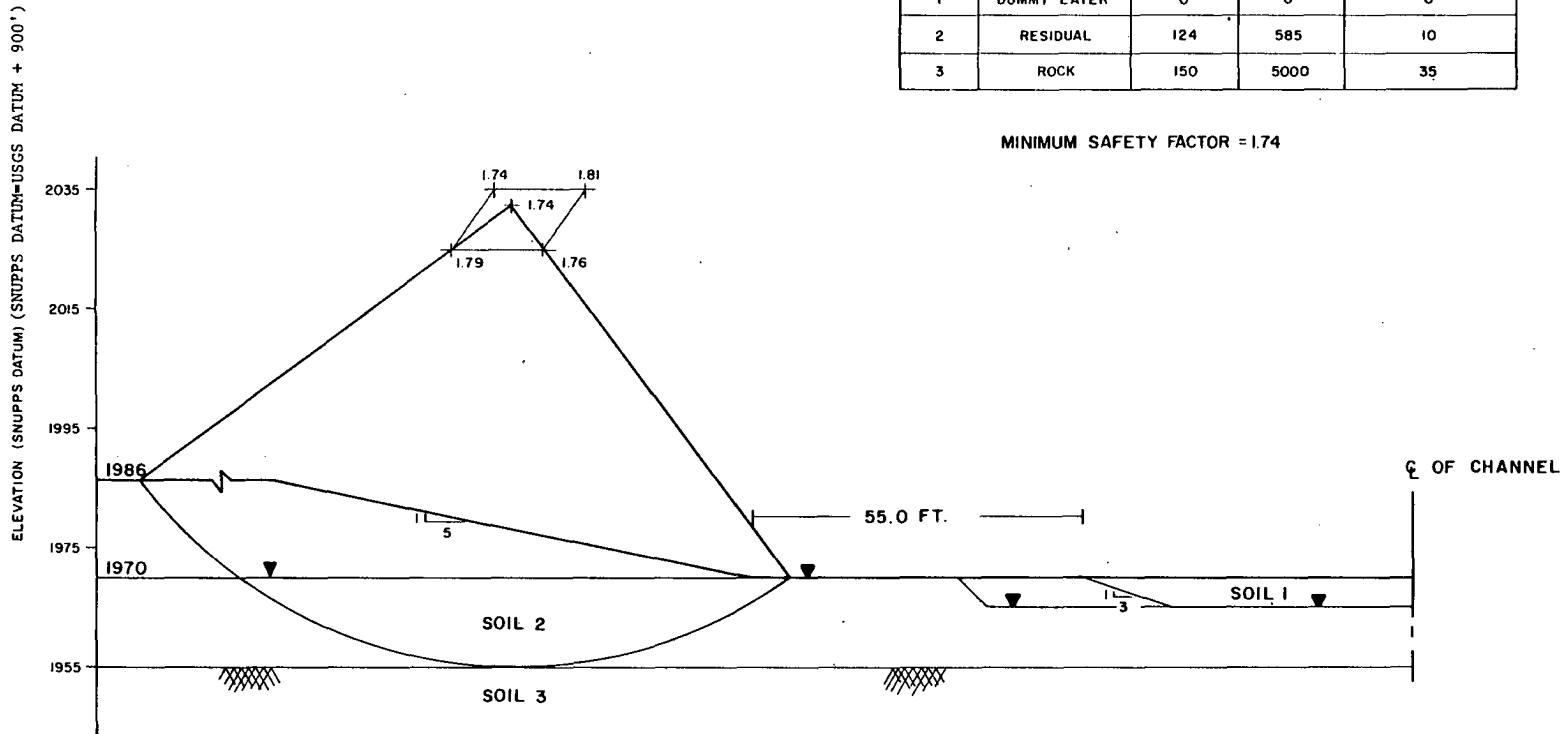

Rev. 0

**WOLF CREEK
UPDATED SAFETY ANALYSIS REPORT**

Figure 2.5-113n

ESWS Intake Channel Slope
Stability Analysis, 5:1 Slope
End of Construction with SSE -
Total Stress Parameters

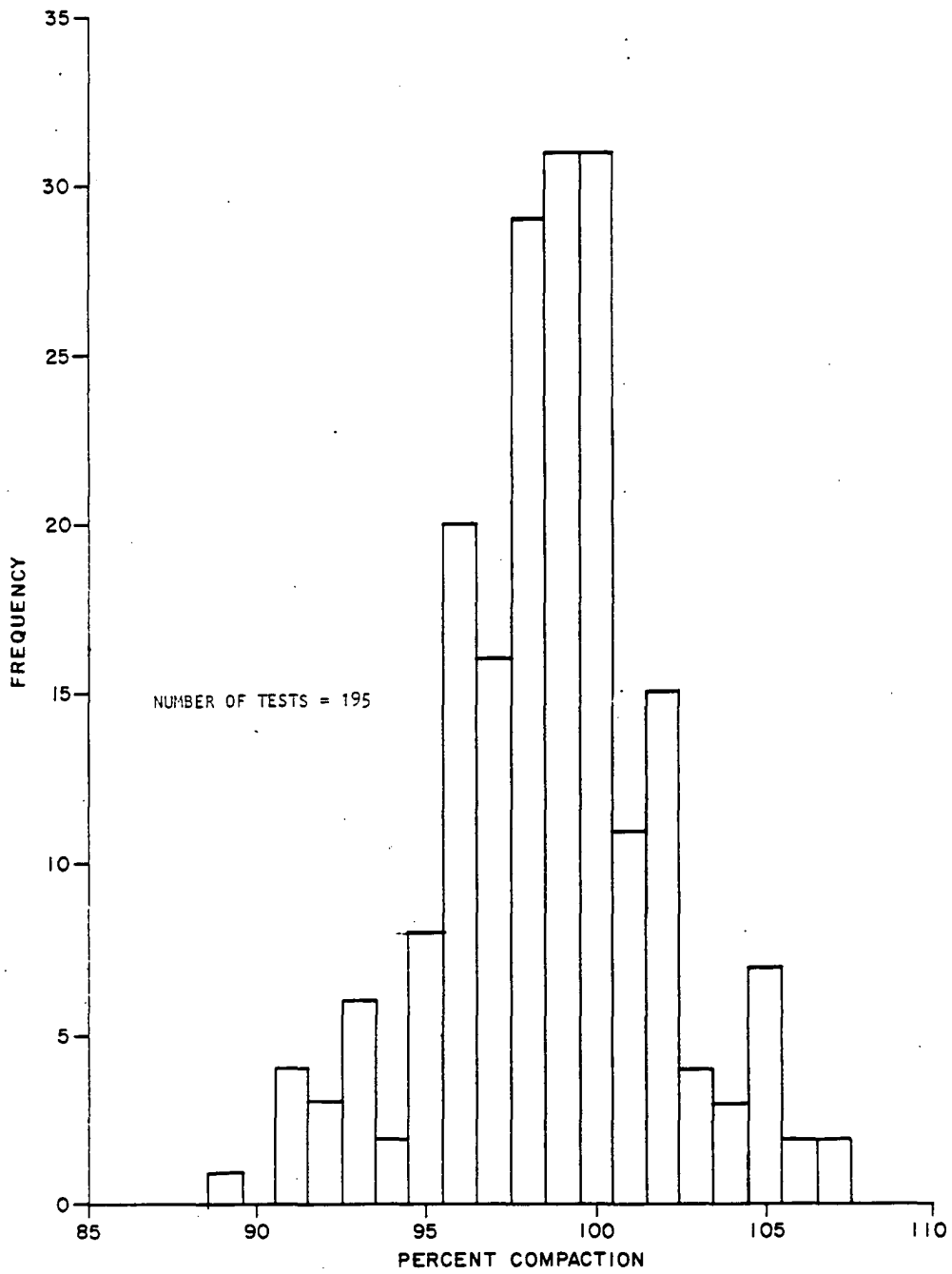

Rev. 0

NOTES:

1. RETESTS ON AREAS WHERE TESTS DID NOT MEET COMPACTION CRITERIA ARE INCLUDED IN THESE PLOTS.
2. MINIMUM COMPACTION IS ASTM D-698.

**WOLF CREEK
UPDATED SAFETY ANALYSIS REPORT**

Figure 2.5-114a

UHS Dam - Earth Fill Embankment
Statistical Distribution Plot

7699-064-07

MATERIAL IDENTIFICATION NO. LWRD-22
80% RELATIVE DENSITY = 117 pcf

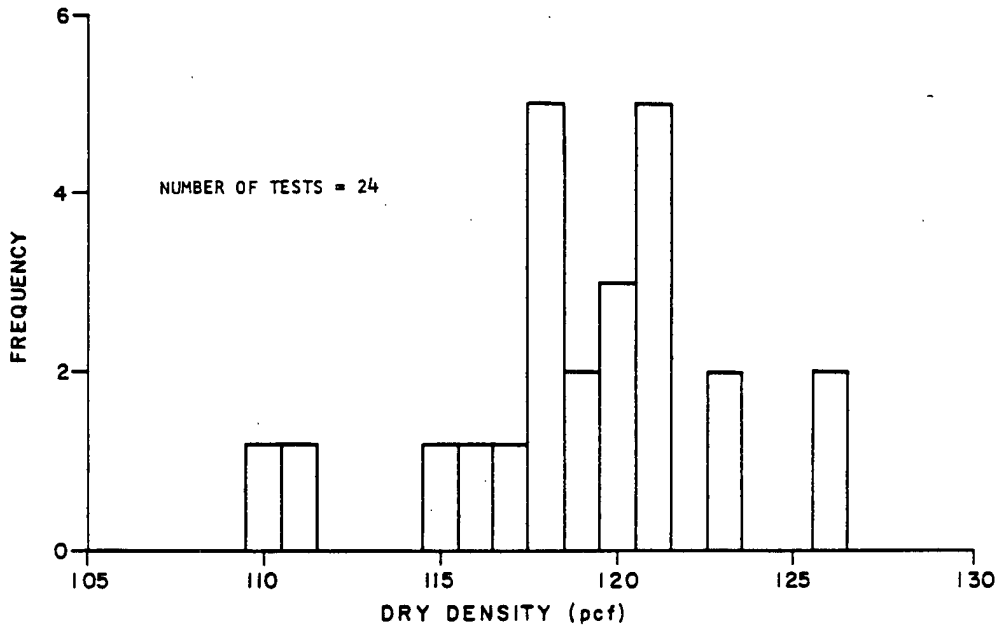

NOTES:

1. RETESTS ON AREAS WHERE TESTS DID NOT MEET COMPACTION CRITERIA ARE INCLUDED IN THIS PLOT.

Rev. 0

WOLF CREEK
UPDATED SAFETY ANALYSIS REPORT

Figure 2.5-114b

UHS Dam - Fine Riprap Bedding
Statistical Distribution Plot

7699-064-07

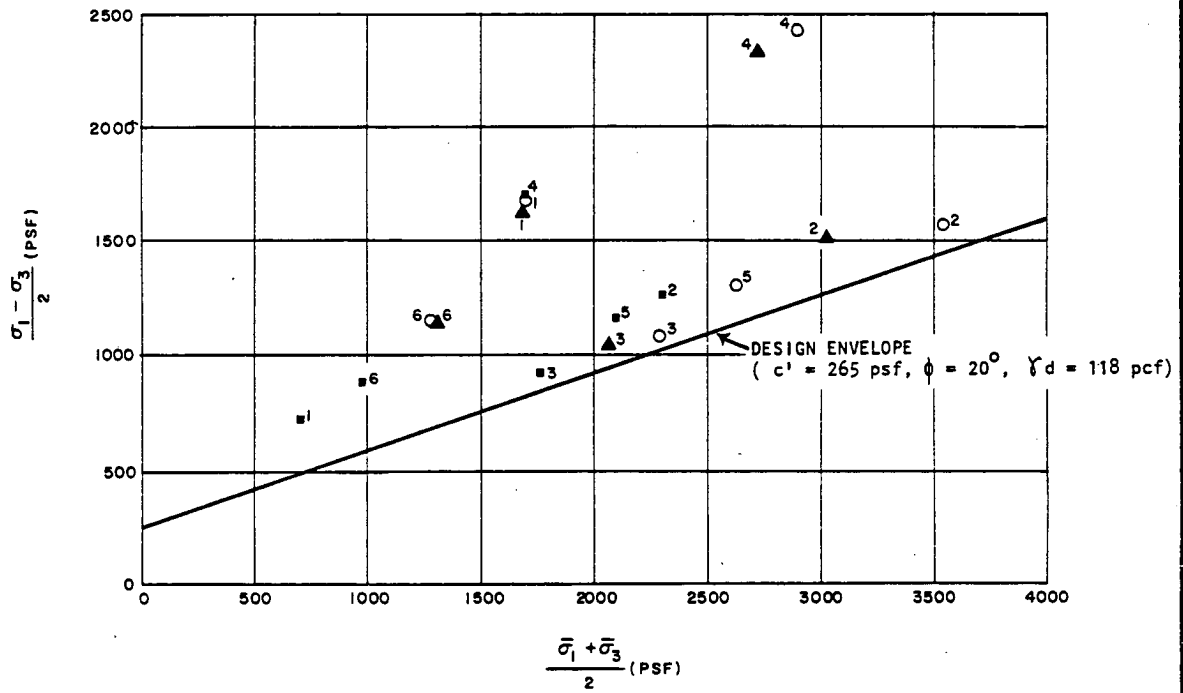

KEY:

3 — INDICATES TEST NUMBER

STRESS CONDITIONS AT:

- ▲ 10% STRAIN
- MAX $\sigma_1 - \sigma_3$
- MAX $\frac{\sigma_1}{\sigma_3}$

Rev. 0

7699-064-07

**WOLF CREEK
 UPDATED SAFETY ANALYSIS REPORT**

Figure 2.5-114c

Consolidated - Undrained Triaxial
 Test Results, Ultimate Heat Sink
 Dam

7699-064-07

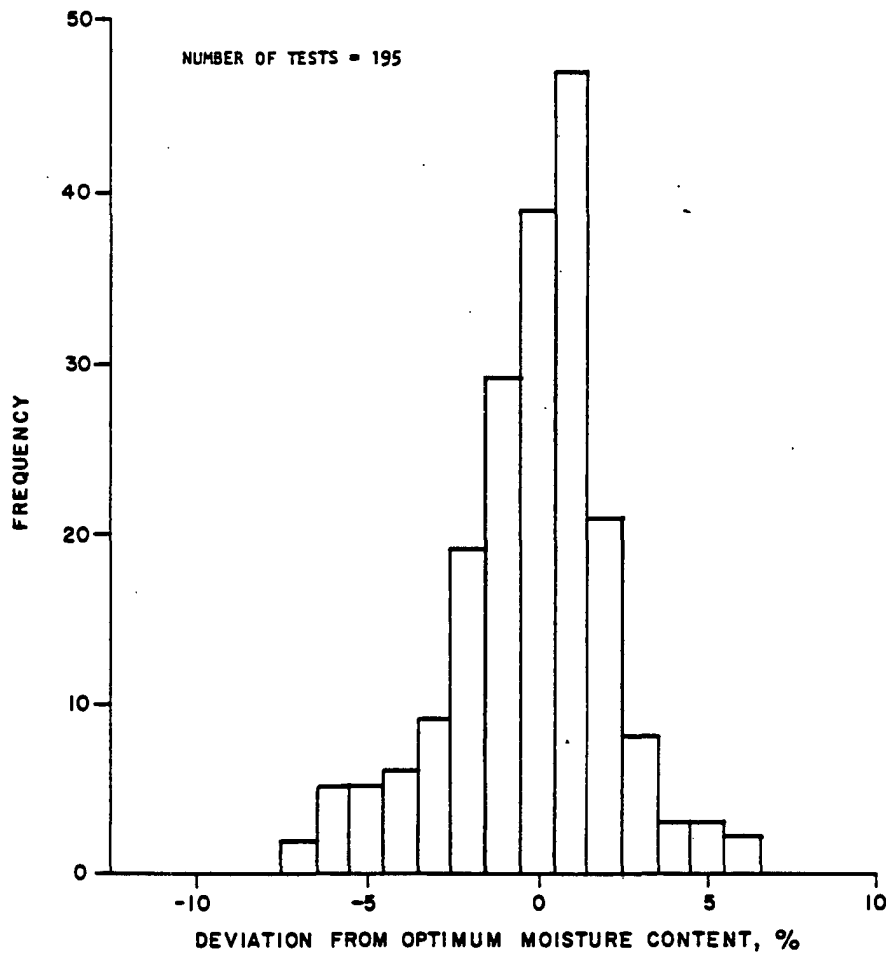

Rev. 0

NOTES:

1. RETESTS ON AREAS WHERE TESTS DID NOT MEET COMPACTION CRITERIA ARE INCLUDED IN THIS PLOT.

WOLF CREEK
UPDATED SAFETY ANALYSIS REPORT

Figure 2.5-114d

UHS Dam - Statistical
Distribution Plot

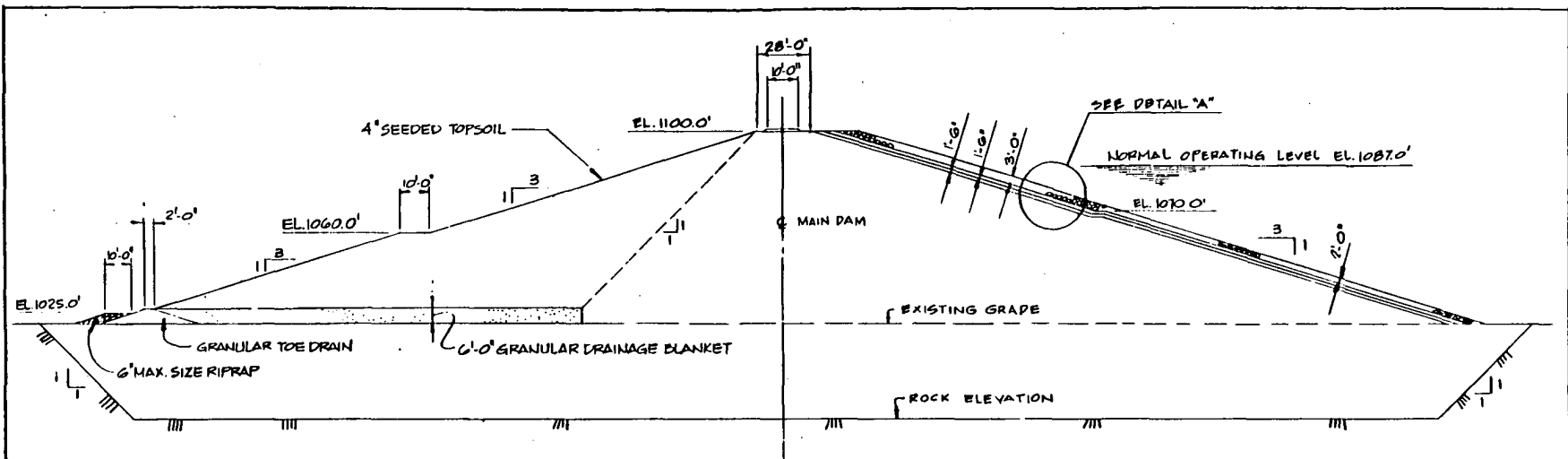

TYPICAL SECTION
MAIN DAM

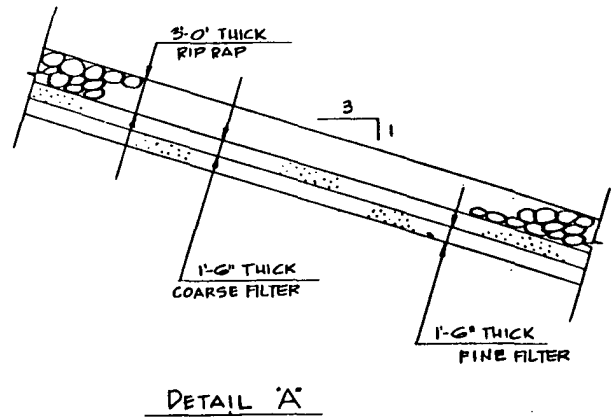

Rev. 0

**WOLF CREEK
UPDATED SAFETY ANALYSIS REPORT**

Figure 2.5-115a

Typical Section - Main Dam

SOIL	SOIL DESCRIPTION	SOIL PARAMETERS		
		DENSITY γ _T PCF	COHESION C PSF	FRICTION ANGLE φ DEGREE
1	COMPACTED CLAY	121	1800	0
2	SAND DRAIN	130	0	32
3	RESIDUAL SOIL	110	1800	0
4	ROCK	150	5000	35

MINIMUM SAFETY FACTOR WITHOUT OBE = 1.52
 MINIMUM SAFETY FACTOR WITH OBE = 1.21

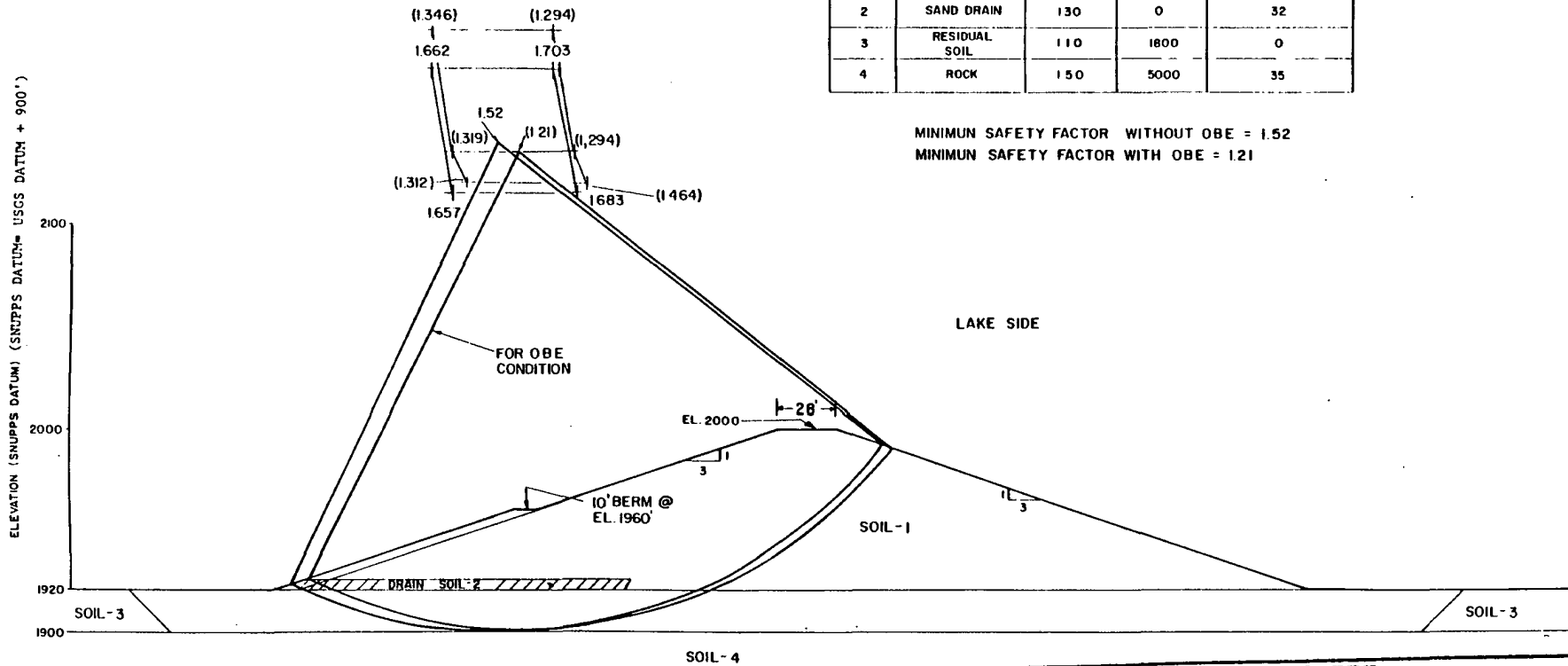

NOTE

1. Values in parenthesis are for OBE condition. OBE of 0.06g

**WOLF CREEK
 UPDATED SAFETY ANALYSIS REPORT**

Figure 2.5-115b

Main Dam - Slope Stability
 Analysis - End of Construction

Rev. 0

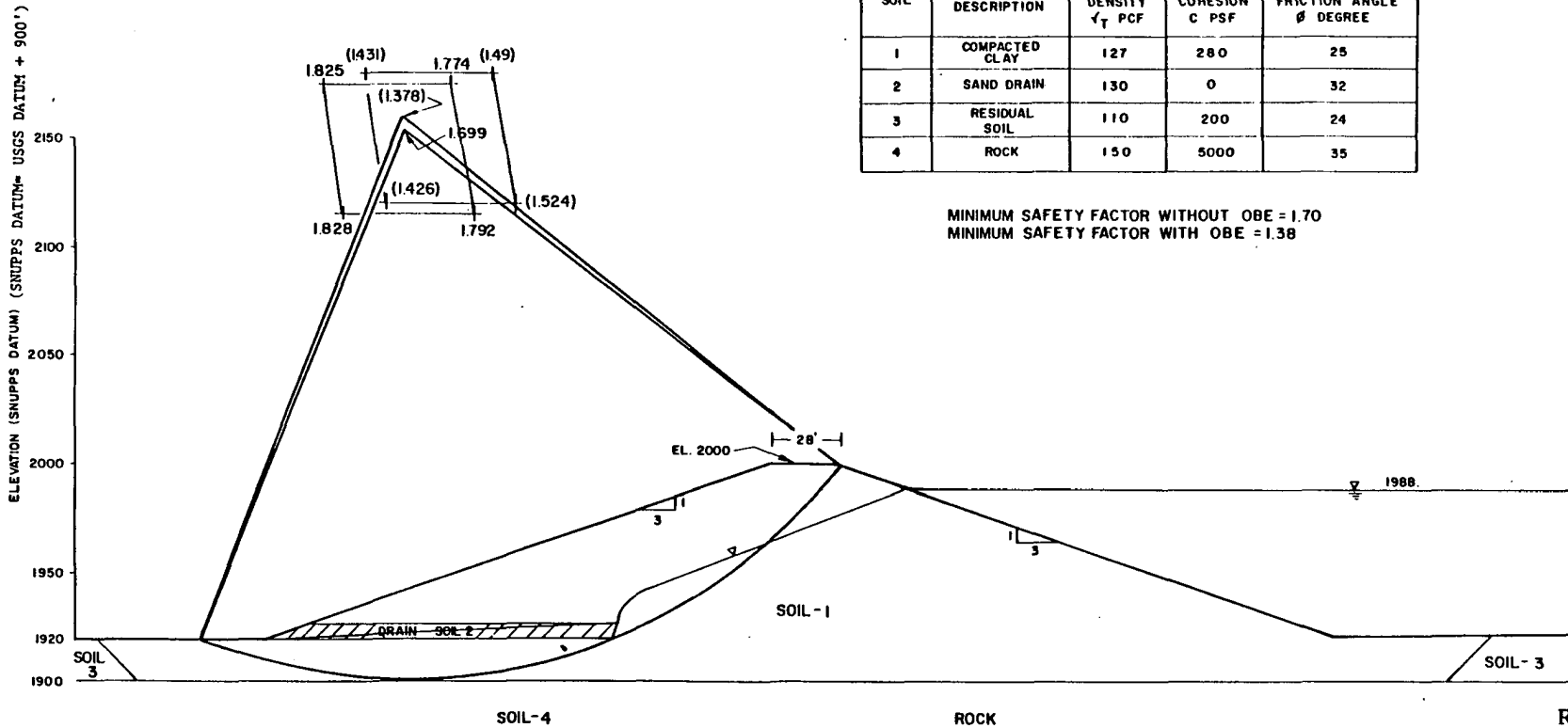

NOTE

1. Values in parenthesis are for OBE condition. OBE of 0.06g

**WOLF CREEK
UPDATED SAFETY ANALYSIS REPORT**

Figure 2.5-115c

Main Dam - Slope Stability
Analysis - Steady State
Conditions

Rev. 0

ELEVATION (SNUPPS DATUM) (SNUPPS DATUM = USGS DATUM + 900')

SOIL	SOIL DESCRIPTION	SOIL PARAMETERS		
		DENSITY γ _t PCF	COHESION c' PSF	FRICTION ANGLE φ DEGREE
1	COMPACTED CLAY	127	280	25
2	SAND DRAIN	130	0	32
3	RESIDUAL SOIL	110	200	24
4	ROCK	130	5000	35
5	RIPRAP	115	0	32

MINIMUM SAFETY FACTOR = 1.20

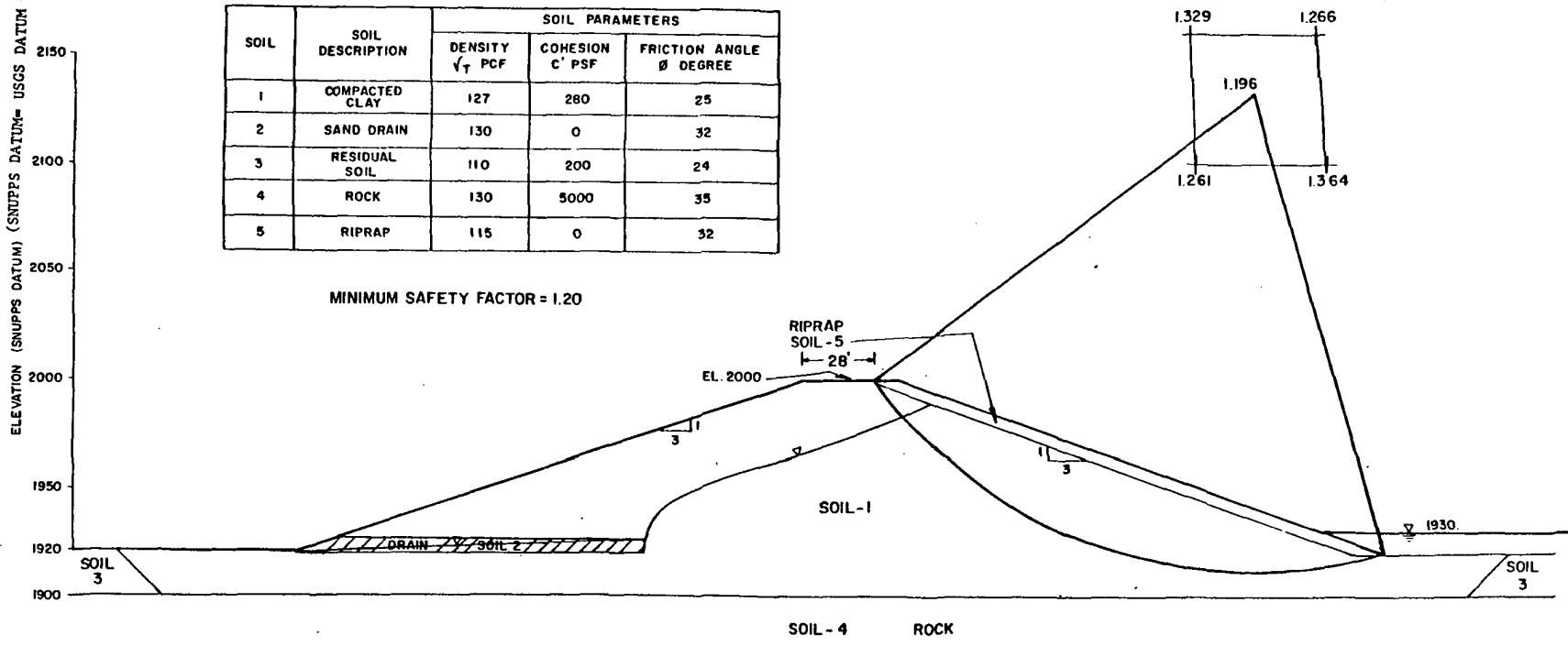

Rev. 0

WOLF CREEK
UPDATED SAFETY ANALYSIS REPORT

Figure 2.5-115d

Main Dam - Slope Stability
 Analysis - Rapid Drawdown

EXPLANATION:

- ⊠ INDICATES SETTLEMENT MONUMENT LOCATION
- Pop HELMADER SHALE MEMBER
- Ppp PLATTSOUTH Limestone MEMBER
- Poh HEEBNER SHALE MEMBER
- Ppl LEAVENWORTH Limestone MEMBER
- Pps SNYDERVILLE SHALE MEMBER

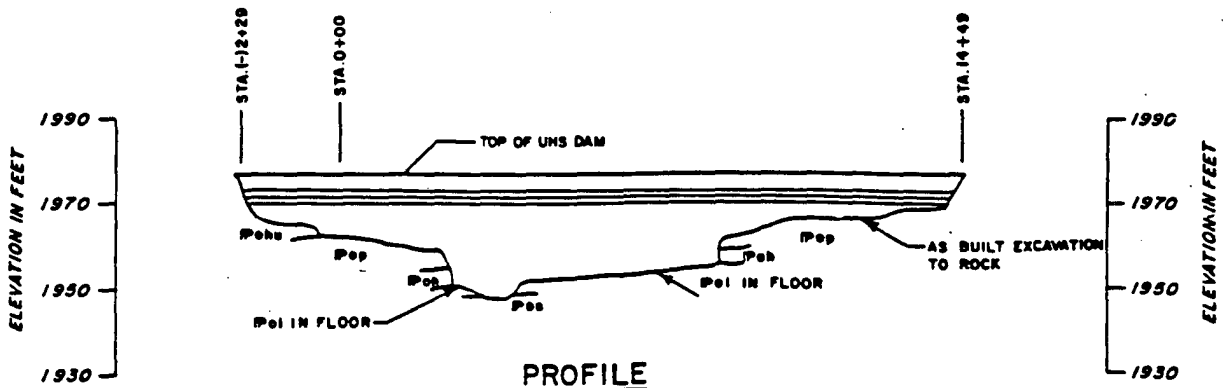
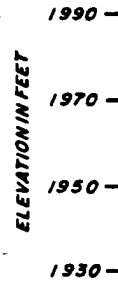
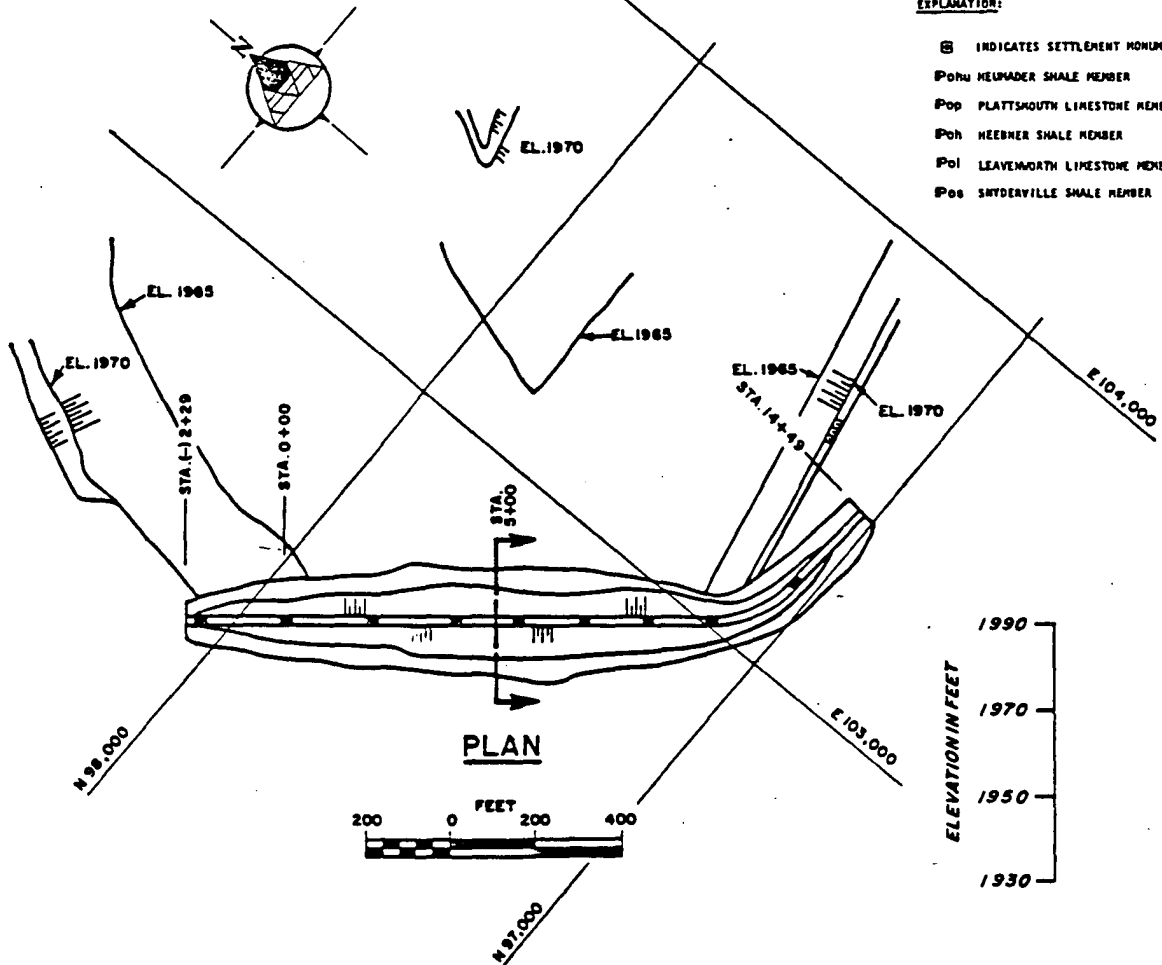

Rev. 0

**WOLF CREEK
UPDATED SAFETY ANALYSIS REPORT**

Figure 2.5-116

Ultimate Heat Sink Dam - Plan and Profile

DRAWING REFERENCES:

TITLED: ULTIMATE HEAT SINK DAM
 PLAN, PROFILE & SECTION
 FOR: WOLF CREEK GENERATING STATION
 UNIT 1; KANSAS GAS & ELECTRIC COMP.
 KANSAS CITY POWER & LIGHT COMPANY
 BY: SARGENT & LUNDY ENGINEERS
 CHICAGO, ILLINOIS
 DRAWING NO.: S-81, REV. E.
 DATED: 8-25-80

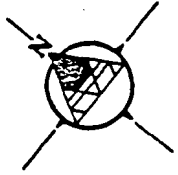

EXPLANATION:

Po1 LEAVENWORTH LIMESTONE MEMBER
Pos SNYDERVILLE SHALE MEMBER

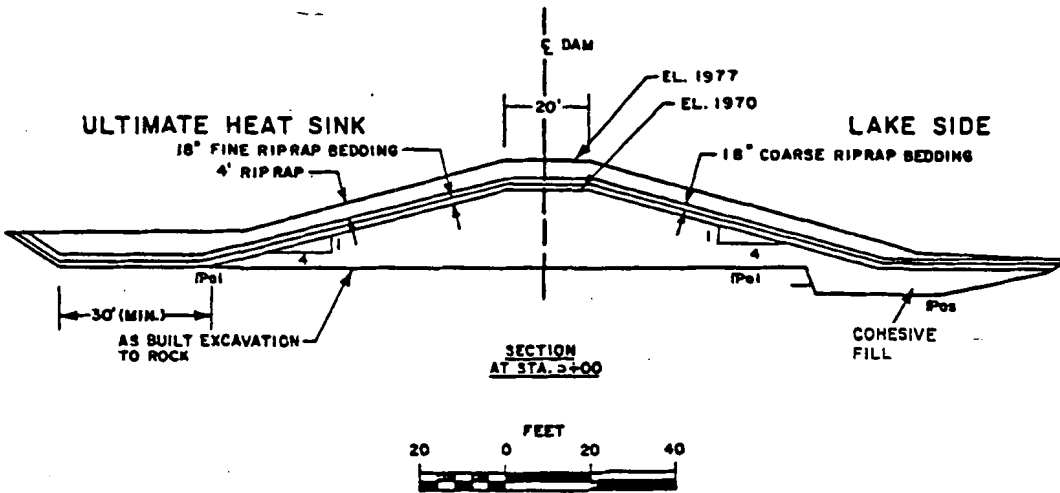

Rev. 0

**WOLF CREEK
UPDATED SAFETY ANALYSIS REPORT**

Figure 2.5-117

Typical Section - UHS Dam

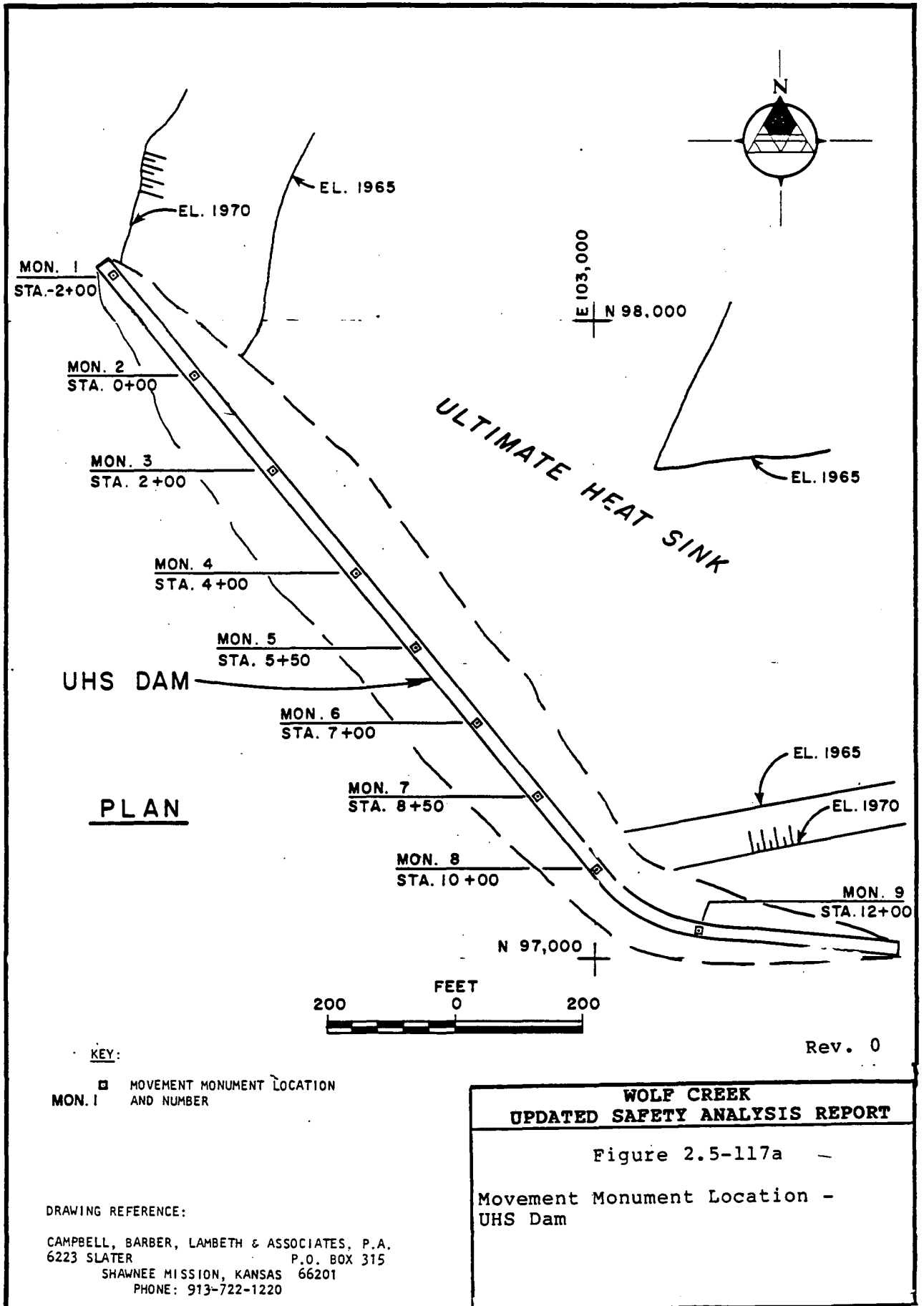

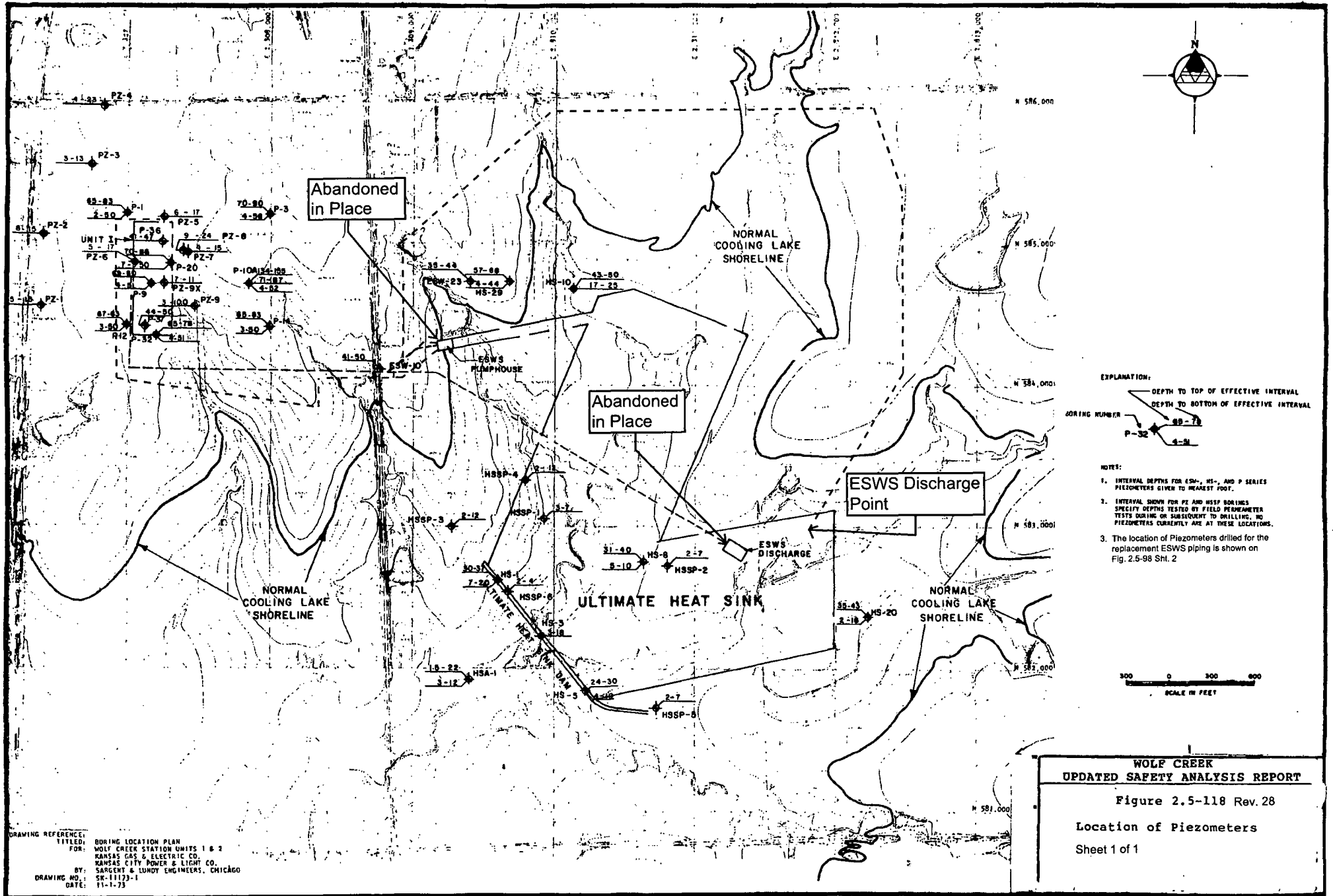

EXPLANATION:

DEPTH TO TOP OF EFFECTIVE INTERVAL
 DEPTH TO BOTTOM OF EFFECTIVE INTERVAL
 BORING NUMBER
 P-32
 4-M

NOTES:

- INTERVAL DEPTHS FOR ESW-, HS-, AND P SERIES PIEZOMETERS GIVEN TO NEAREST FOOT.
- INTERVAL DEPTHS FOR PE AND HSSP BORINGS SPECIFY DEPTHS TESTED BY FIELD PERMEAMETER TESTS DURING OR SUBSEQUENT TO DRILLING. NO PIEZOMETERS CURRENTLY ARE AT THESE LOCATIONS.
- The location of Piezometers drilled for the replacement ESW piping is shown on Fig. 2.5-98 Sht. 2

WOLF CREEK
UPDATED SAFETY ANALYSIS REPORT
 Figure 2.5-118 Rev. 28
 Location of Piezometers
 Sheet 1 of 1

DRAWING REFERENCE:
 TITLED: BORING LOCATION PLAN
 FOR: WOLF CREEK STATION UNITS 1 & 2
 KANSAS GAS & ELECTRIC CO.
 KANSAS CITY POWER & LIGHT CO.
 BY: SARGENT & LUNDY ENGINEERS, CHICAGO
 DRAWING NO.: SK-11173-1
 DATE: 11-1-73

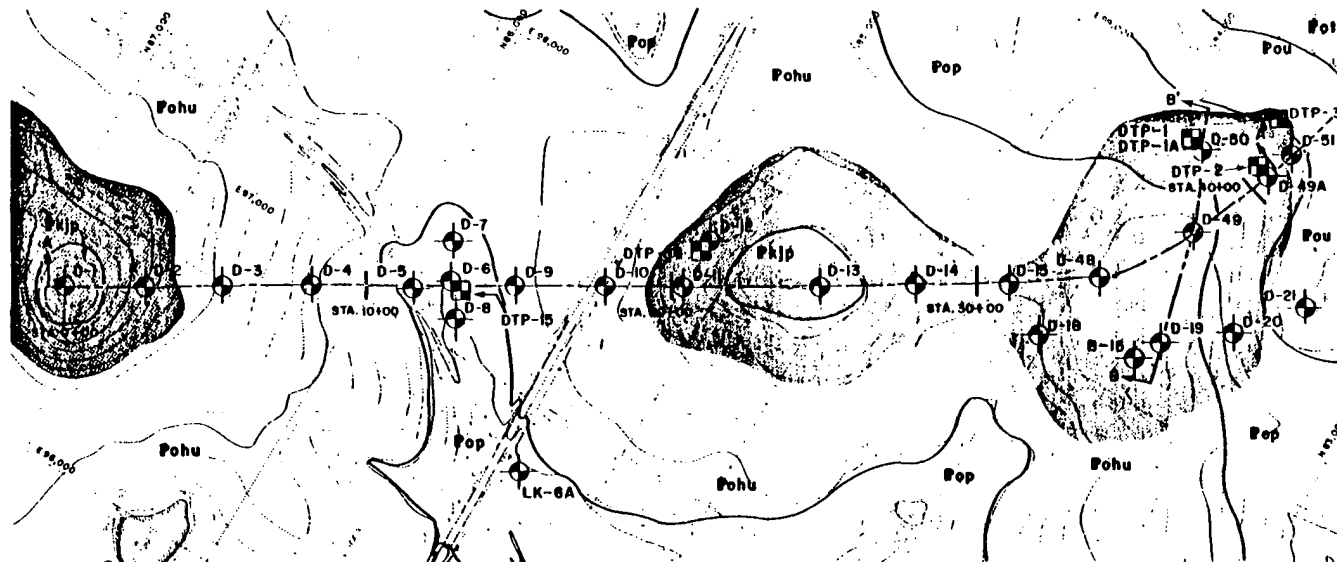

NOTE: THE GEOLOGIC STRIP MAPS INDICATE THE APPROXIMATE SURFACE LIMITS OF THE RESIDUAL SOILS, AS RELATED TO THEIR RESPECTIVE BEDROCK UNIT.

EXPLANATION:

- GEOLOGIC CONTACT
- - - INFERRED GEOLOGIC CONTACT
- | TEST BORING LOCATION AND DEPTH ON SUBSURFACE SECTION
- GROUND LEVEL
- ▬ COOLING LAKE WATER LEVEL

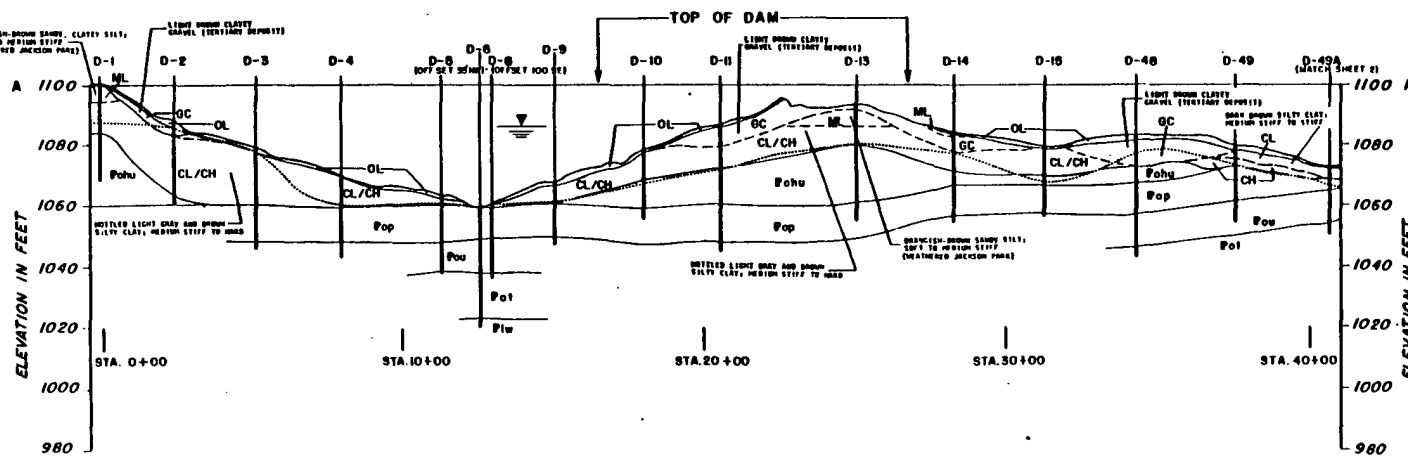

BASE MAP MODIFIED FROM:

TITLED: WOLF CREEK PROJECT
TOPOGRAPHIC MAPS
BY: KAWAS GAS AND ELECTRIC
EDWARDS
DRAWING NUMBER: W025-T-1001
REVISION DATES: 1-14-76
SHEET NUMBER: 26

NOTE:
THE DEPTH AND THICKNESS OF SOIL AND ROCK STRATA INDICATED ON THE SUBSURFACE SECTION WERE OBTAINED BY INTERPOLATING BETWEEN BORINGS. INFORMATION ON ACTUAL SOIL AND ROCK CONDITIONS EXIST ONLY AT BORING LOCATIONS. IT IS POSSIBLE THAT SOIL AND ROCK CONDITIONS BETWEEN BORINGS MAY VARY FROM THOSE INDICATED.

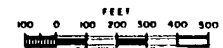

Rev. 0

WOLF CREEK
UPDATED SAFETY ANALYSIS REPORT

Figure 2.5-119 (Sheet 1 of 3)

Plot Plan with Geologic Strip Map
and Main Dam Subsurface Sections
A-A', A'A", and A'-A'''

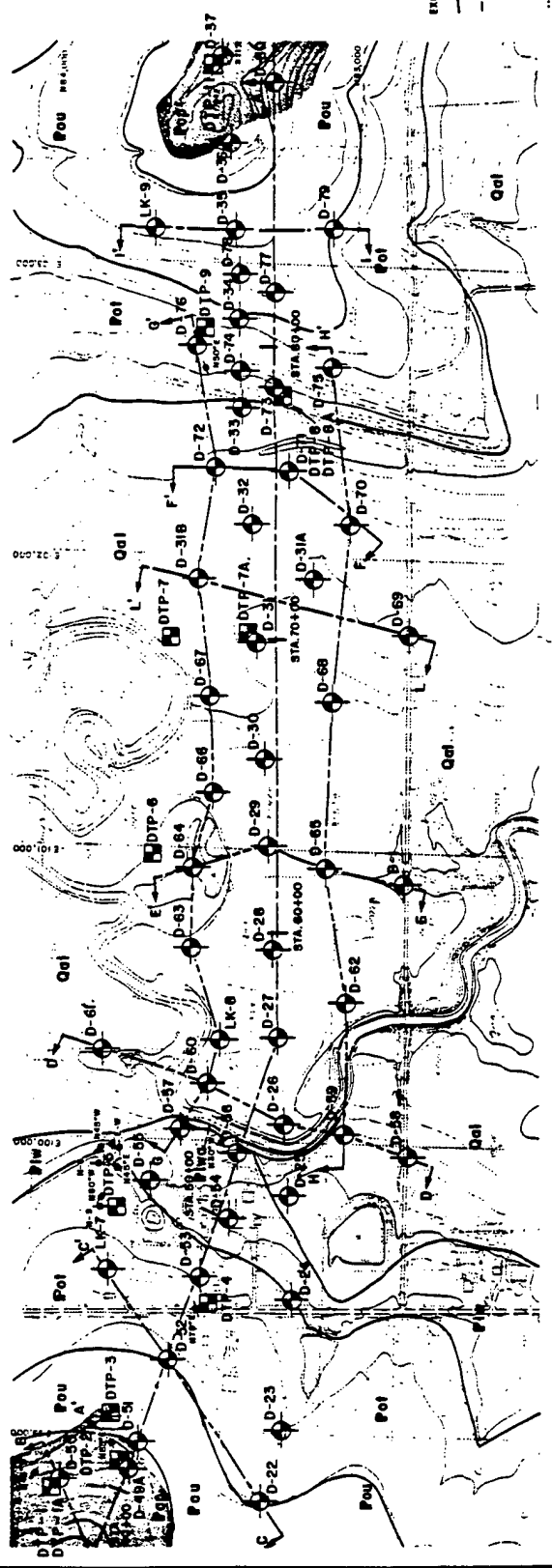
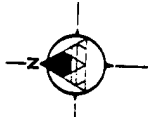

EXPLANATION:
 ————— GEOLOGIC CONTACT
 - - - - - INFERRED GEOLOGIC CONTACT
 - - - - - TEST BORING LOCATION AND DEPTH OF SURFACE SECTION
 - - - - - GROUND LEVEL
 - - - - - COOLING LAKE WATER LEVEL

NOTE: THE GEOLOGIC STRIP MAPS INDICATE THE APPROXIMATE SURFACE LIMITS OF THE REGIONAL SOILS, AS RELATED TO THEIR RESPECTIVE BRUNSON UNIT.

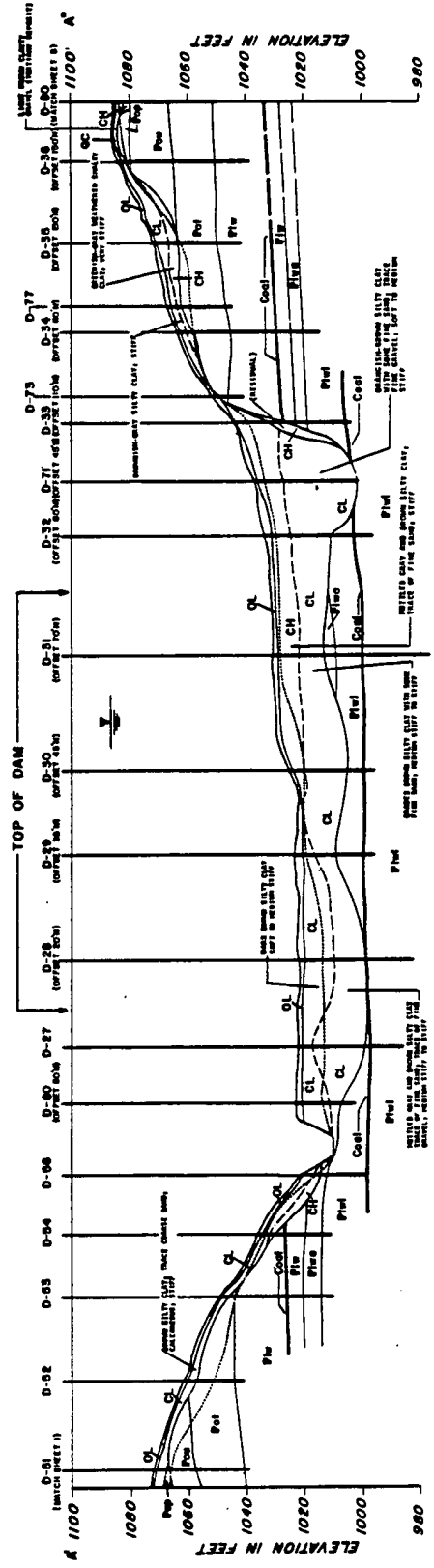

EXPLANATION:
 ————— GEOLOGIC CONTACT
 - - - - - INFERRED GEOLOGIC CONTACT
 - - - - - TEST BORING LOCATION AND DEPTH OF SURFACE SECTION
 - - - - - GROUND LEVEL
 - - - - - COOLING LAKE WATER LEVEL

NOTE: THE GEOLOGIC STRIP MAPS INDICATE THE APPROXIMATE SURFACE LIMITS OF THE REGIONAL SOILS, AS RELATED TO THEIR RESPECTIVE BRUNSON UNIT.

Rev. 0



WOLF CREEK
 UPDATED SAFETY ANALYSIS REPORT
 Figure 2.5-119 (Sheet 2 of 3)

Plot Plan with Geologic Strip Map
 and Main Dam Subsurface Sections
 A-A', A'A", and A'-A'''

DATE AND SOURCE FROM:
 TITLE: WOLF CREEK DAM
 PROJECT NO.:
 DRAWING NO.: 2.5-119
 SHEET NO.: 2 OF 3
 DESIGNED BY: J. L. J.
 CHECKED BY: J. L. J.

NOTE:
 THE DEPTH AND THICKNESS OF SOIL AND ROCK STRATA INDICATED ON THE SURFACE SECTION WERE OBTAINED BY INTERPOLATING BETWEEN BORINGS. AN INDICATION OF ACTUAL SOIL AND ROCK COMPOSITIONS GIVEN IN BORINGS MAY VARY FROM THOSE INDICATED.

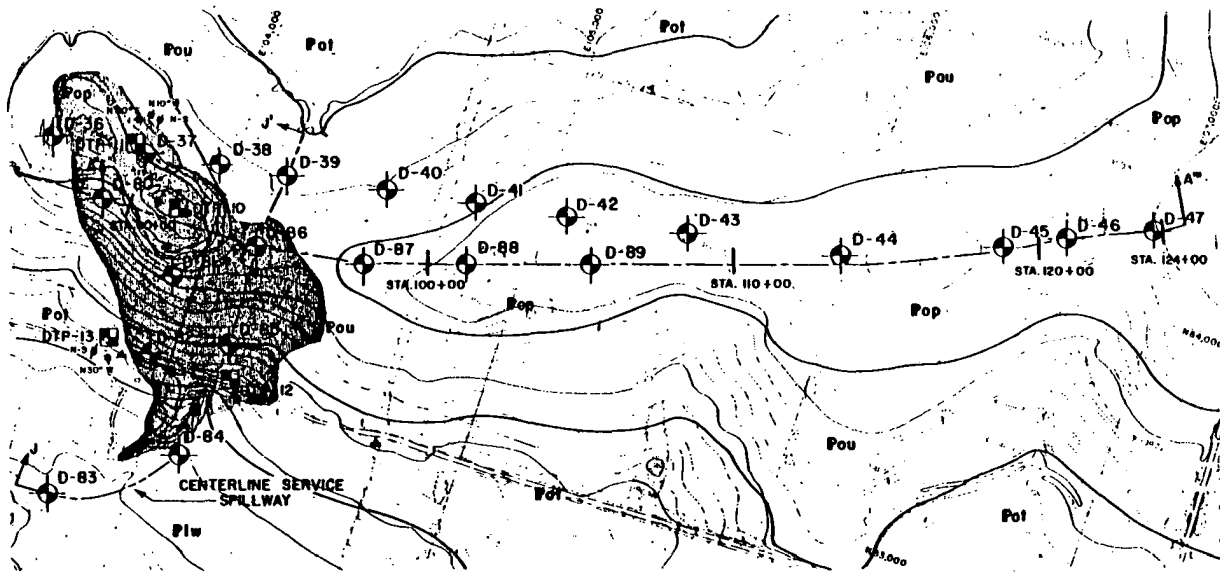

NOTE: THE GEOLOGIC STRIP MAPS INDICATE THE APPROXIMATE SURFACE LIMITS OF THE RESIDUAL SOILS, AS RELATED TO THEIR RESPECTIVE BEDROCK UNIT.

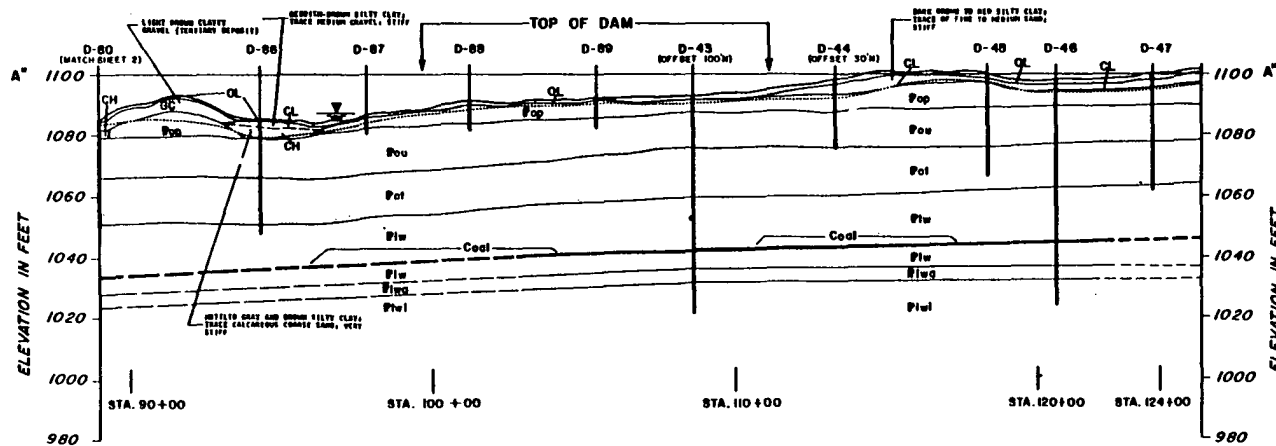

- EXPLANATION:
- GEOLOGIC CONTACT
 - - - INFERRED GEOLOGIC CONTACT
 - | TEST BORING LOCATION AND DEPTH ON SUBSURFACE SECTION
 - GROUND LEVEL
 - ▼ COOLING LAKE WATER LEVEL



Rev. 0

BASE MAP MODIFIED FROM:

TITLED: WOLF CREEK PROJECT
TOPOGRAPHIC MAPS

BY: HAROLD GAS AND ELECTRIC
COMPANY

NOTE:

DRAWING NUMBER: 8015-F-1001

REVISION DATES: 1-14-54

SHEET NUMBER: 24

THE DEPTH AND THICKNESS OF SOIL AND ROCK STRATA INDICATED ON THE SUBSURFACE SECTION WERE OBTAINED BY INTERPOLATING BETWEEN BORINGS. THE INFORMATION ON ACTUAL SOIL AND ROCK CONDITIONS EXIST ONLY AT BORING LOCATIONS. IT IS POSSIBLE THAT SOIL AND ROCK CONDITIONS BETWEEN BORINGS MAY VARY FROM THOSE INDICATED.

**WOLF CREEK
UPDATED SAFETY ANALYSIS REPORT**

Figure 2.5-119 (Sheet 3 of 3)

Plot Plan with Geologic Strip Map
and Main Dam Subsurface Sections
A-A', A'A", and A'-A'''

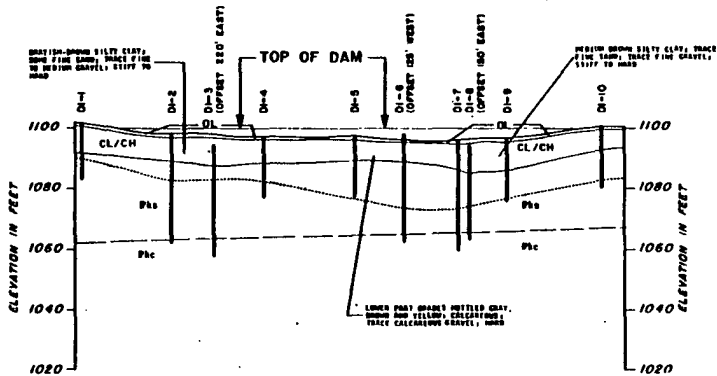
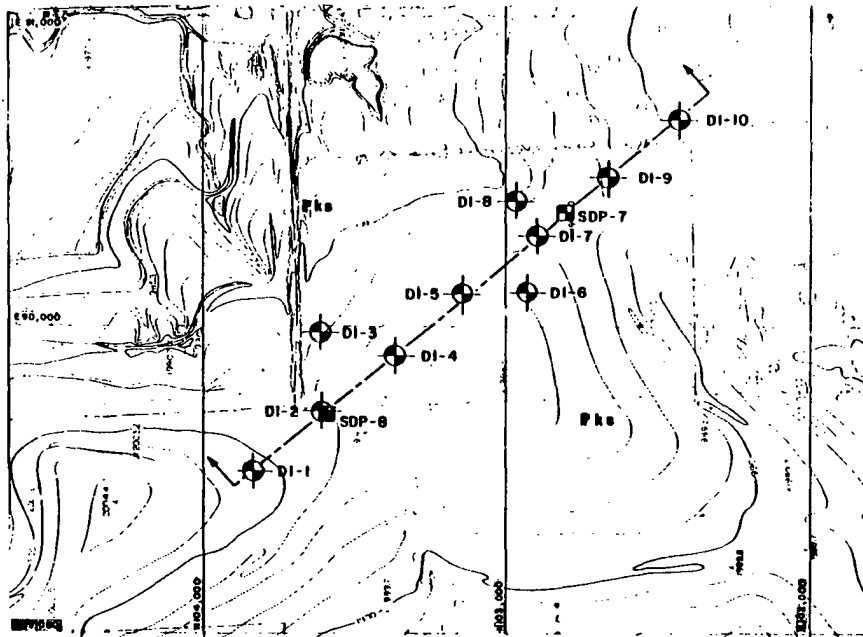

Rev. 0

**WOLF CREEK
UPDATED SAFETY ANALYSIS REPORT**

Figure 2.5-120

Plot Plan with Geologic Strip Map
and Subsurface Section - Saddle
Dam I

BASE MAP MODIFIED FROM:
TITLED: WOLF CREEK PROJECT
TOPOGRAPHIC MAPS
BY: KANSAS GAS AND ELECTRIC
COMPANY
DRAWING NUMBER: 802.5-1-1007
REVISION DATED: 5/12/76
SHEET NUMBER: 12 AND 10

NOTE:
THE DEPTH AND THICKNESS OF SOIL AND ROCK STRATA INDICATED ON THE SUBSURFACE SECTION WERE OBTAINED BY INTERPOLATING BETWEEN BORINGS. INFORMATION ON ACTUAL SOIL AND ROCK CONDITIONS EXIST ONLY AT BORING LOCATIONS. IT IS POSSIBLE THAT SOIL AND ROCK CONDITIONS BETWEEN BORINGS MAY VARY FROM THOSE INDICATED.

- EXPLANATION:
- GEOLGIC CONTACT
 - - - - - INFERRED GEOLGIC CONTACT
 - | TEST BORING LOCATION AND DEPTH OR SUBSURFACE SECTION
 - GROUND LEVEL
 - ▽ ELEVING LINE WATER LEVEL

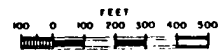
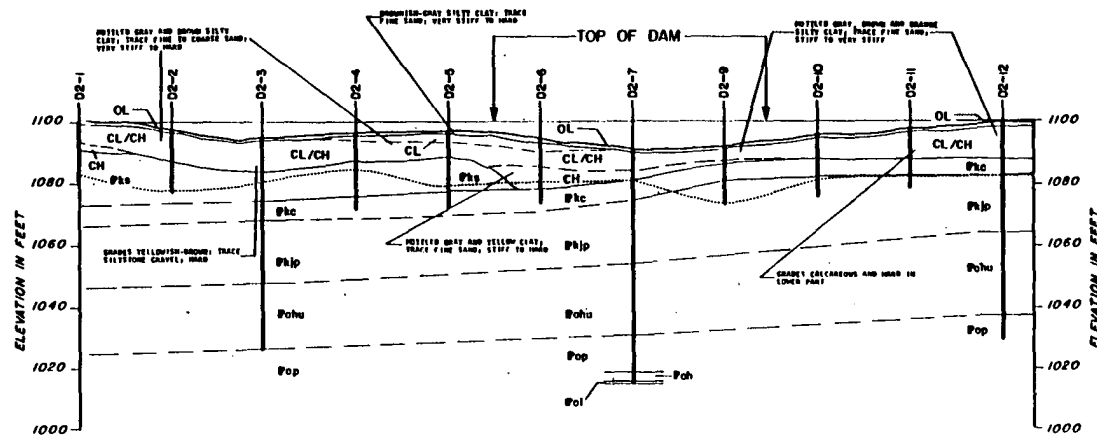
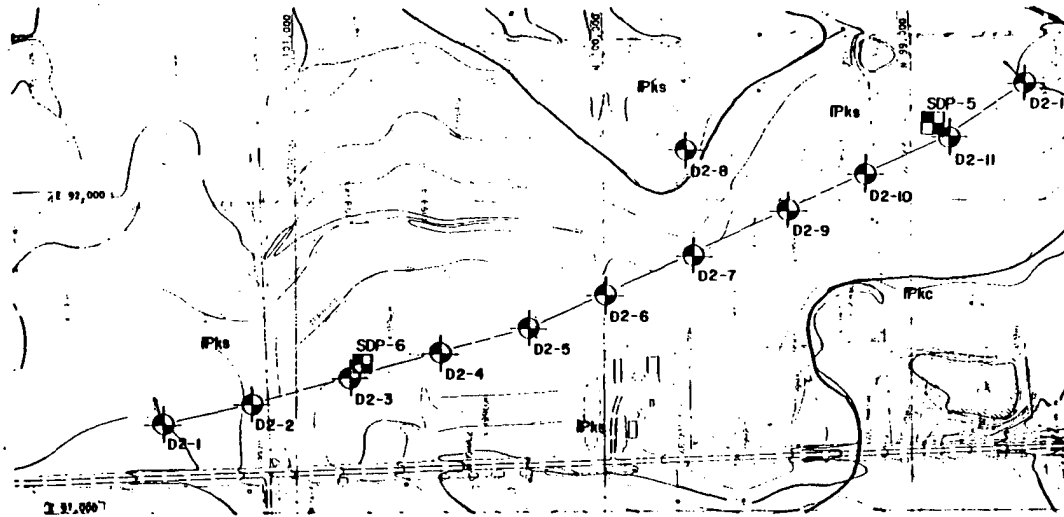

BASE MAP PROVIDED FROM
 TITLED: WOLF CREEK PROJECT
 HYDROGRAPHIC MAPS
 BY: AERIAL, G.A. AND ELECTRIC
 COMPANY
 DRAWING NUMBER: 7075.1 (10/71)
 REVISION DATE: 5-17-76
 SHEET NUMBER: 11

NOTE:
 THE DEPTH AND THICKNESS OF SOIL AND ROCK STRATA INDICATED ON THE SUBSURFACE SECTION WERE OBTAINED BY INTERPOLATING BETWEEN BORINGS. INTERPOLATION ON ACTUAL SOIL AND ROCK CONDITIONS EXIST ONLY AS BORING LOCATIONS. IT IS POSSIBLE THAT SOIL AND ROCK CONDITIONS BETWEEN BORINGS MAY VARY FROM THOSE INDICATED.

EXPLANATION:
 ——— GEOLGIC CONTACT
 - - - - - INFERRED GEOLGIC CONTACT
 | TEST BORING LOCATION AND DEPTH ON SUBSURFACE SECTION
 - - - - - GROUND LEVEL
 - - - - - COOLING LAKE WATER LEVEL

**WOLF CREEK
 UPDATED SAFETY ANALYSIS REPORT**

Figure 2.5-121

Plot Plan with Geologic Strip Map and Subsurface Section - Saddle Dam II

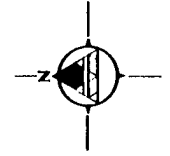
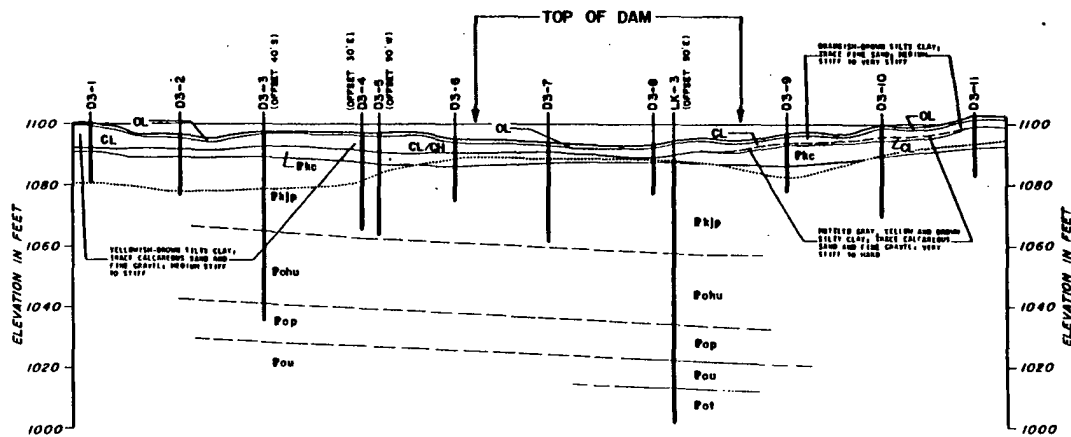
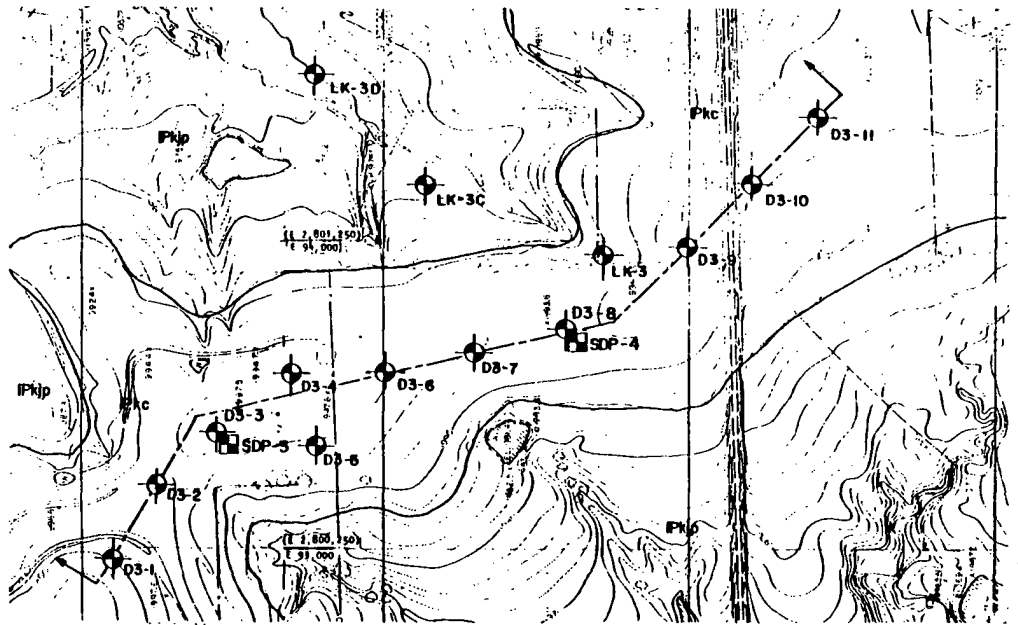

- EXPLANATION:
- GEOLGIC CONTACT
 - - - - - INFERRED GEOLGIC CONTACT
 - | TEST BORING LOCATION AND DEPTH ON SUBSURFACE SECTION
 - GROUND LEVEL
 - COOLING LAKE WATER LEVEL



**WOLF CREEK
UPDATED SAFETY ANALYSIS REPORT**

Figure 2.5-122

Plot Plan with Geologic Strip Map
and Subsurface Section - Saddle
Dam III

BASE MAP MODIFIED FROM

TITLE: WOLF CREEK PROJECT
CONTOUR MAPS
BY: FRANK LAM AND ELECTRIC
CORPORATION

DRAWING NUMBER: 2045-2-100A
REVISION SHEET: 5 OF 24
DATE: 11/28/88

NOTE:

THE DEPTH AND THICKNESS OF SOIL AND ROCK STRATA INDICATED ON THE SUBSURFACE SECTION WERE OBTAINED BY INTERPOLATING BETWEEN BORINGS. INFORMATION ON ACTUAL SOIL AND ROCK CONDITIONS EXIST ONLY AT BORING LOCATIONS. IT IS POSSIBLE THAT SOIL AND ROCK CONDITIONS BETWEEN BORINGS MAY VARY FROM THOSE INDICATED.

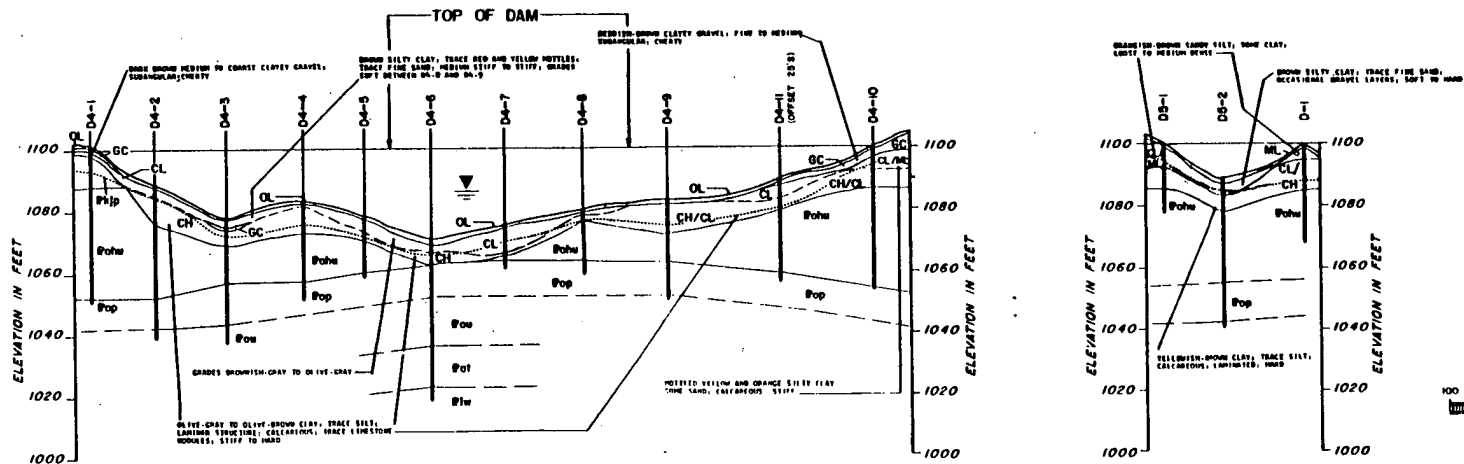
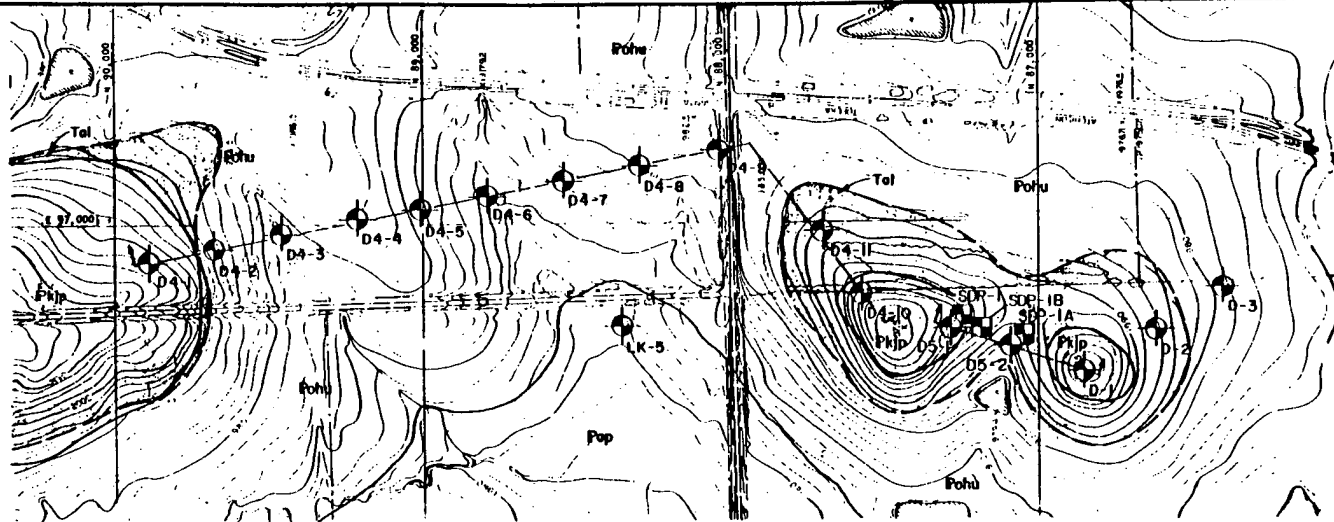

Rev. 0

BASE MAP MODIFIED FROM:

TITLE: WOLF CREEK PROJECT
 GEOGRAPHIC MAP
 BY: RADIAL LAY AND ELECTRIC
 COMPANY

DRAWING NUMBER: 8075.1-1001
 REVISION DATED: 4-12-76
 SHEET NUMBER: 30

NOTE:

THE DEPTH AND THICKNESS OF SOIL AND ROCK STRATA INDICATED ON THE SURFACE SECTION WERE OBTAINED BY INTERPOLATING BETWEEN BORINGS. THE DEVIATION ON ACTUAL SOIL AND ROCK CONDITIONS EXIST ONLY AT BORING LOCATIONS. IT IS POSSIBLE THAT SOIL AND ROCK CONDITIONS BETWEEN BORINGS MAY VARY FROM THOSE INDICATED.

EXPLANATION:

- GEOLGIC CONTACT
- - - - - INFERRED GEOLGIC CONTACT
- | TEST BORING LOCATION AND DEPTH ON SURFACE SECTION
- GROUND LEVEL
- ▽ COILING LOW WATER LEVEL

**WOLF CREEK
 UPDATED SAFETY ANALYSIS REPORT**

Figure 2.5-123

Plot Plan with Geologic Strip Map
 and Subsurface Section - Saddle
 Dams IV and V

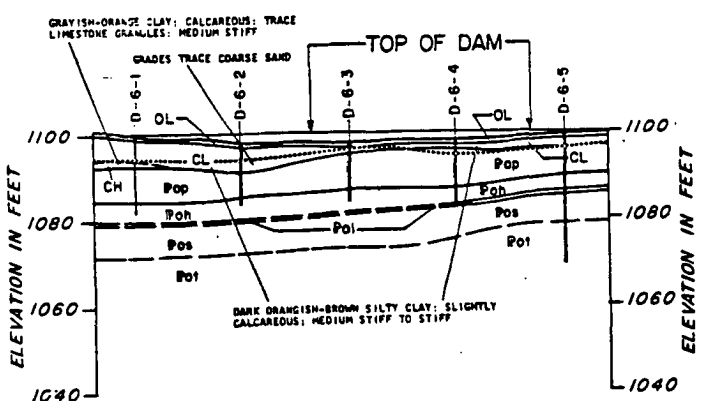
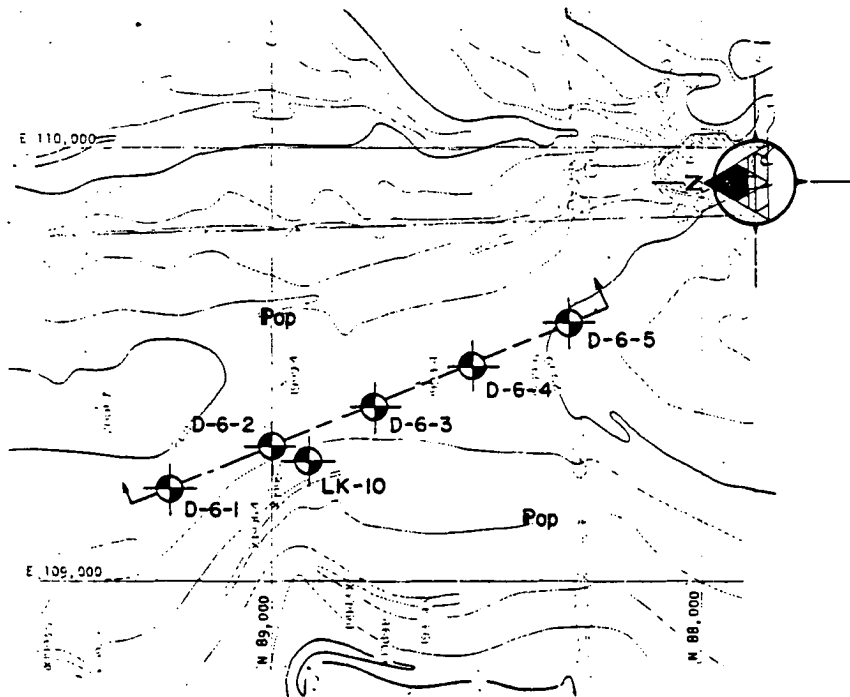

NOTE:

THE DEPTH AND THICKNESS OF SOIL AND ROCK STRATA INDICATED ON THE SUBSURFACE SECTION WERE OBTAINED BY INTERPOLATING BETWEEN BORINGS. INFORMATION ON ACTUAL SOIL AND ROCK CONDITIONS EXIST ONLY AT BORING LOCATIONS. IT IS POSSIBLE THAT SOIL AND ROCK CONDITIONS BETWEEN BORINGS MAY VARY FROM THOSE INDICATED.

EXPLANATION:

- GEOLOGIC CONTACT
- INFERRED GEOLOGIC CONTACT
- TEST BORING LOCATION AND DEPTH ON SUBSURFACE SECTION
- GROUND LEVEL
- COOLING LAKE WATER LEVEL

BASE MAP MODIFIED FROM:
 TITLED: WOLF CREEK PROJECT TOPOGRAPHIC MAPS
 BY: KANSAS GAS AND ELECTRIC COMPANY
 DRAWING NUMBER: 8025-E-1001
 REVISION DATED: 5-17-74
 SHEET NUMBER: 21

**WOLF CREEK
 UPDATED SAFETY ANALYSIS REPORT**

Figure 2.5-124

Plot Plan with Geologic Strip Map
 and Subsurface Section - Saddle
 Dam VI

Rev. 0

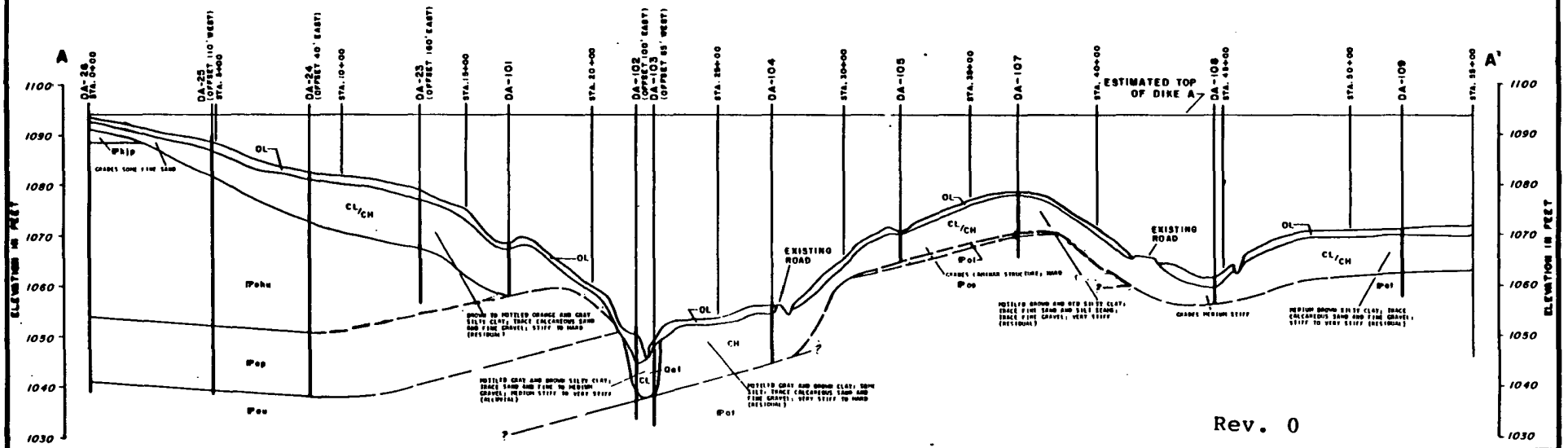
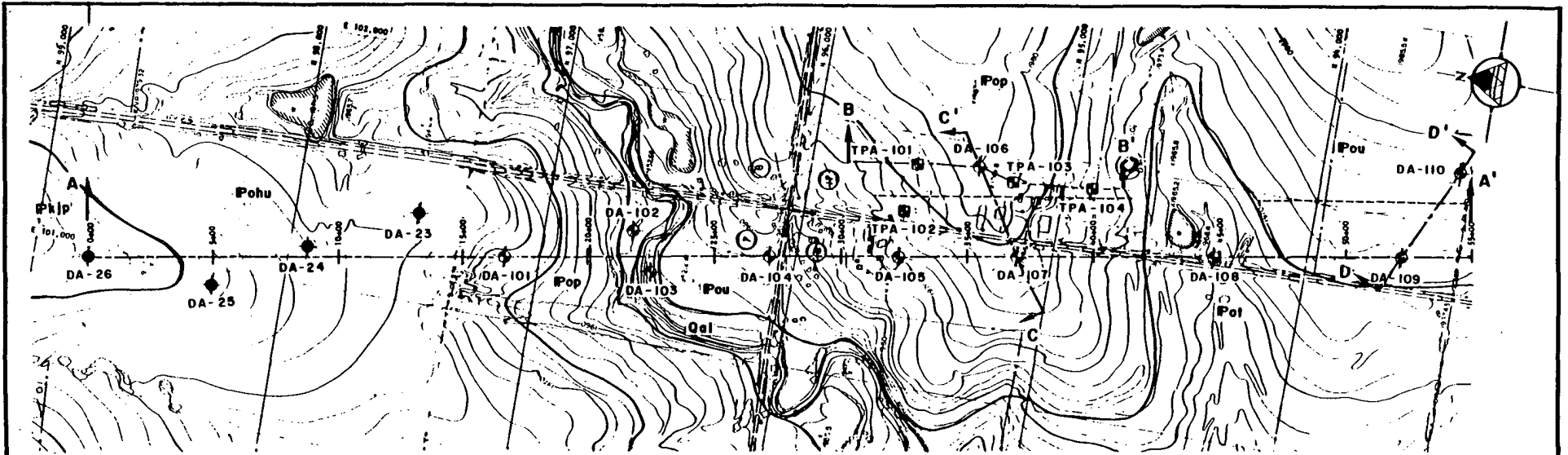

Rev. 0

BASE MAP MODIFIED FROM:
 TITLED: WOLF CREEK PROJECT TOPOGRAPHIC MAPS
 BY: KANSAS GAS AND ELECTRIC COMPANY
 DRAWING NUMBER: 8025-E-1001
 LATEST REVISION DATED: 5-5-75
 SHEET NUMBERS: 14 & 17

NOTE:
 THE DEPTH AND THICKNESS OF SOIL AND ROCK STRATA INDICATED ON THE SUBSURFACE SECTION WERE OBTAINED BY INTERPOLATING BETWEEN BORINGS. INFORMATION ON ACTUAL SOIL AND ROCK CONDITIONS EXISTS ONLY AT BORING LOCATIONS. IT IS POSSIBLE THAT SOIL AND ROCK CONDITIONS BETWEEN BORINGS MAY VARY FROM THOSE INDICATED.

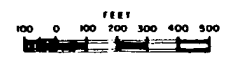

EXPLANATION:
 ——— GEOLOGIC CONTACT
 - - - - - INFERRED GEOLOGIC CONTACT
 [Symbol] TEST BORING LOCATION AND DEPTH ON SUBSURFACE SECTION

**WOLF CREEK
 UPDATED SAFETY ANALYSIS REPORT**

Figure 2.5-125

**Plot Plan with Geologic Strip Map
 and Subsurface Section A-A' -
 Baffle Dike A**

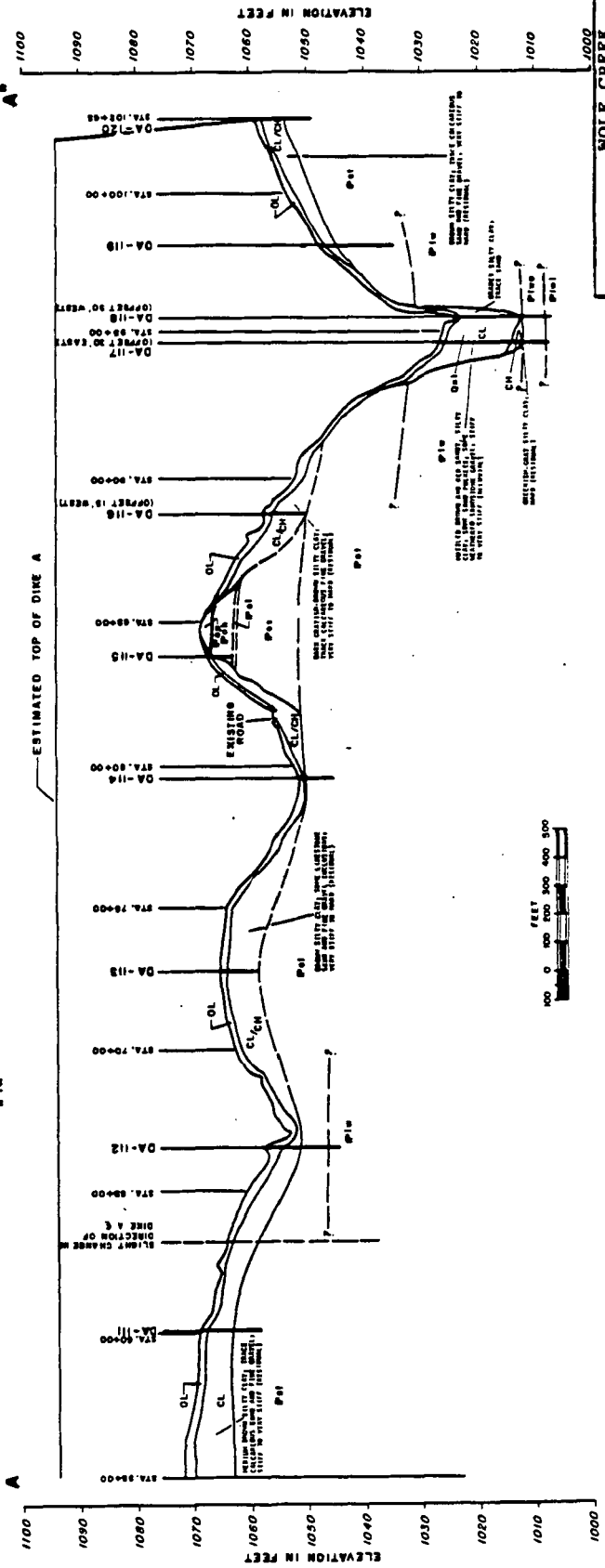
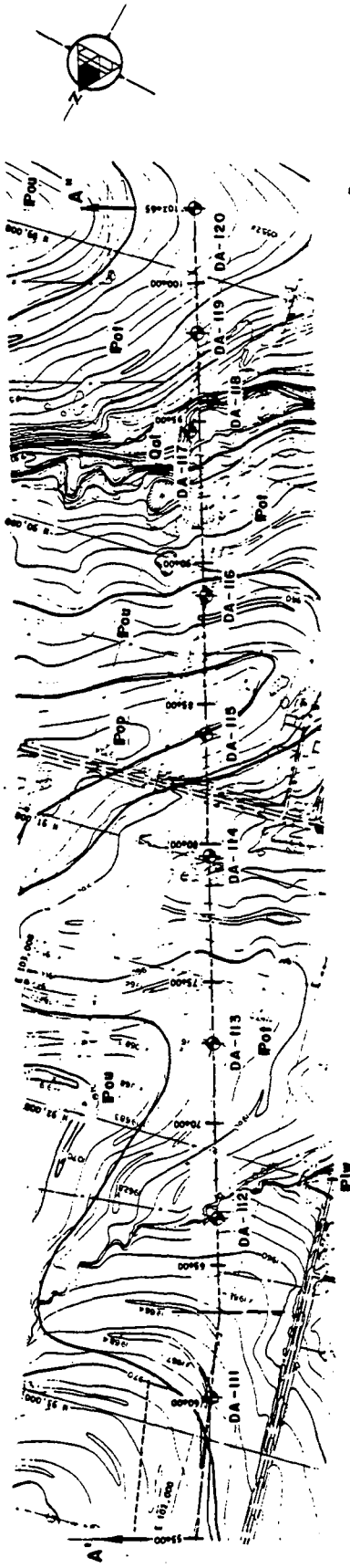

**WOLF CREEK
UPDATED SAFETY ANALYSIS REPORT**

Figure 2.5-126

**Plot Plan with Geologic Strip Map
and Subsurface Section - A'-A' -
Baffle Dike A**

EXPLANATIONS:

- GEOLGIC CONTACT
- INFERRED GEOLGIC CONTACT
- PILE LOCATING LOCATION AND WIDTH
- IN SUBSURFACE SECTION

NOTE:
THE DEPTH AND THICKNESS OF SOIL AND ROCK STRATA IMPLICATED ON THE SUBSURFACE SECTION ARE ESTIMATED FROM AVAILABLE INFORMATION. THE ACTUAL SOIL AND ROCK CONDITIONS EXIST ONLY AT BORING LOCATIONS. IT IS POSSIBLE THAT SOIL AND ROCK CONDITIONS BETWEEN BORINGS MAY VARY FROM THOSE INDICATED.

BASE MAP MODIFIED FROM:
TITLED: WOLF CREEK PROJECT
TOPOGRAPHIC MAPS
BY: HARGREAS AND ELECTRIC
COMPANY
DRAWING NUMBER: 8019-E-1001
LATEST REVISION DATED: 5-5-75
SHEET NUMBERS: 17, 18, 20 & 21

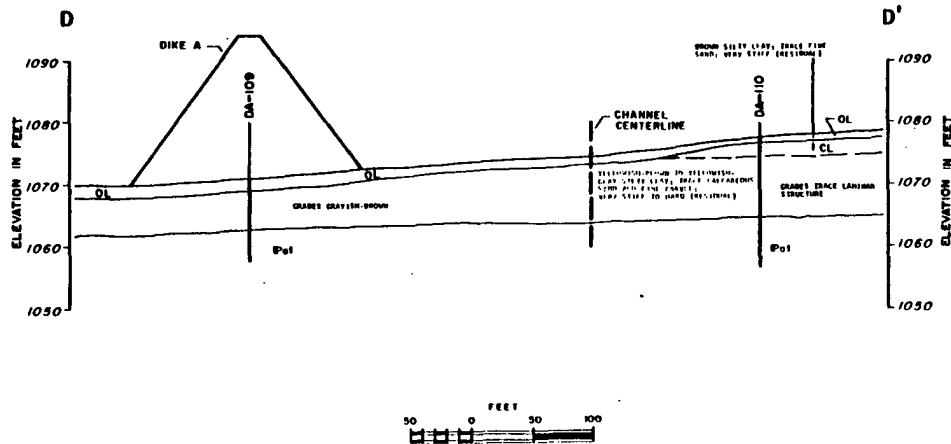
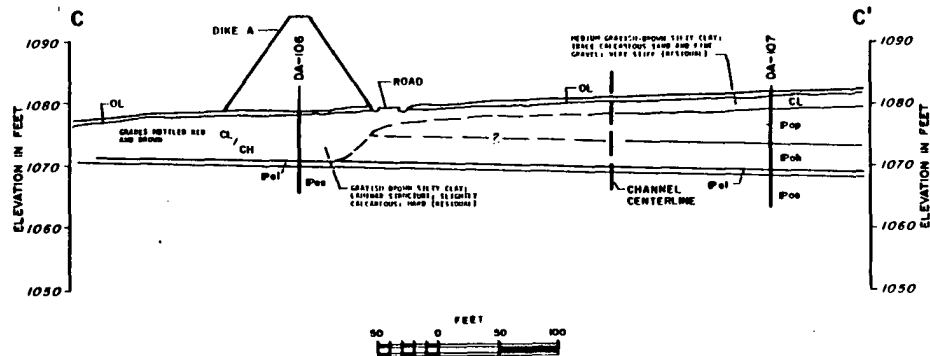
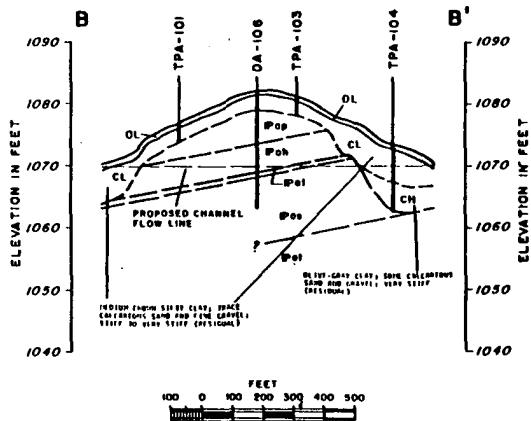

NOTE:
 THE DEPTH AND THICKNESS OF SOIL AND ROCK STRATA INDICATED ON THE SUBSURFACE SECTION WERE OBTAINED BY INTERPOLATING BETWEEN BORINGS. INFORMATION ON ACTUAL SOIL AND ROCK CONDITIONS EXISTS ONLY AT BORING LOCATIONS. IT IS POSSIBLE THAT SOIL AND ROCK CONDITIONS BETWEEN BORINGS MAY VARY FROM THOSE INDICATED.

LEGEND:
 ——— GEOLOGIC CONTACT
 - - - - - INFERRED GEOLOGIC CONTACT
 | BORING LOCATION AND DEPTH OR 'SUBSURFACE SECTION'

Rev. 0

**WOLF CREEK
 UPDATED SAFETY ANALYSIS REPORT**

Figure 2.5-127

Subsurface Sections B-B', C-C',
 and D-D' - Baffle Dike A

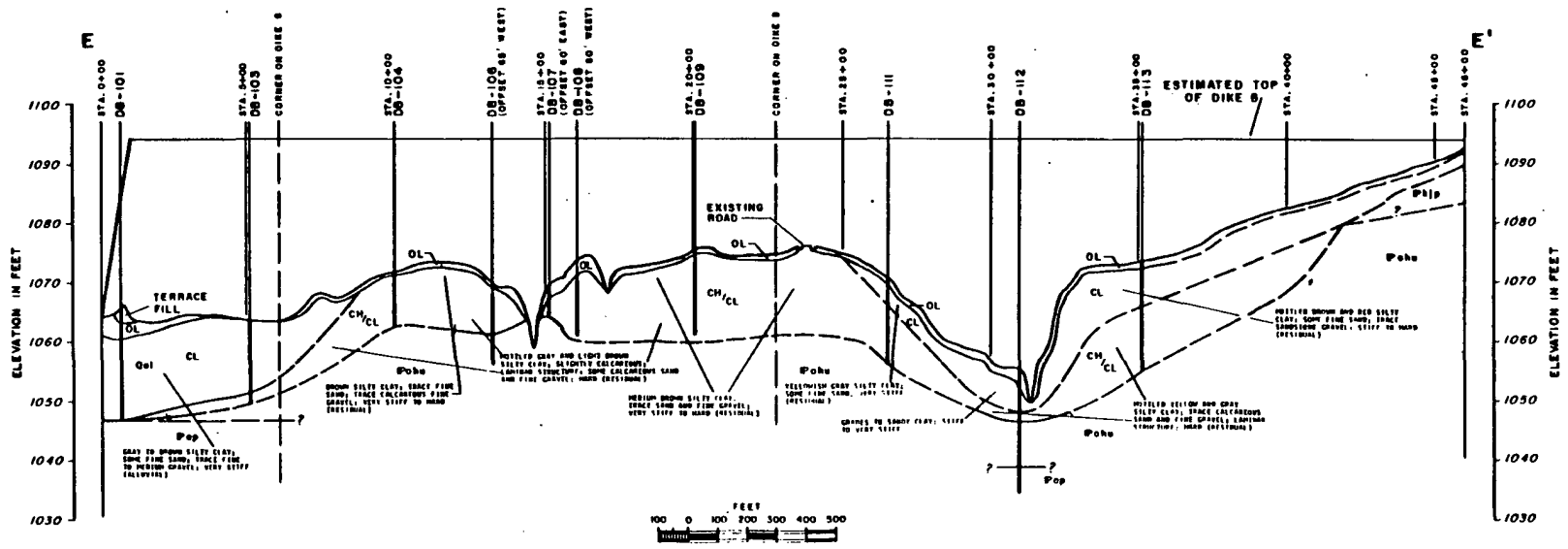
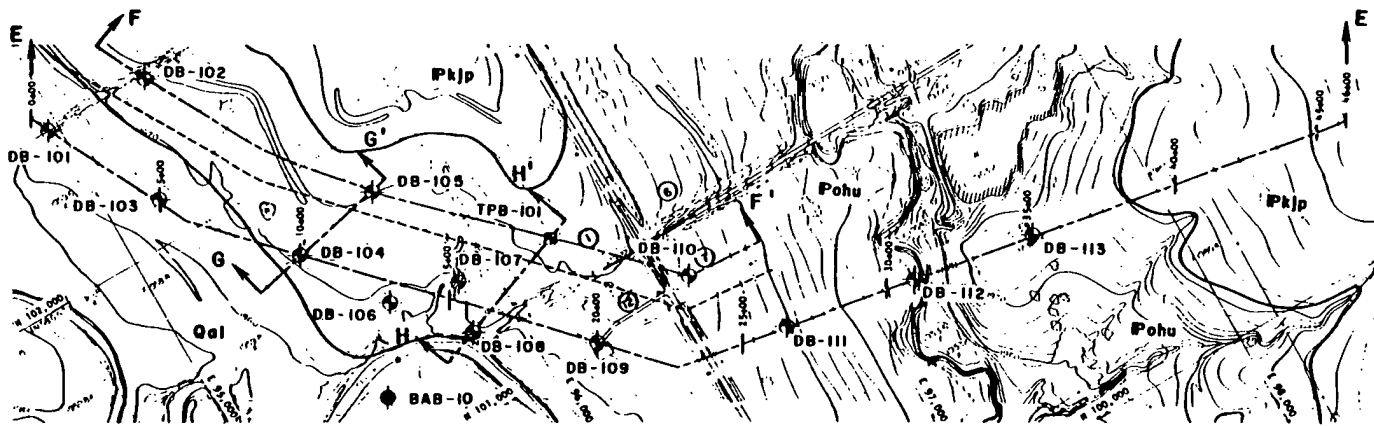

Rev. 0

**WOLF CREEK
UPDATED SAFETY ANALYSIS REPORT**

Figure 2.5-128

Plot Plan with Geologic Strip Map
and Subsurface Section E-E' -
Baffle Dike B

BASE MAP MODIFIED FROM:
TITLED: WOLF CREEK PROJECT
TOPOGRAPHIC MAPS
BY: KANSAS GAS AND ELECTRIC
COMPANY
DRAWING NUMBER: 8025-E-1001
LATEST REVISION DATED: 5-5-75
SHEET NUMBERS: 13 B 14

NOTE:
THE DEPTH AND THICKNESS OF SOIL AND ROCK STRATA INDICATED ON THE SUBSURFACE SECTION WERE OBTAINED BY INTERPOLATING BETWEEN BORINGS. INFORMATION ON ACTUAL SOIL AND ROCK CONDITIONS EXISTS ONLY AT BORING LOCATIONS. IT IS POSSIBLE THAT SOIL AND ROCK CONDITIONS BETWEEN BORINGS MAY VARY FROM THOSE INDICATED.

EXPLANATION:
— GEOLGIC CONTACT
- - - INTERFERED GEOLGIC CONTACT
| TEST BORING LOCATION AND DEPTH ON SUBSURFACE SECTION

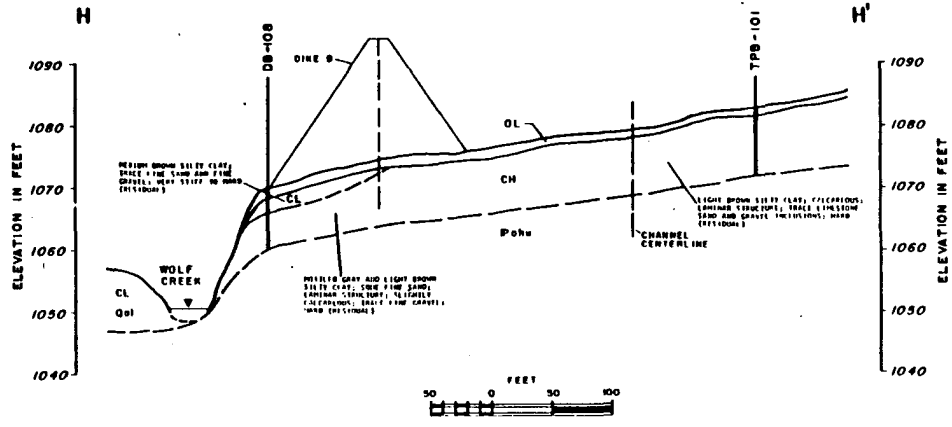
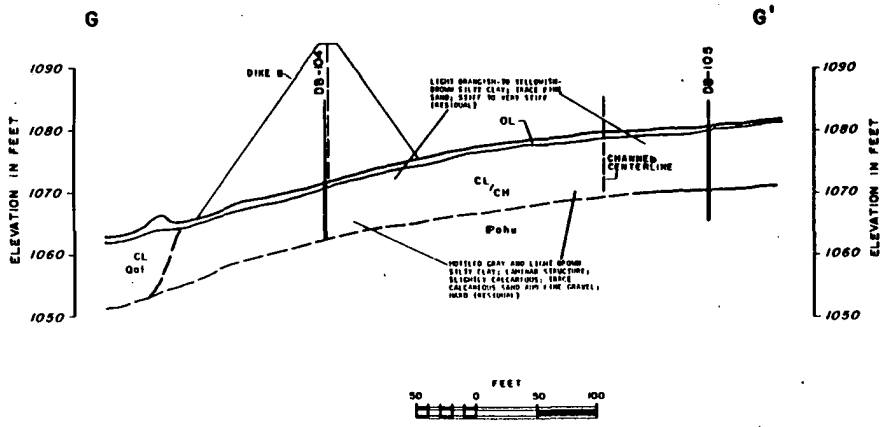
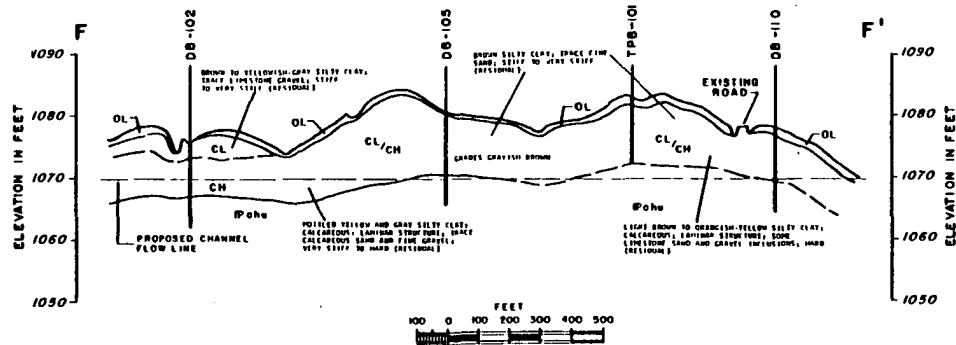

NOTE:
 THE DEPTH AND THICKNESS OF SOIL AND ROCK STRATA INDICATED ON THE SUBSURFACE SECTION WERE OBTAINED BY INTERPOLATING BETWEEN BORINGS. INFORMATION ON ACTUAL SOIL AND ROCK CONDITIONS EXISTS ONLY AT BORING LOCATIONS. IT IS POSSIBLE THAT SOIL AND ROCK CONDITIONS BETWEEN BORINGS MAY VARY FROM THOSE INDICATED.

EXPLANATION:
 ——— GEOLGIC CONTACT
 - - - - - INTEREDED GEOLGIC CONTACT
 | TEST BORING LOCATION AND DEPTH OR SUBSURFACE SECTION

Rev. 0

**WOLF CREEK
 UPDATED SAFETY ANALYSIS REPORT**

Figure 2.5-129

Subsurface Sections F-F', G-G',
 and H-H' - Baffle Dike B

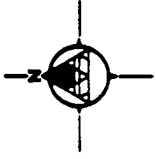

INDICATES TEST PT. LINE LOCATOR
INDICATES BORROW SITE AND
PROPER LETTER DESIGNATION.



Rev. 0

WOLF CREEK
UPDATED SAFETY ANALYSIS REPORT

Figure 2.5-130

Plot Plan - Borrow Areas

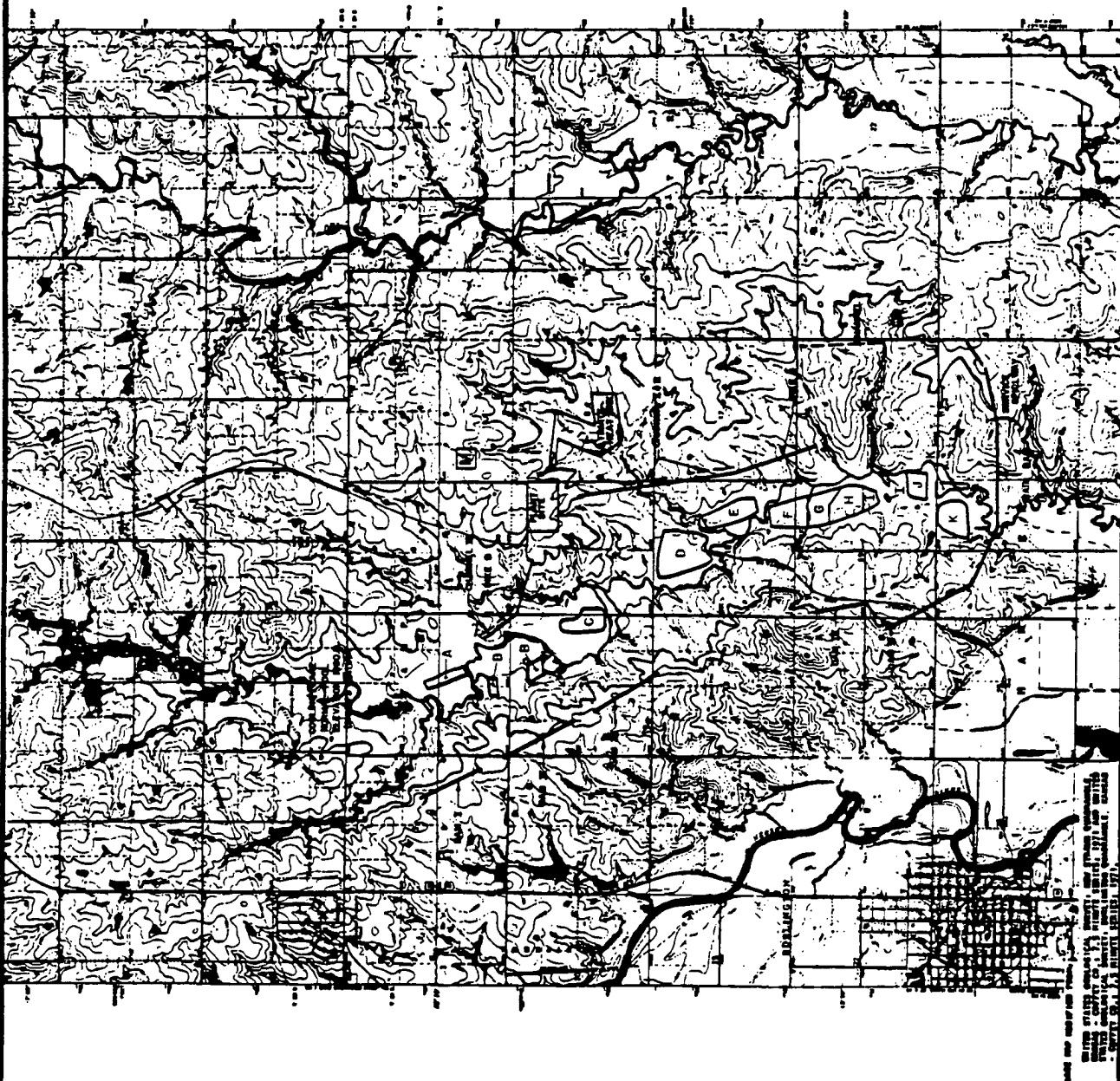

DATE: 10/15/77
BY: J. S. BROWN
CHECKED: J. S. BROWN
APPROVED: J. S. BROWN
PROJECT: WOLF CREEK
SHEET: 2.5-130

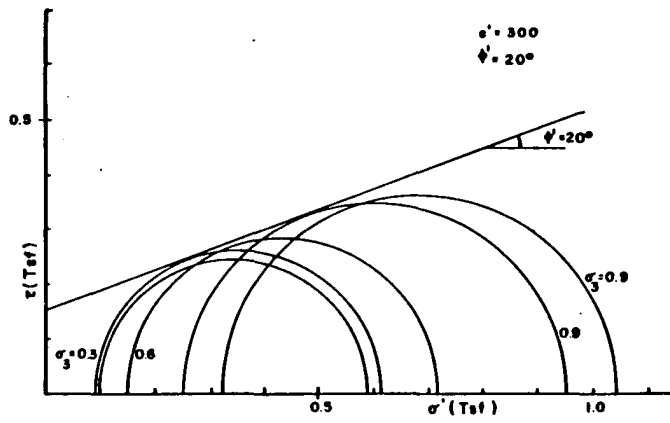

cV Test on TP-1

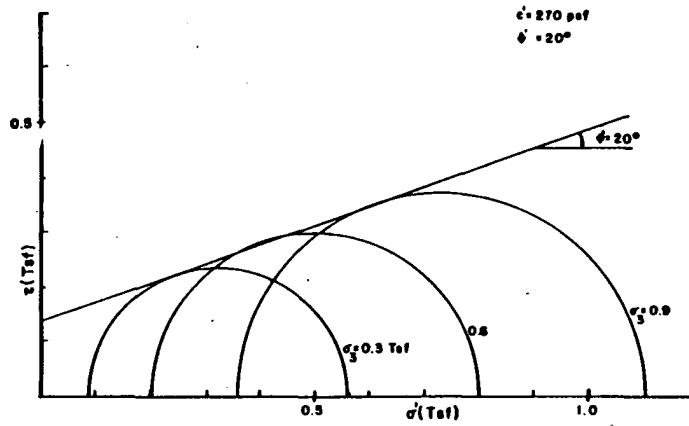

cV Test on TP-3

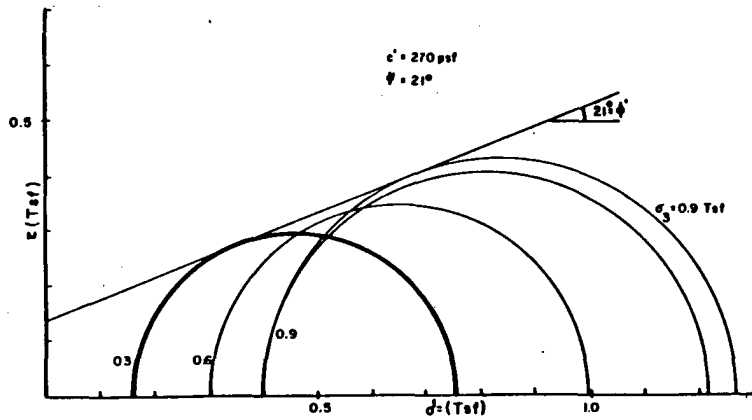

cV Test on TP-2

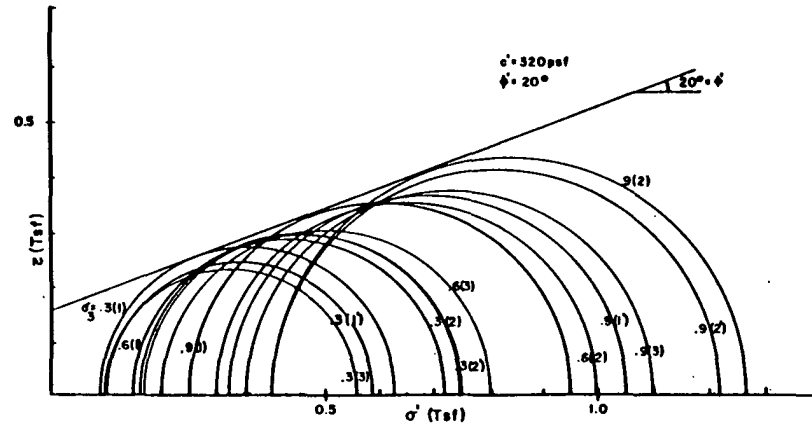

cV Test on TP-1, TP-2 and TP-3

Rev. 0

WOLF CREEK
 UPDATED SAFETY ANALYSIS REPORT
 Figure 2.5-131
 Mohr Diagram for Consolidated
 Undrained Test

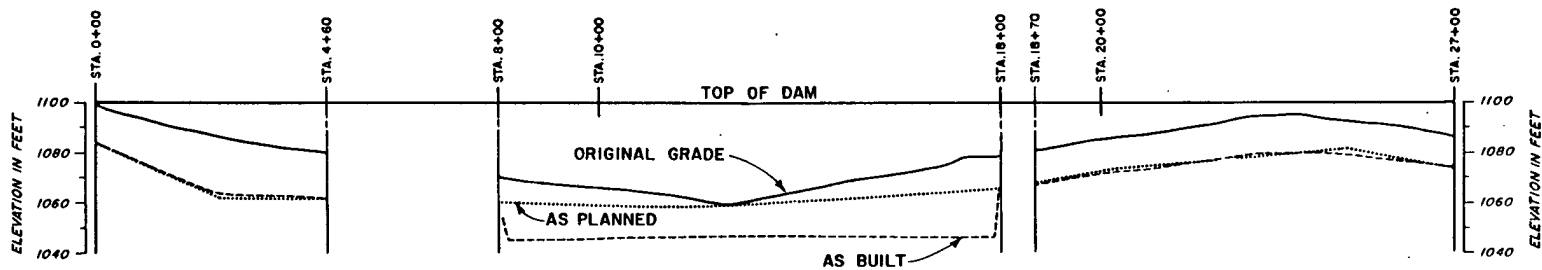

CENTERLINE PROFILE FOR MAIN DAM KEY TRENCH

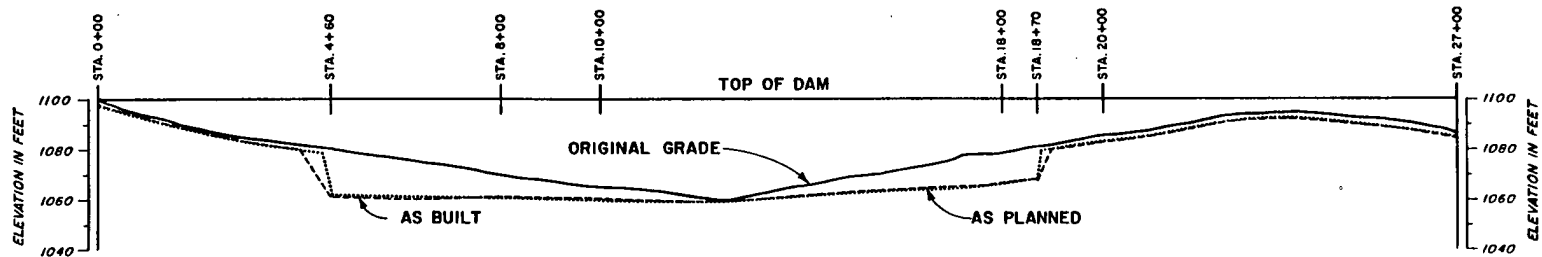

CENTERLINE PROFILE FOR MAIN DAM FOUNDATION

Rev. 0

**WOLF CREEK
UPDATED SAFETY ANALYSIS REPORT**

Figure 2.5-132 (Sheet 1 of 4)

Centerline Profiles for Main Dam
& Keytrenches



REFERENCE:
SARGENT AND LUNDY
DRAWINGS S250, S29E

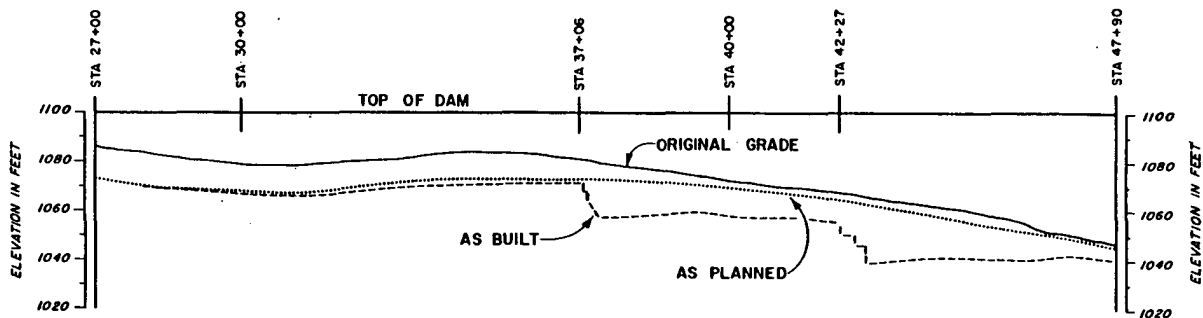

CENTERLINE PROFILE FOR MAIN DAM KEY TRENCH

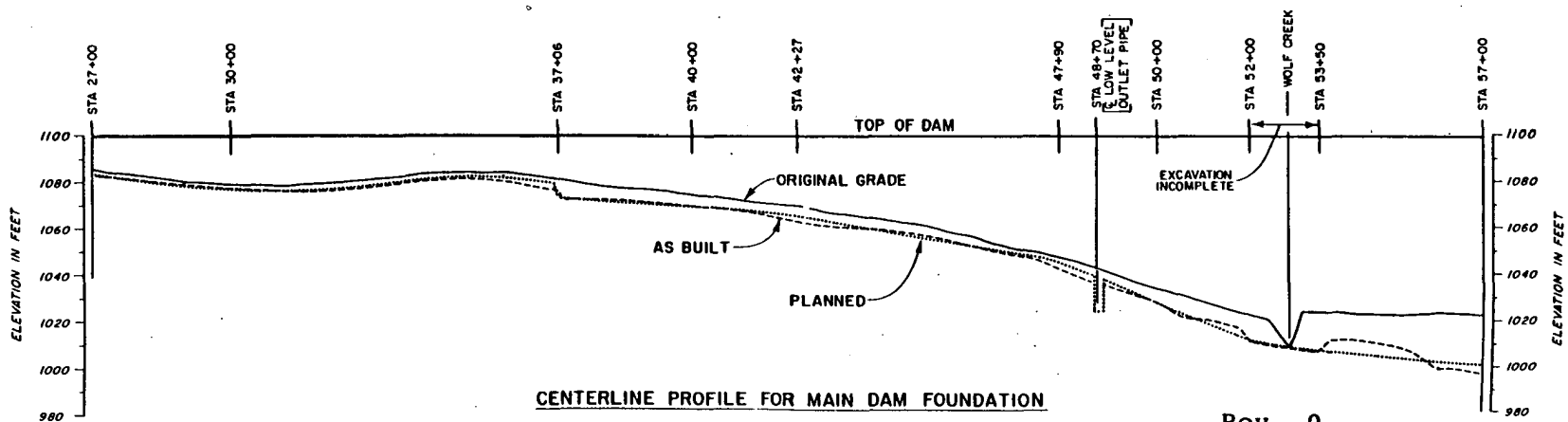

CENTERLINE PROFILE FOR MAIN DAM FOUNDATION

Rev. 0

**WOLF CREEK
UPDATED SAFETY ANALYSIS REPORT**

Figure 2.5-132 (Sheet 2 of 4)

Centerline Profiles for Main Dam
& Keytrenches



REFERENCE:
SARGENT AND LUNDY
DRAWINGS S26E, S29E

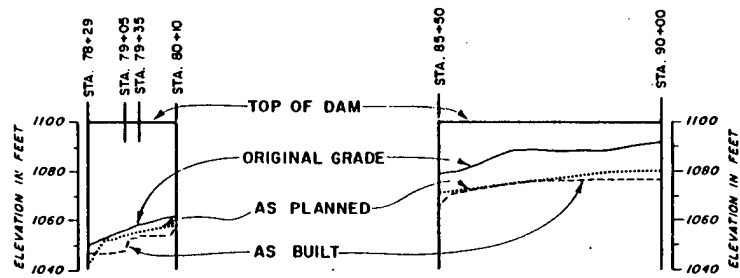

CENTERLINE PROFILE FOR MAIN DAM KEY TRENCH

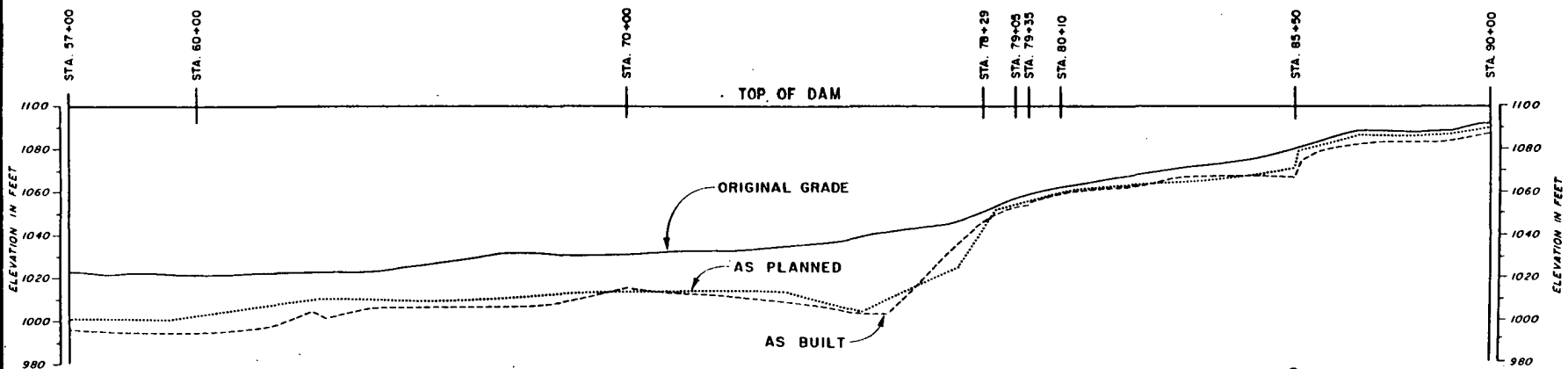

CENTERLINE PROFILE FOR MAIN DAM FOUNDATION

Rev. 0



REFERENCE
SARGENT AND LUNDY
DRAWINGS S27C, S29E

WOLF CREEK
UPDATED SAFETY ANALYSIS REPORT

Figure 2.5-132 (Sheet 3 of 4)

Centerline Profiles for Main Dam
& Keytrenches

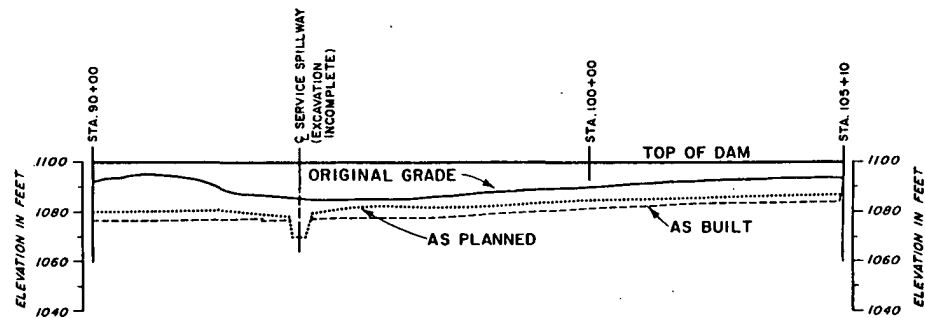

CENTERLINE PROFILE FOR MAIN DAM KEY TRENCH

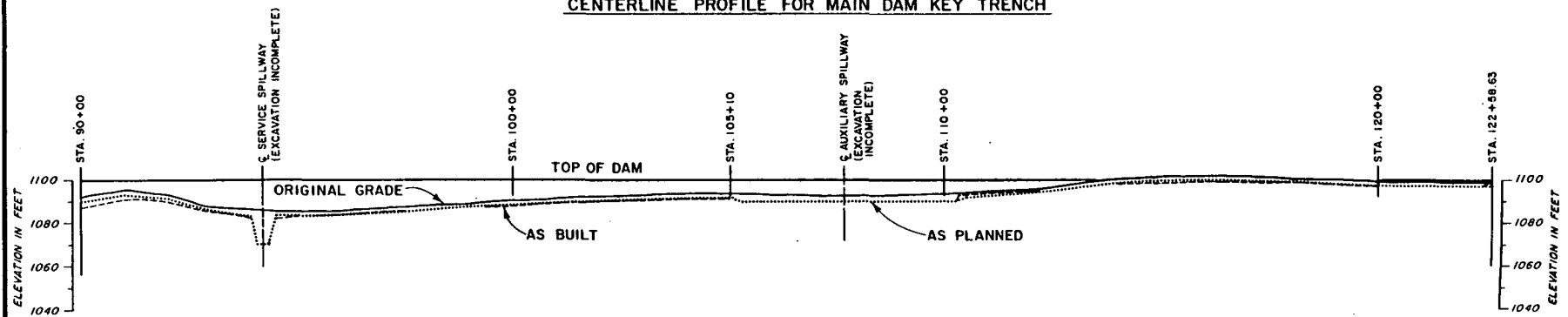

CENTERLINE PROFILE FOR MAIN DAM FOUNDATION

Rev. 0

**WOLF CREEK
UPDATED SAFETY ANALYSIS REPORT**

Figure 2.5-132 (Sheet 4 of 4)

Centerline Profiles for Main Dam
& Keytrenches

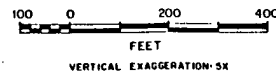

REFERENCE:
SARGENT AND LUNDY
DRAWINGS 5280, 529E

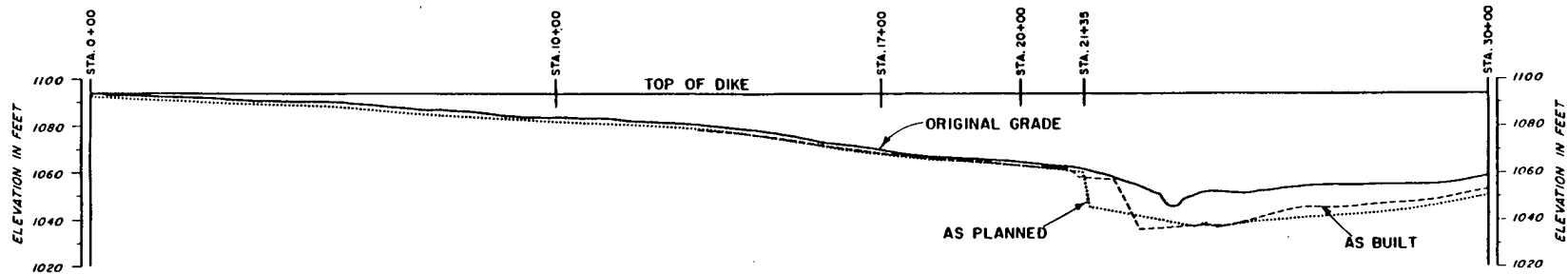

CENTERLINE PROFILE FOR BAFFLE DIKE "A"

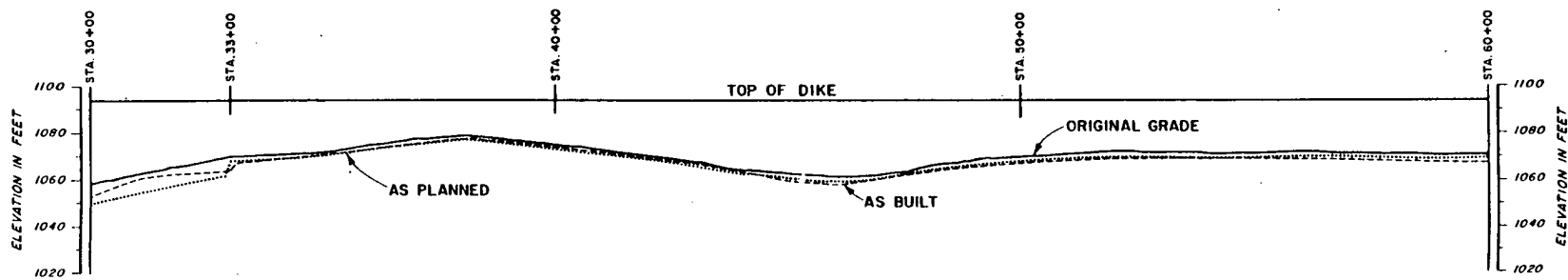

CENTERLINE PROFILE FOR BAFFLE DIKE "A" (CONT'D)

Rev. 0

**WOLF CREEK
UPDATED SAFETY ANALYSIS REPORT**

Figure 2.5-133 (Sheet 1 of 3)

Centerline Profiles for Baffle
Dikes



REFERENCE:
SARGENT AND LUNDY
DRAWINGS S46E, S45C, S47D

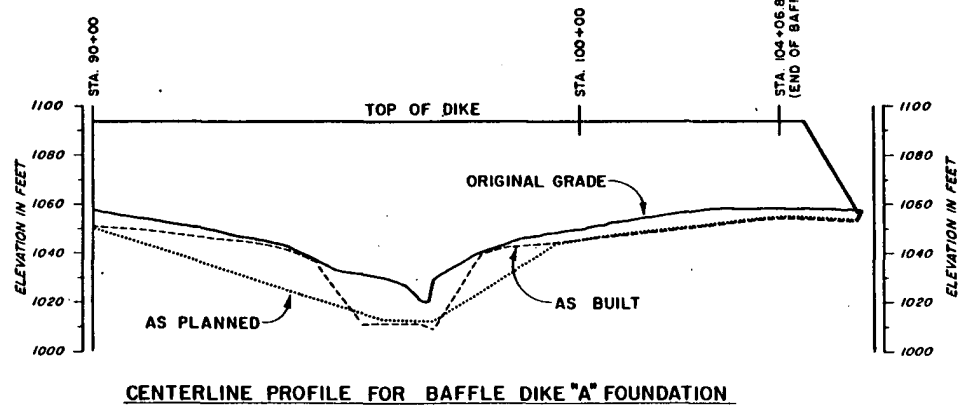
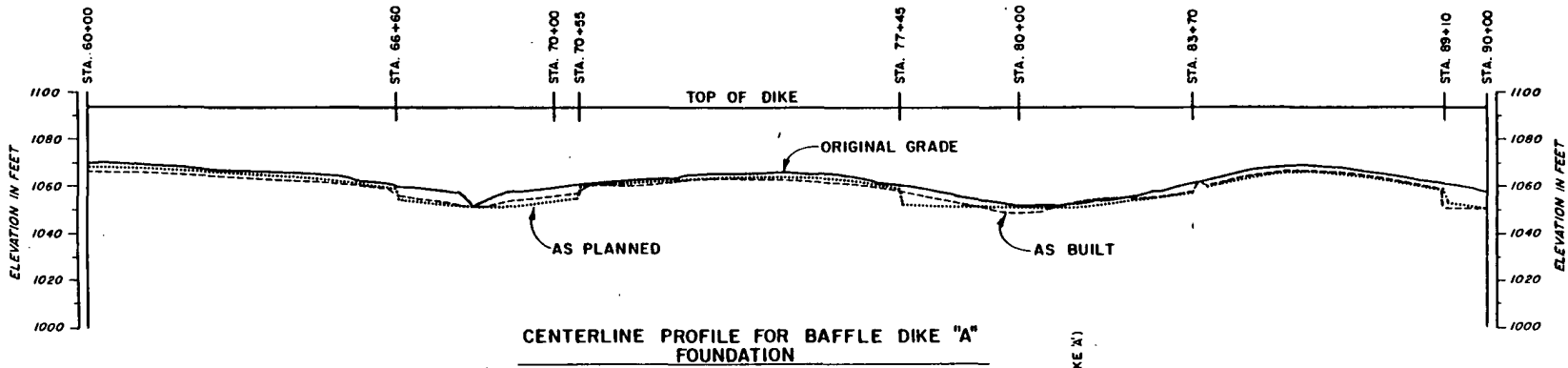

REFERENCE:
SARGENT AND LUNDY
DRAWINGS 548C, 549C, 549C

Rev. 0

WOLF CREEK UPDATED SAFETY ANALYSIS REPORT
Figure 2.5-133 (Sheet 2 of 3)
Centerline Profiles for Baffle Dikes

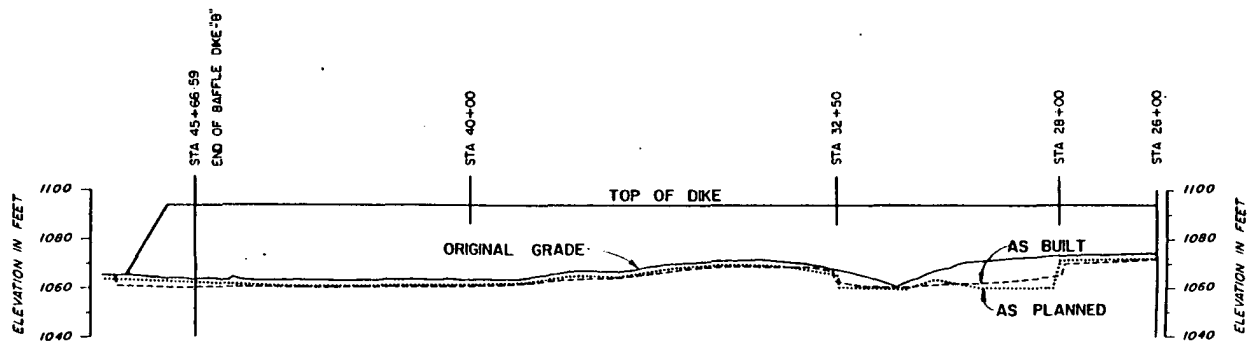
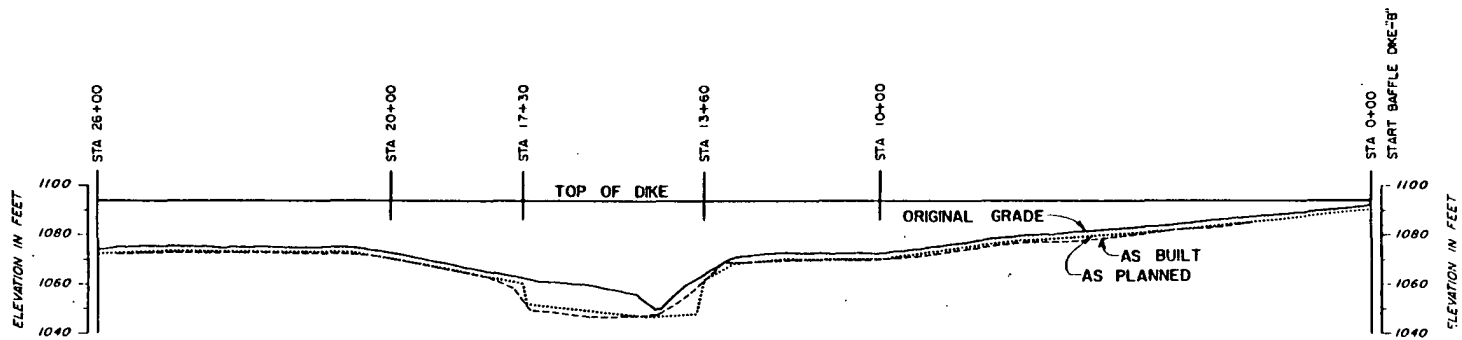

CENTERLINE PROFILE FOR BAFFLE DIKE "B" FOUNDATION

Rev. 0



REFERENCE:
SARGENT AND LUNDY
DRAWINGS S50D, S51B, S45C

WOLF CREEK
UPDATED SAFETY ANALYSIS REPORT

Figure 2.5-133 (Sheet 3 of 3)

Centerline Profiles for Baffle
Dikes

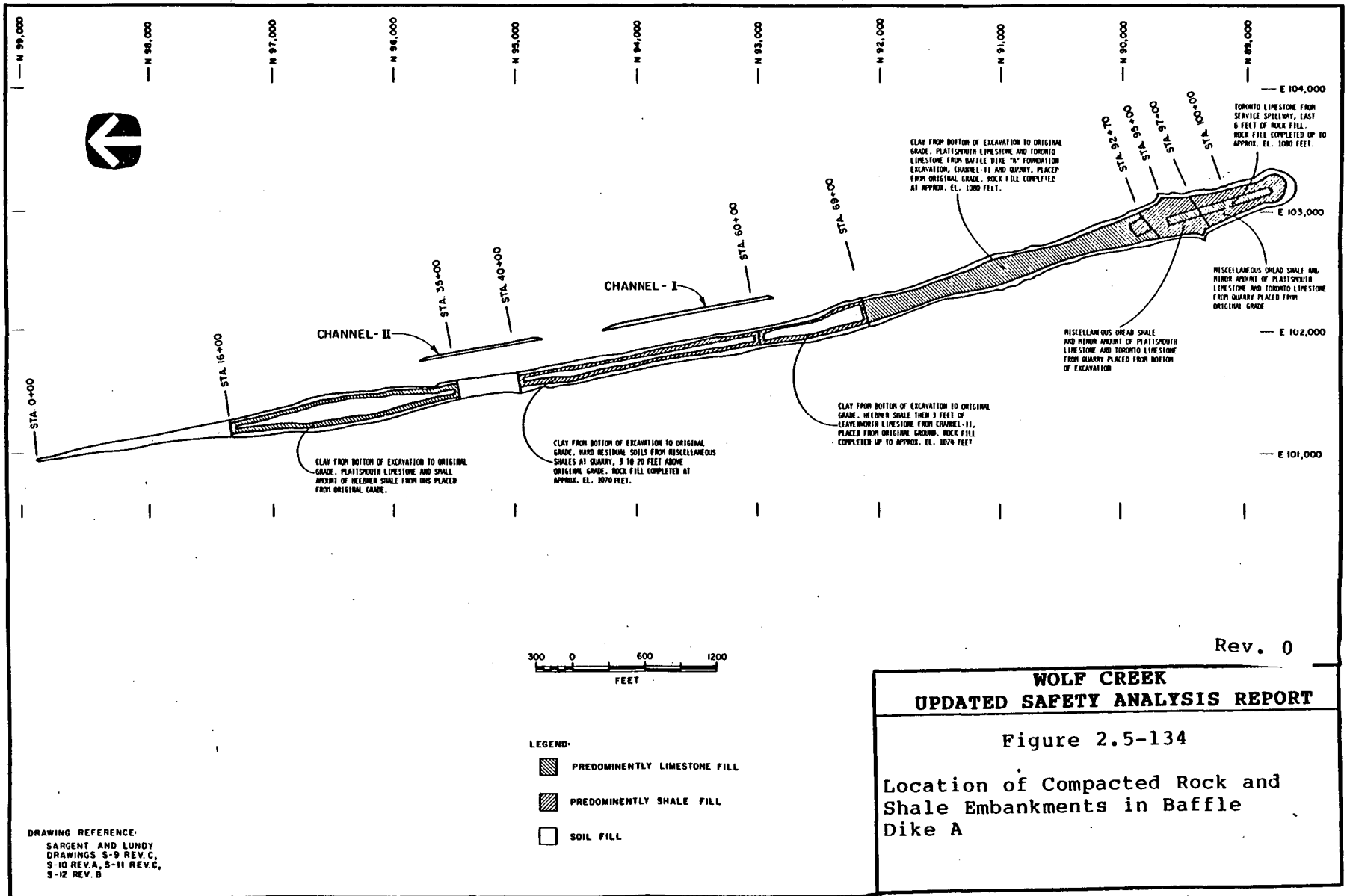

Mat. Description	Mat. Dimensions	Remarks			
No.	Length	Width	Thick.	SP	
1	Construction clay	11.0	1.0	0	
2	Gravel	1.0	1.0	0	Minimums and Maximums from this table may vary under actual job conditions.
3	Gravel	1.0	1.0	0	
4	Gravel	1.0	1.0	0	

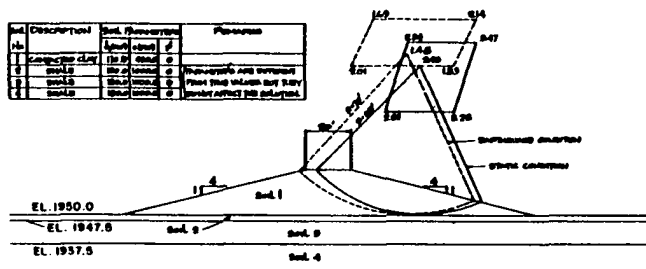

END OF CONSTRUCTION

Mat. Description	Mat. Dimensions	Remarks			
No.	Length	Width	Thick.	SP	
1	Construction clay	11.0	1.0	0	
2	Gravel	1.0	1.0	0	Minimums and Maximums from this table may vary under actual job conditions.
3	Gravel	1.0	1.0	0	
4	Gravel	1.0	1.0	0	

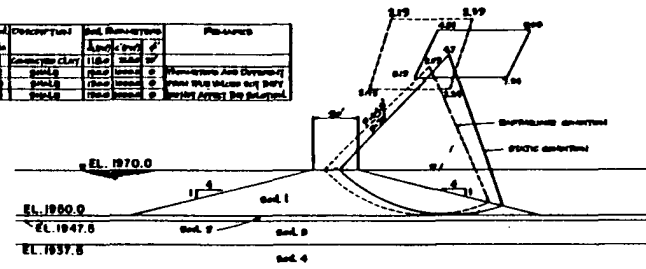

FULLY SUBMERGED CONDITION

Mat. Description	Mat. Dimensions	Remarks			
No.	Length	Width	Thick.	SP	
1	Construction clay	11.0	1.0	0	
2	Gravel	1.0	1.0	0	Minimums and Maximums from this table may vary under actual job conditions.
3	Gravel	1.0	1.0	0	
4	Gravel	1.0	1.0	0	

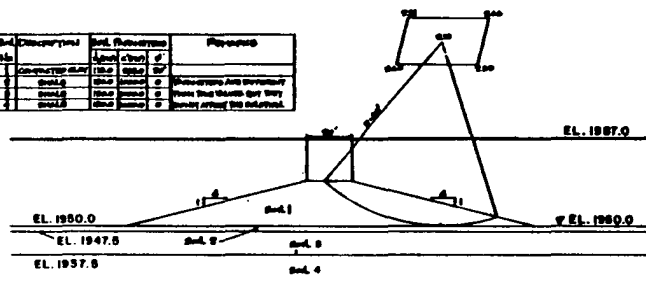

SUDDEN DRAWDOWN CONDITION (FROM 1970.0 TO 1950.0)

Mat. Description	Mat. Dimensions	Remarks			
No.	Length	Width	Thick.	SP	
1	Construction clay	11.0	1.0	0	
2	Gravel	1.0	1.0	0	Minimums and Maximums from this table may vary under actual job conditions.
3	Gravel	1.0	1.0	0	
4	Gravel	1.0	1.0	0	

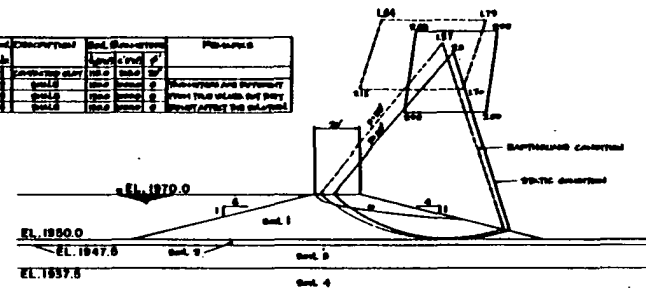

STEADY STATE SEEPAGE CONDITION

Rev. 0

**WOLF CREEK
UPDATED SAFETY ANALYSIS REPORT**

Figure 2.5-135

Stability Analysis Results - UHSD

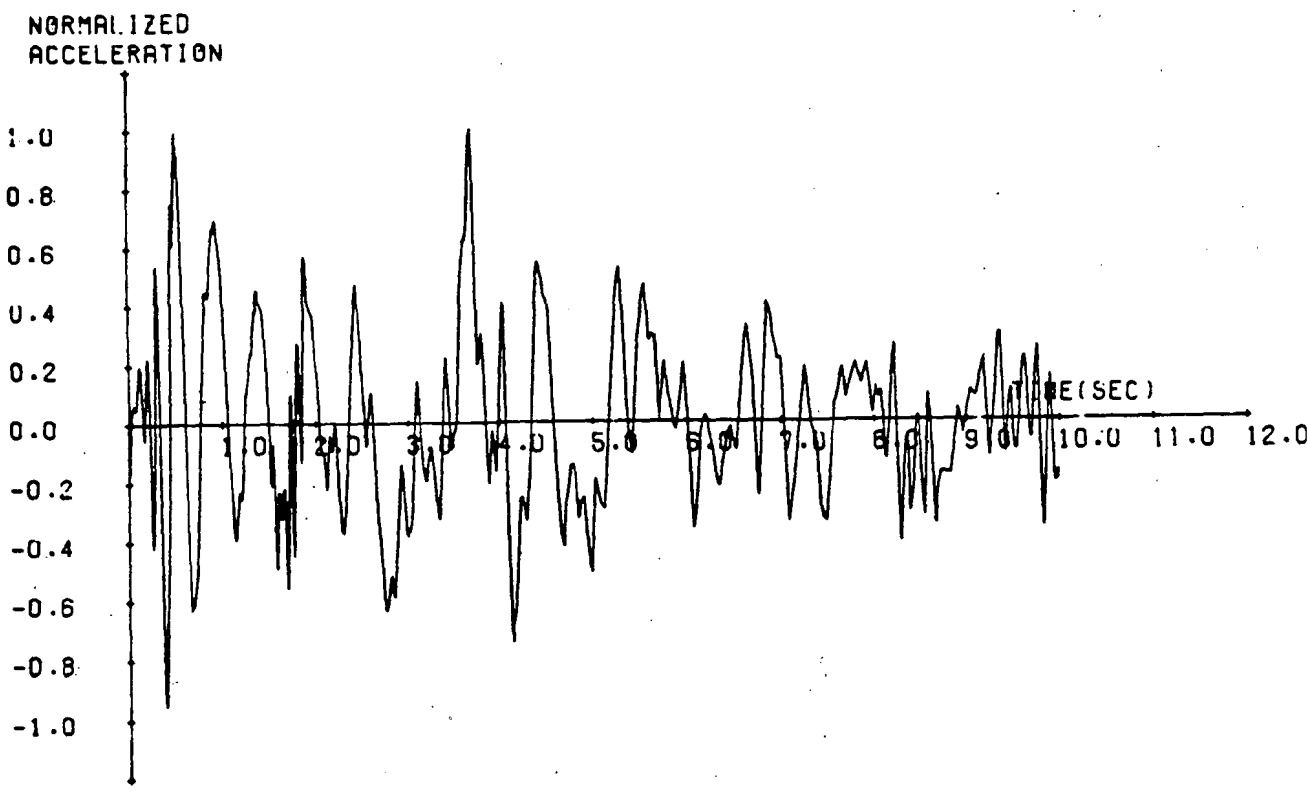

Rev. 0

WOLF CREEK UPDATED SAFETY ANALYSIS REPORT
Figure 2.5-136 Artificial Accelerogram for Horizontal Ground Motion

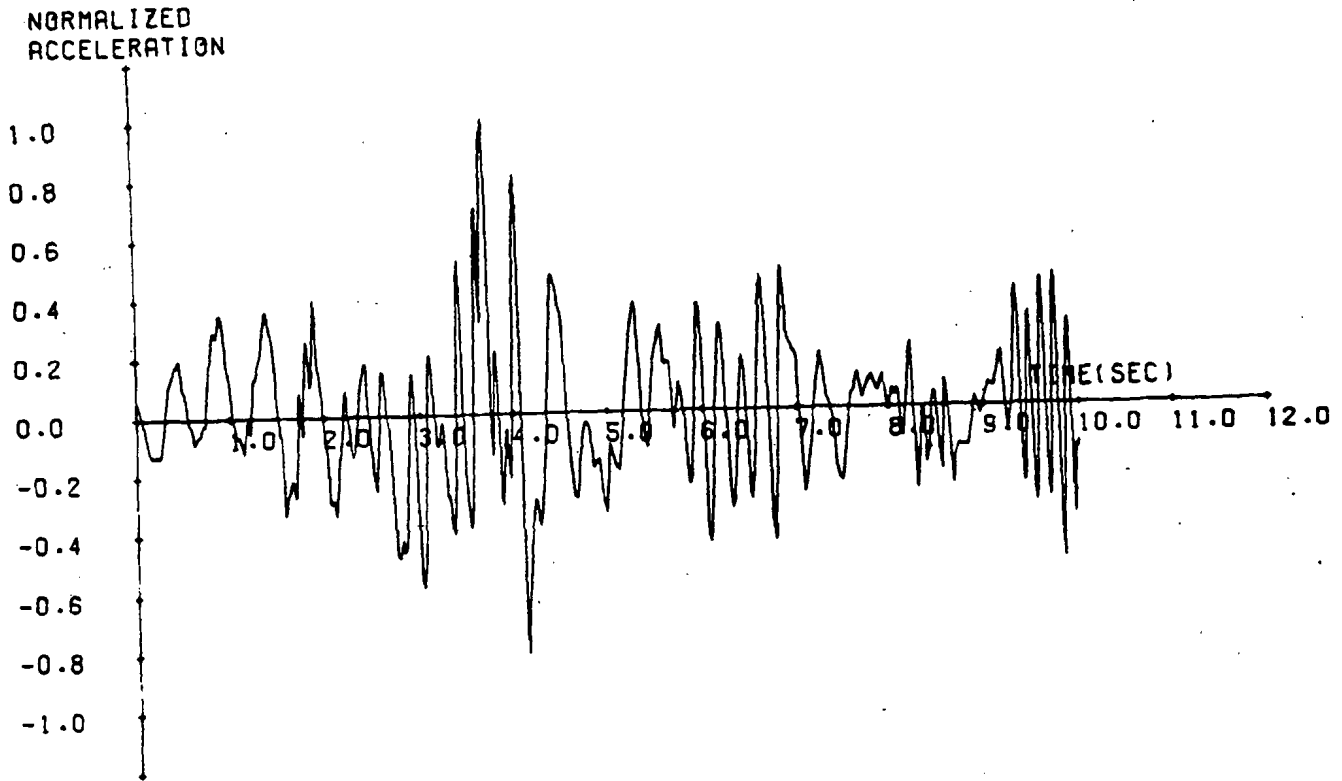

Rev. 0

**WOLF CREEK
UPDATED SAFETY ANALYSIS REPORT**

Figure 2.5-137

Artificial Accelerogram for
Vertical Ground Motion

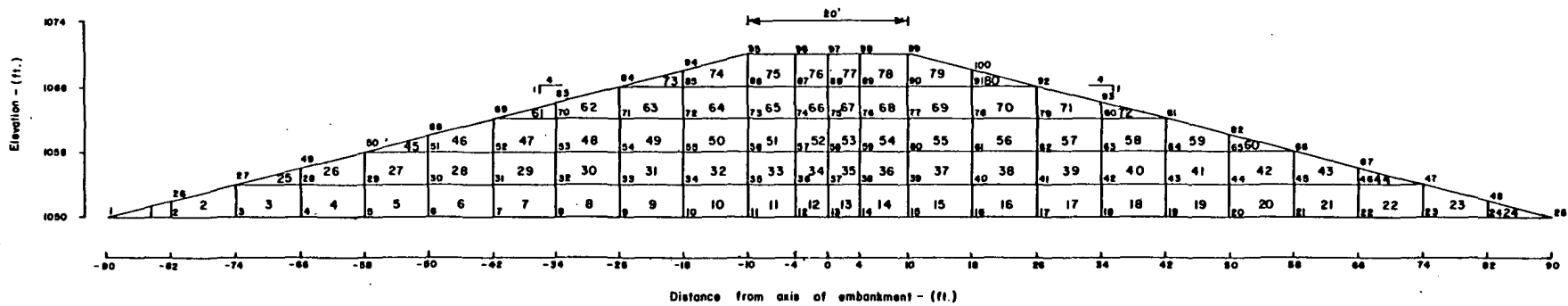

Rev. 0

**WOLF CREEK
UPDATED SAFETY ANALYSIS REPORT**

Figure 2.5-138

Submerged UHS Dam - Finite
Element Representation for
Dynamic Analysis

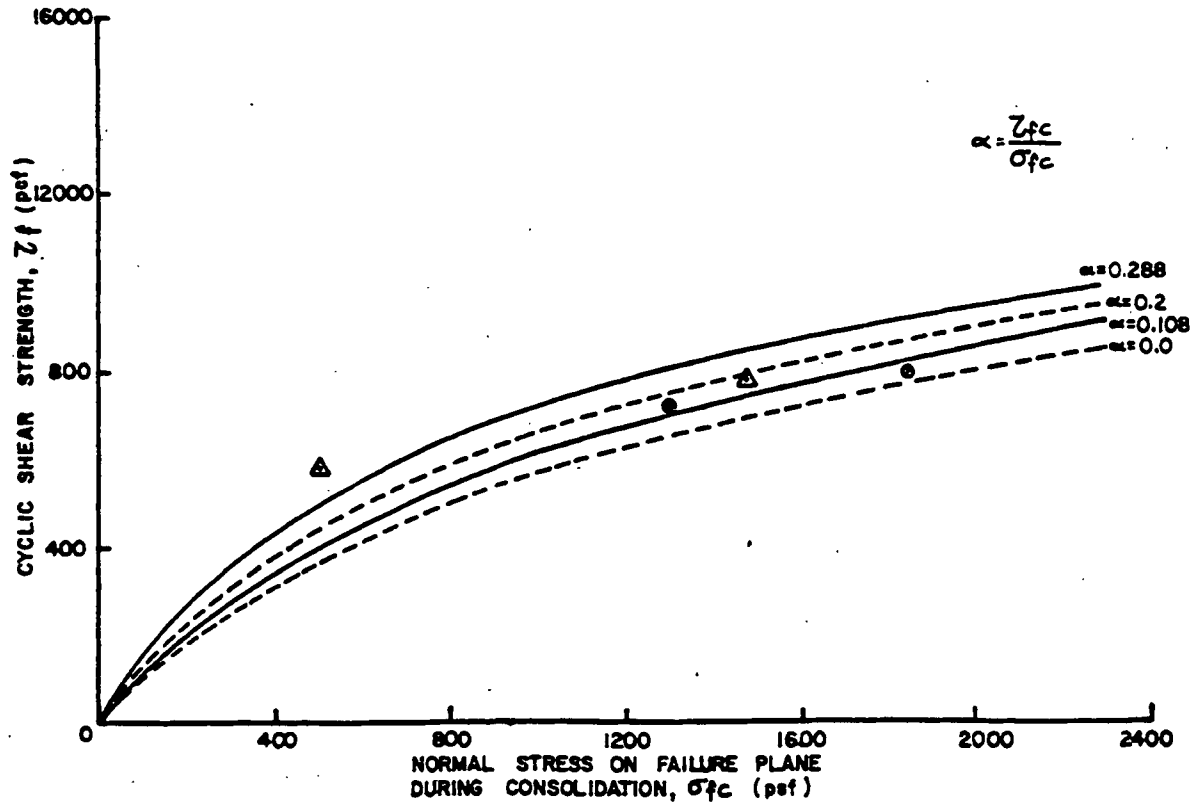

Rev. 0

**WOLF CREEK
UPDATED SAFETY ANALYSIS REPORT**

Figure 2.5-139

Cyclic Shear Strength for Five
Percent Strain and Five Cycles
Versus Normal Effective Stress

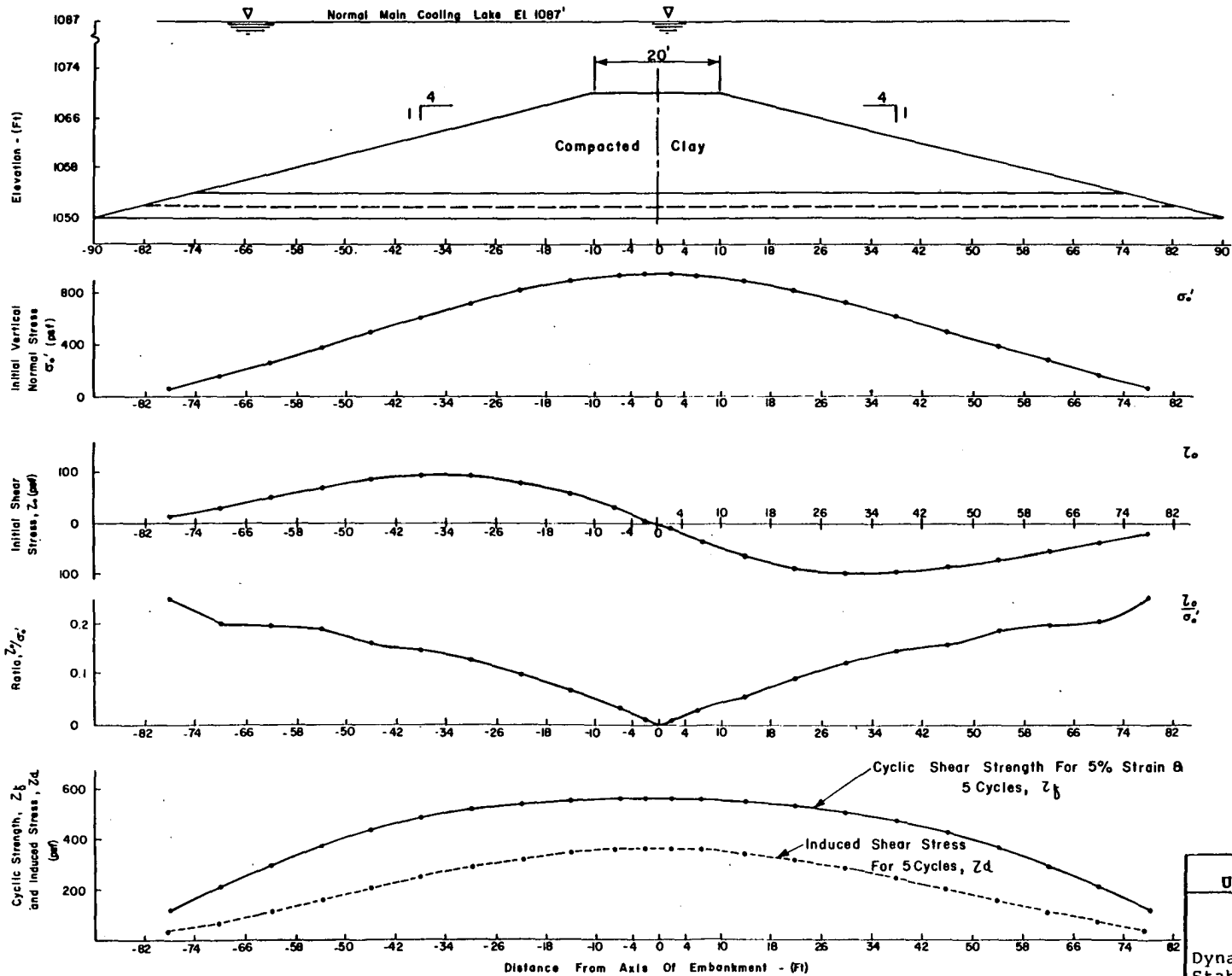

Rev. 0

**WOLF CREEK
UPDATED SAFETY ANALYSIS REPORT**

Figure 2.5-140

Dynamic Analysis of Soil
Stability Along the Base of UHSD
(Elevation 1052')

● PHASE 7, TEST NO. 1

SPECIMEN SIZE AT START OF DYNAMIC TEST:
 AREA (A₀) : 6.65 SQ. IN.
 HEIGHT (H₀) : 6.48 IN.
 LATERAL CONFINING PRESSURE (σ₃) : 600 PSF
 CONSOLIDATION STRESS RATIO (K_c) : N.A.
 CYCLIC AXIAL STRESS (Δσ₁) : ± 400 PSF
 TOTAL NUMBER CYCLES: 11
 MEAN TOTAL AXIAL STRAIN AT END OF DYNAMIC TEST: 0.04%

▼ PHASE 7, TEST NO. 2

SPECIMEN SIZE AT START OF DYNAMIC TEST:
 AREA (A₀) : 6.59 SQ. IN.
 HEIGHT (H₀) : 6.47 IN.
 LATERAL CONSOLIDATION PRESSURE (σ₃) : 400 PSF
 CONSOLIDATION STRESS RATIO (K_c) : 1.75
 CYCLIC AXIAL STRESS (Δσ₁) : ± 400 PSF
 TOTAL NUMBER CYCLES: 11
 MEAN TOTAL AXIAL STRAIN AT END OF DYNAMIC TEST: 0.01%

■ PHASE 7, TEST NO. 3

SPECIMEN SIZE AT START OF DYNAMIC TEST:
 AREA (A₀) : 6.53 SQ. IN.
 HEIGHT (H₀) : 6.33 IN.
 LATERAL CONSOLIDATION PRESSURE (σ₃) : 1200 PSF
 CONSOLIDATION STRESS RATIO (K_c) : 1.75
 CYCLIC AXIAL STRESS (Δσ₁) : ± 940 PSF
 TOTAL NUMBER CYCLES: 11
 MEAN TOTAL AXIAL STRAIN AT END OF DYNAMIC TEST: 0.2%

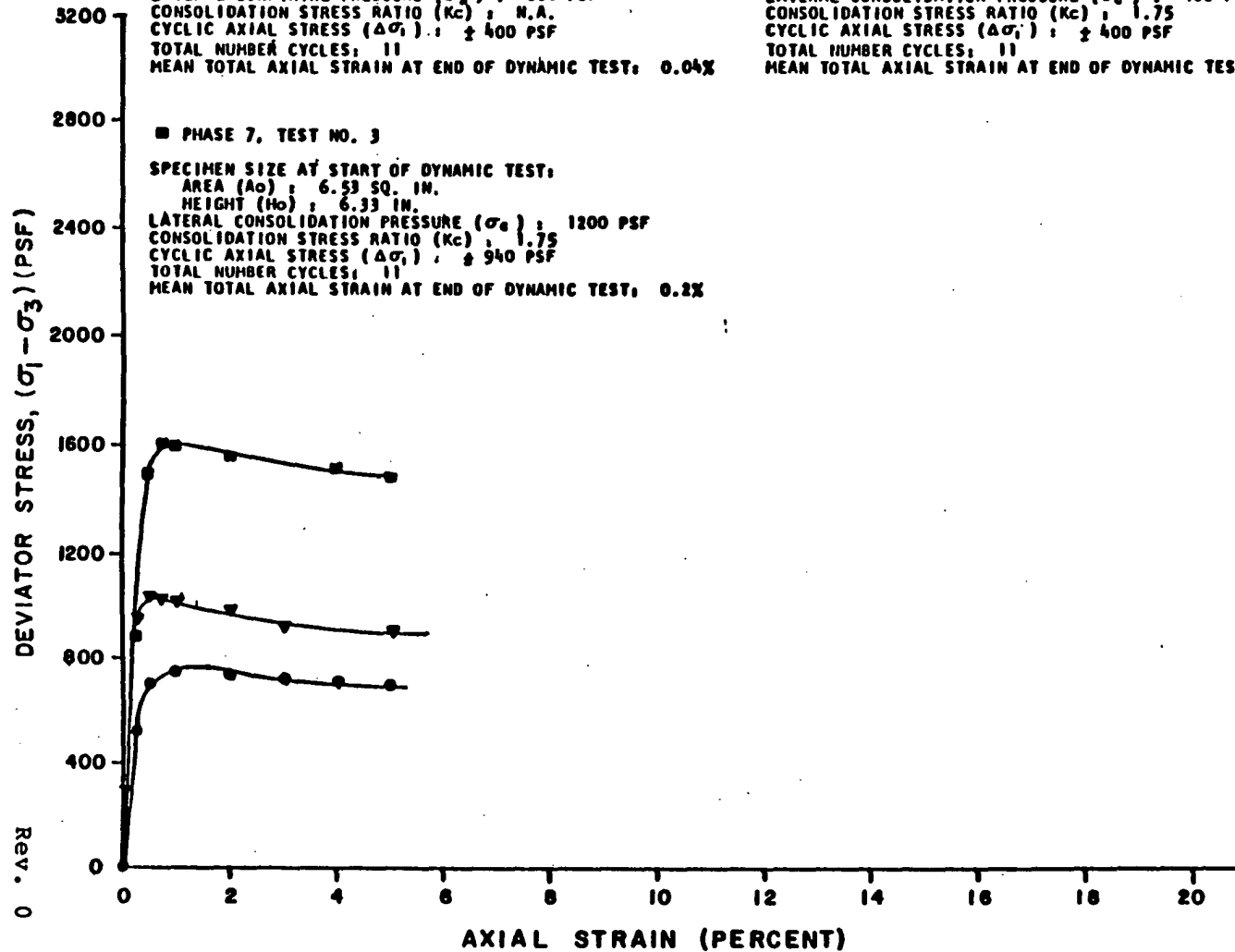

Rev. 0

WOLF CREEK
 UPDATED SAFETY ANALYSIS REPORT
 Figure 2.5-141
 Results of Static Triaxial Tests
 After Cyclic Stressing

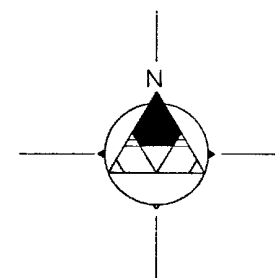

- KEY:**
- MOVEMENT MONUMENT LOCATION AND NUMBER
MON. 1 (SEE NOTE)
 - 1 PIEZOMETER LOCATION AND NUMBER
 - △ INCLINOMETERS

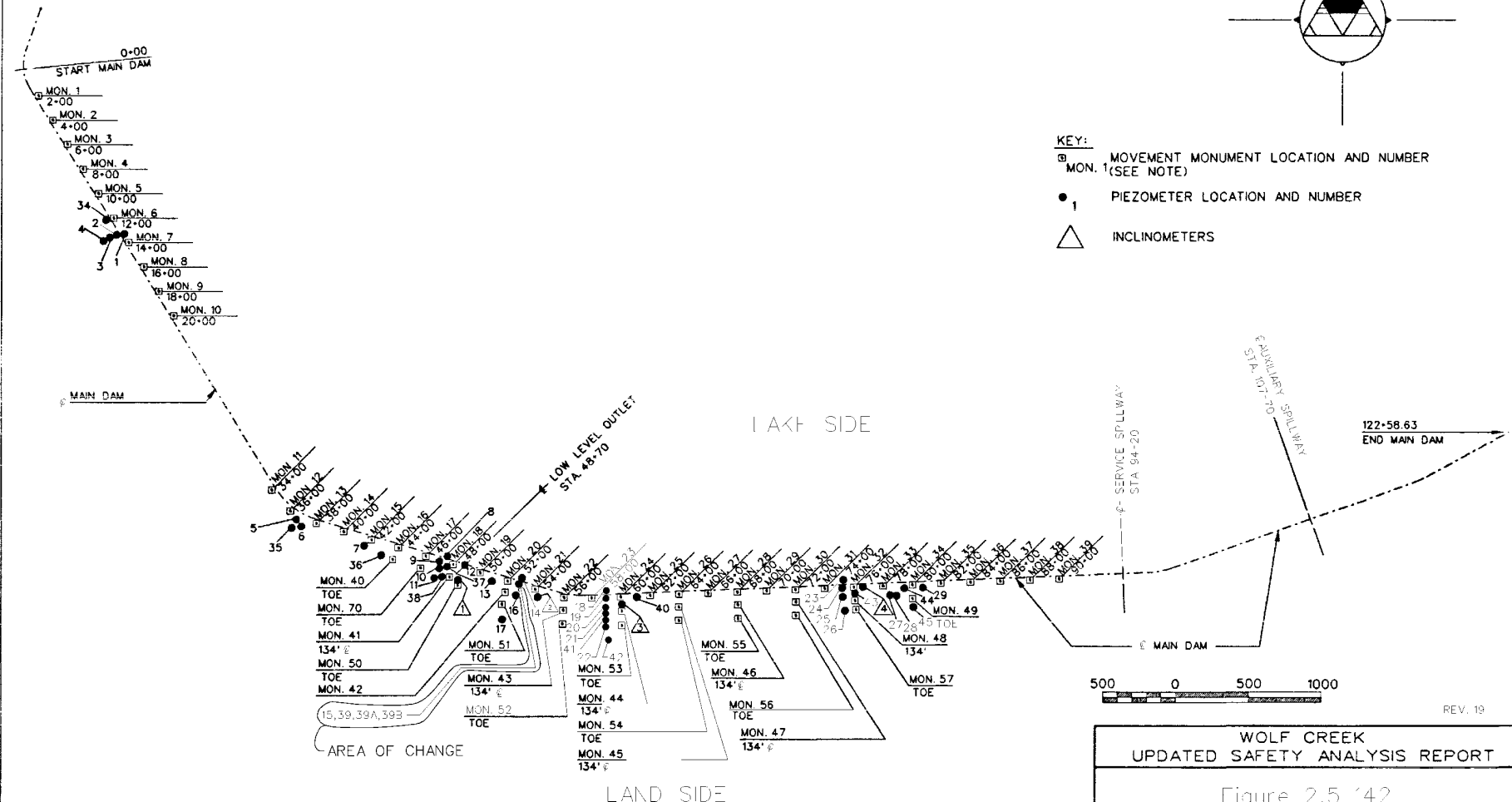

DRAWING REFERENCE:
 MONUMENT LOCATION MAP WOLF CREEK
 GENERATING STATION BY CAMPBELL,
 BARBER, LAMBETH & ASSOCIATES; JOB
 NO. 3800365, REV. 2; DATED: 12-17-80

NOTE: NEW MOVEMENT MONUMENTS ADDED IN 1987
 HAVE BEEN LOCATED WITHIN 5'-8" OF
 EXISTING MARKERS SHOWN.



REV. 19

**WOLF CREEK
 UPDATED SAFETY ANALYSIS REPORT**

Figure 2.5 '42
 MOVEMENT MONUMENT AND
 PIEZOMETER LOCATIONS
 MAIN DAM

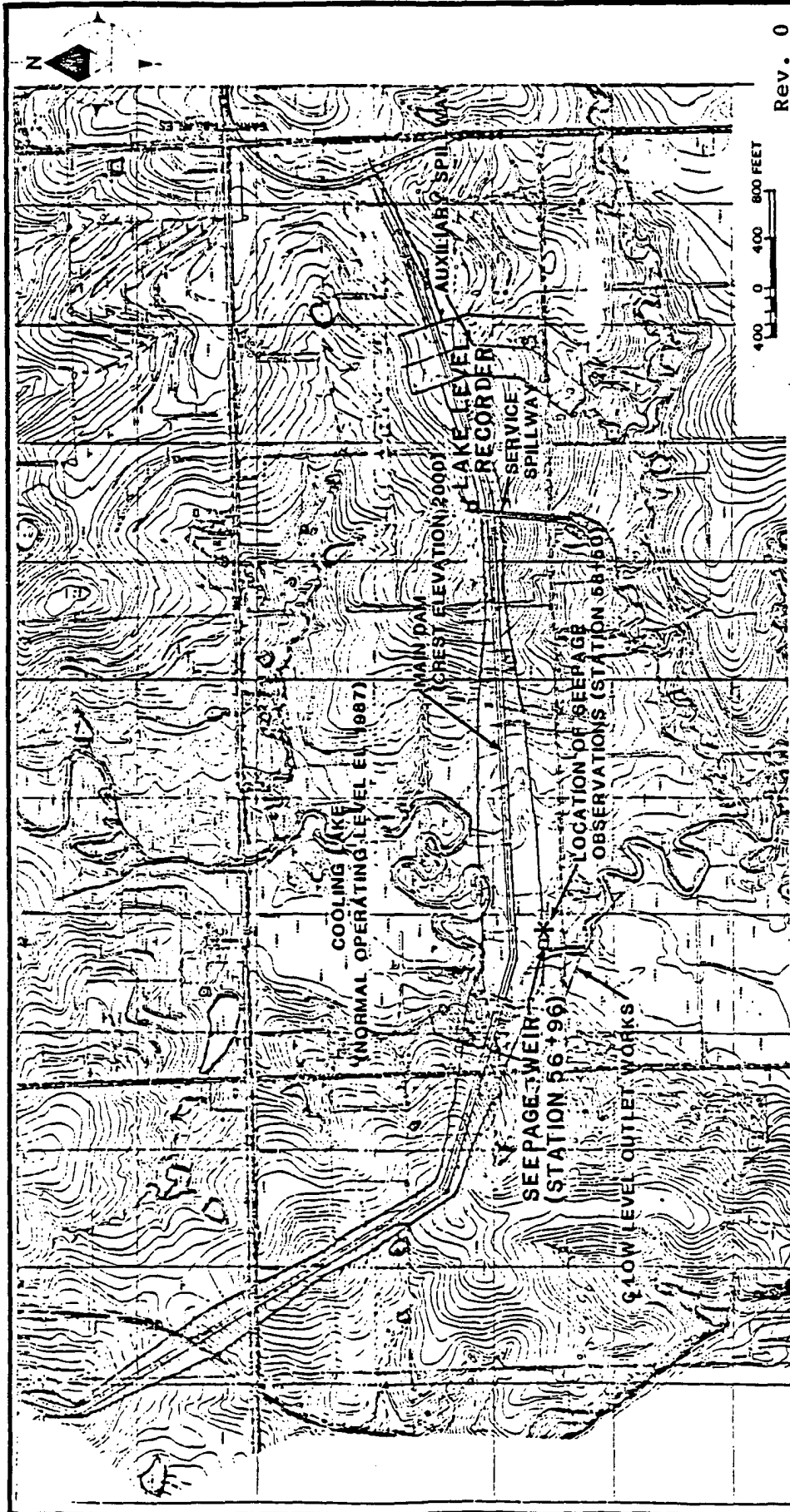

WOLF CREEK
UPDATED SAFETY ANALYSIS REPORT

Figure 2.5-143

Location of Seepage Observations
 at Main Dam

OBSERVED SEEPAGE
(Downstream Toe of Main Dam at Station 68+60)

1981

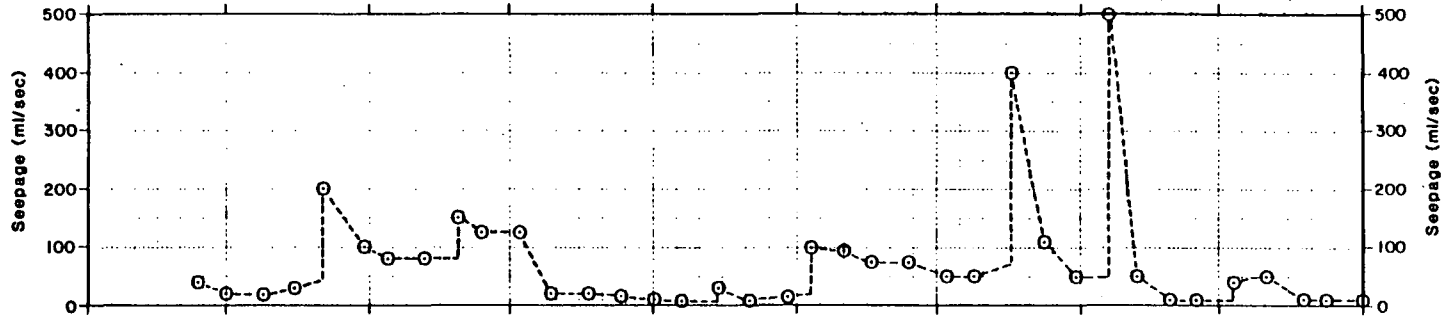

PRECIPITATION
(On-Site Meteorological Monitoring System Data)

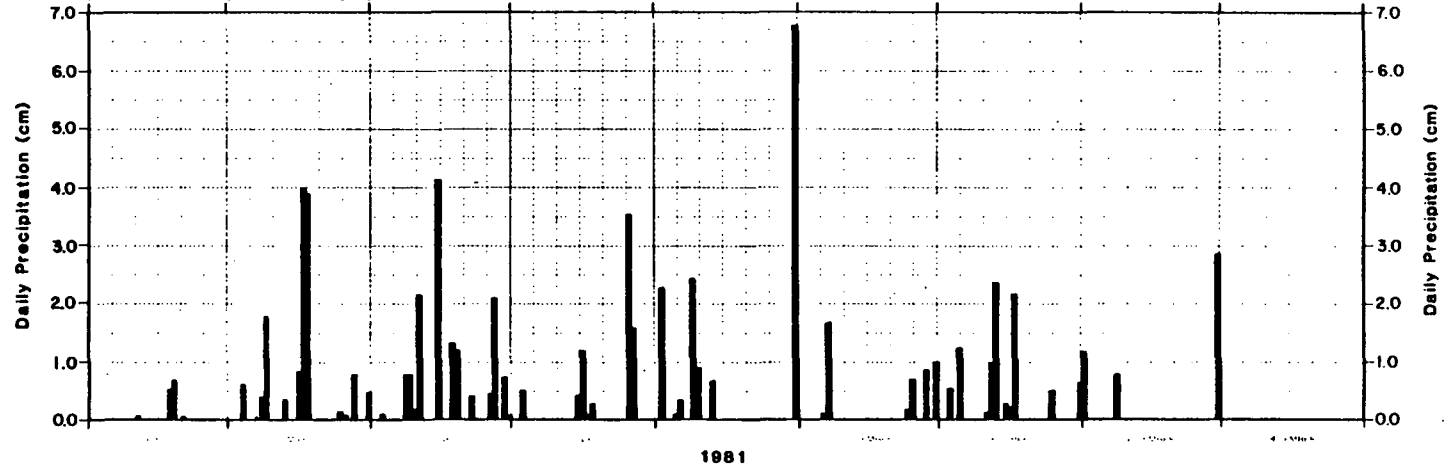

1981

Rev. 0

WOLF CREEK
UPDATED SAFETY ANALYSIS REPORT

Figure 2.5-144 (Sheet 1 of 3)

Observed Seepage and
Precipitation Data

OBSERVED SEEPAGE
(DOWNSTREAM TOE OF MAIN DAM AT STATION 58+50)

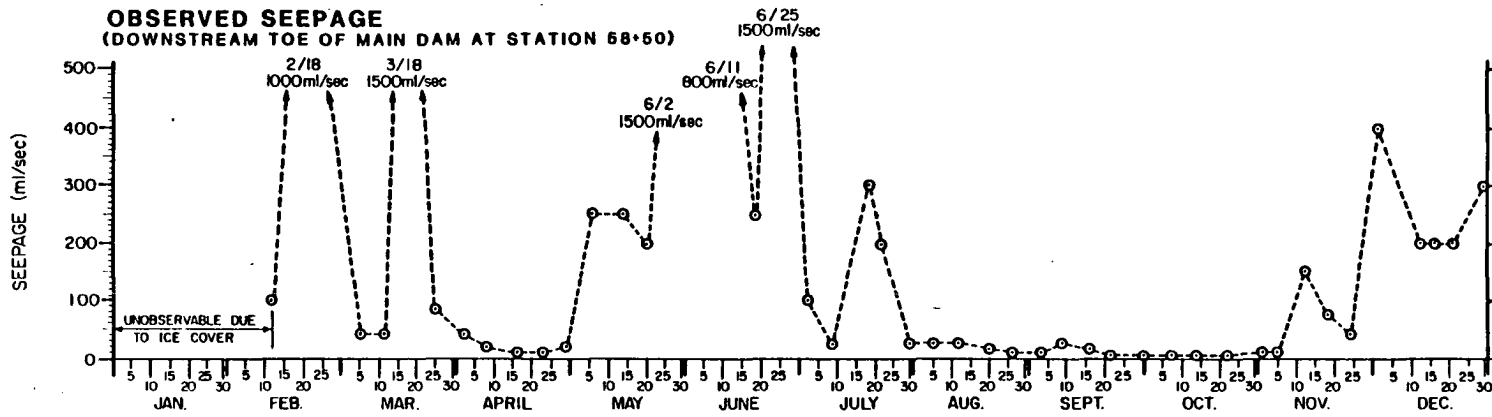

PRECIPITATION

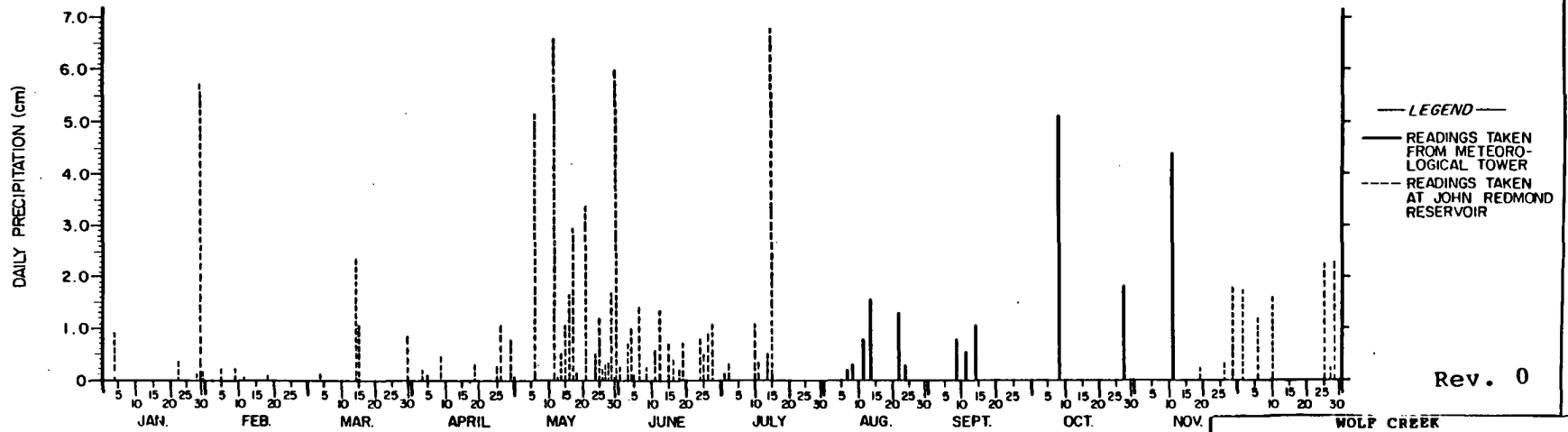

Rev. 0

WOLF CREEK
UPDATED SAFETY ANALYSIS REPORT
Figure 2.5-144 (Sheet 2 of 3)
Observed Seepage and
Precipitation Data

1982

OBSERVED SEEPAGE
(DOWNSTREAM TOE OF MAIN DAM AT STATION 58+50)

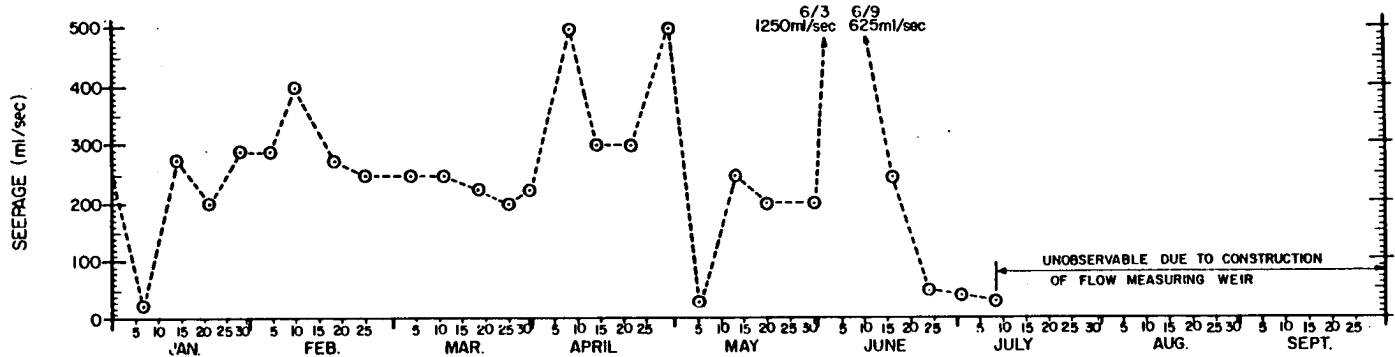

PRECIPITATION

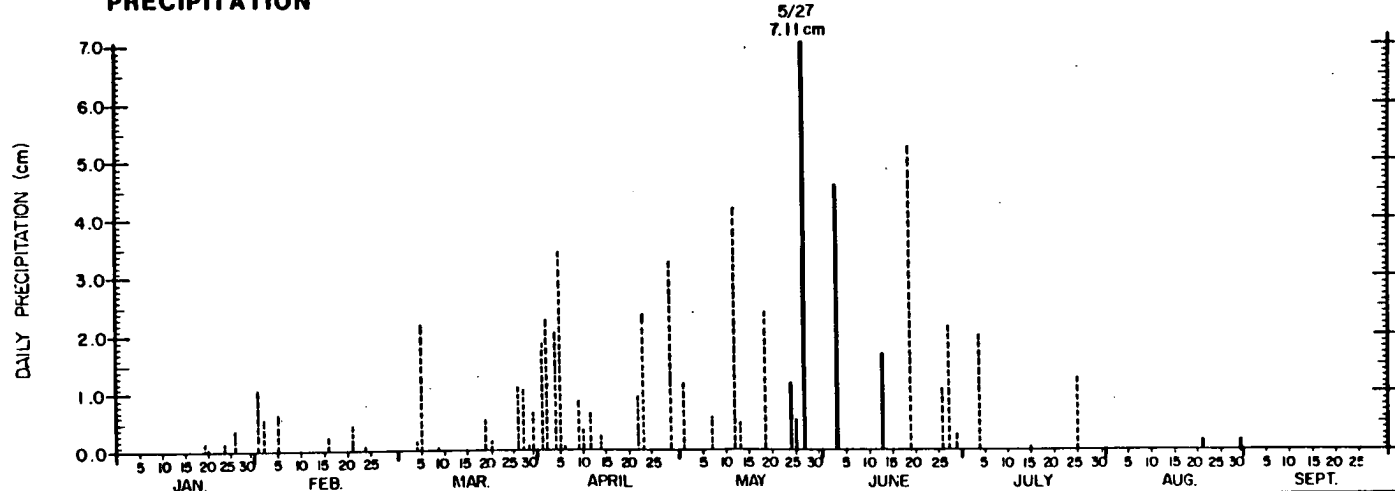

—LEGEND—
 — READINGS TAKEN FROM METEOROLOGICAL TOWER
 - - - READINGS TAKEN AT JOHN REDMOND RESERVOIR

Rev. 0

WOLF CREEK
 UPDATED SAFETY ANALYSIS REPORT
 Figure 2.5-144 (Sheet 3 of 3)
 Observed Seepage and
 Precipitation Data

1983

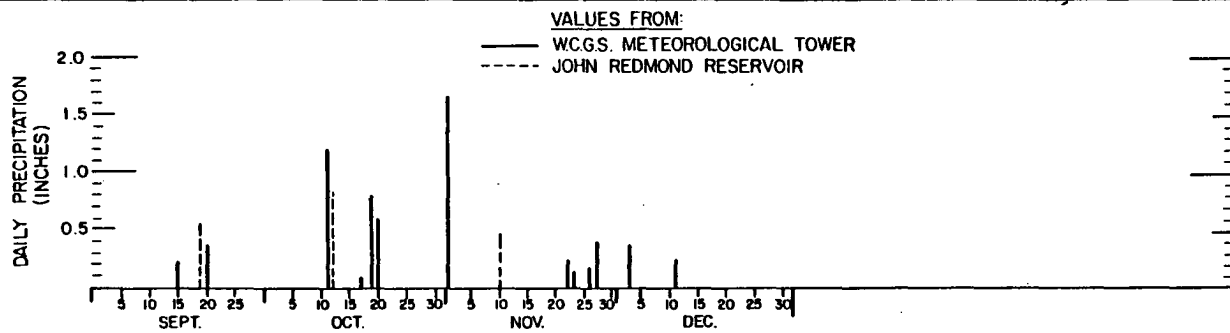

NOTES:

1. WEIR COMPLETED DURING THE FIRST HALF OF AUGUST; IT HAD NO MEASURABLE FLOW PRIOR TO SEPTEMBER 15.
2. THE MAXIMUM ANTICIPATED SEEPAGE THROUGH THE MAIN DAM, AS MEASURED AT THE WEIR, IS 3,000 LINEAR FEET TIMES 0.000006 cfs/LF, EQUAL TO 0.0180 cfs.
3. WEIR READINGS ARE UNRELIABLE FROM DECEMBER 16 THROUGH DECEMBER 31, SINCE THE WEIR WAS FROZEN OVER.
4. SNOWFALL AMOUNTS ARE UNAVAILABLE FOR DECEMBER.
5. THIS PEAK IS CAUSED BY SNOW MELT RUNOFF.

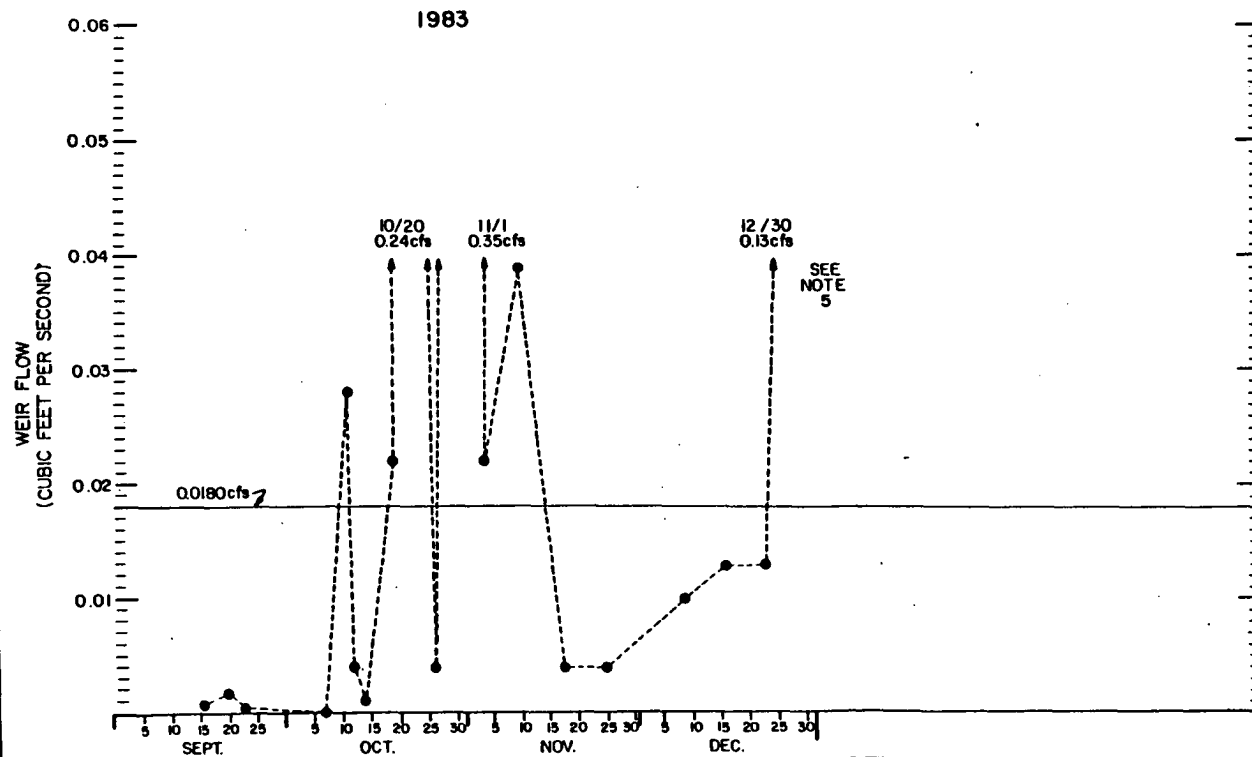

Rev. 0

WOLF CREEK
 UPDATED SAFETY ANALYSIS REPORT

Figure 2.5-145 (Sheet 1 of 2)

Measured Seepage and
 Precipitation Data

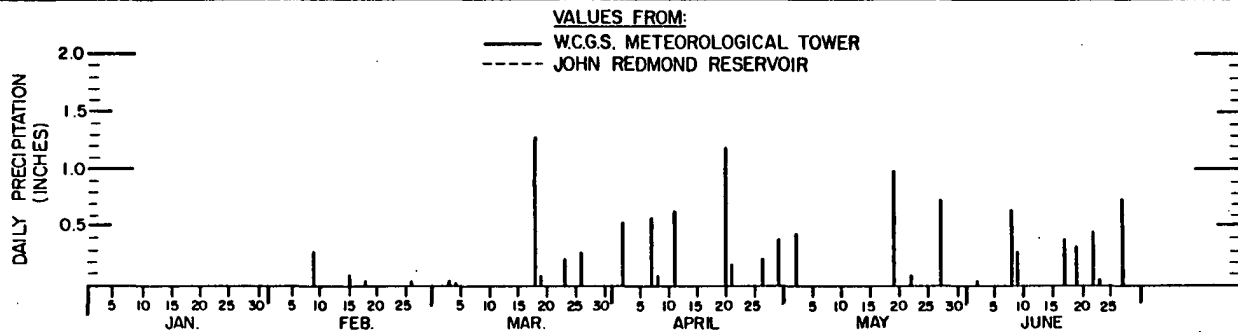

NOTES:

1. THE MAXIMUM ANTICIPATED SEEPAGE THROUGH THE MAIN DAM, AS MEASURED AT THE WEIR, IS 3000 LINEAR FEET TIMES 0.000006 cfs/LF, EQUAL TO 0.0180 cfs.
2. WEIR READINGS ARE UNRELIABLE FROM JANUARY 1 THROUGH JANUARY 27, SINCE THE WEIR WAS FROZEN OVER.
3. SNOWFALL AMOUNTS ARE UNAVAILABLE FOR JANUARY AND FEBRUARY.
4. THIS PEAK IS CAUSED BY SNOW MELT RUNOFF.

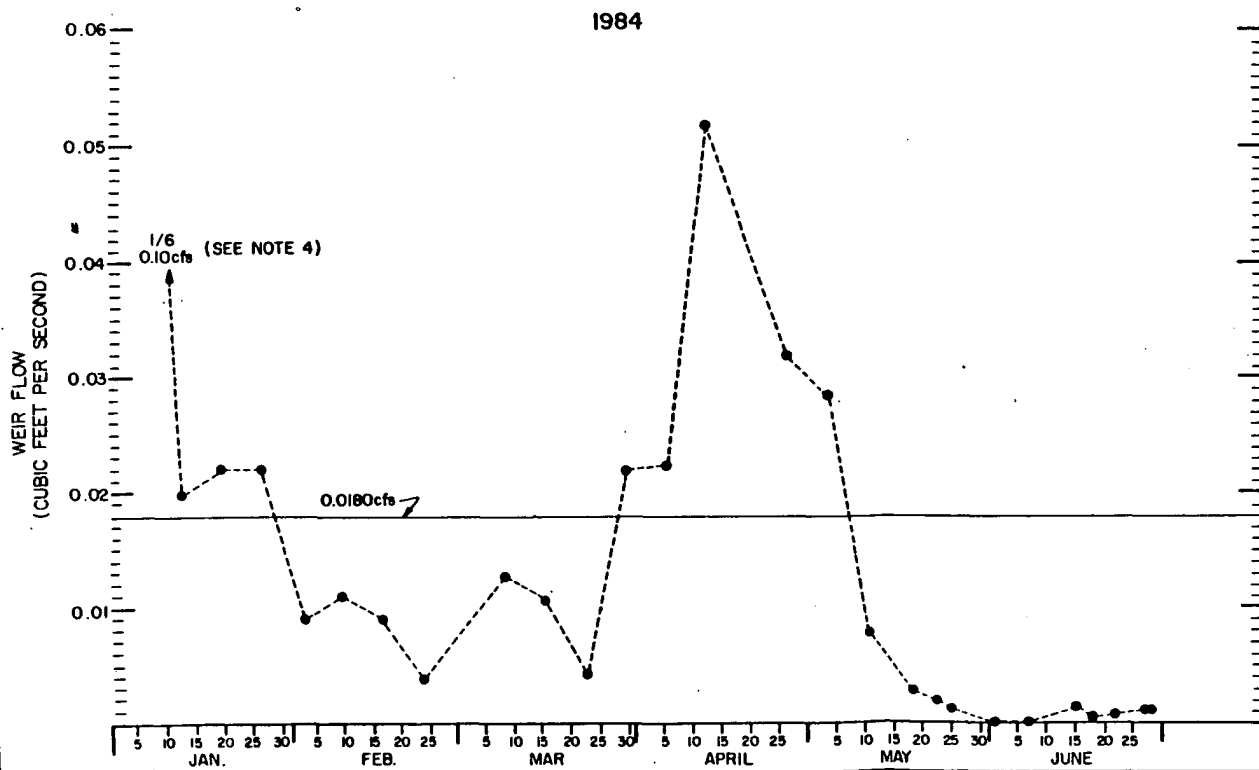

Rev. 0

**WOLF CREEK
 UPDATED SAFETY ANALYSIS REPORT**

Figure 2.5-145 (Sheet 2 of 2)

Measured Seepage and
 Precipitation Data

WOLF CREEK
UPDATED SAFETY ANALYSIS REPORT
 Figure 2.5-146
 SSE Horizontal Design Spectra

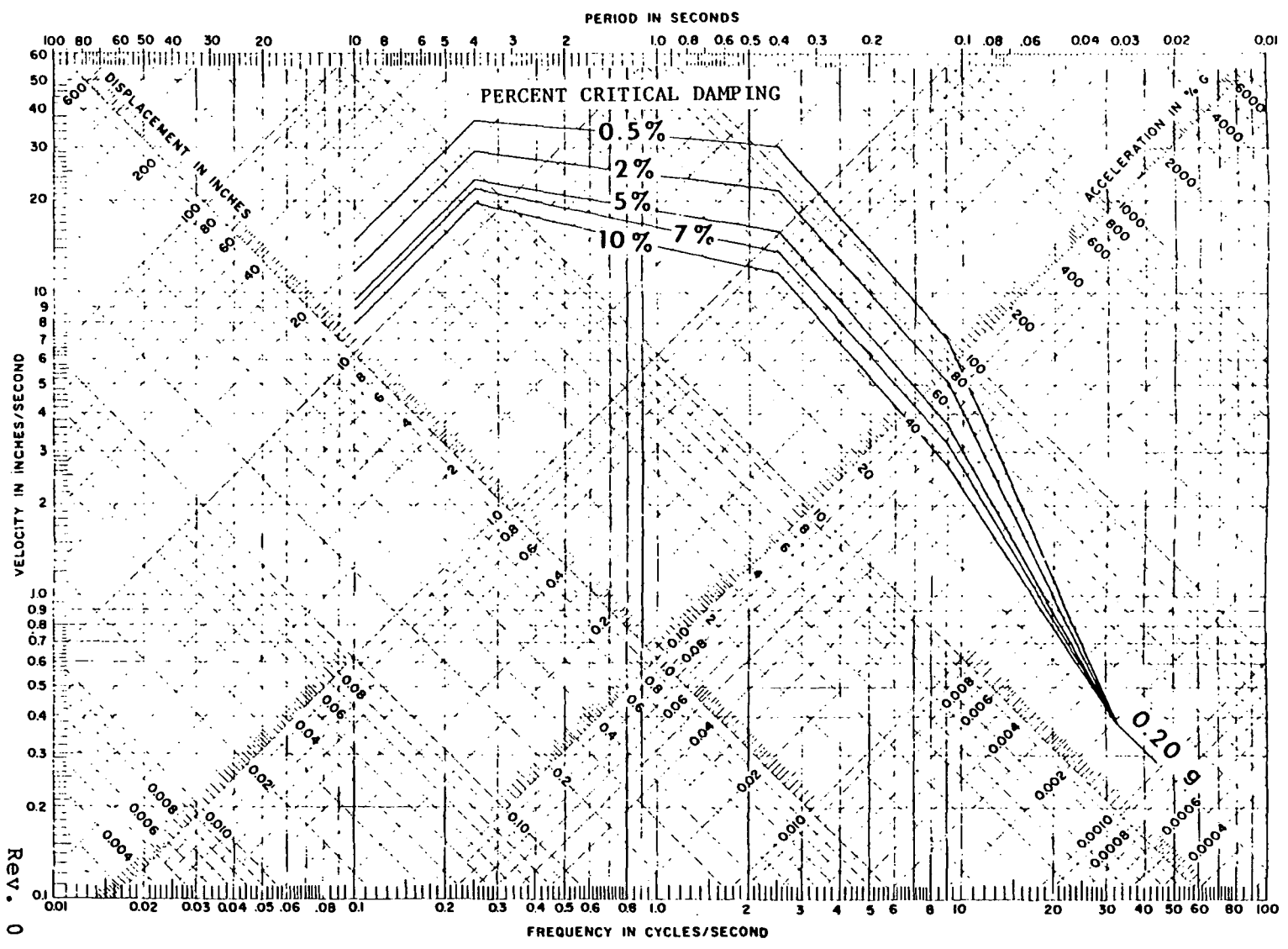

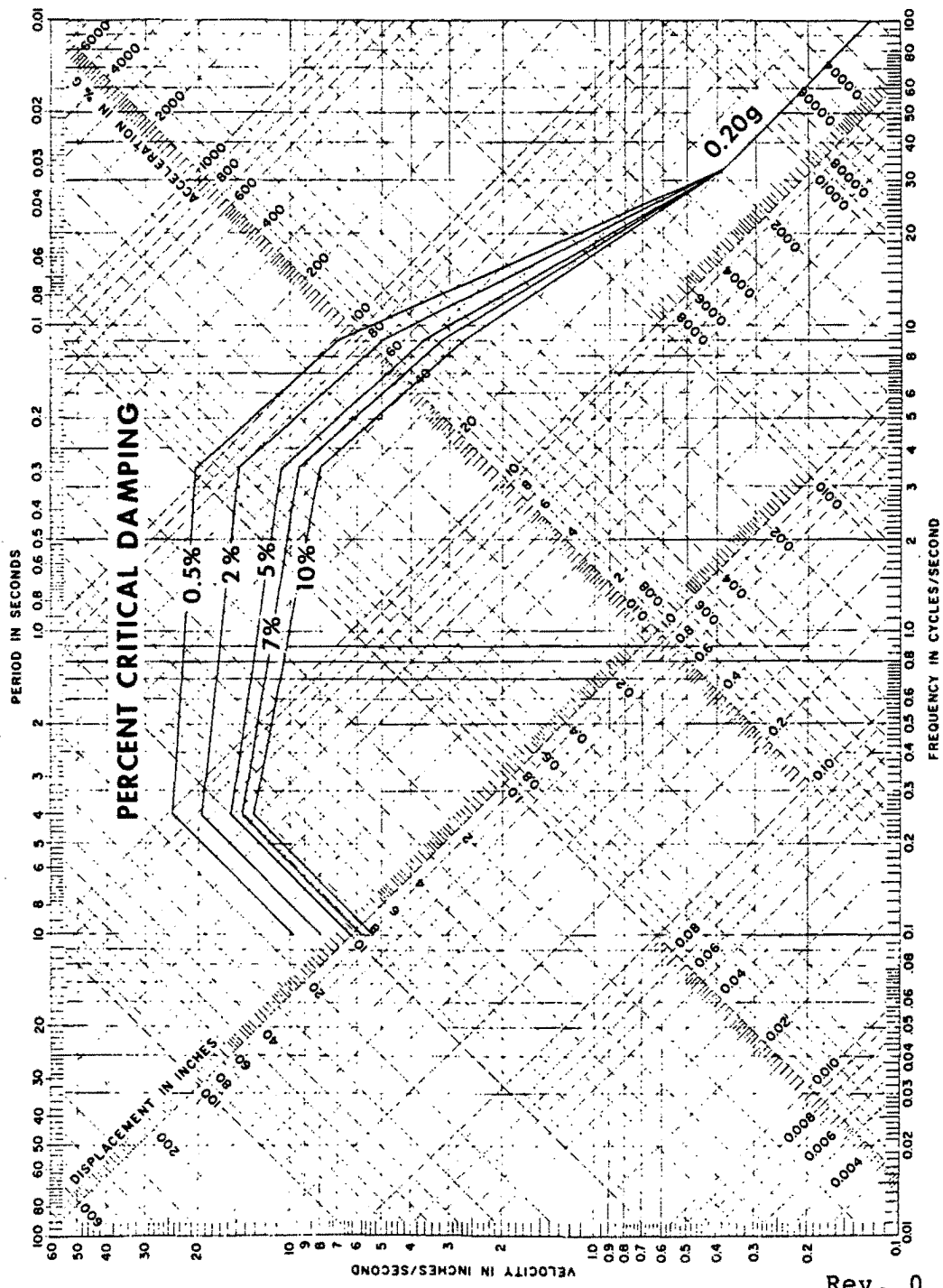

Rev. 0

**WOLF CREEK
UPDATED SAFETY ANALYSIS REPORT**

Figure 2.5-147
SSE Vertical Design Spectra

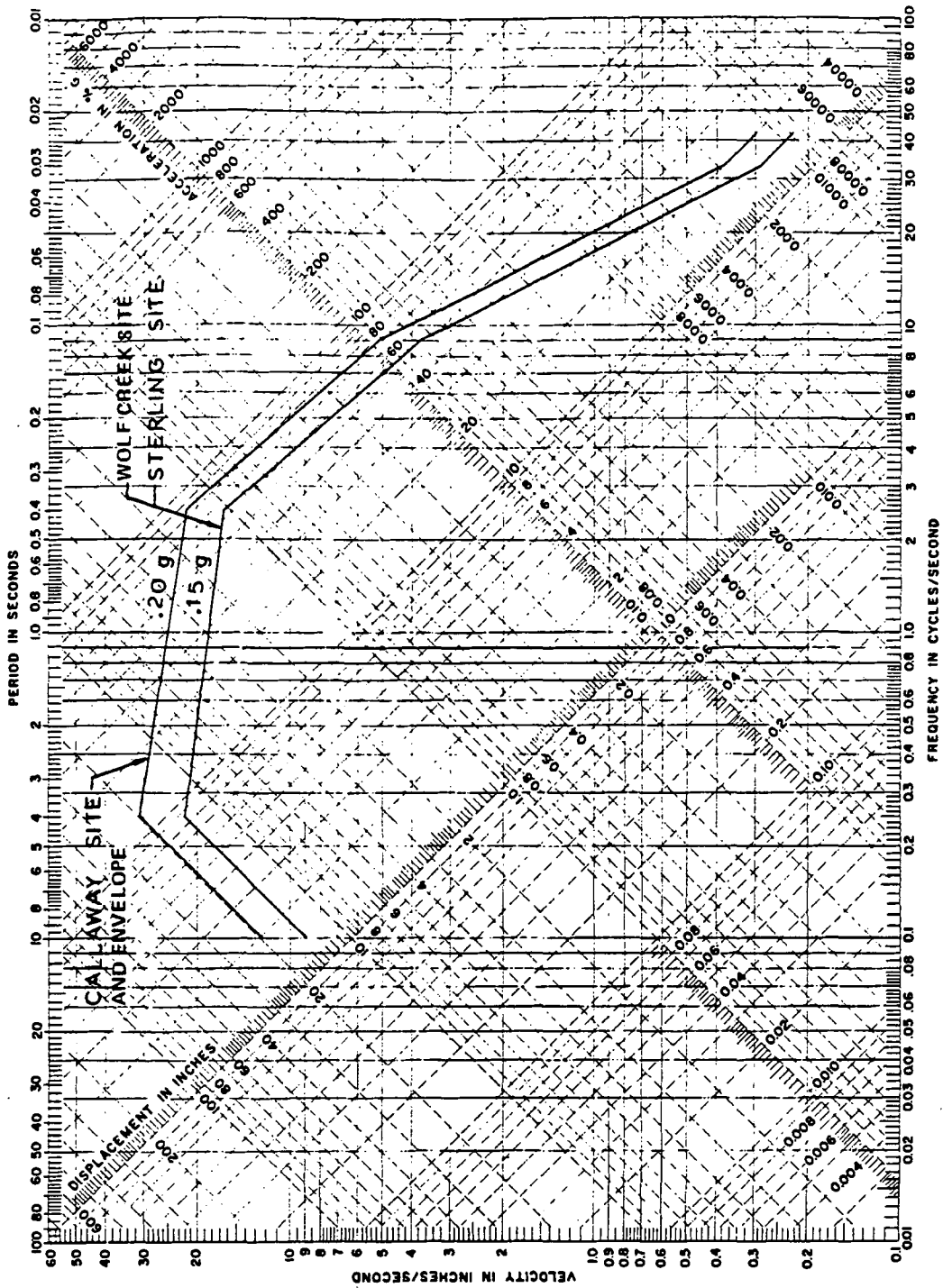

Rev. 0

**WOLF CREEK
UPDATED SAFETY ANALYSIS REPORT**

Figure 2.5-148

Envelope of Site SSE Horizontal
Design Spectra for 2% Damping

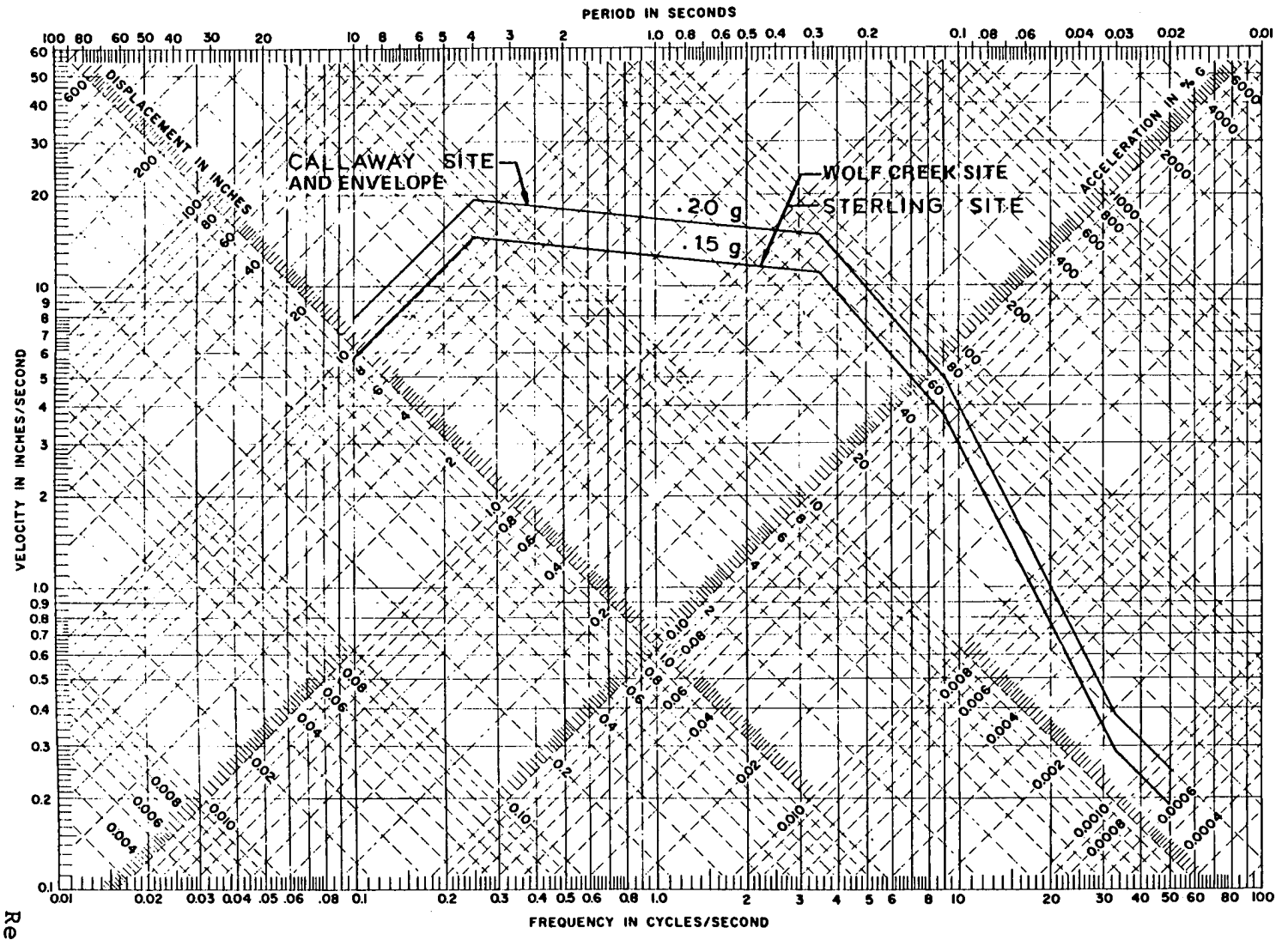

WOLF CREEK
UPDATED SAFETY ANALYSIS REPORT

Figure 2.5-149

Envelope of Site SSE Vertical
 Design Spectra for 2% Damping

Rev. 0

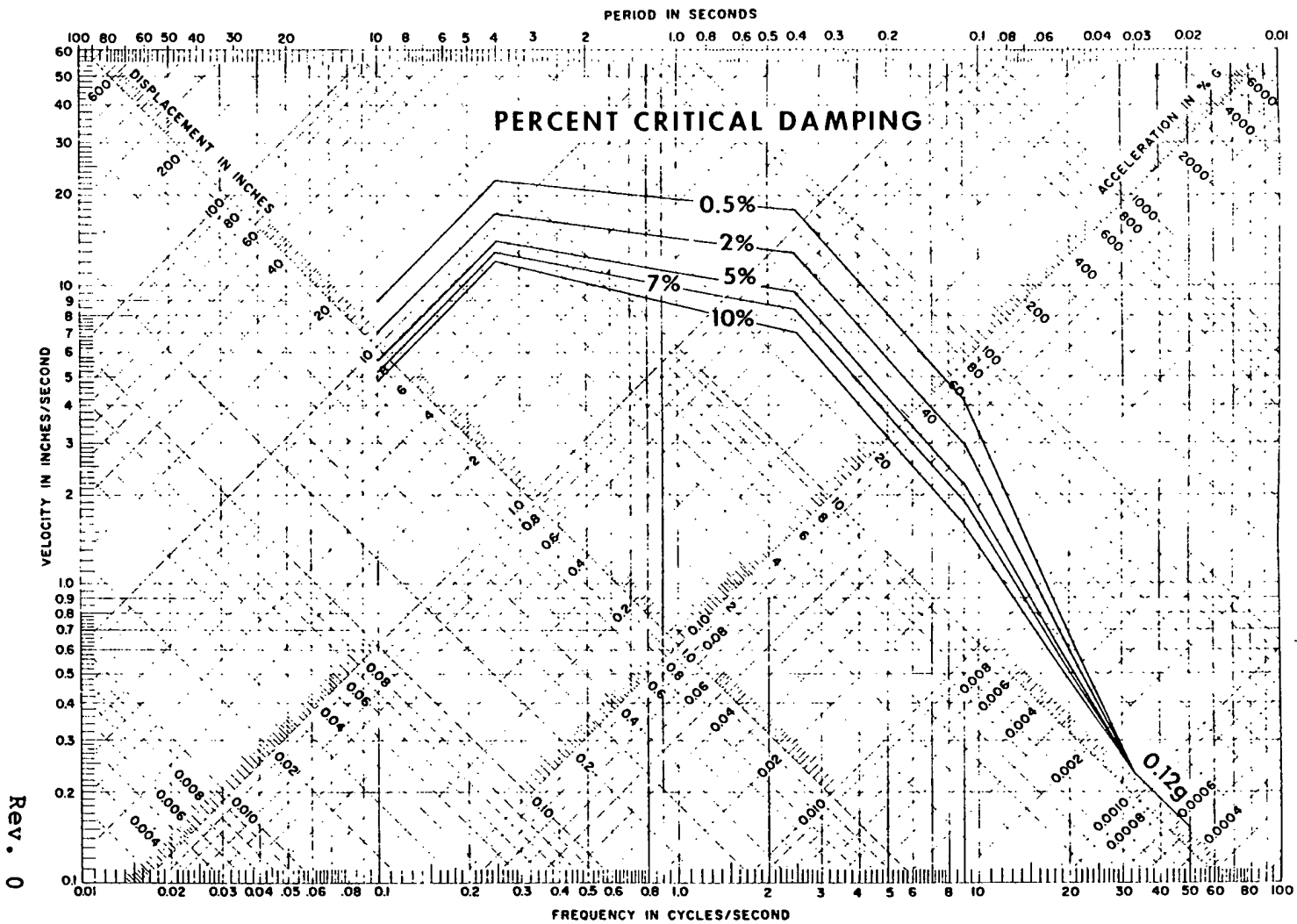

Rev. 0

WOLF CREEK
 UPDATED SAFETY ANALYSIS REPORT

Figure 2.5-150

OBE Horizontal Design Spectra

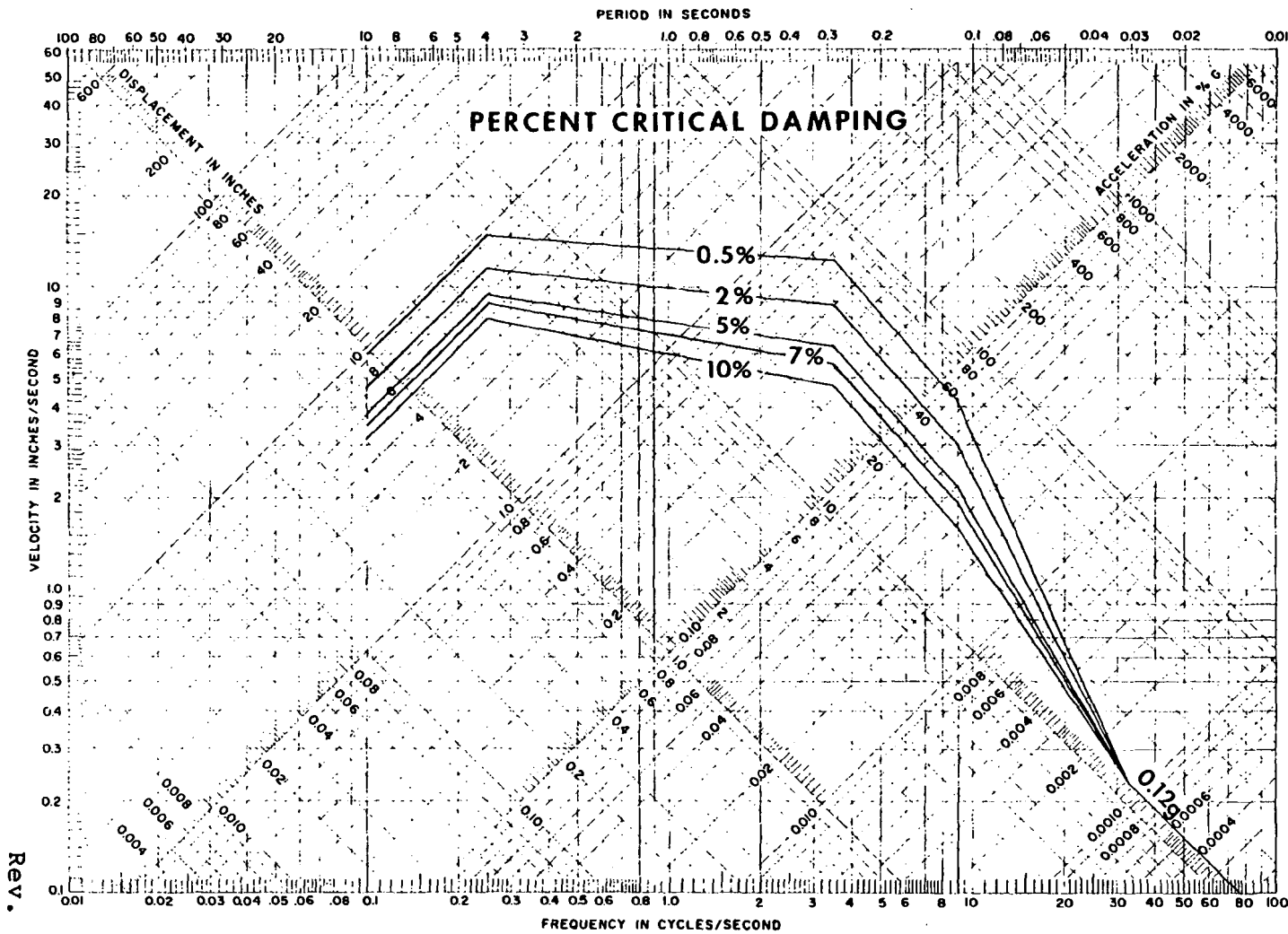

Rev. 0

WOLF CREEK
UPDATED SAFETY ANALYSIS REPORT
 Figure 2.5-151
 OBE Vertical Design Spectra

LATERAL EARTH PRESSURE EQUATIONS

SITE	DESIGN WATER TABLE ELEVATION	UNIT WEIGHTS (PCF)			STATIC PRESSURES				DYNAMIC PRESSURES			
		MOIST	SATURATED	BUOYANT	P_0	P_{S1}	P_{S2}	P_W	ENVELOPING OBE = 0.12G		ENVELOPING SSE = 0.20G	
									P_Q'	P_S'	P_Q'	P_S'
TYRONE ENERGY PARK (5)	BELOW GRADE $H_1 = 7.50'$	125	133	70	0.75Q	$94H_1$	$52.5H_2$	$62H_2$	42Q	$\frac{1476 \cdot 395H_2 + 14.7H_2^2}{(7.5 + H_2)}$.82Q	$\frac{2882 + 771H_2 + 28.7H_2^2}{(7.5 + H_2)}$
	BELOW WALL $H_2 = 0$				0.75Q	$94H_1$	—	—	42Q	$26H_1$.82Q	$51H_1$
WOLF CREEK	AT GRADE $H_1 = 0$	—	130	68	0.65Q	—	$106H_2^{(4)}$	—	.18Q	$15H_2^{(4)}$.30Q	$27H_2^{(4)}$
CALLAWAY	AT GRADE $H_1 = 0$	—	150	88	.33Q	—	$92H_2^{(4)}$	—	.18Q	$18H_2^{(4)}$.30Q	$30H_2^{(4)}$
STERLING	AT GRADE $H_1 = 0$	—	127	65	0.70Q	—	$108H_2^{(4)}$	—	.12Q	$11H_2^{(4)}$.20Q	$19H_2^{(4)}$

NOTES:

1. THE EQUATIONS SHOWN IN THE TABLE ARE USED TO COMPUTE THE LATERAL EARTH PRESSURES AT THE TOP AND BOTTOM OF THE CATEGORY I FOUNDATION WALLS OF THE STANDARD PLANT AT EACH SITE. THE DYNAMIC EFFECT OF THE EARTH PRESSURES AT EACH SITE IS BASED ON THE ENVELOPING SSE AND OBE.
2. THE MAXIMUM EARTH PRESSURES COMPUTED AT THE TOP AND BOTTOM OF THE WALLS ARE TAKEN AS THE ENVELOPING PRESSURES AND ARE USED IN DESIGN OF THE CATEGORY I STRUCTURES.
3. THE FOLLOWING DEFINITIONS APPLY:
 - P_0 = STATIC PRESSURE DUE TO SURCHARGE LOADING
 - P_{S1} = STATIC PRESSURE DUE TO SOIL ABOVE WATER TABLE
 - P_{S2} = STATIC PRESSURE DUE TO SOIL BELOW WATER TABLE
 - P_W = HYDROSTATIC PRESSURE DUE TO GROUNDWATER
 - P_S' = DYNAMIC PRESSURE DUE TO SOIL
 - P_Q' = DYNAMIC PRESSURE DUE TO SURCHARGE LOADING
 - H_1 = DEPTH TO GROUNDWATER TABLE
 - H_2 = DEPTH FROM GROUNDWATER TABLE TO BOTTOM OF FOUNDATION WALL
 - H = TOTAL DEPTH OF WALL
= $H_1 + H_2$
4. INCLUDES EFFECT OF HYDROSTATIC PRESSURE.
5. THE LATERAL EARTH PRESSURES AT THE TYRONE ENERGY PARK SITE ARE ANALYZED FOR THE CONDITIONS OF GROUNDWATER AT 7.50' BELOW GRADE AND GROUNDWATER BELOW THE FOUNDATION WALL.
6. ALL PRESSURES IN POUNDS PER SQUARE FOOT (PSF).

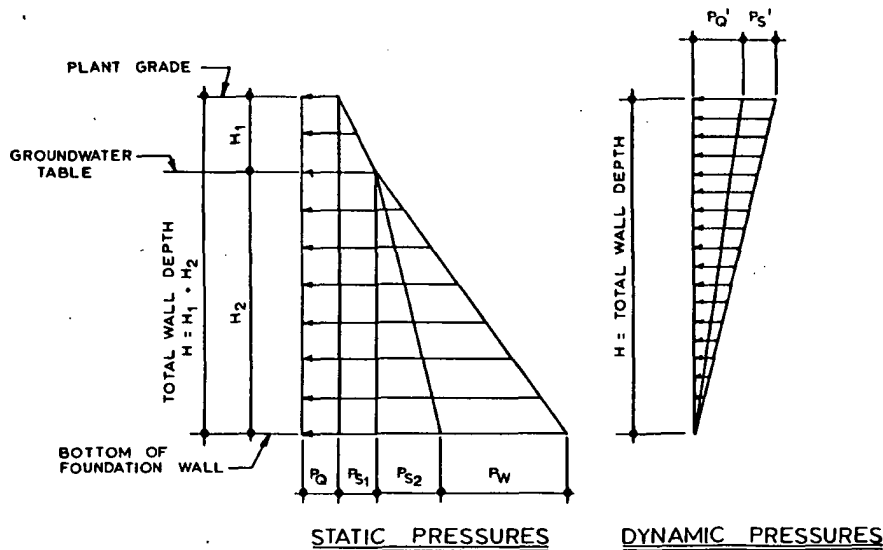

**WOLF CREEK
UPDATED SAFETY ANALYSIS REPORT**

Figure 2.5-152

Lateral Earth Pressure Schematic