

# NTT Technical Review

12  
2012

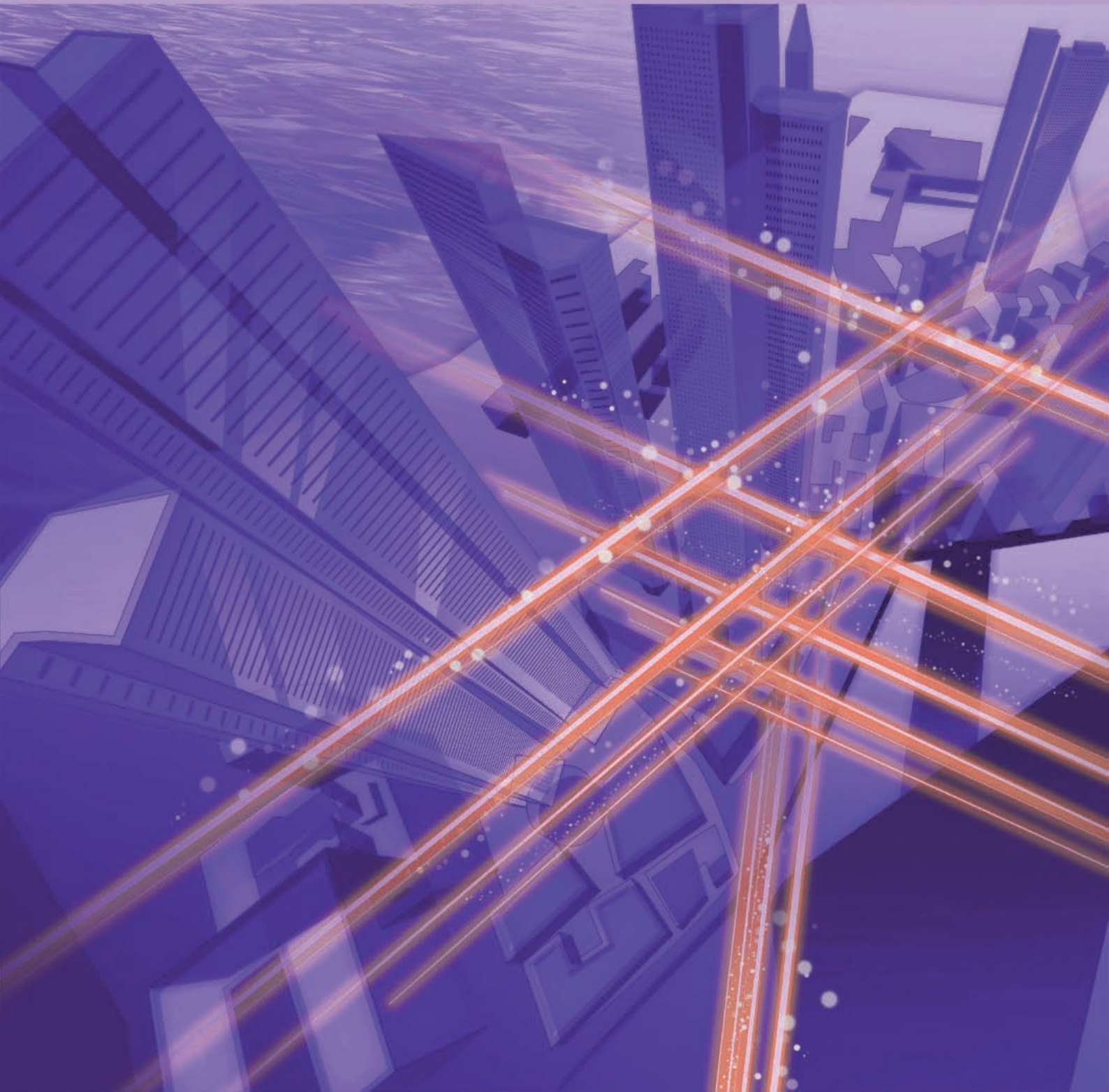

December 2012 Vol. 10 No. 12

# NTT Technical Review

December 2012 Vol. 10 No. 12



## View from the Top

Kaoru Kato  
President and Chief Executive Officer, NTT DOCOMO, Inc.

## Feature Articles: Platform Technologies for Open Source Cloud Big Data

IaaS Platform Using OpenStack and OpenFlow Overlay Technology

PaaS Software Based on Cloud Foundry

NoSQL Database Characteristics and Benchmark System

Efficient Large-scale Data Analysis Using MapReduce

Jubatus in Action: Report on Realtime Big Data Analysis  
By Jubatus

## Feature Articles: Optical Semiconductor Technologies for Photonic Networks

High-speed Tunable Distributed Amplification Distributed Feedback (TDA-DFB) Lasers

Electroabsorption Modulator Integrated Light Sources for Future High-speed Ethernet

High-speed Photodetector Technologies

InGaAs Metamorphic Laser for Low-power-consumption Operation

Current-injection Photonic-crystal Laser

## Regular Articles

Advertising Effectiveness Measurement Using Crowd Measurement and Facial Image Processing Techniques

## Global Standardization Activities

Report on ITU Radiocommunication Assembly 2012 and ITU World Radiocommunication Conference 2012

## **Practical Field Information about Telecommunication Technologies**

Weather-resistance Tests for Recycled Polyethylene

## **External Awards**

External Awards

## Creating New Value in the Spirit of “Speed and Challenge”

***Kaoru Kato***  
***President and Chief Executive Officer,***  
***NTT DOCOMO, Inc.***



### Overview

Competition in Japan’s mobile communications market is becoming increasingly severe, fueled by the rapidly expanding sales of smartphones and the appearance of global players. In this environment, NTT DOCOMO must prove its worth as a leading company in the mobile communications business, and to do so, it is orchestrating all of its expertise and know-how to meet the increasingly diverse and advanced needs of its customers. In the aftermath of the Great East Japan Earthquake, we sat down with Kaoru Kato, President of NTT DOCOMO, to ask him about the role of mobile communications as a major lifeline for society, recognizing his experience in spearheading restoration measures at many disaster sites.

---

### Facing the future without a moment to lose

—*Mr. Kato, congratulations on your appointment as President of NTT DOCOMO. To begin with, could you tell us something about your guiding principles and management policies?*

Well, since starting my career at NTT, I have been involved in the planning and development of mobile communications systems and mobile phones. I have witnessed the evolution of mobile communications and mobile phones from the early days of the industry and have confronted a wide variety of issues over the years. The business environment of today is undergoing great change, but we are making an all-out effort to apply the knowledge that we have accumulated and the collaborative ties that we have formed both inside and outside the company in order to achieve a management style that can respond swiftly to change.

Keeping the above spirit in mind and adhering to the policies of my predecessor, I have proposed the spirit of “Speed and Challenge.” When taking up a new post, some people become rather tense, thinking

that they must do something different from their predecessor. Although that could also have been the case with me, I intend to respect the ideas of the former president in carrying out the company’s management vision, especially since I worked with him on various issues over the years. As you know, the mobile communications market is changing at an unprecedented speed and so are customer needs. To respond to such an unpredictable environment, I would like to take up new challenges, knowing that we have not a moment to lose.

To this end, we are implementing the following two initiatives at NTT DOCOMO: “evolution of services by pursuing innovation” and “new value creation through convergence.”

---

### Making *smart life* a reality

The first initiative “evolution of services by pursuing innovation” means creating new services that link smartphones with the “DOCOMO cloud”. Let me take Photo Collection as an example of the services offered through the cloud. This is a storage service

that enables the user to store up to 5 GB of photos and video clips free of charge in the personal cloud. Photos and videos taken with a smartphone or other devices or stored on a personal computer can be automatically uploaded to the cloud and then viewed from a smartphone, personal computer, tablet or other device as desired.

The Photo Collection service can be linked with the organizing function on the cloud, which is capable of identifying faces and scenes and automatically grouping those photos and videos according to certain categories such as date, person, event, place, model, and service. The service can also be linked with external services such as Evernote, Eye-Fi, and HighCam for enhanced storage, viewing, and organization of photos and videos.

In addition, we are enhancing the functions of Shabette-Concier, a voice-agent app, Mail-Hon'yaku Concier, an app for translating text messages, and Hanashite Hon'yaku, a speech translation app. We are also starting to provide the docomo mail and docomo phonebook services to expand to a full lineup of cloud-linked apps (software applications). Shabette-Concier now gives more accurate replies by linking with i-concier, another DOCOMO service. Mail Hon'yaku Concier translates text messages composed by the user on their smartphone into the other party's language in the cloud. This app, which currently supports Japanese-to-English & English-to-Japanese, Japanese-to-Korean & Korean-to-Japanese, and Japanese-to-Chinese & Chinese-to-Japanese, can be used for text-based communications as in email and social networking services (SNSs). We take pride in this app because it helps the user to send messages in a foreign language and facilitates their communication with people who speak other languages. Finally, the docomo mail and docomo phonebook services store the user's email and phonebook data in the cloud, thereby enabling the user to access the data from multiple devices and to recover the data if necessary. These services are making the user's life safer, smarter and more convenient.

---

#### Evolving the mobile phone into a convenience store in your hand

---

“New value creation through convergence,” the second of our new initiatives, means merging the smartphone with various areas involving the lives and lifestyles of people.

The smartphone, which can fit into your hand, encapsulates the performance of a supercomputer of



just a few decades ago. Despite its small size, it incorporates functions for enjoying music, TV, movies, and books and for assisting the user in fields such as shopping, health, and medical care. For how long are we separated from our mobile phones during the course of a day? We only have to think about our daily life to answer this question. The fact is that the mobile phone is a device that most users have near at hand at all times as a means of receiving a wide array of services and products. It is becoming, in a sense, a convenience store in your hand. We are accelerating the realization of this vision through our dshopping service, which enables users to safely and conveniently purchase products that are carefully screened by NTT DOCOMO. We are also committed to forming alliances with other enterprises to further enhance mobile shopping. Our aim here is to provide our customers with total shopping support.

To implement these two initiatives rapidly, we need to reform our corporate structure and revise our business processes to keep up with the times. Measures must also be taken to make organizational changes and enhance personnel training.

---

#### Mission and dream arising from personal experience of the Japan Airlines plane crash

---

It is my belief that NTT DOCOMO is a company

with a mission to provide its customers with safe and secure services and with a dream to enhance and enrich the lives of its customers through highly convenient products. This is why I want to create a workplace in which each and every employee can eagerly and enjoyably take on new challenges. At the same time, I want to be someone who my subordinates can easily talk to and feel relaxed around. In particular, I want to be a person to whom anyone can say anything, even if it concerns difficult situations or bad news. I don't mind standing and talking if I can hear about problems while they are still in the budding stage.

*—From what experiences did this mission and dream arise?*

This dream to enhance and enrich the lives of our customers through highly convenient products has come about in various ways: from my past involvement in the planning and development of mobile communications and mobile phones, from my expectations for further evolution and progress of mobile systems and products, and from my wish to provide customers with convenient products and thrilling experiences above and beyond anything that they have ever seen before. Of course, I realize that NTT



DOCOMO is entering a very difficult period in our business history, but I also know that there is much satisfaction to be gained from doing work that has great potential for enriching people's lives.

Though it would be hard to explain the evolution of our perception of our mission in just a few words, let me say that my past work at actual disaster sites has had a big influence. In 1985, a Japan Airlines plane crashed into Mount Osutaka in Gunma Prefecture. I was told to head for the crash site with several mobile phones. Unlike today's lightweight models, each of these weighed about one kilogram and had a shoulder strap. I pushed my way up steep mountain paths and eventually arrived at the crash site. It was a horrible scene that I can hardly put into words. The only means of communications at the site was through radio equipment, and it took some time to establish communications even with the incident command center, but the mobile phones that I brought with me greatly improved communications between the crash site and the command center. As a result, I became more confident about the usefulness of mobile phones. Last year's Great East Japan Earthquake underscored our role as a communications operator to connect at all times: during emergencies so that people can check on their loved ones and at normal times so that people can simply communicate with each other. Our mission to connect people is something that we should never forget.

*DOCOMO is the closest to customers  
among all NTT Group companies*

---

*—Could you say a few words to NTT DOCOMO employees?*

Certainly. First, I would emphasize that NTT DOCOMO must transform itself into an integrated service company. Continuing to focus our efforts only on the mobile communications business as we have been doing so far can only lower our corporate value. I would like all of us at NTT DOCOMO to be fearless and energetic in creating new value and markets.

Here, I would reiterate that communication devices are first and foremost tools, and to enable them to be used to their full extent, it is important that we listen closely to the people using them, namely, our customers. The role of docomo shops and NTT DOCOMO information centers is not just to sell mobile phones and network services: they are also places where customers can talk freely to us about their needs. Of course, there are times when it is technically difficult

to satisfy customer wishes, and requests related to service quality can sometimes be quite demanding. Nevertheless, I truly believe that making an effort to satisfy each and every customer request leads to a beneficial cycle in which the services that we provide are continuously enhanced and expanded and the mobile devices that we offer have increasingly higher levels of performance.

This endeavor is not limited to projects and activities at NTT DOCOMO headquarters: to become a truly integrated service company, headquarters and all company offices and retail sites in the field must move forward as one. My aim is to visit NTT DOCOMO offices and retail sites throughout the country to listen to the ideas and opinions of those who deal directly with our customers and to bring their voices back to headquarters. Let's bring about a true revolution for the company by working in a unified manner wherever you are: at headquarters, regional offices, or retail sites.

Furthermore, NTT DOCOMO is closest to customers among companies in the NTT Group in the sense that we provide communications over the mobile phone—an item that people keep close at hand day in and day out. We are therefore in a most effective position to listen to customer needs and to convey to customers the services and plans of the entire NTT Group. In short, I want us to be a company that is truly welcoming and hospitable to our customers while cooperating and collaborating with other NTT Group companies. Let's explore new worlds in the spirit of "ONE docomo"!

#### Facing R&D with a "70% is OK" mindset while learning from our customers

—Mr. Kato, could you also leave us with a message to everyone in the R&D department?

Yes, I would tell our research and development (R&D) personnel to place importance on speed and to pursue R&D in the spirit that even 70% is OK. I think that the NTT Group and the R&D department tend to have the idea that products must be perfect. Although this is undeniably a noble aspiration, we must make a decision about product or service development at some point in time even before perfection has been reached in order to keep up with the rapidly changing market. I hesitate to say this, but seeking total perfection often makes you lose your sense of time. Services and products that customers desire should be provided as quickly as possible and anything in those ser-



vices or products that turns out to be inadequate should then be corrected immediately. In short, I would like our R&D personnel to adopt the attitude of "if it's done wrong, it's OK to make a course correction and then, redo it" in their work. In this regard, our customers can assist in making a service even better by giving us feedback.

I believe that success comes after accumulating many failures. It is not necessary to be 100% successful all the time. What is needed is the ability to ascertain what is of true value, what is truly needed. Of course, it might be difficult to tell whether what you have at a certain point in time is 70% of what you need, but I will continue to talk about the need for this "70% is OK" attitude until it becomes embedded in R&D.

A top manager once said to me: "If people say that you are saying the same thing again and again, you can be sure that your words have finally penetrated their minds." Fortunately, there have been more opportunities for me to talk with leaders in various fields since I became president. From here on, I would like to share with R&D personnel and other NTT DOCOMO employees some of the wise advice of those leaders who have overcome many difficult situations as well as the words of wisdom that support my ideas and outlook.

Last but not least, my personal motto is "good can come out of misfortune." Good and bad times are the way of the world. Since I entered NTT, it certainly has not been smooth sailing all the time, and I cannot say that I have always been highly motivated. Actually, when I was in charge of achieving a practical in-flight telephone service, I had to conduct

a very strict airworthiness test that had to be passed. By making an extreme effort, I was successful in completing this test in what seemed to be an impossibly short time. This success revealed to me how hardship and pain are sometimes necessary to get things done. Even today, I have a vivid memory of those tough times. Difficult and painful situations can sometimes lead to good results. Furthermore, while there are only a limited number of things that a person can complete on his or her own, there are many things that can be achieved by seeking the cooperation of people around you. Something that has been achieved through much hardship necessarily becomes a valuable possession of the people involved. Let's move forward together without losing heart!

### **Interviewee profile**

#### ■ Career highlights

Kaoru Kato started his career at Nippon Telegraph and Telephone Public Corporation (now NTT) in 1977. He has been involved in the mobile phone business since the early days of the industry. He served as Executive Vice President and Member of the Board of Directors and Managing Director of the Corporate Strategy & Planning Department at NTT DOCOMO Kansai, Inc. beginning in 2007 and as Executive Vice President and Member of the Board of Directors and Managing Director of the Corporate Strategy & Planning Department at NTT DOCOMO from 2008. He assumed his current position in June 2012.



## IaaS Platform Using OpenStack and OpenFlow Overlay Technology

*Shintaro Mizuno, Hiroshi Sakai, Daigoro Yokozeki, Koji Iida, and Takaaki Koyama*

### Abstract

This article describes how OpenStack and a virtual network controller that uses OpenFlow overlay technology can be orchestrated to deploy virtual environments with complex network configurations, as in on-premise systems, in an on-demand manner.

### 1. Introduction

There is increasing use of infrastructure as a service (IaaS), in which virtual servers, virtual storage, and other such virtual environments are provided, as exemplified by Amazon Web Services. This situation has given rise to an open source software (OSS) community whose objectives are reduced cost and open development in the construction of IaaS platforms.

### 2. OpenStack

OpenStack [1] is an OSS IaaS platform development project established by NASA and Rackspace in 2010. The NTT Group is among the 183 companies and 3386 individuals that currently make up that growing community. OpenStack version 5 was released in April 2012 under the code name “Essex”. OpenStack is one of the most prominent of the OSS IaaS platforms and is now being used in commercial services as well as for other purposes. In April 2012, 19 companies including AT&T, HP, IBM, Rackspace, and Red Hat established the OpenStack Foundation to promote the development and use of OpenStack, raising expectations for even more widespread adoption of the platform.

OpenStack comprises multiple services (functional modules), including a virtual server management function, object storage, and network management. Users can select the services they need to flexibly construct an IaaS platform (Fig. 1). This article focuses on the platform’s virtual server management

and network control functions. We describe a method of constructing a flexible virtual environment that combines virtual servers and virtual networks through cooperation with those OpenStack functions.

### 3. Virtual networks

As in hybrid clouds, there are use cases for cloud systems that include virtual networks as well as virtual servers to constitute virtual systems in a cloud environment while maintaining the system configuration and integrity with conventional enterprise systems. The virtual network is one kind of technology for implementing such use scenarios [2].

### 4. Technology for implementing virtual networks

A number of ways of connecting virtual servers to isolated customer virtual networks in the cloud have been proposed. One is to allocate a virtual local area network (VLAN) to each customer to form virtual networks in units of a VLAN. In the approach using VMware\*1 or other such products, a particular VLAN is assigned to the virtual server. The virtual servers on the same VLAN engage in closed communication. This approach requires the prior setting up of a VLAN with switches and other communication devices in the datacenter.

\*1 VMware: A PC/AT compatible emulator that runs on Windows and Linux.

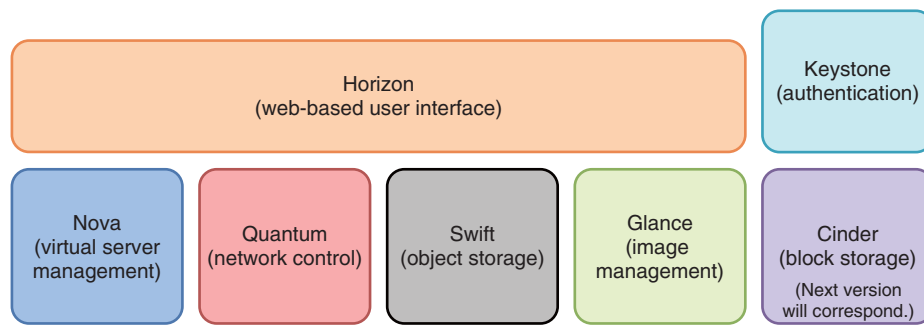

Fig. 1. OpenStack services.

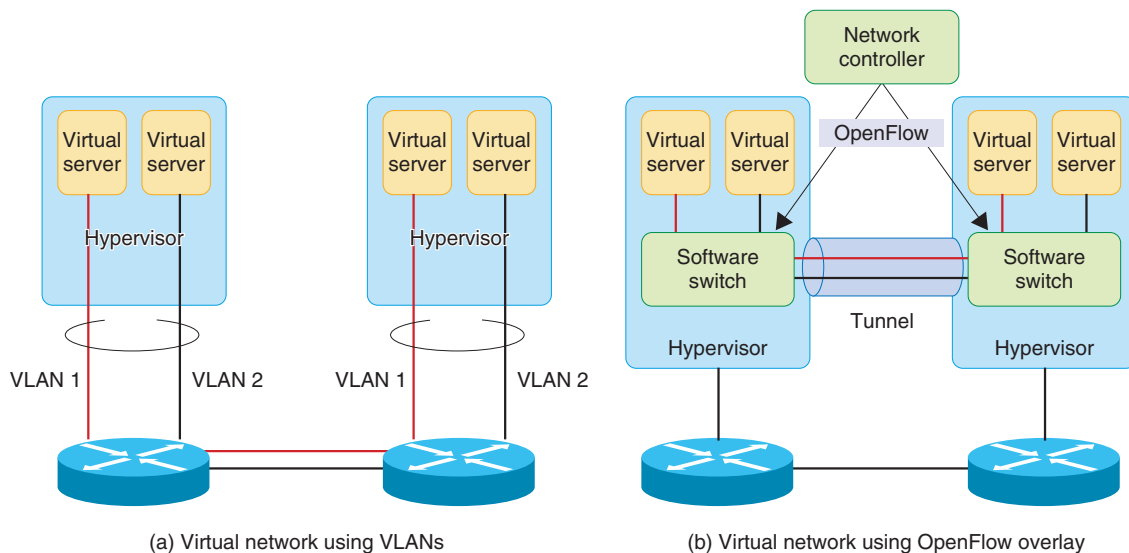

Fig. 2. Examples of virtual networks.

One method for connecting virtual servers that does not require control of the settings of communication devices is the *overlay* method, which involves extending tunnels between software switches on a hypervisor to establish communication paths between virtual servers running on the hypervisors. OpenFlow or other such tools are used to control the software switches (Fig. 2). Another method is the *hop-by-hop* method.

### 5. Network controller

In OpenFlow, a server referred to as the network controller manages the creation, setup, and deletion of virtual networks. The network controller manages the network devices, software switches, and other

functions on the hypervisor to construct virtual networks. Network controllers are provided by several companies (including NEC, Cisco, Nicira, and NTT), and each company has its own approach to network virtualization, including the methods described above.

### 6. OpenStack network control function

In OpenStack, the network control function is provided by the Quantum service, which provides an application programming interface (API) for creating, setting up, and deleting virtual networks. One feature of Quantum is a plugin architecture. Quantum itself provides only common functions such as authentication and an API for higher-level appli-

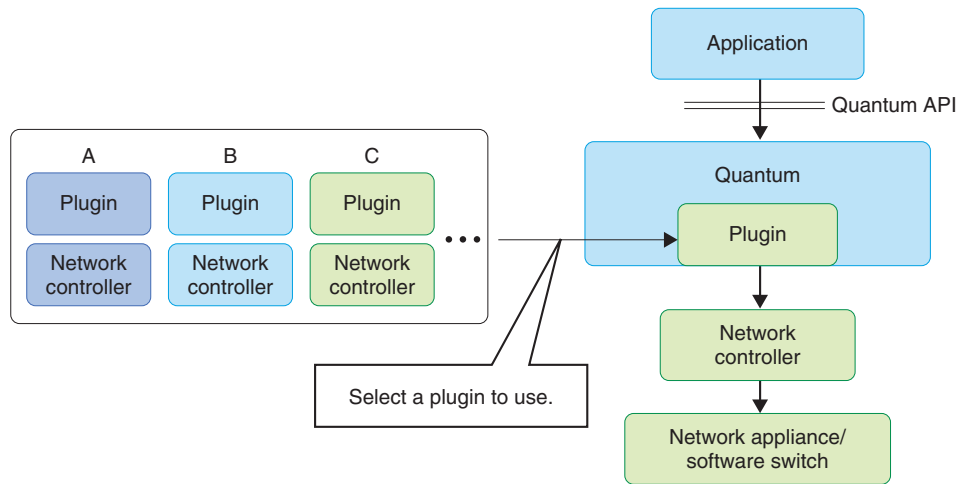

Fig. 3. Architecture of Quantum plugins.

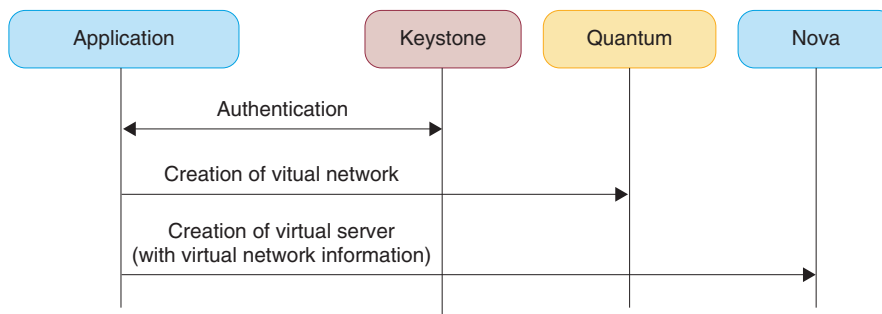

Fig. 4. Example of service call procedure.

cations. The virtual network functions are incorporated into the existing network controller. As described above, network controllers are already available from several third-party vendors, and flexible connection to the controllers is possible with Quantum plugins for the various controllers. That makes it possible to use any network function flexibly via a unified Quantum API (Fig. 3).

### 7. Cooperation between virtual server management and network control functions

In OpenStack, management functions for virtual servers and networks are individual services that are called by their respective APIs to construct a virtual environment from virtual servers and virtual networks.

A procedure for constructing a virtual environment

from virtual servers and virtual networks is illustrated in Fig. 4. When OpenStack is used to provide an IaaS cloud service, these procedures for calling the various services are performed according to the use case and customer requirements to create the virtual environment.

### 8. Work being done at NTT

NTT is using OpenStack to construct an environment for verifying IaaS platforms in various use cases (Fig. 5). That environment uses a Nicira network controller as a network controller attached to a Quantum network controller to implement OpenFlow-based overlay virtual networks. Three typical use cases that were verified in our laboratory are described below.

(1) Construction of a flexible virtual environment

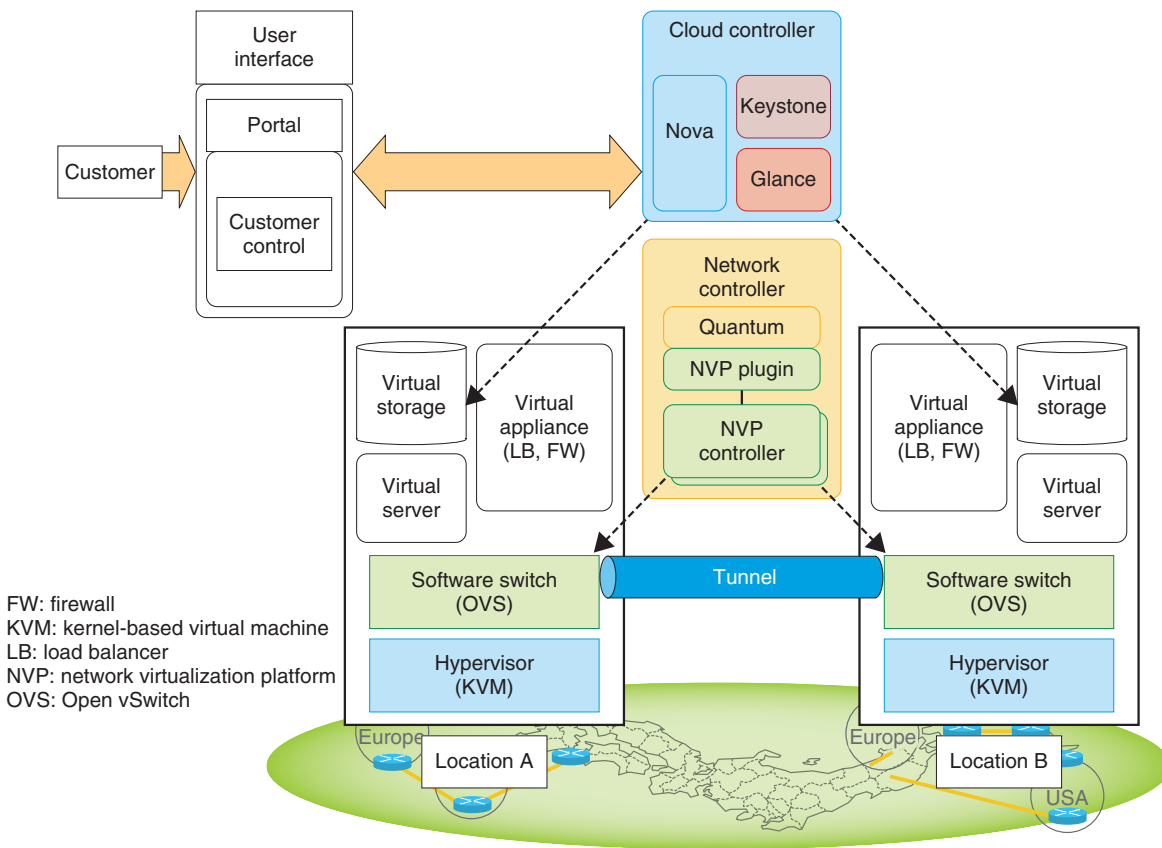

Fig. 5. NTT's test environment. Software switches distributed across Japan simulate a global virtual network.

Any number of virtual networks can be created for a customer. Combining them with virtual servers enables the same configuration flexibility as provided by on-premises systems, including cascaded multi-layer networks and demilitarized zones\*2.

Flexible system configuration enables effective use of existing software and other such assets as well as continuity in the use of firewalls and other network settings. It can therefore reduce the cost of system reconfiguration in the case of migration to a virtual environment.

Because a virtual environment can be constructed in the cloud while maintaining compatibility with existing systems, the building of hybrid clouds that interwork with existing systems and cloud services can further expand the range of uses of cloud services. For this use case, a multilayer virtual network is constructed for each customer, and multiple virtual servers are placed on each network and assigned arbitrary

IP (Internet protocol) addresses. We confirmed that communication with outside networks is possible in such a system (Fig. 6).

(2) Office migration

Office migration is a use case that assumes the need to temporarily move a virtual environment to a different location to maintain business continuity during a disaster, pandemic, or other anomalous situation or to reduce the cost of electrical power.

With the abovementioned overlay virtual network, a tunnel can even be constructed between remote software switches if IP connectivity is available. It is thus possible to construct a virtual network that involves a remote datacenter and create a single network environment that spans multiple locations. Doing so enables on-demand migration of virtual servers between datacenters without the need to change physical network settings. Previously, this would have required constructing individual Layer-2 VPNs and changing network settings within the datacenter.

NTT has constructed an environment in which

\*2 Demilitarized zone (DMZ): A network segment that lies between trusted networks and external networks.

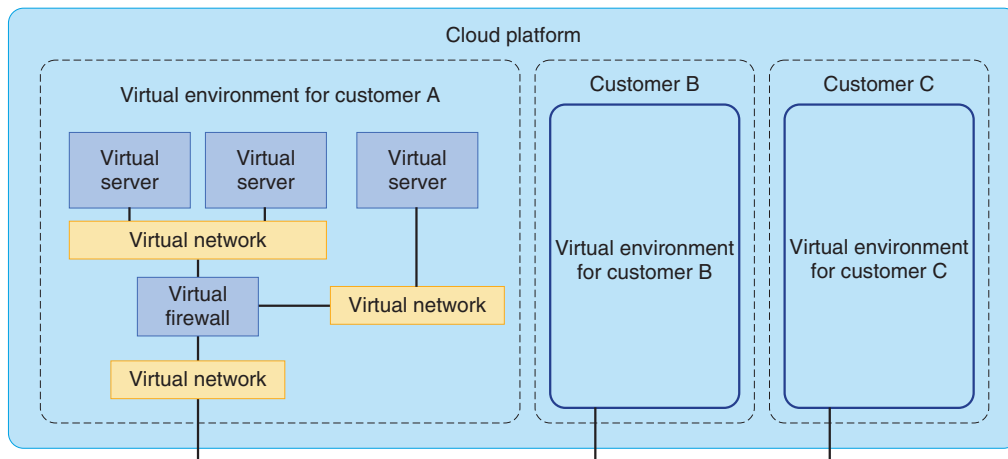
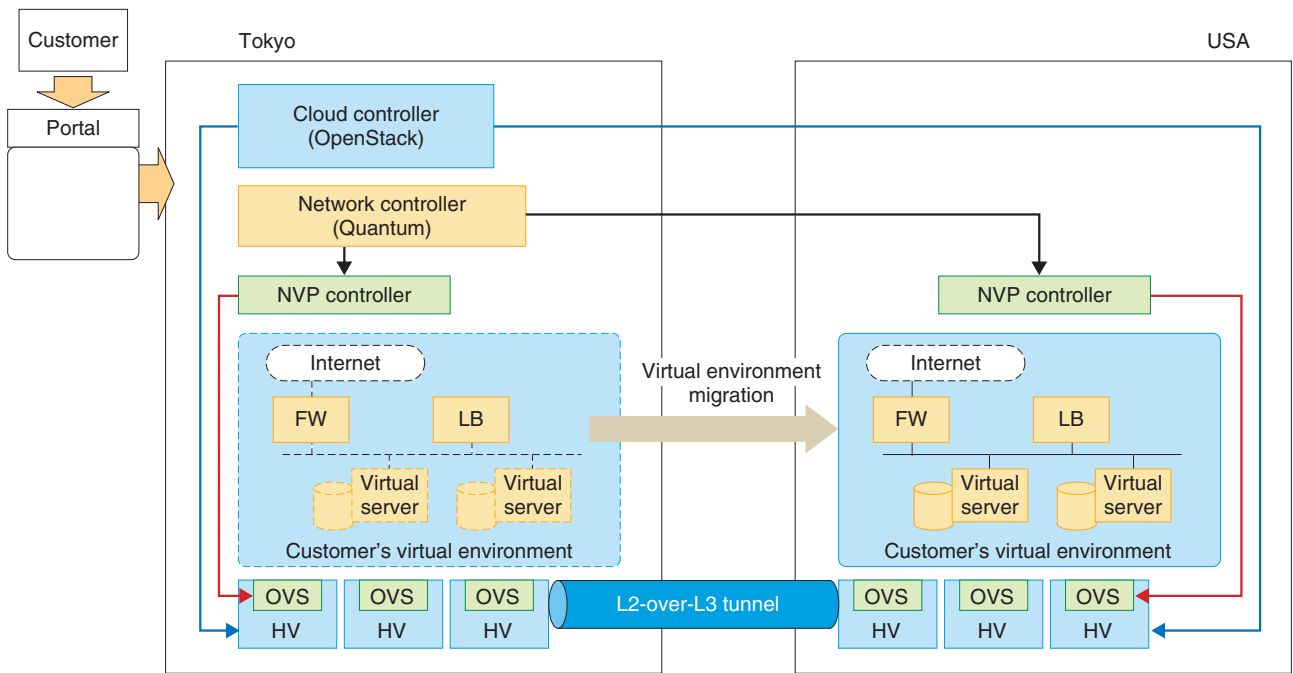

Fig. 6. Flexible configuration of virtual environment.



HV: hypervisor  
L2: Layer 2  
L3: Layer 3

Fig. 7. Virtual environment migration.

network controllers can be arranged to construct virtual networks between arbitrary datacenters and in which virtual servers can be freely placed and moved to enable unified control of multiple datacenters. We have confirmed that in this use case the customer can construct a virtual environment in any datacenter and

move the entire environment to a different location as required (Fig. 7).

We demonstrated these results jointly with NTT Communications at the Open Networking Summit held in April 2012. The demonstration system was constructed at three actual locations in Japan, the

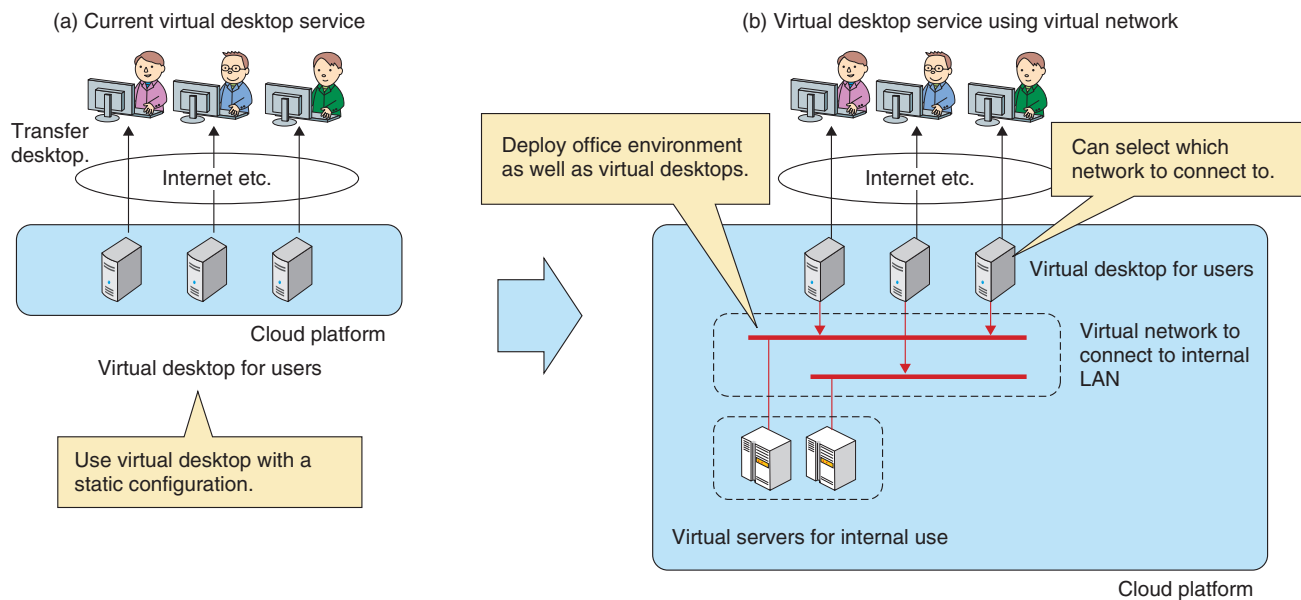

Fig. 8. Flexible virtual office environment.

USA, and Europe and migration of virtual environments among datacenters in different countries was verified.

### (3) Flexible virtual office environment

In the flexible virtual office environment use case, an IaaS platform is applied as an in-house system to provide a virtual desktop environment to company employees. A virtual desktop is a service that provides remote access to the desktop of a virtual server, thus presenting the same working environment regardless of the terminal being used.

Combining virtual network technology and a virtual desktop environment allows dynamic network construction and setup, making it possible to switch the virtual desktop to a different network without performing any extra configuration in the physical network. In this use case, the virtual-desktop users can switch networks on-demand according to their assigned tasks. We are now testing the basic operation of this use case and considering the application of OpenStack (Fig. 8).

## 9. Concluding remarks

We described the use of OpenStack, an OSS IaaS platform, in the construction of IaaS platforms. Specifically, we have verified use cases that involve interworking with a network controller and we presented examples of application to cloud services. For that task, we focused on the network, which is a core competence of the NTT Group. In the two years or so since the beginning of the OpenStack project, various proposals have been made by the active OpenStack community. We intend to continue to cooperate closely with that community to improve OpenStack functionality and raise the quality to the level required for commercial use.

## References

- [1] OpenStack. <http://www.openstack.org>
- [2] H. Kitazume, T. Koyama, T. Kishi, and T. Inoue, "Network Virtualization Technology for Cloud Services," NTT Technical Review, Vol. 9, No. 12, 2011. <https://www.ntt-review.jp/archive/ntttechnical.php?contents=ntr201112fa4.html>



**Shintaro Mizuno**

Senior Research Engineer, Cloud System SE Project, NTT Software Innovation Center.

He received the B.E. and M.E. degrees from Tokyo Institute of Technology in 1995 and 1997, respectively. Since joining NTT in 1997, he has been working on authentication systems, secure communication systems, and information security. His current research interests include cloud management system and software defined networks.



**Koji Iida**

Senior Research Engineer, Cloud System SE Project, NTT Software Innovation Center.

He received the B.E. and M.Sc. degrees from Keio University, Kanagawa, in 1993 and 1995, respectively. He joined NTT Information Platform Laboratories in 1995 and studied enterprise communication middleware and distributed object technologies. He moved to NTT Information Sharing Platform Laboratories in 2007 and researched identity management technology and cloud computing technology. As a result of organizational changes in July 2012, he is now in NTT Software Innovation Center.



**Hiroshi Sakai**

Senior Research Engineer, Supervisor, Cloud System SE Project, NTT Software Innovation Center.

Since joining NTT in April 1993, he has contributed to the development of network service systems including intelligent networks and the Next Generation Network (NGN). His current research interests include an OSS-based cloud management system and software defined networks.



**Takaaki Koyama**

Senior Research Engineer, Cloud System SE Project, NTT Software Innovation Center.

He received the B.A. and M.M.G. degrees in media and governance from Keio University, Tokyo, in 1994 and 1996, respectively. He joined NTT Software Laboratories in 1996 and studied software CALS. Since 1999, he has been studying GMN-CL, which is a kind of IP-VPN technology, and developing some network equipment. Recently, his research interests have extended to enterprise cloud network systems. He is a member of the Information Processing Society of Japan.



**Daigoro Yokozeki**

Senior Research Engineer, Cloud System SE Project, NTT Software Innovation Center.

He received the B.E. and M.Sc. degrees from Waseda University, Tokyo, in 1996 and 1998, respectively. He joined NTT Information Platform Laboratories in 1998 and studied web middleware and distributed database technologies. He moved to NTT Software Innovation Center in 2012 and is currently researching cloud computing and virtual networking technologies.

## PaaS Software Based on Cloud Foundry

*Yudai Iwasaki, Shunsuke Kurumatani, Tsutomu Nomoto, Takahiko Nagata, and Shinichi Nakagawa*

### Abstract

NTT is developing platform-as-a-service (PaaS) software based on Cloud Foundry, which is open-source PaaS software. We introduce the advantages of developing applications on a PaaS, the features of Cloud Foundry, and our efforts to put these developments into commercial use.

### 1. Introduction

The cost and difficulty of developing applications is increasing. Modern ones are becoming connected to the network and required to handle a huge number of users. They depend on various types of middleware and may run on more than 100 servers. In addition, to ensure that they are kept up to date with the changing market, they are also required to be flexible.

NTT is developing platform-as-a-service (PaaS) software\*<sup>1</sup> based on Cloud Foundry [1], which is a cloud-computing-based open source software PaaS (open PaaS), to enable us to develop and manage applications more easily, quickly, and flexibly at a lower cost.

### 2. Advantages of PaaS for service development

PaaS is a layer on top of the infrastructure-as-a-service (IaaS) layer that provides ready-to-use middleware environments to service developers (**Fig. 1**). This middleware includes operating systems, web servers, database management systems (DBMSs), and application frameworks, and it is essential to run cloud applications. However, with the functionality of modern applications becoming much more sophis-

ticated, middleware environments are also becoming much more complex. This means that efficient management of the middleware is critical to control service costs. However, middleware is commonly shared by various applications. For example, a middleware set composed of a Linux operating system, Apache web server, MySQL DBMS, and Perl (or PHP or Python) programming language is referred to as LAMP and is very popular, especially for web applications. Therefore, a PaaS includes the provision of common middleware environments for service developers and their management for users.

The greatest advantage of using a PaaS as a service environment is the reduced cost and faster speed of service development and management. In addition, a PaaS makes large-scale development easy and does not require such a large initial investment, so it enables a small flexible startup with on-demand scale-up.

During a development, cost reductions are achieved by reducing the number of man-hours required to set up both the hardware and middleware for the services. Without a PaaS, developers must build their application environments by themselves. For example, they must install servers at their datacenter and set up operating systems, DBMSs, web servers, and any other software they need in each machine. This is manageable if there are only a few machines, but if there are over a hundred servers, it becomes a very labor-intensive task. A PaaS enables such simple tasks to be offloaded to the PaaS providers. The only necessary step is to input the required amount of

\*<sup>1</sup> In this article, we use “PaaS software” to refer to a stack of technologies (also known as a platform) for constructing a PaaS and “application” to refer to a service application that runs on the PaaS. A PaaS user is a user that develops and deploys applications on the PaaS; an application user is a person that uses the application.



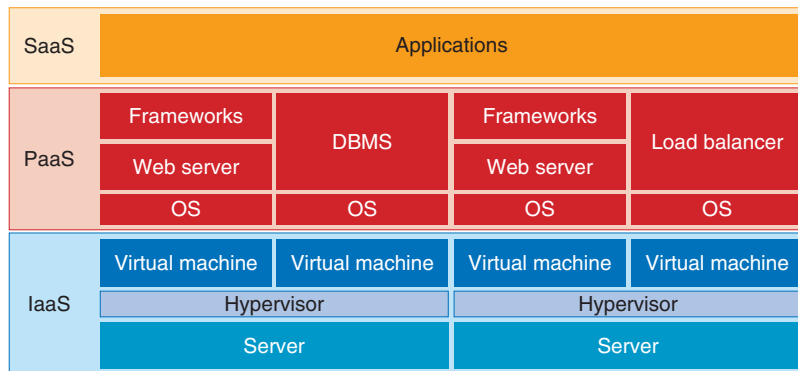

OS: operating system  
SaaS: software as a service

Fig. 1. Technology stack of cloud computing.

resources into the management console. The environment can be set up immediately with fewer man-hours and less lead-time.

Another benefit during the development process is that a PaaS can offer developers mature tools for building high-performance applications. Creating high-performance scalable applications in a distributed environment generally requires deep and extensive know-how. With a PaaS, however, such know-how is included in the tools (backend systems and software development kit (SDK) or application programming interface (API)). Users can easily develop high-level applications using the provided tools.

A PaaS also allows users to reduce the costs of operating user services. Such services typically require system updates such as patches for bugs and security fixes for operating systems and middleware that have been in operation for an extended time. In addition, server hardware and software must be constantly monitored 24 hours a day, 7 days a week to ensure correct functioning. The PaaS takes over these simple tasks and allows the service provider to deliver complex services with minimal monitoring.

Another reason to use a PaaS is flexibility. It allows computing resources to be consumed on demand. This means that users do not have to continuously reserve sufficient resources to handle peak times such as monthly batch processing or irregular user events. In addition, providers can start services with a minimum number of servers and add additional resources step by step. This is a big advantage when an experimental service is being started.

Several commercial PaaS offerings are in operation, for example, Google App Engine, Sales Force’s

Heroku and Force.com, and Microsoft Azure. Each has its own characteristics in terms of support for languages, middleware, and frameworks (Table 1). For example, Google App Engine provides easy-to-scale middleware, and Heroku supports many programming languages such as Ruby and JavaScript. Force.com differs from the other services in providing useful business logic.

### 3. Cloud Foundry: open-source PaaS software

Cloud Foundry is open source software developed mainly by VMware in a project that started in 2011. By contrast, most PaaS software such as Google App Engine and Heroku uses closed proprietary software. Since the source code of Cloud Foundry is open, anyone can use it to build their own PaaS. Despite its newness, Cloud Foundry has become a popular type of PaaS software. For example, Active State and AppFog have developed and are selling PaaS solutions based on Cloud Foundry, and Rakuten is using Cloud Foundry for its in-house PaaS. In the NTT Group, NTT Communications is planning to launch a public PaaS based on Cloud Foundry [2].

Cloud Foundry has three main features, which are described below.

#### (1) No vendor lock-in

PaaS users can avoid vendor lock-in with specific PaaS vendors by using the open-source Cloud Foundry. In general, PaaS offerings differ in usage such as in the API that is provided or the process used to deploy applications. This means that it is difficult to migrate an application developed for a specific PaaS to another PaaS. The migration might require the

Table 1. List of existing PaaS offerings.

Name	Vendor	Source code	Supported programming languages*	Features
Google App Engine	Google	Closed	Java, Python, Go	Easy to develop highly scalable applications using BigTable and related APIs
AWS Elastic Beanstalk	Amazon	Closed	.NET, PHP, Java	Supports various other services provided in AWS
Windows Azure (Cloud Services)	Microsoft	Closed	.net, JavaScript, Java, PHP, Python	Integrates well with Microsoft's products including its integrated development environment
Force.com	salesforce.com	Closed	Apex	Provides various types of business logic
Heroku	salesforce.com	Closed	Ruby, Java, Python, Clojure, Scala, JavaScript	Supports many programming languages
Cloud Foundry	VMWare	Cloud Foundry	Java, JavaScript, Ruby, Scala	Commercial service using Cloud Foundry by VMware
AppFog	AppFog	Cloud Foundry	Java, Python, JavaScript, .Net, Ruby, PHP	Commercial service based on Cloud Foundry
Stackato	ActiveState	Cloud Foundry	Java, Python, Perl, PHP, Ruby, JavaScript, Clojure, Scala, Erlang	Private PaaS solution based on Cloud Foundry
OpenShift	Red Hat	OpenShift	Java, Ruby, JavaScript, Python, PHP, Perl	Red Hat's commercial Paas offering using OpenShift

\* Languages listed on official sites. PaaS offerings may support other compatible languages or have restriction for support.

application to be redesigned or rebuilt. This can impose several risks; for example, PaaS users might be forced to accept a price increase, or the service might suddenly be suspended by the provider. In contrast, when PaaS users (i.e., application developers) use a Cloud-Foundry-based PaaS, all of their developed applications are compatible with each other, so they can run them with less risk. They can choose the best PaaS provider at the moment and even build their own private PaaS environment using Cloud Foundry.

(2) Flexible configuration

Cloud Foundry is designed with sufficient flexibility to satisfy a huge variety of needs for PaaS environments. The Cloud Foundry system consists of several components, and users can set up their environment by choosing the necessary combination and number of components for their needs (**Fig. 2**). Cloud Foundry supports a wide range of environments—from a private PaaS on a single server to a huge public PaaS on a cluster of over a thousand servers—and can be set up to suit the scale as well as its reliability and support features. Moreover, users can add components on demand, so it is possible to start with the minimum configuration and increase the scale as the load grows.

(3) Support for languages and frameworks

Cloud Foundry supports most of the major programming languages such as Ruby, Java, and JavaScript. It also supports a variety of popular frameworks used for building web applications; for exam-

ple, Ruby on Rails, Sinatra, Spring, and Node.js are supported as default. DBMS, MySQL, and PostgreSQL are supported, and other modern forms of DBMS such as MongoDB and Redis are also supported. PaaS users can develop their applications in their own way even in Cloud Foundry's PaaS environment. This makes it easy to introduce a PaaS to the development process with no additional costs.

Another example of an open PaaS is OpenShift Origin. Developed by Red Hat as an open-source version of their PaaS called OpenShift, it was announced on April 30, 2012. At the time of writing, Cloud Foundry has advantages over the younger OpenShift Origin in its more mature quality and market perception. However, Red Hat has a lot of experience and has made significant contributions to open source software development, e.g., to Linux and KVM, which are popularly used for cloud systems. Therefore, we need to monitor further development of OpenShift Origin.

#### 4. Contributions by NTT

NTT is developing its own PaaS software based on Cloud Foundry. Although Cloud Foundry is a promising PaaS software solution that has many good features, as described above, it is still not perfect, especially when used for NTT's PaaS software. For example, its reliability and convenience in commercial usage were not sufficient in the early phase, and

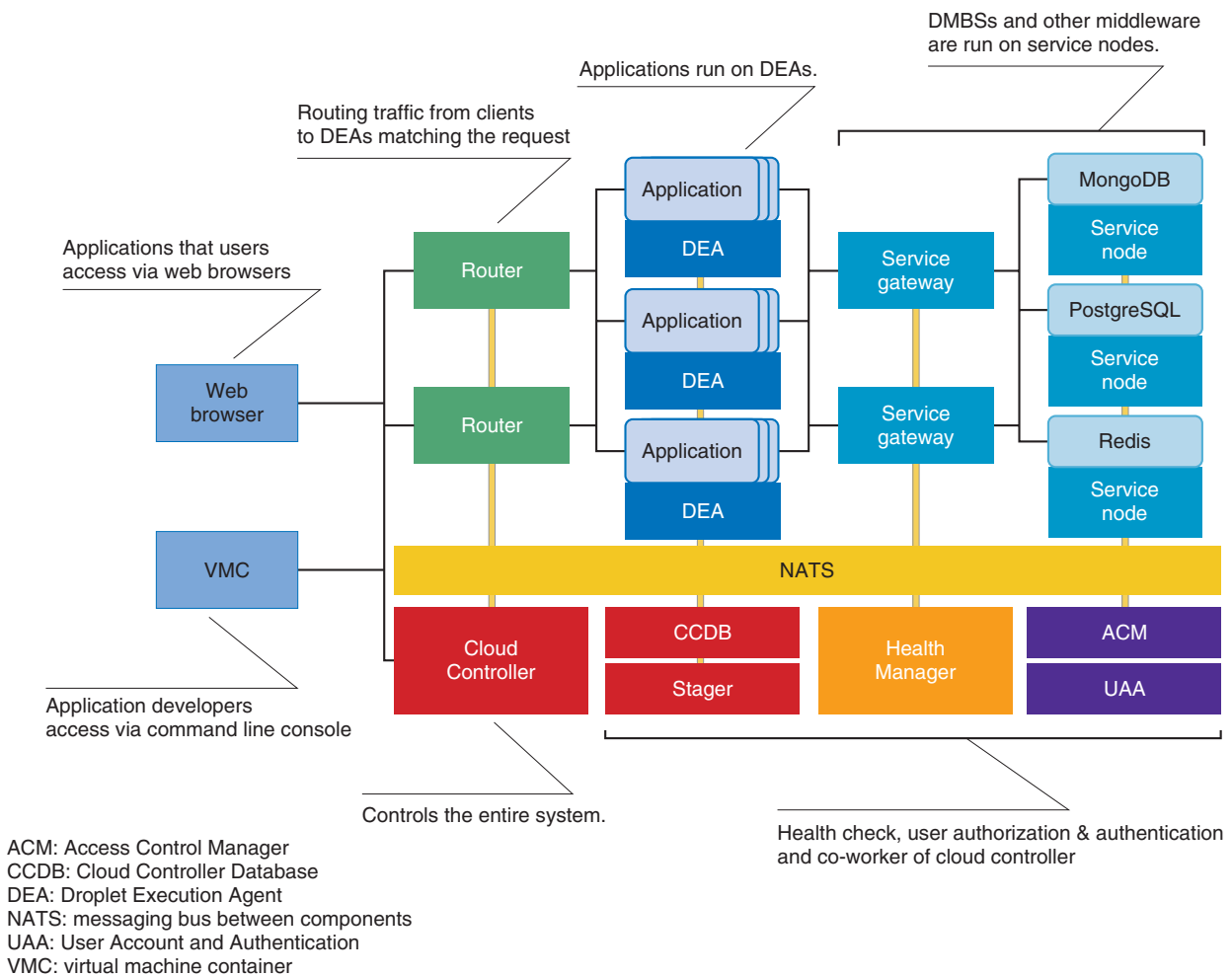

Fig. 2. Components of Cloud Foundry.

integration with other NTT services was naturally not provided by other vendors. In addition, Cloud Foundry is still not in wide use, and this is an obstacle that prevents it from growing as an open source software solution. Therefore, we have been making efforts to improve Cloud Foundry.

#### 4.1 Contributions to Cloud Foundry

##### (1) Reliability of Cloud Foundry components

Because Cloud Foundry was a very young project when we started our development, it did not have sufficient reliability to be used for a commercial service based on it. Therefore, NTT has been examining the performance and scalability of Cloud Foundry by conducting various tests and fixing any problems revealed by them. For example, we solved a problem involving an important component that was a single

point of failure and a problem where some components could not be restored after failures by fixing the source code and adding additional external systems.

##### (2) Convenience of Cloud Foundry

Since convenience is important for commercial services, we created an installer for the virtual machine container (VMC), which is the console for PaaS users, and we are now developing a function for linking the VMC and version control systems such as Git.

##### (3) Integration with IaaS software

Although Cloud Foundry has a flexible component system, as described above, to leverage the features, it is essential to integrate it with an IaaS layer under Cloud Foundry. Therefore, NTT is developing a management system that controls both Cloud Foundry and the underlying IaaS systems. This orchestration

system increases competitiveness against other providers because it reduces operating costs and maximizes datacenter utilization, despite using vendor-lock-in-free open source software.

#### 4.2 Contributions to the community

The presence of active communities is indispensable in the long-term evolution of open source software. We launched the Japan Cloud Foundry Group in collaboration with NTT Communications and are fostering a developers' and users' community of Cloud Foundry in Japan [3]. In addition, we have opened the source code created in the first two of our abovementioned contributions (component reliability and convenience) by committing them to the official repository, and we also provide the know-how in workshops.

---

#### 5. Conclusion and future work

---

Cloud Foundry is promising open-source PaaS software that has many good features. It enables us to develop applications more easily, quickly, and flexibly at a lower cost. However, if we use Cloud Found-

ry as it is, it will be difficult to compete in the cloud computing market, which is becoming highly competitive. Therefore, NTT is continuously developing its own PaaS software by improving upon the features of Cloud Foundry. In addition, we are investigating possible future integration with other NTT products such as Jubatus [4] and other open source software such as Hadoop\*<sup>2</sup>.

---

#### References

---

- [1] Cloud Foundry. <http://www.cloudfoundry.com>
- [2] NTT Communications Press release (in Japanese). <http://www.ntt.com/release/monthNEWS/detail/20120627.html>
- [3] NTT Press release (in Japanese). <http://www.ntt.co.jp/news2012/1202/120224a.html>
- [4] K. Horikawa, Y. Kitayama, S. Oda, H. Kumazaki, J. Han, H. Makino, M. Ishii, K. Aoya, M. Luo, and S. Uchikawa, "Jubatus in Action: Report on Realtime Big Data Analysis by Jubatus," NTT Technical Review, Vol. 10, No. 12, 2012. <https://www.ntt-review.jp/archive/ntttechnical.php?contents=ntr201212fa5.html>

---

\*<sup>2</sup> Hadoop: Java software framework that supports distributed processing of big data.

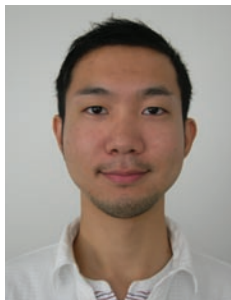
**Yudai Iwasaki**

Engineer, Platform Technology SE Project, NTT Software Innovation Center.

He received the B.A. and M.M.G. degrees from Keio University, Kanagawa, in 2009 and 2011, respectively. He joined NTT Information Sharing Platform Laboratories in 2009. As a result of organizational changes in April 2012, he is now in NTT Software Innovation Center. His research topics are the Semantic Web and cloud computing technology.

**Shunsuke Kurumatani**

Researcher, Distributed Computing Technology Project, NTT Software Innovation Center.

He received the B.A. degree in environmental information from Keio University, Kanagawa, in 2009. Since joining NTT Information Sharing Platform Laboratories in 2009, he has been engaged in R&D of mobile cloud computing technology and an application PaaS. His research interests include web technology, accessibility, and mobile cloud computing. As a result of organizational changes in April 2012, he is now in NTT Software Innovation Center. He is a member of the Institute of Electronics, Information and Communication Engineers (IEICE).

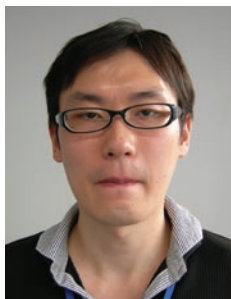
**Tsutomu Nomoto**

Engineer, Cloud System SE Project, NTT Software Innovation Center.

He received the B.E. and M.E. degrees in engineering from the University of Electro-Communications, Tokyo, in 2008 and 2010, respectively. Since joining NTT Information Sharing Platform Laboratories in 2010, he has been engaged in R&D of operations management software. As a result of organizational changes in April 2012, he is now in NTT Software Innovation Center.

**Takahiko Nagata**

Senior Research Engineer, Cloud System SE Project, NTT Software Innovation Center.

He received the B.E. and M.E. degrees from the Faculty of Instrumentation Engineering, Hiroshima University in 1993 and 1995, respectively. Since joining NTT Information and Communication Systems Laboratories in 1995, he has been engaged in R&D of high-speed communication processing boards, reliable multicast delivery systems, secure electronic voting systems, and secure file delivery systems. During 2005–2008, he worked in a department supporting the development of systems in NTT WEST. He is currently engaged in R&D of cloud computing technology. As a result of organizational changes in April 2012, he is now in NTT Software Innovation Center.

**Shinichi Nakagawa**

Senior Research Engineer, Cloud System SE Project, NTT Software Innovation Center.

He received the B.S. degree in physics from Saitama University in 1987 and the M.S. degree in physics from Chiba University in 1989. He joined NTT in 1989. He is a member of IEICE.

## NoSQL Database Characteristics and Benchmark System

*Kota Tsuyuzaki and Makoto Onizuka*

### Abstract

The NTT Software Innovation Center has been researching and developing NoSQL (Not Only SQL; SQL: structured query language) databases as storage platforms for big data. In this article, we discuss the characteristics of NoSQL databases and their benchmark system. We also report the results of applying the benchmark to MongoDB, a typical example of a NoSQL database.

### 1. Introduction

The amount of enterprise data has been dramatically increasing, and such large-scale data is referred to as *big data*. Many services and analytical applications based on big data have emerged, and users want to obtain or mine the most recent and useful knowledge from big data. Handling big data requires advanced technology for data storage. In particular, NoSQL (Not Only SQL; SQL: structured query language) databases have attracted attention for big data storage. NoSQL is designed specifically to manage big data, a task for which commonly used relational database management systems (RDBMSs) are not well suited.

We describe the main features and characteristics of NoSQL databases and report the results of a NoSQL benchmark using MongoDB [1] as an example.

### 2. NoSQL

#### 2.1 Features

The three main features of NoSQL databases are scale-out, replication, and flexible data structure (Fig. 1). We explain these three features below.

Scale-out refers to achieving high performance by using many general-purpose machines in a distributed manner. Distributing the data over a large number of machines enables scaling of the data set and distribution of the processing load. A common feature of many NoSQL databases is that data is automatically distributed to new machines when they are added to

the cluster, so the performance is also improved. Scale-out is evaluated in terms of scalability and elasticity.

Replication is the copying of data to achieve data redundancy and load distribution. Even if data consistency has been lost among the replicas, it is eventually achieved: this is known as *eventual consistency*. Replication is evaluated in terms of consistency and availability.

A flexible data structure means that there is no need to define a structure as a *database schema*. Traditional RDBMSs require pre-defined schemas, and redefining them carries a high cost. NoSQL, on the other hand, does not require defined schemas, so users can store data with various different structures in the same database table. However, most NoSQL databases do not support high-level query languages such as SQL, which is used by RDBMSs, so products that support either simple relational operations or indexing have been released. This feature is evaluated qualitatively.

#### 2.2 Characteristics and benchmark system

Because NoSQL databases feature scale-out and replication, a NoSQL benchmark should take scalability, elasticity, consistency, and availability into account as well as performance. We explain each characteristic and describe the benchmarking software design points concerning these characteristics.

Scalability indicates how the performance of a NoSQL database cluster scales with the number of physical machines. If performance improves as

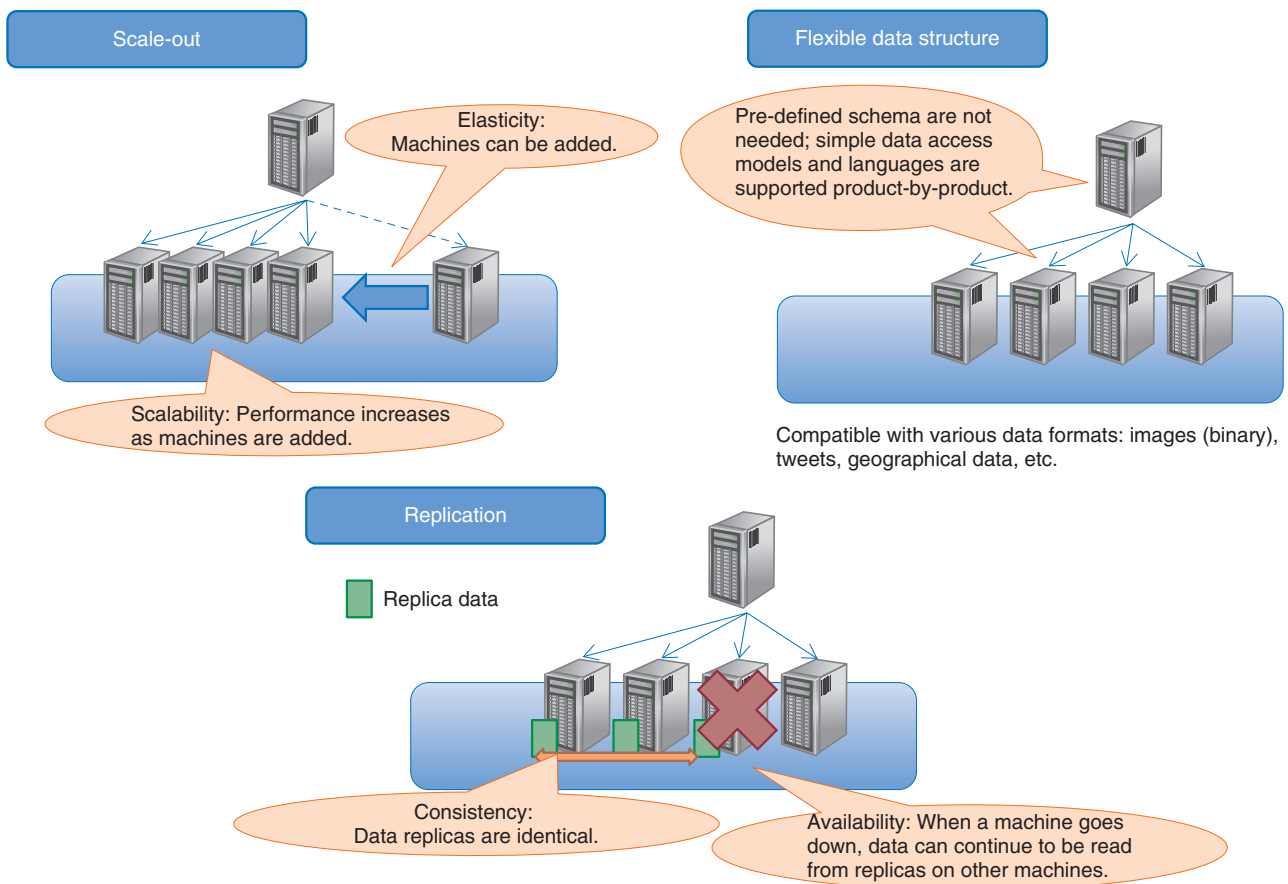

Fig. 1. NoSQL database features and characteristics.

machines are added to a NoSQL database cluster, we can say that the NoSQL product has high scalability. In scalability benchmarking with many physical machines, the load generator, which benchmarks the NoSQL database cluster, is often a bottleneck. An effective approach for preventing this is to design benchmark software as a distributed system running on the cluster (Fig. 2).

Elasticity enables the addition of physical machines to a cluster while the NoSQL database is running on it. Elasticity benchmarking involves measuring the impact of adding a physical machine to the NoSQL database cluster. The benchmarking requires the addition of a machine while the performance is being measured. The impact of adding a physical machine has been reported for NoSQL benchmarking with the Yahoo! Cloud Serving Benchmark (YCSB) [2]. That paper [2] also reported a performance instability issue was arose during several hours of elasticity for Cassandra, a NoSQL database product.

Consistency is a measure of the strength of data integrity. The parameters used to evaluate it include the number of replicas and the latency within the cluster. The consistency benchmarking software must check the consistency among replicas in an update-heavy workload, so data management of that workload, in which data should be updated, is necessary.

The final characteristic, availability, refers to the ability of the overall system to continue operating during a network failure, called a *network partition*, or a physical machine failure. High availability means that the system can work without interruption and without degraded performance, even when some machines go down and the network is partitioned or both. In general, network partitioning makes it difficult to ensure both consistency and availability at the same time, so NoSQL databases are designed to prioritize one or the other in operation. Measuring the effect on performance in addition to that on operating continuity is important in the index for availability as

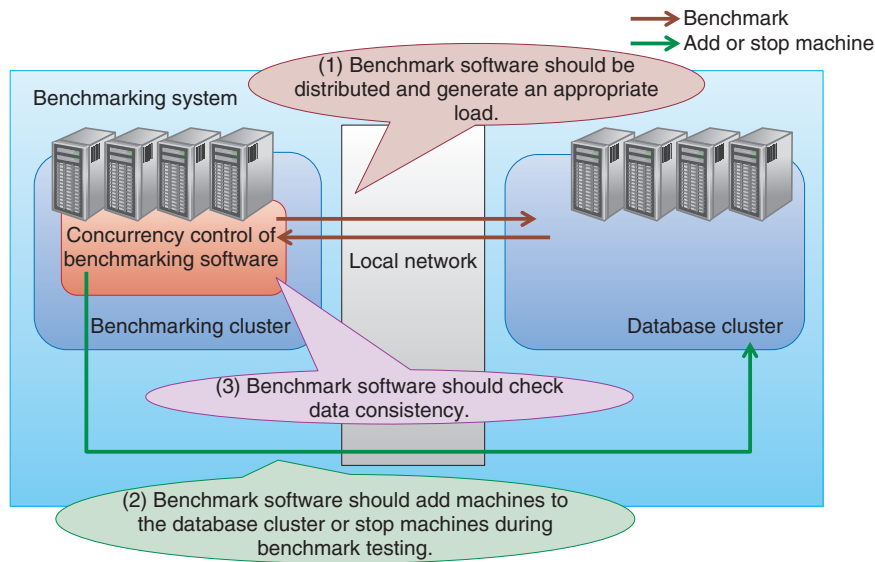

Fig. 2. Important points concerning benchmarking system configuration and benchmarking.

well as that for elasticity. The important points regarding benchmark software are summarized below.

- (1) It should be distributed and should generate an appropriate load.
- (2) It should add machines to the database cluster or shut down machines automatically during benchmark testing.
- (3) The benchmark software should check data consistency.

We present selected benchmark results obtained using custom benchmark software based on YCSB, which can automatically execute items (1) and (2).

### 3. Benchmarking evaluation

#### 3.1 Benchmarking and evaluation of MongoDB

This benchmark test assumed a service in which user data is continually increasing, such as blog articles in a social networking service (SNS). The target software for the benchmarking was MongoDB, which features scale-out, replication, and a flexible data structure. Scalability is generally measured in the benchmarking of NoSQL databases [3] and MongoDB does not allow eventual consistency. Therefore, we present the results for elasticity and availability, which are particularly important when designing a system such as the SNS described above, by using a NoSQL database with data having those characteristics.

The performance of MongoDB depends on whether

or not the entire data set resides in physical cache memory; therefore, we used two data sets: a small data set that could be fully stored in cache memory and a large data set that was too large to fully reside in cache memory, so data swapping was necessary.

#### 3.2 Elasticity benchmark results

The results for elasticity are presented in Fig. 3, where the horizontal axis is elapsed time from the beginning of measurement and the vertical axis is performance relative to the throughput for ideal scaling from the addition of one machine. A physical machine was added 600 seconds after the beginning of measurement.

Comparing the results for the small and large data sets in Figs. 3(a) and (b), we can see that the performance of MongoDB with the large data set became unstable just after the machine was added and the performance gradually decreased. This behavior was caused by the increase in disk access during data migration of the large data set. Since there was a large reallocation load on the disks after the machine was added, the NoSQL took a lot of time to complete the data migration.

When the data set was small, as in Fig. 3(a), the impact of adding the physical machine ended after a minute or two and performance then became stable again. However, the throughput did not reach the ideal value for adding a machine in the case of the small data set. This indicates that the added machine



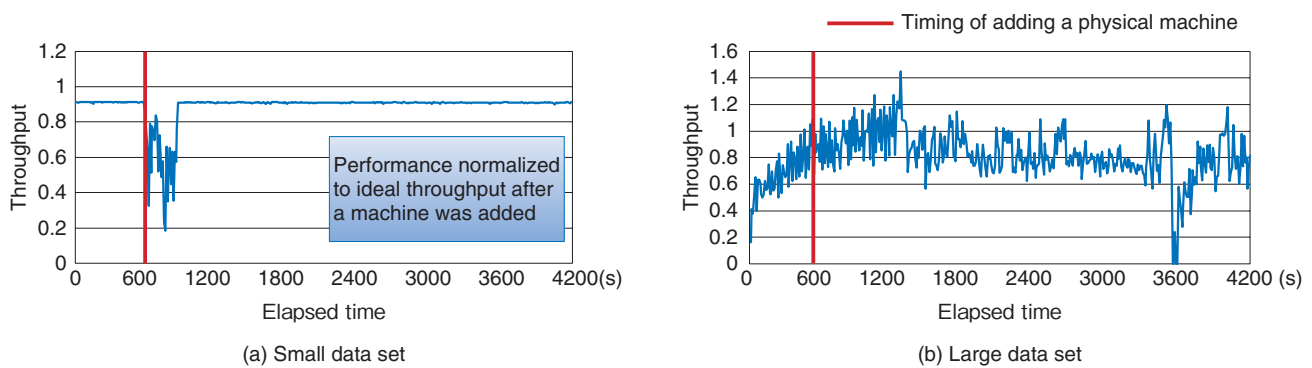

Fig. 3. Effect of elasticity benchmarking process on NoSQL database performance.

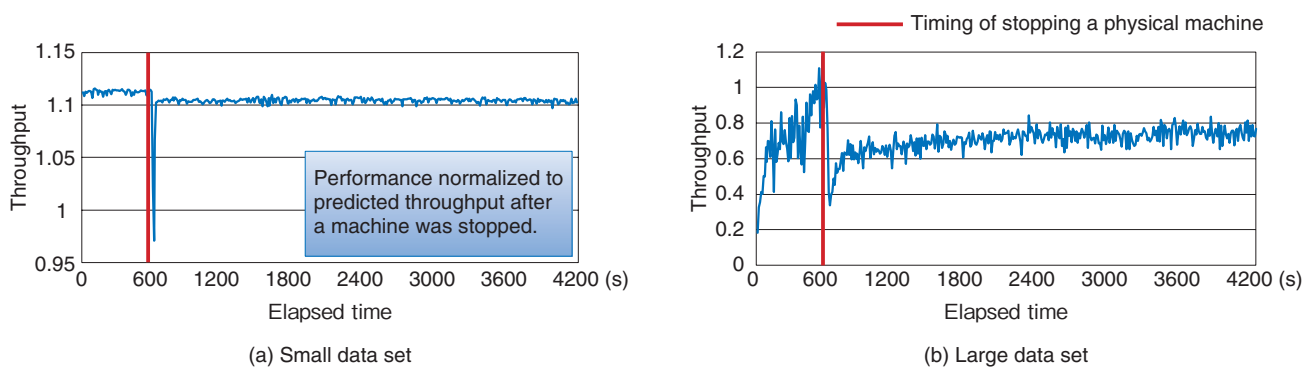

Fig. 4. Effect on performance during NoSQL database availability benchmarking.

was used inefficiently.

### 3.3 Availability benchmark results

The benchmark results for availability are presented in **Fig. 4**. The horizontal axis is time and the vertical axis is the measured throughput for when a machine had gone down.

Comparing the results for the small and large data sets in Figs. 4(a) and (b), we see that, after a machine was stopped, performance took longer to recover for the large data set than for the small data set. The performance for the large data set did not return to the previous level, remaining at only about 70% of the ideal performance. We believe that this was caused by increased disk access for reading data on machines that had replicas of data on the stopped machine. This increase in disk access caused a bottleneck in the entire system.

For the small data set in Fig. 4(a), the decrease in performance with the stopped machine was greater

than expected. We believe that this is because there was almost no effect from the input/output load for the small data set.

## 4. Concluding remarks

Our benchmark testing of MongoDB for elasticity and availability revealed that data size has a significant impact on database performance when the system is extended or machines are taken off-line. However, these characteristics vary with the NoSQL product. Therefore, when designing the system configuration of actual systems that use NoSQL databases, one should benchmark elasticity and availability as well as performance and scalability. For example, the trade-off with the impact on performance and recovery time must be estimated and reflected in the system design in terms of the number of machines and the hardware configuration.

Our future work includes trying to improve the

benchmarking of elasticity and availability to expand the use of NoSQL for big data. We believe that techniques for controlling the trade-off between performance and features on the basis of such benchmarking results will become more important in the future. The NTT Software Innovation Center will continue to engage in research and development of technology for handling big data.

---

## References

- [1] MongoDB. <http://www.mongodb.org/>
- [2] B. F. Cooper, A. Silberstein, E. Tam, R. Ramakrishnan, and R. Sears, "Benchmarking cloud serving systems with YCSB," Proc. of the ACM Symposium on Cloud Computing 2010 (ACM SOCC 2010), Indianapolis, IN, USA.
- [3] T. Dory, "Comparing Scalable NOSQL Databases," <http://www.slideshare.net/ThibaultDory/comparing-nosql-databases-benchmark>
- [4] J. Miyazaki and M. Onizuka, "Current trends and techniques on data cloud," the Information Processing Society of Japan, Vol. 52, No. 6, pp. 684–692, 2011 (in Japanese).



**Kota Tsuyuzaki**

Distributed Computing Technology Project, NTT Software Innovation Center.

He received the M.E. degree in information science from Waseda University, Tokyo, in 2010. Since joining NTT in 2010, he has been engaged in R&D of NoSQL databases. As a result of organizational changes in July 2012, he is now in NTT Software Innovation Center.



**Makoto Onizuka**

Distinguished Technical Member, Distributed Computing Technology Project, NTT Software Innovation Center and Visiting Associate Professor at the Graduate School of Information Systems, University of Electro-Communications.

He received the Ph.D. degree in computer science from Tokyo Institute of Technology in 2007. His primary research interests include systems and algorithms for data-intensive cloud computing.

## Efficient Large-scale Data Analysis Using MapReduce

*Rui Kubo, Yoshifumi Fukumoto, and Makoto Onizuka*

### Abstract

Techniques for efficiently analyzing large-scale collections of data, such as log data or sensor data, are attracting attention as important for improving the operating speed of businesses and enhancing the user experience. This article outlines MapReduce, which is a typical framework for analyzing big data, and introduces our techniques for achieving high-speed analytical processing by extending MapReduce.

### 1. Introduction

#### 1.1 Background of MapReduce

MapReduce is a framework for efficiently processing the analysis of big data on a large number of servers. It was developed for the back end of Google's search engine to enable a large number of commodity servers<sup>\*1</sup> to efficiently process the analysis of huge numbers of webpages collected from all over the world [1].

On the basis of this research, software was developed<sup>\*2</sup> by the Apache project to implement MapReduce, which was published as open source software (OSS) [2]. Since anyone can use OSS, this enabled many organizations, such as businesses and universities, to tackle big data analysis [3] in a way that only a few research institutes could do in the past owing to the complexity and high cost of the analytical system.

In the NTT Group, there is also an increasing number of cases involving big data analysis in a wide range of situations such as back-end systems for search engines, analysis and reporting systems for communications traffic and logs, and advertising recommendation engines.

#### 1.2 Mechanism of MapReduce

MapReduce provides an application programming interface (API) and middleware for developers who want to analyze big data. More specifically, when a developer defines processing that is compliant with two types of APIs, the map and reduce functions, processing is distributed efficiently for execution on multiple servers (**Fig. 1**).

The mechanism of MapReduce ensures that the complexity involved in developing a system that works on numerous servers can be concealed from the developer. More specifically, this approach has the following advantages.

- Scheduling: The servers that execute the processing defined by the map and reduce functions are selected automatically by the middleware. The middleware selects a nearby server in which a chunk of the data is stored to be the map function execution server. This reduces the volume of data transfers and enables efficient processing.
- Synchronized processing: data transfers between servers for the map and reduce functions are synchronized.
- Fault tolerance: To ensure that processing can continue overall even when several servers have failed, data backups and intermediate processing results are stored automatically. If a failure actually occurs, servers restart the processing using the backups and intermediate processing results.

The scheduling and synchronization processing become more complex as the scale of the data and

\*1 Commodity server: An ordinary inexpensive personal-computer-based server using commodity components.

\*2 The OSS community is actively advancing development by adding functions and fixing bugs.

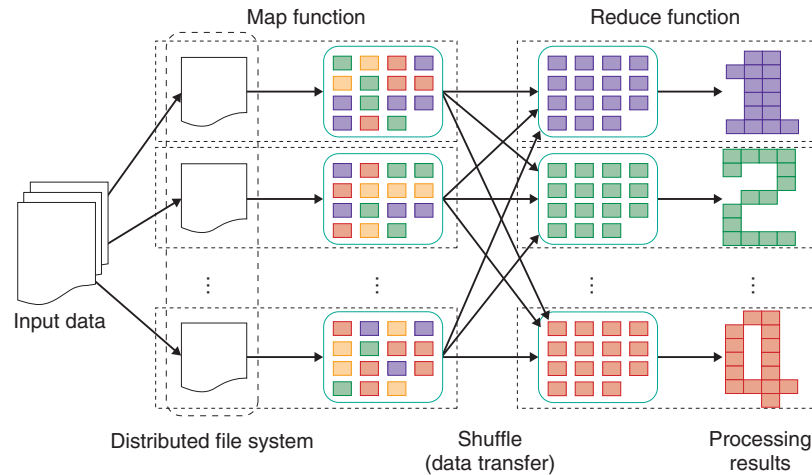

Fig. 1. Flow of MapReduce processing.

servers increases; thus, server breakdowns often occur. Since such complexities are concealed from the developer by MapReduce, he or she can focus on developing big data analysis methods.

We have been researching and developing techniques for achieving high-speed analytical processing by extending MapReduce. Increased efficiency is extremely important for achieving cost advantages such as improving the system's response time and reducing the number of servers. Below, we introduce the features and suitable usage situations for three techniques that we have developed: PJoin, Map Multi-Reduce, and MRFusion.

## 2. New techniques

### 2.1 PJoin

There are many developers who have used structured query language (SQL) when querying a database. Data manipulations that are frequently used with SQL include selecting, projecting, aggregating, and joining. Such data manipulations are frequently used in various situations. However, if databases that were designed some time ago are now given big data to handle, problems arise: the processing time is long and much time is necessary to obtain results. Therefore, there is a demand for techniques that produce results even more efficiently, even with big data.

PJoin can be used to join data efficiently. For example, if we analyze the log of an e-commerce site, we can obtain a best-seller product ranking for each profile by joining user data (profiles of all the users,

such as their ages and genders) and purchase history data (purchase histories of all the products), as shown in **Fig. 2**. PJoin makes it possible to quickly obtain such results even more efficiently.

Previously proposed techniques<sup>\*3</sup> [4] that can be used to perform joining with MapReduce have drawbacks. One drawback is constraints on the size of input data and another is the large volume of communications<sup>\*4</sup> generated between servers, which forms bottlenecks, so the results cannot be obtained efficiently.

In the preprocessing phase, PJoin creates data that represent reference information between data to be joined<sup>\*5</sup> and rearranges the input data to enable efficient joining. This overcomes the drawbacks of the previously proposed techniques and makes it possible to quickly obtain results efficiently, even when joining big data (**Fig. 3**).

Since a feature of PJoin is to perform quick and efficient joining by performing preprocessing, it is most suitable for use in situations such as querying repeated joins with large chunks of data.

### 2.2 Map Multi-Reduce

Map Multi-Reduce can be used to efficiently

\*3 Typical techniques are Memory-backed Join, Map-side Join, and Reduce-side Join.

\*4 Processing that hands over generated processing results between the map and reduce functions.

\*5 Only some of the rows, such as a primary key and external keys, are joined beforehand, as in the semi-join method in distributed database studies.

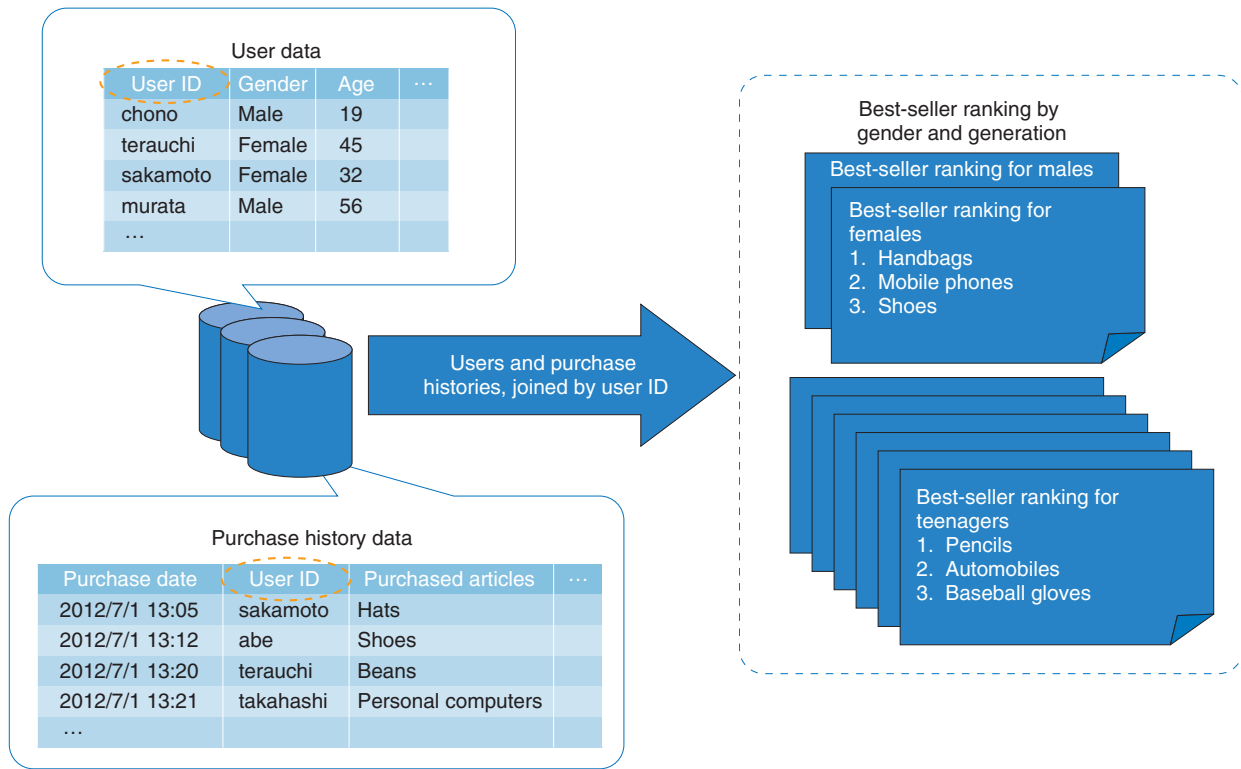

Fig. 2. Example of efficient joining by PJoin.

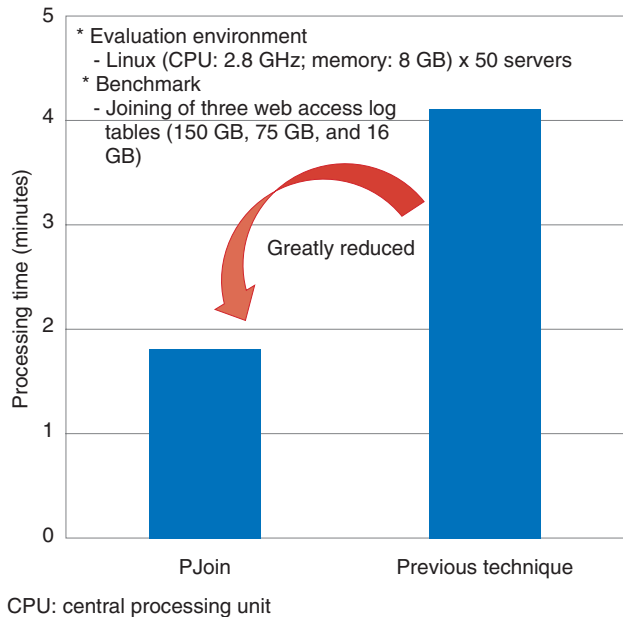

Fig. 3. PJoin processing time.

perform aggregations in data manipulations such as SQL. When analyzing the log of an e-commerce site, this technique makes it possible to perform calculations efficiently to obtain total or average daily or seasonal sales from the purchase histories of all products, as shown in Fig. 4.

To increase the speed of aggregation by MapReduce, it is common to reduce the volume of data being transferred between the map and reduce functions without changing the overall processing results\*6. Previously proposed techniques\*7 have various drawbacks, such as placing a larger load on the developer, but attempts to reduce this load also reduce efficiency.

Our Map Multi-Reduce is an extension of the Map-Reduce middleware. It enables the reduction of a wider range of data transferred between the map and reduce functions on the middleware side. This overcomes the drawbacks of the previously proposed techniques, enabling results to be quickly obtained

\*6 Processing that is equivalent to the reduce function, executed beforehand by the server that executes the map function.

\*7 Typical techniques are Combiner and In-mapper Combining.

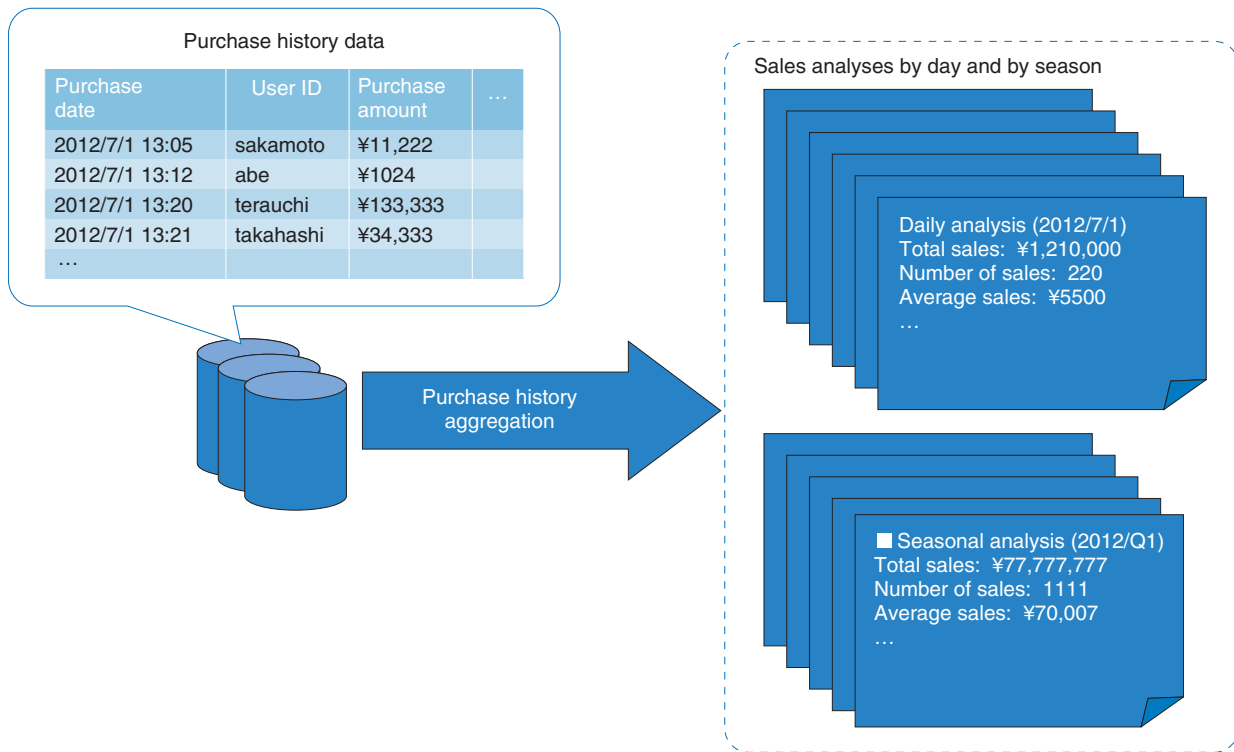

Fig. 4. Example of efficient aggregation with Map Multi-Reduce.

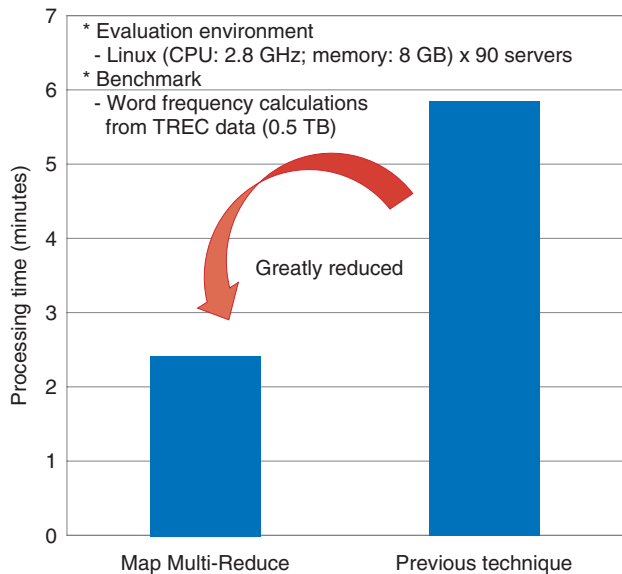

Fig. 5. Map Multi-Reduce processing time.

efficiently while keeping the load on the developer small (Fig. 5). When Map Multi-Reduce is used, there is an overhead\*8 due to the reduction of the transferred data, so it is most suitable for use with data and processing where the reduction effect is expected to be large\*9.

### 2.3 MRFusion

MRFusion is a technique that can be used to repeat analytical processing of the same data. For example, to optimize product recommendations on an e-commerce site, such as that shown in Fig. 6, it is necessary to apply various kinds of analytical processing to histories of past purchases by trial and error. If the trial and error is not done sufficiently well, accurate recommendation models cannot be constructed and the e-commerce site will recommend products that the customer does not want. MRFusion ensures that the trial and error (iterative processing) for con-

\*8 Overhead: Processing time that initially did not exist.

\*9 In the example of the e-commerce site discussed in this article, the reduction effect is larger for the processing to obtain total sales for each season than that for daily total sales.

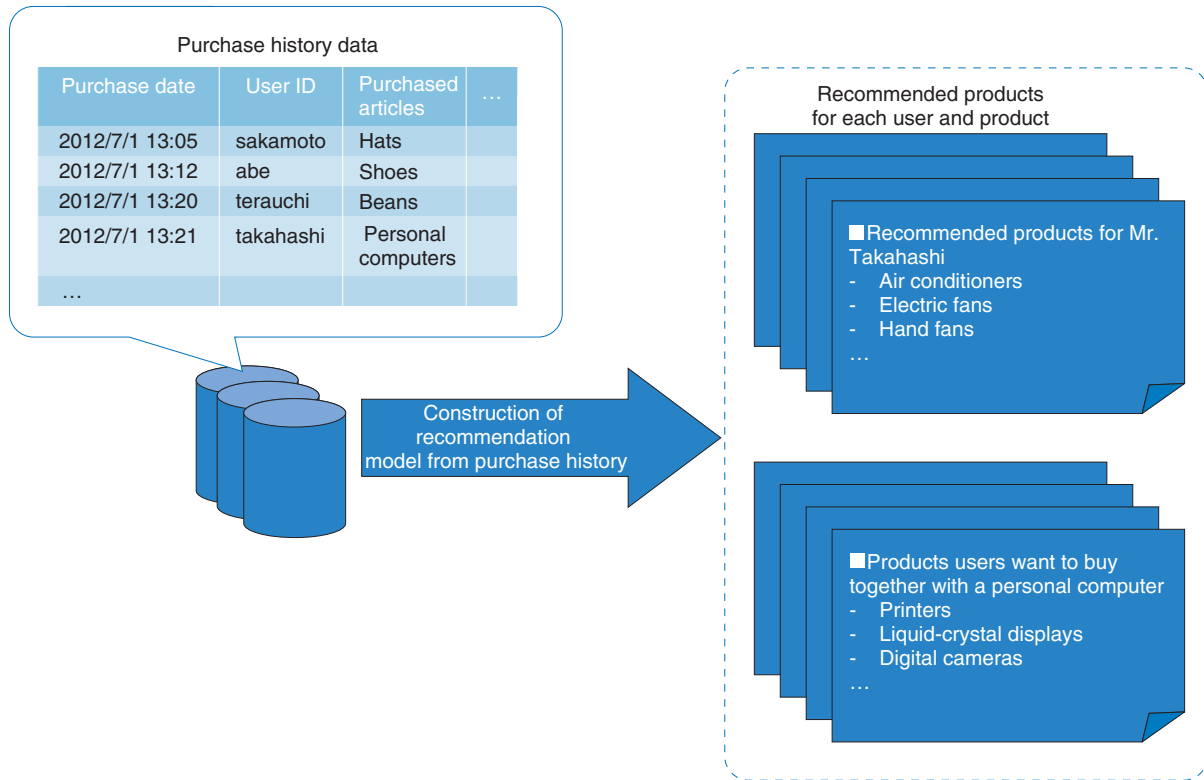

Fig. 6. Example of efficient model construction with MRFusion.

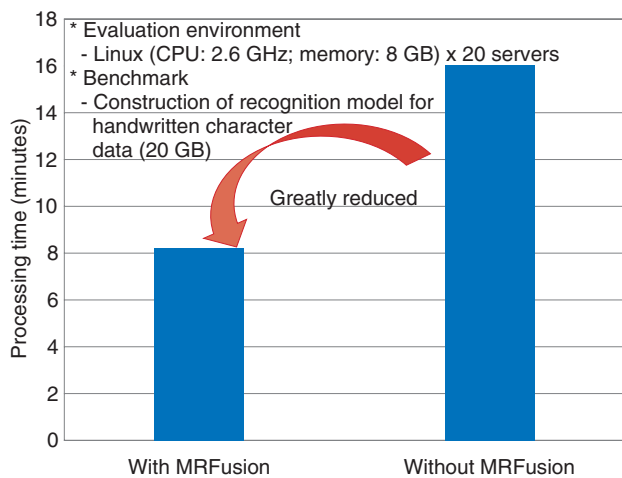

Fig. 7. MRFusion processing time.

structuring valuable models can be done quickly and efficiently.

Usually with MapReduce, when a developer wants to repeat analytical processing efficiently as de-

scribed above, he or she must personally create the processing logic to enable acceleration for each variation of the analytical and iterative processing every time. This imposes a large load on the developer and also hinders rapid introduction of the latest analysis algorithms.

As an extended version of the MapReduce middleware, MRFusion provides automatic detection of the same processing parts among multiple processing with the same data, combines them, and performs batch execution. This keeps the load on the developer small and enables the quick and efficient execution of multiple processing such as that described above (Fig. 7). Forcibly expanding the automatic detection range in this way can sometimes lead to side effects. Therefore, when MRFusion is being used, the most suitable usage method is to first apply it to small-scale data, check for an acceleration effect and any side effects, and then, if there do not seem to be any side effects, apply it to big data.

### 3. Concluding remarks

Attention is focusing on cloud computing, and the importance of using big data is now being recognized. It is also becoming more and more necessary to have information processing systems that are capable of processing big data.

We introduced three techniques that we have implemented to extend MapReduce and increase its speed. In the future, we plan to research and develop techniques for efficient processing that can be used over a wider range, as well as various easy-to-use tech-

niques, to help create value-added services that use big data.

### References

- [1] J. Dean and S. Ghemawat, "MapReduce: Simplified Data Processing on Large Clusters," OSDI '04. [http://static.usenix.org/events/osdi04/tech/full\\_papers/dean/dean\\_html/index.html](http://static.usenix.org/events/osdi04/tech/full_papers/dean/dean_html/index.html)
- [2] Apache Hadoop. <http://hadoop.apache.org/>
- [3] Hadoop Wiki. <http://wiki.apache.org/hadoop/PoweredBy>
- [4] J. Lin and C. Dyer, "Data-Intensive Text Processing with MapReduce," Morgan and Claypool Publishers, 2010.



**Rui Kubo**

Research Engineer, Distributed Computing Technology Project, NTT Software Innovation Center.

He received the M.S. degree in information systems from the University of Electro-Communications, Tokyo, in 2003. Since joining NTT in 2003, he has been engaged in R&D of sensor networks and distributed computing. As a result of organizational changes in July 2012, he is now in NTT Software Innovation Center. He is a member of the Japanese Society for Artificial Intelligence.



**Makoto Onizuka**

Distinguished Technical Member, Distributed Computing Technology Project, NTT Software Innovation Center and Visiting Associate Professor at the Graduate School of Information Systems, University of Electro-Communications.

He received the Ph.D. degree in computer science from Tokyo Institute of Technology in 2007. His primary research interests include systems and algorithms for data-intensive cloud computing.



**Yoshifumi Fukumoto**

Research Engineer, Distributed Computing Technology Project, NTT Software Innovation Center.

He received the B.E. degree from the Faculty of Environment and Information Studies from Keio University, Kanagawa, in 2009. Since joining NTT in 2009, he has been engaged in R&D of distributed computing and distributed storage. As a result of organizational changes in July 2012, he is now in NTT Software Innovation Center. He is a member of the Database Society of Japan.



## Jubatus in Action: Report on Realtime Big Data Analysis by Jubatus

*Keitaro Horikawa, Yuzuru Kitayama, Satoshi Oda, Hiroki Kumazaki, Jungyu Han, Hiroyuki Makino, Masakuni Ishii, Koji Aoya, Min Luo, and Shohei Uchikawa*

### Abstract

This article revisits Jubatus, a scalable distributed framework for profound realtime analysis of big data that improves availability and reduces communication overheads among servers by using parallel data processing and by loosely sharing intermediate results. After briefly reviewing Jubatus, it describes the technical challenges and goals that should be resolved and introduces our design concept, open source community activities, achievements to date, and future plans for expanding Jubatus.

### 1. Introduction

There is little doubt that data is of great value and importance in databases, data mining, and other data-centered applications. With the recent spread of networks, attention is being focused on the large quantities of a wide variety of data being generated and transmitted as *big data*. This trend is accelerating [1] as a result of advances in information and communications technology (ICT), which simplifies the collection and analysis of big data.

Even now, there is a strong need to make new discoveries and find patterns that were not noticed before, by taking huge amounts of data in a certain area that has been stockpiled, such as a dozen or so years of clinical data, and analyzing it from all angles, as one scenario in which big data is put to good use in business. This trend is not limited to operations confined to a specific area; it includes the possibility of swiftly finding new business possibilities or synergistic effects by focusing on relationships in big data spanning different fields or specialist areas. We think that this trend will expand into cross-domain big data analysis in the future<sup>\*1</sup>.

There are two major types of big data and techniques for analyzing it.

- (1) Stockpile type: Lumped high-speed analysis of accumulated big data (batch processing)
- (2) Stream type: Sequential high-speed analysis of data stream being continuously generated without accumulation (realtime processing)

With case (2) in particular, the ambiguity inherent in the environment is creating a growing need to make judgments and decisions on the basis of insufficient information.

In this article, we revisit Jubatus, a framework intended for realtime stream-type big data analysis that provides profound analysis ability by online machine learning as added value. Jubatus was introduced in the June 2012 issue of NTT Technical Review [1]. That article focused on a key mechanism called *mix*. In this article, after briefly reviewing Jubatus, we describe the technical challenges and goals that should be resolved and introduce our design concept, open source community activities,

<sup>\*1</sup> Cross domain: Access to data spanning different domains.  
[http://en.wikipedia.org/wiki/Cross-domain\\_solution](http://en.wikipedia.org/wiki/Cross-domain_solution)

achievements to date, and future plans for expanding Jubatus.

## 2. Jubatus

### 2.1 Overview

Jubatus is a scalable distributed computing framework for online machine learning. The origin of the name is the Latin term for that agile animal the cheetah. It is pronounced “yu-ba-tus”. Developed jointly by Preferred Infrastructure Corporation and NTT Software Innovation Center, it is currently published on websites as a Japan-originated big data open source project [2]–[4].

The goal of Jubatus is to enable swift and profound analysis of stream-type big data. One example of its use is as a social media application for automatically classifying the huge number of tweets<sup>\*2</sup> (over 8000 per second) generated all over the world. This processing includes the three requirements: large volume, fast, and profound. In other words, it supports natural language processing and automatic multcategory classification, at high speed without lag, of a data stream of 16 Mbit/s.

However, these three requirements basically have a trade-off relationship and it is intrinsically difficult to satisfy all of them simultaneously. Jubatus satisfies both profound analysis and scalability. Here, profound analysis is the automatic categorization of unstructured information intended for human beings, such as natural language. It can also replace human labor for unclearly formulated processing work, such as recommendation, prediction, and relationship discovery. From the technical perspective, it involves challenges in the areas of machine learning, artificial intelligence, and pattern recognition.

On the other hand, scalability encompasses the issues of (1) increases in processing requests and (2) increases in data size. Issue (1) can be further divided into throughput (volume of requests to be handled per unit time) and response (response for each instance, without lag). In general, batch processing focuses on throughput while realtime processing focuses on response. Approaches to issue (2) are either processing the data without waiting or dividing and storing it.

Jubatus answers the need for making prompt judgments in situations exhibiting uncertainty and ambiguity. After our comprehensive investigation of the

design concept, under which information for judgment is being collected continuously and decisions are being made without lag, we separate the profound analysis (functionality) from the scalability (non-functionality). More specifically, a profound analysis design likens the logic of online machine learning to an *engine or central processing unit* (CPU), which can be continuously upgraded as removable analysis modules. A scalable design is seen as a common infrastructure *chassis or motherboard*, which can be scaled by installing analysis modules into the common framework. The ultimate goal of Jubatus is to provide everyone with scalable machine learning. Our policy is to provide a broadly easy-to-understand online machine learning framework for big data that is easy to use, with hardware that scales out over inexpensive commodity servers to enable massively parallel distributed processing and software that is not restricted to a few data scientists, programmers, and specialists.

### 2.2 Applicable areas

Google’s PageRank is well known as a technique for calculating the importance of web pages from all over the world [5]. Since website link structures are updated comparatively slowly, batch analysis is suitable in this case. Social media such as Twitter tweets, on the other hand, are characterized by having finer granularity than the web, by having light content, by having small chunks of data that are transmitted in large numbers from a wider demographic than that of web users, and by the immediacy of information being vital. Through social media, we can analyze how a broad user population reacts to changes and events in the external environment and make effective practical use of realtime analysis of stream-type big data, with cases applied to business enterprises.

We have provided primary classifications of Twitter information as an application of Jubatus. Since the information representation is in natural language and is presented with a limited number of characters, expressions having distinctive omissions, abbreviations, coined words, jargon, and mannerisms were included in the analysis subject matter. From the over 2000 tweets per second in the Japanese language alone, it is difficult for humans themselves to extract and organize useful information instantly by sight. Therefore, general-purpose primary filters that provide major classifications and refining functions are useful. Using the approximately 1600 companies listed on the first section of the Tokyo Stock Exchange as the classification categories, Jubatus speedily

\*2 Tweets: short messages sent using the popular social networking service and microblogging service Twitter.

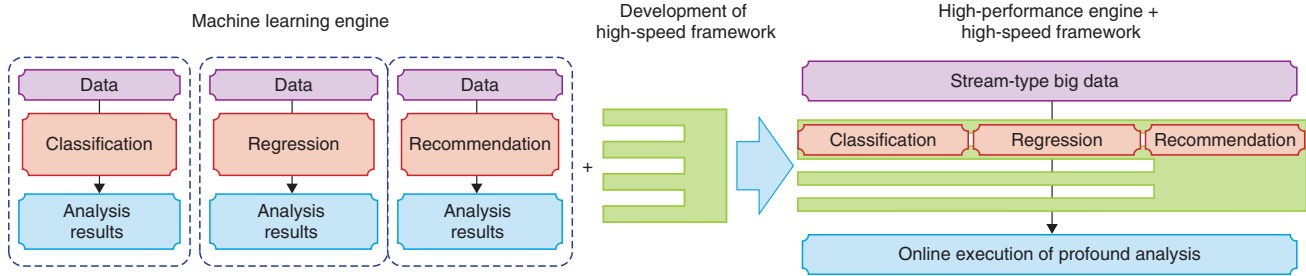

Fig. 1. Outline of the design concept.

classifies the 2000 tweets per second into their corresponding business categories and supplies information to an analysis application. This implementation uses an online machine learning technique called Jubatus classifiers (multi-valued classification). We used highly trustworthy published information, such as Wikipedia, as training data and automatically constructed a learning model for classification. Unlike item classification by keyword matching or related words, we use online learning to update the vector equations of separate planes that divide an n-dimensional feature vector space<sup>\*3</sup> into a number of categories.

We can also expect the system to become smarter on its own by continuing to incorporate big data from outside, with the effect that even unknown words will be classified appropriately. The categories for the primary classification are not limited to businesses: it is possible to broaden the application to countries, local governments, municipalities, celebrities, products, and etc.

### 2.3 Architecture and functions

The design concept of Jubatus is outlined in Fig. 1. As stated above, Jubatus is composed of a cluster of machine learning engines and a high-speed framework that supports them.

In contrast to previous machine learning engine units, which usually handled small- to medium-scale data and required batch processing and individual development, Jubatus has a huge variety of engines installed in a high-speed framework and a development mechanism with common specifications for high-speed big data processing with errors within a

permitted range tolerated [6]. June 2012 saw the release of version 0.3 of Jubatus and we are planning to augment the lineup of machine learning functions and strengthen the support framework. The types of machine learning that we currently support so far are outlined in Table 1.

Jubatus will be useful for applications that require speedy judgment. It is expected to be able to discover and analyze original relationships among the data volume from different domains.

### 2.4 Distributed processing architecture

The distributed processing architecture is shown in detail in Fig. 2. The stream of big data flows from left to right. Clients are configured of a number of user processes and proxy processes.

The proxy processes relay clients' requests to the server processes, enabling the servers be transparent to the user processes. User processes are implemented by using the Jubatus client application programming interface (API); they are written in a scripting language or in a general programming language.

We appreciate the outside contributions from the open source community, so we enabled the use of a large variety of language bindings [7], such as Python, Ruby, and Java. Communications between proxy processes and server processes are based on MessagePack [8] remote procedure calls (RPCs). Non-block input/output enables more efficient communications and synchronization control. The server processes perform the training, prediction processing, and learning model synchronization, which has linearly increasing performance with the number of servers. In addition, Zookeeper [9] processes manage the cooperation between proxy and server processes, the balancing between distributed servers, the monitoring of server state (alive/dead), and the selection of new leaders.

\*3 n-dimensional feature vector space: n is the number of words that characterize the Japanese language. In this case, it is approximately 2000.

Table 1. Examples of functionalities for machine learning.

Supported machine learning engines	Functionalities for machine learning
Classification	Learning request Classification request
Regression	Learning request Analogy request
Recommendation	Update or deletion of row data (user ID/items) Search for similar data Figure out recommendation items
Statistics	Update Calculation of: sum, deviation, maximum & minimum, entropy, moment
Graph mining	Node creation, deletion, update, reference Edge creation, deletion, update, reference Centrality measures Shortest path calculations between two nodes

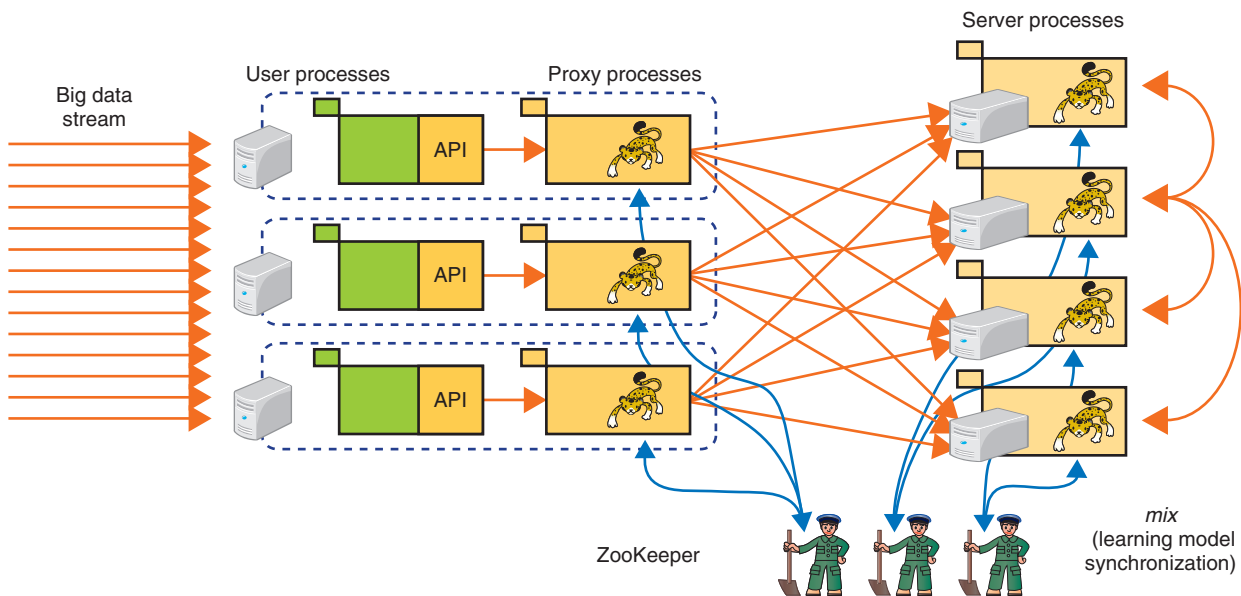

Fig. 2. Distributed processing architecture.

Table 2. Characteristics of Jubatus distributed processing.

	Batch processing	Jubatus
Processing capability	Stockpile type: Lumped process with data accumulation	Stream type: on-demand processing without data accumulation
Running time	Scheduled type: Start and end timing are defined.	24 hours per day, 7 days per week, i.e., non-stop

The characteristics of Jubatus distributed processing are compared with those of batch processing in **Table 2**. For example, when there are 1000 distrib-

uted parallel processing servers, batch processing (e.g., using Map-Reduce) means that the 1000 servers all execute Map simultaneously, and then all of them

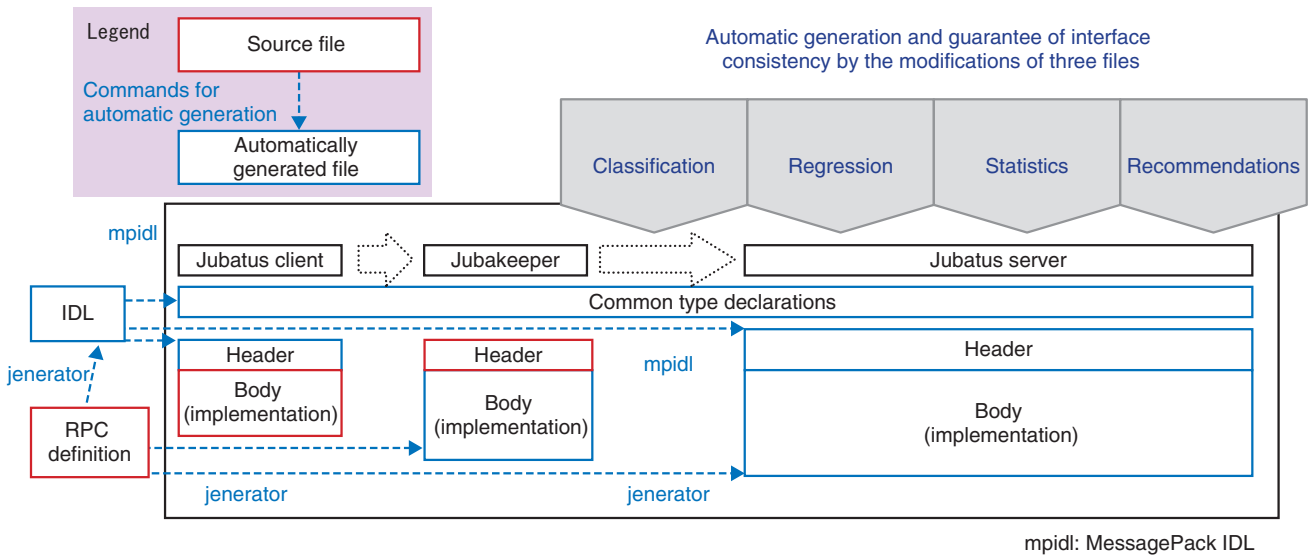

Fig. 3. Automatic creation of template interface by IDL.

together execute Reduce to summarize the results. By contrast, with Jubatus, each server repeats the learning and analysis autonomously.

In parallel processing among distributed servers, one technique for satisfying both profound analysis and scalability is *mix* processing [1], [6], [10]. This processing can be regarded as resembling a group study meeting for self-teaching and checking answers (or called synchronization) with others. If all the 1000 servers synchronize their answers after every single learning or analysis task, then overall there will be a huge drop in processing speed due to the waiting time, but a moderate frequency of synchronization may enable the data learning and analysis without any decrease in overall performance.

Let us introduce *mix* processing and the unified update-mix-analyze (UMA) interface.

- Update: Asynchronous execution of update-related queries and additions or changes to big data
- Mix: Loose sharing of intermediate analysis results within the component servers
- Analyze: Abstraction interface that suggests the execution of reference queries and analysis requests from clients.

The aim is to implement a common interface that is independent of the analysis logic. In the future, we will continue upgrading the machine learning engine, but designing and maintaining an easy-to-understand framework with consistent interfaces are also impor-

tant tasks.

### 3. Improvements in development efficiency

To improve the agility of development and ease the burden on developers, a full range of designs and tools is being provided in Jubatus.

#### (1) Feature vector conversion

Whatever the data, it is necessary to capture its feature vectors as the input format for machine learning. Conversely, if feature vectorization is successful, the machine learning algorithms only need to be processed appropriately. We have provided a tool that defines this important feature vectorization by means of an outgoing settings file, without hard-coding it as program logic.

#### (2) IDL and jenerator

In Jubatus version 0.01, any addition to the analysis logic led to the need for manual editing and verification of seven files every time. Therefore, we devised a mechanism for automatically maintaining interface consistency and localizing the interface alteration work. We define the interface by using an interface description language (IDL) file, and template skeletons of six files are generated automatically by a tool called a *jenerator* (Fig. 3). As a result, approximately 3000 lines of code can be generated automatically by using a 100-line definition file, and unification of the source code maintenance work is also improved by IDL. The meaning and usage of the API can be simply

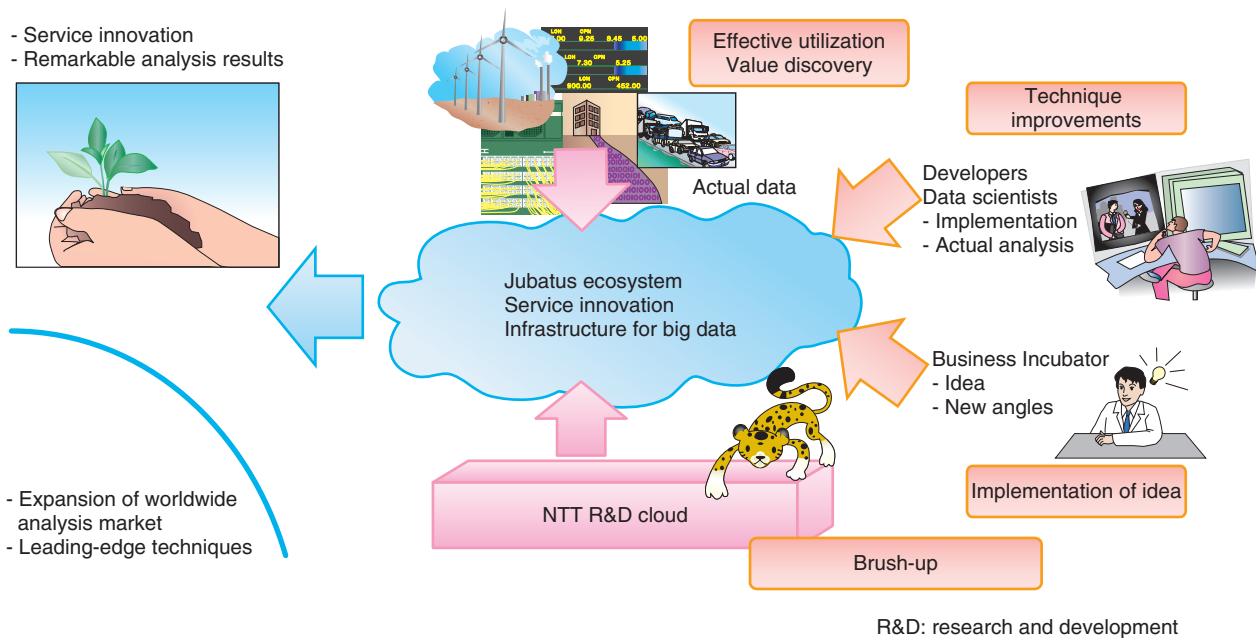

Fig. 4. Jubatus ecosystem.

understood just by reading the IDL file, which greatly improves the development efficiency.

#### 4. Performance evaluation

We verified the performance beforehand while expanding the analysis logic. This evaluated the scalability of Jubatus.

- (1) Classification: We classified Twitter tweets on a global scale (8000 per second) with two or three commodity servers. An accuracy rate of 90% in batch processing was achieved with data obtained within 10 s. The quantity of training data was not necessarily that large.
- (2) Recommendations: The update frequency of online shopping transactions can be over 100,000 times per second per server and it is possible to produce recommendations for 30 million users within a response time of 0.1 s (approximately ten times as fast as Mahout). We also verified that the throughput (number of registered data items per second) scales up linearly with increasing number of servers.
- (3) Graph mining
  - Addition of 100 million edges: by ten commodity servers in parallel for 5 minutes
  - Scalability in edge addition through an increase in the number of servers: (1, 2, 4, 8) servers ==>

(3, 6, 13, 25) at 10,000 edges per second (throughput).

- Analysis latency: {update, mix, centrality}: 0.1 to 0.3  $\mu$ s per node; {shortest-path}: from 0.1  $\mu$ s to several tens of microseconds per node (paths of approximately 1000 hops). This is up to a thousand times as fast as one well-known graph database product.
- Data size: Retention of over 16 million edges per server (8 GB of memory) ==> Retention of 100 million edges with 50 GB.

#### 5. Open source status and future schedule

As of July 2012, Jubatus is in its third version and an OSS release is available. It provides an integrated, easy-to-use infrastructure aimed at specialists, programmers, and developers. It also provides an infrastructure designed to let data scientists slot in analysis algorithms that they want to try out and rapidly scale up. The open source community will continue to work actively on this.

A Jubatus analysis idea contest (Jubatus Challenge Japan 2012) was held from July to September, 2012 [11]. The aim of this contest was to seek ideas and business scenarios that reveal the potential of Jubatus to the maximum by active application of open innovation. An important point is the design of a Jubatus

ecosystem. Our main challenge is to act like a catalyst in a chemical reaction amidst organic links formed by main components without any deficiencies in the Jubatus infrastructure technology, machine learning algorithms, big data, or data scientists, in other words, to design a realtime machine learning and analysis ecosystem such as that shown in **Fig. 4**.

## 6. Future expansion

To date, the big data analysis business has centered on making industrial use of the discovery of previously unnoticed relationships by data mining, and batch processing analysis has centered on taking a large volume of data that had been stockpiled and analyzing it from many angles by trial and error to obtain original discoveries. Henceforth, it will be important to perform research and development from the following viewpoints.

- (1) Cross domain relationship analysis: Instead of analyzing big data confined to a specific area, discover original business possibilities and synergistic effects from relationships within big data spanning different fields or specialist areas.
- (2) Realtime analysis: Support speedy operations and create competitive advantages by making rapid decisions based on stream-type data analysis.
- (3) Profound, realtime, big data analysis: Develop highly value-added techniques that meet the

need for automatic judgment (based on machine learning) where decision logic has not been previously defined, but can reflect any change in status rapidly on the fly for automatic judgment on the microsecond time-scale to provide rigorous analysis results that cannot wait until tomorrow or the day after and where actions taken through human judgment (decision-making route) would be too slow.

In the future, we will continue to promote open source development and open innovation and the expansion of real-life cases.

## References

- [1] S. Oda, K. Uenishi, and S. Kinoshita, "Jubatus: Scalable Distributed Processing Framework for Realtime Analysis of Big Data," NTT Technical Review, Vol. 10, No. 6, 2012. <https://www.ntt-review.jp/archive/ntttechnical.php?contents=ntr201206ra2.html>
- [2] Jubatus website. <http://jubat.us/>
- [3] Jubatus on Twitter. <https://twitter.com/jubatusofficial>
- [4] Jubatus on github. <https://github.com/jubatus/jubatus>
- [5] "The PageRank Citation Ranking: Bringing Order to the Web," <http://infolab.stanford.edu/~backrub/pageranksub.ps>
- [6] NTT Press release, "Leading Development of Scalable Distributed Computing Framework for Real-Time Analysis of Big Data," <http://www.ntt.co.jp/news2011/1110e/111026a.html>
- [7] Language binding. [http://en.wikipedia.org/wiki/Language\\_binding](http://en.wikipedia.org/wiki/Language_binding)
- [8] MessagePack. <https://github.com/msgpack/msgpack-rpc>
- [9] Zookeeper. <http://zookeeper.apache.org/>
- [10] S. Oda, S. Nakayama, K. Uenishi, and S. Kinoshita, "Jubatus: Distributed Processing Technique Enabling Realtime Processing of Big Data," IEICE Tech. Rep., Vol. 111, No. 409, IN2011-126, pp. 35–40, Jan. 2012.
- [11] Jubatus Challenge. <http://www.facebook.com/JubatusChallenge2012>



**Keitaro Horikawa**

Senior Research Engineer, Supervisor, Distributed Computing Technology Project, NTT Software Innovation Center.

He received the B.S. and M.S. degrees in information engineering from Niigata University in 1988 and 1990, respectively. Since joining NTT in 1990, he has been engaged in R&D of software design and architecture, concurrent distributed object computing, metaprogramming and computational reflection, single-sign-on for web services, lightweight programming languages, mobile cloud computing and big data computing, CSCW, CSCL, and game theoretical modeling for decision making and human factors in R&D. He received the Best Paper Award for Young Researchers from the Information Processing Society of Japan (IPSI) National Convention in 1995. As a result of organizational changes in April 2012, he is now in NTT Software Innovation Center. He is currently managing distributed computing projects including Jubatus. He has PMP certification by PMI and TOGAF 9 certification by the Open Group.



**Yuzuru Kitayama**

Senior Research Engineer, Distributed Computing Technology Project, NTT Software Innovation Center.

He received the B.E. and M.S. degrees in engineering from Kobe University, Hyogo, in 1996 and 1998, respectively. Since joining NTT in 1998, he has been engaged in the development and management of large-scale web search systems and R&D of distributed processing systems. As a result of organizational changes in April 2012, he is now in NTT Software Innovation Center.



#### Satoshi Oda

Researcher, Distributed Computing Technology Project, NTT Software Innovation Center.

He received the B.E. and M.E. degrees in engineering from Keio University, Kanagawa, in 2003 and 2005, respectively. Since joining NTT Information Sharing Platform Laboratories in 2005, he has been engaged in R&D of information security, fast implementation of cryptography, and security protocols. As a result of organizational changes in April 2012, he is now in NTT Software Innovation Center. He received the 2007 Outstanding Presentation Award from the Japan Society for Industrial and Applied Mathematics (JSIAM) and the 2009 Life Intelligence and Office Information System (LOIS) Research Award. He is a member of JSIAM.



#### Hiroki Kumazaki

Researcher, Distributed Computing Technology Project, NTT Software Innovation Center.

He received the B.E. and M.E. degrees in engineering from Nagoya Institute of Technology, Aichi, in 2010 and 2012, respectively. Since joining NTT Software Innovation Center in 2012, he has been researching distributed computing systems.



#### Jungkyu Han

Researcher, Distributed Computing Technology Project, NTT Software Innovation Center.

He received the B.S. and M.S. degrees in computer science and engineering from Seoul National University, Korea, in 2005 and 2007, respectively. Since joining NTT in 2007, he has been engaged in R&D of stream data accumulation and distributed processing systems. As a result of organizational changes in April 2012, he is now in NTT Software Innovation Center. His current interests include big data analysis.



#### Hiroyuki Makino

Researcher, Distributed Computing Technology Project, NTT Software Innovation Center.

He received the B.E. and M.S. degrees in engineering from Doshisha University, Kyoto, in 2007 and 2009, respectively. Since joining NTT Information Sharing Platform Laboratories in 2009, he has been engaged in R&D of identity federation systems and distributed processing systems. As a result of organizational changes in April 2012, he is now in NTT Software Innovation Center. He is a member of the Institute of Electronics, Information and Communication Engineers (IEICE).



#### Masakuni Ishii

Researcher, Distributed Computing Technology Project, NTT Software Innovation Center.

He received the B.S. degree in mathematics and computer science from the University of Arizona, USA, in 2007 and the M.S. degree in computer engineering from Keio University, Kanagawa, in 2009. Since joining NTT in 2010, he has been engaged in R&D of stream data accumulation and distributed processing systems. As a result of organizational changes in April 2012, he is now in NTT Software Innovation Center. He is a member of IPSJ.



#### Koji Aoya

Senior Research Engineer, Distributed Computing Technology Project, NTT Software Innovation Center.

He received the M.S. degree in mathematics from Osaka University in 2001. After joining NTT Information Sharing Platform Laboratories in 2001, he was engaged in R&D of information security, fast implementation of cryptography (especially ECDSA), and some applied protocols such as electronic money. In 2007, he was transferred to NTT DATA Corporation, where he was engaged in marketing and developed some solutions for retail and airline industries in the related departments. Since moving to NTT Software Innovation Center in 2012, he has been incubating and developing the market for Jubatus.

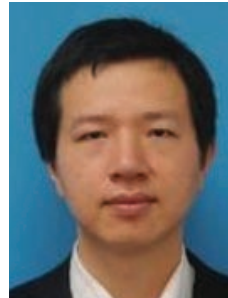

#### Min Luo

Scientist, Distributed Computing Technology Project, NTT Software Innovation Center.

He received the B.S. and M.S. degrees from Wuhan University, China, in 2004 and 2007, respectively, and the Ph.D. degree in computer science from Tokyo Institute of Technology in 2011. After that, he was a full-time Associate Researcher at Tokyo Institute of Technology. Since joining NTT Software Innovation Center in 2012, he has been engaged in research on realtime big data analysis. He received the Best Paper Award from the International Conference on Web-Age Information Management (WAIM) in 2010.



#### Shohei Uchikawa

Senior Research Engineer, Supervisor, Group Leader, Distributed Computing Technology Project, NTT Software Innovation Center.

He received the B.E. degree in information engineering from Tokyo Institute of Technology in 1988. After joining NTT Information Processing Systems Laboratories in 1988, he was engaged in developing operating system software for the Denden Information Processing System (DIPS) and designing a high-availability information system that uses DIPS. Following the gradual termination of the DIPS project in the 1990s, he took on the job of integrating several high-availability client/server type information systems as a systems engineer. In 2008, he moved to NTT Communications as a general manager in the Platform Service Department and he contributed to the company's application service provider business. He returned to NTT in 2011. As a result of organizational changes in April 2012, he is now in NTT Software Innovation Center.



## High-speed Tunable Distributed Amplification Distributed Feedback (TDA-DFB) Lasers

*Nobuhiro Nunoya, Hiroyuki Ishii, and Ryuzo Iga*

### Abstract

In this article, we describe experimental results and an accurate wavelength control method for tunable distributed amplification distributed feedback (TDA-DFB) lasers, which can offer fast wavelength switching and high controllability because wavelengths can be changed continuously. They should provide light sources for future photonic networks such as wavelength routing systems.

### 1. Introduction

The capacity of optical fiber communication networks has increased greatly through the use of wavelength division multiplexing (WDM) systems, where signals with multiple wavelengths are transported in a single fiber. Since signals with different wavelengths do not interfere with each other, they can be separated easily by using an arrayed waveguide grating or other interferometer device.

A wavelength routing system has been studied for future photonics network systems, where transmission paths are selected dynamically by using the wavelength of the signal lightwave as destination information. High-speed wavelength switching reduces the amount of data that must be transmitted and makes possible optical switching systems without electrical bandwidth and delay limitations. There is a real need for light sources that can change wavelength quickly and accurately for use in systems that use dynamic wavelength switching.

The various tunable wavelength lasers, which can be roughly divided into hybrid and monolithic types, are shown in **Fig. 1**. The hybrid types consist of both a semiconductor part for gain and other material parts for tuning, so they are also called external cavity lasers. Their wavelengths can be controlled by changing the center wavelength of the external filter or reflector. The tuning speed depends on the response of the external filter or reflector. On the other hand,

the monolithic types have gratings or other structures for selecting the wavelength in the semiconductor, and the lasing wavelength is changed by changing the refractive index.

The refractive index of the semiconductor can be changed by changing its temperature, which can be easily and stably controlled with a Peltier device. As a result, a tunable distributed feedback (DFB) laser array with temperature control [1], [2] which is an extremely stable tunable wavelength laser, has been developed. However, since the temperature-induced refractive index change is relatively slow, high-speed wavelength changing is very difficult to achieve.

Carrier effects, such as the plasma effect and the band filling effect, induced by current injection, also cause a refractive index change. Since these phenomena happen quickly, they are used in tunable distributed Bragg reflector (DBR) lasers [3] as well as sampled grating (SG) DBR lasers [4] and superstructure grating (SSG) DBR lasers [5]. However, a change in the reflection peak wavelength is incompatible with a longitudinal mode (phase) change because the gain region and the wavelength tuning region are separated. Therefore, a phase tuning section is needed so that multiple sections can be controlled for stable operation. In addition, a feedback function that corrects the operating condition is difficult to achieve because there is a possibility of mode hopping during wavelength switching and long-term operation.

Tunable wavelength lasers with high-speed and

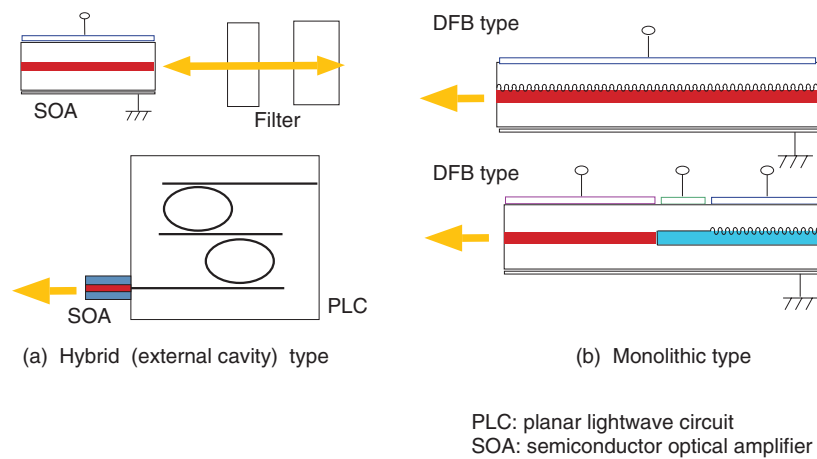

Fig. 1. Kinds of tunable wavelength lasers.

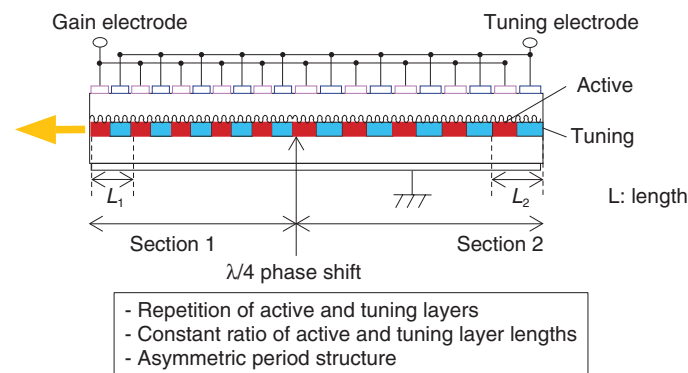

Fig. 2. Cross sectional schematic view of TDA-DFB laser.

accurate wavelength switching, require mode-hop-free operation with a single tuning electrode that utilizes carrier effects induced by current injection. The tunable distributed amplification distributed feedback (TDA-DFB) laser was invented in our laboratory for high-speed and mode-hop-free operation [6]–[8].

## 2. TDA-DFB laser with asymmetric structure

A schematic view of a TDA-DFB laser is shown in Fig. 2. Active gain and tuning layers for wavelength control are arranged alternately along the cavity, which is similar to a structure that combines a DFB laser and a DBR laser. While the repetition periods of the active and tuning layers differ on the left hand side (section 1) and right hand side (section 2) by a  $\lambda/4$  phase shift, their ratio is constant throughout the

entire cavity. Since the electrodes for the same layers are connected to each other in the device, the wavelength of the TDA-DFB laser can be controlled by a single tuning electrode.

The tuning principle of the TDA-DFB laser is explained in Fig. 3. Before tuning, the wavelengths of the reflection peaks of sections 1 and 2 are the same because the refractive indices of the tuning and active layers are the same. Moreover, since the phase condition is satisfied at the Bragg wavelength owing to the  $\lambda/4$  phase shift, lasing occurs at the reflection peak wavelength. When the tuning current is increased, the refractive index of the tuning layer is reduced and both the reflection peak and longitudinal modes move synchronously to the shorter wavelength side. Since the ratio of the active layer length to tuning layer length is constant, as previously mentioned, the

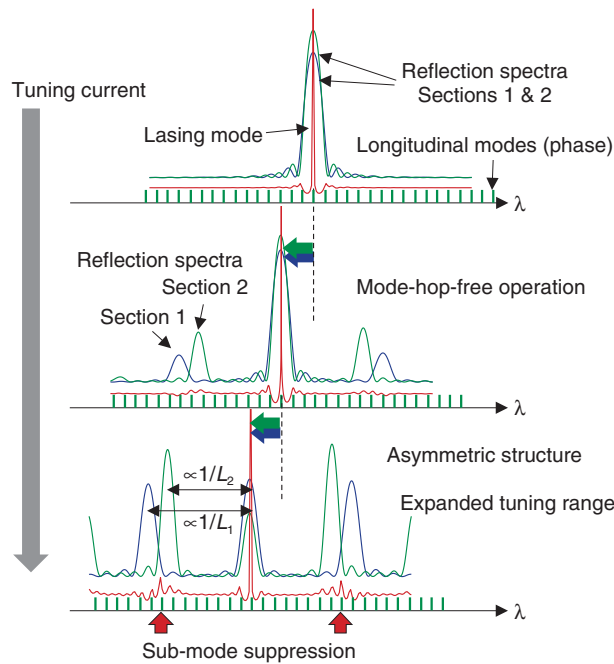

Fig. 3. Principle of mode-hop-free tuning.

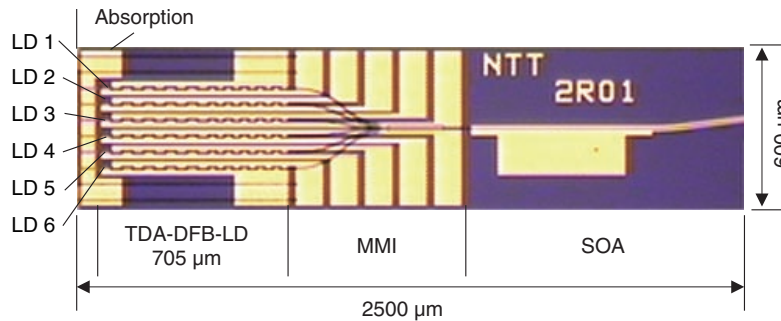

Fig. 4. Photograph of top view of TDA-DFB laser array.

average Bragg wavelength change is proportional to the longitudinal mode (phase) change related to cavity length. As shown by these results, mode-hop-free tuning can be achieved.

When the refractive index of the tuning layer is further reduced by increasing the tuning current, satellite reflection peaks are generated beside the main reflection peak with a period that is inversely proportional to the repetition period of the active and tuning layers. However, since the asymmetric structure with different repetition periods prevents overlaps between the satellite peaks of sections 1 and 2, no sub-modes are generated. Consequently, the continuous tuning

wavelength range for TDA-DFB lasers with an asymmetric structure can be expanded.

A top view of a monolithically integrated TDA-DFB laser array is shown in **Fig. 4**. One TDA-DFB laser can change wavelength by 7 nm to 8 nm. To cover the C band (wavelength range from 35 nm to 40 nm) used for optical fiber communication, six TDA-DFB lasers with an asymmetric structure, a multimode interference (MMI) coupler, and a semiconductor optical amplifier (SOA) are integrated monolithically. The relationship between the lasing wavelength and the tuning voltage for each laser diode (LD) is shown in **Fig. 5**. A tuning wavelength

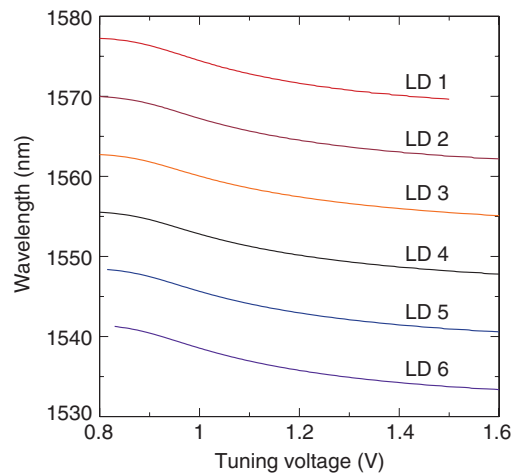

Fig. 5. Relationship between wavelength and tuning voltage.

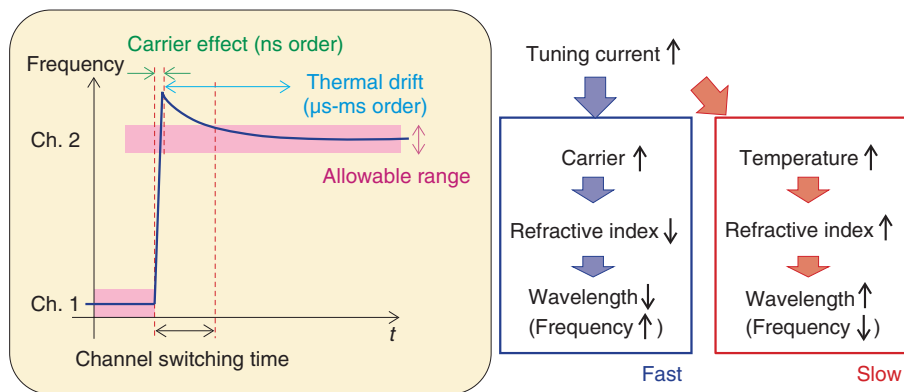

Fig. 6. Diagram of channel switching (left) and explanation of phenomena (right).

range of more than 40 nm can be obtained by covering the different wavelength ranges of the lasers with different grating periods. The results in Fig. 5 show a wavelength slightly shorter than the C band, but optimized grating periods will provide operation over the entire C band.

### 3. Channel switching

The frequency variations that occur during channel switching operation are explained in Fig. 6. Carrier effects occur within a few nanoseconds in carrier-injection-type tunable wavelength lasers. However, a temperature change is simultaneously produced by the heat generated by the current injection. Therefore, relatively slow wavelength variations also appear

(thermal drift). Since the refractive index changes caused by carrier effects and the thermal effect are opposite, frequency variations are observed, as shown in Fig. 6. Since the TDA-DFB laser can operate without mode hopping during thermal drift, it is easy to control the wavelength, and the wavelength variations can be calculated.

The channel switching time is defined as the time taken for a wavelength to enter the allowable wavelength range. For high-speed switching, it is important to reduce the thermal drift by suppressing the temperature change [8]–[10]. With the TDA-DFB laser array, variations in generated heat can be reduced by utilizing the array's tuning layers as heat compensators. Controlling the tuning current of one of the other lasers so that it is opposite to the tuning

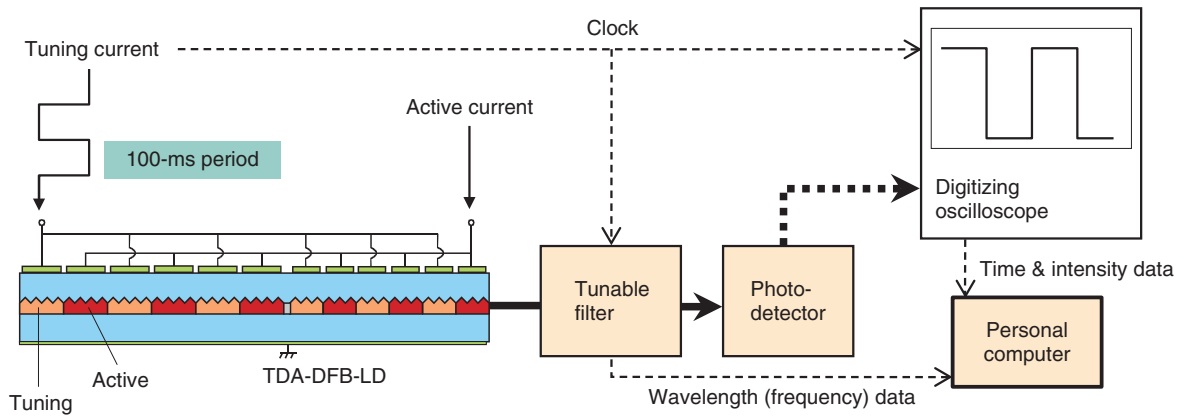

Fig. 7. Measurement setup for monitoring wavelength trajectory during channel switching.

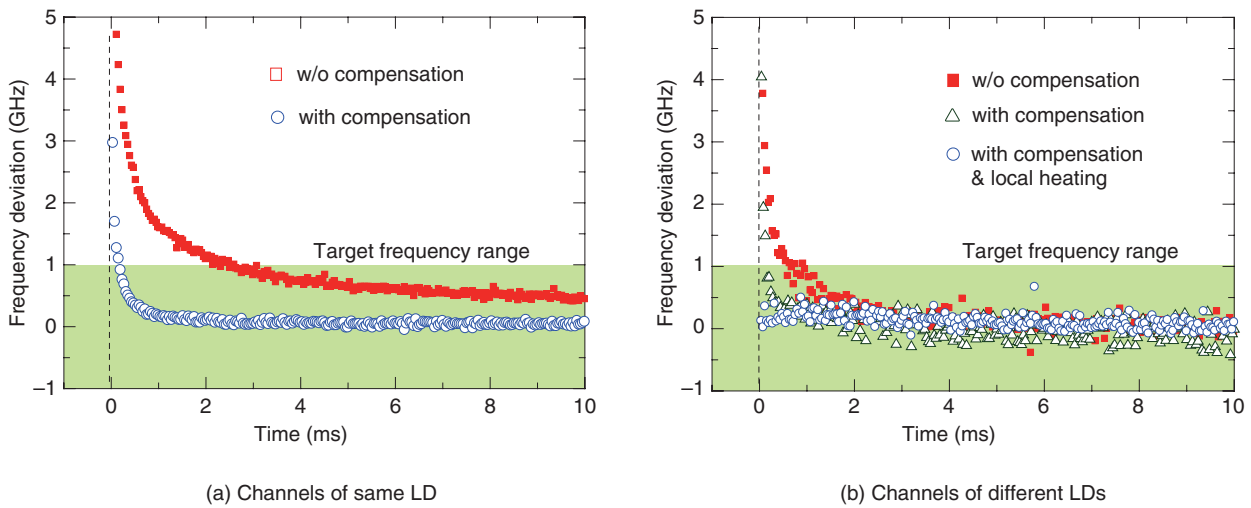

Fig. 8. Peak wavelength traces during channel switching.

current of the operating laser enables the generated heat to be kept constant.

The measurement setup for monitoring the change in wavelength during channel switching is shown in Fig. 7. For channel switching between channels of the same laser, the active current is constant and the tuning current changes within 100 ms. While the transparent wavelength of the tunable filter is being changed, time domain intensity profiles are measured repeatedly. They are combined, and the peak wavelength can then be traced. Details of the experiment, such as the injection current for each region, are given elsewhere [8].

The results of channel switching in the same laser

are shown in Fig. 8(a). With thermally compensated operation, when the tuning current increases, the tuning current of the next laser decreases. Without thermal compensation, the switching time, which is defined as an allowable frequency range of 1 GHz, was 3 ms. With thermal compensation, the switching time was reduced to less than 0.2 ms.

Results obtained for switching between channels in different lasers are shown in Fig. 8(b). For thermally compensated operation, the tuning current was injected continuously to keep the heat constant while the active current was switched between the two lasers. As a result, the channel switching time was reduced to around 0.3 ms. However, even if the total current

injected into the entire chip is constant, the large active current will be changed, which will induce a large local temperature change. To suppress this, we attempted to use local heating by applying a relatively large tuning current before switching. We succeeded in suppressing the local temperature variation and, as a result, the thermal drift fell to less than 1 GHz with a time resolution of 40  $\mu$ s.

#### 4. Conclusion

A TDA-DFB laser with an asymmetric structure, which is a kind of high-speed tunable wavelength laser without mode hopping, has been developed for future WDM network systems. The mode-hop-free tuning range was expanded to about 8 nm by using an asymmetric period structure. Consequently, a tuning range of over 40 nm was obtained for a monolithically integrated TDA-DFB laser array, consisting of six asymmetric TDA-DFB lasers, an MMI coupler, and an SOA.

We also demonstrated thermal drift reduction during channel switching by using a thermal compensation technique. The channel switching time with a frequency deviation of less than 1 GHz was reduced from 3 ms to 0.2 ms when both channels were in the same laser. For channel switching between different lasers, a channel switching time of less than 40  $\mu$ s was achieved by using thermal compensation with the local heating.

The asymmetric TDA-DFB laser array will be useful for advanced photonic networks based on WDM systems because of its high-speed and accurate wavelength tuning. In the future, we will research both

device structures and operating methods to make even faster and more accurate channel switching.

#### References

- [1] H. Ishii, K. Kasaya, and H. Oohashi, "Spectral Linewidth Reduction in Widely Wavelength Tunable DFB Laser Array," *IEEE J. Sel. Top. Quantum Electron.*, Vol. 15, No. 3, pp. 514–520, 2009.
- [2] H. Ishii, K. Kasaya, and H. Oohashi, "Wavelength-tunable Lasers for Next-generation Optical Networks," *NTT Technical Review*, Vol. 9, No. 3, 2011.  
<https://www.ntt-review.jp/archive/ntttechnical.php?contents=ntr201103fa7.html>
- [3] M. Yamaguchi, M. Kitamura, S. Murata, I. Mito, and K. Kobayashi, "Wide range wavelength tuning in 1.3  $\mu$ m DBR-DC-PBH-LDs by current injection into the DBR region," *Electron. Lett.*, Vol. 21, No. 2, pp. 63–65, 1985.
- [4] V. Jayaraman, Z. -M. Chuang, and L. A. Coldren, "Theory, design, and performance of extended tuning range semiconductor lasers with sampled gratings," *IEEE Journal of Quantum Electron.*, Vol. 29, No. 6, pp. 1824–1834, 1993.
- [5] Y. Tohmori, Y. Yoshikuni, T. Tamamura, H. Ishii, Y. Kondo, and M. Yamamoto, "Broad-Range Wavelength Tuning in DBR Lasers with Super Structure Grating (SSG)," *IEEE Photon. Technol. Lett.*, Vol. 5, No. 2, pp. 126–129, 1993.
- [6] H. Ishii, Y. Kondo, F. Kano, and Y. Yoshikuni, "A tunable distributed amplification DFB laser diode (TDA-DFB-LD)," *IEEE Photon. Technol. Lett.*, Vol. 10, No. 1, pp. 30–32, 1998.
- [7] N. Nunoya, H. Ishii, Y. Kawaguchi, Y. Kondo, and H. Oohashi, "Wide-band tuning of tunable distributed amplification distributed feedback laser array," *Electron. Lett.*, Vol. 44, No. 3, pp. 205–207, 2008.
- [8] N. Nunoya, H. Ishii, Y. Kawaguchi, R. Iga, T. Sato, N. Fujiwara, and H. Oohashi, "Tunable Distributed Amplification (TDA-) DFB Laser with Asymmetric Structure," *IEEE J. Sel. Top. Quantum Electron.*, Vol. 17, No. 6, pp. 1505–1512, 2011.
- [9] H. Okamoto, H. Yasaka, K. Sato, Y. Yoshikuni, K. Oe, K. Kishi, Y. Kondo, and M. Yamamoto, "A wavelength-tunable duplex integrated light source for fast wavelength switching," *J. Lightwave. Technol.*, Vol. 14, No. 6, pp. 1033–1041, 1996.
- [10] N. Fujiwara, H. Ishii, H. Okamoto, Y. Kawaguchi, Y. Kondo, and H. Oohashi, "Suppression of Thermal Wavelength Drift in Super-Structure Grating Distributed Bragg Reflector (SSG-DBR) Laser with Thermal Drift Compensator," *IEEE J. Sel. Top. Quantum Electron.*, Vol. 13, No. 5, pp. 1164–1169, 2007.



**Nobuhiro Nunoya**

Senior Research Engineer, Photonics Device Laboratory, NTT Photonics Laboratories.

He received the B.E., M.E., and Ph.D. degrees in physical electronics from Tokyo Institute of Technology in 1997, 1999, and 2001, respectively. He joined NTT Photonics Laboratories in 2002. From 2008 to 2009, he was a visiting researcher at the University of California, Santa Barbara, CA, USA. His research interests include semiconductor lasers and integrated devices for optical communications. He is a member of the Japan Society of Applied Physics (JSAP), the Institute of Electronics, Information and Communication Engineers (IEICE), and the IEEE/Photonics Society.

---



**Ryuzo Iga**

Senior Research Engineer, Photonics Device Laboratory, NTT Photonics Laboratories.

He received the B.E. and M.E. degrees in applied fine chemistry and the D.E. degree in electromagnetic energy engineering from Osaka University in 1985, 1987, and 1995, respectively. Since joining NTT Opto-electronics Laboratories in 1987, he has been engaged in research on the crystal growth of III-V semiconductor compounds. His doctoral dissertation was on selective growth by laser-assisted MOCVD. In 1999, he joined NTT Photonics Laboratories. His current research interests include MOVPE growth technologies for the fabrication of optical integrated devices. He is a member of JSAP.

---



**Hiroyuki Ishii**

Research Group Leader, Senior Research Engineer, Supervisor, Photonics Device Laboratory, NTT Photonics Laboratories.

He received the B.E., M.E., and Ph.D. degrees in electronics and communication engineering from Waseda University, Tokyo, in 1988, 1990, and 1999, respectively. Since joining NTT Opto-electronics Laboratories (now NTT Photonics Laboratories) in 1990, he has been engaged in developmental research on semiconductor lasers and integrated devices for optical communications systems. He is a member of JSAP, IEICE, and the IEEE/Photonics Society.

---

## Electroabsorption Modulator Integrated Light Sources for Future High-speed Ethernet

*Takeshi Fujisawa, Shigeru Kanazawa, Kiyoto Takahata, and Hiroyuki Ishii*

### Abstract

Recent progress in electroabsorption modulator integrated distributed feedback (EADFB) lasers for high-speed data communications is described. For 100 Gigabit Ethernet (100GbE) applications, an ultrasmall optical semiconductor chip, in which four 1.3- $\mu\text{m}$  25-Gbit/s EADFB lasers and an optical multiplexer are monolithically integrated, has been developed for future 100GbE transceivers. This small chip enables the overall transmitter size and the number of optical components to be significantly reduced compared with conventional 100GbE transmitters. Furthermore, for future beyond-100-Gbit/s applications, we have developed 50-Gbit/s EADFB lasers and obtained very clear eye openings even after 40-km transmission.

### 1. Introduction

To cope with the demand for huge data capacities in local area networks (LANs), 100 Gigabit Ethernet (100GbE) has recently been standardized [1]. In 100GbE, the optical transmitter consists of four 1.3- $\mu\text{m}$ , 25-Gbit/s light sources with a lane spacing of 800 GHz and an optical multiplexer (MUX). So far, work has focused mainly on the development of discrete 25-Gbit/s light sources [2]–[6] for the first-generation transceiver, which is called a centum form-factor pluggable (CFP) transceiver. Since optical components in this transceiver are placed discretely, the size, power consumption, and number of optical components are large. Moreover, since there is a limitation on the transceiver size, reductions in size and power consumption are essential, and these require large-scale-integration of the discrete components.

Future high-speed LANs beyond 100 Gbit/s will use a multilane system. Therefore, it is essential to increase the serial data rate of the discrete light source in order to reduce the required number of wavelength lanes, which will lead to smaller transmitters, lower power consumption, and reduced fabrication cost.

This article describes recent progress in electroabsorption modulator integrated distributed feedback (EADFB) lasers for high-speed data communications. For 100GbE applications, an ultrasmall optical semiconductor chip [7]–[9], in which four 1.3- $\mu\text{m}$  25-Gbit/s EADFB lasers and an optical MUX are monolithically integrated, has been developed for future 100GbE transceivers. This small chip enables the overall transmitter size and the number of optical components to be significantly reduced compared with those of conventional 100GbE transmitter. Furthermore, for future beyond-100-Gbit/s applications, we have developed 50-Gbit/s EADFB lasers [10] and obtained very clear eye openings even after 40-km transmission.

### 2. Monolithically integrated light source for 100GbE

A micrograph of the fabricated device is shown in **Fig. 1**. It consists of four 1.3- $\mu\text{m}$  EADFB lasers and a multimode interferometer (MMI) coupler for the MUX. InGaAlAs-based compressive-strained quantum wells (QWs) are used for the DFB lasers and



monitor photodiodes (PDs) and the lasing mode is the transverse electric (TE) mode. To increase the output power of the DFB lasers while retaining single mode lasing, we introduced a novel rear-grating structure [9]. This structure is composed of two sections: one is a conventional  $\lambda/4$  wavelength-shifted grating placed at the rear facet side and the other is just an active region without a grating placed at the front facet side. Both facets are coated with antireflection films. With the active region placed in front of the conventional phase-shifted DFB laser, the lasing mode is amplified in the active region and the longitudinal optical distribution becomes asymmetric, resulting in high output power from the front facet. The design is described in more detail in Ref. [9].

For an electroabsorption modulator (EAM), an effective way to reduce the power consumption of the electrical driver is to reduce the EAM's driving voltage. To do this, we used InGaAlAs-based, tensile-strained QWs to obtain a large extinction ratio and steep extinction curves [11]. We also made the total thickness of the insulator region small to effectively bias the QW region with low voltage.

A shallow-ridge waveguide is buried with benzocyclobutene (BCB) for the EADFB laser section to ensure a large modulation bandwidth. The low dielectric constant of BCB makes the parasitic capacitance lower, and hence the electric/optical (E/O) bandwidth larger. An MMI coupler is used for the MUX because of its small length and low wavelength sensitivity. Deep-ridge waveguides with the InGaAsP-core buried with BCB were used for the MUX region. Since deep-ridge waveguides have stronger optical confinement owing to the large refractive index contrast in the lateral direction, they have low bending and radiation losses compared with shallow-ridge waveguides, leading to a smaller chip size.

Metal-organic vapor-phase epitaxy (MOVPE) was used for crystal growth and a butt-joint technique was used to optimize the structures of the DFB laser, EAM, PD, and MUX, separately. The lengths of the DFB lasers, monitor PDs, EAMs, and MMI are 400  $\mu\text{m}$ , 150  $\mu\text{m}$ , 150  $\mu\text{m}$ , and 250  $\mu\text{m}$ , respectively. The width of the MMI is 20  $\mu\text{m}$ . The distance between adjacent EADFB lasers is 600  $\mu\text{m}$ . The fabricated chip is as small as 2.0 mm  $\times$  2.4 mm and it is packaged in a specially designed module [8].

The module output power as a function of the injection current to the DFB lasers is shown in Fig. 2. All measurements for the module were done at 40°C. From the shorter wavelength side, we label the wavelength lanes 0 to 3. The output power at the injection

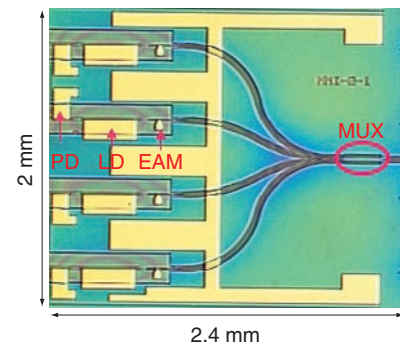

Fig. 1. Micrograph of the fabricated chip.

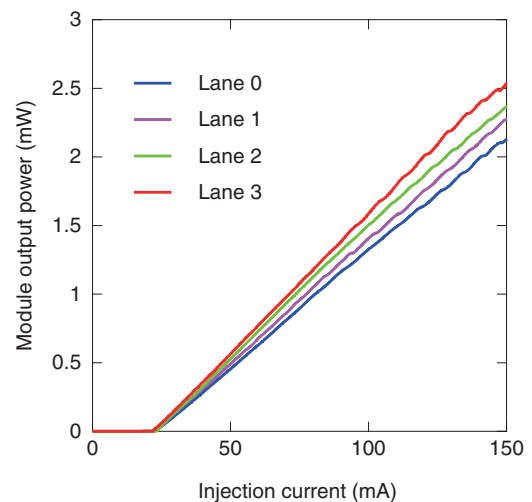

Fig. 2. Module output power as a function of injection current.

current of 150 mA was over 2 mW for all the lanes. The lasing spectra at the injection current of 100 mA are shown in Fig. 3. Single-mode lasing with a side mode suppression ratio of over 50 dB was obtained for all lanes, showing the usefulness of the rear-grating structure for DFB lasers used in monolithically integrated devices. The static extinction curves are shown in Fig. 4. The injection current to the DFB lasers was 100 mA. Static extinction ratios larger than 20 dB as well as steep extinction curves suitable for low-voltage operation were obtained for all lanes. The dynamic extinction ratios of the EAMs as a function of driving voltage ( $V_{pp}$ ) are shown in Fig. 5. The bias voltage to the modulator was set at a level where the cross point of the optical eye diagram was 50%. For all lanes, the dynamic extinction ratios were

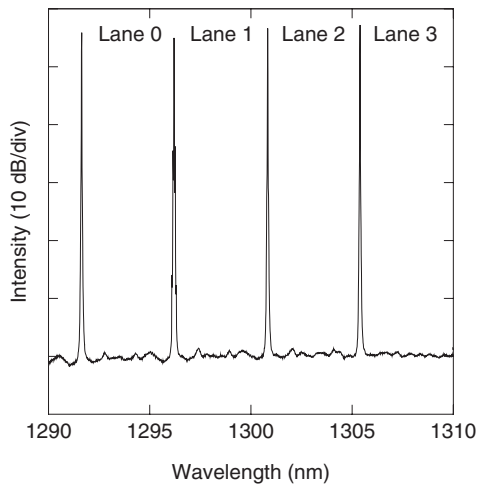

Fig. 3. Lasing spectra of the monolithically integrated light source.

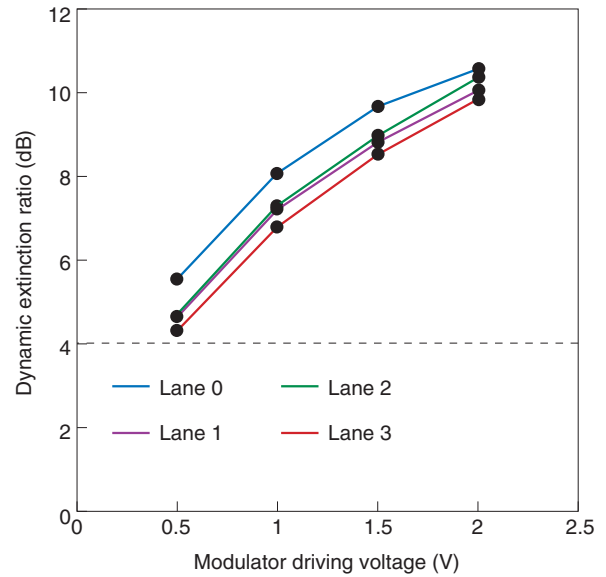

Fig. 5. Dynamic extinction ratio as a function of driving voltage for 25-Gbit/s operation.

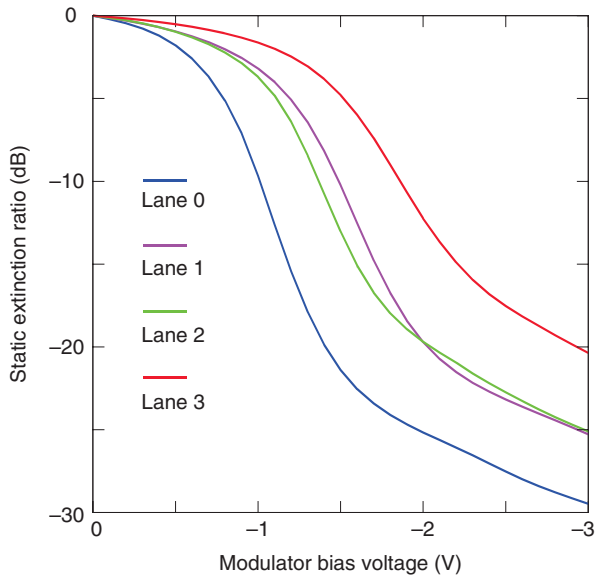

Fig. 4. Static extinction curves.

larger than 4 dB, which is the minimum value for 10-km 100GbE (100GBASE-LR4) even with a driving voltage of 0.5 V.

With the module, we performed a 10-km transmission experiment on single-mode optical fiber using a 25-Gbit/s, non-return-to-zero,  $2^{31}-1$  pseudorandom bit stream signal. The eye-diagrams after 10-km transmission with  $V_{pp} = 0.5$  V, 1 V, and 2 V for all the lanes are shown in Fig. 6. The bias voltages and

dynamic extinction ratios to the modulator are summarized in Tables 1 and 2. Clear eye openings were obtained for all driving voltages even after 10-km transmission.

### 3. EADFB lasers for beyond-100-Gbit/s applications

For future high-speed LANs beyond 100 Gbit/s, the serial data rate should be increased to reduce the required number of lanes. Fewer lanes enables reductions in the size, power consumption, and fabrication cost of the whole transmitter. For this purpose, we developed 50-Gbit/s discrete EADFB lasers [10]. The basic structure of the device is described in Refs. [5], [6]. The lasing spectra of the EADFB lasers are shown in Fig. 7. The measurement was done at 45°C. From the shorter wavelength side, we label the lanes 0 to 7. The wavelength spacing is 400 GHz (half of that for 100GbE). The layer structure was the same for all the EADFB lasers. The 50-Gbit/s eye diagrams after 40-km transmission are shown in Fig. 8. The driving voltages were 2 V and the dynamic extinction ratios were larger than 8 dB for all lanes. Very clear eye openings were obtained. Since all the EADFB lasers had the same layer structure, we could integrate them monolithically, as in the case of the 100GbE light source.

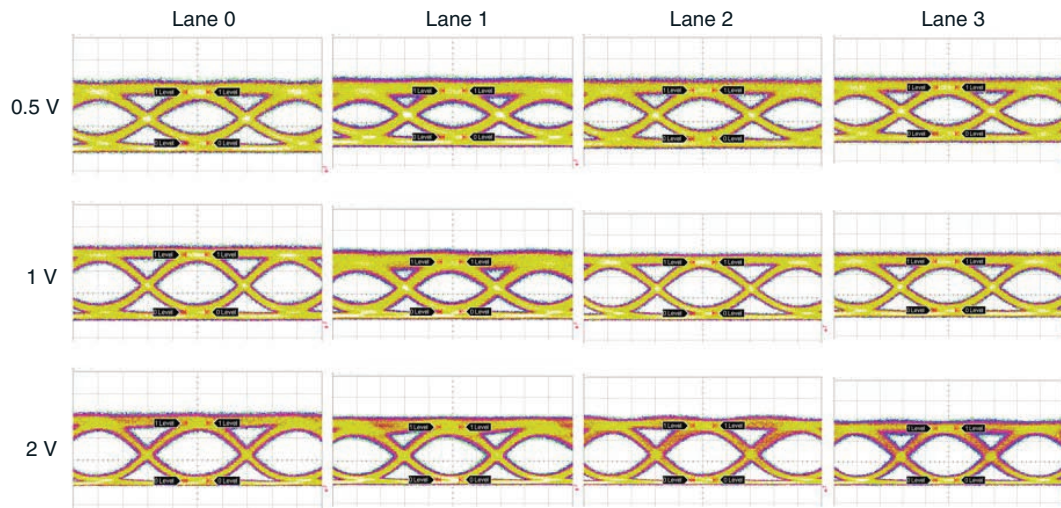

Fig. 6. 25-Gbit/s eye diagrams for all the lanes after 10-km transmission for different values of  $V_{pp}$ .

Table 1. Bias voltages to EAMs.

$V_{pp}$ (V)	Lane 0 (V)	Lane 1 (V)	Lane 2 (V)	Lane 3 (V)
0.5	-1.08	-1.28	-1.51	-1.74
1	-0.95	-1.14	-1.43	-1.64
2	-0.93	-1.06	-1.26	-1.53

Table 2. Dynamic extinction ratios of EAMs.

$V_{pp}$ (V)	Lane 0 (dB)	Lane 1 (dB)	Lane 2 (dB)	Lane 3 (dB)
0.5	4.99	5.05	4.32	4.4
1	8.11	9.31	6.97	6.92
2	10.78	10.63	9.79	9.88

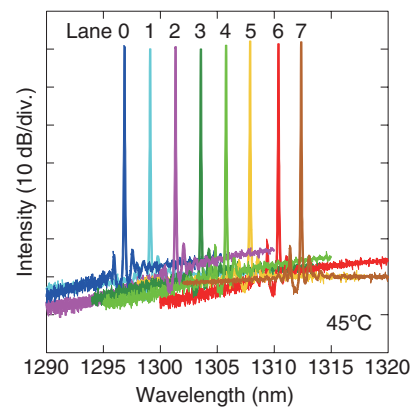

Fig. 7. Lasing spectra of 50-Gbit/s EADFB lasers.

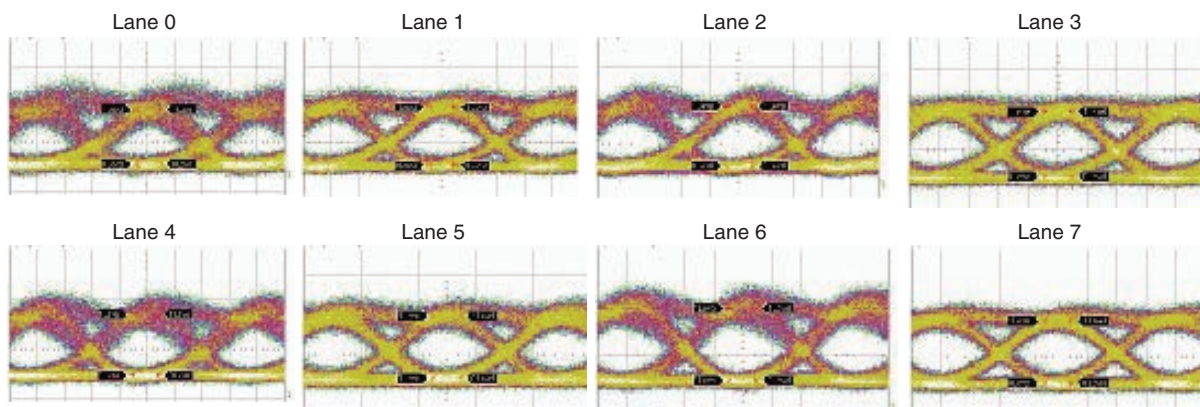

Fig. 8. 50-Gbit/s eye diagrams after 40-km transmission.

## 4. Conclusion

Recent progress in 1.3- $\mu\text{m}$  InGaAlAs-based EADFB lasers for high-speed data communications was described. For 100GbE, an ultrasmall integrated light source was developed. Monolithic integration of the optical components on one chip let us reduce the size of the 100-Gbit/s transmitter chip. This small chip enables us to make small-form-factor 100GbE transceivers. For beyond-100-Gbit/s applications, 50-Gbit/s EADFB lasers were also developed. These devices are promising for future high-capacity data links.

## References

- [1] 100GbE Task Force. <http://www.ieee802.org/3/ba/>
- [2] H. Oomori, H. Ooe, M. Seki, Y. Fujimura, K. Matsumoto, and Y. Murakami, "An extremely compact electro-absorption modulator integrated DFB laser module for 100Gbps Ethernet over 75km SMF reach," Proc. of the 34th European Conference and Exhibition on Optical Communication (ECOC 2008), P.2.0.7, Brussels, Belgium, 2008.
- [3] H. Takahashi, T. Shimamura, T. Sugiyama, M. Kubota, and K. Nakamura, "High-power 25-Gb/s Electroabsorption Modulator Integrated with a Laser Diode," IEEE Photon. Technol. Lett., Vol. 21, No. 10, pp. 633–635, 2009.
- [4] T. Saito, T. Yamatoya, Y. Morita, E. Ishimura, C. Watatani, T. Aoyagi, and T. Ishikawa, "Clear eye opening 1.3 $\mu\text{m}$ -25/43 Gbps EML with novel tensile-strained asymmetric QW absorption layer," Proc. of the 35th European Conference and Exhibition on Optical Communication (ECOC 2009), P.8.1.3, Vienna, Austria, 2009.
- [5] T. Fujisawa, M. Arai, N. Fujiwara, W. Kobayashi, T. Tadokoro, K. Tsuzuki, Y. Akage, R. Iga, T. Yamanaka, and F. Kano, "25-Gbit/s 1.3- $\mu\text{m}$  InGaAlAs-based electroabsorption modulator integrated with a DFB laser for metro-area (40 km) 100-Gbit/s Ethernet system," IEE Electronics Lett., Vol. 45, No. 17, pp. 900–901, 2009.
- [6] T. Fujisawa, K. Takahata, T. Tadokoro, W. Kobayashi, A. Ohki, N. Fujiwara, S. Kanazawa, T. Yamanaka, and F. Kano, "Long-reach 100Gbit Ethernet light source based on 4x25-Gbit/s 1.3- $\mu\text{m}$  InGaAlAs EADFB lasers," IEICE Trans. on Electronics, Vol. E94-C, No. 7, pp. 1167–1172, 2011.
- [7] T. Fujisawa, S. Kanazawa, H. Ishii, N. Nunoya, Y. Kawaguchi, A. Ohki, N. Fujiwara, K. Takahata, R. Iga, F. Kano, and H. Oohashi, "1.3- $\mu\text{m}$ , 4x25-Gbit/s, monolithically integrated light source for metro area 100-Gbit/s Ethernet," IEEE Photonics Technology Lett., Vol. 23, No. 6, pp. 356–358, 2011.
- [8] S. Kanazawa, T. Fujisawa, A. Ohki, H. Ishii, N. Nunoya, Y. Kawaguchi, N. Fujiwara, K. Takahata, R. Iga, F. Kano, and H. Oohashi, "A compact EADFB laser array module for a future 100-Gbit/s Ethernet transceiver," IEEE Journal of Selected Topics in Quantum Electronics, Vol. 17, No. 5, pp. 1191–1197, 2011.
- [9] T. Fujisawa, S. Kanazawa, K. Takahata, W. Kobayashi, T. Tadokoro, H. Ishii, and F. Kano, "1.3- $\mu\text{m}$ , 4x25G, EADFB laser array module with large-output-power and low-driving-voltage for energy-efficient 100GbE transmitter," Optics Express, Vol. 20, No. 1, pp. 614–620, 2012.
- [10] T. Fujisawa, K. Takahata, W. Kobayashi, T. Tadokoro, N. Fujiwara, S. Kanazawa, and F. Kano, "1.3- $\mu\text{m}$ , 50-Gbit/s electroabsorption modulators integrated with a DFB laser for beyond 100G parallel LAN applications," IET Electronics Lett., Vol. 47, No. 12, pp. 709–710, 2011.
- [11] H. Fukano, T. Yamanaka, M. Tamura, and T. Kondo, "Very-low-driving voltage electroabsorption modulators operating at 40Gb/s," J. Lightwave Technol., Vol. 24, pp. 2219–2224, 2006.



**Takeshi Fujisawa**

Researcher, Photonic Device Laboratory, Optical Integrated Device Research Group, NTT Photonics Laboratories.

He received the B.E., M.E., and Ph.D. degrees in electronic engineering from Hokkaido University in 2001, 2003, and 2005, respectively. His current research interests include theoretical modeling of optoelectronic devices and development of semiconductor lasers. He is a member of IEEE and the Institute of Electronics, Information and Communication Engineers (IEICE). From 2003 to 2006, he was a Research Fellow of the Japan Society for the Promotion of Science.



**Shigeru Kanazawa**

Researcher, Photonic Device Laboratory, Optical Integrated Device Research Group, NTT Photonics Laboratories.

He received the B.S. and M.S. degrees in electronics and communication engineering from Tokyo Institute of Technology in 2005 and 2007, respectively. He joined NTT Photonics Laboratories in 2007. He has been engaged in R&D of optical semiconductor devices and integrated devices for optical communications systems. He is a member of Japan Society of Applied Physics (JSAP) and IEICE.



**Kiyoto Takahata**

Senior Research Engineer, Photonic Device Laboratory, Optical Integrated Device Research Group, NTT Photonics Laboratories.

He received the B.E. and M.E. degrees in physical engineering from Kyoto University in 1988 and 1990, respectively, and the Ph.D. degree in electronics and communication engineering from Tokyo Institute of Technology in 2010. In 1990, he joined NTT Opto-electronics Laboratories (now NTT Photonics Laboratories), where he was initially engaged in research on a wavelength conversion device based on a semiconductor laser. Since 1993, he has been engaged in research on high-speed monolithically integrated photoreceivers, ultrafast optical packet processing based on optoelectronic circuits, and semiconductor lasers. He is a member of JSAP and IEICE.



**Hiroyuki Ishii**

Senior Research Engineer, Supervisor, Photonic Device Laboratory, Optical Integrated Device Research Group, NTT Photonics Laboratories.

He received the B.E., M.E., and Ph.D. degrees in electronics and communication engineering from Waseda University, Tokyo, in 1988, 1990, and 1999, respectively. Since joining NTT Opto-electronics Laboratories (now NTT Photonics Laboratories) in 1990, he has been engaged in developmental research on semiconductor lasers and integrated devices for optical communications systems. He is a member of JSAP, IEICE, and the IEEE/Photonics Society.

## High-speed Photodetector Technologies

*Yoshifumi Muramoto, Toshihide Yoshimatsu, Masahiro Nada, and Tadao Ishibashi*

### Abstract

We have developed several kinds of high-speed photodetector technologies for broadband photonic networks. This article reviews three of NTT's high-speed photodiodes: ultrahigh-speed photodiodes, specially designed photodiodes with high responsivity and low operating voltage, and avalanche photodiodes.

### 1. Introduction

Because of the popularity of the Internet and video-on-demand services, the capacity of photonic network systems must be continuously increased. A semiconductor photodetector, which converts an optical signal into an electrical signal, is a key device in receivers in photonic network systems. The general demands for photodetectors are faster operating speeds for higher bit-rates, higher efficiency for better sensitivity, and lower operating voltage for lower power consumption by the receiver.

In the 1990s, we developed the uni-traveling-carrier photodiode (UTC-PD) structure that makes the best use of electron transport and has the advantages of simultaneous high-speed and high-output operation [1]. Since UTC-PDs can maintain their photodetection function for input signals with frequencies above 1 THz, they have been used as terahertz microwave generators [2].

In the receivers of photonic network systems, high responsivity is also very important to improve receiver sensitivity. To meet this requirement, we have developed the maximized-induced-current photodiode (MIC-PD) by modifying the UTC-PD [3]. The MIC design can maximize the responsivity at a required bandwidth by means of a hybrid (combined p-type and depleted (p: positive semiconductor)) absorption layer. This technology has been successfully applied to photodiodes for 100-Gbit/s receivers of digital coherent transmission systems.

Moreover, avalanche photodiodes (APDs), which provide amplification as well as photodetection, are used in access and metro networks and Ethernet. We had already developed APDs for 10-Gbit/s operation but there have recently been requests for high-speed APDs, e.g., for 25-Gbit/s receivers for 100-Gbit/s-based Ethernet.

### 2. Ultrahigh-speed photodiodes (UTC-PDs)

One widely used photodetector is the p-i-n photodiode (pin-PD), which has a depleted absorption layer of intrinsic semiconductor (i-layer) between positively and negatively doped electrode layers (p- and n-type semiconductor layers). In a pin-PD, two types of charge carriers—both negative electrons and positive holes—are photogenerated and contribute to the external induced current. Because holes have a much lower velocity than electrons (1/10 the speed), the device's response speed is dominated by hole transport. Therefore, we developed the UTC-PD, which can achieve ultrahigh-speed operation, by removing this limiting factor for the pin-PD. As illustrated in **Fig. 1**, carriers are generated in the p-type absorption layers and only electrons are injected into the depleted carrier collection layer, whose thickness is designed independently of the absorption layer. Since the holes are majority carriers in the p-type absorption layer, their transport is the collective motion with a high response time determined by the dielectric relaxation time. Eventually, only electrons behave as

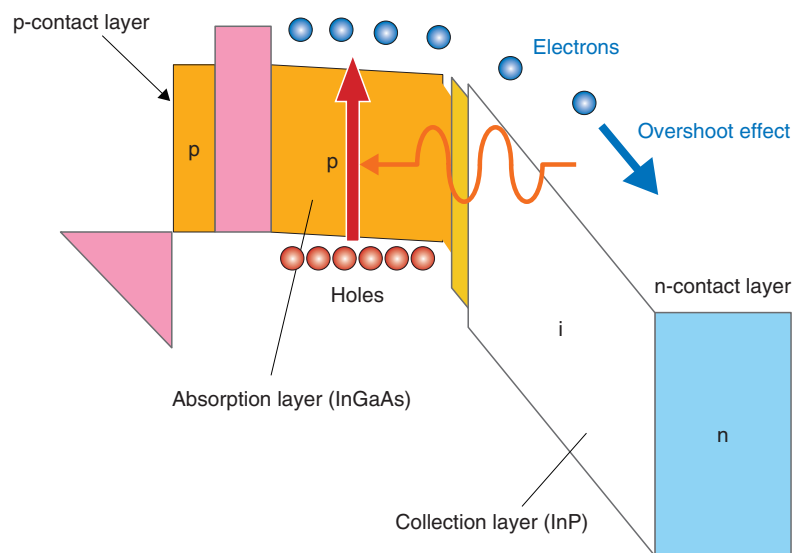

Fig.1. Schematic band diagram of UTC-PD.

active carriers in the UTC-PD; thus, UTC-PDs can achieve ultrahigh-speed and high-current operation without the space-charge-effect induced by hole accumulation.

A 3-dB bandwidth (f<sub>3dB</sub>) of over 300 GHz has been obtained for a UTC-PD. We have developed a UTC-PD-based terahertz photomixer module for frequencies beyond 1 THz [2].

### 3. Specially designed PD with high responsivity and low operating voltage: MIC-PD

A drawback of the UTC-PD is low responsivity when the absorber has been designed to be relatively thin in order to achieve high-speed operation. To optimize both the response speed and responsivity, we have developed the MIC-PD. In the MIC-PD design, the absorption layer consists of p-type and depleted layers, as shown in **Fig. 2**. Although there is hole transport contributing to the output current, the thickness of the depleted absorption layer does not have to be as large as in a pin-PD, and it is adjusted to retain the advantage of the high-speed potential of the UTC-PD. This combined p-type and depleted absorption layer allows us to maximize responsivity and operating speed simultaneously. Namely, the responsivity can be higher than that of a UTC-PD with the same bandwidth and the operating speed can be higher than that of a pin-PD with the same responsivity.

We have developed various MIC-PD structures for advanced photonic network systems. One is a dual

polarization quadrature phase shift keying (DP-QPSK) (or digital coherent) system [4], which is now being intensively investigated toward future high-speed, high-capacity optical transmission systems. In this system, the PD is required to operate in a wide bandwidth with a high average photocurrent induced by a high-power local oscillator input. Because a high photocurrent induces a space charge effect in the depletion layer of a PD, bandwidth reduction occurs. To overcome this problem, we have developed a composite-field MIC-PD which can optimize the bandwidth by suppressing the space charge effect even at low bias voltages [5]. The band diagrams and electric field distributions of a conventional MIC-PD and the new composite-field MIC-PD are shown in Figs. 2(a) and (b), respectively. An f<sub>3dB</sub> of more than 30 GHz is required for a PD in a 100-Gbit/s digital coherent system. To meet these system needs, the thickness of the photoabsorption layer is reduced in order to shorten the carrier-transit time. A thinner absorption layer generally results in higher device capacitance, which reduces the operating speed. However, by incorporating an undoped carrier collection layer of a wide-bandgap material, we were able to widen the depletion width and maintain low junction capacitance. Moreover, an n-type field control layer tailors the step-like field profile, leading to sufficient field for hole transport in the depleted absorber even at a low bias voltage. In the collection layer, only electrons are traveling carriers; here, a low field (10 kV/cm) is sufficient to keep the electron transit time

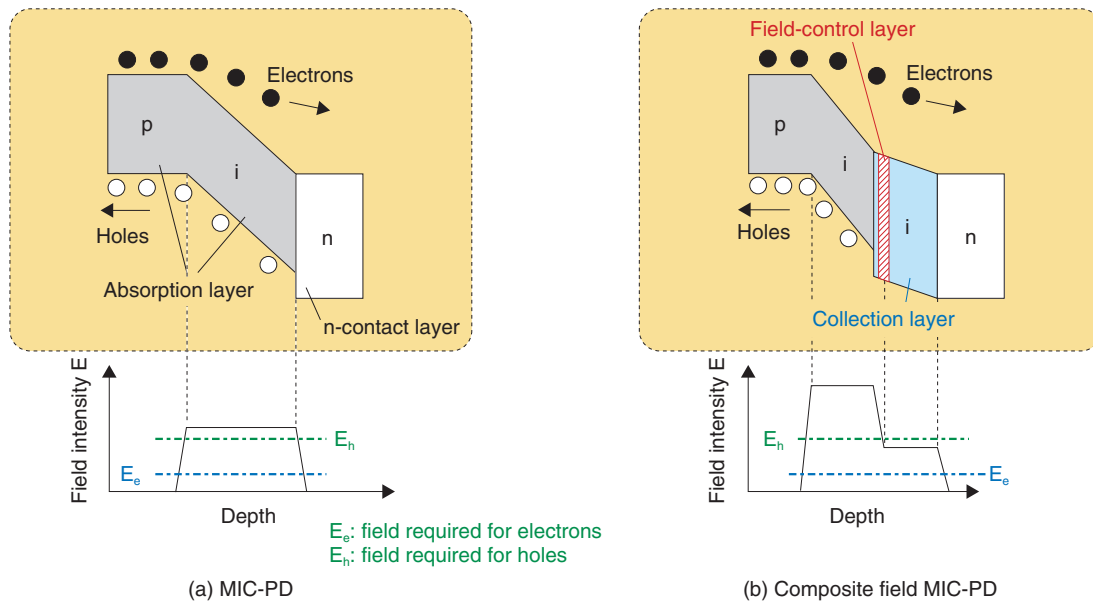

Fig. 2. Schematic band diagram and field intensities of conventional MIC-PD and new composite-field MIC-PD.

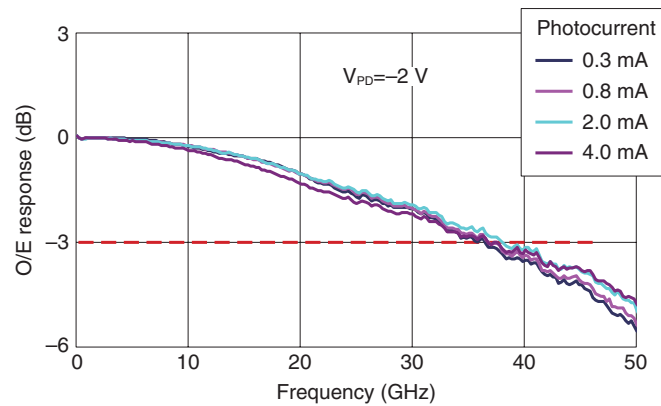

Fig. 3. Frequency response curves of fabricated composite-field MIC-PD.

short. An important point is that the field control layer generates a much higher electrical field in the depleted absorption layer and the partial absorber layer suppresses the space charge effect. Consequently, the composite-field MIC-PD allows a lower operating voltage and higher output current with higher responsivity than a conventional PD.

The frequency responses of a fabricated composite-field MIC-PD for optical-to-electrical (O/E) conversion with average photocurrents of 0.3 mA, 0.8 mA, 2.0 mA, and 4.0 mA are shown in Fig. 3. The reverse bias voltage supplied to the PD was as low as 2.0 V,

which suits the common power supply voltage with a transimpedance amplifier of +3.3 V. The f3dB reached more than 35 GHz for average photocurrent from 0.3 mA to 4.0 mA. We confirmed that there was no degradation in the frequency response caused by the space charge effect up to 4 mA. These good results show that composite-field MIC-PDs are suitable devices for receivers front-end of 100-Gbit/s digital coherent systems.

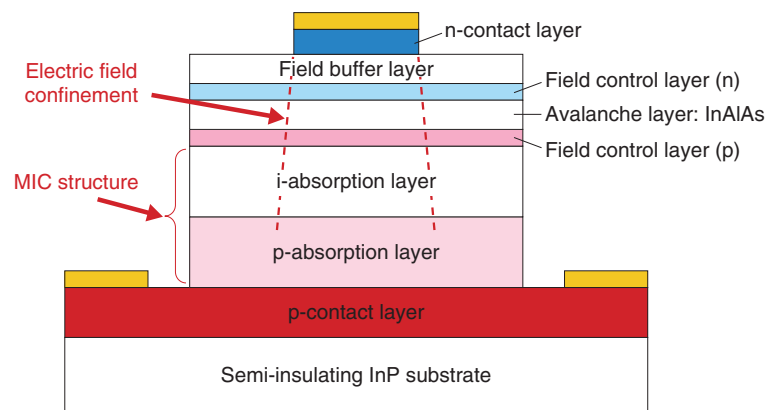

Fig. 4. Schematic cross section of the high-speed APD.

#### 4. High-speed APDs

APDs offer improved responsivity because of the internal gain due to the multiplication of carriers in a high electric field. This function of APDs is very important and they have been used in the 10-Gbit/s metro and access systems. The technology trend is now toward systems with higher bit rates such as the 100-Gbit/s Ethernet system in which the speed of each lane is 25 Gbit/s (25 Gbit/s  $\times$  4 channels). For use in such novel high-speed systems, we have developed a new APD with the MIC design [6].

The schematic cross section of our high-speed APD is shown in Fig. 4. The general figure of merit of an APD is expressed by the product of the multiplication factor ( $M$ ) and  $f3dB$ . This product depends on the material and thickness of the avalanche layer. We chose InAlAs as the material to obtain a higher  $M$ - $f3dB$  product.

Another feature of our device is that field confinement is achieved by the inverted p-down structure with a top n-contact. Field confinement is very important for device reliability in order to avoid degradation caused by suppression of the leakage current on the surface. Zn diffusion [7] and/or Si-ion implantation [8] are conventionally used for APD fabrication, but we decided not to use them in order to simplify the fabrication process. This simplicity also allows better reproducibility and lower fabrication cost. However, the field confinement becomes the source of edge breakdown at the periphery of the n-contact mesa, which limits operation at a large multiplication factor in active area. To solve this problem, we added a field buffer layer underneath the n-contact layer and n-type field control layer.

The variation in  $f3dB$  with multiplication factor  $M$  is shown in Fig. 5. The maximum value of  $f3dB$  was 23 GHz, and it decreased with increasing  $M$ . For  $M$  higher than 15,  $f3dB$  values fell on a straight line, indicating an  $M$ - $f3dB$  product of 235 GHz. Owing to the high responsivity achieved the MIC design, high multiplied responsivity of 9.1 A/W was obtained at  $f3dB$  of 18.5 GHz.

High multiplied responsivity with sufficient bandwidth is important in practical network systems. The present result is compared with previously reported values in Fig. 6. As seen in this figure, the obtained value of 168 GHz A/W for our APD is superior to all other reported ones. Consequently, our APD is a promising candidate for high-speed network systems, e.g., 100-Gbit/s Ethernet systems with 25-Gbit/s operation.

#### 5. Conclusion

The MIC design, which is a modification of the UTC-PD structure, can optimize responsivity and operating speed. MIC-PDs for 100-Gbit/s digital coherent system possess high current capability while maintaining a high  $f3dB$ , even at a low bias voltage. Our APD structure is fabricated with an inverted p-down layout to utilize the MIC design and field confinement by a top n-contact mesa. To avoid local breakdown associated with field confinement, a field buffer layer is applied. The best measured multiplied responsivity of 9.1 A/W was obtained at  $f3dB$  of 18.5 GHz, which is sufficient performance for 25-Gbit/s operation in 100-Gbit/s Ethernet systems.



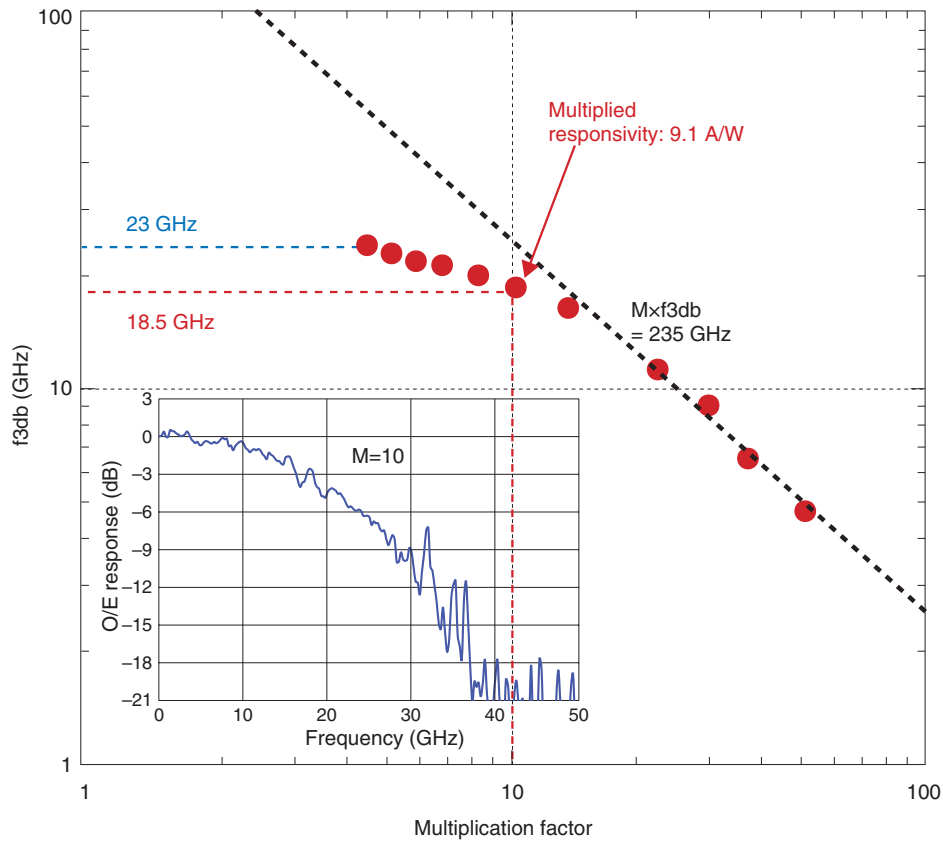

Fig. 5. Gain-bandwidth characteristics of fabricated APD.

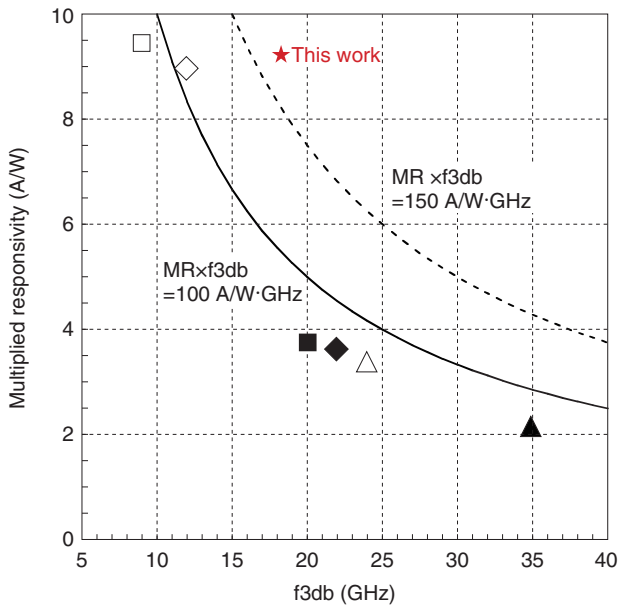

Fig. 6. Summary of published multiplied responsivity (MR) against f3db in operating conditions.

### Acknowledgment

This work was partly supported by the Ministry of Internal Affairs and Communications of Japan through the R&D project “High-speed Optical Transport System Technologies”.

### References

- [1] T. Ishibashi and H. Ito, “Uni-traveling-carrier photodiodes,” Tech. Dig. Ultrafast Electronics and Optoelectronics, Lake Tahoe, CA, USA, pp. 83–87, 1997.
- [2] A. Wakatsuki, Y. Muramoto, and T. Ishibashi, “Development of Tera-hertz-wave Photomixer Module Using a Uni-traveling-carrier Photo-diode,” NTT Technical Review, Vol. 10, No. 2, 2012. <https://www.ntt-review.jp/archive/ntttechnical.php?contents=ntr201202fa5.html>
- [3] Y. Muramoto and T. Ishibashi, “InP/InGaAs pin photodiode structure maximising bandwidth and efficiency,” Electron. Lett., Vol. 39, No. 24, pp. 1749–1750, 2003.
- [4] Y. Miyamoto, A. Sano, E. Yoshida, and T. Sakano, “Ultrahigh-capacity Digital Coherent Optical Transmission Technology,” NTT Technical Review, Vol. 9, No. 8, 2011. <https://www.ntt-review.jp/archive/ntttechnical.php?contents=ntr201108fa2.html>
- [5] T. Yoshimatsu, Y. Muramoto, S. Kodama, T. Furuta, N. Shigekawa, H. Yokoyama, and T. Ishibashi, “Suppression of space charge effect in MIC-PD using composite field structure,” Electron. Lett., Vol. 46, No.

- 13, 2010.
- [6] M. Nada, Y. Muramoto, H. Yokoyama, T. Ishibashi, and S. Kodama, "InAlAs APD with high multiplied responsivity-bandwidth product (MR-bandwidth product) of 168 A/W-GHz for 25 Gbit/s high-speed operations," *Electron. Lett.*, Vol. 46, pp. 397–399, 2012.
- [7] E. Yagyū, E. Ishimura, M. Nakaji, S. Ihara, Y. Mikami, H. Itamoto, T. Aoyagi, K. Yoshiara, and Y. Tokuda, "Design and Characteristics of Guardring-Free Planar AlInAs Avalanche Photodiodes," *Journal of Lightwave Technology*, Vol. 27, No. 8, pp. 1011–1017, 2009.
- [8] Y. Hirota, Y. Muramoto, T. Takeshita, T. Ito, H. Ito, A. Ando, and T. Ishibashi, "Reliable non-Zn-diffused InP/InGaAs avalanche photodiode with buried n-InP layer operated by electron injection mode," *Electron. Lett.*, Vol. 40, No. 21, pp. 1378–1379, 2004.



#### Yoshifumi Muramoto

Senior Research Engineer, High-Speed Devices and Technology Laboratory, NTT Photonics Laboratories.

He received the B.E. and M.E. degrees from Osaka Prefecture University in 1990 and 1992, respectively. He joined NTT Opto-Electronics Laboratories in 1992 and has been engaged in research on monolithically integrated photoreceivers and high-speed photodetectors. He is a member of the Institute of Electronics, Information and Communication Engineers (IEICE) and the Japan Society of Applied Physics (JSAP).



#### Masahiro Nada

Researcher, High-Speed Devices and Technology Laboratory, NTT Photonics Laboratories.

He received the B.E. and M.E. degrees from the University of Electro-Communications, Tokyo, in 2007 and 2009, respectively. Since joining NTT in 2009, he has been involved in research on high-speed, high-sensitivity avalanche photodiodes. He is a member of IEICE, JSAP, and IEEE.



#### Toshihide Yoshimatsu

Senior Research Engineer, High-Speed Devices and Technology Laboratory, NTT Photonics Laboratories.

He received the B.E. and M.E. degrees in applied physics from Tohoku University, Miyagi, in 1998 and 2000, respectively. He joined NTT Photonics Laboratories in 2000. He has been engaged in research on ultrafast optoelectronic devices. He received the SSDM Paper Award from SSDM in 2004. He is a member of IEICE and JSAP.



#### Tadao Ishibashi

Research Professor at NTT Photonics Laboratories and Engineering Manager at NTT Electronics Corporation.

He received the B.E., M.E., and Ph.D. degrees in applied physics from Hokkaido University in 1971, 1973, and 1986, respectively. Since joining Nippon Telegraph and Telephone Public Corporation (now NTT) in 1973, he has been involved in research on high-speed and optoelectronic semiconductor devices, including IMPATT diodes, field-effect transistors, heterostructure bipolar transistors, high-speed photodiodes, avalanche photodiodes, THz photomixers, and Mach-Zehnder modulators. He received the Ichimura Award in 1992 and IEICE Electronics Society Award in 2001. He is a fellow of IEICE, JSAP, and IEEE.

## InGaAs Metamorphic Laser for Low-power-consumption Operation

*Masakazu Arai, Wataru Kobayashi, and Masaki Kohtoku*

### Abstract

In this article, we review our efforts to reduce the power consumption of optical transmitter modules for Ethernet and telecommunications use. To reduce the power consumption, we aim to eliminate the light source's temperature controller and improve the stability of the output power and modulation characteristics under ambient temperature conditions. We describe a 1.3- $\mu\text{m}$ -range metamorphic laser on a GaAs substrate that exhibits improved temperature characteristics. It has a characteristic temperature of 220 K and is capable of lasing up to 200°C. In addition, the bias current for 10-Gbit/s modulation at high temperature has been reduced. This laser is promising for uncooled light sources operating with low power consumption.

### 1. Introduction

Network traffic is rapidly increasing and so is the energy consumed by communication systems. Therefore, it is important to find a way to reduce the power consumption of transmitter modules. In an optical transmission module, a temperature controller such as a Peltier device consumes more power than other components. The temperature controller suppresses deviations in laser characteristics such as output power and modulation characteristics, which are sensitive to the ambient temperature. If we can improve the laser's temperature characteristics, we may be able to eliminate the need for a temperature controller, which will allow a significant reduction in power consumption.

In this article, we describe our efforts towards achieving a 1.3- $\mu\text{m}$ -range laser with low power consumption. The 1.3- $\mu\text{m}$  range has zero dispersion and is used for metro, access, and Ethernet systems.

For 1.3- and 1.55- $\mu\text{m}$ -range optical fiber communication light sources, an InGaAsP-based laser has already been used. It is fabricated on an InP substrate and an InGaAsP quantum well is used as the active region. This type of laser performs well at around room temperature; however, an increase in the ambient temperature degrades the output power and the injection current (operating current) increases, as

shown in **Fig. 1(a)**. Therefore, a temperature controller has been indispensable and power consumption has been difficult to reduce. There is strong demand for a laser with good temperature characteristics, as shown in **Fig. 1(b)**.

The temperature dependence of a laser can be explained as follows. The laser light is amplified by current injection in a quantum well acting as an active region. As the ambient temperature is increased, the injected electrons tend to overflow from the quantum well into other regions such as the barrier layer, the separately confined heterostructure (SCH), and the cladding layer, as shown in **Fig. 2**. The electrons that overflow from the quantum well recombine with holes without light emission, which leads to an increase in threshold current at high temperature. Therefore, to stabilize the laser performance against temperature fluctuations, it is necessary to make a deep quantum well that has a large potential gap from the barrier layer.

Several materials used for 1.3- $\mu\text{m}$ -range lasers and their performances are listed in **Table 1**. With a conventional active region made from InGaAsP-based material on an InP substrate, it is difficult to make deep potential quantum wells and have an operating current at high temperature of over 40 mA at 10 Gbit/s. InGaAlAs-based materials on an InP substrate have been studied with a view to improving the

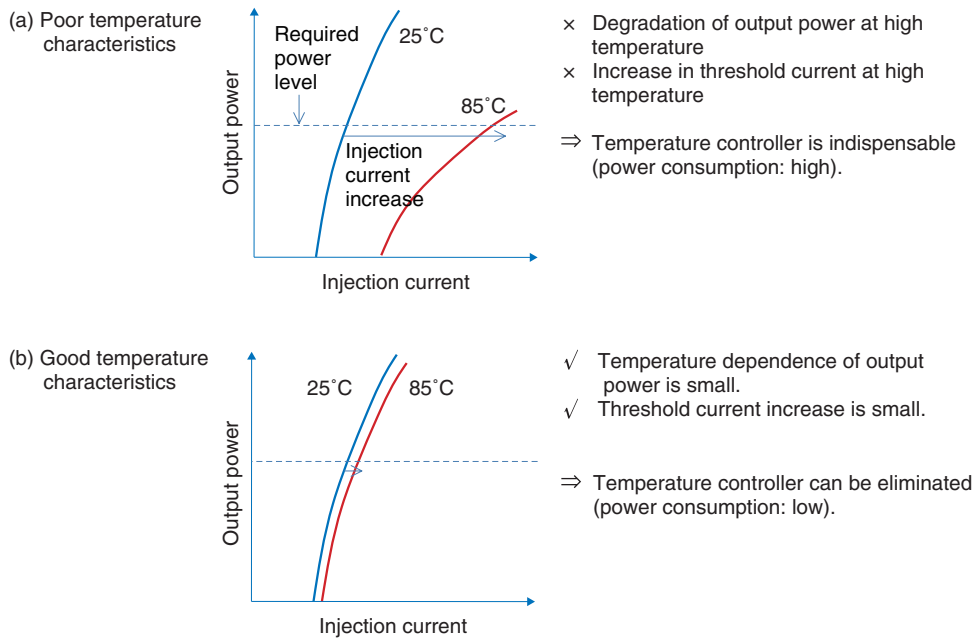

Fig. 1. Temperature characteristics of lasers.

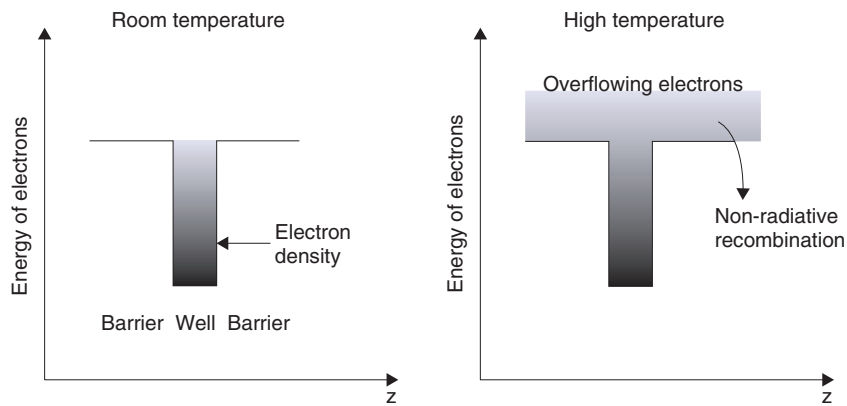

Fig. 2. Degradation mechanism at high temperature (carrier overflow from quantum well).

Table 1. Materials for 1.3- $\mu\text{m}$ -range lasers and their performances.

Substrate	Active region material	Operating current for 10 Gbit/s at 85°C for L=200 $\mu\text{m}$	Features
InP	InGaAsP	42 mA	Poor temperature characteristics Temperature controller required High reliability
	InGaAlAs	33 mA	Better temperature characteristics than InGaAsP
GaAs	InGaAs metamorphic	15 mA	Better temperature characteristics than InGaAlAs

L: cavity length

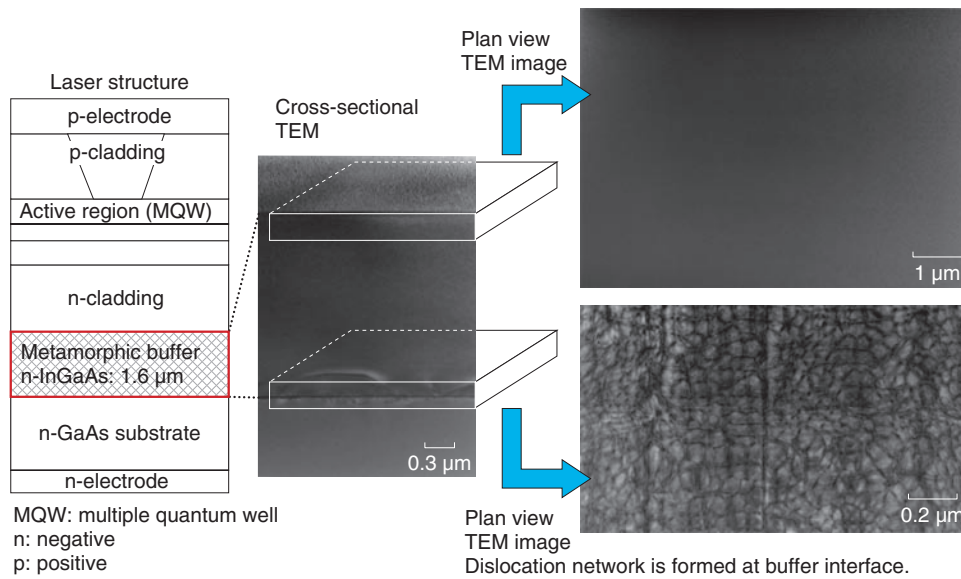

Fig. 3. Transmission electron microscope (TEM) images of metamorphic buffer.

temperature, and they are gradually being used for uncooled light sources. On the other hand, strained InGaAs lasers on a GaAs substrate have superior temperature characteristics to those on an InP substrate because a larger band offset between the cladding and SCH can be selected. However, the critical thickness of a strained quantum well limits the emission wavelength to below 1.2  $\mu\text{m}$ . To overcome this obstacle, InGaAsN quantum wells and InAs quantum dot lasers that provide 1.3- $\mu\text{m}$  emission on a GaAs substrate have been developed. However, their reliability and modulation speed still need to be improved. Another approach is to use a metamorphic buffer on GaAs [1]–[3]. This technique enables us to use materials with a lattice constant between that of InP and GaAs and to make a 1.3- $\mu\text{m}$ -range laser on a GaAs substrate with good temperature characteristics.

## 2. Metamorphic growth technique

The metamorphic growth technique allows us to grow a material whose lattice constant is different from that of the substrate. Therefore, we can design the device materials without being constrained by substrate lattice-constant limitations. In this study, we used an InGaAs layer grown on a GaAs substrate under special conditions by metal-organic vapor phase epitaxy (MOVPE). Conventionally, strain relaxation occurs if the strained layer thickness

exceeds the critical thickness and threading dislocations appear in the upper layer and the surface tends to become rough. With metamorphic growth, a stable dislocation network is formed in the thin layer between GaAs and the InGaAs buffer layer, which leads to a low threading dislocation density in the upper layer. We can regard this layer as a virtual InGaAs substrate because the strain is fully relaxed and there is little surface roughness. Transmission electron microscope images of a fabricated metamorphic laser are shown in **Fig. 3**. We confirmed that the dislocations are concentrated at the buffer boundary and the dislocation density is low enough to make a high-performance laser.

## 3. Fabrication and characteristics

A schematic of the fabricated metamorphic laser is shown in **Fig. 4**. The metamorphic buffer consists of n-doped  $\text{In}_{0.12}\text{Ga}_{0.88}\text{As}$  1.6  $\mu\text{m}$  thick (n: negative). The  $\text{In}_{0.1}\text{Ga}_{0.9}\text{As}$  layer with reduced indium content on this metamorphic buffer is fully relaxed and acts as a virtual InGaAs substrate. The n-InGaAlAs lower cladding layer is lattice matched to the virtual  $\text{In}_{0.1}\text{Ga}_{0.9}\text{As}$  substrate. The active layer consists of three compressive-strained InGaAs quantum wells sandwiched between  $\text{In}_{0.1}\text{Ga}_{0.9}\text{As}$  barrier layers. The p-InGaP upper cladding has the same refractive index and lattice constant as the lower n-InGaAlAs cladding (p: positive). We chose InGaAlAs for the lower

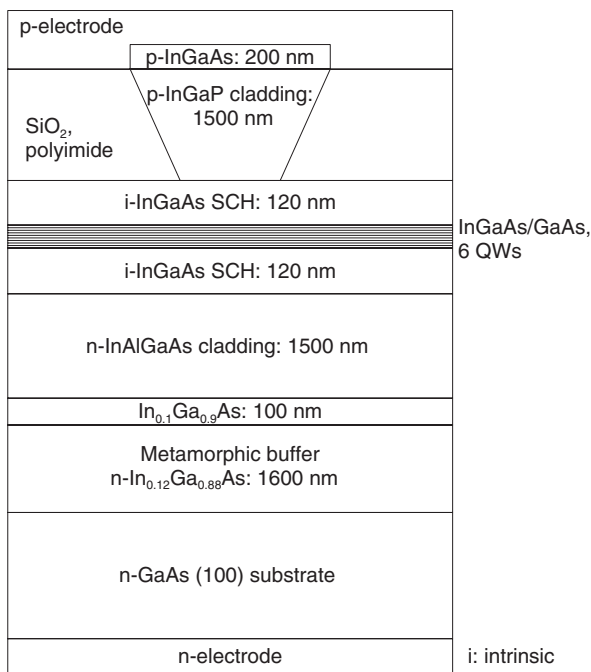

Fig. 4 . Schematic of fabricated metamorphic laser.

cladding because it has better surface roughness than InGaP cladding. On the other hand, we chose InGaP for the upper cladding because it has the advantage of letting us make a ridge structure by wet chemical etching. This technique enables a narrow ridge structure and single lateral mode operation. We made and evaluated a Fabry-Pérot-type laser structure.

The temperature dependence of the output power is shown in **Fig. 5**. This device had a 200- $\mu\text{m}$ -long cavity. One facet had a highly reflective coating and the other was in the as-cleaved condition. Insets show the lasing spectra at various currents at room temperature. We confirmed high output power and lasing at up to 140°C. Eye diagrams obtained with 10-Gbit/s non-return-to-zero direct modulations are shown in **Fig. 6**. We confirmed clear eye openings from 25°C to 100°C and the potential for making an uncooled light source.

#### 4. Improvements in temperature characteristics

As mentioned above, a metamorphic laser consists of materials whose lattice constants are between those of InP and GaAs, so the design is very flexible.

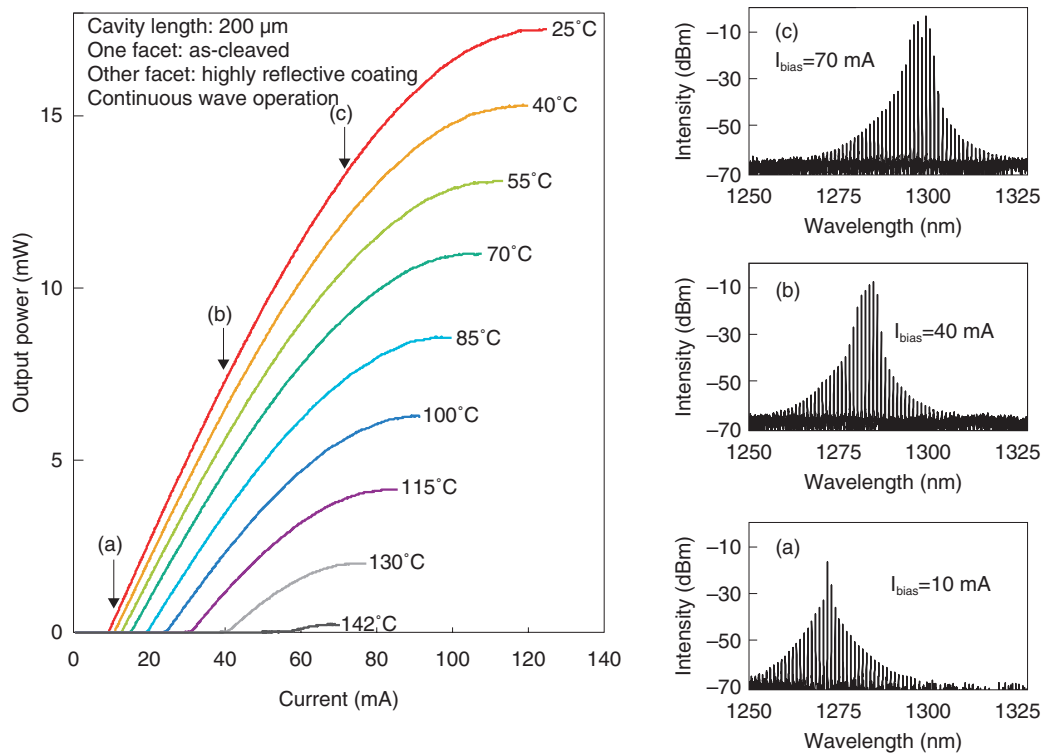

Fig. 5. Temperature dependence of output power and lasing spectra.

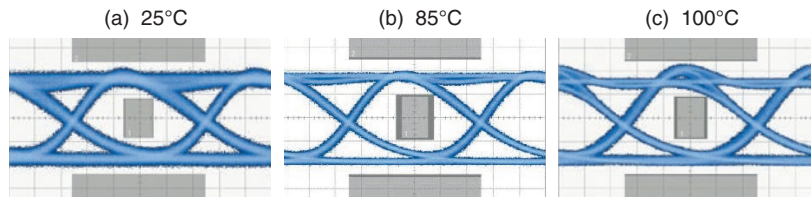

Fig. 6. 10-Gbit/s eye diagrams of metamorphic laser.

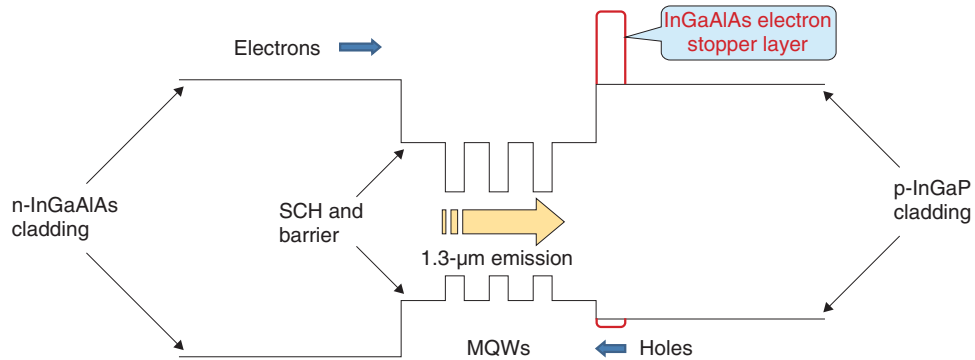

Fig. 7. Band diagrams of improved device using an InGaAlAs electron stopper.

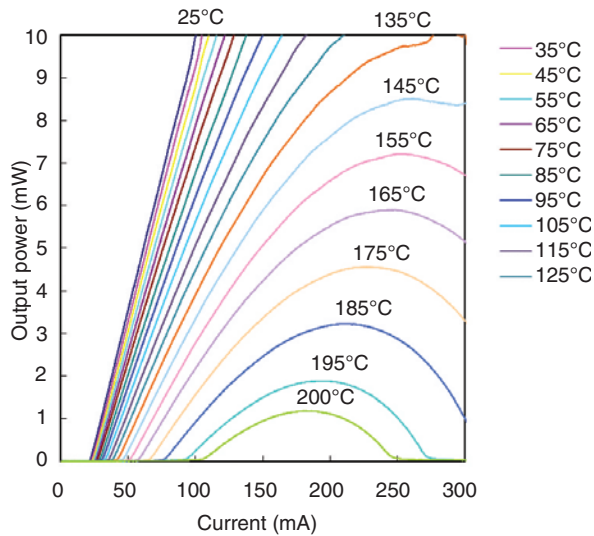

Fig. 8. I-L characteristics of improved devices.

We are optimizing the device structure by performing simulations and experiments. Here, we report some of our results. Band diagrams of a metamorphic laser before and after improvement are shown in Fig. 7.

For the cladding materials, we used n-InGaAlAs and p-InGaP for the reasons mentioned above. We newly introduced a p-InGaAlAs layer as an electron stopper into the p-InGaP cladding and obtained improved temperature characteristics.

The temperature dependence of the I-L (injection current versus output light power) characteristics of 1200- $\mu\text{m}$ -long devices is shown in Fig. 8. The temperature dependence of the threshold current was lower than in the case without an electron stopper layer. The maximum operating temperature is as high as 200°C, compared with 175°C for the laser without an electron stopper layer. The characteristic temperature  $T_0$ , which indicates the threshold increase as a function of temperature, was improved from 80 K to 220 K.  $T_0$  at temperatures between  $T_1$  and  $T_2$  (in °C) is expressed as

$$I_{th}(T_2) = I_{th}(T_1) \cdot \exp((T_2 - T_1)/T_0).$$

By contrast, a conventional laser on an InP substrate has a characteristic temperature between 50 K and 80 K. With its high characteristic temperature, the metamorphic laser exhibits only a small increase in threshold current at high temperature. Therefore,

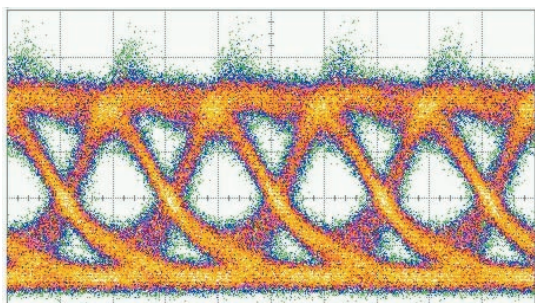

Fig. 9. Eye diagram for improved device for 10-Gbit/s low-bias operation.

the operating current for uncooled operation can be reduced, which makes this laser a good candidate for a low-power-consumption light source.

The eye diagram of a 200- $\mu\text{m}$ -long device for direct modulation below  $85^\circ\text{C}$  is shown in **Fig. 9**. The bias current for 10-Gbit/s modulation below  $85^\circ\text{C}$  is as low as 15 mA, which is about half the value for a conventional laser on an InP substrate and low-power-consumption operation was confirmed. We believe that this laser can be used as a light source in

environments where the temperature exceeds  $100^\circ\text{C}$  in an integrated circuit.

## 5. Concluding remarks

We are conducting trials of low-power-consumption light sources using a metamorphic laser. This laser offers high-speed operation and good temperature characteristics, which enable it to operate with low power consumption. In the future, we will apply this technique to a distributed feedback laser and integration with other types of substrates.

## References

- [1] T. Uchida, H. Kurakake, H. Soda, and S. Yamazaki, "1.3  $\mu\text{m}$  InGaAs/GaAs strained quantum well lasers with InGaP cladding layer," *Electron. Lett.*, Vol. 30, No. 7, pp. 563–565, 1994.
- [2] I. Tångring, S. M. Wang, M. Sadeghi, A. Larsson, and X. D. Wang, "Metamorphic growth of 1.25–1.29  $\mu\text{m}$  InGaAs quantum well lasers on GaAs by molecular beam epitaxy," *Journal of Crystal Growth*, Vol. 301–302, pp. 971–974, 2007.
- [3] M. Arai, T. Fujisawa, W. Kobayashi, K. Nakashima, M. Yuda, and Y. Kondo, "High-temperature operation of 1.26  $\mu\text{m}$  Fabry-Perot laser with InGaAs metamorphic buffer on GaAs substrate," *Electron Lett.*, Vol. 44, No. 23, pp. 1359–1360, 2008.



### Masakazu Arai

Senior Research Engineer, Crystal Growth and Fabrication Process Research Group, NTT Photonics Laboratories.

He received the B.E., M.E., and Ph.D. degrees from Tokyo Institute of Technology in 1999, 2001, and 2003, respectively. During his Ph.D. work, he was engaged in the design and fabrication of vertical cavity surface-emitting lasers. From April 2003 to March 2004, he was at the P&I Lab, Tokyo Institute of Technology as a post-doctoral scientist. He joined NTT Photonics Laboratories in 2004. He has been engaged in research on the MOVPE growth of III-V semiconductors and the development of semiconductor lasers. He is a member of the IEEE Photonics Society and the Japan Society of Applied Physics (JSAP).



### Masaki Kohtoku

Senior Research Engineer, Group Leader of the Crystal Growth and Fabrication Process Research Group, NTT Photonics Laboratories.

He received the B.E., M.E., and Ph.D. degrees from Tokyo Institute of Technology in 1989, 1991, and 2006, respectively. In 1991, he joined NTT Photonics Laboratories, where he has since been engaged in research on InP-based monolithic integrated circuits and silica-based PLCs. His work mainly involves the design, fabrication, trimming, and characterization of AWGs and their integrated devices. He is a member of JSAP and IEICE.



### Wataru Kobayashi

Researcher, Crystal Growth and Fabrication Process Research Group, NTT Photonics Laboratories.

He received the B.S. and M.S. degrees in applied physics and the Ph.D. degree in nanoscience and nanoengineering from Waseda University, Tokyo, in 2003, 2005, and 2011, respectively. He joined NTT Photonics Laboratories in 2005. He has been engaged in R&D of optical semiconductor devices. He is a member of the Institute of Electronics, Information and Communication Engineers (IEICE).



## Current-injection Photonic-crystal Laser

*Takaaki Kakitsuka and Shinji Matsuo*

### Abstract

This article introduces current-injection photonic-crystal lasers featuring ultralow power consumption, which were achieved by using photonic-crystal nanocavities and small buried active regions fabricated through a crystal regrowth process. They should provide light sources suitable for future lower-power-consumption information and communications technology (ICT) devices.

### 1. Introduction

#### 1.1 Development of photonic networks

Photonic networks have been developed for long-reach optical-fiber communications (telecom). Recently, optical communication technologies have begun to be applied to short-reach data transmission in datacenters (datacom) as optical interconnections between routers and datacenters and between racks and between electronic circuit boards, as shown in **Fig. 1**. The next challenge is photonic networks for inter-chip and intra-chip transmission (computercom) in microprocessors.

The development has been driven by the explosive growth in information volume on networks including the Internet with the spread of FTTH (fiber to the home), which has increased the need for high-speed information processing at datacenters. Information and communications technology (ICT) devices with large information capacities, high functionality, and high-speed operation have been developed. These ICT devices use electrical data transmission, but the transmission capacity per pin in a microprocessor is limited and an increase in the transmission capacity necessitates greater power consumption. Photonic networks based on wavelength division multiplexing (WDM) are suitable for high-capacity transmission. In addition, the energy consumption per bit is expected to be lower for optical transmission than for electrical transmission for high-speed operation. Therefore, the application of optical interconnection and WDM-based photonic networks to short-reach data

transmission has begun to be discussed.

#### 1.2 Optical sources for photonic networks

Photonic networks consist of various kinds of optical devices: the most essential one is a semiconductor laser as a light-emitting device. The relationships between the active region areas of semiconductor lasers and their energy costs are shown in **Fig. 2**. In general, semiconductor lasers with larger active regions can generate higher output power, but require higher injection current for high-speed modulation and thus have a higher energy cost. For long-reach telecom applications, semiconductor lasers with large active regions are essential because high output power is required. For short-reach applications, on the other hand, semiconductor lasers with small active regions are essential because of the greater need to reduce their energy costs. Vertical cavity surface emitting lasers (VCSELs), which can have shorter cavity lengths and smaller active regions, have recently begun to be applied to datacom applications. However, even VCSELs have limits on how much the active region can be reduced in size. For computercom use, the energy cost of a semiconductor laser should be less than 10 fJ/bit, which requires a semiconductor laser with an active region smaller than  $1 \mu\text{m}^2$ , as shown in Fig. 2. Such lasers have not been achieved yet. NTT has focused on photonic crystal, which has the potential to enable the fabrication of semiconductor lasers with tiny cavities and small active regions.

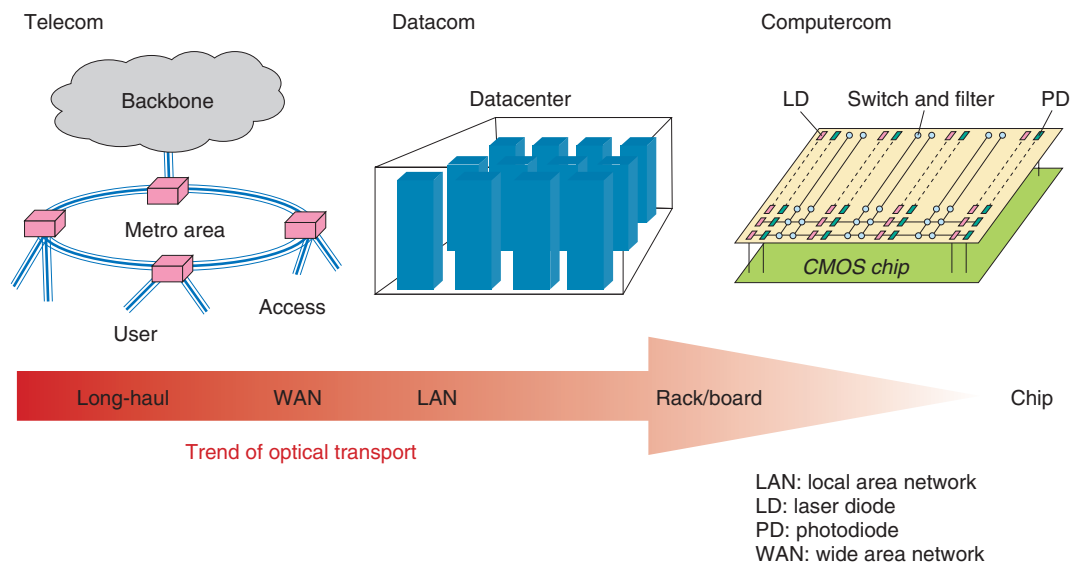

Fig. 1. Trend of short-reach photonic network.

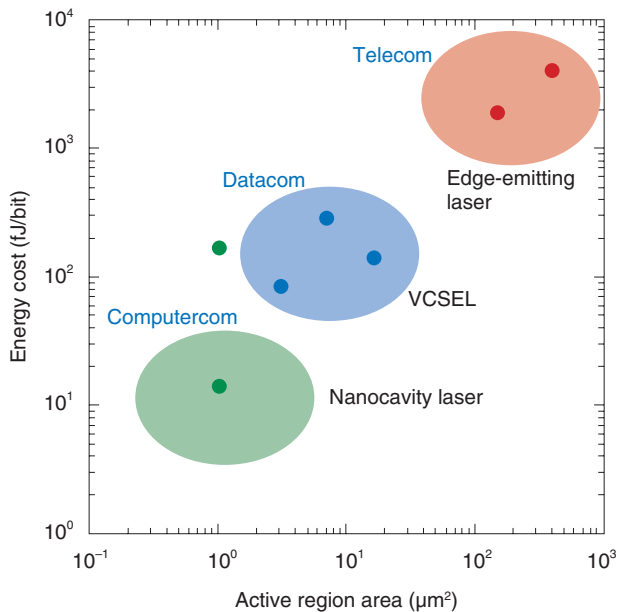

Fig. 2. Energy cost of semiconductor lasers.

## 2. Photonic crystal

A photonic crystal is an artificial structure whose refractive index is periodically modulated with sub-micrometer periodicity [1]. A scanning electron microscope (SEM) image of a two-dimensional photonic crystal with periodically placed air holes in the

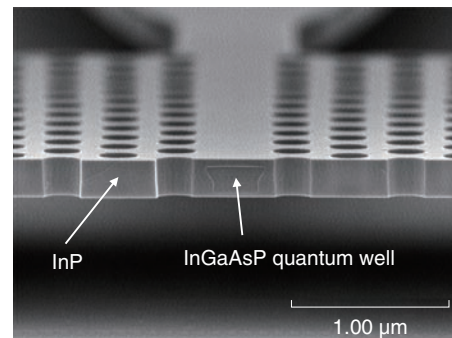

Fig. 3. SEM image of photonic crystal.

semiconductor slab is shown in **Fig. 3**. The semiconductor and air have significantly different refractive indices, and their periodic placement in the photonic crystal prevents light of a particular wavelength from existing in the semiconductor. This behavior, which is like a photonic insulator, is a feature of a photonic crystal. If some air holes are removed in a linear fashion (creating a line defect structure) from a two-dimensional photonic crystal with a slab structure, as shown in Fig. 3, then the lightwave can exist in the line defect region. In other words, the line defect acts as a waveguide. In this way, photonic crystals can control lightwaves by the alignment and size of the air holes.

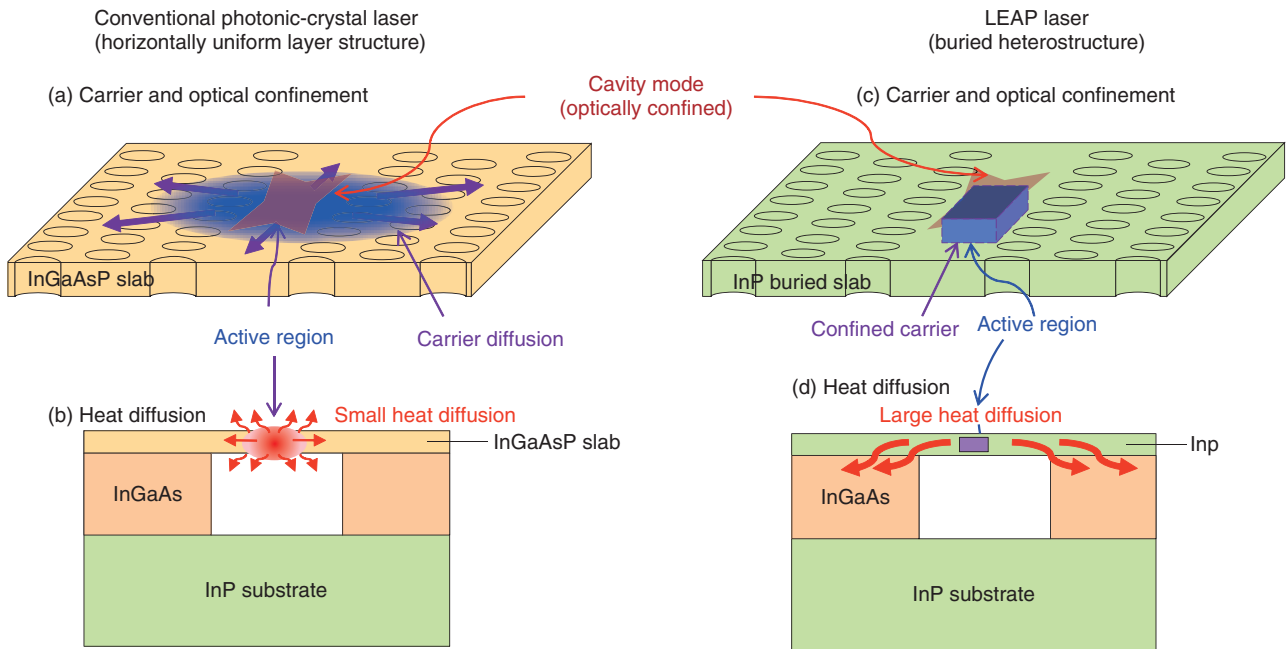

Fig. 4. Comparison of the conventional photonic-crystal laser and LEAP laser.

### 3. Lambda-scale embedded active region photonic-crystal (LEAP) laser

Various photonic-crystal lasers have been reported; however, most of them are fabricated using a horizontally uniform layer slab structure, like InGaAsP MQW (multiple quantum well) with high thermal resistance, as illustrated in **Figs. 4(a)** and **(b)**. The semiconductor laser needs to confine both light and electrical charge carriers in the active region for lasing. Therefore, ordinary semiconductor lasers have a double-heterostructure, in which the active region is sandwiched by wide-bandgap semiconductors. However, photonic-crystal lasers with a horizontally uniform layer structure can confine only light not carriers because they cannot have a double-heterostructure horizontally against the substrate. Therefore, the lasing characteristics of photonic-crystal lasers with the horizontally uniform layer structure are significantly limited because their performance is adversely affected by carrier diffusion and a temperature rise. To solve these problems, we have utilized a structure with the active region limited to within a line defect in the photonic crystal slab (buried heterostructure) (**Figs. 4(c)** and **(d)**). We call this laser the lambda-scale embedded active-region photonic-crystal laser, or LEAP laser for short. Since the refractive index of

the active region (InGaAsP- or InGaAlAs-based MQW) is higher than that of the region burying it (InP), the lightwave is strongly confined in the active region. The active region can also confine carriers because its bandgap is smaller than that of the burying region. In addition, the thermal conductivity of InP (68 W/m·K) is higher than that of InGaAsP (4 W/m·K) and this enables effective heat diffusion (**Fig. 4(d)**).

The advantages of the buried heterostructure are shown in **Fig. 5**. The optical input-output characteristics of optically pumped photonic-crystal lasers using an optical pump wavelength of 0.98  $\mu\text{m}$  and pumping diameter of 4  $\mu\text{m}$  were numerically simulated. In the conventional photonic-crystal laser with the horizontally uniform layer structure, generated carriers spread outside the cavity and the low thermal conductivity causes a significant rise in temperature. Since high temperature degrades the optical properties of the active region, the laser's resulting output power is low. On the other hand, in a buried-heterostructure laser with an active region of  $4 \times 0.3 \mu\text{m}^2$ , carriers are strongly confined in the active region and the temperature rise is negligible. Therefore, high output power can be obtained at room temperature. The use of the buried heterostructure is expected to greatly improve the lasing characteristics of photonic-crystal

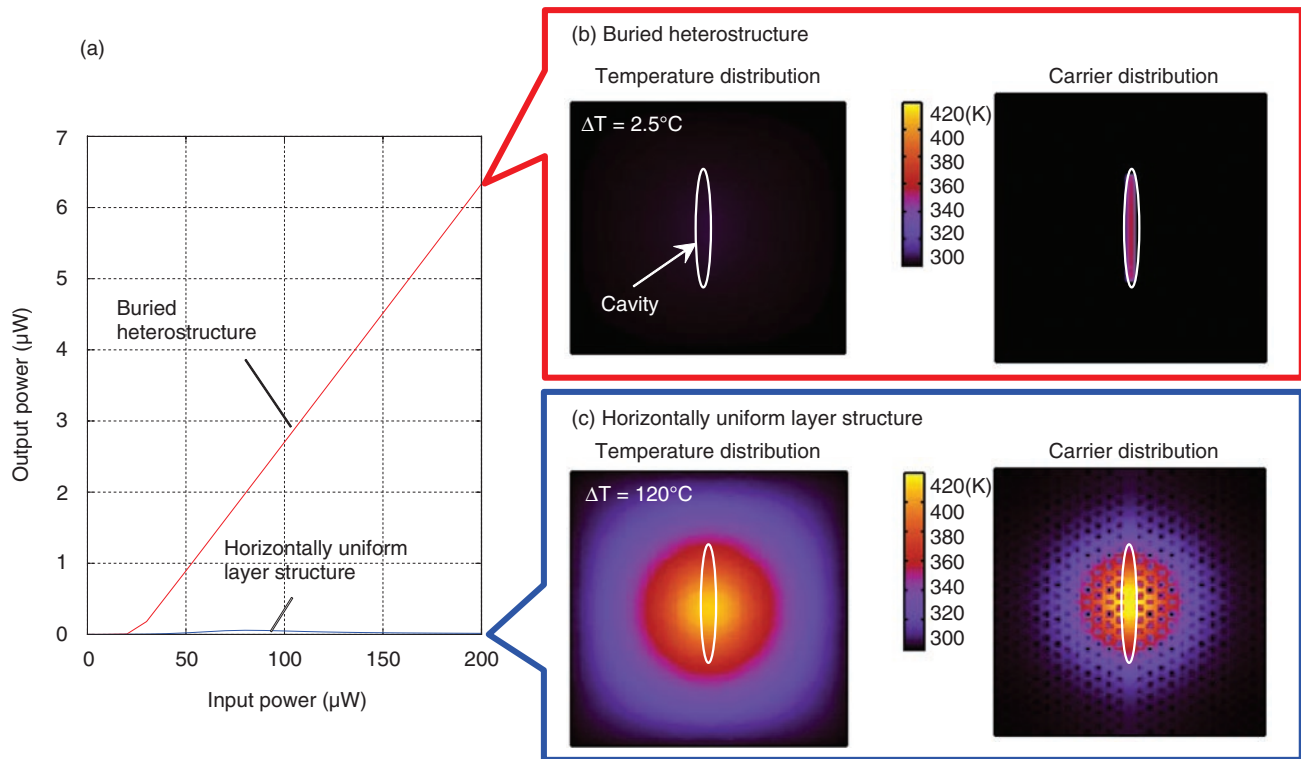

Fig. 5. Simulated lasing characteristics: (a) light-in light-out (L-L) curve, (b) temperature distribution and carrier distribution of the buried heterostructure and (c) horizontally uniform layer structure at input power of 200  $\mu\text{W}$ .

lasers.

Taking advantage of NTT's expertise in laser fabrication, especially crystal regrowth techniques for semiconductors, we successfully fabricated the buried-heterostructure active region in the line-defect waveguide in the photonic crystal slab. The size of the active region is  $5 \times 0.3 \times 0.15 \mu\text{m}^3$ . Input and output interfaces are easily fabricated using line-defect waveguides. We have successfully demonstrated optically pumped photonic-crystal lasers operating with power consumption of less than 10 fJ/bit [3].

#### 4. Current-injection LEAP laser

We made an optically pumped LEAP laser using the buried heterostructure for the first time. However, for practical use in a photonic network, current-injection operation is essential. Current-injection operation of a semiconductor laser requires a pin-junction (p: positive-type semiconductor, i: intrinsic semiconductor, n: negative-type semiconductor). In ordinary lasers, the pin-junction is fabricated in the direction perpendicular to the substrate. Since the LEAP laser

needs a slab structure, a pin-junction in the perpendicular direction is difficult to fabricate. We fabricated a pin-junction in the plane of the photonic-crystal slab by using Zn diffusion and Si ion implantation into the non-doped InP burying region. The fabricated current-injection LEAP laser is shown in **Fig. 6(a)**. This is the world's first current-injection photonic-crystal laser operating with continuous-wave light at room temperature [4]. We achieved a threshold current of 0.39 mA. High-speed modulation at 10 Gbit/s and energy cost of 170 fJ/s were also demonstrated. However, initial devices suffered from a large leakage current, which limited the resulting reductions in threshold current and energy cost despite the active region being small. The origin of the leakage current was the InGaAs etching layer sustaining the air bridge. The small bandgap of InGaAs causes the current leakage. We successfully reduced the leakage current by using InAlAs, which has a larger bandgap than InP, instead of InGaAs for the etching layer. The measured current-light-output curve is shown in **Fig. 6(b)**. Lasing with a very low threshold current of 14  $\mu\text{A}$  was successfully demonstrated at room

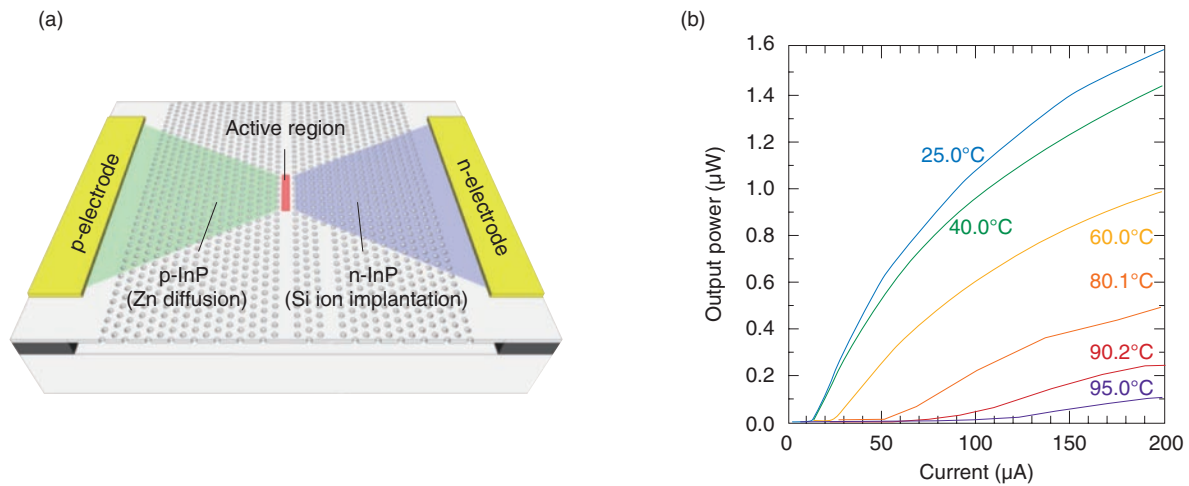

Fig. 6. (a) Structure and (b) lasing characteristics of current-injection LEAP laser.

temperature (25°C). The use of an InGaAlAs-MQW active region enabled high-temperature operation up to 95°C. These figures for low threshold current and high operating temperature are records for photonic-crystal lasers [5].

## 5. Conclusion

The LEAP laser is a key device for future photonic networks with large capacity and low power consumption. We believe that current-injection LEAP lasers operating with power consumption of less than 10 fJ/bit will be achieved in the near future. We will continue our research and development toward integration of the LEAP laser with silicon photonics and CMOS (complementary metal oxide semiconductor) and ultimately aim at devices integrating microprocessors and photonic networks.

## References

- [1] M. Notomi, "Manipulating Light by Photonic Crystals," NTT Technical Review, Vol. 7, No. 9, 2009. <https://www.ntt-review.jp/archive/ntttechnical.php?contents=ntr200909rp1.html>
- [2] S. Matsuo, A. Shinya, T. Kakitsuka, K. Nozaki, T. Segawa, T. Sato, Y. Kawaguchi, and M. Notomi, "High-speed ultracompact buried heterostructure photonic-crystal laser with 13 fJ of energy consumed per bit transmitted," Nat. Photon., Vol. 4, No. 9, pp. 648–654, 2010.
- [3] S. Matsuo, A. Shinya, C.-H. Chen, K. Nozaki, T. Sato, Y. Kawaguchi, H. Taniyama, and M. Notomi, "20-Gbit/s directly modulated photonic crystal nanocavity laser with ultra-low power consumption," Opt. Express, Vol. 19, No. 3, pp. 2242–2250, 2011.
- [4] S. Matsuo, K. Takeda, T. Sato, M. Notomi, A. Shinya, K. Nozaki, H. Taniyama, K. Hasebe, and T. Kakitsuka, "Room-temperature continuous-wave operation of lateral current injection wavelength-scale embedded active-region photonic-crystal laser," Opt. Express, Vol. 20, No. 4, pp. 3773–3780, 2012.
- [5] T. Sato, K. Takeda, A. Shinya, K. Nozaki, H. Taniyama, W. Kobayashi, K. Hasebe, T. Kakitsuka, M. Notomi, and S. Matsuo, "95°C cw Operation of InGaAlAs Multiple-quantum-well Photonic-crystal Nanocavity Laser with Ultra-low Threshold Current," Proc. of the IEEE Photonics Conference, WF-2, Burlingame, California, USA, 2012.

**Takaaki Kakitsuka**

Senior Research Engineer, Nano-structure Photonic Device Research Group, Advanced Opto-electronics Laboratory, NTT Photonics Laboratories and NTT Nanophotonics Center.

He received the B.S. and M.S. degrees in physics and the Dr.Eng. degree from Kyushu University, Fukuoka, in 1994, 1996, and 2012, respectively. He joined NTT Opto-electronics Laboratories in 1996. He has been engaged in research on semiconductor lasers and optical functional devices. From 2009 to 2011, he was in NTT Research and Development Planning Department. He is a member of the IEEE Photonics Society, the Institute of Electronics, Information and Communication Engineers (IEICE), the Japan Society of Applied Physics (JSAP), and the Physical Society of Japan.

---

**Shinji Matsuo**

Senior Research Engineer, Supervisor, Group Leader, Nano-structure Photonic Device Research Group, Advanced Opto-electronics Laboratory, NTT Photonics Laboratories and NTT Nanophotonics Center.

He received the B.E. and M.E. degrees in electrical engineering from Hiroshima University in 1986 and 1988, respectively and the Ph.D. degree in electronics and applied physics from Tokyo Institute of Technology in 2008. In 1988, he joined NTT Opto-electronics Laboratories, Atsugi, where he was engaged in research on photonic functional devices using MQW-pin modulators and VCSELs. In 1997, he researched optical networks using WDM technologies at NTT Network Innovation Laboratories, Yokosuka. Since 2000, he has been researching high-speed tunable optical filters and lasers for photonic packet switching and photonic-crystal lasers for computercom applications at NTT Photonics Laboratories, Atsugi. He is a member of the IEEE Photonics Society, IEICE, and JSAP.

---

## Advertising Effectiveness Measurement Using Crowd Measurement and Facial Image Processing Techniques

*Hiroyuki Arai, Naoki Ito, Kaori Kataoka, and Yukinobu Taniguchi*

### Abstract

As digital signage becomes more common, there is increasing need for camera-based techniques that can measure the effectiveness of advertising. NTT is researching and developing 1) a crowd measurement technique to measure the number of people at a location; 2) a transient-audience measurement technique to measure the number of people passing through that location; and 3) a face detection, orientation estimation, and attribute classification technique to detect faces in an image and estimate the age and sex of each person. Version 3 of our advertising effectiveness measurement system combines these three techniques.

### 1. Introduction

Digital signage is rapidly becoming common at places where people gather, such as stations and commercial facilities, as a tool for providing services such as information guides and advertising. Its usage formats have recently diversified to include studies on its application as a means of providing information during disasters, and digital signage is expected to permeate all aspects of our lives in the future [1].

Concerning the spread of digital signage, we are seeing the start of advertising distribution in a format in which the media companies that own the signage sell advertising spots (locations and times for displaying ads) and advertisers purchase those spots to display their ads. This is raising questions about how much effectiveness can be expected for a given expenditure and whether the resultant effectiveness matches expectations, so it has become necessary to measure and comprehend the advertising effectiveness of digital signage.

In simple terms, advertising effectiveness has many facets, such as the exposure effectiveness (how many

people does the advertising reach), perception effectiveness (what impressions and information are given to the audience), and action effectiveness (by how much does the number of customers or sales volume increase), which are similar to television program viewing rate and website page views. Of these, exposure effectiveness is thought to be a basic and also common index as a foundation for comprehending advertising effectiveness. For digital signage, exposure effectiveness is assumed to be information such as the number of people at that location—the total number of people at a given instant (total audience) and the number of people passing through (transient audience)—and, of those, the number of people actually looking at the screen and their attributes (sex and age) (**Fig. 1**).

NTT has developed three techniques that use images captured by cameras with the aim of applying them to the measurement of digital signage advertising effectiveness: 1) a crowd measurement technique [2] that measures the total number of people at a location, 2) a transient audience measurement technique that measures the total number of people passing through

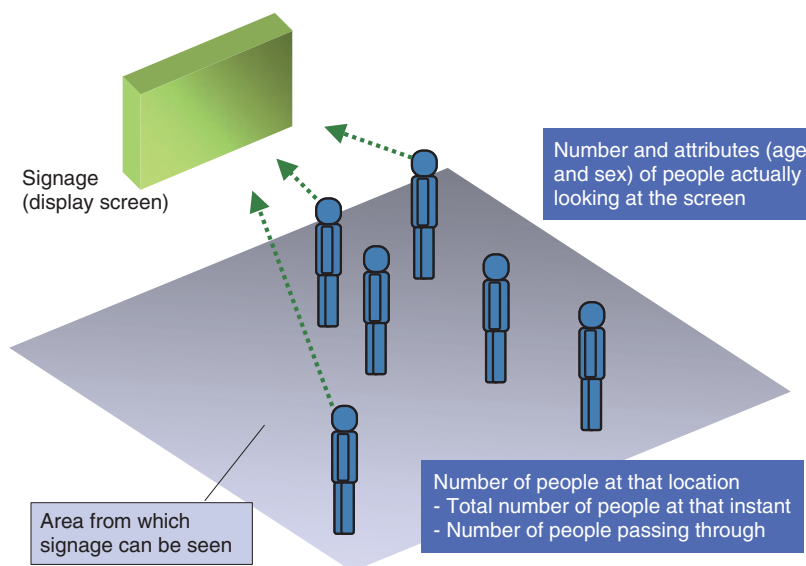

Fig. 1. Assumed advertising effectiveness index of digital signage.

that location, and 3) a face detection, orientation estimation, and attribute classification technique [2] that detects faces in an image and estimates the orientations of those faces and the age and sex of those people. The latest version V3 (version 3) of our advertising effectiveness measurement system integrates these techniques. Below, we overview these image processing techniques and our advertising effectiveness measurement system V3.

## 2. Image processing techniques

### 2.1 Crowd measurement technique

The crowd measurement technique developed at NTT can measure the total number of people within an image at the instant it was acquired. Previous techniques for measuring the total number of people in an image generally involve detecting specific shapes such as the whole body or upper half of each person in an image, or following individual moving objects within a series of images (using a tracking technique), or a combination of those. However, those previous techniques can suffer from occlusion, whereby one person is superimposed on another in the image, as shown in the upper part of **Fig. 2**, which makes correct detection difficult. For that reason, previous techniques have the problem that they can be applied only to comparatively limited numbers of people (such as about 5–10).

NTT's crowd measurement technique [2] estimates

the total number of people within an image in a manner that avoids the effects of occlusion by utilizing the area of an image. It works by modeling the geometrical relationships between the camera, floor, and people and the geometrical relationships between them in the image, as shown in the lower part of **Fig. 2**. This approach is completely different from those of previous techniques in that it does not detect each person individually, but makes it possible to estimate approximately how many people are there overall. The features of this technique are that it can estimate the number of people in a crowded situation and it enables the use of general-purpose cameras that are pointing obliquely downward. A more detailed description is given in Ref. [3].

### 2.2 Transient audience measurement technique

Transient audience measurement is a technique used in a location that people pass through, such as a passageway, in order to measure how many people pass through it. This has already been partially implemented as a technique for measuring the transient audience from an image. In a typical setup of the current method, the camera is attached to a high point such as the ceiling; it captures images taken in the downward direction, and the technique determines the transient audience number by image analysis. Although one of the features of the conventional method is that it enables accurate measurement, it is only applicable to a limited area because measurement



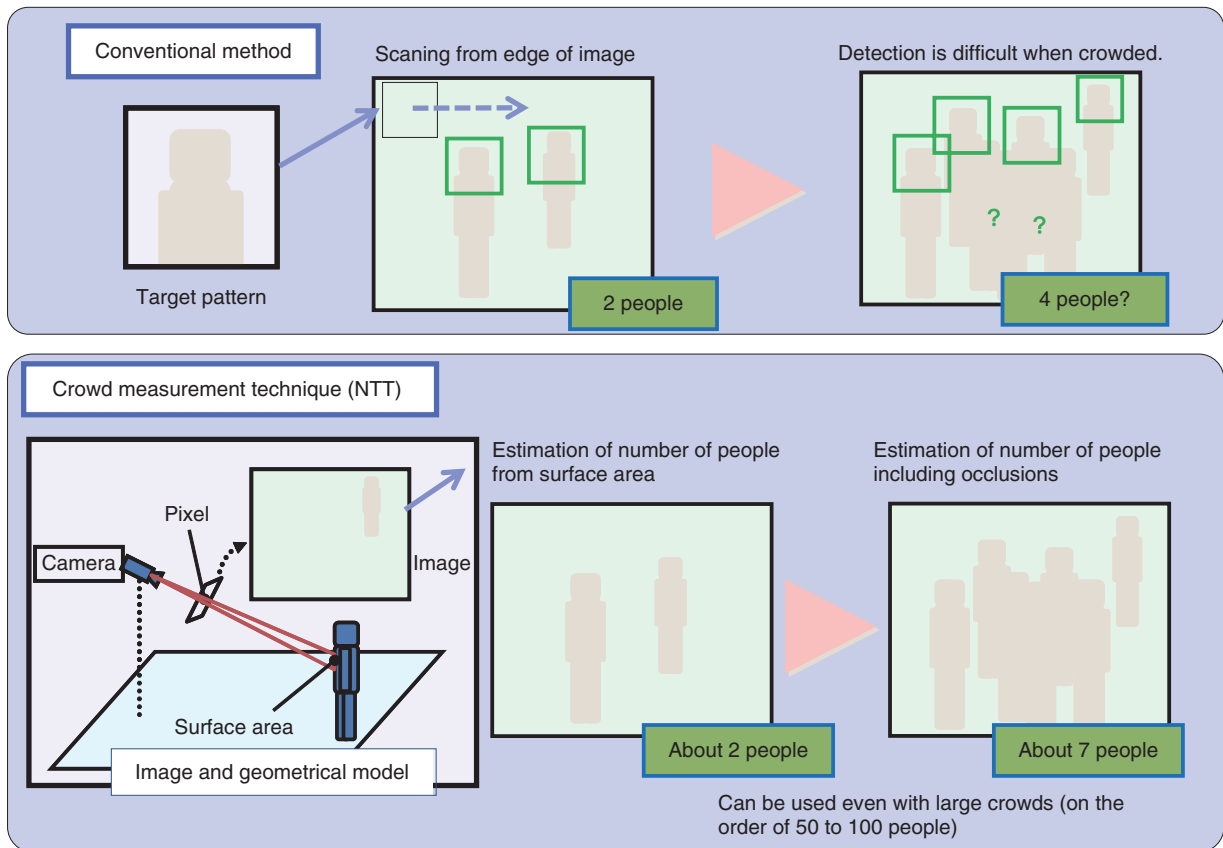

Fig. 2. Overview of crowd measurement techniques.

is possible only under the camera or nearby, which makes it difficult to measure the transient audience in an entire passageway or station concourse, for example.

To measure within a wider range, it is necessary to install a camera that points obliquely downward and use images captured within a wide range. A previous technique that can be applied in such a case is called tracking. This detects each person individually from an image and traces that person’s movement path. Various improvements have already been made to the tracking technique, but the occlusion problem (people overlapping or being hidden in the images) inevitably makes it difficult to perform stable measurements in places such as station passageways, and the processing results can drop greatly for a crowd.

To exceed the limitations of the existing techniques, NTT has developed a transient audience measurement technique that uses an approach that is completely different from previous ones. It calculates the final transient audience by combining two tech-

niques: a fluid analysis technique that is applied for crowded conditions and a one-dimensional tracking technique aimed at greater measurement accuracy in uncrowded condition.

### 2.2.1 Fluid analysis technique (measurement algorithm applied to crowds)

The fluid analysis technique can estimate the transient audience by treating the overall flow of people as if it were the flow of a fluid. The basic concept is shown in **Fig. 3**, where to simplify the explanation, we show the view directly downward whereas in practice the processing is done on images captured by a camera pointing obliquely downward. In general, the flow rate of a liquid or gas in a pipe can be calculated as the product of the pipe’s cross-sectional area, the fluid’s speed, and the fluid’s density; however, this concept can also be applied to a flow of people. In other words, when the processing area is set on an image or on the floor, we can calculate the transient audience (flow rate) at a later stage if we have (1) the density (number of people within the area) and (2) the

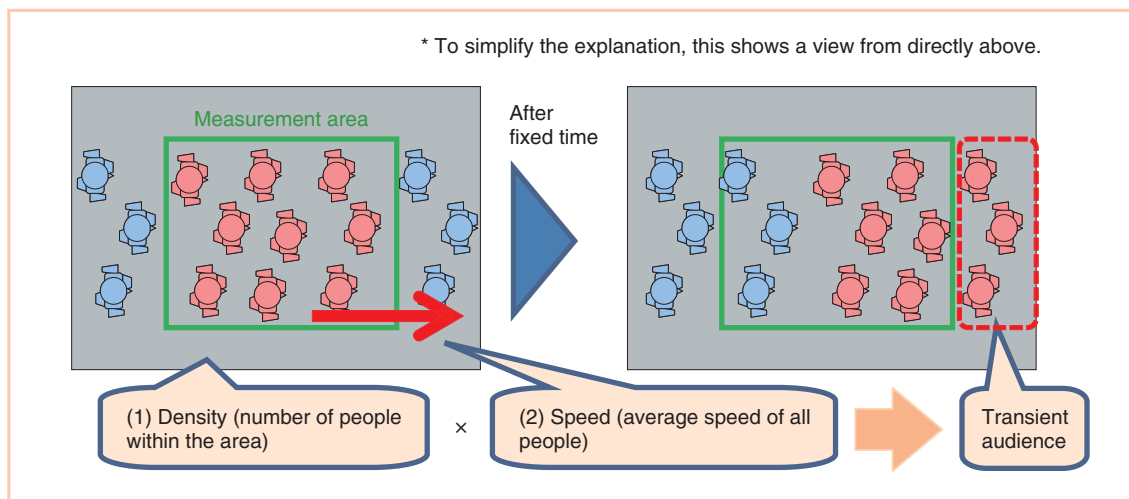

Fig. 3. Overview of fluid analysis for transient audience measurement.

movement speed of people. We can calculate the number of people within the area (1) by using the crowd measurement technique described above and we can calculate their speed (2) by taking several consecutive images in a time series and detecting corresponding pairs of feature points and considering the similarity of their feature vectors. Note that since perfect correspondence is rare, we chose to use an algorithm that determines speed through a voting mechanism, which can avoid the influence of feature point miscorrespondence. Note also that the description relates to one-way flow, for simplicity, but in practice it is also applicable to flows in both directions in passageways. This technique enables us to calculate the transient audience in a stable manner, even in locations such as a crowded station concourse, specifically in a state where there are several dozen people, e.g., 50 or 100, in front of the screen.

### 2.2.2 One-dimensional tracking technique (measurement algorithm during quiet times)

The fluid analysis technique described above has the great advantage that it enables stable measurement even when the area is crowded, but it does have the disadvantage that the accuracy is insufficient during quiet times when the number of people is between one and five. To overcome that disadvantage, we have developed a one-dimensional tracking technique that can measure highly accurately during quiet times and also enables rapid processing (Fig. 4). It detects the image area to which a moving object belongs, forms an input image series, and projects that area in a one-

dimensional version in accordance with a conversion coefficient called a weighting value. The theoretical background of the weighting value is given in Ref. [3]. The results of this processing are such that a peak in the projected values corresponds to the position of a person, and the sum of projected values in the vicinity of that peak corresponds to the number of people in that vicinity (the number of people contributing to that peak). We can measure the transient audience for each direction of movement by estimating the person-number at each peak in the projected values and simultaneously following their positions.

Note that the final transient audience is computed by creating a weighted average of the numbers obtained by fluid analysis and one-dimensional tracking. The weight is adjusted to suit the congestion level, which is estimated by the crowd measurement technique described in section 2.1.

### 2.3 Face detection, orientation estimation, and attribute classification technique

The face detection, orientation estimation, and attribute classification technique developed at NTT picks out faces within images, estimates the orientation of each detected face, and estimates the attributes (sex and age) of that person. These three processes share the same fundamentals in common: each process pre-analyzes a large quantity of image data gathered beforehand and utilizes that analysis in making its decisions (Fig. 5).

Examples of attribute classification are given below. First of all, a large volume of image data of the

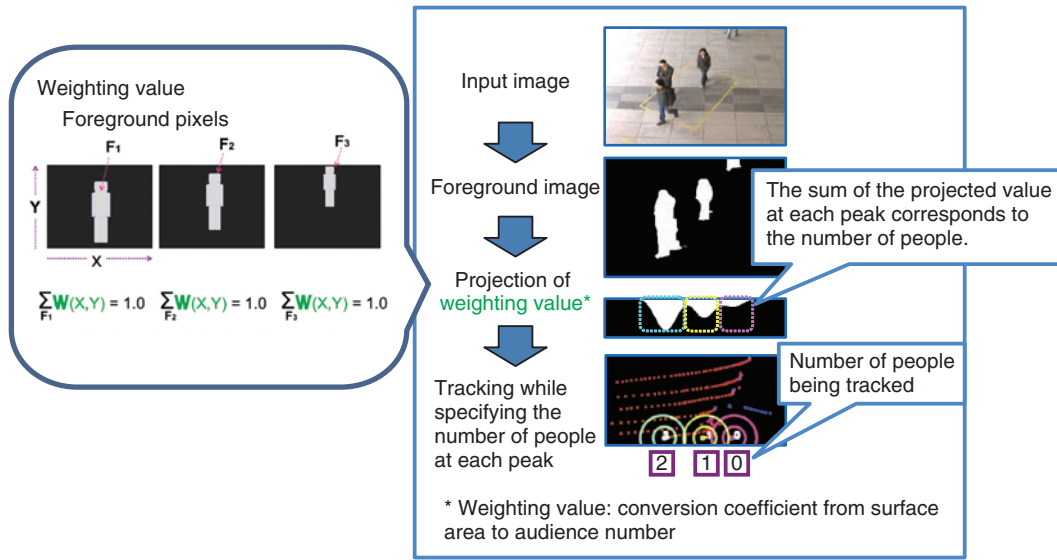

Fig. 4. Overview of one-dimensional tracking technique.

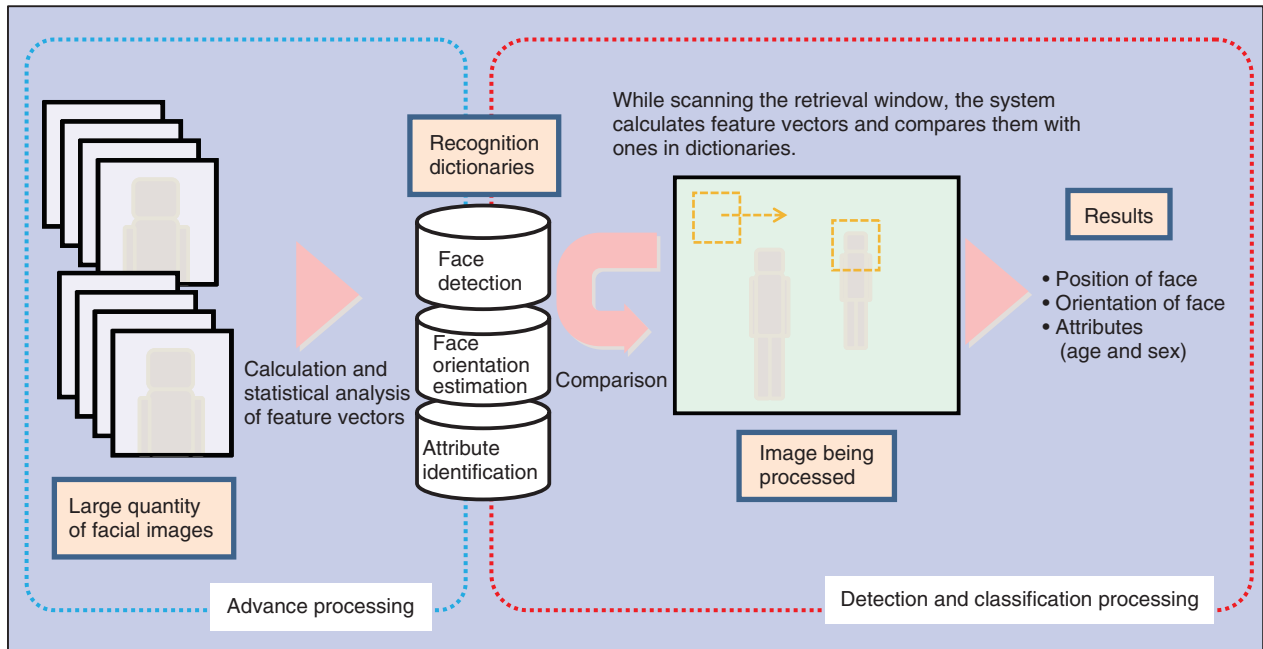

Fig. 5. Overview of face detection, orientation estimation, and attribute classification technique.

faces of people of both sexes and various different ages, captured from various different angles, is gathered beforehand. A feature vector, which is the digitization of the features of the entire face, is calculated for each facial image. Then, for each age and sex group, the technique analyzes what kind of distri-

bution the feature vectors have. The analysis results are called a recognition dictionary. During the actual processing, the system decides which age and sex group the face belongs to by calculating the feature vectors for the entire face in a manner similar to the recognition dictionary creation process, for the face

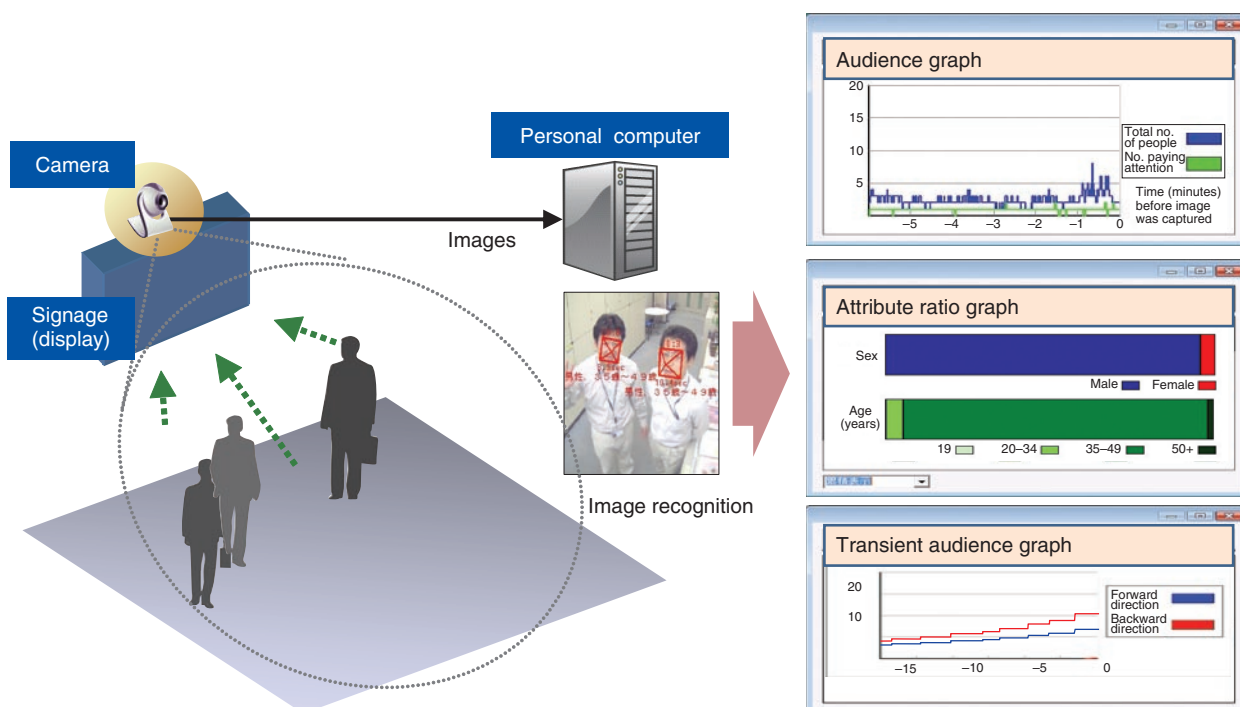

Fig. 6. Overview of advertising effectiveness measurement system V3.

area within the image detected by the face detection processing, and by comparing them with those in the recognition dictionary.

### 3. Advertising effectiveness measurement system V3

Our advertising effectiveness measurement system V3 combines the above-described crowd measurement technique; transient audience measurement technique; and face detection, orientation estimation, and attribute classification technique. It can measure the advertising effectiveness index of digital signage. An overview is shown in **Fig. 6**. The abovementioned image processing is done while camera images are being imported to a personal computer, and the results are output as log data in real time. The system can use either one or two cameras and perform processing in one of the following two formats: (1) all of the image processing is done by one camera or (2) face detection, orientation estimation, and attribute classification are done by the camera close to the signage while the crowd measurement and transient audience measurement are done by the second camera, which captures a wider range. The attribute classification results are output in accordance with mar-

keting segments which denote females between the ages of 20 and 34 as F1 and males between the ages of 35 and 49 as M2.

### 4. Conclusion

This article introduced image processing techniques for measuring the advertising effectiveness of digital signage and the measurement system V3. We will proceed with implementing these techniques as methods of measuring digital signage advertising effectiveness. In addition, since these techniques could be applied to fields other than digital signage, such as marketing information acquisition and safety management support in locations where large numbers of people gather, such as stations and various event facilities, we would like to proceed with not only the advertising effectiveness of digital signage but also validation of its applicability to fields such as safety management support in various locations.

### References

- [1] K. Muramoto, "Digital Signage Standardization," NTT Technical Review, Vol. 10, No. 10, 2012.  
<https://www.ntt-review.jp/archive/ntttechnical.php?contents=ntr201210gls.html>

- [2] T. Kinebuchi, H. Arai, I. Miyagawa, S. Ando, K. Kataoka, and H. Koike, "Image Processing Techniques for Measuring Advertising Effectiveness of Digital Signage," NTT Technical Review, Vol. 7, No. 12, 2009.  
<https://www.ntt-review.jp/archive/ntttechnical.php?contents=ntr200912sf2.html>
- [3] H. Arai, I. Miyagawa, H. Koike, and M. Haseyama, "Estimating Number of People Using Calibrated Monocular Camera Based on Geometrical Analysis of Surface Area," IEICE Trans. on Fundamentals of Electronics, Communications and Computer Sciences, Vol. E92-A, No. 8, pp. 1932–1938, 2009.



**Hiroyuki Arai**

Senior Research Engineer, Image Media Processing Group, Visual Media Project, NTT Media Intelligence Laboratories.

He received the M.S. degree in physics and Ph.D. degree in information science from Hokkaido University in 1991 and 2009, respectively. Since joining NTT in 1991, he has been engaged in research on map recognition systems, image processing, and pattern recognition. He was a fellowship researcher of the Natural Vision Project of the National Institute of Information and Communications Technology of Japan (NICT) from 2000 to 2005. He is a member of the Institute of Electronics, Information and Communication Engineers (IEICE), and the Institute of Image Information and Television Engineers of Japan.



**Naoki Ito**

Research Engineer, Image Media Processing Group, Visual Media Project, NTT Media Intelligence Laboratories.

He received the M.E. degree from Toyohashi University of Technology, Aichi, in 2001. He joined NTT in 2001 and engaged in research on character recognition. He moved to NTT EAST in 2004 and engaged in the development of security systems. He moved to NTT Cyber Space Laboratories in 2008. As a result of organizational changes in July 2012, he is now in NTT Media Intelligence Laboratories. He is a member of IEICE.



**Kaori Kataoka**

Research Engineer, Image Media Processing Group, Visual Media Project, NTT Media Intelligence Laboratories.

She received the B.S. and M.S. degrees in physics from Waseda University, Tokyo, in 1998 and 2000, respectively. Since joining NTT Cyber Space Laboratories in 2000, she has been engaged in research on image processing and pattern matching. As a result of organizational changes in July 2012, she is now in NTT Media Intelligence Laboratories. She is a member of IEICE.



**Yukinobu Taniguchi**

Senior Research Engineer, Supervisor, Image Media Processing Group, Visual Media Project, NTT Media Intelligence Laboratories.

He received the B.E., M.E., and Dr.Eng. degrees in mathematical engineering from the University of Tokyo in 1990, 1992, and 2002, respectively. He joined NTT Human Interface Laboratories in 1992. As a result of organizational changes in July 2012, he is now in NTT Media Intelligence Laboratories. He received the Best Paper Award from IEICE in 2000. He is a member of IEICE, the Information Processing Society of Japan, and the Association for Computing Machinery.

---

## Report on ITU Radiocommunication Assembly 2012 and ITU World Radiocommunication Conference 2012

*Masashi Nakatsugawa*

### Abstract

This report summarizes the activities and outcomes of the Radiocommunication Assembly 2012 (RA-12) and World Radiocommunication Conference 2012 (WRC-12), which were held from January to February 2012 in Geneva, Switzerland. RA and WRC are the major conferences of ITU-R (International Telecommunication Union, Radiocommunication Sector).

### 1. Radiocommunication Assembly 2012

The Radiocommunication Assembly (RA) convenes before the World Radiocommunication Conference (WRC) to approve draft Recommendations prepared by Study Groups (SGs) of ITU-R (International Telecommunication Union, Radiocommunication Sector), to review and approve draft ITU-R Resolutions which describe the working methods and processes of the SGs, to evaluate the activities of the SGs, and to approve the Questions and structure of the SGs including the appointment of SG Chairmen and Vice-Chairmen for the next study period. RA-12 [1], [2] was held on January 16–20, 2012, at the Centre International de Conférences Genève (CICG) in Switzerland. 526 participants attended the conference from 102 Member States. There were 28 Japanese delegates, of which eight were from NTT and NTT DOCOMO.

The structure of RA-12 is shown in **Fig. 1**. Under the Plenary, which manages the coordination over the entire conference activities, five committees, COM1 to COM5, were established. Among these committees, COM4 and COM5 handled the items related to the procedures and processes of the SG activities.

#### 1.1 Approval of draft Recommendations

RA-12 considered the draft Recommendations prepared by the SGs. Four (three new and one revised) draft Recommendations were approved, while one was referred back to the SG for reconsideration. One of the new Recommendations was ITU-R M.2012, which defines detailed specifications for IMT-Advanced radio interfaces (IMT: International Mobile Telecommunications). Two radio interfaces, LTE-Advanced based on 3GPP and WirelessMAN-Advanced based on IEEE, were included in the Recommendation (LTE: Long Term Evolution, 3GPP: 3rd Generation Partnership Project, MAN: metropolitan area network). The objective of the draft revised Recommendation that was not approved was to cease adjustment of UTC (coordinated universal time) with a leap second. Three main opinions were expressed: to support the revision (USA, Japan, and some others), to oppose the revision (UK, China, and some others), and to require more information before forming an opinion (Arab and African countries). It was difficult to reach a consensus. RA-12 decided to request further study by SG7 and to propose that the issue be discussed at WRC-12 as an agenda item for a future WRC.

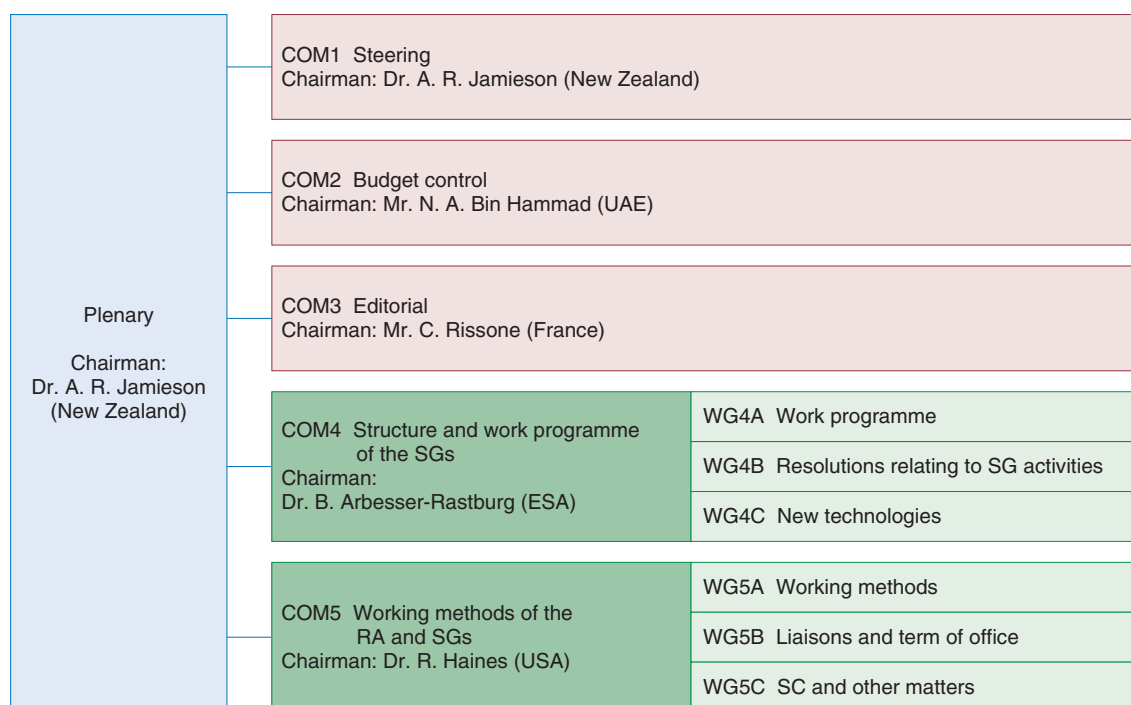

Fig. 1. Structure of RA-12.

## 1.2 Approval of ITU-R Resolutions

RA-12 reviewed ITU-R Resolutions defining various matters concerning ITU-R activities. It approved 32 (6 new and 26 revised) ITU-R Resolutions and suppressed one. New Resolutions include a study on the technical requirements for utilizing cognitive radios, a study on reducing the energy consumption of wireless communication systems to reduce greenhouse gas emissions, a study on the spectrum usage of electronic news gathering (ENG) systems for global/regional harmonization, and agreement for academic organizations to participate in ITU-R activities. Revised Resolutions describe working procedures and methods applied for SG activities; clarifying the provisions for approval of ITU-R Recommendations that are not based on Questions; facilitation of the procedure for simultaneous adoption and approval (PSAA) without the two-stage correspondence process and reduction of the voting period from 3 months to 2 months; and guidelines for electing SG Vice-Chairman to balance the distribution between region, gender, and expertise, for facilitating participation by developing countries, and for determining the total number of Vice-Chairmen taking account of the SG workload.

## 1.3 Approval of Questions

RA-12 approved 223 Questions including a study on technologies and performance of radio communication systems for the smart grid system and assessment of the impact on the existing systems, future trends in millimeter-wave fixed radio systems, and investigation of super-high-vision systems.

## 1.4 Appointment of the Chairman and Vice-Chairmen of each SG

The structure of the SGs in the previous study period was maintained (Fig. 2). The Chairman and Vice-Chairmen of each SG were elected. Dr. Akira Hashimoto (NTT DOCOMO), Noriyuki Kawai (KDDI), and Yukihiro Nishida (NHK) were elected as Chairman of SG5, Vice-Chairman of SG4, and Vice-Chairman of SG6, respectively.

## 2. World Radiocommunication Conference 2012

WRC is the largest ITU-R international conference. It is normally held every three or four years to update the Radio Regulations (RR). The RR provide international rules and regulations for spectrum allocation to radio services, use of satellite orbits, and administrative and operational procedures for radio stations, all

SG1 Spectrum management Chairman: Dr. S. Y. Pastukh (Russian Federation) Vice-Chairmen: 11
SG3 Radiowave propagation Chairman: Mr. B. Arbesser-Rastburg (ESA) Vice-Chairmen: 8
SG4 Satellite services Chairman: Mr. C. Hofer (USA) Vice-Chairmen: Mr. N. Kawai (KDDI) and 9 others
SG5 Terrestrial services Chairman: Dr. A. Hashimoto (NTT DOCOMO) Vice-Chairmen: 11
SG6 Broadcasting service Chairman: Mr. C. Dosch (Germany) Vice-Chairmen: Mr. Y. Nishida (NHK) and 11 others
SG7 Science services Chairman: Mr. V. Meens (France) Vice-Chairmen: 5

Fig. 2. SG structure, and the Chairmen and Vice-Chairmen.



Japan's seats were located far back on the ground floor because they were assigned according to French alphabetical order.

Fig. 3. View of the main conference room.

of which are needed for the use of radio waves. WRC-12, which was preceded by RA-12, was held for a period of four weeks from 23 January to 17 February 2012 at the same venue as RA-12 [3], [4]. Approximately 3000 participants from 160 Member States

attended (**Fig. 3**); there were 71 delegates from Japan in WRC-12, among which eight were from the NTT Group (NTT and NTT DOCOMO).

The structure of WRC-12 is shown in **Fig. 4**. Under the Plenary, there were seven Committees: the



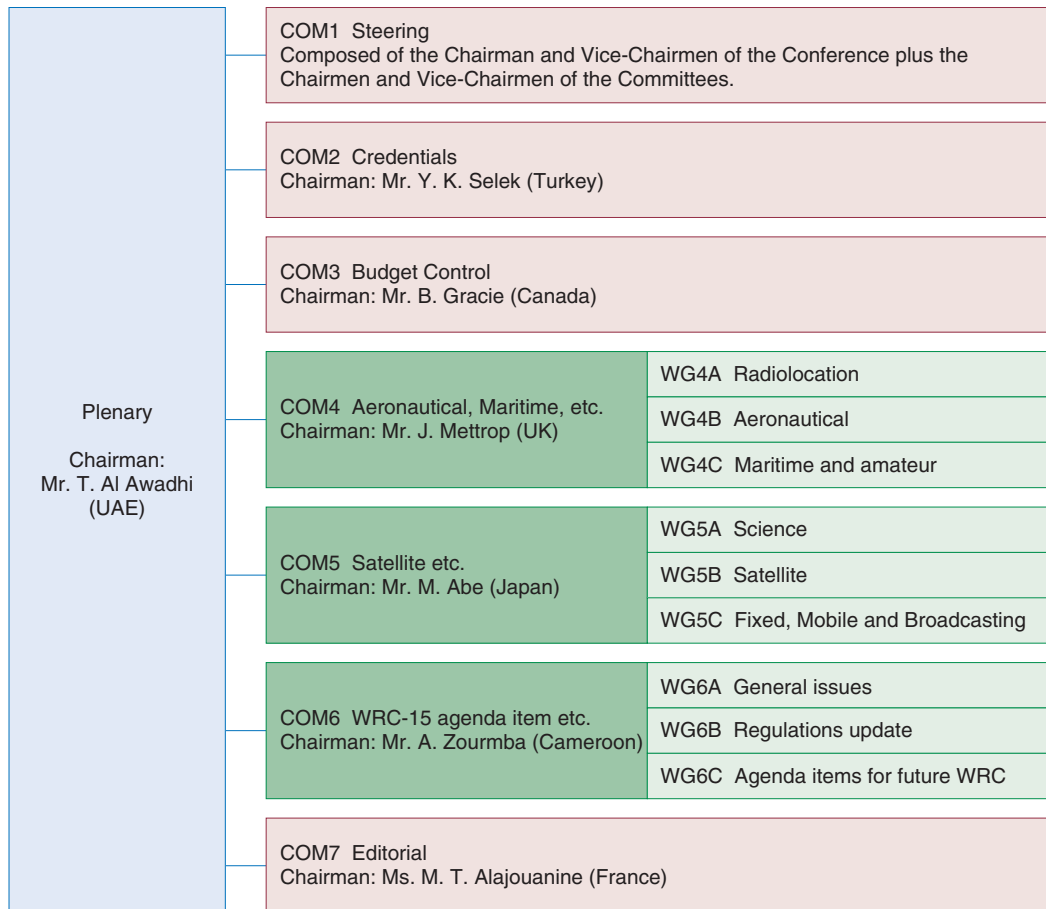

Fig. 4. Structure of WRC-12.

Steering Committee, Credentials Committee, Budget Control Committee, Editorial Committee, and three Committees for specific agenda items. The WRC-12 agenda items are shown in Fig. 5 and some of them are discussed below.

### 2.1 Worldwide/regional harmonization of spectrum for electronic news gathering (ENG) (A.I. 1.5)

This agenda item was intended to identify a common frequency for electronic news gathering (ENG). The conclusion, reached after enthusiastic discussion that resulted in no frequency being identified for ENG, was that it is possible to avoid the impact on existing broadcasting and telecommunications services in Japan. Since ITU-R Resolution 59 was adopted to promote the development of the database summarizing the frequencies available for ENG in each country, a WRC Resolution on the frequency

database of existing services was not adopted.

### 2.2 Long-term spectrum availability for the aeronautical mobile-satellite (R) service in the bands 1525–1559 MHz and 1626.5–1660.5 MHz (A.I. 1.7)

Procedures such as frequency coordination meetings were considered because of increasing demand for aircraft communications. Japan sought flexibility in frequency coordination for Multi-functional Transport Satellite (MTSAT).

As a result, methods for objectively determining spectrum requirements were adopted, and it was specified that there would be a call for a meeting of the notifying administrations to review the issues if unsatisfactory points were found in the coordination result. Thus, a new frequency coordination procedure was implemented toward the new spectrum that Japan required.

A.I. 1.1	To delete country footnotes or to have country name deleted from footnotes, if no longer required
A.I. 1.2	Enhancing the international regulatory framework
A.I. 1.3	To consider spectrum requirements and possible regulatory actions in order to support the safe operation of UAS
A.I. 1.4	Introduction of new aeronautical mobile (R) service (AM(R)S) systems in the bands 112–117.975 MHz, 960–1164 MHz and 5000–5030 MHz
A.I. 1.5	Worldwide/regional harmonization of spectrum for electronic news gathering (ENG)
A.I. 1.6	Spectrum use by the passive services between 275 GHz and 3000 GHz, and possible procedures for free-space optical-links
A.I. 1.7	Long-term spectrum availability for the aeronautical mobile-satellite (R) service in the bands 1525–1559 MHz and 1626.5–1660.5 MHz
A.I. 1.8	Technical and regulatory issues relative to the fixed service in the bands between 71 GHz and 238 GHz
A.I. 1.9	New digital technologies for the maritime mobile service
A.I. 1.10	Frequency allocation requirements with regard to operation of safety systems for ships and ports and associated regulatory provisions
A.I. 1.11	A primary allocation to the space research service (Earth-to-space) within the band 22.55–23.15 GHz
A.I. 1.12	To protect the primary services in the band 37–38 GHz from interference resulting from aeronautical mobile service operations
A.I. 1.13	Spectrum usage of the 21.4–22 GHz band for the broadcasting-satellite service and the associated feeder-link bands in Regions 1 and 3
A.I. 1.14	Implementation of the radiolocation service in the range 30–300 MHz
A.I. 1.15	Possible allocations in the range 3–50 MHz to the radiolocation service for oceanographic radar applications
A.I. 1.16	Passive systems for lightning detection in the meteorological aids service in the frequency range below 20 kHz
A.I. 1.17	To ensure the adequate protection of mobile service and other services in the band 790–862 MHz in Regions 1 and 3
A.I. 1.18	Radiodetermination-satellite service (space-to-Earth) allocations in the band 2483.5–2500 MHz
A.I. 1.19	Regulatory measures and their relevance, in order to enable the introduction of software-defined radio and cognitive radio systems
A.I. 1.20	Spectrum identification for gateway links for high altitude platform stations (HAPS) in the range 5850–7075 MHz
A.I. 1.21	Primary allocation to the radiolocation service in the band 15.4–15.7 GHz
A.I. 1.22	Effect of emissions from short-range devices on radiocommunication services
A.I. 1.23	Allocation of about 15 kHz in parts of the band 415–526.5 kHz to the amateur service on a secondary basis
A.I. 1.24	Extending existing allocation to the meteorological-satellite service in the band 7750–7850 MHz to the band 7850–7900 MHz
A.I. 1.25	Possible additional allocations to the mobile-satellite service
A.I. 2	To examine the revised ITU-R Recommendations incorporated by reference in the Radio Regulations
A.I. 4	To review the resolutions and recommendations of previous conferences
A.I. 7	Possible changes of procedures for frequency assignments pertaining to satellite networks
A.I. 8.1	Report of the Director of the Radiocommunication Bureau
A.I. 8.1.1	Activities of the Radiocommunication Sector; Issue A: Protection of radiocommunication services against interference from ISM equipment Issue B: Updating of the “Remarks” columns in the Tables of Article 9A of Appendix 30A and Article 11 of Appendix 30 to the Radio Regulations Issue C: Earth observation applications
A.I. 8.1.2	Difficulties or inconsistencies encountered in the application of the Radio Regulations
A.I. 8.1.3	Action in response to Resolution 80 (Rev.WRC-07)
A.I. 8.2	Items for inclusion in the agenda for the next WRC

Fig. 5. WRC-12 agenda items.

### 2.3 Technical and regulatory issues related to the fixed service in the bands between 71 GHz and 238 GHz (A.I. 1.8)

Sharing conditions between fixed service (FS) and passive services such as radio astronomy and the Earth Exploration-Satellite Service (EESS) in the bands between 71 GHz and 238 GHz were considered. There were two conflicting positions—no change to the current RR to promote studies on fixed wireless system (FWS) or the introduction of a mandatory spectrum emission mask to protect passive service—and a compromise was sought. The final agreement was to introduce recommended values for the spectrum mask with revision of Resolution 750. As the footnote concerning mask implementation

allows administrations to continue to use their existing spectrum mask, no modifications to Japan’s regulation are needed. Moreover, study activities at ITU-R have been reinforced because Resolutions 731 and 732, which were the basis of the sharing study, were retained with some revisions.

### 2.4 A primary allocation to the space research service (Earth-to-space) within the band 22.55–23.15 GHz (A.I. 1.11)

New frequency allocation to the space research service (SRS) (Earth-to-space), e.g., SELENE2, was considered under this agenda item. Japan has some existing systems offering FS in the band being considered, such as entrance links to mobile base stations

and subscriber radio.

Spectrum at 22.55–23.15 GHz was newly allocated to SRS (Earth-to-space), which is in line with the Japanese proposal. The operation and development of FS in the band 22.55–23.15 GHz is not constrained because of the very limited number of SRS earth stations in the world and because their locations should be sufficiently far from international borders in accordance with the restriction specified in the relevant footnote.

### **2.5 Possible allocations in the range 3–50 MHz to the radiolocation service for oceanographic radar applications (A.I. 1.15)**

This item treats a proposal to allocate spectrum to oceanographic radars performing sea surface monitoring for wave heights, ocean currents, and large objects' tracks. The need for data to mitigate the effects of disasters, including tsunamis, to observe climate change, and to ensure safe maritime travel led to consideration of a new spectrum allocation for operational use by oceanographic radar networks. Eight frequency bands were newly allocated to the radiolocation service, including the band (24,450–24,600 kHz) proposed by Japan.

### **2.6 Regulatory measures and their relevance, in order to enable the introduction of software-defined radio and cognitive radio systems (A.I. 1.19)**

It was considered whether RR revisions were needed to enable the introduction of software-defined radio (SDR) and cognitive radio (CR) systems, and the conclusion was that no changes were needed. Regarding CR, the RCC (Regional Commonwealth in the Field of Communications) insisted that new WRC Resolutions be produced, while APT (Asia Pacific Telecommunity), CITEL (Inter-American Telecommunication Commission), CEPT (European Conference of Postal and Telecommunications Administrations) were of the view that no such Resolution was needed. Finally, Resolution 956 was suppressed, and a new WRC Recommendation was approved.

### **2.7 Spectrum identification for gateway links for high altitude platform stations (HAPS) (A.I. 1.20)**

Spectrum identification for gateway links for high altitude platform stations (HAPS) in the range 5850–7075 MHz was considered. Two bands, 6440–6520

MHz and 6560–6640 MHz, were identified for the HAPS gateway links in Australia and four African countries for national use. Requisites are to satisfy sharing conditions described in the ITU-R Report to protect existing services and to gain explicit consent from administrations possibly affected by the HAPS gateway links before operation commences. Although Japan has its FWS in the band being considered, there will be no problem if sharing conditions are satisfied.

### **2.8 Possible additional allocations to the mobile-satellite service (A.I. 1.25)**

New spectrum allocation to the mobile-satellite service (MSS) from several candidate bands was considered. Japan tried to avoid allocation to MSS of the nationally allocated bands used for broadcasting and telecommunication services. There was no allocation to MSS under this agenda item, but a new agenda item for WRC-15, to consider a new allocation to MSS in the range 22–26 GHz, was approved.

### **2.9 Items for inclusion in the agenda for the next WRC (A.I. 8.2)**

The agenda items for the next WRC in 2015 (WRC-15) are shown in **Fig. 6**. Among them, the following items were proposed by Japan.

- to consider additional spectrum allocations to the mobile service on a primary basis and identification of additional frequency bands for IMT (International Mobile Telecommunications) and related regulatory provisions, to facilitate the development of terrestrial mobile broadband applications
- to consider possible additional primary allocations to the fixed-satellite service (FSS) (Earth-to-space) of 250 MHz in Region 2 and 300 MHz in Region 3 within the range 13–17 GHz
- to consider a primary allocation to the radiolocation service for automotive applications in the 77.5–78.0 GHz frequency band

In addition, the following agenda items were proposed by other regional organizations or produced from the discussions at RA-12 or WRC-12.

- to examine the results of ITU-R studies on the use of the frequency band 694–790 MHz by the mobile (except aeronautical mobile) service in Region 1 and take the appropriate measures
- to consider the use of frequency bands allocated to the FSS not subject to Appendices 30, 30A and

A.I. 1.1	Additional frequency bands for International Mobile Telecommunications (IMT)
A.I. 1.2	Use of the frequency band 694–790 MHz by the mobile service in Region 1
A.I. 1.3	Broadband public protection and disaster relief (PPDR)
A.I. 1.4	Amateur service on a secondary basis within the band 5250–5450 kHz
A.I. 1.5	Use of frequency bands allocated to the FSS for unmanned aircraft systems (UAS)
A.I. 1.6	To consider possible additional primary allocation:
A.I. 1.6.1	Fixed-satellite service of 250 MHz in the range between 10 GHz and 17 GHz in Region 1
A.I. 1.6.2	Fixed-satellite service of 250 MHz in Region 2 and 300 MHz in Region 3 within the range 13–17 GHz
A.I. 1.7	Use of the band 5091–5150 MHz by the FSS (Earth-to-space)
A.I. 1.8	Earth stations located on board vessels (ESVs)
A.I. 1.9	To consider:
A.I. 1.9.1	Fixed-satellite service in the frequency bands 7150–7250 MHz and 8400–8500 MHz
A.I. 1.9.2	Possibility of allocating the bands 7375–7750 MHz and 8025–8400 MHz to the maritime-MSS
A.I. 1.10	Mobile-satellite service within the frequency range from 22 GHz to 26 GHz
A.I. 1.11	Primary allocation for the Earth exploration-satellite service (Earth-to-space) in the 7–8 GHz range
A.I. 1.12	Extension of the allocation to the EESS (active) in the frequency band 9300–9900 MHz by up to 600 MHz
A.I. 1.13	Possibility of increasing the 5 km distance limitation for the space research service (space-to-space) allocation
A.I. 1.14	Continuous reference time-scale, whether by the modification of UTC or some other method
A.I. 1.15	On-board communication stations in the maritime mobile service
A.I. 1.16	New Automatic Identification System (AIS) to improve maritime radiocommunication
A.I. 1.17	Possible spectrum requirements and regulatory actions to support wireless avionics intra-communications (WAIC)
A.I. 1.18	Primary allocation to the radiolocation service for automotive applications in the 77.5–78.0 GHz frequency band
A.I. 2	To examine the revised ITU-R Recommendations incorporated by reference in the Radio Regulations
A.I. 4	To review the resolutions and recommendations of previous conferences
A.I. 7	Possible changes, and other options of procedures for frequency assignments pertaining to satellite networks
A.I. 8	To delete country footnotes or to have country name deleted from footnotes, if no longer required
A.I. 9	Report of the Director of the Radiocommunication Bureau
A.I. 10	Items for inclusion in the agenda for the next WRC

Fig. 6. WRC-15 agenda items.



Fig. 7. Indication of signed Administrations.

30B for the control and non-payload communications of unmanned aircraft systems in non-segregated airspaces

- to consider the feasibility of achieving a continuous reference time-scale, whether by the modification of UTC or some other method

### 3. Future activities

Most of the revised RR signed by administrations at WRC-12 (**Fig. 7**) will take effect internationally from January 2013. In line with this, Japanese laws and regulations will also be updated and revised in 2012.

As the agenda items for WRC-15 include spectrum allocations to specific systems such as IMT and FSS, it should draw worldwide attention to these matters. The NTT Group will continue to make contributions to the ITU-R and APG (APT Conference Preparatory Group) meetings toward WRC-15.

### References

- [1] ITU-R RA-12.  
<http://www.itu.int/ITU-R/index.asp?category=conferences&rlink=ra-12&lang=en>
- [2] Ministry of Internal Affairs and Communications, “Results of ITU RA-12,” Jan. 2012 (in Japanese).
- [3] ITU-R WRC-12.  
<http://www.itu.int/ITU-R/index.asp?category=conferences&rlink=wr-c-12&lang=en>
- [4] Ministry of Internal Affairs and Communications, “Results of ITU WRC-12,” Feb. 2012 (in Japanese).

**Masashi Nakatsugawa**

Executive Manager, Wireless Access Systems Project, NTT Access Network Service Systems Laboratories.

He received the B.E. degree in electronics and communication engineering and the M.E. degree in electrical engineering from Waseda University, Tokyo, in 1987 and 1989, respectively, and the M.S. degree in electrical engineering from the California Institute of Technology, USA, in 1999. He joined NTT Radio Communication Systems Laboratories in 1989. His research experience includes MMIC circuit design, packaging technology, software-defined radio, and wide-area wireless access systems. From 2010 to 2012, he was a senior manager at the Radio Division, Technical Planning Department, NTT, where he was involved in regulatory and standardization activities for wireless systems. He is currently responsible for the development of fundamental technologies for wireless access systems. He received the 1996 Young Engineer Award from the Institute of Electronics, Information and Communication Engineers (IEICE), and the YRP Award from the YRP (Yokosuka Research Park) R&D Promotion Committee in 2002. He is a member of IEEE, IEICE, and the Japan Society of Applied Physics.

---

## Weather-resistance Tests for Recycled Polyethylene

### Abstract

This article reports on weather-resistance tests performed on recycled plastic materials by the Technical Assistance and Support Center to evaluate the effectiveness of resource-saving technologies. Since the formulation of the NTT Global Environmental Charter in 1991, the NTT Group has been increasingly committed to deploying resource-saving technologies in its telecommunication facilities toward a recycling-oriented society. In 2002, both NTT EAST and NTT WEST began to deploy communication cables using recycled plastic materials collected during facility upgrading and to design facilities so that the communication infrastructure makes a positive contribution to global environment protection efforts.

This is the fourteenth in a bimonthly series on the theme of practical field information about telecommunication technologies. This month's contribution is from the Materials Engineering Group, Technical Assistance and Support Center, Maintenance and Service Operations Department, Network Business Headquarters, NTT EAST.

### 1. Introduction

Communication cables extend for a total of two million kilometers throughout Japan and new cable deployment in conjunction with facility upgrading continues on a daily basis. Plastic materials in communication cables are used for the cable jacket and for the dielectric layer between the signal line and ground line in metallic cable. In particular, polyethylene (PE) is widely used in communication cables because of its high shock resistance, superior electrical insulation properties, and low-loss characteristics as an insulator.

PE is the leading type of plastic produced in Japan (Table 1). There has been much interest in ways of recycling some of the base material from spent PE in order to save resources, and many manufacturers are pursuing the development of PE recycling technologies. The NTT Group has to deal with a huge amount of communication cables, and the use of recycled PE in communication cables could make a big contribution to the creation of a recycling-oriented society from the viewpoint of resource saving. With this in mind, the NTT Group has been promoting the deployment of cables using recycled PE.

### 2. Weather-resistance test for recycled plastic materials

#### 2.1 Test conditions

Many types of communication facilities require long-term reliability of 10 years or more. These include communication cables, which are used for long periods of time after initial installation, so long-term reliability is a requirement. In addition, communication cables must be deployable in a variety of environments including communication buildings, underground tunnels, and outdoor settings. It is generally known that PE deteriorates under ultraviolet light and heat. Thus, when PE is intended to be used for the communication cable jackets, its long-term reliability in an outdoor environment is an important issue.

Before recycled communication cables using recycled PE for their outer jackets are deployed, they are checked to determine whether they pass standard performance tests with respect to weather resistance. However, their weather-resistance characteristics should be checked in real environments when facilities are being studied to ensure that they will exhibit high reliability and when maintenance plans are

Table 1. Plastic production by type.

Unit: 1000 tons

	2000	2005	2010
Polyethylene (PE)	3342	3240	2684
Polypropylene	2721	3063	2467
Vinyl chloride resin	2410	2151	1602
Styrene resin	2024	1734	1265
Polyethylene terephthalate (PET)	699	684	572
Other thermoplastic resins	1561	1787	1463
Thermohardening resins	1457	1286	920
Other resins	233	199	211
Total	14,446	14,145	11,185

Ratio of PE production to total plastic production	23.13%	22.91%	24.00%
--	--------	--------	--------

Source: The Japan Plastics Industry Federation



Fig. 1. Recycled PE samples set up at an outdoor exposure site. The magnified view on the right shows sheen remaining.

being formulated. Weather-resistance testing data is also extremely valuable for facility optimization design work, which is an ongoing endeavor. Consequently, the Technical Assistance and Support Center has been planning outdoor exposure experiments targeting recycled PE in actual environments and is currently conducting a verification experiment on the long-term reliability of cable outer jackets using recycled material. The plan for this verification experiment is outlined below. (In this article, we report on deterioration characteristics for exposure periods up to 7 years.)

- 1) Exposure periods/location: Samples shall be exposed in an outdoor environment at a location in Okinawa for fiscal years 2004–2014 and shall be collected and evaluated 1, 3, 5, 7, and 10 years after installation. The experimental setup for outdoor sample exposure is shown in Fig. 1.
- 2) Evaluation standards and items: A tensile test conforming to in-house standards shall be per-

formed to evaluate tensile strength and elongation.

- 3) Samples: Samples having 0%, 50%, and 100% recycled material shall be prepared for comparison purposes. A sample shall be in the form of a sheet 1.0 mm thick.
- 4) Tensile test: From a sample sheet that has been subjected to the exposure test for a scheduled number of years, No. 3 test specimens conforming to JIS K 6251 shall be punched out and subjected to a tensile test at a speed of 200 mm/min using a high-precision, universal testing machine (Shimadzu Scientific Instruments Autograph AG-X (Fig. 2)). The number of samples per test shall be 5.

## 2.2 Test results (for 7-year test)

This section presents the results of weather-resistance tests obtained to date for samples exposed for several periods up to 7 years. Using the pre-exposure-test characteristics of the samples for reference, we

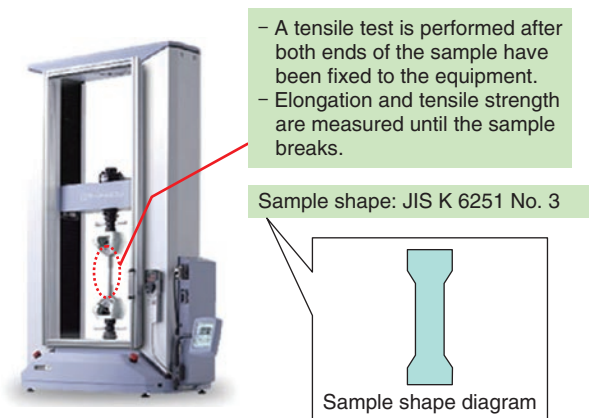

Fig. 2. Tensile test machine and sample shape.

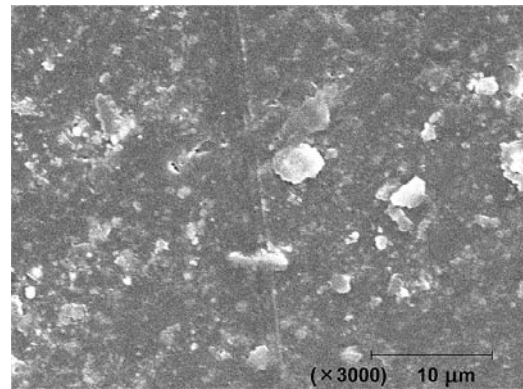

Fig. 3. Surface of recycled PE sample after 7 years of outdoor exposure.

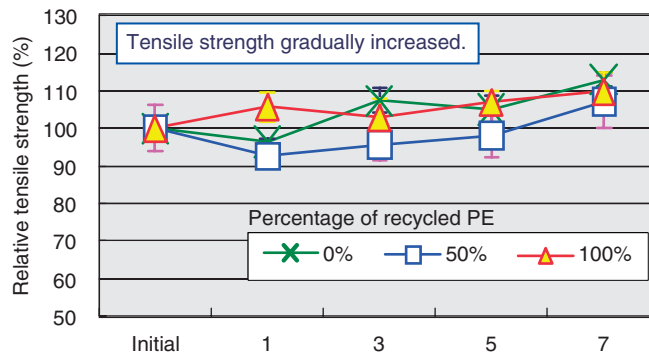

Fig. 4. Change in tensile strength.

examined the changes in these characteristics after the test. Specifically, we took a sample that had been subjected to the exposure test for the specified time period and first made a visual inspection of its surface. We then evaluated the sample’s rate of elongation and tensile strength by means of a tensile test.

- 1) Visual surface inspection: We found that samples collected from the exposure-test site had become distorted from their original shape. We also noticed that they retained their sheen (Fig. 1 (right)) and that no significant traces of ultraviolet-light deterioration were evident. A scanning electron microscopy image of the surface of a sample exposed in an actual outdoor environment for 7 years is shown in **Fig. 3**. The magnification is  $\times 3000$ . While some unevenness could be seen in the sample’s surface, no cracks or similar defects could be observed on the surface despite the long exposure.

- 2) Tensile test: We collected samples exposed for each of the scheduled test periods and subjected them to a tensile test. Results are shown in **Figs. 4 and 5**.

Figure 4 plots the average value and variation (indicated by an error bar) for five samples of the relative fracture strength (as a percentage of the initial value) after each scheduled exposure period. These results show that the tensile strength of the sample PE gradually increased as the sample deteriorated through exposure. This indicates that a sample of this material hardens as a result of deterioration, which is how ordinary PE behaves when left to deteriorate.

Figure 5 plots the change in the magnitude of elongation at sample fracture (as a percentage of the initial value) for each exposure period. The vertical axis shows the relative elongation. The change over the 7-year period shows that the amount of elongation tended to decrease as deterioration progressed. We



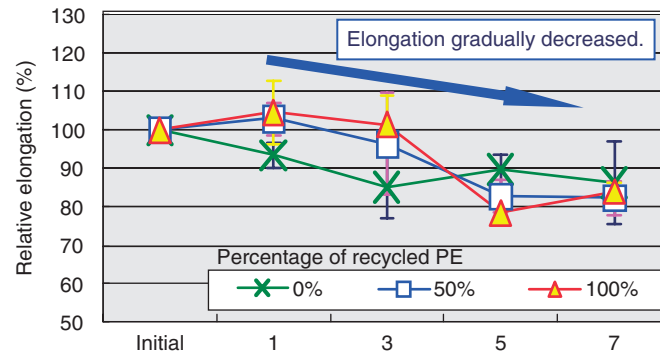

Fig. 5. Change in elongation.

conclude that the material's hardening with deterioration made elongation increasingly difficult, which is the same behavior as shown by ordinary PE. A comparison of sample characteristics for different mixing ratios of recycled materials (0%, 50%, and 100%) showed no substantial observable differences in tensile strength or elongation retention.

Moreover, for all mixing ratios, the elongation rate of freshly produced recycled material (data not shown) sufficiently exceeded the valued specified in the domestic standard for using such material for a communication cable outer jacket (NTT-required elongation rate: 400% or greater).

The above results show that using recycled PE for communication cable outer jackets in an outdoor environment presents no problems in long-term use of at least 7 years.

### 3. Summary

It has been 10 years since NTT EAST and NTT WEST began to use recycled PE in the outer jackets of metal cable used for communication purposes. Fortunately, there have been no field reports of problems with recycled PE, which suggests that the weather-resistance standards applied at the time of

deployment were valid. We think that the data presented in this report reinforces the validity of those standards. Specifically, the results of our study show that recycled PE used in outdoor communication facilities has stable characteristics for at least 7 years in actual environments.

The NTT Group is involved in a variety of activities for reducing environmental load. We think that the straightforward material evaluation described in this report is an important means of judging the validity of such activities and of providing valuable data for improving facility technologies in the future.

### 4. Concluding remarks

We presented the results of weather-resistance tests for recycled PE used in communication cable outer jackets. We hope that the information provided here contributes to the reader's understanding of communication-facility materials. In addition to tests related to the materials introduced here, the Technical Assistance and Support Center is also investigating problems in facilities and equipment with undetermined causes. If you have a problem that cannot be explained, please consult with us at the Technical Assistance and Support Center.

# External Awards

## **GFP2012 Best Innovation Design Paper Award (3rd place)**

**Winners:** Rai Takahashi (Rai Kou), Hiroshi Fukuda, Tai Tsuchizawa, Hidetaka Nishi, Tatsuro Hiraki, and Koji Yamada, NTT Microsystem Integration Laboratories

**Date:** August 31, 2012

**Organization:** IEEE 9th International Conference on Group IV Photonics (GFP2012)

For “Silicon/silica-hybrid delay line interferometer for DPSK demodulation”.

A 1-bit delay line interferometer based on silicon/silica-hybrid waveguides is demonstrated for a differential phase-shift keying (DPSK) demodulator. A 10-Gb/s non-return-to-zero DPSK signal is demodulated with error-free operation in telecommunications bands.

**Published as:** R. Kou, H. Fukuda, T. Tsuchizawa, H. Nishi, T. Hiraki, and K. Yamada, “Silicon/silica-hybrid delay line interferometer for DPSK demodulation,” Proc. of 2012 IEEE 9th International Conference on Group IV Photonics (GFP), pp. 174–176, San Diego, CA, USA.

## **Best Paper Award**

**Winners:** Takuya Otsuka, Takashi Aoki, Eiichi Hosoya, and Akira Onozawa, NTT Microsystem Integration Laboratories

**Date:** September 20, 2012

**Organization:** IEEE Computer Society, MCSoc201

For “An Image Recognition System for Multiple Video Inputs over a Multi-FPGA System”.

A multi-user shared FPGA-based cloud computing platform is presented for an image recognition application with multiple video inputs (FPGA: field programmable gate array). The platform is made of a sea of FPGA devices connected as a hierarchical ring network. The users place IP (Internet protocol) cores called tiles on the platform and connect them together to form a sequence. An architecture featuring a parallel pipeline of tiles and an intra-tile selector network was chosen to let users work their own tile sequences in parallel without causing any interference with other users.

A set of application programming interfaces (APIs) for writing tiles, deleting tiles, and configuring the intra-tile selector network is implemented. With the APIs, the system manipulates the tiles on

FPGAs in response to users’ demands. The platform is suitable for running applications requiring low-latency and high-throughput data-processing capability. A HOG (histograms of oriented gradients) feature extractor and a Real AdaBoost classifier are implemented to perform image recognition.

**Published as:** T. Otsuka, T. Aoki, E. Hosoya, and A. Onozawa, “An Image Recognition System for Multiple Video Inputs over a Multi-FPGA System,” Proc. of 2012 IEEE 6th International Symposium on Embedded Multicore SoCs (MCSoc 2012), Aizu-Wakamatsu, Fukushima, Japan.

## **Outstanding Paper Award**

**Winners:** Dinesh Babu Jayagopi<sup>†1</sup>, Dairazalia Sanchez-Cortes<sup>†1</sup>, Kazuhiro Otsuka<sup>†2</sup>, Junji Yamato<sup>†2</sup>, and Daniel Gatica-Perez<sup>†1</sup>

<sup>†1</sup> Idiap Research Institute

<sup>†2</sup> NTT Communication Science Laboratories

**Date:** October 25, 2012

**Organization:** ACM ICMI2012 (14th ACM International Conference on Multimodal Interaction)

For “Linking Speaking and Looking Behavior Patterns with Group Composition, Perception, and Performance”.

This paper addresses the task of mining typical behavioral patterns from small-group face-to-face interactions and linking them to social-psychological group variables. Towards this goal, we define group speaking and looking cues by aggregating automatically extracted cues at the individual and dyadic levels. Then, we define a bag of nonverbal patterns (bag-of-NVPs) to discretize the group cues. The topics learnt using the Latent Dirichlet Allocation (LDA) topic model are then interpreted by studying the correlations with group variables such as group composition, group interpersonal perception, and group performance. Our results show that both group behavior cues and topics have significant correlations with (and predictive information for) all the above variables. For our study, we use interactions with unacquainted members i.e., newly formed groups.

**Published as:** D. B. Jayagopi, D. Sanchez-Cortes, K. Otsuka, J. Yamato, and D. Gatica-Perez, “Linking Speaking and Looking Behavior Patterns with Group Composition, Perception, and Performance,” Proc. of the International Conference on Multimodal Interaction (ICMI), Santa Monica, USA, 2012.