

COLTRI[®] COMPRESSORS

MADE IN ITALY



USE AND MAINTENANCE MANUAL

MCH-6

High pressure compressor for pure breathing air and technical gases

QUICK GUIDE



WARNING:

- This guide is intended only as a rapid introduction to use of the compressor.
- This guide is not meant to replace the use and maintenance manual.
- This compressor must not be used before reading the entire use and maintenance manual.

Preliminary tasks:

- Position the compressor in the selected area (see section "3.1.1").
- If necessary connect the air intake extension (see section "3.1.2").
- Check the oil level; if the compressor is new fill the oil sump with the oil supplied with the compressor (see section "5.3").
- Check that the cartridge is inside the filter (see chap "5.4");

Bottle refill (see section "4.3"):

- fit the hose connector 1 on the bottle connector 2 (closed) (A);
- open the condensate discharge valve 3 on the separator (B);
- start the compressor (C);
- close the discharge (B);
- open the tank valve 4 (A);
- discharge the condensate every 10-15 minutes of use (B).

When refill is complete:

- switch off the compressor (C);
- close the bottle valve 4 (A);
- open the condensate discharge valve 3 and let all the air bleed out (B);
- disconnect the coupling 1 from the bottle (A).

Maintenance:

- Periodically change the air intake filter (see section "5.2").
- Check the lubricating oil level every 5 hours (see section "5.3").
- Change the lubricating oil every 50 hours (see section "5.3").
- Periodically change the purifier filter cartridge (see section "5.4").
- Discharge the condensate (see section "5.5").
- Check transmission belt tension and if necessary change them (see section "5.6").
- Periodically change the hoses (see section "5.7").

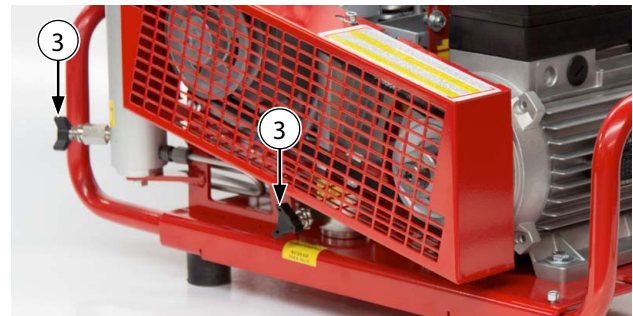
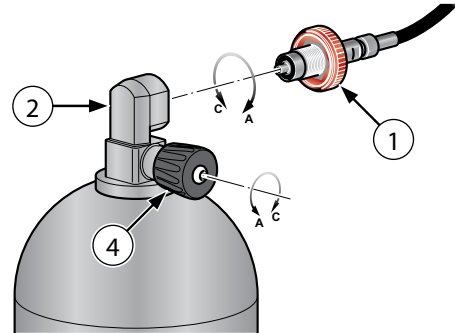

a) Start b) Stop

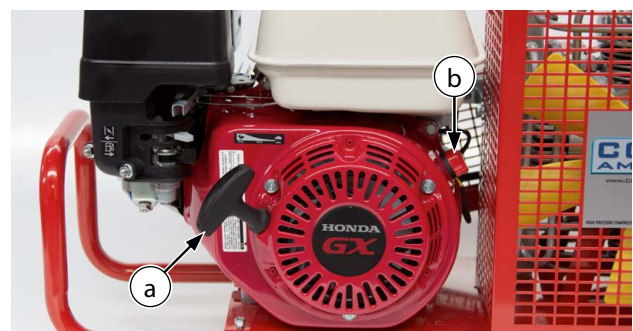
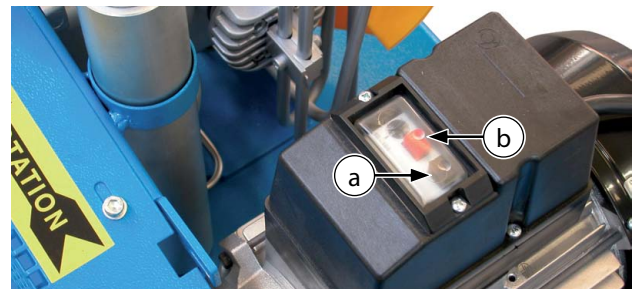

CONTENTS

1 - GENERAL	5
1.1 Warranty	5
1.2 Responsibility	6
1.3 Purpose of the machine	6
1.4 Identification the compressor	7
2 - TECHNICAL DATA	8
2.1 Pressure circuit	10
2.2 Wiring diagram	10
3 - HANDLING AND INSTALLATION	11
3.1 Installation	11
3.1.1 Positioning	11
3.1.2 Air intake extension connection	12
4 - USING THE COMPRESSOR	13
4.1 Checking the safety valves	13
4.2 Starting and shutting down	14
4.2.1 Starting and shutting down with internal combustion engine	14
4.2.2 Starting and shutting down with electric motor	15
4.2.3 Automatic shutdown with pressure switch	15
4.3 Tank refill	16
5 - MAINTENANCE	18
5.1 Scheduled maintenance table	18
5.2 Changing the intake filter	19
5.3 Checking and changing the lubricating oil	20
5.4 Purifier filter	22
5.4.1 Filter cartridge replacement frequency calculation table	22
5.4.2 Changing the purifier filter cartridge	23
5.5 Condensate discharge	24
5.6 Transmission belt	25
5.6.1 Checking transmission belt tension / changing belts	25
5.7 Changing the flex hose	26

1 - GENERAL

1.1 WARRANTY



IMPORTANT: The materials supplied by AEROTECNICA COLTRI SpA are covered by a 1 year warranty, the validity of which begins when the compressor is put into service as proven by the delivery document.

AEROTECNICA COLTRI SpA shall repair or replace those parts it acknowledges to be faulty during the warranty period.

In replacing the faulty part AEROTECNICA COLTRI SpA shall not be liable for any other expenses sustained by the dealer or his customer such as presumed damage (present or future), lost earnings or fines.

Routine and unscheduled maintenance must be carried out in compliance with the instructions contained in this manual. Should the required work not be covered by the manual or assistance be required you are advised to contact AEROTECNICA COLTRI SpA in writing, even where agreements have already been made on the phone. AEROTECNICA COLTRI SpA cannot be held liable for any delays or failure to execute work. AEROTECNICA COLTRI SpA cannot be held liable for any damage or malfunctions caused by work carried out on the compressor by unauthorised personnel.

AEROTECNICA COLTRI SpA guarantees that its compressors are free from defects design, workmanship and the used materials for a period of 1 year starting from the date of delivery of the compressor; should the customer note any flaws and/or defects he must report them, in writing, to AEROTECNICA COLTRI SpA within 8 days of their discovery otherwise the warranty shall be rendered null and void.

The warranty only covers flaws and faults that occur where the compressor is used properly in compliance with the instructions contained in this manual and where periodic maintenance is carried out.

The warranty does not cover faults caused by improper use of the compressor, exposure to atmospheric agents (rain etc.) or damage during transport; all materials subject to wear and those subject to periodic maintenance are not covered by the warranty and are to be paid for by the customer in full; in any event the warranty is rendered null and void if the compressor is tampered with or if work is carried out on it by personnel who have not been authorised by AEROTECNICA COLTRI SpA.

A compressor that has been acknowledged as faulty on account of flaws in design, workmanship or used materials shall be repaired or replaced free of charge by AEROTECNICA COLTRI SpA at its plant in San Martino della Battaglia (BRESCIA); costs regarding transport, delivery of spare parts and any materials subject to wear shall be met by the customer.

Should warranty-covered work need to be carried out on the customer's premises, travel and accommodation costs for personnel sent by AEROTECNICA COLTRI SpA. shall be met by the customer.

The act of taking delivery of machines and/or faulty components or the sending of technicians to assess the presumed defects and/or flaws reported by the customer does not in itself imply acknowledgement that the defect is covered by warranty.

Repairs and/or replacements made by AEROTECNICA COLTRI SpA during the warranty period do not in any way prolong the latter itself.

Acknowledgement that a defect is covered by warranty does not in itself mean that AEROTECNICA COLTRI SpA is in any way liable to award compensation.

AEROTECNICA COLTRI SpA cannot be held liable for any other direct or indirect damages imputable to compressor defects and flaws (loss of production or earnings etc.) except in cases where serious negligence is demonstrated.

1.2 RESPONSIBILITY

AEROTECNICA COLTRI SpA considers itself exonerated from any responsibility or obligation regarding injury or damage caused by:

- failure to observe the instructions contained in this manual that concern the running, use and maintenance of the compressor;
- violent actions or incorrect manoeuvres during use or maintenance of the compressor;
- modifications made to the compressor without prior written authorisation from AEROTECNICA COLTRI SpA;
- incidents beyond the scope of routine, proper use of the compressor.

In any case, should the user impute the incident to a defect of the compressor, he/she must demonstrate that the damage has been a major and direct consequence of this "defect".



WARNING: Maintenance and repairs must only be carried out using original spare parts. AEROTECNICA COLTRI SpA cannot be held liable for any damages caused by failure to observe this rule. The compressor is guaranteed as per the contractual agreements made at the time of sale. Failure to observe the regulations and instructions for use contained in this manual shall render the warranty null and void.

1.3 PURPOSE OF THE MACHINE



DANGER: The compressor may be used together with Nitrox mixers up to a maximum of 40% oxygen and only with certified systems that feature an alarm system and that prevent the introduction of oxygen percentages above the permitted maximum and/or incorrect mixes.



IMPORTANT: AEROTECNICA COLTRI compressors provide breathable air at high pressure in compliance with EN12021 air quality requisites.

The compressors mod. MCH-6 have been designed and built for the purpose of obtaining excellent quality breathing air by drawing it from the surrounding environment. The air, which must be free from any harmful fumes, is passed through an intake filter and, after the pumping and filtration cycle, is stored in bottles constructed to contain air at high pressure.

The compressor can also be used to obtain other non-breathable gases for industrial use such as:

- Nitrogen
- Helium
- Nitrox 40% max O₂

Any other use is inappropriate: the manufacturer cannot be held liable for any personal injury or damage to objects / the machine itself caused by improper use.



DANGER:

- Use only tested, certified bottles: do not exceed the working pressure indicated on them.
- Aspirate unpolluted air.
Use the compressor in areas free from dust, risk of explosion, corrosion and fire.
- It is forbidden to use the compressor with an internal combustion engine indoors.
Make sure that air intakes are a long way from fume exhausts.
- Improper use could have serious consequences for the user .
- Do not disconnect the hose from the fittings or the clamp when it is under pressure.
- Drain the condensate regularly as illustrated in section "5.5 Condensate discharge".
- Change the air purification filters regularly as described in section "5.4.2 Changing the purifier filter cartridge".
- The power lead plug must be disconnected:
 - if there is a problem during use
 - before carrying out any cleaning or maintenance tasks.
- Never pull the plug out by tugging the lead. Make sure the lead is not bent at a sharp angle and that it does not rub against any sharp edges. Use of extensions is not recommended.



DANGER:

- Never run the compressor when:
 - the power lead is damaged;
 - there is evident damage;
 - the covers/guards are removed.
- All routine and unscheduled maintenance tasks must be carried out with the compressor at standstill, the electrical power supply disconnected and the pumping circuit depressurised.
- After switching off the compressor wait about 30 minutes before carrying out any maintenance tasks so as to prevent burns.
- The high pressure flex hose that connects to the bottle (also called the refill hose) must be in good condition, especially in the areas near the fittings.
The plastic sheath that covers the pipe must not show any signs of abrasion otherwise damp could get in, corrode the steel braid and weaken it.
The hose must be changed periodically (yearly) or when it shows signs of wear.
Failure to observe this rule could seriously endanger the users' safety.
Make sure the minimum bending radius of the hose is no less than 250 mm.

To ensure maximum working efficiency, AEROTECNICA COLTRI has constructed the compressor with carefully selected components and materials. The compressor is tested prior to delivery. Continued compressor efficiency over time will also depend on proper use and maintenance as per the instructions contained in this manual.

All the components, connections and controls used in its construction have been designed and built to a high degree of safety so as to resist abnormal strain or in any case a strain greater than that indicated in the manual. Materials are of the finest quality; their introduction and storage in the company and their utilisation in the workshop are controlled constantly so as to prevent any damage, deterioration or malfunction.



DANGER:

- Before carrying out any work on the compressor each operator must have a perfect understanding of how the compressor works, know how to use the controls and have read the technical information contained in this manual.
- It is forbidden to use the compressor under conditions / for purposes other than those indicated in this manual and AEROTECNICA COLTRI cannot be held liable for breakdowns, problems or accidents caused by failure to observe this rule.
- Check that the fittings provide a proper seal by wetting them with soapy water: eliminate any leaks.
- Do not attempt to repair high pressure hoses by welding them.
- Do not empty the bottles completely, not even during winter storage, so as to prevent damp air getting in.
- It is forbidden to tamper with, alter or modify, even partially, the systems and equipment described in this instruction manual, especially as safety guards and safety symbols are concerned.
- It is also forbidden to carry out work in any way other than that described or to neglect the illustrated safety tasks.
- The safety information and the general information given in this manual are highly important.

1.4 IDENTIFICATION THE COMPRESSOR

Each compressor has an identification label attached to its frame.

AEROTECNICA COLTRI S.p.A.

Via Dei Colli Storici 177
25010 DESENZANO DEL GARDA (BRESCIA)
WWW.COLTRISUB.IT - MADE IN ITALY



MODEL	MCH-6		
TYPE	SC000000		
S/N	000	NR. MON.	000
YEAR	2014		
MOTOR	HONDA		
POWER	3,6kW	Lwa	75 db

2 - TECHNICAL DATA

	STANDARD		COMPACT	
	MCH-6/SH	MCH-6/SH EU	MCH-6/SH	MCH-6/SH EU COMPACT
Engine Petrol	Honda	Honda EU	Honda	Honda EU
Engine power (kW)	3,6	3,6	3,6	3,6
Engine power (Hp)	4,8	4,8	4,8	4,8
Engine rpm (giri/min)(rpm)	3600	3000	3600	3000
Pumpin Unit (giri/min)(rpm)	2800	2350	2800	2350
Working pressure (bar)	200-225-300-330			
Working pressure (PSI)	2900-3200-4300-4700			
Delivery rate (l/min)	100	90	100	90
Delivery rate (m ³ /h)	6	5,4	6	5,4
Delivery rate (CFM)	3,5	3,2	3,5	3,2
Refill time 10l / 0-200bar (min)	20	22	20	22
Noise level Lwa (dB)	80,5	75	80,5	75
Dry weight (Kg)	37	38,5	47,3	48,8
Dry weight (lb)	81,6	84,9	104	107,5
Dimensions (mm)	780x350x320		730x470x370	
Dimensions (inches)	30,7x13,7x12,5		28,7x18,5x14,5	

	MCH-6/SR	MCH-6/SR COMPACT
Engine Petrol	Robin-Subaru	
Engine power (kW)	4,2	
Engine power (Hp)	5,6	
Engine rpm (giri/min)(rpm)	4000	
Pumpin Unit (giri/min)(rpm)	2800	
Working pressure (bar)	200-225-300-330	
Working pressure (PSI)	2900-3200-4300-4700	
Delivery rate (l/min)	100	
Delivery rate (m ³ /h)	6	
Delivery rate (CFM)	3,5	
Refill time 10l / 0-200bar (min)	20	
Noise level Lwa (dB)	81,9	
Dry weight (Kg)	37	54,8
Dry weight (lb)	81,6	120,8
Dimensions (mm)	780x350x320	730x470x370
Dimensions (inches)	30,7x13,7x12,5	28,7x18,5x14,5

	MCH-6/EM			MCH-6/EM COMPACT			MCH-6/EM COMPACT (3kW)
Electric Engine	Single-phase						
Engine power (kW)	2,2			2,2			3
Engine power (Hp)	3			3			4
Engine rpm (giri/min)(rpm)	2800	3400		2800	3400		2800
Voltage (V)	230	115	230	230	115	230	230
Frequency (Hz)	50	60	60	50	60	60	50
Absorption (A)	14	29	14	14	29	14	28
Pumpin Unit (giri/min)(rpm)	2250			2250			2800
Working pressure (bar)	200-225-300-330			200-225-300-330			200-225-300-330
Working pressure (PSI)	2900-3200-4300-4700			2900-3200-4300-4700			2900-3200-4300-4700
Delivery rate (l/min)	80			80			100
Delivery rate (m³/h)	4,8			4,8			6
Delivery rate (CFM)	2,8			2,8			3,5
Refill time 10l / 0-200bar (min)	25			25			20
Noise level Lwa (dB)	91			91			95
Dry weight (Kg)	39,5			57,1			57,1
Dry weight (lb)	87			125,8			125,8
Dimensions (mm)	650x350x390			730x470x370			730x470x370
Dimensions (inches)	25,5x13,7x15,3			28,7x18,5x14,5			28,7x18,5x14,5

	MCH-6/ET				MCH-6/ET COMPACT			
Electric Engine	Three-phase							
Engine power (kW)	2,2				2,2			
Engine power (Hp)	3				3			
Engine rpm (giri/min)(rpm)	2800		3400		2800		3400	
Voltage (V)	230	400	230	400	230	400	230	400
Frequency (Hz)	50	50	60	60	50	50	60	60
Absorption (A)	11,5	6,7	11,5	6,7	11,5	6,7	11,5	6,7
Pumpin Unit (giri/min)(rpm)	2800				2800			
Working pressure (bar)	200-225-300-330				200-225-300-330			
Working pressure (PSI)	2900-3200-4300-4700				2900-3200-4300-4700			
Delivery rate (l/min)	100				100			
Delivery rate (m³/h)	6				6			
Delivery rate (CFM)	3,5				3,5			
Refill time 10l / 0-200bar (min)	20				20			
Noise level Lwa (dB)	95				95			
Dry weight (Kg)	39				56,7			
Dry weight (lb)	85				125			
Dimensions (mm)	650x350x390				730x470x370			
Dimensions (inches)	25,5x13,7x15,3				28,7x18,5x14,5			

2.1 PRESSURE CIRCUIT

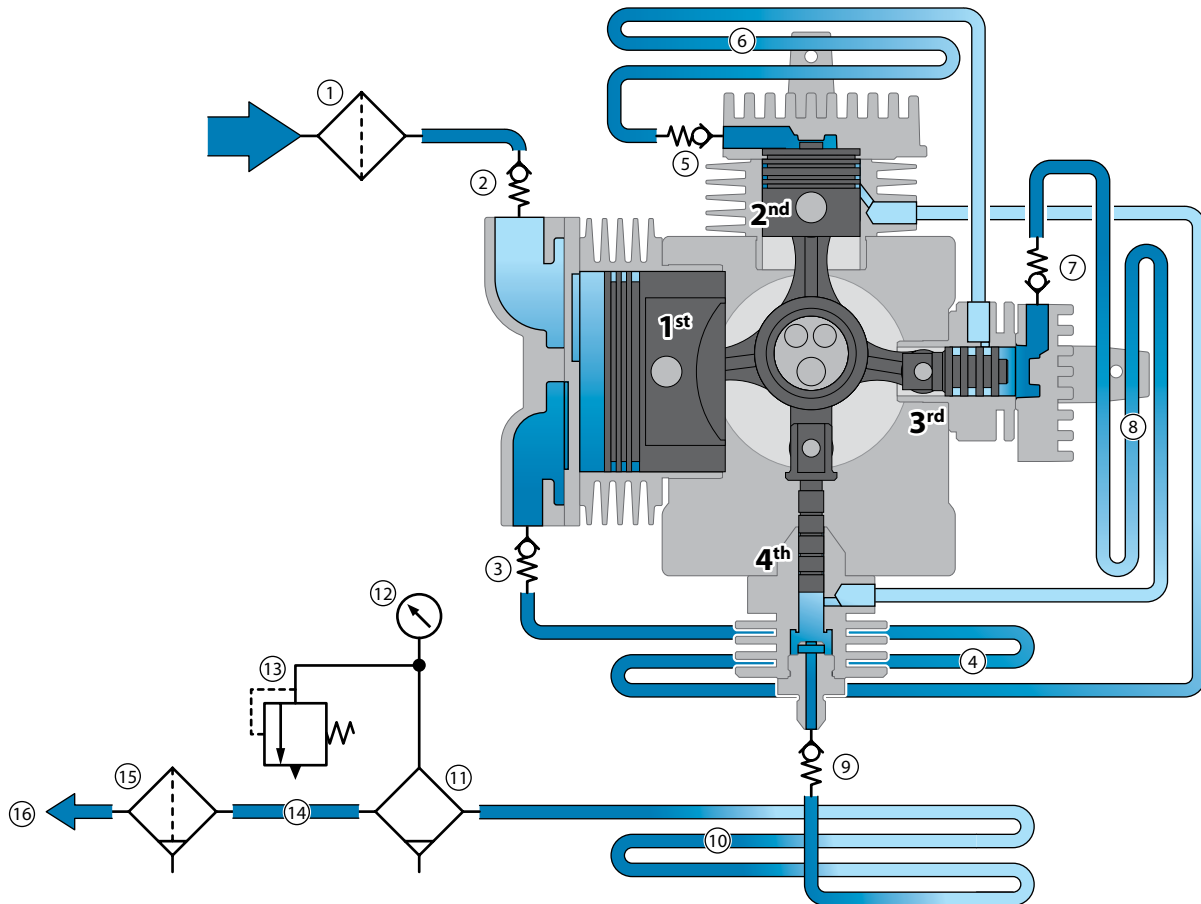

- | | |
|---|---|
| 1 Intake filter | 9 Outlet valve 4 th stage |
| 2 Intake valve 1 st stage | 10 Final cooling pipe |
| 3 Outlet valve 1 st stage | 11 Condensate separator |
| 4 Cooling pipe 1 st -2 nd stage | 12 Pressure gauge |
| 5 Outlet valve 2 nd stage | 13 Safety valve |
| 6 Cooling pipe 2 nd -3 rd stage | 14 Cooling pipe separator/ filter |
| 7 Outlet valve 3 rd stage | 15 Active carbon air filter/molecular sieve |
| 8 Cooling pipe 3 rd -4 th stage | 16 Flex hose |

2.2 WIRING DIAGRAM

MCH-6/EM	
SCHEMA NUMERO	: 09-00014
Numero Fasi e Frequenza	: 1P+N+T 50/60HZ
Tensione Nominale impianto	: 230VAC
Tensione Circuiti di comando	: 230VAC
Tensione Circuiti di segnale	:
Potenza Totale Impianto	:
Corrente Pieno Carico	:
Corrente Carico Maggiore	:
Potere di Interruzione	:
Grado di protezione	: IP54

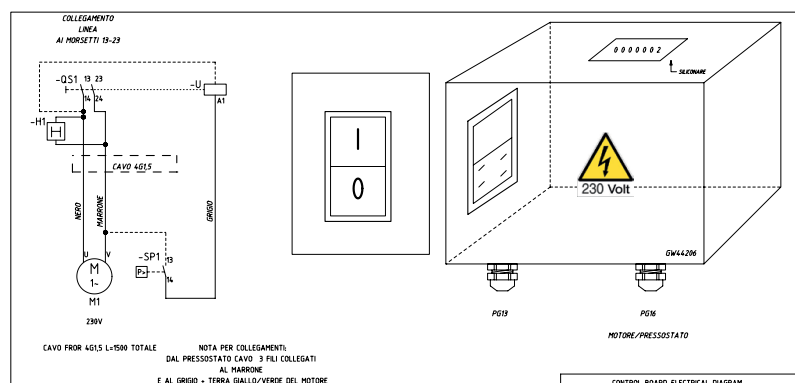

3 - HANDLING AND INSTALLATION

3.1 INSTALLATION



WARNING: Before proceeding with the installation tasks described below, read Chapter 3 "SAFETY REGULATIONS" carefully.

3.1.1 Positioning

- Position the compressor in the designated area and check it is level. For compressor dimensions please consult section "2 Technical data".
- Check that the area in which the compressor is to be positioned is adequately ventilated: good air exchange (more than one window), no dust and no risk of explosion, corrosion, fire and absence of harmful or toxic fumes and gases.
- If ambient temperatures exceed 45°C air conditioning will be necessary.
- Position the compressor no closer than 1 m to surrounding walls; the gap between compressor and ceiling should be at least 1.5 m. These distances ensure proper compressor operation and proper cooling of the pumping unit.
- Make sure that lighting in the area is sufficient to identify every detail (such as the writing on the info labels); use artificial lighting where daylight is on its own insufficient.

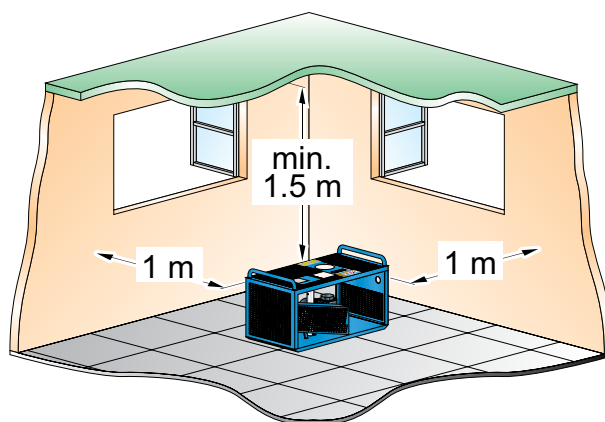
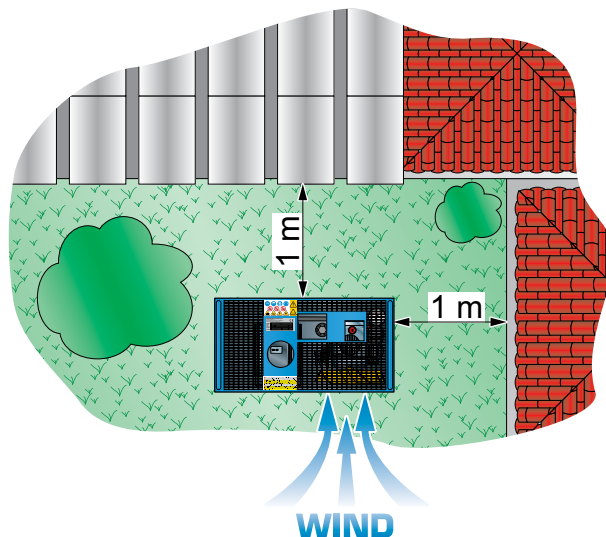

WARNING: Compressors with internal combustion engines must only be installed outdoors.

3.1.2 Air intake extension connection

If the compressor is installed in an area without the necessary ventilation requisites described in section 3.1.1 "Positioning", it will be necessary to install an air intake extension leading in from outdoors or a place with the cited ventilation requisites.

- The extension, supplied as an optional, must be connected to the intake connector.
- Remove the intake filter (a)
- Attach the fitting (b)
- Connect the extension pipe (c) to the fitting (b).
- Fit the intake filter (a) on the other end of the extension pipe.
- Position the end of the extension with the air intake filter in a properly ventilated area sheltered from weather and exhaust fumes.
- Point the air intake against the wind.
- Check that there are no kinks or breaks along the pipe. If it is damaged replace it.

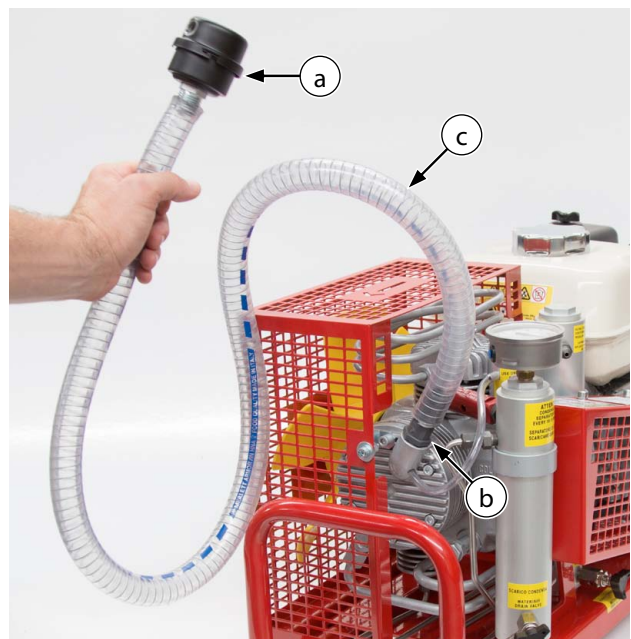
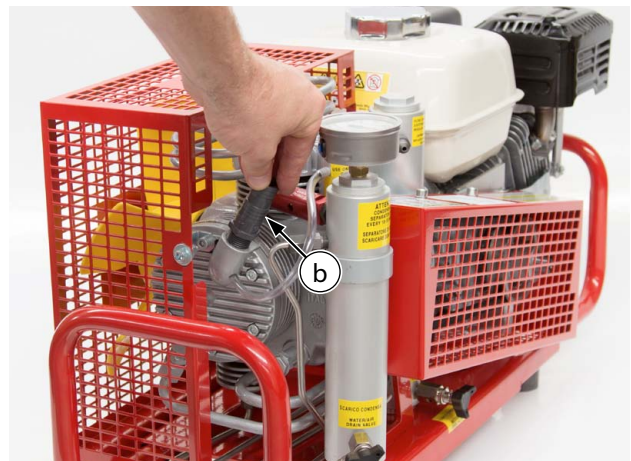
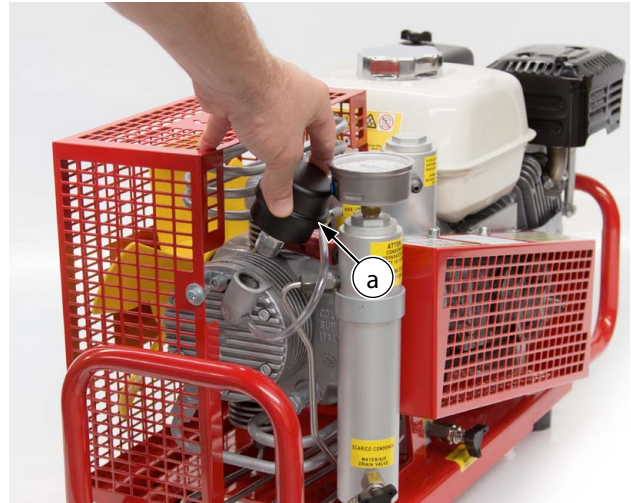













WARNING: Use only a flexible pipe with internal steel braiding reinforcement so as to prevent kinks and a consequent reduction of cross-section.
Do not aspirate harmful gases or exhaust fumes.

4 - USING THE COMPRESSOR

4.1 CHECKING THE SAFETY VALVES

The final safety valve protects bottles from being filled with air at too high a pressure; the valve setting is made at the time of testing the compressor.

The safety valve are pre-adjusted to:

Nominal Operating Pressure	Sticker	SAFETY VALVE	
		without pressure switch	with pressure switch
200 bar 2900 PSI	 Cod: ADESIVO/200	 Cod:6-05-015/2/200	 Cod:6-05-015/2/225
225 bar 3200 PSI	 Cod: ADESIVO/225	 Cod:6-05-015/2/225	 Cod:6-05-015/2/250
300 bar 4300 PSI	 Cod: ADESIVO/300	 Cod:6-05-015/2/300	 Cod:6-05-015/2/330
330 bar 4700 PSI	 Cod: ADESIVO/330	 Cod:6-05-015/2/330	



IMPORTANT:

Tampering with the safety valve to increase the pressure setting is strictly forbidden. Tampering with the safety valve can seriously damage the compressor, cause serious injury to personnel and renders the warranty null and void.

Should the safety valve fail to work properly contact the AEROTECNICA COLTRI assistance service.



DANGER: The safety valves must be replaced every 5 years.

4.2 STARTING AND SHUTTING DOWN

4.2.1 Starting and shutting down with internal combustion engine



IMPORTANT: These tasks must be carried out by qualified personnel who have been trained to use the compressor.

Before starting the compressor read the attached engine use and maintenance manual carefully.

Before starting the engine open the condensate discharge points to prevent a "strained" start.

- shift the fuel lever (a) to ON.
- if the engine is cold shift the air lever (b) to the closed position.
- if the engine is hot the choke (b) must be in the open position.
- shift the accelerator lever (c) about a 1/3 of the way from its minimum position.
- turn the shutdown switch to the ON position.
- gently pull the starter handle (d) until the cord is taut then tug it sharply.
- re-accompany the handle gently back to its original position to prevent damage to the start mechanism.
- repeat the procedure if necessary.
- if the air lever was in the closed position at the start gradually shift it to the open position as the engine warms up.
- to stop the engine in the event of an emergency turn the shutdown switch (e) to the OFF position.
- to stop the engine under routine working conditions shift the accelerator lever to MIN.
- turn the shutdown switch (e) to the OFF position.
- shift the fuel valve lever (a) to OFF.

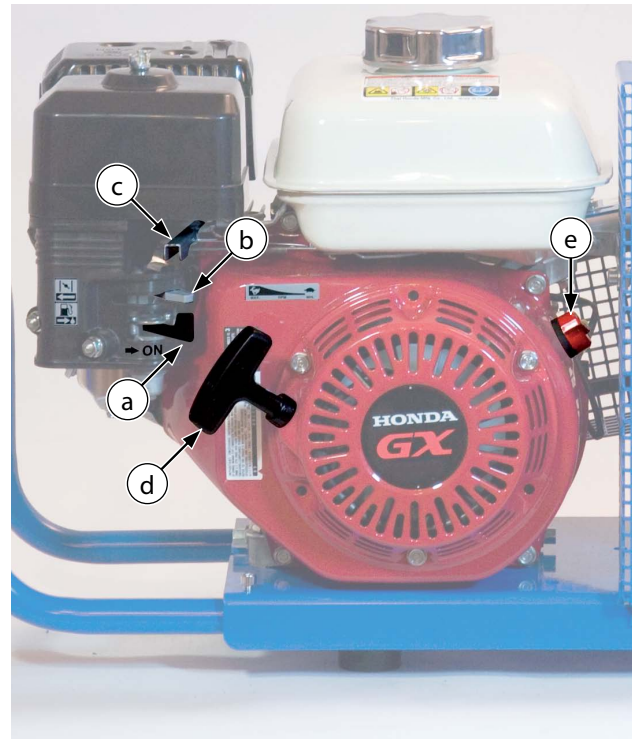

WARNING: Carbon monoxide is a toxic gas: Breathing it can cause loss of consciousness and death. Avoid areas or actions that will expose people to carbon monoxide.



IMPORTANT: When using the compressor with a petrol or diesel combustion engine the rotation speed of the engine must be to swing of accelerator level or with the engine not to a minimum.

4.2.2 Starting and shutting down with electric motor

 **IMPORTANT:** These tasks must be carried out by qualified personnel who have been trained to use the compressor.

Before starting the engine open the condensate discharge (c) points to prevent a “strained” start.

- Check the voltage and that there is a proper earth contact.
- connect the compressor up to the mains power supply.
- press the start pushbutton (a), ON position.
- close the condensate discharge points.

To switch the motor off again press the start pushbutton (b), OFF position (red pushbutton).

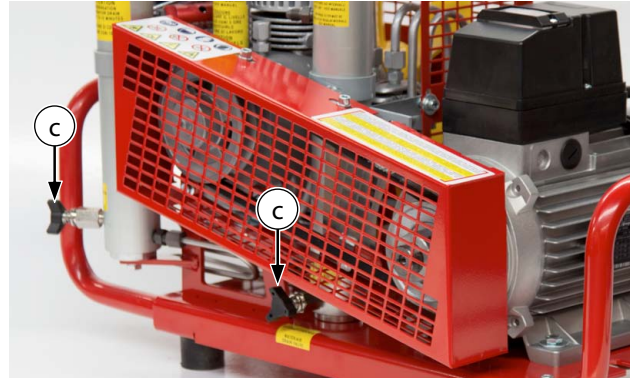

MCH-6/EM

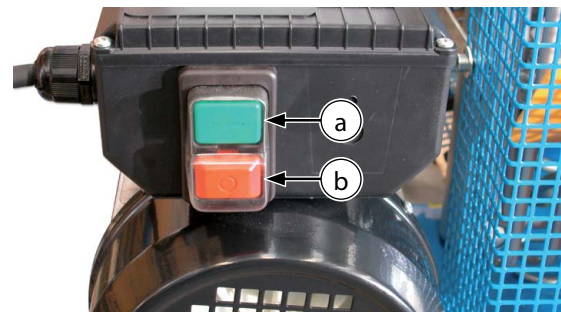

MCH-6/ET

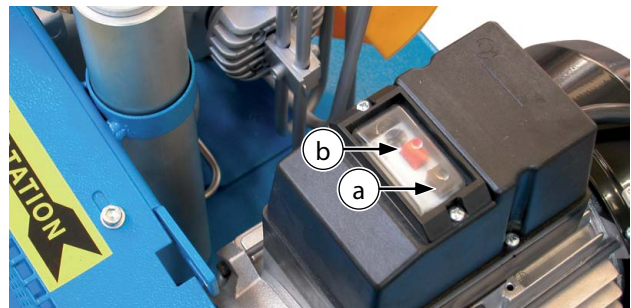

 **IMPORTANT:** For models with three-phase electric motor check that the direction of rotation of the electric motor is as indicated by the arrow on the cover.

4.2.3 Automatic shutdown with pressure switch

The compressor can be equipped with a pressure switch (a) so that it shuts down automatically when it reaches the pressure set by the manufacturer.

When the set pressure is reached the compressor stops.

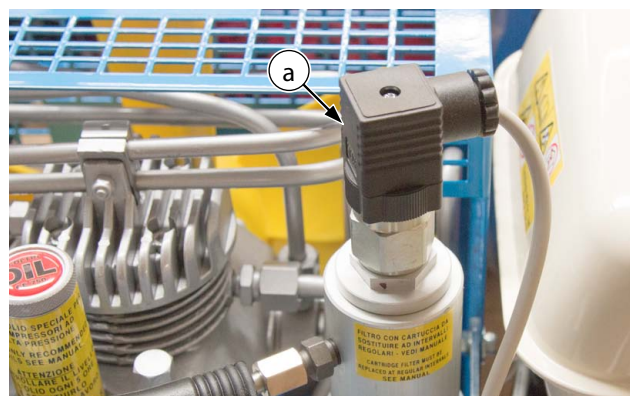

4.3 TANK REFILL



IMPORTANT: During refill the operator must be in the work area.



WARNING: During bottle refill those not involved in the refill procedure must maintain a safety distance of at least 3 metres. Also, it is forbidden to disconnect the hoses from the fittings or the fill valve while the machine is under pressure.



IMPORTANT: If an emergency situation arises during refill shut down the compressor immediately (see "4.2 Starting and shutting down").

The compressor is nevertheless equipped with a safety system that shuts it down automatically when:

- The pressure setting on the pressure switch has been reached.
- The electrical power supply is temporarily cut.
- The electric motor overload device is tripped.

Following an emergency shutdown always make sure the cause of the emergency has been eliminated before proceeding with another refill.



WARNING: Use only tested bottles (as proven by a test stamp and/or certificate).

The working and bottle refill pressures are shown on the bottles themselves.

It is forbidden to refill them at a pressure greater than that indicated.

The available bottle refill connectors are:

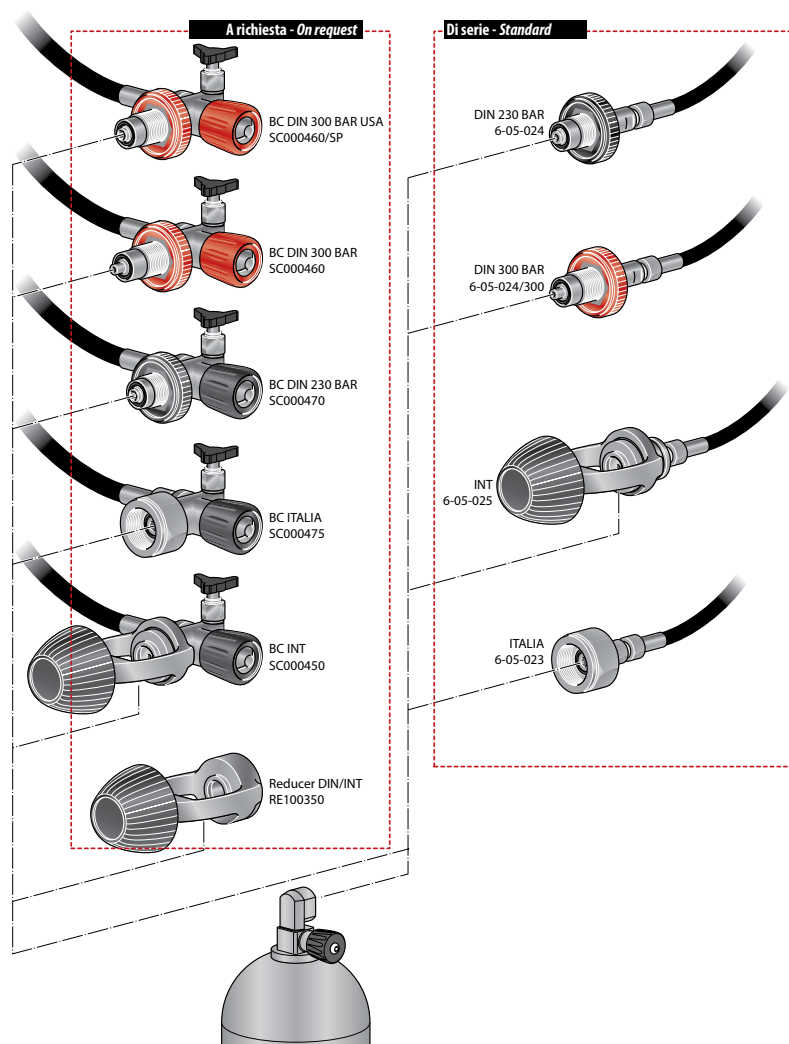

To refill bottles with standard connectors (1):

- Fit the hose connector (g) to the bottle valve (b).
- Screw in the fixing knob (h) until it is completely tightened.
- Start the compressor.
- Open the valve (e) by rotating it anticlockwise.
- When the refill has been completed shut the compressor down.
- Close the valve (e) by rotating it clockwise.
- Open the condensate drain valves (i) (see "7.9 Condensate discharge") until all the residual air in the compressor has been expelled.
- Unscrew the fixing knob (h) by rotating it anticlockwise.
- Disconnect the bottle coupling.

To refill bottles with BC connectors (2):

- Fit the hose connector (a) to the bottle valve (b).
- Screw in the fixing knob (c) until it is completely tightened.
- Check that the bleed valve (f) is closed by rotating it clockwise.
- Open the valve (d) by rotating it anticlockwise.
- Start the compressor.
- Open the valve (e) by rotating it anticlockwise.
- When the refill has been completed shut the compressor down.
- Close valves (d) and (e) by rotating them clockwise.
- Open the bleed valve (f) by rotating it anticlockwise until all the residual air in the fitting has been expelled.
- Unscrew the fixing knob (c) by rotating it anticlockwise
- Disconnect the bottle coupling.

1

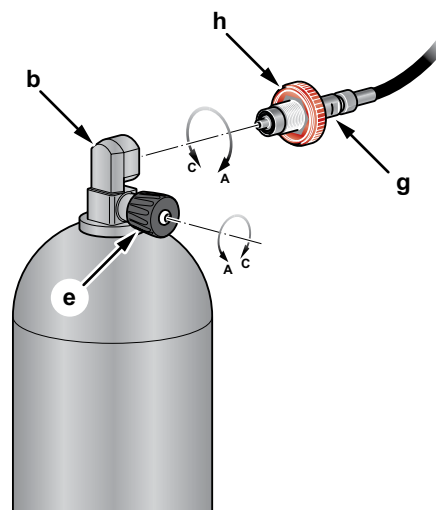

2

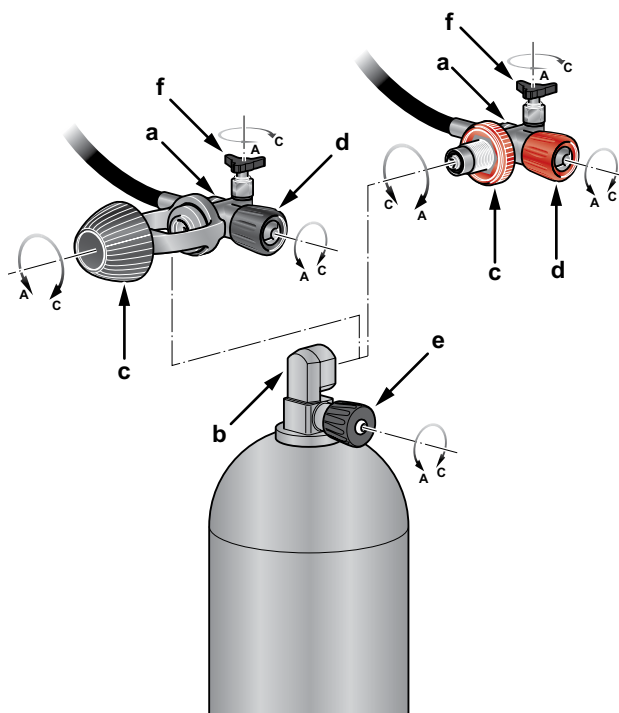

5 - MAINTENANCE

5.1 SCHEDULED MAINTENANCE TABLE

Maintenance	Before every refill	Hours												Yers				
		5	10	25	50	100	250	500	1000	1500	2000	3000	4000	1	2	3	4	5
Intake filter				○	●									●				
Lubricating oil	○	○		●										●				
Main functions check				○														
Belt wear and tension			○				●											
1 st , 2 nd , 3 rd stage valves						○	●											
4 th stage valves						○	●											
HP water/oil separator					○						●							●
Cuerpo filtro HP					○						●							●
1 st , 2 nd , 3 rd stage segments							●											
4 th stage							●											
Check and replace HP flex hoses			○					●										●
Fitting/hose leak					○													
General check-up					○													
Pumping unit, general overhaul								○										
Safety valve								●										●

○ = Checking and cleaning ● = Change



IMPORTANT: Maintenance interval times are indicative only and may vary according to the conditions under which the compressor is used.

5.2 CHANGING THE INTAKE FILTER



DANGER: Do not carry out these tasks if the compressor has only just shut down; wait for the compressor to cool.

All maintenance work must be carried out with the compressor OFF and the power supply lead unplugged from the mains socket.

After putting the compressor into service the intake filter must be changed after the first 50 working hours. The air filter must then be changed every 100 working hours or annually.

To change the filter proceed as follows:

- turn the air filter cover (a) by rotating it clockwise;
- remove the air filter cartridge (b);
- replace the cartridge with a new one;
- re-close the cover (a): screw it back on anticlockwise.

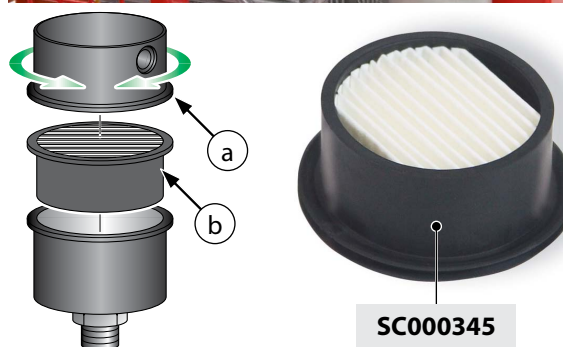
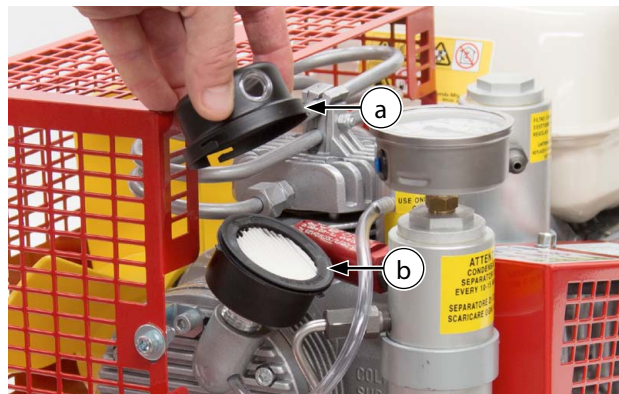

IMPORTANT: If the compressor is used in a dusty environment the filter change interval should be reduced to every 50 hours.

5.3 CHECKING AND CHANGING THE LUBRICATING OIL

After putting the compressor into service the lubricating oil must be changed after the first 5 working hours. The lubricating oil must be changed every 50 hours working hours or annually.



IMPORTANT: The compressor must be placed on a solid surface with a tilt of no more than 5°.



DANGER: Do not carry out these tasks if the compressor has only just shut down; wait for the compressor to cool.

Any oil spilt during the oil change could cause personnel to slip; wear protective garments and anti-slip footwear and remove any traces of oil immediately.

Both oil is classified as special wastes and must therefore be disposed of in compliance with the anti-pollution laws in force.

All maintenance work must be carried out with the compressor OFF and the power supply lead unplugged from the mains socket.

Oil table	
Sump capacity (litres)	0,3
Recommended oils	COLTRI OIL CE750 - CHEMLUBE 751 - ANDEROL 755



SC000430
PETROL AND DIESEL
ENGINE OIL



SC000496
PUMPING GROUP OIL



SC000495
PUMPING GROUP OIL

Checking the oil level

The oil level must be checked every 5 working hours of the compressor.

The oil level must be between the minimum and the maximum shown on the dipstick (a).

If the oil level is above the maximum level:

- position a recipient under the drain valve (b) so that the oil flows into the exhausted oil recipient;
- open the push-lock plug (c);
- open the drain valve (b) and let the oil flow out until the oil level returns within the max. and min. limits shown on the dipstick (a);
- close the drain valve (b).

If the oil level is below the minimum level:

- top up with oil until the level returns within the max. and min. limits on the dipstick (a);
- close the top-up plug (c) by exerting a slight pressure on it.

Changing the lubricating oil

The lubricating oil must be changed after the first 5 working hours (running in) then every 50 working hours or annually.

To change the oil proceed as described:

- position a recipient under the drain plug (b) so that the oil flows into the exhausted oil recipient (recipient capacity of at least 1 litre required);
- remove the push-lock plug (c);
- open the plug (b) and let all the oil flow out;
- close the drain plug (b);
- open the air vent (d);
- fill the oil sump with 0.3 litres of oil from top oil plug (see "5.3 Oil table");
- close the air vent (d);
- close the oil top-up plug (c);
- switch on the compressor and run it depressur area for 30 seconds;
- switch off the compressor and wait 5 minutes;
- check the oil level (a); if it is not between the min. and max. limits on the dipstick (a) proceed with the tasks described in paragraph "Checking the oil level".

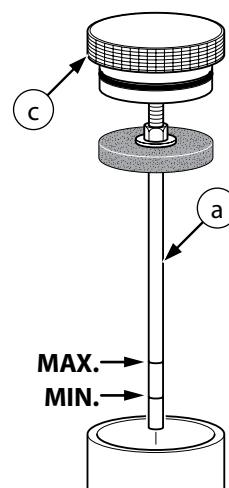
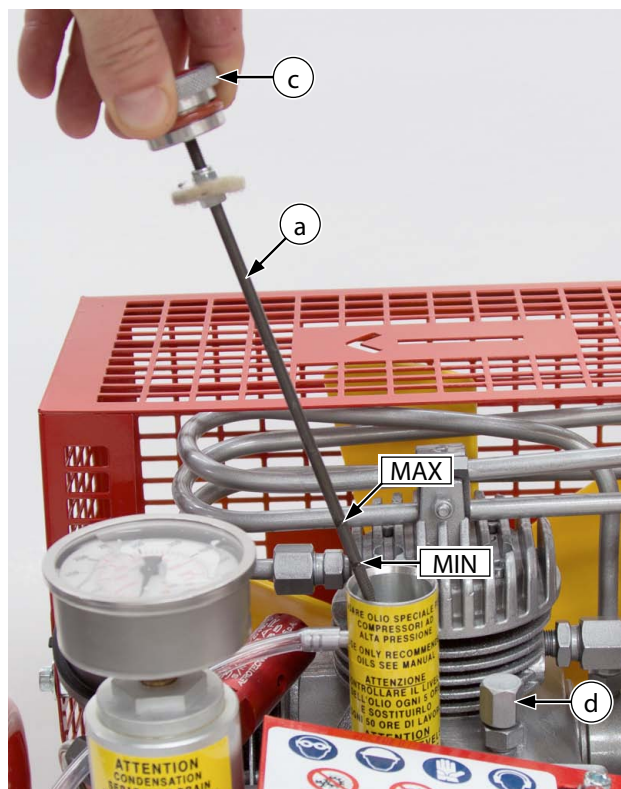

5.4 PURIFIER FILTER

The filter must be replaced at intervals calculated on the basis of the characteristics of the environment in which the compressor is located or annually. To calculate these intervals refer to the table below.
The filter must nevertheless be replaced before the air becomes malodorous.



IMPORTANT: If the compressor is used in an environment where CO (exhaust fumes) may be present it is compulsory to use CO-fixing filters; these can be supplied on request.



IMPORTANT: For compressors used in the USA and CANADA the use of LAWRENCE FACTOR filtration cartridges is recommended.



DANGER: Do not carry out these tasks if the compressor has only just shut down; wait for the compressor to cool.

All maintenance work must be carried out with the compressor OFF and the power supply lead unplugged from the mains socket.

Depressurise the entire compressor circuit before carrying out any maintenance tasks.

To depressurise the entire compressor circuit proceed as follows in the section "Condensate discharge".



DANGER: You **MUST** replace the filtration cartridge at the specified intervals. Failure to observe this instruction can place staff in serious danger and could cause serious damage or injury.

5.4.1 Filter cartridge replacement frequency calculation table

Temperature		Correction factor	Filter duration		n° bottles by 15l	
°C	°F		Work hours		Recharge 0-200bar	
°C	°F		80 l/min	100 l/min	80 l/min	100 l/min
50	122	0,2	(44x0,2)= 8,8	(35x0,2)= 7	11	14
40	104	0,34	(44x0,34)= 15	(35x0,34)= 12	19	24
30	86	0,57	(44x0,57)= 25	(35x0,57)= 20	32	40
20	68	1	44	35	56	70
10	50	1,2	(44x1,2)= 53	(35x1,2)= 42	67	84
5	41	1,4	(44x1,4)= 61	(35x1,4)= 49	78	98
0	32					
-5	23	1,6	(44x1,6)= 70	(35x1,6)= 56	90	112
-10	14					
-15	5					

5.4.2 Changing the filters purifier cartridge

To change the filters purifier cartridge (b) proceed as follows:

- vent all the compressed air inside the circuit;
- unscrew the filter cap (a);
- remove the filter cartridge (b) and replace it with a new one;
- change the O-ring (c) on the cap (a) every time the filter is changed;
- close the filter cap (a).



WARNING: The filters purifier cartridge are classified as special waste: they must be disposed of in compliance with the anti-pollution standards in force.



IMPORTANT: It is essential that there be a filtration cartridge (e) inside the filters (a) every time the compressor is used.



IMPORTANT: Every 5 years or ever 3000 hours it will be necessary to change the filter body (d).

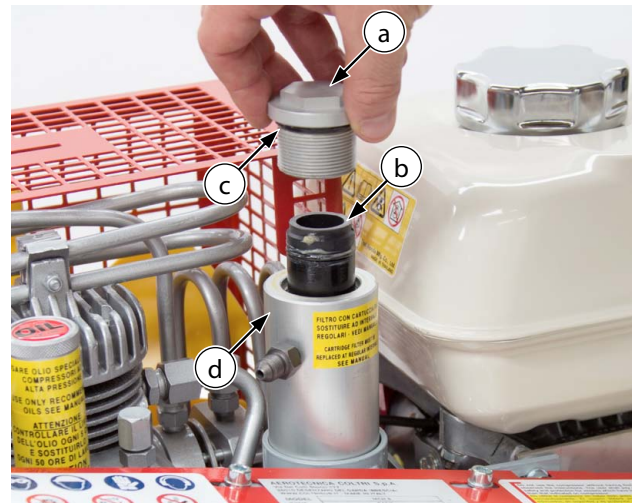

SC000340
Active carbon
Molecular sieve



SC000340/SM
Molecular sieve



SC000340/CARB
Active carbon



SC000340/CO-CATALYST
Hopkalite - Active carbon
Molecular sieve

5.5 CONDENSATE DISCHARGE



DANGER: Do not carry out these tasks if the compressor has only just shut down; wait for the compressor to cool.

All maintenance work must be carried out with the compressor OFF and the power supply lead unplugged from the mains socket.

Condensation accumulates in the condensate separator; the condensate must be discharged every 10-15 minutes of compressor use.

To discharge the condensate open the drain valves (a) and (b) in sequence and collect the condensate in an appropriate recipient.

Close the valves.

For compressors with automatic condensate discharge the condensate must be collected at the discharge point (c) in appropriate recipients.

Every 250 hours it is necessary to replace the SINTERED FILTER inside the solenoid valve fitting (d).

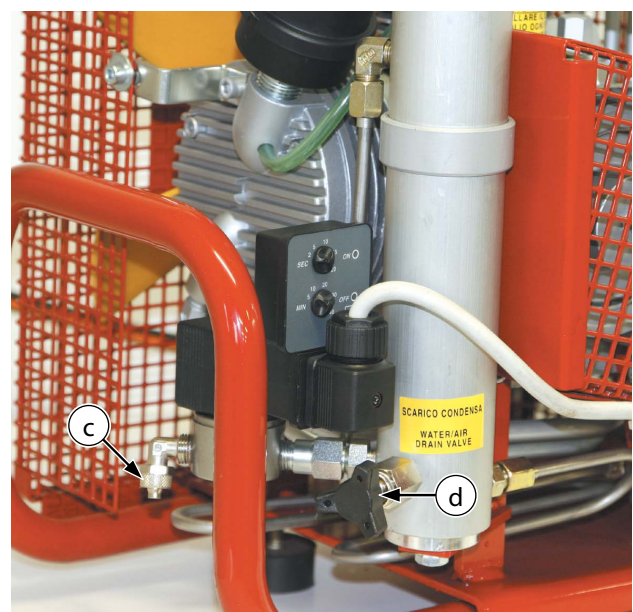
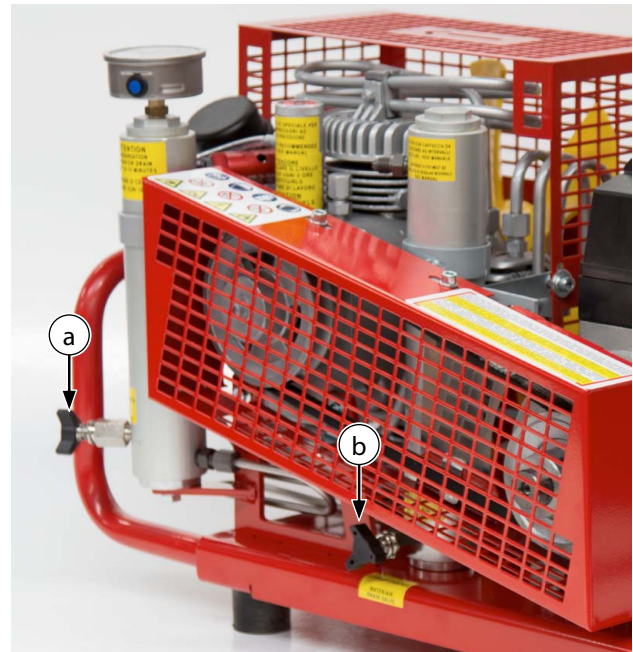

IMPORTANT: Every 5 years or ever 3000 hours it will be necessary to change the condensate separator body.



DANGER: You MUST drain the condensate at the specified intervals. Failure to observe this instruction can place staff in serious danger and could cause serious damage or injury.

5.6 TRANSMISSION BELT

Belt tension must be checked monthly.

The transmission belts must be replaced every 500 working hours of the compressor.



DANGER: Do not carry out these tasks if the compressor has only just shut down; wait for the compressor to cool.

All maintenance work must be carried out with the compressor OFF and the power supply lead unplugged from the mains socket.

5.6.1 Checking transmission belt tension / changing belts

The transmission belt must be replaced annually or every 500 working hours of the compressor.

To check belt tension remove the cover (a) by removing the fixing screws (b) and exert a pressure of approximately 10 Kg on the belt (c); check that the belt does not flex by more than 1 cm with respect to its original position.

Should it flex more than this:

- loosen the engine fixing screws (d);
- loosen the screw (e);
- if the belt is worn or close to its scheduled time for replacement change it with a new one (f);
- remove the belt (c);
- withdraw the engine by about 5 mm;
- fix the screws (d);
- tighten the screw (e);
- re-fit the belt (c);
- re-check belt tension;
- re-fit the cover (a).

If the tension of the new belt still fails to comply with the necessary requisites contact AEROTECNICA COLTRI assistance service.

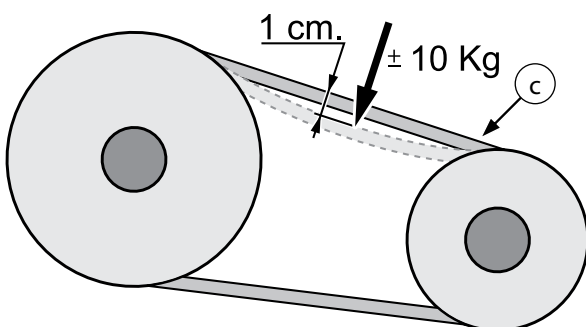
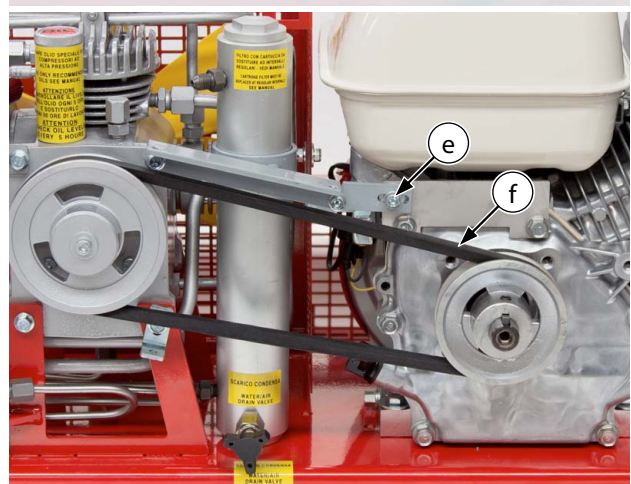
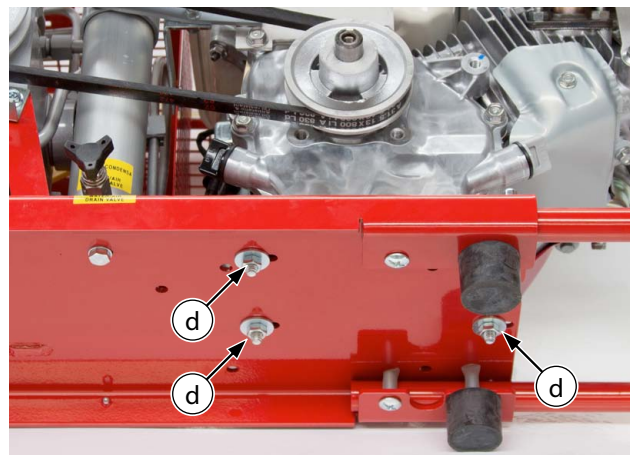
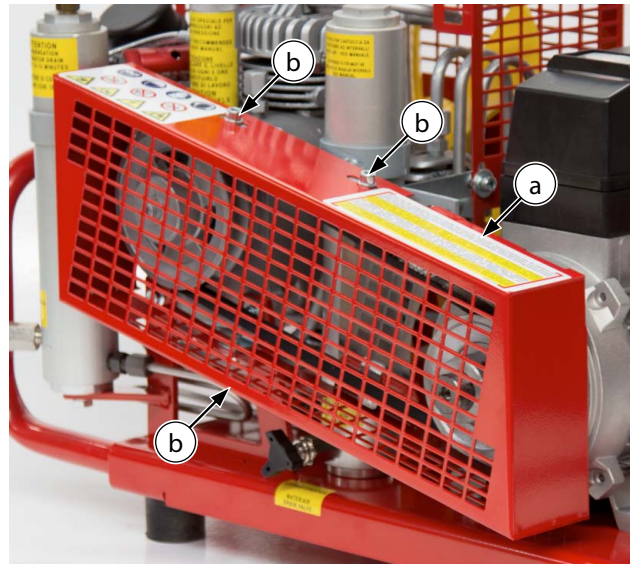

5.7 CHANGING THE FLEX HOSES



IMPORTANT: The hoses must be changed periodically (every 3 years or ever 1000 hours) or when they show signs of abrasion/wear/damage.

The bending radius of the hoses must not be less than 250 mm.



DANGER:

Do not carry out these tasks if the compressor has only just shut down; wait for the compressor to cool.

All maintenance work must be carried out with the compressor OFF and the power supply lead unplugged from the mains socket.

Vent the air from the compressor before carrying out any maintenance tasks.

Tank refill pressure is very high; therefore, before refilling the tanks check that the hoses are perfectly connected and in good condition. Check also that the valves on any unused hoses are closed properly so as to prevent the dangers that derive from hose whiplash.

When the tanks are being refilled unauthorised personnel must remain at a distance of at least 3 metres.

It is strictly forbidden to disconnect the hoses from the fittings or refill valve when the machine is under pressure.

To change the bottle refill hose proceed as follows:

- disconnect the bottle refill hoses by unscrewing the fitting (a) at its extremity (17 mm wrench);
- replace the old hose with a new one;
- screw the hose onto the connector (b);
- use a dynamometric wrench to tighten the hoses on the compressor with a torque of 15 Nm.

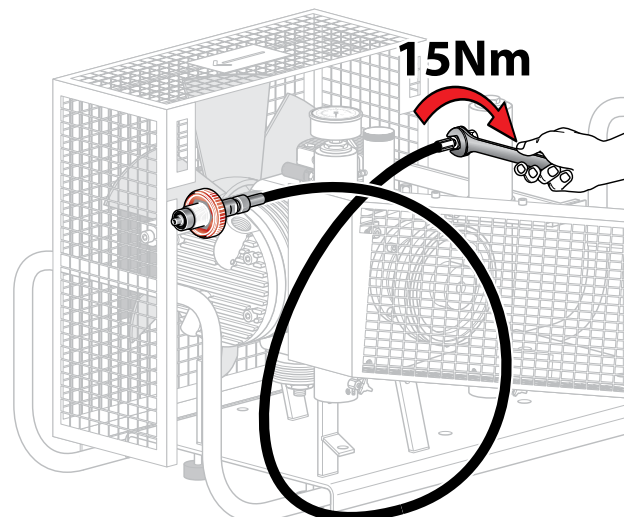
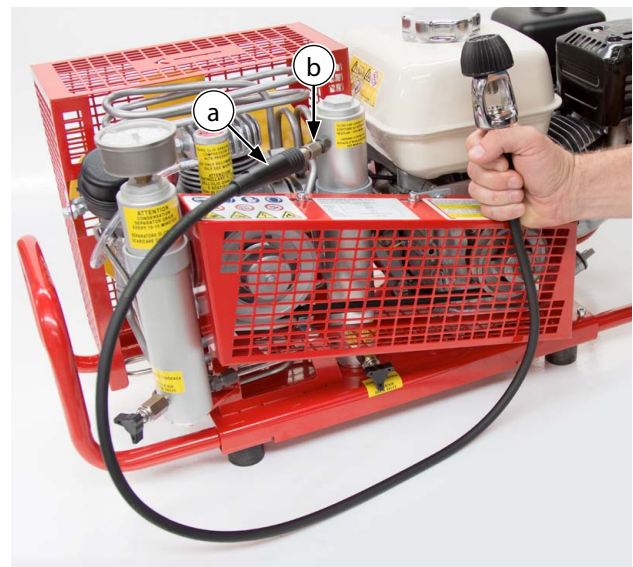

COLTRI ASIA PACIFIC

Bangkok branch

No. 94/5 , Moo. 3 , T. Khao Hin Sorn - A .Phanomarakarm, Chachoengsao. 24120 Thailand
Tel: + 66 38 855 103 to 5 Fax: + 66 38 855 106

Phuket branch

42/5-6 Moo. 5, Rawai, Maung, Phuket 83130 Thailand
Tel: +66 076 384476 Fax: +66 076 384475

www.aerotecnicacoltriasiapacific.com

e-mail: robin@aerotecnicacoltriasiapacific.com

COLTRI SUB EGYPT

Sharm El Sheikh branch

El Rowayset (Industrial Area) - Sharm El Sheikh - South Sinai - Egypt
Tel: +20 (0) 366 44 74 Fax: +20 (0) 366 44 73

Hurghada branch

El Nasr Road, - Hurghada, Red Sea, Egypt
Tel: +20 65 355 1952 Fax: +20 65 355 6485

www.coltrisubegypt.com

e-mail: info@coltrisubegypt.com

bruno@coltrisubegypt.com

manager@coltrisubegypt.com

COLTRI AMERICAS

12493 NW 44th Street, Unit5 - Coral Springs, FL 33065

Tel: 1-954-344-2420 Fax: 1-954-344-2421

www.coltriamericas.com

e-mail: info@coltriamericas.com

david@coltriamericas.com

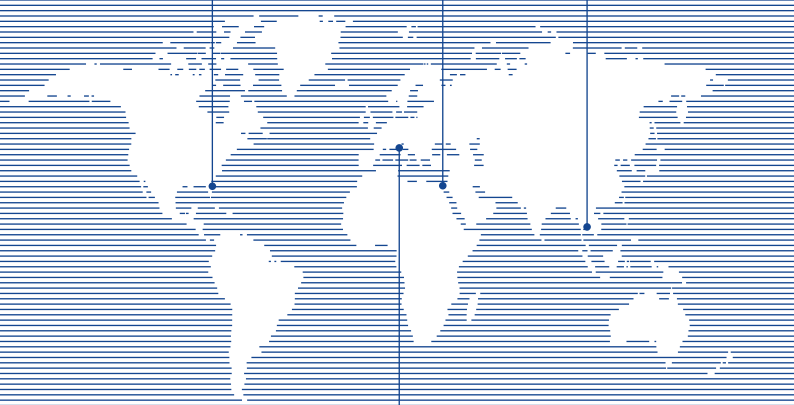

MU-MCH6-0015-EN-R



AEROTECNICA COLTRI Spa

Via Colli Storici, 177

25010 SAN MARTINO DELLA BATTAGLIA (BS) ITALY

Tel. +39 030 9910301

Fax. +39 030 9910283

www.coltrisub.it

sales@coltrisub.it

