

# Evaluating Alternatives for Decommissioning California's Offshore Oil and Gas Platforms

A TECHNICAL ANALYSIS TO INFORM STATE POLICY



## About the OST

---

The [California Ocean Science Trust \(OST\)](#) is a nonprofit 501(c)(3) public benefit corporation established pursuant to the [California Ocean Resources Stewardship Act of 2000](#) to encourage coordinated, multi-agency, multi-institution approaches to translating ocean science to management and policy. In order to achieve its mission of ensuring that the best available science is applied to California ocean policies and management, the OST has established two programs:

- *Science Integration to the State*: OST provides integration of a scientific perspective, data synthesis, and information for decision-making processes of California state agencies and coordinating bodies, such as the California Ocean Protection Council (OPC). The OST serves the state by coordinating expert advice and acting as liaison and bridging institution.
- *Piloting, Developing, and Incubating New Ventures*: This program focuses on developing and institutionalizing new and innovative approaches for improved linking of science with policy and management. As its first such project, the OST is incubating the Marine Protected Areas (MPA) Monitoring Enterprise.

More information about the OST is available at <http://www.calost.org>.

### COVER PHOTOS

Platform Irene, North of Point Arguello: Linda Snook

Conducting Platform Surveys, Lovelab, Platform Gina: James Forte

Juvenile Vermillion Rockfish (*Sebastes miniatus*). Bottom of Platform Grace: Donna Schroeder

# **Evaluating Alternatives for Decommissioning California's Offshore Oil and Gas Platforms: A Technical Analysis to Inform State Policy**

Submitted to the California Ocean Science Trust

Primary author: Dr. Brock B. Bernstein

Co-authors: Mr. Andy Bressler

Mr. Peter Cantle

Dr. Max Henrion

Dr. DeWitt John

Dr. Sarah Kruse

Dr. Daniel Pondella

Dr. Astrid Scholz

Mr. Tim Setnicka

Mr. Surya Swamy

Researchers: Ms. Laurel Fink

Ms. Bridget McCann

## Preface

---

### ***About the Study:***

In 2007, the California Natural Resources Agency began investigating issues surrounding alternatives for decommissioning of the 27 oil and gas platforms in California’s State Tidelands and off the Outer Continental Shelf. The Natural Resources Agency established a three-phase process to formulate and inform policy options (further described in Section 1 of this report).

For Phase II (“Conduct Comprehensive Investigation”) of this process, in October 2008 the Natural Resources Agency partnered with the California Ocean Science Trust (OST) – a 501(c)(3) nonprofit public benefit corporation – to release a Request for Proposals (RFP) for a “Study to Provide Information Related to Oil and Gas Platform Decommissioning Alternatives in California.” As described in the RFP, the purpose of this study was “to assemble and examine scientific and legal information that will frame future state policy discussion on the alternatives for decommissioned platforms.” This report and the accompanying PLATFORM decision model are the final products of the study.

### ***Study Funders:***

This study was funded jointly by the following entities:

California Ocean Protection Council  
Sportfishing Conservancy

Chevron Corporation  
United Anglers

Ocean Conservancy

### ***Study Process:***

In accordance with its mission of supplying California decision makers with rigorous and objective technical information, the OST was tasked by the Natural Resources Agency with coordinating all aspects of the study. Drawing from respected and venerable models such as the National Academies, the OST designed a comprehensive, deliberative study process with the goal of ensuring a thorough, balanced, and unbiased final report that would be a useful reference for decision-makers. OST’s process encompassed extensive expert technical review of the RFP, revision and release of the RFP, and selection and oversight of a qualified project team. Furthermore, through a public nomination process the OST convened an Expert Advisory Committee (EAC) (see Appendix 6 for more information). This multidisciplinary, 15-member body included academics, industry experts, and agency representatives. The EAC’s charge was to work with the OST and the project team to guarantee that the state received authoritative and credible advice on this important issue. The EAC informed the selection of the project team by providing comments on the proposals, reviewed and submitted detailed comments to the OST on the team’s interim products and report drafts, provided general advice on the study process and approach, and deepened the expertise that shaped project findings. In addition to the guidance provided by the EAC, the California Attorney General's Office advised the OST, the project team, and the EAC on issues regarding the legal components of the study.

For more information about the RFP, the study process, and the Expert Advisory Committee please visit [http://www.calost.org/Oil\\_gas.html](http://www.calost.org/Oil_gas.html).

# Table of Contents

---

Preface.....	i
About the Study:.....	i
Study Funders:.....	i
Study Process: .....	i
List of Tables .....	v
List of Figures.....	viii
List of Acronyms .....	xii
Executive Summary .....	xiv
Prioritize decommissioning options.....	xvi
Comparative analysis .....	xix
Decision model.....	xxii
Partial removal: institutional and legal issues.....	xxii
Summary .....	xxiv
1.0. Introduction.....	1
1.1. Project background.....	1
1.2. Organization and goals of the analysis.....	4
2.0. Decommissioning Background.....	7
2.1. Physical setting.....	8
2.2. Platforms’ useful lifetimes .....	8
2.3. Decommissioning experience .....	9
2.3.1. Limited experience applicable to California .....	10
2.3.2. Completed decommissioning projects.....	10
2.3.3. Proposed decommissioning projects .....	13
2.4. Decision context.....	14
3.0. Legal and Regulatory Contexts.....	18
3.1. Regulatory authorities and processes .....	19
3.1.1. Core legal authorities.....	19
3.1.2. NEPA and CEQA processes.....	25
3.2. The public trust doctrine .....	29
3.2.1. The scope of the public trust .....	29
3.2.2. Public trust responsibilities of state and local agencies.....	30
3.2.3. Federal public trust responsibilities.....	31
3.3. Environmental justice and equity.....	31

3.3.1. Environmental justice.....	31
3.3.2. Concerns about impacts on local communities.....	32
3.4. Feasibility, costs, liability, and revenue.....	32
4.0. Prioritizing Decommissioning Options.....	34
4.1. Options retained for detailed analysis.....	35
4.1.1. Complete platform removal.....	39
4.1.2. Partial platform removal – engineering description through disposal.....	55
4.2. Options not analyzed in detail.....	58
4.2.1. Deep water disposal.....	59
4.2.2. Alternative energy.....	61
4.2.3. Liquefied natural gas (LNG) terminal.....	63
4.2.4. Aquaculture.....	65
4.2.5. Other options.....	67
5.0. Comparative Analysis of Options.....	69
5.1. Overview of analysis approach.....	70
5.2. Boundary conditions.....	72
5.2.1. Exclude aspects that are the same across options.....	73
5.2.2. Exclude aspects that are data poor, difficult to quantify, and/or likely to be relatively small.....	74
5.3. Analysis of options.....	79
5.3.1. Marine resources.....	79
5.3.2. Air emissions.....	103
5.3.3. Socioeconomic impacts.....	115
5.3.4. Ocean access.....	128
5.3.5. Birds and marine mammals.....	135
5.3.6. Water quality.....	146
5.3.7. Decommissioning costs and avoided costs.....	149
5.3.8. Programmatic costs.....	156
5.4. Model integration.....	157
5.5. Data gaps.....	159
6.0. Institutional Challenges Related to the Partial Removal Option.....	167
6.1. Mechanisms for transfer of ownership.....	169
6.1.1. Directly to state.....	169
6.1.2. Transfer to other entity.....	177
6.2. Addressing liability concerns.....	179
6.2.1. Background.....	180

6.2.2. Current federal and state provisions defining liability .....	182
6.2.3. Liability sources of concern and mechanisms for addressing them .....	184
6.2.4. Mechanisms for achieving broader protection .....	188
6.2.5. Transfer or acceptance of ownership.....	193
6.3. Mechanisms for transfer, allocation, and management of funds from avoided costs .....	194
6.3.1. Formula for sharing avoided costs .....	195
6.3.2. Mechanisms for allocating and managing funds .....	195
6.4. Managing an expanded artificial reef program .....	198
7.0. Answers to Stakeholders' Questions .....	200
7.1. Questions related to biology / ecology / environment.....	200
7.2. Key questions related to economics .....	203
7.3. Key Questions Related to State Administration.....	204
7.3.1. Liability and Indemnification .....	204
7.3.2. Regulatory Enforcement and Institutional Control .....	205
7.3.3. Access and Ownership .....	205
7.4. Key Questions Related to Visual Resources and Esthetics .....	205
7.5. Key Questions Related to Alternative Uses .....	206
References.....	207
Appendix 1: Regional Context.....	1
Appendix 2: Legislation and Related Documents .....	1
Appendix 3: Estimates of Biological Production.....	1
Appendix 4: PLATFORM – The OST Oil & Gas Platform Decommissioning Decision Support Tool: User Guide.....	1
Appendix 5: Multi-Attribute Utility Analysis.....	1
Appendix 6: Expert Advisory Committee Selection .....	1

## List of Tables

---

Table ES.1. Summary of alternative use and disposal options considered in this report. The complete removal and partial removal / artificial reefing use options, along with the onshore dismantling and disposal option, are considered in detail. Other use and disposal options are described and evaluated in summary form. All options shown, with one exception, are legally allowable under existing law. Transfer of ownership of platforms in the OCS to the state, while allowed under federal law, would require new state enabling legislation. ....	xviii
Table 1.1. Offshore oil and gas platforms in the southern California region. ....	2
Table 2.1. Key elements of the overall decision context affecting the choice between decommissioning options. These factors frame the more detailed analysis in Sections 5 and 6..	16
Table 4.1. Summary of alternative use and disposal options considered in this report. The complete removal and partial removal / artificial reefing options, along with the onshore dismantling and disposal option, are considered in detail. Other use and disposal options are described and evaluated briefly. All options shown, with one exception, are legally allowable under existing law. Transfer of ownership of platforms in the OCS to the state, while allowed under federal law, would require new state enabling legislation. ....	36
Table 4.2. Summary of the major engineering steps in the decommissioning process, along with the key differences between the complete and partial removal options. ....	38
Table 4.3. Summary of the factors involved in decision making about shell mound disposition.	50
Table 4.4. The major engineering steps in the partial platform removal option, with similarities to and differences from the complete removal option noted. ....	55
Table 5.1. Summary of the likely effect on the analysis decommissioning options of those aspects removed from consideration. See following subsections for a more complete discussion. ....	73
Table 5.2. Summary of the overall difference between the complete and partial removal options for each impact category. The entry in each cell in the Complete vs. Partial Removal column states the condition under complete removal (e.g., there will be much less biological production under the complete removal option).....	81
Table 5.3. Biomasses of fishes observed, by species, around all platforms in October – November of 1996. Biomasses are given for bottoms (within two meters of the bottom) of platforms and midwater (from two meters above the bottom to 26 meters from the sea surface), with percent of totals for those parts of the platforms. Biomass is kilograms/m <sup>2</sup> . Family totals are given in boldface. YOY is young-of-the-year (source: Love et al. (2000), Table 2). ....	86
Table 5.4. The distribution of potential sources of benthic impacts across the two main decommissioning options.....	103
Table 5.5. Equipment assumptions for the complete and partial removal options for Platform Harmony. HP refers to horsepower. ....	111
Table 5.6. Emission factors and fuel consumption (in grams/kW-hr) <sup>(1)</sup> for the Platform Harmony decommissioning example.....	112



Table 5.7. Worst-case emission estimates for complete and partial removal of the Platform Harmony topsides / jacket.....	113
Table 5.8. Qualitative summary of the direction of likely impacts of complete and partial removal on fisheries and nonconsumptive uses under each decommissioning option and management policy (i.e., take vs. no take). Up and down arrows indicate positive and negative impacts, respectively. An equal sign indicates no change. Multiple symbols in a single cell reflect cases where impacts could vary depending on the segment (e.g., gear type) of the interest group involved and/or on platform-specific circumstances.....	116
Table 5.9. Estimates of the value of marine recreational fishing in California. ....	123
Table 5.10. Likely preferred decommissioning option for each of the five major user groups considered. ....	129
Table 5.11. Location of platforms relative to location of recreational rockfish fishing grounds. Percentages are the percentage of recreational fishing grounds within each distance from shore (based on data from CSLC MRM Division).....	131
Table 5.12. Increase in access to areas around platforms under the complete removal option. All values in nautical miles <sup>2</sup> . Percentages are of the combined total of state and federal waters off the State of California. ....	132
Table 5.13. Increase in access to areas around platforms under the partial removal option. All values in nautical miles <sup>2</sup> . Percentages are of the total state and federal waters off the State of California. ....	133
Table 5.14. Short- and long-term effects of decommissioning on birds. Short-term refers to the period of the decommissioning activities, while long-term refers to the post-decommissioning timeframe. The two decommissioning options are not shown separately because their effects are similar in kind for both complete and partial removal options.....	136
Table 5.15. Short- and long-term effects of decommissioning on marine mammals. Short-term refers to the period of the decommissioning activities, while long-term refers to the post-decommissioning timeframe. The two decommissioning options are not shown separately because their effects are similar in kind for both complete and partial removal options. ....	136
Table 5.16. Occurrence of threatened and endangered bird species in or near the 4H decommissioning site (adapted from Table 3.4-5 in SAIC (2003)).....	139
Table 5.17. Species of marine mammals and their periods of occurrence locally (adapted from Table 2.4-5 in Padre Associates, Inc. (2005)). Species highlighted in bold are more likely to be found in the Santa Barbara Channel. ....	142
Table 5.18. Occurrence of threatened and endangered species of marine mammals in or near the 4H decommissioning site (adapted from Table 3.4-3 in SAIC (2003)).....	143
Table 5.19. The distribution of potential sources of water quality impacts across the two main decommissioning options.....	149
Table 5.20. Types of activities within the overall permitting and regulatory compliance cost element.....	152

Table 5.21. Travel time, mobilization / demobilization costs, and day rate costs for the types of HLVs likely to be used in California decommissioning projects. .... 153

Table 6.1. Summary of the main characteristics of the Gulf of Mexico state artificial reefing programs (see Appendix 2 for additional background and Section 6.2.2.1 for details on liability). ..... 172

Table 6.2. Summary of mechanisms already existing in state and federal law, or that could be included in enabling legislation establishing an expanded state artificial reefing program, that address the major sources of liability associated with the partial removal option..... 181

Table 6.3. Possible mechanisms for achieving broader protection against all sources of liability. Several of these mechanisms were suggested in discussions with state, federal, and industry managers and are somewhat speculative in nature. .... 190

## List of Figures

---

Figure ES.1. Locations of offshore platforms in the southern California region (source: Earthguide.ucsd.edu/fuels/images/platforms.jpg).....	xiv
Figure ES.2. A segment of one of the larger California platforms onshore prior to its installation. For scale, a large red crane is in the foreground and a number of trucks and other vehicles are on the shoreline behind the platform at the right edge of the picture (courtesy of Proserv Offshore, Inc.).....	xv
Figure ES.3. Summary of the decommissioning options considered. Complete removal and partial removal were analyzed in greater detail and are shown in bold type. Options in italics in the gray boxes were not considered in detail in the analysis. Rationale for prioritizing options is summarized in Table ES.1 and explained in more detail in Section 4.0. ....	xvii
Figure ES.4. The Heavy Lift Vessel Hermod is in the 4000 ton lift category that would be required to decommission the larger California platforms (source: Scheepvaartnieuws, scheepvaartnieuws.punt.nl/upload/mot_1496.jpg, accessed January 28, 2010).....	xx
Figure ES.5. The top-level user interface for the PLATFORM decision model, illustrating the four major types of functions (see text in Section 5.4 and Appendices 4 and 5 for more detail). ....	xxiii
Figure ES.6. Depiction of the pathways for transferring ownership of a decommissioned platform.....	xxiv
Figure 1.1. Locations of offshore platforms in the southern California region (source: Earthguide.ucsd.edu/fuels/images/platforms.jpg).....	3
Figure 2.1. Elevation views illustrating the size of representative offshore oil platforms in comparison to well-known landmarks. The horizontal line represents the height of Platform Harmony, the largest platform offshore southern California (Table 1.1) (modified from <a href="http://synclaire.net/blog/2008/02/oil-platform-comparison/">http://synclaire.net/blog/2008/02/oil-platform-comparison/</a> ). ....	11
Figure 3.1. Broad permitting jurisdictions, depending on the location of decommissioning activities (adapted from Manago and Williamson 1998, p. 18).....	20
Figure 3.2. Summary of the decommissioning options considered. Complete removal and partial removal were analyzed in greater detail and are shown in bold type. Options in italics in the gray boxes were not considered in detail in the analysis. See Section 4 for a more detailed discussion. Numbers in parentheses refer to notes on the following page describing key legal authorities for each stage of decommissioning. ....	21
Figure 3.3. Schematic diagram of the NEPA process (adapted from U.S. EPA and several state websites). ....	27
Figure 3.4. Schematic diagram of the CEQA process ( <a href="http://ceres.ca.gov/ceqa/flowchart/index.html">http://ceres.ca.gov/ceqa/flowchart/index.html</a> ). ....	28
Figure 3.5. Major steps in the decommissioning permit process, broadly applicable to both state waters and to the OCS. The environmental review and public comment steps depicted here correspond to steps in the NEPA and CEQA processes illustrated in Figure 3.3 and 3.4. The	

timeline is intended for illustrative purposes and could differ depending on the specific project (from Manago and Williamson (1998), p. 19).....	29
Figure 4.1. Depiction of major structural components of a generic offshore platform (from Manago and Williamson (1998), workshop notes p. 223).....	41
Figure 4.2. Schematic illustrating the configuration of the pipeline riser bend as the pipeline transitions from the seafloor to the vertical platform (source: Antares Offshore, <a href="http://www.antaresoffshore.com/images/close%20up%20of%20pltfm%20with%20risers%201.JPG">http://www.antaresoffshore.com/images/close up of pltfm with risers 1.JPG</a> , accessed January 28, 2010). .....	42
Figure 4.3. Heavy lift vessel Hermod in port (source: Scheepvaartnieuws, <a href="http://scheepvaartnieuws.punt.nl/upload/mot_1496.jpg">scheepvaartnieuws.punt.nl/upload/mot_1496.jpg</a> , accessed January 28, 2010).....	43
Figure 4.4. Bottom feeder lifting device (image courtesy of Proserv Offshore, Inc.).....	44
Figure 4.5. The McDermott DB50 is one of several derrick barges that fall into the 4000 ton class of HLVs (source: technology, <a href="http://www.offshore-technology.com/projects/north-america_gallery.html">http://www.offshore-technology.com/projects/north-america_gallery.html</a> , accessed January 28, 2010).....	45
Figure 4.6. Platform A, an example of an integrated topside design (source: <a href="http://bayneweb.com/images/blogPics/flkr/oilPlatform.jpg">http://bayneweb.com/images/blogPics/flkr/oilPlatform.jpg</a> , accessed January 29, 2010). .....	46
Figure 4.7. Platform Harvest, an example of a hybrid topside design (source: <a href="http://www.cosmic.ucar.edu/oceanPI2008/photos/harvest_platform.png">http://www.cosmic.ucar.edu/oceanPI2008/photos/harvest_platform.png</a> , accessed January 28, 2010). .....	46
Figure 4.8. Illustration of the components of a generic platform deck (from Gebauer et al. 2004, figure 10-2). .....	47
Figure 4.9. Illustration of jacket piles for a generic platform structure (adapted from <a href="http://www.esru.strath.ac.uk/EandE/Web_sites/98-9/offshore/rig.jpg">http://www.esru.strath.ac.uk/EandE/Web_sites/98-9/offshore/rig.jpg</a> , accessed January 28, 2010). .....	48
Figure 4.13. Illustration of the initial steps of the partial removal operation in which jacket sections are dropped to the seafloor (from Twachtman Snyder & Byrd, Inc. 2000, Figure 3.16). .....	57
Figure 4.14. Illustration of the latter steps of the partial removal operation in which jacket sections are dropped to the seafloor (from Twachtman Snyder & Byrd, Inc. 2000, Figure 3.17). .....	58
Figure 4.15. Decision framework for deep water disposal (from London Convention 1997).....	59
Figure 4.16. California Energy Commission map of wind power potential at 50 meters height (source: AWS Truewind (2006)). .....	62
Figure 4.17. Location of proposed LNG terminals along the west coast of North America as of April 2010 (source: California Energy Commission 2010).....	64
Figure 4.18. Floating “AquaPod” steel-and-wire mesh net pen for Snapperfarm, Inc. to raise cobia in deep water off Culebra, Puerto Rico (source: <a href="http://gcaptain.com/maritime/blog/wp-content/uploads/2009/03/aquapod_fish-farm1.jpg">http://gcaptain.com/maritime/blog/wp-content/uploads/2009/03/aquapod_fish-farm1.jpg</a> ) (accessed March 21, 2010).....	68

Figure 5.1. Example influence diagram illustrating the conceptual approach to modeling decommissioning impacts on marine mammals. Following the terminology for multi-attribute analysis (see Section 5.4 for more detail), each impact category is termed an “attribute”; here, the attribute is marine mammals. Boxes with “impact” in their title represent the type and magnitude of impacts on mammals. Those containing “attribute” in their title represent the relative scale of the impact. Green rectangles represent decision nodes. ....	70
Figure 5.2. Conceptual structure of the analysis of decommissioning impacts on the biological production of platform communities. ....	83
Figure 5.3. Density by depth zone of young-of-the-year rockfishes observed at all platforms surveyed, 1995–2001(source: Love et al. (2003), Fig. 3.5).....	87
Figure 5.4. Model results showing sources and destinations of larvae. Color intensity at each point shows the probability of dispersal of kelp bass larvae from an origin patch (vertical axis) to a destination patch (horizontal axis) by geographical region. Note that larvae from a mainland origin site reach destination sites on the islands, but larvae from origin sites on the islands do not reach destination sites on the mainland (source: Watson et al. 2009). ....	91
Figure 5.5. Potential connectivity patterns for kelp bass and kelp rockfish larvae released from the simulation patches containing platforms Holly, Habitat, and Eureka and Emmy. The black patch on each plot is the nearest simulation patch to the oil drilling rigs. Values of potential connectivity quantify the probability that larvae from the source patch are advected to other sites within the Southern California Bight given the spawning season for the organism (kelp bass = Jun-Oct & kelp rockfish = Feb-Jun) and its pelagic larval duration (kelp bass = 30 d & kelp rockfish = 60 d). Results follow work by Watson et al. (2009).....	92
Figure 5.6. Overview of the population dynamics modeling approach used to estimate biological (fish) production on platforms under current conditions and the partial removal decommissioning option (see Appendix 3 for more detail).....	95
Figure 5.7. Standing stocks (B) in kilograms for all fish species for the eight platforms used in the modeling analysis. Values represent mean values calculated across years. ....	96
Figure 5.8. Somatic growth (G) in kilograms for all fish species calculated over five-year intervals ( $t_{1-5}$ ) at the eight offshore platforms selected for the modeling analysis. Somatic growth is the annual growth in size of individual fish; gonadal production was not included.....	97
Figure 5.9. Bocaccio recruitment in Year 1 and subsequent growth of these young-of-the-year (in kg) calculated over five years ( $R_1$ - $R_5$ ) at the eight platforms selected for the modeling analysis.....	97
Figure 5.10. Standing stocks (B) and the adjusted standing stock ( $B_{adj}$ ) under the partial removal option at the eight platforms selected for the modeling analysis.....	98
Figure 5.11. Mean yield ( $Y'$ ) and adjusted yield ( $Y'_{adj}$ ) at year 5 for the eight platforms selected for the modeling analysis. Adjusted yield refers to overall platform yield (i.e., somatic growth plus the recruitment and subsequent growth of bocaccio in Year 1) adjusted for the loss of the upper 85 feet of the platform. ....	99
Figure 5.12. Conceptual structure of the qualitative analysis of benthic impacts in the PLATFORM model. ....	102

Figure 5.13. Components of the modeling approach for estimating emissions for a decommissioning project. ....	109
Figure 5.14. Placeholder modules in PLATFORM indicating basic relationships between components that may contribute to broader socioeconomic impacts. These modules could be expanded if these data gaps are filled in the future. ....	116
Figure 5.15. Conceptual model of the factors that may influence the socioeconomic impacts of decommissioning options on fisheries. ....	119
Figure 5.16. Conceptual structure of the analysis of impacts on ocean access. This influence diagram is taken from PLATFORM. ....	129
Figure 5.17. Conceptual structure of the analysis of impacts on birds. ....	138
Figure 5.18. Conceptual structure of the analysis of impacts on marine mammals. ....	141
Figure 5.19. Conceptual structure of the qualitative analysis of water quality impacts in the PLATFORM model. ....	147
Figure 5.20. Overall conceptual structure of the decommissioning costing analysis, taken from PLATFORM. ....	150
Figure 5.21. The top-level user interface for the PLATFORM decision model, illustrating the four major types of functions (see text and Appendices 4 and 5 for more detail). ....	158
Figure 5.22. Illustration of the PLATFORM drop-down menu that permits users to apply several different types of statistical distributions to input data. ....	160
Figure 5.23. Example cumulative frequency (or probability) distribution of decommissioning costs for Platforms A, B, and C under one decommissioning scenario. In this case, there is a 70% probability that the decommissioning cost of Platform C is less than or equal to \$16 million. .	160
Figure 5.24. Example probability band plots for predicted fish biomass yield at platform C over a five-year period. Probability bands, or confidence bands, are shown as percentiles (5%, 25%, 50%, 75%, and 95%). The 50% line is the median prediction. ....	161
Figure 6.1. Possible pathways for transferring ownership of a decommissioned platform and the broad legislative and/or regulatory authority that would control such transfers, discussed in Sections 6.1.1 and 6.1.2. Entities in <i>bold italics</i> represent potential ultimate owners of the decommissioned platforms. ....	170

## List of Acronyms

---

ACOE	United States Army Corps of Engineers
AHP	Analytica Hierarchy Process
CARE	California Artificial Reef Enhancement Program
CARP	California Artificial Reef Program
CCC	California Coastal Commission
CCMP	California Coastal Management Program
CDFG	California Department of Fish and Game
CEQA	California Environmental Quality Act
CIAP	Coastal Impact Assessment Program
CINMS	Channel Islands National Marine Sanctuary
CERCLA	Comprehensive Environmental Response Compensation and Liability Act
CRANE	Cooperative Research and Assessment of Nearshore Ecosystems
CREF	Coastal Resources Enhancement Fund
CSTR	California Ships to Reefs Program
CWA	Clean Water Act
CZMA	Coastal Zone Management Act
DCOR	Dos Cuadras Offshore, LLC
DPP	Development and Production Proposal
EA	Environmental Impact Analysis
EAC	Expert Advisory Committee
ECA	Emissions Control Area
EFH	Essential Fish Habitat
EFP	Exempted Fishing Permit
EIR	Environmental Impact Report
EIS	Environmental Impact Statement
EPA	Environmental Protection Agency
ESA	Endangered Species Act
FCF	Fishermen's Contingency Fund
FEF	Fisheries Enhancement Fund
FERC	Federal Energy Regulatory Commission
FONSI	Finding of No Significant Impact
FWS	United States Fish and Wildlife Service
GOM	Gulf of Mexico
HLV	Heavy Lift Vessel
HSWRI	Hubbs Sea World Research Institute
LFCF	Local Fishermen's Contingency Fund
LLC	Limited Liability Company
LFCF	Local Fishermen's Contingency Fund
LNG	Liquefied natural gas
MAUT	Multi-Attribute Utility Theory
MSFCMA	Magnuson-Stevens Fisheries Conservation and Management Act
MLPA	Marine Life Protection Act

MOU	Memorandum of Understanding
MMPA	Marine Mammal Protection Act
MMS	Minerals Management Service
MPA	Marine Protected Area
NAA	National Aquaculture Act
NFEA	National Fishing Enhancement Act
NMFS	National Marine Fisheries Service
NEPA	National Environmental Policy Act
NGO	Non-Governmental Organization
NMFS	National Marine Fisheries Service
NOAA	National Oceanographic and Atmospheric Organization
NOAAAct	National Offshore Aquaculture Act
NPDES	National Pollutant Discharge Elimination System
OCS	Outer Continental Shelf
OPA	Oil Pollution Act
OPR	Office of Planning and Research
OCSLA	Outer Continental Shelf Lands Act
OSPR	Office of Spill Prevention and Response
OST	California Ocean Science Trust
PAH	Polycyclic aromatic hydrocarbons
PERL	Pacific Energy Resources, Ltd.
POCS	Pacific Outer Continental Shelf
POOL	Pacific Operators Offshore, Ltd.
PXP	Plains Exploration and Production Company
ROMS	Regional Oceanic Modeling System
ROV	Remotely Operated Vehicle
SCB	Southern California Bight
SCH	State Clearinghouse
SLC	State Lands Commission
USCG	United States Coast Guard
USDA	United State Department of Agriculture



## Executive Summary

---

Decommissioning of the 27 oil and gas platforms offshore southern California (Figure ES.1) is an unavoidable issue that will face California's ocean managers at some point in the future as the platforms reach the end of their useful production lifetimes (predicted for the 23 platforms in federal waters to occur sometime between 2015 and 2030; no such estimates are available for platforms in state waters). A number of different decommissioning options exist and each will result in an array of environmental and socioeconomic impacts, some positive and some negative. These impacts, and their costs and benefits, will be perceived and valued differently by stakeholders with differing perspectives. For example, some will see the need to decommission platforms that have reached the end of their useful production lifetime as an opportunity to fulfill operators' original lease obligations and remove these large structures from the ocean, thereby restoring the seabed to its original, natural state. Decommissioning can also be viewed as an opportunity to derive a greater return on the investment represented by the platforms by converting them to other potentially valuable uses with economic and/or scientific benefits. Yet another perspective is that decommissioning provides a chance to preserve a large part of the biological communities that inhabit offshore platforms, thus conserving an ecological resource that contributes to biological production locally and perhaps regionally. Finally, decommissioning may be an opportunity for the state to achieve financial benefit through its share of avoided decommissioning costs, thus increasing resources available to support efforts that produce environmental and socioeconomic benefits.

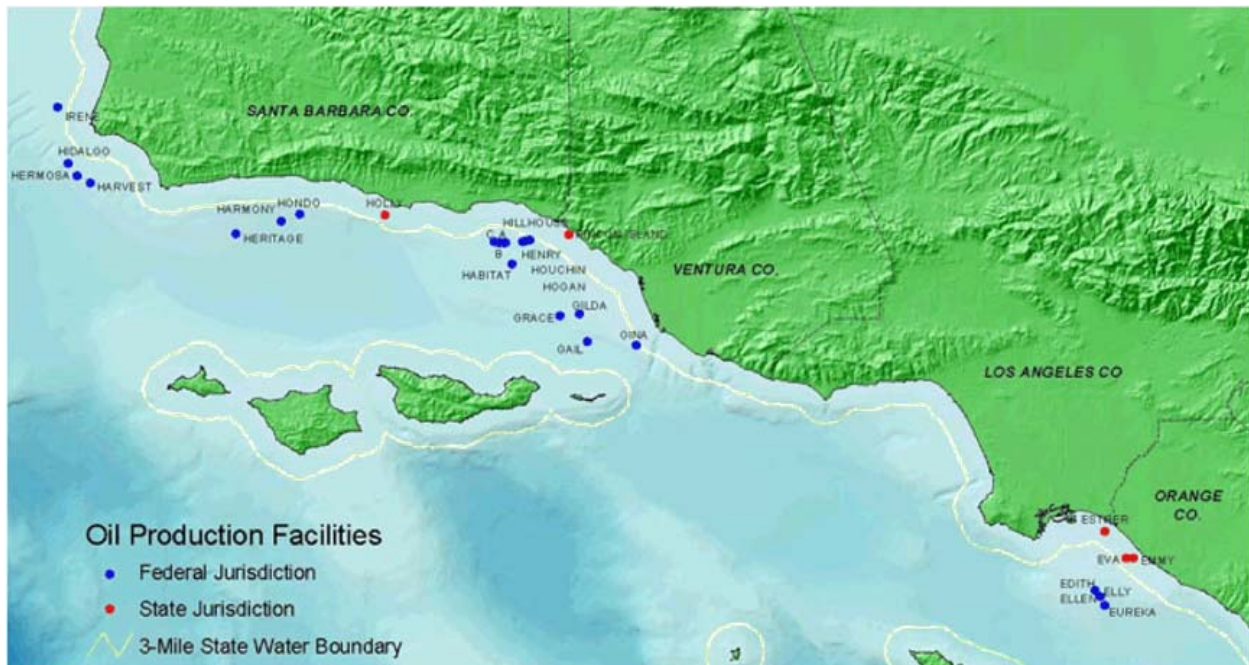

Figure ES.1. Locations of offshore platforms in the southern California region (source: [Earthguide.ucsd.edu/fuels/images/platforms.jpg](http://Earthguide.ucsd.edu/fuels/images/platforms.jpg)).

Each of these outcomes could potentially be achieved by implementing one or another of a range of possible decommissioning options. The challenge for decision makers is therefore to evaluate available information to determine whether and how these various outcomes could be achieved and the mix of costs and benefits associated with each. Making such judgments is not an easy process because decommissioning is a complex and costly engineering undertaking that involves an extremely wide range of legal, environmental, socioeconomic, and policy issues. For example, almost 30% of the California platforms are in water depths exceeding 400 feet, with the deepest at 1198 feet (taller than the Empire State Building) (Figure ES.2). As a result they are of such large dimension and mass that their removal would exceed any platform decommissioning project ever performed.



**Figure ES.2. A segment of one of the larger California platforms onshore prior to its installation. For scale, a large red crane is in the foreground and a number of trucks and other vehicles are on the shoreline behind the platform at the right edge of the picture (courtesy of Proserv Offshore, Inc.)**

Thus, the core objective of this study was to create an analysis and a decision framework that will assist decision makers and other interested parties in understanding and investigating the implications of different decommissioning options and making a choice among these. We addressed this objective by accomplishing three goals:

- Prioritize potential decommissioning options and identify the most viable for more detailed analysis
- Summarize available information on these options to present a comparative analysis of impacts, costs, and benefits across a wide range of issues, focusing on those aspects of decommissioning that will contribute most to a choice among options (e.g., the analysis excludes or minimizes those aspects that are the same across options)
- Examine the existing legal / regulatory framework to identify mechanisms that would aid in implementing decommissioning options

The remainder of this Executive Summary presents key findings and conclusions related to each of these three goals. We emphasize this study was not intended to provide recommendations on the choice among decommissioning options. Rather, it organizes and presents detailed information on the key aspects of decommissioning, identifying tradeoffs among these various aspects, and rigorously examining the implications of these tradeoffs in a structured evaluation framework.

### ***Prioritize decommissioning options***

In addition to their complete removal, a number of different possible uses for decommissioned offshore oil and gas platforms have been proposed over the past several decades (Figure ES.3). It is important to understand that, except for the partial removal and artificial reefing option, all other uses merely postpone, but do not do away with, the need to eventually remove platforms when they reach the end of their structural lifetimes.

Not all of the alternative uses or disposal options are equally viable technically, economically, or politically. Our evaluation showed that only a subset were likely to be seriously considered for the majority of the southern California platforms and could potentially be implemented. These options included two use options (complete removal and partial removal as part of conversion to an artificial reef) and one disposal option (onshore dismantling). Partial removal is defined as removal of the platform deck and jacket down to a depth of 85 feet below the sea surface. Table ES.1 summarizes the results of this evaluation.

It is important to note that the partial removal option, which involves conversion of the decommissioned platform to an artificial reef, is feasible for only one (Platform Holly) of the four platforms in state waters. This is because the partial removal option involves removal of the platform structure to 85 feet below the water line to reduce the risk of ship strikes and to minimize the need for surface buoys or other markings. The other three state platforms are in water depths too shallow to implement this option.

Section 4 of the report includes descriptions of these options and provides detailed engineering descriptions of the complete and partial removal options.

### Overview of Decommissioning Options

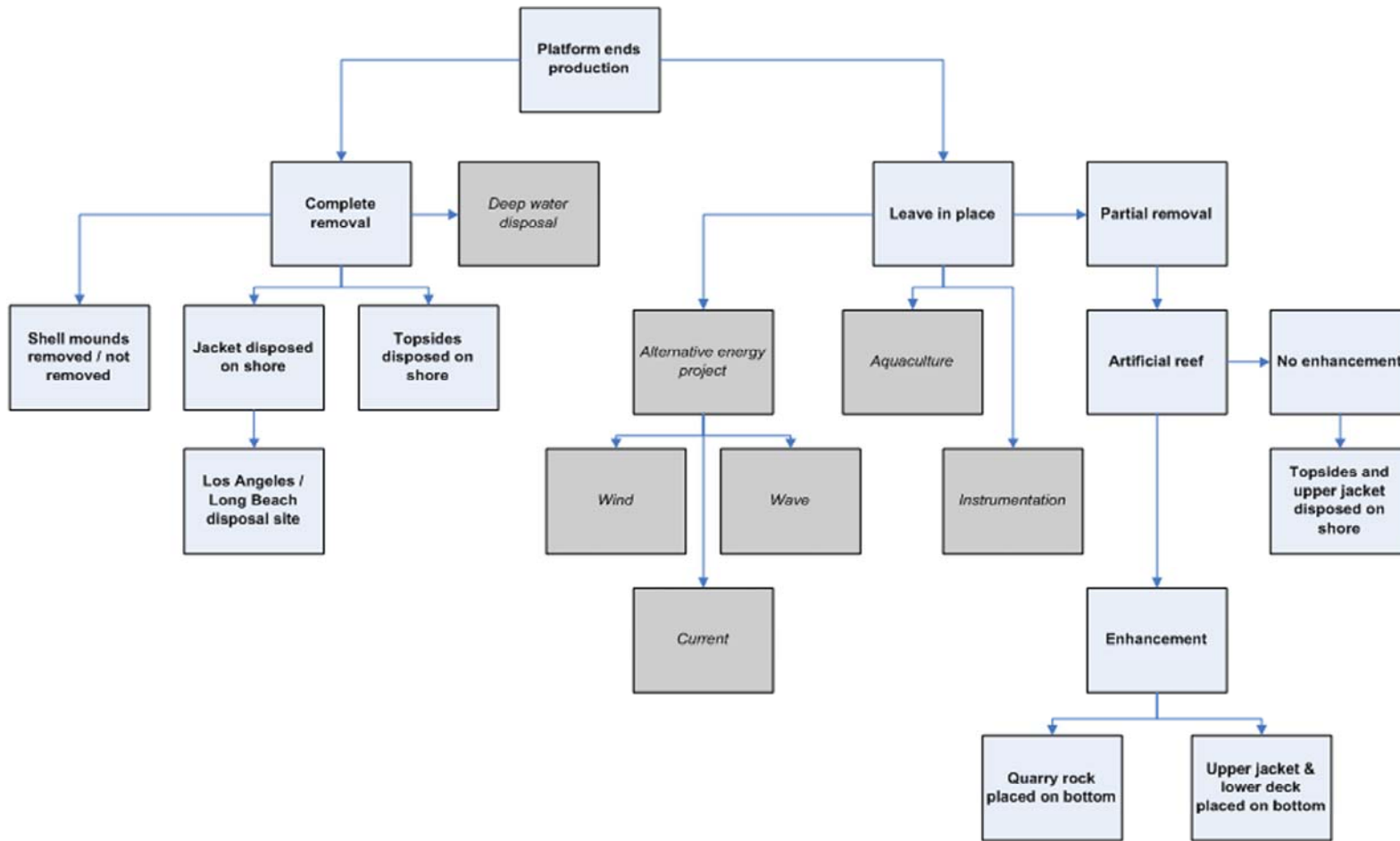

Figure ES.3. Summary of the decommissioning options considered. Complete removal and partial removal were analyzed in greater detail and are shown in bold type. Options in italics in the gray boxes were not considered in detail in the analysis. Rationale for prioritizing options is summarized in Table ES.1 and explained in more detail in Section 4.0.

**Table ES.1. Summary of alternative use and disposal options considered in this report. The complete removal and partial removal / artificial reefing use options, along with the onshore dismantling and disposal option, are considered in detail. Other use and disposal options are described and evaluated in summary form. All options shown, with one exception, are legally allowable under existing law. Transfer of ownership of platforms in the OCS to the state, while allowed under federal law, would require new state enabling legislation.**

Option	Prioritization	Rationale
<i>Alternate uses</i>		
Complete removal	Evaluated in detail	<ul style="list-style-type: none"> <li>• Required in leases</li> <li>• Highly valued by key stakeholders</li> <li>• Technically feasible for all platforms</li> <li>• Costed out in detail by MMS</li> </ul>
Partial removal / artificial reefing	Evaluated in detail	<ul style="list-style-type: none"> <li>• Highly valued by key stakeholders</li> <li>• Abundant precedent in Gulf of Mexico</li> <li>• Fiscal incentive for both operators and state</li> <li>• Technically feasible for all but 3 state platforms</li> <li>• Detailed costs based on MMS estimates for complete removal</li> </ul>
Artificial reefing using entire platform	Evaluated briefly	<ul style="list-style-type: none"> <li>• Highly valued by key stakeholders</li> <li>• Fiscal incentive for both operators and state</li> <li>• Increased liability due to retention of surface structure makes this of much less interest to state</li> </ul>
Alternative energy	Evaluated briefly	<ul style="list-style-type: none"> <li>• Some interest here and in Gulf of Mexico</li> <li>• No projects implemented on platforms</li> <li>• Current technology does not require platforms</li> <li>• Not technically feasible at large majority of platforms</li> <li>• No current interest by project proponents</li> <li>• Economic viability not demonstrated</li> </ul>
Aquaculture	Evaluated briefly	<ul style="list-style-type: none"> <li>• Some interest here and in Gulf of Mexico</li> <li>• No projects implemented on decommissioned platforms</li> <li>• Economic viability not fully demonstrated</li> </ul>
<i>Disposal</i>		
Onshore dismantling	Evaluated in detail	<ul style="list-style-type: none"> <li>• Required for deck structures containing hydrocarbons and other pollutants</li> <li>• Required for complete removal option (assuming no deep water disposal)</li> <li>• Technically feasible</li> <li>• Costed out in detail by MMS</li> </ul>

**Table ES.1. Continued.**

Option	Prioritization	Rationale
<i>Disposal</i>		
Placement of upper portion on bottom	Evaluated in partial detail	<ul style="list-style-type: none"> <li>• Useful as reef enhancement under the partial removal option</li> <li>• Valued by key stakeholders</li> <li>• No objection from state or federal managers</li> </ul>
Deep water disposal	Evaluated briefly	<ul style="list-style-type: none"> <li>• Potential fiscal incentive for operators</li> <li>• Little interest among state and federal managers</li> </ul>

### ***Comparative analysis***

The comparative analysis even of just the two decommissioning options selected is complicated not only by the number of possible suboptions available (i.e., the unshaded boxes in Figure ES.3) but also by the wide range of issues that could affect the choice among options. These issues include marine resources, air emissions, socioeconomic impacts, access to ocean resources, marine mammals and birds, water quality, direct decommissioning costs (and avoided costs), and longer-term program costs. We therefore bounded the analysis by excluding aspects of decommissioning that are identical across both options or that are data poor, difficult to quantify, or likely to be very small. Such aspects included, for example, employment and broader (regional, statewide) socioeconomic impacts, and tax consequences of platform donation under the partial removal and reefing option. We then used a combination of evaluation and synthesis of existing information together with analyses performed specifically for this project to conduct a systematic analysis of likely impacts on each issue listed above. Because of the number of issues and the complexity of potential impacts, we present only the most significant findings and conclusions of the analysis here.

We found that not all impacts were equally likely or significant. Impacts on benthic communities, birds, marine mammals, and water quality are likely to be localized and short term, and/or well managed. In all cases, the potential for impact is somewhat greater under the complete removal option because larger equipment will be on site for a longer period of time. In contrast, impacts on ocean access, and the socioeconomic costs and benefits of changes in access to platform locations, included a mix of positive and negative effects that could be important to some parties at some locations. Potentially interested user groups include recreational and commercial fishermen, nonconsumptive boaters and SCUBA divers, and commercial shipping. While we quantified the amount of area opened or closed to each use type for each decommissioning option, we were able to conduct only a qualitative analysis of potential socioeconomic impacts. There are large data gaps for this issue, along with uncertainties about how some user groups will respond to changes in access to the area around platforms.

In contrast, air emissions are likely to be an important issue, especially for complete removal of larger platforms. While data gaps prevented estimations of air emissions for all platforms and all decommissioning options, we did conduct a worst case analysis, represented by the complete removal of Platform Harmony, the largest and deepest platform offshore southern California. This analysis showed that the large diesel engines on the Heavy Lift Vessels (Figure ES.4) and other support vessels, on station for extended periods of time, will produce large amounts of emissions. Our analysis was not definitive and should be considered as a rough estimate; we were not able to obtain emissions factors for all equipment that would be involved in decommissioning and we could not predict the outcome of negotiations with regulatory agencies that could reduce emissions somewhat. Nevertheless, it appears that air emissions will be an important concern, especially for the larger projects, and the data gaps we encountered would most likely be filled as part of the engineering design and environmental review phases of any decommissioning project.



**Figure ES.4. The Heavy Lift Vessel Hermod is in the 4000 ton lift category that would be required to decommission the larger California platforms (source: Scheepvaartnieuws, [scheepvaartnieuws.punt.nl/upload/mot\\_1496.jpg](http://scheepvaartnieuws.punt.nl/upload/mot_1496.jpg), accessed January 28, 2010).**

The nature of potential effects on marine resources currently inhabiting platforms is an area of significant concern to managers and resource users. Some outcomes were relatively clear. For example, complete platform removal will result in the death of all attached organisms and the

dispersal of fish to other reefs, where they may be subject to the high fishing mortality prevalent throughout the Southern California Bight. The use of explosives, though not likely, will most probably result in the loss of all fish inhabiting the platform. The ultimate outcome of the partial removal option is less certain. Monitoring data at many of the platforms show that fish communities on the platforms, particularly of rockfish, are at higher densities and contain larger individuals than seen on natural reefs. In addition, studies have shown that young-of-the-year rockfish are also present in much higher densities on some platforms than on natural reefs. Partial removal will leave intact much of the fish community, particularly rockfish, although organisms attached to the upper portion of the platform would be lost. Recent data also show that young-of-the-year rockfish recruit almost exclusively below the 85 foot cutoff depth envisioned for the partial removal option. As a result, this option would most likely not eliminate platforms' function as a nursery area for juvenile fishes, particularly rockfish.

Platforms converted to artificial reefs could be subject to fishing pressure that would reduce the fish populations remaining after decommissioning. While the California Department of Fish and Game could restrict fishing by California registered vessels on state-owned reefs in federal waters, it is likely that such restrictions would not apply to out of state vessels. In addition, any such restrictions must not conflict with provisions of the federal Magnuson-Stevens Fishery Conservation and Management Act or regulations established by the Pacific Fisheries Management Council. However, the Council has not designated platforms as essential fish habitat or focused fishery regulations specifically on platforms. Restrictions on fishing activity on the artificial reefs might be seen to conflict with the intent of the National Fishing Enhancement Act, which provides the legal mechanism for transferring platform ownership to the state (or other entities) for the purposes of creating artificial reefs to improve fishing. Despite these potential legal issues, sportfishing groups in southern California have publicly confirmed on several occasions their willingness to accept certain fishing restrictions that would maintain the biological productivity of the platforms and protect populations of overfished species. (This discussion pertains almost exclusively to platforms in federal waters because only one state platform (Platform Holly) is suitable for the partial removal option.)

Another major question related to the partial removal option is the amount of biological production associated with platform communities. Using data from platform monitoring surveys, we conducted population dynamics modeling of fish communities on eight platforms with data adequate for the modeling analysis. While this analysis resulted in quantitative estimates of production, data gaps prevented quantitative comparisons of platform production to that in other communities and ecosystems in southern California, or any rigorous estimate of the overall contribution of platform communities to the regional ecosystem. We also conducted modeling of larval dispersal patterns that suggested platforms can function both as sources and as sinks, or recruitment locations, for fish larvae in the region.

We also conducted a detailed analysis of decommissioning costs, using recently updated cost estimates from the Minerals Management Service (MMS). These estimates pertained only to complete platform removal and we worked with MMS and their contractor to develop detailed cost estimates for partial removal for each platform. The complete removal of all 27 offshore platforms, grouped into the seven decommissioning projects defined by MMS, would cost an estimated \$1.09 billion, while partial removal of these platforms, grouped into the same set of



projects, would cost \$478 million, with avoided costs of \$616 million (with minor rounding). Avoided costs are costs that are saved by conducting the less extensive partial removal option.

### ***Decision model***

These findings and conclusions provide useful insights into the expected effects of the two main decommissioning options. However, the analysis in this report suffers, as is the case for all such assessments, from two important limitations. First, there is an extremely large number of possible combinations of platforms that could be selected for decommissioning, decommissioning options and suboptions, separate sources and types of impact, and approaches to valuing important costs and benefits. The report cannot investigate each of these in detail. Second, different parties will have different perspectives or preferences that will lead them to value impacts or outcomes differently. For example, one person might value preservation of biological production most highly and another following through on lease requirements to completely remove platforms at the end of their useful production lifetimes.

We have therefore developed a supporting tool for this report, the PLATFORM decision model (Figure ES.5), that provides an interactive environment in which users can investigate the cost and other implications of specific decommissioning projects in more detail. The decision model enables users to thoroughly investigate how different decommissioning choices and evaluation methods affect the relative desirability of different potential decisions. In addition, PLATFORM enables users to assess platforms individually or as part of larger, multi-platform projects, and similarly to examine individual impact categories (attributes) or integrate over all impacts to develop a global comparison between different possible decommissioning projects. The decision model also allows users to weight issues to reflect their own preferences and to investigate how different preferences affect the choice among decommissioning options, features that can prove useful in evaluating sources of conflict or disagreement. PLATFORM has been loaded with quantitative data on decommissioning costs, biological production estimates, and changes to ocean access, as well as with qualitative assessment frameworks for all other issues addressed in the report. The model thus provides a structured means of working more directly with the key data and information developed for this analysis.

### ***Partial removal: institutional and legal issues***

The partial removal option would necessarily trigger a complex legal and regulatory process that would require new state legislation and decisions about how to deal with ownership transfers, liability, and the use of the state's share of cost savings from foregoing complete platform removal. These issues required thorough description and analysis in order to define constraints, opportunities, and decision options for the state. The report therefore responds directly to requests from state managers in agencies that would be directly involved in platform decommissioning to examine a range of possible legal and management approaches for resolving the still undefined aspects of the partial removal option. As one manager stated it, "We'd like to know what would happen 'after' [the transfer of ownership] in the partial removal option." We emphasize that the extensive discussion of this topic is not intended to imply that partial removal and artificial reefing is the preferred option. It is instead intended to address what would be involved if this option were selected.

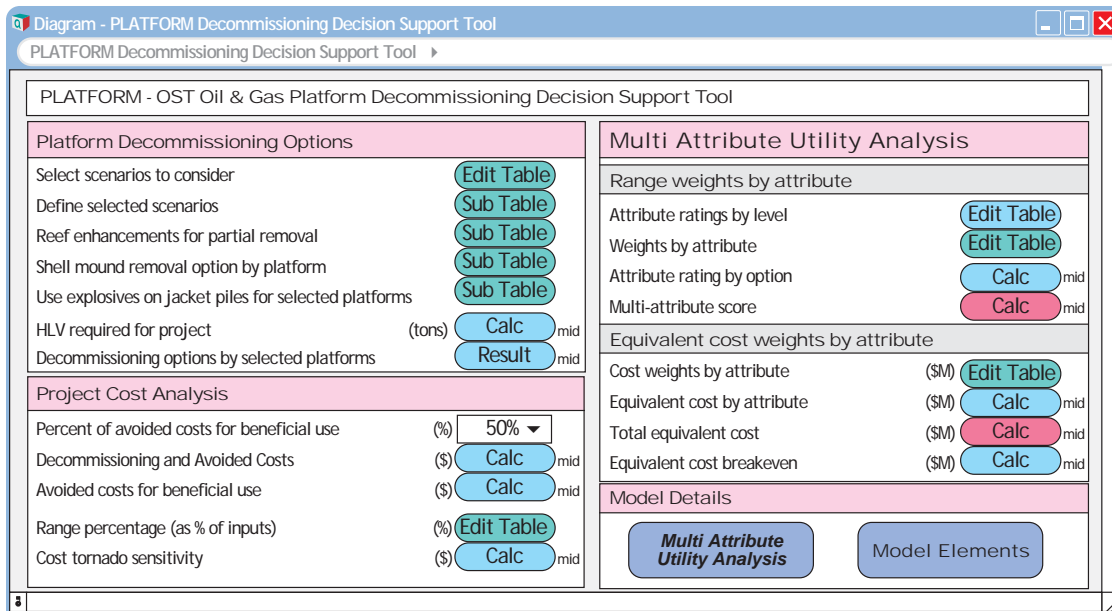

**Figure ES.5. The top-level user interface for the PLATFORM decision model, illustrating the four major types of functions (see text in Section 5.4 and Appendices 4 and 5 for more detail).**

While the mechanism for transferring ownership of a platform converted to an artificial reef is clearly described in federal law, California currently cannot accept ownership of an artificial reef located in federal waters. The partial removal and artificial reefing option (Figure ES.6) would therefore require new state enabling legislation, the requirements for which are clear and described in detail in Section 6 of the report. Potential liability associated with a large artificial reef has been a consistent concern whenever a rigs-to-reefs program is discussed. We identify and discuss several well-developed mechanisms for dealing with liability concerns, as well as legal precedents, in California and in other states.

Under the partial removal option, there would be significant funds available to the state, although the exact distribution of avoided costs between the state and the operator remains to be negotiated, since there is no requirement for any specific percentage share either party would receive. There are well-established mechanisms for receiving these funds, retaining them for specific uses, and then allocating and managing them. While the state would need to implement a more robust artificial reef program in order to manage these platform reefs, the scope of the program would depend on decisions about how to manage the reefs and for what purposes. While there are a number of significant legal and institutional issues involved implementing a partial removal and reefing option, there are useful precedents for all of these issues that could readily be applied in California.

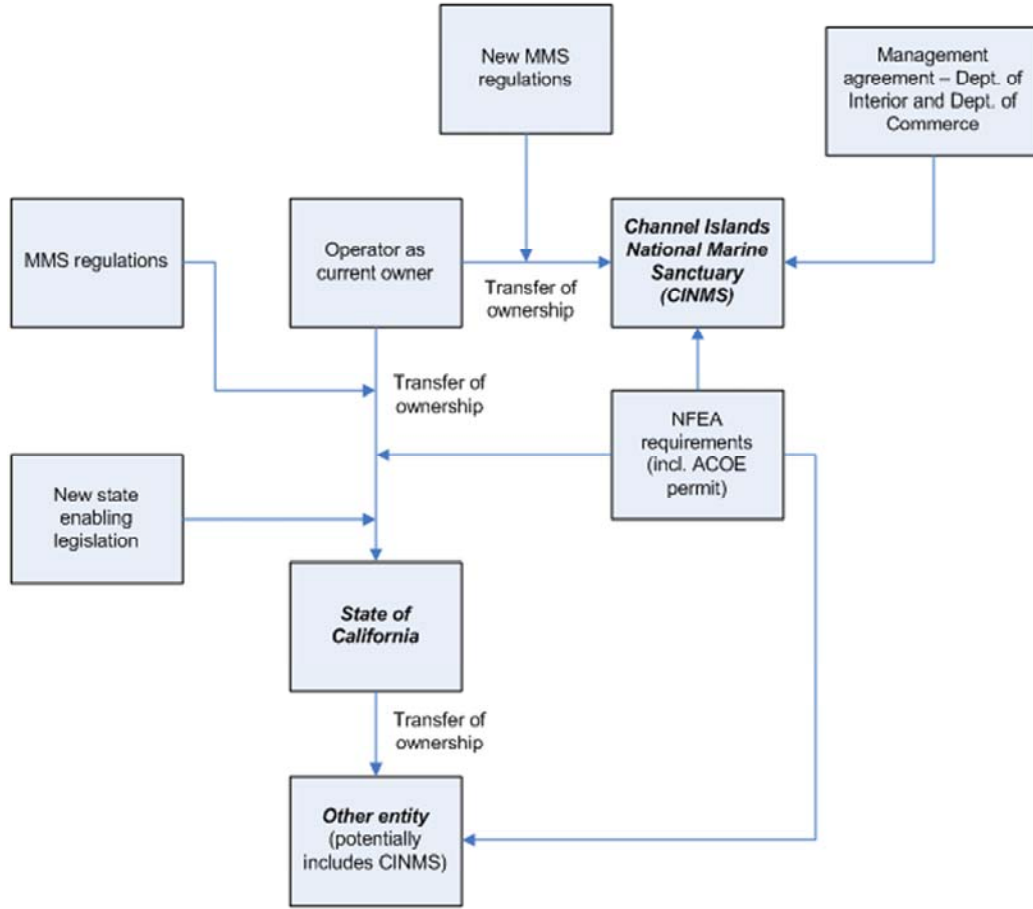

**Figure ES.6. Depiction of the pathways for transferring ownership of a decommissioned platform.**

### **Summary**

There are a number of potential decommissioning options that could be implemented when the offshore platforms reach the end of their useful lifetimes, but only two of them are likely to be feasible: complete removal and partial removal to 85 feet with the remainder of the platform converted to an artificial reef. The legal and regulatory frameworks for both options are clearly defined, although the partial removal option would require new state legislation to allow the state to accept ownership of platforms in federal waters. The full range of impacts to be expected as a result of both options can be described qualitatively and some can be quantified to varying degrees. However, significant data gaps prevent the full quantification of all potential impacts. Despite these limitations, the information gathered here enables an in-depth comparison of the two primary decommissioning options and the interactive decision model that accompanies the report allows users to more fully investigate the implications of the two options and of different ways of valuing or weighting the costs and benefits of the options.

## 1.0. Introduction

---

There are currently 27 operating oil and gas platforms in State Tidelands and on the federal Outer Continental Shelf (OCS) off California (Table 1.1, Figure 1.1) that eventually will be decommissioned as they reach the end of their useful oil and gas production lifetimes. Existing offshore oil and gas leases require lessees in both state and federal waters to completely remove the production facility (i.e., the platform, including jacket, drilling rig, conductors, and all infrastructure and utilities) and to restore the seafloor to its pre-platform condition when the facility is no longer producing oil and gas. However, in the time since most of these leases were signed, and due to technological advances, feasible alternatives to full removal have emerged. As a result, laws and regulations have changed in response to allow such alternative uses, although existing leases, which predate these new laws and regulations, continue to contain provisions requiring complete removal. Such uses range from aquaculture to alternative energy production to artificial reefs intended to enhance biological production and/or fishing opportunities. As explained further in Section 1.2, the objective of this study was to create an analysis and a decision framework useful to decision makers and other interested parties in understanding and investigating the implications of alternative decommissioning options and making a choice among these.

### 1.1. Project background

In response to this evolving economic, technical, and legal/regulatory context, the California Natural Resources Agency in 2007 began investigating the issues surrounding alternatives for decommissioned<sup>1</sup> platforms in the State Tidelands and on the OCS. Beginning with a scoping meeting with 25 ocean and coastal conservation stakeholders, the Natural Resources Agency established a three-phase process to formulate and inform policy options. The three phases include:

#### **KEY CONCEPTS**

**Overview** - There are currently 27 operating oil and gas platforms off the California coast: 4 in State Tidelands and 23 on the federal Outer Continental Shelf (OCS), in water depths ranging from 30 to 1198 feet. While existing leases require complete removal of platforms once production ends, feasible alternatives have emerged as technology has advanced, and laws and regulations have changed in response to allow consideration of such alternative uses.

**Project Background** - This project is part of a three-phase process leading to a policy evaluation by the California Natural Resources Agency of platform decommissioning options. The report and decision model are the product of an intensive investigation of these alternatives, managed by the California Ocean Science Trust (OST) and supported by an Expert Advisory Committee (EAC).

**Organization and Goals of the Analysis** - The project's objective was to create an analysis and decision framework useful to decision makers in understanding the implications of decommissioning options and choosing among these. An accompanying interactive decision model (PLATFORM) enables users to define specific decommissioning projects, starting assumptions, and values, and investigate their potential consequences in detail.

---

<sup>1</sup> Decommissioning refers to the process of ending oil and gas production, plugging and abandoning wells, and either removing the platform or converting it to an alternate use.

**Table 1.1. Offshore oil and gas platforms in the southern California region.**

<b>Platform</b>	<b>Water depth (feet)</b>	<b>Installation date</b>	<b>Deck weight (tons)</b>	<b>Total weight (tons)</b>	<b>Operator</b>
<i>OCS</i>					
A	188	1968	1357	6405	Dos Cuadras Offshore LLC (DCOR)
B	190	1968	1357	6535	Dos Cuadras Offshore LLC (DCOR)
C	192	1969	1357	5796	Dos Cuadras Offshore LLC (DCOR)
Edith	161	1983	4134	9147	Dos Cuadras Offshore LLC (DCOR)
Ellen	265	1980	5300	14016	Rise Energy LLC / SP Beta Properties LLC
Elly	255	1980	4700	9400	Rise Energy LLC / SP Beta Properties LLC
Eureka	700	1984	8000	38360	Rise Energy LLC / SP Beta Properties LLC
Gail	739	1987	7693	33924	Venoco
Gilda	205	1981	3792	11690	Dos Cuadras Offshore LLC (DCOR)
Gina	95	1980	447	1426	Dos Cuadras Offshore LLC (DCOR)
Grace	318	1979	3800	11256	Venoco
Habitat	290	1981	3514	9044	Dos Cuadras Offshore LLC (DCOR)
Harmony	1198	1989	9839	78380	Exxon Mobil Corp.
Harvest	675	1985	9024	32815	Plains Exploration and Production Company (PXP)
Henry	173	1979	1371	4046	Dos Cuadras Offshore LLC (DCOR)
Heritage	1075	1989	9826	67515	Exxon Mobil Corp.
Hermosa	603	1985	7830	29516	Plains Exploration and Production Company (PXP)
Hidalgo	430	1986	8100	22478	Plains Exploration and Production Company (PXP)
Hillhouse	190	1969	1200	5929	Dos Cuadras Offshore LLC (DCOR)
Hogan	154	1967	2259	5497	Pacific Operators Offshore, Ltd. (POOLLIC)
Hondo	842	1976	8450	28713	Exxon Mobil Corp.
Houchin	163	1968	3591	6977	Pacific Operators Offshore, Ltd. (POOLLIC)
Irene	242	1985	2500	8646	Plains Exploration and Production Company (PXP)
<i>State waters</i>					
Emmy	45	1963	2201	3947	Aera Energy
Eva	58	1964	2000	3597	Dos Cuadras Offshore LLC (DCOR)
Esther	30	1990	2000	3050	Dos Cuadras Offshore LLC (DCOR)
Holly	211	1966	2890	5772	Venoco

1. Issues identification, completed in early 2008, which described information needs, defined a set of key stakeholder questions (addressed specifically in Section 7 of this report), and laid the groundwork for a Request for Proposal (RFP) for a comprehensive investigation of the major issues currently surrounding decommissioning

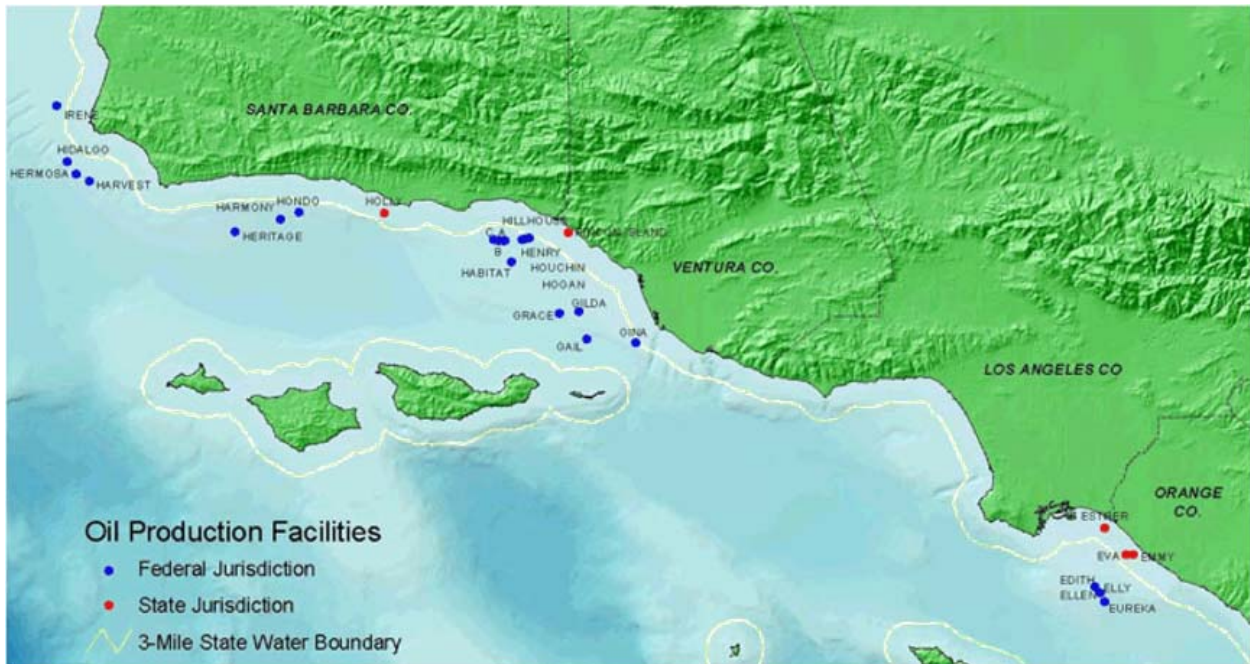

**Figure 1.1. Locations of offshore platforms in the southern California region (source: [Earthguide.ucsd.edu/fuels/images/platforms.jpg](http://Earthguide.ucsd.edu/fuels/images/platforms.jpg)).**

2. Comprehensive investigation, managed by the California Ocean Science Trust (OST) and supported by an Expert Advisory Committee (EAC), to be performed by a contracting team and resulting in a report reviewed by the EAC at key steps during its development
3. Policy evaluation during which the Natural Resources Agency will use the report to develop policy options that may lead to new federal regulations, state legislation, and/or other mechanisms to address decommissioning options for offshore oil and gas platforms

This report is the product of Phase 2 and assembles and examines scientific and legal information that will frame future state policy discussions on the alternatives for decommissioned platforms. This report is targeted primarily at decision makers within the California Natural Resources Agency, as well as other state and federal agencies with a role in decision making about offshore oil and gas platform decommissioning (e.g., California Coastal Commission (CCC), State Lands Commission (SLC), Regional Water Quality Control Boards, Minerals Management Service (MMS), National Marine Fisheries Service (NMFS), U.S. Army Corps of Engineers (ACOE)). Other audiences who may find this report and its accompanying decision model (PLATFORM) useful are members of the California Legislature and their staff, oil companies with offshore leases, local governments in the coastal zone, environmental groups, and the general public.

We emphasize that this report and its companion decision model (PLATFORM) are NOT intended to provide recommendations on the choice among decommissioning options. Rather,

they are intended to organize and present detailed information on the key aspects of decommissioning, identify tradeoffs among these various aspects, and rigorously examine the implications of these tradeoffs in a structured evaluation framework.

## **1.2. Organization and goals of the analysis**

This project was focused on the following goals:

- Collect, organize, and summarize as much as possible of the available information about the implementation process and impacts (both positive and negative) of alternative decommissioning options for offshore oil platforms in southern California
- Evaluate the economic and technical feasibility of a range of decommissioning options and prioritize for more detailed analysis those that are most feasible and most applicable to California platforms
- Focus this detailed analysis on those aspects of the decommissioning options that would contribute to a decision among them (i.e., exclude or minimize those aspects that are the same across options)
- Summarize findings about the positive and negative impacts of decommissioning options and provide a decision tool to assist users in exploring the implications of implementing the options
- Investigate the institutional and legal aspects of the selected options, particularly the rigs-to-reefs option which is more complex and uncertain

The objective of the present study was to create an analysis and a decision framework useful to decision makers and other interested parties in understanding and investigating the implications of alternative decommissioning options and making a choice among these. In support of this core objective, the interactive decision model (PLATFORM) that supplements this report enables users to define specific decommissioning projects they may have an interest in and investigate the implications of different assumptions, perspectives, and ways of valuing a range of impacts, costs, and benefits.

The following paragraphs describe the focus and content of each major section of the report. Each section and major subsection is organized to include an initial summary followed by more detailed technical information. This enables readers to understand the report's major findings and to be selective about which issues they want to read in greater detail.

**Section 2** provides a brief history of decommissioning efforts and uses this to help describe the present decision context for decommissioning.

**Section 3** frames the analysis by describing and summarizing the existing legal and regulatory context for decommissioning. These goals, laws, and regulations are then explained in more detail throughout the report as needed to fully describe the decommissioning process and the procedural, legal, and regulatory options available to state managers.

**Section 4** describes the range of decommissioning alternatives and presents the rationale for focusing the detailed analysis on two primary removal options, complete removal and partial removal with the remaining portion of the platform left in place as an artificial reef, and one disposal option, dismantling ashore in the Los Angeles / Long Beach area. The engineering and logistical aspects of these options are then described in detail. We give particular attention to shell mounds, because the disposition of shell mounds was the most controversial aspect of decommissioning Chevron's platforms Hazel, Heidi, Hilda, and Hope (known as the 4H project) in 1996. Section 4's in-depth description provides essential background for understanding the subsequent analysis of the environmental, cost, and socioeconomic impacts of each decommissioning alternative in Section 5.

**Section 5** presents the detailed analysis of the two main options, beginning with a discussion of boundary conditions that define which aspects of the decommissioning options are excluded from or included in the analysis. For example, aspects that are identical across both main alternatives are excluded since they do not contribute to a choice between the options. In addition, aspects that are data poor, difficult to quantify, or likely to be very small are also excluded. The likely effect of these exclusions on the analysis varies depending on their size and how central they are to predicting the impacts of each decommissioning option. In addition to analyses of biological, environmental, and socioeconomic impacts of decommissioning, Section 5 includes a detailed analysis of the costs of complete and partial platform removal, including estimates of avoided costs, or the savings from selecting the partial removal option. We based all costs, with two minor exceptions, on the most recent Minerals Management Service (MMS) estimates of decommissioning costs (Proserv Offshore 2010). This provided a consistent, authoritative, and fully documented basis for estimating and comparing costs across options.

Section 5 also describes the PLATFORM decision model, developed as a supporting tool for this report, and presents illustrative, integrated analyses of representative decommissioning projects. The number of possible combinations of platforms selected for decommissioning, decommissioning options and suboptions, and approaches to valuing important costs and benefits is extremely large and it would not be informative to present such a mass of detail in this report. The decision model is therefore intended as an interactive environment in which users can investigate the cost and other implications of specific decommissioning projects in more detail.

Three features of the PLATFORM model deserve particular attention. First, it provides users with the ability to investigate each aspect of a decommissioning option (e.g., costs, impacts on biological production, air emissions) in depth, and to compare the results of different decommissioning projects and options for each type of impact. Second, the model has the capability to integrate impacts, both quantitative and qualitative, into an overall project score. Third, and most importantly, the model provides users the flexibility to weight different costs and benefits as they see fit, in order to capture and investigate the effects of different perspectives and values on the overall analysis. For example, some users may weight potential effects on marine mammals highly, while others would weight effects on biological production or predicted air emissions most highly. The decision model allows users to explore how their own values and preferences influence the choice among options.



**Section 6** describes the institutional and legal aspects of the partial removal and artificial reefing option. While complete removal is an expensive and complex engineering process, there is little follow up or involvement by the state required (with the possible exception of shell mounds) once the platform is removed. The partial removal and artificial reefing option, in contrast, triggers a complex legal and regulatory process that would require new state legislation and decisions about how to deal with ownership transfers, liability, and the use of the state's share of cost savings from foregoing complete platform removal. These issues required thorough description and analysis in order to define constraints, opportunities, and decision options for the state. Section 6 therefore responds directly to requests from state managers to examine a range of possible legal and management approaches for resolving the still undefined aspects of the partial removal option. As one manager stated it, "We'd like to know what would happen 'after' [the transfer of ownership] in the partial removal option." We emphasize that Section 6 is not intended to imply that partial removal and artificial reefing is the preferred option. It is instead intended to address what would be involved if this option was selected.

**Section 7** addresses specific questions posed by stakeholders as part of Phase 1 of the Natural Resources Agency's planning process. Many of these questions were answered in the detailed analyses in Sections 5 and 6, while others cannot be answered until a specific decommissioning project is defined and scoped in detail.

All analyses and assessments in this report, and in PLATFORM, were conducted using existing data and information, with the following exceptions. All cost data are from the most recent decommissioning cost estimates prepared by MMS (Proserv Offshore 2010), with the exception of rough cost estimates we obtained from contracting firms for shell mound dredging and the placement of reef enhancement materials around the base of platforms. All assessments of environmental and socioeconomic impacts were based on published data, with the exception of calculations of areas around platforms likely to be opened or closed to access under different scenarios and data on income from dive boat trips to existing platforms obtained through phone interviews with charter companies. In addition, biological production estimates were based on available monitoring data from the platforms and derived using standard modeling methods described in detail in Appendix 3.

Several other appendices provide background information on the region and describe sources of map-based information (Appendix 1), include text of key legislation and other legal documents that help define the legal context for rigs-to-reefs programs (Appendix 2), and provide a users guide to the decision model (Appendix 4).

## 2.0. Decommissioning Background

---

Some specific background details are necessary for understanding and applying the information contained in this report and the PLATFORM decision model. These include the physical settings of oil and gas platforms, expected production lifetimes, the history of decommissioning in California and elsewhere, and potential for alternative uses of decommissioned platforms.

From a physical setting and production perspective, while there has been some offshore decommissioning experience in California, there has been a substantial amount of such experience in the Gulf of Mexico. However, all Gulf of Mexico decommissioning projects occurred in relatively shallow water. Almost 30% of the California platforms are in water depths exceeding 400 feet, with the deepest at 1198 feet. As a result, their removal would exceed any platform decommissioning project ever performed. In addition, differences in economic, environmental, and political contexts reduce the direct applicability of the Gulf of Mexico decommissioning experience to California.

Historically, all completed decommissioning projects in California (with the exception of Platform Henry, a smaller jack-up rig) initially included proposals for conversion to artificial reefs (commonly termed rigs-to-reefs), but did not consider other alternative uses. Although none of these plans were implemented, they provide useful insight into the key issues associated with decommissioning in general and with this option in particular. More recently, other alternative uses, such as aquaculture and wave energy production, have been proposed for decommissioned platforms.

However, such proposals are few in number, none have been implemented, and technological advances and market factors appear to have reduced interest in using platforms for these

### KEY CONCEPTS

**Physical Setting** - In 1947, the first offshore oil and gas platform was constructed in less than 20 feet of water in the Gulf of Mexico. Subsequently, approximately 6800 offshore structures have been installed in 53 countries worldwide; roughly 4000 exist in the United States, of which 3728 are in the Gulf of Mexico. The 27 California platforms are located from very near shore in shallow depths to approximately ten miles offshore in water depths of nearly 1200 feet. Nearly 30% of California platforms are in water depths that exceed any decommissioning project ever performed.

**Useful Lifetimes** - In 2009, MMS estimated that all the platforms located in the Pacific Outer Continental Shelf (POCS) will reach the end of their useful life between 2015 and 2030. Such estimates are necessarily uncertain because a platform's useful lifetime depends on the economics of oil and gas production. Under current law and regulations, at the end of its useful life, a platform must be decommissioned and removed or transferred to alternate use.

**Decommissioning Experience** - California's decommissioning experience is relatively limited (only seven platforms have been decommissioned) but does provide insight into important environmental and management issues relevant to future decommissioning projects. All seven projects initially included artificial reefing proposals, although none were implemented. Other alternative uses such as aquaculture and LNG terminals have been suggested more recently but not implemented.

**Decision Context** - Decisions about when and how to decommission offshore oil platforms in southern California will involve complex tradeoffs among economic, environmental, and political outcomes. The decision context in California differs in important ways from that in the Gulf of Mexico, limiting to some degree the direct applicability of the extensive decommissioning experience in the Gulf of Mexico.

purposes. Thus, there is a much smaller body of experience on which to base conclusions about the issues such uses might arise with respect to platform decommissioning.

### **2.1. Physical setting**

Since the first U.S. offshore oil and gas platform was constructed in the Gulf of Mexico in 1947 in less than 20 feet of water, approximately 6800 offshore structures have been installed in 53 countries worldwide. Of those roughly 4000 reside in the United States (Alghamdi and Radwan 2005). California offshore oil and gas operations are relatively limited compared to other producing offshore areas. For example, there are 27 oil and gas platform structures located offshore California (Table 1.1, Figure 1.1) while there are currently 3728 platforms operating in federal waters in the Gulf of Mexico ([www.mms.gomr.gov](http://www.mms.gomr.gov)) and approximately 490 offshore oil and gas installations operating in the North Sea and North East Atlantic of which 112 are large steel structures (Osmundsen and Tveteras 2000). Over 2000 additional offshore installations are located off the coasts of South America, West Africa, the Middle East, Asia and Australia (Alghamdi and Radwan 2005).

The California platforms are located at distances from the coast ranging from near the beach to as much as ten miles at sea. These platforms were installed between 1968 and 1989 and are in water depths ranging from 30 feet for Platform Esther to 1198 feet for Platform Harmony (Table 1.1, Figure 1.1). In this region, platforms are located in areas of soft bottom rather than rocky habitat. Appendix 1 describes additional sources of map-based information (and presents sample maps) on ecological resources, administrative boundaries, and human uses in the region.

### **2.2. Platforms' useful lifetimes**

In 2009, MMS estimated that all the platforms located in the Pacific Outer Continental Shelf (POCS) will reach the end of their useful life<sup>2</sup> in the 2015 to 2030 time period (Proserv Offshore 2010), at which point they must be decommissioned and either removed or transferred to alternate use. There are no analogous projections for the four platforms in state waters. Platform useful life predictions can be difficult because they can be affected by many factors; “useful life” should not be confused with a platform’s “structural life”, when a platform becomes structurally unable to continue operations.

Platform structural life can be extended significantly with proper maintenance such as cathodic protection systems, regular marine growth removal from the jacket legs, and timely application of protective coatings to combat corrosion. Similarly, the production and processing equipment on-board will last many years if properly maintained and can be replaced when mechanically necessary or technologically warranted. Thus, with proper maintenance and barring catastrophic damage (e.g., hurricane, explosion), a platform’s structural life can be extended significantly.

In contrast, economics dictate the useful life of a platform. Operators will continue operations as long as the platform can produce acceptable earnings or cash flow. Once oil or gas production

---

<sup>2</sup> The end of a platform’s useful life is the point at which continued operation no longer produces acceptable earnings or cash flow. As this section explains, a number of technical and economic factors affect this judgment.

falls below a rate that produces acceptable earnings or cash flow, and no alternatives exist to improve production rates, the reservoir over which the platform sits is considered economically depleted. At that point, the operator will propose to either MMS or SLC that production be terminated and the platform decommissioned. Agency staff would review the data and projections on which the proposal was based before allowing decommissioning to proceed.

Because the economics of oil and gas production is uncertain, useful life projections often change over time. The most obvious variable is the value of the oil and gas produced. As the world oil price swings wildly (e.g., more than \$145 to under \$34 per barrel within six months in 2008), so do the projections for useful platform life. If sustained, a radical oil price drop can dramatically produce projected useful lifetime, assuming production remains constant, because it reduces the income generated by the platform. Similarly, new regulations can increase operators' financial obligations and may shift an operation with marginal earnings or cash flow into the red, thus shortening useful life. Evolving technology may also increase recoverable reserves or decrease costs to extend useful platform life. Conversely, evolving technology could also increase production rates thereby decreasing platform useful life by enabling faster recovery of recoverable reserves. Confusing the matter even further, the platform may be one component in a multi-component project that, although operating at a loss, is necessary to maintain project operations that are profitable overall.

If the operator believes the factors negatively affecting platform economics will be transitory in nature, the operator may elect to continue to operate at a loss until conditions improve. Conversely, if the operator believes economic conditions will not improve, the operator may elect and be allowed to shut in the platform pending decommissioning.

As a result of such factors, predictions of a platform's useful life are highly uncertain, complicating efforts to plan for eventual decommissioning. We make no attempt to predict or analyze such factors, to make or use calculations of petroleum reserves, or to estimate the remaining useful lifetime of offshore platforms in southern California. The PLATFORM model is designed to compare the costs and benefits of alternative decommissioning scenarios, without attempting at this point to predict when decommissioning might occur.

### ***2.3. Decommissioning experience***

California's decommissioning experience is relatively limited, although it does provide useful insight into the environmental and management issues likely to be important in any future decommissioning projects. While there is extensive decommissioning experience in the Gulf of Mexico, its applicability to California is limited. This is because California platforms may present unique technical challenges due to their large size and greater water depth and because of substantial differences between the economic, environmental, and political contexts in California and the Gulf of Mexico.

All seven of the decommissioning projects completed in California resulted in complete removal and onshore disposal of platform structures. While artificial reefing was proposed during planning for all seven projects, it was never implemented and no other alternative uses for the platforms were proposed. More recently, other alternative uses (e.g., liquefied natural gas (LNG))

terminal, aquaculture, wave energy) have been proposed for other platforms but none of these have been implemented (see Section 4.2 for more detail).

### **2.3.1. Limited experience applicable to California**

Consistent with the relatively small size of the California offshore operations, California offshore oil and gas platform decommissioning experience is limited. To date only seven platforms in the region have been decommissioned. Platform Harry, a modified jack-up rig, was decommissioned in 1974. Two additional platforms, Texaco's Helen and Herman, were removed in 1988 and Chevron's platforms Hazel, Heidi, Hilda, and Hope (known as the 4H project) were removed in 1996 (Culwell 1997). Similarly, in the North Sea, as of 2006, very few offshore structures and no large fixed steel oil and gas platforms had been decommissioned (Ekins et al. 2006). In contrast, as of 2007, approximately 7,000 offshore platforms had been installed in the Gulf of Mexico, of which approximately 3,000 have been decommissioned. Most of these decommissioned Gulf of Mexico platforms (93%) have been complete removals with 260 (7%) converted to artificial reefs by various means (Orange County Coastkeeper 2007). The Gulf of Mexico thus clearly represents a substantial resource of experience for offshore decommissioning technology and removing damaged platforms in the Gulf of Mexico after Hurricane Katrina added valuable new experience to this reservoir of knowledge (R. Byrd, pers. comm. 2009).

What is unique about the oil and gas platforms in southern California is that almost 30% of them are located in water depths exceeding 400 feet, with the deepest at a water depth of 1198 feet. As a result they are of such large dimension and mass (Table 1.1, Figure 2.1) that their removal would exceed any platform decommissioning project ever performed.

No documented platform decommissioning projects in the Gulf of Mexico or the North Sea have involved fixed leg steel platform structures in water depths exceeding 400 feet. While processes have been extremely well developed for decommissioning platforms in the Gulf of Mexico, the technology developed in the Gulf of Mexico to date has not provided all the answers to the technical challenges posed by the deep water platforms offshore California. These challenges will require industry to adapt and improve on existing decommissioning technology.

### **2.3.2. Completed decommissioning projects**

All seven California decommissioning projects, which involved the plugging and abandonment of 134 wells (McGinnis et al. 2001), were located in state waters in water depths of 100 – 140 feet. The platforms themselves were removed by explosives and heavy machinery that pulled the structures from the ocean bottom and all biomass encrusting the structures was destroyed during the decommissioning process. The environmental impact report (EIR) for the 4H decommissioning project (see below) provides a representative picture of the decommissioning project (see below) provides a representative picture of the technical and environmental issues involved in decommissioning (SAIC 2003). Because these platforms were located in state waters, they could have been transferred to state ownership as artificial reefs under provisions of the state's 1958 artificial reefing law, a fact that contributed to persistent proposals to convert decommissioned platforms to reefs.

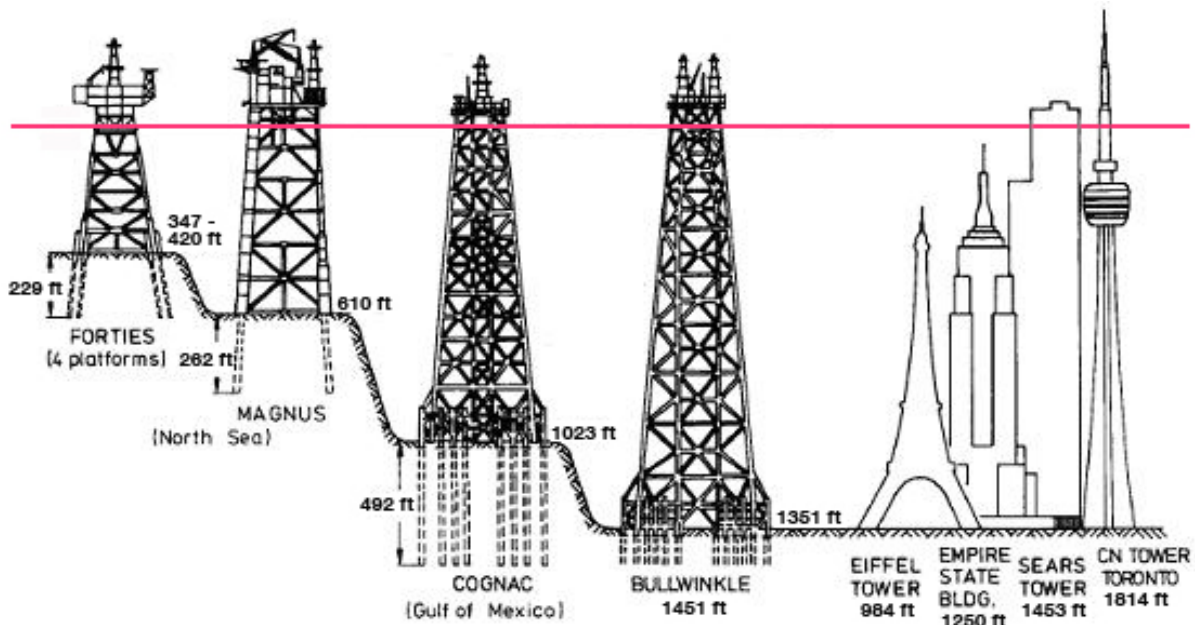

**Figure 2.1. Elevation views illustrating the size of representative offshore oil platforms in comparison to well-known landmarks. The horizontal line represents the height of Platform Harmony, the largest platform offshore southern California (Table 1.1) (modified from <http://synclaire.net/blog/2008/02/oil-platform-comparison/>).**

Platform Harry, decommissioned in 1974, was located approximately one mile off Point Conception in 100 feet of water. Original decommissioning plans proposed moving parts of the platform to a different location as an artificial reef. This plan was ultimately abandoned because the proposed site was too remote to be accessible to fishermen and because of controversy over navigational issues and potential liability. As a result, the main deck structure was reused and the jacket scrapped onshore (McGinnis et al. 2001, [www.slc.ca.gov](http://www.slc.ca.gov)).

Decommissioning plans for Platforms Helen and Herman, located 30 miles west of Goleta in the Santa Barbara Channel and decommissioned in 1988, also originally included reuse as artificial reef structures, with the jackets to be transported to Santa Monica Bay for reefing. The proposal was rejected due to opposition by environmental representatives who questioned the value of artificial reefs and the reuse of platform materials for this purpose (Frumkes 2002). As described further in Manago and Williamson (1998), deep water disposal was also considered and discarded and both platforms were thus completely removed and scrapped at a shipyard in Long Beach. Although this was the first large-scale offshore decommissioning project in California, the platform removal itself proceeded smoothly, except for some difficulties with mechanical cutting of the piles below the bottom, or mudline. Together the two platforms had a steel weight of approximately 3000 tons with an additional 1000 tons (estimated) of marine growth

encrusting the structures. Decomposition of marine growth attached to the structure can cause significant odor problems at and in the vicinity of the shipyard. The size of the jacket structures also presented a significant problem during unloading from the transport barge and a 500 ton derrick barge was required to offload the materials at the site.

Artificial reefing was again proposed during the initial discussion of the 4H decommissioning project offshore of Carpinteria in 1992. However, the CCC and the California Department of Fish and Game (CDFG) determined that decommissioned platform structures were not suitable as reefing materials (McGinnis et al. 2001, Frumkes 2002). Later, in 1994, another proposal was made to use portions of the platforms as test reefs at the Sycamore Canyon Ecological Reserve near Port Hueneme ([www.slc.ca.gov](http://www.slc.ca.gov)). The reefs would have tested the viability of using platform materials as reefs, but the option was abandoned because of concerns about liability, permitting delays, and resistance from environmental and commercial fishing groups. Resolution of concerns related to air emissions also delayed the project for approximately one year as emissions offsets were negotiated and implemented (Manago and Williamson 1998).

As described in Manago and Williamson (1998), the four platforms were completely removed and scrapped onshore at a facility in the Port of Long Beach, with the steel scrap recycled and sold. Certain aspects of the platforms' structure required developing new methods for cutting the platforms into smaller sections, conducting some disassembly operations at sea, and lifting sections onto the transport barge. Together the four platforms had a steel weight of more than 10,000 tons with an additional 2700 tons of marine growth. As occurred in the Helen and Herman project, onshore crane capacities were extremely limited and the project's offshore derrick barge was required to offload materials at the site.

The shell mounds under the four platforms, consisting of drilling muds covered by compacted shells, were left in place and have remained a source of controversy, focused primarily on uncertainty about the relative magnitude of the environmental impacts and benefits associated with removing them compared to leaving them in place (SAIC 2003) (see Section 4.1.1.2 for more detail). Chevron is obligated, both under terms of its lease and the approved abandonment plan, to ensure that the area previously occupied by the platforms is free of obstructions and accessible to commercial fishing activities. Removing the shell mounds would result in a range of short-term impacts to water and sediment quality, with possible secondary toxic effects on marine life. Conversely, leaving the shell mounds in place would result in an ongoing risk that contaminants could migrate from the shell mounds, potentially resulting in toxicity to or bioaccumulation in marine biota. A number of studies (summarized in SAIC 2003) were conducted in an attempt to resolve uncertainty about the likely outcomes of each option (i.e., removal vs. leaving shell mounds in place). These studies showed that some contaminants are present in certain species, although the source of these contaminants was not directly tied to shell mounds. The studies also concluded that contaminants are currently not being released from the shell mounds to other areas but that there is some evidence of contamination in organisms living on the mounds. In addition, the mounds' continued stability over the long term is unpredictable. Both options (i.e., removal, leaving in place) would require some sort of mitigation or remediation, once one or the other is selected (SAIC 2003).

Other non-platform decommissionings include Exxon Mobil's Belmont Island and Ventura County's Sea Cliff Pier. Belmont Island was proposed for reefing in 1998, but the SLC did not approve the plan (McGinnis et al. 2001). Complete removal was encouraged although the site was popular among recreational fishermen (Frumkes 2002). Liability issues were a main source of concern, as was controversy between recreational interests (e.g., fishing, SCUBA divers) on one hand and commercial fishing interests and environmental groups on the other. Belmont Island was completely removed but concrete from the structure was used at Bolsa Chica artificial reef.

### **2.3.3. Proposed decommissioning projects**

Two additional decommissioning projects, which were proposed but never completed, furnish some insight into issues involved with options such as aquaculture, liquefied natural gas (LNG) terminals, and alternative energy. As discussed further in Section 4.2, advances in both aquaculture and wave energy technologies have decreased interest in the use of decommissioned platforms for these purposes.

When Venoco's Platform Grace was scheduled to end production, the Hubbs Sea World Research Institute (HSWRI) proposed using the decommissioned platform to house a large mariculture research program, the Grace Mariculture Project. The program was designed to research the feasibility of using offshore platforms for marine aquaculture. The project was intended to cultivate species experiencing fishing pressure in California waters, including white seabass, striped seabass, California halibut, California yellowtail, and bluefin tuna. The permitting process was scheduled to start in January 2004, and to continue through 2007. However, there were no regulations in place at that time (prior to the National Offshore Aquaculture Act of 2007) that defined a permitting process, leading to considerable jurisdictional issues. There were also concerns about water quality impacts due to potential contamination from the aquaculture operation (pers. comm., S. Poulter, Padre Associates). Ultimately, HSWRI's lease was not renewed when Platform Grace's wells returned to production in 2007 after a rebound in oil prices (pers. comm. P. Sylvia, HSWRI). HSWRI is currently exploring opportunities to perform a similar project in the Gulf of Mexico on similar species.

In 2007, the Community Environment Council of Santa Barbara, a private entity, proposed a wave energy project for Nuevo's Platform Irene ([www.fypower.org](http://www.fypower.org)). The proposal involved mooring a 4 – 5 megawatt wave power system to the platform and using the platform's existing 4.5 mile electrical connection to shore to transmit produced energy to shore (pers. comm. S. Poulter, Padre Associates). The project was intended to produce energy sufficient to power 3000 – 4000 homes. Complex jurisdictional issues delayed the permitting process and the proposal was stalled indefinitely when Nuevo sold the platform to a different operator. Planning never advanced beyond this preliminary stage, and no detailed engineering or economic analyses were performed. Pacific Gas & Electric in December 2009 applied for a Federal Energy Regulatory Commission (FERC) preliminary permit to study the feasibility of a wave energy project within state waters in this area, but has no plans to utilize Platform Irene, which is on the OCS.



## **2.4. Decision context**

Decisions about when and how to decommission offshore oil platforms in southern California will involve complex tradeoffs among economic, environmental, and political outcomes under uncertainty and against the background of strong differences in values. There is a range of possible decommissioning options (see Section 4), from complete removal to aquaculture, alternative energy production, and artificial reefing. Decisions about the two main decommissioning options selected for detailed analysis here, complete removal of platforms or partial removal and conversion of the remaining structure to an artificial reef (see Section 4), are likely to be especially contentious. Thus, an understanding of the underlying decision context (Table 2.1) related to these options will be useful for assessing the analyses and discussion in the following report sections.

Table 2.1 indicates that key aspects of the decision context vary greatly in terms of how well they are defined and the degree of controversy and/or uncertainty associated with them. In addition, while there may be clear legal and regulatory frameworks in place for some options, such as that established by the National Fishing Enhancement Act (NFEA) and MMS regulations for a rigs-to-reefs program, scientific uncertainty and a lack of consensus among key interest groups may complicate the implementation of those legal mechanisms. In general, the factors in Table 2.1 fall into three categories:

- Those that are well characterized, with clear definitions of process and/or substantial precedent
- Those with some degree of uncertainty, either because of knowledge gaps or legal/management frameworks that are not fully adapted to particular options
- Those that reflect differences in values and/or perception and that therefore may not be fully resolved by additional information or more fully developed legal, regulatory, or management procedures

As for many complex public policy decisions, the most challenging aspects are those related to uncertainty and values differences, particularly where these combine to make it difficult to identify an option that is clearly preferred by all stakeholders. For example, McGinnis et al. (2001) point out the presence of a long-standing and broad-based consensus in coastal states in the Gulf of Mexico about the ecological, commercial, and recreational value of artificial reefs and describe how this has led to the widespread use of such reefs in marine management programs. In contrast, there is substantial scientific uncertainty about the value of offshore platforms as habitat in California and differing values about the relative benefits of maintaining such habitat versus returning the seabed to its natural condition. Similarly, differing perceptions of risk, particularly where these occur over different timeframes, make it difficult to quantitatively compare and choose among decommissioning options based on their predicted environmental impact. For example, the complete removal option would result in substantial air emissions both at sea and at onshore processing facilities while alternative use options would involve the potential of longer-term contaminant impacts from shell mounds. Finally, past events may frame perceptions and preferences in ways that continue to affect decision making over the long term. This has been the case in southern California, where the reputation of the oil and gas

industry in California was decimated by the 1969 oil well blowout on Platform A and the resulting oil spill in the Santa Barbara Channel. This event contributed to strong resistance to any

**Table 2.1. Key elements of the overall decision context affecting the choice between decommissioning options. These factors frame the more detailed analysis in Sections 5 and 6.**

Key decision factor	Description
Legal / regulatory	<ul style="list-style-type: none"> <li>• Current leases, for platforms in both OCS and state waters, require complete removal</li> <li>• Federal laws and regulations now enable alternative uses after decommissioning</li> <li>• Agency roles in decommissioning well defined</li> <li>• Mechanism for transfer of platforms in the OCS to state ownership (e.g., in a rigs-to-reefs program) is clearly defined in federal law but would require new state legislation to be implemented</li> </ul>
Environmental / ecological	<ul style="list-style-type: none"> <li>• Competing concerns about the potential impacts of removing platforms vs. leaving them in place</li> <li>• Alternative uses, with the exception of artificial reefing, would require eventual removal of the platform</li> <li>• Uncertainty about the ecological effects of artificial reefing, especially at the regional scale</li> </ul>
Feasibility / cost	<ul style="list-style-type: none"> <li>• Little concern about overall technical feasibility of complete removal, although deeper platforms may require adaptation of current methods</li> <li>• Technical feasibility / value of some alternative uses (e.g., wind and wave energy, aquaculture) not fully established</li> <li>• Feasibility of partial removal and reefing fully established</li> <li>• Only one platform in state waters is in water deep enough to meet requirements of the partial removal option</li> </ul>
Social acceptability / controversy	<ul style="list-style-type: none"> <li>• Absence of scientific consensus on a clearly preferred option</li> <li>• No consensus among interest groups on preferred option(s)</li> <li>• Strong preference among some parties for complete removal, based on concerns about contamination and the value of returning habitats to their natural condition</li> <li>• Strong preference among other parties for maintaining the platforms' habitat value and providing recreational fishing opportunities</li> </ul>
Liability	<ul style="list-style-type: none"> <li>• Liability is clearly defined and managed for complete removal</li> <li>• Partial removal and transfer to state ownership as artificial reef raises concerns about liability that must be addressed with new legislation and/or management policies</li> <li>• Liability for other alternative uses a lesser concern</li> </ul>
Cost	<ul style="list-style-type: none"> <li>• Cost of complete removal, particularly for larger platforms, a concern for operators</li> <li>• Alternative uses would result in cost savings</li> <li>• Partial removal and reefing, with a state share of avoided costs</li> </ul>

further expansion of offshore oil and gas development (Smith and Garcia 1995) and to advocacy for the complete removal of platforms when production ceases. Additional studies, such as Freudenburg and Gramling (1993), Frumkes (2002), and McGinnis et al. (2001), have detailed the combination of historical, socioeconomic, biophysical, and legal factors that affect perceptions of offshore oil development, rigs-to-reefs programs, and other issues and that will therefore influence the choice among decommissioning options for offshore platforms in California. The following sections of this report examine these factors in detail in the context of decision making about alternative decommissioning options. The supplementary decision model, PLATFORM, also allows users the flexibility to examine how their own perceptions and values might influence such decisions.

### 3.0. Legal and Regulatory Contexts

---

Decisions about decommissioning will take place in the related and overlapping contexts formed by decision makers' goals and the legal and regulatory frameworks (at both the state and federal level) that specify requirements, responsibilities and authorities, and constraints. While, for the most part, legal authorities and decision pathways are clearly defined, these overlapping contexts are complex, and the ways in which they apply to decommissioning depend on whether platforms are in state waters or the OCS. These contexts also depend on the choice of decommissioning option, e.g., complete removal or one among several potential alternative uses. In this section, we have addressed this complexity by sketching broad outlines of these contexts to provide an overview for the more detailed discussions in Sections 4, 5, and 6. For example, this section describes the broad scope of MMS authority in the OCS, but leaves the details of regulations pertaining to specific aspects of platform removal to the relevant subsections of Section 4. Similarly, this section outlines the requirements of the National Fishing Enhancement Act (NFEA) as they pertain to state artificial reefing programs, but leaves any detailed discussion to those subsections of Section 6 that deal with this topic at greater length.

The following subsections divide the legal and decision-making contexts related to decommissioning into four broad categories: regulatory requirements; the public trust doctrine; environmental justice and equity; and feasibility, costs, liability, and revenue. The regulatory requirements and decision processes for complete removal of decommissioned platforms are well defined and managers at both the state and federal levels are familiar with these definitions. Regulatory requirements are therefore described at relevant places throughout the report without additional discussion. In contrast, several aspects of the

#### KEY CONCEPTS

**Regulatory Authorities and Processes** - The policies, statutes, and regulations that create the legal framework for all potential decommissioning options are well defined, as are the agency roles related to each. Somewhat different authorities pertain to state waters and the federal OCS, although there is some overlap, depending on the decommissioning option. In general, these authorities would be implemented under the environmental assessment and decision-making process defined by National Environmental Policy Act (NEPA) requirements for platforms in the OCS and California Environmental Quality Act (CEQA) requirements for those in state waters.

**The Public Trust Doctrine** - The public trust doctrine applies primarily to state waters and prescribes the uses to which state lands may be put and the resources to be protected for the people of the state. The State Lands Commission (SLC) and the California Department of Fish and Game (CDFG) are the state agencies with primary responsibility for ensuring the public trust is protected.

**Environmental Justice and Equity** - Both state and federal law require that potential environmental justice issues be addressed explicitly, and the MMS and Cal/EPA would have primary responsibility for addressing this issue in any decommissioning project. Environmental justice issues were not a major factor in previous California decommissioning projects, although concerns have arisen in the past about broader negative impacts on local communities from offshore oil and gas development.

**Feasibility, Costs, Liability, and Revenue** - These four issues will differ substantially across decommissioning options and may have an important influence on the choice among options. In addition to the regulatory requirements and constraints, there are other issues that may influence the choice among options. These include the technical feasibility and costs of alternative decommissioning options, the state's exposure to potential liability, and the potential revenue the state could realize from the partial removal option.

other major option selected for detailed examination (partial removal and artificial reefing) remain uncertain. Much of the discussion of this option necessarily focuses on examining a range of potential legal and management approaches for resolving these uncertainties. We emphasize that this more detailed discussion (primarily in Section 6) is not intended to imply that partial removal and artificial reefing is the preferred option. It is instead intended to address what would be involved if this option is selected. At this point, though the overall legal framework for implementing the partial removal option is clear, it is not possible to predict how the details of this option might be implemented.

### **3.1. Regulatory authorities and processes**

There are three major (and many more subsidiary) aspects to the permitting and approval of decommissioning. Some pertain to all projects and some are triggered depending on which option (e.g., complete removal vs. an alternate use) is chosen. These include:

- The major policies, statutes, and regulations that create the overarching legal framework for decommissioning
- The National Environmental Policy Act (NEPA) and California Environmental Quality Act (CEQA) environmental impact analysis requirements that structure the overall decision process itself
- Specific permitting and decision pathways that structure the decommissioning process

Each of these aspects is summarized briefly here, with additional detail provided in following sections where they help explain specific elements of decommissioning projects.

#### **3.1.1. Core legal authorities**

There are two main factors that determine which legal authorities (and agencies) come into play at any point in the decommissioning process: the location of an activity and the specific decommissioning option or suboption being considered or implemented. Figure 3.1 illustrates the lead agencies for activities in the OCS, in state waters, and on shore. For the OCS, the Outer Continental Shelf Lands Act (OCSLA) (43 U.S.C. §§ 1331-1356a) provides MMS with full authority to manage the oil and gas leasing program on the OCS, including rulemaking and enforcement authority, and 30 Code of Federal Regulations (C.F.R.) details MMS decommissioning regulations. For state waters, the California Public Resources Code, Division 6 details the authority of the SLC and Chapter 3 of the SLC's regulations (California Code of Regulations (C.C.R.), tit. 2, ch. 3) defines its responsibilities related to oil and gas leases, including provisions for the permitting, operation, and surrender of such leases. The SLC's policies and procedures related to decommissioning are detailed in CCR tit. 2, §§ 2122-2125, 2128 (q). On shore, county and/or city governments exercise overall authority over activities within their jurisdictions.

While the SLC has authority over oil and gas operations in state waters, the CCC, in partnership with coastal cities and counties, plans and regulates the use of land and water in the coastal zone.

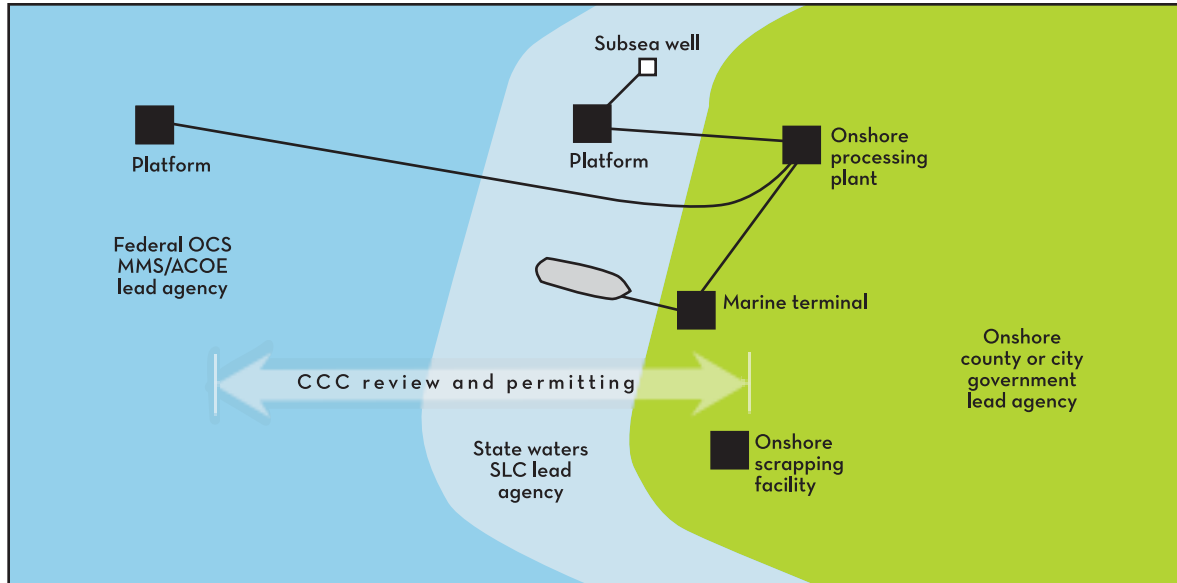

**Figure 3.1. Broad permitting jurisdictions, depending on the location of decommissioning activities (adapted from Manago and Williamson 1998, p. 18).**

The California Coastal Act of 1976 (Cal. Pub. Resources Code § 30000 et seq/) extended the CCC’s permit authority in the coastal zone indefinitely and the Federal Coastal Zone Management Act (CZMA) (Title 16 U.S.C. § 1451 et seq. and CZMA (15 C.F.R. Parts 923 and 930)) gives the CCC regulatory control (i.e., federal consistency review authority) over all federal activities and federally licensed, permitted, or assisted activities, wherever they may occur (i.e., landward or seaward of the coastal zone boundaries if the activity affects coastal resources). Thus, federal license or permit activities (including decommissioning in the OCS) that have reasonably foreseeable coastal effects must be fully consistent with the enforceable policies of state coastal management programs. This CCC federal consistency review authority is reflected in Figure 3.1.

The second factor that determines which legal authorities (and agencies) come into play is the specific decommissioning option or suboption being considered. Figure 3.2 outlines the major decommissioning options that have been proposed or implemented and indicates which have been selected for more detailed analysis in Sections 4 – 7 (see Section 4 for descriptions of each option and a discussion of how they were prioritized for this analysis).

For most options, there is a set of core legal authorities (and agencies) that come into play and another set of consultation or oversight activities that are triggered depending on the specific option selected and/or the particular circumstances of decommissioning. Given the complexity of decommissioning, these authorities and roles can be fluid, depending on the specifics of any given project. Thus, a background overview that orients readers to the overall legal and regulatory contexts that structure decommissioning decisions will be useful. To help accomplish this, Figure 3.2 includes parenthetical numbered references to the following brief notes (numbers reflect the flow of decision pathways through Figure 3.2, i.e., top to bottom in each of the two

## Overview of Decommissioning Options

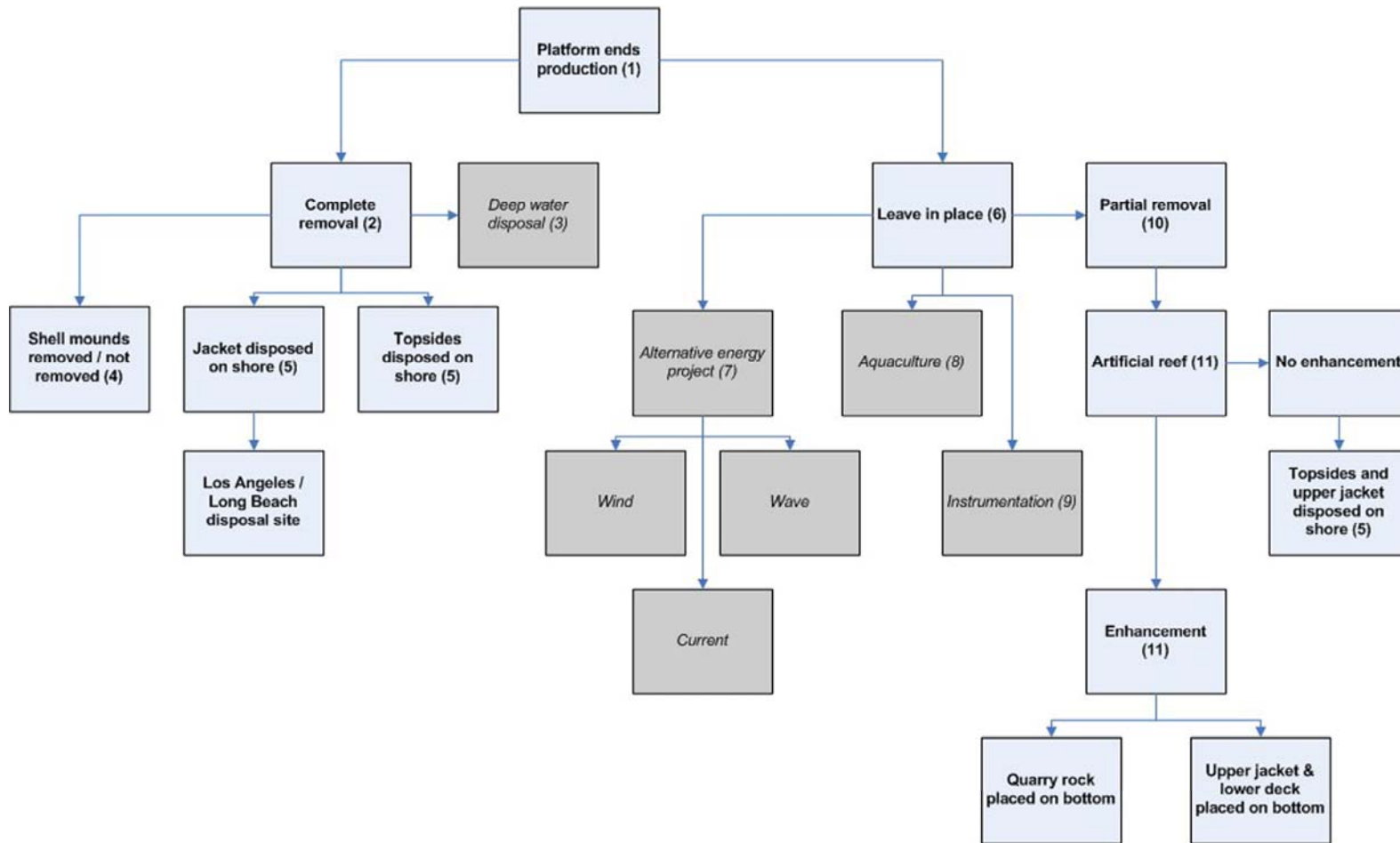

Figure 3.2. Summary of the decommissioning options considered. Complete removal and partial removal were analyzed in greater detail and are shown in bold type. Options in italics in the gray boxes were not considered in detail in the analysis. See Section 4 for a more detailed discussion. Numbers in parentheses refer to notes on the following page describing key legal authorities for each stage of decommissioning.



major branches of the flowchart, and should not be interpreted as a prioritization of authorities). These notes describe the core legal authorities and agencies related to each decommissioning option, with references to relevant legislation and regulation, as well as pointers to other sections of the report where these topics are discussed in greater detail. Following the numbered notes, a set of bullet points then describes additional consultation or oversight activities that may be required. Core legal authorities related to the decommissioning pathways in Figure 3.2 include the following:

1. Current leases require operators to continue production as long as it is economic, and MMS and SLC staff must confirm operators' projections and agree with any proposal to end production and move to decommissioning. MMS regulations (30 CFR Part 250 subpart K) structure this process for platforms in the OCS but SLC procedures are less formal; in either case, negotiations between operators and agency staff would result in a draft decommissioning or abandonment plan.
2. Current leases for platforms in both state waters and the OCS require that platforms be completely removed and the bottom restored to its original condition after production ends; decommissioning procedures are clearly defined in MMS regulations (30 C.F.R. Part 250 ) and SLC regulations (C.C.R. tit. 2 §§ 2122-2125, 2128 (q)) (see Sections 4.1.1.1 and 4.1.1.2 for more detail)
3. Deep water disposal of clean materials is allowed under the Convention on the Prevention of Marine Pollution by Dumping of Wastes and Other Matter 1972 (London Convention) and the U.S. Ocean Dumping Act, and the U.S. EPA has permitting authority under these laws (see Section 4.2.1 for more detail)
4. Current leases for platforms in both state waters and the OCS require that the bottom be restored to its original condition after platforms are removed and these lease requirements are reflected in MMS regulations (30 C.F.R. § 250.1703(e)) and the SLC's enforcement of lease provisions; however, this requirement can be waived by the MMS (in federal waters) or the SLC (in state waters) if shell mound removal is infeasible and/or the impacts of removal would outweigh the impacts of leaving the shell mound in place (see Sections 4.1.1.1 and 4.1.1.2 for more detail)
5. Onshore disassembly and disposal of the jacket and topsides would be conducted either under a coastal development permit from the CCC or as part of the CCC's evaluation of a consistency certification submitted under the requirements of the CZMA; additional permits from the relevant city or county and the air quality management district may also be required(see Section 4.1.1.1 and Section 5.3.2 (air emissions) for more detail)
6. Current law (MMS regulations in 30 C.F.R. § 250.1730) allows offshore platforms to be left in place to fulfill alternate uses (see also #'s 7, 8, 9, 10, and 11 below)
7. The Energy Policy Act of 2005 (Pub. L. 109-58) added a new paragraph (p) to section 8 of the OCSLA (43 U.S.C. § 1337(p)) stating that MMS is authorized to issue a lease, easement, or right-of-way on the OCS for activities that, among other things (see section 4.2.2 for more detail):

- Produce or support production, transportation or transmission of energy from sources other than oil and gas
- Use existing facilities on the OCS for energy-related purposes or for other marine-related purposes

MMS issued detailed regulations in 2009 (MMS 2009) describing the decision process for implementing the Act, including for the conversion of offshore oil and gas platforms to alternative uses

8. The National Aquaculture Act of 1980 (16 U.S.C. § 2801 et seq., as amended 2002) created a framework for a National Aquaculture Development Plan and charged the Secretaries of Agriculture, Commerce, and Interior with its creation and implementation, and thus provides a legal framework for aquaculture facilities offshore (see section 4.2.3 for more detail); these authorities were further clarified in the National Offshore Aquaculture Act of 2007, introduced as H.R. 2010 on April 24, 2007, but not yet passed into law
9. Ocean instrumentation projects, for either research or operational purposes, would be covered under provisions of the Energy Policy Act of 2005 (see #7 above) that refer to other marine-related purposes
10. Partial removal of a platform, consisting of removal of the deck (or topsides) and upper portion of the jacket is one method of converting decommissioned platforms to artificial reefs (see #11) and all procedures for partial removal would be controlled by MMS and SLC regulations; any decommissioning proposal that entails less than complete platform removal would require an amended lease (see Section 4.1.2 for more detail)
11. Decommissioned platforms can be converted to artificial reefs and transferred to state ownership in accordance with MMS regulations (for platforms in the OCS) and under provisions of NFEA (Pub. L. 98-623, Title II, enacting 16 U.S.C. § 1220d and 33 U.S.C. §§ 2101 through 2106) (for platforms in either the OCS or state waters). This requires the existence of a state artificial reef program, a permit from the ACOE issued to CDFG, and mechanisms for addressing sources of liability. Implementing this option for platforms in the OCS would require new state legislation because current state law does not permit the state to accept ownership of platforms outside of state waters. The National Artificial Reef Plan (NARP), written in 1985 pursuant to NFEA, and revised in 2007, allows for the planning, siting, permitting, constructing, installing, monitoring, managing, and maintenance of artificial reefs, including those constructed from decommissioned oil and gas platforms, within and seaward of state jurisdictions (see Section 6 for more detail)
12. Under the partial removal option, a variety of materials could be used to enhance reef habitat around the bottom of the platform, including quarry rock or other natural materials, or the clean upper portions of the platform (i.e., the lower deck and upper jacket), after obtaining necessary approvals from MMS, CDFG, and the CCC (see Section 5.3.1.3 for more detail)
13. In addition to and/or stemming directly from these core legal authorities, there are multiple state, federal, and local consultation, oversight, or permitting actions triggered for different aspects of the decommissioning process, depending on the methods used and whether complete removal or an alternate use is selected. In many cases, the lead agency is responsible for ensuring that such interactions take place. Depending on their role, these

other agencies can be formally identified as “responsible agencies” under CEQA and “cooperating agencies” under NEPA. Other agencies that may be involved in the decommissioning process include:

- ACOE, which would issue any necessary permits under Section 404 of the CWA related to discharge of dredged or fill material, and permits under Section 10 of the Rivers and Harbor Act of 1899 related to construction on or over, and any obstruction or alteration of, navigable waters of the United States (Manago and Williamson 1998, McGinnis et al. 2001)
- NMFS, which is responsible for aquatic species and would provide information to the lead agency for any required Section 7 consultations under the Endangered Species Act (ESA) related to threatened or endangered marine mammals, and would issue an incidental take authorization under Section 101(a)(5) of the Marine Mammal Protection Act (MMPA) in the event that explosives are used during the decommissioning project (Manago and Williamson 1998)
- U.S. Fish and Wildlife Service (FWS), which is responsible for threatened and endangered species such as sea otters and certain sea birds, and would provide information to the lead agency for any required Section 7 consultations under the ESA (Manago and Williamson 1998)
- U.S. EPA, which would issue National Pollutant Discharge Elimination System (NPDES) permits under Section 301 of the CWA related to activities in the OCS with the potential to impact water quality, and would oversee any Section 404 permit issued by the ACOE (Manago and Williamson 1998)
- U.S. Coast Guard (USCG), which would oversee proper use of aids to navigation (33 C.F.R. §§ 62 and 67), and manage responses to any discharges or spills (33 C.F.R. § 153, Oil Pollution Act of 1990 (OPA) (Manago and Williamson 1998)
- U.S. Department of Transportation, whose Office of Pipeline Safety would oversee activities related to abandonment of all pipelines (49 C.F.R. § 192.727) (Manago and Williamson 1998)
- CCC, which would issue a coastal development permit for all decommissioning activities within state waters or provide a consistency certification for projects in the OCS under the requirements of the CZMA (McGinnis et al. 2001)
- California Regional Water Quality Control Boards, which are responsible for compliance within state waters with the CWA and the California Ocean Plan and would issue water quality certifications or NPDES permits for decommissioning actions that could affect water quality in state waters (Manago and Williamson 1998)
- Local air quality management districts, which would require air pollution permits that would set enforceable emission limitations for equipment used in decommissioning, either at sea or onshore (Manago and Williamson 1998)
- Local cities and counties, which would conduct oversight and permitting of activities on shore that could produce noise, odors, air emissions or other impacts (Manago and Williamson 1998)

These and other specific permitting or oversight actions are described in detail in relevant portions of Sections 4 – 7.

### 3.1.2. NEPA and CEQA processes

The decision-making processes for evaluating, modifying, and approving projects undertaken by federal and state agencies are defined by the National Environmental Policy Act of 1969 (NEPA) (42 U.S.C. § 4321 et seq.) and the California Environmental Quality Act (CEQA) (Pub. Resources Code § 21000 et seq.), respectively. These two processes would therefore provide the overarching structure for project development and decision making prior to the actual decommissioning itself. NEPA and/or CEQA processes would be triggered once a draft abandonment plan has been formulated. Before removal/abandonment actions commence, the operator would also have requested and received approval for specific implementation plans such as the project work plan, mitigation compliance programs, waste management plans, critical operations plan, and a safety plan (Associates 2002).

NEPA requires that any major action taken or funded by a federal agency first be examined to determine its potential environmental (including human health) impacts. The White House Council on Environmental Quality has issued general guidelines for all federal agencies' NEPA procedures and each federal agency also issues its own supplemental NEPA procedures either as regulations (published in the Federal Register) or as policy guidelines. However, a recent Government Accountability Office report (GAO 2010) found that MMS lacks a formal NEPA guidance handbook. CEQA requires a similar evaluation of environmental impacts for any project undertaken or funded by a state or local agency, including instances where the government's role is to issue a discretionary permit. The State Clearinghouse ([www.ceqanet.ca.gov](http://www.ceqanet.ca.gov)) within the Office of Planning and Research is a primary source of information on CEQA.

As Figures 3.3 and 3.4 illustrate, both processes include provisions that define types of projects that do not require this environmental review. These categorical exclusions (NEPA) and categorical exemptions (CEQA) typically apply to projects that can be shown to have a very low risk of significant environmental impact. For projects not subject to an exclusion or exemption, both processes include an initial lower level of less intensive review, termed environmental assessment (EA) under NEPA and initial study under CEQA, to determine if environmental impacts will be significant. If these studies find that projects will not have a significant environmental impact, then a Finding of No Significant Impact (FONSI) (NEPA) or a negative declaration (CEQA) would be filed. In all other cases, a more substantive environmental impact study (EIS) (under NEPA) or environmental impact report (EIR) (under CEQA) must be performed. The 4H decommissioning project in the early 1990s was conducted under a mitigated negative declaration (MND No. 652, SLC) that determined platform removal would not have significant environmental impacts that could not readily be mitigated. However, given ongoing controversy over the 4H project's shell mounds, continued concern about coastal and ocean resources, as well as the size and complexity of the remaining platforms, all experts we interviewed, both inside and outside of state and federal agencies, agreed that it is not likely that decommissioning could be accomplished at present with a FONSI or a negative declaration.

NEPA and CEQA are distinct but sometimes complementary processes. California law (Pub. Resources Code § 21080(b)(14)) guides public agencies on the applicability of CEQA to projects outside California that undergo NEPA review and have emissions or discharges that would

significantly affect the environment of California. Section 15277 of the CEQA Guidelines clarifies that:

CEQA does not apply to any project or portion thereof located outside of California which will be subject to environmental impact review pursuant to the National Environmental Policy Act of 1969 or pursuant to a law of that state requiring preparation of a document containing essentially the same points of analysis as in an Environmental Impact Statement prepared under the National Environmental Policy Act of 1969. Any emissions or discharges that would have a significant effect on the environment in the State of California are subject to CEQA where a California public agency has authority over the emissions or discharges.

There are thus three general scenarios relevant to CEQA applicability to decommissioning projects. First, decommissioning projects in state waters would of course require CEQA review. Second, CEQA review would be required if a project, even located in federal waters, would significantly impact the environment in state territory, assuming a state or local agency has discretionary decision-making authority over such impacts. Third, if a project were to take place entirely in the OCS and the deck and other portions were transported elsewhere for disposal (e.g., Portland, Mexico) without entering state territory, CEQA would not be invoked.

Thus CEQA would apply to any project within state waters, to those parts of an OCS project that occur on state territory (e.g., bringing the deck ashore for disassembly and disposal), or to those aspects of a project in the OCS that have the potential to impact state waters (e.g., spills, discharges) or state air quality (e.g., emissions). If a part of the project in the OCS did affect state territory (e.g., disposal of the deck at a scrap yard in Long Beach) then the CEQA review would focus primarily on the portion of the project causing the impact on the state, but not on the project as a whole, again assuming the presence of a state or local agency with relevant decision-making authority. While these scenarios seem well defined in theory, in practice it may not be immediately apparent how and where the CEQA process would be involved for OCS decommissioning projects, what the scope of the review would be, or which agency would be the lead agency for the review. When the platforms were first installed, a joint NEPA / CEQA review process was used and that may be a possibility for decommissioning as well. Both CEQA Guidelines and NEPA regulations encourage cooperation "to the fullest extent possible to reduce duplication between NEPA and comparable state and local requirements," including the preparation of a joint document (40 CFR § 1506.2). Such uncertainties about how the CEQA process might unfold will most likely not be resolved until a specific decommissioning project is proposed, which would then provide a concrete basis for discussion and coordination among state and federal agencies.

The permitting process for decommissioning projects in both state waters and the OCS would follow the generic process illustrated in Figure 3.5, which reflects the NEPA and CEQA processes described above and would be applicable to both complete and partial removal options.

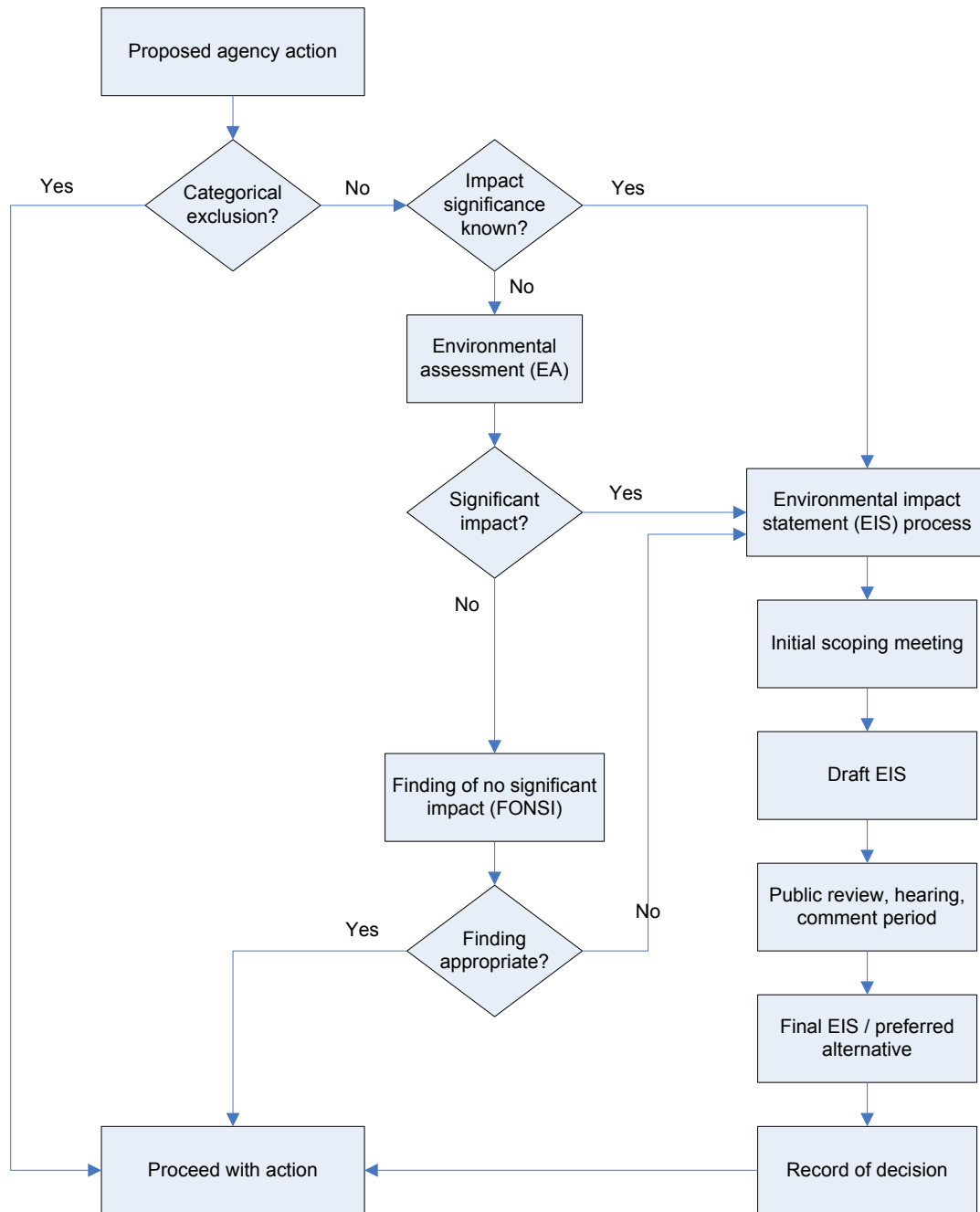

Figure 3.3. Schematic diagram of the NEPA process (adapted from U.S. EPA and several state websites).

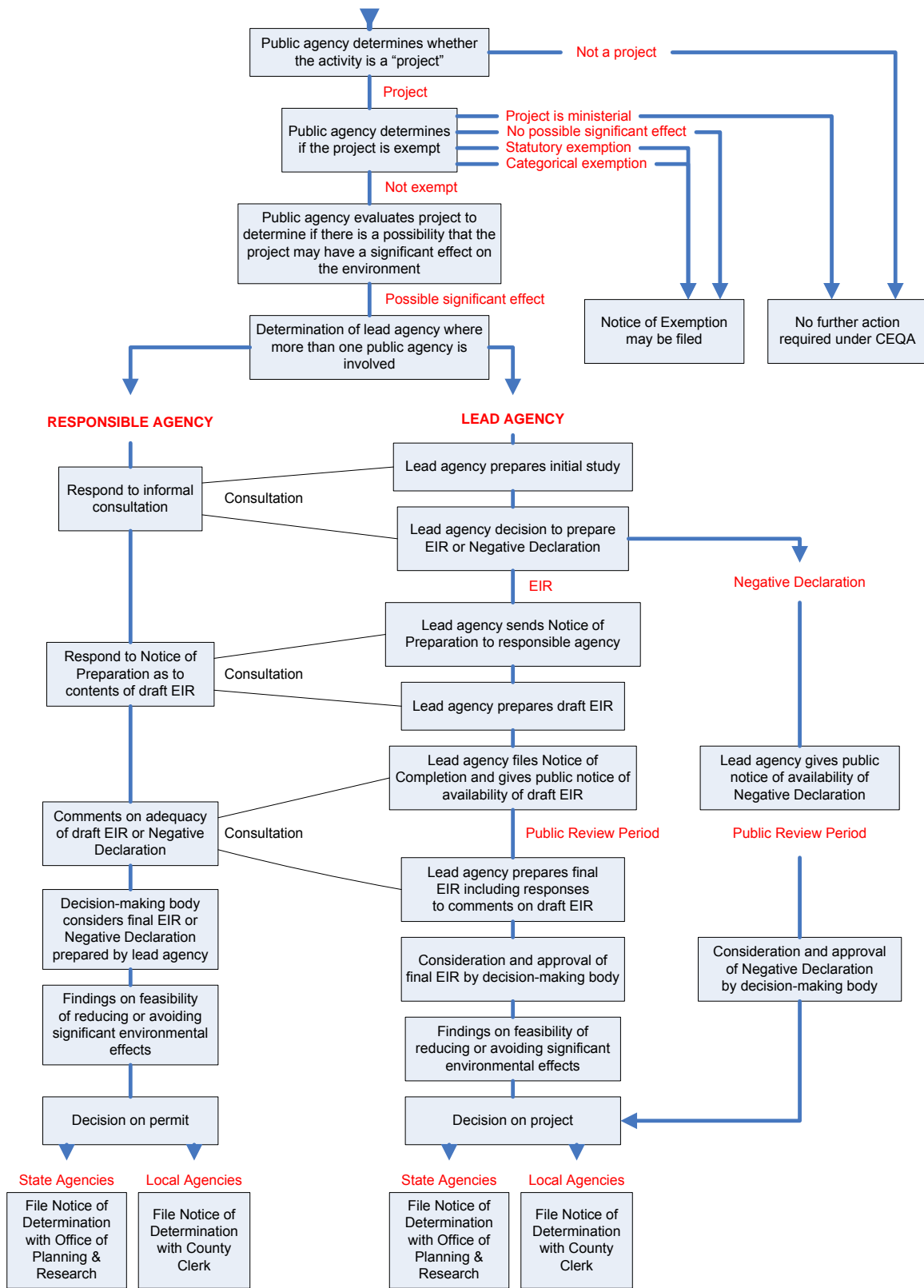

Figure 3.4. Schematic diagram of the CEQA process (<http://ceres.ca.gov/ceqa/flowchart/index.html>).



**Figure 3.5. Major steps in the decommissioning permit process, broadly applicable to both state waters and to the OCS. The environmental review and public comment steps depicted here correspond to steps in the NEPA and CEQA processes illustrated in Figure 3.3 and 3.4. The timeline is intended for illustrative purposes and could differ depending on the specific project (from Manago and Williamson (1998), p. 19).**

### **3.2. The public trust doctrine**

Key aspects of the state’s interest in the choice among decommissioning options stem from the public trust doctrine pursuant to which the states hold title to their sovereign lands, which include tide and submerged lands and the beds of navigable waterways. The public trust doctrine prescribes the uses to which these lands may be put and the resources that are to be protected for the people of the state, who are the beneficiaries of the public trust. It also provides some of the legal and regulatory authorities that decision makers depend on when dealing with platform decommissioning.

#### **3.2.1. The scope of the public trust**

The origins of the public trust doctrine are traceable to Roman law concepts of common property. The air, the sea, the seashore and the rivers were incapable of private ownership and forever dedicated to public use. Under English common law, this principle evolved into the public trust doctrine where the sovereign held tide and submerged lands and navigable waterways, not in a proprietary capacity, but as trustee under a public trust for the benefit of all the people for uses such as commerce, navigation, and fishing. After the American Revolution, each of the original thirteen states succeeded to this sovereign right and duty. Each state became the trustee of these lands within its boundaries and must hold them in trust for the common use and benefit of all of the people of the state. Under the equal footing doctrine, later admitted



states, like California, possess the same rights over and hold the same responsibilities for these lands as do the original thirteen states. California holds title in trust to all beds of navigable waterways as well as tide and submerged lands from the shore to a distance of three miles, including the lands surrounding the Channel Islands. It may not sell these lands and must use them pursuant to the terms of the public trust. Pursuant to legislative authority (Pub. Resources Code § 6301), the SLC administers California's public trust lands.

Initially the public trust doctrine prescribed three uses to which public trust lands could be put - commerce, navigation and fishing. The California Supreme Court, one of the leading exponents and proponents of the public trust doctrine, has expanded this original triad of uses. In *Marks v. Whitney*, 6 Cal.3d 251, 259-60 (1971), the California court said that the public trust embraces the right of the public to use the navigable waters of the state for bathing, swimming, boating, and general recreational purposes. The court also said that the public trust doctrine is an evolving doctrine that is sufficiently flexible to encompass changing public needs. One of these needs is the preservation of public trust lands in their natural state for scientific study, as open space, and as habitat for birds and marine life. See also *National Audubon Society v. Superior Court*, 33 Cal.3d 419, 435 (1983).

The courts have given the Legislature broad authority to commit public trust lands to various and sometimes competing uses and the Legislature must balance these competing uses (SLC 2010).

In the case of decommissioning of platforms in state waters, the public trust doctrine will guide decisions about decommissioning oil and gas platforms in several ways:

- The Legislature and government agencies must consider the full range of public trust uses of the sites where the platforms (and pipelines and other structures) are located and resolve any competition among these various uses in the interest of the public, the beneficiary of the public trust
- After decommissioning, the sites must be managed for the benefit of all of the public throughout California, not just for that of purely local interests
- The Legislature and government agencies must consider the long-term benefits and detriments of the various decommissioning options, not just the immediate benefits

### **3.2.2. Public trust responsibilities of state and local agencies**

The Legislature has authorized the SLC to administer public trust lands, but retains the authority to make decisions regarding their use and management. Unless the Legislature intervenes, the SLC will be the agency that decides among the various competing public trust uses for the lands within its jurisdiction where decommissioned platforms are located. This would not include OCS lands because California's public trust lands do not include the OCS. In addition, state agencies, including CDFG, have specific public trust responsibilities, as explained in a recent California appellate decision *Center for Biological Diversity, Inc. v. FPL Group, Inc.*, 166 Cal.App.4th 1349, 1359-64 (2008). This decision notes that public agencies such as CDFG have public trust responsibilities not only for wildlife habitat but for the wildlife itself. Other state and local agencies must consider the public trust implications of their decisions as well.

### **3.2.3. Federal public trust responsibilities**

There are no federal public trust lands, and there is no clear authority for applying this doctrine to federal lands. While federal agencies have authorities and responsibilities under statute for the management of federal lands, this is different in kind from the inherent authority the states hold as a result of the historical development of the public trust doctrine as described above (Section 3.2.1.), which has occurred entirely in the context of state-owned lands. Legal scholars have voiced divergent theories about the presence in the law of a federal public trust doctrine. The authority for a federal public trust doctrine has arisen in the context of federal condemnation of state public trust lands, but such condemnation actions are not relevant to the OCS and the platforms located there. However, the federal government does have a responsibility to insure that the oceans are free of impediments to navigation pursuant to its power under the Commerce Clause of the U.S. Constitution.

### **3.3. Environmental justice and equity**

Equity has been an important issue in past debates about offshore oil and gas development and will be important in decision making about decommissioning. There are at least two dimensions to this issue: statutory requirements concerning environmental justice, and long-standing local concerns about environmental, social, economic, and/or aesthetic impacts on local communities.

#### **3.3.1. Environmental justice**

California Government Code section 65040.12(e) defines environmental justice as:

“fair treatment of people of all races, cultures, and incomes with respect to the development, adoption, implementation, and enforcement of environmental laws, regulations, and policies.”

California law gives Cal/EPA a central role in assuring environmental justice. The Cal/EPA Intra-agency Environmental Justice Strategy (Cal/EPA 2004) and other state websites concerning environmental justice activities say little about offshore oil and development or coastal issues. Much of the work to ensure environmental justice in California and elsewhere has focused on terrestrial issues, especially on the impacts of toxic substances on poor communities and minority groups. In addition, there are no specific environmental justice concerns identified in any of the reports, conferences, or peer-reviewed publications on decommissioning in southern California reviewed for this project.

Nonetheless, environmental justice issues may arise in the decommissioning process. For example, concerns may arise that air emissions resulting from the decommissioning process might have disproportionate impacts on poor communities or racial minorities, or that difficult waste management problems will arise at sites near such communities where platform sections are disassembled for recycling and disposal. In such cases, the SLC would apply its environmental justice policy (SLC 2010) to ensure that the agency specifically considers environmental justice as part of the CEQA process for decommissioning projects.

In addition, Executive Order 12898 (Federal Register 1994, vol. 59, no. 32) charges each federal agency with:

“identifying and addressing, as appropriate, disproportionately high and adverse human health or environmental effects of its programs, policies, and activities on minority populations and low-income populations”

This requires an environmental justice analysis of communit(ies) potentially affected by a federal action. Therefore, when MMS writes an EIS for decommissioning, or any other NEPA document, it must specifically address environmental justice issues.

### **3.3.2. Concerns about impacts on local communities**

For many years, there have been public concerns about the potential for broader negative impacts from offshore oil development on local communities, especially along the coast of the Santa Barbara Channel (e.g., Vincent et al. 2001, Raftican 2006, Schroeder and Love 2004, Smith and Garcia 1995). These concerns have often been framed by local agencies and advocacy groups as an equity issue because of disproportionate local impacts. Any potential impacts on Native American communities would be considered under the cultural resources, and perhaps the environmental justice, sections of the CEQA analysis. Controversy about potential impacts on local communities is very likely to continue when oil production at offshore platforms begins to taper off and specific decommissioning projects are considered in more detail.

### **3.4. Feasibility, costs, liability, and revenue**

In addition to the regulatory requirements and constraints described above, there is, however, another set of goals that are specific to the decommissioning process that will strongly influence the choice among decommissioning options. These relate to the technical feasibility and costs of alternative decommissioning options, the state’s exposure to potential liability under a partial removal (i.e., rigs-to-reefs) option, and the potential revenue the state could realize from the partial removal option.

As discussed in Section 4.4., the water depth and size of offshore platforms in southern California will pose technical challenges that may require site-specific modifications to decommissioning methods developed in the GOM and elsewhere. As a result of the high cost of removing such large structures, industry, which will conduct and pay for decommissioning, clearly has a fundamental interest in ensuring that decommissioning methods are technically feasible and that costs are manageable. While platforms’ predicted decommissioning could be compared to revenues they have produced, this information is not readily available and obtaining it would have been beyond the scope of this project. State and federal agencies also have an indirect interest in these two goals, since substantial technical difficulties and costs of fully removing deeper water platforms would complicate planning and permitting both for any future oil and gas development offshore, as well for any future decommissioning projects. Earlier decommissioning efforts in California, involving relatively smaller platforms, did not require that these issues be directly addressed.

Under a partial removal option that transfers ownership of the platform to the state as an artificial reef, the state would have a strong interest in avoiding or managing the costs of any liability or litigation that might stem from accidents or damages that may be associated with the structure and its use. Thus, an important goal for the state would be to develop an explicit definition of liability and how it would be managed. Another key aspect of a partial removal option would be a transfer of funds to the state that would represent a proportion of the avoided costs from implementing partial as opposed to complete platform removal. An important goal for the state would therefore be to define the share of avoided costs that would flow to the state, as well as how these funds would be managed and allocated.

Finally, a partial removal option would require the state to create (by statute) a formal artificial reef program to fulfill the functions defined in NFEA as a condition of taking ownership of any platforms and accepting a share of the avoided decommissioning costs. In 2000, legislation was introduced in California that would have provided a process to consider allowing portions of decommissioned platforms off the California coast to serve as artificial reefs. This legislation was passed by the state legislature, but was vetoed by Governor Davis. The state thus would have a strong interest in ensuring that such a statute was well crafted and that the artificial reef program functioned effectively to meet both the goals of NFEA and those of the public trust doctrine. Section 6 discusses in detail these and other issues that would have to be addressed in any new enabling legislation.

## 4.0. Prioritizing Decommissioning Options

---

Over the past several decades, a number of different possible uses for decommissioned offshore oil and gas platforms have been proposed as alternatives to their complete removal (Figure 3.2). It is important to note that, with the exception of the rigs-to-reefs option, all such uses do not eliminate the need for a decision about platform removal; they merely postpone it. This is because the platform, even if converted to an alternate use (e.g., wind energy, aquaculture), will eventually reach the end of its structural life. The most frequently discussed options include platform use:

- As artificial reefs, either left in place or transferred to a designated reefing location
- In offshore wind energy projects, either as sites for wind turbines or as an offshore maintenance and logistics base
- In offshore wave energy projects, either as a site for anchoring wave energy generating equipment or as an offshore maintenance and logistics base
- As LNG terminals
- As platforms for solar panel arrays
- In offshore aquaculture projects, either as a site for anchoring aquaculture facilities or as an offshore maintenance and logistics base
- As sites for ocean instrumentation or tourism

While some alternative uses (e.g., wind energy) require leaving the entire platform in place, others, particularly the reefing option, involve removal and disposal of portions of the platform. Thus, multiple disposal options are applicable to both complete and partial removal, including:

- Onshore dismantling and recycling, or landfilling, for platform components at shipyards in the Los Angeles / Long Beach area
- Placement of the clean upper jacket and lower deck structure on the ocean bottom at the base of the platform under the partial removal (artificial reefing) option
- Deep water disposal for jacket and lower deck structures that are not contaminated by hydrocarbons or other pollutants

### **KEY CONCEPTS**

**Alternatives Retained for Detailed Analysis** – After conducting a careful initial assessment of the feasibility of numerous decommissioning alternatives, two main decommissioning options have been retained and analyzed in detail: complete removal with onshore dismantling and disposal and partial removal with onshore dismantling and disposal of the platform deck and all structures down to 85 feet below the ocean surface. A number of activities, such as abandonment and plugging of the well, are identical in both options. The mass of steel and other materials to be transported and handled onshore differs substantially between the two options, especially for the larger platforms.

**Options Not Analyzed in Detail** - Several potential decommissioning options have been addressed only briefly, including deep water disposal, alternative energy (e.g., wind, wave), aquaculture, LNG terminal, and miscellaneous other options. These options have been removed from further consideration because they are not technically or economically feasible, have been superseded by newer technology, or have been identified as a much lower priority by management agencies.

Not all alternative uses or disposal options are equally viable technologically, economically, or politically. Therefore, our charge was to prioritize decommissioning options for detailed analysis. Table 4.1 presents the results of this exercise using the following criteria:

- Viability within a ten-year timeframe
- Existing legal framework for implementation
- Technical feasibility
- Economic viability
- Degree of acceptance by state and federal managers from agencies with decision-making authority
- Degree of interest from proponents
- Relevance to the majority of southern California platforms

We applied these criteria qualitatively and found, as Table 4.1 and Section 4.2 illustrate, that options sorted clearly into the two categories Evaluated in Detail and Examined Briefly and Eliminated (see also Figure 3.2 for a visual depiction of all potential options). Two use options (complete removal and partial removal as part of conversion to an artificial reef) and one disposal option (onshore dismantling) receive detailed analysis. In addition, the analysis of the partial removal option includes a suboption, placement of the clean upper jacket and lower deck structure on the ocean bottom as reef enhancement

Section 4.1 describes the engineering procedures for the complete removal (Section 4.1.1) and partial removal (Section 4.1.2) options, with onshore disposal included in the description of complete platform removal. The engineering descriptions are important for a full understanding of the legal, economic, and environmental implications of each option. However, readers interested in a less detailed summary should read only the initial paragraphs of each subsection, which provide an overview of the detailed technical material. Section 4.2 describes options that were excluded from detailed analysis. For each of these options, we include a description of the option, the relevant regulatory background, the degree to which the option has been implemented in previous decommissioning efforts, the reason(s) it was not selected for detailed analysis, and the degree to which future changes in technology or policy could change the prioritization of the excluded options.

#### ***4.1. Options retained for detailed analysis***

This section provides detailed descriptions of the engineering activities involved in the two use options and one disposal option retained for in-depth analysis: complete removal with disposal onshore, and partial removal with the platform converted to an artificial reef and the deck and upper jacket structures disposed of onshore. These procedures are well established (Proserv Offshore 2010), although the complete removal of the deeper platforms may pose challenges because no platforms at the depths of the largest California platforms have yet been decommissioned anywhere in the world.

**Table 4.1. Summary of alternative use and disposal options considered in this report. The complete removal and partial removal / artificial reefing options, along with the onshore dismantling and disposal option, are considered in detail. Other use and disposal options are described and evaluated briefly. All options shown, with one exception, are legally allowable under existing law. Transfer of ownership of platforms in the OCS to the state, while allowed under federal law, would require new state enabling legislation.**

Option	Prioritization	Pros	Cons
<i>Alternate uses</i>			
Complete removal	Evaluated in detail	<ul style="list-style-type: none"> <li>• Required in leases</li> <li>• Highly valued by key stakeholders</li> <li>• Technically feasible for all platforms</li> <li>• Costed out in detail by MMS</li> </ul>	
Partial removal / artificial reefing	Evaluated in detail	<ul style="list-style-type: none"> <li>• Highly valued by key stakeholders</li> <li>• Abundant precedent in Gulf of Mexico</li> <li>• Fiscal incentive for both operators and state</li> <li>• Technically feasible for all but 3 state platforms</li> <li>• Detailed costs based on complete removal estimates</li> </ul>	<ul style="list-style-type: none"> <li>• Applicable only to one platform (Holly) in state waters because of shallow water depths</li> </ul>
Artificial reefing using entire platform	Examined briefly and eliminated	<ul style="list-style-type: none"> <li>• Highly valued by key stakeholders</li> <li>• Fiscal incentive for both operators and state</li> </ul>	<ul style="list-style-type: none"> <li>• Increased liability due to retention of surface structure makes this of much less interest to state</li> </ul>
Alternative energy	Examined briefly and eliminated	<ul style="list-style-type: none"> <li>• Some interest here and in Gulf of Mexico</li> </ul>	<ul style="list-style-type: none"> <li>• No projects implemented on platforms</li> <li>• Current technology does not require platforms</li> <li>• Not technically feasible at large majority of platforms</li> <li>• No current interest by project proponents</li> <li>• Economic viability not demonstrated</li> </ul>

**Table 4.1. Continued**

Option	Prioritization	Pros	Cons
<i>Alternate uses</i>			
Aquaculture	Examined briefly and eliminated	<ul style="list-style-type: none"> <li>• Some interest here and in Gulf of Mexico</li> </ul>	<ul style="list-style-type: none"> <li>• No projects implemented on decommissioned platforms</li> <li>• Economic viability not fully demonstrated</li> </ul>
Others (e.g., instrumentation, hotels)	Examined briefly and eliminated		<ul style="list-style-type: none"> <li>• Little interest</li> <li>• Economic viability not demonstrated</li> <li>• Current ocean instrumentation technology does not require platform</li> </ul>
<i>Disposal</i>			
Onshore dismantling	Evaluated in detail	<ul style="list-style-type: none"> <li>• Required for deck structures containing hydrocarbons and other pollutants</li> <li>• Required for complete removal option (assuming no deep water disposal)</li> <li>• Technically feasible</li> <li>• Costed out in detail by MMS</li> </ul>	
Placement of upper portion on bottom	Evaluated in detail	<ul style="list-style-type: none"> <li>• Useful as reef enhancement under the partial removal option</li> <li>• Valued by key stakeholders</li> <li>• No objection from state or federal managers</li> </ul>	
Deep water disposal	Examined briefly and eliminated	<ul style="list-style-type: none"> <li>• Potential fiscal incentive for operators</li> </ul>	<ul style="list-style-type: none"> <li>• Little interest among state and federal managers</li> </ul>



While these engineering procedures have been described elsewhere (e.g., Manago and Williamson 1998, Gebauer et al. 2004, Proserv Offshore 2010), summarizing them here is valuable for two reasons. First, not all readers may be familiar with the specific steps involved in decommissioning and the following material thus provides a common, shared set of information for all readers. Second, the discussion of avoided costs and specific environmental and socioeconomic impacts in Section 5 presumes an understanding of the decommissioning process. Table 4.2 summarizes the major engineering steps in the decommissioning process and indicates the key differences between the complete and partial removal options.

Section 4.1.1.2 discusses shell mounds in some detail. This is because the disposition of the shell mounds underneath the 4H platforms proved to be the most controversial part of that decommissioning project and this issue remains unresolved 14 years after the platforms were removed. Thus, an in-depth understanding of the legal, logistical, and scientific aspects of this issue will be important in assessing options for dealing with shell mounds under the complete removal option (shell mounds would necessarily be left in place under the partial removal option).

**Table 4.2. Summary of the major engineering steps in the decommissioning process, along with the key differences between the complete and partial removal options.**

Decommissioning element	Description	Complete vs. partial removal
Well abandonment	<ul style="list-style-type: none"> <li>Remove down-hole equipment</li> <li>Plug well</li> <li>All effort occurs below ocean floor surface</li> </ul>	Identical in both options
Platform preparation	<ul style="list-style-type: none"> <li>Inspect structural condition</li> <li>Flush/clean all process piping and equipment</li> <li>Detach all deck modules and equipment in preparation for removal</li> <li>Remove marine growth to about 100 feet below water line</li> </ul>	Identical in both options
Conductor removal	<ul style="list-style-type: none"> <li>Sever conductors below the ocean floor</li> <li>Lift and cut / unscrew conductors into 40-foot lengths</li> <li>Barge conductors to shore</li> </ul>	Conductors removed only to 85 feet below ocean surface in partial removal option
Pipeline and power cable disposition	<ul style="list-style-type: none"> <li>Disconnect pipeline and power cables from platform</li> <li>Flush pipeline and fill with seawater</li> <li>Cut both pipeline and power cable at seafloor</li> <li>Cap pipeline and bury ends</li> <li>Bury power cable ends</li> <li>Both likely to be abandoned in place to minimize bottom disturbance</li> </ul>	Identical in both options

**Table 4.2. Continued**

<b>Decommissioning element</b>	<b>Description</b>	<b>Complete vs. partial removal</b>
Heavy lift vessel (HLV) mobilization and demobilization	<ul style="list-style-type: none"> <li>Group platforms to enable HLV mobilization and demobilization costs to be shared</li> <li>Select HLV based on single heaviest lift envisioned</li> <li>HLV transit to and from southern California from Gulf of Mexico, Asia, or North Sea</li> <li>Widened Panama Canal may shorten transit times and costs for some HLVs</li> </ul>	Partial removal requires much smaller and less costly lifting equipment
Platform deck removal	<ul style="list-style-type: none"> <li>Decks and topsides of small platforms may be removed in a single lift</li> <li>Decks and topsides of larger platforms may require multiple lifts</li> <li>All decks and topsides transported to shore for processing</li> </ul>	Identical in both options
Platform jacket removal	<ul style="list-style-type: none"> <li>Sever piles that fix platform to ocean floor</li> <li>Piles cut below the ocean floor</li> <li>Lift jacket, either whole or in pieces, using HLV</li> <li>Transport piles and jacket to shore for processing</li> </ul>	Jacket removed only to 85 feet below ocean surface in partial removal option
Platform structure transportation and disposal	<ul style="list-style-type: none"> <li>Large mass of steel will result from complete removal</li> <li>Platform structure will be processed at Port of Los Angeles or Port of Long Beach</li> <li>Process includes disassembly, recycling, disposal</li> </ul>	Mass to be transported and disposed of much less in partial removal option
Site clearance	<ul style="list-style-type: none"> <li>Pre- and post-decommissioning site surveys</li> <li>Regulations and leases require that all debris and other impediments be removed</li> <li>Site clearance confirmed with test trawling</li> <li>Disposition of shell mounds is contentious</li> <li>Shell mounds may be left in place based on negotiation with MMS or SLC</li> </ul>	Site clearance around platform identical in both options Shell mounds left in place in partial removal option

#### **4.1.1. Complete platform removal**

Complete removal of offshore platforms involves removal of the deck and other above-water structures, the jacket and conductors, and all debris on the bottom. However, shell mounds may or may not be removed, depending on the feasibility of removing the mounds, particularly in deep water, and an assessment of the relative environmental and socioeconomic costs and benefits of removal vs. leaving them in place (see Section 4.1.1.2 for more detail). While MMS regulations (30 C.F.R. § 250.1703(e)) and SLC regulations (C.C.R. tit. 2 § 2122) and operator

leases, in both the OCS and state waters, require that all obstructions be removed and the bottom be returned to its original condition, abandonment plans may specify that shell mounds would be left in place, although this would require modifying the lease (see Section 3.1.1 for more detail).

#### *4.1.1.1. Engineering description through disposal*

In complete removal, the entire platform structure must be removed and brought to shore for handling and disposal. This includes the platform deck structure or “topsides” that contains the processing equipment and personnel quarters, as well as the platform jacket which is the structure that is affixed to the ocean floor and supports the deck structure (Figure 4.1).

**Well abandonment:** Well abandonment, which can be a major expense, involves removing down-hole equipment (e.g., packers, pumps, tubing), plugging (cement plug) the open hole and perforated intervals, and plugging all casing stubs where casing has been cut and recovered, and placement of a surface plug (Proserv Offshore 2010). The federal regulations describing these requirements (30 C.F.R. § 250.1715) are similar to California state requirements (C.C.R. tit. 2 §§ 2122-2125, 2128 (q)). All well abandonment work takes place within the well-bore below the ocean floor’s surface, does not alter the platform structure, and will be carried out in the same manner under all decommissioning options. Because well abandonment will be identical for all decommissioning options and will have no impact on the choice between decommissioning options, it is not a consideration in our analysis and its costs are not incorporated into PLATFORM.

**Platform preparation:** Preparation of the deck structure and the jacket begins with inspections above and below the water line to review the structural condition of the platform and document any concerns prior to dismantling. All loose materials and small equipment would be transferred off the platform for handling ashore. All process piping and equipment will then be flushed and cleaned of hydrocarbons. Modules and equipment identified for removal from the deck will be detached from the structure. All interconnecting piping and wiring between the modules will also be cut and, where required, pad eyes will be welded onto the various modules at strategic locations for connecting slings in preparation for crane lifting. Diving crews will also remove marine growth from the platform jacket and well conductors to about 100 feet below the water line, with the debris dropped to the ocean floor beneath the platform (Proserv Offshore 2010). It is important that this work take place before the heavy lift vessel (HLV) arrives on site to start work because any delays in the HLV schedule once it arrives are costly. Platform preparation will be identical for all decommissioning options and will have no impact on the choice between decommissioning options. Its costs are not incorporated into PLATFORM.

**Conductor removal:** Well conductors (Figure 4.1) are large diameter pipes through which the casing and tubing for oil and gas wells are fed during drilling. Conductor removal cost is proportional to their number (0 – 64) and length (30 – 1198 feet water depth) and their mass can exceed 13,000 tons of cement-contaminated steel for an individual platform. Complete platform removal requires severing conductors 15 or more feet below the ocean floor (mud line) in the OCS (30 C.F.R. § 250.1716(a)) and not more than 5 feet below the mud line in state waters (C.C.R., tit. 2, § 2128 q(1)(L)). Conductor severing can be performed with explosive charges or mechanical or abrasive cutting methods (Gebauer et al. 2004). Explosives are the cheapest and

## Platform Schematic

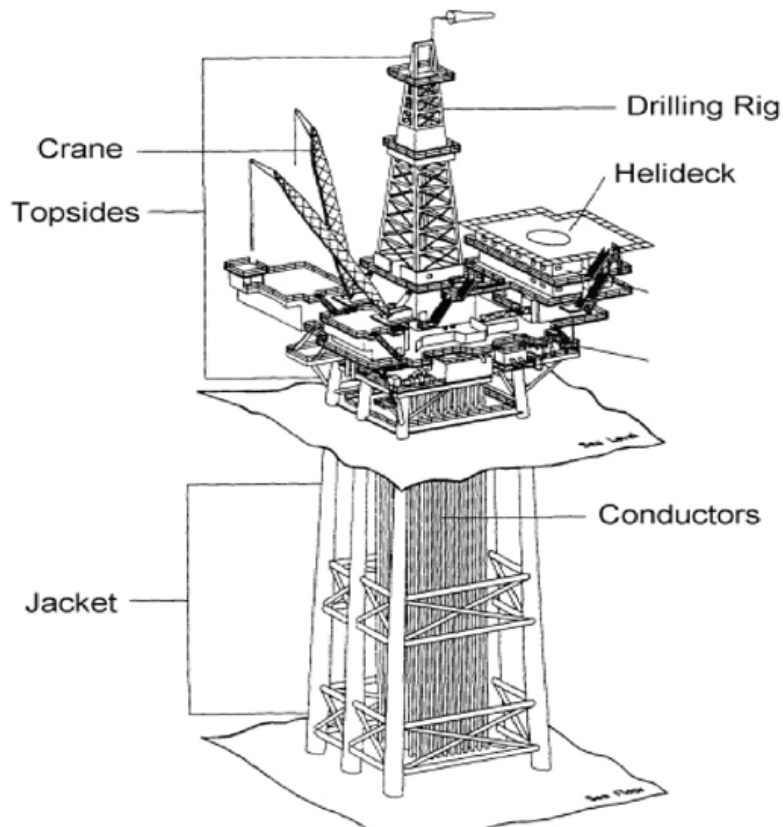
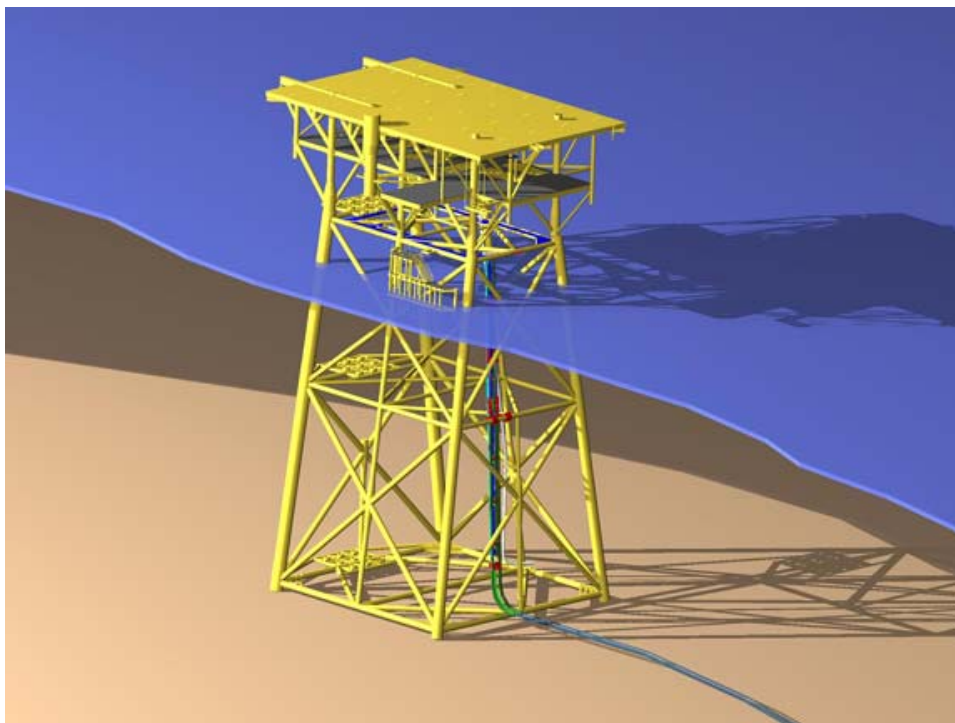

**Figure 4.1. Depiction of major structural components of a generic offshore platform (from Manago and Williamson (1998), workshop notes p. 223).**

most reliable option, while abrasive and mechanical cutting costs are about 30% and 50%, respectively, more than explosives (Alghamdi and Radwan 2005). While Proserv Offshore (2010) assumes conductors will be cut using abrasive cutting methods, the discussion of impacts on fish and invertebrates (Section 5.3.1) and marine mammals (Section 5.3.5.2) addresses impacts due to explosives because their possible use is a major concern for many stakeholders. Once severed, conductors will be lifted, cut or unscrewed at 40 foot intervals, and placed on the work boat or barge for transportation to shore, with additional marine growth removed as the conductor is pulled (Proserv Offshore 2010). Removal of marine growth to the greatest extent possible is important to reduce odor impacts in and around the onshore decommissioning site.

**Pipelines and power cables:** Seafloor pipelines transport oil and gas to shore and some platforms also incorporate a seafloor power cable to provide power for platform equipment. Both pipeline(s) and power cable will be disconnected from the platform (Figure 4.2). The pipeline(s) will be flushed to the shore base, filled with sea water, and cut off at the seafloor some distance

away from the platform and at the surf zone onshore. The pipeline ends will be capped and, if abandoned in place, pipeline ends will be buried to three feet or covered with a concrete mat (30 C.F.R. § 250.1751). Similarly the power cable will be cut and, if abandoned in place, the ends buried (TSB 2000). Conversations with state and federal agency staff strongly suggest that pipelines and power cables will be abandoned in place. This is accepted practice in the OCS as long as the pipelines and power cables pose no hazard to vessel traffic, fishing activities, or other offshore uses and pose no environmental threat (30 C.F.R. § 250.1750). Removing them would create substantial disturbance to bottom habitats and result in increased air emissions from vessels and equipment needed for removal (Scandpower Risk Management 2004) and abandonment in place has been allowed for a number of offshore state pipelines.



**Figure 4.2. Schematic illustrating the configuration of the pipeline riser bend as the pipeline transitions from the seafloor to the vertical platform (source: Antares Offshore, [http://www.antaressoffshore.com/images/close up of pltfrm with risers 1.JPG](http://www.antaressoffshore.com/images/close_up_of_pltfrm_with_risers_1.JPG), accessed January 28, 2010).**

The disposition of pipelines and power cables will be identical for all decommissioning options and decisions about how to deal with pipelines and power cables have no impact on the choice between decommissioning options. Thus pipeline and power cable decommissioning is not a consideration in our analysis and their costs are not incorporated into PLATFORM.

**Mobilization and demobilization of the HLV and support vessels:** The HLV and associated anchor handling tugs represent the single most expensive aspect of platform decommissioning. The day rates for these vessels range from \$156,000 per day for the smallest 500 ton HLV to \$252,000 or more per day for a 4000 ton HLV (Figure 4.3), with transit time typically charged at 90% of the working day rate. Because there are no ocean-going HLVs located on the West Coast, they must be brought from the Gulf of Mexico, the North Sea, or Asia, with round trip travel estimated at from 100 to 200 days. The HLV mobilization and demobilization costs can thus range from \$14 million to \$45 million, depending on location and size of the HLV selected (Proserv Offshore 2010).



**Figure 4.3. Heavy lift vessel Hermod in port (source: Scheepvaartnieuws, [scheepvaartnieuws.punt.nl/upload/mot\\_1496.jpg](http://scheepvaartnieuws.punt.nl/upload/mot_1496.jpg), accessed January 28, 2010).**

Decommissioning plans generally assume that platforms will be grouped into larger projects to share these high HLV mobilization and demobilization costs. Because the choice of HLV depends on the single heaviest lift, the mix of platforms for a project is critical to ensuring optimization of HLV time and costs. Many alternative lifting methods continue to be considered in an effort to reduce the high HLV cost and to provide the lifting capabilities needed for California deep water projects. However, a recent review determined that most would be less efficient than a conventional HLV at removing a deep water platform jacket (TSB 2000). It might be possible to scale up more recent innovative technology developed to recover hurricane

damaged platforms in the Gulf of Mexico (i.e., the Versabar Bottom Feeder (Byrd 2008) (Figure 4.4)). Future development of one of these lifting technologies could reduce both the costs and the safety risks associated with California deep water platform removals.



**Figure 4.4. Bottom feeder lifting device (image courtesy of Proserv Offshore, Inc.).**

The widening of the Panama Canal, projected for completion as soon as 2014, will eventually enable passage of vessels with up to a 49 meter beam (160 feet width), significantly reducing travel times and mobilization and demobilization costs for small HLVs. A mono-hull 4400 ton HLV identified for use in this project, like the McDermott DB50 at 150.9 feet wide (Figure 4.5), which is based in the Gulf of Mexico but works worldwide, may be able to pass through this widened canal. Unfortunately the larger semi-submersible HLVs would still be unable to pass through the widened canal.

Additionally, lifting and positioning techniques that do not require the extensive anchor spreads typical of conventional HLVs are desirable because they reduce bottom impacts, which can be substantial. For example, a typical anchor spread might involve from eight 13-ton anchors to 14 40-ton anchors that can extend out 5,000 to 7,000 feet radially from the HLV. Newer dynamic vessel positioning technology is available on many HLVs and can eliminate the need for anchors and the ocean bottom impacts associated with their use. This method is likely to be used for California decommissioning projects. Until newer options are proven viable, this report and PLATFORM use the lifting options and costs presented in Proserv Offshore (2010): a 500 ton, a 2000 ton, and a 4000 ton HLV.



**Figure 4.5.** The McDermott DB50 is one of several derrick barges that fall into the 4000 ton class of HLVs (source: technology, [http://www.offshore-technology.com/projects/north-america\\_gallery.html](http://www.offshore-technology.com/projects/north-america_gallery.html), accessed January 28, 2010).

**Platform deck removal:** California platforms include many topside designs, ranging from integrated designs used for smaller platforms (Figure 4.6) to more complex modular and hybrid designs Figure 4.7) in which modules are lifted and installed separately onto the module support frame (Figure 4.8) (Gebauer et al. 2004). In addition to these design variations, California platform deck structure weights vary considerably, from 477 tons for platform Gina to 9800 tons for platform Harmony. After platform preparation, the topsides can be removed in several ways. With a sufficiently large HLV, the topside of a small platform can be removed in a single lift and placed on a barge for transportation to shore. For larger platforms, it may be necessary to divide lifts into groups of modules or even individual modules to avoid exceeding the HLV's lifting capacity. The deck structure or modules could be cut into smaller sections for removal to further minimize lifting weights and HLV requirements. In the modular platform design, after all the modules are removed, the module support frame (Figure 4.8), a framework affixed to the top of the jacket to support the modules, is removed and set on the cargo barge (Proserv Offshore 2010).





**Figure 4.6. Platform A, an example of an integrated topside design (source: <http://bayneweb.com/images/blogPics/flkr/oilPlatform.jpg>, accessed January 29, 2010).**



**Figure 4.7. Platform Harvest, an example of a hybrid topside design (source: [http://www.cosmic.ucar.edu/oceanPI2008/photos/harvest\\_platform.png](http://www.cosmic.ucar.edu/oceanPI2008/photos/harvest_platform.png), accessed January 28, 2010).**

## Deck Configurations

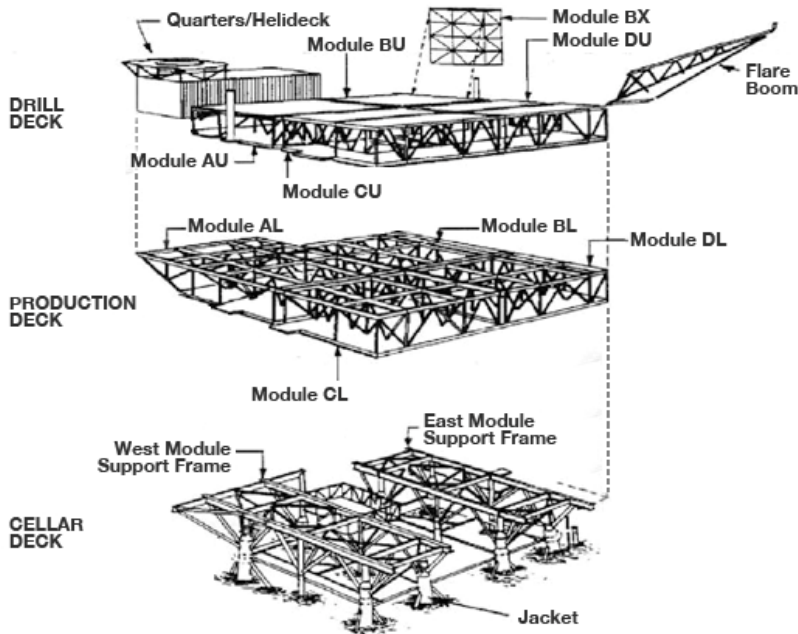

Figure 4.8. Illustration of the components of a generic platform deck (from Gebauer et al. 2004, figure 10-2).

**Platform jacket removal:** Platform jackets stand in water depths from 30 to almost 1200 feet and weigh from less than 400 tons to almost 43,000 tons. For complete platform removal, the first step in removing the jacket is to sever the piles that fix the platform to the ocean floor. These (Figure 4.9) are simply large diameter pipes driven through the legs of the jacket or sleeves at the base of the jacket into the seafloor to fix the jacket to the ocean floor. Piles must be severed at least fifteen feet below the seafloor in federal waters and not more than five feet below the seafloor in state waters using methods described above for conductor removal. The mass of the piles ranges from 125 to 13,950 tons.

The complete platform removal option assumes that the complete jacket structure will be removed from the ocean floor and transported to shore. Until newer lift options have been proven, Proserv Offshore (2010) and PLATFORM assume that the jacket will be dismantled in place if it is too large to be lifted in a single HLV lift. Each section will then be lifted onto a barge utilizing a conventional HLV. This sequential approach would be required for large platforms such as Harmony, which would require approximately 43 individual lifts and almost 100 days to remove the jacket structure from the ocean after the piles had been severed (Proserv Offshore 2010).

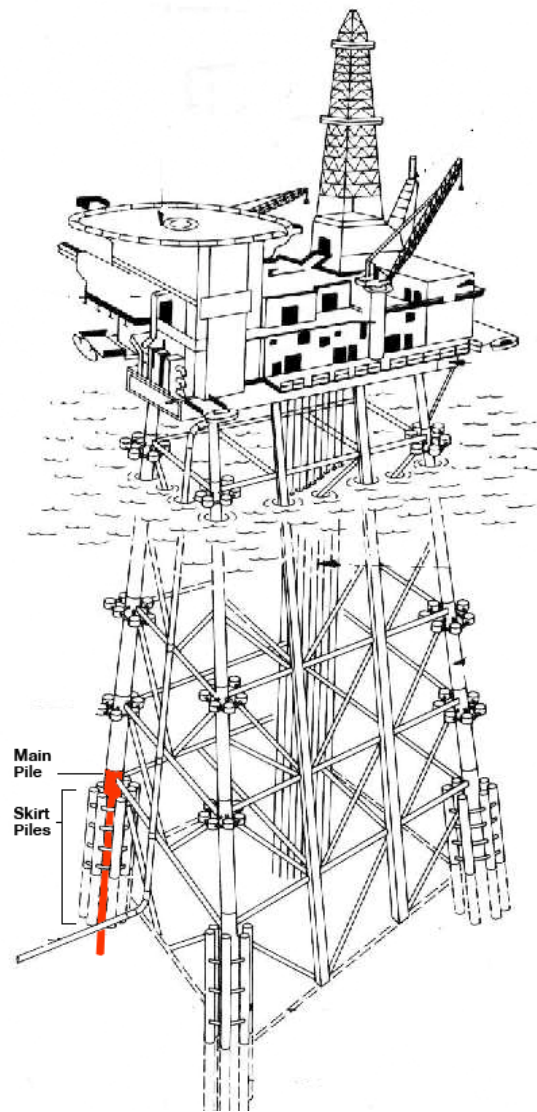

Figure 4.9. Illustration of jacket piles for a generic platform structure (adapted from [http://www.esru.strath.ac.uk/EandE/Web\\_sites/98-9/offshore/rig.jpg](http://www.esru.strath.ac.uk/EandE/Web_sites/98-9/offshore/rig.jpg), accessed January 28, 2010).

**Platform structure transportation and disposal:** Complete removal of all platforms in southern California would result in a mass of steel exceeding 375,000 tons (Table 1.1) and the mass of steel from individual deep water platforms (>400 foot water depth) ranges from 21,000 to 65,000 tons. The fact that these platforms will most likely be decommissioned in groups of two to six highlights the need for a large onshore facility for disassembly and processing (Proserv Offshore 2010). The 4H decommissioning project produced only 10,000 tons of steel and this overtaxed the onshore receiving facilities in the Los Angeles Basin, even though most of the scrap processed in the Los Angeles Basin at that time was shipped in bulk to the Far East (Culwell 1997). Proserv Offshore (2010) determined that onshore facilities capable of offloading large volumes of steel and with sufficient acreage for staging platform structures for dismantling

currently exist in southern California. As a result, Proserv Offshore (2010) assumes that the platform structures will be transported to either the Port of Los Angeles or Long Beach and all cost comparisons in this report and in PLATFORM are based on this assumption. The cargo barges used to transport materials recovered from the decommissioning process will be mobilized from the Port of Los Angeles or Long Beach, while the dive vessels, work boats, and crew boats will be mobilized from the general southern California area (Proserv Offshore 2010).

In addition to the recyclable scrap steel, other non-ferrous (non-metallic) and contaminated metal materials will be recovered from the offshore facilities. This may include hazardous material such as PCB's or asbestos in addition to non-hazardous wastes such as cement, plastic, wood, and non-asbestos insulation. These materials will need to be recycled or properly disposed.

**Site clearance:** Site clearance will usually involve a survey of the ocean floor under and around the platform prior to decommissioning to identify the location of all pipelines and power cables, old mooring and anchoring systems, and sensitive features such as hard bottom and kelp beds, supplemented by historical data if available. After platform removal, a second site survey will be performed to identify remaining obstructions that may interfere with other ocean uses in the area such as commercial or recreational fishing or vessel traffic. This post-removal survey also will identify any bottom damage incurred during decommissioning, such as anchor scars or other habitat impacts, as well as any items that may have been lost to the ocean floor during decommissioning. Once all debris is recovered, the site clearance will be confirmed with test trawling (Manago and Williamson 1998, Gebauer et al. 2004). Additional details regarding the site clearance regulations and site clearance alternatives for OCS platforms can be found in C.F.R. § 250.1740. For those platforms located in state waters, C.C.R., tit. 2, § 2122 and specific language contained in each lease defines the site clearance requirements. However, requirements in the state statute are not as detailed as those in MMS regulations and actions needed to comply with such leases are subject to negotiation with the state.

Shell mounds are a site clearance issue of particular concern and are discussed separately and at greater length in Section 4.1.1.2 below.

#### *4.1.1.2. Shell mounds*

The presence of shell mounds that accumulated beneath Chevron's 4H platforms Hazel, Heidi, Hope, and Hilda is an issue associated with their decommissioning that has not been completely resolved, even 14 years after the platforms themselves were removed. While formally part of the decommissioning process, dealing with shell mounds necessarily occurs after the platform is removed, because removing shell mounds requires unrestricted access to the bottom. The degree of controversy about the environmental costs and benefits of removing shell mounds vs. leaving them in place (SAIC 2003, see also Section 2.3.2) and the amount of additional study involved in decision making related to the 4H shell mounds highlight the potential sensitivity of this issue. However, shell mounds were successfully removed and site clearance completed after the removal of platforms Harry, Helen, and Herman and after the removal of Exxon's mooring offshore of Gaviota in 1994 (Manago and Williamson 1998). The following sections summarize more detailed information about shell mounds under southern California platforms and a synopsis of this discussion is presented in Table 4.3.

**Table 4.3. Summary of the factors involved in decision making about shell mound disposition.**

Factor	Synopsis
Source	<ul style="list-style-type: none"> <li>• Accumulated drill cuttings and drilling mud from well development phase</li> <li>• Shells of organisms living attached to platform structure (e.g., mussels, barnacles) detached due to natural die-off, wave turbulence, and routine cleaning of jacket</li> </ul>
Size	<ul style="list-style-type: none"> <li>• Up to 26 feet high</li> <li>• Volume ranges from &lt;400 to &gt;9,000 m<sup>3</sup></li> <li>• Sometimes substantial differences among mounds due to location, currents, depth, number of wells, age of platform, regulations in place at time of drilling</li> <li>• Largest mounds in shallow water on flat bottom</li> <li>• Surveyed platforms at &gt;430 feet depth had no significant shell mounds</li> <li>• Platform age and seafloor slope explains 91/7% of variation in shell mound size</li> </ul>
Composition	<ul style="list-style-type: none"> <li>• Three main layers, with most contamination in the middle layer</li> <li>• Contaminants associated with drilling, oil, and platform operations</li> <li>• Metals (barium, chromium, lead, zinc, nickel), PAHs, PCBs</li> <li>• New regulations in the 1970s required discharge permits and reduced contaminants in drilling muds</li> </ul>
Habitat	<ul style="list-style-type: none"> <li>• Shell mounds under existing platforms used by many fish and invertebrate species</li> <li>• Community structure the same as on platform jacket but species richness lower and individual fish are smaller</li> <li>• Juveniles of economically important fish species (lingcod, some rockfish) at high densities on shell mounds</li> <li>• Removal of entire platform reduces size of shell mound and its habitat value</li> <li>• Partial removal reduces input of new material and eventually will reduce size of shell mound and its habitat value</li> </ul>
Methods of removal	<ul style="list-style-type: none"> <li>• Sonar and remotely operated vehicle surveys to document obstructions</li> <li>• A variety of dredging and trawling methods, combined with remotely operated vehicles</li> <li>• It may be logistically infeasible to remove shell mounds at the deeper platform locations</li> <li>• Capping is an alternative to removal, but will not meet MMS and SLC requirements to remove obstructions</li> </ul>
Contamination concerns	<ul style="list-style-type: none"> <li>• Dredging and smoothing of the seafloor will create one-time, short-term turbidity and sediment resuspension events, with suspended sediments settling out within one km of the shell mound</li> <li>• Smoothing will create a larger disturbance than dredging</li> <li>• Removal could lead to temporary exceedances of state and/or federal water quality criteria for several contaminants and localized toxicity to sensitive organisms</li> <li>• Dispersal of contaminated sediments could result in longer-term bioaccumulation in benthic organisms such as crabs</li> <li>• Leaving shell mounds in place would avoid these impacts, but would leave open the possibility of future impacts if mounds are disturbed by a large event (e.g., storms, trawling, anchoring)</li> </ul>

**Regulatory requirements:** For platforms in the OCS, MMS regulations (30 C.F.R. § 250.1703(e)) and lease provisions governing decommissioning require that the bottom be returned to its original condition (e.g., “Clear seafloor of all obstructions created by your lease and pipeline right-of-way operations”). Section 250.1700 (b) defines obstructions as “structures, equipment, or objects that were used in oil, gas, or sulfur operations or marine growth that, if left in place, would hinder other users of the OCS, and may include, but are not limited to, shell mounds, wellheads, and casing stubs.” As for pipelines and power cables, shell mound removal can likely be waived if it is determined the mounds pose no obstacles to other OCS users, as it would not be considered an obstruction.

For platforms in state waters, decisions about shell mound removal are based on information from the EIR and made as part of negotiations to determine whether the operator’s abandonment plan meets the provisions of the lease (see Sections 3.1.1 and 3.1.2). Depending on the results of this process, shell mounds may be left in place at the discretion of the SLC, on a case by case basis. Although no explicit criteria have been formulated by the SLC, the reasons for such a decision might include some or all of the following: they do not interfere with other uses, they pose no substantial risk, they provide useful habitat for some species (when platform structures are left in place as an artificial reef), or removing them may cause more bottom impacts and/or contamination than leaving them in place (because removal would necessitate dredging, which would disturb the bottom and resuspend in-place materials). In the case of the 4H decommissioning project, the platforms were located in an area where the mounds at the time posed an obstruction to commercial fishing and therefore were required to be removed. However, studies indicated that the area would remain untrawlable even after the mounds were removed. There were additional concerns that removal operations would resuspend contaminated sediments and create water and sediment quality impacts (L.A. de Wit Consultant 2001). These issues have not yet been resolved.

**Source and size:** During platforms’ well development phase, the drill cuttings and drilling mud from the drilling process were typically discharged overboard and accumulated on the ocean floor under and around the platform. In addition to refuse from the drilling operations, organisms (typically clams, mussels, and barnacles) that attach themselves to the platform structure dislodge and over time accumulate on the ocean floor. These drill cutting and shell mounds can accumulate into a sizable volume over the life of a platform. Additional shell and organic material is added to the mound from the routine cleaning of the jacket down to a depth of approximately 20 feet below the surface.

Several studies (L.A. de Wit Consultant 2001, MEC Analytical Systems 2003, Weston Solutions, Inc. 2007) at sites where platforms have been completely removed and at existing active platforms occasionally found substantial differences among shell mounds. These differences were attributed to differing oceanographic conditions, number of wells per platform, volume of discharge material, water depth, differing rates of material accumulation among mounds, age of the platform, and associated changes in regulatory restrictions related to drilling muds and discharges that may have changed over the life of a platform (Weston Solutions, Inc. 2007).

A study (MEC Analytical Systems 2003) of 16 mounds surrounding oil platforms in the Santa Barbara Channel (Gail, Gina, Grace, Hidalgo, Houchin, Hondo, Henry, Hermosa, Gilda, Habitat,

Hogan, Hillhouse, Irene, A, B, and C) found that shell mounds could be as high as 26 feet above the ocean floor with volumes that ranged from <400 to 9,550 m<sup>3</sup> of material. The largest shell mounds form under platforms in shallower water located on flat bottom (MEC Analytical Systems 2003), while platforms located in water depths greater than 350 feet and with more than a 1% bottom slope have smaller (or in some cases nonexistent) mounds. In deep water, falling material disperses over a wider area, especially on the outer continental shelf or continental slope where currents tend to be stronger. This dispersal flattens the slope of the mound so that it blends in more with the surrounding bottom topography. Thus, the four platforms (out of 16 surveyed) with no significant shell mounding were in waters deeper than 430 feet with a bottom slope of less than 1.1% (MEC Analytical Systems 2003). Platform age is also correlated with shell mound size because younger platforms have had less time for shell mounds to accumulate. A regression analysis found that platform age and slope of the seafloor accounted for 91.7% of the variability in the height, volume, and horizontal extent of shell mounds (MEC Analytical Systems 2003).

**Composition:** Shell mounds typically have three main layers: an upper layer consisting of shell hash, an intermediate layer of drill cuttings and mud fluids, and the underlying seafloor layer of native marine sediments (L.A. de Wit Consultant 2001). In general, the highest levels of contamination are in the middle layer, which can contain elevated concentrations of barium (a component of most drilling muds), chromium (used historically as a drilling mud additive), lead (present in pipe dope used in drilling operations), zinc (present in lubricating oils), nickel (a component of crude oil), and several polycyclic aromatic hydrocarbons (PAHs) in different layers of the mound, with the highest concentrations typically found in the mounds' middle layer (L.A. de Wit Consultant 2001, SAIC 2003, Weston Solutions, Inc. 2007). In addition, PCBs were present in mounds from three of the 4H platforms and may have been present in cutting oils used during drilling or in other materials discarded from the platforms (L.A. de Wit Consultant 2001, SAIC 2003). For discussion of potential contaminant effects on biota, including both direct toxicity and bioaccumulation, see below.

The chemical composition of shell mounds varies depending on the regulations and drilling practices current at the time drilling occurred. Prior to passage of the CWA in 1972, there were no restrictions on the composition of discharged drilling muds, but discharges of oil-based and non-generic drilling muds was subsequently prohibited and platforms were required to obtain NPDES permits for their discharges (Weston Solutions 2007). Since the CWA discharge regulations were implemented, oil based drilling muds have been replaced with other less hazardous materials and many drilling operations began to recover drill cuttings and spent drilling mud and transport this waste to shore for disposal rather than discharging it overboard.

**Shell mounds as habitat:** Many fish and invertebrate species use shell mounds under existing platforms as habitat (Love et al. 1999, Bomkamp et al. 2004, Love et al. 2003, Love and York 2005, 2006). For example, 35 fish species, including 18 rockfishes (*Sebastes* spp.), were found on shell mounds during surveys of Platforms Irene, Hidalgo, Harvest, Hermosa, Holly, Grace, and Gail (Love et al. 1999), but this survey also found that individual fish were smaller and species richness was lower on the shell mounds than on the platform's jacket near the bottom. However, community structure on the shell mounds appears to be the same as on the associated platform and both are therefore considered part of a single platform system (Love et al. 1999). Juvenile representatives of economically important fish species, such as lingcod (*Ophiodon*

*elongatus*) were found in higher densities on Platform Irene's shell mound than any other artificial or natural reef in southern California (Love et al. 1999, 2003) and shell mounds under existing platforms may be a nursery habitat for lingcod and a variety of rockfish species. Shell mounds under existing platforms also attract a rich community of marine invertebrates, usually dominated by large sea stars such as *Asterina miniata*, *Pisaster ochraceous*, and *Pisaster giganteus* and also including commercially important species such as rock crabs (Page et al. 1999, Love and Schroeder 2004).

It appears that shell mounds lose much of their habitat value when the platform is removed (L.A. de Wit Consultant 2001, Bomkamp et al. 2004). Because the shell mound benthic community is supported by falling organic material from the platform jacket which acts as both a food subsidy and habitat structure, the cessation of this input when platforms are removed results in a substantial reduction in species abundance on the shell mound (L.A. de Wit Consultant 2001, Bomkamp et al. 2004). Shell mounds also settle with time once the input of material from the platform is removed, which decreases their vertical profile substantially and therefore the amount of available habitat.

**Methods for shell mound removal:** Site clearance and shell mound removal methods are described in detail in Manago and Williamson (1998) and L.A. de Wit Consultant (2001). Manago and Williamson (1998) note that site clearance was completed successfully during the decommissioning of platforms Harry, Helen, and Herman, and following the removal of Exxon's Single Anchor Leg Mooring offshore of Gaviota in approximately 500 feet of water. The Harry, Helen, and Herman site clearance operations were completed without incident and the Exxon operation was notable as the deepest site cleared to that time (1994) on the OCS. In contrast, the shell mounds under the 4H platforms were not successfully removed due to the volume of material, the high relief of the mounds, and their composition (Manago and Williamson 1998, L.A. deWit Consultant 2001). As a result, the EIR considered the possible use of explosives to break up the shell mounds prior to either dredging or trawling. Ocean disposal of contaminated dredged shell mound material could be problematic, since any material to be disposed would first need to be evaluated with toxicity and bioaccumulation studies; material that failed such tests would need to be disposed of on shore. More recent discussions with dredging experts (pers. comm., M. McGuire, Weston Solutions, 2009) suggest that it may be logistically infeasible with current methods to remove shell mounds at the deeper platform locations off southern California.

An alternative to removing the shell mound is to isolate the contaminated material in the shell mound by capping, using one of two methods (L.A. de Wit Consultant 2001). Level bottom capping involves placing the contaminated material on a flat portion of the seafloor and then covering the material with uncontaminated sediments. This method necessarily involves movement of the mound material from its original location, or spreading the mound material out to lower its vertical profile. Contained aquatic disposal, the second type of capping, involves capping the mound in place with uncontaminated sediments. Both methods have the goal of minimizing the potential for contaminant migration through the capping material. However, neither method of capping would comply with MMS and SLC requirements to remove obstructions from the bottom, and capping in deep water can be extremely difficult.



**Contamination concerns:** Contaminants in the shell mounds create concerns related to water quality, sediment contamination, and bioaccumulation; however, these concerns differ depending on whether shell mounds would be removed or left in place.

If shell mounds are removed, water clarity during excavation and removal of the mounds is predicted to decrease and some portion of contaminated sediments will be resuspended into the water column. Modeling of estimated contaminant concentrations at the dredge site and 100 meters away indicates that chromium, copper, lead, zinc, PAHs, and PCBs could exceed one or more acute or chronic California Ocean Plan or U.S. EPA water quality criteria (SAIC 2003). While such exceedances could produce toxic effects on sensitive organisms, such impacts would be temporary and non-recurring, and likely to be localized within a limited portion of the water column. After dredging, activities to smooth the seafloor would create turbidity plumes for five to seven days and are expected to disturb a greater amount of sediment, and resuspend more solids, than the dredging activities themselves (SAIC 2003).

Suspended sediments from dredging and smoothing activities could also create broader and longer-term effects on surrounding benthic sediment quality, as resuspended sediment disperses and then settles to the bottom. Modeled estimates of this impact suggest that resuspended sediments, and any contaminants bound to them, would settle to the bottom within about one km of the original mound (SAIC 2003). These contaminated sediments would include metals, which are not biodegradable. In addition to direct toxicity to benthic organisms, there are concerns about potential bioaccumulation of contaminants dispersed as a result of mound removal activities. While there are no direct studies of this potential impact (because no mounds have been removed), bioaccumulation studies on existing shell mounds provide some insight into the likelihood and magnitude of such impacts. A caged mussel study (SAIC 2003) at each of the 4H shell mounds and at reference sites nearby indicated little to no bioaccumulation of toxins in mussel tissue, even after storms which could have disturbed the mounds, and over 90% survival at all sites. In contrast, red and yellow rock crabs (*Cancer antennarius* and *C. anthonyi*, respectively) collected at several of the shell mounds contained significantly higher concentrations of several metals, including nickel, cadmium, copper, and zinc (SAIC 2003). In addition, certain PCB's were detectable in California sea cucumber (*P. californicus*) tissues taken from the vicinity of the 4H shell mounds. These studies demonstrate that some human-derived contaminants are present in the area and biologically available, although the sources of these contaminants were not directly tied to the shell mounds (SAIC 2003).

If shell mounds are left in place, impacts due to sediment resuspension and dispersal would not be an issue, primarily because most contaminants are in the shell mounds' inner layer and are covered by a top layer of uncontaminated material. Other studies, in addition to the caged mussel study mentioned above, suggest that the surface layers of existing shell mounds are not highly toxic and that contaminants from the shell mounds move into nearby sediments only as the result of large episodic events (L.A. de Wit Consultant 2001, Phillips et al. 2006). These data led Phillips et al. (2006) to conclude that contaminants within the mounds would remain sequestered within them unless disturbed by a large event (e.g., large storm, trawling, anchoring).

#### 4.1.2. Partial platform removal – engineering description through disposal

In the partial removal option the platform deck structure will be removed and brought to shore for dismantling and recycling or disposal. In addition, the conductors and jacket (Figure 4.1) will be removed to a depth of at least 85 feet below sea level to reflect state managers’ clear preference that the artificial reef avoid any interference with marine vessel traffic and preclude or reduce the need for surface buoys or other warnings. All other components of the platform, including jacket and conductors below 85 feet, would be left in place. Because the jacket is left in place, there is no need to sever pilings. The cut off jacket sections, the lower portion of the deck, and the support frame (Figure 4.8) may be placed on the ocean floor as reef enhancement after thorough cleaning.

Marking of artificial reefs is a major concern for some stakeholders because of potential hazards to shipping and fishing activities (see Section 6.2.3.5 for more detail). The USCG has jurisdiction over waterway safety and navigation under the Ports and Waterways Safety Act as amended (33 U.S.C. § 1221 et seq. and 4 U.S.C. § 86) gives the USCG the authority to mark obstruction by sunken materials. In practice, the District Commander will determine whether a particular structure must be marked as an obstruction and artificial reefs in the Gulf of Mexico 85 feet or more below the water surface are not typically marked (Stephan et al. 1990, McGinnis et al. 2001). In the Gulf of Mexico, as described in the Texas Artificial Reef Plan (Stephan et al. 1990) regulations established by the USCG district commander state that reefs whose clearance from the water surface is between 85 and 200 feet require only an unlighted yellow buoy, although waivers may be granted if the reef is more than two nautical miles from fairways, channels, or anchorages, there is no history of deep draft traffic in the area, and the entire reef complex is adequately marked or included on updated National Ocean Service navigational charts. The District Commander in the Gulf of Mexico has routinely granted waivers to any marking requirements to reefs below 85 feet based on these criteria.

**Table 4.4. The major engineering steps in the partial platform removal option, with similarities to and differences from the complete removal option noted.**

Partial removal element	Comparison to complete removal option
Well abandonment	Identical to complete removal
Platform preparation	Identical to complete removal
Conductor removal	Only down to 85 feet below sea surface
Pipeline and power cable disposition	Identical to complete removal
HLV mobilization and demobilization	Smaller and less costly lifting equipment
Platform deck removal	Identical to complete removal
Platform jacket removal	Only down to 85 feet below sea surface
Platform structure transportation and disposal	Smaller mass to be transported and disposed of; cut off jacket sections, lower portion of the deck, and the support frame (Figure 4.8) may be placed on the ocean floor as reef enhancement
Site clearance	Identical to complete removal around platform but shell mounds left in place

Table 4.4 lists the major activities involved in partial platform removal, with similarities to and differences from complete removal noted. The following material discusses only those activities that differ between the two options.

**Platform preparation:** Platform preparation for the deck structure in the partial platform removal option is identical to that described for the complete removal option, as both require removal of this structure. The marine growth removal task for partial removal may be less intensive if the upper section of the jacket is placed on the bottom as reef enhancement. However, because the cost of removing marine growth is small compared to overall costs, and is not significantly affected by including or excluding from the cost estimates marine growth removal from the upper section of the jacket, costs for platform preparation and removing marine growth are represented in PLATFORM as equivalent, regardless of which decommissioning option is selected. However, foregoing the removal of marine growth from jacket portions placed on the sea floor would dramatically reduce the amount of this material dislodged to the sea floor. On the other hand, these organisms quickly die in any case once removed from their preferred habitat in the upper water column.

**Conductor removal:** In the complete removal option, the conductors (Figure 4.1) must be removed entirely. In the partial removal option, the conductors are left in place from the ocean floor up to approximately 85 feet below the water line. The presence of conductors adds complexity to the jacket structure, enhancing the amount and variety of habitat provided by the artificial reef. Conductor severing can be performed using methods described for the complete removal option, although any use of explosive charges is extremely unlikely because it would negatively impact the very habitat the jacket structure is being left to enhance.

**Mobilization and demobilization of the HLV and support vessels:** In a decommissioning project, the maximum single lift weight requirement (i.e., deck module lift or jacket section lift) dictates the size of HLV required. In the partial removal case, the heaviest deck lift will determine the HLV requirements. This is because only a portion of the jacket will be removed and it is likely these jacket sections will be cut into smaller pieces as needed to be compatible with the HLV sizing requirements dictated by the deck or module lifts. In addition, cutting deck modules into smaller pieces could reduce the size of HLV required. Thus, selection of a smaller HLV may be possible for the partial removal option, greatly reducing HLV day-rate costs associated with mobilization, demobilization, and on-site decommissioning work. The number of days the HLV will be on site will also be significantly reduced as the majority of the jacket structure is being left in place. As a result, HLV costs for the partial removal options will be significantly lower.

**Platform jacket removal:** In the partial removal option the jacket is left standing, and the piles that fix the jacket to the ocean floor left in place, after the top jacket section is removed down to 85 feet below the water line. Jacket cutting can be performed using methods described for the complete removal option, although any use of explosive charges is extremely unlikely because it would negatively impact the very habitat the jacket structure is being left to enhance.

There are two choices for disposition of the removed jacket portion. One is transport to shore where it would be cut up for recycling. The second is to set this portion of the jacket on the

bottom beside the main jacket structure to add complexity to the artificial reef. In one scenario, the top section of the jacket could be set on the bottom using the HLV used to remove the platform deck. Another method involves cutting the jacket support members to enable pulling the cut jacket sections over with a tug or other large vessel (Twachtman Snyder & Byrd 2000) (Figures 4.13 and 4.14). However, state managers have expressed their preference for the first method (lowering the jacket with the HLV) because of the additional disturbance to the bottom habitat created by toppling.

## Partial Removal

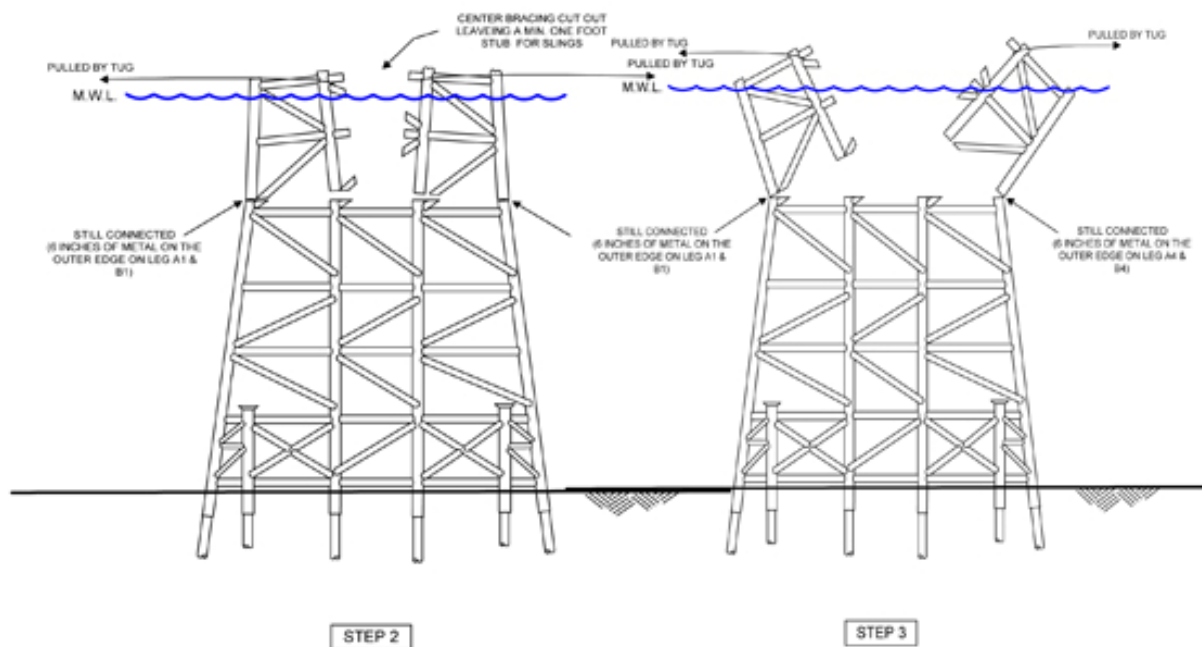

**Figure 4.13. Illustration of the initial steps of the partial removal operation in which jacket sections are dropped to the seafloor (from Twachtman Snyder & Byrd, Inc. 2000, Figure 3.16).**

**Platform structure transportation and disposal:** Partial removal of all the oil and gas platforms off the California coast would require handling and recycling an estimated 146,000 tons of steel, less than half the amount produced by the complete removal option, assuming all cut off jacket sections are brought ashore. If the cut off jacket sections are left offshore as reef enhancement, the mass of steel coming to shore decreases to about 113,000 tons. Because there is a cost associated with barging this material to shore and cutting it up for recycling, there is thus a significant cost savings to be realized by converting the platform jacket structures to artificial reefs. At a \$384 per ton estimated cost to transport, dismantle and recycle the steel mass (excluding any scrap value of the steel) (Proserv Offshore 2010) using the upper jacket sections as reef enhancement could avoid approximately \$102 million in structure recycling costs alone.

## Partial Removal

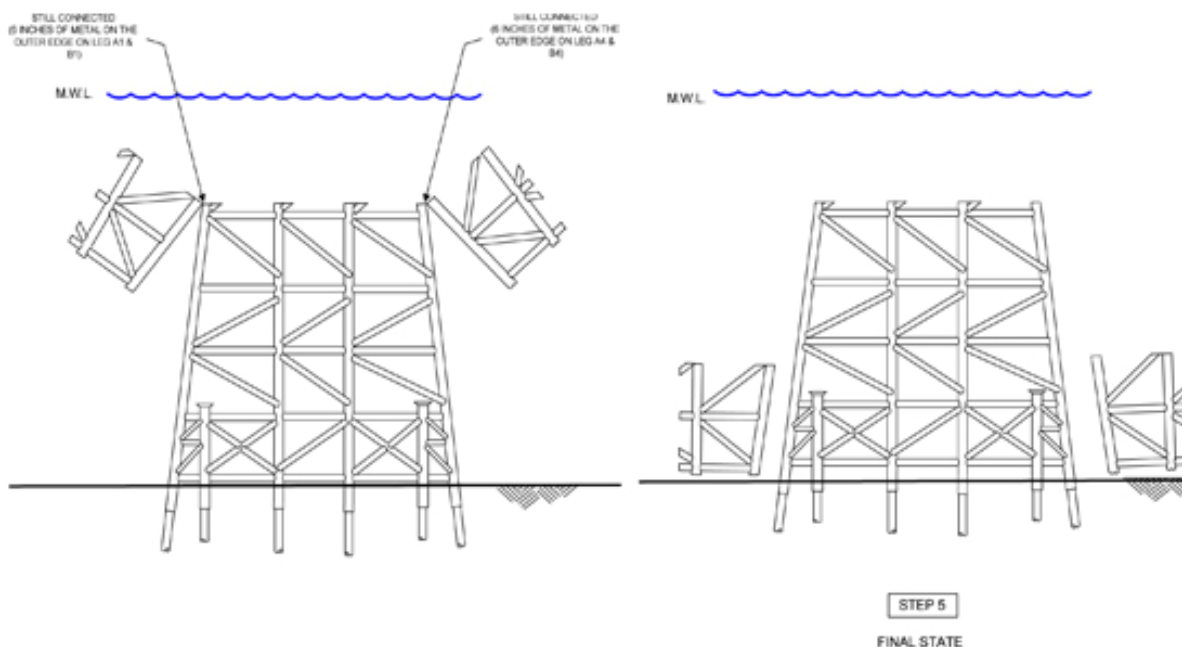

Figure 4.14. Illustration of the latter steps of the partial removal operation in which jacket sections are dropped to the seafloor (from Twachtman Snyder & Byrd, Inc. 2000, Figure 3.17).

**Site clearance:** Even when performing a partial platform removal, a pre-decommissioning underwater site survey would be performed because the need still exists to identify any obstructions that may interfere with other ocean users and deployment of any needed anchor spreads for the HLV. The post-project survey would also be performed to identify any bottom damages incurred during decommissioning as well as any items that may have been lost during decommissioning. Although the site would still be occupied by the platform jacket, the site clearance may be confirmed using test trawling around the jacket on the decommissioned site, although the federal site clearance regulations are not definitive on this issue when portions of the jacket are left in place.

### **4.2. Options not analyzed in detail**

Several additional options have been considered for alternative uses and/or disposal of decommissioned platforms. These are described briefly in the following subsections, along with a summary of the relevant legal and regulatory background, past efforts at implementing the option, the rationale for excluding it from detailed consideration in this study, and a statement about what changes might make the option viable in the future.

### 4.2.1. Deep water disposal

Under the complete removal option, the jacket structure could be disposed of in deep water, either in U.S. waters on the outer continental shelf or in international waters, since these materials are steel that has not come into contact with oil or other potential contaminants. This disposal route would involve permitting through U.S. EPA, as well as a formal disposal site designation process. However, under guidelines and regulations established by both the Convention on the Prevention of Marine Pollution by Dumping of Wastes and Other Matter 1972 (London Convention) and U.S. EPA under the U.S. Ocean Dumping Act, deep water disposal would only be pursued following a finding that there is a need for ocean disposal, i.e., that other alternatives are not practical. In addition, anything that is the product of an industrial process is banned from disposal at a designated ocean dumping site (Figure 4.15).

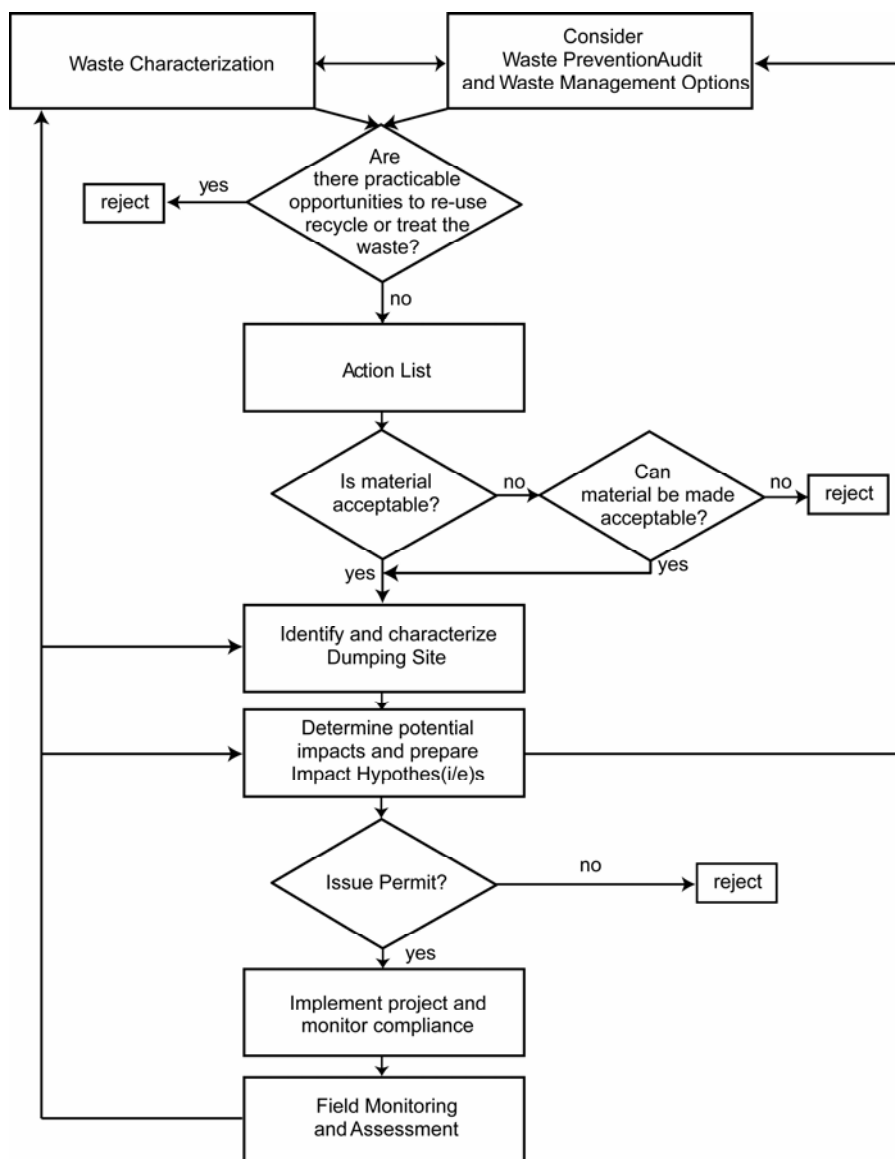

Figure 4.15. Decision framework for deep water disposal (from London Convention 1997).

The 1996 Protocol to the London Convention (London Convention 1997) lists materials prohibited from ocean disposal and specifically lists vessels and platforms as exempt from the outright prohibition:

"'Industrial waste' ... does not apply to:...(d) vessels and platforms or other man-made structures at sea, provided that material capable of creating floating debris or otherwise contributing to pollution of the marine environment has been removed to the maximum extent"

However, such non-prohibited materials are still regulated and any disposal effort must proceed through extensive assessments related to identifying and designating an appropriate disposal site.

The U.S. EPA disposal site designation process requires comprehensive data collection. Permitting for most open ocean disposal sites for dredged material requires a year of baseline data, followed by a full EIS and rulemaking process, which can take two to three years to complete and cost \$2 million to \$5 million or more, a cost that is typically borne by the project proponent. However, because disposal of platform jackets, as opposed to dredged material, will not involve sediment placement, the need for extensive oceanographic data collection (current meter moorings) and site-specific dispersion/deposition modeling would be greatly reduced. In addition, the time needed for baseline studies might be substantially shorter than it would otherwise be. The scope of any EIS would also be affected by whether the disposal site was intended for a single use or for multiple platform disposals. This would affect the scope of the EIS including the number of options looked at. However, issuance of a disposal permit, even after designation of a disposal site, would depend on the project-specific practicability of alternatives to ocean disposal, including abandonment in place and onshore disassembly and metal recycling.

While deep water disposal of both platforms and ships are allowed under U.S. and international law, the permitting pathways differ. There are no existing general permits for platforms, as there are for steel or concrete vessels, which can be scuttled at sea. For example, scuttling a vessel under the general permit requires simply completing a form letter, obtaining USCG certification, and explaining why the ship cannot be cut up and recycled onshore. Unlike platform disposal, which would require a formally designated disposal site, ships can be disposed of at approved (as opposed to designated) locations. These are locations selected by the project proponent that meet certain requirements (e.g., a minimum depth of 500 fathoms and a minimum of 12 miles offshore). While it is not clear whether a general permit for platform disposal could be developed, platforms disposal sites could not overlap dredged material disposal sites, because of the different materials involved.

The distinction between disposal within U.S. territorial waters and international waters is moot. U.S. EPA regulations and authority under the Ocean Dumping Act applied both to the 200 mile limit and to anything transported from the U.S., on a U.S. flagged ship, or by a U.S. national to international waters. The Ocean Dumping Act thus covers everything going out to sea from U.S. shores. In addition, the U.S. is a signatory to the London Convention, which has decision criteria similar to those applied by U.S. EPA. Because current OCS leases require platform removal at the end of production, offshore disposal would require that MMS approve a major revision to the

platform's Development and Production Plan. This in turn would trigger a CCC review under the federal consistency provisions of the CZMA, which gives the state authority to review OCS plans and major revisions to OCS plans.

This disposal option was not retained for detailed analysis because staff at CCC and MMS indicated that they would not likely approve deep water disposal. However, since this disposal option is legal under both U.S. and international law, it could be considered for implementation if agency priorities changed in the future.

#### **4.2.2. Alternative energy**

Recent years have seen a dramatic increase in interest in developing alternative energy projects offshore. This interest has focused primarily on wind and wave energy, with some attention to tidal or current energy projects and a smaller amount to solar projects. For example, a number of offshore wind farms are in various stages of the permitting process on the Atlantic and Gulf coasts of the U.S., and a number of wave energy projects have received preliminary FERC licenses in Oregon and northern California. This interest has been reflected in the development of regional and national management and regulatory frameworks to guide the development and implementation of such projects. For example, the West Coast Governors' Agreement has established an Alternative Energy Working Group, and MMS has published a final programmatic EIS on alternative energy development on the OCS (MMS 2007) and more recently regulations addressing the reuse of oil and gas platforms for alternative uses (MMS 2009).

MMS (2007) notes that decommissioned offshore platforms could possibly serve as electric service platforms for offshore wind farms. These platforms are envisioned as providing a common electrical interconnection for the turbines in the array and as a central service facility that could provide a helicopter landing pad, control and instrumentation systems, cranes, communications, staff and service facilities, and temporary living quarters. In addition, platforms have often been mentioned as a site for locating wind turbines themselves.

Despite this interest and discussion, there are no active plans to use oil platforms in any wind projects currently in the planning phase in either Europe or the U.S. The size of units currently being considered for offshore use (3.5 – 5 MW) are so large that only one could fit on a platform, and the number and locations of platforms does not match the design requirements of current wind farm proposals, which include larger numbers of units spaced about seven to ten rotor diameters apart. The potential for use of decommissioned platforms as central support facilities for an offshore wind farm is limited by the fact that methods for siting wind turbines in depths greater than 100 feet have not yet been commercialized and are focusing increasingly on individual floating structures. There are only four platforms sited in depths less than 100 feet (Table 1.1) and these are in inshore locations with only poor wind energy potential (Figure 4.3) and where impacts on viewsheds would be an important concern. There has been limited interest in placing large wind turbines (one per platform) on Harvest, Hermosa, Hidalgo, and Irene when they end production, but this has not progressed beyond the stage of preliminary discussion and planning. These are the only platforms in southern California located where wind energy potential would make such a project feasible (Figure 4.16). Even if all four platforms were



## California Wind Resources Annual Wind Power at 50 Meter Elevation

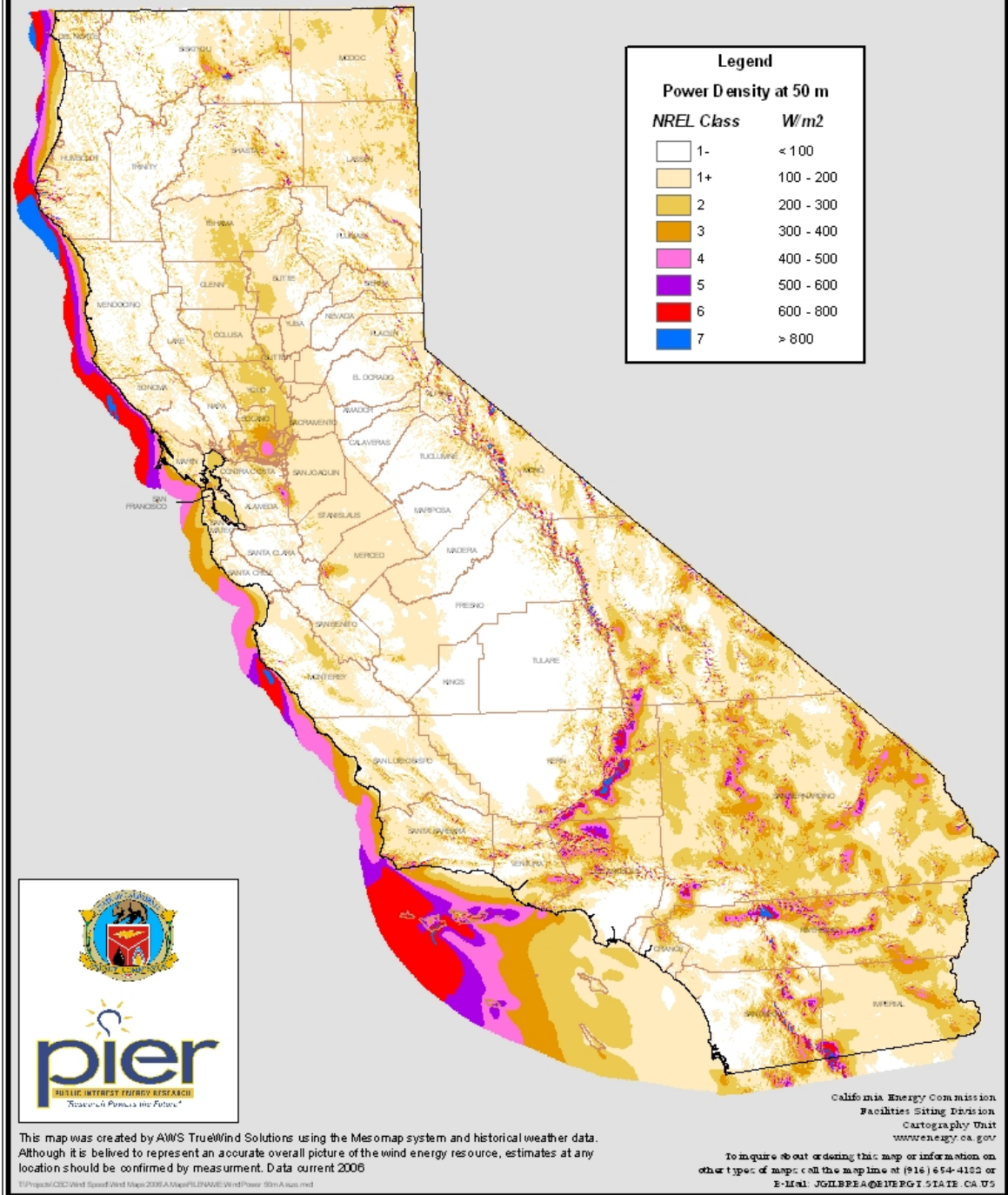

Figure 4.16. California Energy Commission map of wind power potential at 50 meters height (source: AWS Truewind (2006)).

converted to wind energy platforms, the number of turbines (four) would be far below the number included in other wind energy projects, such as the recently approved Cape Wind project in Massachusetts, which includes 130 offshore turbines.

MMS (2007) also summarizes existing wave energy technology and notes that many proposed technologies are suitable for deeper water but that none of these designs, which are based on arrays of tethered surface or subsurface units, have a need for a central service platform. In addition, Bedard (2007), Wilson and Beyene (2007), and the California Energy Commission (PIER 2007) note that wave energy potential south of Point Conception is limited, an assessment borne out by the fact that all of the projects currently in the development or licensing phase are north of Point Conception. There are four platforms north of Point Conception (Hermosa, Harvest, Hidalgo, and Irene) that are located in an area with higher wave energy potential, and Irene was proposed as an electrical service platform for a wave project north of Point Conception, but this project did not advance beyond the preliminary planning stages. Pacific Gas & Electric in December 2009 applied for a FERC preliminary permit to study the feasibility of a wave energy project within state waters in the Point Conception area, but this proposal does not include the use of an offshore oil and gas platform.

Designs for current energy projects are based on adaptations of tidal energy technology or large ocean currents such as the Gulf Stream are still in the development and demonstration phase (MMS 2007). Required depths for such technologies range from 300 to 500 meters (985 to 1,640 feet) and envision large submerged turbines which would make an oil platform unsuitable because it would interfere with the action of the submerged turbines.

No specific designs for offshore solar energy projects have been proposed.

Decommissioning options based on the reuse of platforms offshore southern California were not considered further because of the lack of serious interest by project proponents in using decommissioned platforms, and the mismatch between platform locations and energy potential within the constraints of technologies presently available and envisioned for the next five to ten years. This option could become more attractive in the future as technology changes and the economics of offshore wind and wave energy are more fully investigated. It is important to note that alternative uses other than artificial reefing do not eliminate the need for removing the platform. Instead, the use of a decommissioned platform for alternative energy purposes simply changes the timeline of the removal process, since at some point the facilities will ultimately reach the end of their useful lifetime and need to be removed.

#### **4.2.3. Liquefied natural gas (LNG) terminal**

In the past several years, a number of coastal or offshore LNG terminals have been proposed for the West Coast (Figure 4.17) (California Energy Commission 2010). Of these, only the Clearwater Port project included an offshore oil and gas platform in its design. The Clearwater Port project planned to convert Platform Grace, located 12.6 miles off the coast of Oxnard, CA to a LNG receiving terminal. Plans called for the platform to be connected to the Southern California Gas Company pipeline network and storage infrastructure through a 28-mile pipeline alongside an existing undersea pipeline corridor. The project prompted a number of concerns

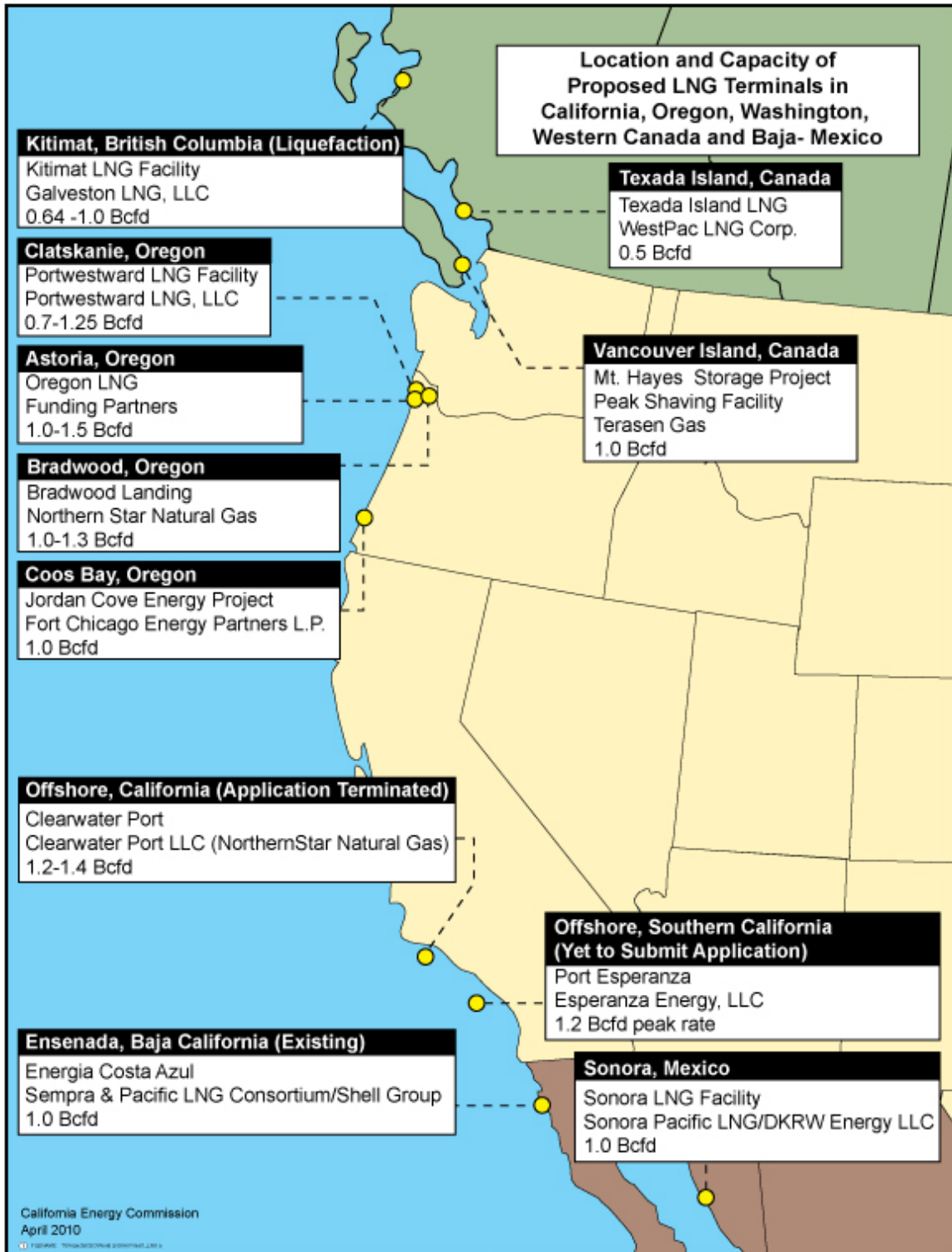

Figure 4.17. Location of proposed LNG terminals along the west coast of North America as of April 2010 (source: California Energy Commission 2010).

related to potential environmental impacts as well as to risks of the proposed pipelines that would run through the City of Oxnard. The USCG suspended the environmental review process in October 2007 and requested that NorthernStar Natural Gas address 396 specific issues as a precondition of restarting the review process (California Energy Commission 2010). In March 2010, the SLC terminated the project application for a general lease right of way, citing the lack of activity on the application. Platform Grace resumed production in October 2007.

While the Clearwater Port project was under review, other events, both local and elsewhere, altered the economic and policy landscape for LNG terminals in southern California. The application for the Cabrillo Port project, a proposal by BHP Billiton to build floating LNG storage and processing facility approximately 14 miles offshore of the Los Angeles / Ventura County line, was denied in 2007 by the California State Lands Commission, the Coastal Commission and by Governor Schwarzenegger because environmental review in part showed the project would, “result in significant and unmitigated impacts to California’s air quality and marine life” ([www.energy.ca.gov/lng/projects.html](http://www.energy.ca.gov/lng/projects.html)). In addition, projects in Oregon continued to move forward, the LNG terminal in Ensenada, Baja California became operational in 2008, and Spectra Energy continued development of its Bronco Pipeline which will link natural gas supplies in the Rocky Mountains to markets in the Pacific Northwest and California. The availability of natural gas supply from these other sources, combined with concerns about the risks of such projects, resulted in a drop in interest in pursuing an LNG terminal in California.

#### **4.2.4. Aquaculture**

As demand for fish and seafood in the United States rises, wild-capture fisheries are not likely to keep pace due to decreases in fish populations from overfishing and other causes, and the resulting catch restrictions on marketable species (GOM Fishery Management Council 2009). Aquaculture has been proposed as a means of helping to fill such demand, and as a possible method for replenishing depleted wild fish stocks. It has frequently been suggested as an alternative use for decommissioned offshore oil and gas platforms. Despite the presence of a recently developed legal framework for permitting and several attempts to establish aquaculture on both operating and decommissioned platforms, there have been no successful aquaculture projects on offshore platforms anywhere in the world.

A number of federal laws define the legal and regulatory infrastructure for offshore aquaculture, beginning with the passage of the National Aquaculture Act of 1980 (NAA) (16 U.S.C. § 2801 et seq.) (Fletcher and Weston 2000). NAA’s reauthorization in 1985 designated the U.S. Department of Agriculture (USDA) as the lead federal authority on aquaculture, but NOAA in 1998 and 1999 adopted policies that assumed the Department of Commerce as the lead federal authority (GOM Fishery Council 2007). Such regulatory uncertainty was widely acknowledged as the major barrier to the development of aquaculture in federal waters (NOAA 2008).

Following recommendations of the 2004 U.S. Commission on Ocean Policy, the National Offshore Aquaculture Act of 2007 (NOAAAct) (introduced as H.R. 2010 on April 24, 2007, but not yet passed into law) was intended to provide the necessary authority to the Secretary of Commerce to establish a regulatory system for offshore aquaculture in federal waters. NOAAAct and subsequent policies (GOM Fishery Council 2009) defined a regulatory program that

included a permitting process and a framework for coordination with other uses such as offshore oil and gas leases and commercial and recreational fishing. In addition, Section 388 of the Energy Policy Act of 2005 states that the federal government may grant a lease, easement, or right of way on the OCS for activities that “use, for ... other authorized marine-related purposes, facilities currently or previously used for activities authorized under this Act” (e.g., offshore oil and gas platforms). MMS then issued detailed regulations (MMS 2009) describing the decision process for implementing the Act, including the conversion of offshore oil and gas platforms to alternative uses. In December of 2009, Congresswoman Capps of California introduced the National Sustainable Offshore Aquaculture Act of 2009 (H.R. 4363) ([www.govtrack.us/congress/bill.xpd?.bill=h111-4363](http://www.govtrack.us/congress/bill.xpd?.bill=h111-4363)), intended to establish a clear framework for offshore aquaculture regulations. The bill was referred to committee on January 4, 2010.

In the absence of definitive federal legislation, all offshore aquaculture operations in the OCS to date have been managed under an exempted fishing permit (EFP) according to provisions of the Magnuson-Stevens Fisheries Conservation and Management Act (MSFCMA). This is currently the only legal pathway to permit commercial offshore marine aquaculture projects, including those using decommissioned oil and gas platforms. However, several federal agencies also have regulatory authority over related issues, including the authority to grant other required permits (Fletcher and Weston 2000, GOM Fishery Council 2007, NOAA 2007, GOM Fishery Council 2009, P. Sylvia, Hubbs Sea World Research Institute, pers. comm. 2010) (see Section 3.1.1 for more detail). For example, ACOE has primary review authority over any installation that may hinder navigation, and U.S. EPA, acting under the Clean Water Act, requires discharge permits for all aquaculture projects in the open ocean (40 C.F.R. § 122.24).

A number of projects in the Gulf of Mexico have attempted to use offshore platforms as a base for aquaculture operations. These include:

- A Texas Sea Grant project in Texas waters (late 1980s to early 1990s) to grow redfish in cages suspended from a working platform; storms damaged many cages, the operation interfered with workboat access to the platform, and fish production costs were more than six times market value (Waldemar Nelson, Int. 2001, GOM Fishery Council 2007)
- A Watermark Corporation project in Louisiana waters (mid 1990s) that was abandoned in the permitting phase (GOM Fishery Council 2007)
- A Sea Fish Mariculture project in the OCS (mid 1990s to late 1990s) to grow several fish species in pens attached to a working platform; storms damaged pens and the platform’s gas production activities interfered with the project, which was abandoned in 1999
- A Gulf Marine Institute of Technology / Biomarine Technologies project in Texas waters (late 1990s) to grow fish in cages attached to four converted decommissioned platforms; an ACOE permit was granted but the Texas Land Commissioner ordered the platforms dismantled. The decision was overturned in court but the project appears to have become dormant

Only one platform-based offshore aquaculture project has been proposed for the OCS in California, the HSWRI Platform Grace Mariculture Project, described in Section 2.3.3. The project was intended to test the feasibility of using offshore platforms for sustainable marine

aquaculture and was designed to place hatchery tank systems on the main platform deck and moor four cages in close proximity to platform (HSWRI 2003). Permitting for this project included a total of 20 agencies, and six permits were obtained (P. Sylvia, HSWRI, pers. comm. 2010). Delays occurred because permitting took place before the 2007 passage of NOAA Act and it was not clear whether NOAA or ACOE was the lead agency. Plans to use the platform as a liquefied natural gas terminal and the later resumption of oil production made the aquaculture project infeasible (GOM Fishery Council 2007). HSWRI's subsequent plans for offshore aquaculture utilize floating pens and do not require platforms or other fixed structures (Figure 4.18).

While there are currently five offshore aquaculture facilities in the U.S., from Hawaii to New Hampshire, none use offshore platforms in their operations. A task force created in 2005 by the Louisiana Department of Natural Resources to determine how standing oil and gas platforms may be utilized for offshore marine aquaculture concluded that more research was needed for such projects to be feasible (LA Dept. of Natural Resources 2005, GOM Fishery Council 2007). Unresolved concerns include local sediment and water column contamination from concentrated feeding operations and impacts on wild stocks (Krop et al. 2007), as well as the potential contamination of farmed seafood due to close association with oil and gas platforms (<http://www.gomr.mms.gov/homepg/regulate/envIRON/techsumm/1995/95-0045.html>). Economic concerns include the competition of aquaculture with commercial and recreational fishing communities, and the exclusive use of public resources for profit (HSWRI 2003).

Decommissioning options based on the reuse of platforms offshore southern California for aquaculture were not considered further because of the past history of failure of such projects, the worldwide absence of any successful projects, and the current lack of serious interest by project proponents in using decommissioned platforms for this purpose. In addition, the rapid development of new technologies for independently moored aquaculture facilities appears to be reducing the need to use platforms in such projects. The use of decommissioned platforms for aquaculture thus appears unlikely in the next five to ten years.

#### **4.2.5. Other options**

A number of other uses have been proposed for decommissioned oil and gas platforms but not implemented. Two that have received some attention are the reuse of platforms as locations for mooring elements of ocean observing systems and as offshore hotels. However, neither the Central California Ocean Observing System (CeNCOOS) nor the Southern California Coastal Ocean Observing System (SCCOOS) have seriously considered the use of platforms for siting buoys or other types of sensors. Large structures may interfere with measurements and platforms are not always ideally located for the pattern of measurements desired. A design for an offshore hotel sited on a decommissioned platform won the 2008 grand prize for Radical Innovations in Hospitality ([www.radicalinnovationinhospitality.com](http://www.radicalinnovationinhospitality.com)), but there have been no serious attempts to acquire platforms or permit them for this purpose.



**Figure 4.18. Floating “AquaPod” steel-and-wire mesh net pen for Snapperfarm, Inc. to raise cobia in deep water off Culebra, Puerto Rico (source: [http://gcaptain.com/maritime/blog/wp-content/uploads/2009/03/aquapod\\_fish-farm1.jpg](http://gcaptain.com/maritime/blog/wp-content/uploads/2009/03/aquapod_fish-farm1.jpg)) (accessed March 21, 2010).**

## 5.0. Comparative Analysis of Options

---

This section describes the detailed analysis of the two main decommissioning options, beginning with an overview of the analysis approach and the boundary conditions that defined the scope of the analysis. Section 5.3 then presents background information and findings for each of the major impact categories ranging from biological resources to air emissions, socioeconomics, and decommissioning costs. This set of categories was identified based on review of previous environmental impact assessments, reports on decommissioning, and interviews with state and federal managers and other stakeholders. The analysis and discussion of each issue is organized so that the initial few paragraphs provide a synopsis of the issue and the findings, followed by a more detailed discussion that summarizes key information with numerous references to the technical and scientific literature. The synopsis of each impact category includes an influence diagram (Figure 5.1) that depicts the conceptual structure of the analysis and reflects the internal organization of the PLATFORM model. This helps provide insight into the rationale for the judgments about the nature and magnitude of predicted impacts.

### KEY CONCEPTS

**Overview of Analysis Approach** - Each of several issues is analyzed in detail, based on a review and synthesis of available data and information. In some cases, data gaps limited the scope of analysis and a list of data gaps is provided at the end of this section. Three targeted analyses conducted for this study provided estimates of biological production on the platforms, regional larval dispersal patterns, and the spatial extent of changes to ocean access. All decommissioning costs, with minor exceptions, are based on the latest MMS decommissioning cost estimates for California platforms. The PLATFORM decision model can be used to investigate specific issues in greater detail as well as integrate across all issues, both quantitative and qualitative.

**Boundary Conditions** – The analysis is bounded to improve the focus of the analysis and promote consistency in the comparison of decommissioning options. Issues were excluded if they are identical under both options (and thus do not contribute to the choice between options), data poor, difficult or impossible to quantify, or relatively small. These include a range of issues such as well abandonment, closure of shoreside facilities, effects on the broader regional and state economy, and tax consequences, among others.

**Issue by Issue Analysis** - This subsection describes the relevant management context and technical background for each major issue and assesses how each issue could be affected by the two main decommissioning options. Issues include marine resources, air emissions, socioeconomic impacts, ocean access, impacts on birds and marine mammals, impacts on water quality, decommissioning and avoided costs, and programmatic costs. A Key Concepts text box is included at the beginning of the individual subsections related to each issue.

**Model Integration** - The PLATFORM decision model provides a structured means of working more directly with the key data and information developed for this analysis. It allows users to define customized decommissioning projects, calculate project costs and avoided costs, estimate issue-specific impacts (where data are available), and perform integrated multi-attribute analyses using a variety of methods to weight each issue (or attribute) to reflect users' preferences or values.

**Data Gaps** - Given the extensive amount of data collection, analysis, and evaluation conducted over the past 20 years, the persistence of data gaps reflects the complexity of decommissioning issues, even when focused on only two main options. This subsection briefly summarizes data gaps related to each portion of the analysis and describes effort needed to address each data gap.



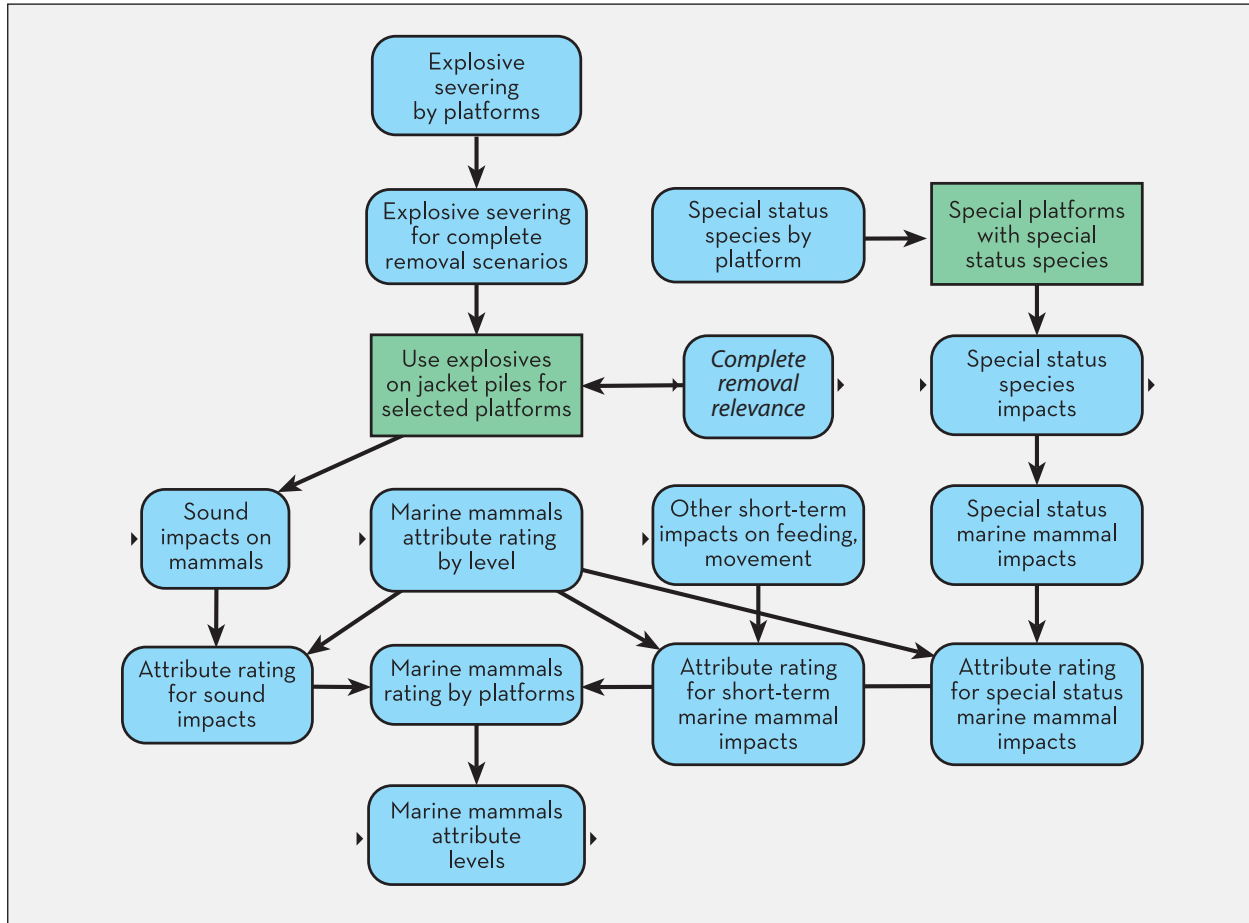

**Figure 5.1. Example influence diagram illustrating the conceptual approach to modeling decommissioning impacts on marine mammals. Following the terminology for multi-attribute analysis (see Section 5.4 for more detail), each impact category is termed an “attribute”; here, the attribute is marine mammals. Boxes with “impact” in their title represent the type and magnitude of impacts on mammals. Those containing “attribute” in their title represent the relative scale of the impact. Green rectangles represent decision nodes.**

In addition, three appendices provide additional information on the biological production modeling (Appendix 3), a users’ guide for the PLATFORM decision model (Appendix 4), and a technical description of the multi-attribute analysis approach available in PLATFORM to integrate quantitative and qualitative information across all impact categories (Appendix 5).

### **5.1. Overview of analysis approach**

This section presents the detailed analysis of the two main options, complete and partial platform removal, beginning with a discussion of boundary conditions that define which aspects of the options are excluded from or included in the analysis. For example, aspects that are identical across both main options are excluded since they do not contribute to a choice between the

options. In addition, aspects that are data poor, difficult to quantify, or likely to be very small are also excluded. The comparative analysis of the two main options then examines their potential impacts on a range of factors that past studies, as well as our interviews with agency decision makers and other stakeholders, highlighted as key to the choice between options. These include marine resources, air emissions, socioeconomic impacts, access to ocean resources, marine mammals and birds, water quality, direct decommissioning costs (and avoided costs), and longer-term program costs of a state artificial reef program under the partial removal option.

For each issue, we review, summarize, and synthesize available data and information, including relevant legal and regulatory background specific to each issue, in order to develop an overall description of how the impacts of each option will differ. We present quantitative information where this is available and develop qualitative conclusions where data gaps exist (data gaps are summarized in Section 5.5). All summaries and conclusions are based directly on published data, with the following exceptions:

- Biological production estimates were derived by applying standard population modeling approaches to existing monitoring data from southern California platforms; such modeling had not previously been done
- Larval dispersal patterns were modeled with methods used in the MLPA reserve siting process by seeding the model with larval releases from current platform locations
- Estimates of the overall spatial extent of changes to ocean access were derived from data on existing exclusion zones around platforms
- Estimates of the cost of partial removal for each platform were derived from the costs of total platform removal provided in Proserv Offshore (2010), working in close consultation with MMS and Proserv Offshore to identify specific cost elements involved only in the partial removal option
- Estimates of avoided costs were then calculated as the difference between total and partial removal cost estimates
- Rough estimates of shell mound removal costs were obtained from an experienced contracting firm (D. Moore, Weston Solutions, pers. comm., 2009)
- Rough estimates of reef enhancement costs were obtained from the Southern California Wheeler North Reef project

Section 5.0 also includes a subsection on the PLATFORM decision model that provides users with the ability to investigate each aspect of a decommissioning option (e.g., costs, impacts on biological production, ocean access) in depth and to compare the results of different decommissioning projects and options.

There is a very large number of possible combinations of decommissioning options and sub-options (Figure 3.2). For example, platforms can be grouped in any number of ways to form decommissioning projects, and individual platforms within those projects could be selected for partial or complete removal. If complete removal is selected, explosives may or may not be used and shell mounds may or may not be removed. If partial removal is selected, the bottom may or may not be enhanced with the upper portions of the jacket, quarry rock, or other materials. This

results in a very large number of different estimates of decommissioning costs and potential scenarios of environmental and socioeconomic impact and it was beyond the scope of this study to describe all possible combinations of options, suboptions, and impacts. The PLATFORM decision model is the environment in which users can investigate the cost and other implications of specific decommissioning projects in more detail.

The model also has the capability to integrate all impacts, both quantitative and qualitative, into an overall project score. Most importantly, the model provides users the flexibility to weight different costs and benefits as they see fit, in order to capture and investigate the effects of different perspectives and values on the overall analysis. For example, some users may weight potential effects on marine mammals highly, while others weight air emissions or effects on biological production most highly. The decision model allows users to explore how their own values and preferences influence the choice among options.

## **5.2. Boundary conditions**

As Sections 1 – 4 show, the decommissioning options themselves are varied, the permitting and decision-making process is lengthy and demanding, and the array of potential costs and benefits, or outcomes, encompasses an extremely wide range of environmental, economic, and social issues. Addressing every potential impact associated with each decommissioning option, however, is not always possible or necessarily conducive to the project goal of supporting decision making about the choice between decommissioning options. In addition, a meaningful comparison of the decommissioning options would be impossible if different aspects of the analysis have substantially different spatial, functional, or procedural boundaries. Therefore, certain costs and benefits have been excluded from the analysis, or explicitly bounded, if they meet one or more of the following criteria:

- They may have the same impact under both partial and complete removal: Costs and benefits that are the same under both decommissioning options are irrelevant to the choice between the options
- They may be data poor: Primary data collection was not possible in this study and estimates for some potential impacts are not available in the existing literature
- They may be difficult or impossible to quantify: In some cases, the value may not be clear because different stakeholders have different values; in other cases, dollar estimates for non-market, non-use values (e.g., the value of a scenic ocean view) may not be accurate due to empirical and/or conceptual problems (e.g., while people have experience making choices with market goods and services, they are unfamiliar with placing dollar values on ecosystem goods and services and may be unsure about how to do so)
- They may be relatively small: Some costs and benefits, even if weighted heavily, are extremely small relative to other factors in the analysis
- We may not have identified them: Although our review has been as thorough as possible given time and budgetary constraints, it is possible we have overlooked issues that some interested parties feel are pertinent

In order to acknowledge the limitations of our analysis and provide transparency about the impacts we were not able to include, this subsection describes the potential impacts are excluded from the analysis, why they are excluded, and the likely impact of their exclusion on the analysis (Table 5.1). For some, data may become available in the future, and for these we have included placeholders or a default value in PLATFORM that can easily be modified by users at a later time.

**Table 5.1. Summary of the likely effect on the analysis decommissioning options of those aspects removed from consideration. See following subsections for a more complete discussion.**

Reason excluded	Likely effect on analysis
<i>Identical in both options</i>	
• Well abandonment	• None
• Platform preparation	• None
• Pipeline and power cable disposition	• None
• Platform deck removal	• None
• Closure of shoreside facilities	• None
• Aesthetics	• None
<i>Data poor, hard to quantify, small</i>	
• Employment	• Very small
• Broader regional / state economy	• Very small
• Tax consequences	• Small to moderate depending on magnitude and policy implications
• Mitigation costs or credits	• Small based on lack of legal basis and of precedent for artificial habitats
• Non-MMS permitting costs	• Small because permitting requirements likely to be similar for both options

### 5.2.1. Exclude aspects that are the same across options

There are several direct and indirect aspects of decommissioning that will be identical (or nearly so) under both main decommissioning options. As a result, analysis of these aspects will not contribute to a choice between the options and they were excluded from any detailed analysis.

#### 5.2.1.1. Well abandonment and other decommissioning operations

As described above (Section 4.1.1.1), there are several aspects of decommissioning that will be identical in both options. Well abandonment and pipeline and power cable disposition are essential aspects of ending production and will be carried out identically whether the platform is removed completely or not. Similarly, platform preparation and platform deck removal are required for both complete and partial removal and the deck will be processed onshore identically under both options. Shoreside facilities related to processing and transport of oil and gas product from the offshore platforms will also be shut down in identical fashion whether the

platform is removed completely or left partially in place. While impacts of these activities may be substantial, they will not influence the choice between decommissioning options.

#### *5.2.1.2. Aesthetics*

Another consideration in the decommissioning process is the aesthetic impacts on home and landowners and on-shore recreationalists (i.e., swimmers, beach goers, hikers, and picnickers). In the short term, these impacts will be negative under both decommissioning options, due to noise, increased vessel traffic, and the fact that HLVs and other support vessels will be stationed offshore for periods of time, although their duration will be less under the partial removal option. In the long term, after decommissioning is complete, the impacts on aesthetics likely will be positive due to more unobstructed, scenic ocean views. Landowners and on-shore recreationists would experience greater impacts for a longer period under the complete removal option because larger equipment would be on site for a longer period of time. In the long term, landowners and on-shore recreationists would likely be indifferent between partial and complete removal (Schroeder and Love 2004) because both remove all visible parts of the platform structure.

The long-term aesthetic impacts on on-shore recreationists could be estimated using a travel cost model such as that used by Parliament and Merchant (1986), who assessed the effect of environmental change on the use and value of California beaches. The aesthetic impact on landowners could be estimated based on the change in property values associated with more scenic ocean views, which can be calculated using a hedonic pricing model. We do not estimate these aesthetic impacts; however, as they will be the same under partial and complete removal and are therefore not relevant to the choice between decommissioning options.

### **5.2.2. Exclude aspects that are data poor, difficult to quantify, and/or likely to be relatively small**

There are several aspects of the various consequences and impacts of the decommissioning options that are difficult or impossible to quantify at this point, or whose effects are likely to be so small that they could not be distinguished from background or from the effects of larger and more dominant factors. These issues are summarized in the following subsections.

#### *5.2.2.1. Employment and broader socioeconomic impacts*

Socioeconomic impact assessment can be used to estimate the effect of a change in the economy on the social, environmental, and economic welfare of a community or ecosystem. It typically includes indicators such as changes in employment and income levels, demographics, aesthetics, demand for public services, and housing market and retail/service value. Socioeconomic impacts are typically broken down into direct (i.e., 1<sup>st</sup> order) and indirect (i.e., 2<sup>nd</sup> and 3<sup>rd</sup> order) impacts. Direct impacts are changes in industry output/value-added, expenditures (including wages to employees), and employment. Indirect impacts are changes in other industries (supply chain) or in personal consumption by employees and households caused by the multiplier effect. The multiplier effect is based on the premise that when new money enters an economy, a portion of it is re-spent, thereby creating additional economic impacts.

In decommissioning, the direct effect is the platform removal itself, which affects access to the site and the biological productivity of the site. Impacts on employment and on the broader regional/state economy (including impacts on shoreside businesses, tourism, and the State of California due to increases or decreases in fees/tax receipts from tourism or fishing) are indirect impacts. At this time it is not possible to estimate a dollar value for these impacts because by definition they flow from other impacts we are not considering (e.g., while revenues to shoreside businesses could potentially increase if removal of the top 85 feet of the platforms increased beach tourism, it is not certain that a more scenic ocean view would increase tourism).

With regard to the physical decommissioning of the platforms, the more expensive option (i.e., complete removal) will most probably generate more jobs due to longer time and greater effort required for removal. In the short term, removal will generate jobs for steel workers and marine engineers but eliminate jobs for rig cleaning firms (NOAA 2003-4). In the long term, the impact on jobs will depend on the degree to which the decommissioning contracts are captured by local companies (Ekins, Vanner, and Firebrance 2005).

With regard to the broader regional/state economy, the more expensive option (i.e., complete removal) will stimulate more economic activity through the multiplier effect. On the other hand, partial removal may increase tourism revenue over the long term if platform access is opened to nonconsumptive users and/or recreational fishing. Ocean and coastal tourism contributed nearly \$10 billion to California's economy in 1992 (Hahn and Layne-Farrar 2003) and could include impacts on businesses due to alternative ocean uses by recreational and charter fishermen (e.g., changes in the use of local harbors, increased sales of bait and fuel).

Because such impacts on employment and on the broader regional/state economy flow from other impacts we are not considering, we are not able to estimate them at this time. If these data gaps are filled, then an input-output model could be used to estimate the impact of both decommissioning options on employment and on the broader regional/state economy. However, such broader socioeconomic impacts under both options are likely to be small in relation to the size of the regional economy.

#### *5.2.2.2. Tax consequences*

There may be positive tax consequences for the operator stemming from the donation of a platform under the partial removal option, which would result in the removal of a major asset from the operator's balance sheet. However, the tax consequences of this financial action are not immediately obvious.

If an oil and gas company treats the costs of decommissioning and cleanup as contingent liabilities, which are not booked, it may realize a large accounting loss upon transferring ownership of its platforms (assets) to the state. In other words, substantial assets will disappear from its books without any corresponding decrease in liabilities. This accounting loss will lower the company's tax liabilities (i.e., allow it to take a tax write off). This potential cost factor could be evaluated as described below. However, because such an evaluation depends on detailed, company-specific accounting data and on decisions that have yet to be made about how platform

donations to the state would be accounted for, tax consequences were not incorporated into PLATFORM at this time.

The size of the tax write off will depend both on the costs of decommissioning and cleanup and on the assessed value of the contingent liability. We consider two scenarios: complete removal and clean-up, as per current regulations, and conveying the platforms to the state as artificial reefs after partial removal. Let:

$a$  = value of the platforms (assets)  
 $L$  = initial liability recorded on the company's books  
 $L_{CR}$  = liability remaining on the books after complete removal  
 $L_{PR}$  = liability remaining on the books after partial removal  
 $c_{CR}$  = costs of complete removal  
 $c_{PR}$  = costs of partial removal

Therefore, the tax impact under the complete removal scenario is:  $(-a+(L-L_{CR})-c_{CR})$ \*(marginal tax rate) and the tax impact under the partial removal scenario is:  $(-a+(L-L_{PR})-c_{PR})$ \*(marginal tax rate).

Under the complete removal scenario,  $L_{CR} = 0$ , so the company would receive a tax gain assuming that the value of the platform ( $a$ ) and the costs of complete removal ( $c_{CR}$ ) are larger than the initial liability recorded on the company's books ( $L$ ).

Under the partial removal scenario, the tax implications for the company are unclear. While the value of a platform ( $a$ ) will be the same as in the complete removal scenario,  $L_{PR}$  may be greater than zero depending on indemnification considerations (i.e., whether any residual liability stays with the company). In the Gulf of Mexico, several states (e.g. Louisiana, Texas and Mississippi) have established rigs-to-reefs programs that allow for the complete transfer of ownership and liability to the state upon decommissioning (see Section 6.2.2.1 for more detail). If California establishes a similar program,  $L_{PR} = L_{CR} = 0$ . In that case, the only difference in potential tax savings between the complete and partial removal scenarios will be based on the cost of decommissioning, as presumably  $c_{PR} < c_{CR}$ . Depending on the size of liability remaining on the books after partial removal ( $L_{PR}$ ) and on the difference in costs between complete and partial removal ( $c_{CR}-c_{PR}$ ), it is not clear whether the company would realize a larger accounting loss (and receive a bigger tax gain) in the partial removal scenario or whether it would realize a smaller accounting loss (and receive a smaller tax gain).

Decision makers wanting to include the potential cost savings of tax write offs in a future version of PLATFORM may obtain estimates for  $a$  and  $L$  from each company's 10-K and other SEC filings and estimates for  $c_{CR}$  and  $c_{PR}$  from Section 5.3.7 of this report. As stated previously,  $L_{PR}$  will depend on whether California passes specific legislation authorizing the transfer of ownership and liability to the state upon decommissioning. The potential impact of such tax consequences of platform donation on the choice between options could be small to moderate, depending on their magnitude, both in absolute terms and relative to operator revenue. The policy implications of decisions about how to deal with these tax consequences could also outweigh their strictly economic impacts.

### *5.2.2.3. Mitigation, offsets, and compensation*

In principle, the issue of mitigation, offsets, and compensation arises because leaving a platform in place rather than removing it generates resource services such as those for fisheries discussed in Section 5.3.1. These services can be thought of either in terms of mitigation credits created in the partial removal scenario, or in terms of avoided costs of mitigation in the complete removal option.

In the partial removal case, the operator donates a structure that is then designated as an artificial reef that generates resource services, for example, creating habitat for a threatened species. Under one scenario, the operator could then claim those resource (or ecosystem) services as mitigation for other environmental impacts it is responsible for, or bank and trade them. There are a number of conservation and mitigation banks in California, such as those for wetlands and other habitats (<http://www.dfg.ca.gov/habcon/conplan/mitbank/catalogue/catalogue.html>), which essentially allow for the creation and trade in environmental impact offsets. They work best for habitat types that are rare or threatened by development and other pressures, and/or for species that are endangered, listed, or otherwise subject to regulations that mandate their protection.

Implementing such a mitigation approach, however, is constrained by a number of factors. Not all platforms may provide the level of resource services needed to provide useful mitigation credits. Furthermore, a recent legislative attempt to create a rigs-to-reefs program, SB 1 (see Appendix 2 for more detail), specifically prohibited the use of rigs-to-reefs conversions for mitigations. In addition, according to the Office of NOAA's General Counsel, the species that generally appear to benefit most from platform habitats are only designated as overfished under NMFS regulation, but not listed as threatened or endangered under the ESA. Further, platforms are not listed as essential fish habitat (J. Feder, pers. comm., 2009). This means there is no regulatory framework that would create sufficient value for habitat offsets or banking. There therefore does not appear to be a strong basis in either state or federal regulations for creating mitigation credits.

Another approach is to consider resource services created or maintained by partial removal as a contribution to the avoided costs of complete removal. In effect, the partial removal option would not so much create environmental value as it would help operators avoid the potentially large costs from mitigating impacts to resources caused by complete platform removal. According to the Office of CDFG's Counsel, these costs can potentially amount to millions of dollars and have been recognized as an issue in previous discussions between the state and the operators (J. Milton, pers. comm., 2009).

On the state side, CEQA provides the mechanism for considering mitigation for the habitat that would be destroyed under full removal. Since the CCC also has broad consistency review authority, they could conceivably require mitigation for impacts created in federal waters. Consultations with CCC staff suggest, however, that they have historically not required mitigation and would be unlikely to recommend it in this case. This is because platforms were originally installed for a particular purpose, oil and gas production, and any habitat benefits that accrued were incidental to that original purpose. In the past, when similar issues have arisen, the



CCC has not required mitigation for what is an incidental benefit. In addition, there is a concern that this would open the door to permittees requesting mitigation credits when installing structures in the ocean that might provide incidental habitat benefits (A. Dettmer, pers. comm., 2009).

There are, however, examples of mitigation undertaken with the costs borne by operators. For example, when ARCO wanted to remove the Bird Island structure in southern California, they initiated a private effort to create substitute habitat in collaboration with Audubon and SLC. This effort was a response to objections from birders who had pointed out that brown pelicans and other species used the platform structure and that it was therefore roosting habitat for a listed species. What came before the CCC for approval was a project that included platform removal and installation of new roosting habitat as a package. The CCC reviewed the potential impacts of putting in new platforms as roosting habitat, but did not explicitly review it as a mitigation action. Another example is Chevron's 4H removal project, where, in addition to leaving the shell mounds in place, Chevron reached an agreement with local trawler associations to provide them with equipment to help them avoid damage to their nets caused by the shell mounds. Specific boats were provided with GPS units to avoid the mounds and equipped with special nets which could roll over and around any shell mounds. This cost Chevron \$1.5 million (McGinnis et al. 2001).

In addition, there are other authorities that could potentially require mitigation. In particular, MMS regulations (30 CFR § 250.1726(d)) require the submission of an initial platform removal application that includes plans to protect marine life and the environment during decommissioning operations, including a brief assessment of the environmental impacts of the operations, and procedures and mitigation measures that will be taken to minimize the impacts. Mitigation is also addressed through the ACOE permit evaluation process (33 CFR§ 320.4(r)). Since current MMS regulations require the fish and wildlife agency of the adjacent state to hold the ACOE permit under NFEA and NARP, mitigation could be required under that process as well (Joe Milton, pers. comm., 12 Oct 2009).

In this context it might be relevant to consider the extent to which the marine protected areas being implemented under the MLPA serve as *de facto* habitat banks for the kinds of habitats that would be removed by complete removal. In that case, part of the shared cost savings from partial removal could be used for monitoring, research and evaluation of those MPAs. There are precedents for such mitigation payments for ecosystem research to mitigate undersea cables or the Luckenback oil spill, for example (S. Mastrup, pers. comm., 2009).

Potential mitigation strategies, like broader socioeconomic impacts and the tax consequences of platform donation, are complex issues that depend on decisions that have not yet been made and/or data that are difficult or expensive to obtain. For these reasons, they fell outside the scope of this study, which focused primarily on readily available data and other assessments. However, given the lack of legal precedent for considering artificial habitat as a source of mitigation credit, the likely effect of this factor on the choice between decommissioning options is small.

#### *5.2.2.4. Non-MMS permitting costs*

The analysis includes permitting and regulatory compliance costs estimated in Proserv Offshore (2010) (see Section 5.3.7). However, this set of cost estimates did not include costs related to obtaining permits from local agencies. Such costs will depend on the scope of the particular project, the requirements of each permitting agency, the degree to which permitting agencies coordinate their efforts, and any arrangements made between the proponent and the agency for recovery of the agency's own internal costs. They will thus be difficult, if not impossible, to quantify in the abstract. For example, for past decommissioning projects, the Santa Barbara County Air Pollution Control District established a cost-reimbursable arrangement with the applicant and charged according to what the permit application and associated negotiations created for the District's labor and related costs (e.g., engineering and permit analysis, supervision and management, attendance at meetings, hearings). In addition, local and state permitting costs for the Chevron 4H project provide a benchmark (albeit an old one that is most likely an underestimate) that suggests what the minimum size of such permitting costs might be. However, as for the MMS-related permitting costs (Section 5.3.7), we assume that, given the complexity of both decommissioning options, permitting costs are likely to be similar for both options.

### **5.3. Analysis of options**

The following subsections provide a detailed analysis of impacts on a range of issues that previous studies have demonstrated are important to the choice between decommissioning options. Table 5.2 briefly summarizes the general conclusion of the analysis for each impact category, judges the relative importance of each impact category to the choice between decommissioning options, and summarizes new data needed to more rigorously predict the outcome for each impact category of the different decommissioning options.

#### **5.3.1. Marine resources**

This subsection summarizes current knowledge about fish and invertebrate communities on the platforms (shell mound communities are addressed in Section 4.1.1.2). It then describes the impacts likely to result from each decommissioning option. Estimates of biological production from platform communities do not exist but would be useful to decision makers in evaluating potential decommissioning impacts on local communities and the regional ecosystem. We therefore modeled the potential impacts of the partial removal option on fish production. The model is based on available monitoring data from studies of the platforms and uses standard population dynamics modeling methods to estimate biological production over a five-year timeframe (see Appendix 3 for methods details). Figure 5.2 illustrates the overall conceptual structure of the biological production modeling analysis, which produces an estimate of the amount of biological production from fish communities on platforms under the partial removal option. We then attempt to put these estimates in a larger regional context, using a combination of available information and larval dispersal modeling conducted for this project.

## KEY CONCEPTS

**Marine Resources** - Offshore platforms support unique communities of fish and invertebrates that are similar to those on natural reefs. On platforms, rockfish populations tend to have higher densities and larger individual sizes than reef populations. We expect the partial removal option would retain the bulk of these populations and their biological production. While the productivity of fish populations on platforms appears high, it is difficult to put this into a larger regional context because of uncertainties about the level of regional productivity and the contribution platform populations may make to populations at this larger scale. Depending on the basis of comparison (e.g., Santa Barbara Channel rocky habitat below 30 meters depth vs. all rocky habitat in the Southern California Bight) platforms may make a moderate to very small contribution to regional habitat.

**Air Emissions** - Air emissions were an important issue in previous decommissioning projects and remain a concern, due to potential impacts on both human health and the climate. Data gaps prevented generating emissions estimates for all platforms. A worst case estimate for decommissioning Harmony, the largest platform, suggests that complete removal would result in substantially larger emissions than the partial removal option, particularly of NO<sub>x</sub> (600 vs. 89 tons) and CO<sub>2</sub> (29,400 vs. 4,400 tons).

**Socioeconomic Impacts** - Data gaps and uncertainty about how resource users would respond to decommissioning prevented development of quantitative estimates of impacts on commercial fishing, recreational fishing, nonconsumptive SCUBA diving, and ecosystem values. However, we were able to assess the likely direction of impacts of complete and partial removal on each use, with nonconsumptive SCUBA having the largest difference between options and commercial fishing the smallest difference.

**Ocean Access** - The areal extent of changes in ocean access will differ for five key user groups, including recreational fishing, nonconsumptive boating, nonconsumptive SCUBA diving, commercial shipping, and commercial fishing. This section presents quantitative estimates of changes in ocean access for each user group, along with each group's likely preferred decommissioning option. Some groups (e.g., commercial shipping) are likely to be insensitive to the choice between options, while others (e.g., recreational fishing) will prefer partial removal. Commercial fishermen's preference varies depending on gear type. Artificial reefs created under the partial removal could be vulnerable to spills from new leasing and production activities.

**Birds and Marine Mammals** - Birds and marine mammals may experience short-term impacts due to interference with roosting, feeding, and migration, as well as the effects of any explosive use. Long-term impacts include a mix of potential positive and negative effects, although these have not been quantified and are difficult to predict. While there are some threatened and endangered species in the region, their observed distribution and the mitigation practices that will be required during decommissioning make negative impacts on these species unlikely.

**Water Quality** - The likelihood of substantial water quality impacts appears to be relatively small, although a full assessment of this issue suffers from data gaps. The two decommissioning options differ primarily in the greater risk of spills and discharges from vessels under the complete removal option (due to longer time on site) and the resuspension of shell mound material under the complete removal option (shell mounds would be left in place under the partial removal option).

**Decommissioning and Avoided Costs** - All cost estimates, with only minor exceptions, are based on recent MMS estimates for decommissioning California platforms. Cost estimates for partial removal are based on adjustments to complete removal costs prepared in collaboration with the MMS contractor. Complete removal of all 27 platforms, grouped into seven projects as defined by MMS, would cost an estimated \$1.09 billion. Partial removal would cost \$478 million, with avoided costs of \$616 million (with minor rounding).

**Programmatic Costs** - The partial removal option would require ongoing programmatic costs for an artificial reef program. Such costs could include program staffing, non-staffing program costs, administration, liability insurance premiums, and cathodic protection (i.e., corrosion protection) for the reefs. While there are state artificial reef programs in the Gulf of Mexico, their costs are not a useful guide for California because of differences in environmental and management contexts. Most programmatic costs, with the exception of cathodic protection, cannot be estimated at this time.

**Table 5.2. Summary of the overall difference between the complete and partial removal options for each impact category. The entry in each cell in the Complete vs. Partial Removal column states the condition under complete removal (e.g., there will be much less biological production under the complete removal option).**

Impact category	Complete vs. partial removal	Relative importance to overall analysis	Extent of new data needed
<i>Marine resources</i>			
• Biological production	Much less production	Large	Significant data needed to estimate production at all platforms and put platform production into regional context
• Soft bottom benthic communities	Slightly higher chance of impact	Small	None
<i>Air emissions</i>	Much greater emissions	Large	Significant data needed to estimate emissions for each platform; requires detailed, project-specific engineering analysis
<i>Socioeconomic impacts</i>			
• Commercial fishing	Impact probably small and varies depending on gear type, management policy	Medium	Additional data on fishing locations, information on likely response of commercial fishermen, and cost and income factors
• Recreational fishing	Varies depending on platform, management policy	Medium	Additional data on fishing locations, information on likely response of recreational fishermen, and expenditures per trip
• Nonconsumptive use	Less opportunity for use	Small	
• Ecosystem value	Uncertain, depends on valuation method	Medium	Valuation surveys and economic analysis
<i>Ocean access</i>			
• Recreational fishing	Varies depending on platform, management policy	Medium	Information on likely response of recreational fishermen
• Nonconsumptive use	Much less access	Medium	Information on likely response of SCUBA divers and other users
• Commercial shipping	No effect	Small	
• Commercial fishing	Varies depending on gear type, management policy	Small	Information on likely response of commercial fishermen

**Table 5.2. Continued.**

<b>Impact category</b>	<b>Complete vs. partial removal</b>	<b>Relative importance to overall analysis</b>	<b>Extent of new data needed</b>
<i>Birds</i>	Slightly higher chance of impact	Small	More detailed information on abundance and distribution, interactions with platforms, sound profiles of decommissioning equipment
<i>Marine mammals</i>	Slightly higher chance of impact	Small	More detailed information on abundance and distribution, interactions with platforms, sound profiles of decommissioning equipment
<i>Water quality</i>	Slightly higher chance of impact	Small	Estimates of risk of incidental spills or discharges during decommissioning, estimates of contaminant dispersion and impacts from shell mounds
<i>Decommissioning costs</i>			
• Platform removal costs	Much greater	Large	None
• Avoided costs	Much greater	Large	None
• Programmatic costs	Much less	Small	Definition of management goals and estimates of program scope

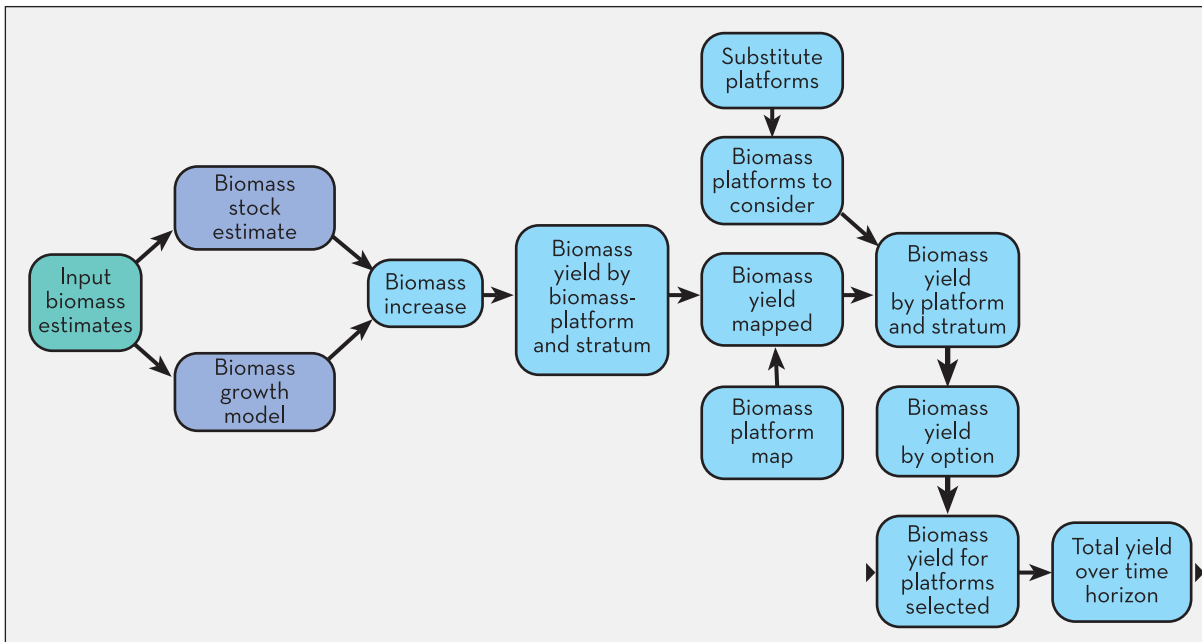

**Figure 5.2. Conceptual structure of the analysis of decommissioning impacts on the biological production of platform communities.**

Oil platforms offshore southern California support biological communities of fish and invertebrates that are similar in many ways to those on natural rocky reefs yet also have unique characteristics. Because the two decommissioning options will impact these communities in such dramatically different ways, there is substantial interest in the nature of the platform communities, how they compare to communities on natural rocky reefs, and how specifically they will be affected by different decommissioning options. In addition, because of the commercial and ecological importance of several species in the platform community, particularly rockfish, there is equivalent interest in as yet unanswered questions about how the platform communities fit into and contribute to the larger regional ecosystem. While many of the fish and invertebrate species living on and around the platforms are subject to management plans by state and/or federal management agencies, none of these management or regulatory frameworks impinges directly on decommissioning activities or decision making about which decommissioning option to choose. The Pacific Fisheries Management Council has not designated offshore platforms as essential fish habitat, nor has CDFG taken any related actions for platforms in state waters. Thus, there are no permitting or other regulatory requirements that must be met as part of the decommissioning process.

The following subsections provide more detailed information on fish and invertebrate communities on platforms and estimates of decommissioning impacts on the biological production from these communities. The model allows for these predictions to be extended over a five-year period into the future, which is the longest period it is feasible and realistic to model, given the high degree of temporal variability in the southern California marine ecosystem. In addition, we include a brief summary of larval settlement and dispersal patterns regionally

because of unanswered questions about the importance of biological production from platform communities to the regional ecosystem. As for other sections, readers should refer to the description of data gaps (Section 5.5) for more detail on those aspects of the assessment that were constrained due to the availability of only limited data.

The following subsections contain a detailed review of the current literature on reef and platform communities and rockfish larval settlement patterns, combined with results of modeling of larval dispersal and of biological production by platform communities. The following bulleted summary is followed by more detailed discussion:

- Platform communities and food webs
  - Offshore platforms maintain highly diverse communities of fish and invertebrates, with the fish community dominated by rockfish species
  - These communities are similar to those on natural reefs but have greater densities of fishes, and larger individual sizes for many species, particularly mussels, sea stars, and rockfish
  - Platform foodwebs have not been well studied; however, because most rockfish are piscivores they are less dependent on invertebrate food sources, including those on shell mounds
  - The fall of organic material from the upper portion of the platform structure to the bottom helps to support shell mound communities
- Production, habitat, and larval dispersal in regional contexts
  - The platform structure includes habitats for both settlement and growth. Rockfish appear to settle predominantly below 85 feet (26 meters) and move deeper as they age
  - Platforms' overall regional contribution to hard substrate is likely to be extremely small, depending on how this is calculated, but they could constitute a larger amount of the hard substrate below a depth of 50 meters
  - Modeling of larval dispersal suggests that platforms provide an important opportunity for recruitment of fish larvae and that many larvae from the platforms would settle elsewhere in the region
  - Studies of bocaccio indicate that recruitment of bocaccio to platforms constitute 20% of the average yearly, and 40% of the median, value for the entire species
  - Data gaps prevent quantitative comparisons of platform production to that in other communities and ecosystems in southern California, and any rigorous estimate of the overall contribution of platform communities to the regional ecosystem
- Effects of decommissioning
  - Complete platform removal would destroy all sessile invertebrates; if explosives are not used, then fish are likely to disperse to other reefs in the region. Whether they would then suffer higher recreational fishing mortality in comparison to the artificial reef would depend on fishing pressure on the artificial reef
  - Under the complete removal option, all fish would suffer extremely high mortality if explosives are used

- Because 85 feet is the depth at which the platform would be cut off under the partial removal option, and most rockfish settlement appears to occur below this depth, partial platform removal would not eliminate the platforms' potential nursery function
- Partial platform removal would destroy sessile invertebrates on the upper 85 feet of the platform, while fish in this portion of the structure would probably move down the platform or disperse to other reefs
- Partial removal would retain the existing community below 85 feet with production reduced substantially only for the shallower platforms or if unrestricted recreational fishing occurred; recreational fishing groups have publicly expressed their willingness to accept restrictions on fishing that would protect the productive capacity of the platform reefs

#### 5.3.1.1. Platform communities

The offshore platforms are located in a physically and ecologically complex and variable region (Dailey et al. 1993, Page et al. 2008). The platforms themselves are complex structures (Figure 4.1) in water as deep as 1200 feet and located as far as about 10 miles offshore (Table 1.1, Figure 1.1). They provide a large surface area of hard substrate for sessile invertebrates (Love and Schroeder 2004) and many species of fish, several of which are classified as overfished (Love et al. 2003). The attached invertebrate community varies in thickness with depth, with the thickest portion at shallower depths (Wolfson et al. 1979, Love and Schroeder 2004, Continental Shelf Associates 2005). This encrusting layer, which is dominated by mussels and other bivalves, contributes to the formation of a shell mound on the seafloor bottom beneath the platform (see Section 4.1.1.2 for more detail). Because fishing is generally restricted at most platforms, they function as de facto marine reserves, acting as habitat and nursery grounds for species, such as the cowcod (*Sebastes levis*), that are largely ecologically extinct from southern California (Love et al. 2003, Love and York 2004, Love et al. 2006).

**Fish communities:** Platforms provide both food and habitat for fishes in an area where these would otherwise be absent (Love et al. 2000). The majority (typically > 90%) of the fishes found on California platforms are rockfishes of the genus *Sebastes* (42 spp. in total), but greenlings (*Hexagrammidae*), damselfishes (*Pomacentridae*), seaperches (*Embiotocidae*), and several other less frequently occurring groups also occur (Love et al. 1999) (Table 5.3). In addition, cryptic fishes inhabit the empty mussel shells and crevices both on the jacket structure and in the shell mound below (Rauch 2003, 2004, 2007).

As Table 5.3 suggests, different depth zones, or strata, on the platforms support different fish assemblages, a vertical pattern that is important in evaluating the impacts of the partial removal option. Love et al. (2003) document three distinct fish assemblages: upper (26 meters to the surface), midwater (two meters off the bottom to 26 meters from the surface), and bottom (lower two meters). The midwater zone appears to serve a nursery function for several fish species, including cabezon (*Scorpaenichthys marmoratus*), painted greenling (*Oxylebius pictus*), and rockfishes (*Sebastes* spp.), with young-of-the-year rockfishes the most common size classes in this stratum (Love et al. 2003) (Figure 5.3). In contrast, adult and sub-adult rockfishes dominate



**Table 5.3. Biomasses of fishes observed, by species, around all platforms in October – November of 1996. Biomasses are given for bottoms (within two meters of the bottom) of platforms and midwater (from two meters above the bottom to 26 meters from the sea surface), with percent of totals for those parts of the platforms. Biomass is kilograms/m<sup>2</sup>. Family totals are given in boldface. YOY is young-of-the-year (source: Love et al. (2000), Table 2).**

FAMILY	COMMON NAME	SCIENTIFIC NAME	BOTTOM		MIDWATER	
			BIOMASS	% TOTAL	BIOMASS	% TOTAL
Scorpaenidae	Rockfishes		<b>96.83</b>	<b>84.66</b>	<b>38.81</b>	<b>85.90</b>
	Kelp rockfish	<i>Sebastes atrovirens</i>	0	0	0.34	0.75
	Brown rockfish	<i>S. auriculatus</i>	0.82	0.71	0	0
	Gopher rockfish	<i>S. carnatus</i>	0.01	<0.1	0.23	0.51
	Copper rockfish	<i>S. caurimus</i>	12.12	10.59	0.47	1.04
	Greenspotted rockfish	<i>S. chlorostictus</i>	8.80	10.94	0.56	1.23
	Starry rockfish	<i>S. constellatus</i>	0.02	<0.1	0	0
	Darkblotched rockfish	<i>S. crameri</i>	0.07	<0.1	0	0
	Calico rockfish	<i>S. dalli</i>	1.40	1.22	0.08	0.18
	Greenstriped rockfish	<i>S. elongatus</i>	0.32	0.28	0	0
	Swordspine rockfish	<i>S. ensifer</i>	0.03	<0.1	0.08	0.17
	Widow rockfish	<i>S. entomelas</i>	1.86	1.62	24.08	53.15
	Yellowtail rockfish	<i>S. flavidus</i>	0.08	<0.1	0	0
	Chilipepper	<i>S. goodei</i>	0	0	0.82	1.82
	Squarespot rockfish	<i>S. hopkinsi</i>	0.46	0.40	0.51	1.12
	Vermilion rockfish	<i>S. miniatus</i>	20.84	18.22	0	0
	Blue rockfish	<i>S. mystinus</i>	0.74	0.65	0.29	0.64
	Bocaccio rockfish	<i>S. paucispinis</i>	14.35	12.55	3.68	8.12
	Canary rockfish	<i>S. pinniger</i>	1.18	1.03	0	0
	Rosy rockfish	<i>S. rosaceus</i>	0.46	0.40	0.07	0.15
	Greenblotched rockfish	<i>S. rosenblatti</i>	3.89	0.15	0	0
	Yelloweye rockfish	<i>S. ruberrimus</i>	0.06	<0.1	0	0
	Flag rockfish	<i>S. rubrivinctus</i>	1.44	1.26	0.55	1.21
	Bank rockfish	<i>S. rufus</i>	0.29	0.25	0	0
	Halfbanded rockfish	<i>S. semicinctus</i>	26.21	22.91	0.04	<0.1
	Olive rockfish	<i>S. serranoides</i>	0.03	<0.1	0	0
	Treefish	<i>S. serriceps</i>	0.19	0.17	0.04	<0.1
	Pygmy rockfish	<i>S. wilsoni</i>	0.04	<0.1	0	0
	Sharpchin rockfish	<i>S. zacentrus</i>	0.10	<0.1	0.04	<0.1
	Shortspine thornyhead	<i>Sebastolobus alascanus</i>	<0.1	<0.1	0	0
	<i>Sebastomus</i> group <sup>1</sup>		0.31	0.27	0.37	0.82
Rockfish YOY	<i>Sebastes</i> spp.	0.72	0.63	6.56	14.47	
Hexagrammidae	Greenlings		<b>12.88</b>	<b>11.25</b>	<b>2.72</b>	<b>6.01</b>
	Kelp greenling	<i>Hexagrammos decagrammus</i>	0	0	<0.1	<0.1
	Lingcod	<i>Ophiodon elongatus</i>	12.35	10.80	0	0
	Painted greenling	<i>Oxylebius pictus</i>	0.51	0.44	2.72	6.01
	Shortspine combfish	<i>Zaniolepis frenata</i>	0.01	<0.1	0	0
	Combfish sp.	<i>Zaniolepis</i> sp.	0.01	<0.1	0	0
	Pomacentridae	Damselfishes		<b>0</b>	<b>0</b>	<b>0.54</b>
Blacksmith		<i>Chromis punctipinnis</i>	0	0	0.54	1.20
Embiotocidae	Seaperches		<b>4.57</b>	<b>3.99</b>	<b>3.02</b>	<b>6.65</b>
	Pile perch	<i>Damalichthys vacca</i>	3.71	3.24	1.18	2.60
	Sharpnose surfperch	<i>Phanerodon atripes</i>	0.49	0.43	1.84	4.05
	Unident. sea perches		0.20	0.17	0	0
Gadidae	Pink surfperch	<i>Zalembeus rosaceus</i>	0.17	0.15	0	0
	Cods		<b>0</b>	<b>0</b>	<b>0.20</b>	<b>0.44</b>
Cottidae	Pacific hake	<i>Merluccius productus</i>	0	0	0.20	0.44
	Sculpins		<b>0</b>	<b>0</b>	<b>0.03</b>	<b>0.07</b>
Bathymasteridae	Unidentified sculpin		0	0	0.03	0.07
	Ronquils		<b>0.03</b>	<b>0.03</b>	<b>0</b>	<b>0</b>
Agonidae	Unidentified ronquil		0.03	0.03	0	0
	Poachers		<b>0.01</b>	<b>0.01</b>	<b>0</b>	<b>0</b>
Flatfish	Unidentified poacher		0.01	0.01	0	0
	Flatfish		<b>0.06</b>	<b>0.06</b>	<b>0</b>	<b>0</b>
	Sanddabs	<i>Citharichthys</i> sp.	0.01	0.01	0	0
	Unident. flatfish		0.05	0.05	0	0

<sup>1</sup> *Sebastomus* group may include greenblotched, greenspotted, pinkrose, rosethorn, rosy, stary, or swordspine rockfishes.

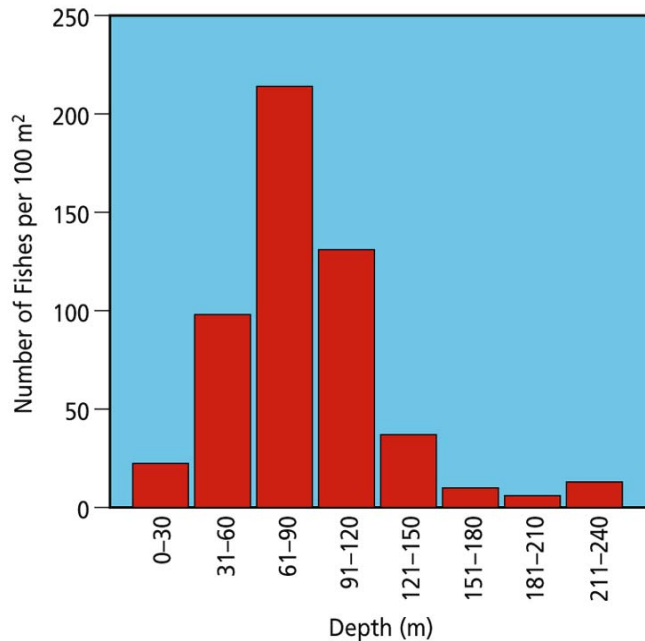

**Figure 5.3. Density by depth zone of young-of-the-year rockfishes observed at all platforms surveyed, 1995–2001 (source: Love et al. (2003), Fig. 3.5).**

the bottom stratum, although young-of-the-year rockfishes also appear here, particularly during strong recruitment years (Love et al. 2003).

The vertical distribution of larval settlement, or recruitment, is an important factor in evaluating the impacts of the partial removal option because this option involves removing the upper 85 feet (26 meters) of the platform. Past discussions of this option have commonly assumed that the bulk of larval fish recruitment to platforms occurs in the upper ten meters (approximately) of the water column and that larval settlement would therefore be significantly reduced under the partial removal option. This assumption is not borne out by recent evidence. While Love et al. (2003) reported young-of-the-year bocaccio in the upper 30 meters of the platform (Figure 5.3), they also confirmed (Love et al. 2006) that none of these juveniles were found above 26 meters. This result was extended to all rockfish by Nishimoto et al. (2008) who confirmed that young-of-the-year rockfish are found almost exclusively below 26 meters. Thus, these studies demonstrate that partial platform removal to a water depth of 85 feet (26 meters) would most likely not eliminate the potential nursery function of these structures for rockfishes (Love 2009).

Another issue related to evaluating the utility of platforms as habitat under the partial removal option, is the degree to which they are merely fish attracting devices, a widely used role for artificial structures throughout the world, as opposed to production reefs, i.e., the attraction versus production controversy (Osenberg et al. 2002, Pondella et al. 2002). If platforms act only as fish aggregation devices, then when fished they will actually decrease nearshore resources because fishing is more efficient on the concentrated population. Evidence of rockfish

recruitment to the platforms, the presence of a range of size classes, the fact that adult rockfish in the bottom stratum tend to be larger than rockfish on natural reefs (Love et al. 2003, Love et al. 2007), and the evidence of biological production on the platforms (see Section 5.3.1.3) suggest that the platforms support resident populations. However, it is likely that fish are also attracted to platforms, as they are to natural outcrops (Carr et al. 2003, Love et al. 2003, Love et al. 2007). Studies of site fidelity of lingcod and rockfish species (Lowe et al. 2009) show there is some movement among habitats but that migration is limited, and Hartmann (1987) showed that young-of-the-year bocaccio individuals tagged at several platforms in the Santa Barbara Channel were recovered on natural reefs as adults years later, as much as 150 km away from their original tagging site. However, there are no quantitative estimates of immigration and emigration rates that could be applied to platform and reef communities across the region.

**Invertebrate communities:** Oil platforms also support a wide variety of invertebrate species, both on the jacket structure and on the surrounding shell mound (see Section 4.1.1.2 for more detail on shell mounds). Mussels (*Mytilus galloprovincialis* (formerly *edulis*) and *Mytilus californianus*) create large masses surrounding the platform's support members; these mussels are then covered with barnacles (*Megabalanus californicus*), anemones (*Anthopleura elegantissima* and *Metridium senile*), large seastars (*Pisaster ochraceus* and *Pisaster giganteus*), and various other smaller species (e.g., tunicates, bryozoans, sponges, amphipods, hydroids) (Page and Hubbard 1987, Bram et al. 2005, Page et al. 2008). The composition, diversity, and coverage of the invertebrate community vary among platforms and with depth on individual platforms (Page and Hubbard 1987, Bram et al. 2005, Page et al. 2008). Individuals on the platforms can have higher growth rates than normal (Bram et al. 2005), with mussels reaching sizes near the upper limits known (Page and Hubbard 1987). Less is known about invertebrate recruitment to platforms than for fishes, although recruitment patterns appear to reflect prevailing oceanographic gradients (Ponti et al. 2002, Page et al. 2008).

**Platforms vs. natural reefs:** Fish and invertebrate communities on platforms resemble those on nearby natural reefs, though with some important differences in species composition and relative abundance (Carr et al. 2003). Platforms do not support macroalgae (e.g., kelps) or the fish and invertebrate species associated with them (Carr et al. 2003, Bram et al. 2005). Platforms, particularly those located in deeper water and/or further from shore, are also underrepresented in fishes with limited larval dispersal, such as surfperches (Carr et al. 2003). In contrast, individuals of several species are larger and occur at higher densities on platforms compared to natural reefs, possibly because of lower fishing pressure on platform populations (Love et al. 2003, Love et al. 2007). For example, young-of-the-year blue rockfish (*Sebastes mystinus*) at Platform Holly had higher growth rates than individuals at a nearby natural reef (Love et al. 2007) and young-of-the-year of all rockfishes occurred at higher densities over a five-year period at Platform Hidalgo than at North Reef (Love et al. 2003). Love et al. (2003) attribute the larger sizes of adults to the fact that platforms act as de facto no-take reserves that are mostly free from fishing pressure. They also believe that the extraordinary abundance of young-of-the-year fishes is a result of the fact that platforms occupy a large portion of the midwater (>85 ft) where presettlement juveniles of many rockfish species are most likely to be encountered and of the fact that there are few predators associated with the midwater portions of platforms.

The vertical extent of the larger platforms, combined with their complex three-dimensional structure, provides a large amount of hard substrate, although its relative contribution to hard substrate in the region has not been quantified (Carr 2003). In the Gulf of Mexico, platforms contribute about 10 – 28% of the regional reef habitat (Scarborough-Bull and Kendall 1994, Stanley and Wilson 2003). While Holbrook et al. (2000) judged platforms' regional contribution to hard substrate to be extremely small, more recent estimates (Scarborough-Bull 2008) indicate that platforms could constitute a large amount of the hard substrate below a depth of 50 meters.

Exotic species are also occasionally found on the platforms. For example, the bryozoan *Watersipora subtorquata* occurs in high cover on Platform Gilda where it has displaced the mussel community over part of the structure, while an anemone, *Diadumene sp.*, occurs on Platform Gail (Page et al. 2006, Page et al. 2008). Such populations may benefit some fish. For example, the diet of at least one reef fish consisted largely of exotic caprellid amphipods (Page et al. 2006).

#### 5.3.1.2. Larval dispersal patterns and regional connectivity

Estimating biological production on individual offshore platforms (see Section 5.3.1.3 for more detail) is one aspect of assessing decommissioned platforms' potential value as artificial reefs. Any assessment that extends beyond the local platform environment should necessarily also address the degree to which larvae produced by platform communities contribute to the maintenance and/or recovery of regional populations of these species. This question has not been rigorously evaluated and is a substantial data gap in attempting to compare the ecological effects of the two main decommissioning options. This subsection presents results of larval dispersal modeling conducted for this project by researchers involved in the MLPA process, in which analogous questions are critical to the spacing of reserves in the regional network.

**Overview:** The amount of connectivity in fish larval dispersal between an offshore platform and other platforms and/or natural reefs is difficult to assess. Recruitment of young-of-the-year fish to both platforms and natural reefs varies greatly from year to year (Love et al. 2007). Because platform midwaters support a higher density of young-of-the-year rockfishes than natural reefs nearby (Love et al. 1999, Carr et al. 2003, Love et al. 2003), it is likely that a platform's structural complexity and high vertical profile provide juvenile pelagic rockfishes (and larvae of other species) with a strong stimulus to trigger settlement (Carr et al. 2003). In addition, Love et al. (2007) showed through an analysis of fish birth dates that fish recruiting to platform habitats were most likely from the same group as those that recruited to a natural reef inshore.

An indication of the potential value of offshore platform habitat to the regional ecosystem is the finding that juvenile bocaccio (and likely other species of *Sebastes* spp.) settling on a platform would otherwise have been transported offshore and perished, as opposed to finding a natural reef (Emery et al. 2006). Because virtually all rockfish settlement on the platforms appears to take place below 26 meters (Love et al. 2003, Love et al. 2006, Nishimoto et al. 2008), the partial removal decommissioning option would not affect platforms' function as a potential settlement habitat of last resort. On the other hand, limited data on regional recruitment make it impossible to estimate what proportion of total recruitment in the region this represents.

For invertebrates, Page et al. (2008) found that platform invertebrate assemblages were associated with along-channel regional oceanographic gradients in the Santa Barbara Channel. Although the major invertebrate taxa were common to all platforms, their relative abundance (as percent cover) varied along the channel, such that platforms in proximity to each other tended to have invertebrate assemblages that were more similar to each other than to platforms further away (Page et al. 2008). Because of limited data on settlement and dispersal patterns for invertebrates on offshore platforms, the following modeling analysis focuses only on fish larvae.

**Modeling connectivity:** Determining the ultimate fate of larvae produced on a platform is integral to evaluating the linkage between platform production and the surrounding ecosystem. A new modeling tool relevant to this question is currently being used to assist the Master Plan Science Advisory Team for the South Coast Study Region of the California MLPA process. This modeling tool is an adaptation of the Regional Oceanic Modeling System (ROMS) model and is used to determine the probability of larval connectivity throughout the Southern California Bight. This work is being done in Dr. Dave Siegel's lab in the Institute for Computational Earth System Science and Department of Geography at UC Santa Barbara. The model is based on estimates of larval production of adult fishes along the coastline derived from CDFG's Cooperative Research and Assessment of Nearshore Ecosystems (CRANE) data and other information on spawning period and larval duration. Figure 5.4 illustrates an example using kelp bass, predicting that larvae from a mainland origin site reach destination sites on the offshore islands, but that larvae from origin sites on the islands do not reach destination sites on the mainland. This surprising finding suggests that larvae from the mainland are seeding the islands but that islands do not contribute a significant source of kelp bass larvae to the mainland. Such modeling could improve understanding of the potential contribution of platform communities to regional production and population maintenance and recovery.

Dr. Siegel's Lab prepared model runs using as a source population sections of coastline proximate to coastal platforms along the Santa Barbara and Orange County coastlines for which the model was already calibrated. Patterns of potential larval connectivity (Figure 5.5) were created by simulating millions of water parcel trajectories within a numerical solution of the four-dimensional circulation of the Southern California Bight (Mitarai et al. 2009, Watson et al. 2009). The numerical ocean circulation model solutions were used to advect passive particles simulating individual larvae. The ocean model is nested within a larger domain and is forced at the boundaries (top and side) by observations (Dong and McWilliams 2007). The inner nested model's spatial and temporal resolutions are 1 km and 6 hours, respectively and model output is available for the years 1996 to 2003. The model has been validated using a great number of available data sets (e.g., high-frequency radar data, current meters, current profilers, hydrographic measurements, tide gauges, drifters, and altimeters) and has performed very well (Dong et al. 2009). Trajectories and Lagrangian probability distributions are calculated following methods presented in Mitarai et al. (2009).

To simulate potential larval connectivity, Watson et al. (2009) considered trajectories for the appropriate spawning season and pelagic larval duration. Kelp bass typically spawn from June to October and larvae are in the plankton for about 30 days. Kelp rockfish typically spawn from

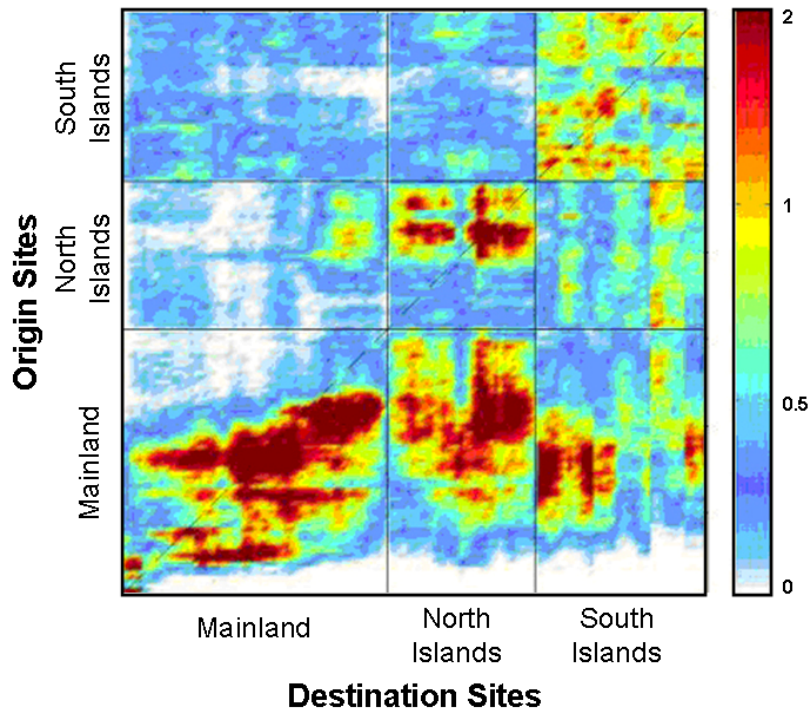

**Figure 5.4. Model results showing sources and destinations of larvae. Color intensity at each point shows the probability of dispersal of kelp bass larvae from an origin patch (vertical axis) to a destination patch (horizontal axis) by geographical region. Note that larvae from a mainland origin site reach destination sites on the islands, but larvae from origin sites on the islands do not reach destination sites on the mainland (source: Watson et al. 2009).**

February to June and their larvae are planktonic for about 60 days. Larvae were modeled as passive particles, an assumption consistent for larvae of these species (see discussion in Watson et al. 2009). Particles are released from 10 km diameter patches, which contain the platforms of interest (i.e., platform Holly is found in patch 51, platform Habitat is in patch 47, and platforms Eureka and Emmy are in patch 23). The resulting plots (Figure 5.5) show the degree of connectivity of patches containing the platforms of interest and patches throughout the Southern California Bight.

The results of these modeling runs demonstrate there could be regional connectivity via larvae produced at platforms dispersing to both the mainland and islands, but that these recruitment patterns are likely dependent on location and species. For instance, model runs of kelp bass recruitment (the left-hand side of Figure 5.5) show that larvae released from Habitat, Emmy, and Eureka probably recruit primarily on the mainland, while larvae released from Holly likely recruit heavily at the Channel Islands. Kelp bass and kelp rockfish in all three simulations have very different results. Kelp rockfish in all three simulations (the right-hand side of Figure 5.5) recruit heavily at the Channel Islands, especially Santa Barbara, San Clemente and Santa Catalina, a pattern that differs significantly from that displayed by kelp bass.

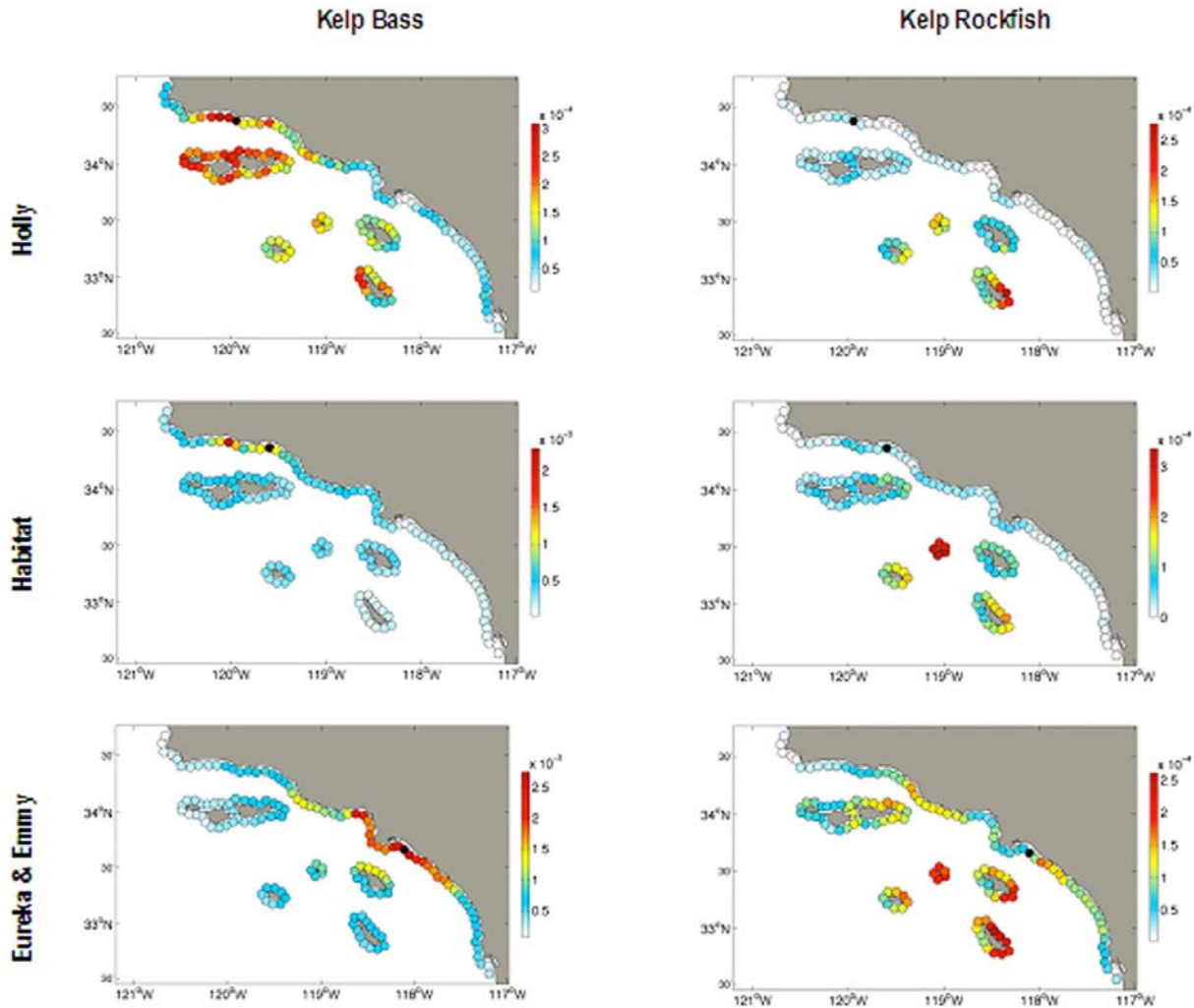

**Figure 5.5. Potential connectivity patterns for kelp bass and kelp rockfish larvae released from the simulation patches containing platforms Holly, Habitat, and Eureka and Emmy. The black patch on each plot is the nearest simulation patch to the oil drilling rigs. Values of potential connectivity quantify the probability that larvae from the source patch are advected to other sites within the Southern California Bight given the spawning season for the organism (kelp bass = Jun-Oct & kelp rockfish = Feb-Jun) and its pelagic larval duration (kelp bass = 30 d & kelp rockfish = 60 d). Results follow work by Watson et al. (2009).**

The calculations of potential larval connectivity presented here are useful for examining the behavior of larvae whose transport is dominated by near-surface and near-coastal currents. However, many platforms and species of interest are in offshore waters, spawning may occur at depths greater than 100 m, and recruitment (particularly for rockfish) occurs below 26 meters in depth. As a result, the surface water parcel analysis described here would not be valid for these

locations and species, a limitation especially important for deep living rockfish. A similar targeted analysis can easily be conducted for these species, for which data requirements would be spawning season, location and depth, pelagic larval duration, and settlement depth. Probability distributions of larval recruitment could then be calculated to indicate where larvae spawned by these deep living species would be transported. This model can readily be adapted for all platforms and various spawning depths and this capability would prove extremely useful for future decommissioning analyses.

### *5.3.1.3. Decommissioning impacts on platform communities*

There are three questions central to assessing the respective outcomes of the two decommissioning options and that have been raised in past assessments of the ecology of platform communities and the outcomes of rigs-to-reefs conversions (Carr and Hixon 1997, Caselle et al. 2002, Helvey 2002, SLC 2007, Bull et al. 2008):

1. What is the current local biological production of platform communities?
2. What would the biological production of these communities be under the two main decommissioning options?
3. What is the importance of this production to the regional ecosystem?

We address these three questions as follows:

- Question 1 with a biological production model that uses monitoring data collected from the platforms and standard population dynamics modeling methods (see Appendix 3 for more detail) to estimate the annual production from existing fish communities on offshore platforms (invertebrate production was not modeled because data gaps were too extensive to overcome.)
- Question 2 for the partial removal option by adjusting the production model to estimate production after fish populations in the upper 85 feet of the water column are removed
- Question 2 for the complete removal option by applying available information about fish dispersal to other reefs and fishing mortality in the Southern California Bight
- Question 3 by assessing information on larval dispersal from the preceding subsection in combination with information about the relative contribution of offshore platforms to rocky substrate in the region

While limited to some degree by the assumptions made necessary by data gaps, we believe the biological production modeling described below is useful to decision makers for a number of reasons. The modeling clarifies the type of data and analyses needed to answer the three questions posed above. It also produces production estimates that, though not highly precise, do show the differences between decommissioning options, provide predictions that are the best available with current knowledge, and that while not perfect are helpful in developing preliminary estimates of the potential value of platform reefs.



The following subsections briefly summarize the modeling approach (see Appendix 3 for more detail) and then present results and discussion pertinent to each of the three questions. Model estimates are extended over time for a five year period because the high temporal variability in the Southern California Bight ecosystem makes it unrealistic to extend model projections beyond this length of time.

**Production modeling approach:** Figure 5.6 summarizes the main steps in the modeling approach and highlights several key features. Only eight platforms of the 27 offshore southern California had the combination of data from the three depth strata and replication over time to fulfill the requirements of the modeling approach. PLATFORM therefore provides users the option to apply modeling estimates from one of these eight platforms to others that are similar in size and water depth. Data gaps require that the modeling approach necessarily make certain decisions and assumptions, which are conservative where possible in order to avoid overestimating production. These include (see Appendix 3 for more detail):

- The initial size structure of the fish population on a platform strongly influences the production estimate because production in the model is based on somatic growth and growth slows as fishes age
- Gonadal production is not included in the production estimate because of the high mortality experienced by larvae; as a result, production is somewhat underestimated because gonadal production could be considerable in larger fish
- Growth rates for each species are assumed to be the same across all platforms and growth data for some fishes are not available
- While recruitment is included in the model, only bocaccio data were used because it was the only platform species for which recruitment data was available, and applying bocaccio data to other species would have required making unsupported assumptions; as a result recruitment is underestimated
- The model includes only one pulse of recruitment, in Year 1 of the five-year modeling period, as an attempt to reflect interannual variability in recruitment, and due to limited data on bocaccio recruitment, the accuracy of this estimate is unclear
- A size dependent predation based annual mortality rate (Peterson and Wroblewski 1984) is applied at the beginning of each year, before growth is calculated; applying the annual mortality term prior to estimating growth will somewhat underestimate production
- Mortality, immigration, and emigration terms assumed to be consistent across platforms, but could vary from platform to platform

As in all such models, the underlying assumptions affect the degree to which the model captures reality and thus the reliability and usefulness of its predictions. Given the limitations of the available data, modeled production estimates may be more reliable for some platforms than for others, depending on which of the various assumptions had the largest effect in any particular situation.

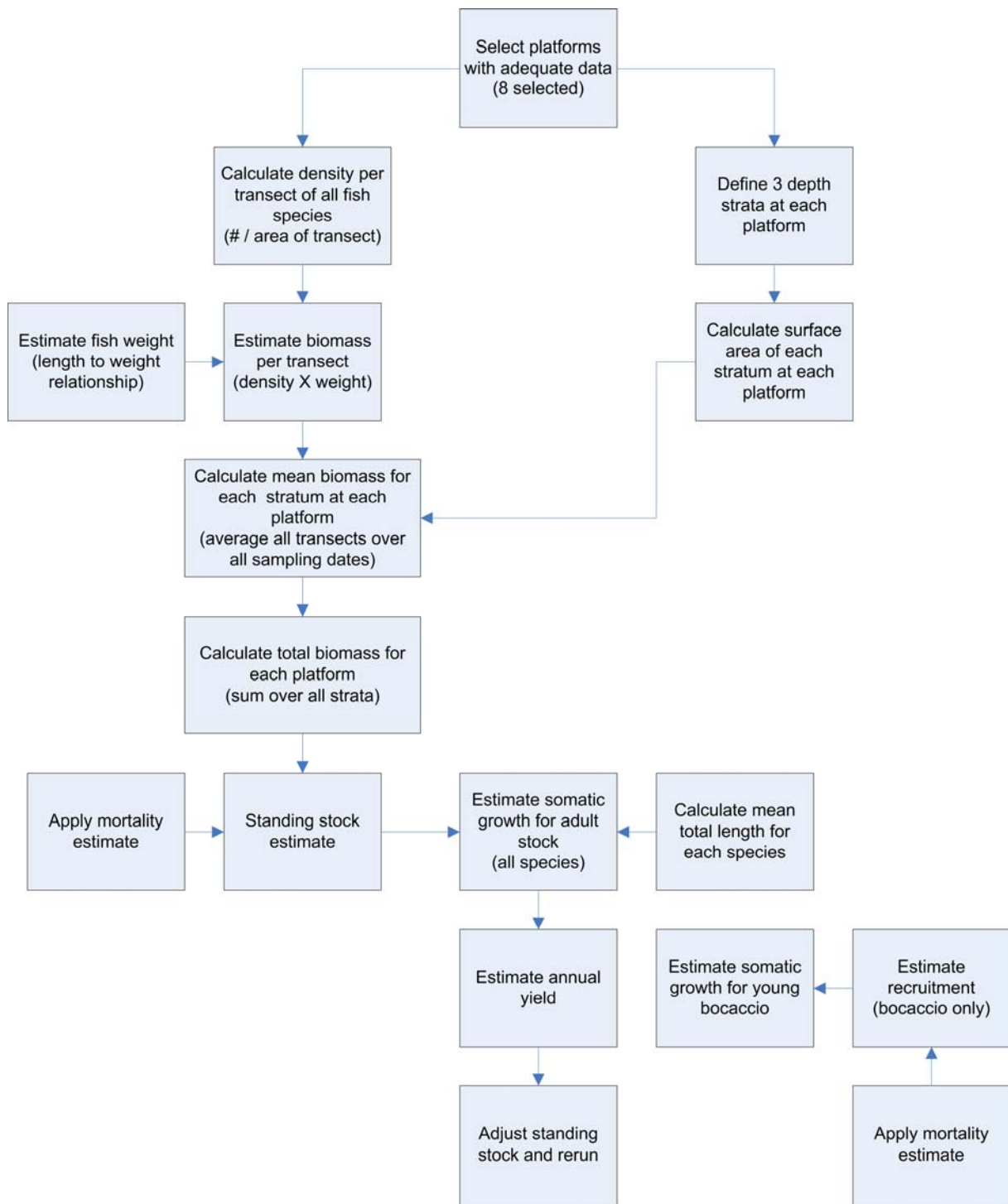

**Figure 5.6. Overview of the population dynamics modeling approach used to estimate biological (fish) production on platforms under current conditions and the partial removal decommissioning option (see Appendix 3 for more detail).**

**Estimates of local production:** We present summary results that are explained in greater detail in Appendix 3. Figure 5.7 shows that standing stocks currently vary widely across the eight platforms used in the modeling analysis. These differences reflect differences in platform size, structure, and the composition of the fish community on each platform (Love et al. 2000, Love and Schroeder 2005, Love and York 2006, Love and Nishimoto 2009).

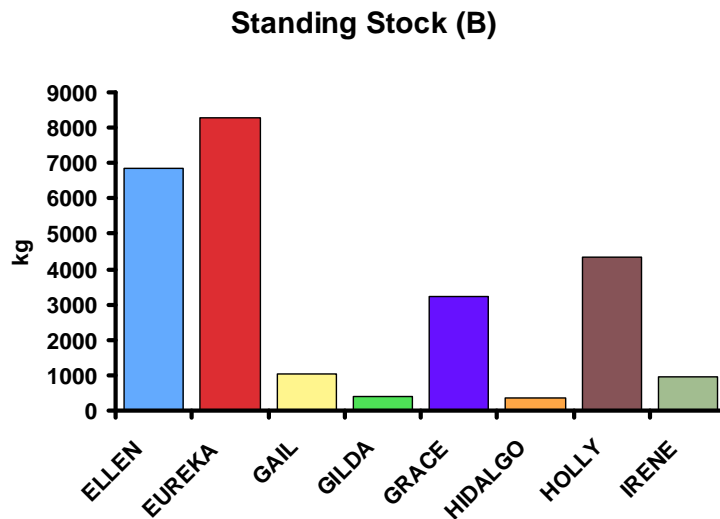

**Figure 5.7. Standing stocks (B) in kilograms for all fish species for the eight platforms used in the modeling analysis. Values represent mean values calculated across years.**

The model uses these standing stock estimates as a starting point for estimating somatic growth (growth in size) over a five year timespan (Figure 5.8). Somatic growth differs somewhat across platforms depending on the size and age distribution of populations at each platform. For example, fish populations at Holly were dominated by younger age classes that grow faster; thus, as these fish age their growth rate slows down.

Fish populations on platforms are replenished by recruitment of young-of-the-year. Recruitment data for platforms usable in the production model were available only for bocaccio (recruitment data in Nishimoto et al. 2008 do not include densities and depth information is incomplete) and the model includes a one-time input of young-of-the-year for this species in Year 1. Figure 5.9 illustrates the relatively rapid growth of these young fish over the subsequent four-year period. Note, however, that the somatic growth of adult fish (Figure 5.8 provides a much larger contribution to the standing stock on platforms than does the input from recruitment and the subsequent growth of these young-of-the-year.

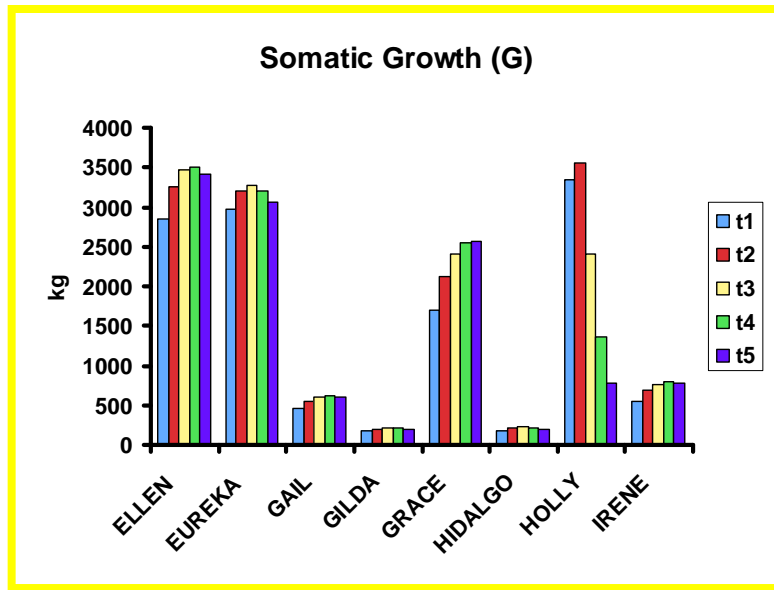

Figure 5.8. Somatic growth (G) in kilograms for all fish species calculated over five-year intervals ( $t_{1-5}$ ) at the eight offshore platforms selected for the modeling analysis. Somatic growth is the annual growth in size of individual fish; gonadal production was not included.

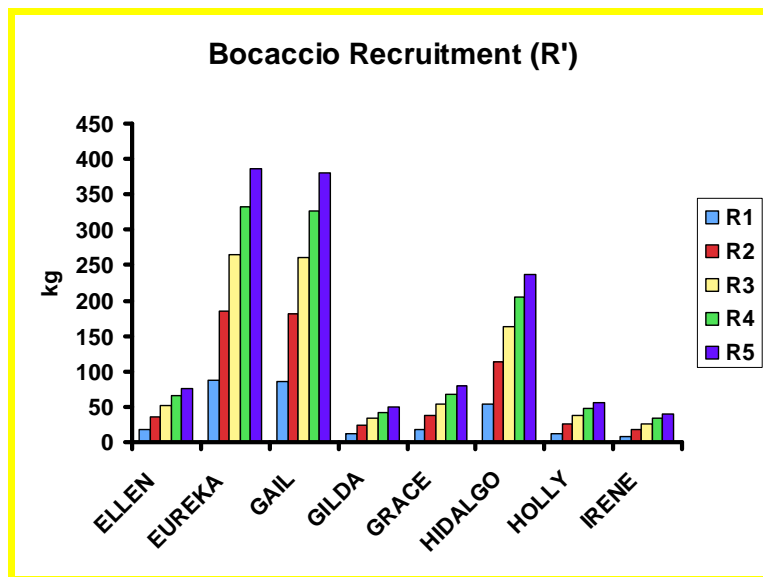
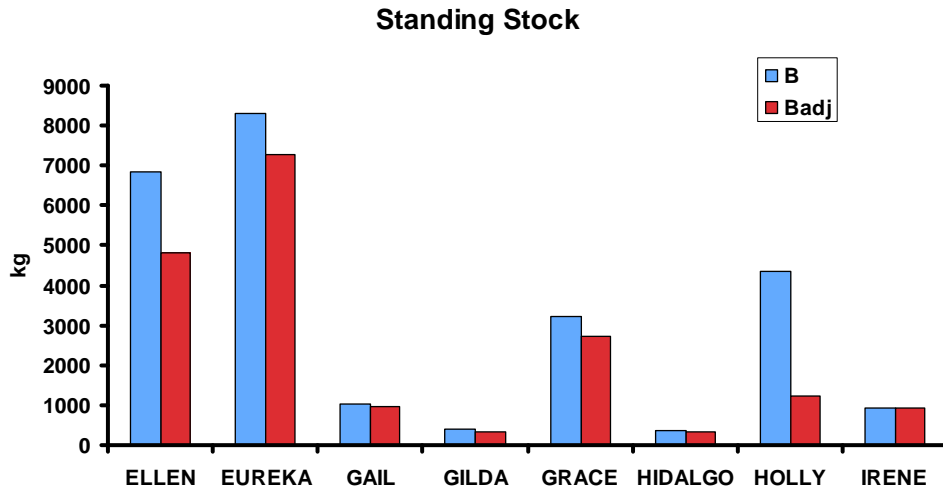

Figure 5.9. Bocaccio recruitment in Year 1 and subsequent growth of these young-of-the-year (in kg) calculated over five years ( $R_1-R_5$ ) at the eight platforms selected for the modeling analysis.

**Estimated results of partial removal:** The partial removal option involves removing the upper 85 feet (26 meters) of a platform. Because monitoring data from the platforms are stratified by depth, it is a straightforward procedure to adjust the standing stock for each platform to reflect the removal of all fishes in the upper 85 feet of the water column (Figure 5.10). The proportional decrease in standing stock is greatest for the shallower platforms (Table 1.1), Ellen (265 feet) and Holly (211 feet), because the upper 85 feet represents a much larger proportion of the habitat than for the deeper platforms.



**Figure 5.10. Standing stocks (B) and the adjusted standing stock (B<sub>adj</sub>) under the partial removal option at the eight platforms selected for the modeling analysis.**

The production model calculates yield as the sum of somatic growth of adults of all species and the input and subsequent growth of young-of-the-year bocaccio (Figure 5.6). As described for Figure 5.10, the production model can readily be rerun to estimate yield under the partial removal option by removing from the model all fishes from the upper stratum. Note, however, that partial removal will not affect bocaccio recruitment because all bocaccio have been observed to settle below 85 feet (26 meters) on platforms (see Section 5.3.1.1 for more detail). Figure 5.11 shows that, as for standing stock, the greatest reduction in yield under the partial removal option occurs for the shallowest platforms, Ellen and Holly. In most cases the proportional decrease in yield is relatively small (see Appendix 3 for more detail).

By removing the upper portion of the platform, the partial removal option will also remove much of the encrusting organisms that eventually fall to the bottom and provide input to the shell mound community. The potential impact of this reduction in organic input to the benthic community on platform fish populations is not clear. Rockfish, which dominate the platform fish community, are a diverse assemblage of fishes that feed opportunistically on invertebrates (both

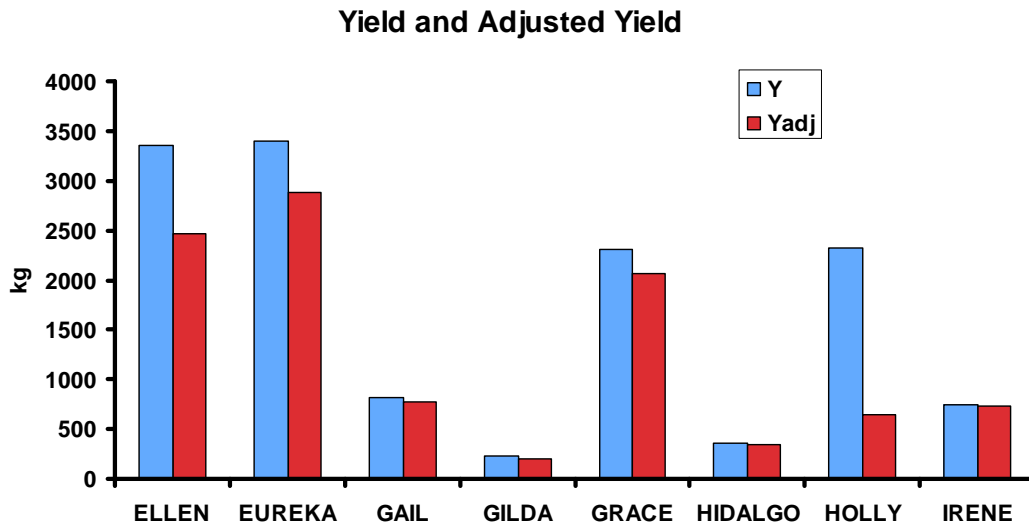

**Figure 5.11. Mean yield (Y') and adjusted yield (Y'<sub>adj</sub>) at year 5 for the eight platforms selected for the modeling analysis. Adjusted yield refers to overall platform yield (i.e., somatic growth plus the recruitment and subsequent growth of bocaccio in Year 1) adjusted for the loss of the upper 85 feet of the platform.**

benthic and planktonic) and fishes (Love et al. 2002). Because they feed on whatever is abundant in their environment, it is not possible to predict the effects of changes to the shell mound community; also these changes may reduce the food supply for rockfish in the bottom stratum of the platform.

An unknown aspect of the partial removal option is the degree to which fish populations on the artificial reef would be subject to fishing pressure, primarily from recreational fishermen. Such fishing, depending on its intensity, could dramatically reduce standing stocks, and thus production, on the platforms. While CDFG could restrict fishing on the artificial reefs for vessels registered in California, it is likely that it would have no authority over vessels from outside the state (see Section 6.1.1.3 for more detail). The degree of fishing pressure would depend on a variety of factors, including a platform's distance from port, fuel costs, and whether fishermen would be willing to voluntarily restrict fishing in order to preserve standing stocks. Recreational fishing groups in southern California have stated publicly that they are willing to restrict fishing effort to the upper portions of platform reefs in order to protect the productive capacity of platforms related to groundfish and any other overfished species (G. Steinbach, pers. comm., 2010).

**Platform production in context:** It would be useful to have a frame of reference for interpreting these production estimates in order to provide some sense of whether platform production is relatively high, medium, or low compared to other marine systems. Biological production estimates are frequently reported for other marine systems, but these are typically based on

standing stock estimates multiplied by assumed growth and/or reproduction factors rather than on empirical estimates derived from measuring cohorts over a number of years (L. Allen, pers. comm., 2010). As a result, production estimates, such as those reported by Hood (1993) for a number of southern California fish populations, are not comparable to those reported here for offshore platforms, and there are no empirically derived production estimates available to provide a reasonable basis of comparison for those derived for platform fish populations (L. Allen, pers. comm., 2010).

**Reef enhancement:** The partial removal option includes a suboption that involves enhancing the bottom habitat around the base of the platform with quarry rock, concrete, or other materials, or by placing the upper portion of the jacket and the lower portion of the deck on the bottom (Love et al. 2003, Schroeder and Love 2004) (see Section 4.1.2 for more detail). Because using platform structures as reef enhancement has never been carried out in California, there are no empirical data that provide a basis for estimating its potential effects on production. However, upper portions of decommissioned platforms have been used as reef enhancement in the Gulf of Mexico and on the east coast of Florida (A. Scarborough-Bull, MMS, pers. comm. 2009, G. Gitschlag, NMFS, pers. comm. 2009). This experience suggests that the effects of placing the upper platform structure on the bottom adjacent to the current structure would depend on the final orientation of the crossbeams relative to the bottom because this greatly influences the performance of the habitat at this level (Love and York 2006). Such concerns about orientation could be greatly reduced by adding reef material (e.g., quarry rock, concrete) to the bottom around the base of the platform. Quarry rock and concrete have been used successfully in reefing projects in southern California since the early 1960s (Carlisle et al. 1964), and side-by-side comparisons have shown them to be similar in performance to natural reefs (Pondella et al. 2006, Reed et al. 2006). Use of such materials would significantly augment the habitat in the lower two meters of the water column that large fishes prefer, as long as they were designed to avoid sinking into soft sediments. However, it is not possible to determine whether and to what degree young-of-the-year fishes would recruit to reef enhancement structures placed on the bottom.

**Predicted effects of complete removal:** Under the complete removal option, populations of sessile invertebrates would suffer 100% mortality and the use of explosives in decommissioning would most likely result in extremely high mortality for fishes, as occurred in the 4H decommissioning project (SAIC 2003). If fishes successfully emigrated from a decommissioning site, they would most likely then be subjected to the high levels of fishing mortality present throughout the Southern California Bight. While the fate of these fish cannot be predicted with certainty, it is likely that the long-term prognosis for the complete removal option is a significant loss of the fish that emigrated from the platforms.

**Importance of platform production to the regional ecosystem:** The production estimates summarized above and detailed in Appendix 3 are difficult to interpret as raw numbers without additional information that helps put them into a context that will support decision making about decommissioning options. There are four pieces of information that may help accomplish this, although none of them are definitive:

- First, as described in Section 5.3.1.1, many fishes and invertebrates on platforms occur at higher densities, are larger, and grow faster than the same species on natural reefs in the region
- Second, as described in Section 5.3.1.2, platforms appear to act as both sources and sinks (settlement locations) of larvae in the Southern California Bight, although it is not possible to estimate the overall importance to the ecosystem of these functions
- Third, recent fish surveys of bocaccio populations on eight oil and gas platforms in southern California using manned research submersibles (Love et al. 2006) provide an estimate of the relative contribution of bocaccio standing stock on platforms to the regional ecosystem. Love et al. (2006) found that the density of bocaccio juveniles was at least an order of magnitude higher on platforms than on natural reefs and that the young-of-the-year bocaccio on platforms constituted 20% of the average yearly value and 40% of the median value for the entire species. While this study provides a useful estimate of potential regional contribution, this is the only available study of this key issue
- Fourth, the ratio of habitat area provided by platforms to that provided by natural rocky reefs in the region could provide another indication of platforms' relative ecological importance. Thus, if platforms represent a miniscule proportion of overall rocky habitat area in the region, then they could be considered relatively unimportant, despite their productivity and effectiveness as recruitment habitat. While simple conceptually, it is not clear in practice how to actually calculate and interpret this ratio and several different ratios are reasonable, depending on how platform area is calculated, and on the definition of habitat and region. For example, the production model uses the outer surface area of the platform structure (about 75 ha) (see Appendix 3 for more detail). However, the actual surface area of all platform structural components, which would be much larger, could also be calculated from platforms' engineering specifications, although this would be a time-consuming effort. In addition, because different species and particularly age classes of fish do not use the entire platform but inhabit different portions of the platform structure, this figure could change (and be smaller) for different age classes of fish. The denominator of this ratio, the area of natural habitat, could be defined in various ways. For example, there is evidence that reef communities beyond 30 meters depth differ from those in shallower water (Allen and Pondella 2006, Allen et al. 2006). Because the partial removal option would remove platform structures down to 26 meters below the water line, this suggests that natural habitat below 30 meters depth is the appropriate basis of comparison (e.g., Love et al. 2000, Love et al. 2003). On the other hand, all rocky habitat to the shoreline could be included in the estimate of natural habitat area. Finally, platform habitat area could be compared to natural habitat in the Santa Barbara Channel (where most platforms are located) or in the Southern California Bight as a whole (CDFG 2008). However, whatever denominator is used for this ratio, the amount of platform habitat area (calculated as the outer surface of the structures), is a very small proportion (less than 1%) of the natural rocky habitat in the Southern California Bight
- Fifth, the issue of habitat limitation is key to any discussion of the contribution of artificial reef habitat to regional populations and to the ecosystem as a whole. The area calculations in the preceding bullet strongly suggest that habitat (defined simply as rocky substrate) is not limiting. Conversely, the documented benefits of MPAs (even when small) that protect populations from fishing suggest that habitat area alone is insufficient for evaluating the contribution of a particular piece of habitat to the regional ecosystem. Thus, data



documenting the high densities of young-of-the-year recruits on platforms suggest that their value in some respects may be disproportionate to their area. There is insufficient data at this time to resolve this issue or to quantify it to any greater degree

#### 5.3.1.4. Benthic (ocean bottom) habitat

Manago and Williamson (1997) describe benthic impacts that could result from decommissioning (they include encrusting communities on the platform legs in their definition of “benthic” but the discussion in this subsection focuses only on the ocean bottom.), which mostly stem from sources of physical disturbance, and the conceptual approach to the qualitative assessment of these impacts is illustrated in Figure 5.12 (see Section 5.4 for a detailed description of the qualitative analysis approach).

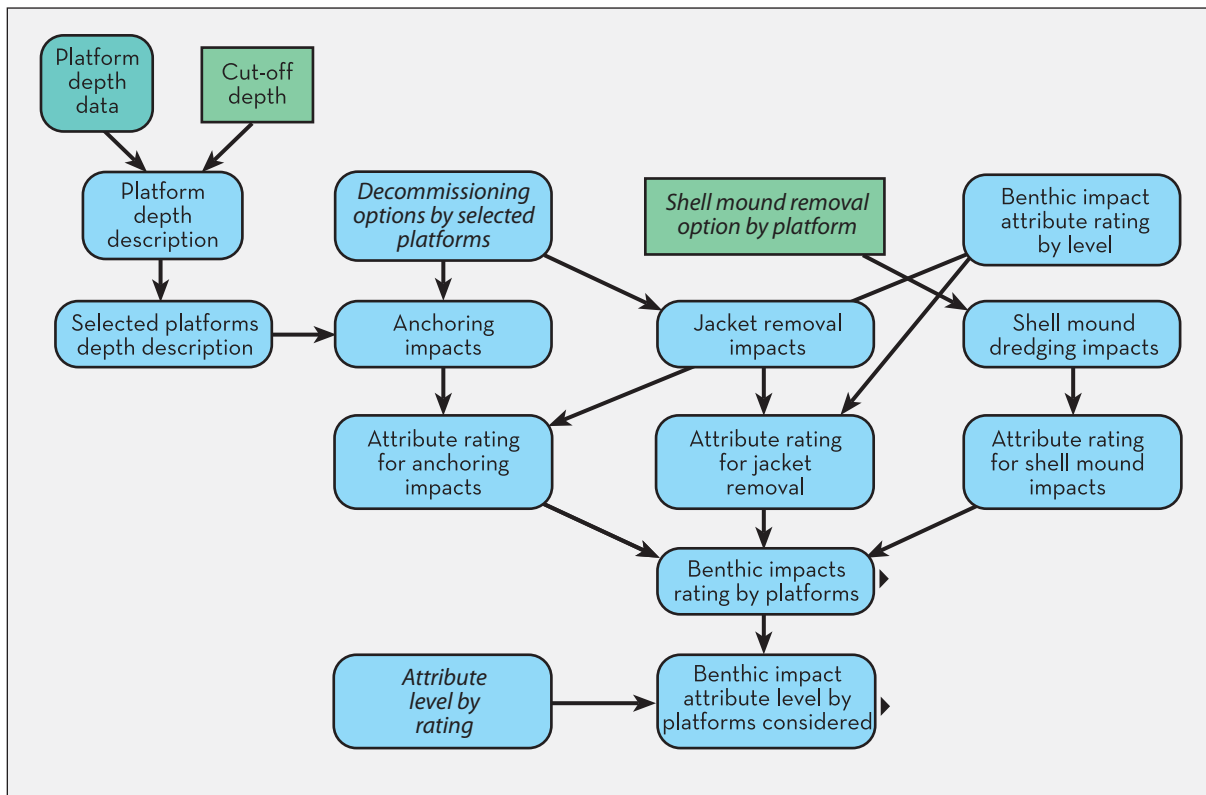

**Figure 5.12. Conceptual structure of the qualitative analysis of benthic impacts in the PLATFORM model.**

Soft-bottom benthic communities in habitats occupied by offshore platforms include well characterized populations of invertebrates that live both in the sediment and on the sediment surface, as well as populations of fishes such as sanddabs (*Citharichthys* spp.), lizardfish (*Synodus lucioceps*), and various species of flatfishes, including some commercially important species (e.g., California halibut) (SAIC 2003). These communities are widespread throughout the Southern California Bight.

There are three potential sources of decommissioning impact on benthic habitats surrounding a platform (Table 5.4), including anchoring of vessels involved in decommissioning, cutting and removal of jacket legs, and site clearance activities. (Potential impacts from shell mound removal are described in Section 4.1.1.2.) Because HLVs and other support vessels are likely to use dynamic positioning rather than anchoring (Proserv Offshore 2010; R. Byrd, pers. comm., 2010) anchoring impacts are likely to be minimal at most. Any such impacts that do occur would be greater under the complete removal option. This is because equipment (and, for the larger platforms, larger equipment) will necessarily be on site for a longer period of time. Cutting and removal of jacket legs will occur only during complete removal and Manago and Williamson (1998) note that, “Cutting of structures via mechanical or explosive methods also appears to have a relatively local effect on the benthos. The effects of cutting are usually limited to a relatively narrow band around the structure...”. Site clearance, which involves clearing the area around the platform (see Sections 4.1.1.1) may create surficial disturbance under both the partial and complete removal options. However, if shell mounds are removed, which would occur only under the complete removal option, and then this operation could create a more significant disturbance, depending on the methods used to remove the mounds (see Section 4.1.1.2 for a more detailed discussion of shell mound removal methods and impacts).

**Table 5.4. The distribution of potential sources of benthic impacts across the two main decommissioning options.**

Potential source of disturbance	Complete removal	Partial removal
Vessel anchoring	Minimal, but greater probability due to larger vessels and longer time on site	Minimal, but lesser probability due to smaller vessels and shorter time on site
Cutting and removal of jacket legs	Occurs only under this option	Would not occur under this option
Site clearance	Occurs under both options; shell mound removal occurs only under this option	Occurs under both options; shell mound removal would not occur under this option

### 5.3.2. Air emissions

In this section, we consider the potential air emissions impacts under the complete and partial removal decommissioning options. We describe the environmental and human health issues associated with air emissions from the equipment used in the decommissioning process, characterize the types of emissions that are of concern, and then briefly explain how the regulatory system would come into play in specific decommissioning projects. We then describe the methods used to estimate project-specific emissions and present a worst-case example, using the largest and deepest platform off southern California, ExxonMobil’s Harmony, in 1200 feet of

water. The complexity of the problem and the lack of site- and project-specific data preclude evaluating such impacts quantitatively in PLATFORM for all platforms and decommissioning options. However, the model does include placeholder modules (see Figure 5.13 below) identifying relationships between the components of the analysis. As for other sections, readers should refer to the description of data gaps (Section 5.5) for more detail on those aspects of the assessment that were constrained due to the availability of only limited data.

#### *5.3.2.1. Overview*

The vast majority of air pollution emissions from platform decommissioning will stem from combustion of fuel by diesel engines, which are used in virtually all phases and activities of the decommissioning process. The number of engines required is large, the engine size and likely age range is broad, the number of applications for which the engines are used is considerable, and the uses occur both offshore (e.g., at the platform itself, in its vicinity and in transit to and from it) and onshore (e.g., in port, at offloading, salvage and recycling facilities, and in material transportation) (see Section 3.4 for a detailed description of the decommissioning process). Thus, the potential for air pollution emissions is correspondingly large, as well.

As technology has improved and the water depth of offshore leases has increased, platform support structures (“jackets”) have necessarily grown in size, such that the sheer weight and physical bulk of a deep water platform are many times greater than for a shallow water counterpart. For example, Venoco’s platform Holly, installed in 1968 in 211 feet of water and weighing approximately 7500 tons, is dwarfed by ExxonMobil’s platform Harmony, set in 1989 in 1200 feet of water, and weighing approximately 43,000 tons. Because platform removal will be performed with diesel engines, a simple but reliable rule is that the deeper the water in which a platform is set and the higher the percentage of the platform that is to be removed, salvaged, and disposed, the greater will be the associated air pollution emissions. Thus, from an emissions perspective, the partial removal, salvage and disposal of a platform set in 150 feet of water will generate considerably less air pollution than the partial or complete removal, salvage and disposal of a platform set in 1000 or more feet of water.

#### *5.3.2.2. Characterizing air pollution*

Combustion of diesel fuel produces exhaust that contains a multitude of air contaminants. These are generally characterized in three somewhat overlapping categories, as described below.

**Criteria pollutants** are those for which federal and/or state health-based air quality standards have been established. Criteria pollutant standards address several widespread chemical compounds that are emitted from diverse sources and which harmfully affect public health and the environment. In particular, these pollution standards are intended to protect sensitive population sectors (such as people with asthma, children, and the elderly) and the public welfare (including protection against visibility impairment and damage to crops, animals, vegetation and buildings).

Criteria pollutants include oxides of nitrogen, oxides of sulfur, ozone, carbon monoxide, and particulate matter (including particles less than 10 microns in diameter, or PM<sub>10</sub>, and particles

less than 2.5 microns in diameter, referred to as *fine particulate matter* or PM<sub>2.5</sub>). Hourly, daily, and annual emission limits on these pollutants are typically specified in permits issued by air pollution regulatory agencies. Ozone, the principal component of smog, is not directly emitted in exhaust, but rather forms over time under conducive atmospheric conditions and in conjunction with “precursor” pollutants that are emitted by a wide range of sources, including combustion sources. Limits on ozone precursors, such as reactive organic compounds (ROC) and oxides of nitrogen (NO<sub>x</sub>), are therefore also specified in air pollution permits. Additionally, NO<sub>x</sub> and oxides of sulfur (SO<sub>x</sub>), as well as ROC, are precursors to PM<sub>2.5</sub> pollution, and may have emission limits imposed for this reason.

The diesel exhaust that will be emitted during a platform decommissioning project contains all of the criteria and precursor pollutants listed above. Numerous control strategies and techniques exist and more are being developed to reduce diesel exhaust pollutants, and these advances are made more promising by the advent of ultra-low sulfur diesel fuel. California law mandates that diesel fuel used in most applications contain no more than 0.0015% sulfur by weight (CARB 2004). Prior to this requirement, the higher sulfur fuel content and resultant sulfur-containing compounds in the exhaust stymied otherwise proven emission control technologies, such as catalytic reduction. With the ultra-low sulfur content requirement in place, substantial advances in control of NO<sub>x</sub>, SO<sub>x</sub>, PM, and toxic emissions are being made. Diesel engines used in any California coastal decommissioning projects would be expected to comply with the diesel fuel sulfur content requirements that apply (M. Nazemi, pers. comm., 2009; K. Zozula, pers. comm., 2009; M. Goldman, pers. comm., 2009).

**Toxic air pollutants** are those which cause cancer or other serious disease, reproductive and genetic defects, and adverse environmental impacts. These pollutants are addressed by regulatory programs and requirements at both federal and state levels. Local programs and requirements may also exist, according to the occurrence and potential impact of the pollutant. Federally, US Environmental Protection Agency identifies and regulates toxic species as Hazardous Air Pollutants (HAPs) under Section 112 of the Clean Air Act, and lists more than 180 elements and compounds that are determined to be hazardous when emitted to the air. The State of California regulates these pollutants as Toxic Air Contaminants (TACs), and they comprise a list of more than 230 chemicals and compounds determined by the state to be harmful to human health (CARB 2008).

The diesel exhaust that will be emitted to the atmosphere from platform decommissioning is a complex mixture of many gases and fine particles (including soot or black carbon), and contains more than 40 known toxic air pollutants (OEHHA/ALAC 2001). Many scientific studies have evaluated the human health effects attributable to diesel PM<sub>10</sub> and PM<sub>2.5</sub> and current regulatory programs that limit exposure to diesel particulate matter focus on the PM<sub>10</sub> and PM<sub>2.5</sub> size fractions and the cancer and non-cancer diseases associated with them.

More recent studies, however, have elucidated the important role that ultrafine particles (those less than .1 micron in diameter, or PM<sub>1</sub>) play in cardiovascular, respiratory, immunological, and neurophysiologic diseases (Araujo et al 2008; USEPA 2009a; Delfino 2008; Froines 2008). Much of this role is attributable to the minute particle size that allows translocation across the tissues that line the nasopharyngeal, pulmonary, and cardiovascular systems. However, a given

volume of PM<sub>1</sub> also has several orders of magnitude more particle surface area in comparison to a like volume of PM<sub>10</sub> or PM<sub>2.5</sub>. This dramatic increase in surface area provides a corresponding ability to adsorb and deliver toxic compounds, such as metals and polycyclic aromatic hydrocarbons, deep in cellular and subcellular tissue where much physiological damage can be done (Froines 2008). The dual effects of ultrafine particles – extreme small size coupled with great surface area – are being attributed an increasingly large role in the health effects of diesel PM emissions. Emission control technologies that reduce the PM<sub>10</sub> and PM<sub>2.5</sub> components in the exhaust stream (e.g., regenerative diesel particulate filters) appear to be somewhat effective in also reducing the ultra-fine component, and more research is underway in this area.

**Greenhouse gases and aerosols**, here collectively referred to as **GHG**, are those human-produced gaseous and airborne particle compounds that serve to trap heat within the earth's lower atmosphere (the troposphere). In particular, anthropogenic emissions of carbon dioxide, methane, and nitrous oxide, as well as a host of persistent fluorine-containing carbon compounds, have been identified as causative in accelerated warming of the earth's climate and concomitant changes in terrestrial and oceanic ecosystems (IPCC 2007). Carbon dioxide is the most important and most abundant of these GHG compounds (IPCC 2007). Approximately 22 lb of CO<sub>2</sub> are generated for every gallon of diesel fuel burned (USEPA 2005). Additionally, recent research indicates that black carbon aerosol, the sooty component of diesel exhaust, is second only to CO<sub>2</sub> in its global warming significance (Moffet and Prather 2009) and is particularly important in contributing to rapid warming of the Arctic region in the last three decades (Shindell and Faluvegi 2009).

Carbon dioxide is a combustion product found abundantly in diesel exhaust, as are carbon-based particulates (as noted above), and any platform decommissioning effort would create considerable GHG emissions. Though the multiple harmful effects and potential outcomes of climate change have been recognized for more than two decades, regulatory efforts to curb GHG emissions are still relatively new. With the California Global Warming Solutions Act (AB32, 2006), the state is a leader in this regulatory push. Nonetheless, GHG emissions, per se, are not regulated through any enforceable permitting system, but rather through broader analysis and mitigation measures applied using the California Environmental Quality Act. Thus, analysis and quantification of emissions, associated impacts, and potential mitigations for GHG attributable to a decommissioning project would likely be addressed during the project's environmental review stage (M. Nazemi, pers. comm., 2009; K. Zozula, pers. comm., 2009; M. Goldman, pers. comm., 2009), which in the case of most platforms, would need to address federal (NEPA) and possibly state (CEQA) standards of analysis. This situation would change with the passage of climate change legislation that would regulate GHG under a cap and trade system.

#### *5.3.2.3. Air pollution regulation*

Three air pollution control or air quality management districts are the primary regulators of platform air emissions and would likewise regulate platform decommissioning emissions off the coast of California. These are, from south to north, the South Coast Air Quality Management District, the Ventura County Air Pollution Control District, and the Santa Barbara County Air Pollution Control District. The South Coast district is recognized as both a world leader in advancing air pollution science and technology, and as a region having some of the most

persistently unhealthful air quality in the country. Ventura County, to the north and west of South Coast, is also challenged with unhealthful air, but to a lesser degree. Santa Barbara County, the furthest west of the three districts, has the best air quality and yet still does not attain all the applicable health-based pollution standards. Based on information provided by representatives of each agency, the essential commonalities are as follows.

All three districts would require air pollution permits for equipment used in decommissioning (e.g., heavy lift vessels, cargo barges, support vessels, cranes, and compressors). Permits would identify equipment approved for use and specify enforceable emission limitations for such equipment, according to established limits in each district's rulebook. Because each district is a non-attainment area for state and/or federal ozone, PM<sub>10</sub> and PM<sub>2.5</sub> standards, decommissioning projects would need to apply Best Available Control Technology for VOC, NO<sub>x</sub>, SO<sub>x</sub>, and PM emissions to equipment items proposed for use. Ultra-low sulfur diesel fuel would be required in virtually all diesel engine applications, and air quality impact analysis could be required if calculated project emissions would be expected to cause or contribute to the violation of an air quality standard. Districts are prohibited by state law (H&SC 32301.13) from requiring emission mitigation ("offsets") for decommissioning projects. It is an untested question whether offsets-like mitigation for decommissioning emissions could be required under CEQA.

Air Toxic Control Measures (ATCM) are emission reduction programs passed by the California Air Resources Board (CARB) that address specific toxic pollutants and the sources that create them. Depending on the source and equipment, ATCMs are implemented and enforced by local districts or by the CARB itself. Numerous ATCMs have been adopted during this decade that reduce diesel PM, NO<sub>x</sub>, and SO<sub>x</sub> from a range of diesel-powered activities and sources. The ATCMs that will most likely apply to decommissioning projects are for:

- Portable diesel engines greater than 50 horsepower, which are regulated by the Portable Engine ATCM
- The ATCM requiring that the sulfur content of diesel fuel be no more than 15 parts per million by weight (ppmw) for diesel engines other than marine vessel engines
- The commercial harbor craft ATCM that applies to tugs, crew and supply vessels, requiring the use of 15 ppmw sulfur diesel fuel and the replacement of older engines with engines meeting new emission standards

Platform decommissioning projects in state waters are also subject to health risk modeling and analysis under each district's Air Toxic Hotspots Program (M. Nazemi, pers. comm., 2009; K. Zozula, pers. comm., 2009; M. Goldman, pers. comm., 2009). In a health risk evaluation, the projected toxic emissions from decommissioning (e.g., diesel PM) are quantified and modeled for acute and chronic health effects on the public. The model, CARB's Hotspots Analysis and Reporting Program, uses expected equipment emissions and a meteorological dataset representative of the project site to predict pollutant dispersion, downwind concentrations, and associated health-related impacts. If significant health impacts are anticipated due to the project's emissions, the operator must go through a public notification process to inform those potentially affected, and reduce the anticipated risks to a less than significant level. Significance levels for

cancer and non-cancer risk vary slightly among the three districts, but typically an increase in cancer risk greater than one per 100,000 (or 10 in a million) is considered a significant increase.

While platforms located in federal waters are not subject to the Air Toxic Hotspots Program, health risk impacts attributable to a decommissioning project in federal waters could be addressed during CEQA/NEPA analysis prior to decommissioning. However, given the larger distances to the nearest public and ventilation conditions associated with most platforms in federal waters, it is unlikely that decommissioning emissions would create significant cancer or non-cancer impacts onshore.

A new regulatory framework that may apply to future decommissioning projects are the final emission standards announced by USEPA in December 29 for the Emission Control Area (ECA) for North American waters (<http://www.epa.gov/otaq/oceanvessels.htm>). These standards are identical to those adopted in the amendments to Annex VI to the International Convention for the Prevention of Pollution from Ships. The ECA would affect ocean-going vessels entering US ports and would require that they use relatively low sulfur-content fuels when in the control area. This would have the concomitant effect of allowing control of other pollutants (e.g., PM and NO<sub>x</sub>), as well. The ECA is in draft form and has not yet been approved. The approval process will include the US and Canada, as well as the International Maritime Organization and the sulfur limit is not likely to go into effect until 2015, with emission controls in 2016. Even after final approval, it is likely that local Air Pollution Control District and Air Quality Management District regulations, along with the state's existing diesel requirements (including sulfur fuel content and emission limits), will do much more to control platform decommissioning emissions than would the proposed ECA.

Finally, the Ports of Los Angeles and Long Beach may consider implementing an air emissions regulatory bubble in the area around the ports, extending some distance out to sea, in response to continuing concerns from the CARB about air emissions from shipping and from port operations. It is not clear how any such bubble might function, nor what its relationship would be to existing air pollution regulations.

#### *5.3.2.4. Calculating emissions*

To quantify a decommissioning project's total air pollution profile, emissions from each phase, component, and equipment item used for the project must be calculated and summed as part of a comprehensive engineering analysis. Key inputs are needed to calculate emissions from specific articles of equipment. The following figure (Figure 5.13) is taken from PLATFORM and illustrates how the input factors are combined to develop the overall emissions estimate.

**Emission factors** exist for each criteria and precursor pollutant, according to engine age and fuel type. Because of technology improvements, older engines generally have higher emission factors than newer engines of like size, and uncontrolled engines have higher emission factors than those with some level of control. A common source of generally accepted emission factors for a very broad range of emitting equipment is USEPA's AP-42 (USEPA 2009b). With larger or more

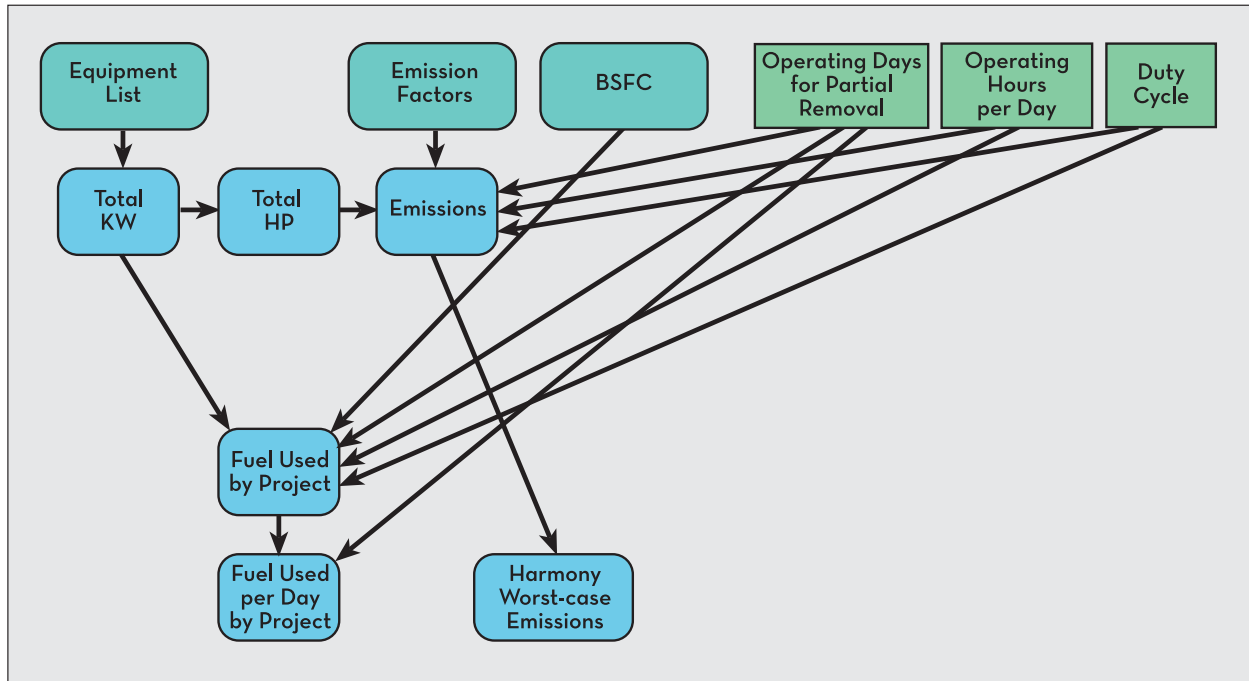

**Figure 5.13. Components of the modeling approach for estimating emissions for a decommissioning project.**

unusual equipment items (e.g., heavy lift vessel engines), local districts may choose to use manufacturers' source test data, or require exhaust stack testing to derive more specific factors both for more accurate prediction of emissions and for determining compliance with emission limits. Further, many newer diesel engines currently in use are "certified" by USEPA to a certain emission rate for pollutants, and these certified levels are assumed in the engineering analysis.

**Duty cycle** describes the overall use of the equipment and what portion of time it is running at different capacities (e.g., idling, full-throttle).

**Fuel sulfur content**, as noted above, is an important determinant in whether emission reductions from diesel engines can be achieved, since sulfur products formed during the combustion process tend to foul particulate filters, catalysts and similar control technologies. The state's ATCM requirement to use diesel fuel with no more than 15 ppmw sulfur is an important step forward in reducing PM, NO<sub>x</sub> and SO<sub>x</sub> from diesel engines.

**Engine size, age, and fuel consumption rate** affect air emissions. Older, larger, and less fuel-efficient engines are higher emitters of criteria and toxic compounds than are newer, smaller, and more fuel-efficient engines. Newer engines can make use of enhanced control technologies, e.g., oxidation catalysts, diesel particulate filters, and combustion process modifications, which are not available to older classes of engines. These attributes are typically reflected in the emission factors associated with each engine or engine class.



#### *5.3.2.5. Decommissioning experience to date*

The most immediate example of a recent California coastal decommissioning project is the 1996 removal of Chevron's four platforms, Hope, Heidi, Hilda and Hazel (generally called the 4H Project) from approximately two miles offshore Carpinteria, California. The project received an air pollution permit from the Santa Barbara County Air Pollution Control District and a paper was published describing the project's stages, equipment, and associated emissions (Sheehan 1997). Given the relatively shallow water (approximately 100 - 150 feet) and proximity to shore, this project is a useful measure by which to gauge other nearshore decommissioning projects.

While it is noted that shell mounds and cuttings subtending the four platform locations have not been fully removed to date, and it could thus be argued that platform decommissioning is not complete, the effort to remove the four platforms required more than 120,000 gal of diesel fuel (at the then-applicable standard of 500 ppmw sulfur content) (Sheehan 1997). Criteria pollutant emissions attributable to the 4H Project were 21.6 tons NO<sub>x</sub>; 1.3 tons ROC; 14.2 tons CO; 0.5 tons SO<sub>x</sub>; and, 1.3 tons PM (Sheehan 1997). CO<sub>2</sub> emissions for the project would have amounted to approximately 1320 tons (USEPA 2005).

Considering the regulatory changes that have occurred since the 4H Project was undertaken, (e.g., the requirement to use diesel fuel with no more than 15 ppmw sulfur content, the wide use of newer, certified portable engines, and the greater availability of catalytic and filtration controls), it is reasonable to expect that nearshore, shallow water projects of similar size would have substantially lower emissions than created by the 4H Project in 1996.

#### *5.3.2.6. Estimating emissions from deepwater platform decommissioning*

Deepwater platforms, that is, those in waters deeper than 400 feet (Byrd and Velazquez 2001) present a significantly greater engineering challenge, as noted throughout this report, and air pollution emissions will essentially be proportional to the platform's depth (as reflected in the size and weight of the jacket structure) and the amount of the platform that is to be removed (that is, partial or full removal). The deepest and heaviest platform offshore California is ExxonMobil's platform Harmony, set in 1200 feet of water six miles south of Tajiguas, Santa Barbara County. Estimating the air pollution generated from this platform's complete or partial removal creates the "worst-case" emissions scenarios compared to other, less substantial platforms. We are therefore calculating the projected emissions from Platform Harmony's partial removal (topsides and jacket structure to -85 feet below mean sea level) to complete platform removal (the entire topsides and jacket structure to 15 feet below mud line). This exercise is described below.

While the state of the art is changing rapidly based on experience, for example, from debris removal efforts necessitated by Hurricane Katrina in 2005, in the current analysis, both full and partial removal scenarios are expected to require a HLV (see Section 4.1.1.1 and Figures 4.3 and 4.5) to accomplish the task (Byrd and Velazquez 2001). HLVs of the size envisioned for California decommissioning projects contain several large (e.g., more than 3200 hp each) diesel engines used to run electric generators that produce power for use throughout the vessel, and operation of these diesel engines contributes significantly to the overall emission profile of a

decommissioning program. This is particularly the case during the topsides and jacket removal stage of decommissioning, when careful lifting, controlling and placing of massive platform pieces calls for tremendous power and produces concomitant emissions (Sheehan, 1997; Byrd and Velazquez 2001).

**Equipment assumptions:** The monohulled crane vessel DB50 (Figure 4.5), operated by J. R. McDermott, Inc., is an HLV with the lifting capacity considered at this writing to be appropriate to decommission Platform Harmony. Specifications for the DB50 and its array of engines were gleaned from vessel fact sheets provided on McDermott’s website (<http://www.jraymcdermott.com/services/Vessels/db50.htm>). Notwithstanding these information sources, numerous assumptions were required regarding the array, specifications and operation of necessary equipment both on the *DB50* and on its associated support vessels to estimate and compare air pollution emissions from partial and full removal. Table 5.5 lists the equipment assumptions used for this analysis.

**Table 5.5. Equipment assumptions for the complete and partial removal options for Platform Harmony. HP refers to horsepower.**

Vessel <sup>(1)</sup>	Power (kW)	HP	# Eng.	Tot. kW	Tot. HP
<i>DB50 Heavy Lift Vessel</i> <sup>(2)</sup>					
Mains	2700	3621	5	13,500	18105
Thrusters	2400	3218	4	9600	12,872
<i>Anchor Handling Tug (x1)</i> <sup>(3)</sup>					
Mains	4474	6000	2	8949	12,000
Thrusters	447	600	2	895	1200
Aux. Generators	1050	1408	2	2100	2816
<i>Support Vessel (x1)</i> <sup>(4)</sup>					
Mains	932	1250	2	1864	2500
Aux. Generators	200	268	2	400	536
<i>Offshore Tugs (x4 tot.; 2 at any time)</i> <sup>(5)</sup>					
Mains	2289	3070	4	9157	12,280
Aux. Generators	112	150	4	447	600
<i>Cargo Barges (x8 tot.; 4 at any time)</i> <sup>(6)</sup>					
Generators	500	671	4	2000	2682

Table 5.5 Notes:

1. Source: Equipment spread based on Table 6.1.2-2 of MMS (2001)
2. Source: J.R. McDermott fact sheet for HLV *DB50*
3. Source: Based on vessel similar to AHT *Blizzard* (International Transport Contractors)
4. Source: Based on vessel similar to DSV *Sea Lion* (Global Industries Offshore)
5. Source: Based on vessel similar to OST *Patriot Service* (Hornbeck Offshore Transportation)
6. Assumes each barge has a single 500 kW diesel generator on board for power

**Emission factors, fuel consumption and operating assumptions:** With the exception of SO<sub>x</sub>, all pollutant emission factors and brake-specific fuel consumption (BSFC) for the engines of the vessels shown in Table 1 were derived from Tables 2-9 and 2-16 of USEPA (2009c). Diesel fuel was assumed to meet CARB ultralow sulfur requirement of 15 ppmw and to weigh 7.05 lb/gal for all engines, and a SO<sub>x</sub> factor was derived calculating sulfur emissions as SO<sub>2</sub>. The emission factors used in this analysis are shown in Table 5.6.

**Table 5.6. Emission factors and fuel consumption (in grams/kW-hr) <sup>(1)</sup> for the Platform Harmony decommissioning example.**

Equip Location/Type'	NO <sub>x</sub>	ROC	SO <sub>x</sub> <sup>(2)</sup>	CO	CO <sub>2</sub>	PM <sub>10</sub>	PM <sub>2.5</sub>	BSFC <sup>(1)</sup>
<i>DB50 Heavy Lift Vessel</i>								
Mains	13.20	0.50	0.0061	1.10	646.08	0.47	0.43	203
Thrusters	13.20	0.50	0.0061	1.10	646.08	0.47	0.43	203
<i>Anchor Handling Tug (x1)</i>								
Mains	13.20	0.50	0.0061	1.10	646.08	0.47	0.43	203
Thrusters	13.90	0.40	0.0065	1.10	690.71	0.49	0.45	217
Aux. Generators	13.20	0.50	0.0061	1.10	646.08	0.47	0.43	203
<i>Support Vessel (x1)</i>								
Mains	13.20	0.50	0.0061	1.10	646.08	0.47	0.43	203
Aux. Generators	13.90	0.40	0.0065	1.10	690.71	0.49	0.45	217
<i>Offshore Tugs (x4 total; 2 at any time)</i>								
Mains	13.20	0.50	0.0061	1.10	646.08	0.47	0.43	203
Aux. Generators	13.90	0.40	0.0065	1.10	690.71	0.49	0.45	217
<i>Barges (x8 total; 4 at any time)</i>								
Generators	13.90	0.40	0.0065	1.10	690.71	0.49	0.45	217

Table 5.6 Notes:

1. Emissions factors (except SO<sub>x</sub>, see Note 2) and Brake Specific Fuel Consumption (BSFC) from USEPA (2009c), Tables 2-9 and Table 2-16, as presented, with no rounding. More precise, engine-specific emission factors and fuel use rates could be determined by source testing of vessel engines to be used in decommissioning exercises
2. Assumes only CARB Ultra Low Sulfur Diesel (7.05 lb/gal and 15 ppmw S); SO<sub>x</sub> calculated as SO<sub>2</sub>

In the partial removal case, the *DB50* and its support vessels were assumed to be on site for 20 days (derived from MMS, 2004), operating 20 hrs per day. In the full removal case, the *DB50* and its support vessels were assumed to be on site for 135 days (MMS, 2004), operating 20 hr per day. The assumed vessel duty cycles for both cases were 35% (*DB50* mains) and 40% (*DB50* thrusters), and 25% (other vessels' mains) and 30% (other vessels' auxiliaries).

**Platform Harmony emission estimates:** Based on the equipment, emission factors, duty cycles and fuel use rates described and assumed for this analysis, the removal of Platform Harmony's topsides and jacket structure down to a depth of -85 feet below mean sea level would produce

worst-case emissions of: 89 tons NO<sub>x</sub>, 3 tons ROC, 7 tons of CO, 4400 tons of CO<sub>2</sub>, 3 tons of PM<sub>10</sub> and 3 tons of PM<sub>2.5</sub> (Table 5.5). Sulfur emissions would amount to less than one ton for the project (Table 5.5). The full removal scenario would create worst-case emissions of: 600 tons NO<sub>x</sub>, 22 tons ROC, 50 tons CO, 29,400 tons CO<sub>2</sub>, 21 tons PM<sub>10</sub>, and 20 tons PM<sub>2.5</sub> (Table 5.7). Sulfur emissions would amount to less than one ton for full removal (Table 5.5). Note that these estimates include only the onsite operation of equipment described in Table 5.3. The transit of these vessels to the decommissioning site, particularly the HLV, which will have to come from Europe or Asia, will produce additional emissions that are not estimated here.

**Table 5.7. Worst-case emission estimates for complete and partial removal of the Platform Harmony topsides / jacket.**

Tons of Emissions							
All numerical entries rounded to nearest whole number except CO <sub>2</sub> (rounded to nearest 100) and SO <sub>x</sub> .							
	NO <sub>x</sub>	ROC	SO <sub>x</sub>	CO	CO <sub>2</sub>	PM <sub>10</sub>	PM <sub>2.5</sub>
Partial Removal	89	3	<1	7	4,400	3	3
Full Removal	600	22	<1	50	29,400	21	20

**Discussion:** Not surprisingly, the scenario comprising full removal of Platform Harmony’s topsides and jacket structure produces approximately 6.75 times more of each pollutant than the partial removal scenario, a ratio represented by the time the HLV and its support vessels are on station for each scenario. These “time on station” estimates (that is, 20 days for partial removal, and 135 days for full removal) include a 20% contingency, and are therefore inflated to account for delays attributable to weather, sea state, equipment problems and other variables. What cannot be factored in to this analysis is the result of any permit-driven engineering efforts or negotiations between operators and air pollution regulatory agencies to reduce the decommissioning emission profile. Thus, while use of CARB diesel with 15 ppmw S fuel content is assumed in the analysis, no consideration is given here to the concomitant improvements in availability and function of add-on control systems (e.g., diesel oxidation catalysts, particulate filters) this fuel allows, or to engine modifications and other potential mitigations that would have the desirable effect of markedly lowering either scenario’s anticipated emissions.

Air pollution emissions from the 1996 Chevron 4H Project benefited substantially from permit-driven negotiations between the project operator and the regulatory agency, the Santa Barbara County Air Pollution Control District. Although Chevron’s original permit application anticipated 120 tons of NO<sub>x</sub> from the 4H decommissioning, during permit negotiations Chevron re-evaluated the number, sizes and necessity of engines it had applied to use, and opted to install controls or make combustion modifications to many of the 94 engines remaining after the evaluation. The overall results of this negotiation netted an 80% reduction in NO<sub>x</sub> emissions

from the project (Sheehan, 1997). On this basis, it is reasonable to expect that permit-related negotiations for future programs will likewise reduce considerably the emissions that ultimately result from platform decommissioning.

#### *5.3.2.7. Other considerations*

As stated elsewhere, the current evaluation considers only a segment of deepwater platform decommissioning, that is, the topsides and jacket removal. Not included in this emissions estimating exercise are the transit of equipment, particularly the HLV, to the decommissioning site, and other necessary tasks, including plugging and abandonment of wells; platform preparation and marine growth removal; removal of conductors, pipelines and power cables; ocean transport of platform materials; recycling and disposal of platform materials at suitable onshore facilities; and site clearance. All of these stages have power needs provided primarily by diesel engines, and thus add to the overall emission profile of the decommissioning process. However, as explained in Section 5.2., many of these activities are identical across all decommissioning options and thus do not contribute to the choice between options, and others are data gaps that could not be filled given availability of information and the constraints of the project.

Another important issue concerns transportation of recovered platform structural elements to suitable onshore facilities where recycling and disposal can be accomplished. The ocean transport of decommissioned platform structures is necessarily performed by tugs towing cargo barges. The greater the portion of the platform that is removed, the larger the number of trips that are necessary to transport the recovered materials. Air pollution emissions will increase accordingly.

The location of onshore recycling and disposal facilities also plays an important role in decommissioning emissions. In 1996, materials from the Chevron 4H Project were barged in numerous trips to Long Beach Harbor, CA for scrapping and disposal. Proserv Offshore (2010) assumes the Port of Los Angeles and/or Port of Long Beach will be used for onshore recycling and disposal. Operations at these locations will raise environmental justice concerns (see Section 3.3) that will need to be addressed in the regulatory and permitting process. Both facilities have “clean port” initiatives in place and recycling and disposal activities would need to comply not only with these initiatives, but with any environmental justice initiatives, as well. Facilities handling disposal of scrap or debris within these two ports could certainly be affected by environmental justice activities (M. Nazemi, pers. comm., 2009) and the ability of either port to accomplish the recycling and disposal should not be considered a foregone conclusion.

Previous evaluations have suggested that a facility on the Columbia River in Portland, OR is capable of handling the mass and volume of materials attributable to deepwater platforms of the size under consideration here (Byrd 2003). However, the distance to this facility from Southern California waters and the number of tug-and-tow vessel trips that would be required have not been evaluated in this assessment, nor have any emissions from Portland-based onshore equipment that would be necessary (e.g., cranes, generators, shredders, compactors, truck and/or rail transportation and the like). Environmental justice concerns are likely to be less of an issue

for the Oregon facility because it is not immediately adjacent to urbanized areas with disadvantaged minority communities.

#### *5.3.2.8. Estimating decommissioning emissions from other platforms*

The above-described exercise considers the largest, deepest, and heaviest platform offshore California, Platform Harmony, as a worst case estimate that presents the possible upper bound of emissions from decommissioning a single platform. The exercise shows that a comparison of HLV “time on station” for the two decommissioning options provides a general multiplier of 6.75, i.e., full removal of Platform Harmony’s jacket and topsides creates approximately 6.75 times more air pollution than partial removal down to -85 feet below mean sea level.

It is tempting to generate order-of-magnitude emissions estimates by using the Harmony emissions estimates as a baseline and then applying this basic index (that is, the expected time on station for full removal divided by expected time on station for partial removal) to all platforms offshore California for which the expected time on station is known. However, this approach would produce misleading estimates because it does not account for the different decommissioning equipment “spreads” expected to be used for many of these other platforms. Because different decommissioning projects will require different types of equipment (e.g., due to water depth, platform size and weight), such estimates would not represent the potential emissions profile of the equipment likely to be used for removing other platforms, even though accurate estimates of time on station are available. After considering this issue closely, we have determined it is more supportable to limit our analysis to assessing the worst-case full and partial removal scenarios for Platform Harmony.

### **5.3.3. Socioeconomic impacts**

In this section, we consider the potential socioeconomic impacts under the complete and partial removal decommissioning options for three user groups:

- Commercial fishing
- Recreational fishing
- Nonconsumptive SCUBA diving

We also consider impacts on ecosystem value, but were limited primarily to qualitative descriptions of these impacts. A major challenge in estimating socioeconomic impacts on these user groups and on the ecosystem itself is that the majority of such impacts are second-order, that is, their magnitude and even their direction result from changes in other factors such as access to fishing grounds (see Section 5.3.4.), populations of fish and other resources (see Section 5.3.1.), the market price for commercial catch, the location of the platforms (e.g., platforms near cities, major arterials, and/or harbors will likely be visited more frequently than those far away), and the availability of substitute sites, weather, and currents, among others. This challenge is compounded by the lack of quantitative economic data on both commercial and recreational fisheries at the local and regional scale. However, PLATFORM (see Section 5.4 for more detail) does include placeholder modules (Figure 5.14) that identify general relationships among the

components of this issue. Note that, as described in Section 4.2, we exclude broader socioeconomic impacts on employment and the regional economy.

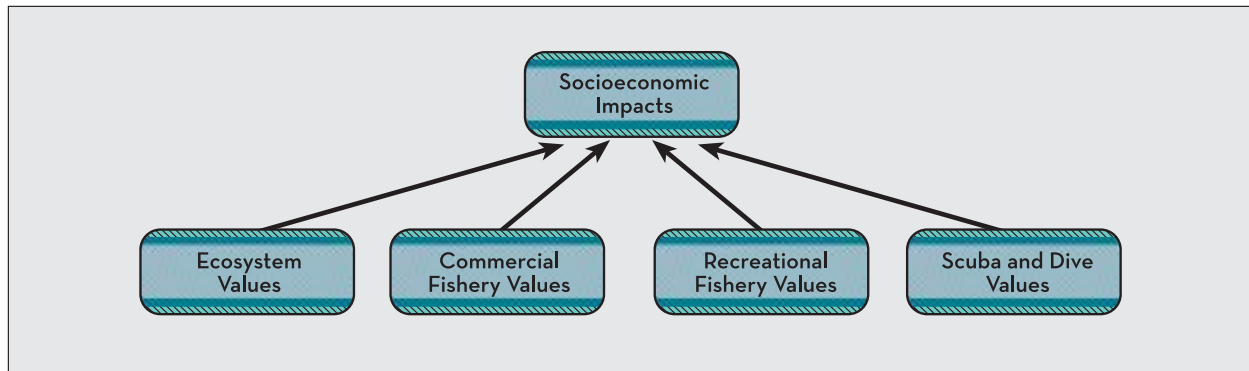

**Figure 5.14. Placeholder modules in PLATFORM indicating basic relationships between components that may contribute to broader socioeconomic impacts. These modules could be expanded if these data gaps are filled in the future.**

Table 5.8 summarizes the potential direction of overall socioeconomic impacts of the two main decommissioning options on fisheries and nonconsumptive uses. In several cases, interactions between multiple kinds and sources of impact could create different or competing effects that make it impossible to develop simple predictions of overall decommissioning impacts. In particular, the direction of socioeconomic impacts will depend in large part on whether the sites are designated for consumptive use after decommissioning occurs, a decision that will affect not only the behavior of the three user groups, but will also potentially affect marine resource populations.

**Table 5.8. Qualitative summary of the direction of likely impacts of complete and partial removal on fisheries and nonconsumptive uses under each decommissioning option and management policy (i.e., take vs. no take). Up and down arrows indicate positive and negative impacts, respectively. An equal sign indicates no change. Multiple symbols in a single cell reflect cases where impacts could vary depending on the segment (e.g., gear type) of the interest group involved and/or on platform-specific circumstances.**

User group	Partial removal		Complete removal	
	Take	No take	Take	No take
Commercial fishing	↑ ↓	=	↑ ↓	=
Recreational fishing	↑	= ↓	=	=
Nonconsumptive dive	= ↓	= ↓	↓	↓

If platforms are completely removed and sites opened to consumptive use, this will increase accessible area for both commercial and recreational fishermen, although this area may not be attractive to recreational fishers and the value of increased access may be offset to some unknown degree by the loss of platform habitat. Complete removal under both take and no-take (see Section 6.1.1.3 for more detail on limits to state authority to restrict fishing in the OCS) scenarios would negatively impact nonconsumptive SCUBA diving uses by removing diving opportunities. Partial removal would also reduce diving opportunities but to a lesser degree. If platforms are partially removed and sites opened to consumptive use, some commercial fishermen who use fixed gear may benefit if they target species that platforms aggregate and/or increase the production of, while fishermen using mobile gear will continue to experience interference with their activities. In this scenario, access for recreational fishermen would increase. If platforms are partially removed and the sites designated as no-take areas for California vessels, the situation for commercial fishermen would remain unchanged. Any recreational fishermen who currently fish near the platforms would experience a loss of use. A large uncertainty under both options is the degree to which biological production on platforms contributes to regional populations of valued species. While Section 5.3.1. estimates changes to biological production at the scale of individual platforms, such estimates cannot reliably be extended to larger regional scales or longer time periods, although there is some evidence that platforms could be making contributions to some depleted populations, especially of rockfish. Thus, increases in access under either option could be offset to some extent by the loss to regional production. As a result, it is not possible to predict potential effects on commercial and/or recreational fishermen who fish some distance away from the platforms.

It is difficult to estimate the magnitude of these socioeconomic impacts. Since the contribution of platforms to available hard substrate habitat offshore California is uncertain, there may be only a negligible difference between completely removing this habitat and leaving some of it in place. However, if the areas opened up are of high demand and/or high species value, even a small change could have substantial impacts. For example, rocky habitat associated with the Rincon Oil Island located off Ventura County, California provides excellent lobster fishing grounds and trap fishers would oppose seeing this habitat removed (Schroeder & Love 2004).

Similarly, we were unable to quantify effects on ecosystem value because of data gaps on the value stakeholders place on various aspects of the ecosystem. We were therefore limited to qualitatively describing how each decommissioning option is likely to impact stakeholders' preferences, and predict that such impacts will be a mix of positive and negative impacts for each option. For example, partial removal will leave existing habitat in place below 85 feet for some species (higher ecosystem value), while complete removal will not. At the same time, complete removal will contribute to a clear seabed and uphold the principle of site restoration (higher ecosystem value), while partial removal will not. Such tradeoffs highlight values differences among stakeholders that can only be compared more rigorously with more detailed data on stakeholders' preferences.

As for other sections, readers should refer to the description of data gaps (Section 5.5) for more detail on those aspects of the assessment that were constrained due to the availability of only limited data.



### *5.3.3.1. Fisheries and nonconsumptive use impacts*

A baseline description of the economics of recreational and commercial fishing in the Southern California Bight and how this activity is related to oil platform decommissioning more generally is a useful starting point for a description of the potential socioeconomic impacts of oil platform decommissioning on commercial and recreational fishing.

Commercial fisheries landings in California have declined dramatically since the 1970s (Hahn and Layne-Farrar 2003), with metric tonnage (mt) falling from 552,559 mt in 1975 to 142,946 mt in 2008 (NOAA Annual Commercial Landing Statistics). While trends in landings in southern California are similar to those for the state as a whole, it is more difficult to quantify catches and income locally and regionally, although efforts to do so are underway as part of the MLPA process. In addition, in recent years, area closures, marine protection initiatives, discussion of Marine Spatial Planning, and increased interest in renewable energy development (e.g., offshore wind farms, wave energy projects) have heightened the potential for competition for access to commercial fishing grounds.

As described in Section 2, the contrast between California and the Gulf of Mexico provides a useful context for understanding the artificial reefing issue, as well as a good deal of the impetus behind this option in California. Along the Gulf of Mexico coast, recreational fishermen not only fish near oil and gas platforms, but also have helped drive the creation of state and federal policies on artificial reefs (Schroeder and Love 2004). Hiatt and Milton (2002) estimated that almost 25% of the 4.5 million recreational fishing trips taken in 1999 occurred within 300 feet of oil platform structures and reefs and that the annual total economic output from these trips was \$324.6 million (approximately \$418.7 million in 2009\$). Recreational fishermen in these states are active participants in broad coalitions that supported enabling legislation for creating artificial reef programs, which focus on enhancing fishery resources and increasing recreational and commercial fishing opportunities.

Recreational fishing is a hugely popular activity in southern California as well. The United Anglers of Southern California estimate that recreational fishermen contribute tens of millions of dollars (or more) to California's economy annually (Southwick 2002). While recreational fishing interests have expressed strong interest in a rigs-to-reefs option for California, it is not clear whether demand for fishing near offshore platforms would be similar to that seen in the Gulf of Mexico.

Figure 5.15 shows that the majority of potential fisheries-related socioeconomic impacts are second-order impacts which flow or result from other more direct impacts that in turn stem primarily from changes in access to fishing grounds and trends in populations of fish and other marine resources. It is thus important to assess the likely nature of these more direct impacts of each decommissioning option before attempting to assess potential socioeconomic impacts. For example, if habitat on existing oil platform structures supports increased stocks of recreationally and/or commercially relevant species (Love and Schroeder 2007), then removing this habitat may indirectly impact commercial and recreational fisheries (and perhaps the broader economy) by negatively affecting fish populations (see Section 5.3.1. for a discussion of potential impacts on fisheries stocks). At the same time, as discussed in Section 5.3.4, the complete removal option may allow for increased (albeit marginal) ocean bottom access because most fishermen who use

mobile gear (e.g., trawlers and longliners) prefer unobstructed, smooth ocean bottom for their fishing activities. It should also be noted that these two impacts are likely interrelated. There may even be a feedback loop in which, for example, overall species population size affects fisheries management decisions about access, which will affect population size, which will affect fisheries management decisions about access, and so on.

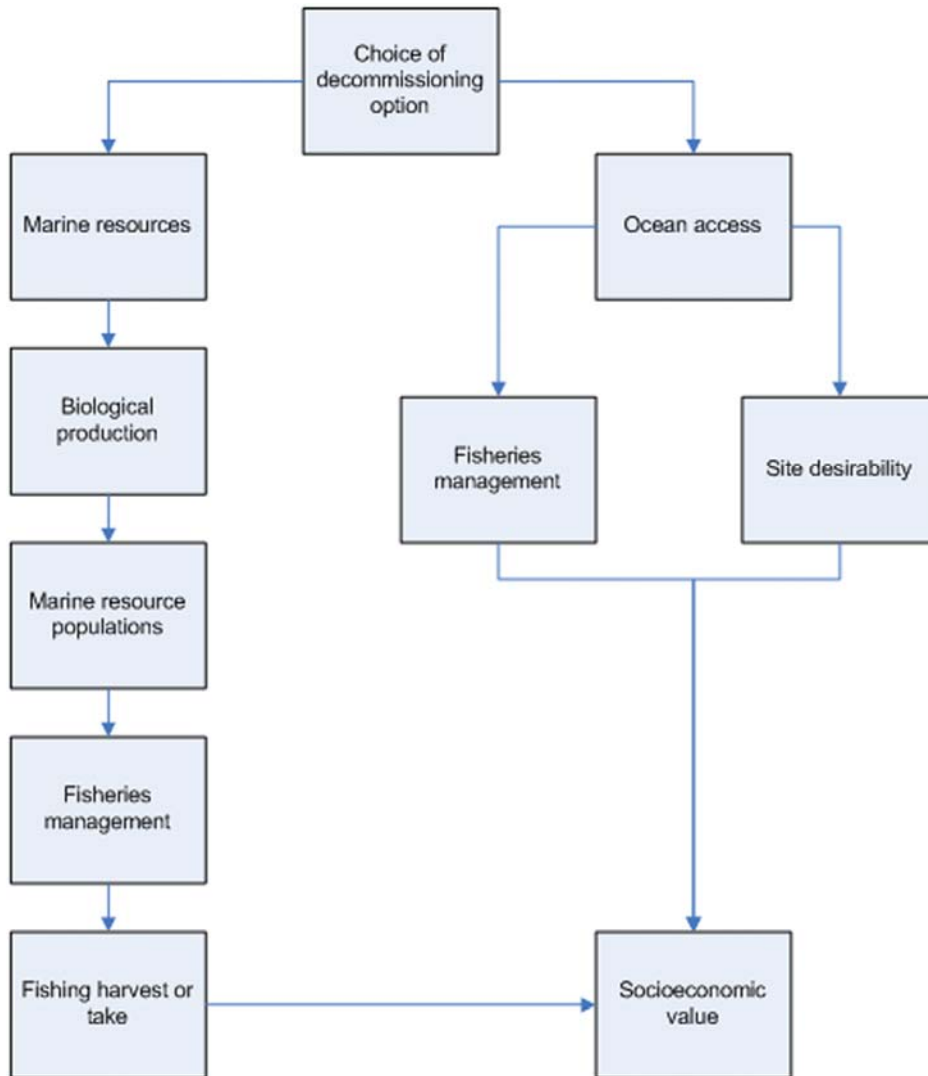

**Figure 5.15. Conceptual model of the factors that may influence the socioeconomic impacts of decommissioning options on fisheries.**

Several issues make it difficult to estimate a dollar value for the potential socioeconomic impacts on commercial and recreational fisheries. First, as seen in Figures 5.14 and 5.15, the potential impacts are dependent on a series of other potential impacts. At each step, risk and uncertainty associated with each potential lower-level impact can be compounded as these are combined to

create overall socioeconomic impacts. In addition, there are a variety of factors not related to the choice of decommissioning that affect fishing ability and income, such as management closures, weather, fuel prices, market prices, local/regional/national economic conditions, and the availability of substitute goods, among others. These additional considerations make it even more difficult to fully characterize the potential socioeconomic impacts associated with a decommissioning option. The following subsections on commercial and recreational fishing and on nonconsumptive uses therefore discuss the type, size, and direction of potential economic impacts primarily in narrative and qualitative terms.

Both decommissioning options will have a combination of short- and long-term impacts. Short-term direct impact will result from additional vessel traffic, debris in the water, and noise under complete removal and to a lesser extent under partial removal. There will be two primary long-term direct impacts of decommissioning: changes in access to fishing grounds and effects on species populations. While the first of these can be estimated to some degree (Section 5.3.4.), the second varies depending on the spatial scale at which the impact is analyzed (Section 5.3.1.). Therefore, for purposes of this discussion, we focus only on the platform scale and assume that, if the platform sites are opened to consumptive use, the long-term impacts on recreational and commercial fishermen will stem primarily from changes in access. Under the partial removal option, increased access to recreational fisheries will reduce platforms' long-term productivity by increasing mortality on the targeted fishes.

**Commercial fishing:** An important factor in determining the ultimate effect of the potential changes to access is the effect of platforms on biological production. Much of the research to date on the importance of platforms to biological production (see Section 5.3.1. for more detail) has focused on the Gulf of Mexico. In this region, the continental shelf is mostly gently sloping with a soft bottom, making it highly suitable for the creation of artificial reefs. As one measure of the importance of artificial hard substrate the Gulf of Mexico, platforms have been estimated to provide nearly 2,000 square miles of hard substrate, increasing the amount of reef habitat, which is relatively scarce in this region, by 27% (Lukens et al. 2004).

There are a number of geological and other differences between California and the Gulf of Mexico; however, that limit the direct applicability of findings from the Gulf to southern California. While a thorough quantification of substrate types throughout the region is not yet available, it appears that platforms represent a small contribution to the amount of overall hard substrate here in California but provide a larger amount of the hard substrate below a depth of 50 meters (Scarborough-Bull et al. 2008). Therefore, deeper water platforms may provide considerable hard substrate in the soft-bottom outer shelf regions in which they occur (Scarborough-Bull et al. 2008). In addition, as discussed in Section 5.3.1., the impact of platform habitat on biological production also varies depending on the spatial scale at which the impact is assessed, with the impact most probably declining with increasing spatial scale. Therefore, while platforms are probably important reef habitat in the Gulf of Mexico, their importance offshore California is uncertain.

As seen in Figures 5.14 and 5.15, the association of oil platform decommissioning and commercial fisheries occurs through compounding of multiple impacts. In addition, there may be multiple impacts (i.e., on access and on marine resources) and the direction of these impacts may

vary, e.g., increased access counterbalanced by habitat loss. These issues, coupled with other exogenous factors driving commercial fishery harvests, make it difficult at this time to quantitatively assess the potential economic impact of each decommissioning option on commercial fisheries.

Despite those constraints, it is possible to consider the likely direction of each decommissioning option. In the case of complete removal, which may allow access to small areas of the ocean, the impacts on certain valuable species may outweigh this potential gain in area, particularly if the areas were to be designated no take for California registered vessels. Based on six years of data collected along the California OCS, Love et al. (2003) suggest that “platforms act as de facto marine refuges.” A subsequent study by Love et al. (2005) found evidence that platforms were important for the larvae production of bocaccio and cowcod, which would contribute to the recovery of these two overfished species. In addition, Hahn and Layne-Farrar (2003) note that in the case of rockfish populations:

Combined with the severely overfished and depleted state of these fish species, the platforms could be making economic contributions to the rockfish fishery that would be lost if the platforms were completely removed upon decommissioning. The full impact of platform removal would be to slow the recovery versus what is estimated and therefore to lengthen the time during which fishing restrictions would be imposed.

In the case of partial removal, increased access (assuming a take designation) may predominantly benefit only stationary gear types, but the continued production from platform communities may contribute to the regional maintenance or recovery of populations also targeted by other gear types.

**Recreational and charter fishing:** The picture for recreational fishing is somewhat clearer. There are published quantitative estimates of the economic value of marine recreational fishing in California overall, and of recreational fishing at platforms in the Gulf of Mexico, although our ability to apply these figures to recreational fishing near platforms in southern California is limited. This is because of the lack of site-specific data for southern California on the number of fishing trips, average expenditures per trip, and estimates of how this might change under each decommissioning option. Despite this, it seems clear that the partial removal option would result in an increase in recreational fishing activity, unless the artificial reefs were designated as no-take zones for California vessels.

Under the complete removal option, if the platform sites are open to fishing by California registered vessels, the socioeconomic impact on recreational fisheries likely will be minimal. Without the aggregation and/or production of fish around platforms, recreational fishermen will only have an incentive to fish at former platform sites if the high relief shell mounds that formed under platforms are left in place and prove to be attractive to species targeted by recreational fishermen even in the absence of the platform structure. However, recreational fishermen, depending on other site selection factors, could still choose not to use these sites. If the shell mounds are cleared and the ocean floor restored to its original condition, recreational fishermen likely will have no more incentive to fish at former platform sites than to fish at other open ocean sites.

Recreational fishermen are likely to benefit under the partial removal option if the platform sites are designated take zones. Certain species may have higher densities (Love & Schroeder 2007) and/or larger sizes (Love et al. 2003) at platforms, although recreational fishing groups in southern California have publicly stated their willingness to accept certain restrictions that would protect the productivity of groundfish populations and other overfished species on the platforms (G. Steinbach, pers. comm. 2010). In addition, variables such as weather, currents, the locations of ports or launch points relative to platforms, and the availability of substitute fishing sites will also affect fishermen's decisions. Platforms located in the Gulf of Mexico, where there is little natural reef habitat, are a popular destination for recreational fishermen; in 1987, Wilson et al. (1987) estimated that 75% of all trips made by Louisiana recreational fishermen targeted platforms. Offshore California, some recreational fishermen have historically fished at platform sites. For example, biweekly interviews from April 1975 to April 1978 with crewmembers of a 16 meter sportfishing vessel based out of Santa Barbara indicated that the vessel spent approximately 18.2% of its total fishing time around five oil platforms, compared with 18.4% over a four-mile natural reef site and 2.4% over a six-mile natural reef site (Love & Westphal 1990). In 1989, subsequent discussions with Santa Barbara party vessel operators indicated that platforms were still fished for small rockfish (Love & Westphal 1990). Moreover, a representative for the Southern California Commercial Passenger Fishing Vessel Industry and board member of the Sport Fishing Association of California stated in 1997 that leaving the platform jackets in place would benefit his user group (McCrea 1997). These historical usage patterns and anecdotal data suggest that at least some recreational fishermen today may be interested in fishing at the platform sites.

If a platform site is designated a no-take site for California registered vessels, the potential direct impacts on recreational fishermen under complete and partial removal will be the same and are therefore not considered here. It is possible, though, that the potential indirect impacts may be more positive under partial removal if a no-take zone contributes to increased biomass of key recreational species that migrate outside the no-take area and are accessible to fishermen.

While the primary data collection and analysis necessary to estimate the potential dollar value impacts associated with each of these options is outside the scope of this report, we highlight here one potential method for filling this data gap and analyzing potential impacts in the future. Other researchers in southern California have used a travel cost model (see Section 5.5 for more detail) to estimate the non-market value of recreational fishing. In short, the travel cost model estimates the amount spent (typically by one individual for one day) to participate in an activity. For estimates of the consumer surplus (i.e., the additional spending beyond what is required to participate in the activity) for recreational fishing, please see <http://www.oceaneconomics.org/nonmarket/valEstim.asp#recfish>. We do not include these values here as they are either dated (e.g., Wegge et al. 1986) or use an unknown methodology (e.g., Kling & Herriges 1995).

Table 5.9 presents the findings of two such studies on the economic value of marine recreational fishing in California. (In order to facilitate comparison between the studies, all dollar values have been converted to 2009\$.)

**Table 5.9. Estimates of the value of marine recreational fishing in California.**

Source	Region	Year	User group	Expenditures/ day
US FWS and US Census Bureau <sup>1</sup>	CA	2006	Saltwater anglers (residents and nonresidents)	\$157 <sup>3</sup>
NOAA <sup>2</sup>	Southern CA	2000	Party/charter boat (residents)	\$103 <sup>4</sup>
			Private/rental boat (residents)	\$47 <sup>5</sup>
			Party/charter boat (nonresidents)	\$618 <sup>6</sup>
			Private/rental boat (nonresidents)	\$275 <sup>7</sup>

<sup>1</sup> (U.S. Fish and Wildlife Service and U.S. Census Bureau 2007)

<sup>2</sup> (Gentner, Price, and Steinback 2001)

<sup>3</sup> Average expenditures/saltwater angler of \$1,569 multiplied by 761,000 anglers and divided by 7,606,000 user days/year.

<sup>4</sup> Total trip expenditures of \$86,735,000 by residents fishing from party/charter boats divided by 840,443 user days/year.

<sup>5</sup> Total trip expenditures of \$78,283,750 by residents fishing from private/rental boats divided by 1,675,297 user days/year.

<sup>6</sup> Total trip expenditures of \$71,617,500 by nonresidents fishing from party/charter boats divided by 115,813 user days/year

<sup>7</sup> Total trip expenditures of \$19,051,250 by nonresidents fishing from private/rental boats divided by 69,205 user days/year.

These estimates are for recreational fishing in the open ocean and may or may not be directly applicable to fishing near or on platforms. Hiett and Milton (2002) found that users accessing platforms in the Gulf of Mexico generally spent more per day than those fishing in the open ocean. Based on data collected in 1999, Hiett and Milton (2002) estimated the difference in expenditures/year between users and non-users of platforms in the Gulf at \$2,015/angler (converted to 2009\$). This difference in expenditures in the Gulf is substantial. Similar data do not appear to exist for California; however, the Gulf example suggests that there are likely to be economic benefits associated with recreational fishing at oil platforms or platforms converted to artificial reefs and that these values could be substantial.

In addition to collecting data on average expenditures/user day or trip, it would be necessary to establish a baseline estimate of total recreational fishers and the relative increase (or decrease) in this baseline associated with each decommissioning option. If the platform sites are designated ‘take zones’ for recreational fishing after the decommissioning process, they could attract new users who did not previously fish, draw existing users away from substitute fishing sites and/or be utilized by individuals who currently fish near the platforms. Therefore, as mentioned previously, to estimate the added value of the platforms, one would need to look at the change in total users (or the change in total trips) across the entire population. Baseline estimates of total user days and total user trips by saltwater fishermen in California can be found in the National Survey of Fishing, Hunting, and Wildlife-Associated Recreation, which is conducted every five years.

Multiplying the change in total users by the average expenditures/user day (or the change in trips by the average expenditures/trip) would provide an estimate of the potential dollar value impact associated with each decommissioning option. We have included placeholders for these values in PLATFORM.

**Nonconsumptive use:** Nonconsumptive SCUBA divers enjoy diving at platforms because of the opportunities they provide for wildlife viewing and underwater photography (Vallete 1999, Schroeder & Love 2004). In California, some platforms are accessed for recreational diving, although it appears that in some cases the companies owning the platforms may limit access even to boats under 100 feet. While we were not able to locate existing studies assessing the overall value of platforms to divers and dive operations, we provide here two examples of values that would potentially be impacted under the complete removal option and to some degree under the partial removal option.

The *Peace* Dive Boat, while no longer able to access the platforms near Ventura for recreational diving, previously operated 6 – 10 trips/year to Platform Grace, generating revenues of approximately \$3,000/day (E. Bowman, pers. comm., 2010). Assuming that these were single-day trips and assuming passengers were not interested in diving at non-platform sites, Platform Grace was responsible for \$18,000–\$30,000 in annual revenues to the *Peace* Dive Boat outfit. The *Magician* Dive Boat, which operates out of San Pedro, currently accesses Platforms Eureka, Elly, and Ellen (J. Lewis, pers. comm., 2010). While the vessel has operated fewer recreational diving trips to these sites in the past two years, in prior years it operated approximately 20 trips/year to the platforms, generating revenues of about \$2,500/trip. This suggests that Platforms Eureka, Elly, and Ellen have contributed substantial annual revenues for the *Magician* Dive Boat.

The transferability of these estimates to other platforms offshore California is limited, however, for two reasons. First, platforms may vary in their desirability as dive sites, due to differences in the abundance and diversity of species found at each. Second, other factors (e.g., company cost structure, vessel capacity, inter- and cross-industry rivalry) will affect the revenues earned by each recreational dive outfit. Nevertheless, these estimates do suggest that there is both current and future economic value associated with nonconsumptive SCUBA diving at platforms that would lead divers and dive operations to prefer partial removal over complete removal.

Partial removal will allow for nonconsumptive diving opportunities starting at 85 feet below the surface. Of the 27 rigs offshore California, 22 are in over 150 feet of water (Table 1.1) and will likely provide opportunities for diving even after the top 85 feet are removed. However, the captain of the *Magician* Dive Boat suggested that fewer divers would be interested in diving to these deeper depths. In general, we can assume that platforms located further from shore will be visited less frequently, although Wilson et al. (1987) found that SCUBA divers in Louisiana were willing to travel 19–47 miles from shore to access Gulf of Mexico platforms. The furthest that divers in California would have to travel to access the platforms offshore California is 10.5 miles (Figure 1.1). Thus, it appears that none of the platforms are so far from shore as to preclude their potential use by divers. Three of the four state platforms are located in shallow water, which may result in limited remaining structure after partial removal option, or partial removal may not be considered a viable option for these platforms.

The primary data collection and analysis necessary to estimate the potential socioeconomic value of complete and partial removal is outside the scope of this project. However, one potentially relevant study illustrates the data collection and analysis methods that could be used to estimate these values in the future. In 2001, MMS used a basic travel cost model to estimate the non-market value of nonconsumptive diving (i.e., the amount spent to participate in the activity). Based on information about the *Liberty* Dive Boat's scheduled diving trips out of Channel Islands Harbor to platform Grace, MMS estimated that each converted oil platform near Channel Islands Harbor could provide \$10,000/year in SCUBA diving value if it is left in place (McGinnis et al. 2001). In 2009\$, \$10,000/year is approximately \$12,100/year. Since dollar values derived through the travel cost method are site-specific, this estimate of \$12,100/year applies only to the four platforms (i.e., Grace, Gina, Gilda, and Gail) near Channel Islands Harbor. There are no estimates in the literature for the value of recreational diving at the other 23 platforms.

Similar to calculating the impact on economic value associated with recreational fishing, a basic travel cost model could be used to estimate the economic value associated with dive trips if the necessary data were collected. For estimates of the consumer surplus (i.e., the additional spending beyond what is required to participate in the activity) for nonconsumptive divers, please see Leeworthy and Wiley (2003) and Leeworthy et al. (2005). We have included placeholders in PLATFORM in the event data become available in the future.

#### 5.3.3.2. *Ecosystem value*

Ecosystem value is a phrase used to describe loosely the benefits that people receive from ecosystem services and impacts on such benefits may differ significantly between the partial and complete removal options. It is necessary to recognize that multiple potential impacts (and associated perceived or stated values from stakeholders) generally fall under the broad category of ecosystem value. In many cases, ecosystem value cannot be measured directly by observing market prices because there is no market for many ecosystem services; it can only be estimated using one of several economic methods, summarized in references such as Bjornstad and Kahn (1996), Champ et al. (2003), Hanley and Spash (1993) or NOAA Coastal Ocean Program (1995). The three components of ecosystem value we consider are:

- Existence/stewardship/cultural value
- Bequest value
- Option value

**Existence/stewardship/cultural value:** This is the value people derive from simply knowing that natural resources exist and are maintained. For example, surveys reviewed by Loomis and White (1996) found a statistically significant willingness to pay among non-angling households to increase fish populations even when the species considered were not threatened with extinction. This suggests that non-angling households benefit from knowing that fish populations are kept healthy. It also suggests that the level of fish populations that is best for society is greater than the minimum viable population size.



**Bequest value:** This is associated with knowing that protection today will preserve ecosystem services for future generations. It is measured by choosing a discount rate to convert the future benefit of a healthy, intact natural environment to its present-day equivalent. Bequest value is relevant to this analysis because the choice of decommissioning option will affect how much of the existing habitat provided by the platform structure is left intact and, for some stakeholders, what type of ocean environment we are leaving for future generations.

**Option value:** This is received from keeping open the possibility of ecosystem services for future use (e.g., keeping genetic information available for medicinal research and/or genetic engineering applications). Option value is difficult to quantify because there is no consensus regarding the time period or geographic area over which impacts should be measured (Schroeder & Love 2004) or which species and/or habitats should be protected first.

**Impacts on ecosystem value:** Certain impacts on ecosystem value will be the same under partial and complete removal because both decommissioning options will remove the top 85 feet of each platform. This zone is important for recruitment of certain species, although it may not be as important as lower portions of the platforms for biomass and larval production (see Section 5.3.1. for more detail). Furthermore, a six-year study by Love et al. (2003) suggest that “platforms act as de facto marine refuges”; in some places, they provide critical opportunities for settlement before larvae are swept out to sea and die. In addition, the topsides of platforms provide habitat for birds and marine mammals; in 1977, researchers observed 20 species of birds and four species of marine mammals including sea lions and gray whales at Chevron’s 4H platforms (McGinnis et al. 2001). While the loss of this habitat may negatively impact many species, Russell (2005) found that in the northern Gulf of Mexico, birds may benefit from removal due to a decrease in mortality due to disorientation and collisions (see Section 5.5.3.1). There are no similar studies the southern California region, although MMS has recently funded a study (MMS Contract # M08PC20024) to examine the effects of artificial lighting on birds in the Pacific OCS Region. For more details on the potential biological impacts of each decommissioning option, please see Section 5.3.4. All these impacts, however, will be the same under partial and complete removal, since they affect resources at the ocean surface or in the upper portion of the water column. As they do not influence the choice between decommissioning options, we do not consider them further.

Partial and complete removal options differ in their impacts on ecosystem value with respect to the lower portion of the platform structure. Partial removal will preserve habitat below 85 feet; complete removal will not (see Section 5.3.4.1. for information on what species are found above 85 feet and what species, and at what sizes and densities, are found below 85 feet). However, complete removal may help restore soft bottom habitats (NOAA 2003-4).

For stakeholders who place a high value on marine habitat, and on diversity of habitat types, it is likely that they will perceive a higher ecosystem value under the partial removal option. This value may be considerably higher if habitat below 85 feet is important to overfished, endangered, or threatened species, such as bocaccio, which is currently listed as a “species of concern”. Fish assemblages at platforms and natural reefs tend to be similar with two main exceptions. Big fish are more abundant at platforms and platforms usually support higher densities of young rockfish than natural reefs (Love et al. 2003). This suggests that some platforms provide nursery grounds

for certain rockfish such as bocaccio and that populations near platforms are important to the population at large and to the chance of recovery. Cowcod, another overfished species, has also been found at platforms. While the densities of mature bocaccio and cowcod are highly variable across platforms and natural reefs, Love et al. (2005) found notably high densities of both species at platform Gail. They estimated that one hectare of sea floor at platform Gail was equivalent to 72 hectares at an average natural reef for bocaccio and 26 hectares at an average natural reef for cowcod (see Section 5.3.1. for a more detailed discussion).

The presence of exotic species on platforms may also impact ecosystem value. One species of bryozoan, *Watersipora subtorquata*, occurs in high cover on Platform Gilda where it has displaced the mussel community over part of the structure, while another species, *Diadumene sp.* (the anemone), occurs on Platform Gail (Page et al. 2008; Page et al. 2006). These non-native species were also found in nearby harbors and structures along the coast. The exotic species could negatively affect populations of native species but could also benefit some fish populations (e.g., the diet of at least one reef fish consisted largely of exotic caprellid amphipods) (Page et al. 2006).

For stakeholders who want an ocean without platforms, it is likely that they will perceive the ecosystem value to be higher under the complete removal option. Complete removal will not necessarily result in a seabed unmarked by industrial activities if pollution or debris from other sources remain (Ekins et al. 2005). Nevertheless, for certain stakeholders, especially those opposed to the oil industry, the commitment to remove all platform structures upon abandonment is important. For example, a representative of a local Surfrider Foundation stated: “We’re not convinced that the alleged scientific benefit to habitat is worth the sort of larger social encouragement it gives the oil companies” (Schroeder and Love 2004).

In summary, we find similarities and differences between the impacts of partial and complete removal on ecosystem value, which to a large degree is dependent on stakeholders’ preferences. Both options will remove habitat to 85 feet below the surface, leading to a loss of habitat above 85 feet. This likely will have a negative impact on some marine mammals (less habitat) and a possible positive impact on birds (less disorientation, collisions, and resulting mortality). Partial removal will leave existing habitat in place below 85 feet for some species (higher ecosystem value); complete removal will not. At the same time, complete removal will contribute to a clear seabed and uphold the principle of site restoration (higher ecosystem value), while partial removal will not. This tradeoff, between habitat preservation under partial removal and site restoration under complete removal, highlights a difference of values between different stakeholders.

A contingent valuation (CV) model (Bjornstad and Kahn 1996, Champ et al. 2003, NOAA Coastal Ocean Program 1995), might allow some estimate of ecosystem value; however, the time and expense required to collect data for a CV model is beyond the scope of this project. We have included a placeholder in PLATFORM to allow decision makers to include an estimate of ecosystem value in future analyses.

#### 5.3.4. Ocean access

In this section, we consider the potential ocean access impacts under complete and partial removal decommissioning options for the five user groups identified below. Where possible, we quantify impacts in terms of the nautical miles<sup>2</sup> either opened or remaining closed to specific activities. These impacts depend in part on the nature of current restrictions and on patterns of recreational and commercial uses. For our purposes, ocean access relates to the ability of users to access or use the ocean and the presence of offshore platforms and their potential decommissioning present a variety of opportunities and constraints for key user groups including:

- Recreational fishing (e.g., charter boat fishing, private vessel fishing, etc.)
- Nonconsumptive boating (e.g., private vessel, charters for bird/animal viewing, etc.)
- Nonconsumptive dive/SCUBA
- Commercial shipping
- Commercial fishing

User groups may access or prioritize access to different strata of the ocean (e.g., surface, water column, bottom) differently and will thus have a direct interest in the choice of decommissioning option because these will affect these strata in different ways. Figure 5.16 illustrates the overall conceptual structure of the analysis, which is based primarily on defining the degree to which access would be constrained under each decommissioning option and how such constraints might affect each user group's activities. As Figure 5.16 illustrates, the output of the modeling analysis is an estimate of the areal extent of any restrictions on access and their relationship to the combined total area of state and federal waters off California.

In addition to these quantitative estimates, we describe what is likely to be each user group's preferred decommissioning option (Table 5.10).

The following subsections provide more detailed information on the estimates of access impacts on each user group and on the rationale for the qualitative assessments of each user group's preferred option. We include a brief discussion of the potential interaction between the partial removal option and future leasing activities because this issue was raised by a key state agency representative, although such interactions are unlikely at best. As for other sections, readers should refer to the description of data gaps (Section 5.5) for more detail on those aspects of the assessment that were constrained due to the availability of only limited data.

##### 5.3.4.1. Current restrictions

Oil platforms off the coast of California in federal waters currently have safety zones established around them by the U.S. Coast Guard District Commander, under authority provided by 33 CFR 147 for the OCS and 33 CFR 165 for state waters, which may extend for a maximum distance of

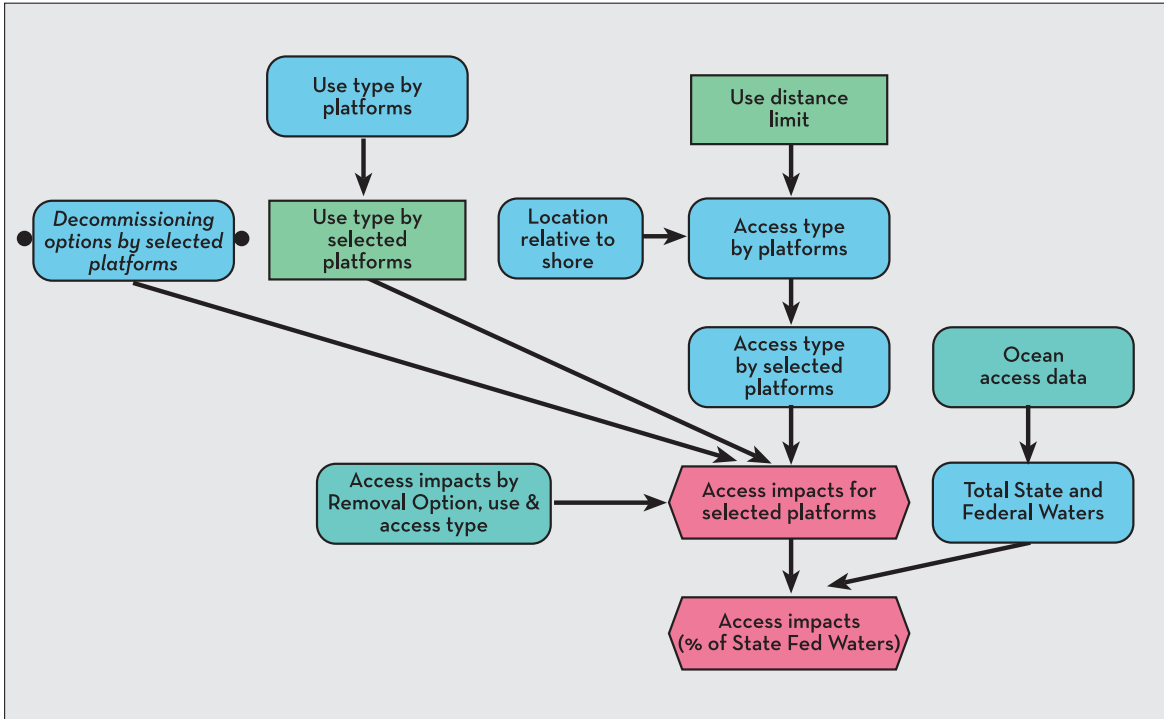

Figure 5.16. Conceptual structure of the analysis of impacts on ocean access. This influence diagram is taken from PLATFORM.

Table 5.10. Likely preferred decommissioning option for each of the five major user groups considered.

User group	Preferred option	Reason
Recreational fishing	Partial	Availability of new fishing opportunities on artificial reef
Nonconsumptive boating	None	Both options remove surface structures and are thus identical at the ocean surface
Nonconsumptive dive	Partial	Availability of new diving opportunities on the artificial reef
Commercial shipping	None	Remain in established shipping lanes that avoid platform locations No realistic risk of collision in either option
Commercial fishing	Varies	Complete removal benefits trawlers and longliners by removing obstructions Partial removal may benefit fishermen who use fixed gear

500 meters around the facility, but may not interfere with recognized sea lanes essential to navigation. Furthermore, for each platform, the regulations describe that “no vessel may enter or remain in this safety zone except:

- “(1) An attending vessel
- (2) A vessel under 100 feet in length overall not engaged in towing
- (3) A vessel authorized by the Commander, Eighth Coast Guard District”

According to these regulations, boats smaller than 100 feet may enter the safety zone; however, users may still choose to avoid the platforms due to the risk of gear and equipment damage/loss. Thus, site availability, the legal ability to access an oil platform site (as defined above), is not the only factor affecting choices about whether or not to use the site. Other factors such as weather, currents, distance from port, and site desirability, among others, may affect such choices. Comprehensive data describing the extent to which platform safety zones are currently accessed by user groups (with boats smaller than 100 feet) were not available at the time of this study, although we were able to gather some anecdotal information (for example, recreational party boats conduct SCUBA diving trips to Platforms Grace and Edith; see the discussion on nonconsumptive use in Section 5.3.3.1. for more detail). Collection of these types of data, in order to establish baseline use patterns, is necessary to assess the potential economic impact on user groups accessing these areas. However, in this section we will attempt to describe broadly potential impacts associated with different access scenarios.

#### *5.3.4.2. Recreational fishing patterns*

Recreational fishermen in the Gulf of Mexico fish an average of 25 miles from shore and charter fishermen in Louisiana may travel up to 16 – 40 miles to fish (Wilson et al. 1987). In California, all 27 platforms are within 10.5 miles of shore (SLC MRM Division); however, it is likely that the decision to access certain platforms is more a function of distance from port or launch point, which in many cases is greater than from distance to shore. To provide a first cut estimate of current recreational fishing use patterns in southern California, we analyzed data collected by Ecotrust for the South Coast Study Region of the Marine Life Protection Act (MLPA) Initiative (Scholz et al. 2009). We analyzed data collected from recreational fishermen targeting rockfish, a species whose relationship with platform habitat has been established (see Section 5.3.1.1). Fifty-nine percent of the recreational rockfish fishing grounds are within three nautical miles of shore (i.e., within state waters), 33% are between three and ten nautical miles from shore, and the remaining 8% are beyond ten nautical miles from shore. Table 5.11 shows the number of platforms that fall within these three ranges.

While multiple factors are likely to affect fishing choices under either decommissioning option, this preliminary analysis suggests that platforms located closer to shore and/or closer to major coastal ports will be accessed more often by recreational fishers than those located further away.

**Table 5.11. Location of platforms relative to location of recreational rockfish fishing grounds. Percentages are the percentage of recreational fishing grounds within each distance from shore (based on data from CSLC MRM Division).**

Distance from shore (nautical miles)	# of platforms	% of recreational rockfish fishing grounds
<3 miles	4	59%
3-10 miles	22	33%
>10 miles	1	8%

#### 5.3.4.3. Short- and long-term effects

Decommissioning impacts on ocean access may be short-term or long-term. We define potential short-term impacts as those that may occur during the platform removal process itself and potential long-term impacts as those that may occur after decommissioning is complete. The number of days necessary for removal varies both by decommissioning option and by platform. Based on estimates from Proserv Offshore (2010), the number of days for complete removal (not including prep time or contingency time) ranges from 29 – 147 days<sup>3</sup>, with an average of 57 days across all platforms. Similarly, the estimated number of days for partial removal ranges from 28 – 51 days, with an average of 38 days. During this time, there will likely be increased congestion and vessel traffic through the area around the decommissioning site and between the site and mainland ports and staging locations. In addition, if the barges and machinery necessary for removal have wide anchor spreads, the no-go zones around each platform may be slightly larger than they are now. These potential short-term impacts are not included in PLATFORM due to their limited duration, their relative similarity to the status quo, and the fact that they will likely be small compared to the existing volume of shipping traffic.

Potential long-term impacts, which we discuss below, will be included in the model as an estimate of the increased area available to users, and as an input to potential impacts on economic value associated with commercial and recreational fishing and SCUBA diving.

**Complete removal option:** The complete removal option will result in a clean ocean surface and an unobstructed water column. Depending on whether the shell mounds beneath the platform are removed or left in place, it may also result in an unobstructed ocean bottom. Fishermen and boaters will see a marginal increase in accessible area due to removal of the platform itself, while vessels over 100 feet will see an additional increase in accessible area associated with elimination of the safety zone. Trawl and longline fisheries likely will see the greatest increase in access due to elimination of hazards (e.g. platform, shell mounds) that could potentially snag these users’ gear and equipment (McGinnis et al. 2001; Ekins et al. 2005). In contrast, the impact on commercial shippers, recreational fishermen, and nonconsumptive divers may be zero – shipping vessels will most likely continue to use established shipping lanes and routes; divers do

<sup>3</sup>This does not include the estimate for the Emmy satellite.

not generally dive in the open ocean; and the bottom types where platforms have been located are not very desirable to recreational fishers, who tend to prefer rocky, high relief areas (Schroeder & Love 2004).

Table 5.12 estimates the increase in ocean surface, water column, and ocean bottom area available to access under the complete removal option as an absolute value (i.e., nautical miles<sup>2</sup>) and as a percentage of the total state and federal waters off the State of California. Based on interviews with commercial fishermen, we assume that they currently give platforms a wider berth than do other users and that their increase in access would therefore be greater if platforms are completely removed.

**Table 5.12. Increase in access to areas around platforms under the complete removal option. All values in nautical miles<sup>2</sup>. Percentages are of the combined total of state and federal waters off the State of California.**

User group	Per platform	All platforms	All platforms (% of total)
Recreational fishing	0	0	0.00%
Nonconsumptive boating	0.30	8.10	0.04%
Nonconsumptive dive/scuba	0	0	0.00%
Commercial shipping	0.30	8.10	0.04%
Commercial fishing	1.60	43.20	0.21%

**Partial removal option:** The partial removal option will differ from complete removal in that only the ocean surface and the top 85 feet of the water column will be cleared; the shell mounds on the ocean bottom, along with the portion of the platform 85 feet or more below the surface will remain. Under the partial removal option, we consider two cases: if a platform site is designated as a ‘take’ zone, that is, the take of fish and other marine species is permitted, and if a site is set aside as a ‘no take’ zone in state waters, or as a no-take zone for California-licensed vessels in federal waters of the OCS (see Section 6.1.1.3 for more detail on the state’s authority to control fishing activities in the OCS). Given the locations of the platforms and the distance vessels would have to travel from other jurisdictions, we assume that any no-take designation around platforms in the OCS for California vessels would result in a near-complete de facto no-take zone. It is possible that a combination of these two management approaches (i.e., take and no-take) will be used across the 27 sites considered in this study.

If a platform site is designated as a ‘take’ zone, all five user groups will see a marginal increase in area they can, in principle, access. The actual impact of this increase on commercial shipping will likely be zero because platform locations are outside shipping routes and there will be little risk of collision (the top of the cut off platform would be below the draft of the largest supertanker). The impact on commercial fisheries is unclear — while those with mobile gear

(e.g., trawlers, longliners, driftnetters) will likely avoid the sites due to the risk of gear and equipment damage/loss (Wilson et al. 1987), those with stationary gear (e.g., hook and line, trap, crabbers, lobstermen, shell fishermen who use nets) may choose to now access these areas (McGinnis et al. 2001). Removal of potential hazards potentially will allow for increased access by nonconsumptive boaters and recreational fishermen, and nonconsumptive divers will see increased access to sites with platform habitat (below 85 feet) still intact.

If the platform sites are set aside as no take reserves, nonconsumptive users (i.e., shippers, boaters, and divers) will see a marginal increase in area to access, but consumptive users (i.e., commercial and recreational fishermen) will not. Table 5.13 estimates the increase in ocean surface, water column, and ocean bottom area available to access under the partial removal scenario as an absolute value (i.e., nautical miles<sup>2</sup>) and as a percentage of the total state and federal waters off the State of California.

**Table 5.13. Increase in access to areas around platforms under the partial removal option. All values in nautical miles<sup>2</sup>. Percentages are of the total state and federal waters off the State of California.**

User group	Per platform	All platforms	All platforms (% of total)
Shipping	0.30	8.10	0.04%
Nonconsumptive boating	0.30	8.10	0.04%
Nonconsumptive dive/scuba	0.007	0.19	0.00%
Recreational fishing	0.007	0.19	0.00%
Commercial fishing	0.30	8.10	0.04%

#### 5.3.4.4. Preferred option

Based on access considerations only, each user group considered will have a preferred decommissioning option. Commercial shipping vessels and nonconsumptive boaters will likely be indifferent between complete and partial removal because both options will remove all surface structures and there will be little risk of collision and/or damage to any vessel. Nonconsumptive divers likely will prefer partial removal as this will provide them with access to new diving opportunities (Schroeder and Love 2004). Recreational fishermen will probably also prefer partial removal, as they would have the opportunity to fish directly above the platforms as well as along the sides of the platforms. The preferred option for commercial fishermen is unclear – while complete removal may benefit trawlers and longliners, who need unobstructed ocean floor, partial removal may benefit fishermen who use stationary gear types (e.g., hook and line, trap, crabbers, lobstermen, shell fishermen who use nets).



A number of data gaps exist at this time, and filling gaps could affect the analysis and/or our expectations about the option preferred by one or more user groups. One data gap is the uncertainty of future fisheries management decisions. There may be interest in setting aside some or all of the platform sites as no take zones, but it is not clear which platforms might receive this designation. Another data gap is the desirability of the platforms to commercial and recreational fishermen. An estimate of this value could be obtained through either primary data collection or a review of existing data (e.g., Ecotrust's data collection effort for the MLPA Initiative). We have included placeholders in PLATFORM in the event data on the desirability of the platforms to commercial and recreational fishermen become available.

#### *5.3.4.5. Impacts on trawling*

As discussed in the previous section, the decommissioning options could have a range of consequences on commercial fishing opportunities, by either increasing access or leaving remaining de facto closures in place. These changes to access would be overlaid on spatial management controls on commercial trawling, which is prohibited in certain essential fish habitat (EFH), rockfish conservation areas, and cowcod conservation areas. The Point Conception EFH includes platforms Hermosa, Harvest, Hidalgo, and Irene. Rockfish conservation areas protect certain depth contours that include Hondo, Hermosa, Harvest, Gail, and Eureka. Cowcod conservation areas are further offshore (near and including San Nicholas and San Clemente islands) and are removed from any platforms. The EFH and rockfish conservation closures would therefore limit the ability of the two major trawl fisheries in southern California, for California Halibut (*Paralichthys californicus*) and Ridgeback Prawn (*Sicyonia ingens*), to utilize areas opened to access by the complete removal of these platforms. In currently trawled areas, removal of platforms A, B, C, Hillhouse, Hogan, Henry, Houchin, Habitat, Grace, Gilda, Gail, Gina, and Holly would increase trawling access. Platforms Heritage, Harmony and Hondo appear to be in unsuitable trawling habitat. Platform Irene appears to be on the edge of the trawling track directly north of Point Conception and therefore in an area that may be of interest to trawlers.

#### *5.3.4.6. Impacts on new oil and gas leasing activities*

In the event that new offshore oil and gas leasing and/or drilling is planned in the future, the complete and partial removal options would affect such activities in almost identical ways. However, it is not possible at this point to assess the likelihood of such future leasing and/or drilling activities; this would depend on a combination of political and economic factors that are difficult to predict and are beyond the scope of this project.

Despite political opposition in California to offshore oil and gas leasing, the Bush administration issued a draft five-year leasing program that identified 2.8 million acres in the Santa Barbara Channel and Santa Maria Basin for leasing. Many exploratory drilling efforts occurred in units in proximity to producing units with platforms (e.g., Sword, Bonito). While these leases were bought back by the federal government, they nevertheless represent undeveloped reserves in proximity to existing platforms. They are close enough that a major spill from a new platform or connecting pipeline in these units could adversely affect marine resources on the artificial reef.

However, with current technology that utilizes slant drilling, platforms can extract oil and gas within a radius of several miles around the platform. Thus, it is unlikely that any new drilling or new platform construction would take place in the direct vicinity of decommissioned platforms under either the complete or partial removal options. Utilizing slant drilling, new wells could be drilled from a distance into the vicinity of older decommissioned platforms, as long as the new operators had very good information on the locations and bottom end points of the old wells. When platforms are decommissioned, under both the complete and partial removal options, the wells are plugged but not for their entire length. Thus, a new operator would want to avoid inadvertently drilling into an old well because they might encounter high pressures that could damage equipment. Under the partial removal option, the presence of an artificial reef (i.e., a decommissioned platform) on an oil and gas lease would not prevent the development of oil and gas resources under the reef. This is because directional drilling would enable the new operators to access resources under the artificial reef from some miles away. This discussion pertains primarily to decommissioned platforms in the OCS because any resources within state waters (i.e., three miles from shore) would be readily accessible from an onshore drilling site.

In addition to these operational considerations, the CCC would review any federal actions in the OCS under its consistency review authority. This would not be triggered by the presence of a state-owned artificial reef in the OCS but would occur as a function of the state's existing legal authority to review any federal activity that may produce direct effects on state territory. Nevertheless, as part of that review, the CCC may decide to consider the presence of a state-owned artificial reef in the vicinity of any proposed new drilling and/or platform construction, although it is difficult to predict what form this consideration might take. For example, if the artificial reef is an active recreational fishing site, the CCC could consider how the presence and operation of a new platform would impact recreational users. Conversely, if the artificial reef has been designated a no-take zone for California licensed vessels, the CCC could argue against nearby development activities because of the risk of impacts such as oil spills and platform discharges, among other factors.

### **5.3.5. Birds and marine mammals**

In this section, we summarize available information on the abundance and distribution of birds and marine mammals in the region, and on the potential impacts of decommissioning operations. However, any quantitative prediction or estimate of such impacts would require detailed information on bird and marine mammal distribution and abundance at each platform, as well as sound profiles of the types of equipment involved in decommissioning, and species-specific knowledge about sound impacts. It would also depend on more site-specific information on the risks posed to birds by collisions with platforms and on the importance of platforms as roosting and feeding sites. In the absence of such information, our overall assessment is necessarily qualitative in nature (Tables 5.14 and 5.15). For both birds and marine mammals, we found little to distinguish between the complete and partial removal decommissioning options, although there were differences between expected short- and long-term impacts. The risks of the identified short-term impacts may be greater for the complete removal option because equipment will be on site for a longer period of time.

**Table 5.14. Short- and long-term effects of decommissioning on birds. Short-term refers to the period of the decommissioning activities, while long-term refers to the post-decommissioning timeframe. The two decommissioning options are not shown separately because their effects are similar in kind for both complete and partial removal options.**

	Positive	Negative
Short-term		<p>Increased flight hazards and increased mortality from additional equipment on site</p> <p>Interference with roosting and feeding behaviors</p> <p>Explosive removal may affect diving birds</p>
Long-term	Reduced flight hazards and decreased mortality	Permanent removal of roosting and feeding sites

**Table 5.15. Short- and long-term effects of decommissioning on marine mammals. Short-term refers to the period of the decommissioning activities, while long-term refers to the post-decommissioning timeframe. The two decommissioning options are not shown separately because their effects are similar in kind for both complete and partial removal options.**

	Positive	Negative
Short-term		<p>Potential increased disturbance of migration and feeding behaviors</p> <p>Noise effects of explosives can be significant</p>
Long-term	<p>Removal of sound sources</p> <p>Removal of all impediments to movement</p>	<p>Removal of potential feeding areas</p> <p>Noise effects of explosives can potentially result in long-term damage</p>

Offshore platforms are used by marine mammals and birds as both haul out or roosting areas and feeding grounds, and many of the platforms are situated in or near migration routes for both birds and marine mammals. These organisms’ use of the platform structures and nearby areas raises concerns about the potential negative impacts of decommissioning activities. These concerns are particularly important to the public and to managers because birds and marine mammals arouse intense public interest and are explicitly protected under provisions of several federal laws (Migratory Bird Treat Act of 1918, as amended (16 U.S.C. §§ 703-712), Endangered Species Act of 1972, as amended (16 U.S.C. § 1531 et seq.), Marine Mammal Protection Act of 1972, (as amended (16 U.S.C. §§ 1361-1407)). As a result of these concerns and legal protections, MMS decommissioning regulations call for mitigation of the potential impacts of explosive use, based on detailed requirements (i.e., monitoring surveys, exclusion zones, suspension of operations) established in NMFS’s Biological Opinion (NMFS 2006). (These regulations include sea turtles, but this section focuses on birds and marine mammals because sea turtles are rarely if ever

encountered around the California platforms (Padre Associates Inc. 2005, SAIC 2003). Extensive monitoring surveys conducted during the 4H Project documented the presence of a handful of threatened or endangered bird species on or around the platforms but only one such marine mammal species (humpback whale).

While there is information on the local distribution and relative abundance of the bird and marine mammal species of most concern (either because they are most abundant or because of their protected status), there is little information on decommissioning impacts that is directly relevant to the southern California region. For example, studies in the Gulf of Mexico document the importance of offshore platforms as bird roosting sites during feeding and as resting stops during migration. In addition, platforms in the Gulf of Mexico are a source of mortality due to nighttime disorientation and collisions. However, analogous studies have not been conducted in California. Similarly, there are laboratory and theoretical studies that suggest birds would be susceptible to noise and particularly to the loud sounds and concussive effects of explosives. However, no bird injuries or mortalities resulted from detonations during the 4H Project (SAIC 2003).

Current understanding of potential decommissioning impacts on marine mammals is also somewhat uncertain and the prediction of specific impacts is limited both by the lack of data on more than a few species and by the lack of any data on possible long-term impacts. The largest potential source of impact is increased levels of sound, which has been shown to affect movement and feeding patterns. Equipment operating on-site and increased vessel traffic between platforms and nearby ports would be important sources of increased sound, although, as with birds, the possible use of explosives during decommissioning is the primary source of concern. As with birds, however, no impacts were observed during any of the 4H Project's decommissioning operations (SAIC 2003).

As for other sections, readers should refer to the description of data gaps (Section 5.5) for more detail on those aspects of the assessment that were constrained due to the availability of only limited data.

#### 5.3.5.1. *Birds*

The overall conceptual structure of the analysis of potential decommissioning impacts on birds is illustrated in Figure 5.17.

The Southern California Bight (SCB) is home to a diverse group of marine avifauna. About 195 species of birds live within this region, both along the coastline and at the Channel Islands (Mason et al. 2007). The majority of these species vary significantly in abundance throughout the year since they are migratory species traveling the Pacific Flyway. Common marine avifauna within this region include loons (*Gaviidae*), grebes (*Podicipedidae*), shearwaters and petrels (*Procellariidae*), cormorants (*Phalacrocoracidae*), scoters (*Aythiinae*), murrelets and murre (*Alcidae*), gulls, and terns (*Laridae*). Birds are protected under several levels of regulation in California. Most are protected under the federal Migratory Bird Treaty Act and several have threatened or endangered status under the federal Endangered Species Act (ESA).

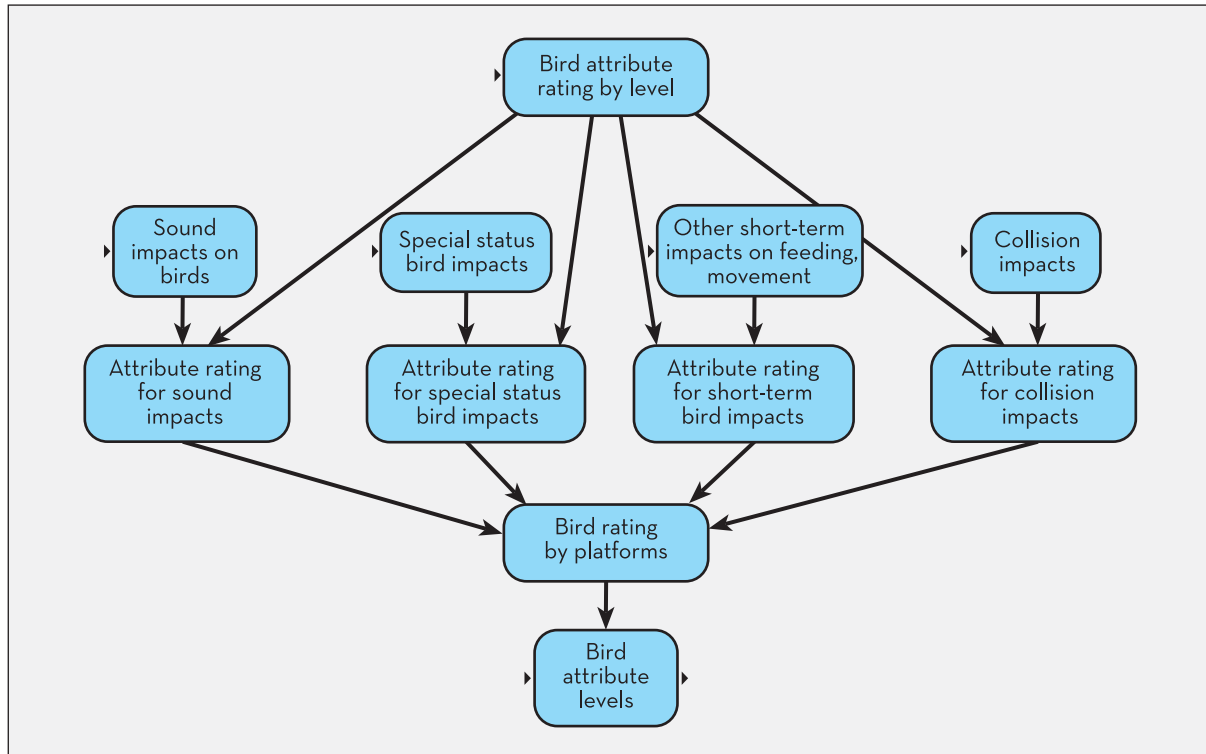

**Figure 5.17. Conceptual structure of the analysis of impacts on birds.**

**Distribution and status:** During the 4H decommissioning project in the Santa Barbara Channel, the most abundant avifauna observed within the immediate area were western gulls (*Larus occidentalis*) and California brown pelicans (*Pelecanus occidentalis californicus*) (SAIC 2003). Other species included the double-crested cormorant (*Phalacrocorax auritus*), the sooty shearwater (*Puffinus griseus*), the northern phalarope (*Lobipes labatus*), and the northern fulmar (*Fulmaris glacialis*). Table 5.16 lists birds with special status observed during the 4H decommissioning Project.

Several other birds that may occur around platforms off California are classified as Species of Special Concern (SAIC 2003), including:

- Double-crested cormorant (*Phalacrocorax auritus*)
- Elegant tern (*Sterna elegans*)
- Western snowy plover (*Charadrius alexandrinus nivosus*)
- Long-billed curlew (*Numenius americanus*)
- California gull (*Larus californicus*)
- Common loon (*Gavia immer*)
- Ashy storm petrel (*Oceanodroma homochroa*)
- Black storm petrel (*Oceanodroma melania*)
- Rhinoceros auklet (*Cerorhinca monocerata*)

**Table 5.16. Occurrence of threatened and endangered bird species in or near the 4H decommissioning site (adapted from Table 3.4-5 in SAIC (2003)).**

Species	Status	Occurrence in SCB	Reported near Project Site*	Potential Occurrence
California brown pelican	Endangered	Common	Common	Likely
Marbled murrelet	Threatened	Uncommon and only seasonal	No	Possible nearshore
California least tern	Endangered	April through September	No	Possible; low numbers
Western snowy plover	Threatened	Uncommon	No	Extremely remote offshore
Light-footed clapper rail	Endangered	Uncommon	No	Extremely remote offshore
Xantus' murrelet	Threatened (CA)	Common	No	Possible

\* Within 4 nmi

Sources: USFWS 1980, 1983, 1997 and 2001; Keane 2000; MMS 2001

**Platform and decommissioning impacts:** Birds are attracted to offshore oil platforms due to structural stimuli, food concentrations in the area, oceanographic processes, lights and flares, and the opportunity to use the structures as resting stops along migration routes (Wiese et al. 2001, Farnsworth and Russell 2007). Of these, the most likely reasons for their use of oil platforms are the availability of roosting habitat at sea and the provision of reliable food sources (Wiese et al. 2001). Birds can be up to seven times more dense (birds/ km<sup>2</sup>) within a 500-meter radius of an oil platform than surrounding waters (Tasker et al. 1986), but very little additional research has been done on bird's usage of oil platforms as habitat. The bulk of the work discussed below has been performed at platforms in the Gulf of Mexico or the North Sea.

Wiese et al. (2001) found that oil platforms in the north-west Atlantic Ocean may have detrimental effects on migratory birds because they are attracted to the platforms by artificial lighting and flares. Bird mortalities have been reported in this area due to impact on the structure, or burning by the flares. Birds, most likely from an instinct that associates light and smell with food, have been known to circle platforms or their associated flares for days on end until eventually dying of starvation (Bourne 1979). These circulating flight patterns not only put birds at risk for collisions, but also cause a non-useful expenditure of energy (Russell et al. 2005). Available information from the Gulf of Mexico estimates that some 200,000 deaths of migratory birds from collision with offshore oil platforms occur each year (Russell 2005). Such information does not exist for platform collisions off California. However, since the southern California coastline is part of the Pacific Flyway, the potential for collisions is present.

In the Gulf of Mexico, birds utilize platforms as resting stops during on their migration routes (Farnsworth and Russell 2007, Russell et al. 2005). These species may be utilizing platforms as visual cues for organizing their flock, since their calls were heard from platforms in the Gulf of Mexico primarily during nighttime hours (Farnsworth and Russell 2007). According to Russell et al. (2005) on birds in the Gulf of Mexico, platforms have three primary impacts on migrant birds: they provide habitat for resting and feeding, they induce nocturnal circulations, and they result in some mortality through collisions. Particularly in the spring, during the late period of migration for many bird species, platforms seem to be beneficial for birds that may be close to starvation, and need a stopover habitat to complete their journey (Russell et al. 2005). In the Gulf of Mexico, where nearly 4000 offshore platforms are installed, these structures appear to facilitate the evolution of trans-Gulf migration patterns by providing “stepping stones” allowing certain migratory species to cross the Gulf successfully using a series of shorter flights (Russell et al. 2005). A particularly important beneficiary species of oil platforms in the Gulf of Mexico has been the Peregrine Falcon (*Falco peregrinus*). This endangered species underwent a dramatic recovery that began to occur during the rapid expansion of offshore oil production in the Gulf of Mexico. Currently, the majority of juvenile Peregrine Falcons living in the Gulf of Mexico area utilize oil platforms during the fall for both resting and hunting, which suggests that this species may soon establish a breeding population on the Gulf of Mexico platform archipelago (Russell et al. 2005).

If explosives are used during the decommissioning process, their effects on diving birds in the immediate vicinity could be significant, and mitigation surveys would therefore be conducted as in previous projects (SAIC 2003). There is little research on the effects of explosive underwater sound on diving birds. One study suggested that diving birds subjected to impulse levels of more than 45 psi–millisecond would suffer heavy losses. Below 20 psi–millisecond, 50 percent of the birds could suffer from slight lung injuries or tympanic membrane ruptures, but would be expected to survive (SAIC 2003). In general, it is accepted that diving birds may be especially susceptible to the concussive effects of underwater detonations because of their small body sizes. Birds can probably detect and localize very low frequency sounds, especially if such sounds are intense (Bowles 1995) and much of the sound spectrum produced by a detonation would be audible to birds and could result in harassment if the birds were close to the detonation site (SAIC 2003). Wildlife hazard and buffer zones (a radius around the project within which the observation of key species would require that activities that pose a risk be suspended) would therefore be established around construction zones during decommissioning. The size of these zones would be based on experience from past projects, the best estimates of safe sound pressure zones, and the current state of knowledge of bird hearing (SAIC 2003). Despite the potential for such impacts, no bird injuries or mortalities resulted from detonations used during the 4H Platform Decommissioning Project (SAIC 2003).

Since both decommissioning options, complete and partial removal, will remove all surface structures, as well as underwater structures down to at least 85 feet depth, there will be no difference in the two options’ long-term effects on birds. In the short term, during decommissioning activities, potential impacts of the two options are similar in kind, but the risk of short-term impacts may be greater for the complete removal option because equipment will be on site for a longer period of time. Table 5.14 summarizes the positive and negative short- and long-term effects of decommissioning on birds.

### 5.3.5.2. Marine mammals

The overall conceptual structure of the analysis of decommissioning impacts on marine mammals is illustrated in Figure 5.18.

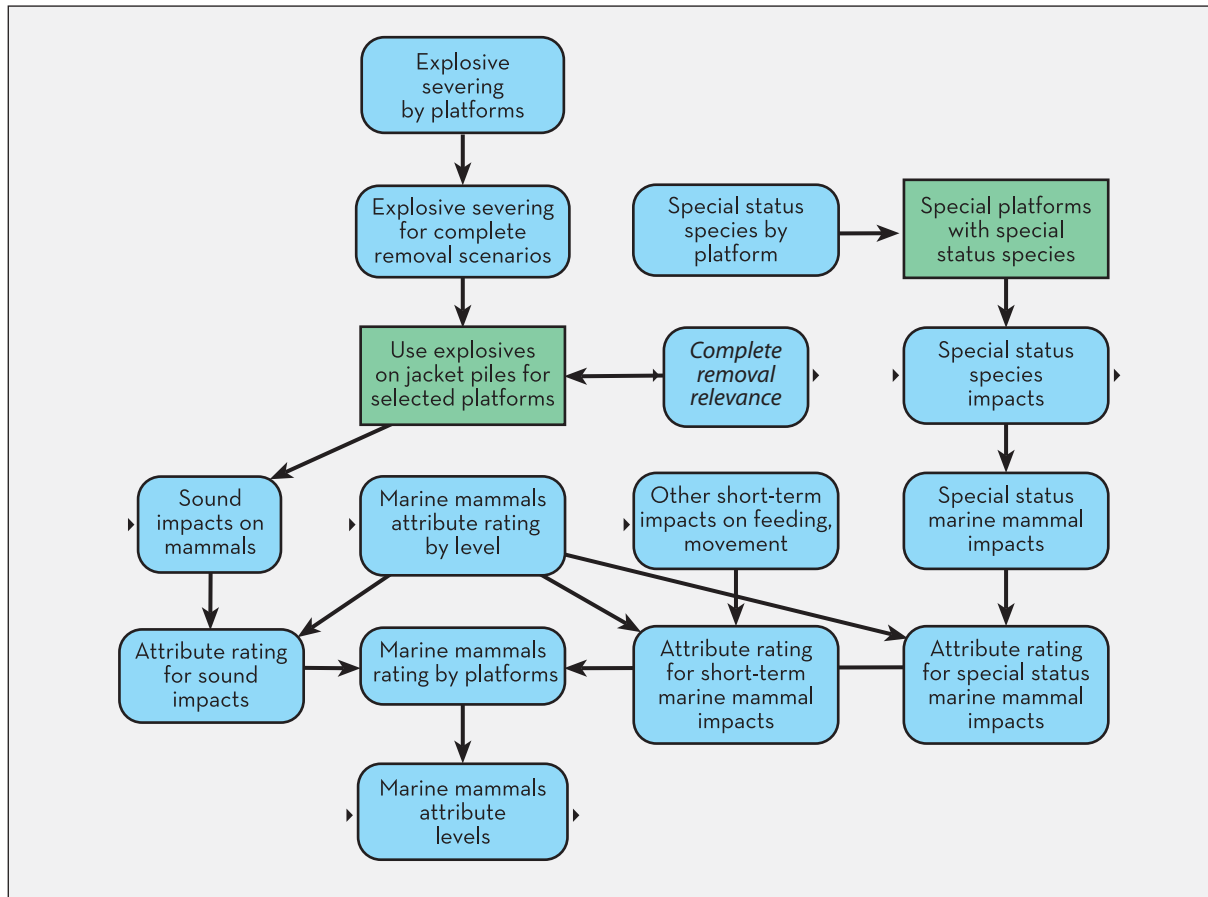

**Figure 5.18. Conceptual structure of the analysis of impacts on marine mammals.**

At least 42 species of marine mammals have been reported to occur in the SCB, but less than half of these are common residents, with the remainder occurring only occasionally or migrating through the region seasonally. All marine mammals are protected under the federal Marine Mammal Protection Act (MMPA) and its amendments. Off California, six species of marine mammals are listed as endangered under the federal ESA, while another three species are listed as threatened.

**Distribution and status:** Table 5.17 illustrates the seasonal occurrence of the more common marine mammals found locally in the northern portion of the SCB.



**Table 5.17. Species of marine mammals and their periods of occurrence locally (adapted from Table 2.4-5 in Padre Associates, Inc. (2005)). Species highlighted in bold are more likely to be found in the Santa Barbara Channel.**

Species	Month of Occurrence											
	J	F	M	A	M	J	J	A	S	O	N	D
<b>California gray whale</b>	■	■	■	■	■	■	□	□	□	□	■	■
Fin whale (E)	□	□	□	□	■	■	■	■	■	■	□	□
Blue whale (E)	□	□	□	□	■	■	■	■	■	■	□	□
Humpback whale (E)	□	□	□	□	■	■	□	□	■	■	■	■
<b>Common dolphin (both spp.)<sup>(1)</sup></b>	■	■	■	■	■	■	■	■	■	■	■	■
Northern right-whale dolphin	■	■	■	■	■	□	□	□	□	□	□	■
<b>Pacific white-sided dolphin<sup>(2)</sup></b>	■	■	■	■	■	■	■	■	■	■	■	■
Risso's dolphin	■	■	■	■	■	■	■	■	■	■	■	■
Dall's porpoise <sup>(1)</sup>	■	■	■	■	■	■	■	■	■	■	■	■
<b>Bottlenose dolphin</b>	■	■	■	■	■	■	■	■	■	■	■	■
<b>California sea lion</b>	■	■	■	■	■	■	■	■	■	■	■	■
Northern elephant seal <sup>(3)</sup>	■	■	■	■	■	■	■	■	■	■	■	■
<b>Pacific harbor seal</b>	■	■	■	■	■	■	■	■	■	■	■	■
Relatively even distribution	■		□				■				■	
	Not expected to occur						More likely to occur due to seasonal distribution					

(E) Federally listed Endangered species

(T) Federally listed Threatened species

(1) Winter-Spring distribution is mostly south of Pt. Conception

(2) Spring-Summer distribution is mostly south of Pt. Conception

(3) Common near land during winter breeding season and spring molting season

Sources: Bonnell and Dailey (1995), Bonnell et al. 1981, NMFS (2000)

In addition to these more commonly occurring species, several others found in the SCB are listed as endangered or threatened (Table 5.18), although most of these are rarely observed in the region. For example, the only federally listed marine mammal species observed during the 4H Platform Shell Mounds Disposition project were two blue and eight humpback whales, none of which were observed closer than 14 nm from the nearest shell mound (SAIC 2003). The California gray whale (*Eschrichtius robustus*) was delisted in 1993 after the stock recovered (Rugh et al. 1999). Some species are listed as ‘depleted’ under the MMPA, i.e., their population has fallen below optimum sustainable levels; such species include both the northern right whale and the sperm whale. Unlike for many other threatened or endangered species, no critical habitat has been established for marine mammals in the SCB. As a result, habitat is not a consideration in mitigating the potential impacts of decommissioning projects.

**Table 5.18. Occurrence of threatened and endangered species of marine mammals in or near the 4H decommissioning site (adapted from Table 3.4-3 in SAIC (2003)).**

Species	Status	Occurrence in SCB	Reported Near Project Site*	Potential Occurrence
Sei whale	Endangered	Extremely rare	No	Extremely remote
Blue whale	Endangered	Seasonally abundant in channel	No	Remote
Fin whale	Endangered	Uncommon in channel	No	Extremely remote
Humpback whale	Endangered	Seasonally abundant in channel	Occasionally in season	Possible in season
Northern right whale	Endangered	Extremely rare	No	Extremely remote
Sperm whale	Endangered	Rare in channel	No	Extremely remote
Steller sea lion	Threatened	Extremely rare	No	Extremely remote
Guadalupe fur seal	Threatened	Rare	No	Extremely remote
Southern sea otter	Threatened	Small numbers elsewhere	No	Unlikely

Extensive marine mammal surveys were conducted by Chevron between 1996 and 1998 in preparation for the planned decommissioning of five platforms (Gail and Grace, south of Ventura; Hermosa, Harvest and Hidalgo, southwest of Point Arguello) (Howorth 1998b, SAIC 2003). These studies provide some insight into the species likely to be seen during future decommissioning projects in the region. Species observed included Common dolphin (*Delphinus* spp.), Bottlenose dolphin (*Tursiops truncatus*), Risso's dolphin (*Grampus griseus*), Pacific white-sided dolphin (*Lagenorhynchus obliquidens*), California gray whale (*Eschrichtius robustus*), Blue whale (*Balaenoptera musculus*), Humpback whale (*Megaptera novaeangliae*), Minke whale (*Balaenoptera acutorostrata*), California sea lion (*Zalophus californianus c.*), and Pacific harbor seal (*Phoca vitulina richardsi*) (SAIC 2003).

Monitoring conducted during the 4H decommissioning project documented the occurrence of only six species of marine mammals in the immediate vicinity of the structures, only two of which (California sea lion and Pacific harbor seal) were observed in or near the 3,000-foot hazard zone established to protect marine mammals from the effects of explosives (SAIC 2003):

- Humpback whale (*Megaptera novaeangliae*)
- Minke whale (*Balaenoptera acutorostrata*)
- Long-beaked common dolphin (*Delphinus capensis*)
- Coastal bottlenose dolphin (*Tursiops truncatus*)

- California sea lion (*Zalophus californianus c.*)
- Pacific harbor seal (*Phoca vitulina richardsi*)

While informative, it is not necessarily safe to assume that platforms further offshore than the 4H platforms would also have a similarly low number of marine mammals present during decommissioning activities.

**Platform and decommissioning impacts:** The main potential source of impact on marine mammals is increased noise from decommissioning activities. Increased levels of ocean noise can negatively affect marine mammals by interfering with their ability to detect other sounds such as echoes from prey or calls from their own species (McDonald et al. 2008). Areas of the ocean with high vessel traffic can have double the acoustic power of less trafficked locations; large oil tankers can contribute twice as much noise to a region as cargo ships, and 100 times more noise than research vessels (Hatch et al. 2008). Thus, the presence of large vessels on-site during decommissioning, as well as increased traffic to and from nearby ports, would raise concerns about potential sound impacts. In addition, the presence of many vessels along a migration route can increase the chances of ship strikes on marine mammals. However, the use of explosives on the platform legs would add the most significant amount of noise to the surrounding environment, although these would be short-term events.

In general, marine mammal hearing is poorly studied with only limited information available on individual species. Documented, short-term responses of cetaceans to anthropogenic noise include longer dive times, shorter surface intervals, evasive movements away from the sound source, and changes in vocalization durations or levels (Norris 1994, Croll et al. 2001). Despite increased concerns about the effects of anthropogenic noise on marine mammals, long-term effects are extremely hard to quantify (Croll et al. 2001) because the spatial and temporal scales of such studies are simply too short to distinguish long-term effects (Andre 2009). Nevertheless, Croll et al. (2001) argue that increased noise may be creating biologically significant reductions in foraging efficiency, survival, and/or reproductive success. Since decommissioning activities are likely to continue for some time (it may require several months of staging and on-site effort to completely remove the larger platforms, and it is likely that several platforms will be decommissioned as a group because of the cost of mobilizing and demobilizing decommissioning equipment), both short- and long-term sound impacts are a potential concern.

In California, gray whales have received particular attention with regards to offshore oil activities because they pass through southern California twice each year, from December to May, and their migration route passes close to shore in areas such as the Santa Barbara Channel and Santa Maria Basin. Studies on effects of oil platform noise on gray whales found that migrating whales showed avoidance reactions to oil exploration (e.g., airgun) (Malme et al. 1983) and construction (e.g., pipeline and cable-laying) (MMS 2009) sounds in their migration path. Migrating gray whales exposed to platform noises as diverse as drillship, semi-submersible, drilling platform, and production platform sounds showed avoidance reactions corresponding to distances of 3,300 feet from a drillship to only 12 - 65 feet from the other mentioned sources (MMS 2009). In contrast, captive belugas showed no observable reaction to playbacks of such noises (Thomas et al. 1990).

Decommissioning will create a potentially large but short-term (i.e., months rather than years) and localized increase in ambient noise levels due to the presence of large decommissioning equipment operating on site, increased support vessel traffic, and the possible use of explosives. The available information summarized above suggests that this may have short-term negative effects on marine mammals' movement patterns and on their ability to communicate and feed in the nearby vicinity. To comply with procedures established by NOAA ([http://www.nmfs.noaa.gov/pr/pdfs/permits/application\\_rig\\_removal\\_gulf.pdf](http://www.nmfs.noaa.gov/pr/pdfs/permits/application_rig_removal_gulf.pdf)) pursuant to MMPA requirements at 50 CFR 216.014 to mitigate such potential impacts, wildlife hazard and buffer zones would be established around construction zones during decommissioning, with the size of such zones based on experience from past projects, including the effects (if any) of past projects on marine life, the best estimates of safe sound pressure zones, and the current state of knowledge about marine mammal hearing (SAIC 2003). In past decommissioning projects such as the 4H Project and projects in the Gulf of Mexico, a 3,000-foot marine mammal hazard zone was required for any projects using explosive charges. MMS regulations require monitoring for marine mammals when explosives are used and also require that operations using explosives be suspended until marine mammals have cleared the area. In addition, efforts would be made to restrict the use of explosives to times of year least likely to interfere with migrating whales. No impacts on marine mammals were observed during any of the 4H Project's decommissioning operations (SAIC 2003).

In addition to their potential negative impacts, oil platforms have also been observed as feeding grounds for dolphins and porpoises, and haul out/ resting grounds for California sea lions (Coghlan 2009). For example, porpoise clicking patterns similar to those used for feeding were measured at an oil platform in the North Sea, suggesting that these animals were using the platform as a feeding ground (Coghlan 2009).

Since both decommissioning options, complete and partial removal, will remove all surface structures, as well as underwater structures down to at least 85 feet depth, there will be only minor differences in the two options' effects on marine mammals over the long term. In the short term, during decommissioning activities, potential impacts of the two options are similar in kind, but the risk of short-term impacts may be greater for the complete removal option because equipment will be on site for a longer period of time. Table 5.15 summarizes the positive and negative short- and long-term effects of decommissioning on marine mammals.

A number of data gaps exist that limit the ability to quantify the qualitative impacts described in Tables 5.9 and 5.12 for birds and marine mammals. These include detailed information on bird and marine mammal distribution and abundance at and around each platform and in the larger region, as well as sound profiles of the types of equipment involved in decommissioning, and species-specific knowledge about sound impacts. It would also depend on more site-specific information on the risks posed to birds by collisions with platforms and on the importance of platforms as roosting and feeding sites. MMS is undertaking a study to acquire more data on the benefits and risks offshore platforms pose to birds in the region.

### 5.3.6. Water quality

Significant impacts to marine water quality include (SAIC 2003, D. Gregorio, pers. comm. 2010):

- Any violation of water quality standards or waste discharge limitations
- Substantial increases in turbidity
- Substantial increases in dissolved oxygen demand
- Contamination resulting in significant mortality of marine organisms
- Exposure of aquatic organisms to contaminant concentrations that may cause acute toxicity or bioaccumulation
- Any alteration of water circulation that may result in a further degradation of water quality
- Invasive marine species entering state waters in vessels' ballast water or as fouling organisms on hulls

However, the likelihood of substantial impacts from these sources appears to be relatively small. The following subsections describe the regulatory context for addressing water quality concerns and the potential sources of such impacts. The influence diagram in Figure 5.19 illustrates the conceptual structure of this analysis. Because of the lack of quantitative data on potential water quality impacts at each platform under each decommissioning option, water quality is addressed qualitatively in the PLATFORM model.

#### 5.3.6.1. Regulations pertaining to water quality

MMS and California regulations that define the decommissioning process do not directly address water quality except indirectly through regulations that require spill prevention and spill contingency planning and clean up. However, there are other regulatory frameworks and permitting requirements, both state and federal, that decommissioning projects must comply with.

The U.S. EPA has regulatory responsibility for water quality issues related to decommissioning in the OCS, while the relevant Regional Water Quality Control Board would issue a water quality certification for decommissioning projects in state waters. The California Ocean Plan (SWRCB 2001) establishes water quality objectives for California's ocean waters and provides the basis for regulating wastes discharged into the state's ocean and coastal waters. However, the Ocean Plan is not applicable to either vessel discharges or dredged material management (both of which are relevant to decommissioning; see following subsection) (SAIC 2003).

The CWA prohibits the discharge of oil or hazardous substances in Territorial Waters (i.e., out to 12 nm) in quantities harmful to public health or to the environment. The Act also created the National Pollutant Discharge Elimination System (NPDES) of permits that specifies minimum standards for discharged wastewaters, requires states to establish standards specific to water bodies, and designates the types of pollutants to be regulated, including suspended solids and oils (SAIC 2003). As required by the CWA, the U.S. EPA (1996) developed the National Ambient

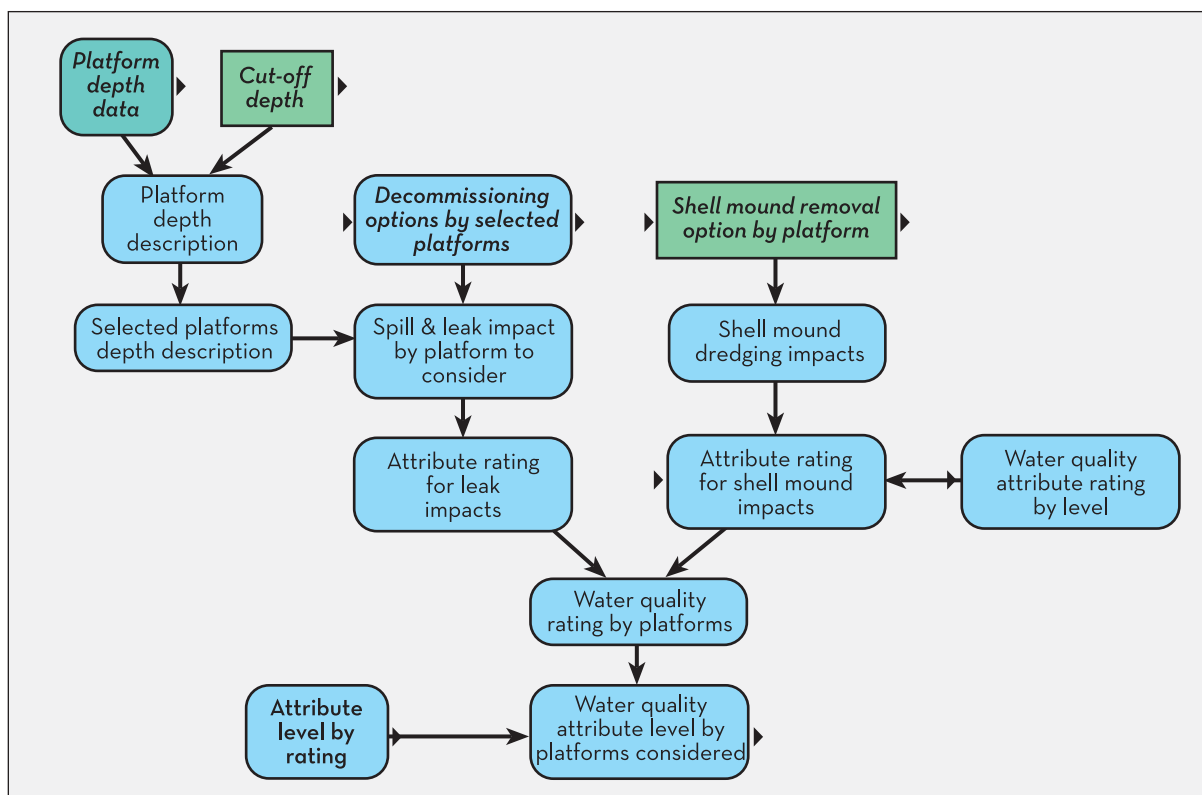

**Figure 5.19. Conceptual structure of the qualitative analysis of water quality impacts in the PLATFORM model.**

Water Quality Criteria, which established numerical maximum concentration levels for contaminants in discharges to surface waters for the protection of both ecological and human health. Although not themselves regulatory requirements, these criteria can be used to develop regulatory requirements based on the suggested concentration levels (SAIC 2003).

Under 30 C.F.R. § 250.203, 30 C.F.R. § 250.204, and 30 C.F.R. § 254, a lessee is required to submit an oil spill contingency plan to MMS prior to submitting decommissioning plans. These spill contingency plans implement the requirements under the OPA that made MMS responsible for reviewing and approving spill contingency plans. Current lessees with MMS-approved spill contingency plans now may expand their plans to also include facilities in state waters in the same geographic area. Operators in state waters with plans approved by the state must submit a copy of the plan to MMS for approval.

At the state level, the local Regional Water Quality Control Board would issue a water quality certification for decommissioning if little or no discharge, sediment resuspension, or bottom disturbance were expected. Certification is intended to confirm that all relevant state regulations (e.g., California Ocean Plan) are being complied with. If discharges were considered significant, then the Regional Water Quality Control Board would issue a discharge permit. For platforms in federal waters, the Regional Water Quality Control Board would assess whether the platform was close enough that discharges could affect state waters. In such a case, decommissioning then

would have to comply with the California Ocean Plan and the certification and permitting procedure would be the same as for state waters, except that the permit would be issued in conjunction with U.S. EPA.

In addressing potential introduction of non-native species from vessel hulls, any ship entering California waters requires coverage under and compliance with the Vessel General Permit issued by the U.S. EPA, related to discharges, which has already received a water quality certification from the California State Water Resources Control Board. While the SLC is the state agency responsible for addressing impacts due to invasive species, the SLC does not have regulatory authority under the CWA. To address this regulatory gap, the Vessel General Permit specifies that permittees (i.e., vessels) must comply with the SLC regulations related to preventing the import of invasive species into California waters. In this regard, HLVs and other decommissioning vessels would be treated identically to other vessels entering California waters.

#### *5.3.6.1. Decommissioning impacts*

Concerns about water quality impacts due to decommissioning activities focus on four potential sources of impact. The first is accidental spills or discharges from surface vessels or from materials released during disassembly of the platform deck or flushing of the pipelines and machinery that contained oil, electrical fluids, and other contaminants. The second potential source of water quality impacts is the resuspension of contaminated materials in shell mounds during dredging to remove them and the third is resuspension of sediments from anchors used to position decommissioning vessels. Because circulation patterns in the Southern California Bight are highly variable seasonally, water quality impacts from these sources could be transported in several directions from the impact site. In addition to these concerns related to the discharge and/or spread of contaminants, there is a fourth and long-standing concern about invasive marine species entering California waters via ships arriving at California ports from other regions, transported either in ballast water or as fouling organisms on ships' hulls. This concern would apply to vessels, such as HLVs, that would be required in decommissioning projects and would need to transit to California from other locations such as the Gulf of Mexico or the North Sea.

Table 5.19 shows that the potential for release of contaminants from disassembly of the platform deck and flushing of pipelines and other equipment is the same across both decommissioning options. This is because this activity is identical for both complete and partial platform removal. The risk of spills or discharges from surface vessels, and the amount of sediment resuspension from anchoring, is greater under the complete removal option, because of the greater time on site and the larger equipment needed for complete removal. However, the planned use of dynamic positioning for HLVs will largely remove any risk of significant bottom disturbance from anchoring. In addition, any increased risk related to complete removal would be marginal for the platforms in relatively shallow water, since the additional effort needed for complete removal would not be large. Shell mound removal would occur only under the complete removal option, since it would be impossible to remove shell mounds with the platform structure remaining in place. The composition of shell mounds and available data on the spread of contaminants from shell mounds are discussed in detail in Section 4.1.1.2.

**Table 5.19. The distribution of potential sources of water quality impacts across the two main decommissioning options.**

Potential source of impact	Complete removal	Partial removal
Spills / discharges from surface vessels	Greater probability due to longer time on site	Lesser probability due to shorter time on site
Release of contaminants from disassembly	Identical in both options	Identical in both options
Resuspension of shell mound material during removal	Occurs only under this option	Would not occur under this option
Resuspension of sediment from anchoring	Greater due to larger equipment and longer time on site But minimal overall due to planned use of dynamic positioning	Lower due to smaller equipment and less time on site
Entry of invasive species	Identical in both options	Identical in both options

### 5.3.7. Decommissioning costs and avoided costs

Decommissioning is a costly operation and the relative costs of each option are an important factor in decision making about decommissioning. Fortunately, recent detailed MMS costs estimates (Proserv Offshore 2010) provide a reliable basis for estimating the costs of a range of decommissioning projects, including both complete and partial removal. There are a large number of combinations of potential decommissioning projects and we have therefore input detailed costing factors into PLATFORM to enable users to investigate a number of alternative decommissioning projects and approaches. Figure 5.20 illustrates the high-level conceptual structure of the costing analysis. Because of the complexity of the costing process and the extremely large number of potential decommissioning projects, this section focuses on explaining the key costing assumptions and the differences between the complete and partial removal options. However, to provide some sense of the overall scale of costs involved, complete removal of all 27 offshore platforms, grouped into the seven decommissioning projects defined by Proserv Offshore (2010), would cost an estimated \$1.09 billion, while partial removal of these platforms, grouped into the same set of projects, would cost \$478 million, with avoided costs of \$616 million (with minor rounding).

The following subsections describe detailed costing assumptions that provide the basis for the user-defined costing analyses available in PLATFORM. As for other aspects of the analysis, data gaps related to costing are described in Section 5.5.



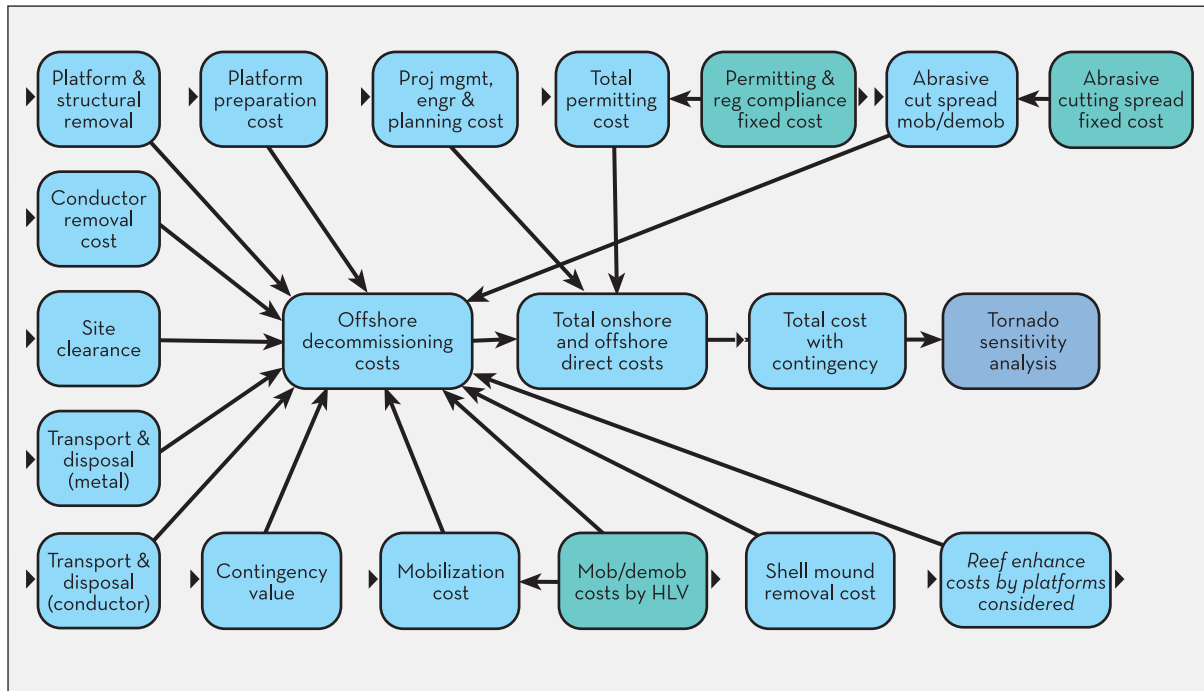

**Figure 5.20. Overall conceptual structure of the decommissioning costing analysis, taken from PLATFORM.**

### 5.3.7.1. Platform decommissioning cost assumptions

Proserv Offshore (2010) was prepared by MMS to develop updated costs for decommissioning oil and gas platforms and related facilities in the OCS off the California coast; all costs in the analysis below, with minor exceptions as noted, are based on the Proserv Offshore (2010) estimates. MMS envisions updating these cost estimates at five-year intervals, which will help ensure that those responsible for funding decommissioning of offshore platforms federal leases meet the financial bonding requirements for facility abandonment (30 CFR 256 subpart I section 256.53(f)). The Proserv Offshore (2010) cost data are included in PLATFORM and the model can readily be updated if desired as new cost data become available.

Costs specifically not included in Proserv Offshore (2010) include:

- Decommissioning pipelines and power cables located in state tidelands
- Decommissioning marine terminals, piers, and other infrastructure located in state tidelands
- Decommissioning associated onshore processing facilities
- Costs of capping or removal of shell mounds
- Costs of enhancing an artificial reef with quarry rock

- Special environmental mitigation costs (e.g., retrofit, habitat restoration) except those for mitigating impacts to air quality and mitigating impacts to commercial fishermen for loss due to preclusion from the area during decommissioning.

These costs, with the exception of costs related to shell mound removal and reef enhancement, are not included in PLATFORM because they are identical in both complete and partial removal (see Section 4.1.1.1 for more detail) and thus do not influence the choice of decommissioning option. The expenditure will occur regardless of the decommissioning option chosen. In addition, there are two types of costs included in Proserv Offshore (2010) that are not included in PLATFORM for the same reasons:

- Subsea pipeline and power cable decommissioning
- Well abandonment

It should be noted that our access to detailed engineering design and structural data for the platforms located in state waters was limited. As a result, structural data such as jacket and deck weights were estimated by drawing dimensional analogies to the platforms located in federal waters.

The following subsections discuss each of the cost categories identified in Proserv Offshore (2010), describe how the data was used in the detailed costing model, and explain any differences between costs for the complete and partial removal options.

#### *5.3.7.2. Project management, engineering, and planning*

Proserv Offshore (2010) recognized that the project management, engineering, and planning cost is related to the structure's size and complexity and thus estimated these costs as 8% percent of the platform structure removal costs, excluding costs related to HLV mobilization and demobilization, permitting and regulatory compliance, materials disposal, weather contingency, and miscellaneous work contingency. We use the same 8% value in the detailed costing model. However, for the partial removal option, a lower cost for structure removal will result in a correspondingly lower cost for project management, planning, and engineering.

#### *5.3.7.3. Permitting and regulatory compliance*

Table 5.20 identifies several categories of costs involved in permitting and regulatory compliance.

Proserv Offshore (2010) judged that the overall cost estimate of \$2.555 million would be consistent across projects that included different numbers of platforms (e.g., two vs. six) because the scope of the activities would remain consistent for projects of different size. PLATFORM therefore uses this fixed project permitting and regulatory cost regardless of the number of platforms involved in a user-specified decommissioning project and the model automatically distributes this fixed cost equally among platforms selected for decommissioning.

**Table 5.20. Types of activities within the overall permitting and regulatory compliance cost element.**

Cost category	Per-project cost
NEPA/CEQA documents (EIS/EIR)	\$ 2.0 million
Execution plan preparation	\$100,000
Data collection and field surveys	\$ 60,000
Agency processing fees and staff time	\$165,000
Environ. mitigation fees:	
Air & fisheries	\$ 100,000
Marine mammal	\$ 65,000
Mitigation and monitoring compliance	\$ 65,000
Total cost per project	\$2.555

Platforms in state waters were treated identically to those in the OCS in terms of permitting costs. While permitting costs for platforms in state waters may be less because they are generally smaller and state requirements may be less involved than federal requirements, any cost differences would be insignificant to the overall decommissioning costs.

Partial platform removal permitting requirements would be similar to those required for complete removal. However, the smaller HLVs and shorter project duration needed for partial removal would result in lower levels of air emissions and perhaps lower costs for air quality permitting. Conversely, the partial removal option will require additional permitting related to conversion of the remaining platform structure to an artificial reef. Without performing a complete EIR/EIS on a given project, it is not possible to determine the actual magnitude of these cost differences. Because these costs are relatively compared to other decommissioning cost categories, we made no attempt to further delineate permitting costs for the partial platform removal case and PLATFORM assumes these costs are the same as those estimated for the complete removal option.

#### *5.3.7.4. Platform preparation and marine growth removal*

As described in section 4.1.1.1, platform preparation would be required for both the complete and partial removal options because both require removal of the deck structure.

Similarly, marine growth will be removed from the platform structure and the conductors down to approximately 100 feet below the water line in both the complete and partial removal options. However, if partial removal involved placing the upper portion of the jacket on the bottom adjacent to the remaining platform structure as reef enhancement, marine growth removal would not be needed. Because these cost differences are minor, the same costs for platform preparation and marine growth removal are used in PLATFORM regardless of which decommissioning option is selected.

#### 5.3.7.5. Well plugging and abandonment

Well plugging and abandonment costs are not included in the detailed cost modeling. This activity was excluded from our evaluation because this work is required by regulation regardless of the decommissioning option selected and it will therefore have no influence on the choice of decommissioning option.

#### 5.3.7.6. Conductor removal

As described in more detail in Section 4.1.1.1, conductors must be removed entirely for complete platform removal but will be left in place under the partial removal option from the ocean floor up to approximately 85 feet below the ocean surface. PLATFORM uses the Proserv Offshore (2010) casing removal costs for the complete removal cost estimate and reduces these costs by a factor proportional to the percent of total conductor height removed to derive a cost estimate for partial removal.

#### 5.3.7.7. Mobilization and demobilization

Section 4.1.1.1 discusses HLV costs in detail and these are summarized in Table 5.21. Proserv Offshore (2010) specifies HLV requirements for each platform decommissioning project, with the HLV size determined by the maximum single lift weight (i.e., deck module lift or jacket section lift) involved in a decommissioning project.

**Table 5.21. Travel time, mobilization / demobilization costs, and day rate costs for the types of HLVs likely to be used in California decommissioning projects.**

Heavy Lift Vessel	Travel time	Mob / demob	Day rate
500 ton HLV	100 days from SE Asia	\$14.04 million	\$156,000
2000 ton HLV	100 days from SE Asia	\$18.36 million	\$204,000
4000 ton HLV	200 days from N Sea	\$45.36 million	\$252,000

In PLATFORM, users select the platforms to be included in the decommissioning project and the decommissioning option, either partial or complete removal, for each platform. PLATFORM then applies the Proserv Offshore (2010) HLV requirements to the decommissioning project based on estimates for heaviest lift in each project. Lift weights for complete removal are taken from Proserv Offshore (2010) and for partial removal based on the heaviest single deck module (or section) lift based on weight data in Proserv Offshore (2010). PLATFORM distributes the mobilization / demobilization costs for the selected HLV equally among however many platforms are included in the decommissioning project. The HLV selections in PLATFORM can be overridden if users wish.

#### *5.3.7.8. Platform and structural removal*

Proserv Offshore (2010) provides platform structure removal costs (i.e., deck, jacket, and pile), including weather and miscellaneous work contingencies, for all 23 OCS platforms for only for the complete removal option. Structural removal costs for the partial removal option include the deck removal cost, but exclude the pile removal costs. Jacket removal costs for the complete removal option were reduced by a factor proportional to the percent of jacket height that would be removed in the partial removal option. These structural removal costs also include the costs to load and transport the materials to the port of Long Beach or Los Angeles for subsequent handling at a scrap / recycling facility.

#### *5.3.7.9. Pipeline and power cables*

Pipeline and power cable abandonment costs are not included in the cost modeling.

#### *5.3.7.10. Transportation and disposal*

Proserv Offshore (2010) includes cost data for disposal of the platform structures at scrap facilities in the Long Beach and Los Angeles area, including applicable costs for onshore transportation of materials. Disposal costs of \$384 / ton include site preparation, materials offloading of the cargo barges, materials handling, materials demolition, and materials scrap processing. This cost estimate does not include any scrap recycle value. PLATFORM applies the same per-ton cost in both the complete and partial removal options. Proserv Offshore (2010) also includes a separate cost estimate for disposing of cement contaminated casing in Bakersfield, CA for disposal.

#### *5.3.7.11. Site clearance*

Proserv Offshore (2010) includes costs for pre- and post-decommissioning side scan surveys, post-decommissioning debris removal, test trawling to ensure the area is clear of obstructions, and shell mound geotechnical and biological surveys. These activities would be adjusted in the partial removal option. Test trawling will be reduced by the area still occupied by the remaining platform jacket and the shell mound survey will most probably be scaled back or eliminated. However, because these activities are a relatively small percentage of the entire site clearance cost, PLATFORM uses the same cost for both complete and partial removal options, i.e., \$709,000 for platforms in less than 300 feet of water and feet \$1,282,000 for platforms at greater depths.

#### *5.3.7.12. Shell mound removal*

Shell mound removal is not included in Proserv Offshore (2010) but is included in PLATFORM because regulations and leases require the removal of obstructions (see Section 4.1.1.2 for more detail) and shell mounds under some platforms can contain as much as 12,500 cubic yards of material. The removal of large amounts of shell mound material, particularly at the deeper platforms, could involve a significant expense. We have included shell mound volumes for 16 OCS platforms (see Section 4.1.1.2 for more detail) in PLATFORM and shell mound volumes for the remaining platforms could be estimated if desired with an equation described in MEC Analytical Systems (2003). We obtained very rough estimates for shell mound removal from a

dredging contractor working off California and in the Gulf of Mexico (D. Moore, Weston Solutions, pers. comm., 2009), including \$125 / cubic yard excluding disposal for a four-platform project, and a fixed mobilization / demobilization cost of \$240,000. For comparison, costs for the 4H decommissioning project in 1996 averaged approximately \$297/cubic yd (in \$2009), and a \$328,000 mobilization / demobilization cost (in \$2009). The difference between these two cost estimates reflects the inclusion of onshore disposal costs in the 4H cost estimate. Because we were unable to obtain disposal cost estimates, PLATFORM uses the 4H estimate of \$217 / cubic yard including disposal.

#### *5.3.7.13. Reef enhancement*

Under the partial removal option, reef enhancement (e.g., placing boulders or concrete around the base of the platform) is a potential suboption included in PLATFORM. Proserv Offshore (2010) does not include cost estimates for this activity, nor are data available for enhancement of reefs at depths and locations similar to those occupied by offshore platforms in California. We therefore used cost data from the enhancement of the Southern California Edison Wheeler North Reef artificial reef project (H. Elwany, pers. comm., 2009). The costs for placing a single layer of 1 – 2 foot diameter rock in a water depth of about 45 feet averaged approximately \$60,000 per acre, including the cost of the rock itself and transportation and placement costs.

#### *5.3.7.14 Weather contingency factor*

Proserv Offshore (2010) includes a weather contingency factor that can be applied to the platform preparation, conductor removal, the contingency portion of deck and jacket removal, pile removal, and site clearance cost categories. This contingency factor varies by platform: 15% for Harvest, Hermosa, Heritage, Hidalgo, and Irene, 10% for platforms in the Santa Barbara Channel, and 5% for the south coast E platforms. PLATFORM uses the same contingency factor for both complete and partial removal options.

#### *5.3.7.15. Miscellaneous work contingency factor*

Proserv Offshore (2010) also includes a 15% general work contingency factor to cover unanticipated issues that is applied to all major decommissioning operations and is consistent across the complete and partial removal options.

#### *5.3.7.16. Platforms not costed*

PLATFORM does not enable users to select the partial removal for the four E platforms in state waters (Emmy, Emmy Satellite, Esther, and Eva) because they are located in less than 60 feet of water (Table 1.1) and the partial removal option involves removing the upper 85 feet of the platform.

#### *5.3.7.17. Avoided costs*

PLATFORM computes avoided costs for the partial removal option as the simple difference between the total cost of complete platform removal and partial platform removal. Because

partial removal is a less intensive activity than complete removal (Table 4.2), avoided costs are always positive.

### **5.3.8. Programmatic costs**

Programmatic costs are relevant only to the partial removal option because this option will require ongoing effort to manage the resulting artificial reefs. We identify several categories of such costs, including:

- Artificial reef program staffing
- Other non-staffing program costs
- Administration
- Liability insurance premiums
- Other costs
- Cathodic protection for the artificial reefs (i.e., protection from corrosion to extend the life of the reef structure)

We were unable to develop quantitative estimates of these costs, except for cathodic protection of the reefed platforms. PLATFORM therefore enables users to enter their assumed costs for these categories and to enter and apply a discount rate to estimate the net present value of a five-year stream of programmatic costs (the five-year timeframe matches the maximum length of time considered valid for projecting estimates of biological production (see Appendix 3 for more detail)).

Based on interviews with state agency managers, the initial stages of planning and establishing the legal and management infrastructure needed to implement a rigs-to-reefs program will most likely involve an interdisciplinary team within the California Natural Resources Agency (see Section 6.4 for more detail). The level of effort needed for this team to accomplish its task is unclear and experience from the development of analogous reefing programs in the Gulf of Mexico is not a useful guide. The environmental and political contexts are completely different in these two areas and the scale of avoided costs (and therefore the level of interest from stakeholder groups) orders of magnitude higher in California than in the Gulf of Mexico.

Other programmatic costs are flexible and/or uncertain at this time. For example, there are no legal provisions in NFEA or in ACOE regulations related to artificial reefs that mandate a particular level of monitoring or management effort or any specific amount of liability coverage. Such decisions would be at the discretion of state managers, based on their perspectives on resource management goals and on judgments about the level of risk exposure acceptable to the state. As one point of comparison, the State of Louisiana has spent a total of \$1 million on maintenance, administration, and monitoring of their artificial reef program over the past seven years, while the trust set up to accept the state's share of avoided costs receives about \$5 million each year in additional contributions and currently contains over \$30 million. Interest income on the trust amounts to about \$7 million per year, which is used for research and grants that fund a range of ocean-related projects. In contrast, the maintenance, monitoring and administration side

of the reef program has only cost about a \$1 million over the last seven years (D. Peter, Louisiana Wildlife and Fisheries, pers. comm., 2009). This comparison may not be directly relevant to a California rigs-to-reefs program, however. Many artificial reefs in the Gulf of Mexico are in shallow water and have used toppled platforms to form reefs. Because of their shallow depth, these reefs require markings under USCG regulations, with buoys costing between \$1,000 and \$10,000 per reef, depending on the size of the reef. While buoys would not be required under the partial removal option considered here, California artificial reefs may be monitored or managed more intensively because of their importance as habitat for important species such as rockfish and/or because of their attractiveness to fishermen as unique fishing opportunities.

Cathodic protection to prevent corrosion is considered routine maintenance by platform operators and involves maintaining a sufficient mass of sacrificial anodes on the structure to inhibit corrosion of the steel. Such a program could extend the life of an artificial reef's steel structure indefinitely. Cathodic maintenance costs include costs for mobilization / demobilization from the Port of Los Angeles to each platform location and on-site diver survey time based on costs in Proserv Offshore (2010). PLATFORM assumes cathodic maintenance will be scheduled on a five year. These estimated costs could be reduced if divers were mobilized from Port Hueneme instead of Los Angeles and if work was coordinated with other reef surveys or with platforms still operating in the area.

#### **5.4. Model integration**

We have developed a supporting tool for this report, the PLATFORM decision model, which provides an interactive environment in which users can investigate the cost and other implications of specific decommissioning projects in more detail. As described in previous sections of this report, the number of possible combinations of platforms selected for decommissioning, decommissioning options and suboptions, separate sources and types of impact, and approaches to valuing important costs and benefits is extremely large. The decision model therefore enables users to thoroughly investigate how different decommissioning choices and evaluation methods affect the relative desirability of different potential decisions. In addition, PLATFORM enables users to assess platforms individually or as part of larger, multi-platform projects, and similarly to examine individual impact categories (attributes) or integrate over all impacts to develop a global comparison between different possible decommissioning projects. PLATFORM has been loaded with quantitative data on decommissioning costs, biological production estimates, and changes to ocean access, as well as with qualitative assessment frameworks for the other issues addressed in Section 5.3. The model thus provides a structured means of working more directly with the key data and information developed for this analysis.

PLATFORM has several features that deserve particular attention; Appendices 4 and 5 describe the model in detail and include step-by-step example scenarios to illustrate every aspect of the model's functions and output. Figure 5.21 illustrates the initial, or top-level, user interface for the model.





**Figure 5.21. The top-level user interface for the PLATFORM decision model, illustrating the four major types of functions (see text and Appendices 4 and 5 for more detail).**

There are four quadrants to the user interface screen in Figure 5.21 that support different approaches to more detailed analysis of the decommissioning options (see Appendices 4 and 5 for more detail), including:

- Upper left quadrant, which enables users to define customized decommissioning projects by making choices about a number of project specifics. Under the Scenarios options, users can define a project that includes one or more specific platforms and whether they will be partially or completely removed, or left as is. Users can also define multiple projects, or scenarios, to allow for side-by-side comparison of decommissioning outcomes.
- Lower left quadrant that calculates project costs and avoided costs for the scenarios defined in the upper left quadrant. PLATFORM allows users to specify what percentage of the avoided costs from partial removal will be applied to beneficial uses (e.g., donated to a state-established trust fund), in 10% increments from 0 – 100%.
- Upper right quadrant that supports two different methods of multi-attribute analysis (see Appendix 5 for more detail), a method that combines quantitative and qualitative assessments into a single analysis framework. PLATFORM allows users to view analysis results attribute-by-attribute or to integrate across all attributes to derive a single overall score for each decommissioning scenario. Users can select between two different weighting approaches that allow them to reflect their individual preferences in the analysis. Thus, users have the flexibility to weight different costs and benefits as they see fit in order to capture and investigate the effects of different perspectives and values on the overall analysis.
- Lower right quadrant that allows users to delve more deeply into the model’s underlying analytical structure, algorithms, and input datasets.

In addition to these features, PLATFORM contains contextual documentation that provides definitions of variables and processes and other explanatory background to help users understand each step in their analysis. PLATFORM also contains tools for investigating the relative influence of decision choices on the final outcome. For example, the Equivalent Cost Breakeven option in the upper right quadrant enables users to identify what changes in inputs would cause the overall ranking of the decommissioning scenarios to change. Such analyses of switchover or breakeven points can be an extremely useful method of understanding where differences in inputs (e.g., costs, qualitative impact assessments) or values (e.g., weights applied to these inputs) affect the choice between decommissioning options and where they do not. Thus, PLATFORM helps users to better define which differences make a difference (to decision making).

PLATFORM also contains a number of pre-programmed features that support a more detailed examination of how uncertainty might affect the analysis results. For example, uncertainty about both the input decommissioning costs and the fish standing stock in the biological production model is characterized by a probability distribution (lognormal) based on the variability as defined in Proserv Offshore (2010) (for costs) and Appendix 3 (for biological production). This uncertainty estimate is propagated downstream throughout the analysis and, as illustrated in Figure 5.22, PLATFORM permits users to readily choose among a variety of statistical views of uncertainty and quickly view the analysis results in a range of tabular and graphical output formats. For example, Figure 5.23 illustrates a cumulative frequency (or probability) distribution of decommissioning costs for three platforms (A, B, and C) and Figure 5.24 a set of probability bands for predicted fish biomass yield for platform C.

In summary, PLATFORM is an important complement to this report intended to provide users with more direct access to the data and information that form the basis for this report, along with a variety of tools for performing a wide variety of analyses that may help them answer particular questions about decommissioning that may not have been addressed in this report.

### **5.5. Data gaps**

As described in Section 5.1 and within each of the individual subsections in Section 5.3, there are a number of data gaps that limited our ability in many cases to complete a full evaluation of all impacts for all platforms across all aspects of the two main decommissioning options (Figure 3.2). The fact that such data gaps remain after the extensive amount of data collection, analysis, and evaluation conducted over the past 20 years reflects the complexity of the decommissioning issue, even when focused on only two main options.

The following subsections briefly summarize data gaps related to each portion of the analysis, referenced to the report sections in which these issues are discussed in greater detail. We only address data gaps that would contribute to assessing the differences between the two main decommissioning options, total or partial removal. Data gaps related to aspects that are identical under both options are not included.

The following subsections also repeat material discussed in the referenced sections, but are collected here for convenience.

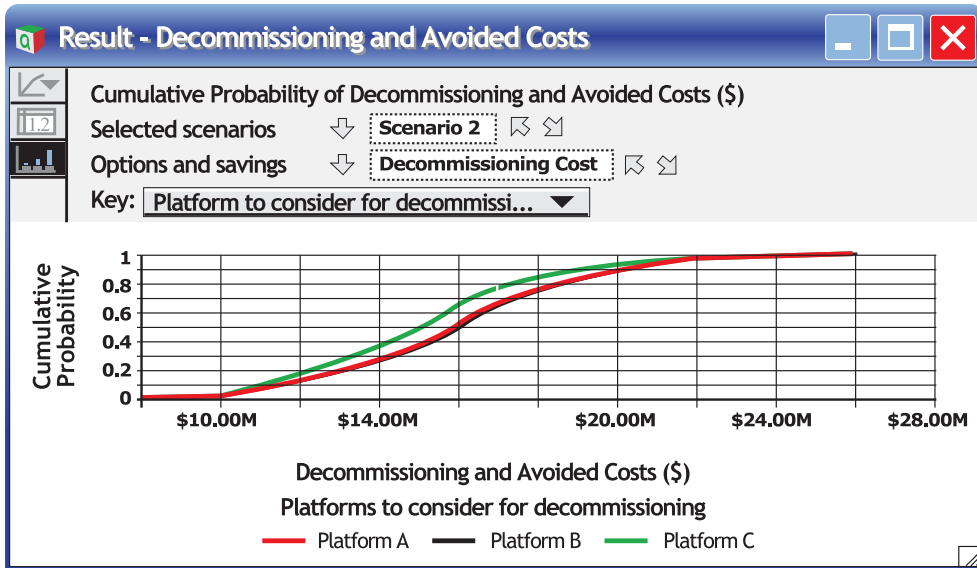

Figure 5.22. Illustration of the PLATFORM drop-down menu that permits users to apply several different types of statistical distributions to input data.

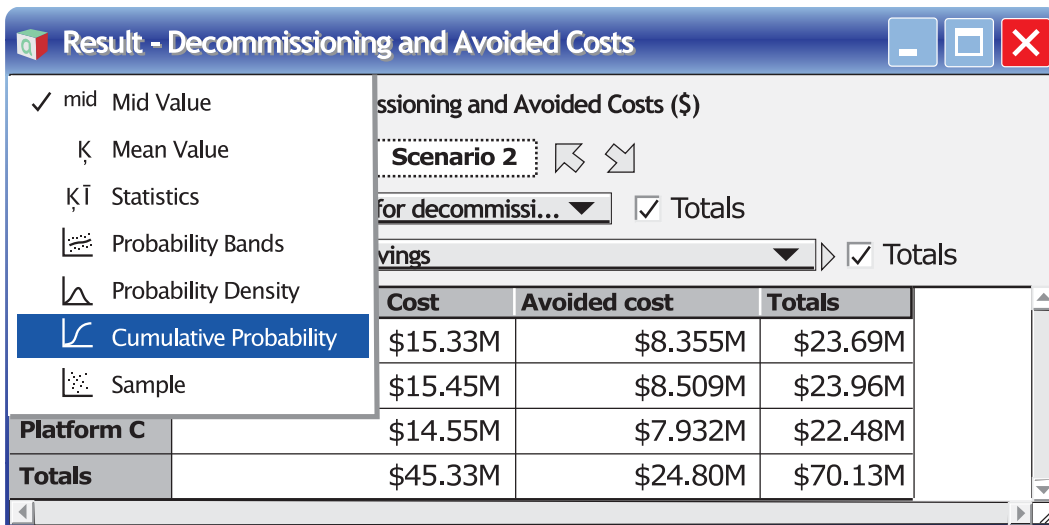
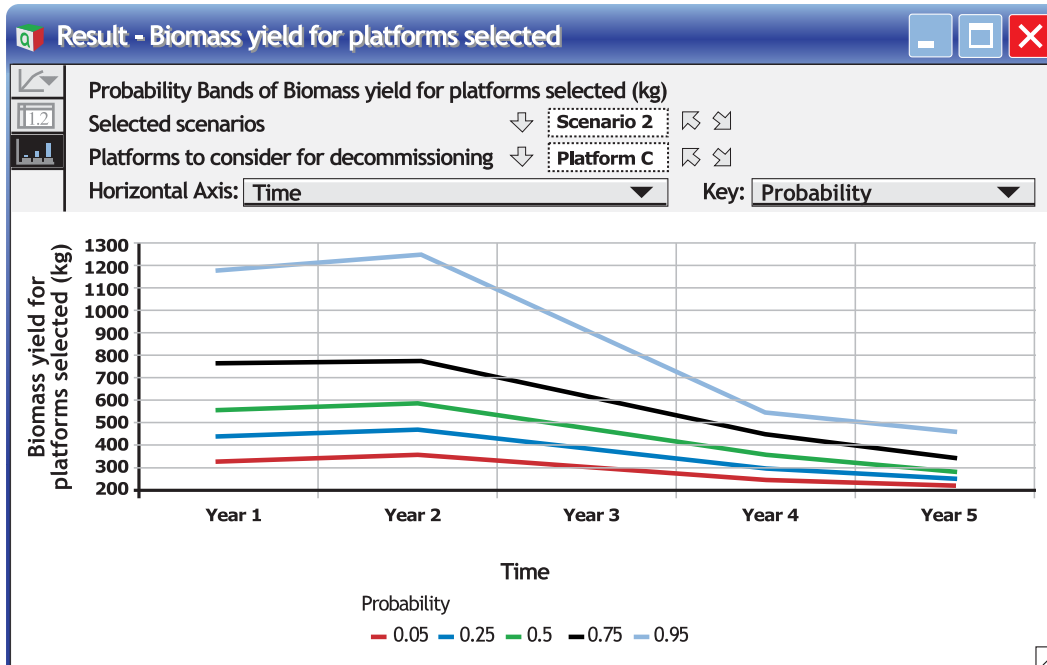

Figure 5.23. Example cumulative frequency (or probability) distribution of decommissioning costs for Platforms A, B, and C under one decommissioning scenario. In this case, there is a 70% probability that the decommissioning cost of Platform C is less than or equal to \$16 million.



**Figure 5.24. Example probability band plots for predicted fish biomass yield at platform C over a five-year period. Probability bands, or confidence bands, are shown as percentiles (5%, 25%, 50%, 75%, and 95%). The 50% line is the median prediction.**

**Employment and broader economic impacts (5.2.2.1):** Since the impacts on employment and on the broader regional/state economy flow from other impacts we are not considering, we are not able to estimate them at this time. We have left placeholders in the PLATFORM model for many of the identified data gaps. If these data gaps are filled, then an input-output model could be used to estimate the impact of both decommissioning options on employment and on the broader regional/state economy.

**Non-MMS permitting costs (5.2.2.4):** Proserv Offshore (2010) did not include non-MMS permitting costs in their decommissioning cost estimates. Such costs will be dependent on the scope of the particular project, the requirements of each permitting agency, the degree to which permitting agencies coordinate their efforts, and any arrangements made between the proponent and the agency for recovery of the agency’s own internal costs. In addition, we assume that, given the complexity of both decommissioning options, permitting costs are likely to be similar for both options.

**Tax consequences of platform donation (5.2.2.2):** Depending on how platforms are carried on operators’ books, and how the donation is accounted for, there could be a variety of tax consequences stemming from the donation of a decommissioned platform to the state (or other entity if regulations were changed to permit that). We provide a general formula for estimating tax consequence, but many of the inputs are unavailable at this time and/or would require obtaining financial data from individual companies. Given current uncertainty about how

platform donations will be accounted for, and the fact that needed enabling legislation has not been passed, we judged that this issue could not be rigorously evaluated at present.

**Platforms as reef habitat (5.3.1.1):** In assessing broader socioeconomic impacts, we were unable to comprehensively estimate the importance of platforms as additional reef habitat offshore California under the partial removal option (i.e., their marginal contribution to existing reef area and to biological production from existing reefs). As discussed in Section 5.3.1., the impact of platform habitat on biological production varies depending on the spatial scale at which the impact is analyzed. Therefore, we assume that if the platform sites are opened up to consumptive use, the long-term impacts on fishermen will stem primarily from changes in access and this access will reduce their long-term productivity by increasing the mortality on the targeted fishes. Filling this data gap will require more complete mapping data about the location of hard substrate in the OCS. It will also require additional knowledge about the processes affecting biological production on individual platforms, as well as about the ecosystem dynamics that control the effects of this production at different time and space scales.

**Importance of the platforms as refugia (5.3.1.1):** In assessing broader socioeconomic impacts, the biological importance of platforms as sources of adults that might migrate to (spillover) other reefs has not been fully assessed. In the classic marine reserve model, protected areas (which the platforms have been) are the source of adults that migrate out from the reserve and help to support populations in nearby areas that are subject to fishing pressure. In terms of the spillover of fishes from the platforms, recent research in the Santa Barbara Channel found that that 30% of tagged groundfish left the platforms six days after release (Lowe et al. 2009), although this percentage varied widely by species and platform. The loss of these fish from the platforms is through either movement or mortality; the movement component is the closest estimate to spillover at this time. The impact of such spillover on populations on natural reefs, however, is not well understood. Filling this data gap would require additional tagging studies, conducted across multiple platforms and natural reefs, and continued for long enough to assess how spillover varies over time.

**Fish communities on platforms (5.3.1.1):** Estimates of decommissioning impacts on standing stock and production are based on monitoring data that describe the biological communities present at different depth strata at offshore platforms. However, complete data for structural parameters and fish communities all platforms are not available. Some platforms lacked any monitoring data, and others lacked complete data on size and distribution in all depth strata. We made assumptions necessary to estimate production impacts for all platforms in the PLATFORM model, for example, by assuming that platforms with similar structures and at similar depth would have similar biological communities. PLATFORM notes where such assumptions were made and the model could readily be updated with new data when and if these become available. Appendix 3 includes tables that identify detailed data gaps related to platform structural parameters, biological monitoring coverage, and growth and other population dynamics parameters needed to improve the production model.

**Air emissions (5.3.2):** Air emissions from decommissioning represent a significant source of impact, particularly for the complete removal of the larger platforms in deep water. We developed an approximate estimate for the worst case of complete removal of Platform

Harmony, the largest platform offshore southern California. Completing even approximate estimates for the other platforms was beyond the scope of this project, since it would have required a substantial effort to more fully define the specific equipment spreads for each project and gather and process a substantial amount of raw data. The PLATFORM model contains a basic conceptual structure as a placeholder for more complete data when these become available.

**Non-market value of nonconsumptive diving (5.3.3):** Similar to calculating the impact on economic value associated with recreational fishing, a basic travel cost model could be used to estimate the economic value associated with dive trips if the necessary data were collected. In 2001, the Minerals Management Service (MMS) used a basic travel cost model to estimate the non-market value of nonconsumptive diving at Platform Grace. There are no estimates in the literature for the value of recreational diving at the other 23 platforms. In addition, there are no estimates for the value of recreational diving following the removal of the top 85 feet of the platforms, which will likely decrease their value to divers. For estimates of the consumer surplus (i.e., the additional spending beyond what is required to participate in the activity) for nonconsumptive divers, please see Leeworthy and Wiley (2003) and Leeworthy et al. (2005). We have included placeholders in the PLATFORM model in the event data become available in the future.

**Ecosystem value (5.3.3):** Non-market valuation techniques (i.e. contingent valuation, etc.) could provide some estimate of ecosystem value; however, the time and expense required to collect data for these types of analyses is beyond the scope of this project. Implementing a contingent valuation approach would involve conducting surveys to determine how much people would be willing to pay (or accept) to either ensure the continued existence of an ecosystem feature or be compensated for its loss. We have included a placeholder in the PLATFORM model to allow decision makers to include an estimate of ecosystem value in future analyses.

**Economic value of recreational fishing associated with oil platforms or reefs (5.3.3):** If the platform sites are designated ‘take zones’ for recreational fishing after the decommissioning process, they could attract new users who did not previously fish, draw existing users away from substitute fishing sites and/or be utilized by individuals who currently fish near the platforms. Therefore, to estimate the added value of the platforms, one would need to look at the change in total users (or the change in total trips) across the entire population as well as to collect data on average expenditures/user day or trip. Baseline estimates of total user days and total user trips by saltwater fishermen in California can be found in the National Survey of Fishing, Hunting, and Wildlife-Associated Recreation, which is conducted every five years. Multiplying the change in total users by the average expenditures/user day (or the change in trips by the average expenditures/trip) would provide an estimate of the potential dollar value impact associated with each decommissioning option. We have included placeholders for these values in the PLATFORM model.

**Non-market value of recreational fishing (5.3.3):** Other researchers in southern California have used a travel cost model to estimate the non-market value of recreational fishing. In short, the travel cost model estimates the amount spent (typically by one individual for one day) to participate in an activity. For estimates of the consumer surplus (i.e., the additional spending beyond what is required to participate in the activity) for recreational fishing, please see

<http://www.oceaneconomics.org/nonmarket/valEstim.asp#reefish>. We do not include these values here as they are either dated (e.g., Wegge et al. 1986) or use an unknown methodology (e.g., Kling and Herriges 1995). We have included placeholders in the PLATFORM model in the event data become available in the future.

**Future fisheries management decisions (5.3.4):** In assessing impacts on ocean access, uncertainty about future fisheries management decisions complicated our assessment of the possibility that some or all of the platform sites could be set aside as no take under the partial removal option. It is not clear which or how many platforms might receive this designation and fisheries management decisions could affect our expectation about the preferred option of one or more user groups. The analysis could be revisited at such time as these management policies become clearer.

**Desirability as fishing sites (5.3.4):** In assessing impacts on ocean access, we were also unable to assess rigorously the potential desirability of the platforms to commercial and recreational fishermen under the partial removal option. An estimate of this value could be obtained through either the collection of additional primary data on fishing patterns and preferences, or a review of existing data (e.g., Ecotrust's data collection effort for the MLPA Initiative<sup>4</sup>). We have included placeholders in the PLATFORM model in the event data on the desirability of the platforms to commercial and recreational fishermen become available.

**Decommissioning cost assumptions (5.3.7):** We were unable to obtain the deck weights, jacket weights, pile weights, number of piles or maximum single lift weights for platforms in state waters. These include Emmy (for which we do have deck weight), Emmy satellite, Eva, and Esther. Additionally we were unable to obtain the maximum single lift weights for platform Holly. These weights are needed to determine engineering and planning costs, platform structural removal costs, HLV requirements, and transportation and disposal costs. As a result these values were estimated by making dimensional and visual comparisons to platforms for which we had this data.

**Permitting and regulatory compliance (5.3.7):** Quantifying the difference in permitting costs between the complete and partial platform removal option is not possible without knowing the full scope of the each respective EIR/EIS. We assume the permitting costs for these two decommissioning options would be similar and it is likely that the magnitude of these costs is not significant in terms of the overall project cost.

**Site clearance (5.3.7.11):** Proserv Offshore (2010) report did not address partial platform removal options. The site clearance costs for partial removal would be less than complete platform removal as the trawling areas would be reduced and the shell mound survey work may be deemed unnecessary. Because the site clearance work scope would not likely be significantly reduced, the complete platform removal site clearance costs were used for the partial platform removal case in the model.

---

<sup>4</sup> Data collected as part of the MLPA process would require additional clearance by fishing communities in order to be utilized as a part of another process (see Scholz et al. 2010 for additional details on data availability).

**Shell mound and drill cutting pile removal (4.1.1.2):** There are a number of specific data gaps that limited our ability to accurately estimate the costs of removing shell mounds under the complete removal option.

Data on shell mound volumes was incomplete. We used shell mound volumes determined by MEC Analytical Systems and Sea Surveyor (2003), which estimated volumes for 16 of the 19 OCS platforms in the Santa Maria and Santa Barbara Basin. Of the three OCS platforms not surveyed, this study concluded that the two newest platforms, Harmony and Heritage, likely had insignificant shell mound accumulation and the shell mound beneath platform Harvest would be similar to that under the adjacent platform Hermosa. PLATFORM uses these data but does not attempt to estimate shell mound accumulations under the remaining four “E” OCS platforms or the four state water platforms. When these eight platforms are selected for shell mound removal the model indicates to the user that the data do not exist. MEC Analytical Systems and Sea Surveyor (2003) provide an equation that uses platform age and the slope of the ocean floor under the platform to calculate a reasonably accurate estimate of shell mound accumulation. However, we were unable to obtain the bottom slope data needed to estimate shell mound volumes under the eight platforms not surveyed.

Cost estimates for removing shell mounds were uncertain and inconsistent. We had available estimates of shell mound removal costs for the Chevron 4H project (McGinnis et al. 2001) and estimates developed through our recent consultations with a dredging contractor. McGinnis et al. (2001) estimated that removal of the 45,000 cubic yards of 4H shell mound material would cost \$10 million. While McGinnis et al. (2001) did not specify whether this cost included disposal, we assume that disposal costs were included because these shell mounds contain some drilling waste contaminants that would likely have required disposal as hazardous waste. After allowing for a mobilization / demobilization cost of \$240,000 (estimated by the dredging contractor), the 4H cost estimate results in a cost of \$217 / cubic yard. In contrast, the dredging contractor we consulted estimated that shell mound removal (at depths where dredging would be feasible) would cost \$125 / cubic yard (plus the mobilization / demobilization cost) for a four-platform project.

PLATFORM has been loaded with the shell mound removal cost estimates derived from McGinnis et al. (2001), with the assumption that this cost includes disposal. When more accurate data become available it would be beneficial to update the model to reflect project-specific metrics.

**Reef enhancement (5.3.7.13):** Because we could locate no artificial reef enhancement data specific to enhancing platform structures, we used the Southern California Edison Wheeler North reef project to develop cost estimates for placing quarry rock around a platform jacket. The costs for the Edison project averaged approximately \$60,000 per acre for a single layer of one to two foot diameter rock at a depth of 45 feet in 2008. This is likely an underestimate for offshore platform reef enhancement as the water depths at the platforms are typically deeper and the acreage of rock placement for the platform projects may be much less than the 150 acres covered in the Wheeler North Reef project.



To ensure PLATFORM incorporated a framework to simulate this artificial reef enhancement option, these reef enhance costs are imbedded in Platform as well as the assumption that each platform would involve one acre of rock placement. When artificial reef enhancement data that more specific to the offshore platform decommissioning projects are available, the model can readily be updated.

**Programmatic costs (5.3.8):** Indirect program costs pertain primarily to the partial removal option, since this would require state involvement in establishing and then managing an expanded artificial reef program. Indirect costs would include short-term efforts such as drafting legislation, negotiating with platform operators, defining funding mechanisms, and implementing the legal and management infrastructure needed for an ongoing program. Longer-term indirect costs would include

any maintenance of the reefs themselves, staffing of an expanded artificial reef program within the Department of Fish and Game, monitoring of conditions on the reefs, expanded management and enforcement related to fishing activity on state property in the OCS, and insurance or other costs for managing potential liability. Many of these costs are flexible and dependent on management decisions. For example, there are no legal requirements in NFEA, NARP, or in ACOE regulations related to artificial reefs that mandate a particular level of monitoring or management effort or any specific amount of liability coverage. Such decisions would be at the discretion of state managers, based on their perspectives on resource management goals and on judgments about the level of risk exposure acceptable to the state. We have therefore not developed quantitative cost estimates and have left placeholders in the PLATFORM model that can be expanded at such time as detailed costs become available.

## 6.0. Institutional Challenges Related to the Partial Removal Option

---

The preceding sections have:

- Described the rationale and context for this study
- Summarized the history of past decommissioning projects in California
- Reviewed past efforts to implement a rigs-to-reefs program that would convert decommissioned offshore platforms to artificial reefs (i.e., rigs-to-reefs)
- Described the legal and regulatory framework for both decommissioning and an artificial reefs program
- Prioritized a range of decommissioning options to focus on two major options: complete removal and partial removal with conversion to artificial reefs
- Presented a detailed comparison of the economic, environmental, and socioeconomic costs and benefits of these two options
- Illustrated a decision model designed to help stakeholders explore these two options in terms of implementation implications and dissimilar preferences that could cause costs and benefits to be weighted differently

### KEY CONCEPTS

**Mechanisms for Transfer of Ownership** - Under the partial removal option, there are a number of methods for transferring ownership of the artificial reef to federal, state, or other non-governmental ownership. The most likely pathway for transferring ownership, to a state artificial reef program, is allowed for in federal law but new state legislation would be required to allow the state to accept ownership of platforms in the OCS. This section reviews the relevant laws and regulations, along with past experience in the Gulf of Mexico and California, and describes the specific issues new state enabling legislation should address.

**Addressing Liability Concerns** - Potential liability to the state has been a persistent concern associated with the partial removal option. Major potential sources of liability include pollution from abandoned wells or shell mounds, fatalities / injuries to divers, loss of or damage to commercial fishing gear, ship collisions with the artificial reef, and state litigation costs. Some of these (e.g., pollution from abandoned wells, ship collisions) are very unlikely and there are well-established legal and risk management mechanisms for addressing each type of liability. Overall, the potential for significant liability to the state under the partial removal option appears low.

**Mechanisms for Managing Funds** - The partial removal option is likely to result in the state receiving a share of avoided decommissioning costs, though this share would have to be defined either in new state legislation or through negotiations with the operators. There are a variety of mechanisms for allocating and managing such funds, with a state trust fund (either an existing fund such as the Ocean Protection Trust Fund or a new fund established by new enabling legislation) the most straightforward. Spending priorities could be defined in the legislation and implemented through either continuous or yearly appropriations.

**Managing an Artificial Reef Program** - The partial removal option will require that the existing artificial reef program be expanded. The scope of such a program will depend on the number of new artificial reefs and management goals established by CDFG and may include monitoring, enforcement, and reef maintenance (e.g., cathodic protection to prevent corrosion). Uncertainty about any future program scope makes it impossible to cost out the program at this time.

In addition to providing readers with a detailed comparison of two major decommissioning options and placing this comparison in an overall management and legal/regulatory framework, the preceding sections also highlight two important distinctions between the legal and regulatory framework for each option. First, the process for implementing the complete removal option is well described and well established, at both state and federal levels, with requirements for complete removal detailed in operator leases and regulations, and supported by a large amount of past experience. In contrast, the partial removal and artificial reefing option, which involves transferring ownership of platforms to the state, remains undefined in many important respects. This is particularly true with regard to the state's legal authority to accept ownership, address various sources of liability, manage funds from the state's share of avoided costs, and define the content of new state legislation needed to address these issues. Second, the partial removal option, involving conversion of the platform to an artificial reef, would be voluntary. A decision on the part of both an operator and the state to implement this option would therefore depend on mechanisms established for addressing the issues just enumerated.

Specifically, Section 6 examines a range of possible legal and management approaches to address the remaining ambiguous aspects of the partial removal option. As one state manager from an agency that would be involved in decommissioning stated it, "We'd like to know what would happen 'after' [the transfer of ownership] in the partial removal option." This section draws on a variety of sources in responding to this request, including relevant state and federal legislation, artificial reefing programs in the Gulf of Mexico, programs (e.g., shipwreck diving) that face analogous liability concerns, and interviews with knowledgeable experts both inside and outside of state and federal agencies, including CCC, CDFG, SLC, California Attorney General's Office, NMFS, and MMS.

We emphasize three key features of Section 6:

- It is not intended in any way to advocate for the partial removal option or to assume its adoption is a foregone conclusion
- It is presented from a "what if" perspective, i.e., what could the state do to address outstanding issues if the partial removal option was selected
- It focuses primarily on the transfer of platforms in the OCS to state ownership because only one platform (Holly) is located in state waters at a depth that would accommodate the partial removal option

The following subsections focus on four key issues central to establishing and managing a state artificial reefing program, including:

- Mechanisms for transferring platform ownership and the requirements for new enabling legislation that would allow such transfers
- Sources of liability and provisions for addressing these
- The transfer, allocation, and management of the state's share of funds from avoided costs
- The management of a state artificial reef program required in federal rigs-to-reefs regulations

## **6.1. Mechanisms for transfer of ownership**

Any use of decommissioned platforms as artificial reefs would necessarily involve transfer of ownership of the platform, as well as the responsibilities and liabilities related to such ownership, to the state or other entity with the legal authority to accept such ownership. The following subsections summarize the legal mechanisms currently in place to transfer ownership of platforms in federal waters to the state and explore other potential options that would have to be enabled by new legislation.

In brief, there are clear legal procedures established in federal law for transferring platform ownership from operators to the state, as long as criteria established in NFEA, MMS regulations, and ACOE permitting requirements are met. Once decommissioning has been completed and the state has assumed ownership, MMS no longer has regulatory authority; subsequently, the state would be free transfer ownership to another entity. However, new state legislation would be required to enable the state to assume ownership of artificial reefs in the OCS. In this section, we describe the specific issues such legislation would have to address. We also examine an alternative ownership transfer directly to the Channel Islands National Marine Sanctuary (CINMS), which discusses artificial reefing in its most recent management plan. Figure 6.1 outlines the various pathways available for transferring platform ownership that are discussed in detail in the following subsections.

### **6.1.1. Directly to state**

The most straightforward legal mechanisms involve transfer of ownership of a decommissioned platform from an operator directly to the state.

#### *6.1.1.1. Existing enabling legislation and regulations*

As described in Sections 1.2.2.1 and 3.4.2.2, NFEA specifies that ownership of an artificial reef must be transferred to a permittee authorized and permitted by the ACOE and that the permittee shall be fully liable for all damages if permit requirements are not complied with (33USC 2104). In addition, MMS regulations require that a platform in the OCS acquired by the state become part of the state's artificial reef program (30CFR 250.1730) and that, in turn, the state must acquire an ACOE permit and accept title and liability for the structure and its operation as an artificial reef. Finally, the National Artificial Reef Plan (NARP) of 2007 (Appendix 2) details the provisions of NFEA to be carried out by each state. Because California cannot change federal laws and regulations, it must take title to any partially removed platform on the OCS and assume liability if it wants to convert the platform to a reef. Any alternative to this pathway for initial ownership transfer would require a change in federal law, as shown in Figure 6.1.

Currently the only state authority to use decommissioned platforms as artificial reefs is given under California Fish & Game Code § 6421(a), which established the Nearshore Sport Fish Habitat Enhancement Program, and California Fish & Game Code §§ 6420 – 6425, which established the California Artificial Reef Program (CARP). These programs have overseen the establishment and development of artificial reefs within the state's three-mile limit; however, under this current legal authority, the state does not have the ability to establish any state-owned

or -sponsored artificial reefs on federal OCS lands, including using decommissioned platforms. Notably, the state does own one artificial reef outside state waters: the Bolsa Chica Reef, which was established before CARP took effect and the “state waters” limitation in CARP (California Fish & Game Code § 6423) was established.

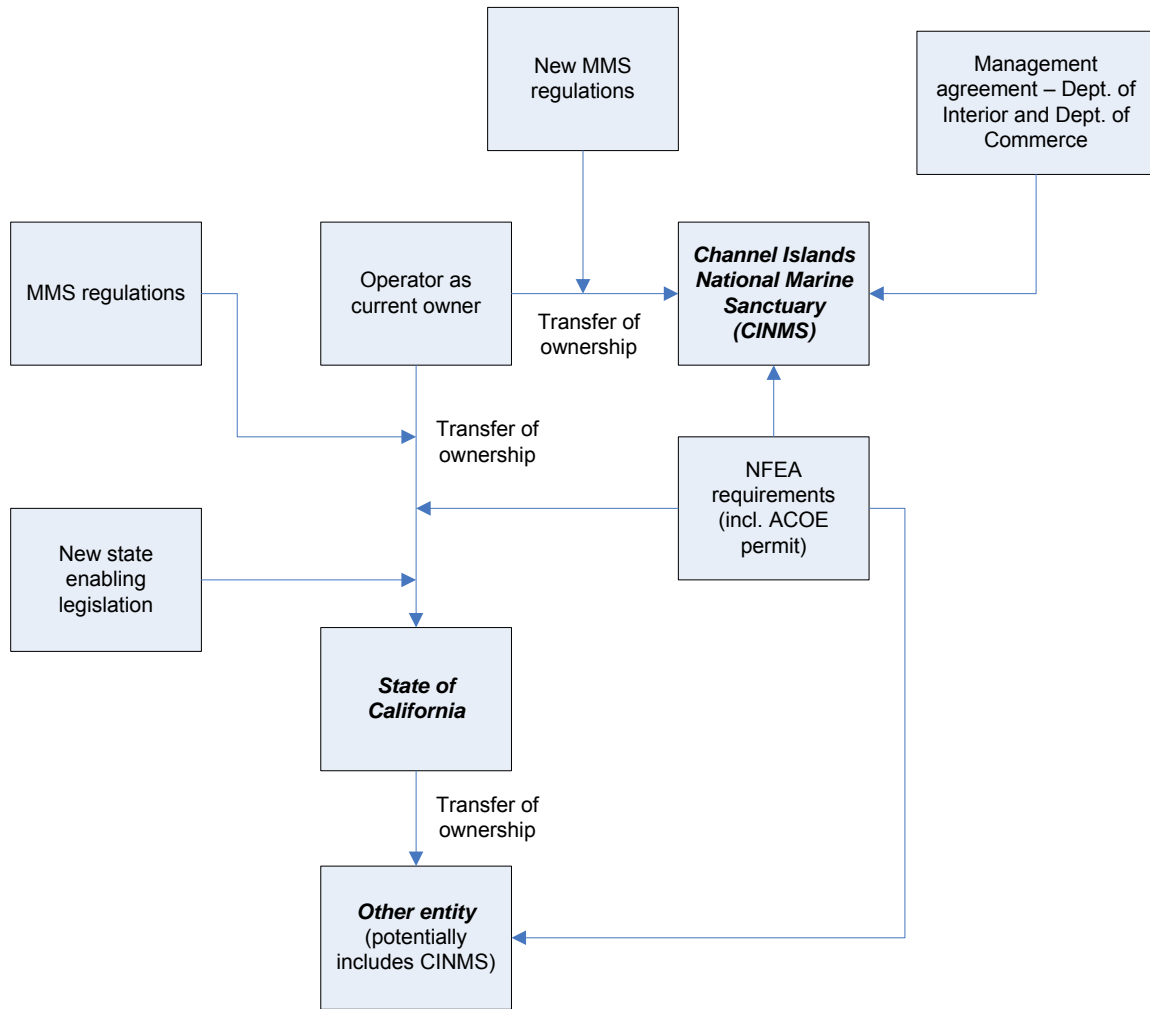

**Figure 6.1. Possible pathways for transferring ownership of a decommissioned platform and the broad legislative and/or regulatory authority that would control such transfers, discussed in Sections 6.1.1 and 6.1.2. Entities in *bold italics* represent potential ultimate owners of the decommissioned platforms.**

If relatively straightforward new legislation is adopted (see Section 6.1.1.3 for more detail) and operators are willing to donate decommissioned platforms and commit a percentage of avoided decommissioning costs to the state, the state, in turn, could accept ownership and associated liability via the authority provided by the NFEA and obtain required permits from the ACOE. Thus, under existing law, only the four platforms located in state waters would be available for the partial removal and artificial reefing option. Of these, three (Emmy, Eva, Esther) are located

in very shallow water (less than 60 feet depth) and not suitable for the artificial reefing option which involves removing the topsides and the jacket legs down to 85 feet below the sea surface. Only Holly, in 211 feet of water, is suitable for the partial removal option. The 23 platforms in federal waters of the OCS are all potentially available for the partial removal and artificial reefing option.

Legal mechanisms to allow states to accept ownership of decommissioned platforms in the OCS have been implemented successfully in the Gulf of Mexico (Table 6.1) and are described in more detail in Appendix 2, which also includes examples of state legislation and deeds of donation. Most states in the Gulf of Mexico have artificial reefs and reefing areas whose permits are held by a state agency. Note, however, that all the ACOE artificial reef permits in Florida are held by coastal county and municipal governments, with the exception of the artificial reef fisheries management research area permit held by the University of Florida on the state's northwest coast. These permits are issued jointly by the Florida Department of Environmental Protection and the ACOE and comply with NFEA requirements. Thus, the Florida Fish and Wildlife Conservation Commission holds no artificial reef permits nor does it retain title to any materials placed on the seafloor within the boundaries of permitted reefing areas. Such title is assumed by the local coastal governments who are the permit holders.

#### *6.1.1.2. Past efforts to pass enabling legislation in CA*

In 1958, California started developing an artificial reef program under the direction of the Department of Fish and Game (Schmitt 2001), primarily to enhance sportfishing opportunities off the California coast. Though the program constructed many reefs in state waters, it did not have a formal legal basis to do so until the passage of NFEA in 1984, which gave individual states the authority to create an artificial reef program, and the Wallop-Breaux amendment to the Sport Fish Restoration Act, which allocated funding to artificial reef programs (McGinnis et al. 2001). In 1985, California passed Senate Bill 70, which established the California Artificial Reef Program (CARP), and allocated \$500,000 in funding to CDFG to run the program.

Though operators' leases require complete removal when decommissioning oil and gas platforms, the partial removal and rigs-to-reef option has been considered many times (see Section 2.3.1 for more detail). The uncertainty and controversy accompanying these past proposals highlighted the need for a more definitive state policy in this area. In 1998, the Rigs to Reef Bill, Senate Bill 2173, would have allowed for partial platform removal for artificial reefing purposes, but died in committee in the state senate (McGinnis et al. 2001). In 2000, the second attempt at rigs-to-reef legislation, Senate Bill 241, acknowledged the possible value of decommissioned oil and gas platforms as valuable fish attraction and reproduction sites, and provided a rigs-to-reef option in lieu of complete removal. Senate Bill 241 also extended the CDFG's management authority into federal waters, which would have enabled the state to take ownership of platforms under the provisions of NFEA. The bill would have created the California Endowment for Marine Preservation, to receive the state's share of decommissioning cost savings, and would have established a board of trustees to allocate these funds to enhance coastal habitat and marine life. The trust would also have supported the monitoring and maintenance of artificial reefs and all hazard markers. Ultimately, Senate Bill 241 did not come to the floor for a vote, but was carried over to the next year.

**Table 6.1. Summary of the main characteristics of the Gulf of Mexico state artificial reefing programs (see Appendix 2 for additional background and Section 6.2.2.1 for details on liability).**

Issue	Texas	Louisiana	Mississippi	Alabama	Florida
Location	State and federal waters	Most 30 – 70 miles offshore (58 of 59 in federal waters)	State and federal waters	State and federal waters	State and federal waters
Depth	60 feet and deeper	45 feet and deeper	60 feet and deeper	70 feet and deeper	14 feet and deeper
Permittee	State Also allows for non-state permittees	State	State	State	Local coastal governments University
Liability	State assumes all liability	State assumes all liability State protected by statute	State assumes all liability	State assumes all liability	Permittee assumes liability (local / county, nonprofit)
Dedicated account	Artificial Reef Account Accepts variety of public and private monies	Artificial Reef Trust Fund	Mississippi Artificial Reef Fund Accepts variety of public and private monies	No formal fund Uses federal, state, local, and private funds for reef development and management	No formal fund at the state level Programs accept federal, state, and local funds Many counties have individual reef funds
Donation %	50%	50%	50%	50%	50%
Management	Parks and Wildlife Department	Department of Wildlife and Fisheries	Mississippi Gulf Fishing Banks (nonprofit fishermen's organization) Department of Natural Resources	Alabama Marine Resources Division	Local permittees Marine Fisheries Management Section

In 2001, Senate Bill 241 was amended and reintroduced as Senate Bill 1. Changes to the bill included the removal of language that treated the donation of avoided decommissioning costs to the California Endowment for Marine Preservation as a tax and provisions for the appropriation of monies from the state general fund for incorporating and operating the trust. It also removed a member of the sport fishing industry from the endowment's board and relieved the industry of its proposed research duties. Senate Bill 1 also added additional language regarding liability, including continuing liability of any operator for seepage or leaks from platform wells, and indemnification of the state from any liability that could result from the transfer of platform ownership to the state. The bill was passed by the assembly and senate but vetoed by Governor Gray Davis, who stated in his veto message:

“This bill would allow for the conversion of decommissioned offshore oil platforms and production facilities into artificial reef. Offshore oil facilities are currently required to be completely removed when petroleum production ceases. There is no conclusive evidence that converted platforms enhance marine species or produce net benefits to the environment.”  
(Davis 2001)

Opponents also faulted Senate Bill 1 for vague and ambiguous language concerning liability and indemnification as documented in the Senate Committee Analysis reports (Parks and Wildlife Committee 2001a, b). Therefore, opponents argued that, despite the bill's language, there may be “undisclosed liabilities” for the state (Parks and Wildlife Committee 2001b). Opponents also argued that any indemnity agreement between former owner/operators and the state would be decided at the time of decommissioning and would therefore be “completely speculative.” The Senate Committee analysis stated, “If the indemnifying mechanism crafted by DFG is ineffective, or the liability underestimated, the state is liable for damages, and has no immunity against tort claims” (Parks and Wildlife Committee 2001b). Of particular concern were risks associated with recreational diving, potential damage to commercial fishing vessels, and the possibility of ship strikes. Other concerns centered around uncertainties regarding management of the endowment generated from the state's share of decommissioning cost savings, how these funds would ultimately be spent, and what ratio of cost savings operators be obligated to donate to the endowment.

#### *6.1.1.3. Requirements for state enabling legislation*

As described in Section 6.1.1.1, new legislation would be required for the state to utilize authorities contained in the NFEA and accept ownership of decommissioned platforms in the OCS for use as artificial reefs. Such legislation must specifically state its authorization of a state-directed artificial reefing program consistent with the provisions and requirements of NFEA (33 U.S.C. § 2104). The state would then be allowed to accept ownership of decommissioned platforms and apply for the required ACOE artificial reefing permit. While drafting legislation is the purview of state agencies, we describe a number of elements that are essential for both meeting the requirements of NFEA and addressing past concerns about liability and managing the expanded artificial reefing program.

Note that the following discussion is relevant primarily to implementing the partial removal option in the OCS, because Section 208 of the NFEA specifically states the NFEA has no



jurisdiction or authority over states in their ownership or management of artificial reefs within state boundaries. However, 23 of the 27 platforms offshore southern California are in the OCS and only one of the state platforms (Holly) is in water depths suited to the partial removal option. The following subsections describe requirements related to:

- Program objectives
- Standards for artificial reef design
- Agency responsibilities
- NFEA requirements for a state artificial reef development plan
- Public involvement
- Allocation of the state's share of avoided decommissioning costs
- Liability and indemnification
- Environmental compliance requirements (NEPA and CEQA)
- Use of reefs for mitigation

**Clear objective(s):** The inclusion of a clearly stated intent and set of objectives (e.g., enhance sportfishing, achieve net benefit for the environment) would provide needed guidance for program managers. Based on the program's objective(s), artificial reefs made from decommissioned offshore platforms would either be managed separately or as part of an expanded CARP that includes reefs constructed of other material. Objectives motivating current artificial reefing programs include:

- Deep water disposal – the legal disposal of items in the ocean under a USEPA permit (see Section 4.2.1 for more detail), although controversial, is often supported by proponents who argue that this practice improves marine habitats, especially in areas where hard bottom substrate is limited
- Military Sinking Exercise (SINKEX) – the disposal of decommissioned warships on OCS lands after their use as weapons testing targets, favored by the military because it is an inexpensive way to dispose of these vessels and allowed by the FY04 National Defense Authorization Bill (HR 1588 Sec 1013), which gave the Department of Defense authorization to donate decommissioned ships for use as artificial reefs (GlobalSecurity.Org 2010)
- Ships to reefs programs – the sinking of ships, military or otherwise, to establish underwater attractions for divers and used in both Florida and California (i.e. San Diego's Wreck Alley)
- Commercial and sport fishing – California's existing artificial reefing program, and many in the Gulf of Mexico, are designed to enhance recreational and/or fishing opportunities

California could narrow or expand the intent of enabling legislation. For example, Senate Bill 1 (see Section 6.1.1.2) required any platform-based artificial reef to have as its primary objective a net positive effect on the environment, rather than serving primarily as a disposal program or an attraction for divers or recreational fishermen. However, any intent that required limitations on fishing would operate under specific legal constraints. The state can readily limit fishing in state waters under its sovereign authority to manage state resources, but the state's authority to restrict

commercial and recreational fishing in the OCS would be limited to fishing vessels registered in California. While the artificial reef would be owned by the state, the biological resources on and around the reef would remain under federal jurisdiction. Still, for artificial reefs in either state waters or the OCS, any such restrictions would most likely not fall under the purview of the MLPA because the MLPA's jurisdiction would not extend to reefs in the OCS, and platforms converted to artificial reefs in state waters would not meet the size and habitat guidelines established for the MLPA's MPA designation process.

Restrictions on fishing by vessels registered in California at a donated platform could be seen to conflict with the provisions of NFEA, whose primary purpose is to enhance fishing. This has typically been interpreted to mean that NFEA-permitted artificial reefs must be available for fishing. In addition, designation of artificial reefs in the OCS as no-take areas for California vessels could raise concerns about conflicts with federal fisheries regulations established by the Pacific Fisheries Management Council. Discussions with NOAA's Office of General Counsel confirm that the state can manage its own vessels (commercial and recreational fishing vessels registered with the state) even in federal waters, to the extent that those regulations do not conflict with federal law (including federal fishing regulations under the Magnuson-Stevens Fishery Conservation and Management Act), with the understanding that the state cannot manage fishing vessels from other states in areas beyond state waters. Such an application of state authority may be controversial with respect to the assumption that existing federal regulations implicitly allow fishing in the area. A possible solution to this potential conflict would be a formal declaration from the Pacific Fishery Management Council and the NMFS stating that restrictions on fishing at state-owned artificial reefs in the OCS do not conflict with federal fishery regulations.

**Establish state standards for platform-based artificial reefs:** Section 2102 of NFEA establishes national standards for artificial reefs made of any materials, which should be plainly listed and adopted by new state legislation.

**Establish agency responsibilities:** New enabling legislation should identify the entity (or entities) authorized to serve as the permittee and manager of platform-based artificial reefs, and perhaps the source of funding for the permit application and review process. For example, SB 1 proposed that CDFG act as the primary authority for managing and operating such artificial reefs and that SLC be the lead agency for CEQA compliance). As discussed in Sections 6.1.2 and 6.2.5, NFEA does not necessarily require that the state retain permanent ownership of platforms donated as artificial reefs.

**Mandate to develop an artificial reef development plan:** NFEA and MMS both require that states implement unique, state-specific artificial reef plans, subject to acceptance, before MMS can consider less than total platform removal and before the state is able to apply for a permit to accept a decommissioned offshore platform as an artificial reef. Such a plan would place reef management in the larger context of state (and perhaps federal) resource and user management goals and objectives, particularly state and federal fishery management plans. For example, NMFS has the authority to specify areas around artificial reefs to be Special Management Zones based on recommendations of the Regional Fishery Management Councils, if an artificial reef is within essential fish habitat or a habitat area of particular concern. (NOAA 2007) (see Section

4.3.6 for more detail on location of offshore platforms in relation to fishery management zones). However, artificial habitat itself has not in the past been designated as critical or essential wildlife habitat.

**Determine public involvement:** As in other state resource management programs, the state may desire to establish a mechanism to provide for public and non-governmental involvement in the state review, acceptance, and management of a rigs-to-reefs artificial reefing program. Issues to consider that could be included in enabling legislation include the size membership of any oversight or advisory boards or committees, their role(s) and governance, sources (s) of funding to support their activities, and which entity would be responsible for managing a public involvement process.

**Clarify allocation of avoided costs:** Under the scenario envisioned for implementing a state rigs-to-reefs program, operators would donate the decommissioned platform to the state and contribute a portion of the avoided decommissioning costs to a designated fund. This will require a detailed procedure for calculating avoided costs and defining tax consequences. It will also require authorizing the acceptance of donated monies, establishing a trust fund (or designating an existing fund) to hold donated monies, and specifying how trust fund resources should be allocated (see Section 6.3 for more detail).

**Liability and indemnification:** Section 2104 (a) (3) of NFEA requires that ownership of the reef material be clear and that the owner have the ability to maintain and assume liability for future damages. Section 1204 (c) (1) requires that anyone receiving a permit for an artificial reef under the authority of NFEA shall not be liable for damages caused by activities required to be undertaken under the terms and conditions of the permit if the permittee is in compliance with current terms and conditions. Such activities include both placement and operation of the reef after decommissioning, but not the decommissioning activity itself. For example, in Louisiana, commercial fishing nets have been snagged on artificial reefs on several occasions. In all cases, the artificial reefs complied with all USCG regulations for the marking of obstructions, and the state was not found liable in maritime court. Similarly in Texas, an oil platform was being towed offshore for installation and struck a recently deployed structure within a designated artificial reefing site. The state of Texas was only briefly involved during the initial reporting of the incident and then removed from any further involvement because the platform should not have been towed through an established artificial reef site that met all USCG regulations for marking of obstructions (D. Peter, Louisiana Department of Wildlife and Fisheries, formerly of Texas Parks and Wildlife Department, pers. comm., 2009).

Section 2104 (c) (3) of the NFEA requires that the state demonstrate the ability to cover other sources of liability for any permitted artificial reef. While the state's liability is limited, enabling legislation could require additional mechanisms to further limit the state's potential liability (see Section 6.2 for more detail). In addition, enabling legislation should clearly state that the NFEA federal indemnification authorities are adopted and included in the state's artificial reef program.

**Environmental compliance requirements:** Legislation should specifically require NEPA and CEQA review with respect to potential effects of a rigs-to-reefs project on the environment of California. Whether it entails a rigs-to-reefs exception or not, decommissioning requires a major

federal action and an environmental impact statement under NEPA. If the state should choose to extend its reach into federal waters as a permittee by accepting ownership of a platform from the private sector, with the associated long-term management and liability considerations, it would likely be considered a major state action that would require CEQA compliance.

**Mitigation for other projects and circumstances:** Enabling legislation should specify whether and to what degree donated platforms converted to artificial reefs can be used as mitigation for other projects. Senate Bill 1 specifically disallowed such mitigation credits.

### **6.1.2 Transfer to other entity**

NFEA does not necessarily require that artificial reefs be owned by a state, and in the past, the ACOE has permitted artificial reefs owned by a variety of public and private entities, as long as the entities can meet the NFEA requirements, especially those related to liability coverage. This flexibility provides additional options for ownership and management of the decommissioned platforms. In the first scenario below, the state would still be required, under MMS regulations, to initially accept ownership of the platform, but could then transfer ownership to another entity. The second scenario describes the potential for a federal artificial reefing program under the management of the Channel Islands National Marine Sanctuary (CINMS), which would involve a transfer of ownership either directly from the operator to CINMS or indirectly from the state to CINMS (Figure 6.1).

#### *6.1.2.1. Transfer to local government or non-governmental organization*

The lead permitting agency, the ACOE, will issue artificial reef permits to a range of entities (as illustrated by the experience in Florida, described in Section 6.1.1.1), which could in theory include private citizens, fishing clubs, and private organizations, as long as they carried adequate liability insurance that met NFEA requirements. While the ACOE in practice has not issued such permits in recent years because of concerns about the capacity of smaller organizations to fulfill their long-term management responsibilities, there is no legal reason such permits could not be issued. Moreover, current federal law specifies that establishing artificial reefs from decommissioned offshore oil platforms requires that the platforms be owned by the state and permitted for use as reefs by MMS (30 C.F.R. § 250.1730). Once the title of a partially decommissioned platform is transferred to the state, MMS requirements have been fulfilled and MMS no longer has any regulatory authority, allowing the possible transfer of ownership or title from the state to another owner.

For example, the mission of the existing California Artificial Reef Enhancement (CARE) program could be expanded to accept ownership of decommissioned platforms directly from operators and manage them as artificial reefs. CARE is a successful 501(c)3 nonprofit public benefit corporation whose current mission states, “The goal of CARE is to encourage additional research and educate Californians about artificial reefs and their role in the marine ecosystem” (www.calreefs.org 2009). CARE is largely funded by the oil and gas industry, which may have an interest in supporting an expanded role for CARE. Under this scenario, with a private organization as the permit holder, ACOE and CDFG would provide regulatory oversight similar

to that in Florida where the Florida Department of Environmental Protection and ACOE issue and oversee artificial reefing permits (See 6.1.1.1 for details).

While such transfers of ownership are legally feasible, there are two issues that could make its implementation problematic. The first, a procedural issue, is that local coastal governments cannot own property in the OCS and it is not clear that CARE (or another nonprofit) can accept ownership of an artificial reef located in federal waters. The second, a financial issue, is that details regarding the disposition of the share of avoided costs to be donated by the operator have yet to be determined. For example, it is possible that ownership of the artificial reefs could be transferred to a local government or nonprofit, along with enough funds to fulfill management and liability responsibilities, and the remainder of the funds might be transferred to the state (see Section 6.3 for more detail). The advantage of this mechanism to the state would be the avoidance of liability (see Section 6.2.5 for more detail) and any costs involved in managing the artificial reefs.

#### *6.1.2.2. Transfer to a federal rigs-to-reef program*

A new program could be established that would allow operators to transfer ownership of decommissioned platforms to NOAA's Channel Islands National Marine Sanctuary (CINMS), which would then assume management responsibility. As described below, this option fits within both national policy and the recently revised CINMS Management Plan (U.S. Department of Commerce 2008) as legally viable and potentially beneficial for both the Sanctuary and the state. However, neither CINMS nor MMS has expressed interest in this mechanism and MMS has clearly stated that its policy is to support state artificial reefing programs. This ownership transfer mechanism is presented in response to state managers' requests to explore as full a range as possible of potentially feasible mechanisms.

The National Marine Sanctuary Program has developed a Policy on Permit Applications for Artificial Reef Development (15 C.F.R. Part 922) which includes guidelines for considering the placement of artificial reefs within sanctuaries. Locally, the CINMS Management Plan and its accompanying Final EIS (U.S. Department of Commerce 2008) address the current laws and policies regarding artificial reefs within CINMS and explain that artificial reefs can be permitted within the Sanctuary. Under current law and management policies, artificial reefs can be permitted within the Sanctuary (U.S. Department of Commerce 2008, p. 166). While incorporating offshore platforms into the CINMS boundary as artificial reefs would require a boundary revision, which would be a substantial effort, a review of the current Sanctuary boundary is explicitly called for in the current Management Plan (U.S. Department of Commerce, p. 122). Any boundary revision intended to incorporate decommissioned platforms need not include area(s) contiguous with the present CINMS boundary, but could include only areas around individual platforms.

A direct ownership transfer from the operator to the CINMS is also allowed under NARP, but, for platforms in the OCS, would require an amendment to current MMS regulations (30 C.F.R. § 250.1730), which require that a decommissioned platform intended as an artificial reef may only be transferred to an appropriate state artificial reef program. Under this potential mechanism, the

operator could transfer portions of the avoided cost to a CINMS Specified Donation Account and to a state-designated trust fund (see Section 6.3 for more detail).

Artificial reefs within the CINMS boundary could be actively managed through a management agreement between the Department of Interior and the Department of Commerce, which would not require additional legislation. One local example is the management agreement between the National Park Service and the Department of Defense, in effect since the late 1960s, which allows the Park Service to actively manage San Miguel Island by staffing it, building facilities, and spending millions of dollars on natural and resource management issues. Section 1442 of the National Marine Sanctuary Act specifically empowers the Secretary of the Interior to enter into a variety of cooperative agreements and to accept donations of funds, property, and services.

Transfer of the decommissioned platforms to a federal artificial reefing program has several distinct advantages. First, CINMS is in close proximity to existing offshore platforms and is a willing partner in and supporter of marine resource monitoring, research, and management in the region. Second, the specific requirements for legislation to enable direct donation of decommissioned platforms to CINMS are clear but would require new enabling legislation that codifies the process for transfer of both ownership and monies, acceptance of an increased level of government liability, use of donated funds to support both state and federal activities, modification or amendment to the existing CINMS Management Plan, and adjustment of the Sanctuary boundaries. Third, there is a rationale for federal-state cost sharing and cooperative management, as exhibited in the numerous memoranda of understanding (MOUs) and management agreements between the federal government and the State of California for the purpose of managing public resources and ecosystems for the broader public good.

## **6.2 Addressing liability concerns**

State managers have identified a number of sources of liability that would pose concerns under the two decommissioning options being considered: complete removal and partial removal as part of a state managed artificial reef program. The following subsections discuss liability associated with both options, but concentrate primarily on the partial removal option. This is because liability related to complete platform removal, for the most part, has been well defined in existing law, regulations, and permits. In contrast, there is greater uncertainty about the state's liability exposure under the partial removal option and ways in which this liability might be managed. State managers have noted that a satisfactory solution to their liability concerns is an essential prerequisite for the implementation of any partial removal / artificial reefing policy.

Liability is a complex issue. Not only are there multiple potential sources of liability, there are multiple approaches to dealing with these sources, either separately or in the aggregate. Therefore, any solution that the state adopts would be constrained to some degree by existing law and practice, yet have the opportunity to draw on experience from other arenas. This subsection includes the following:

- A background review of basic liability concepts related to offshore leases and platform decommissioning

- A brief description of current federal and state provisions describing liability and the assignment of responsibility associated with decommissioning
- A description of potential sources of liability of major concern, along with mechanisms in place for addressing concerns in California and elsewhere
- An outline of mechanisms (e.g., insurance, bonding) that could be applied globally to deal with a range of liability concerns, along with specific examples from other programs illustrating these mechanisms
- A more detailed discussion of how the transfer of reef ownership to a non-state entity would affect the state's liability

Table 6.2 briefly summarizes the mechanisms available in federal and state law for addressing the major sources of liability described by state managers and discussed in more detail in issues associated with liability and described in more detail in Section 6.2.3. As the following subsections explain, there are well-established mechanisms for defining, limiting, and managing liability associated with artificial reefs created under the partial removal option.

### **6.2.1. Background**

While liability for offshore oil and gas facilities can be transferred from operator to operator and from landowner to landowner or any combination thereof (termed “serial liability”), once liability is created it does not go away (NRC 1985, p. 41). Exposure to damage claims can be minimized in a number of ways (e.g., sharing, insurance, bonding) that can help pay any awarded damages; still, liability continues to exist in the form of “lingering liability” for some entity (McGinnis et al. 2001). For this reason, sales of leases require the express, written approval of the MMS or SLC, which attempt to insure state and federal governments from liability by requiring a lessee to provide bonding to cover any incidents. In the oil industry it is standard business practice for operators to cover lingering liability by sharing such liability through written contracts and agreements. Thus, sequential sales of such leases include written agreements that specify who will accept what liabilities and provide some type of legal instrument to insure the landowner if a problem occurs.

In general, these sorts of mechanisms have been applied to the use of decommissioned platforms in artificial reefing programs. For example, when the State of Mississippi accepts a platform for its artificial reef program, via a deed of donation from the operator and under provisions of NFEA, the agreement specifically states that the donor (the oil company) retains liability for any claims or damages stemming from leaks or seeps of hydrocarbons and the State of Mississippi assumes liability for everything else related to use of the platform as an artificial reef (State of Mississippi 2009). Despite the broad application of such mechanisms in a variety of reefing and other programs, concerns about the state's potential liability remain. As discussed in NRC (1985), the greater the amount of platform remaining after decommissioning, the larger the exposure to liability, and only complete platform removal with onshore disposition or with deep water disposal under permit from the USEPA (see Sections 3.1 and 4.2.1 for more detail) eliminates the tort liability burden almost entirely. No other method of disposal or abandonment affords the same degree of protection from continuing liability (NRC 1985, p. 3).

**Table 6.2. Summary of mechanisms already existing in state and federal law, or that could be included in enabling legislation establishing an expanded state artificial reefing program, that address the major sources of liability associated with the partial removal option.**

Sources of liability	Federal law			State law		
	OPA	Leases and MMS regs	NFEA	Leases, SLC regs, Harbors & Navigation Code	Enabling rigs-to-reefs legislation	CA Tort Claims Act, AB 634
Pollution from abandoned wells	Liability for operators in perpetuity Oil Spill Liability Trust Fund	Liability for operators in perpetuity, bonding requirements	Protects operators from liability due to platform, but not abandoned wells	Liability for operators in perpetuity		
Pollution from shell mounds		Liability for operators in perpetuity, bonding requirements		Liability for operators in perpetuity		
Fatalities and injuries to divers			Protects operators from liability if permit complied with		Includes immunity against liability	Explicitly protects state and local gov'ts re SCUBA diving on artificial reefs
Loss of or damage to commercial fishing gear		Existing compensation mechanisms that could be adapted to artificial reefing program	Protects operators if permit complied with		Includes immunity against liability and/or compensation mechanism	
Ship strikes, other external events			Protects operators if permit complied with		Protects state	
Litigation costs for state agencies					Could be compensated through share of avoided costs	



## **6.2.2. Current federal and state provisions defining liability**

Current legal provisions in place that define liability as it relates to the decommissioning of offshore oil platforms provide a starting point for considering the sources of liability of concern to the state. These provisions are defined in state and federal laws and regulations related to rigs-to-reefs programs specifically, and decommissioning more generally. In the Gulf of Mexico, these provisions have proved effective in limiting liability to artificial reef programs.

### *6.2.2.1. Liability associated with a rigs-to-reefs program*

In the past, operators were reluctant to participate in artificial reefing programs because participation would necessarily involve leaving a structure in place without some form of liability release (Athanasopoulos et al. 1999). The NFEA resolved this issue by providing legal authority that allowed liability for the platform (but not for the abandoned well itself, which remains the responsibility of the operator in perpetuity) to be transferred from operators to artificial reef sponsors (e.g., state artificial reefing programs) as part of the donation process. The NFEA also states that reef sponsors are absolved of liability due to external events if the reef meets permitting requirements (e.g., depth, USCG navigation notifications and markings) (Athanasopoulos et al. 1999).

In practice, liability for donated platforms has been transferred to a state at the time the state accepts the deed of donation upon completion of decommissioning. Specific language in legislation establishing Gulf of Mexico artificial reefing programs (e.g., Louisiana Fisheries Enhancement Act Section 639.10. Liability, Texas Artificial Reef Act of 1989 (Texas Parks and Wildlife Code, Subtitle H, Chapter 89, Subchapter A, Section 89.061. Liability)) and in deeds of donation through which operators transfer title to the platform to the state (e.g., Mississippi Act of Donation and Title Transfer, Article VII- Liability) explicitly mirror NFEA language and limit liability exposure of the state, donors of reef materials, and reef managers. As illustrated by the examples in Section 6.1.1.3, these provisions have proved effective in shielding artificial reef programs in the Gulf of Mexico from liability. Representative examples of state legislation and deeds of donation can be found in Appendix 2.

### *6.2.2.2. Liability on OCS lands*

MMS regulations, which were promulgated originally by a Federal Register Notice dated June 29, 1979 (44 FR 38276), state that operators and lessees are liable for the all obligations defined in leases and MMS regulations, including those related to decommissioning and removal of obstructions (30 C.F.R. Part 250, Subpart Q). These obligations continue even when leases are assigned to other parties. Such responsibilities are typically guaranteed by the operator's purchase of performance bonds, whose value may be periodically increased as estimated decommissioning costs increase. MMS will not allow these bonds to be terminated if any obligations have not been fulfilled (MMS, GOMR, Notice to Lessees 93-2N, Oct. 1993).

When the original lessees assign leases to other parties, MMS looks first to the designated operator to perform these obligations, but should the operator be unable to perform these, the MMS will require any or all of the lessee(s) to ensure compliance. If there is no current lessee

available, the MMS normally requires other lessees who held the lease during or after facilities' installation to perform these functions. The MMS is not authorized or funded to assume responsibility for these obligations (MMS, GOMR, Notice to Lessees 93-2N, Oct. 1993).

In addition to these MMS regulations, OPA liability standards apply to all MMS leases/permittees on OCS lands. Even after well abandonment and decommissioning, the lessee retains liability in perpetuity under federal law as a "responsible party" as defined in the OPA (33 U.S.C. § 1702(a)), including for removal of spills and payments of any related damages. "Responsible party" includes a person leasing an area in which the facility is located, the permittee of the area in which the facility is located, or the holder of a right of use or easement for the area in which the facility is located (Randal 1991). In the event that lessees no longer exist, cleanup costs can be paid by the Oil Spill Liability Trust Fund.

#### *6.2.2.3. Liability on state lands*

California has defined strict joint and several liability for offshore oil exploration and production under California Harbors and Navigation Code section 294. Upon termination of operations and completion of decommissioning, including abandoning wells to current standards and restoring the area to its native condition (or as close as practicable), the state minimizes an operator's liability through the acceptance by the SLC of a quit claim deed from the operator(s) or lessee. After 15 years have elapsed, operators in California bear no responsibility for replugging and abandoning wells that leak if they were originally plugged and abandoned to the standards of the California Division of Oil, Gas and Geothermal Resources in effect at the time (PRC 3251.5(a)). Even if the federal OPA were to hold operators liable for cleaning up a spill from a properly plugged and abandoned well more than 15 years after it was properly plugged and abandoned, it would not require the operator to pay the costs of replugging and re-abandoning the well. Those costs would be borne by funds for dealing with deserted wells (PRC 3258) and this liability would ultimately fall to the state if assessments on operators were not sufficient to cover the costs. However, these liability provisions would apply equally under both the complete and partial removal option because wells will be plugged and abandoned identically in both cases and because the state (or other entity) would take ownership only of the platform and not the underlying well.

However, in the event the SLC judges that all issues related to decommissioning of the platform have not been resolved at the time of original decommissioning, the SLC may refuse to accept such a deed, with the result that the lessee continues to retain liability and the obligations of the lease remain in force. In addition, as described above, OPA specifies that operators remain liable in perpetuity for any leaks or damage from abandoned wells, even after the SLC's issuance of a quit claim deed.

In California, the Secretary of the California Natural Resources Agency has designated the CDFG's Office of Spill Prevention and Response (OSPR) to act on behalf of the public as a state trustee for natural resource damage and restoration assessments under the Comprehensive Environmental Response Compensation and Liability Act (CERCLA) when oil spills do occur. In such cases, OSPR coordinates with other state agencies such as the State Water Resources Control Board, and with federal trustees such as NOAA and FWS as necessary.

### **6.2.3. Liability sources of concern and mechanisms for addressing them**

During our review of available documents and in interviews with state managers, state managers identified five specific and one general source of liability (see Table 6.2), including:

- Pollution due to seeps, leaks, and blowouts from abandoned wells
- Pollution from shell mounds left in place
- Fatalities and injuries due to divers using a platform that has been converted to an artificial reef
- Loss of or damage to commercial fishing gear due to entanglement with a platform that has been converted to an artificial reef
- Ship strikes / collisions with a platform left in place as an artificial reef
- Litigation costs associated with defense of claims made against the state for damages associated with either decommissioning option

#### *6.2.3.1. Pollution from abandoned wells*

Pollution from abandoned wells could stem from seeps, leaks, or blowouts. This is a highly visible issue in southern California because of experience with the 1969 well blowout in the Santa Barbara Channel. However, an important distinction is that both the 1969 blowout in the Santa Barbara Channel and the 2010 blowout on the Deepwater Horizon rig occurred on active wells, while the issue at hand is wells that have been plugged and abandoned after production has ceased. Modern methods of well abandonment are highly reliable and MMS records indicate there have been no leaks or other problems with abandoned wells in the OCS. Section 6.2.2.3 describes provisions for assigning liability for leaks after wells have been abandoned. NFEA provisions with regards to liability address only the residual platform and not the abandoned wells. Thus, converting a decommissioned platform into an artificial reef, either on site or at a different location, does not affect the operator's continuing liability for events related to the abandoned well itself.

As explained in Section 4.2.1.1, well abandonment will be carried out identically under both decommissioning options. Thus, while potential problems with abandoned wells are an issue for all decommissioning projects, it is not relevant to the choice between complete and partial removal options and thus not examined further in this analysis (see also Section 4.2.1.1).

#### *6.2.3.2. Pollution from shell mounds*

Shell mounds would necessarily be left in place under the partial removal option and could also be left in place, at the discretion of management agencies, under the complete removal option. As discussed in detail in Section 4.1.1.2, concerns about pollution stem from two sources: leaching and resuspension. Shell mounds left in place might leach contaminants into surrounding water and/or sediments, with the potential for direct toxicity or bioaccumulation. If removed, for example by dredging, some contaminants sequestered within a shell mound would be disturbed, resuspended, and dispersed, again with the potential for toxicity or bioaccumulation. While operators have the responsibility, in both state and federal waters, to remove all obstructions,

policy addressing potential pollution associated with shell mounds is less clear. However, operators would retain liability for any impacts from shell mounds under any management scenario because the shell mounds are directly integral to operations and are not the responsibility of the land owner.

#### *6.2.3.3. Fatalities and injuries to divers*

Under the partial removal option, platforms would be converted to artificial reefs that would be then potentially accessible for recreational use, including SCUBA diving. This is a potentially hazardous activity, and state managers have expressed concerns about if and how the state might be held liable in the event of diver fatalities or injuries on artificial reefs. There is immunity from this source of liability under state law, and experience from other states with rigs-to-reefs, ships-to-reefs, and shipwreck diving programs provide useful examples of how the state can limit its liability from this source.

**Immunity under California law:** The California Tort Claims Act (Government Code § 810 et seq.) provides for general immunity from liability for public entities:

815. Except as otherwise provided by statute:

(a) A public entity is not liable for an injury, whether such injury arises out of an act or omission of the public entity or a public employee or any other person.

In 1983, the California Legislature passed Assembly Bill 555 which enacted Government Code section 831.7 to create a qualified immunity for public entities from lawsuits arising from an injured party's hazardous recreational activity (as long as no fee is charged for the activity). The bill defined "hazardous recreational activity" to include diving into the water and other water-related activities, but did not expressly address SCUBA diving. In 1995, the Legislature passed Assembly Bill 700, amending section 831.7 to include mountain biking, paragliding, and windsurfing as hazardous recreational activities, but again did not include SCUBA diving.

Assembly Bill 634, passed in January 2010, addresses this omission by specifically adding SCUBA diving to the list of hazardous recreational activities that may take place on public property and providing that people participating in SCUBA diving do so at their own risk. It extends to the state and local governments legal immunity from liability for divers who injured or killed while diving off or near artificial reefs on their own. As part of a mechanism to provide funding for a ships-to-reefs program (see subsection below) operated by a nonprofit, the bill would maintain the protection against liability even when a usage fee is charged.

**Rigs-to-reefs programs:** Several Gulf of Mexico state reefing programs allow recreational diving on artificial reefs within their waters. Most such programs are immunized against liability resulting from diving accidents as part of their respective state statutes (see Section 6.2.2.1 and Appendix 2 for more detail) and therefore none of these states have made any additional provisions for addressing potential liability from this source. No deaths have been documented as a result of a recreational diving accident on an artificial reef, so these statutes have remained unchallenged and interviews with managers of several of these state programs confirm that a

claim has never been made against a state for damages due to diver injury or fatality related to the artificial reefs (see also Ships-to-Reefs Programs below).

**Ships-to-reefs programs:** Programs that sink unneeded military and private vessels for use by recreational divers are somewhat analogous to rigs-to-reefs programs in that an artificial underwater structure is intended for recreational use. The Ships to Reefs International Association coordinates such artificial reefing efforts on an international basis and U.S. members of Ships to Reefs International coordinate a national artificial reefing program. Despite Florida's large (over 400 military vessels) program, the lack of specific language addressing liability in the legislation establishing the program, and a number of diving fatalities on permitted artificial reefs, there has been no litigation directed at the permit holder during the last 18 years (J. Dodrill, Florida Fish and Wildlife Conservation Commission, pers. comm., 2009).

California Ships to Reefs (CSTR) has developed a plan that would involve a public-private partnership with the SLC, under which CSTR would lease lands from the SLC on which to sink ships. CSTR would then contract for the installation and maintenance of aids to navigation and mooring buoys required under USCG regulations. As long as CSTR owns the reefs and leases the ocean bottom from SLC, there would be no liability exposure for the state; all liability would be borne by CSTR, which could purchase insurance to cover its potential liability. Assembly Bill 634, described above, would immunize the reef owner/manager, as well as state and local governments, from all liability related to SCUBA diving on artificial reefs. Assembly Bill 634 would thus protect the state from liability from this source for state-owned artificial reefs and would also protect local non-profits or local governments who might accept a transfer of ownership from the state, as described above in Section 6.1.2.1.

**Shipwreck diving programs:** There are a number of locations in the Great Lakes and along the Atlantic coast of the U.S. where shipwrecks (as opposed to deliberately placed wrecks, as above) are regularly used by recreational divers. Many such locations (e.g., Whitefish Point Underwater Preserve in Michigan) have experienced numerous diver fatalities, which have sometimes resulted in litigation yet in other cases have not. Several states have specific laws and regulations regarding shipwreck diving liability that limit the state's exposure, whereas others assume risk is accepted by each individual diver or dive company. Examples of state laws that expressly limit state liability include:

- Michigan Aboriginal Records and Antiquities Act, Part 761
- Abandoned Shipwreck Act of 1987 (43 U.S.C. § 2101 *et seq.*)
- Georgia Recreational Properties Act (O.C.G.A. 51-3-20)

Dive companies typically require that divers sign liability waivers with indemnity clauses. Some dive companies have had lawsuits brought against them based on the Death on the High Seas Act (46 U.S.C. § 303), though none have been successful. While they are neither decommissioned platforms nor designated as artificial reefs, many of the liability concerns associated with shipwreck diving programs mirror those expressed with respect to rigs-to-reefs programs and solutions crafted by other states could be useful models for California.

#### *6.2.3.4. Loss of or damage to commercial fishing gear*

The complete and partial removal options would result in somewhat different liability scenarios related to loss of or damage to commercial fishing gear. Under the complete removal option, risk of loss or damage to commercial fishing gear would remain if management agencies decide that shell mounds should be left in place. This liability would be a concern for the lessee because the shell mounds are directly integral to operations and are not the responsibility of the land owner. Under the partial removal and artificial reefing option, the platform below 85 feet of water would be left in place as an artificial reef and would pose some risk to trawl or longlining gear that are deployed at depths deeper than 85 feet. However, the NFEA provisions would protect the state against claims for damages due to loss of commercial fishing gear (see Section 6.2.2.1 for more detail). In addition, loss of or damage to commercial fishing gear is a common enough concern that well-established mechanisms are in place for evaluating claims of loss in both federal (Manage and Williamson 1997) and state waters and providing for compensation in these cases.

In the OCS, the Fishermen's Contingency Fund (FCF), established under the OCS Lands Act, 43 U.S.C. 1841-1846, compensates U.S. commercial fishermen and other eligible citizens for property and economic loss caused by obstructions related to oil and gas development activities. NMFS administers and processes FCF claims under regulations established in 30 CFR 296, while MMS coordinates communications with OCS lease holders and maintains the database for reported obstructions. Payments into the FCF are made through periodic assessments against all holders of exploration permits, leases, easements, or pipeline right-of-ways, issued or maintained under the OCS Lands Act. However, the FCF only relates to claims of damage due to active platform operations, based on the assumption that all platforms would be completely removed at the end of their production lifetime. Potentially, this fund could be extended to include platforms converted to artificial reefs owned by the state or other entity, although it would require amending relevant portions of the regulations.

In state waters, the State of California does not have a specific contingency fund to compensate commercial fishermen for any damage incurred as a result of offshore oil and gas on either state or federal lands. However, in 1987 the County of Santa Barbara established the Local Fishermen's Contingency Fund (LFCF) to assist fishermen who incur gear loss or damage as a result of OCS oil and gas development activity. Although initially established as a complement to the FCF, the LFCF provides a functional model for liability contingencies that may be applied more broadly to serve a wider range of state needs.

#### *6.2.3.5. Ship strikes*

Two unique uses of the Santa Barbara Channel increase the chances of possible ship collisions with decommissioned oil platforms converted to artificial reefs. The first of these is the weapons testing conducted by the Naval Air Warfare Test Center, Weapons Division, which tests a variety of weapons, including underwater weapons systems, nuclear submarines, surface ships, and aircraft. Documentation of close calls and near misses from the Navy's testing activities is difficult to obtain. However, as one example, on August 20, 1988, the Navy attempted to sink a large target vessel, the 457-foot USS *Tortuga*, in the open ocean south of Santa Cruz Island. A weather change and darkness prevented sinking and the vessel drifted over 20 miles to beach on the southwest side of San Miguel Island. Under a different set of current and wind conditions, the

USS *Tortuga* might have crashed into an operating oil platform (T. Setnicka, formerly Channel Islands National Park, pers. comm. 2009). The same year, the collision of a German submarine with a North Sea platform confirmed that such incidents, while rare, are possible (Pulsipher 1996). In such instances, however, it is likely that the federal government would be liable for any damages.

The second unique use of the Santa Barbara Channel is as a primary conduit for shipping traffic in the region. As a result, a collision with another ship, an operating oil platform, or a shallow artificial reef is a possibility that, were it to occur, could have severe consequences. Ship collisions have occurred in the region, for example the 1987 collision of the bulk ore carrier *Pac Baroness* and the Panamanian freighter the *Atlantic Wing* southwest of Point Conception ([www.incidentnews.gov/incident/6499](http://www.incidentnews.gov/incident/6499)). Given that the partial removal option envisions removing the platform structure to 85 feet below the sea surface, and that the largest ships in the world, the TI class of supertankers (USCG 2010), have a draft of just under 81 feet (Euronav 2010), a direct ship strike on a platform reef is extremely unlikely. Even if a collision between two or more ships resulted in a sinking ship that impacted a submerged platform reef, the state would be protected against liability from ship strikes under provisions of the NFEA, as described in Section 6.2.2.1.

#### 6.2.3.6. *Litigation costs for state agencies*

The state is primarily self insured; that is, it defends itself against lawsuits and pays damage claims with funds from government accounts. Agencies' legal staffs are thus tasked with defending against claims of liability as part of their role and function and large cases can initially be underfunded and understaffed. In particular, state managers have expressed concerns about the potential costs to defend against claims arising from one or more of the sources of liability identified above. This situation would remain as it currently is under the complete removal option. However, under the partial removal option, the availability of resources from avoided costs (see Section 6.3) could help fund such litigation costs. Further, mechanisms could be established to allocate funds received as the state's share of avoided costs to be used to reimburse the state's legal costs to defend against lawsuits claiming damages due to the artificial reef program. In addition, the state could purchase insurance coverage through the Office of Risk and Insurance Management as described in more detail in Section 6.2.4.5.

### **6.2.4. Mechanisms for achieving broader protection**

There are a number of mechanisms used both in the oil and gas industry, and more widely by private and public entities, to shield against liability and minimize financial losses. This subsection describes some of the most commonly used mechanisms that may be applicable to the risks described above, including:

- Shared liability
- Continuation of operators' bonds
- Other MMS surety models
- Industry-funded insurance trust fund

- State purchased insurance
- Catastrophe bonds
- Indemnification

These are summarized in Table 6.3 and discussed in greater detail in the following subsections.

Many of the mechanisms described below involve insurance or bonding and for this reason it is useful to understand the basic difference between insurance and bonds. Insurance is the transfer of risk to a third party, usually a professional risk bearer such as an insurance company which will make payouts to cover insured losses. Insurance companies do not attempt to recover amounts paid on behalf of or to the insured. In contrast, with bonds, the surety, or the company providing the bonding, expects zero losses. The surety will thus attempt to recoup its losses from the bonded organization if it is called upon following a trigger event.

Several of the mechanisms described below are somewhat speculative strategies suggested in discussions with state, federal, and industry managers. In addition, all are optional strategies that could not be mandated by either the state or federal governments, nor would either government be compelled to accept them if offered. The application of these strategies, with the exception of state purchased insurance or catastrophe bonds, would therefore be subject to negotiation.

#### *6.2.4.1. Operators continue to share liability with the state*

Under the partial removal option, platform ownership is transferred only after production has been terminated and all lease provisions have been met. In this circumstance, both MMS and the SLC have regulatory procedures for releasing operators from liability, and the NFEA extended these provisions to cover the donation of a decommissioned platform to an approved state artificial reef program. While there is no current legal authority to require operators to retain a share of liability after ownership of the platform is transferred, it is possible that MMS and the state could use the potential savings in decommissioning costs as an incentive for operators to continue to share liability. Such an arrangement, though possible in principle, has not been attempted in other artificial reef programs.

#### *6.2.4.2. Continuation of operator's bonds*

Both the state and the federal governments require the use of bonds during oil exploration and extraction activities. Such bonds are intended to ensure that all operators performing activities under respective jurisdictions fully comply with regulatory and lease requirements and provide or demonstrate adequate financial resources to protect the state or federal government from incurring any financial loss (e.g., 30 C.F.R. Part 250, Subpart A and 30 C.F.R. Part 256, Subpart I). For OCS leases, MMS developed a supplemental bond program intended to further protect the U.S. from incurring costs involved with oil and gas abandonment and site clearance on the OCS.



**Table 6.3. Possible mechanisms for achieving broader protection against all sources of liability. Several of these mechanisms were suggested in discussions with state, federal, and industry managers and are somewhat speculative in nature.**

Mechanism	Description	Precedent	How implemented
Shared liability	Operator retains share of liability after decommissioning and transfer of ownership	Not attempted previously	No legal authority; would require negotiation
Continuation of operators' bonds	Operator maintains some portion of existing performance bonds in force	Not attempted previously	No legal authority; would require negotiation
Other MMS surety models	Extension of abandonment trust accounts, third party guarantees, and/or pledged U.S. Treasury securities	Not attempted previously	No legal authority; would require negotiation
Industry-funded insurance trust fund	Beneficiary of trust fund is the state; private funding ensures premium cannot be diverted to other uses	Not attempted previously	No legal authority; would require negotiation
State purchased insurance	Useful if unfamiliar, uncertain, and/or large exposures that exceed state's willingness to self insure; managed by Office of Risk and Insurance Management	Well established precedent for state government	State could implement this independently; could be funded internally, by portion of avoided costs, or by operator as part of ownership transfer
Catastrophe bonds	Used to cover large but low probability risk; often structured as bonds; arranged through specialized brokers	Widely used in other arenas	State could implement this independently; could be funded internally, by portion of avoided costs, or by operator as part of ownership transfer
Indemnification	Voluntary contracts to not hold one or more parties liable and to "make whole" losses incurred; indemnification of the state would likely require a third party insurance carrier	Not used in Gulf of Mexico reefing programs	No legal authority; would require negotiation
Federal liability defense credit	Fund set aside specifically to cover costs associated with liability to local, state, federal government entities and other parties	Established precedent in federal programs	Legal authority exists; would require legislation to establish the fund

Using historical data and a costing formula, MMS developed a minimum bond level to ensure the coverage of costs incurred in removing these facilities keeps pace with cost increases over time (MMS, GOM, Guidelines for Lease Surety Bonds, NTL No. 2000-G16).

Under the partial removal option, the state could negotiate with operators to continue funding bonds to cover liability associated with the potential residual effects of petroleum production activities. There is no current legal authority to require this, assuming that the operator has met all lease provisions, although the potential savings from avoided decommissioning costs could be used as an incentive to encourage operators to continue to finance the costs of managing liability. Though possible in principle, this mechanism has not been attempted in other artificial reef programs.

#### *6.2.4.3. Other surety models applied by MMS*

A number of specific financial mechanisms are allowed by MMS to ensure financial obligations related to platform operation and decommissioning will be met. These include:

- Abandonment Trust Accounts, allowed by 30 C.F.R. § 256.56. An operator may put funds in a government interest-bearing account to be used in the manner of a bond. The advantage of this mechanism is that no bond needs to be purchased from a bonding company, thus saving fees and other costs of purchase.
- Third party guarantee in lieu of bonding can occur when another company or organization provides a guarantee that all lease obligations will be fulfilled, to defer the requirement of obtaining supplemental bonds (30 C.F.R. § 256.57)
- Pledged U.S. Treasury securities may be substituted for corporate surety bonds. The U.S. Treasury Department's regulations permit any individual, partnership, or corporation to deposit with a Federal Reserve Bank, for safekeeping for MMS, certain obligations issued or guaranteed by the United States as a substitute for any required corporate surety bond.

Once leases are terminated and platforms are transferred to the state, there would be no legal authority to enforce the continued use of any of these mechanisms. On the other hand, these methods provide an option for managing liability under scenarios where operators would have an incentive to continue doing so.

#### *6.2.4.4. Industry funded insurance trust fund*

This mechanism would involve the establishment of an industry-funded insurance co-operative to pool funds for liability insurance to cover the state's risks related to the partial removal option. In this scenario, the state would be named as the beneficiary of the trust fund. A privately funded insurance trust fund would ensure premium monies would be beyond the reach of state government, and thus avoid their diversion of these funds to other uses. As with the three surety mechanisms above, use of an industry funded approach would depend on a negotiated agreement with operators that would provide incentive for them to participate in managing liability after their leases were terminated.

#### *6.2.4.5. State purchased insurance*

In the public arena, the state usually retains or self insures much of its risk. However, there are some exceptions for which the state purchases traditional insurance policies to transfer its risk. This typically occurs when there is a unique loss exposure or set of exposures with which the state risk management department is unfamiliar, and/or when a potential risk is uncertain enough or large enough that the state is unwilling to self insure. A benefit of transferring the risk to a professional risk bearer is access to detailed information the insurer presumably has about the loss experience for this set of exposures. Furthermore, the insurer will have a professional loss control department that will assist the insured in managing their loss exposures through risk evaluations and assessments that can generate valuable feedback for the insured.

In the case of risk exposures related to an artificial reefing program, the state's Office of Risk and Insurance Management (<http://www.orim.dgs.ca.gov/Services/isuprorata.htm>), a part of the Department of General Services, would manage the process of negotiating coverage obtained through the state's insurance broker(s). Such a policy would be custom written to fit the specific set of risks involved and typically include the coverage of litigation costs. In return, the carrier typically has the right to choose the attorneys and settle as they see fit, rather than using the services of the State Attorney General's office. However, with a large policy for a public entity, the state may have the option of participating in the choice of counsel. The funding for such insurance could come from internal state funds, be paid from the state's share of avoided costs, or be paid in advance by a lessee as part of the negotiated terms for transferring ownership of platforms to the state.

#### *6.2.4.6. Catastrophe bonds*

Catastrophe bonds (also known as cat bonds) are risk-linked securities that transfer a specified set of risks from a sponsor to investors. They are often structured as floating rate bonds whose principal is lost if specified trigger conditions are met. If triggered the principal is paid to the sponsor. The triggers are often linked to major natural catastrophes such as floods, hurricanes, and earthquakes. Catastrophe bonds are typically used by insurers as an alternative to traditional catastrophe reinsurance (<http://www.ambest.com/ratings/methodology/QuickRef-CatBonds.pdf>). Catastrophe bonds could be used to address risks that state managers believe are of low probability but would have extreme consequences. Assuming that platforms are cut off at 85 feet below the sea surface, extreme events associated with the artificial reefs, such as ship strikes, would be highly unlikely, and leaks from abandoned wells would be covered under existing legislation. However, the use of catastrophe bonds would be available in the event state managers were concerned that some other unforeseen event might occur. As with the state purchased insurance described in the preceding subsection, funding for a catastrophe bond could come from internal state funds, be paid from the state's share of avoided costs, or be paid in advance by a lessee as part of the negotiated terms for transferring ownership of platforms to the state.

#### *6.2.4.7. Indemnification*

Several of the mechanisms described above for protecting the state against various forms of liability could be structured to include indemnification. Indemnification agreements are a

contractual promise between two parties to not hold one of them liable for future legal action, fines, or financial loss, as consequence of conducting legal business operations or activities. The concept of indemnification also includes a requirement to make the indemnified party "whole" by paying losses they may suffer from certain causes. Indemnification agreements are voluntary obligations that are typically entered into by contract in contrast to legal liability.

Indemnification agreements also apply to situations in which the loss is caused by negligence or accident, rather than an intentional act of malice or illegal activities. Indemnification agreements can be implemented through an insurance contract, in which the surety compensates the beneficiaries of the policies for their actual economic losses as long as these are within the insurance policy limit.

Artificial reefing legislation in the Gulf of Mexico does not include indemnification clauses, in which one party compensates another for their loss. They do, however, specify who does or does not retain liability for certain events related to the abandoned well and the decommissioned platform. It is likely that no one entity could indemnify the state on a long-term basis against liability except, perhaps, for the federal government. Indemnification agreements would be voluntary, because they are contractual relationships. Thus, they could not be required by the state but could be part of a negotiated agreement about provisions of the transfer of platform ownership to the state. Particularly for operators that are not highly capitalized, such indemnification of the state would likely involve a third party such as an insurance carrier.

#### *6.2.4.8. Federal liability defense credit*

A fund set aside to cover future costs associated with liability local, state, or federal government entities or other parties (see Section 6.3.2.2).

### **6.2.5. Transfer or acceptance of ownership**

The mechanisms for managing liability discussed above (Section 6.2.4) all assume that the state maintains ownership of the donated platform and manages it as part of the state's artificial reef program. There are, however, other approaches that involve transfer of part or all of the state's ownership to another entity, or acceptance of ownership directly by another entity (see Sections 6.1.2.1 and 6.1.2.2). Five types of ownership transfers that could be useful in removing or reducing the state's liability include transfer of ownership to:

- Local government
- A nonprofit land trust
- A limited liability company
- A private organization
- CINMS

First, ownership could be accepted by local government, under appropriate permits from ACOE and the relevant state agency, as described above in Section 6.1.2.1. Under provisions of NFEA, and as illustrated in the case of Florida, liability would then reside with the permit holder, not with the state which would merely be one of the permitting agencies.

Second, liability could be shared with a land trust. The state could transfer all or part of artificial reef ownership to a nonprofit group (e.g., the hypothetical Friends of Artificial Reefs), established under IRS Code 501 (c)(3), through a land trust. In such an arrangement, the trustee (i.e., the Friends nonprofit) agrees to take ownership of a piece of real property, i.e., the artificial reef, for the benefit of the resource and public. One advantage from the standpoint of liability is that claims and liens against the trust would be limited because of the trust's limited assets.

Third, interested parties could establish a limited liability company (LLC) to take ownership of an artificial reef. The LLC would own and manage the artificial reef and, because the LLC's assets would be limited, in turn this potentially would limit liability claims.

However, it is likely that in these arrangements, the non-state owner would be required to carry insurance adequate to comply with the liability provisions of NFEA and the expectations of ACOE, the lead permitting agency. This requirement could thus limit the utility of such arrangements as a mechanism for limiting liability exposure.

Fourth, artificial reefs could be transferred to private organizations whose owners would have limited liability under the state's Recreational Use Statute (California Civil Code § 846) with an amendment to the statute. The statute accomplishes this by granting nongovernment landowners broad immunity from liability for personal injuries or property damage suffered by land users pursuing recreational activities on the owner's land. Private ownership of an artificial reef is allowed under both NFEA and ACOE permitting guidelines. Therefore, the potential immunization benefits of Section 846 and those afforded under NFEA would apply to a privately owned artificial reef if the program were structured to meet the statute requirements. While Section 846 does not currently include SCUBA diving, the law could be amended to include SCUBA diving. An important requirement of Section 846 is that it only applies as long as no use fees are charged for use of the lands. Thus, commercial activities on private lands are not covered under the immunity provisions of the statute.

A legal issue that would need to be further defined is what constitutes an "owner" under this statute and whether or not a transfer of property rights other than fee simple rights would be covered under the statute. Section 846 allows for an owner of any estate or any other interest in real property, whether possessory (i.e., fee simple) or nonpossessory (i.e., easement or license), to be covered under this statute as long as the requirements of the statute are being met. This suggests that with a nonpossessory interest, a private permittee or lessee would be covered by the statute.

Finally, as described in Section 6.1.2.2, ownership could be transferred to CINMS, in which case the federal government would manage any liability associated with the artificial reefs.

### ***6.3. Mechanisms for transfer, allocation, and management of funds from avoided costs***

As Section 5.3.7 documents, the partial removal option will result in a substantial amount of avoided costs over time, particularly as larger platforms are decommissioned. However,

significant issues related to the disposition of these funds will need to be addressed, including the formula for dividing avoided costs between operators and the state or other entities, mechanisms for allocating funds to various purposes, and mechanisms for managing funds over time. While artificial reefing programs in the Gulf of Mexico provide some models for how to resolve these issues, their relevance is somewhat limited because of the relatively small amounts of money involved in the Gulf of Mexico and differences in the type and scale of resource management in the two regions. These funds in the Gulf of Mexico are typically spent on purchase and maintenance of buoys and other site markers (many reefs are in relatively shallow water), on program staffs (which are typically very small), and on monitoring and resource management activities. However, the funds generated by artificial reefing in the Gulf of Mexico are significantly less than those potentially available in California. This is because many of the platforms in California are much larger, and therefore more expensive to remove, than those in the Gulf of Mexico.

### **6.3.1. Formula for sharing avoided costs**

Avoided decommissioning costs in the Gulf of Mexico are typically split 50-50 between the operator and the state. This split resulted from early negotiations between operators and states and has been included in all applicable reefing legislation in the Gulf of Mexico. While an equal split has often been assumed to be the default for California as well, there is nothing in NFEA or MMS regulations that specifies the proportion of cost savings to be allocated to the operator, the state, and/or other entities.

Interviews with state managers confirmed that no prior agreements have been made with owners, operators, and/or lessees of platforms currently in production offshore California, although it was previously suggested that a sliding scale based on depth (which is a crude surrogate for decommissioning cost) might be useful. Because any such agreement would be the result of future discussions and policy making, the PLATFORM model enables users to define the proportion of avoided costs allocated to the state at anywhere from 0% – 100% in 10% increments.

### **6.3.2. Mechanisms for allocating and managing funds**

There are a number of potential mechanisms for allocating and managing the share of avoided costs contributed by operators. While contribution to the Ocean Protection Trust Fund represents the most straightforward mechanism, we also describe others. These are intended as illustrative examples that might provide useful suggestions for establishing accounts and making decisions about how funds should be spent. We understand that in many cases (e.g., the compensation and mitigation funds) the original source of funds was quite different from that envisioned here. Thus, some, but not all, aspects of the following examples may prove useful.

#### *6.3.2.1. State trust fund*

Ensuring that the state's share of avoided decommissioning costs is allocated to specific purposes would require legislation that either established a new trust fund or designated an existing trust fund for this purpose. This could be accomplished in the new state enabling

legislation described above in Section 6.1.1.3. Trust funds are special funds in the state treasury intended for designated uses. There are no rules for naming such funds, other than that they should include “trust fund” in their name, which signals clearly that it is not to be used for other purposes. Without this provision in law, funds given to the state would simply be added to the general fund. The enabling legislation would need to state that money received from avoided costs would be deposited in the named trust fund, and that money from the trust fund would be spent pursuant to an appropriation from the Legislature. The legislation would also specify the recipient(s) of the appropriation and the allowed uses on which money could be spent. This would constrain the Legislature to spend money from the trust fund as defined by the legislation; future Legislatures could change the designated uses of the trust funds only by repealing the original legislation and passing new legislation. Such definitions can be quite general. For example, the legislation could specify as the recipient the Ocean Protection Trust Fund, which specifies in statute (California Oceans Protection Act) the purposes funds may be used to accomplish. This is a convenient option as the Ocean Protection Trust Fund is already established and a mechanism, through the Ocean Protection Council, already exists for making decisions about allocating money from the fund.

Money from the trust fund could be appropriated each year or through a continuous appropriation so that money would be automatically allocated each year. Under a continuous appropriation, anything that goes into the trust fund automatically goes out to the recipient(s), and the legislation can specify percentages and/or amounts of the appropriation to be allocated to defined recipients. Under a yearly appropriation, the Legislature would act each year to appropriate money, but the legislation could still specify percentages or amounts to be directed to specific recipients. The legislation could also specify that all or some of the trust fund’s appropriation be allocated to local government, a nonprofit (see also Section 6.1.2.1), or a federal agency such as CINMS (see Section 6.1.2.2), and could accomplish this simply by specifying the recipient of the money and purpose(s) to be accomplished.

#### *6.3.2.2. Federal donation accounts*

Funds from avoided decommissioning costs could be allocated to and then held in specified federal donation accounts. Allocation could occur either directly, from the operator, or via an appropriation from a state trust fund. Once received, monies held in specified federal donation accounts are outside the reach of Congress because they are non-appropriated funds. However, Congress would have broad oversight of a donation program, and each agency has rules about the process of approving and accepting donations. Donations must be deemed appropriate and necessary for a particular project. Acceptance of donations is discretionary and the levels of review before acceptance would increase as the amount of the proposed donation grows. If ownership of decommissioned platforms was transferred to a federal rigs-to-reefs program, perhaps as part of the National Marine Sanctuary Program (see Section 6.1.2.2), enabling legislation would be needed to clarify the process for donating funds and specify the donation account and its purpose. As for state trust funds, purposes for donation accounts can be specified in broad terms.

In addition to a donation account, a liability defense credit could be established. Such a credit would allow a portion of funds from avoided decommissioning costs to be credited toward any

future liability costs incurred by local, state, or federal governments, former operators, and/or other entities who might suffer damages related to the decommissioned platform. Eligibility for such reimbursement would be defined by the legislation establishing the program.

### *6.3.2.3. Compensation and mitigation funds*

Specific funds have often been established to compensate stakeholders for damages from oil spills, oil and gas development, major pollution events, or other impacts. Such funds provide examples to draw on when considering mechanisms for disbursing funds derived from avoided decommissioning costs.

For many years, there have been public concerns about negative impacts from offshore oil development on local communities, especially along the coast of the Santa Barbara Channel, and controversy about such impact may well continue even as production tapers off and ultimately ends, especially if platforms are left in place as artificial reefs (McGinnis et al. 2001, Raftican 2006, Schroeder and Love 2004, Smith and Garcia 1995). Citing environmental studies conducted when offshore leases were written, Santa Barbara County determined that, even though the majority of oil and development was on OCS lands outside the county and state boundaries, that “the construction and operation [of oil extraction in the Channel] cause significantly adverse impacts to four categories of coastal resources: (a) environmentally sensitive resources, (b) aesthetics, (c) recreation, and (d) tourism . . . after all feasible direct mitigation has been implemented” (Santa Barbara County 2008). Establishing and permitting onshore facilities to support offshore operations fell directly to the county, which required mitigation fees be paid to several accounts ([www.countyofsb.org/energy/mitigation](http://www.countyofsb.org/energy/mitigation)) as part of the permit approval process. These mitigation accounts included:

- Coastal Resources Enhancement Fund (CREF) to mitigate for impacts on coastal resources
- Fisheries Enhancement Fund (FEF) to help mitigate significant impacts of offshore oil and gas development on commercial fisheries and the local commercial fishing industry
- Local Fishermen’s Contingency Fund (LFCF) to assist fishermen who incur gear loss or damage as a result of OCS oil and gas development activity and who cannot necessarily demonstrate that the damage was due to a federal project

In addition to these local programs, additional funds for these purposes are provided to county government from the state’s share of royalties on federal oil leases, allocated through the Coastal Impact Assistance Program (CIAP). The CIAP was created in 2005 and the Department of Interior, though MMS has since then provided over \$250 million in annual grants to six OCS oil and gas producing states. ([www.doi.gov.news/09\\_News\\_Releases/071309a.html](http://www.doi.gov.news/09_News_Releases/071309a.html), July 13, 2009).

Other processes established for remediation, restoration, and compensation provide additional examples of how such funds may be allocated and managed. Following the Exxon Valdes oil spill in 1989, Exxon has paid \$900.8 million for damages and restoration, with funds spent on habitat protection, cleanup, research and education, and program administration. It appears that only general criteria, rather than a systematic rating system, were used for allocating these funds



(Alaska Attorney General 2009) and many groups and committees played roles in the often-complex process of allocating these funds. As another example, Montrose Chemical Corporation and four co-defendants agreed to pay \$140.2 million plus interest for discharges of DDT and PCBs in the Southern California Bight (MSRP 2005) and clear criteria were established for allocating funds.

These and other similar examples suggest mechanisms and decision criteria that could be considered in establishing a process for allocating funds derived from the partial removal option. However, criteria for disbursing funds from avoided decommissioning costs could reasonably be expected to be broader and more inclusive than for either of the two examples above. This is because state enabling legislation would not be restricted to focusing the use of a trust fund only on the effects of oil and gas production.

#### ***6.4. Managing an expanded artificial reef program***

The CDFG currently manages a network of 23 artificial reefs in its southern California region. These reefs were established over a long period of time and for different purposes, using a variety of materials. While earlier reefs were intended exclusively to enhance recreational fishing opportunities, reefs constructed more recently, such as the Wheeler North Artificial Reef constructed by Southern California Edison near San Onofre, have also focused on resource enhancement and/or mitigation. These reefs require little if any management and are monitored to different degrees. Where extensive monitoring does occur, such as at the reefs near San Onofre, it is motivated by a specific agency interest, such as the success of permit-mandated mitigation. Thus, the existing artificial reef program within CDFG does not play an active role in planning, management, or monitoring related to existing artificial reefs.

In contrast, a rigs-to-reefs program, using the partial removal decommissioning option to create new artificial reefs, could require an expanded commitment from CDFG, depending on the level of management, monitoring, or other oversight considered appropriate. For example, if ownership of the reefs is transferred from the state to another entity (see Section 6.1.2), the state's involvement in direct management activities may be minimal. On the other hand, if the state retains ownership of the reefs, it could monitor the status of resources and enforcement of allowed uses related to each reef, depending on the objectives identified in enabling legislation and/or developed by the state's artificial reef program. Given that many of the reefs are some distance offshore, extended management, monitoring, and maintenance could prove costly and require additional boats, staff, or other resources. Thus, the scale and scope of the state's artificial reef program under the partial removal option will depend on a series of policy decisions involving ownership and use designations for the artificial reefs. It is not possible at this point in time to predict which approach the state will choose. We have therefore not attempted to describe the scope of or cost out in detail a potential CDFG artificial reef program.

However, the types of activities the state may need to undertake to develop an expanded artificial reef program can be generally described. Because CARP is currently poorly staffed and funded, the activities described here can be considered new activities. An initial effort would be required to plan and then establish the legal and management infrastructure needed to implement a rigs-to-reefs program and then manage it over the long term. This would most likely involve an

interdisciplinary team within the Resources Agency led by the coordinator of CARP and involving a pelagic fisheries biologist, a benthic fisheries biologist, a warden, an economist, a toxicologist, an engineer, a lawyer, and support staff. This team's activities would include drafting legislation, negotiating the terms of ownership transfer with the operators, defining detailed formulas for calculating avoided costs, obtaining insurance and/or other forms of liability coverage, defining spending priorities for any state share of avoided costs, and defining long-term management priorities for the artificial reefs. The level of effort needed to complete these tasks is unclear and experience from the development of analogous reefing programs in the Gulf of Mexico is not a useful guide. The environmental and political contexts are completely different in the two areas and the scale of avoided costs (and therefore the level of interest from stakeholder groups) orders of magnitude higher in California than in the Gulf of Mexico.

For example, the State of Louisiana has spent a total of \$1 million on maintenance, administration, and monitoring of its artificial reef program over the past seven years, while the trust set up to accept the state's share of avoided costs receives about \$5 million each year in additional contributions and currently contains over \$30 million. Interest income on the trust amounts to about \$7 million per year, which is used for research and grants that fund a range of ocean-related projects. In contrast, the maintenance, monitoring and administration side of the reef program has only cost about a \$1 million over the last seven years (D. Peter, Louisiana Wildlife and Fisheries, pers. comm., 2009). This comparison may not be directly relevant to a California rigs-to-reefs program. Many artificial reefs in the Gulf of Mexico are in shallow water and have used toppled platforms to form reefs. Because of their shallow depth, these reefs are required markings under USCG regulations to be marked with buoys that cost between \$1,000 and \$10,000 per reef, depending on the size of the reef. While buoys would not be required under the partial removal option considered here, since USCG regulations do not require surface markings for obstructions below a depth of 85 feet, California artificial reefs may be monitored or managed more intensively because of their importance as habitat for important species such as rockfish and/or because of their attractiveness to fishermen as unique fishing opportunities.

## 7.0. Answers to Stakeholders' Questions

---

The key questions identified in this section were developed in consultation with interested stakeholders, the Inter-Agency Decommissioning Working Group and other technical experts, and California Natural Resources Agency staff and consultants. One goal of this study was to answer these questions as completely as possible within the constraints of available data and information. Some questions unfortunately could not be answered, either because information does not exist or because the question is relevant only within the context of a specific decommissioning project. For those questions that can be answered, we provide a concise response, along with references to other sections of the report with additional detail.

Each question is listed in order, followed immediately by the concise answer in *italics*.

### 7.1. Questions related to biology / ecology / environment

1. Using benthic habitat maps, estimate the regional contribution of platform substrate to hard substrate in State Tidelands and the federal Outer Continental Shelf, using available sea floor maps or other resources.

*Detailed mapping data, particularly for the OCS, is not available for all areas at the level of spatial resolution necessary to answer this question accurately. The relative contribution of platforms to overall hard substrate is likely to be very small, although they may represent a significant contribution to the area of pinnacle reefs. Section 5.3.1.3 provides estimates, based on MLPA mapping data that suggest the surface area of platforms could constitute as much as 3.8% of the natural rocky habitat below 30 meters in the region. However, such estimates are problematic both because of how platform area is calculated (e.g., surface area vs. footprint), questions about whether the basis of comparison should be natural habitat below 30 meters depth or all rocky habitat including shallow water, and the lack of reliable mapping data for shallow habitats.*

- a. Using the best oceanographic, biological or other information available, estimate the range and degree of connectivity in early life history stages of key species between platform communities and natural communities. Key species include threatened, endangered, and managed species.

*Answering this question in full would require expanding the ROMS model currently used in the MLPA reserve design process to include data from deeper layers where larvae of many important species are released. This is because the ROMS model at present address only surface currents and dispersion. Extensive model runs for different species and locations would then be required to answer this question in full. However, we did collaborate with oceanographers at UCSB to conduct exploratory model runs for two species and a limited number of platform locations to explore the issue connectivity between platforms and other habitats in the region. The methods and results of this preliminary analysis are described in Section 5.3.1.2.*

- b. How do demographic rates (e.g., birth, death and migration rates) for key species vary between platform and natural habitats?

*Available monitoring data document the abundance, size, and vertical distribution on platforms of key fish and invertebrate species and provide limited comparisons to analogous factors on natural reefs. However, such studies have not measured demographic rates for populations on platforms and such data are also sparse for most populations on natural reefs, particularly in deeper water. The available data are summarized at some length in Section 5.3.1.1 and Appendix 3.*

- c. What changes may occur in species richness, diversity, density and biomass among the decommissioning alternatives when compared to (1) existing platform habitat, and (2) soft sediment habitat (simulating pre-construction conditions)?

*This question cannot be answered completely because no studies have completely documented the diversity, species richness, and biomass of platform communities. Monitoring studies have instead focused primarily on fish communities and selected larger invertebrates. Despite that, some reliable conclusions can be drawn from the available data. Of the two main decommissioning options, complete removal will have the largest impact. While mobile species will move to other habitats, there are only limited data on migration between habitats, particularly at depth, which makes providing a detailed, quantitative answer to this question. Thus, we assume that complete removal, with or without the use of explosives, will result in the loss of the biomass and production at this location. Mobile fish species will most likely be subject to high fishing mortality at other locations in the region. Partial removal, which would involve removal of the platform structure down to a depth of 85 feet below the surface, would result in the loss of standing stock and production related to that upper stratum. However, recent studies document that the large majority of larval recruitment on platforms occurs below the 85 foot cutoff depth for the partial removal option. This upper stratum would be removed under both decommissioning options considered. The available studies related to this question are summarized in detail in Sections 5.3.1.1 and 5.3.1.3.*

2. What changes may occur in the distribution and abundance of key species among decommissioning alternatives? (This includes demolition and removal impacts.)  
*This question is very similar to question 2.c. Impacts on platform-associated organisms can be generally predicted. Complete removal will result in the loss of all attached organisms, while mobile fish and invertebrates will move to other habitats. Use of explosives will most probably result in the complete loss of both attached and mobile fish and invertebrates associated with the platform, and we include this assumption in the PLATFORM model. Partial removal will result in the loss of all attached organisms in the upper 85 feet of the structure, but recruitment of fishes, particularly rockfish, will be largely unaffected. Both complete and partial removal may result in some benthic impacts if anchoring is used, but current plans call for the use of dynamic positioning which would eliminate the need for anchoring. Complete removal will in addition result in benthic impacts due to the excavation and cutting of the jacket legs. These will most likely be localized and short-term in nature, but shell mound removal could result in more extensive disturbance. See Sections 4.1.1.2 (for shell mound issues) and 5.3.1 for impacts on marine resources.*
3. Given observed differences in habitat structure, oceanographic conditions, and typical species assemblages, how may trophic structure differ between platform and natural reef

habitat? How would platform trophic structure change according to each decommissioning alternative?

*Differences between community structure on platforms and natural reefs have been described in number of studies (see Section 5.3.1.1 for more detail). Under the complete removal option, all organisms associated with the platform would either be removed or dispersed. There would thus be no trophic structure remaining at the site. Under the partial removal option, community structure on the platform would remain the same as before decommissioning, except for the upper 85 feet of the jacket legs, which would be removed. The contribution of food and habitat structure from deposition from this upper portion of the jacket legs would be removed from the system, which would affect growth and production for organisms in the shell mound habitat at the bottom of the platform. However, such effects have not been modeled or analyzed in detail and there is little detailed information on trophic relationships (see Section 5.3.1.3 for a discussion of decommissioning impacts on platform communities).*

4. What are the water quality impacts (e.g., oil spill risk, sediment and contaminant suspension) attributable to each decommissioning alternative?

*There is little risk of an oil spill, since the wells will have been completely shut in prior to any platform decommissioning activities. In addition, well abandonment, pipeline abandonment, and flushing of all platform components that were exposed to oil products or other contaminants will be identical across all decommissioning options. Water quality and sediment contamination impacts are likely to be small and localized, with the largest impacts (or risk of impact) associated with complete removal including removal of shell mounds. See Sections 4.1.1.2 (shell mounds), 5.3.1.2 (benthic), and 5.3.6 (water quality) for more detail.*

5. What are the noise impacts to living marine resources (fish, marine mammals and birds etc) including those resulting from the use of explosives, attributable to each decommissioning alternative?

*Non-explosive methods have improved a great deal and the default assumption in the analysis is that explosives will not be used, although the PLATFORM model does provide users the ability to select explosive severing if they wish to explore the impacts of this method. Available information (see Section 5.3.5 for more detail) suggests that impacts due to explosives will be minimal if standard procedures for suspending operation when marine mammals are in the vicinity are followed. Noise impacts from the use of other equipment are not likely to be significant.*

6. For an entire decommissioning project, which includes transportation to and from the site, on-station emissions, recycling, land filling, and ongoing maintenance impacts, what are the air pollution emissions (e.g., criteria pollutants, toxics, and greenhouse gases) attributable to each decommissioning alternative, where the analysis also includes the disposition of platform-associated shell mounds, and decommissioning of pipelines and power cables?

*It is not possible to answer this question with available information. This would require a complete engineering analysis based on the specifications of the exact equipment to be used in the decommissioning project, as well as on the results of negotiations between project proponents and regulatory agencies to identify operational methods that would minimize emissions. In addition, there is a wide range of possible means of implementing some aspects*

*such as transport of materials to recycling yards and landfills (e.g., emissions from trucks per ton are orders of magnitude greater than those for rail transport). We have described categories of likely emissions, along with the regulatory framework for this issue, and completed a worst case estimate for the major elements of decommissioning Platform Harmony, the largest platform offshore southern California. See Section 5.3.2. for more detail.*

7. Among the “structural alternatives” for decommissioning (identified in section 2.4 above), compare and contrast the relative impacts between them (e.g., topping versus toppling, or removing versus towing).

*Decommissioning alternatives for detailed analysis were narrowed to two, complete and partial removal with conversion to an artificial reef. State agency representatives stated that toppling and towing were not likely to be approved in California. A more complete rationale for prioritizing the two main alternatives Section 4. The report, particularly Section 4, and the PLATFORM model provide a detailed analysis of the differences between these two options.*

## **7.2. Key questions related to economics**

1. What are the potential costs to state and local governments and non-profit agencies created by each decommissioning alternative? Who would be liable and what are the potential costs of this liability? Would moving liability to a nonprofit be feasible and save money?

*Costs to state and local governments and nonprofits would depend not only on the decommissioning option selected, but on the size of the project (i.e., number of platforms) and their location. In addition, different permitting entities and nonprofits would be involved to different degrees and some may have mechanisms for recovering all or part of their costs from project proponents. We thus did not address this particular cost in detail (see Section 5.2 for a discussion of boundary conditions for the analysis). In terms of liability, the report includes a detailed examination of this issue and mechanisms, including transfers of ownership to non-state entities, for dealing with liability. See Section 6.2. for more detail.*

2. How do you estimate and validate the costs and cost-savings associated with the various decommissioning alternatives? Include all mitigation costs.

*Section 5.3.7 provides a detailed explanation of costs and the calculation of avoided costs for both main decommissioning options. All costs for complete removal, with the exception of rough estimates for dredging shell mounds and enhancing artificial reefs with quarry rock, were obtained from MMS estimates in Proserv Offshore (2010) and we derived costs for partial removal from these estimates, in consultation with MMS staff and the EAC. Mitigation is a complex issue and we did not derive cost estimates for reasons explained in detail in section 5.2.2.3.*

3. How can state revenues from a rigs-to-reefs program be managed to ensure that these monies will result in an increase in funding for coastal and ocean environmental programs and not be offset by deductions in current funding? What alternatives could be utilized to ensure long-term security of funds for intended coastal and ocean environmental programs?

*Enabling legislation could establish a trust fund, or designate an existing trust fund, to receive funds from a rigs-to-reefs program. Procedures for ensuring these monies are spent as intended are described in Section 6.3.2.*

4. What are the economic and fiscal impacts to state and local government attributable to each of the following activities under the various platform decommissioning alternatives: a) commercial fishing; b) recreational and sport fishing; c) sport-diving; d) other industries/stakeholders that may be significant; and e) other impacts deemed appropriate by the study consultant?

*Such second and third order effects can be estimated with econometric models, but this would have required data gathering that was beyond the scope of this project. In addition, such downstream effects are likely to be small compared to the overall regional economy. See Section 5.2.2.1 for a more detailed discussion.*

5. What are the potential non-market benefits or costs from: a) habitat preservation or destruction (e.g., of sandy bottom); and b) impacts on key species (e.g., mussels, crabs, scallops, sea stars)?

*The data required to perform an analysis of non-market valuations was not readily available. We included a placeholder in the PLATFORM model in the event that data become available in the future. See Section 5.3.3.2 for more detail.*

6. What are the impacts on the oil and gas industry? Specifically: a) What are the economic and fiscal impacts associated with each of the decommissioning alternatives? b) What is the likelihood that these impacts would cause platforms to be decommissioned early? c) Do any of the decommissioning alternatives change the taxes paid by oil and gas companies to state and federal governments? What tax deductions could be taken? d) How would each decommissioning alternative change incentives to invest in future oil and gas activities?

*The analysis does estimate the direct costs associated with each decommissioning option (see Section 5.3.7). However, evaluating whether such costs would affect decisions about when to terminate production or whether to invest in future development is a complex challenge because the oil industry is extremely sensitive to policies and events at larger (e.g., national and international) scales. This level of economic and business analysis was thus beyond the scope of the study. In terms of the tax consequences of decommissioning (see Section 5.2.2.2), this would have required access to oil companies' books and a complex accounting analysis.*

### **7.3. Key Questions Related to State Administration**

#### **7.3.1. Liability and Indemnification**

1. Identify all types of liability that could arise under each decommissioning alternative. For example, the Bidder could examine case studies in the Gulf of Mexico regarding claims for personal injury and property damage from platform decommission and estimate any liability for a CA program.

*See Section 6.2. for a detailed discussion of liability.*

2. What types of liability-limiting methods should be available to permittees under each decommissioning alternative?

*See Section 6.2 for a detailed discussion.*

### **7.3.2. Regulatory Enforcement and Institutional Control**

1. Who will be responsible for managing the following activities post-decommissioning: safety, operations and maintenance, and enforcement of applicable regulations?

*This question applies primarily to the partial removal and artificial reefing option. The scope and allocation of responsibilities will depend to some extent on decisions made about the ultimate ownership of the artificial reef (see Section 6.1). In addition, if the platform is removed to a depth of 85 feet or more below the sea surface, then there are no legal requirements for operations, maintenance, or safety. The degree of enforcement to apply would be at the discretion of the state or other owner based on decisions about whether to control access to the artificial reef in any way.*

2. What is the feasibility and cost of maintaining adequate safety and navigational warning devices, and what are the liability consequences if they fail (e.g., refer to 4H platforms removal project)?

*We assume that this applies to the post-decommissioning period. Under both the complete and partial removal options, there would be no legal requirements to maintain on-site safety or navigational warning devices because there would be no structure left above the 85 foot depth specified in Coast Guard regulations.*

3. What federal and/or state regulatory and legislative changes might be needed to support each of the decommissioning alternatives? Specifically, what regulatory approvals and process would be required if a decommissioned platform was converted to any of the decommissioning alternatives?

*Section 6.1.1.3 details requirements for new state enabling legislation to implement a rigs-to-reefs program under the partial removal option.*

### **7.3.3. Access and Ownership**

1. What possible scenarios can be developed for access to a decommissioned platform site? This includes a variety of uses, e.g., fishing, diving, etc.

*Section 5.3.4 describes a range of impacts on ocean access under a variety of scenarios. Section 5.3.3 examines the broader socioeconomic impacts of such scenarios.*

2. How is ownership of a site determined under each decommissioning alternative (National Fishing Enhancement Act 33 U.S.C. Sec. 2101 et seq.)?

*See Section 6.1. for a detailed discussion of mechanisms for transfer of ownership.*

### **7.4. Key Questions Related to Visual Resources and Esthetics**

1. What are the positive and negative consequences to visual resources of all decommissioning alternatives? What is the nature and extent of visual and aesthetic impacts?



*Such impacts are classified under the heading of aesthetic impacts and discussed in Section 5.2.1.2. While the duration and extent of these impacts can be estimated, data were not readily available to estimate their economic valuation.*

2. What are the durations of the visual and aesthetic impacts?  
*See Section 5.2.1.2 for a discussion of aesthetic impacts. The duration of visual and aesthetic impacts will depend on the number of platforms decommissioned, their locations, and the decommissioning option selected (complete removal will have a longer duration than partial removal).*

### **7.5. Key Questions Related to Alternative Uses**

1. What are the possible alternative uses of decommissioned platforms (e.g. wind or wave energy extraction), and what are their consequences?  
*Alternative uses of decommissioned platforms (other than as artificial reefs) are described in Section 4.2. For reasons explained, these alternatives were not analyzed in detail.*
2. How would liability be assessed for each alternative use?  
*Please see Section 6.2. for a detailed discussion of liability. However, this discussion focuses only on the two main decommissioning options selected for detailed analysis, for reasons explained in Section 4.*

## References

---

- Abrahamson, A., Brandt, I., Brunstrom, B., Sundt, R.C., Jorgensen, E.H. 2008. Monitoring contaminants from oil production at sea by measuring EROD activity in Atlantic cod (*Gadus morhua*). *Environmental Pollution*. 153:169-175.
- Alghamdi, A.A., Radwan, A.M. 2005. Decommissioning of Offshore Structures: Challenges and Solutions. Department of Mechanical Engineering, King Abdulaziz University. Jeddah, Saudi Arabia, In: *International Conference on Computational Methods in Marine Engineering, MARINE 2005*: P. Bergan, J. Garcia, E. Oate, and T. Kvamsdal, (Eds) © CIMNE, Barcelona, 2005.
- Allen, L. G. and D. J. Pondella, II. 2006. Ecological classification. Chapter 4, In: *The Ecology of Marine Fishes: California and Adjacent Waters* (L. G. Allen, D. J. Pondella, II, and M. Horn, editors) pp. 81-113. University of California Press, Los Angeles.
- Ambrose, R.F., Anderson, T.W. 1990. Influence of an artificial reef on the surrounding infaunal community. *Marine Biology*. 107: 41-52.
- AMEC Earth & Environmental, Inc. (AMEC). 2002a. Draft Sampling and Analysis Plan – Dredged Material Testing for Ocean Disposal – Chevron 4H Shell Mound Project. April.
- AMEC Earth & Environmental, Inc. (AMEC). 2002b. Draft Report – Dredged Material Testing for Ocean Disposal – Chevron 4H Shell Mound Project. August.
- Andre, M. 2009. The sperm whale sonar: Monitoring and use in mitigation of anthropogenic noise effects in the marine environment. *Nuclear Instruments and Methods in Physics Research*. 602: 262-267.
- Angliss, R.P., D.P. DeMaster, and A.L. Lopez. 2001. Alaska marine mammal stock assessments, 2001. NMFS, Alaska Fisheries Science Center. NOAA Technical memorandum NMFS-AFSC-124.
- Associates, Inc. 2002. Project Closure Report for ExxonMobil Belmont Island Decommissioning Program: p. 3-1.
- Athanassopoulos, J.D.E. 1999. Offshore Oil Platform Decommissioning: A comparative study of strategies and the ecological, regulatory, political, and economic issues involved in decommissioning planning. UCSB, M.S. Thesis in Environmental Science.
- Athanassopoulos, J.D., Dalton, J.S., Fischer, A.P. 1999. Decommissioning: A Comparative Offshore Oil Platform Study of Strategies and the Ecological, Regulatory, Political, and Economic Issues Involved in Decommissioning Planning, Group Project University of California, Donald Bren School of Environmental Science and Management, June, 1999.

- Araujo, J.A., Barajas, B., Kleinman, M., Wang, X., Bennett, B.J., Gong, K.W., Navab, M., Harkema, J., Sioutas, C., Lulis, A.J., and Nel, A.E. 2008. Ambient Particulate Pollutants in the Ultrafine Range Promote Early Atherosclerosis and Systemic Oxidative Stress. *Circulation Research*. 102: 589-596.
- AWS Truewind. 2006. California wind energy resource modeling and measurement. Prepared for California Energy Commission Public Interest Energy Research Program. CEC-500-2006-062.
- Bascom, W., Mearns, A.J., Moore, M.D. 1976. A biological survey of oil platforms in the Santa Barbara Channel. *J. Petroleum Technology*. pp.1280-1284.
- Bedard, R. 2007. Power and Energy from the Ocean Energy Waves and Tides: A Primer. Electric Power Research Institute: May 14, 2007.
- Black's Law Dictionary, Sixth Edition. 1999. West Publishing Company.
- Boehlert, G. 2008. A Summary of Ecological Issues Associated with Wave Energy Development in the Pacific Northwest. Oregon State University, Hatfield Marine Science Center. September 2008 (power point).
- Bomkamp, R. E., H. M Page, and J. E. Dugan. 2001. Distribution, Abundance, and Growth of Mobile Benthic Invertebrates on Shell Mounds in the Santa Barbara Channel. Unpublished research, presented at 2001 Western Society of Naturalists meeting.
- Bomkamp, R.E., Page, H.M., Dugan, J.E. 2004. Role of food subsidies and habitat structure in influencing benthic communities of shell mounds at sites of existing and former offshore oil platforms. *Marine Biology*. 146: 201-211.
- Bonnell, M.L., B.J. Le Boeuf, M.O. Pierson, D.H. Dettman, G.D. Farrens, and C.B. Heath. 1981. Summary of marine mammal and seabird surveys of the Southern California Bight area, 1975-1978. Part 1 - Pinnipeds of the Southern California Bight. Final Report to the Bureau of Land Management, NTIS Report Number PB81248171. 535 pp.
- Bonnell, M.L. and M.D. Dailey. 1995. Marine mammals. Ecology of the Southern California Bight. M.D. Dailey, D.J. Reish, and J.W. Anderson (eds). University of California Press. Berkeley, California.
- Bortone, S.A., Cody, R.P., Turpin, R.K., Bundrick, C.M. 1998. The impact of artificial-reef fish assemblages on their potential forage area. *J. Italian Zoology*. 65: S265-267.
- Bourne, W.R.P. 1979. Birds and gas flares. *Marine Pollution Bulletin*. 10: 124-125.
- Bowles, A.E. 1995. Responses of wildlife to noise. In: *Wildlife and Recreationists*. Knight, R.L. and K.J. Gutzwiller (eds.). Island Press, Washington, D.C. pp.154-212.

Bram, J.B., Page, H.M., Dugan, J.E. 2005. Spatial and temporal variability in early successional patterns of an invertebrate assemblage at an offshore oil platform. *J. Experimental Marine Biology*. 317: 223-237.

Bridger, C.J. 2002. Development of a Responsible Offshore Aquaculture Industry in the Gulf of Mexico-Research and Development Strategy. Gulf of Mexico Offshore Aquaculture Consortium, USM Colleg of Marine Sciences.

Brooks, J.M., Carr, S., Darnell, R., Fay, R.R., Green, R.H., Harper, D., McEachran, J., Montagna, P., Presley, B.J., Rezak, R., Safe, S., Fournie, J.W., McDonald, S.J., Wiesenburg, D.A., Kelly, F.J., Wade, T., and Wolff, G.A. 1995. Technical Summary: MMS Publication 95-0045 Gulf of Mexico Offshore Monitoring Experiment (GOOMEX), Phase I: Sub-lethal Response to Contaminant Exposure: Final Report. Minerals Management Service. <http://www.mms.gov/itd/abstracts/95-0045a.html>

Bull, A.S., Love, M.S., Schroeder, D.M. 2008. Artificial reefs as fishery conservation tools: contrasting the roles of offshore structures between the Gulf of Mexico and the Southern California Bight. *American Fisheries Society Symposium* 49: 899-915.

Bull, A.S., Kendall, J.J. 1994. An indication of the process: Offshore platforms as artificial reefs in the Gulf of Mexico. *Bulletin of Marine Science*. 55: 1086-1098.

Byrd, R. 2003. On-shore disposal. Presentation at USDOJ, Minerals Management Service Decommissioning Workshop, Avalon, CA. October 2003.

Byrd, R.C., and Velazquez, E.R. 2001. State of the Art of Removing Large Platforms Located in Deep Water. Paper prepared for and presented at Offshore Technology Conference, Houston, TX, May 2001. OTC 12972.

Byrd, R. 2008. Article Offshore Platform Decommissioning: Tales from the Gulf of Mexico

Cailliet, G. M. 2000. Final Report. Biological characteristics of nearshore fishes of California: a review of existing knowledge and proposed additional studies. For the Pacific Ocean Interjurisdictional Fisheries Management Plan Coordination and Development Project.

California Air Resources Board. 2004. Airborne Toxic Control Measure to Reduce Particulate Emissions from Diesel-Fueled Engines – standards for Non-vehicular Diesel Fuel. California Code of Regulations, Title 17, Section 93114.

California Air Resources Board. 2008. California Air Toxics Program: Substances Identified as Toxic Air Contaminants. CARB website, [www.arb.ca.gov/toxics/id/taclist.htm](http://www.arb.ca.gov/toxics/id/taclist.htm), accessed September 18, 2009.

CDFG 2008. Draft Regional Profile of the MLPA South Coast Study Region Point Conception to the California/Mexico border (September 15, 2008 draft). <http://www.dfg.ca.gov/mlpa/scprofile.asp>

California Department of Fish and Game (CDFG), Marine Region. 2008. State Fisheries Evaluation Project. Review of California Halibut Trawl Fishery in the California Halibut Trawl Grounds. Report to the California Fish and Game Commission, 6/27/2008.

California Department of Fish and Game (CDFG). 2001. California's Living Marine Resources: A Status Report: Culture of Mussels. December 2001.

California Energy Commission. 2010. West coast LNG prospects and proposals. [http://www.energy.ca.gov/lng/documents/3\\_WEST\\_COAST\\_LNG\\_PROJECTS\\_PROPOSALS.PDF](http://www.energy.ca.gov/lng/documents/3_WEST_COAST_LNG_PROJECTS_PROPOSALS.PDF). Accessed May 10, 2010.

California Environmental Protection Agency (EPA). 2004. Intra-agency Environmental Justice Strategy, August 2004

California Ocean Protection Council (OPC). 2006. Overview of Ocean and Coastal Laws, 2006b

California Ocean Protection Council (OPC). 2006. A Vision for our Oceans and Coast, Five year strategic plan, 2006a.

California Office of Environmental Health Hazard Assessment (OEHHA) and American Lung Association of California (ALAC). 2001. Health Effects of Diesel Exhaust: a fact sheet. From OEHHA website, [http://oehha.ca.gov/public\\_info/facts/pdf/diesel4-02.pdf](http://oehha.ca.gov/public_info/facts/pdf/diesel4-02.pdf), accessed September 18, 2009.

California State Lands Commission (SLC). 2009. Mineral Resources Management Division, Oil Facilities. [http://www.slc.ca.gov/Division\\_Pages/MRM/Rigs\\_to\\_Reef/oilfacilities.html](http://www.slc.ca.gov/Division_Pages/MRM/Rigs_to_Reef/oilfacilities.html) (accessed August 10, 2009).

California State Lands Commission (SLC). 2007. Mineral Resources Management Division. Rigs to Reefs Workshop: Rigs to Reefs in California. [http://www.slc.ca.gov/Division\\_Pages/MRM/Rigs\\_to\\_Reef/Whitepaper.html](http://www.slc.ca.gov/Division_Pages/MRM/Rigs_to_Reef/Whitepaper.html) (accessed September 2, 2009).

California State Lands Commission (SLC). 2001. Public Trust Policy for the California State Lands Commission. [www.slc.ca.gov/Policy\\_Statements/Public\\_Trust/Public\\_Trust\\_Policy.doc](http://www.slc.ca.gov/Policy_Statements/Public_Trust/Public_Trust_Policy.doc).

California State Lands Commission (SLC). Public Trust Doctrine: Institutes of Justinian 2.1.1, [http://www.slc.ca.gov/Policy\\_Statements/Public\\_Trust/Public\\_Trust\\_Doctrine.pdf](http://www.slc.ca.gov/Policy_Statements/Public_Trust/Public_Trust_Doctrine.pdf)

California State Lands Commission (SLC). Public Trust Doctrine: Las Siete Partidas 3.28.6, [http://www.slc.ca.gov/Policy\\_Statements/Public\\_Trust/Public\\_Trust\\_Doctrine.pdf](http://www.slc.ca.gov/Policy_Statements/Public_Trust/Public_Trust_Doctrine.pdf)

California State Lands Commission (SLC). 2010. The public trust doctrine. [www.slc.ca.gov/Policy/Statement/Public\\_Trust\\_Home\\_Page.html](http://www.slc.ca.gov/Policy/Statement/Public_Trust_Home_Page.html). Accessed January 10, 2010.

California State Lands Commission (SLC). 2010.  
[http://www.slc.ca.gov/Division\\_Pages/DEPM/DEPM\\_Programs\\_and\\_Reports/Shell\\_Mounds/Chevron\\_Shell\\_Mounds.html](http://www.slc.ca.gov/Division_Pages/DEPM/DEPM_Programs_and_Reports/Shell_Mounds/Chevron_Shell_Mounds.html)

California State Lands Commission (SLC). 2010. Environmental justice policy.  
[http://www.slc.ca.gov/policy\\_statements/Env\\_Justice/Environmental%20Justice%20Policy%20Final%20Web.pdf](http://www.slc.ca.gov/policy_statements/Env_Justice/Environmental%20Justice%20Policy%20Final%20Web.pdf). Accessed March 10, 2010.

California State Lands Commission (SLC) website.  
[www.slc.ca.gov/division\\_pages/depm/depm\\_programs\\_and\\_reports/chevron\\_long\\_wharf/pdf/publicreviewprocess.pdf](http://www.slc.ca.gov/division_pages/depm/depm_programs_and_reports/chevron_long_wharf/pdf/publicreviewprocess.pdf)

California Supreme Court. 2008. Environmental Protection and Information Center v. California Department for Forestry and Fire Protection 44 Cal4th 459 (EPIC) p. 515.

Cantelmo F.R.; Tagatz, M.E.; Rao, K.R. 1979. Effect of barite on meio fauna in a flow-through experimental system. *Marine Environmental Research*. 2: 301-310.

Capps, Lois, Congresswoman. 2009. Capps Introduces Comprehensive, Sustainable Offshore Aquaculture Legislation. <http://capps.house.gov/2009/12/capps-introduces-comprehensive-sustainable-offshore-aquaculture-legislation.shtml>. December 18, 2009.

Carlisle, J. G., Jr., C. H. Turner, and E. E. Ebert. 1964. Artificial habitat in the marine environment. California Department of Fish and Game, Fish Bulletin, 124. 93 pp.

Carr, M.H., Hixon, M.A. 1997. Artificial reefs: The importance of comparisons with natural reefs. *Fisheries*. 22(4): 28-33.

Carr, M.H., McGinnis, M.V., Forrester, G.E., Harding, J., Raimondi, P.T. 2003. Consequences of alternative decommissioning options to reef fish assemblages and implications for decommissioning policy. Final Technical report, MMS Pacific OCS region. U.S. Department of the Interior.

Carr, R.S., Chapman, D.C., Presley, B.J., Biedenbach, J.M., Robertson, L., Boothe, P., Kilada, R., Wade, T., Montagna, P. 1996. Sediment porewater toxicity assessment studies in the vicinity of offshore oil and gas production platforms in the Gulf of Mexico. *Canadian J. Fish Aquat.* 53: 2618-2628.

Carretta, J.V., J. Barlow, K.A. Forney, M. M. Muto, and J. Baker. 2001. U.S. Pacific marine mammal stock assessments: 2001. NMFS. Southwest Fisheries Science Center. NOAA Technical Memorandum NOAA-TM-NMFS-SWFCS-317.

Carretta, J.V., M.M. Muto, J. Barlow, J. Baker, K.A. Forney, and M. Lowry. U.S. Pacific marine mammal stock assessments: 2002. NOAA Technical Memorandum, NOAA-TM-NMFS SWFSC-346. December 2002.

Caselle, J.E., Love, M.S., Fusaro, C., Schroeder, D. 2002. Trash or habitat? Fish assemblages on offshore oilfield seafloor debris in the Santa Barbara Channel, California. *ICES J. Marine Science*. 59: S258-S265.

Center for Biological Diversity, Inc. v. FPL Group, Inc. (2008) 166 Cal.App.4th 1349, 1359-64

CEQA Guidelines. <http://ceres.ca.gov/ceqa/guidelines/>

City of Berkeley v. Superior Court. 1980. 26 Cal.3d 515, at p. 521.

Clarke, G. L., W. T. Edmondson, and W. E. Ricker. 1946. Mathematical formulation of biological productivity. *Ecological Monographs*, 16:336-337.

Coghlan, A. 2009. Oil rigs may be fit for porpoise. 21 Mar 2009.  
<http://www.newsscience.com/article/mg20127004.400-oil-rigs-may-be-fit-for-porpoise.html>

Continental Shelf Associates 2005 and Wolfson et al. 1979.

Crane, N.L., Lashkari, K.L. 1996. Sound production of grey whales, *Eschrichtius robustus*, along their migration route: A new approach to signal analysis. *J. Acoustical Society of America*. 100: 1878-1886.

Croll, D.A., Clark, C.W., Calambokidis, J., Ellison, W.T., Tershy, B.R. 2001. Effect of anthropogenic low-frequency noise on the foraging ecology of *Balaenoptera* whales. *Animal Conservation*. 4: 13-27.

Culwell, A.S. 1997. Removal and Disposal of Deck and Jacket Structures, contained within Mango & Williamson, OCS report MMS 98-0023, Decommissioning and Removal of Oil and Gas Facilities Offshore California: Recent Experiences and Future Deepwater Challenges, September 23-25 1997 Public Workshop.

Dailey, M.D., Reish, D.J., and Anderson, J.W. 1993. *Ecology of the Southern California Bight*. University of California Press, Los Angeles, CA.

Dauterive, L. 2000. Rigs-to Reefs Policy, Progress, and Perspective, Minerals Management Service, OCS Report MMS 2000-073: p. 1., October 2000.

Davis, G. 2001. Governor's Veto Message. SB 1. [http://info.sen.ca.gov/pub/01-02/bill/sen/sb\\_0001-0050/sb\\_1\\_cfa\\_20010914\\_034105\\_asm\\_floor.html](http://info.sen.ca.gov/pub/01-02/bill/sen/sb_0001-0050/sb_1_cfa_20010914_034105_asm_floor.html)

Debreu, G. 1959. Topological Methods in Cardinal Utility Theory, In K. J. Arrow, S. Karlin and P. Suppes (Eds), *Mathematical Methods in the Social Sciences 1959*, Stanford University Press, Stanford, CA, 1960, 16-26.

Delfino, R.J. 2006. Cardiovascular Health and Exposure to Ultrafine Particles. Presented at South Coast Air Quality Management District conference, Ultrafine Particles: The Science, Technology, and Policy Issues, Diamond Bar, CA. May 2006.

Demex/TEI Construction Services. 2000. Explosive Technology Report, included in appendix of: Twachtman, Snyder, & Byrd, Inc, for the MMS; State of the Art of Removing Large Platforms located in Deep Water, November 2000.

Donation Deed, State of Mississippi, 2009

Act\_of\_Donation\_and\_title\_transfer\_mississippi.pdf (uploaded by Bridget 9/8/09)

Dong, C., Idica, E., McWilliams, J.C., 2009. Circulation and multiple-scale variability in the Southern California Bight. *Progress in Oceanography*.

Dong, C.M., McWilliams, J.C., 2007. A numerical study of island wakes in the Southern California Bight. *Continental Shelf Research*, 27, 1233-1248.

Eighth U. S. Coast Guard District Policy For Marking Artificial Fishing Reefs In The Gulf Of Mexico' Eighth District Commander USCG

Ekins, P., Vanner, R., and Firebrace, J. 2005. Decommissioning of Offshore Oil and Gas Facilities: Decommissioning Scenarios: A Comparative Assessment Using Flow Analysis. Policy Studies Institute. London, UK.

Ekins, P., Vanner, R., Firebrace, J. 2006. Decommissioning of Offshore Oil and Gas Facilities: a Comparative Assessment of Different Scenarios, June 2006.

Electronic Code of Federal Regulations. 2009. Title 33: Navigation and Navigable Waters. [http://ecfr.gpoaccess.gov/cgi/t/text/textidx?&c=ecfr&tpl=/ecfrbrowse/Title33/33tab\\_02.tpl](http://ecfr.gpoaccess.gov/cgi/t/text/textidx?&c=ecfr&tpl=/ecfrbrowse/Title33/33tab_02.tpl) (accessed October 12, 2009).

Emery, B.M., Washburn, L., Love, M.S., Nishimoto, M.M., Ohlmann, J.C. 2006. Do oil and gas platforms off California reduce recruitment of bocaccio (*Sebastes paucispinis*) to natural habitat? An analysis based on trajectories derived from high-frequency radar. *Fish Bulletin*. 104: 391-400.

Environmental Law Institute. 2003. NEPA Deskbook, Washington, D.C.: p. 318, March 2003.

Euronav. 2010. Owned vessels. <http://www.euronav.com/fleet.asp>. Accessed March 14, 2010

Executive Order 12898 of February 11, 1994. Federal Actions To Address Environmental Justice in Minority Populations and Low-Income Populations. Vol. 59, No. 32, Wednesday, February 16, 1994.



- Fabi, G., Luccarini, F., Panfili, M., Solustri, C., Spagnolo, A. 2002. Effects of an artificial reef on the surrounding soft-bottom community (central Adriatic Sea). *ICES J. Marine Science*. 59: S343-S349.
- Farnsworth, A., Russell, R.W. 2007. Monitoring flight calls of migrating birds from an oil platform in the northern Gulf of Mexico. *J. Field Ornithology*. 78: 279-289.
- Fernandez, L. 2005. A diversified portfolio: joint management of non-renewable and renewable resources offshore. *J. Resource and Energy Economics*. 27: 65-82.
- Fishburn, P.C. 1970. *Utility Theory for Decision Making*, Wiley, New York, 1970.
- Fletcher, K.M., and Weston, G. 2000. The Legal & Regulatory Environment: Offshore Aquaculture Permitting Process in the Gulf of Mexico. Mississippi-Alabama Sea Grant Legal Program.
- Freudenburg, W.R., Gramling, R. 1993. Socioenvironmental factors and development policy: understanding opposition and support for offshore oil. *Socio-ecological Forum*. 8: 341-364.
- Froines, J. 2006. Ultrafine Particle Health Effects. Presented at South Coast Air Quality Management District conference, Ultrafine Particles: The Science, Technology, and Policy Issues, Diamond Bar, CA. April 2006.
- Frumkes, D.R. 2002. The status of the California rigs-to-reefs programme and the need to limit consumptive fishing activities. *ICES J. Marine Science*. 59: S272-S276.
- Gebauer, D., Hoffman, C., Lim, E.L., Mitchell, M., Shackell, G., Smith, J., White, F.L., Tyagi, R. 2004. Offshore Facility Decommissioning Costs, Pacific OCS Region, MMS, September 17, 2004.
- Gentner, B., Price, M., Steinback, S. 2001. Marine Angler Expenditures in the Pacific Coast Region, 2000. Technical Memorandum NMFS-F/SPO-49, NOAA. Silver Spring, MD.
- Gitschlag, G.R., Schirripa, M.J., Powers, J.E. 2001. Estimation of fisheries impacts due to underwater explosives used to sever and salvage oil and gas platforms in the U.S. Gulf of Mexico. Final Report. OCS study MMS 2000-087.
- Gitschlag, G.R., Schirripa, M.J., Powers, J.E. 2003. Impacts of Red Snapper mortality with the explosive removal of oil and gas structures on stock assessments of red snapper in the Gulf of Mexico. *American Fisheries Society*. 36: 83-94.
- GlobalSecurity.Org. 2010. SINKEX – Sinking Exercise. <http://www.globalsecurity.org/military/ops/sinkex.htm>. Accessed March 13, 2010

Grant, A., Briggs, A.D. 2002. Toxicity of sediments from around a North Sea oil platform: are metals or hydrocarbons responsible for ecological impacts? *Marine Environmental Research*. 53: 95-116.

Gulf of Mexico Fishery Management Council and National Oceanic and Atmospheric Administration (NOAA), National Marine Fisheries Service (NMFS). 2009. Fishery Management Plan For Regulating Offshore Marine Aquaculture in the Gulf of Mexico. January 2009.

Gulf of Mexico Fishery Management Council, National Oceanic & Atmospheric Administration. Generic Amendment to: The Gulf of Mexico Fishery Management Council's Red Drum, Reef Fish, and Stone Crab Fishery Management Plans and the Gulf of Mexico and South Atlantic Fishery Management Council's Joint Spiny Lobster and Coastal Migratory Pelagics Fishery Management Plans to Provide for Regulation of Offshore Marine Aquaculture. December 2007.

H. T. Harvey & Associates. 2008. Developing Wave Energy in Coastal California: Potential Socio-economic and Environmental Effects. California Energy Commission, California Ocean Protection Council. November, 2008.

Hahn, R.W., Layne-Farrar, A. 2003. An Economic Analysis of a Rigs to Reefs Program for the California Outer Continental Shelf. NERA. Chicago, IL.

Hartmann, A.R. 1987. Movement of scorpionfishes (Scorpaenidae) in the Southern California Bight. *California Fish & Game* 73: 68-79.

Hatch, L., Clark, C., Merrick, R., Van Parijs, S., Pontirakis, D., Schwehr, K., Thompson, M., Wiley, D. 2008. Characterizing the relative contributions of large vessels to total ocean noise fields: A case study using the Gerry E. Studds Stellwagen Bank National Marine Sanctuary. *Environmental Management*. 42: 735-752.

Helvey, M. 2002. Are southern California oil and gas platforms essential fish habitat? *ICES J. Marine Science*. 59: S266-S271.

Hernandez, F.J., Jr., Shaw, R.F., Cope, J.C., Ditty, J.G, Benfield, M.C. Farooqi, T. 2001. Across-shelf Larval, Post-larval, and Juvenile Fish Communities Collected at Offshore Oil and Gas Platforms and a Coastal Rock Jetty West of the Mississippi River Delta. Prepared by the Coastal Fisheries Institute, Louisiana State University. OCS Study MMS 2001-077. U.S. Department of the Interior, Minerals Management Service, Gulf of Mexico OCS Region, New Orleans, LA. 144 pp.

Hiett, R.L., Milon, J.W. 2002. Economic Impact of Recreational Fishing and Diving Associated with Offshore Oil and Gas Structures in the Gulf of Mexico: Final Report. OCS Study MMS 2002-010. U.S. Dept. of the Interior, Minerals Management Service, Gulf of Mexico OCS Region, New Orleans, LA. 98 pp.

Hill, M. 2008. Alternative Energy on the OCS. Alternative Energy Program, Minerals Management Service (MMS). Fort Bragg Energy Forum, January 19, 2008. (Power Point).

Holbrook, S.J., Ambrose, R.F., Botsford, L., Carr, M.H., Raimondi, P.T. and Tegner, M.J. 2000. Ecological Issues Related to Decommissioning of California's Offshore Production Platforms. Select Scientific Advisory Committee on Decommissioning, University of California.

Hood, D.W. 1993. Ecosystem interrelationships. pp. 782-835 In: Ecology of the Southern California Bight, ed. Dailey, M.D., Reish, D.J., Anderson, J.W. University of California Press, Berkeley, CA.

Howorth, P.C. 1965-2001. Director. Santa Barbara Marine Mammal Center, California. Unpublished field notes.

1997a. Summary report: wildlife mitigation, Chevron wellhead removal. Report for Chevron in satisfaction of agency requirements.

1997b. Final report: wildlife monitoring, South Bay ocean outfall, piling removal blasting project. Report for Case Foundation Company in satisfaction of agency requirement

1996. Summary report: wildlife mitigation, 4H platform removal project. Report for Chevron in satisfaction of agency requirements.

Hubbs Sea World Research Institute. February 19, 2009. Fact Sheet, Offshore Aquaculture Demonstration Project.

Intergovernmental Panel on Climate Change (IPCC). 2007. Climate Change 2007: Synthesis Report. An Assessment of the Intergovernmental Panel on Climate Change, Plenary XXVII, Valencia, Spain, 2007.

Jenner, C. 2008. Summary of Ecological Issues- Offshore Wind Energy Experiences from the United Kingdom. Alternative Energy Development in the West Coast Ocean Environment. September 23, 2008. (power point).

Johnson, T.D., Barnett, A.M., DeMartini, E.E., Craft, L.L., Ambrose, R.F., Purcell, L.J. 1994. Fish production and habitat utilization on a southern California artificial reef. Bulletin Marine Science. 55(2-3): 709-723.

Jorgensen, T., Lokkenborg, S., Soldal, A.V. 2002. Residence of fish in the vicinity of a decommissioned oil platform in the North Sea. ICES J. Marine Science 59: S288-S293.

Kaiser, M.J. 2006. The Louisiana artificial reef program. Marine Policy. 30: 605-623.

Kasprzak, R.A. 1998. Use of oil and gas platforms as habitat in Louisiana's artificial reef program. Gulf of Mexico Science. 1: 37-45.

Keane, K. 2000. California least tern breeding survey, 1998 season. Draft report to the California Department of Fish and Game.

Keenan, S.F., Benfield, M.C., Blackburn, J.K. 2007. Importance of the artificial light field around offshore petroleum platforms for the associated fish community. *Marine Ecology Progress Series*. 331: 219-231.

Keeney, R.L. and Raiffa, H. 1993. *Decisions with Multiple Objectives: Preferences and Value Tradeoffs*. New York, New York: Cambridge University Press.

Keeney, R. L. 1968. Quasi-Separable Utility Functions, *Naval Res. Logist. Quart.*, 15(1968), 551-565.

Kellison, G.T., Sedberry, G.R. 1998. The effects of artificial reef vertical profile and hole diameter on fishes off South Carolina. *Bulletin Marine Science*. 62(3): 763-780

Khan, R.A., Ryan, P. 1991. Long-term effects of crude oil on common murre (Uria aalge) following rehabilitation. *Bulletin Environmental Contamination and Toxicology*. 46: 216-222.

Kling, C.L., Herriges, J.A. 1995. An Empirical Investigation of the Consistency of Nested Logit Models with Utility Maximization. *American Journal of Agricultural Economics*. 77(4): 875-884.

Krantz, D.H. 1964. Conjoint Measurement: The Luce-Tukey Axiomatization and Some Extensions, *J. Math. Psychology*. 1: 248-277.

Krop, L. 2007. Orange County Coastkeeper. Rigs to Reefs Conference Proceedings, Orange County, CA, March 30, 2007. p. 72.

Krop, L., Polefka, S., Richmond, S., and Dutton, J. 2007. Open Ocean Aquaculture in the Santa Barbara Channel: An emerging challenge for the Channel Islands National Marine Sanctuary. Conservation Working Group of the CINMS Advisory Council. July 20, 2007.

L.A. de Wit Consultant. 2001. Shell Mounds Environmental Review, Vol 1. Final Technical Report. Prepared for the California State Lands Commission and the California Coastal Commission, March 2001.

Lakhal, S.Y., Khan, M.I., Rafiqul Islam, M. 2009. An Olympic framework for a green decommissioning of an offshore oil platform. *Ocean and Coastal Management*. 52: 113-123.

[law.justia.com/california/codes/hnc/290-294.html](http://law.justia.com/california/codes/hnc/290-294.html) 2009

Lease PRC 3150

Leeworthy, V.R., Wiley, P.C. 2003. Socioeconomic Impact Analysis of Marine Reserve Alternatives for the Channel Islands National Marine Sanctuary. NOAA. Silver Springs, MD.

Leeworthy, V. R., Wiley, P. C. and Stone, E. A. 2005. Socioeconomic Impact Analysis of Marine Reserve Alternatives for the Channel Islands National Marine Sanctuary. NOAA. Silver Springs, MD.

Lewbel, G.S., Howard, R.L., Gallaway, B.J. 1987. Zonation of dominant fouling organisms on northern Gulf of Mexico petroleum platforms. *Marine Environmental Research*. 21: 199-224.

Lewis, R.D. and McKee, K.K. 1989. A Guide to the Artificial Reefs of Southern California. Nearshore Sportfish Enhancement Program, California Department of Fish and Game.

Lindquist, D.C., Shaw, R.F., Hernandez, F.J., Jr. 2005. Distribution patterns of larval and juvenile fishes at offshore petroleum platforms in the north-central Gulf of Mexico. *J. Estuarine, Coastal, and Shelf Science*. 62: 655-665.

Lissner, A.L., Taghon, G.L., Diener, D.R., Schroeter, S.C., Dixon, J.D. 1991. Recolonization of deep-water hard-substrate communities: potential impacts from oil and gas development. *J. Ecological Applications*. 1(3): 258-267.

London Convention. 1997. Specific guidelines for assessment of platforms or other man-made structures at sea, International Maritime Organization (IMO) website, [http://www.imo.org/includes/blastDataOnly.asp/data\\_id%3D17024/5-Platforms.pdf](http://www.imo.org/includes/blastDataOnly.asp/data_id%3D17024/5-Platforms.pdf)

London Convention. 2007. 1996 protocol to the Convention on the Prevention of Marine Pollution by Dumping of Wastes and Other Matter, 1972 (as amended in 2006). [www.londonconvention.org](http://www.londonconvention.org). (Accessed December 13, 2009).

Loomis, J.B., White, D.S. 1996. Economic Values of Increasingly Rare and Endangered Fish. *Fisheries*. 21(11): 6-10.

Louisiana Department of Natural Resources. Final Report of Findings and Recommendations to the Louisiana Legislature and Governor. Louisiana Platforms for Mariculture. January 2005.

Love, M.S., Brothers, E., Schroeder, D.M., Lenarz, W.H. 2007. Ecological performance of young-of-the-year blue rockfish (*Sebastes mystinus*) associated with oil platforms and natural reefs in California as measured by daily growth rates. *Bulletin Marine Science*. 80(1): 147-157.

Love, M.S., Caselle, J., Snook, L. 1999. Fish assemblages on mussel mounds surrounding seven oil platforms in the Santa Barbara Channel and Santa Maria Basin. *Bulletin Marine Science*. 65(2): 497-513.

Love, M.S., Goldberg, S.R. 2009. A histological examination of the ovaries of Pacific Sanddab, *Citharichthys sordidus*, captured at two oil platforms and two natural sites in the Southern California Bight. *Bulletin Southern California Academy of Sciences*. 108(2): 45-51.

Love, M.S. and M.M. Nishimoto. 2009. Spatial and Seasonal Variation in the Biomass and Size Distribution of Juvenile Fishes Associated with a Petroleum Platform off the

California Coast, 2008 Annual Report. OCS Study MMS 2009-54. Marine Science Institute, University of California, Santa Barbara, California. MMS Cooperative Agreement Number M08AX12732.

Love, M.S., Yoklavich, M., Schroeder, D.M. 2009. Demersal fish assemblages in the Southern California Bight based on visual surveys in deep water. *Environmental Fish Biology*. 84: 55-68.

Love, M.S., Schroeder, D.M., Nishimoto, M.M. 2003. The ecological role of oil and gas production platforms and natural outcrops on fishes in Southern and Central California: a synthesis of information. U.S. Department of the Interior, U.S. Geological Survey, Biological Resources division, Seattle, Washington, 98104, OCS Study MMS 2003-032.

Love, M.S., D.M. Schroeder. 2005. Ecological performance of OCS platforms as fish habitat off California. MMS OCS Study 2005-005. Marine Science Institute, University of California, Santa Barbara, California. MMS Cooperative Agreement Number 1435-01-03-CA-72694.

Love, M.S., Schroeder, D.M. 2007. A characterization of the fish assemblage of deep photic zone rock outcrops in the Anacapa Passage, southern California, 1995 to 2004, with evidence of a regime shift. *CalCOFI*, Vol 48.

Love, M.S., Schroeder, D.M., Lenarz, W., MacCall, A., Bull, A.S., Thorsteinson, L. 2006. Potential use of offshore marine structures in rebuilding an overfished rockfish species, bocaccio (*Sebastes paucispinus*). *Fish Bulletin*. 104: 383-390.

Love, M.S., Schroeder, D.M., Lenarz, W.H. 2005. Distribution of Bocaccio (*Sebastes paucispinus*) and Cowcod (*Sebastes levis*) Around Oil Platforms and Natural Outcrops Off California with Implications for Larval Production. *Bulletin of Marine Science* 77(3): 397-408.

Love, M.S., York, A. 2006. The relationship between fish assemblages and the amount of bottom horizontal beam exposed at California oil platforms: fish habitat preferences at man-made platforms and (by inference) at natural reefs. *Fish Bulletin*. 104: 542-549.

Love, M.S., Caselle, J.E., Snook, L. 2000. Fish assemblages around seven oil platforms in the Santa Barbara Channel area. *Fish Bulletin*. 98: 96-117.

Love, M. S., M. Yoklavich, and D. M. Schroeder. 2008. Demersal fish assemblages in the Southern California Bight based on visual surveys in deep water. *Environ. Biol. Fish.* DOI 10.1007/s10641-008-9389-8.

Love, M.S., York, A. 2005. A comparison of the fish assemblages associated with an oil/gas pipeline and adjacent seafloor in the Santa Barbara Channel, Southern California Bight. *J. Marine Science*. 77(1): 101-117.

Lowe, C.G., Anthony, K.M., Jarvis, E.T., Bellquist, L.F., Love, M.S. 2009. Site fidelity and movement patterns of groundfish associated with offshore petroleum platforms in the Santa Barbara Channel. *Marine and Coastal Fisheries*. 1:71-89.

Luce, R. D. and J. W. Tukey. 1964. Simultaneous Conjoint Measurement: A New Type of Fundamental Measurement, *J. Math. Psychology*. 1: 1-27.

Lukens, R.R., Selberg, C., Ansley, H., Bailey, C.M., Bedford, D., Bell, M., Buchanan, M., Dauterive, L, Dodrill, J., Figley, B., Francesconi, J., Heath, S. R., Horn, B., Kasprzak, R., LaPorta, C., Malkoski, V., Martore, R.M., Meier, M.H., Mille, K., Satchwill, R., Shively, D., Steimle, F. and Tinsman, J. 2004. Guidelines for Artificial Reef Materials, Second Edition, Number 121. Artificial Reef Subcommittees, Atlantic and Gulf States Marine Fisheries Commissions.

Malme, C.L., Miles, P.R., Clark, C.W., Tyack, P., Bird, J.E. 1983. Investigations of the possible effects of underwater noise from petroleum industry activities on migrating gray whale behaviour: final report for the period of 7 June 1982- 31 July 1983. Report No. 5366, prepared by Bolt, Beranek and Newman Inc., Cambridge, MA, USA, for U.S. Minerals Management Service, Alaska OCS office, Anchorage, USA.

Manago, F., Williamson, B., eds. 1997. Proceedings: Public Workshop on Decommissioning and Removal of Oil and Gas Facilities Offshore California: Recent Experiences and Future Deepwater Challenges. Minerals Management Service and California State Lands Commission. Ventura, CA, September 23-25.

Manago, F., B. Williamson (eds.) Proceedings: Public Workshop, Decommissioning and Removal of Oil and Gas Facilities Offshore California: Recent Experiences and Future Deepwater Challenges, September 1997. MMS OCS Study 98-0023. Coastal Research Center, Marine Science Institute, University of California, Santa Barbara, California. MMS Cooperative Agreement Number 14-35-0001- 30761. 269 pp.

Martin, C.J.B. 2009. Species composition and abundance of the fishes at offshore petroleum platforms on the San Pedro Shelf, southern California. California State University, Long Beach. M.S. Thesis in Biology.

Mason J.W., McChesney, G.J., McIver, W.R., Carter, H.R., Takekawa, J.Y., Golightly, R.T., Ackerman, J.T., Orthmeyer, D.L., Perry, W.M., Yee, J.L., Pierson, M.O., McCrary, M.D. 2007. At-sea distribution and abundance of seabirds off southern California: A 20-year comparison. *Studies in Avian Biology* 33(1-101).

MBC Applied Environmental Sciences. 1987. Ecology of Oil/Gas Platforms Offshore California. Minerals Management Service, Pacific OCS Region OCS Study MMS 86-0094. February.

McDonald, M.A., Hildebrand, J.A., Wiggins, S.M., Ross, D. 2008. A 50-year comparison of ambient noise near San Clemente Island: A bathymetrically complex coastal region off southern California. *J Acoustical Society of America* 124(4): 1985-1992.

McGinnis, M.V., Fernandez, L., Pomeroy, C. 2001. The Politics, Economics, and Ecology of Decommissioning Offshore Oil and Gas Structures. MMS OCS Study 2001-006. Coastal Research Center, Marine Science Institute, University of California, Santa Barbara, California. MMS Cooperative Agreement Number 14-35-0001-30761. 98 pp.

McKay, M., Nides, J., Vigil, D. eds. 2000. Proceedings: Gulf of Mexico fish and fisheries: bringing together new and recent research, October 2000. U.S. Dept. of the Interior, Minerals Management Service, Gulf of Mexico OCS Region, New Orleans, La. OCS Study MMS 2002-004. 674 pp.

MEC Analytical Systems, Inc. and Sea Surveyor, Inc. 2003. Final Report: An assessment and physical characterization of shell mounds associated with outer continental shelf platforms located in the Santa Barbara Channel and Santa Maria Basin, California. MMS Pacific OCS Region report, February 2003. MMS contract # 1435-01-02-CT-85136.

Meier, M. 2009. California State Lands Commission, telephone interview with Tim Setnicka, July 6, 2009.

Metha, S. 1999. Dismantling of Oil Rig Approved, Los Angeles Times, December 04, 1999, p. 4.

Minerals Management Service (MMS). 2000. Platform Ecology Studies funded by the Minerals Management Service's Environmental Studies Program: An annotated Bibliography. January 2000. MMS 2000-073, OCS Report

Minerals Management Service (MMS). 2001. Draft Environmental Impact Statement - Delineation Drilling Activities in Federal Waters Offshore Santa Barbara County, California. Prepared by Pacific OCS Region, Camarillo, California. June 2001.

Minerals Management Service (MMS). 2004. Operational and Socioeconomic Impact of Non-explosive removal of Offshore Structures. U.S. Department of the Interior, OCS Study MMS 2004-074.

Minerals Management Service (MMS). 2007. Programmatic Environmental Impact Statement for Alternative Energy Development and Production and Alternate Use of Facilities on the Outer Continental Shelf: Final Environmental Impact Statement. U.S. Department of the Interior, MMS 2007-046.

Minerals Management Service (MMS). 2009. Renewable Energy and Alternate Uses of Existing Facilities on the Outer Continental Shelf. 30 CFR Parts 250, 285, and 290. U.S. Department of the Interior. Federal Register Vol. 71, No. 81. ACTION: Final rule.

Minerals Management Service (MMS), Rigs to Reef Information. 2009.  
<http://www.gomr.mms.gov/homepg/regulate/envion/rigs-to-reef/information>



US Minerals Management Service (MMS). 2001. Delineation Drilling Activities in Federal Waters Offshore Santa Barbara County, California. Dept. of the Interior, MMS, Environmental Impact Statement, Chap. 6, Cumulative Impact Analysis for the 36 Undeveloped Leases (2002-2030).

US Minerals Management Service (MMS). 2004. Offshore Facility Decommissioning Costs, Pacific OCS Region. Dept. of the Interior, Minerals Management Service Pacific OCS Region, Camarillo, CA. 80 pp.

Minerals Management Service (MMS) Website, [www.mms.gov/omm/pacific/lease/lease.htm](http://www.mms.gov/omm/pacific/lease/lease.htm)

Minerals Management Service (MMS) web site,  
<http://www.gomr.mms.gov/homepg/fastfacts/WaterDepth/WaterDepth.html>

Minerals Management Service (MMS), Gulf of Mexico Region. 1993. Notice to Lessees 93-2N, October, 1993 [www.mms.gov/ntls/Attachments/ntl93-2n.htm](http://www.mms.gov/ntls/Attachments/ntl93-2n.htm)

Minerals Management Service (MMS). Fishermen's Contingency Fund,  
<http://www.gomr.mms.gov/homepg/regulate/regs/laws/fcf.html>

Minerals Management Service (MMS), Pacific OCS Region. 2009. Possible effects of OCS Gas and Oil Activities on the California Gray Whale.  
<http://www.mms.gov/omm/pacific/enviro/graywhale.htm>  
Web article referenced 9/09/09.

Minerals Management Service (MMS) web site,  
[www.mms.gov/ntls/Attachments/ntl93-2n.htm](http://www.mms.gov/ntls/Attachments/ntl93-2n.htm) -Notice to Lessees 93-2N, Oct. 1993.

Minerals Management Service (MMS). 2009. Renewable energy and alternate uses of existing facilities on the Outer Continental Shelf; final rule. 30 CFR Parts 250, 285, and 290.

Mitarai, S., Siegel, D.A., Watson, J.R., Dong, C., McWilliams, J.C. 2009. Quantifying connectivity in the coastal ocean with application to the Southern California Bight. *J. Geophysical Research* 114; in press.

Moffet, R.C. and Prather, K.A. 2009. In-situ measurements of the mixing state and optical properties of soot with implications for radiative forcing estimates. *Proceedings of the National Academy of Sciences*, doi:10.1073/pnas.0900040106.

MSRP Final RP/EIS/EIR October 2005

National Audubon Society v. Superior Court (1983) 33 Cal.3d 419, 435,

National Marine Fisheries Service (NMFS). 2000b. Biological opinion: section 7 consultation on authorization to take listed marine mammals incidental to commercial fishing operations

under section 101(a)(5)(E) of the Marine Mammal Protection Act for the California/Oregon drift gillnet fishery. Endangered Species Division, Office of Protected Resources, NMFS.

National Marine Fisheries Service (NMFS). 2006. Endangered Species Act Section 7 consultation biological opinion: Permitting structure removal operations on the Gulf of Mexico Outer Continental Shelf; Authorization for take of marine mammals incidental to structure removals on the Gulf of Mexico Outer Continental Shelf. Endangered Species Division, Office of Protected Resources, NMFS.

NMSP artificial reef policy statement and permitting guidelines:

[http://sanctuaries.noaa.gov/management/pdfs/arpolicy\\_071205.pdf](http://sanctuaries.noaa.gov/management/pdfs/arpolicy_071205.pdf)

National Oceanic and Atmospheric Administration (NOAA). 2003. Report #: 2003-4. Rigs to Reefs: The Socio-Economics of Transforming Petroleum Production and Processing Platforms to Artificial Reefs.

National Oceanic and Atmospheric Administration (NOAA). 2009. Annual Commercial Landing Statistics. [http://www.st.nmfs.noaa.gov/st1/commercial/landings/annual\\_landings.html](http://www.st.nmfs.noaa.gov/st1/commercial/landings/annual_landings.html) (accessed August 19, 2009).

National Oceanic and Atmospheric Administration (NOAA). 2007. National Artificial Reef Plan (as amended): Guidelines for siting, construction, development, and assessment of artificial reefs. United States Department of Commerce, National Oceanic and Atmospheric Administration.

National Oceanic and Atmospheric Administration (NOAA). 2008a. The National Offshore Aquaculture Act of 2007. [http://aquaculture.noaa.gov/pdf/06\\_whole07act.pdf](http://aquaculture.noaa.gov/pdf/06_whole07act.pdf)

National Atmospheric and Atmospheric Administration (NOAA). 2008b. The National Offshore Aquaculture Act of 2007. <http://aquaculture.noaa.gov/us/2007.html>. Accessed March 22, 2010.

National Oceanographic and Atmospheric Administration (NOAA). 2008. Offshore Aquaculture in the United States: Economic Considerations, Implications & Opportunities. July 2008

National Oceanographic and Atmospheric Administration (NOAA). 2000. Xantus' murrelet. In Channel Islands National Marine Sanctuary, the living sanctuary. [www.santuaries.nos.noaa.gov/pgallery/pgchannel/living/living\\_1.html](http://www.santuaries.nos.noaa.gov/pgallery/pgchannel/living/living_1.html)

National Research Council (NRC). 1985. Committees on Disposition of Offshore Platforms, Marine Board, The National Academies Press, Washington DC, 1985, pg. 41.

Nishimoto, M. M., M. S. Love, L. Washburn, D. M. Schroeder, B. M. Emery. 2008. assessing the fate of juvenile rockfish at offshore petroleum platforms and natural reefs in the Santa Barbara Channel. OCS study MMS 2007-008.

Norris, T.F. 1994. Effects of boat noise on the acoustic behaviour of humpback whales. J. Acoustical Society of America 96: 3251.

Office of the Attorney General, State of Alaska Department of Law. 2009. Legacy of an Oil Spill: 20 Years after the Exxon Valdez – Draft.

Orange County Coastkeeper. 2001. Report on Rigs-to-Reef Conference, March 30, 2001. Huntington Beach, CA.

Osenberg, C. W., C. M. St. Mary, J. A. Wilson, and W. J. Lindberg. 2002. A quantitative framework to evaluate the attraction-production controversy. *ICES Journal of Marine Science* 59: S214-S221.

Osmundsen, P., Tveteras, R. 2000. Disposal of Petroleum Installations- Major Policy Issues. January, 2000.

Padre Associates, Inc. 2005. Draft Initial Study/ Draft Negative Declaration ExxonMobil Seacliff Pier Complex Decommissioning Program Amendment to the Approved Execution Plan. Prepared for the California State Lands Commission, July 2005.  
[http://www.slc.ca.gov/Division\\_Pages/DEPM/DEPM\\_Programs\\_and\\_Reports/ExxonMobilSeacliffPier/ExxonMobilSeacliff\\_ND.html](http://www.slc.ca.gov/Division_Pages/DEPM/DEPM_Programs_and_Reports/ExxonMobilSeacliffPier/ExxonMobilSeacliff_ND.html)

Page, H.M., Culver, C.S., Dugan, J.E., Mardian, B. 2008. Oceanographic gradients and patterns in invertebrate assemblages on offshore oil platforms. *ICES J. Marine Science*. 65: 1-11.

Page, H.M., Dugan, J. 1999. Effect of offshore oil platform structures on the distribution patterns of commercially important benthic crustaceans, with emphasis on the rock crab. Final technical report. OCS Study MMS 99-0018.

Page, H.M., Dugan, J. 2000. Early development of fouling communities on offshore oil platforms. In: University of California, Southern California Educational Initiative, Annual Report, July 2000.

Page, H.M., Dugan, J.E., Culver, C.S., Hoesterey, J.C. 2006. Exotic invertebrate species on offshore oil platforms. *Marine Ecology Progress Series* 325: 101-107.

Page, H.M., Hubbard, D.M. 1987. Temporal and spatial patterns of growth in mussels (*Mytilus edulis*) on an offshore platform: relationships to water temperature and food availability. *J. Experimental Marine Biology and Ecology*. 111: 159-179.

Parker, N.C. 1989. History, Status, and Future of Aquaculture in the United States.  
<http://www.aces.edu/dept/fisheries/education/documents/HistoryofAquaculture.pdf>

Parks and Wildlife Committee. 2001b. California SB-1, Water, Parks & Wildlife Committee Analysis, Sept 12, 2001.

Parks and Wildlife Committee. 2001a. California SB-1 As Amended, Water, Parks & Wildlife Committee Analysis, Third Reading, Amended: 5/16/01

Parliament, C., Merchant, J.P. 1986. Effects of Environmental Change on Recreation Use and Value: An Application to Offshore Rigs in California. Staff Paper. Institute of Agriculture, Forestry and Home Economics, University of Minnesota. St. Paul, MN. pp. 86-34

Peabody, M.B. 2004. The fidelity of red snapper (*Lutjanus campechanus*) to petroleum platforms and artificial reefs in the northern Gulf of Mexico. Louisiana State University, M.S. Thesis.

Peabody, M.B., Wilson, C.A. 2006. Fidelity of red snapper (*Lutjanus campechanus*) to petroleum platforms and artificial reefs in the northern Gulf of Mexico. U.S. Dept. of the Interior, Minerals Management Service, Gulf of Mexico OCS Region, New Orleans, LA. OCS Study MMS 2006-005. 64 pp.

Peterson, I and J. S. Wroblewski. 1984. Mortality rate of fishes in the pelagic ecosystem. *Can. J. Fish. Aquat. Sci.* 41:1117-1120.

PIER. 2007. Summary of PIER funded wave energy research. California Energy Commission, PIER Program. CEC-500-2007-083.

Pollak, R, A. 1967. Additive von Neuniann-hlorgenstern Utility Functions. *Ecorioinefrim.* 35: 485-494.

Pondella, II, D. J., L. G. Allen, M. T. Craig and B. Gintert. 2006. Evaluation of eelgrass mitigation and fishery enhancement structures in San Diego Bay, California. *Bulletin Marine Science* 78(1): 115-131.

Ponti, M., Abbiati, M., Ceccherelli, V.U. 2002. Drilling platforms as artificial reefs: distribution of macrobenthic assemblages of the Paguro wreck (northern Adriatic Sea). *J. Marine Science.* 59: S316-S323.

Proserv Offshore. 2010. Decommissioning cost update for removing Pacific OCS Region offshore oil and gas facilities. Minerals Management Service report MMS M09PC00024

Pulsipher, A.G. 1996. (ed) Proceedings: An International Workshop on Offshore Lease Abandonment and Platform Disposal: Technology, Regulation and Environmental Effects, April 1996, Center for Energy Studies, Louisiana State University, Baton Rouge Louisiana. MMS Contract 14-35-0001-30794. 312 pages.

Raftican, T. 2006. Decommissioning California's offshore platforms: Rigs to reefs in politically hot waters. Conference Workshop Paper, CoastNet Conference, Sept 15, 2005, London UK.

Raftican, T., Steinbach, G. 2009. Decommissioning California's Offshore Platforms: Rigs to Reefs in Politically Hot Waters. California Artificial Reef Enhancement Program. [http://library.coastweb.info/726/1/Microsoft\\_Word\\_-\\_Raftican\\_paper.pdf](http://library.coastweb.info/726/1/Microsoft_Word_-_Raftican_paper.pdf) (accessed September 28, 2009).

Randal, R.V. 1991. Environmental Law Institute, Oil Pollution Deskbook

- Rauch, T.J. 2003. Equilibrial blenniid assemblages on offshore petroleum platforms. *Environmental Biology of Fishes*. 68: 301-305.
- Rauch, T.J. 2007. Interspecific dominance does not exclude sub-dominant blennies from offshore petroleum platforms. *Environmental Biology Fishes*. 78: 347-351.
- Rauch, T.J. 2004. Predators and the distribution and abundance of blennies on offshore petroleum platforms. *Gulf and Caribbean Research*. 16(2): 141-146.
- Reed, D. C., S. C. Schroeter and D. Huang. 2006. An experimental investigation of the use of artificial reefs to mitigate the loss of giant kelp forest habitat. A case study of the San Onofre Nuclear Generating Station's artificial reef project. California SeaGrant, University of California, San Diego Publication No. T-058.
- Ricker, W. E. 1975. Computation and interpretation of biological statistics of fish populations. *Bulletin of the Fisheries Research Board of Canada*, 191. 382pp.
- Rothbach, D. 2007. Rigs –to Reefs: Refocusing the Debate in California Duke Environmental Law and Policy Forum, pg 283-295.
- Rugh, D.J., M.M. Muto, S.E. Moore, and D.P. DeMaster. 1999. Status review of the eastern North Pacific stock of gray whales. NOAA, National Marine Fisheries Service, National Marine Mammal Laboratory, Seattle, Washington.
- Russell, R.W. 2005. Interactions between migrating birds and offshore oil and gas platforms in the northern Gulf of Mexico: Final Report. U.S. Dept. of the Interior, Minerals Management Service, Gulf of Mexico OCS Region, New Orleans, LA. OCS Study MMS 2005-009. 348 pp.
- Saaty, T. L. 1980. *The Analytic Hierarchy Process*, McGraw-Hill, New York.
- Santa Barbara County Planning and Development Department. 2009. Coastal Resources Enhancement Fund: Status Report of Grants, 1988-2008, p. 2.
- Santos, M.N., Monteiro, C.C. 2007. A fourteen-year overview of the fish assemblages and yield of the two Algarve artificial reefs (southern Portugal). *Hydrobiologia*. 580: 225-231.
- Scarborough-Bull, A.S. 1989. Fish assemblages at oil and gas platforms compared to natural hard/live bottom areas in the Gulf of Mexico. *Coastal Zone*.
- Scarborough-Bull, A.S. 1993. Study planning, testing, and reality: platform removal and associated biota. *Diving for Science*, 1993.
- Scarborough-Bull, A.S., Love, M.S., Schroeder, D.M. 2008. Artificial reefs as fishery conservation tools: Contrasting the roles of offshore structures between the Gulf of Mexico and the Southern California Bight. *American Fisheries Society Symposium* 49: 899-915.

Scandpower Risk Management. 2004. An Assessment of Safety and Costs Associated with Sub-sea Pipeline Disposals, for MMS Report no. 32.701.001/R1.

Schmitt, R.J. 2000. Southern California Educational Initiative Annual Report. Marine Science Institute, University of California, Santa Barbara.

Scholz, A.J., Kruse, S., Steinback, C., Bonkoski, J., and Hetrick, S. 2009. (forthcoming). Commercial and recreational fishing grounds and their relative importance off the South Coast of California. Ecotrust. Portland, OR.

Schroeder, D.M., Love, M.S. 2004. Ecological and political issues surrounding decommissioning of offshore oil facilities in the Southern California Bight. *Ocean and Coastal Management*. 47: 21-48.

Science Applications International Corporation. 2003. Chevron 4H Platform Shell Mounds Disposition. Prepared for the California State Lands Commission. EIR Report # 718. December 2003.

[http://www.slc.ca.gov/Division\\_Pages/DEPM/DEPM\\_Programs\\_and\\_Reports/Shell\\_Mounds/Chevron\\_Shell\\_Mounds.html](http://www.slc.ca.gov/Division_Pages/DEPM/DEPM_Programs_and_Reports/Shell_Mounds/Chevron_Shell_Mounds.html)

Science Applications International Corporation. 2003. Investigations of Water Quality Using Caged Mussels Bioassays and Surficial Sediment Quality at the 4H Shell Mounds. Prepared for the California State Lands Commission, Sept. 2003.

Sheehan, P.E. 1997. Air quality and platform removal from the Santa Barbara Channel: A case study. *Society Petroleum Engineering*. SPE38256. 6 pp.

Shindell, D. and Faluvegi, G. 2009. Climate response to regional radiative forcing during the twentieth century. *Nature Geoscience* 2: 294-300.

Side, J. 1997. The future of North Sea oil industry abandonment in the light of the Brent Spar decision. *J. Marine Policy*. 21: 45-52.

Smith, E.R.A.N., Garcia, S.R. 1995. Evolving California opinion on offshore oil development. *Ocean and Coastal Management*. 26: 41-56.

Soldal, A.V., Svellingen, I., Jorgensen, T., Lokkeborg, S. 2002. Rigs to reefs in the North Sea: hydroacoustic quantification of fish in the vicinity of a semi-cold platform. *ICES J. Marine Science*. 59: S281-S287.

Southwick, R. 2002. The Economic Effects of Sportfishing Closures in Marine Protected Areas: The Channel Islands Example. Southwick Associates, Inc. Fernandina Beach, FL.

State of Louisiana. 2009. Wildlife and Fisheries, RS Code 56, Sections 639.1 et. seq.

Stephan, C.D., Dansby, B.G., Osburn, H.R., Matlock, G.C., Riechers, R.K., Rayburn, R. 1990. Texas Artificial Reef Fishery Management Plan. Texas Parks and Wildlife Department.

Stephens, S.M., Frankling, S.C., Stagg, R.M., Brown, J.A. 2000. Sub-lethal effects of exposure of juvenile turbot to oil produced water. *Marine Pollution Bulletin*. 40: 928-937.

Stevens, J.S. 1980. The Public Trust: A Sovereign's Ancient Prerogative Becomes the People's Environmental Right. *14 UC Davis Law Review*, pgs.195-224.

Supreme Court of California. 1971. *Marks v. Whitney*, 6Cal.3rd 251, 259-260.

Tagatz, M.E.; Tobia, M. 1978. Effect of barite barium sulfate on development of estuarine communities. *Estuarine and Coastal Marine Science*. 7: 401-408.

Tagatz, M.E.; Ivey, J.M.; Lehman, H.K.; Oglesby, J.L. 1978. Effects of a lignosulfonate type drilling mud on development of experimental estuarine macro benthic communities. *SO Northeast Gulf Science*. 2: 35-42.

Tasker, M.L., Jones, P.H., Blake, B.F., Dixon, T.J., Wallis, A.W. 1986. Seabirds associated with oil production platforms in the North Sea. *Ring and Migration* 7: 7-14.

Texas Parks and Wildlife. 2009. Code 89. Artificial Reefs, Sections 89.001 et. seq.

Thomas, J.A., Kastelein, R.A., Awbrey, F.T. 1990. Behavior and blood catecholamines of captive belugas during playbacks of noise from an oil platform. *J. Zoological Biology*. 9: 393-402.

Turnipseed, M., Crowder L.B., Sagarin, R., Roady, S.E. 2009. Legal Bedrock for Building America's Ocean Ecosystems. *Science* 324, 183.

Twachtman, Snyder, and Byrd, Inc. 2000. State of the Art of removing Large Platforms located in Deep Water, U.S. Minerals Management Service, Final report, November 2000.

Twachtman, Snyder, and Byrd, Inc. 2003. Comparative Health and Safety Risk Assessment of Decommissioning Large offshore Platforms, Final report, In: Case Studies for Decommissioning of Three Offshore Platforms in the Pacific OCS Region, U.S. Minerals Management Service, June 2003.

Twachtman, Snyder, and Byrd, Inc. 2004. Center for Energy Studies. Operational and Socioeconomic Impact of Non-explosive Removal of Offshore Structures. OCS Study MMS 2004-074, Minerals Management Service. New Orleans, LA.

United States Coast Guard (USCG). 2010. Maritime Information Exchange. <http://psix.uscg.mil/PSIX/PSIXDetails.aspx?VesselID=626419>. Accessed March 14, 2010.

U.S. Department of Commerce. National Oceanic and Atmospheric Administration. National Marine Sanctuary Program. 2008. Channel Islands National Marine Sanctuary Management Plan / Final Environmental Impact Statement. Silver Spring, MD.

US Environmental Protection Agency. 2005. Emission Facts: Average Carbon Dioxide Emissions Resulting from Gasoline and Diesel Fuel. Office of Transportation and Air Quality, USEPA. EPA420-F-05-001.

US Environmental Protection Agency. 2009a. Proposal to Designate an Emission Control Area for Nitrogen Oxides, Sulfur Oxides and Particulate Matter. Technical Support Document: Chapter 4, Quantified Health Impacts Analysis. Assessment and Standards Division, Office of Transportation and Air Quality, USEPA. EPA-420-R-09-007.

US Environmental Protection Agency. 2009b. Technology Transfer Network Clearinghouse for Inventories and Emissions Factors: Emissions Factors and AP 42. From USEPA website at <http://www.epa.gov/ttn/chief/ap42/index.html>, accessed Sep 21, 2009.

US Environmental Protection Agency. 2009c. Current Methodologies in Preparing Mobile Source Port-Related Emission Inventories – Final Report. Prepared for USEPA Office of Policy, Economics and Innovation by ICF International, Fairfax, VA. 116 pp.

U.S. Fish and Wildlife Service and U.S. Census Bureau. 2007. 2006 National Survey of Fishing, Hunting, and Wildlife-Associated Recreation. FHW/06-CA.

USFWS (U.S. Fish and Wildlife Service). 2001a. Spring surveys, 1983-2001. Website [www.werc.usgs.gov/otters/casurveydata.html](http://www.werc.usgs.gov/otters/casurveydata.html).

2001b. Western snowy plover (*Charadrius alexandrinus nivosus*) Pacific coast draft recovery plan. Portland, Oregon. 630 pp.

1999. USGS reports continued decline of California sea otters. U.S. Department of the Interior, U.S. Geological Survey, Western Ecological Research Center, Sacramento, California.

1997. Recovery plan for the threatened marbled murrelet (*Brachyramphus marmoratus*) in Washington, Oregon, and California. Portland, Oregon. 203 pp.

1983. California brown pelican recovery plan. Prepared by the USFWS under contract with Franklin Gress (California Department of Fish and Game) and Daniel W. Anderson (University of California, Davis). February.

1980. California least tern recovery plan. Prepared by the USFWS, Region 1, Portland, Oregon, in cooperation with the Recovery Team. April.

U.S. Supreme Court. 1842. *Martin v. Waddell*: 41 U.S. (16Pet.) 367, 410.



Vardaro, M.F., Parmley, D., Smith, K.L., Jr. 2007. A study of possible reef effects caused by a long-term camera in the deep North Pacific. *Deep-Sea Research*. 54: 1231-1240.

Villreal, T.A., Hanson, S., Qualia, S., Jester, E.L.E., Granade, H.R., Dickey, R.W. 2007. Petroleum production platforms as sites for the expansion of ciguatera in the northwestern Gulf of Mexico. *J. Harmful Algae*. 6: 253-259.

Watson, J.R., S. Mitarai, Siegel, D.A., Caselle, J., Dong, C., McWilliams, J.C. 2009. Realized and potential larval connectivity in the Southern California Bight. *Marine Ecology-Progress Series* 401: 31-48.

Wegge, T.C., Hanemann, W.M. and Strand, I. E. 1986. An Economic Assessment of Marine Recreational Fishing in Southern California. Technical Memorandum NOAA-TM-NMFS-SWR-015, NOAA Southwest Region. Terminal Island, CA.

Weldon, C., Kroon, D. 1992. Corrosion Control Survey Methods for Offshore Pipelines. MMS-International Workshop on Pipeline safety, 1992. Texas A&M.

Weston Solutions, Inc. and Science Applications. 2007. Physical and Chemical Characteristics of the Platform Gina Shell Mound, MMS final report. March 2007.

Wiese, F.K., Montevicchi, W.A., Davoren, G.K., Huettmann, F., Diamond, A.W., Linke, J. 2001. Seabirds at risk around offshore oil platforms in the north-west Atlantic. *Marine Pollution Bulletin*. 42: 1285-1290.

Wilson, C.A., Van Sickle, V.R., and Pope, D. L. 1987. Louisiana Artificial Reef Plan. Technical Bulletin 41, Louisiana Department of Wildlife and Fisheries. Baton Rouge, LA.

Wilson, C.A., Pierce, A., and Miller, M.W. 2003. Rigs and Reefs: a Comparison of the Fish Communities at Two Artificial Reefs, a Production Platform, and a Natural Reef in the Northern Gulf of Mexico. Prepared by the Coastal Fisheries Institute, School of the Coast and Environment. Louisiana State University. U.S. Dept. of the Interior, Minerals Mgmt. Service, Gulf of Mexico OCS Region, New Orleans, LA. OCS Study MMS 2003-009. 95 pp.

Wilson, J.H., Beyene, A. 2007. California Wave Energy Resource Evaluation. *J. Coastal Research*. 23: 679-690.

Zavis, A., LaGanga, M.I. 2009. Budget deal's oil-drilling component draws mixed reviews, Los Angeles Times, July 21, 2009, p A1.

## **Appendix 1: Regional Context**

---

There are four online data and information sources, developed by a number of state and federal agencies, that provide a regional context for consideration of decommissioning alternatives. They include information on human uses, natural habitats, ecological resources, and coastal and marine infrastructure. Each online system implements its own data validation and quality control procedures. However, while there is some information sharing across resources (for example, between the Ocean Uses Atlas and Marine Map), there is no overall coordinated effort to identify overlaps, fill data gaps, ensure the use of common and authoritative data sources, or address other data quality issues relating to all four systems as a group.

The following subsections describe each of the four readily available sources of information for the southern California region:

- California Ocean Uses Atlas, maintained by NOAA’s Marine Protected Areas Center and Marine Conservation Biology Institute
- Marine Map, maintained by UC Santa Barbara for the California MLPA MPA designation process
- Southern California MLPA Regional Profile, created to support the MLPA MPA designation process
- Multipurpose Marine Cadastre, maintained by a number of agencies to provide cadastral data

Descriptions of each of these systems are followed by a set of representative maps illustrating key features of the region and demonstrating the sorts of products that can be readily created by the online mapping systems.

### ***California Ocean Uses Atlas***

The California Ocean Uses Atlas Project, a public-private partnership between NOAA’s Marine Protected Areas Center and Marine Conservation Biology Institute, maps the range of significant human uses of the ocean in state and federal waters off the California coast. It is intended to inform management and policy decisions among federal and state agencies responsible for California’s ocean ecosystems.

The Atlas data were collected through participatory GIS workshops in four regions throughout California. For each region, the data describe the location and extent to which the ocean environment is used for fishing, non-industrial/military, and non-consumptive uses. The data layers are organized into four categories:

1. fishing
  - a. dominant use areas
    - i. commercial: benthic mobile, dive fishing, and pelagic
    - ii. recreational: boat-based fishing, dive fishing, kayak fishing, and shore-based fishing
  - b. future trends: commercial dive fishing and recreational boat-based fishing
  - c. maximum footprint
    - i. commercial: benthic mobile gear, dive fishing, and pelagic

- ii. recreational: boat-based fishing, dive fishing, kayak fishing, and shore-based fishing
2. industrial/military
  - a. dominant use areas: cruise ships, military operations, oil/natural gas, and shipping
  - b. future trends: alternative energy and aquaculture
  - c. maximum footprint: aquaculture, cables, cruise ships, military operations, mining, oil/natural gas, and shipping
3. non-consumptive
  - a. dominant use areas: beach use, boating, paddling, sailing, scuba/snorkeling, surface water sports, swimming, tidepooling, and wildlife viewing
  - b. future trends: boating, sailing, scuba/snorkeling, and wildlife viewing
  - c. maximum footprint: beach use, boating, paddling, sailing, scuba/snorkeling, surface water sports, swimming, tidepooling, and wildlife viewing
4. baseline: coastal cities, state freeway system, county boundaries, state boundaries, water, Mexico, and California

[http://mpa.gov/science\\_analysis/atlas.html](http://mpa.gov/science_analysis/atlas.html)

### ***Marine Map***

MarineMap is a web-based tool that allows users to draw, evaluate and discuss prospective MPAs. It allows users to receive immediate feedback on the protections and impacts afforded by the proposals they draw. They can then adjust their proposals or share their proposals with others.

Specifically, MarineMap allows users to:

- visualize social and ecological attributes of coastal areas
- draw and assemble networks of prospective MPAs
- specify types of regulations to be applied to each MPA, as well as goals and objectives fulfilled
- generate reports that assess MPAs according to scientific guidelines as well as social and economic impacts
- share MPA boundaries and networks with other users
- discuss results with others in online forum
- quickly and easily modify existing MPA concepts as the process evolve

The Marine Map data layers are organized into 10 categories:

1. The base category contains data layers for satellite/aerial imagery, bathymetry, nautical charts, study regions, graticules, isobaths, bioregions, and coastline buffers
2. The biological category contains data layers for marine mammals, sea bird diversity, and grunion spawning locations
3. The consumptive category contains data layers for recreational fishing, halibut trawl grounds, and human use layers. The human use layers were provided by the California Ocean Uses Atlas Project and contain dominant use areas, future trends, and maximum footprint for non-consumptive, industrial/military, and fishing uses
4. The cultural category contains data layers for place names and surfing locations

5. The draft category contains data layers for vessel observations
6. The habitat category contains data layers for estuaries, eelgrass, nearshore habitats, hard and soft substrata, and predicted substrate
7. The management category contains data layers on coastal energy, research and monitoring, cowcod conservation area, existing state MPAs, rockfish conservation areas (RCAs) for commercial non-trawlers, RCAs for commercial trawlers, RCAs for recreational fishermen, military areas, and beach nourishment
8. The non-consumptive category contains data layers on coastal access and recreation, including boat launch sites, shore dive locations, ports and harbors, and coastal access points
9. The physical category contains watersheds, agricultural impacts to watersheds, urban impacts to watersheds, and water quality
10. The SAT analyses category contains data layers for shore types, kelp persistence, substrate proxy (0-30m), maximum extent of kelp, and substrate as evaluated by the Science Advisory Team

<http://marinemap.org/>

### ***Southern California MLPA Regional Profile***

The MLPA Regional Profile was created with the intention of supplying stakeholders with the knowledge they need to develop and evaluate proposals for Marine Protected Areas (MPAs) in the south coast study region. Toward this purpose, MLPA Initiative staff compiled and developed spatial data layers and conducted geographic information system (GIS) analyses. The data they collected were reviewed and revised based on input from regional stakeholders before being made public.

The MLPA Region Profile contains background information and data on the biological, oceanographic, socioeconomic, and governance characteristics of the region. These data include:

- Brief descriptions of the five coastal counties in the study region, including overall economic and population statistics and the wages paid in ocean-based economies.
- Commercial fishing statistics on some of the major commercial fisheries within the study region, average annual landings, the overall number of commercial fishing vessels, the commercial fishing port complexes, and individual ports and harbors.
- Locations of kelp harvest and aquaculture leases in the study region.
- Recreational fishing statistics on some of the major recreational fisheries within the study region and angler days for boat-based fishing modes (Commercial Passenger Fishing Vessels, kayak angling and private/rental vessels), shore-based fishing modes (beach/bank fishing and from manmade structures), and other fishing modes (spearfishing and clamming).
- Information on scientific collecting under permits issued by the DFG.
- Information on coastal tourism, including coastal park visitation rates.
- Descriptions of non-consumptive activities, including beachgoing, surfing, boating, scuba diving, kayaking, tidepooling, and wildlife viewing.
- Information on alterations to the coast, including beach nourishment, beach grooming, dredging, coastal armoring, and coastal lighting.

- Vessel traffic.

[http://www.dfg.ca.gov/mlpa/pdfs/rpsc/body\\_part1.pdf](http://www.dfg.ca.gov/mlpa/pdfs/rpsc/body_part1.pdf)

### ***Multipurpose Marine Cadastre***

The Multipurpose Marine Cadastre, a marine information system for the outer continental shelf and state waters, provides direct access to marine cadastral data. These data include digital authoritative marine boundary data distributed by various agencies and data commonly used to support alternative energy siting. The tool is used both for alternative energy siting and research as well as for larger marine spatial planning efforts.

Data can be viewed through both ArcIMS and Google Earth applications. Data sets available include:

- Jurisdictional Boundaries and Limits
  - State Seaward Boundary: Alaska, Atlantic, Gulf of Mexico, and Pacific
  - Revenue Sharing Boundary: Alaska, Atlantic, Gulf of Mexico, and Pacific
  - Territorial Sea Boundary: Alaska; California; Florida and Alabama; Georgia; Hawaiian Islands; Howland, Baker, and Jarvis Islands; Johnston Island; Maine; Mississippi and Louisiana; New Hampshire and Massachusetts; New Jersey, Delaware, and Maryland; Northwestern Hawaiian Islands; Oregon and Washington; Puerto Rico and U.S. Virgin Islands; Rhode Island and New York; Texas; Virginia, North Carolina, and South Carolina; and Wake Island
  - Contiguous Zone: Alaska; California; Florida and Alabama; Georgia; Hawaiian Islands; Howland, Baker, and Jarvis Islands; Johnston Island; Maine; Mississippi and Louisiana; New Hampshire and Massachusetts; New Jersey, Delaware, and Maryland; Northwestern Hawaiian Islands; Oregon and Washington; Puerto Rico and U.S. Virgin Islands; Rhode Island and New York; Texas; Virginia, North Carolina, and South Carolina; and Wake Island
  - Exclusive Economic Zone: Alaska, American Samoa, Caribbean, East Coast, Gulf of Mexico, Hawaiian Islands, Howland and Baker Islands, Jarvis Island, Johnston Island, Northern Mariana Islands, Palmyra Atoll-Kingman Reef, Wake Island, and West Coast
  - Submerged Lands Act Boundary: Alaska, Atlantic, Gulf of Mexico, and Pacific
  - Federal Fishery Management Areas
  - National Estuarine Research Reserves - All MPAs
  - National Marine Sanctuaries: Thunder Bay, Stellwagen Bank, Monitor National, Gray's Reef, Florida Keys, Flower Garden Banks, Channel Islands, Monterey Bay, Gulf of the Farallones, Cordell Bank, Olympic Coast, Hawaiian Islands Humpback Whale, Fagatele Bay, and Northwestern Hawaiian Islands
  - Coastal National Park Service
  - Coastal Indian Lands
  - Coastal National Wildlife Refuges: Pacific Region, Southwest Region, Great Lakes - Big Rivers Region, Southeast Region, Northeast Region, Mountain - Prairie Region, Alaska Region, and California and Nevada

- Minerals Management Service Protraction Diagrams: Alaska, Atlantic, Gulf of Mexico, and Pacific
- Outer Continental Shelf Lease Blocks: Alaska, Atlantic, Gulf of Mexico, and Pacific
- Federal Outer Continental Shelf Administrative Boundaries: Atlantic, Gulf of Mexico, and Pacific
- Federal Georegulations
  - Clean Water Act
  - Coastal Zone Management Act
  - Endangered Species Act
  - Marine Mammal Protection Act
  - Magnuson-Stevens Fishery Conservation Act
  - National Environmental Policy Act
  - Outer Continental Shelf Lands Act
  - Coastal Barrier Resources Zones
- Navigation and Marine Infrastructure
  - Deep Stratigraphic Wells
  - Wells
  - Gulf of Mexico Drilling Platforms
  - Ports
  - Shipping Lanes
  - Gulf of Mexico Pipelines
  - Gulf of Mexico Fairways
  - Gulf of Mexico Minerals Management Service Active Leases
  - Wrecks and Obstructions
- Geology and Seafloor Data
  - California Bathymetry Contours (10m intervals)
  - New Jersey Bathymetry Contours (10ft intervals)
  - Northeast Bathymetry Contours (10m intervals)
  - Northwest Bathymetry Contours (10m intervals)
- Marine Habitat and Biodiversity
  - Pinniped Haul Outs (California)
  - Rookeries (California)
  - Essential Fish Habitat Points (California)
  - Kelp Canopy (California)
  - Essential Fish Habitat (California)
  - Rocky Reefs (California)
  - Seagrass Beds (California)
- Additional WMS Services and ArcGIS Servers
  - NOAA Electronic Nautical Chart WMS Service
  - Marine-Geo.org Bathymetry WMS Service
  - ESRI Geography Network ArcIMS Service
  - NOAA Raster Nautical Chart ArcGIS Server
  - U.S. Marine Cadastre WMS Service

**<http://www.csc.noaa.gov/mbwg/htm/multipurpose.html>**

Legend Find Results Print Help Info

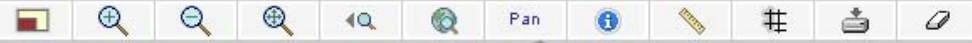

- Deep Stratigraphic Wells
- Wells
- Liquefied Natural Gas Sites
- Drilling Platforms
- Transmission Lines
- Ports
- Shipping Lanes
- Pipelines
- Fairways
- Minerals Management Service
- Wrecks and Obstructions
- Military Danger Zones

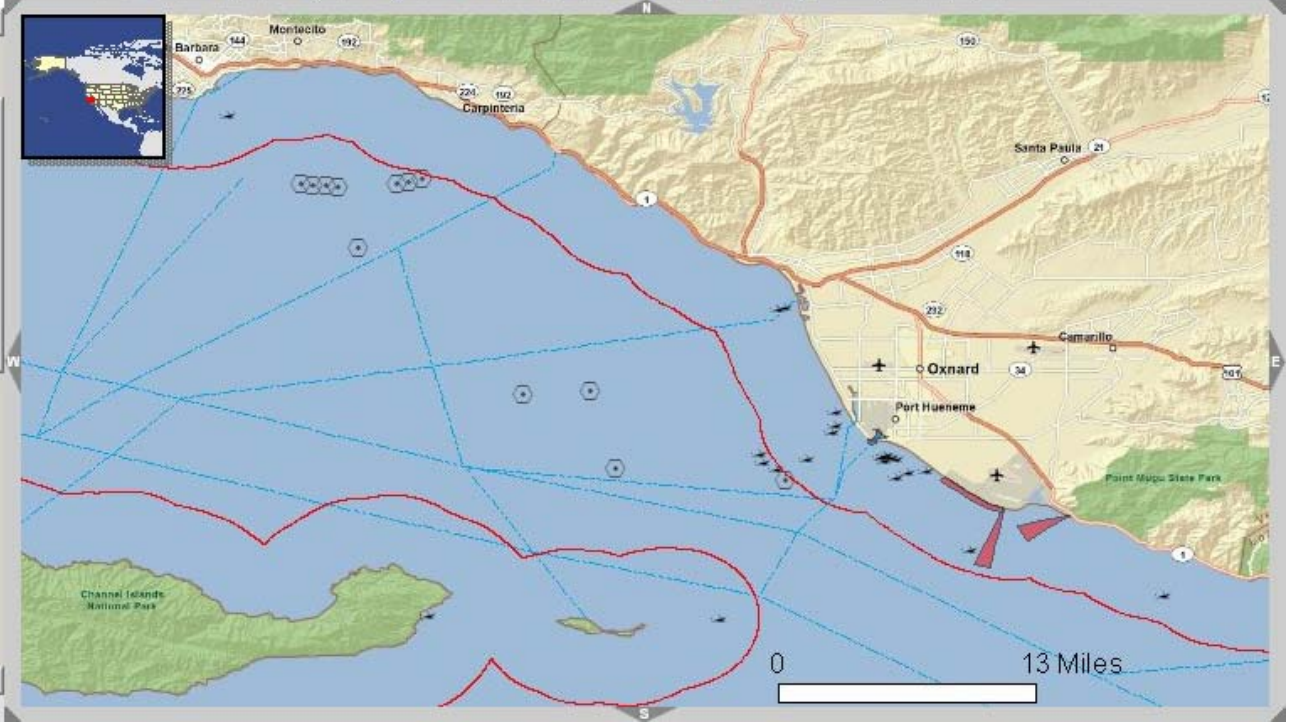

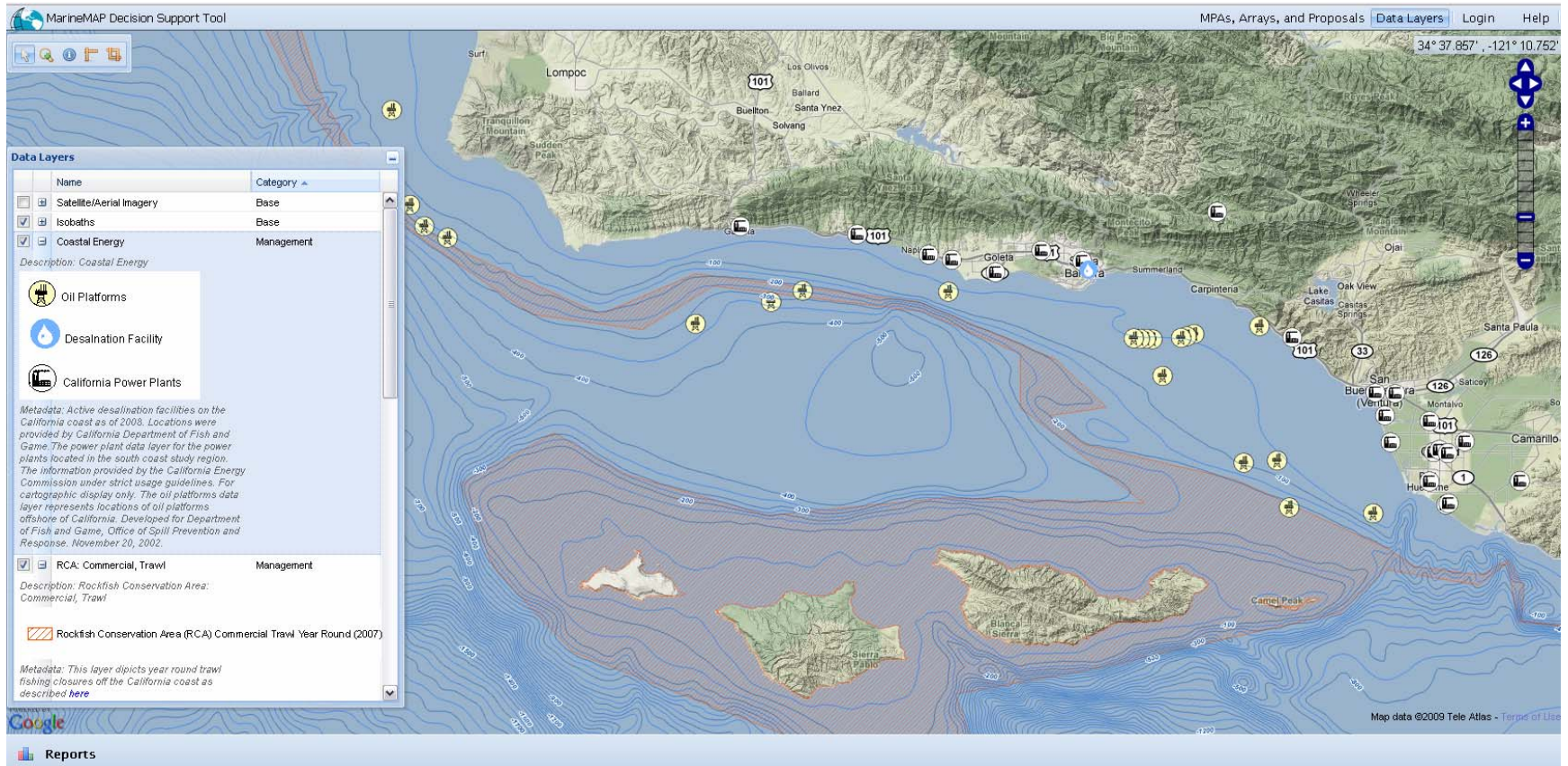



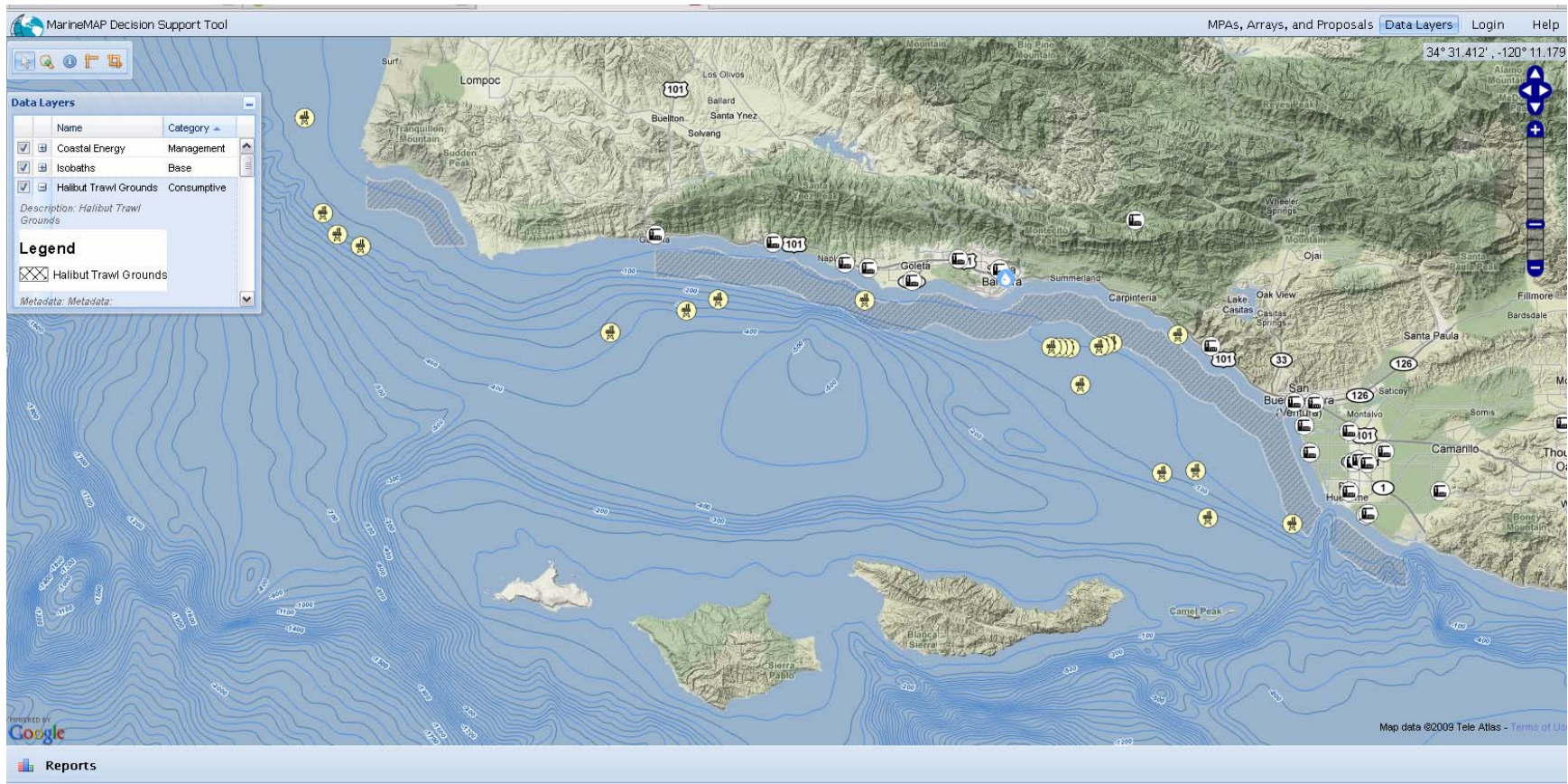

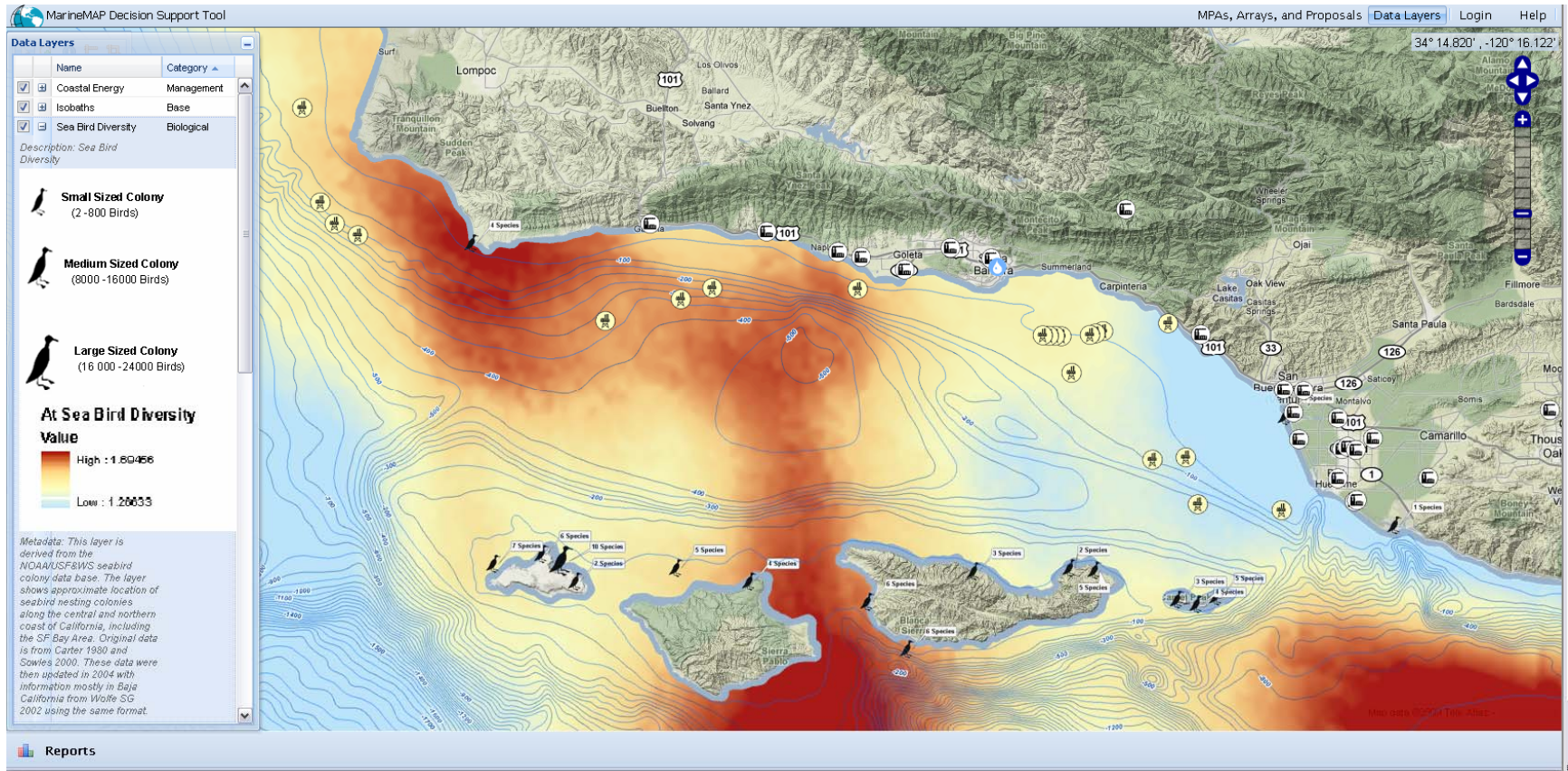

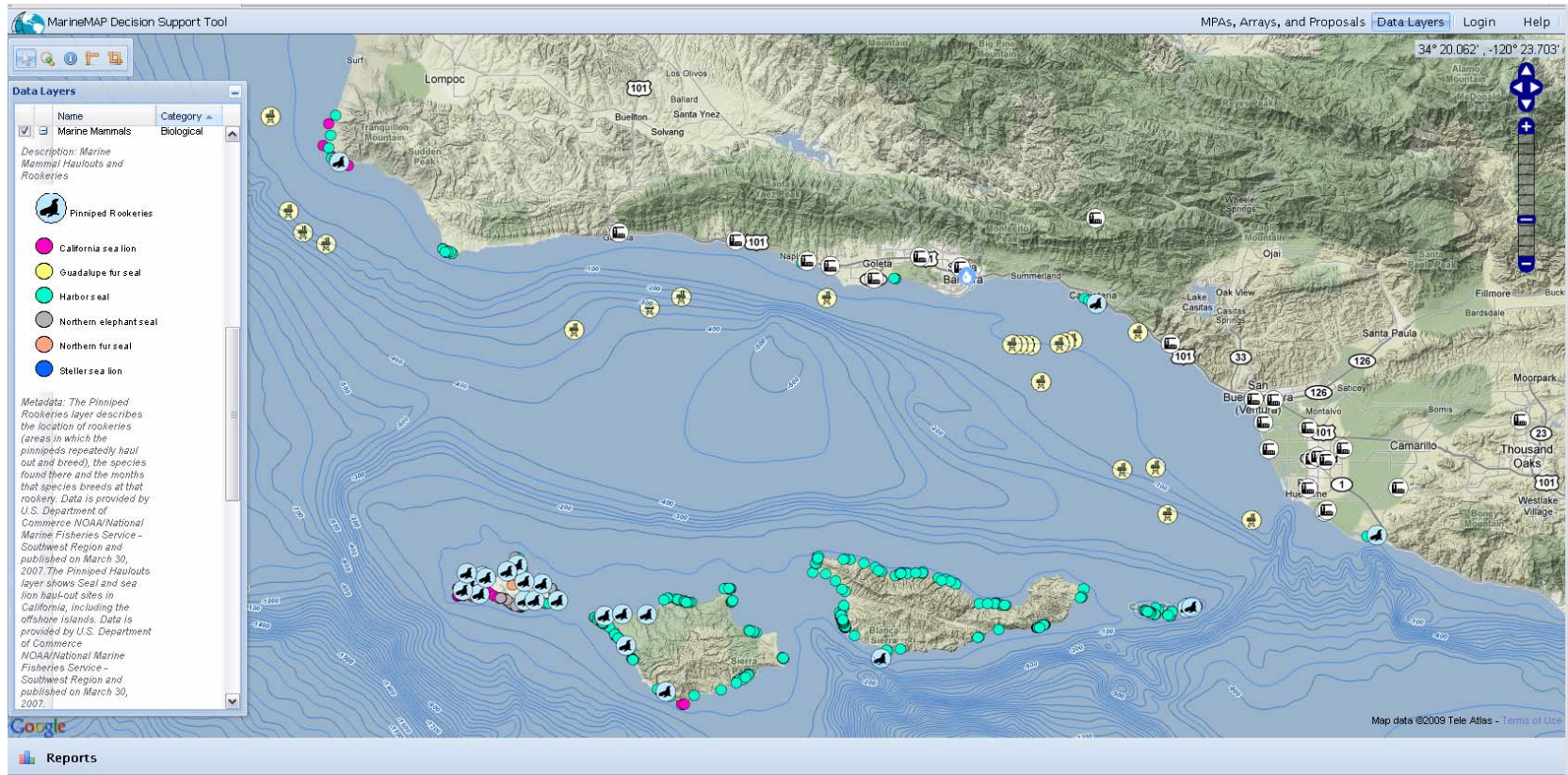

## **Appendix 2: Legislation and Related Documents**

---

Appendix 2 includes a number of documents referred to in the body of the report, including:

- California Senate Bill 1 of 2000 (SB 1)
- National Fisheries Enhancement Act (NFEA)
- Texas Artificial Reef Act of 1989
- Louisiana Fisheries Enhancement Act
- Sample ACOE permit application (from Louisiana Artificial Reef Plan)
- Louisiana Act of Donation (from Louisiana Artificial Reef Program)
- State of Mississippi Act of Donation and Title Transfer
- ACOE Final Artificial Reef Permit for St. John's County Department of Parks and Recreation

## **California Senate Bill 1 of 2000 (amended SB 241)**

BILL NUMBER: SB 241      AMENDED  
BILL                      TEXT

AMENDED IN SENATE    JANUARY 3, 2000

INTRODUCED BY    Senator Alpert

JANUARY 26, 1999

An act to add Division 20.6 (commencing with Section 30960) to the Public Resources Code, relating to marine preservation –  
~~and making an appropriation therefor .~~

### LEGISLATIVE COUNSEL'S DIGEST

SB 241, as amended, Alpert. California Endowment for Marine Preservation.

Existing law declares that the Pacific Ocean and its rich marine living resources are of great environmental, economic, aesthetic, recreational, educational, scientific, nutritional, social, and historic importance to the people of California.

This bill would establish the California Endowment for Marine Preservation in order to create a permanent source of funding for projects that will enhance the quality, use, and enjoyment of the open coastal marine resources of the state. The endowment would be governed by a board of directors, with membership and duties prescribed by the bill.

The bill would require the endowment to coordinate its activities with the Department of Fish and Game, the California Coastal Commission, the Bay Conservation and Development Commission, the State Lands Commission, and appropriate federal agencies.

The bill would specify that no employee of the endowment is an employee of the State of California or subject to specified provisions of existing law governing employer-employee relations.

The bill would require each owner and operator of certain offshore oil platforms or production facilities *who chooses to participate and* who receives government permits that allow the platform or facility to remain in place, to deposit an unspecified amount with the endowment. ~~The assessment on these owners and operators would constitute a tax and would result in a change in state taxes for the purpose of increasing state revenues within the~~

~~meaning of Section 3 of Article XIII A of the California Constitution, and thus would require for passage the approval of 2/3 of the membership of each house of the Legislature.~~

The bill would require the endowment to submit a report to the Legislature concerning, among other things, the operations, activities, and financial condition of the endowment.

~~—The bill would appropriate an unspecified sum from the General Fund to the endowment as a loan for the purposes of incorporating and commencing operations, as specified.~~

Vote: ~~2/3~~ majority .

Appropriation: ~~yes~~ no . Fiscal

committee: yes. State-mandated local program: no.

THE PEOPLE OF THE STATE OF CALIFORNIA DO ENACT AS FOLLOWS:

SECTION 1. Division 20.6 (commencing with Section 30960) is added to the Public Resources Code, to read:

DIVISION 20.6. CALIFORNIA ENDOWMENT FOR MARINE PRESERVATION  
CHAPTER 1. FINDINGS AND DECLARATIONS

30960. The Legislature hereby finds and declares all of the following:

(a) The Pacific Ocean and its rich marine living resources are of great environmental, economic, aesthetic, recreational, educational, scientific, social, and historic importance to the people of California.

(b) Sustainable sport and commercial fishing is a vital, growing part of California's dynamic culture that generates more than \$5.7 billion annually in economic benefits for the state, including its coastal communities ~~and local economies. Recreational fishing has accounted for more than 88 percent of the total income of, value added to, and employment generated by, the fishing industry in the state.~~ *and local economies.*

(c) Programs to enhance the marine fishery resources of the state are needed to prevent overfishing, facilitate long-term protection of fish habitats, and foster sustainable growth in tourism industries attracted by California's unique natural environment.

(d) *A program that will speed up the abandonment of offshore oil platforms will enhance the environmental, aesthetic, and recreational features of the coastal environment.* Any offshore oil platforms that are nearing possible retirement should be removed as quickly as possible to improve the aesthetic character of the areas of the California coast that have been impacted by offshore oil

activities.

(e) A program that would remove the visible structure of an oil platform while allowing part of the subsea portion to be abandoned in place will facilitate and hasten the removal of platforms and will benefit the state by improving the aesthetics of the California coast *and reducing possible damage from oil spills from the producing platforms* .

(f) *The State of California recognizes the need to formulate its environmental and resource management policies based on the best available scientific information and should utilize the University of California, the California State University, and other institutions of higher learning in this state to the fullest extent possible to assist it in achieving that goal.*

## CHAPTER 2. DEFINITIONS

30965. Unless the context requires otherwise, the following definitions govern the construction of this division:

(a) "Board" means the Board of Directors of the California Endowment for Marine Preservation.

(b) "Endowment" means the California Endowment for Marine Preservation.

(c) "Open coastal marine resources" means those marine resources that use open coastal waters as their habitat.

(d) "Open coastal waters" means the area composed of the submerged lands of the state and the lands of the Outer Continental Shelf.

(e) "Outer Continental Shelf" means those lands designated as Outer Continental Shelf lands pursuant to the federal Outer Continental Shelf Lands Act (43 U.S.C.A. Sec. 1331 et seq.).

(f) "State waters" means waters within the seaward boundary of the state as defined in Section 1312 of Title 43 of the United States Code.

## CHAPTER 3. ESTABLISHMENT

30970. The California Endowment for Marine Preservation is hereby established. The endowment is subject to this division and to the Nonprofit Public Benefit Corporation Law (Pt. 2 (commencing with Sec. 5110), Div. 2, Title 1, Corp. C.). If there is a conflict between this division and the Nonprofit Public Benefit Corporation Law, this division shall prevail.

30971. Nothing in this division shall be construed to do any of the following:

(a) Relieve the prior owner or operator of an oil facility from any continuing liability under (1) any state statute or regulation regarding liability for the spilling of oil or (2) the federal Oil

Pollution Act of 1990 (33 U.S.C.A. Sec. 2701 et seq.), if the liability is associated with seepage or release of oil from an oil facility that was decommissioned pursuant to an order of, or any action taken by, and in accordance with, any applicable rule or regulation of, the United States Department of the Interior's Minerals Management Service or the State Lands Commission.

(b) Alter any existing law that establishes liability for damages, including, but not limited to, damages from components of decommissioned oil facilities.

(c) Establish any liability on the part of the state.

(d) Require any agency with jurisdiction to approve the abandonment of an oil platform in place.

(e) Promote, encourage, or facilitate offshore oil exploration, development, and production within California's open coastal waters.

*(f) Require the United States Department of the Interior's Mineral Management Service or the State Lands Commission to modify, amend, or alter an existing oil and gas lease to approve the abandonment of an oil platform in place.*

*(g) Relieve the prior owner or operator of an Outer Continental Shelf oil well from any continuing liability under the federal Oil Pollution Act of 1990 (33 U.S.C. Sec. 2701 et seq.) associated with seepage or release of oil from an oil facility that was decommissioned pursuant to an order of, or an action taken by, and in accordance with an applicable rule or regulation of, the United States Department of the Interior Minerals Management Service.*

*(h) Alter any existing law that establishes liability for damages arising with respect to artificial reefs or reef materials, including, but not limited to, components of decommissioned oil facilities.*

*(i) Establish any liability on the part of the state.*

#### CHAPTER 4. BOARD OF DIRECTORS

30975. The endowment is governed by the Board of Directors of the California Endowment for Marine Preservation.

30976. The board consists of nine members appointed as follows:

(a) The Speaker of the Assembly shall appoint one member who shall be an expert in marine science from the University of California, the California State University, or other accredited university.

(b) The Speaker of the Assembly shall appoint one member who shall be from a nonprofit public interest organization with an emphasis on the enhancement of open coastal marine resources and habitat.

(c) The Senate Committee on Rules shall appoint one member who shall be an expert in marine fisheries from the University of California, the California State University, or other accredited



university.

(d) The Senate Committee on Rules shall appoint one member who shall be from a nonprofit public interest organization with an emphasis on the enhancement of open coastal marine resources and habitat.

(e) The Governor shall appoint five members as follows:

(1) The Secretary of the Resources Agency, or his or her designee, who shall also serve as chairperson.

(2) A representative of the public.

(3) A person who has served as a local government elected official, or who has worked for a local government, with jurisdiction over, or directly adjacent to, open coastal waters.

(4) A representative of the ~~sports~~ fishing industry.

(5) A representative of marine conservation organizations representing the interests of recreational fishing.

30977. The term of office of each member of the board is six years. However, the term of office for the first board member appointed pursuant to subdivision (a) of, and paragraphs (1) and (2) of subdivision (e) of, Section 30976 is two years. The term of office for the first board members appointed pursuant to subdivision (c) of, and paragraphs (4) and (5) of subdivision (e) of, Section 30976 is four years.

30978. Any vacancy on the board shall be filled by the appointing power by appointment for the unexpired term.

30979. (a) The board shall conduct its initial meeting as soon as possible after January 1, ~~2000~~ 2001 .

(b) The board shall meet as often as required, but at least twice per year.

(c) Members of the board shall attend at least 50 percent of all duly convened meetings of the board in a calendar year. A member who fails to attend at least 50 percent of all duly convened meetings of the board in a calendar year forfeits membership on the board. The vacancy shall be filled pursuant to Section 30978.

(d) Members of the board shall receive no salary but shall be paid one hundred dollars (\$100) per day for each meeting and shall be reimbursed for all necessary travel expenses.

## CHAPTER 5. POWERS AND DUTIES

30980. The members of the board first appointed shall serve as incorporators of the endowment and shall take whatever actions are necessary to establish the endowment pursuant to the Nonprofit Public Benefit Corporation Law (Pt. 2 (commencing with Sec. 5110), Div. 2, Title 1, Corp. C.).

30981. (a) The purpose of the endowment is to create a permanent source of funding for projects that will enhance the quality, use, and enjoyment of the open coastal marine resources of the state. To achieve this objective, the endowment may do any or all of the following:

(1) Support research into open coastal marine fisheries, ~~sport fishing,~~ marine habitat, or other related research.

*In so doing, the board shall endeavor to take maximum advantage of the resources available from the University of California, the California State University, and other institutions of higher learning in this state with expertise in marine resource issues.*

(2) Support projects in open coastal waters that ~~enhance the state's sport fishing industry, including sport diving or other sustainable activities.~~ *enhance sustainable marine activities, including sport fishing, recreational fishing and diving, mariculture, and other compatible activities.*

(3) Support projects in open coastal waters to enhance the habitat for open coastal marine life.

(4) Support programs in open coastal waters that lead to enforcement of laws regulating the take of open coastal marine species, the protection of habitat, and the protection and monitoring of open coastal marine species and habitat with an emphasis on innovative approaches.

(5) Support other activities in open coastal waters that substantially carry out the purpose of the endowment.

(6) *Fund maintenance and hazard markers and provide other protections of public safety for decommissioned offshore oil platforms or production facilities for which decommissioning savings were donated to the endowment pursuant to subdivision (a) of Section 30986.*

(b) The endowment may fund projects within each of the categories described in subdivision (a). The endowment shall attempt to achieve a geographic balance throughout the state's coastal areas in allocating funding.

(c) The board may also do all of the following:

(1) Obtain grants from, and contract with, individuals and with private, local, state, and federal agencies, organizations, and institutions.

(2) Contract with, or make grants to, conservation organizations, institutions of higher education, and local, state, and federal agencies.

(3) Loan funds to private, local, state, and federal agencies, organizations, and institutions.

(d) The endowment shall create a business plan for a five-year period. The endowment shall update the plan annually.

(e) On or before February 1 each year, the endowment shall submit a report to the Assembly Committee on Water, Parks, and Wildlife and the Senate Committee on Natural Resources for the preceding fiscal year. The report shall include all of the following:

(1) The updated business plan created pursuant to subdivision (d).

(2) A comprehensive and detailed report of the endowment's operations, activities, financial condition, and accomplishments under this section.

(3) A listing of each recipient of a grant from the endowment and the purposes and amount of that grant.

(4) A listing of any loan that the endowment has received and the plan for repaying the loan.

(5) A report of each independent audit required pursuant to subdivision (d) of Section 30985.

30981.5. Members of the board and appropriate staff shall be available to testify before appropriate committees of the Legislature.

30982. The endowment shall not contribute to, or otherwise support, any political party or candidate for elective public office.

30983. The endowment may hire employees and may obtain legal counsel. No employee of the endowment is an employee of the State of California. No employee of the endowment is subject to Chapter 10.3 (commencing with Section 3512) of, or Chapter 10.5 (commencing with Section 3525) of, Division 4 of Title 1 of the Government Code. Employees of the endowment have the right to representation consistent with the National Labor Relations Act (29 U.S.C.A. Sec. 151 et. seq.).

30984. The endowment shall coordinate its activities with the Department of Fish and Game, the California Coastal Commission, the Bay Conservation and Development Commission, the State Lands Commission, and appropriate federal agencies, including the National Marine Fisheries Service and the United States Department of the Interior's Minerals Management Service. Nothing in this division limits the authority and responsibility of any of these agencies.

## CHAPTER 6. FINANCIAL TRANSACTIONS AND AUDITS

30985. (a) The endowment may receive charitable contributions or any sources of income that may be lawfully received, including loans from the state.

(b) The endowment shall administer any funds it receives in accordance with this division.

(c) The endowment shall invest and manage any funds it receives in accordance with the Nonprofit Public Benefit Corporation Law (Pt. 2

(commencing with Sec. 5110), Div. 2, Title 1, Corp. C.).

(d) The accounts of the endowment shall be audited annually in accordance with generally accepted auditing standards by independent certified public accountants.

(e) The financial transactions of the endowment for any fiscal year may be audited by the Bureau of State Audits. A report of each audit completed pursuant to this subdivision shall be made to the Legislature and the Governor.

(f) Each recipient of assistance by grant or contract pursuant to this division shall keep records reasonably necessary to disclose fully the amount of the assistance, the disposition of the assistance, the total cost of the project or undertaking in connection with which the assistance is given or used, the amount and nature of that portion of the cost of the project or undertaking supplied by other sources, and other records that will facilitate an effective audit. Each recipient of a fixed price contract awarded pursuant to competitive bidding procedures is exempt from the requirements of this subdivision.

(g) The endowment, or its authorized representative, and the Bureau of State Audits shall have access to any records necessary for the purpose of auditing and examining all funds received or expended by the recipients of assistance.

30986. (a) If the owner and operator of a decommissioned offshore oil platform or production facility within state waters or Outer Continental Shelf waters adjacent to state waters receives all applicable government permits to allow the offshore oil platform or production facility to remain in place, \_\_\_\_ percent of the cost savings to the owner or operator from leaving the facility in place, rather than removing the facility, shall be deposited with the endowment. The endowment may take any action necessary to recover the cost savings from the owner or operator. *Cost savings do not include any costs incurred by the operator in connection with obtaining any government permits or approvals, or both, including required research, evaluation, and mitigation.*

(b) The endowment shall ensure that any estimate of the cost savings calculated pursuant to subdivision (a) is reasonably accurate.

~~SEC. 2. The sum of \_\_\_\_ dollars (\$\_\_\_\_) is hereby appropriated from the General Fund to the California Endowment for Marine Preservation established pursuant to Division 20.6 (commencing with Section 30960) of the Public Resources Code as a loan to the endowment for the purposes of incorporating and commencing operation until the endowment has sufficient income to repay the debt. The loan shall be repaid with interest calculated at the rate earned by the Pooled Money Investment Fund on January 1, 2000.~~

*(c) The intent of this section is to establish a voluntary program*

*through which an individual owner or operator of one or more offshore oil platforms or production facilities may choose to participate with the assent of all permitting agencies, whether they are state, local, or federal.*

*30987. Nothing in this division is intended, nor shall it be construed, to limit or affect the authority or duties of any state or local agency, including but not limited to, the State Lands Commission, the California Coastal Commission, and the Department of Fish and Game. Nothing in this division is intended, nor shall be it construed, as an approval of any particular method of abandonment.*

# ***United States National Fisheries Enhancement Act***

From the U.S. Code Online via GPO Access  
[wais.access.gpo.gov]  
[Laws in effect as of January 20, 2004]  
[Document not affected by Public Laws enacted between  
January 20, 2004 and December 23, 2004]  
[CITE: 33USC2101]

## TITLE 33--NAVIGATION AND NAVIGABLE WATERS

### CHAPTER 35--ARTIFICIAL REEFS

#### Sec. 2101. Congressional statement of findings and purpose

(a) The Congress finds that--

(1) although fishery products provide an important source of protein and industrial products for United States consumption, United States fishery production annually falls far short of satisfying United States demand;

(2) overfishing and the degradation of vital fishery resource habitats have caused a reduction in the abundance and diversity of United States fishery resources;

(3) escalated energy costs have had a negative effect on the economics of United States commercial and recreational fisheries;

(4) commercial and recreational fisheries are a prominent factor in United States coastal economies and the direct and indirect returns to the United States economy from commercial and recreational fishing expenditures are threefold; and

(5) properly designed, constructed, and located artificial reefs in waters covered under this chapter can enhance the habitat and diversity of fishery resources; enhance United States recreational and commercial fishing opportunities; increase the production of fishery products in the United States; increase the energy efficiency of recreational and commercial fisheries; and contribute to the United States and coastal economies.

(b) The purpose of this chapter is to promote and facilitate responsible and effective efforts to establish artificial reefs in waters covered under this chapter.

(Pub. L. 98-623, title II, Sec. 202, Nov. 8, 1984, 98 Stat. 3394.)

## References in Text

This chapter, referred to in text, was in the original "this title", meaning title II of Pub. L. 98-623, which in addition to enacting this chapter also enacted section 1220d of Title 16, Conservation, and amended sections 1220, 1220a, 1220b, and 1220c of Title 16.

## Short Title

Section 201 of title II of Pub. L. 98-623 provided that: "This title [enacting this chapter and section 1220d of Title 16, Conservation, and amending sections 1220 to 1220c of Title 16] may be cited as the 'National Fishing Enhancement Act of 1984'."

### Sec. 2102. Establishment of standards

Based on the best scientific information available, artificial reefs in waters covered under this chapter shall be sited and constructed, and subsequently monitored and managed in a manner which will--

- (1) enhance fishery resources to the maximum extent practicable;
- (2) facilitate access and utilization by United States recreational and commercial fishermen;
- (3) minimize conflicts among competing uses of waters covered under this chapter and the resources in such waters;
- (4) minimize environmental risks and risks to personal health and property; and
- (5) be consistent with generally accepted principles of international law and shall not create any unreasonable obstruction to navigation.

(Pub. L. 98-623, title II, Sec. 203, Nov. 8, 1984, 98 Stat. 3395.)

### Sec. 2103. National artificial reef plan

Not later than one year after November 8, 1984, the Secretary of Commerce, in consultation with the Secretary of the Interior, the Secretary of Defense, the Administrator of the Environmental Protection Agency, the Secretary of the Department in which the Coast Guard is operating, the Regional Fishery Management Councils, interested States, Interstate Fishery Commissions, and representatives of the private sector, shall develop and publish a long-term plan which will meet the purpose of this chapter and be consistent with the standards established under section 2102 of this chapter. The plan must include--

-----  
\\ So in original. Probably should be ``Management".  
-----

- (1) geographic, hydrographic, geologic, biological, ecological, social, economic, and other criteria for siting artificial reefs;
- (2) design, material, and other criteria for constructing artificial reefs;
- (3) mechanisms and methodologies for monitoring the compliance of artificial reefs with the requirements of permits issued under section 2104 of this title;
- (4) mechanisms and methodologies for managing the use of artificial reefs;
- (5) a synopsis of existing information on artificial reefs and needs for further research on artificial reef technology and management strategies; and
- (6) an evaluation of alternatives for facilitating the transfer of artificial reef construction materials to persons holding permits issued pursuant to section 2104 of this title, including, but not limited to, credits for environmental mitigation and modified tax obligations.

(Pub. L. 98-623, title II, Sec. 204, Nov. 8, 1984, 98 Stat. 3395.)

#### Transfer of Functions

For transfer of authorities, functions, personnel, and assets of the Coast Guard, including the authorities and functions of the Secretary of Transportation relating thereto, to the Department of Homeland Security, and for treatment of related references, see sections 468(b), 551(d), 552(d), and 557 of Title 6, Domestic Security, and the Department of Homeland Security Reorganization Plan of November 25, 2002, as modified, set out as a note under section 542 of Title 6.

Sec. 2104. Permits for construction and management of artificial reefs

(a) Secretarial action on permits

In issuing a permit for artificial reefs under section 403 of this title, section 1344 of this title, or section 1333(e) of title 43, the Secretary of the Army (hereinafter in this section referred to as the ``Secretary") shall--

- (1) consult with and consider the views of appropriate Federal agencies, States, local governments, and other interested parties;



(2) ensure that the provisions for siting, constructing, monitoring, and managing the artificial reef are consistent with the criteria and standards established under this chapter;

(3) ensure that the title to the artificial reef construction material is unambiguous, and that responsibility for maintenance and the financial ability to assume liability for future damages are clearly established; and

(4) consider the plan developed under section 2103 of this title and notify the Secretary of Commerce of any need to deviate from that plan.

(b) Terms and conditions of permits

(1) Each permit issued by the Secretary subject to this section shall specify the design and location for construction of the artificial reef and the types and quantities of materials that may be used in constructing such artificial reef. In addition, each such permit shall specify such terms and conditions for the construction, operation, maintenance, monitoring, and managing the use of the artificial reef as are necessary for compliance with all applicable provisions of law and as are necessary to ensure the protection of the environment and human safety and property.

(2) Before issuing a permit under section 1342 of this title for any activity relating to the siting, design, construction, operation, maintenance, monitoring, or managing of an artificial reef, the Administrator of the Environmental Protection Agency shall consult with the Secretary to ensure that such permit is consistent with any permit issued by the Secretary subject to this section.

(c) Liability of permittee

(1) A person to whom a permit is issued in accordance with subsection (a) of this section and any insurer of that person shall not be liable for damages caused by activities required to be undertaken under any terms and conditions of the permit, if the permittee is in compliance with such terms and conditions.

(2) A person to whom a permit is issued in accordance with subsection (a) of this section and any insurer of that person shall be liable, to the extent determined under applicable law, for damages to which paragraph (1) does not apply.

(3) The Secretary may not issue a permit subject to this section to a person unless that person demonstrates to the Secretary the financial ability to assume liability for all damages that may arise with respect to an artificial reef and for which such permittee may be liable.

(4) Any person who has transferred title to artificial reef construction materials to a person to whom a permit is issued in

accordance with subsection (a) of this section shall not be liable for damages arising from the use of such materials in an artificial reef, if such materials meet applicable requirements of the plan published under section 2103 of this title and are not otherwise defective at the time title is transferred.

(d) Liability of the United States

Nothing in this chapter creates any liability on the part of the United States.

(e) Civil penalty

Any person who, after notice and an opportunity for a hearing, is found to have violated any provision of a permit issued in accordance with subsection (a) of this section shall be liable to the United States for a civil penalty, not to exceed \$10,000 for each violation. The amount of the civil penalty shall be assessed by the Secretary by written notice. In determining the amount of such penalty, the Secretary shall take into account the nature, circumstances, extent, and gravity of the violation. The Secretary may compromise, modify, or remit with or without conditions, any civil penalty which is subject to imposition or which has been imposed under this section. If any person fails to pay an assessment of a civil penalty after it has become final, the Secretary may refer the matter to the Attorney General for collection.

(Pub. L. 98-623, title II, Sec. 205, Nov. 8, 1984, 98 Stat. 3396.)

Sec. 2105. Definitions

For purposes of this chapter--

(1) The term "artificial reef" means a structure which is constructed or placed in waters covered under this chapter for the purpose of enhancing fishery resources and commercial and recreational fishing opportunities.

(2) The term "State" means a State of the United States, the District of Columbia, Puerto Rico, the United States Virgin Islands, American Samoa, Guam, Johnston Island, Midway Island, and Wake Island.

(3) The term "waters covered under this chapter" means the navigable waters of the United States and the waters superjacent to the Outer Continental Shelf as defined in section 1331 of title 43, to the extent such waters exist in or are adjacent to any State.

(Pub. L. 98-623, title II, Sec. 206, Nov. 8, 1984, 98 Stat. 3397.)

Sec. 2106. Savings clauses

(a) Tennessee Valley Authority jurisdiction

Nothing in this chapter shall be construed as replacing or superseding section 831y-1 of title 16.

(b) State jurisdiction

Nothing in this chapter shall be construed as extending or diminishing the jurisdiction or authority of any State over the siting, construction, monitoring, or managing of artificial reefs within its boundaries.

(Pub. L. 98-623, title II, Sec. 208, Nov. 8, 1984, 98 Stat. 3398.)

# ***Texas Artificial Reef Act of 1989***

## PARKS AND WILDLIFE CODE

### SUBTITLE H. ARTIFICIAL REEFS

#### CHAPTER 89. ARTIFICIAL REEFS

##### SUBCHAPTER A. GENERAL PROVISIONS

§ 89.001. DEFINITIONS. In this chapter:

(1) "Artificial reef" means a structure or system of structures constructed, placed, or permitted in water covered under this chapter for the purpose of enhancing fishery resources and commercial and recreational fishing opportunities.

(2) "National Fishing Enhancement Act" means Title II of Public Law No. 98-623, enacting 16 U.S.C. Section 1220d and 33 U.S.C. Sections 2101 through 2106 and amending 16 U.S.C. Sections 1220 through 1220c.

(3) "Reef materials" includes only materials allowed under the national artificial reef plan adopted under the National Fishing Enhancement Act for construction of artificial reefs.

(4) "Water covered under this chapter" means the navigable water of Texas and water of the federal fisheries conservation zone adjacent to Texas water.

Added by Acts 1989, 71st Leg., ch. 47, § 1, eff. May 1, 1989.

§ 89.002. GENERAL DUTIES. (a) The department shall promote, develop, maintain, monitor, and enhance the artificial reef potential in water covered under this chapter.

(b) In carrying out the duties under Subsection (a) of this section, the department shall:

(1) plan and review permit applications for artificial reefs;

(2) coordinate with relevant state and federal agencies;

(3) hold public hearings on proposed artificial reefs;

(4) oversee maintenance and placement requirements of artificial reefs; and

(5) develop rules and guidelines, in conjunction with the advisory committee, in the collection of fees, grants, and donations to the artificial reef account.

Added by Acts 1989, 71st Leg., ch. 47, § 1, eff. May 1, 1989.  
Amended by Acts 1993, 73rd Leg., ch. 679, § 58, eff. Sept. 1, 1993.

§ 89.0025. RULES. The commission may adopt rules and guidelines as necessary to implement this chapter.

Added by Acts 2005, 79th Leg., ch. 190, § 1, eff. May 27, 2005.

§ 89.003. DEPARTMENT AUTHORIZED TO SERVE AS PERMITTEE. (a) The department may apply for a federal permit and serve as permittee for an artificial reef located in water covered under this chapter if the establishment of the reef complies with this chapter and the National Fishing Enhancement Act.

(b) In applying for a permit under this section, the department shall:

(1) consult with and consider the views of appropriate federal and state agencies, local governments, and other interested persons;

(2) ensure that the provisions in the permit for siting, constructing, monitoring, maintaining, and managing an artificial reef are consistent with the criteria and standards established under this chapter and the National Fishing Enhancement Act;

(3) ensure that title to an artificial reef component or construction material is unambiguous; and

(4) consider the national artificial reef plan adopted under the National Fishing Enhancement Act and notify the Secretary of the United States Department of Commerce of any need to deviate from that plan.

Added by Acts 1989, 71st Leg., ch. 47, § 1, eff. May 1, 1989.

§ 89.004. PERSON OTHER THAN DEPARTMENT AS PERMITTEE. The department shall review and comment on an application for an artificial reef permit by a person other than the department to ensure that the conditions of the permit are consistent with the

state artificial reef plan and the National Fishing Enhancement Act.

Added by Acts 1989, 71st Leg., ch. 47, § 1, eff. May 1, 1989.

§ 89.005. USE OF BRIDGES, TUNNELS, AND CAUSEWAYS.

Text of section as added by Acts 2001, 77th Leg., ch. 968, § 46

(a) The department, in cooperation with the Texas Department of Transportation and local governments, may use obsolete bridges, tunnels, and causeways to create artificial reefs under this chapter.

(b) The department may receive from the Texas Department of Transportation the transfer of obsolete bridges, tunnels, and causeways to create artificial reefs.

(c) The department may provide assistance, including money, to a local government to fulfill the purposes of this section.

(d) Any money appropriated to the department for the artificial reef program under this chapter may be used for the purposes of this section.

Added by Acts 2001, 77th Leg., ch. 968, § 46, eff. Sept. 1, 2001.

For text of section as added by Acts 2001, 77th Leg., ch. 1137, § 1, see § 89.005, post.

§ 89.005. USE OF BRIDGES, TUNNELS, AND CAUSEWAYS.

Text of section as added by Acts 2001, 77th Leg., ch. 1137, § 1

(a) The Texas Department of Transportation shall coordinate with the department and local governments to use obsolete bridges, tunnels, and causeways to create artificial reefs under this chapter.

(b) The Texas Department of Transportation may transfer obsolete bridges, tunnels, and causeways to the department to create artificial reefs.

(c) The department may provide assistance, including money, to a local government to fulfill the purposes of this section.

(d) Any money appropriated to the department for the artificial reef program under this chapter may be used for the purposes of this section.

Added by Acts 2001, 77th Leg., ch. 1137, § 1, eff. June 15, 2001.

For text of section as added by Acts 2001, 77th Leg., ch. 968, § 46, see § 89.005, ante.

§ 89.006. REEF CONSTRUCTION BY OTHERS. The department may authorize a person to place a donation of reef materials in a permitted zone in accordance with this chapter and commission rules and guidelines.

Added by Acts 2005, 79th Leg., ch. 190, § 1, eff. May 27, 2005.

#### SUBCHAPTER B. STATE ARTIFICIAL REEF PLAN

§ 89.021. STATE ARTIFICIAL REEF PLAN. (a) The department shall develop a state artificial reef plan that meets the purpose of this chapter and is consistent with the standards under Section 89.023 of this code.

(b) The department shall administer and enforce the plan in accordance with this chapter and the National Fishing Enhancement Act.

(c) The department shall develop any additional technical information needed to carry out the plan.

(d) Repealed by Acts 1999, 76th Leg., ch. 925, § 2(5), eff. Sept. 1, 1999.

Added by Acts 1989, 71st Leg., ch. 47, § 1, eff. May 1, 1989.  
Amended by Acts 1999, 76th Leg., ch. 925, § 2, eff. Sept. 1, 1999.

§ 89.022. REQUIRED PROVISIONS. The state artificial reef plan must include:

(1) operational guidelines for the plan, including specific participant roles, and projected funding requirements for the plan;

(2) geographic, hydrographic, geological, biological, ecological, social, economic, and other criteria for permitting and siting artificial reefs;

- (3) design, materials, and other criteria for establishing, constructing, and maintaining artificial reefs;
- (4) mechanisms and methodologies for monitoring artificial reefs in compliance with the requirements of permits issued under the National Fishing Enhancement Act;
- (5) mechanisms and methodologies for managing the use of artificial reefs;
- (6) a map that depicts priority areas for artificial reef development consistent with this chapter and the National Fishing Enhancement Act; and
- (7) provisions for managing the artificial reef account in a manner that will assure successful implementation of the plan.

Added by Acts 1989, 71st Leg., ch. 47, § 1, eff. May 1, 1989.  
Amended by Acts 1993, 73rd Leg., ch. 679, § 59, eff. Sept. 1, 1993.

§ 89.023. STANDARDS. An artificial reef located in water covered under this chapter must be sited, constructed, maintained, monitored, and managed in a manner that:

- (1) enhances and conserves fishery resources to the maximum extent practicable;
  - (2) facilitates access and use by Texas recreational and commercial fishermen;
  - (3) minimizes conflicts among competing uses of water and water resources;
  - (4) minimizes environmental risks and risks to personal and public health and property;
  - (5) is consistent with generally accepted principles of international law and national fishing law and does not create any unreasonable obstruction to navigation;
  - (6) uses the best scientific information available;
- and
- (7) conforms to the state artificial reef plan.

Added by Acts 1989, 71st Leg., ch. 47, § 1, eff. May 1, 1989.

§ 89.024. COMPLETION DATE. The department must complete the state artificial reef plan on or before September 1, 1990.

Added by Acts 1989, 71st Leg., ch. 47, § 1, eff. May 1, 1989.



§ 89.025. REEFS CONSISTENT WITH PLAN. (a) All artificial reefs developed in state water must be consistent with the state artificial reef plan.

(b) Comments and recommendations by a state agency regarding artificial reefs in federal water must be consistent with the state artificial reef plan.

Added by Acts 1989, 71st Leg., ch. 47, § 1, eff. May 1, 1989.

#### SUBCHAPTER C. ARTIFICIAL REEF ACCOUNT

§ 89.041. ARTIFICIAL REEF ACCOUNT. (a) The artificial reef account is a separate account in the general revenue fund.

(b) The account is composed of all funds received under Section 89.043 of this code, including interest and earnings.

(c) No state general revenue funds shall be expended in the development or implementation of this plan.

Added by Acts 1989, 71st Leg., ch. 47, § 1, eff. May 1, 1989.

Amended by Acts 1993, 73rd Leg., ch. 679, § 60, eff. Sept. 1, 1993.

§ 89.042. DEDICATION. The funds received under Section 89.043 of this code are dedicated to the department for the purpose of carrying out this chapter, including siting, designing, constructing, monitoring, and otherwise managing an artificial reef or artificial reef system.

Added by Acts 1989, 71st Leg., ch. 47, § 1, eff. May 1, 1989.

Amended by Acts 1993, 73rd Leg., ch. 679, § 60, eff. Sept. 1, 1993.

§ 89.043. GRANTS, DONATIONS, AND OTHER ASSISTANCE. The department may accept grants, donations of money or materials, and other forms of assistance from private and public sources.

Added by Acts 1989, 71st Leg., ch. 47, § 1, eff. May 1, 1989.

Amended by Acts 1993, 73rd Leg., ch. 679, § 60, eff. Sept. 1, 1993.

#### SUBCHAPTER D. MISCELLANEOUS PROVISIONS

§ 89.061. LIABILITY. (a) The state, an agency of the state, or an insurer of the state or agency of the state is not liable for damages caused by an activity required under the terms and conditions of a permit for an artificial reef.

(b) A person who has transferred title of artificial reef construction materials to the state is not liable for damages arising from the use of the materials in an artificial reef if the materials meet applicable requirements of the National Fishing Enhancement Act and applicable regulations of the United States Department of the Interior.

Added by Acts 1989, 71st Leg., ch. 47, § 1, eff. May 1, 1989.

# **Louisiana Fisheries Enhancement Act**

From the Louisiana Artificial Reef Plan, November 1987, Louisiana Department of Wildlife and Fisheries

Act 100

1986 REGULAR SESSION

## **LOUISIANA FISHING ENHANCEMENT ACT— ESTABLISHMENT AND MAINTENANCE OF ARTIFICIAL REEFS**

ACT NO. 100

HOUSE BILL NO. 1111

AN ACT

To enact R.S. 36:610(H) and to enact Subpart M of Part VII of Chapter 1 of Title 56 of the Louisiana Revised Statutes of 1950, to be comprised of R.S. 56:639.1 through R.S. 56:639.10, to provide for the establishment and administration of the Louisiana Artificial Reef Development Program; to provide for agency participation in the program; to provide for the creation, placement, composition, powers, and duties of the Louisiana Artificial Reef Development Council; to provide for the acceptance and receipt of grants, donations of monies or materials, and other forms of assistance by the Department of Wildlife and Fisheries; to provide for the establishment of the Artificial Reef Development Fund, deposit into the fund, and expenditures from the fund; to provide for the funding of certain research projects, the development and preparation of the Louisiana Artificial Reef Development Plan, and the review of the plan by legislative committee; to provide for certain required contents of the plan; to provide for the acquisition of permits for the establishment of artificial reefs; to provide for the liability of participants in and donors to the program; and to provide for related matters.

Be it enacted by the Legislature of Louisiana:

Section 1. Subpart M of Part VII of Chapter 1 of Title 56 of the Louisiana Revised Statutes of 1950, comprised of R.S. 56:639.1 through R.S. 56:639.10, is hereby enacted to read as follows:

SUBPART M. ARTIFICIAL REEFS

§639.1. Title

This Subpart shall be known and may be cited as the "Louisiana Fishing Enhancement Act".

§639.2. Purposes

The purpose of this Act is to promote and facilitate effective establishment and maintenance of artificial reefs in the offshore waters of Louisiana, as provided in this Act and in compliance with the National Fishing Enhancement Act. It is the further purpose of this Act to provide for the jurisdiction and cooperation of various state agencies in the implementation of any plan or program developed pursuant to this Act.

§639.3. Definitions

As used in this Subpart, the following terms shall have the meanings ascribed to them in this Section, unless the context clearly indicates otherwise:

- (1) "Artificial reef" means a structure or system of structures which is constructed, placed, or permitted in waters covered under this Subpart for the purpose of enhancing fishery resources and commercial and recreational fishing opportunities.
- (2) "Commission" means the Louisiana Wildlife and Fisheries Commission.
- (3) "Department" means the Louisiana Department of Wildlife and Fisheries.
- (4) "Geological Survey" means the Louisiana Geological Survey.

Act 100

1986 REGULAR SESSION

(5) "Initiative" means the Artificial Reef Initiative at Louisiana State University, which is developing a Louisiana Artificial Reef Development Plan.

(6) "National Fishing Enhancement Act" means the federal artificial reef development legislation, PL 98-623, Title II.

(7) "Reef materials" means any materials allowed under the National Artificial Reef Plan, adopted pursuant to the National Fishing Enhancement Act for construction of artificial reefs.

(8) "Secretary" means the secretary of the Louisiana Department of Wildlife and Fisheries.

(9) "Waters covered under this Act" means the navigable waters of Louisiana and waters of the federal fisheries conservation zone adjacent to Louisiana waters.

(10) "Wetland Resources" means the Center for Wetland Resources at Louisiana State University.

§639.4. Establishment of standards

Artificial reefs in waters covered under this Act shall be sited, constructed, and subsequently maintained, monitored, and managed based upon the best scientific information available; and, in a manner which shall:

(1) Enhance and conserve fishery resources to the maximum extent practicable.

(2) Facilitate access and utilization by Louisiana recreational and commercial user groups.

(3) Minimize conflicts among competing uses of waters covered under this Act and the resources in such waters.

(4) Minimize environmental risks and risks to personal and public health and property.

(5) Be consistent with generally accepted principles of international law and national fishing law, and not create any unreasonable obstructions to navigation.

§639.5. Artificial Reef Development Program; authorities and responsibilities of cooperating agencies

A. There is hereby created the Louisiana Artificial Reef Development Program, hereinafter called the "program", to promote, develop, maintain, monitor, and enhance the artificial reef potential in the waters covered under this Act. The department, geological survey, and wetland resources shall be primary participants in this program and shall operate out of the Artificial Reef Development Fund under the direction of the Louisiana Wildlife and Fisheries Commission, hereinafter called the "commission".

B. The department shall administer and enforce the program as provided in this Subpart and in accordance with the National Fishing Enhancement Act. The department shall plan and review permit applications with advice from wetland resources; coordinate with relevant state and federal agencies; hold joint public hearings on proposed reefs; oversee maintenance and placement requirements of the reefs; and develop additional technical information needed to carry out the program.

C. The Center for Wetland Resources shall provide technical support to the department for program development. The center shall additionally:

(1) Prepare, update, and provide the department with technical, biological, and operational criteria for site selection and development.

(2) Assist the department in preparing permit applications for artificial reefs.

(3) Assist in biological monitoring.

(4) Evaluate and recommend reef sites.

(5) Evaluate reef potential and design.

(6) Update exclusion mapping.

(7) Promote public awareness of the program.

D. Geological Survey shall provide geotechnical support for reef siting by determining bottom suitability and identifying geologic hazards, evaluating the potential for future oil, gas, and other mineral production in reef sites, and by analyzing the potential for using artificial reefs to supplement the state's coastal protection effort as described in the Coastal Environment Protection Master Plan. Geological Survey shall also serve as liaison with the United States Department of the Interior regarding the interaction of the program with federal outer continental shelf leasing and production activities.

E. The Louisiana Sea Grant College Program shall coordinate fisheries research projects that might be proposed by Louisiana universities to support the program.

§639.6. Louisiana Artificial Reef Development Council

A. To oversee the program, there is hereby created the Louisiana Artificial Reef Development Council, hereinafter referred to as the "council", which shall be within the Louisiana Department of Wildlife and Fisheries. The council will be composed of the secretary of the Department of Wildlife and Fisheries, the director of the Geological Survey, and the dean of the Center for Wetland

Resources at Louisiana State University, or their designees. The council shall select a chairman.

B. The council is empowered to oversee development and implementation of the Louisiana Artificial Reef Development Plan. The council is charged with providing guidance to the commission and department on policy and procedural matters concerning the program and shall make recommendations to the department regarding the allocation of funds to various program components.

§639.7. Preparation of the Louisiana Artificial Reef Development Plan

A. The Louisiana Artificial Reef Initiative is directed to complete its work on the Louisiana Artificial Reef Development Plan, hereinafter called the "plan", within one year of the effective date of this Act.

B. The initiative shall present the plan to the council for approval. Upon unanimous approval by the council, and after review by the department, the plan shall be presented by October 1, 1987, to the House and Senate Natural Resources Committees for their approval.

C. All artificial reefs developed in state waters shall be consistent with the approved plan. State agency comments and recommendations on artificial reefs in federal waters shall also be consistent with the approved plan.

D. The plan shall include:

(1) Operational guidelines for the program, including specific participant roles and projected funding requirements for program elements.



Act 100

1986 REGULAR SESSION

(2) Geographic, hydrographic, geological, biological, ecological, social, economic, and other criteria for permitting and siting artificial reefs.

(3) Design, material, and other criteria for establishing, constructing, and maintaining artificial reefs.

(4) Mechanisms and methodologies for monitoring artificial reefs in compliance with the requirements of permits issued under Section 205 of the National Fishing Act.

(5) Mechanisms and methodologies for managing the use of artificial reefs.

(6) An exclusionary map which depicts priority areas for artificial reef development consistent with this Act and the National Fishing Enhancement Act.

(7) Provisions for updating the plan based on findings of the Artificial Reef Development Program.

(8) Provisions for managing the Reef Fund in a manner which will assure successful program implementation.

§639.8. Department of Wildlife and Fisheries; Artificial Reef Development Fund

A. The secretary is authorized to accept and receive grants, donations of monies or materials, and other forms of assistance from private and public sources which are provided to the state for the purpose of siting, designing, constructing, monitoring, and otherwise managing an artificial reef system.

B. Any funds received by the department pursuant to the provisions and purposes of this Subpart shall be deposited immediately upon receipt into the state treasury.

C. There is hereby established a fund in the state treasury to be known as the Artificial Reef Development Fund, hereinafter referred to as the "Reef Fund" or "Fund", into which the state treasurer shall each fiscal year, and beginning with the 1986-87 Fiscal Year, deposit the funds received as provided in R.S. 56:639.8(A) and (B), after those revenues have been deposited in the Bond Security and Redemption Fund. Out of the funds remaining in the Bond Security and Redemption Fund after a sufficient amount is allocated from that fund to pay all obligations secured by the full faith and credit of the state that become due and payable within each fiscal year, the treasurer, prior to placing such funds in the state general fund, shall pay into the Reef Fund an amount equal to the funds deposited by the department into the treasury as provided in Subsection B. The monies in the Reef Fund shall be used solely as provided by Subsection E herein and only in the amounts appropriated by the legislature. All unexpended and unencumbered monies in the Reef Fund at the end of the fiscal year shall remain in the fund. The monies in the fund shall be invested by the state treasurer in the same manner as monies in the state general fund, and interest earned on the investment of these monies shall be credited to the fund, again, following compliance with the requirement of Article VII, Section 9(B) of the Louisiana Constitution, relative to the Bond Security and Redemption Fund.

D. The council shall review and comment on proposed expenditures from the fund at the time of budget preparation by the department. The department shall maintain records of the sources of money received and the purpose therefor, as well as the person or persons to whom money is paid and the purpose therefor.

Vouchers or receipts shall be kept for all money paid out. The department shall employ such personnel as are necessary to meet the department's responsibilities under the program. The department shall allocate from the fund an amount sufficient to pay the salaries of personnel assigned to or responsible for the conduct of the program and shall allocate such amount as necessary for related operating expenses. Money appropriated or otherwise made available to the participants in the program for authorized purposes shall be withdrawn from the treasury on warrant of the secretary or his designee.

E. Monies may be withdrawn directly from the Reef Fund for the operation of the program as described in R.S. 56:639.5, including administrative and field support for the permitting, establishing, monitoring, and maintenance of artificial reefs established pursuant to this Subpart until such time that the council determines that the annual interest earnings from the fund are sufficient to run the program.

F. The secretary shall insure that the Reef Fund contains sufficient reserves to operate the program in a manner consistent with the state plan.

G. In future years, if interest income exceeds operational costs, marine fisheries research and habitat enhancement projects may be funded through the department, the Louisiana Sea Grant College Program, and the Coastal Environment Protection Program within the Geological Survey.

§639.9. Permitting for the construction and management of artificial reefs

A. The state of Louisiana is empowered to serve as permittee for artificial reefs in waters covered under this Act, provided such reefs are consistent with and established within the guidelines of this Subpart and the National Fishing Enhancement Act. The secretary is hereby empowered to administer and enforce the program for the state of Louisiana.

B. In acquiring necessary federal permits for artificial reefs, the secretary or his designee shall:

(1) Consult with and consider the views of appropriate federal agencies, state, and local governments, and other interested parties.

(2) Ensure that the provisions for siting, constructing, monitoring, maintaining, and managing any artificial reef developed pursuant to this Subpart be consistent with the criteria and standards established under this Subpart and the National Fishing Enhancement Act.

(3) Ensure that title to any artificial reef component or construction material is unambiguous.

(4) Consider the National Artificial Reef Plan developed under Section 204 of the National Fishing Enhancement Act, and notify the secretary of the United States Department of Commerce of any need to deviate from that plan. The secretary of the Department of Wildlife and Fisheries, in consultation with the other members of the council, shall also review and comment on other artificial reef permit applications to insure that artificial reef permits sought by groups other than Louisiana are consistent

Act 100

1986 REGULAR SESSION

with the state plan developed under this Subpart and the National Fishing Enhancement Act. -

§639.10. Liability

A. The department, the state of Louisiana and its agencies, and any insurer of these groups shall not be liable for damages caused by activities required to be undertaken under the terms and conditions of state and federal permits acquired for reef development.

B. Any person or company who has transferred title of artificial reef construction materials to the state of Louisiana shall not be liable for damages arising from the use of such materials in an artificial reef, if such materials meet applicable requirements of the National Artificial Reef Plan published under Section 204 of the National Fishing Enhancement Act, and United States Department of Interior regulations.

Section 2. R.S. 36:610(H) is hereby enacted to read as follows:

§610. Transfer of agencies to Department of Wildlife and Fisheries

\* \* \*

H. The Louisiana Artificial Reef Development Council (R.S. 56:639.6) is placed within the Department of Wildlife and Fisheries and shall exercise and perform its powers, duties, functions, and responsibilities in the manner provided for agencies transferred in accordance with Part III of Chapter 22 of this Title.

Section 3. This Act shall become effective upon signature by the governor or, if not signed by the governor, upon expiration of the time for bills to become law without signature by the governor, as provided in Article III, Section 18 of the Constitution of Louisiana.

Approved June 23, 1986.

# Sample ACOE Permit Application

From Louisiana Artificial Reef Plan

APPLICATION FOR DEPARTMENT OF THE ARMY PERMIT <small>(33 CFR 325)</small>		OMB APPROVAL NO. 0702-0036 <small>Expires 30 June 1986</small>	
<p>The Department of the Army permit program is authorized by Section 10 of the River and Harbor Act of 1899, Section 404 of the Clean Water Act and Section 103 of the Marine, Protection, Research and Sanctuaries Act. These laws require permits authorizing activities in or affecting navigable waters of the United States, the discharge of dredged or fill material into waters of the United States, and the transportation of dredged material for the purpose of dumping it into ocean waters. Information provided on this form will be used in evaluating the application for a permit. Information in this application is made a matter of public record through issuance of a public notice. Disclosure of the information requested is voluntary; however, the data requested are necessary in order to communicate with the applicant and to evaluate the permit application. If necessary information is not provided, the permit application cannot be processed nor can a permit be issued.</p> <p>One set of original drawings or good reproducible copies which show the location and character of the proposed activity must be attached to this application (see sample drawings and instructions) and be submitted to the District Engineer having jurisdiction over the location of the proposed activity. An application that is not completed in full will be returned.</p>			
1. APPLICATION NUMBER (To be assigned by Corps)		3. NAME, ADDRESS, AND TITLE OF AUTHORIZED AGENT	
		None	
2. NAME AND ADDRESS OF APPLICANT		Telephone no. during business hours	
Fred R. Harris 852 West Branch Road Blue Harbor, Maryland 21705		A/C ( ) _____ (Residence) A/C ( ) _____ (Office)	
Telephone no. during business hours		Statement of Authorization: I hereby designate and authorize _____ to act in my behalf as my agent in the processing of this permit application and to furnish, upon request, supplemental information in support of the application.	
A/C (301) 585-2779 (Residence) A/C ( ) _____ (Office)		SIGNATURE OF APPLICANT	DATE
4. DETAILED DESCRIPTION OF PROPOSED ACTIVITY			
4a. ACTIVITY			
Build timber bulkhead and pier and fill.			
4b. PURPOSE			
To provide boat access and prevent erosion of shoreline at my place of residence.			
4c. DISCHARGE OF DREDGED OR FILL MATERIAL			
Approximately 200 cubic yards of upland fill will be placed between new bulkhead and existing shoreline.			

ENG FORM 4345, Apr 83

EDITION OF 1 OCT 77 IS OBSOLETE

(Proponent: DAEN-CWO-N)

5. NAMES AND ADDRESSES OF ADJOINING PROPERTY OWNERS, LESSEES, ETC., WHOSE PROPERTY ALSO ADJOINS THE WATERWAY

Mary L. Clark 850 West Branch Road Blue Harbor, Maryland 21703  (301) 585-8830	Harry N. Hampton 854 West Branch Road Blue Harbor, Maryland 21703  (301) 585-3676
--	---

6. WATERBODY AND LOCATION ON WATERBODY WHERE ACTIVITY EXISTS OR IS PROPOSED  
West Branch of the Haven River on Blue Harbor.

7. LOCATION ON LAND WHERE ACTIVITY EXISTS OR IS PROPOSED

ADDRESS:  
852 West Branch Road  
STREET, ROAD, ROUTE OR OTHER DESCRIPTIVE LOCATION

King Edward, Maryland 21703  
COUNTY STATE ZIP CODE

Town of Blue Harbor  
LOCAL GOVERNING BODY WITH JURISDICTION OVER SITE

8. Is any portion of the activity for which authorization is sought now completed?  YES  NO  
If answer is "Yes" give reasons, month and year the activity was completed. Indicate the existing work on the drawings.

9. List all approvals or certifications and denials received from other federal, interstate, state or local agencies for any structures, construction, discharges or other activities described in this application.

ISSUING AGENCY	TYPE APPROVAL	IDENTIFICATION NO.	DATE OF APPLICATION	DATE OF APPROVAL	DATE OF DENIAL
Town of Blue Harbor	Zoning	BH25172	6/20/82	6/30/82	
Md DNR	Certification	DNR258WQ	6/11/82	8/12/82	

10. Application is hereby made for a permit or permits to authorize the activities described herein. I certify that I am familiar with the information contained in this application, and that to the best of my knowledge and belief such information is true, complete, and accurate. I further certify that I possess the authority to undertake the proposed activities or I am acting as the duly authorized agent of the applicant.

*Med R. Harris* Oct. 15, 1982  
SIGNATURE OF APPLICANT DATE

\_\_\_\_\_  
SIGNATURE OF AGENT

\_\_\_\_\_  
DATE

The application must be signed by the person who desires to undertake the proposed activity (applicant) or it may be signed by a duly authorized agent if the statement in Block 3 has been filled out and signed.

18 U.S.C. Section 1001 provides that: Whoever, in any manner within the jurisdiction of any department or agency of The United States knowingly and willfully falsifies, conceals, or covers up by any trick, scheme, or device a material fact or makes any false, fictitious or fraudulent statements or representations or makes or uses any false writing or document knowing same to contain any false, fictitious or fraudulent statement or entry, shall be fined not more than \$10,000 or imprisoned not more than five years, or both.

Do not send a permit processing fee with this application. The appropriate fee will be assessed when a permit is issued.

**Louisiana Act of Donation**

From Louisiana Artificial Reef Program

ACT OF DONATION

STATE OF LOUISIANA

TO THE STATE OF LOUISIANA

PARISH OF EAST BATON ROUGE

FROM

**ACT OF DONATION**

BEFORE US, the undersigned notaries, duly commissioned and qualified in and for the parish(es)/county and state(s) hereinafter stated, and in the presence of the competent witnesses hereinafter named and undersigned, on the respective dates hereinafter stated, personally came and appeared \_\_\_\_\_, acting on behalf of  (insert name)  Corporation, who declared the following, to wit:

1. He is the  (insert title)  of  (insert name) Corporation , hereinafter called "Donor", a  (insert state of incorporation)  corporation, whose address is  (insert address) .

2. He is duly authorized to make the donations specified herein and to execute this Act of Donation on behalf of Donor.

and

JAMES H. JENKINS, JR., acting on behalf of the Louisiana Department of Wildlife and Fisheries, who declared the following, to wit:

1. He is the Secretary of the Louisiana Department of Wildlife and Fisheries, the agency charged with administering and enforcing the Louisiana Artificial Reef Development Program, pursuant to La. R.S. 56:639.5(B).

2. He is duly authorized to accept the donations specified herein and to execute this Act of Donation on behalf of the Louisiana Department of Wildlife and Fisheries, acting on behalf of the State of Louisiana ("Donee").



**ARTICLE I - DEFINITIONS**

- 1.1 **Agreement.** "Agreement" shall mean this Act of Donation from  (insert name of Donor)  to the State of Louisiana through the Louisiana Department of Wildlife and Fisheries.
- 1.2 **Artificial Reef Fund.** "Artificial Reef Fund" shall mean the Louisiana Artificial Reef Development Fund, LSA R.S. 56:639.8.
- 1.3 **Donated Structure.** "Donated Structure" shall mean the  (insert description of structure)  to be used as an Artificial Reef.
- 1.4 **Donee.** "Donee" shall mean the State of Louisiana through the Louisiana Department of Wildlife and Fisheries.
- 1.5 **Donor.** "Donor" shall mean  (insert name of entity)  Corporation.
- 1.6 **Conservation Fund.** "Conservation Fund" shall mean the Louisiana Wildlife and Fisheries Conservation Fund, as established in La. Const. 1974, Art. VII, Section 10-A.
- 1.7 **Louisiana Fishing Enhancement Act.** "Louisiana Fishing Enhancement Act" shall mean the Louisiana Fishing Enhancement Act, LSA R.S. 56:639.1, et seq..
- 1.8 **Louisiana Plan.** "Louisiana Plan" shall mean the Louisiana Artificial Reef Plan.
- 1.9 **Louisiana Artificial Reef Development Program.** "Louisiana Artificial Reef Development Program" shall mean the Louisiana Artificial Reef Development Program, LSA R.S. 56:639.5.
- 1.10 **National Fishing Enhancement Act.** "National Fishing Enhancement Act" shall mean the National Fishing Enhancement Act of 1984, 33 USCA 2101, et seq..
- 1.11 **National Artificial Reef Plan.** "National Artificial Reef Plan" shall mean the National

Artificial Reef Plan, 33 USCA 2103.

- 1.12 **Notification of Acceptance.** "Notification of Acceptance" shall mean the document entitled "Notification of Acceptance of Structure Placement and Acceptance of Title", a copy of which is attached hereto and made a part hereof.
- 1.13 **Person.** "Person" or "Persons" shall mean both natural and juridical persons as defined by Louisiana Civil Code Article 24.
- 1.14 **Structure Site.** "Structure Site" shall mean the site described in Article 5.1 below.

#### **ARTICLE II - DONATION OF STRUCTURE**

- 2.1 **Donation of Structure.** In consideration of the mutual covenants and conditions set forth below, and for the purpose of enhancing fishing resources within and adjacent to the coast of the State of Louisiana, Donor, in accordance with the National Fishing Enhancement Act (and more particularly the National Artificial Reef Plan, and the Louisiana Fishing Enhancement Act (and more particularly the Louisiana Artificial Reef Development Program), does hereby irrevocably donate, transfer, carry, assign, and deliver unto the Donee the following described structure, which is hereinafter collectively referred to as "Donated Structure", to wit:

**(INSERT DESCRIPTION OF STRUCTURE)**

#### **ARTICLE III - WARRANTIES**

- 3.1 **Disclaimer.** This donation is made by Donor without any warranty, either express or implied, and in particular any warranty as to the condition, fitness, or usability of said

structure for any purpose, except as provided as follows, or as otherwise provided in this Agreement.

- 3.2 **Materials.** Donor warrants that the materials donated meet the applicable requirements of the National Artificial Reef Plan, the Louisiana Artificial Reef Plan, and any and all permits issued according to those plans, including but not limited to the permit issued by the U.S. Army Corps of Engineers.
- 3.3 **Hazardous Material.** Donor warrants that, except for possible trace amounts, the Donated Structure is free of any hydrocarbons or other hazardous materials listed in any current federal, Louisiana state, or local law, ordinance, rule, regulation, order, decree, or requirement.
- 3.4 **Good Title.** Donor warrants that their title to the Donated Structure is free and clear of all encumbrances of any kind or description.

#### ARTICLE IV - PERMITS

- 4.1 **Permits.** As set out in La. R.S. 56:639.9, Donee shall be responsible for obtaining the required permits for the construction and management of an artificial reef at the Structure Site described below pursuant to the National Fishing Enhancement Act and the Louisiana Fishing Enhancement Act.

#### ARTICLE V - LOCATION AND PLACEMENT

- 5.1 **Location.** Operations to place the Donated Structure on the floor of the Gulf of Mexico shall be conducted by Donor at the site selected by the Donee. The Donated Structure

shall be placed such that a minimum clearance of fifty (50) feet below the mean low sea level of the surface of the water is maintained, in such a manner that the Donated Structure shall be acceptable by the U.S. Coast Guard for the use of unlit aids to navigation to mark the site. The general location for the placement of the Donated Structure ("Structure Site") is as follows:

AREA/BLOCK \_\_\_\_\_ POLAR COORDINATES

- 5.2 **Position.** Donor shall place the Donated Structure at the Structure Site described above on the floor of the Gulf of Mexico in a horizontal/vertical (choose one) position.
- 5.3 **Accepted Range.** Donor shall place the Donated Structure as accurately as possible on the Structure Site described above, but in no case shall the Donated Structure be placed more than five hundred (500) feet from the Structure Site on the floor of the Gulf of Mexico. Furthermore, in no case shall the Donated Structure be placed such that a minimum clearance of fifty (50) feet below the mean low sea level of the surface of the water is not maintained.
- 5.4 **Representation.** Donor shall provide, at its expense, for a representative of Donee to be present at the Structure Site described above at the time of placement of the Donated Structure. Donee's representative shall act as an observer only and shall not serve, nor be deemed to serve, in any operational or advisory capacity whatsoever. Notwithstanding the above, Donee's representative may advise the Donor on placement of the Donated Structure but only at the specific request of the Donor, its agents, employees, or representatives. In such instances, it is specifically understood that Donor shall assume all responsibility for and all liability which may be associated with, any action resulting

from Donor's acting upon such advise, and for any and all consequences arising therefrom.

- 5.5 Disclaimer.** Donor shall assume all responsibility for and all liability which may be associated with the transport and disposition of the Donated Structure, or any part thereof. Donee shall assume no liability for the transport and disposition of the Donated Structure, or any part thereof. The Donor shall be solely responsible for the Donated Structure until such time as it has been properly placed on the sea floor at the Structure Site specified above and all other terms and conditions of this Agreement, including but not limited to Donee's mailing of the completed "Notification of Acceptance" as specified in Article VIII herein, have been fulfilled.
- 5.6 Structure Site Permits.** Donor warrants that the Donated Structure shall be sited and placed in accordance with all terms, conditions, and special conditions of all U.S. Army Corps of Engineers permits, and all other permits issued to construct the artificial reef, in addition to all specifications contained herein.
- 5.7 Completion.** Donor's proper placement of the Donated Structure at the Structure Site described above and completion of all terms and conditions of this Agreement, including but not limited to Donee's mailing of the completed "Notification of Acceptance" as specified in Article VIII herein, shall relieve Donor of any and all obligations or requirements to further transport or move the structure.
- 5.8 Surveyor's Plat.** Donor agrees to furnish Donee with a certified surveyors plat of the final location and clearance of the Donated Structure within thirty (30) days following final placement of the Donated Structure.

**ARTICLE VI - TITLE**

- 6.1 **Passing of Title.** After the completion of Donor's operations to place the Donated Structure at the Structure Site described above, and after all other terms and conditions of this Agreement, including but not limited to Donee's mailing of the completed "Notification of Acceptance" as specified in Article VIII herein have been fulfilled, title to the Donated Structure shall pass from Donor to Donee free and clear of all encumbrances of any kind or description.

**ARTICLE VII - LIABILITY**

- 7.1 **Delivery of Structure - Donor's Actions.** Donor shall be solely responsible for the Donated Structure until all terms and conditions of this Agreement, including but not limited to Donee's mailing of the completed "Notification of Acceptance" as specified in Article VIII herein, have been fulfilled. Donor shall indemnify and hold Donee harmless from and against any and all claims, demands, or causes of action of any description in favor of any person for damage or loss to persons or property arising from Donor's actions or failure to act during the operations required to deliver the Donated Structure and to properly place it on the Structure Site described above and until such time as all other terms and conditions of this Agreement, including but not limited to Donee's mailing of the completed "Notification of Acceptance" as specified in Article VIII herein, have been fulfilled.
- 7.2 **Delivery of Structure - Donee's Negligence.** Donor shall be solely responsible for the

Donated Structure and its delivery until such time as all terms and conditions of this Agreement, including but not limited to Donee's mailing of the completed "Notification of Acceptance" as specified in Article VIII herein, have been fulfilled. However, Donor assumes no liability and extends no indemnity to Donee for injury or loss sustained by Donee, its employees, agents or third parties, arising solely out of the negligence of Donee, its agents, or employees, during the operations required to deliver the Donated Structure to the Structure Site described above. It is understood and agreed that Donee's representative will serve as an observer only and shall not act, nor be deemed to act, in an operational or advisory capacity during the operations required to deliver and properly place the Donated Structure at the Structure Site. Notwithstanding the above, Donee's representative may advise the Donor on placement of the Donated Structure but only at the specific request of the Donor, its agents, employees, or representatives. In such instances, it is specifically understood and agreed that Donor shall assume all responsibility for, and all liability which may be associated with, any actions which may result from Donor's acting upon such advice, and for any and all consequences arising therefrom.

**7.3 Title Passage of Structure.** Donee shall be responsible for Donated Structure only after all terms and conditions of this Agreement, including but not limited to Donee's mailing of the completed "Notification of Acceptance" as specified in Article VIII herein, have been fulfilled. Donee shall have neither any interest in, responsibility for, nor liability for the Donated Structure or any part thereof until all terms and conditions of this Agreement, including but not limited to Donee's mailing of the completed "Notification of Acceptance" as specified in Article VIII herein, have been fulfilled. Donee agrees to indemnify and

hold Donor harmless from and against any and all claims, demands, or causes of action in favor of any person for damage or loss that may occur to persons or property arising after title to Donated Structure passes to the Donee and arising out of or in any way connected with use of the Donated Structure, or any appurtenances attached thereto by Donee or other persons, provided that the Donated Structure meets the requirements of the National Artificial Reef Plan and the Louisiana Artificial Reef Development Program, except that Donor hereby assumes responsibility and liability for any personal injury, property damages, loss or damage of any description, including but not limited to loss or damage to fish or wildlife, or fish or wildlife habitat, which may result from a spill, seepage, or release from the Donated Structure of hydrocarbons or hazardous materials that are listed in any current federal, state or local law, ordinance, rule, regulation, order, decree, or requirement.

7.4 **Notice of Claims.** In all aforesaid instances wherein the Donee agrees to indemnify the Donor, if such a claim, demand, or cause of action is filed against Donor, Donor shall promptly notify Donee in writing and by certified mail. This notice shall be addressed to the Secretary, Department of Wildlife and Fisheries, and shall specify the nature of and the specific basis for such claim, demand, or cause of action and the amount claimed, or the estimated amount claimed to the extent then known. In all aforesaid instances wherein the Donor agrees to indemnify the Donee, if such a claim, demand, or cause of action is filed against Donee, Donee shall promptly notify Donor in writing and by certified mail. This notice shall be addressed to \_\_\_\_\_, and shall specify the nature of and the specific basis for such claim, demand, or cause of action and the amount claimed,



or the estimated amount claimed to the extent then known.

**7.5 Legal Representation.** In all instances wherein the Donee agrees to indemnify the Donor, at the election of the Donee, the Donee shall either provide legal representation for Donor against such claim, demand or cause of action, or reimburse Donor for all reasonable costs incurred by Donor in defending against such claim, demand or cause of action, provided that the Donor provides written notice to the Donee as provided above.

**7.6 Disclaimer - Liability for Maintenance and Repair.** After all terms and conditions of this Agreement, including but not limited to Donee's mailing of the completed "Notification of Acceptance" as specified in Article VIII herein, have been fulfilled, Donor shall have no obligation or duty whatsoever to provide for the maintenance or repair of the Donated Structure or any appurtenance attached thereto.

#### **ARTICLE VIII - ACCEPTANCE**

**8.1 Appearance by Donee.** Donee hereby appears for the purpose of accepting both the Donated Structure and the funds upon the fulfillment of the conditions specified below.

**8.2 Obligation to Accept by Donee.** Donee hereby obligates itself to accept the donation of both the Donated Structure and the funds specified herein upon the fulfillment of the following conditions:

- a. Donor has in fact delivered the Donated Structure to the proper Structure Site as specified herein;
- b. Donor has completed any and all operations to place the Donated Structure at the Structure Site as specified herein;
- c. Donor has conducted a survey and procured a certified surveyor's plat of the Donated

Structure at the Structure Site after operations have been completed in full;

- d. Donor has delivered the certified surveyor's plat, as specified in section "c", above to the Donee;
- e. Donee has received, examined, and accepted Donor's certified surveyor's plat and has sent to Donor by certified mail a completed and signed "Notification of Acceptance of Structure Placement and Acceptance of Title", ("Notification of Acceptance") a blank copy of which is attached hereto and made a part hereof, by certified mail. Unless otherwise agreed, Donee will mail such notification within three (3) working days following receipt of the certified surveyor's plat from Donor, provided that Donee accepts such certified surveyor's plat as indicating proper placement of the Donated Structure at the Structure Site.

**8.3 Acceptance by Donee.** Donee's acceptance of the Donated Structure and funds shall be deemed to occur and title shall pass only upon the fulfillment of the conditions specified in Section 8.2 (a-e) above. Acceptance shall particularly be deemed to occur and title shall pass at 12:00 midnight on the date that Donee mails to Donor the completed "Notification of Acceptance". Acceptance shall not be deemed to occur at any time prior to the fulfillment of said conditions. It is specifically understood and agreed that Donee shall have no ownership interest in the Donated Structure unless and until Donee mails the completed "Notification of Acceptance" and any and all liability for actions, occurrences, or omissions which might occur prior to Donee's mailing of the completed "Notification of Acceptance", other than those arising solely out the direct negligence of the Donee, as provided in Section 7.2 above, shall be the sole responsibility of the Donor.

**ARTICLE IX - DONATION TO ARTIFICIAL REEF FUND**

9.1 **Donation to the Artificial Reef Fund.** Donor agrees to and shall donate to the Conservation Fund the sum of \$\_\_\_\_\_, as provided by the Louisiana Fishing Enhancement Act and the Louisiana Artificial Reef Development Program, with such sums then to be placed in the Artificial Reef Fund for the benefit of the Louisiana Artificial Reef Development Program pursuant to the Louisiana Fishing Enhancement Act and the Louisiana Artificial Reef Development Program, as presently written. The Donor shall deliver the aforesaid sum to the Donee simultaneously with delivering the certified surveyor's plat to the Donee. Acceptance of the aforesaid sum shall be deemed to occur upon Donee's acceptance of the Donated Structure and title passage of the Donated Structure as evidenced by the Donee's mailing of the completed Notification of Acceptance as provided in Article VIII herein.

## **State of Mississippi Act of Donation and Title Transfer**

(courtesy of Erik Broussard, Mississippi Department of Marine Resources)

### **ACT OF DONATION TO THE STATE OF MISSISSIPPI FROM: ACT OF DONATION AND TITLE TRANSFER**

\_\_\_\_\_, a \_\_\_\_\_ corporation  
(hereinafter referred to as “Donor”), represented by \_\_\_\_\_  
and  
acting on behalf of \_\_\_\_\_, who declared the following, to  
wit:

1. He is the \_\_\_\_\_ of, \_\_\_\_\_ whose address is  
\_\_\_\_\_, and whose agent, for purposes of service of process, is  
\_\_\_\_\_, who can be located at  
\_\_\_\_\_.

2. He is duly authorized to make the donations and title transfer specified herein and  
execute this Act of Donation and Title Transfer on behalf of Donor;  
and

William W. Walker, PhD, acting on behalf of the Mississippi Department of Marine  
Resources, who declared the following, to wit:

1. He is the Executive Director of the Mississippi Department of Marine Resources,  
the agency charged with administering and enforcing the Artificial Reef  
Development Plan for the State of Mississippi, pursuant to Miss. Code Ann. §§  
49-15-305 (2)(f) and 49-15-15 (q).

2. He is duly authorized to accept the donations specified herein and to execute this  
Act of Donation on behalf of the Mississippi Department of Marine Resources,  
acting on behalf of the State of Mississippi (“Donee”).

### **ARTICLE I – DEFINITIONS**

**1.1. “Agreement”** means this Act of Donation and Title Transfer from  
(\_\_\_\_\_) to the State of Mississippi, by and through the Mississippi  
Department of Marine Resources.

**1.2. “Artificial Reef Fund”** means the Artificial Reef Program Account within the  
state’s Seafood Fund, as provided in Miss. Code Ann. § 49-15-17 (1)(b).

**1.3. “COE Permitted Site”** means the artificial reef site described in Article 5.1 below,  
and encompasses an area 4000’ x 4000’, which is the location for the placement of  
the Donated Structure, as permitted by the U.S. Corps of Engineers.

**1.4. “Donated Structure”** means the (\_\_\_\_\_), to be used as an artificial  
reef, and is to be used to describe collectively, those materials being donated.

**1.5. “Donee”** means the State of Mississippi, by and through the Mississippi Department  
of Marine Resources.

**1.6. “Donor”** means (\_\_\_\_\_).

**1.7. “Latitude and Longitude”** means coordinate positions provided in measurements  
from a differential global positioning system receiver.

**1.8. “Mississippi Artificial Reef Plan”** means the Artificial Reef Development Plan for  
the State of Mississippi, developed pursuant to Miss. Code Ann. § 49-15-15 (q).

**1.9. “National Fishing Enhancement Act”** means the National Fishing Enhancement

Act of 1984, 33 U.S.C.A. § 2101, et seq.

**1.10. “National Artificial Reef Plan”** means the National Artificial Reef Plan, 33 U.S.C.A. § 2103.

**1.11. “Notification of Acceptance”** means the document issued by the Donee entitled “Notification of Acceptance of Structure Placement and Title”, a copy of which is attached hereto and made a part hereof.

**1.12. “Person”** means both natural and juridical persons.

**1.13. “Structure Site”** means the specific point, as described in latitude and longitude coordinates, located within the COE permitted site, where the Donated Structure is to be placed.

## **ARTICLE II – DONATION OF STRUCTURE**

**2.1. Donation of Structure.** In consideration of the mutual covenants and conditions set forth below, and for the purpose of enhancing fishing resources in waters within and adjacent to the coast of Mississippi, Donor, in accordance with the National Fishing Enhancement Act, the National Artificial Reef Plan, and the Mississippi Artificial Reef Plan, does hereby irrevocably grant, donate, transfer, carry, assign, and deliver unto the Donee the following described Donated Structure, to wit:

Said Donated Structure’s dimensions are as follows:

Height of Jacket (at its current location): Approximately ft. (includes portion of Structure + 15 ft above water)

Dimension of Jacket Base: Approximately ft x ft (center to center of legs at mud line)

Dimension of Jacket Top: Approximately ft x ft (center to center of legs at +15 ft)

The center of Donated Structure prior to donation is described as:

Latitude =

Longitude =

x =

y =

To have and to hold said Donated Structure unto Donee and its assigns forever, subject to the following disclaimer and warranties.

## **ARTICLE III – WARRANTIES**

**3.1. Donor Disclaimer.** This donation is made by Donor without any warranty, either express or implied, and in particular, any warranty as to the condition, fitness, or usability of said Donated Structure for any purpose, except as provided as follows or as otherwise provided in this Agreement.

**3.2. Materials.** Donor warrants that the materials donated meet the applicable requirements of the National Fishing Enhancement Act, the National Artificial Reef Plan, the Mississippi Artificial Reef Plan, and any and all permits issued according to those plans, including, but not limited to, the permit issued by the U.S. Army Corps of Engineers.

**3.3. Hazardous Material.** Donor warrants that, as of the date of transfer, except for possible trace amounts which may be allowed by law, the Donated Structure is free

of any hydrocarbons or other hazardous materials listed or described in any current federal, Mississippi state, or local law, ordinance, rule, regulation, order, decree, or requirement.

**3.4. Good Title.** Donor warrants that its title to the Donated Structure is free and clear of all encumbrances of any kind or description.

**ARTICLE IV – PERMITS**

**4.1. Donee Responsibilities.** Donee shall be responsible for obtaining the required permits for the construction and management of an artificial reef at the Structure Site described below, pursuant to the applicable requirements of the National Fishing Enhancement Act of 1984 and the Mississippi Artificial Reef Plan.

**ARTICLE V – LOCATION AND PLACEMENT**

**5.1. Location.** Operations to place the Donated Structure on the sea floor of the Gulf of Mexico shall be conducted by Donor at the site selected by the Donee. The Donated Structure shall be placed such that a minimum clearance above the highest point of the structure is fifty (50) feet below the mean low sea level of the surface of the water is placed within the boundaries of the permitted site, in such a manner that the Donated Structure shall be acceptable by the U.S. Coast Guard for the use of unlit aids to navigation to mark the site. The location of the Structure Site and the COE Permitted Site # is further defined hereunder in NAD27/Clark 1866:

Structure Site:

Latitude =

Longitude =

x =

y =

COE Permitted Site Corner Coordinates:

Northwest Corner:

Latitude =

Longitude =

x =

y =

Northeast Corner:

Latitude =

Longitude =

x =

y =

Southeast Corner:

Latitude =

Longitude =

x =

y =

Southwest Corner:

Latitude =

Longitude =

x =

y =

**5.2. Position.** Donor shall place the Donated Structure at the Structure Site, as described in 5.1 above, and on the sea floor in a horizontal position.

**5.3. Accepted Range.** Donor shall place the Donated Structure as accurately as possible on the Structure Site described in 5.1 above, but in no case shall the Donated Structure be placed more than five hundred (500) feet from the Structure Site.

**5.4. Placement of Buoy by Donor.** Upon placement of the Donated Structure, the Donor shall also deploy a buoy if requested by the Donee. Said buoy shall conform to all U.S. Coast Guard specifications and Donee specifications. Said buoy shall be depicted on the Surveyor's plat required below, pursuant to paragraph 5.9.

**5.5. Representative of Donee.** Donor shall provide, at its expense, for a representative of Donee to be present at the Structure Site at the time of placement of the Donated Structure. Donee's representative shall act as an observer only and shall not serve, nor be deemed to serve, in any operational or advisory capacity whatsoever, and Donor shall assume all responsibility for any action Donor takes during the placement of the Donated Structure.

**5.6. Donee Disclaimer.** Donor shall assume all responsibility for all liability which may be associated with the transport and disposition of the Donated Structure, or any part thereof. Donee shall assume no liability for the transport and disposition of the Donated Structure, or any part thereof. The Donor shall be solely responsible for the Donated Structure until such time as it has been properly placed on the sea floor at the Structure Site described above in 5.1., and until all other terms and condition of this Agreement, including but not limited to Donee's mailing of the completed Notification of Acceptance as specified in Article VIII herein, have been fulfilled.

**5.7. Structure Site Permits.** Donor warrants that the Donated Structure shall be sited and placed in accordance with all terms, conditions, and special conditions of all U.S. Army Corps of Engineers permits, and all other permits issued to construct the artificial reef, in addition to all specifications contained herein.

**5.8. Completion.** Donor's proper placement of the Donated Structure at the Structure Site described above and completion of all terms and conditions of this Agreement, including, but not limited to, Donee's mailing of the completed Notification of Acceptance, shall relieve Donor of any and all obligations or requirements to further transport or move the Donated Structure.

**5.9. Surveyor's Plat.** Donor agrees to furnish Donee with a certified surveyor's plat of the final location and clearance of the Donated Structure, including location of buoy, within thirty (30) days following final placement of the Donated Structure and buoy.

## **ARTICLE VI – TITLE**

**6.1. Passing of Title.** After the completion of Donor's placement of the Donated Structure and buoy at the Structure Site and delivery of Surveyor's Plat, and the completion of all other terms and conditions of this Agreement, including, but not

limited to, Donee's mailing of the completed Notification of Acceptance have been fulfilled, title to the Donated Structure and buoy shall pass from Donor to Donee free and clear of all encumbrances of any kind or description.

## **ARTICLE VII – LIABILITY**

**7.1. Delivery of Structure – Donor's Actions.** Donor shall be solely responsible for the Donated Structure until all terms and conditions of this Agreement, including, but not limited to, Donee's mailing of Notification of Acceptance have been fulfilled. Donor shall indemnify and hold Donee harmless from and against any and all claims, demands, or causes of action of any description in favor of any person for damage or loss to persons or property arising from Donor's actions or failure to act during the operations required to deliver the Donated Structure and to properly place it at the Structure Site described above, and until such times as all other terms and conditions of this Agreement have been fulfilled.

**7.2. Delivery of Structure – Donee's Negligence.** Donor shall be solely responsible for the Donated Structure and its delivery until such time as all terms and conditions of this Agreement, including, but not limited to, Donee's mailing of the completed Notification of Acceptance have been fulfilled. It is understood and agreed that Donee's representative will serve as an observer only and shall not act, nor be deemed to act, in an operational or advisory capacity during the operations to deliver and properly place the Donated Structure at the Structure Site.

**7.3. Title Passage of Structure and Buoy.** Donee shall be responsible for Donated Structure and buoy only after all terms and conditions of this Agreement, including, but not limited to, Donee's mailing of the Notification of Acceptance as specified in Article VIII herein, have been fulfilled. Donee shall not have any interest in, responsibility for, or liability for the Donated Structure or any part thereof until all terms and conditions of this Agreement have been fulfilled. After all terms and conditions of this Agreement have been fulfilled, Donee will be responsible for any and all claims, demands, or causes of action in favor of any person for damage or loss that may occur to persons or property arising after title to Donated Structure passes to Donee and arising out of or in any way connected with use of the Donated Structure, or any appurtenances attached thereto by Donee or other persons, provided that the Donated Structure meets the requirements of the National Artificial Reef Plan and the Mississippi Artificial Reef Plan, except that Donor hereby assumes responsibility and liability for any personal injury, property damages, loss or damage of any description, including, but not limited to, loss or damage to fish or wildlife, or fish or wildlife habitat, which may result from a spill, seepage, or release from the Donated Structure of hydrocarbons or hazardous materials that are listed or otherwise described in any current federal, Mississippi state or local law, ordinance, rule, regulation, order, decree, or requirement, other than those trace amounts allowed under Article III, Section 3.3 of this agreement.

**7.4. Notice of Claims.** In all aforesaid instances wherein the Donee agrees to accept responsibility (i.e., after all the terms and conditions of this Agreement have been fulfilled), if such a claim, demand, or cause of action is filed against Donor, Donor shall promptly notify Donee in writing and by certified mail. This notice shall be addressed to the Executive Director, Mississippi Department of Marine Resources,



and shall specify the nature of and the specific basis for such claim, demand, or cause of action and the amount claimed, or the estimated amount claimed to the extent then known. In all aforesaid instances wherein the Donor agrees to accept responsibility (i.e., after all terms and conditions of the Agreement have been fulfilled), if such a claim, demand, or cause of action is filed against Donee, Donee shall promptly notify Donor in writing and by certified mail. This notice shall be addressed to

\_\_\_\_\_, and shall specify the nature of and the specific basis for such claim, demand, or cause of action and the amount claimed, or the estimated amount claimed to the extent then known.

**7.5. Legal Representation.** In all instances wherein the Donee agrees to accept responsibility (i.e., after all the terms and conditions of this Agreement have been fulfilled), at the election of the Donee, the Donee shall either provide legal representation for Donor against such claim, demand or cause of action, or reimburse Donor for all reasonable costs incurred by Donor in defending against such claim, demand or cause of action, provided that the Donor provides written notice to the Donee as provided above.

**7.6. Disclaimer – Liability for Maintenance and Repair.** After all terms and conditions of this Agreement, including, but not limited to, Donee’s mailing of the completed Notification of Acceptance, have been fulfilled, Donor shall have no obligation or duty whatsoever to provide for the maintenance or repair of the Donated Structure of any appurtenance attached thereto.

## **ARTICLE VIII -- ACCEPTANCE**

**8.1. Obligations of Donee and Donor.** Donee hereby obligates itself to accept the donation of both the Donated Structure and the funds specified herein upon the fulfillment of the following conditions:

- a. Donor has delivered the Donated Structure to the proper Structure Site as specified herein;
- b. Donor has completed any and all operations to place the Donated Structure at the Structure Site as specified herein, including, but not limited to, buoying the structure to Donee’s specifications;
- c. Donor has conducted a survey, procured a certified surveyor’s plat of the Donated Structure at the Structure Site after the operations have been completed in full, and delivered the certified surveyor’s plat to the Donee;
- d. Donee has received, examined, and accepted Donor’s certified surveyor’s plat and has sent to Donor by certified mail a completed and signed Notification of Acceptance. Unless otherwise agreed, Donee will provide Notification of Acceptance within ten (10) business days of receiving the certified surveyor’s plat, provided that Donee accepts said plat as sufficient representation of proper placement of the Donated Structure at the Structure Site.

**8.2. Acceptance by Donee.** Donee’s acceptance of the Donated Structure and funds shall be deemed to occur and title shall pass only upon the fulfillment of the conditions specified in Section 8.1 (a-d) above. More particularly, acceptance shall be deemed to occur and title shall pass at 12:00 midnight on the date that Donee mails to Donor the Notification of Acceptance. Acceptance shall not be deemed to occur at any time prior to the fulfillment of said conditions. It is specifically

understood and agreed that Donee shall have no ownership interest in the Donated Structure unless and until Donee mails the completed Notification of Acceptance, and any and all liability for actions, occurrences, or omissions which might occur prior to Donee's mailing of the completed Notification of Acceptance, other than those arising solely out of the direct negligence of the Donee, as provided in Section 7.2 above, shall be the sole responsibility of the Donor.

**ARTICLE IX – DONATION TO ARTIFICIAL REEF FUND**

**9.1. Donation to the Artificial Reef Fund.** Donor agrees to and shall donate to the state's Artificial Reef Fund the sum of \_\_\_\_\_, as provided by the Seafood Fund statute and more particularly, the special provision for the Artificial Reef Fund. The Donor shall deliver the aforesaid sum to the Donee simultaneously with delivery of the certified surveyor's plat to the Donee. Acceptance of the aforesaid sum shall be deemed to occur upon Donee's acceptance of the Donated Structure and title passage of the Donated Structure as evidenced by the Donee's mailing of the completed Notification of Acceptance, as provided in Article VIII herein.

**9.2.** Donee acknowledges and covenants with the Donor that the donation herein shall be used solely for promoting, constructing, monitoring and maintaining artificial fishing reefs in the marine waters of the State of Mississippi and in adjacent federal waters.

**ARTICLE X – FORUM SELECTION**

**10.1. Laws and Jurisdiction of Mississippi.** This Agreement shall be governed by and construed in accordance with the laws of the State of Mississippi. The Donor and Donee expressly agree that the laws of the State of Mississippi shall govern the validity, construction, interpretation and effect of this agreement. Further, the Donor and Donee expressly agree that the Courts of the State of Mississippi shall have exclusive jurisdiction over the parties in any action at law relating to the subject matter or the interpretation of this agreement.

IN WITNESS WHEREOF, the parties have executed this Act of Donation and Title Transfer on the date set forth below.

DONOR DONEE  
MISSISSIPPI DEPARTMENT OF MARINE RESOURCES

\_\_\_\_\_  
( ) William W. Walker, PhD  
( ) Executive Director

STATE OF §  
COUNTY OF §

PERSONALLY appeared before me, the undersigned authority in and for the jurisdiction aforesaid, the within named \_\_\_\_\_, of \_\_\_\_\_, in the above and foregoing instrument of writing, who acknowledged to me that he signed and delivered the above and foregoing instrument of writing on the day and year and for the purposes therein mentioned. GIVEN under my hand and official seal of office on this the \_\_\_\_\_ day of, 2000.

(Seal)  
Notary Public in and for the State of  
My Commission Expires:

STATE OF MISSISSIPPI §  
COUNTY OF HARRISON §

PERSONALLY appeared before me, the undersigned authority in and for the jurisdiction aforesaid, the within named William W. Walker, PhD, Executive Director of the Mississippi Department of Marine Resources in the above and foregoing instrument of writing, who acknowledged to me that he signed and delivered the above and foregoing instrument of writing on the day and year and for the purposes therein mentioned.

GIVEN under my hand and official seal of office on this the \_\_\_\_ day of \_\_\_\_\_, 2000.

(Seal)  
NOTARY PUBLIC  
My Commission Expires:

---

**ACOE Final Artificial Reef Permit for St. John's County  
Department of Parks and Recreation**

Courtesy of John Dodrill, Florida Fish and Wildlife Conservation Commission

**DEPARTMENT OF THE ARMY PERMIT**

**Permittee:** St. Johns County  
Parks and Recreation Department  
Attn: Mr. Wil Smith  
P.O. Drawer 349  
St. Augustine, Florida 32085-0349

**Permit No:** SAJ-1998-1508(IP-BAL)

**Permit Site Name:** High School Reef

**Issuing Office: U.S. Army Engineer District, Jacksonville**

NOTE: The term "you" and its derivatives, as used in this permit, means the permittee or any future transferee. The term "this office" refers to the appropriate district or division office of the Corps of Engineers having jurisdiction over the permitted activity or the appropriate official of that office acting under the authority of the commanding officer.

You are authorized to perform work in accordance with the terms and conditions specified below.

**Project Description:** The Permittee is authorized to construct an artificial reef site by using material which is clean and free from asphalt, creosote, petroleum, other hydrocarbons and toxic residues, loose free floating material or other deleterious substances. Materials/structures will be configured and constructed to be stable in a 20 year return interval storm event at the depth of placement (see Depth, Profile & Clearance paragraph below). Materials will be designed, selected and deployed in such a manner as to avoid entrapping marine life.

The deployments will consist of the following material:

- 1) Prefabricated artificial reef modules composed of steel, concrete, rock or a combination of these materials; no module will weigh less than 1000 pounds.
- 2) Natural rock boulders and other pre-cast material, such as, culverts (inside diameter no less than 36 inches), stormwater junction boxes, power poles; no piece will weigh less than 500 pounds.
- 3) Clean steel and concrete bridge demolition materials (no piece will weigh less than 500 pounds), such as slabs or pilings with all steel reinforcement rods severed as close to the concrete surface as possible but not to extend more than 6 inches to ensure the rod will not create a fishing tackle or diver ensnaring hazard. The material must be clean and free from asphalt, petroleum, other hydrocarbons and toxic residues, and comply with the U.S. Environmental Protection Agency Ocean Disposal Standards.

**Depth, Profile & Clearance:** The approximate depth of water within the site varies from a depth of -55 feet to -57 feet relative to Mean Lower Low Water (MLLW) depending on the location. The proposed area is 0.25 mile by 0.25 mile. A minimum clearance of 50' off the top of the deployed material relative to MLLW shall be maintained. The work described above is to be completed in accordance with the 3 pages of drawings dated September 26, 2006, affixed at the end of this permit instrument.

**Project Location:** The project is located in the Atlantic Ocean off St. Johns County approximately 13.6 nautical miles and 50 degrees from the Vilano Bridge.

**Latitude & Longitude:**

NW Corner 30.06213°/-81.10813° (30°03.7278'N/81°06.4878'W)  
NE Corner 30.06213°/-81.10313° (30°03.7278'N/81°06.1878'W)  
SW Corner 30.05763°/-81.10813° (30°03.4578'N/81°06.4878'W)  
SE Corner 30.05763°/-81.10313° (30°03.4578'N/81°06.1878'W)

The attached drawing depicts the configuration with the latitude and longitude.

**Permit Conditions**

**General Conditions:**

1. The time limit for completing the work authorized ends on \_\_\_\_\_. If you find that you need more time to complete the authorized activity, submit your request for a time extension to this office for consideration at least one month before the above date is reached.

2. You must maintain the activity authorized by this permit in good condition and in conformance with the terms and conditions of this permit. You are not relieved of this requirement if you abandon the permitted activity, although you may make a good faith transfer to a third party in compliance with General Condition 4 below. Should you wish to cease to maintain the authorized activity or should you desire to abandon it without a good faith transfer, you must obtain a modification of this permit from this office, which may require restoration of the area.

3. If you discover any previously unknown historic or archeological remains while accomplishing the activity authorized by this permit, you must immediately notify this office of what you have found. We will initiate the Federal and State coordination required to determine if the remains warrant a recovery effort or if the site is eligible for listing in the National Register of Historic Places.

4. If you sell the property associated with this permit, you must obtain the signature and the mailing address of the new owner in the space provided and forward a copy of the permit to this office to validate the transfer of this authorization.

5. If a conditioned water quality certification has been issued for your project, you must comply with the conditions specified in the certification as special conditions to this permit. For your convenience, a copy of the certification is attached if it contains such conditions.

6. You must allow representatives from this office to inspect the authorized activity at any time deemed necessary to ensure that it is being or has been accomplished in accordance with the terms and conditions of your permit.

**Special Conditions:**

- 1. Reporting Addresses:** The Permittee shall reference this permit number, SAJ-1998-1508(IP-BAL) on all correspondence.  
All forms, documentation, and correspondence required by the conditions of this permit shall be submitted to the following addresses: U.S. Army Corps of Engineers (Corps), Regulatory Division, Enforcement Section, P.O. Box 4970, Jacksonville, FL 32232 and Jon Dodrill, Florida Fish and Wildlife Conservation Commission (FWC) Artificial Reef Program, 620 S. Meridian Street, Box 4B2, Tallahassee, FL 32399.
- 2. Proof of Receipt:** The Permittee shall provide the Corps with proof of receipt that all forms, reports and documentation submitted to FWC were received within 2 weeks after the required timeframes of the form. This consists of the *Florida Artificial Reef Materials Cargo Manifest and Pre-Deployment Notification*, Pre-deployment Inspection report, *Florida Artificial Reef Materials Placement Report and Post-Deployment Notification*, As-Built Report, and Close-out Placement report. (Proof of receipt may be a copy of the signed signature card from a certified letter.)
- 3. Deployment Window:** Artificial reef material shall not be deployed between November 15 and April 15 for the conservation of endangered Northern right whales.
- 4. Pre-Deployment Placement Area Inspection:** The Permittee shall have divers inspect the placement area 30 days to one year prior to deployment to ensure the substrate is sufficient to support the material and no live bottom is present in the deployment area. The inspection should include probing the area with a ¼ inch aluminum rod to ensure appropriate substrate is present to ensure the deployment material will be stable and not sink into the sand. The probe should not penetrate the sand more than 12". The Permittee understands that no authorization is granted by this permit for the construction of artificial reefs within 200 feet of any submerged beds of sea grasses or macroalgae, coral reefs, live bottom, areas supporting growth of sponges, sea fans, soft corals, and other sessile macroinvertebrates generally associated with rock outcrops, oyster reefs, scallop beds, clam beds, or areas where there are unique or unusual concentrations of bottom dwelling marine organisms, or a previous deployed artificial reef. In addition, the area should be inspected for cultural

resources, such as sunken vessels, ballast, historic refuse piles, or careenage areas. The results of the pre-deployment inspection shall be submitted to the Corps and FWC at least 2 weeks prior to deployment and may be submitted with the *Florida Artificial Reef Materials Cargo Manifest and Pre-Deployment Notification* submitted pursuant to item 5 below.

5. **Pre-Deployment Notification:** The Permittee shall send the Corps and FWC a copy of the *Florida Artificial Reef Materials Cargo Manifest and Pre-Deployment Notification*, at least two weeks before the deployment of any material authorized by this permit. Attachment 2 of this permit is a copy of the *Florida Artificial Reef Materials Cargo Manifest and Pre-Deployment Notification*.

6. **Authorized Material:** No artificial reef material other than those listed in the project description is authorized for deployment under this permit.

7. **Daylight Hours:** All loading of artificial reef material, departure of the vessel for construction of the reef and placement of the material on the reef will be accomplished during daylight hours, unless prior approval is granted by the Corps.

8. **Manifest:** The Permittee will ensure there is a copy of the *Florida Artificial Reef Materials Cargo Manifest and Pre-Deployment Notification* and the Corps' permit on board the vessel used to transport reef materials. The manifest shall contain an itemized list of all the material carried on board to be used as reef material.

9. **Location Coordinates:** The Permittee shall ensure the reef materials are placed within the boundaries described in the project description and depicted on the permit drawings. Latitude and longitude coordinates for each deployment shall be verified using a Differential Global Positioning System (DGPS) unit. The Permittee needs to ensure the DGPS unit is accurate within 1-3 meters.

10. **Potential Hazard to Navigation:** The Permittee shall contact the U.S. Coast Guard office immediately by phone at (904-564-7500) if the material is deployed in a location other than the area authorized or the deployed material exceeds the height of the authorized project. Within 24 hours of the deployment, the permittee shall send the Corps



via overnight courier the location of the unauthorized material in latitude and longitude coordinates, water depth above the material from MLLW, description of the material, the name of the U.S. Coast Guard personnel who was contacted and time, and an explanation as to why the deployed material missed the authorized project site. The address for overnight mail is: U.S. Army Corps of Engineers (Corps), Regulatory Division, Enforcement Section, 701 San Marco Boulevard, Room 372, Jacksonville, FL 32207-8175.

11. **Placement Report:** Each time material is deployed at the reef site, the Permittee will submit a materials placement report to the Corps and FWC within 30 days after the deployment, to include at a minimum, an inventory of the type, dimensions, and amount of materials deployed, methods used for cleaning the material, latitude and longitude of where the materials were placed, and the approximate deployment configurations, including height of the material after placement. Attachment 3 of this permit is a copy of the *Florida Artificial Reef Materials Placement Report and Post-Deployment Notification*.

12. **As-Built Report:** The Permittee shall submit the as-built report within 6 months after each placement to the Corps and FWC. The report shall be certified by a licensed surveyor or engineer. The purpose of the report is to establish a baseline for future comparisons. The report shall include a hydrographic survey referenced at low tide to document the height of each deployment and the DGPS coordinates to verify each location. The report shall include the as-built condition of the deployed material established through the use of SCUBA divers. This includes a radial point map with the latitude and longitude that substantiates the existing configuration of the deployed material. Also, include information on the condition, durability and stability of the material and general information on the diversity and quantity of fish and associated biota. A side scan survey may be conducted in place of using SCUBA divers to document the material deployed. The report shall be limited to a few pages per deployment. Representative photographs and/or video, if available, are encouraged to be submitted. The as-built report can be conducted the same day as the deployment of the material.

13. **Close-out Placement Report:** The Permittee shall submit a close-out placement report within 3 months after the authorization date provided in general condition 1 has closed. The intent of the report is to provide information on the location (latitude & longitude), the date material deployed, durability and stability of each deployment. The report needs to indicate changes from the as-built report (special condition 12), such as but not limited to, current location (latitude and longitude), information on whether the material moved, and changes to the deployment configuration. The report shall be limited to no more than a one page per deployment, information on subsidence, durability, diversity of and quantity of biota shall be included.

14. **Manatee Protection:** The Permittee shall ensure that wharf fenders are installed when reef material is off loaded from the wharf to a barge to reduce the risk of a vessel crushing a manatee. The wharf fenders shall be installed with appropriate materials to provide sufficient standoff space of at least 4 feet under compression. Also, fenders or buoys providing a minimum standoff space of at least 4 feet under compression shall be utilized between two vessels that are moored together.

15. **Entrapment:** Material shall be designed, selected and deployed in such a manner as to avoid entrapping marine life. Observations of entrapped marine turtles or marine mammals on any artificial reef built under this permit or previous artificial reef permits shall be reported immediately to the Corps and FWC.

16. **Entanglement:** To avoid the risk of entanglement to marine animals, buoys or anchor lines shall not be attached to reef structures or the seafloor to mark reef locations. Also, the use of any Fish Attraction Devices is prohibited.

17. **Sea Turtle and Smalltooth Sawfish Guidelines:** The Permittee shall comply with the "National Marine Fisheries Service's Sea Turtle and Smalltooth Sawfish Construction Guidelines" provided in Attachment 4 of this permit.

18. **Measures to Reduce Vessel Strikes with Protected Species:** The Permittee shall comply with the "Vessel Strike Avoidance Measures and Injured or Dead Protected Species Reporting" guidance provided in Attachment 5 of this permit.

19. **Navigation Obstruction:** The Permittee understands and agrees that, if future operations by the United States require the removal, relocation, or other alteration, of the structures or work herein authorized, or if in the opinion of the Secretary of the Army or his authorized representative, said structure or work shall cause unreasonable obstruction to the free navigation of the navigable waters, the Permittee will be required, upon due notice from the Corps of Engineers, to remove, relocate, or alter the structural work or obstructions caused thereby, without expense to the United States. No claim shall be made against the United States on account of any such removal or alteration.

**Further Information:**

1. Congressional Authorities: You have been authorized to undertake the activity described above pursuant to:

(x) Section 10 of the Rivers and Harbors Act of 1899 (33 U.S.C. 403).

(x) Section 404 of the Clean Water Act (33 U.S.C. 1344).

( ) Section 103 of the Marine Protection, Research and Sanctuaries Act of 1972 (33 U.S.C. 1413).

2. Limits of this authorization.

a. This permit does not obviate the need to obtain other Federal, State, or local authorizations required by law.

b. This permit does not grant any property rights or exclusive privileges.

c. This permit does not authorize any injury to the property or rights of others.

d. This permit does not authorize interference with any existing or proposed Federal projects.

3. Limits of Federal Liability. In issuing this permit, the Federal Government does not assume any liability for the following:

a. Damages to the permitted project or uses thereof as a result of other permitted or unpermitted activities or from natural causes.

b. Damages to the permitted project or uses thereof as a result of current or future activities undertaken by or on behalf of the United States in the public interest.

c. Damages to persons, property, or to other permitted or unpermitted activities or structures caused by the activity authorized by this permit.

d. Design or construction deficiencies associated with the permitted work.

e. Damage claims associated with any future modification, suspension, or revocation of this permit.

4. Reliance on Applicant's Data: The determination of this office that issuance of this permit is not contrary to the public interest was made in reliance on the information you provided.

5. Reevaluation of Permit Decision: This office may reevaluate its decision on this permit at any time the circumstances warrant. Circumstances that could require a reevaluation include, but are not limited to, the following:

a. You fail to comply with the terms and conditions of this permit.

b. The information provided by you in support of your permit application proves to have been false, incomplete, or inaccurate (see 4 above).

c. Significant new information surfaces which this office did not consider in reaching the original public interest decision.

Such a reevaluation may result in a determination that it is appropriate to use the suspension, modification, and revocation procedures contained in 33 CFR 325.7 or enforcement procedures such as those contained in 33 CFR 326.4 and 326.5. The referenced enforcement procedures

provide for the issuance of an administrative order requiring you comply with the terms and conditions of your permit and for the initiation of legal action where appropriate. You will be required to pay for any corrective measures ordered by this office, and if you fail to comply with such directive, this office may in certain situations (such as those specified in 33 CFR 209.170) accomplish the corrective measures by contract or otherwise and bill you for the cost.

6. Extensions: General Condition 1 establishes a time limit for the completion of the activity authorized by this permit. Unless there are circumstances requiring either a prompt completion of the authorized activity or a reevaluation of the public interest decision, the Corps will normally give favorable consideration to a request for an extension of this time limit.

Your signature below, as permittee, indicates that you accept and agree to comply with the terms and conditions of this permit.

\_\_\_\_\_  
\_\_\_\_\_  
(PERMITTEE)

(DATE)

\_\_\_\_\_  
(PERMITTEE NAME-PRINTED)

This permit becomes effective when the Federal official, designated to act for the Secretary of the Army, has signed below.

\_\_\_\_\_  
\_\_\_\_\_  
(DISTRICT ENGINEER)  
Paul L. Grosskruger  
Colonel, U.S. Army

(DATE)

When the structures or work authorized by this permit are still in existence at the time the property is transferred, the terms and conditions of this permit will continue to be binding on the new owner(s) of the property. To validate the transfer of this permit and the associated liabilities associated with compliance with its terms and conditions, have the transferee sign and date below.

\_\_\_\_\_  
(TRANSFEEE-SIGNATURE) (DATE)

\_\_\_\_\_  
(NAME-PRINTED)

\_\_\_\_\_  
(ADDRESS)

\_\_\_\_\_  
(CITY, STATE, AND ZIP CODE)

***Attachments to Department of the Army  
Permit Number SAJ-1998-1508(IP-BAL)***

1. PERMIT DRAWINGS: 3 pages, dated 26 September 2006
2. Florida Artificial Reef Materials Cargo Manifest and Pre-Deployment Notification
3. Florida Artificial Reef Materials Placement Report and Post-Deployment Notification
4. National Marine Fisheries Service's Sea Turtle and Smalltooth Sawfish Construction Guidelines
5. Vessel Strike Avoidance Measures and Injured or Dead Protected Species Reporting (10 pages)

## Appendix 3: Estimates of Biological Production

---

This technical appendix details the technical methods used to develop estimates of biological production for fish communities on offshore platforms under current conditions and the partial removal option. As explained below, the modeling approach uses monitoring data from the platforms and a combination of standard population dynamics methods to accomplish this. A number of appendices to this appendix follow the explanatory text and provide data tables

Understanding the amount and kind of uncertainty associated with these modeled estimates is important in evaluating their applicability to decision making about decommissioning options. The biological production module within PLATFORM calculates the current standing (biomass) stock of each species for those platforms that were modeled. It also calculates the future production and standing stock based on selected decommissioning options. The uncertainty about the standing stock is characterized by a lognormal distribution given some estimate of the mean fish biomass (grams) and standard error. This uncertainty is then propagated downstream so that users can view the resulting uncertainty in the outputs, such as the “Biomass yield for platforms selected.” These functions of PLATFORM are described in more detail in the users’ guide (Appendix 4).

### Estimates of platform standing stock and production

#### *Stock Estimate*

In order to determine what the biological implications are for the various decommissioning options a standard stock estimate was completed using data collected from the platforms. The data used for this stock estimate were collected during scientific surveys using two person submarines from 1996-2008 (Appendix I) and were provided by Milton Love. Observers recorded the number and size class of fishes (total length (TL)) along belt transects that varied in length depending upon the dimensions of the platform (Love et al. 2003). From this data set we have the best estimate of what fishes reside on the various platforms and how their density and size varies with depth. The goal for the stock estimate is to give the best estimation of the fish density and biomass at an unknown time in future when decommissioning takes place.

To calculate fish density (# fishes / m<sup>2</sup>), the number of individuals counted along a transect was divided by the surface area of the transect. The transect surface area is defined as the length of the transect multiplied by the width of the transect (2m). However, the stock is the amount of biomass on each platform; to calculate this, fish length (TL) estimates (Appendix II) were transformed to weight in grams using the weight-length conversion equation of the form:

$$g = aTL^b$$

Where  $g$  = grams,  $TL$  = Total Length in millimeters, and  $a$  and  $b$  are species specific coefficients of the power function. For some species only standard length (SL) to weight conversion equations were available. In these cases,  $TL$  was converted to  $SL$  using the linear function:

$$SL = (TL - b)/a$$

Length weight conversion equations were obtained from the primary literature, RecFin ([www.recfin.org](http://www.recfin.org)), or generated from Vantuna Research Group unpublished data sets. For fishes or larger taxonomic groups without known conversion parameters, the most similar trophic and taxonomic species was used (Appendix III). All conversion equations were tested for accuracy using known lengths and weights of fishes overlain on the power equation plots.



Stock estimates were calculated for three depth strata (Figure 1). The bottom stratum was defined as the lowest 2 m of a platform, which is occupied primarily by adult rockfishes for most platforms (Love et al. 1999, Milton Love, personal communication). The middle stratum (midwater) is from 2 m off the bottom to 26 m from the surface. This area is the remainder of the platform below the partial removal depth. The upper stratum is the section of the platform that will be removed if it is topped during decommissioning (from 26 m to the surface). The amount of sampling in terms of number of replicates (Table 1) and years (Appendix I) varied significantly among platforms. Some platforms and depth strata were well studied while others were not. In addition, due to the nature of the sampling (costs and logistics), there are not many replicates per sampling period, particularly in the critical bottom strata. In order to increase confidence in the stock estimates data across multiple years was used. Thus, stock estimates were made for eight well-studied platforms that represented the various habitats and biogeographic regions where the platforms are found. To give the best estimate of what the fish stocks will be in the future, first the average biomass density ( $\text{g/m}^2$ ) for each species across all years and replicates was calculated for each of these eight platforms, individually (Appendix IV).

Table 1. Number of replicates summed across all years per strata and platform (source: Milton Love, submersible database)

Platform	strata		
	bottom	middle	upper
Edith	6	6	5
Ellen	5	9	2
Elly	2	4	2
Emy			
Esther			
Eureka	3	29	1
Eva			
Gail	15	95	1
Gilda	4	11	11
Gina			
Grace	15	57	4
Habitat		8	7
Harmony	3	9	
Harvest	10	29	1
Henry		2	3
Heritage		3	
Hermosa	11	41	
Hidalgo	11	38	
Hillhouse		4	6
Hogan		1	2
Holly	27	21	7
Hondo	4	22	1
Houchin		1	2
Irene	15	19	
Platform A		8	6
Platform B		8	6
Platform C		8	4

Biomass density was scaled to the surface area each platform for each depth strata (Appendix V and VI). The surface area of the three depth strata was calculated using the proportion of each stratum relative to the total depth of the platform (Table 2). For instance, Platform Grace is at a depth of 96 m and the surface area of the platform is 25,862 m<sup>2</sup>. The surface area of bottom strata was calculated as  $2\text{m}/96\text{m} * 26,862 \text{ m}^2 = 539 \text{ m}^2$ . The surface area of the remaining depth strata were calculated in a similar fashion. One caveat is that this estimate assumes uniform platform size with depth, but platforms are wider at the base than at the surface. Thus, this underestimates the surface area at the base. For Platform Holly, no surface area estimates were available; thus, Platform C (the nearest platform of similar size and depth) was used for this estimate, adjusted for water depth. Finally, this biomass density was then scaled to the surface area of each depth strata for each platform. The total biomass (B) for the platform can then be estimated by summing biomass estimates from the three depth strata: bottom (B<sub>b</sub>), middle (B<sub>m</sub>) and upper (B<sub>u</sub>). Thus, total biomass for a platform follows:

$$\mathbf{B} = \mathbf{B}_b + \mathbf{B}_m + \mathbf{B}_u$$

Complete removal is the loss of B. For the partial removal option the adjusted stock will be:

$$\mathbf{B}_{\text{adj}} = \mathbf{B}_b + \mathbf{B}_m$$

Figure 1. Platform schematic with depth strata used in biomass and production estimates.

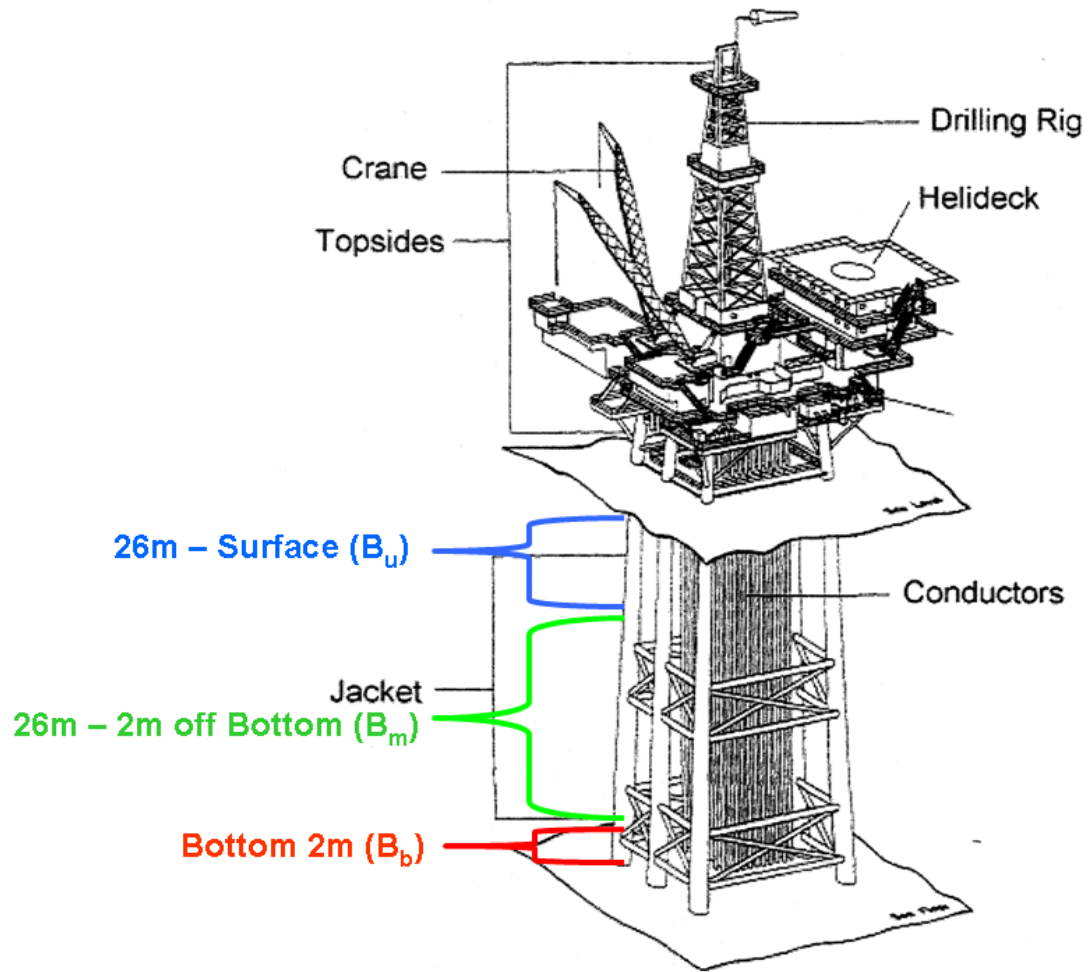

Table 2. Platform surface area calculations by depth strata.

Platform	Bottom (m <sup>2</sup> )	Middle (m <sup>2</sup> )	Upper (m <sup>2</sup> )
Edith	703	7379	9136
Ellen	697	18110	9055
Elly	361	9378	4689
Emy			
Esther			
Eureka	1028	94564	13362
Eva	536		4019
Gail	951	93185	12361
Gilda	629	10694	8178
Gina	235		3171
Grace	539	18319	7004
Habitat	608	18226	7898
Harmony			
Harvest	772	68359	10041
Henry			
Heritage			
Hermosa	926	72199	12033
Hidalgo	1128	57543	14668
Hillhouse			
Hogan	226	2150	2942
Holly	556	10555	7222
Hondo	526	59724	6841
Houchin	210	2205	2729
Irene	408	9169	5298
A	556	8333	7222
B	556	8333	7222
C	556	8333	7222

For partial removal and placing the jacket on the sea floor, the new biomass figure will be a function of the current platform biomass. The assumption is that the new habitat will have a similar fish community to the proximate platform. This biomass calculation will have the addition of an adjusted (*i*) bottom and midwater value scaled to the size of the jacket placed on the bottom such that:

$$\mathbf{B} = \mathbf{B}_b + \mathbf{B}_m + \mathbf{B}_{bi} + \mathbf{B}_{mi}$$

### ***Local production***

Platform production may be a critical component of the ecosystem in Southern California. With significantly high densities of overfished and/or protected species residing on them, a logical question concerns their overall production and an estimate of its significance on various scales. To begin to evaluate this, a novel model has been developed to estimate the local production of fishes. This model uses the information on standing stock and fish life history parameters to predict changes in production over time and under the various platform decommissioning options considered in this report. Production is the change in biomass (*B*) over time (*t*) (Clarke et al., 1946). When production is positive this is referred to as the yield (*Y*) (Ricker 1975) such that:

$$Y = \Delta B/t$$

Since most of the platforms were surveyed annually, and the calculated production rates are from the empirical data, we can assume that the best inputs for the model will be annual rates (*t* = 1) as opposed to daily, monthly or instantaneous rates. The output of the model is g/m<sup>2</sup>/yr. The total yield (*Y*) is a function of two factors: the standing stock biomass (*B*), plus the surplus production (*Y'*). Surplus production is the annual growth (*G*) in the adult stock (i.e. gonadal and somatic growth) plus recruitment (*R*), such that for any production component (Ricker 1975):

$$Y = B + Y' \text{ and } Y' = G + R$$

Only somatic growth was used to estimate *G*. Due to high larval mortality, estimates of fecundity were not used. This was done to be conservative in the production estimate. However, the connectivity of fish stocks to natural reefs was modeled in Section 5.3.1.2 of the main report. The standing stock biomass (*B*) is also a function of immigration (*z*) and emigration (*y*) rates, instantaneous natural mortality (*M*) and instantaneous fishing mortality (*F*). Fishing mortality is considered negligible as the area around most platforms due to security concerns. There are no current estimates of *z* and *y* and for this exercise, and these values were assumed to be equal (K. Anthony, personal communication). To calculate the somatic growth (*G*) over time, the model begins with the mean total length (TL) of each fish species and the total biomass per platform by strata estimated from the survey data. This length was used as the starting length at time 0 (*t*<sub>0</sub>) for the model run using the von Bertalanffy growth equation and the corresponding length at the end of the time period (*t*) (Figure 2):

$$t = 1/k * \ln[(L_{\infty} - L_t) / L_{\infty}] + t_0$$

Where *L*<sub>*t*</sub> = length at time *t*; *L*<sub>∞</sub> = theoretical maximum length; *k* = constant expressing the rate of approach to *L*<sub>∞</sub>; and, *t*<sub>0</sub> = theoretical age at which *L*<sub>*t*</sub> = 0. In a few instances, *L*<sub>*t*</sub> > *L*<sub>∞</sub> causing a negative value for *L*<sub>∞</sub> - *L*<sub>*t*</sub>, and in these instances *L*<sub>∞</sub> was adjusted to the maximum reported size. Growth parameters used in the model are given in Appendix VI. These length estimates were then transformed to a weight estimate using the species specific length-weight equations. From these

two weights the percent increase was calculated for each time period. This percent increase was then used to adjust the stock estimate (B) over time.

Figure 2. Visual representation of fish growth and calculation of  $L_t$  at annual intervals over five years ( $t_0$ - $t_5$ ) used in production model.

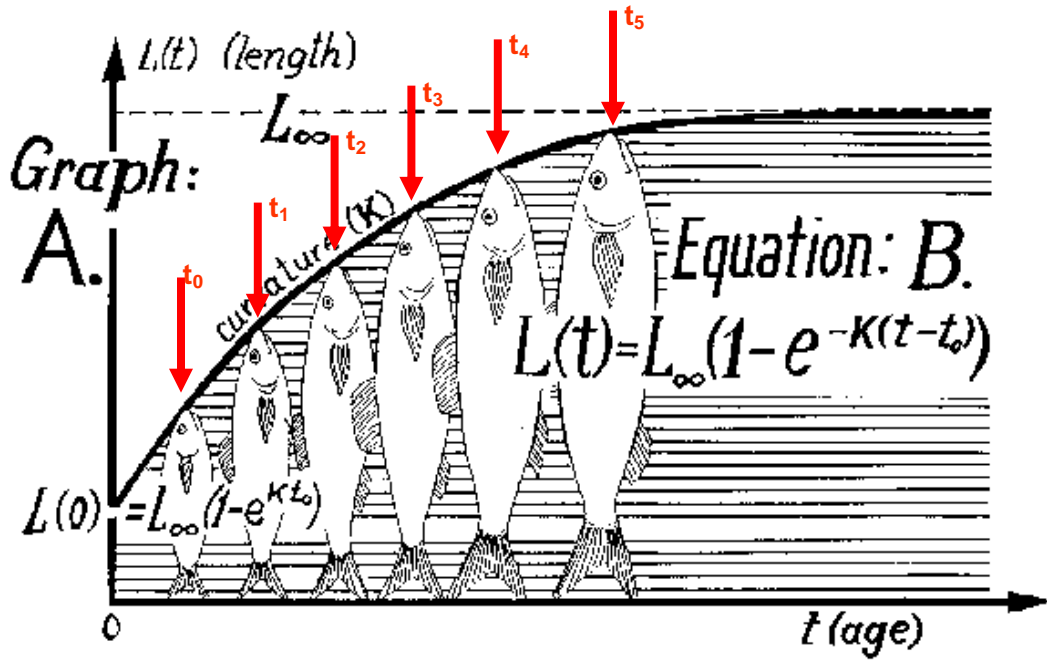

## Mortality

There are three methods typically used to introduce mortality rates into a production model such as the one used here, including:

- Applying natural or estimated mortality rates from the literature
- Empirically estimating mortality from year-to-year changes in the standing stock of specific populations
- Applying a size-dependent mortality rate to the standing stock estimated in each year of the model run

While there are some natural mortality rates in the literature, they are not directly applicable to the range of species found on the platforms. In addition, they are generally not size specific, requiring that a single mortality rate be applied to all size classes in the population. This would not reflect natural differences in mortality rate across size classes, in which smaller fish have higher mortality than larger, older fish. Empirically estimating mortality from actual year-to-year monitoring data provides a relevant estimate of the populations of direct interest. However, obtaining such consistently sampled data is problematic. In this case, gaps in sampling across platforms and strata meant that it would not have been possible to calculate mortality for each species within each stratum and for each platform. While these data gaps could have been filled with imputed data, this procedure would have involved statistical estimations that would have made the mortality estimates less empirical, thus lessening the value of the approach. Differences in the size and frequency of data gaps across species, strata, and platforms would have introduced an additional source of uncertainty since imputed estimates would necessarily differ in terms of the amount of data they were based on and the number of missing data points each imputed estimate was intended to replace. In addition, this approach assumes that missing fish have died when they have merely emigrated. Applying a size-dependent mortality rate to a starting population addresses some of these shortcomings in that it generates a complete dataset with no data gaps and captures the change in mortality rate with fishes' size. In addition, aggregating data from multiple sampling events allows for calculating standard errors which, in turn, provide a measure of uncertainty and the basis for estimating the potential range of mortality rates.

This third method was used for the modeling in this project and involved the following steps:

1. Estimate stock size and size distribution for each of 72 species within each stratum, using data from all eight platforms and all sampling events. While aggregating data in this fashion removes spatial and temporal detail, it has the benefit of producing a completely filled in data table with no missing values. This data table of stock sizes is the starting point for the model calculations
2. Apply a size- and species-specific mortality rate to the original standing stock for each species. This produces the starting point for the next iteration of the growth model

The technical description follows:

Annual natural mortality  $M(w)$  was estimated using a size dependent predation based mortality rate (Peterson and Wroblewski 1984):

$$M(w) = ckw^{-x}$$

Where  $M(w)$  was the annual expectation of death due to predation;  $c$  (1.22) is a constant based upon the predator prey size ratio;  $k$  (0.14) is growth efficiency;  $w$  is the dry weight of the fish estimated from a wet weight ratio of 0.2;  $x$  (0.25) is the weight exponent accounting for growth and metabolic rate. To be conservative, the annual mortality rate was used to adjust the stock size at the beginning of the yearly time period (as opposed to the end) prior to the estimate of somatic growth. In this model large fishes have low mortality and small fishes have high mortality. For instance, a cowcod at 587 mm TL had an annual mortality rate of 3.6%, while the rate for a small bocaccio (75 mm TL) was 16%. Annual mortality rates ranged from 2-26.5% depending upon fish size consistent with known estimates. The full set of mortality estimates calculated for each species and each year is provided in Appendix VII. Minimum and maximum estimates were based on standard errors obtained from averaging multiple sampling events to obtain the starting population for the model.

### **Recruitment (R)**

Recruitment is a critical life history stage for fishes and the strength of recruiting year classes can dramatically structure adult populations for many years. It is critical to know what the impacts of the various decommissioning options will have on fish recruitment because this will be an important factor in the long-term performance of these structures. On the platforms as in natural reefs, recruitment varies by depth and taxonomic category. Using scuba the following percentage of recruits by various shallow depths was reported (Love et al. 2003). Other than the warm water damselfishes, the greatest percentage of all taxa including all commercial and recreational species recruited primarily to a depth greater than 26 m. Due to safety concerns, scuba divers only survey to 36 m limiting the understanding of the entire platform's contribution to fish recruitment, especially rockfishes. Data for recruitment for submersible surveys were available for young-of-year (YOY) bocaccio (Table 1; Love et al. 2006) and are summarized below (Figure 4). In this study 99.5% of bocaccio recruited to a depth of 26 m or greater. As is the case with bocaccio, most rockfish primarily recruit below the partial removal depth of 26 m (Nishimoto et al. 2008).

For the production model, the recruitment term requires information pertaining to depth and density of recruitment. These data were available from the literature for bocaccio (Love et al. 2006). The shallowest density reported for YOY's in this study was at 25 m, while most YOY bocaccio recruited to the middle strata and some were present at the platform bases. Those reported at 26 m were included in the upper strata to be conservative. The grand mean YOY bocaccio density was calculated at all three depth strata as the overall average of the reported density values. These were: upper strata 80.5/100m<sup>2</sup>, middle strata 56.5/100m<sup>2</sup> and the bottom strata 61.8/100m<sup>2</sup>. Because the recruitment estimate is scaled to the surface area of the various depth strata, in the upper strata the density estimate was applied to only the bottom 2m. Otherwise, the recruitment biomass estimate would overestimate the total contribution of the strata. In addition, YOY bocaccio were only observed in the upper strata at platforms Grace and Gilda in the submersible surveys. A single year class was run through the model beginning at  $t_0$ . No other fishes were added to the recruitment component of the production model due to data availability. This is a conservative juvenile production estimate, because it is only using a single species and a single year class. The recruitment module followed the overall platform module with a starting size class of 75 mm TL.



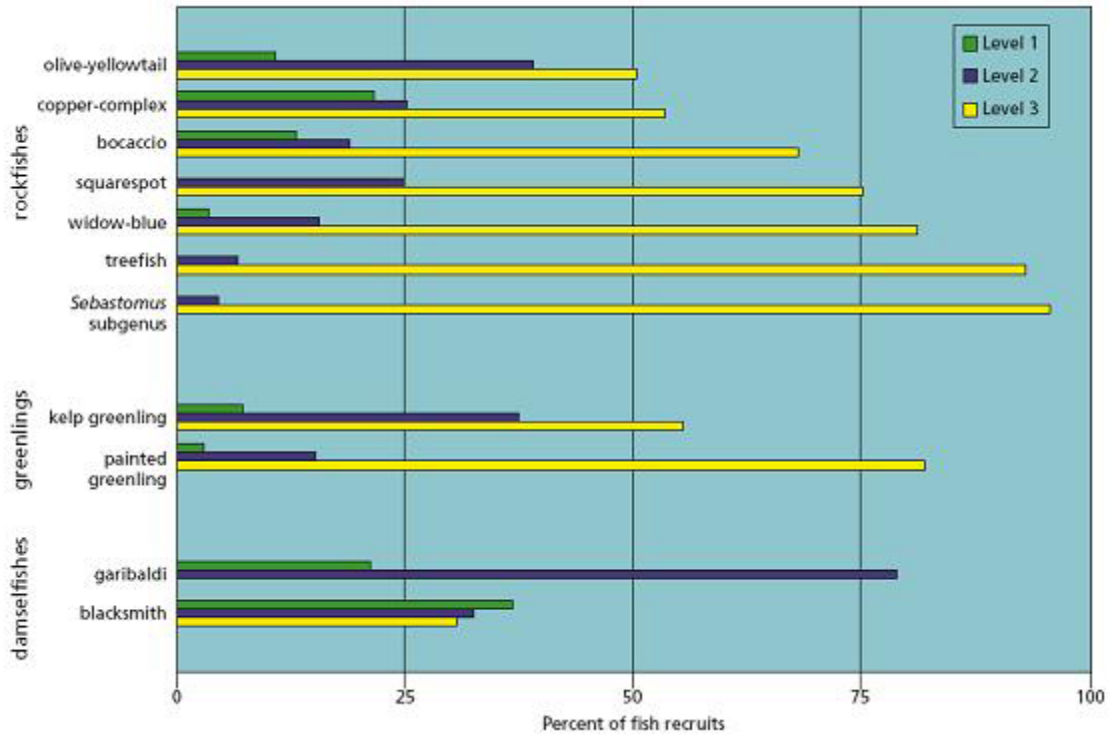

Figure 3. Percent of juvenile fish observed during scuba surveys at different depths on offshore platforms during 1995-2000. Depth ranges for each strata level 1 (6-12 m), level 2 (15-26 m), level 3 (27-36 m) (source Love et al. 2003).

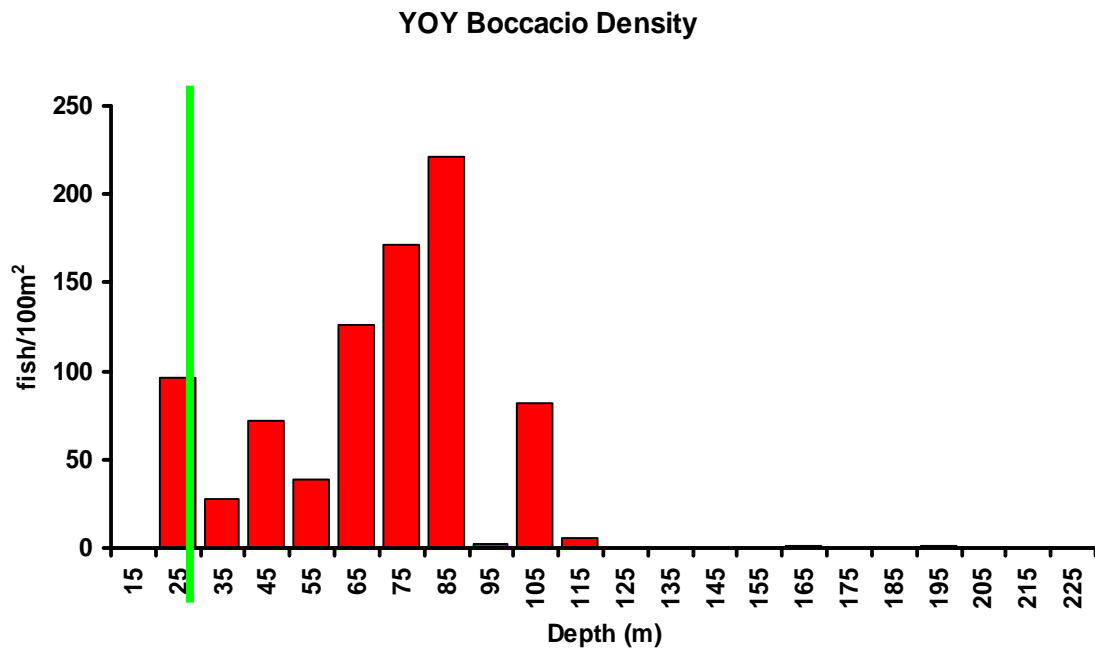

Figure 4. The mean YOY bocaccio density with depth. The green line is the cut off depth for the upper strata.

## Local Production Estimate

Eight platforms (Ellen, Eureka, Gail, Gilda, Grace, Hildago, Holly, and Irene) were used to estimate local production lost due to platform removal or cropping to 26 m. These were well studied platforms in terms of numbers of replicates per strata (Table 1) and years surveyed (Appendix I). In addition, these platforms represented the various depths, biogeographic zones and whether or not they were on the continental shelf, slope or basin. For Platform Hidalgo and Irene, upper strata data from Platform Harvest was used, which is proximate and located in a similar water depth. Total production  $Y'$  was calculated as the sum of somatic growth (G) adjusted for mortality and recruitment (R) and adjusted growth of the bocaccio cohort. The model was run for five years. Since production estimates were not calculated for all platforms, in Analytica users can choose to use these estimates for other platforms using Table 3. The standing stocks (B) at the beginning of the model run ( $t_0$ ) and mean TL are presented (Appendix II and IV). These biomass estimates were verified by comparison to previous estimates from the same platforms (Love et al. 1999; bottom strata only). While the current estimates are drawn from the same data set, they are calculated from a greater time series.

Estimates of mean standing stock for the eight platforms varied from 354 – 8297 kg per platform (Table 4, Figure 5). The platforms off Orange County, Eureka and Ellen, had the highest standing stocks (Table 4), which were fairly comparable despite the variation in depth (Eureka = 212 m, Ellen = 80 m). Both of these platforms had high biomass densities of widow rockfish (*Sebastes entomelas*), squarespot rockfish (*S. hopkinsi*) and blacksmith (*Chromis punctipinnis*, Appendix IV). Of the Santa Barbara Channel platforms, Holly and Grace had the highest biomass. Widow rockfish and bocaccio (*S. paucispinis*) had the highest biomass estimates at these platforms (Appendix IV). Since the bocaccio recruitment pulse was to surface area, its effect was related to size of the platform. At Platform Hidalgo, it accounted for 30% of the yield after the first year, and 19% of the first year's yield at Platform Gail.

Overall the growth (G) of adults was the largest contributor to the platform production (Table 4). This growth slowed or decreased overtime due to how fishes grow over time (Figure 2). As fishes mature and get larger their growth slows, as is evidenced by the flattening of the von Bertalanfy growth curve. Thus, as the model progresses through the years, fish size increases and the corresponding growth rates decrease. At platform Holly there were relatively large numbers of small fishes at the beginning of the model run, magnifying this effect by showing a steeper decline in growth over the five years studied. Similarly, the bocaccio recruitment pulse starts as an understandably small amount of biomass and then increases dramatically over the next five years (Figure 7). This increase in biomass is a result of the rapid growth rate prior to maturation. The relatively high mortality for the higher size classes is not enough to offset this growth.

Table 3. User defined production estimates for Analytica.

Platform	use platform
EDITH	ELLEN
ELLEN	ELLEN
ELLY	ELLEN
EMY	ELLEN
ESTHER	ELLEN
EUREKA	EUREKA
EVA	ELLEN
GAIL	GAIL
GILDA	GILDA
GINA	GILDA
GRACE	GRACE
HABITAT	HOLLY
HARMONY	HIDALGO
HARVEST	HIDALGO
HENRY	HOLLY
HERITAGE	HIDALGO
HERMOSA	HIDALGO
HIDALGO	HIDALGO
HILLHOUSE	HOLLY
HOGAN	HOLLY
HOLLY	HOLLY
HONDO	HIDALGO
HOUCHIN	HOLLY
IRENE	IRENE
PLATFORM A	HOLLY
PLATFORM B	HOLLY
PLATFORM C	HOLLY

Table 4. Starting total stock estimates (B), somatic growth (G), bocaccio recruitment biomass ( $R_0$ ) and recruitment growth ( $R_{1-5}$ ) for each platform in kilograms.

<b>Stock</b>	<b>B</b>	<b>G<sub>1</sub></b>	<b>G<sub>2</sub></b>	<b>G<sub>3</sub></b>	<b>G<sub>4</sub></b>	<b>G<sub>5</sub></b>
ELLEN	6843	2843	3260	3468	3508	3420
EUREKA	8297	2976	3211	3275	3208	3054
GAIL	1030	464	547	594	612	609
GILDA	386	182	203	209	204	193
GRACE	3208	1691	2119	2402	2542	2559
HIDALGO	354	179	215	223	211	189
HOLLY	4360	3338	3564	2411	1365	783
IRENE	942	552	687	764	789	774
<b>Recruitment</b>	<b>R<sub>0</sub></b>	<b>R<sub>1</sub></b>	<b>R<sub>2</sub></b>	<b>R<sub>3</sub></b>	<b>R<sub>4</sub></b>	<b>R<sub>5</sub></b>
ELLEN	32	17	36	52	66	76
EUREKA	161	87	185	264	333	387
GAIL	158	86	182	260	328	381
GILDA	21	11	24	34	43	50
GRACE	33	18	38	54	68	80
HIDALGO	99	54	114	162	204	238
HOLLY	23	12	26	38	47	55
IRENE	16	9	19	27	33	39
<b>Production (Y)</b>	<b>B + R</b>	<b>Y'<sub>1</sub></b>	<b>Y'<sub>2</sub></b>	<b>Y'<sub>3</sub></b>	<b>Y'<sub>4</sub></b>	<b>Y'<sub>5</sub></b>
ELLEN	6875	2860	3297	3520	3574	3496
EUREKA	8458	3063	3396	3539	3541	3441
GAIL	1188	550	729	855	940	990
GILDA	407	194	227	243	247	243
GRACE	3241	1709	2158	2457	2611	2639
HIDALGO	453	233	328	385	416	427
HOLLY	4383	3351	3590	2448	1413	839
IRENE	958	561	705	790	823	813

Figure 5. Standing stocks (B) in kilograms for eight Southern California oil platforms. Values represent mean values calculated across years (Table 4).

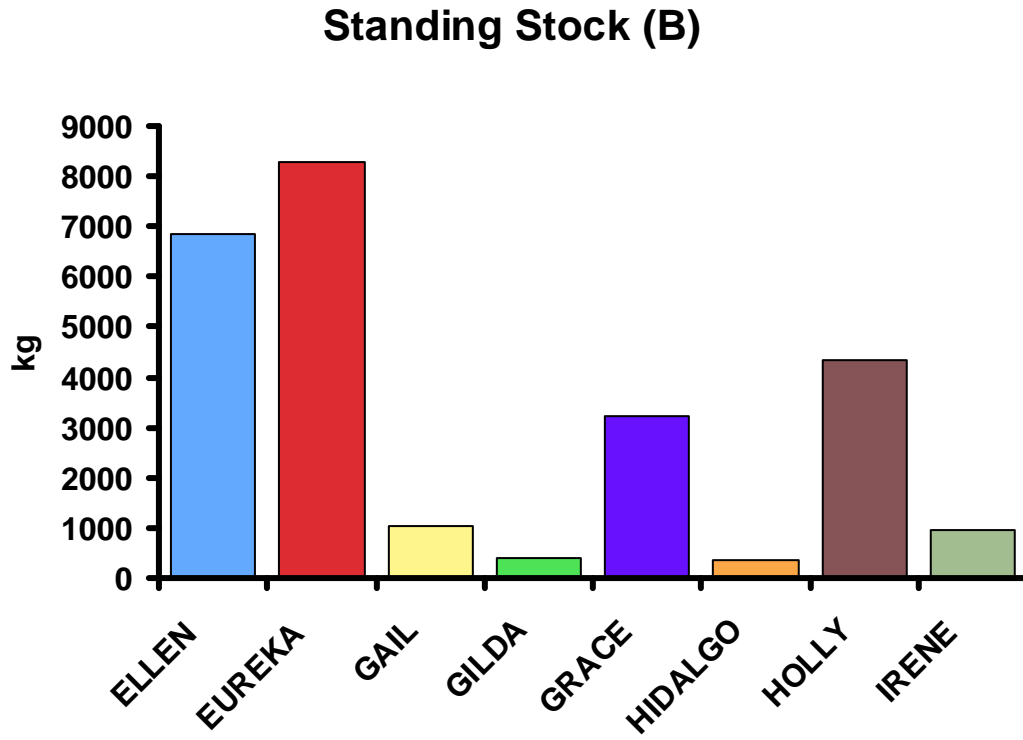

Figure 6. Somatic growth (G) in kilograms calculated over five-year intervals ( $t_{1-5}$ ) at eight Southern California Oil platforms.

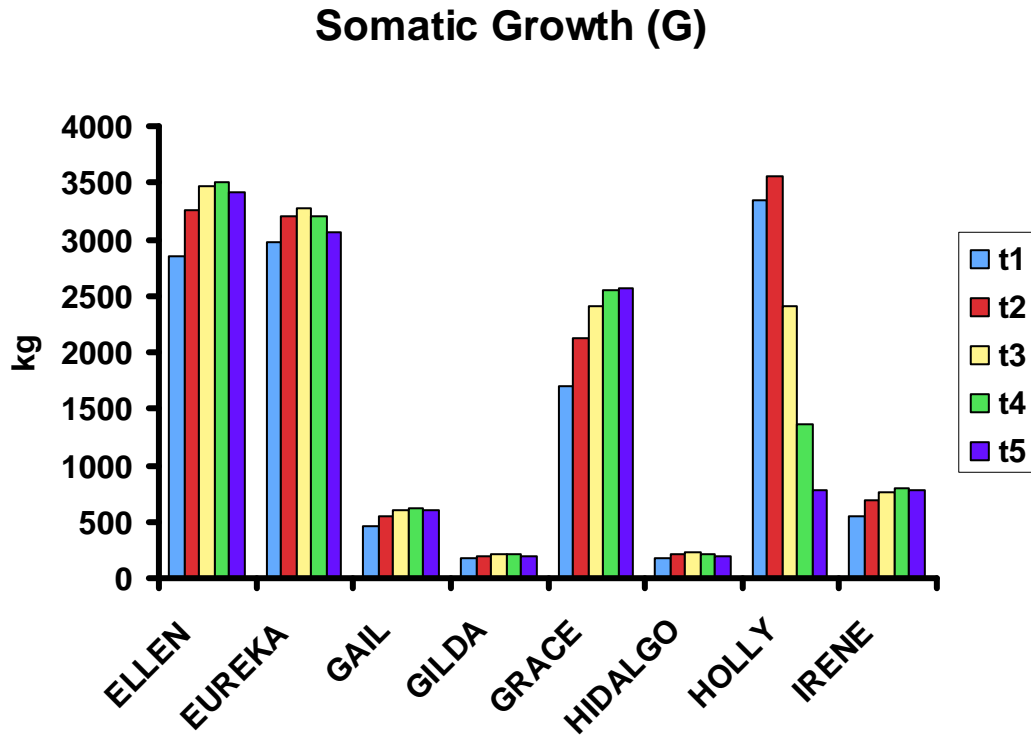

Figure 7. Bocaccio recruitment of YOYs (in kg) calculated over five years (R<sub>1</sub>-R<sub>5</sub>) at eight Southern California oil platforms.

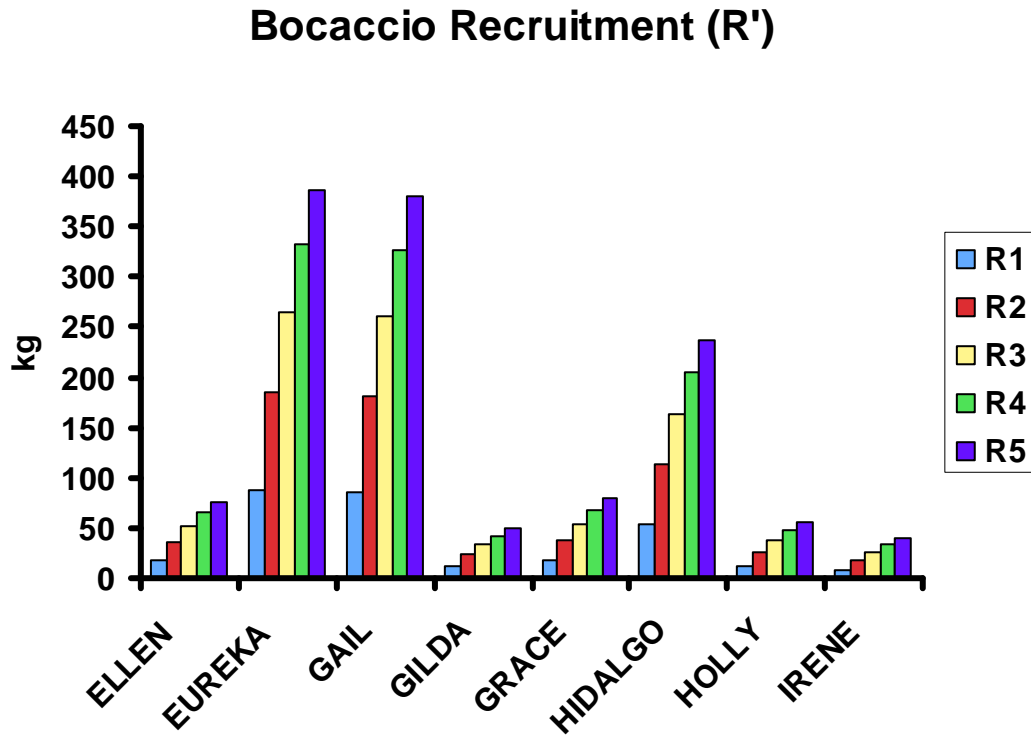



Table 5. Starting total stock estimates (B), somatic growth (Y'), recruitment biomass (R<sub>0</sub>) and recruitment growth (R<sub>1-5</sub>) for each platform in kilograms for eight topped Southern California Platforms.

<b>Stock</b>	<b>B<sub>adj</sub></b>	<b>G<sub>adj(1)</sub></b>	<b>G<sub>adj(1)</sub></b>	<b>G<sub>adj(1)</sub></b>	<b>G<sub>adj(1)</sub></b>	<b>G<sub>adj(1)</sub></b>
ELLEN	4799	2140	2413	2537	2533	2432
EUREKA	7269	2533	2713	2745	2668	2518
GAIL	974	432	508	550	565	561
GILDA	321	156	175	183	180	172
GRACE	2712	1518	1901	2147	2260	2261
HIDALGO	327	170	205	214	204	184
HOLLY	1232	760	816	640	471	368
IRENE	920	545	679	757	784	770
<b>Recruitment</b>	<b>R<sub>adj(0)</sub></b>	<b>R<sub>adj(1)</sub></b>	<b>R<sub>adj(2)</sub></b>	<b>R<sub>adj(3)</sub></b>	<b>R<sub>adj(4)</sub></b>	<b>R<sub>adj(5)</sub></b>
ELLEN	32	17	36	52	66	76
EUREKA	161	87	185	264	333	387
GAIL	158	86	182	260	328	381
GILDA	19	10	22	31	40	46
GRACE	32	17	37	52	66	76
HIDALGO	99	54	114	162	204	238
HOLLY	23	12	26	38	47	55
IRENE	16	9	19	27	33	39
<b>Production (Y)</b>	<b>B<sub>adj</sub> + R<sub>adj</sub></b>	<b>Y'<sub>adj(1)</sub></b>	<b>Y'<sub>adj(1)</sub></b>	<b>Y'<sub>adj(1)</sub></b>	<b>Y'<sub>adj(1)</sub></b>	<b>Y'<sub>adj(1)</sub></b>
ELLEN	4831	2157	2450	2589	2599	2509
EUREKA	7430	2620	2898	3010	3000	2905
GAIL	1133	518	690	811	893	942
GILDA	340	166	197	214	220	218
GRACE	2744	1536	1937	2199	2326	2337
HIDALGO	425	223	319	377	409	421
HOLLY	1255	773	842	677	518	423
IRENE	937	554	698	784	817	809

Figure 8. Standing stocks (B) and the adjusted standing stock ( $B_{adj}$ ) under the partial removal option at eight Southern California oil platforms.

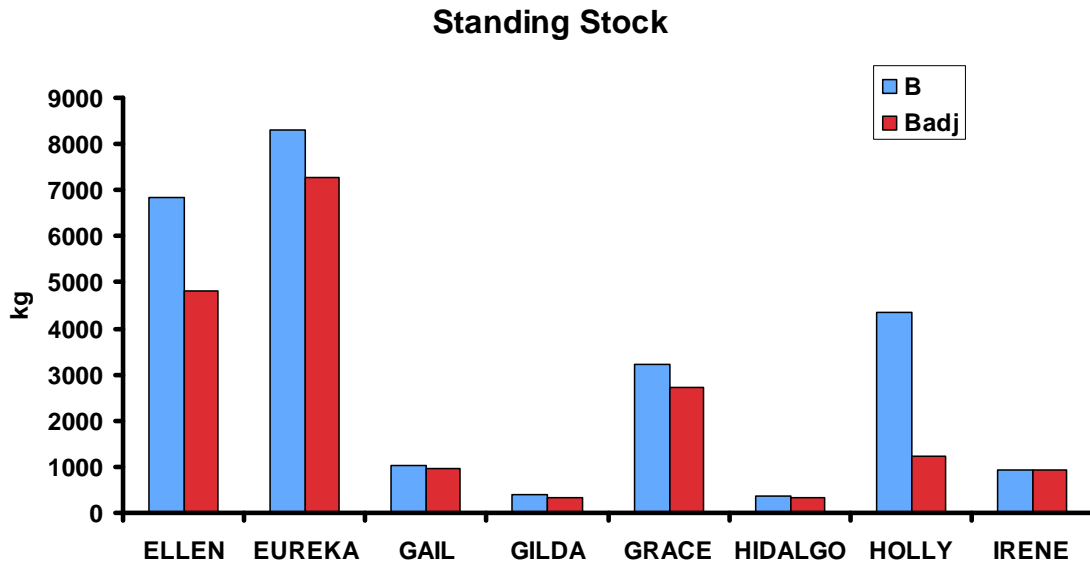

Figure 9. Bocaccio recruitment estimates (R), and adjusted recruitment ( $R_{adj}$ ) under the partial removal option at the end of year 1 for each platform in kilograms.

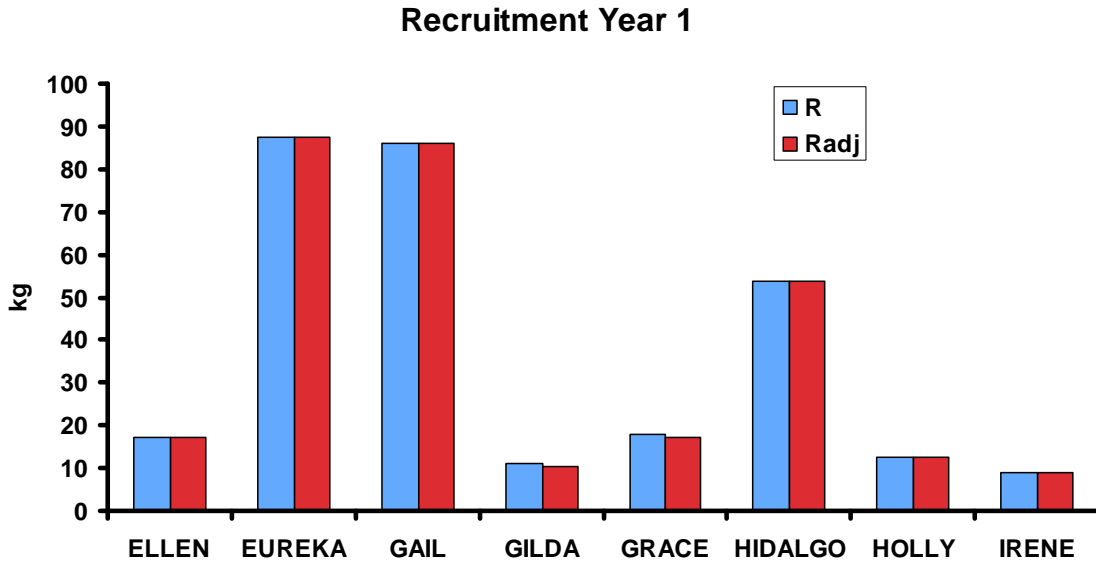
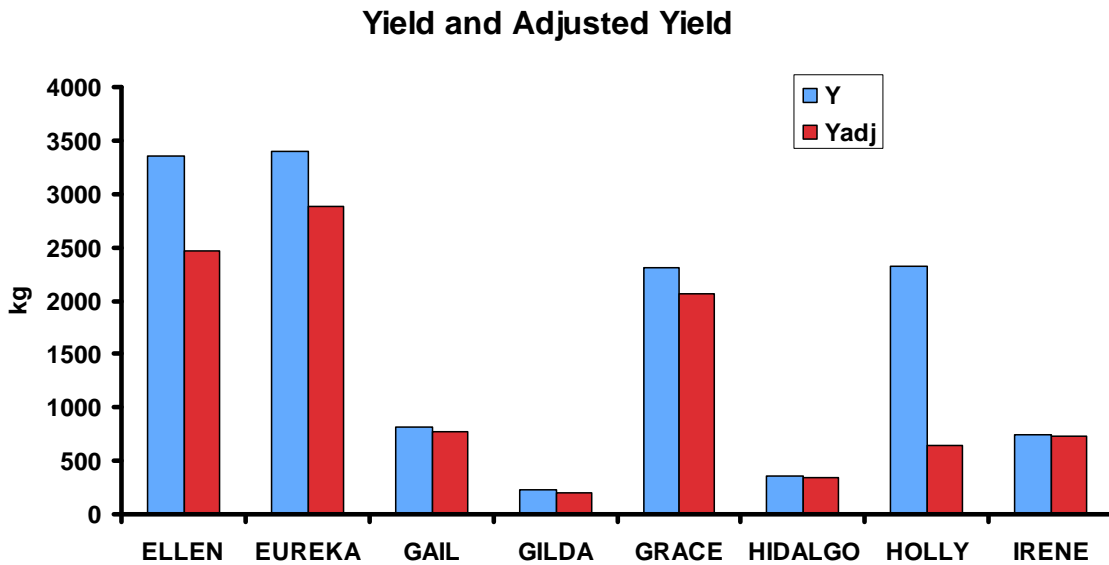

Figure 10. Mean yield ( $Y'$ ) and adjusted yield ( $Y'_{adj}$ ) in kilograms at Year 5 for all species modeled under the partial removal option for each platform.



Data Gaps.

1) A complete engineering evaluations of platform structural parameters (known parameters below)

<b>Platform</b>	<b># jacket legs</b>	<b>Main piles diameters (#/inches)</b>	<b># skirt piles</b>	<b>diam skirt piles (inches)</b>	<b>#conductors</b>	<b>Depth (m)</b>	<b>Footprint (m<sup>2</sup>)</b>	<b>Surface Area (m<sup>2</sup>)</b>	<b>Volume (m<sup>3</sup>)</b>
Edith	12	54	0		23	49	2879	17,217	102,216
Ellen	8	4/66 & 4/48	0		64	80	2511	27,861	
Elly	12	2/42 & 10/48	0		0	80	2949	14,427	
Emmy						14			
Esther									
Eureka	8	0	24	60	60	212	4635	108,954	
Eva						17	669	4555	11,633
Gail	8	60	12	72	22	224	5327	106,497	1,198,176
Gilda	12	48	0		64	62	2342	19,501	132,800
Gina	6	42	0		12	29	561	3406	16,414
Grace	12	42	8	48	35	96	3090	25,862	244,196
Habitat	8				20	88	2284	26,731	139,872
Harmony	8	72	20	84	51	363	10606		
Harvest	8	60	20	72	21	205	5859	79,173	444,720
Henry	8	42	0		24	52	1505	8,577	50,403
Heritage	8	72	26	84	49	326			
Hermosa	8	60	12	72	16	184	5142	85,158	944,097
Hidalgo	8	60	8	72	10	130	4154	73,339	564,086
Hillhouse	8		0		52	58			
Hogan	12	36	0		40	47	1435	8,190	68,350
Holly						66			21,515
Hondo	8	48	12	54	28	255	4649	67,091	514,210
Houchin	8	36?	0		36	49	1435	8,190	68,350
Irene	8	60	0		24	73	2633	14,874	192,793
Platform A	12	40	0		55	58	1930	16,111	80,541
Platform B	12	40?	0		55	58	1930	16,111	80,541
Platform C	12	40?	0		43	58	1930	16,111	80,541

2) More surveys of platforms.

Studied Platforms and strata.

Platform	bottom	middle	upper
EDITH	X	X	X
ELLEN	X	X	X
ELLY	X	X	X
Emy			
Esther			
EUREKA	X	X	X
Eva			
GAIL	X	X	X
GILDA	X	X	X
Gina			
GRACE	X	X	X
Habitat		X	X
HARMONY	X	X	
HARVEST	X	X	X
Henry		X	X
Heritage		X	
HERMOSA	X	X	
HIDALGO	X	X	
Hillhouse		X	X
HOGAN		X	X
HOLLY	X	X	X
HONDO	X	X	X
Houchin		X	X
IRENE	X	X	
Platform A		X	X
Platform B		X	X
Platform C		X	X

3) Fish species in biological model without known von Bertalanffy growth parameters.

*Anarrhichthys ocellatus*  
*Chromis punctipinnis*  
*Cryptotrema corallinum*  
*Enophrys taurina*  
*Hypsypops rubicundus*  
*Lythrypnus dalli*  
*Oxyjulis californica*  
*Phanerodon atripes*  
*Pronotoqrammus multifasciatus*  
*Pseudopriacanthus serrula*  
*Rathbunella alleni*  
*Rathbunella hypoplecta*  
*Rhacochilus vacca*  
*Rhinogobiops nicholsii*  
*Sebastes aurora*  
*Sebastes babcocki*  
*Sebastes dallii*  
*Sebastes eos*  
*Sebastes lentiginosus*  
*Sebastes macdonaldi*  
*Sebastes moseri*  
*Sebastes rubrivinctus*  
*Sebastes rufinanus*  
*Sebastes simulator*  
*Sebastes wilsoni*  
*Sebastes zacentrus*  
*Sebastolobus alascanus*  
*Zalembeius rosaceus*

Appendix I. Survey periods and depth strata for submersible fish transects, 1996-2008.

Platform	1996			1997			1998			1999			2000			2001			2002	
	bottom	middle	upper	bottom	middle	upper	bottom	middle	upper	bottom	middle	upper	bottom	middle	upper	bottom	middle	upper	bottom	middle
A												X	X							
B												X	X							
C												X								
EDITH							X	X	X											
ELLEN																				
ELLY																				
EUREKA																				
GAIL	X	X		X	X		X		X	X	X	X		X	X	X		X	X	
GILDA														X	X		X	X		
GRACE	X	X		X	X		X		X	X	X	X	X	X	X	X		X	X	
HABITAT													X	X			X	X		
HARMONY																				
HARVEST		X		X	X	X	X		X	X	X	X								
HENRY													X	X						
HERITAGE																				
HERMOSA	X	X		X	X	X	X		X	X	X	X								
HIDALGO	X	X		X	X	X	X		X	X	X	X			X	X				
HILLHOUSE													X	X						
HOGAN													X	X						
HOLLY	X	X	X	X	X	X	X		X						X	X				
HONDO																				
HOUCHIN													X	X						
IRENE	X	X		X	X	X	X		X	X	X	X			X	X				

Platform	2003			2004			2005			2006			2007			2008		
	bottom	middle	upper	bottom	middle	upper	bottom	middle	upper	bottom	middle	upper	bottom	middle	upper	bottom	middle	upper
A		X	X		X	X					X			X	X			
B		X	X		X	X								X	X			
C		X	X		X	X								X	X			
EDITH							X	X		X	X	X	X	X	X	X	X	X
ELLEN							X	X		X	X	X	X	X	X	X	X	X
ELLY							X	X	X	X	X	X						
EUREKA							X	X		X	X		X	X	X			
GAIL	X	X		X	X	X	X	X		X	X	X	X	X		X	X	
GILDA	X	X	X	X	X	X					X		X	X	X	X	X	X
GRACE	X	X	X	X	X		X	X	X				X	X		X	X	
HABITAT					X	X								X	X			
HARMONY				X	X													
HARVEST				X	X	X												
HENRY					X	X												
HERITAGE																		X
HERMOSA				X					X	X								
HIDALGO				X	X		X	X		X	X							
HILLHOUSE		X	X		X	X								X	X			
HOGAN																		
HOLLY	X	X		X	X	X	X	X	X	X	X		X	X	X	X	X	X
HONDO				X	X	X				X	X					X	X	
HOUCHIN																		
IRENE				X	X		X	X		X	X					X	X	

Appendix II. Mean total length of fishes by strata (b = bottom, m = midwater, u = upper) used in production model.

Taxa	ELLEN			EUREKA			GAIL			GILDA		
	b	m	u	b	m	u	b	m	u	b	m	u
<i>Anarrhichthys ocellatus</i>	1400											
<i>Chromis punctipinnis</i>		164	64		183	113		89	63	150		108
<i>Enophrys taurina</i>												
<i>Girella nigricans</i>												300
<i>Hexagrammos decagrammus</i>								100		200	150	
<i>Hypsypops rubicundus</i>			188		186	200						
<i>Ophiodon elongatus</i>	683	400		589			589			203	200	
<i>Oxyjulis californica</i>												250
<i>Oxylebius pictus</i>	181	98			117		175	92		144	99	120
<i>Paralabrax clathratus</i>									250		300	360
<i>Paralichthys californicus</i>										250		
<i>Phanerodon atripes</i>	175	204									103	
<i>Phanerodon furcatus</i>										150	100	
<i>Phanerodon sp.</i>	188											200
<i>Pronotogrammus multifasciatus</i>	200											
<i>Pseudopriacanthus serrula</i>					100							
<i>Rathbunella alleni</i>	163											
<i>Rathbunella hypoplecta</i>	200									150		
<i>Rathbunella sp.</i>	200									220		
<i>Rhacochilus vacca</i>	250	300								226	229	300
<i>Rhinogobiops nicholsii</i>	100				50							
<i>Scorpaena guttata</i>	188									250		
<i>Scorpaenichthys marmoratus</i>	536	450			348			261		178	195	200
<i>Sebastes atrovirens</i>	300	292	300		228					190	300	273
<i>Sebastes auriculatus</i>	250									244		
<i>Sebastes babcocki</i>							300					
<i>Sebastes carnatus</i>		217			218			150		150		
<i>Sebastes caurinus</i>	304	320			231			225		187	139	100
<i>Sebastes chlorostictus</i>				275	242		218	183		100		
<i>Sebastes constellatus</i>	264	50			150		200			133	50	
<i>Sebastes crameri</i>					200		300	150				
<i>Sebastes dallii</i>	151									144	50	
<i>Sebastes elongatus</i>							207					
<i>Sebastes ensifer</i>	133				143		167	125				
<i>Sebastes entomelas</i>	200	172			278		433	93		200	235	
<i>Sebastes eos</i>							330	150				
<i>Sebastes flavidus</i>												
<i>Sebastes goodei</i>							231	200		100	100	
<i>Sebastes helvomaculatus</i>				200	233		250					
<i>Sebastes hopkinsi</i>	132	112			119			85		100	57	50
<i>Sebastes jordani</i>	100				96			125			105	
<i>Sebastes lentiginosus</i>	164				145							
<i>Sebastes levis</i>				588			522					
<i>Sebastes macdonaldi</i>							497					



Appendix II. continued.

Taxa	ELLEN			EUREKA			GAIL			GILDA		
	b	m	u	b	m	u	b	m	u	b	m	u
<i>Sebastes melanostomus</i>						250						
<i>Sebastes miniatus</i>	352			430	350		450			166		
<i>Sebastes moseri</i>								142				
<i>Sebastes mystinus</i>	200	170			217			133			200	
<i>Sebastes ovalis</i>					163			100				
<i>Sebastes paucispinis</i>	256	191		408	216		434	169		200	198	174
<i>Sebastes pinniger</i>	400									181		
<i>Sebastes rastrelliger</i>					275							300
<i>Sebastes rosaceus</i>	188				203					131		50
<i>Sebastes rosenblatti</i>	350			319	246		275	175				
<i>Sebastes ruberrimus</i>					250			100		150		
<i>Sebastes rubrivinctus</i>	187			230	172		208	124		133		
<i>Sebastes rufinanus</i>					75							
<i>Sebastes rufus</i>				200	213		500	150				
<i>Sebastes saxicola</i>							136				100	
<i>Sebastes semicinctus</i>	140	100						50		101		
<i>Sebastes serranoides</i>	225							167		218	219	
<i>Sebastes serriceps</i>	233	50			200			50		100	75	
<i>Sebastes simulator</i>				196	178		198	172				
<i>Sebastes spp.</i>	52	51	50		67		240	93		136	59	
<i>Sebastes umbrosus</i>	182				172							
<i>Sebastes wilsoni</i>					117							
<i>Sebastes zacentrus</i>					100		200	125				
<i>Sebastolobus alascanus</i>												
<i>Semicossyphus pulcher</i>		272	476		225	260						
<i>Trachurus symmetricus</i>			150									
<i>unknown sebastomus</i>	188	50		171	159		220	120		150	50	
<i>Zalemnius rosaceus</i>	150									166		

Appendix II. continued.

Taxa	GRACE			HIDALGO			HOLLY			IRENE		
	b	m	u	b	m	u	b	m	u	b	m	u
<i>Anarrhichthys ocellatus</i>				500						1000		
<i>Chromis punctipinnis</i>		251	233					158	121		50	
<i>Enophrys taurina</i>							133					
<i>Girella nigricans</i>												
<i>Hexagrammos decagrammus</i>	281	250		200	160		311	350		229	200	
<i>Hypsypops rubicundus</i>												
<i>Ophiodon elongatus</i>	267	219		376			253	219		224	190	
<i>Oxyjulius californica</i>												
<i>Oxylebius pictus</i>	170	91	139	121	82	120	157	80	108	161	102	120
<i>Paralabrax clathratus</i>												
<i>Paralichthys californicus</i>												
<i>Phanerodon atripes</i>		140					153	167	244	238		
<i>Phanerodon furcatus</i>		200										
<i>Phanerodon sp.</i>							202	200	150	233		
<i>Pronotogrammus multifasciatus</i>												
<i>Pseudopriacanthus serrula</i>												
<i>Rathbunella alleni</i>							200					
<i>Rathbunella hypoplecta</i>							194	163				
<i>Rathbunella sp.</i>	200						173	150		150		
<i>Rhacochilus vacca</i>							281	277	280	240	205	
<i>Rhinogobiops nicholsii</i>							72	61		83		
<i>Scorpaena guttata</i>							220					
<i>Scorpaenichthys marmoratus</i>		200			150	250			233		200	250
<i>Sebastes atrovirens</i>		304	308			300	267	249	256	250		300
<i>Sebastes auriculatus</i>		150					272	256		347		
<i>Sebastes babcocki</i>												
<i>Sebastes carnatus</i>							218	194		180		
<i>Sebastes caurinus</i>	260	242			100		220	196		215	216	
<i>Sebastes chlorostictus</i>	216	180		202	100		200			125		
<i>Sebastes constellatus</i>	250	75		217			125			56		
<i>Sebastes crameri</i>				150								
<i>Sebastes dallii</i>	190	100					150	145		150		
<i>Sebastes elongatus</i>	250			175								
<i>Sebastes ensifer</i>	200	125		127								
<i>Sebastes entomelas</i>	160	142		200	98		108	182		93	118	
<i>Sebastes eos</i>	300											
<i>Sebastes flavidus</i>	250	59	50		100		218	50		216	99	
<i>Sebastes goodei</i>	200	200					150					
<i>Sebastes helvomaculatus</i>												
<i>Sebastes hopkinsi</i>	161	98		115	99	75	112	117		55	50	75
<i>Sebastes jordani</i>	200			100							100	
<i>Sebastes lentiginosus</i>												
<i>Sebastes levis</i>		150		264			75					
<i>Sebastes macdonaldi</i>												
<i>Sebastes melanostomus</i>												
<i>Sebastes miniatus</i>	272	400		370			219	175		242		

Appendix II. continued.

Taxa	GRACE			HIDALGO			HOLLY			IRENE		
	b	m	u	b	m	u	b	m	u	b	m	u
<i>Sebastes moseri</i>	175	208										
<i>Sebastes mystinus</i>	240	131	300			150	268	171	100	228	209	150
<i>Sebastes ovalis</i>												
<i>Sebastes paucispinis</i>	228	151	100	390	106		160	130		211	152	
<i>Sebastes pinniger</i>	282			391			198			233	50	
<i>Sebastes rastrelliger</i>												
<i>Sebastes rosaceus</i>	201	200		169			146	168		112		
<i>Sebastes rosenblatti</i>	250			236								
<i>Sebastes ruberrimus</i>	200			262			100	50		130		
<i>Sebastes rubrivinctus</i>	187	141		211	85		138	133		150	50	
<i>Sebastes rufinanus</i>												
<i>Sebastes rufus</i>				200								
<i>Sebastes saxicola</i>				100								
<i>Sebastes semicinctus</i>	171			119	129		129	79		115		
<i>Sebastes serranoides</i>	225	53					201	191	200	218	200	
<i>Sebastes serriceps</i>	190	125				50	203	163		150		50
<i>Sebastes simulator</i>	175											
<i>Sebastes spp.</i>	73	77	50	81	70	200	67	54	50	52	87	200
<i>Sebastes umbrosus</i>							162	175		200		
<i>Sebastes wilsoni</i>				140	100							
<i>Sebastes zacentrus</i>				140								
<i>Sebastolobus alascanus</i>							150					
<i>Semicossyphus pulcher</i>												
<i>Trachurus symmetricus</i>		200						158	150			
<i>unknown sebastomus</i>	205	122		156	85		116	90		104	81	
<i>Zalambius rosaceus</i>	161						168	50				

Appendix III. Scientific name, common name, conversion parameters, primary reference and/or species proxy for all fishes observed on the Southern California oil platforms.

Scientific name	common name	a (TL)	b (TL)	Reference
<i>Anarrhichthys ocellatus</i>	wolf-eel	0.00000503	3.091	RecFin
<i>Argentina sialis</i>	Pacific argentine	0.00005566	2.59	<i>Atherinops affinis</i> (RecFin)
<i>Careproctus melanurus</i>	blacktail snailfish	0.000000112	3.42744	<i>Gymnothorax mordax</i> (Quast 1968)
<i>Chilara taylori</i>	spotted cusk-eel	0.000000112	3.42744	<i>Gymnothorax mordax</i> (Quast 1968)
<i>Chromis punctipinnis</i>	blacksmith	0.000291	2.4964	RecFin
<i>Citharichthys sordidus</i>	Pacific sanddab	0.00000143	3.3708	RecFin
<i>Citharichthys sp.</i>	unknown sanddab	0.00000143	3.3708	<i>C. sordidus</i> (RecFin)
<i>Cryptotrema corallinum</i>	deepwater kelpfish	0.00001*	3.0512*	RecFin
<i>Cymatogaster aggregata</i>	shiner surfperch	0.000006	3.1813	<i>Alloclinus holderi</i> (VRG)
<i>Engraulis mordax</i>	northern anchovy	0.0000056	2.984	RecFin
<i>Enophrys taurina</i>	bull sculpin	0.0000179	2.896	<i>Leptocottus armatus</i> (RecFin)
<i>Errex zachirus</i>	rex sole	0.000000241	3.555	RecFin
<i>Girella nigricans</i>	opaleye	0.0000145	3.0492	RecFin
<i>Hexagrammos decagrammus</i>	kelp greenling	0.000026	2.8928	RecFin
<i>Hydrolagus collieri</i>	spotted ratfish	0.00000631	2.97	RecFin
<i>Hypsypops rubicundus</i>	garibaldi	0.000036*	3.18	Quast 1968 (tl-sl equation, VRG)
<i>Icelinus spp.</i>	Icelinus sculpins	0.0000358	2.9	<i>Hemilepidotus spinosus</i> (RecFin)
<i>Leuroglossus stilbius</i>	CA smoothtongue	0.00005566	2.59	<i>Atherinops affinis</i> (RecFin)
<i>Lycodes pacificus</i>	blackbelly eelpout	0.000000112	3.42744	<i>Gymnothorax mordax</i> (Quast 1968)
<i>Lyconema barbatum</i>	bearded eelpout	0.000000112	3.42744	<i>Gymnothorax mordax</i> (Quast 1968)
<i>Lyopsetta exilis</i>	slender sole	0.000000241	3.555	<i>Glyptocephalus zachirus</i> (RecFin)
<i>Lythrypnus dalli</i>	bluebanded goby	0.00002*	2.9624*	VRG
<i>Medialuna californiensis</i>	halfmoon	0.0000737	2.7338	RecFin
<i>Merluccius productus</i>	Pacific hake	0.00000633	3.03	RecFin
<i>Microstomus pacificus</i>	dover sole	0.000000241	3.555	RecFin
<i>Mola mola</i>	ocean sunfish	454	3.05	Martin 2008**
<i>Ophiodon elongatus</i>	lingcod	0.0000116	2.99	RecFin
<i>Oxyjulis californica</i>	senorita	0.0000045	3.16	RecFin
<i>Oxylebius pictus</i>	painted greenling	1.8155E-06	3.384	DeMartini and Anderson 1980
<i>Paralabrax clathratus</i>	kelp bass	0.00000272	3.27	RecFin
<i>Paralichthys californicus</i>	California halibut	0.00000849	3.033	RecFin
<i>Phanerodon atripes</i>	sharpnose surfperch	0.0000137	2.98	RecFin
<i>Phanerodon furcatus</i>	white surfperch	0.0000137	2.978	RecFin
<i>Phanerodon spp.</i>	Surfperch spp.	0.0000137	2.978	<i>Phanerodon furcatus</i> (RecFin)
<i>Platichthys stellatus</i>	starry flounder	0.00000163	3.34	RecFin
<i>Plectobranthus evides</i>	bluebarred prickleback	0.000000112	3.42744	<i>Gymnothorax mordax</i> (Quast 1968)
<i>Pleuronectes vetulus</i>	English sole	0.0000946	2.589	RecFin
<i>Pleuronichthys coenosus</i>	C-O turbot	0.00000956	3.19554	RecFin
<i>Pleuronichthys verticalis</i>	hornyhead turbot	0.00000282	3.3	RecFin
<i>Pronotogrammus multifasciatus</i>	threadfin bass	0.00000521	3.1541	<i>Sebastes serranoides</i> (RecFin)
<i>Pseudopriacanthus serrula</i>	popeye catalufa	0.0000322	2.9084	<i>Rhacochilus toxotes</i> (RecFin)
<i>Raja sp.</i>	unknown skate	0.0000243	2.8549	<i>Raja binoculata</i> (RecFin)
<i>Rathbunella alleni</i>	stripefin ronquil	0.00003*	2.7544*	VRG

Appendix III. continued.

<i>Rathbunella hypoplecta</i>	Bluebanded ronquil	0.00003*	2.7544*	<i>Rathbunella alleni</i> (VRG)
<i>Rathbunella</i> sp.	unknown ronquil	0.00003*	2.7544*	<i>Rathbunella alleni</i> (VRG)
<i>Rhacochilus vacca</i>	pile perch	0.00000926	3.099	RecFin
<i>Rhinogobiops nicholsii</i>	blackeye goby	0.000006*	3.2822*	VRG
<i>Sardinops sagax</i>	Pacific sardine	0.0000032	3.15	RecFin
<i>Scliorhinidae</i>	catshark	0.0000209	2.88	<i>Triakis semifasciata</i> (RecFin)
<i>Scomber japonicus</i>	Pacific mackerel	0.00000137	3.3936	RecFin
<i>Scorpaena guttata</i>	spotted scorpionfish	0.0000141	3.063	RecFin
<i>Scorpaenichthys marmoratus</i>	cabezon	0.0000882	2.7203	RecFin
<i>Sebastes atrovirens</i>	Kelp rockfish	0.0000328	2.862	RecFin
<i>Sebastes auriculatus</i>	brown rockfish	0.000026	2.9336	RecFin
<i>Sebastes aurora</i>	aurora rockfish	0.0000244	2.832	Wilkins 1998
<i>Sebastes babcocki</i>	redbanded rockfish	0.0000235	2.9431	RecFin
<i>Sebastes carnatus</i>	gopher rockfish	0.0000205	2.9573	RecFin
<i>Sebastes caurinus</i>	copper rockfish	0.0000165	3.018	RecFin
<i>Sebastes chlorostictus</i>	greenspotted rockfish	0.0000205	2.9573	RecFin
<i>Sebastes constellatus</i>	Starry rockfish	0.00000531	3.195	RecFin
<i>Sebastes crameri</i>	darkblotched rockfish	0.0000295	2.824	Wilkins 1998
<i>Sebastes dallii</i>	calico rockfish	0.00000443	3.182	RecFin
<i>Sebastes diploproa</i>	splitnose rockfish	0.00000284	3.2438	RecFin
<i>Sebastes elongatus</i>	greenstriped rockfish	0.00000476	3.1531	RecFin
<i>Sebastes ensifer</i>	swordspine rockfish	0.00000446	3.2565	RecFin
<i>Sebastes entomelas</i>	widow rockfish	0.00000291	3.2543	RecFin
<i>Sebastes eos</i>	pink rockfish	0.0000205	2.9573	RecFin
<i>Sebastes flavidus</i>	yellowtail rockfish	0.0000113	3.0402	RecFin
<i>Sebastes goodei</i>	chilipepper	0.00000284	3.2438	RecFin
<i>Sebastes helvomaculatus</i>	rosethorn rockfish	0.0000168	2.9943	RecFin
<i>Sebastes hopkinsi</i>	squarespot	0.00000324	3.2505	RecFin
<i>Sebastes jordani</i>	shortbelly rockfish	0.00000388	3.16	RecFin
<i>Sebastes lentiginosus</i>	freckled rockfish	0.0000058	3.1969	RecFin
<i>Sebastes levis</i>	cowcod	0.0000185	2.9807	RecFin
<i>Sebastes macdonaldi</i>	Mexican rockfish	0.0000966	2.664	RecFin
<i>Sebastes melanops</i>	black rockfish	0.0000197	2.9548	RecFin
<i>Sebastes melanostomus</i>	blackgill rockfish	0.0000122	3.042	<i>S. umbrosus</i> (RecFin)
<i>Sebastes miniatus</i>	vermilion rockfish	0.0000268	2.9165	RecFin
<i>Sebastes moseri</i>	Moser's rockfish	0.00000521	3.1541	<i>S. serranoides</i> (RecFin)
<i>Sebastes mystinus</i>	blue rockfish	0.0000162	2.9884	RecFin
<i>Sebastes ovalis</i>	speckled rockfish	0.00000324	3.2505	RecFin
<i>Sebastes paucispinis</i>	bocaccio	0.00000583	3.0941	RecFin
<i>Sebastes pinniger</i>	canary rockfish	0.0000105	3.0556	RecFin
<i>Sebastes rastrelliger</i>	grass rockfish	0.00000576	3.235	RecFin
<i>Sebastes rosaceus</i>	rosy rockfish	0.0000168	2.9943	RecFin
<i>Sebastes rosenblatti</i>	greenblotched rockfish	0.0000205	2.957	RecFin
<i>Sebastes ruberrimus</i>	yelloweye rockfish	0.000013	3.0571	RecFin
<i>Sebastes rubrivinctus</i>	flag rockfish	0.0000235	2.9431	RecFin
<i>Sebastes rufinanus</i>	dwarf-red rockfish	0.00000284	3.2438	<i>S. diploproa</i> (RecFin)
<i>Sebastes rufus</i>	bank rockfish	0.0000186	2.9605	RecFin
<i>Sebastes saxicola</i>	stripetail rockfish	0.00000707	3.1201	RecFin

Appendix III. continued.

<i>Sebastes semicinctus</i>	halfbanded rockfish	0.00000443	3.182	RecFin
<i>Sebastes serranoides</i>	olive rockfish	0.00000521	3.1541	RecFin
<i>Sebastes serriceps</i>	treefish	0.012404	1.89	RecFin
<i>Sebastes simulator</i>	pinkrose rockfish	0.0000168	2.9943	RecFin
<i>Sebastes spp</i>	unknown rockfishes	0.00000443	3.182	<i>S. semicinctus</i> (RecFin)
<i>Sebastes umbrosus</i>	Honeycomb rockfish	0.0000058	3.1969	RecFin
<i>Sebastes wilsoni</i>	pygmy rockfish	0.00000388	3.16	<i>S. jordani</i> (RecFin)
<i>Sebastes zacentrus</i>	sharpchin rockfish	0.0000113	3.07	Martin 1997 (FL)
<i>Sebastolobus alascanus</i>	shortspine thornyhead	0.0000141	3.063	RecFin
<i>Sebastolobus spp.</i>	thornyheads	0.0000141	3.063	<i>Sebastalobus alascanus</i> (RecFin)
<i>Semicossyphus pulcher</i>	Sheephead	0.0000295	2.9066	RecFin
<i>Squalus acanthias</i>	spiny dogfish	0.00000189	3.09	RecFin
<i>Symphurus atricauda</i>	California tonguefish	0.00000266	3.2953	<i>Citharichthys stigmaeus</i> (RecFin)
<i>Synodus lucioceps</i>	California lizardfish	0.00000331	3.16	RecFin
<i>Torpedo californica</i>	pacific electric ray	0.0007348	2.778	Miller 2008
<i>Trachurus symmetricus</i>	jack mackerel	0.00000331	3.2232	RecFin
<i>unknown agonidae</i>	poachers	1.64E-08	3.95516	<i>Syngnathus leptorhynchus</i> (Quast 1968 <sup>***</sup> )
<i>unknown sebastomus</i>	Sebastomus	0.0000058	3.1969	<i>S. umbrosus</i> (RecFin)
<i>Zalambius rosaceus</i>	pink seaperch	0.0000137	2.98	VRG
<i>Zaniolepis frenata</i>	shortspine combfish	0.00001*	3.0512*	VRG
<i>Zaniolepis latipinnis</i>	longspine combfish	0.00001*	3.0512*	VRG
<i>Zaniolepis spp</i>	combfishes	0.00001*	3.0512*	VRG

\*calculated from SL, converted from TL

\*\* $W_t=454*(TL/10)^{3.05}$

\*\*\*adjusted two decimal places

Appendix IV. Standing stock (B) in kilograms at the start of the model run ( $t_0$ ) per depth strata.

Taxa	ELLEN			EUREKA			GAIL		
	bottom	middle	upper	bottom	middle	upper	bottom	middle	upper
<i>Anarrhichthys ocellatus</i>	29.45								
<i>Chromis punctipinnis</i>		364.61	946.66		98.05	895.52		64.92	45.94
<i>Enophrys taurina</i>									
<i>Girella nigricans</i>									
<i>Hexagrammos decagrammus</i>								0.06	
<i>Hypsypops rubicundus</i>			18.38		28.56	46.27			
<i>Ophiodon elongatus</i>	72.25	4.29		23.86			65.75		
<i>Oxyjulis californica</i>									
<i>Oxylebius pictus</i>	2.38	3.45			4.09		0.02	7.36	
<i>Paralabrax clathratus</i>									9.29
<i>Paralichthys californicus</i>									
<i>Phanerodon atripes</i>	0.05	18.98							
<i>Phanerodon furcatus</i>									
<i>Phanerodon sp.</i>	0.11								
<i>Pronotogrammus multifasciatus</i>	0.04								
<i>Pseudopriacanthus serrula</i>					0.22				
<i>Rathbunella alleni</i>	0.09								
<i>Rathbunella hypoplecta</i>	0.05								
<i>Rathbunella sp.</i>	0.02								
<i>Rhacochilus vacca</i>	0.52	6.15							
<i>Rhinogobiops nicholsii</i>	0.004				0.04				
<i>Scorpaena guttata</i>	0.21								
<i>Scorpaenichthys marmoratus</i>	17.41	564.71			137.41			8.99	
<i>Sebastes atrovirens</i>	0.38	180.94	49.60		128.96				
<i>Sebastes auriculatus</i>	0.10								
<i>Sebastes babcocki</i>							0.13		
<i>Sebastes carnatus</i>		5.02			25.55			0.23	
<i>Sebastes caurinus</i>	2.88	29.21			187.38			1.35	
<i>Sebastes chlorostictus</i>				0.87	34.39		8.30	0.91	
<i>Sebastes constellatus</i>	4.11	0.04			28.70		0.01		
<i>Sebastes crameri</i>					15.57		0.03	2.01	
<i>Sebastes dallii</i>	0.78								
<i>Sebastes elongatus</i>							1.31		
<i>Sebastes ensifer</i>	0.04				3.48		0.03	0.35	
<i>Sebastes entomelas</i>	0.82	2004.02			2281.19		0.37	21.39	
<i>Sebastes eos</i>							0.35	0.18	
<i>Sebastes flavidus</i>									
<i>Sebastes goodei</i>							0.16	0.31	
<i>Sebastes helvomaculatus</i>				0.43	5.52		0.03		
<i>Sebastes hopkinsi</i>	23.52	1085.56			2522.06			26.70	
<i>Sebastes jordani</i>	5.59				1.17			0.21	
<i>Sebastes lentiginosus</i>	0.37				4.76				
<i>Sebastes levis</i>				36.10			79.66		
<i>Sebastes macdonaldi</i>							25.25		
<i>Sebastes melanostomus</i>					1.79				

Appendix IV. continued.

Taxa	ELLEN			EUREKA			GAIL		
	bottom	middle	upper	bottom	middle	upper	bottom	middle	upper
<i>Sebastes miniatus</i>	53.92			22.35	9.52		0.15		
<i>Sebastes moseri</i>								0.70	
<i>Sebastes mystinus</i>	0.21	3.09			285.74			0.74	
<i>Sebastes ovalis</i>					484.63			0.03	
<i>Sebastes paucispinis</i>	4.11	50.59		13.29	129.02		177.91	244.03	
<i>Sebastes pinniger</i>	1.29								
<i>Sebastes rastrelliger</i>					11.39				
<i>Sebastes rosaceus</i>	6.94				65.67				
<i>Sebastes rosenblatti</i>	0.23			23.99	113.33		31.07	2.75	
<i>Sebastes ruberrimus</i>					1.99			0.14	
<i>Sebastes rubrivinctus</i>	8.34			0.74	46.32		0.69	29.21	
<i>Sebastes rufinanus</i>					0.84				
<i>Sebastes rufus</i>				0.09	93.94		0.19	1.68	
<i>Sebastes saxicola</i>							0.84		
<i>Sebastes semicinctus</i>	144.62	0.16						0.00	
<i>Sebastes serranoides</i>	0.12							0.73	
<i>Sebastes serriceps</i>	7.39	0.21			3.04			0.13	
<i>Sebastes simulator</i>				15.94	48.41		9.18	11.21	
<i>Sebastes spp</i>	0.57	34.98	0.38		189.85		1.08	138.32	
<i>Sebastes umbrosus</i>	19.95				7.18				
<i>Sebastes wilsoni</i>					5.57				
<i>Sebastes zacentrus</i>					0.25		0.01	0.15	
<i>Sebastolobus alascanus</i>									
<i>Semicossyphus pulcher</i>		29.38	997.04		13.55	85.77			
<i>Trachurus symmetricus</i>			31.68						
unknown sebastomus	3.90	0.76		2.07	110.39		4.80	2.15	
<i>Zalembeus rosaceus</i>	0.15								



Appendix IV. continued.

Taxa	GILDA			GRACE			HIDALGO		
	bottom	middle	upper	bottom	middle	upper	bottom	middle	upper
<i>Anarrhichthys ocellatus</i>							0.10		
<i>Chromis punctipinnis</i>	0.02		11.50		189.37	213.44			
<i>Enophrys taurina</i>									
<i>Girella nigricans</i>			3.86						
<i>Hexagrammos decagrammus</i>	0.03	0.17		1.00	0.17		0.10	0.99	
<i>Hypsypops rubicundus</i>									
<i>Ophiodon elongatus</i>	5.07	2.78		3.83	3.48		10.87		
<i>Oxyjulis californica</i>			0.20						
<i>Oxylebius pictus</i>	0.99	3.73	3.35	0.59	3.70	3.76	0.36	5.39	7.59
<i>Paralabrax clathratus</i>		0.53	3.73						
<i>Paralichthys californicus</i>	0.04								
<i>Phanerodon atripes</i>		4.06			6.64				
<i>Phanerodon furcatus</i>	0.24	0.04			0.15				
<i>Phanerodon sp.</i>			1.02						
<i>Pronotogrammus multifasciatus</i>									
<i>Pseudopriacanthus serrula</i>									
<i>Rathbunella alleni</i>									
<i>Rathbunella hypoplecta</i>	0.01								
<i>Rathbunella sp.</i>	0.08			0.01					
<i>Rhacochilus vacca</i>	1.62	6.39	21.46						
<i>Rhinogobiops nicholsii</i>									
<i>Scorpaena guttata</i>	0.08								
<i>Scorpaenichthys marmoratus</i>	0.26	5.38	5.23		0.54			0.43	6.00
<i>Sebastes atrovirens</i>	0.14	2.05	7.68		60.02	87.77			8.22
<i>Sebastes auriculatus</i>	1.74				0.78				
<i>Sebastes babcocki</i>									
<i>Sebastes carnatus</i>	0.01								
<i>Sebastes caurinus</i>	1.66	5.26	0.03	0.68	4.45			0.06	
<i>Sebastes chlorostictus</i>	0.00			1.96	0.47		17.64	0.09	
<i>Sebastes constellatus</i>	0.03	0.004		0.04	0.02		0.30		
<i>Sebastes crameri</i>							0.01		
<i>Sebastes dallii</i>	3.91	0.002		0.10	0.01				
<i>Sebastes elongatus</i>				0.01			0.66		
<i>Sebastes ensifer</i>				0.01	0.05		0.11		
<i>Sebastes entomelas</i>	0.33	175.11		9.55	1536.81		2.68	31.47	
<i>Sebastes eos</i>				0.22					
<i>Sebastes flavidus</i>				0.45	0.09	0.01		0.12	
<i>Sebastes goodei</i>	0.00	0.03		0.03	1.58				
<i>Sebastes helvomaculatus</i>									
<i>Sebastes hopkinsi</i>	0.01	2.35	0.01	3.84	65.71		0.15	3.50	0.23
<i>Sebastes jordani</i>		34.08		0.01			0.001		
<i>Sebastes lentiginosus</i>									
<i>Sebastes levis</i>					0.13		2.11		
<i>Sebastes macdonaldi</i>									
<i>Sebastes melanostomus</i>									

Appendix IV. continued.

Taxa	GILDA			GRACE			HIDALGO		
	bottom	middle	upper	bottom	middle	upper	bottom	middle	upper
<i>Sebastes miniatus</i>	10.67			56.42	1.59		21.12		
<i>Sebastes moseri</i>				0.01	0.72				
<i>Sebastes mystinus</i>		4.31		2.00	41.53	31.08			2.80
<i>Sebastes ovalis</i>									
<i>Sebastes paucispinis</i>	18.03	3.51	5.47	4.80	372.82	147.40	6.32	2.27	
<i>Sebastes pinniger</i>	0.37			0.63			23.67		
<i>Sebastes rastrelliger</i>			1.56						
<i>Sebastes rosaceus</i>	0.14		0.01	0.57	0.24		0.50		
<i>Sebastes rosenblatti</i>				0.10			1.77		
<i>Sebastes ruberrimus</i>	0.01			0.01			0.54		
<i>Sebastes rubrivinctus</i>	0.08			3.71	4.29		8.01	0.49	
<i>Sebastes rufinanus</i>									
<i>Sebastes rufus</i>							0.01		
<i>Sebastes saxicola</i>		0.04					0.003		
<i>Sebastes semicinctus</i>	16.73			153.39			28.17	1.83	
<i>Sebastes serranoides</i>	0.34	4.15		0.05	0.10				
<i>Sebastes serriceps</i>	0.04	0.52		0.25	0.33				0.41
<i>Sebastes simulator</i>				0.02					
<i>Sebastes spp</i>	0.10	3.19		0.30	162.74	12.48	0.76	152.13	1.90
<i>Sebastes umbrosus</i>									
<i>Sebastes wilsoni</i>							0.24	0.08	
<i>Sebastes zacentrus</i>							0.08		
<i>Sebastolobus alascanus</i>									
<i>Semicossyphus pulcher</i>									
<i>Trachurus symmetricus</i>					5.17				
unknown Sebastomus	0.04	0.03		1.18	2.78		1.08	0.43	
<i>Zalembeus rosaceus</i>	0.28			0.23					

## Appendix IV. continued.

Taxa	HOLLY			IRENE		
	bottom	middle	upper	bottom	middle	upper
<i>Anarrhichthys ocellatus</i>				0.62		
<i>Chromis punctipinnis</i>		2.56	67.35		2.11	
<i>Enophrys taurina</i>	0.01					
<i>Girella nigricans</i>						
<i>Hexagrammos decagrammus</i>	1.76	11.77		0.48	0.25	
<i>Hypsypops rubicundus</i>						
<i>Ophiodon elongatus</i>	5.19	2.19		9.91	0.70	
<i>Oxyjulis californica</i>						
<i>Oxylebius pictus</i>	1.38	11.38	8.49	1.70	10.06	6.00
<i>Paralabrax clathratus</i>						
<i>Paralichthys californicus</i>						
<i>Phanerodon atripes</i>	1.63	3.57	18.57	0.04		
<i>Phanerodon furcatus</i>						
<i>Phanerodon</i> sp.	1.78	0.22	0.40	0.17		
<i>Pronotogrammus multifasciatus</i>						
<i>Pseudopriacanthus serrula</i>						
<i>Rathbunella alleni</i>	0.04					
<i>Rathbunella hypoplecta</i>	0.04	0.36				
<i>Rathbunella</i> sp.	0.29	0.07		0.05		
<i>Rhacochilus vacca</i>	2.53	41.03	50.72	3.53	3.95	
<i>Rhinogobiops nicholsii</i>	0.17	0.23		0.00		
<i>Scorpaena guttata</i>	0.19					
<i>Scorpaenichthys marmoratus</i>			10.80		0.32	4.74
<i>Sebastes atrovirens</i>	1.74	51.38	48.32	0.03		6.50
<i>Sebastes auriculatus</i>	6.47	5.79		21.85		
<i>Sebastes babcocki</i>						
<i>Sebastes carnatus</i>	0.48	3.75		0.07		
<i>Sebastes caurinus</i>	25.63	34.26		42.56	18.11	
<i>Sebastes chlorostictus</i>	0.08			0.01		
<i>Sebastes constellatus</i>	0.09			0.002		
<i>Sebastes cramerii</i>						
<i>Sebastes dallii</i>	19.06	7.16		2.22		
<i>Sebastes elongatus</i>						
<i>Sebastes ensifer</i>						
<i>Sebastes entomelas</i>	2.06	175.53		5.31	376.48	
<i>Sebastes eos</i>						
<i>Sebastes flavidus</i>	0.43	0.15		0.74	6.65	
<i>Sebastes goodei</i>	0.00					
<i>Sebastes helvomaculatus</i>						
<i>Sebastes hopkinsi</i>	1.96	156.43		0.11	0.002	0.18
<i>Sebastes jordani</i>					185.51	
<i>Sebastes lentiginosus</i>						
<i>Sebastes levis</i>	0.01					
<i>Sebastes macdonaldi</i>						
<i>Sebastes melanostomus</i>						
<i>Sebastes miniatus</i>	28.93	0.31		32.97		

Appendix IV. continued.

Taxa	HOLLY			IRENE		
	bottom	middle	upper	bottom	middle	upper
<i>Sebastes moseri</i>						
<i>Sebastes mystinus</i>	0.66	4.23	1.24	1.17	3.02	2.21
<i>Sebastes ovalis</i>						
<i>Sebastes paucispinis</i>	0.29	1.76		1.50	55.70	
<i>Sebastes pinniger</i>	3.06			1.19	0.01	
<i>Sebastes rastrelliger</i>						
<i>Sebastes rosaceus</i>	2.35	2.40		0.05		
<i>Sebastes rosenblatti</i>						
<i>Sebastes ruberrimus</i>	0.01	0.01		0.02		
<i>Sebastes rubrivinctus</i>	0.47	0.93		0.08	0.004	
<i>Sebastes rufinanus</i>						
<i>Sebastes rufus</i>						
<i>Sebastes saxicola</i>						
<i>Sebastes semicinctus</i>	6.32	0.51		8.63		
<i>Sebastes serranoides</i>	0.77	16.48	5.94	0.32	0.34	
<i>Sebastes serriceps</i>	0.86	1.99		0.01		0.32
<i>Sebastes simulator</i>						
<i>Sebastes spp</i>	1.25	10.67	1.35	0.79	120.37	1.50
<i>Sebastes umbrosus</i>	0.37	0.29		0.01		
<i>Sebastes wilsoni</i>						
<i>Sebastes zacentrus</i>						
<i>Sebastolobus alascanus</i>	0.004					
<i>Semicossyphus pulcher</i>						
<i>Trachurus symmetricus</i>		563.17	2914.48			
<i>unknown sebastomus</i>	0.39	1.04		0.33	0.45	
<i>Zalemnius rosaceus</i>	1.60	0.002				

Appendix V. Reported platform structural parameters (source MMS); values given in red were from MBC 1987.

Platform	# jacket legs	Main piles diameters (#/inches)	# skirt piles	diam skirt piles (inches)	#conductors	Depth (m)	Footprint (m <sup>2</sup> )	Surface Area (m <sup>2</sup> )	Volume (m <sup>3</sup> )
Edith	12	54	0	n/a	23	49	2879	17,217	102,216
Ellen	8	4/66 & 4/48	0	n/a	64	80	2511	27,861	
Elly	12	2/42 & 10/48	0	n/a	0	80	2949	14,427	
Emmy		n/a	n/a	n/a		14			
Esther		n/a	n/a	etc					
Eureka	8	0	24	60	60	212	4635	108,954	
Eva		n/a				17	669	4555	11,633
Gail	8	60	12	72	22	224	5327	106,497	1,198,176
Gilda	12	48	0		64	62	2342	19,501	132,800
Gina	6	42	0		12	29	561	3406	16,414
Grace	12	42	8	48	35	96	3090	25,862	244,196
Habitat	8				20	88	2284	26,731	139,872
Harmony	8	72	20	84	51	363	10606		
Harvest	8	60	20	72	21	205	5859	79,173	444,720
Henry	8	42	0		24	52	1505	8,577	50,403
Heritage	8	72	26	84	49	326			
Hermosa	8	60	12	72	16	184	5142	85,158	944,097
Hidalgo	8	60	8	72	10	130	4154	73,339	564,086
Hillhouse	8		0		52	58			
Hogan	12	36	0		40	47	1435	8,190	68,350
Holly						66			21,515
Hondo	8	48	12	54	28	255	4649	67,091	514,210
Houchin	8	36?	0		36	49	1435	8,190	68,350
Irene	8	60	0		24	73	2633	14,874	192,793
Platform A	12	40	0		55	58	1930	16,111	80,541
Platform B	12	40?	0		55	58	1930	16,111	80,541
Platform C	12	40?	0		43	58	1930	16,111	80,541

Appendix VI. Von Bertalanffy growth parameters used in production model. Parameters are from Love et al. 2002 and Caillet 2000. For rockfishes and small fishes with unknown parameters, growth parameters from *Sebastes semicinctus* were used.

Taxa	$L_{\infty}$ (Max TL)	$k$	$t_0$
<i>Anarrhichthys ocellatus</i>	2030	0.21	-0.42
<i>Chromis punctipinnis</i>	400.2	0.15	-1.34
<i>Cryptotrema corallinum</i>	250	0.37	-1.37
<i>Enophrys taurina</i>	250	0.37	-1.37
<i>Girella nigricans</i>	283.6 (660)	0.5534	-0.1098
<i>Hexagrammos decagrammus</i>	460	0.21	-0.42
<i>Hypsypops rubicundus</i>	202 (360)	0.425	-0.782
<i>Lythrypnus dalli</i>	250	0.37	-1.37
<i>Ophiodon elongatus</i>	1149.99	0.128	-2.1097
<i>Oxyjulis californica</i>	250 (251)	0.37	-1.37
<i>Oxylebius pictus</i>	184	0.31968	1.488
<i>Paralabrax clathratus</i>	698	0.06	-3.5
<i>Paralichthys californicus</i>	1217.51	0.1414	0.4073
<i>Phanerodon atripes</i>	202 (290)	0.425	-0.782
<i>Phanerodon furcatus</i>	202 (262)	0.425	-0.782
<i>Phanerodon sp</i>	202 (290)	0.425	-0.782
<i>Pronotogrammus multifasciatus</i>	519	0.18	-1.57
<i>Pseudopriacanthus serrula</i>	202	0.425	-0.782
<i>Rathbunella alleni</i>	250	0.37	-1.37
<i>Rathbunella hypoplecta</i>	250	0.37	-1.37
<i>Rathbunella sp.</i>	250	0.37	-1.37
<i>Rhacochilus vacca</i>	440	0.425	-0.782
<i>Rhinogobiops nicholsii</i>	250	0.37	-1.37
<i>Scorpaena guttata</i>	443	0.13	-1.9
<i>Scorpaenichthys marmoratus</i>	679	0.457	0.84
<i>Sebastes atrovirens</i>	285 (351.41)	0.29	-0.03
<i>Sebastes auriculatus</i>	514	0.16	-0.55
<i>Sebastes aurora</i>	250	0.37	-1.37
<i>Sebastes babcocki</i>	655	0.37	-1.37
<i>Sebastes carnatus</i>	341	0.2256	-0.5
<i>Sebastes caurinus</i>	456	0.1	-3.7
<i>Sebastes chlorostictus</i>	444	0.1282	-0.2
<i>Sebastes constellatus</i>	450	0.09	-3.11
<i>Sebastes crameri</i>	417.8	0.16	-1
<i>Sebastes dallii</i>	250	0.37	-1.37
<i>Sebastes diploproa</i>	299	0.16	-2.01
<i>Sebastes elongatus</i>	296.5	0.12	-2.73
<i>Sebastes ensifer</i>	176 (250)	0.14	-1.04
<i>Sebastes entomelas</i>	526.88	0.21456	-0.1148
<i>Sebastes eos</i>	250 (560)	0.37	-1.37
<i>Sebastes flavidus</i>	522.1	0.17	-0.75
<i>Sebastes goodei</i>	520	0.2	-1.04
<i>Sebastes helvomaculatus</i>	286.6	0.1	-2.77
<i>Sebastes hopkinsi</i>	252.5	0.18	-3.36
<i>Sebastes jordani</i>	281	0.25	-2.51

## Appendix VI. continued.

Taxa	$L_{\infty}$ (Max TL)	$k$	$t_0$
<i>Sebastes lentiginosus</i>	250	0.37	-1.37
<i>Sebastes levis</i>	858	0.06	-1.3
<i>Sebastes macdonaldi</i>	660	0.37	-1.37
<i>Sebastes melanops</i>	532.5	0.15	-2.84
<i>Sebastes melanostomus</i>	553.9	0.04	-4.66
<i>Sebastes miniatus</i>	687.98	0.09841	-0.6901
<i>Sebastes moseri</i>	250	0.37	-1.37
<i>Sebastes mystinus</i>	400.2	0.15	-1.34
<i>Sebastes ovalis</i>	499.9	0.05	-4.94
<i>Sebastes paucispinis</i>	812.97	0.14784	-0.6439
<i>Sebastes pinniger</i>	715	0.1123	-0.6
<i>Sebastes rastrelliger</i>	513	0.11	-2.41
<i>Sebastes rosaceus</i>	329	0.12	-0.7
<i>Sebastes rosenblatti</i>	579.9	0.05	-2.47
<i>Sebastes ruberrimus</i>	659.3	0.04	-11.65
<i>Sebastes rubrivinctus</i>	250	0.37	-1.37
<i>Sebastes rufinanus</i>	250	0.37	-1.37
<i>Sebastes rufus</i>	456 (552)	0.09	-3.9
<i>Sebastes saxicola</i>	173.8	0.19	-3.78
<i>Sebastes semicinctus</i>	181.4 (250)	0.37	-1.37
<i>Sebastes serranoides</i>	519	0.18	-1.57
<i>Sebastes serriceps</i>	306.4	0.233	-1.167
<i>Sebastes simulator</i>	250	0.37	-1.37
<i>Sebastes spp</i>	250 (301)	0.37	-1.37
<i>Sebastes umbrosus</i>	249	0.11	-0.54
<i>Sebastes wilsoni</i>	250	0.37	-1.37
<i>Sebastes zacentrus</i>	250 (450)	0.37	-1.37
<i>Sebastolobus alascanus</i>	341	0.2256	-0.5
<i>Sebastolobus spp.</i>	341	0.2256	-0.5
<i>Semicossyphus pulcher</i>	698	0.06	-3.5
<i>Trachurus symmetricus</i>	602.86	0.93504	-3.252
<i>unknown sebastomus</i>	249 (251)	0.11	-0.54
<i>Zalembeus rosaceus</i>	202	0.425	-0.782

Appendix VII. Maximum and minimum mortality estimates for each species for each year. Species-specific mortality estimates were applied to all strata and all platforms.

	Year 1		Year 2		Year 3		Year 4		Year 5		Minimum	Maximum
	Min	Max	Min	Max	Min	Max	Min	Max	Min	Max		
<i>Anarrhichthys ocellatus</i>	2.11	4.68	1.98	3.29	1.89	2.69	1.82	2.36	1.77	2.15	1.77	4.68
<i>Chromis punctipinnis</i>	6.58	17.99	6.26	11.76	6.01	9.43	5.82	8.18	5.67	7.39	5.67	17.99
<i>Enophrys taurina</i>	12.01	12.01	10.10	10.10	9.15	9.15	8.60	8.60	8.27	8.27	8.27	12.01
<i>Girella nigricans</i>	5.66	5.66	4.13	4.13	3.61	3.61	3.37	3.37	3.25	3.25	3.25	5.66
<i>Hexagrammos decagrammus</i>	5.47	13.53	5.24	9.29	5.08	7.56	4.95	6.63	4.85	6.05	4.85	13.53
<i>Hypsypops rubicundus</i>	5.74	6.08	5.73	5.94	5.72	5.85	5.71	5.80	5.70	5.76	5.70	6.08
<i>Ophiodon elongatus</i>	3.52	9.16	3.32	6.43	3.16	5.18	3.04	4.47	2.94	4.00	2.94	9.16
<i>Oxyjulis californica</i>	7.48	7.48	7.47	7.47	7.46	7.46	7.46	7.46	7.46	7.46	7.46	7.48
<i>Oxylebius pictus</i>	9.04	17.99	9.01	13.93	8.98	12.03	8.97	10.96	8.96	10.31	8.96	17.99
<i>Paralabrax clathratus</i>	5.41	7.28	5.18	6.72	4.98	6.26	4.81	5.90	4.66	5.59	4.66	7.28
<i>Paralichthys californicus</i>	7.60	7.60	5.56	5.56	4.58	4.58	3.99	3.99	3.61	3.61	3.61	7.60
<i>Phanerodon atripes</i>	7.39	14.05	7.05	11.34	6.85	10.13	6.72	9.49	6.64	9.12	6.64	14.05
<i>Phanerodon furcatus</i>	8.59	14.39	8.57	11.49	8.56	10.22	8.55	9.55	8.54	9.17	8.54	14.39
<i>Phanerodon sp</i>	7.64	10.62	7.19	9.76	6.93	9.28	6.77	8.99	6.68	8.82	6.68	10.62
<i>Pronotogrammus multifasciatus</i>	8.66	8.66	7.21	7.21	6.35	6.35	5.79	5.79	5.41	5.41	5.41	8.66
<i>Pseudopriacanthus serrula</i>	12.60	12.60	10.11	10.11	9.01	9.01	8.44	8.44	8.10	8.10	8.10	12.60
<i>Rathbunella alleni</i>	9.50	10.96	9.02	9.85	8.73	9.24	8.54	8.86	8.41	8.62	8.41	10.96
<i>Rathbunella hypoplecta</i>	9.50	11.58	9.02	10.18	8.73	9.42	8.54	8.98	8.41	8.70	8.41	11.58
<i>Rathbunella sp.</i>	8.89	11.58	8.64	10.18	8.48	9.42	8.37	8.98	8.30	8.70	8.30	11.58
<i>Rhacochilus vacca</i>	5.90	7.93	5.25	6.12	4.91	5.36	4.71	4.97	4.59	4.75	4.59	7.93
<i>Rhinogobiops nicholsii</i>	12.47	22.02	9.12	11.37	7.75	8.72	7.04	7.56	6.63	6.93	6.63	22.02
<i>Scorpaena guttata</i>	6.42	8.01	6.00	7.12	5.67	6.50	5.42	6.06	5.22	5.72	5.22	8.01
<i>Scorpaenichthys marmoratus</i>	3.88	9.23	3.64	5.25	3.51	4.26	3.43	3.84	3.38	3.62	3.38	9.23
<i>Sebastes atrovirens</i>	5.92	8.36	5.77	7.27	5.67	6.66	5.59	6.27	5.54	6.01	5.54	8.36
<i>Sebastes auriculatus</i>	5.18	9.59	4.93	7.66	4.73	6.60	4.58	5.93	4.46	5.47	4.46	9.59
<i>Sebastes babcocki</i>	6.77	6.77	5.43	5.43	4.82	4.82	4.48	4.48	4.28	4.28	4.28	6.77



	Year 1		Year 2		Year 3		Year 4		Year 5		Minimum	Maximum
	Min	Max	Min	Max	Min	Max	Min	Max	Min	Max		
Sebastes carnatus	7.49	9.88	6.91	8.34	6.52	7.46	6.25	6.89	6.05	6.51	6.05	9.88
Sebastes caurinus	5.46	13.12	5.29	10.53	5.16	9.01	5.04	8.01	4.94	7.30	4.94	13.12
Sebastes chlorostictus	6.31	13.33	5.98	10.32	5.73	8.71	5.53	7.71	5.36	7.02	5.36	13.33
Sebastes constellatus	6.55	24.72	6.25	16.27	6.00	12.63	5.79	10.58	5.61	9.26	5.61	24.72
Sebastes crameri	6.53	10.66	6.28	9.03	6.08	8.05	5.92	7.39	5.79	6.92	5.79	10.66
Sebastes dallii	9.06	26.20	8.41	13.81	8.02	10.67	7.77	9.29	7.61	8.54	7.61	26.20
Sebastes elongatus	7.44	9.84	7.32	9.28	7.22	8.83	7.13	8.48	7.05	8.19	7.05	9.84
Sebastes ensifer	7.87	11.53	7.66	11.05	7.49	10.67	7.36	10.37	7.24	10.11	7.24	11.53
Sebastes entomelas	4.68	16.34	4.53	9.70	4.41	7.45	4.32	6.33	4.25	5.66	4.25	16.34
Sebastes eos	5.51	9.88	4.77	8.60	4.38	7.92	4.15	7.52	4.01	7.26	4.01	9.88
Sebastes flavidus	7.01	23.81	6.22	11.95	5.69	8.77	5.33	7.26	5.05	6.38	5.05	23.81
Sebastes goodei	7.96	15.71	6.75	9.93	6.02	7.76	5.54	6.63	5.21	5.95	5.21	15.71
Sebastes helvomaculatus	6.76	7.99	6.69	7.75	6.63	7.55	6.57	7.38	6.53	7.23	6.53	7.99
Sebastes hopkinsi	10.25	26.49	9.53	17.49	9.01	13.83	8.62	11.85	8.32	10.62	8.32	26.49
Sebastes jordani	9.25	16.50	8.65	12.48	8.23	10.58	7.94	9.49	7.73	8.81	7.73	16.50
Sebastes lentiginosus	9.33	10.31	8.28	8.77	7.69	7.97	7.34	7.51	7.12	7.23	7.12	10.31
Sebastes levis	3.56	16.49	3.49	11.58	3.43	9.23	3.37	7.83	3.32	6.89	3.32	16.49
Sebastes macdonaldi	4.36	4.36	4.09	4.09	3.92	3.92	3.82	3.82	3.75	3.75	3.75	4.36
Sebastes melanostomus	6.86	6.86	6.62	6.62	6.41	6.41	6.22	6.22	6.05	6.05	6.05	6.86
Sebastes miniatus	4.36	9.02	4.21	7.47	4.09	6.52	3.98	5.87	3.89	5.40	3.89	9.02
Sebastes moseri	8.39	11.37	8.00	9.62	7.76	8.72	7.60	8.21	7.49	7.89	7.49	11.37
Sebastes mystinus	6.00	13.64	5.80	10.51	5.64	8.87	5.51	7.87	5.40	7.19	5.40	13.64
Sebastes ovalis	10.13	15.08	9.37	13.05	8.76	11.61	8.25	10.52	7.83	9.68	7.83	15.08
Sebastes paucispinis	5.01	15.59	4.59	9.19	4.29	6.98	4.06	5.85	3.88	5.15	3.88	15.59
Sebastes pinniger	4.88	23.89	4.59	12.19	4.36	8.84	4.18	7.20	4.03	6.23	4.03	23.89
Sebastes rastrelliger	5.47	5.87	5.16	5.47	4.92	5.16	4.72	4.92	4.56	4.72	4.56	5.87
Sebastes rosaceus	7.90	22.55	7.51	15.64	7.20	12.54	6.95	10.76	6.74	9.61	6.74	22.55
Sebastes rosenblatti	5.28	8.82	5.16	8.15	5.05	7.61	4.95	7.17	4.86	6.80	4.86	8.82
Sebastes ruberrimus	6.39	22.62	6.11	16.78	5.87	13.64	5.66	11.66	5.47	10.29	5.47	22.62

	Year 1		Year 2		Year 3		Year 4		Year 5		Minimum	Maximum
	Min	Max	Min	Max	Min	Max	Min	Max	Min	Max		
Sebastes rubrivinctus	7.09	21.80	6.96	12.06	6.87	9.50	6.80	8.36	6.76	7.74	6.76	21.80
Sebastes rufinanus	19.84	19.84	12.77	12.77	10.39	10.39	9.24	9.24	8.60	8.60	8.60	19.84
Sebastes rufus	4.13	10.08	4.11	8.94	4.08	8.13	4.06	7.53	4.04	7.06	4.04	10.08
Sebastes saxicola	11.36	14.42	10.95	13.13	10.63	12.24	10.39	11.61	10.19	11.14	10.19	14.42
Sebastes semicinctus	9.86	26.20	9.71	16.32	9.61	13.17	9.54	11.67	9.50	10.85	9.50	26.20
Sebastes serranoides	7.90	24.61	6.77	12.17	6.07	8.87	5.60	7.32	5.27	6.42	5.27	24.61
Sebastes serriceps	6.15	12.74	5.97	9.04	5.84	7.69	5.74	6.98	5.67	6.53	5.67	12.74
Sebastes simulator	8.04	8.95	7.59	8.11	7.31	7.63	7.13	7.33	7.01	7.15	7.01	8.95
Sebastes spp	7.53	26.20	7.45	13.81	7.40	10.67	7.36	9.29	7.34	8.54	7.34	26.20
Sebastes umbrosus	7.97	9.42	7.81	9.02	7.67	8.70	7.56	8.43	7.45	8.20	7.45	9.42
Sebastes wilsoni	12.25	16.00	10.32	11.84	9.34	10.13	8.78	9.23	8.43	8.71	8.43	16.00
Sebastes zacentrus	7.98	13.59	7.54	10.14	7.26	8.71	7.09	7.96	6.97	7.53	6.97	13.59
Sebastolobus alascanus	9.50	9.50	7.97	7.97	7.10	7.10	6.55	6.55	6.17	6.17	6.17	9.50
Semicossyphus pulcher	4.15	7.16	4.07	6.58	4.00	6.13	3.93	5.77	3.88	5.47	3.88	7.16
Trachurus symmetricus	8.86	11.17	4.65	4.82	3.97	4.02	3.76	3.78	3.69	3.69	3.69	11.17
unknown sebastomus	7.39	24.14	7.31	18.29	7.24	15.18	7.17	13.24	7.12	11.92	7.12	24.14
Zalembeius rosaceus	9.76	24.07	9.28	14.09	8.99	11.36	8.82	10.14	8.71	9.50	8.71	24.07



Lumina Decision Systems  
26010 Highland Way  
Los Gatos, CA 95033-9758

MAIN +1 (650) 212-1212  
FAX +1 (650) 240-2230

Info@Lumina.com  
www.Lumina.com

# PLATFORM - The OST Oil & Gas Platform Decommissioning Decision Support Tool: User Guide

May 16, 2010:



Prepared for:

## Introduction

The PLATFORM Oil & Gas Platform Decommissioning Decision Support Tool is a multi-attribute decision analysis framework to enable decision makers and stakeholders to choose among viable alternatives for decommissioning oil & gas platforms. The framework applies utility theory in giving the decision makers the ability to quantify the desirability of certain alternatives. It organizes the decision options into a hierarchy, identifying the main decision options at the top, with variations of each decision at lower levels. It allows the decision maker to make decisions about how to decommission platforms individually or as a group.

PLATFORM offers a range of outputs to evaluate results, including the total decommissioning cost by platform, avoided costs based on decommissioning alternative selected, and a multi-attribute score for each alternative. It takes as inputs the user-selected decommissioning option for each platform, platform-specific decisions about reef enhancements, shell mound removal and the use of explosives, as well as quantified inputs such as decommissioning costs and biomass estimates of marine species.

PLATFORM is highly interactive and supports rapid changes to key assumptions, to explore their effects on key outputs. It supports sensitivity analysis to compare the effects of alternative assumptions, including tornado diagrams to compare the effects of changes to key inputs.

## This document

This document is a draft User Guide. It describes the input data and controls, the outputs it generates, and the assumptions underlying its calculations. Please contact Lumina if you have any questions, find problems, or have suggestions for the User Guide or the decision support tool. As a general rule, Lumina recommends that PLATFORM users go through the Analytica Tutorial before using the tool. While this is not mandatory, it will help the user navigate the tool with greater ease and confidence.

## System requirements

You can run the model on any personal computer running Microsoft Windows since Windows 2000. You will also need the free Analytica 4.2 Player to run the model. If you do not have this, email [support@lumina.com](mailto:support@lumina.com) to obtain a license code and link from which to download the latest version of Analytica Player.

## How to contact us

If you have any question or comments regarding this draft User Guide or model, please contact Surya Swamy at:

Phone: 650-212-1212

Email: [support@lumina.com](mailto:support@lumina.com)

## Starting up the model

This section introduces the general structure and layout of the model. Start up the model by double-clicking on the Platform DA model file. You will see the main user interface window, looking like this:

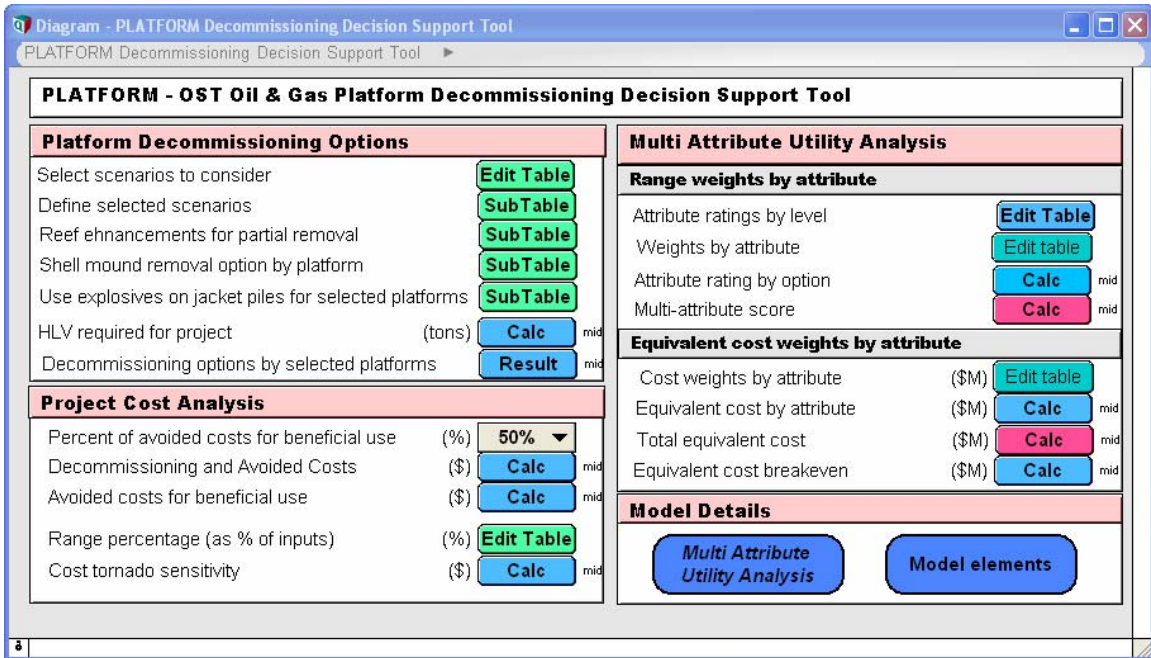

The next few sections of this User Guide describe the key sections of this user interface page.

## Platform Decommissioning Options

The top left section of the user interface lets you select a number of scenarios (projects) to consider, as well as which platforms to consider for selected scenarios. It also allows you to control key aspects of the decommissioning process, including for e.g. which removal alternative to consider for a given platform and whether or not to allow for shell mound removal.

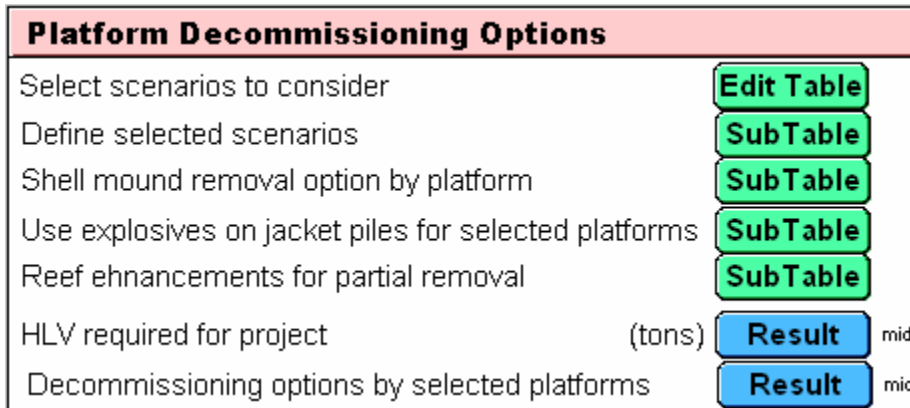

Select scenarios to consider

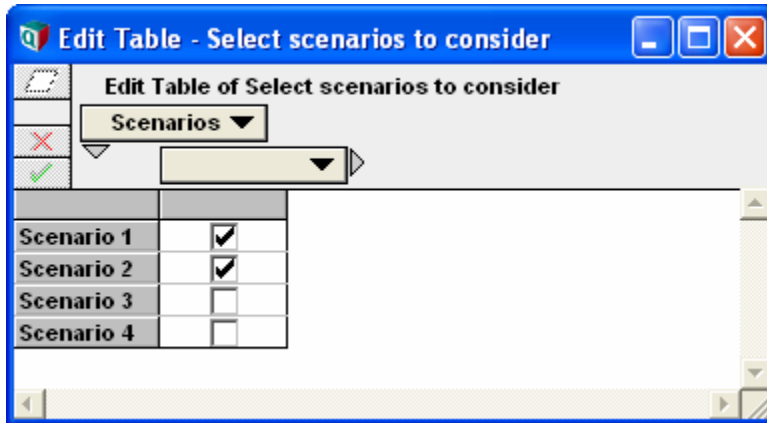

The Select scenarios to consider edit table lets you select a number of scenarios to consider. It is possible to select either single or multiple platforms for decommissioning within each scenario. If no platforms are to be considered for decommissioning in a particular scenario, then please uncheck (de-select) that scenario.

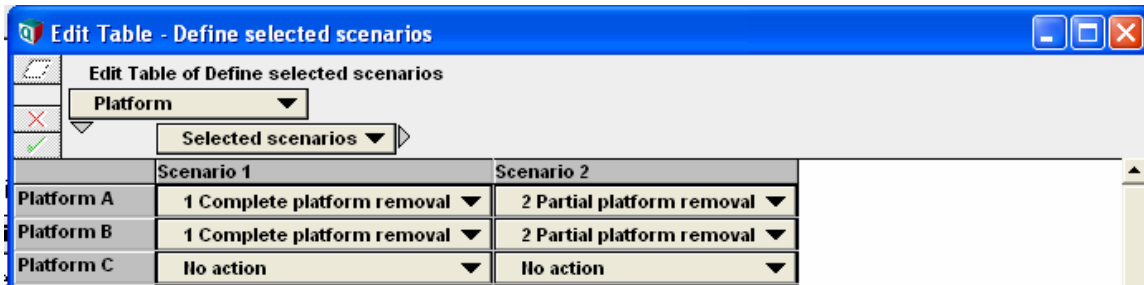

The Define selected scenarios edit table lets you choose a removal option for each platform, for each selected scenario:

- 1 Complete platform removal: Selects complete removal of the platform
- 2 Partial platform removal: Selects partial removal of the platform
- No action: Implies the platform is not being considered as part of the decommissioning project

### Other top-level decommissioning options

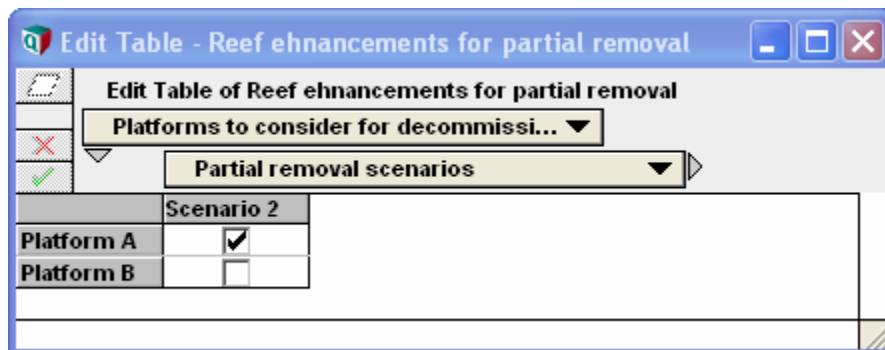

The Reef enhancements for partial removal table lets you make individual decisions about reef enhancements for platforms for which partial removal is selected. Note, if partial removal is not selected for any platform in the selected scenarios, then this screen will appear blank.

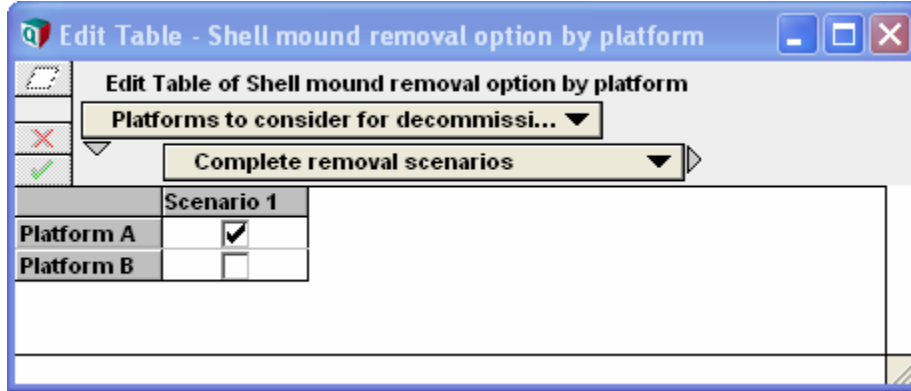

The Shell mound removal option by platform table lets you make individual decisions about shell mound removal for platforms for which complete removal is selected. Note, if complete removal is not selected for any platform in the selected scenarios, then this screen will appear blank.

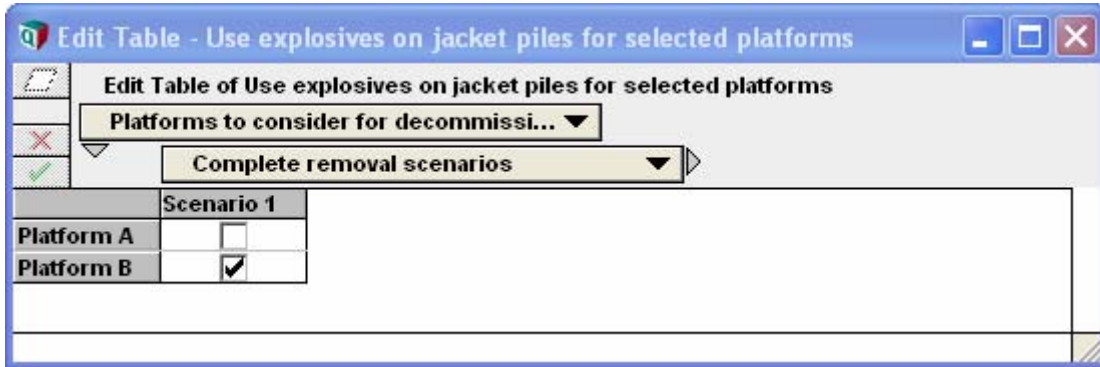

The Use explosives on jacket piles for selected platforms table lets you make individual decisions about explosive severing for platforms for which complete removal is selected. Note, if complete removal is not selected for any platform in the selected scenarios, then this screen will appear blank.

### Intermediate Outputs

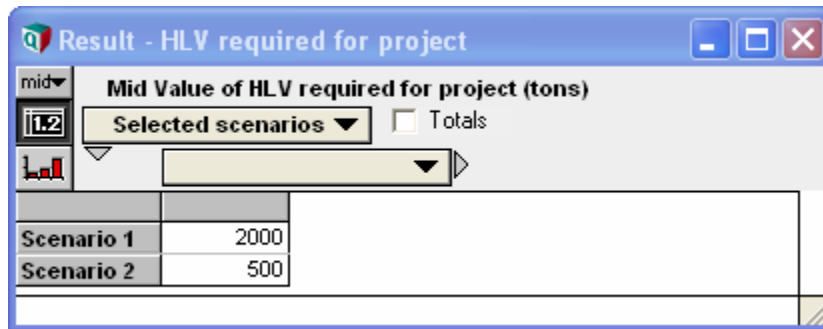

By clicking on the button HLV required for project the model informs the user of the HLV size required to perform this work for each selected scenario.

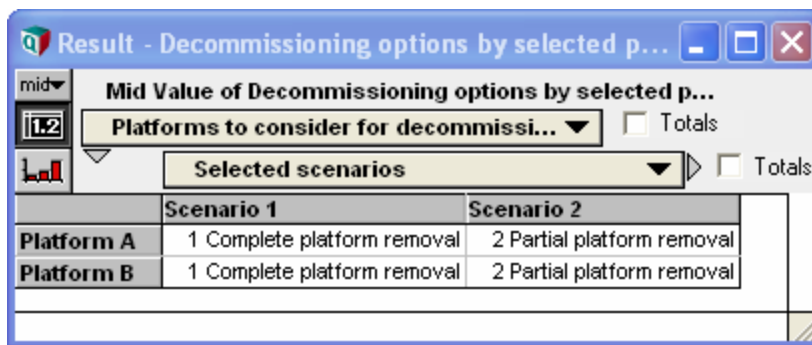

The Decommissioning options by selected platform result displays the list of platforms that are selected as well as their decommissioning option by scenario, to verify the correct platform selections have been made by the user as noted in the above figure.

## Project Cost Analysis

The bottom left section of the top-level UI presents the cost analysis results from PLATFORM. This section appears on the top-level UI since cost is a key part of the quantitative analysis that the tool enables.

Project Cost Analysis		
Percent of avoided costs for beneficial use	(%)	50% ▼
Decommissioning and Avoided Costs	(\$)	Calc mid
Avoided costs for beneficial use	(\$)	Calc mid
Range percentage (as % of inputs)	(%)	Edit Table
Cost tornado sensitivity	(\$)	Calc mid

### Percent of avoided costs for beneficial use

The Percent of avoided costs for beneficial use menu controls what percent of avoided costs go toward the State, Oil Companies or other beneficial uses.

HLV required for project	(tons)	0%	mid
Decommissioning options by selected platforms		10%	mid
<b>Project Cost Analysis</b>			
Percent of avoided costs for beneficial use	(%)	✓ 50% ▼	
Decommissioning and Avoided Costs	(\$)	60%	mid
Avoided costs for beneficial use	(\$)	70%	mid
Range percentage (as % of inputs)	(%)	80%	
		90%	
		100%	



## Decommissioning and Avoided Costs

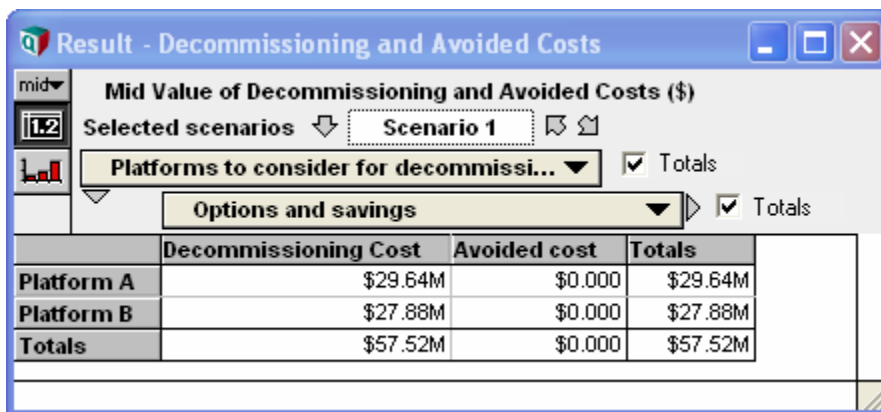

	Decommissioning Cost	Avoided cost	Totals
Platform A	\$29.64M	\$0.000	\$29.64M
Platform B	\$27.88M	\$0.000	\$27.88M
<b>Totals</b>	<b>\$57.52M</b>	<b>\$0.000</b>	<b>\$57.52M</b>

The Decommissioning and avoided costs button displays the decommissioning costs for each platform selected. The second column lists the avoided costs, calculated as the cost difference between the complete removal and partial removal options for the platforms considered. These cost results are listed for each selected platform and scenario.

## Avoided costs for beneficial use

As described above, the avoided costs for beneficial use computes the amount of avoided costs that go toward the State, Oil Companies or other beneficial uses.

## Tornado Sensitivity Plot

The Range percentage (as % of inputs) allows the user to specify the percentages of the input values to be used as the high and low end for input to the tornado sensitivity analysis. The default is set to +/-25% of the input values. It is possible to adjust this range individually for each sensitivity variable.

The Cost tornado sensitivity displays the sensitivity of the total decommissioning costs to changes in each input cost category. The fundamental analysis behind a tornado diagram consists of varying only one input variable at a time, keeping all other variables at their nominal values.

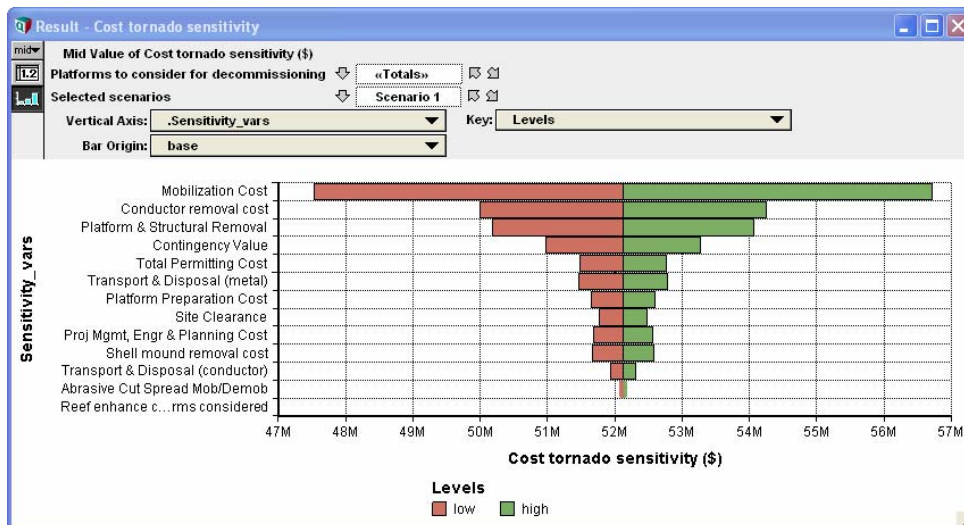

## Multi-Attribute Utility Analysis

The top right section of the user interface screen lets you evaluate the Multi-Attribute Utility Analysis (MAUA) framework within PLATFORM.

Multi Attribute Utility Analysis		
<b>Range weights by attribute</b>		
Attribute ratings by level		<b>Edit Table</b>
Weights by attribute		<b>Edit table</b>
Attribute rating by option		<b>Calc</b> mid
Multi-attribute score		<b>Calc</b> mid
<b>Equivalent cost weights by attribute</b>		
Cost weights by attribute	(\$M)	<b>Edit table</b>
Equivalent cost by attribute	(\$M)	<b>Calc</b> mid
Total equivalent cost	(\$M)	<b>Calc</b> mid
Equivalent cost breakeven	(\$M)	<b>Calc</b> mid

There are two main ways to use the MAUA to assess options to compare decisions on all the key attributes. First, you can simply view the selected option for each platform and its effect on each attribute, using the **Attribute ratings by option** result, as shown below:

The screenshot shows a window titled "Result - Attribute rating by option". It includes a dropdown for "Mid Value of Attribute rating by option" set to "mid", a "Selected scenarios" dropdown set to "Scenario 1", and a table of attributes. The table has columns for "Platform A" and "Platform B".

	Platform A	Platform B
Air Quality	Good	Good
Water Quality	Worst	Worst
Marine Mammals	Worst	Worst
Birds	Medium	Medium
Strict Compliance	Best	Best
Marine Resource Impacts - Benthic	Worst	Worst
Marine Resource Impacts - Fish Biomass (kg)	0	0
Increased area of ocean access (Sq. na mi)	0.44	0.44
Monetary Costs (\$M)	29.5	30.1

This table shows for each platform, the level of each qualitative attribute on the qualitative scale, Worst to Best. . It shows a quantified estimate of the impact for the last three attributes, for fish biomass in kilograms, for increased ocean access in square nautical miles, and for monetary costs in millions of dollars (2007).

To view the description of what these attribute values mean in practical terms, you will need to access the qualitative descriptions provided within each attribute's module.

The second way is to use scaling and weighting to convert these attribute levels into an overall score for each platform decision option selected. PLATFORM offers two methods for assigning

weights to the attributes to combine them into an overall score for each platform. **Relative weights by attribute and Cost weight by attribute.**

	Worst	Poor	Medium	Good	Best
Air Quality	0	25	50	75	100
Water Quality	0	25	50	75	100
Marine Mammals	0	25	50	75	100
Birds	0	25	50	75	100
Strict Compliance	0	25	50	75	100
Marine Resource Impacts - Benthic	0	25	50	75	100
Marine Resource Impacts - Fish Biomass (kg)	0	25	50	75	100
Increased area of ocean access (Sq. na mi)	0	25	50	75	100
Monetary Costs (\$M)	0	25	50	75	100

**Relative weights by attribute:** The first edit table on the top-right of the user interface screen allows you to select the attribute ratings by level. For the qualitative attributes, we map the five levels into numerical ratings from 0 (Worst) to 100 (Best). Note, the default ratings are assigned linearly. You can adjust these mappings for the intermediate levels to suit your views (you must leave worst as 0 and Best as 100, which define the end points of the scale).

The table below illustrates the relative weights by attribute approach to assigning weights.

Attributes	Weights	Best Outcome	Worst Outcome
Air Quality	3	Zero Emissions due to no decommissioning operations	Emissions due to a 4400 ton HLV being on-site for 113+ service days, required for complete removal
Water Quality	2	Status quo	Accidental discharge of minimal amount of contaminated material at sea surface for deeper platforms when complete removal is selected. Or shell mound removal leads to increase in contaminant levels and minor increase in water column or sediment toxicity
Marine Mammals	3	Status quo	Explosives are used during complete removal causing greater disturbance, disorientation, and possibly death
Birds	1	Reduced mortality due to platform removal and elimination of collisions with platforms, loss of offshore roosting locations compensated by onshore locations	Loss of offshore roosting locations leads to increased energy requirements and slight reduction in survival and/or fitness, which could contribute to significant increase in mortality that outweighs reduced mortality from elimination of collisions with platforms

The drop-down menu in the second column titled 'Weights' allows you to assign relative weights for attributes, indicating the relative importance of each attribute range from worst to best [5-Best, 1- Worst]. Each weight specifies the relative importance of changing that attribute from its worst to best level. You should start by considering which attribute range you consider has the largest impact. Suppose, that you consider that the range for costs from 0 to \$400 million is as or more significant than the effect of changing any other attribute from Best to Worst levels. You should start by setting the weight of that attribute to 5.

Then find the attribute that you consider the next most important. Suppose you decide that the impact on marine mammals is more (or as) important as any other attribute except cost. Ask yourself: What's the relative importance to you changing the impact on marine mammals from Worst (*Explosives are used during complete removal causing disturbance, disorientation and possible death*) to Best (*status quo*) and changing costs from 0 to \$400 million. If you consider that this change in impacts on marine mammals is a bit more than half as important to you as the change in costs, you might set the weight for the Marine mammals attribute to 3.

You then repeat this process with each attribute until you've set a weight for all eight attributes.

Next, click on the **Result** button for the **Multi-attribute score**, based on the weighted sum of scores on each attribute, averaged over all selected platforms for each scenario selected, as shown below.

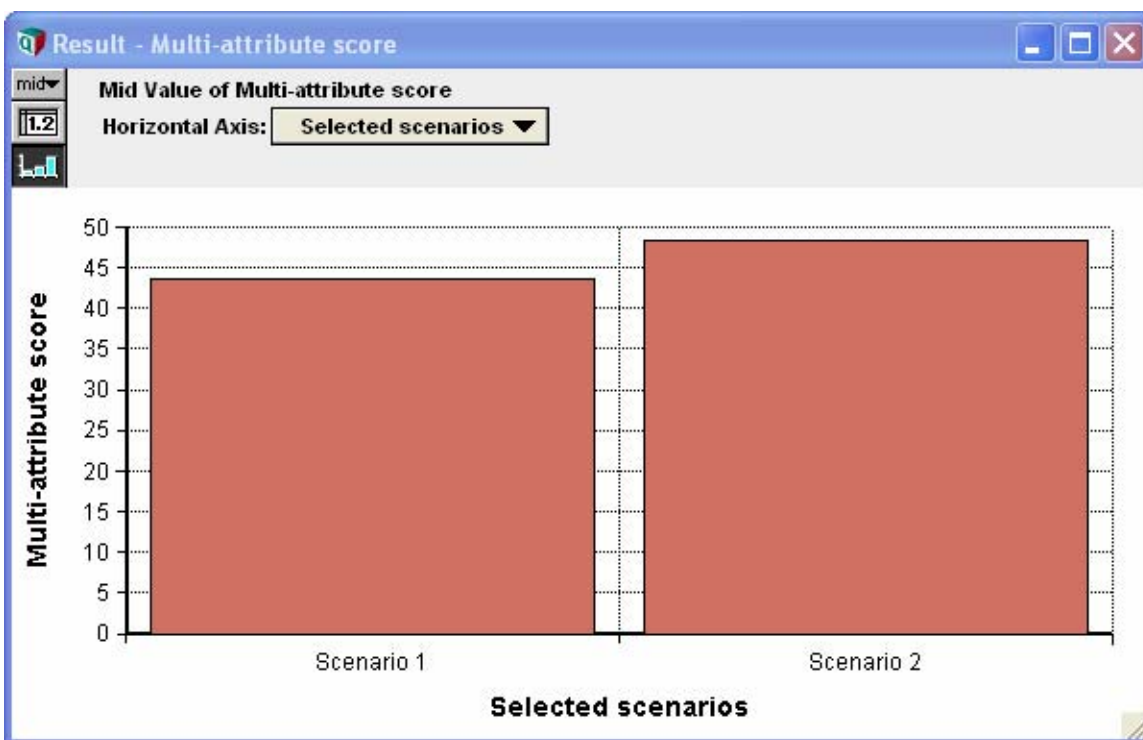

In the above result, the utility scores for Scenario 2 and 1 are 48 and 40 respectively. To compare the effect of a different removal, select a different decommissioning option from the edit table on the top left hand side of the user interface

The second method of weighting attributes uses equivalent costs. Click on **Cost weight by attribute**, which allows you to set the equivalent cost in dollars (or millions of dollars) of changing each attribute from its best to worst level.

Cost equivalents by attributes			
Attributes	Cost Equivalent (\$M)	Best Outcome	Worst Outcome
Air Quality	20	Zero Emissions due to no decommissioning operations	Emissions due to a 4400 ton HLV being on-site for 113+ service days, required for complete removal
Water Quality	50	Status quo	Accidental discharge of minimal amount of contaminated material at sea surface for deeper platforms when complete removal is selected. Or shell mound removal leads to increase in contaminant levels and minor increase in water column or sediment toxicity
Marine Mammals	40	Status quo	Explosives are used during complete removal causing greater disturbance, disorientation, and possibly death
Birds	50	Reduced mortality due to platform removal and elimination of collisions with platforms, loss of offshore roosting locations compensated by onshore locations	Loss of offshore roosting locations leads to increased energy requirements and slight reduction in survival and/or fitness, which could contribute to significant increase in mortality that outweighs reduced mortality from elimination of collisions with platforms

By definition, the equivalent cost of the Cost attribute is \$400 million, its current worst value. If you consider that the cost of going from the best air quality (status quo) to the worst air quality (Emissions due to a 4400 ton HLV being on-site for 113+ service days, required for complete removal) is \$20 million, you should put 20 in the row for Air quality. There's no reason the equivalent cost of an attribute cannot be greater than the \$400 million for Cost.

The Total equivalent cost result compares the equivalent costs for all the selected platforms and scenarios. We draw the same conclusion from the below graphs as we did from the multi-attribute scores above.

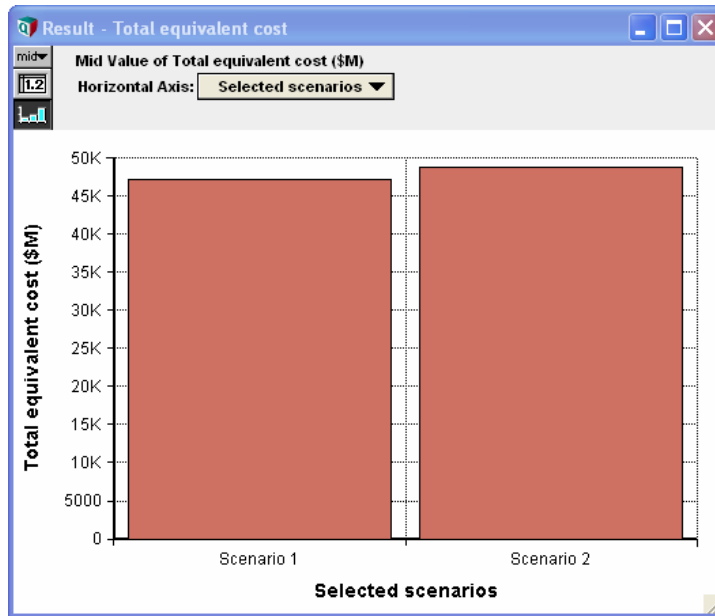

Total equivalent Cost for Scenarios 2 and 1 are computed based on the weighted sum of equivalent costs for each attribute, averaged over all selected platforms for each scenario selected.

The Equivalent cost breakeven result computes the breakeven or switchover cost weight for a given attribute that would cause the ranking of the scenarios (based on estimated equivalent cost) to change. For e.g. If the equivalent cost for scenario 1 is higher than that of scenario 2 for Platform A, the switchover cost weight computed for a given attribute for Platform A is the modified cost weight which if used in place of the original cost weight of that attribute will result in the equivalent costs for scenarios 1 and 2 for Platform A being equal. Thus, the term switchover or breakeven cost weight. Note, if the breakeven cost weight for a given attribute is INF that only means both scenarios were ranked equally for that attribute and platform.

Mid Value of Equivalent cost breakeven (\$M)		
Attributes	Platforms to consider for decommis	
	Platform A	Platform B
Air Quality	-INF	-INF
Water Quality	-38.95	-40.23
Marine Mammals	-48.95	-50.23
Birds	-INF	-INF
Strict Compliance	74.48	75.11
Marine Resource Impacts - Benthic	-58.95	-60.23
Marine Resource Impacts - Fish Biomass (kg)	57.9	57.87
Increased area of ocean access (Sq. na mi)	17.39K	17.64K
Monetary Costs (\$M)	804.6	793.3

## Model Details

The bottom left hand section of the user interface screen contains two modules to access the details of the model.

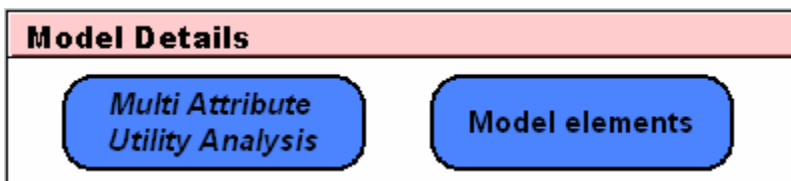

Double clicking on the first module, Multi Attribute Utility Analysis, will open up the underlying influence diagram for the MAUA framework. The second module, Model elements, contains all key modules of the model, as shown below:

## Model elements

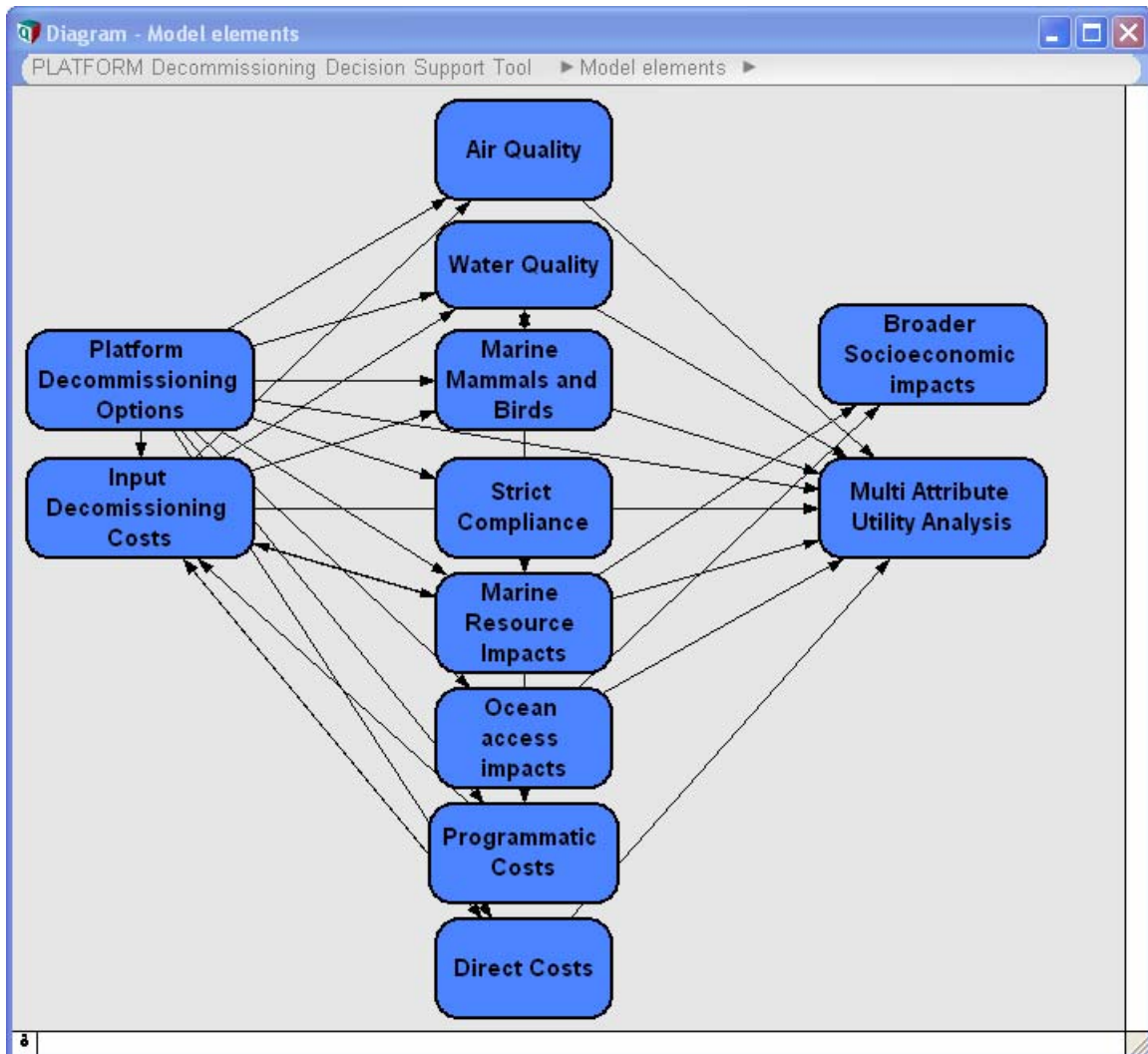

This module allows PLATFORM modelers and advanced users to explore the detail structure of the model by double-clicking on any of the blue module nodes. Note, most users will not need to do, but the structure is accessible for those that wish to explore it.

## Platform Decommissioning Options

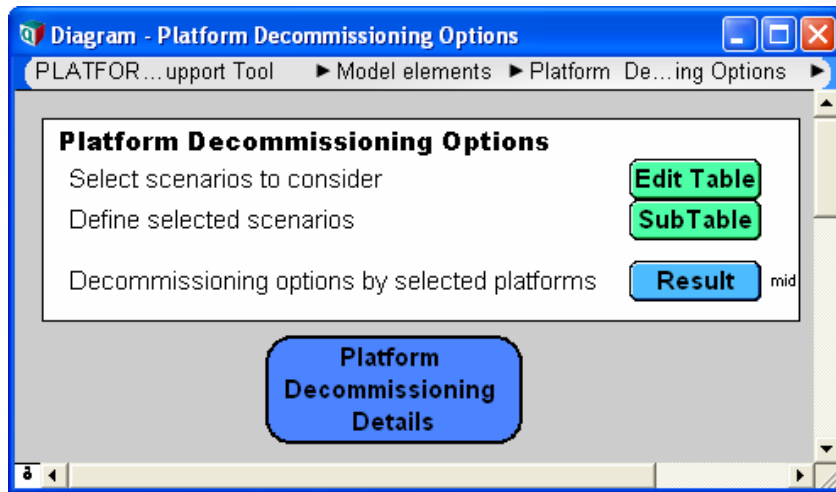

This module allows you to select decommissioning options for various platforms. The first input node, **select scenarios to consider**, is the same as that on the top-level user interface. Additionally, this module displays as an output the set of platforms selected for decommissioning. One can also look at which platforms have been selected for complete and partial removal. To access the details of the module, double-click on **Platform Decommissioning Details**.

## Input Decommissioning Costs

This module contains the input decommissioning cost tables as part of the project cost analysis. The first set of input nodes relate to the input costs for complete removal.

The **Input Decommissioning Costs** edit table contains the platform complete removal costs, disaggregated by the cost categories, from Proserve Offshore (2010) in 2009\$.

The **Mob/demob costs by HLV** edit table contains the mobilization and demobilization costs associated with each HLV size. Depending on the size of the HLV needed for a given project, the relevant mob/demob cost from this table is shared equally amongst the selected platforms.

The **Permitting & Regulatory Compliance Fixed Cost** is a fixed \$2.555M cost that will be shared equally among those platforms selected for decommissioning.

The **Decommissioning Cost Multiplier** table contains multipliers for each cost category to allow the model operator to adjust each cost category up or down to reflect newer data, adjust for inflation, etc.

The **Actual/Estimated Cost Distribution** input variable is a probability distribution of the actual/estimated costs based on data obtained from approximately 40 projects involving 120 structures.



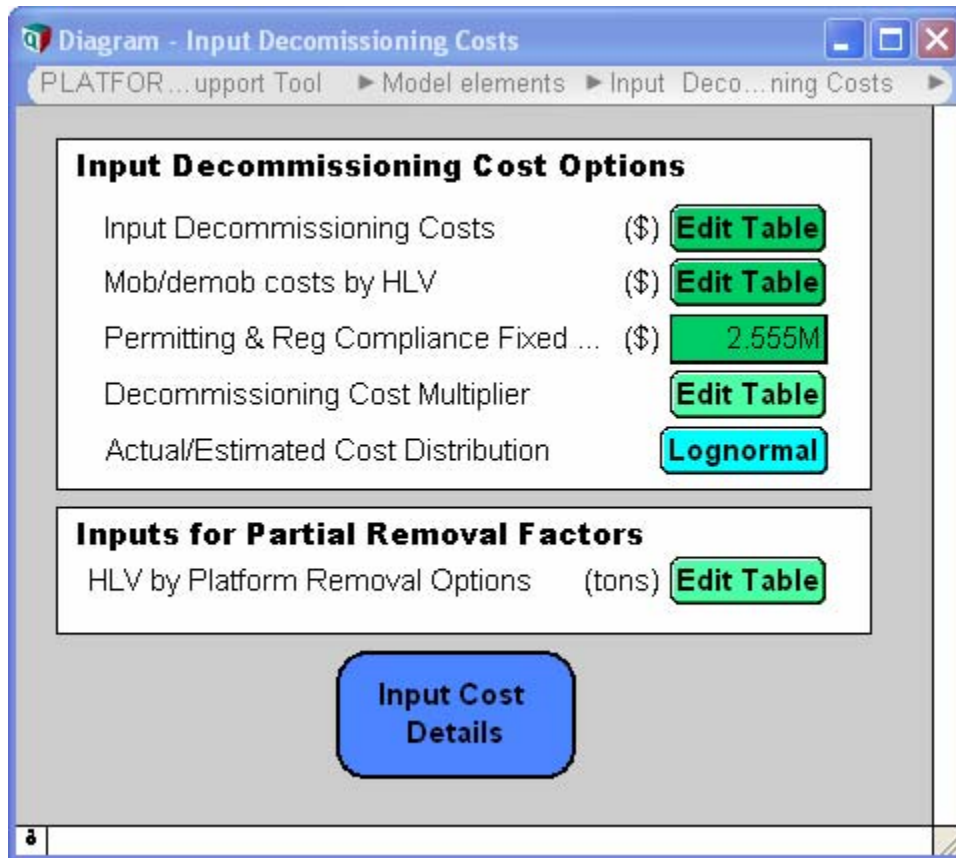

The next set of input nodes in this module are inputs for computing the partial removal factors. Since cost data was only available for complete removal, these factors are used to scale the complete removal costs for partial removal. The **HLV by Platform Removal Options** edit table specifies the HLV size in tonnes for each decommissioning alternative for all platforms, as specified in the MMS report.

More details on the input decommissioning cost calculations can be found in the **Input Cost Details** module

## Air Quality

**Platform Harmony Emissions Estimates**

Operating Days for Partial Removal	(days)	<b>Edit Table</b>
Operating Hours per day	(hours per day)	<b>20</b>
Duty Cycle		<b>Edit Table</b>
BSFC	(g fuel/kwhr)	<b>Edit Table</b>
Equipment List		<b>Edit Table</b>
Emission Factors	(g/kW-hr)	<b>Edit Table</b>
Harmony Worst-case emissions	(tons)	<b>Calc</b> mid

**Air Quality Impacts**

Attribute level by threshold	<b>Result</b> mid
Air quality attribute levels by platforms considered	<b>Result</b> mid

**Platform Harmony Emissions Details**    **Air Quality Impacts**    **Air Quality Attribute Level Descriptions**

This module contains the details on how air quality impacts have been assessed in the model. There are two parts to the air quality module user interface. The first contains details on the Platform Harmony Emissions Estimates. Due to the lack of credible data, it was not possible to model air emissions for all platforms. However, we have explicitly quantified the associated emissions for Platform Harmony, considered to be a worst-case scenario for air quality.

For the purposes of the multi-attribute analysis, we have also modeled air quality impacts qualitatively. We assume the air emissions from the decommissioning operation are roughly correlated with the level of effort and the time on station of large equipment. Given this, we calculate the impact factor as the product of the number of service days the HLVs have to be on-site for both complete and partial removal and the size of the HLV (tons) selected for the project. We treat the highest and lowest impact factors as the upper and lower bounds on air emissions and divide them into five threshold levels based on the five-point scale.

To read the qualitative descriptions for each attribute level for air quality, double-click on the **Air Quality Attribute Level Descriptions** module. To access the underlying qualitative model, double-click on **Air Quality Impacts** module. Finally, to explore the details behind the Platform Harmony emissions estimates, double-click on **Platform Harmony Emissions Details**.

## Water Quality

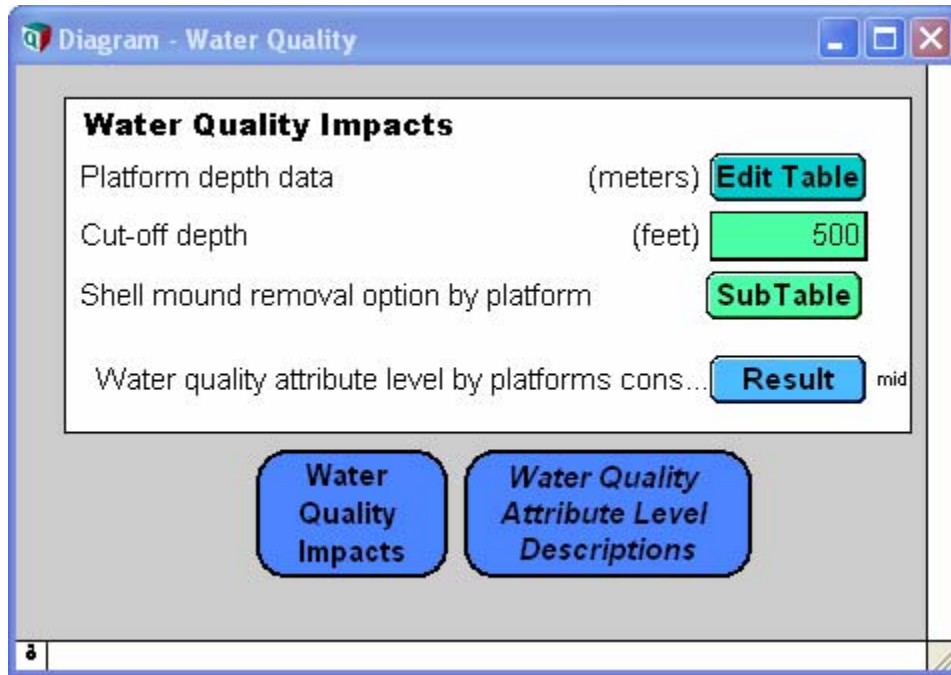

Water quality has been treated qualitatively in the model. The model considers two main impact categories for water quality - accidental spills & discharges and shell mound dredging impacts.

The model user can specify the **cut-off depth** beyond which platforms are considered deep. Depending on the platforms considered for decommissioning, the model uses the cut-off depth and **Platform depth data** to determine whether they are deep or shallow.

For platforms for which complete removal is selected, the model user can control whether or not to incorporate shell mound removals, just as in the top-level user interface.

To access the detailed descriptions for the water quality impacts double-click on **Water Quality Attribute Level Descriptions**. The **Water Quality Impacts** module contains the underlying influence diagram for this module.

## Marine Mammal and Birds

Impact on marine mammals has been treated qualitatively in the MAUA. For platforms for which complete removal is selected, the model user can control whether or not to use explosive severing on jacket piles. This decision affects what the net impacts on marine mammals are during the decommissioning operation. The impacts on birds are also treated qualitatively in this model.

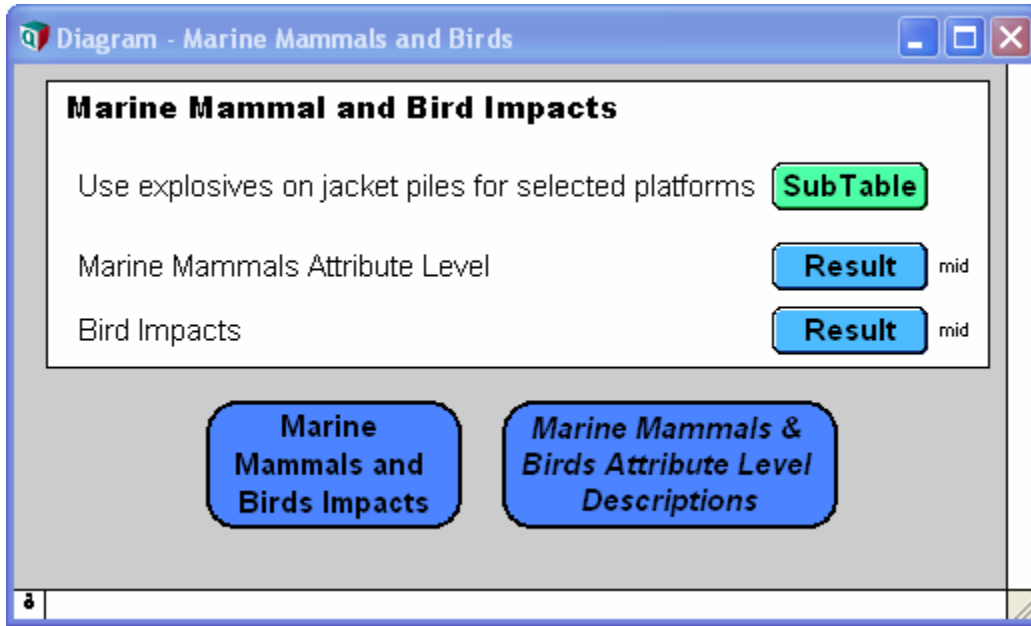

The **Marine Mammals & Birds Attribute Level Descriptions** module provides a summary of the attribute level descriptions for the short-term impacts on birds and mammals. The **Marine Mammals and Birds Impacts** module contains the underlying influence diagrams.

## Strict Compliance Impacts

Strict Compliance suggests that oil companies should be required to fulfill the terms of their leases which require complete removal of platforms when production ends. This judgment is strengthened by the long-term memories of the 1969 Santa Barbara oil spill, as a result of which many local stakeholders are disinclined to enable oil companies to achieve cost savings through a partial removal option. This attribute has been treated qualitatively in the model. Click on the **Strict Compliance Attribute Level Descriptions** to learn more about the attribute level descriptions.

## Marine Resource Impacts

Marine Resource Impacts include benthic impacts, which have been treated qualitatively, and biological impacts, which have been explicitly quantified in this model.

The first section of the Marine Resource Impacts user interface contains the key inputs and outputs relevant to the biological impacts model.

The **Input Biomass estimates** edit table contains the input biomass estimates and parameters used to model the biological impacts.

The **Biomass stock** table computes the current fish biomass stock, in kilograms.

The **Biomass yield for platforms selected** result summarizes the previous result by summing over all the biomass species for the selected platforms over a four-year time horizon.

The **Total Yield over time horizon** computes the total biological yield for all platforms and scenario selected.

The **Substitute Platforms** table lists the substitute platforms used whenever there is a data gap for a platform selected for decommissioning.

The next section of the user interface pertains to the benthic impacts, which are modeled qualitatively. The model considers three main impact categories for benthic impacts - anchoring impacts, shell mound dredging impacts and jacket removal impacts. To access the detailed attribute level descriptions double-click on the **Benthic Impacts Attribute Level Descriptions**. The **Biological Impacts** and **Benthic Impacts** modules contain detailed models underneath them, which can also be accessed by double-clicking on them.

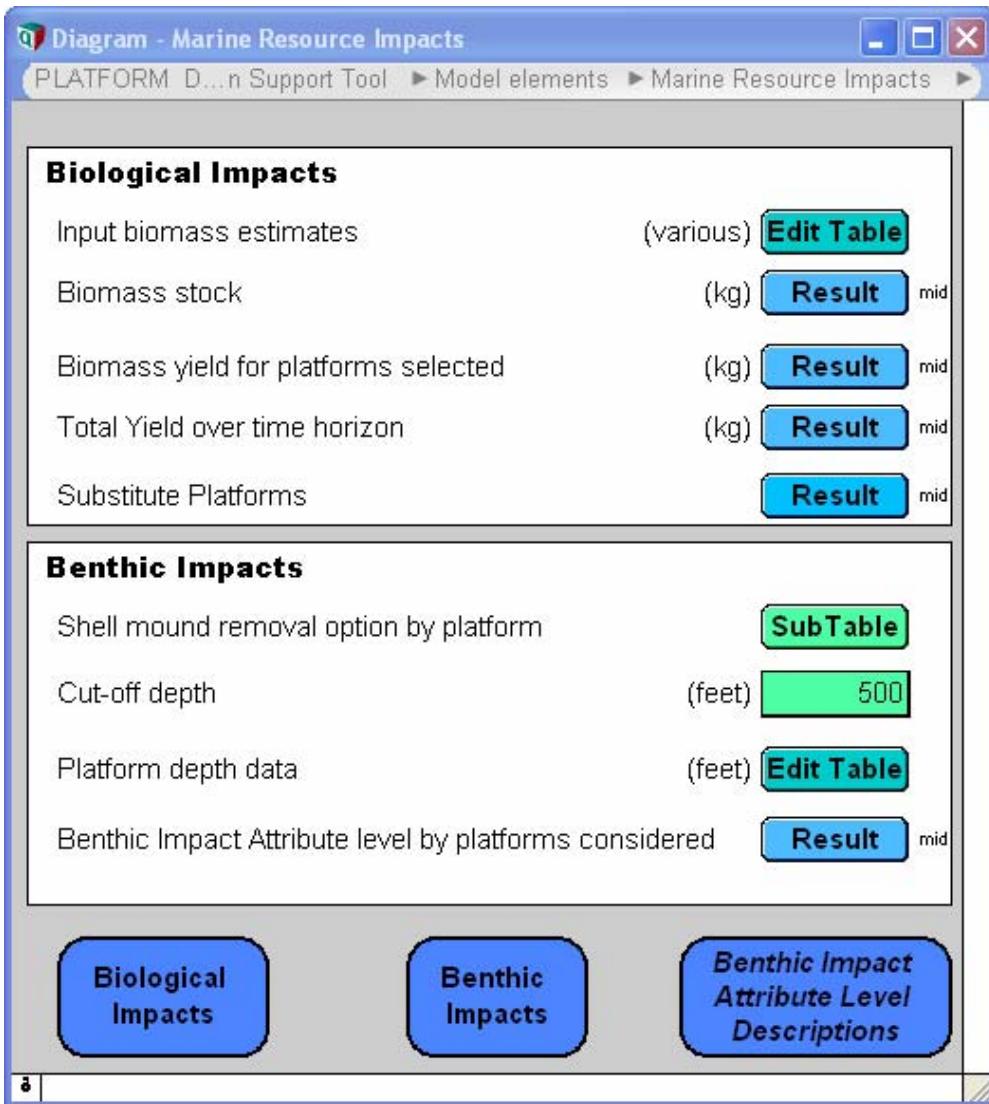

### Ocean Access Impacts

This module computes the increased area of ocean access (square nautical miles) due to platform decommissioning. PLATFORM allows the user to select the **use-type** for selected **platforms**, which determines whether a platform is considered to be “take” or “no-take”. The user can also specify the **use distance limit**, which is the distance from the port beyond which the likelihood of user groups choosing to access this platform is low.

The Ocean Access Impacts Module Details module contains the underlying model details, which can be accessed by double-clicking.

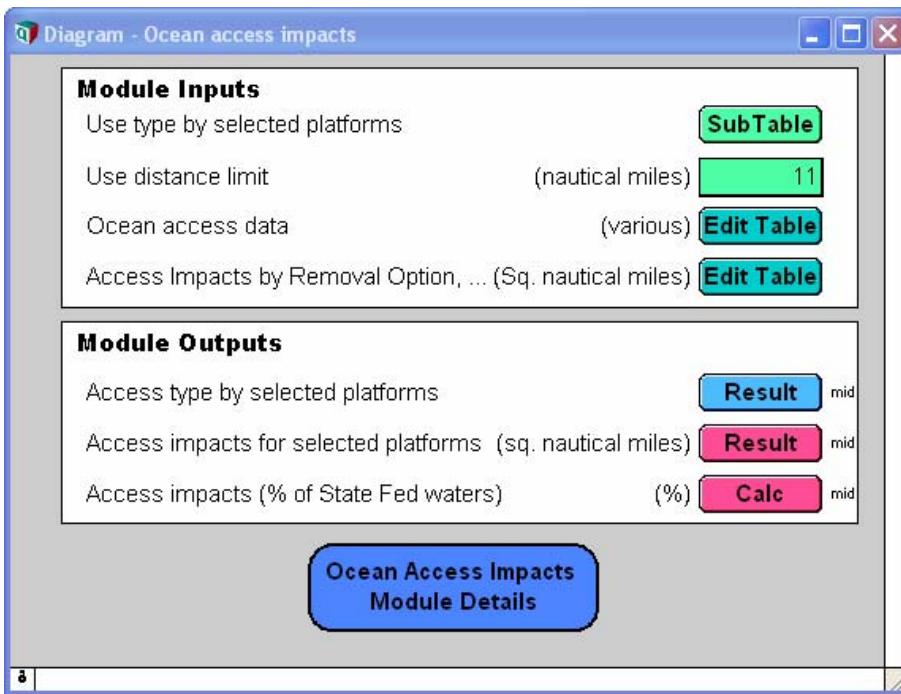

## Programmatic Costs

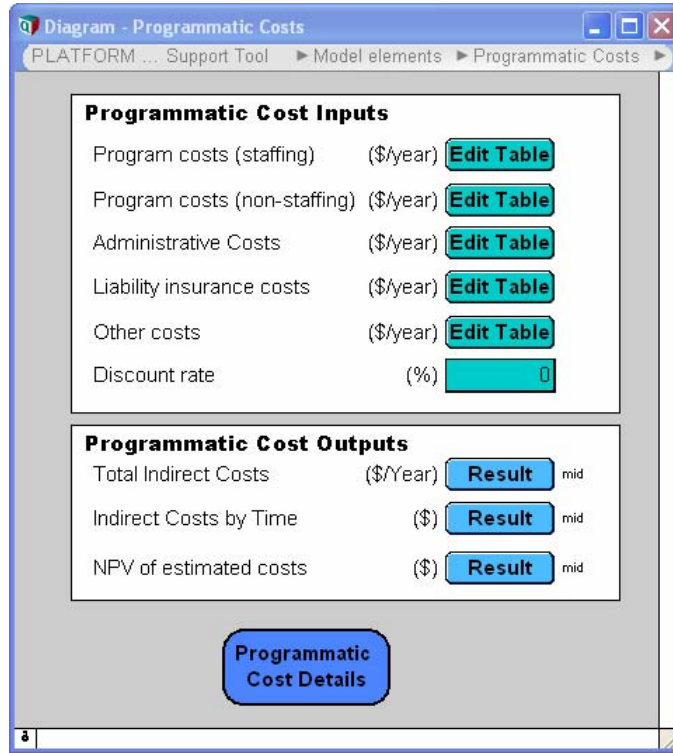

At this point, indirect costs are not being modeled explicitly in PLATFORM due to data gaps. This is an area for future consideration should more credible data become available.

## Direct Costs

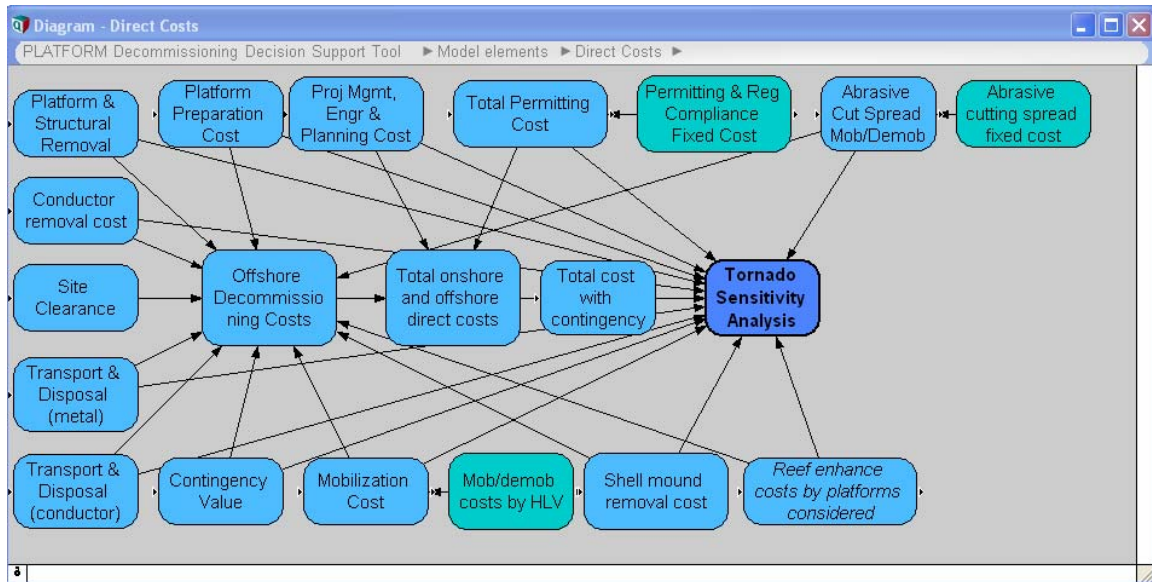

This module contains the details of the Direct Costs which are part of the project cost analysis. It also includes a sub-module for the Tornado Sensitivity Analysis.

### Broader Socioeconomic Impacts

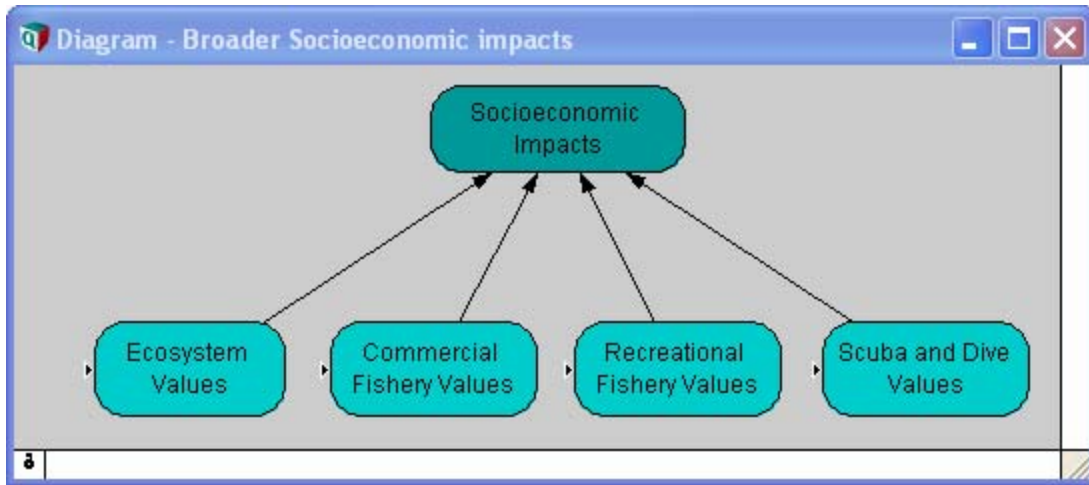

The model currently does not explicitly quantify or treat qualitatively the socioeconomic impacts. This is an area for future consideration.



## Multi-Attribute Utility Analysis

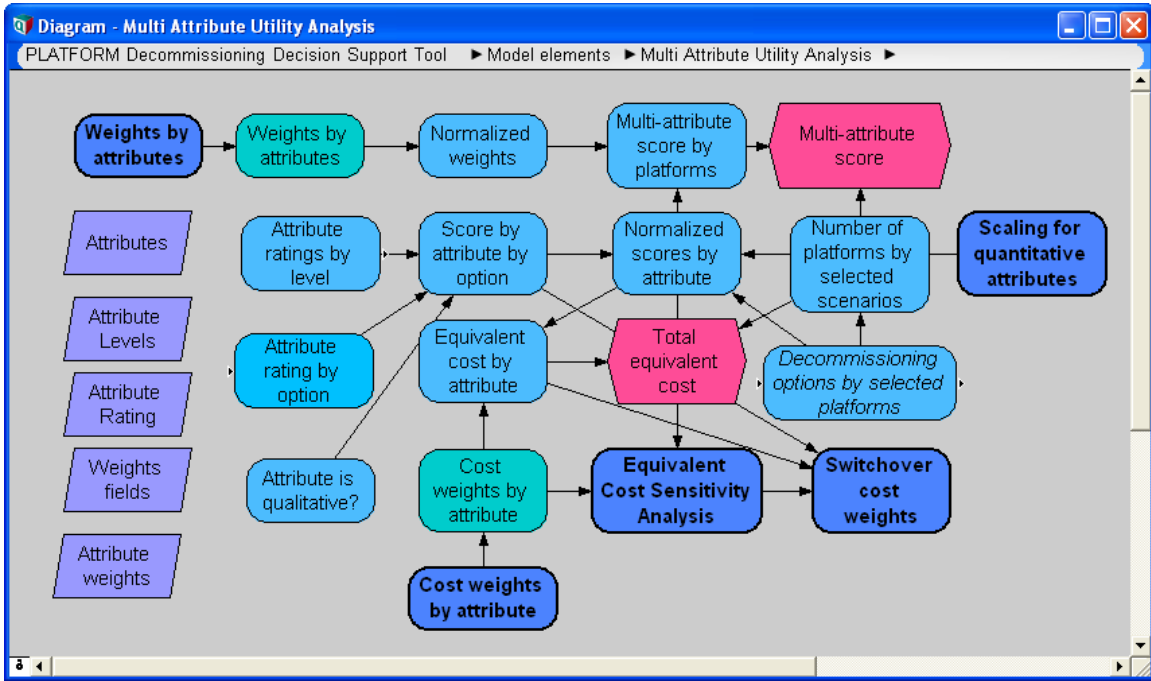

This module contains the details of the MAUA framework described earlier in the user guide.

### Viewing uncertainty in the PLATFORM Model

You may display the uncertainty about key results using Monte Carlo simulation, by requesting an uncertain view to display, including:

- Mean over the distributions: This will usually be similar but not the same as the Mid value.
- Probability bands
- Cumulative probability distribution
- Probability density distribution

#### Uncertainty in decommissioning costs

Within PLATFORM, the uncertainty about the input decommissioning costs are characterized by a probability distribution (lognormal) of the ratio of actual to estimated decommissioning costs based on data estimated on approximately 40 projects involving 120 structures. This uncertainty is then propagated downstream so one can view the uncertainty about the output cost results. In the top-level user interface, when viewing the “decommissioning and avoided

costs” result node, it is possible to switch to an uncertain view by clicking on the mid drop-down menu on the top left hand side of the result node, as shown below.

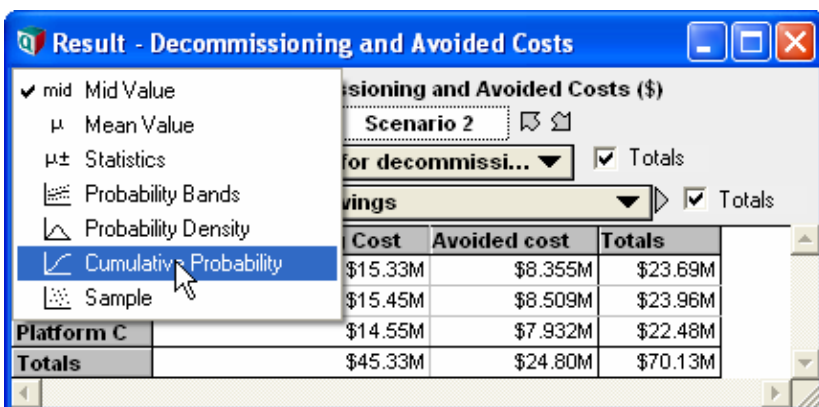

One possible uncertainty view is the cumulative probability distribution (CDF), which one might look at graphically. To switch between the tabulated view and graphical view, click on the bar graph icon to the top left, as illustrated below.

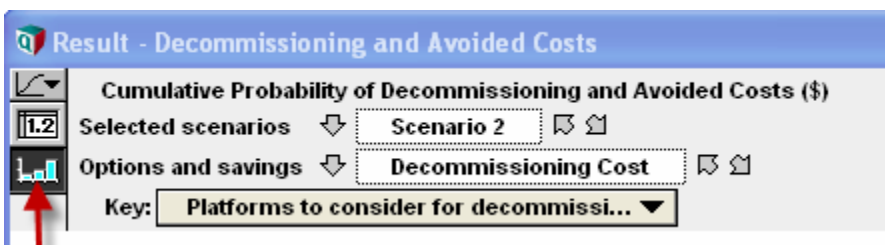

The CDF plots the possible values of the uncertain quantity, in this case the decommissioning costs, along the horizontal (X) axis. The vertical (Y) axis of the graph at each value of X show the probability that the quantity is less than or equal to that X value. For e.g. the graph below suggests that, for Scenario 2 as is defined, there is a 70% probability that the decommissioning cost of Platform C is less than or equal to \$16M.

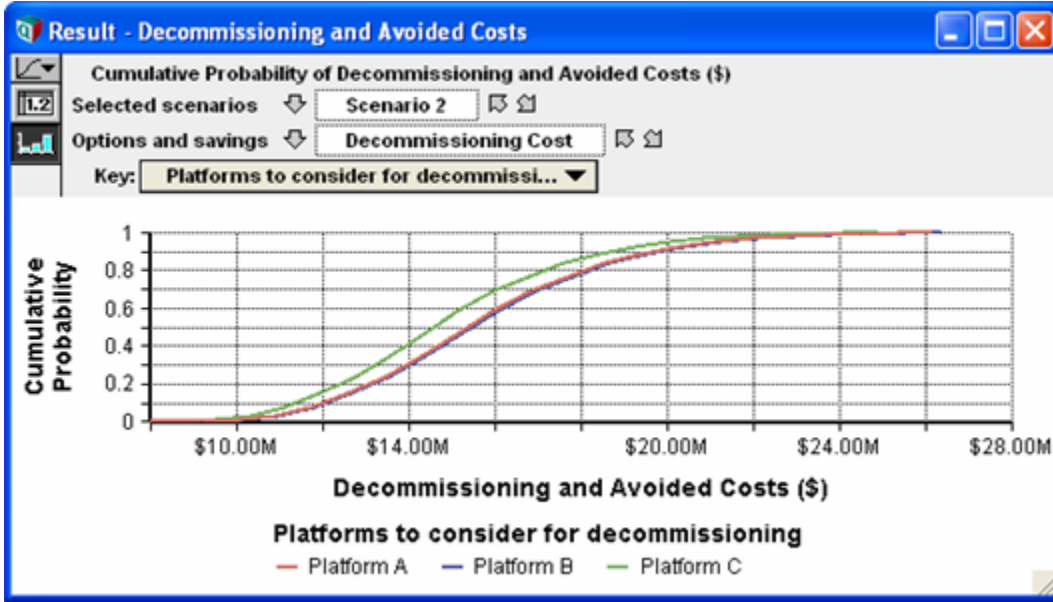

Uncertainty in biological production impacts

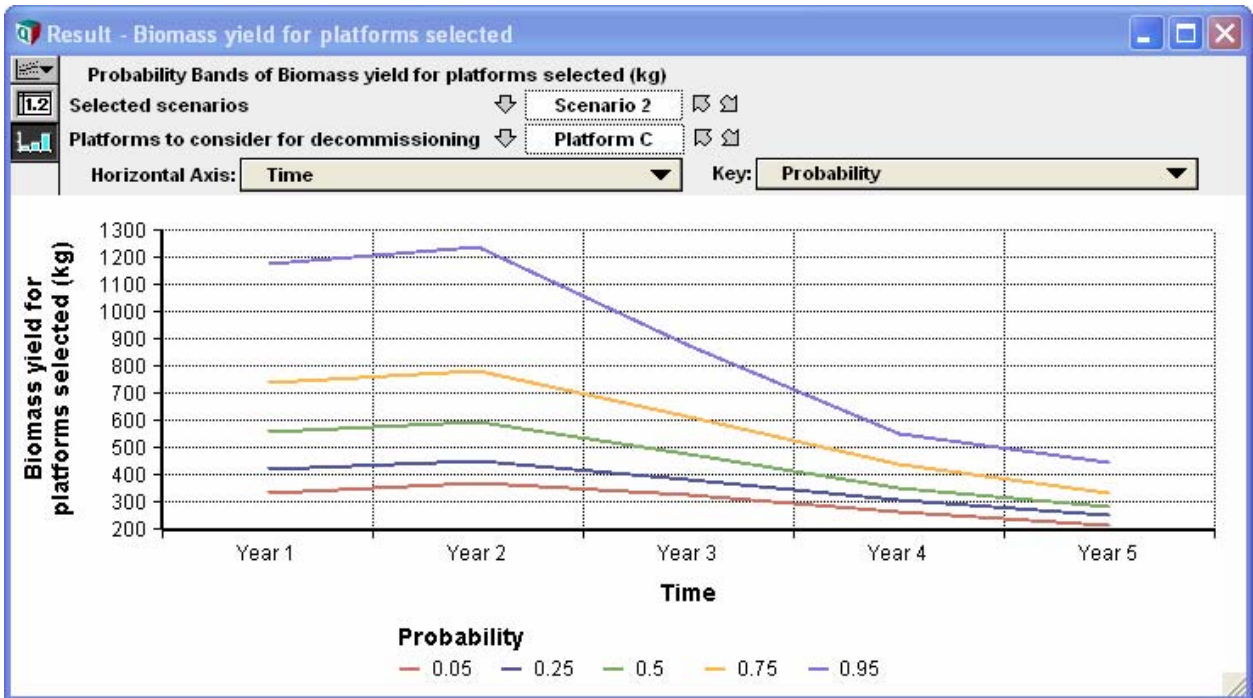

The biological production module within PLATFORM calculates the current standing (biomass) stock of each species per platform. It also calculates the future production and standing stocks based on selected decommissioning options. The uncertainty about the standing stock is characterized by a

lognormal distribution given some estimate of the mean fish biomass (grams) and standard error. This uncertainty is then propagated downstream so we can look at the resulting uncertainty in the outputs, such as the “Biomass yield for platforms selected.” As described above, click on the mid drop-down menu to select the appropriate uncertainty view. One option is to select the probability bands view or “confidence bands”, which shows the percentiles from its distribution - for example, 5%, 25%, 50%, 75%, and 95% percentiles. In the graph below, these appear as bands around the median (50%) line.

## **Appendix 5: Multi-Attribute Utility Analysis**

---

Choosing among decommissioning alternatives is complicated by the fact that each option involves multiple characteristics, or attributes, that are important to decision makers. Some attributes, such as cost, can more readily be quantified. For others, such as impacts on marine mammals or on the broader regional economy, data gaps and/or inherent uncertainty means they can only be described and evaluated qualitatively. Focusing only or primarily on quantitative attributes can undermine the quality of decisions because qualitative attributes can be as important as, or more important than, those that can be quantified. Attributes discussed in the preceding subsections ranged from those that can be quantified relatively reliably (decommissioning costs) to ones with quantitative but uncertain estimates (biological production) to those that can only be addressed in qualitative terms (impacts on marine mammals).

Because both quantitative and qualitative attributes are important to consider in decisions about decommissioning, we have included both types of attributes within a single integrated decision framework based on multi-attribute utility theory (MAUT). The MAUT approach, involving additive utility functions and preference modeling, has been researched and studied in great detail over a period of decades. Fishburn (1970) and Keeney and Raiffa (1976) provide excellent summaries of the background and history of MAUT. The historical development of the MAUT approach can be traced through the work of Debreu (1960), Luce and Tukey (1964), Krantz (1964), Pollak (1967), Keeney (1968), and others.

We use a framework sometimes referred to as the Analytica Hierarchy Process (AHP) (Saaty 1980), which supports the ability to assign relative values to qualitative attributes so they can be included in the quantitative multi-attribute scoring of decision options. This is a key aspect of the approach we apply because it allows users to integrate the entire range of attributes into a single analysis. The approach allows attribute weights (smart values that reflect relative importance to users, or values) to be set explicitly and adjusted by users. This permits users to systematically explore the effects on the choice of decommissioning option of different perceptions of the relative value, importance, or weighting of each attribute. This method is highly effective in enabling users to conduct their own sensitivity analysis to identify breakeven points and evaluate preference trade-offs between conflicting objectives or choices.

Applying this approach involves the following steps, which are described below and then applied to illustrative decommissioning scenarios:

- Define a utility function that scales the importance or impact of each attribute from 0 to 1
- Define and rate each attribute on a five-point scale scored from best (100) to worst (0) that reflects the range of conditions that might occur as a result of decommissioning
- Scale and normalize attribute scores for a given decommissioning scenario in terms of each attribute's Best-to-Worst range; this will result in a proportion somewhere between 0 and 1 for each attribute
- Weight the attributes to reflect user preferences about the relative importance of each attribute
- Calculate the overall multi-attribute score

### **Define the utility function**

The brief description provided here is for those interested in the basic structure of the underlying utility function. The utility function describes how the scores of the weighted attributes are added to arrive at an overall integrated score for a particular choice, using the weights applied to each attribute to take account of the user's judgments about the relative importance of each attribute. The general form of the utility function that has  $m$  attributes is:

$$U(x_1, \dots, x_m) = \sum_{i=1}^m w_i U_i(x_i) \quad (1)$$

where  $U_i$  represents the utility value of some attribute  $i$ ;  $x_i$  is the input value of the attribute of interest; and  $w_i$  is the weight assigned to attribute  $i$ . Utility values always range from zero to one, where zero is the value of the worst option and one is the value of the best.

### **Define and rate attributes**

The main attributes included in the analysis are listed in Table 1, along with a description of whether they are treated quantitatively or qualitatively in the analysis. Attributes are treated qualitatively where a lack of credible data and/or the inherent uncertainty associated with the extent and magnitude of potential impacts made it impractical to quantify them. With two exceptions, these are identical to the issues examined in Section 5.3 and the descriptions and ratings for each attribute reflect the analyses and assessments described in Section 5.3. Socioeconomic impacts were not included because the extent of data gaps for this issue, combined with the uncertainty in the overall direction of impacts under each decommissioning option, made it infeasible to model. Strict compliance was added as an attribute to reflect a perspective shared by certain stakeholders that strongly and independently affects the choice between decommissioning options. Taken together, these attributes provide the basis, for purposes of this analysis, for decisions about the choice between the two main decommissioning options.

**Table 1.** Attributes included in the multi-attribute analysis and whether they are treated quantitatively or qualitatively in the analysis.

Attribute	Treatment
Marine resource impacts - fish biomass (kg)	Quantitative
Marine resource impacts – benthic communities	Qualitative
Air emissions	Qualitative
Increased area of ocean access (Sq. na mi)	Quantitative
Birds	Qualitative
Marine mammals	Qualitative
Water quality	Qualitative
Monetary costs (\$M)	Quantitative
Strict compliance	Qualitative

In order to enable the qualitative attributes to be included in the quantitative multi-attribute scoring of decision options, we adopted a five-point scale, ranging from best (100) to worst (0). Thus, each attribute level is associated with a corresponding numeric score (Table 2). This approach allows all qualitative attributes to be placed on the same scale and removes the problems associated with attempting to compare attributes with inherently different scales (e.g., water quality and marine mammals). For this step in the attribute rating process, each attribute is rated on the five-point scale without reference to other attributes. For example, the Worst potential water quality impact is identified and assigned a score of 100 without reference to what the Worst marine mammal impact might be. Some scores are not relevant to some attributes, where, for example, there might realistically be only three likely types of outcome (e.g., Best, Poor, Worst). While applying this scaling approach necessarily requires making judgments about what constitutes Best or Medium, for example, we make this process as transparent as possible in the following subsections by describing explicitly the meaning of each condition for each attribute. Although this particular five-point scoring method is subjective, it is an accepted approach within the MAUT school of thought.

**Table 2:** Attribute scores associated with each attribute level for those attributes evaluated qualitatively.

Attribute level	Attribute score
Best	100
Good	75
Medium	50
Poor	25
Worst	0

The following paragraphs describe the definitions and ratings for each attribute used in the analysis.

**Marine resource impacts – fish biomass yield (kg):** The decommissioning impacts on fish production have been quantified explicitly as biomass yield (see Section 5.3.1.1 and Appendix 3 for more detail) in PLATFORM. The biological production model estimates standing stock, recruitment, somatic growth, and overall yield of fishes using as input to the model monitoring studies conducted on the platforms. It then calculates future yield over a five-year timeframe for the decommissioning options selected in PLATFORM. Results for each user-defined set of decommissioning options are presented as illustrated in Figure 1 and it is these biomass estimates that are used in the multi-attribute analysis.

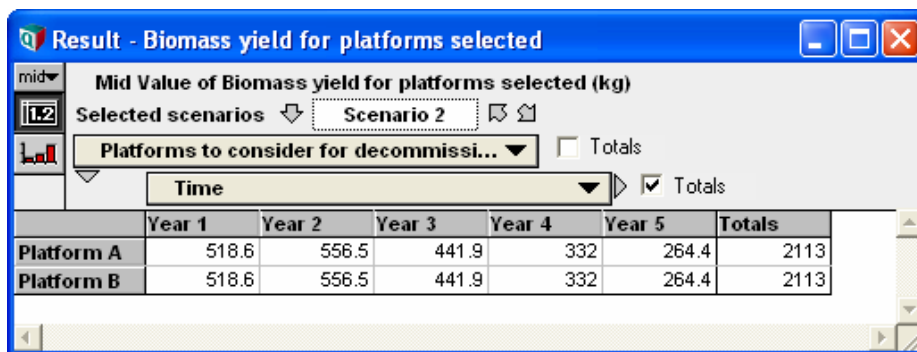

**Figure 1.** Example of PLATFORM model output of biomass yield for a set of user-defined decommissioning options.

**Marine resource impacts – benthic communities:** Impacts on benthic communities are treated qualitatively in PLATFORM and the multi-attribute analysis, which includes three main impact categories: anchoring, shell mound dredging, and jacket removal (see Section 5.3.1.2 for more detail). If anchoring is used, impacts will be Worst for complete removal of deeper platforms because larger HLVs will be on site for longer periods. Even for shallow platforms, anchoring is likely to have some impact and the attribute level for this condition is rated as Poor. In both cases, anchor spreads will have some negative benthic impact. Table 3 presents the descriptions, scores, and conditions for the anchoring impact attribute levels.

**Table 3:** Attribute level descriptions for benthic impacts related to anchoring the HLV and other vessels.

Benthic impacts		Anchoring impacts	
Attribute level	Attribute score	Qualitative description	Condition
Best	100	Status quo Use of dynamic positioning	No action Partial or complete removal
Good	75	NA	
Medium	50	Anchoring for partial removal of platforms creates minor localized, short-term impacts	Partial removal
Poor	25	Anchoring for complete removal of shallow platforms creates some localized impacts on bottom habitat.	Complete removal for shallow platforms
Worst	0	Anchoring for complete removal of deep platforms creates more widespread impacts on bottom habitat.	Complete removal for deep platforms

The modeling of shell mound dredging on benthic impacts is similar to the modeling of dredging on water quality, as described below (Table 9)

Jacket removal would occur only under the complete removal option. Because jacket removal is likely to create only localized and short-term disturbances from excavating, cutting, and then pulling the jacket, the attribute level is Poor. For partial removal, the attribute level is Best because the jacket at the lower levels of the platform will be left undisturbed. The descriptions, scores, and conditions for the jacket removal impact attribute levels are provided in Table 4.

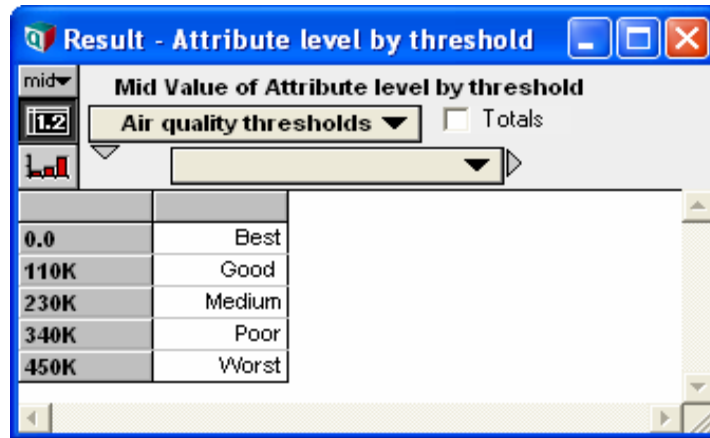

**Table 4:** Attribute level descriptions for benthic impacts related to jacket removal, which occurs at depth only in the complete removal option.

Benthic impacts		Jacket removal impacts	
Attribute level	Attribute score	Qualitative description	Condition
Best	100	Status quo Jacket left undisturbed at lower levels of platform	No action Partial removal
Good	75	NA	
Medium	50	NA	
Poor	25	Jacket removal and site clearance create localized and short-term disturbances from cutting and pulling the jacket	Complete removal
Worst	0	NA	

The attribute scores for each of the three impact categories are combined into a single score for benthic impacts by taking the lowest score (worst attribute level) for a given platform. For example, if a platform's score for anchoring impact is 50 (Medium), 25 (Poor) for shell mound dredging, and 25 (Poor) for jacket removal, the net score for benthic impacts would be 25 (Poor). This overall score is subsequently used as part of the multi-attribute analysis.

**Air emissions:** Air emissions are treated qualitatively in the multi-attribute analysis (see Section 5.3.2 for more detail on data gaps). We assume the air emissions from the decommissioning operation are roughly correlated with the overall level of effort required for the project and the time on station of large equipment such as HLVs. Based on these assumptions, we calculate an air emissions impact factor as the product of the number of service days the HLVs must be on site for a particular project and the size of the HLV (tons) selected for the project, using information from Proserv Offshore (2010) that has been input into PLATFORM. We use the highest and lowest calculated impact factors as the upper and lower bounds on air emissions and divide them into five threshold levels to create a five-point scale. The air emissions impact factors, scaled according to five thresholds, are shown in Figure 2.



**Figure 2.** PLATFORM output screen showing the attribute level associated with the five threshold levels of the air emissions factor.

We then specify a qualitative description for each attribute level for air emissions, as well as the condition associated with each description (Table 5). For example, the air emissions attribute for complete removal of a platform that requires a 4400 ton HLV to be on site for 100 or more service days is ranked Worst, while the air emissions attribute when emissions are zero due to no action is ranked Best.

**Table 5.** Attribute level descriptions of air emissions impacts.

Air emissions		Air emissions impacts	
Attribute level	Attribute score	Qualitative description	Condition
Best	100	Zero emissions due to no decommissioning operations	No action
Good	75	Emissions due to either a 500, 2000, or 4400 ton HLV used on site for anywhere from 7 to 51 days for both complete and partial removal	Complete / partial removal
Medium	50	Emissions due to a 2000 ton HLV being on site for 104+ service days, or a 4400 ton HLV used for 65+ service days, required for complete removal	Complete removal
Poor	25	Emissions due to a 4400 ton HLV being on site for 73+ service days, required for complete removal	Complete removal
Worst	0	Emissions due to a 4400 ton HLV being on site for 113+ service days, required for complete removal	Complete removal

PLATFORM determines the required HLV size based upon the decommissioning option selected by the user and the size of platform(s) to be decommissioned. This HLV requirement, along with the number of service days on site for each decommissioning project, provides the basis for the thresholds described in Table 5.21. This in turn provides the rationale for determining the attribute score for a specific project. These attribute scores are then used in calculating the computing a multi-attribute score.

**Ocean access (sq. nautical miles):** This attribute is treated quantitatively in PLATFORM and the method of estimating changes in ocean access under each decommissioning option is described in Section 5.3.6. The model allows users to select whether decommissioned sites will be open to consumptive uses, which is reflected in the designation of each platform as a “take” or “no-take” area. PLATFORM calculates the increase in accessible ocean area for platforms selected by the user and this estimate of surface area is used as part of the multi-attribute analysis.

**Birds:** Potential impacts on birds are treated qualitatively in PLATFORM and the multi-attribute analysis (see Section 5.3.5 for more detail). Both complete and partial platform removal will likely result in reduced mortality due to elimination of collisions with platforms. However, there is a chance that loss of offshore roosting locations will lead to increased energy requirements and a slight reduction in survival and/or fitness. Thus, the model assumes the net attribute level for both removal options to be Medium. Table 6 presents the descriptions, scores, and conditions for impacts, both short- and long-term, on attribute level for birds.

**Table 6.** Attribute level descriptions of short- and long-term impacts on birds. Only three levels are used for this attribute because of the lack of more specific information on decommissioning impacts on bird populations.

Birds		Impacts (short- and long-term) on birds	
Attribute level	Attribute score	Qualitative description	Condition
Best	100	Reduced mortality due to platform removal and elimination of collisions with platforms; loss of offshore roosting locations compensated by onshore locations	Complete or partial removal
Good	75	NA	
Medium	50	Reduced mortality from platform removal and the loss of offshore roosting locations are balanced out causing a medium impact on birds	Complete or partial removal
Poor	25	NA	
Worst	0	Loss of offshore roosting locations leads to increased energy requirements and slight reduction in survival and/or fitness, which could contribute to significant increase in mortality, although extremely unlikely. Platform has special status species and sound impacts are high from explosive use	Complete or partial removal

**Marine mammals:** Potential impacts on marine mammals are treated qualitatively in PLATFORM and the multi-attribute analysis (see Section 5.3.5 for more detail). Under the complete removal option, In the long-term, both complete and partial removal have similar potential impacts on marine mammals. In the short-term, marine mammals will be more affected by complete removal because of the greater intensity and length of offshore operations. Use of explosives results in an attribute level of Worst because of the potential severity of sound impacts on marine mammals. If no explosives are used, then the attribute level is Poor because there remains the potential for noise and vessel traffic impacts on movement, migration, or foraging. Under the partial removal option, the attribute level is Medium because sound impacts, although still present, will most likely be less than under the complete removal option. Only three levels, rather than five, were created for this attribute because of the lack of more specific information about ways in which the decommissioning options could affect marine mammal populations. The descriptions, scores and conditions for the short-term impacts on marine mammals are provided in Table 7.

**Table 7.** Attribute level descriptions of short- and long-term impacts on marine mammals.

Birds			
Impacts (short- and long-term) on marine mammals			
Attribute level	Attribute score	Qualitative description	Condition
Best	100	Status quo	No Action
Good	75	NA	
Medium	50	Little or no impacts on movement or migration if partial removal is selected	Partial Removal
Poor	25	Complete removal without explosives causes some disturbance or disorientation	Complete Removal without Explosive Severing
Worst	0	Explosives are used during complete removal causing disturbance, disorientation and possible death	Complete Removal with Explosive Severing

**Water quality:** Impacts on water quality are treated qualitatively in PLATFORM and the multi-attribute analysis, which includes two main sources of impact: accidental spills and discharges, and shell mound dredging impacts (see Section 5.3.6 for more detail). Because the potential for water quality impacts increases with the number and length of time vessels and other equipment on site, we assume the potential for such impacts is greater for deep water platforms. Users can specify the water depth beyond which platforms are considered to be deep water platforms. PLATFORM then uses this depth, along with the water depth of platforms selected for the decommissioning scenario, so categorize the selected platforms as either deep water or shallow water platforms. Complete removal of deep water platforms is assigned an attribute level of Worst in terms of their potential for spills and accidental discharges of contaminated material at the sea surface, while complete removal of shallow water platforms is assigned an attribute level of Poor. Partial removal of all platforms (both deep and shallow) is assigned an attribute value of Medium because this decommissioning option is less involved than for complete removal and would be conducted in similar fashion for both categories of platforms. The descriptions, scores and conditions for the short-term impacts on marine mammals are provided in Table 8.

**Table 8.** Attribute level descriptions for water quality impacts that stem from accidental spills and discharges.

Water quality		Accidental spills and discharges impacts	
Attribute level	Attribute score	Qualitative description	Condition
Best	100	Status quo	No action
Good	75	NA	
Medium	50	Spill or discharge of contaminated material when partial removal is selected	Partial removal
Poor	25	Accidental discharge of minimal amount of contaminated material at sea surface for shallow platforms when complete removal is selected	Complete removal for shallow platforms
Worst	0	Accidental discharge of minimal amount of contaminated material at sea surface for deeper platforms when complete removal is selected	Complete removal for deep platforms

For platforms for which complete removal is selected, PLATFORM users can choose whether to include shell mound removal as part of the decommissioning process. Because the potential for water quality impacts is greatest if shell mounds are dredged (see Section 4.1.1.2 for more detail), this is assigned an attribute level of Worst. If shell mounds are not removed, then the attribute level is ‘medium’, while partial removal results in a ‘medium’ attribute level. The descriptions, scores and conditions for the shell mound dredging impact attribute levels are provided in Table 9.

**Table 9.** Water quality shell mound dredging impact attribute level descriptions

Water quality		Shell mound dredging impacts	
Attribute level	Attribute score	Qualitative description	Condition
Best	100	Status quo	No action
Good		Little or no increase in toxicity or bioaccumulation from shell mounds left in place with bottom undisturbed	Partial removal
Medium	50	Minor increase in toxicity due to shell mounds left in place after partial removal	Partial removal
Poor	25	Minor increase in toxicity or bioaccumulation due to shell mounds left in place after complete removal	Complete removal without shell mound removal
Worst	0	Shell mound removal leads to increase in contaminant levels and short-term, localized, minor increase in water column or sediment toxicity when complete removal & shell mound removal are selected	Complete removal with shell mound removal

The attribute scores for spills and discharges are combined with those for shell mound dredging into a single attribute score for water quality by taking the lowest score (worst attribute level) for a given platform. For example, if a platform’s score for accidental spills and discharges is 50 (Medium) and 25 (Poor) for shell mound dredging impacts, the net score for water quality is 25 (Poor). These attribute scores are then used in the multi-attribute analysis.

**Costs (2009\$):** Decommissioning costs for both complete and partial removal options are quantified as described in Section 5.3.7. PLATFORM includes two modules related to decommissioning cost. The first module, programmatic costs or indirect costs, is associated with program staffing, operations and administration, and liability insurance coverage. PLATFORM calculates the net present value of estimated indirect costs over a discrete, five-year time frame, using a discount rate selected by users from a range of possible choices. Because future programmatic costs have not been estimated and are highly uncertain, PLATFORM allows users to input their assumptions about potential programmatic costs of a long-term rigs-to-reefs program. These costs are then used as a quantitative input to the multi-attribute analysis. PLATFORM also calculates the direct costs of decommissioning itself, including the complete and partial removal options, and suboptions such as shell mound dredging and reef enhancement. PLATFORM also calculates the avoided cost as the difference between the costs of complete and partial removal. The key outputs from the direct cost analysis, which are used in the multi-attribute analysis, are the total decommissioning and avoided costs for the selected platforms.

**Strict Compliance:** An important subset of stakeholders firmly holds a set of opinions or judgments that combine to create strong support for the complete removal option. One important element in this overall perspective is that human activity in the oceans is likely to create negative impacts and that the ocean environment is at risk from such impacts. A corollary of this judgment is that the residue of human activities, particularly substantial ones such as offshore platforms, should be completely removed from the ocean as soon as such activities are completed. A major intent of this ethic is to reduce any remaining risks of such activities to the greatest extent possible. Closely tied to this set of judgments is another that holds that industry, particularly large industry, should be held to its commitments. In the context of offshore oil and gas production in southern California, this means that oil companies should be required to fulfill the terms of their leases which require complete removal of platforms when production ends. This judgment is strengthened by the long-term memories of the 1969 Santa Barbara oil spill, as a result of which many local stakeholders are disinclined to enable oil companies to achieve cost savings through a partial removal option. The descriptions, scores and conditions for strict compliance impact attribute levels are provided in Table 10.

**Table 10:** Strict Compliance impacts attribute level descriptions

Water quality		Shell mound dredging impacts	
Attribute level	Attribute score	Qualitative description	Condition
Best	100	Oil companies fulfill the terms of their leases which require complete removal of platforms when production ends	Complete removal
Good	75	NA	
Medium	50	NA	
Poor	25	NA	
Worst	0	Oil companies do not fulfill the terms of their leases which require complete removal of platforms when production ends	Partial removal

### **Scale the attributes**

In our analysis, the multi-attribute utility function is used to compute a weighted sum of the scores on each attribute, as shown in equation (1). Each qualitative attribute has an assigned score on the aforementioned five-point numeric scale. The quantitative attribute values, such as cost and increased area of ocean access, are scaled using interpolation to obtain their normalized scores. A general formula to normalize the attributes is:

$$U_i = \frac{x - Worst}{Best - Worst} \quad (2)$$

Where “Worst” refers to the criterion with the least favorable score and “Best” refers to the criterion with the most favorable score. Once individual utility values for each attribute are normalized using equation (2), those values are multiplied by their respective weights.

### **Weight the attributes to reflect preferences**

The tool offers two methods for assigning weights to the attributes to combine them into an overall score for each platform.

Attribute range weights can be used to assign a number from 0 – 5 to express the relative importance of each attribute range. The weights specify the relative importance of changing that attribute from its worst to best level. A key point to remember is that *you are not setting the importance of the attributes* in the abstract — is effect on air quality more or less important than the effect on cost? You are setting *range weights*. After setting the ratings and weightings, you can view the overall score for each platform. You can then change the decision option for one or more platforms and see how the score changes. In this way, it may help you see the implications of your preferences for the relative scores of different decision options.

The equivalent costs method allows the user to specify the relative importance of each attribute as the dollar cost society should be willing to pay to move the attribute from its worst to best value, or equivalently, the dollar value society should accept in compensation if the attribute were moved from its best to worst value. After assigning these cost weights, you can again view the overall score for each option for each platform.

The equivalent cost method requires users to monetize each attribute while the range weighting method appears to avoid the necessity of converting all attributes into dollars. However, they are mathematically equivalent. Both result in assigning weights that allow apparently incommensurable attributes to be converted into a common scale, so that we can multiply the levels by the weights and add them together. The following example scenarios below walk through illustrative examples illustrating how users might choose to weight attributes to reflect their preference.

### **Calculate the multi-attribute score**

If attribute range weights are used, then the relevant result is the multi-attribute score (across all attributes) computed for each decommissioning scenario selected. A scenario can comprise a single platform selected for decommissioning or multiple platforms. If multiple platforms are selected for each scenario, then PLATFORM computes a multi-attribute score for each scenario, based on the weighted sum of scores on each attribute, averaged over all the platforms selected for decommissioning within each scenario. The platform or scenario with the highest score is considered to have the highest utility across all criteria. Alternatively, if equivalent costs are preferred, then PLATFORM will provide the total equivalent cost (\$M) as an output.

### Example scenarios

This subsection steps through a sample evaluation of decommissioning options using PLATFORM. The project selected is one of the six decommissioning projects defined in Proserv Offshore (2010) for the 23 OCS platforms in southern California. Sample decommissioning project IV, which includes the decommissioning of platforms Gilda, Habitat, and Irene, is used in the following example. selected. These three platforms are all located in water depths less than 300 feet.

### Defining decommissioning scenarios

To conduct a multi-attribute analysis for this decommissioning project, users will start with the user interface screen displayed when PLATFORM is opened (Figure 1).

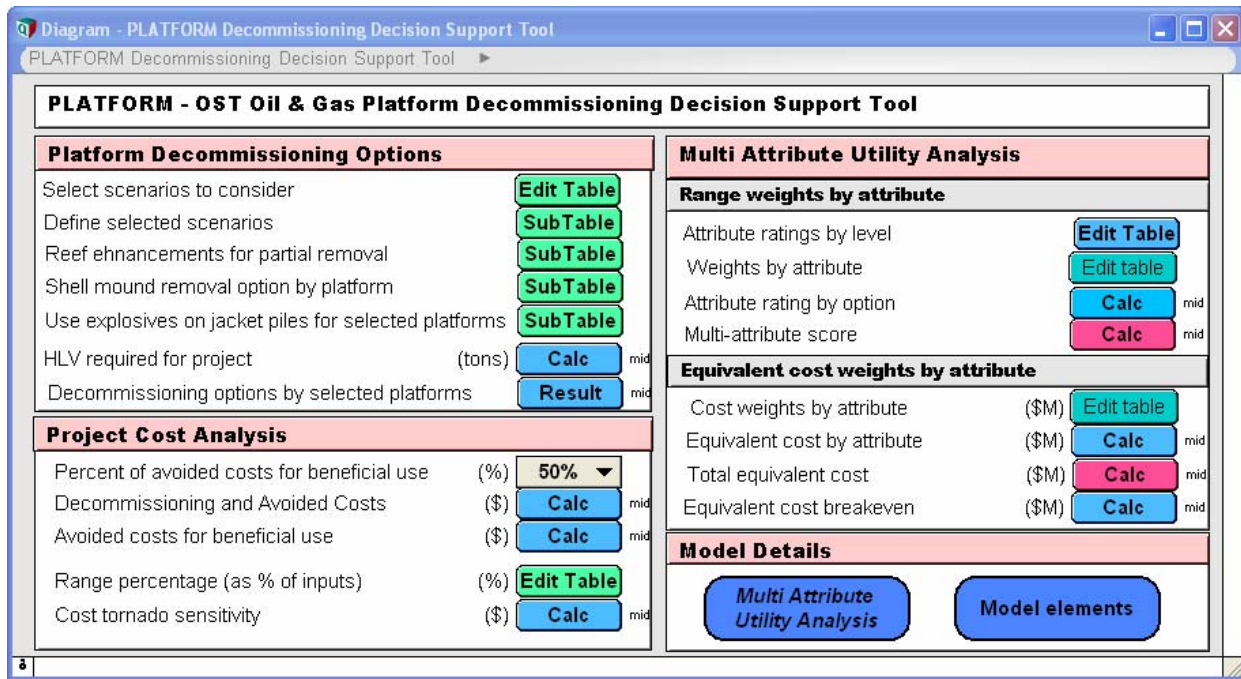

**Figure 1.** Initial, or top-level, user interface screen displayed when PLATFORM is opened.

Users' first step is to select the number of scenarios to consider, because PLATFORM allows users to directly compare multiple decommissioning scenarios for either the same or different sets of platforms (see Appendix 4 for more detail). Making these selections involves simply clicking on the Edit Table button for Select Scenarios to Consider in Figure 1 and then checking the boxes the appropriate number of boxes, as illustrated in Figure 2.



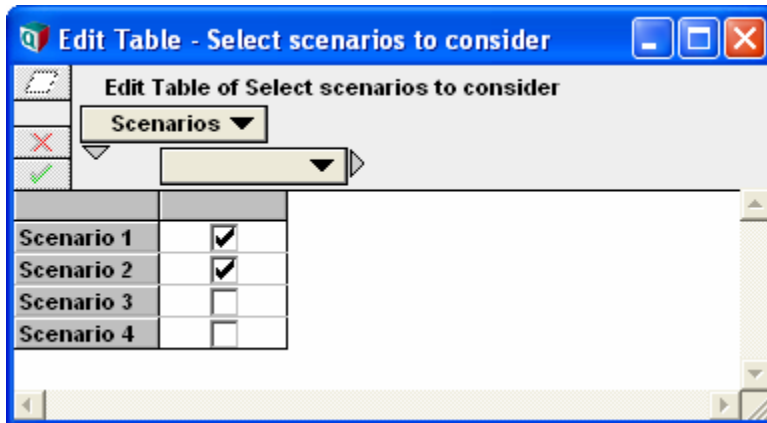

**Figure 2.** Selecting multiple scenarios to consider requires checking the appropriate number of boxes.

The next step is to define these scenarios by clicking on the Edit Table button for Define Selected Scenarios in Figure 1.

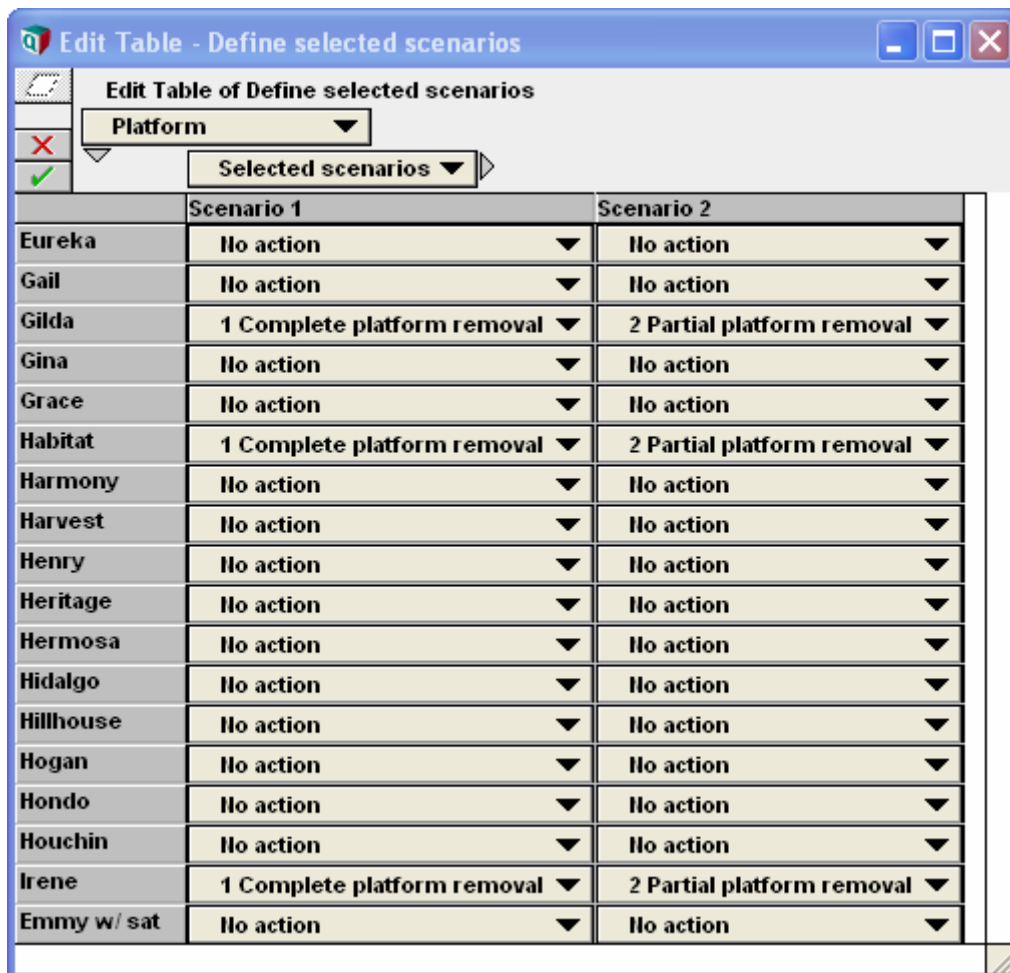

**Figure 3.** Defining the selected scenarios involves selecting one choice for each platform in each scenario from the pull-down menu for each choice. The illustrated Scenario 1 is MMS decommissioning project IV, which in this case is being compared to the partial removal of all platforms as Scenario 2.

The pull-down menus in Figure 3 allow users to select among three options for any given platform in a scenario: Complete Platform Removal, Partial Platform Removal, and No Action. Scenario 1 illustrated in Figure 3 involves the complete removal of platforms Gilda, Habitat, and Irene which corresponds to MMS decommissioning project IV. Scenario 2 consists of the partial removal of these same platforms (although selecting the same platforms is not a requirement of the analysis). After making the selection the user must click on the Check Mark located in the upper left hand corner of the pull-down menu screen shown in Figure 3 to confirm the selections before closing this screen.

The next option on the top-level user interface screen (Figure 1) allows users to decide whether the project will include any reef enhancements for those scenarios and platforms that include partial removal (Scenario 2 in this case). For this example, we leave all the boxes unchecked indicating that reef enhancement will not be included in the decommissioning project evaluated in Scenario 2.

The shell mound removal sub-table (accessed through the upper left-hand portion of the top-level user interface screen illustrated in Figure 1, allows users to decide whether shell mounds will be removed or left in place for any platforms and scenarios designated for complete removal (Scenario 1 in this case). For this example, we leave all the boxes unchecked indicating that shell mounds will be left in place after the platform is removed.

The next option on the user interface screen (Figure 1) allows users to select explosive severing on jacket piles for platforms and scenarios designated for complete removal. For this example, we leave all the boxes unchecked, indicating that explosives will not be used.

The HLV Required for Project option on the user interface screen (Figure 1) identifies the largest HLV size required for the selected platform decommissioning options for each scenario. PLATFORM makes this choice based on the weights of each platform component and HLV lifting capacities.

This series of steps defines the details of the decommissioning project and the two scenarios. Implementing the multi-attribute analysis involves now moving to the upper right-hand portion of the top-level user interface screen illustrated in Figure 1, reproduced below in Figure 6.

<b>Multi Attribute Utility Analysis</b>		
<b>Range weights by attribute</b>		
Attribute ratings by level		<b>Edit Table</b>
Weights by attribute		<b>Edit table</b>
Attribute rating by option		<b>Calc</b> mid
Multi-attribute score		<b>Calc</b> mid
<b>Equivalent cost weights by attribute</b>		
Cost weights by attribute	(\$M)	<b>Edit table</b>
Equivalent cost by attribute	(\$M)	<b>Calc</b> mid
Total equivalent cost	(\$M)	<b>Calc</b> mid
Equivalent cost breakeven	(\$M)	<b>Calc</b> mid

**Figure 6.** The multi-attribute analysis options, taken from the upper right-hand portion of the top-level user interface screen illustrated in Figure 1.

### Rating attributes individually

There are two main ways to use the multi-attribute analysis features of PLATFORM to view and select methods for comparing decision options on all eight attributes: First, users can simply view the selected decision option for each platform and its effect on each attribute, using the Attribute Ratings by Option selection in Figure 6, as illustrated below in Figure 7, which shows the level of each qualitative attribute on the qualitative five-point scale of Best to Worst. Note that these ratings are taken from the set of possible ratings or scores for each option defined in Tables 3 – 10. For example, because Scenario 1 involves complete removal of all three platforms, the rating for Strict Compliance is necessarily Best, while the rating for Benthic impacts is necessarily Poor. Figure 7 also shows the quantified estimate of impact for the 1 three quantified attributes: fish biomass in kilograms, increased ocean access in square nautical miles, for cost in millions of dollars (2009\$).

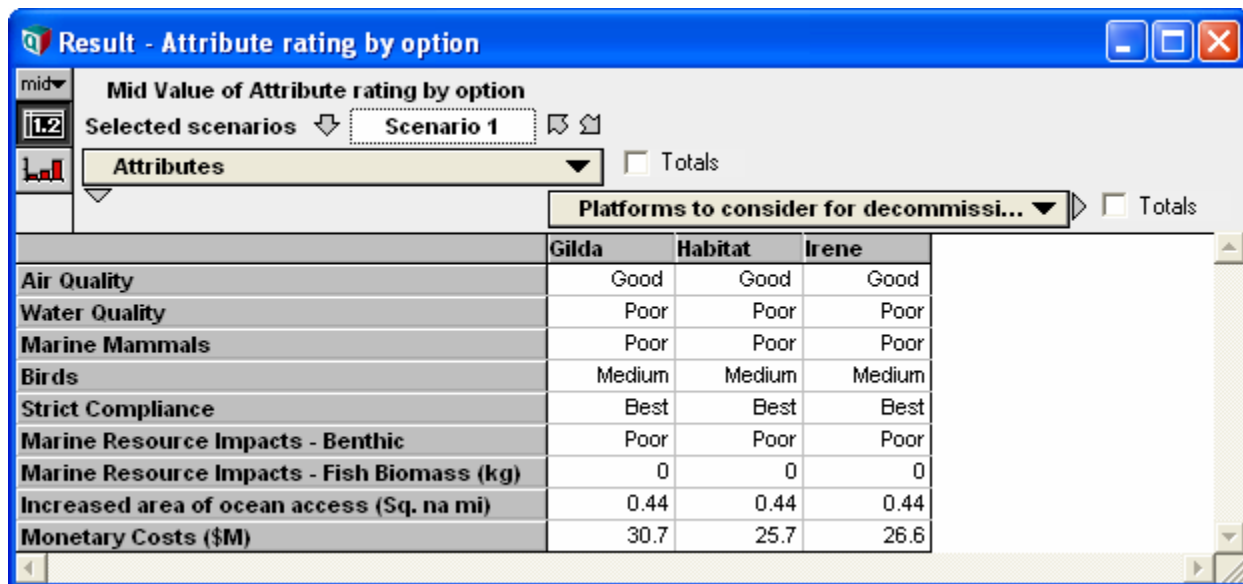

**Figure 7.** The attribute ratings, or scores, associated with each attribute for the Scenario 1 project involving the complete removal of the three platforms.

The second way users can compare the scenarios' effects on the attributes is to use scaling and weighting to convert the individual attribute levels into an overall score for each platform decision option selected. This allows users to make a direct global comparison between scenarios.

The first Edit Table choice in Figure 6 enables users to select Attribute Ratings by Level. The ratings for the qualitative attributes shown in Figure 7 are mapped onto numeric ratings that range from 0 (Worst) to 100 (Best), using as a starting point the default values shown in Table 2. Note that these default values reflect a linear scale and PLATFORM allows users to adjust the ratings for the intermediate attribute levels to reflect their own views (although the endpoints must remain anchored at 0 for Worst and 100 for Best). For example, a user might decide that Poor should be rated as 10 on the 100-point scale rather than 25 (the default rating in Table 2). For purposes of this example, we will use the default values. This simply changes the output table shown in Figure 7 to one that contains numeric ratings rather than the qualitative ones shown.

### **Combining attribute scores into an overall score**

PLATFORM then offers two methods for assigning weights to the attributes in order to combine them into an overall score for each platform: Range Weights by Attribute and Cost Weight by Attribute. Figure 8 illustrates the former.

Weights by Attributes			
Attributes	Weights	Best Outcome	Worst Outcome
Air Quality	3	Zero Emissions due to no decommissioning operations	Emissions due to a 4400 ton HLV being on-site for 113+ service days, required for complete removal
Water Quality	2	Status quo	Accidental discharge of minimal amount of contaminated material at sea surface for deeper platforms when complete removal is selected. Or shell mound removal leads to increase in contaminant levels and minor increase in water column or sediment toxicity
Marine Mammals	3	Status quo	Explosives are used during complete removal causing greater disturbance, disorientation, and possibly death
Birds	1	Reduced mortality due to platform removal and elimination of collisions with platforms, loss of offshore roosting locations compensated by onshore locations	Loss of offshore roosting locations leads to increased energy requirements and slight reduction in survival and/or fitness, which could contribute to significant increase in mortality that outweighs reduced mortality from elimination of collisions with platforms

**Figure 8.** PLATFORM menu screen that allows users to assign weights to individual attributes to reflect their preferences.

The drop-down menu in the second column titled Weights allows users to assign relative weights for attributes that reflect their perception of the relative importance of each attribute's range from worst to best [5: Best, 1: Worst]. Each weight specifies the relative importance of changing that attribute from its Worst to Best level. Users should begin this process by considering which attribute range they consider has the largest impact. For example, if a user considers the range for the Cost attribute from \$0 to \$400 million is as or more significant than the effect of changing any other attribute from its Best to Worst level, then the weight of the Cost attribute should be set to 5.

Users then identify the attribute they consider the next most important. For example, a user might decide that the impact on marine mammals is more (or as) important as any other attribute except cost. They would then evaluate the question: What is the relative importance to me of changing the impact on marine mammals from Worst (*Explosives are used during complete removal causing disturbance, disorientation and possible death*) to Best (*status quo*) and changing costs from \$0 to \$400 million? If the answer is that this change in impacts on marine mammals is a bit more than half as important as the change in costs, the user might set the weight for the marine mammals attribute to 3. This exercise is then repeated with each attribute until weights have been set for all eight attributes.

Clicking on the Calc button for the Multi-Attribute Score on the screen illustrated in Figure 6 causes PLATFORM to calculate a weighted sum of scores over all attributes, averaged over all selected platforms for each scenario, as illustrated in Figure 9. This overall score allows for a global comparison between the two decommissioning scenarios. Figure 9 shows that, for the scenarios defined above for

decommissioning project IV, scenario 2 has a marginally better score than scenario 1, favoring partial removal of the platforms. Users can then conduct their own sensitivity analysis by changing the decision option for one or more platforms to examine how this might affect the overall score. This sort of exploration can assist users to better understand the implications of their preferences in terms of their influence on the scores of different decision options. For example, if the Strict Compliance attribute is rated to be as important as costs, and both attributes are assigned a weight of 5, then scenario 1 receives a higher score, favoring complete removal of all the platforms selected.

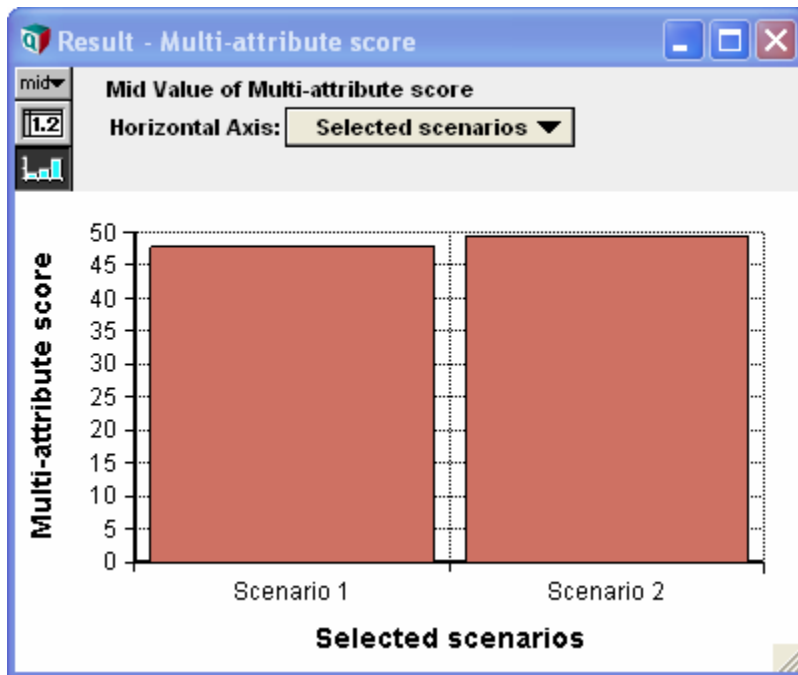

**Figure 9.** Example output showing the overall weighted multi-attribute scores for the two scenarios using the Weights by Attribute feature shown in Figure 6.

The second method of weighting attributes to arrive at an overall score uses equivalent costs. Clicking on Cost Weight by Attribute in Figure 6 enables users to set the equivalent cost in dollars (or millions of dollars) of changing each attribute from its Best to its Worst level. By definition, the equivalent cost of the Cost attribute is \$400 million, its current Worst value. If users consider that the cost of going from the Best air quality (status quo) to the Worst air quality (Emissions due to a 4400 ton HLV being on site for over 113 service days, as required for complete removal) is \$20 million, then 20 should be entered into the row for Air Quality in Figure 10. There is no reason that the equivalent cost of an attribute cannot exceed the \$400 million value for the cost attribute, if, for example, they believe that changing a particular attribute from its Best to its Worst level is worth more than \$400 million. Figure 10 illustrates the PLATFORM interface for entering equivalent costs for each attribute.

Diagram - Cost weights by attribute

PLATFORM Decommissioning Decision Support Tool ▶ Model elements ▶ Multi-Attribute Utility Analysis ▶ Cost weights by attribute ▶

Cost equivalents by attributes			
Attributes	Cost Equivalent (\$M)	Best Outcome	Worst Outcome
Air Quality	20	Zero Emissions due to no decommissioning operations	Emissions due to a 4400 ton HLV being on-site for 113+ service days, required for complete removal
Water Quality	50	Status quo	Accidental discharge of minimal amount of contaminated material at sea surface for deeper platforms when complete removal is selected. Or shell mound removal leads to increase in contaminant levels and minor increase in water column or sediment toxicity
Marine Mammals	40	Status quo	Explosives are used during complete removal causing greater disturbance, disorientation, and possibly death
Birds	50	Reduced mortality due to platform removal and elimination of collisions with platforms, loss of offshore roosting locations compensated by onshore locations	Loss of offshore roosting locations leads to increased energy requirements and slight reduction in survival and/or fitness, which could contribute to significant increase in mortality that outweighs reduced mortality from elimination of collisions with platforms

**Figure 10.** The PLATFORM interface for entering equivalent costs for each attribute.

Clicking the Calc button for Total Equivalent Cost on the screen illustrated in Figure 6 causes PLATFORM to calculate the equivalent costs for all attributes, averaged over all selected platforms for each scenario (Figure 11). For the defined scenarios, Figure 11 shows that the complete and partial removal options are essentially equivalent.

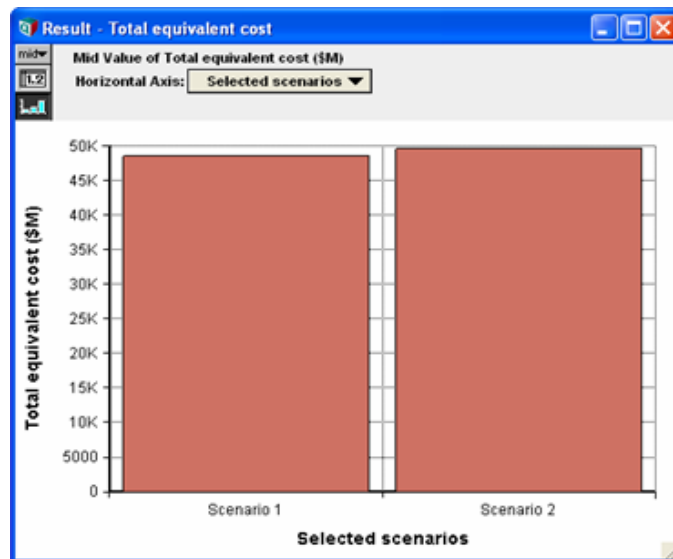

**Figure 11.** Example output showing the overall equivalent costs for the two scenarios using the Equivalent Cost feature shown in Figure 6.

As we described for the Range Weights by Attribute example, we can adjust the equivalent cost weight by attribute for the strict compliance attribute so that it is at least as important as the monetary cost. This causes the outcome to favor complete removal for the platforms selected. In addition, making adjustments to the platform-specific decisions on explosive use, shell mound removal, and reef enhancements will also cause corresponding changes in the total equivalent cost comparison between the two scenarios.

Clicking the Calc button for Equivalent Cost Breakeven on the screen illustrated in Figure 6 will display the breakeven or switchover cost weight for a given attribute that would cause the ranking of the scenarios (based on estimated equivalent cost) to change. For example, if the equivalent cost for scenario 1 is higher than that of scenario 2 for platform Gilda, the switchover cost weight computed for a given attribute for platform Gilda is the modified cost weight which if used in place of the original cost weight of that attribute will equalize the equivalent costs for scenarios 1 and 2 for Platform Gilda. This PLATFORM feature is a useful tool for identifying and examining switchover or breakeven points that could influence a change in decision. Note that if the breakeven cost weight for a given attribute is INF that only means both scenarios were ranked equally for that attribute and platform. This result provides a useful way to analyze the sensitivities of the cost weights to the overall equivalent cost.

Some users may find both of the weighting methods require making judgments they perceive as too difficult or unreliable. Such users can focus on the first method shown, which simply displays attribute scores without attempting to combine them mathematically. On the other hand, arriving at a decision with this method will still require users to find some way to combine all attributes intuitively. We do not make any claims here about which approach is better. PLATFORM provides these options so that users can choose the method they find most useful.



**Announcement: December 17, 2008**

**California Ocean Science Trust Announces Members of Expert Advisory Committee for Oil and Gas Platform Decommissioning Study**

The California Ocean Science Trust announces the selection of 15 members to the Expert Advisory Committee for the Study to Provide Information Related to Oil and Gas Platform Decommissioning Alternatives in California.

This study will help the state examine the alternatives for decommissioning existing oil and gas platforms in State Tidelands and in the Federal Outer Continental Shelf off the California coast. Information developed through this study will be used by the California Natural Resources Agency to evaluate and inform policy discussions.

The Expert Advisory Committee will play a critical role in ensuring that the state receives authoritative and robust advice on oil and gas platform decommissioning. They will inform the selection of the study team, review the selected team's products, provide advice on the study process, and deepen the expertise that helps to shape the project findings.

Members of the Committee were selected for their expertise in the following fields: marine ecology; oil and gas development; water quality; air quality; socioeconomics; coastal policy and law; and project management.

The newly appointed members of the Expert Advisory Committee are:

- Dr. Todd Anderson, San Diego State University
- Doug Anthony, Energy Division of Santa Barbara County
- Dr. Ann Bull, Minerals Management Service
- Dr. Robert Byrd, Proserv Decommissioning Contractors & Engineers, Inc.
- Dr. Elizabeth Chornesky, Freelance Analyst
- Alison Dettmer, California Coastal Commission
- Dr. Linda Fernandez, University of California, Riverside
- Gregg Gitschlag, National Marine Fisheries Service
- Dominic Gregorio, State Water Resources Control Board
- Sean Hecht, University of California, Los Angeles
- Dr. Sonke Mastrup, California Department of Fish and Game
- Dr. Michael McGinnis, University of California, Santa Barbara
- Dr. Mark Page, University of California, Santa Barbara
- Dr. Arthur Winer, University of California, Los Angeles

For more information about the Expert Advisory Committee and the study, please visit <http://www.calost.org>.

