



OIL

**OFFSPRING
INTERNATIONAL
LIMITED**



OFFLOADING HOSES



Contents



4	About Offspring International
6	About MAN Oil & Marine
8	Hose Range
9	Single Carcass Hoses
10	Double Carcass Hoses
11	Double Carcass Leak Detection System
12	FreeFlex Hoses
14	Hoses for Reeling Systems
16	Long Length Hoses
18	Dock Hoses
18	LPG Hoses
19	Storage & Handling
19	Ancillary Items
20	Offshore Ops – Integrated Terminal Management
22	Marine Breakaway Couplings
23	PLEM Control

Offspring International

Offspring International specialises in equipment for mooring, offloading and control systems to optimise terminal operations both offshore and quayside.

Offspring (OIL) offers a fully integrated supply of equipment for SPM and CBM buoy mooring, hoses, breakaway couplings, PLEM control systems, together with a comprehensive Offshore Ops terminal monitoring and management system. Using experience and expertise gained over 30 years, Offspring is able to support other mooring applications including renewables, chain ferries, port operations, aquaculture etc.

Based in Dudley near Birmingham, UK, with a subsidiary office in Laguna Niguel, California, Offspring International supplies a range of SPM and tandem offtake mooring systems following the OCIMF 2018 'Recommendations for Equipment Employed in the Bow Mooring of Conventional Tankers at Single Point Moorings', including single or dual hawser configuration, single leg-type mooring hawser and grommet-type mooring hawser manufactured and supplied in strict accordance with the OCIMF 2000 Guidelines for the Purchasing and Testing of SPM Hawasers.

Integrated SPM & CBM supply

Offspring offers a complete service for Single Point Mooring systems, from design and supply of the entire offtake system, to replacement of mooring hawsers, hoses and associated hardware. Our approach is based on experience of providing SPM systems across the globe; we take a systematic approach to assessing the offshore environment, hawser and hose design, testing, and installation conditions.

All Offspring International SPM systems and products offer outstanding operational performance, reliability and safety, and include chafe chains, mooring hawsers, pick-up and messenger ropes, support buoys, shackles, associated fittings and load-monitoring equipment. In addition, Offspring is able to supply floating, submarine and catenary hoses in accordance with GMPHOM 2009.

Industry Partners

Offspring is the exclusive worldwide agent for Lankhorst Offshore for SPM systems and Paladon Systems' Pipeline End Manifold Control Systems, as well as international agent for MAN Oil & Marine floating marine and submarine offloading hoses and for Marine Division valves and actuators. In addition, Offspring has a strong partnership with fluid transfer systems specialist Techflow Marine; Offspring offers Techflow's Quay Reel® flexible loading and unloading system.

Offshore Ops – Enhanced Terminal Monitoring

Offshore Ops, working in partnership with Offspring International, offers industry leading software and technologies for mooring and offloading operations. Offshore Ops' fully OCIMF SMOG 2015 compliant Integrated Terminal Management System has been systematically developed over 12 years to provide 'live' data on a wide range of operational and environmental factors, as well as effective operations management, significantly reducing risk and enhancing mooring and offloading safety and performance.



**OIL IS A DEDICATED TEAM OF
MOORING PROFESSIONALS,
BRINGING OVER 100 YEARS'
EXPERIENCE IN OFFSHORE
MOORING LINES AND
SYSTEMS.**



The compact modular system offers a range of terminal management, environmental and equipment monitoring devices, seamlessly integrated into a single, secure software package. Offshore Ops' Integrated Terminal Management System has been developed based on the needs of single and multi-operator terminals. It comprises an array of sensors on the offloading buoy, together with a portable monitoring unit used by the mooring master on the tanker, providing 'live' data on all aspects of offloading operations.

Offshore Ops' Terminal Management System allows oil terminals to maximise terminal availability and efficiency, increase safety, reduce operating costs and reduce environmental incidents.

Navigational Moorings

Offspring International has supplied navigation buoy moorings for over 20 years. Offspring offers the complete mooring assembly, comprising: sinkers, shackles, swivels, bridles and pendant chain. Mooring Buoys are available in several designs: inflatable, rotationally moulded, PU elastomer coated foam filled, modular and steel.

Offspring International - Strength and Depth

Offspring has a worldwide customer base together with a comprehensive international network of agents. Offspring International values long-term, customer relationships and so a commitment to excellence in customer service is one of our key strengths. We go beyond the normal pre-sales technical advice and project management expected when delivering mooring and offloading systems on-time and within budget. Our service also includes post-installation reviews and through-life support.



MAN Oil & Marine's origins lie, through Manuli Hydraulics - Oil & Marine Division, in 1959 when Uniroyal pioneered the concept of floating and submarine hose systems.

In 1973 Dardanio Manuli SpA and Uniroyal entered into a joint venture to produce hoses for the Oil & Marine industries, later becoming Manuli Hydraulics - Oil & Marine Division. After almost five decades as a leading offshore hose manufacturer, in 2020 Manuli Hydraulics - Oil & Marine Division became MAN Oil & Marine. The company continues to develop industry leading offloading hoses at its state-of-the-art technology & product development centre.

Today MAN Oil & Marine's product range includes:

- Floating and Submarine Single Carcass Hoses for Oil Suction and Discharge
- Antipollution Floating and Submarine Double Carcass Hoses for Oil Suction and Discharge
- Helix Free (No Body Wire) Single & Double Carcass Floating and Submarine Hoses
- Long Length Hoses for dynamic riser, jumper and flowline applications
- Dock Hoses for suction and discharge petroleum products, suitable for several onshore applications, such as refineries, shore tanks and across the energy sector
- Second Generation (BS EN 1762:2003) Liquefied Petroleum Gas (LPG) hoses for suction and discharge applications.

OCIMF & Quality Standards

All MAN Oil & Marine loading and discharge hoses fully comply with the requirements of the "Oil Companies International Marine Forum Guide to Manufacturing and Purchasing Hoses for Offshore Moorings, 5th Edition (2009)" (OCIMF GMPHOM 2009 compliant) as certified by the American Bureau of Shipping (ABS) as well as under American Petroleum Institute's API Specification Q1, API-17K and other applicable standards.

All MAN Oil & Marine hoses are designed and manufactured under a quality system in accordance with ISO 9001:2008 as well as UNI EN ISO 14001 – Environmental Management System and UNI EN OHAS 18001 – Occupational Health and Safety Management System.

Design Capabilities

MAN Oil & Marine offers turn-key engineered systems combining all the hose related components for any offshore project. MAN Oil & Marine technical staff provide static and dynamic analysis of hose systems (using OrcaFlex® software), thermal and fluid flow estimation, finite element stress analysis, and other technical support to help customers integrating MAN Oil & Marine hoses into their overall transfer system. MAN Oil & Marine's experienced engineers and technicians are also available for onsite support as well as operations planning and evaluation.



OrcaFlex® Software

MAN Oil & Marine provides system design support for new projects and for existing terminals using OrcaFlex® software. MAN Oil & Marine uses OrcaFlex® for flexible line system design and analysis.

Finite Element Analysis software OrcaFlex® is a marine dynamics program developed by Orcina Ltd. OrcaFlex® is widely used in the offshore industry for analysing submarine hoses, flexible risers, cable lay, installation of subsea equipment, oceanographic moorings, pull-in etc.

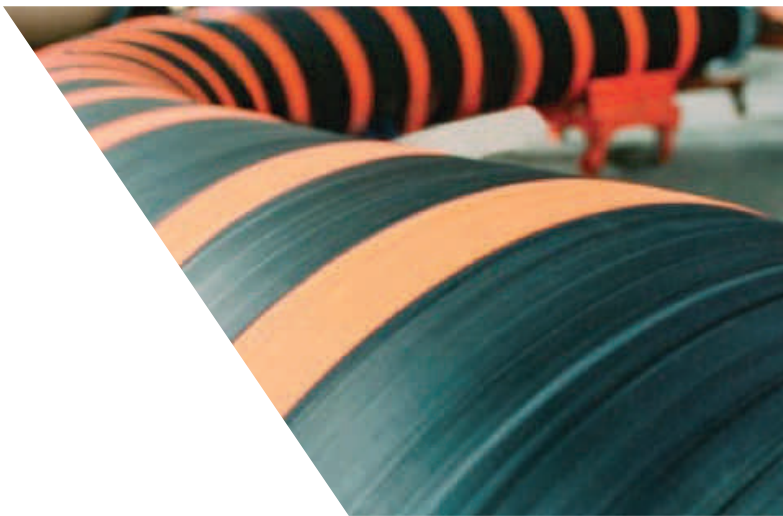

Aldo Occari Technology & Product Development Centre

MAN Oil & Marine benefits from the Aldo Occari Technology & Product Development Centre in Bologna near its Ascoli Piceno manufacturing facility. The centre is equipped with state-of-the-art test facilities and laboratory equipment, over an area of more than 2000m², including:

- Differential Scanning Calorimetry
- Thermo Gravimetric Analysis
- Dynamic Mechanical Analyzer
- Ageing Test
- Thermostatic Bath
- Ozone Resistance
- Cold Flexibility Test.

In addition to its own R&D Department, MAN Oil & Marine uses the services of specialised, third-party test engineers and equipment to produce detailed, unbiased reports.



Hose Product Range

Offspring offers a range of MAN Oil & Marine hoses for a variety of applications. All hoses are manufactured and tested in accordance with GMPHOM 2009.

Single Carcass Hoses

MAN Oil & Marine's Floating and Submarine single carcass hoses are designed for Oil Suction and Discharge. Single carcass hoses are available with either Steel Cord Reinforcement (Poseidon) or Textile Cord Reinforcement (Nautilus).

Double Carcass Hoses

MAN Oil & Marine's Antipollution Floating and Submarine double carcass hoses are ideal for Oil Suction and Discharge. Double carcass hoses are available with either Steel Cord Reinforcement (Poseidon) or Textile Cord Reinforcement (Nautilus). Double carcass hoses are designed so that if the main carcass fails, the secondary carcass contains the leak, protecting the environment. MAN Oil & Marine's Dual Antipollution Safety Hose has the only failure alert device on the market that monitors the integrity of the primary and secondary carcasses.

FreeFlex Hoses

MAN Oil & Marine's FreeFlex hose is the result of over 25 years' experience designing and manufacturing helix-free hoses. As its name indicates, the FreeFlex hose does not have a helical, steel wire body like conventional oil suction and discharge hoses. The whole carcass is free to flex as necessary to react to the extreme loads that are often applied during handling or service. Once the load has been removed FreeFlex returns to its original shape with no permanent deformation.

Long Length Hoses

Exclusively made by MAN Oil & Marine Long Length hoses are bonded elastomeric conduits for dynamic riser, jumper, flowline, applications. Lightweight, collapsible and kinkable, MAN Oil & Marine Long Length Hoses are ideal for fuel transfer in commercial and military applications.



Hoses for Reeling Systems

MAN Oil & Marine has designed a dedicated hose range of floating and submarine hoses, single and double carcass, capable of being stored on a reel in one or more layers.

Dock Hoses

Hoses for suction and discharge petroleum products, suitable for several onshore applications, such as refineries, shore tanks and across the energy sector. MAN Oil & Marine Dock hoses exceed the basic requirements of all International rules because their construction is a direct derivative of designs, technology and quality control procedures used in the building of marine hoses for offshore application, with long operational life and total environmental safety in mind.

LPG Hoses

Second Generation (BS EN 1762:2003) of hoses for Liquefied Petroleum Gas in suction and discharge applications.

Ancillary Items

Offspring International supplies a range of ancillary items enabling the safe installation and operation of offloading hoses.



Single Carcass Hoses







MAN Oil & Marine's single carcass hoses are designed for Oil Suction and Discharge.

Manufactured and tested according to GMPHOM 2009, the floating or submarine hoses are available in two lines: Poseidon (Steel Cord Reinforced) or Nautilus (Textile Cord Reinforced). Any special requirements from other specifications can be included on request.







Both the Poseidon and Nautilus range of hoses are available with diameters between 6-24" (150-600mm) in standard lengths of 30ft (9m), 35ft (10m) or 40ft (12m).

Advantages of MAN Oil & Marine's single carcass hoses include:

- Liner compounds with high aromatic resistance
- Superior Pressure Surge resistance
- Higher Collapse Resistance
- Higher Tensile Load Resistance
- Increased Resistance to Bending; the hose can be bent to a MBR of 1* (Nautilus) / 2* ID (Poseidon)
- Equipped with New lifting lugs for higher SWL (Safe Working Loads)
- Higher Burst Pressures
- Higher Adhesion values between layers
- Negligible buoyancy loss of buoyancy material under external pressure
- Higher cover abrasion resistance
- Show no hose degradation after dynamic test.

SUBMARINE HOSES		POSEIDON	NAUTILUS
	One end reinforced submarine hose	H3006 UF	H7006 UF
	Mainline submarine hose	H3030 UF	H7070 UF
	Tail submarine hose	H3030T UF	H7070T UF
	Reducer submarine hose	H3232 UF	H7272 UF
	Fully reinforced submarine hose	H3737 UF	H7777 UF
	Tanker rail submarine hose	H3838 UF	H7878 UF

Submarine hoses can be built with location collars for the application of deepwater floats on request

FLOATING HOSES		POSEIDON	NAUTILUS
	One end reinforced half floating hose	H3006 HF	H7006 HF
	Mainline submarine hose	H3030 FF	H7070 FF
	Tail full floating hose	H3030T FF	H7070T FF
	Reducer full floating hose	H3232 FF	H7272 FF
	Fully reinforced full floating hose	H3737 FF	H7777 FF
	Tanker rail full dumbbell floating hose	H3838 DF	H7878 DF

Hoses for special applications can be manufactured on request

Double Carcass Hoses



MAN Oil & Marine's floating or submarine Dual Anti-pollution Safety Hoses (DASH) are ideal for Oil Suction and Discharge.

All MAN Oil & Marine double carcass hoses are manufactured and tested according to GMPHOM 2009, with any special requirements of other specifications included on request.







MAN Oil & Marine's hoses are available in two lines: Poseidon (Steel Cord Reinforced) or Nautilus (Textile Cord Reinforced). Both the Poseidon and Nautilus range of hoses are available with diameters between 6-24" (150-600mm) in standard lengths of 30ft (9m), 35ft (10m) or 40ft (12m).

Advantages of MAN Oil & Marine's double carcass hoses include:

- Liner compounds with high aromatic resistance
- Superior Pressure Surge resistance
- Higher Collapse Resistance
- Higher Tensile Load Resistance
- Increased Resistance to Bending; the hose can be bent to a MBR of 1* (Nautilus) / 2* ID (Poseidon)
- Higher resistance of the Secondary Carcass of Double Carcass Hoses
- New lifting lugs for higher SWL (Safe Working Loads)
- New mechanical Leak Detectors for Double Carcass Hoses
- Designed with two independent carcasses in case of double carcass hoses
- Higher Burst Pressures
- Higher Adhesion values between layers
- Negligible buoyancy loss of buoyancy material under external pressure
- Higher cover abrasion resistance
- Show no hose degradation after dynamic test.

SUBMARINE HOSES			POSEIDON	NAUTILUS
	One end reinforced submarine hose	DASH	H3006 UF	H7006 UF
	Mainline submarine hose	DASH	H3030 UF	H7070 UF
	Tail submarine hose	DASH	H3030T UF	H7070T UF
	Reducer submarine hose	DASH	H3232 UF	H7272 UF
	Fully reinforced submarine hose	DASH	H3737 UF	H7777 UF
	Tanker rail submarine hose	DASH	H3838 UF	H7878 UF

Submarine hoses can be built with location collars for the application of deepwater floats on request

FLOATING HOSES			POSEIDON	NAUTILUS
	One end reinforced half floating hose	DASH	H3006 HF	H7006 HF
	Mainline full floating hose	DASH	H3030 FF	H7070 FF
	Tail full floating hose	DASH	H3030T FF	H7070T FF
	Reducer full floating hose	DASH	H3232 FF	H7272 FF
	Fully reinforced full floating hose	DASH	H3737 FF	H7777 FF
	Tanker rail full dumbbell floating hose	DASH	H3838 DF	H7878 DF

Hoses for special applications can be manufactured on request

Double Carcass Hose Leak Detection System

Double carcass hoses are designed so that if the main carcass fails, the secondary carcass contains the leak, protecting the environment.

Most leak detection systems only monitor the main carcass, but what if the secondary carcass also fails? MAN Oil & Marine's Dual Anti-pollution Safety Hose (DASH) has the only failure alert device (FAD) on the market that monitors the integrity of both the primary and secondary carcasses.

Tested in accordance with GMPHOM 2009, MAN Oil & Marine's unique FAD system gives the DASH user a reliable, durable system for assuring that their double carcass hose is working. The mechanical FAD consists of a stainless-steel base covered with clear plastic lens, which is protected by a stainless-steel cage. The system works by means of the presence of pressure between the primary and secondary carcasses of the hose.

When a leak occurs from the primary carcass it is contained by the secondary carcass, increasing the pressure. Once the fluid reaches the FAD base, it activates, raising the coloured piston which is visible from a distance.

Design & Testing

The design of MAN Oil & Marine's mechanical leak detection system means it does not require servicing or maintenance. It also ensures that external factors, such as ice, does not interfere with its operation. Once activated, the FAD can be reset and used again.

The FAD has been subjected to the prototype hose burst test. After the primary carcass burst the leak detection immediately activated and continued to indicate a carcass leak after the burst of the secondary carcass. Following the test, it was found the FAD had not incurred any damage.

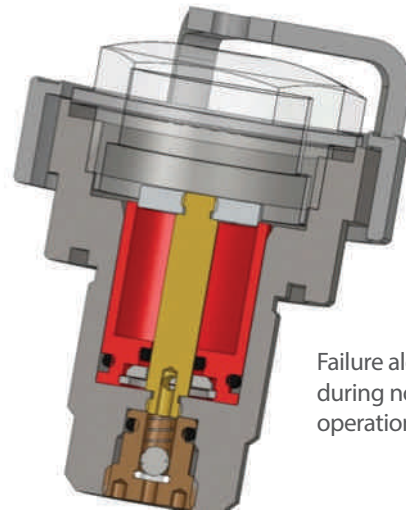
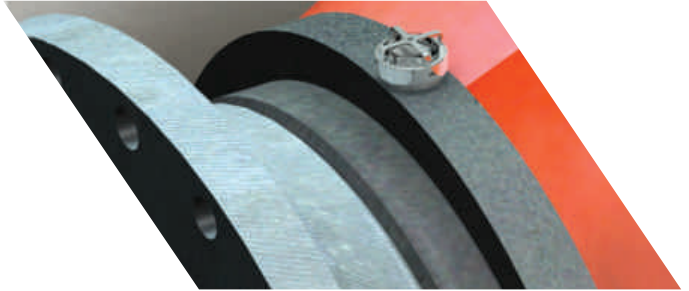

Failure alert device during normal operation

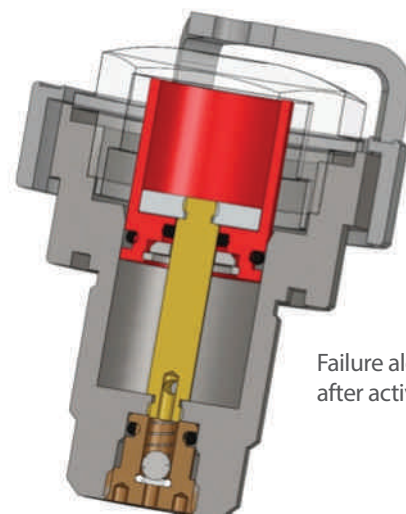

Failure alert device after activation

FreeFlex Hoses



MAN Oil & Marine's FreeFlex hose is the result of over 25 years' experience designing and manufacturing helix-free hoses.

The FreeFlex hose combines MAN Oil & Marine's marine hose experience with the lessons and technology gained through designing and manufacturing collapsible and kinkable long length hoses for military and offshore oil applications. FreeFlex hoses can be crushed and kinked without damaging the hose. Once the load on the hose has been removed FreeFlex returns to its original shape with no permanent deformation.

As its name indicates, the MAN Oil & Marine FreeFlex hose does not have a helical, steel body wire like conventional oil suction and discharge hoses. The whole carcass is free to flex as necessary to react the extreme loads that are often applied to marine hose during handling or service.

Like all MAN Oil & Marine marine hose, the basic performance requirements for the FreeFlex were taken from as well as manufactured and tested according to GMPHOM 2009. Additionally, MAN Oil & Marine considered special requirements from major petroleum companies. The FreeFlex Hose is certified by RTD (Rontgen Technische Dienst b.v.) and ABS (American Bureau of Shipping).

Advantages of FreeFlex

The basic carcass of the FreeFlex hose consists of the tube, breaker, cover, and wire cord reinforcing layers that have proven themselves in MAN Oil & Marine's conventional marine hoses. Above the wire plies, in place of the rigid steel helix, are layers of hard rubber overwrapped with additional wire plies.

This design enables the hard rubber and wire reinforcing plies to work together when the hose is stressed. Under kink or

collapse loads, the layers flatten and rebound together. The loads do not deform a rigid, steel body wire which would, in turn, permanently damage the hose carcass. Instead, the carcass is able to kink or collapse and then fully recover its original shape without damage or permanent deformation.

The FreeFlex design also accommodates extreme tension loads better than conventional marine hoses. When a conventional hose elongates, the underlying plies pull down and away from the rubber around the rigid helix. Under high elongation, this can cause delamination between the layers. When a tensile load is applied to the FreeFlex all the layers elongate and neck down together then rebound uniformly when the load is removed.

The MAN Oil & Marine FreeFlex Hose offers many technical advantages over standard marine hose:







- Full recovery from collapse or kink
- Smaller allowable bending radius
- Higher allowable tensile load
- Higher allowable elongation
- Higher fatigue resistance.

These technical advantages yield operational advantages over standard marine hose:

- FreeFlex is not damaged by accidental kinks or collapses
- FreeFlex is less likely to be damaged by improper handling
- FreeFlex is more durable under severe sea conditions
- FreeFlex can operate in deeper water.







The MAN Oil & Marine FreeFlex Hose is available in 6", 8", 10", 12", 16", 20" and 24" nominal inside diameters.

Single Carcass

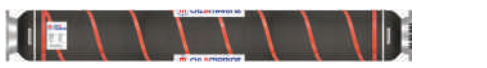
SUBMARINE HOSES		
	One end reinforced submarine hose	H5006 UF
	Mainline submarine hose	H5050 UF
	Tail submarine hose	H5050T UF
	Reducer submarine hose	H5252 UF
	Fully reinforced submarine hose	H5757 UF
	Tanker rail submarine hose	H5858 UF

Submarine hoses can be built with location collars for the application of deepwater floats on request

FLOATING HOSES

	One end reinforced half floating hose	H5006 HF
	Both end reinforced full floating hose	H5007 FF
	Mainline full floating hose	H5050 FF
	Tail full floating hose	H5050T FF
	Reducer full floating hose	H5252 FF
	Fully reinforced full floating hose	H5757 FF
	Tanker rail full dumbbell floating hose	H5858 DF

Hoses for special applications can be manufactured on request





Double Carcass

SUBMARINE HOSES

	One end reinforced submarine hose	DASH	H5006 UF
	Mainline submarine hose	DASH	H5050 UF
	Tail submarine hose	DASH	H5050T UF
	Reducer submarine hose	DASH	H5252 UF
	Fully reinforced submarine hose	DASH	H5757 UF
	Tanker rail submarine hose	DASH	H5858 UF

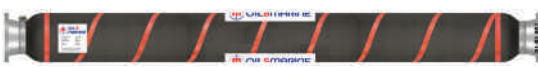
Submarine hoses can be built with location collars for the application of deepwater floats on request

FLOATING HOSES

	One end reinforced half floating hose	DASH	H5006 HF
	Mainline full floating hose	DASH	H5050 FF
	Tail full floating hose	DASH	H5050T FF
	Reducer full floating hose	DASH	H5252 FF
	Fully reinforced full floating hose	DASH	H5757 FF
	Tanker rail full dumbbell floating hose	DASH	H5858 DF

Hoses for special applications can be manufactured on request

Hoses for Reeling Systems

MAN Oil & Marine has designed a dedicated hose range of floating and submarine hoses, single and double carcass, capable of being stored on a reel in one or more layers.





As these hoses are required to be recovered and wrapped around a reel after the completion of product transfer, MAN Oil & Marine's Single and Double Carcass Poseidon hoses for Reeling Systems have enhanced handling properties compared to the standard GMPHOM 2009 Poseidon hoses:

- Higher Tensile Load Resistance – The conditions encountered during retrieval, deployment and operating place greater static and dynamic tensile loads on the hose string
- Higher Collapse Resistance – Wrapping hoses on a reel results in higher radial loads
- Higher Crush Loading Resistance – Negligible loss of buoyancy of the floatation material when subjected to external crush loads.

Special steel fittings have been designed to minimize the stresses induced within the hose string when bent around the reel. To avoid contact between the flange rim and reel surface, the hoses are provided with enlarged hose termination ends.







Single Carcass

SUBMARINE HOSES		
	One end reinforced submarine hose	H3737R UF
	Mainline submarine hose	H3737M UF
	Tail submarine hose	H3737T UF
	Reducer Submarine hose	H3737Red UF
	Rail submarine hose	H3737TK UF

Submarine hoses can be built with location collars for the application of deepwater floats on request





FLOATING HOSES

	One end reinforced full floating hose	H3737R FF
	Mainline full floating hose	H3737M FF
	Tail full floating hose	H3737T FF
	Reducer full floating hose	H3737Red FF
	Tanker rail full dumbbell floating hose	H3737TK DF

Hoses for special applications can be manufactured on request





Double Carcass

SUBMARINE HOSES

	One end reinforced submarine hose	DASH	H3737R UF
	Mainline submarine hose	DASH	H3737M UF
	Tail submarine hose	DASH	H3737T UF
	Reducer submarine hose	DASH	H3737Red UF
	Tanker rail submarine hose	DASH	H3737TK UF

Submarine hoses can be built with location collars for the application of deepwater floats on request

FLOATING HOSES

	One end reinforced half floating hose	DASH	H3737R FF
	Mainline full floating hose	DASH	H3737M FF
	Tail full floating hose	DASH	H3737T FF
	Reducer full floating hose	DASH	H3737Red FF
	Tanker rail full dumbbell floating hose	DASH	H3737TK DF

Hoses for special applications can be manufactured on request

Long Length Hoses

Exclusively made by MAN Oil & Marine, Long Length hoses are bonded elastomeric conduits for dynamic riser, jumper and flowline applications.



Lightweight, collapsible and kinkable, MAN Oil & Marine Long Length Hoses are ideal for fuel transfers applications in the commercial and military fields.

Bonded pipes are constructed of steel / textile reinforcements and elastomeric materials bonded and vulcanized together. Bonded flexibles offer a number of advantages over unbonded flexibles / rigid pipeline:

Key Features

- Lightweight hose construction with minimum handling equipment required in the field
- Low minimum bend radius with 4* ID for MAN Oil & Marine conduit
- Kink recoverable. The hose recovers its original shape without any damage or permanent deformation
- Easy and rapid to repair in the field with specially designed fittings
- Easy to deploy and retrieve. MAN Oil & Marine hoses can be installed using standard workboats and marine equipment
- The MAN Oil & Marine conduit floats in empty condition and sinks when full of water or oil
- Low cost impact
- Rapidly installable including in severe sea conditions
- High elasticity, when a tensile load is applied to the MAN Oil & Marine conduit all the layers elongate and neck down together and then rebound uniformly when the load is removed
- Deployment cost reduced – DP1 Vessel
- Procurement lead time reduced
- Reduced sensitivity to spanning and VIV
- Dynamic riser installed along with flowline
- Project timescales should be reduced.



Pipe Flanges & Flanged Fittings

Offspring offers a range of pipe flanges and flanged fittings for Long Length Hoses:

- Standards typically according to ASME B16.5 or according to client's request
- Main type of flanges – Welding Neck, Swivel, Reducing, Threaded, Slip On etc
- Class – 150, 300, 600, 900 etc
- Facings – Flat Face, Raised Face, Ring Joint, Lapped Joint
- High & Low temperature applications
- Special Connections – Hammer Union type, Compact Flanges.

SATURN Hoses

MAN Oil & Marine's SATURN hose is a steel wire cord reinforced long length hose; the SATURN line offers the possibility to customize the hose's performance capabilities to the application as per customer requirements. SATURN hoses can be configured as follows:

	SATURN MD			SATURN MD HP			SATURN MD EX			SATURN HD			SATURN HD HP			SATURN HD EX					
Nominal Diameter (mm)	100	150	200	100	150	200	100	150	200	100	150	200	100	150	200	100	150	200			
Tube Compound	NBR			HNBR			FKM			NBR			HNBR			FKM					
Main Reinforcement	HT Steel Wire Cord									Heavy Duty HT Steel Wire Cord											
Number of Plies	6																				
Cover Reinforcement	Polyester																				
Cover Compound	CR																				
Working Pressure (bar)	80	55	55	80	55	55	80	55	55	175	125	100	175	125	100	175	125	100			
Test Pressure (bar)	120	83	83	120	83	83	120	83	83	263	188	150	263	188	150	263	188	150			
Burst Pressure (bar)	400	290	250	400	290	250	400	290	250	867	444	436	867	444	436	867	444	436			
Working Temperature (°C)	-30 / 100			-30 / 120			-30 / 150			-30 / 100			-30 / 120			-30 / 150					
Fittings	BUILT-IN									CRIMPED			BUILT-IN			CRIMPED			BUILT-IN		
Inner Diameter (mm)	101.6	152.4	203.2	101.6	152.4	203.2	101.6	152.4	203.2	101.6	152.4	203.2	101.6	152.4	203.2	101.6	152.4	203.2			
Outside Diameter (mm)	151.2	204.0	256.8	151.2	204.0	256.8	151.2	204.0	256.8	162.0	214.8	267.6	162.0	214.8	267.6	162.0	214.8	267.6			
Weight in Air Empty (kg/m)	21.6	31.3	41.5	21.4	31.0	41.0	21.8	31.7	42.0	30.7	43.7	57.2	30.5	43.4	56.7	30.9	44.1	57.7			
Weight in Seawater Empty (kg/m)	3.2	-2.2	-11.6	3.0	-2.5	-12.1	3.4	-1.8	-11.1	9.5	6.6	-0.4	9.4	6.2	-1.0	9.8	6.9	0.1			
Weight in Seawater Full of Oil - SG=0,850 (kg/m)	10.1	13.3	16.0	9.9	13.0	15.4	10.3	13.7	16.5	16.4	22.1	27.1	16.3	21.7	26.6	16.7	22.4	27.6			
Weight in Seawater Full of Seawater - SG=1,025 (kg/m)	11.5	16.5	21.7	11.3	16.2	21.1	11.7	16.9	22.2	17.8	25.3	32.8	17.7	24.9	32.3	18.1	25.6	33.3			
Axial load at break (kN)	376	500	700	376	500	700	376	500	700	695	916	1005	695	916	1005	695	916	1005			
External Collapse Pressure - Empty Hose (bar)	3.5	2.0	1.7	3.5	2.0	1.7	3.5	2.0	1.7	11.4	6.4	5.4	11.4	6.4	5.4	11.4	6.4	5.4			
Bending Stiffness - Empty Hose (kNm ²)	0.25	0.5	2.0	0.25	0.5	2.0	0.25	0.5	2.0	0.5	1.1	3.3	0.5	1.1	3.3	0.5	1.1	3.3			
Bending Stiffness @ 21 bar (kNm ²)	0.65	1.5	5.0	0.65	1.5	5.0	0.65	1.5	5.0	0.6	2.0	5.8	0.6	2.0	5.8	0.6	2.0	5.8			
Torsional Stiffness - Empty Hose (kNm ²)	100.0	400.0	450.0	100.0	400.0	450.0	100.0	400.0	450.0	213	346	693	213	346	693	213	346	693			
Torsional Stiffness @ 21 bar (kNm ²)	200.0	650.0	900.0	200.0	650.0	900.0	200.0	650.0	900.0	222	671	1321	222	671	1321	222	671	1321			
Axial Stiffness - Empty Hose (kN)	127.1	440.0	800.0	127.1	440.0	800.0	127.1	440.0	800.0	459	606	1043	459	606	1043	459	606	1043			
Axial Stiffness @ 21 bar (kN)	255.7	1180.0	1600.0	255.7	1180.0	1600.0	255.7	1180.0	1600.0	1045	1734	1851	1045	1734	1851	1045	1734	1851			
Key Properties	Medium Duty Application: • Crude Oil up to 60% AR • Oxygenated fuel up to 15% • Working Temp.: Up to 100 °C			Medium Duty High Performance Application: • Crude Oil up to 60% AR • Oxygenated fuel up to 15% • Sour Service up to 5% of H2S • Working Temp.: Up to 120 °C			Medium Duty Extreme Performance Application: • Crude Oil up to 100% AR • Oxygenated fuel up to 15% • Sour Service up to 2% of H2S • Working Temp.: Up to 150 °C			Heavy Duty Application: • Crude Oil up to 60% AR • Oxygenated fuel up to 15% • Working Temp.: Up to 100 °C			Heavy Duty High Performance Application: • Crude Oil up to 60% AR • Oxygenated fuel up to 15% • Sour Service up to 5% of H2S • Working Temp.: Up to 120 °C			Heavy Duty Extreme Performance Application: • Crude Oil up to 100% AR • Oxygenated fuel up to 15% • Sour Service up to 2% of H2S • Working Temp.: Up to 150 °C					

ORION Hoses

MAN Oil & Marine's ORION hose is a textile reinforced long length hose; the ORION line offers the possibility to customize the hose's performance capabilities to the application as per customer requirements. ORION hoses can be configured as follows:

	ORION 4			ORION 4 HP			ORION 4 EX			ORION 6			ORION 6 HP			ORION 6 EX		
Nominal Diameter (mm)	100	150	200	100	150	200	100	150	200	100	150	200	100	150	200	100	150	200
Tube Compound	NBR			HNBR			FKM			NBR			HNBR			FKM		
Main Reinforcement	Polyester Tire Cord																	
Number of Plies	4									6								
Cover Compound	CR																	
Design Pressure (bar)	15	10	10	15	10	10	15	10	10	20	15	15	20	15	15	20	15	15
Test Pressure (bar)	15	10	10	15	10	10	15	10	10	20	15	15	20	15	15	20	15	15
Burst Pressure (bar)	68	48	36	68	48	36	68	48	36	100	70	55	100	70	55	100	70	55
Working Temperature (°C)	-30 / 100			-30 / 120			-30 / 150			-30 / 100			-30 / 120			-30 / 150		
Inner Diameter (mm)	101.6	152.4	203.2	101.6	152.4	203.2	101.6	152.4	203.2	101.6	152.4	203.2	101.6	152.4	203.2	101.6	152.4	203.2
Outside Diameter (mm)	124.8	175.6	226.4	124.8	175.6	226.4	124.8	175.6	226.4	130.4	181.2	232.0	130.4	181.2	232.0	130.4	181.2	232.0
Weight in Air Empty (kg/m)	5.5	7.9	10.3	5.4	7.9	10.3	5.8	8.5	11.1	7.0	10.0	13.0	6.9	10.0	13.0	7.3	10.6	13.8
Weight in Seawater Empty (kg/m)	-7.1	-16.9	-30.9	-7.1	-17.0	-31.0	-6.7	-16.3	-30.1	-6.7	-16.4	-30.3	-6.8	-16.5	-30.3	-6.3	-15.8	-29.5
Weight in Seawater Full of Oil - SG=0,850 (kg/m)	-0.2	-1.4	-3.4	-0.2	-1.4	-3.4	0.2	-0.8	-2.6	0.2	-0.9	-2.7	0.1	-1.0	-2.8	0.6	-0.3	-1.9
Weight in Seawater Full of Seawater - SG=1,025 (kg/m)	1.2	1.8	2.3	1.2	1.7	2.3	1.6	2.4	3.1	1.6	2.3	3.0	1.6	2.2	2.9	2.0	2.8	3.7
Key Properties	Standard Application: • Crude Oil up to 60% AR • Oxygenated fuel up to 15% • DP from 10 to 15 bar • Working Temp.: Up to 100 °C			High Performance Application: • Crude Oil up to 60% AR • Oxygenated fuel up to 15% • Sour Service up to 5% of H2S • Working Temp.: Up to 120 °C			Extreme Performance Application: • Crude Oil up to 100% AR • Oxygenated fuel up to 15% • Sour Service up to 2% of H2S • Working Temp.: Up to 150 °C			Standard Application: • Crude Oil up to 60% AR • Oxygenated fuel up to 15% • Working Temp.: Up to 100 °C			High Performance Application: • Crude Oil up to 60% AR • Oxygenated fuel up to 15% • Sour Service up to 5% of H2S • Working Temp.: Up to 120 °C			Extreme Performance Application: • Crude Oil up to 100% AR • Oxygenated fuel up to 15% • Sour Service up to 2% of H2S • Working Temp.: Up to 150 °C		

Dock Hoses

Hoses for suction and discharge petroleum products, suitable for several onshore applications, such as refineries, shore tanks and across the energy sector.



MAN Oil & Marine Dock Hoses exceed the basic requirements of MAN Oil & Marine's offshore marine hoses, which are produced with long operational life and total environmental safety in mind.

MAN Oil & Marine's Series C - medium duty dock hoses are available in 3", 4", 6", 8", 10", & 12" nominal inside diameters. Other hose constructions such as long length for special applications, light weight or double carcass are available on special request.

	C6515						C6520					
Duty	Light Weight						Medium Weight					
Diameter (Inches)	3	4	6	8	10	12	3	4	6	8	10	12
Reinforcement	Textile Reinforced						Textile Reinforced					
Working Pressure (psi)	150						225					
Key Properties	<ul style="list-style-type: none"> • Suction & Discharge Hose • Smooth Bore • Body Wire Construction 						<ul style="list-style-type: none"> • Suction & Discharge Hose • Smooth Bore • Body Wire Construction 					

Long Length Dock Hoses

4", 6" & 8" Dock Hoses up to 300m



LPG Hoses

Second generation suction and discharge hoses for Liquefied Petroleum Gas.

Series G

The G2005 type SD is a textile reinforced 25 bar working pressure hose for Liquefied Petroleum Gas (LPG) in suction and discharge applications. Hose specification: BS EN 1762:2003 Type SD.

Lining

NBR rubber compound, smooth bore, resistant to n-pentane and aromatic contents up to 50%.

Reinforcement

Multiple plies of Polyester Tyre cords plus stainless steel helical wire embedded in synthetic rubber.

Cover

Synthetic black chloroprene rubber compound: weather, oil, abrasion and seawater resistant.

Fittings

Built-in nipples flanged according to customer requirements.

Nominal Bore

3", 4", 6", 8", 10" & 12"

Temperature Range

-30 to 70 °C

Ancillary Items

Offspring International offers a range of ancillary items enabling the safe installation and operation of offloading hoses.

Hose Pick-up and Hang-off Chains

The Hose Pick-Up and Hang-Off chain can be configured to accommodate both standard and project specific hose sizes. The galvanised chains are resistant to seawater corrosion.

Hose Floats

Manufactured from polyethylene foam covered with a seamless polyurethane elastomer skin, the hose floats are resistant to impact, abrasion, UV degradation and chemical attack - making them extremely durable. Designed for ease of deployment and installation, the floats can be customised for both surface and subsea applications.

Spool Pieces

Spool Pieces are manufactured from galvanised steel and suitable for Class 150 ANSI, Class 300 ANSI, and other flange types. Comprising two WNF Flanges, the spool pieces are supplied with or without lifting lugs.

Camlock Couplings

The Camlock Coupling flanges are designed to enable automatic location of the hose flange within the cam blocks, enabling a quick swift and hazard-free connection and disconnection. It is suitable for Class 150 ANSI, Class 300 ANSI, DIN and other flange types. Existing flange or pipe arrangements can be used with the Camlock Coupling.

Butterfly Valves

Rubber Lined, Type ITS (Wafer Type) Butterfly Valves are available for Class 150 ANSI, Class 300 ANSI, DIN and other flange types. These can be supplied in a range of sizes, together with elastomeric rubber seals resistant to the product in transfer.

Blind Flanges

Offspring offers Blind Flanges in aluminium and galvanised steel to protect the hose when not in service. Available in Class 150 ANSI, Class 300 ANSI, DIN and many other flange types, the flanges prevent seawater entering the hose.

Hose Repair Kit

In the case of major damage, such as kinking, broken helix wires and collapsed linings, a hose should be immediately retired. However, minor damage to the outer cover can be successfully repaired.

The hose repair kit includes: Belzona 2311 SR Elastomer, Belzona 2911 / 2921 GP Conditioner, Belzona 9111 Cleaner / Degreaser, Belzona 9341 Reinforcing Tape, Steel Wire Brush, Belzona Mixing Spatula, Small Disposable Working Surface and Small Short-bristle Brush.

Storage and Handling

MAN Oil & Marine hoses are designed to be robust under the harsh conditions of the marine environment, however, they can be damaged from improper handling.

Lifting

When handling hoses adequate support is key to preventing over-bending (kinking), which can lead to damage and premature retirement. The recommended method of lifting a single hose section is to use a spreader bar and lifting straps and then set down the hose on adequate supports. The spreader bar provides a three-point lift with a strap over the nipple area at each end and additional strapping, as appropriate, spaced equally between the end straps on hoses up to 12.2 metres long.

Lifting straps should be flat nylon or equivalent reinforced cloth bands, and at least 150mm wide to prevent localised damage and chafing of the hose cover. Wire ropes are completely unsuitable for use as lifting straps.

Hose Storage

Ideally hoses should be stored in cool, dark, dry areas on steel framed pallets in accordance with the OCIMF "Guide to Purchasing, Manufacturing and Testing of Loading and Discharge Hoses for Offshore Moorings". Pallets prevent damage or distortion to hoses, which may occur if stored directly on the ground, as well as facilitate examination and make the hose markings easily accessible. For locations where extreme temperatures apply, especially very cold locations, additional measures may be necessary such as storage in a climatically controlled warehouse.

After being used a hose should be drained, flushed out with water and then returned to a suitable storage environment.

Offshore Ops – Integrated Terminal Management



Offshore Ops' Terminal Management System allows oil terminals to maximise terminal availability and efficiency, increase safety, reduce operating costs and reduce environmental incidents through a range of industry leading software and technologies.

Offshore Ops' fully OCIMF SMOG 2015 compliant Integrated Terminal Management System has been systematically developed over 12 years to provide 'live' data on a wide range of operational and environmental factors, as well as effective operations management, significantly reducing risk and enhancing mooring and offloading safety and performance. The compact modular system offers a range of terminal management, environmental and equipment monitoring devices, seamlessly integrated into a single, secure software package.

In addition, the software enables greater efficiency in terminal management by allowing comprehensive monitoring and control over consignment scheduling, asset management and policy and procedural adherence.

Offshore Ops – Enhanced Terminal Monitoring

Offshore Ops' Integrated Terminal Management System has been developed based on the needs of single and multi-operator terminals. It comprises an array of sensors on the offloading buoy, together with a portable monitoring unit used by the mooring master on the tanker, providing 'live' data on all aspects of offloading operations.

Benefits of the system include the ability to maximise Uptime and minimise Downtime, by monitoring various offloading and weather conditions to ensure it is safe to continue to operate.

Improved Mooring Operations

Combined GPS and compass heading monitoring of both the buoy turntable and tanker ensures trouble-free moorings. Tanker disorientation can be picked up early, allowing corrective action to be taken. In the event the buoy moves off-station, indicating a possible mooring chain failure, the integrated system will automatically issue an alert.

Offshore Ops' modular Integrated Terminal Management System enhances offloading operations by offering the ability to monitor operations from anywhere, including inspection and maintenance schedules to ensure equipment performance, and real-time data to the tanker, allowing safer mooring. All buoy and tanker data is encrypted during transmission.

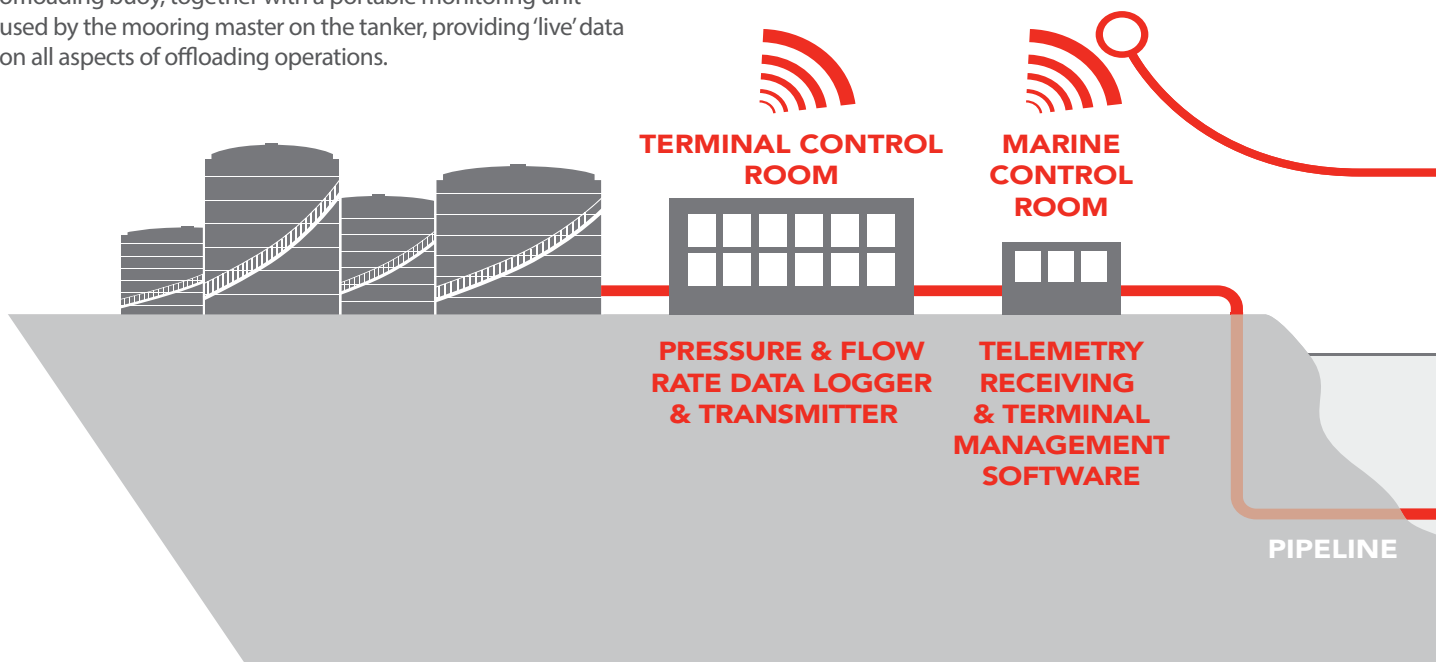

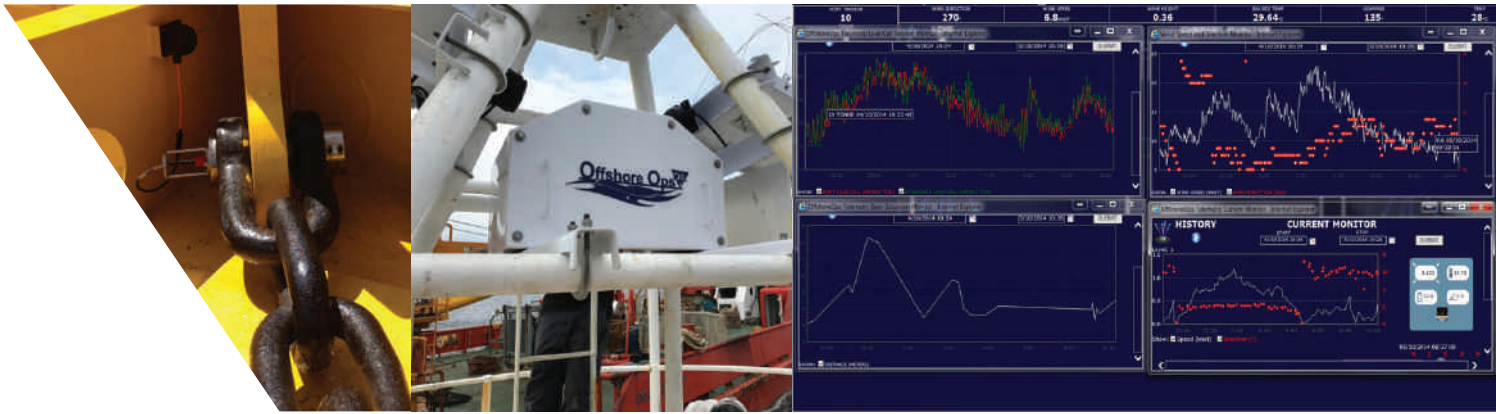

System Benefits

In addition to the mooring and environmental advantages of using the Integrated Terminal Management System, the operational benefits include:

- Consignment scheduling
- Asset register
- Planned maintenance
- Policy and Procedural adherence.

Consignment Scheduling

Plan and schedule arrival of vessels and their cargoes and maintain a full history of every vessel's movements from arrival into Port, demurrage times, loading / discharge times, and volume of cargo.

Planned Maintenance

The predetermined inspection and equipment change-out regime embedded in the system ensures that all parts of the SPM are checked and verified as per industry best practice and / or available standards.

Asset Register

Maintain a stock list of all spares held in store, min / max stock levels, replacement lead times and so on. Record date that the asset is put into service, dates inspected, date retired, amount of work performed by the asset to assist in determining when defined retirement criteria are reached and to future consider whether longer / shorter service life is appropriate.

Policy and Procedural Adherence

All company policies can be stored and updated on the system with pre-set authorisation levels. New revisions are flagged automatically to specified users when they log onto the system. It records when users have read and accepted the revised procedures or require further guidance.

The same system can be used for training, for issuing permits to work, and for creating work procedures.

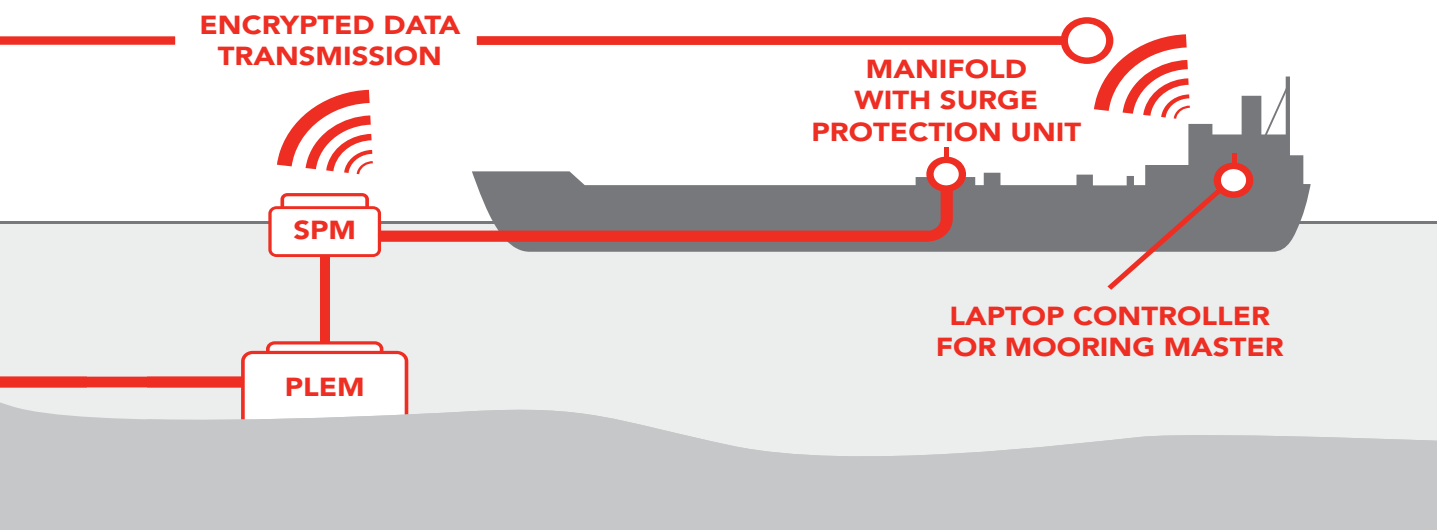

Marine Breakaway Couplings

Hose transfer operations in harsh offshore environments are at risk of tanker breakaway and internal surge pressures, causing oil spills and damage to hoses and fittings. To mitigate the risks of transfer operations Offspring International offers a range of marine breakaway coupling designs from leading producers.

Petal Valve Coupling

Breakaway couplings are an essential component in maintaining the environmental integrity of tanker offloading operations. Seamlessly integrated within the flexible hose string, petal valve couplings use flanged ANSI connections for direct bolting to hose end flanges, together with optional buoyancy units. The coupling is full bore ensuring uninterrupted flow and zero pressure loss.

On-site Reassembly After Activation

Its design makes the petal valve uniquely capable of on-site reassembly after activation and can be quickly back in service following an incident, reducing terminal downtime. There is no need to return the coupling to be reset.

Benchmark Setting Design

The coupling's petal valve closure design sets a benchmark for minimal oil leakage and petal valve engineering integrity, while the forged metal construction is built to last. The coupling allows breakout load and surge pressure to be adjusted to suit specific SPM / terminal applications by changing the titanium alloy weak-bolts, without disassembling the unit, up to max 50 tons, equivalent to 40 barg of internal pressure.

Rapid Activation

The coupling separates when a pre-set load or internal pressure exceeds break bolt capacity, forcing the coupling apart. The central sleeve is pulled out allowing closure of the upstream petal valves within a few seconds, significantly reducing oil flow.

Next the four smaller petals close - closure time is adjustable to suit flow requirements - completing upstream valve closure. Two-stage petal valve closure provides optimal anti-pressure surge protection. Continued axial load forces the second set of weak bolts to break, allowing the sleeve to separate and activate the downstream valve petals.

The coupling uses a novel system of pre-set spring dampeners for the two-stage closure, allowing complete closure times to be adjusted to suit each installation. There is no leakage of hydraulic oil into the sea.

Flip Flap Coupling

The Flip Flap marine breakaway coupling offers passive monitoring of floating hoses and protection from excessive axial load and surge pressures. The standard coupling configuration comprises two sets of Flip Flap disc valves positioned either side of a calibrated titanium alloy weak-bolt flange assembly.

The two halves of the Flip Flap separate once either a pre-set load, internal pressure or combination of both activates the weak-bolts. As the valves close liquid transfer is prevented, containing liquid within each section of the separated hose. The Flip Flap's disc valves ensure 100% leak-free shut-off.



PLEM Control

Offshore loading and unloading Single Point Mooring and Conventional Buoy Mooring systems feature a PLEM containing single and multiple valves to control flow to and from the terminal.

Smooth operation of the valves is critical to maximising tanker movements and trouble-free scheduling. Offspring International offers a range of PipeLine End Manifold (PLEM) control systems as part of its integrated supply of mooring and offloading systems.

Available under an exclusive agreement with valve actuator manufacturer, Paladon Systems, Offspring International offers several PLEM control systems for SPM and CBM loading and offloading.

The PLEM valve control systems can be operated from the surface or subsea, and autonomously with the innovative Autonomous Shutdown Valve.

SPM PLEM Control

The PLEM is connected to the SPM CALM buoy via flexible submarine hose(s), typically in either a "Chinese lantern" or "Lazy S" configuration, enabling oil to be transferred to and from the tanker via a floating hose. OIL offers the following PLEM control options:

Manually controlled valve – operated by diver. Ideal for shallow water where calm Sea States are the norm. These valves are normally left permanently open and only closed for a hose change out or in the event of an emergency. Remote double-acting valve operation from the SPM buoy. The PLEM valve is controlled using a double-acting hydraulically operated actuator, powered open and closed by Hydraulic Power Unit (HPU) mounted on the CALM buoy and connected by a control umbilical.

Remote single-acting valve operation from the SPM buoy. The PLEM valve is controlled using a single-acting, hydraulically operated actuator, powered open by a HPU mounted on the CALM buoy and connected by umbilical. The valve is

held open by hydraulic pressure and fails safe via the actuator's spring when the hydraulic pressure to the actuator is lost.

Autonomous Shutdown Valve

With increasing demands for more efficient tanker scheduling and greater loading / offloading availability, Offspring International offers Paladon Systems' patented Autonomous Shutdown Valve (ASV). Fully autonomous and self-contained, the ASV offers terminal operators fail-safe offloading operations, greater system availability, and emergency shutdown capability.

Suitable for CALM buoy and conventional buoy mooring systems, the ASV removes the restrictions on offloading operations typically imposed by manual valve operation that can require expensive diver interventions and are only possible during fair weather.

The ASV also replaces the extended chain of components needed with a hydraulically operated valve actuator, powered open by a CALM buoy mounted HPU; effectively removing reliance on a surface control umbilical. It also eliminates the need for frequent maintenance visits to the buoy for checking and recharging of HPU system pressure.

CBM PLEM Control

For CBM offloading operations, OIL offers a diver operated valve PLEM control option, as well as the Autonomous Shutdown Valve and its associated benefits.

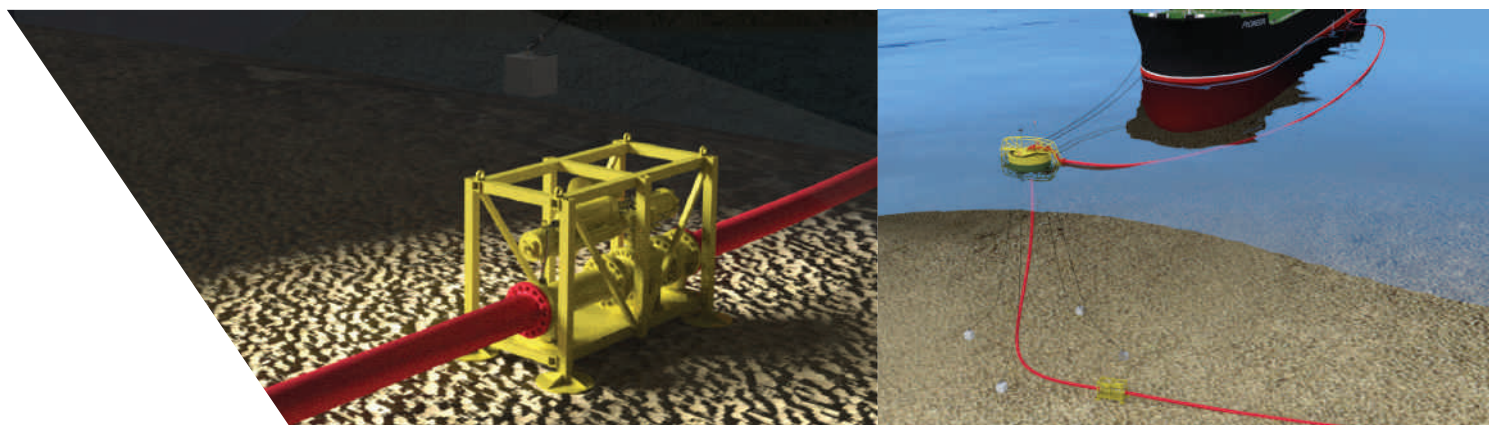



Offspring International is a leading supplier of equipment for mooring, offloading and control systems to optimise terminal operations both offshore and quayside.

Offspring offers a fully integrated supply of equipment for SPM and CBM moorings, hoses, breakaway couplings, valves & actuators, together with a comprehensive terminal monitoring and management system.



For more information on Offspring International Mooring and Offloading Systems
call +44 (0)1384 453880
email mail@offspringinternational.com or visit
www.offspringinternational.com



UK
Offspring International HQ
 Offspring International Ltd
 Unit 8, Castle Court 2
 Castlegate Way
 Dudley, West Midlands
 DY1 4RH, UK

Tel: +44 (0) 1384 453 880
 Fax: +44 (0) 1384 453 888
 Email: mail@offspringinternational.com

USA
Offspring International Office
 Offspring International Ltd
 28577 Jaeger Drive
 Laguna Niguel
 CA 92677
 USA

Tel: +1 949 215 3268
 Email: nigel.grainger@offspringinternational.com

