



# WM WasteByRail<sup>®</sup> — A Carbon-Neutral Solution for Metro's Sustainable Future

Proposal Response for RFP 3396  
Solid Waste Transport Services  
Property and Environmental Services Department of Metro

Submitted by Waste Management Disposal Services of Oregon, Inc.  
January 24, 2018





# Table of contents

Section A   Transmittal Letter .....	I
Section B   Questionnaire.....	1
Section C   Exceptions to Standard Agreement and RFP .....	39
Section D   Financial Capability .....	40
Section E   Appendices.....	40
Appendix 1   Organizational Chart with Ownership Percentages and Management Arrangements .....	41
Appendix 2   Good Company Environmental Assessment and Climate Trust Carbon Offsets .....	43
Appendix 3   Equipment Specifications .....	53
Appendix 4   Project Timeline .....	197
Appendix 5   Kittelson & Associates Traffic/Transportation Analysis .....	199
Appendix 6   Railyard and Staging Facility Site Plans .....	205
Appendix 7   AT&T Equipment Tracking Platform .....	213
Appendix 8   Inspection and Incident Reporting Forms .....	217
Appendix 9   Walsh Safety information .....	275
Appendix 10   Financial Statements .....	283
Appendix 11   ECONorthwest Economic Impact Study .....	289
Appendix 12   <b>UPRR’s 2016 Social, Environmental and Economic Sustainability Progress Report</b> .....	299
Appendix 13   Subcontractors and Suppliers 2018 Vendor Inclusion and Diversity Plan .....	339
Appendix 14   Equal Employment Opportunity Policy .....	347
Appendix 15   <b>WM’s 2016 Sustainability Report</b> .....	349
Appendix 16   <b>WM’s 2017 Sustainability Report Update</b> .....	351
Appendix 17   Exceptions to the Standard Agreement and RFP .....	363
Appendix 18   Consent of Surety Letter .....	371







January 24, 2018

Ms. Julie Hoffman  
Metro Procurement Services  
600 NE Grand Avenue  
Portland, OR 97232-2736

Re: RFP 3396, Solid Waste Transport Services

Dear Ms. Hoffman:

Waste Management Disposal Services of Oregon, Inc. (WM) is pleased to submit this response to Metro’s Request for Proposals 3396, Solid Waste Transport Services. Our region’s sustainable future is bright, thanks to progressive programs initiated by Metro, enthusiastic community support for Metro’s important work, and the power of partnerships with logistics providers like WM. When innovation comes to town, everyone wins.

Surprised to receive a transportation proposal from WM? Think again! We are materials management experts ... and that includes logistics expertise to move materials near, far and to all points in between, using many transportation modes. We are excited to share a proven, reliable solution for Metro’s solid waste transport services. It is WM WasteByRail®.

### WM’s Transportation Solution for Metro’s Sustainable Future

With help from the Good Company, we analyzed truck, rail and barge to WM’s Columbia Ridge. The answer was clear: the best choice for Metro’s sustainable future is WM’s WasteByRail®, with its impressive performance for environmental metrics including particulate matter (PM), nitrogen oxides (NOx), fuel use (MMBTU) and sulfur oxides (SOx). See Appendix 2 for the Good Company analysis.

We propose using rail to move solid waste from the Metro area to Columbia Ridge in Arlington, Oregon. Material will travel by truck from Metro Central and Metro South to an intermodal facility in Portland. From there, the containers will travel by rail to the landfill. Our environmentally efficient logistics plan, is made even better by carbon offsets to give Metro a carbon-neutral solid waste transportation solution.



### Why Rail?

Rail moves America. It is dependable, fast and cost-effective. Why rail for Metro? Reliability, sustainability and flexibility. With rail:

- Metro is assured of a reliable mode of long-distance transportation, generally unaffected by weather;
- Metro enjoys an environmentally friendly, cost-effective solution that supports the regional community, fully meeting the three tenets of sustainability; and
- Metro has peace of mind, knowing solid waste can move easily by another mode of transportation, or to another location, if needed; it is the flexibility you need for this all-important community service.





## Moving Materials from Point A to Point B ... Seamlessly

WM will be the single point of contact, offering administrative efficiency for Metro staff. We will coordinate services with a team of highly-qualified subcontractors. Walsh Trucking Company LTD (Walsh) will provide **transportation (the “dray”) from Metro transfer stations to and from the intermodal facility.** Union Pacific Railroad (UPRR) will provide turnkey intermodal service at their Albina Railyard and rail transportation to and from Columbia Ridge. This all-star team offers Metro the ultimate assurance of seamless service.



## Minimizing Environmental Impacts

**Regional waste hauling is Metro’s largest source of Scope 1 emissions.**<sup>1</sup> With WM’s WasteByRail® solution for Metro, we can change that. By partnering with The Climate Trust, we have identified high-quality carbon credits from their Oregon Offsets Projects portfolio. The Climate Trust is a non-profit organization based in Portland. They are dedicated to ensuring the environmental integrity of carbon markets. Our proposal includes the purchase of sufficient credits to offset 100 percent of the transportation greenhouse gases (GHGs) over the contract life.



Our transportation solution provides cleaner air and an enhanced viewshed for the Columbia River Gorge National Scenic Area (NSA). With WM WasteByRail®, say goodbye to nearly 15,000 long-haul trucks driving through this majestic landscape each year. Say hello **to an innovative approach to moving Metro’s solid waste.**

Even our purposeful equipment selection protects the environment. Working with our chassis manufacturer, we designed a new chassis configuration that supports a larger intermodal container payload. With a larger **payload, we can minimize the container loads needed to move Metro’s solid waste.** Fewer containers mean fewer truck trips through the metropolitan area. Fewer truck trips, mean less congestion and cleaner air. Who would have thought equipment choice could be so green? Your trusted partner, Waste Management.

## Using Metro’s Waste for Green Alternatives



Imagine using our everyday garbage for safe and green beneficial uses, right here in the Metro region.

**WM recognizes Metro’s commitment to diversion** and innovation. We have technology opportunities for beneficial reuse, creating new things from municipal solid waste. We first brought you SpecFuel®, **an energy product, in our 2015 response to Metro’s RFEOI.** Since then, WM has continued its collaboration with several partners, advancing other green technologies and solutions.

WM is positioned to advance these green solutions because of our commitment to innovation. No other environmental service provider is as invested in alternative technologies. We welcome the opportunity to work with Metro to incorporate groundbreaking, transformational technology as part of our materials management solution. Together, we can change the nature of discards management.

Our WM WasteByRail® solution is flexible and able to accommodate a new technology in another location. Consider the possibility of siting a new green technology near Metro South. With haulers directed to this new facility, we could alleviate the congestion around Metro South, keeping it available for the public. This could **eliminate Metro’s need to build a new transfer station** in the region. Now there is a green idea!

<sup>1</sup> Metro and the Good Company. (2013). *Greenhouse Gas Emissions Inventory Fiscal Year 2012-2013* (p. 5). Portland: Metro. Retrieved from [https://www.oregonmetro.gov/sites/default/files/2014/04/18/12012013\\_greenhouse\\_gas\\_emissions\\_inventory\\_internal\\_2012-13.pdf](https://www.oregonmetro.gov/sites/default/files/2014/04/18/12012013_greenhouse_gas_emissions_inventory_internal_2012-13.pdf)





WM WasteByRail® is the Best Solution for Metro

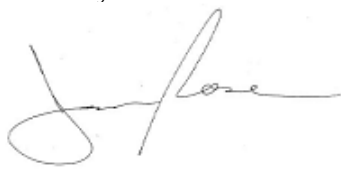
 <h3>ENVIRONMENTAL</h3> <p><b>15,000 trucks off the road</b> for a smaller carbon footprint</p> <p>Cleaner air and <b>enhanced viewshed</b> for Columbia River Gorge National Scenic Area</p> <p><b>100% carbon-neutral</b> transportation solution</p>	 <h3>OPERATIONAL CONSIDERATIONS &amp; REDUCTION OF RISK TO METRO</h3> <p>Industry <b>safety leader</b> and <b>trusted operational partner</b></p> <p>Impeccable <b>financial strength</b> and <b>stability</b></p> <p><b>Reliability</b> and <b>flexibility</b> with intermodal transport by rail</p>	 <h3>COMMUNITY &amp; DIVERSITY</h3> <p><b>New jobs</b> and robust <b>community investment</b></p> <p>Delivering <b>diversity, equity</b> and <b>inclusion</b> for employees and vendor partners</p> <p>Supports <b>economic vitality</b> in <b>Gilliam County</b></p>
<h3>COST</h3>  <p>Volume <b>discount</b></p> <p>Total transportation &amp; disposal <b>rate savings</b> with <b>Columbia Ridge</b></p>		

We confirm that our proposal is a firm offer valid for one year from the proposal date. We acknowledge receipt and understanding of all addenda, one through seven, issued as part of this RFP. As President of Waste Management Disposal Services of Oregon, Inc., I have the authority to sign legally-binding agreements.

Our contact for this procurement is Public Sector Manager Dean Kampfer, (503) 493-7831, dkampfer@wm.com. We look forward to addressing your questions and sharing more about our comprehensive transportation solution.

On behalf of our team, thank you for the opportunity to submit our proposal. We look forward to working with Metro on this exciting project and continuing our long-standing service to Metro.

Sincerely,



Jason Rose  
President, Waste Management Disposal Services of Oregon, Inc.







## WM is Metro's Low Risk/High Reward Partner



Trusted partner  
and ethical  
industry leader



A worry-free  
implementation  
for Metro



Rate  
Savings

Financial strength = Peace of mind





# Waste Management Transportation Proposal At-a-Glance

## Environment

**WM's WasteByRail® dramatically reduces Metro's carbon footprint for** transporting waste. Taking long haul trucks off the road results in cleaner air, less roadway congestion and a more natural, more majestic viewshed for Oregonians and the millions of people who visit the Columbia River Gorge NSA every year.

✓ Particulate matter	Using rail means 3.6 million fewer annual <u>total</u> truck miles on roads and highways and 36 million fewer total truck miles over ten years (Page 5, Good Company Appendix 2 and Kittelson Traffic Study Appendix 5)
✓ NOx in Columbia River Gorge NSA	Rail provides the lowest NOx, eliminating 2.4 million annual truck miles through the Columbia River Gorge NSA and 24 million truck miles over ten years (Pages 26 and 36, Good Company Appendix 2 and Kittelson Traffic Study Appendix 5)
✓ Fuel use in Columbia River Gorge NSA (proxy for SOx)	With rail, significant fuel savings will result with only 100 <b>trains/year needed to carry Metro's waste, compared to</b> 15,000 truck trips (Page 5-6, and Good Company Appendix 2)
✓ Greenhouse gases (CO <sub>2</sub> )	Our carbon- <b>neutral solution eliminates Metro's largest</b> source of Scope 1 emissions (Page 5 and Good Company Appendix 2)
✓ Noise and traffic effects on neighborhoods (Portland and Vancouver)	No distinguishable noise or traffic impacts due to using only formally designated state and/or local freight corridors avoiding neighborhood streets and active retail centers; our solution eliminates almost 39,000 annual truck miles <u>within</u> the Portland metropolitan area and 390,000 truck miles over the ten-year contract  (Pages 23 and 26, and Kittelson Traffic Study Appendix 5)

## Operational Considerations/Reduction of Risk to Metro

WM WasteByRail® provides reliable, flexible and sustainable service that reduces risk today and in the future. WM is a trusted and expert service partner with impeccable financial strength and stability.

✓ Ability to move waste in a timely manner by providing sufficient equipment and personnel	WM, Walsh and UPRR are committed to providing sufficient equipment and personnel, assuring Metro of outstanding service; infrastructure is already in place at Columbia Ridge and we are adding 11,600 feet of dedicated track at <b>the Portland railyard, more than enough to service Metro's</b> volume  (Pages 3-4, 9-16, 34-35 and Railyard Facilities Appendix 6)
--	---



<p>✓ Operational procedures/location of supervisory personnel will ensure coordination resulting in reliable, timely service</p>	<p>Careful planning and sufficient personnel ensure outstanding service delivery</p> <p>(Pages 3-4 and 9-10)</p>
<p>✓ Likely effectiveness of contingency plans for dealing with planned and unplanned service disruptions such as inclement weather, lock closures, strikes, etc.</p>	<p>Flexibility is built into our transportation solution, with multiple:</p> <ul style="list-style-type: none"> <li>• Road routes to the Portland railyard</li> <li>• Transportation modes to Columbia Ridge (rail, truck or barge)</li> <li>• WM-owned and third-party landfill alternatives</li> </ul> <p>(Pages 19 and 20)</p>
<p>✓ Equipment maintenance procedures and facilities</p>	<p>Our equipment maintenance programs are more stringent than manufacturer recommendations (Page 16)</p> <p>Our container maintenance facility is located at Columbia Ridge, ensuring timely repair and return to service (Pages 11 and 13)</p> <p>Mobile third-party container repair vendors available for work outside of Arlington (Pages 16-17)</p>
<p>✓ Equipment replacement schedules</p>	<p>Stringent company guidelines followed:</p> <ul style="list-style-type: none"> <li>• Replacements determined per age of equipment, life to date operating hours, maintenance costs and changes in operation needs</li> <li>• Rebuilds determined based on life of operating hours, fuel use and overall condition of equipment</li> </ul> <p>(Page 17)</p>
<p>✓ Ability to maximize payloads</p>	<p>Our chassis and 40-foot intermodal containers are lightweight but durable, capable of transporting heavy net-ton payloads to reduce the number of truck trips and increase volume on unit trains</p> <p>(Page 6, 8 and 15, and Equipment Specifications Appendix 3)</p>
<p>✓ Emphasis placed on safety procedures/training and employee evaluation - safety statistics</p>	<p><b>WM's Standard Safety and Health Management System is:</b></p> <ul style="list-style-type: none"> <li>• OSHA recognized approach to health and safety</li> <li>• Focused on risk mitigation, worksite analysis and hazard control</li> <li>• Safety training compliant with all federal and state regulations</li> </ul> <p>Our total recordable injury rate is substantially below industry average</p> <p>(Pages 17-19)</p>





<p>✓ Emergency procedures for dealing with accidents and releases to the environment</p>	<p>Our team has detailed control and response protocols for all aspects of our transportation plan; we also maintain outside agreements with spill responders</p> <p>(Pages 20-21)</p>
<p>✓ Flexibility of the system in adapting to changes in technology, fuel supplies, or transfer station relocations/additions</p>	<p>Innovative GPS technology to track containers and chassis inventory over the life of the contract (Page 13 and AT&amp;T Equipment Appendix 7)</p> <p>Central railyard location easily accessible from any transfer station/facility location (Pages 7 and 8, and Railyard Facilities Appendix 6)</p> <p>Ample system capacity provides flexibility for Metro as service needs change and grow (Page 11 and Railyard Facilities Appendix 6)</p>
<p>✓ Financial strength of proposing entity</p>	<p>As a Fortune 200 company, <b>WM's</b> financial strength provides stability to Metro</p> <p>WM has excellent credit ratings</p> <p>(Pages 22-23)</p>
<p>✓ Sustainable practices proposed</p>	<p>Trains, trucks and equipment use ultra-low sulfur diesel fuel (Pages 5-7, 26, 36, and Equipment Specifications Appendix 3)</p> <p>New over-the-road trucks for Portland container transfer are fuel efficient to minimize environmental impact (Page 7 and Equipment Specifications Appendix 3)</p> <p>Portland railyard includes highly efficient rubber tired gantry crane (Pages 6 and 12, and Equipment Specifications Appendix 3)</p> <p>Unique chassis design increases container payload and reduces truck trips (Pages 6-7 and 15, and Equipment Specifications Appendix 3)</p>

### Community and Diversity

**WM's WasteByRail® creates new jobs, ensures robust community partnership investments in both Portland and Gilliam County and sustains Metro's role as an economic engine in Gilliam County.**

<p>✓ Diversity of workforce (recruiting, developing, retaining)</p>	<p>Workforces at WM, UPRR and Walsh reflect diversity, equity and inclusion today; for the future, WM and UPRR are developing new recruiting pathways to increase diversity, while Walsh is working to sustain diversity through its employee referrals program and targeted hiring fairs</p> <p>(Pages 29-33)</p>
---	--



<p>✓ Wages and benefits for all positions (reviews, increases, reporting)</p>	<p><b>Sending Metro’s waste by rail will create 24 new jobs in</b> Portland and eight new jobs in Gilliam County (Pages 23-24)</p> <p>The average wage at Columbia Ridge exceeds the Gilliam County living wage calculator and goes beyond to include a full suite of benefits (Page 34)</p> <p>One family-wage job in Gilliam County has significantly greater economic value than one family-wage job in Morrow, Klickitat or Wasco counties (ECONorthwest Report, Appendix 11).</p>
<p>✓ Subcontractors and suppliers (COBID usage)</p>	<p>WM will spend \$8.8 million with certified minority- and veteran-owned businesses in 2018 and is proactively working to further diversify its supplier network (Pages 35-36)</p> <p>WM is committed to transparency with Metro; we will report COBID usage to Metro in our Annual Partnership Report (Page 33)</p>
<p>✓ Commitment to community relations (good neighbor, reporting)</p>	<p>Rail solution reduces truck miles on Portland-area roads, with no distinguishable noise or traffic impacts anticipated (Pages 23 and 26, and Kittelson Traffic Study Appendix 5)</p> <p>Portland and Gilliam County will benefit from new jobs and generous community partnership investments from WM and UPRR (Pages 23-24)</p> <p><b>Railing Metro’s waste to Columbia Ridge maintains host fees to fund critical services, community infrastructure, economic development and affordable housing in Gilliam County (Pages 25-26)</b></p> <p>WM will demonstrate community partnership through transparency and open dialogue with regular reports to the Gilliam County Commissioners and the Columbia Ridge Community Advisory Council and with outreach to the Overlook Neighborhood Association in Northeast Portland (Page 26)</p> <p>We will report to Metro regarding community relations as part of our Annual Partnership Report to Metro (Page 33)</p>

Cost

WM offers Metro competitive pricing and great service, the true definition of VALUE.

- ✓ See page 39 for our pricing
- ✓ **WM’s transportation solution delivers the best economic and environmental value to Metro and rate payers**





## Section B | Proposal questionnaire

A. ORGANIZATIONAL INFORMATION | 1. Name of lead firm that will enter into an agreement, type of firm (corporation, partnership, individual, LLC, or other - if "other," please describe). | 2. Please provide the following information for the firm: address, phone number, email address and website, federal tax ID#, Project Manager for the proposal and direct contact information - contact name, title / position, direct phone number and email address of contact | 3. How many years has your firm used its present name? | 4. List all names your firm has used to conduct business (include dates and states of incorporation for each

Waste Management Disposal Services of Oregon, Inc. (WM), a Delaware corporation, federal tax ID 36-3548405, will be the lead firm that contracts with Metro for solid waste transport services. WM is at 7227 NE 55<sup>th</sup> Avenue, Portland, Oregon, 97218, wmnorthwest.com. **WM's project manager and Metro's primary contact for this proposal is Dean Kampfer, Public Sector Solutions Manager, dkampfer@wm.com, (503) 493-7831.**

WM has been operating under its current name for 30 years. It was incorporated in Delaware on October 22, 1987, and qualified to conduct business in Oregon on November 13, 1987.

5. Please submit an organizational chart showing ownership percentages and management arrangements between the firm that would enter into an agreement, and any other entities participating in the execution of this proposal.

Waste Management Disposal Services of Oregon, Inc., a Delaware corporation, is a direct subsidiary of Waste Management Holdings, Inc., a holding company for all subsidiaries of its parent, Waste Management, Inc. (WMI). WMI is a public company, regulated by the Securities and Exchange Corporation (SEC). Please see Appendix 1 for the organizational chart showing ownership percentages and management arrangements for this agreement.

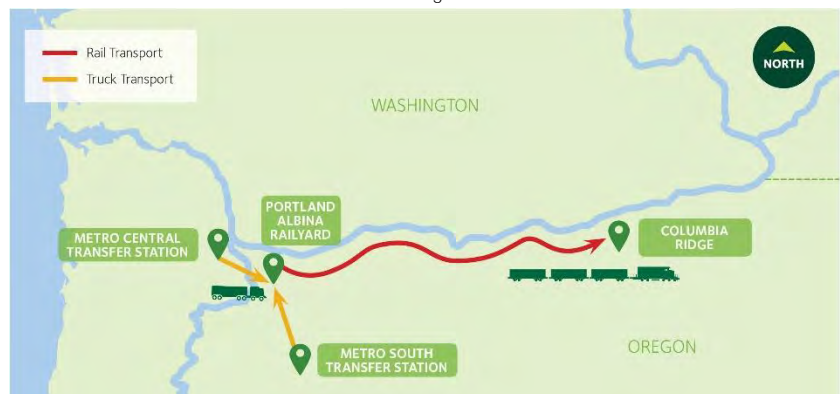
This proposal is offered by WM in collaboration with Union Pacific Railroad (UPRR), Walsh Trucking Company LTD (Walsh) and a top-tier team of qualified, experienced subcontractors. To build understanding about the roles for UPRR, Walsh and others, we begin with a brief overview of our proposal to rail Metro solid waste to our Columbia Ridge Landfill (Columbia Ridge):

**Our rail solution steps up to address Metro's needs for cost-effective and reliable waste transport, and goes beyond to deliver cleaner air and a dramatically smaller carbon footprint.** By taking 15,000 trucks off the road every year, that is 15,000 fewer round trips/year or 60 fewer round trips/day, Metro will eliminate 2.4 million trucks miles through the Columbia River Gorge National Scenic Area (NSA) every year and 24 million truck miles over 10 years, see Figure 1.

Essential to this smart and sustainable solution is the development of a dedicated railyard, conveniently located in Portland between the Metro transfer stations. Securing a Class I rail property that is permitted and accessible with a trained team of professionals in place, see Figure 2, has required considerable research and planning in light of Metro's needs and local infrastructure limitations. With this rail property now available for Metro, the opportunity to choose rail for a more sustainable future is exciting and real.

Our team shares a history of working together, allowing WM to access experienced personnel and resources to provide the best transportation solution for Metro and the local communities vested in this contract. Our team is identified in Figure 3.

Figure 1. Rail eliminates all Metro solid waste truck traffic through the Columbia River Gorge NSA.





Union Pacific Railroad is our Class I rail transportation partner from Portland to Columbia Ridge. UPRR is one of North America's premier railroad franchises, providing service to two-thirds of the United States. WM and UPRR currently partner to ship six unit trains weekly from the Puget Sound area to Columbia Ridge. UPRR owns the Portland Albina railyard featured in our proposal and is committed to building a new state-of-the-art Portland intermodal operation to support Metro.

transportation partner from Portland to Columbia Ridge.

Figure 2. UPRR is committed to supporting Metro.



Loup Logistics Company (Loup) is our Portland Albina railyard intermodal operations partner, a wholly-owned subsidiary of UPRR. Loup offers a robust portfolio of shipping and logistics services as well as a greater breadth of expertise available to serve Metro. WM now partners with Loup as we transport waste to our landfills across the U.S.



Watco Transportation Services LLC (Watco) is one of the largest shortline railroad holding companies in the U.S., with 37 short line railroads operating on more than 5,000 miles of track and 33 industrial contract switching locations. Watco is our shortline rail partner at Columbia Ridge and will continue to provide exceptional service to support Metro.



Walsh Trucking Company LTD, family owned and operated for more than 50 years, provides the highest level of quality and safety in the trucking industry. The company began transporting solid waste in 2000 and is one of the largest transporters of wood residuals and solid waste in the Northwest. Walsh has an exceptional performance record as the current Metro solid waste transporter. Walsh will provide trucking between the transfer stations and the Portland Albina railyard, and contingency trucking in the rare event of a rail disruption.



Harris Group, Inc. (Harris), headquartered in the Pacific Northwest, is an industry-leading engineering consulting firm with a strong background in material handling and process industries. Their railroad industry experience includes work with BNSF, UPRR, CSX Transportation, Weyerhaeuser, Anheuser-Busch, JR Simplot and port authorities, including the ports of Portland and Seattle. Harris is responsible for design of the Portland Albina railyard.

Figure 3. Our team incorporates the best transportation companies in the industry.



Tidewater has been safely transporting commodities on the Columbia and Snake River system for 83 years. Tidewater has evolved into a multi-commodity transportation and terminal company serving the diverse transportation needs of the Pacific Northwest. Headquartered in Vancouver, Washington, Tidewater operates from the Port of Astoria, Oregon, to the inland Port of Lewiston, Idaho. Tidewater provides a contingency barge transportation option to Columbia Ridge if a transportation disruption occurs.



6. Describe the supervisory structure that will be used to perform the work, list the names of supervisory personnel if available, and where their offices will be located.

Our team will remain the same from development through transition to daily operations. We have integrated our Pacific Northwest senior management team in the organizational structure to provide the highest quality service for Metro and to provide immediate, direct access to our senior resources and as well as project personnel. Figure 4 provides our team’s supervisory structure. Additional detail on our supervisory personnel, including qualifications, responsibilities and office locations, are provided in Table 1.

Figure 4. The WM team has assigned our best personnel to Metro.

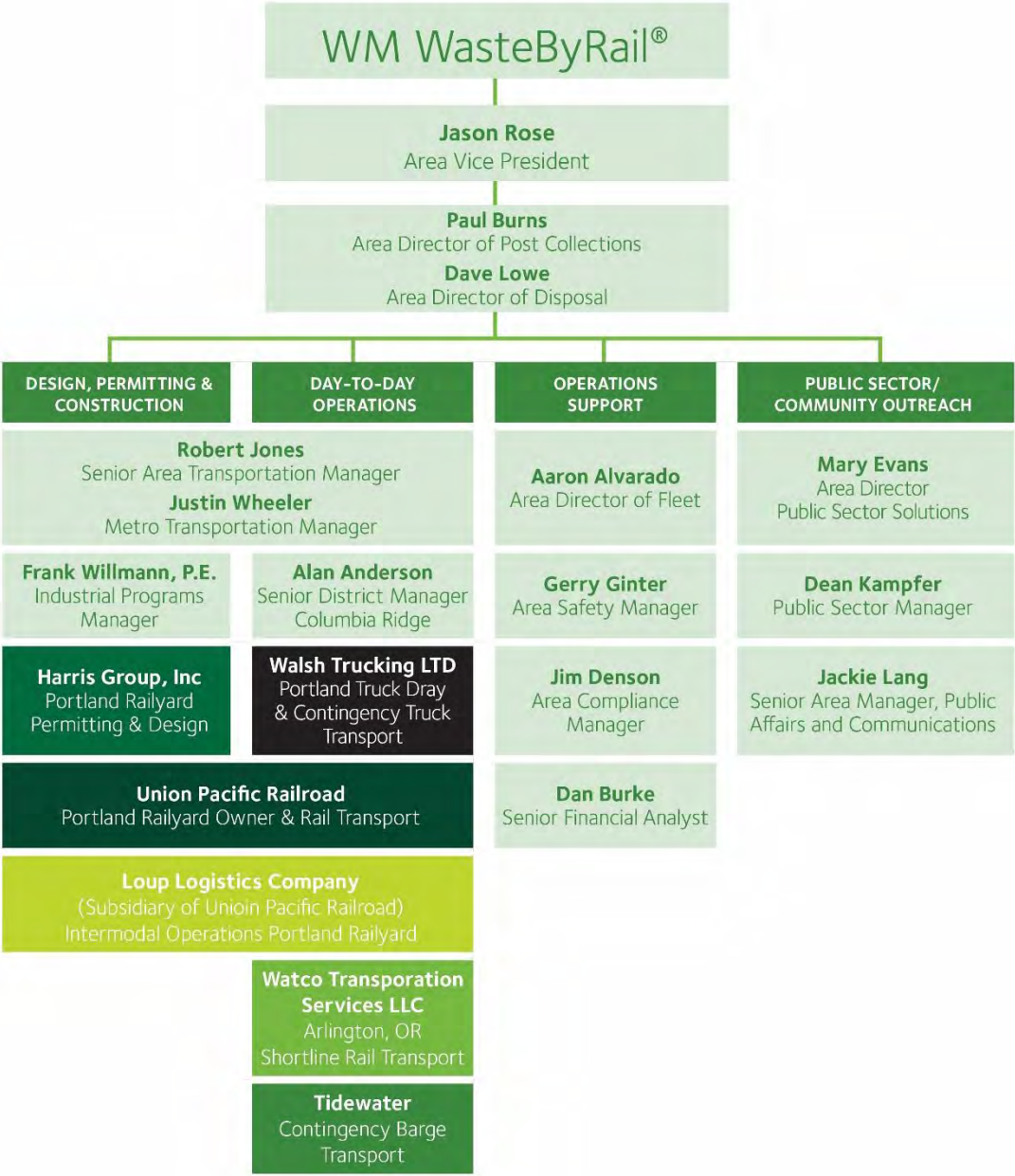




Table 1. The WM team is highly experienced in key operational components.



	AREA OF INDUSTRY EXPERIENCE								
	Years of Experience	Project Development	Permit, Design, Construction & Startup	Day-to-Day Rail Operations	Day-to-Day Truck Operations	Day-to-Day Barge Operations	Day-to-Day Landfill Tipper Operations	Maintenance, Safety & Environmental Compliance	Community Outreach & Engagement
<b>Jason Rose</b> , Area Vice President, Kirkland, WA <i>Leader of PNW Market Area</i>	18	✓	✓					✓	✓
<b>Aaron Alvarado</b> , Area Director of Fleet, Kirkland, WA <i>Oversight of fleet and maintenance programs</i>	25	✓						✓	
<b>Paul Burns</b> , Area Director of Post Collections, Portland, OR <i>Oversees aspects of transportation operations</i>	28	✓	✓	✓	✓	✓	✓	✓	✓
<b>Mary Evans</b> , Area Director Public Sector Solutions, Kirkland, WA <i>Oversees public sector and community outreach/engagement programs</i>	31	✓	✓						✓
<b>Dave Lowe</b> , Area Director Disposal, Spokane, WA <i>Oversees all aspects of landfill operations</i>	40	✓	✓	✓	✓		✓	✓	✓
<b>Robert Jones</b> , Senior Area Transportation Manager, Kirkland, WA <i>Oversight of regional transportation programs</i>	13	✓		✓	✓	✓		✓	✓
<b>Justin Wheeler</b> , Portland Metro Transportation Manager <i>Located in Seattle, WA. Will relocate to Portland to support Metro contract</i>	11	✓		✓	✓	✓		✓	✓
<b>Jackie Lang</b> , Sr. Area Manager, Public Affairs & Communications, Portland, OR <i>Oversight of community outreach, engagement programs &amp; media relations</i>	26	✓							✓
<b>Alan Anderson</b> , Senior District Manager, Columbia Ridge, Arlington, OR <i>Oversight of Columbia Ridge operations</i>	24	✓	✓	✓	✓		✓	✓	✓
<b>Jim Denson</b> , Area Compliance Manager, Portland, OR <i>Oversight of environmental compliance programs</i>	25	✓	✓	✓	✓	✓	✓	✓	✓
<b>Gerry Ginter</b> , Area Safety Manager, Portland, OR <i>Oversight of safety programs</i>	21	✓	✓					✓	
<b>Dan Burke</b> , Sr Financial Analyst, Kirkland, WA <i>Responsible for Columbia Ridge's financials</i>	18	✓						✓	
<b>Dean Kampfer</b> , Public Sector Manager, Portland, OR <i>Metro contract negotiation and implementation interface</i>	38	✓							✓
<b>Frank Willmann, P.E.</b> , Industrial Programs Manager, Seattle, WA <i>Support of Portland Albina railyard design and development</i>	33	✓	✓	✓	✓	✓		✓	✓
<b>SUBCONTRACTORS</b>									
<b>Harris Group, Inc.</b> , Portland, OR <i>Portland rail yard design and permitting</i>	Combined	✓	✓					✓	✓
<b>Loup Logistics Company</b> (subsidiary of Union Pacific), Portland, OR <i>Portland Albina railyard transload operations</i>	Combined	✓	✓	✓	✓			✓	✓
<b>Tidewater</b> , Vancouver, WA <i>Contingency barge transport to Columbia Ridge</i>	Combined	✓	✓			✓		✓	✓
<b>Union Pacific Railroad</b> , Portland, OR <i>Portland Albina railyard owner and Class I railroad operations</i>	Combined	✓	✓	✓				✓	✓
<b>Walsh Trucking Company LTD</b> , Troutdale, OR <i>MCS and MSS truck dray to Portland railyard and contingency truck transport to Columbia Ridge</i>	Combined	✓	✓		✓		✓	✓	✓
<b>Watco Transportation Services LLC</b> , Arlington, OR <i>Shortline railroad operations at Arlington, OR</i>	Combined	✓	✓	✓				✓	✓

\*Individual resumes will be provided upon request.

7. Please list and explain the status of any lawsuit(s) material to your ability to carry out the functions outlined in this RFP for Waste Transport Services, and in which you or a company affiliated with you (i.e. a parent corporation, a corporation in which you own an interest, or a corporation in which your parent corporation owns an interest, as applicable) are a party.

Neither WM nor any affiliated company is involved in any lawsuits that are material to our ability to carry out the functions outlined in this RFP.



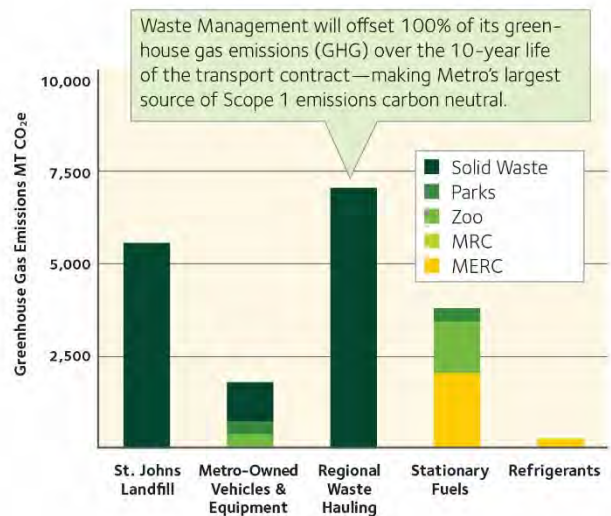
**B. EVALUATION CRITERIA | 1. Environmental | A. Fuel Use and Emission Calculations:** In evaluating the environmental impacts of transportation proposals, Metro will use fuel use estimates and published emission factors to calculate the impact of transportation to each of the landfills that are included in a proposal. Metro will also consider specific impacts on the Columbia River Gorge national scenic area (NSA). The analysis of environmental impacts will focus on the generation of PM, NOx, SOx and greenhouse gases. Because of a lack of available emissions data, diesel fuel use will be used as a proxy for SOx emissions. Adjustments will be made for the sulfur content of different fuels (such as low sulfur diesel, ultra-low sulfur diesel (ULSD), Biodiesel, and Compressed Natural Gas) with emission factors adjusted accordingly.

To assist us in developing the most environmentally sustainable transportation plan possible, WM partnered with Good Company to benchmark rail, barge and truck transportation options. Based in Eugene, Oregon, the Good Company provides environmental performance assessment and planning, focusing on sustainability related to infrastructure and materials management projects for transportation authorities, ports and private industry.

The benchmarking process used our best estimate of solid waste container weights, transload locations, transportation equipment and travel distances to determine how rail transportation is expected to perform against other transportation options for PM, NOx, SOx and greenhouse gases (GHGs). Benchmarking identified opportunities to reduce our transportation environmental footprint. After evaluating strategies, we incorporated internal enhancements to reduce environmental impacts and provide Metro the best net benefit. This includes our commitment to use when possible ultra-low sulfur diesel (ULSD), highly efficient rail locomotives, yard equipment, trucks and emissions control equipment to improve air quality.

After integrating best practices, we looked externally to minimize our environmental footprint through the purchase of carbon offset credits. The result is a new partnership with the Climate Trust for the purchase of a high-quality carbon offset portfolio. The portfolio will offset 100 percent of GHGs over the 10-year life of the transportation contract, allowing us to offer Metro a carbon neutral transportation solution. The Climate Trust offsets portfolio consists of high-quality credits from the Eastern Oregon Grassland Conservation Project with The Nature Conservancy in Wallowa County, and a Western Oregon Landfill Gas Capture Project in Douglas County. Both projects follow Climate Action Reserve (CAR) protocols and verification standards. CAR develops its own protocols and requires that projects meet stringent requirements to confirm the offsets generated are real, additional, permanent, verifiable and enforceable. CAR protocols are developed to the highest standards and are used in California's Cap and Trade system to generate compliance-grade credits. The grassland project is the first of its kind in the U.S. and creates a cooperative for small ranches in eastern Oregon for access to carbon markets and revenue in exchange for no-till easements to maintain the associated carbon storage into perpetuity.

Figure 5. WM provides carbon neutral transportation.



With the purchase of carbon offsets, we believe rail transportation is preferable compared with other modes of transportation for the GHG criteria, allowing Metro to fully address its largest source of Scope 1 operational emissions, see Figure 5. Our carbon neutral solution builds on our industry-leading commitment to minimize the carbon impact of our business. Our innovative approach provides reliable, sustainable transportation, minimizing overall road congestion, improving air quality and enhancing visual impacts in the Portland metropolitan area and Columbia River Gorge NSA. Appendix 2 includes the Good Company assessment, which shows the relative impacts of transportation modes and demonstrates how we will invest in a healthier environment. An overview of our partnership with the Climate Trust for carbon offsets is also included in Appendix 2. Additionally, we invite you to learn more about our work as a company to reduce the use of carbon and preserve natural resources by reviewing WM's 2016 biennial Sustainability Report and the 2017 update in Appendices 15 and 16.



B. Emission Factors | 2) Rail: NOx, PM and CO2 emissions from locomotives will be calculated using emission factors in grams of pollutant per gallon (gal) of fuel use. The emission factors will be based on engine Tier standards, as defined in the EPA Technical Guidance Document Technical Highlights, Emission Factors for Locomotives, EPA420-F-09-025, April 2009. Using these factors, along with the locomotive engine annual fuel consumption and annual miles traveled, annual emissions will be calculated. | 3) Truck (Line-Haul and Container Drayage): NOx, PM and CO2 emissions from the use of trucks will be calculated using the EPA 2017 SmartWay Truck Carrier Tool. The model is available at <https://www.epa.gov/smartway/smartway-truck-carrier-partner-resources>.

Information needed to support Metro calculations has been provided in this proposal.

C. Fuel Use Calculations: Please provide the following information for the relevant transportation mode for your proposal: For information that varies depending on the transfer station and landfill combination, indicate clearly which combination the information pertains to (e.g., MCS to Columbia Ridge): 2) Rail Fuel Use | a) Rail Transport: Provide the following parameters and, where appropriate, provide relevant documentation for the line-haul to and from Portland-area yard and landfill(s): (1) Average length of train (number of railcars) and container configuration, e.g., double-stack, single stack, etc., and number of containers per rail car, to each landfill you're proposing on. | (2) Number of tons, containers, and average length of cars holding Metro's waste on each trip to each landfill you're proposing on, both in terms of individual car length and the overall length of the coupled railcars. | (3) Average number of locomotives and average fuel use for each line-haul trip from Portland-area rail terminal to each landfill. | (4) Average number of locomotives and average fuel use for each line-haul trip from each landfill to Portland rail terminal.

WM is pleased to offer dedicated unit train service between Portland and Columbia Ridge. Rail service will consist of two weekly dedicated trains carrying 85-90 double-stack well-cars/train with 170-180 40-foot intermodal containers (5,100-5,400 solid waste tons/train). Total train length will range between 6,500-7,000 feet. The average loaded weight/container will be 30 tons. Containers will be double stacked on rail well-cars, each approximately 77 feet long.

To support full volume from MCS and MSS, UPRR will operate two C44AC or similar locomotive units/train that meet the **United States Environmental Protection Agency's (EPA)** Tier 0 to Tier 4 emissions standards. Watco will operate two UPRR supplied C44AC or similar locomotive units for the shortline haul from Arlington to Columbia Ridge. **Because locomotives are network assets that move fluidly throughout UPRR's system, the specific locomotive type and age will vary to support the Metro rail service.** UPRR fully understands the **importance of reducing fuel emissions and remains committed to providing the best possible "green"** locomotive options. UPRR owns nearly 8,500 locomotives with more than 96 percent of its fleet meeting the Tier 0 to Tier 4 emissions standards. UPRR considers fuel use information confidential.

We have the flexibility to adjust the frequency of weekly trains based on volume or service needs. Unit trains **will operate on a scheduled network and offer tremendous flexibility and resilience to support Metro's long-term transportation needs.** Appendix 3 provides rail equipment and container specifications.

(5) Average fuel use per trip at Portland-area rail terminal, and the type of engines and type of fuel used at the rail terminal.

A high efficiency rubber tired gantry (RTG) crane will transfer containers between trucks and rail well-cars. Fuel use at the Portland Albina railyard is primarily for RTG crane operation. The Mi-Jack® RTG crane will have a diesel/electric drive and will use ULSD fuel. Mi-Jack® estimates that about 50 gallons of diesel will be consumed to load one unit train of 170-180 containers. Transfer trucks will bring containers to the RTG crane for direct transfer to rail to minimize truck idle time. UPRR will operate two C44AC locomotives/train using ULSD fuel for car switches within the railyard. In-yard rail movement will be highly limited as the yard layout has been designed for maximum efficiency to manage unit train operation and eliminate the need for well-car switching during loading operations. A top-pick will be stationed at the site for incidental container transfers. On average, the top-pick is expected to consume approximately five gallons/hour of ULSD fuel when operating. Specifications for the Portland Albina railyard equipment is provided in Appendix 3. Note that although a specifications sheet for a similar Mi-Jack® RTG crane is included, our equipment will be custom designed.





(6) Average fuel use per trip at landfill-area rail terminal, and the type of engines and type of fuel used at the rail terminal.

Top-picks will transfer containers between trucks and rail well-cars. Fuel use at the Columbia Ridge railyard is primarily for top-pick operation. On average, each top-pick consumes approximately five gallons of ULSD fuel/hour. To transload a unit train with 170-180 containers, two top-picks will be used over ten hours with an estimated total ULSD fuel consumption of 100 gallons/train. Specifications for railyard equipment is provided in Appendix 3. Watco will operate two UPRR supplied C44AC or similar locomotive units using ULSD fuel to perform car switches within the railyard. In-yard rail movement will be limited as the yard has been designed for maximum efficiency to manage train service and eliminate the need for railcar movement during loading operations.

(7) Line-haul miles from your Portland-area rail terminal to gate of each landfill.

The Portland Albina railyard is a short distance southeast of Swan Island on the east side of the Willamette River, near the interchange of I-5 and I-405, allowing rapid movement of containers from the transfer stations, see Figure 7.

Double stacked intermodal containers will be transported on dedicated unit train service from Portland directly to Columbia Ridge with an expected rail transit time of about five hours to cover the 139-mile distance, see Figure 6. Our receiving railyard is on Columbia Ridge property, which eliminates public road truck dray requirements for disposal.

Figure 7. The Portland Albina railyard is centrally located to best serve Metro transfer stations.



Figure 6. Dedicated train service provides rapid five-hour transit time.



(8) Provide the year of manufacture, the manufacturer name and the locomotive engine model number for each locomotive engine used to transport Metro's waste. If you expect locomotive engines to change over the course of a 10-year contract, provide a schedule documenting the year in which you anticipate the year-of-manufacture changing for any locomotive engines.

Working with UPRR, WM will proactively communicate new locomotive technology and related benefits to Metro on a regular basis. UPRR owns over 6,500 locomotives. Because locomotives are network assets that **move fluidly throughout UPRR's system, the specific locomotive type and age will vary** to transport the Metro waste. UPRR fully understands the importance of reducing fuel emissions and remains committed to providing **the best possible "green" locomotive options. Locomotives meet the EPA Tier 0 to Tier 4 standards and operate on ULSD fuel.** Information on UPRR locomotives is provided in Appendix 3.

b) Drayage by Truck: Provide the following parameters and, where appropriate, provide relevant documentation: (1) Tractor model(s) type and year, (2) average payload (tons per load), and (3) type of fuel (e.g., ULSD, biofuels). If a mix of fuel types will be used, estimate the percentage of miles traveled using each fuel type.

New, 2020 Mack Anthem four-axle or 2020 Peterbilt 571 four-axle tractors will be purchased for trucking



between transfer stations and the Portland Albina railyard. Specifications are provided in Appendix 3. The average payload/container will be 30 tons. Tractors will use ULSD fuel.

*(4) Fleet-average fuel use (miles per gallon). Show how you calculated average over all miles traveled (to and from MCS/MCS to your Portland-area rail terminal, and from your landfill rail terminal to landfill working face). Include idling at the rail terminals, TSS, landfills.*

New, 2020 tractors are expected to operate at 4.7 miles/gallon, accounting for idle time and traffic. At the Columbia Ridge railyard, tractors average four gallons/hour and make two five-mile roundtrips to the landfill working face/hour, which calculates to approximately 2.5 miles/gallon. Container transfer operations in the Portland and Columbia Ridge railyards will be direct transfer to minimize tractor idle times.

*(5) One-way miles between MCS and MSS to your Portland-area rail terminal.*

One-way truck miles between MCS and the Portland Albina railyard is 9.2 miles and between MSS and the Portland Albina railyard is 23.2 miles, see Figure 8. The Portland Albina railyard is ideally located to efficiently serve both transfer stations.

Figure 8. The Portland Albina railyard facilitates short truck transfer times.



*(6) One-way miles between your landfill rail terminal(s) and gate of each landfill for each landfill you are proposing on.*

The Columbia Ridge railyard is located on Columbia Ridge property. Columbia Ridge is unique as it is the only landfill in the Northwest with rail access on site and is ready to immediately accept Metro solid waste. From the railyard to the landfill gate is about 0.25 miles, although rail traffic does not use the gate. The landfill working face is about 2.5 miles from the railyard and transport on public roads is not required on any segment of the truck dray.

*(7) Average number of stops at a Metro transfer station daily made by each tractor (in tenths of trip).*

We anticipate approximately 28 daily stops at MCS and 35 daily stops at MSS. This is based on 2020 volume estimates provided by Metro of 220,256 tons at MCS and 275,351 tons at MSS. We have allocated three transfer tractors at MCS and four transfer tractors at MSS. Therefore, we anticipate the average number of daily stops by each vehicle will be 9.3 at MCS and 8.8 at MSS using two 10-hour shifts.

*(8) Describe fueling and operations of hosting activities.*

Mobile service trucks will be available to fuel equipment at the Portland Albina and Columbia Ridge railyards. UPRR has designated primary fueling stations at the Portland Albina railyard and the Hinkle, Oregon, railyard near Columbia Ridge, and will supply mobile fuel trucks should the need arise. Locomotive fuel schedules are **closely managed through UPRR’s Harriman Dispatch Center in Omaha, Nebraska. This is a routine function for UPRR** as they manage their extensive locomotive fleet and dispatch assets. Upon arrival at the Portland Albina or Hinkle railyard, UPRR, at their discretion, will rotate the existing locomotives with new fully fueled power units. Chassis transfer vehicles at MCS and MSS will be fueled on location through agreements with transfer



station operators. Walsh will maintain outside service agreements for tractor fueling at the end of each shift.

2. Operational Considerations / Reduced Risk to Metro | A. Provide an operational plan to demonstrate how your operation would function with the following volumes of waste for a given week. This should include information listed below but include times of activity and how they relate to any given day in this example week. Provide the same for the second table. This scenario reflects if one or the other transfers stations had a disruption and those tons were redirected to the other station. Rather than two tables, the increase of 75% is applied to both stations.

Two sets of RFP tables were provided identifying inbound volume to MCS and MSS. The first table showed typical inbound tons over a week. The second table outlined a 75 percent volume surcharge if disruption occurs. This data has been converted into two graphs, Figures 9 and 10, showing scenarios in daily container counts based on 30 tons/container. MCS and MSS typically generated between 28 to 36 intermodal containers/day. In the 75 percent surge scenario, this increased to 48 to 54 containers/day at MCS and 54 to 63 containers/day at MSS.

We will operate two 10-hour shifts to transfer containers to the Portland Albina railyard and will begin moving trailers at MSS at 5 a.m. and will shuttle containers to the on-site staging yard for delivery to the railyard. We will concentrate on moving these containers during the day since there is limited trailer storage on site. We will begin moving trailers at MCS at 5 a.m. and will transport them to the staging yard adjacent to MCS. There is parking for approximately 30 trailers at this site, which allows our team to concentrate on MSS during the day and shift focus to both transfer stations during a second shift. The estimated roundtrip drive time between MCS and the Portland Albina railyard is less than two hours inclusive of container transfer time. The estimated roundtrip drive time between MSS and the Portland Albina railyard is less than 2.5 hours, inclusive of container transfer time.

Volume fluctuations between MCS and MSS will have minimal impact on railyard operation due to similarity in truck transfer time. The railyard operates 24 hours/day, seven days/week, and is designed with staging capability of approximately 96 chassis and 288 containers. Design throughput capacity is 750,000 tons/year using a RTG crane, a 50 percent buffer over Metro disposal of approximately 500,000 tons/year and well above future Metro solid waste projections. Containers arriving at the Portland Albina railyard will be loaded directly to reduce idle time. Once containers are emptied and reloaded on the train at Columbia Ridge, the train will be routed back to Portland. This approach provides tremendous flexibility in managing solid waste flow and minimizes likelihood of delays. To expedite truck cycle times, we will leverage our 24 hour/day access at the Portland Albina railyard to match our intent to operate two trucking shifts.

Figure 9. The Portland Albina railyard is centrally located to serve Metro Central Station.

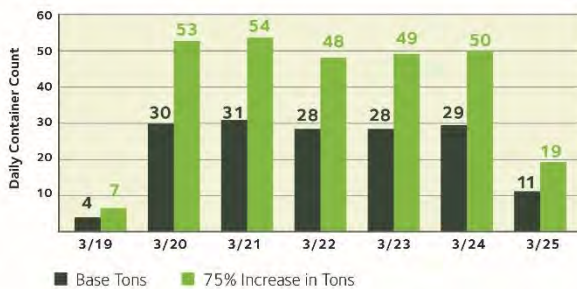
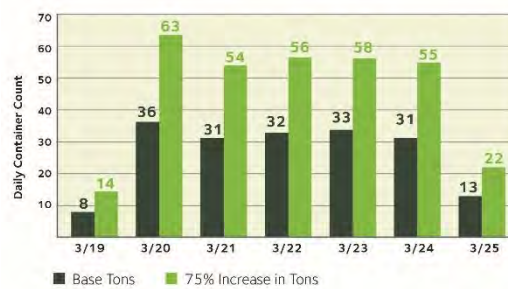


Figure 10. The Portland Albina railyard is centrally located to serve Metro South Station.



Managing both transfer stations: Our most efficient transportation plan is predicated on award of MCS and MSS to minimize the capital development cost impact of the Portland Albina railyard and to minimize impacts of transfer station volume fluctuations. UPRR has committed to develop the railyard and provide dedicated train service and rail well-car inventory. Walsh has committed truck resources for transportation between the two transfer stations and the Portland Albina railyard. **WM will purchase containers and truck chassis. Our team's commitments, coupled with WM's existing dedicated regional capacity and extensive equipment fleet, will provide consistent daily capabilities with the ability to efficiently manage Metro solid waste, regardless of how volumes are allocated between the two transfer stations.**

Managing one transfer station: If we are awarded transportation of only one transfer station, we will allocate





resources to efficiently manage typical transfer station volume at that location. If there is a significant surge in volume at one of the transfer stations, we will implement one of two possible plans. If the surge results from **one of the transfer station's change in operation status, we will work with the other contract holder and Metro** to share resources to manage the fluctuation. If the surge results from an outside influence, such as major storm, we will mobilize additional resources from our extensive local equipment and personnel pool as well as our subcontractor relationships. Since the Portland Albina railyard has been designed with full build-out for up to 750,000 tons/year, a temporary surge in volume will have no impact on railyard operation.

1) Provide a project timeline with critical path items described, beginning with contract award.

A project timeline beginning with contract award is provided in Appendix 4. Construction is needed only at the Portland Albina railyard as all rail infrastructure is in place at Columbia Ridge. We do not anticipate any permitting or construction complications since the Portland Albina railyard is now an operating railyard. Equipment delivery times have been verified and are well within the required timeline. We are highly confident in our ability to have the systems and equipment in place prior to the contract start date of January 1, 2020.

2) Provide the name and title of your contact person during mobilization and for other key personnel, including their roles throughout contract mobilization and implementation.

**WM's** Senior Transportation Manager, Rob Jones, (425) 247-6518, rjones40@wm.com, **will be Metro's primary** contact during mobilization.

A summary of key personnel and their roles is provided in Table 1 on page 4.

3) Describe the proposed travel route(s) in detail (street level) from transfer stations to the landfill and back.

Travel routes from the transfer stations to the Portland Albina railyard and continuing to Columbia Ridge are provided below.

MCS to the Portland Albina railyard, see Figure 11:

- 61st Ave to NW Front Avenue
- Right on NW Front Avenue
- Right on NW Kittridge Avenue
- Left on NW Yeon Avenue
- Merge onto I-405
- Merge onto I-5
- Exit 303 to Going Street
- West on Going Street
- Merge on Lagoon Ave
- Left on Anchor Street
- Merge onto Channel Avenue
- East on Channel Avenue, which becomes Going Street
- Merge right on Greeley Avenue ramp
- South on Greeley Avenue
- Right on Russel Street

Figure 11. The Metro Central Station route is on formally designated freight corridor.



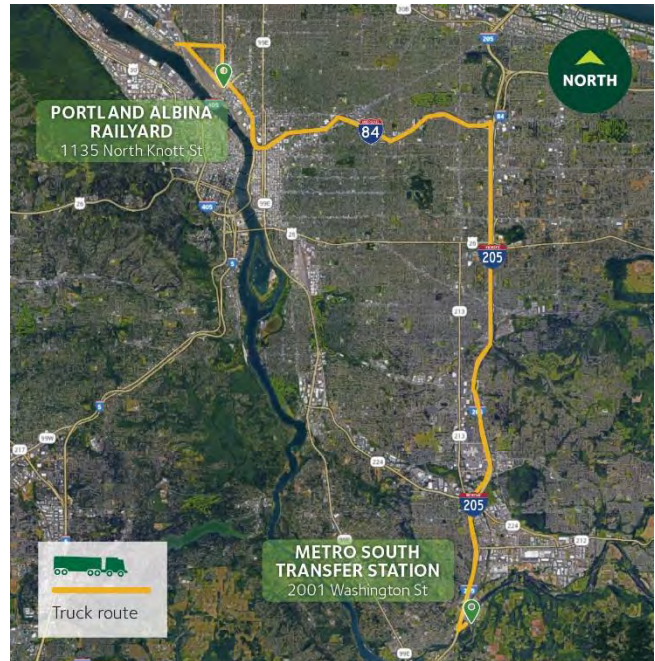


MSS to the Portland Albina railyard, see Figure 12:

- Left onto Washington Street
- Right on Clackamas River Drive
- Right on Hwy 213
- Merge onto 205
- Exit 21B to I-84 west
- Merge onto I-5 north
- Exit 303 to Going Street
- West on Going Street
- Merge on Lagoon Ave
- Left on Anchor Street
- Merge onto Channel Avenue
- East on Channel Avenue, which becomes Going Street
- Merge right on Greeley Avenue ramp
- South on Greeley Avenue
- Right on Russel Street

The UPRR mainline travels from Portland on the Oregon side of the Columbia River through Arlington, Oregon, where the mainline connects with shortline track that travels south to Columbia Ridge. Containers will be transported by train to Columbia Ridge and will then be trucked a short 2.5-mile distance on Columbia Ridge property to the landfill working face for disposal. Empty containers will be returned by train. Appendix 5 provides a traffic analysis prepared by Kittelson & Associates.

Figure 12. The Metro South Station route is on formally designated freight corridor.



4) List the location (and provide a map) of any staging/storage areas and describe how they will be used.

Walsh will maintain a staging area on property leased from Burlington Northern Santa Fe Railway (BNSF) adjacent to MCS. This property has space to stage approximately 30 chassis and is shown in Appendix 6. Walsh will also use the existing storage area at MSS with space to stage approximately 10 chassis. The Portland Albina railyard has storage capacity design for approximately 96 chassis and 288 containers, see Appendix 6. The Columbia Ridge railyard has unlimited container storage space around the railyard. Our Columbia Ridge container maintenance shop, where containers will be inspected and repaired prior to routing back to Portland, is near the railyard. Our container repair facility location is identified on the Columbia Ridge railyard drawing provided in Appendix 6.

5) For the travel route(s) presented above, provide the following: a) A description (including drawings) of sites for staging equipment and any terminals, their current status in terms of ownership/permitting, and any development required to use (i.e. paving, etc.).

**WM's resolute commitment** to environmental compliance will confirm that **Metro's solid waste is managed** safely, in compliance with laws and regulations, and most importantly, in a manner that protects public health and the environment. WM will use the following properties and terminals as part of this agreement.

Portland Albina railyard is a high-volume railyard owned by UPRR and situated on approximately 150 acres at 1135 North Knott Street in Portland, Oregon. WM, in partnership with UPRR, will build a new intermodal operation on the eastern portion of the railyard with 11,600 linear feet of track, see Figure 13, for rail loading and will have capacity for staging approximately 150 well-cars. Development includes construction of new rail track, installation of a RTG crane and pavement/ stormwater system improvements. This will allow management of approximately 300 containers in the yard without the need to move rail well-cars.

The intermodal operation is designed to exceed the annual projected Metro throughput of approximately 500,000 tons/year and will be able to manage 750,000 tons/year, a 50 percent buffer over current Metro



requirements. The railyard will use a highly efficient RTG crane to transfer containers. With an operational design capacity between 20 to 30 container lifts/hour, the Mi-Jack® Products manufactured RTG crane provides container transfer capability that exceeds the anticipated daily container volume in this contract. A second RTG crane may be phased in as container volume increases. A top-pick will be located at the railyard as backup for additional container management flexibility. Significant truck queuing space, container storage (288 containers) and chassis storage (96 chassis) is incorporated in the design. Metro operations will have priority site access.

Figure 13. The Portland Albina railyard will have 11,600 linear feet of Metro dedicated track.



Columbia Ridge railyard is located at 18177 Cedar Springs Lane in

Arlington, Oregon. Owned by WM, the Columbia Ridge railyard is a fully constructed high-volume intermodal railyard now operating and ready to immediately accept Metro solid waste. The railyard has more than 26,000 linear feet of existing track, see Figure 14, with an asphalt paved yard and LED yard lighting, which allows for extended operating hours. The railyard is built to manage three million tons/year of container throughput, with room to grow. The landfill working face is 2.5 miles from the railyard with no transport over public roads required. This allows containers to be turned quickly from the railyard to the tipper and back for return to Portland. Unloading equipment stationed at the railyard consists of a fleet of top-picks and a railcar mover. No modification or additional construction is necessary to support Metro.

Figure 14. The Columbia Ridge railyard has over 26,000 feet of existing track.



Additional information on the Portland Albina and Columbia Ridge railyards can be found:

- Equipment requirements (Portland Albina and Columbia Ridge) - Table 2 on page 13
- Permitting requirements (Portland Albina and Columbia Ridge) - Table 3 on page 14
- Equipment specifications (Portland Albina and Columbia Ridge) - Appendix 3
- Development timeline (Metro contract) - Appendix 4
- Railyard design and facility features (Portland Albina and Columbia Ridge) - Appendix 6

Figure 15. Trailer staging near MCS has been secured.



Walsh will continue to lease from BNSF the staging area near MCS located along Line Segment 47, Mile Post 4.25 (there is no legal address) in Portland that now supports the Metro contract, see Figure 15 and Appendix 6. No permitting or construction is required.



b) What equipment will be staged at each site.

Table 2 on the following page summarizes our team’s projected equipment needs at each stage of our operation.





Table 2. Equipment has been identified and sourced.

 <b>EQUIPMENT TYPE</b>	Portland Albina Railyard		Columbia Ridge Railyard		MCS	MSS	 <b>NOTES</b>
	EXISTING	ADDITIONAL	EXISTING	ADDITIONAL	ADDITIONAL	ADDITIONAL	
<b>Railcar Mover</b>	0	0	1	0	N/A	N/A	Railcar mover is on site at Columbia Ridge.
<b>Gantry Crane</b>	0	2	0	0	N/A	N/A	One Rubber Tired Gantry crane will be initially installed and a second may be phased in as demand increases.
<b>Top-Picks</b>	0	1	3	1	N/A	N/A	One top-pick will be stationed at Portland for supplemental/contingency container transfer. One top-pick will be added at Columbia Ridge.
<b>Chassis</b>	N/A	N/A	16	5	10	12	Walsh will provide trucking at MCS and MSS to the Portland railyard. WM will transfer containers at Columbia Ridge.
<b>Intermodal Containers</b>	N/A	N/A	N/A	N/A	252	314	Intermodal containers have a delivery time of less than six months. Delivery will be coordinated with the transition plan.
<b>Tractors</b>	N/A	N/A	16	5	3	4	Walsh will provide trucking at MCS and MSS to the Portland railyard. WM will transfer containers at Columbia Ridge.
<b>Rail Well Cars</b>	N/A	250	N/A	N/A	N/A	N/A	UPRR will provide dedicated well-cars and unit train service to Columbia Ridge.
<b>Chassis Transfer Vehicles</b>	N/A	N/A	N/A	N/A	2	2	Two chassis shuttle vehicles will be staged at MCS and MSS (primary and backup). Shuttle operations will be performed by Walsh.
<b>Landfill Tipper</b>	N/A	N/A	4	1	N/A	N/A	One additional primary tipper will be added at Columbia Ridge.

*c) Proposed schedules for staging equipment in relation to the movement described above.*

Staging of chassis and containers at both railyards, MSS and the leased property adjacent to MCS, will be adjusted daily dependent on multiple factors, including projected transfer station volumes, rail schedules, local traffic and weather. Factors affecting transportation will be monitored by project staff to confirm efficient equipment use. The Portland Albina railyard has been designed with careful consideration to effectively manage the flow of daily volumes, potential growth and to provide a critical buffer for potential service interruptions. Additional container inventory will be staged at the Columbia Ridge railyard so that containers are available for timely train routing back to Portland. Since our container maintenance facility is adjacent to the Columbia Ridge railyard, repairs will be completed quickly to return containers to the equipment pool. Our plan has been designed to provide an ample allocation of rolling stock inventory at each touch point, the Portland Albina railyard, Columbia Ridge railyard, MSS and staging near MCS, so equipment will always be available for transfer station operations.

*d) Fueling locations and fueling schedules.*

Please see page 8 for details on fueling locations and schedules.

*e) Describe where supervisory personnel will be located.*

WM will have a dedicated transportation manager and supporting logistics team in Portland to manage and interact with Metro. A listing of supervisory personnel and their locations is provided in Table 1 on page 4.

*f) Describe how you will comply with equipment tracking requirements and what system (software and hardware) you are proposing to utilize.*

WM has an existing partnership with AT&T to provide a comprehensive asset tracking platform. Through real-time GPS technology, Metro will have complete visibility to assigned containers. This is a proven technology we



are now using in other markets to help improve equipment utilization and protect our assets and cargo. WM will work directly with AT&T to procure the hardware, software and services required to support Metro. Key technology features include:

- Creating and customizing reports and distribution lists based on asset tracking needs.
- Ability to define actions, situations and events critical to operations.
- Expected battery life under normal operating circumstances of two-years.
- Receiving real-time alerts when containers are moved outside a designated area.

The GPS tracking sensors are rated to operate in sub-zero temperatures and can withstand rainy, snowy Pacific Northwest winters. The sensors are battery operated and do not require solar power like other tracking devices. WM will keep a 10-20 percent replacement inventory to support routine maintenance and will work with Metro to confirm tracking and reporting requirements are fulfilled. See Appendix 7 for a detailed product sheet.

6) Describe any proposed backhaul opportunities. Include: a) The commodity being backhauled, its origin and the frequency of the backhaul. | b) How the backhaul will affect Metro schedules. | c) The benefit to Metro, including any rate reduction being offered to Metro. | d) A description of how you could continue to profitably offer services at your proposal price should this backhaul no longer be available to you.

We have not included commodities backhaul in our proposal.

7) Provide an inventory of permits you will be responsible for and will have to obtain, and include the schedule for permits in the timeline requested in item 5, above.

Anticipated permit requirements for development needed to implement the contract is provided in Table 3.

Table 3. Implementation requires few permits.

LOCATION	PERMIT INVENTORY	
<b>Portland Albina Railyard</b>	Oregon Department of Transportation	Pre-Application for State Highway Approach
	Oregon Department of Transportation Rail	Agent for the Federal Railroad Administration
	City of Portland	Pre-Application Conference for Type II Application
	City of Portland	Bureau of Development Services • Planning                      • Environmental Services • Transportation              • Water • Fire
<b>Columbia Ridge</b>	No permits are necessary. The railyard is fully constructed and operational.	

8) Describe how containers / trailers will be unloaded at each proposed landfill, including any staging, shuttles, tippers, staff for tippers and who will own the equipment. Any costs associated with this should be listed and will be used in the cost evaluation criteria.

WM operates a state-of-the-art railyard at Columbia Ridge with more than 26,000 linear feet of track with capability to manage containers and bulk loaded materials. Rail service is exclusively by unit train, with trains generally arriving six to seven days/week. Trains are processed daily between 6 a.m. and 4:30 p.m. The railyard has certified scales, bulk materials removal capability and LED stadium lighting allowing for safe, extended operating hours.

Top-picks are used to transfer containers between railcars and tractors. Top-picks work in tandem with the fleet truck rotation, with one top-pick removing empty containers and placing them on the railcar, while the other top-pick removes loaded containers from the railcar and places them on chassis for transport to the landfill. The railyard uses heavy duty tractors to move containers approximately 2.5 miles to the landfill working face. Since the railyard is on Columbia Ridge property, public roads are not used for transportation. Tractors load the chassis/container configuration on the tipper. The chassis/container is tipped to deposit material in the landfill. Tractors then reconnect to the chassis and transport the empty container back to the railyard, collecting another full container and repeating the process. Containers are inspected after emptying





by the tipper operator before closing the container door to confirm all material has been removed and for serviceability prior to placement back on the railcar. Containers requiring repair will be dropped at the on-site container maintenance facility and a replacement container will be placed on the train.

All equipment associated with railyard, trucking and tipper operation is owned and operated by WM. Rail locomotives and well-cars will be supplied by UPRR. Current and anticipated equipment inventory is summarized in Table 2 on page 13. Equipment specifications are provided in Appendix 3. Tippers meet EPA Tier 3 emission standards. Top-picks at the Columbia Ridge railyard individually meet EPA Tier 4F emission standards, Tier 3 emission standards and EPA Tier 2 emission standards (top-pick maintained as a spare). Tractors meet the EPA Tier 4F emission standards. Costs for this segment of transportation has been included in our pricing.

*B. Equipment | 3) For any rail portion of the work: a) Describe the number of railcars proposed, their dimensions, manufacturer, year built, rated payload capacity and projected payloads (both by railcar and by individual intermodal containers). | b) Describe how many railcars are projected to be used per train. | c) Describe the locomotives that will be used, including make, model year, and quantity of locomotives per train, engine types and rated horsepower. | d) Describe the terminals (and loading/unloading equipment) proposed for the project and their status (i.e., are they currently constructed?). | e) Describe the number of tractors/chassis and containers to be used. | (1) Include drawings (specifications) of tractor/chassis/container combination, with sufficient detail to determine feasible payloads, including the calculations showing the maximum road legal payload for the over-the-road equipment configuration. | (2) Include assumptions for: i. Average MSW bale length and weight (must be consistent with Metro's existing compaction equipment). ii. Bale placement in container | f) Provide make and model year of proposed over-the-road equipment. | g) Provide make and model year of shuttle equipment, include drawings (specifications). | h) Describe the tipper(s) (engineer line drawings, other specifications, manufacturer and year built) or whether you will contract for tipping services with the respective landfill(s) or others. | i) Provide delivery/mobilization schedules for the proposed equipment. | j) Document which equipment will be dedicated to the project.*

UPRR estimates 250 well-cars will be provided. The well-cars will be sourced from TTX, one of the largest railcar leasing companies in the world. UPRR has thousands of active well-cars under lease from TTX. Since these well-cars will be sourced through a large equipment pool, manufacturer and manufacture year will vary. Typical specifications are provided in Table 4 and a specifications sheet is provided in Appendix 3. Each container will have a payload of 30 tons and will be transported double-stacked.

Table 4. Rail well-cars have been sourced.

DIMENSIONS (Approximate)			
Length, over couplers	76' 8¾"	Height, extreme (loaded*)	20' 2"
Length, between truck centers (per well)	62' 7"	Width, extreme	10' 7 15/16"
Height, top of rail to top of side sill	4' ¾"	Well Size	53' x 102¾"
Height, rail to support surface (empty)	12' ¾"	*Loaded with two 9'6" stacked containers	
WEIGHT/CAPACITY (Estimated)		CURVE NEGOTIABILITY RADIUS	
Light weight	54,000 lbs.	Uncoupled	180'
Gross rail load	220,000 lbs.	Coupled to like car	303'
Load Limit	166,000 lbs.	Coupled to 40' base car	299'

Please see page 6 for details on the locomotives that will be used to transport Metro solid waste. Also, please see pages 11-12 for a description of the Portland Albina and Columbia Ridge railyard terminals.

WM will provide five additional tractors and chassis at Columbia Ridge to support Metro. Seven tractors and 22 chassis will be dedicated to the combined transfer from MCS/MSS and Portland Albina railyard. A total of 566 intermodal containers, each 40 feet long, will be purchased to support contract volume. Tractor specifications and chassis and container specifications are included in Appendix 3. The average bale length will be 34 feet and weigh 30 tons.

New, 2020 Mack Anthem four-axle or 2020 Peterbilt 571 four-axle tractors will be purchased to support trucking between the transfer stations and the Portland Albina railyard, see specifications in Appendix 3.

New, 2020 Kalmar yard trucks (Ottawa T2 4x2 Tier 4F Off Road) will be staged at MCS and MSS to support the transport of Metro's solid waste. Specifications are provided in Appendix 3. Two units will be staged at each location.



WM owns and operates four tipper at Columbia Ridge, with manufacture dates of 2008, 2009, 2015 and 2017. Tipper specifications are provided in Appendix 3. WM will add one additional tipper and will operate this equipment.

A project timeline is provided in Appendix 4 identifying delivery/mobilization of equipment. Equipment delivery will not impact our ability to initiate the contract on January 1, 2020. The longest lead time projection for any piece of equipment is for installation of the RTG crane at the Portland Albina railyard. Final design and manufacture order will be initiated as an early action item once the contract is executed. Rolling stock (chassis and containers) and truck/top-pick equipment delivery is expected to be less than six months and will be phased in our implementation plan to match delivery with facility readiness.

Equipment requirements in Table 2, on page 13, outline equipment that will be dedicated to Metro.

*C. Equipment and Equipment Maintenance: Describe in detail your approach to maintenance on the equipment, buildings, and grounds during the life of the contract. Please distinguish between Contractor-supplied (including subcontractors) and Metro-supplied items as appropriate. Also, address the following detailed items: 1) Maintenance Plan- General | a) Inspection Plans and Procedures | b) Forms | c) Reporting | d) Documentation | e) Coordination with Metro*

Maintenance procedures and specifications are conducted over and above manufacturer recommendations and at the highest level of accuracy. WM prides itself on sustaining a world-class fleet of late model trucks, chassis and heavy equipment. Our team has an extensive network of contractors and repair facilities throughout the Pacific Northwest with service technicians available 24 hours/day. WM uses state-of-the-art technology to troubleshoot and maintain equipment. Preventative maintenance compliance goals are set at 95 percent and are commonly exceeded. Our primary goal is safe, environmentally friendly, operationally efficient and problem-free operations. Maintenance of the grounds and facilities are primarily conducted with WM staff trained in facility maintenance. As necessary, third-party subcontractors are employed to address specific issues such as wind damaged roofs, complex plumbing and garage door maintenance.

Our team has an extensive library of preventive maintenance forms that are individualized for each unit classification (i.e., chassis, crane, truck, etc.). Example maintenance, facility inspection and safety forms are provided in Appendix 8. Inspections are compiled and reported to appropriate personnel to confirm program requirements are documented and completed, and that deficiencies are addressed. Documents are retained as required by government agency standards and are kept for the life of the equipment to spot trends and make necessary adjustments to maintenance schedules and protocol. Ample guidance and lead time will be provided to Metro for any scheduled maintenance items that may impact Metro operations. We anticipate monthly meetings with Metro. Activities that may affect Metro will be brought to Metro's attention immediately.

*2) Preventative maintenance plan (equipment, facility, grounds) | a) Schedule | b) Testing | c) Reporting*

Our team has a comprehensive maintenance philosophy. Compliance with high maintenance standards requires strict adherence to preventative maintenance schedules, employment of highly skilled and trained technicians and use of new technology. For example, Walsh equipment is fitted with Meritor tire inflation systems and Groeneveld automatic lube systems. The tire inflation system maximizes tire life, reduces the possibility of tire failure and increases fuel mileage. The lube system minimizes wear on integral parts such as slack adjusters, bushings, and s-cams, which extends the components lifespan and increases the safety aspects of the vehicle. These premium investments help maintain what is an extremely successful preventative maintenance program. Our team takes pride maintaining clean and orderly facilities as a foundation for safe and efficient operations.

All equipment will meet testing and certification requirements. All records keeping will be completed in electronic files and hard binders. Documents are retained as required by regulatory agency standards and are kept for the life of the equipment.



3) Replacement | a) Schedule for replacement of major equipment and containers / trailers | b) Schedule and methods for replacing major components (engines, transmissions, container /trailer floors, etc.)

If a determination is made that a piece of major equipment is unsafe for use, it will be pulled from service. If it is determined that repair is not viable, equipment will be replaced. Equipment will be replaced based on multiple factors, including the age of equipment, life to date operating hours, maintenance costs and changes in operation needs. The need for rebuilds will be determined based on the life of operating hours, fuel use and overall condition of equipment. Rebuilds will be completed per company guidelines. Tractors will generally be replaced at 800,000 to 1 million miles depending on the condition of the unit. Chassis that no longer meet Metro requirements or our standards will be replaced.

4) Miscellaneous: Describe how the following elements will be accomplished, and what resources will be subcontracted and when: a) Major Repairs | b) Emergency Repairs | c) Use of Subcontractors | d) Spare Parts Utilization | e) Fleet equipment cleaning and frequency

Major repairs to railyard equipment, trucks and rolling stock will be completed by in-house certified technicians or local third-party vendors. Heavy equipment and tractors will be continually evaluated during the expected life cycle to determine an actual retirement date. We will contract with qualified third-party vendors to provide emergency and after-hours services. Examples of third party vendors include Michelin National Account and Teague's Tires Service. Our team will use pre-qualified subcontractors to meet our stringent internal maintenance requirements. An inventory will be kept on the most frequently used parts. We insist that our suppliers carry an extensive inventory of parts to meet our needs. We pride ourselves on the appearance of equipment. Minimum frequency of cleaning is anticipated to be quarterly. Depending on weather and road conditions, this schedule may be lengthened or shortened to meet contract requirements.

5) Safety: Describe the following elements of your safety programs and policies. | a) Training | b) Reporting | c) Illness and injury prevention programs (I2P2) | d) Inspections | e) Investigations | f) OSHA reportable incidents or accidents in the last five years involving transport of solid waste material.

Illness and injury prevention programs: There is no other consideration as important as safety when selecting a transporter. At WM, we recognize safety as a core value. To prevent workplace injuries and accidents, WM uses a compliance and safety training system called the Standard Safety and Health Management System (SSHMS). It is an Occupational Safety and Health Administration (OSHA) recognized approach to health and safety, focusing on risk mitigation, worksite analysis, hazard control and safety training, which is compliant with federal and state regulations. The SSHMS program is based on six pillars comprised of health, process, hazard awareness, hazard communication, compliance and job-specific programs. **These are WM's Safety Core Values, see Table 5.**

Table 5. WM's safety core values.

<b>Health</b>	Blood-borne pathogens, respiratory program, ergonomics and hearing conservation.
<b>Process</b>	Reporting injuries and hazards, safety committee guidelines and investigations.
<b>Hazard awareness</b>	Job hazard analysis, facility inspection programs and personal protective equipment programs.
<b>Hazard communication</b>	Hazardous communication, emergency preparedness and response and fire prevention programs.
<b>Compliance</b>	Hazardous energy control, fall protection and confined space programs.
<b>Job-specific programs</b>	Specialized programs including asbestos awareness and Department of Transportation (DOT) requirements.

Training: **To instill WM's safety culture, new employees attend an orientation that includes training on WM's Life Critical Rules, which are job rules developed to prevent accidents and injuries. Additionally, all employees attend a three-day orientation including comprehensive training on OSHA required programs, basic ergonomics and an introduction to WM's safety programs. Prior to job assignment, employees are provided additional job-specific training outlining safety precautions and actions that must be taken before proceeding with various tasks. Ongoing training is provided to all employees based on their job responsibilities, including technical skills and safety requirements. We also conduct regularly scheduled training that includes safety meetings and site visit vendor presentations.**





UPRR shares WM’s unwavering commitment to safety as a core value. UPRR’s Total Safety Culture (TSC), a voluntary, employee-owned process focused on training, observations, and feedback, is a valuable component of their safe workplace culture. TSC directly empowers employees to address risky behaviors. The values of the program are shared and supported by UPRR’s senior management, see Table 6. UPRR’s safety training is tracked in their learning and compliance management systems to confirm that UPRR is complying with applicable laws and that training is provided as needed to meet company timelines for training.

Table 6. UPRR is focused on safety.

<b>Statutory required</b>	<b>Required by federal law and enforced by an administrative agency.</b>
<b>Generalized</b>	<b>Required by UPRR to confirm fundamental operational safety elements are understood by operating employees.</b>
<b>Craft or job specific</b>	<b>Required to be completed by employees with a specific job with specific risks that must be understood and mitigated.</b>
<b>Remedial</b>	<b>For employees with an identified need for enhanced or refresher safety training</b>

Walsh also maintains a strict policy to protect the safety and health of their employees and maintains strict adherence to all federal and state occupational health and safety standards.

Inspections: WM confirms compliance with health and safety programs by completing monthly and annual internal audits and monthly equipment and facility inspections. WM periodically uses Oregon OSHA consultants to validate compliance programs and training. Operations teams have monthly safety committee meetings. These committees participate in regularly scheduled inspections of the entire facility. We also use our workers’ **compensation and liability insurance carriers’ expertise in evaluating our workplace for additional safety** suggestions. Any defects are prioritized and a plan for correction is developed immediately. We have included example facility inspection forms in Appendix 8.

UPRR conducts monthly safety reviews at the corporate level, covering all areas of operation. Each region also conducts two operations safety audits at each of their respective service units. Locally, managers conduct regular audits of employee safety behaviors using a standardized evaluation process. The effectiveness of the management team’s ability to find and mitigate risk under this process is regularly evaluated and adjusted, if needed, at both the unit and regional levels.

Walsh conducts monthly safety committee meetings. These committees also participate in regularly scheduled **inspections. They also use their worker’s compensation and liability insurance carriers’ expertise in evaluating** the workplace for additional safety opportunities.

Investigations: WM thoroughly investigates every incident involving both injuries and accidents to determine root cause and contributing factors. The investigation is required to be completed immediately, and often involves site management, safety committees and the safety team. Managers and safety committee members are trained on investigation techniques. Investigations require a written form that documents the initial critical information. Pictures, video and witness statements are also required. Once the investigation is completed and the root causes are determined, the team creates an action plan of prevention activities. Included in these activities are follow up and communication to the workgroup, re-training for the employee if the incident is preventable and area-wide communications for any serious injury or accident. All incidents are reported in our online accident and injury management system, which automatically reports and uploads OSHA and DOT required information (OSHA 300 and DOT Registers). All incidents are stored for data analysis, trending and document archiving.

UPRR has a response protocol for all incidents that requires immediate and appropriate mobilization of personnel and resources and provides timely, regular feedback to management as to the status, severity and community impact of any incident as well as those actions being taken to restore safe operations.

Walsh has investigative and response protocols in place for accidents. In the event of a serious accident, they utilize forensic and reconstruction specialists from their insurance carrier to assist with the investigation. Each vehicle is equipped with disposable cameras to document the scene of an accident. Drivers are instructed to contact dispatch immediately via radio if they are involved in an accident, regardless of who is at fault or how minor the incident may appear.



Reporting: At WM, all **employees' injuries (i.e., workers' compensation) and accidents are reported to the site manager, safety manager and human resources**, incidents are assessed and response is planned and executed immediately. Reporting comprises two well-defined processes, internal and external. Externally, we provide immediate notification to various federal, state and local agencies in the event of an incident. This process follows specific protocols to confirm full compliance with reporting and updating to agencies.

Walsh reports traffic accidents to their terminal manager and safety manager. Incidents are assessed and an appropriate response is planned and executed.

OSHA reportable incidents or accidents in the last five years involving transport of solid waste material: Verifying the success of our training programs, WM has some of the lowest incident frequencies in the industry. **WM's experience modifier is currently .74 (2016-2017) and has averaged .73 over the last five years.** WM's total recordable incident rate (TRIR) is substantially below industry average over the past five years, see Table 7. WM's OSHA recordable incidents in the last five years involving transport of solid waste material is provided in Table 8.

Table 7. WM's TRIR is below industry average.

ORG NAME	2012 TRIR	2013 TRIR	2014 TRIR	2015 TRIR	2016 TRIR	2017 TRIR	TRIR AVG. 2012-2016
<b>Industry Rate</b> Waste Collection – 562100	6.10	6.00	7.00	6.40	5.00	N/A	6.10
<b>WM Corp</b>	2.88	3.08	3.21	2.99	3.08	2.80	3.05
<b>WM</b>	3.68	5.52	2.91	2.79	5.46	4.76	4.07

Table 8. WM's OSHA recordable incidents 2013 - 2017.

	2013	2014	2015	2016	2017
<b>Incident</b>	0	0	1	1	5

UPRR is proud to have an exceptional safety record in what is already the safest industry for ground freight transportation. According to the U.S. Bureau of Labor Statistics, railroads have lower employee injury rates than most other modes of transportation and major industry groups, even grocery stores. From 2006 to 2016, UPRR reduced employee reportable injury rates by 58 percent, crossing accidents by 16 percent and reportable rail equipment incidents by 41 percent. UPRR is not required by the Federal Railroad Administration to document the contents of containers for rail equipment incidents (derailments). In the last five years, no one **has used "solid waste" as the contents description.** Therefore, UPRR has no record of any reportable rail equipment incidents in which solid waste was being transported. UPRR continues to incorporate innovative technology and solutions to decrease derailments and enhance safety, including:

- Ultrasonic wheel-defect detection that scan railcar wheels every 60-90 days to eliminate derailments caused by broken wheels.
- Wayside detectors identify potential failures in rail equipment components to produce a report card for each car and locomotive.

Walsh safety statistics are provided in Appendix 9.

*D. General Contingency Plans: Describe how you plan to deal with the following: 1) Site/ External communications during service outages. | 2) Work stoppages. | 3) Inclement weather. | 4) Equipment failure. | 5) Route closures (routine or otherwise). Provide any back up routes proposed. | 6) Spill response/control procedures. | 7) Accident/Incident investigation. | 8) Potential for a 20% reduction in Metro MSW tons being delivered and transported.*

**Rail provides a safe and reliable means of transportation.** WM's WasteByRail® program began in 1990 and has grown into a national transportation program serving our landfills across the U.S. While the program has grown and evolved over time, the service reliability has remained high. UPRR's Portland subdivision is a vital artery for their network. Between 2011-2015, UPRR invested \$570M in its Oregon infrastructure to support growth and operational efficiencies.



Site/external communications during service outages: Our team will primarily use cellular based communication systems. Trucks will be equipped with two-way radios for short-range communication on the road, at railyards, at the landfill and transfer stations. We will have land-based phone service available in the event the cellular system is down. If necessary, we will send people **to Metro's transfer stations to facilitate** dispatch of equipment.

Work stoppages: In the event of a work stoppage, our team will draw upon our extensive network of WM and third-party professionals to develop a workforce to keep transportation running smoothly until normal operations are resumed. On a short-term basis, Walsh has more than 75 drivers employed in the Portland metropolitan area who can assist with little notice. WM is non-union at Columbia Ridge. UPRR maintains a set percentage of trained and certified management staff who, in the event of a work stoppage, can seamlessly transition to perform daily train operations.

Inclement weather: Although highly infrequent, sometimes flooding, mud slides or other inclement weather conditions may temporarily prevent use of the rail corridor or a road used to dray from a transfer station to the railyard. A key feature of our proposal is the flexibility to transport along multiple Portland area roads to access the Portland Albina railyard and the ability to implement multiple options to move containers from Portland to Columbia Ridge. If extreme weather or other factors force road closures, container transfer will be rescheduled for weekend or low traffic night-time transfer.

Our capabilities were on full display in both 2016 and 2017 when the Northwest experienced extraordinary snow and devastating wildfires. Between December 2016 and January 2017, multiple snow and ice storms crippled travel in the Pacific Northwest, leaving abandoned vehicles and snow-choked roads. Travel proved slow-going with many roads closed or too dangerous to maneuver. Our rail program experienced only limited train delays and maintained container inventory to provide uninterrupted service for our customers. Local governments served by other disposal contractors turned to WM for assistance.

The Columbia Gorge wildfires in late 2017 destroyed over 40,000 acres forcing an extended I-84 closure. The interstate closure was the longest in recent memory with eastbound lanes shut down for nearly three weeks. Interstate commerce ground to a halt creating backlogs of freight and difficult shipping conditions, including **truck transport of Metro solid waste. In contrast, UPRR's mainline running from Portland through the Gorge was** shut down less than 24 hours and service disruption was extremely limited. WM did not deviate from its normal transportation plan and rail service levels remained consistent throughout this catastrophic event.

Equipment failure: Our plan includes redundancy **for Metro's protection**. At all stages of our plan, equipment is in place to support work, even in the event of equipment failure. Walsh will purchase and operate new trucks for Portland trucking and will have backup units available for immediate deployment, if needed. In the event of a catastrophic equipment failure, such as a major recall or fire, Walsh has spare units within their fleet to keep Metro operations running smoothly. The Portland Albina railyard will be a new facility with state-of-the-art equipment. UPRR has a large network of local equipment available to support scheduled unit train service to Columbia Ridge to maintain regular operations. WM maintains surplus/backup equipment at Columbia Ridge to prevent service disruptions.

Route closures (routine or otherwise): In the event of a road closure in Portland, WM will re-route drivers to alternate roads between transfer stations and the Portland Albina railyard. If a rail closure occurs between Portland and Columbia Ridge, WM will implement contingency transportation options to continue to move solid waste to Columbia Ridge for disposal. Our contingency options include:

1. WM has allocated sufficient resources and space to stockpile several hundred containers at the Portland Albina railyard for a short duration.
2. WM will use Walsh to transport containers by truck directly to Columbia Ridge.
3. WM will use Tidewater to transport containers through the Tidewater Vancouver, Washington, terminal or the Tidewater Portland, Oregon, terminal (once constructed) to the Tidewater Boardman, Oregon, terminal for transport to Columbia Ridge.
4. WM will use Walsh to transport intermodal containers directly to other available landfills.

Spill response/control procedures: Our employees are trained to prevent spills, contain spills if they occur and report/request assistance if necessary. To prevent spills and the release of hazardous materials into





the environment, our team will develop detailed spill control and response protocols for all aspects of our transportation plan. These plans will detail the procedures for inspection, investigation, on-site and external reporting, remedial action, clean up procedures and employee training. As part of these protocols, containers and vehicles will be inspected upon arrival at each transfer point for leaks and other noticeable defects, which might cause or increase the risk of a spill. If a spill occurs, management will initiate an investigation that identifies root causes and will develop actions to prevent recurrences. The employee first identifying a spill condition will initiate clean-up procedures immediately after the spill is identified. For spills of hazardous wastes that exceed the Reportable Quantity (RQ), the details of the spill will be promptly (within 24 hours of discovery) reported to appropriate agencies including the Oregon Division of Emergency Services, National Response Center and the Oregon Department of Environmental Quality.

UPRR has an Emergency Response Plan that is compliant with existing federal regulations 29 CFR 1910.120(q) and 49 CFR 130. UPRR adheres to the National Incident Management System (NIMS), and is a certified member of the Responsible Care Management System (RCMS).



**NWFF**  
**ENVIRONMENTAL**  
First in Response,  
First in Service.™

Walsh has an agreement with NWFF Environmental (NWFF) to respond to spills and be the lead cleanup administrator. NWFF provides spill response 24 hours/day, seven days/week. Since 1991 NWFF has earned a reputation for competency and efficiency in land-based spills cleanup throughout the Pacific Northwest and is known for quick deployment and an extensive fleet of rapid

response vehicles and trailers.

Accident/Incident investigation: Please see page 18 for an overview of our accident/incident investigation programs.

Potential for a 20 percent reduction in Metro MSW tons being delivered and transported: A 20 percent reduction in Metro volume will not impact our transportation plan. Dependent on volume, our team will flex staffing to match requirements to provide seamless solid waste transport.

*E. Experience/Qualifications | 1) Comparable Projects: Please list the projects you and any proposed subcontractor have undertaken similar to the work for which the proposal is being submitted. Include contacts and phone numbers, a description of your role (i.e., prime or subcontractor or owner) and how the project was similar to the work called for in this RFP. If you have not had similar experience, include experience from affiliated entities and indicate how the proposer would access the expertise. Include enough information to, at a minimum, satisfy the "Qualifications / Experience" requirements in Section IV of the RFP.*

WM has unparalleled success managing long-haul transportation programs similar in magnitude and complexity to the Metro contract. Our highlighted experience required local collaboration to develop and successfully implement the programs to achieve exceptional results. Our team develops successful and collaborative relationships with staff and elected leadership wherever we serve. Table 9 on the following page lists contracts with similar aspects to proposed services under this contract.



Table 9. WM has a well-established record of long-haul transportation experience.

Project	Contract Period	Annual Tonnage	Transport Method	Design/Build	Rail	Truck	Barge	Disposal	Highlights	Key Proposed Staff
<b>CITY OF SEATTLE, SEATTLE PUBLIC UTILITIES</b>										
<b>Prime Contractor</b> <b>Multi-year MSW contract</b> SEATTLE, WA	Aug 1990- Mar 2028	308,000	Rail	✓	✓	✓		✓	Design/build/operation of Columbia Ridge rail facility. Container transport through the UPRR Seattle Argo yard for disposal at Columbia Ridge. WM manages rail transportation and disposal services.	Alan Anderson Paul Burns Jim Denson Mary Evans Gerry Ginter Robert Jones Justin Wheeler Frank Willmann, P.E.
Reference: Hans Van Dusen, Solid Waste Contracts Manager, Seattle Public Utilities (206) 684-4657, hans.vandusen@seattle.gov										
<b>KITSAP COUNTY SOLID WASTE DIVISION</b>										
<b>Prime Contractor</b> <b>Multi-year MSW contract</b> PORT ORCHARD, WA	Jul 2002- Jul 2022	207,000	Rail	✓	✓			✓	Design/build/operation of the Olympic View Transfer Station/rail facility. WM manages rail transportation and disposal services.	Alan Anderson Paul Burns Mary Evans Gerry Ginter Robert Jones Justin Wheeler Frank Willmann, P.E.
Reference: Pat Campbell, Senior Program Manager, Kitsap County Public Works (360) 337-4626, campbell@co.kitsap.wa.us										
<b>PORTLAND METRO</b>										
<b>Prime Contractor</b> <b>Multi-year MSW contract</b> PORTLAND, OR	Jan 1990- Jan 2019	499,000	Truck					✓	Transportation performed by others and coordinated with WM for disposal at Columbia Ridge.	Alan Anderson Paul Burns Gerry Ginter Dean Kampfer Jackie Lang
Reference: Tom Chaimov, Acting Program Director – Solid Waste Operations, Portland Metro (503) 797-1681, tom.chaimov@oregonmetro.gov										
<b>VARIOUS CUSTOMERS</b>										
<b>Rail &amp; Barge Transload Facility Owner/Operator Alaska Street and Duwamish Reload Facilities</b> SEATTLE, WA	Feb 1996 - Ongoing	585,000	Rail/ Barge	✓	✓	✓	✓	✓	Design/build/operation of two rail reload facilities for materials inbound by truck or barge. Materials are shipped to Columbia Ridge via UPRR.	Alan Anderson Paul Burns Jim Denson Gerry Ginter Robert Jones Justin Wheeler Frank Willmann, P.E.
Reference: Keith Benson, President, City Transfer, Inc. (253) 850-1775, keithb@citytransferinc.com										

2) *Financial Capability and Risk: For the purpose of determining financial risk, Metro will conduct an assessment of the financial capability of proposing companies, including, but not limited to, an assessment of each company's recent performance, short-term liquidity, and long-term solvency. Please provide the three most recent years' financial statements for the entity or entities who will guarantee execution of the services outlined in this RFP. In the case of a joint venture or general partnership of more than one company, please submit such statements for each joint venture party or general partner. Financial statements should be audited or, if audited financials are not available, then independently reviewed by a Certified Public Accountant. You may submit such additional information and supporting documentation as you deem adequate to demonstrate the financial capability of your company. The completeness of the information you submit, its veracity, and the extent to which it has been independently verified will impact Metro's judgment of financial risk.*

We have included copies of our most recent audited financial statements in Appendix 10. We have also provided a link to our financial history, which includes our annual reports where complete footnotes and **auditor's notes and opinions may** be found at [investors.wm.com](http://investors.wm.com). Our financial statements are prepared and applied on a consistent basis and are audited in accordance with Generally Accepted Accounting Principles.



As a wholly-owned, indirect subsidiary of Waste Management, Inc., Waste Management Disposal Services of Oregon, Inc. does not report financial results. All financial reporting occurs through our parent entity, in which we have provided the requested financial statements. As a publicly traded company, Waste Management, Inc. is held to the most stringent regulations for accurate and timely financial disclosure.

Also, we have achieved solid investment-grade credit ratings from three major rating agencies. Most recently, WM has been assigned ratings of A- by **Standard & Poor's**, **BBB by Fitch**, and **Baa2 by Moody's**. The ratings are based on expectations that our leadership will maintain good liquidity, pursue a moderate financial policy, and allocate capital in a disciplined manner. **WM's** credit outlook from each agency is characterized as stable.

Financing plan: Our financial strength gives Metro the comfort of knowing we will fulfill our obligations. Company revenue in 2016 was \$13.6 billion with an asset base of more than \$20 billion. As shown in the attached financial statements and in our full financial reports at [investors.wm.com](http://investors.wm.com), Waste Management, Inc. generates strong and consistent cash flow. We will finance all investments internally for the capital requirements of the new agreement, which may include, but is not limited to, property, trucks, equipment, containers, reserves, etc. This eliminates the need for capital expenditures by Metro. Our financial strength means Metro has a stable service partner.

*3. Community and Diversity | A. The Appendix contains information related to the amount of waste received at the two transfer stations, as well as when waste is loaded into the transporter's container and weighed (outbound). Describe when loads of waste will move through the system described above on a typical weekday.*

Please see page 6-10 for an outline of our typical operations plan.

*B. Give your assessment of how your proposed activities will: 1) Impact noise and traffic in neighborhoods. | 2) Enhance regional freight mobility in the Metro area. | 3) Support development of economic activity in the communities surrounding each landfill you are proposing on. | 4) Produce positive/negative effects on the Columbia River Gorge NSA. | 5) Explain how you intend to minimize negative impacts and who at your company is responsible for community relations.*

Impact noise and traffic in neighborhoods: Trucks will use designated state and/or freight corridors when traveling between the transfer stations and the Portland Albina railyard. No segment of either route uses streets serving residential neighborhoods or active retail centers. We expect no distinguishable noise or traffic impacts on existing nearby residential neighborhoods, based on the traffic analysis prepared by Kittelson & Associates provided in Appendix 5. In addition, rail transportation will eliminate all Metro truck traffic that now travels through the town of Arlington.

Enhance regional freight mobility in the Metro area: A transportation solution that incorporates a dedicated, permitted Class 1 rail property that is both **conveniently located between Metro's transfer stations and also capable of supporting Metro's requirements represents a remarkably unique window of opportunity for Metro**. Our rail solution makes the Portland Albina railyard available to Metro as the catalyst for a new and cost-effective way to transport waste to achieve a sustainable, long-term and carbon neutral transportation solution. Use of rail will have a significant positive transportation impact by reducing the number of truck miles driven on Portland area roads. Shipment by rail will result in approximately 38,526 fewer annual truck miles in the Portland area and a reduction of around 385,260 truck miles over the 10-year contract. A traffic analysis prepared by Kittelson & Associates is provided in Appendix 5.

Support development of economic activity in the communities surrounding each landfill you are proposing on: **WM's rail solution will bring important economic benefits to both the Portland area and Gilliam County**. In Portland, the benefits will be new jobs and community partnership investments. For Gilliam County, the benefits will include new jobs, community partnership investments and disposal host fees based on Metro tonnages received at Columbia Ridge.

Jobs in Portland: **Transporting Metro's waste by rail will support 24 jobs** in Portland. This includes six new jobs - two administrative positions in Portland (WM), two gantry crane operators and two general laborers at the Portland railyard (Loup) - plus 18 drivers to support container trucking from transfer stations to the Portland railyard (Walsh).





Jobs in Gilliam County: Eight new jobs will be added in Gilliam County as part of our rail solution for Metro. Six new WM positions (one top-pick operator and five truck drivers) will support the Columbia Ridge railyard and trucking operations. The other new jobs will be two locomotive conductor positions for Watco. To these jobs, add the family-wage jobs that WM already provides at Columbia Ridge, as well as the indirect and induced jobs connected to Columbia Ridge. For more information on the 111 jobs at Columbia Ridge, with an average wage of \$41,700 plus substantial benefits, please see the 2017 economic analysis by ECONorthwest in Appendix 11.

Community investment in North/Northeast Portland: WM has a track record in North/Northeast Portland as a strong local employer, environmental steward and community partner. Our history in this community provides deep roots and a healthy foundation for community relations connected to this proposal.

For context, WM located our regional operations in North/Northeast Portland, **one of Portland's most diverse** and economically challenged areas, more than 15 years ago. Today, we provide more than 200 middle-wage and management jobs here. We have also nurtured long-standing partnerships with community organizations that are effectively fostering equity, economic opportunity and community prosperity in our neighborhoods and **industrial corridor. For more information on WM's support** of nonprofits that provide opportunities for at-risk youth and advance Diversity, Equity and Inclusion (DEI) in North/Northeast Portland, see the Diversity section in the following pages.

Because North/Northeast Portland is home for WM, it is also the ideal location for our partnership with UPRR, to provide a carbon-neutral transportation solution for Metro. **WM's rail solution** will partner Metro with a rail enterprise that has a long history as a steady and generous community supporter. In 2016, UPRR donated more than \$390,000 to 50 Oregon charitable organizations through the Union Pacific Foundation, matching gifts and corporate contributions. Recipients included organizations committed to environmental stewardship, support for Latino and African American families, science learning, and the arts as empowerment for underserved children and adults with developmental disabilities. **Here's a partial list of** Portland-area organizations that received funding from Union Pacific in 2016:

Black Parent Initiative, Friends of Trees, Latino Network, Lower Columbia Estuary Partnership, Oregon Bravo Youth Orchestras, Oregon Museum of Science and Industry, Phame Academy, Sandy River Basin Watershed Council, United Way of the Columbia Gorge, United Way of the Columbia-Willamette and Willamette Riverkeeper.

Looking forward, UPRR **is committed to continued community support through its "Building Community"** program to help make communities safe, prosperous and vibrant. A key element of future giving will be UPRR's newly revamped Local Grants Program focused on safety, workforce development and community spaces in Northeast Portland, the Columbia Gorge and other areas where UPRR operates.

Community investment in Gilliam County: For 28 years, WM has been a strong and steady supporter of youth **and community vitality in Arlington, Condon and across Gilliam County. In 2017 alone, WM's contributions totaled more than \$50,000. Here's a look at how WM's giving has helped** strengthen community life over the years:

- Chambers of Commerce in Arlington and Condon: **WM's donation of \$25,000/year** to the local chambers helps support programming for year-round events that bring people together to celebrate community such as the summer concert series, the artisan market, fish derby, the Fourth of July celebration and Main Street events to support local businesses.
- Gilliam County Fair: WM has generously supported the Gilliam County Fair, donating thousands of dollars over the years as the winning bidder for champion hogs and steers. In 2015, to recognize 25 years as a strong local employer and community partner, we

Figure 16. WM is a proud supporter of the Gilliam County Summer Concert Series.



Figure 17. WM provides \$5,000 annually to support the Gilliam County fair and directly reward every youth exhibitor.



initiated a program that provides \$5,000/year to support fair programming and directly reward every youth exhibitor. The WM Premium celebrates community partnership and salutes future community leaders by providing each youth exhibitor a cash award. It has also reinvigorated the youth exhibit program, drawing 68 young exhibitors in 2017 to demonstrate their work ethic and leadership skills. To recognize how WM Premium has boosted youth engagement, the Gilliam County Fair Board honored WM in 2017 with the Gilliam County Fair Hero Award.

- College scholarships: To support education as a foundation for a strong and healthy Gilliam County, the WM Community Partnership Scholarship Program recognizes graduating seniors from Arlington and Condon high schools for their academic accomplishments and leadership. In 2017, WM awarded \$8,000 in scholarships to 11 students.
- Senior Care Center, Saddle Club, Bingo Night and more: Additional WM donations have included \$20,000 for the senior center in Arlington, and ongoing support for local rodeos, the Saddle Club, community bingo, youth groups and youth sports.

Host fees: The WM rail solution will continue the payment of disposal host fees to Gilliam County, providing **critical dollars for the county's general fund as well as major capital improvement and economic development** projects for Arlington, Condon and across the county. WM initiated the voluntary host fee agreement with Gilliam County 28 years ago as a demonstration of community partnership. The terms are negotiated by the County and WM at scheduled intervals, and payments are based on volumes of material received at Columbia Ridge. In 2017, WM paid \$3.8 million in host fees to Gilliam County, with \$1.2 million connected to the Metro contract. **If Metro chooses WM's rail solution to send volumes from both transfer stations to Columbia Ridge** in the years ahead, the host fee payments will continue as a strong and stable demonstration of this important community partnership.

Here's a snapshot of how Gilliam County has used the WM host fees in recent years:



High speed broadband to connect school kids to the world and entrepreneurs to the global marketplace: Host fees from the Metro contract are connecting the cities of Arlington and Condon to the world. Metro funds are being used to run fiber to every residence in the cities of Arlington and Condon. In 2017 alone, Metro host fees totaling \$2 million were used to help the two cities bridge the digital divide. Access to high speed broadband will provide school children the opportunity to learn much like many of their urban counterparts. Rural entrepreneurs will use the power of the internet to connect to the global marketplace.



Affordable housing: As in the Metro region, the lack the affordable housing is a critical and multifaceted issue in Gilliam County. The underlying factors are different in this rural landscape, and yet the threat to the economy and community livability is as pressing. Metro is helping address the affordable housing crisis in Gilliam County through the Homestead Tax Rebate. Metro host fees help make home ownership possible and sustainable for more than 500 Gilliam County families and individuals every year. After paying property taxes, homeowners receive a rebate of up to \$500. The program has been a lifeline for aging residents on fixed incomes and young families juggling the responsibilities of first-time homeownership, jobs and family life.



A stable and sustainable Main Street: Downtown Condon, the Historic Main Street District, had always been a gathering place, where people come to be part of the community and to do business. However, it was badly in need of a facelift and an energy boost to stabilize its role in the community. Using host fees from the Metro contract, the City and local business owners have rebuilt facades to their original historical elegance. Metro host fees provided \$750,000 in



**addition to shop owners' investments. Reuse of the old buildings provided a sustainable solution, and the improvements have boosted the town's economy through added traffic and a lifted community spirit.**



Emergency services and wellness: Host fees from the Metro contract bring basic services to rural areas that urban areas take for granted. If you have a heart attack in Portland, you expect help from a medic within minutes. In rural Gilliam County, which stretches 1,223 square miles with two people per square mile, the emergency response challenge is different. That is why \$20,000 from Metro host fees stands out as critical investment for emergency services. The Metro funds recently went to the South Gilliam County Ambulance Service for a LifePak 15 defibrillator and to North Gilliam County for CPR training. Metro host fees also paid for wellness center exercise equipment in Condon.

Produce positive/negative effects on the Columbia River Gorge NSA: Rail transport will have a significant positive impact on the Columbia River Gorge NSA by taking 15,000 trucks off the road every year (15,000 round trips). That is 60 fewer trucks (60 round trips) per day on I-84. **Choosing WM's rail solution will eliminate 2.4 million annual truck miles through the scenic area and 24 million truck miles over 10 years.** That means cleaner air for everyone. For the scenic area, fewer trucks will also mean less highway congestion and a more natural majestic view shed for Oregonians and the 3-4 million people who visit the scenic area every year. A traffic analysis prepared by Kittelson & Associates is provided in Appendix 5.

Explain how you intend to minimize negative impacts and who at your company is responsible for community relations: Protecting the environment and achieving a reputation as a valued community partner requires a dedicated and long-term approach. For our rail solution, WM and UPRR will minimize negative impacts through strategies including those noted below:

Minimize noise and traffic in Portland neighborhoods: We expect no distinguishable noise or traffic impacts on existing nearby residential neighborhoods, based on the 2017 traffic study by Kittelson & Associates provided in Appendix 5. Trucks will use designated state and/or freight corridors when traveling between the transfer stations and the Portland Albina railyard. No segment of either route is located on streets serving residential neighborhoods or active retail centers.

Reduce truck miles on Portland-area roads: Use of rail will have a significant positive transportation impact by reducing the number of truck miles driven on Portland area roads. The result will be approximately 38,526 fewer annual truck miles within the Portland area and a reduction of around 385,260 truck miles over the 10-year contract. For more information, see the traffic analysis prepared by Kittelson & Associates provided in Appendix 5.

Achieve greater fuel efficiency: Freight trains are four times more fuel efficient than trucks on a ton/mile basis. In addition, **UPRR's** fuel-saving operations include the use of ULSD fuel, green locomotives and innovative fuel efficiency technologies plus pioneering idle reduction systems for cleaner air.

Secure carbon credits through the Climate Trust: The WM proposal goes an important step further to support **Metro's world-class sustainability leadership.** By partnering with the Climate Trust to purchase a high-quality carbon offsets portfolio, our proposal offsets 100 percent of GHGs over the 10-year life of the transportation contract, making this a premier, carbon neutral solution and the #1 sustainability choice for Metro.

Initiate outreach to the Overlook Neighborhood Association: **Portland's neighborhood associations provide vital connectivity and collaboration.** With active and sustained participation from hundreds of community leaders and volunteers, the associations have emerged over the years as key to building inclusive, safe and livable neighborhoods. WM knows and values the local neighborhood associations because North/Northeast Portland is our home. To build understanding about our work with UPRR at the Albina railyard, we will commit to open dialogue with the Overlook Neighborhood Association by attending periodic association meetings and soliciting feedback.

Sustain outreach to Gilliam County: Open and transparent communications has been central to our community partnership success in Gilliam County. To support our rail solution for Metro, our Columbia Ridge leadership team will continue to attend public meetings of the Gilliam County Commissioners to build understanding about site operations, environmental performance, and community engagement. We will continue to attend these meetings in person, at least four times a year. In addition, Columbia Ridge leaders will continue to





manage our Community Advisory Council process with quarterly meetings and an annual tour to keep the community informed about **the site's** operations and environmental performance.

Community relations leadership:

For WM in Portland and Gilliam County:  
Jackie Lang  
Senior Area Manager/Public Affairs and Communications  
jjlang@wm.com

For UPRR in Portland:  
Aaron Hunt  
Public Affairs Director  
amhunt@up.com

*C. Diversity: Metro defines diversity as the variance or difference amongst people such as race, ethnicity, gender, age, religion, nationality, language preference, socioeconomic status, disability, sexual orientation, gender identity and others. **Metro's Equity in Contracting Program** encourages the use of minority-owned businesses, woman-owned businesses, businesses that service disabled veterans own and emerging small businesses, as defined under State law in ORS Chapter 200 and as certified by the Certification Office of Business Inclusion and Diversity (referred to here as COBID Certified Businesses) to the maximum extent practical.*

DEI are core values at WM, a solid and foundational aspect of our business strategy for growth in the 21<sup>st</sup> century. Our work to achieve DEI is anchored in the fundamental understanding that meaningful organizational change requires more than a list of action items.

We know this to be true because of our own experience, and our success, in building a company culture where safety is a core value. This success did not come easily, or overnight. It was hard won, involving a steadfast commitment from company leadership, coupled with training and evaluation at every level of the organization.

The result is a companywide culture where a safety mindset is now an intrinsic component of how we approach every aspect of our work. It is fundamental to who we are and how we do things. It is also a key part of our success as a healthy and safe partner for local governments.

**WM's** approach to DEI is much the same. We have made a companywide commitment; we have acknowledged that our journey requires significant company investment, training and evaluation; and we expect authentic and profound organizational change over time.

Just as we have achieved world-class performance as a safety leader, we are committed to building an inclusive, equitable and diverse workplace. Our path forward involves interconnected strategies, measurement and a commitment to continuous improvement.

Our commitment to DEI: WM is committed to fostering a workplace where everyone is valued and respected. To achieve an inclusive, equitable and diverse workplace, our teams are actively engaged to:

- Champion an inclusive culture that embraces individual differences and unique needs while driving innovation
- Leverage the diverse talent of our workforce to enhance business growth
- Cultivate relationships with strategic business and community partners that will give us the ability to access, attract and retain a diverse workforce

Leading the way in ethical behavior and respect for others: WM requires annual Ethics and Code of Conduct training, which addresses proper workplace behavior regarding inclusion and respect for others.

At WM, we walk the talk, as demonstrated by the recognition received for our ethics training, ethical business practices and social responsibility:



**World's Most Ethical Companies List:** In 2017, for the tenth year, the Ethisphere Institute recognized WM for upholding ethical business practices that benefit our employees, our partners and the communities we serve.





100 Best Corporate Citizens List: Again in 2017, Corporate Responsibility Magazine named WM a top corporate citizen among public companies evaluated for corporate responsibility and sustainability performance.



BBB Award for Excellence: This 2017 award from the Better Business Bureau recognized WM for high ethical standards of behavior.



FTSE4Good Index: Also in 2017, the **Financial Times and Stock Exchange (“footsie”)** put WM at the top of its worldwide list of companies that meet globally recognized standards for corporate responsibility related to the environment, people, communities and governance.

DEI at UPRR: **UPRR’s** commitment to diversity recognizes that recruiting and maintaining a diverse workforce provides access to the skills and character needed to innovative and grow. To continue to diversify its workforce as well as its pool of vendors and suppliers, a taskforce is actively working to develop new strategies for recruiting from underrepresented populations.

One of UPRR’s **strategies that** is delivering positive results involves Employee Resource Groups, which are employee networks sponsored by executives to promote welcoming, inclusive and diverse workplaces. The employee networks address issues of concern, share best practices, educate employees and celebrate diversity. Approximately 3,000 employees across the company participate in eight groups: Asian Employee Resource Organization, Black Employee Network, LGBT Employee Network, Council of Native American **Heritage, Latino Employee Network, Women’s Initiative to Lead, Educate, Achieve and Develop, Emerging Professionals Network** and the UPRR **Veterans Network**. For more information, see UPRR’s 2016 Building America Report in Appendix 12.

DEI at Walsh: Walsh is constantly working to recruit and retain a diverse workforce. Walsh has been uniquely successful in attracting military veterans, with veterans filling nearly 40 percent of current driver positions. For **more on Walsh’s** efforts to diversify its workforce, see **“diversity of workforce” on page 33**.

WM, UPRR and Walsh are all equal opportunity employers.

Building diversity among our suppliers and vendors: WM is actively working to add more minority-owned and women-owned businesses to our circle of suppliers and vendors. This includes identifying and reaching out to underrepresented groups, such as minority-, women- and veteran-owned businesses, to work with us and add value to our supply chain.

**Jackie Lang** @greengirlwest · 17 Nov 2017  
Yes! to greater diversity in the recycling & garbage industry! WM supports the Women in Trucking initiative to start 150 women-owned small trucking companies. Let's do it! bit.ly/2iqnpux



The WM Vendor Inclusion and Diversity Program focuses on assisting businesses that have been historically overlooked in the procurement process while maintaining a balance between high levels of service, quality and competitive pricing. The program makes sure these businesses have the opportunity and the support they need to participate in WM bid processes.

One way to build diversity, when the pool of available diverse vendors is small, is to step up to help more women and minorities start and sustain their own successful businesses. WM is doing exactly that. As a member of Women In Trucking, we are currently championing a new initiative to start 150 women-owned small trucking companies within 12 months. The program will offer accessible financing as well as operational and business support for women interested in entering the trucking industry.

**WM’s Subcontractors and Suppliers 2018 Vendor Inclusion** and Diversity Plan is provided in Appendix 13. For more on our work to increase diversity among our suppliers and vendors, please see page 35.



*D. Diversity of Workforce: Describe your efforts to recruit, develop and retain a diverse workforce. Identify your goals for **workforce diversity of the facility operations' workforce**. Include **race, ethnicity, gender, veteran status** and disability. Identify the diverse nature of the people who will perform work in all levels of the organization at the local facility, and steps that will be taken if the diversity falls below that level. Describe any First Source Hiring program you participate in. If not currently participating and one is available in your community, will you participate for the duration of this contract? Do you currently **"ban the box"** (remove from your hiring applications the check box that asks if applicants have a criminal record) in your employment applications? If not, would you be willing to eliminate this from your screening of applicants? Describe how you will report to Metro.*

Recruiting, developing, and retaining a diverse workforce: **WM's** work to recruit, develop and retain a diverse workforce focuses on immediate and long-term interconnected strategies, measurement and a commitment to continuous improvement. Our goals are as follows:

1. Provide equal employment opportunities
2. Strengthen DEI by applying an equity lens to employee recruiting, development and retention
3. Continue to expand the presence of military veterans and women in our ranks
4. Achieve placement goals for women and minorities where Affirmative Action data shows an underutilization of females and minorities
5. Sustain our diverse and inclusive workforce by making our workplaces more welcoming, inclusive, supportive and fun

Ensuring equal employment opportunity: As an equal opportunity employer, WM is committed to an environment free from discrimination. As such, employment decisions are made by placing the most qualified person in each job without regard to race, color, sex, pregnancy, sexual orientation, gender identity, religion, marital status, age, national origin, disability, genetic information, veteran status, citizen status or other protected group status as defined by federal, state or local laws. This policy applies to all terms and conditions of employment, including hiring, placement, promotion, demotion, transfer, recall, recruitment, recruitment advertising, lay-off or termination, rate of pay or other forms of compensation and selection for training. We also have in place annual Affirmative Action plans to analyze and monitor the workforce composition. We **distribute WM's Equal Employment Opportunity Policy** to all employees annually. Please see Appendix 14 for a copy of this policy.

As a Federal Contractor, WM is mandated by federal regulations to undertake good faith recruiting and outreach efforts for females, minorities, veterans and people with disabilities. Our focus is to give equal consideration to all candidates, with the end goal of developing a diverse and high-performing workforce comprised of individuals with different views, opinions and experiences.

Applying an equity lens to strengthen DEI at Columbia Ridge and other WM operations that serve Metro:



Intertwine Alliance Equity Cohort: WM stepped up in 2014 to provide financial support and leadership for the Intertwine Alliance, which is a coalition of 150 public, private and nonprofit entities working to leverage outdoor experiences as pathways for racial equity, wellness, stewardship, recreation and positive economic and social outcomes. As an official Intertwine Alliance Partner, WM is

**helping shape the Alliance's mission and program** execution. Our first major project with the Alliance involved providing project leadership and \$150,000 in funding for a groundbreaking new mobile app designed to make outdoor experiences accessible for all.

*"Connecting Portland-area residents with nature and making nature accessible to all requires strong public, nonprofit, and private sector leadership. For the Intertwine Alliance, WM is a reliable and engaged corporate partner. The relationship began with a sizable financial contribution and continues today with company executives committing their time and leadership to Intertwine projects including The Daycation app and our diversity/equity/inclusion work."*

*Michael Wetter  
Executive Director, The Intertwine Alliance*

Beginning in 2016, we stepped up to be part of the **Alliance's ongoing learning community to strengthen DEI** at Columbia Ridge and other WM operations that serve Metro. As a member of the Intertwine Alliance Equity Cohort, we are finding value in ongoing opportunities to learn from authorities in the equity field and to share best practices with a diverse mix of local community organizations. Derron Coles, Ph. D. has provided invaluable DEI training to WM leaders, including those responsible for Columbia Ridge.





Valuing our military veterans for their leadership, teamwork and safety skills: When it comes to developing career pathways, WM is a clear leader in recruiting, hiring, retaining and developing military veterans. We maintain a network of veteran employment outreach partners for recruiting purposes. We frequently advertise with key veteran employment resources, such as G.I. Jobs and Military Times, and we participate in more than 100 military job fairs a year.

In 2014, we hired more military veterans than any other year in company history. Why? Because veterans have had rigorous training and hands-on experience in leadership, safety and teamwork. Specifically, we find that military training translates particularly well to WM positions for vehicle maintenance, construction, engineering and supply chain logistics. Our retention rate is also high for veterans, fueled by job satisfaction that many veterans say is directly connected to the WM safety culture and team mindset.

Today, one in 14 WM employees is a veteran, spouse of a vet or current reservist. This includes veterans in our workforce at Columbia Ridge and veterans providing direct support for Columbia Ridge for human resources, recruiting, landfill gas management and fleet.



**Our role as one of the country's top employers of military veterans** is recognized throughout the industry. Six times, G.I. Jobs has named WM a "Top Military Friendly Employer." Five times, the Military Times has named WM a "Best for Vets" employer, and U.S. Veterans Magazine has honored us as "Best of the Best" as a military employer. In the last two years alone, our Portland operations was honored twice with the Patriotic Employer Award from the Office of the U.S. Secretary of Defense in recognition of our proactive and concerted efforts to accommodate the scheduling needs of WM employees on active duty assignments.



Expanding the presence of women in our ranks: As the waste industry has traditionally been male-dominated, WM is actively focusing on women as we recruit, hire and develop talent. Our Columbia Ridge recruiting team uses social media and recruiting partners that specifically focus on opportunities for women and minorities. Job boards that we currently use include: Jobs4Women.net, Women for Hire and Women in Business and Industry.

Other strategies underway to interest women in roles at WM include:

- Hosting WM National Career Days that involve social media campaigns specifically focused on recruiting women;
- Encourage local WM women operators and drivers to tell their stories to the media, as they did across the Pacific Northwest in 2017 via social media, TV news stories and columns that ran in community newspapers; and
- Leveraging our membership in Women in Trucking to advance recruitment for women in driver, fleet, dispatch, maintenance and operations positions, including leadership roles.



**WOMEN IN TRUCKING**  
2007-2017 • STEERING TOWARD DIVERSITY

**Redefining the Road**  
The official magazine of the Women In Trucking Association

As a Platoon Leader of a construction company in the Army, **Michele Zambrano** became knowledgeable about many types of equipment, ranging from a Humvee to a 50-ton truck. When she joined Waste Management as District Manager, she says, "I quickly realized that I found my home. It was very much like being back in the field where I belong, leading troops. This time, the troops are CDL drivers and their equipment is a trash truck."



The WM Recruiting Team is recruiting minorities through postings and networking involving the following jobsites and organizations: AfricanAmericanJobsite.com, AsianAmericanJobsite.com, BabyBoomerJobs.net, BlackPerspective.com, CampusPride.jobs, Diversityjobs.ca, DiversityJobsite.com, Diversityworkers.com, HispanicJobsite.com, Hispanic-Today.com, Lgbtjobsite.com, MinorityJobsite.com, RetiredStars.com, SeniorJobsNetwork.com, Diversity.jobs and WayFindersCareers.com.

As we look ahead, our Columbia Ridge Recruiting Team is expanding its recruiting network to include the Urban League of Portland, Partners in Diversity, Diversity Jobs, Center for Equity and Inclusion, Goodwill Industries and Portland Metro Veterans Connection.

Sustaining our diverse and inclusive workforce: To retain more women and minorities, we are aggressively working to make our workplaces more welcoming, inclusive, supportive and fun. That is why our retention work must provide for flexible and creative career planning and talent management, such as mentoring, job shadowing and leadership cohorts. Our recruiting team must take an energetic and strategic approach to nurturing existing recruiting relationships, while identifying emerging pathways with an expanding list of organizations serving women and minority populations. Then, if diversity slips, we will be poised to quickly **“reset” to achieve our goals for a workplace that is inclusive, equitable and diverse.**

Best for Women: When it comes to work-life balance, telecommuting and flexible scheduling, maternity support, wellness programs, professional **development and mentoring, WM is in the winner’s circle for the 2017 Women’s Choice Award. The award process evaluated** women represented in the overall WM workforce and in leadership positions.

Best of the Best for Professional Women: After evaluating hundreds of Fortune 1000 companies, Professional **Women’s Magazine named** WM to its 2017 list of the best employers for professional women. Professional **Women’s Magazine** promotes the advancement of multicultural women in all aspects of business and employment to provide equal opportunity.

Best for Millennials: Our commitment to an equitable, inclusive and welcoming workplace is earning positive **reviews from millennial women, as evidenced by our 2017 Women’s Choice Award.** This award recognizes WM as **one of the country’s top employers for millennial women.**



Building better career pathways for minorities, LGBTQ and under-represented populations: The workforce at our new WM Dispatch Center in Portland demonstrates our commitment to inclusion and diversity, with 25 percent of the total workforce (36 employees) self-identifying as Hispanic, Latino, African American or non-Caucasian. In addition, 21 of the 31 employees self-identify as women, as do all five supervisors.

For Columbia Ridge, diversity at the Dispatch Center presents an emerging career pathway for employees who want to grow as managers in our post collections group. Our dispatchers are already highly skilled in technology systems, customer service, communications, scheduling and routing, and they demonstrate daily that they know how to be part of healthy and successful teams. We are developing this pathway as we bring Columbia Ridge employees in to talk about career opportunities. For those dispatch employees interested in learning **more, we are hosting “career pathway tours” at Columbia Ridge and helping them develop official Career Development Plans.**



The Blueprint Foundation and Green Workforce Collaborative: We are excited to be in the early stages of building career pathways at WM for young adults from black and Native American communities, in partnership with The Blueprint Foundation and the Green Workforce Collaborative.

Figure 18. Area high school students learned about the importance of wildlife habitats at our Hillsboro Landfill.

*“Advancing inclusion and equity in the workplace is a critical and immediate challenge in the Portland metropolitan region. WM has stepped up to understand this challenge and begin to make change happen. I am excited to have WM as a partner in the Green Workforce Collaboration, to help develop career pathways in the environmental fields for young Blacks and Native American adults.”*

*Derron Coles, Ph.D.  
Executive Director, The Blueprint Foundation*

Blueprint provides career mentoring and project-based, environmental science learning for students from North/Northeast Portland high schools including Roosevelt, Grant, Benson Polytechnic and De La Salle North. Our first project with Blueprint involved hosting students at the WM recycling



center and landfill near Hillsboro, where we addressed three primary questions: What makes a wetland healthy and welcoming for wildlife? Why does a company that manages recycling and garbage also manage 200 acres of wetland habitat for bald eagles, riparian uplands, open waters and a rookery home to Great Blue Herons and Great Egrets? What does it take to work here?

Future plans with Blueprint students include tours and hands-on projects at Columbia Ridge, the Renewable Energy Plant and our compressed natural gas fueling station in North Portland. To support these learning experiences, and to begin to position Blueprint as a career pathway for Columbia Ridge, we have made an initial donation of \$10,000.



Green Workforce Collaborative: The Green Workforce Collaborative is an Ecotrust initiative, in partnership with The ReBuilding Center, Self Enhancement Inc., The Blueprint Foundation and the Native American Youth and Family Center. The Collaborative is increasing job opportunities and career pathways in environmental sectors for young adults from African American and Native American communities.

**WM’s delegate to Green Workforce Collaborative is Katie Krueger, Manager of the WM Dispatch Center. With Katie’s leadership, we look forward to helping achieve the Collaborative’s goals and to building strong and sustainable career pathways to WM operations across Oregon.**

LGBTQ: We are pleased to be recognized as a top employer for LGBTQ Quality and Inclusion on the 2018 Corporate Equality Index. This recognition shows we are on the right path as we work to foster equal opportunity and create a workplace where all employees are valued and respected.



**Jackie Lang** @greengirlwest - 27 Nov 2017  
WM is proud to be named one of the “Best Places To Work For LGBTQ Equality and Inclusion” by Human Rights Campaign (@HRC)! We’re committed to fostering equal opportunity in the Oregon cities and counties we serve. [bit.ly/2Ahjkk3](https://bit.ly/2Ahjkk3)



Straight Path: WM has supported Straight Path’s career fair, back-to-school campaign and adopt-a-family project for years. As we work towards a more diversified and inclusive workforce, we see Straight Path as another career pathway for jobs at WM. Straight Path is a Northeast Portland force for mentoring and employment for individuals overcoming barriers created by poverty, dysfunctional families, gang affiliation, substance abuse, criminal behavior and institutionalization.



Enhancing recruitment and accommodations for people with disabilities: Surveys through the Department of Labor and benchmark data from other companies tell us work is needed to recruit and accommodate individuals with disabilities. We are working proactively and continuously to implement best practices to make WM more welcoming and to provide the appropriate accommodations for people with disabilities.





## Diversity at Columbia Ridge

- We are proud to have U.S. Marine Corps veteran Alan Anderson as our senior district manager, and highest-ranking leader at Columbia Ridge. Alan spent four years in the Marine Corps, completing his commitment rising to the rank of corporal, with an honorable discharge. Alan is responsible for financial oversight and all aspects of operations, compliance, engineering/construction, landfill gas management and human resources for the site. Landfill supervisor and military veteran Todd Terp is also on the Columbia Ridge leadership team.
- Twenty-two percent of the site leadership team at Columbia Ridge identify as female.
- Eighteen percent of the Columbia Ridge workforce identify as female, and women are represented across the facility in work groups including finance, operations, driver, operator, mechanic and waste approvals.
- Twelve percent of the workforce identify as non-Caucasian.
- Recruiting for Columbia Ridge is managed by a woman and veteran, retired U.S. Army Chief Petty Officer Karina Mangione.
- Leadership for landfill gas management at Columbia Ridge is provided by retired U.S. Coast Guard Lieutenant Damian Schmitt.

First Source Hiring: We would welcome the opportunity to participate in a First Source Hiring program for this contract. We currently do not participate in a program for Columbia Ridge and look forward to leveraging this type of initiative to hire dislocated workers and economically disadvantaged individuals.



Ban the Box: WM, UPRR and Walsh have **“banned the box.”** We do not ask applicants if they have criminal records as part of our broader commitment to be an inclusive employer and the best community partner.

Reporting results to Metro: We look forward to keeping Metro informed about our work connected to community and diversity in Portland and Gilliam County. As part of our commitment to measurement and continuous improvement, we will report on our initiatives, processes and results in an Annual Partnership **Report to Metro. This report will summarize WM’s ongoing work in the community. It will also will examine** existing and emerging career pathways for veterans, women, minorities, LGBTQ and populations that are under-represented in our workforce as well as employee recruitment strategies, placement and retention results, employee engagement, professional development planning and compensation/benefits.

**UPRR’s diversity of workforce:** UPRR has received impressive recognition for its leadership in diversity and inclusion, particularly related to military veterans, and it is easy to see why, 17.5 percent of all UPRR employees are military veterans, and 20 percent of all new hires in 2017 were veterans.

This success has earned UPRR recognition as **one of America’s Top Military Employers by G.I. Jobs, “Best for Vets” by Military Times, and “Most Valuable Employer” by civilianjobs.com.** In addition, Forbes Magazine in 2017 named UPRR to **the 500 “Best Large Employers List” in part because of its progress creating a welcoming and inclusive workplace.**

UPRR is also working to recruit more women for positions at all levels. Today, women make up only 6 percent **of UPRR’s total workforce. To address this, UPRR is aggressively** recruiting women in new ways, including strategies to help women see themselves at UPRR. As an example, the UPRR website features stories of women working at UPRR on transportation, engineering, mechanical and technical teams. The company has also **introduced a women’s mentoring program and is partnering with women’s skilled trade organizations, women’s veterans’ groups, technical and trade schools, and women affinity groups connected to 28 universities.** Recent results are encouraging, with 16.7 percent of its 2017 Operating Management Trainee program being women.

Should diversity numbers drop in the Portland area, UPRR will revisit its recruiting strategies to assess local improvement opportunities.

**Walsh’s diversity of workforce:** Walsh has been remarkably successful recruiting and retaining military veterans for maintenance and driver positions. In fact, nearly 40 percent of all Walsh driver jobs are held by veterans. **All members of Walsh’s dispatch/operations support team self-identify as women.** Considering drivers



specifically, 5 percent self-identify as women and 12 percent self-identify as non-Caucasian.

Walsh participates in hiring fairs for minorities and veterans, recruits through the local trucking association and has its own employee referral program that rewards employees for referrals that result in new hires.

Should diversity numbers drop, Walsh has committed to revisiting its hiring protocol to assess improvement opportunities and to researching additional hiring fairs.

*E. Wage and Benefits for All Positions: Provide complete wage and benefits package for apprentice positions (if applicable), entry level, journey level and other operations positions. Estimate the number and/or percentage of the workforce that will be classified at each level. What percent of the Living Wage for apprentice positions (if applicable), entry level, journey level and other operations positions do you pay at your destination county and county of origin. Use the “2 Adult (1 Working), 2 Children” fields at the following link (also listed below). <http://livingwage.mit.edu/> 2017. Describe the process for wage review, inflation increases and potential for raises, promotion and advancement. Describe how you will report this information to Metro. (Clackamas County \$28.42, Gilliam County \$24.82 per hour, Klickitat County \$23.72 per hour, Multnomah County \$28.42, Morrow County \$24.81 per hour, and Wasco County \$25.59 per hour)*

WM is committed to being an employer of choice and provides living wages and benefits supports this goal. The average wage for our employees at Columbia Ridge and supporting railyard exceed the Gilliam County living wage calculator of \$24.82 per hour ([livingwage.mit.edu](http://livingwage.mit.edu)) for a family of four (two adults and two children). WM offers a full suite of benefits including medical, dental, vision, disability, and life insurances, wellness program, Second MD program that provides access to world-class medical experts for second opinions (available to employees and their extended family members at no cost), 401(K) with generous employer-paid matching up to six percent of wages, employee stock purchase plan, legal services, annual performance bonuses for many exempt positions and all employees have access to a robust discount purchase program.

WM conducts regular wage and benefits reviews to assess market competitiveness and adjust wage ranges and benefit offerings as needed. All employees receive regular performance feedback coupled with annual compensation reviews. Raises are provided based on work performance (merit) and economic conditions. Being an “**employer of choice**” includes offering advanced opportunities for all employees. We are proud of the career possibilities afforded to our employees. We provide expansive learning and development solutions. All employees participate in annual training that includes job-specific programs as well as a variety of general professional development trainings. We offer training programs delivered face-to-face and virtually through mobile and online communications. We partner with colleges and credit-granting organizations to provide employees, and in some cases their families, with tuition discounts, scholarships, grants, waived fees and customized programs. By creating a continuous learning culture, we empower employees to expand their horizons and create meaningful careers at WM.

Also, relevant to the discussion about wages and benefits, is how one family-wage job in Gilliam County compares to one family-wage job in Klickitat, Morrow and Wasco counties. A 2017 economic analysis by ECONorthwest finds that a single family-wage job in Gilliam County has significantly greater impact for two reasons: there are more jobs in each of the other counties and average wages in Klickitat and Morrow counties are higher than in Gilliam County. For more information, see the ECONorthwest study in Appendix 11.

*F. Staffing Plan: Provide a staffing plan that shows the following elements and contains the following information: 1) Number and type of positions, and where each will be based. | 2) Management résumés. | 3) Describe how fluctuations in activity/waste flow will be accommodated. | 4) Schedules by position. | 5) Position descriptions. | 6) Training specifications for each position. | 7) Discuss dedicated (full time) positions vs. dual role, temporary positions and/or part time positions. | 8) Location of support activities. | 9) Indicate which positions will be shared between facilities.*

Number and type of positions, and where each will be based: Management positions and locations are identified in Figure 4 on page 3 and Table 1 on page 4. WM will add one top-pick operator and five truck drivers at Columbia Ridge to support railyard and trucking operations. WM will add two administrative positions at the Portland Albina railyard. Walsh expects to support this contract with 18 drivers for transportation between transfer stations and the Portland Albina railyard. Loup expects to add two RTG operators and two general laborers at the Portland Albina railyard.



Management résumés: WM has provided an overview of our supervisory structure in Figure 4 on page 3 and a personnel qualifications matrix in Table 1 on page 4.

Describe how fluctuations in activity/waste flow will be accommodated: Our team generally employs full-time labor. In the event of Metro flow fluctuations, we will make every effort to flex labor accordingly by adding staff if volume increases or reassign personnel to other projects if volume decreases.

Schedules by position: To facilitate intermodal container transport from MCS and MSS to the Portland Albina railyard, two ten-hour shifts will be used for Portland trucking and Portland Albina railyard operation. Columbia Ridge will generally operate on a day shift schedule.

Position descriptions: An overview of key positions has been provided in Figure 4 on page 3 and Table 1 on page 4. The number and type of positions are outlined on page 34.

Training specifications for each position: A detailed overview of safety related training programs is provided starting on page 17. In general, WM training specifications are as follows:

- Management Positions - Code of conduct, management essentials, six core leadership courses through Development Dimensions International, Inc. (DDI), art of interviewing, harassment, meal breaks, monthly environmental compliance and other job specific safety training.
- Railyard Equipment Operators - Code of conduct, harassment, meal breaks, job specific safety training, lock-out-tag-out and environmental compliance.
- Tracker Divers - Code of conduct, harassment, meal breaks, job specific safety training, lock-out-tag-out and environmental compliance.
- Administration - Code of conduct, management essentials, six core leadership courses through DDI, art of interviewing, harassment, meal breaks and job specific safety training.
- Field Labor - Code of conduct, harassment, meal breaks, job specific safety training, lock-out-tag-out and environmental compliance.

Discuss dedicated (full time) positions vs. dual role, temporary positions and/or part time positions: Management positions are full-time and will support dual roles on the Metro contract and other projects. Operations personnel in Portland will generally be full-time employees dedicated to Metro. Columbia Ridge operations personnel will generally be full-time employees serving dual roles supporting Metro and other rail related work.

Location of support activities: Metro management support will be generally located in our office at 7227 NE 55th Avenue in Portland, Oregon. Intermodal container maintenance will be managed at our maintenance facility located at Columbia Ridge immediately adjacent to the railyard. Walsh operations will be administered out of Troutdale, Oregon and UPRR operations will be administered out of Portland, Oregon. WM regional senior management support will be located in our Market Area office at 720 4th Avenue in Kirkland, Washington.

Indicate which positions will be shared between facilities: Management positions are cross functional between operations. There are no operational positions other than Portland truck drivers that will be shared between facilities.

*G. Subcontractors and suppliers/Use of COBID-certified subcontractors and suppliers (or similar certification in Washington): Provide examples of existing relationships, outreach efforts and past success. Provide an estimate of projected COBID-certified firm utilization in design, construction of equipment and in proposed operation, in terms of annual percentage and dollars spent annually. Describe how you will report to Metro the realized, accurate COBID utilization for each project phase. For any subcontractors being used for this proposal, please provide the information listed above.*

**It is WM's privilege, policy and practice to proactively seek to partner with diversity vendors and suppliers** including businesses owned by minorities, women and veterans as well as small and disadvantaged businesses. To facilitate the continuous growth of our network of diversity vendors and suppliers, we participate in minority business trade fairs and actively partner with dozens of local and national organizations to connect with small and diverse vendors and suppliers. WM procurement teams also source diverse suppliers through **state and local databases as well as WM's web-based diversity supplier repository.**



As a company, our level of expenditures with diversity vendors and suppliers is growing continuously. For **Metro, WM's commitment to vendor diversity shines at Columbia Ridge through our long-standing partnerships** with two diversity vendors:

- Pacific Northwest Equipment, which is a certified veteran-owned business, is our primary vendor to build and supply intermodal containers for the Metro contract. Expenditures of \$5.8 million are projected with this vendor for the first year of the Metro contract. This amount represents 100 percent of the new capital expenditures for design and construction of the intermodal containers that will be **used to transport Metro's waste by rail. (WDVAVOB).**
- West Rail Construction, which is a certified minority-owned business, is our primary vendor to provide rail support services, including switch upgrades, track inspections and support work as needed at Columbia Ridge railyard. Expenditures of \$3 million are projected with this vendor for 2018 alone and they will continue to support us through the Metro contract. This represents 100 percent of our expenditures for this type of service. (MBE M5M69211792, Washington, WESTRCC995PD, Oregon, COBID 149280).

We will report the realized, accurate COBID utilization for each project phase in our Annual Partnership Report to Metro. For more information on our plan and methodology, please see our Subcontractors and Suppliers 2018 Vendor Inclusion and Diversity Plan Appendix 13.

*H. Sustainability: Describe in detail the sustainable practices (e.g., environmental and social practices beyond that required by law or regulation) that will be used in your operations.*

WM and UPRR are offering Metro the #1 most sustainable transportation solution. It is a solution fitting for **Metro's world-class sustainability leadership** because it will deliver a smaller carbon footprint, cleaner air and fuel efficiencies, all in a package that is carbon neutral and anchored in the triple bottom line to encompass people, the planet and prosperity.

The foundation is **WM's** track record as a sustainability leader and green innovator as the largest recycler in North America, the leader in generating renewable energy from landfills, a champion for GHG reductions and Lifecycle Thinking, and the most experienced and successful green technology collaborator in the industry. See our 2016 Sustainability Report in Appendix 15 and the 2017 update in Appendix 16. To this, add UPRR, **America's premier railroad, recognized repeatedly as a climate change leader and a champion for clean** locomotives and fuel efficiencies. Working together, WM and UPRR offer Metro the opportunity to significantly reduce I-84 congestion, provide for cleaner air and reduce visual impacts through the Columbia Gorge NSA. **Here's more on our plan:**

**Smaller carbon footprint:** Our rail solution delivers cleaner air and a dramatically smaller carbon footprint by taking 15,000 trucks off the road every year (that is 15,000 fewer round trips/year, or 60 fewer round trips/day). This will allow Metro to eliminate 2.4 million trucks miles through the Columbia River Gorge NSA every year and 24 million truck miles over 10 years. In Portland, there also will be fewer trucks on the road and less roadway congestion as shipment by rail results in approximately 38,526 fewer annual truck miles and 385,260 fewer truck miles over the 10-year contract. That means cleaner air for everyone. For the Columbia Gorge NSA, fewer trucks also mean less highway congestion and a more natural and majestic viewshed for Oregonians and the 3-4 million people who visit the scenic area every year. For more information, see the traffic analysis from Kittelson & Associates in Appendix 5.

**Carbon credits through the Climate Trust:** The WM proposal goes an important step further to support **Metro's** world-class sustainability leadership. By partnering with the Climate Trust to purchase a high-quality carbon off-sets portfolio, our proposal offsets 100 percent of GHGs over the 10-year life of the transportation contract, making this a premier, carbon-neutral solution and the **best choice for Metro's sustainable future.**

This includes our commitment to use, when possible, ULSD fuel, highly efficient rail locomotives, yard equipment, trucks and emissions control equipment to improve air quality.

**Greater fuel efficiency:** Freight trains are four times more fuel efficient than trucks on a ton/mile basis. In **addition, UPRR's fuel-saving** operations include the use of ULSD fuel, green locomotives and innovative fuel





efficiency technologies plus pioneering idle reduction systems for cleaner air.

People, the planet, and prosperity: For the people and prosperity aspects of the sustainability equation, WM stands out with our work to achieve an inclusive, equitable and diverse workplace, and to be a strong employer and valued **community partner**. **WM's commitment and track record in these areas are** clearly outlined throughout this proposal.

**For the planet, WM's unparalleled sustainability leadership is reflected in all we do, in the services we provide** to customers, the design and operation of our facilities, and our interactions in the communities where we live and do business. WM employees work every day to be responsible environmental stewards and to protect the health and wellbeing of our employees, neighbors, customers and communities.

**In fact, WM's sustainability leadership has resulted in important recognition. Here's an at-a-glance look at our most recent sustainability awards:**



Wildlife Habitat Council Gold Certification: **Prestigious certification for WM's Hillsboro Landfill**, earned in 2017. Our local team of environmental managers and engineers earned this recognition for enhancing wetlands and wildlife habitats along the Tualatin River in partnership with Jackson Bottom Wetlands, Portland Audubon and Pacific University.



Sustainability at Work: City of Portland certification for achieving specific **sustainability goals at WM's** Portland operations. WM employee volunteers led efforts to win this recognition on behalf of 200 WM drivers and employees. WM is the only recycling and solid waste company to earn certification from the City of Portland.



Clean Cities Award: Voted #1 by the Columbia-Willamette Clean Cities Coalition for our leadership and investment in trucks powered by natural gas for a smaller carbon footprint. For every diesel truck that WM replaces with natural gas, we reduce our greenhouse gas emissions by 22 metric tons, per year. That is a 21 percent emissions reduction, per truck.



SWANA Silver: National award for innovative waste reduction and recycling outreach programs to elementary and middle schools. This 2017 award is from the **Solid Waste Association of North America, the nation's leading professional association in the solid waste field**. **WM's outreach included theatrical assemblies, hands-on classroom workshops, customized technical assistance, project assistance and family outreach booths that reached nearly 40,000 students, teachers, administrators and parents across Snohomish County, Washington.**



Corporate Conservation Leadership Award: **The Wildlife Habitat Council's top award honoring WM's deep commitment to conservation and wildlife habitat**. We won this award in 2017 for achievements in biodiversity and conservation education.



CDP Climate A List: **Recognition again in 2017 for WM's climate leadership**, meaning fewer emissions and a lower-carbon future for the communities we serve.

**We invite you to learn more about WM's work for the environment in our 2016 biennial Sustainability Report and the 2017 update in Appendices 15 and 16.**

UPRR: What makes UPRR a sustainability leader? Smaller carbon footprint than truck transport, clean locomotives, continuous improvements in fuel efficiencies, and pioneering systems for clean air. **Here's more:**



- Smaller carbon footprint: Trains are one of **the nation’s most environmentally friendly modes of** moving freight. UPRR can move one ton of freight 452 miles on a single gallon of diesel fuel, generating a carbon footprint that is 75 percent less than trucks.
- Clean locomotives: UPRR is investing aggressively in new locomotives that meet EPA Tier 0, Tier 1, Tier 2, Tier 3 or Tier 4 emissions guidelines. Today, more than 96 percent of UPRR’s **locomotives are** EPA certified.
- Fuel efficiencies: UPRR has increased fuel efficiencies by 18 percent since 2000. Today, the railroad squeezes the most out of every drop of fuel, focusing on conservation through better locomotive technology and employee training and involvement.
- Clean air: UPRR’s **comprehensive** plan to reduce idling time is important because locomotive shutdowns can save 15-24 gallons of fuel, per locomotive, per day. The plan includes automatic stop/start equipment for all new and older locomotives.

**UPRR’s environmental stewardship has repeatedly earned an “A” rating on the Carbon Disclosure Project’s (CDP) Climate Change Survey and was listed on CDP’s S&P Climate Disclosure Leadership Index in 2016.**

Leadership status recognizes companies demonstrating best practices, leadership and understanding of climate change risks and opportunities. Case in point, in 2016, UPRR used 91 million fewer gallons of diesel and reduced water consumption by 290 million gallons of water, and UPRR was the only Class I railroad to report water consumption to CDP.

Newsweek Magazine named UPRR **to its Green 2016 list for the company’s corporate sustainability and** environmental impact, based on consultation with leading sustainability minds from NGOs and academic and accounting communities around the world. UPRR’s **2016** ranking was 81, up from position 121 in 2015. See **UPRR’s 2016 Social, Environmental and Economic Sustainability Progress Report** in Appendix 12.

Walsh: At Walsh, sustainability drives decisions, big and small, from fuel purchases and tire maintenance to reusable dishware and utensils in the office. For the Metro contract, here is an at-a-glance look at **Walsh’s** commitment to sustainable operations:

- Renewable fuels: Walsh will use the highest amount of renewable fuels allowed under guidance from engine manufacturers.
- Smart, synthetic oils: To reduce the amount of oil used, Walsh will use synthetically enhanced oils in the engine, transmission and rear ends. Enhanced oils allow for longer oil change intervals, which reduces the amount of oil used.
- Oil recycling: All oils removed from equipment will be recycled or repurposed in a used oil heat system. As a supporter of the Oregon Energy Fund, Walsh will help those in need stay warm in the winter by donating oil to heat homes.
- Tires: All tires will be monitored closely to cap them and extend core life. When the tires are no longer useable, they will be recycled.
- Chemicals: Walsh will use recycled antifreeze, and then recycle all antifreeze after use. All parts cleaners will be on a closed loop system, all washing fluid will be recycled, and environmentally friendly cleaners will be used.
- Recycled heat: The Walsh maintenance facility at Troutdale uses a recycled heat system.



4. Cost Proposal: Proposers will complete the Transportation Price Proposal spreadsheet, and submit the completed spreadsheet as part of the proposal. The spreadsheet requests the following information. | A. What is your proposed cost per load? (Please express in both numbers and words.) | 1) Does the per-load cost include fuel costs? | 2) If the answer to A.1 is no, please complete item #4 of the Pricing Inputs table on page 15. | B. What is the average payload size of each load that is used as the basis for your cost per load? | C. What percentage (i.e., 75%, 50%, 25%, etc.) of the consumer price index (West All Urban Size Class A- as more fully described in the Contract Terms and Conditions appended to the RFP) do you propose for annual adjustment to per load prices? | (Item D must be completed only if you responded “No” to item A.1.) D. What is your proposed fuel cost per load? (Please express in both numbers and words.) | E. Currently Metro’s transportation operator averages 34-ton payloads in the trailers servicing MCS and MSS. (Current trailer specifications for a 34-ton payload are available in Appendix I.) Any reduction or increase in average container/trailer payloads will result in additional costs or savings, respectively, to Metro for operations at the transfer stations. The following costs will be applied only to additional containers that would result because of average payloads less than or greater than 34 tons. [MCS \$125.27 per load (Increased cost to Metro for loads less than 34 tons), MSS \$88.55 per load (Increased cost to Metro for loads less than 34 tons), MCS \$110.15 per load (Reduced cost to Metro for loads greater than 34 tons), and MSS \$88.55 per load (Reduced cost to Metro for loads greater than 34 tons)].

### Pricing Input Form for Waste Management

1. Percent of CPI proposed: Reda
2. Guaranteed container capacity: 30.0 tons/container
3. Price per container (excluding fuel and tipping)

Metro Transfer Station	3. Price per Container - Columbia Ridge	3.a Discount Price per Container – Columbia Ridge	4. Gallons of Fuel per Container*	5. Fuel Price per Gallon*	6. Tipper Price - Columbia Ridge
Central	Redacted				

\*Applies only to Walsh over the road fuel use in Portland.

## Section C | Exceptions to standard agreement and RFP

Carefully review the Standard Agreement attached hereto as Appendix A and incorporated herein. This is the standard agreement that successful respondents to this RFP will be required to execute. RFP respondents wishing to propose any exceptions or alternative clauses to the agreement or to any specified criteria within this RFP must propose those exceptions or alternative clauses in their proposal. Metro is not required to consider contract revisions proposed during contract negotiation and award. Proposed exceptions or alternative clauses should be accompanied by explanatory comments that are succinct, thorough and clear.

WM appreciates the opportunity to review and provide comment on the Transportation Standard Agreement (Agreement). This Agreement will guide and inform our partnership for many years into the future. In Appendix 17, we have outlined each exception, noting the Agreement Section number, general topic of concern, a description of the text we are concerned with, suggested language and the reason(s) for our concern.

Our exceptions largely address practical and reasonable solutions, to construct a mutually beneficial Agreement to reflect our partnership. For example, Section 18.5 allows Metro to cancel the Agreement at any time and for any reason. This concerns us. Under this Agreement, we will invest significant and substantial resources to service Metro. If Metro can cancel the Agreement for convenience, WM’s investments could be jeopardized.

There are several Sections within the Agreement that require reporting details that would reveal WM’s confidential and proprietary information. Because of these business concerns, we look forward to discussing Metro’s desire for specific information and tailoring the Agreement to protect WM’s interests while meeting Metro’s information needs.

Some exceptions seek to clarify and establish clear expectations. For example, a few Sections deal with hazardous waste, title to solid waste and what is/is not acceptable waste and how it is/is not to be handled. WM looks forward to clarifying intent and establish appropriate obligations for WM and Metro regarding these and other items.



We look forward to meeting with you in person to discuss the solutions that lead to a mutually beneficial partnership Agreement.

## Section D | Financial capability

*Include a letter per Appendix C from a qualified Surety Company in a form which includes all the major elements of the sample letter. The letter should indicate limits for single bonds and aggregate capacity.*

Included in Appendix 18 is a consent of surety letter from Western Surety Company **that confirms WM's ability** to provide the required Performance and Labor and Materials Payment bond and outlines the limits for single bonds and aggregate capacity.

## Section E | Appendices

Included in this section are the following appendices that support **WM's proposal for the transport of Metro's** solid waste to the Columbia Ridge.

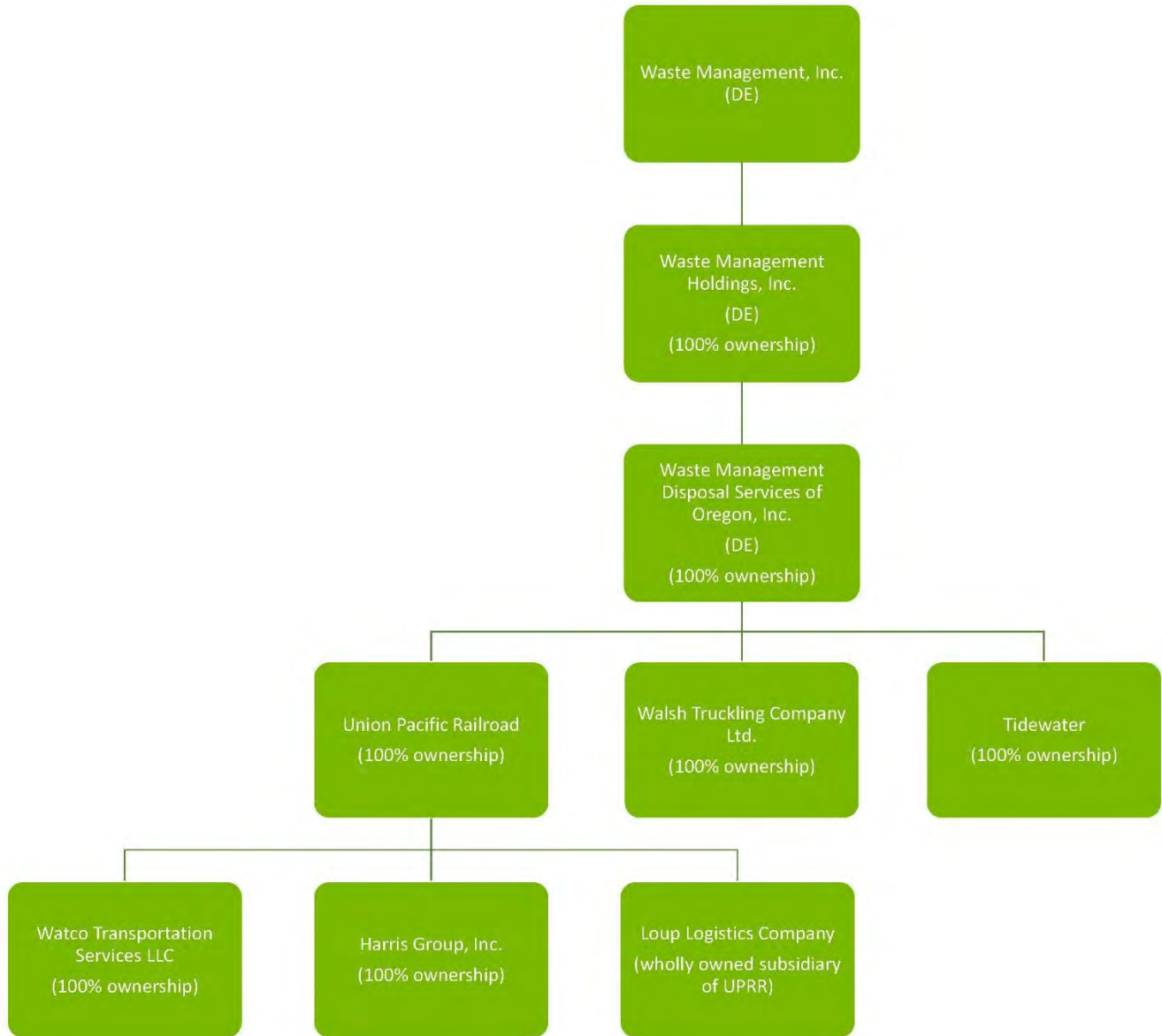




# Appendix 1: Organizational Chart with Ownership Percentages and Management Arrangements



# Organizational Chart with Ownership Percentages and Management Arrangements



# Appendix 2: Good Company Environmental Assessment and Climate Trust Carbon Offsets



## Environmental Analysis of Waste Transport for Metro RFP 3396

**By:** Aaron Toney, Senior Associate, [aaron.toney@goodcompany.com](mailto:aaron.toney@goodcompany.com)  
Josh Proudfoot, Principal, [joshua.proudfoot@goodcompany.com](mailto:joshua.proudfoot@goodcompany.com)

**Date:** January 10<sup>th</sup>, 2018

### INTRODUCTION

To support Waste Management's (WM) proposal for Portland METRO RFP 3396 – Solid Waste Transport, Good Company benchmarked the environmental performance of WM's preferred waste transport approach versus other potential transport modes to the Columbia Ridge Landfill.

### METHODOLOGY AND ASSUMPTIONS

WM's proposed approach is to transport waste from Metro's Central and South transfer stations (TS) to Columbia Ridge Landfill primarily by rail. Trucks will be used to transport the waste from Metro's TS to Union Pacific's Portland rail terminal and again from the destination rail terminal to Columbia Ridge Landfill.

Good Company compared WM's approach to barge and truck transport (with truck drayage as appropriate) from Metro's Central and South TS. The metrics for comparison include greenhouse gas emissions (GHGs); particulate matter emissions (PM); Nitrogen Oxide emissions (NOx) in the Columbia Gorge National Scenic Area (NSA); and fuel use in the NSA (proxy for SOx emissions).

Two versions of the analysis were completed – Baseline and WM Approach (incorporating carbon offsets):

- **Baseline:** In the initial analysis Good Company conducted for WM, US fleet averages were used to compare all possible modes in order to identify appropriate mitigation recommendations for WM. A subset of the full analytical analysis prepared by Good Company is presented in this report.
- **WM Approach:** Actual data based on WM's planned mitigation actions (purchase of carbon offsets) and engine and fuel specifications from WM's transportation vendors were incorporated.







**SUMMARY OF FINDINGS**

**High-Level Findings**

- **Waste Management will offset 100% of its greenhouse gas emissions (GHG) over the 10-year life of the transport contract – making waste transport carbon neutral - by purchasing carbon offsets from The Climate Trust.** See the related attachment for offset project details.
  - With the purchase of carbon offsets, WM’s rail transport approach is expected to be preferable to all other modes for the GHG criteria.
  - The purchase of offsets will allow Metro to fully and completely address its largest source of Scope 1 operational emissions. See Figure 1 for details.
  - The Climate Trusts offsets are high quality and will be produced from grassland conversion and landfill gas capture projects located in Oregon.
- **Waste Management’s rail transport approach is likely to be deemed preferable<sup>1</sup> to barge transport for PM and NOx emissions and competitive, albeit slightly greater than, truck transport.**
- **Waste Management’s rail transport approach is likely to be deemed competitive with barge transport and will likely outperform truck transport, in regard to fuel use and SOx emissions.**

Figure 1: Metro agency-wide emissions from government operations (FY 12-13).

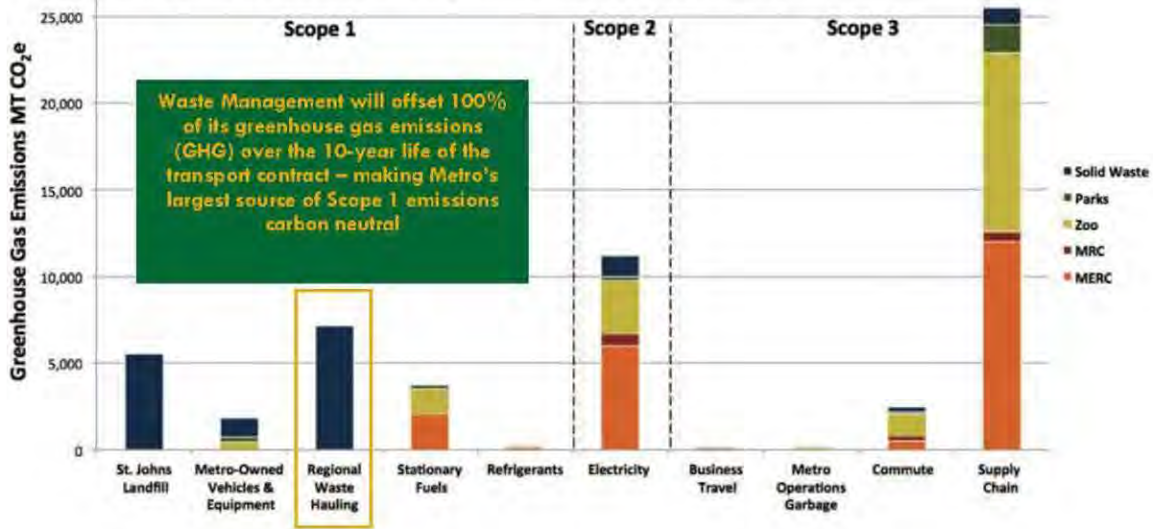


Figure 2 compares the Baseline scenario and WM Proposed Approach for various transport modes departing from Metro’s two transfer stations. Rail and barge scenarios include truck drayage from the transfer stations to the line-haul transfer and line-haul transfer to landfill. Details of the scenarios presented in Figure 2 are further explained in

<sup>1</sup> This finding is based on a review of Tidewater vessels (<http://www.tidewater.com/tugs>) and the associated assumption that they will be using Tier 3 engines.





Appendix A. The following subsections provide a narrative detail for each of Metro's environmental evaluation criteria in the RFP.

**Metro Evaluation Criteria 1: Greenhouse Gases – see Figures 1, 2, and 3**

Good Company completed modeling work shown in Figure 2. Rail to Columbia Ridge is competitive with barge transport for GHGs (depending on actual engine and hauling capacity factors). Rail and barge are both expected to perform significantly better than truck transport due to greater hauling efficiencies.

To address any potential deficit compared to barge transport – Good Company recommended that Waste Management contact a number of known, reputable regional carbon-offset providers in order to purchase carbon offsets to ensure carbon neutral performance over the 10-year life of the contract. The Climate Trust offered the most compelling proposal for offsets produced from Oregon-based grassland conversion and landfill gas projects.

**Metro Evaluation Criteria 2: Particulate Matter (PM10) in National Scenic Area – see Figures 2 and 4**

Waste Management's rail transport approach, which will likely use Tier 4 engines will likely outperform barge transport. This finding is based on the assumption that barges will be running Tier 3 engines. Final performance comparisons are highly sensitive to actual engine specifications and fuel use. Should barges also be running Tier 4 engines – emissions between rail and barge will be more competitive.

**Metro Evaluation Criteria 3: Nitrogen Oxides (NOx) in National Scenic Area – see Figures 2 and 5**

Waste Management's rail transport approach, which will likely use Tier 4 engines will likely outperform barge transport. This finding is based on the assumption that barges will be running Tier 3 engines. Final performance comparisons are highly sensitive to actual engine specifications and fuel use. Should barges also be running Tier 4 engines – emissions between rail and barge will be more competitive.

**Metro Evaluation Criteria 4: Fuel Use and Sulphur Oxides (SOx) in NSA – see Figures 2, 6, and 7**

Energy use is a reasonable predictor of SOx performance; therefore, it's reasonable to assume that rail transport will significantly outperform trucks on this criterion, provided sulfur content of the fuel is equal across modes. Rail is expected to perform significantly better than truck transport due to greater hauling efficiencies and assuming identical fuel specifications.





**Figure 2:** Baseline and WM Approach comparison for various transport modes by RFP environmental criteria. Baseline results are based on average model age of the average US fleet (as represented by Argonne National Laboratories GREET model) and WM Approach is based on information received from WM and their partners.

**NOTE: Green denotes best performance whereas red signifies worst performance.**

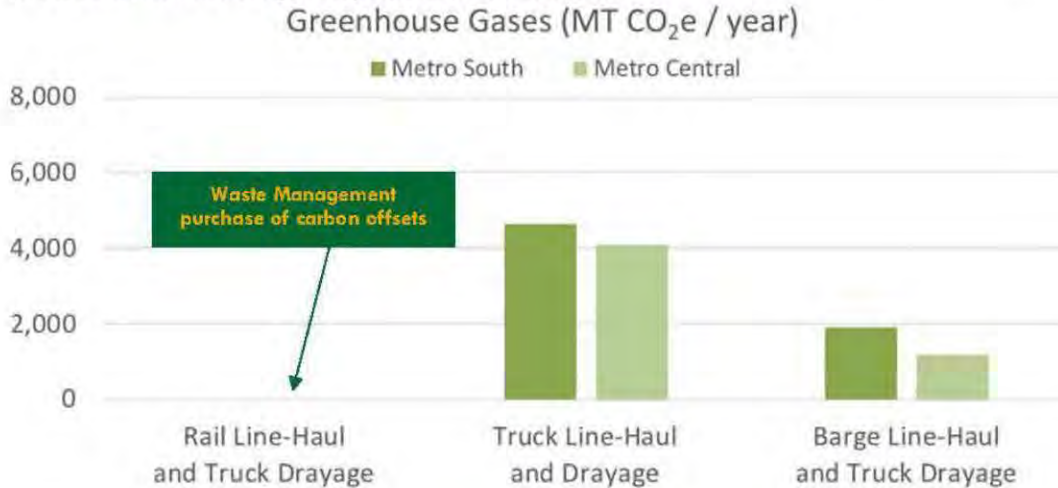
Scenario	Origin	Line Haul Mode	Direct GHGs (MT CO2e / year)	Direct PM10 (kg PM10 / year)	Direct Nox in NSA (kg NOx / year)	Fuel Use in NSA (SOx Proxy) (MMBTU / year)	Direct SOx - LS Diesel (kg SOx / year)
Baseline	Metro Central	Rail and Truck Drayage	1,635	424	10,322	10,438	0.3
WM Approach	Metro Central	Rail and Truck Drayage	0	44	1,690	10,438	0.3
Baseline	Metro Central	Truck and Drayage	4,081	25	1,275	32,267	1.0
Baseline	Metro Central	Barge and Truck Drayage	1,173	173	5,241	7,706	0.2
Baseline	Metro South	Rail and Truck Drayage	2,325	592	11,778	11,910	0.4
WM Approach	Metro South	Rail and Truck Drayage	0	53	1,929	11,910	0.4
Baseline	Metro South	Truck and Drayage	4,656	29	1,454	36,818	1.1
Baseline	Metro South	Barge and Truck Drayage	1,906	201	5,980	8,793	0.3







**Figure 3:** WM Approach direct GHGs from waste transport modes for Metro Central and South County Transfer Stations. **NOTE 1: Smaller bars are preferable (i.e. fewer annual emissions).** Note 2: Columbia Ridge, Rail Line-Haul includes Waste Management purchase of carbon offsets.



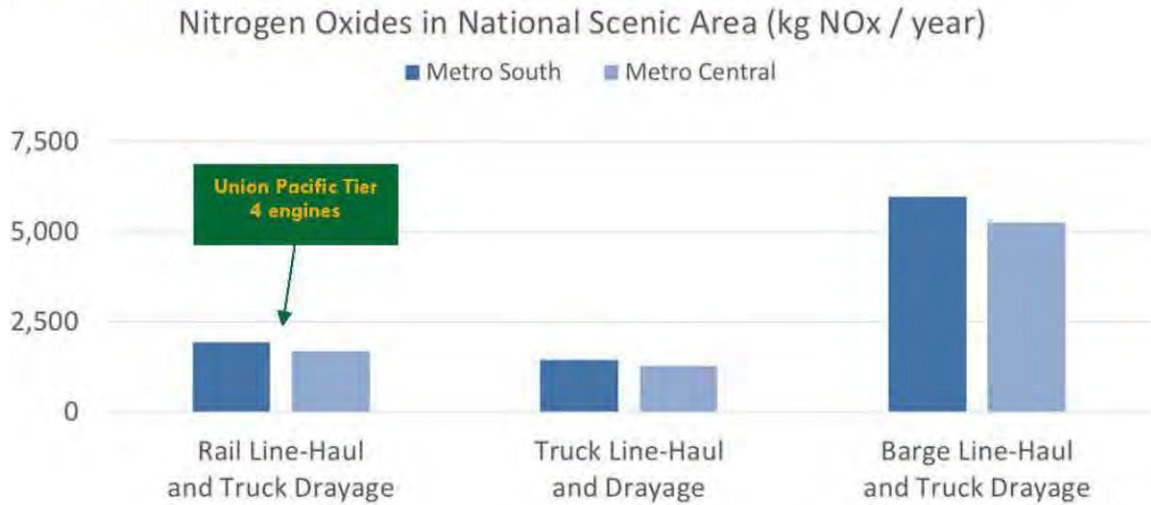
**Figure 4:** WM Approach direct PM<sub>10</sub> from waste transport modes (based on WM data and assumptions) for Metro Central and South County Transfer Stations. **NOTE: Smaller bars are preferable (i.e. fewer annual emissions)**



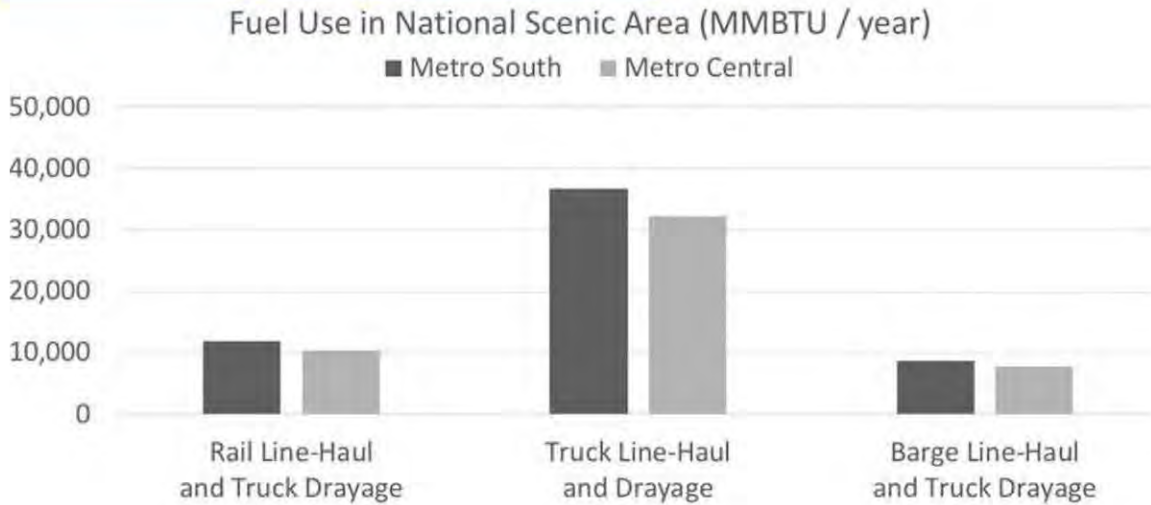




**Figure 5:** WM Approach direct NOx from waste transport modes for Metro Central and South County Transfer Stations. **NOTE: Smaller bars are preferable (i.e. fewer annual emissions)**

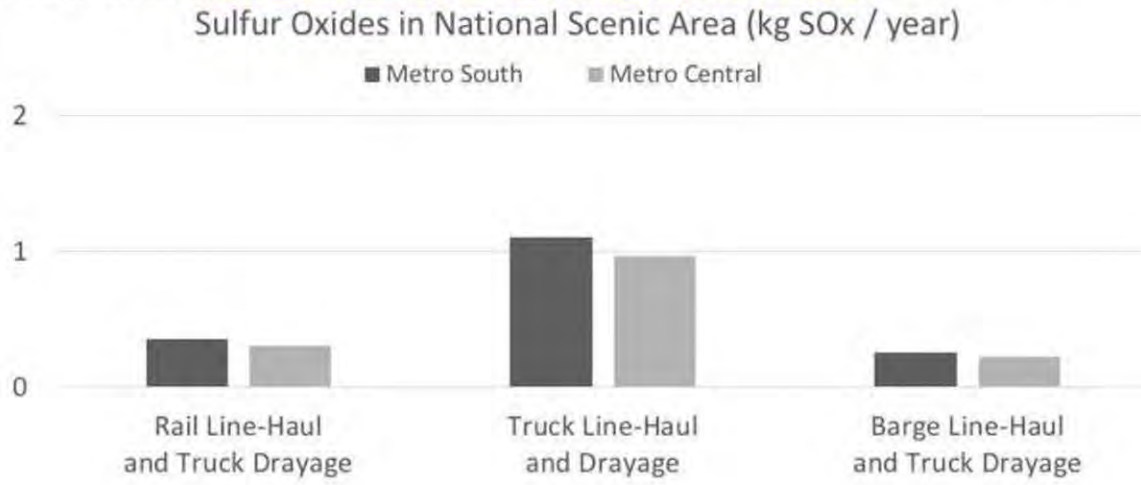


**Figure 6:** WM Approach fuel use (MMBTU) from waste transport modes for Central and South TS. **NOTE: Smaller bars are preferable (i.e. fewer annual emissions)**





**Figure 7:** WM Approach direct SOx for Metro Central and South County Transfer Stations, assuming low-sulfur diesel for all modes. **NOTE: Smaller bars are preferable (i.e. fewer annual emissions)**





**APPENDIX A: TRANSPORTATION METHODOLOGY, DATA, AND ASSUMPTIONS**

Good Company built an Excel-based model using data and factors provided by Waste Management and the following resources:

- Argonne National Lab, Greenhouse Gas, Regulated Emissions, and Energy Use in Transportation model (2017 GREET)
- Environmental Protection Agency, Motor Vehicle Emissions Simulator model (2014 MOVES)
- Technical Highlights, Emission Factors for Locomotives, EPA420-F-09-025, April 2009
- 2017 SmartWay Truck Carrier Partner Tool: Technical Documentation
- Emissions factors for Marine Tier Engines, FR 73 37096, June 30, 2008
- Texas A&M Transportation Institute (2017), A MODAL COMPARISON OF DOMESTIC FREIGHT TRANSPORTATION EFFECTS ON THE GENERAL PUBLIC: 2001–2014
- Union Pacific, Fuel Conservation Website, Accessed online 11/17 at <https://www.up.com/aboutup/environment/operations/index.htm>
- Tidewater Barge Lines website, Solid waste hauling capacity and tug engine power, Accessed online 11/2017 at <http://www.tidewater.com/barge-lines>, <http://www.tidewater.com/deck>
- Shaver, Tug engine power, Accessed online 11/2017 at <https://shavertransportation.com/fleet/>

**Methodology:** Distances provided by Waste Management and calculated using ARCGIS were used in conjunction with Metro data on annual solid waste weights from the Central and South transfer stations along with various emissions and energy factors to estimate annual emissions for the environmental metrics. Sensitivities were considered for various fuel blends and engine model years and tiers. Results presented assume recent model year engine factors, which are based on GREET average assumptions.

**Figure 8:** Summary of data and assumptions used in emissions and fuel use calculations

Description	Unit	Origin	Value			Source
			Rail + Truck	Truck only	Barge + Truck	
Annual Solid Waste Weight - Central	wet short tons / year		232,376	232,376	232,376	Metro RFP 3396
Annual Solid Waste Weight - South	wet short tons / year		265,150	265,150	265,150	Metro RFP 3396
Line-Haul Distance	one-way miles	Metro Central	139	142	144	Measured using ARCGIS
Truck Haul Drayage	one-way miles	Metro Central	12	0	6	Measured using ARCGIS
Line-Haul Distance	one-way miles	Metro South	139	142	144	Measured using ARCGIS
Truck Haul Drayage	one-way miles	Metro South	26	0	24	Measured using ARCGIS
% of Line-Haul Miles in National Scenic Area			60%	58%	58%	Measured using ARCGIS
Line-Haul Energy Efficiency	ton-mile / gallon of diesel		477	145	647	Texas A&M Transportation Institute, A MODAL COMPARISON OF DOMESTIC FREIGHT TRANSPORTATION EFFECTS ON THE GENERAL PUBLIC: 2001–2014
Truck Haul from Origin to Line-Haul + Line-Haul to Landfill	ton-mile / gallon of diesel		145	145	145	Texas A&M Transportation Institute, A MODAL COMPARISON OF DOMESTIC FREIGHT TRANSPORTATION EFFECTS ON THE GENERAL PUBLIC: 2001–2014
Diesel Fuel Lower Heating Value	BTU / gallon		128450	128450	128450	Argonne National Lab, GREET 2017
GHG emissions factor - Line Haul (Baseline)	kg/MMBTU		78.6	78.5	78.4	GREET 2017
GHG emissions factor - Line Haul (Scenario)	kg/MMBTU		78.6	78.5	78.4	EPA420-F-09-025, April 2009 Rail
PM10 emissions factor (Baseline)	kg/MMBTU		0.0240	0.0014	0.0295	GREET 2017
PM10 emissions factor (Scenario)	kg/MMBTU		0.0024	0.0005	0.0130	FR 73 37096, June 30, 2008 Barge
NOX emissions factor (Baseline)	kg/MMBTU		0.9889	0.1893	0.8979	GREET 2017
NOX emissions factor (Scenario)	kg/MMBTU		0.1619	0.0395	0.5801	2017 SmartWay Truck Carrier Partner Tool: Technical Documentation





### The Climate Trust's Oregon Offset Projects

The Climate Trust proposes to provide 40,000 offsets from the following two projects, which adhere to stringent third-party protocols to ensure the offsets represent real and additional reductions:

#### **Eastern Oregon Grassland Conservation with The Nature Conservancy**

*Project location:* Wallowa County, Oregon

*Protocol:* Climate Action Reserve Grassland Project Protocol 2.0

*Project summary:*

Eastern Oregon is home to large cattle ranches with swaths of intact grasslands. These grasslands, home to threatened and endangered species like the sage grouse and lesser prairie chicken, are under increasing pressure to convert to conventional wheat and commodity crop production. When this conversion occurs, carbon sequestered in the soil is lost.



In 2000, The Nature Conservancy Oregon Chapter purchased 27,000 acres of grasslands in Wallowa County, Oregon launching an ambitious conservation initiative called the Zumwalt Prairie Preserve. The Climate Trust is providing capital to support The Nature Conservancy's work to record no-till conservation easements on private ranches in the region to grow this preserve.

The credits offered here are generated by two ranches, which total 8,210 acres, one of which recorded a conservation easement in 2017 and the other of which will record a conservation easement in 2018. These easements ensure the ranches, and the soil carbon they sequester, will be maintained in perpetuity. This will be the first carbon cooperative of its kind to allow small ranches to access carbon markets.

#### **Western Oregon Landfill Gas Capture**

*Project location:* Douglas County, Oregon

*Protocol:* Climate Action Reserve Landfill Gas Protocol 3.0

*Project summary:*

This 1.6 MW landfill gas to energy project installed 30 new gas wells and a generator to a Douglas County Public Works Department landfill. The landfill opened in 1970, voluntarily installed seven landfill gas extraction wells and a flare in 2001, and anticipates closing in 2030. Because the Douglas County landfill is relatively small, capturing and destroying methane is not required by law. Therefore, the project's emission reductions are considered additional. This additionality test has been verified through the Climate Action Reserve's landfill gas protocol 3.0. The project generates offsets by combusting the methane collected at the landfill. The combustion process generates electricity, which is sent to the grid.

#### **About The Climate Trust**

The Climate Trust is a non-profit organization based in Portland, Oregon that has been working to ensure the environmental integrity of carbon markets for 20 years. We accelerate the pace of carbon mitigation through the deployment of conservation finance. We value air, water and soil through the development, purchase and sale of qualified offsets and a relentless investment in people and projects with environmental purpose. We are committed to staving off a disastrous rise in global temperatures by accelerating the pace of carbon mitigation through increased deployment of finance.



# Appendix 3: Equipment Specifications



This page intentionally left blank



# Equipment Specifications: Rail Locomotive and Railcar Specifications



# Protecting our environment, now and for the future.



## CLEANER LOCOMOTIVES

Trains are one of the nation's most environmentally friendly modes of moving freight. Union Pacific can move one ton of freight 452 miles on a single gallon of diesel fuel, generating a carbon footprint that is 75 percent less than trucks.

Locomotive fuel accounts for nearly all of our Greenhouse Gas Emissions, making it a key focus for our environmental innovations.

- Since 2000, U.P. has achieved a 18 percent improvement in fuel efficiency. Today, the railroad squeezes the most out of every drop of fuel, focusing on conservation through better locomotive technology and employee training and involvement.
- Union Pacific has spent approximately \$8 billion since 2000 to purchase nearly 4,600 new locomotives that meet EPA Tier 0, Tier 1, Tier 2, Tier 3 or Tier 4 emissions guidelines.
- We retired more than 3,200 older locomotives and overhauled or rebuilt more than 6,700 locomotive diesel engines with emissions control upgrades.
- More than 96% of our nearly 8,500 locomotives are certified under existing U.S. Environmental Protection Agency Tier 0, Tier 1, Tier 2, Tier 3 or Tier 4 emissions standards.





## PIONEERING TECHNOLOGY

Union Pacific is committed to reducing emissions and improving air quality in our operations through constant development and evaluation of innovative technologies.

- UP developed a comprehensive plan to reduce unnecessary locomotive idling time. All new locomotives have automatic Stop-Start equipment and older locomotives are being retrofitted with it. Locomotive shutdowns can save 15-24 gallons of fuel, per locomotive, per day. In total, 87 percent of our locomotive fleet is equipped with this technology.
- With its UP 9900, the signature unit in a series of 25 locomotives in California, Union Pacific has tested three emissions-reducing technologies. Working with the California Air Resources Board, we are jointly analyzing the locomotives' emissions reduction capability and anticipate an 85 percent reduction in particulate matter.
- To reduce yard emissions, Union Pacific pioneered the Genset switcher, which uses ultra-low emissions, EPA-certified, off-road diesel engines. The Genset reduces fuel use by 37 percent.
- UP has evaluated other experimental technology for reducing particulate matter and emissions of oxides of nitrogen, such as hybrid locomotives. These serve as stepping stones for other fuel and emissions-reducing innovations.

## EMPLOYEE ENGAGEMENT

Employees understand that protecting the environment is part of every job, and they are developing world-class energy-conservation techniques to move more freight with less fuel.

- Through simulator training and peer coaching, locomotive engineers are honing their train operating techniques to conserve energy. They also utilize technology like a vehicle's cruise control system and software that analyzes train operations through advanced GPS maps, prompting throttle and brake actions.
- Other innovative employee efforts under way include assigning power by tons per axle to reduce fuel consumption and locomotive wear, and increasing use of distributed power to reduce in-train forces and drag while saving fuel and train starts.

## OPPORTUNITIES ACROSS THE SYSTEM

Union Pacific's conservation efforts aren't limited to locomotives. Whether working in train yards or administrative offices, employees are making environmentally friendly choices every day.

- UP has a wide-reaching resource management initiative that results in the railroad diverting about 67 percent of its waste from the landfill. This includes metals, cross-ties, c-waste and more.
- We operate and maintain 90 wastewater treatment facilities across our system.
- Spill Prevention Control and Countermeasure plans have been prepared and implemented at 136 Union Pacific facilities that store, transfer or use oil products.
- Union Pacific continues to pursue conservation initiatives in other areas including expanded recycling programs and energy efficiency upgrades.

## MORE INFORMATION

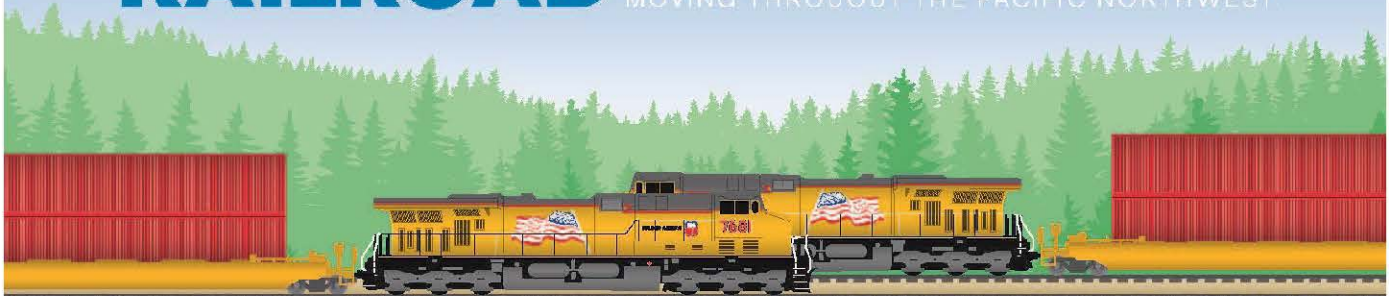
Union Pacific publishes an annual Sustainability and Citizenship Report at [up.com](http://up.com).

# UNION PACIFIC Portland: A Modern Rail Hub



## CREATING A **MORE EFFICIENT RAILROAD**

TO REDUCE FUEL USAGE AND EMISSIONS, AND  
**IMPROVE DELIVERY TIMES FOR GOODS**  
MOVING THROUGHT THE PACIFIC NORTHWEST



**SIDINGS** ALLOW TRAINS TO PASS WITHOUT IDLING OR BLOCKING THE MAINLINE





**ALL-PURPOSE 53' DOUBLE-STACK CAR**

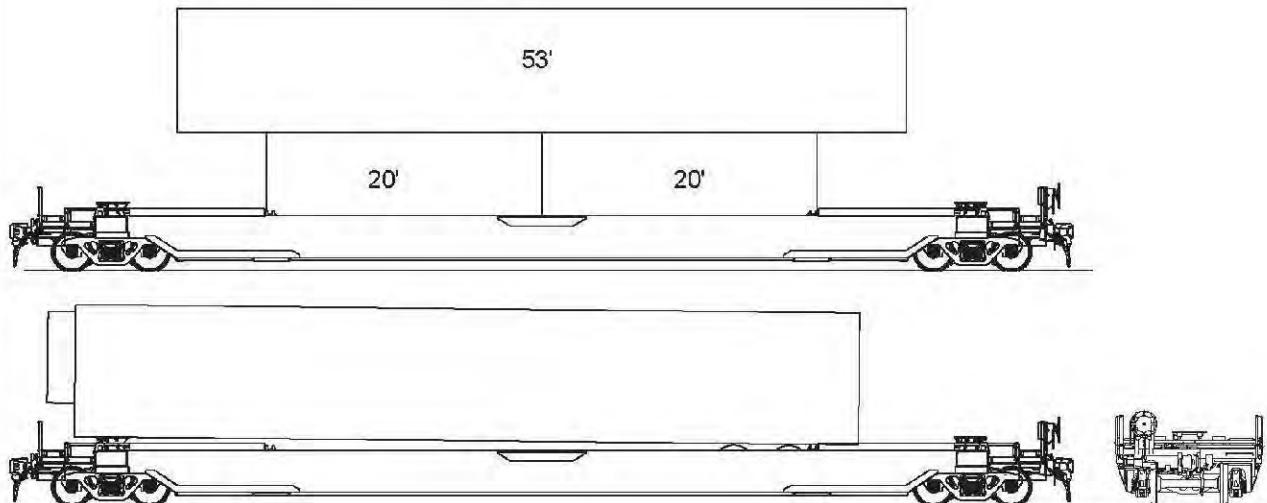
The 53' All-Purpose (AP53) double-stack well car is a single unit designed to maximize flexibility. It can carry either containers or trailers with ease. The AP53 has a 53' well to accommodate containers from 20' to 53' long, as well as containers from 40' to 53' long in the top position. Additionally, the AP53 can accommodate two 28' pup trailers or one long trailer up to 57' long. Each car is capable of carrying nose-mounted containers or trailer refrigeration units.

The AP53 can be operated as a single car or be configured as a multiple-unit drawbar car.



DIMENSIONS (Approximate)			
Length, over couplers	76' 8 3/4"	Height, extreme (loaded <sup>A</sup> )	20' 2"
Length, between truck centers (per well)	62' 7"	Width, extreme	10' 7 15/16"
Height, top of rail to top of side sill	4' 3/16"	Well Size	53' x 102 3/8"
Height, rail to support surface (empty)	12' 1/16"	<sup>A</sup> Loaded with two 9' 6" stowed containers	
WEIGHT / CAPACITY (Estimated)		CURVE NEGOTIABILITY RADIUS	
Light weight	54,000 lbs.	Uncoupled	180'
Gross rail load	220,000 lbs.	Coupled to like car	303'
Load limit	166,000 lbs.	Coupled to 40' base car	299'

These general dimensions are representative and subject to change without notice as required by customer specifications or design improvements by Greenbrier.



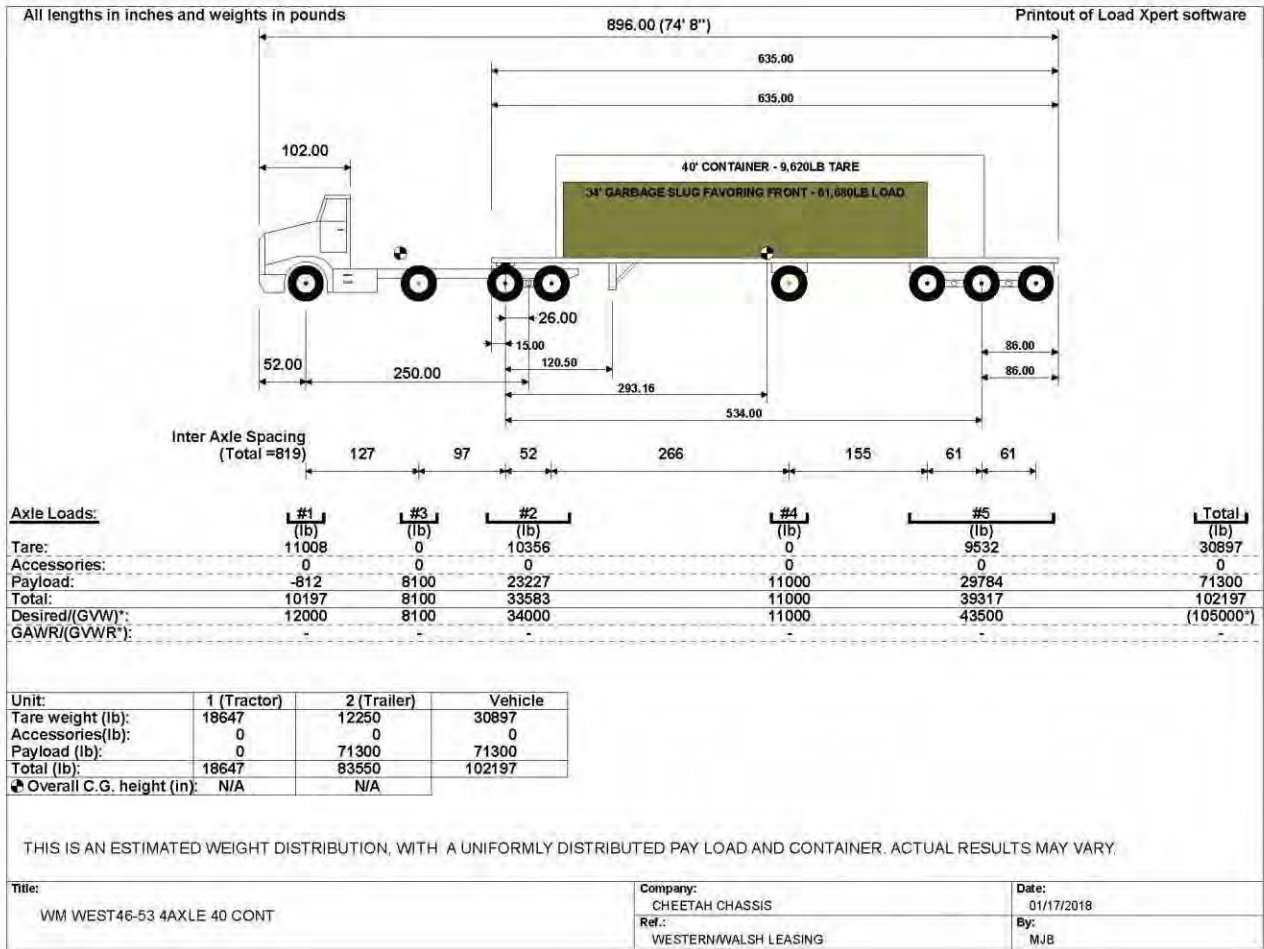
This page intentionally left blank





# Equipment Specifications: Chassis and Intermodal Container Specifications





## 40' MSW Intermodal Refuse Container Information



This type of waste container is typically use in the collection and transport of Transfer Station compactor processed Municipal Solid Waste (MSW) materials.

The particulars of these container are:

### Dimensions:

Exterior:	Interior:
Length: 40' 0"	39' 1 7/8"
Width: 8' 0"	7' 7 5/8"
Height: 8' 6"	7'11 1/8"
Cubic Capacity:	2,369 cu.ft.
Max. Gross Weight:	80,000 lbs
Tare Weight:	9,620 lbs
Cargo Weight:	70,380 lbs



### Features:

- Single Full Width Door
- Weighted Front Vent
- Door Hinges right or left hand
- Sump Floor with raised rear sill
- Smooth Interior Walls
- Units are certified for intermodal use via truck, railroad, ship and barge.

7701 South 200th Street  
Kent, WA 98032

P: (253) 872-7474  
F: (253) 872-7479  
[www.prwgroup.com](http://www.prwgroup.com)

Marine Cargo Containers  
Sales / Leasing





**WMX 40' x 8' x 8'6"**

---

**WMX 40' x 8' x 8'6"**

STEEL DRY MSW CONTAINER  
FOR  
ISO 1AA TYPE

MODEL NO. : GS-D456-TWB  
SPECIFICATION NO. : SD456-TWB-A  
ISSUE DATE : NOV. 03, 2017  
REVISED DATE : JAN 04, 2018

**Owner code and Serial No. :**

**WMXU 980701 ~ 980752 (52 units)**

**GUANGDONG HYUNDAI CONTAINER CO., LTD.**

Page: 1 of 16

GUANGDONG HYUNDAI CONTAINER owns proprietary rights to the information disclosed. It is issued for engineering information only and may not be reproduced or manufactured without permission from GUANGDONG HYUNDAI.







## Contents

1. General	3
2. Dimensions and ratings	5
3. Materials	6
4. Construction	7
5. Preservation	11
6. Markings	12
7. Testing and inspection	13
8. Warranty	15
9. Revision	16



## 1. General

### 1. Operational environment

The container shall be manufactured for the carriage of dry cargo and for the transport by land(road and rail) and sea(above and below deck),and will be suitable for the environmental conditions imposed by these modes of transport.All materials used in the construction shall be suitable for extremes of temperature range from -40 °C (-40 °F) To + 80 °C (+176 °F) without effecting the container's strength or water-tightness.

### 1.2 Standard and regulation

Each container and every constructional part shall be designed ,manufactured and Tested in accordance with requirements of under mantioned authorities and standards.

#### 1.2.1 ISO/TC-104

- 830 - Terminology
- 6346 - Coding, identification and marking
- 1161 - Corner fittings specification

#### 1.2.2 The Convention for Safe Containers (C.S.C)

#### 1.2.3 Classification Society (KR)

### 1.3 Handling

The container is constructed to be capable of being handled without permanent deformation that will render them unsituble for used unde following conditions.

- 1) Lifting, full or empty, at top corner fittings by means of spreaders fitted with hooks, shackles or twistlocks.
- 2) Lifting, full or empty, at bottom corner fittings using slings with terminal fittings at sling angles of 30°minimum to be horizontal plane.



#### 1.4 Transportation

The container is constructed to be suitable for transportation in normal operating conditions and in the marine, road and rail modes.

- A. Marine - In the cell guides : Five (5) high stacked based on 36,300 kg M.G.W.
  - On the deck : Five (5) high stacked and secured at the corner fittings by vertical and/or diagonal lashings.
  
- B. Road - : On the flat bed or skeleton chassis, to be secured only at four bottom corner fittings.
  
- C. Rail - : On the flat cars or special container cars, container secured to chassis in Trailer On Flat Car (TOFC) operation, or container secured to car at four bottom corner fittings in Container On Flat Car (COFC) operation.



## 2. Dimensions and ratings

### 2.1 External dimensions

Length	12,192 (+0,-10) mm	(40' +0 -3/8")
Width	2,438 (+0,-5) mm	(8' +0 -3/16")
Height	2,591 (+0,-5) mm	(8' 6" +0 -3/16")

### 2.2 Internal dimensions (nominal)

Length	11,937 mm	(39' 1 15/16")
Width	2,328 mm	(7' 7 41/64")
Height	2,414 mm	(7' 11 1/16")

### 2.3 Internal capacity (nominal)

67.08 m <sup>3</sup>	(2,369 Cu.ft)
----------------------	---------------

### 2.4 Door opening dimensions (nominal)

Width	2,286 mm	(7' 6")
Height	2,257 mm	(7' 4 7/8")

### 2.5 Gooseneck tunnel dimensions

Length	3,243
Width	1,032 +0,-3 mm
Height	120 +0,-3 mm

### 2.6 Ratings

Max. gross weight	36,300 kg	(80,000 lb)
Payload	31,935 kg	(70,380 lb)
Tare weight (±2%)	4,365 kg	(9,620 lb)

### 2.7 Corner protrusions

- 2.7.1 The lower faces of bottom corner fittings protrude from lower faces of all transverse members in the base of the container by 17 mm and from lower faces of side bottom rails by 12mm.
- 2.7.2 The upper faces of top corner fittings protrude from upper face of the highest point of the roof by 6 mm.
- 2.7.3 The outer side faces of corner fittings protrude from outside faces of corner posts by 6 mm.
- 2.7.4 Under 1.8R(MGW) no part of the base of the container protrudes more than 6 mm below the plane formed by the lower faces of the bottom corner fittings at the time of maximum deflection.





### 3. Materials

The materials used in construction are as follows.

Where used	Materials
<b>Front End Assembly</b>	
Panel , Top and Bottom rail	Corten A
Corner fitting	SCW480
<b>Base Assembly</b>	
Bottom side rail , Cross member	Corten A
<b>Rear End Assembly</b>	
Rear corner post (outer)	Corten A
Rear corner post ( inner )	Corten A
Door header , Door panel , Door member	Corten A
Locking rod	STK400
Locking cam	SF440, Forged
Door hinge lug	S20C
Cam keeper	SF440, Forged
Door hinge blade	SF440, Forged
Lashing bar	SS400
Corner fitting	SCW480, Weldable steel casting
Door locking handle	S20C
Door hinge pin	SUS304
Door hardward	S45C
<b>Side Wall Assembly</b>	
Side panel	Corten A
<b>Roof Assembly</b>	
Roof panel	Corten A
Floor	SS400 or Q235B

Material	Yield point (Kg/sq.mm)	Tensile strength (Kg/sq.mm)
Corten A	35	49
SS400	24	41
STK400	24	41
SF440	23	45
SCW480	28	49
SUS304	21	53
S20C	25	41



## 4. Construction

### 4.1 Base frame

The base frame will be composed of two (2) bottom side rails, 29(23+6) ranks cross members including one (1) gooseneck tunnel assembly which are welded together as a sub-assembly.

#### 4.1.1 Side bottom rail

- Gauge : 4.5 mm.
- Geometry : 305 x 55 x 50 x 4.5 mm pressed channel section.
- Assembly : Upper and lower seams between side bottom rail outer and inner are stitch welded.
- Features : 4.5 mm reinforcement plates positioned vertically full height inside rail and welded to rail and castings.

#### 4.1.2 Cross member

- Gauge : 4.0 & 4.5 mm.
- Geometry : 122 x 45 x 45 mm (4.0x23) channel section and 122 x 45 mm angle section.
- Assembly : Continuous weld to bottom side rails on both side of cross member. Each cross member is welded with tapered position to bottom side rail..

#### 4.1.3 Gooseneck tunnel

- Gauge : Tunnel plate 4.5 mm; outriggers 4.0 mm; bolster 4.0mm;end rail 4.5 mm.  
Bolster – 4.0mm flat plate welded to longitudinal guide rails.  
End rail – 4.5 mm x 122 x 118 tube.

#### 4.1.4 Floor

- Gauge : 4.0 mm and 3.0 mm.
- Geometry : Flat plate.
- Assembly : The floor will be welded with cross members.

### 4.2 Front frame

Front frame will be composed of one front bottom rail, two corner posts, one front top rail, four corner fittings,one small window, and a front wall,which are welded together as a sub-assembly.

#### 4.2.1 Front bottom rail

- Gauge : Upper – 3.0 mm;  
Lower – 8.0 mm.
- Geometry : Upper - 60 x 60 x 3.0 mm square tube.  
Lower – 8.0 mm in center, 8.0 mm for outer.
- Assembly : Upper and lower to be continuously welded.

#### 4.2.2 Front corner post

- Gauge : 8.0 mm.
- Geometry : Cold formed one-piece open section.

#### 4.2.3 Front top rail

- Gauge : Upper – 3.0 mm flat plate.  
Lower – 60 x 60 x3.0 mm square tube.
- Geometry : Square tube lower rail with upper plate and 3.0 mm thick roof gussets at each top corner.

- Assembly : External seam is continuously welded, while internal seam is only caulked with sealant.
- 4.2.4 Front panel
- Gauge : 3.0 mm.
- Geometry : The front panels vertically are jointed together to tube by means of automatic MIG welding.
- Assembly : Continuously welded to front frame at outside and stitch welded internally to corner posts at inside and sealant caulking between stitch welds.
- 4.3 Rear frame
- Rear frame will be composed of two corner posts, one door sill, one door header and four corner fittings, which are welded together as a sub-assembly.
- 4.3.1 Rear corner post
- Gauge : Outer - 6.0 mm.  
: Inner - 6.0mm.
- Geometry : Each corner post is constructed with an inner post and an outer part of a pressed section, welded together to form a hollow section.
- Features : Five (5) sets of hinge lugs are welded to right outer section of the rear corner post.
- 4.3.2 Door sill
- Gauge : 4.5 mm
- Geometry : Pressed special channel section.
- Features : Four(4) pieces weled to inside of door sill, which three (3) pieces internal stiffeners at the behind of each cam keeper location.The uper face of the door sill has a 20 mm slope for better drainage.
- 4.3.3 Door header
- Gauge : Upper - 6.0 mm  
: Lower - 4.0 mm.
- Geometry : The door header is constructed with a lower part of cold formed "U" section and an upper part of pressed plate, continuously welded together to form a boxed section.The door header is thin profile.
- Features : Four (4) pieces internal stiffeners at the behind of each cam keeper location.
- 4.4 Door and hardware
- The door is constructed with steel frames and door panel, which are welded together as a sub-assembly.
- 4.4.1 Door
- Gauge : Panel - 3.0 mm.





- Horizontal member - 200 x 50 x 3.0 mm thick pressed channel.
- Vertical member - 100 x 50 x 4.0 mm rectangular tube.
- Geometry : The door panel horizontally corrugated into trapezium section with 45 mm depth will be continuously welded to door frame. The topside corner of each door to be chamfered to maximize the door opening height.
- Features : Door is capable of swinging 270 degrees when fully opened.  
A door chain holder (SS41) on door and rope ring on right bottom side rail to retain the door in open position.
- 4.4.2 Hinge blade
  - Geometry : Forged steel
  - Features : Door is suspended by five grease zerker hinges with nylon bushes and stainless steel washers.
  - Treatment : Electro zinc plate.
- 4.4.3 Hinge pin
  - Geometry : 12.7 mm diameter bar
  - Assembly : Welded to the hinge lugs.
- 4.4.4 Locking rod assembly
  - Type : Bolt-on with secure cam & keeper and Anti-theft handle.
  - Geometry : Locking mechanism – Bloxwich model BE 2566 MN type.
  - Size : Bar - 34 mm outer diameter x 3.2 mm thick.
  - Location : Three (3) locking bars per door.
  - Features : Handle to be same direction type.
  - Assembly : Bolted on doors after completion of the painting of container. (Not painted)
  - Treatment : Hot dip galvanized.
- 4.5 Gasket for door
 

Rubber gasket for door is attached with sealing compound. Gasket retainer and blind rivets after painting of the container.

  - 4.5.1 Rubber gasket
    - Geometry : Extruded in double lip "J" section with modified "C" section lower edge.
    - Feature : Continuous gasket with vulcanized corner joint.
    - Assembly : Gasket to be fitted after final painting of container.
  - 4.5.2 Gasket retainer
    - Material : SUS304
    - Gauge : 1.0 mm
    - Feature : Pressed angle section
  - 4.5.3 Securing devices
    - Geometry : 4.8 mm diameter stainless steel blind rivet.
- 4.6 Side
  - 4.6.1 Side top rail
    - Geometry : 60 x 60 x 3.0 mm S.Q. tube
  - 4.6.2 Panel
    - Gauge : Trapezium section 2.0 mm, flat plate 3.0 mm.



- Geometry : Trapezium section corrugated 40 mm depth welded to a flat plate.
- Assembly : Continuously welded externally to side frame and front and rear corner post.

#### 4.7 Roof

- Gauge : 1.6 mm
- Geometry : Die-stamped corrugated steel plate.
- Features : Roof panel will be cambered with approximately 6 mm upward to ensure complete water drainage.
- Assembly : Butt welded together to form one panel by automatic MIG welding.

#### 4.8 Corner fitting

- Geometry : Designed in accordance with ISO/1161



## 5. Preservation

### 5.1 Surface preparation of steel work

#### 5.1.1 Prior to assembly

- 1) All steel components, prior to forming, will be shot blasted to Swedish Standard SA 2.5 and anchor profiles of 25 to 35 microns depth to remove rust, mill scale etc. and applied weldable zinc rich primer approximately 10 microns.
- 2) Locking rod assemblies, which are welded with gear cams, bars holder and handle hinges, bearing brackets and locking handles are hot dipping galvanized (Thickness: minimum 64 microns).
- 3) Hinge blades, hinge lugs, lashing rings, lashing bars and floor cover, gear camkeepers are electro zinc plated. ( Thickness : minimum 8 microns )

#### 5.1.2 After assembly

- 1) All welding slags, spatters and other foreign matters are removed.
- 2) Welded area on the surfaces is shot blasted.
- 3) All steel surfaces are cleaned by means of clean and dry compressed air to remove all shot blasting media and dust before painting.

### 5.2 Painting

The paint to be applied within an hour after shot blasting.

#### 5.2.1 Outside

- |   |   |                                    |
|---|---|------------------------------------|
| 1) Epoxy zinc rich primer                         | : | 30 microns (Including shop primer) |
| 2) Epoxy zinc phosphate primer                    | : | 40 microns                         |
| 3) Acrylic resin finish<br>(RAL 6002, Leaf Green) | : | 50 microns                         |
| Total D.F.T.                                      | : | 120 microns                        |

#### 5.2.2 Inside

- |   |   |                                    |
|---|---|------------------------------------|
| 1) Epoxy zinc rich primer                     | : | 30 microns (Including shop primer) |
| 2) Epoxy high build<br>(RAL 7035, Light Grey) | : | 60 microns                         |
| Total D.F.T.                                  | : | 90 microns                         |

#### 5.2.3 Underside

- |                           |   |   |
|---------------------------|---|---|
| 1) Epoxy zinc rich primer | : | 30 microns (Including shop primer steel parts only) |
| 2) Bitumen/wax.type       | : | 200 microns   |
| Total D.F.T.              | : | 230 microns   |

## 6. Markings

### 6.1 Lettering

The containers will be marked in accordance with owner's marking specifications and other required regulations.

### 6.2 Decal application

Decals will be applied after painting and drying. The adhered surface will be clean and smooth. All dirt and porosity will be removed between decal and adhered surface.

### 6.3 Material

The material of decals is cast vinyl film with permanent adhesive and having a minimum 7 years life. The consolidated certification data plate of CSC approval is of stainless steel and will be engraved in permanent manner and fixed with stainless steel rivets.



## 7. Testing and inspection

### 7.1 Materials and parts inspection

All the materials and parts are inspected by the manufacturer's quality control department to make sure of using the qualified components of the containers.

### 7.2 Proto-type container

A proto-type container manufactured in accordance with this specification will be tested and certified by inspectors nominated by owner.

### 7.3 Proto-type test agenda

	Test item	Test load & method
7.3.1	Stacking	Test load = 65,340 kg/post Offset: 38 mm longitudinally, 25 mm laterally. Internal load = 1.8R-T Time duration: 5 mins.
7.3.2	Lifting from top corner fittings	Internal load = 2R-T: Vertically. Time duration: 5 mins.
7.3.3	Lifting from bottom corner fittings.	Internal load = 2R-T: 30° angled. Time duration: 5 mins.
7.3.4	Restraint	Test load = 2R: 36,300kg per side rail. Internal load = R-T Time duration: 5 mins.
7.3.5	End wall (front & door)	Test load = 0.4P Compressed air is used by air bag. Time duration: 5 mins.
7.3.6	Side wall strength	Test load = 0.6P Compressed air is used by air bag. Time duration: 5 mins.
7.3.7	Floor strength	Truck load = 5,460 kg By ISO test truck.
7.3.8	Roof strength	Test load = 300 kg On 600 x 300 mm center area. Time duration: 5 mins.
7.3.9	Racking (transverse)	Test load = 15,240 kg Two times for pushing & pulling. Time duration: 5 mins.
7.3.10	Racking (longitudinal)	Test load = 7,620 kg Two times for pushing & pulling. Time duration: 5 mins.



※Note

R = Maximum gross weight	:36,300 kg
P = Payload	: 31,935 kg
T = Tare weight	: 4,365 kg

\* Water leaking test

After construction finished, every container will be tested for water tightness with water on floor and spray on wall.

7.4 Batch test

7.4.1 Test frequency

Every 100th container

7.4.2 Test item

Top lifting, bottom lifting and floor strength test to be carried out with same method and procedures as proto-type test.

7.5 Production line of container

7.5.1 Every container will be manufactured under effective quality control procedures to meet the specified standards.

7.5.2 Every container will be checked for dimensions and door operation. Every container will be manufactured under effective quality control procedures to meet the specified



## 8. Warranty

### 8.1 Paint warranty

The paint system applied on the container surfaces will be guaranteed against corrosion and/or paint failure for a period of three (3) years and be based on "RE3" of "European degree of rusting standards". The warranty will be applied to all kinds of faults or failures affecting more than 10% of the painted surface and partial or total repainting will be assured for the container(s) at manufacturer's expense. Normal wear/tear, or corrosion caused by acid, alkaline solution or result from damages by abrasion impact or accident are excluded.

### 8.2 Other warranty

All decals applied for marking will be guaranteed for a period of seven (7) years. All containers will be guaranteed by the manufacturer against any defects and/or omission in construction, poor workmanship and defective materials for a period of one (1) year. The defects set forth herein will be duly rectified in reasonable manners such as replacement, correction, installation or reinforcement to make the container satisfactory to the specification and suitable for its intended service at manufacturer's expense. Any damages caused by mis-handling, mis-securing, mis-loading, impact and other natures of accident are excluded.





## 9. Revision

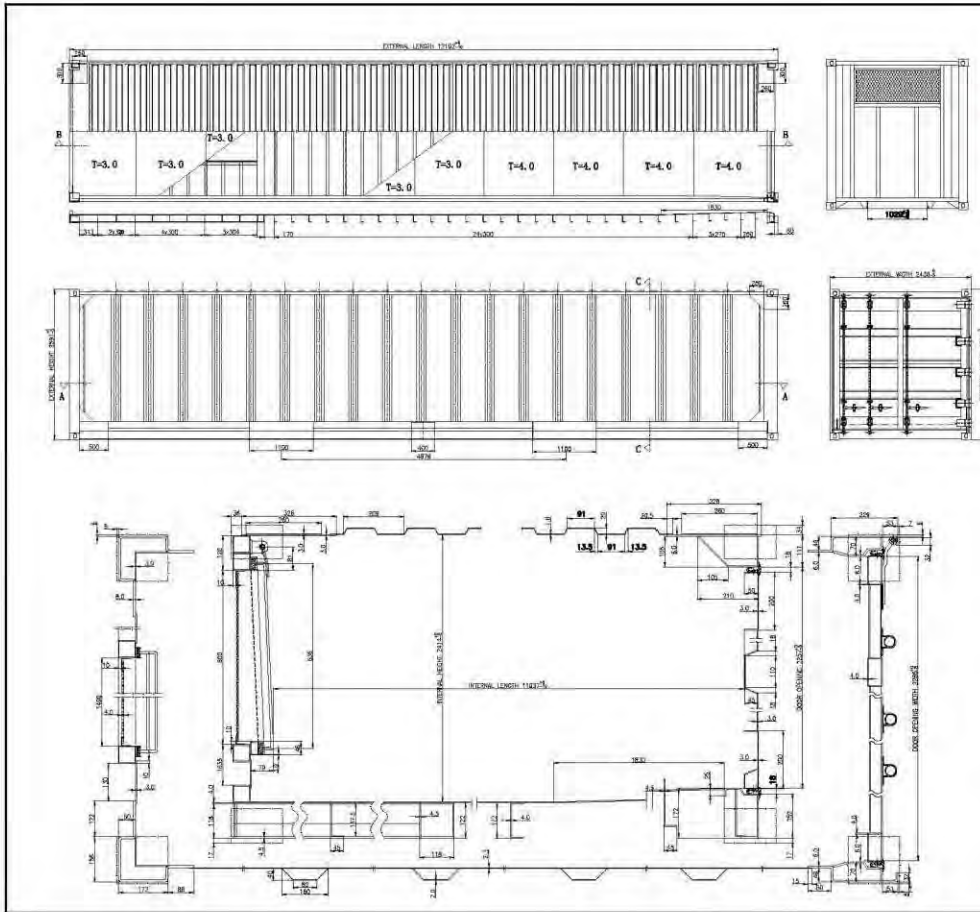
- 1. Changed the tare weight from 4730 kg to 4365 kg.  
Changed the payload from 31570 kg to 31935 kg.

2017.11.17

- 1. Corrected the internal width.

2018.01.04



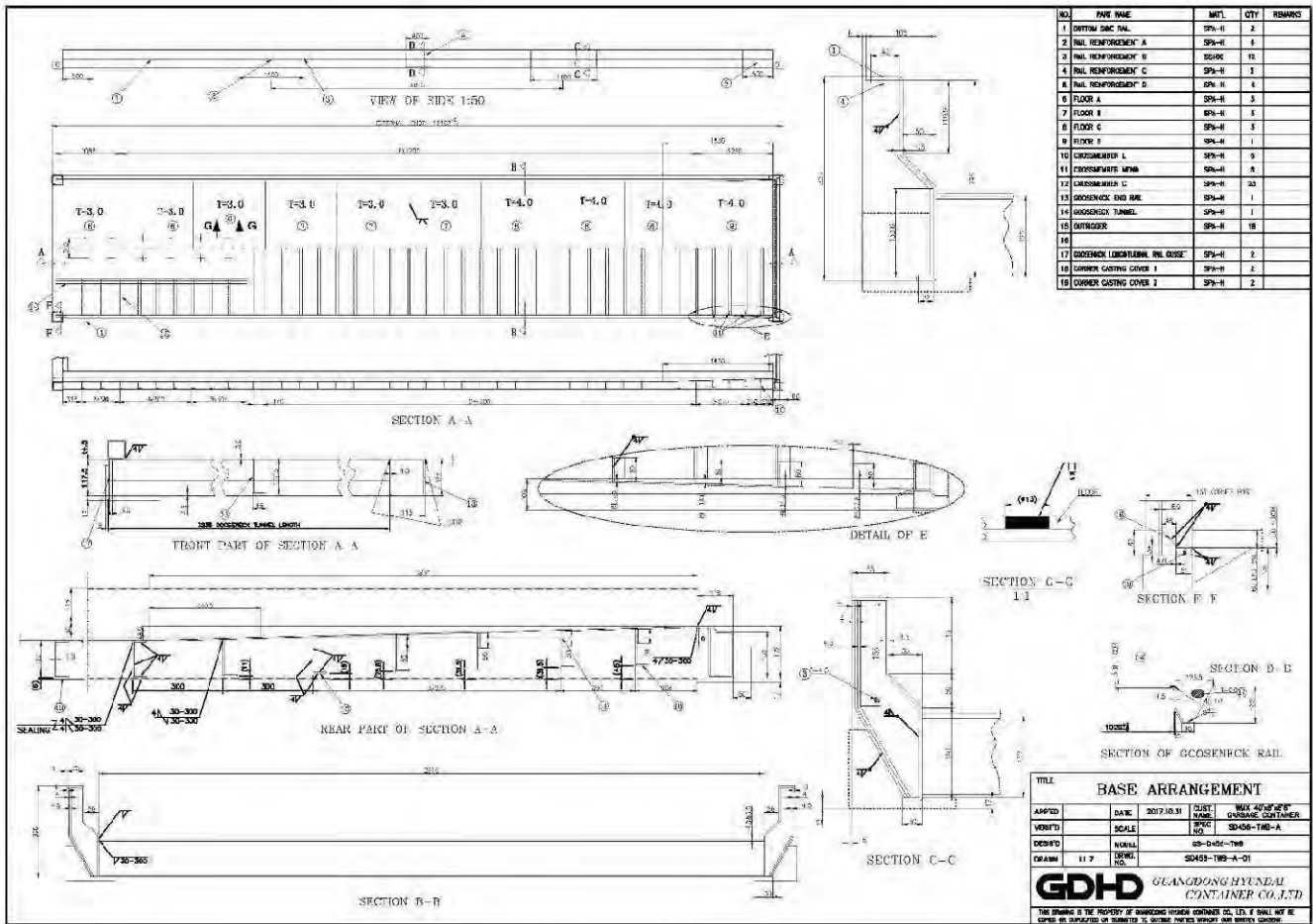


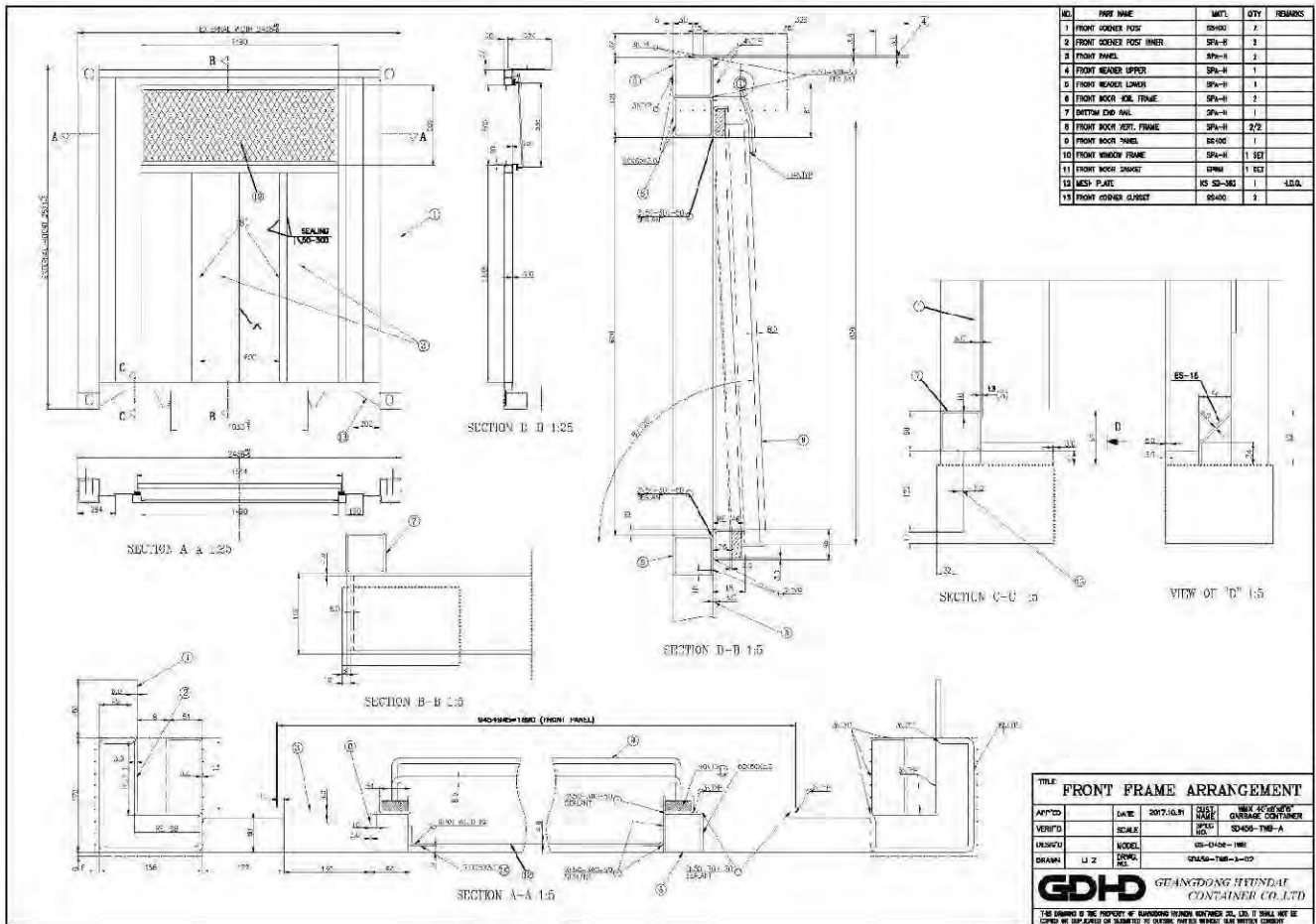
EXTERNAL	LENGTH	12182 mm	40' - 0"	±0.5
	WIDTH	2438 mm	8' - 0"	±0.5
	HEIGHT	2287 mm	7' - 6"	±0.5
DIFFERENCE BETWEEN TWO CHANNELS	DOOR WIDTH INSIDE	2358 mm	7' - 7 1/4"	±0.5
	DOOR HEIGHT INSIDE	2287 mm	7' - 6"	±0.5
INTERNAL	LENGTH	11827 mm	38' - 9 1/2"	±0.5
	WIDTH	2403 mm	7' - 7 1/4"	±0.5
	HEIGHT	2287 mm	7' - 6"	±0.5
DOOR OPENING	WIDTH	2358 mm	7' - 7 1/4"	±0.5
	HEIGHT	2287 mm	7' - 6"	±0.5
MAX. GROSS	WEIGHT	36300 kg	80000 lb	
	TYPE	WEIGHT	4300 kg	9500 lb
MAX. PAYLOAD	WEIGHT	28800 kg	63500 lb	
	TYPE	WEIGHT	3400 kg	7500 lb
NETIC	CUBIC CAPACITY	67.28 CBM	2389 CUFT	

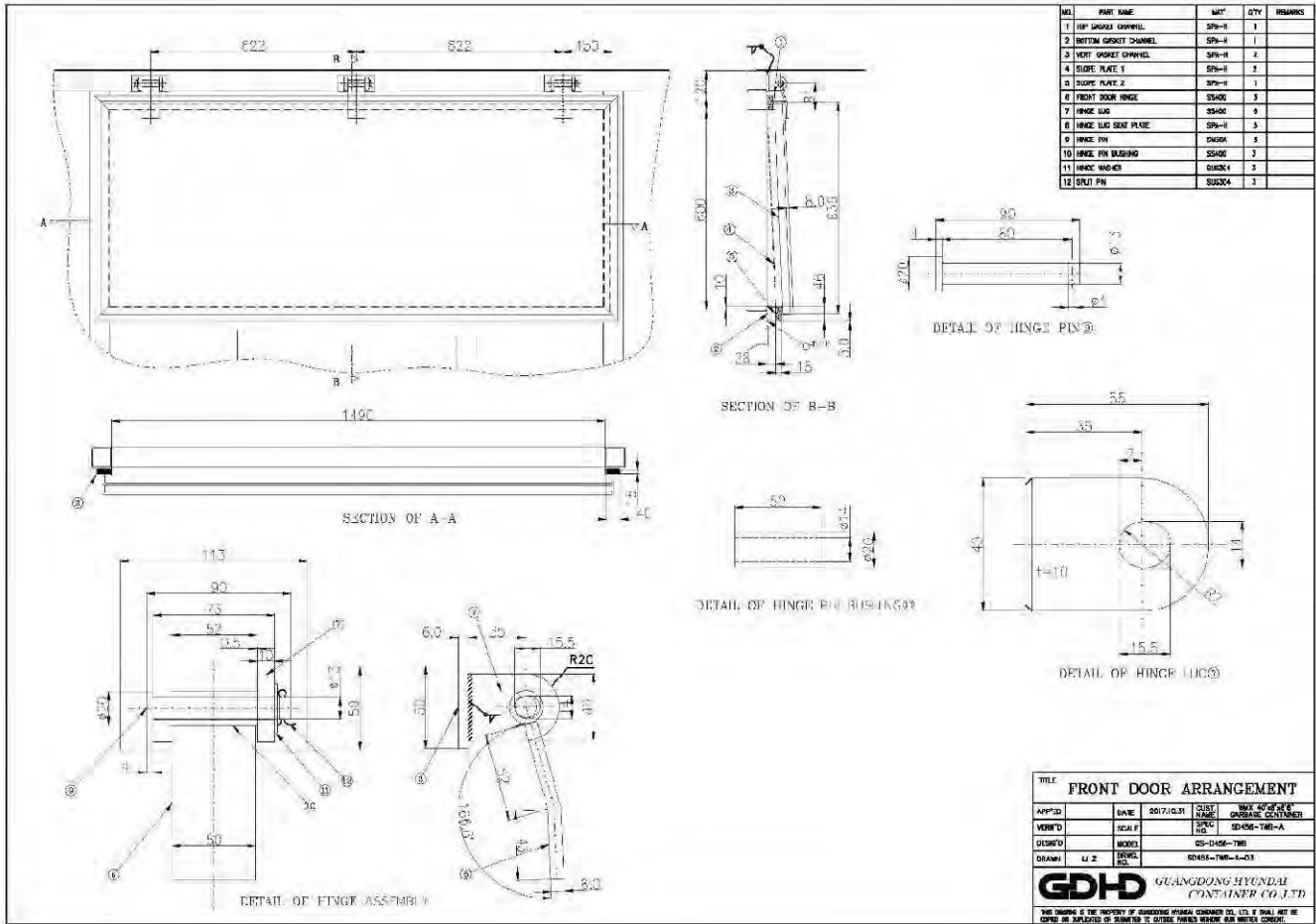
<b>WARNING: EXCESSIVE WEIGHT BEYOND THE INTERNAL WEIGHT.</b>			
<b>WARNING: EXCESSIVE WEIGHT BEYOND THE TARE WEIGHT AND PAYLOAD.</b>			
NO.	REV. DATE	ISSUE	DETAIL OF REVISION
<b>TITLE: GENERAL ARRANGEMENT</b>			
APPROVED	DATE	REV. NO.	REV. BY
DESIGNED	SCALE	NO.	NO.
DRAWN	NO.	NO.	NO.
<b>GDH GUANGDONG HYUNDAI CONTAINER CO., LTD</b>			
<small>THIS DRAWING IS THE PROPERTY OF GUANGDONG HYUNDAI CONTAINER CO., LTD. IT SHALL NOT BE REPRODUCED OR TRANSMITTED IN ANY FORM OR BY ANY MEANS, ELECTRONIC OR MECHANICAL, INCLUDING PHOTOCOPYING, RECORDING, OR BY ANY INFORMATION STORAGE AND RETRIEVAL SYSTEM.</small>			

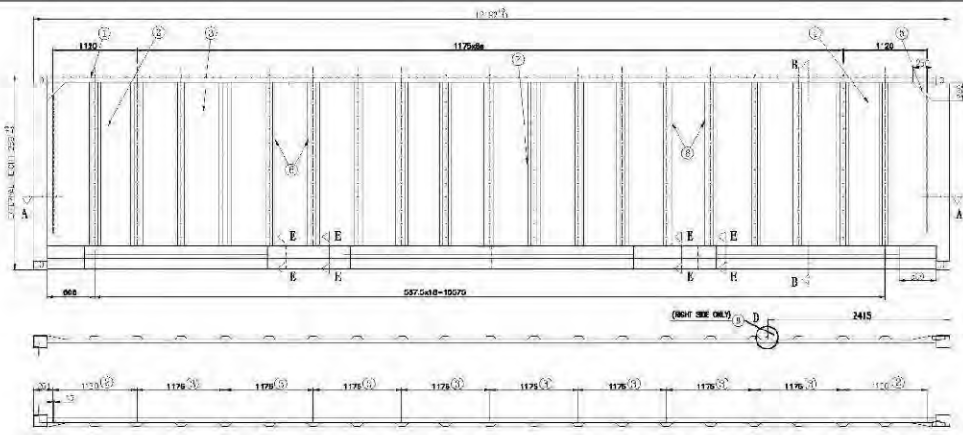




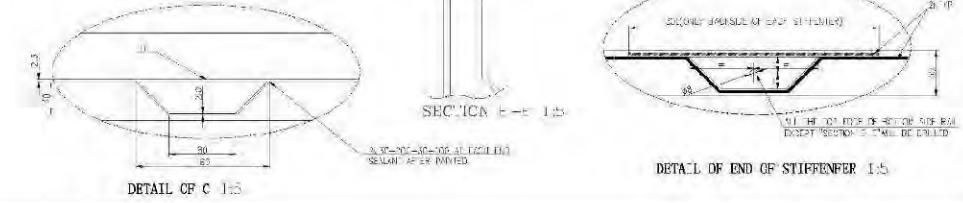
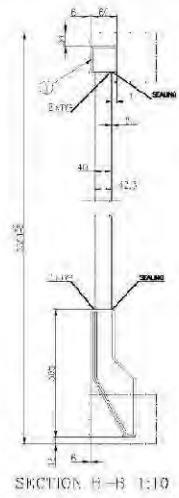
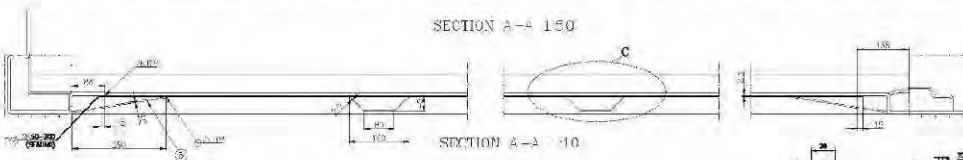








NO.	PART NAME	MAT.	QTY.	REMARKS
1	TOP SIDE PANEL	SPH-H	2	
2	SIDE PANEL A	SPH-H	1	
3	SIDE PANEL B	SPH-H	16	
4				
5	CORNER REINFORCEMENT	SPH-H	8	
6	STP. A	SPH-H	4/4	
7	STP. B	SPH-H	30	
8	DOOR HOOK (RIGHT SIDE ONLY)	SS40C	1	



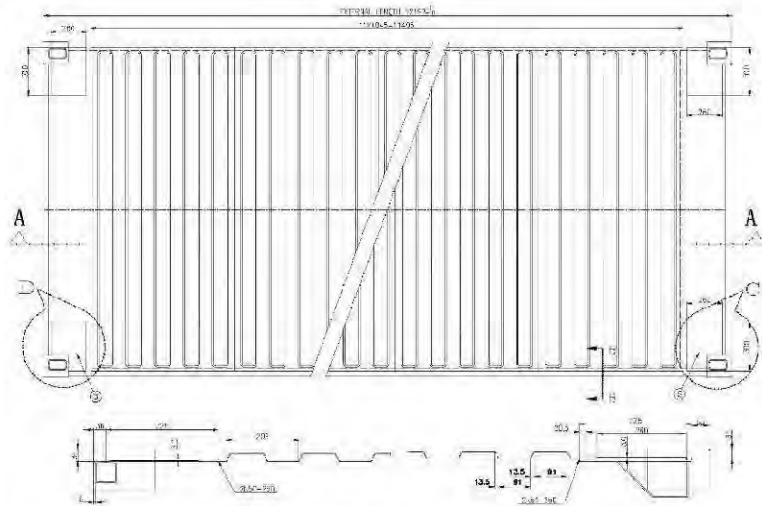
NOTE: L/H SIDE AS DRAWN, R/H SIDE OPPO. HAND

TITLE				
SIDE ARRANGEMENT				
APPROD.	DATE	2017.02.21	DEPT.	MAX. 40' DRY BULK STORAGE CONTAINER
VERIFIED	SCALE		PROJECT	SD-80-TMB-A
DESIGNED	MODEL			CS-D006-TMB
DRAWN	LI 2		REVISED	SD-80-TMB-A-04
<b>GDH</b>		GANGDONG HYUNDAI CONTAINER CO. LTD.		
<small>ALL DIMENSIONS ARE IN MILLIMETERS UNLESS OTHERWISE SPECIFIED. DIMENSIONS IN PARENTHESES ARE FOR REFERENCE ONLY. DIMENSIONS IN BRACKETS ARE FOR INFORMATION ONLY.</small>				

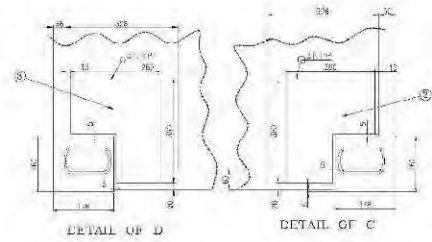




NO.	PART NAME	MAT.	QTY	REMARKS
1	ROOF PANEL	SPR-H	11	
2	ROOF GUSSET	SPR-H	2	
3	FRONT GUSSET	SPR-H	1	

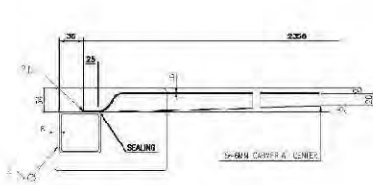


SECTION A-A

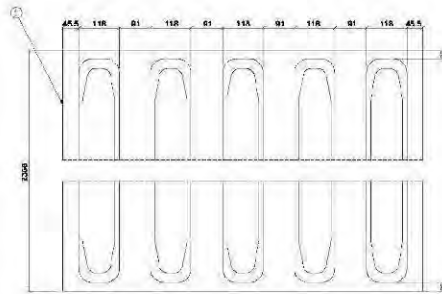


DETAIL OF D

DETAIL OF C

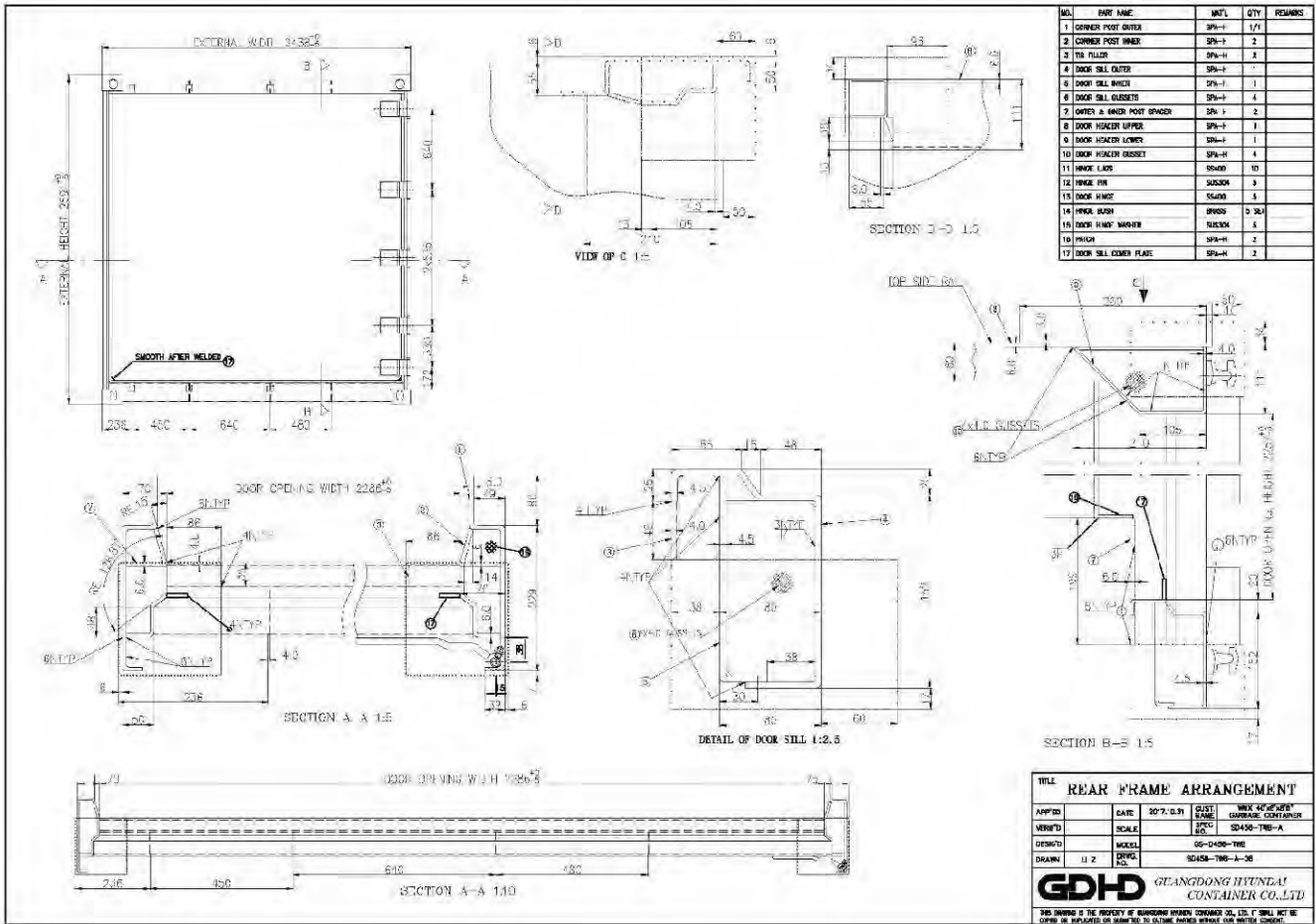


SECTION 3-B



TITLE				
<b>ROOF ARRANGEMENT</b>				
APPROD	DATE	2017.10.21	QTY	11
VERIFIED	BY	SPR-H	NO.	2
DESIGNED	MODEL	GS-D456-TMB	NO.	1
DRAWN	LI 2	SPR-H	NO.	1
<b>GDH</b> GUANGDONG HYUNDAI CONTAINER CO., LTD.				
<small>ALL DIMENSIONS ARE IN MILLIMETERS UNLESS OTHERWISE SPECIFIED. THIS DRAWING IS THE PROPERTY OF GUANGDONG HYUNDAI CONTAINER CO., LTD. &amp; SHALL NOT BE LOANED OR REPRODUCED IN ANY MANNER WITHOUT THE WRITTEN CONSENT.</small>				











# Equipment Specifications: Portland Albina Railyard Equipment Specifications



# MJ 900P TRAVELIFT® PORT 8 WHEEL CRANE SPECIFICATIONS •CONTAINER APPLICATION•



3111 West 167<sup>th</sup> Street, Hazel Crest, Illinois 60429  
Phone (708) 596-5200 • Fax (708) 225-2312  
www.mi-jack.com  
ISO 9001-2000 CERTIFIED

**CAPACITY**.....90,000 LBS (40,823KG)

**STANDARD EQUIPMENT**

20'-40' telescopic "C" series spreader with ISO/ANSI Twist Locks  
• Cummins Diesel QSM11 engine with grid heater • 300 gallon fuel tank • Low oil pressure engine shutdown • High temperature shutdown • Automatic inching control for gantry mode • Solid state over hydraulic stepless controls • Traveling inward facing operator's cab with tinted safety glass • Windshield wiper • Tilting operator's seat • Instrument panel group including oil pressure gauge and hourmeter • 4 Red strobe lights • 4 Motion alarms • Electronic steer • Emergency shutdown for hydraulic tank • Vivid yellow paint w/black wheels • (8) 18.00 x 33 Bias Ply tires • Anti sway for front to back and side to side spreader stability • 90 degree transverse steering

**ENGINE**

Make and Model.....Tier 3 Cummins Diesel QSM11  
Fuel.....No. 2 Diesel  
No. of Cylinders.....6  
Fuel Supply.....Cummins Electronic  
Air Cleaner.....Dry Type  
Oil Filter.....Renewable Cartridge  
Cooling System.....Pressurized Radiator  
Horsepower  
Gross @ Flywheel.....400 hp @ 2100 rpm  
298 kW @ 2100 rpm  
Maximum Torque @ Flywheel.....1,400 lbs. ft. @ 1400 rpm  
1,898 Nm @ 1400 rpm

**ELECTRICAL**

Voltage.....24 Volt  
Alternator.....90 Amps  
Batteries (2).....1400 CCA @ 0°F (-18°C) for 30 sec.

**MAIN HYDRAULICS**

Hoist, Traverse, and Drive Pump.....Electric proportional over variable displacement piston pump

**DRIVE SYSTEM**

Hydrostatic on drive wheels. Fixed displacement piston pump and planetary gearbox with roller chain final drive at each drive wheel.  
Chain.....ANSI 180

**BRAKING SYSTEM**

Service.....Automatic hydrostatic braking  
Parking.....MultiDisc "SAHR"<sup>1</sup>

**STEERING**

Electrically controlled hydraulic power steering. Double acting cylinder, one at each steering wheel yoke. All wheel rotation to 90° and lead wheel steering in normal and transverse mode.

**TRAVERSE (TROLLEY) SYSTEM**

Fixed displacement piston motors and planetary gear boxes at trolley drive wheels. Stepless controls for smooth operation.  
Brake.....MultiDisc "SAHR"<sup>1</sup>  
Wheels.....(4) flangeless wheels with roller guides on rails

**HOIST SYSTEM**

Hoist drum is directly coupled to a planetary gearbox. Hoist is driven by an electric proportional pressure compensated variable displacement motor. Automatic high speed with lighter loads. Direct mounted counter balance valve. Stepless control for smooth operation.

Brake.....MultiDisc "SAHR"<sup>1</sup>  
Wire Rope (Hoist).....7/8" EEIPS, Class 6x37 Warrington Seale Reeving.....trolley / spreader - 8 parts  
Sheave Pitch Diameter (Hoist).....27.78" (706mm)  
Wire Rope (Anti-Sway).....5/8" DYFORM® 6  
Sheave Pitch Diameter (Anti-Sway).....18.13" (461mm)

**PERFORMANCE**

Traverse Speed.....220 fpm (67 m/min)

Hoist Speed

Rated Capacity.....65.0 fpm (20 m/min)  
Empty.....130.0 fpm (40 m/min)

Level Drive Speed at Rated Capacity	Gradeability at Rated Capacity Paved
--	--

Laden (Forward and Reverse)....4.2 mph (6.8 km/h)....2.2%

**SERVICE CAPACITIES**

	U.S.	METRIC
Fuel Tank.....	300 gals	1136L
Hydraulic System <sup>2</sup> .....	175 to 225 gals	662 to 851L
Hydraulic Reservoir.....	130 gals	492L
Hydraulic Reservoir (Spreader).....	45 gals	170L
Cooling System.....	33 qts	31L
Engine Oil (w/Filter).....	36 qts	34L
Pump Drive Transmission.....	4 qts	3.8L

**CAB**

Solarium view cab design for operator's comfort and maximum visibility. Joystick fingertip controls for safe and smooth operation.

**OPTIONAL EQUIPMENT**

Cab air conditioning • Cab heater • Camera system for crane corners and spreader • Intercom communication system • Optional crane dimensions • Drive disable wheel guards • Auto guidance (Steering) • Wheel chocks • Manual side guides for spreader • Trolley mounted maintenance jib • Automatic cable lubrication • Automatic steering lubrication • Spreader damage prevention system • Weigh load system • Storm tie downs • Fire suppression package • Spreader skew in each direction, ± 5° • Spreader pitch in each direction ± 2.5° • Intermediate spreader stops of 30' or 35' • Tool package • Hydraulic driven generator to power two cab works lights and the air conditioner at low engine idle which automatically switches on when the Travelift's primary functions have not been utilized for ten minutes • 500 gallon fuel tank • Circle steer about crane center

1-"SAHR" spring applied hydraulic release; Automatic Actuation; No mechanical adjustment

2-System capacity varies depending on height and width of unit.

NOTE: MI-JACK PRODUCTS reserves the right to change specifications without notice and without incurring any obligation relating to such a change.

10/31/07





## MJ 900P TRAVELIFT® PORT CRANE

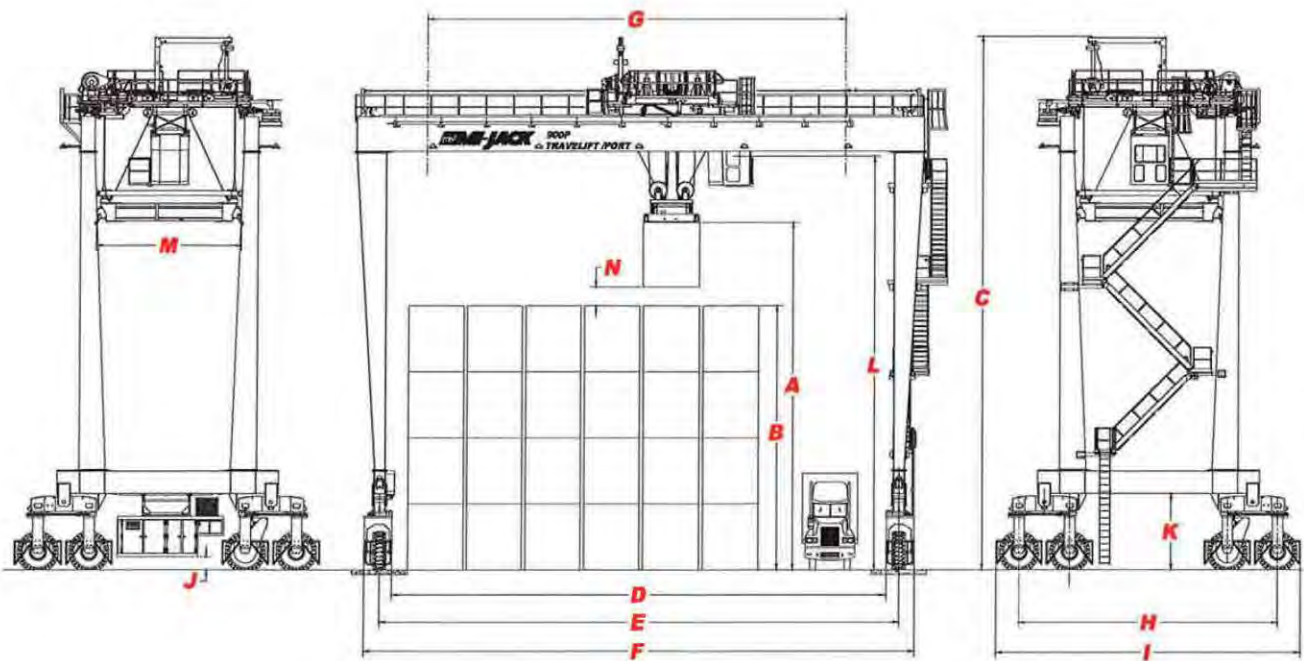
### ESTIMATED SHIPPING WEIGHTS:

TWISTLOCK HT	ICW 6+1W	37' 4"	WB
40'-6" 4H = 1 over 3	279,176 lbs 126,633 kg		
50'-0" 5H = 1 over 4	287,000 lbs 130,182 kg		

### GROUND BEARING PRESSURE:

TWISTLOCK HT	ICW 6+1W	37' 4"	WB
40'-6" (minspan) 4H = 1 over 3	131 psi 903 kPa		
50'-0" (minspan) 5H = 1 over 4	132 psi 910 kPa		

### DIMENSIONAL DATA



Any combination of widths, heights, and lengths shown are available except as noted in charts. Dimensional variations may occur based upon optional equipment characteristics. All crane dimensions are capable of full capacity. Consult factory for optional dimension and ratings.

A	B	C	D	E	F	G
HEIGHT TO BTM OF SPRADR	HEIGHT OF CONTAINER	OVERALL HEIGHT	I.C.W. <sup>(1)</sup> (6+1W)	TREAD WIDTH	OVERALL WIDTH AT GROUND <sup>(2)(3)</sup>	TROLLEY TRAVEL
3H 31'-0" (9.45 m)	19'-0" (5.79 m)	57'-10" (17.63 m)				
4H 40'-6" (12.34 m)	28'-6" (8.69 m)	67'-4" (20.52 m)	71'-5" (21.76 m)	75'-0" (22.86 m)	79'-5" (24.21 m)	60'-5" (18.42 m)
5H 50'-0" (15.24 m)	38'-0" (11.58 m)	76'-10" (23.42 m)				

H	I	J	K	L	M	N
WHEELBASE	OVERALL LENGTH	GROUND TO ENG. FRAME	GROUND TO SIDE BEAM	OPERATOR EYE LEVEL	SPREADER TWISTLOCKS <sup>(4)</sup>	CONTAINER CLEARANCE <sup>(5)</sup>
37'-4" (11.38 m)	44'-1" (13.43 m)	2'-1" (0.64 m)	11'-2" (3.40 m)	40'-6" (12.34 m) 3H 50'-0" (15.24 m) 4H 59'-6" (18.14 m) 5H	20'-0" to 40'-0" (6.10 m to 12.19 m)	2'-6" (0.76 m)

(1) Measured from face of yoke. Subtract 4" (0.10 m) for service box mounted on inside of sidebeam

(2) Add 6'-3" (1.9 m) for overall width at top.

(3) Add 13" (0.3 m) for Cab travel beyond overall width at top.

(4) Add 10" (0.25 m) to SPREADER TWISTLOCKS for overall length

(5) Dimension of containers shown are 8' wide by 9'-6" high

**NOTE:** All heights above ground include 3" tire deflection for an unloaded crane. Up to 2" additional should be deducted for tire deflection at rated load. Inside, outside and height dimensions are nominal and may vary due to manufacturing standards and structural deflection. 10/31/07

**NOTE:** MI-JACK PRODUCTS reserves the right to change specifications without notice and without incurring any obligation relating to such a change.









## TS-9972 Reach Stacker

### Specifications

Rated Container Capacity 99,000-lbs. (45 t)

First Row / 4-high Stacking 9.5-ft. (2.9 m)

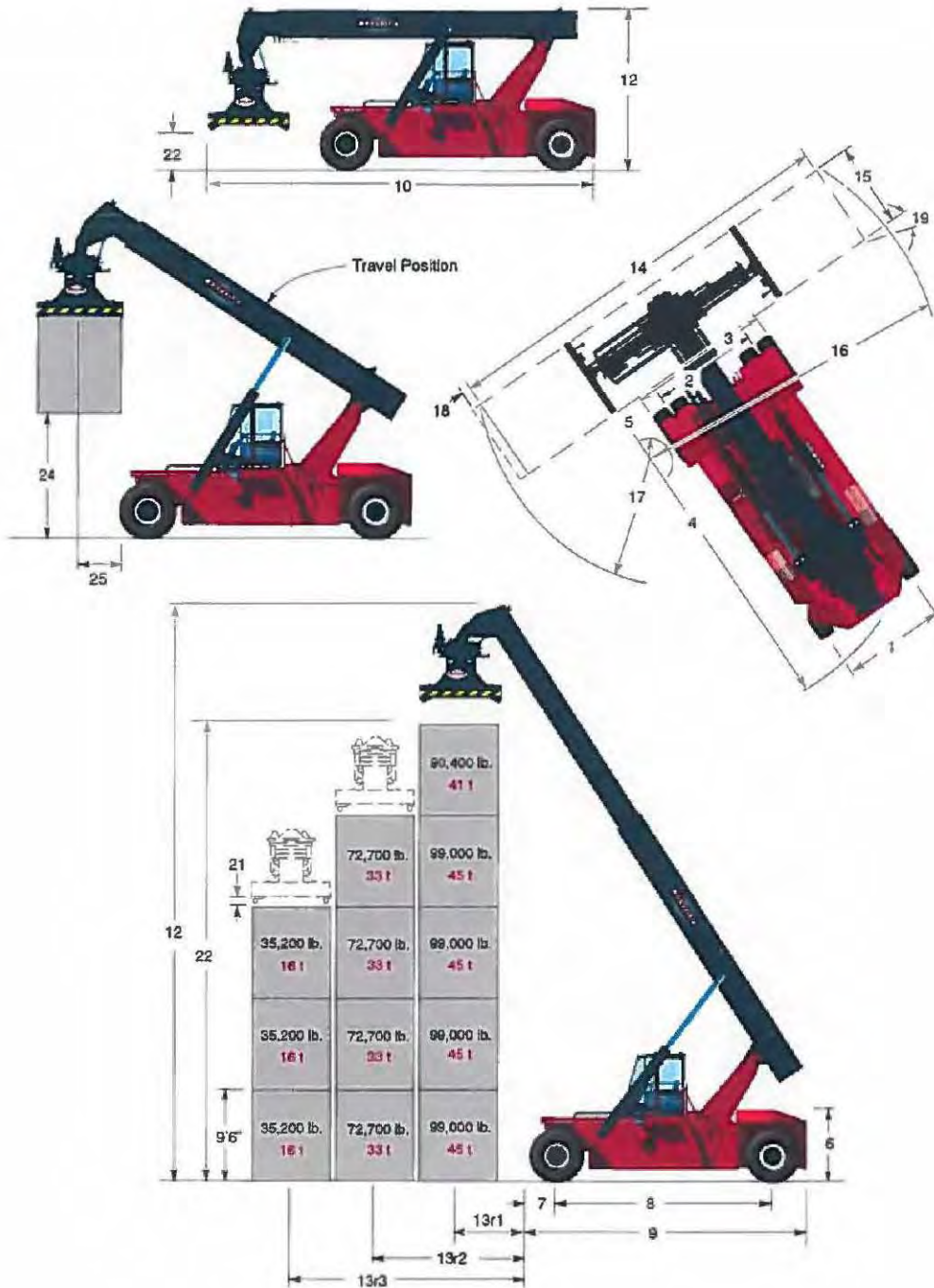
Rated Container Capacity 90,400-lbs. (41 t)

First Row / 5-high Stacking 9.5-ft. (2.9 m)

256-in. (6,500 mm) Wheelbase



# TS-9972 Reach Stacker



# TS-9972 Reach Stacker

Manufacturer's Name		TAYLOR				
Manufacturer's Designation		TS-9972 Reach Stacker				
		English		Metric		
Rated 9.5-ft. (2.9 m) Container Capacity	1st Row 4-High 9.5-ft. (2.9 m) Stack Capacity At 81"-in. (2 057 mm) Cent. Of Grav.	lb (t)	89,000		45	
	1st Row 6-High 9.5-ft. (2.9 m) Stack Capacity At 81"-in. (2 057 mm) Cent. Of Grav.	lb (t)	80,400		41	
	2nd Row 4-High 9.5-ft. (2.9 m) Stack Capacity At 157"-in. (3,988 mm) Cent. Of Grav.	lb (t)	72,700		33	
	3rd Row 3-High 9.5-ft. (2.9 m) Stack Capacity At 257"-in. (6,528 mm) Cent. Of Grav.	lb (t)	35,200		16	
Nominal Load Moment With Attachment 1st Row And 99,000-lbs. (45 t) Load		in-lb (N-m)	11,246,400		129,581	
Tractive Effort At Stall		lb (kN)				
Vehicle Weight - Empty	Drive Axle	lb (kg)	82,000		37,194	
	Steer Axle	lb (kg)	79,500		36,060	
Vehicle Weight - Loaded With 99,000-lbs. (45 t) Load	Drive Axle	lb (kg)	220,500		100,017	
	Steer Axle	lb (kg)	38,800		18,892	
Tires - Drive And Steer			18.00 x 25 - 40 PR E4 Smooth Tread			
Tire Inflation Pressure (Contact Pressure)		psi (Bar)	145		10	
<b>Machine Dimensions</b>						
1 - Width Across Counterweight		in (mm)	136		3,454	
2 - Tread Width, Drive Axle		in (mm)	120		3,048	
3 - Width Over Drive Tires		in (mm)	185		4,191	
4 - Outside Turn Radius (Tailswing)		in (mm)	330		8,382	
5 - Inside Turn Radius		in (mm)	32		813	
6 - Height To Top Of Counterweight		in (mm)	84.5		2,146	
7 - Drive Axle CL To Face Of Tires (Nominal)		in (mm)	32.0		800	
8 - Wheelbase		in (mm)	256		6,500	
9 - Overall Length Of Chassis		in (mm)	328		8,331	
10 - Overall Length Of Complete Unit (Boom Down And Retracted)		in (mm)	460		11,684	
11 - Overall Manual Movement Of Cab Forward For Servicing		in (mm)	90		2,438	
12 - Height To Top Of Boom	Fully Lowered	in (mm)	188		4,775	
	Fully Raised	in (mm)	710		18,034	
Operator Eye To Ground Approximate		in (mm)	132		3,353	
<b>Attachment Dimensions</b>						
13 - Center Of Gravity Distance From Tire Face (Container Stacking)	1st Row (r1)	in (mm)	81		2,057	
	2nd Row (r2)	in (mm)	157		3,988	
	3rd Row (r3)	in (mm)	257		6,528	
14 - Length Of Attachment (Nominal)	Expanded	in (mm)	480		12,192	
	Retracted	in (mm)	240		6,096	
15 - Width Of Attachment (Nominal)		in (mm)	96		2,438	
16 - Turn Radius, Far Corner Of Container (Retracted)		in (mm)	257	6,528	370	9,398
17 - Turn Radius, Near Corner Of Container (Retracted)		in (mm)	109	2,769	167	4,242
18 - Sideshift ±		in (mm)		31.5		800
19 - Attachment Rotation (CW / CCW)		deg.°		85 / 185		
20 - Boom Angle (Max)		deg.°		59.5		
21 - Length Of Twistlock Below Attachment (Nominal)		in (mm)		4		102
22 - Height To Tip Of Twistlock - Min. / Max		in (mm)	44	1,118	594	15,086
23 - Minimum Aisle For 90° Stacking with 4-in. (102 mm) Clearance		ft-in (m)	447	11,350	528	13,408
24 - Bottom Of 9.5-ft. (2.9 m) Container To Ground At Travel Position		in (mm)		139		3,531
25 - Center Of Gravity Distance At Travel Position		in (mm)		35		899
26 - Mechanical Pile Slope end to end (non-powered 3°)		in (mm)	12	305	24	610
27 - Underclearance midway along the wheelbase		in (mm)		14		356
<b>Travel And Lift Speeds</b>						
Travel Speed (Max) - Forward And Reverse		mph (km/h)	14.0	22.5	13.3	21.4
Lift Speed (Max)		fpm (m/s)	42	21	40	20
Lowering Speed (Max)		fpm (m/s)	60	31	60	31

**NOTE:** Performance specifications are for machines equipped as described on the back page of this specification sheet. Performance specifications are affected by the condition of the vehicle, its components, and the nature and condition of the operating area. If these specifications are critical, the proposed application should be discussed with your Taylor sales representative.

Contact factory for capacities, stack heights, and unit weights if optional pile slope is added.





## TS-9972 Reach Stacker

### Engine

Cummins QSM11-C335 electronic turbocharged, charged air aftercooled (air to air) diesel engine. Rated power of 335-hp (250 kW) at 2100 rpm. Maximum power of 365-hp (272 kW) at 1800 rpm. The 4-cycle in-line 6 cylinder engine has 660 cubic in. (10.8 liter) displacement. The bore is 4.92 in. (125 mm) x 5.79 in. (147 mm) stroke. Peak torque is 1235 ft-lbs (1674 N-m) at 1400 rpm (SAE J1349). This peak torque is maintained from 1000 to 1400 rpm. Emission certification: US EPA Tier III, Carb Tier III, EU Stage III. 180 gal. (681 L) fuel tank.

Standard features are electronic diagnostic and maintenance monitor, fuel/water separator and engine/transmission protection systems. Equipped with engine and transmission protection systems which include engine kill for high coolant temperature, high or low oil pressure, low coolant level, and transmission high oil temperature.

### Air Cleaner

The 2-stage heavy-duty, dry type air cleaner has a built-in pre-cleaner, safety element, and a restriction warning light.

### Cooling System

The deaeration tanks location allows the coolant level to be checked from ground and provides optimum engine cooling.

### Electrical, Instrumentation, and Accessories

Electric / electronic control of the machine is based on CANBUS technology with diagnostic capability.

The instrument panel is pre-wired to accommodate heavy-duty accessories. All wiring is number coded.

Standard equipment includes a key-type anti-restart ignition system, 24 volt two 200 amp-hour batteries, a main battery disconnect switch, indicator lights, thermal reset circuit breakers, back-lighted instruments.

Ten work lights, 4 on Boom (controlled by one switch), 2 on each side approximately at mid point of outer boom. 4 on chassis (controlled by one switch), 1 on each side of counterweight, 2 on front of chassis, 1 on each side at front fenders, 2 on attachment, 1 each end to illuminate rear twistlock housing and container casting approach. The amber rotating lights, forward-actuated warning alarm, reverse-actuated warning alarm, are all key-switch actuated. The inside and outside rear view mirrors are standard.

Tail lights, stop lights, turn signal lights, air horn, and tilt steering are standard.

The load moment indicator includes digital gauges, indicators, and warning lights including load messages, in cab twistlock indicator lights, transmission messages and gear indicator, voltmeter / ammeter gauge, fuel low level indicator, engine coolant temperature gauge, engine oil pressure gauge, transmission oil temperature gauge, fuel gauge, hour meter and speedometer indicator, and engine RPM gauge. Tier III engine electronic diagnostic light package.

A rear visibility aid camera system, diagnostic through display for attachment, and air conditioning are standard.

### Transmission

The four-speed, electronic, fully reversing, modulated, powershift transmission has declutch with brakes behind the declutch feature and an electric shift control. An Automatic Powershift Control feature is standard. The filler pipe dipstick and large, heavy-duty, oil filter are easily accessible. Separate coolant to-oil cooler. The integrally built torque converter has constant-mesh gear sets actuated by hydraulic clutch packs.

### Drive Axle

The high-stability, wide stance, planetary drive axle's housing is bolted to the frame.

### Steer Axle

The single-cylinder design steer axle with tapered wheel bearings is fully sealed and never needs adjusting.

### Brake System

The internal force-cooled, wet disc, service brakes (and the hydraulic oil) are cooled by a cooler separate from the transmission cooler. The drive-axle mounted disc brake is spring applied for parking and air actuated for parking brake off.

### Power Steering

The hydrostatic steering system with priority valve provides constant response at all engine speeds.

### Chassis

The all-welded frame has a bolt-on, contoured, counterweight. Hinged doors and bolt-on covers provide easy access to all service points. Center mounted cab with skyview window can be hydraulically moved to access components. The standard cab is shock mounted and has a tinted and laminated front windshield; all other glass is safety glass. The standard cab also has electric front, rear and top wipers, a heater/defroster with front and side window defrosting and air conditioning. The adjustable, air suspension seat has flip-down, adjustable angle arm rest and an orange operator seat belt.

### Hydraulic System

The large capacity hydraulic tank has a tank breather, return line filters with replaceable elements in the tank, and an external sight gauge. An air-to-oil cooler, separate from the transmission cooler, cools the hydraulic system oil (and service brakes). The variable displacement type pumps are converter driven. The system has load sensing with proportional distribution controls for the boom lifting and extension controls. The dual, double-acting lift cylinders are pinned to the boom, powered up and not powered down (gravity only), when lowering the boom. All cylinders have chrome-plated rods, and self-adjusting packing. The valves are controlled by a conveniently located multifunctional arm rest mounted "joystick" control lever. Lift and boom extension are electric over hydraulic. All other functions are electric over hydraulic. 150 gal. (568 L) hydraulic tank.

### Boom and Container Attachment

The telescopic boom is high-strength steel. Double-acting hydraulic cylinders provide precise boom movements. The expandable attachment has standard ISO twistlocks for 20-ft. (6.1 m) and 40-ft. (12.2 m) positions. The hydraulic motor and gear reduction system permit 95° CCW and 185° CW attachment rotation. The attachment has +/- 31.5-in. (800 mm) sideshift. Electrical safety sensors prevent twistlocks from being locked or unlocked when not "seated," and prevent attachment extension or retraction when twistlocks are "locked" or "seated." A twistlock safety interlocking system ensures correct locking procedure. In cab signal lights are amber, green and red. Two twistlock work lights are standard.

This vehicle is certified to meet the applicable design and performance criteria required for Powered Industrial Trucks in OSHA Safety and Health Standards, Title 29 CFR, Part 1910.178, and the applicable design and performance requirements in ANSI B56.1 that were in effect at the time of manufacture. These standards also apply to the user and should be adhered to while operating this vehicle.

This vehicle is also certified to meet the applicable design and performance criteria required by F.E.M. 4.001q stability standard for freight container handling variable reach industrial trucks.

All specifications are subject to change without notice. Some operating data may be affected by the condition of the operating area. If these specifications are critical, contact the factory.

**Taylor Machine Works, Inc.**  
650 North Church Avenue  
Louisville, Mississippi 39339-2017  
Phone (662) 773-3421 Fax (662) 773-9146

TS-7 (3/10)  
Printed in U.S.A.





# Equipment Specifications: Columbia Ridge Railyard and Tractor Equipment Specifications





## Taylor “Big Red” Loaded Container Handlers

THDC-954/THDC-955 at 101-in load center / Rated Capacity 80,000-lbs. at 2-High Stacking  
 THDC-954 Rated Capacity 75,000-lbs. at 3 and 4-High Stacking / THDC-955 Rated Capacity 75,000-lbs.  
 at 3, 4 and 5-High Stacking / 236-in wheelbase

THDC-974 at 97-in Load Center / Rated Capacity 90,000-lbs. at 2-High Stacking  
 Rated Capacity 85,000-lbs. at 3 and 4-High Stacking  
 106-in Load Center / Rated Capacity 82,000-lbs. at 2-High Stacking  
 Rated Capacity 80,000-lbs. at 3 and 4-High Stacking / 236-in wheelbase

THDC-975 at 97-in Load Center / Rated Capacity 90,000-lbs. at 2-High Stacking  
 Rated Capacity 80,000-lbs. at 5-High Stacking  
 106-in Load Center / Rated Capacity 82,000-lbs. at 2-High Stacking  
 Rated Capacity 75,000-lbs. at 5-High Stacking / 236-in wheelbase





## Taylor Loaded Container Handler Series THDC-954 /955 and THDC-974 /975

- Tier III Cummins QSM11-335 turbocharged engine
- Three speed fully reversing, modulated, powershift transmission with declutch and electric shift control
- Rugged high-strength, all welded chassis and frames
- Ergonomically designed shock-mounted operator stations
- Fingertip full hydrostatic steering
- Lower fan speed and engine speed for less noise
- Large 240-gallon capacity steel wall fuel tank
- Large 200-gallon capacity steel wall hydraulic tank
- Cooling system with wide fin spacing to reduce dirt build-up and provide optimum engine cooling
- Meets new proposed ANSI B56.1 standard
- All daily checks can be made from running board



Drive axle



Steer axle

### Steer Axle

Single hydraulic cylinder design with tapered wheel and king-pin bearings is fully sealed and never needs adjusting. Greaseable heavy trunnion mounts with replaceable bearings. Through bolt cylinder mounting. Simple, proven durable design with links directly to spindle.

### Drive Axle

The high stability, wide stance outboard planetary drive axle utilizes a hypoid ring gear and pinion. Proven, force cooled, wet disc brakes. Axle mounted spring-on, air-off parking brake with brake saver system does not allow operator to drive through parking brakes. Friction type rims for easy mounting and dismantling.

### Hydraulic System

Large 200-gallon capacity hydraulic tank has a spin-on tank breathers, dual wire-mesh strainers, and a full flow, 10-micron, return-line filters with a replaceable elements in the tank. Controls valves are separate, stacked, spool-type. The tilt-lock valve prevents mast drift and reduces torsional stress. Self-aligning, bearing mounted, lift cylinders have chrome rods and self-adjusting packing. Hydraulic oil is cooled through an air/oil cooler on the fan side of the radiator. Hydraulic system utilizes a converter driven gear type pump. Bolt-on tank for easy removal and cleaning.



THDC-955

### Engines

Tier III certified Cummins QSM11-335 electronic turbocharged, charge-air-cooled diesel. 335 gross brake horsepower at 2,100 rpm and 365 gross brake horsepower at 1,800 rpm. Peak torque 1235 ft-lbs. at 1400 rpm. Includes engine and transmission protection system. Electronic diagnostics on engine with fault code history for fast problem location. Built in shut down system standard. High capacity cooling system for dependable operation in all environments. Serviced from running board. 240-gallon fuel tank capacity.



### Transmission

Heavy-duty 3-speed powershift transmission has operator controlled air declutch. Separate air to oil transmission cooler. Transmission cooler has wide fin spacing to resist plugging. Flexplate drive. Full direction modulation. Filter is remote mounted to reduce oil spills.



Cummins QSM11-335



Remote mounted transmission cooler

### Electrical System

The 1-piece instrument panel is prewired with color coded wiring to accommodate heavy-duty accessories with flip down service access. Gauges include fuel level, ammeter, hour meter, air pressure, engine oil pressure, engine coolant temperature, transmission oil pressure, and transmission oil temperature. 12-volt electrical system and two 220-amp hour batteries; 160-amp alternator.

### Brake System

The internal force-cooled, wet disc, service brakes are air-actuated and utilize a pedal to combine transmission declutch and brakes. The parking brake control is mounted on the instrument panel. The drive line brake is spring applied for parking.





## Operator Station

Ergonomically designed to provide maximum comfort and ease of control for the operator. Center mount, two-door elevated operator cab is shock mounted with excellent visibility through mast, forward and rear, meeting proposed visibility standards. Easy on/off access to operator station with anti-slip steps and handrails for 3-point mounting and dismounting meets proposed ANSI B56.1 standard. Durable premium vinyl adjustable mechanical suspension seat with arm rests and anti-cinch operator restraints allows movement for operator comfort. Fingertip full hydrostatic steering. Multi-function joystick and accessory controls are conveniently located. Tilt steering wheel. Convex, wide angle rear view mirrors. Left pedal combines both brake and inching controls. Forward and reverse alarm standard.



Conveniently mounted gauges and systems warning lights and controls



Anti-slip steps and handrails for 3-point mounting and dismounting (meets new proposed ANSI B56.1 standard)



Tilt steering



Hinge down instrument panel



Joystick control with individual fingertip hydraulic and electronic controls for smooth precise control



Excellent visibility forward and rear meeting proposed visibility standards

## Attachment

Four point top pick loaded container attachment. Rated capacity 80,000-lbs. on THDC-954 and THDC-955. Rated Capacity 90,000-lbs. on THDC-974 and THDC-975. THDC-954 and THDC-974 stack 4-high 9'6" THDC-955 and THDC-975 stack 5-High 9'6" Handles ISO containers 8' to 8'6" wide, 8' to 9'6" high and 20' to 53' long. Twistlock interlock system ensure correct locking procedure.  $\pm 24"$  side shift. Twistlock work lights and signal lights.  $\pm 5$  degrees hydraulic slewing. 5-in reach on THDC-954 and THDC-955. 9-in. reach on THDC-974 and THDC-975. 3 degrees non-powered pile slope standard.  $\pm 4$  degrees hydraulic pile slope optional.



Note: Components are subject to change without notice.

## Mast / Carriage

Standard ULTRA-VU 2-stage mast with excellent visibility. 32-ft 6-in lift on THDC-954 and THDC-974. 42-ft. lift on THDC-955 and THDC-975. Common greaseable, shielded main rollers with dual tapered type bearings. Common side thrust wear pads are adjustable. Mast pivot housing is 2-piece bolt-on for easy, safe service removal. Dual flow fuses prevent load from falling in event of hose failure. Emergency manual lowering valve system.



THDC-955



THDC-954







## After Market Support

"You Can Depend On Big Red" is a personal and collective commitment from the Taylor "Big Red" Team to every customer. Customer needs and expectations are priorities for Taylor engineering, manufacturing, marketing, and service organizations. Sudden Serv Inc. and our worldwide Taylor dealer network are ready to respond to your requests for support requirements twenty-four hours a day, seven days a week!

Warranty - 12 month or 2,000 hours parts and labor. Optional warranties are available.



THDC-974

### Standard Equipment List

Cummins QSM11-335 Electronic Turbocharged, Charge-Air-After-Cooled (Air to Air) Diesel Engine • 240 Gallon Capacity Heavy Gauge Steel Fuel Tank w/Lockable Fuel Cap and Strainer • 2-Stage Dry-type Air Cleaner w/Safety Element, Restriction Indicator • 12-Volt Electrical System w/160 Amp Alternator • Reset Circuit Breakers • Key-type Anti-restart Ignition System • Tilt Steering • 220 Amp-Hour Batteries • Air Horn • Keyswitch-actuated Amber Strobe Light • Reverse-actuated Backup Alarm • Forward Alarm • Rear View Mirrors • Powershift Transmission - 3-Speed Fully Reversing Modulated, w/Declutch and Electric Shift Control • Single Hydraulic Cylinder Designed Steer Axle • Wide Stance Outboard Planetary Drive Axle with Hypoid Ring Gear and Pinion w/ Wet Disc Brakes • Transmission Mounted, Spring Applied, Air Off Parking Brake w/ Brake Saver System • Fingertip Full Hydrostatic Steer-On-Demand Steering System • Multi-function Joystick Controls • Center Mount, 2-Door Elevated Operator Cab Shock Mounted w/Skyview Window • Vinyl Covered Mechanical Suspension Seat w/Arm Rest and Anti-cinch Operator Restraint • Large 200-gallon capacity Hydraulic Tank • Spin-on Tank Breathers with Dual Wire Mesh Strainers and Full Flow 10-Micron Return Filters • ULTRA-VU 2-Stage Mast Standard 32-ft 6-in Lift on THDC-954 and THDC-974 • 42-ft Lift on THDC-955 and THDC-975 • Greaseable Mast and Carriage Main Rollers w/ Shielded, Tapered Roller Bearings and Chain Rollers w/ Shielded Tapered Roller Bearings • Handles ISO containers 8' to 8'6" wide, 8' to 9'6" high and 20' to 53' long • Twistlock interlock system ensures correct locking procedure • ± 24" side shift • Twistlock work lights and signal lights • ± 5 degrees hydraulic stowing • 5-in reach on THDC-954 and THDC-955 • 9-in. reach on THDC-974 and THDC-975 • 3 degrees non-powered pile slope standard • ± 4 degrees hydraulic pile slope optional • 18.00R25 Radial Tires • Support Data Supplied Upon Delivery



## TAYLOR MACHINE WORKS, INC.

650 North Church Avenue

Louisville, Mississippi 39339-2017

(662) 773-3421 / Fax (662) 773-9146

[www.taylorbigred.com](http://www.taylorbigred.com)

TMW/RR-800





# HERCULES

FULL WIDTH CAB

- CAN-Bus Control System
- Larger Cab with controls integrated into seat
- Air Ride, High Back Swivel Seat with Joystick controls
- Automatic/Manual Power-Shift Transmission
- Digital Gauge Display
- On Board Diagnostics
- Neutral Braking
- Programmed Throttle Control
- 100 CFM Rotary Compressor



**TRACKMOBILE®**   
**MOBILE RAILCAR MOVERS**

1602 Executive Drive • LaGrange, GA 30240 • USA  
706.884.6651 • Fax: 706.884.0390 • [www.trackmobile.com](http://www.trackmobile.com)



**TRACKMOBILE®**

# HERCULES FULL WIDTH CAB SPECIFICATIONS

**MAXIMUM TRACTIVE EFFORT:**

- 45,078 lbs to 46,332 lbs [20,447 kg to 21,016 kg] double coupled
- 28,743 lbs to 29,997 lbs [13,038 kg to 13,606 kg] single coupled

**DRIVE TRAIN CONFIGURATION:**

- Power transmitted through torque converter, transmission, and transfer case to a No-Spin differential and planetary axle assemblies.
- **Engine:** Cummins QSB6.7 turbocharged diesel engine, 6 cylinder, 4 cycle.
- **Transmission and Torque Converter:** Funk DF Series, four speed forward and reverse.
- **Transfer Case:** Heavy duty hardened alloy steel spur gears. Oil bath lubrication.
- **Rail Drive Axles:** Two Axletech Model PRLC, planetary type.
- **Roadwheel Drive:** Interlocking lug drive.

**FRAME:**

Heavy-duty, 2" [51 mm] thick welded frame.

**BRAKES:**

- **Rail & Road:** Hydraulic actuated disc brakes.
- **Train Brakes:** 100 CFM.
- **Parking:** Spring applied, air released, disc/caliper arrangement.
- **Neutral Braking:** Automatically applies brakes in neutral.

**RAILWHEELS:**

27" [686 mm] heat treated cast steel. (AAR) specification.

**ROADWHEELS:**

16 ply 9.00x20 heavy duty mine service, rubber tires.

**RAIL GAUGE:**

Standard gauge: 56 1/2" [1435 mm]

**ELECTRICAL SYSTEM:**

12 Volt DC, 160 Amp Alternator, 925 CCA Dual Batteries.

**AIR INTAKE SYSTEM:**

3 Stage Filtration, High efficiency pre-cleaner tubes, Primary filter, safety filter.

**POWER STEERING:**

Hydraulic steering system, pivoting steering wheel.

**HYDRAULIC SYSTEM:**

Constant pressure hydraulic system, with piston pump.

**COUPLERS:**

Two heavy-duty cast steel, AAR style, Air operated, electrically controlled knuckle release

**SANDERS:**

Air operated, electrically controlled eight sanders.

**LIGHTS:**

Operator's cab, interior dome, one clear, one red  
 Rail Mode & Road Mode - 6 LED lights 3 each front & rear  
 2 tail & stop combination, rear mounted  
 2 Lateral work lights to illuminate roadbed.  
 Step lights.

**OPERATOR CAB:**

Totally enclosed 360 degree visibility. Sound level under 85 dBA. Two doors, front & rear. Isolation mounts for body frame and cab. Air suspension seat with 180° swivel. Full instrumentation with digital video display. Cup holders. Rear coupler alignment camera. Arm rest controls. Rearview mirror. Cab heater. Defroster fans. Sun visor. Windshield wipers and washers. Strobe light. Fold down jump seat.

**WARNING SIGNAL:**

Blast type air horn, automatic backup alarm for road operation. Electric alarm.

**OPTIONS:**

Fire extinguishers, air conditioning, auxiliary transmission oil cooler, performance package (additional 3,900 LBS and 185 HP), battery wrap heater, cab window extension, camera location options, cold weather fluids, cylinder rod protectors, engine block heater, engine oil pan heater, foam filled tires, (GCS) Ground Control System, hydraulic tank heater, MAX-TRAC wheel slip control, MAX-TRAN® automatic weight transfer system, radio control, switch control spot light, train air charge indicator, transmission oil heater, track mirrors/cab side, track mirrors/off side, turn signals, V shaped snow plow, wide traverse couplers for sharp curves/long cars.

HERCULES DIMENSIONS			
	On Rail AAR Clearance Pattern Maintained		On Road
Wheel Base	127.0"	3226 mm	65.4" 1661 mm
Length	170.0"	4318 mm	170.0" 4318 mm
Width	101.0"	2565 mm	101.0" 2585 mm
Height	**142.2"	3612 mm	150.6" 3825 mm
Weight	37,022 lbs [16,828 kg]		

TABLE OF PERFORMANCE			
Maximum Speed* (Both Directions)	On Rail		On Road
Low	2.4 MPH	[3.9 km/h]	1.5 MPH [2.4 km/h]
2nd gear	4.0 MPH	[6.4 km/h]	2.5 MPH [4.0 km/h]
3rd gear	8.0 MPH	[12.9 km/h]	5.1 MPH [8.2 km/h]
4th gear	13.6 MPH	[21.9 km/h]	8.7 MPH [14.0 km/h]

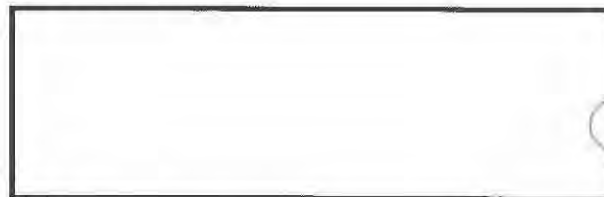
\*Actual speeds obtained will depend on grade, load, track conditions and other factors.

\*\*Shipping height will increase by 1 1/2" due to rail flange plus any necessary truck blocking required.

Trackmobile® LLC reserves the right to change specifications at any time without prior notice.



**TRACKMOBILE® LLC**  
 1602 Executive Drive  
 LaGrange, Georgia 30240 USA  
 (706) 884-6651 FAX (706) 884-0390  
 E-Mail: trackmobile@trackmobile.com  
 www.trackmobile.com



 A Marmon Group/Berkshire Hathaway Company

061200







**TRACKMOBILE®**  
MOBILE RAILCAR MOVERS

*Leading Railcar Mobility Since 1948*

**Quality  
Performance  
Reliability**



Up to 49,450 lbs. of Tractive Effort

**TITAN**  
Heavy Duty Hauling







## TITAN Special Features

### SAFETY

Multiple air lines for front and rear track machine  
 reversing directions. In addition, to other standard  
 safety features, Titan also offers these  
 additional safety features:

- Application Lock-Out
- Computer Controlled Diesel Exhaust System
- Improved Hydraulic Controls, Quick and Slow
- 2nd-Hand Control System
- On-Board Diagnostic System
- Digital Gauge Display
- Repair Blocking
- Impact Sensor/Recorder
- Radio Remote Control System\*
- GCS Remote\*
- MAX™ Automatic Weight Transfer System\*
- In-Cab Charge Indicator\*
- Adjustable Control\*



Automatic Weight Transfer System

\*A number of cats moved may vary based on track conditions, load, and other factors.

## EXCEEDING EXPECTATIONS

Move Up to 60 Cars\*



### MAINTENANCE MADE EASY

Easy maintenance helps keep your machine and your crew on the job. The wide opening access door to engine invites more frequent checks. In addition to ground level access to all routine service points, we offer these convenient service features making maintenance easy and reducing downtime:

- Grouped service points
- Easy-to-change and access filters
- Easily accessible, marked fluid drain points
- See-through fluid reservoirs / sight gauges
- Accessible external disc brakes
- Advanced diagnostic monitor and test ports
- Long life sealed axles

up to 20% life of rubber wheel types



95B-6.7 Liter Cummins Electronic Turbocharged Diesel Engine



Goodyear™ air springs, stabilizing shock absorbers, and isolation mounts



Heavy-duty split main frame with oscillating bearing trees as the pivot



# UNPARALLELED SERVICE AND SUPPORT

## Industry's Most Experienced Dealer Network

Trackmobile dealers provide the industry's best and most experienced sales and service support. Many of our dealers have been working with railcar movers, specifically Trackmobile, since its introduction in the early 1950's.

From being there to help select the right machine for your operations, to providing knowledgeable ongoing support, Trackmobile dealers help keep your business on track. Our customers have reported maintaining up to 99.7% uptime, due to Trackmobile dependability and unsurpassed customer service support.



## Trackmobile and Our Dealers Offer:

- More than 110 factory trained technicians plus service technicians
- NEW Trackmobile railcar movers
- Late model rental units for emergencies and increased production times
- Machine demonstrations
- On site and in shop Operator training and certification
- On site and in shop service and repair
- 24 Hour Emergency service
- Service & Parts for all makes and models of Trackmobiles
- Dedicated railcar technicians operating customized railcar service vehicles
- Quality reconditioned railcar movers
- Machine safety evaluations
- Free site surveys

## Time is Money

Getting it right the first time requires having the right tools and the right parts. Trackmobile has an inventory of parts to service even our legacy models. Understanding uptime is a significant factor in operational success. Because of this, our dealers and their service departments also stock sufficient inventories to complete routine maintenance and most emergency calls. It takes a team with great partnership to "get the job done."

**Your business + Our Dealers + Trackmobile Customer Service = Winning Team**

### TRACKMOBILE® LLC

1602 Executive Drive • LaGrange, GA 30240 • USA

706.884.6651 • Fax: 706.884.0390

Email: [Trackmobile@trackmobile.com](mailto:Trackmobile@trackmobile.com)

[www.trackmobile.com](http://www.trackmobile.com)



A Marmen/Berkshire Hathaway Company

© 2016 TRACKMOBILE® LLC

TI-BROP Rv 011616





# BUILT FOR THE WORK YOU DO.

THE CAT® CT660 VOCATIONAL TRUCK



# BUILT FOR THE WORK YOU DO.

THE CAT® CT660 VOCATIONAL TRUCK



## HEAVY-DUTY, REDEFINED.

**YOU WORK HARD EVERY DAY**—and you count on rugged, reliable products to keep your operation up and running. For nearly a century, Caterpillar has helped customers like you get the job done, with equipment that meets the demands of the world's toughest industries. Today, that includes the only vocational trucks worthy of the Cat® name.

The first in a full line of vocational trucks built for a wide array of applications, the Class 8 CT660 redefines heavy-duty—while delivering all the power, performance and productivity you expect from Caterpillar. Plus, it's backed by the unmatched support of the North American Cat Dealer Network, with more than 400 service locations and 2,300 service bays.

Loaded with features and options for the toughest jobs, the CT660 is your next dump truck, concrete mixer, waste carrier or all-around heavy hauler—and it's here to work for you.

**BUILT FOR IT.**







# BUILT FOR WORK, ON ANY JOB.

**WE DIDN'T MESS AROUND** when we set out to develop our new line of vocational trucks. We spent hundreds of hours on the road asking customers to describe the ideal truck. Our design team rode alongside drivers and gathered input on everything from space and comfort to visibility and performance.

What we learned inspired and influenced our design decisions, both inside and outside the cab. The result? The CT660 is the truck you told us you need for today's demanding jobs—custom built to your specifications, so you can put it to work for your business right away.





# VOCATIONAL APPLICATIONS

AVAILABLE IN TRUCK OR DAY-CAB CONFIGURATIONS, THE CT660 SUPPORTS A WIDE RANGE OF BODY TYPES FOR THESE APPLICATIONS AND MORE:

- » AGGREGATES
- » AGRICULTURE
- » ASPHALT
- » CIVIL CONSTRUCTION
- » CONCRETE
- » FORESTRY
- » GOVERNMENTAL
- » HEAVY HAUL
- » LANDSCAPING
- » LEASE/RENTAL
- » MANUFACTURING
- » MINING/QUARRY
- » OIL & GAS
- » PAVING
- » PIPELINE
- » PUBLIC SERVICES
- » RECOVERY
- » ROAD CONSTRUCTION
- » SANITATION/REFUSE
- » SITE CONSTRUCTION
- » TRANSPORTATION
- » UTILITY
- » WHOLESALE & RETAIL





# HARD WORK NEVER LOOKED SO GOOD.

WITH ITS AERODYNAMIC LINES, refined curved hood, striking black grille and bold Cat badge, the CT680 is sure to turn heads. But its real beauty lies in its features—designed by Caterpillar to deliver the performance and rugged durability you demand on the road and the jobsite.



1. 2019 EPA fuel economy estimates for 2019 CAT CT680 with 340-hp engine and 13.5L transmission are 20 mpg city/28 mpg highway/23 mpg combined. Actual mileage may vary. See dealer for more information.

2. 2019 EPA fuel economy estimates for 2019 CAT CT680 with 340-hp engine and 13.5L transmission are 20 mpg city/28 mpg highway/23 mpg combined. Actual mileage may vary. See dealer for more information.

3. 2019 EPA fuel economy estimates for 2019 CAT CT680 with 340-hp engine and 13.5L transmission are 20 mpg city/28 mpg highway/23 mpg combined. Actual mileage may vary. See dealer for more information.

4. 2019 EPA fuel economy estimates for 2019 CAT CT680 with 340-hp engine and 13.5L transmission are 20 mpg city/28 mpg highway/23 mpg combined. Actual mileage may vary. See dealer for more information.

5. 2019 EPA fuel economy estimates for 2019 CAT CT680 with 340-hp engine and 13.5L transmission are 20 mpg city/28 mpg highway/23 mpg combined. Actual mileage may vary. See dealer for more information.

6. 2019 EPA fuel economy estimates for 2019 CAT CT680 with 340-hp engine and 13.5L transmission are 20 mpg city/28 mpg highway/23 mpg combined. Actual mileage may vary. See dealer for more information.

7. 2019 EPA fuel economy estimates for 2019 CAT CT680 with 340-hp engine and 13.5L transmission are 20 mpg city/28 mpg highway/23 mpg combined. Actual mileage may vary. See dealer for more information.

8. 2019 EPA fuel economy estimates for 2019 CAT CT680 with 340-hp engine and 13.5L transmission are 20 mpg city/28 mpg highway/23 mpg combined. Actual mileage may vary. See dealer for more information.





# THE ULTIMATE WORK ENVIRONMENT.

FOR DECADES, we've been designing machine cabs that combine comfort and functionality—and it shows in the CT660's spacious interior. Ergonomic details reduce driver fatigue. Interior features enhance driver and jobsite safety and productivity. And the cab's distinctive look provides an ideal complement to the truck's unique exterior.

- » **SPACIOUS WIDE CAB DESIGN** delivers ultimate comfort and optimized storage
- » **LEATHER-WRAPPED STEERING WHEEL** with tilt and telescoping functions provides a comfortable driving posture
- » **EASY-TO-REACH COMPARTMENTS** provide quick access to paperwork and log books
- » **BACK-PANEL STORAGE** and oversized side pockets keep important items within reach
- » **INTERIOR SURFACES** and materials allow for easy cleaning and optimum durability
- » **PREMIUM GRADE SOUND INSULATION** kit and interior materials dramatically reduce noise
- » **ROUTING AND CLIPPING WIRE SYSTEM** in panels minimizes vibration and cab noise
- » **CAB MIRRORS** deliver excellent secondary visibility with standard and convex mirrors combined in a single package
- » **OVERHEAD AND UNDER DASH LIGHTS** illuminate for safer entry and exit—and for working while stopped
- » **MAP LIGHTS** adjust to shine directly where they're needed
- » **HEATING AND AIR CONDITIONING CONTROLS** are easy to access and handle
- » **HVAC VENTS** are positioned for optimum air flow and comfort in any climate







## CONTROL PANEL

THE CT660'S ERGONOMICALLY DESIGNED DASHBOARD and center stack layout give drivers complete command and control. All controls, levers, switches and gauges are positioned to maximize safety and minimize fatigue, so drivers can stay focused on the job at hand.

- **PRIMARY GAUGES** are clearly visible through the steering wheel, making it easy to locate and view key indicators quickly and safely.
- **LARGE ROCKER SWITCHES** are easy to see and reach and offer "soft touch" tactile feedback when activating a switch.
- **LARGE, EASY-TO-READ GAUGES** feature a black dial face, white font and red needles to ensure quick recognition and maximum readability consistent with all Cat machines.
- **SPEEDOMETER AND TACHOMETER** are combined into a single large gauge for reduced space claim and to leave room for other optional gauges, including those designed for your specific application.
- **WARNING SIGNALS** provide alerts to any critical system situation with bright indicator lights and audible alarms.
- **GAUGE PANEL** is easily removed for any repair work.





## DRIVER'S SEAT

A COMFORTABLE DRIVER IS A SAFE, PRODUCTIVE DRIVER, and the CT660 driver's seat delivers comfort all shift long—helping drivers feel less fatigued and more alert to hazards or obstacles.

- ▶ **AIR SUSPENSION AND HIGHLY ADJUSTABLE LUMBAR SUPPORT** offer extreme comfort that feels and fits just right.
- ▶ **OPTIONAL FULLY ADJUSTABLE SEAT** fits any size driver comfortably.
- ▶ **EASY-TO-REACH ADJUSTMENT LEVERS** make it easy to stay focused on the job.
- ▶ **OPTIONAL FULLY ADJUSTABLE DUAL ARM RESTS** flip up and out of the way.
- ▶ **THREE-POINT SHOULDER BELT** keeps the driver secured.
- ▶ **ADDITIONAL HEAD AND NECK SUPPORT** is available with a high seat back option.
- ▶ **OPTIONAL CAT COMFORT SEATS** offer tough, heavy-duty construction, combined with extra thick, contoured cushions for enhanced comfort and less fatigue.



# THE POWER TO WORK EVEN HARDER.

**UNDER THE HOOD**, the CT660 is powered by a Cat CT Series Vocational Truck Engine with ratings specific to vocational truck applications and a horsepower/torque combination to tackle the toughest jobs.

Featuring an ideal match of power and performance, your Cat CT engine will meet the demands of your specific job and operating conditions. So whether your next Cat Vocational Truck is a dump truck, concrete mixer, waste carrier or heavy hauler, it will be equipped with the right horsepower and torque to match the demands of your work.







- » **HIGH-PRESSURE, COMMON-RAIL FUEL SYSTEM** features ideal injection pressure for precise injection timing and optimal combustion
- » **THIRTY PERCENT LESS INTERIOR NOISE** and much lower vibration enhance comfort and productivity
- » **DUAL SEQUENTIAL TURBOCHARGERS** and high-pressure injection system deliver broad peak torque characteristics
- » **KEY SYSTEMS AND COMPONENTS** are easily accessed, from valve cover to oil filter to fuel filter
- » **SINGLE ELECTRONIC CONTROL MODULE** and fewer electrical connections result in less diagnostic and maintenance time
- » **REAR POWER TAKE-OFF (PTO)** drives engine power to your attachments

#### CAT C13 ENGINE

- Unique engine ratings created specifically for vocational applications, resulting in the ultimate horsepower/torque combinations
- Highly efficient Selective Catalytic Reduction (SCR) solution
- Upgraded in-cylinder technology with a proven aftertreatment system
- Quiet, light engine architecture that delivers low cost of operation
- High-pressure common-rail fuel system with injection pressures of 2200 bar (approximately 32,000 psi)
- Two-stage turbochargers with interstage cooler



#### CAT CT13 SPECIFICATIONS

<b>ENGINE TYPE</b>	Diesel, 4-Cycle
<b>CONFIGURATION</b>	In-line 6-Cylinder
<b>DISPLACEMENT</b>	12.4 L (758 cu. in.)
<b>BORE AND STROKE</b>	4.96 in. & 6.94 in. (12.6 cm & 17.6 cm)
<b>COMPRESSION RATIO</b>	17:1
<b>ASPIRATION</b>	Deaf Series Turbochargers, Intercooler and Aftercooler
<b>COMBUSTION SYSTEM</b>	Direct Injection
<b>LUBRICATION SYSTEM CAPACITY</b>	42 Quarts (40 L)
<b>COOLANT DRAIN INTERVAL</b>	600,000 miles (965,606 km)
<b>TOTAL ENGINE WEIGHT (DRY)</b>	2490 lbs. (11089 kg)
<b>DIMENSIONS</b>	L 56 in. x W 37 in. x H 49 in. (L 150 cm x W 94 cm x H 125 cm)
<b>VALVES</b>	4 Valves Per Cylinder, Overhead Cam Actuated
<b>HORSEPOWER</b>	365-475 hp (268 - 349 kW) @ 1700 rpm
<b>PEAK TORQUE</b>	1250-1700 lb-ft (1695 - 2305 Nm) @ 1000 rpm

#### CAT CT13 PERFORMANCE DATA

HORSEPOWER (BHP @ 1700 RPM)	TORQUE PEAK (LB-FT @ 1000 RPM)	GOV. SPEED (RPM)	FULLY DEVELOPED TORQUE (LB-FT @ 800 RPM)
365	1250	2100	686
370	1356	2100	770
380	1458	2100	811
410	1450	2100	826
430	1550	2100	868
475	1700	2100	950



# SHIFT INTO WORK MODE, AUTOMATICALLY.

USED FOR YEARS in vocational applications around the world, the Cat CX31 Automatic Transmission has a proven track record for quality and reliability that helps maximize uptime. Performance-matched with Cat CT Series Vocational Engines, it delivers rugged durability, fuel economy and smooth shifting for optimum power and efficiency. The new CX31 HT (High Torque) enables users to specify the CX transmission in applications with up to 1850 lb-ft engine ratings. And Cat dealers know the CX31 inside and out because they've been supporting it in various on-highway applications since 2008.







- » **CATERPILLAR ENGINEERED LIGHTWEIGHT DESIGN** features the industry's highest power-to-weight ratio and full power shifting, leading to improved truck productivity.
- » **AUTOMATIC SHIFTING** is simple to learn and operate, making it easier for you to find, train and retain productive drivers.
- » **ELECTRONIC CONTROL MODULE (ECM)** regulates gear shifts based on driver throttle demand and vehicle speed to optimize engine performance and reduce diesel use.
- » **LIVE POWER TAKE-OFF (PTO) OPTIONS** include two side locations and a Cat exclusive high-output rear PTO for improved packaging, performance and serviceability.
- » **DIAGNOSTIC TOOLS AND PROCEDURES** are the same as Cat dealers use for other Cat machines.
- » **JOB SITE SAFETY** is enhanced as drivers no longer need to operate the clutch or remove their hands from the wheel during shifts.
- » **WARRANTY AND EXTENDED SERVICE COVERAGE** is matched to the engine and backed by the best parts and service network in the industry.
- » **OTHER TRANSMISSION OPTIONS AVAILABLE FOR THE CT660 INCLUDE THE MANUAL AND ULTRASHIFT™ PLUS VOCATIONAL TRANSMISSIONS BUILT BY EATON.**

Ultrasht™ Plus Vocational Transmission is a registered trademark of Eaton Corporation.

CAT CX31 AUTOMATIC TRANSMISSION
• Speeds: 6 forward/1 reverse
• Engine: CAT D710
• Torque Converter: Cast aluminum design with lock-up clutch
• Clutches: Electro-hydraulic fully modulated, oil cooled, multidisc
• Maximum Gross Input Power hp (kw): 550 (410)
• Maximum Gross Input Torque lb-ft (N-m): 1700 (2300)
• Maximum Input Speed: 2500 rpm
• Length: 35.3 in. (896 mm)
• Multiple electronic interlock capabilities to control power, speed, gear selection, direction and PTO operations
• Power Take-Off: Two side locations and a Cat exclusive high-output rear PTO
• Side PTO capacity lb-ft (N-m): 700 (950), rotation same as engine, ratio determined by PTO adaptor
• Rear PTO capacity lb-ft (N-m): 1000 (1350), rotation opposite of engine, at 1.25 engine speed
• Optional Input Shaft Hydraulic Retarder
• Overall Weight (approx.): 306 lbs. (141 kg)
• Overall Weight with Retarder Option: 1088 lbs. (494 kg)
• Overall Length with Retarder Option: 35.4 in. (900 mm)



# BUILT FOR THE WORK YOU DO.

**THE CT660 SITS ON A STRONG FOUNDATION**—built to handle whatever vocational body or equipment your application requires. The chassis features a set-back axle (SBA), with both 116-inch and 122-inch bumper to back of cab (BBC) lengths available. Both provide an extra tight turning radius for enhanced maneuvering and driving performance.



■ **CLASS-LEADING WHEEL CUT**  
means unsurpassed maneuverability

■ **TUNED CAB AIR SUSPENSION SYSTEM**  
absorbs the road shock and vibration transmitted through the frame mounts, producing a quieter, smoother and more comfortable ride

■ **MULTI-LEAF FRONT SUSPENSION** options include shackles type, single or two-stage springs and slipper type, with compatible shock absorbers available for all options

■ **REAR SUSPENSION** options include selections from Hendrickson and Chalmers

■ **AXLE CHOICES** from Meritor, Dana and Fabco include 6XA, 6XB, 6XC and 4XA configurations that offer the optimized load carry capability your jobsite demands

■ **ABS FRONT AND REAR BRAKES**  
ensure reliable and safe braking power

■ **FUEL TANKS** of aluminum alloy save weight and are available in 60, 70, 90, 100 and 120 gallon capacities, with single left, single right or dual under cab/back of cab options available





#### CHASSIS

A

- Set-Back Axle (SBA), 116-inch and 122-inch Bumper to Back of Cab (BBC) available
- Industry-leading turning radius
- Durable, heat-treated alloy steel frame rails
- 12.0-inch rail size - 110,000 and 120,000 psi yield strength
- Length variable in 2.0-inch increments
- Available with rail reinforcements: one or two frame reinforcements available
- Superior routing and slipping of all hoses and wires

#### AXLES

B

- Mentor, Dana and Fabco options available
- 6X4, 6X6 and 4X4 configurations available

#### SUSPENSION

C

##### FRONT

- Multi-leaf, shackles type, single or two-stage spring
- Multi-leaf, slipper type
- Compatible shock absorber selection

##### REAR

- Hendrickson suspension offerings: HaulMaxx, HN, RT/RTe, RS, R, PnPMaxx
- Chalmers high articulation

#### FUEL TANKS

D

- Fuel tanks available in 60, 80, 100 and 120 gallon capacities
- 55 Gallon Diesel exhaust fluid tank
- Single left, single right or dual under cab/back of cab options available
- Aluminum alloy construction





# A SMARTER WAY TO WORK.



**GETTING ACCURATE, TIMELY INFORMATION** about how, when and where your truck is being used can help you reduce costs, enhance performance and improve security. That's why the CT660 comes standard with Product Link, Caterpillar's comprehensive asset and fleet management tool. It lets you remotely monitor location, productivity, maintenance and more—for one truck, many trucks or your entire fleet of equipment.

Product Link™ features a highly intuitive, web-based user interface, robust and integrated onboard hardware with cellular connectivity and an open-system design for mixed-fleet use. You can use it to:

- ▶ See your entire fleet at a glance or zoom in for a detailed look at individual trucks
  - ▶ Track fuel use and costs, location history, working time versus idle time and more
  - ▶ Get odometer, engine hour and transmission PTO hour updates
  - ▶ Receive fault code or suspicious movement alerts via email or text message
  - ▶ Set up site boundaries to detect movement outside an authorized area
  - ▶ Identify opportunities for driver training
  - ▶ Manage PM service with service intervals and service due alerts, latest fluid analysis results and click through to your Cat dealer for parts and service
  - ▶ Quickly use your smartphone to locate your truck on a map, view fault codes or opt. alerts and identify high idler and service due areas when you're on the go
- PLUS, YOUR PRODUCT LINK SERVICE SUBSCRIPTION IS COMPLIMENTARY FOR THE FIRST THREE YEARS YOU OWN YOUR CT660.**





# WORK MORE. SERVICE LESS.

TO HELP KEEP YOUR UPTIME HIGH and operating costs low, we've built dozens of efficient maintenance and repair features into the CT660—giving technicians and drivers easy access to key service points. Most require a little or no special tooling.

- ▶ **HEADLIGHT BULBS AND WINDSHIELD WIPER BLADES** can be replaced in minutes without any tools.
- ▶ **COOLANT, WASHER RESERVOIRS AND AIR FILTERS** are accessible from ground level for easy maintenance and replacement—no special tools required.
- ▶ **MODULAR DESIGN OF THE GRILLE** and three-piece bumper makes it simple to replace a damaged component—quickly, cost effectively and without any special tools.
- ▶ **MIRRORS** are cord mounted for greater stability, eliminating time spent readjusting or retightening mirror bolts.





# THE BEST TEAM, READY TO WORK FOR YOU.



**WITH THE CT660**, you're not just getting a rugged, dependable truck. You're getting the backing of the best on-the-ground support team in the business.

Cat Dealers have set the standard for service and support in the on-highway and heavy construction industries for generations. And now they're bringing that same expertise and commitment to vocational trucks, with bumper-to-bumper service, fast parts availability, competitive financing, unmatched warranty support and more—so you can get to work fast and stay on the job longer.

Plus, because Cat dealers know how different work applications and environments will affect your truck, they can help you order the exact CT660 you need—with customized options ranging from transmissions to suspensions and axles.

» **24/7 ONLINE PARTS ORDERING**, combined with unmatched parts availability and timely delivery, means you'll be up and running in no time.

» **UNMATCHED WARRANTY COVERAGE** delivers all the protection you need in one comprehensive package—with extended warranties and a variety of scheduled maintenance programs also available.

» **FINANCING, LEASING AND INSURANCE** solutions available through Cat Financial and Cat Insurance make it simple and affordable to acquire and protect your CT660.





# SERIOUSLY DRIVEN.

THE CT660 IS A SERIOUSLY POWERFUL TRUCK built for seriously productive work. It's loaded with the features and options you told us you wanted in a next-generation vocational truck. It's designed for unparalleled driver satisfaction, maximum payloads, unprecedented uptime and low cost of ownership in dozens of applications. And it's backed by the best dealer support and parts availability in the industry.

A natural extension of our rugged product line, the CT660 delivers what no one else can—all the power, performance and durability you expect from Cat products. And now, it's here to work for you.

**BUILT FOR IT.**



## FOR MORE INFORMATION

VISIT [DRIVECAT.COM](http://DRIVECAT.COM) OR TALK TO YOUR CAT DEALER TODAY TO LEARN MORE ABOUT THE CT690. JOIN US ONLINE TO STAY UP-TO-DATE ON THE LATEST CAT TRUCK AND INDUSTRY NEWS.

 CAT VOCATIONAL TRUCKS

 @CAT\_TRUCK





LEDT0035-04 | Cat.com DriveCat.com © 2013 Caterpillar Inc. All Rights Reserved Printed in USA

CAT, CATERPILLAR, their respective logos, "Caterpillar Yellow" and the "Power Edge" trade dress, BUILT FOR IT, as well as corporate and product identity used herein, are trademarks of Caterpillar and may not be used without permission.





This page intentionally left blank



# Equipment Specifications: Portland Tractor and Yard Truck Equipment Specifications





# Anthem











# Rediscover an American legend.

We took more than a century of experience building America and put it to work tackling the challenges of our industry. The result? The new Mack Anthem™—a truck that will make you rethink what's possible on the highway. Boldly designed and engineered tough, Anthem is born ready for whatever the road demands.

#### **BUILT FOR YOUR BUSINESS.**

Efficient in every sense of the word, Anthem saves on fuel and reduces maintenance costs while maximizing uptime—and your bottom line.

#### **DESIGNED FOR THE DRIVER.**

Anthem's cab design and driver environment are built around the way work gets done on the road, keeping drivers comfortable, safe and focused all day long.





# Built for your business.

---

## EFFICIENT DESIGN

Anthem's advanced aerodynamics and purpose-built design put function at the forefront and reduce day-to-day costs.

---

## DEPENDABLE SUPPORT

From parts and service to our 24/7 Uptime Centers, Mack has the right combination of people and technology to keep you on the road.

---

## THE STRENGTH OF A LEGEND

Anthem comes standard with our proprietary Mack® engines, transmissions and axles, delivering unrivaled performance and fuel efficiency.

4







Day Cab

48-inch Flat Top Sleeper

70-inch Stand Up Sleeper





# Aerodynamic never looked so Mack.

The new Mack Anthem™ challenges the expectations of aerodynamic design with a bold look that dramatically improves efficiency up to 3%.



By displacing air to the sides, as well as over the hood and roof, Anthem cuts wind resistance and improves fuel economy by up to 3%.

6







**Roof Fairings with Adjustable Trim Tab**

Improves air flow from the cab to the trailer (70-inch Stand Up Sleeper only).

**Hood Mirrors**

Single support decreases wind resistance compared to tripod designs and folds on impact to prevent damage.

**Hood and Fenders**

Hood slope and fender design direct air over and around the trailer.

**Close-Out Flange**

Prevents air flow between hood and bumper and moves air around the cab.

**Air Dam**

Reduces turbulence under the vehicle for less drag.

**Covered Tow Loops**

Cuts down on wind resistance and creates a clean look.





# Built to last.

Mack Anthem™ drives down operating costs with durability that stands up to the rigors of the road and keeps you out of the shop.



## Breakaway Hood Mirrors

The mounts are spring-loaded to rotate when hit, preventing damage to the hood and lowering parts and repair costs.

## Breakaway Side Mirrors

Strong hinges with zero plastic, tougher materials and spring-loaded mounts help keep maintenance costs down.

## Durable Components

From bolts to latches, all Anthem components are made from tough, long-lasting materials.

## LED Lights

LED headlights are 66% brighter, last longer, use less energy and provide better visibility.

8



# Smart serviceability.

Anthem's tilt-assist hood and functional, modular design allow service professionals to access, repair and replace components more quickly.

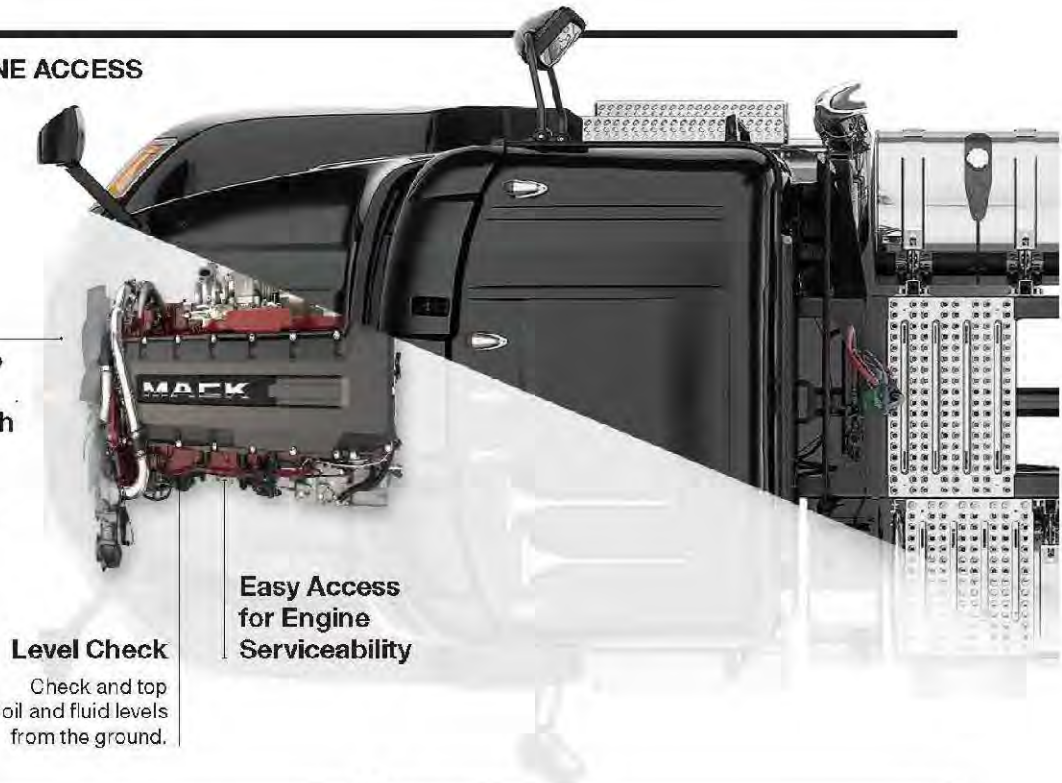
---

## EFFICIENT ENGINE ACCESS

### Mack MP® Engine

#### Single-Point Latch and Tilt Assist

Requires 50% less effort to open for easy access to the engine.



Easy Access for Engine Serviceability

#### Level Check

Check and top off oil and fluid levels from the ground.

---

## 3-PIECE HOOD

The 3 pieces are bonded together but can be separated and repaired individually for lower replacement costs.



---

## 3-PIECE BUMPER

The 3 pieces can be ordered as separate replacement parts for improved serviceability and lower repair costs.



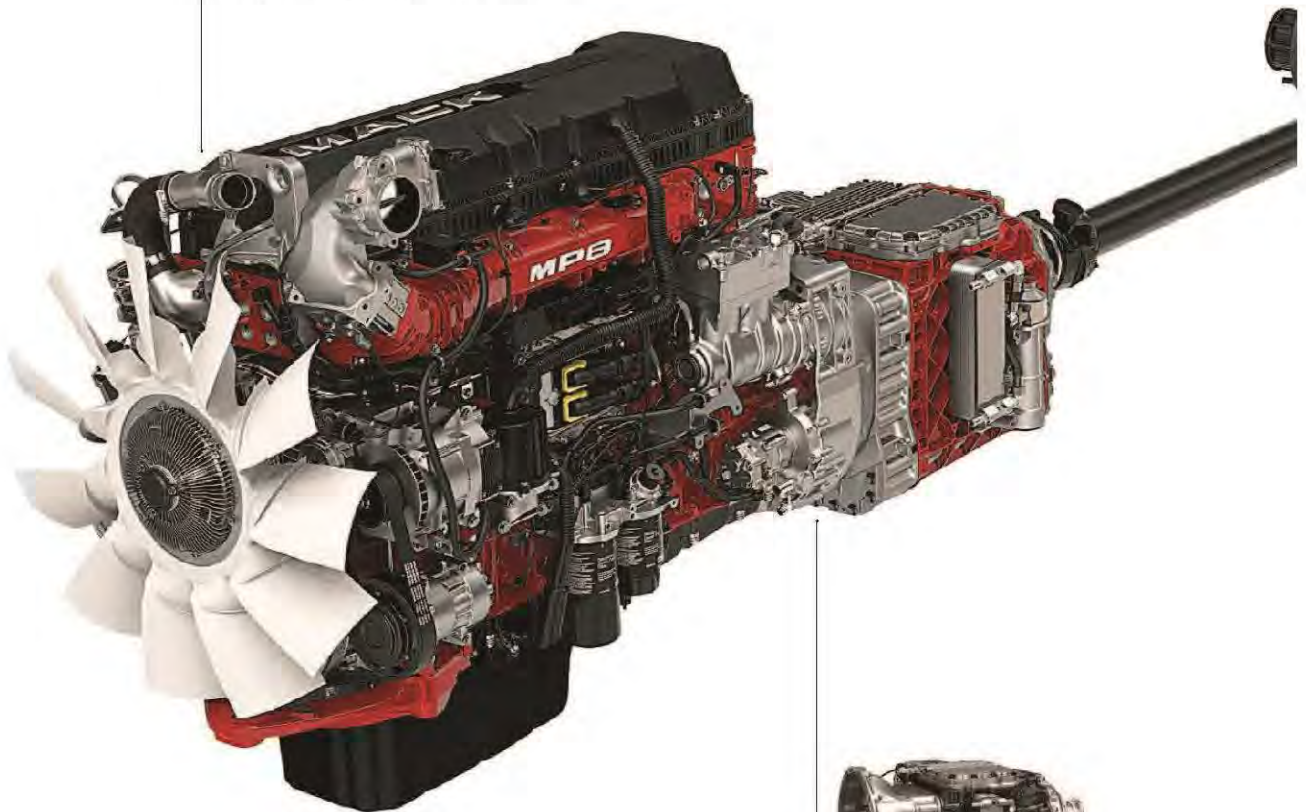


# Powered by Mack's integrated powertrain.

Engineered for efficiency and performance, and proudly assembled in Mack's Hagerstown, Maryland facility, our integrated powertrain is the toughest in the game. Bar none.

## Mack MP® Engines

With horsepower, torque and superior fuel economy, Mack's MP® engines conquer the highway, mile after mile.



## Mack Transmissions

Mack's transmissions are designed and built to perform at the highest level in the most demanding conditions, just like the rest of the truck.





**Mack Axles**

Built to handle long hauls and the relentless punishment of the road.

**Mack Suspensions**

Engineered to be lighter and stronger, for enhanced reliability and outstanding performance.



**Wave Piston Design**

By adding small waves to the piston bowl, the engine can burn fuel more efficiently for reduced fuel consumption and lower emissions.



Mack Wave Piston



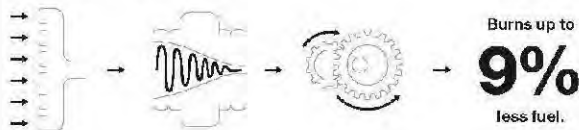
Standard piston combustion efficiency



Mack Wave Piston combustion efficiency

**MP®8-TC Engine**

The MP®8-TC with turbocompounding captures lost energy and converts it to power, burning up to 9% less fuel in highway operations.



Hot exhaust captured from engine.

Exhaust gas converted to mechanical energy by turbo unit.

Turbo delivers torque to the crankshaft.

Burns up to **9%** less fuel.

**mDRIVE™**

Mack's industry-leading automated manual transmission expands your driver base and reduces costs.



**Smarter Hauling**

mDRIVE™ continuously monitors changes in grade, acceleration, vehicle weight and more to optimize fuel economy.

**Easy to Operate**

Drivers can manage mDRIVE™ with just the press of a button, making it more comfortable and easier to operate, even for new drivers.

**Minimal Service**

Proven technology and superior design mean mDRIVE™ requires minimal service, significantly reducing maintenance costs and downtime.





# With Mack<sup>®</sup> Connect, it's uptime all the time.

Mack's exclusive uptime and productivity solution, Mack Connect, combines intelligent software, predictive analytics, driver assist technologies and more to help you keep your trucks—and your business—moving forward.

Connected Driving



Connected Business



Connected Support







## CONNECTED SUPPORT

Your trucks are only profitable when they're on the road and on the job. Maximize your uptime with intelligent maintenance systems and time-saving repair processes.

### Over The Air (OTA) Software Updates

Wirelessly updates software without disrupting your schedules, while increasing operational efficiency and uptime. Requires Mack® GuardDog® Connect.

### Mack® GuardDog® Connect

GuardDog Connect automatically monitors your truck's performance and quickly alerts OneCall® of any maintenance or repair needs. OneCall's 24/7 support and roadside assistance leverages Mack® ASIST to give drivers, dealers and Uptime Center staff access to all of the repair information they need—all while you're still on the road.

### Certified Uptime Centers

Dealers identify quick fixes and put them in the fast lane for completion, while giving larger repairs the attention they need and putting you back on the road faster.

### Preventive Maintenance

Keeps your trucks in top shape by planning a service schedule that matches the usage and miles of your vehicle, so we can repair or replace components before it impacts your business.



## CONNECTED BUSINESS

To succeed in the modern trucking industry you need to run a modern trucking company. Drive profitability and gain insights at every turn with Mack's fleet management systems. Our open platform sends vehicle data directly to your own fleet management software for analysis, so you're not locked into a proprietary system. Partners include:

### Telogis®

Advanced fleet management and compliance tools that integrate directly with GuardDog® Connect or your own smartphone, tablet or other connected device.

### Omnictracs

Integrated telematics providing real-time insights into vehicle location and driver behaviors.

### WheresMyConcrete

Real-time data for dispatch, transparency for customers, and critical analytics to improve operations.

### Geotab®

Business intelligence and benchmarking data for older fleets to improve productivity, reduce fuel consumption, enhance driver safety and improve compliance.



## CONNECTED DRIVING

The trucking business is all about making margins and driving efficiency. Get the most out of your trucks and your drivers with built-in fuel management and driver assist technologies like Mack® Predictive Cruise.

### Information and Entertainment

Bluetooth®, satellite radio, cell phone integration and more to make life on the road as enjoyable as possible.

### Mack Predictive Cruise

Proprietary Mack technology that stores hilly terrain in GPS data to optimize engine speed and fuel efficiency on saved routes.

### Bendix® Wingman® Fusion™

Driver assist and safety technology combining radar, camera, brakes and the SafetyDirect® web portal from the leader in collision mitigation.

### Roll Stability

The Bendix® ESP® full-stability system helps drivers mitigate rollovers and loss-of-control in situations on wet and dry roadways through advanced sensors and throttle and braking interventions.

### Collision Avoidance

Automatically alerts the driver and, if needed, applies the foundation brakes to mitigate or prevent a potential collision with a forward moving vehicle or stationary object.







# Support at every turn.

Nearly 600 authorized dealers and parts and service locations coast to coast. Nearly 1,400 Master Technicians. When you need assistance, the Mack network is ready to deliver.





### CERTIFIED UPTIME CENTERS

Average trucking industry dwell time for a repair is 4 days, but the average repair actually takes less than 4 hours. Mack's Certified Uptime Centers identify the quick fixes and put them in the fast lane for completion, while giving larger repairs the attention they need.

### INVESTING IN SERVICE

The Mack Dealer Network is committed to quick, quality service. That's why our dealers have invested nearly \$600 million since 2010 to modernize facilities, improve access to parts and train service professionals to help get you back on the road.

### FAMILY EXPERIENCE

Whether you're behind the wheel or managing the fleet, when you run with Mack, you're part of the family. That means you'll always get personalized attention and the support you need to keep your business running strong. Just pick up the phone; there's always a real person ready at the other end of the line. Mack OneCall®: 1-800-866-1177.







# Designed for the driver.

---

## COMMAND THE ROAD

Anthem's intuitive instrument panel and steering wheel give drivers total confidence and control in the cockpit.

---

## UTILITY FROM TOP TO BOTTOM

Configure Anthem's best-in-class storage for as much or as little as you need to store.

---

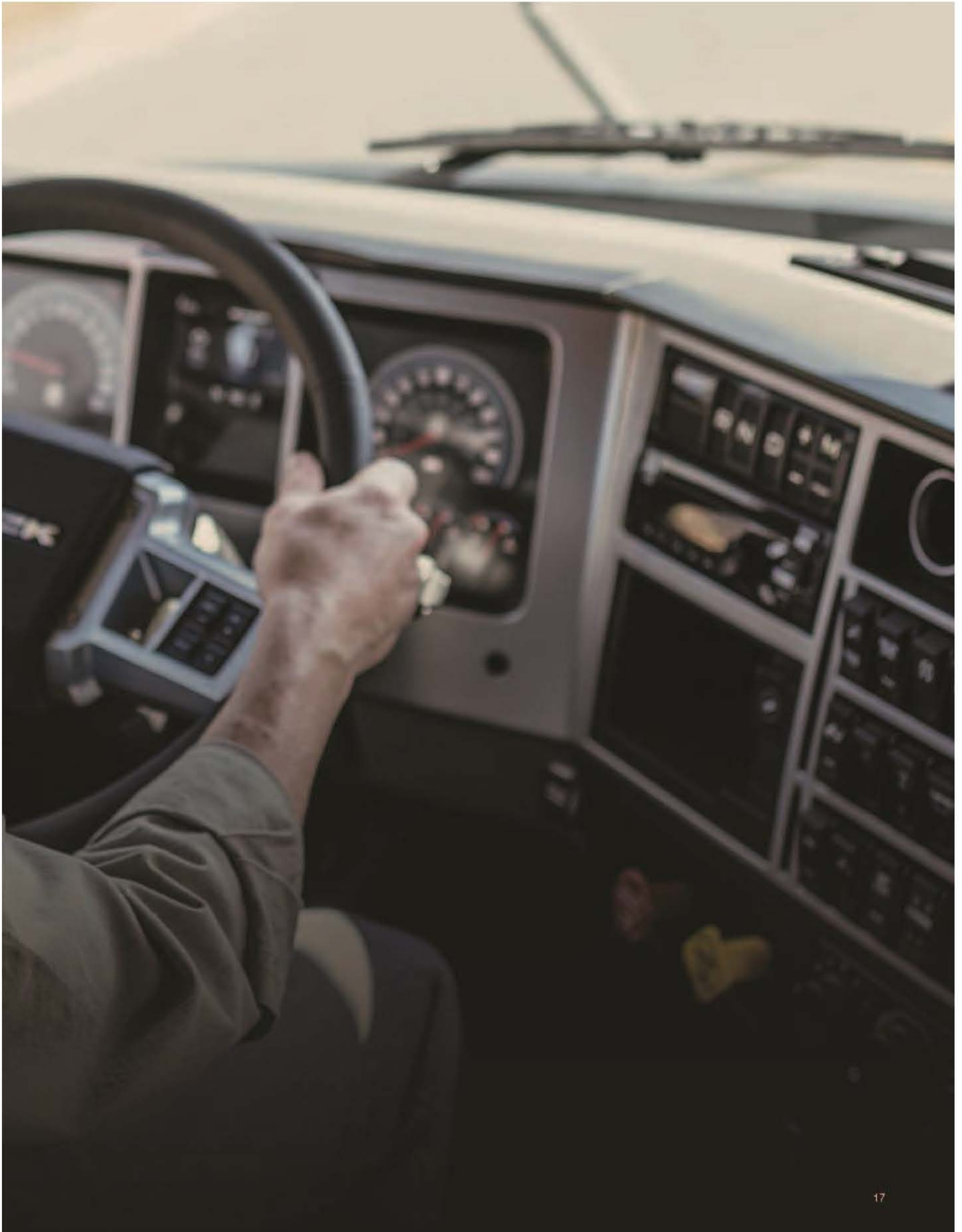
## COMFORT FOR THE LONG HAUL

A spacious interior and American craftsmanship give drivers the comfort they need to feel at home.

16







# Control at your fingertips.

Built to work and designed with purpose, the Mack Anthem's automotive-inspired controls make operation easy, safe and comfortable.



## Illuminated Controls

Keep eyes on the road with familiar, automotive-style controls.

## Flat-Bottom Steering Wheel

An industry-first, allowing more belly room and clearance for entry or exit. Add to that a racecar-style grip, enhanced dash visibility and clipboard-friendly surface for better control and maximum comfort.





### Information and Entertainment Display

7" touchscreen, along with smart steering wheel buttons, manages tools like SiriusXM®, Weather Band, TomTom truck navigation, Apple CarPlay and optional back-up camera.

### D-Panel Gauges

Customize the dash with 4 optional auxiliary gauges.

### Power Window, Lock and Mirror Controls

Provide more comfort and control than manual windows.

### Light Control Module

Runs all exterior lights from one place with an automotive feel.

### Rocker Switches

New larger, robust rocker switches are laser etched to be readable for life.

### mDRIVE™ Controls

Intuitive placement—and the option to install it even higher on the dash—gives drivers comfortable access without taking eyes off the road.

### Right Stalk

Manages engine brake and Co-Pilot®

### Left Stalk

Manages high beams, self-canceling turn signals and wipers.



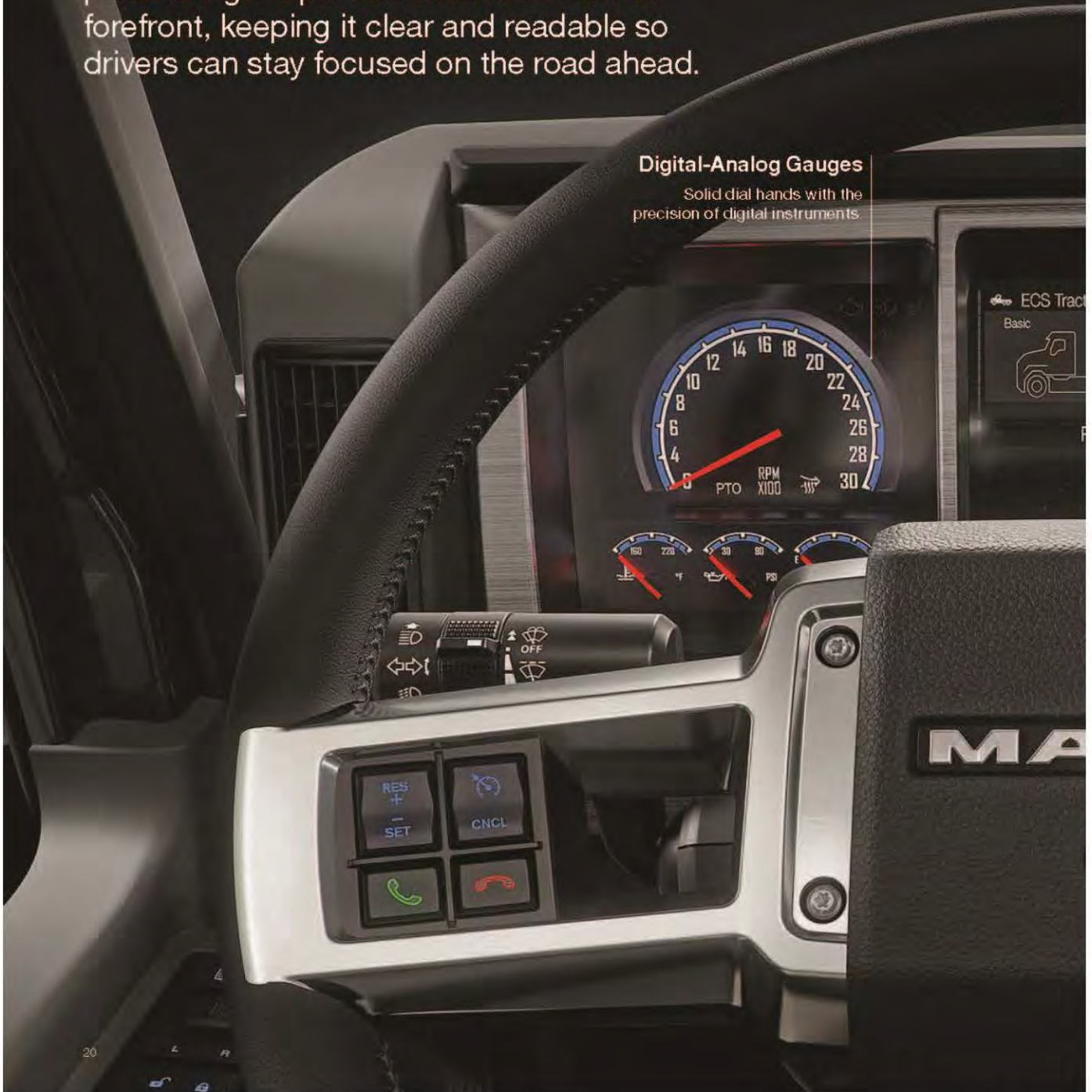


# Information at a glance. Eyes on the road.

Drivers manage constant demands on their attention. The Mack Anthem™ instrument panel brings important information to the forefront, keeping it clear and readable so drivers can stay focused on the road ahead.

## Digital-Analog Gauges

Solid dial hands with the precision of digital instruments.



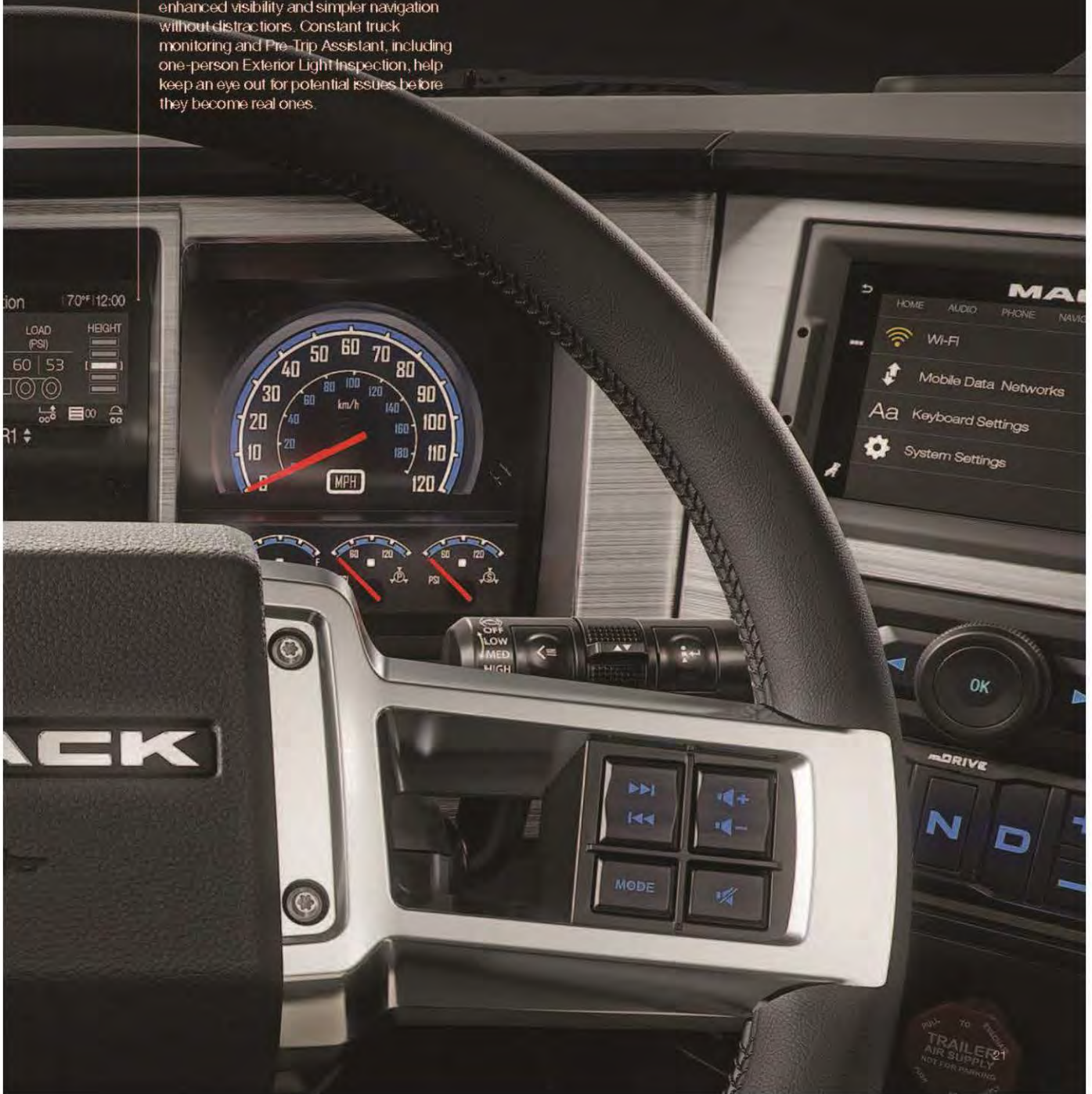
20





### Mack® Co-Pilot™

5" full-color digital display provides enhanced visibility and simpler navigation without distractions. Constant truck monitoring and Pre-Trip Assistant, including one-person Exterior Light Inspection, help keep an eye out for potential issues before they become real ones.



# Unmatched comfort.

Anthem's spacious cab, stand up sleeper and premium materials create an interior that's as comfortable as it is functional.



Anthem's generous ceiling height lets drivers stand up in the cab and walk right through to the sleeper. Driver model shown at 5'10".





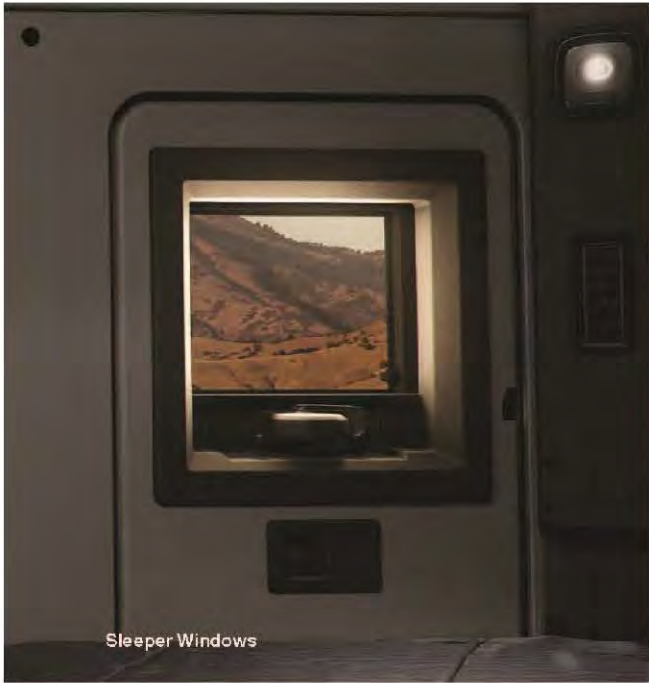


### **Mack-Exclusive Seats**

We partnered with Sears Seating to build seats that improve driver comfort and support, while taking on daily wear and tear.

- ▶ Air suspension
- ▶ Optional swivel base
- ▶ 30+ feature and fabric combinations





Sleeper Windows



Sleeper Control Panel



Amenities

24







Sleeper Lighting

# Home away from home.

We built the the Mack Anthem™ 70-inch Stand Up Sleeper with 35% more space to give drivers plenty of room to get comfortable, rest well and stay focused on the road.



Flexible Work Space

## SLEEPER WINDOWS

Sleeper windows feature self-contained built-in shades that block 100% of light. The screened windows tilt out to let air in and keep rain out.

## SLEEPER CONTROL PANEL

Access power outlets and USB ports and control the sleeper stereo, interior lighting and high-performing HVAC from one convenient panel.

## SLEEPER LIGHTING

Dimmable pipe light around the perimeter of the driver environment, bunk task light, reading lights and overhead lights are all bright, long-lasting LED.

## AMENITIES

Opt for a spacious, stainless steel refrigerator or choose from prep kits—including power outlets—for a refrigerator, microwave or flat-screen TV. Add cup holders with integrated storage above the bottom bunk for easy access to everything.

## FLEXIBLE WORK SPACE

Versatile pullout surfaces behind the driver and passenger seats create a comfortable space for a meal or catching up on email.

## IDLE-FREE POWER

Idle Free® electric APU lets drivers run the HVAC system without idling, saving fuel and maintenance costs.







**Front Overhead Console**

Generous storage with tough materials, interior LED light controls and a dedicated CB radio box.

**Safe, secure storage.**

Even on rough roads, electronics, drinks and gear stay in place with Anthem's industry-leading storage.





**Side Overhead Cabinets**

Deep storage areas above the driver and passenger doors create a secure space for gear in the 70-inch Stand Up Sleeper.

**Non-Slip Electronics Tray**

Charge electronics securely with the USB port, phone holder and non-slip rubber fuse relay center cover.

**Additional Storage**

Oversized cup holders fit large drinks and there's room for keys, devices and more in the easy-to-clean unit.





# Everything in its place.

Mack Anthem™ offers cabinets, work surfaces, wardrobes and shelving to keep the living space organized, functional and ready to work.



## Under-Bunk Storage

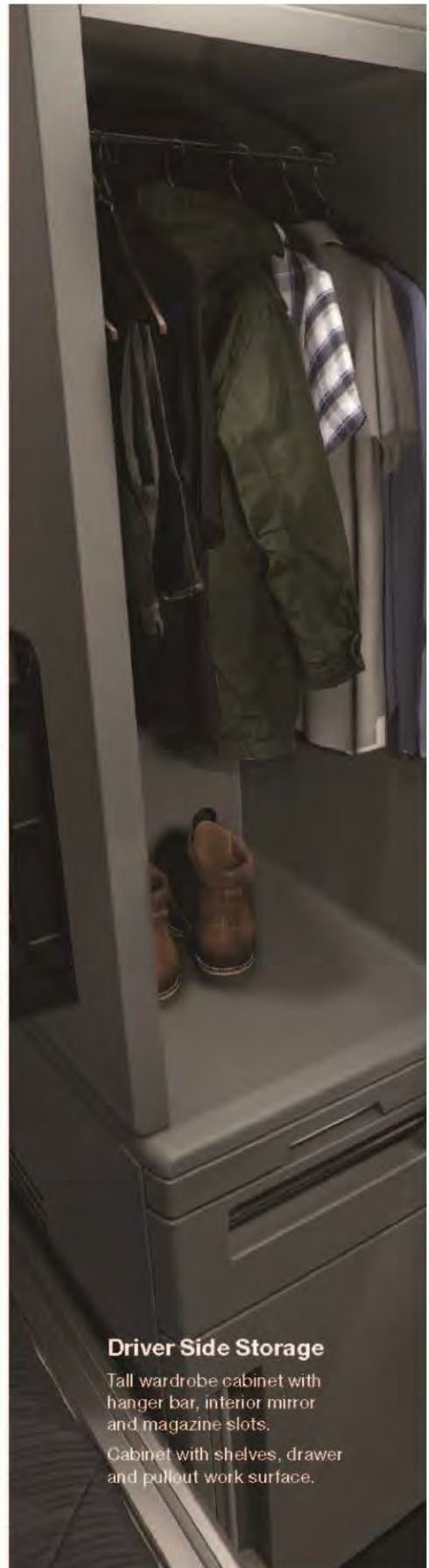
Illuminated, 3-compartment storage.



## Bunk Wall Storage

Back wall cup holder and open storage bin or 3-cabinet overhead storage (single bunk only).

28



## Driver Side Storage

Tall wardrobe cabinet with hanger bar, interior mirror and magazine slots.

Cabinet with shelves, drawer and pullout work surface.







### Passenger Side Storage

Microwave cabinet, DVD/storage slot, top storage.  
TV prep kit (up to 24" flat panel), mounting brackets,  
power outlet.  
Drawer-style refrigerator and storage drawer  
Microwave, TV and refrigerator spaces are also  
available as cabinets.



# Your Anthem. Your way.

## EXCLUSIVE MACK ANTHEM™ PAINT COLORS AND EXTERIOR TRIM



● Mack Black



● Graphite Gray



● Liquid Silver



● Arctic White



● Lacquer Red



● Cobalt Blue



● Mountain Green

### Exterior Trim



Bold Black



Mirror Chrome Bright





---

## BUNKS AND STORAGE

**Single Bunk**  
with lower storage



**Single Bunk**  
with full storage



**Double Bunk**  
with full storage



---

Additional storage options available; contact your Mack dealer for more information.





## DASH AND INTERIOR TRIM PACKAGES






### Standard

-  Gunmetal dash
-  Charcoal door trim
-  Steel Gray interior trim
-  Interior trim also available in Sierra Tan (Day Cab only)





### Premium

-  Aluminum dash and door trim
-  Steel Gray interior trim
-  Interior trim also available in Sierra Tan (Day Cab only)



### Ultra

(70-inch Stand Up Sleeper only)

-  Woodgrain dash and door trim
-  Steel Gray interior trim with Dark Saddle inserts

## SEATS



### Standard

Durable vinyl construction for low maintenance and easy cleaning.



### Premium

Vinyl construction and cloth inserts combine style with performance.



### Ultra

Ultraleather® in Dark Saddle for a premium feel that delivers comfort and durability.

## STEERING WHEELS



### Standard

Urethane foam rim  
Gunmetal spokes  
All controls located on the D-panel  
Also available with steering wheel controls and Satin Aluminum spokes



### Premium

Leather-wrapped rim  
Leather horn pad  
Satin Aluminum spokes  
Steering wheel controls



### Ultra

(70-inch Stand Up Sleeper only)

Leather-wrapped rim with Dark Saddle leather inserts  
Leather horn pad  
Satin Aluminum spokes  
Steering wheel controls




## READY-TO-ORDER PACKAGES

Mack Anthem™ is fully customizable for your needs, budget and application. For simpler ordering, we've built three interior options packages to choose from.

	STANDARD	PREMIUM	ULTRA
<b>Dash and Door Trim Pieces</b>	Gunmetal dash and Charcoal door trim	Aluminum dash and door trim with stitched door insert panel	Woodgrain dash and door trim Ultraleather® diamond-embossed door insert panels, Ultraleather® diamond-embossed sleeper side- and rear-wall panels, soft-touch headliner
<b>Interior</b>	Steel Gray Also available in Sierra Tan (Day Cab only)	Steel Gray Also available in Sierra Tan (Day Cab only)	Steel Gray/Dark Saddle
<b>Steering Wheel</b>	Foam—Gunmetal spokes without control switches Upgrade option: Foam grip with aluminum spokes with control switches	Premium leather steering wheel—Aluminum spokes with control switches	Premium leather steering wheel with Dark Saddle leather accent—Aluminum spokes with control switches
<b>Seats</b>	Vinyl Upgrade option: Vinyl with cloth inserts	Vinyl with cloth inserts Upgrade option: Ultraleather® seats	Ultraleather® with Dark Saddle diamond-embossed leather inserts
<b>Radio and Speakers</b>	Standard	Premium radio Premium speakers	Premium+ with aux amp and subwoofer, woofers, tweeters and full range
<b>Floor Covering</b>	Polyurethane	Polyurethane with inserts	Polyurethane with inserts
<b>Overhead Console</b>	3-bin netted storage (Day Cab and 48-inch Flat Top Sleeper) 3-bin storage with doors, dedicated CB radio space and 2 optional above-door bins with doors (70" Stand Up Sleeper)	3-bin netted storage (Day Cab and 48-inch Flat Top Sleeper) 3-bin storage with doors, dedicated CB radio space and 2 optional above-door bins with doors (70-inch Stand Up Sleeper)	3-bin storage with doors, dedicated CB radio space and 2 above-door bins with doors
<b>Door Controls</b>	Power windows and locks Upgrade option: motorized and heated side mirrors	Power windows and locks Upgrade option: motorized and heated side mirrors	Power windows & locks with motorized and heated side mirrors





We're born of the American spirit. Of grit and determination and a passion for hard work. We stand behind our word. And step up when others back down. We stick together through thick and thin and always treat people like family. We believe in living for today and building for tomorrow. Together, we stand for what matters. And we promise to keep our eye on the horizon and never stop moving forward.

**We are Mack.**  
**This is our Anthem.**

Experience Anthem in virtual reality.  
Visit [MackTrucks.com/Anthem](https://www.macktrucks.com/Anthem)

©2017 Mack Trucks, Inc. EHO-ANTH-0917-00.












1-800-922-MACK  
MackTrucks.com

©2017 Mack Trucks.

 [facebook.com/MackTrucks](https://facebook.com/MackTrucks)

 [twitter.com/MackTrucks](https://twitter.com/MackTrucks)

 [youtube.com/MackTrucks](https://youtube.com/MackTrucks)

 [linkedin.com/company/mack-trucks](https://linkedin.com/company/mack-trucks)

 [plus.google.com/+macktrucks](https://plus.google.com/+macktrucks)

BRO-ANTH-0917-CX

**BORN READY.**







MACK ANTHEM™ EXTERIOR

# BUILT FOR YOUR BUSINESS.



The Mack Anthem challenges your expectations of a highway truck with a bold design that delivers serious aerodynamics. Efficiency and durability is built into every component, reducing your maintenance costs while maximizing uptime—and your bottom line.

[MackTrucks.com/Anthem](http://MackTrucks.com/Anthem)



**BORN READY.**





# MACK ANTHEM™ EXTERIOR



## ADVANCED AERODYNAMICS

Anthem challenges the expectations of aerodynamic design with a bold look that displaces air to the sides, as well as over the hood and roof, to cut wind resistance and improve fuel economy by up to 3%. From the hood slope and fairings to the mirrors and air dam, every component is engineered to maximize efficiency.



## UNPARALLELED DURABILITY

Anthem helps drive down maintenance costs with durability and long-lasting components. LED headlights are 66% brighter and last longer. Breakaway hood mirrors and side mirrors have hinges with zero plastic and spring-loaded mounts that rotate when hit, preventing damage to the hood.



## SMART SERVICEABILITY

Anthem's functional and modular design gives service professionals easy access to repair and replace components. The single-point hood latch and tilt assist requires 50% less effort to open, while the 3-piece hood and 3-piece bumper can be separated and repaired in pieces for lower replacement costs.

## CUSTOMIZE YOUR ANTHEM.

### Exclusive Mack Anthem Paint Colors



Mack Black



Graphite Gray



Lacquer Red



Arctic White



Liquid Silver



Mountain Green



Cobalt Blue

### Exterior Trim



Bold Black



Mirror Chrome Bright

### Cab Configurations

Day Cab



48-inch Flat Top Sleeper



70-inch Stand Up Sleeper



©2017 Mack Trucks, Inc. All rights reserved. Mack, Mack® and the Bulldog design, Bulldog and all other marks contained herein are registered trademarks of Mack Trucks, Inc. and/or Mack Trucks, Inc. affiliated companies. All other marks contained herein are the property of their respective owners.

SS-ANEXT-OX-0917





# SED

PRODUCT INFORMATION

**PID Code/Condition:** 100-1757  
**Description:** Mack MP7-395C US17  
**Date:** March 1, 2017



## Sales Engineering

Mack Trucks, Inc.  
Allentown, PA 18103  
United States

Phone: 800 868 6225  
Fax: 610 351 8791

MackTrucks.com

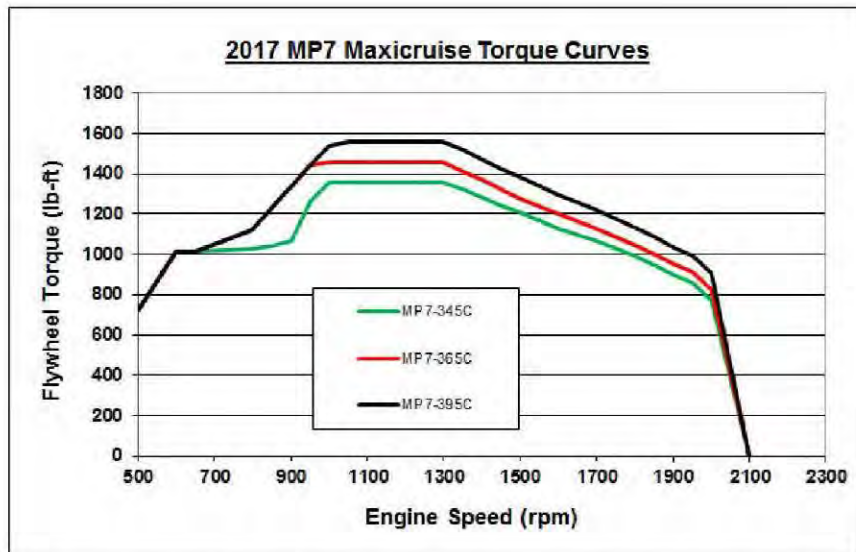
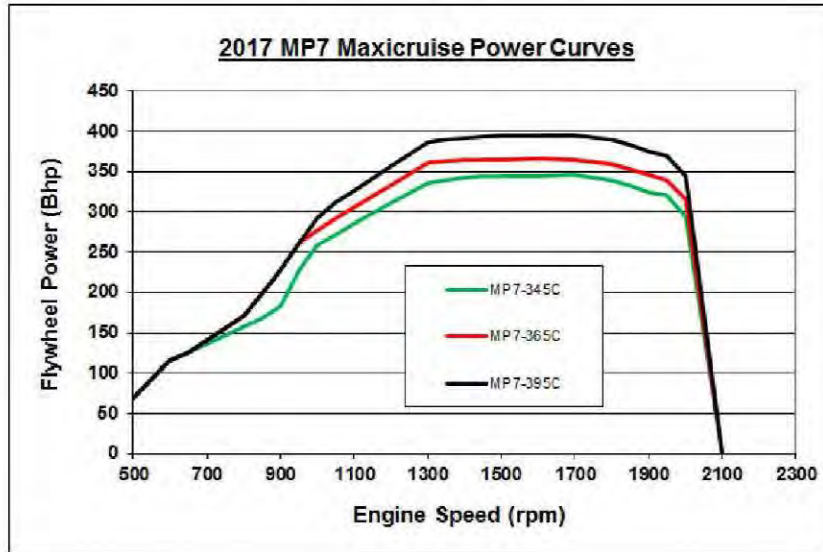
## FEATURES:

- High Torque MAXICRUISE Diesel Engine
- Maximum Horsepower 395 BHP [295 kW]
- Variable Flow Water Pump
- Electronic Common Rail Fuel Injection
- V-MAC IV Total Vehicle Electronics System
- Wide Operating Range 600 – 2000 RPM
- Variable Geometry Turbocharger
- Extended Service Intervals
- MACK PowerLeash Engine Brake
- Variable Speed Water Pump

*The information in this document was accurate as of the date of release and pertains to the current version of Mack's Sales Tool. Mack Trucks, Inc. reserves the right to make changes in specifications, equipment or design, or to discontinue models or options without notice.*

S A L E S - E N G I N E E R I N G - D E P A R T M E N T





The information in this document was accurate as of the date of release and pertains to the current version of Mack's Sales Tool. Mack Trucks, Inc. reserves the right to make changes in specifications, equipment or design, or to discontinue models or options without notice.

S A L E S • E N G I N E E R I N G • D E P A R T M E N T







**SPECIFICATIONS:**

Peak HP [kW] @ RPM	395 [295] @ 1450 – 1700
HP [kW] @ Governed RPM	345 [235] @ 1950
Max. Torque lb. ft. [Nm] @ RPM	1560 [2115] @ 1050 - 1300
Type	Direct Injection Diesel
Number of Cylinders	6, In-Line
Bore & Stroke, inches [mm]	4.84 X 5.98 [123 X 152]
Displacement, cubic inches [L]	659 [11]
Compression Ratio	16:1
Firing Order	1 - 5 - 3 - 6 - 2 - 4
Torque Rise	60%
Clutch Engagement . lb. ft. [Nm] @ RPM	1121 [1520] @ 800
Idle Speeds:	
Low	Adjustable, 600 RPM
High	2000 RPM
Engine Brake Retarding Power[If Applicable]	420 HP [313 kW] @ 2000 RPM
Weight, Dry [Approximate] lbs. [kg]	2207 [1001]
Flywheel Housing	Die Cast Aluminum
Cylinder Block	Alloyed Grey Cast Iron with Ladder Frame Reinforcement
Cylinder Liners	Full Wet Design, Plateau Honed
Cylinder Head Assembly:	
Type	Grey Cast Iron Slab Head with Intermediate Deck
Configuration	Single Overhead Cam, 4 valves per Cylinder
Valve Type	Poppet
Valve Insert Material	Super Alloy [Serviceable]
Piston and Rings:	
Piston Type	Monotherm Single Piece Steel with Closed Cooling Gallery
Pin Diameter, inches [mm]	2.125 [55]
Rings	2 Compression, 1 Oil Control
Crankshaft:	
Material	Forged, Carbon Steel
Heat Treatment	Induction Hardened Journals/Fillet
Main Bearing Diameter inches [mm]	4.5 [114]
Charge Air Cooling	Chassis Mounted, Air – To – Air
Fuel System	High Pressure F2 Common Rail
Fuel Supply Pump	ZF Meritor
Fuel Filter	Spin On, Disposable

*The information in this document was accurate as of the date of release and pertains to the current version of Mack's Sales Tool. Mack Trucks, Inc. reserves the right to make changes in specifications, equipment or design, or to discontinue models or options without notice.*

S A L E S   •   E N G I N E E R I N G   •   D E P A R T M E N T





Lubrication System:  
 Type . . . . . Full Pressure, Wet Sump  
 Oil Filters .. 2 Spin On Full Flow Disposable, Single Bypass Disposable  
 Oil Cooler . . . . .Stainless Steel Plate  
 Total Oil Capacity . . . . . 32 Quarts, Includes Filters  
 Drain Plug . . . . . Magnetic

Cooling System:  
 Capacity Quarts [L] . . . . . 17 [16]  
 Thermostats . . . . . 180 Degrees F, 82 Degrees C  
 Hose Material . . . . . Mack Brand EPDM

Air Compressor:  
 Type . . . . . Meritor/WABCO  
 Standard Capacity:  
 GU7, & GU8 . . . . . 18.7 cfm [8.9L/s]  
 MRU, LR . . . . . 37.4 cfm [17.8L/s]

Turbocharger Holset, Sliding Nozzle Ring variable Geometry with Water Cooled  
 Actuator and Bearings, and Electronic Controls

Accessory Belt . . . . .Poly – V with Automatic Tensioners

EGR System:  
 Single EGR Valve Assembly . . . . . Modulated Cast Stainless Steel  
 EGR Cooler . . . . . Stainless Steel Tube and Insert Gas to Coolant

**OIL/FILTER SERVICE INTERVALS:**

Refer to the latest version of the Mack Maintenance and Lubrication Manual

**OPTIONAL EQUIPMENT:**

- High Capacity Air Compressor
- 120 Volt and 240 Volt Engine Block Heater
- Oil Pan Heater
- Oil Change System
- High Capacity Alternator
- Heavy Duty Air Cleaner [Model Specific]

*The information in this document was accurate as of the date of release and pertains to the current version of Mack's Sales Tool. Mack Trucks, Inc. reserves the right to make changes in specifications, equipment or design, or to discontinue models or options without notice.*

S A L E S • E N G I N E E R I N G • D E P A R T M E N T





## V-MAC IV FUNCTIONS:

### 4<sup>TH</sup> Generation Vehicle Management And Control System

#### **V-MAC IV PRODUCTIVITY FEATURES:**

- PTO [4] and Electronic Hand Throttle Control
- Engine "Smart fan Control"
- "Smart Idle" Speed Regulator
- GuardDog Routine Maintenance Monitoring

#### **V-MAC IV DRIVER CONVENIENCE FEATURES:**

- Full Featured Cruise Control
- Cruise and Brake Engine Brake Control
- Programmable Engine Governor
- Idle Cooldown
- Daytime Running Light [DRL] Override

#### **V-MAC IV FUEL ECONOMY FEATURES:**

- Vehicle Speed Limiting
- Engine "Sweet Spot Indicator"
- Fuel Economy Incentive Program
- Idle Shutdown

#### **V-MAC IV RELIABILITY FEATURES:**

- Engine Protection
- Starter Protection
- Differential Lock Auto Control

#### **V-MAC IV SAFETY AND SECURITY FEATURES:**

- Tamper Resistant Speed Sensor
- Theft Deterrence
- 5<sup>th</sup> Wheel Slide Unlock Vehicle Speed Limiting
- Air Suspension Deflated Vehicle Speed Limiting

#### **V-MAC IV SERVICEABILITY FEATURES:**

- SAE J1587 AND J1939 Diagnostic Port
- Electronic Fault Logging with Fault Reporter
- VCADS PC Based Service Software
- OBD II Style Diagnostic Connector
- DataMax Comprehensive On-Board Data Logger

*The information in this document was accurate as of the date of release and pertains to the current version of Mack's Sales Tool. Mack Trucks, Inc. reserves the right to make changes in specifications, equipment or design, or to discontinue models or options without notice.*

S A L E S   -   E N G I N E E R I N G   -   D E P A R T M E N T







**GEARING RECOMMENDATIONS:**

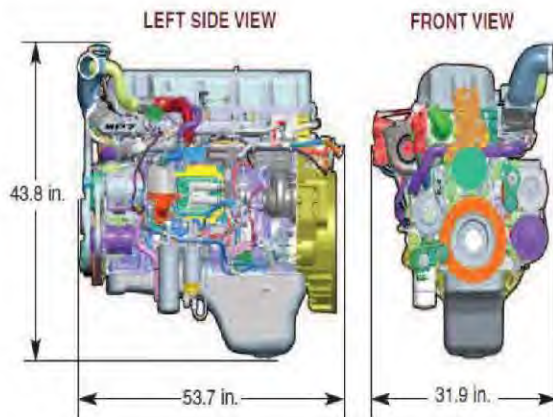
Proper Gearing is necessary to achieve optimum vehicle performance and fuel economy. Vehicle specifications, including engine, transmission, axle ratio, and tire selection should generally be selected to meet the following criteria:

<b>Startability</b>	Highway Applications . . . . .	≥ 10%
	On-Off Highway Applications . . . . .	≥ 16%
<b>Gradeability</b>	@ Cruise Max. MPH . . . . .	≥ 0.5%
	@ Peak Torque, Top Gear . . . . .	≥ 1.5%
<b>Cruise RPM</b>		<b>1275-1375</b>

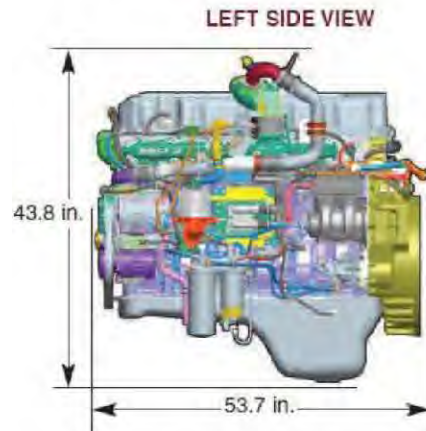
Refer to your current sales tool to obtain startability, gradeability and cruise RPM results for each unique vehicle specification. Special service applications, road surfaces, high Gross Combination Weights or other factors may require different gearing considerations.

**DIMENSIONS:**

Conventional Chassis



Low Cab Forward Chassis

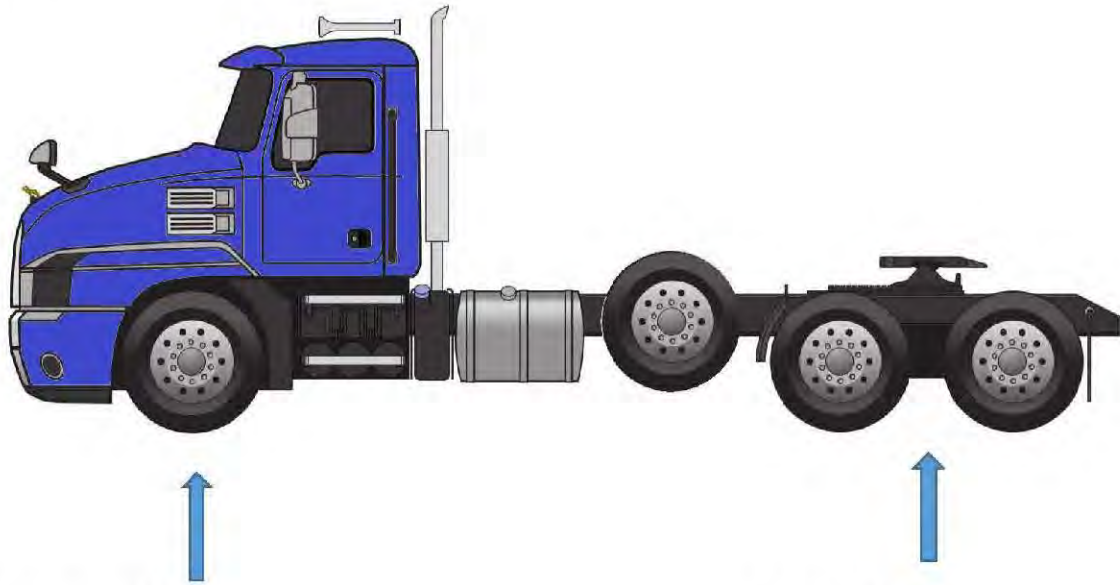


*The information in this document was accurate as of the date of release and pertains to the current version of Mack's Sales Tool. Mack Trucks, Inc. reserves the right to make changes in specifications, equipment or design, or to discontinue models or options without notice.*

S A L E S • E N G I N E E R I N G • D E P A R T M E N T



**Walsh Leasing LLC.**



**Front axle 10,654 Lbs.**

**Rear axle 7,993 lbs.**

**Wheel base 244" 13.5K lift axle. 120 gal fuel. (Weights include driver and fuel)**























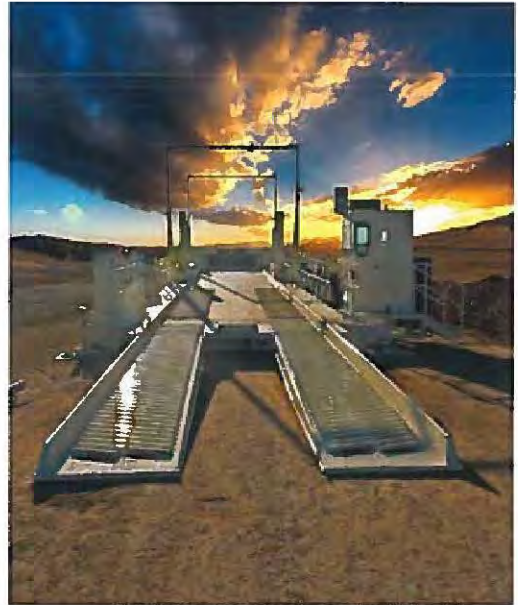
This page intentionally left blank



# Equipment Specifications: Columbia Ridge Tipper Specifications



# COLUMBIA TIPPERS





# OVER 35 YEARS

For over 35 years, Columbia Industries has specialized in the design and fabrication of heavy equipment used in the oilfield and transportation industries. Our foundation has been built on a reputation for excellence in everything that we do. We take pride in our commitment to our customers, our products and services, and our team of outstanding employees.

We revolutionized trailer unloading technology with the Columbia Trailer Tipper, and continue to provide custom solutions to customers all over the world. Oilfield equipment includes rig walking systems, fast moving and self-propelled wheeled systems, module and camp trailers, pipe handling equipment, and hydraulic power units. Transportation equipment includes heavy duty off-road axes and suspensions, and trailer tippers for unloading of solid waste, biomass and bulk materials.



# WHY COLUMBIA?



## LEAD TIME

Columbia Industries takes pride in fast delivery with **4-6 week lead time**.

# COLUMBIA INDUSTRIES



## DURABLE

With an average **15-20 year service life**, our long lasting, durable tippers will save you exponentially in maintenance costs.



## ISO CERTIFIED

Every Tipper that leaves our facility is held to ISO standards, some of the **highest standards in the world**.



## PROFIT

Columbia Tipper's **process an average of 10-12 loads per hour**, saving you time and increasing profit.







# QUALITY COMES FIRST IN EVERYTHING WE DO

At Columbia Industries quality comes first in everything we do. All of our products are designed by experienced engineers, built to ISO & API (American Petroleum Institute) standards, and backed by a one year warranty. With customer service and product support being our top priorities, we have also designed an all inclusive worry-free support plan, ColumbiaCare, to ensure you have all the support you need.

We have been in business long enough to truly know quality and that is what we strive for, every step of the way.







An all in one digital control unit accepts John Deere and CAT engines, making tracking hours and engine stats a breeze.



The new tipper catwalk folds down for easy access and exit from the tipping deck.



Our improved pivot system is stronger than ever, evenly distributing weight throughout the rear cross member.



We have improved our rotating backstop to better absorb trailer impact.



The new enclosed ramp cylinder design protects the cylinder and strengthens the king pin section.



# TIPPER MODELS

We seek at every opportunity to design products ensuring these essential characteristics:  
**Safety, Durability, Reliability, Value, and Innovation.**

recycling



agriculture



coal



wood



aggregate



bulk





## LFT 5000/6500 Portable Tipper

### INDUSTRIES SERVED:

Solid Waste  
Aggregate  
Agriculture  
Coal



The LFT 5000/6500 Portable Tipper is designed with features that allow it to be as versatile as possible for your site.

### Capacity:

50 and 65 tons

### Cycle Time:

Efficient 5 Minute Tipping Cycle

### Self Cleaning Ramps, Transition, and Deck:

Incorporated efficient self-cleaning design to eliminate debris buildup.

### Tilting Angle:

The 63 degree tipping angle ensures the trailer is completely unloaded.

### Trailer Lengths:

An optional hydraulically operated rotating backstop allows for 48' and 53' trailers.

### Power Unit:

Diesel or Propane

### On-Site Mobilization:

Each unit can be easily relocated within your landfill by the use of an optional tipper dolly or semi-tractor with a fifth wheel connection.





The Bulk Products BPT 5000 Tipper is designed for use at facilities that need the efficiency of a tipper along with the ability to move the unit within the site to fit your bulk product unloading needs.

**Capacity:**

**Cycle Time:**

Efficient 5 Minute Tipping Cycle

**Tilting Angle:**

The 63 degree tipping angle ensures the trailer is completely unloaded.

**Trailer Lengths:**

An optional hydraulically operated rotating backstop allows for 48' and 53' trailers.

**Power Unit:**

Diesel or Electric

**On-Site Mobilization:**

Each unit can be relocated by the use of an optional tipper dolly or semi-tractor with a fifth wheel connection.

## BPT 5000 Semi-Portable Tipper

### INDUSTRIES SERVED:

Wood Byproduct  
Agriculture  
Aggregate  
Coal  
Recycling





The FIT 5000/6500 Tipper is custom designed for facilities that need the efficiency of a tipper in a fixed location. Fixed Install Tipper can accommodate dumping into receiving hoppers, onto conveyor systems, into buildings, and directly to tipping floors.

## FIT 5000/6500 Fixed Installation Tipper

### INDUSTRIES SERVED:

Wood Byproduct  
Agriculture  
Aggregate  
Coal  
Recycling

#### Capacity:

50 and 65 Tons

#### Cycle Time:

Efficient 5 Minute Tipping Cycle

#### Tilting Angle:

The 63 degree tipping angle ensures the trailer is completely unloaded.

#### Trailer Lengths:

An optional hydraulically operated rotating backstop allows for 48' and 53' trailers.

#### Power Unit:

Electric

#### Custom Designed:

Each unit is custom designed to fit your facility's specific needs.







GETSUPPORT



### FIELD SERVICE

Columbia Industries is here to support you. Our Field Service professionals are highly experienced and knowledgeable. If needed, we will dispatch a certified technician to service your equipment, ensuring your business runs smoothly.



### INSPECTION PROGRAM

Uninterrupted operations is critical in today's marketplace. Columbia Industries has developed a yearly inspection program to identify and remedy potential safety and operational issues. The Field Service professional provides a detailed list of each inspection item with corresponding pictures and recommended remedy actions.



### WARRANTY

Columbia Industries offers a warranty on all products, followed by a worry free support plan, ColumbiaCare. Both ColumbiaCare and a complimentary three month period of your warranty, commits to offering 24/7 phone support, expedited replacement parts, and rapid response from an experienced technician for on site service.







# What's Your Tipping Point?

Let us help you design your solution.





# COLUMBIA INDUSTRIES

**CUSTOM DESIGN & BUILD**



**RIG WALKING SYSTEMS**



**CATWALKS & HYDRAULICS**



**TRILER TIPPERS**



**WHEELED MOVING SYSTEMS**



**KB AXLES**



**1.503.531.0600**  
**[www.columbiacorp.com](http://www.columbiacorp.com)**  
**5775 NW Wagon Way, Hillsboro, OR 97124**

© 2015 Columbia Industries LLC, All Rights Reserved PR 0002-070115



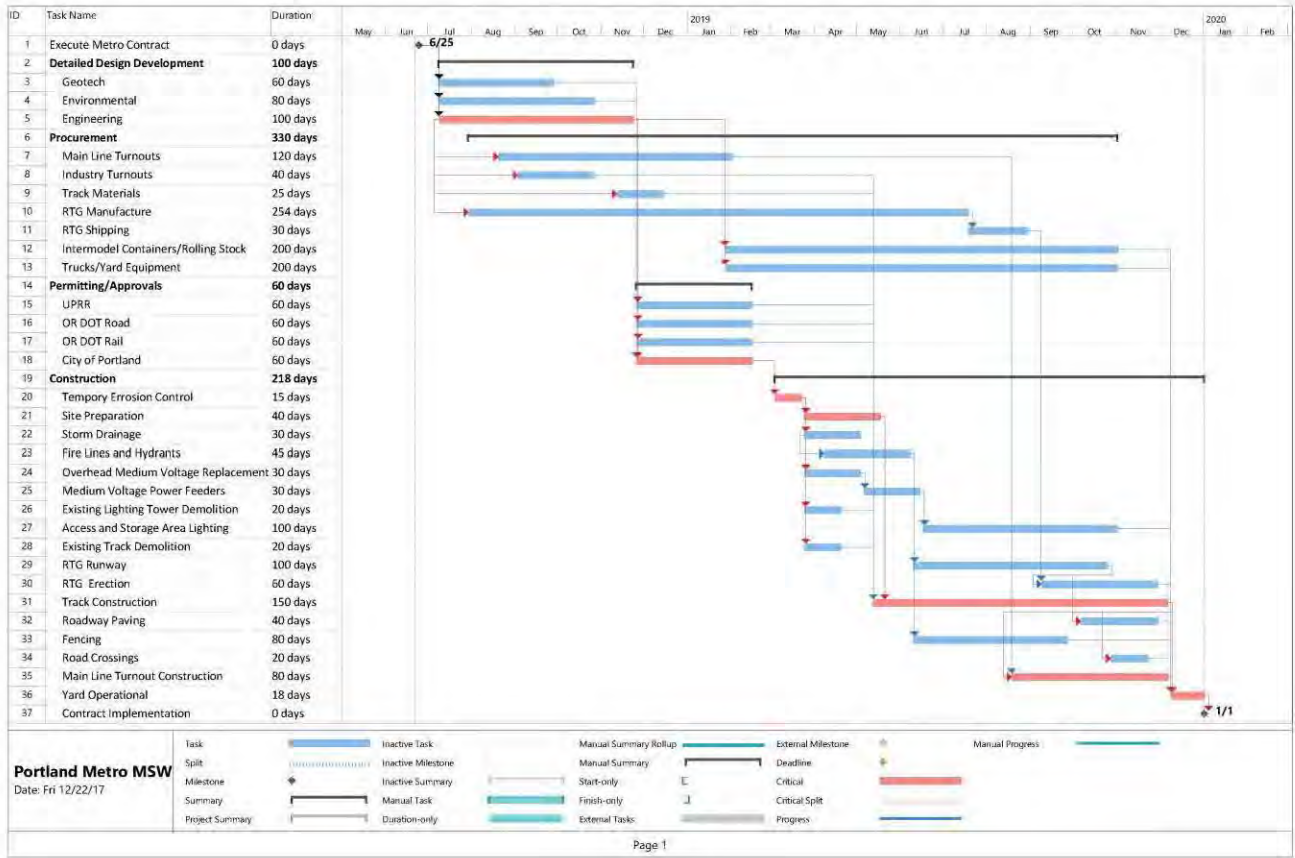
This page intentionally left blank





# Appendix 4: Project Timeline





# Appendix 5: Kittelson & Associates Traffic/Transportation Analysis



January 16, 2018

Project #: 22131

Ian Townsend  
Harris Group  
1750 NW Naito Parkway, Suite 200  
Portland, OR 97209

***RE: Metro Proposal for Solid Waste Transport Services – Traffic/Transportation Analysis Narrative***

Dear Ian,

The following letter contains traffic/transportation narrative/statistics for use or consideration in the Metro Proposal for Solid Waste Transport Services.

## **METRO CENTRAL STATION (MCS) AND METRO SOUTH STATION (MSS) TRUCK ROUTING SCENARIOSALBINA YARD**

A formal container truck routing plan was developed between the MCS and MSS stations to the proposed Union Pacific Rail Yard (Albina Yard location). Each routing plan was developed according to the following parameters:

- Utilize designated freight routes as recognized in the Oregon Highway Plan and Preferred city truck routes as designated in the City of Portland Freight Master Plan.
- Utilize routes that would have no direct impacts to existing retail or residential areas.

The resulting detailed routing plan directions and a map are provided in the sections below.

### **MCS to Albina Yards**

- 61st Ave to NW Front Avenue
- Right on NW Front Avenue
- Right on NW Kittridge Avenue
- Left on NW Yeon Avenue
- Merge onto I-405
- Merge onto I-5
- Exit 303 to Going Street
- West on Going Street

FILENAME: C:\USERS\FWILLMAN\APPDATA\LOCAL\MICROSOFT\WINDOWS\INETCACHE\CONTENT.OUTLOOK\PKN5JWMM\22131  
TRANSPORTATION NARRATIVE.DOCX



- Merge on Lagoon Ave
- Left on Anchor Street
- Merge onto Channel Avenue
- East on Channel Avenue...becomes Going Street
- Merge right on Greeley Avenue ramp
- South on Greeley Avenue
- Right on Russel Street



**Table 1 – MCS to Albina Yard Routing Statistics**

	Proposed Routing Distance (round trip)	Percentage of Proposed Route on Formally Designated Freight Corridors	Percentage of Proposed Route on Streets Serving Residential Neighborhoods or Active Retail Centers
MCS to Albina Yards	18.4 miles	100%	0%

As shown in Table 1, the MCS to Albina Yard route would be a total of 18.4 miles long (round trip). 100% of this route is located on formally designated state and/or local freight corridors. In addition, no segments of the route are located on streets serving residential neighborhoods or active retail centers. As such, there should be no distinguishable noise or traffic impacts on existing nearby residential neighborhoods.



**MSS to Albina Yard**

- Left onto Washington Street
- Right on Clackamas River Drive
- Right on Hwy 213
- Merge onto 205
- Exit 21B to I-84 west
- Merge onto I-5 north
- Exit 303 to Going Street
- West on Going Street
- Merge on Lagoon Ave
- Left on Anchor Street
- Merge onto Channel Avenue
- East on Channel Avenue...becomes Going Street
- Merge right on Greeley Avenue ramp
- South on Greeley Avenue
- Right on Russel Street



**Table 2 – MSS to Albina Yard Route Statistics**

	Proposed Routing Distance (round trip)	Percentage of Proposed Route on Formally Designated Freight Corridors	Percentage of Proposed Route on Streets Serving Residential Neighborhoods or Active Retail Centers
MSS to Albina Yard	46.4 miles	100%	0%

As shown in Table 2, the MSS to Albina Yard route would be a total of 46.4 miles long (round trip). 100% of this route is located on formally designated state and/or local freight corridors. In addition, no segments of the route are located on streets serving residential neighborhoods or active retail centers. As such, there should be no distinguishable noise or traffic impacts on existing nearby residential neighborhoods.





## CONTAINER TRUCK VS. RAIL SHIPMENT MILEAGE FIGURES

The proposal to utilize rail rather than individual container trucks to haul municipal solid waste (MSW) from the individual MCS and MSS transfer stations to the Columbia Ridge Landfill has some significant impacts on the number of container truck miles that will potentially be driven on Portland area highways and through the Columbia River Gorge National Scenic Areas.

For both scenarios, the following table compares to the projected number of annual container trucks generated by each transfer station and the total annual container truck miles traveled in the Portland Metropolitan Area and Columbia River Gorge National Scenic Area.

**Table 3 – Container Truck Miles Traveled Statistics**

	Projected Number of Annual Container Trucks	Projected Annual Container Truck Miles Traveled Through the Portland Metropolitan Area	Projected Annual Container Truck Miles Traveled Through the Columbia River Gorge National Scenic Area	Total Projected Annual Container Truck Miles Traveled
<b>Existing Container Trucks Direct to Columbia River Landfill (Round Trip)</b>				
MCS to/from Columbia River Landfill	6,853 trucks <sup>2</sup>	287,826 miles <sup>3</sup>	1,123,892 miles <sup>4</sup>	1,946,252 miles <sup>5</sup>
MSS to/from Columbia River Landfill	7,794 trucks <sup>2</sup>	342,936 miles <sup>6</sup>	1,278,216 miles <sup>4</sup>	2,213,496 miles <sup>7</sup>
	14,647 trucks	630,762 miles	2,402,108 miles	4,159,748 miles
<b>Proposed Container Trucks to Albina Yard Rail Station (Round Trip)</b>				
MCS to/from Albina Yard	8,321 trucks <sup>8</sup>	153,106 miles <sup>9</sup>	0 miles	153,106 miles <sup>10</sup>
MSS to/from Albina Yard	9,464 trucks <sup>8</sup>	439,130 miles <sup>11</sup>	0 miles	439,130 miles <sup>11</sup>
	17,785 trucks	592,236 miles	0 miles	592,236 miles

<sup>1</sup> Assumes MCS will process 233,000 tons of MSW per year and that the assumed net weight per long-haul container is 34 tons.

<sup>2</sup> Assumes the MSS will process 265,000 tons of MSW per year and that the assumed net weight per long-haul container is 34 tons.

<sup>3</sup> MCS travel path through the Portland Metropolitan Area is approximately 42 miles (round trip).

<sup>4</sup> MSS travel path through the Portland Metropolitan Area is approximately 44 miles (round trip).

<sup>5</sup> The Columbia River Gorge National Scenic Area comprises approximately 164 miles of the I-84 corridor (round trip).

<sup>6</sup> MCS travel path to the Columbia River Landfill is approximately 284 miles (round trip).

<sup>7</sup> MSS travel path to the Columbia River Landfill is approximately 284 miles (round trip).

<sup>8</sup> Assumes MCS will process 233,000 tons of municipal solid waste (MSW) per year and that the assumed net weight per container is 28 tons.

<sup>9</sup> Assumes the MSS will process 265,000 tons of MSW per year and that the assumed net weight per container is 28 tons.

<sup>10</sup> MCS travel path through the Portland Metropolitan Area to the Albina Yard rail station is approximately 18.4 miles (round trip).

<sup>11</sup> MSS travel path through the Portland Metropolitan Area to the Albina Yard rail station is approximately 46.4 miles (round trip).

As shown in Table 3, shipping the MSW via rail instead of individual container trucks will result in approximately 38,526 fewer annual container truck miles traveled within the Portland Metropolitan Area, 2,402,108 fewer annual container truck miles traveled through the Columbia River Gorge National Scenic Area, and 3,567,512 fewer annual container truck miles traveled in total.

Sincerely,  
KITTELSON & ASSOCIATES, INC.



Matt Hughart, AICP  
Associate Planner

This page intentionally left blank



# Appendix 6: Railyard and Staging Facility Site Plans



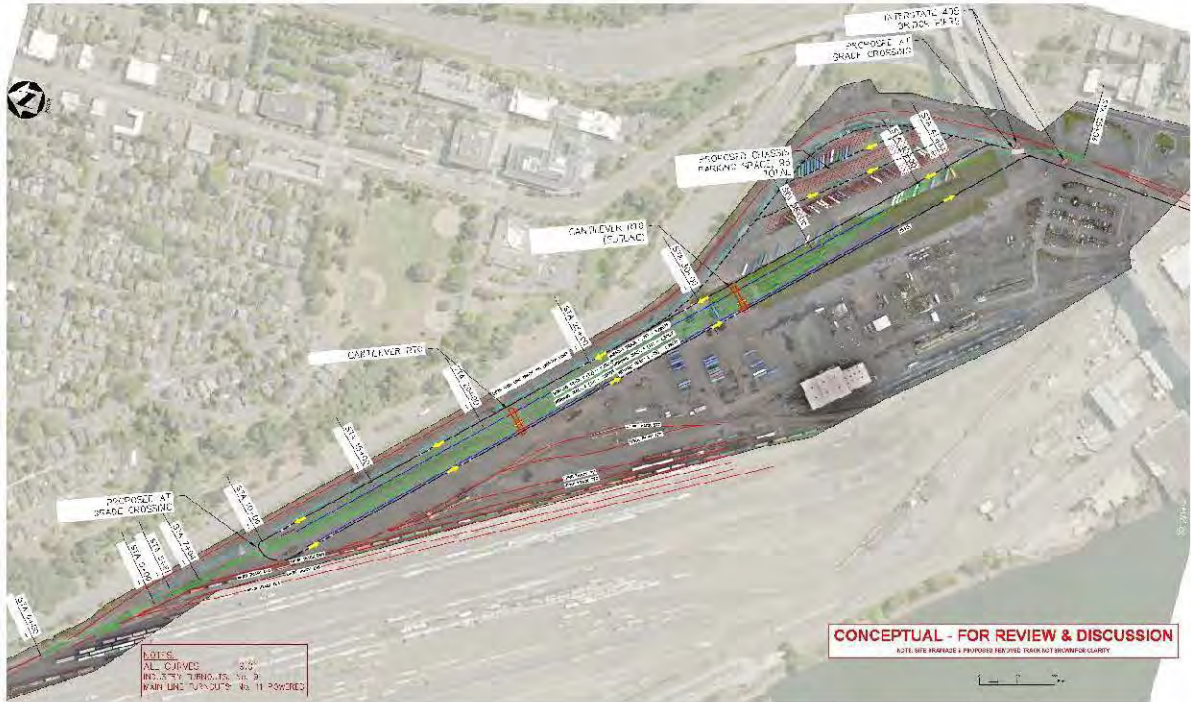


This page intentionally left blank



# Railyard and Staging Facility Site Plans: Union Pacific Railroad Portland Albina Railyard





NOTES:  
 ALL CURVES 500'  
 INDUSTRY TURNOUTS SHALL BE  
 MAIN LINE TURNOUTS. SEE 11-1502002

**PRELIMINARY NOT FOR CONSTRUCTION**

WASTE MANAGEMENT  
 ENVIRONMENTAL  
 ENGINEERING

**GENERAL NOTES**  
 THE INFORMATION ON THIS PLAN IS FOR INFORMATION ONLY. IT IS NOT TO BE USED FOR CONSTRUCTION. THE INFORMATION ON THIS PLAN IS SUBJECT TO CHANGE WITHOUT NOTICE. THE INFORMATION ON THIS PLAN IS NOT TO BE USED FOR CONSTRUCTION. THE INFORMATION ON THIS PLAN IS NOT TO BE USED FOR CONSTRUCTION.

DATE: 11/11/2011  
 TIME: 10:00 AM  
 PROJECT: 11-1502002

**UNION PACIFIC RAILROAD**  
 1000 WEST 10TH AVENUE  
 DENVER, CO 80202  
 PHONE: 303.462.1000  
 FAX: 303.462.1001  
 WWW.UTAHRAILROAD.COM





# Railyard and Staging Facility Site Plans: Columbia Ridge Landfill Railyard





# Railyard and Staging Facility Site Plans: Trailer Staging Near MCS





### Trailer Staging Near MCS

Located along Line Segment 47, Mile Post 4.25



# Appendix 7: AT&T Equipment Tracking Platform





## AT&T Asset Tracker

No matter what business you are in, missing, lost or stolen assets can cost you time and money. AT&T Asset Tracker enables you to track and manage your high-value assets, helping you to save money and run your business more effectively. Whether your business uses trailers, containers, construction equipment, or other portable equipment, you'll always know where your assets are and what they are doing. With additional sensor readings you can be instantly alerted in cases of unauthorized activity, such as open doors, fuel theft or usage of PTO (Power Take Off) equipment.

### Tracking for any asset

- **Transportation equipment:** assets that move daily or sit for long periods, such as trailers and shipping containers
- **Mobile office or storage:** assets that stay on site for long periods, such as construction offices or storage containers
- **Unpowered construction or field service equipment:** assets that change locations intermittently, such as pumps, compressors, and generators
- **Powered construction equipment:** assets that move on site and between sites, such as bobcats, backhoes and cranes
- **Refrigerated trailers:** trailers and containers that require climate control monitoring

### Tracking technology adapted to your needs

AT&T Asset Tracker adapts its operation to your asset's current status; changing transmission modes based on whether your asset is stationary or on the move.

- **Stationary without power:** transmits location once a day
- **Stationary with power:** transmits location every 4 hours
- **Moving with or without power:** starts transmitting on motion after 5 minutes, and continues to transmit every hour until motion stops\*
- **Device is tampered with or a significant change in sensor\*\* data values:** immediately transmits an alert, along with location and status information

\* Motion-enabled setting. Frequency of transmission is adjustable.

\*\* Up to 2 sensor connections, digital or analog. Sensors can be purchased separately.

### Rechargeable battery

The AT1000 Series feature a rechargeable battery. The built-in charger enables the device to recharge whenever it is connected to power. The device automatically notifies you of charging activity and battery status via alerts. The AT1000XT has the ability to recharge the battery in subzero temperatures.

### Long battery life

Since the device only transmits when it needs to, activity-based transmission modes maximize battery life, delivering more time in the field and less time in the shop.

### AT1000 Series key features

- Compact and simple to install
- 3G HSPA network
- 4 activity-based transmission modes: stationary, moving, connected to power and change in sensor status.
- Onboard 3D accelerometer
- Emergency push button
- 2 configurable I/O sensors (available on AT1000 and AT1000XT)
- Durable IP67 certified casing
- Over-the-air configuration and firmware upgrades
- 1 year warranty





### AT1000 Series technical specifications

#### Communication

- 3G HSPA - 3-band (850/1900/AWS) class 33; HSPA Cat.8 (7.2 Mbps) DL/Cat.6 (5.7 Mbps) UL; TCP/IP or UDP-IP, PDU SMS
- SIM - Internal, replaceable, 1.8V Remote PIN code management
- Antenna - Internal multi-band GSM antenna

#### GPS

- Technology - Internal module, SiRFIII GSC3F/LP single chipset
- Sensitivity (tracking) - -159 dBm
- Acquisition (normal) - Cold < 42 sec, Warm < 35 sec, Hot < 1 sec

#### Inputs & Outputs

- AT1000/AT1000XT Inputs - Two internally pulled up general purpose inputs
- AT1000B Inputs - N/A

#### Interfaces

- COM (RS 232) Port - AT1000 Serial Protocol; Debug, Configuration, FW upgrade
- 3D Accelerometer - Movement detection
- MMI - 2 LED status indication; activation / distress button; tamper switch

#### Power

- Input voltage - 4.2 V 1A CCCV
- Internal battery - Li-Polymer, 3.7V, 13.6 Ah, rechargeable
- AT1000/AT1000B battery life - up to 3 years without recharge based on 1 ping per day or ~850 pings
- AT1000XT battery life - up to 13 months based on 1 ping per day or ~395 pings

#### Dimensions & Weight

- Dimensions - ~6.10in x 3.19in x 1.77in
- Weight - ~17.28 ounces

#### Environment

- Temp, operating - -4° - 140° F
- AT1000/AT1000B Temp, charging - 32° - 113° F
- AT1000XT Temp, charging - 14° - 113° F
- Temp, storage - -4° - 95° F
- Ingress Protection - IP67
- Vibration, Impact - ISO 16750
- Mounting - Magnetic or screw mounted cradle; tampering detection

#### Certifications

- CE - CE EMC & R&TTE according to 89/336/EEC or 1995/5/EC; CE Safety EN60950-1:2001+A11:2004
- FCC - Part 15 Subpart B, part 22/24 compliant
- PTCRB - TRP, TIS Spurious and harmonics emission

### AT&T Fleet Complete Asset Tracker

#### Solution Details:

- Bundled and Unbundled options are available

#### Included:

- AT1000 Device
- AT&T Fleet Complete Web Portal
- 1 Yr Hardware Warranty
- Data Plan
- Unlimited Training and Support

#### Requirements:

- AT&T Billing Account

For more information visit [att.fleetcomplete.com](http://att.fleetcomplete.com) or contact your local AT&T Fleet Complete regional sales manager.

#### Important Information

General: AT&T Fleet Complete ("Fleet Complete") as described herein is available to AT&T's qualified customers participating in AT&T's contract with NASPO ValuePoint. AT&T Fleet Complete is subject to the terms and conditions of the NASPO ValuePoint Agreement, and applicable Sales Information. For qualified customers on the NASPO ValuePoint Agreement, Any Additional Product Terms not allowable under applicable law will not apply, and the NASPO ValuePoint Agreement will control in the event of any material conflict between the NASPO ValuePoint Agreement and the Additional Product Terms.

Pricing: Prices do not include taxes or other fees and are subject to change. Rates are not subject to any additional discounts under any AT&T discount plan. Additional credit and eligibility restrictions apply. Additional charges, terms, conditions and restrictions may apply. Offer and pricing subject to change without notice. AT&T privacy policy may be viewed at [www.att.com/privacy](http://www.att.com/privacy).

05/23/17

© 2017 AT&T Intellectual Property. All rights reserved. AT&T and the AT&T logo are trademarks of AT&T Intellectual Property.



This page intentionally left blank



# Appendix 8: Inspection and Incident Reporting Forms







## PREVENTIVE MAINTENANCE INSPECTION CHECKLIST TRAILER TIPPER

Location	Unit #	Inspection Date	Hour Meter Reading	Repair Order Number

INSPECT ALL ITEMS BELOW AND PLACE AN "X" IN THE APPROPRIATE CONDITION COLUMN. ALL REQUIRED PERSONAL PROTECTIVE EQUIPMENT IS TO BE USED AS REQUIRED DURING THE COURSE OF THE INSPECTION. OK = ALL CONDITIONS ARE SATISFACTORY; NS = NEEDS SERVICE

PRIOR TO INSPECTION A COMPLETE AND THOROUGH CLEANING IS REQUIRED - INCLUDE ALL BELLY PANS, FLOOR PANELS, COMPONENTS, COMPARTMENTS, ATTACHMENTS, FRAME AND CAB. NOTE: CLEANING MUST BE ENTERED AS A SEPARATE JOB IN COMPASS USING JOB CODE 02-999.

DURING INSPECTION CHECK FOR DAMAGE, FLUID LEAKS, LOOSE BOLTS, DEBRIS BUILDUP, DEBRIS WRAPPING, WIRE WRAPPING AND FOR EXCESSIVE WEAR TO: WHEELS, TIRES, OUTRIGGERS, DECK, RAMPS, CYLINDERS, ENGINE COMPARTMENT, CAB, LIGHTS, HOSES, AND SAFETY EQUIPMENT.

### "C" Service - 250 hours or 180 days (Items 1-49)

	Item	OK	NS
1	All LOTO Requirements Are To Be Followed per WM Policy		
2	Master Key Function - Inspect		
3	Strobe Light Wired to the Master Disconnect - Inspect		
4	Pre-wash Visual Inspection		
5	Wash Complete Machine		
6	Radiator Core / aftercooler - Inspect/Clean Both Sides		
7	Hydraulic Cooler - Inspect/Clean		
8	Air Conditioning Condenser - Inspect/Clean		
9	Battery & Hold Downs - Clean/Inspect/Clean Compartment		
10	Electrical/Cables/Wiring Harness/Hold Downs - Inspect		
11	All Lines, Hoses and Connections - Inspect		
12	Oil Samples - all compartments		
13	Check ALL Fluid Levels		
14	Safety Labels - Inspect/Replace As Needed		
15	Hand Rails/Steps - Inspect		
16	Fuse Panel - Inspect/Clean		
17	Fire Extinguishers/Brackets - Inspect		
18	Doors and Sheet Metal - Inspect/Lubricate		
19	Door and Window Seals - Inspect		
20	Window Washer - Fill		
21	Window Wiper - Inspect		
22	Operator Controls/Lights/Instrument Panel/ Gauges - Inspect		
23	Operator's Station - Inspect		
24	Cab Filters - Clean/Inspect		
25	Engine Air Filter Indicator - Inspect (change filter by indicator)		
26	Engine Compartment - Inspect		
27	Engine Fill Cap Seal - Inspect		
28	Engine Dip Stick, Seal and Tube - Inspect		
29	Engine Crankcase Breather - Clean/Inspect		
30	Engine Pre-Cleaner - Inspect/Clean		
31	Engine Air Induction System - Inspect		
32	Belts/Pulleys - Inspect/Adjust/Grease Tensioner		
33	Coolant System Inspection		
34	Starter/Alternator - Inspect		
35	Fuel Lines, Hoses and Connections - Inspect		
36	Fuel Tank Cap and Strainer - Inspect/Clean		
37	Fuel Tank Water and Sediment - Drain		
38	Tires - Check Overall Condition (air pressure, cracks, damage)		
39	Tire Pressure - Check and Record in the Comments Section of PM Form		
40	Wheels - Check lug nuts/bolt torque/inspect for cracks		
41	Front Ramps - Inspect		
42	Outriggers and Pads - Inspect		
43	Wing Bearing - Inspect for cracks		
44	Lift Cylinders - Inspect for leaks, cracks, bending, check alignment		
45	Cylinders - Check for excessive oil leakage around packing and scoring of stages. A light film of oil on stages is normal.		
46	Main Deck and Frame - Inspect for cracks both raised and lowered		
47	Main Deck Bearing - Measure movement & Slack (1/4" max slack allowed)		
48	Lubricate All Points on Machine - Inspect Grease Lines/Zerk Fittings		
49	Wrap-up Visual Inspection		

### "D" Service - 500 hours or 550 days (Items 1-56)

	Item	OK	NS
50	Change Engine Oil		
51	Change ALL Fluid Filters - use high efficiency		
52	Cut Open Filters - Inspect		
53	Cooling System - Level 1 Coolant Sample		
54	Water Pump - Inspect Weep Hole		
55	Radiator Relief Valve - Inspect		
56	Cab Air Filter - Change Cab Filters		

### "F" Service - 2000 hours or 730 days (Items 1-65)

(Performance Adjustments To Be Performed by Qualified Tech)		OK	NS
57	Electronic Unit Injector - Inspect/Adjust		
58	Engine - Check Governor High and Low Idle Speed		
59	Engine Valve Rotators - Inspect (refer to WM maintenance manual)		
60	Engine Valve Lash - Inspect/Adjust (refer to OEM maintenance manual)		
61	Engine Crankshaft Vibration Damper - Inspect		
62	Engine Mounts/Inspect		
63	Hydraulic Oil - Check Oil Analysis/Change as Needed		
64	Hydraulic Tank Breaker Relief Valve/Clean		
65	Cooling System - Change Hoses and Coolant (if needed)		

### "TIP" Service - 365 days

Landfill Tipper Inspection: have a qualified, competent third party inspect the complete tipper for structural and operational integrity: main frame, deck, ramps, outriggers, wings, backstop, cab, engine, suspension, dolly  
Job Code: 06-0PM-TIP

**REQUIRED REPAIRS/COMMENTS (additional comments should be noted on the back of the PMI form)**


CONDITIONS INDICATED ON THIS FORM ARE CURRENT AS OF THE TIME OF THE INSPECTION. MACHINE IS SAFE TO OPERATE.

Inspector's Name(s) and Signature(s): \_\_\_\_\_

Approving Official Name and Signature: \_\_\_\_\_





## PREVENTIVE MAINTENANCE INSPECTION Trailers

Refer to OEM References for Specific Procedures and/or Instructions

**F Inspection      Annual Inspection      (Check as appropriate)**

UNIT NUMBER	HUBOMETER READING	THERMETER READING	INSPECTION DATE	APE CAMPAIGN'S QUET TSB NUMBER	REPAIR ORDER NUMBER	STAR CARD REPAIR TIME
-------------	-------------------	-------------------	-----------------	--------------------------------	---------------------	-----------------------

Inspect all items below and place an X in the appropriate condition column. All Lock out Tag out requirements are to be followed in accordance with company policy. All required Personal Protective Equipment is to be used as required during the course of the inspection. The technician must establish a consistent starting and ending point for all PM Inspections.  
OK = All conditions are satisfactory NC = Needs Correction N/A = Not Applicable for Application

GENERAL						OK	NC	N/A			
1	Check license, decals, registration and placards										
2	Check lights and electrical components										
3	Check kingpin for damage or excessive/unusual wear										
4	Check draw tongue (if applicable) check operation of tongue jack. Lubricate as necessary										
5	Check body panels, roof, floor										
6	Check doors, seals, hinges and latching mechanisms. Lubricate as necessary										
7	Check safety chains, container tie-downs, load binders, tarps										
8	Check hydraulic lines/hoses, couplers, cylinders, valves, reservoir, controls, hydraulic motor										
9	Check landing gear. Lubricate as necessary										
10	Check mud flaps and rear under ride protection										
11	Check suspension springs, hangers, bushings, torque arms, beams, pads										
12	Check suspension "U" bolts for tightness & torque as necessary										
13	Check complete underbody, frame structure and weldments for cracks and breaks										
14	Check wheel seals and proper oil level in hubs										
15	Check tires for damage/wear. Check matching of size/type/brand. Gauge pressures and tread depths (record below)										
15a	Right Side	Forward Axle		Rear Axle		Spare Tire					
		<input type="text"/>	<input type="text"/>	<input type="text"/>	<input type="text"/>	<input type="text"/>					
	Left Side	<input type="text"/>	<input type="text"/>	<input type="text"/>	<input type="text"/>						
		<input type="text"/>	<input type="text"/>	<input type="text"/>	<input type="text"/>						
16	Check wheels for damage and torque										
17	Check wheels for loose fasteners (by using torque wrench or wheel torque indicators) -- or unusual wear in all areas										
18	Check brake system for damagewear: drums, lining, slack adjuster/ push rod angle, cam shafts, chambers. Lubricate as applicable										
19	Check and record push rod travel adjust brakes if necessary										
18A 19A	Right Side		Forward Axle			Rear Axle					
			Shoe Thickness	Top	Bottom	Hub Stroke	Top	Bottom	Hub Stroke		
			<input type="text"/>	<input type="text"/>	<input type="text"/>	<input type="text"/>	<input type="text"/>	<input type="text"/>	<input type="text"/>	<input type="text"/>	<input type="text"/>
	Left Side		<input type="text"/>	<input type="text"/>	<input type="text"/>	<input type="text"/>	<input type="text"/>	<input type="text"/>	<input type="text"/>	<input type="text"/>	<input type="text"/>
20	Check air system for leaks, damage to any air hoses lines or tubes, tanks										
21	Check and drain all air tanks, check spring brake application										
22	Check spare tire rack										
23	Check hub to hub axle alignment										
23a	Before Adjustment		After Adjustment								
	A	<input type="text"/>	A	<input type="text"/>							
	B	<input type="text"/>	B	<input type="text"/>							
	C	<input type="text"/>	C	<input type="text"/>							
	D	<input type="text"/>	D	<input type="text"/>							
24	Check/adjust hydraulic tank oil level checks/ service filter. Filter cap & breather as necessary										
25	Check operation of unit: controls, cycle time, unloading speed										
26	Check condition of cables and hooks										
27	Check condition of roll off hoist components										
28	Check operation of auto tarper. Lubricate as necessary										
<b>TRANSFER TRAILERS</b>						OK	NC	N/A			
29	Check compactor pin box or locking structure										
<b>EJECTOR TYPE</b>						OK	NC	N/A			
30	Check ejector cylinder. Lubricate as necessary										
31	Check ejector blade, rollers, tracks and guide shoes										
<b>WALKING FLOOR</b>						OK	NC	N/A			
32	Check floor slats, linkage, bearings, locks										
33	Check front shield										
34	Check deck bolts and cylinders. Torque to specs										
<b>TANK TRAILERS</b>						OK	NC	N/A			
35	Clean vacuum pump exterior, remove air filter cover (if applicable) and clean in fuel oil; spray 1 qt. of fuel oil into housing with pump idling										
36	Check vacuum pump connecting hoses, bolted flanges and connections										
37	Check vacuum manifold piping, hoses, clamps connectors, gaskets, end caps										
38	Check product valve										
39	Check unloading/suction hoses for kinks, worn spots, leaks, hose coupling ends and gaskets										
40	Check hose tubes and baskets										
41	Check tank body										
42	Check ladders, mounting and catwalks										
43	Check hatch covers, locks, hinge and gasket										











## PREVENTIVE MAINTENANCE INSPECTION Medium Duty/Heavy Duty Support Vehicle PMA (Includes Federal Annual Inspection)

UNIT NUMBER	ODOMETER READING	HR. METER READING	INSPECTION DATE	WORK ORDER NUMBER
ANNUAL INSP. EXPIRATION	REGISTRATION EXPIRATION	LICENSE PLATE NUMBER	ARE ANY CAMPAIGNS DUE? TSB NUMBER	

Inspect all items below and place an X in the appropriate condition column. All Lock Out Tag Out (LOTO) requirements are to be followed in accordance with company policy. All required Personal Protective Equipment (PPE) is to be used as required during the course of the inspection. The technician must establish a consistent starting and ending point for all Preventive Maintenance Inspections (PMI).

**OK = All Conditions are Satisfactory    NC = Needs Correction    N/A = Not Applicable for Application**



The equipment repair request or backlog file has been reviewed to verify validity and accuracy of stored data. <input type="checkbox"/> YES		CONDITION		
<b>Walk Up Inspection</b>		OK	NC	N/A
1	Visual Walk Around/Leaks/Damage and Vehicle ID Standards (Record Damage on Graphics Above)			
2	Check Fluids and Record Levels, Indicate Low Level Amounts and Condition: (S) Satisfactory (U) Unsatisfactory			
2d	Windshield Washer Fluid <u>          </u> ALWAYS TOP OFF    Hydraulic Brake Fluid <u>          </u> Quantity Added <u>          </u>			
<b>In Cab/Start Up Inspection</b>		OK	NC	N/A
3	Check for Overall Cab Cleanliness and Safety Hazards (Objects on Floor: Around Pedals, on Dash, and/or Under Seat)			
5	Turn Key Switch On, Engine Remains Off, Check Warning Lights Alarms/Buzzers			
6	Start Engine, Observe Initial Gauge Operation, Listen for Unusual Noises in Starting and Engine Systems, Check Shutdown System			
7	Verify Park Brake Holding Capacity			
<b>Move Truck to Shop</b>		OK	NC	N/A
8	Verify Service Brake Operation - Perform Rolling Stop and Check for Unusual Operation			
9	Verify Chassis Controls and Accessories Operation			
9b	Horns and Back-up Alarm Operation			
9c	Wiper/Washer Operation			
9e	Check Automatic Transmission Neutral Interlock System			
9i	Inspect Seat Belts			
9k	Verify Operation/Functionality of the Speedometer and Odometer			
12	Check Glass/Mirror Condition and Operation, Power/Heated Mirror Operation - Operation/Functionality of All External Lighting Devices			
<b>Body Operation/Controls</b>		OK	NC	N/A
16	<b>Boom/Crane Truck</b> - Verify Operation of All Body Control Functions and Safety Devices/Indicators			
16a	Check Functionality of the Control Panel Main Power Switch and the Control Panel Warning Lights			
16b	Check Functionality of All Work System Lights (Strobe, Rear, and Side)			
16c	Check the Function of All Emergency Stop Controls, Both Inside and Outside of the Cab			
16d	Extend and Retract Outriggers and Platforms			
16e	Lift, Lower, and Rotate Mast/Boom			
16f	Extend and Retract Mast/Boom			
16g	Activate/Test Throttle Up Control			
16h	Check Neutral Safety Interlock with Throttle Advance			
17	<b>Container Handling Truck</b> - Verify Operation of All Body Control Functions and Safety Devices/Indicators			
17a	Check Functionality of the Control Panel Main Power Switch and the Control Panel Warning Lights			
17b	Check Functionality of All Work System Lights (Strobe, Rear, and Side)			
17c	Lift, Tilt, and Rotate the Container Handling Attachment			
18	<b>Port-O-Let Truck</b> - Verify Operation of All Body Control Functions and Safety Devices/Indicators			
18a	Check Four-Way Valve Operation			
18b	Check Vacuum/Pressure Pump Operation			
18c	Check Vacuum Relief Safety Valve Operation			
18d	Check Pressure Relief Safety Valve Operation			
18e	Check Fresh Water System Operation			
19	<b>Service Truck</b> - Verify Operation of All Accessory Devices (Welders, Air Compressors, Lift Gates, Etc.)			



<b>In Shop Inspection with Power</b>		<b>OK</b>	<b>NC</b>	<b>N/A</b>
20	Perform Full Steering Test, Record Free Play in Steering Wheel: _____ Inches			
23	Perform Dynamic Air Pressure Drop Test			
24	Perform Static Air Pressure Drop Test			
26	Check and Record Primary Circuit Low Pressure Warning: _____ PSI (Light) (Buzzer) (Both)			
28	Check and Record Secondary Circuit Low Pressure Warning: _____ PSI (Light) (Buzzer) (Both)			
<b>Walk Around Inspection</b>		<b>OK</b>	<b>NC</b>	<b>N/A</b>
31	Inspect Lockout Switch, Mounting, Functionality, Lockability (Replace Faulty Switch Immediately)			
34c	Inspect/Lubricate Pedals			
35	Inspect Wiper Arms and Blades			
37	Inspect Lights, Reflectors, Safety Decals, Reflective Tape			
39	Inspect Fuel Tank/Mounting/Leak/Cap/Lines and Hoses			
40	Inspect Benders or Mud Flaps/Bumper/Under Ride Devices - Check Cab Steps and Hand Holds			
46	Inspect Battery Cable Condition, Routing and Clamping			
<b>Body Inspection/Lubrication</b>		<b>OK</b>	<b>NC</b>	<b>N/A</b>
47	<b>Boom/Crane Truck</b> - Inspect/Lubricate the Body Components			
47a	Inspect Crane Mounting for Damage or Looseness			
47b	Inspect Hydraulic Valve, Lines, and fittings for Condition, Mounting, Routing, Leaks			
47c	Inspect/Lubricate Outriggers and Platforms			
47d	Inspect Mast and Rotation Unit for Condition and Damage, Lubricate Rotator Pivot Points and Mast Assembly			
47e	Inspect Boom, Cable and Cargo Handling Hook/Claw Condition and Mounting			
47f	Inspect Flatbed Condition, Including Attachment to Frame, and Tiedowns			
47g	Check Annual Crane/Boom Certification Documentation and Expiration Date, Record Date: _____			
48	<b>Container Handling Truck</b> - Inspect/Lubricate the Body Components			
48a	Inspect Condition of Lift, Tilt, and Rotate Hydraulic Controls, Lines, and fittings			
48b	Inspect Mounting to Frame and Structural Condition of Body Components			
48c	Inspect Forks and Rotator Plate for Condition and Mounting, Lubricate Fork Shaft and Rotator Pivot Points and Assembly			
48d	Inspect Safety Supports and Container Locks/Tiedowns			
49	<b>Port-O-Let Truck</b> - Inspect/Lubricate the Body Components			
49a	Inspect Four-Way Valve for Leaks, Mounting and Damage			
49b	Inspect Vacuum Pump for Leaks, Mounting and Damage			
49c	Inspect Primary Shut Off Trap for Mounting and Damage			
49d	Inspect Secondary Moisture Trap and Pre-Filter for Mounting, Damage, or Restriction			
49e	Check Oil Catch Muffler and/or Oil Separator for Leaks and Damage			
49f	Inspect Man Way and Seal for Leaks, Mounting and Damage			
49g	Check Vacuum and Pressure Relief Valves for Leaks, Mounting and Damage			
49h	Inspect Main and Fresh Water Tanks for Leaks, Mounting, Overall Condition and Damage			
49i	Inspect Vacuum Hoses and Hose Hangers (as Applicable) for Mounting, Overall Condition and Damage			
50	<b>Service Truck</b> - Inspect/Lubricate All Body Components and Accessory Devices			
50a	Inspect Overall Body Condition for Mounting and Damage			
50b	Check Compartment Doors, Latches and Locks for Operation; Lubricate Door Hinges, Latches, and Locks			
50c	Check Oil/Fluid Levels and Filters on Accessory Equipment (Welders, Air Compressors, Etc.)			
50d	Check Condition and Serviceability of Safety Equipment for Roadside Work			
51	Inspect/Lubricate 5th Wheel, Condition, Mounting, and Operation, Inspect Bittle Hook Condition and Mounting (If Equipped)			
<b>Raised Front End Inspection/Lubrication</b>		<b>OK</b>	<b>NC</b>	<b>N/A</b>
53	Inspect Kingpins, Knuckle to Axle Clearance, Grease King Pins/Spring Hangers/Shackle Pin			
<b>Under Vehicle Inspection/Lubrication</b> (Wheels Chocked - Brakes Released)		<b>OK</b>	<b>NC</b>	<b>N/A</b>
55	Inspect Spindles/Knuckle Steering Linkage/Kod Linds			
56	Inspect Suspension Mounts, Shock Absorbers, Spring Hangers, Shackles, U-bolts & Springs and Torque Rods			
57	Grease Kingpins/Spring Hangers/Shackle Pin, Ensure Thrust Bearing Takes Grease TRUCK ON GROUND			
58	Inspect Engine/Starter/Wiring/Cooling System/Hydraulics for Leaks and Damage			
59	Inspect Engine/Trans-Mounts, Bell Housing Bolts, Transmission Cooling Lines Routing and Clamping - Check Breather			
60	Verify Manual Transmission Oil Level, Top Off Oil and Check Condition - Check Breather			
62	Inspect/Lubricate Drive Line/U-Joints/Center Bearing - ENSURE ALL CAPS PURGE WHEN LUBRICATED			
63	Inspect Allison/Telma Retarder Condition, Connections, Cable Routing and Clamping			
64	Inspect Cross-Members/Frame Rails/Mount Bolts/Loose Routing and Clamping			



Under Vehicle Inspection/Lubrication (Continued)																							
65	Inspect Rear Axle(s) Oil Level and Pinion Seal; Check for Leaks; Clean or Replace Breathers; Check Wheel Seals Condition and Oil Level; Check for Housing Cracks																						
66	Inspect/Lubricate Steerable Tag or Pusher Axle																						
67	Check Drum and Rotor Wear/Condition																						
68	Record Remaining 1/32" of Brake Lining or Air Disc Brake Pad Thickness (Using Mechanical Wear Indicators):																						
68a	<table border="1" style="width: 100%; border-collapse: collapse;"> <tr> <td style="width: 20%;"></td> <td style="width: 15%;">STEER</td> <td style="width: 15%;">PUSH</td> <td style="width: 15%;">DRIVE AXLES</td> <td style="width: 15%;">TAG</td> </tr> <tr> <td>RIGHT SIDE</td> <td><input type="text"/></td> <td><input type="text"/></td> <td><input type="text"/></td> <td><input type="text"/></td> </tr> <tr> <td>LEFT SIDE</td> <td><input type="text"/></td> <td><input type="text"/></td> <td><input type="text"/></td> <td><input type="text"/></td> </tr> </table>		STEER	PUSH	DRIVE AXLES	TAG	RIGHT SIDE	<input type="text"/>	<input type="text"/>	<input type="text"/>	<input type="text"/>	LEFT SIDE	<input type="text"/>	<input type="text"/>	<input type="text"/>	<input type="text"/>							
		STEER	PUSH	DRIVE AXLES	TAG																		
	RIGHT SIDE	<input type="text"/>	<input type="text"/>	<input type="text"/>	<input type="text"/>																		
	LEFT SIDE	<input type="text"/>	<input type="text"/>	<input type="text"/>	<input type="text"/>																		
69 Check Brake Adjuster Angle, Push Rod Travel, and Record in Inches Below:																							
69a	<table border="1" style="width: 100%; border-collapse: collapse;"> <tr> <td style="width: 20%;"></td> <td style="width: 15%;">STEER</td> <td style="width: 15%;">PUSH</td> <td style="width: 15%;">DRIVE AXLES</td> <td style="width: 15%;">TAG</td> </tr> <tr> <td>RIGHT SIDE</td> <td><input type="text"/></td> <td><input type="text"/></td> <td><input type="text"/></td> <td><input type="text"/></td> </tr> <tr> <td>LEFT SIDE</td> <td><input type="text"/></td> <td><input type="text"/></td> <td><input type="text"/></td> <td><input type="text"/></td> </tr> </table>		STEER	PUSH	DRIVE AXLES	TAG	RIGHT SIDE	<input type="text"/>	<input type="text"/>	<input type="text"/>	<input type="text"/>	LEFT SIDE	<input type="text"/>	<input type="text"/>	<input type="text"/>	<input type="text"/>							
		STEER	PUSH	DRIVE AXLES	TAG																		
	RIGHT SIDE	<input type="text"/>	<input type="text"/>	<input type="text"/>	<input type="text"/>																		
	LEFT SIDE	<input type="text"/>	<input type="text"/>	<input type="text"/>	<input type="text"/>																		
70 Inspect Brake Chamber/Brake Adjuster Condition, Air Disc Brake Running Clearances; Inspect Pin for Free Movement; Remove Chamber Plug and Inspect for Hung Up Caging Plates <b>REPLACE BRAKE CHAMBER PLUG</b>																							
70a	Lubricate Automatic Slack Adjusters and S-Cams with PyroFlex Blue or Equivalent <b>HAND GREASE ONLY</b>																						
71	Inspect Brake Lines/Valves/Brackets, Security of Mounting, Routing, Clamping																						
<b>Engine Compartment Inspection/Lubrication</b>				OK NC N/A																			
81	Inspect Belts, Idler Pulley/Spring Tensioner, Fan, Hub, and Shroud																						
82	Check Engine for Fluid Leaks																						
83	Inspect Air Compressor and Power Steering Pump Condition and Mounting																						
86	Inspect Turbocharger and Exhaust Components, Including DPF Back-Pressure Monitor and Other Accessories																						
87	Inspect Radiator, CAC Cleanliness and Air Seals																						
88	Inspect/Lubricate Hydraulic Pump Shaft and U-joints																						
91	Inspect/Lubricate Steering System Box/Shaft/Link/Joints																						
<b>Tire and Wheel Inspection</b>				OK NC N/A																			
94	Inspect Tires, Condition, Cuts, Punctures - Remove Foreign Objects																						
95	Inspect Wheel Condition, Cracks, Damage																						
96	Check Wheel Fastener Torque																						
98	Inspect Hub Cap, Plug and Oil Level/Condition																						
100	Check Air Pressure & Tread Depth - Record to Chart Below:																						
100a	<table border="1" style="width: 100%; border-collapse: collapse;"> <tr> <td style="width: 20%;"></td> <td style="width: 15%;">STEER</td> <td colspan="2" style="width: 15%;">TIRE INFLATION/TREAD DEPTH</td> <td style="width: 15%;">PUSH</td> <td style="width: 15%;">DRIVE AXLES</td> <td style="width: 15%;">TAG</td> </tr> <tr> <td>RIGHT SIDE</td> <td><input type="text"/></td> <td><input type="text"/></td> <td><input type="text"/></td> <td><input type="text"/></td> <td><input type="text"/></td> </tr> <tr> <td>LEFT SIDE</td> <td><input type="text"/></td> <td><input type="text"/></td> <td><input type="text"/></td> <td><input type="text"/></td> <td><input type="text"/></td> </tr> </table>		STEER	TIRE INFLATION/TREAD DEPTH		PUSH	DRIVE AXLES	TAG	RIGHT SIDE	<input type="text"/>	<input type="text"/>	<input type="text"/>	<input type="text"/>	<input type="text"/>	LEFT SIDE	<input type="text"/>	<input type="text"/>	<input type="text"/>	<input type="text"/>	<input type="text"/>			
		STEER	TIRE INFLATION/TREAD DEPTH		PUSH	DRIVE AXLES	TAG																
	RIGHT SIDE	<input type="text"/>	<input type="text"/>	<input type="text"/>	<input type="text"/>	<input type="text"/>																	
	LEFT SIDE	<input type="text"/>	<input type="text"/>	<input type="text"/>	<input type="text"/>	<input type="text"/>																	
<b>Non-Standard Inspection Items (See Section 6 of PM Manual)</b>																							
Check COMPASS for Pending/Due Non-PM Standard Jobs (i.e. Valve Lash Adjustments, DPF Clearing, Etc.)			Check when Completed																				
This certifies that this inspection conforms to all requirements of Federal Regulation 49CFR, Part 396 subpart 17-23. Conditions indicated on this form are current as of the time of this inspection.																							
Inspector's Name(s) and Signature(s) _____																							
Approving Official Name and Signature _____																							
<b>Annual Inspection Certificate (Must be qualified IAW 49 CFR Part 396.19 to complete this inspection criteria)</b>																							
After completion of inspection, if all shaded code column items are in compliance, this qualifies as the Annual Inspection Form.																							
Complete this box for certification.																							
Date of Inspection: _____																							
Name and address of Motor Carrier where the Inspection Report is maintained:																							
Name _____																							
Address _____																							
City _____ State _____ Zip _____																							
This Vehicle has passed an annual inspection conducted in accordance with 49 CFR, Part 396.17 FMCSR.																							
Authorized Signature _____			Certificate Number _____																				







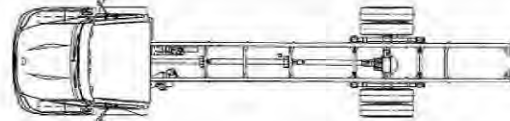
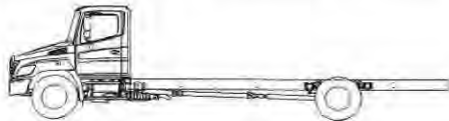


## PREVENTIVE MAINTENANCE INSPECTION Medium Duty/Heavy Duty Support Vehicle PMB (Includes Federal Annual Inspection)

UNIT NUMBER	ODOMETER READING	HR. METER READING	INSPECTION DATE	WORK ORDER NUMBER
ANNUAL INSP. EXPIRATION	REGISTRATION EXPIRATION	LICENSE PLATE NUMBER	ARE ANY CAMPAIGNS DUE? TSB NUMBER	

Inspect all items below and place an X in the appropriate condition column. All Lock Out Tag Out (LOTO) requirements are to be followed in accordance with company policy. All required Personal Protective Equipment (PPE) is to be used as required during the course of the inspection. The technician must establish a consistent starting and ending point for all Preventive Maintenance Inspections (PMI).

**OK = All Conditions are Satisfactory    NC = Needs Correction    N/A = Not Applicable for Application**



The equipment repair request or backlog file has been reviewed to verify validity and accuracy of stored data. <input type="checkbox"/> YES		CONDITION		
<b>Walk Up Inspection</b>		OK	NC	N/A
1	Visual Walk Around/Leaks/Damage and Vehicle ID Standards (Record Damage on Graphics Above)			
2	Check Fluids and Record Levels, Indicate Low Level Amounts and Condition: (S) Satisfactory (U) Unsatisfactory			
2a	Engine Oil Level OK    Oil Below Add Mark    Above Add Mark    Not Registering on Dipstick			
2b	Transmission    Quantity Added    Hydraulic System    Quantity Added			
2c	Power Steering System    Quantity Added    Cooling System    Quantity Added			
2d	Windshield Washer Fluid    ALWAYS TOPOFF    Hydraulic Brake Fluid    Quantity Added			
<b>In Cab/Start Up Inspection</b>		OK	NC	N/A
3	Check for Overall Cab Cleanliness and Safety Hazards (Objects on Floor Around Pedals, on Dash, and/or Under Seat)			
5	Turn Key Switch On, Engine Remains Off, Check Warning Lights Alarms/Buzzers			
5a	Low Oil Pressure Warning Passes Self Test			
5b	ABS System Warning Passes Self Test			
5c	Low Coolant Level Warning			
5d	Check Engine Light/Electronic Malfunction Lamp Active Fault(s) Indicated			
5e	Transmission Malfunction Indicator (Fault Codes)			
6	Start Engine, Observe Initial Gauge Operation, Listen for Unusual Noises in Starting and Engine Systems, Check Shutdown System			
7	Verify Park Brake Holding Capacity			
<b>Move Truck to Shop</b>		OK	NC	N/A
8	Verify Service Brake Operation - Perform Rolling Stop and Check for Unusual Operation			
9	Verify Chassis Controls and Accessories Operation			
9a	Heater/AC/Defrost/Blower Operation			
9b	Horns and Back-up Alarm Operation			
9c	Wiper/Washer Operation			
9e	Check Automatic Transmission Neutral Interlock System			
9f	Clutch Operation and Starter Interlock Operation, Record Clutch Free Play: _____ Inches			
9i	Inspect Seat Belts			
9j	Auto Neutral/Work Brake			
9k	Verify Operation/Functionality of the Speedometer and Odometer			
12	Check Glass/Mirror Condition and Operation, Power/Heated Mirror Operation - Operation/Functionality of All External Lighting Devices			
13	Check Functionality of Lift Axle to Include Reverse-Up Function as Applicable			
<b>Body Operation/Controls</b>		OK	NC	N/A
16	<b>Boom/Crane Truck</b> - Verify Operation of All Body Control Functions and Safety Devices/Indicators			
16a	Check Functionality of the Control Panel Main Power Switch and the Control Panel Warning Lights			
16b	Check Functionality of All Work System Lights (Strobe, Rear, and Side)			
16c	Check the Function of All Emergency Stop Controls, Both Inside and Outside of the Cab			
16d	Extend and Retract Outriggers and Platforms			
16e	Lift, Lower, and Rotate Mast/Boom			





<b>Body Operation/Controls (Continued)</b>		<b>OK</b>	<b>NC</b>	<b>N/A</b>
16f	Extend and Retract Mast/Boom			
16g	Activate/Test Throttle Up Control			
16h	Check Neutral Safety Interlock with Throttle Advance			
17	<b>Container Handling Truck</b> - Verify Operation of All Body Control Functions and Safety Devices/Indicators			
17a	Check Functionality of the Control Panel Main Power Switch and the Control Panel Warning Lights			
17b	Check Functionality of All Work System Lights (Strobe, Rear, and Side)			
17c	Lift, Tilt, and Rotate the Container Handling Attachment			
18	<b>Port-O-Let Truck</b> - Verify Operation of All Body Control Functions and Safety Devices/Indicators			
18a	Check Four-Way Valve Operation			
18b	Check Vacuum/Pressure Pump Operation			
18c	Check Vacuum Relief Safety Valve Operation			
18d	Check Pressure Relief Safety Valve Operation			
18e	Check Fresh Water System Operation			
19	<b>Service Truck</b> - Verify Operation of All Accessory Devices (Welders, Air Compressors, Lift Gates, etc.)			
<b>In Shop Inspection with Power</b>		<b>OK</b>	<b>NC</b>	<b>N/A</b>
20	Perform Full Steering Test, Record Free Play in Steering Wheel: _____ Inches			
21	Blasd Air System to Governor Cut-In Pressure, Record Pressure: _____ PSI (Minimum 100 PSI)			
22	Record System Cut-Out Pressure and Confirm Air Dryer Purge. Record Pressure: _____ PSI			
23	Perform Dynamic Air Pressure Drop Test			
24	Perform Static Air Pressure Drop Test			
25	Verify Operation of Reservoir Check Valves			
26	Check and Record Primary Circuit Low Pressure Warning: _____ PSI (Light) (Buzzer) (Both)			
27	Test Emergency Spring Brake Operation			
28	Check and Record Secondary Circuit Low Pressure Warning: _____ PSI (Light) (Buzzer) (Both)			
29	Check Function of the Park Brake Valve(s). Record the PSI When the Valve Self Sets: _____ PSI			
30	Check Air System Build Up Time, Record Time: _____ Seconds			
<b>Walk Around Inspection</b>		<b>OK</b>	<b>NC</b>	<b>N/A</b>
31	Inspect Lockout Switch, Mounting, Functionality, Lockability (Replace Faulty Switch Immediately)			
32	Check Safety Equipment (Fire Extinguisher, Spill Kit, Triangles)			
33	Check Door Operation and Latch/Striker, Hinges, Door and Frame, and Door Seals LUBRICATE ALL APPROPRIATE POINTS			
34a	Inspect Seats, Cushions, Mounting, Lubricate Rollers and Track			
34b	Inspect Steering Column Integrity			
34c	Inspect/Lubricate Pedals			
35	Inspect Wiper Arms and Blades			
36	Inspect Front Mounted Hydraulic Pump, Condition and Mounting, Lubricate PTO Shaft			
37	Inspect Lights, Reflectors, Safety Decals, Reflective Tape			
38	*ALL CYLINDERS RETRACTED - Inspect Hydraulic System, Tank Mounting/Breather/Cylinders/Hoses/Valve Body/Filter(s)			
39	Inspect Fuel Tank/Mounting/Leaks/Cap/Lines and Hoses			
40	Inspect Fenders or Mud Flaps/Bumper/Lider Ride Devices - Check Cab Steps and Hand Holds			
<b>Batteries and Cables</b>		<b>OK</b>	<b>NC</b>	<b>N/A</b>
43	Inspect Battery Box Mounting and Cover			
46	Inspect Battery Cable Condition, Routing and Clamping			
<b>Body Inspection/Lubrication</b>		<b>OK</b>	<b>NC</b>	<b>N/A</b>
47	<b>Boom/Crane Truck</b> - Inspect/Lubricate the Body Components			
47a	Inspect Crane Mounting for Damage or Looseness			
47b	Inspect Hydraulic Valve, Lines, and fittings for Condition, Mounting, Routing, Leaks			
47c	Inspect/Lubricate Outriggers and Platforms			
47d	Inspect Mast and Rotation Unit for Condition and Damage, Lubricate Rotator Pivot Points and Mast Assembly			
47e	Inspect Boom, Cable and Cargo Handling Hook/Claw Condition and Mounting			
47f	Inspect Flashed Condition, Including Attachment to Frame, and Tiedowns			
48	<b>Container Handling Truck</b> - Inspect/Lubricate the Body Components			
48a	Inspect Condition of Lift, Tilt and Rotate Hydraulic Controls, Lines, and Fittings			
48b	Inspect Mounting to Frame and Structural Condition of Body Components			





<b>Body Inspection/Lubrication (Continued)</b>		<b>OK</b>	<b>NC</b>	<b>N/A</b>															
48c	Inspect Forks and Rotator Plate for Condition and Mounting. Lubricate Fork Shaft and Rotator Pivot Points and Assembly																		
48d	Inspect Safety Supports and Container Locks/Tiedowns																		
49	<b>Port-O-Let Truck</b> - Inspect/Lubricate the Body Components																		
49a	Inspect four-Way Valve for Leaks, Mounting and Damage																		
49b	Inspect Vacuum Pump for Leaks, Mounting and Damage																		
49c	Inspect Primary Shut Off Trap for Mounting and Damage																		
49d	Inspect Secondary Moisture Trap and Pre Filter for Mounting, Damage, or Restriction																		
49e	Check Oil Catch Muffler and/or Oil Separator for Leaks and Damage																		
49f	Inspect Man Way and Seal for Leaks, Mounting and Damage																		
49g	Check Vacuum and Pressure Relief Valves for Leaks, Mounting and Damage																		
49h	Inspect Main and Fresh Water Tanks for Leaks, Mounting, Overall Condition and Damage																		
49i	Inspect Vacuum Hoses and Hose Hangers (as Applicable) for Mounting, Overall Condition and Damage																		
50	<b>Service Truck</b> - Inspect/Lubricate All Body Components and Accessory Devices																		
50a	Inspect Overall Body Condition for Mounting and Damage																		
50b	Check Compartment Doors, Latches and Locks for Operation; Lubricate Door Hinges, Latches, and Locks																		
50c	Check Oil/Fluid Levels and Filters on Accessory Equipment (Welders, Air Compressors, Etc.)																		
50d	Check Condition and Serviceability of Safety Equipment for Roadside Work																		
51	Inspect/Lubricate 5th Wheel, Condition, Mounting, and Operation. Inspect Pintle Hook Condition and Mounting <i>(If Equipped)</i>																		
<b>Raised Front End Inspection/Lubrication</b>		<b>OK</b>	<b>NC</b>	<b>N/A</b>															
52	Verify Wheel Bearing End Play and Operation																		
53	Inspect Kingpins, Knuckle to Axle Clearance, Grease King Pins/Spring Hangers/Shackle Pin																		
<b>Under Vehicle Inspection/Lubrication</b>																			
<b>(Wheels Chocked-Brakes Released)</b>		<b>OK</b>	<b>NC</b>	<b>N/A</b>															
55	Inspect Spindles/Knuckle Steering Linkage/Kod Linds																		
56	Inspect Suspension Mounts, Shock Absorbers, Spring Hangers, Shackles, U-bolts & Springs and Torque Rods																		
57	Grease Kingpins/Spring Hangers/Shackle Pin. Ensure Thrust Bearing Takes Grease <b>TRUCK ON GROUND</b>																		
58	Inspect Engine/Starter/Wiring/Cooling System/Hydraulics for Leaks and Damage																		
59	Inspect Engine/Trans-Mounts, Bell Housing Bolts, Transmission Cooling Lines Routing and Clamping - Check Breather																		
60	Verify Manual Transmission Oil Level, Top Off Oil and Check Condition - Check Breather																		
61	Inspect Air Dryer Mounting, Connections, and Wiring																		
62	Inspect/Lubricate Drive Line/U-Joints/Center Bearing <b>INSURE ALL CAPS PURGE WHEN LUBRICATED</b>																		
63	Inspect Allison/Telma Retarder Condition, Connections, Cable Routing and Clamping																		
64	Inspect Cross Members/Frame Rails/Mount Bolts/Hoses Routing and Clamping																		
65	Inspect Rear Axle(s) Oil Level and Pinion Seal; Check for Leaks; Clean or Replace Breathers; Check Wheel Seals Condition and Oil Level; Check for Housing Cracks																		
66	Inspect/Lubricate Steerable Tag or Pusher Axle																		
67	Check Drum and Rotor Wear/Condition																		
68	Record Remaining 1/32" of Brake Lining or Air Disc Brake Pad Thickness (Using Mechanical Wear Indicators)																		
68a	<table border="1" style="width:100%; border-collapse: collapse;"> <thead> <tr> <th></th> <th style="text-align: center;">STEER</th> <th style="text-align: center;">PUSH</th> <th style="text-align: center;">DRIVE AXLES</th> <th style="text-align: center;">TAG</th> </tr> </thead> <tbody> <tr> <td style="text-align: center;">RIGHT SIDE</td> <td style="text-align: center;"><input type="text"/></td> <td style="text-align: center;"><input type="text"/></td> <td style="text-align: center;"><input type="text"/></td> <td style="text-align: center;"><input type="text"/></td> </tr> <tr> <td style="text-align: center;">LEFT SIDE</td> <td style="text-align: center;"><input type="text"/></td> <td style="text-align: center;"><input type="text"/></td> <td style="text-align: center;"><input type="text"/></td> <td style="text-align: center;"><input type="text"/></td> </tr> </tbody> </table>		STEER	PUSH	DRIVE AXLES	TAG	RIGHT SIDE	<input type="text"/>	<input type="text"/>	<input type="text"/>	<input type="text"/>	LEFT SIDE	<input type="text"/>	<input type="text"/>	<input type="text"/>	<input type="text"/>			
	STEER	PUSH	DRIVE AXLES	TAG															
RIGHT SIDE	<input type="text"/>	<input type="text"/>	<input type="text"/>	<input type="text"/>															
LEFT SIDE	<input type="text"/>	<input type="text"/>	<input type="text"/>	<input type="text"/>															
69	Check Brake Adjuster Angle, Push Rod Travel, and Record in Inches Below:																		
69a	<table border="1" style="width:100%; border-collapse: collapse;"> <thead> <tr> <th></th> <th style="text-align: center;">STEER</th> <th style="text-align: center;">PUSH</th> <th style="text-align: center;">DRIVE AXLES</th> <th style="text-align: center;">TAG</th> </tr> </thead> <tbody> <tr> <td style="text-align: center;">RIGHT SIDE</td> <td style="text-align: center;"><input type="text"/></td> <td style="text-align: center;"><input type="text"/></td> <td style="text-align: center;"><input type="text"/></td> <td style="text-align: center;"><input type="text"/></td> </tr> <tr> <td style="text-align: center;">LEFT SIDE</td> <td style="text-align: center;"><input type="text"/></td> <td style="text-align: center;"><input type="text"/></td> <td style="text-align: center;"><input type="text"/></td> <td style="text-align: center;"><input type="text"/></td> </tr> </tbody> </table>		STEER	PUSH	DRIVE AXLES	TAG	RIGHT SIDE	<input type="text"/>	<input type="text"/>	<input type="text"/>	<input type="text"/>	LEFT SIDE	<input type="text"/>	<input type="text"/>	<input type="text"/>	<input type="text"/>			
	STEER	PUSH	DRIVE AXLES	TAG															
RIGHT SIDE	<input type="text"/>	<input type="text"/>	<input type="text"/>	<input type="text"/>															
LEFT SIDE	<input type="text"/>	<input type="text"/>	<input type="text"/>	<input type="text"/>															
70	Inspect Brake Chamber/Brake Adjuster Condition, Air Disc Brake Running Clearances; Inspect Pin for Free Movement; Remove Chamber Plug and Inspect for Hung Up Caging Plate <b>REPLACE BRAKE CHAMBER PLUG</b>																		
70a	Lubricate Automatic Slack Adjusters and S-Cams with PyroFlex Blue or Equivalent <b>HAND GREASE ONLY</b>																		
71	Inspect Brake Lines/Valves/Brackets, Security of Mounting, Routing, Clamping																		
<b>Engine Compartment Inspection/Lubrication</b>		<b>OK</b>	<b>NC</b>	<b>N/A</b>															
72	Sample Engine Oil																		
74a	Change Fuel Filter(s)																		

Engine Compartment Inspection/Lubrication (Continued)		OK	NC	N/A																										
74b	Conduct Coolant Nitrite and Freeze Point Tests Using Appropriate Testing Devices, Replace Coolant and/or Filter as Required by Test Result Results: Nitrite Level _____ FH Level _____ Freeze Point _____																													
74c	Fuel Water Separator (Change as Required by Indication on Gauge or Filter)																													
74d	Change OEM Oil Spinner (Centrifugal) Cartridge and Any Non-Extended Life Oil Filters																													
75	Pressurize Cooling System and Test Cap, Check for Leaks and Remove Pressure Tester After Item #87																													
76	Inspect Cab Structure/Mounts/Tilt Assembly and Any Rooftop Mounted Accessories																													
78	Inspect Coolant System for Leaks, Damage, Routing and Clamping, and Broken Studs/Bolts																													
79	Inspect Air Induction System for Leaks, Damage, Routing and Clamping, and Broken Studs/Bolts on the Air Cleaner Housing																													
80	Record Air Filter Restriction _____ (In/Min) REPLACE FILTER AS REQUIRED BY RESTRICTION																													
81	Inspect Belts, Idler Pulley/Spring Tensioner, Fan, Hub, and Shroud																													
82	Check Engine for Fluid Leaks																													
83	Inspect Air Compressor and Power Steering Pump Condition and Mounting																													
86	Inspect Turbocharger and Exhaust Components, Including DPF Back-Pressure Monitor and Other Accessories																													
87	Inspect Radiator, CAC Cleanliness and Air Seals																													
88	Inspect/Lubricate Hydraulic Pump Shaft and U-joints																													
89	Clean and Service Crankcase Filter																													
90	Inspect A/C Compressor, Drier, Tubing, Hoses, for Damage, Wear, Routing and Clamping																													
91	Inspect/Lubricate Steering System/Steer/Shaft/Link/Joints																													
<b>Tire and Wheel Inspection</b>		OK	NC	N/A																										
94	Inspect Tires, Condition, Cuts, Punctures - Remove Foreign Objects																													
95	Inspect Wheel Condition, Cracks, Damage																													
96	Check Wheel Fastener Torque																													
98	Inspect Hub Cap, Plug and Oil Level/Condition																													
100	Check Air Pressure & Tread Depth - Record to Chart Below:																													
100a	<table border="1" style="width: 100%; text-align: center;"> <thead> <tr> <th colspan="2"></th> <th colspan="8">TIRE INFLATION/TREAD DEPTH</th> </tr> <tr> <th colspan="2"></th> <th colspan="2">STEER</th> <th colspan="2">PUSH</th> <th colspan="2">DRIVE AXLES</th> <th colspan="2">TAG</th> </tr> </thead> <tbody> <tr> <td>RIGHT SIDE</td> <td><input type="text"/></td><input type="text"/></tr></tbody></table>						TIRE INFLATION/TREAD DEPTH										STEER		PUSH		DRIVE AXLES		TAG		RIGHT SIDE	<input type="text"/>	<input type="text"/>	<input type="text"/>	<input type="text"/>	<input type="text"/>
		TIRE INFLATION/TREAD DEPTH																												
		STEER		PUSH		DRIVE AXLES		TAG																						
RIGHT SIDE	<input type="text"/>																													
LEFT SIDE	<input type="text"/>	<input type="text"/>	<input type="text"/>	<input type="text"/>	<input type="text"/>																									

**Non-Standard Inspection Items (See Section 6 of PM Manual)**					
Check COMPASS for Pending/Due Non-PM Standard Jobs (i.e. Valve Lash Adjustments, DPF Cleaning, Etc)		Check when Completed			
This certifies that this inspection conforms to all requirements of Federal Regulation 49CFR, Part 396 subpart 17-23. Conditions indicated on this form are current as of the time of this inspection.					
Inspector's Name(s) and Signature(s) \_\_\_\_\_					
Approving Official Name and Signature \_\_\_\_\_					
**Annual Inspection Certificate (Must be qualified IAW 49 CFR Part 396.19 to complete this inspection criteria)**					
After completion of inspection, if all shaded code column items are in compliance, this qualifies as the Annual Inspection Form. Complete this box for certification.					
Date of inspection: \_\_\_\_\_					
Name and address of Motor Carrier where the inspection report is maintained:					
Name \_\_\_\_\_					
Address \_\_\_\_\_					
City \_\_\_\_\_ State \_\_\_\_\_ Zip \_\_\_\_\_					
This Vehicle has passed an annual inspection conducted in accordance with 49 CFR, Part 396.17 FMCSR.					
Authorized Signature \_\_\_\_\_ Certificate Number \_\_\_\_\_					
PM Item	Required Repairs			Priority	Job Code






## PREVENTIVE MAINTENANCE INSPECTION Medium Duty/Heavy Duty Support Vehicle OIL (Includes Federal Annual Inspection)

UNIT NUMBER	ODOMETER READING	HR. METER READING	INSPECTION DATE	WORK ORDER NUMBER
ANNUAL INSP. EXPIRATION	REGISTRATION EXPIRATION	LICENSE PLATE NUMBER	ARE ANY CAMPAIGNS DUE? TSB NUMBER	

Inspect all items below and place an X in the appropriate condition column. All Lock Out Tag Out (LOTO) requirements are to be followed in accordance with company policy. All required Personal Protective Equipment (PPE) is to be used as required during the course of the inspection. The technician must establish a consistent starting and ending point for all Preventive Maintenance Inspections (PMI).

OK = All Conditions are Satisfactory    NC = Needs Correction    N/A = Not Applicable for Application



The equipment repair request or backlog file has been reviewed to verify validity and accuracy of stored data.		I	YES	CONDITION		
Walk Up Inspection				OK	NC	N/A
1	Visual Walk Around/Leaks/Damage and Vehicle ID Standards (Record Damage on Graphics Above)					
2	Check Fluids and Record Levels, Indicate Low Level Amounts and Condition: (S) Satisfactory (U) Unsatisfactory					
2a	Engine Oil Level OK _____ Oil Below Add Mark _____ Above Add Mark _____ Not Registering on Dipstick _____					
2b	Transmission    Quantity Added    Hydraulic System    Quantity Added					
2c	Power Steering System    Quantity Added    Cooling System    Quantity Added					
2d	Windshield Washer Fluid    ALWAYS TOP OFF    Hydraulic Brake Fluid    Quantity Added					
In Cab/Start Up Inspection				OK	NC	N/A
3	Check for Overall Cab Cleanliness and Safety Hazards (Objects on Floor Around Pedals, on Dash, and/or Under Seat)					
4	Check Cab for Valid Permits, Licenses, Insurance, and Registration Paperwork, Accident Investigation Kit, and Annual Inspection Sticker					
5	Turn Key Switch On, Engine Remains Off, Check Warning Lights Alarms/Buzzers					
5a	Low Oil Pressure Warning Passes Self Test					
5b	ABS System Warning Passes Self Test					
5c	Low Coolant Level Warning					
5d	Check Engine Light/Electronic Malfunction Lamp Active Fault(s) Indicated					
5e	Transmission Malfunction Indicator (Fault Codes)					
6	Start Engine, Observe Initial Gauge Operation, Listen for Unusual Noises in Starting and Engine Systems, Check Shutdown System					
6a	Indicate Charging System Voltage _____ and Oil Pressure Reading _____					
7	Verify Park Brake Holding Capacity					
Move Truck to Shop				OK	NC	N/A
8	Verify Service Brake Operation - Perform Rolling Stop and Check for Unusual Operation					
9	Verify Chassis Controls and Accessories Operation					
9a	Heater/AC/Defrost/Blower Operation					
9b	Horns and Back-up Alarm Operation					
9c	Wiper/Washer Operation					
9d	Dash/Interior Lighting					
9e	Check Automatic Transmission Neutral Interlock System					
9f	Clutch Operation and Starter Interlock Operation, Record Clutch Free Play _____ Inches					
9g	Accelerator Pedal Condition and Travel (Includes In-Cab Linkage Points)					
9h	Retarder Lights, Ensure Telma/Allison Retarder is Switched On					
9i	Inspect Seat Belts					
9j	Auto Neutral/Work Brake					
9k	Verify Operation/Functionality of the Speedometer and Odometer					
10	Check AM/FM and Two Way Radio					
11	Check Monitors/Camera/Scales/On-Board Computer Unit (OBCU)					
12	Check Glass/Mirror Condition and Operation, Power/Heated Mirror Operation - Operation/Functionality of All External Lighting Devices					
13	Check Functionality of Lift Axle to Include Reverse-Up Function as Applicable					





<b>Body Operation/Controls</b>		<b>OK</b>	<b>NC</b>	<b>N/A</b>
14	Verify Body Controls are Clearly Labeled			
15	Check Hydraulic Pump and PTO Operation			
16	<b>Boom/Crane Truck - Verify Operation of All Body Control Functions and Safety Devices/Indicators</b>			
16a	Check Functionality of the Control Panel Main Power Switch and the Control Panel Warning Lights			
16b	Check Functionality of All Work System Lights (Strobe, Rear, and Side)			
16c	Check the Function of All Emergency Stop Controls, Both Inside and Outside of the Cab			
16d	Extend and Retract Outriggers and Platforms			
16e	Lift, Lower, and Rotate Mast/Boom			
16f	Extend and Retract Mast/Boom			
16g	Activate/Test Throttle Up Control			
16h	Check Neutral Safety Interlock with Throttle Advance			
17	<b>Container Handling Truck - Verify Operation of All Body Control Functions and Safety Devices/Indicators</b>			
17a	Check Functionality of the Control Panel Main Power Switch and the Control Panel Warning Lights			
17b	Check Functionality of All Work System Lights (Strobe, Rear, and Side)			
17c	Lift, Tilt, and Rotate the Container Handling Attachment			
18	<b>Port-O-Let Truck - Verify Operation of All Body Control Functions and Safety Devices/Indicators</b>			
18a	Check Four Way Valve Operation			
18b	Check Vacuum/Pressure Pump Operation			
18c	Check Vacuum Relief Safety Valve Operation			
18d	Check Pressure Relief Safety Valve Operation			
18e	Check Fresh Water System Operation			
19	<b>Service Truck - Verify Operation of All Accessory Devices (Welders, Air Compressors, Lift Gates, Etc.)</b>			
<b>In Shop Inspection with Power</b>		<b>OK</b>	<b>NC</b>	<b>N/A</b>
20	Perform Full Steering Test. Record Free Play in Steering Wheel: _____ Inches			
21	Bleed Air System to Governor Cut-In Pressure. Record Pressure: _____ PSI (Minimum 100 PSI)			
22	Record System Cut-Out Pressure and Confirm Air Dryer Purge. Record Pressure: _____ PSI			
23	Perform Dynamic Air Pressure Drop Test			
24	Perform Static Air Pressure Drop Test			
25	Verify Operation of Reservoir Check Valves			
26	Check and Record Primary Circuit Low Pressure Warning: _____ PSI (Light) (Buzzer) (Both)			
27	Test Emergency Spring Brake Operation			
28	Check and Record Secondary Circuit Low Pressure Warning: _____ PSI (Light) (Buzzer) (Both)			
29	Check Function of the Park Brake Valve(s). Record the PSI When the Valve Self Sets: _____ PSI			
30	Check Air System Build Up Time. Record Time: _____ Seconds			
<b>Walk Around Inspection</b>		<b>OK</b>	<b>NC</b>	<b>N/A</b>
31	Inspect Lockout Switch, Mounting, Functionality, Lockability (Replace Faulty Switch Immediately)			
32	Check Safety Equipment (Fire Extinguisher, Spill Kit, Triangles)			
33	Record Fire Extinguisher Inspection Expiration Date: _____			
34	Check Door Operation and Latch/Striker, Hinges, Door and Frame, and Door Seals LUBRICATE ALL APPROPRIATE POINTS			
34a	Inspect Seats, Cushions, Mounting, Lubricate Rollers and Track			
34b	Inspect Steering Column Integrity			
34c	Inspect/Lubricate Pedals			
35	Inspect Wiper Arms and Blades			
36	Inspect Front Mounted Hydraulic Pump, Condition and Mounting, Lubricate PTO Shaft			
37	Inspect Lights, Reflectors, Safety Decals, Reflective Tape			
38	*ALL CYLINDERS RETRACTED - Inspect Hydraulic System, Tank Mounting/Breather/Cylinders/Hoses/Valve Body/Filter(s)			
38a	Recycle Fluid Through Filter Buggy			
39	Inspect Fuel Tank/Mounting/Leaks/Cap/Lines and Hoses			
40	Inspect Fenders or Mud Flap; Bumper/Under Ride Devices Check Cab Steps and Hand Holds			
41	Inspect Body Mounting Bolts, Flat Bar, Rear Hinge/Mount Maintenance Lift (if Equipped)			
42	Inspect Camera, Mounting, Condition, Wiring			
42	Inspect License Plate(s)/Registration Sticker(s)			



<b>Batteries and Cables</b>		<b>OK</b>	<b>NC</b>	<b>N/A</b>
43	Inspect Battery Box Mounting and Cover			
44	Clean/Service Batteries/Cables/Hold Downs			
45	Load-Test Batteries - P=Pass, F=Fail <b>Battery #1:</b> (P) (F) <b>Battery #2:</b> (P) (F) <b>Battery #3:</b> (P) (F) <b>Battery #4:</b> (P) (F)			
46	Inspect Battery Cable Condition, Routing and Clamping			
<b>Body Inspection/Lubrication</b>		<b>OK</b>	<b>NC</b>	<b>N/A</b>
47	<b>Boom/Crane Truck</b> - Inspect/Lubricate the Body Components			
47a	Inspect Crane Mounting for Damage or Looseness			
47b	Inspect Hydraulic Valve, Lines, and fittings for Condition, Mounting, Routing, Leaks			
47c	Inspect/Lubricate Outriggers and Platforms			
47d	Inspect Mast and Rotation Unit for Condition and Damage, Lubricate Rotator Pivot Points and Mast Assembly			
47e	Inspect Boom, Cable and Cargo Handling Hook/Claw Condition and Mounting			
47f	Inspect Flatbed Condition, Including Attachment to Frame, and Tiedowns			
47g	Check Annual Crane/Boom Certification Documentation and Expiration Date, Record Date: _____			
48	<b>Container Handling Truck</b> - Inspect/Lubricate the Body Components			
48a	Inspect Condition of Lift, Tilt, and Rotate Hydraulic Controls, Lines, and Fittings			
48b	Inspect Mounting to Frame and Structural Condition of Body Components			
48c	Inspect Forks and Rotator Plate for Condition and Mounting, Lubricate Fork Shaft and Rotator Pivot Points and Assembly			
48d	Inspect Safety Supports and Container Locks/Tiedowns			
49	<b>Port-O-Let Truck</b> - Inspect/Lubricate the Body Components			
49a	Inspect Four-Way Valve for Leaks, Mounting and Damage			
49b	Inspect Vacuum Pump for Leaks, Mounting and Damage			
49c	Inspect Primary Shut Off Trap for Mounting and Damage			
49d	Inspect Secondary Moisture Trap and Pre-Filter for Mounting, Damage, or Restriction			
49e	Check Oil Catch Muffler and/or Oil Separator for Leaks and Damage			
49f	Inspect Man Way and Seal for Leaks, Mounting and Damage			
49g	Check Vacuum and Pressure Relief Valves for Leaks, Mounting and Damage			
49h	Inspect Main and Fresh Water Tanks for Leaks, Mounting, Overall Condition and Damage			
49i	Inspect Vacuum Hoses and Hose Hangers (as Applicable) for Mounting, Overall Condition and Damage			
50	<b>Service Truck</b> - Inspect/Lubricate All Body Components and Accessory Devices			
50a	Inspect Overall Body Condition for Mounting and Damage			
50b	Check Compartment Doors, Latches and Locks for Operation; Lubricate Door Hinges, Latches, and Locks			
50c	Check Oil/Fluid Levels and Filters on Accessory Equipment (Welders, Air Compressors, Etc.)			
50d	Check Condition and Serviceability of Safety Equipment for Roadside Work			
51	Inspect/Lubricate 5th Wheel, Condition, Mounting, and Operation, Inspect Pintle Hook Condition and Mounting (If Equipped)			
<b>Raised Front End Inspection/Lubrication</b>		<b>OK</b>	<b>NC</b>	<b>N/A</b>
52	Verify Wheel Bearing End Play and Operation			
53	Inspect Kingpins, Knuckle to Axle Clearance, Grease King Pins/Spring Hangers/Shackle Pin			
53a	Indicate Pin Movement from Circumference of Tire or Tapered Vertical Clearance: <b>Left Steer Horizontal/Vertical</b> ____ / ____ <b>Right Steer Horizontal/Vertical</b> / <b>Left Tag Horizontal/Vertical</b> / <b>Right Tag Horizontal/Vertical</b> /			
54	Check Steering Stops and Settings			
<b>Under Vehicle Inspection/Lubrication</b>		<b>OK</b>	<b>NC</b>	<b>N/A</b>
<b>(Wheels Chocked - Brakes Released)</b>				
55	Inspect Spindle/Knuckle Steering Linkage/Rod Ends			
56	Inspect Suspension Mounts, Shock Absorbers, Spring Hangers, Shackles, U bolts & Springs and Torque Rods			
57	Grease Kingpins/Spring Hangers/Shackle Pin, Ensure Thrust Bearing Takes Grease - TRUCK ON GROUND			
58	Inspect Engine/Starter/Wiring/Cooling System/Hydraulics for Leaks and Damage			
59	Inspect Engine/Trans-Mounts, Bell Housing Bolts, Transmission Cooling Lines Routing and Clamping - Check Breather			
60	Verify Manual Transmission Oil Level, Top Off Oil and Check Condition - Check Breather			
61	Inspect Air Dryer Mounting, Connections, and Wiring			
62	Inspect/Lubricate Drive Line/U-joints/Center Bearing - ENSURE ALL CAPS PURGE WHEN LUBRICATED			
63	Inspect Allison/Telma Retarder Condition, Connections, Cable Routing, and Clamping			
64	Inspect Cross-Members/Frame Rails/Mount Bolts/Hoses Routing and Clamping			
65	Inspect Rear Axle(s) Oil Level and Pinion Seal; Check for Leaks, Clean or Replace Breathers; Check Wheel Seals Condition and Oil Level; Check for Housing Cracks			
66	Inspect/Lubricate Steerable Tag or Pusher Axle			
67	Check Drum and Rotor Wear/Condition			





Under Vehicle Inspection/Lubrication (Continued)					OK	NC	N/A	
66	Record Rotating 1/32" of Brake Lining or Air Disc Brake Pad Thickness (Using Mechanical Wear Indicators)							
66a		STEER	PUSH	DRIVE AXLES	TAG			
	RIGHT SIDE	<input type="text"/>	<input type="text"/>	<input type="text"/>	<input type="text"/>	<input type="text"/>	<input type="text"/>	
	LEFT SIDE	<input type="text"/>	<input type="text"/>	<input type="text"/>	<input type="text"/>	<input type="text"/>	<input type="text"/>	
67	Check Brake Adjuster Angle, Push Rod Travel, and Record in Inches Below:							
67a		STEER	PUSH	DRIVE AXLES	TAG			
	RIGHT SIDE	<input type="text"/>	<input type="text"/>	<input type="text"/>	<input type="text"/>	<input type="text"/>	<input type="text"/>	
	LEFT SIDE	<input type="text"/>	<input type="text"/>	<input type="text"/>	<input type="text"/>	<input type="text"/>	<input type="text"/>	
70	Inspect Brake Chamber/Brake Adjuster/Condition, Air Disc Brake Running Clearance, Inspect Pin for Free Movement, Restore Chamber Plug and Inspect for Hung Up Coating Plate - REPLACE BRAKE CHAMBER PLUG							
70a	Lubricate Automatic Slack Adjusters and S-Cams with Penetrating Oil or Equivalent - HAND GREASE ONLY							
71	Inspect Brake Lines/Vegetal Growth, Security of Mounting, Routing, Clamping							
<b>Engine Compartment Inspection/Lubrication</b>					OK	NC	N/A	
72	Sample Engine Oil							
73	Change Engine Oil and Filters, Including the OEM Oil Service (Consumable) Can tags							
74	Change Fuel Filter(s)							
74a	Conduct Coolant Nitric and Freeze Point Tests Using Appropriate Testing Device, Replace Coolant and/or Filter as Required by Test Results. Record: Nitric Level _____ PH Level _____ Freeze Point _____							
74b	Fuel/Water Separator (Change as Required by Indication on Gauge or Filter)							
75	Pressure Cooking System and Test Caps, Check for Leaks and Restore Pressure Tower After Test # 20							
76	Inspect Cab Structure/Mounting Assembly and Any Rock or Mounted Accessories							
77	Inspect Brake Hoses and Cords							
78	Inspect Control System for Leaks, Damage, Routing and Clamping, and Broken Studs/Bolts							
79	Inspect Air Intake System for Leaks, Damage, Routing and Clamping, and Broken Studs/Bolts on the Air Cleaner Housing							
80	Record Air Filter Restriction _____ (In H <sub>2</sub> O) - REPLACE FILTER AS REQUIRED BY RESTRICTION							
81	Inspect Belts, Idler Pulley/Spring Tensioner, Fan, Hubs, and Shields							
82	Check Engine for Fluid Leaks							
83	Inspect Air Compressor and Power Steering Pump Condition and Mounting							
84	Check Fuel/Water Separator for Leaks, Damage, and Mounting							
85	Inspect Fuel Pump and Linkage							
86	Inspect Turbochargers and Exhaust Components - Including DPF Back-Pressure Monitor and Other Accessories							
87	Inspect Radiator, A/C Cleanliness and Air Seals							
88	Inspect/Lubricate Hydraulic Pump, Shell and U-joints							
89	Clean and Service Crankcase Filter							
90	Inspect A/C Compressor, Drier, Tubing, Hoses, for Damage, Wear, Routing and Clamping							
91	Inspect/Lubricate Steering System/Bowl/Shell/Link/Joints							
92	Inspect Alternator (Including Mounting/Wiring)							
93	Inspect Sags (Including Mounting/Wiring)							
<b>Tire and Wheel Inspection</b>					OK	NC	N/A	
94	Inspect Tires, Condition, Cuts, Punctures - Restore Foreign Objects							
95	Inspect Wheel Condition, Cracks, Damage							
96	Check Wheel Fastener Torque							
97	Inspect Valve Stem and Caps (Dust Seal)							
98	Inspect Hub Caps, Plug and Oil Level/Condition							
99	Check Dual Matching							
100	Check Air Pressure & Tread Depth - Record in Chart Below:							
100a		STEER	TIRE INFLATION/TREAD DEPTH		DRIVE AXLES		TAG	
			PUSH					
	RIGHT SIDE	<input type="text"/>	<input type="text"/>	<input type="text"/>	<input type="text"/>	<input type="text"/>	<input type="text"/>	<input type="text"/>
	LEFT SIDE	<input type="text"/>	<input type="text"/>	<input type="text"/>	<input type="text"/>	<input type="text"/>	<input type="text"/>	<input type="text"/>







**CRL-SITE  
SELF-INSPECTION  
RAIL YARD INSPECTION**

Please describe the exact safety concern and location for those items checked in the NO column on the last page of this section.

**YES NO**

**Month of January, 2018**

1.    \_\_\_ \_\_\_ Yard clean and free of debris
  2.    \_\_\_ \_\_\_ paved area is free of dirt and excess rock
  3.    \_\_\_ \_\_\_ all traffic (trucks and vehicles) are obeying the 25 mph speed limit
  4.    \_\_\_ \_\_\_ 8' buffer zone away from edge of rail (this goes for parked vehicles and containers)
  5.    \_\_\_ \_\_\_ rail transport vehicle is parked away from track being worked  
- lights are on if dark or low visibility conditions exist
  6.               dust conditions \_\_\_ low \_\_\_ mid \_\_\_ high
- Gondola area**
7.    \_\_\_ \_\_\_ pad is swept clean
  8.               sump level \_\_\_ low \_\_\_ mid \_\_\_ high



**CRL-SITE  
SELF-INSPECTION  
RAIL YARD INSPECTION**

Please describe the exact safety concern and location for those items checked in the NO column on the last page of this section.

**YES NO**

**Month of January, 2018**

ITEM # \_\_\_\_: What is to be corrected? \_\_\_\_\_

Person assigned to correct? \_\_\_\_\_

How is item to be corrected? \_\_\_\_\_

When will item be corrected? \_\_\_\_\_

ITEM # \_\_\_\_: What is to be corrected? \_\_\_\_\_

Person assigned to correct? \_\_\_\_\_

How is item to be corrected? \_\_\_\_\_

When will item be corrected? \_\_\_\_\_

ITEM # \_\_\_\_: What is to be corrected? \_\_\_\_\_

Person assigned to correct? \_\_\_\_\_

How is item to be corrected? \_\_\_\_\_

When will item be corrected? \_\_\_\_\_

INSPECTED BY \_\_\_\_\_

DATE \_\_\_\_\_

REVIEWED BY \_\_\_\_\_

DATE \_\_\_\_\_

Please return to Health & Safety Administrative Assistant.  
C:\Users\willman\OneDrive - Waste Management\Documents\Wastebyrail\Proposals\Portland Metro MSW\PROPOSAL  
CONTENT\ATTACHMENT INSPECTION FORMS\CRL Rail Yard Inspection.doc  
1/8/2018







# Supervisor's First Report of Incident

**Be Safe - Secure the Scene - Be Professional - Don't Assume**

Site ID	At Scene Investigator's Name	Date & Time Arrived On Scene
---------	------------------------------	------------------------------

<b>EMPLOYEE INVOLVED INFORMATION</b>		
Last Name, First Name, Middle Initial		Employee ID
Job Description at Time of Incident	Department at Time of Incident	How Long in Current Department
Date & Time employee began work	Supervisor's Name	Supervisor's Employee ID

<b>INCIDENT INFORMATION</b> <input type="checkbox"/> Vehicle Accident <input type="checkbox"/> Injury <input type="checkbox"/> Ops Liability		
Time & Date of Incident	Type (Vehicle Accident/Ops. Liability Type or Injury Type)	Critical Incident <input type="checkbox"/> Yes <input type="checkbox"/> No
Address of Incident (Be Specific! Provide nearest actual street address)	City	Zip/Postal Code

### VEHICLE ACCIDENT / OPERATIONAL LIABILITY

<b>WM Vehicle / Equipment</b>			
Equipment Type	Unit Number	Year	Make
Was Non-Standard Safety Equipment Installed? (List)	Vehicle Damage	Model	
Point of Initial Impact	Interior Distractions	Seat Belt Condition	
WM Action at Time of Accident:			

<b>Other Vehicle / Equipment</b>			
Vehicle Type	License Plate / Unit Number	Year	Make
Vehicle Damage	Color	Model	
Point of Initial Impact	Interior Distractions	Seat Belt Condition/Airbag Deployed	
OTHER Vehicle Action at Time of Accident:			

<b>Roadway / Physical Evidence</b>			
Speed Limit / Posted (Y/N)	Weather Conditions	Lighting Conditions	Median Type
Roadway Profile 1-4 (strait/curved)	2. (level, uphill, downhill, hillcrest)	3. (asphalt, concrete, dirt, gravel)	4. (wet / dry)
Lane Profile	Lane Markings Present		Traffic Control Devices

<b>Intersection Accident</b> <input type="checkbox"/> Yes <input type="checkbox"/> No	
Initial Impact in Relation to Intersection (prior to, within, after)	Level of Intersection

<b>Struck Pedestrian</b> <input type="checkbox"/> Yes <input type="checkbox"/> No	
Pedestrian Location	Pedestrian Action

<b>DOT</b>			
Number of Fatalities	Number of DOT Injuries	Number of Vehicles Towed	Hazardous Materials Released? <input type="checkbox"/> Yes <input type="checkbox"/> No



<b>CLAIMANT DATA (Other Driver / Operator)</b>			
Name		Driver's License Number	Phone
Address		City	Zip/Postal Code
Owners Name		Insurance Carrier / Phone / Policy Number	
Address		City	Zip/Postal Code
<b>Other Parties Involved</b>			
Name		Phone	Involvement / Injured?
Name		Phone	Involvement / Injured?
<b>Property Damage Data</b>			
Business Name		Contact Name	Phone
<b>Witness Data</b>			
Name		Phone	Involvement
Name		Phone	Involvement
<b>Police Data</b>			
Ticket Issued <input type="checkbox"/> Yes <input type="checkbox"/> No		If Yes, To Whom <input type="checkbox"/> WM <input type="checkbox"/> Others	Report Number
Name of Officer		Badge Number	
		Police Department	
<b>INJURY</b>			
Injury Cause		Injury Cause Detail	
Action at Time of Injury		Injury Type	Body Part
Was PPE Required? <input type="checkbox"/> Yes <input type="checkbox"/> No	Was PPE Worn at Time of Incident? <input type="checkbox"/> Yes <input type="checkbox"/> No	List PPE Worn	
<b>OSHA</b>			
Was Employee Treated in an Emergency Room? <input type="checkbox"/> Yes <input type="checkbox"/> No		Was Employee Hospitalized Overnight as an Inpatient? <input type="checkbox"/> Yes <input type="checkbox"/> No	
Name of Physician or Health Care Professional		Name of health Care Facility	
Address of Health Care Facility		City	Zip/Postal Code
Needle stick Injury? <input type="checkbox"/> Yes <input type="checkbox"/> No	Brand of Needle Stick Device	Where did the Injury Occur? (Be Specific)	
What Object or Substance Directly Harmed the Employee? (Be Specific!)			
What Was the Employee Doing Just Before the Injury? (Be Specific!)			
What Happened? (Describe what the employee was doing when injured, what the injury was, and what directly caused the injury)			



**OPERATOR ACTIONS / STATEMENTS**

**Employee Statement**

Ask open ended questions to determine what happened (who, what, where, when, why), and closed ended questions to verify facts (Y/N, one answer).

Describe your actions just prior to the incident.

**Other Operator Statement**

Ask open ended questions to determine what happened (who, what, where, when, why), and closed ended questions to verify facts (Y/N, one answer).

Describe your actions just prior to the incident.

**Witness Statement**

Ask open ended questions to determine what happened (who, what, where, when, why), and closed ended questions to verify facts (Y/N, one answer).





**SKETCH OF INCIDENT SCENE**



**North Indicator**

**Basic Items to Include in Sketch**

- |  |   |
|--|---|
| - Roads, Bridges, Rail Road Tracks, etc. | - Lane Profile & Markings                         |
| - Traffic Control Devices                | - Trees and Other Obstructions                    |
| - Location of Vehicles                   | - Skid Marks                                      |
| - Point of Initial Impact                | - Vehicle / Pedestrian Action at Time of Incident |



# DRIVER'S VEHICLE INSPECTION REPORT

AS REQUIRED BY THE D.C.T. FEDERAL MOTOR CARRIER SAFETY REGULATIONS

**1** CARRIER: Walsh Trucking  
**2** ADDRESS: Location Where Truck Is Parked  
**3** DATE: 3/14/2012 **4** TIME: 6:00 (A.M.) P.M.  
CHECK ANY DEFECTIVE ITEM AND GIVE DETAILS UNDER REMARKS

**5** TRACTOR/TRUCK NO. 543 **6** ODOMETER READING 126017

- |   |   |  |
|---|---|--|
| <input type="checkbox"/> Air Compressor<br><input type="checkbox"/> Air Lines<br><input type="checkbox"/> Battery<br><input type="checkbox"/> Belts and Hoses<br><input type="checkbox"/> Body<br><input type="checkbox"/> Brake Accessories<br><input type="checkbox"/> Brakes, Parking<br><input type="checkbox"/> Brakes, Service<br><input type="checkbox"/> Clutch<br><input type="checkbox"/> Coupling Devices<br><input type="checkbox"/> Defroster/Heater<br><input type="checkbox"/> Drive Line<br><input type="checkbox"/> Engine<br><input type="checkbox"/> Exhaust<br><input type="checkbox"/> Fifth Wheel<br><input type="checkbox"/> Fluid Levels<br><input type="checkbox"/> Frame and Assembly | <input type="checkbox"/> Front Axle<br><input type="checkbox"/> Fuel Tanks<br><input type="checkbox"/> Horn<br><input type="checkbox"/> Lights<br><input type="checkbox"/> Head/Stop<br><input type="checkbox"/> Tail/Dash<br><input type="checkbox"/> Turn Indicators<br><input type="checkbox"/> Clearance/Marker<br><input type="checkbox"/> Mirrors<br><input type="checkbox"/> Muffler<br><input type="checkbox"/> Oil Pressure<br><input type="checkbox"/> Radiator<br><input type="checkbox"/> Rear End<br><input type="checkbox"/> Reflectors | <input type="checkbox"/> Safety Equipment<br><input type="checkbox"/> Fire Extinguisher<br><input type="checkbox"/> Flags/Flares/Fusees<br><input type="checkbox"/> Reflective Triangles<br><input type="checkbox"/> Spare Bulbs and Fuses<br><input type="checkbox"/> Spare Seal Beam<br><input type="checkbox"/> Starter<br><input type="checkbox"/> Steering<br><input type="checkbox"/> Suspension System<br><input type="checkbox"/> Tire Chains<br><input type="checkbox"/> Tires<br><input type="checkbox"/> Transmission<br><input type="checkbox"/> Trip Recorder<br><input type="checkbox"/> Wheels and Rims<br><input type="checkbox"/> Windows<br><input type="checkbox"/> Windshield Wipers<br><input type="checkbox"/> Other |
|---|---|--|

**7** TRAILER(S) NO.(S) 4779

- |  |  |  |
|--|--|--|
| <input type="checkbox"/> Brake Connections<br><input type="checkbox"/> Brakes<br><input type="checkbox"/> Coupling Devices<br><input type="checkbox"/> Coupling (King) Pin<br><input type="checkbox"/> Doors | <input type="checkbox"/> Hitch<br><input type="checkbox"/> Landing Gear<br><input type="checkbox"/> Lights - All<br><input type="checkbox"/> Reflectors/Reflective Tape<br><input type="checkbox"/> Spot | <input type="checkbox"/> Suspension System<br><input type="checkbox"/> Tarpaulin<br><input type="checkbox"/> Tires<br><input type="checkbox"/> Wheels and Rims<br><input type="checkbox"/> Other |
|--|--|--|

**8** Remarks: If needed, remarks need to be legible.

---



---



---

**9**  CONDITION OF THE ABOVE VEHICLE IS SATISFACTORY

DRIVER'S SIGNATURE John Doe #7217

- ABOVE DEFECTS CORRECTED  
 ABOVE DEFECTS NEED NOT BE CORRECTED FOR SAFE OPERATION OF VEHICLE

MECHANIC'S SIGNATURE \_\_\_\_\_

**DVIR must include the following information:**

DRIVER'S SIGNATURE \_\_\_\_\_

**ORIGINAL**

- 1 Name of Company
- 2 Address (Where truck is parked)
- 3 Date
- 4 Time
- 5 Tractor number
- 6 Odometer reading
- 7 Trailer number
- 8 Remarks if needed (Must be legible)
- 9 Check if condition of vehicle is satisfactory
- 10 Driver signature and employee number

The DVIR must be filled out daily. One copy is turned in with driver's paperwork, and the other is left in the tractor. The next driver to use the vehicle must make sure any safety defects noted on the previous DVIR have been corrected and signed off by the mechanic making the repairs.



WALSH TRUCKING CO. LTD  
PM Checklists

Unit: 42010 (Refuse Trailer) Main Shop PM: TRAILER PM/A-PM  
RO # \_\_\_\_\_ Date \_\_\_\_\_

Hubo Mileage \_\_\_\_\_ Mechanic # \_\_\_\_\_

Block wheels and Release Brakes

Mechanics: Place your initials if OK or Needs Repair

Check all below OK, NA NR Comments  
Last date of DOT inspection [\_\_\_\_\_] [\_\_\_\_\_] \_\_\_\_\_  
If less than 120 days, need to perform.

Clean 7-wire plugs, check lights [\_\_\_\_\_] [\_\_\_\_\_] \_\_\_\_\_  
Treat 7-wire and tarp plugs with dielectric grease [\_\_\_\_\_] [\_\_\_\_\_] \_\_\_\_\_

Check mudflaps & anti-spray skirts [\_\_\_\_\_] [\_\_\_\_\_] \_\_\_\_\_

Is reflective tape installed [\_\_\_\_\_] [\_\_\_\_\_] \_\_\_\_\_  
(Sides & rear)  
Wide turn sticker on rear [\_\_\_\_\_] [\_\_\_\_\_] \_\_\_\_\_  
(tailgate)

Check king pin for wear, king pin [\_\_\_\_\_] [\_\_\_\_\_] \_\_\_\_\_  
plate, I-beams, supports for  
cracks.  
Check and lube 5th wheel plate and [\_\_\_\_\_] [\_\_\_\_\_] \_\_\_\_\_  
pintle hitches

Check hub oil levels, windows for [\_\_\_\_\_] [\_\_\_\_\_] \_\_\_\_\_  
cracks and leaks. Check lug  
nuts. Check tires for wear or  
damage & proper inflation.

Have chain hangers been installed [\_\_\_\_\_] [\_\_\_\_\_] \_\_\_\_\_  
with tire chains on them?

Check operation of landing legs & [\_\_\_\_\_] [\_\_\_\_\_] \_\_\_\_\_  
look over upper & lower mounts  
Check frame rails for cracks, [\_\_\_\_\_] [\_\_\_\_\_] \_\_\_\_\_  
check crossmembers, X-bracing,  
gussets & belly pan for cracks  
and/or damage.

Check crossmembers under belly for [\_\_\_\_\_] [\_\_\_\_\_] \_\_\_\_\_  
damage.

Check frame rails, transfer beam [\_\_\_\_\_] [\_\_\_\_\_] \_\_\_\_\_  
and X-bracing for cracks and/or  
damage.

Check sub-frame rails and cross- [\_\_\_\_\_] [\_\_\_\_\_] \_\_\_\_\_  
members, gussets, bolsters and





crossmembers under rear floor  
 for cracks and/or damage.

Page Two (2)

Mechanics: Place your initials if OK or NEEDS REPAIR  
 Check all below OK, NA NR Comments

=====  
 Check brake linings and drums, all [ ] [ ]  
 brake related components,  
 (chambers, air lines, hoses,  
 slack adjusters, air tanks, s-  
 cams and bushings) (max .030"  
 play).  
 Check for air leaks in valves and [ ] [ ]  
 lines.  
 Check wheel seals for seepage. [ ] [ ]  
 =====

=====  
 Check all suspension related com- [ ] [ ]  
 ponents, (air bags, leaf springs  
 u-bolts, swing arm bolts, equalizers,  
 mounts and spring hangers, shocks  
 and mounting hardware and  
 torque arms.  
 =====

=====  
 Retorque air ride suspension pivot [ ] [ ]  
 bolts to 500 ft/lbs. Note if equipped  
 with shear/lock style pivot bolts  
 =====

=====  
 Check tailgate, latch & handle, [ ] [ ]  
 hinges & pins, ladder for wear  
 & damage.  
 Does the tailgate close securely? [ ] [ ]  
 =====

=====  
 Check over all flooring for damage [ ] [ ]  
 Replace any loose and/or mis-  
 sing floor bolts, repair holes  
 in flooring.  
 =====

=====  
 Check top rails, corner braces, [ ] [ ]  
 center ties & corner gussets  
 for loose and/or broken bolts  
 and hucks.  
 =====

=====  
 Check complete tarp system & rel- [ ] [ ]  
 ated components, (bars, stops,  
 return rope, crank handle, 'J' hooks,  
 chains, front & rear header plates,  
 tarp strap puller & mounting  
 hardware.  
 =====

After having completed this checklist and making needed repairs, lube all  
 zerk fittings on s-cams, slack adjusters, landing legs and tarp crank



---

handle u-joint.

Adjust the brakes, apply and release service brakes to check operation.

Set and release emergency brakes to check operation.

MAKE SURE SHOP TOOLS AND LADDERS ARE REMOVED FROM EQUIPMENT!

Person releasing equipment for use \_\_\_\_\_



PM Checklists

Unit: 969 (Tractor 4 Axle) Eugene

PM: B-PM/Mack MP7 14EPA

RO # \_\_\_\_\_ Date \_\_\_\_\_

HUB Mileage \_\_\_\_\_ Mechanic # \_\_\_\_\_

EVERY 15,000 Miles A Service: Lube chassis, check gear oil, power steering & wet kit oil levels. Fill washer reservoir, check ECM fault tables.

EVERY 30,000 Miles B Service: Perform A service & change engine oil & filters. Change air filter if needed. Change wet kit hydraulic filter. Get a 5th wheel puller.

[ OK ] [ NR ] - Mechanics: Place your initials if OK or NEEDS REPAIR

[ ] [ ] - 1. Check all lights-Headlight low & high beam-dash lights & hook-up lights. Check mirror heat. Check door adjustment and latches.

[ ] [ ] - 2. Check condition of driver's seat.

[ ] [ ] - 3. Check wiper operation & blade condition & washers.

[ ] [ ] - 4. Check clutch freeplay and clutch brake. Must have 1-1/2" freeplay.

[ ] [ ] - 5. Check speedo & tach operation. Check fire extinguisher and triangles.

[ ] [ ] - 6. Check gauges, low air buzzer, warning lights and repair as needed.

[ ] [ ] - 7. Check front of truck for loose license plate, grille bumper, etc.

[ ] [ ] - 8. Make visual check of lug nuts, tires and wheels.

[ ] [ ] - 9. Change oil and filters.

[ ] [ ] - 10. Jack up front axle and check kingpins for looseness Lube zerks.

[ ] [ ] - 11. Check wheel bearings for tightness. Fill hubs to level. Check condition of oil & repair as needed.

[ ] [ ] - 12. Check u-joints for looseness, check carrier bearings and through shaft and advise.

[ ] [ ] - 13. Replace any worn u-joints or carrier bearings.

[ ] [ ] - 14. Lube chassis complete.

[ ] [ ] - 15. Inspect tag axle assy, king pins, air bags & repair as needed, raise & lower it.

[ ] [ ] - 16. Inspect shocks and stops and repair as needed.

[ ] [ ] - 17. Check all air lines from valves to chambers & repair any worn hoses. Check valves for leaks and repair as needed.





Page Two (2)

- [ OK ] [ NR ] - Mechanics: Place your initials if OK or NEEDS REPAIR.
- [ ] [ ] - 18. Inspect brake lining & components and repair as needed. Adjust all brakes.
- [ ] [ ] - 18a. Check torque on anchor plate bolts and caliper mounting bolts. If loose call Mike Booth at (503)880-9843 immediately.
- [ ] [ ] - 19. Check trans oil level and fill as needed. Inspect for leaks. \_\_\_\_\_ # added
- [ ] [ ] - 20. Check front diff for leaks, oil level and fill if low. Clean vent. \_\_\_\_\_ # added
- [ ] [ ] - 21. Check rear diff for leaks, oil level and fill if low. Clean vent. \_\_\_\_\_ # added
- [ ] [ ] - 22. Check transmission bellhousing bolts and tighten as needed.
- [ ] [ ] - 23. Check all motor mounts and cab mounts and replace if needed.
- [ ] [ ] - 24. Tighten steer axle u-bolts and inspect springs, pins and hangers.
- [ ] [ ] - 25. Tighten rear axle u-bolts, inspect air bags & ride height.
- [ ] [ ] - 26. Tighten torque arm bolts and inspect bushings.
- [ ] [ ] - 27. Check leveling valve & suspension dump system.
- [ ] [ ] - 28. Check 5th wheel jaws for tightness and adjust as needed. Lube 5th wheel complete. Check 5th wheel mounting pins and bushings and repair if needed.
- [ ] [ ] - 29. Drain air tanks and check air dryer operation. Repair as needed.
30. Engine Compartments-
- [ ] [ ] - A. Check radiator, heater and other hoses for hardness and leaks.
- [ ] [ ] - B. Check belts for wear, adjustment and alignment.
- [ ] [ ] - C. Check alternator bracket for tightness.
- [ ] [ ] - D. Check for fuel leaks and repair as needed.
- [ ] [ ] - E. Check for exhaust leaks. Check condition of components.
- [ ] [ ] - F. Check for loose starter mounting & cable connections.
- [ ] [ ] - G. Check all wiring and replace any bare wiring.
- [ ] [ ] - H. Check A/C operation, all brackets, hoses, belt, etc and repair as needed.
- [ ] [ ] - I. Check turbo shaft end play & pressure test charge air/intake system.



- [ ] [ ] - J. Check that fan hub bracket mount nuts are tight.  
=====
- [ ] [ ] - 31. Check radiator fluid level and check DCA concentration. Adjust if needed. Pressure test cooling system.  
=====
- [ ] [ ] - 32. Check anti-freeze level and adjust as needed. To -20 degrees.  
=====

Page Three (3)

- [ OK ] [ NR ] - Mechanics: Place your initials if OK or NEEDS REPAIR.  
=====
- [ ] [ ] - 33. Check batteries - load test and change any bad batteries. Check fluid levels.  
=====
- [ ] [ ] - 34. Clean cable ends and battery terminals. Apply protective coating.  
=====
- [ ] [ ] - 34(A) Clean trailer electrical power cable plugs and receptacles and treat with dielectric grease.  
=====
- [ ] [ ] - 35. Check tire pressure - inflate steer tires to 110 psi and tag and drive tires to 100 psi.  
=====
- [ ] [ ] - 36. Inspect & repair tire chains as needed.  
=====
- [ ] [ ] - 37. Inspect & repair 1/4 fenders & mud flaps as needed.  
=====
- [ ] [ ] - 38. Record date of last DOT Inspection \_\_\_\_/\_\_\_\_/\_\_\_\_  
Perform DOT Inspection if 90 days or less remain.  
=====
- [ ] [ ] - 39. Download life and trip recorder. Verify date and time are set correctly.  
=====

[32nd PSI] [ ] [ ]  ____/16_	[32nd PSI] [ ] [ ]  ____/16_	[32nd PSI] [ ] [ ]  ____/16_	[32nd PSI] [ ] [ ]  ____/16_	[32nd PSI] [ ] [ ]  ____/16_
	[32nd PSI] [ ] [ ]  ____/16_	[32nd PSI] [ ] [ ]  ____/16_	[32nd PSI] [ ] [ ]  ____/16_	[32nd PSI] [ ] [ ]  ____/16_
	[32nd PSI] [ ] [ ]  ____/16_	[32nd PSI] [ ] [ ]  ____/16_	[32nd PSI] [ ] [ ]  ____/16_	[32nd PSI] [ ] [ ]  ____/16_
[32nd PSI] [ ] [ ]  ____/16_	[32nd PSI] [ ] [ ]  ____/16_	[32nd PSI] [ ] [ ]  ____/16_	[32ND PSI] [ ] [ ]  ____/16_	[32nd PSI] [ ] [ ]  ____/16_







**DRIVER / EVALUATION - PART I - VEHICLE ROAD TEST**

Division Central Employee \_\_\_\_\_

Type of Equipment: Tractor & Trailer

Truck Make Mack Unit # 869 Year \_\_\_\_\_ Engine \_\_\_\_\_ Trans \_\_\_\_\_  
 Examined By \_\_\_\_\_ Title \_\_\_\_\_ Date \_\_\_\_\_

Parts I & II are to be completed for the purpose of qualifying / evaluation of the driver. Evaluations to be completed initially and annually and will be indicated as such below.

Initial                      Annual

**PART I - ROAD TEST**

PRE-TRIP INSPECTION AND STARTUP	Needs		
	Excell.	Accept.	Improv
Check around unit, tires, lights, oil and water.....	<input type="checkbox"/>	<input type="checkbox"/>	<input type="checkbox"/>
Checks seat and mirror adjustment.....	<input type="checkbox"/>	<input type="checkbox"/>	<input type="checkbox"/>
Checks instruments for normal readings and understands the same.....	<input type="checkbox"/>	<input type="checkbox"/>	<input type="checkbox"/>
Checks all truck controls/understands function of the same.....	<input type="checkbox"/>	<input type="checkbox"/>	<input type="checkbox"/>
Checks safety equipment: Fire ext., triangles, low air warning system.....	<input type="checkbox"/>	<input type="checkbox"/>	<input type="checkbox"/>
Tests steering, brake action and parking break.....	<input type="checkbox"/>	<input type="checkbox"/>	<input type="checkbox"/>
Checks operation of all unit functions-cycles unit.....	<input type="checkbox"/>	<input type="checkbox"/>	<input type="checkbox"/>
Checks and maintains necessary equipment required, i.e., tarps, pinning pipes, straps, shovels, etc.....	<input type="checkbox"/>	<input type="checkbox"/>	<input type="checkbox"/>
Reviews previous day vehicle inspection report		<input type="checkbox"/>	<input type="checkbox"/>
Complets pre trip section on current day vehicle inspection report		<input type="checkbox"/>	<input type="checkbox"/>
REMARKS: _____			

OPERATION OF VEHICLE			
A. Motor			
Operates engine within proper RPM range without lugging or over-revving.....	<input type="checkbox"/>	<input type="checkbox"/>	<input type="checkbox"/>
Checks instruments at regular intervals.....	<input type="checkbox"/>	<input type="checkbox"/>	<input type="checkbox"/>
B. Clutch and Transmission			
Starts unit in first gear without slipping clutch or jerking.....	<input type="checkbox"/>	<input type="checkbox"/>	<input type="checkbox"/>
Upshifts smoothly without grinding gears at proper RPM.....	<input type="checkbox"/>	<input type="checkbox"/>	<input type="checkbox"/>
Downshifts properly at proper engine RPM without clashing gears.....	<input type="checkbox"/>	<input type="checkbox"/>	<input type="checkbox"/>
Starts on grade without vehicle rolling backwards.....	<input type="checkbox"/>	<input type="checkbox"/>	<input type="checkbox"/>
REMARKS: _____			

C. Brakes/Slowing and Stopping			
Applies brakes with smooth even action.....	<input type="checkbox"/>	<input type="checkbox"/>	<input type="checkbox"/>
Adjusts speed for range of headlights.....	<input type="checkbox"/>	<input type="checkbox"/>	<input type="checkbox"/>
Gears down properly before descending steep hills.....	<input type="checkbox"/>	<input type="checkbox"/>	<input type="checkbox"/>
Uses engine break correctly (if so equipped).....	<input type="checkbox"/>	<input type="checkbox"/>	<input type="checkbox"/>
Uses brakes to hold truck on grade.....	<input type="checkbox"/>	<input type="checkbox"/>	<input type="checkbox"/>
REMARKS: _____			

Anticipates stops in advance to avoid hard breaking.....	Needs		
	Excell.	Accept.	Improv
Stops leaving proper space in front of truck.....	<input type="checkbox"/>	<input type="checkbox"/>	<input type="checkbox"/>
Stops before pedestrian crosswalks.....	<input type="checkbox"/>	<input type="checkbox"/>	<input type="checkbox"/>
Stops before crossing sidewalks when coming out of alleys.....	<input type="checkbox"/>	<input type="checkbox"/>	<input type="checkbox"/>
REMARKS: _____			

DRIVING IN TRAFFIC, PASSING AND TURNING			
A. Highway - Speed			
Observes speed limits.....	<input type="checkbox"/>	<input type="checkbox"/>	<input type="checkbox"/>
Adjusts speed properly to changing conditions: weather, road construction, traffic, etc.....	<input type="checkbox"/>	<input type="checkbox"/>	<input type="checkbox"/>
Slows down in advance of curve and danger zones.....	<input type="checkbox"/>	<input type="checkbox"/>	<input type="checkbox"/>
Stays in proper lane without weaving or excessive lane changes.....	<input type="checkbox"/>	<input type="checkbox"/>	<input type="checkbox"/>
Follows at proper interval/maintains 3-4 second interval.....	<input type="checkbox"/>	<input type="checkbox"/>	<input type="checkbox"/>
REMARKS: _____			

B. Passing			
Passes only in safe locations with sufficient space ahead.....	<input type="checkbox"/>	<input type="checkbox"/>	<input type="checkbox"/>
Signals changing lanes before and after passing.....	<input type="checkbox"/>	<input type="checkbox"/>	<input type="checkbox"/>
Warns vehicle ahead of intention to pass.....	<input type="checkbox"/>	<input type="checkbox"/>	<input type="checkbox"/>
Returns to right lane promptly, but only when safe.....	<input type="checkbox"/>	<input type="checkbox"/>	<input type="checkbox"/>
Does not pass unnecessarily or excessively.....	<input type="checkbox"/>	<input type="checkbox"/>	<input type="checkbox"/>
Continually checks mirrors - both sides - throughout the passing procedure.....	<input type="checkbox"/>	<input type="checkbox"/>	<input type="checkbox"/>
REMARKS: _____			

C. Intersections and Traffic Signs/Signals			
Slows down in advance and checks traffic conditions, regardless of traffic controls.....	<input type="checkbox"/>	<input type="checkbox"/>	<input type="checkbox"/>
Is prepared to stop if necessary.....	<input type="checkbox"/>	<input type="checkbox"/>	<input type="checkbox"/>
Anticipates signal changes correctly, does not run yellow or jump green.....	<input type="checkbox"/>	<input type="checkbox"/>	<input type="checkbox"/>
Comes to a complete stop at all signs.....	<input type="checkbox"/>	<input type="checkbox"/>	<input type="checkbox"/>
REMARKS: _____			

Revised 12/8/2017



	Needs		
	Excell	Accept	Improv
<b>D. Grade Crossings</b>			
Slows down for grade crossings or any rough roads.....	<input type="checkbox"/>	<input type="checkbox"/>	<input type="checkbox"/>
If required to stop, stops between 15 to 50 feet before grade crossing.....	<input type="checkbox"/>	<input type="checkbox"/>	<input type="checkbox"/>
Selects proper gear and does not shift gears while crossing grade.....	<input type="checkbox"/>	<input type="checkbox"/>	<input type="checkbox"/>
REMARKS: _____			

<b>E. Turning</b>			
Gets into proper lane well in advance and turns on signals (100 feet).....	<input type="checkbox"/>	<input type="checkbox"/>	<input type="checkbox"/>
Takes proper position at approach/restricts traffic from passing on right when preparing to turn right.....	<input type="checkbox"/>	<input type="checkbox"/>	<input type="checkbox"/>
Observes traffic conditions/pedestrians and turns only when intersection is clear.....	<input type="checkbox"/>	<input type="checkbox"/>	<input type="checkbox"/>
Maintains proper curve and turn without swinging wide or cutting short.....	<input type="checkbox"/>	<input type="checkbox"/>	<input type="checkbox"/>
Complete turn correctly into proper lane.....	<input type="checkbox"/>	<input type="checkbox"/>	<input type="checkbox"/>
When making left turn, wheels are straight before proceeding into the turn.....	<input type="checkbox"/>	<input type="checkbox"/>	<input type="checkbox"/>
REMARKS: _____			

<b>E. Backing and Parking</b>			
Before backing, checks mirrors for adequate clearances all around truck-right side, left side, rear overhead, (gets out of cab if necessary).....	<input type="checkbox"/>	<input type="checkbox"/>	<input type="checkbox"/>
Back up using most effective approach to back straight in, avoids backing to blind side.....	<input type="checkbox"/>	<input type="checkbox"/>	<input type="checkbox"/>
Uses caution and prudent speed while backing.....	<input type="checkbox"/>	<input type="checkbox"/>	<input type="checkbox"/>
REMARKS: _____			

	Pass	Fail
<b>Cab Items</b>		
Insurance card (current)	<input type="checkbox"/>	<input type="checkbox"/>
Vehicle registration card & Sticker (Current)	<input type="checkbox"/>	<input type="checkbox"/>
Fire extinguisher (full, secured, pin in place)	<input type="checkbox"/>	<input type="checkbox"/>
Cab clean and in order all items secure	<input type="checkbox"/>	<input type="checkbox"/>
Window & mirrors clean no obstructions	<input type="checkbox"/>	<input type="checkbox"/>
FMCSR Regulation pocket book (with in reach of seat belted driver)	<input type="checkbox"/>	<input type="checkbox"/>
Multi jurisdictional permit (current)	<input type="checkbox"/>	<input type="checkbox"/>
REMARKS: _____		

	Needs		
	Excell	Accept	Improv
<b>B. Parking</b>			
Parks vehicle in proper space-off pavement or in legal parking space.....	<input type="checkbox"/>	<input type="checkbox"/>	<input type="checkbox"/>
Applies spring brakes when parked.....	<input type="checkbox"/>	<input type="checkbox"/>	<input type="checkbox"/>
Uses emergency warning signal if applicable.....	<input type="checkbox"/>	<input type="checkbox"/>	<input type="checkbox"/>
Carefully re-enters traffic from parked position.....	<input type="checkbox"/>	<input type="checkbox"/>	<input type="checkbox"/>
REMARKS: _____			

<b>COUPLING AND UNCOUPLING OF TRAILERS</b>			
(If applicable)	<input type="checkbox"/>	<input type="checkbox"/>	<input type="checkbox"/>
Connects glad hands and light lines properly.....	<input type="checkbox"/>	<input type="checkbox"/>	<input type="checkbox"/>
Connects glad hands to trailer to apply brakes before coupling.....	<input type="checkbox"/>	<input type="checkbox"/>	<input type="checkbox"/>
Couples without difficulty.....	<input type="checkbox"/>	<input type="checkbox"/>	<input type="checkbox"/>
Visually checks king pins/pintle hook assembly to be certain of proper coupling.....	<input type="checkbox"/>	<input type="checkbox"/>	<input type="checkbox"/>
Checks coupling by applying hand valve and gently applying pressure by trying to pull away from the trailer.....	<input type="checkbox"/>	<input type="checkbox"/>	<input type="checkbox"/>
Spot trailer correctly on hard surface before uncoupling trailer.....	<input type="checkbox"/>	<input type="checkbox"/>	<input type="checkbox"/>
Checks Trailer registration (on front box)	<input type="checkbox"/>	<input type="checkbox"/>	<input type="checkbox"/>
Uses fifth wheel puller each time disconnect is required.....	<input type="checkbox"/>	<input type="checkbox"/>	<input type="checkbox"/>
REMARKS: _____			

<b>MISCELLANEOUS</b>			
<b>A. General Driving Habits</b>			
Consistently alert and attentive - eyes constantly moving to get the big picture, uses mirrors.....	<input type="checkbox"/>	<input type="checkbox"/>	<input type="checkbox"/>
Anticipates problems and responds to changing conditions.....	<input type="checkbox"/>	<input type="checkbox"/>	<input type="checkbox"/>
Demonstrates defensive driving tactics.....	<input type="checkbox"/>	<input type="checkbox"/>	<input type="checkbox"/>
Considerate of other drivers/yields right of way.....	<input type="checkbox"/>	<input type="checkbox"/>	<input type="checkbox"/>
Maintains calm professional attitude at all times.....	<input type="checkbox"/>	<input type="checkbox"/>	<input type="checkbox"/>
REMARKS: _____			

<b>POST-TRIP INSPECTION</b>			
Completes vehicle inspection at end of day ensures inspection books stays in	<input type="checkbox"/>	<input type="checkbox"/>	<input type="checkbox"/>
Reports any repairs required.....	<input type="checkbox"/>	<input type="checkbox"/>	<input type="checkbox"/>
Fuels up unit correctly.....	<input type="checkbox"/>	<input type="checkbox"/>	<input type="checkbox"/>
Maintains cab clean and orderly.....	<input type="checkbox"/>	<input type="checkbox"/>	<input type="checkbox"/>
Parks truck in proper place.....	<input type="checkbox"/>	<input type="checkbox"/>	<input type="checkbox"/>
Other _____	<input type="checkbox"/>	<input type="checkbox"/>	<input type="checkbox"/>

COMMENTS: \_\_\_\_\_

Discussed with driver:	Yes	No	Driver Signature _____
Qualified:	Yes	No	Needs improvement on _____
Reviewed By _____			Date _____
(Terminal Manager)			
Reviewed By _____			Date _____
(Safety Manager)			
Evaluation Completed By _____			Date _____
(Driver Trainer / Safety Department Representative )			





## DRIVER / EVALUATION - PART II

	Needs		
	Excell	Accept	Improv
Uses proper personal protective equipment as required.....	<input type="checkbox"/>	<input type="checkbox"/>	<input type="checkbox"/>
Uses proper method of entering and exiting cab.....	<input type="checkbox"/>	<input type="checkbox"/>	<input type="checkbox"/>
Uses correct lifting methods (bent knees).....	<input type="checkbox"/>	<input type="checkbox"/>	<input type="checkbox"/>
Pushes container to truck vs. pulling.....	<input type="checkbox"/>	<input type="checkbox"/>	<input type="checkbox"/>
Does not try to move items beyond his physical capabilities.....	<input type="checkbox"/>	<input type="checkbox"/>	<input type="checkbox"/>
Checks and secures load as required.....	<input type="checkbox"/>	<input type="checkbox"/>	<input type="checkbox"/>
Uses 2-way radio correctly.....	<input type="checkbox"/>	<input type="checkbox"/>	<input type="checkbox"/>
Stops truck with service brake, not parking brake.....	<input type="checkbox"/>	<input type="checkbox"/>	<input type="checkbox"/>
Has adequate knowledge or route, streets.....	<input type="checkbox"/>	<input type="checkbox"/>	<input type="checkbox"/>

REMARKS: \_\_\_\_\_

	Needs			N/A
	Excell	Accept	Improv	Waste
<b>Tarping Procedures</b>				
Makes sure all PPE in on correctly prior to exiting the truck.....	<input type="checkbox"/>	<input type="checkbox"/>	<input type="checkbox"/>	<input type="checkbox"/>
Exits truck using the "3 point system".....	<input type="checkbox"/>	<input type="checkbox"/>	<input type="checkbox"/>	<input type="checkbox"/>
Removes strap puller prior to removeing the tarp bar from the holder.....	<input type="checkbox"/>	<input type="checkbox"/>	<input type="checkbox"/>	<input type="checkbox"/>
Positions self in the "power zone" position with tarp handle.....	<input type="checkbox"/>	<input type="checkbox"/>	<input type="checkbox"/>	<input type="checkbox"/>
Rolls tarp away while maintaining "power zone" position.....	<input type="checkbox"/>	<input type="checkbox"/>	<input type="checkbox"/>	<input type="checkbox"/>
If needed , walk the bar / push it over the last few feet to remove slack in the tarp.....	<input type="checkbox"/>	<input type="checkbox"/>	<input type="checkbox"/>	<input type="checkbox"/>
Ensures entire tarp is hanging over top rail.....	<input type="checkbox"/>	<input type="checkbox"/>	<input type="checkbox"/>	<input type="checkbox"/>
Secures handle.....	<input type="checkbox"/>	<input type="checkbox"/>	<input type="checkbox"/>	<input type="checkbox"/>
Pulls all straps starting from the rear moving forward using the strap puller.....	<input type="checkbox"/>	<input type="checkbox"/>	<input type="checkbox"/>	<input type="checkbox"/>
Secures strap puller in holder on trailer.....	<input type="checkbox"/>	<input type="checkbox"/>	<input type="checkbox"/>	<input type="checkbox"/>
Places one twist in strap securing straps moving from the front of the trailer to the rear of the trailer.....	<input type="checkbox"/>	<input type="checkbox"/>	<input type="checkbox"/>	<input type="checkbox"/>
Does not over tighten strap binder / ratchet.....	<input type="checkbox"/>	<input type="checkbox"/>	<input type="checkbox"/>	<input type="checkbox"/>
Ensures tag axels are down as walk back to tractor occurs (units with loads only).....	<input type="checkbox"/>	<input type="checkbox"/>	<input type="checkbox"/>	<input type="checkbox"/>

REMARKS: \_\_\_\_\_

COMMENTS:

Discussed with driver: Yes No Driver Signature  
 Qualified: Yes No ent on Date  
 Reviewed By (Terminal Manager) Date  
 Reviewed By (Safety Manager) Date  
 Evaluation Completed By (Driver Trainer / Safety Department Representative ) Date

	Needs		
	Excell	Accept	Improv
<b>Mill &amp; LANDFILL OPERATIONS</b>			
Wears hard hat whenever at site.....	<input type="checkbox"/>	<input type="checkbox"/>	<input type="checkbox"/>
Observes speed limits in.....	<input type="checkbox"/>	<input type="checkbox"/>	<input type="checkbox"/>
Follows instructions as to where to dump - ensures product is dumped in correct spot.....	<input type="checkbox"/>	<input type="checkbox"/>	<input type="checkbox"/>
Maintains proper interval spacing between vehicles.....	<input type="checkbox"/>	<input type="checkbox"/>	<input type="checkbox"/>
Operates unit prudently over soft terrain without unnecessary spinning of wheels, jerking,refrains from using breaks to level load etc.....	<input type="checkbox"/>	<input type="checkbox"/>	<input type="checkbox"/>
Observes all site safety rules.....	<input type="checkbox"/>	<input type="checkbox"/>	<input type="checkbox"/>
Utilizes Tag/ Drop axles does periodic checks through out shift to ensure proper function.....	<input type="checkbox"/>	<input type="checkbox"/>	<input type="checkbox"/>
Observes proper procedure for opening hopper, latches etc.....	<input type="checkbox"/>	<input type="checkbox"/>	<input type="checkbox"/>
Dumps load smoothly.....	<input type="checkbox"/>	<input type="checkbox"/>	<input type="checkbox"/>
Drives with doors open no further than necessary.....	<input type="checkbox"/>	<input type="checkbox"/>	<input type="checkbox"/>
Cleans body out as applicable.....	<input type="checkbox"/>	<input type="checkbox"/>	<input type="checkbox"/>
Knows and follows towing procedures.....	<input type="checkbox"/>	<input type="checkbox"/>	<input type="checkbox"/>
Inspects truck before leaving mill / landfill.....	<input type="checkbox"/>	<input type="checkbox"/>	<input type="checkbox"/>
Ensures overall tractor & trailer weight is legal prior to going on load legalizes / communicates with dispatcher or supervisor if load is not.....	<input type="checkbox"/>	<input type="checkbox"/>	<input type="checkbox"/>
Checks trailer scale / ensures load meets legal over the road requirements.....	<input type="checkbox"/>	<input type="checkbox"/>	<input type="checkbox"/>

REMARKS: \_\_\_\_\_

**Hours of Service Logging / Electronic log operation**

Can successfully log in/out of system.....	<input type="checkbox"/>	<input type="checkbox"/>	<input type="checkbox"/>
Can successfully add / delete truck, trailer & bol data in asset section.....	<input type="checkbox"/>	<input type="checkbox"/>	<input type="checkbox"/>
Can successfully check for updates, change password & report a bug if need be.....	<input type="checkbox"/>	<input type="checkbox"/>	<input type="checkbox"/>
Can successfully log on/ off duty & understands how to log meal periods.....	<input type="checkbox"/>	<input type="checkbox"/>	<input type="checkbox"/>
Understands how to read/ navigate hours graph.....	<input type="checkbox"/>	<input type="checkbox"/>	<input type="checkbox"/>
Can successfully verify log status & can edit status if need be.....	<input type="checkbox"/>	<input type="checkbox"/>	<input type="checkbox"/>
Can successfully apply adverse driving condition/ 16-hour exemption exemption if need be.....	<input type="checkbox"/>	<input type="checkbox"/>	<input type="checkbox"/>
Can successfully create a DOT compliance report if need be.....	<input type="checkbox"/>	<input type="checkbox"/>	<input type="checkbox"/>

REMARKS: \_\_\_\_\_





## DEFENSIVE DRIVING

	CHECK ONE				
	4	3	2	1	0
<b>AIM HIGH IN STEERING</b>					
Keeps vehicle centered in the lane.....	<input type="checkbox"/>				<input type="checkbox"/>
Sees moving and fixed objects at least a block away in city traffic and at least one half mile ahead on expressways or highways.....	<input type="checkbox"/>				<input type="checkbox"/>
Maintains a safe following distance.....	<input type="checkbox"/>				<input type="checkbox"/>
Avoids swerving when passing other vehicles, turning or approaching parked vehicles.....	<input type="checkbox"/>				<input type="checkbox"/>
Reduces speed to allow for poor conditions or reduced visibility.....	<input type="checkbox"/>				<input type="checkbox"/>
Subtotal	- - - - -				

<b>GET THE BIG PICTURE</b>					
Avoids being boxed in when lanes ahead are blocked.....	<input type="checkbox"/>				<input type="checkbox"/>
Avoids severe braking and abrupt turns.....	<input type="checkbox"/>				<input type="checkbox"/>
Adjusts speed when approaching intersections on <i>stale green</i> traffic signals.....	<input type="checkbox"/>				<input type="checkbox"/>
Correctly anticipates moves of other drivers and pedestrians and avoids conflicts.....	<input type="checkbox"/>				<input type="checkbox"/>
Slows down before entering "no control" intersections or where there is a possibility of conflict.....	<input type="checkbox"/>				<input type="checkbox"/>
Subtotal	- - - - -				

<b>KEEP YOUR EYES MOVING</b>					
Keeps eyes moving at least every two eight seconds.....	<input type="checkbox"/>				<input type="checkbox"/>
Checks the rear before changing lanes, turning or stopping.....	<input type="checkbox"/>				<input type="checkbox"/>
Stays clear of erratic drivers.....	<input type="checkbox"/>				<input type="checkbox"/>
Checks in all directions and leaves a space cushion before starting up at intersections.....	<input type="checkbox"/>				<input type="checkbox"/>
Disposes of eye holding distractions quickly.....	<input type="checkbox"/>				<input type="checkbox"/>
Subtotal	- - - - -				

	CHECK ONE				
	4	3	2	1	0
<b>LEAVE YOURSELF AN OUT</b>					
Recognizes the lane of least resistance and positions the vehicle accordingly.....	<input type="checkbox"/>				<input type="checkbox"/>
Allows extra following distance when crowded by a tailgater.....	<input type="checkbox"/>				<input type="checkbox"/>
When possible, leaves at least one side open for swerving room.....	<input type="checkbox"/>				<input type="checkbox"/>
Passes only when there is space, visibility and distance to do so safely.....	<input type="checkbox"/>				<input type="checkbox"/>
Quickly re-establishes space around the vehicle when space diminishes.....	<input type="checkbox"/>				<input type="checkbox"/>
Subtotal	- - - - -				

<b>MAKE SURE THEY SEE YOU</b>					
Alerts non-attentive drivers and pedestrians with gentle tap of the horn or of the lights to get eye contact (includes those on bicycles and motor cycles).....	<input type="checkbox"/>				<input type="checkbox"/>
Turns on lights when visibility is low in order to be seen.....	<input type="checkbox"/>				<input type="checkbox"/>
Tries to obtain eye contact with people when conditions dictate that it should be done.....	<input type="checkbox"/>				<input type="checkbox"/>
Gives early signals for turns of lane changes and checks to see if they are heeded.....	<input type="checkbox"/>				<input type="checkbox"/>
Doesn't ride in the blind zone of drivers on left or right.....	<input type="checkbox"/>				<input type="checkbox"/>
Subtotal	- - - - -				

Total	- - - - -				
<b>SCORE</b>	- - - - -				

**SCORING:**  
 4 points for ALWAYS  
 3 points for MOST OF THE TIME  
 2 points for OCCASIONALLY  
 1 point for RARELY  
 0 points for NEVER

REMARKS: \_\_\_\_\_  
 \_\_\_\_\_  
 \_\_\_\_\_  
 \_\_\_\_\_  
 \_\_\_\_\_



## Tipper Helper - Training Document

Division Solid Waste Employee \_\_\_\_\_  
 Title \_\_\_\_\_ Date \_\_\_\_\_  
 Evaluated By \_\_\_\_\_  
 Type of evaluation \_\_\_\_\_  
 Initial \_\_\_\_\_ Annual \_\_\_\_\_

*Excell. Accept. Improv*

Uses proper personal protective equipment as required.....	<input type="checkbox"/>	<input type="checkbox"/>	<input type="checkbox"/>
Uses proper method of entering and exiting all areas of tipper .....	<input type="checkbox"/>	<input type="checkbox"/>	<input type="checkbox"/>
Uses correct lifting methods (bent knees).....	<input type="checkbox"/>	<input type="checkbox"/>	<input type="checkbox"/>
Pushes container to truck vs. pulling.....	<input type="checkbox"/>	<input type="checkbox"/>	<input type="checkbox"/>
Does not try to move items beyond his physical capabilities.....	<input type="checkbox"/>	<input type="checkbox"/>	<input type="checkbox"/>
Checks and secures Trailer Doors as required ensuring all 200 series doors are completely latched to trailer side each time	<input type="checkbox"/>	<input type="checkbox"/>	<input type="checkbox"/>
Checks and secures Trailer Doors as required ensuring all 400 series doors are completely latched to trailer side on (L) side and secured by bunge on (R) side each time	<input type="checkbox"/>	<input type="checkbox"/>	<input type="checkbox"/>
Uses 2-way radio correctly.....			
Maintains position on tipper rear decks that allows to be seen by truck driver as well as tipper operator.....	<input type="checkbox"/>	<input type="checkbox"/>	<input type="checkbox"/>
Displays a high level of communication between Tipper operator both with hand signals and verbal.....	<input type="checkbox"/>	<input type="checkbox"/>	<input type="checkbox"/>
Uses down time to clean deck and maintain a safe work environment.....	<input type="checkbox"/>	<input type="checkbox"/>	<input type="checkbox"/>

COMMENTS: \_\_\_\_\_  
 \_\_\_\_\_  
 \_\_\_\_\_  
 \_\_\_\_\_  
 \_\_\_\_\_

Discussed with Employee Yes No Employee Date  
 Qualified: Yes No Needs improvement on \_\_\_\_\_  
 Reviewed By \_\_\_\_\_ Date  
 (Terminal Manager)  
 Reviewed by \_\_\_\_\_ Date

Revised 12/8/2017



## Driver Accident Scene Procedure Check list

Come to a complete stop, take a deep breath and try to remain calm. Activate 4-way flashers .Are you injured? If so, it might be best to wait in the cab of the truck until emergency personal can respond. You can injure yourself further by getting out of the truck. If not injured follow below check list.

- (1) \_\_ Check for injuries of other motorists use extreme caution when exiting the cab.
- (2) \_\_ Set Warning devices
- (3) \_\_ Do not move the vehicle unless instructed by Manager or Police
- (4) \_\_ Contact your Supervisor or Manager as soon as possible
- (5) \_\_ Discuss accident only with proper authorities do not admit fault, do not speak with reporters or media refer them to Troutdale
- (6) \_\_ Take as many photos at as many angles that you safely can photos of all involved property ,vehicles, & individuals do NOT photograph injured individuals
- (7) \_\_ Obtain names and addresses (use witness forms)
- (8) \_\_ Complete exoneration card if it applies
- (9) \_\_ Document your account of the accident on the accident and claims report. Please be as detailed as possible noting things such as road & weather conditions,

Please turn in this form when all checks are complete





**ACCIDENT AND CLAIMS INFORMATION REPORT**  
**WALSH TRUCKING CO. LTD**

---

DRIVER NAME: \_\_\_\_\_ EMP. # \_\_\_\_\_ DATE OF ACCIDENT : \_\_\_\_\_

TIME: \_\_\_\_\_ TRACTOR VIN: \_\_\_\_\_ TRAILER VIN: \_\_\_\_\_  
(LAST 6 NUMBERS) (LAST 6 NUMBERS)

WEATHER: \_\_\_\_\_ ROAD CONDITION: \_\_\_\_\_ VISIBILITY: \_\_\_\_\_

---

VEHICLE #2: MAKE \_\_\_\_\_ YEAR \_\_\_\_\_ MODEL \_\_\_\_\_

VEHICLE LICENSE #: \_\_\_\_\_ EXPIRATION DATE: \_\_\_\_\_

DRIVER NAME: \_\_\_\_\_ PHONE #: \_\_\_\_\_

ADDRESS: \_\_\_\_\_

DRIVER'S LICENSE # \_\_\_\_\_ DRIVER'S LICENSE EXPIRATION \_\_\_\_\_ DATE OF BIRTH \_\_\_\_\_

INSURANCE COMPANY NAME \_\_\_\_\_ POLICY NUMBER \_\_\_\_\_ EXPIRATION \_\_\_\_\_

AGENT NAME: \_\_\_\_\_ PHONE #: \_\_\_\_\_

---

LOCATION OF ACCIDENT: \_\_\_\_\_  
\_\_\_\_\_  
\_\_\_\_\_

DESCRIPTION OF ACCIDENT: \_\_\_\_\_  
\_\_\_\_\_  
\_\_\_\_\_

DESCRIPTION OF DAMAGE: \_\_\_\_\_  
\_\_\_\_\_  
\_\_\_\_\_

WITNESS NAMES: \_\_\_\_\_ PHONE #: \_\_\_\_\_  
\_\_\_\_\_  
\_\_\_\_\_

ADDITIONAL COMMENTS: \_\_\_\_\_  
\_\_\_\_\_  
\_\_\_\_\_



**AUTHORITIES NOTIFIED**

STATE TROOPER: \_\_\_\_\_  
(NAME) (PHONE #) (LOCATION)

LOCAL POLICE: \_\_\_\_\_  
(NAME) (PHONE #) (LOCATION)

FIRE DEPT: YES \_\_\_ NO \_\_\_ LOCATION: \_\_\_\_\_

AMBULANCE: YES \_\_\_ NO \_\_\_ COMPANY: \_\_\_\_\_

DEPT OF TRANSPORTATION: YES \_\_\_ NO \_\_\_

DIESEL/OIL SPILLED: YES \_\_\_ NO \_\_\_

PROPER CLEAN-UP: YES \_\_\_ NO \_\_\_ BY WHOM: \_\_\_\_\_

LOAD SPILLED: YES \_\_\_ NO \_\_\_ CLEAN UP BY: \_\_\_\_\_

TRAFFIC CONTROL: YES \_\_\_ NO \_\_\_ BY WHOM: \_\_\_\_\_

**TOWING**

TOWING COMPANY: \_\_\_\_\_

WHICH VEHICLES WERE TOWED: \_\_\_\_\_ HOW MANY TOW TRUCKS: \_\_\_\_\_

LOCATION VEHICLES TOWED TO: \_\_\_\_\_

DAMAGE CAUSED BY TOW TRUCKS: \_\_\_\_\_

\_\_\_\_\_

\_\_\_\_\_

**DRIVER**

DRUG TEST ADMINISTERED WITHIN 32 HOURS: YES \_\_\_ NO \_\_\_

IF NO, EXPLAIN: \_\_\_\_\_

\_\_\_\_\_

\_\_\_\_\_

ALCOHOL TEST ADMINISTERED WITHIN 2 HOURS: YES \_\_\_ NO \_\_\_

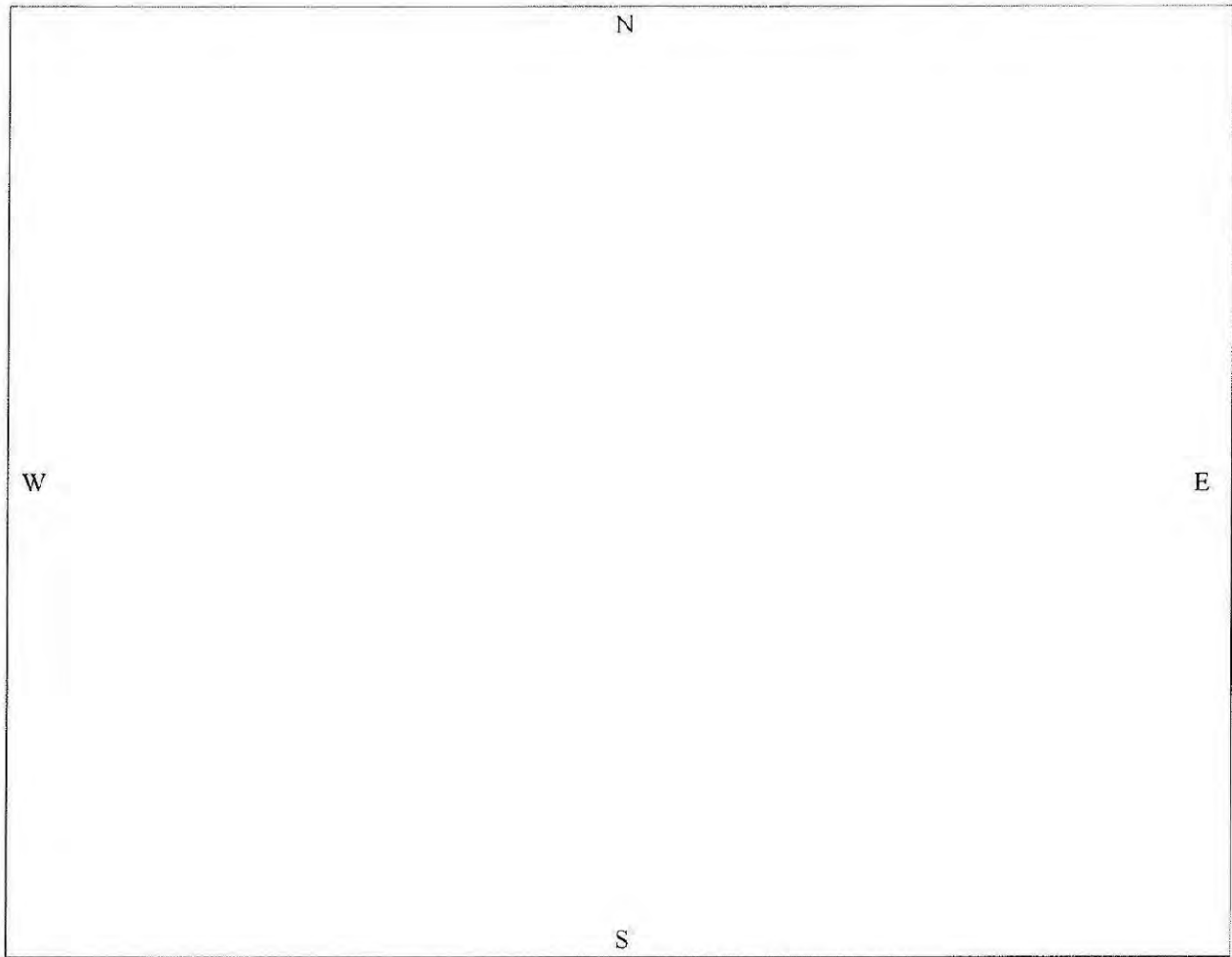
IF NO, EXPLAIN: \_\_\_\_\_

\_\_\_\_\_

\_\_\_\_\_



DRAW DIAGRAM OF ACCIDENT SCENE



N

W

E

S

DRIVER'S COMMENTS: \_\_\_\_\_

\_\_\_\_\_

\_\_\_\_\_

\_\_\_\_\_

\_\_\_\_\_

INVESTIGATOR'S COMMENTS: \_\_\_\_\_

\_\_\_\_\_

\_\_\_\_\_

\_\_\_\_\_

\_\_\_\_\_





### WITNESS CARD

Did you see the accident \_\_\_\_\_ Did anyone appear injured \_\_\_\_\_ Were you riding in a vehicle involved \_\_\_\_\_ Which one \_\_\_\_\_ Who do you think was responsible for the accident \_\_\_\_\_

Your Name \_\_\_\_\_  
Address \_\_\_\_\_

Phone \_\_\_\_\_

**PLEASE RETURN THIS CARD TO THE DRIVER**

**Thank You!**

© Copyright 1995 & Published By  
J. J. KELLER & ASSOCIATES, INC. - Neenah, WI 54957-0368

33F-3 / 131-F-2  
Rev. 5/95  
RM 5809

### WITNESS CARD

Did you see the accident \_\_\_\_\_ Did anyone appear injured \_\_\_\_\_ Were you riding in a vehicle involved \_\_\_\_\_ Which one \_\_\_\_\_ Who do you think was responsible for the accident \_\_\_\_\_

Your Name \_\_\_\_\_  
Address \_\_\_\_\_

Phone \_\_\_\_\_

**PLEASE RETURN THIS CARD TO THE DRIVER**

**Thank You!**

© Copyright 1995 & Published By  
J. J. KELLER & ASSOCIATES, INC. - Neenah, WI 54957-0368

33F-3 / 131-F-2  
Rev. 5/95  
RM 5809

### WITNESS CARD

Did you see the accident \_\_\_\_\_ Did anyone appear injured \_\_\_\_\_ Were you riding in a vehicle involved \_\_\_\_\_ Which one \_\_\_\_\_ Who do you think was responsible for the accident \_\_\_\_\_

Your Name \_\_\_\_\_  
Address \_\_\_\_\_

Phone \_\_\_\_\_

**PLEASE RETURN THIS CARD TO THE DRIVER**

**Thank You!**

© Copyright 1995 & Published By  
J. J. KELLER & ASSOCIATES, INC. - Neenah, WI 54957-0368

33F-3 / 131-F-2  
Rev. 5/95  
RM 5809

### WITNESS CARD

Did you see the accident \_\_\_\_\_ Did anyone appear injured \_\_\_\_\_ Were you riding in a vehicle involved \_\_\_\_\_ Which one \_\_\_\_\_ Who do you think was responsible for the accident \_\_\_\_\_

Your Name \_\_\_\_\_  
Address \_\_\_\_\_

Phone \_\_\_\_\_

**PLEASE RETURN THIS CARD TO THE DRIVER**

**Thank You!**

© Copyright 1995 & Published By  
J. J. KELLER & ASSOCIATES, INC. - Neenah, WI 54957-0368

33F-3 / 131-F-2  
Rev. 5/95  
RM 5809



## EXONERATION CARD

TO WHOM IT MAY CONCERN

I hereby exonerate and free from all negligence or blame driver \_\_\_\_\_ and his employer in connection with an accident involving the undersigned which occurred at \_\_\_\_\_ on this date \_\_\_\_\_

Location \_\_\_\_\_

Name \_\_\_\_\_

Signature \_\_\_\_\_ Date \_\_\_\_\_

Address \_\_\_\_\_

Witnessed By \_\_\_\_\_

Signature \_\_\_\_\_ Date \_\_\_\_\_



© Copyright 1997 U.S. APPLIED WASTE MANAGEMENT, INC.  
Lynchburg, VA 24502 • Tel: 434-237-4200  
Printed in the United States

3SP-5 Rev. 5/97  
RM 5813

## EXONERATION CARD

TO WHOM IT MAY CONCERN

I hereby exonerate and free from all negligence or blame driver \_\_\_\_\_ and his employer in connection with an accident involving the undersigned which occurred at \_\_\_\_\_ on this date \_\_\_\_\_

Location \_\_\_\_\_

Name \_\_\_\_\_

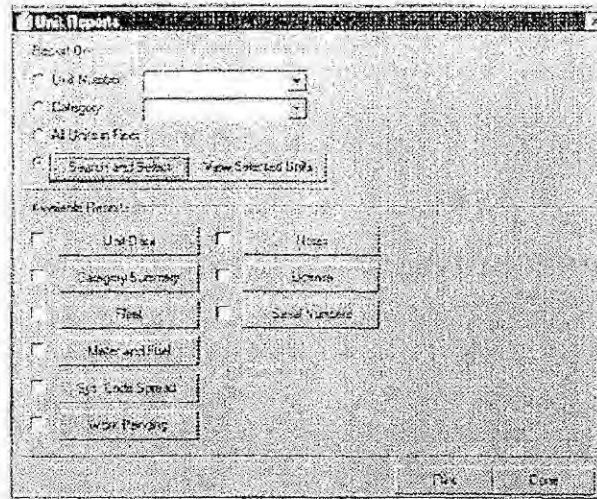
Signature \_\_\_\_\_ Date \_\_\_\_\_

Address \_\_\_\_\_

Witnessed By \_\_\_\_\_

Signature \_\_\_\_\_ Date \_\_\_\_\_





On screen viewing & Data Export is only available on a report by report basis.

Any report can be produced by Searching for units that meet certain criteria.

You may print multiple reports by clicking on the Check Box and clicking Print

### Common Options to Unit Reports

Click on the radio button of your choice to select that option.

**Report On** - Reports can be produced by selecting one of these four basic options.

**Unit Number** – Single units, reported one unit at a time. Enter a unit number or select one from the drop down box.

**Category** – Group of like single units reported on one report. Enter a category or select one from the drop down box.

**All Units In Fleet** – All units reported on one page report.

**Search and Select** – Any units that meet your search criteria of the fleet database, then produce any report.

Click on the Search and Select button and choose what combination of specifications to group together for reporting purposes. You may exclude items from the search by clicking on the Exclude box on any item.

**Other Common Report Options** - There are many types of reports, each allowing you to customize its output based on the options available on the particular report. Most unit reports have certain common options available.

**Print – View – OK or Done.** All reports can be printed, viewed on screen, sent to a data file and you can exit any screen by clicking on OK or Done.

**Date Option** – Enter a report date. The report period in which this date falls will be displayed by date range, and used to produce the report.



**Date Option** – Enter a report date. The report period in which this date falls will be displayed by date range, and used to produce the report.

**Meter Options** – You may select to use the primary meter, a meter of your choice, or all meters to produce report(s) using each meter selected.

**Sort Options** – Each report will allow you to produce the reports in a sorted order. Each sort option differs depending upon the report.

**Range Options or Selectable Options** – Some reports allow you to select ranges of information (From – To) or select from a list of different possibilities.

**Multiple Report Printing Feature** – This feature allows you to produce multiple or all reports at the same time by selecting which reports to produce by clicking on the Print Check Box to the left of the report button. You can accept each report's default settings or customize each report's output, then print them all at the same time.

**Selected Units Are Displayed** – The total number of units and the unit number(s) with category descriptions that will appear on the selected reports will be displayed on the left side of each report option screen.

**Page Forward or Backward Arrows** – If you select the View option, and if you're reporting on more than one unit or the report selected has more than one page, the program will display the number of pages and allow you to move forward or back using this arrow keys.

## Unit Report

The unit report is the centerpiece of the Dossier' 32 program. As maintenance is controlled on a unit by unit basis, at a glance, this report will inform you of the big picture of costs, operations and specifications about a individual vehicle.

1. Click on the Report Icon.

Review the selected units box with View/Print option

2. Click on Unit's.

3. Click on the Report On feature you wish.

4. Click on the Unit Data button.

5. Click on the appropriate Meter, Report Date option

6. Click on the Report Type and select whether to produce a standard one page Unit Data Summary, or more detailed report.

Your options are:

**Unit Data Summary (1 unit per page).** This is the program's default one page unit report.

**Unit Data Summary With Full Specs.** This is the same financial report but it displays all specifications.

**Full Detailed System Codes.** This report displays all system code in detail. This report can be several pages long for each unit depending upon how many system cost codes are used with the program.

**Full Detailed System Codes and Specs.** This report displays all details of a full unabridged Unit Summary Report. This report can be several pages long for each unit depending upon how many system cost codes are used with the program.



7. Click on Print All Now to produce consecutive Unit Summary reports or click on an individual unit in the Selected Units Box and then click on either View Or Print to produce a report on one individual unit.
8. Click OK to exit this report area.

## Category Report

The Category report displays the same data as the Unit Summary report except that it is a grouped report. This report helps you see the big picture of costs, operations and the fuel types for a pre-qualified group of individual units.

1. Click on the Report Icon.
2. Click on Units.
3. Click on a Report Style to select a type of report.
4. Category Summary Report ( 1 page ). This is the program's standard one page category report.  
Full Detailed System Codes (multiple pages). This report displays all details of a full unabridged Category Summary Report. This report can be several pages long depending upon how many system cost codes are used with the program.  
Review the Units Selected.
5. Select the Meter(s) Options to use on the report.
6. Select the Report Date for this report or change it.
7. Click on the either the View or Print button to produce the report.
8. Click on OK to return to the previous menu.

## Fleet Report

The Fleet report displays the same data as the Unit and Category Summary reports except that it includes all units in the program and it displays the data on a "Cost Per Unit" basis. It takes all costs and divides them by the total number of units on the program to determine this value.

This single report helps you see the big picture of costs and operational data for your entire fleet of equipment.

1. Click on the Report Icon.
2. Click on Units.
3. Click on the Report On option All Units In Fleet.
4. Click on Fleet Report in the Available Reports area.
5. Select a Report Style to produce.  
Fleet Summary Report ( 1 page ). This is the program's standard one page fleet report.  
Full Detailed System Codes (multiple pages). This report displays all details of a full unabridged Fleet Summary Report. This report can be several pages long depending upon how many system cost codes are used with the program.
6. Review the Units Selected.



This report only produces "Cost Per Unit, (CPU)" meters are ignored on this fleet report.

7. Select the Report Date for this report or change it.
8. Click on the either the View or Print button to produce the report.
9. Click on OK to return to the previous menu.

## Meter and Fuel Report

The Meter and Fuel report displays meters run, fuel used, mpg, costs and cost per mile or other meter, current meter reading details for the month, year and life.

All units are presented in a spreadsheet layout with a combined total line and an average line to help you quickly see which units are out of line with the average.

Reports can be produced to include any fuel item or fluid type.

1. Click on the Report Icon.
2. Click on Units.
3. Click on the Report On option you wish.
4. Click on the Meter and Fuel button in the Available Reports area.
5. Select a Fuel and Meter Spreadsheet to report from the drop box.
6. Review the Units Selected.
7. Select a Meter to use with the report.
8. Select the default Report Date or change it.
9. Choose whether to include Category SubTotals or not.
10. Click on the either the View or Print button to produce the report.
11. Click on OK to return to the previous menu.

## Sys. Code Spreadsheet

The System Code Spreadsheet allows you to report on a single system cost code or a group of codes, any sub-total or the total line, using a spreadsheet style report with a total and average bottom line.

Each code included on the report will include month, year and life parts and labor costs with totals, and cost per meter selected.

1. Click on the Report Icon.
2. Click on Units.
3. Click on the Report On option you wish.
4. Click on the Sys. Code Spreadsheet button in Available Reports area.
5. Select the System Code or Codes you wish by clicking on the check box to the right of the system code. Select as many as you wish. To see more codes, use the scroll bar to move up or down.

You may also select a Sub-Total or Total line which are located at the bottom of the scroll listing of system codes. Clicking on either of these will automatically





place a check mark in the appropriate system codes. Clicking on Total Line will automatically checkmark all system codes.

You may also select to Mark or Unmark All Items by clicking on the button at the bottom of the System Code Display.

6. Click on the check box to report on "Print Only Units With Costs." Off will print reports for all units whether they have any data or not.
7. Select a Meter to use with the report.
8. Select the default Report Date or change it.
9. Click on either the View or Print button to produce the report.
10. Click on OK to return to the previous menu.

## Work Pending Report

The Work Pending report will keep you abreast of deferred work. Data can be reported based on Open work or Closed work information.

The Open or Closed reports can be generated based on any combination of Priority Code, Reported By, Open Date Range, System Code, Grouped By Unit or Category, and whether to report on just Open items.

1. Click on the Report Icon.
2. Click on Units.
3. Click on the Report On option you wish.
4. Click on the Work Pending button in Available Reports area.
5. Select either Open or Closed reports, and select data options from the appropriate report area. Use as many data selections as you wish.

Priority Code

Reported By

Open Date Range or specific date

System Code

Grouped By

6. Click on the check box to report on "Open" Items only.
7. Click on either the View or Print button to produce the report.
8. Click on OK to return to the previous menu.

## Notes Reporting

The Notes report displays any typed note in a unit's file.

1. Click on the Report Icon.
2. Click on Units.
3. Click on the Report On option you wish.
4. Click on the Notes button in Available Reports area.



5. Choose to Sort by Unit Number or Category then Unit Number by making a selection from the drop box
6. Review the Selected Units
7. Click on either the View or Print button to produce the report
8. Click on OK to return to the previous menu.

## License Reports

The License report displays information about a unit's various licenses or permits. This information can be used for scheduling license and permit renewals or for simply looking up a unit by its license or permit number.

1. Click on the Report Icon.
2. Click on Units.
3. Click on the Report On option you wish
4. Click on the License button in Available Reports area
5. Choose which of the two reports you wish to produce by clicking on their respective radio button.

**License Plate Report** - Displays units with their license plates. You can display them in one of three orders. Sort by - Unit Number, Category, or Plate Number by making a selection from the drop box.

**License & registration Report** - This report displays renewal dates based on selecting the issuing state and the type of license from the drop box. You can further refine the list by searching for specific issue or expiration dates, or a specific Document #.

6. Review the Selected Units.
7. Click on either the View or Print button to produce the report
8. Click on OK to return to the previous menu.

## Serial Number Reports

The Serial Number report displays the serial numbers you have entered to units. There are two different styles. The first is a spreadsheet for displaying up to three serial numbers. The second is a listing that will display up to nine serial numbers.

1. Click on the Report Icon.
2. Click on Units.
3. Click on the Report On option you wish.
4. Click on the Serial Numbers button in Available Reports area
5. Choose which of the two reports you wish to produce by clicking on their respective radio button.

**Three Field Report** - Displays unit number, category and basic chassis serial number with up to three additional numbers of your choosing from the drop boxes



Nine Fields Report – Displays unit number, category and basic chassis serial number with up to nine additional numbers of your choosing from the drop boxes

Sort by - Unit Number, Category, or Chassis Serial Number or any serial number by making a selection from the drop box

6. Review the Selected Units.
7. Click on either the View or Print button to produce the report.
8. Click on OK to return to the previous menu

## PM Services Report & PM Checklist

The PM Services report displays the schedule of preventive maintenance services of your choice and whether they are due or overdue. Pick from the available options to select the PM report by name, how it will be sorted and whether to produce PM Checklists for each unit.

1. Click on the Report Icon
2. Click on Units.
3. Click on the Report On option you wish.
4. Click on the PM Services button in Available Reports area.
5. Select one of the following PM reports by clicking on the radio button:

Single PM – Select the PM to print from the drop box.

Linked PMs – This report will show the highest ranking PM service due or overdue of the linked A-B-C-D PM services.

All PMs – Select "Show Due & Overdue", "Overdue Only" or "Show All" regardless whether it is currently due or not.

6. Click on the PM Checklist box to turn printing of the checklists on or off.
7. Click on Sort and choose how the report should be sorted.

Review the Selected Units.

8. Click on either the View or Print button to produce the report and/or checklists.
9. Click on OK to return to the previous menu.

## Repair Order History Report

The Repair Order History report displays repair order information in a summarized format. You have twelve items from which to make selection to be included in your search for matching repair order data. Leave everything blank to select ALL.

1. Click on the Report Icon.
2. Click on Units.
3. Click on the Report On option you wish.
4. Click on the Repair Order History button in Available Reports area





5. Choose which items to be included in the Repair Order, search by choosing it from the item's drop box, by entering data, or selecting a date range. You may choose to include one or more items in your search.

Review the Selected Units.

6. Click on either the View or Print button to produce the report.
7. Click on OK to return to the previous menu.

### List All Units Report

The List All Units report displays unit information with basic specifications in a listing format. This report might be considered a inventory listing of units. This list is excellent for use with insurance departments or for asset management.

1. Click on the Report Icon.
2. Click on Units.
3. Click on the Report On option you wish.
4. Click on the List All Units button in Available Reports area.

Review the Selected Units.

5. Click on either the View or Print button to produce the report.
6. Click on OK to return to the previous menu.

### Custom Unit Listing Report

The Custom Unit Listing report displays unit information in a spreadsheet layout. The report defaults the first four columns: unit #, the category, the Mfg. Yr. and license # and allows you to list up to five additional columns of information selected from a list of available unit specifications.

1. Click on the Report Icon.
2. Click on Units.
3. Click on the Report On option you wish.
4. Click on the Custom Unit Listing button in Available Reports area.
5. Select what additional columns of specs to display from the five drop boxes.
6. Choose how they should be sorted on the report by clicking on the Sort By list.
7. Click on either the View or Print button to produce the report.
8. Click on OK to return to the previous menu.





# REPAIR ORDER

Repair Order #: 1038899  
Repair Order Date: 3/3/2017

WALSH TRUCKING CO. LTD  
Main Shop  
WALSH TRUCKING COMPANY, LTD.  
1650 NW SUNDIAL ROAD  
TROUTDALE, OR. 97060

Date: 12/13/2017 at 1:33 PM Pacific

Page 1 of 1

## Unit: 42010 - Main Shop (Refuse Trailer)

Vehicle Make: Western      Differentials:      Tire Size: 285/75R 24.5  
Wheel type: Hub Piloted Aluminum      Trans. Model:      Engine Model:

Date / Time (In-Out)	Status	Repair Class	Serial Number	License	Meter Reading(s)
Date In: 3/3/2017	CLOSED	Scheduled	5DN12534XAB000420	HU52069	247,747 Miles
Date Out: 3/3/2017					
Time In:	Location	Repair Stage	Mechanic/Vendor		
Time Out:	Main Shop	Complete	1 (MECHANICS, TROUTDALE)		
			Year: 2010		

### Mechanic Instructions / Complaints

Trailer PMS, DOT Inspection (AVIR)

### Parts

VMRS Code	Part Number	Description	Failure Code	Qty	Cost Per	Cost	Total Cost
013-000-000 Brakes	2258J1336	Offset Return Spring - NOTE		2.00	\$17.20	\$34.39	\$34.39
013-000-000 Brakes	89936B	123537 Hub Pilot Drum		4.00	\$137.15	\$548.60	\$548.60
013-000-000 Brakes	KIT8824HD	4" Q+ Hardware Kit		2.00	\$5.93	\$11.66	\$11.66
013-000-000 Brakes	MA2124702	4" Q+ Brake Shoe		4.00	\$18.70	\$74.80	\$74.80
013-000-000 Brakes	MA2124707	Q+ Brake Shoe		8.00	\$20.75	\$166.00	\$166.00
013-000-000 Brakes	MKT4515QHD	Q-Shoe Hardware Kit		4.00	\$4.98	\$19.92	\$19.92
013-000-000 Brakes	PFT6BBLK100	1/2" Nylon Tubing		2.00	\$0.68	\$1.36	\$1.36
017-000-000 Tires, Tubes, Liners & Valves	983841	Polished 24.5 Alum HP Wheel		1.00	\$335.78	\$335.78	\$335.78
017-000-000 Tires, Tubes, Liners & Valves	TIR285R24.5 HSR2	New Steer Tire		1.00	\$359.37	\$359.37	\$359.37
017-000-000 Tires, Tubes, Liners & Valves	TIR285R24.5 LMSA	Recap Trailer Tire		2.00	\$156.86	\$313.72	\$313.72
PMS-000-000 Preventative Maintenance	No Parts Used	Work Description Only		1.00	\$0.00	\$0.00	\$0.00
							<b>\$1,865.60</b>

### Work Performed

VMRS System	Repair Reason	Work Description
PMS Preventative Maintenance	Drivers report	Trailer PMS, DOT Inspection (AVIR)
013 Brakes	Drivers report	Relined Axle #1,2,3 drums on Axle #2,3, Repaired airline
017 Tires, Tubes, Liners & Valves	Drivers report	New Wheel and tire Axle #4R, Recaps Axle #2L

Mechanic Signature: \_\_\_\_\_  
Supervisor Signature: \_\_\_\_\_

Parts Cost	\$1,865.60
Parts Tax	\$0.00
Labor Cost	\$0.00
Labor Tax	\$0.00
<b>Grand Total</b>	<b>\$1,865.60</b>







# REPAIR ORDER

Repair Order #: 1038220  
Repair Order Date: 3/8/2017

WALSH TRUCKING CO. LTD  
Main Shop  
WALSH TRUCKING COMPANY, LTD.  
1650 NW SUNDIAL ROAD  
TROUTDALE, OR. 97060

Date: 12/13/2017 at 1:10 PM Pacific

Page 1 of 3

## Unit: 917 - Arlington (Tractor 4 Axle)

Vehicle Make: Mack      Differentials: Mer MT-40-14X 3.36      Tire Size: 285/75R 24.5  
Wheel type: Hub Piloted 24.5AL      Trans. Model: mDrive - ATO2612D      Engine Model: MP7-395C 2010 EPA

Date / Time (In-Out)	Status	Repair Class	Serial Number	License	Meter Reading(s)
Date In: 3/8/2017	CLOSED	Unscheduled	1M1AW02Y5EM042007	YCCT80 1	681,619 Miles
Date Out: 3/10/2017					
Time In:	Location	Repair Stage	Mechanic/Vendor		
Time Out:	Main Shop	Complete	1 (MECHANICS, TROUTDALE)		
			Year: 2014		

### Mechanic Instructions / Complaints

Replace cyl head.

### Parts

VMRS Code	Part Number	Description	Failure Code	Qty	Cost Per	Cost	Total Cost
001-000-000 Air Conditioning, Heating & Ventilating System	R134A	Freon		3.00	\$4.46	\$13.38	\$13.38
002-000-000 Cab & Sheet Metal	82713432(21007401)	Hood Strut Shock		1.00	\$41.63	\$41.63	\$41.63
002-000-000 Cab & Sheet Metal	84710395-25165476 (3QM315M)	LH Hood Latch Bracket, CX		1.00	\$10.07	\$10.07	\$10.07
002-000-000 Cab & Sheet Metal	91-20	Wiper Blade		2.00	\$6.04	\$12.08	\$12.08
012-000-000 Axles - Non-Driven, Rear	3721AX(54201-108)	Brake Drum, Cast		2.00	\$98.26	\$196.52	\$196.52
012-000-000 Axles - Non-Driven, Rear	MA2124702	4" Q+ Brake Shoe		4.00	\$18.70	\$74.80	\$74.80
012-000-000 Axles - Non-Driven, Rear	MKT4515QHHD	Q-Shoe Hardware Kit		2.00	\$4.98	\$9.96	\$9.96
013-000-000 Brakes	20378449	Elbow, Air Tank		1.00	\$18.08	\$18.08	\$18.08
017-000-000 Tires, Tubes, Liners & Valves	TIR255R22.5 RY023	New Yokohama Tag Tire		2.00	\$240.51	\$481.02	\$481.02
027-000-000 Transmission - Automatic	22755853	Gear Selector		1.00	\$341.82	\$341.82	\$341.82
041-000-000 Air Intake System	20592783(11ME269M)	CAC Clamp, MP7		1.00	\$23.18	\$23.18	\$23.18
041-000-000 Air Intake System	85137462	CAC Hose Clamp		1.00	\$13.86	\$13.86	\$13.86
041-000-000 Air Intake System	996457(20976035)	Intake Manifold Flange Screw		12.00	\$0.78	\$9.36	\$9.36
042-000-000 Cooling System	20968839	Coolant Fill Cap - CXU		1.00	\$17.80	\$17.80	\$17.80
042-000-000 Cooling System	21411441-7MH523M	Fan Ring		1.00	\$151.06	\$151.06	\$151.06
042-000-000 Cooling System	21412639(21237213)	MP7 Thermostat		1.00	\$86.99	\$86.99	\$86.99
042-000-000 Cooling System	85147374	Fan Drive Kit Update - NOTE		1.00	\$1,347.89	\$1,347.89	\$1,347.89
042-000-000 Cooling System	984736	Flange Bolt, M8 x 28MM - NOTE		6.00	\$0.55	\$3.30	\$3.30
042-000-000 Cooling System	FREIGHT IN	Self Explanatory		1.00	\$79.75	\$79.75	\$79.75
043-000-000 Exhaust System	21095721(11ME390M)	4" Gasket, MP7 Exhaust - NOTE		1.00	\$7.81	\$7.81	\$7.81
043-000-000 Exhaust System	21095726(11ME391M)	MP7 Flex Pipe Gasket, 5" - NOTE		1.00	\$12.42	\$12.42	\$12.42
043-000-000 Exhaust System	21344787	Exhaust Manifold Bolt		10.00	\$10.67	\$106.70	\$106.70
043-000-000 Exhaust System	21403962	DPF Delta Pressure Sensor		1.00	\$32.01	\$32.01	\$32.01







# REPAIR ORDER

Repair Order #: 1038220  
Repair Order Date: 3/8/2017

WALSH TRUCKING CO. LTD  
Main Shop  
WALSH TRUCKING COMPANY, LTD.  
1650 NW SUNDIAL ROAD  
TROUTDALE, OR. 97060

Date: 12/13/2017 at 1:10 PM Pacific

Page 2 of 3

Part Number	Description	Quantity	Unit Price	Net Price	Net Price
044-000-000 Fuel System	21344311 Fuel Pipe	1.00	\$38.63	\$38.63	\$38.63
045-000-000 Power Plant	1547252 Sealing Ring, Coolant System	1.00	\$4.92	\$4.92	\$4.92
045-000-000 Power Plant	20412482 Bolt, Rocker Shaft - Inboard	7.00	\$11.46	\$80.22	\$80.22
045-000-000 Power Plant	20526428 Jake Solenoid O-Ring - NOTE	1.00	\$4.39	\$4.39	\$4.39
045-000-000 Power Plant	21015266 Bolt, Camshaft Idler Gear	5.00	\$7.44	\$37.20	\$37.20
045-000-000 Power Plant	21454379 Acc Belt Tensioner	1.00	\$256.88	\$256.88	\$256.88
045-000-000 Power Plant	21454379 Acc Belt Tensioner	-1.00	\$0.00	(\$257.15)	(\$257.15)
045-000-000 Power Plant	21460409 MP7 Accessory Belt	1.00	\$32.30	\$32.30	\$32.30
045-000-000 Power Plant	21482604 Exhaust Manifold Bolt w/Stud	2.00	\$16.43	\$32.86	\$32.86
045-000-000 Power Plant	21528673(21345128) MP7 EGR Valve Bolt	4.00	\$31.84	\$127.36	\$127.36
045-000-000 Power Plant	21533184 MP7 De-Carbonizing Kit - NOTE	1.00	\$660.00	\$660.00	\$660.00
045-000-000 Power Plant	21659720 Air Inlet Elbow, Turbo	1.00	\$34.75	\$34.75	\$34.75
045-000-000 Power Plant	3979639 Gasket, Mixer To Intake Manifold	2.00	\$14.18	\$28.36	\$28.36
045-000-000 Power Plant	8192804 Bolt, Cam Dampener/Inj Hold Down	5.00	\$1.81	\$9.05	\$9.05
045-000-000 Power Plant	85013085 Cylinder Head, MP7-07/10 - NOTE	1.00	\$4,129.25	\$4,129.25	\$4,129.25
045-000-000 Power Plant	85116577 MP7 Turbo Mount Kit - NOTE	1.00	\$78.53	\$78.53	\$78.53
045-000-000 Power Plant	85124530 EGR Hose Kit	1.00	\$40.15	\$40.15	\$40.15
045-000-000 Power Plant	85143384 MP Injectors, 6PK *10EPA	1.00	\$2,858.10	\$2,858.10	\$2,858.10
045-000-000 Power Plant	984761(975105) Bolt, Rocker Arm - Outboard	7.00	\$1.02	\$7.14	\$7.14
045-000-000 Power Plant	993167 Spacer Sleeve	12.00	\$2.07	\$24.84	\$24.84
045-000-000 Power Plant	994445 Bolt, Piston Cooler	9.00	\$0.53	\$4.77	\$4.77
045-000-000 Power Plant	996457(20976035) Intake Manifold Flange Screw	12.00	\$0.78	\$9.36	\$9.36

**\$11,333.40**

VMRS System	Repair Reason	Work Description
043 Exhaust System	Drivers report	DPF differential pressure sensor
045 Power Plant	Drivers report	Injector 6 pack, hold down bolts, accy tensioner/belt, cylinder head, decarbonizing kit. Accy tensioner take off for 988.
044 Fuel System	Drivers report	Fuel pipe.
042 Cooling System	Drivers report	Fan drive update kit, freight in for fan drive. Fan ring, thermostat.
041 Air Intake System	Drivers report	CAC clamps, intake manifold flange screws.
002 Cab & Sheet Metal	Drivers report	LH hood latch bracket, LH hood shock. 3/2/17 - TD replaced wiper blades.
017 Tires, Tubes, Liners & Valves	Drivers report	New original tag tires.
012 Axles - Non-Driven, Rear	Drivers report	Relined tag axle brakes w/drums. 5/4/17-Arl. repaired R tag axle fender.
027 Transmission - Automatic	Drivers report	Gear selector.
013 Brakes	Drivers report	3/28/17 - TD replaced battery box air tank elbow.
001 Air Conditioning, Heating & Ventilating System	Drivers report	5/8/17-Arl. recharged A/C freon.

Parts Cost	\$11,333.40
Parts Tax	\$0.00
Labor Cost	\$0.00
Labor Tax	\$0.00

Mechanic Signature: \_\_\_\_\_





# REPAIR ORDER

Repair Order #: 1038220  
Repair Order Date: 3/8/2017

WALSH TRUCKING CO. LTD  
Main Shop  
WALSH TRUCKING COMPANY, LTD.  
1650 NW SUNDIAL ROAD  
TROUTDALE, OR. 97060

Date: 12/13/2017 at 1:10 PM Pacific  
Supervisor Signature: \_\_\_\_\_

Page 3 of 3  
Grand Total \$11,333.40



Union Pacific Railroad



Draft Template

Questionnaire	Questionnaire Description	Version	Status	Completed Date	Inspector Name	Location	Score
Draft Template	Draft Template	Complete	1	01/19/2018	Darnel Davis	Draft Template	0.0

Question	Response	Comments	Images	Attached Documents
<i>Courage to Care</i>				
Was Stand-down Safety meeting conducted during inspection	Yes			
<i>Pre-Inspection</i>				
All accidents/incidents reported to UPDS within 24 hrs; UPDS Form 1A utilized to report such incidents	Yes			
Annual fire extinguisher inspection report	Yes			
Crane operator certification	Yes			
Employees cRailSafe certified	Yes			
Equipment hours reported weekly	Yes			
Forklift operator certification	Yes			
Railcar mover operator certification	Yes			
Scale permit up-to-date	Yes	7/17		
<i>Office Compliance</i>				
Emergency Contacts Listed	Yes			
Emergency Evacuation Map displayed	In Compliance			
Emergency Evacuation Plan documented	In Compliance			
First Aid Kit on hand and stocked	Yes			
Frequency of safety meetings	In Compliance	Daily meetings		
Housekeeping (exits clear from debris)	Yes			
No Smoking signs	Yes			





Question	Response	Comments	Images	Attached Documents
OSHA Job Safety and Health: It's the Law (OSHA 3165) poster displayed	Yes			
Office Exit Signs (operational)	Yes			
Office Fire Extinguisher inspection up-to-date	Yes			
Overall Condition (damage, repairs, upkeep of facility)	Acceptable			
SDS sheets for environmentally sensitive materials	Yes			
Sign for Hours of operation displayed	Yes			
The Uniform Services Employment and Reemployment Rights Act posted	Yes			
Traffic flow plan displayed	Yes			
Visitor Check In Log completed, in/out times	In Compliance			
<b>Facility Compliance</b>				
Drivers utilizing PPE (vests, shoes, eye protection, hard hats)	Yes			
General Housekeeping (landscaping, pest control, yard sweep, orderly and safe condition)	In Compliance			
Landscaping / Weed-Pest Control	In Compliance			
No smoking signs posted	Yes			
Outdoor Fire Extinguishers annual inspections up-to-date	Yes			
Overall condition (yard clean, potholes, etc)	Not in compliance			
Railport Yard Fenced / Secure	Yes			
Speed limits signs	Yes			
Stop signs	Yes			
Sufficient clearance from track (9 ft)	In Compliance			
Track and switches free of debris	In Compliance			
Track and switches visibly inspected at least once a week	Yes			
UPDS contact sign current and in good condition	YES			
Visible track defects, e.g. gaps at joints, ties missing or deteriorating	No			
Yard Exit Signs	Not applicable			
Yard security (security cameras and lights in yard operational)	Yes			

Question	Response	Comments	Images	Attached Documents
<i>Equipment Operation</i>				
Daily equipment inspection checklist	Yes			
Employees safely operating ( no phone usage, honks horn)	Yes			
Employees utilizing PPE in yard ( i.e vests, shoes, eye protection, hard hat)	Yes			
Fire extinguisher accessible and up to date with inspection	Yes			
Motor shut off when unattended	Yes			
Parking brake set when unattended	Yes			
Seat belts in use while operating	Yes			
<i>HazMat</i>				
Appropriate Hazmat placards/signs	Yes			
Appropriate spill containment being used	Yes			
Environmentally sensitive materials stored in proper, clearly marked containers	Yes			
Fire Extinguisher mounted where flammables are located	Yes			
Fuel Tank Containment	Yes			
<i>Rail/Truck Loading</i>				
Blue flag derrails in place prior to loading	No			
Cargo inspected after loading	Yes			
Photos taken after loading	Yes			
Piece count verified after loading	Yes			
Procedure to process incoming trucks	Yes			
Procedure to process outgoing trucks	Yes			
Process for reporting damage or shortages	Yes			
Railcar brakes secured prior to loading	Not Applicable			
Railcars/trucks inspected before loading	Yes			
Wheel chocks in place prior to unloading	Yes			
<i>UPDS Accessories</i>				
Brakes sticks on-site ( good condition, how many on-hand )	Yes			
Dock Plate / Ramp	Yes			

Question	Response	Comments	Images	Attached Documents
Railcar chocks ( good condition, how many on hand )	Yes			
Truck Wheel chocks	Yes			





# Appendix 9: Walsh Safety information





# WALSH TRUCKING COMPANY LTD.

## Summary of Work-Related Injuries and Illnesses Report

(OSHA'S Form 300A)

Year: 2017

(Rev. 2004)

Jan to Nov

### Number of Cases

	(G) Deaths	(H) Days Away From Work	(I) Job Restriction or Transfer	(J) Other Recordable Cases
Total Cases	0	2	0	1

### Number of Days

	(K) Days Away From Work	(L) Job Restriction or Transfer
Total Days	9.0	0.0

### Injury and Illness Types

	(1) Injuries	(2) Skin Disorders	(3) Respiratory Conditions	(4) Poisonings	(5) Hearing Loss	(6) All Other Illnesses
Total Number	3	0	0	0	0	0

### Establishment Information

#### Name and Address:

WALSH & SONS TRUCKING, LTD.  
1650 N.W. SUNDIAL RD.  
TROUTDALE, OR 97060

#### Industry Description:

#### Standard Industrial Classification:

### Employment Information

Annual average number of employees: 62.00

Total hours worked by all employees: 0

### Certification Signature

I certify that I have examined this document and that to the best of my knowledge the entries are true, accurate and complete.

*Heidi Fulper*  
Company Executive

*HR Manager*  
Title

503-667-1912  
Phone

11/30/17  
Date





# WALSH TRUCKING COMPANY LTD.

## Summary of Work-Related Injuries and Illnesses Report

(OSHA'S Form 300A)

Year: 2016

(Rev. 2004)

### Number of Cases

	(G) Deaths	(H) Days Away From Work	(I) Job Restriction or Transfer	(J) Other Recordable Cases
Total Cases	0	8	0	1

### Number of Days

	(K) Days Away From Work	(L) Job Restriction or Transfer
Total Days	54.0	141.0

### Injury and Illness Types

	(1) Injuries	(2) Skin Disorders	(3) Respiratory Conditions	(4) Poisonings	(5) Hearing Loss	(6) All Other Illnesses
Total Number	9	0	0	0	0	0

### Establishment Information

#### Name and Address:

WALSH TRUCKING COMPANY LTD.  
17701 Cedar Springs Lane  
Arlington, OR 97812

Industry Description: Transportation

Standard Industrial Classification: 4213

### Employment Information

Annual average number of employees: 62.00

Total hours worked by all employees: 133700.00

### Certification Signature

I certify that I have examined this document and that to the best of my knowledge the entries are true, accurate and complete.

*Kevin Fulger* \_\_\_\_\_ HR Manager  
 Company Executive Title  
 503-667-1912 \_\_\_\_\_  
 Phone Date 2/1/2017

POST 2/1/2017 to 4/30/2017







# WALSH TRUCKING COMPANY LTD.

## Summary of Work-Related Injuries and Illnesses Report

(OSHA'S Form 300A)

Year: 2015

(Rev. 2004)

### Number of Cases

	(G) Deaths	(H) Days Away From Work	(I) Job Restriction or Transfer	(J) Other Recordable Cases
Total Cases	0	4	0	0

### Number of Days

	(K) Days Away From Work	(L) Job Restriction or Transfer
Total Days	24.0	52.0

### Injury and Illness Types

	(1) Injuries	(2) Skin Disorders	(3) Respiratory Conditions	(4) Poisonings	(5) Hearing Loss	(6) All Other Injuries
Total Number	4	0	0	0	0	0

### Establishment Information

#### Name and Address:

WALSH TRUCKING COMPANY LTD.  
Solid Waste Division  
17701 Cedar Springs Lane  
Arlington, OR 97812

Industry Description: Transportation

Standard Industrial Classification: 4213

### Employment Information

Annual average number of employees: 58.00

Total hours worked by all employees: 151,243.22

### Certification Signature

I certify that I have examined this document and that to the best of my knowledge the entries are true, accurate and complete.

  
\_\_\_\_\_  
Company Executive

HR Manager  
\_\_\_\_\_  
Title

503-667-1912  
\_\_\_\_\_  
Phone

1/29/2016  
\_\_\_\_\_  
Date

POST 2/1/2016 to 4/30/2016





# WALSH TRUCKING COMPANY LTD.

## Summary of Work-Related Injuries and Illnesses Report

(OSHA'S Form 300A)

Year: 2014

(Rev. 2004)

### Number of Cases

	(G) Deaths	(H) Days Away From Work	(I) Job Restriction or Transfer	(J) Other Recordable Cases
Total Cases	0	2	2	1

### Number of Days

	(K) Days Away From Work	(L) Job Restriction or Transfer
Total Days	71.0	66.0

### Injury and Illness Types

	(1) Injuries	(2) Skin Disorders	(3) Respiratory Conditions	(4) Poisonings	(5) Hearing Loss	(6) All Other Illnesses
Total Number	5	0	0	0	0	0

### Establishment Information

#### Name and Address:

WALSH TRUCKING COMPANY LTD.  
17701 CEDAR SPRINGS LANE  
ARLINGTON, OR 97812

#### Industry Description:

#### Standard Industrial Classification:

### Employment Information

Annual average number of employees:

56.00

Total hours worked by all employees:

169354

### Certification Signature

I certify that I have examined this document and that to the best of my knowledge the entries are true, accurate and complete.

Heidi Fulper/ag \_\_\_\_\_ HR Manager \_\_\_\_\_  
 Company Executive Title  
503-447-1912 \_\_\_\_\_ 1/30/15 \_\_\_\_\_  
 Phone Date





# WALSH TRUCKING COMPANY LTD.

## Summary of Work-Related Injuries and Illnesses Report (OSHA'S Form 300A)

Year: 2013

(Rev. 2004)

### Number of Cases

	(G) Deaths	(H) Days Away From Work	(I) Job Restriction or Transfer	(J) Other Recordable Cases
Total Cases	0	3	1	1

### Number of Days

	(K) Days Away From Work	(L) Job Restriction or Transfer
Total Days	183.0	21.0

### Injury and Illness Types

	(1) Injuries	(2) Skin Disorders	(3) Respiratory Conditions	(4) Poisonings	(5) Hearing Loss	(6) All Other Illnesses
Total Number	5	0	0	0	0	0

### Establishment Information

#### Name and Address:

WALSH TRUCKING COMPANY LTD.  
1650 N.W. SUNDIAL RD.  
TROUTDALE, OR 97060

Industry Description: Transportation

Standard Industrial Classification: 4213

### Employment Information

Annual average number of employees: 61.00

Total hours worked by all employees: 122139.13

### Certification Signature

*I certify that I have examined this document and that to the best of my knowledge the entries are true, accurate and complete.*

\_\_\_\_\_  
Company Executive

\_\_\_\_\_  
Title

\_\_\_\_\_  
Phone

\_\_\_\_\_  
Date







# WALSH TRUCKING COMPANY LTD.

## Summary of Work-Related Injuries and Illnesses Report

(OSHA'S Form 300A)

Year: 2012

SOLID WASTE

(Rev. 2004)

### Number of Cases

	(G) Deaths	(H) Days Away From Work	(I) Job Restriction or Transfer	(J) Other Recordable Cases
Total Cases	0	8	0	2

### Number of Days

	(K) Days Away From Work	(L) Job Restriction or Transfer
Total Days	55.0	108.0

### Injury and Illness Types

	(1) Injuries	(2) Skin Disorders	(3) Respiratory Conditions	(4) Poisonings	(5) Hearing Loss	(6) All Other Illnesses
Total Number	10	0	0	0	0	0

### Establishment Information

#### Name and Address:

WALSH TRUCKING COMPANY LTD.  
1650 N.W. SUNDIAL RD.  
TROUTDALE, OR 97060

Industry Description: Transportation

Standard Industrial Classification: 4213

### Employment Information

Annual average number of employees: 61.80

Total hours worked by all employees: 120267.00

### Certification Signature

I certify that I have examined this document and that to the best of my knowledge the entries are true, accurate and complete.

*Deidi Julpes*

Company Executive

HR MANAGER

Title

503-667-1912

Phone

1/31/2013

Date

POST - Feb 1 through April 30



This page intentionally left blank



# Appendix 10: Financial Statements



## REPORT OF INDEPENDENT REGISTERED PUBLIC ACCOUNTING FIRM

The Board of Directors and Stockholders of Waste Management, Inc.

We have audited the accompanying consolidated balance sheets of Waste Management, Inc. (the "Company") as of December 31, 2016 and 2015, and the related consolidated statements of operations, comprehensive income, cash flows, and changes in equity for each of the three years in the period ended December 31, 2016. These financial statements are the responsibility of the Company's management. Our responsibility is to express an opinion on these financial statements based on our audits.

We conducted our audits in accordance with the standards of the Public Company Accounting Oversight Board (United States). Those standards require that we plan and perform the audit to obtain reasonable assurance about whether the financial statements are free of material misstatement. An audit includes examining, on a test basis, evidence supporting the amounts and disclosures in the financial statements. An audit also includes assessing the accounting principles used and significant estimates made by management, as well as evaluating the overall financial statement presentation. We believe that our audits provide a reasonable basis for our opinion.

In our opinion, the financial statements referred to above present fairly, in all material respects, the consolidated financial position of Waste Management, Inc. at December 31, 2016 and 2015, and the consolidated results of its operations and its cash flows for each of the three years in the period ended December 31, 2016, in conformity with U.S. generally accepted accounting principles.

We also have audited, in accordance with the standards of the Public Company Accounting Oversight Board (United States), Waste Management, Inc.'s internal control over financial reporting as of December 31, 2016, based on criteria established in Internal Control-Integrated Framework issued by the Committee of Sponsoring Organizations of the Treadway Commission (2013 framework) and our report dated February 16, 2017 expressed an unqualified opinion thereon.

/s/ ERNST & YOUNG LLP

Houston, Texas  
February 16, 2017



**WASTE MANAGEMENT, INC.**  
**CONSOLIDATED BALANCE SHEETS**  
(In Millions, Except Share and Par Value Amounts)

	December 31,	
	2016	2015
<b>ASSETS</b>		
Current assets:		
Cash and cash equivalents .....	\$ 32	\$ 39
Accounts receivable, net of allowance for doubtful accounts of \$24 and \$25, respectively ..	1,700	1,549
Other receivables .....	432	545
Parts and supplies .....	90	92
Other assets .....	122	120
Total current assets .....	2,376	2,345
Property and equipment, net of accumulated depreciation and amortization of \$17,152 and \$16,420, respectively .....	10,950	10,665
Goodwill .....	6,215	5,984
Other intangible assets, net .....	591	477
Investments in unconsolidated entities .....	320	360
Other assets .....	407	536
Total assets .....	\$20,859	\$20,367
<b>LIABILITIES AND EQUITY</b>		
Current liabilities:		
Accounts payable .....	\$ 799	\$ 721
Accrued liabilities .....	1,085	1,064
Deferred revenues .....	493	472
Current portion of long-term debt .....	417	253
Total current liabilities .....	2,794	2,510
Long-term debt, less current portion .....	8,893	8,676
Deferred income taxes .....	1,482	1,391
Landfill and environmental remediation liabilities .....	1,675	1,584
Other liabilities .....	695	839
Total liabilities .....	15,539	15,000
Commitments and contingencies		
Equity:		
Waste Management, Inc. stockholders' equity:		
Common stock, \$0.01 par value; 1,500,000,000 shares authorized; 630,282,461 shares issued .....	6	6
Additional paid-in capital .....	4,850	4,827
Retained earnings .....	7,388	6,939
Accumulated other comprehensive income (loss) .....	(80)	(127)
Treasury stock at cost, 190,966,584 and 183,105,326 shares, respectively .....	(6,867)	(6,300)
Total Waste Management, Inc. stockholders' equity .....	5,297	5,345
Noncontrolling interests .....	23	22
Total equity .....	5,320	5,367
Total liabilities and equity .....	\$20,859	\$20,367



**WASTE MANAGEMENT, INC.**  
**CONSOLIDATED STATEMENTS OF OPERATIONS**  
(In Millions, Except per Share Amounts)

	Years Ended December 31,		
	2016	2015	2014
Operating revenues .....	\$13,609	\$12,961	\$13,996
Costs and expenses:			
Operating .....	8,486	8,231	9,002
Selling, general and administrative .....	1,410	1,343	1,481
Depreciation and amortization .....	1,301	1,245	1,292
Restructuring .....	4	15	82
(Income) expense from divestitures, asset impairments and unusual items ..	112	82	(160)
	<u>11,313</u>	<u>10,916</u>	<u>11,697</u>
Income from operations .....	2,296	2,045	2,299
Other income (expense):			
Interest expense, net .....	(376)	(385)	(466)
Loss on early extinguishment of debt .....	(4)	(555)	—
Equity in net losses of unconsolidated entities .....	(44)	(38)	(53)
Other, net .....	(50)	(7)	(29)
	<u>(474)</u>	<u>(985)</u>	<u>(548)</u>
Income before income taxes .....	1,822	1,060	1,751
Provision for income taxes .....	642	308	413
Consolidated net income .....	1,180	752	1,338
Less: Net income (loss) attributable to noncontrolling interests .....	(2)	(1)	40
Net income attributable to Waste Management, Inc. ....	<u>\$ 1,182</u>	<u>\$ 753</u>	<u>\$ 1,298</u>
Basic earnings per common share .....	<u>\$ 2.66</u>	<u>\$ 1.66</u>	<u>\$ 2.80</u>
Diluted earnings per common share .....	<u>\$ 2.65</u>	<u>\$ 1.65</u>	<u>\$ 2.79</u>
Cash dividends declared per common share .....	<u>\$ 1.64</u>	<u>\$ 1.54</u>	<u>\$ 1.50</u>

**CONSOLIDATED STATEMENTS OF COMPREHENSIVE INCOME**  
(In Millions)

	Years Ended December 31,		
	2016	2015	2014
Consolidated net income .....	\$1,180	\$ 752	\$1,338
Other comprehensive income (loss), net of tax provision (benefit):			
Derivative instruments, net .....	12	9	1
Available-for-sale securities, net .....	5	(2)	4
Foreign currency translation adjustments .....	28	(159)	(124)
Post-retirement benefit obligation, net .....	2	2	(12)
Other comprehensive income (loss), net of tax provision (benefit) .....	<u>47</u>	<u>(150)</u>	<u>(131)</u>
Comprehensive income .....	1,227	602	1,207
Less: Comprehensive income (loss) attributable to noncontrolling interests .....	(2)	(1)	40
Comprehensive income attributable to Waste Management, Inc. ....	<u>\$1,229</u>	<u>\$ 603</u>	<u>\$1,167</u>





**WASTE MANAGEMENT, INC.**  
**CONSOLIDATED STATEMENTS OF CASH FLOWS**  
(In Millions)

	Years Ended December 31,		
	2016	2015	2014
Cash flows from operating activities:			
Consolidated net income	\$ 1,180	\$ 752	\$ 1,338
Adjustments to reconcile consolidated net income to net cash provided by operating activities:			
Depreciation and amortization	1,301	1,245	1,292
Deferred income tax (benefit) provision	73	30	(118)
Interest accretion on landfill liabilities	91	89	88
Interest accretion on and discount rate adjustments to environmental remediation liabilities and recovery assets	—	1	14
Provision for bad debts	42	36	42
Equity-based compensation expense	90	72	65
Excess tax benefits associated with equity-based transactions	(28)	(15)	(5)
Net gain on disposal of assets	(24)	(18)	(35)
(Income) expense from divestitures, asset impairments and other, net	110	87	(127)
Equity in net losses of unconsolidated entities, net of dividends	44	42	42
Loss on early extinguishment of debt	4	555	—
Change in operating assets and liabilities, net of effects of acquisitions and divestitures:			
Receivables	(78)	(178)	(268)
Other current assets	(12)	16	(19)
Other assets	78	(7)	22
Accounts payable and accrued liabilities	174	(112)	117
Deferred revenues and other liabilities	(85)	(97)	(117)
Net cash provided by operating activities	<u>2,960</u>	<u>2,498</u>	<u>2,331</u>
Cash flows from investing activities:			
Acquisitions of businesses, net of cash acquired	(611)	(554)	(35)
Capital expenditures	(1,339)	(1,233)	(1,151)
Proceeds from divestitures of businesses and other assets (net of cash divested)	43	145	2,253
Net receipts from restricted trust and escrow accounts	—	51	19
Investments in unconsolidated entities	(21)	(20)	(33)
Other, net	(4)	3	(58)
Net cash provided by (used in) investing activities	<u>(1,932)</u>	<u>(1,608)</u>	<u>995</u>
Cash flows from financing activities:			
New borrowings	3,057	2,337	2,817
Debt repayments	(2,682)	(2,764)	(3,568)
Premiums paid on early extinguishment of debt	(2)	(555)	—
Common stock repurchase program	(725)	(600)	(600)
Cash dividends	(726)	(695)	(693)
Exercise of common stock options	63	77	93
Excess tax benefits associated with equity-based transactions	28	15	5
Acquisitions of and distributions paid to noncontrolling interests	(1)	(1)	(125)
Other, net	(47)	31	(1)
Net cash used in financing activities	<u>(1,035)</u>	<u>(2,155)</u>	<u>(2,072)</u>
Effect of exchange rate changes on cash and cash equivalents	—	(3)	(5)
Increase (decrease) in cash and cash equivalents	(7)	(1,268)	1,249
Cash and cash equivalents at beginning of year	39	1,307	58
Cash and cash equivalents at end of year	<u>\$ 32</u>	<u>\$ 39</u>	<u>\$ 1,307</u>



WASTE MANAGEMENT, INC.

CONSOLIDATED STATEMENTS OF CHANGES IN EQUITY  
(In Millions, Except Shares in Thousands)

	Waste Management, Inc. Stockholders' Equity								
	Total	Common Stock		Additional Paid-In Capital	Retained Earnings	Accumulated Other Comprehensive Income (Loss)	Treasury Stock		Noncontrolling Interests
		Shares	Amounts				Shares	Amounts	
Balance, December 31, 2013	\$6,002	630,282	\$ 6	\$4,596	\$6,289	\$ 154	(165,962)	\$(5,338)	\$ 295
Consolidated net income	1,338	—	—	—	1,298	—	—	—	40
Other comprehensive income (loss), net of tax provision (benefit)	(131)	—	—	—	—	(131)	—	—	—
Cash dividends	(693)	—	—	—	(693)	—	—	—	—
Equity-based compensation transactions, including dividend equivalents, net of tax provision (benefit)	195	—	—	79	(6)	—	3,779	122	—
Common stock repurchase program	(600)	—	—	(180)	—	—	(9,569)	(420)	—
Distributions paid to noncontrolling interests	(34)	—	—	—	—	—	—	—	(34)
Acquisitions of noncontrolling interests and divestiture of Wheelabrator business	(188)	—	—	90	—	—	—	—	(278)
Other, net	—	—	—	—	—	—	7	—	—
Balance, December 31, 2014	\$5,889	630,282	\$ 6	\$4,585	\$6,888	\$ 23	(171,745)	\$(5,636)	\$ 23
Consolidated net income	752	—	—	—	753	—	—	—	(1)
Other comprehensive income (loss), net of tax provision (benefit)	(150)	—	—	—	—	(150)	—	—	—
Cash dividends	(695)	—	—	—	(695)	—	—	—	—
Equity-based compensation transactions, including dividend equivalents, net of tax provision (benefit)	171	—	—	62	(7)	—	3,457	116	—
Common stock repurchase program	(600)	—	—	180	—	—	(14,823)	(780)	—
Other, net	—	—	—	—	—	—	6	—	—
Balance, December 31, 2015	\$5,367	630,282	\$ 6	\$4,827	\$6,939	\$(127)	(183,105)	\$(6,300)	\$ 22
Consolidated net income	1,180	—	—	—	1,182	—	—	—	(2)
Other comprehensive income (loss), net of tax provision (benefit)	47	—	—	—	—	47	—	—	—
Cash dividends	(726)	—	—	—	(726)	—	—	—	—
Equity-based compensation transactions, including dividend equivalents, net of tax provision (benefit)	186	—	—	69	(7)	—	3,556	124	—
Common stock repurchase program	(725)	—	—	(45)	—	—	(11,241)	(680)	—
Other, net	(9)	—	—	(1)	—	—	(177)	(11)	3
Balance, December 31, 2016	\$5,320	630,282	\$ 6	\$4,850	\$7,388	\$ (80)	(190,967)	\$(6,867)	\$ 23



# Appendix 11: ECONorthwest Economic Impact Study





---

# Metro and Waste Management: Economic Impacts in Gilliam County

---

January 2018

**ECONorthwest**  
ECONOMICS • FINANCE • PLANNING

KOIN Center  
222 SW Columbia Street  
Suite 1600  
Portland, OR 97201  
503.222.6060



## Executive Summary

---

Metro's relationship with Gilliam County has fundamentally shaped the economic underpinnings and trajectory of this rural Oregon county for nearly three decades. This report quantifies specific impacts of Waste Management's operations in Gilliam County, 28 years after Columbia Ridge was constructed and began operations to serve Metro. This report focuses on jobs, economic output and property taxes as well as the WM host fees that have provided a steady and strong funding source for Gilliam County's general fund, capital improvement plan and economic development.

### Topline findings:

- WM is the largest employer in Gilliam County, accountable for nearly 30% of all jobs in the County (including multiplier effects). In fact, WM's employment impact in Gilliam County is three times greater than Intel's employment impact in Washington County.
- WM is directly associated with 20% of the County's total economic output, 15% of the labor income, and 21% of the jobs.
- WM supported (direct + indirect + induced) a total of \$37.5 million of output in 2017, \$24.5 million from Columbia Ridge, of which \$4.9 million is attributable to the Metro contract.
- WM supported a total of \$9.6 million of wages and benefits in 2017, \$6.8 million from the Columbia Ridge, of which \$1.2 million is attributable to the Metro contract. The average wage at Columbia Ridge is \$41,700 plus benefits: medical, dental, vision, disability, life insurance, wellness program, 401(k) with WM matching up to 6% of wages, employee stock purchase plan, legal services, performance bonuses for many exempt positions, and employee discount programs.
- WM contributed \$5 million in revenue (\$3.8 million in host fees) to Gilliam County and local jurisdictions in 2017.
- WM contributed \$50,000 to local charitable organizations in 2017.
- For Gilliam County, losing the jobs directly attributable to the Metro contract would be the equivalent of Intel laying off half of its workforce in Washington County.





## Background

---

Gilliam County is the third smallest county in Oregon, with a 2017 population of 1,995. Similar to many rural counties in Oregon, its population has been declining—decreasing about 8% over the past 40 years.<sup>4</sup> There were 810 jobs in Gilliam County in October 2017, of which 21% were directly employed by WM, and an additional 6% supported through multiplier effects (combined to account for 27% of all jobs in the county). These jobs impacts are only calculated for annual operating expenditures; numerous other jobs are supported throughout Gilliam County—government and private jobs—through fiscal contributions, including the WM host fees.

Columbia Ridge receives waste from across the region, with nearly 20% of the tonnage connected to the Metro contract. Columbia Ridge was constructed and began operations in 1990 explicitly to serve Metro. Over 28 years, the facility's importance to Gilliam County has been as impactful as any private business for an individual county in Oregon.

For example, Oregon's largest private employer — Intel — directly employs 6% of the employees in Washington County. WM's impact is roughly 3.5 times larger in Gilliam County. The portion of jobs directly connected to the Metro contract is about 3.1% of the total employment in Gilliam County. Using the Intel reference, the jobs in Gilliam County connected to Metro equate to roughly half of the jobs provided by Intel in Washington County. For Gilliam County, losing the WM jobs connected directly to the Metro contract would be comparable to Washington County losing half of the Intel workforce.

Focusing on the jobs connected only to the Metro contract also provides insight into how this number of jobs would impact Wasco, Morrow and Klickitat counties. A single family-wage job has significantly greater economic impact in Gilliam County. This is because there are more jobs in the other counties and because average wages in Morrow and Klickitat counties are higher than the average wage in Gilliam County. For example, the relative impact of a single WM family wage job in Gilliam County is 10 times greater than a single job in Wasco County.

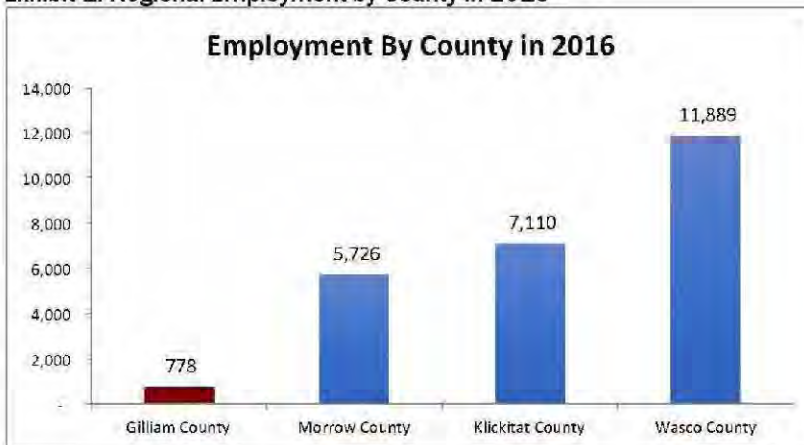
---

<sup>4</sup> Portland State University, Population Resource Center.





**Exhibit 1. Regional Employment by County in 2016<sup>2</sup>**



Source: Bureau of Labor Statistics

**Exhibit 2. Average Annual Pay by County in 2016**



Source: Bureau of Labor Statistics

<sup>2</sup> The number of jobs in 2016 was selected to correspond to the income data in Figure 2. Income data is only available through 2016. The jobs counts differ from the most current job count referenced earlier in the report.



Gilliam County collected \$9 million in property taxes for fiscal year 2015-16. WM's property taxes accounted for 10% of the property tax revenue.

In addition to property taxes that support local jurisdictions, WM also pays an annual host fee, which totaled \$3.8 million in 2017. The largest share of the WM host fee directly supports the Gilliam County general fund. For the 2017-18 fiscal year, the Gilliam County general fund had a budget of \$5.7 million. WM host fees accounted for \$880,000, or 15%, of the Gilliam County general fund budget.

WM host fees also help incentivize homeownership and make housing more affordable in Gilliam County. In 2017, the Homestead Tax Rebate Program used \$253,000 in WM host fees to provide rebates up to \$500 of property tax for eligible properties, benefitting 520 households.

## Economic Impact Analysis Results

WM's operations in Gilliam County consist of two facilities – Columbia Ridge and ChemWaste. WM provided ECONorthwest with operations data for the calendar year of 2017 to calculate the impact of operating the two facilities. These do not account for all potential impacts, specifically those supported through fiscal revenues including the WM host fees. Convention for economic impacts studies is to not include government jobs supported through fiscal revenue. However, the broad range of activities supported in Gilliam County will be discussed below in the fiscal impacts section.

WM directly supports \$31.7 million in economic output; this is 20% of Gilliam County's total output. WM directly employs 170 people each year (21% of all jobs), and pays \$8.2 million in wages and benefits (15% of all wages and benefits). WM's operations support additional supply chain (indirect) and consumer expenditures throughout Gilliam County (see Exhibit 3).

**Exhibit 3. Stabilized Annual Operational Impacts in Gilliam County, 2017**

Type of Impact	Direct	Indirect	Induced	Total
Output	\$31,317,568	\$3,241,485	\$2,582,370	\$37,141,423
Value Added	\$18,016,213	\$1,441,106	\$1,225,283	\$20,682,602
Labor Income	\$8,165,573	\$843,573	\$514,016	\$9,523,162
Employment	172	26	22	220

Source: ECONorthwest using data from Waste Management and the IMPLAN model

Annual stabilized operations support a total (including multiplier impacts) of \$37.5 million in output, \$9.6 million in labor income, and 218 jobs in Gilliam County. Exhibit 4 (on page 5) shows the impacts from operations only at Columbia Ridge. This facility represents the largest share of WM operations in Gilliam County, of which nearly 20% of the tonnage is attributable to the Metro contract. Approximately \$4.9 million of the output is attributable to the Metro contract, along with supporting \$1.15 million in income and the equivalent of 25 jobs.



Exhibit 4. Columbia Ridge Impacts in Gilliam County, 2017

Type of Impact	Direct	Indirect	Induced	Total
Output	\$24,450,591	\$2,478,349	\$1,974,408	\$28,903,347
Value Added	\$13,638,012	\$1,101,829	\$936,817	\$15,676,658
Labor Income	\$5,790,302	\$644,972	\$393,002	\$6,828,276
Employment	111	20	17	148

Source: ECONorthwest using data from Waste Management and the IMPLAN model

## Fiscal Impact Analysis

WM provided ECONorthwest with direct state personal income tax, property tax, host fees, and other taxes and fees that WM pays associated with their Gilliam County operations.

ECONorthwest also calculated the state personal income tax and property tax supported through the indirect and induced impacts of WM operations in Gilliam County.

### Operations

Exhibit 5 shows the fiscal impacts from WM operations in Gilliam County. Indirect and induced taxes are generated from suppliers and households supported through income earned that is supported by WM. Indirect and induced taxes are added to direct in the "Total" column of the table below.

Exhibit 5. Annual Fiscal Impacts from Operations in Gilliam County, 2017

Type of Impact		
State Personal Income Tax	\$495,715	\$545,739
Property Tax	\$896,431	\$933,684
Host fees and other fees	\$4,042,050	\$4,042,050
<b>Total</b>	<b>\$5,434,196</b>	<b>\$5,521,473</b>

Source: ECONorthwest using data from Waste Management, the IMPLAN model, and Oregon Department of Revenue

Income tax estimates represent only the State of Oregon personal income tax and do not include federal or other local business income taxes. WM operations supported \$5.4 million in taxes annually at the state and local levels. Taxes supported from suppliers and associated household spending add to the direct taxes, increasing associated fiscal revenue by \$87,000.

### WM Host Fees

Host fees paid by WM represent a large portion of the total revenues contributed to support public sector activity in Gilliam County. In 2017, WM paid Gilliam County \$3.8 million to support a range of annual public sector operating expenses as well as large capital improvement and economic development projects. Host fees are not public revenues required by statute, but rather the result of a private agreement negotiated between WM and Gilliam County. Terms are negotiated at scheduled intervals, and payments are based on volumes of waste received at Columbia Ridge. Here's how the majority of the WM host fees were directed in 2017:



## Exhibit 6. WM host fees 2017 - recipients/projects

Fund/Recipient
City of Arlington
City of Condon
City of Lonerock
Gilliam County general fund
County road fund
County capital projects fund
County bridge fund
County law enforcement fund
County homestead tax rebate
County economic development fund
County north end special projects grant fund
County south end special project grant funds
Homestead rebate endowment fund
County small business loan fund

Source: Waste Management, and Gilliam County

## Economic Impacts Methodology

The economic impact analysis calculates how direct operations at WM interact with the Gilliam County economy through multiplier effects. This is accomplished by using an economic model (Input-Output) that traces economic transactions between individuals and businesses. The software used for this analysis is called IMPLAN. It relies on public economic data to track expenditures as they circulate throughout Gilliam County.

Operations at WM generate expenditures that purchase goods, services, and labor. Suppliers and laborers in turn spend a portion of this money, generating subsequent impacts elsewhere in the economy. These subsequent rounds of spending continue until the money is eventually saved, taxed, or spent outside of Gilliam County. This is referred to as the "multiplier effect."

Economic impact analysis uses specific language to refer to different measurements of economic activity:

### Economic measures:

- Output represents the value of all goods and services produced from an entity or event, and is the broadest measure of economic activity.
- Labor Income is total compensation. For a paid employee, it is the employer's cost of wages, salaries, commissions, bonuses, payroll taxes, health insurance, retirement benefits, life insurance, per diems, and other benefits. IMPLAN also counts earnings of self-employed persons in labor income.



- Jobs, according to IMPLAN's methodology, are measured in terms of full-year-equivalents (FYE). One FYE job equals work over 12 months in a given industry (this is the same definition used by the federal government's Bureau of Labor Statistics). For example, two jobs that last six months each count as one FYE job. Likewise, one construction job lasting 24 months equals two FYE jobs. A job can be full-time or part-time, seasonal or permanent; IMPLAN counts jobs based on the duration of employment.

#### Types of Impacts:

- **Direct Effects** result from an expenditure related to construction or operations of WM. The direct effects are derived from data supplied by WM.
- **Indirect Effects** are the goods and services purchased for construction and operations. The initial spending of the project generates the first round of indirect impacts. Suppliers will also purchase additional goods and services; this spending leads to additional rounds of indirect impacts. Indirect effects are often referred to as "supply-chain" impacts.
- **Induced Effects** are the purchases of goods and services from household incomes. The direct and indirect effects increase employment and income in the city, and induce further consumption. For example, an employee will use their income to purchase groceries or take their children to the doctor. These induced impacts are often referred to as "consumption-driven" impacts.

It is important to note that this analysis measures the gross impacts of WM, and does not consider alternative scenarios. Gross impacts include all economic impacts supported by the entity, regardless of what impacts would have occurred without the entity.

Gross impacts are an upper bound estimate of potential impacts on the economy and should not be considered net new impacts.



This page intentionally left blank





Appendix 12:  
**UPRR's 2016 Social, Environmental and  
Economic Sustainability Progress  
Report**



UNION PACIFIC

# 2016 Building America Report

A report to communities on our social, environmental and economic sustainability progress.





# About the Report

Union Pacific's mission of service defines us and drives our commitment to safely transport products across the country, provide good jobs, operate ethically and invest in our communities.

This report details our progress in key areas supporting social, economic and environmental sustainability pillars: operating safely, strengthening communities, engaging employees and working to preserve the environment. We also summarize our 2016 financial performance.

We used the Global Reporting Initiative's global sustainability reporting standards as a guide to report our most material social responsibility issues. This publication focuses on initiatives and accomplishments from the 2016 calendar year and includes 2016 data unless otherwise noted.

## Table of Contents

<b>Letter to Stakeholders</b> . . . . .	3	<b>Operating Safely</b> . . . . .	14	<b>Preserving the Environment</b> . . . . .	31
<b>Our Company</b> . . . . .	4	Rail Safety Maintenance . . . . .	14	Highlights, Challenges and Opportunities . . . . .	31
Financial Performance . . . . .	4	Positive Train Control . . . . .	16	Our Approach to Environmental Management . . . . .	31
What We Carry . . . . .	5	Handling Hazardous Materials Safely . . . . .	17	Environmental Risks . . . . .	32
Risk Oversight Approach . . . . .	6	Best Employee Safety Performance in History . . . . .	18	Fuel Efficiency . . . . .	33
Sustainability Management Approach . . . . .	6	Public Safety . . . . .	20	Incorporating Technology . . . . .	31
Key Performance Indicators . . . . .	7	<b>Strengthening Our Communities</b> . . . . .	22	Energy Conservation . . . . .	35
Stakeholder Engagement . . . . .	8	Meeting Local Needs . . . . .	23	Land Preservation . . . . .	38
Key Awards and Recognition . . . . .	9	Making a Difference in Our Communities . . . . .	24	Compliance . . . . .	38
<b>Economic Impact</b> . . . . .	10	<b>Engaging Employees</b> . . . . .	25	<b>Looking Ahead</b> . . . . .	39
Investing in Infrastructure . . . . .	10	Embracing Employee Needs . . . . .	25		
Creating Local Economic Opportunity . . . . .	11	Helping People Develop . . . . .	26		
Local Economic Opportunities . . . . .	12	Embedding an Ethical Approach . . . . .	27		
Enabling Innovation and Sustainability . . . . .	13	Establishing a Diverse and Inclusive Workplace . . . . .	28		
Generating Opportunity Through Our Supply Chain . . . . .	13	Keeping Employees Healthy, Happy and Well . . . . .	29		

*On the cover: from top to bottom, Track Supervisor Demarcus Thompson, Carman Refugio Rickford, Occupational Health Nurse Trudy Forbes and Electrician Steve Saing.*





# Letter to Stakeholders

Sustainability is fundamental to Union Pacific's vision of Building America. Our rail network crosses 28 states, connecting communities to opportunity and our country to sustainable economic growth. It is our duty to deliver products in a safe, reliable, fuel-efficient and environmentally responsible manner.

Union Pacific is committed to operating responsibly and serving customers with excellence, which our 48,000 employees accomplish with ingenuity and integrity. Community and infrastructure investments also play an important role in Union Pacific's mission to serve. Each section of this Building America Report describes key initiatives and reflects on our performance over the last year.



**OUR VISION**  
Building America

**OUR MISSION**  
The Men and Women of Union Pacific  
are Dedicated to Serve

**OUR VALUES**  
Passion for Performance  
High Ethical Standards  
Work as a Team

- **Economic Impact** illustrates how Union Pacific drives economic growth in the 28 states where we operate through direct employment, capital investments and in-state sourcing efforts.
- **Operating Safely** details our relentless investments and innovations to maintain a safe rail network. This section also showcases our ongoing efforts to increase public safety near railroad tracks.
- **Strengthening Communities** demonstrates the role Union Pacific plays in our 7,000 communities. This includes investments in developing workforces, employees' donations and volunteer efforts, and partnerships with colleges and universities.
- **Engaging Employees** outlines our commitment to our employees by creating fulfilling careers including well-being, training and development investments.
- **Preserving the Environment** highlights efforts to increase fuel efficiency, reduce carbon emissions and partnerships with communities and government agencies to preserve ecosystems across our network.

Our sustainability approach is evolving. One of the most exciting developments is the Union Pacific Foundation's renewed focus on partnerships centered on safety, workforce development and enhancing community spaces. This will enable us to multiply the positive impact we have in the communities we serve. Details of the Foundation's evolving role are outlined in the Strengthening Communities section.

We are proud of the work we do and understand there always is more to learn. This report is part of our ongoing conversation with you, our stakeholders, and we truly value your feedback.

**Lance Fritz**  
Chairman, President, and CEO



# Our Company

Union Pacific Railroad is the principal operating company of Union Pacific Corporation (NYSE: UNP). We are one of America's most recognized companies, with a heritage of building the country and a vision to keep doing so.

Our rail network connects 23 states in the western two-thirds of the country, providing a critical link in the global supply chain. Over the last 10 years, from 2007 to 2016, Union Pacific invested approximately \$34 billion in our network and operations, supporting America's transportation infrastructure and enabling economic growth.



## Financial Performance

Union Pacific adds value to the U.S. economy through our operations' profits and shareholder returns. In 2016, we reported net income of \$4.2 billion or \$5.07 per diluted share. This represents a 1 and 8 percent decrease, respectively, compared to the \$4.8 billion or \$5.49 per diluted share we reported in 2015. We had operating revenues of \$19.9 billion compared to \$21.8 billion in 2015, a 9 percent decrease, and operating income of \$7.3 billion compared to \$8.1 billion, a 10 percent decrease.

Market factors such as soft energy prices, the impact of the strong U.S. dollar on exports and a sluggish domestic consumer economy were the major drivers of a 7 percent decline in total volume last year. Carloadings were down in four of our six commodity groups, including a 20 percent decrease in coal traffic alone. On the positive side, a large U.S. grain harvest, along with strong global demand, drove a significant increase in our grain shipments, especially in the latter part of the year.



## What We Carry

Union Pacific moves the goods American families and businesses use every day. Our diversified business mix includes food we eat, cars we drive, chemicals to clean water and steel to build cities.

Our railroad serves many of the fastest growing cities in the United States and connects all major West Coast and Gulf Coast ports to Canada, Mexico and the country's eastern gateways. We have roughly 10,000 direct customers, and work to deliver products in a safe, reliable, fuel-efficient and environmentally responsible manner.

### DIVERSIFIED BUSINESS PRODUCTS

#### Agricultural Products

The whole grains and other agricultural goods we haul feed America and many other parts of the world.

#### Automotive

We transport automotive parts, finished vehicles and aftermarket vehicles, taking them from assembly plants, operating or accessing distribution centers for all major auto manufacturers, and distributing imported vehicles from the West Coast and Gulf of Mexico.

#### Chemicals

Chemicals we carry help clean drinking water, produce plastics and fertilize crops. We also transport petrochemicals, crude oil and soda ash.

#### Coal

Coal generated about 30 percent of America's electricity in 2016, according to the U.S. Energy Information Administration. We ship coal from mines in the Southern Powder River Basin, Utah, Colorado, southern Wyoming and southern Illinois, delivering to electric plants as well as ports.

#### Industrial Products

We carry a broad range of raw materials and finished goods including steel, pipe, frac sand, cement, military equipment, wind turbine components and lumber.

#### Intermodal

We transport intermodal freight containers for domestic and international shippers, moving products such as electronics, toys, furniture and clothing. One Union Pacific intermodal train takes up to 300 trucks off America's congested highways.

#### Mexico Markets

We are the leading freight transportation services provider between the United States and Mexico, and the only railroad to serve all six major Mexico gateways.

### 2016 FREIGHT REVENUE





## Risk Oversight Approach

We operate a dynamic enterprise risk management process with continuous monitoring to identify and address potential risks. This includes risks arising in the ever-changing economic, political and legal environments in which Union Pacific operates.

Management identifies and prioritizes enterprise risks and regularly presents them to our board of directors for review and consideration. Our chief compliance officer reports to the board on risk mitigation strategies, supported by senior executives responsible for implementing risk mitigation. We also report risk factors in our Annual Report Form 10-K.

Our board's audit committee oversees the company's enterprise risk internal audit. Internal auditors present their findings on mitigating controls and processes to the committee, which in turn reports to the board.

## Sustainability Management Approach

Our business grows by understanding the needs of our communities and customers – and responding to those needs with dedication and commitment. Our sustainability approach reflects this. We are committed to engaging employees in our mission, transporting products safely, providing good jobs, operating ethically and investing in America's communities.



Greg Wilson, Inspection Vehicle Operator

### OUR SUSTAINABILITY AND CITIZENSHIP GOALS

Union Pacific's Building America report details the company's progress against the key pillars of our sustainability and citizenship strategy:

- Operating a safe, efficient and environmentally responsible rail network that delivers the best customer experience.
- Providing employees with the safest work environment.
- Constantly improving employee, customer and public safety through training, education, innovation and investment.
- Developing programs and processes making us an employer of choice.
- Investing in our network infrastructure to enhance safety, service and efficiency.
- Growing our business profitably and responsibly so we can invest in the future and make positive impacts on employees, communities, customers and shareholders.
- Creating economic strength and improving quality of life in the 7,000 communities where we operate.

We track our performance toward those goals using the Key Performance Indicators (KPIs) shown in the table on page 7.

### BUSINESS AND INDUSTRY AFFILIATIONS

Union Pacific is a member of many national industry and business organizations including those listed below.

- |                                      |   |   |
|--------------------------------------|---|---|
| • American Frozen Foods Institute.   | • National Association of Manufacturers.          | • Operation Lifesaver.                          |
| • American Wind Energy Association.  | • National Business Group on Health.              | • United States-Mexico Chamber of Commerce.     |
| • Association of American Railroads. | • National Freight Transportation Association.    | • U.S. Chamber of Commerce.                     |
| • Food Shippers of America.          | • National Grain and Feed Association.            | • Women's Business Enterprise National Council. |
| • GoRail.                            | • National Minority Supplier Development Council. |   |
| • GreenBiz Executive Network.        | • National Safety Council.                        |   |



## Key Performance Indicators

FINANCIAL	2014	2015	2016
<b>Reported net income</b>	\$5.2 billion	\$4.8 billion	\$4.2 billion
<b>Operating revenue</b>	\$24.0 billion	\$21.8 billion	\$19.9 billion
OPERATING SAFELY	2014	2015	2016
<b>Rail crossing accidents</b> (per million train miles)	2.34	2.28	2.43
<b>Reportable injury rate</b> (per 200,000 employee-hours)	0.98	0.87	0.75
<b>Public outreach</b>	About 13,580 events reached more than 629,500 people	More than 15,000 events reached more than 600,000 people	More than 14,500 events reached more than 498,000 people
STRENGTHENING COMMUNITIES	2014	2015	2016
<b>Capital program</b> (private funds, no taxpayer dollars)	\$4.1 billion	\$4.3 billion	\$2.5 billion
<b>Spend with minority- and women-owned businesses</b>	\$509 million	\$423 million	\$323 million
ENGAGING EMPLOYEES	2014	2015	2016
<b>Percent of employees unionized</b>	85%	85%	85%
<b>Workforce diversity</b>	6% Female, 94% Male 2% Asian 11% Black 73% Caucasian 12% Hispanic 2% Native American	6% Female, 94% Male 2% Asian 11% Black 73% Caucasian 12% Hispanic 2% Native American	6% Female, 94% Male 2% Asian 11% Black 72% Caucasian 13% Hispanic 2% Native American
<i>U.S. Population 2015 census data (permits reporting of more than one race): 5% Asian, 13% Black, 77% Caucasian, 17% Hispanic, 1% Native American</i>			
PRESERVING THE ENVIRONMENT	2014	2015	2016
<b>Energy usage</b>	48.4 million megawatt hours	44.5 million megawatt hours	40.3 million megawatt hours
<b>Water usage withdrawals</b>	1.78 billion gallons	1.54 billion gallons	1.25 billion gallons
<b>GHG emissions</b>			
Intensity per million gross ton miles	12.6 metric tons	12.7 metric tons	12.6 metric tons
Locomotive fossil fuel emissions (scope 1)	11,850,514 metric tons	10,834,984 metric tons	9,913,870 metric tons
Fossil fuel emissions (scopes 1 and 2)	12,636,733 metric tons	11,383,549 metric tons	10,385,250 metric tons
Employee travel (scope 3)	19,977 metric tons	19,803 metric tons	19,603 metric tons
Purchases from biomass sources	37,744 metric tons	129,600 metric tons	119,872 metric tons
<b>Waste</b>			
Total waste generated	1.05 million tons	1.04 million tons	1.15 million tons
Tonnage diverted from landfills	81%	68%	67%
<b>E-waste</b>	Approximately 270,000 pounds recycled or reused	Approximately 270,000 pounds recycled or reused	Approximately 270,000 pounds recycled or reused



## Stakeholder Engagement

Everything Union Pacific does is built on our vision, mission and values. Our strategy drives value to Union Pacific's key stakeholders – shareholders, communities, employees and customers. Union Pacific's approach to sustainability requires engaging with our four key stakeholder groups to understand their evolving needs.



### EMPLOYEES

Union Pacific employees work 24/7 in more than 7,000 communities across our service area. We engage employees through:

- Communication from our CEO in many forms including online and in-person town halls with question-and-answer sessions. CEO system-wide videos cover key issues such as safety and employee engagement, and a CEO blog highlights observations in the field and topics affecting the company.
- Information Television network
- Senior management town halls with question-and-answer sessions
- Employee clubs, resource groups, networks, focus groups and surveys.
- Labor Relations Connection, an online portal for union employees.
- Ethics bulletins and our values line, allowing employees to report concerns anonymously.



Union Pacific Safety Manager Kevin Barnett and League City, Texas Mayor Pat Hallisey at a community event in the Houston area.



Union Pacific employees live and work in many of the communities we serve. We are dedicated to operating safely for the good of our customers and the places we call home.

### CUSTOMERS

Communication is at the heart of our customer relationships, enabling us to develop solutions meeting their changing needs and supporting their growth. We engage with customers through:

- Social media.
- Customer bulletins.
- Regular meetings and customer web portals.
- Customer satisfaction surveys, evaluations and suggestions.
- Our National Customer Service Center.

### COMMUNITIES

Union Pacific's business has a positive impact on local communities through economic development, good-paying jobs and reduced congestion on roads. We seek to support communities and manage potential negative impacts through:

- Local public affairs representatives, who work with elected officials, economic development alliances, civic groups and other community organizations.
- Our national 24/7 emergency hotline. In addition to emergency response, operators work with callers reporting issues such as blocked crossings.
- Event sponsorships and employee volunteering.
- The Union Pacific Foundation.
- Our Crossing Accident Reduction and Education Safety program, UP CARES.
- Free safety training for emergency responders.
- Inside Track, our self-publishing website for communities.
- Social media platforms including Facebook, LinkedIn, Twitter, Instagram and YouTube.





## SHAREHOLDERS

Clear communication with shareholders is important to Union Pacific. We engage them through:

- Annual reports, proxy statements and SEC filings.
- Our Investor Relations site featuring upcoming events, public filings, industry reports, shareholder resources and answers to frequently asked questions.
- Annual Building America Report and Fact Book.
- Shareholder meetings with management and investor conferences.
- Quarterly earnings reports and conference calls.

## Other Key Audiences

### REGULATORY OFFICIALS

Union Pacific works closely with regulatory officials to align our business with the country's infrastructure requirements and shape a responsible and sustainable operating environment:

- Transparent compliance reports, voluntary agreements and in-person meetings.
- Ongoing dialogue via staff in Washington, D.C., and across our network.
- Participation in the Association of American Railroads and U.S. Environmental Protection Agency's SmartWay Transport Partnership.
- Employee and corporate regulatory and legislative advocacy.
- The Union Pacific Environmental Management Program.
- Agreements with the California Air Resources Board and other states.
- Collaboration with U.S. Customs and Border Protection and other government agencies.

### SUPPLIERS

Suppliers are an important part of Union Pacific's business – they help us serve our customers with excellence and provide quality materials. We manage suppliers through our [supplier code of conduct](#) and quality program, engaging them through:

- Electronic commerce capabilities.
- Supplier performance tracking system.
- Supplier diversity program.

## Key Awards and Recognition

Union Pacific is proud of the external recognition for efforts to operate safely, strengthen communities, engage employees and preserve the environment. We were recognized with the following awards in 2016:

- No. 1 in Fortune's Most Admired among trucking, transportation and logistics companies for the sixth consecutive year.
- Named in Forbes' 200 Most Trustworthy Companies and Best Employers' lists.
- Recognized as America's Top Military-Friendly Employer by G.I. Jobs.
- Named Best for Vets Employer by Military Times.
- Named to the Most Valuable Employer in Military list by civilianjobs.com.
- Recognized as a Globally Certified Healthy Workplace by the Global Centre for Healthy Workplaces.
- Named a Top Green Provider by Food Logistics.
- Moved up 40 spots on Newsweek's Green Rankings for the world's largest companies on corporate sustainability and environmental impact.
- Recognized as top performer in the Soy Transportation Coalition Railroad Report Card.
- Named to CDP's Climate Leadership Index.



Union Pacific machinist Alia Eden works on locomotives at a shop in Salt Lake City, Utah.

# Our Economic Impact

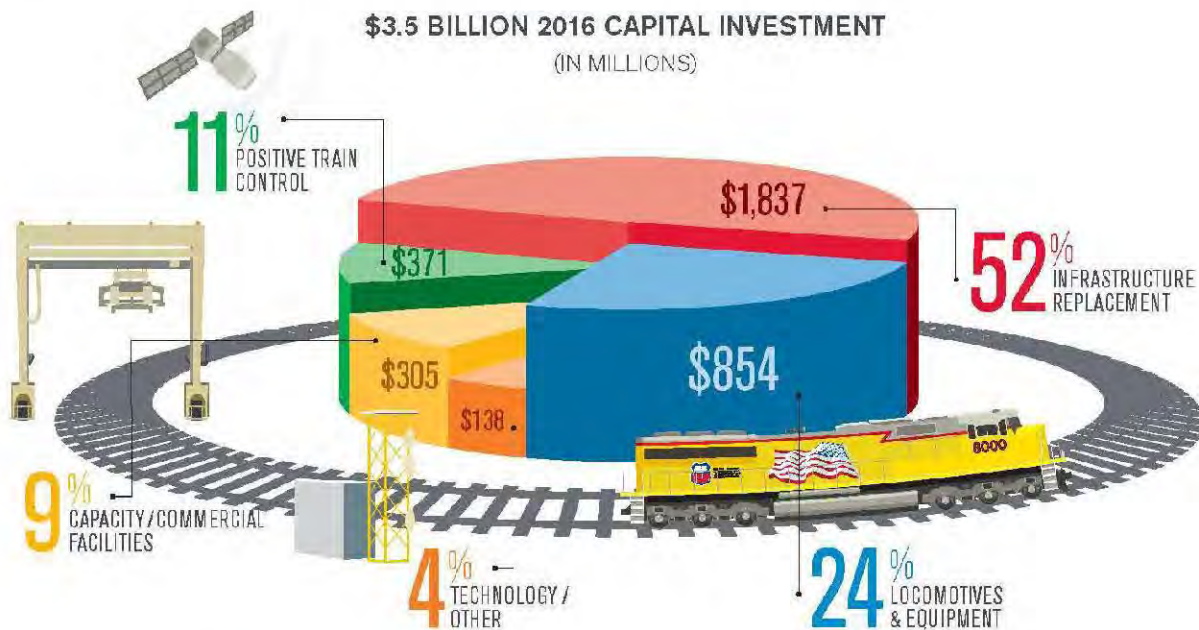
Union Pacific exists to build America. Our positive economic impact isn't just a by-product of our business; it's central to our vision and purpose.

Our railroad connects communities and resources, generating opportunity and supporting growth in the 23 states where we operate, and across the country. We create economic value not only through returns generated for shareholders, but also employment for roughly 43,000 employees, the business we give suppliers, and every business opportunity, commercial relationship and innovative idea our network makes possible.

## Investing in Infrastructure

Union Pacific's capital investments create economic opportunity through employment and supply chain activity. They also represent investments in building a sustainable rail network that can support economic growth for generations to come. The more we invest in building a safe and efficient railroad today, the more opportunity our infrastructure can support communities going forward.

The chart on this page shows the level of infrastructure capital investments Union Pacific made in 2016.



### Infrastructure replacement

Our largest form of capital investment strengthens our rail network through track, signal and bridge replacement projects.

### Locomotives and equipment

New and upgraded locomotives, rail cars and equipment investments to meet customer needs, enhance safety and reduce our environmental impact.

### Capacity and commercial facilities

New commercial facilities and network expansions increase capacity to support economic growth and opportunities to serve new locations.

### Positive train control (PTC)

An advanced automatic train stopping system designed to prevent train-to-train collisions and accidents caused by excessive train speeds or unauthorized movements. Helping to build a safer rail network.

### Technology

From apps managing train systems to enhanced track inspection systems, we continually invest in new technologies to enhance safety, efficiency and service.





## Creating Local Economic Opportunity

Union Pacific Railroad owns and operates more than 32,000 miles of railroad track in 23 states across the western two-thirds of the United States. We create economic opportunities for local communities through direct employment with Union Pacific and the opportunities created by local employee spending. Our capital investments create additional jobs and business opportunities through our supply chain. The following chart shows Union Pacific's economic impact in the 23 states where we operate. In the following pages, we explore other local economic opportunities we support.

State	Employees	Payroll*	Route Miles	Capital Investment*	In-State Purchases*
Arizona	1,126	104.5	691	59.5	26.5
Arkansas	2,654	296.7	1,325	133.6	34.7
California	4,450	414.3	3,291	230.1	231.0
Colorado	948	96.5	1,503	82.2	124.8
Idaho	817	79.2	848	47.7	18.4
Illinois	4,004	344.7	2,318	129.9	1,200.0
Iowa	1,563	135.3	1,383	62.4	72.3
Kansas	1,283	126.0	2,196	75.4	220.8
Louisiana	1,121	112.9	1,143	131.1	18.8
Minnesota	418	38.4	645	11.4	112.3
Missouri	2,445	210.7	1,541	87.9	406.9
Montana	11	0.9	125	1.5	2.4
Nebraska	8,741	926.7	1,066	251.4	154.0
Nevada	502	42.6	1,193	54.6	5.8
New Mexico	474	45.0	618	14.6	1.3
Oklahoma	333	36.7	1,172	90.1	171.1
Oregon	1,515	134.9	1,073	75.5	157.6
Tennessee	49	3.8	14	0.0	58.7
Texas	7,356	692.4	6,307	801.9	1,400.0
Utah	1,239	116.5	1,248	45.2	138.6
Washington	311	28.3	532	20.1	129.3
Wisconsin	378	38.4	930	7.3	55.0
Wyoming	1,070	87.8	874	55.1	46.1
<b>Total</b>	<b>42,808</b>	<b>4,043.2</b>	<b>32,036</b>	<b>2,468.5</b>	<b>4,786.4</b>

\*In millions



## Local Economic Opportunities

### CONNECTING ARIZONA TO THE WORLD

The Port of Tucson is a vital logistics hub connecting Arizona and northern Mexico with the world. Through access to the Pacific seaports of Los Angeles and Long Beach, the port enables transportation for commodities such as lumber, sheetrock, steel and grain, stimulating trade on both sides of the border. Thanks to a \$5 million investment modernizing the port, funded through a federal TIGER 2013 grant, this capacity to drive economic growth has significantly increased. In May 2016 Union Pacific announced a new container export facility completion and an expansion of the port's rail infrastructure. Improvements included siding track extensions, powered switches that increase train and operating efficiencies and a new main line switch to increase the flexibility of operations at the site.



Union Pacific joined local, state and federal officials at a ribbon-cutting ceremony at the Port of Tucson, Arizona. Photo was not taken on live track.

### KEEPING FREIGHT MOVING IN OREGON

Rail passengers, businesses and the environment will benefit from the public-private partnership announced by Union Pacific, BNSF and the state of Oregon. The partnership will support a \$13 million investment to improve the North Portland Junction, one of the most congested points in the region's rail network. The junction connects Portland's rail network with that of Washington, and markets across the country.

Project funding includes an \$8.3 million state grant, \$3.9 million from Union Pacific and a contribution from BNSF. Increased track speeds and improved traffic flow will reduce delays and transit times, enable more efficient freight transport and cut emissions from locomotives through reduced wait times in the area.



A public-private partnership will improve rail congestion in Oregon.

### BUILDING A SOUTH TEXAS ROAD NETWORK – THROUGH RAIL

The economic potential of the southern Texas region faces one major constraint – a lack of stone deposits to help the road infrastructure required for growth. Union Pacific and aggregate supplier Martin Marietta are changing that.

Medina Rock & Rail, a new quarry 40 miles west of San Antonio, supports concrete demand more than 200 miles away. Rock and other heavy freight move on Martin Marietta and Union Pacific's rail infrastructure, including one of the largest privately-funded rail projects in the United States. Medina Rock & Rail's connection to Union Pacific's main line and loading technology that fills 135 car trains in six hours has secured South Texas stone supplies for the next half-century.



Building a 12-mile stretch of Interstate 69 in Texas recently required more than half a million tons of Martin Marietta's aggregate moved on Union Pacific trains.



## Enabling Innovation and Sustainability

The rail infrastructure that Union Pacific maintains and operates doesn't just support business as usual. It's also an innovation enabler. By helping businesses source new types of raw material, and forming new partnerships, our network supports the transition toward a more sustainable economy.

### CONNECTING LOUISIANA WOOD PELLETS WITH THE WORLD'S ENERGY SUPPLIERS

Wood pellets are one of the most versatile forms of biomass, a renewable alternative to fossil fuels produced by compressing organic material from trees, plants and agricultural and urban waste. Thanks to Union Pacific, wood pellets produced in Louisiana are now playing a key role in generating electricity in the United Kingdom. During the year, Union Pacific hauled 300,000 tons of wood pellets from Louisiana, destined for the U.K., helping its countries meet their commitment to reduce greenhouse gas emissions by at least 80 percent by 2050. During the first half of 2016, biomass accounted for 20 percent of the U.K.'s renewable energy output.

### DELIVERING BIODIESEL TO HIGH TRAFFIC STATES

Biodiesel is a cleaner alternative fuel produced from renewable products such as recycled cooking oil, soybean oil, corn oil and animal fats that reduces greenhouse gas emissions from vehicles by between 57 percent and 87 percent. Union Pacific is playing a key role in the expanding demand for biodiesel, transporting the fuel from the Midwest — where 70 percent of production takes place, to California, Texas and other states seeking low-carbon fuel. During 2016, Union Pacific hauled enough biodiesel to replace 324 million gallons of petroleum.



Compressed wood pellets are unloaded off a railcar at a Drax Biomass facility.

### CONNECTING GLASS CULLET TO NATIONWIDE ENERGY SAVING

Glass bottles and jars are 100 percent recyclable. By moving the broken glass, called cullet, used to make new glass and fiberglass materials, Union Pacific contributes to this process. Every ton of recycled glass saves sand, soda ash and limestone. Recycling glass also saves energy and equivalent greenhouse gas emissions. Over the last three years, cullet moved by Union Pacific has saved enough sand to fill more than 2,000 professional beach volleyball courts.



Union Pacific transports broken glass used to make products such as insulation.

## Generating Opportunity Through Our Supply Chain

Union Pacific spent more than \$6 billion through our network of more than 53,000 suppliers during 2016. Our supply chain includes businesses in every one of the 23 states in which we operate, and this spending represents a significant portion of the economic impact our business generates.

Union Pacific was the first U.S. railroad to establish a supplier diversity program more than 30 years ago. Suppliers support our operations with fuel, engineering services, construction materials and much more. Union Pacific purchased approximately \$325 million goods and services from more than 500 minority and women-owned businesses in nearly 40 states. Our spending with diverse suppliers grew an average of more than 2 percent from 2006 to 2016. Approximately 15 percent of our critical suppliers reported purchasing goods and services from diverse suppliers, demonstrating their support for our diversity initiative — a 4 percent increase from 2015.



# Operating Safely

Safety is Union Pacific's number one priority because nothing is more important than protecting our employees and communities. Safety is also a critical component of our customer commitment.

We invest significant resources in training employees, developing innovative technologies and increasing rail safety awareness. Our ultimate goal is to operate an incident-free environment, which we advance toward every day.

## Rail Safety Maintenance

Rigorously maintaining quality rail infrastructure is foundational to our ability to operate safely. It helps prevent derailments, provides a safe path for train crews and avoids shipment delays for customers.

Union Pacific inspects railroad tracks, locomotives and other equipment on a continuous basis. Our track inspection program customizes schedules and techniques to examine each rail line. We inspected five million track miles across our 52,000-mile network in 2016, supporting the goal of meeting or exceeding federal requirements.

Efforts to strengthen our rail infrastructure contributed to a 17 percent improvement in FRA reportable derailments from 2015 to 2016. Track safety is a major focus for Union Pacific and we continue working toward our goal of eliminating accidents on our network.

### SAFETY INSPECTION FLEET

We use state-of-the-art equipment to inspect rail lines regularly.

Lasers and cameras in Union Pacific's Geometry Cars capture images of track structures and test for defects, covering nearly 80,000 track miles per year. We are testing an unmanned geometry car equipped with an axle-mounted generator instead of a fuel tank. The cars report type, severity and location of track defects in near real time. More information on Union Pacific's track inspection fleet is available [online](#).



The rail test truck's 48 ultrasonic transducers identify air gaps in the track, indicating the rail part needing maintenance, with high-frequency sound.

### DRONE INSPECTIONS

Union Pacific positioned 14 drones across the system in 2016. Drones allow us to assess our infrastructure and respond to incidents affecting our network. We continue exploring new applications for drone technology to increase safety across our railroad.



Union Pacific used drones to assess weather-related damage in Doyle, California.



## MACHINE VISION

Our Machine Vision system equipped with lasers and cameras captures three dimensional images of passing trains. It takes 50,000 photos every second, providing remote inspectors with detailed information regardless of time or weather conditions.

Machine Vision eliminated hours of manual rail car inspections made after trains arrived at rail yards. Inspectors now identify trouble spots noted in reports accessible as soon as trains arrive, saving time and focusing their efforts on making repairs. Streamlining inspections reduces delays and the possibility of problems missed during manual visual inspections. Machine Vision is available in Union Pacific yards in Nebraska, Iowa and Arkansas.



*Remote rail car inspectors receive detailed images of rail cars as they travel through Machine Vision.*



## A DIFFERENT KIND OF PUCK

Embedded transponders known as pucks mark rail road crossings, switches and other track elements crucial to safely operate remote controlled locomotive movements. Union Pacific's technology team developed a new, 3D-printed puck reader designed to improve usability. We are currently rolling out new readers across our network.

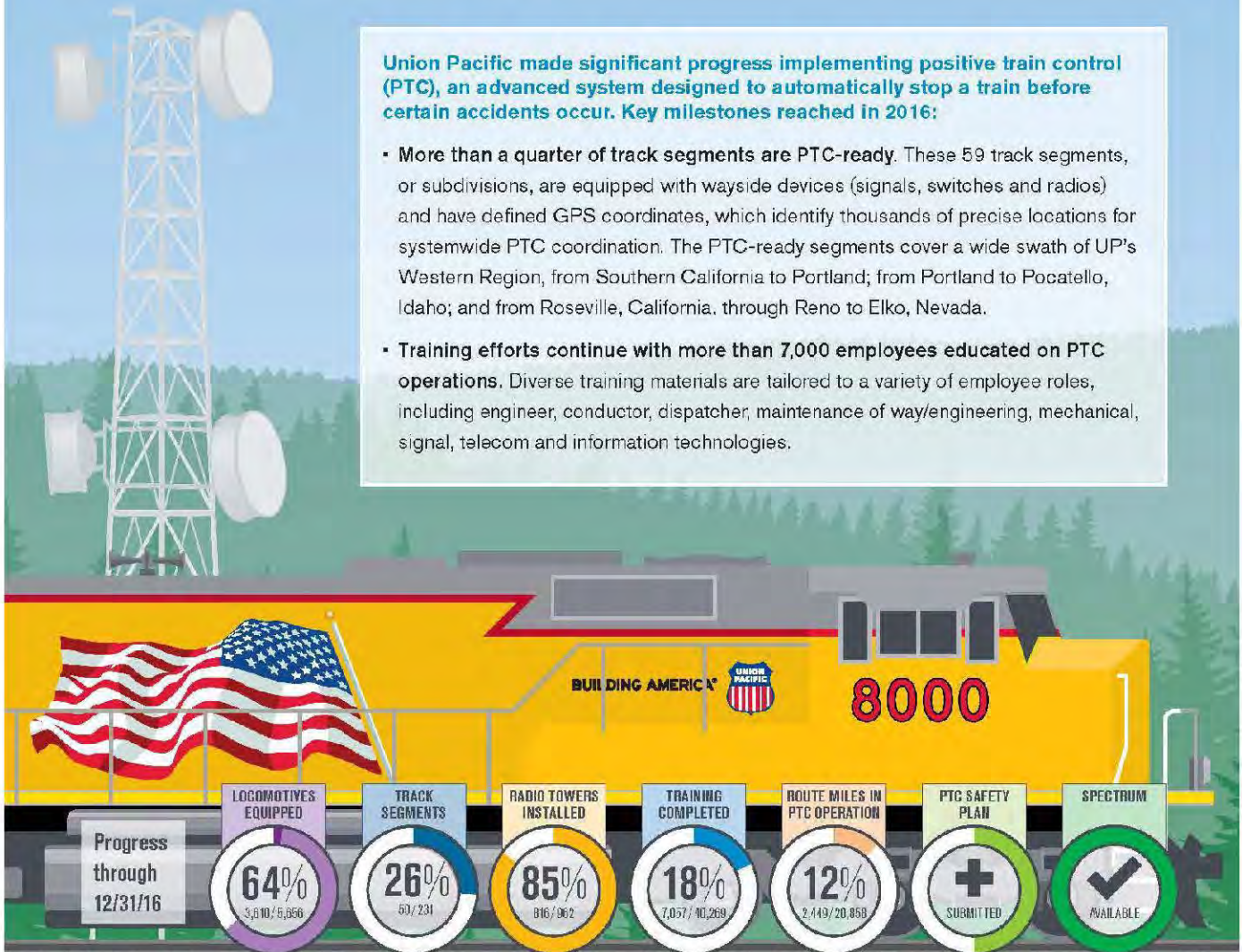
*Senior Systems Engineer Royce Conroy, left, holds the first puck reader prototype. Associate Project Engineer Evan Milton, right, holds the final prototype.*



# Positive Train Control

**Union Pacific made significant progress implementing positive train control (PTC), an advanced system designed to automatically stop a train before certain accidents occur. Key milestones reached in 2016:**

- **More than a quarter of track segments are PTC-ready.** These 59 track segments, or subdivisions, are equipped with wayside devices (signals, switches and radios) and have defined GPS coordinates, which identify thousands of precise locations for systemwide PTC coordination. The PTC-ready segments cover a wide swath of UP's Western Region, from Southern California to Portland; from Portland to Pocatello, Idaho; and from Roseville, California, through Reno to Elko, Nevada.
- **Training efforts continue with more than 7,000 employees educated on PTC operations.** Diverse training materials are tailored to a variety of employee roles, including engineer, conductor, dispatcher, maintenance of way/engineering, mechanical, signal, telecom and information technologies.



More than 3,600 Union Pacific locomotives are fully PTC equipped with the exception of a single component: the PTC-compatible, crash-hardening memory (black box). We expect to make significant locomotive installation progress in 2017, once a supplier-related black box issue is addressed.

Union Pacific is running PTC operations on nearly 2,500 route miles in California, Oregon, Idaho, Nevada and Washington as part of revenue service demonstration, an ongoing and multifaceted test of the PTC system in a defined corridor. Upon FRA approving Union Pacific's safety plan, these miles will become officially PTC operable and our progress will increase significantly.

## WHAT PTC DOES:

✓ Automatically stops a train before certain accidents caused by human error occur, including train-to-train collisions, derailments caused by excessive train speed, unauthorized train entry into work zones or movements through misaligned track switches.

## WHAT PTC DOES NOT DO:

✗ Will not prevent vehicle-train accidents at railroad crossings, stop trains when pedestrians are on the tracks, or prevent incidents due to track or equipment malfunctions.



## Handling Hazardous Materials Safely

Union Pacific is obligated to transport hazardous materials by federal law and we take our responsibility seriously. Transporting these products requires special handling, rigorous inspections, strict operating procedures and other safeguards. We met the American Chemistry Council's stringent Responsible Care® Management System certification requirements for the 20th consecutive year, recognizing our commitment to move hazardous materials safely.

Union Pacific focuses on accident prevention, preparedness, response and recovery. Prevention efforts reduced reportable derailments across the network by 52 percent. Our Hazardous Management Group consists of highly-trained experts in hazardous material transportation safety who work with customers and inspect tank cars ensuring processes are properly secured.



Union Pacific Hazardous Materials Manager Paul Hoyt discusses safe chemical handling procedures with emergency responders and community leaders in Hercules, California.

### ACCIDENT RESPONSE

While 99.99 percent of rail hazardous materials shipments are transported without incident, Union Pacific is prepared to respond when accidents occur. We worked closely with emergency responders after 16 crude oil tank cars derailed near Mosier, Oregon, June 3, 2016. Our hazardous materials experts from across the country were immediately dispatched to address the incident and protect the environment. While there were no injuries, the accident greatly affected the community.

Union Pacific cooperated with local, state and federal officials as we worked to safely restore the area. Protective barriers were quickly positioned as a precautionary measure to contain and collect potential oil discharge into the Columbia River. A thin sheen surfaced at an outfall to the river the day after the accident, but dissipated before reaching the protective boom. The barrier remained in place as we restored the site to further ensure oil did not enter the river.

We took action and replaced lag bolts with a spike fastening system in the Columbia River Gorge after determining the accident was caused by broken lag bolts. While both systems are equally safe, rail spikes provide higher levels of defect detectability during track inspections.

As a result of what we learned, Union Pacific began a phased plan to increase inspections on rail lines and replace lag bolts with spike fastening systems across our network. While the replacement program is under way, Union Pacific track inspectors will conduct walking inspections on tracks with lag bolt fastening systems. These walking inspections will not be required once spike fastening systems are installed.

We have a clear focus – to operate our trains safely and protect our communities. The fastening system replacement program reinforces our commitment to rail safety as we strive to improve upon our 99.99 percent chemical transportation safety record, and achieve our goal of zero incidents.



Union Pacific uses different inspection methods including a safety inspection fleet that uses technology to identify imperfections. Finding and addressing these issues helps ensure trains operate on a safe, reliable railroad.



## EMERGENCY RESPONSE TRAINING

Union Pacific provides fire departments and other emergency responders along our routes with comprehensive training on minimizing derailment-caused impacts. We provided classroom and hands-on training to approximately 2,500 local, state and federal first-response agencies in 2016.

We also sponsored 70 emergency responders from 11 states to attend a rail-specific HAZMAT training center in Pueblo, Colorado. The five-day tank car safety training course focused on tank car assessments, repairs and controlling hazardous material spills safely. Training also included a large-scale simulation of a hazardous material incident providing emergency responders with hands-on experience responding to accidents.

## SAFETY THROUGH SECURITY

The Union Pacific Police Department is a team of highly trained special agents dedicated to maintaining the security and integrity of our railroad. The department holds certification from the Commission on Accreditation for Law Enforcement Agencies, which is considered the gold standard in public safety accreditation and recognizes agencies that meet the highest standards of law enforcement.

The police department uses security monitoring technology to protect critical infrastructure from intruders around the clock. It coordinates its operation with U.S. Customs and Border Protection (CBP), the U.S. Coast Guard, the Federal Bureau of Investigation, the Central Intelligence Agency, the Department of Homeland Security, the Transportation Security Administration and local law enforcement. Union Pacific was the first U.S. railroad named a partner in the CBP's Customs Trade Partnership Against Terrorism.



Union Pacific trained more than 45,000 emergency responders among communities we serve in the past 30 years.

## Best Employee Safety Performance in History

Union Pacific became the safest U.S. railroad and achieved the best annual employee safety performance in our 154-year history in 2016. This marked our second consecutive year as the top-performing railroad in employee safety. The employee reportable injury rate, measured by the number of injuries for every 200,000 employee hours worked, improved by 14 percent from 0.87 in 2015 to 0.75 in 2016. We are grateful to our employees for their unwavering safety focus, contributing to a year without an employee fatality. This marks a major advance toward our ultimate goal of zero accidents and zero injuries. However, we recognize the journey is ongoing. Union Pacific continues improving technology, enhancing processes and fostering a culture focused on operating safely.

## COURAGE TO CARE AND SAFETY STAND DOWNS



Jan Yates is among many Houston volunteers participating in employee-driven safety initiatives.

Our employees are our eyes and ears when it comes to embedding safe behaviors. They identify risks, initiate action to mitigate those risks and work to keep each other safe.

Courage to Care, a voluntary commitment made by Union Pacific employees since 2012, empowers employees to look out for their peers and "stop the line" on any operation that could result in an incident. The company also occasionally pauses system-wide operations for safety stand downs, giving employees an opportunity to have candid safety discussions and share experiences to learn from each other.





## SAFETY SPOTLIGHT

Jessie Delgado, a Supply Chain materials clerk in West Colton, California, received Union Pacific's highest safety honor, the J.C. Kenefick Safety Award.

As safety captain, Delgado created monthly safety raffles for her work location. Employees entered the contest after identifying risks and solutions eliminating risks. The raffles produced visible results such as securely wrapped items on tall shelves and properly stacked pallets. It also increased employee engagement, with employees offering assistance to each other.

Putting JP's safety training into action, Delgado helped save the life of a fellow employee having a heart attack. She also improved traffic flow at a nearby, busy intersection, adding a safe refuge to reduce risk.

Since its inception in 1986, the J.C. Kenefick Safety Award annually has recognized a union employee who demonstrated outstanding job safety achievements. Jessie Delgado was recognized for her safety driven leadership.



## ENHANCING SIMULATOR TRAINING

Union Pacific uses nearly 80 full-size locomotive simulators to replicate the experience of operating a locomotive along our tracks. Engineers spent nearly 18,000 hours training on these simulators in 2016, up from 17,000 hours in 2015. We expanded real-time remote training, increasing simulator training accessibility.

We also use more than 200 remote-controlled locomotive (RCL) simulators to provide hands-on training for licensed remote operators. In their daily work, operators use a small computer console to direct locomotives in rail yards. Remote control operators spent nearly 4,000 hours training on RCL simulators in 2016, down from 7,000 hours in 2015. Workforce reductions, as Union Pacific aligned resources to meet market conditions, contributed to decreased training hours.



Alexis Howle, technical training instructor, applies her past experience as a brakeman, conductor and locomotive engineer in the classroom teaching new hires in Salt Lake City.

## MONITORING PERFORMANCE AND EMBEDDING SAFER BEHAVIORS

Union Pacific is rolling out video technology across our locomotives and vehicles to monitor drivers' and engineers' performance, and ensure safety, security and situational awareness. On the vast majority of occasions, this proactive performance sampling validates and confirms the professionalism of our employees. It also increases our in-depth understanding of our people's response to different situations, enabling us to improve coaching and embed safer behaviors.

We installed new in-cab cameras inside 1,500 locomotives, increasing the total number of such cameras to over 8,400. The in-cab cameras complement external-facing track image recorders (TIRs) providing a complete view of incidents. We also integrate event recorder data on train speed, throttle and brake settings, traction power levels and horn use.

By the end of 2016, we had installed 961 DriveCams across our vehicle fleet. DriveCams are positioned below rearview mirrors, and record 12-second video clips triggered by driving events such as hard braking, swerving and excessive speed. DriveCam captures images from eight seconds before an incident occurs and four seconds afterwards, enabling trained, third-party personnel to analyze the causes of such incidents. We plan to roll out DriveCam to new and retrofitted vehicles during 2017.





## Public Safety

Keeping our communities safe involves proactive outreach to raise awareness and prevent risk-taking behavior near our tracks. We made significant progress in both areas through Union Pacific's Crossing Accident Reduction Education and Safety (UP CARES) program in 2016.

### RAISING AWARENESS ACROSS COMMUNITIES AND MEDIA PLATFORMS

Union Pacific's 2016 railroad safety campaign addressed sobering consequences of risky behavior near railroad tracks, reaching more than 32 million people through social media. We also reached out to schools, cities and professional driving companies. These community organizations recognized train safety is a community concern and were a big part of the rail safety campaign's success.

#### Your Life is Worth the Wait Videos

What's your life worth? That was the question Union Pacific asked in [Your Life is Worth the Wait](#) videos featuring drivers tempted to beat trains at rail road crossings, which are described below.

A hurried woman weaves her car through traffic to avoid being late to a high-stakes job interview, considers racing an approaching train across a railroad crossing. She slams on the brakes and recognizes stopping the car prevented a catastrophic accident. The woman glances at her daughter's picture and recognizes her life was worth the wait.



A teen races his truck to get his panicked date home before curfew. The young woman tells him to hurry as a train moves toward a railroad crossing they need to pass. The truck stops seconds before the train passes and both teens realize waiting for the train saved their lives. The young woman calls her father to let him know she will be late.



#### Selfies off the Tracks

Two [animated videos](#) addressed pedestrian safety and the dangers of taking selfies near railroad tracks. The videos featured a soccer fan taking a selfie on the field during game action and people taking selfies in front of landmarks. While there are all kinds of unique places to take selfies, Union Pacific reminded everyone that railroad tracks are not among them.



#### Earbuds Aren't your Buds

A Pandora commercial asked Chicago-area passenger train commuters to turn down the volume on earbuds anytime they are near railroad tracks.





## PROACTIVELY ENGAGING COMMUNITIES THROUGH UP CARES

Our UP CARES program recognizes that the most compelling arguments for staying safe around railroad tracks are often those delivered face to face. During 2016, our employee volunteers delivered more than 14,500 rail safety presentations to more than 498,000 pedestrians, motorists and professional truck drivers across our 20-state network.

UP CARES also addresses risky driver behavior around railroad tracks. Union Pacific special agents partner with local and state police departments to observe driver behavior at railroad crossings. Officers stop drivers who risk their own safety and the lives of others. We carried out nearly 200 UP CARES operations of this kind during 2016, stopping and educating more than 10,000 drivers.

### Combating railroad photo trend with an award-winning campaign

Union Pacific's deliberately startling high school photo safety campaign was awarded Bronze at the 2016 Telly Awards, which recognize outstanding online and cable TV commercials. We launched the campaign in 2015 to address a worrying trend of high school seniors organizing photo shoots on train tracks. It compares snapping photos on tracks to posing for senior pictures in the middle of a busy road, bringing to life the extreme dangers involved.



### SAFETY SPOTLIGHT

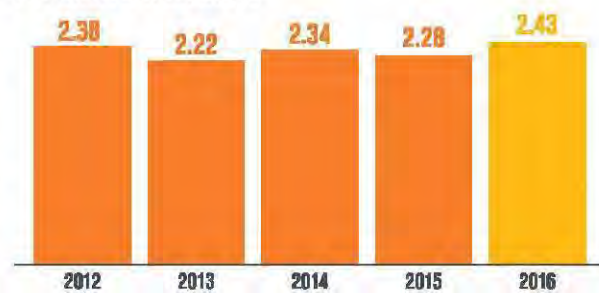
The sudden popularity of the Pokémon Go smartphone game brought an unwelcome side effect: fans playing on railroad property. We responded by developing a meme to emphasize rail safety, which reached nearly 500,000 people on Facebook and Twitter.



## ANALYZING PATTERNS TO KEEP CROSSINGS SAFE

Roughly 4 percent of railroad crossings are responsible for 25 percent of crossing-related accidents. By analyzing the characteristics of these crossings, Union Pacific is able to make tailored improvements to help motorists and enhance safety. First launched in 2015, our Crossing Assessment Process is already delivering significant gains through leveraging this insight. At a railroad crossing in Fairfield, Arkansas, which had 24 reported incidents of motorists turning onto tracks in five years, we worked with local officials to add warning signs to caution drivers from turning too early – and landing on railroad tracks.

### CROSSING ACCIDENTS Per Million Train Miles



## RESPONDING TO INCIDENT REPORTS

Union Pacific's Response Management Communications Center (RMCC) processes emergency and non-emergency calls from communities across our 20-state system. The RMCC team operates around the clock, responding to emergencies, reports of vehicles stuck on railroad tracks, criminal activity and other concerns. Drivers and pedestrians can contact the RMCC through the phone number posted near railroad crossings: 888-JP-RR-COP (877-7237).

In 2016, the Commission on Accreditation for Law Enforcement Agencies (CALEA) awarded our RMCC team its second distinguished accreditation, recognizing an advanced standard of compliance across policy and procedures, administration, operations and support services. RMCC received its first CALEA accreditation in 2013 and is one of 95 public safety communication centers recognized for emergency response and professional excellence in this way.





# Strengthening Our Communities

Union Pacific takes tremendous pride in our community relationships and efforts to improve the places where we live and work. We support communities through the Union Pacific Foundation, local funding programs, volunteer efforts and other forms of assistance. Union Pacific sponsored hundreds of events in communities across our network and was part of more than 200 organizations, such as chambers of commerce and economic development organizations.

Union Pacific's lines of communication are open to local and state agency officials, neighborhood groups and local citizens. Union Pacific's public affairs representatives facilitate resources and address operations-related concerns reported directly through our 24/7 community line and website. Communities are one of Union Pacific's key stakeholders and we are committed to serving and investing in their futures.

## Union Pacific Foundation in Our Communities

The Union Pacific Foundation has helped thousands of nonprofit organizations achieve their missions for nearly 60 years. Our giving program has evolved with the changing needs of the cities, counties and states we call home.

As Union Pacific looks to the future, our new Building Community Investments program renews our support in three important areas to our business and communities: safety, workforce development and community spaces. While the program will not be fully implemented until 2018, recent gifts have already supported causes aligned with these key initiatives. Details on our new community investment priorities are listed below.

### SAFETY



Communities thrive when citizens feel safe. Union Pacific is committed to helping communities prevent and prepare for accidents and emergencies, ensuring citizens get home safely at the end of each day. This

reflects Union Pacific's commitment to the safety of our employees and communities through which our railroad passes. We prioritize funding for programs achieving the following objectives:

- Prevent accidents and emergencies through education and awareness efforts, particularly around pedestrian, bike, driver and rail safety.
- Improve safe access to public places including, but not limited to, signage and proper lighting.
- Prevent crime and violence through efforts addressing root causes and mitigating future incidents.
- Prepare and equip citizens and independent, non-profit emergency responders to effectively respond to accidents and emergencies when they occur. Union Pacific supports publicly funded emergency responders separately through a variety of corporate programs.

### WORKFORCE DEVELOPMENT



Union Pacific believes the following are essential elements for a prosperous community: a skilled workforce and jobs paying good wages. We prioritize funding for programs that seek to:

- Educate and prepare local workforces for good living wage jobs through community colleges, vocational and career training programs, workforce readiness initiatives including job placement and on-the-job experience.
- Prepare youth for future careers, self-sufficiency and high school graduations from an early age. Support STEAM skills development necessary to transition into careers of the choice such as Science, Technology, Engineering and Mathematics (STEM) programs.
- Create a pipeline of workers proficient in middle-skills jobs such as those offered by Union Pacific. This involves growing awareness of opportunities and benefits associated with those careers, as well as training in specific skills such as welding, diesel mechanical work, machine operations and civil and electrical engineering.
- Encourage and support diversity and inclusion in the workplace through outreach and cultivating a diverse workforce.
- Provide training and mentorship for non-profit and small business professionals to help them grow and advance their organizations.

### WORKFORCE DEVELOPMENT SPOTLIGHT

The Union Pacific Foundation donated \$23,000 to support workforce development and computer training programs at Dona Ana Community College's campus in Sunland Park, New Mexico, and \$24,000 to the Texas A&M International University Planetarium in Laredo, Texas to create shows that can engage young people with STEM subjects.



## COMMUNITY SPACES



Vibrant communities attract businesses, tourists and skilled workers. We seek to ensure citizens within our communities have access to special places celebrating cultural diversity, artistic expression, our natural

environment and the social interactions that enrich our lives. We believe such community spaces contribute to the distinct identity of cities or towns. This creates destinations where families, businesses and visitors want to be. We prioritize funding for programs and projects that:

- Foster an appreciation for arts, culture and diversity with a focus on efforts bringing community members together.
- Preserve and share the unique history of local communities including projects documenting their connections to Union Pacific's history and other rail-related efforts.

The Union Pacific Foundation proudly supports local United Way organizations across our operating regions. Union Pacific and the Union Pacific Foundation have a longstanding partnership with the United Way which we believe is a vital resource and contributor to communities across the country.

- Provide clean, safe, and positive outdoor recreational or educational opportunities fostering an appreciation for our natural environment.
- Beautify neighborhoods and main street areas by improving the living environment, promoting commerce and attracting more residents, businesses and visitors to town.
- Lay the groundwork for prosperous communities through planning and multiple stakeholder engagement.

### COMMUNITY SPACES SPOTLIGHT

Our \$10,000 donation to the San Antonio River Foundation will provide 20 percent of the funding required for renewable photovoltaic lighting at Confluence Park. When completed, Confluence Park will provide the community with an innovative learning space, designed to inspire students and adults to preserve the area's waterways.

**The Union Pacific Foundation supported thousands of organizations working to make our communities better places for almost 60 years. Organizations supported in 2016 include those listed below. More information is available in Union Pacific's [Inside Track news page](#).**

- **The Heartland Equine Therapeutic Riding Academy (HETRA)** in Gering, Nebraska, which provides an alternative to hospital therapy for those with disabilities.
- **Mujeres de la Tierra**, an organization which teaches women and their children to take ownership and leadership of Los Angeles-area neighborhoods.
- **The Colorado Center for the Blind** in Littleton, Colorado, to which our funding has helped provide education and sports programs.
- **The Fort Bend Children's Discovery Center** in Sugar Land, Texas, an organization transforming communities through innovative child-centered learning.





## Making a Difference in Our Communities

Union Pacific's business is inextricably linked with communities—and we strive to tackle problems, find solutions and make positive impacts. This includes recruiting efforts and responding in times of crisis.

### UNIVERSITY PARTNERSHIPS

Union Pacific's partnerships with universities and colleges across America support students navigating transitions into the professional world. Our initiatives include student mentoring, mock interviews, rail yard tours and internship opportunities. Students also are challenged to find innovative solutions for real-world business challenges.

In Spring 2013, 30 students learned about preparing for successful careers as auditors or financial analysts at a two-day leadership summit at the Union Pacific Center in Omaha, Nebraska. Sessions covered leadership, corporate life, effective presentations, networking and opportunities at Union Pacific. Participants built leadership skills and networked with peers from 12 Union Pacific partner universities.

### SUPPORTING COMMUNITIES IN CRISIS



With more than 70,000 residents seeking assistance, the Federal Emergency Management Agency declared Louisiana's 2016 flooding a major disaster. When a crisis such as this strikes one of our communities, Union Pacific responds through a broad range of different community channels.

We donated \$10,000 directly to the American Red Cross to support disaster relief and matched our employees' contributions.

Friend-to-Friend, an employee-operated organization that helps fellow colleagues in need, provided additional financial assistance to 30 Union Pacific employees affected by the flooding. Union Pacific also made a \$15,000 contribution supporting the Louisiana Small Business Rebirth Fund's efforts to provide quick relief for impacted businesses with triage loans.

In addition to financial support, our Peer Support network was on hand 24/7 to help Union Pacific employees affected by the disaster.

### UNIVERSITY SPOTLIGHT

At Brigham Young University, students helped develop a device improving aerodynamic and fuel efficiency of Union Pacific trains. We are exploring additional applications for the device across our network. More information available on page 34.

*Justin Millerberg lines up Arrowcage 3.0 for wind tunnel testing, which led to improved intermodal rail car aerodynamics.*



### COMMUNITY SUPPORT



The sister-city relationship between Omaha, Nebraska and Xalapa, Veracruz, Mexico goes beyond cultural exchanges. In 2016, the city of Omaha asked Union Pacific to support a humanitarian effort by delivering four ambulances, breathing

machines and other life-saving tools to Xalapa's emergency responders. Our employees redesigning rail cars to accommodate the unique 2,000-mile delivery—all at no charge. The equipment helps address a dangerous shortfall in emergency services for Veracruz's residents living far from the nearest hospital.

### LEADING THE FIGHT AGAINST SUICIDE



Seventy-six suicides and 11 suicide attempts took place on Union Pacific railroad tracks in 2016. More than 200 Union Pacific train crew members witnessed these tragedies unfold. In addition, suicide among employees and their families

makes us vividly aware suicide is a national issue.

In August, we hosted the inaugural Rail Summit Conference on Suicide Prevention, uniting 50 transportation professionals from different rail businesses and associations across the country. Union Pacific hosted a system-wide Suicide Awareness Day a month later, raising awareness of support networks available when our employees reach crisis points in their lives.

### MATCHING OUR EMPLOYEES' GENEROSITY

Union Pacific's GivePlus program matches employee donations to non-profit organizations, dollar-for-dollar, up to an agreed maximum matching limit for each employee. Our annual employee matching limit increased to \$25,000 per employee in 2015. We matched our employees' generosity and donated \$2.3 million for non-profit organizations improving our communities, a \$500,000 increase from 2015.





# Engaging Employees

Union Pacific's dedicated employees are passionate about their role in building America. We strive to provide them with fulfilling careers and professional development opportunities, helping us serve customers with excellence.

## Embracing Employee Needs

Union Pacific draws thriving talent, energizes current employees and develops them to carry our mission and lead the transportation industry into the future. Key engagement initiatives revolve around our culture, workplace relationships, employee rewards, job responsibilities and personal growth opportunities.

### EMPLOYEE BENEFITS

Union Pacific offers a comprehensive benefits program including medical insurance, educational assistance and a 401(k). Benefits may vary based on non-union and collective bargaining agreement employees. For full details, please see the Building America [web pages](#).

Work schedules required to run our railroad's around-the-clock operations can be challenging and employees often need extra support caring for loved ones. The Bright Horizons Care Advantage™ database refers employees to supportive care providers and services listed below.

- Center-based and in-home child care
- Elderly care
- Pet care
- Housekeeping
- Tutoring and homework help

### LABOR AGREEMENTS

Union Pacific works with 15 major rail unions representing approximately 85 percent of roughly 46,000 full-time employees.

Labor agreements became subject to modification January 1, 2015, launching the latest round of ongoing negotiations with unions. Existing agreements remain in effect until new agreements are reached or the Railway Labor Act's procedures are exhausted. The process involves mediation, cooling-off periods and the possibility of Presidential Emergency Board and congressional intervention. Contract negotiations historically continue for an extended period of time and rarely cause work stoppages.



Locomotive engineer Thomas Moses, left, and Eddie Fehris before operating trains to separate locations.

### AUXILIARY WORK AND TRAINING STATUS (AWTS)

Train and yard service reductions due to business declines resulted in employee furloughs. Approximately 65 percent of all train and yard employees were eligible to be covered under AWTS agreements providing limited benefits.

AWTS agreements provide up to eight work or training days per month and continue full health care benefits and service months contributing to Railroad Retirement. Employees continue training to sharpen their skills and prepare for full-time employment when customer demands increase.

#### POPULATION (TOTAL COMPANY)

<b>Approximately 43,000</b>	
<b>Traditionalists</b> (born before 1946)	<1%
<b>Baby Boomers</b> (born 1946-1964)	28%
<b>Generation X</b> (born 1965-1981)	52%
<b>Millennial</b> (born 1982-1997)	20%

#### SENIOR MANAGEMENT

<b>Female</b>	19%
<b>Male</b>	81%
<b>Asian</b>	1%
<b>Black</b>	9%
<b>Caucasian</b>	84%
<b>Hispanic</b>	5%
<b>Native American</b>	1%





## Helping People Develop

The work of building, maintaining and operating a railroad is challenging. Union Pacific's commitment to employee training and development is vital for cultivating the high quality workforce we need. It also plays a critical role in keeping our employees safe and ensuring we operate ethically.

2016 TRAINING	NONAGREEMENT	AGREEMENT
Total Hours	447,572	2,239,712
Number Employees	5,672	33,344
Avg hrs/Employee	67	58

*Union Pacific conducted 2 million hours of safety-related training, a slight decrease from 2.1 million hours in 2015 driven primarily by a reduced workforce.*

2016 RETENTION RATE	OPERATIONS MANAGEMENT TRAINEE	FIELD MANAGEMENT TRAINEE
2013	51%	76%
2014	56%	81%
2015	58%	78%
2016	37%	80%

### DEVELOPING SKILLS

Training and development focus on setting goals and achieving great results. Union Pacific believes how employees accomplish their work is equally important as what they accomplish. Our core competencies foster a culture of performance and growth supporting our vision, mission and values. In addition to work-related skills, we develop employees' capabilities in eight core competencies.

- Building relationships and influencing others
- Handling adversity
- Confronting problems with courage
- Leading teams
- Embracing change
- Making effective decisions
- Acting strategically
- Focusing on customers

We offer skills development opportunities for employees at all levels of Union Pacific. These include:

- New Employee Onboarding Program – Courses on communication and industry-specific training through an interactive, instructor-led learning experience.
- Skill Development – Technical communication, safety and environmental courses.
- Managerial and Leadership Development – Management and leadership courses helping employees grow and develop.
- Transitioning Managers – Courses helping newly promoted managers lead teams.
- Transportation Operations Training – Operational excellence courses strengthen employee skills and train for superior service.
- Field Management and Operations Management Training Programs – These programs prepare employees for frontline management positions within the Operating Department.
- Emerging Leaders – Leadership programs maintaining a strong pipeline of future leaders including day-training courses to 10-month programs. Ongoing, self-directed learning tools to foster employee development also are available.

### EMPLOYEE SPOTLIGHT: RECOGNIZING THE VALUE OF MENTORSHIP

Union Pacific's Coach of the Year Awards recognize those providing excellent one-to-one guidance and support to future frontline leaders, through our Operations Management Training program. In 2016, we recognized 10 exceptional coaches, who were nominated by the more than 100 trainees mentored through the program during the year.

Honorees included William Barclay, director Terminal Operations; Adam Brock, director Mechanical Maintenance; Glenn Bulanek, senior manager Terminal Operations; Casey Clark, senior manager Terminal Operations; Thomas Cooper, manager Track Maintenance; Gerald Hoelting, manager Terminal Operations; Jonathan Jett, manager Yard Operations; Daniel Jones, director System Locomotive Facility; Steven Kirby, manager Terminal Operations; and Preston Lawless, manager Track Projects.



*From left, Lance Good, transportation associate, with his coach Casey Clark, senior manager Terminal Operations.*



## Embedding an Ethical Approach

Union Pacific's brand and business stems from employees' character, people with whom we choose to do business and the decisions we make. Providing training and tools needed to help employees make the right decisions is a priority.

Our Policy on Ethics and Business Conduct, *The How Matters*, explains the company's expectation of ethical conduct, as well as our zero-tolerance policy toward dishonesty. Union Pacific employees operate under the following high ethical standards:

- **Honesty:** Being truthful when dealing with customers, suppliers, shareholders and fellow employees.
- **Fairness:** Treating everyone fairly.
- **Integrity:** Voicing concerns when we believe our company or colleagues are not acting ethically or complying with the law.
- **Respect:** Maintaining a foundation of trust and respect with colleagues, customers, regulators, suppliers and other stakeholders.
- **Loyalty:** Ensuring no employee is or appears to be, subject to influences, interests or relationships that conflict with the company's best interests.
- **Accountability:** Holding ourselves, peers and customers to the company's high standards.
- **Adherence to the law:** Complying with all laws.
- **Compliance with policies:** Complying with the letter and spirit of company policies.

### ETHICS AWARENESS

Union Pacific educates employees about ethics and why they are important throughout the year. We focus on *The How Matters*, and how we do our jobs is as important as what we accomplish. Published articles, periodic ethics bulletins and mandatory training modules remind employees of Union Pacific's ethical standards. In 2016, we held our third annual *Ethics Awareness Week*, a company-wide initiative focusing on our values and business conduct required of all employees.

## Establishing a Diverse and Inclusive Workplace

Union Pacific recruits talented people dedicated to our mission of service who are passionate about performing to the best of their abilities. We are committed to diversity and recognize people come from all backgrounds and walks of life.

Recruiting and maintaining a diverse workforce provides access to the skills and character we need, resulting in innovative ideas to grow business. Drawing on different experiences and expertise is critical for strategic decision making, problem solving, leadership development and creativity.

Union Pacific makes great efforts to increase diversity through recruiting and helping employees from all groups advance their careers with Union Pacific. However, we still have work to do. We are committed to improving and strengthening performance to establish a workplace reflecting the diverse communities we serve.

We established a diversity taskforce to develop strategies for recruiting talented people from underrepresented backgrounds at Union Pacific.

### OUR DIVERSITY POLICY

All Union Pacific employees have the fundamental right to fair treatment within a discrimination-free workplace. We create a work environment that respects and values differences which is essential for employees to reach their fullest potential in our business.

We are committed to a work environment free of offensive behavior directed at a person's race, color, national origin, religion, gender, sexual orientation, age, gender identity, veteran status or disability. This includes offensive behavior directed at employees, customers and visitors to company facilities and other people employees may contact during the normal course of work.

For full details, please see the Building America webpages.



The presidents of each of Union Pacific's Employee Resource Groups, from left, Eric Humphrey, Black Employee Network; Jim Astuto, UPVETS; Heather Davis, BRIDGES; Santha Krishnan, Asian Employee Resource Organization; Robert Natta, Latino Employee Network; Melissa Robinson, UP Ties; Diane Savage, Council of Native American Heritage, and Julie Phillips, LEAD; A Woman's Initiative.

### EMPLOYEE RESOURCE GROUPS

Union Pacific's Employee Resource Groups (ERGs) are nurturing networks promoting a diverse workplace where everyone does their best work. Each ERG has an executive sponsor directing the leadership team's attention to issues of particular concern. ERGs support their members, educate other employees and support the communities we serve.

While most ERGs traditionally host annual conferences for respective members, all eight ERGs came together for Union Pacific's first collective ERG conference in 2016. The groups shared best practices and celebrated diversity at all levels of Union Pacific.

About 3,000 employees across Union Pacific are involved in one or more Employee Resource Groups, which include:

- Asian Employee Resource Organization: AFRO
- Black Employee Network: BEN
- LGBT Employee Network: BRIDGES
- Council of Native American Heritage: CCNAH
- Latino Employee Network: LEN
- A Woman's Initiative – Lead Educate Achieve and Develop: LEAD
- Emerging Professionals Network: UP Ties
- Union Pacific Veterans Network: UPVETS

Additional information on each ERG can be found in the [online Building America Report](#).



## ENCOURAGING WOMEN TO SEE THEMSELVES AT UNION PACIFIC

Women make up approximately 5 percent of Union Pacific's total workforce and represent one of the company's biggest diversity opportunities. At the same time, businesses such as ours face a growing shortfall of skilled trade workers due to fewer men and women choosing to learn a trade.

Union Pacific hired 4% more women into our Operating Management Trainee program 16.7% vs. 12.2% in 2015. We continue recruiting and encouraging women to see themselves succeeding at Union Pacific. In 2016, Union Pacific's [careers website](#) featured stories of women working in Transportation, Engineering, Mechanical and Technical teams. We partnered with women's skilled trade organizations, women's veterans groups, technical and trade schools, and women affinity groups of 28 universities. Union Pacific shared opportunities with women who possess skilled trade experience. We also introduced support systems offering women's mentoring and child-care options.



Manager of Yard Operations, Leif Durant talks with Brakemen Jason Pendley (left) and Aileen Hammer in Salt Lake City's Roper Yard.

## Keeping Employees Healthy, Happy and Well

We are determined to help employees stay healthy and well. Our wellness program helps employees take charge of their well-being with tools to manage physical and mental health. Available resources include coaching, access to fitness centers, health education programs, health screenings and flu shots.

The System 1 Health Injury Protocol program assists employees who may be at risk for injury because of low fitness levels. It provides access to personal training and nutritionist consultations, helping them achieve their fitness goals. When employees sustain injuries, Union Pacific's Return to Work program offers meaningful work within their physical capabilities. We also provide education and assistance to help with substance abuse, staying alert, and stress-related conditions.

Other employee wellness programs include:

- Personalized health coaching, helping employees and their spouses manage stress, depression, smoking, diabetes, nutrition education and weight management.
- Employee assistance program, offering all employees and their families counseling and referral services for personal or work-related problems.
- System health facility program, giving employees access to more than 5,000 gyms located near LP work sites, including gyms from industry leaders such as Gold's Gym, Lifetime Fitness and Anytime Fitness.
- Wellness incentives encouraging annual wellness assessments and physicals for non-union employees.

### UNION PACIFIC WELLNESS CHALLENGE

Launched in 2013, the Worksite Wellness Challenge recognizes Union Pacific locations adopting world-class wellness programs. The challenge evaluates and scores all sites on wellness and safety education objectives. Points are awarded based on employee engagement levels. Approximately 72 percent of Transportation and Mechanical work units achieved platinum or gold status through the Challenge in 2016.





## EMPLOYEE SPOTLIGHT: APPLYING RAILROAD SKILLS IN A COMBAT ZONE

Nate Westover's experience as a Union Pacific senior manager for strategic sourcing made an important difference when the 13-year U.S. Army reservist was deployed to Iraq May 2015 to April 2016. Nate was sent to Iraq to perform petroleum support operations – but on arrival, he received a much larger responsibility. A new base camp supporting special regional operations needed procurement and logistics support, making Nate ideally suited for the job. In September 2016, following his return from Iraq, Nate was presented with the Bronze Star for meritorious service in a combat zone. The award recognized his leadership in ensuring food, fuel supplies and life support services were available for the camp. It's a vivid demonstration of how the skills learned at Union Pacific carry weight in all walks of life.

*Nate Westover, senior manager – strategic sourcing, applied UP experience to facilitate resources at a new base camp in northern Iraq. The U.S. Army honored him with the Bronze Star Medal.*

## SPREADING BEST PRACTICE ON PEER SUPPORT

A central role in Union Pacific's approach to well-being is played by peer support networks with trained employees offering confidential advice and guidance to their colleagues. This strengthens bonds between our people and builds a sense of community within Union Pacific, providing support from those with an inherent understanding of the rail industry.

Peer support leadership conferences in Iowa, Texas and California, enabled networking, sharing best practices and building momentum for a vital part of our well-being support structure. Union Pacific brought together 400 volunteers from regional peer support programs to provide invaluable support to those facing crises at home or work.

## EMPLOYEE ASSISTANCE PROGRAM

We operate an employee assistance helpline available to employees 24/7. It provides access to trained employee volunteers equipped to help colleagues work through the emotional impacts of life-changing events. Support is entirely confidential – and can provide a bridge to professional support services where needed.

## EMPLOYEES ACTIVELY SERVING

Union Pacific's Support our Troops initiative encourages employees to send messages to our railroad's uniformed soldiers on active service around the world on Memorial Day 2016. We sent an American flag, messages and care packages to our 15 employees stationed overseas. This marked the 13th year we supported our troops in this way.

## COMMITMENT TO MILITARY VETERANS

Each year, the job search websites [www.monster.com](http://www.monster.com) and [www.military.com](http://www.military.com) partner to compile a list of the Best Companies for Veterans. Union Pacific is proud to have earned sixth place in the 2016 ranking, our second year on the Top 10 list. The Best Companies for Veterans list rates businesses on veteran support, recruitment, onboarding and retention policies. At the start of 2017, the website [www.militaryfriendly.com](http://www.militaryfriendly.com) also recognized Union Pacific as a Military Friendly Employer.



*Looking on as Chairman Vance Fritz signs the Employer Support of the Guard and Reserve document are, back row, from left, UPVE's leadership representatives Brian Detweiler, associate systems engineer-information technologies; Tammy Anderson, senior manager Industrial Track Construction; and Jim Asiuto, manager-Data Integrity. Front row, from left, Nate Westover, senior manager-Strategic Sourcing; Fritz; and Jesse Miller, senior manager-Short Line Development.*





# Preserving the Environment

A healthy environment is an essential foundation for a strong country – and a strong economy. Our vision of building America involves protecting and strengthening this foundation.

Railroads are one of the most fuel efficient means of transportation, generating fewer carbon emissions than long-haul trucks or air transport. Moving freight on trains also reduces traffic gridlock on America's overtaxed highways and carbon emissions from idling vehicles.

Union Pacific moves freight in an environmentally friendly way, enabling sustainable economic growth, but still recognizes the importance of not being complacent about our operations' impact. As the world seeks to improve environmental sustainability, we are doing our part to reduce our carbon footprint and help our customers do the same.

## Highlights, Challenges and Opportunities

Freight trains are four times more fuel efficient than trucks on a ton-mile basis. On average, Union Pacific moved a ton of freight 452 miles on a gallon of diesel fuel in 2016, compared to long-haul trucks which move a ton of freight approximately 134 miles on a gallon of diesel fuel.

Union Pacific again earned an "A" rating on the Carbon Disclosure Project's (CDP) Climate Change Survey and inclusion on CDP's S&P Climate Disclosure Leadership Index in 2016. Leadership status recognizes companies demonstrating best practices, leadership efforts and understanding climate change risks and opportunities. We are proud of our achievements, resulting from the eighth consecutive year of submitting climate change data to CDP.

## GREEN RANKING

Union Pacific ranked number 81 among all U.S. businesses in Newsweek's 2016 Green Ranking, an improvement from our position as number 121 in 2015.

## Our Approach to Environmental Management

Union Pacific's goal is to be a leader in moving goods in a fuel-efficient and environmentally responsible manner. Environmental Management System policies and procedures provide a pathway for the company to meet or exceed applicable environmental laws and regulations. Our environmental management efforts are based on the following strategic pillars:

- **Prevention:** Acting to reduce environmental damage from operations, including carbon emissions and climate impact.
- **Preparedness:** Working with customers and communities to prepare an effective response to future environmental issues.
- **Response:** Responding to emergencies involving environmentally sensitive materials to minimize health, environmental, operational and financial impact.
- **Recovery:** Restoring the environment from contamination for which Union Pacific is responsible.



Union Pacific's Environmental Management System improves processes and tracks performance. We strive to improve our performance by investing in technology, maintaining track equipment and training employees in more environmentally friendly behaviors.

Every Union Pacific employee must commit to preventing pollution, continuously improving and complying with all regulations, according to the company's environmental policy signed by Chairman, President and CEO Lance Fritz.

Union Pacific's Environmental Management Group (EMG) oversees environmental compliance. It is integrated into daily operations. EMG rigorously plans, coordinates and communicates best environmental practices. It also engages employees in our environmental management mission and vision.





## ENVIRONMENTAL RISK MANAGEMENT

Union Pacific's vice president of safety is directly responsible for the progress of the company's environmental efforts. He reports to the chairman, president and CFO regarding environmental policy compliance. In addition, the vice president of safety reports directly to the board of directors at least once a year.

Continuous improvement in achieving the Company's fuel efficiency goals, which directly impact our emissions, is tied to compensation based on our performance review process.

## COMPLIANCE

Union Pacific is subject to federal and state environmental statutes and regulations related to public health and environment, which are administered and monitored by the U.S. Environmental Protection Agency (EPA) and other federal and state agencies. Primary laws affecting rail operations are included below:

- Resource Conservation and Recovery Act, regulating solid and hazardous waste management and disposal.
- Comprehensive Environmental Response, Compensation and Liability Act, governing contaminated property cleanup.
- Clean Air Act, regulating air emissions.
- Clean Water Act, protecting the country's waters.

## OUR ENVIRONMENTAL PARTNERSHIPS

Union Pacific collaborates with a range of partners to identify opportunities to reduce our environmental impact and manage our land responsibly. Information on organizations we work with is listed below:

- Membership in the GreenBiz Executive Network, a peer-to-peer learning forum for sustainability executives from some of the world's largest companies.
- The California Council for Environmental and Economic Balance, a nonprofit, non-partisan coalition of industry, labor and public leaders working to solve the most pressing environmental policy problems facing California.
- The Association of American Railroads Sustainability Task Force, a rail industry forum sharing sustainability best practices. In 2016, Union Pacific partnered with other railroads to host the 6th Annual Railroad Sustainability Symposium at the University of Illinois at Urbana-Champaign.

## Environmental Risks

Extreme weather results in harsh working environments for employees, increased rail maintenance costs and negative service impacts. Blizzards, floods and hurricanes can lead to slower train speeds, service interruptions, track damage and recovery costs.

Our company acts to strengthen our network's resiliency from potential effects of extreme weather events. We have established emergency response procedures, which include moving required resources to regions likely to be affected. We are pursuing improvements that further increase our infrastructure's resiliency, including mitigating the impact of potential sea level rise.

Renewable energy growth and other proactive measures tackling carbon emissions reductions change can result in opportunities. Union Pacific continues to support wind turbine and other clean energy technology shipments.

Union Pacific educates public and elected officials about the environmental benefits of moving goods by rail. We work closely with public agencies to advance emissions reduction technology, while delivering immediate benefits in improved air quality. As part of this collaboration, we strategically locate our lower-emitting locomotives in parts of the country where communities fail to meet federal and national air quality standards.

For additional information on how climate change could have a material adverse effect on operations, results, financial condition and liquidity, see the risk factors in Union Pacific's Annual Report, Form 10-K and CD filings.



## GREENHOUSE GAS (GHG) EMISSIONS PERFORMANCE

Union Pacific locomotives produced 9,913,370 metric tons of GHG emissions from fossil fuels in 2016, down from 10,834,984 metric tons in 2015 due primarily to decreased freight volumes. Biomass source emissions were 119,372 metric tons, including 34,026 from renewable fuels. This is a decrease from 128,600 metric tons in 2015, which included 35,534 from renewable fuels.

Scope 3 emissions from employee travel totaled 18,603 metric tons, a decrease from 19,908 metric tons in 2015. Employee travel includes rental car fuel and commercial air travel. We worked with suppliers to identify Scope 3 emissions generated on Union Pacific's behalf. Suppliers representing an estimated 27 percent of Scope 3 spend produced emissions totaling 239,386 metric tons in 2016, compared to 266,746 in 2015.

Scope 3 emissions from Union Pacific's largest fuel suppliers' extraction, production and transportation were 2,566,657 metric tons, down from 2,779,030 in 2015.

## Fuel Efficiency

Fuel efficiency is a critical part of Union Pacific's sustainability approach. Diesel fuel accounts for more than 11 percent of Union Pacific's operating expenses. We strive to appropriately balance financial returns, environmental performance and social commitment.

Fuel efficiency and carbon emission reductions fluctuate based on business volumes and commodity mix. Fuel efficiency improves when trains move heavier shipments. We improved our fuel efficiency rate by 0.8 percent, compared to the 0.6 percent decrease in 2015. The improvement brings us closer to our goal of reducing locomotive fuel consumption rate by 0.5 percent annually from 2015 to 2017.

## WORKING WITH CUSTOMERS TO REDUCE AND MEASURE EMISSIONS

Customers seeking to reduce carbon emissions can calculate savings by choosing rail by using Union Pacific's online Carbon Emissions Estimator. Many customers also receive annual emissions savings estimates compared to moving goods with other transportation modes. In 2016, Union Pacific customers eliminated an estimated 29 million metric tons of GHG emissions by choosing rail over truck transportation.

## VERIFICATION OF UNION PACIFIC RANKING AS CLIMATE CHANGE LEADER

Union Pacific worked with independent organizations to ensure an accurate annual greenhouse gas inventory and emissions calculation. Trinity Consultants assists with methodology to accurately measure and calculate GHG inventory. GHD Limited verified our GHG emissions inventory.



## INVESTING IN NEW LOCOMOTIVES

Union Pacific acquired 160 new locomotives that meet the EPA's stringent Tier 4 emissions standards in 2016, adding to the 100 locomotives purchased in 2015. Tier 4 standards reduce particulate emissions from diesel locomotives by as much as 90 percent and nitrogen oxide emissions by as much as 80 percent. We plan to purchase additional Tier 4 locomotives in 2017.

Union Pacific has invested about \$8.5 billion in purchasing more than 4,500 new locomotives since 2000. These locomotives all meet the EPA's Tier 0 to Tier 4 standards. We retired more than 3,200 older, less fuel efficient locomotives over the same period.

Since 2000, we overhauled or rebuilt more than 3,700 diesel engines with emissions control upgrades. As a result of new locomotive and refurbishment programs, more than 96 percent of Union Pacific locomotives meet Tier 0 to Tier 4 EPA emissions standards.





## Incorporating Technology

Technology plays a fundamental role in Union Pacific's fuel efficiency performance. The following technologies all help improve fuel efficiency across the system.

- The LEADER (Locomotive Engineer Assist/Display and Event Recorder) system uses GPS maps to analyze train operations and prompt engineers when to accelerate and when to brake. During 2016, our 451 LEADER-enabled locomotives completed 9.2 million trip miles.
- Trip Optimizer (TO) automatically controls a locomotive's throttle, which helps keep trains on schedule while minimizing fuel use. This system calculates the most efficient way of operating a locomotive by considering factors such as train length, weight, track conditions, weather and locomotive performance. Our 987 TO locomotives made 6.8 million trip miles in 2016.
- The Smart Consist system selects throttle notch combinations for the best fuel economy. We have deployed Smart Consist in 408 locomotives.

Process improvements reduce GHG emissions by optimizing maintenance work. Union Pacific's cross-functional Fuel Mizers Load Testing Reduction Team implemented an efficient process for locomotive tests that ensures engines and generators produce enough horsepower to pull loaded rail cars. The process reduced fuel consumption by more than 2.6 million gallons and improved reliability in 2016. Teams also use ultrasound technology to test underground conditions for steel pipes used for fuel. It allows us to identify irregularities without uncovering the pipes.

### NEW TECHNOLOGY SOLUTIONS FROM A NEW GENERATION OF ENGINEERS

Union Pacific and Brigham Young University's Capstone program gave students an opportunity to test new aerodynamic technologies that dramatically impact fuel efficiency. Students from the university tested Arrowedge, a device that reduces drag and improves freight container efficiency. Union Pacific deployed Arrowedge in 2014, and new generations of students helped us conduct wind tunnel testing. Arrowedge 3.0, is the latest version, which cuts manufacturing costs for the drag reduction system by 88 percent. We are manufacturing 50 devices to be deployed across our railroad.



Trip Optimizer display.



Guided wave technology allows Union Pacific's fuel team to take a closer look at the railroad's underground assets.



### NATIONAL COUNCIL OF STATE LEGISLATORS VISIT PROVISO YARD

Union Pacific welcomed 80 legislators and state officials extending the National Conference of State Legislators' Annual Legislative Summit in Chicago at our Proviso Yard in November. They were briefed on Union Pacific's safety and environmental improvement efforts. The officials received an up-close look at Tier 4 and GenSet locomotives, PTC operations, Arrowedge and track inspection vehicles. Union Pacific's hazardous materials experts demonstrated tank cars and emergency equipment inside a box car converted into a classroom for emergency responder training sessions. The group also received a tour of the Union Pacific – Metra West Line.

*Mike Iden, Union Pacific's general director of car and locomotive engineering, explains how Arrowedge reduces aerodynamic drag on trains and improves fuel efficiency.*





## EVALUATING ALTERNATIVE FUELS

Union Pacific has been at the forefront of testing alternative fuels for locomotives since 1952 when we launched a project to explore the use of gas turbines to power locomotives.

The company continues evaluating LNG-powered locomotives as a commercially reliable and economical option. In previous years we met with community leaders, first responders and employees along the test route to discuss the multi-year project details and safety precautions. We will continue to maintain open lines of communication to update communities of progress and new developments.

## Energy Conservation

Union Pacific's utility conservation projects reduced energy consumption by more than 4 million kWh, which is enough to power approximately 870 U.S. homes annually. Many projects were simple, employee-driven solutions such as installing LED lighting, replacing compressors and turning equipment off at the end of the day.

ENERGY CONSUMPTION*	2014	2015	2016
Diesel	1,171.2 gallons	1,071.3 gallons	979.9 gallons
Gasoline	12.7 gallons	11.9 gallons	11.5 gallons
Other fuel	13.6 gallons	17.7 gallons	11.4 gallons
Electricity	6,271 kilowatt hours	6,594 kilowatt hours	6,489 kilowatt hours
Natural gas	720.4 standard cubic feet	1,145.5 standard cubic feet	573.6 standard cubic feet

\*Estimated in millions

## LEVERAGING SOLAR POWER

Solar power provides a ready source of energy in remote locations that can help Union Pacific reduce exposure to fluctuating energy markets. Union Pacific's solar power use includes the following initiatives:

- Solar powered active warning signals which consume approximately 2.8 million kWh of electricity each year.
- The Joliet Intermodal Terminal is powered by solar and wind energy, featuring 273 solar panels generating 72,000 kWh annually.
- Our Santa Teresa facility draws 40 percent of its power from on-site solar panels.
- Solar panels for refrigerated rail cars provide electricity to maintain battery charge, ensuring the cars are ready to move at all times.



Solar grids at the Joliet Intermodal Terminal near Chicago.



## Waste Management

Union Pacific generated an estimated 1.1 million tons of waste in 2016, and diverted approximately 67 percent of this waste from landfills. Our multi-year efforts reduced federal large-quantity hazardous waste generator sites from 25 to three.

### EXTENDING RAILROAD TIE LIFECYCLE

Union Pacific continued testing durable materials to increase railroad tie lifecycles, expanding its ability to stabilize the track and reducing waste. We seek a sustainable rail tie with commercial and environmental benefits. Tests are currently focused on new composite materials and a new two-stop wood tie treatment process.

### DISPOSING E-WASTE

Union Pacific recycles electronics no longer in use, commonly known as e-waste. We recycled or distributed more than 270,000 pounds of electronic equipment and more than 1.6 million pounds of signal batteries in 2016. In November, we invited employees to drop off obsolete and unwanted electronics at our headquarters in Omaha, to mark America Recycles Day.

### RECYCLING FUEL AND OIL

We recycled more than 3.8 million gallons of oil and fuel at our facilities. Union Pacific facilities have systems to catch spills, extract engine oil from wastewater and use fuel nozzles to shut off automatically, preventing locomotive fuel tank overflow.



*Union Pacific replaces millions of ties each year and seeks to expand their life cycle.*

## Water management

Managing thousands of utility accounts across our network can be challenging. We analyzed the accounts and researched irregularities and identified opportunities to conserve thousands of gallons. We made changes and repairs that eliminated unnecessary water use. A solution in Commerce, California, was as simple as accessing an underground water leak, which reduced water consumption by an estimated 120,000 gallons a year.

Union Pacific used an estimated 1.25 billion gallons of water in 2016, a reduction from 1.54 billion gallons in 2015. We continue exploring ways to conserve water. We help protect water resources from our operations through spill prevention controls and countermeasure plans at 126 facilities. Ninety wastewater treatment facilities capture and treat water from equipment washing and maintenance. We also treat captured wastewater to comply with government regulations and wastewater discharge permits.

### REPORTING WATER TO CDP

Union Pacific was the only Class I railroad to report water consumption to CDP, which we submitted for the third consecutive year in 2016. The company's "C" rating reflects Union Pacific's awareness of the impacts of business activities on the environment, people, ecosystems and vice versa. The CDP results help Union Pacific's efforts to measure, monitor and report water consumption. We remain committed to evaluating the situation and exploring steps to reduce water use.

## GIVING THE GREAT SALT LAKE FREEDOM TO FLOW

A causeway built to support railroad tracks over Utah's Great Salt Lake has divided the Western Hemisphere's largest saltwater lake since 1957. While it enabled waters of the north and south ends of the lake to mix, it changed the surface level and salt content. The northern end of the lake became lower and saltier, due to a lack of fresh water.



Union Pacific's rock-fill railroad causeway stretches 20 miles across the Great Salt Lake, the largest salt water lake in the Western Hemisphere.

In 2016, Union Pacific engineers constructed a 180-foot bridge, increasing the flow of water between the north and south ends. The increased flow improved conditions for tiny crustaceans and brine shrimp, which cannot survive in water that is too salty. Brine shrimp eggs are used in aquaculture to feed some types of fish and baby shrimp that don't survive well on artificial feed.

Utah supplies one-third of the world's brine shrimp supply, which contributes \$57 million annually to its economy. Brine shrimp population declines in the Great Salt Lake could negatively impact world-wide seafood prices.

Brine shrimp are important to the Great Salt Lake's unique ecological system. Along with brine flies, they are the main food source for migratory birds. The lake is a massive refueling station for birds completing migrations from places like South America, Russia and Mexico. The Fared Grebe, a water bird, actually doubles its weight eating the Great Salt Lake's brine shrimp before completing its migration south for the winter.

Adjustable earthen control berms enable Union Pacific to respond to changing ecological requirements. Scientists will monitor the bridge's impact over the next five years. Models predict water levels at the south end will drop, stabilizing the Great Salt Lake's waters mix more freely.

## BRIDGING THE GAP TO FRESHWATER SUPPLIES IN LOUISIANA

Union Pacific constructed a 109-foot steel bridge spanning the Bayou Lafourche in Louisiana in a project led by Bayou Lafourche Fresh Water District in 2016. The new bridge does more than support two rail lines crossing wetlands. Replacing a previous box-culvert structure allows for greater freshwater flow from the Mississippi River.

Improved freshwater flow helps prevent saltwater incursions while providing freshwater supplies for approximately 300,000 businesses and residents near the bayou. It also prevents wetland loss, which protects shores from wave action, reduces flood impacts and absorbs pollutants. Bayou Lafourche's water quality provides a habitat for plants and animals found nowhere else.



The 106-mile Bayou Lafourche in southwest Louisiana stretches from the Mississippi River in Donaldsonville to the Gulf of Mexico in southern Lafourche Parish. Photo courtesy of Bayou Lafourche Fresh Water District.

**UNION PACIFIC REDUCED WATER CONSUMPTION BY 290 MILLION GALLONS IN 2016.**





## Land Preservation

A healthy environment supports healthy, vibrant local communities – and their economies. Union Pacific is committed to being a responsible steward of the land we own. We work to preserve our ecosystems, improve our resiliency and reduce our impacts.

Union Pacific implements Habitat Conservation Plans to protect ecosystems and endangered species in various locations. Plans in the western half of our network included the desert tortoise, endangered southwestern willow flycatcher and valley elderberry longhorn beetle.

We also manage 30 miles of trees to control sand from blowing across the track in the Mojave Desert and actively manage several wetland areas.

### USING OUR NETWORK TO ESTABLISH HABITAT CORRIDORS

Union Pacific's vast rail network provides an opportunity to establish ecologically significant habitat corridors across wide areas of the central and western United States. In 2015, we joined the Wildlife Habitat Council (WHC) to leverage this potential for preserving and improving pollinator habitats. Starting with lands on which we do not run railroad operations, we are working with the WHC to establish a suitable habitat to support migrating species such as the Monarch butterfly to travel between winter and summer territories. Union Pacific also joined the Rights of Way Habitat working group, supported by the University of Illinois at Chicago to enhance our efforts.

### INVESTING IN FUTURE ENVIRONMENTAL STEWARDS

Union Pacific awarded Daisy Lazcon from Beach Park, Illinois, a \$500 conservation project scholarship for her volunteer efforts to reestablish native plants under the Center for Conservation Leadership Program's guidance. Daisy removed invasive plants from nature preserves and planted seeds to improve biologic diversity and practice environmental stewardship.



## Compliance

Union Pacific is committed to following applicable laws and regulations in all areas of our operations. From time to time, we are involved in legal proceedings, claims and litigation that occur in connection with our business. For example, we received notices from the EPA and state environmental agencies alleging that we are or may be liable under federal or state environmental laws for remediation costs at various sites throughout the United States, including sites on the Superfund National Priorities List or state superfund lists. We cannot predict the ultimate impact of these proceedings and suits because of the number of potentially responsible parties involved, the degree of contamination by various wastes, the scarcity and quality of volumetric data related to many of the sites, and the speculative nature of remediation costs. Where we are found in violation of specific rules or regulations, we seek remedy through the appropriate channels.





# Looking Ahead

## FEEDBACK

For questions on this report or to provide feedback, contact Union Pacific via email at [sustainability@up.com](mailto:sustainability@up.com).

## OUR COMMITMENT

Since our founding more than 150 years ago, Union Pacific has driven economic growth in America. Our mission, vision and values all are focused on completing tasks better tomorrow than we do today, enabling Union Pacific to remain critical to the American economy in the centuries to come. We will continue to strive to be the best in the business in our safety initiatives, on our tracks, in our communities, across our workforce and for our environment. The 2016 Union Pacific Building America Report shares our initiatives and progress thus far. We are proud of our accomplishments and our work to improve our operations. In the years ahead, we will continue to invest in our employees, communities and infrastructure because they shape our growth and success.

## ADDITIONAL RESOURCES

For ongoing updates on our citizenship and sustainability efforts, visit [www.up.com](http://www.up.com).

- **Media.** Up-to-date information about Union Pacific
- **Environment.** Sustainability commitments and progress
- **Employees.** Programs and services available to the members of our workforce
- **Customers.** Product offerings and business groups
- **Investors.** Annual report, proxy statements and other SEC filings
- **Communities.** News, photos and video about Union Pacific, our employees and the communities where we operate

## CAUTIONARY INFORMATION

Our 2016 Building America Report provides additional explanatory information regarding Union Pacific that may not be available, included or directly derived from information in the company's Annual Report. This report includes statements and information regarding future expectations or results of the company that are not historical facts. These statements and information are, or will be, forward-looking as defined by the federal securities laws. Forward-looking statements and information can be identified by use of forward-looking terminology (and derivations thereof), such as "believes," "expects," "may," "should," "will," "would," "intends," "plans," "estimates," "anticipates," "projects" and other words or phrases of similar intent. Forward-looking statements and information generally include the following: the company's expectations or forecasts with respect to general economic conditions in the United States and the world; the company's financial and operational performance; increases of the company's earnings; demand for the company's rail service; improving customer service; enhancing profitability, volume and revenue growth; efficiency improvements and increasing returns; and improving asset utilization. Statements also include the effectiveness or growth of new and newer services; management of network volumes; increasing shareholder value; total amount of capital investments; competition and effectiveness of capacity expansion and other capital investments, and other investments in infrastructure improvements; returns on capital investments; improvements regarding safety of our operations and equipment; improving efficiencies in fuel consumption; preserving the environment and communities where the company operates; and effectiveness of plans, programs and initiatives to reduce costs and other efficiency improvements. Forward-looking statements and information should not be read as a guarantee of future performance or results and will not necessarily be accurate indications of the times that, or by which, such performance or results will be achieved. Forward-looking statements and information are subject to risks and uncertainties that could cause actual performance or results to differ materially from those expressed in the statements. Forward-looking statements and information reflect the good faith consideration by management of currently available information and may be based on uncertain assumptions believed to be reasonable under the circumstances. However, such information and assumptions (and, therefore, such forward-looking statements and information) are or may be subject to variables or unknown or unforeseeable events or circumstances over which management has little or no influence or control.

The risk factors in Item 1A of the company's [Annual Report on Form 10-K](#), filed Feb. 3, 2017, could affect our future results and could cause those results or other outcomes to differ materially from those expressed or implied in the forward-looking statements and information. This report should be read in consideration of these risk factors. To the extent circumstances require or the company deems it otherwise necessary, the company will update or amend these risk factors in subsequent Annual Reports, periodic reports on Form 10-Q or current reports on Form 8-K. Forward-looking statements speak only as of the date the statement was made. We assume no obligation to update forward-looking information to reflect actual results, changes in assumptions or changes in other factors affecting forward-looking information. If we do update one or more forward-looking statements, no inference should be drawn that we will make additional updates with respect thereto or with respect to other forward-looking statements.

# Appendix 13: Subcontractors and Suppliers 2018 Vendor Inclusion and Diversity Plan



# Subcontractors and Suppliers

## 2018 Vendor Inclusion and Diversity Plan

The corporate plan includes data that shall not be disclosed outside the government and shall not be duplicated, used or disclosed (in whole or in part) for any purpose other than to evaluate this plan. This restriction does not limit the government's right to use information contained in this plan if it is obtained from another source without restriction. Information in this document consists of Waste Management confidential information and/or proprietary commercial or financial information exempted from public disclosure under the provision of 5 use 5520(b)(4) the freedom of information act.

### 1.0 TYPE OF PLAN

This Small Business, Small Disadvantaged Business, Small Women Owned Business, HUBZone Small Business, Veteran Owned Small Business and Service Disabled Veteran Owned Small Business Subcontracting Plan, along with any attachments, is submitted to fulfill the Company's obligation under Public Law 95-507, Federal Acquisition Regulations 52.219, and other relevant regulations issued pursuant thereto. This Plan is a "Commercial Plan" and is an annual company-wide Plan for all of the Company's commercial products and services.

### 2.0 POLICY STATEMENT

It is Waste Management's current policy to include small businesses; those owned by minorities, women and service disabled veterans among its sources for suppliers - into valuable partners and suppliers of high-quality, cost-competitive products and services. All businesses and functions are accountable for execution of this policy.

It is the company's current mission to develop a growing portfolio of viable and competitive small businesses; including those owned by minorities, women and service disabled veterans that will enable our company to increasingly utilize a supplier base which truly reflects the diversity of our customer base.

Our Supplier Diversity objectives support the organization in growing and expanding the WM overall business and shareholder value by engaging and developing diverse value-added suppliers thus creating a sustainable competitive advantage.

It is Waste Management's privilege, policy and practice to proactively seek diversified suppliers. Through Supplier Diversity, we currently build relationships with businesses that are at least 51% owned by minorities, women, and service-disabled veterans capable of providing commodities and services at competitive prices.

Waste Management, in accordance with our business values, strives to conduct business with all suppliers in an environment that demonstrates mutual trust, fairness, respect, integrity and inclusion of different perspectives.

#### Spend Goals - Past, Present and Future

Waste Management has shown continuous improvement year after year in our level of expenditures with small business concerns. Waste Management is committed to utilizing Small Business, Small Disadvantaged Business, Small Women Owned Business, HUBZone Small Business, Veteran Owned Small Business and Service Disabled Veteran Owned Small Business in achieving our corporate spend goals.



We are collecting spend data reflecting these SBA categories going forward as we build our small business program.

Separate dollar and percentage goals, expressed in terms of percentages of total subcontracting dollars, for the use of small business, veteran-owned small business, service-disabled veteran-owned small business, HUBZone small business, small disadvantaged business, and women-owned small business concerns as subcontractors are forecasted and listed below:

- A. Total estimated dollar value and percent of planned subcontracting with small businesses (include veteran-owned small, service-disabled veteran-owned small, HUBZone small, small disadvantaged, and women-owned small business concerns): (% of "c") \$175,000,000 and 5.00%
- B. Total estimated dollar value and percent of planned subcontracting with large business (all business concerns classified as "other than small"): (% of "c") \$3,325,000,000 and 95.0%
- C. Total estimated dollar value of all planned subcontracting for an individual contract plan; or the offerors total projected sales, expressed dollars, and the total value of projected subcontracts to support the sales for a commercial plan; i.e., the sum of A and B above: \$ (100 Percent) \$3,500,000,000 and 100.00%
- D. Total estimated dollar value and percent of planned subcontracting with veteran-owned small businesses: (% of "c") \$1,750,000 and 0.05%
- E. Total estimated dollar value and percent of planned subcontracting with service-disabled veteran owned small businesses: (% of "c") \$350,000 and 0.01%
- F. Total estimated dollar value and percent of planned subcontracting with HUBZone small businesses: (% of "c") \$17,500,000 and 0.50%
- G. Total estimated dollar value and percent of planned subcontracting with small disadvantaged businesses: (% of "c") \$70,000,000 and 2.00%
- H. Total estimated dollar value and percent of planned subcontracting with women-owned small businesses: (% of "c") \$70,000,000 and 2.00%

### 3.0 PRODUCTS AND SERVICES

All qualified small businesses participate in all of the categories of products and services sourced by WM. The following is a partial list of those products and services.

Lubricants  
Marketing & Advertising Promotions  
Building and Grounds Maintenance  
Class 8 Vehicle Parts  
Class 8 Vehicle Repair & Maintenance Class 8 Vehicle Sales  
Computers Containers Disposal  
Employee Related Products & Services Engineering  
Environmental Testing Equipment Rental Fuel & Gases  
Heavy Equipment Heavy Equipment Parts  
Heavy Equipment Rental  
Heavy Equipment Repair & Maintenance Hurricane | Disaster Debris Removal Labor  
Landfill Specific Products & Services  
Material Sorting or Transfer Station Specific Odor Control  
Office Related Products & Services Print & Stationery  
Professional Services Real Estate



Safety Supplies  
Security  
Shop & Maintenance Supplies Support Vehicles Service & Parts Telecom  
Tires Training  
Transportation Travel Uniforms Water

#### **4.0 METHODOLOGY FOR DETERMINING CORPORATE SPEND GOALS**

Under the direction of WM's Corporate Procurement organization with the assistance of the Supplier Diversity Team, Group Level involvement is engaged through the Procurement Director level and corporate level support teams. Group sourcing teams submit strategies, spend analysis and objectives, and supply chain inclusion with small business enterprises. The goal planning exercise includes a review of; the next year's estimated budget, historical spend, changes/gaps in major suppliers, a comprehensive action plan for the upcoming year and recommendations for the projected goal. The diverse spend level of each of the Groups is then assessed based upon the availability of qualified suppliers and other factors. Goals are then reported and reviewed by the supplier diversity program administrator and WM's Vice President / Chief Procurement Officer. Attainability is reviewed and a determination is made which ensures that goals represent a meaningful contribution and continuous improvement to WM's supplier diversity initiatives. Upon agreement and acceptance of goals by all involved parties, the objectives are combined to form WM's Corporate spend goal and disbursed company wide.

#### **5.0 METHODOLOGY FOR SUPPLIER IDENTIFICATION**

##### **5.1 Total Supplier Management System (TSMS) - Supplier Repository**

WM utilizes a web-based supplier repository where all company procurement professionals have access to locate and source diverse suppliers. This comprehensive database has information about supplier certification status, geographical service area, products and services they provide and much more. We encourage all potential diverse suppliers to register by entering their company profile at [www.suppliers.wm.com](http://www.suppliers.wm.com)

##### **5.2 Trade Fairs**

Corporate Procurement as well as selective WM employees actively participates in select Minority Business Opportunity Trade Fairs across the country. A partial list of national and local organizations that WM continues to support include: National Minority Supplier Development Council (NMSDC), Minority Enterprise Development Week (MEDWEEK), Women Business Enterprise National Council (WBENC), Government Procurement Connections (GPC) Small Business Development Centers (SBDC), SBA Opportunity Fairs, U.S. Hispanic Chamber of Commerce, Asian Business Association, The National Center of Native Americans as well as ISM, NAACP, and the Urban League.

##### **5.3 Other Sources of Information**

WM's procurement organization utilizes all available sources of information to locate small and large diverse business suppliers. Sources of information include state and local lists of minority suppliers, NMSDC database, WBENC database and the SBA System for Award Management (SAM) database, among others.

#### **6.0 PROGRAM ADMINISTRATION PLAN**

##### **6.1 Supplier Diversity Program**

The Supplier Diversity Program consists of processes and systems, which support the use of and partnership with diversified suppliers. Through Supplier Diversity, we currently build relationships with





businesses that are 51% owned, operated and controlled by minorities, women, and service-disabled veterans capable of providing commodities and services at competitive prices and have the following credentials listed below. Our current path (2009) includes partnerships with small, veteran-owned small business, service-disabled veteran-owned small, HUBZone small, small disadvantaged, and women- owned small business concerns.

- a. A Strong financial profile and a strong credit rating
- b. An impeccable safety record
- c. Ability to facilitate strategic alliances
- d. A Successful, long term customer relationship history including customer feedback on quality and reliability of the commodities or services
- e. Community involvement and outreach
- f. Positive position in the market for workforce and supplier diversity

Supplier Diversity Program content criteria include the following:

- a. Senior Leadership support and clear expectations for a strong supplier diversity program
- b. Processes documented and deployed which allow for consistent implementation of the supplier diversity policy and program.
- c. Effective communications internally to key stakeholders within the company
- d. Effective external communications to suppliers and constituents regarding the supplier diversity program
- e. Measurement systems and methodology for sustaining the supplier diversity program
- f. An active supplier development program with adequate investment in suppliers who can benefit from the mentoring process
- g. Performance objectives and expectations that permeate the organization to assure shared responsibility for effective implementation of the supplier diversity program at Waste Management

These criteria can be part of a self-assessment process, which can be administered on an annual basis.

The responsible person for overseeing WM's diverse supplier initiatives is on the Corporate Procurement staff. Specific information follows:

Program Administrator: Address:  
Telephone | Fax: E-mail:

**John Velandia**  
Category Manager - Diversity  
1021 Main Street, Houston, Texas 77002  
(713) 394-2273 / (713) 328-7405  
jvelandi@wm.com

The Program Administrator is responsible for the daily management of the Supplier Diversity Program and is appointed the small business liaison related to all purchasing activities that include:

Duties: Has general overall responsibility for the contactor's subcontracting program, i.e. developing, preparing, and executing individual subcontracting plans and monitoring performance relative to the requirements of this particular plan. These duties include, but are not limited to, the following activities:

- a. Developing and promoting company-wide policy initiatives that demonstrate Waste Management's support for awarding contracts and subcontracts to small, veteran-owned small, service-disabled veteran-owned small, HUBZone small, small disadvantaged, and women-owned small business; and assure that small, veteran-owned small, service-disabled veteran-owned





- small, HUBZone small, small disadvantaged, and women-owned small business are included on the source lists for solicitations for products and services they are capable of providing ;
- b. Developing and maintaining bidder's lists of small, veteran-owned small, service-disabled veteran-owned small, HUBZone small, small disadvantaged, and women-owned small business concerns from all possible sources;
  - c. Ensuring periodic rotation of potential subcontractors on bidders' lists;
  - d. Ensuring that procurement "packages" are designed to permit the maximum possible participation of small, veteran-owned small, service-disabled veteran-owned small, HUBZone small, small disadvantaged, and women-owned small business;
  - e. Make arrangements to identify small, veteran-owned small, service-disabled veteran-owned small, HUBZone small, small disadvantaged, and women-owned small business through multiple sources such as SSA's SUB-Net (<http://web.sba.gov/subnetU>), the SAM Portal Search (<https://www.sam.gov>), the National Minority Supplier Development Council, Women's Business Enterprise National Council, Vendor Information Service, the Office of Minority Business Data Center in the Department of Commerce, the facilities of local small business, minority associations, and contact with federal agencies' Small Business Specialists;
  - f. Overseeing the establishment and maintenance of contact and subcontract award records;
  - g. Attending or arranging for the attendance of company counselors at Business Opportunity Workshops, Minority Business Enterprise Seminars, Trade Fairs, Procurement Conferences, etc.;
  - h. Ensure that small, veteran owned small, service-disabled veteran-owned small, HUBZone small disadvantaged, and women-owned small business concerns are made aware of subcontracting opportunities and how to prepare responsive bids to the company;
  - i. Conducting or arranging for the conduct of training for procurement personnel regarding the intent and impact of Section 8(d) of the Small Business Act on purchasing procedures;
  - j. Monitoring the company's performance and making any adjustments necessary to achieve the subcontract plan goals;
  - k. Preparing, and submitting timely, required subcontracting reports;
  - l. Coordinating the Waste Management's activities during the conduct of compliance reviews by federal agencies;
  - m. Providing technical assistance; e.g., engineering, quality control, and managerial assistance to small, veteran-owned small, service-disabled veteran-owned small, HUBZone small, small disadvantaged, and women-owned small business.

## 6.2 Procurement Group Supplier Diversity Advocates

Procurement Group Supplier Diversity Advocates represent major market areas within Waste Management. Supplier Diversity Advocates are contact points for all types of diverse suppliers interested in providing goods and services to WM. Each advocates' in-depth knowledge of their facilities' operation and requirements enables them to provide timely and knowledgeable responses to supplier inquiries. They also effectively assist diverse suppliers in the presentation of their capabilities to appropriate location personnel.

## 7.0 EFFORTS TO PROVIDE EQUITABLE OPPORTUNITY

The following efforts will be taken to assure that small business, veteran-owned, service-disabled veteran owned; Hubzone small business, small disadvantaged business and woman-owned business concerns will have an equitable opportunity to compete for business:

Internal efforts to guide and encourage procurement personnel:

- a. Maintenance of small, small disadvantaged and women-owned small business concerns source lists, guides, and other data identifying small, veteran-owned, service-disabled veteran owned HUBZone, small disadvantaged and women-owned business concerns and utilized by buyers in soliciting subcontracts
- b. Utilization of supplier repository to include identification of small, veteran-owned, service-disabled veteran owned HUBZone, small disadvantaged and women-owned business concerns





- c. Internal efforts to guide and encourage buyers to procure from small, veteran-owned, service-disabled veteran owned HUBZone, small disadvantaged and women-owned businesses
- d. Monitor activities to assure compliance with the subcontracting plan
- e. Present workshops, seminars, and training programs

Outreach efforts to obtain sources:

- a. Contacting minority, women's, and small business trade associations
- b. Contacting business development organizations
- c. Attending small, veteran 's, minority, and women 's business procurement conferences and trade fairs
- d. Locating sources from the System for Award Management(SAM) Portal.
- e. Utilizing newspaper and magazine ads to encourage new sources
- f. Posting Notices of Sources Sought and/or Requests for Proposals or Requests for Quotations on SSA's SUB-Net.

## 8.0 INCLUSION CLAUSE/FLOW-DOWN CLAUSE

Currently, all e-procurement opportunities have inclusion language regarding WM's diverse supplier initiatives.

Waste Management agrees to include the provisions under FAR52.219-8, "Utilization of Small Business Concerns," in all subcontracts that offer further subcontracting opportunities. All subcontractors, except small business concerns, that receive subcontracts in excess of \$700,000 (\$1,500,000 for construction) must adopt and comply with a plan similar to the plan required by FAR 52.219-9, "Small Business Subcontracting Plan" This data is reported to, and tracked by, WM on a quarterly basis.

The following language is included in standard purchase terms and agreements: "Waste Management and Supplier shall support the utilization and development of qualified small, veteran-owned, service-disabled veteran owned small, HUBZone small, small disadvantaged and women-owned small business concerns and minority-owned enterprises (MBE). Supplier shall have processes to encourage the placement of, and shall make good faith efforts to place; ten percent (10%) of the total dollar amount of the Supplier's awarded Agreement related purchases of services and materials from small, veteran-owned, service-disabled veteran owned small, HUBZone small, small disadvantaged and women-owned small businesses and minority-owned enterprises (MBE).

## 9.0 COOPERATION AND REPORTING

Assurances that the offeror will (i) cooperate in any studies or surveys as may be required, (ii) submit periodic reports in order to allow the Government to determine the extent of compliance by the offeror with the subcontracting plan, and (iii) Summary Subcontract Report, in accordance with the instructions on the forms.

## 10.0 MAINTENANCE, PERFORMANCE, AND COMMUNICATION

### 10.1 Record Maintenance

The following types of records will be maintained to demonstrate procedures which have been adopted to comply with the requirements and goals set forth in this Plan, and to ensure maximum practicable utilization of small business, HUBZone small business, small women owned business, veteran owned small business, service disabled veteran owned small business and small disadvantaged business concerns. These records will be maintained on a Company-wide basis, unless otherwise

- a. Small, small disadvantaged, women owned small, HUBZone small, veteran owned small and service disabled veteran owned small business concern source lists, guides and other data identifying such suppliers.

- b. Organizations contacted for small, HUBZone small, small disadvantaged, and women-owned small business sources.
- c. c. Records on each subcontract solicitation resulting in an award of more than \$150,000, indicating (A) whether small business concerns were solicited and if not, why not, (B) whether small disadvantaged business concerns were solicited and if not, why not, and (C) whether women owned business concerns were solicited and if not, why not, (D) whether HUBZone small businesses were solicited and if not, why not and (E) whether veteran owned small business were solicited and if not, why not and (F) whether service disabled veteran owned small business concerns were solicited and if not, why not {G} if applicable, the reason awards were not made to a SB/SDB/WBENOSB/SDVOSB/HUBZ business concern.
- d. Records to support other outreach efforts, e.g. contacts with minority and small business trade associations, attendance at small and minority business procurement conferences and trade fairs.
- e. Records to support internal activities to (A) guide and encourage purchasing personnel, e.g., workshops, seminars, training programs, incentive awards; and to (B) monitor activities to evaluate compliance.

## 10.2 WM's Supplier Diversity Program

WM's Supplier Diversity Program provides a focal point and coordination function for WM's outreach programs involving diverse business relationships. Representing WM market areas and organizations, the Supplier Diversity team performs its primary functions through assistance from the Supplier Diversity program manager, business analyst and supplier diversity advocates.

## 10.3 External Communications

As an ongoing part of its communications activities, WM continues to advertise its programs and opportunities through a variety of media. WM will place ads in national magazines targeting minority and women audiences, as well as SB/SDB/WBENOSB/SDVOSB/HUBZ business concerns as in local minority and government contracting business publications, M/WBE association publications, and other publications, which could provide a unique opportunity for WM to reach the diverse business community.

## 10.4 Internal Communications

WM uses various methods for increasing employee awareness of supplier diversity and small business efforts and programs and encourages individual involvement throughout the company. A Supplier Diversity Intranet Web Page and quarterly SD Newsletter is in place discussing WM's commitment, activities, quarterly results, supplier lists, and information important to the growth and development of diverse suppliers.

## 10.5 Indirect Cost Allocation

Purchases of goods and services by Waste Management's U.S., are regarded as indirect expenditures to establish the subcontracting goals for this commercial plan. Indirect costs have been included in the dollar and percentage subcontracting goals as stated in Section 2.0 GOALS.



# Appendix 14: Equal Employment Opportunity Policy



## WASTE MANAGEMENT EQUAL EMPLOYMENT POLICY

It is the policy of Waste Management to afford equal opportunity for employment to all individuals regardless of race, color, religion, sex, pregnancy, sexual orientation, gender identity, national origin, age, disability or veteran status.

As part of this policy, Waste Management will (1) recruit, hire, promote and train all applicants and employees in all job titles without regard to their race, color, religion, sex, pregnancy, sexual orientation, gender identity, national origin, age, disability or veteran status; (2) ensure that all personnel actions, such as compensation, benefits, transfers, layoffs, return from layoffs, company-sponsored training, education, tuition assistance, and social and recreational programs will be administered without regard to race, color, religion, sex, national origin, age, disability or veteran status; and (3) ensure that promotion decisions are in accord with principles of equal employment opportunities by imposing only valid requirements for promotional opportunities.

Waste Management will not discharge or in any other manner discriminate against employees of applicants because they have inquired about, discussed, or disclosed their own pay or the pay of another employee or applicant. However, employees who have access to the compensation information of other employees or applicants as a part of their essential job functions cannot disclose the pay of other employees or applicants to individuals who do not otherwise have access to compensation information, unless the disclosure is (a) in response to a formal complaint or charge, (b) in furtherance of an investigation, proceeding, hearing, or action, including an investigation conducted by Waste Management, or (c) consistent with Waste Management's legal duty to furnish information.

Waste Management has developed an Affirmative Action Plan to support its commitment to the principle of equal employment opportunity. This Plan describes the policies and procedures used in Waste Management's operations to carry out its commitment. The Director of Ethics and EEO Compliance, with support of IIR managers, will establish and monitor the implementation of personnel policies to guide Waste Management in pursuing equal employment opportunity and affirmative action for its employees as EEO Administrator.

Waste Management is committed to take action to ensure nondiscrimination. The cooperation and commitment of every employee is necessary in achieving effective and meaningful employment opportunity equal in every respect for all employees. Equal employment opportunity is the law and a sound and just policy to which Waste Management is firmly committed.

The successful achievement of a non-discriminatory employment program requires maximum cooperation between all employees. In fulfilling its part of this cooperative effort, management is committed to leading the way by establishing and implementing affirmative action procedures and practices that will ensure our objective of equitable employment opportunity for all.

The realization of that goal has my full support.

Jim Fish  
President and Chief Executive Officer  
January 2017



## Appendix 15:

# WM's 2016 Sustainability Report

(included in the back of the printed Proposal and provided in the following link for electronic access:

[http://www.wm.com/sustainability/pdfs/2016SustainabilityReport\\_WM.pdf](http://www.wm.com/sustainability/pdfs/2016SustainabilityReport_WM.pdf))



This page intentionally left blank



Appendix 16:  
**WM's 2017** Sustainability Report  
Update



# Leading Change

2017 Sustainability Report Update







# Waste Management in Summary

(Information presented in this report is for the year ending December 31, 2016, unless noted)

Waste Management, Inc. (NYSE: WM), based in Houston, Texas, is the leading provider of comprehensive waste management and environmental services in North America.

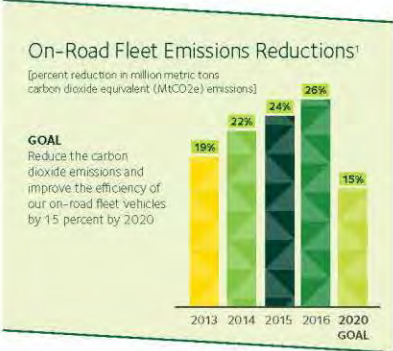
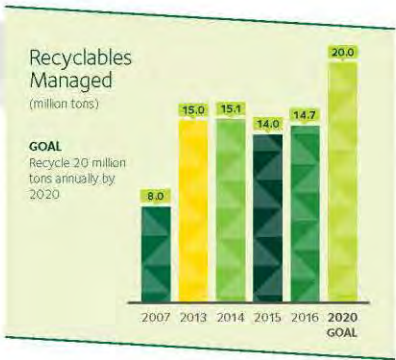


<sup>1</sup> As of Q3 2017. Updated to reflect most recent number as our natural gas fleet grows throughout the year, and our recycling infrastructure investments fluctuate.



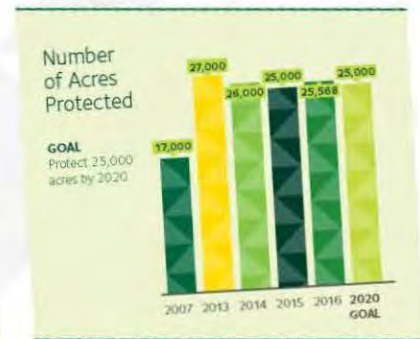
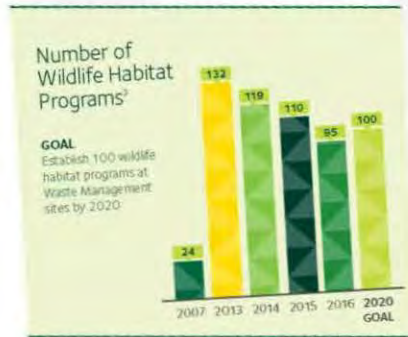
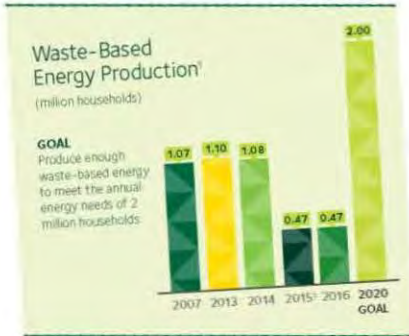
# Goals & Progress

Our goals focus on measurable benefits to the environment. For 2016, we are particularly pleased to report that our recycling productivity increased slightly despite continued challenges in the commodity markets. We decreased emissions from our fleet, exceeding our 2020 goal by 73 percent. Consistent expansion of our natural gas fleet, as well as the increasing use of non-fossil Renewable Natural Gas fuel in our trucks contribute to this reduction. For the second year in a row, our greenhouse gas-reducing services saved over three times the total GHG emissions Waste Management's operations generated all year. We also have retained our conservation focus, continuing to exceed our 2020 goal of protecting 25,000 acres as certified wildlife habitat.



<sup>1</sup> Note that we have determined that in prior years, the fleet emissions tracking inadvertently included some off-road diesel and aviation emissions as well as the on-road emissions that were intended to be the universe for this metric. In addition, the data came from fuel logs, which have been reviewed against tax credit logs to enhance accuracy. Since we are adding diversity to our fuel types, especially with the use of Renewable Natural Gas, we are refining our reporting to distinguish among kinds of fuel. The prior years' numbers have been reviewed for consistent reporting and are restated here. The restatement uses U.S. EPA SmartWay methodology for its calculations.





<sup>1</sup> Total includes landfill gas-to-energy, waste-to-energy, solar, waste-based fuel and steam  
<sup>2</sup> Reflects the impact of the divestiture of the Wheelabrator waste-to-energy business  
<sup>3</sup> Numbers reflect both "Lands for Learning" projects and specific habitat sites.

4 2017 SUSTAINABILITY REPORT UPDATE



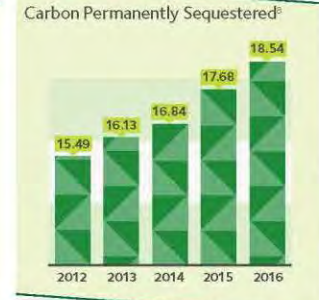
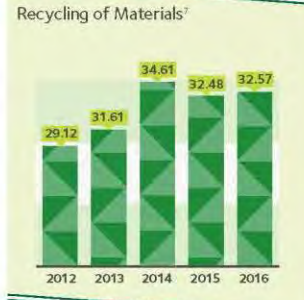
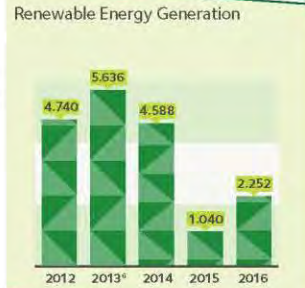


# Sustainability Key Performance Indicators<sup>1</sup>

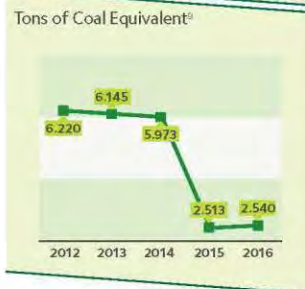
## GHG Footprint (million metric tons CO<sub>2</sub> equivalent)



## Potential Avoided GHG Emissions<sup>5</sup> (million metric tons CO<sub>2</sub> equivalent)



## Waste-Based Energy Benefits



# Sustainability Key Performance Indicators<sup>1</sup>, cont.



Resource Savings Achieved Through Recycling



Safety Performance



Philanthropy



For footnotes, see page 11.



# 2016 Recycling Performance

## Why We Recycled

				
<p>To Save <b>117.5 Million</b> Mature Trees</p>	<p>To Meet the Annual Municipal Waste Disposal Needs of <b>48.1 Million</b> People</p>	<p>To Avoid <b>31.4 Million</b> Metric Tons of GHG Emissions</p>	<p>Enough Timber Resources to Produce <b>1.99 Trillion</b> Sheets of Copypaper</p>	<p>To Save <b>37.5 Million</b> Cubic Yards of Landfill Airspace</p>
				
<p>To Fulfill the Annual Power Needs of <b>1.88 Million</b> Homes</p>	<p>To Supply Enough Fresh Water for <b>27.8 Million</b> People for a Month</p>	<p>By Conserving <b>19.6 Billion</b> kWh of Electricity</p>	<p>To Save Through Recycling the Virgin Materials Needed to Replace <b>10.68 Million</b> Tons of Paper, Metal, Plastic and Glass</p>	<p>To Save <b>62.5 Billion</b> Gallons of Water</p>

## Where We Recycled

- Material Recovery Facilities (MRFs)
- 43 Single Stream
  - 4 Dual Stream
  - 37 Paper Only or Other Commercial Materials
  - 8 Construction and Demolition Debris
  - 6 High Grade
  - 6 Other

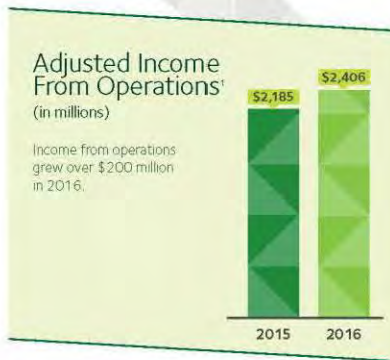
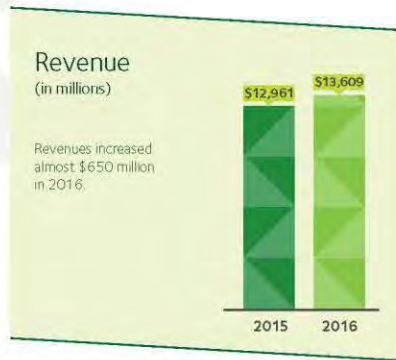


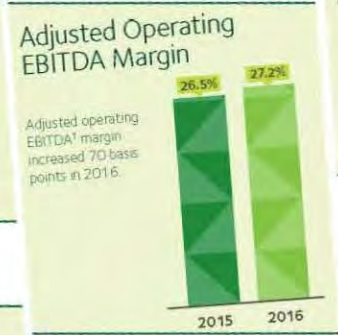
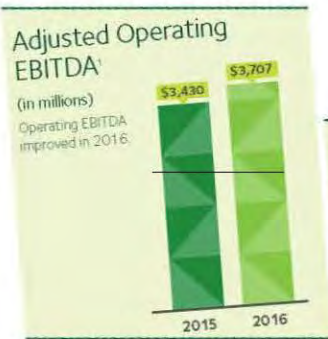


# Economic Impact

*We had great success in 2016, driving earnings and cash flow growth to record levels that exceeded our own expectations. As we have demonstrated over the last few years, strong pricing, the execution of our service delivery optimization programs, and growing the right kind of volume drive margin expansion. We did this as a team, working together to execute upon our top strategic priorities.*

**Jim Fish, President and CEO**





For footnotes, see page 11.





# Corporate Awards



**10 Consecutive Years**  
The Ethisphere Institute



**2016 and 2017**



**GHG Reporting Since 2004**  
CDP (formerly Carbon Disclosure Project)

The following are representative of the many awards Waste Management has received in the past three years:

 **Corporate Sustainability**

- » Change the World, Fortune Magazine 2015
- » FTSE4Good Index Series 2011-2017
- » Euronext Vigeo World 120 Index 2012-2015
- » 100 Best Corporate Citizens, Corporate Social Responsibility Magazine 2015
- » Dow Jones Sustainability Index, North American Indices, 13 of the past 15 years

 **Environmental**

- » 50 Hottest Companies in Bioenergy, Biofuels Digest 2014-2015
- » Champions of the Environment Award, New York City College of Technology 2015
- » Sport for the Environment Winner, Beyond Sport 2014

 **Business Recognition**

- » Supplier of the Year Services Award, BASF 2015
- » Recycler of the Year Business Category, MassRecycle 2015
- » Supplier Leadership Award, Sustainable Purchasing Leadership Council 2016

 **Community**

- » Corporate Conservation Leadership Award, Wildlife Habitat Council 2017
- » Community Partner of the Year, Wildlife Habitat Council 2015
- » Corporate Lands for Learning of the Year, Wildlife Habitat Council 2015
- » Best Community Partner, Neighborhood Alliance of Central Oklahoma 2015
- » Gold Award for Educational Program Excellence, SWANA 2015

 **Workplace Recognition**

- » "Best for Vets" Employer, Military Times 2010-2017
- » Corporate Equality Index Score 90+, Human Rights Campaign 2011-2016
- » Top Military Friendly® Employer, G.I. Jobs/military.com 2010-2017
- » 50 Best Companies to Sell For, Selling Power Magazine 2015-2017
- » Employer of Excellence Award, Texas Workforce Commission 2015
- » Top 50 Employers, Equal Opportunity Publications 2016







# Footnotes



## Key Performance Indicators

- <sup>1</sup> Since 2013, we have used the modified 100-year global warming potentials (GWPs) promulgated by the U.S. EPA. Pertinent to our carbon footprint, U.S. EPA revised the GWP for methane from 21 to 25 and the GWP for nitrous oxide from 310 to 298.
- <sup>2</sup> We have corrected our 2012 process number to include power generation and refrigerants used at sites included in previous years' calculations but exempted by the EPA's GHG reporting rule. We are including these units for consistency over time, amending last year's reporting number.
- <sup>3</sup> We have changed our methodology for calculating fleet efficiency to conform to U.S. EPA's most recent (2013) SmartWay Truck Tool. In order to evaluate relative emissions and progress toward our 2020 transport emissions reduction goal, we have recalculated our 2007 baseline for collection vehicles and our 2011–2013 emissions using the 2013 tool. In addition, we have changed our database for making these SmartWay calculations from our prior reliance on fuel logs to the use of records compiled for tax credit and fee purposes. The tax documentation reflects fuel purchased in a year, including some insignificant amounts of fuel stored (rather than used) in a given year. We believe the corporate tax records are more complete than the facility-specific fuel logs. The transition to these records accounts for part of the increase in emissions from 2012 to 2013. Note that our transportation emissions reported here include those from both our collection fleet and our non-collection "yellow iron" (i.e., off-road equipment such as forklifts and excavators) used on site. A small amount of fuel in this category is used for nontransportation purposes (e.g., running emergency generators or barbecue grills on site), but we do not subtract these from our transportation totals.
- <sup>4</sup> We are in transition in the way we track electricity data. In 2013, we hired a third party to assist in developing and reporting electricity data, making use of the enterprise accounting system's coding of accounts paid. We believe that this accounting system is more accurate than our previous estimation, which used a representative sample of Waste Management operations to project entity-wide emissions. We believe our previous estimations, in fact, erred on the high side. The dramatic reduction in energy use in 2013 is thus likely due in large part to overestimation in prior years, rather than a true reduction from previous emissions.
- <sup>5</sup> We are reporting these data to inform our customers and the public about the potential GHG reduction benefits associated with carbon storage in landfills, our renewable energy production and the value of the recyclable materials we collect and process. We are not presuming to characterize how emerging regulatory programs will allocate credit for these avoided emissions, so we do not claim these GHG reduction benefits as our own nor attempt to deduct these reductions from our carbon footprint.
- <sup>6</sup> Increases in productivity in 2013 were primarily the result of running our waste-to-energy plants at higher capacity and including energy generated from wind projects in our calculations.
- <sup>7</sup> The GHG savings figures for 2012 were based upon estimates made using the National Recycling Coalition (NRC) Environmental Benefits Calculator. Consistent with our efforts to align our reporting more closely with current U.S. EPA methods where possible, we have converted our estimates of the benefits of recycling to those developed using U.S. EPA's Waste Reduction Model (WARM), which reports benefits in MTCO<sub>2</sub>e (the measure consistent with the other units reported in this chart). Our 2012 emissions remain those calculated using the NRC model, but they have been converted to MTCO<sub>2</sub>e for purposes of comparison. (Note that our 2012 report erroneously stated the recycling savings were already expressed as MTCO<sub>2</sub>e.) Also note that U.S. EPA has yet to include updated GWP numbers in its WARM software. In our calculations, we assume that, by recycling, we divert materials from the average landfill nationally, not solely from our modern landfills with landfill gas-to-energy capacity. If instead our recycling were to divert materials only

- from our own modern landfills, the emissions reductions achieved by recycling would only be 31,613,385 in 2013. Note also that the increase in emissions reductions realized by recycling does not correspond arithmetically to the increase in total tons recycled. That is because paper recycling achieves very high emissions reductions, and the relative proportion of paper in the recycling stream is declining as consumer shifts from paper-based information to electronics (e.g., from newspapers to e-readers).
- <sup>8</sup> For a discussion of the protocols that govern this calculation of carbon storage or sequestration, see pg 109 of the Appendix in our 2016 report document.
- <sup>9</sup> Tons of coal equivalent is calculated based on the equivalent number of households that could be powered by Waste Management energy production. Note that standard industry assumptions about household energy use differ for the waste-to-energy and landfill gas-to-energy sectors. Standard waste-to-energy reporting is 1,000 households per installed megawatt, while the household conversion for landfill gas-to-energy is based upon U.S. Energy Information Administration data that is updated yearly. We have not included the energy value of our wind projects in this entry because there is no sector conversion template comparable to that for waste to energy and landfill gas-to-energy.
- <sup>10</sup> Modern landfills are post-1993 and are permitted under 40 CFR Part 258 Subtitle D. Off-site contamination is regulatory corrective action required to address off-site impacts to groundwater.
- <sup>11</sup> WM modern landfill liners continue to perform as designed, not allowing leakage through the liner that required corrective action to clean up groundwater under neighboring priorities. We have also received questions asking whether the metric refers to potential landfill leaking or a more general facility reference, and have clarified.

## Economic Impact

- <sup>1</sup> Adjusted Income from Operations, Adjusted Operating Margin, Adjusted Operating EBITDA, Adjusted Operating EBITDA Margin, and Adjusted Earnings Per Diluted Share (Adjusted EPS) are not defined by generally accepted accounting principles (GAAP). We believe that these non-GAAP measures provide useful information to investors by excluding items that the company does not believe reflect its fundamental business performance and/or are not representative or indicative of our results of operations. The company defines Operating EBITDA as income from operations before depreciation and amortization. Adjusted Operating Margin and Adjusted Operating EBITDA Margin are each calculated as a percentage of as-reported revenues.
- Free Cash Flow is also a non-GAAP measure. The company discloses Free Cash Flow because we believe that it is indicative of the company's ability to pay its quarterly dividends, repurchase common stock, fund acquisitions and other investments and, in the absence of refinancings, to repay its debt obligations; however, the use of Free Cash Flow as a liquidity measure has material limitations because it excludes expenditures such as declared dividend payments and debt service requirements. The company defines Free Cash Flow as net cash provided by operating activities, less capital expenditures, plus proceeds from divestitures of businesses and other assets (net of cash divested).
- Non-GAAP measures should not be considered a substitute for financial measures presented in accordance with GAAP. Operating EBITDA and Free Cash Flow may not be comparable to similarly titled measures reported by other companies. For quantitative reconciliations of non-GAAP measures to the most comparable measure calculated in accordance with GAAP, please see the financial tables accompanying WM's press release dated February 16, 2017, announcing full year 2016 earnings and comparisons to 2015: <http://investor.wm.com/phoenix.zhtml?c=1167434&e=real-earnings-newsArticle&iid=3246622>



# Appendix 17: Exceptions to the Standard Agreement and RFP



**Metro Transportation RFP - Section C Appendix, Exceptions to Standard Agreement and RFP**

Please see below for Waste Management’s exceptions to the Transportation Standard Agreement and RFP. We look forward to discussing mutually agreeable terms and conditions for our partnership.

Item	Transportation Agreement Section	Topic	Description/Text	Comment/Proposed Alternative Language
1	1.2	Definition of “Force Majeure”	“‘Force majeure’ means riots, wars, civil disturbances, insurrections, acts of terrorism, epidemics, acts of nature <b>whose effects prevent safe passage of vehicles upon state or federal highways for a continuing period of not less than 14 days</b> and federal or state government orders, any of which is beyond the reasonable anticipation of the applicable party and which prevents performance of this Agreement, but only to the extent that the applicable party is exerting due diligence to resume performance at the earliest possible time.”	Please remove the bolded text. It is not reasonable to exclude an uncontrollable circumstance from force majeure merely because its duration is less than 14 days or does not cause the shut-down of a highway.
2	3.7.3(10)	Yearly Report - Wages & Benefits	This section requires the annual report to include a report on wages and benefits packages.	Please delete this section. It would require disclosure of confidential and proprietary information on wages and benefits.





Item	Transportation Agreement Section	Topic	Description/Text	Comment/Proposed Alternative Language
3	5.1	Title to Solid Waste	<p>“If the seal affixed to any load of Solid Waste in the Contractor’s possession is broken after being affixed at the transfer station of origin or before unloading at the disposal site destination, title to that load of Solid Waste immediately passes to the Contractor. Nothing in this paragraph is intended to limit Contractor’s responsibilities or liabilities as described elsewhere in this Agreement.”</p>	<p>While WM does not object to title to Acceptable Solid Waste transferring to Contractor if the seal is broken, WM cannot agree that title to Unacceptable Solid Waste transfers. If Metro causes Unacceptable Waste to be tendered to the transportation contractor, title to and liability for the Unacceptable Solid Waste must remain with Metro.</p> <p>WM recommends revisions to the existing provision as follows:</p> <p>“If the seal affixed to any load of Acceptable Solid Waste in the Contractor’s possession is broken after being affixed at the transfer station of origin or before unloading at the disposal site destination, title to that load of Acceptable Solid Waste immediately passes to the Contractor. Title to and liability for any Unacceptable Solid Waste shall remain with Metro. Nothing in this paragraph is intended to limit Contractor’s responsibilities or liabilities as described elsewhere in this Agreement.”</p>
4	7.1	Metro-Provided Fuel	<p>This Article gives Metro the option to provide fuel for the transportation services.</p>	<p>Due to our rail proposal, this provision should be limited to road vehicles used to transport waste from Metro’s transfer stations to the railhead.</p>



Item	Transportation Agreement Section	Topic	Description/Text	Comment/Proposed Alternative Language
5	9.2.1(a)	Payments for Change in Law	<p>“Metro will reimburse Contractor, subject to the terms and conditions of this Article, for reasonable, actual increased costs due to changes in local and county laws if and only if the changes are applicable to all business in the relevant county or local area. Metro will not compensate Contractor for any increased costs due to changes in local or county laws to the extent that the laws are applicable only to Contractor, Contractor’s activities in connection with this Agreement, or to persons or entities engaged in the waste management or transportation industries.”</p>	<p>Please clarify Metro’s intent with this provision. Contractor should be allowed in all circumstances, to pass through changes in law that directly affect the services or cost of services under the Agreement.</p> <p>We suggest removal of the “all business” application to accomplish the intended result.</p>
6	9.6	Interest on Late Payments	<p>“On or before the ___th day of each month [to be determined], Contractor will submit to Metro a billing statement that indicates the number of loads or tons of Solid Waste disposed from each transfer station pursuant to this Agreement. The Contractor will furnish to Metro the required detailed information as set forth in this Agreement and as Metro may request to aid in the preparation of monthly payments. After approval by Metro, Metro will pay the Contractor within 30 days from the date it received Contractor’s billing statement.”</p>	<p>This section omits any reference to payment of interest on past due amounts. Please add a reasonable interest rate of 1.0% per month for late payments.</p> <p>Additionally, please clarify Metro’s approval of billing statements cannot be unreasonably withheld.</p>
7	12.2.2(3)	Records re Cost and Pricing Data	<p>“Contractor and subcontractors must maintain any other records necessary to clearly document: ...</p> <p>3. Any cost and pricing data relating to this Agreement.</p>	<p>Since we are bidding, as instructed, on a price per load, WM recommends deleting this subsection.</p>



Item	Transportation Agreement Section	Topic	Description/Text	Comment/Proposed Alternative Language
8	12.2.4 12.2.5 12.2.7 12.2.9	Privileged Documents	These provisions would arguably require disclosure of confidential or privileged documents and communications.	These provisions should apply only to non-privileged, non-proprietary records. All references to "non-privileged, non-proprietary" records or documents should be clarified.
9	13.2(1) & (2)	Indemnification	<p>"Contractor must indemnify and hold Metro harmless from and against any and all claims, causes of action, demands, suits, damages, penalties, charges, judgments, liabilities, or losses of whatsoever character (all hereinafter referred to as "claims"). Contractor must also indemnify and hold Metro harmless from all expenses and costs arising from these claims including, but not limited to, attorneys' fees upon trial and upon appeal. These requirements apply to any and all claims or expenses allegedly or actually resulting result from (whether directly or indirectly):</p> <ol style="list-style-type: none"> <li>1. The performance or nonperformance of any provision or requirement of this Agreement by Contractor, its officers, employees, subcontractors, agents or servants;</li> <li>2. Any of the acts or omissions of Contractor, its officers, employees, subcontractors, agents or servants at any Metro transfer station or disposal site;"</li> </ol>	<p>The indemnification should apply only to claims arising from or relating to (1) a breach of the Agreement by the Contractor, or (2) the negligent or willful act or failure to act of the Contractor. As drafted, the indemnification is overly broad and could require the Contractor to indemnify Metro for claims that are no fault of the Contractor, but merely relate to the Agreement.</p> <p>WM recommends replacing subsections (1) and (2) with the following:</p> <ol style="list-style-type: none"> <li>1. The <b>breach</b> of any provision or requirement of this Agreement by Contractor, its officers, employees, subcontractors, agents or servants;</li> <li>2. Any of <b>the negligent or willful</b> acts or omissions of Contractor, its officers, employees, subcontractors, agents or servants at any Metro transfer station or disposal site;</li> </ol>





Item	Transportation Agreement Section	Topic	Description/Text	Comment/Proposed Alternative Language
10	13.2 (new)	Comparative Negligence		This agreement should include a provision expressly stating that the Contractor is responsible only to the extent that a claim arises from its fault. The indemnification should not include claims for damages to the extent that they arise from Metro's fault or other third party.
11	13.3(1) & (2)	Duty to Defend		See Comment above for Section 13.2(1) and 13.2(2).
12	13.3 (new)	Duty to Defend		See Comment above for Section 13.2 (new).
13	18.1	Termination & Right to Cure		We suggest the final Agreement consolidate and make consistent all conditions addressing breaches and cure periods. The Agreement contains inconsistent and conflicting references to breach and cure period, and cure after a Force Majeure event. See, e.g., Articles 16, 17, and 18, and Sections 4.1 and 4.3.
14	18.1	Default > 30 days	"Alternatively, for each and every event of default under sub-Article 17.1 and 17.3 that lasts longer than 30 days, Metro is entitled to terminate or suspend this Agreement immediately and without the necessity of notice to Contractor."	We suggest deleting this provision. It is inconsistent with other provisions that allow for a 10-day cure period after notice from Metro.



Item	Transportation Agreement Section	Topic	Description/Text	Comment/Proposed Alternative Language
15	18.5	Termination for Convenience	Notwithstanding any provision to the contrary in this Agreement, including Article 2 ("Term"), Metro has the right to terminate this Agreement at any time for convenience.	Please delete this section. To prepare for and implement the requirements of this Agreement, WM will invest significant capital and resources, all of which would be jeopardized if Metro is able to terminate the Agreement at any time for convenience. Furthermore, the cure period should allow either (1) completion of the cure within 10 days, or (2) commencement of the cure within 10 days if it is not reasonable to complete the cure within 10 days.
16	20.2.3 (1 of 2)	Termination for Force Majeure	"If an event or events of force majeure preclude Contractor's use of both its Primary and Back-Up Transport Systems, then Metro has the right, in its sole, reasonable discretion, to terminate this Agreement."	WM feels force majeure should not be a cause for termination of the Agreement by the very nature of force majeure. As such, please delete this provision. It fails to state the length of time that Contractor is unable to use its Transport System. And it undermines the very purpose of a force majeure clause - <i>i.e.</i> , excuse a party from performance if the party is unable to perform for reasons outside of its control.
17	20.2.3 (2 of 2)	Termination for Force Majeure	"Additionally, in the event that any single event of force majeure lasts longer than 45 days (including, but not limited to Contractor not being able to use its Primary Transport System), then Metro has the right, in its sole, reasonable discretion, to terminate this Agreement."	For the same reasons stated above, please clarify this provision. The 45-day period is too short and should be replaced with at least 6 months. Moreover, provided that the costs to Metro are no higher, the Agreement should not be subject to termination if the Contractor is providing the services, whether through its Back-Up Transport System or otherwise.



This page intentionally left blank





# Appendix 18: Consent of Surety Letter



Metro  
Property & Environmental Services Department  
600 NE Grand Avenue  
Portland, OR 97232-2736

Re: RFP 3396 Solid Waste Transport Services

January 24, 2018

We, Western Surety Company, as the surety company for Waste Management Disposal Services of Oregon, Inc. are familiar with the above referenced RFP Pre-Qualification Requirement as provided by our Principal. Having reviewed the submittal we could provide the indicated option for Waste Management Disposal Services of Oregon, Inc.:

- 1. Performance and Labor and Materials Payment bond in the amount of \$2,000,000 on the required forms
  - a. Bond limits for single projects \$50,000,000.00
  - b. Aggregate bond program \$100,000,000.00
  - c. Surety AM Best Rating A Excellent
  - d. Broker contact information Aon Risk Services Southwest, Inc., 5555 San Felipe, Suite 1500, Houston, Texas 77056 (832-476-6000)
  - e. Length of time with this surety company 15 Years +
  
- 2. Irrevocable Letter of Credit in the amount of \$1,000,000 in an acceptable format
  - a. Length of time with financial institution \_\_\_\_\_
  - b. Banker contact information \_\_\_\_\_

Final decision to provide above security is conditioned upon review of offered contract and is a matter between us and our client.

Sincerely,

Western Surety Company

Signature:   
Misty Wright, Attorney-in-Fact



# Western Surety Company

## POWER OF ATTORNEY APPOINTING INDIVIDUAL ATTORNEY-IN-FACT

Know All Men By These Presents, That WESTERN SURETY COMPANY, a South Dakota corporation, is a duly organized and existing corporation having its principal office in the City of Sioux Falls, and State of South Dakota, and that it does by virtue of the signature and seal herein affixed hereby make, constitute and appoint

**Lupe Tyler, Lisa A Ward, Wendy W Stuckey, Michael J Herrod, Nancy Thomas, Donna L Williams, Melissa L Fortier, Anoop Chawla Adlakha, Vanessa Dominguez, Misty Wright, Individually**

of Houston, TX, its true and lawful Attorney(s)-in-Fact with full power and authority hereby conferred to sign, seal and execute for and on its behalf bonds, undertakings and other obligatory instruments of similar nature

### - In Unlimited Amounts -

and to bind it thereby as fully and to the same extent as if such instruments were signed by a duly authorized officer of the corporation and all the acts of said Attorney, pursuant to the authority hereby given, are hereby ratified and confirmed.

This Power of Attorney is made and executed pursuant to and by authority of the By-Law printed on the reverse hereof, duly adopted, as indicated, by the shareholders of the corporation.

In Witness Whereof, WESTERN SURETY COMPANY has caused these presents to be signed by its Vice President and its corporate seal to be hereto affixed on this 17th day of July, 2017.



WESTERN SURETY COMPANY

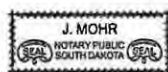
*Paul T. Bruflat*

Paul T. Bruflat, Vice President

State of South Dakota }  
County of Minnehaha } ss

On this 17th day of July, 2017, before me personally came Paul T. Bruflat, to me known, who, being by me duly sworn, did depose and say: that he resides in the City of Sioux Falls, State of South Dakota; that he is the Vice President of WESTERN SURETY COMPANY described in and which executed the above instrument; that he knows the seal of said corporation; that the seal affixed to the said instrument is such corporate seal; that it was so affixed pursuant to authority given by the Board of Directors of said corporation and that he signed his name thereto pursuant to like authority, and acknowledges same to be the act and deed of said corporation.

My commission expires  
June 23, 2021



*J. Mohr*

J. Mohr, Notary Public

### CERTIFICATE

I, L. Nelson, Assistant Secretary of WESTERN SURETY COMPANY do hereby certify that the Power of Attorney hereinabove set forth is still in force, and further certify that the By-Law of the corporation printed on the reverse hereof is still in force. In testimony whereof I have hereunto subscribed my name and affixed the seal of the said corporation this 24th day of January, 2018.



WESTERN SURETY COMPANY

*L. Nelson*

L. Nelson, Assistant Secretary

Form F4280-7-2012





This page intentionally left blank





March 2, 2018

Ms. Julie Hoffman, CPPB  
Metro Procurement Services  
Property and Environmental Services  
600 NE Grand Avenue  
Portland, Oregon 97232-2736

SUBJECT: Metro RFP 3396 Solid Waste Transport Services - WM follow up questions

*\*\* sent by email only \*\**

Dear Ms. Hoffman:

Thank you for the opportunity to answer follow up questions on Waste Management's (WM) proposal to **Metro's** RFP 3396 - Solid Waste Transport Services.

1. **On P6, your proposal states** *"Rail service will consist of two weekly dedicated trains carrying 85-90 double-stack well-cars/train with 170-180 40-foot intermodal containers (5,100-5,400 solid waste tons/train)." Since this indicates that waste must be stored at the Albina Yard in Portland for several days between rail transport of the containers, does WM or the UPRR have permitting to stage loaded containers of waste for this period of time at the Albina yard? If so, how does the permit read for loaded solid waste containers and how will WM mitigate odors during summer storage when the heat exceeds 90+ degrees Fahrenheit at those time? Provide supporting documentation. Also, what if there is an issue with rail that precludes the two weekly loads from moving? How much storage space do you have, and what is the contingency plan?*

WM understands there are no specific permits required for UPRR to store loaded containers of solid waste at the Albina railyard. Upon contract award, WM will work with UPRR to ensure all necessary permits, if any, for receiving, storing, and transloading loaded containers of solid waste are in place. WM does not anticipate that permitting will present any issues for using the Albina rail yard.

- Transloading of closed containers (containing other commodities/materials) from one mode of transportation to another is already allowed and occurring elsewhere at the Albina railyard.
- WM believes that the proposed rail transloading operations at the Albina railyard will be exempt from local permitting requirements because of federal preemption under the Interstate Commerce Commission Termination Act. See 49 USC § **10501(b)** ("The jurisdiction of the Board over ... transportation by rail carriers ... is exclusive."); see also *City of Auburn v. United States*, 154 F.3d 1025, 1031 (9th Cir. 1998) (ICCTA preempts state and local regulation of rail lines); *Albany & E. R.R. Co. v. Linn County*, **2013 U.S. Dist. LEXIS 65228 (D. Or. 2013)** ("it is well-established that transloading **qualifies as rail transportation.**"). WM anticipates no permitting issues for the temporary storage of loaded intermodal containers before rail transport.

Rail service between the Albina railyard and Columbia Ridge will be a closed-loop, dedicated unit-train operation. Our team will closely control equipment and scheduling to ensure rail equipment and containers arrive on time. The preliminary design for the Albina railyard includes 11,600 linear feet of track providing rail capacity to stage approximately 150 well-cars and management of approximately 300 containers directly on these well-cars in the rail yard. Each unit train will carry 85-90 double-stacked well-cars/train, or 170-180 intermodal containers/train.

After building one unit-train, the railyard will have additional, already staged well-car capacity to directly load another 120-130 containers to well-cars to begin building the next unit-train. This additional well-car staging capacity serves as a buffer until the next set of empty well-cars and containers are moved into the transload area, eliminating double handling of containers or placing containers on the ground. As noted on page 13, Table 2 of our proposal, 250 well-cars will be allocated to this contract, enough to build nearly three unit-trains. This ensures that as each unit-train leaves the Albina railyard, there will always be sufficient well-car and container inventory present at the Albina railyard to build the next unit-train. For extra short-term surge capacity, if needed, the railyard also has space to stage up to 96 chassis with containers, and open space to manage another several hundred stacked intermodal containers.

WM has nearly 30 years of experience moving municipal solid waste by rail using customized approaches that expeditiously move intermodal containers through the transportation system to the landfill. At the Albina railyard, we will use a First-In, First-Out (FIFO) approach to ensure containers are efficiently moved through the railyard. Using FIFO, odors will not be an issue due to the short one to three-day staging period. Odors are typically not an issue with sealed intermodal containers. For example, WM provides solid waste service to a municipality, using one unit-train each week and has had no odor issues.

We also invite Metro to visit our Columbia Ridge railyard to assess the lack of odors associated with inbound containers filled with municipal solid waste for generally three to six days. WM also commits to Metro that should rail transportation be delayed during warm weather periods for an extended time that may initiate odor issues, WM will proactively transport containers using an appropriate alternative contingency transportation method outlined below (i.e. #2, 3 or 4).

If short-term rail service delays occur between Portland and Columbia Ridge, WM will implement contingency transportation options to move solid waste from the transfer stations for disposal. Our contingency options include:

1. WM has allocated sufficient resources and space to stockpile several hundred containers at the Portland Albina railyard for a short duration.
2. WM will use Walsh to transport containers by truck directly to Columbia Ridge.
3. WM will use Tidewater to transport containers through the Tidewater Vancouver, Washington, terminal or the Tidewater Portland, Oregon, terminal (once constructed) to the Tidewater Boardman, Oregon, terminal for transport to Columbia Ridge.
4. WM will use Walsh to transport intermodal containers directly to other landfills.



2. **On P9 Operational Considerations. In the second paragraph, you state “less than 2 hour” transfer time between MCS and Albina yard. Provide ranges for travel time from both stations that consider light or heavy traffic.**

In developing our proposal, we captured 24-hour travel time plots for MSS to the Albina railyard and MCS to the Albina railyard. We assumed the reverse directions would be equivalent. The travel times calculated were based on using iPeMS (Iteris Performance Measurement System) speed data, averaged over three mid-week days in November 2017. Each plot provided the travel time that could be expected when beginning the trip over a 24-hour period. For example, MCS to the Albina railyard would take a little as 15-minutes during the night (when there is no traffic congestion on the system) to 31 minutes during the most heavily traveled PM peak hours. MSS to the Albina railyard would take about 28 minutes during the night, but could take upwards of 61 minutes during the AM and PM peak periods. We estimated the following road travel times:

MCS to the Albina railyard:

- Minimum Travel Time (7:00 PM to 5:00 AM) - Approximately 15 minutes (estimated 30 minutes round trip)
- Average travel time during light traffic periods (6:00 AM to 2:00 PM) - Approximately 18 minutes (estimated 36 minutes round trip)
- Average travel time during heavy traffic periods (3:00 PM to 6:00 PM) - Approximately 25 minutes (estimated 50 minutes round trip)
- Maximum Travel Time (PM Peak) - Approximately 31 minutes (estimated 62 minutes round trip)

MSS to the Albina railyard:

- Minimum Travel Time (7:00 PM to 5:00 AM) - Approximately 28 minutes (estimated 56 minutes round trip)
- Average travel time during light traffic periods (10:00 AM to 2:00 PM) - Approximately 35 minutes (estimated 70 minutes round trip)
- Average travel time during heavy traffic periods (6:00 AM to 9:00 AM and 3:00 PM to 6:00 PM) - approximately 50 - 55 minutes (100 - 110 minutes round trip)
- Maximum Travel Time (AM and PM Peak) - Approximately 61 minutes (estimated 122 minutes round trip)

Please see the attached 24-hour travel time plots for MCS and MSS captured in November 2017. Within these plots are minimum and maximum ranges, representing the reliability of the travel route. The larger the spread between the minimum and maximum lines, the more variability existing in the route time during that travel period. The spread is the greatest during the AM and PM peak travel periods when congestion on the system is the highest.

3. *On P11, Item 5, your proposal states, “in partnership with UPRR, will build a new intermodal operation”. What is the certainty that this will happen and what is your contingency plan if that fails to come to fruition?*

The WM team and our partners UPRR and Loup Logistics, are confident in our ability to build the rail transportation solution at the Albina railyard within the time frame needed to support Metro provided the timely execution of the contract. We are exclusively focused on the Albina railyard site and the unique opportunity to eliminate the high volume of solid waste long-haul trucks now travelling through the Columbia River Gorge National Scenic Area.

Over the past six months, WM has closely worked with UPRR and our rail engineering consultant to design the state-of-the-art solution in the preliminary design drawing included in our proposal Appendix 6. We have carefully developed and are confident in our implementation schedule provided in our proposal Appendix 4. UPRR has obtained **internal approvals and sign-off from all levels within their company to move forward with development once awarded this business.**

**Please see the attached** letter from UPRR and their wholly owned subsidiary Loup Logistics Company reinforcing their commitment to this contract.

4. *Under OSHA reportable incidents or accidents in the last five years involving transportation of solid waste material (page 19): In Table 8, what types of incidents occurred in 2017 and why do you think the rate of incidents climbed to 5 from 0 or 1 in previous years?*

The 2017 incidents were minor injuries related to soft tissue. Two injuries were to knees involving slip/fall incidents. The remaining three injuries involved the wrist and hand, and were related to overexertion. The recent rise in injuries can, in part, be explained by an increase in hiring at Columbia Ridge. Four of the five OSHA injuries involved employees with two or less years of seniority. In response, we have improved our New Employee Orientation Program and are now conducting this orientation at Columbia Ridge. Besides orientation upgrades, we have developed a new On the Job Training Program that all new operators must complete.

5. *On P39, your Pricing Input Form has a disclaimer above it (item 3.) citing “Price per container (excluding fuel and tipping)”. What is the pricing including fuel and tipping?*

In our Pricing Input Form, provided on P39 of our proposal, the Item (3) note should have stated more clearly that pricing **“includes fuel, and excludes the price for tipper operations and tipper fuel”**. This correction has been made to the pricing form on the next page.

The additional cost for tipping is provided in Item (6) at \$17.94/container and includes the cost of tipper fuel.

The total cost/container, including all fuel, is Item (3 or 3.a) plus Item (6).

Pricing Input Form for Waste Management (all pricing includes fuel)

1. Percent of CPI proposed: **Re 0%**
2. Guaranteed container capacity: 30.0 tons/container
3. Price per container (Column 3 pricing excludes the tipper operations cost found in Column 6)

Metro Transfer Station	3. Price per Container - Columbia Ridge	3.a Discount Price per Container - Columbia Ridge (based on selecting WM for both transfer stations)	4. Gallons of Fuel per Container*	5. Fuel Price per Gallon*	6. Tipper Price - Columbia Ridge (fuel included)
Central	Redacted				

\*Applies only to Walsh over the road fuel use in Portland.

Please let me know if you have other questions or need clarification about our proposal. You can reach me at 503.493.7831 or [dkampfer@wm.com](mailto:dkampfer@wm.com).

Waste Management looks forward to working with Metro during the solid waste transport services RFP process.

Sincerely,



Dean Kampfer  
Public Sector Manager

CC: Will Elder, Metro

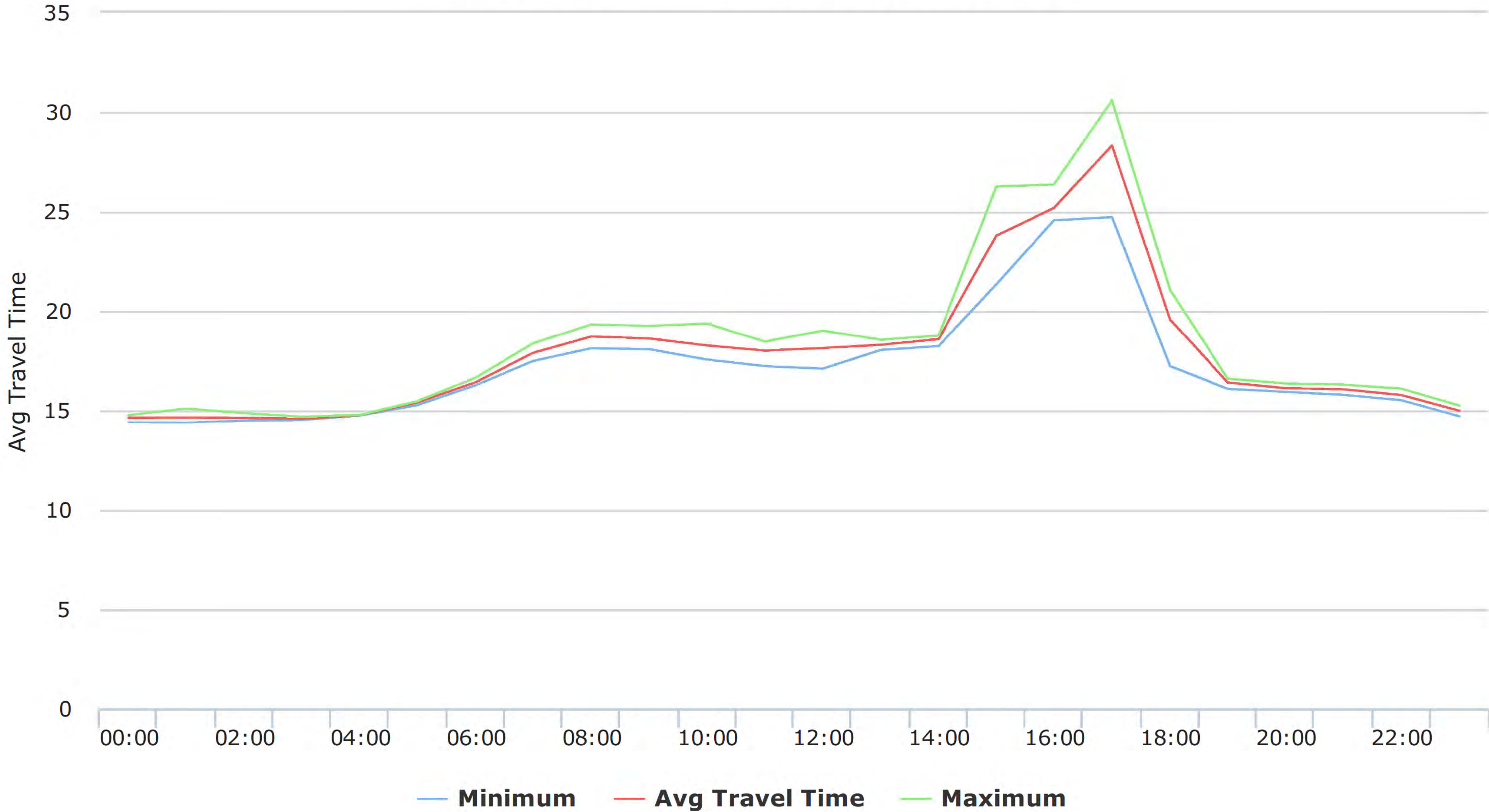
Attachments: Travel Time Plots for MCS  
Travel Time Plots for MSS  
UPRR and Loup Letter of Commitment



# Avg Travel Time

MCS to Albina Railyard (One-Way Plot)

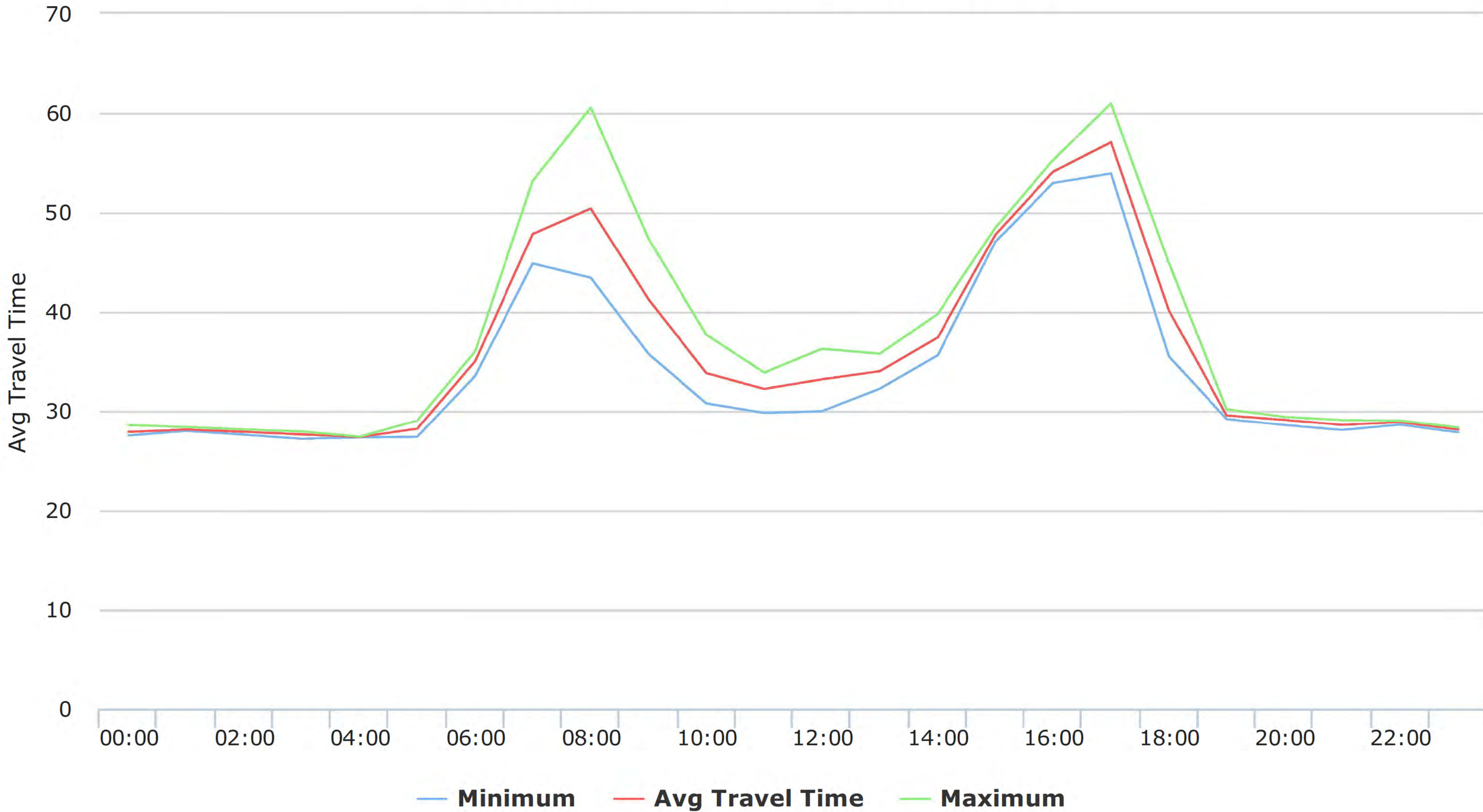
Tue 11/28/2017 to Thu 11/30/2017 (Days=Tu,We,Th)



# Avg Travel Time

MSS to Albina Railyard (One-Way Plot)

Tue 11/28/2017 to Thu 11/30/2017 (Days=Tu,We,Th)







**BUILDING AMERICA®**



March 1, 2018

Metro Procurement Services  
600 NE Grand Ave  
Portland, OR 97232-2736  
Attention: Ms. Julie Hoffman

RE: *Proposed Portland Solid Waste Rail Shipment Facility*

Dear Ms. Hoffman,

Union Pacific and its subsidiary company, Loup Logistics, are strongly committed to pursuing alongside Waste Management the contemplated project to transport loaded containers of municipal solid waste to Union Pacific's Albina yard in Portland, Oregon for further shipment by rail.

Union Pacific and Loup have evaluated and vetted this rail transportation opportunity. Both organizations, in their respective capacities as owner of the Albina yard and operator of the proposed rail facility, are thrilled to be involved in this important, future opportunity. We look forward to the potential for an efficient and safe rail option to assist in the transportation of Metro's municipal solid waste. Therefore, both Union Pacific and Loup Logistics support development of the rail facility, as proposed by Waste Management. Both organizations believe the January 1, 2020 operational start date for the rail facility is reasonable and achievable, assuming the timely processing and acceptance of the pending Waste Management proposal.

We appreciate the opportunity to be involved. We look forward to a successful rail facility project and eventual operation, joining Waste Management in service to Metro and the City of Portland.

Sincerely,

Jacqueline Bendon, AVP Industrial  
Union Pacific Railroad

Michael Coleman, Sr. Director Commercial Carload  
Loup Logistics