

Multi-Purpose Labels

PDC Healthcare offers a wide array of Laser Sheet Labels, Label & Tape Dispensers, Thermal Transfer Labels & Ribbons, and other multi-purpose labeling solutions to meet the needs of virtually any application.

Choose from a large selection of labeling products and ribbons that are fully compatible with your facility's existing printer system. Please use our cross-reference guides to match the right ribbon to the right application, based on your facility's printer model and label size.

If you cannot find stock labels that match your specific requirements, PDC Healthcare can customize any Laser Sheet Label, Dot Matrix Label, Direct Thermal Label or Thermal Transfer Label at an affordable price. PDC Healthcare can also custom design a label solution for your specialized software system or application.

Multi-Purpose Labels help healthcare organizations meet applicable patient safety regulatory guidelines, including:

- **The Joint Commission National Patient Safety Goals:** Identify Patients Correctly, Improve Staff Communication, Use Medicines Safely, Prevent Infection, Identify Patient Safety Risks, and Prevent Mistakes in Surgery.

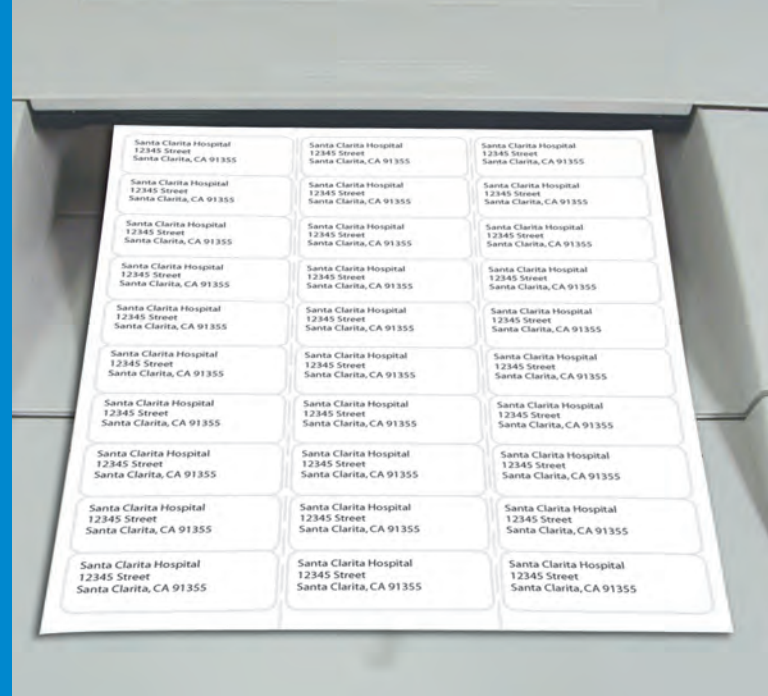
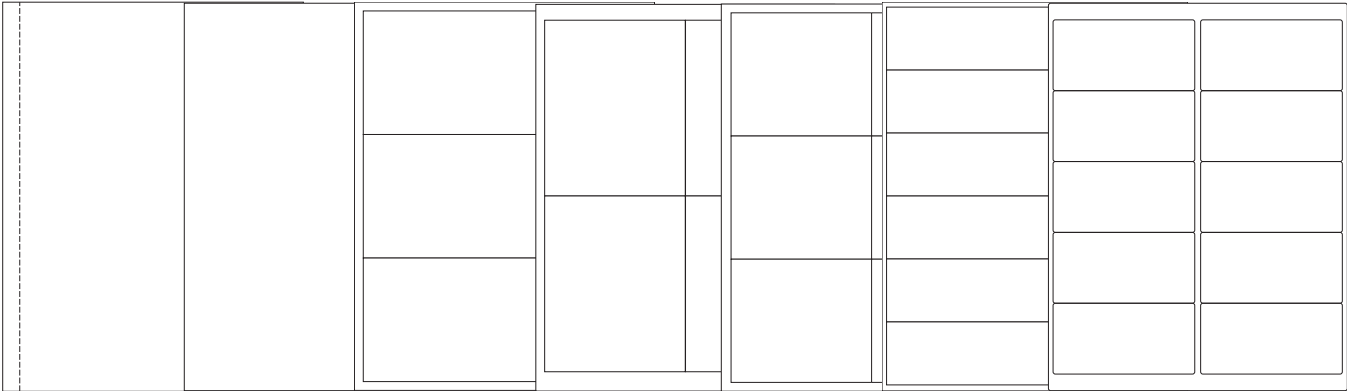

Table of Contents

Laser Sheet Labels	145
Direct Thermal Labels	146
Dot Matrix Labels.....	149
Thermal Transfer Ribbons	151
Thermal Transfer Labels	155
Label/Tape Dispensers.....	156
Time Tape®	157

Multi-Purpose Laser Labels



LS1302 LS11812 LS1305 LS54 LS3134 MZWHP01 DPSSL2-4-M

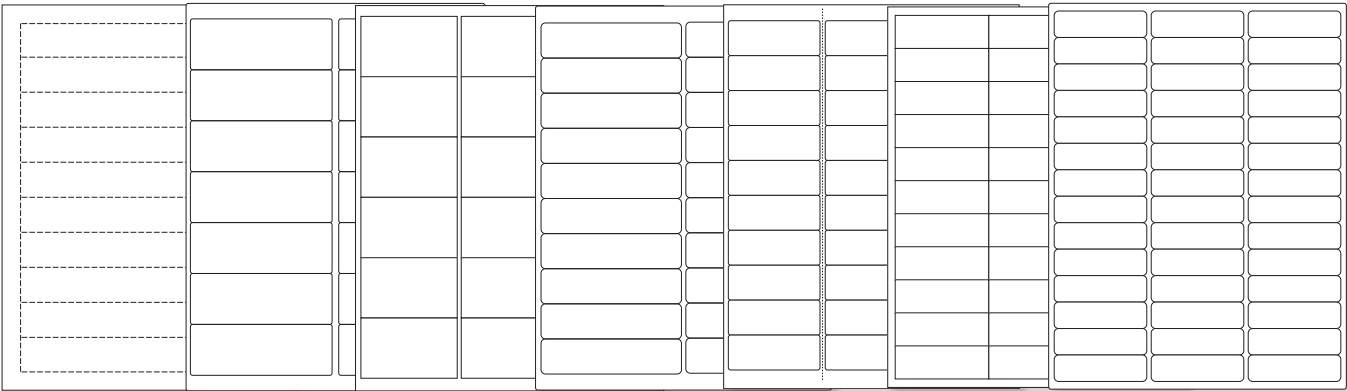

LS1300 DPSSL17-4 LS2515 DPSSL1-4-M DPSSL1-258
DPSSL1-258-MI DPSSL1-256 DPSSL34-258

MULTI-PURPOSE

Product Number	Label Size	Sheet Size	Labels/Sheet	Material/Adhesive	Sheets/Box
LS1302	8" x 11"	8-1/2" x 11"	1	Laser/Glove-Friendly Permanent	100
LS11812	8-1/2" x 11"		1		100
LS1305	8" x 3-1/2"		3		100
LS54	4" x 5"		4		100
LS3134	4" x 3-1/3"		6		100
MZWHP01	8-1/4" x 1-3/4"		6		100
DPSSL2-4-M	4" x 2"		10		100
LS1300	8" x 1"		10		100
DPSSL17-4	4" x 1-7/16"		14		100
LS2515	2-1/2" x 1-9/16"		18		1,000
DPSSL1-4-M	4" x 1"		20		1,000
DPSSL1-258	2-5/8" x 1"		30		100
DPSSL1-258-MI	2-5/8" x 1"		30		1,000
DPSSL1-256	2-5/6" x 1"		33		250
DPSSL34-258	2-5/8" x 3/4"		42		250
DPSSL78-78	7/8" x 7/8"		63		100
DPSSL12-2	2" x 1/2"		80		100
LS5167	1-3/4" x 1/2"		80		100

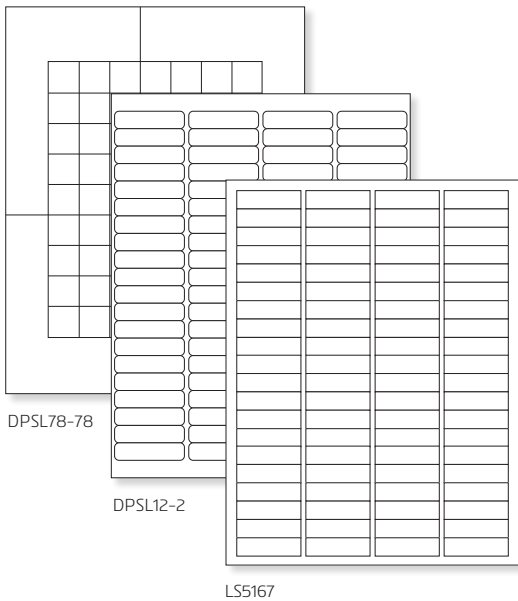

MULTI-PURPOSE DIRECT THERMAL LABELS

1" Core – Wound Out (Labels are on the outside of the roll)

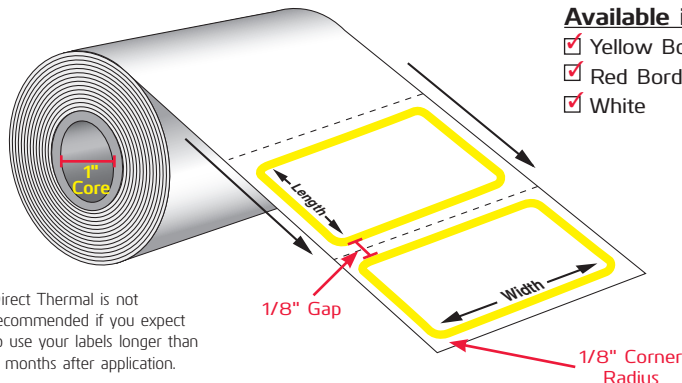

Direct Thermal is not recommended if you expect to use your labels longer than 6 months after application.

Available in:

- Yellow Border
- Red Border
- White



1" Core – for Eltron LP, TLP Series and other printers

- 1/8" corner radius
- Perforated, 1/8" gap between labels
- Maximum 4" outer diameter, fits printers using 1" cores and accepting 4" outer diameter rolls
- Glove-Friendly permanent or removable adhesive

DIRECT THERMAL – 1" Core					
Glove-Friendly PERMANENT ADHESIVE			REMOVABLE		Qty.
White – No Border	Red Border	Yellow Border	White – No Border	Size	
Product Number	Product Number	Product Number	Product Number		
THERMD16	THERMDRB16	THERMDYB16	THERMDR16	2" x 1"	1,300/RL – 8RLS/CS
THERMD17	THERMDRB17	THERMDYB17	–	2" x 1-1/2"	960/RL – 8RLS/CS
THERMD50	THERMDRB50	–	–	2" x 1-1/4"	1,300/RL
THERMD19	THERMDRB19	THERMDYB19	THERMDR19	2-1/2" x 1"	1,300/RL – 8RLS/CS
THERMD20	THERMDRB20	THERMDYB20	THERMDR20	2-1/2" x 1-1/2"	960/RL – 8RLS/CS
THERMD18	THERMDRB18	THERMDYB18	THERMDR18	2-1/4" x 1-1/4"	1,100/RL – 8RLS/CS
THERMD45	THERMDRB45	THERMDYB45	THERMDR45	2-3/4" x 2"	735/RL – 8RLS/CS
THERMD42	THERMDRB42	THERMDYB42	THERMDR42	3" x 1"	1,300/RL – 8RLS/CS
THERMD44	THERMDRB44	THERMDYB44	THERMDR44	3" x 1-1/2"	760/RL – 8RLS/CS
THERMD22	THERMDRB22	THERMDYB22	THERMDR22	3" x 2"	735/RL – 8RLS/CS
THERMD23	THERMDRB23	THERMDYB23	THERMDR23	3" x 3"	500/RL – 8RLS/CS
THERMD24	THERMDRB24	THERMDYB24	THERMDR24	3-1/2" x 1"	1,300/RL – 8RLS/CS
THERMD25	–	THERMDYB25	THERMDR25	3-1/2" x 1-1/2"	760/RL – 8RLS/CS
THERMD35	THERMDRB35	THERMDYB35	THERMDR35	4" x 1"	1,300/RL – 8RLS/CS
THERMD26	THERMDRB26	THERMDYB26	THERMDR26	4" x 1-1/2"	960/RL – 8RLS/CS
THERMD30	THERMDRB30	THERMDYB30	THERMDR30	4" x 1-1/4"	960/RL – 8RLS/CS
THERMD53	–	–	–	4" x 1-3/4"	1,200/RL – 8RLS/CS
THERMD27	THERMDRB27	THERMDYB27	THERMDR27	4" x 2"	735/RL – 8RLS/CS
THERMD28	THERMDRB28	THERMDYB28	THERMDR28	4" x 2-1/2"	600/RL – 8RLS/CS
THERMD31	THERMDRB31	THERMDYB31	THERMDR31	4" x 2-3/8"	600/RL – 8RLS/CS
THERMD29	THERMDRB29	THERMDYB29	THERMDR29	4" x 3"	500/RL – 8RLS/CS
THERMD49	–	–	–	4" x 6"	350/RL – 8RLS/CS

DON'T SEE THE EXACT LABEL YOU NEED?

Please call (800) 435-4242 for pricing on other label or core sizes.

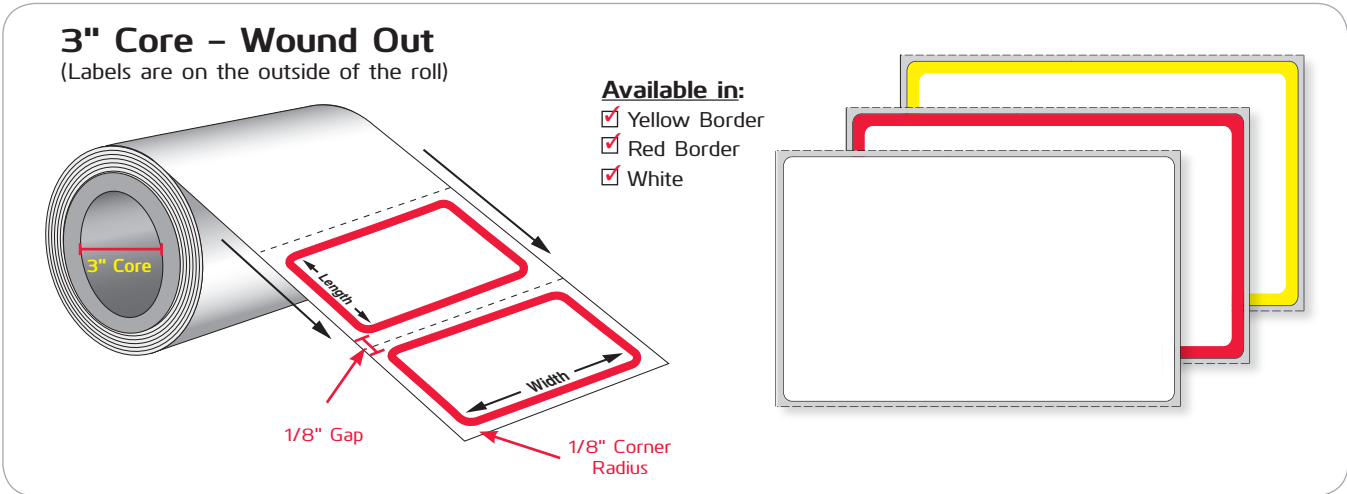

3" Core - for Zebra®, Intermec, Datamax® and other printers

- 1/8" corner radius
- Perforated, 1/8" gap between labels
- Maximum 8" outer diameter, fits printers using 3" cores and accepting 8" outer diameter rolls
- Glove-Friendly permanent or removable adhesive

DIRECT THERMAL - 3" Core					
Glove-Friendly PERMANENT ADHESIVE			REMOVABLE		Qty.
White - No Border	Red Border	Yellow Border	White - No Border	Size	
Product Number	Product Number	Product Number	Product Number		
THERMD3	THERMDRB3	THERMDYB3	THERMDR3	2" x 1"	5,000/RL - 8RLS/CS
THERMD46	THERMDRB46	THERMDYB46	THERMDR46	2" x 1-3/8"	3,500/RL - 8RLS/CS
THERMD4	THERMDRB4	THERMDYB4	THERMDR4	2" x 1-1/2"	3,500/RL - 8RLS/CS
THERMD5	THERMDRB5	-	THERMDR5	2-1/4" x 1-1/4"	4,000/RL - 8RLS/CS
THERMD2	THERMDRB2	THERMDYB2	THERMDR2	2-1/2" x 1"	5,000/RL - 8RLS/CS
THERMD6	THERMDRB6	THERMDYB6	THERMDR6	2-1/2" x 1-1/2"	3,500/RL - 8RLS/CS
THERMD7	THERMDRB7	THERMDYB7	THERMDR7	3" x 1"	5,000/RL - 8RLS/CS
THERMD37	THERMDRB37	THERMDYB37	THERMDR37	3" x 1-1/4"	4,000/RL - 8RLS/CS
THERMD8	THERMDRB8	THERMDYB8	THERMDR8	3" x 2"	2,500/RL - 8RLS/CS
THERMD9	THERMDRB9	THERMDYB9	THERMDR9	3" x 3"	1,500/RL - 8RLS/CS
THERMD14	THERMDRB14	THERMDYB14	THERMDR14	3-1/2" x 1"	5,000/RL - 8RLS/CS
THERMD15	THERMDRB15	THERMDYB15	THERMDR15	3-1/2" x 1-1/2"	3,500/RL - 8RLS/CS
THERMD36	THERMDRB36	THERMDYB36	THERMDR36	3-1/2" x 2"	2,500/RL - 8RLS/CS
THERMD43	THERMDRB43	THERMDYB43	THERMDR43	3-1/2" x 2-1/2"	2,000/RL - 8RLS/CS
THERMD41	THERMDRB41	THERMDYB41	THERMDR41	3-1/2" x 3-1/2"	1,500/RL - 8RLS/CS
THERMD38	THERMDRB38	THERMDYB38	THERMDR38	4" x 1"	5,000/RL - 8RLS/CS
THERMD32	-	THERMDYB32	THERMDR32	4" x 1-1/4"	4,000/RL - 8RLS/CS
THERMD10	THERMDRB10	THERMDYB10	THERMDR10	4" x 1-1/2"	3,500/RL - 8RLS/CS
THERMD11	THERMDRB11	THERMDYB11	THERMDR11	4" x 2"	2,500/RL - 8RLS/CS
THERMD12	-	THERMDYB12	THERMDR12	4" x 2-1/2"	2,000/RL - 8RLS/CS
THERMD13	THERMDRB13	THERMDYB13	THERMDR13	4" x 3"	1,500/RL - 8RLS/CS
THERMD39	THERMDRB39	THERMDYB39	THERMDR39	4" x 4"	1,500/RL - 8RLS/CS
THERMD48	-	-	-	4" x 6"	1,000/RL - 8RLS/CS

MULTI-PURPOSE

DIRECT THERMAL LABELS

Direct Thermal Labels

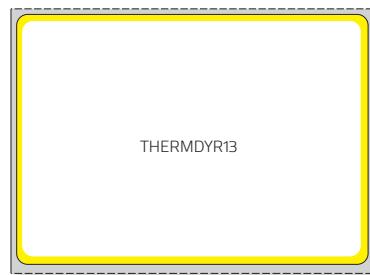
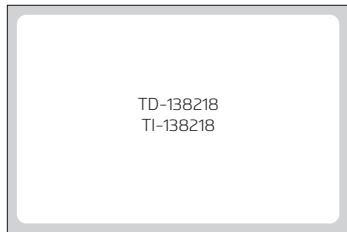

For more Direct Thermal Labels, see pages 146–147.

Product Number	Label Size	Carrier Width	Core Size	Wound	Color	Material/Adhesive	Qty.
TI-1212	1" x 2-1/2"	2-5/8"	3"	Out	White	Direct Thermal IR/Glove-Friendly Permanent	4,000/RL - 4RLS/BX
TI-12	2" x 1"	2-1/8"	3"	Out	White	Direct Thermal IR/Glove-Friendly Permanent	4,000/RL - 4RLS/BX
TD-1316218	2-1/8" x 1-3/16"	2-3/8"	3"	Out	White	Direct Thermal/Glove-Friendly Permanent	4,000/RL - 4RLS/BX
TD-138218	2-1/8" x 1-3/8"	2-1/4"	3"	Out	White	Direct Thermal/Glove-Friendly Permanent	4,000/RL - 5RLS/BX
TI-138218	2-1/8" x 1-3/8"	2-1/4"	3"	In	White	Direct Thermal IR/Glove-Friendly Permanent	4,000/RL - 5RLS/BX
THERMIRD19	2-1/2" x 1"	2-5/8"	1"	Out	White	Direct Thermal IR/Permanent	1,300/RL - 8RLS/CS
THERMDY43	3-1/2" x 2-1/2"	3-5/8"	3"	Out	Yellow	Direct Thermal/Glove-Friendly Permanent	2,000/RL - 8RLS/CS
THERMDR47	3-3/8" x 7/8"	3-1/2"	1"	Out	White	Direct Thermal/Removable	2,750/RL - 2RLS/CS
THERMDYR12	4" x 2-1/2"	4-1/8"	3"	Out	Yellow Border	Direct Thermal/Removable	2,000/RL - 8RLS/CS
THERMDYR13	4" x 3"	4-1/8"	3"	Out	Yellow Border	Direct Thermal/Removable	1,500/RL - 8RLS/CS

Thermal Cleaning Card

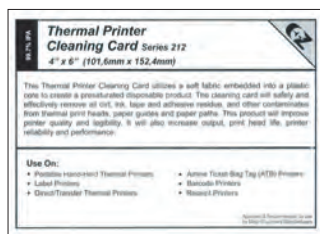

- Cleans built up dirt, adhesive and other debris
- An unclean printhead will lead to label jamming and printing void (blank printing area or line)
- Easy to use, prevents maintenance and replacement costs

Product Number	Card Size	Description	Qty.
CT4OPGB	4" x 6"	Thermal Clean Card	25/BX

EDP/Dot Matrix Labels

PDC Healthcare has a wide variety of labeling products in stock that are compatible with your Dot Matrix printers. These labels are designed for multi-purpose applications throughout your facility. PDC Healthcare can also custom design a label solution for your specialized software system or application.

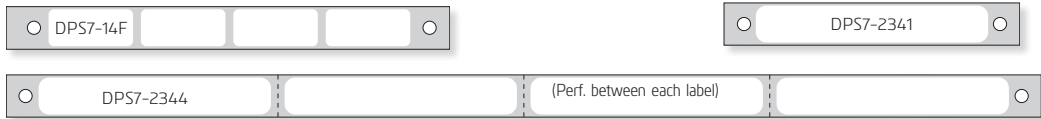

Product Number	Label Size	Carrier Width	Core Size	Material/Adhesive	Qty.
DPS7-14F	1" x 7/16"	5-1/4"	Fanfold/EDP	Smudgeproof Flexo/Permanent	25,000/BX
DPS7-2341	2-3/4" x 7/16"	3-1/2"		Smudgeproof Litho/Glove-Friendly Permanent	10,000/BX
DPS7-2344	2-3/4" x 7/16"	12-1/4"		Smudgeproof Litho/Glove-Friendly Permanent	40,000/BX

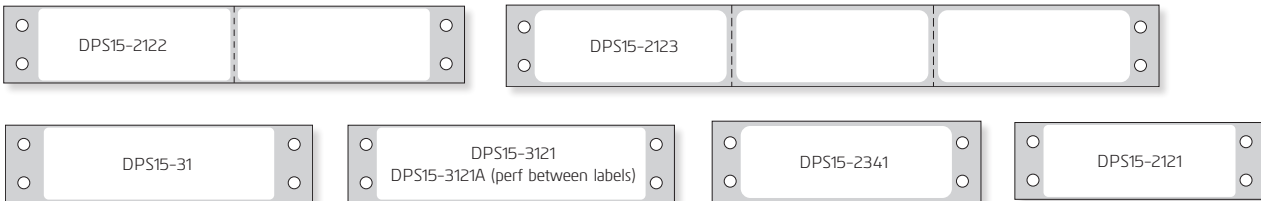

Product Number	Label Size	Carrier Width	Core Size	Material/Adhesive	Qty.
GDLT16	2" x 15/16"	2-3/4"	Fanfold/EDP	Smudgeproof Litho/Glove-Friendly Permanent	10,000/CS
DPS15-2121	2-1/2" x 15/16"	3-1/4"		Smudgeproof Litho/Glove-Friendly Permanent	5,000/BX
DPS15-2122	2-1/2" x 15/16"	6"		Smudgeproof Litho/Glove-Friendly Permanent	10,000/BX
DPS15-2123	2-1/2" x 15/16"	8-1/2"		Smudgeproof Litho/Glove-Friendly Permanent	15,000/BX
DPS15-2341	2-3/4" x 15/16"	3-1/2"		Smudgeproof Litho/Glove-Friendly Permanent	5,000/BX
DPS15-31	3" x 15/16"	4"		Smudgeproof Litho/Glove-Friendly Permanent	5,000/BX
DPS15-3121	3-1/2" x 15/16"	4-1/4"		Smudgeproof Litho/Glove-Friendly Permanent	5,000/BX
DPS15-3121A	3-1/2" x 15/16"	4-1/4"		Smudgeproof Litho/Glove-Friendly Permanent	5,000/BX
DPS15-3121FR	3-1/2" x 15/16"	4-1/2"		Smudgeproof Flexo/Removable	5,000/BX

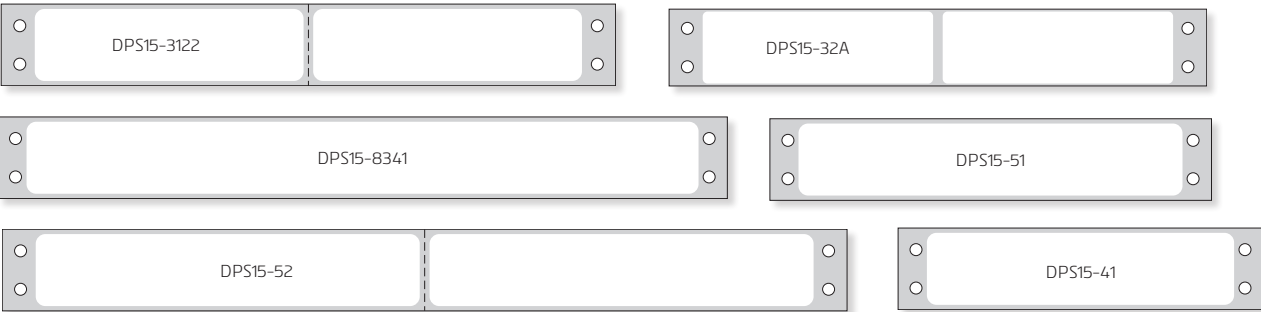
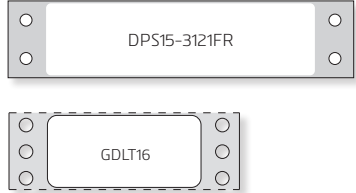

Product Number	Label Size	Carrier Width	Core Size	Material/Adhesive	Qty.
DPS15-32A	3" x 15/16"	7"	Fanfold/EDP	Smudgeproof Litho/Glove-Friendly Permanent	10,000/BX
DPS15-3122	3-1/2" x 15/16"	8"			10,000/BX
DPS15-41	4" x 15/16"	4-3/4"			5,000/BX
DPS15-51	5" x 15/16"	5-3/4"			5,000/BX
DPS15-52	5" x 15/16"	11"			10,000/BX
DPS15-8341	8-3/4" x 15/16"	9-1/2"			5,000/BX

MULTI-PURPOSE

DOT MATRIX LABELS

EDP/Dot Matrix Labels

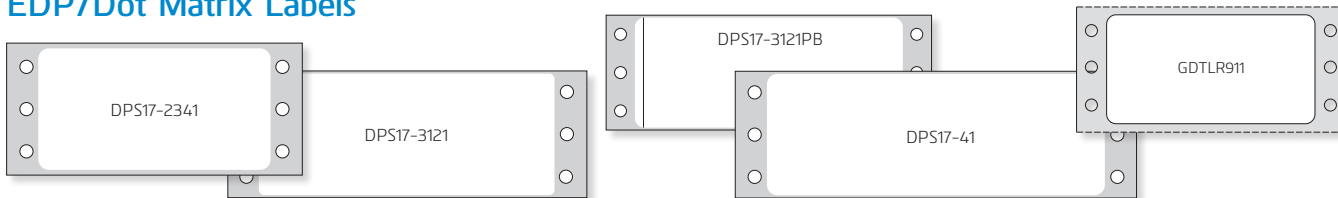

Product Number	Label Size	Carrier Width	Core Size	Material/Adhesive	Qty.
GDTLR911	2-3/4" x 1-7/16"	3-1/2"	Fanfold/EDP	Smudgeproof Litho/Removable	5,000/CS
DPS17-2341	2-3/4" x 1-7/16"	3-1/2"		Smudgeproof Litho/Glove-Friendly Permanent	5,000/BX
DPS17-3121	3-1/2" x 1-7/16"	4-1/4"		Smudgeproof Litho/Glove-Friendly Permanent	5,000/BX
DPS17-3121PB	3-1/2" x 1-7/16"	4-1/4"		Smudgeproof Litho Piggyback/Glove-Friendly Permanent	5,000/BX
DPS17-41	4" x 1-7/16"	4-3/4"		Smudgeproof Litho/Glove-Friendly Permanent	5,000/BX



Product Number	Label Size	Carrier Width	Core Size	Material/Adhesive	Qty.
DPS115-2341	2-3/4" x 1-15/16"	3-1/2"	Fanfold/EDP	Smudgeproof Litho/ Glove-Friendly Permanent	5,000/BX
DPS115-3121	3-1/2" x 1-15/16"	4-1/4"			
DPS115-41	4" x 1-15/16"	5"			
DPS115-51	5" x 1-15/16"	6"			

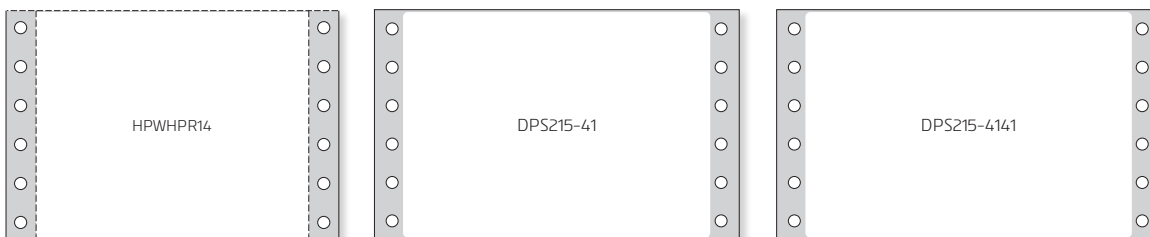

Product Number	Label Size	Carrier Width	Core Size	Material/Adhesive	Qty.
HPWHPR14	3-1/2" x 2-15/16"	4-1/2"	Fanfold/EDP	Smudgeproof Litho/Removable	2,500/CS
DPS215-41	4" x 2-15/16"	4-3/4"		Smudgeproof Litho/Glove-Friendly Permanent	2,500/BX
DPS215-4141	4-1/4" x 2-15/16"	5"		Smudgeproof Litho/Glove-Friendly Permanent	5,000/BX

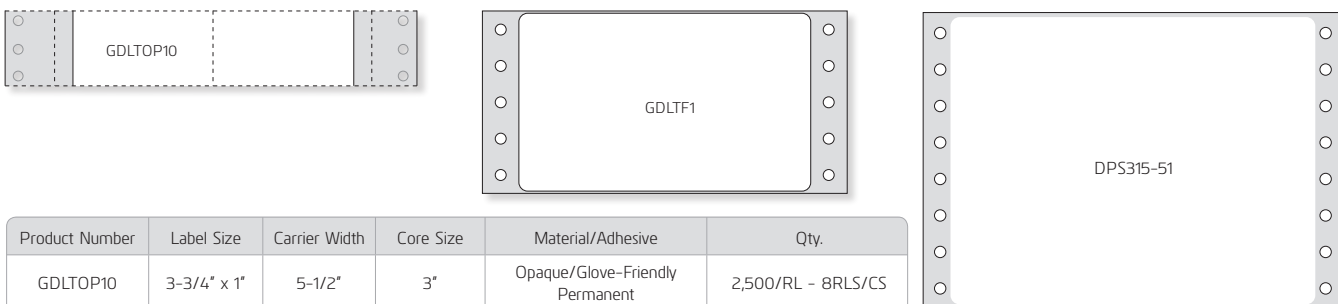

Product Number	Label Size	Carrier Width	Core Size	Material/Adhesive	Qty.
GDLTOP10	3-3/4" x 1"	5-1/2"	3"	Opaque/Glove-Friendly Permanent	2,500/RL - 8RLS/CS
GDLTF1	4" x 2-7/16"	4-3/4"	Fanfold/EDP	Smudgeproof Litho/ Glove-Friendly Permanent	5,000/BX
DPS315-51	5" x 3-15/16"	5-3/4"	Fanfold/EDP	Smudgeproof Litho/ Glove-Friendly Permanent	2,500/BX

What is the Thermal Transfer Advantage?

- The printed image is much more durable
- You will use lower energy settings on your equipment
- You can choose from a variety of colors
- All thermal transfer printing is IR scannable

PDC Healthcare offers different ribbon formulations to ensure that you have the best price/performance solution for every label application. Throughout the catalog there are a wide selection of pre-determined ribbon/label combinations to choose from. Below are a few additional guidelines to follow when matching the right ribbon for the right application.

Wax Ribbon Formulations

Our wax ribbons are well-suited for basic general purpose applications throughout your facility. These formulations work well with a variety of paper stocks and promote higher productivity.

- They are more cost effective
- Require a lower melting temperature
- Are well suited for shelf and bin labeling

Wax/Resin Ribbon Formulations

Premium wax/resin ribbons are well-suited for the demanding printing results needed in the Admissions, Laboratory and Pharmacy departments. These formulations are abrasion and solvent resistant, providing exceptional performance. They work well with a variety of paper stocks, including a variety of synthetics, and promote high-resolution printing.

- Moderately priced
- Perform well on moderate heat and steam applications
- Have excellent print quality for applications with longevity standard

Premium Resin

Our premium resin ribbons are well-suited for use with labels that are exposed to challenging applications such as heat, reagents and solvents. These well-rounded formulations perform under the difficult environments of your Laboratory, Pharmacy and Blood Bank.

- They are priced for performance
- Work best on the smooth surface of a synthetic stock
- Have excellent print quality for applications with longevity standards

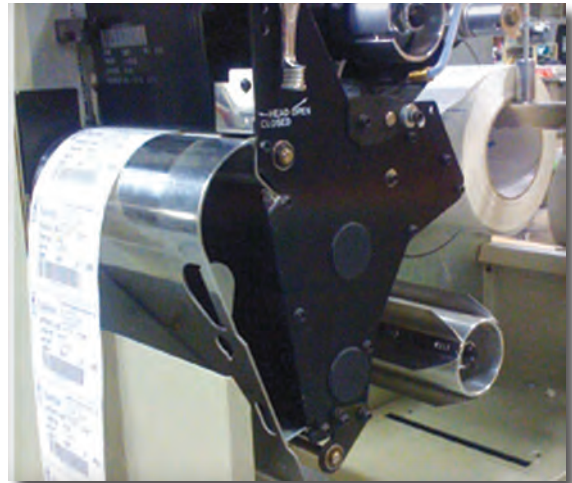

MULTI-PURPOSE

THERMAL TRANSFER RIBBONS



PDC Healthcare offers a variety of ribbon formulations to ensure optimal performance from your thermal printer, label stock and label applications. Listed below are our most popular ribbons based on the printer model and label size. PDC Healthcare offers a vast selection of additional ribbons. For the printers listed below and more, please contact your PDC Healthcare Sales Representative at (800) 435-4242 or visit www.pdchealthcare.com to match a ribbon to your label stock and thermal printer.

Fast Wax Ribbon

General Purpose Wax – Economy Wax

BENEFITS

- Reliable, solid-performing wax ribbon
- Prints at fast speeds
- Prints at energy levels well below most competitive wax ribbons
- Excellent print quality on uncoated label stocks
- Backcoat protects printhead

PRINTERS – Datamax/Fargo/Sato					
Product Number	Width Millimeters	Width Inches	Length Meters	Length Feet	Box Qty.
TTR-FFS076F1	76	2.99	360	1,181	6
TTR-FFS102F1	102	4.02			
TTR-FFS110F1	110	4.33			
PRINTERS – Datamax-Ovation, Ovation 2 & WinOvation					
TTR-FRD110FW	110	4.33	360	1,181	6
PRINTERS – Intermec 3400/3240/3440					
TTR-FID06428	64	2.52	153	502	6
TTR-FID10428	104	4.09			1
TTR-FID11428	114	4.49			6
PRINTERS – Intermec 4420/4440					
TTR-FID104FX	104	4.09	450	1,476	6
PRINTERS – Zebra – XI and Z					
TTR-FRD06028	60	2.36	300	984	6
TTR-FRD08028	80	3.15	300	984	
TTR-FRD080F1	80	3.15	450	1,476	
TTR-FRD083F1	83	3.27	450	1,476	
TTR-FRD089F1	89	3.50	450	1,476	
TTR-FRD09528	95	3.75	300	984	
TTR-FRD10228	102	4.02	300	984	
TTR-FRD102F1	102	4.02	450	1,476	
TTR-FRD10428	104	4.09	300	984	
TTR-FRD11028	110	4.33	300	984	
TTR-FRD15228	152	5.98	300	984	

GP725 Wax Ribbon

Resin Enhanced Wax – Capable and Cost Effective

BENEFITS

- Deep, dark bar codes, text and graphics
- Unbeatable performance at high speeds
- Prints on a wide range of substrates including coated, uncoated and some synthetic label stock
- Good durability, antistatic – ideal for RFID
- Guardian2 backcoat extends printhead life

PRINTERS – Datamax – I, M, W Class and, Prodigy-Max					
Product Number	Width Millimeters	Width Inches	Length Meters	Length Feet	Box Qty.
TTR-FGA03825	38	1.50	360	1,181	6
TTR-FGA05325	53	2.09			
TTR-FGA06425	64	2.52			
TTR-FGA11025	110	4.33			
PRINTERS – Intermec 3240					
TTR-FID07625	76	2.99	153	502	6
TTR-FID10425	104	4.09			
PRINTERS – Sato 8400/8450/M8400RV, XL400/410, CL408/412/608/612					
TTR-FST11075	110	4.33	410	1,345	6
PRINTERS – Zebra – XI and Z					
TTR-FRD06025	60	2.36	300	984	6
TTR-FRD06075	60	2.36	450	1,476	
TTR-FRD08375	83	3.27	450	1,476	
TTR-FRD08975	89	3.50	450	1,476	
TTR-FRD09575	95	3.75	450	1,476	
TTR-FRD10275	102	4.02	450	1,476	
TTR-FRD11025	110	4.33	300	984	
TTR-FRD11075	110	4.33	450	1,476	



Clean Start® makes cleaning effortless!

- A leading liner is built right into your thermal transfer ribbons to clean your printhead when you change your ribbon
- Non-abrasive – safe to use with every ribbon you load
- Fast and easy to use
- Maintains excellent print quality
- Prolongs printhead life
- Minimizes costly downtime

MULTI-PURPOSE THERMAL TRANSFER RIBBONS

High Mark Wax Ribbon

General Purpose – Added Durability

BENEFITS

- Prints at low heat settings
- Specially formulated backcoat protects printhead
- Outstanding print performance on coated stocks
- Offers higher durability than most wax formulas

PRINTERS – Datamax – I, M, W Class and, Prodigy-Max					
Product Number	Width Millimeters	Width Inches	Length Meters	Length Feet	Box Qty.
TTR-FGA076HM	76	2.99	360	1,181	6
TTR-FGA080HM	80	3.15			1
TTR-FGA089HM	89	3.50			6
TTR-FGA102HM	102	4.02			1
TTR-FGA114HM	114	4.49			6
PRINTERS – Datamax/Fargo/Sato					
TTR-FFS038F1	38	1.50	360	1,181	6
PRINTERS – Datamax-Ovation, Ovation 2 and WinOvation					
TTR-FGA064H5	64	2.52	110	360	6
PRINTERS – Eltron TLP 2242/2642/2742/3642					
TTR-FED083HM	83	3.27	91	300	6
TTR-FED110HM	110	4.33			1
PRINTERS – Eltron TLP					
TTR-FED1104H	110	4.33	74	243	6
PRINTERS – Intermec 3400/3240/3440					
TTR-FID104HM	104	4.09	153	502	1
TTR-FID104HP	104	4.09		502	6
TTR-FID10635	106	4.17	151	497	6
PRINTERS – Zebra – Intermec 4400					
TTR-FID064HM	64	2.52	457	1,499	6
TTR-FID091HM	91	3.58			6
TTR-FID106HM	106	4.17			1
PRINTERS – Zebra – Intermec 8646/3400					
TTR-FID07601	76	2.99	153	502	6
TTR-FID08301	83	3.27			
PRINTERS – Sato 8400/8450/M8400RV, XL400/410, CL408/412/608/612					
TTR-FST053HM	53	2.09	410	1,345	6
TTR-FST076HM	76	2.99			
PRINTERS – Zebra – XI and Z					
TTR-FRD060H3	60	2.36	300	984	1
TTR-FRD060HM	60	2.36	450	1,476	1
TTR-FRD064H3	64	2.52	300	984	6
TTR-FRD064HM	64	2.52	450	1,476	6
TTR-FRD076HM	76	2.99	450	1,476	1
TTR-FRD080H3	80	3.15	300	984	6
TTR-FRD080HM	80	3.15	450	1,476	6

PRINTERS – Zebra – XI and Z					
Product Number	Width Millimeters	Width Inches	Length Meters	Length Feet	Box Qty.
TTR-FRD089HM	89	3.50	450	1,476	6
TTR-FRD095H3	95	3.74	300	984	6
TTR-FRD095HM	95	3.75	450	1,476	1
TTR-FRD102H3	102	4.02	300	984	1
TTR-FRD102HM	102	4.02	450	1,476	6
TTR-FRD110H3	110	4.33	300	984	1
TTR-FRD110HM	110	4.33	450	1,476	6
TTR-FRD114H3	114	4.49	300	984	6
PRINTERS – Zebra – Eltron TLP2844					
TTR-FED0844H	83	3.31	74	242	36

Prime Mark Wax/Resin Ribbon

A Solid Performer on Semi-Gloss and Gloss Stock

BENEFITS

- Moderate scratch and smudge resistance
- Withstands multiple scans and rough handling
- Good quality when printing complex formats
- Specially formulated backcoat protects printhead

PRINTERS – Datamax – I, M, W Class and, Prodigy-Max					
Product Number	Width Millimeters	Width Inches	Length Meters	Length Feet	Box Qty.
TTR-FGA06455	64	2.52	360	1,181	6
TTR-FRA08955	89	3.50			
TTR-FRA10255	102	4.02			
PRINTERS – Eltron HT 146					
TTR-FED110PT	110	4.33	256	840	6
PRINTERS – Eltron TLP 2242/2642/2742/3642					
TTR-FED11050	110	4.33	91	298	6
PRINTERS – Intermec 3400/3240/3440					
TTR-FID076PM	76	2.99	153	502	6
TTR-FID104PM	104	4.09			
PRINTERS – Sato 8400/8450/M8400RV, XL400/410, CL408/412/608/612					
TTR-FST07655	76	2.99	410	1,345	6
TTR-FST11055	110	4.33			
PRINTERS – Zebra – XI and Z					
TTR-FRD04050	40	1.57	450	1,476	6
TTR-FRD06050	60	2.36		1,476	6
TTR-FRD08350	83	3.27		1,476	6
TTR-FRD08955	89	3.50		984	6
TTR-FRD10250	102	4.02		1,476	6
TTR-FRD11050	110	4.33		1,476	1
TTR-FRD16550	165	6.50		1,476	6

MULTI-PURPOSE

THERMAL TRANSFER RIBBONS

R2 Prime Wax/Resin Ribbon

Excellent Durability

BENEFITS

- Stands up to cleaners and mild chemicals
- Excellent scratch and smudge resistance
- Moderate level of steam resistance
- Well-suited for demanding labeling applications
- Backcoat protects printhead

PRINTERS - Datamax - I, M, W Class and Prodigy-Max					
Product Number	Width Millimeters	Width Inches	Length Meters	Length Feet	Box Qty.
TTR-FGA053RP	53	2.09	360	1,181	6
TTR-FGA102RP	102	4.02			
PRINTERS - Intermec 3400/3240/3440					
TTR-FID104RP	104	4.09	153	502	6
PRINTERS - Intermec 8646/3400					
TTR-FID07602	76	2.99	153	502	1
TTR-FID08302	83	3.27			
PRINTERS - Zebra - XI and Z					
TTR-FRD060RP	60	2.36	300	984	6
TTR-FRD102RP	102	4.02	300	984	
TTR-FRD110R2	110	4.33	450	1,476	

SP330 Resin Ribbon

Super Premium Resin - The Ultimate in Durability

BENEFITS

- Maximum durability for harsh labeling applications
- Highest level of resistance to abrasion, heat, steam and various chemicals
- Ideal for laboratory or central service
- Prints exceptionally on high-end synthetic labels
- Backcoat protects printhead

PRINTERS - Datamax - I, M, W Class and Prodigy-Max					
Product Number	Width Millimeters	Width Inches	Length Meters	Length Feet	Box Qty.
TTR-FGA03830	38	1.50	360	1,181	12
TTR-FGA06430	64	2.52			6
TTR-FGA08930	89	3.50			6
TTR-FGA10230	102	4.02			6
TTR-FGA11030	110	4.33			6
PRINTERS - Eltron TLP 2242/2642/2742/3642					
TTR-FED06430	64	2.52	91	298	6
PRINTERS - Intermec 3400/3240/3440					
TTR-FID10430	104	4.09	153	502	6
PRINTERS - Intermec 4400					
TTR-FID10630	106	4.17	457	1,499	6

PRINTERS - Intermec 8646/3400					
Product Number	Width Millimeters	Width Inches	Length Meters	Length Feet	Box Qty.
TTR-FID07604	76	2.99	153	502	12
TTR-FID08304	83	3.27			6
PRINTERS - Sato 8400/8450/M8400RV, XL400/410, CL408/412/608/612					
TTR-FST11030	110	4.33	410	1,345	6
PRINTERS - Zebra - XI and Z					
TTR-FRD04030	40	1.57	300	984	12
TTR-FRD04033	40	1.57	450	1,476	6
TTR-FRD06030	60	2.36	300	984	6
TTR-FRD08030	80	3.15	300	984	6
TTR-FRD08333	83	3.27	450	1,476	6
TTR-FRD08930	89	3.50	300	984	6
TTR-FRD08933	89	3.50	450	1,476	6
TTR-FRD10230	102	4.02	300	984	6
TTR-FRD10233	102	4.02	450	1,476	1
TTR-FRD11030	110	4.33	300	984	6
TTR-FRD11033	110	4.33	450	1,476	6

Calculating the Number of Ribbons Needed for a Label Order:

Formula:

Vertical Length of label + distance between labels (usually 1/8") x quantity of labels / 12" (to get ft.) / by length of ribbon (in ft.) = number of ribbons.

Example:

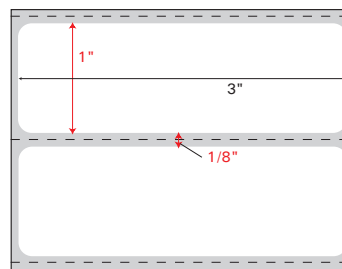

Calculate number of ribbons needed for 50,000 labels, 3" x 1" label with 1/8" between the labels. Ribbon size of 3-1/2" x 1,476'

SAMPLE DATA	1"	Label Length	
	+ .125"	Between Labels	
	= 1.125"	TOTAL Length	
	x 50,000	Number of Labels	
	= 56,250"	TOTAL in Inches	
	÷ 12	Divided by 12 to get feet	
= 4,688'	TOTAL in Feet		
÷ 1,476'	Divided by length of ribbon		
= 3.18 or 4	TOTAL # of Ribbons Needed (round up)		

Thermal Transfer Ribbon Storage Conditions

For optimal print results, thermal transfer printing should occur in the temperature range of 41°F to 95°F at 45% to 85% relative humidity. Suggested storage conditions for up to one year duration are 23°F to 104°F at 20% to 85% relative humidity. Exposing thermal transfer ribbons to direct sunlight or moisture will cause damage to the ribbons.

Multi-Purpose Thermal Transfer Label Solutions

These high-quality paper labels are ideal for many bar code labeling applications in your Healthcare facility. They are comprised of a white ultra smooth, absorbent paper facestock excellent for use in standard and high-speed thermal transfer printers. They feature superior printability and produce crisp bar codes and text. The adhesive can be applied to most surfaces and the label material is highly recommended for use when longevity is a requirement.



Ribbon Recommendation: A wax or resin enhanced wax ribbon is recommended for optimal print performance and results for paper labels. These ribbons and labels are well suited for basic general purpose applications. Resin ribbon is recommended for film labels where extra durability is needed.

Product Number	Label Size	Carrier Width	Core Size	Wound	Material/Adhesive	Qty.
THERMT52	2" x 1"	2-1/8"	1"	Out	Thermal Transfer/Glove-Friendly Permanent	1,300/RL - 8RLS/CS
TTR-42	2" x 4"	2-1/8"	3"	Out	Thermal Transfer/Glove-Friendly Permanent	1,450/RL - 6RLS/BX
THERMT18	2-1/4" x 1-1/4"	2-3/8"	1"	Out	Thermal Transfer/Glove-Friendly Permanent	1,100 RL - 8RLS/CS
THERMT21	2-1/2" x 1"	2-5/8"	3"	Out	Thermal Transfer/Glove-Friendly Permanent	5,000/RL - 8RLS/CS
THERMT22	2-1/2" x 1"	2-5/8"	3"	In	Thermal Transfer/Glove-Friendly Permanent	2,500/RL
THERMT6	2-1/2" x 1-1/2"	2-5/8"	3"	Out	Thermal Transfer/Glove-Friendly Permanent	3,500/RL - 8RLS/CS
TTR-114212	2-1/2" x 1-1/4"	2-5/8"	3"	Out	Thermal Transfer/Glove-Friendly Permanent	3,800/RL - 6RLS/BX
TTR-13	3" x 1"	3-1/8"	3"	Out	Thermal Transfer/Glove-Friendly Permanent	5,500/RL - 2RLS/BX
TTR-13Z	3" x 1"	3-1/8"	3"	Out	Thermal Transfer/Glove-Friendly Permanent	2,500/RL - 4RLS/BX
THERMT57	3" x 1"	3-1/8"	3"	Out	Thermal Transfer Synthetic/Glove-Friendly Permanent	5,000/RL
THERMT60	3" x 1"	3-1/8"	1"	Out	Thermal Transfer/Glove-Friendly Permanent	1,300/RL - 8RLS/CS
THERMT8	3" x 2"	3-1/8"	3"	Out	Thermal Transfer/Glove-Friendly Permanent	2,500 RL - 8RLS/CS
THERMT20	3-1/2" x 1"	3-5/8"	3"	Out	Thermal Transfer/Glove-Friendly Permanent	5,000/RL - 8RLS/CS
ATWHP02	3-1/2" x 1"	3-5/8"	3"	Out	Thermal Transfer/Glove-Friendly Permanent	5,000/RL
THERMT50	3-1/2" x 1"	3-5/8"	1"	Out	Thermal Transfer/Glove-Friendly Permanent	1,300/RL - 8RLS/CS
DPTT-112312	3-1/2" x 1-1/2"	3-5/8"	3"	Out	Thermal Transfer/Glove-Friendly Permanent	4,000/RL - 3RLS/CS
THERMT39	3-1/2" x 2-1/2"	3-5/8"	3"	Out	Thermal Transfer/Glove-Friendly Permanent	2,000/RL - 8RLS/CS
TT-RAD1X4	4" x 1"	4-1/8"	3"	Out	Thermal Transfer/Glove-Friendly Permanent	5,000/RL - 2RLS/BX
THERMT10	4" x 1-1/2"	4-1/8"	3"	Out	Thermal Transfer/Glove-Friendly Permanent	3,500/RL - 8RLS/CS
THERMT41	4" x 1-1/2"	4-1/8"	1"	Out	Thermal Transfer/Glove-Friendly Permanent	760/RL - 8RLS/CS
LMEDR21*	4" x 2"	4-1/8"	3"	Out	Thermal Transfer/Glove-Friendly Permanent	2,800/RL
THERMT11	4" x 2"	4-1/8"	3"	Out	Thermal Transfer/Glove-Friendly Permanent	2,500/RL - 8RLS/CS
THERMT15	4" x 2-3/8"	4-1/8"	3"	Out	Thermal Transfer/Glove-Friendly Permanent	2,500/RL - 8RLS/CS
THERMT12	4" x 2-1/2"	4-1/8"	3"	Out	Thermal Transfer/Glove-Friendly Permanent	2,000/RL - 8RLS/CS
THERMT13	4" x 3"	4-1/8"	3"	Out	Thermal Transfer/Glove-Friendly Permanent	1,500/RL - 8RLS/CS
THERMT17	4" x 4"	4-1/8"	3"	Out	Thermal Transfer/Glove-Friendly Permanent	1,000/RL - 8RLS/CS

*LMEDR21 has a horizontal perf

Ribbon and Label Combinations



Product Number	Size	Core Size	Material/Adhesive	Qty.
TTRS-1124A	4" x 1-1/2"	3"	Thermal Transfer Synthetic/ Glove-Friendly Permanent	3,600/RL-2RLS/BX
TTR-FRD10233	4.02" x 1,476'	-	Premium Resin Ribbon	1/BX

MULTI-PURPOSE

LABEL / TAPE DISPENSERS

Single and Multiple Roll Plastic Dispensers

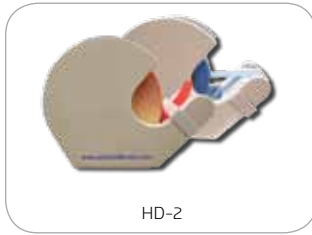

Product Number	Description
HD-2	Plastic hand-held tape and label dispenser. Holds a variety of tape and/or label products up to a total of 1-1/8". Includes 2 spacers and a plastic clip to lock dispenser. Can be used as a single or multiple roll dispenser with pre-dispensing label mode. Size: 1-7/8"W x 3-1/2" H x 4-1/2"D
1052P-B	Plastic label dispenser that can hold multiple rolls up to a total of 8-1/2". Includes inserts, hanging bars and bottom suction cups for secure placement. Size: 9"W x 4-5/8" H x 6"D
500P	Plastic label dispenser that can hold multiple rolls of tape and label products up to a total of 9". For rolls with 1" cores. Holds up to eleven 1/2" rolls. Includes flip-top cover and bottom suction cups for secure placement. Size: 9-7/8"W x 3-3/8"H x 4-1/2"D
500P-LBL-INS	Insert slots for the 500P dispenser.
60P	Plastic label dispenser that can hold multiple rolls of tape and label products up to a total of 9-1/4". For rolls with 3" cores. Includes flip-top cover and bottom suction cups for secure placement. Size: 9-13/16"W x 6"H x 7-1/4"D
3161	Weighted plastic dispenser. Adjustable for rolls with 1" or 3" cores - 1/2", 3/4" and 1" widths. Size: 3-1/2"W x 3-1/4"H x 7-3/4"D
500P-LAN	Plastic label dispenser that can hold 15 rolls of Anesthesia tape or label products. Includes inserts, hanging bars and bottom suction cups for secure placement. Meant for tape and label products. Size: 2-1/2"W x 3-1/2"H x 4-1/2"D.
500P-LAN-LBL	Plastic label dispenser that can hold 15 rolls of Anesthesia label products. Includes inserts, hanging bars and bottom suction cups for secure placement. For label products only. Size: 12-1/2"W x 3-1/2"H x 4-1/2"D.
DPL-SP1	Clear plastic dispenser for labels. Can hold up to a total of 13". Size: 13-1/2"W x 4-1/2"H x 4-3/4"D
DSP-10W	Metal dispenser can be wall mounted. Holds up to eleven 1/2" rolls. Quick change arms lift up to replace rolls independently. Size: 18"W x 3"H x 8-1/2"D
DPM-16	Metal tape dispenser that is divided into 4 sections. Can hold up to 16 rolls of 1/2" wide tape. Size: 12-1/4"W x 3-5/16"H x 5"D
DSP-HC10	Clear plastic dispenser for labels only. Can hold up to ten 1/2" rolls, and includes 9 removable dividers. Size: 8-1/4"W x 5"H x 5-1/2"D

Time Tape®

Time Tape® —
the toughest, most
reliable labeling tape in
the industry!

Stock Time Tape® 500" Rolls

Stock Time Tape® in 500" Rolls - Available in the 18 stock colors shown below			
Product Number	Tape Width	Core Size	Qty.
T-512	1/2"	1"	500*/RL
T-534	3/4"		
T-501	1"		
T-5112	1-1/2"		
T-502	2"		

Stock Time Tape® 2160" Rolls

Stock Time Tape® in 2160" Rolls - Available in the 18 stock colors shown below			
Product Number	Tape Width	Core Size	Qty.
T-1260	1/2"	3"	2160*/RL
T-3460	3/4"		
T-160	1"		
T-11260	1-1/2"		
T-260	2"		



To order, add the "color number" to the end of the product number. For example, 1/2" x 500" in green is T-512-3.

Time Tape®, 500" Rainbow Packs

Stock Time Tape® in 500" Rolls - Rainbow Pack			
Product Number	Tape Width	Colors per Box	Box Qty.
T-512-RP	1/2"	(5) White, (4) Yellow, (3) Blue, (3) Green, (3) Orange, (3) Red, (3) Pink	24 Rolls
T-534-RP	3/4"	(4) White, (2) Yellow, (2) Blue, (2) Green, (2) Orange, (2) Red, (2) Pink	16 Rolls
T-501-RP	1"	(2) White, (2) Yellow, (2) Blue, (2) Green, (1) Orange, (2) Red, (1) Pink	12 Rolls

Time Tape® is also available in a convenient Rainbow Pack, which contains assorted rolls of 500" tape. The Rainbow Pack is available in three widths and priced per box. Order in full box quantities.

CUSTOM COLORS

Time Tape® can also be manufactured to match your specific color requirements. When ordering custom imprinted Time Tape®, please specify the following:

1) Length of the roll and quantity:

<input type="checkbox"/> 500" <input type="checkbox"/> 2160"	1/2" W	3/4" W	1" W	1-1/2" W	2" W
Minimum Qty. (500")	24	24	24	24	24
Minimum Qty. (2,160")	12	8	6	8	6

2) Width of the roll:

1/2" 3/4" 1" 1-1/2" 2"

3) Repeat length of the imprint:

Repeat length is the distance from the beginning of one imprint to the beginning of the next imprint.

REPEAT REPEAT REPE
(The repeat length is = 1-1/2")

4) Exact wording needed:

For best results, include a sample or a sketch

5) Tape Color:

Choose from one of the 18 colors shown above.

6) Color Matching:

Any color not selected from the 18 shown above is subject to a \$25.00 ink matching charge. Add 20% for each additional imprint ink color.

YOUR IMPRINT HERE

7) Reverse Plates:

When a light colored type on a dark background is needed, there is an additional 25% tinting charge.

8) Perforation:

Add an additional 10% to the tape price for perforations between imprints.

9) Special Logos:

Custom logos or unique graphics/type are subject to an additional plate charge of \$35.00 for one color and \$50.00 for two colors.

10) Proof:

Upon written request with your purchase order, we will supply a one-color proof of your label. This proof must be returned within 30 days with your approval before the order can be processed. Proof orders that are cancelled will be billed for all production charges incurred prior to cancellation.

Call your PDC Healthcare representative at
(800) 435-4242 for more details.