

# PERI Rental Criteria

## PERI UP Fassade Scaffold



**Contact**

**PERI GmbH**  
**Formwork Scaffolding**  
**Engineering**  
 P.O. Box 1264  
 89264 Weissenhorn, Germany  
 Phone +49 (0) 7309.950-0  
 Fax +49 (0) 7309.951-0  
 rental-criteria@peri.de

Content	Page	Changes made	Date   Initial	Page
Decking UDS	2	New Version	03/2017   fw	
Decking Gap Filler	7			
Frames	9			
Access Deck UAL	24			
Toeboard Wood UPT-3	29			
Guard Rail	31			
Glossary	35			

# PERI Rental Criteria

## PERI UP Fassade Scaffold



### Steel Deck UDS

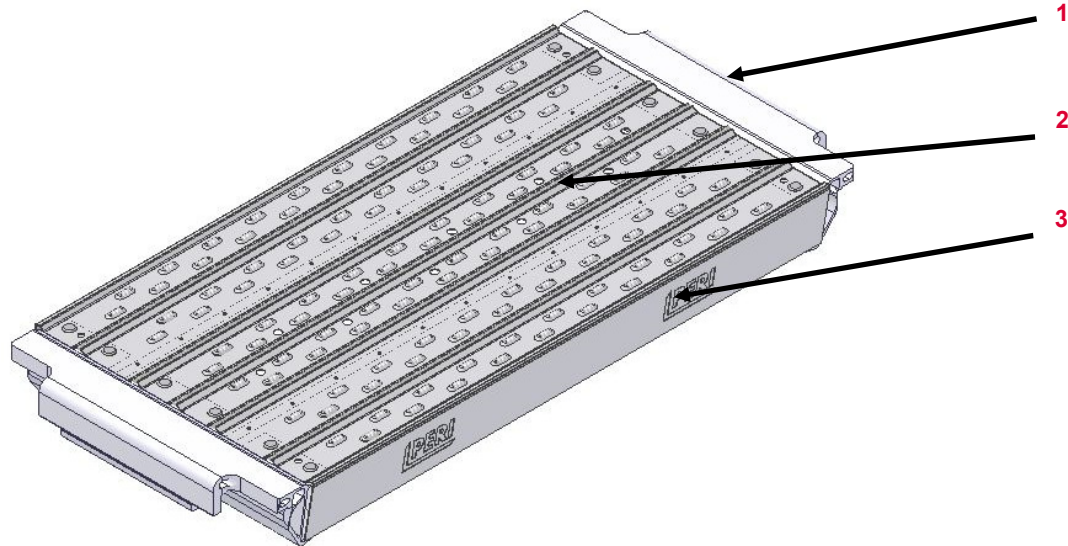















Nr.	Description	Article number
1	Hinge	
2	Decking	
3	Side profile	

Valid for	Article Numer
Steel Deck 32x72	100488
Steel Deck 32x104	100486
Steel Deck 32x150	100355
Steel Deck 32x200	100373
Steel Deck 32x250	100375
Steel Deck 32x300	100377
Steel Deck 32x400	100820

# PERI Rental Criteria

## PERI UP Fassade Scaffold











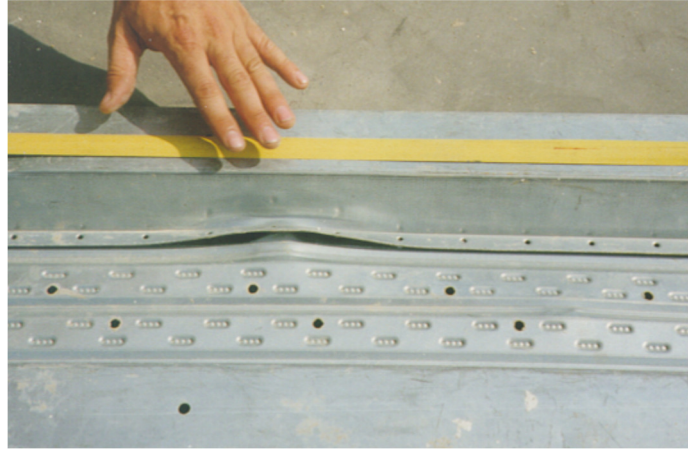





Steel Deck UDS	Description	Instruction	Billing condition	Type
	<p><b>33.20.01 Local dent in Side profile</b></p> <ul style="list-style-type: none"> <li>■ No deformation of Tox-connection</li> </ul>	 		
	<p><b>33.20.02 Sideway dent in side profile</b></p> <ul style="list-style-type: none"> <li>■ Insertion of decking easily possible</li> </ul>	 		
	<p><b>33.20.03 Dent in end of decking</b></p>			

# PERI Rental Criteria

## PERI UP Fassade Scaffold

























Steel Deck UDS	Description	Instruction	Billing condition	Type
	<p><b>33.20.04 Dent in decking surface</b></p> <ul style="list-style-type: none"> <li>■ &gt; 10 mm</li> <li>■ Or Tox-connection damaged</li> </ul>	<ul style="list-style-type: none"> <li>■ &gt; 10 mm:  </li> <li>■ Or Tox-connection damaged:  </li> </ul>	<ul style="list-style-type: none"> <li>■ &gt; 10 mm: </li> <li>■ Or Tox-connection damaged: </li> </ul>	<ul style="list-style-type: none"> <li>■ &gt; 10 mm: </li> <li>■ Or Tox-connection damaged: </li> </ul>
	<p><b>33.20.05 Dent in side of decking</b></p> <ul style="list-style-type: none"> <li>■ &gt; 10 mm</li> </ul>	<ul style="list-style-type: none"> <li>■ &gt; 10 mm:  </li> </ul>	<ul style="list-style-type: none"> <li>■ &gt; 10 mm: </li> </ul>	<ul style="list-style-type: none"> <li>■ &gt; 10 mm: </li> </ul>

# PERI Rental Criteria

## PERI UP Fassade Scaffold













Steel Deck UDS	Description	Instruction	Billing condition	Type
	<p><b>33.20.06 Hole in decking</b></p> <ul style="list-style-type: none"> <li>■ <math>\leq 10</math> mm and rib undamaged</li> <li>■ Or <math>&gt; 10</math> mm</li> <li>■ Or rib damaged</li> </ul>	<ul style="list-style-type: none"> <li>   </li> <li>   </li> </ul>	<ul style="list-style-type: none"> <li>  </li> <li>  </li> </ul>	<ul style="list-style-type: none"> <li>  </li> <li>  </li> </ul>
	<p><b>33.20.07 Welded holes in decking</b></p> <ul style="list-style-type: none"> <li>■ <math>\leq \varnothing 25</math> mm</li> <li>■ Or profile affected</li> <li>■ Or rib affected</li> </ul>	<ul style="list-style-type: none"> <li>   </li> <li>   </li> </ul>	<ul style="list-style-type: none"> <li>  </li> <li>  </li> </ul>	<ul style="list-style-type: none"> <li>  </li> <li>  </li> </ul>
	<p><b>33.20.08 Rusty surface</b></p> <ul style="list-style-type: none"> <li>■ Rust just on surface level</li> </ul>	<ul style="list-style-type: none"> <li>  </li> </ul>	<ul style="list-style-type: none"> <li>  </li> </ul>	<ul style="list-style-type: none"> <li>  </li> </ul>

# PERI Rental Criteria

## PERI UP Fassade Scaffold



Steel Deck UDS	Description	Instruction	Billing condition	Type
	<p><b>33.20.09 Broken   Missing rivet</b></p>			
	<p><b>33.20.10 Bracket of lifting protection</b></p> <ul style="list-style-type: none"> <li>■ Bent</li> <li>■ Or broken</li> </ul>	<ul style="list-style-type: none"> <li></li> <li></li> </ul>	<ul style="list-style-type: none"> <li></li> <li> 089008 089009 (72, 104)</li> </ul>	<ul style="list-style-type: none"> <li></li> <li></li> </ul>

# PERI Rental Criteria

## PERI UP Fassade Scaffold



Decking Gap Filler UD	Nr.	Description	Article number
-----------------------	-----	-------------	----------------

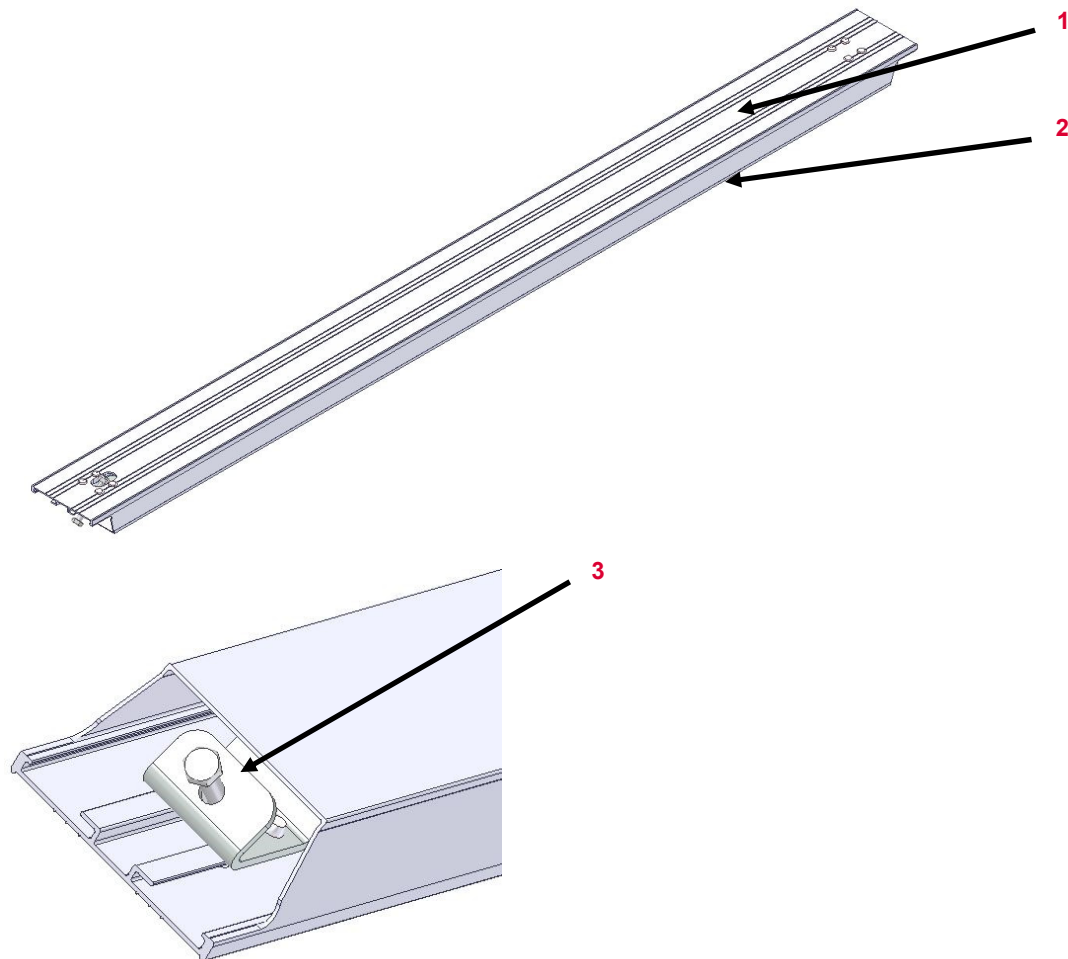









- |   |               |
|---|---------------|
| 1 | Decking       |
| 2 | Bottom side   |
| 3 | Sheet gap bar |

Valid for	Item number
Decking Gap UD 7/150	101360
Decking Gap UD 7/200	101372
Decking Gap UD 7/250	101373
Decking Gap UD 7/300	101375
Decking Gap UD 11/150	101394
Decking Gap UD 11/200	101378
Decking Gap UD 11/250	101379
Decking Gap UD 11/300	101381

# PERI Rental Criteria

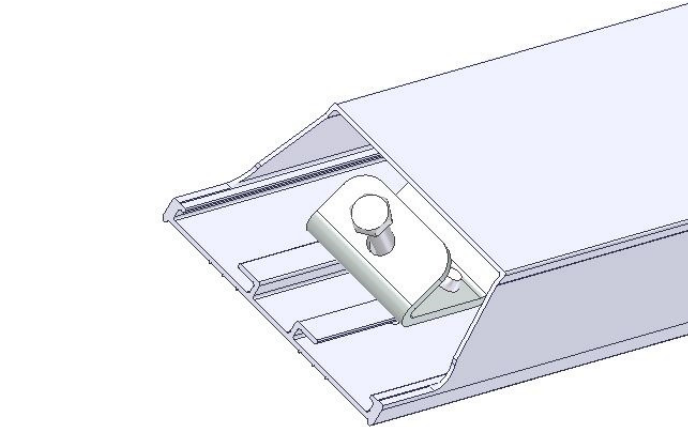
## PERI UP Fassade Scaffold



Decking Gap Filler	Description	Instruction	Billing condition	Type
	<p><b>33.20.11 Deformation of decking gap bar</b></p> <ul style="list-style-type: none"> <li>■ Insertion of decking gap impossible</li> </ul>			
	<p><b>33.20.12 Sheet of decking bar deformed   missing</b></p>			



# PERI Rental Criteria

## PERI UP Fassade Scaffold



### Base Frame UVF | T- Frame UVT | L- Frame UVL

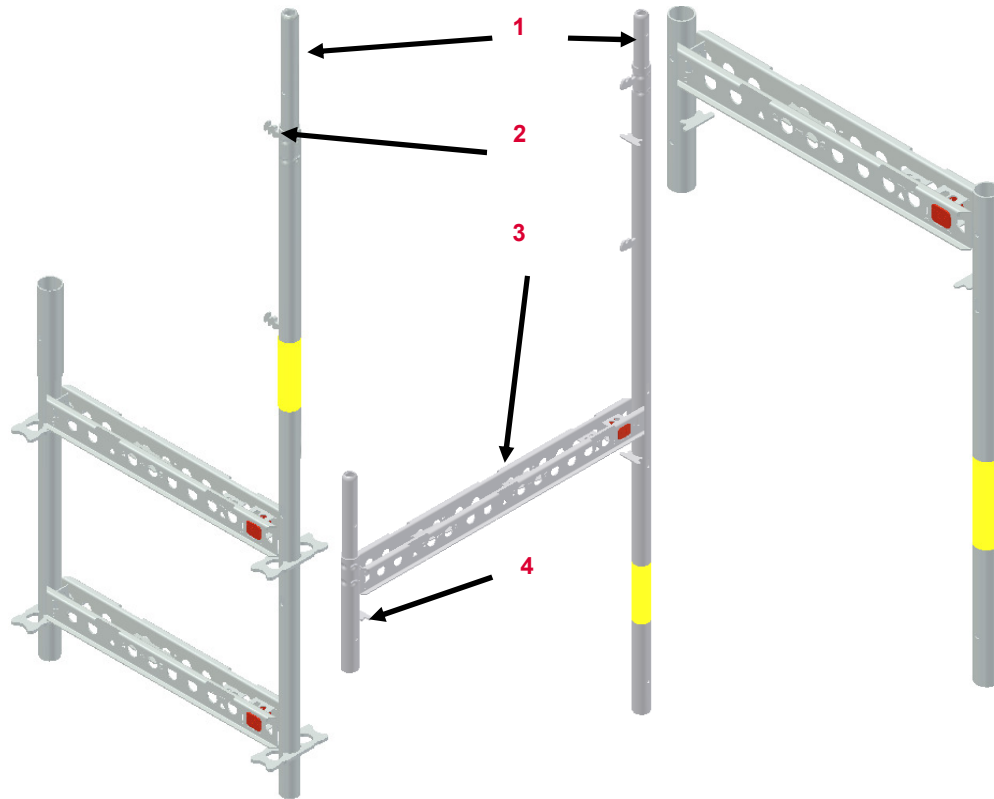

Nr.	Description	Article number
1	Spigot	
2	Guard Rail Connection	
3	Wedge	
4	Stopper plate	

Valid for	Item number
Base Frame UVF 72/124	100200
Base Frame UVF 104/124	100208
Base Frame UVF 72/174	100170
Base Frame UVF 104/174	100172
T- Frame UVT 72/200	100212
T- Frame UVT 104/200	100216
L- Frame UVL 72/100	100217
L- Frame UVL 104/100	100219
Pavement Gantry UVG 104/240	106965
Pavement Gantry UVG 176/240	100322

# PERI Rental Criteria

## PERI UP Fassade Scaffold



Frame Damage	Description	Instruction	Billing condition	Type
--------------	-------------	-------------	-------------------	------



### 33.20.13 Vertical Pipe bent

- No dents in pipe and > 3,0 mm to ≤ 15 cm
- Or > 15 cm



088244



### 33.20.14 Decking Profile bent

- Insertion of decking possible and damage local at profile
- Insertion of decking no longer possible











088244

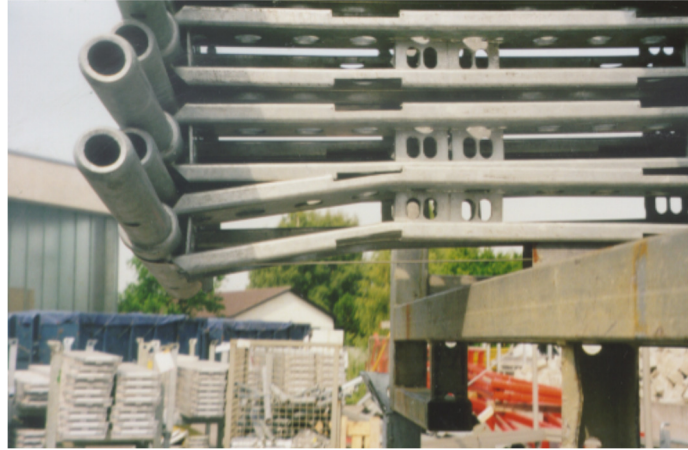

# PERI Rental Criteria

## PERI UP Fassade Scaffold











Frame Damage	Description	Instruction	Billing condition	Type
	<p>33.20.15 Decking profile bent</p>			
	<p>33.20.16 Stopper plate bent</p> <ul style="list-style-type: none"> <li>■ No damage to welding</li> </ul>		 088244	

# PERI Rental Criteria

## PERI UP Fassade Scaffold















Frame Damage	Description	Instruction	Billing condition	Type
	<p>33.20.17 Missing stopper plate</p>			
	<p>33.20.18 Spigot of vertical pipe bent</p> <ul style="list-style-type: none"> <li>All visible deformations</li> </ul>	 		

# PERI Rental Criteria

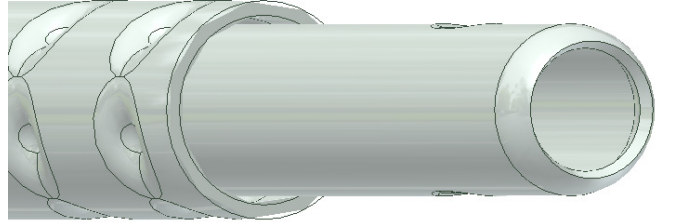
## PERI UP Fassade Scaffold















Vertical Bar UVE   UVM (116857   116855)	Description	Instruction	Billing condition	Type
	<p><b>33.20.19 Guard rail connection bent</b></p> <ul style="list-style-type: none"> <li>■ If possible</li> <li>■ Or if no longer possible</li> </ul>	<ul style="list-style-type: none"> <li>■ If possible: </li> <li>■ Or if no longer possible:  </li> </ul>	<ul style="list-style-type: none"> <li>■ If possible: </li> <li>■ Or if no longer possible: </li> </ul>	<ul style="list-style-type: none"> <li>■ If possible: </li> <li>■ Or if no longer possible: </li> </ul>
	<p><b>33.20.20 Spigot deformed</b></p> <ul style="list-style-type: none"> <li>■ All visible deformations</li> </ul>	<ul style="list-style-type: none"> <li>■ All visible deformations:  </li> </ul>	<ul style="list-style-type: none"> <li>■ All visible deformations: </li> </ul>	<ul style="list-style-type: none"> <li>■ All visible deformations: </li> </ul>

# PERI Rental Criteria

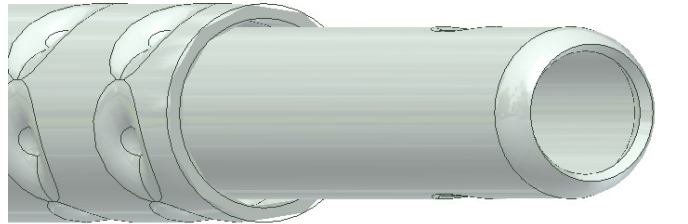
## PERI UP Fassade Scaffold



Spigot Tube UV 165 (100220)	Description	Instruction	Billing condition	Type
	<p><b>33.20.21 Guard rail holder bent</b></p> <ul style="list-style-type: none"> <li>■ If possible</li> <li>■ Or if no longer possible</li> </ul>	<ul style="list-style-type: none"> <li>■ If possible: </li> <li>■ Or if no longer possible:  </li> </ul>	<ul style="list-style-type: none"> <li>■ If possible: </li> <li>■ Or if no longer possible: </li> </ul>	<ul style="list-style-type: none"> <li>■ If possible: </li> <li>■ Or if no longer possible: </li> </ul>
	<p><b>33.20.22 Spigot deformed</b></p> <ul style="list-style-type: none"> <li>■ All visible deformations</li> </ul>	<ul style="list-style-type: none"> <li>■ All visible deformations:  </li> </ul>	<ul style="list-style-type: none"> <li>■ All visible deformations: </li> </ul>	<ul style="list-style-type: none"> <li>■ All visible deformations: </li> </ul>

# PERI Rental Criteria

## PERI UP Fassade Scaffold



### Decking Transom UHD

Nr.	Description	Article number
-----	-------------	----------------

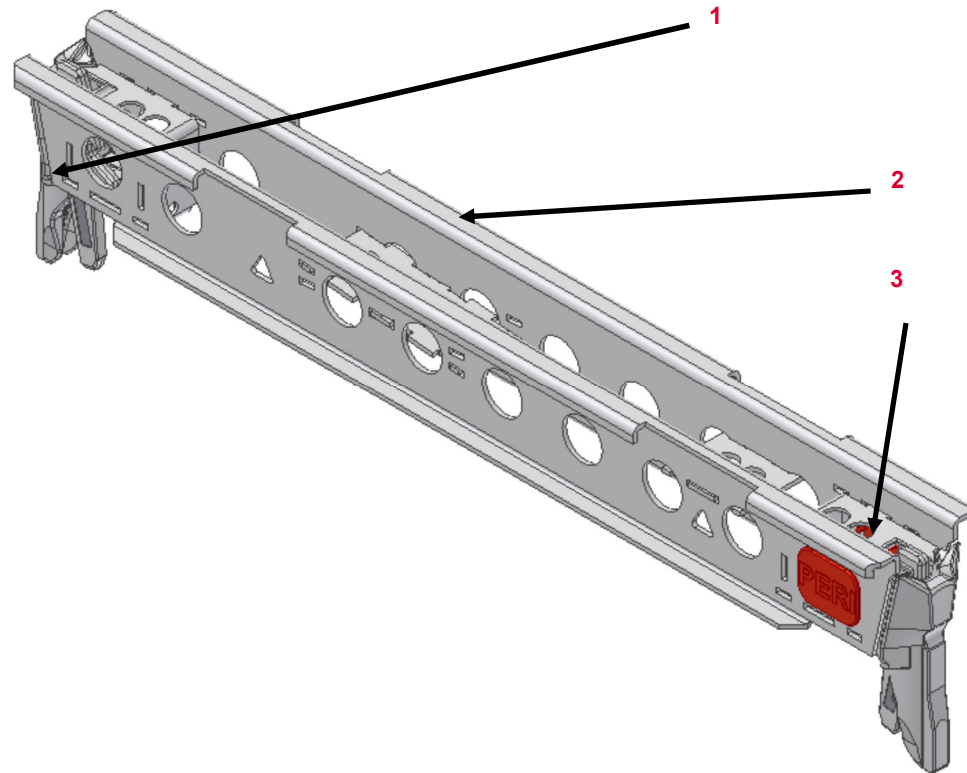

- |   |           |
|---|-----------|
| 1 | Wedge     |
| 2 | Profile   |
| 3 | Wedge box |

Valid for	Item number
Decking Transom UHD 72	100031
Decking Transom UHD 104	100039
Decking Transom UHD 150	100076
Decking Transom UHD 200	100079
Decking Transom UHD 250	100082
Decking Transom UHD 300	100085

# PERI Rental Criteria

## PERI UP Fassade Scaffold



Decking Transom UHD	Description	Instruction	Billing condition	Type
---------------------	-------------	-------------	-------------------	------



### 33.20.23 Profile bent

- > permitted bent (L/300)



Component	Perm. bending
UHD 72	3 mm
UHD 104	4 mm
UHD 150	5 mm
UHD 200	7 mm
UHD 250	8 mm
UHD 300	10 mm



### 33.20.24 Wedge box smashed

- If possible
- Or if welding damaged













# PERI Rental Criteria

## PERI UP Fassade Scaffold



Decking Transom UHD	Description	Instruction	Billing condition	Type
	<p>33.20.25 Local deformation of profile</p>		 088244	
	<p>33.20.26 Wedge fallen out   Safety sheet broken off</p>			

# PERI Rental Criteria

## PERI UP Fassade Scaffold



Face Brace UBF	Nr.	Description	Article number
----------------	-----	-------------	----------------

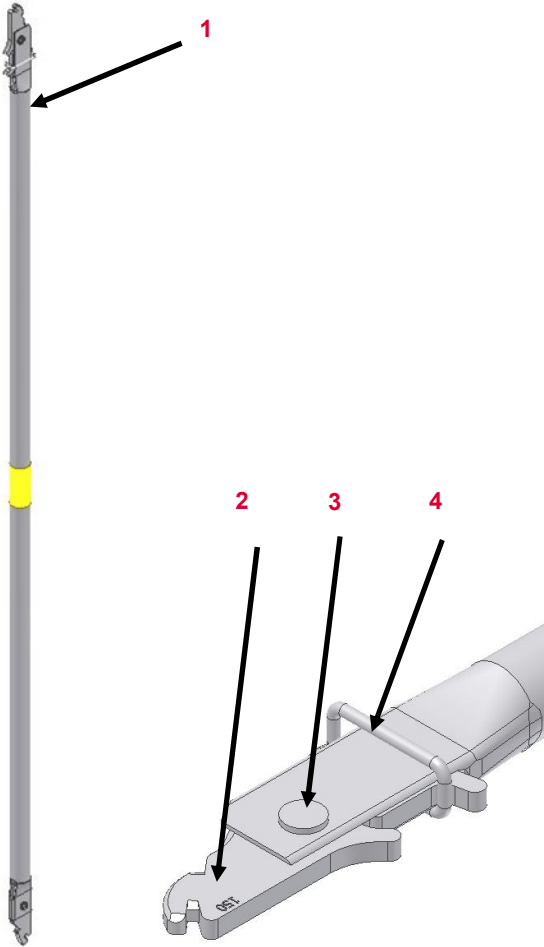

1	Diagonal	
2	Diagonal head	
3	Half-hollow-rivet	100251
4	Safety ring	100252

Valid for	Item number
Face Brace UBF 150/200	100247
Face Brace UBF 200/200	100253
Face Brace UBF 250/200	100257
Face Brace UBF 300/200	100261

# PERI Rental Criteria

## PERI UP Fassade Scaffold



Face Brace UBF	Description	Instruction	Billing condition	Type
----------------	-------------	-------------	-------------------	------

**33.20.27 Pipe profile bent**



- ≤ permitted bent (L/500)
- Or > permitted bent



088244



Component	Permitted bent
UBF 150/200	4 mm
UBF 200/200	5 mm
UBF 250/200	6 mm
UBF 300/200	7 mm



**33.20.28 Lower diagonal head broken**













100249 (bottom head)  
100250 (top head)



# PERI Rental Criteria

## PERI UP Fassade Scaffold



Face Brace UBF	Description	Instruction	Billing condition	Type
	<p><b>33.20.29 Diagonal head</b></p> <ul style="list-style-type: none"> <li>Every deformation &gt; 5 mm</li> </ul>	<p>  100249 (bottom head)            100250 (top head)         </p>		
	<p><b>33.20.30 Diagonal head heavily soiled</b></p> <ul style="list-style-type: none"> <li>If soiling cleanable</li> <li>Or if no longer cleanable</li> </ul>	<p>  </p> <p>  </p>	<p>     </p>	<p>     </p>

# PERI Rental Criteria

## PERI UP Fassade Scaffold



Guardrail UPG	Nr.	Description	Article number
---------------	-----	-------------	----------------



1	Ending profile
2	Profile

Valid for	Item number
Guardrail UPG 72	107045
Guardrail UPG 104	107050
Guardrail UPG 150	100265
Guardrail UPG 200	100266
Guardrail UPG 250	100267
Guardrail UPG 300	100268
Guardrail UPG 400	100810

# PERI Rental Criteria

## PERI UP Fassade Scaffold



Guardrail UPG	Description	Instruction	Billing condition	Type
---------------	-------------	-------------	-------------------	------



### 33.20.31 Guardrail bent

■ No dents in profile and  $\leq$  allowed bending ( $l/100$ )



■ Or dents in profile



■ Or  $>$  permitted bent ( $l/100$ )











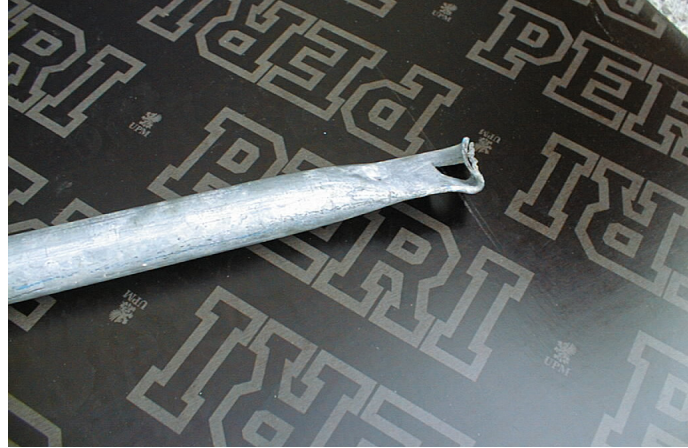

Component	Perm. bent
UPG 150	15 mm
UPG 200	20 mm
UPG 250	25 mm
UPG 300	30 mm
UPG 400	35 mm

# PERI Rental Criteria

## PERI UP Fassade Scaffold



Guardrail UPG	Description	Instruction	Billing condition	Type
	<p><b>33.20.32 Ending profile</b></p> <ul style="list-style-type: none"> <li>■ Bent angle &lt; 45°</li> </ul>			
	<p><b>33.20.33 Ending profile strongly bent</b></p> <ul style="list-style-type: none"> <li>■ Cracks in steel</li> <li>■ Or bent angle &gt; 45°</li> </ul>	 	 	 

# PERI Rental Criteria

## PERI UP Fassade Scaffold



### Access Deck UAL

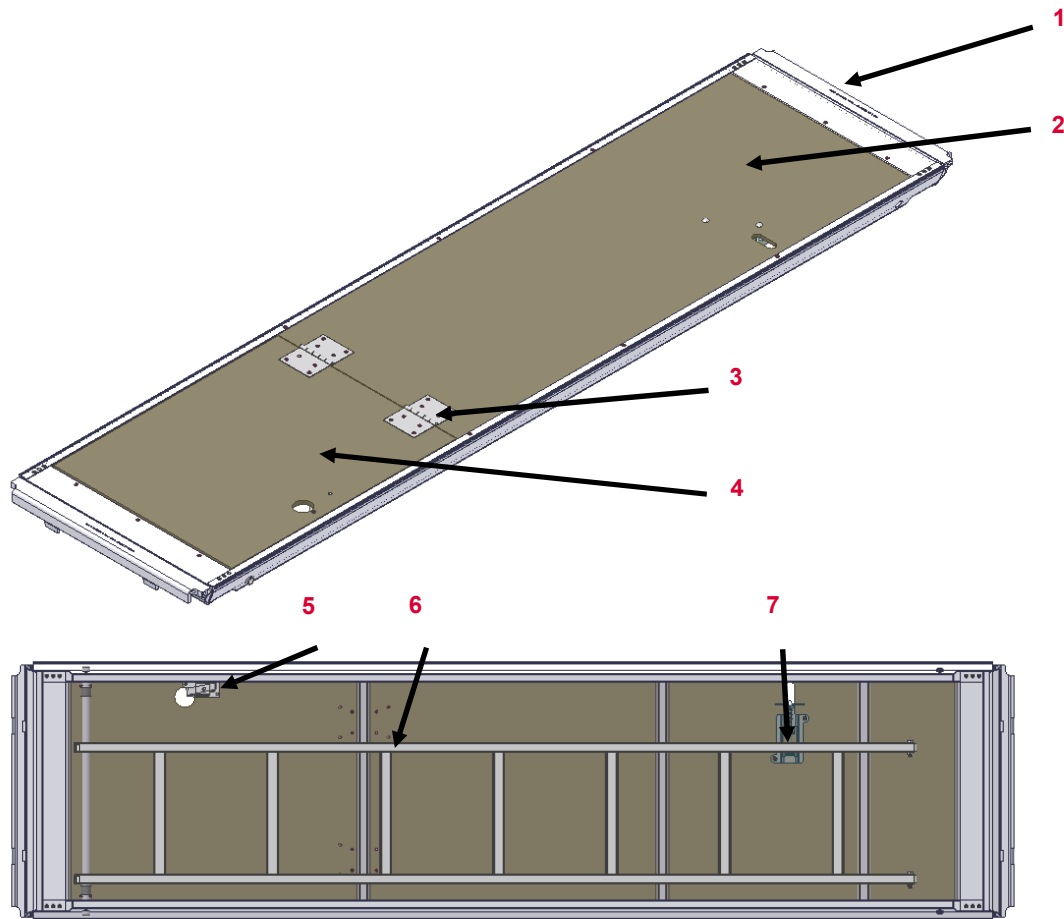

Nr.	Description	Article number
1	Hinge	114667
2	Decking	
3	Hinge	100468
4	Hatch decking	114671
5	Latch	115566
6	Ladder	100470
7	Spring Lock	126588

Valid for	Item number
Access Deck w. Ladder UAL-2 64x250/3	114825
Access Deck w. Ladder UAL-2 64x300/3	114812
Access Deck UAL-3 64x250/3K	126481
Access Deck UAL-3 64x300/3K	126482
Access Deck UAL-3 64x200/3K	126480
Access Deck UAL-3 64x200/3	114811



# PERI Rental Criteria

## PERI UP Fassade Scaffold



Access Deck UAL	Description	Instruction	Billing condition	Type
-----------------	-------------	-------------	-------------------	------



**33.20.34 Local damage to aluminium profile**

- Insertion of access deck easily possible

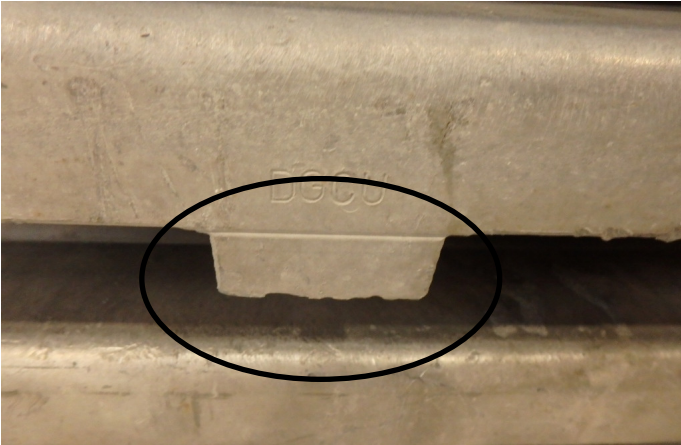

**33.20.35 Hinge**















- Hinge cracked
- Or hinge torn out



# PERI Rental Criteria

## PERI UP Fassade Scaffold











Access Deck UAL	Description	Instruction	Billing condition	Type
	<b>33.20.36 Ladder</b>			
	<ul style="list-style-type: none"> <li>■ Cracked welding</li> </ul>			
	<ul style="list-style-type: none"> <li>■ Or missing</li> </ul>			
<ul style="list-style-type: none"> <li>■ Or dent in step</li> </ul>				
	<b>33.20.37 Hole in access deck</b>			

# PERI Rental Criteria

## PERI UP Fassade Scaffold

















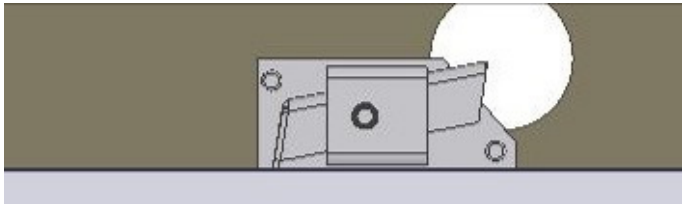

Access Deck UAL	Description	Instruction	Billing condition	Type
	<p><b>33.20.38 Welding broken at strut</b></p> <ul style="list-style-type: none"> <li>■ No deformation of strut</li> </ul>			
	<p><b>33.20.39 Welding in strut cracked</b></p> <ul style="list-style-type: none"> <li>■ With deformation of strut</li> </ul>		 088273	

# PERI Rental Criteria

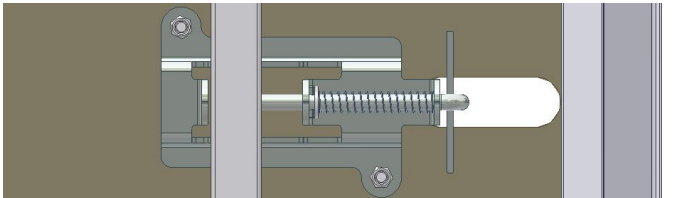
## PERI UP Fassade Scaffold



Access Deck UAL	Description	Instruction	Billing condition	Type
	33.20.40 Hole in decking			
	33.20.41 Hinges not functional		 089030	
	33.20.42 Latch not functional		 089024	
	33.20.43 Spring Lock not functional			

# PERI Rental Criteria

## PERI UP Fassade Scaffold



Toeboard Wood UPT-3	Nr.	Description	Article number
---------------------	-----	-------------	----------------

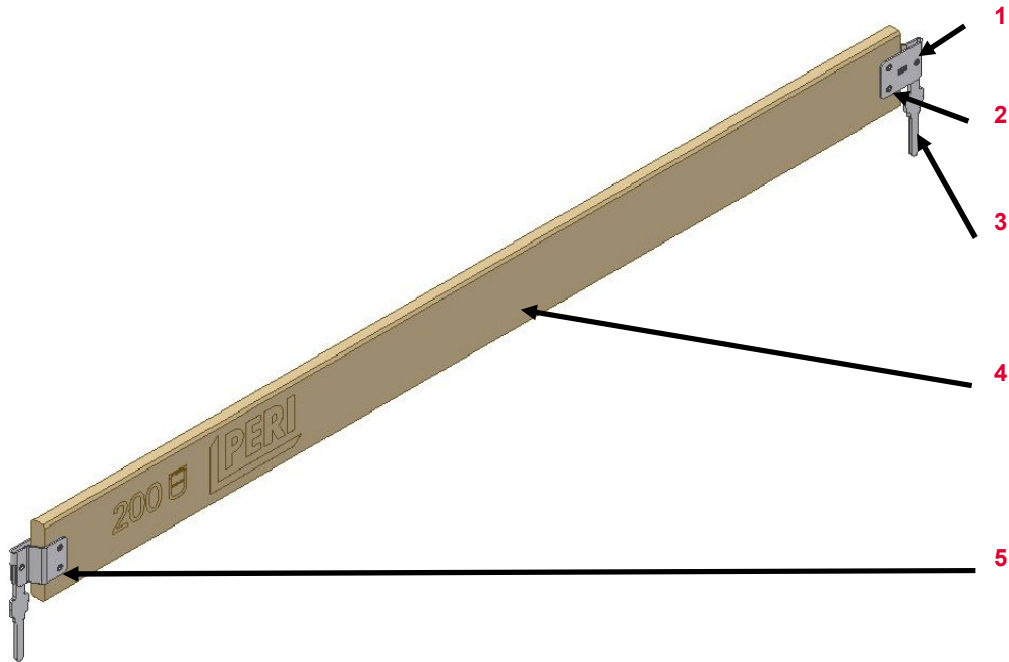















1	Rivet 75x18	100136
2	Rivet DIN 75x41	100384
3	Toeboard spigot	125169
4	Toeboard	
5	Toeboard hinge	108065

Valid for	Item number
Toeboard Wood UPT-3 72	126858
Toeboard Wood UPT-3 104	126868
Toeboard Wood UPT-3 150	125172
Toeboard Wood UPT-3 200	125173
Toeboard Wood UPT-3 250	125174
Toeboard Wood UPT-3 300	125175
Toeboard Wood UPT-3 400	125176

# PERI Rental Criteria

## PERI UP Fassade Scaffold



Toeboard Wood UPT-3	Description	Instruction	Billing condition	Type
	33.20.44 Hinge damaged	 100385 (Hinge) 100383 (Spigot) 100384 (Rivet 8x75x41) 100699 (Rivet 8x75x23)		
	33.20.45 Toeboard broken	 		
	33.20.46 Toeboard worn	 		

# PERI Rental Criteria

## PERI UP Fassade Scaffold



### End Guardrail UPX

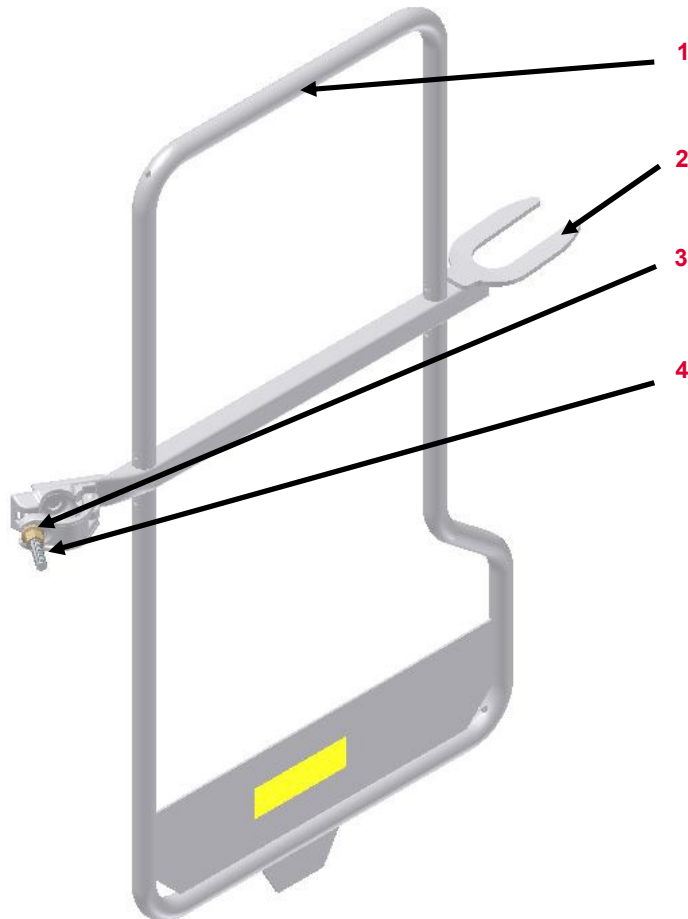









Nr.	Description	Article number
1	Guard Rail	
2	Fork	
3	Nut	710340
4	Hammer head bolt	710290

Valid for	Article number
End Guardrail UPX 32	101579
End Guardrail UPX 74	100444
End Guardrail UPX 104	100349

# PERI Rental Criteria

## PERI UP Fassade Scaffold



End Guardrail UPX	Description	Instruction	Billing condition	Type
	<p><b>33.20.47 Fork bent</b></p> <ul style="list-style-type: none"> <li>■ Deviation <math>\leq 20</math> mm in addition to prior Deviation (12 mm)</li> </ul>		 088244	
	<p><b>33.20.48 Toeboard bent</b></p>		 088244	



# PERI Rental Criteria

## PERI UP Fassade Scaffold



Decking Transom Spigot UES (101576)	Description	Instruction	Billing Condition	Type
-------------------------------------	-------------	-------------	-------------------	------



**33.20.49 Missing dowel ping**



710910 (Dowel pin)



089402



**33.20.50 Wedge bent**



101568 (Wedge)  
710910 (Dowel pin)



# PERI Rental Criteria

## PERI UP Fassade Scaffold



Base Beam UVA (101702; 100870)	Description	Instruction	Billing Condition	Type
--------------------------------	-------------	-------------	-------------------	------



**33.20.51 Missing dowel pin**



710910 (Dowel pin)



089042



**33.20.52 Missing shoes at Base Beam**



101689 (Shoe)



089036



















- No damage to base beam

# PERI Rental Criteria

## Glossar Icons



Icon	Significance	Icon	Significance	Icon	Significance
	Not Ok– material is scrap		Billing necessary (customer)		Optical damage
	OK– material stays in rental park		No Billing necessary		Functional damage
	Scrap material– it's not permitted to hand out the material because of safety aspects		Shorten the material		Functional damage— it's <b>not</b> permitted to hand out the material
	Repair according to instruction		Mark the material		Static damage— it's <b>not</b> permitted to hand out the material
	Fix material cold– Afterwards check weld seams and bordering components		Replace damaged material		
	Repair after local economic efficiency calculation		Replace missing material		
	Clean the material				