

THE PHYSIOLOGIST

The American Physiological Society was founded in 1887 for the purpose of promoting the increase of physiological knowledge and its utilization. The APS Constitution and Bylaws appears in the FASEB Membership Directory. Officers: *President*, Walter C. Randall, Loyola University, Maywood, IL; *President-Elect*, Alfred P. Fishman, University of Pennsylvania Hospital, Philadelphia, PA; *Past President*, Francis J. Haddy, Uniformed Services University of the Health Sciences, Bethesda, MD; *Council*, Walter C. Randall, Alfred P. Fishman, Francis J. Haddy, Leon E. Farhi, Franklyn G. Knox, Jack L. Kostyo, John B. West; *Executive Secretary-Treasurer*, Orr E. Reynolds, 9650 Rockville Pike, Bethesda, MD 20814.



A Publication for Physiologists and Physiology, Orr E. Reynolds, Editor

Volume 26, Number 2

April 1983

Historical Articles

- History of Collaboration by Department of Physiology at New York
University School of Medicine. H. Chasis 64

Public Affairs

- Congress May Have Three Choices in Legislation Proposed for Animals. W. M. Samuels 71

Essay

- Is Medical Research in Jeopardy? W. C. Randall 73

- Announcements 77

International News

- Rodolfo Margaria. 78

Society News

- APS Fall Meeting & IUPS Congress Travel Plans 79
1983 APS Fall Meeting Activities 79
Sea-Bird Energetics Symposium 79
Honors and Awards 80
Rapid Communications. H. E. Morgan 80
Member Contributions 81
New Study on Job Opportunities in Science and Engineering 81
News from Senior Physiologists 82
Statistics on APS Membership 86
Association of Chairmen of Departments of Physiology Analysis of
Annual Questionnaire - 1982/83 87

The Physiology Teacher

- Role of Computer Graphics in Simulations for Teaching Physiology. H. I. Modell,
A. J. Olszowka, J. L. Plewes, and L. E. Farhi 93
PuFT: Computer-Assisted Program for Pulmonary Function Tests. J. Boyle III 97
Static Mechanical Properties of Lungs and Chest Wall of the Dog. A. H. Mines,
J. R. Goerke, D. R. Abendschein, and N. C. Staub 102
New Computer-Based Teaching Programs. H. G. Hempling 108
Book Reviews 109

The Physiologist (ISSN 0031-9376) is published bimonthly by the American Physiological Society, 9650 Rockville Pike, Bethesda, MD 20814. Subscriptions: Distributed with the Physiology Teacher to members as part of their membership; nonmembers and institutions, \$40.00 per year in the United States; elsewhere \$50.00. The American Physiological Society assumes no responsibility for the statements and opinions advanced by contributors to *The Physiologist*.

Cover: See Historical Article, p. 64

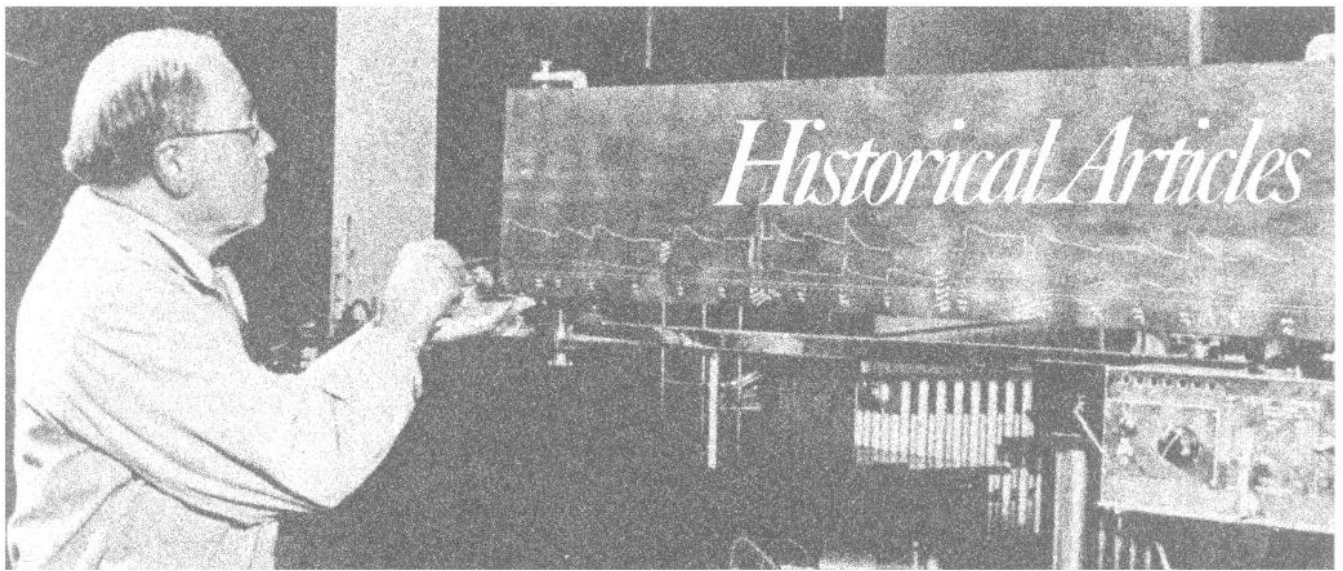

History of Collaboration by Department of Physiology at New York University School of Medicine

HERBERT CHASIS

New York University School of Medicine
New York, New York 10016

The need for collaboration in research among members of a medical school faculty appears to have increased in recent years in keeping with the growing complexity of biological investigation. Many problems facing medical science today require the cooperation of investigators with training in biochemistry, molecular biology, physical chemistry, genetics, immunology, as well as the natural history of disease. There have been many collaborative studies involving members of two or more departments in medical school faculties both here and abroad, and probably each story starts in the same way, one scientist needing the help of another.¹

The collaborative effort in which I participated for some thirty years (1928-1958) received its impetus from John Henry Wyckoff, its leadership from Homer William Smith, and its initial act from William Goldring. In 1928 as a second-year medical student I had at Wyckoff's suggestion joined Goldring to participate in the research activities of the hypertensive and renal

diseases laboratory. It was Goldring, a clinical scientist, who needed help, it was Smith, the basic scientist, who supplied the help, and it was Wyckoff who created an academic environment that fostered any attempt to increase medical knowledge. Chance, as it usually does in all stories, played an important role.

In a visit to the Rockefeller Institute in 1928 to discuss with Thomas Addis his method of the examination of urinary sediment in a quantitative manner, Goldring (1898-1981), while waiting to see Addis, visited with Donald Van Slyke about renal function testing. Van Slyke suggested that the urea clearance might be useful in studying changes in renal function in patients with acute febrile disease. Goldring took his suggestion back to Bellevue and studied patients with pneumonia and erysipelas during their acute febrile stage and during convalescence. He could not discern a pattern of renal dysfunction, due to the great variability of the observed urea clearances. Wyckoff suggested that the new Professor of Physiology, Homer Smith, might be of help. Smith had been interested in the renal physiology of fishes and turtles and soon found that his previous work was not helpful in analyzing the data Goldring had brought to him. He concluded that unless the rates of glomerular filtration and tubular absorption were known, i.e., the physiological factors that affect the renal handling of urea, the variations in urea clearance observed by Goldring could not be rationally interpreted. This conclusion started a search for a method of measuring the rate of glomerular filtration. Rehberg (11) had used endogenous creatinine to measure the rate of glomerular filtration, but Smith reasoned that a substance used to quantitate glomerular filtration rate in humans had to be neither excreted nor reabsorbed by the renal tubule following its freely filtered passage through the glomerular membrane. Experiments by Jolliffe (6) showed that xylose, which is not excreted by aglomerular fish, might be used to measure filtration rate, and in 1932 Jolliffe, Shannon, and Smith (7) used the nonmetabolized sugar xylose to measure glomerular filtration in the dog. In 1933 comparison of the action of phlorizin on the excretion of glucose, xylose, sucrose, creatinine, and urea in humans by Chasis, Jolliffe, and Smith (3) confirmed the observation that had been made in the dog, that phlorizin raised the glucose-to-xylose

¹The need for basic scientists to be members of teams working with clinical scientists or alone but in a clinical setting is manifest in a recent report by Blankenship (1). Approximately 53% of the total Ph.D. faculty members in medical schools are in clinical departments; some 31% of Ph.D. recipients in basic biomedical fields view their research as clinical in nature. Of the membership of the American Physiological Society employed in medical schools 33% are in clinical departments; of these members 17% hold the Ph.D. degree only and 14% hold Ph.D. and M.D. degrees.

ratio to 1.00. However, tubular reabsorption of about 10% of xylose made this carbohydrate unsuitable for the measurement of filtration rate. Smith deduced that a larger carbohydrate molecule was needed for this purpose and suggested inulin as a test material, and this proved to be a correct assumption (13,14). At about the same time that Smith started using the inulin clearance as a measure of the glomerular filtration rate, A. N. Richards came to New York to speak at a meeting of the Society of Experimental Biology and Medicine on renal function, and it was discovered that both laboratories were working on the same problems using the same substances (xylose, inulin, and creatinine) (12). With the introduction of the inulin clearance the way was open to study tubular excretion and tubular reabsorption in a quantitative manner. In 1935 Shannon (15), studying phenol red excretion in the dog, showed that at high plasma levels the tubules became saturated and excreted the dye at a constant maximal rate. This maximal limitation in tubular excretion is now established as a characteristic feature of tubular activity. It was also in 1935 Goldring, Clark, and Smith (5) demonstrated that the phenol red clearance at low plasma levels offered a close approximation to the renal blood flow. The renal clearances of Diodrast and *p*-aminohippurate at low plasma levels replaced phenol red as measures of renal blood flow, and their maximum rate of tubular excretion (for which the expression T_m was coined) could be used to characterize the total functional tubular tissue of the kidneys. In 1938 Smith, Goldring, and Chasis (18) established the rates of glomerular filtration and renal blood flow and a value for the tubular excretory mass in the normal human kidney. In 1941 Shannon, Farber, and Troast (16) showed that a similar limiting maximal rate characterized the reabsorption of glucose by the tubules.

These newly described methods for quantitative measurement of renal blood flow and filtration rate together with the saturation methods (Diodrast T_m and glucose T_m) made available new avenues of approach to the study of the distribution of blood and glomerular filtrate among the functional units of the kidney and have had a profound effect on the acquisition of knowledge concerning the normal and diseased kidney. As the work progressed through the forties and fifties the renal group at New York University School of Medicine were considered leaders in this field of medicine, and Smith was recognized as the dean of renal physiologists. The scientific efforts of Smith and his associates, as well as contributions of others, were published in 1951 in *The Kidney: Structure and Function in Health and Disease* (Oxford Univ. Press), which came to be known as the "bible."

Once the collaboration of the Departments of Physiology and Medicine had established these methods other departments in the medical school initiated research programs: members of the Departments of Obstetrics, Physiology, and Medicine studied renal hemodynamics and function in pregnancy and eclampsia; Anesthesiology, Physiology, and Medicine studied the effect of anesthesia on the circulation with reference to arteriolar autonomy; Surgery, Physiology, Medicine, and Pharmacology collaborated during World War II in studies of shock (a joint study of New York and Columbia Universities); Pediatrics, Medicine, and Physiology looked into the development of renal functions in infant;

Surgery and Physiology studied the significance of the renal juxtamedullary circulation; and Urology and Physiology investigated the renal concentrating operation at low urine flows. From these examples it is quite clear that the Department of Physiology was the key member of the collaborations and Homer Smith the essential partner.

The collaboration between the Departments of Physiology and Medicine continued until Smith's retirement in 1960. In addition to the key papers cited describing the work in the early days of the collaboration, members of the Department of Medicine continued the association, and joint authorship with Smith of later scientific publications included the following members of the Department of Medicine: David S. Baldwin, Stanley E. Bradley, Joseph J. Bunim, Saul J. Farber, Jack Harnes, William H. Hulet, Jules Redish, George E. Schreiner, Philip R. Steinmetz, and Morris Ziff.

A knowledge of the background of the people involved in the collaboration of the Departments of Medicine and Physiology may aid in understanding why the team succeeded.

Wyckoff (1881-1937) was born in India, where his parents were Dutch Reform American missionaries. He



spent two years at Rutgers College, received his M.D. degree from University and Bellevue Hospital Medical College in 1907 and interned at Bellevue Hospital. He started his career as a faculty member in 1910 and subsequently became Professor and Chairman of the Department of Medicine, Dean, and Director of the Third (New York University) Medical

Division of Bellevue Hospital. Wyckoff's interest and studies were in cardiovascular disease. In 1919 he had taken over the direction of the first cardiac clinic in the United States, a clinic started in 1911 by Dr. Hubert V. Guile at the inspiration and instigation of Mary E. Wadley, head of Social Service at Bellevue. Using the model of the Bellevue Hospital Cardiac Clinic, other cardiologists formed the New York Heart Association, which in turn participated in founding the American Heart Association.

Wyckoff's criteria for selection of medical students and faculty were intellectual ability, dedication to work, and character. He did not allow sex, color, or creed to influence the selections. However, he did report that when scholarship alone was used in the selection of students applying for admission to medical school, there was a decrease in medical school failures (19). He stressed the need for exposing medical students to laboratory research and for the members of his Department of Medicine to have space and funds for the development of their own research programs. He believed that physicians would derive maximal benefits from their medical education if they returned some time during their training to one of the preclinical departments. William Goldring, Norman Jolliffe, James Shannon, and I were some of the younger members of the Department of Medicine who benefited from this opportunity to spend a year or more as a full-time member of the Department

of Physiology. He believed that by engaging in research the staff improved as teachers and as physicians in the care of the sick.

Wyckoff obtained a gift from a Mrs. Tiffany in 1919 with which the first Einthoven Quartz String Electrocardiograph was obtained for use in the medical school. It was installed in the Department of Physiology located on the fifth floor of the medical school building on the southwest corner of 26th Street and First Avenue. Overhead wires were run from the hospital a tenth of a mile away to the medical school building. I suspect that operation of this early type of electrocardiograph posed a challenge; it was quite large and heavy, weighing 250 pounds with its alkaline battery, more suitable for use in the laboratory than on the crowded wards of the hospital. Tracings were taken on patients on the wards of Bellevue Hospital. Once the leads had been placed on the patient a flag was waved from a sixth-floor window in Bellevue Hospital as a signal to start recording the electrocardiogram. One of the early papers by Wyckoff and Goldring (20) in which the electrocardiograph records were used was a study of the action of ouabain. Although this study was carried out by members of the Department of Medicine, it does indicate that Wyckoff felt free to obtain help from members of the Department of Physiology, and two years later when he was approached by Goldring, who was having difficulty in interpreting physiological data obtained in patients, he arranged for the young man to consult the new Chairman of the Department of Physiology, Homer William Smith.

Homer W. Smith (1895-1962) was born in Denver, Colorado, and graduated from the University of Denver in 1917 with an A.B. degree; he did graduate work with William H. Howell at Johns Hopkins University School of Hygiene and Public Health leading to a degree of D.Sc. in 1921; then from 1923 to 1925 he worked with Walter B. Cannon at Harvard University as a Fellow of the National Research Council; from 1925 to 1928 he was Chairman of the Department of Physiology at the University of Virginia School of Medicine; and from 1928 to his retirement in 1960 he was Professor and Chairman of the Department of Physiology and Biophysics at New York University School of Medicine.

During World War I Smith worked with E. K. Marshall, Jr., and their association continued over the years. One of Smith's early interests was chemistry, and in 1921 he authored a series of articles published in the *Journal of Physical Chemistry* on the nature of the secondary valence. He then became interested in the chemical nature of body fluids and published studies on the composition of these fluids in fishes and turtles. This interest in body fluids led him to the kidney and its evolution over millions of years to become the present organ. In 1930 he published a paper with E. K. Marshall, Jr., on the glomerular development of the vertebrate kidney in relation to habitat (8). By now the kidney became Smith's chief interest, as he believed that this organ was the primary site at which the composition

of body fluids was determined. In 1931 he published a paper entitled "The regulation of the composition of the blood of teleost and elasmobranch fishes, and the evolution of the vertebrate kidney" (17). Wyckoff and Goldring then provided the impetus that set Smith off on a quest that took him to all aspects of renal function, to the structure and circulation of the kidney, to the evolution of the human kidney, and to salt and water metabolism. Robert Pitts called the 30 years (1930-1960) of renal physiology the Smithian Era (10), and in the *Handbook of Physiology* (section 8), *Renal Physiology*, the editors Jack Orloff and Robert W. Berliner in dedicating the book to Smith said, "Homer W. Smith (1895-1962), in a manner virtually unique in the history of modern science, dominated renal physiology for more than 30 years of his productive and inspiring life" (9). Smith had the ability to interpret data in a way that led to fundamental broad concepts, first having developed methods to study functions that produced the data, then proceeding to introduce approaches to test the validity of the concept. In the development of chemical analytic methods he would require extensive recovery checks before introducing them into experimental programs.

The team met two or three evenings a week for planning, three mornings a week to make the observations in human subjects (Goldring on Mondays, Chasis on Wednesdays, and Hilmert Ranges on Fridays). The technical work was done in the laboratories of the Department of Physiology with Smith supervising the selection and performance of the analytic methods, examining the data on a daily basis, and putting points on graphs as the work progressed. The evening meetings were exciting as we watched the accumulated data support or negate a tentative thesis. The planning of the protocols required the utmost care in order to avoid any harm to the subjects or to the patients studied in the hospital. Two well-trained research nurses cared for the patients and with the technicians were responsible for the care of equipment used in the studies. Smith assumed the task of writing the reports, and even if another one of us wrote a first draft, we frequently would not recognize it when Smith returned it to us.

As the work progressed and the results indicated that new methods had been developed that permitted investigators to extend their studies of kidney function and hemodynamics, an air of excitement and accomplishment pervaded the laboratory. Visitors from here and abroad came to observe and to work; at lunch



Left to right: H. Ranges, H. Chasis, H. Smith, and W. Goldring.

time heated discussions took place on subjects ranging from nationalistic political theories to the quality of a tenor's performance at the Metropolitan Opera the night before.

Collaboration in investigation in the 1930's fulfilled a practical as well as a scientific need. Financial support for research was limited, since the program antedated the establishment of the National Institutes of Health and medical school budgets were small. The Commonwealth Fund helped to defray the cost of technical and nursing aid once the program was in progress. Smith received his medical school salary, and members of the Department of Medicine supported themselves by engaging in a limited private practice of medicine. Life was hectic, since Smith had all the additional responsibilities of chairing a department and Goldring, Chasis, and Ranges as members of the Department of Medicine had their teaching duties, hospital rounds, and attendance at outpatient clinics. The research program of the team functioned for some 25 years with changes in personnel (Ranges dropped out in 1945) as research fellows were added. The work was put aside during the war years (1941-1945), when Smith and Chasis took on assignments for the War Department.

At this late date it is difficult to attempt to answer the question of whether success of the project required a collaborative effort or whether the end result could have been accomplished without it. At present investigators with long-term financial support and a fellowship program to supply manpower do carry out similar investigative programs successfully. It does seem though that, at that period, collaboration was essential for our program. Smith, working in comparative renal physiology, saw the need for understanding and quantitating tubular excretion and reabsorption and glomerular filtration in order to help interpret renal function data from patients with renal disease. The clinicians, using such simplistic evidence of kidney dysfunction as abnormal blood concentrations of urea and symptoms of uremia, required the kind of help that Smith could attempt to give. Furthermore the clinicians could assume responsibility for the selection and care of patients in Bellevue Hospital, carry out the observations necessary for the studies done in the hospital, and utilize their knowledge of the natural history of hypertensive and renal diseases in interpreting the results. We did not differentiate between basic and clinical science and were surprised when Dr. R. A. McCance, Professor of Physiology at the University of Cambridge, on a visit to our laboratories, expressed envy of the investigative programs being carried out by a team composed of members of the Departments of Physiology and Medicine. He recounted his own experience in studies he had completed describing the affect of salt depletion in man. His subjects were medical student volunteers who moved into McCance's home for the duration of the study and for whom Mrs. McCance prepared and served meals. McCance attributed the difficulty he faced in this regard to the barrier that existed between the preclinical and clinical departments in England.

It is difficult to appreciate the extent of Smith's productivity in the 30-year period from 1930 to 1960. In preparing a selected collection of his works in *Homer William Smith, His Scientific and Literary Achievements* (2), we gained some insight into his output. Smith worked seven days a week, 12 hours a day,

and 52 weeks a year (the three summer months at the Mount Desert Island Marine Biology Laboratory in Maine); yet as departmental chairman his door was always open for a conference, and he rewrote many papers of his associates and members of his department. In addition to his scientific contributions as a physiologist Smith also made contributions in the fields of philosophy and naturalism. He authored *Man and His Gods*, *From Fish to Philosopher*, and *Kamongo*. He had the library at New York University School of Medicine establish a room which contained books dealing with man's place in nature, since he believed that medical students and faculty should be exposed to a broad base of scientific thought.

The Department of Physiology and Biophysics at New York University School of Medicine today is the descendant of two departments of physiology in two separate colleges, the first established in 1841 as University Medical College and the second established in 1861 as Bellevue Hospital Medical College. In 1898 the two schools merged to become



the University and Bellevue Medical College. The first Department of Chemistry and Physiology had **John W. Draper** (1811-1882) as Professor from 1850 to 1867. Draper was a chemist, botanist, physicist, and physiologist who initially studied at the University of London, where he analyzed a fossil hydrocarbon. He left

England allegedly because of a belief in "republican institutions" and obtained an M.D. degree from the University of Pennsylvania in 1836. He subsequently became Professor of Chemistry at William and Mary College in Virginia and then at Hampden-Sydney College. His contributions in the fields of solar light, radiant heat, influence of electricity on capillary attraction, and photography were recognized internationally; his physiological studies were on respiration and circulation of blood. In 1863 in an anniversary discourse at the New York Academy of Medicine he said "It is for us, then, in our special sphere as physicians, to give what help we may to the investigation of nature, and especially to the investigation of the structure, the functions, the diseases of man. Our incitement should be not merely the intention of relieving the infirmities with which we are called upon to heal, but also that equally noble one of increasing the happiness of our race by increasing its knowledge" (4). Draper's interests were broad; he authored *Text-Book on Natural Philosophy*, *History of the Intellectual Development of Europe*, *Conflict Between Science and Religion*, and *Thoughts on the Future Civil Policy of America*. It is interesting to note that this first chairman of the Department of Physiology at New York University not only worked and wrote in science but also in philosophy, religion, history, and government and that a century later, Homer Smith, occupying the same chair, should also produce works in philosophy, religion, and government.

John Draper's son Henry occupied the Chair in Physiology at the University Medical College from 1868 to 1874, John W. S. Arnold from 1875 to 1883, Lewis A. Stimson from 1884 to 1885, and William G. Thomp-

son from 1887 to 1895.

In 1861 the Bellevue Hospital Medical College opened with **Austin Flint II** (1836-1915) as Professor of Physiology and Microscopy; he occupied the chair from 1861 to 1897. Austin Flint II was one of six generations of Doctors Flint (1733-1955). He obtained a degree in Medicine in 1857 from Jefferson Medical College and had held professorships in Physiology in Buffalo and New Orleans before settling down at the Bellevue Hospital Medical College in



1861. He had been interested in physiology as a medical student and his thesis, "The phenomena of capillary circulation," was published in the *American Journal of Medical Sciences*. Flint was deeply influenced by the work of Claude Bernard and wrote a detailed appreciation of "Claude Bernard and his physiological works," published in the *American Journal of the Medical Sciences* in 1878. Among his significant publications were *Physiology of Man* (five volumes), *Textbook of Human Physiology* (IV edition 1888), *Relations of Physiology to the Practice of Medicine* (1886), and *The Revolution in Medicine* (1890).

Flint was both an experimentalist and a keen observer of disease in his patients. He made physiological observations in a wide variety of subjects including the etiology of fever, the eye as an optical instrument, the excretory and glycogenic function of the liver, and the mechanism of respiration including experiments on the effects on respiration of cutting off the supply of blood from the brain and medulla oblongata. He studied the source of muscular power by observing the diet and nitrogenous excretion in a male who walked 317.5 miles in 5 consecutive days, his results reported in a paper in the *New York Medical Journal*, June 1871, entitled "Physiological effects of severe and prolonged muscular exercise." During the same span of years he published clinical observations such as "An analysis of one hundred and six cases of paronychia" in the *Buffalo Medical Journal*, October 1855, and "Four selected typical cases of diabetes mellitus not before reported" in the *New York Medical Journal*, November 22, 1884. In an address on "The relations of physiology to the practice of medicine" published in *Transactions of the New York State Medical Association* in 1885, Flint concluded by saying, "In the advancement of medical knowledge physiology and pathology go hand in hand. The ideal physician is profoundly versed in physiology; and the ideal physiologist is no less deeply versed in the practice of medicine."

The presence of William H. Welch as Professor of Pathological Anatomy and General Pathology at Bellevue Hospital Medical College must have stimulated interest in research and medical education. In 1878 Welch, who had interned at Bellevue Hospital, set up a pathology laboratory in the hospital on his return to New York from time spent abroad working in the laboratories of Cohn, Cohnheim, and Koch in histology, pathology, and bacteriology. Welch was a giant in his scientific contributions to infectious diseases and medical education. In the seven years at Bellevue

before he left New York in 1885 to become Professor of Pathology at Johns Hopkins University Hospital and Medical School, he must have created an exciting atmosphere at the College and was in turn stimulated by his contacts with the Austin Flints, father the Professor of Medicine and son the Professor of Physiology.

The two Professors of Physiology, Draper and Flint, were both experimentalists with a wide range of interests, and both appreciated that as members of a medical school faculty their students should be exposed to research in the development of knowledge in physiology as well as disease.

The third Professor of Physiology to engage in collaboration was **Graham Lusk** (1866-1932). Following



graduation from Columbia School of Mines, he received his Ph.D. in 1891 in Munich, having worked under Carl Voit. He left a Professorship in Physiology at Yale Medical School in 1898 to chair the Department of Physiology at the newly formed University and Bellevue Hospital Medical College. He spent the next eleven years teaching and at-

tracting a strong staff as well as heading an investigative team engaged in studies of the metabolism of carbohydrates, proteins and fats, clinical calorimetry, measurement of the surface area of humans, and thermodynamics. Lusk had a respiration calorimeter built for use in his laboratory and then had one adapted for use in Bellevue Hospital. He arranged for one of his co-workers, E. F. DuBois, to receive an appointment to the hospital staff and to join Warren Coleman, a clinician, in a study of 10 patients with typhoid fever. Lusk believed that medicine was not "scientific" and needed the benefit of physiology just as physiology had benefited from physics and chemistry. The separation of medicine and physiology was commented on in his Harvey Lecture on Metabolism and Diabetes in November 1908. He said, "some may question the right of a laboratory man, a physiologist, to present to medical men a scientific discussion of a diseased condition. In defense I can only quote to you the stirring words of Magendie, written in Paris as long ago as 1836, as an introductory to his *Elements of Physiology*.... 'In a few years physiology, which is already allied with the physical sciences, will not be able to advance one particle without their aid. Physiology will acquire the same rigor of method, the same precision of language and the same exactitude of result as characterize the physical sciences. Medicine, which is nothing more than the physiology of the sick man, will not delay to follow in the same direction and to reach the same dignity. Then all those false impressions which, as food for the weakest minds, have so long disfigured medicine, will disappear.' "

In an attempt to trace Wyckoff's strong belief of the necessity for members of his (or any) department of medicine to be engaged in investigation, one can speculate that he had been exposed to a tradition that existed in the Department of Physiology at New York University. Graham Lusk's basic science contributions in the field of metabolism of foods, thermodynamics, and calorimetry were outstanding, but he also arranged

to study patients with diabetes mellitus and typhoid fever in Bellevue Hospital at a time when Wyckoff was a medical student and later a member of the house staff.

In addition, the scientific and medical communities in New York City at the turn of the century had members who recognized the need for collaboration not only in the laboratory and at the bedside but also in hearing of progress in their respective fields. Samuel James Meltzer, who was born in Russia in 1851, attended schools at home and in Prussia and studied philosophy and medicine at University of Berlin. A year later he moved to New York and started a private practice in medicine. He had spent three years in the Physiological Institute of Berlin and, while caring for patients, carried on experimental work in laboratories at Bellevue Hospital Medical College, at the College of Physicians and Surgeons of Columbia University, and finally at the Rockefeller Institute for Medical Research. On January 19, 1903 a meeting was held at the residence of Graham Lusk to discuss an idea of Meltzer's that an association be formed to cultivate "the experimental method of investigation in the sciences of animal biology and medicine." Those who attended the meeting by invitation were James Ewing, Holmes C. Jackson, Frederic S. Lee, Graham Lusk, S. J. Meltzer, George B. Wallace, and William J. Gies. The result of this meeting was the birth of the Society for Experimental Biology and Medicine. Graham Lusk conceived the idea that physicians practicing in the New York area might be interested in hearing lectures on scientific subjects by leading investigators in their respective fields. He conferred with Samuel J. Meltzer, who at first discouraged Lusk but a few days later helped him organize a meeting on the anniversary of Harvey's birth, April 11, 1905, at Lusk's home. This first meeting was attended by Meltzer, W. H. Park, E. K. Dunham, Ewing, Lee, Herter, Flexner, Wallace, T. C. Janeway, Levene, Opie, Abel, and Lusk, and thus the Harvey Society was born. These two societies were established within the two-year period of 1903-1905, the idea for the Harvey Society conceived by a Ph.D. (Lusk) to aid in the education of practicing physicians and the Society for Experimental Biology and Medicine conceived by a practicing physician (Meltzer) to encourage research. The respective degrees held by Lusk and Meltzer did not limit their actions nor their interests. Wyckoff was exposed, then, not only to a tradition at his own medical school but to a medical and scientific community in New York City actively engaged in promoting contact and exchange between basic and clinical scientists.

In writing this story of the collaboration between the Departments of Physiology and Medicine at New York University School of Medicine that started in 1928, I thought it might be of interest as an example of a developing trend due to the growing complexities of modern science. I was led astray to some degree by comments made by visitors from here and abroad who marveled at an experimental program that involved a team of basic and clinical scientists working simultaneously in the experimental animal and in the human subject in the laboratory and in the hospital. As an investigator I should not have been surprised when I went back to the history of our Department of Physiology to find that from its very inception the need for the act of collaboration was appreciated and practiced. Homer Smith played the same important role that his predecessors, John Draper, Austin Flint II, and Graham Lusk, had played before. There appears to

have been an almost continuous thread of cooperation, collaboration, and consultation tying the departments together. The role that the location of the school in New York City played in attracting personnel may have contributed to some degree and may account for leaders such as Draper, Flint, Lusk, and Smith having settled in the Chair of Physiology and Wyckoff in Medicine. The school has had a close association with Bellevue Hospital, and the large number and varied disease states of its patient population offered stimulus and an opportunity for research programs. In addition the fact that Bellevue Hospital is a public institution may have acted to introduce a bias in the makeup of its clinical faculty. Physicians would be attracted who were primarily interested in teaching, in medical care of the indigent, and in continuing their education rather than in establishing a large private practice, which of necessity requires affiliation with a private hospital. A clinical faculty so constituted would be more apt to extend their knowledge by initiating research programs. This would lead in some instances to a need for consultation with members of the basic science faculty, and these contacts would be conducive to collaborative studies.

As one of the collaborators, I look back to those years with great pleasure for both the excitement and the sense of accomplishment that the team experienced. Investigators experience sensations similar to those of professional gamblers, waiting for the data of the last experiment to confirm or negate a concept, to find that the guess was right or wrong, to have won or lost. The gratification is in the search.

Collaboration among members of a medical school faculty continues to be an essential practice in furthering the research activities of an institution. The nature of the collaboration as to the origin of the members of the team appears to be changing in that more basic scientists (Ph.D.'s or M.D.-Ph.D.'s) are becoming members of clinical departments. This trend may be due to the growing complexity of scientific methodology and to increase in available funds for salaries and research grants in combined basic and clinical research projects. Whatever the reasons, this apparent increase in collaboration is a healthy sign, for increase in collaborative studies should result in increased productivity. The makeup of the team, whether the members are M.D., Ph.D., or M.D.-Ph.D. and whether they are from a preclinical or clinical department, is unimportant; what is important is that collaboration, when necessary, should be available. Charles Draper and Austin Flint were M.D.'s working in a preclinical

Historical Articles

Historical Articles Section Editor: Orr E. Reynolds, APS; Associate Editors: Horace Davenport, Department of Physiology, University of Michigan; Ralph Kellogg, Department of Physiology, University of California, San Francisco; Arthur B. Otis, Department of Physiology, University of Florida; Executive Editor: M.C. Shelesnyak, APS.

department (physiology), whereas Graham Lusk, a Ph.D., tackled clinical problems throughout his career.

I suppose to every new generation of scientists the challenge of taking on a research project frequently inspires the thought that, at least in one aspect of the problem, he or she might need the help of a scientist knowledgeable in a recently developed specialized field. I started this history with the thought that the need for collaboration at present is due to the increasing complexity of biological investigation. I end it having learned that physiologists (basic scientists) have been involved in clinical research and physicians (clinical scientists) have been involved in basic research at New York University for the past 130 years. Moreover, the founding of both the Harvey Society and the Society for Experimental Biology and Medicine in New York City at the turn of the century suggests that the metropolitan professional community as a whole recognized the need for exchange of information among basic and clinical scientists.

I am indebted to Van Afes, Archivist at New York University Medical and Dental Centers, for locating and making available copies of original documents.

References

1. Blankenship, J. E. The role of the Ph.D. physiologist in a clinical department. *Physiologist* 24(6): 20, 1981.
2. Chasis, H., and W. Goldring (Editors). *Homer William Smith. His Scientific and Literary Achievements*. New York: New York Univ. Press, 1965.
3. Chasis, H., N. Jolliffe, and H. W. Smith. The action of phlorizin on the excretion of glucose, xylose, sucrose, creatinine and urea by man. *J. Clin. Invest.* 12: 1083, 1933.
4. Draper, J. W. *The Historical Influence of the Medical Profession*. New York: Balliere, 1863.
5. Goldring, W., R. W. Clark, and H. W. Smith. The phenol red clearance in normal man. *J. Clin. Invest.* 15: 221, 1936.
6. Jolliffe, N. The excretion of xylose by glomerular and aglomerular kidneys. *Proc. Soc. Exp. Biol. Med.* 28: 5, 1930.
7. Jolliffe, N., J. A. Shannon, and H. W. Smith. The use of non-metabolized sugars in the measurement of the glomerular filtration rate. *Am. J. Physiol.* 100: 301-312, 1932.
8. Marshall, E. K., Jr., and H. W. Smith. The glomerular development of the vertebrate kidney in relation to habitat. *Biol. Bull.* 59: 135, 1930.
9. Orloff, J., and R. W. Berliner (Editors). Preface. In: *Handbook of Physiology. Renal Physiology*. Washington, DC: Am. Physiol. Soc., 1973, sect. 8, p. v-vi.
10. Pitts, R. F. Homer William Smith. *Natl. Acad. Mem.* 39: 445, 1967.
11. Rehberg, P. B. Studies on kidney function. I. The rate of filtration and reabsorption in the human kidney. *Biochem. J.* 20: 447, 1926.
12. Richards, A. N., B. B. Westfall, and P. A. Bott. Renal excretion of inulin, creatinine and xylose in normal dogs. *Proc. Soc. Exp. Biol. Med.* 32: 73, 1934.
13. Shannon, J. A. The excretion of inulin by the dogfish, *Squalus acanthias*. *J. Cell. Comp. Physiol.* 5: 301, 1934.
14. Shannon, J. A. The excretion of inulin by the dog. *Am. J. Physiol.* 112: 405-413, 1935.
15. Shannon, J. A. The excretion of phenol red by the dog. *Am. J. Physiol.* 113: 602-610, 1935.
16. Shannon, J. A., S. Farber, and L. Troast. The measurement of glucose *Tm* in the normal dog. *Am. J. Physiol.* 133: 752-761, 1941.
17. Smith, H. W. The regulation of the composition of the blood of teleost and elasmobranch fishes, and the evolution of the vertebrate kidney. *Copeia* 4: 147, 1931.
18. Smith, H. W., W. Goldring, and H. Chasis. The measurement of the tubular excretory mass, effective blood flow and filtration rate in the normal human kidney. *J. Clin. Invest.* 17: 263, 1938.
19. Wyckoff, J. Relation of collegiate to medical student scholarship. *Bull. Assoc. Am. Med. Coll.* 2: 1, 1927.
20. Wyckoff, J., and W. Goldring. Intravenous injection of ouabain in man. *Arch. Int. Med.* 39: 488, 1927.

Published by the American Physiological Society



New Printing

Circulation of the Blood Men and Ideas Edited by Alfred P. Fishman and Dickinson W. Richards (deceased) 1982/879 pages/248 illustrations/*\$3246-1/\$56.00/\$67.25 outside the US

Excitation and Neural Control of the Heart Edited by Matthew N. Levy and Mario Vassalle 1982/312 pages/illustrated/*4952-6/\$33.50/\$40.00 outside the US

New Perspectives on Calcium Antagonists Edited by George B. Weiss 1982/252 pages/122 illustrations/*9201-4/\$38.50/\$46.25 outside the US

Disturbances in Neurogenic Control of the Circulation Edited by Francois M. Abboud, Henry A. Fozzard, Joseph P. Gilmore, Donald J. Reis 1981/288 pages/130 illustrations/*0001-2/\$38.50/\$46.25 outside the US

The Heart Edited by Robert M. Berne and Nick Sperelakis 1979/978 pages/612 illustrations/*0605-3/\$130.00/\$156.00 outside the US

Vascular Smooth Muscle Edited by David F. Bohr, Andrew P. Somlyo, Harvey V. Sparks, Jr. 1980/694 pages/331 illustrations/*0606-1/\$95.00/\$114.00 outside the US

Order your copies through **Williams & Wilkins**, Department LM — 428 East Preston Street, Baltimore, Maryland 21202

Or order **free** by phone. Call 1-800-638-0672 from anywhere in the US except Alaska and Hawaii. From Maryland phones call 301-528-4221 collect. From Canada call collect between 9 and 4 EST 301-528-4223.

Compact recording camera

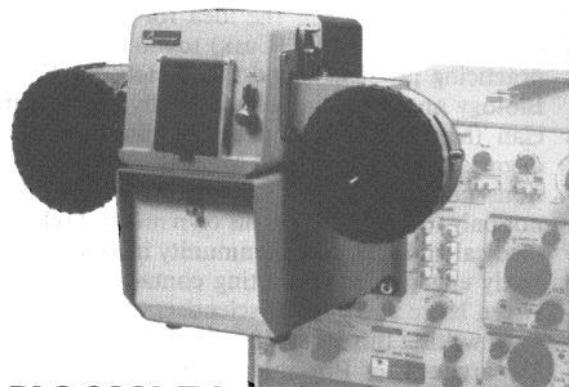

The RLG-6201 Tektronix compatible

The hood-mounting base allows for the easy connection to most Tektronix oscilloscopes. The DC motor for the film drive increases the reliability, while realizing a considerable reduction in size and weight for well-balanced mounting on an oscilloscope. Film speeds in 12 steps from 1mm/sec to 500mm/sec are controlled electronically, plus half and single frame modes.

For details, write or call collect at (714) 957-3340.



NIHON KOHDEN (AMERICA), INC.

1652 Deere Avenue, Irvine, CA 92714 (714) 957-3340 Collect calls invited

Congress May Have Three Choices In Legislation Proposed for Animals

While the House of Representatives continues to push for research animal reforms for programs and projects funded by the National Institutes of Health, the mood of the Senate has changed to developing legislative proposals that 1) would broaden the scope of such reforms by amending the Animal Welfare Act or 2) would place other matters of using animals in research on hold until a study of the issues can be completed.

As of this writing two bills pertaining to animals in research have been introduced in the Senate, and the renewal authorization for the National Institutes of Health has been amended by a House subcommittee to include research animal reforms.

One of the bills that has been introduced is S. 657, the "Improved Standards for Laboratory Animals Act." The bill is sponsored by Sen. Robert J. Dole (R-KS) and is endorsed by Sens. John Melcher (D-MT), Jennings Randolph (D-WV), Ted Stevens (R-AK), Charles H. Percy (R-IL), and John Heinz (R-PA). The bill has been assigned to the Senate Agriculture Committee for its review and approval.

The purpose of this bill is to amend Section 13 of the Animal Welfare Act by requiring the establishment of institutional animal studies committees at all research facilities. The committees would be charged with making at least twice-a-year inspections of all animal areas of the facility and with reviewing research methods and practices which involve the use of animals to ensure that animal pain and distress are minimized and to ensure compliance with the standards for appropriate animal care, treatment, and methodology.

The committees would notify both the Secretary of Agriculture and the Federal agency granting an award that such inspections have been made. The committees would also notify the US Department of Agriculture's Animal and Plant Health Inspection Service of conditions found to be unacceptable. Such notifications, however, would be made only after the administrative representative of the facility had been made aware of the unacceptable conditions and corrective actions had not been taken.

Each committee would be composed of at least one veterinarian and at least one person not affiliated with the institution. No more than three persons from the same administrative unit of the institution would be permitted to serve on a committee.

The bill would also require the Secretary of Agriculture to add to the Animal Welfare Act's current standards provisions to ensure that research animals receive adequate exercise and that research animals are separated by species whenever necessary for humane handling. The Secretary would also be charged with developing standards for research facilities, including standards for animal care, treatment, and methodology

in experimental procedures so as to ensure that animal pain and distress are minimized.

There is no mention in the bill of requirements for accreditation or for mechanisms to develop alternative methods. The bill does establish the National Agricultural Library as the clearinghouse for providing information about methods that would reduce or replace animal use, minimize pain and distress, and prevent unnecessary duplication of animal experiments.

With the exceptions of the Secretary's requirements to develop additional standards and the role of the National Agricultural Library, the bill, by and large, is a copy of Sections 203 and 301 of the bill sponsored in the last Congress by Rep. Doug Walgren (D-PA). Last year Dole and Melcher did sponsor in the Senate a companion bill to the Walgren bill. Both the House and Senate initiatives died in committee.

Instead of reintroducing his bill in this session of the Congress, Walgren attached to the National Institutes of Health Renewal Authorization Bill (HR 1555) amendments that would require the Division of Research Resources to develop a plan by June 1, 1984, for alternative methods in research and for reducing the number of animals being used in research; requiring the Secretary of the US Department of Health and Human Services (DHHS) to establish standards for the care and treatment of research animals used in NIH-funded programs; and requiring all NIH-funded programs using animals to establish institutional animals studies committees to conduct inspection of all animal facilities at least twice a year and to certify that the standards to be developed by DHHS are being maintained.

A similar legislative initiative was introduced by Rep. Edward Madigan (R-IL) as a substitute for the Walgren amendment during the House Subcommittee markup on HR 1555, but was defeated on a 10-8 vote.

The Walgren amendments were approved by the House Subcommittee on Health and the Environment in March, and the full Committee on Commerce and Energy is expected to act upon the bill in April.

The third proposal has been introduced by Sens. Orrin G. Hatch (R-UT) and Edward M. Kennedy (D-MA), entitled the "Animal Research Study Act of 1983." This bill would require the Secretary of DHHS, through the National Institutes of Health, to contract with the National Academy of Sciences or other nonprofit organizations to conduct an 18-month study of the use of live animals in biomedical and behavioral research.

The proposed study would assess the status of the use of live animals in research at all federally supported institutions and, if possible, those research institutions not receiving Federal funds. The study would seek to determine the types and numbers of animals used in research during the last five years, prepare an analysis of whether the number of animals used has increased or decreased, and explore methods that can be used to conduct research for which there are alternatives to the use of live animals.

The proposed study would also assess the implications of mandatory standards and accreditation including the financial impact on research facilities should such standards and accreditation be imposed. Addi-

tionally, an evaluation would be made as to the extent to which accreditation of laboratories protects animals against inhumane treatment.

Also included in the study would be a review of all Federal and state laws and regulations governing the use of live animals in research, an evaluation of efforts by the DHHS to decrease the number of live animals used in research, and an evaluation of DHHS efforts to ensure that humane care, treatment, and appropriate use of live animals are being maintained by research institutions.

Because the proposed bill does not authorize funds for the study, the cost would be borne by funds already appropriated for the DHHS.

A similar legislative initiative was introduced by Rep. Edward Madigan (R-IL) as a substitute for the Walgren amendment during the House Subcommittee markup on HR 1555 but was defeated on a 10-8 vote.

Four Primate Centers Are Targets for Demonstrations

Four of the seven regional primate centers have been selected by the Mobilization for Animals as the targets for mass public demonstrations on April 24, which has been designated by animal welfare organizations as "World Laboratory Animal Day." The four centers are the New England Regional Primate Center at Southborough, MA, Wisconsin Regional Primate Center at Madison, California Regional Primate Center at Davis, and the Yerkes Regional Primate Center in Atlanta.

Mobilization for Animals (MFA) is a recently organized militant international coalition of approximately 100 animal welfare groups, of which 70 are in the United States. The headquarters office is in Jonesboro, TN, and its efforts are coordinated by Dr. Richard Morgan, a professor of English at Eastern Tennessee State University.

The public demonstrations are designed to bring attention to the effort by the MFA to pressure the Senate and House appropriations committees to reduce or eliminate funds for the regional centers in Fiscal Year 1984. Targeted specifically in this lobbying effort is the funding for the centers at Beaverton, OR, and Covington, LA, which MFA hopes to have closed within the year for reasons of "relative inaccessibility, high disease and mortality rates, geographical redundancy, and duplication of work."

The MFA wants to use the funds that would be appropriated for these two centers to "repatriate resident primates to natural habitats or wildlife refuges, or to place them in MFA-approved research facilities (and) under the direction of MFA member groups." The MFA is also seeking within each primate center or related facility and at the National Institutes of Health that MFA-designated members be given 25% of the voting membership on all policy making, review, and advisory committees that are concerned with the treatment and care of animals, the conduct of experiments, pain classification, and funding requests.

William M. Samuels, CAE

CALL FOR PAPERS

Use and Need for Laboratory Animals in Research

Because of the increasing public focus on the use of laboratory animals in research, there is growing need for both the scientific and education communities to make known how animals have benefited research and why animals will continue to be needed for research and education.

Articles on the use and continuing need for laboratory animals would be welcomed for consideration for publication in *The Physiologist*. The publication of such articles not only could help broaden the public's understanding of the issues but could also serve as useful references in the Society's continuing debates with the antivivisectionists and in providing data to Federal and state legislative and regulatory bodies.

Symposium on Animals and Their Alternatives in Research and Testing

The Symposium on Animals and Their Alternatives in Research and Testing will be held at the 149th Annual Meeting of the American Association for the Advancement of Science, Detroit, MI, May 30, 1983. The objective of the symposium is to examine the scientific, economic, and policy issues associated with the use of animals and animal alternatives in research and testing. These issues are especially relevant now that progress in techniques such as tissue culture and computer modeling is being used to support legislative initiatives to reduce the number of animals used and to fund alternatives to animal research. The state of the art of alternatives to animal testing will be discussed by A. M. Goldberg using examples from the Johns Hopkins Center for Alternatives to Animals Testing. E. C. Melby, Jr., Cornell College of Veterinary Medicine, will address the unavoidable use of animals when assessing the safety and effectiveness of new drugs. The point of view from the pharmaceutical industry will be presented by J. W. Ward, A. H. Robins Co. Emphasis will be placed on the economic, humane, and pragmatic issues involving the discovery and development of drugs which continue to improve the health of mankind. F. L. Trull, Association for Biomedical Research, will review and analyze proposed federal legislation to more tightly control the use of animals. How the scientific community can play an active role in the direction of current and future legislation will be presented. *For additional information contact: AAAS Meetings Office, 1101 Vermont Ave. NW, Washington, DC 20005.*

Walter C. Randall

Is Medical Research in Jeopardy?

I recently attended the 55th annual scientific meeting of the American Heart Association, where several hundred scientists from all over the world convened to present and discuss their data describing new approaches to the understanding and treatment of cardiovascular diseases. I heard many papers containing totally new information in my own field of interest and received valuable new insights into improving and extending my research protocols and teaching notes for my medical physiology and graduate student lectures. I have spent my entire professional career in teaching and medical research. The AHA meeting was typical of many I regularly attend each year, designed to facilitate exchange of research information and insights among investigators and invariably leading to greater depth of knowledge of human disease and its control. From such meetings, thousands of physicians acquire new information directly applicable to their patients' problems, often potentially lifesaving. Similarly, laboratory scientists and teachers carry new ideas back to their research benches, classrooms, and hospital wards. Additional details of the reported research will appear in the journals months from now, to be sure, but each of the participants in the meetings gained valuable inspirational momentum as well.

As I listened to paper after paper, I recognized immense advances in the understanding of coronary heart disease: totally new mechanistic concepts of function, new receptor agonists and antagonists, new sites of therapeutic drug action, new statistics on carefully controlled therapeutic trials, etc. Such new knowledge is especially meaningful to me since this is my area of research interest, but it also has an even deeper personal significance. My attendance at this meeting was one of my first ventures away from my institution and hospital after undergoing quadruple aortocoronary bypass surgery only a few weeks earlier. I heard several reports and saw

many demonstrations comparing up-to-the-minute surgical and pharmacologic treatments of coronary heart disease. Many experts continue to debate the advantages of surgery versus medical treatments, but I have been favorably impressed with results that combined the best from each discipline. Having faced almost certain deterioration and probable death from heart muscle ischemia and now being able to perform daily tasks and even moderate exercise, I deeply appreciate the fantastic progress that has come out of the kind of research I heard described during that week in Dallas.

As a medical school teacher and research investigator for more than 40 years, I recognized that some 80% of the new knowledge and new technology that made my recovery from severe coronary vascular disease possible was simply not available to cardiologists and their patients 15 years ago. People who suffered from even less serious heart disease died or were hopelessly crippled with prolonged, painful disease. I thought of the dramatic, almost miraculous diagnostic and therapeutic advances that have marked the past 10 to 15 years in my own field of research and that culminated in the prompt identification of the cause of my debilitating chest pain, as well as its almost instantaneous surgical correction. All of this was based on the same kind of penetrating, meaningful research that I had heard described at the AHA sessions. Without this kind of research hundreds of thousands of lives would have been lost. From this perspective, is medical research not one of the best investments of time, energy, talent, and money that has been made with public funds?

What are the ingredients of such research? To what, and to whom, do we owe the dramatic, life-saving advances in knowledge? I think immediately of those research scientists, including some physicians, who are not content to simply handle patients' disease problems, as did their predecessors, and who insist on deeper understanding of the way in which the body functions. They forgo the rich financial rewards of medical practice and pass their new insights freely to the

Dr. Randall is Professor of Physiology at the Stritch School of Medicine, Loyola University of Chicago; he is President of the American Physiological Society.

clinical physician. What a magnificent partnership exists between these two levels of medical expertise: one to develop better understanding and one to offer the results promptly and efficiently to the public. It is clear that each must be supportive of the other and constantly mindful of a meaningful and intimate interdependence.

In cardiovascular research, the fantastic increase in knowledge of the heart and vascular system has largely occurred in the past 20 to 30 years. In other words, nearly everything that is currently known about the heart and its diseases has evolved during the lifetime of living investigators. True, many elder statesmen among practitioners achieved excellent care of patients without the benefit of highly developed instrumentation but, rather, through experience, perceptive observation, and informed intuition. Many physicians included vasospasm in their explanations of myocardial ischemia, only to be told for many years that such a mechanism did not exist. It is only within the past five to 10 years that coronary vasospasm has been convincingly demonstrated. While William Heberden (1710-1801) and John Hunter (1728-1793) accurately described anginal pain and correctly ascribed it to disease in the arterial system supplying nutrients and oxygen to heart muscle, they knew little of the metabolic, neural, and humoral mechanisms normally regulating this system. It is hard to imagine a modern hospital without its intensive care units, but such did not exist, even in advanced research settings, as recently as a quarter of a century ago.

Research Funding

This period corresponds closely to the existence of the National Institutes of Health, which were created in 1949 with relatively limited funding. The ensuing three decades have seen the growth and development of an immensely productive period of federally supported research. While the direct influence of such research funding by government can be related to concurrent dramatic reduction in mortality and morbidity due to heart disease, the scientific community has not clearly and systematically articulated the numerous specific contributions to health of ongoing scientific investigation. Otherwise, I doubt that Congress and the administration would seriously consider curtailing such relatively small expenditures of public tax money. It is probably correct to assume that virtually every family in the United States has been touched by the lifesaving contributions or enhancement in quality of life to be traced directly to this expenditure of tax money. Scientists shudder at the shortsighted policies of Presidents Johnson and Nixon in restricting NIH and NSF funding, disastrously exacerbated by inflationary increments in research costs. Recent administrative curtailment of funds for medical research cruelly chills the incentive for young scientists and physicians to choose this direction for a pro-

fessional career, posing a serious threat to future staffing of university faculties and teaching hospitals. A more immediate effect of the curtailment of research funding is being felt by established investigators, who are unable to obtain funding for exceedingly high-quality research proposals. Many scientists at the Heart Association meeting told me they refused to waste so much time re-writing and reapplying and were dropping out of the research pool.

There is an obvious lack of communication between medical scientists and the taxpaying public. People are surprisingly unaware of the advances in health care that have come about totally through research. Yet we can recall the terrible fear of the crippling effects of poliomyelitis. Only a generation ago, thousands of young people died of rheumatic heart disease. The development of antibiotics during the second World War revolutionized the treatment of infectious diseases. The production of insulin and its lifesaving contributions to thousands of productive citizens is casually taken for granted. Who can challenge the medical as well as the socioeconomic triumphs represented by cardiac valve replacement, correction of congenitally misplaced vessels in infants, heart transplantation, and aortocoronary bypass? All of these dramatic developments were the products of recent research, much of it supported by NIH funding.

Use of Animals

Another important concern for the productive pursuit of research is the question of appropriate models for study. My own research over the years has involved experiments with dogs, primarily because they reproduce almost without restraint, because their functional anatomy is readily applicable to problems in human medicine, and because a huge surplus of animals is doomed for destruction by pounds—often by less humane methods than their sacrifice in experimental laboratories. Such animals were available without charge or for a delivery charge of approximately \$2.50 during the 1950s and 1960s, and most rational people felt such utilization was a clear service to the community. The recent surge of emotionally charged arguments of cruelty by publicity-seeking individuals has caused the costs of such animal models to become prohibitive (\$200 to \$300) in many areas. Without comparable increments in research funding, there can only be a serious limitation on the number of experiments—and therefore on the amount of new scientific information acquired—from ongoing research.

While some carefully considered legislation has positively served the research community through requirement of upgraded physical facilities and professional care of experimental animals, other laws have imposed costly requirements that are unnecessary or even capricious. Many congressional leaders have been taken in by the emotion-

al outcry of individuals who do not understand what they are asking for. During a recent prime-time radio broadcast in Chicago, a listener called in to declare: "All investigators who employ experimental animals are worse than Hitler." Unfortunately, these are the people who write voluminously to their congressmen and who support organizations of like-minded people who admit they would rather have experiments carried out on human patients than on animals. Other types of irresponsible encroachment on the availability of animals for use in research come from editorials or feature articles designed to sell newspapers rather than to communicate useful information. Recent articles in *The New York Times*, *The Chicago Tribune*, and other large newspapers have emphasized unusual instances of abuse, with obvious intent to create the impression that they are the rule rather than the exception.

Even some poorly informed medical students accept these arguments by saying they can learn better from textbooks than from experience with anesthetized animals. In teaching medical students, I have often had to reeducate a first-year student, who in his first cutdown on an anesthetized animal's veins mistakenly cuts through an artery or venous branch. I remind him, and all of his classmates, that I am glad he made this kind of mistake in the laboratory rather than in the hospital emergency room, where he will first encounter a patient in deep shock. These students invariably apply themselves diligently to the laboratory study of functional anatomy before "practicing" on human patients.

It is equally important for medical students to appreciate their utter dependence on research for their future ability to offer patients the best in diagnostic and treatment skills. The medical student must understand that many of the "facts" described in today's textbooks will have changed by the time they are used in practice. Research is constantly introducing new technology, new interpretations, new treatments.

Still another problem is posed by the small but vocal groups who would stifle research by totally eliminating the use of experimental animals. Such groups have introduced legislation that would require that a large fraction of NIH funds available for research be diverted to the development of substitutes for experimental animals. The proponents argue that computers, mathematical models, and cell cultures may be developed to replace the use of whole animals.

The fallacy in this reasoning is revealed in my own field of research. We have recently discovered a region in the dog heart that contains previously unsuspected automatic cells; these can effectively replace the cells that automatically generate each individual heartbeat. Physiology textbooks currently state that with disease or destruction of the sinoatrial node, or pacemaker of the heart, the beat must originate from a slower, less stable pacemaker center in the atrioventricular region.

In this kind of dysfunction, artificial pacemakers may be installed in human patients. Unfortunately, surgeons may resort to this device too frequently, at great expense and at risk of poor results. They have done so for lack of knowledge of the presence and function of the inferior atrial subsidiary pacemakers. Thus, if we were forced to accept the best teachings of the most recent textbooks to derive information for the computer, we would have to expect wrong answers.

Special emphasis on the dog as an experimental model directly applicable to human disease is reflected in the protocols of papers presented at the Heart Association meeting. Of the sessions I attended (dealing mostly with cardiac regulation, dynamics, and coronary blood flow), nearly all of the experiments were carried out on dogs. About half of the 1,500 papers reported studies on human subjects, while half involved experimental animals (dog, rat, rabbit, lamb, etc).

Modern Medical Technology

The crucial importance of animals in medically oriented research is perhaps most dramatically illustrated by the original studies underlying development of techniques and procedures now used in treating human disease. For example, a key instrument employed in human catheterization is the Swan-Ganz catheter. As this instrument was inserted into my peripheral vessel and threaded into my heart during my recent catheterization, I recalled that its original development was financed by the NIH only a few years ago. In fact, I sat on the NIH team that evaluated its application for research and development funding. In the original scientific paper describing this instrument, the authors referred to an earlier paper in which the concept of a flotation catheter had been developed in a totally different context, with the dog serving as the experimental model.

Another vitally important procedure employed in routine as well as highly specialized cardiovascular studies in human disease today is the accurate recording of blood pressure by the resistance wire strain gauge pressure transmitter. This device has revolutionized our ability to examine the cardiodynamic status of the heart and vascular system and is available in every modern medical center. It was developed for measurement of blood pressure in humans under excessive gravitational stresses but was first thoroughly tested in the dog in 1947. It was adapted to measurements of intracardiac pressures in 1958 and for prolonged, continuous measurement of arterial pressure in patients only as recently as 1962.

Heart Surgery

In tracing the evolution of experiments necessary before modern open heart surgery could have been accomplished, Drs. Julius Comroe and Robert Dripps recounted the step-by-step advance.

chiseled out by thousands of workers in many branches of science over a number of years (Circ Res 35:661, 1974). Surgeons regularly reported that the dog laboratory was the single most important component. That is where the surgeons had to test hypotheses and techniques and perfect their skills.

In answer to the question: What knowledge had to be acquired before open heart surgery could become a routinely successful procedure? Comroe and Dripps state that an absolute requirement was the development of a pump-oxygenator to keep the patient alive while the heart was being repaired. The pump-oxygenator was developed with crucial dependence on animal-based experiments. But the pump-oxygenator itself was possible only because of many earlier discoveries. For instance, anticoagulants had to be available to prevent clotting. John Gibbon didn't begin his work on pump-oxygenators until 1934, the year pure, potent heparin became available. This was not a simple coincidence: the most elegant pump designed was doomed to fail unless the blood it pumped remained liquid. Animal experiments played a key role in an earlier discovery—of blood groups, by Karl Landsteiner—which led to blood typing, then to safe blood transfusions, and now to safe blood for use in pump-oxygenators. Still another essential early discovery was the basic knowledge of red blood cells, their life span in the body, and how to preserve them outside the body. This led to the ability to store blood for use in emergencies, then to blood banks, and now to the supply of adequate amounts of compatible blood for use in the pump-oxygenator. A fourth series of studies yielded basic information on the diffusion and exchange of oxygen and carbon dioxide. A fifth was on the synthesis of new plastic materials, which began in chemistry laboratories in 1905, permitting development of plastic tubes, bags, and valves (which are now absolute requirements for a pump that will not damage the blood), as well as an artificial lung that permits proper transport of oxygen and carbon dioxide. Each of these individual steps required acquisition of critical knowledge from animal experiments. Current levels of excellence in heart surgery would not have been possible without them.

But successful open heart surgery requires more than the use of a pump-oxygenator. What else had to be learned before the cardiac surgeon could open the thorax, stop the heart, open the heart, perform the necessary corrective surgery, restart the heart, and care for the patient to ensure full and speedy recovery? Physiologists had to learn about the existence and function of the heart's conducting system and ranges in its normal rhythm. Literally thousands of separate studies involving experimental animal models were required to obtain this vital information. These studies led to the development of electrical defibrillation and to the detection of other serious dysrhythmias, as well as to the ability to reverse

them (cardioversion) or to control them (cardiac pacemaker).

Simultaneously, anesthesiologists had to develop closed-circuit anesthesia and learn to use muscle-relaxing agents that permitted careful, delicate, and painstaking repair of cardiac tissues, rather than the fast slashing and stitching that had been the hallmark of early cardiac surgery. Included in these experimental studies were microscopic procedures necessary to anastomose small blood vessels in such a way as to match endothelial surfaces and prevent rough edges or protruding surfaces that could serve as focal points for clotting. Physiologists also had to learn about control of respiration and mechanical properties of lungs, how to ventilate lungs when the thorax was open, and how to measure blood oxygen, carbon dioxide, and acidity. Only then could precise oxygenation of the patient's blood and proper removal of carbon dioxide be achieved.

A German physicist, Wilhelm Roentgen, had to discover x-rays; a Dutch physiologist, Willem Einthoven, had to devise a sensitive instrument to record the electrical activity of the heart (electrocardiogram); and French, German, and American physiologists (Andre Cournand, Werner Forssmann, and Dickinson Richards Jr.) had to develop the technique of cardiac catheterization—all necessary for accurate preoperative diagnosis—before surgery could be attempted. Physiologists and physicians had to study survival times of completely bloodless organs at normal and at low temperatures so that cardiac surgeons would know the safe time limits for an operation while the heart is completely quiet. They had to determine how to stop the heartbeat by either chemical or electrical means, obviously involving crucially important animal (mostly dog) experiments at every step along the way. Ultimately, this knowledge permitted cardiac surgeons to stop heart action to provide a bloodless, motionless organ on which to operate, with assurance that the heart would beat again when the surgery was completed and that the beat would be vigorous and normal.

It is clear, therefore, that the surgeon did not jump from ignorance to the pinnacle of open heart surgery in a single, giant step or in a dramatically brief period of time. These thousands of interrelated stepping stones had to be laid first over several decades. Cardiac catheterization is now an everyday routine. Its use depends on many advances in basic science, clinical investigations, engineering, and industrial development. The marvels of modern cardiology, which directly or indirectly touch virtually every family in America, are based totally and irrevocably on careful performance of critically controlled animal experiments.

It is my conviction that once the public comes to realize the importance, the absolute essentiality of animal models in creative biomedical research—leading ultimately to recognition and

curing of human disease—people will not accept the dictum that the use of animals for teaching and research is unnecessary. Historically, one can trace virtually every modern medical miracle back to original critical studies in animals. Those who claim that such procedures can now be eliminated because the computer, mathematical models, or cell cultures can replace animal models are not properly informed. Science has only begun to crack the barrier of ignorance surrounding understanding of how the human body operates. All organ systems require much additional examination; they cannot be initially studied in the required depth in living, human subjects. Animal-based experiments will continue to be essential for a considerable period in order to solve existing problems.

There can be no legitimate objection to insistence on maintenance of clean and comfortable quarters for animals employed in research institutions. Properly trained and equipped personnel, under the direction of experienced veterinarians, are essential. Compassionate care of experimental animals is necessary to ensure derivation of reliable information from the investigations. However, current regulations sometimes border upon ridiculously needless and trivial requirements. They add to escalation in the cost of research.

which clearly slows progress. Budgets required for effective research must incorporate the additional charges and thus deprive other important areas of emphasis. It has been estimated that current animal legislation being considered by Congress would increase costs of doing research by more than one billion dollars over the next 10 years. Even these exorbitant expenditures would be preferable to elimination of animal experimentation, but reason dictates more effective and more productive utilization of taxpayers' money.

Thus, virtually all biomedical investigators join in insisting on proper and humane care of animals by the research community, but we feel strongly that many arguments against their use in research are based on superficially emotional and philosophically empty reasoning. We can readily document the essential and intimate relationship between use of animal models and progress in treating human disease. The latter is simply not possible without the former. Much remains to be done in conquering human disease. Do not impede the spectacular progress that has been made during the past 20 to 30 years by foolishly abrogating responsibility to support well-conceived, socially, economically, and ethically needed progress in medicine.

Announcements

Seventh International Congress of Endocrinology

The Seventh International Congress of Endocrinology will be held in Quebec City, Canada, July 1-7, 1984. Ten plenary lectures, 45 symposia, meet-the-professor session, technical sessions, and poster sessions will be presented. A number of satellite symposia are being organized for before or after the Congress. *For additional information contact:* The Secretary, Seventh International Congress of Endocrinology, Le Centre Hospitalier de l'Université Laval, 2705 Boul. Laurier, Ste-Foy, Quebec G1V 4G2, Canada.

ASPET 1983 Fall Meeting

The American Society for Pharmacology and Experimental Therapeutics will hold its annual Fall Meeting in Philadelphia, PA, August 7-11, 1983. Posters, platform sessions, and symposia will make up the program for the meeting. Symposia will cover a wide range of topics including pharmacology of leukotrienes, ageing, peptides positron emission tomographic (PET) scanning applications, and central mechanisms of antihypertensive drugs. *For further information contact:* Dr. Warren S. Chernick, ASPET 83, Hahnemann University, Broad and Vine Streets, Philadelphia, PA 19102. Telephone: (215)448-8260. *For registration materials contact:* Kay Croker, ASPET, 9650 Rockville Pike, Bethesda, MD 20814. *Abstract deadline:* May 2, 1983.

Fourteenth Congress of Collegium Internationale Neuropsychopharmacologicum

The Fourteenth Congress of Collegium Internationale Neuropsychopharmacologicum will be held in Florence, Italy, June 19-23, 1984. *For additional information contact:* Dr. Giorgio Racagni, Chairman, Institute of Pharmacology and Pharmacognosy, University of Milan, Via Andrea del Sarto 21, 20129 Milano, Italy.

First International Workshop on Icosanoids and Ion Transport

The First International Workshop on Icosanoids and Ion Transport will be held in Paris, France, November 17-18, 1983, co-chaired by D. Tosteson, Dean of Harvard Medical School, and the Nobel Prize Winner, Bengt Samuelson. The workshop will explore a possible reciprocal relationship between the arachidonic acid cascade and ion transport mechanisms. The main topics will consist of basic mechanisms of ion transport and the arachidonic acid cascade, the role of ions in the modulation of arachidonic acid cascade, the role of icosanoids in the control of ion transport, pathophysiological models for icosanoids-ion transport interactions, and pharmacological control of icosanoids-ion interactions. Papers may be submitted for either a lecture or a poster session. *Call for Abstracts:* Deadline May 14, 1983. *For further information contact:* Dr. G. Dagher and Dr. J. Diez, Université René Descartes, CHU Necker-Enfants Malades INSERM U7, 161, rue de Sevres 75015 Paris, France.

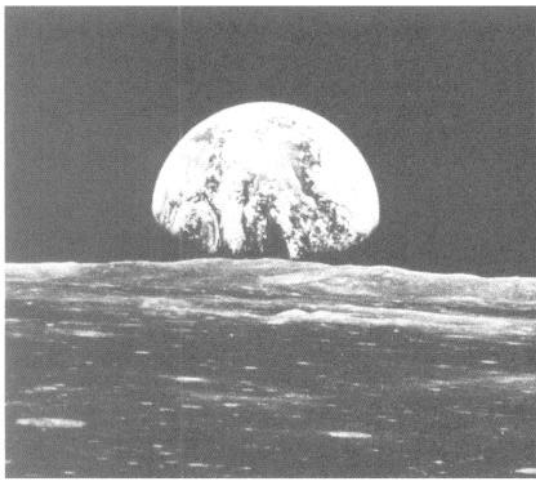

International News

Rodolfo Margaria

Rodolfo Margaria, who died on 29 January 1983, will be remembered in both science and international cooperation toward the preservation and expansion of human values. Margaria traveled widely and made scientific contributions in many of the major physiology laboratories of the world. Each place he visited produced a shower of valuable contributions, frequently with Margaria as a coauthor.

A patriot of his native Italy, Margaria served in the resistance movement during World War II, entered politics briefly thereafter, and continued to work for the broad development of Italian science. A nonconformist in personal behavior, Margaria stimulated those around him by his refreshing approach to life.

Gravitational physiology as well as other branches of physiology and science in general have been the beneficiaries of Rodolfo Margaria's genius. On the basis of a masterly analysis of the mechanics of human locomotion, he and G. A. Cavagna were able to predict with dramatic success the difficulties of normal walking and running and the efficacy of jump progression in lunar subgravity five years before the first astronaut landed on the moon (*Aerosp. Med.* 35: 1140-1146, 1964).

Margaria served with distinction as an IUPS Council member and as IUPS representative to COSPAR from 1965 to 1974. He was instrumental in the formation of this Commission in 1974. He was also Professor Emeritus of the Istituto di Fisiologia Umana, University of Milano, Italy.

(From "Dedication," *Physiologist* 23(6): Suppl., 1980.)

To Roberto Margaria:

I was very distressed to learn of the death of your father on January 29. He was a great man and a cherished friend. Our friendship was formed during 1931-32 when he worked with me in the Harvard Fatigue Laboratory.

My chief, Prof. L. J. Henderson, quickly developed great admiration for his intelligence and scientific brilliance. My colleagues, especially Harold T. Edwards and John H. Talbot, and I formed firm friendships with Rodolfo that, in my case, lasted a life time.

His six investigations during 1931-32 in the Fatigue Laboratory added much to its luster. He had major

responsibility for the concepts, for guiding the investigations, and for writing the papers. The one I rate best became a classic in the field of exercise physiology: Margaria, R., D. B. Dill, and H. T. Edwards. The possible mechanisms of contracting and paying the oxygen debt and the role of lactic acid in muscular contraction. *Am. J. Physiol.* 106: 689-715, 1933.

You may know that your father was a sound sleeper. Sometimes I took my colleagues for weekends to my summer cottage in Hillsboro, New Hampshire. One morning after a late evening of wine and talk I called Rodolfo for breakfast three times without result. I then took my shotgun to his upstairs bedroom and fired it through an open window. That had the desired effect.

At age 91 I look back on a life made happy by close friendships. Pictures of many of those friends hang on the walls of my study. Among them is Rodolfo's taken on the occasion of his stop at the Grand Canyon when he was on the way to present a seminar here in the early 1970's.

May he rest in peace.

Bruce Dill

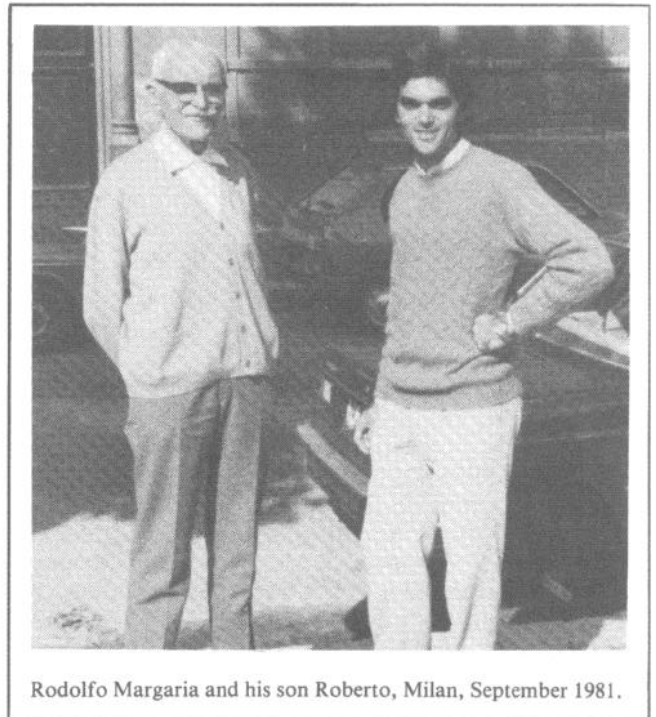

Rodolfo Margaria and his son Roberto, Milan, September 1981.

SOCIETY NEWS

APS Fall Meeting, Honolulu
Aug. 20-24, 1983

XXIX IUPS Congress, Sydney
Aug. 28-Sep. 3, 1983

Travel Plans

Los Angeles/Honolulu: Block seats reserved on American Airlines for \$296.00 round trip (plus lowest fares from home city to Los Angeles).

West Coast to Sydney, Australia: Special low **guaranteed** air fares on Continental Airlines and Qantas Airways for \$849.00 round trip and a 10% reduction on all prices within Australia.

This fare allows stopovers in Honolulu, Melbourne, Sydney, Auckland, and Fiji (on Continental) or Tahiti (on Qantas). In addition we have prepared for you a complete selection of pre- and post-Congress tours including the Outer Islands of Hawaii, tours of Australia (including Heron Island on the Great Barrier Reef), New Zealand, and China.

Please **note:** Regulations stipulate that, in order to qualify for the low fares to Sydney, you must purchase a land package through us at a minimum of \$190.00.

Hotel Accommodations: For your convenience we have blocked hotel rooms in Sydney at special group rates: Hotel Hilton (deluxe category) and Hotel Koala Oxford Square (first class). Both are excellent and centrally located. If you wish to reserve rooms at either of these hotels, do **not** complete the Housing portion of your Registration Form when returning it to Sydney. Instead make your hotel reservations when completing the Chevy Chase Travel reservation form.

Visas: Individuals traveling with Chevy Chase Travel will receive visa information. Those who are not using Chevy Chase Travel should apply for their Australian visas **immediately** in order to allow time for processing. Visa applications may be obtained from the Australian Consulate in the following cities: New York, Chicago, San Francisco, Los Angeles, Honolulu, Houston, and Washington, DC. *For information related to the specific city in which to apply, call Express Visa Service, (202)387-8009.*

For detailed brochure and prices return this coupon:

(APS—Honolulu/Sydney)

TO: Chevy Chase Travel, Inc.
4715 Cordell Ave.
Bethesda, MD 20814

Please send detailed brochure to:

Name: _____

Address: _____

1983 APS Fall Meeting Activities

Sheraton Waikiki Hotel

August 20-24, 1983

Saturday, Aug 20

9:00 A.M. Council Meeting, Koko Krater Room

Sunday, Aug 21

4:30 P. M. Bowditch Lecture

Functional Mapping of Cardiovascular Reflexes and the Heart Using C¹⁴-2-Deoxyglucose

D. Kostreva

Veterans Administration Hospital, Milwaukee

Monday, Aug 22

4:30 P.M. Past President's Address

Crises in Physiological Research

W. C. Randall

Loyola University, Maywood

Followed by

APS Business Meeting

Tuesday, Aug 23

6:00 P.M. Luau

Wednesday, Aug 24

9:00 A.M. Refresher Course

Physiology and Biochemistry of Receptors

J. Spitzer, Organizer

Louisiana State University, New Orleans

Sea-Bird Energetics Symposium

The 1983 APS meeting in Honolulu will include a symposium sponsored by the Comparative Physiology Section, titled Sea-Bird Energetics, organized by G. C. Whittow and H. Rahn. The initial session of the symposium will be held on Tuesday afternoon, August 23, and the second session will be on Wednesday morning, August 24. In addition to the organizers, the speakers' list for the symposium includes the following: R. A. Ackerman, Iowa State University; R. Davis, Scripps Institute of Oceanography; W. R. Dawson, University of Michigan; H. I. Ellis, University of San Diego; G. S. Grant, North Carolina State Museum of Natural History; C. R. Grau, University of California, Davis; G. L. Kooyman, Scripps Institute of Oceanography; Y. Le Maho, Centre National de la Recherche Scientifique (France); S. Lustick, Ohio State University; T. N. Pettit, University of Hawaii; R. E. Ricklefs, University of Pennsylvania; J. A. Wiens, University of New Mexico.

Future Meetings

1983

APS "Fall" Meeting
IUPS Congress

Aug 20-24, Honolulu
Aug 28-Sep 3, Sydney

1984

FASEB Annual Meeting
*APS "Fall" Meeting

Apr 1-6, St Louis
Jul 29-Aug 7, Lexington

1985

FASEB Annual Meeting
*APS "Fall" Meeting

Apr 21-26, Anaheim
Aug 4-9, Buffalo

*Campus meeting

Honors and Awards

Two APS members will be honored by the American College of Physicians during the opening convocation ceremonies of the College's 64th Annual Session in San Francisco, April 11-14, 1983.

Earl H. Wood, MD, will be honored for his investigative research, much of which has made spectacular advances in cardiovascular surgery possible. Dr. Wood, Professor of Physiology and Medicine at the Mayo Medical School, Rochester, MN, will be presented with the College's John Phillips Memorial Award, which recognizes individuals who have made distinguished contributions to internal medicine. Dr. Wood was President of APS in 1980-81.

Jay H. Katz, MD, JD, of New Haven, CT, will be honored with the William C. Menninger Memorial Award for contributions to the science of mental health. Katz, a Yale professor who holds degrees in medicine and law, is known for his contributions to the understanding of family law, human experimentation, decision-making in catastrophic illness, and psychiatry and the law.

Vernon B. Mountcastle, MD, university professor of neuroscience at The Johns Hopkins School of Medicine, has been awarded the International Scientific Prize of the Fyssen Foundation, which encourages scientific study of the mind and behavior. Dr. Mountcastle, who is an APS member, received the prize and \$20,000 in Paris recently. Dr. Mountcastle was honored for nearly four decades of research into the organization and function of the cerebral cortex, or gray matter of the brain, responsible for such mental properties as perception and thought. This research provided one of the foundations for current theories of higher brain function.

The Hopkins neurophysiologist pioneered the study of the electrical properties of individual cells in the cerebral cortex. Using this single-cell recording technique, he discovered in 1950 that the cerebral cortex is organized into a mosaic of columns of nerve cells. The cells within each column are well connected to one another but are poorly connected to cells beside them. Scientists previously believed that the cells of the cortex were connected diffusely. Dr. Mountcastle's studies of cortical organization led him to develop a new theory of brain function based on modules, groups of interconnected brain cells. In a process analogous to the operation of computer hardware, the module receives an "input" of information, processes the information, and responds with an "output" of information. The modules are organized into systems that control the most complex human mental activities, he believes.

Dr. Mountcastle received his medical degree from Hopkins in 1942 and has trained over 40 neurophysiologists in his 35 years as a Hopkins faculty member. He has written more than a hundred scientific articles and has written or edited several textbooks, including several recent editions of the classic *Medical Physiology*. He was Chief Editor of the *Journal of Neurophysiology* and is currently a Section Editor for the *APS Handbook of Physiology* on the nervous system.

Rapid Communications: Interim Report

Rapid Communications were received for *AJP: Cell Physiology* and *AJP: Heart and Circulatory Physiology* during all of 1982. They began to be received for the other journals of AJP in September. Action by the end of the year on all of these manuscripts was compared with that on Special Communications received for these journals during the entire year.

	Rapid Communications	Special Communications
Received	52*	58
Accepted	18	9
Rejected	10	26
Receipt to acceptance (days)	23-142	81-227
Median (days)	49	124
Acceptance to publication (months)	2-6	5-6
Median (months)	3.5	5

* Plus one transferred to regular article category.

Even from this small sample it is clear that Rapid Communications are handled more quickly by the editors and the editorial office. The time from receipt to acceptance usually is shortened by close to 3 months and the time from acceptance to publication by more than a month.

Short manuscripts containing results of unusual interest may be submitted to the *American Journals of Physiology* as Rapid Communications and should be identified as such. Review is accelerated and papers appear in the next available issue after acceptance. These communications must not exceed four journal pages in length, including figures, tables, and references. In general one printed page is equivalent to four double-spaced typewritten pages or to three figures or tables. Rapid Communications are accepted with no more than minor revisions or they are rejected.

H. E. Morgan, Chairman
Publications Committee

Sustaining Associate Members

Abbott Laboratories • American College of Surgeons • American Critical Care • American Medical Association • Baxter Travenol Laboratories, Inc. • Bayer AG/Cutter/Miles • Burroughs Wellcome Co. • Ciba-Geigy Corp. • Grass Instrument Co. • International Minerals & Chemical Corp. • Lederle Laboratories • Eli Lilly & Co. • Marion Laboratories, Inc. • Merck Institute for Therapeutic Research • Merrell Dow Pharmaceuticals, Inc. • Pfizer, Inc. • Revlon Health Care Group • A. H. Robins Co., Inc. • Smith Kline & French Laboratories • E. R. Squibb & Sons, Inc. • Stuart Pharmaceuticals • The Upjohn Co. • Warner-Lambert Pharmaceutical Co. • Waverly Press, Inc. • Wyeth Laboratories

Member Contributions

Contributions to the Society may be made to the General Operating Fund or other designated purpose. The donor may commemorate an event or memorialize an individual.

Contributions from the following members as of February 15, 1983 are gratefully acknowledged.

ABRAMSON, DAVID I
ADLER, HARRY F
ALEXANDER, ROBERT S
ANDERSON, RALPH R
ANGELONE, LUIS
BACANER, MARVIN B
BADE, MARIA L
BALDINI, MARIO G
BANCROFT, RICHARD W
BARGER, A CLIFFORD
BAROFSKY, ANNA-LISA
BEAN, JOHN W
BENJAMIN, FRED B
BENNETT, LESLIE L
BERKOWITZ, JESSE M
BLACKSTONE, EUGENE H
BOTT, PHYLLIS A
BOURGOIGNIE, JACQUES J
BROOKHART, JOHN M
BROWN, ELLEN
BROWN, ERNEST B
BULLOCK, THEODORE H
BUNDE, CARL A
CAVERT, H MEAD
CHASIS, HERBERT
CHERNIACK, NEIL S
CHESLEY, LEON C
CLARK, J KAPP
CLARK, LELAND C
CODE, CHARLES F
COMROE, JULIUS H
CONKLIN, RUTH E
COULSON, RICHARD L
COURNAND, ANDRE F
CRAIG, FRANCIS N
CRAWFORD, EUGENE C
CRAWFORD, MADELEINE F
CRITTENDEN, PHOEBE J
CURRY, DONALD L
DAGGS, RAY G
DAMOUR, MARIE C
DE HART, WILLIAM D
DE TROYER, ANDRE
DILL, DAVID B
DRAGSTEDT, CARL A
DUKES, H HUGH
ECKSTEIN, RICHARD W
ELY, L
ENGELAND, WILLIAM C
EPSTEIN, RALPH A
EVANS, GERALD T
FERGUSON, JAMES L
FISHER, JOHN T
FISHER, VINCENT J
FITZGERALD, ROBERT S
FLEXNER, LOUIS B
FRANKE, FLORENT E
FREEDBERG, A STONE
FREEMAN, JOHN A
GAUNT, ROBERT
GOLDFEDER, ANNA
GONZALEZ, RAMON R
GONZALEZ-SERRATOS, H
GRANGER, HARRIS J
GRAYSON, JOHN
GREELEY, PAUL O
GREEP, ROY O
GRENNELL, ROBERT G
GRINDELAND, RICHARD E

GRUBER, KENNETH A
HADIDIAN, ZAREH
HAGINO, NOBUYOSHI
HALE, HENRY B
HALL, JOHN F
HAMLIN, ROBERT L
HAMPEL, CHESTER W
HARDENBERGH, ESTHER
HARRIS, A SIDNEY
HARTMAN, VIVIAN B
HASSETT, CHARLES C
HAUSBERGER, FRANZ X
HELLEBRANDT, FRANCES A
HEMBROUGH, FREDERICK B
HERRIN, RAYMOND C
HOCKMAN, CHARLES H
HOFFMAN-GOETZ, LAURIE
HOLT, JOHN A
HUF, ERNST G
HUGHES, JOSEPH
HULL, WAYLAND E
HUNTER, JOHN
JAQUES, LOUIS B
KARREMAN, GEORGE
KEHOE, ROBERT A
KINARD, FREDRICK W
KING, THEODORE M
KOHLESTAEDT, KENNETH G
KRAMER, GEORGE C
KRISANDA, JOSEPH M
LAHIRI, SUKHAMAY
LATHROP, DAVID A
LAWRENCE, JOHN H
LEWIS, MILENA L
LICHTON, IRA J
LOMBARDY, R A
LOWENSTEIN, LEAH M
LUFT, ULRICH C
LUISADA, ALDO A
LUTHERER, LORENZ O
LYNNE-DAVIES, PATRICIA
MACINTOSH, FRANK C
MARCUS, MELVIN L
MARSH, DONALD J
MASON, ELEANOR D
MCAFFEE, ROBERT D
MCDERMOTT, DANIEL J
MCDONAGH, PAUL F
METCALFE, JAMES
MEYERS, KENNETH M
MILIC-EMILI, JOSEPH
MILLER, AUGUSTUS T
MILLER, D S
MOE, GORDON K
MOLNAR, GEORGE W
MONGE, CARLOS C
MOORE, E NEIL
NELSON, LEONARD
NELSON, PHILLIP G
NICHOLSON, HAYDEN C
NUWAYHID, BAHIJ S
ORTS, RICHARD J
PARK, SUNG S
PECORA, LOUIS J
PEKAS, JEROME C
PINSON, ERNEST A
PROCTOR, DONALD F
RICHARDS, RICHARD K
ROLF, DORIS B

ROQUEMORE, LOUISE P
SAUNDERS, FRANCIS J
SCHMITT, FRANCIS O
SEARLE, GORDON W
SEEGERS, WALTER H
SHELESNYAK, M C
SHERWOOD, LAURALEE
SHILLING, CHARLES W
SHOCK, NATHAN W
SIMPKINS, JAMES W
SMITH, E NORBERT
SONNENSCHNEIN, RALPH R
SPITZER, ADRIAN
SPURGEON, HAROLD A
STALING, LEAH M
STEVENSON, ROBERT T
STICKNEY, J CLIFFORD
STRUMWASSER, FELIX
SWANK, ROY L
SZEPSENWOL, J
SZURSZEWSKI, JOSEPH H
TANNENBAUM, GLORIA S
TAYLOR, ROBERT E

TRIANANTAPHYLLOPOULOS, E
TURINSKY, JIRI
VAN HARREVELD, A
VAUGHAN, DAVID A
VELARDO, JOSEPH T
VIDOLI, VIVIAN A
WAKERLIN, GEORGE E
WALKER, W GORDON
WATSON, PHILIP D
WEBER, WILLIAM A
WEBSTER, MARION E
WEIR, EVERETT G
WESSLER, STANFORD
WHITE, JOHN I
WIEDMEIER, V TOM
WIEGMAN, DAVID L
WILDE, WALTER S
WILLIAMS, W LANE
WINDLE, WILLIAM F
WITORSCH, RAPHAEL J
WOOD, EARL H
YOSHINAGA, KOJI
ZAPP, JOHN A

New Study on Job Opportunities in Science and Engineering

(From Scientific Manpower Commission)

College graduates in the 1980's will experience a different marketplace than their predecessors, with job opportunities limited in many fields. However, employment for those graduates with a solid background in science or engineering appears particularly promising, according to a new study by the Scientific Manpower Commission.

Despite an estimated 26% decline in the number of 18 year olds by 1992, the total number of college graduates is expected to exceed the number of jobs requiring a college education by about 3.3 million. Nonetheless, the spiraling growth in high technology will create new opportunities in many science and engineering fields.

Today's job offers to new graduates at all degree levels already are disproportionately weighted toward engineering, computer sciences, and physical sciences, relative to the proportion of all graduates who major in those fields. Although more graduates than jobs are expected in some science fields over the next decade, particularly in the social and life sciences, shortages are likely in particular specialties.

While most forecasts predict more graduates than jobs in almost all fields, the need for technically trained individuals in government, law, and many other jobs spheres not directly classified as science or engineering will provide additional employment opportunities for graduates in technical fields.

Opportunities for women are considerably better in technical fields than in most nontechnical fields, despite the fact that employment and advancement opportunities in science or engineering are not yet as good for women as for men. Women have increased their proportion of science and engineering degrees dramatically since 1965, rising from 22% to 37% of all bachelor's degree awards in these fields and from 7% to 23% of all Ph.D.'s.

- Unemployment rates are low among scientists and engineers relative to unemployment among other major occupational groups, as has been true since the early 1960's. Recent graduates of both sexes have somewhat

higher unemployment rates than do graduates who have been in the labor force longer.

• The severe and growing shortage of well-qualified science and math teachers in elementary and secondary schools is a major stumbling block to providing adequate numbers of well-trained scientists and engineers as well as a scientifically literate and technologically understanding citizenry. Math and science teaching is also an additional source of employment opportunities for those with good backgrounds in these fields.

The study concludes that although employment opportunities are only one of the many factors to be considered by students, their parents, and counselors when they are selecting a college major or making career plans, such information is an essential component of informed choice.

Results of the Scientific Manpower Commission study, which was funded by a grant from the National Science Foundation, are presented in the form of a chartbook presentation, *Opportunities in Science and Engineering*, prepared by Betty M. Vetter, Executive Director of the Commission. The 108-page chartbook includes information on the present supply of scientists and engineers, their labor force participation, and employment opportunities, with special emphasis on the entry and advancement of women in these fields. The future supply of and demand for scientists and engineers is also examined.

Copies of *Opportunities in Science and Engineering: A Chartbook Presentation* (108 pages) are \$5 from the Scientific Manpower Commission at 1776 Massachusetts Ave., NW, Washington, DC 20036 (202-223-6995). Press copies are available on request.

News from Senior Physiologists

Steve Krop to Bruce Dill:

Since seeing you last I have retired from the Federal Service (Food and Drug Administration)—in caustic conservative bureaucratise I have “withdrawn snout from public trough.” Frequently on trips to the Library of Congress, I haunt former colleagues at FDA demanding better and safer drugs and food now that I am a taxpayer *without* interest vested in FDA! About a year and a half before retirement, I spent 6 months as the first exchange scientist between FDA and the Polish Ministry of Health at the Medical Academy in Gdańsk (Danzig, pre-World War II) on the Baltic. This is where World War II began in September 1939 and where the Solidarity movement gained such prominence recently. My experiences at the Academy and in nonprofessional relations with the staff were interesting and memorable. Some travels about the country with my wife Mary (and briefly daughter Marianne) were quite interesting, particularly with the bus tour with some of the Academy staff and their families which took us to many byways not normally “toured.” The upper-rank Academy staff are generally quite fluent and literate in English. The required second language in Polish education is Russian, which it seemed to me the Poles try to forget; however, the second language of choice is English. I helped some of the staff studying English in spare time and preparing manuscripts for English scientific journals. Some facility in Polish was very helpful to us in travel, shopping,

socials, and so forth. The Academy staff (Clinical Biochemistry Department, my duty station) are energetic, enthusiastic, and extremely hard-working teachers and researchers led by a forceful and inspiring Prof. Stefan Angielski and his deputy, Dr. Jerzy Rogulski. Among their highest priorities are continuing acquisition of good laboratory equipment and expansion of library; the laboratories and buildings are adequate, most being pre-World War II and I. The Academy is located on a beautiful wooded tract in suburban Gdańsk, 10 minutes by trolley from the historic and business district and the enormous Lenin shipyards. The street leading from Grunwaldska Ave. into the Academy grounds is named Marie Skłodowska Curie St. At the junction of the streets there is a building which bears a memorial marker—it had been a factory making soap from human fat and is now converted to teaching chemistry. Some 20–25 miles westward is the smaller city of Gdynia, developed into a deep sea port about 50 years ago and now having a large shipyard also. There we joined a crowded and festive celebration on a beautiful day for their July 20 post-World War II Independence Day. The people everywhere appeared busily engaged, fairly well dressed and shod. Food stores were well stocked, but shopping lines were common and fresh meats were scarce, though processed meats were plentiful. We were provided with an apartment 20 minutes by trolley from the Academy; my daily prebreakfast task was to wait in line to buy milk, bread rolls, butter, and cheese from a little neighborhood provision shop amid good-natured banter and grousing about “the establishment.” The Polish jokes there are about the Russians—excellent! The last letter from friends in Poland arrived the week before imposition of martial law in December 1981.

Mary has been very busy as president of the Women’s Club of McLean, VA, a member club of the (National) General Federation of Woman’s Clubs whose efforts together with Upton Sinclair’s book “The Jungle” provided the major impetus for enactment of the Pure Food Act of 1906, to which provision and amendments are carried out by the FDA today. Her term expires soon, and she will join the ranks of senior advisors. We visit out four children and nine grandchildren often. Daughter Elaine lives in New Jersey with husband and two teen-age children and recently completed her Ph.D.; daughter Marianne is director of nursing and associate administrator at Norfolk General Hospital; and sons Paul (orthopedic surgeon) and Thomas (dermatologist) are in practice in Virginia Beach, and both teach at Eastern Virginia Medical School. Thomas took his residency with Tom Fitzpatrick at Harvard, a wonderful experience. As you will recall, Fitzpatrick was one of Summerson’s medical officers at Edgewood’s Med Labs.

About a year ago, impelled by an advertisement in *The Physiologist* by C. V. Mosby offering a new edition of Pioneer American Physiologist Beaumont’s classic in digestion, I undertook to obtain information on Beaumont’s youth in Lebanon, Connecticut, his birthplace. My interest in him dates back to graduate school days at Cornell during World War II, where, as a pupil of McKeen Cattell, I enjoyed a varied and exciting physiological background from such teachers as Harley Chambers, Vincent duVigneaud, Bill Summerson, Detlev Bronk, Keffer Hartline, Eugene DuBois,

Ephraim Shorr, and Harold Wolff. Among my possessions is Harley Chambers' copy of the facsimile of Beaumont's book kindly given to me by Harley in 1955. He had received it as a member of the 1929 International Physiological Congress in Boston (I. P. Pavlov, president). The medal to each member of that congress was given to me by Ed Gray. My further interest in Beaumont lies in the fact that my "inlaws" live in Lebanon, CT. Also, I grew up in the adjoining town of Colchester. It remains to be seen how much information on Beaumont's early days I succeed in finding there, but the search has been exciting. At my suggestion Orr Reynolds got C. V. Mosby to donate a copy of the 1981 edition of Myer's book on Beaumont to the recently restored Beaumont homestead in Lebanon as an addition to the memorabilia. (The Beaumont Medical Club of New Haven, CT, acquired the homestead, which was moved 3 miles from its original farm site and rebuilt adjacent to the historic Trumbull House on Lebanon Town Green. It is now the property of the Lebanon Historical Society.)

My consulting work has largely been in the toxicology of new (organic) chemical compounds for various consumer and industrial uses and includes technical document and data reviews relating to regulatory proposals on pesticides, solvents, and the like in considerable variety. There is a possibility that in the near future I will go to mainland China to lecture in pharmacology and toxicology at some of the provincial medical schools. Otherwise reading history and dabbling in languages and music (passive participation mostly, except for whistling and playing the harmonica—by ear!) are my main nonscientific diversions, and I enjoy them very much. At home general house maintenance and repair of appliances get my attention.

Retirement has not suitably affected my interest in developments which further our understanding of physiological mechanisms and adaptations, and I continue to enjoy family and friends. If I were asked for a bit of advice by the younger, it would be as for others, "Give your curiosity free rein and keep following it, using reason to sort out fool's gold that appears along the way."

7908 Birnam Wood Dr.
McLean, VA 22102

Carl F. Schmidt to Edward Adolph:

Sometime ago you led me to believe that my movements, as I approached my ninetieth birthday, would be of interest. A recent development has changed our way of living drastically. It is a stern admonition by my physician (and former pupil) that I must give up driving my automobile. This is because of a fall which physicians seem to agree must have been a form of epilepsy. So I have sold my car and try to go on living as before. Anybody who has been to Florida knows that that's impossible here. So my wife and I have decided to give up our apartment overlooking the Gulf of Mexico and move to a permanent address in a larger establishment up north.

Last month we found a three-bedroom apartment in the same building where we had had a one-bedroom for ten years. We are now packing our belongings, some of them relics of our stay in China sixty years ago. If we

find the climate in the Philadelphia suburbs too cold, we will come back to St. Petersburg to visit our daughter.

I have completely retired, though not far enough to avoid an article for a recent number of the *Journal of Cerebral Blood Flow and Metabolism*. To my amazement this evoked more than 50 requests for reprints.

My sympathies go out to the neurologist who took charge of me after my fall. He had nothing to go on. I had nothing like it before and have had nothing since. What happens next is anybody's guess. I go on just as before, walking a minimum of five miles a day, and expect to go on doing so in the future.

This letter is mostly soliloquy. Thought you should know what is happening to me.

113B Thomas Wynne Apt.
Wynne Wood, PA 19096

A. Pharo Gagge to Robert S. Alexander:

As you can see I am still alive and active. I am still an Associate Editor, *Journal of Applied Physiology*, and actively process 75-100 manuscripts each year. I also continue active participation in the Aerospace Medical Association, American Society of Heating, Refrigeration and Air-Conditioning Engineers, as well as the National Academy of Engineering. Other than my emeritus titles, I am currently a consultant to the John B. Pierce Foundation.

Appreciate your interest and congratulations for the fine work of your Committee of Senior Physiologists.

John B. Pierce Foundation Laboratory
New Haven, CT 06519

[Dr. Gagge's contributions were recently recognized by his being named the Louise and Bill Holladay Distinguished Fellow by the Am. Soc. Heating, Refrigeration & Air-Conditioning Engineers.]

H. K. Hartline to Arthur B. Otis:

Thanks for the birthday greetings from the APS; it is always appreciated. I had to give up lab work six or seven years ago. My central retina gave up on me (the just punishment by the angry, jealous gods, no doubt). So reading is difficult. It gives me a valid excuse for not trying to keep up with the literature or with science in general (wouldn't understand it now anyway). Words of wisdom to younger colleagues? My only advice is "never take any advice." I am much pleased that you remember the *Limulus* optic nerve demonstration. That bit of ancient history is still fun.

Patterson Rd.
Hydes, MD 21082

C. P. Richter to Roy O. Greep

Your birthday note brought back many happy memories of the meetings of the Endocrine Society starting with Cold Spring Harbor. I gave up my rat colony and active experimentation a couple of years ago. A great mistake! The rats and other animals always gave simple reproducible answers to my questions. Now working up much unpublished material, answers have to come from my own thinking—which isn't always as much fun.

135 Oak Street
Foxboro, MA 02035

Statistics on APS Membership

(As of May 1982)

Total Membership 6,133

Distribution by Employment*

	No.	%
Medical Schools	3569	65
Physiology Departments	(1870)	(34)
Other Preclinical Departments	(457)	(8)
Clinical	(1190)	(22)
Administration	(52)	(1)
Hospitals and Clinics	241	4
Veterinary Schools	107	2
Dental Schools	47	1
Public Health and Graduate Schools	216	4
Undergraduate Schools	452	8
Commercial Companies	108	2
Government	334	6
Institutes and Foundations	217	4
Private Practice	46	1
Other, Emeritus or Inactive	122	2

* 5,459 Respondents

Distribution by Earned Degree*

(Includes 656 individuals with multiple doctorate degrees)

	No.
Ph.D.	3582
M.D.	2120
D.V.M.	139
D.D.S. and other	30

* 6,215 Respondents

Principal Type of Work*

	%
Research	70
Teaching	16
Administration	7
Clinical	6
Other	1

* 5,456 Respondents

Distribution by Primary Speciality*

	%
Cardiovascular	20
Neurophysiology	13
Endocrines	10
Respiration	9
Renal	6
Electrolyte and Water Balance	5
Muscle and Exercise	5
Gastrointestinal, Food and Nutrition	4
Cellular and Tissue	4
Environmental	3
Blood	3
Comparative	2
Energy Metabolism and Temperature Regulation	2
Pharmacology	2
Reproduction	2
All Other Categories (None above 1%)	9

*5,349 Respondents.

Distribution by Age*

	No.
70 +	414
60-69	863
50-59	1588
40-49	1866
30-39	1096
20-29	92

*Optional personal data (numbers represent total respondents).

Distribution by Sex*

Female	637
Male	5262

*Optional personal data (numbers represent total respondents).

States in U.S. With More Than 100 Members*

California	670	North Carolina	151
New York	626	Florida	149
Texas	330	New Jersey	145
Pennsylvania	329	Missouri	140
Maryland	314	Virginia	126
Massachusetts	293	Connecticut	125
Illinois	278	Minnesota	121
Ohio	224	Indiana	102
Michigan	181		

*50 States plus Puerto Rico and Virgin Islands.

Distribution by Racial Background and Heritage*

American Indian or Alaskan	6
Asian or Pacific Islander	226
Black	32
White	4101
Hispanic Heritage	85

*Optional personal data (numbers represent total respondents).

APS North American Membership

United States	5,754
Canada	241
Mexico	10

Canadian Provinces With 5 or More Members

Ontario	99
Quebec	66
Alberta	22
British Columbia	20
Manitoba	17
Nova Scotia	8
Saskatchewan	6

Other provinces represented

New Brunswick
Yukon Territory

APS Membership Outside North America

Countries with 5 or more members

Japan	25
United Kingdom	22
Germany, Federal Republic	20
Switzerland	16
Israel	10
Italy	10
France	10
Australia	9
Sweden	7
Denmark	6
Venezuela	6
Belgium	6
Norway	6
Argentina	5
Spain & Canary Islands	5
Greece	5
Netherlands	5

Other countries represented

Poland Hong Kong
Peru Iceland
South Africa India
Hungary Kuwait
New Zealand Lebanon
Nigeria Panama
Austria Paraguay
Brazil Peoples Rep. of China
Chile Portugal
Dominican Republic Rhodesia
Finland Saudi Arabia
British West Indies Taiwan Rep. of China
Singapore USSR
Yugoslavia

ASSOCIATION OF CHAIRMEN OF DEPARTMENTS OF PHYSIOLOGY

ANALYSIS OF ANNUAL QUESTIONNAIRE - 1982/83

Type of Institution:

Physiology Dept. in a MEDICAL (95) or a NON-MEDICAL* (8) school. Total = 103

*Specify type of school: Dental, Osteopath., Vet., Inst. Res., and Basic Sci.

Affiliation: PUBLIC (69) or PRIVATE (34).

Faculty Statistics:*

Bold numbers equal grand totals.
Numbers in light italic are
the means per department.

Numbers of faculty with academic appointments (regular or joint) in your department:

Degree(s) Held └───┬───┬───┬───┘				SUM =	TOTAL =	SUM	└───┬───┘
↓	↓	↓	↓			↓	↓
Ph.D.	M.D.	Both	Other		Total Number of Faculty	Tenured	Not Tenured

Entire salary through your department:

Full time	1119	122	69	36	1259	822	419
	<i>10.86</i>	<i>1.18</i>	<i>.67</i>	<i>.35</i>	<i>12.22</i>	<i>7.98</i>	<i>4.07</i>
Part time	37	9	6	7	51	19	31
	<i>.36</i>	<i>.09</i>	<i>.06</i>	<i>.07</i>	<i>.50</i>	<i>.18</i>	<i>.30</i>

Part of salary through your department, and associated with:

another basic sci. dept.	39	6	0	3	42	33	18
	<i>.38</i>	<i>.06</i>	<i>0</i>	<i>.03</i>	<i>.41</i>	<i>.32</i>	<i>.18</i>
a clinical dept.	24	15	6	1	44	32	15
	<i>.23</i>	<i>.15</i>	<i>.06</i>	<i>.01</i>	<i>.43</i>	<i>.31</i>	<i>.15</i>

No salary through your department, and associated with:

another basic sci. dept.	108	7	3	8	103	77	32
	<i>1.05</i>	<i>.07</i>	<i>.03</i>	<i>.08</i>	<i>1.03</i>	<i>.75</i>	<i>.31</i>
a clinical dept.	159	159	24	4	318	285	246
	<i>1.54</i>	<i>1.54</i>	<i>.23</i>	<i>.04</i>	<i>3.09</i>	<i>2.77</i>	<i>2.39</i>
Other (Emeritus, volunteers, etc.)	157	25	16	14	215	23	148
	<i>1.52</i>	<i>.24</i>	<i>.16</i>	<i>.14</i>	<i>2.09</i>	<i>.22</i>	<i>1.44</i>

*In a correctly completed questionnaire, for each category of faculty listed on the left, the sum of the first four columns (Ph.D., M.D., Both, and Other) should equal the sum of the last two columns (Tenure and Non-tenure), and this number should be entered under "TOTAL". The combined data above are not internally consistent in this regard since we included all data received, even though a few questionnaires were completed incorrectly.

D. Unfilled Positions:

Please indicate the number of unfilled positions in each rank in your department:

Professor	<u>14 (.14)</u>	Assistant Professor	<u>50 (.49)</u>
Associate Professor	<u>15 (.15)</u>	Instructor	<u>5 (.05)</u>

How many of the unfilled positions are due to:

Retirement?	<u>16 (.16)</u>	Failure to promote/tenure?	<u>11 (.11)</u>	Death?	<u>4 (.04)</u>
Creation of new FTE's?	<u>25 (.24)</u>	Others (resignations, etc.)	<u>13 (.13)</u>		

Project number of junior positions expected to become vacant in the next 5 years due to retirement, new FTE's, etc.

yr. 1	<u>36 (.35)</u>	yr.2	<u>42(.41)</u>	yr. 3	<u>34 (.33)</u>	yr. 4	<u>29 (.28)</u>	yr. 5	<u>22 (.21)</u>
-------	-----------------	------	----------------	-------	-----------------	-------	-----------------	-------	-----------------

E. Current Graduate Students and Postdoctoral Fellows:

Number of graduate students currently enrolled in Department Ph.D. program	<u>1043(10.13)</u>
Number of Postdoctoral Fellows currently in your Department	<u>475 (4.61)</u>
Number of vacant Postdoctoral positions	<u>51 (.50)</u>

F. Training Support:

Do you have a training grant that supports predoctoral trainees? YES (34) NO (63)
 Do you have a training grant that supports postdoctoral trainees? YES (33) NO (67)

	<u>Predocctoral</u>	<u>Postdoctoral</u>
What is the average starting stipend for trainees?	<u>\$ 5,609</u>	<u>\$ 14,097</u>
What number of your predoctoral and postdoctoral trainees are supported by:	<u>Mean (No. of Depts.)</u>	
Training grants?	<u>4.66 (32)</u>	<u>2.97 (37)</u>
Individual federally funded awards?	<u>1.90 (10)</u>	<u>2.16 (45)</u>
Research grants?	<u>4.30 (56)</u>	<u>3.35 (52)</u>
State funds?	<u>5.94 (47)</u>	<u>1.75 (12)</u>
Private foundations?	<u>1.21 (14)</u>	<u>2.27 (15)</u>
Institutional awards?	<u>3.44 (39)</u>	<u>1.08 (12)</u>
Medical Scientist Training Programs?	<u>4.71 (7)</u>	<u>1.00 (2)</u>
Other? <u>List: Primarily self-support, military, and foreign government.</u>	<u>2.63 (24)</u>	<u>1.38 (8)</u>

G. Numbers of trainees who have finished Doctoral or Postdoctoral work during the year ending June 30, 1982:

	<u>Doctoral</u>	<u>Postdoctoral</u>
Total number finishing:	<u>137</u>	<u>147</u>
Females	<u>40</u>	<u>19</u>
Blacks	<u>4</u>	<u>2</u>
Other Minorities	<u>9</u>	<u>21</u>
Position Needed	<u>2</u>	<u>8</u>
Research Area:		
Cardiovascular	<u>25</u>	<u>38</u>
Cell/Tissue	<u>26</u>	<u>23</u>
Comparative	<u>2</u>	<u>1</u>
Endocrine	<u>41</u>	<u>26</u>
Environmental	<u>3</u>	<u>1</u>
Gastrointestinal	<u>6</u>	<u>5</u>
General	<u>4</u>	<u>2</u>
Muscle/Exercise	<u>6</u>	<u>2</u>
Neural	<u>30</u>	<u>29</u>
Renal	<u>12</u>	<u>6</u>
Respiratory	<u>7</u>	<u>11</u>

Please assess the degree of satisfaction of your graduates in regard to their opportunities in the job market:

Very Pleased (8) Pleased (37) Neutral (27) Disappointed (13)
 Very Disappointed (2)

How many postdoctoral students are presently taking additional training because they are unable to find a satisfactory position? 39

Years of service as chairman: Medical Public - 8.6 yrs. (60);
Medical Private - 7.0 yrs. (25); Non-medical - 5.4 yrs. (8)

FACULTY SALARIES

All Medical Chairmen's Salaries

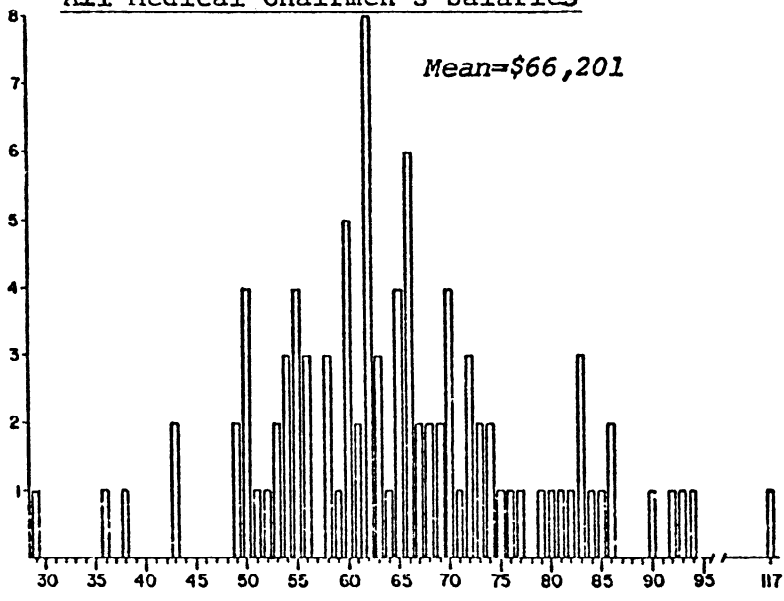

Non-Medical Chairmen's Salaries

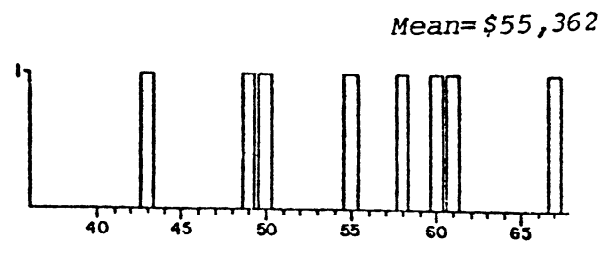

Public Medical Chairmen's Salaries

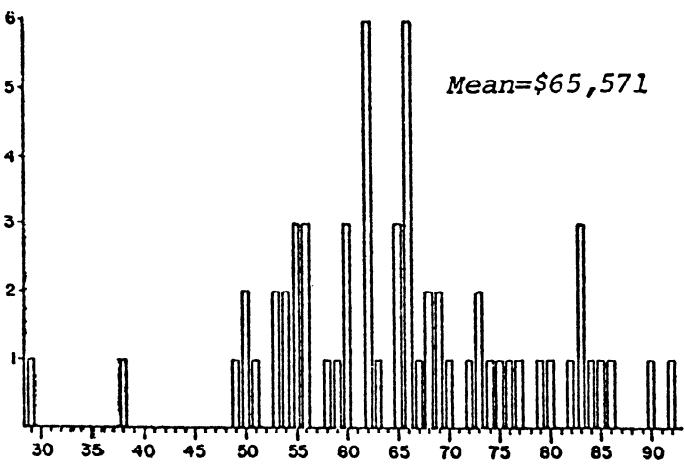

Private Medical Chairmen's Salaries

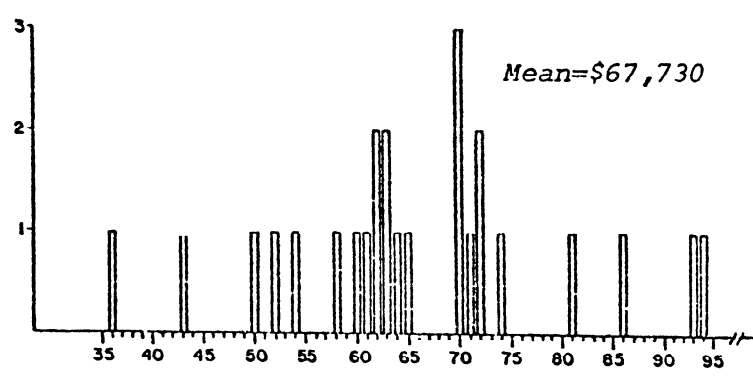

Public Medical Professors' Salaries

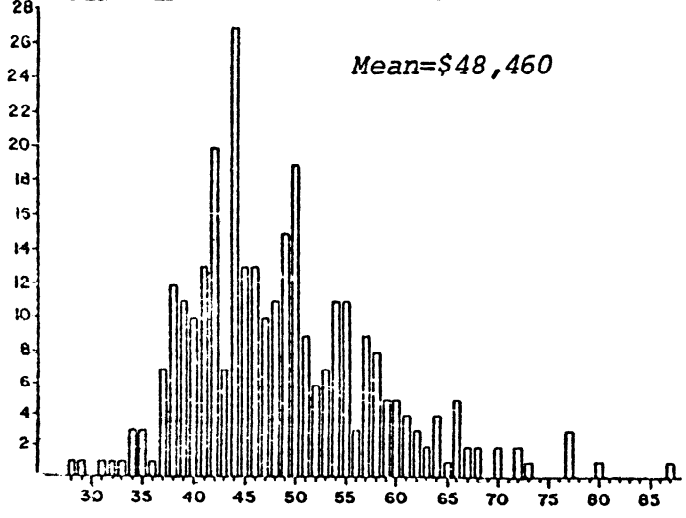

Private Medical Professors' Salaries

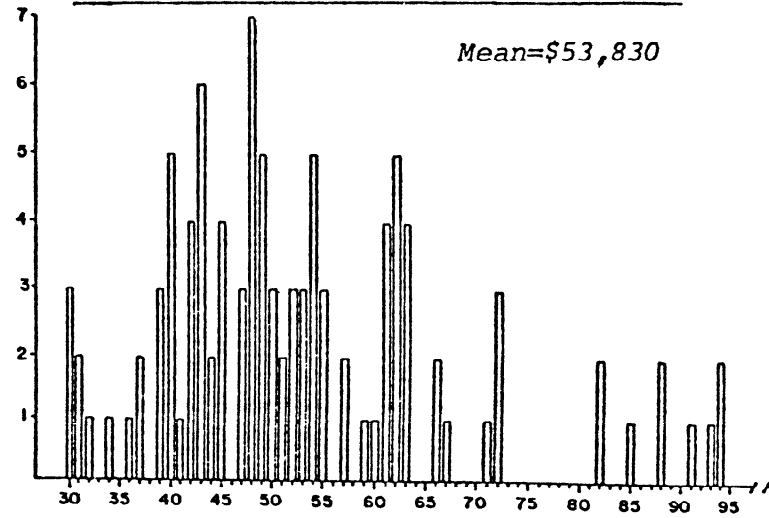

Public Medical Associate Prof. Salaries

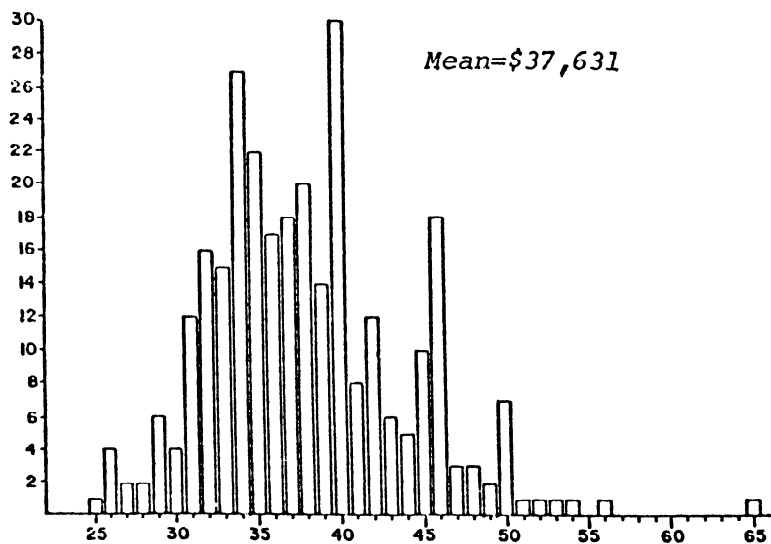

Private Medical Associate Prof. Salaries

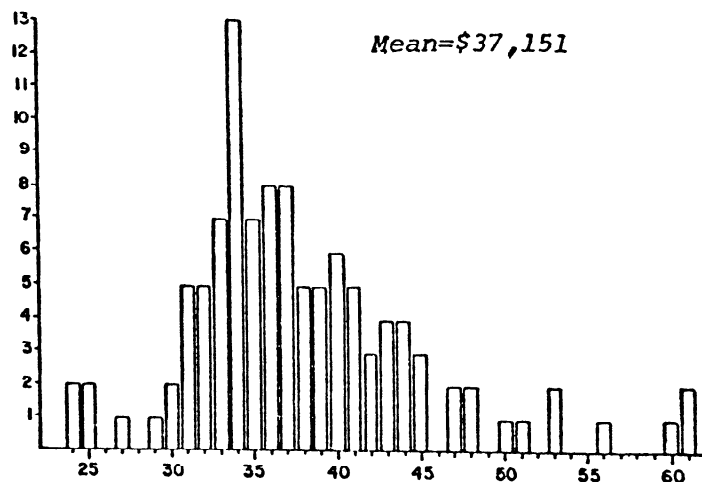

Public Medical Assistant Prof. Salaries

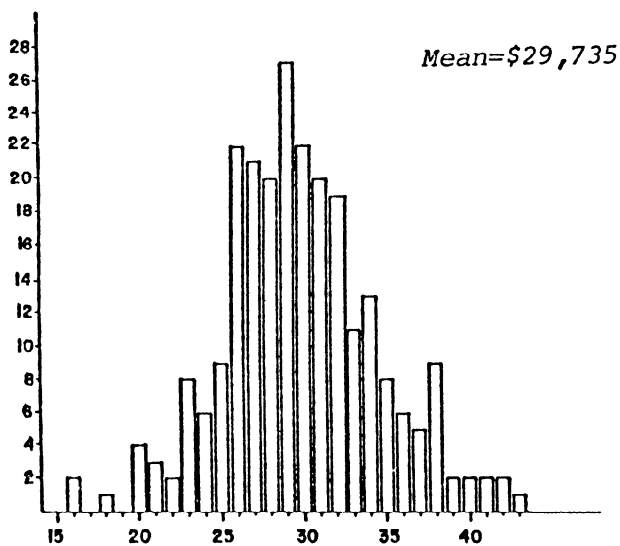

Private Medical Assistant Prof. Salaries

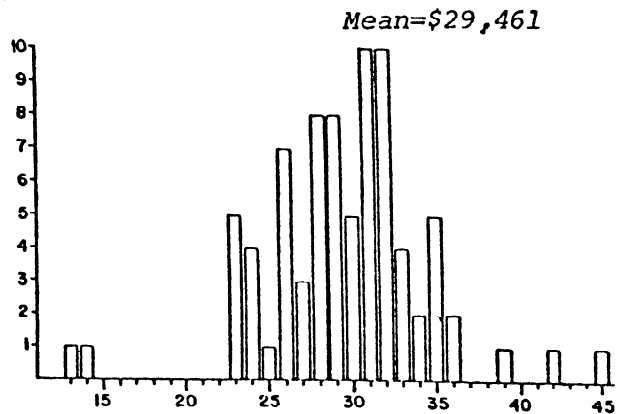

Public Medical Instructors' Salaries

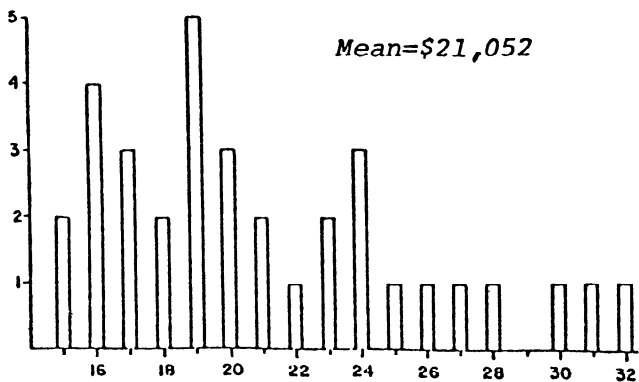

Private Medical Instructors' Salaries

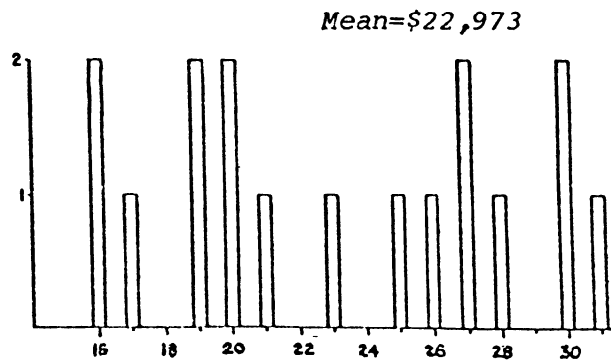

DEPARTMENTAL BUDGET*

	Institutional Sources	Outside Research Grants	Training Grants	Other Budget Support	Total
<u>Private Medical</u>	599,939 (57)	868,219 (25)	155,752 (11)	175,633 (12)	1,161,948 (28)
low	85,400	79,206	22,200	24,500	85,400
high	1,795,500	3,931,600	612,000	1,001,200	5,335,200
<u>Public Medical</u>	723,552 (63)	828,266 (62)	127,706 (29)	127,316 (37)	1,670,568 (63)
low	112,271	10,000	4,000	3,500	112,300
high	1,565,300	2,775,000	389,300	1,562,600	4,998,900
<u>Non-Medical</u>	783,411 (7)	807,385 (6)	202,028 (2)	58,678 (2)	1,437,665 (7)
low	150,000	7,000	95,000	36,500	150,000
high	1,500,000	1,630,000	308,200	80,000	3,438,200
<u>Combined</u>	692,510 (98)	837,658 (93)	138,591 (42)	135,993 (51)	1,508,612 (98)

*Mean expenditures (in dollars) of schools reporting funding. Zero amounts were not included in computation of means or in range setting. The number in parentheses is the total number of departments reporting expenditures in that category.

DEPARTMENTAL SPACE**

	Research	Teaching Labs	Other	Mean No. of Full-time Faculty	Number of Departments
<u>Private Medical</u>	9,865 (27)	3,630 (16)	3,266 (19)	10.4	(26)
<u>Public Medical</u>	12,350 (58)	3,874 (38)	4,283 (43)	13.7	(58)
<u>Non-Medical</u>	9,877 (5)	5,289 (6)	6,378 (5)	12.2	(6)

**Mean amount of space (in square feet) for schools reporting space data. Zero amounts were not included in computation of these means. The number in parentheses is the total number of departments reporting space in that category.

1982/83 ADDENDUM

Have decreases in available funds (Federal, State, or Institutional) had significant negative impact on the operation of your department this year?

Medical Public 39 YES 17 NO Medical Private 12 YES 15 NO

Type of Deficit

Type of Impact	Federal		State		Local		Comment:
	Public/Private	Public/Private	Public/Private	Public/Private	Public/Private	Public/Private	
Tenured Position Lost	1 1	8 1	2 0	1 1	2 0	1 1	Very few written comments were received. Most of these were providing some detail for the numbers reported. The topic you would like to see on this page next year <u>3</u> Women and minorities <u>41</u> Teaching Responsibilities <u>12</u> More detail on space. <u>23</u> Fringe benefit policies <u>32</u> Promotion and Tenure <u>12</u> Current legislative i <u>5</u> Other (specify):
Non-Tenured Position Lost	2 4	8 0	1 1	1 1	1 1	1 1	
Non-Faculty Staff Lost	11 2	13 2	1 1	1 1	1 1	1 1	
Postdoctoral Position Lost	6 4	2 0	2 1	2 1	2 1	2 1	
Predocctoral Position Lost	0 4	6 0	2 1	2 1	2 1	2 1	
Salaries Frozen	3 3	23 1	2 3	2 3	2 3	2 3	
Space Lost	1 0	4 0	3 1	3 1	3 1	3 1	
Equipment Need Unmet	12 6	19 3	3 4	3 4	3 4	3 4	
Operating Budget Decreased	9 7	29 3	2 6	2 6	2 6	2 6	
Other (specify)	2 0	4 0	0 2	0 2	0 2	0 2	

THE PHYSIOLOGY TEACHER

Editor: Orr E. Reynolds, APS

Associate Editors:

Edward M. Eisenstein, Wayne State Univ.

Mary Forsling, Middlesex Hosp.

Med. Sch., London

Ann E. Kammer, Kansas State Univ.

Charles S. Tidball, George Washington Univ.

Arthur J. Vander, Univ. of Michigan

Executive Editor:

M.C. Shelesnyak, APS

Role of Computer Graphics in Simulations for Teaching Physiology

H. I. MODELL, A. J. OLSZOWKA, J. L. PLEWES,
AND L. E. FARHI

Virginia Mason Research Center

Seattle, Washington 98101

Department of Physiology

State University of New York at Buffalo

Buffalo, New York 14214

Computer simulations of physiological systems have been used as adjuncts to more conventional teaching aids for a number of years (1-3,5-7). Until recently, hardware limitations have made graphic presentations a costly enhancement to simulations intended for student use. Development of the microcomputer with its low-cost high-resolution graphics capabilities has added a new dimension to the ways in which computer models may be used to help student understanding of physiological systems. The microcomputer has also enabled some instructors to add simulations with graphics to their arsenal of visual aids in the lecture hall.

To be effective, development and use of any teaching aid in a given setting must adhere to a philosophy governing the form and format of the aid. Modification of existing simulations to include graphics is no exception. In this communication, we present examples for a revision of our earlier series of respiratory physiology models for independent study (5) to demonstrate one such philosophy.

Rationale

The original goals of the program series (4) were maintained in the revision. The primary goal was to promote an *active* learning experience for the individual student. The intent of including graphics was to provide an additional aid to the student's conceptualization of the physiological system.

Several options are available when considering graphical output for simulations. Data generated by the model may be presented in the form of a plot of one variable as a function of another (e.g., arterial PCO_2 as a function of alveolar ventilation). Another possibility is a display of "real-time" data recordings from the simulation. Other options include presenting a "picture" of the model, schematic representation of concepts inherent in the model, and indicating the manner in which model equations are solved.

Presenting steady-state data compiled from several iterations of the model equations seems, at the outset, to be an attractive means of using graphics. The speed with which the task can be accomplished saves the student time, and a considerable amount of data can be presented in this form. These "advantages" are ideal for using simulations in a lecture format. In this mode, the lecturer has at his fingertips a wide variety of examples from which to draw. Thus, illustrative "slides" may be tailored to the audience during the lecture, rather than modifying the presentation to fit a given slide set, should the audience not follow the original flow of the lecture.

In a "laboratory" setting, presentation of compiled data in this manner is detrimental to the goals of the exercise. If the intent is to provide an active learning experience simulating a laboratory experiment or clinical encounter, data should be handled as they would in the real setting; i.e., the student should gather and reduce the data. Direct presentation of data plots obtained from multiple trials eliminates a significant portion of the student's active involvement and, in the extreme, may reduce the active learning component of the exercise to the point where the computer becomes nothing more than a sophisticated "textbook."

Unlike plots of steady-state data, using graphics to present "data recordings" from the simulation contributes to the "reality" of the experiment and enhances the learning experience. In this mode, data are presented as they would be on a recorder during an actual laboratory experiment. The student is then responsible

for data analysis in much the same manner as under actual laboratory conditions. Examples of the type of data that could be presented in this mode include pressure monitored at a variety of sites (e.g., arterial, intrapleural), flow monitored at a variety of sites (e.g., blood, air), and electrical phenomena (e.g., action potentials, electrocardiogram). Also falling under this category are those signals that are normally conditioned on-line during a laboratory experiment. Examples include mean arterial blood pressure, lung flow-volume loops, and integrated electromyogram.

In general, we have elected not to use the "data recording" presentation mode in our series of simulations. Because the majority of our models are steady state rather than dynamic in nature, this choice reflects a focus on consistency among exercises rather than rejection of this presentation mode on philosophical grounds.

We continue to believe that, in most instances, quantitative information is necessary for complete understanding of qualitative concepts (4). Thus, the primary element of the revised outputs is still numerical information. However, this information is presented within the context of a graphical illustration representing some aspect of the model. In this way, the student is presented with a visual aid that may serve as a framework on which the qualitative concept may be built.

The pictorial portions of the revised outputs are intended to aid the student in one of four ways. They indicate the location of measured variables, show how model equations are solved, provide a description of the model, per se, or provide reinforcement of key conceptual elements governing the physiological basis of the simulation. The specific examples below illustrate how these aids may be approached.

Specific Examples

Figure 1 shows an output designed to help the student understand the location of measured variables. The program deals with the alveolar gas equations. The student provides values for tidal volume (V_T), anatomical dead space volume (V_D), respiratory frequency (Freq), and oxygen consumption ($\dot{V}O_2$). In addition to reiterating

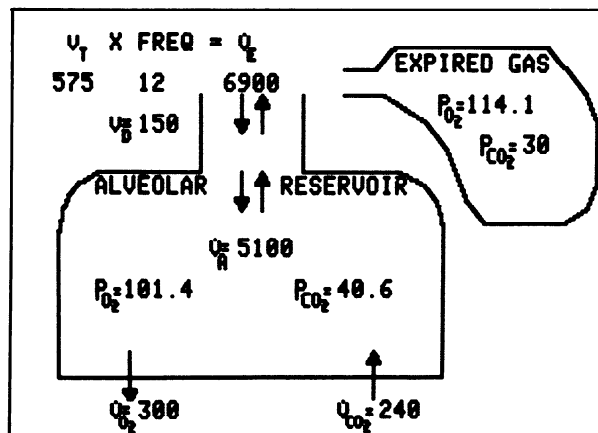

Figure 1

Graphical output from a model of alveolar gas exchange with atmosphere. Purpose of output is to show students where variables are being measured (see text).

the input values, the program returns values for minute ventilation (\dot{V}_E), alveolar ventilation (\dot{V}_A), mixed expired and alveolar gas tensions (P_{O_2} and P_{CO_2}), and carbon dioxide production ($\dot{V}CO_2$).

The schematic representation indicates that minute ventilation is measured at the entrance/exit of the respiratory system, whereas alveolar ventilation refers to gas beyond the dead space volume. Alveolar gas tensions reflect exchange within the alveolar reservoir, whereas mixed expired gas tensions refer to expired gas that has been collected and mixed.

Figure 2 shows a graphic output from an exercise dealing with the effects of anatomic shunt flow on gas exchange. The intent of this pictorial is to help the student understand how the model equations are solved to obtain arterial blood gas composition. The amount of oxygen per minute in blood from the lung is added to the amount of oxygen arriving per minute in the shunted blood. Division of this sum by the total blood flow (Q) yields the oxygen content (C_{O_2}) of arterial blood. To determine the arterial partial pressure of oxygen, the oxyhemoglobin dissociation curve must be consulted. The diagram also shows the analogous relationships for determining arterial carbon dioxide content (C_{CO_2}) and tension.

A sample graphic display providing a description of the model being studied is presented in Figure 3. The exercise deals with gas exchange in a single alveolus and allows the student to determine the effects of the ventilation-perfusion ratio (\dot{V}_A/Q) on the composition of blood and gas leaving the alveolus. The student describes the alveolus under study by providing values for the percent of oxygen in the inspired gas and the ventilation-perfusion ratio of the unit. The model evaluates gas exchange within the unit and returns oxygen and carbon dioxide levels in the gas and blood leaving the alveolus.

The display indicates that inspired gas and mixed venous blood enter the gas exchange unit in proportion to the ventilation and perfusion. The final blood and gas compositions in the unit reflect equilibration of gas partial pressures between the phases. The output emphasizes this point by repeating the equilibrium gas tensions in the boxes representing both gas and blood leaving the unit.

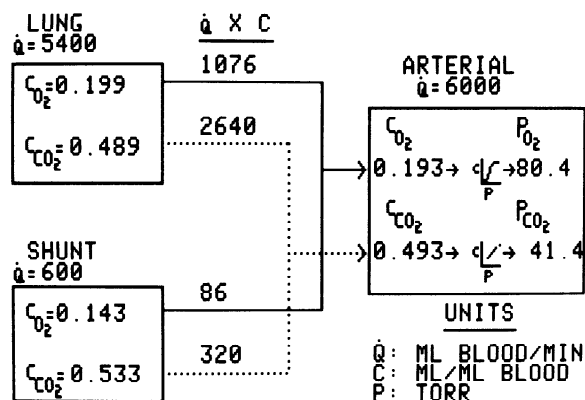

Figure 2

Schematic representation of determinants of arterial blood gas composition. Intent of output is to help students understand how model equations are solved (see text).

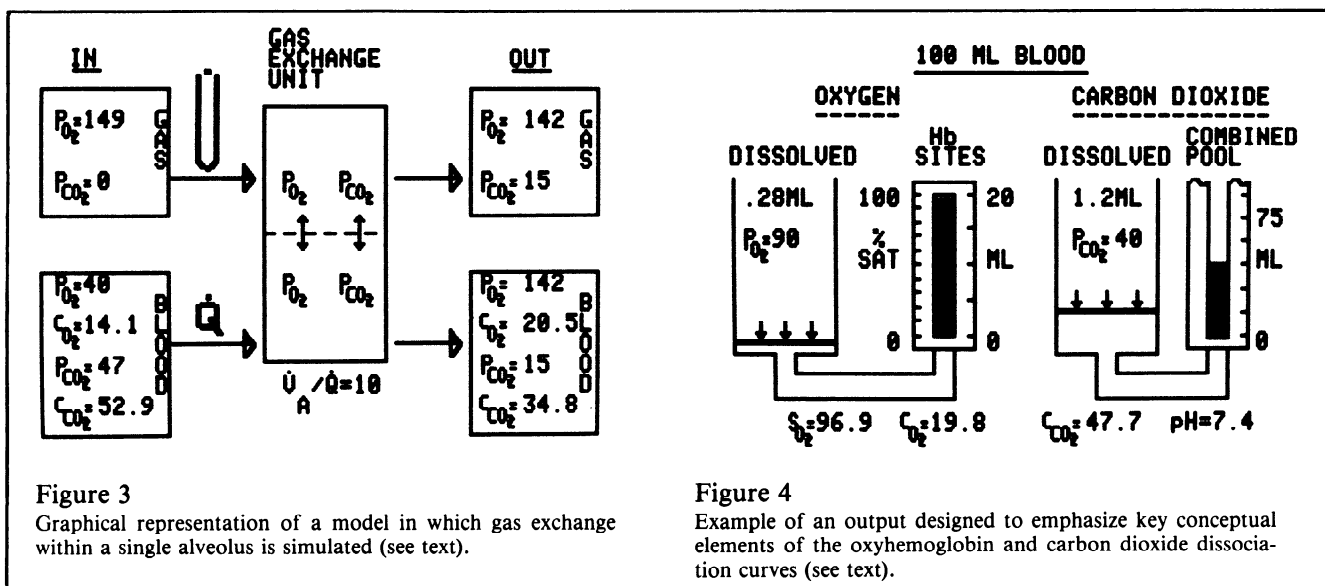

Figure 3
Graphical representation of a model in which gas exchange within a single alveolus is simulated (see text).

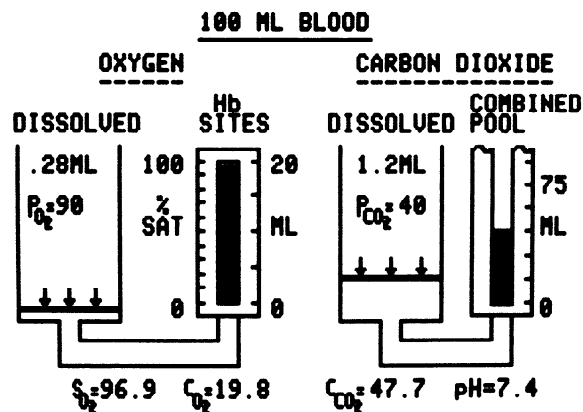

Figure 4
Example of an output designed to emphasize key conceptual elements of the oxyhemoglobin and carbon dioxide dissociation curves (see text).

Figure 4 shows an output designed to emphasize key conceptual elements inherent in the oxyhemoglobin and carbon dioxide dissociation curves. The program from which this output was drawn enables students to study the dissociation curves separately and also to examine how their interaction enhances gas transport. The student provides values for oxygen and carbon dioxide tensions, and the program determines the corresponding values for oxygen content, percent oxyhemoglobin saturation (S_{O_2}), carbon dioxide content, and pH in normal blood.

In addition to presenting the numerical data, this pictorial is intended to reinforce several concepts related to the oxyhemoglobin and carbon dioxide dissociation curves. The "piston" on the left of each panel emphasizes that gas in the dissolved form gives rise to the partial pressure of that gas. The partial pressure of oxygen acts to "fill" the hemoglobin sites, and as indicated by the closed gauge, these sites can be filled to a maximum (i.e., saturated). In a manner similar to oxygen, the carbon dioxide tension acts to establish an equilibrium with the bicarbonate-carbamino combined carbon dioxide pool; however, unlike the "oxygen gauge," the "combined pool" gauge indicates that a maximum amount of combined carbon dioxide is not reached. Finally, oxygen or carbon dioxide content is the sum of that gas bound (oxygen) or combined (carbon dioxide) and dissolved gas.

These examples serve to illustrate the variety of possibilities that are consistent with our governing philosophy. Any given simulation may make use of several graphical outputs to help the student gain an understanding of the underlying physiological concepts. For example, a gas exchange model in our series has a schematic representation of the model, similar in format to Figure 3, as its first output. The student may then choose to examine the various "blocks" of the model, similar to Figure 2, in more detail. Choices include how gas and blood gas compositions are achieved in high and low ventilation-perfusion ratio lung compartments, mixed alveolar gas, arterial blood, and mixed venous blood.

Although presentation of data with an accompanying pictorial can provide a valuable aid to student understanding, this mode serves as only one step in achieving the goals of a set of "laboratory" exercises. To gain full benefit from the exercise, the student must be able to compare a number of trials and have the data in a format that lends itself to further data reduction. As indicated earlier, to preserve the active component of the exercise, data reduction must be performed by the student. Hence, a mechanism must be provided whereby data from a number of trials can be saved. In programs designed to be used with printed output, such as our original series, this is not a problem. In programs designed to be used exclusively with a video display, however, this requirement necessitates a tabular output in addition to the graphical display with a mechanism for comparing at least two trials.

Because of the ease with which data can be manipulated by the computer and the speed of data handling, designers of simulations using graphics for teaching must keep the goals of the exercise in mind and be aware of the danger that the exercise, by virtue of its "elegance," may lose its active learning component.

References

1. Dickinson, C. J. *A Computer Model of Human Respiration*. Baltimore, MD: University Park, 1977.
2. Dickinson, C. J., D. L. Sackett, and C. H. Goldsmith. MAC-MAN: a digital computer model for teaching basic principles of haemodynamics. *J. Clin. Comp.* 2: 42-50, 1973.
3. Harris, C. L., and M. Katzper. Computerized model of kidney regulation by renin-angiotensin. *Physiology Teacher* 3(4): 10-12, 1974.
4. Modell, H. I., L. E. Farhi, and A. J. Olszowka. Physiology teaching through computer simulations—problems and promise. *Physiology Teacher* 3(3): 14-16, 1974.
5. Modell, H. I., A. J. Olszowka, R. A. Klocke, and L. E. Farhi. *Normal and Abnormal Lung Function—A Program for Independent Study*. New York: Am. Thoracic Soc., 1975.
6. Packer, J. S., and J. E. Packer. A teaching aid for physiologists—simulation of kidney function. *Physiology Teacher* 6(4): 1-5, 1977.
7. Shirley, D. W., and R. F. Johnston. Computer simulation of controlled ventilation: a self-teaching tool. *Am. Rev. Respir. Dis.* 108: 138-143, 1973.

PuFT: Computer-Assisted Program for Pulmonary Function Tests

JOSEPH BOYLE III

Departments of Physiology and Medicine
University of Medicine and Dentistry of New Jersey
New Jersey Medical School
Newark, New Jersey 07103

PuFT is a computer program that is designed to help in the understanding and interpretation of pulmonary function tests. The program provides predicted values for common pulmonary function tests (PFT) after patient data such as age, height, weight, and sex have been entered. In addition, the program calculates and plots a graph simulating a forced vital capacity (FVC). The FVC can be altered by changing values for lung volume, maximal expiratory pressure, and airway conductance. The program allows the user to observe what happens to predicted PFT values and the FVC curve when various parameters are altered.

Program Description

The program is written in Microsoft BASIC and has run on a Heath H-89 microcomputer with an Epson MX-80 printer used as a hard-copy device. The regression constants for the prediction formulas were obtained from *Lung Function* by J. E. Cotes, published by Blackwell Scientific Publications in 1975 (1). The FVC curve is calculated using an exponential function and

the time constant of the lung (RC).

$$V(t) = V \exp(-t/RC) \quad (1)$$

where $V(t)$ is the lung volume at time t , V is the present lung volume, and RC is the time constant. *Formula 1* is used twice in the program, at lines 940 and 1190, once to compute the graphing data and the second time to calculate the numerical data for printout. The forced vital capacity as calculated is not a simple exponential, since the time constant is calculated at each time increment from the ratio of volume to flow (V/F); this relationship was proposed by McIlroy et al. (2). Data must be entered for specific airway conductance, lung volumes, and maximal expiratory pressure; the calculations are performed in lines 910-940 and 1160-1190. Flow is a function of the expiratory pressure (PD) and the airway conductance. Both airway conductance and expiratory pressure vary during the FVC from maximal values at total lung capacity (TLC) to minimal values at residual volume (RV), which is consistent with physiological relationships.

Figure 1 represents a sample of the program menu that is initially displayed on the CRT. The menu is designed to be self-explanatory and provides automatic input of data if the user does not have actual PFT data for the initial run-through. The user of the program should know the definitions of the various lung divisions and the pulmonary function tests. In addition, the concept of conductance and the effect of altering lung volume on airway resistance and maximal expiratory pressure should be familiar to the user. Several runs through the program while altering one parameter at a time and comparing the resultant effects will enhance the understanding of the interaction of these parameters on lung mechanics.

The program is designed to provide a printed copy of the input data and the derived PFT values as well as a graph of a forced vital capacity. If a printout of these results is not desired, the LPRINT commands can be deleted or these commands can be preceded by REM statements.

```
PuFT CAN BE USED TO CALCULATE PREDICTED VALUES FOR PULMONARY
FUNCTION TESTS AND LUNG VOLUMES WHEN GIVEN PATIENT'S AGE, HEIGHT,
WEIGHT AND SEX. THE PROGRAM COMPARES PATIENT DATA WITH PREDICTED
VALUES AND IDENTIFIES PFT RESULTS WHICH ARE ABNORMAL FOR THE PATIENT.
THE PROGRAM PROVIDES PAUSES SO THAT THE USER MAY IDENTIFY ABNORMAL RESULTS.
THE PROGRAM CAN ALSO GRAPH A FORCED VITAL CAPACITY THAT CAN BE ALTERED
BY CHANGING LUNG VOLUMES, EXPIRATORY PRESSURE AND AIRWAY CONDUCTANCE.
THE FVC CAN BE USED TO SIMULATE THE EFFECTS OF OBSTRUCTIVE OR RESTRICTIVE
LUNG DISEASE.
```

1. TO CALCULATE PREDICTED PFT VALUES ENTER 1 THEN PRESS RETURN.
2. TO GRAPH A FORCED VITAL CAPACITY ENTER 2 THEN PRESS RETURN.
3. TO EXIT PROGRAM ENTER 3 THEN PRESS RETURN.

? 1

WHAT IS SUBJECT'S NAME (TYPE IN NAME THEN PRESS RETURN).? JOE
ENTER JOE'S AGE (YEARS), HEIGHT (CM), WEIGHT (KG) AND SEX
SEPARATED BY COMMAS; E.G. 20,170,70,M.? 38,175,75,M

ARE JOE'S PFT RESULTS AVAILABLE (ANSWER YES OR NO THEN PRESS RETURN)? YES

ENTER JOE'S TLC? 7.4
ENTER JOE'S FRC? 5
ENTER JOE'S FVC? 3.4
ENTER JOE'S VC? 3.6
ENTER JOE'S FEV1? 2
ENTER JOE'S MVV? 80
ENTER JOE'S DLCO? 18

Figure 1

Printout of initial program menu and data input section of program. User's inputs have been underlined to indicate responses.

```

NAME:   JOE   SEX   M
AGE:   38   YRS   HEIGHT: 175   CM           WEIGHT: 75   KG
TEST   PREDICTED   JOE           %PREDICTED   STAND. DEV.
TLC (L)   6.6825   7.4           110.737     .91
VC (L)   4.664    3.6           77.187     .58
RV (L)   1.921    3.8           197.814    .39
FRC (L)   3.483    5             143.554    .61
RV/TLC (%) 29.734    51.3513      172.702    4.8
FEV1 (L)  3.747    2             53.376     .5
%FEV1    78       58.8235      75.4148    7.19
MVV (L/MIN) 165.22  80           48.4203    29
DLCO (ML/MIN) 31.85  18           56.5149    1.71

```

*****THE NORMAL RANGE IS WITHIN +/- 2 STANDARD DEV. OF PREDICTED*****

IDENTIFY ALL ABNORMAL PFT RESULTS BEFORE PROCEEDING

ANALYSIS OF PFT RESULTS INDICATES:

FRC IS ABOVE NORMAL.
 THE RV IS GREATER THAN NORMAL.
 %RV/TLC IS GREATER THAN NORMAL.
 THE FEV1 IS LESS THAN NORMAL.
 THE %FEV1 IS BELOW NORMAL.
 THE MVV IS BELOW NORMAL.
 THE DLCO IS BELOW NORMAL.

THESE PFT RESULTS ARE MOST CONSISTENT WITH OBSTRUCTIVE LUNG DISEASE.

Figure 2

Top: printout of summary table for PFT section of PuFT. Subject's personal data are printed out above. Second column shows predicted values; third column is subject's own PFT results. Percent predicted and standard deviation are also printed by program. *Bottom:* subsequent CRT screen where computer has identified abnormal PFT results and provides an interpretation.

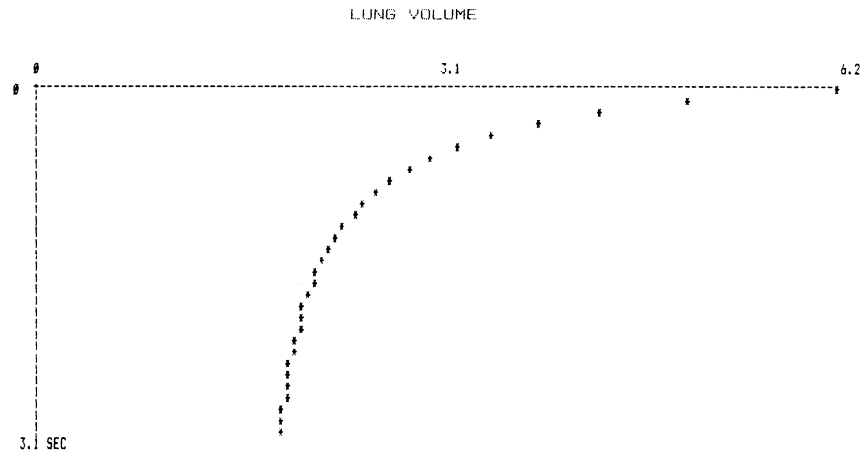

```

FEV1 EQUALS: 3.66504
FEV1% EQUALS: 83
TLC= 6.2     MAXIMAL EXPIRATORY PRESSURE = 80
RV= 1.8 L   SP. AIRWAY CONDUCTANCE= .25

```

TIME	VOLUME	FLOW	RC	PRESSURE
.1	5.07613	12.4	.5	80
.2	4.37381	7.55912	.671524	59.566
.3	3.89091	5.11698	.854764	46.7965
.4	3.53814	3.69797	1.05217	38.0165
.5	3.26936	2.79536	1.26572	31.6026
.6	3.05814	2.18358	1.49725	26.7157
.7	2.88816	1.74889	1.74862	22.8752
.8	2.74878	1.42853	2.02177	19.7846
.9	2.63275	1.18544	2.31877	17.2505
1	2.53496	.996561	2.64184	15.141
1.1	2.45167	.846861	2.99336	13.3629
1.2	2.38012	.726222	3.37593	11.8486
1.3	2.31817	.62761	3.79235	10.5476
1.4	2.26421	.546009	4.24567	9.42136

Figure 3

Graphic printout and data summary for second portion of PuFT. Data may be used to plot out other relationships such as a flow-volume loop or to calculate airway resistance. Lung volume is given in liters; *abscissa* represents time in seconds.

Figure 2 represents a printout of the summary table for PFT results. The data can be entered either manually or automatically depending on the response from the menu of Figure 1. The program automatically prints the table and calculates the predicted values, the percent of predicted results, and the standard deviation of the various PFT. The program pauses while the user identifies abnormal PFT tests, then prints out the abnormal tests, which it identifies (lines 1650-1800), and provides an evaluation of the results as normal or consistent with obstructive or restrictive lung disease (lines 1820-1840).

Figure 3 is a printout of the FVC graph and the computed data that is generated. The program also calculates the forced expired volume at 1 s (FEV1) and the %FEV1 from the computed data. Alterations of the input data can be used to simulate the effects of restrictive or obstructive lung disease so that the user can visualize the effects these changes have on the FVC.

Figure 4 is the computer printout of the BASIC program.

Discussion

Microcomputer-based simulation programs are being used with increasing frequency to aid students in understanding complex physiological relationships (3). Some of the programs are extensive, such as HUMAN-80, which contains 479 computed variables (4) and invokes cardiovascular, renal, endocrine, respiratory, and thermoregulation interactions. There are a number of computer programs available, or to be available shortly, dealing only with the respiratory system, such as MacPuf (5,6), Normal and Abnormal Lung Function (7), and Oxygen Transport (8). These programs are primarily concerned with ventilation and gas exchange aspects of the respiratory system as are the respiratory variables in HUMAN-80. PuFT is presented as a microcomputer program dealing with pulmonary mechanics, is written in MBASIC, and runs on a 48K microcomputer without the need for special graphics commands.

Figure 4

Printout of BASIC program for PuFT. Program is designed to provide a printout of PFT results, FVC, and data from which FVC is derived.

```

10 REM PROGRAM FOR PULMONARY FUNCTION TESTS (PFT) AND FORCED
20 REM VITAL CAPACITY (FVC)
30 REM J. BOYLE, AUG 9, 1982
40 PRINT "PUFT CAN BE USED TO CALCULATE PREDICTED VALUES FOR PULMONARY"
50 PRINT "FUNCTION TESTS AND LUNG VOLUMES WHEN GIVEN PATIENT'S AGE, HEIGHT"
60 PRINT "WEIGHT AND SEX. THE PROGRAM COMPARES PATIENT DATA WITH PREDICTED "
70 PRINT "VALUES AND IDENTIFIES PFT RESULTS WHICH ARE ABNORMAL FOR THE PATIENT."
80 PRINT "THE PROGRAM ALLOWS PAUSES SO THE USER MAY IDENTIFY ABNORMAL RESULTS."
90 PRINT "PROGRAM CAN ALSO GRAPH A FORCED VITAL CAPACITY THAT CAN BE ALTERED"
100 PRINT "BY CHANGING LUNG VOLUMES, EXPIRATORY PRESSURES, AIRWAY CONDUCTANCE."
110 PRINT "THE FVC CAN BE USED TO SIMULATE THE EFFECTS OF OBSTRUCTIVE"
120 PRINT "OR RESTRICTIVE LUNG DISEASE."
130 PRINT:PRINT:PRINT
140 ON ERROR GOTO 1890
150 PRINT "1. TO CALCULATE PREDICTED PFT VALUES ENTER 1 THEN PRESS RETURN."
160 PRINT "2. TO GRAPH A FVC ENTER 2 THEN PRESS RETURN."
170 PRINT "3. TO EXIT PROGRAM ENTER 3 THEN PRESS RETURN."
180 INPUT Q
190 IF Q=2 THEN GOTO 690
200 IF Q=3 THEN GOTO 1870
210 PRINT "WHAT IS SUBJECT'S NAME (TYPE IN NAME THEN PRESS RETURN)";:INPUT N$
220 PRINT "ENTER "N$"S AGE (YEARS), HEIGHT (CM), WEIGHT (KG), AND SEX,
230 PRINT "SEPARATED BY COMMAS; E.G. 20, 170, 70, MALE.";:INPUT A,H,W,S$
240 PRINT "ARE "N$"S PFT RESULTS AVAILABLE? (ANSWER YES OR NO)";:INPUT Q$
250 IF LEFT$(Q$,1) = "N" THEN GOTO 1260
260 PRINT "ENTER "N$"S TLC";:INPUT M
270 PRINT "ENTER "N$"S FRC";:INPUT FRC
280 PRINT "ENTER "N$"S FORCED VITAL CAPACITY";:INPUT F3
290 PRINT "ENTER "N$"S VITAL CAPACITY";:INPUT VC
300 RV=M-VC
310 PRINT "ENTER "N$"S FEV1";:INPUT F
320 PRINT "ENTER "N$"S MVV";:INPUT B
330 PRINT "ENTER "N$"S DLCO";:INPUT D
340 IF LEFT$(S$,1)="M" THEN GOTO 1310
350 IF LEFT$(S$,1)="F" THEN GOTO 1460
360 PRINT "TEST", "PREDICTED", N$, "% PREDICTED", "STAND. DEV."
370 PRINT "TLC (L)", M1, M, M/M1*100, SD1
380 PRINT "VC (L)", VC1, VC, VC/VC1*100, SD2
390 PRINT "RV (L)", RV1, RV, RV/RV1*100, SD3
400 PRINT "FRC (L)", FRC1, FRC, FRC/FRC1*100, SD4
410 PRINT "RV/TLC (%)", R2, (RV/M)*100, ((RV/M)*100)/R2*100, SD5
420 PRINT "FEV1 (L)", F1, F, F/F1*100, SD6
430 PRINT "%FEV1", F1%, F/F3*100, ((F/F3*100)/F1%)*100, SD7
440 PRINT "MVV (L/MIN)", B1, B, B/B1*100, SD8
450 PRINT "DLCO (ML/MIN)", D1, D, D/D1*100, SD9
460 PRINT "*****THE NORMAL RANGE IS WITHIN +/- 2 STAND.DEV. OF PREDICTED.****
****"
470 PRINT:PRINT "IDENTIFY ALL ABNORMAL PFT RESULTS BEFORE PROCEEDING."
480 PRINT:PRINT "PRESS RETURN KEY TO CONTINUE." :Z$=INPUT$(1)
490 GOSUB 1650
500 REM M IS N$ TLC, M1 IS PREDICTED TLC, F IS N$ FEV1, F1 IS PREDICTED FEV1
510 REM RV IS N$ RV, RV1 IS PREDICTED RV, B IS N$ MVV, B1 IS PREDICTED MVV
520 REM FRC IS N$ FRC, FRC1 IS PREDICTED FRC
530 REM D IS N$ DLCO, D1 IS PREDICTED DLCO
540 LPRINT "NAME:"N$, "SEX"S$
550 LPRINT "AGE:"A" YRS", "HEIGHT:"H" CM", "WEIGHT:"W" KG"
560 LPRINT "TEST", "PREDICTED", N$, "%PREDICTED", "STAND. DEV."
570 LPRINT "TLC (L)", M1, M, M/M1*100, SD1
580 LPRINT "VC (L)", VC1, VC, VC/VC1*100, SD2
590 LPRINT "RV (L)", RV1, RV, RV/RV1*100, SD3
600 LPRINT "FRC (L)", FRC1, FRC, FRC/FRC1*100, SD4

```

Figure 4 (continued)

```

610 LPRINT "RV/TLC (%)",R2,(RV/M)*100,((RV/M)*100)/R2*100,SD5
620 LPRINT "FEV1 (L)",F1,F,F/F1*100,SD6
630 LPRINT "%FEV1",F1%,F/F3*100,((F/F3*100)/F1%)*100,SD7
640 LPRINT "MVV (L/MIN)",B1,B,B/B1*100,SD8
650 LPRINT "DLCO (ML/MIN)",D1,D,D/D1*100,SD9
660 LPRINT:LPRINT:LPRINT:LPRINT
670 GOTO 1570
680 REM INPUT FOR FVC
690 PRINT:PRINT"ENTER A VALUE FOR TLC THEN PRESS RETURN";:INPUT M
700 PRINT:PRINT"ENTER A VALUE FOR RV THEN PRESS RETURN";:INPUT RV
710 VC=M-RV
720 PRINT "ENTER MAXIMAL EXPIRATORY PRESSURE (NORMAL = 80) THEN PRESS RETURN";:I
NPUT P
730 PRINT "ENTER SPECIFIC AIRWAY CONDUCTANCE (NORMAL = 0.25) THEN PRESS RETURN";
:INPUT SG
740 PRINT TAB(30) "LUNG VOLUME":REM TITLE OF ORDINATE
750 LPRINT TAB(50) "LUNG VOLUME"
760 Q=INT(72/M):REM SCALE FACTOR FOR PLOTTING
770 Q=INT(120/M):REM
780 LPRINT CHR$(27)"1":LPRINT CHR$(15):REM SETS 10 LPI AND COMPRESSED PRINT FOR
EPSON
790 PRINT TAB(4)"0";TAB((Q*M/2)+4)M/2;TAB((Q*M)+4)M
800 LPRINT TAB(4)"0";TAB((Q*M/2)+4)M/2;TAB((Q*M)+4)M
810 FOR A = 4 TO (Q*M)+4:REM DRAWS ORDINATE
820 PRINT TAB(A)"_";
830 NEXT A
840 FOR B = 4 TO (Q*M)+4
850 LPRINT TAB(B)"_";
860 NEXT B
870 PRINT:LPRINT
880 PRINT "0"TAB(4)";";TAB(Q*M+4)"*"
890 LPRINT "0"TAB(4)";";TAB(Q*M+4)"*":V=M
900 FOR T=.1 TO 2 STEP .1
910 PD=P*(V-RV)/VC
920 F=SG*PD*V*.1
930 RC=V/F
940 V(T)=V*EXP(-.1/RC)
950 PRINT TAB(4)";";TAB((V(T)*Q)+4)"*"
960 LPRINT TAB(4)";";TAB((V(T)*Q)+4)"*"
970 IF ABS(T-1) < .01 THEN FEV1=M-V(T)
980 FEV1%=(FEV1/VC)*100
990 V=V(T)
1000 NEXT T
1010 LPRINT T"SEC":LPRINT:LPRINT
1020 LPRINT CHR$(27)"@":REM TURNS OFF SPECIAL PRINT COMMANDS
1030 LPRINT "FEV1 EQUALS: "FEV1
1040 PRINT T " SEC"
1050 PRINT "FEV1= "FEV1;:PRINT "FEV1%= "FEV1%;:PRINT "TLC= "M
1060 LPRINT "FEV1% EQUALS: "FEV1%
1070 PRINT "RV = "RV, "SP. AIRWAY CONDUCT.= "SG, "EXPIR.PRESS.= "P
1080 LPRINT "TLC= "M,"MAXIMAL EXPIRATORY PRESSURE="P
1090 LPRINT "RV="RV" L","SP. AIRWAY CONDUCTANCE="SG
1100 V=M
1110 PRINT "PRESS RETURN KEY TO CONTINUE":Z#=INPUT$(1)
1120 LPRINT:LPRINT:LPRINT:LPRINT:LPRINT
1130 PRINT "TIME","VOLUME","FLOW","RC","PRESSURE":REM TITLES FOR DATA PRINTOUT
1140 LPRINT "TIME","VOLUME","FLOW","RC","PRESSURE"
1150 FOR T =.1 TO 2 STEP .1
1160 PD=P*(V-RV)/VC
1170 F=SG*PD*V*.1
1180 RC=V/F
1190 V(T)=V*EXP(-.1/RC)
1200 PRINT T,V(T),F,RC,PD
1210 LPRINT T,V(T),F,RC,PD
1220 V=V(T)
1230 NEXT T
1240 PRINT "PRESS RETURN KEY TO CONTINUE":Z#=INPUT$(1)
1250 GOTO 1570
1260 IF LEFT$(S#,1)="F"GO TO 1420
1270 RESTORE 1280:REM AUTOMATIC DATA ENTRY FOR MALES.
1280 DATA 6,3,4.8,4.6,4,180,34
1290 READ M,FRC,F3,VC,F,B,D
1300 RV=M-VC
1310 REM PREDICTION FORMULAS FOR MALES
1320 M1=(.0867*H)-8.49:SD1=.91
1330 VC1=(.052*H)-(.022*A)-3.6:SD2=.58
1340 RV1=(.027*H)+(.017*A)-3.45:SD3=.39
1350 FRC1=(.0578*H)+(.016*A)-(.04*W)-4.24:SD4=.61
1360 R2=(.343*A)+16.7:SD5=4.8
1370 F1=(.0362*H)-(.031*A)-1.41:SD6=.5
1380 F1%=(.373*A)+91.8:SD7=7.19
1390 B1=(1.34*H)-(1.26*A)-21.4:SD8=29
1400 D1=(.326*H)-(.2*A)-17.6:SD9=1.71
1410 GOTO 360
1420 RESTORE 1430:REM AUTOMATIC DATA ENTRY FOR FEMALES
1430 DATA 4.2,2.3,3.1,3.2,2.6,130,25
1440 READ M,FRC,F3,VC,F,B,D
1450 RV=M-VC
1460 REM PREDICTION FORMULAS FOR FEMALES
1470 M1=(.079*H)-(.008*A)-7.49:SD1=.53
1480 VC1=(.052*H)-(.018*A)-4.36:SD2=.42
1490 RV1 = (.032*H)+(.009*A)-3.9:SD3=.39
1500 FRC1=(.053*H)-(.02*W)-4.74:SD4=.46
1510 R2=(.265*A)+21.7:SD5=5.7
1520 F1 =(.0267*H)-(.031*A)-.54:SD6=.36
1530 F1%=(.261*A)+92.1:SD7=5.44

```

Figure 4 (concluded)

```

1540 B1=(.81*H)-(.57*A)-5.5:SD8=10.7
1550 D1=(.212*H)-(.161*A)-2.66:SD9=3.59
1560 GOTO 360
1570 PRINT "WHAT DO YOU WANT TO DO NOW?"
1580 PRINT "1. CALCULATE OTHER PREDICTED PFT VALUES?"
1590 PRINT "2. GRAPH FVC?"
1600 PRINT "3. EXIT PROGRAM"
1610 PRINT "ENTER CHOICE THEN PRESS RETURN";:INPUT Q
1620 IF Q=1 GOTO 210
1630 IF Q=2 GOTO 700
1640 IF Q=3 GOTO 1070
1650 REM COMPUTER INTERPRETATION OF PFT RESULTS
1660 PRINT "ANALYSIS OF PFT RESULTS INDICATES:"
1670 R=0:C=0
1680 IF M1-M>2*SD1 THEN PRINT "TLC IS SMALLER THAN PREDICTED.":R=R+1
1690 IF M-M1>2*SD1 THEN PRINT "TLC IS GREATER THAN PREDICTED.":C=C+1
1700 IF VC1-VC > 2*SD2 THEN PRINT "VITAL CAPACITY IS SMALLER THAN PREDICTED.":R=
R+1:C=C+1
1710 IF FRC-FRC1 > 2*SD4 THEN PRINT "FRC IS ABOVE NORMAL.":C=C+1
1720 IF FRC1-FRC > 2*SD4 THEN PRINT "FRC IS LESS THAN NORMAL.":R=R+1
1730 IF RV-RV1 > 2*SD3 THEN PRINT "THE RV IS GREATER THAN NORMAL.":C=C+1
1740 IF RV1-RV > 2*SD3 THEN PRINT "THE RV IS LESS THAN NORMAL.":R=R+1
1750 IF ((RV/M)*100)-R2 > 2*SD5 THEN PRINT "%RV/TLC IS GREATER THAN NORMAL.":C=C+
1
1760 IF R2-(RV/M)*100 > 2*SD5 THEN PRINT "%RV/TLC IS LESS THAN NORMAL.":R=R+1
1770 IF F1-F > 2*SD6 THEN PRINT "THE FEV1 IS LESS THAN NORMAL.":R=R+1:C=C+1
1780 IF F1%-F/F3*100 > 2*SD7 THEN PRINT "THE %FEV1 IS BELOW NORMAL.":R=R+1:C=C+1
1790 IF B1-B > 2*SD8 THEN PRINT "THE MVV IS BELOW NORMAL.":R=R+1:C=C+1
1800 IF D1-D > 2*SD9 THEN PRINT "THE DLCO IS BELOW NORMAL.":R=R+1:C=C+1
1810 PRINT:PRINT
1820 IF R>C+1 THEN PRINT "THESE PFT RESULTS ARE MOST CONSISTENT WITH RESTRICTIVE
DIS."
1830 IF C>R+1 THEN PRINT "THESE PFT RESULTS ARE MOST CONSISTENT WITH OBSTRUCTIVE
DIS."
1840 IF C<2 AND R<2 THEN PRINT "THESE PFT RESULTS ARE NORMAL."
1850 PRINT:PRINT
1860 RETURN
1870 PRINT "HOPE PuFT PROGRAM HAS BEEN HELPFUL. HAVE A GOOD DAY."
1880 END
1890 PRINT:PRINT:PRINT "YOU HAVE MADE AN ERROR IN ENTERING DATA, PLEASE START OV
ER."
1900 PRINT:PRINT:PRINT "TO CONTINUE PRESS RETURN."::INPUT Q#
1910 GOTO 150

```

PuFT has been tested on a number of medical students and members of the physiology faculty. The response has been encouraging in that the program has been well received and considered to be instructive and easy to use in its final version. Almost all of the test users were novices concerning microcomputers, and some became "hung up" due to errors made during data entry. An error trap routine was added (lines 140 and 1890 to 1910) to solve the problem by allowing the user to start over. Care was also taken to ensure that the menus were self-explanatory and that it was possible to exit the program at each major division.

One of the students who tested the program found it "completely worthless." However, it turned out this individual was a first-year student who had not yet taken physiology. This experience emphasizes the point that this program is not designed to introduce students to the concepts of PFT but rather for furthering an understanding of these tests after the initial exposure to lectures and reading of the basic concepts.

Computer interaction, I am sure, will be the learning format and the laboratory of the future, and we all have much to learn in its application. The computer presents a great many attributes of benefit to the user in that it is immediately interactive, it provides instant commendation for success or chastening for failure, and above all it provides a self-adjusted pace for individual students.

In reality, the software program should be substituted in the above sentence for computer, since it is the software that must be made "user friendly" and designed to provide the proper stimulus and learning environment. Hopefully, this program will provide such a stimulus.

References

1. Cotes, J. E. *Lung Function* (3rd ed.). Oxford: Blackwell, 1975, p. 380-381.
2. McIlroy, M. B., D. F. Tierney, and J. A. Nadel. A new method for measurement of compliance and resistance of the lungs and the thorax. *J. Appl. Physiol.* 18: 424-427, 1963.
3. Tidball, C. S. Teaching computer literacy and physiological simulations. In: *Frontiers in the Teaching of Physiology: Computer Literacy and Simulation*. Bethesda, MD: Am. Physiol. Soc., 1981.
4. Randall, J. E., and T. G. Coleman. Microcomputer implementation of a comprehensive physiological model. In: *Modeling and Simulation on Microcomputers*, edited by L. A. Leventhal. San Diego, CA: Soc. Comp. Simul., 1982, chapt. 7.
5. Dickinson, C. J. A digital computer model to teach and study gas transport between lung, blood and tissues (MacPuf). *J. Physiol. London* 227: 7P-9P, 1972.
6. Dickinson, C. J. *A Computer Model of Human Respiration*. Baltimore, MD: University Park, 1977.
7. Modell, H. I., A. J. Olszowski, J. L. Plewes, and L. E. Farhi. Computer simulations for physiology teaching: role of graphics (Abstract). *Physiologist* 25: 344, 1982.
8. Granger, W. M., and D. A. Miller. A block diagram, graphical and microcomputer analysis of oxygen transport (Abstract). *Federation. Proc.* 40: 377, 1981.

Static Mechanical Properties of Lungs and Chest Wall of the Dog

ALLAN H. MINES, JON R. GOERKE,
DANA R. ABENDSCHEIN, AND
NORMAN C. STAUB

Department of Physiology and
Cardiovascular Research Institute
University of California, San Francisco
San Francisco, California 94143

The purpose of this laboratory exercise is to gain a qualitative and quantitative understanding of the static elastic characteristics of the lungs and chest wall individually and to understand how these give rise to the static elastic characteristics of the respiratory system in vivo.

Most students will probably have used terms such as elasticity, distensibility, and compliance before without having defined them rigorously or used them quantitatively. All these terms are related to one another, but it is most common to discuss the *compliance* of the respiratory system. Compliance is a measure of the ease with which an elastic structure can be made to change in dimensions. Definitions of some relevant terms follow.

Definitions

Pressures (see Figure 1)

Airway pressure (P_{aw}) equals P_A when there is no gas flow and the passage from alveoli to the airway pressure-measuring site is patent.

Alveolar pressure (P_A) is the pressure within the gas contained in the lung's alveoli.

Barometric pressure (P_B) is taken as equal to zero, and all other pressures are referred to it [in San Fran-

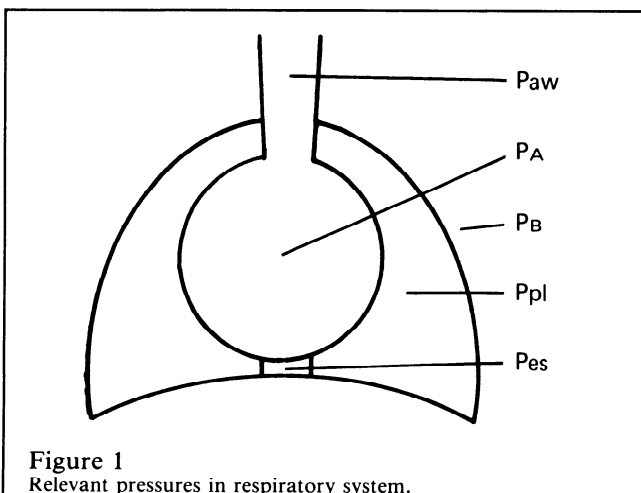

Figure 1
Relevant pressures in respiratory system.

Table 1

Transmural pressure symbols and definitions

Symbol	Name	Definition	Measured As
P_L	Tran-lung pressure	$P_A - P_{pl}$	$P_{aw} - P_{es}$
P_w	Trans-chest wall pressure	$P_{pl} - P_B$	P_{es}
P_{rs}	Trans-respiratory system pressure	$P_A - P_B$	P_{aw}

Table 2

Compliance symbols and definitions

Symbol	Name	Definition	Measured As
C_L	Lung compliance	$\Delta V / \Delta P_L$	$\Delta V / \Delta (P_{aw} - P_{es})$
C_w	Chest wall compliance	$\Delta V / \Delta P_w$	$\Delta V / \Delta P_{es}$
C_{rs}	Lung + chest wall compliance	$\Delta V / \Delta P_{rs}$	$\Delta V / \Delta P_{aw}$

cisco at the altitude of our Physiology laboratories, the absolute $P_B = 745-750$ Torr (mmHg) = 1,013-1,020 cmH₂O].

Intrapleural pressure (P_{pl}) is the pressure in the potential space between the lungs and thoracic wall.

Esophageal pressure (P_{es}) does not necessarily equal P_{pl} , but $\Delta P_{es} = \Delta P_{pl}$ and is the usual clinical measure of average pleural pressure changes.

Transmural Pressure

Transmural means across the wall. Transmural pressures (P_{tm}) are calculated by subtracting the pressure just outside an organ (P_{out}) from the pressure inside it (P_{in}). The various transmural pressures of the respiratory system are defined in Table 1.

Compliance

In the case of a hollow organ such as the lungs or chest wall, compliance is defined as the change in volume of the structure divided by the change in its transmural pressure. Note that the transmural pressure is already a difference between two pressures ($P_{in} - P_{out}$), so this is really a ΔP_{tm} . Table 2 defines various compliances.

The units of compliance are ml/cmH₂O or l/cmH₂O.

Compliances in series (lung and chest wall) cannot be added directly. It should be fairly obvious that the compliance of the lungs plus chest wall system cannot exceed the compliance of the lesser component. [Two concentric balloons will have less compliance (will be stiffer) than either alone.] Compliances in series must be added as reciprocals. Thus

$$1/C_{rs} = 1/C_L + 1/C_w$$

Animal and Equipment

A dog that has been anesthetized with intravenous pentobarbital sodium (30 mg/kg) is provided. This anesthetic is intermediately long acting. Additional doses of 30-60 mg each are required during the exercise to maintain surgical anesthesia.

If you get to the laboratory at the time the exercise is scheduled to begin, the instructors will already have prepared the animal. Should you like to be involved in the animal preparation, please come to the laboratory one hour early. The following procedures constitute the animal preparation: 1) insertion of a balloon-cuffed en-

dotracheal tube; 2) insertion of a catheter into a superficial vein and initiation of a continuous intravenous drip of 0.9% NaCl; and 3) insertion of an esophageal balloon for approximation of intrapleural pressure.

Measurement of Variables

Tidal volume (V_T)

Connect the dog's endotracheal tube to an O_2 -filled spirometer with a fresh cannister of CO_2 absorber. If the spirometer is equipped with a potentiometer driven by the spirometer's movements, the V_T can be recorded on a polygraph. Otherwise, the V_T will be recorded directly on the spirometer kymograph, as shown in Figure 2.

Esophageal pressure (P_{es})

The esophagus is a flaccid organ except during swallowing, so that P_{es} should follow P_{pl} faithfully except during swallowing. To be sure that the pressure in the esophageal balloon faithfully follows P_{es} , the walls of the balloon must be flaccid as well. If they are not, balloon pressure will be greater than P_{es} . With the esophageal balloon in the lower esophagus, suck all gas from the balloon. Now put 0.5 ml back in. When an air-filled pressure transducer is connected to the tube leading from the balloon, the P_{es} should be subatmospheric by a few cmH_2O between breaths and should become even more subatmospheric with each breath. Calibrate so that 10 cmH_2O causes a deflection of 2 cm and set the zero pressure in the center of the recording channel.

Airway pressure (P_{aw})

Insert a needle through the wall of the endotracheal tube as close to the animal as possible. Connect the needle to an air-filled pressure transducer calibrated so that 10 cmH_2O gives a deflection of 2 cm on the polygraph paper. Set the zero pressure line near the bottom of the recording channel. An example of how the record might look is shown in Figure 3.

Experimental Protocol

1) **Calculation of lung compliance during spontaneous breathing.** Set the paper speed at about 10

mm/s and take a 30-s record. Label the tracings and indicate the calibrations of the paper; then measure data and record them on the data sheet provided in this writeup (Figure 4). (Figure 3 shows the sort of data one gets from this part of the exercise.) Calculate C_L . Remember that $P_A = P_{aw}$ only when airflow = 0! Can you calculate passive chest wall compliance from these data? If so, how?

2) **Calculation of lung and chest wall compliance during forced inflation.** Disconnect the spirometer from the animal. With the large plastic syringe, hyperventilate the dog for 5 or 6 breaths. Immediately thereafter, inflate the dog's lungs with 500 ml of gas and hold it for a few seconds. Withdraw 100 ml of gas and hold the new volume until the pressures stabilize; then withdraw another 100 ml of gas, then another, and so forth, until the dog's lung volume is again at functional residual capacity. Again label the tracings, indicate the calibrations on the paper, and record data on the data sheet. (Figure 6 shows the sort of data one gets from this part of the exercise.) Calculate C_L , C_w , and C_{rs} for each ΔV . Plot these data on the graph paper provided. Figure 7 shows the data sheet filled in with data from Figures 3 and 6.

Lab Conference

The conference will focus on the following areas: 1) collection, tabulation, calculation, and display of data; 2) general discussion of elastic properties of lungs and chest wall; and 3) the solving of compliance problems and discussion of their answers. This process is designed to help each student in self-assessment of the mastery of those principles relevant to this exercise.

References

1. Comroe, J. H. Mechanical factors in breathing. In: *Physiology of Respiration*. Chicago, IL: Year Book, 1974.
2. Mead, J., and H. Martin. Principles of respiratory mechanics. *J. Am. Phys. Ther. Assoc.* 48: 478-494, 1968.
3. Mead, J., T. Takishima, and D. Leith. Stress distribution in lungs: a model of pulmonary elasticity. *J. Appl. Physiol.* 28: 596-608, 1970. (Note: for the advanced student).
4. Mines, A. H. Mechanics of breathing. In: *Respiratory Physiology*. New York: Raven, 1981.

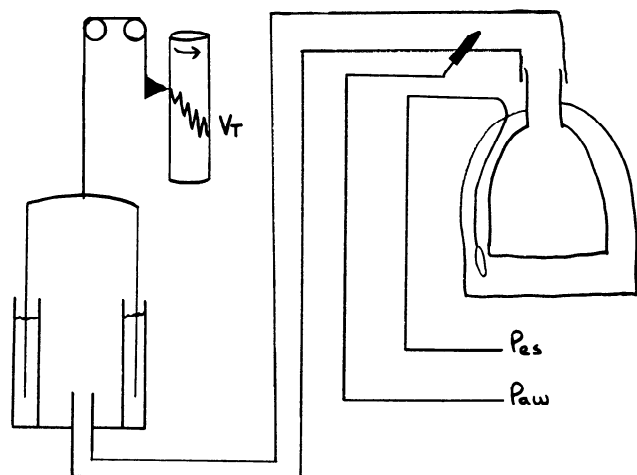

Figure 2
A diagram of animal and equipment.

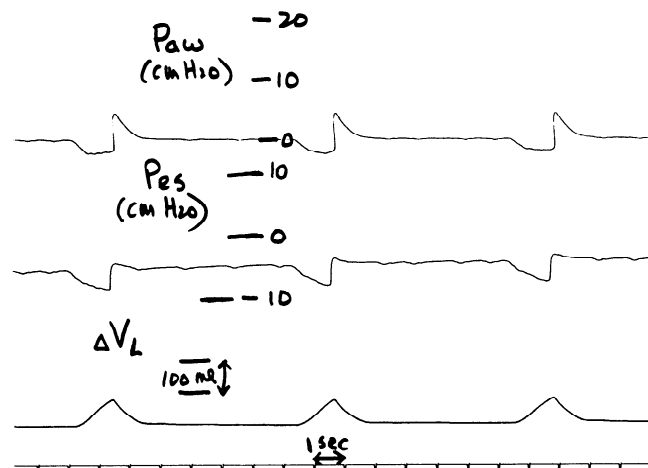
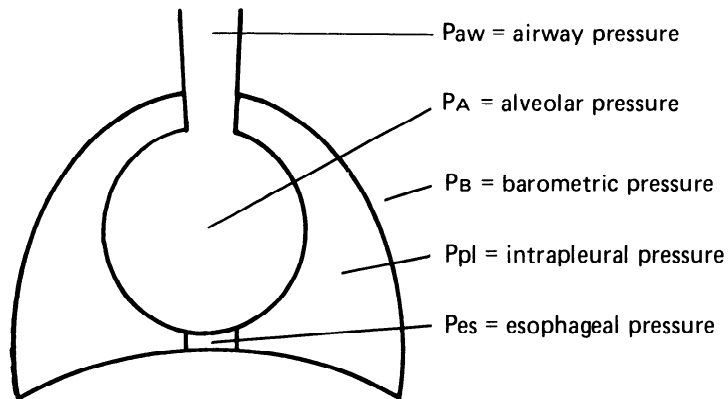

Figure 3
Typical data obtained while the dog is connected to a recording spirometer during spontaneous breathing.

Pulmonary Compliance Data Sheet



lung $P_{tm} = P_L = \text{trans-lung pressure} = P_A - P_{pl}$
 chest wall $P_{tm} = P_w = \text{trans-chest wall pressure} = P_{pl} - P_B$
 total system $P_{tm} = P_{rs} = \text{trans-respiratory system pressure} = P_A - P_B$

Conditions	ml	cmH ₂ O						ml/cmH ₂ O		
	$\Delta\text{Vol, Vol}$	P_{aw}	P_{es}	P_B	P_L	P_w	P_{rs}	C_L	C_w	C_{rs}
Spontaneous breathing										
1.										
2.										
Forced inflation										

Figure 4
Data sheet for dog compliance exercise.

Compliance Problems

A woman has a lung compliance of $0.2 \text{ l/cmH}_2\text{O}$ and a passive chest wall compliance of $0.1 \text{ l/cmH}_2\text{O}$ in the range of normal breathing. Her airway resistance during normal

breathing is $2 \text{ cmH}_2\text{O per l/s}$. When her lungs are stationary at her functional residual capacity (FRC), her intrapleural pressure is $5 \text{ cmH}_2\text{O}$ below atmospheric.

- If she inspires 1.0 liter from FRC and holds it, her transpulmonary pressure (alveolar pressure minus intrapleural pressure) will:
 - rise by $10 \text{ cmH}_2\text{O}$
 - rise by $5 \text{ cmH}_2\text{O}$
 - remain unchanged
 - fall by $5 \text{ cmH}_2\text{O}$
 - fall by $10 \text{ cmH}_2\text{O}$
- If she inspires 1.0 liter from FRC and holds that volume by her respiratory muscles, keeping her airway open, her intrapleural pressure will be:
 - $10 \text{ cmH}_2\text{O}$ below atmospheric
 - $5 \text{ cmH}_2\text{O}$ below atmospheric
 - the same as atmospheric
 - $5 \text{ cmH}_2\text{O}$ above atmospheric
 - $10 \text{ cmH}_2\text{O}$ above atmospheric
- If she inspires 1.0 liter from FRC and then holds it by closing her glottis and completely relaxing her respiratory muscles, her intrapleural pressure will be:
 - $10 \text{ cmH}_2\text{O}$ below atmospheric
 - $5 \text{ cmH}_2\text{O}$ below atmospheric
 - the same as atmospheric
 - $5 \text{ cmH}_2\text{O}$ above atmospheric
 - $10 \text{ cmH}_2\text{O}$ above atmospheric
- If she is completely paralyzed and her lungs are inflated by 1.0 liter and held inflated that much by pressure in a face mask:
 - her transpulmonary pressure will be the same as if she had voluntarily inspired 1.0 liter
 - her transpulmonary pressure will change by the same amount as if she had voluntarily inspired 1.0 liter, but in opposite direction
 - her intrapleural pressure will remain constant, relative to atmospheric
 - her intrapleural pressure will be the same as if she had voluntarily inspired the 1.0 liter and held it with her respiratory muscles
 - her alveolar pressure will be $5 \text{ cm H}_2\text{O}$ above atmospheric

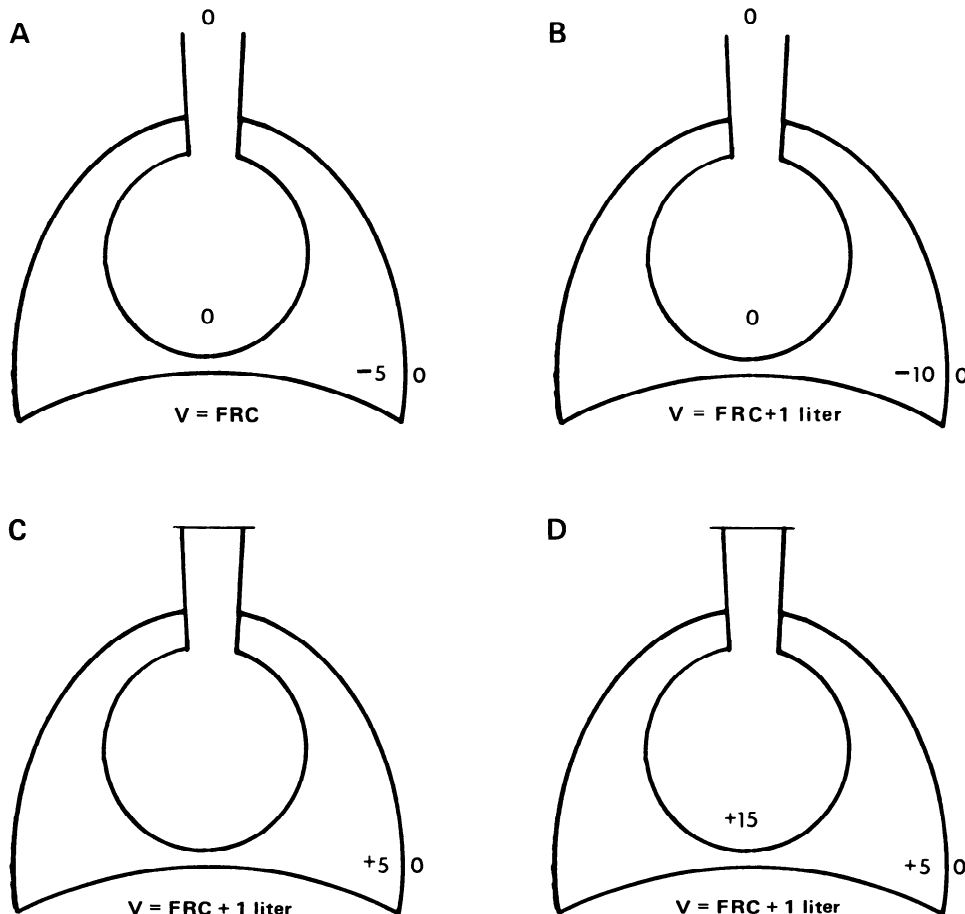

Figure 5
Diagrams of the lungs and chest wall to help understand the answers to problems 1-5.

Answers to Compliance Problems

Generally speaking, there are two aids which students find very helpful in the working of problems such as these. They are the construction of tables to keep track of the various pressures and the drawing of lung-chest wall diagrams for the same purpose. These will be used in this discussion of the answers of these compliance problems.

- Here you are told that 1 liter is inspired and held, but you are not told whether it is held as in problem 2, or as in problem 3. Therefore, you cannot know what the absolute values of P_A or P_{pl} will be. You do know what the P_L is given in the control situation (see Figure 5A and the control values in Table 3). Since you are also given the lung compliance, it is quite straightforward to calculate the amount by which her P_L will change as the 1 liter is inspired and held: $\Delta V/\Delta P_L = C_L$; $\Delta P_L = \Delta V/C_L = +1 \text{ liter}/(0.2 \text{ l/cmH}_2\text{O}) = +5 \text{ cmH}_2\text{O}$. Thus, (2) is correct. The situation is tabulated in row 1 of Table 3.
- This is one of the two ways in which the maneuver of question 1 could have been performed and is pictured in Figure 5B and tabulated in row 2 of Table 3. Since the airway is open and the flow is stopped, the $P_A = 0$. We know that the P_{pl} when flow was stopped at FRC was $-5 \text{ cmH}_2\text{O}$, which tells us that the P_L at the volume was $+5 \text{ cmH}_2\text{O}$. In problem 1 we calculated that the P_L had increased by $+5 \text{ cmH}_2\text{O}$ as the lung volume was increased to FRC + 1 liter and must now be $+10 \text{ cmH}_2\text{O}$. Since the P_A is 0, the P_L must be $-10 \text{ cmH}_2\text{O}$. Answer (1) is correct.
- This is the other way in which the maneuver of problem 1 could have been performed. Since the chest wall is now relaxed, we can use its compliance to determine what its transmural pressure will be at FRC + 1 liter and determine the P_{pl} in that way. The initial P_w at FRC is $-5 \text{ cmH}_2\text{O}$: $\Delta P_w = \Delta V/C_w = +1 \text{ liter}/(0.1 \text{ l/cmH}_2\text{O}) = +10 \text{ cmH}_2\text{O}$. The P_L at FRC + 1 liter must thus be $+5 \text{ cmH}_2\text{O}$, and since $P_B = 0$, the $P_{pl} = +5 \text{ cmH}_2\text{O}$, making answer (4) correct. The situation is pictured in Figure 5C and tabulated in rows 3-5 of Table 3.
- This is the same situation as in problem 3 but asks for P_A . Since we calculated that $P_{pl} = +5 \text{ cmH}_2\text{O}$, and since we know that $P_L = +10 \text{ cmH}_2\text{O}$ at this lung volume (from problems 1 and 2), we know that P_A will be $10 \text{ cmH}_2\text{O}$ greater than P_{pl} , or $15 \text{ cmH}_2\text{O}$. The answer to this problem can be calculated without having recourse to the answers to problems 1, 2, and 3 by considering the lungs and chest wall as one unit. The situation is pictured in Figure 5D and tabulated in rows 3-5 of Table 3, and alternative (5) is correct.

- This is really the same situation as the one in problems 3 and 4. If you check the alternatives, you will see that only one fits. It is (1).

Table 3

Volumes and pressures for compliance problems

Problem No.	Volume, liters	cmH ₂ O					
		P _A	P _{pl}	P _B	P _L	P _w	P _{rs}
Control	FRC	0	-5	0	5	-5	0
1	FRC + 1			0	10		
2	FRC + 1	0	-10	0	10	-10	0
3, 4, 5	FRC + 1	15	5	0	10	5	15

Comments

This exercise is designed to be performed by a group of about six students in one 4-hour laboratory period. Students can take part in the animal preparation and maintenance and should collect, record, process, and plot data. An experienced instructor is responsible for the animal preparation and its stability during the period; we have found that three groups of students can gather data from each animal preparation. We provide several teaching assistants in the classroom to help with group guidance and to answer individual questions. At the end of the exercise we give a self-assessment quiz to the students. The answers to that quiz, together with some of the important logic that might have been used to solve the problems, are presented in written form and verbally by the instructors present.

Sample data are included in Figures 3, 6, and 7, but Figures 6 and 7 would not be included in the syllabus supplied to students. We find that the process by which the students work out what parameters they would like to measure, e.g., P_A , and then consider how to obtain that measurement, by recording P_{aw} when flow is zero, has great pedagogic value.

The only equipment needed besides tubing, needles, and so forth is the following:

- a spirometer, 9 liter or so with CO₂ absorber
- a large calibrated syringe (500 ml, in 100-ml increments)
- esophageal balloons, obtainable commercially
- two strain-gauge pressure transducers (almost any sort)
- a recorder which can record the output of the two transducers simultaneously
- supply of 100% O₂ (helpful but not essential)
- the wherewithal to establish an intravenous drip through which to administer additional anesthesia

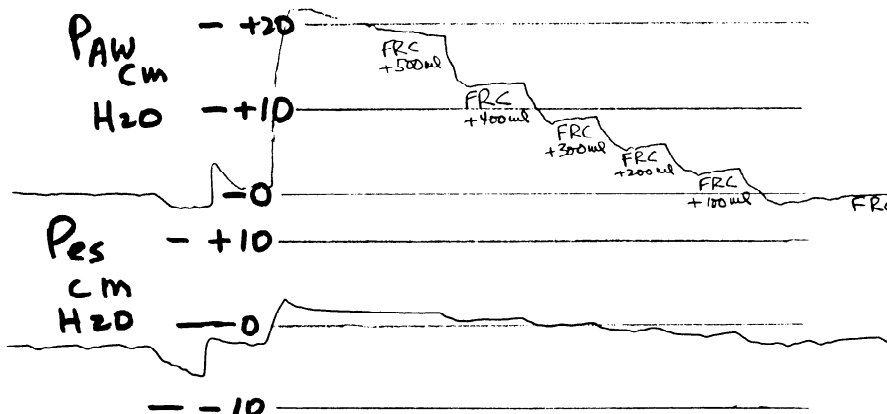
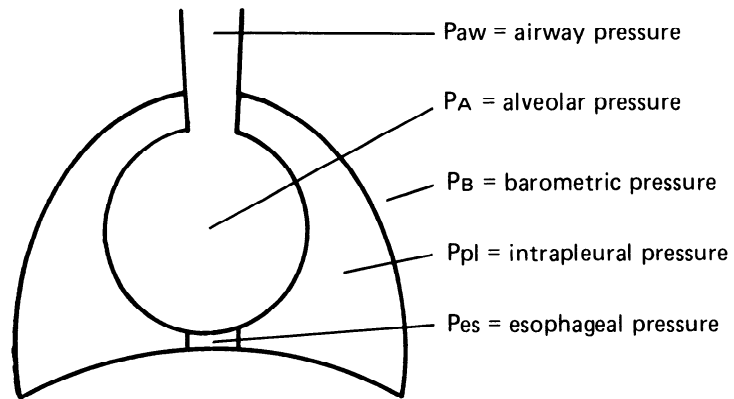

Figure 6

Typical data obtained after the dog is disconnected from the spirometer. A large calibrated syringe is used to inflate the lungs and chest wall to FRC + 500 ml, pause, remove 100 ml and pause, remove 100 ml more and pause, and so forth, down to FRC.

Pulmonary Compliance Data Sheet



lung $P_{tm} = P_L =$ trans-lung pressure = $P_A - P_{pl}$
 chest wall $P_{tm} = P_w =$ trans-chest wall pressure = $P_{pl} - P_B$
 total system $P_{tm} = P_{rs} =$ trans-respiratory system pressure = $P_A - P_B$

Conditions	ml	cmH ₂ O						ml/cmH ₂ O		
	Δ Vol, Vol	P_{aw}	P_{es}	P_B	P_L	P_w	P_{rs}	C_L	C_w	C_{rs}
Spontaneous breathing										
1.	90	0	-5	0	+5	-5	0			
		0	-8.5	0	+8.5	-8.5	0	25.7		
2.										
Forced inflation										
FRC +	500	+18.7	+1.5	0	+17.2	+1.5	+18.7			
FRC +	400	+13.0	+1.0	0	+12.0	+1.0	+13.0	19.2	200	17.5
FRC +	300	+ 9.2	+0.3	0	+ 8.9	+0.3	+ 9.2	32.3	143	26.3
FRC +	200	+ 6.0	-0.2	0	+ 6.2	-0.2	+ 6.0	27.0	200	31.3
FRC +	100	+ 3.1	-0.9	0	+ 4.0	-0.9	+ 3.1	45.5	143	34.5
FRC +	0	0	-1.5	0	+ 1.5	-1.5	0	40.0	167	32.3

Figure 7
 Data sheet for dog compliance exercise filled in with data from Figures 3 and 6.

Letter to the Editor

New Computer-Based Teaching Programs

HAROLD G. HEMPLING
Department of Physiology
Medical University of South Carolina
Charleston, South Carolina 29425

Encouraged by enthusiastic response to our earlier teaching programs in BASIC (1), I would like to inform my fellow physiologists about several additional programs which are in use in our teaching.

Using the Program PERMEA/R2 AND PLOT

We had published a teaching program in BASIC which solved the differential equations of Kedem and Katchalsky (2) by the Euler method of numerical integration (1). I have now adapted this program to output to an X-Y recorder using an analog-to-digital board from Mountain Computer, Santa Cruz, CA, mounted in slot no. 4 of an Apple II Plus microprocessor. I have called the program PERMEA/R2 AND PLOT. I verified its accuracy by comparing its analysis of the experimental data from cells shrinking in hyperosmotic media with a digital analysis using Eq. IV of Lucké et al. (3) and described in the BASIC program CALCULATING LP. Values for the hydraulic coefficient (L_p), calculated by the two procedures using the same raw data, agreed within 5%, which is well within our acceptability of reproducible experimental data.

Two options are offered to ensure maximal sensitivity for the Y-axis and maximal flexibility for the X- or time axis. The user is asked to provide the maximum value for cell volume and the minimum value applicable for the entire series of trials. This interval between maximum and minimum sets the interval corresponding to 255, so that $255/(HI-LO)$ will output 10 V. All subsequent cell volumes $V(I)$ are compared with the low value to establish the proportional output voltages to the Y-axis, viz., $(V(I)-LO)/(HI-LO)*255$.

To obtain flexibility in the time scale, the maximum number of points expected is set at 255 to output 10 V, viz., $255/(\text{maximum no. of points})$. All subsequent choices less than maximum will remain fixed as a proportion of this factor.

The output to the X-Y plotter is a continuous function, with time intervals chosen small enough to minimize steps in the plot but not so small as to prolong the solution of the equations.

Using the Program GRADES

We have prepared a computer program GRADES for use on the Apple II microprocessor. It will do the following:

1. Accept a list of student names.
2. Accept a list of grades from student quizzes and major exams.
3. Permit correction of entered names or grades.
4. Calculate quiz average and overall average of quizzes and major exams according to preselected weightings.
5. Print out a grade list with student's name, quiz average, and overall average and indicate whether student is failing, based on a preselected minimal passing grade.

In our own course, we have used the program to maintain a current assessment of student progress. With the program, we identify students in academic difficulty who may need guidance and counseling.

Using the Program TEXT DISPLAYS

For those of you who are writing your own teaching programs, I have written a program, TEXT DISPLAYS, which permits the user to prepare text material for display on the video screen. I have used it in lecture rooms with closed-circuit TV monitors instead of slides or overheads. I have also found it useful in a self-instructional format, since all the text material may be stored on floppy disks and then be recalled like any other file.

There are three subroutines. What follows is a synopsis of the instructions which serve as the introduction to its use.

ENTER TEXT. This program will allow user to enter his text. In using this program remember the following: 1) do not use commas or colons; 2) go only to the end of the line; 3) 10 lines will fit on one page.

EDIT TEXT. A line of text may be changed. To delete text line replace with *. To add a space between lines put**.

READ TEXT. The present program will ask for the name of the file. To go directly to the text, change statement 45 in program to read Q\$ = "name of your file."

Listings and illustrative material are available on request. To obtain copies of these programs, or our earlier ones, please send a blank floppy disk (16 sector) and indicate the programs wanted. Since we all have tight budgets, please include stamps to cover postage expenses.

References

1. Hempling, H. G., and W. C. Wise. Letter to the Editor *Physiologist* 24(5): 54-56, 1981.
2. Kedem, O., and A. Katchalsky. *Biochim. Biophys. Acta* 27: 229-246, 1958.
3. Lucké, B., H. K. Hartline, and M. McCutcheon. *J. Gen. Physiol.* 14: 405-419, 1931.

Book Reviews

The Science of Photomedicine.

J. D. Regan and J. A. Parrish (Editors)

New York: Plenum, 1982, 658 pp., illus., index, \$75.00

This timely book is designed to be of interest to researchers and clinicians in the field of photobiology, dermatology, and radiology while also being useful as a general reference for practicing physicians. In its preface, the authors state "this book describes the paradigms, experimental data, technical procedures, and science which form the basis of photobiology in medicine." That these goals have largely been achieved is a tribute to the skills of the editors and the 35 contributing authors.

The 23 chapters are grouped into six sections, progressing from basic science to applications. The reader is thus provided with information in a logical sequence that facilitates the understanding of normal and abnormal photobiologic processes in man and the rationale for photoprotection and phototherapy.

Each chapter is written by a different author. Given the broad scope of the book and its relatively small size, it is to be expected that each chapter is an overview of its subject and not an in-depth treatise. Nevertheless, the chapters are well referenced and provide the reader with the ability to obtain additional source material as required.

The authors are drawn from many different groups throughout the United States and Europe. Although this diversity of background does result in some variation in writing style from chapter to chapter, the great majority of the chapters are very readable. Each chapter is self-contained. Cross-referencing between chapters is not extensive. Material in one chapter is occasionally repeated in another chapter. The entire chapter on the photobiology of carotenoid protection could well have formed the introduction to the subsequent chapter on beta-carotene therapy. Similarly, the three chapters addressing dye-light interactions in biologic systems could have been merged into a single chapter. These are minor criticisms and do not detract from the usefulness of the book.

The chapter of photodermatoses is less well organized and less clearly written than other chapters and utilizes a classification system that may be unfamiliar to the great majority of the intended readers. This deficiency is alleviated by the availability of a short text by Harber and Bickers entitled *Photosensitivity Diseases*, which clearly addresses this subject. Unfortunately, that textbook was not referenced in the bibliography at the end of the chapter.

In summary, this book very successfully achieves its overall aim, i.e., presenting the scientific basis for photomedicine. It represents a useful introductory book for its intended readers. It is well worth owning and reading.

Alan N. Moshell
National Institutes of Health

Ecology of Bats. T. H. Kunz (Editor)

New York: Plenum, 1982, 425 pp., illus., index, \$9.50

Because there exists an extensive literature representing a wide range of studies on the biology of bats, there is a need for a unified treatise on this uniquely specialized and primitive mammal. This book meets such a need. *Ecology of Bats*, edited by T. H. Kunz of Boston University, contains 10 chapters, with emphasis on ecology, but in terms of its interrelationship with ethology, physiology, and morphology and with material on evolutionary processes. This latter factor, plus the data on physiology found throughout the book, makes it significant for the comparative physiologist. Thus the book contains material pertinent to comparative physiology and physiological zoology, some chapters being of general interest and others of more specific interest.

Five chapters appear to be of direct interest to the physiologist: Chapter 2 by P. A. Racey on reproduction; Chapter 3 by M. D. Tuttle and D. Stevenson on growth and survival; Chapter 7 by M. B. Fenton on echolocation, insect hearing, and feeding; and Chapter 4 by B. K. McNab, "Evolutionary Alternatives in the Physiological Ecology of Bats," which is most significant. This well-written chapter has highly informative sections on energetics, including factors in energy expenditures and thermal conductances, endothermy, relationship between energetics and life-span, adjusting energy expenditure to tropical and temperate environments, migration, hibernation, energy budgets in the evolution of bat energetics, and water balance (kidney function and balancing a water budget in bats). Chapter 5 by H. G. Eckert, "Ecological Aspects of Bat Activity Rhythms," is also highly interesting and informative. Material is presented on methods for recording bat activity, arousal and timing of flight under external influences (light, temperature, and wind), and the endogenous origin of bat rhythms (circadian, susceptibility of period to exogenous factors, phase response of circadian rhythms to light pulse, entrainment of circadian rhythms, zeitgeber for circadian activity rhythms). There is also a section on ecological adaptation of circadian systems and evolutionary aspects.

Whether the physiologist wishes to study the complete book (worthwhile for general information) is a matter of personal preference, but it appears to me that it would be most useful for background information, especially in the extensive literature-cited sections. It should be mentioned that all the authors have written summaries of their chapters.

I would recommend this book to the comparative physiologist and physiological zoologist as a source book containing pertinent and up-to-date "state-of-the-art" information on bats. For the ecologist and physiological ecologist this book is a must because of the completeness of information and as a "scholarly treatment of the ecology and behavior of bats."

George Jacobs
Vertebrate Zoology, Smithsonian Institution