



Postage Meters

DM300c, DM400c™

Digital Postage Meter

Operator Guide

Canada English Version
SV61991 Rev. C
September 2023

SV61991 Rev. C ©2023 Pitney Bowes Inc.

All rights reserved. This book may not be reproduced in whole or in part in any fashion or stored in a retrieval system of any type or transmitted by any means, electronically or mechanically, without the express, written permission of Pitney Bowes.

We have made every reasonable effort to ensure the accuracy and usefulness of this manual; however, we cannot assume responsibility for errors or omissions or liability for the misuse or misapplication of our products.

Due to our continuing program of product improvement, equipment and material specifications as well as performance features are subject to change without notice. Your digital mailing system may not have some of the features described in this book. Available features vary, depending on the model of your mailing system, installed options, system software level, how your system is set up and the country it is designed to operate in.

E-Z Seal and PB Postage are trademarks or registered trademarks of Pitney Bowes Inc. ENERGY STAR is a registered trademark of the United States Environmental Protection Agency.

FCC Part 15 Compliance

NOTE: This equipment has been tested and found to comply with the limits for a Class B digital device, pursuant to part 15 of the FCC rules. These limits are designed to provide reasonable protection against interference in a residential installation. This equipment generates, uses, and can radiate radio frequency energy and, if not installed and used in accordance with the instruction manual, may cause interference to radio communications. However, there is no guarantee that interference will not occur in a particular installation. If this equipment does cause interference to radio or television reception, which can be determined by turning the equipment off and on, the user is encouraged to try to correct the interference by one or more of the following measures:

- Reorient or relocate the receiving antenna.
- Increase the separation between the equipment and receiver.
- Connect the equipment into an outlet on a circuit different from that to which the receiver is connected.
- Consult the dealer or an experienced radio/TV technician for help.

CAUTION: Changes or modifications to this equipment not expressly approved by the party responsible for compliance could void the user's authority to operate the equipment.

A shielded USB cable must be used with this equipment to ensure compliance with the limits. Use of an unshielded cable is prohibited.

FCC Part 68 Compliance of the G900 Modem

This equipment complies with Part 68 of the FCC rules and the requirements adopted by the ACTA. On the back of this equipment is a label that contains, among other information, a product identifier in the format US:AAAEQ##TXXXX. If requested, this number must be provided to the telephone company.

This equipment is designed to be connected to a Facility Interface Code 02LS2 network with RJ11C network interface.

A plug and jack used to connect this equipment to the premises wiring and telephone network must comply with the applicable FCC Part 68 rules and requirements adopted by the ACTA. A compliant telephone cord and modular plug is provided with this product. It is designed to be connected to a compatible modular jack that is also compliant. See installation instructions for details.

The ringer equivalence number (REN) is used to determine the number of devices that may be connected to a telephone line. Excessive RENs on a telephone line may result in the devices not ringing in response to an incoming call. In most but not all areas, the sum of RENs should not exceed five (5). To be certain of the number of devices that may be connected to a line, as determined by the total RENs, contact the local telephone company. The REN for this product is part of the product identifier that has the format US:AAAEQ##TXXXX. The digits represented by ## are the REN without a decimal point (for example 03 is a REN of 0.3).

If this equipment (3C00, 4C00 mailing machine) causes harm to the telephone network, the telephone company will notify you in advance that temporary discontinuance of service may be required. But if advance notice isn't practical, the telephone company will notify you as soon as possible. Also, you will be advised of your right to file a complaint with the FCC if you believe it is necessary.

The telephone company may make changes in its facilities, equipment, operations, or procedures that could affect the operation of the equipment. If this happens the telephone company will provide advance notice in order for you to make necessary modifications to maintain uninterrupted service.

If trouble is experienced with this equipment (3C00, 4C00 mailing machine), please contact Pitney Bowes, 3001 Summer Street, Stamford, Connecticut 06926 for repair or warranty information. If the equipment is causing harm to the telephone network, the telephone company may request that you disconnect the equipment until the problem is resolved. This equipment is not intended to be repaired by the customer.

Connection to party-line service is subject to state tariffs. Contact the state public utility commission, public service commission, or corporation commission for information.

If the installation site has specially wired alarm equipment connected to the telephone line, ensure the installation of this mailing machine does not disable the alarm equipment. If you have questions about what will disable alarm equipment, consult your telephone company or a qualified installer.

Servicing

This equipment is not intended to be serviceable. Please refer to the warranty information if problems occur. Failed units will be withdrawn by Pitney Bowes service engineers and returned to the U.S. Service Center. For reference purposes, the U.S. Service Center contact address is: Pitney Bowes Inc., 3001 Summer Street, Stamford, Connecticut 06926.

A plug and jack used to connect this equipment to the premises wiring and telephone network must comply with the applicable FCC Part 68 rules and requirements adopted by ACTA. A compliant telephone cord and modular plug is provided with this product. It is designed to be connected to a compatible modular jack that is also compliant. See installation instructions for details.

Industry Canada

This product meets the applicable Industry Canada technical specifications. The Ringer Equivalence Number (REN) is an indication of the maximum number of devices allowed to be connected to a telephone interface. The Ringer Equivalence Number (REN) of this terminal equipment is 1.0. The termination on an interface may consist of any combination of devices subject only to the requirement that the sum of the RENs of all devices does not exceed five.

The abbreviation, IC, before the registration number signifies that registration was performed based on a Declaration of Conformity indicating that Industry Canada technical specifications were met. It does not imply that Industry Canada approved the equipment.

Contact Information List

Canada Contacts	xi
-----------------------	----

1 • Introduction

About Your Digital Mailing System.....	1-2
What is IntelliLink®.....	1-3
Postal Requirements.....	1-4
What's in this Guide.....	1-5
Other Sources of Information	1-6
Getting Help	1-6
Important Safety Notes.....	1-6
Important Telephone Safety Instructions	1-8

2 • Getting to Know Your System

Machine Features—Front (DM300c).....	2-2
Machine Features—Front (DM400c).....	2-4
Control Panel.....	2-6
Machine Features—Rear.....	2-8

3 • Running Mail

Before You Begin	3-3
Checklist	3-3
The Ready Screen.....	3-3
Applying Postage and Running Mail.....	3-4
Selecting a Class or Special Service	3-5
Before Selecting or Changing a Class	3-5
Applying Postage.....	3-6
Processing Lettermail Using the Integrated Weigh Platform.....	3-6
Processing Lettermail Using Manual Weight Entry.....	3-7
Processing Incentive Lettermail	3-8
Printing Postage on an Envelope.....	3-8
Feeding Envelopes	3-9
Processing a Parcel Using the Optional Parcel Rate Module	3-10

Table of Contents

Processing a Parcel Without Using the Optional Parcel Rate Module	3-12
Printing Digital Indicia on Tapes	3-13
Adding Postage to Correct a Mail Piece	3-14
Correcting a Date on a Mail Piece	3-15
Printing a Statement of Mailing or Manifest Payment	3-16
Test Print / Zero Dollar Indicia.....	3-17
Using Presets.....	3-17
Selecting the Normal Preset.....	3-17
Selecting a Custom Preset.....	3-17
Selecting an Account to Track Postage	3-18
Checking and Clearing the Batch Count.....	3-19
Checking the Batch Count.....	3-19
Printing a Record of the Batch Count Information.....	3-20
Clearing the Batch Count	3-20

4 • Printing Options

Printing Options	4-2
Bypass Printing and Seal the Envelope Only	4-3
DM300c Only.....	4-3
DM400c Only.....	4-4
Printing the Date and Time or an Ad on Incoming Mail.....	4-4
Setting or Advancing the Date on the Machine.....	4-5
Printing an Envelope Advertisement	4-6
Downloading an Envelope Ad Into Your Machine.....	4-6

5 • Normal and Custom Presets

What is a Preset?	5-2
Normal Preset / Default Screen	5-2
Custom Presets.....	5-3
Defining Presets.....	5-3
Selecting a Preset.....	5-4
Selecting Custom Presets.....	5-4

Table of Contents

Managing Custom Presets	5-4
Viewing a Custom Preset.....	5-4
Editing a Custom Preset Name.....	5-5
Overwriting a Custom Preset	5-5
Deleting a Custom Preset	5-6

6 • Adding Postage/Connecting to the Data Centre

A Word About Adding Postage.....	6-2
Connecting to the Data Centre using a LAN connection ...	6-2
Checking Funds (Postage) Availability in Machine.....	6-3
Checking Your PB Postage® Account Balance	6-5
Adding Postage	6-5
Printing a Funds Report.....	6-6
Downloads from the Data Centre to Your Machine	6-7
Check for Software Updates.....	6-10
Distributor Settings	6-12

7 • System Options

System Options	7-2
Basic Options.....	7-3
Setting the Time, Date, and Timeouts.....	7-3
Adjusting the Contrast of the Display.....	7-6
Setting Postage Limits (Funds Warnings).....	7-7
Enabling, Changing or Disabling Lock Codes and Passwords.....	7-8
Configuring the Tape Button.....	7-11
Advanced Options	7-12
Meter Withdrawal (Withdrawing Postage Funds).....	7-12
Running Install Mode.....	7-13

8 • Reports

Overview of Reports	8-2
Last 5 Refills Report.....	8-3
Funds Report	8-3

Table of Contents

Single Accounts Report.....	8-3
Multi-Account Summary Report	8-3
Account List Report.....	8-4
System Setup Report	8-4
Error Report.....	8-4
Configuration Report	8-5
Software Version Report	8-5
Printing a Report.....	8-6
Printing to an Attached Printer.....	8-6
Printing on an Envelope or Tape Strip.....	8-6

9 • Departmental Accounting

Overview of the Accounting Feature.....	9-2
Creating New Accounts.....	9-3
Deleting Accounts	9-4
Editing Accounts	9-5
Viewing/Clearing Account Totals	9-6
Clearing All Account Totals	9-7
Turning Account Passwords On (Globally)	9-8
Turning Account Passwords Off (Globally)	9-9
Turning Accounting On	9-10
Turning Accounting Off.....	9-10

10 • Scale Options

Scale Options.....	10-2
Zeroing the Scale	10-3
Setting Weight Change Options	10-3
Setting Class Change Options	10-4
Turning Auto Scale On or Off	10-5
Setting the Scale Location Code	10-6

11 • Maintenance

Printer Maintenance.....	11-2
Printing a Test Pattern.....	11-3
Cleaning the Printer Nozzle	11-4

Table of Contents

Replacing the Ink Cartridge	11-5
Replacing the Print Head.....	11-8
Filling the Moistener (DM400c Only)	11-10
Filling the Moistener (DM300c Only)	11-11
Maintaining the Moistener.....	11-12
Cleaning the Stripper Blade and Brush Assembly (DM400c)	11-12
Cleaning the Shield and Wick (DM400c)	11-13
Removing the Moistener (DM300c)	11-14
Removing the Shield and Wick (DM300c)	11-16

12 • Troubleshooting

Power Questions	12-2
Feeding Questions.....	12-2
Printing Questions	12-3
Moistening Questions	12-3
Display Questions.....	12-4
Adding Postage Questions	12-4
Display Messages	12-5
Viewing System Configuration Levels	12-5

13 • Supplies and Options

Supplies and Accessories.....	13-2
Options	13-3
Weighing Platform	13-3
Moistener.....	13-3
Advertisements.....	13-3
Departmental Accounting	13-3
Equipment Specifications	A-1
IntelliLink® Feature Settings	A-1
Material Specifications.....	A-2
Glossary	B-1

Table of Contents

Pitney Bowes Contact List

Machine Identification

Product Name: DM300c, DM400c Digital Mailing System

PCN: Refer to the label on the back of your DM300c, DM400c

NOTE: If you need to contact customer support, refer to What Information You Need to Provide Customer Support before making the call.

Resources

For Account Information

Visit us online at:

(English) pitneybowes.com/ca and sign in.

(French) pitneybowes.com/ca/fr and sign in.

For Customer Support

Visit us online at:

(English) pitneybowes.com/ca/en and click Support

(French) pitneybowes.com/ca/fr and click Soutien

For Supplies

Visit us online at:

(English) pitneybowes.com/ca and click on Buy Supplies

(French) pitneybowes.com/ca/fr and click on Boutique

To contact the Canada Post (CPC), visit: **www.canadapost.com**

1 • Introduction

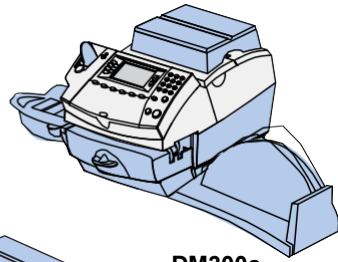

DM300c

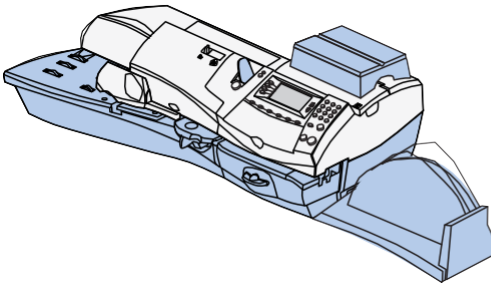

DM400c

This chapter lists the key features of your mailing system, tells you what's in this guide, and presents important safety information.

About Your Digital Mailing System	1-2
What is IntelliLink®	1-3
Postal Requirements	1-4
What's in this Guide	1-5
Other Sources of Information	1-6
Getting Help	1-6
Important Safety Notes	1-6
Important Telephone Safety Instructions	1-8

1 • Introduction

About Your Digital Mailing System

Your digital mailing system's advanced features include:

- Space-saving, compact footprint
- ENERGY STAR® compliant design lowers operating costs and helps preserve the environment
- Large, easy-to-read display shows system status and prompts you through setup operations
- Semi-automatic and automatic envelope feeding, transport, and auto-eject
- Automatic date advance
- User-selectable ad slogans
- Stacker neatly stacks finished envelopes
- Ink jet printing technology provides clear, crisp imprints
- Weighing platform weighs mail pieces
- Integrated rating feature calculates correct postage
- Date and time stamp for use on incoming mail or on sensitive documents
- Accounting feature tracks postage costs by department*
- Password protection limits access to authorized personnel
- Full report printing capability provides hard-copy records of your postage transactions
- In-line moistener wets and seals envelopes
- USB communication ports for exporting report data to a PC and for adding peripherals (scanner, printer)*

***Optional feature**

What is IntelliLink®

IntelliLink® provides you with a digital gateway to an entire suite of services and information to help you move your mail more efficiently and enhance your business performance. It allows you to:

Add Features On Demand

You can easily download envelope ads and optional product enhancements such as departmental accounting.

Download Postal Rate Updates

The latest postal rates are downloaded precisely when you need them.

Keep Your System Current

Software download capability means you'll always have the latest version of your machine's operating system.

1 • Introduction

Postal Requirements

The postage meter on your mailing system is a Postal Security Device (PSD) approved by the Canada Post Corporation to secure funds. Since it is licensed by the Canada Post Corporation, you must follow a few basic requirements.

Add Features On Demand

- Mail must have the correct date and postage amount in the digital indicia.
- Metered mail must bear the postal code of the location where the mail is originated.
- If you move to another Postal Code location, you must update the Postal Code. You can do this by calling Pitney Bowes.

NOTE: If you move your mailing system to a different postal code, you will need to update your system before processing mail at your new location. Refer to the *Pitney Bowes Contact List* at the front of this guide for more information.

- Each time you refill your postage meter (Postal Security Device) through the modem, the PB Postage computer automatically performs a postal inspection. If the postage meter in your mailing machine has not detected a modem refill transaction at certain intervals, the message “Inspection Required” appears on the main screen of the IntelliLink™ Control Centre. (The system will then prompt you to connect to Pitney Bowes and perform an inspection.)
- The postage tape you use must meet Canada Post specifications. To order approved supplies for your mailing system refer to **Chapter 13** - Supplies and Options

What's in this Guide

The Introduction describes the key features of your mailing system. It also includes important safety notes.

Chapter 2, Getting to Know Your System explains the purpose and shows the location of each control and machine feature.

Chapter 3, Running Mail explains how to process mail. The operations covered here are the ones you'll use most often.

Chapter 4, Printing Options explains the various options for printing on your system.

Chapter 5, Normal and Custom Presets explains the Normal and Custom Presets feature for saving commonly-used settings on your machine.

Chapter 6, Adding Postage/Connecting to Data Centre explains how to add postage funds to your system using Pitney Bowes' PB Postage® service and connecting to the Pitney Bowes Data Centre.

Chapter 7, System Setup provides step-by-step instructions for customizing system operation to suit your own needs.

Chapter 8, Reports provides you with a description of reports you can print on your system.

Chapter 9, Accounting Setup provides instructions for setting up the optional accounting feature.

Chapter 10, Scale Options provides instructions for setting up the weighing platform.

Chapter 11, Maintenance explains how to check print quality and take care of the moistener.

Chapter 12, Troubleshooting provides answers to common questions you may have about the performance of your mailing system.

Chapter 13, Supplies and Options lists the supplies available for your mailing system. It also describes options that add to the versatility of your mailing system and enhance the productivity of your mailroom.

Appendix A, Specifications provides material and equipment specifications.

Appendix B, Glossary has a small glossary that explains some of the terms unique to the world of mailing.

1 • Introduction

Other Sources of Information

Refer to the Quick Reference Guide and Quick Install guide provided with your system for frequently used procedures and installation instructions.

Getting Help

As you use your mailing system, there may be times when you need help to solve a specific problem, or you may want additional information about mailing system operation.

Refer to the **Contact Information List** at the front of this guide for more information.

Important Safety Notes

Follow the normal safety precautions for all office equipment.

- Please read all instructions before you attempt to operate the system. Save these instructions for future use.
- Use the power cord supplied with the machine and plug it into a properly grounded wall outlet that's located near the machine and easily accessible. Failure to properly ground the machine can result in severe personal injury and/or fire.
- The power cord wall plug is the primary means of disconnecting the machine from the AC supply. The unit is on whenever it is plugged into a live receptacle, even though the operator display may be off.
- Place the mailing machine base close to an easily accessible wall outlet. DO NOT use a wall outlet controlled by a wall switch or one that is shared with other equipment.
- Do not use an adapter plug on the line cord or wall outlet.
- Do not remove the ground pin from the line cord.
- Make sure the area in front of the wall outlet into which the machine is plugged is free from obstruction.
- DO NOT route the power cord over sharp edges or trap it between pieces of furniture. Make sure there is no strain on the power cord.

Important Safety Notes (continued)

- To reduce the risk of fire or electrical shock, DO NOT attempt to remove covers or disassemble the control panel or its base. The cabinet encloses hazardous parts. If you should drop or otherwise damage the unit, call Pitney Bowes.
- Keep fingers, long hair, jewelry and loose clothing away from moving parts at all times.
- Keep your hands out of the ink cartridge refill holder.
- Avoid touching moving parts or materials while the machine is in use. Before clearing a stall, be sure machine mechanisms come to a complete stop.
- When removing stalled material, avoid using too much force to protect against minor personal injury and damage to the equipment.
- Use the equipment only for its intended purpose.
- Always follow the specific occupational safety and health standards prescribed for your workplace.
- Do not place lighted candles, cigarettes, cigars, etc., on the mailing machine.
- To prevent overheating, do not cover the vent openings.
- Use only Pitney Bowes ink, tape strips, and cleaners. Call the Pitney Bowes Supply Line™ to place orders. If you need Material Safety Data Sheets on the supplies for OSHA requirements, please contact your local Pitney Bowes branch. Refer to the **Contact Information List** at the front of this guide for more information.



CAUTION: In case of an ink spill, leaking ink or excessive ink accumulation, immediately disconnect the power cord from the wall plug and contact Pitney Bowes. Refer to the *Pitney Bowes Contact List* at the front of this guide for more information.

1 • Introduction

2 • Getting to Know Your System

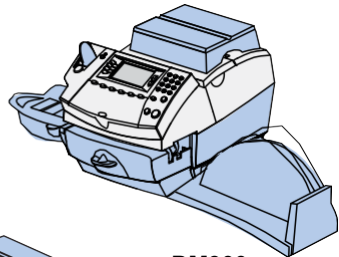

DM300c

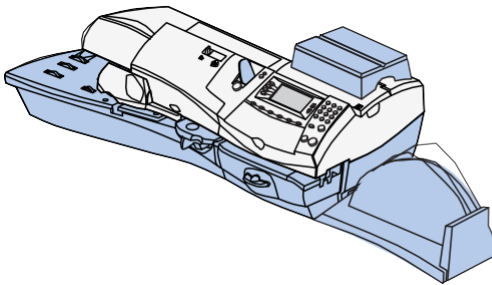

DM400c

In this chapter you'll find out where everything is and what it does.

Machine Features—Front (DM300c)	2-2
Machine Features—Front (DM400c)	2-4
Control Panel	2-6
Machine Features—Rear	2-8

2 • Getting to Know Your System

Machine Features—Front (DM300c)

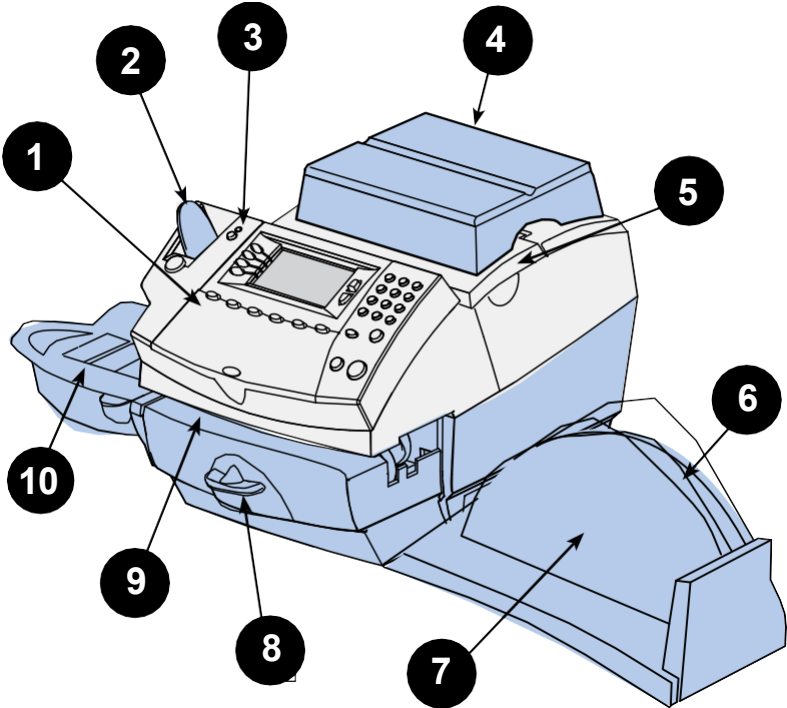

(shown with weighing platform and moistener)

2 • Getting to Know Your System

1. **Control Panel**—allows you to enter and setup information on your machine.
 2. **Tape Feeder**—holds and feeds tapes for printing.
 3. **LED**—lights green when your system is on; lights orange when your system is in “sleep” mode.
 4. **Weighing Platform**—allows you to weigh and calculate postage of a mail piece based on the service selected.
 5. **Ink Access Cover**—opens up to allow replacement of the ink cartridge. See *Chapter 11, Maintenance* for instructions.
 6. **Quick Reference Guide Slot**—allows you store the Quick Reference Guide for easy access.
 7. **Stacker Tray**—allows the neat stacking of finished mail pieces.
 8. **Clearance Lever (two position)**
 - *Home* - printer rollers engaged for processing mail (normal)
 - *Released* - printer rollers disengaged; lower portion of printer deck drops down so you can clear a stalled mail piece.
-
- NOTE:** The machine will not process mail when left in the released position.
-
9. **Printer Deck**—supports your envelope, post card or tape strip as it passes under the printer mechanism.
 10. **Moistener (optional)**—applies sealing fluid to the envelope flap. You can seal envelopes or leave them unsealed, depending on how you feed them.

2 • Getting to Know Your System

1. **Feeder Access Cover**—open this cover to access the moistener bottle.
 2. **Seal/No Seal Lever**—allows you to turn envelope sealing on and off.
 3. **LED**—lights green when your system is on; lights orange when your system is in "sleep" mode.
 4. **Ink Access Cover**—opens up to allow replacement of the ink cartridge. See *Chapter 11, Maintenance* for instructions.
 5. **Weighing Platform**—allows you to weigh and calculate postage of a mail piece based on the service selected.
 6. **Ink Waste Tank**—prevents spillage of ink.
 7. **Control Panel**—allows you to enter and setup information on your machine.
 8. **Printer Clearance Lever (two position)**
 - *Home* - printer rollers engaged for processing mail (normal)
 - *Released* - printer rollers disengaged; lower portion of printer deck drops down so you can clear a stalled mail piece.
-
- NOTE:** The machine will not process mail when left in the released position.
-
9. **Printer Deck**—supports your envelope, post card or tape strip as it passes under the printer mechanism.
 10. **Tape Feeder**—holds and feeds tape strips for printing.
 11. **Moistener**—applies sealing fluid to the envelope flap. You can seal envelopes or leave them unsealed, depending on the position of the Seal/No Seal lever.
 12. **Side Guide**—reduces the skewing of pieces of mail as you feed them into the feeder.
 13. **Feeder Deck**—supports your envelope, post card or tape strip as it waits to be fed into the printer mechanism.
 14. **Quick Reference Guide Slot**—allows you store the Quick Reference Guide for easy access.
 15. **Stacker Tray**—allows the neat stacking of finished mail pieces.

2 • Getting to Know Your System

Control Panel

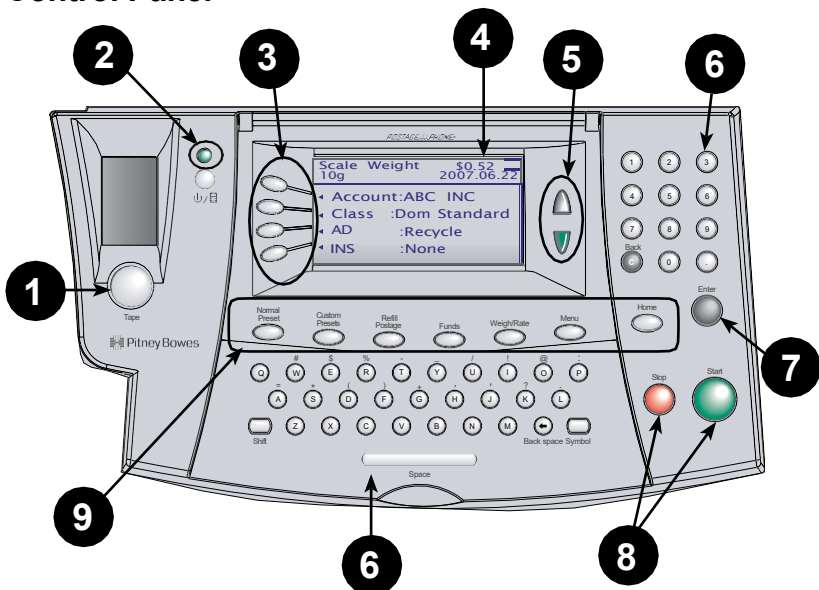

1. **Tape Key**—allows you to print tape(s).
2. **Lock/Power Key**—Dual function. Prevents unauthorized use of your system if lock feature is setup and machine is in "sleep mode"; entering your four-digit password unlocks (awakens) the machine. Also allows you to power up or power down machine.
3. **Screen Selection Keys**—allows you to select a line (one key for each line) on the operator display. Whenever the left arrow (◀) occupies the first position in one of the display lines, you may press the corresponding Screen Selection key to select that line.
4. **Operator Display**—shows the current status of your system and prompts you through all setup operations.
5. **Up/Down Arrow Keys (Scroll Keys)**—allows you to scroll up and down through menu choices in the operator display. If a Page/Up/Down key is lighted, it indicates additional choices are available in a menu (up or down, depending on key) and that Page Up/Down key can be pressed to access these further choices.
6. **Alpha/Numeric and Qwerty Keypads**—allow you to type in numbers and letters for account names, postage values, and other information.
7. **Enter Key**—allows you to accept an entry or choice.

2 • Getting to Know Your System

8. **Start and Stop Keys**—allow you to start/stop the mailing system when running envelopes.
9. **Feature Keys**—allows you quick access to the most common features on the system. Pressing a Feature key takes you immediately to the top-level screen of the feature for that key.
 - **Home**—takes you back to the Home (date/postage) screen.
 - **Normal Preset**—takes you back to the default/home screen. See *Chapter 5, Normal and Custom Presets* for details.
 - **Custom Presets**—press to select from a list of up to 10 custom settings. You can assign a number of values (e.g., class, weight ad, account number and others) to each custom preset. See *Chapter 5, Normal and Custom Presets* for details.
 - **Refill Postage**—allows you to add (refill) postage funds to your machine conveniently via an internet connection. See *Chapter 6, Adding Postage* for details.
 - **Funds**—allows you to check your postage funds and number of mail pieces processed. See *Chapter 6, Adding Postage* for details.
 - **Weigh/Rate**—allows you to weigh and calculate postage based on service selected. See *Chapter 3, Running Mail* for details.
 - **Menu**—allows you to access system setup information such as date, time, postage, accounts, phone parameters, etc. See *Chapter 7, System Options* for details.

IMPORTANT: When you press a Feature key, any entry in the preceding screen is lost unless you have first pressed the **Enter** key to confirm the entry. For example, if you entered an account name and then immediately pressed another Feature key, the account name will not be recorded by the system.

2 • Getting to Know Your System

Machine Features—Rear

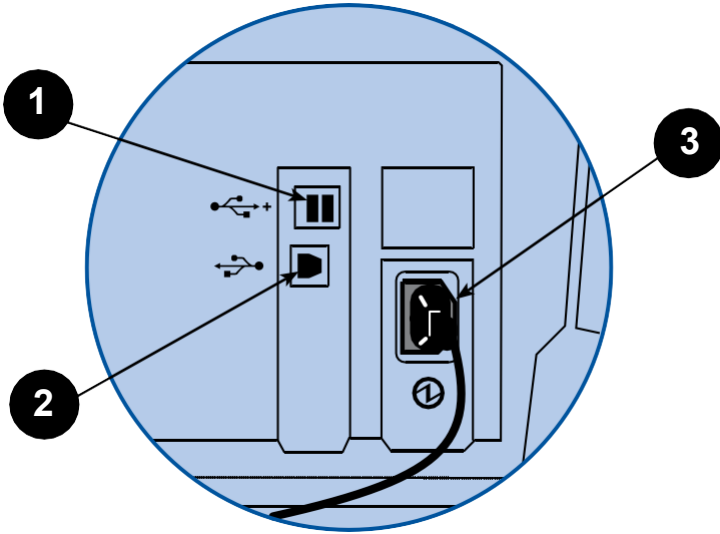

1. **USB A Ports**—allow you to connect to the Pitney Bowes Data Centre via a LAN network, to access your PB Postage account, software updates, rates updates and other features. Also allows you to connect an external weighing platform and scanner.
2. **USB B Port**—for connecting to a PC
3. **Power Receptacle**—connects to AC power cord (supplied).

3 • Running Mail

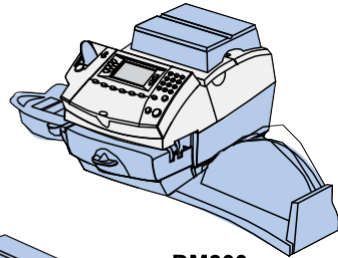

DM300c

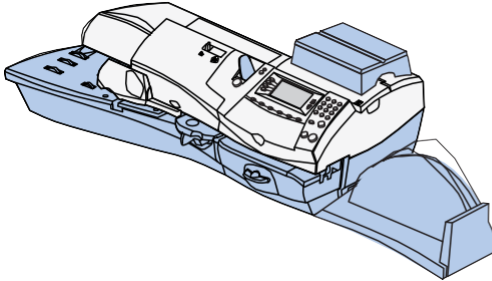

DM400c

This chapter explains how to run mail, your printing options, and using the weighing platform.

Before You Begin.....	3-3
Checklist.....	3-3
The Ready Screen	3-3
Applying Postage and Running Mail	3-4
Selecting a Class or Special Service	3-5
Before Selecting or Changing a Class.....	3-5
Applying Postage	3-6
Processing Lettermail Using the Integrated Weigh Platform	3-6
Processing Lettermail Using Manual Weight Entry	3-7
Processing Incentive Lettermail	3-8
Printing Postage on an Envelope	3-8
Feeding Envelopes	3-9
Processing a Parcel Using the Optional Parcel Rate Module.....	3-10

3 • *Running Mail*

Processing a Parcel Without Using the Optional Parcel Rate Module	3-12
Printing Digital Indicia on Tapes	3-13
Adding Postage to Correct a Mail Piece	3-14
Correcting a Date on a Mail Piece.....	3-15
Printing a Statement of Mailing or Manifest Payment.....	3-16
Test Print / Zero Dollar Indicia.....	3-17
Using Presets.....	3-17
Selecting the Normal Preset.....	3-17
Selecting a Custom Preset.....	3-17
Selecting an Account to Track Postage	3-18
Checking and Clearing the Batch Count.....	3-19
Checking the Batch Count.....	3-19
Printing a Record of the Batch Count Information.....	3-20
Clearing the Batch Count	3-20

Before You Begin

Before you run mail on your system, review the Checklist, Home Screen, and Applying Postage sections below and on the next page.

Checklist

- Make sure your mailing system is plugged into a properly grounded, 110 VAC receptacle. Always follow the safety precautions in *Chapter 1, Introduction*.
- Check the level of sealing solution in the moistener. If you need to add sealing solution, refer to *Chapter 11, Maintenance*.
- If you plan on printing tape strips, make sure you've got an adequate supply. See *Chapter 13, Supplies and Options* for ordering tape strips.
- Check that you have enough postage for your mail run. Press the **Funds** key to view your current balance.
- If running mail longer than a #10 envelope (241.3 mm), slide the stacker tray away from the system.
- The maximum stack height for mail is 3" (76.2 mm). This is the height of the right wall of the stacker tray.

The Ready Screen

When you power up your system, the Ready screen appears on the IntelliLink™ Control Centre operating display. If your system has been set up to require a lock code or password, you are prompted to enter it.

A typical Ready screen is show here:

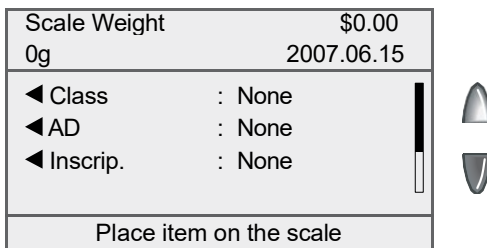

NOTE: If your machine displays Seal Only on the screen simply select the corresponding key to 'Exit Seal Only' to begin.

3 • Running Mail

- To process a mail piece from the Ready screen you must place your mail piece on the scale or enter the weight of the mail piece manually, and then select a class. For more information on processing mail, please refer to the specific topics later in *Chapter 3*.
- If you want to do something other than print postage on an envelope or tape, press the **Menu** key. This provides you with access to other mailing modes and the system setup options. For information on the setup options refer to *Chapter 7* in this guide.

Applying Postage and Running Mail

You can select several different modes for applying postage or running mail on your DM300C or DM400C system. Refer to the appropriate procedure listed here.

1. Applying Postage
2. Printing Postage on an Envelope.
3. Printing the Postage on a Tape Sheet or Tape Strip.
4. Printing Postage Using Presets. Press a key to select certain system values (for example, weight and class) assigned to that key.
5. Selecting an (optional feature) Account.
6. Checking and Clearing the Postage Batch Count on Your System.
7. Adding Postage or Correcting Postage
8. Printing a Statement of Mailing or Manifest Payment
9. Test Print / Zero Dollar Indicia

Selecting a Class or Special Service

Selecting a class is a required action in order to generate the appropriate rate for your mail piece. The procedure for setting a class special service or carrier depends on whether you enter the weight of the mail manually or use the interfaced scale to weigh your mail piece. Each class has its own set of special services. When you select a class only those options available for that selection appear in the display.

Your system automatically calculates the correct postage for your piece of mail based on its weight and the class of service you select

Before Selecting or Changing a Class

Before selecting a class or special feature, please note the following:

- The class that appears in the Ready screen is the one you last selected.
- If you turn off and then turn on the power to your system, the previously selected class automatically clears.
- If you place a piece of mail on the scale, or enter a weight manually, the system automatically prompts you to select a new class if the new weight requires a different class.
- If your system has an attached scale, we recommend that you turn the AutoScale option ON. Refer to the *Setting Up an Attached Scale* section in *Chapter 10* of this guide.

3 • Running Mail

Applying Postage

Processing Lettermail Using the Integrated Weigh Platform

1. If you have the optional accounting feature, from the home screen select **Account** and choose an account.
2. **Weigh Mail Piece** – Place mail piece on the integrated weigh platform.
3. If necessary select **Letters** by pressing the corresponding key next to the display.
4. Select your desired Lettermail sub-class (e.g., Dom Standard, Dom Other, USA, International) by pressing the corresponding key next to the display.
5. Select any desired special services (e.g., Registration) by pressing the corresponding key next to the display. If no special services are required press **Enter**.
6. The screen will now display the postage amount in the top right hand corner with three lines on the left and right side. You are now ready to print the postage.
7. Place envelope in feed deck to print postage (see section 3-9 on Feeding Envelopes for additional instructions).

NOTE: Values between \$0.52 and \$3.49 cannot be entered as this range is representative of the current Canada Post Lettermail rate structure - these values will be adjusted based on future Canada Post Rate Changes. If a value between \$0.52 and \$3.49 (the restricted range at time of publication) is entered, the system will indicate that this is an invalid entry and therefore will not print the indicia. All mailing transactions must be processed by a combination of weight entry (integrated weight platform or manual entry) and making a class selection. The internal rating feature calculates the accurate postage for each mail job.

Processing Lettermail Using Manual Weight Entry

1. If you have the optional accounting feature, from the home screen select **Account** and choose an account.
2. At Ready screen on the IntelliLink™ Control Centre press the **Weigh/Rate** button and then choose “Enter Weight Manually”.
3. Enter weight in grams or choose the **Enter Weight in Kilograms** option to enter weight in kilograms and then press **Enter** or choose “Accept”.
4. Based on your meter configuration you will be prompted to perform 4a and 4b or skip ahead to 4b:
 - a) Select Letters to process Lettermail.
 - b) Select the desired sub-class (e.g., Domestic Standard, Domestic Other, USA, etc.) by pressing the corresponding key next to the display.
5. Select any desired special services (e.g., Registration) by pressing the corresponding key next to the display. If no special services are required press **Enter**.
6. The screen will now display the postage amount in the top right hand corner with three lines on the left and right side. You are now ready to print the postage.
7. Place envelope in feed deck to print postage (see section 3-9 on Feeding Envelopes for additional instructions).

Manual Weight	= \$0.52=
10g	2007.06.08
◀ Account	: None
◀ Class	: Dom Standard
◀ AD	: None
◀ Inscrip.	: None



3 • Running Mail

Processing Incentive Lettermail

Incentive Lettermail is a category of Lettermail that consists of identical items of Standard, Long and Oversize mail as defined by Canada Post that must be deposited in Canada for delivery in Canada. In order to access the applicable Incentive Lettermail price, Customers must enter into an Agreement with Canada Post and ensure that the mail meets certain requirements established by Canada Post.

1. Place mail piece on the integrated weigh platform or key in a weight using the “Enter Weight Manually” function by pressing the **Weigh/Rate** key.
2. At the Select Carrier Screen using the arrow key scroll until you see “Dom Incentive”. Select it by pressing the corresponding key next to the display.
3. Select your desired **Dom Incentive** sub-class (e.g., Machinable, Std Ltr Pres, Oversize Mach or Oversize Std) by pressing the corresponding key next to the display.
4. The screen will now display the postage amount in the top right hand corner with three lines on the left and right side. You are now ready to print the postage.
5. Place envelope in feed deck to print postage (see section 3-9 on Feeding Envelopes for additional instructions).

The following images represent a Machineable Incentive Lettermail and a Presort Incentive Lettermail impression printed adjacent to the Digital Indicia.

INCENTIVE
LETTERMAIL
1A
POSTE-LETTRES À
TARIFS PRÉFÉRENTIELS

Machineable Incentive Lettermail

INCENTIVE
LETTERMAIL
1B
POSTE-LETTRES À
TARIFS PRÉFÉRENTIELS

Presort Incentive Lettermail

Printing Postage on an Envelope

The procedures for printing postage on an envelope are different for the DM300C and DM400C systems. In addition, there are different procedures when using the weigh platform or parcel rating module. Refer to the appropriate procedure in this section.

Feeding Envelopes

Manually Feeding Envelopes (DM300c)

1. If using the moistener, place flap along moistener and move towards the right.

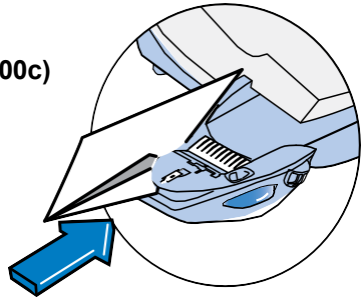

2. Place the envelope up against the registration wall of the system and slide it to the right until the system grasps it. The system prints the digital indicia and ejects the envelope.

Registration Wall

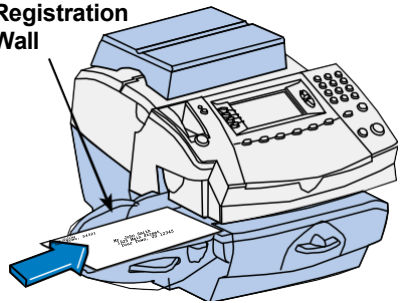

Automatically Feeding Envelopes (DM400c)

Load envelopes onto the feeder and press **Start**. The system automatically feeds the envelope, prints the digital indicia and ejects the envelope.

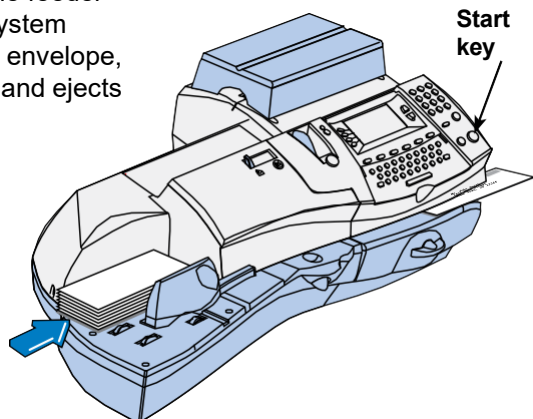

3 • Running Mail

Processing a Parcel Using the Optional Parcel Rate Module

The following outlines the procedure for processing a parcel using the optional Parcel rate module.

1. Place your mail piece on the integrated weigh platform or enter the weight manually through the following steps:
 - a. Press the **Weigh/Rate** button and then select “Enter Weight Manually”.
 - b. Enter the weight in kilograms and then press **Enter** or choose **Accept** to confirm and the system will take you to the class selection option menu (skip to step 3).
2. If you used the integrated weigh platform to weigh your mail piece, you will be prompted to select the **Class**.

Additional sub-class selections and processing steps are required depending on which class selection, and country destination (Domestic, US, International) you select. The steps for the different country destinations are outlined below.

Domestic (Canada) Destinations

3. For Canadian destinations you must select **Domestic Parcel** and then press **Enter** to confirm
4. Select your desired sub-class. For more information on Canada Post Distribution Services (shipping products and services) log on to www.canadapost.ca.
5. Enter the destination code using the QWERTY keyboard and/or the numeric keypad. Based on your entry the system will indicate if it is a postal code or zone. Simply press the corresponding key to continue.
6. Review your postage rate for your parcel and confirm service selection by pressing the corresponding key.
7. Select any appropriate Special Services you desire by following the prompts on the display. Press **Enter** when complete. The postage value will be displayed in the top right hand corner with lines to the left and right side. You are now ready to print the postage.
8. Press the **Tape** button to print postage (see section 3-13 Printing Digital Indicia on Tape for additional information).

US Destinations

3. For US destinations you must select **USA Parcel** and then press **Enter** to confirm.
4. Select your desired sub-class **Expedited USA** or **US Xpresspost**. For more information on Canada Post Distribution Services (shipping products and services) log on to www.canadapost.ca.
5. The system will prompt you to enter a Zone. Key in the appropriate Zone Code and press **Enter** or choose **Accept**.
6. Review your postage rate for your parcel and confirm service selection by pressing the corresponding key.
7. Select any appropriate Special Services you desire by following the prompts on the display. Press **Enter** when complete. The postage value will be displayed in the top right hand corner with lines to the left and right side. You are now ready to print the postage.
8. Press the **Tape** button to print postage (see section 3-13 Printing Digital Indicia on Tape for additional information).

International Destinations

3. For International destinations you must select **Int'l Parcels**.
4. Select your desired sub-class **Small Packet**, **Int'l Surface**, **Int'l Air**, or **Int'l Xpresspost**. For more information on Canada Post Distribution Services (shipping products and services) log on to www.canadapost.ca.
5. The system will prompt you to enter a Country name or Code. If you know the country code enter it now. If you do not know the country code enter the first one or two characters of the country name. A list of all countries beginning with those characters appears in the display. Press the number that corresponds to the country you want and then press **Enter** to confirm.
6. Review your postage rate for your parcel and confirm service selection by pressing the corresponding key.
7. Select any appropriate Special Services you desire by following the prompts on the display. Press **Enter** when complete. The postage value will be displayed in the top right hand corner with lines to the left and right side. You are now ready to print the postage.
8. Press the **Tape** button to print postage (see section 3-13 Printing Digital Indicia on Tape for additional information).

3 • Running Mail

Processing a Parcel Without Using the Optional Parcel Rate Module

This procedure is used for processing Parcels (those mail pieces whose dimensions – size and weight – and associated rates extend outside of the Lettermail rating structure) if you did not purchase the optional parcel rate module. Based on the rate structure provided in your system a Parcel can be considered any mail piece that weighs over 500 grams. In order to process a parcel you will need to know the appropriate postage amount. If you need assistance determining if a mail piece should be rated as Lettermail or as a Parcel or need to obtain the postage rate for the mail piece, contact your local Canada Post retail outlet or log on to www.canadapost.com.

The following outlines the procedure for processing a parcel without the optional Parcel rate module.

1. Key in your desired postage value using the numeric keypad.

NOTE: Values between \$0.52 and \$3.49 cannot be entered as this range is representative of the current Canada Post Lettermail rate structure - these values will be adjusted based on future Canada Post Rate Changes. If a value between \$0.52 and \$3.49 (the restricted range at time of publication) is entered, the system will indicate that this is an invalid entry and therefore will not print the indicia.

2. Press **Enter** to confirm.
3. The amount you entered will appear in the top right corner of your display with lines to the left and right side. You are now ready to print the postage.

Key in Postage	≡ \$xx.xx≡
	2007.06.20
◀ Class	: None
◀ AD	: None
◀ Inscip.	: None

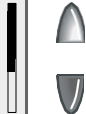

Printing Digital Indicia on Tapes

Printing a Single Tape

1. Push the tape lever to the right and drop tapes down into the slot.

NOTE: The printable side of the tape should be facing towards the control panel display (to the right).

2. Press **Tape** when ready to print. By default, a single tape will be printed.

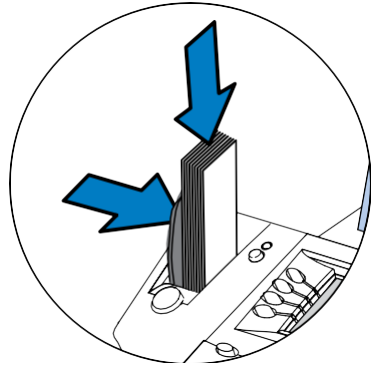

Printing Multiple Tapes

NOTE: Ensure the system is configured to print multiple tapes. Refer to *Chapter 7, System Options, Configuring the Tape Button* for more information.

- If the system is ready to print postage and on the Home screen, simply type in number of tapes you wish to print and press **Tape**
OR
- Press **Tape**. You will be prompted to enter the tape quantity. Press **Start** to begin printing tapes.

Please refer to *Chapter 4* for available Printing Options.

3 • Running Mail

Adding Postage to Correct a Mail Piece

This procedure is used if you have applied the incorrect amount of postage and need to make a correction to ensure that a mail piece has sufficient postage.

1. At the Home screen:
 - Press **Menu** and select "Printing Options".
 - Select "Postage Correction Mode".
 - Key in the postage correction using appropriate decimal places.

Please note that your machine may display a range where a postage amount within a set range cannot be keyed in. For example \$0.52 to \$3.49 is representative of the current Canada Post Lettermail rate structure - these values will be adjusted based on future Canada Post Rate Changes. If a value between \$0.52 and \$3.49 (the restricted range at time of publication) is entered, the system will indicate that this is an invalid entry and therefore will not print the indicia.

2. Press **Enter** or choose **Accept**.

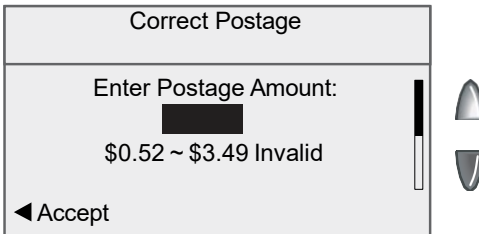

3. Run the mail piece through the system so the that indicia prints on the upper right hand corner of the back side of the envelope (opposite of where initial indicia is printed). Alternatively, you can use a tape sheet to print the correction indicia and place it to the left of the original indicia (for parcels) or as instructed above for letters.

Correcting a Date on a Mail Piece

This procedure is used if you have applied the wrong date to a mail piece and need to make a correction. For example, if you already ran your mail for the day but it was too late for that day's mail pickup, you can apply the next business day's date on the mail pieces so they can be processed correctly by the post office. However, you first need to advance the date on the machine before correcting the date on the mail piece.

NOTE: You cannot change the printed date to a date earlier than the meter's internally held date (in an effort to "backdate" the mail).

1. Press **Menu**.
2. Select "Printing Options".
3. Select "Date Correction Mode":
 - A. Select "Advance One Day" to advance date by one day.
 - B. To advance by more than one day select "Specify Days to Advance" then key in a number (from 1-30) representing the number of days you want to advance the date by. Press **Enter** or choose **Accept** to complete.
4. Run the mail piece through the system so the that indicia prints in the upper right hand corner of the back side of the envelope (opposite of where initial indicia is printed). Alternatively, you can use a tape sheet to print the correction indicia and place it to the left of the original indicia (for parcels) or as instructed above for letters.
5. The display will ask if you want to print more date corrections. Choose **Yes** to continue or **No** to exit.

3 • Running Mail

Printing a Statement of Mailing or Manifest Payment

This procedure is used when you have multiple parcels to send and want to evidence the postage payment for these shipments through one single digital indicia.

1. At the Home screen:
 - Press **Menu** and select “Printing Options”
 - Scroll to “St.of Mailing/Manifest” and press the corresponding key to select.
 - You will be prompted to “Enter Postage Amount”
2. Key in the postage value for the Statement of Mailing or Manifest Payment *using appropriate decimal places* and press **Enter** or choose **Accept**.
3. The system will instruct you to “Insert Envelope or Press Tape” to print the digital indicia.
 - To print on a tape strip press the **Tape** button located on the left side of the control panel.
 - To print on an envelope simply place the envelope up against the registration wall of the of the system and slide it to the right until the system grasps it. The system prints the digital indicia and ejects the envelope.
 - You will need to submit the printed digital indicia with the Statement of Mailing or Manifest which your local Canada Post retail outlet can provide.
4. Press **Tape** to begin printing on a tape strip. The system prints the digital indicia and ejects the tape. Place the tape on the Statement of Mailing or Manifest which your local Canada Post retail outlet can provide.

Test Print / Zero Dollar Indicia

From time to time you or a Pitney Bowes Service Representative may want to conduct a test print to determine if your DM Series print mechanism is operating correctly. We recommend that you use the Test Print or Zero dollar Indicia so that you do not waste your postage funds. The following procedure outlines how to process a Test Print:

1. At the “Home Screen” using the numeric keypad type in ‘0.00’ and press **Enter**.
2. The screen will now display “\$0.00” in the top right hand corner with three lines on the left and right side. You are now ready to print the indicia.
3. Place envelope in feed deck to print (see section 3-9) or Press the **Tape** button to print indicia on tape (see section 3-13).

Using Presets

Selecting the Normal Preset

The Normal Preset is the factory default setting which contains no predetermined mail job settings (e.g., Postage Value, Class, or Weight).

Pressing the **Normal Preset** key will clear your current mail job settings and take you back into Seal Only Mode. From here you can begin a new transaction.

Selecting a Custom Preset

1. At the Ready screen on the IntelliLink™ Control Centre, press the **Custom Presets** key. The display lists all presets stored.
2. Press the corresponding key of the preset you wish to select. The display then shows the selected custom preset values.
3. Print the envelope as described in *Printing Postage on an Envelope* in this chapter, or: Print tapes as described in *Printing Postage on Tape Strips (or Sheets)* in this chapter.

If you'd like to set up custom preset values or change them, see *Chapter 5*.

3 • Running Mail

Selecting an Account to Track Postage

You can select an account to track postage if the optional departmental accounting feature is turned on. See *Chapter 9, Departmental Accounts*, for information on setting up this feature.

1. From Home screen, press the selection key next to Account. The “Select Account” screen displays

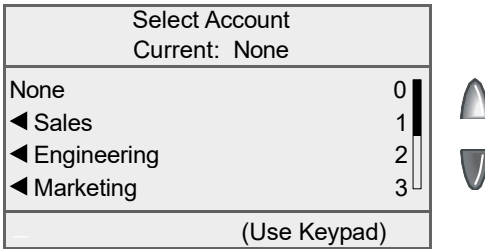

2. Press the down arrow key to see more choices (if lit). To select an account:
 - A. You may either key in the first digit of the account number if you know it and press **Enter**, OR
 - B. Use the appropriate selection key next to the display.
4. If a password has been assigned to this account, you will be prompted to enter one. Key in the four-digit password if necessary.
5. You will return to the Home screen with the name of the account listed.

Checking and Clearing the Batch Count

You can view the accumulated postage value and piece count information from the batch register and print this for your records. You can also clear or reset the batch count to zero.

Checking the Batch Count

1. Press **Funds**.
2. Press the green down arrow key to scroll through the menu and view the Batch Count information. (Batch Count is the last item in the Funds menu list.)

Funds	
Batch Value	: \$ 11.65
Batch Count	: 3
Funds Options (Menu)	

A vertical scroll bar is located to the right of the table. To its right are two arrow keys: a top arrow pointing up and a bottom arrow pointing down.

3. Press **Home** to return to the Home screen.

3 • Running Mail

Printing a Record of the Batch Count Information

1. Press **Funds**.
2. Press **Menu** and select “Print Funds Report”.
3. When prompted either:
 - *Insert an envelope (DM300c)*: Place the envelope up against the back wall of the system and slide it to the right until the system grasps it.
 - *Automatically feed an envelope (DM400c)*: Load envelope onto the feeder and press **Start**.
 - Press the **Tape** button.The Funds Reports is printed (see sample below) and the envelope/tape strip is ejected.
4. Press **Home** to return to the Home screen.

Funds Report	Used: \$065.390	SEP 20 06
	Available: \$10333.610	4: 13P
	Total Pieces: 6765	Batch Count: 1
	Control Sum: \$10399.000	Batch Value: \$000.000
	PBP Serial Number: 8030397	

Clearing the Batch Count

IMPORTANT: Make sure you really want to clear the batch register; once you do, you can't restore the data.

1. Press **Funds**.
2. Press **Menu** and select “Clear Batch Value”.
3. At the Confirm Clear prompt, select “Yes, Clear Value” to confirm. The batch value and batch piece registers return to zero.
4. Press **Home** to return to the Home screen.

4 • Printing Options

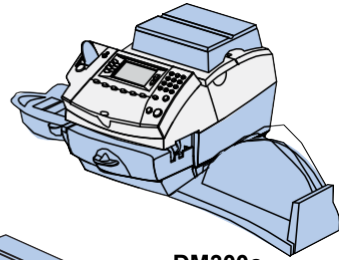

DM300c

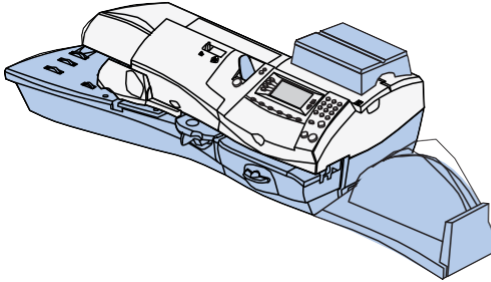

DM400c

This chapter explains your printing options for incoming and outgoing mail.

Printing Options	4-2
Bypass Printing and Seal the Envelope Only	4-3
DM300c Only.....	4-3
DM400c Only.....	4-4
Printing the Date and Time or an Ad on Incoming Mail.....	4-4
Setting or Advancing the Date on the Machine.....	4-5
Printing an Envelope Advertisement	4-6
Downloading an Envelope Ad Into Your Machine.....	4-6

4 • Printing Options

Printing Options

There are various printing options available when processing mail through the system. You can:

- Seal the envelope without printing the digital indicia.
- Print the date and time or an advertisement on incoming pieces of mail.
- Set or advance the date.
- Print/download an envelope advertisement.

Many of these options are available by pressing **Menu** and selecting “Printing Options” (see below).

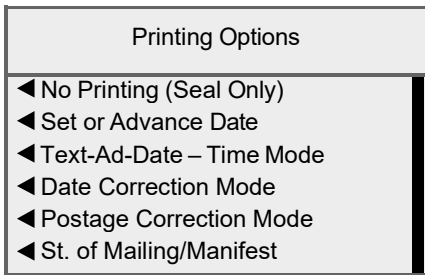

Bypass Printing and Seal the Envelope Only

DM300c Only

If using the optional moistener with pre-addressed envelopes, you can set up your mailing system to seal envelopes without printing a digital indicia on them.

1. Press **Menu**.
2. Select “Printing Options.”
3. Select “No Printing (Seal Only).”
4. Place flap along moistener and move towards the right.
5. Slide the envelope to the right until the system takes hold of it. The system seals and ejects the piece.
6. Select “Return to Normal Mode” when finished to return you to the Home screen.

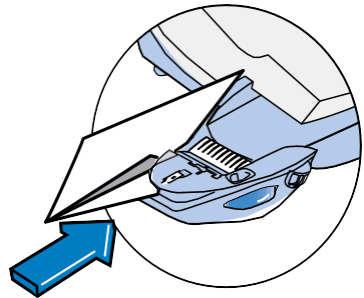

DM400c Only

You can set up your mailing system to seal envelopes without printing a digital indicia on them.

1. Press **Menu**.
2. Select “Printing Options.”
3. Select “No Printing (Seal Only).”
4. Load unsealed envelopes onto the feeder and press **Start**.

4 • Printing Options

Printing the Date and Time or an Ad on Incoming Mail

You can set up your mailing system to print the date and time, or an advertisement on incoming pieces of mail.

1. Press **Menu**.
2. Select “Printing Options.”
3. Select “Text-Ad-Date-Time Mode.”

When Ready Insert Envelope or Press Tape	
◀ Date-Time	: Print
◀ Ad	: None
◀ Return to Normal Mode	

Ad-Date-Time screen on Manual Feed System

- *Date-Time* -This option allows you to toggle between “Print” and “Do Not Print.”
 - *Ad* - This option provides you to select advertisement to print on the envelope/tape.
4. *To manually feed envelopes (DM300c)*: Place the envelope up against the registration wall of the system and slide it to the right until the system grasps it. The system prints the digital indicia and ejects the envelope.

To automatically feed envelopes (DM400c): Load envelopes onto the feeder and press **Start**. The system automatically feeds the envelope, prints the digital indicia and ejects the envelope.

To print tapes: Press **Tape**. Enter the number of tapes and press **Start**.

NOTE: Make sure you orient the mail piece so the date and time prints on a blank section of the mail piece.

5. Select “Return to Normal Mode” when finished to return to the Home screen.

Setting or Advancing the Date on the Machine

NOTE: You can only advance the date for your mail, you can never “backdate” mail to a date less than the current date.

1. Press **Menu**.
2. Select “Printing Options”.
3. Select “Set or Advance Date”. The system displays the current date in YYYY.MM.DD format. You may either:
 - Select “Set to today's date”. You will be returned to the Home screen with the current (today's) date set.
 - Select “Advance one day” to advance date one day for each pressing of the key.
 - Select “Specify days to advance” and key in a number (from 1-30) representing the number of days you want to advance the date, then select “Accept”.

4 • Printing Options

Printing an Envelope Advertisement

1. From Home screen, select “Ad”.

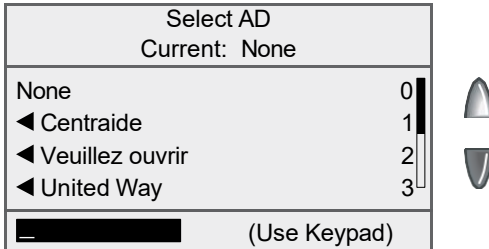

2. The “Select Ad” screen displays. You may either:
 - A. Key in the Ad number and then press **Enter** to select the ad.
 - B. Scroll through ads and then select the ad.
3. You return to the Home screen with the name of the ad listed.

Downloading an Envelope Ad Into Your Machine

Ready-made items can be purchased and downloaded directly into your machine. We can also work with you to create custom ads. To order, contact the Pitney Bowes Supply Line™. Refer to the *Contact Information List* at the front of this guide for more information.

NOTE: Your machine must be connected to the Pitney Bowes Data Centre to perform these downloads. See Chapter 6, *Adding Postage/Connecting to the Data Centre* for more information.

Once the advertisement is ordered and available for download:

1. Press **Menu**.
2. If necessary, press the green down arrow key to scroll through the menu screens.
3. Select “Data Centre Options”.
4. Select “Check for Updates”. The system automatically dials in to the centre.
5. After connection is made, follow the prompts. The appropriate files are downloaded and you return to the Home screen.

5 • Normal and Custom Presets

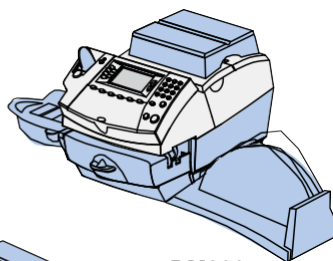

DM300c

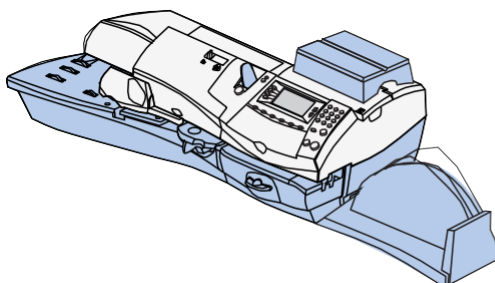

DM400c

This chapter discusses the Normal and Custom Presets feature available on your machine.

What is a Preset?	5-2
Normal Preset / Default Screen	5-2
Custom Presets.....	5-3
Defining Presets	5-3
Selecting a Preset.....	5-4
Selecting Custom Presets.....	5-4
Managing Custom Presets	5-4
Viewing a Custom Preset.....	5-4
Editing a Custom Preset Name.....	5-5
Overwriting a Custom Preset	5-5
Deleting a Custom Preset.....	5-6

5 • Normal and Custom Presets

What is a Preset?

A preset is a setting you can call up at the touch of a key that holds pre-defined settings such as class, manual weight, ad, account number, etc. within your machine.

What's nice is that you don't have to program the settings that go into a preset in the traditional sense. Instead, the system takes a "snapshot" of the current settings on your machine when you define if the machine is setup to run a mail job. For example, if the machine is set up to print an ad, and a postage amount already on the screen, this is the condition that will be recorded by the system when you define a Custom preset.

If you need to change the settings of a preset, just change the machine condition by pressing the appropriate Feature keys and establishing the proper settings (such as No Ad, weight, a specific class, etc.).

The Custom and Preset setting options are available by pressing **Menu** and selecting "Preset Options".

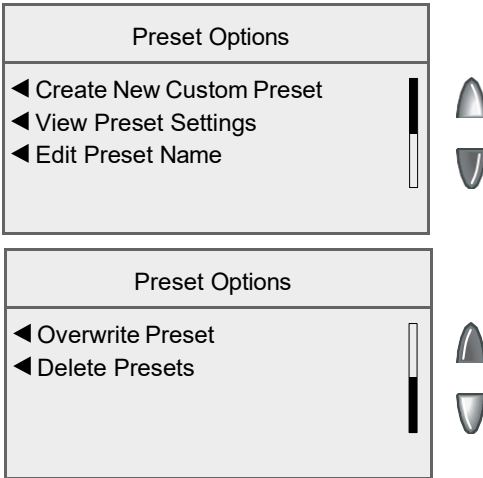

Normal Preset / Default Screen

Your system has a "normal" preset which takes you to the default screen. Your system reverts to the Normal Preset when it powers on or wakes up from sleep mode.

Custom Presets

Your system can store 10 custom presets which are accessed by pressing **Custom Preset** and choosing the desired preset from the menu.

Defining Custom Presets

To define new settings (change the settings) for the Custom Preset:

1. Establish the proper settings on the machine (such as No Ad, manual weight, a specific class, etc.) that you want the preset to contain.
2. Press **Menu**.
3. Press the green down arrow key to scroll through the menu screens.
4. Select "Preset Options."

If you are defining a Custom Preset:

- A. Select "Create New Custom Preset".
- B. The system will prompt for the name of this preset. Type in a name for the preset. It can be up to 16 alpha/numeric characters long. When finished, select "Accept".

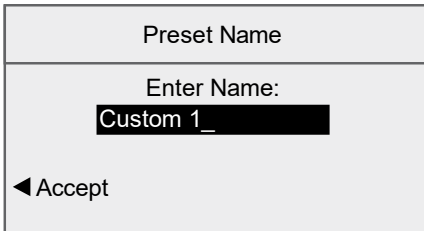

The screenshot shows a screen with a light gray background. At the top, the text "Preset Name" is centered. Below it, the text "Enter Name:" is centered. Underneath that, the text "Custom 1_" is displayed, with the characters "Custom 1_" highlighted in black. At the bottom left, there is a left-pointing arrow followed by the text "Accept".

5. You will be prompted if all current settings are correct.
 - A. If you select "Yes" the new settings are saved and you return to the preset options screen.
 - B. If you select "Not Sure, View Settings", the system will display the preset name and the current settings. Press the down arrow key to see the remainder of the defined settings

NOTE: The values that display will vary, depending upon the settings you have established on the machine.

5 • Normal and Custom Presets

6. Press **Enter** when done viewing the preset settings:
 - A. If you want to use the preset as is, select "Yes".
 - B. If you do not want to use the preset as is, select "Exit" to return to the "Preset Options" screen.
7. Press **Home** to return to the Home screen.

Selecting a Preset

Selecting Custom Presets

1. Press **Custom Presets**.
2. The display lists all presets created on your system. Press the down arrow key to see additional choices (if available).
3. Select the preset you want to use. You return to the Home screen with the preset settings chosen.

Managing Custom Presets

You have the option of viewing, editing the name of, overwriting or deleting a Custom Preset as necessary.

Viewing a Custom Preset

1. Press **Menu**.
2. If necessary, press the green down arrow key to scroll through the menu screens.
3. Select "Preset Options."
4. Select "View Preset Settings". The display lists all presets.
5. Select the preset you want to view. The first screen of defined settings for the Custom Preset is listed. Press the down arrow key to see the remainder of the defined settings.
6. Press **Enter** when done viewing the preset settings.

Editing a Custom Preset Name

You may change the name of a preset if you want.

1. Press **Menu**.
2. If necessary, press the green down arrow key to scroll through the menu screens.
3. Select "Preset Options."
4. Select "Edit Preset Name".
5. The display lists all the Custom Presets. Select the preset you want to edit.
6. The system will prompt for the new name of this preset. Key in the new name for this preset. It can be up to 16 alpha/numeric characters long.
7. When finished, select "Accept". You return to the Preset Options menu.
8. Press **Home** to return to the Home screen.

Overwriting a Custom Preset

Overwriting a preset allows you to save new settings to an existing Custom Preset.

IMPORTANT: Once you overwrite a preset, its settings are gone. You can't recover an overwritten preset.

1. Establish the proper settings on the machine (such as No Ad, class/ weight, a specific departmental account, etc.) that you want the preset to contain.
2. Press **Menu**.
3. If necessary, press the green down arrow key to scroll through the menu screens.
4. Select "Preset Options."
5. Press the down arrow key and select "Overwrite Preset". The display lists all presets.
6. Select the preset you want to overwrite.
7. At the "Confirm Current Selections" screen, select "Yes". The preset is overwritten with the new settings. You return to the Preset Options menu.
8. Press **Home** to return to the Home screen.

5 • Normal and Custom Presets

Deleting a Custom Preset

Deleting a preset removes all the settings assigned to it and removes it from the Presets Menu.

IMPORTANT: Once you delete a preset, its settings are gone. You can't recover a deleted preset.

1. Press **Menu**.
2. If necessary, press the green down arrow key to scroll through the menu screens.
3. Select "Preset Options."
4. Press the down arrow key and select "Delete Presets". The display lists all presets.
5. Select the preset you want to delete.
6. At the "Confirm Delete" screen, select "Yes, Delete". The preset is deleted. You return to the Preset Options menu.
7. Press **Home** to return to the Home screen.

6 • Adding Postage/ Connecting to the Data Centre

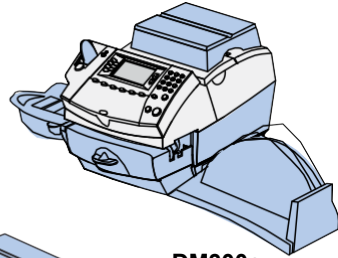

DM300c

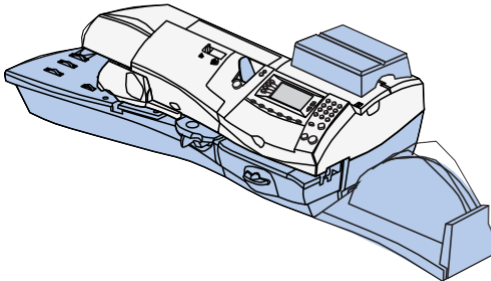

DM400c

This chapter explains how to add postage to your system using Pitney Bowes' PB Postage® service and connecting to the Pitney Bowes Data Centre.

A Word About Adding Postage	6-2
Connecting to the Data Centre using a LAN connection	6-2
Checking Funds (Postage) Availability in Machine.....	6-3
Checking Your PB Postage® Account Balance	6-5
Adding Postage	6-5
Printing a Funds Report.....	6-6
Downloads from the Data Centre to Your Machine	6-7
Check for Software Updates.....	6-10
Distributor Settings	6-12

6 • Adding Postage/Connecting to Data Centre

A Word About Adding Postage

Adding postage funds to your system is fast, easy and convenient. Your system must be connected to the internet as described below.

Connect to the Data Centre using a LAN Network

Connect your system to the Pitney Bowes Data Centre via a LAN network that has Internet access. This provides a quick way to download postage and software updates to your machine.

Plug one end of the Ethernet cable (supplied) to your Internet LAN network port and the other end which couples with a USB adaptor into one of the USB A ports on the back of the machine (see figure below).

You may leave this connected on a permanent basis.

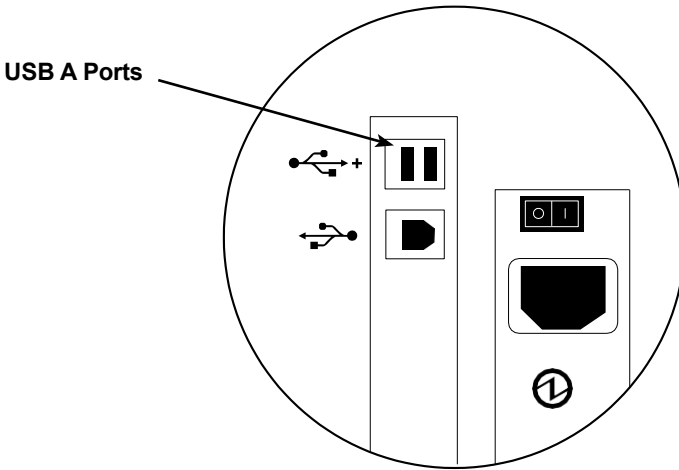



6 • Adding Postage/Connecting to Data Centre

Checking Funds (Postage) Availability in Machine



1. Press **Funds**.
2. View funds used and pieces processed.

Funds	
Available	: \$204.94
Used	: \$17.06
Total Pieces	: 130
Ctl Sum	: \$222.00
More Options (Menu)	



3. Press the down arrow key to view additional information.

Funds	
Batch Value	: \$ 11.65
Batch Count	: 3
More Options (Menu)	



6 • Adding Postage/Connecting to Data Centre

Checking Your PB Postage® Account Balance

You can check your PB Postage account balance at any time, as long as your system is connected to the Pitney Bowes Data Centre.

1. Press **Refill Postage**.
2. Select "Check PBP Balance".
3. The system dials into the Pitney Bowes Data Centre (this may take a few moments). Various screens displays, letting you know the status of the process.
4. The Prepaid and Other balances displays. Select "Continue" to return to the Funds Options menu.

Requesting PBP Balance
Please Wait....

PBP Balance	
Prepaid	: \$ xxxxx
Other	: \$ xxxxx
◀ Refill Postage	
◀ Continue	

NOTE: You can elect to refill postage by selecting "Refill Postage on the PBP Balance screen. Refer to *Adding Postage* in this chapter for more information.

6 • Adding Postage/Connecting to Data Centre

Adding Postage

You can add postage to your machine any time you need to, as long as you have enough funds in your PB Postage account and your system is connected to the Pitney Bowes Data Centre.

1. Press **Refill Postage**.

- You may select "Refill \$xx.00" to add the amount shown.
- Select "Another Amount". Key in the amount in whole dollars that you want to add and select "Accept". Select "Yes" to verify the amount.

Refill Postage	
◀ Refill \$ xx.00	
◀ Another Amount	
◀ Check PBP Balance	

NOTE 1: The minimum amount of postage you can add is \$1.

NOTE 2: The amount shown in the "Refill \$xx.00" selection line represents the amount of postage you added the last time.

3. The system dials into the Pitney Bowes Data Centre (this may take a few moments). Various screens displays, letting you know the status of the process.
4. The Postage Refill complete screen displays.

Postage Refill Complete	
Refilled	: \$ xxxxx
Available	: \$ xxxxx
◀ Print Receipt	
◀ Continue	

5. If a receipt is desired, select "Print Receipt" and follow the prompts OR simply press **Home** to return to Home Screen.

Refill Receipt	Refill: SEP 20 06 4:13P	Account No: 12345678
	Refill Amount: \$200.00	Meter No.: 8030397
	Funds Available in Meter: \$1033.610	SEP 20 06
	Prepaid: \$1600.00	4: 13P
	Additional Funds Available: \$000.000	

6 • Adding Postage/Connecting to Data Centre

Printing a Funds Report

1. Press **Funds**.
2. Press **Menu** and select "Print Funds Report".
3. When prompted either:
 - *Manually feed an envelope (DM300c):* Place the envelope up against the back wall of the system and slide it to the right until the system grasps it.
 - *Automatically feed an envelope (DM400c):* Load envelope onto the feeder and press **Start**.
 - Press the **Tape** key.

The Funds Reports is printed (see sample below) and the envelope/tape strip is ejected.

Funds Report	Used: \$065.390	SEP 20 06
	Available: \$10333.610	4: 13P
	Total Pieces: 6765	Batch Count: 1
	Control Sum: \$10399.000	Batch Value: \$000.000
		PBP Serial Number: 8030397

6 • Adding Postage/Connecting to Data Centre

Downloads from the Data Centre to Your Machine

When you connect to the Pitney Bowes Data Centre to add postage or perform other transactions, the Data Centre may perform the following:

- Download required software updates to your machine
- Download advertisements you ordered
- Perform a remote inspection of your machine as required by the Canada Post Corporation
- Download Postal Code changes, and new postal rates (as required by the Canada Post)

Generally speaking, downloads are considered either mandatory (you must do them at the time you are prompted to on the screen), or non-mandatory (you may decide to download at a later time). However, even non-mandatory downloads can become mandatory if you wait too long to do the download.

Once a download is finished, you will either be prompted to select “Restart Now” to restart the machine or select “Accept” to return you to the screen that you started from, depending on the type of download performed.

A description of the type of downloads that can occur in your machine are presented on the following pages.

System Update

If there has been a feature enhancement or a minor update to the software that runs your machine, you will be notified that a system update is available.

Ad

If there are new ads available that you ordered, you will be notified that you can perform a download to obtain these.

Software Update (Mandatory)

If there has been an important update to the software that runs your machine, you will be notified that a required update is necessary.

6 • Adding Postage/Connecting to Data Centre

Postal Code Update (Mandatory)

If the Postal Code on record at the Pitney Bowes Data Centre does not match the Postal Code of your mailing system, the code will be downloaded into your machine. (When a machine is moved to a new Postal Code, the Data Centre enters the new code into the record. The system is updated when a connection is made to the Data Centre.)

NOTE: If you move locations you must notify Pitney Bowes so that the postal code change can be made.

Postal Inspection (Mandatory)

Each time you add postage to the machine, the Pitney Bowes Data Centre automatically performs a postal inspection as required by Canada Post Corporation. If the interval between inspections is more than 60 days, your machine's display prompts "Inspection Due." If the interval between inspections is more than 90 days, the display prompts "Inspection Required." You won't be able to use your mailing system until your system is inspected.

To satisfy the inspection requirement, simply:

- Add postage (see *Adding Postage* earlier in chapter for procedure) or conduct a Balance Inquiry.
- Connect to the Data Centre as described in the *Connecting to the Data Centre (other than for postage)* later in this chapter.

When an inspection is performed, an "Inspection Complete" screen displays upon completion. The display also notifies you of the date the next inspection is due.

6 • Adding Postage/Connecting to Data Centre

Postal Rate Update (Mandatory)

Postal rates change periodically by the Canada Post Corporation. If new rates are available, you can download them quickly and easily directly from the Pitney Bowes Data Centre.

The new rates are normally available for download at least 7 days before the effective date. If you connect to the Data Centre prior to the effective date and the new rates are available, you will be required to perform the download. However the new rates will not take effect until the effective date. Once the effective date has been reached (or passed), and you have not downloaded the new rates you are required to download the new rates immediately.

The display tells you when a rate change update is complete. It also tells you if the update is immediate or takes effect at a later date by listing the new date.

NOTE: Canada Post Rate Change downloads are mandatory and therefore if you connect and a rate change download is available you will not be given a "Skip" or "Get Later" option.

6 • Adding Postage/Connecting to Data Centre

Check for Software Updates

Use this feature to connect to the Pitney Bowes Data Centre for software downloads, new updates, etc.

1. Press **Menu**.
2. If necessary, press the green down arrow key to scroll through the menu screens.
3. Select "Data Centre Options".

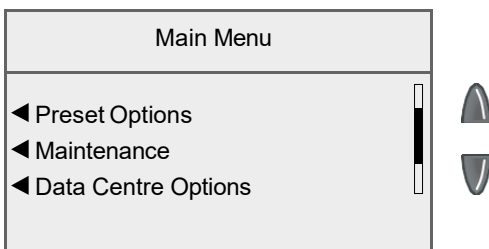

4. Select "Check for Updates".

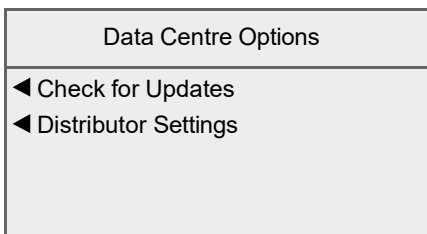

5. After connection is made, if some type of software or postal update or download is available, a message stating so displays.
 - A. If a download is not mandatory, you will be prompted with either "Download Now" or "Skip, Return Home". Select the one that makes sense to you at that time.
 - B. If a download is mandatory, only "Download Now" displays and you must perform the download.

6 • Adding Postage/Connecting to Data Centre

6. After the download has completed, a message stating so displays.
 - A. If you need to reboot the system, the prompt "Restart Now" displays. Select this to restart the system.
 - B. If no rebooting is necessary, simply select "Return Home" to return to the Home screen.

6 • Adding Postage/Connecting to Data Centre

Distributor Settings

This option allows you to modify the connection parameters that your machine uses to connect to the Pitney Bowes Data Centre. A brief description of each parameter is provided on the next page.



CAUTION: Do not change these parameters unless directed to do so by your Pitney Bowes representative.

To access the Distributor Settings:

1. Press **Menu**.
2. If necessary, press the green down arrow key to scroll through the menu screens.
3. Select "Data Centre Options".
4. Select "Distributor Settings".
5. Select the parameter you want to modify from the list appearing in the display. Press the down arrow key if needed to access your choice.

Distributor Settings	
◀ Account ID	: xxxxx...
◀ Password	: xxxxx...
◀ Server IP	: xxxxx...
◀ Server Port	: xxxxx...
Done [Enter]	



Distributor Settings	
◀ Primary DNS	: xxxxx...
◀ Secondary DNS	: xxxxx...
◀ URL	: xxxxx...
Done [Enter]	



NOTE: Refer to *Distributor Setting Parameter Descriptions* in this chapter for an explanation of each of the Distributor Setting parameters.

6 • Adding Postage/Connecting to Data Centre

6. A warning message displays that reminds you that entering a wrong value may result in errors connecting to the Data Centre. Select "Continue".
7. Key in a new entry for that parameter.
 - To modify the existing parameter, select "Edit Options". You can then move the cursor right or left to insert a character. Select "OK" when done.
 - To restore the default settings, select "Restore Defaults".
8. Select "Accept" when done. You return to the Distributor Settings menu.
9. Press **Enter** to return to the Data Centre Options menu.

Distributor Setting Parameter Descriptions

- **Account and User ID** - This is the account number and the user ID that your system uses to dial into the internet service provider (ISP) that allows you to connect to Pitney Bowes.
- **Global Password** - This is the password your system uses to dial into your Internet Service Provider.
- **ANI/LCZ Server IP** - This is the internet address of the Automatic Number Identification (ANI)/Least Cost Zone (LCZ) server that identifies your system and routes your call to a zone that ensures the lowest cost for the connection.
- **ANI/LCZ Server Port** - The server port number identifies the port number on the ANI/LCZ server to which your system connects on dial-up.
- **Primary DNS Server** - This is the internet address of the Pitney Bowes primary Domain Name Server (DNS). The Domain Name Server converts your system name to its IP address.
- **Secondary DNS Server** - This is the internet address of the Pitney Bowes secondary Domain Name Server (DNS).
- **Distributor URL** - The Universal Resource Locator, URL, is the web page to which your system connects during dial-up.

7 • System Options

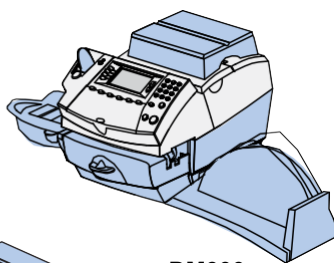

DM300c

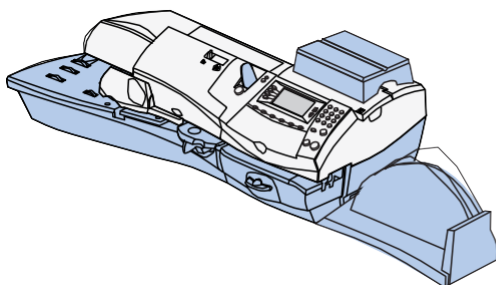

DM400c

This chapter presents system options you can setup or modify, such as setting time, date, passwords, warnings, etc.

System Options	7-2
Basic Options	7-3
Setting the Time, Date, and Timeouts	7-3
Adjusting the Contrast of the Display	7-6
Setting Postage Limits (Funds Warnings)	7-7
Enabling, Changing or Disabling Lock Codes and Passwords	7-8
Configuring the Tape Button	7-11
Advanced Options	7-12
Meter Withdrawal (Withdrawing Postage Funds)	7-12
Running Install Mode	7-13

7 • System Options

System Options

System options allow you to customize the machine settings for the way you run your mail and add security to those features that are sensitive to your organization. Because of the many options available, the options are categorized into "Basic" and "Advanced".

The basic system options are accessed by pressing **Menu** and selecting "Setup Options." You can then select your choice from the menu as shown below.

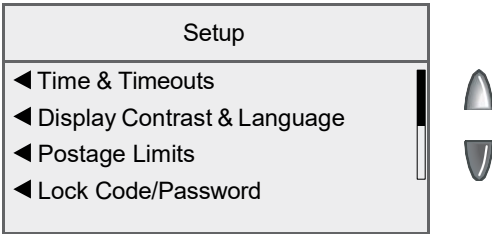

The advanced options are accessed by pressing **Menu**, then pressing the green down arrow key and selecting "Advanced Features", which displays a menu of options as shown below.

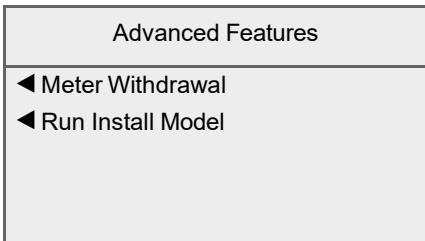

Basic Options

Setting the Time, Date, and Timeouts

You can change the system time/date, set the time/date to daylight saving time, change the time at which your system advances the date/time to the next day, and set the amount of time your system can remain inactive before reverting to the Normal Preset values.

Setting the Time

Sometimes, the time on the machine may need to be corrected due to internal drift or the changeover to Daylight Saving Time.

1. Press **Menu**.
2. Select "Setup".
3. Select "Time and Timeouts".
4. Select "Correct Time Drift".

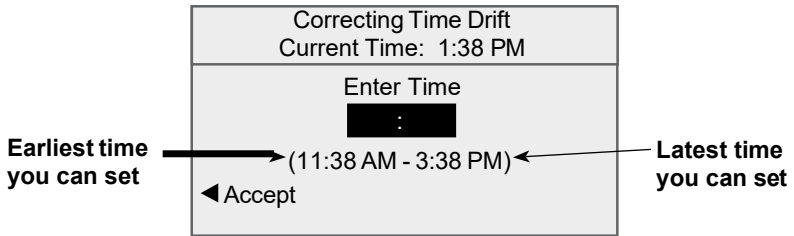

NOTE: You can add/subtract up to 120 minutes (2 hours) from the current time.

5. Key in the new time and select "Accept".
6. Select "Yes". The display returns to Time & Timeouts menu.

7 • System Options

Setting Auto Date Advance Time

Your system can automatically advance the date every day at a time you specify. The date advance time is factory set to 12:00 AM. If your mail is picked up at a certain time each day, you can set the system to advance the date after the mail pickup time. You can also turn the Auto Date Advance Time Feature off.

1. Press **Menu**.
2. Select "Setup".
3. Select "Time and Timeouts".
4. Select "Auto Date Advance Time".

Auto Date Advance Time
Enter Time 12 : 00 AM ◀ Switch AM/PM ◀ Accept

5. Select "Switch AM/PM" to toggle between "AM" and "PM".
6. If necessary, press the **Clear** key to remove the existing time entry.
7. Type in the time. Example: To enter one o'clock, type 1 - 0 - 0. To enter 12:01 o'clock, type 1 - 2 - 0 - 1. (Don't type the hyphens.)
8. Select "Accept". The display returns to Time & Timeouts menu.

Setting the Normal Preset Timeout

The Normal Preset is a defaulted screen that your machine automatically returns to after a set period of time. You can set the amount of time the display takes before it reverts to the Normal Preset.

1. Press **Menu**.
2. Select "Setup".
3. Select "Time and Timeouts".
4. Select "Normal Preset Timeout".

Normal Preset Timeout
Enter Timeout 64 (1-240 minutes) ◀ Accept

5. Key in the amount of minutes (from 1-240) you want the system to wait before returning to the Normal Preset. The default time is 64 minutes.
6. Select "Accept". The display returns to Time & Timeouts menu.

Setting Sleep Mode Timeout

You can set the amount of time the machine waits before entering "Sleep Mode". When the machine is in sleep mode, the display is blank and you can't process mail. You "awaken" the machine by pressing almost any key on the control panel.

NOTE: The Stop and Start keys will not wake the machine.

1. Press **Menu**.
2. Select "Setup".
3. Select "Time and Timeouts".
4. Select "Sleep Mode"
5. Key in the amount of minutes (from 1-240) before the system goes into Sleep Mode.
6. Select "Accept". The display returns to Time & Timeouts menu.

7 • System Options

Setting Daylight Saving Time

1. Press **Menu**.
2. Select "Setup".
3. Select "Time and Timeouts".
4. If necessary, press the green down arrow key to scroll through the menu screens.
5. Select "Daylight Savings". The display shows the current setting.

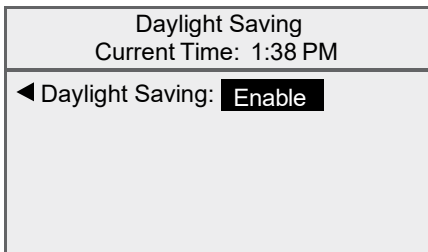

6. Select "Daylight Saving" to toggle between:
 - "Enable" if you want to use Daylight Saving Time, or
 - "Disable" if you don not want to use Daylight Saving Time. (This is the default setting.)
7. Press **Enter** to return to the Time & Timeouts menu.

Adjusting the Contrast of the Display

1. Press **Menu**.
2. Select "Setup".
3. Select "Display Contrast".
4. Select "Increase Contrast" or "Decrease Contrast" to change the contrast level as necessary. The default is 6 lines (shown below).

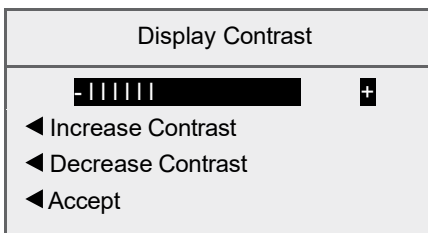

5. Select "Accept" to return to Setup menu.

Setting Postage Limits (Funds Warnings)

You can specify values so that when your postage funds drop below a certain level, or if you try to enter too much postage for a piece of mail, the system displays a warning.

Setting the High Value Warning

You can have the system warn you when you manually key in a postage value that is higher than a maximum amount that you specify. This feature prevents you from accidentally printing a postage value that's more than you need.

1. Press **Menu**.
2. Select "Setup".
3. Select "Postage Limits".
4. Select "High Postage".

High Postage Warning
Enter Amount: \$ 10.00
◀ Accept

5. Key in the amount you want, including the digits to the right of the decimal point. You may enter a fractional value like .75 or \$1.50. (You cannot set the warning higher than 99.99.)
6. Select "Accept" to return to Setup menu.

Setting the Low Funds Warning

You can set up the system so that when the postage remaining reaches a certain level, the system will remind you to add postage.

1. Press **Menu**.
2. Select "Setup".
3. Select "Postage Limits".
4. Select "Low Funds".
5. Key in the amount you want (in whole dollars only).
6. Select "Accept" to return to the Setup menu.

7 • System Options

Enabling, Changing or Disabling Lock Codes and Passwords

Enabling the Lock Code

The Lock Code prevents unauthorized access to your mailing system after the machine has entered sleep mode.

1. Press **Menu**.
2. Select "Setup".
3. If necessary, press the green down arrow key to scroll through the menu screens.
4. Select "Lock Code/Password".
5. Select "Enable Lock Code".

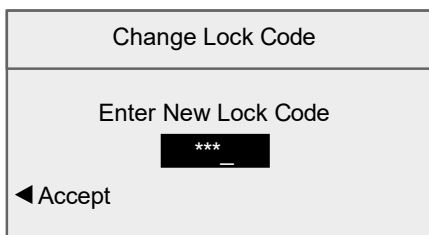

Change Lock Code

Enter New Lock Code

◀ Accept

6. Enter the new Lock Code and select "Accept".
7. Re-enter the new Lock Code again to confirm and select "Accept".
8. At the "Lock Code Enabled" message, select "OK".

Disabling the Lock Code

You can disable the Lock Code if it has been enabled.

1. Press **Menu**.
2. Select "Setup".
3. If necessary, press the green down arrow key to scroll through the menu screens.
4. Select "Lock Code/Password".
5. Select "Disable Lock Code".
6. When prompted, enter the current Lock Code and select "Accept".

Changing the Lock Code

You can change the Lock Code if it has been enabled.

1. Press **Menu**.
2. Select "Setup".
3. If necessary, press the green down arrow key to scroll through the menu screens.
4. Select "Lock Code/Password".
5. Select "Change Lock Code".
6. When prompted, enter the current Lock Code and select "Accept".
7. Enter the new Lock Code, and select "Accept".
8. Re-enter the new Lock Code to confirm and select "Accept". At the "Lock Code Enabled" message, select "OK".

Enabling the Supervisor Password

The Supervisor Password prevents unauthorized access to accounting setup.

1. Press **Menu**.
2. Select "Setup".
3. If necessary, press the green down arrow key to scroll through the menu screens.
4. Select "Lock Code/Password".
5. Select "Enable Password".

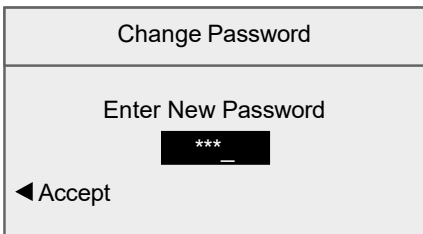

Change Password

Enter New Password

◀ Accept

5. Enter the new Supervisor Password and select "Accept".
6. Re-enter the new Supervisor Password to confirm and select "Accept".
7. At the "Password Enabled" message, select "OK".

7 • System Options

Disabling the Supervisor Password

You can disable the Supervisor Password if it has been enabled.

1. Press **Menu**.
2. Select "Setup".
3. If necessary, press the green down arrow key to scroll through the menu screens.
4. Select "Lock Code/Password".
5. Select "Disable Password".
6. When prompted, enter the current Supervisor Password and select "Accept".

Changing the Supervisor Password

You can change the Supervisor Password if it has been enabled.

1. Press **Menu**.
2. Select "Setup".
3. If necessary, press the green down arrow key to scroll through the menu screens.
4. Select "Lock Code/Password".
5. Select "Change Password".
6. When prompted, enter the current Supervisor Password and select "Accept".
7. Enter the new Supervisor Password, and select "Accept".
8. Re-enter the new password to confirm and select "Accept".
9. At the "Password Enabled" message, select "OK".

Configuring the Tape Button

You can specify the action the system takes when the **Tape** button is pressed.

1. Press **Menu**.
2. Select "Setup".
3. If necessary, press the green down arrow key to scroll through the menu screens.
4. Select "Configure Tape Button".
 - If you always want to print one tape at a time, select "Always Print One Tape".
 - If you want to enter the number of tapes to print, select "Ask For Tape Quantity".

Once you make your selection, the system returns to the Setup Menu.

7 • System Options

Advanced Options

Advanced options allow you access to features that are used very infrequently such as meter withdrawal, etc. The Advanced Feature menu includes:

- Meter Withdrawal (for withdrawing postage funds)
- Run Install Mode

Meter Withdrawal (Withdrawing Postage Funds)

For a meter withdrawal, you need to move any remaining postage from your machine to your PB Postage® account. Normally this is done if you are no longer going to use the machine.

NOTES:

- The system must be connected to the Pitney Bowes Data Centre to perform a meter withdrawal.
-

1. Press **Menu**.
2. If necessary, press the green down arrow key to scroll through the menu screens.
3. Select "Advanced Features".
4. Select "Meter Withdrawal".
5. You will be prompted to "Transfer all funds from meter to PBP account". Select "Continue".
6. The system dials into the Pitney Bowes Data Centre (this may take a few moments). Various screens display, letting you know the status of the process.
7. The Transfer Successful screen displays. Either:
 - Select "Print Receipt" to print a meter withdrawal receipt. Follow the prompts to print the receipt on an envelope or tape strip.
 - Select "Done" to return to the Home screen.

Funds Report	Used: \$065.390	SEP 20 06
	Available: \$10333.610	4: 13P
	Total Pieces: 6765	Batch Count: 1
	Control Sum: \$10399.000	Batch Value: \$000.000
	PBP Serial Number: 8030397	

Running Install Mode

The Run Install Mode option allows you to clear your system, resetting it to the default settings it was shipped with.

7 • System Options

8 • Reports

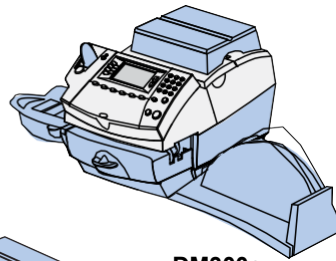

DM300c

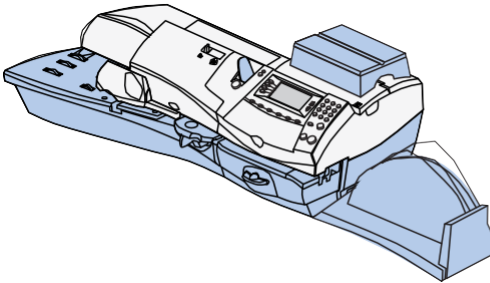

DM400c

This chapter explains how to take advantage of the reporting capabilities of your system.

Overview of Reports	8-2
Last 5 Refills Report.....	8-3
Funds Report	8-3
Single Accounts Report.....	8-3
Multi-Account Summary Report.....	8-3
Account List Report.....	8-4
System Setup Report.....	8-4
Error Report	8-4
Configuration Report	8-5
Software Version Report	8-5
Printing a Report.....	8-6
Printing to an Attached Printer	8-6
Printing on an Envelope or Tape Strip.....	8-6

8 • Reports

Overview of Reports

Your system allows you to print reports for funds usage, postage refills, postage tracked by account, and other valuable data. The reports are accessed by pressing **Menu** and selecting "Reports".

NOTE: Reports may not appear in the same order as below.

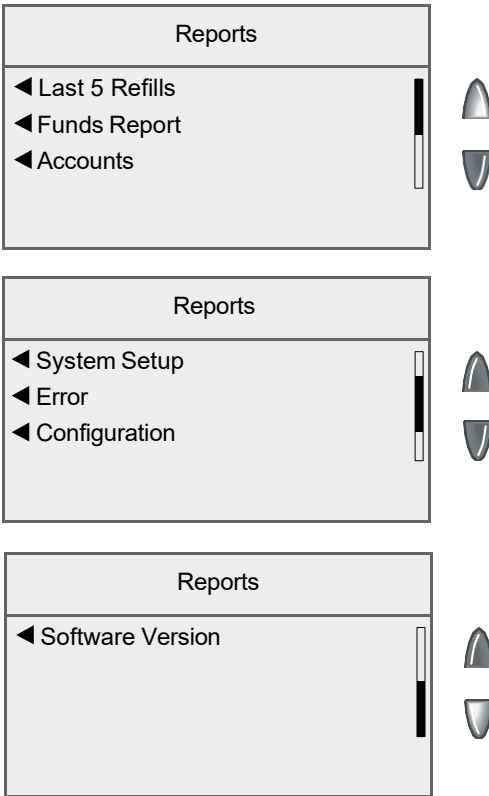

Last 5 Refills Report

This report lists the last 5 postage refills. It must be printed on an envelope or tape strip.

Last 5 Refills	Date of Refill:	Time:	Refill Amount:	Acct No.: 12345678
	DEC 08 06	4:32P	\$025.000	Meter No.: 0011989
				Printed: DEC 12 06

Funds Report

This report lists the postage used, postage available, pieces processed, and other information about your machine usage. It must be printed on an envelope or tape strip.

Funds Report	Used: \$065.390	SEP 20 06
	Available: \$10333.610	4: 13P
	Total Pieces: 6765	Batch Count: 1
	Control Sum: \$10399.000	Batch Value: \$000.000
		PBP Serial Number: 0011989

Single Accounts Report

This report provides the postage history for a single account (if the Departmental Accounting feature is set up on your system). It must be printed on an envelope or tape strip.

Account Report	Account Name: SALES	0011989
	Acct Number: 1	SEP 20 06
	Pieces: 5	4: 13P
	Postage: 001.480	

Multi-Account Summary Report

This report provides the postage history for multiple accounts (if the Departmental Accounting feature is set up on your system). It can be printed on an envelope or tape strip, or by an attached printer.

Account Summary	Account No.	Pieces	Postage	0011989
	1	5	001.480	SEP 20 06
	2	4	001.480	4: 13P
				page 1 of 1

8 • Reports

Account List Report

The Account List Report lists the names and numbers of all accounts that are set up in your machine (if the Departmental Accounting feature is set up on your system). It can be printed on an envelope or tape strip, or by an attached printer.

Account List	Account No.	Account Name	0011989
	1	SALES	SEP 20 06
	2	MARKETING	4: 13P

page 1 of 1

System Setup Report

The System Setup Report is an extensive report that gives you comprehensive information about your total mailing machine. The entire report must be printed on an attached printer. It provides information on:

- Serial Numbers
- Software Versions
- Funds and Piece Information
- Warning Values
- Time Settings
- Advertisements
- Accounting Set Up
- Modem Set Up
- Scale Settings
- Presets

Error Report

This report provides a history of error codes that your machine has encountered.

Error Report	Error Date:	Time:	Identifier:	Count:	0011989
	DEC 08 06	4:25P	1879	001	SEP 20 06
	NOV 15 06	3:14P	Oaff	000	9:25A

page 1 of 1

Configuration Report

This report lists configuration information about your machine and PB Postage® account.

Cfg Report	PBP Serial #: 0011969	PCN: 0000	SEP 20 06
	PBP Account: 999999999	UIC: 510	4: 13P SMR 000
	PSD Ser. #: 4C46000000007E4C	Rate Data:	P7US002B01
	Print Head #: 50000104	Rate Effective:	P7US002B04 2005/08/09
	Printer Ser. #: D0 . 07		2006/01/08

Software Version Report

This report provides system software version information. You may be directed to print this report by a Pitney Bowes agent.

Software Versions	PBP Serial #: 0011969	PCN: 0000	Rate Mgr. #: 03.10	SEP 20 06
	UIC Software Version: 01.02.0042	Platform: B0.02		4: 13P
	Print Mgr.: 0118.0004	PHS: 01.01.0014		
	Low Sector: 01.06.11	Feeder Ver.:		
	Protected Sector: 01.09.14	Feeder Profile:		

8 • Reports

Printing a Report

The report printing options available to you will depend on the type of report you have selected.

Printing to an Attached Printer

1. Press **Menu**.
2. Select "Reports".
3. Select the appropriate report from the list. You may need to press the green down arrow key to view additional reports.
4. When prompted, select "Attached Printer".
5. A message will appear indicating the report will be printed to the attached printer. Select "Return to Report Menu" to continue.

Printing on an Envelope or Tape Strip

1. Press **Menu**.
2. Select "Reports".
3. Select the appropriate report from the list. You may need to press the down arrow key to view additional reports.

NOTE: If it have an attached printer, but want to print on an envelope or tape strip, select "Mailing Machine" when prompted.

- *Print on a manually fed envelope (DM300c):* Place the envelope up against the back wall of the system and slide it to the right until the system grasps it.
-

NOTE: If it is a multi-page report, you will be prompted to insert another envelope.

- *Print on an automatically fed envelope (DM400c):* Load envelopes into the feeder and press **Start**.
 - *Print on a tape strip:* Press **Tape**.
4. You will be prompted to print another report once printing is complete.
 - Select "Yes" to print an additional report.
 - Select "No" to return to the Home screen.

9 • Departmental Accounting

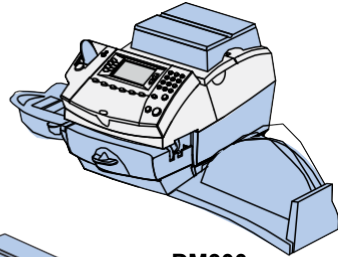

DM300c

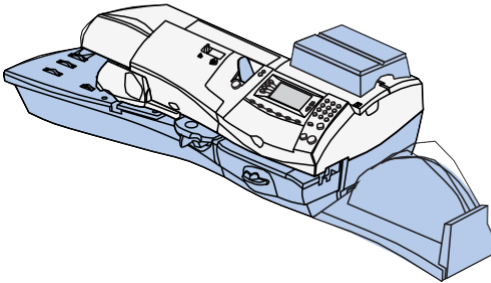

DM400c

This chapter explains how to take advantage of the accounting feature of the system.

Overview of the Accounting Feature	9-2
Creating New Accounts	9-3
Deleting Accounts	9-4
Editing Accounts	9-5
Viewing/Clearing Account Totals	9-6
Clearing All Account Totals	9-7
Turning Account Passwords On (Globally)	9-8
Turning Account Passwords Off (Globally)	9-9
Turning Accounting On.....	9-10
Turning Accounting Off.....	9-10

9 • Departmental Accounting

Overview of the Accounting Feature

When using the accounting feature, you can set your system up to track postage costs incurred by individuals or departments in your organization (e.g., Engineering, Sales, A/R, etc.). The number of accounts available on your system is based on the accounting option you have. Your system stores the following information for each account:

- A name up to 15 alphanumeric characters long.
- An account number (assigned by the system).
- The count total. This is the total number of pieces of mail charged to an account since it was last cleared.
- The value total. This is the total amount of postage charged to an account since it was last cleared.
- An account password

The maintenance of your accounts is done through programs on the Accounts menu (below), accessible by pressing Menu key and selecting "Accounts".

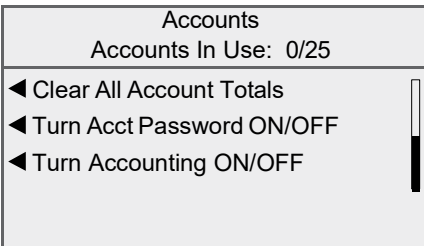
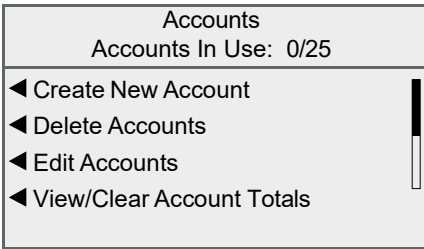

Creating New Accounts

You need to create an account before you can use the departmental accounting feature to track postage.

1. Press **Menu**.
2. Select "Accounts".

Number of Accounts Created

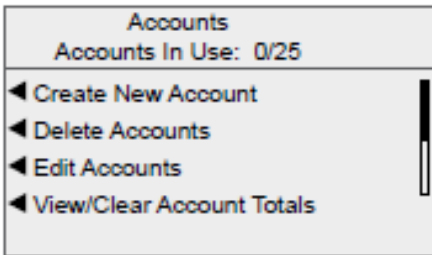

NOTE: If the supervisor password is enabled, you will need to enter it to gain access to all of the accounting functions.

3. Select "Create New Account".

NOTE: If no accounts are present on the system, you will be notified that you need to have at least one account in order to use accounting. Select "Create an Account" to continue.

4. Type in a name for the account. It can be up to 15 alpha/numeric characters long. Select "Accept" to continue.
5. The New Account Created screen appears.
 - A. Select "Name" to edit the account name. Select "Accept" to return to the New Account created screen.
 - B. If the supervisor and account passwords are enabled, you will have the option of adding an account password. Select "Add Acct Password" and enter the 4-digit password. Select "Accept" to return to the New Account Created screen.
 - C. Select "Number" if you would like to change the number assigned to the account. Select a number from the list.
 - D. Select "Done" to return to the Accounts screen.

9 • Departmental Accounting

Deleting Accounts

You can delete an account from the system if necessary.



CAUTION: Make sure you really want to delete an account. Once you do, the account cannot be retrieved.

1. Press **Menu**.
 2. Select "Accounts".
-

NOTE: If the supervisor password is enabled, you will need to enter it to gain access to all of the accounting functions.

3. Select "Delete Accounts".
4. Select an account to delete:

Select Account To Delete	
◀ SALES	1
◀ MARKETING	2
◀ ENGINEERING	3
◀ SERVICE	4
(Use Keypad)	



- Key in the account number and press **Enter**, OR
 - Select the appropriate account from the list. If necessary, press the green down arrow key to scroll through the menu screens.
5. The Confirm Delete screen displays. Select "Yes, Delete" to delete the account.
 - If the deleted account was the last account on the system you will be prompted to "Create New Accounts" or "Turn Accounting OFF". Select the appropriate option and follow the prompts to continue.
 - If the deleted account was not the last account on the system you will be asked if you want to delete another account. Select "Yes" to return to the Select Account screen (step 5). Select "No" to return to the Accounts screen.

Editing Accounts

You can edit an account name and establish passwords for each account if you wish.

1. Press **Menu**.
2. Select "Accounts".

NOTE: If the supervisor password is enabled, you will need to enter it to gain access to all of the accounting functions.

3. Select "Edit Accounts".
4. Select an account to edit:

Select Account To Edit	
◀ SALES	1
◀ MARKETING	2
◀ ENGINEERING	3
◀ SERVICE	4
(Use Keypad)	



- Key in the account number and press **Enter**, OR
 - Select the appropriate account from the list. If necessary, press the green down arrow key to scroll through the menu screens.
5. The Edit Account screen appears.
 - A. Select "Name" if you would like to edit the account name. Select "Accept" to return to the Edit Account screen.
 - B. If the supervisor and account passwords are enabled, you will have the option of editing the account password. Select "Password" and enter the four-digit password. Select "Accept" to return to the Edit Account screen.
 - C. Select "Number" if you would like to change the number assigned to the account. Select a number from the list.
 - D. Select "Done" to return to the Accounts screen.

9 • Departmental Accounting

Viewing/Clearing Account Totals

You can view your account totals anytime using this option.



CAUTION: Make sure you really want to clear an account information. Once you do, the account information is gone forever. The account remains on the system.

1. Press **Menu**.
2. Select "Accounts".

NOTE: If the supervisor password is enabled, you will need to enter it to gain access to all of the accounting functions.

3. Select "View/Clear Account Totals".
4. Select an account to edit:
 - Key in the account number and press **Enter**, OR
 - Select the appropriate account from the list. If necessary, press the green down arrow key to scroll through the menu screens.
5. The account name, pieces, and value of the postage used displays.

Account Totals	
Account: SALES	
Value	: Print
Piece	: None
◀ Clear these Totals	
◀ Done	

If you want to clear the account:

- A. Select "Clear these Totals" to clear the totals for the account.
- B. The Confirm Clear Totals screen displays. Select "Yes, Clear".
- C. If you want to view/clear another account, select "Yes" to return to the Select Account to Clear screen (see step 4). Otherwise, select "No".

If you want to exit:

Select "Done" to return to the Accounts screen.

Clearing All Account Totals

You can clear the postage totals on all accounts when necessary.



CAUTION: Make sure you really want to clear all account information. Once you do, all account information is gone forever. The accounts remain on the system.

1. Press **Menu**.
2. Select "Accounts".

NOTE: If the supervisor password is enabled, you will need to enter it to gain access to all of the accounting functions.

3. Press the down arrow key and select "Clear All Account Totals".

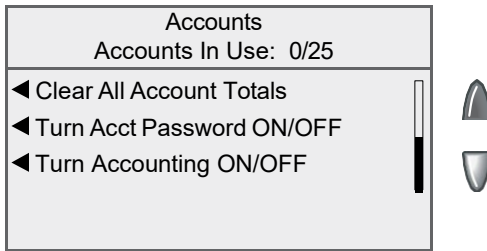

5. When prompted to clear all account totals, select "Yes, Clear All".
6. The system indicates that the totals for all accounts are cleared. Select "OK" to return to the Accounts screen.

9 • Departmental Accounting

Turning Account Passwords On (Globally)

You can turn on the requirement for all operators to enter passwords (if passwords are set up) when choosing an account. You must have the supervisor password enabled to turn the account passwords feature on.

1. Press **Menu**.
2. Select "Accounts".

NOTE: If the supervisor password is enabled, you will need to enter it to gain access to all of the accounting functions.

3. Press the green down arrow key.

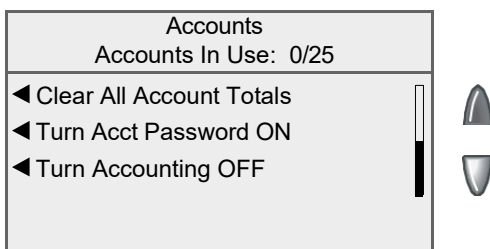

4. Select "Turn Acct Password ON".

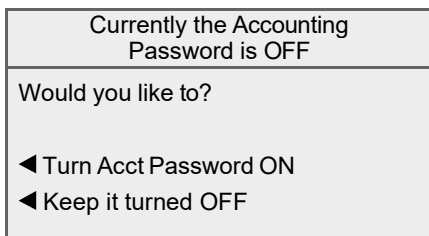

5. When prompted, select "Turn Acct Password ON". The system returns to the Accounts screen.

Turning Account Passwords Off (Globally)

You can turn off the requirement for all operators to enter passwords (if passwords are set up) when choosing an account .

1. Press **Menu**.
2. Select "Accounts".

NOTE: If the supervisor password is enabled, you will need to enter it to gain access to all of the accounting functions.

3. Press the green down arrow key.

Accounts	
Accounts In Use: 0/25	
◀ Clear All Account Totals	
◀ Turn Acct Password OFF	
◀ Turn Accounting OFF	



4. Select "Turn Acct Password OFF".

Currently the Accounting Password is ON
Would you like to?
◀ Turn Acct Password OFF
◀ Keep it turned ON

5. When prompted, select "Turn Acct Password OFF". The system returns to the Accounts screen.

9 • Departmental Accounting

Turning Accounting On

If you have purchased the accounting option, follow the steps below to enable the accounting feature.

1. Press **Menu**.
2. Select "Accounts".

NOTE: If the supervisor password is enabled, you will need to enter it to gain access to all of the accounting functions.

3. When prompted, select "Turn Accounting ON".
 - If no accounts are present on the system, you will be notified that you need to have at least one account in order to use accounting. Select "Create an Account" to continue. Go to step 5 in *Creating an Account* in this chapter to create a new account.
 - If accounts are present on the system, the Accounts screen will appear.

Turning Accounting Off

You can temporarily turn off the Departmental Accounting whenever you wish.

NOTE: You will not be tracking postage by account when this feature is turned off.

1. Press **Menu**.
2. Select "Accounts".

NOTE: If the supervisor password is enabled, you will need to enter it to gain access to all of the accounting functions.

3. Press the **C/Back** key.
4. When prompted, select "Keep it turned OFF".
5. Press **Home** to return to the Home screen. No account is displayed.

10 • Scale Options

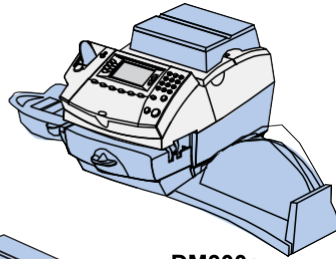

DM300c

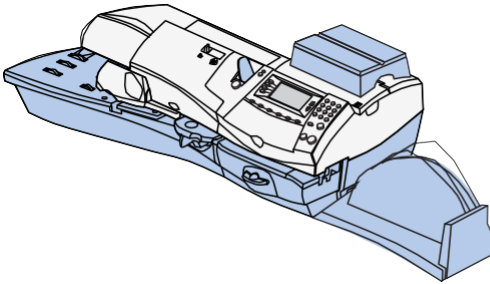

DM400c

This chapter presents system options you can setup or modify the weighing platform.

Scale Options.....	10-2
Zeroing the Scale	10-3
Setting Weight Change Options	10-3
Setting Class Change Options	10-4
Turning Auto Scale On or Off	10-5
Setting the Scale Location Code	10-6

10 • Scale Options

Scale Options

There are several options you can set with your weighing platform such as zeroing the weight on the weighing platform, turning the weighing platform on/off, viewing metric weights, and saving/ changing class or Canada settings when weight changes on your weighing platform.

Scale Options are accessed by pressing the **Weigh/Rate** key.

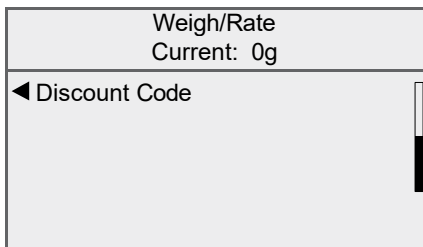
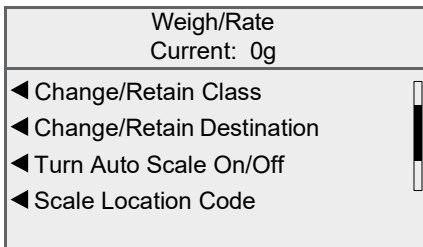
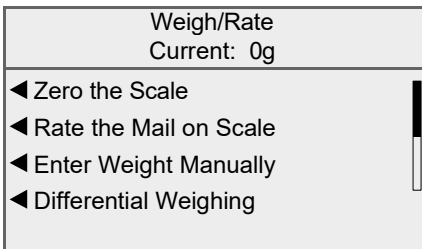

Zeroing the Scale

If you have set your machine to retain the weight from the previous package or mail piece, you will need to run this option to zero out the weighing platform.

1. Press **Weigh/Rate**.
2. Select "Zero the Scale".
3. The weighing platform will zero out the weight and return to the Home screen.

Setting Weight Change Options

You can set how the weighing platform reacts regarding the class of service or Postal Code when the weight changes.

1. Press **Weigh/Rate**.
2. If necessary, press the green down arrow key to scroll through the menu screens.
3. Select "Change/Retain Class".

When New Piece	
◀ Retain Class	: <input checked="" type="checkbox"/> Yes
◀ Retain dest	: <input checked="" type="checkbox"/> Yes
Done [Enter]	

4. Select "Retain Class".
 - Toggle "Yes" if you want the system to retain the class when the weight changes.
 - Toggle "No" if you do not want the system to retain the class when the weight changes.

10 • Scale Options

5. Select "Retain dest".
 - Toggle "Yes" if you want the system to retain the Postal Code/Zone when the weight changes.

NOTE: Not applicable if Retain Class is set to "No".

- Toggle "No" if you do not want the system to retain the Postal Code/Zone when the weight changes.
6. Press **Home** when done to return to the Home screen.

Setting Class Change Options

You can set how the weighing platform reacts regarding the Postal Code when the class of service changes.

1. Press **Weigh/Rate**.
2. If necessary, press the green down arrow key to scroll through the menu screens.
3. Select "Change/Retain Destination"

When New Class	
◀ Retain	: Yes
Done [Enter]	

4. Select "Retain".
 - Toggle "Yes" if you want the system to retain the Postal Code when the class changes.
 - Toggle "No" if you do not want the system to retain the Postal Code when the class changes.
5. Press **Enter** when done to return to the Home screen

Turning Auto Scale On or Off

Use the Auto Scale when you do not want the system to switch to Attached Scale mode when the weighing platform is touched.

1. Press **Weigh/Rate**.
2. If necessary, press the green down arrow key to scroll through the menu screens.
3. If the weighing platform is ON, you will be prompted to "Turn Auto Scale OFF" or "Keep it turned ON". Select the appropriate option.

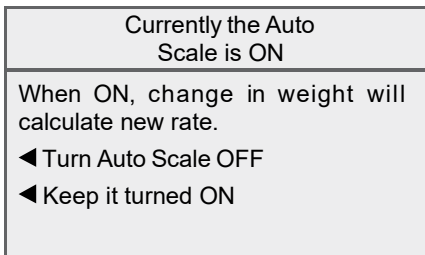

If the weighing platform is OFF, you will be prompted to "Turn Auto Scale ON" or "Keep it turned OFF". Select the appropriate option.

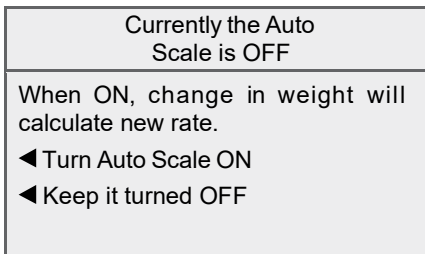

4. Depending on the changes you make, the system will do one of the following:
 - If you elect to turn the weighing platform on or off, you return to the Home screen with either the weighing platform on or off.
 - If you elect to keep the weighing platform in its current mode, you return to the Weigh/Rate menu.

10 • Scale Options

Setting the Scale Location Code

1. Press **Weigh/Rate**.
2. If necessary, press the green down arrow key to scroll through the menu screens.
3. Select "Scale Location Code".

Scale Location Code
Enter Code: <input type="text"/> (1-31)
◀ Accept

4. Enter the location code (from 1 - 31). Refer to the Self Install Guide supplied with your system to determine the location code for your weighing platform/location.
5. Select "Accept".

11 • Maintenance

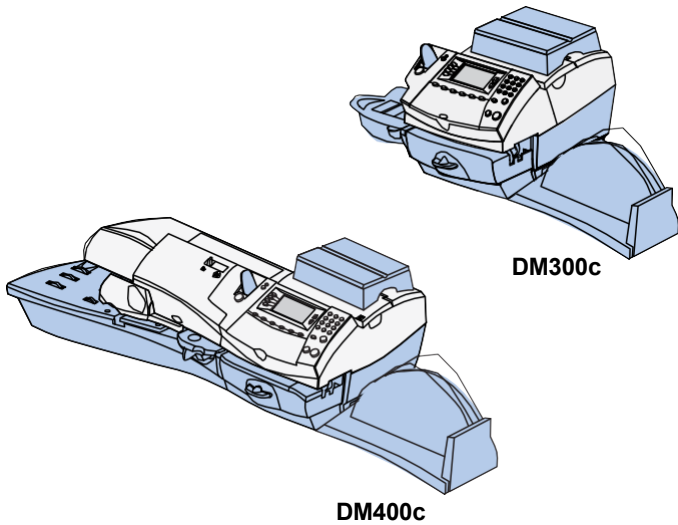

This chapter explains how to maintain your mailing system.

Printer Maintenance.....	11-2
Printing a Test Pattern.....	11-3
Cleaning the Printer Nozzle.....	11-4
Replacing the Ink Cartridge.....	11-5
Replacing the Print Head.....	11-8
Filling the Moistener (DM400c Only).....	11-10
Filling the Moistener (DM300c Only).....	11-11
Maintaining the Moistener.....	11-12
Cleaning the Stripper Blade and Brush Assembly (DM400c).....	11-12
Cleaning the Shield and Wick (DM400c).....	11-13
Removing the Moistener (DM300c).....	11-14
Removing the Shield and Wick (DM300c).....	11-16

11 • Maintenance

Printer Maintenance

The system has several replacement procedures and tests that let you replace the ink cartridge and/or print head, check print performance and help you determine printing problems.

These tests and procedures are accessible by pressing **Menu**, pressing the down arrow key, and selecting "Maintenance", then "Printer Maintenance".

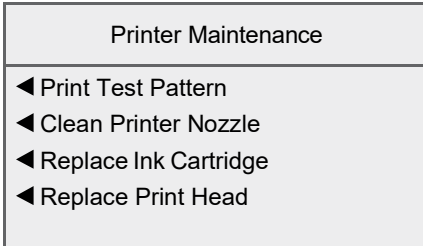

Printing a Test Pattern

The test print allows you to print a test pattern to see if the print head is functioning properly.

1. Press **Menu**.
2. If necessary, press the green down arrow key to scroll through the menu screens.
3. Select "Maintenance".
4. Select "Printer Maintenance".
5. Select "Print Test Pattern".
6. Follow the prompts to print the test pattern on an envelope or tape strip.
7. You are prompted if the test pattern is OK.

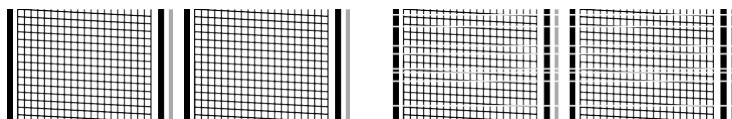

Good Test Print (No Missing Lines)

Poor Test Print (Missing Lines)

- If yes, select "Yes". You return to the Home screen.
- If no, select "No, Clean Nozzle" and the system executes a purge. When the purge is complete, the "Cleaning Complete" screen displays. (This may take a few moments.)

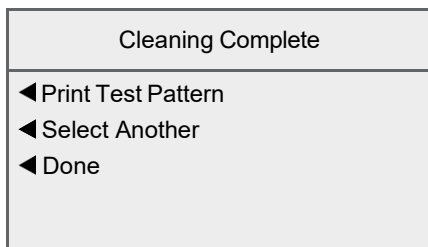

Select "Done" to return to the Printer Maintenance menu.

11 • Maintenance

Cleaning the Printer Nozzle

This option allows you to purge the print heads in an effort to fix a printing problem

1. Press **Menu**.
2. If necessary, press the green down arrow key to scroll through the menu screens.
3. Select "Maintenance".
4. Select "Printer Maintenance".
5. Select "Clean Printer Nozzle".
6. You have a choice of four purges to use. Normally selecting "Purge A" is sufficient to purge the system, unless directed by a Pitney Bowes agent to do otherwise.

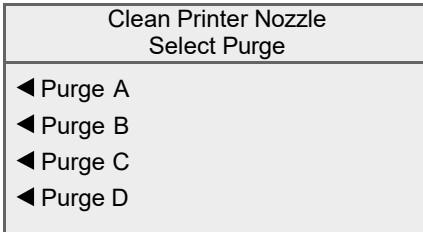

7. The system executes a purge. This may take a few moments. When finished, the Cleaning Complete screen displays.
 - Select "*Print Test Pattern*" to print a test pattern. See *Printing a Test Pattern* in this chapter for more information.
 - Select "Select Another Purge" to choose a different purge.
 - Select "Done" to return to the Printer Maintenance menu.

Replacing the Ink Cartridge

NOTE: We recommend that you keep a spare ink cartridge on hand at all times.

Your actual ink usage will vary, depending on whether you routinely print ads, how many pieces of mail you print a day and other factors. A prompt will appear when the ink supply is low or exhausted.

"Low Ink" Warning - Replace the ink cartridge soon. You can print about another 300 impressions or leave the system running for six days without printing. If you don't have a replacement tank on hand, you should order one now. See *Chapter 13, Supplies and Options* for instructions.



CAUTION: Replace the ink cartridge as soon as you see the "Low Ink" alert.

"Ink Out" Warning - Replace the ink cartridge immediately. The ink supply is gone; you won't be able to print.

1. If you have received an ink warning, skip to step 2. You can navigate through the menus to perform the replacement procedure:
 - A. Press **Menu**.
 - B. If necessary, press the green down arrow key to scroll through the menu screens.
 - C. Select "Maintenance".
 - D. Select "Printer Maintenance".
 - E. Select "Replace Ink Cartridge".
 2. When prompted, open the ink access cover. A "Moving Ink Cartridge" message displays.
-

NOTE: If you are using a weighing platform, remove it before opening the ink access cover.

11 • Maintenance

3. When prompted to "install now", flip open the ink cartridge guard.

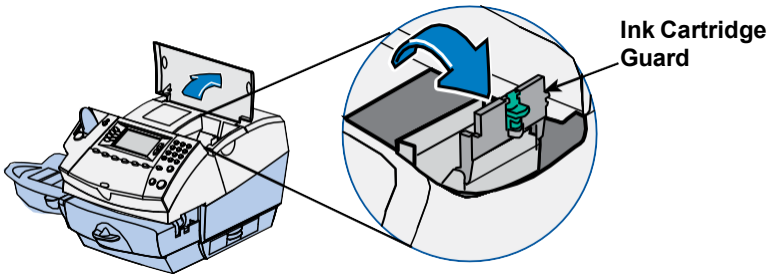

4. Lift up and remove old ink cartridge.

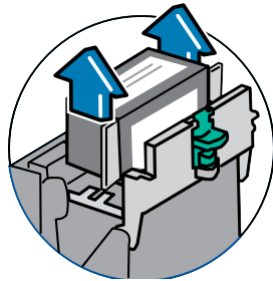

5. Remove tape on bottom of new ink cartridge.

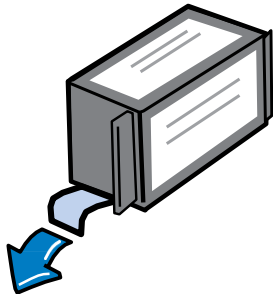

- Lower the ink cartridge into the cavity. The ridges on either side of the cartridge will slide into the grooves.

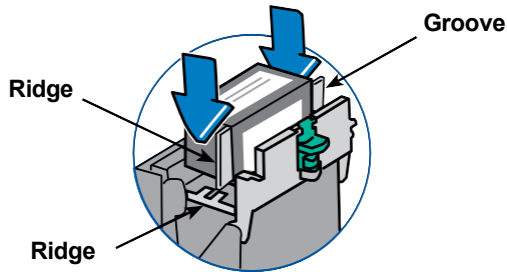

- Rotate guard back to closed position.

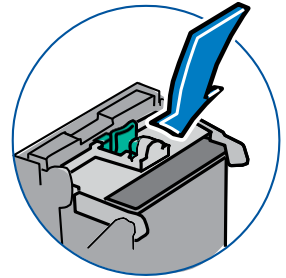

- Close the ink access cover. The system automatically recognizes the new cartridge.

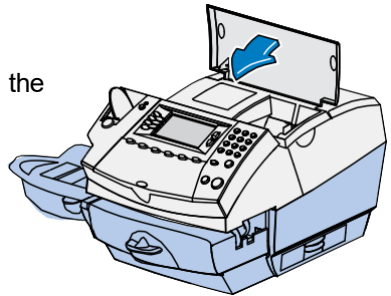

- You are prompted to print a test pattern.
 - Select "Yes, Print Test Pattern" to print a test pattern. See *Printing a Test Pattern* in this chapter for more information.
 - Select "No" if you do not want to print a test pattern. You return to the Home screen.

11 • Maintenance

Replacing the Print Head

Follow the steps below to change in print head on your system.

1. Navigate through the menus to perform the replacement procedure:
 - A. Press **Menu**.
 - B. If necessary, press the green down arrow key to scroll through the menu screens.
 - C. Select "Maintenance".
 - D. Select "Printer Maintenance".
 - E. Select "Replace Print Head".
2. Remove the ink cartridge. Refer to steps 2-4 in *Replacing the Ink Cartridge* in this chapter for more information.
3. Squeeze the two gray tabs on either side of the print head.

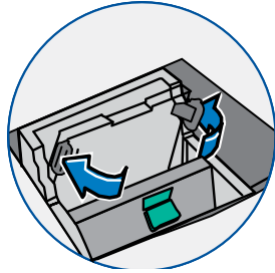

While squeezing, lift and tilt to the right the print head. The print head should come up out of the machine.

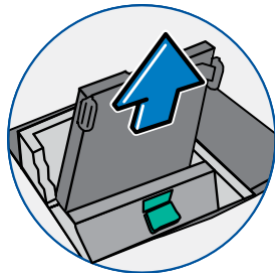

4. **Pull up and remove the black cap on the new print head (if present).** Also remove the protective tape from the bottom.

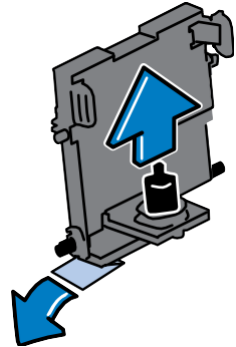

5. Squeeze the two gray tabs on either side of the new print head and slightly angle the print head while sliding it back into its holder.

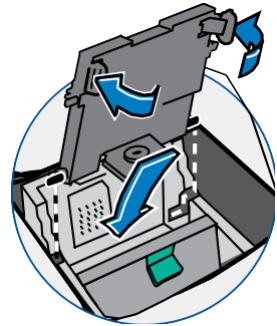

6. Push the print head back into place. You should hear a click when it is seated correctly.

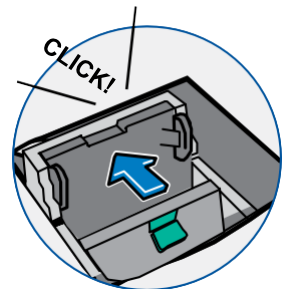

7. Replace the ink cartridge. Follow step 5 - 9 in *Replacing the Ink Cartridge* in this chapter for more information.

11 • Maintenance

Filling the Moistener (DM400c Only)

Refer to the following procedure to refill the moistener.

1. Check the moistener tank to see how much sealing solution is left.

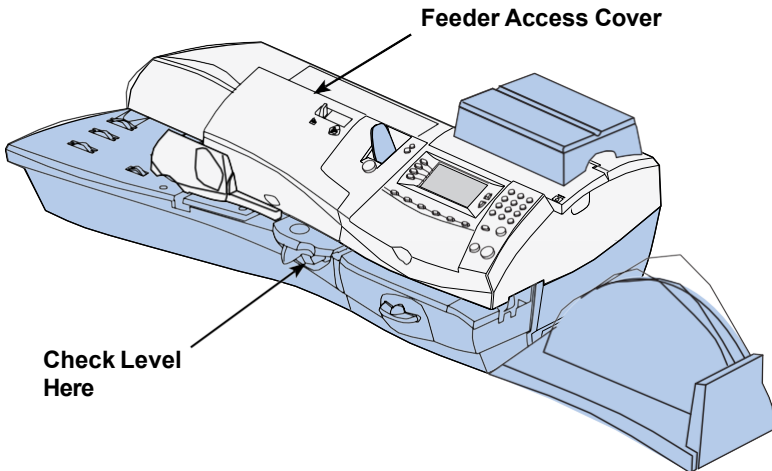

2. Open the feeder access cover and remove the moistener bottle.

Moistener Bottle

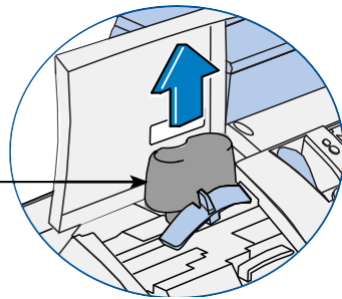

3. Remove the moistener bottle cap and fill the moistener bottle with Pitney Bowes E-Z Seal® sealing solution. We recommend E-Z Seal® because it helps keep your moistener clean and improves sealing efficiency.
4. Replace the moistener bottle cap and place the bottle back in its original location.
5. Close the feeder access cover.

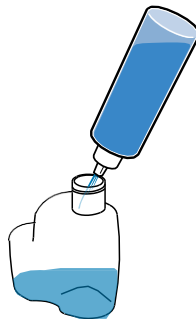

Filling the Moistener (DM300c Only)

Refer to the following procedure to refill the moistener.

1. Check the moistener tank to see how much sealing solution is left.

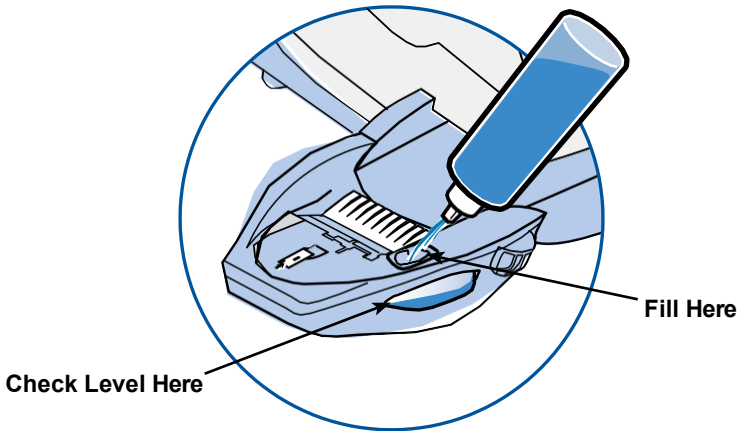

2. Add enough Pitney Bowes E-Z Seal® sealing solution to bring the sealant level up to the bottom of the fill hole. We recommend E-Z Seal® because it helps keep your moistener clean and improves sealing efficiency.
3. If the tank was empty, allow 30 minutes for the moistener brush and wick to get completely wet.



CAUTION: Do not overfill the moistener tank.

11 • Maintenance

Maintaining the Moistener

If you notice incomplete or poor sealing and the moistener tank is full, you may need to clean the moistener brush or wick. If seal quality doesn't improve after cleaning, you can replace the stripper blade and brush assembly or wick as needed. See *Chapter 13, Supplies and Options* for instructions on ordering these supplies for your machine.

Cleaning the Stripper Blade and Brush Assembly (DM400c)

1. Push up on the lever on the stripper blade and brush assembly.
2. While holding the lever up, grasp the assembly and pull it straight out towards you.

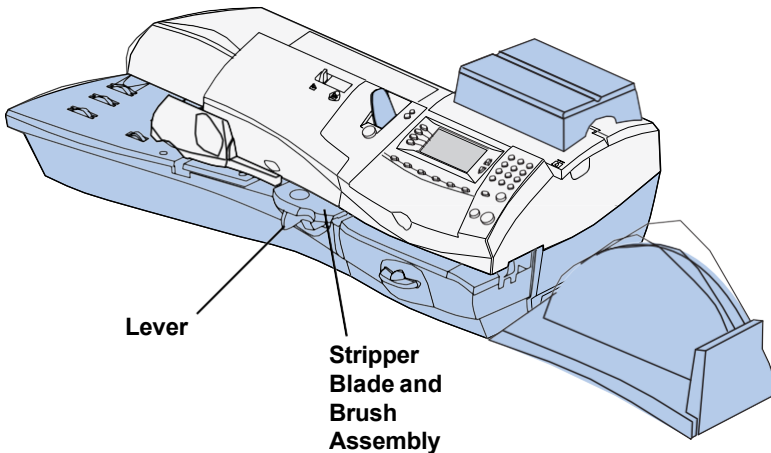

3. Clean the moistener brush by running the it under plain water.

NOTE: Replace the assembly if it cannot be cleaned thoroughly.

4. If you need to clean the wick and shield, continue with *Cleaning the Shield and Wick* on the next page. Otherwise, push up on the release lever on the stripper blade and brush assembly.
5. Slide the assembly back onto the machine. You should hear a click as it engages.

Cleaning the Shield and Wick (DM400c)

1. Open the feeder access cover and remove the moistener bottle. Leave the moistener bottle out until instructed to replace it.
2. Remove the stripper blade and brush assembly.

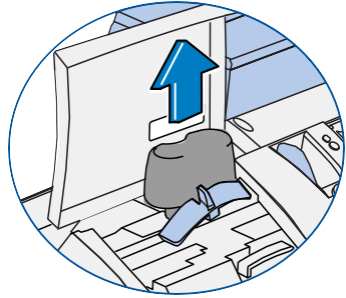

3. Pull the moistener tank straight out towards you. Gently lift the tank up and out.

IMPORTANT: The moistener tank may be full of E-Z Seal® sealing solution. If so, you can pour the solution back into the moistener bottle, or drain the tank into a receptacle.

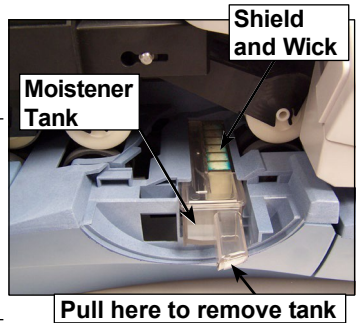

4. Pull up and remove the shield and wick from the moistener tank.
5. Separate wick from the shield. Clean the wick in plain water, and rinse thoroughly.

NOTE: Replace the wick and shield if they cannot be cleaned thoroughly.

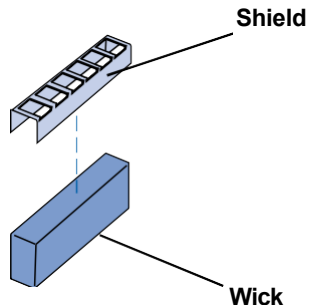

6. Place the wick back into the shield.
7. Push the wick and shield back into moistener tank.
8. Slide the tank back in place.
9. Replace the stripper blade and brush assembly by pushing up on the release lever and sliding the assembly back on its track until it snaps into position.
10. Replace the moistener bottle and close the feeder access cover.

11 • Maintenance

Removing the Moistener (DM300c)

1. Push down on the blue release lever on the moistener.

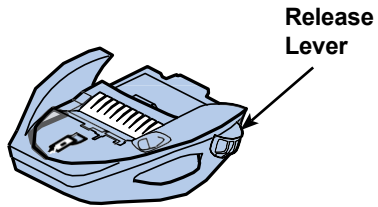

2. Pull the moistener straight out to the left.

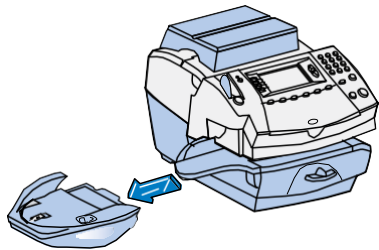

3. Open the hinged brush holder.
4. Grasp the bristles and slide the brush out of the hinged brush holder, toward the front of the moistener tank.

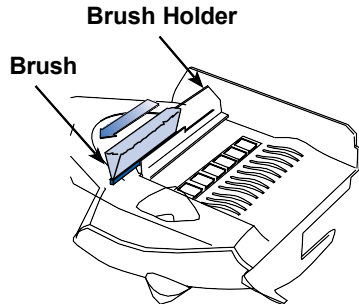

11 • Maintenance

5. Clean the brush in plain water, and rinse thoroughly.

6. Position the brush as shown at right so its bottom edge is under the mounting tabs.

7. Slide the brush back toward the rear of the moistener.

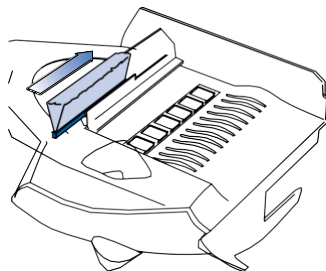

8. If you need to clean the wick and holder, continue with *Removing the Holder and Wick* procedure on the next page. Otherwise, push down on the blue release lever on the moistener.

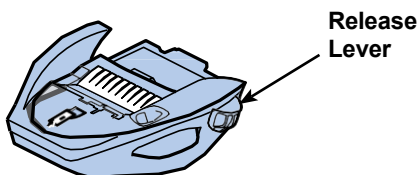

9. Slide the moistener back onto the machine. You should hear a click as it engages.

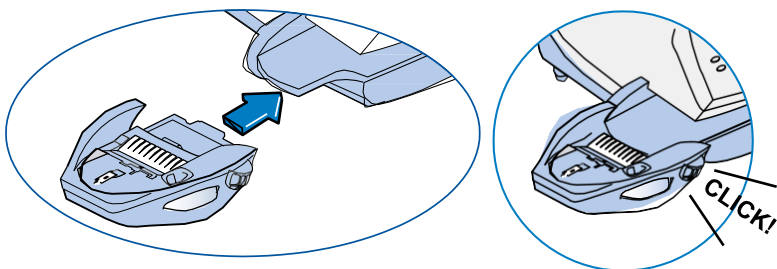

11 • Maintenance

Removing the Shield and Wick (DM300c)

1. Pull up and remove the shield and wick from the moistener.
2. Separate the wick from the shield. Clean the wick in plain water, and rinse thoroughly.

NOTE: Replace the wick and shield if they cannot be cleaned thoroughly.

3. Place the wick back into the shield.
4. Push the wick and shield back into moistener.
5. Reinstall the moistener. Push down on the blue release lever on the moistener.

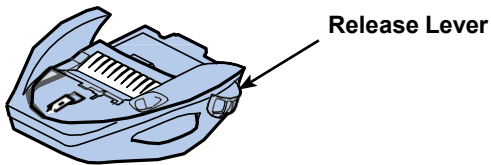
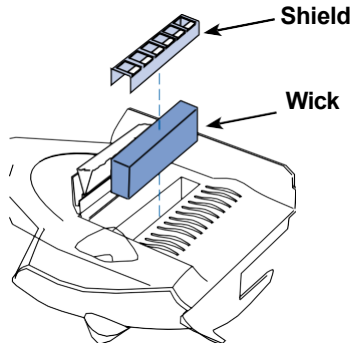

6. Slide the moistener back onto the machine. You should hear a click as it engages.

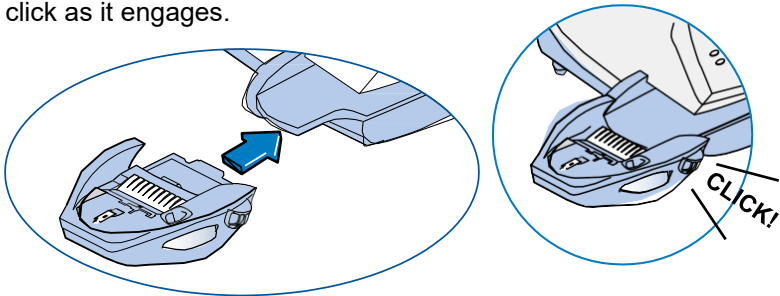

12 • Troubleshooting

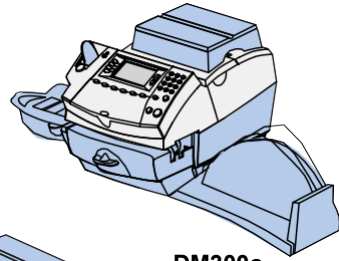

DM300c

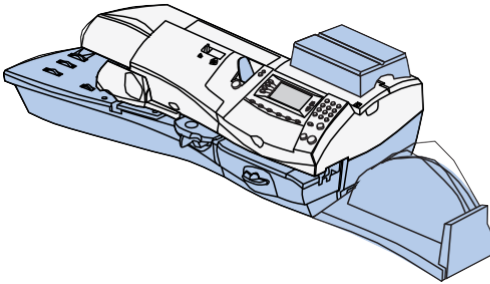

DM400c

This chapter explains how to troubleshoot your mailing system.

Power Questions	12-2
Feeding Questions	12-2
Printing Questions	12-3
Moistening Questions	12-3
Display Questions	12-4
Adding Postage Questions	12-4
Display Messages	12-5
Viewing System Configuration Levels	12-5

12 • Troubleshooting

Power Questions

Question: Why is the display blank?

1. Is power cord plugged into both mailing machine base and wall outlet? Make sure the power cord is not connected to a switched wall outlet.
2. Check power indicator on the machine.
3. Machine may be in sleep mode. Press any key to wake it.

Feeding Questions

Question: How do I clear a stalled envelope?

To clear a stalled envelope:

1. Move printer clearance lever (DM400c) or clearance lever (DM300c) to the "released" position (to the right).
2. Carefully pull envelope out towards the right.

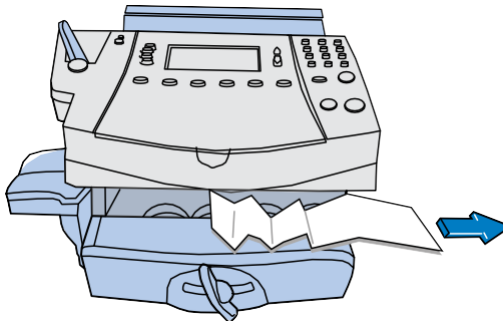

3. Make sure printer deck is clear of paper fragments.
4. Lift the printer clearance lever (DM400c) or clearance lever (DM300c) up and turn to the "home" position (counterclockwise).

To avoid stalled envelopes:

- Make sure your envelopes meet Pitney Bowes published specifications. See *Appendix A, Specifications*.
- Feed envelopes correctly. See the instructions in *Chapter 3, Running Mail*. Don't try to feed oversize envelopes through the machine. Use tape strips instead.
- If running mail longer than a #10 envelope (9.5 inches), slide the stacker tray away from the system.

Printing Questions

Question: Why does the system fail to print?

The machine may be in Seal Only Mode. This mode disables printing. Press **Home** to return to Home screen and resume printing.

Question: Why is the digital indicia is incomplete or streaked? Why is the print quality poor?

The print nozzles may be clogged. Perform a print purge in an effort to fix the printing problem. See *Chapter 11, Maintenance, Cleaning the Print Nozzle* for instructions on performing a print purge.

If Printer Maintenance fails to correct the problem, you may have to replace the print head. Contact Pitney Bowes. Refer to the *Contact Information List* for more information.

Moistening Questions

Question: Why does the system fail to seal envelopes?

- *Incorrect feeding (DM300c only)* - Make sure you slide the envelope flap under the blue edge of the moistener. If you don't, the moistener can't wet the flap.
- *Low sealant level* - Check the sealant level in the moistener tank. If the sealant level is low, add E-Z Seal® solution until it reaches the bottom of the fill hole. See the instructions in *Chapter 11, Maintenance*.
- *Dry moistener brush* - Try wetting the moistener brush. If the brush dries out quickly, replace the moistener wick as explained in *Chapter 11, Maintenance*.
- *Dirty moistener brush* - Remove the moistener brush. Clean it in plain water and rinse thoroughly. See the instructions in *Chapter 11, Maintenance*.
- *Worn moistener brush* - Replace the moistener brush. See the instructions in *Chapter 11, Maintenance*.

For ordering any of these supplies, refer to *Chapter 13, Supplies and Options*.

12 • Troubleshooting

Display Questions

Question: Why is the display hard to read?

The display contrast may need adjustment. See *Chapter 7, System Options, Adjusting the Contrast of the Display* for instructions on adjusting the display contrast.

Adding Postage Questions

Question: Why does the display show a series of messages during the adding postage process?

This is normal activity. The machine is designed to display the progress of the postage refill. If the procedure fails for any reason, the display tells you why. Make the necessary corrections.

Question: Why does the system fail to connect to PB Postage Data Centre?

- *Machine may not be connected to Ethernet network* - Make sure you've connected your machine to a working Ethernet Connection via a LAN/USB cable. Also make sure the connectors are firmly seated in their receptacles.

Display Messages

From time to time your system will display an alert or error message. An alert tells you that something needs attention; an error message usually tells you about a system condition you can fix. In rare instances you may have to call for service or assistance.

Viewing System Configuration Levels

Sometimes in an effort to fix your problem over the phone, the Pitney Bowes agent may request you to look up the software and firmware level that is on your machine. Follow these steps to do this:

1. Press **Menu**.
2. If necessary, press the green down arrow key to scroll through the menu screens.
3. Select "Maintenance".
4. Select "View System Info".
5. There are multiple screens of information available about your machine. Press the green down arrow key to scroll through all the screens if needed.
6. Press **Enter** to return to the Maintenance menu.

12 • Troubleshooting

13 • Supplies and Options

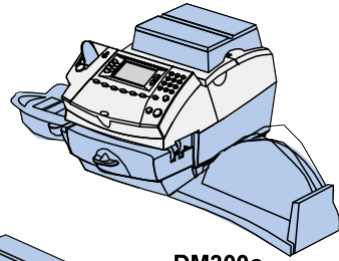

DM300c

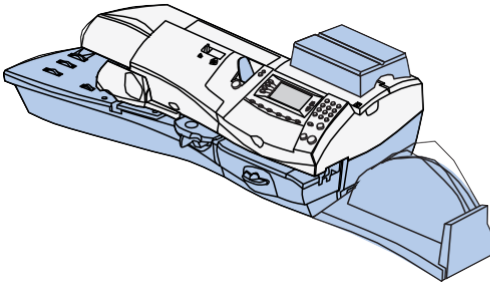

DM400c

This chapter explains how to order supplies and accessories for your digital mailing system. It also tells you a little about optional equipment that can help you get the most value from your Pitney Bowes equipment.

Supplies and Accessories	13-2
Options	13-3
Weighting Platform.....	13-3
Moistener	13-3
Advertisements	13-3
Departmental Accounting.....	13-3

13 • Supplies and Options

Supplies and Accessories

Contact the Pitney Bowes Supply Line™ or visit the Pitney Bowes web site to order supplies and accessories. Refer to the *Contact Information List* at the front of this guide for more information.

Options

Pitney Bowes offers a number of flexible options so you can tailor your mailing system to meet your needs today, and expand them as your business grows tomorrow. Contact your Pitney Bowes Sales Representative or visit the Pitney Bowes web site to order these options. Refer to the *Contact Information List* at the front of this guide for more information.

Weighing Platform

The weighing platform allows you to accurately weigh mail and packages. There are a variety of weighing options to choose from. See *Chapter 3, Running Mail* and *Chapter 10, Scale Options* for details on using the weighing platform.

Moistener

The moistener applies sealing fluid to the envelope flap. You can seal envelopes or leave them unsealed, depending on how you feed them. See *Chapter 3, Running Mail* for details.

Advertisements

Your system comes pre-loaded with ten envelope advertisements. Envelope ads give your mail a professional appearance and can turn your mailings into a powerful promotional tool. Pitney Bowes also offers additional envelope ads. Up to a total of 20 ads are available.

Departmental Accounting

The accounting feature allows you to track postage costs by individual departments. See *Chapter 9 Departmental Accounts* for details.

13 • Supplies and Options

Appendix A • Specifications

Equipment Specifications

<i>Size (including weighing platform)</i>	DM300c: 12.3" (312 mm) H x 19.7" (500 mm) W x 17.5" (444.5 mm) D DM400c: 12.3" (312 mm) H x 33" (840 mm) W x 17.5" (444.5 mm) D
<i>Weight</i>	DM300c: 18.7 lbs. (8.5 kg) approximate DM400c: 28.7 lbs. (13 kg) approximate
<i>Power Requirements</i>	100-240 VAC, 50/60Hz. 1.0A
<i>Communications Ports</i>	2 USB Host, 1 USB Slave; 1 RJ-11, 1 Serial
<i>Operating Temperature</i>	40°F (4°C) to 107°F (43°C)
<i>LCD Display Size</i>	3.5 x 1.7" (88 x 44 mm)
<i>Throughput*</i>	DM300c : 65 lpm DM400c: 90 lpm <i>*Actual throughput will vary, depending on the material used, machine condition, use of moistener, and the skill of the operator.</i>
<i>Print Resolution</i>	600 x 300 dpi
<i>Print Image Area</i>	1" (25.4 mm) x 7" (180 mm)
<i>Internal Envelope Ad Storage</i>	up to 20
<i>Internal Postal Inscription Storage</i>	up to 20
<i>Departmental Accounting</i>	Number of accounts available may vary based on option ordered.

IntelliLink® Feature Settings

<i>Maximum Imprint</i>	\$99.99
<i>Reset Type</i>	PB Postage

Appendix A • Specifications

Material Specifications

<i>Envelope Size</i> (see Figure below)	Minimum: 3.5 x 5" (88.9 x 127 mm) Maximum: 13 x 15" (330 x 381 mm)
<i>Envelope Flap Depth</i>	3" (72.2 mm)
<i>Envelope Thickness</i>	Minimum: .02" (0.20 mm) Maximum (DM300c): 3/8" (9.5 mm) Maximum (DM400c): 5/16" (8 mm)
<i>Stack Height for Mail</i>	3" (76.2 mm) (This is the height of the right wall of the stacker tray.)
<i>Envelope Weight</i>	Minimum: .035 oz. (1 g) Maximum: 16 oz. (450 g)
<i>Tape Size</i>	Minimum: 1.75 x 4" (44.2 x 100 mm) Maximum: 1.76 x 8" (44.7 x 200 mm)

IMPORTANT: For best results, always make sure your material conforms to our published specifications.

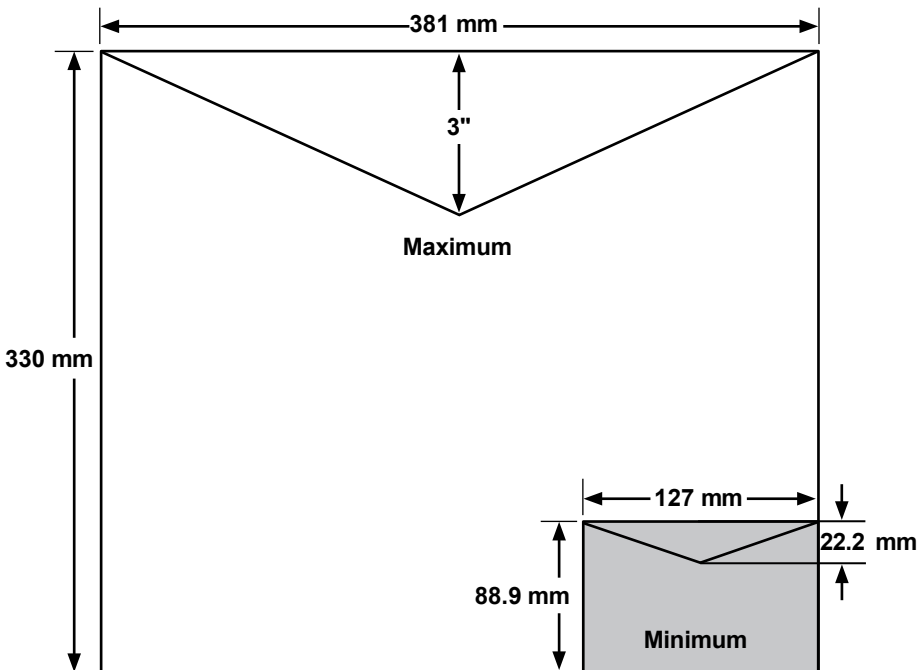

Account—A department (e.g., “Human Resources”) to which postage is charged. Your machine may allow you to set up and choose a number of different accounts. You can assign a unique name to each. The machine stores the total postage used and the number of mail pieces processed for each account.

The accounting feature is optional and the total number of accounts available on your machine depends on the option purchased.

Advertisement (envelope)—An advertising message that appears next to the machine's digital indicia. You can choose from an array of standard and custom ads. See *Chapter 13, Supplies/Options* for more information.

Ascending Register (\$ Used)—The total amount of postage used since the machine was placed in service.

Batch Register—A part of the machine's memory that stores the total postage spent and the number of pieces of mail processed. Your machine stores this information in memory for each account. You can clear the contents of the batch register if you want.

Default—A value or setting the machine automatically uses unless you change it. As delivered, your machine has factory-set defaults or “normal” settings. You may change these if you wish.

Descending Register (\$ Available)—The postage funds available for use.

Digital Indicia—The imprint produced by the machine (the machine stamp). The word “indicia” means postal markings.

They may include:

- An Advertisement. This is an optional part of the machine stamp that lets you convey your own special message to the mail recipient.
- The Date
- The machine's Serial Number
- Postal Code
- Information for Post Office Use

Inspection—The process of examining the postage usage through the machine to assure accurate postal funds accounting. Your machine is subject to remote inspection whenever you add postage to it. If you haven't refilled your machine by modem for 60 days, the display shows the message “Inspection Due” if you haven't refilled it for 90 days, you'll see “Inspection Required.”

Appendix B • Glossary

To do an inspection, simply add postage or connect to the Data Centre as explained in *Chapter 6, Adding Postage/Connecting to Data Centre*.

IntelliLink®—A Pitney Bowes technology that allows you to download machine features, and postal rate and system software updates via a digital link. Future IntelliLink® features will also provide online access to manage your account, purchase supplies and take advantage of a range of professional services.

Lock Code—A four-digit code that serves as a user password. It prevents unauthorized machine use.

Origin Postal Code—The Postal Code assigned to your city or town. Mail processed on your machine must be posted from a location in your Postal Code area.

PB Postage®—A service available through Pitney Bowes that allows you to buy postage and check account status over the phone. It also permits convenient postal inspection by phone.

Presets—A custom machine setting you can call up instantly at the push of a key. You can assign each preset a number of values, depending on the postage mode you're in, how your machine is set up and what options are installed. A preset will always have a name, and could also have an account, ad, class of service, operating mode and other values assigned to it.

Ready Screen—The machine display that shows your current selections. It indicates that you're ready to print postage.

Serial Number—The serial number found on the rear of the machine.

Sleep Mode—An energy-saving feature of your machine that clears the display after a certain period of idle time. Pressing any key wakes up the display.

Tape Strips—A strip of self-adhering paper which you print postage on and apply to a piece of mail or package that is too big to be processed through the machine.