

# Product Specification

## 4-Slot Layer 3 IPv6/IPv4 Routing Chassis Switch

### XGS3-42000R

Version 1.0

This document contains confidential proprietary information and is property of PLANET. The contents of this document should not be disclosed to unauthorized persons without the written consent of PLANET.

#### Change History:

Revision:	Date:	Author:	Change List
1.0	2010/04/22	Neo	Initial Release

Author:	Neo	Editor:	Kent Kang
Reviewed By:	Tom Shih	Approved By:	Tom Shih

# 1. PRODUCT DESCRIPTION

## Overview

The PLANET XGS3-42000R Series is a high performance Layer 3 chassis switch with 4 module slots. It can work in single or redundant management module mode. Slot configuration can be any combination of network interface modules and 1 or 2 management modules. Furthermore, management modules also include network interfaces so total port density and slot usage is increased.

With redundant power supply, fans and management modules, the PLANET XGS3-42000R Series ensures continuous operation and is a fully redundant system. Moreover, all parts are hot swappable. They can be added or exchanged without interrupting the whole system. The XGS3-42000R series is ideal for the core layer of campuses, enterprise networks and the aggregation layer of IP metropolitan networks.

## Performance and Scalability

The XGS3-42000R series supports up to 13 10G ports, 188 Gigabit ports and 156 1000Base-SX/LX SFP slots, providing flexibility and high port density. 10G modules support 4 ports for downlink to L3 Gigabit distribution layer switches or L2 Gigabit switches, aggregating them to the core layer, and preventing port bottlenecks in Gigabit switches. Furthermore, the optional 10Gigabit Ethernet XFP transceivers can be chosen for different distance fiber uplinks. Backup Master ensures the availability of a master controller for network control at any time. Every module is hot swappable, ensuring continued operation of the system while adding or removing a module.

## IPv6 Routing and 10G Ethernet Switch Solutions for the Next Generation Internet Protocol

IPv6 (Internet Protocol version 6) is well known as the next generation Internet Protocol to solve the lack of available IPv4 addresses. IPv6 can provide larger address space than IPv4 for the rapid growing networks. To provide smooth migration path from IPv4 to IPv6 for the future network upgrades, PLANET releases the multi-layer IPv6/IPv4 Gigabit Ethernet Routing Switch, XGS3-42000R, to satisfy the bandwidth requirements and protect network investment for enterprises. The XGS3-42000R is implemented with the following advanced technologies:

- **IPv6 / IPv4 Routing and Management**
- **10G Ethernet Switching**
- **Single IP Address Management**
- **Redundant Power System**

Positioned as the distribution or aggregation layer switch of large networks, the XGS3-42000R supports IP Stacking technology that helps to manage and configure up to 36 units via one single IP address easily. It serves for campus networks and metropolitan IP networks by offering intelligent security features, high performance and flexibility. The XGS3-42000R can also be an excellent choice as a core layer switch for enterprises, data centers or small & medium-sized networks.

### Supports 10Gb Ethernet

10Gb Ethernet which adopts full-duplex technology instead of low-speed, half-duplex CSMA/CD protocol, is a big leap in the evolution of Ethernet. 10Gb Ethernet can be deployed in star or ring topologies. With 10Gb Ethernet technology applied, the XGS3-42000R provides broad bandwidth and powerful processing capacity. It is suitable for metropolitan networks and wide area networks. Using the XGS3-42000R, users can simplify network structures and reduce cost of network construction.

## 2. PRODUCT FEATURES

### ➤ **Hardware and Performance**

- 4 open module slots design:
  - 2 Management Modules with 2 Standard Modules
  - 1 Management Module with 3 Standard Modules
- Up to 188-Port Gigabit copper / 156-Port Gigabit SFP / 13-Port 10G XFP
- Hot-Swappable switching modules
- Non-Blocking wire-speed Layer 2 and Layer 3 switching
- 1 RJ-45 serial console interface on Management Module for Switch basic management and setup

### ➤ **Redundant Power System**

- 100~240V AC Dual power redundant
  - 1 default AC power supply
  - 1 additional open slot for optional power supply
- Active-active redundant power failure protection
- Backup of catastrophic power failure on one supply

### ➤ **IP Stacking**

- IP stacking technology, connect with stack member via any Gigabit or 10G interface
- Single IP address management, supports up to 36 units stacking together

### ➤ **IP Routing Features**

- IP Routing protocol supports RIP v1/v2, OSPF v2, BGP4
- Routing interface provides VLAN routing mode
- Policy based Routing(PBR) for IPv4 and IPv6
- VRRP protocol for redundant routing deploy
- Supports route redistribution

### ➤ **Multicast Routing Features**

- Supports Multicast Routing Protocols:
  - PIM-DM (Protocol Independent Multicast - Dense Mode)

- PIM-SM (Protocol Independent Multicast - Sparse Mode)
- PIM-SSM (Protocol Independent Multicast - Source-Specific multicast Mode)
- DVMRP(Distance Vector Multicast Routing Protocol)

- Supports IGMP v1/v2/v3

➤ **Layer 2 Features**

- Supports Auto-negotiation, Auto-MDI/MDI-x and Half-Duplex / Full-Duplex modes for all 1000Base-T ports.
- Prevents packet loss with back pressure (Half-Duplex) and IEEE 802.3x PAUSE frame flow control (Full-Duplex)
- Support VLAN
  - IEEE 802.1Q Tagged VLAN
  - Up to 4K VLANs groups, out of 4041 VLAN IDs
  - Provider Bridging (VLAN Q-in-Q) support (IEEE 802.1ad)
  - GVRP protocol for VLAN Management
  - Private VLAN Edge (PVE)
- Support Spanning Tree Protocol
  - STP, IEEE 802.1d (Spanning Tree Protocol)
  - RSTP, IEEE 802.1w (Rapid Spanning Tree Protocol)
  - MSTP, IEEE 802.1s (Multiple Spanning Tree Protocol, spanning tree by VLAN)
- Support Link Aggregation
  - 802.3ad Link Aggregation Control Protocol (LACP)
  - Cisco ether-channel (Static Trunk)
  - Maximum 6 trunk groups per module, up to 8 ports per trunk group
  - Up to 16Gbps bandwidth(Duplex Mode)
- Provide Port Mirror (many-to-1)
- Port Mirroring to monitor the incoming or outgoing traffic on a particular port

➤ **Quality of Service**

- 8 priority queues on all switch ports
- Supports for strict priority and Weighted Round Robin (WRR) CoS policies
- Ingress Shaper and Egress Rate Limit per port bandwidth control
- Traffic-policing policies based on application

➤ **Multicast**

- Supports IGMP Snooping v1, v2 and v3
- Querier mode support

➤ **Security**

- IEEE 802.1x Port-Based network access authentication
- MAC-Based network access authentication

- IP-Based Access Control List (ACL)
- MAC-Based Access Control List
- Static MAC

➤ **Management**

- IPv4 / IPv6 Switch Management Interfaces
  - Console / Telnet Command Line Interface
  - Web switch management
  - SNMP v1, v2c, and v3 switch management
  - SSH( Secure Shell) / SSL secure access
- Four RMON groups (history, statistics, alarms, and events)
- IPv6 IP Address / NTP / DNS management
- Built-in Trivial File Transfer Protocol (TFTP) client
- BOOTP and DHCP for IP address assignment
- DHCP / BootP relay and Relay Option 82
- DHCP Server
- DNS-Proxy
- Firmware upload/download via FTP / TFTP
- SNTP (Simple Network Time Protocol)
- LLDP (Link Layer Discovery Protocol )
- User Privilege levels control

## 3. PRODUCT SPECIFICATION

### 3.1 MAIN COMPONENT

Management Module	M24GX
Switch ASIC	Broadcom BCM565xx
Giga PHY	Broadcom BCM5464
10G PHY	NetLOGIC AEL 1002-1613C
CPU	Broadcom BCM5836P
Flash	INTEL IS28F256 32MB
SDRAM	Hynix HY57V561620FTP-H / 256Mbit

## 3.2 FUNCTION SPECIFICATION

### 3.2.1 SPECIFICATION - XGS3-42000R Chassis

<b>Product</b>	<b>XGS3-42000R</b>
<b>Chassis Slots</b>	
<b>Total Number of Slots</b>	4
<b>Max. Management Module<sup>*1</sup></b>	2 (Slot 1, Slot 2)
<b>Max. Standard Module<sup>*2</sup></b>	3 (Slot 2, Slot 3, Slot 4)
<b>Management Module Redundancy</b>	Yes
<b>Number of Power Supply Bays</b>	2
<b>Number of FAN Trays</b>	1, hot-pluggable
<b>Total Port Capacity</b>	
<b>Max. 10G XFP Slot</b>	13
<b>Max. 10/100/1000Base-T</b>	188
<b>Max. 1000Base-SX/LX SFP Slot</b>	156
<b>Modules</b>	
<b>XGS3-M24GX</b>	Management module / 24 10/100/1000Base-T with 12 Shared SFP + 1 10G XFP Slot
<b>XGS3-S24G</b>	Standard module / 24 10/100/1000Base-T with 12 Shared SFP slots
<b>XGS3-S48G</b>	Standard module / 48 10/100/1000Base-T
<b>XGS3-S48GF</b>	Standard module/ 48 1000Base-SX/SL SFP slots
<b>XGS3-S4XG</b>	Standard module / 4 10GBase-SR/LR XFP slots
<b>Performance</b>	
<b>Switch Processing Scheme</b>	Store-and-Forward
<b>Backplane Bandwidth</b>	1.2Tbps
<b>Switching Capacity</b>	376Gbps
<b>Full-Mesh Switching Capacity</b>	160Gbps
<b>Forwarding Rate</b>	282Mpps@64Bytes, Line speed
<b>MAC Table</b>	64K
<b>VLAN Table</b>	4K
<b>ACL Table</b>	16K max.

<b>Routing Table</b>	IPv4 Protocol: 128K max. IPv6 Protocol: 64K max.
<b>Layer 3 Interface</b>	500
<b>Port Queues</b>	8
<b>Flow Control</b>	IEEE 802.3x Pause Frame for Full-Duplex Back pressure for Half-Duplex
<b>Jumbo Frame</b>	9Kbytes
<b>Hardware Specification</b>	
<b>Dimension(W x D x H)</b>	445mm x 421mm x 266mm
<b>Relative Humidity</b>	10%~90%, non-condensing
<b>Operating Temperature</b>	0°C~40°C
<b>Power Input</b>	AC: Input 100~240V, 50~60 Hz;
<b>Power Consumption</b>	≤400W

Remark:

1. Slot 1 with Management Module is required otherwise the system can not normally operates.
2. Slot 2 supports either Management Module or Standard Module. As Management Module installed it backup the Management Module of Slot 1 as a redundancy.

### 3.2.2 SPECIFICATION – Management Module

<b>XGS3-42000R Management Module</b>	
<b>Model Name</b>	
<b>Product</b>	<b>XGS3-M24GX</b>
<b>Hardware Specification</b>	
<b>Copper Ports</b>	24 x 10/100/1000Base-T RJ-45 ports
<b>SFP/mini-GBIC Slots</b>	12 x 1000Base-SX/LX SFP slots
<b>XFP/mini-GBIC Slots</b>	1 x 10GBase-SR/LR XFP slot
<b>Switch Fabric</b>	68Gbps
<b>Throughput</b>	50Mpps@64Bytes
<b>LED</b>	System: PWR, RUN, Master, FAN Ports: 10/100/1000M LNK/ACT 1000M LNK/ACT 10G LNK/ACT

<b>Dimension</b>	339 x 357 x 43mm (W x D x H)
<b>IPv4 Layer 3 functions</b>	
<b>IP Routing Protocol</b>	Static Route, RIPv1/v2, OSPFv2, BGP4 Policy-Based Routing (PBR) LPM Routing (MD5 authentication)
<b>Multicast Routing Protocol</b>	IGMP v1 / 2 / 3, DVMRP, PIM-DM/SM, PIM-SSM
<b>Layer 3 Protocol</b>	VRRP, ARP, ARP Proxy
<b>Routing Interface</b>	Per VLAN
<b>IPv6 Layer 3 functions</b>	
<b>IP Routing Protocol</b>	RIPng, OSPFv3, BGP4+
<b>Multicast Routing Protocol</b>	PIM-SM/DM for IPv6 MLD for IPv6 ( v1 ) MLDv1/v2 MLD Snooping, 6 to 4 Tunnels Multicast receive control Illegal multicast source detect
<b>Layer 3 Protocol</b>	Configured Tunnels , ISATAP, CIDR
<b>Layer 2 function</b>	
<b>Port configuration</b>	Port disable/enable. Auto-negotiation 10/100/1000Mbps full and half duplex mode selection. Bandwidth control on each port Port Loopback detect
<b>VLAN</b>	802.1Q Tagged Based VLAN ,up to 4K VLAN groups Q-in-Q GVRP Private VLAN
<b>Spanning Tree Protocol</b>	STP, IEEE 802.1d (Spanning Tree Protocol) RSTP, IEEE 802.1w (Rapid Spanning Tree Protocol) MSTP, IEEE 802.1s (Multiple Spanning Tree Protocol, spanning tree by VLAN) Root Guard BPDU Guard
<b>Link Aggregation</b>	Static Trunk IEEE 802.3ad LACP Support 8 groups of 8-Port trunk support
<b>QoS</b>	Traffic classification based, Strict priority and WRR 8-level priority for switching - Port Number - 802.1p priority - DSCP/TOS field in IP Packet Policy-based DiffServ



<b>Multicast</b>	<p>IGMP v1 / v2 / v3 Snooping</p> <p>IGMP Proxy</p> <p>IGMP Querier mode support</p> <p>MLDv1 / v2, MLD v1/v2 Snooping</p>
<b>Access Control List</b>	<p>Support Standard and Expanded ACL</p> <p>IP-Based ACL / MAC-Based ACL</p> <p>Time-Based ACL</p> <p>ACL Pool can be used for QoS classification</p> <p>Up to 1K entries</p>
<b>Security</b>	<p>Support MAC+ port binding</p> <p>IPv4 / IPv6 + MAC+ port binding</p> <p>IPv4 / IPv6 + port binding</p> <p>Support MAC filter</p> <p>ARP Spoofing Prevention</p> <p>ARP Scanning Prevention</p> <p>IP Source Guard</p>
<b>Authentication</b>	<p>IEEE 802.1x Port-Based network access control</p> <p>AAA Authentication: IPv4 / IPv6 over RADIUS</p>
<b>SNMP MIBs</b>	<p>RFC-1213 MIB-II</p> <p>IF-MIB</p> <p>RFC-1493 Bridge MIB</p> <p>RFC-1643 Ethernet MIB</p> <p>RFC-2863 Interface MIB</p> <p>RFC-2665 Ether-Like MIB</p> <p>RFC-2674 Extended Bridge MIB</p> <p>RFC-2819 RMON MIB (Group 1, 2, 3 and 9)</p> <p>RFC-2737 Entity MIB</p> <p>RFC-2618 RADIUS Client MIB</p> <p>RFC-2933 IGMP-STD-MIB</p> <p>RFC3411 SNMP-Frameworks-MIB</p> <p>IEEE802.1X PAE</p> <p>LLDP</p> <p>MAU-MIB</p>
<b>Management Function</b>	
<b>System Configuration</b>	<p>Console, Telnet, SSH, Web Browser, SSL, SNMPv1, v2c and v3</p>
<b>Management</b>	<p>Support the unite for IPv4 / IPv6 HTTP and SSL</p> <p>Support the user IP security inspection for IPv4 / IPv6 SNMP</p> <p>Support MIB and TRAP</p> <p>Support IPv4 / IPv6 FTP/TFTP</p> <p>Support IPv4 / IPv6 NTP</p> <p>Support RMOM 1, 2, 3, 9 four group</p> <p>Support the RADIUS authentication for IPv4 / IPv6 telnet user name and password</p> <p>Support IPv4 / IPv6 SSH</p>

	<p>The right configuration for users can adopt radius server's shell management</p> <p>Support the function for timing-reset bases needs</p> <p>Support CLI, support Console ( RS-232 ) , support Telnet</p> <p>Support SNMPv1 / v2c / v3</p> <p>Support Security IP safety net management function : avoid to unlawful landing at nonrestrictive area.</p> <p>Support TACACS+</p>
<b>Standards Conformance</b>	
<b>Regulation Compliance</b>	FCC Part 15 Class A, CE
<b>Standards Compliance</b>	<p>IEEE 802.3 10Base-T</p> <p>IEEE 802.3u 100Base-TX</p> <p>IEEE 802.3z 1000Base-SX/LX</p> <p>IEEE 802.3ab Gigabit 1000T</p> <p>IEEE 802.3ae 10 Gigabit Ethernet</p> <p>IEEE 802.3x Flow Control and Back pressure</p> <p>IEEE 802.3ad Port trunk with LACP</p> <p>IEEE 802.1d Spanning tree protocol</p> <p>IEEE 802.1w Rapid spanning tree protocol</p> <p>IEEE 802.1s Multiple spanning tree protocol</p> <p>IEEE 802.1p Class of service</p> <p>IEEE 802.1Q VLAN Tagging</p> <p>IEEE 802.1x Port Authentication Network Control</p> <p>IEEE 802.1ab LLDP</p>

### 3.2.3 SPECIFICATION – Standard Module

<b>XGS3-42000R Standard Ethernet Module</b>				
<b>Model Name</b>				
<b>Product</b>	<b>XGS3-S24G</b>	<b>XGS3-S48G</b>	<b>XGS3-S48GF</b>	<b>XGS3-S4XG</b>
<b>Hardware Specification</b>				
<b>Copper Ports</b>	24 x 10/100/1000Base-T RJ-45 ports	48 x 10/100/1000Bas-T RJ-45 ports	--	--
<b>SFP/mini-GBIC Slots</b>	12 x 1000Base-SX/LX SFP slots, shared with Port 13 to Port-24	--	48 x 1000Base-SX/LX SFP slots	--
<b>XFP/mini-GBIC Slots</b>	--	--	--	4 x 10GBase-SR/LRXFP slots
<b>Switch Fabric</b>	68Gbps	96Gbps	96Gbps	40Gbps
<b>Throughput</b>	50Mpps@64Bytes	71Mpps@64Bytes	71Mpps@64Bytes	59Mpps@64Bytes

<b>LED</b>	System: PWR, RUN Ports: 10/100/1000M LNK/ACT 1000M LNK/ACT	Ports: 10/100/1000M LNK/ACT	Ports: 1000M LNK/ACT	System: PWR, RUN Ports: 10G LNK/ACT
<b>Dimension</b>	339 x 357 x 43mm (W x D x H)			
<b>Standards Compliance</b>	IEEE 802.3 10Base-T IEEE 802.3u 100Base-TX IEEE 802.3z Gigabit SX/LX IEEE 802.3ab Gigabit 1000T	IEEE 802.3 10Base-T IEEE 802.3u 100Base-TX IEEE 802.3ab Gigabit 1000T	IEEE 802.3z Gigabit SX/LX	IEEE 802.3ae 10G Ethernet

### 3.3 PHYSICAL SPECIFICATIONS:

#### 3.3.1 XGS3-42000R Chassis

- **Dimensions:**

445mm x 421mm x 266mm (W x D x H), 6U height

- **Weight:**

18kg (XGS3-42000R, 1 AC Power Module, No Managed Module or Standard Module)

- **Diagram – XGS3-42000R Chassis + Modules:**

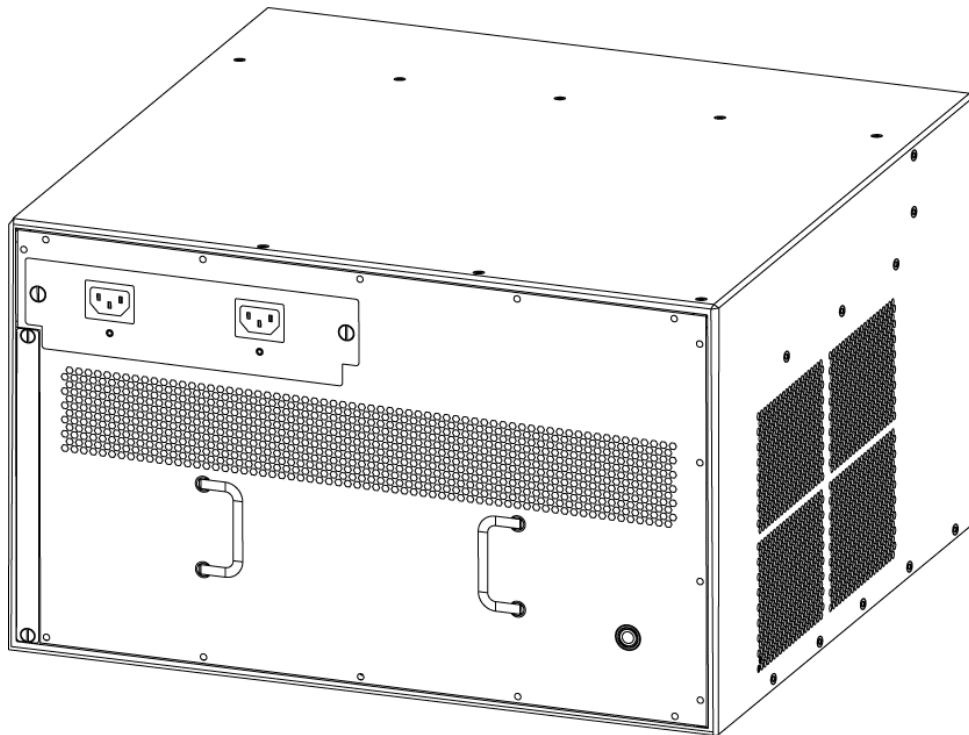
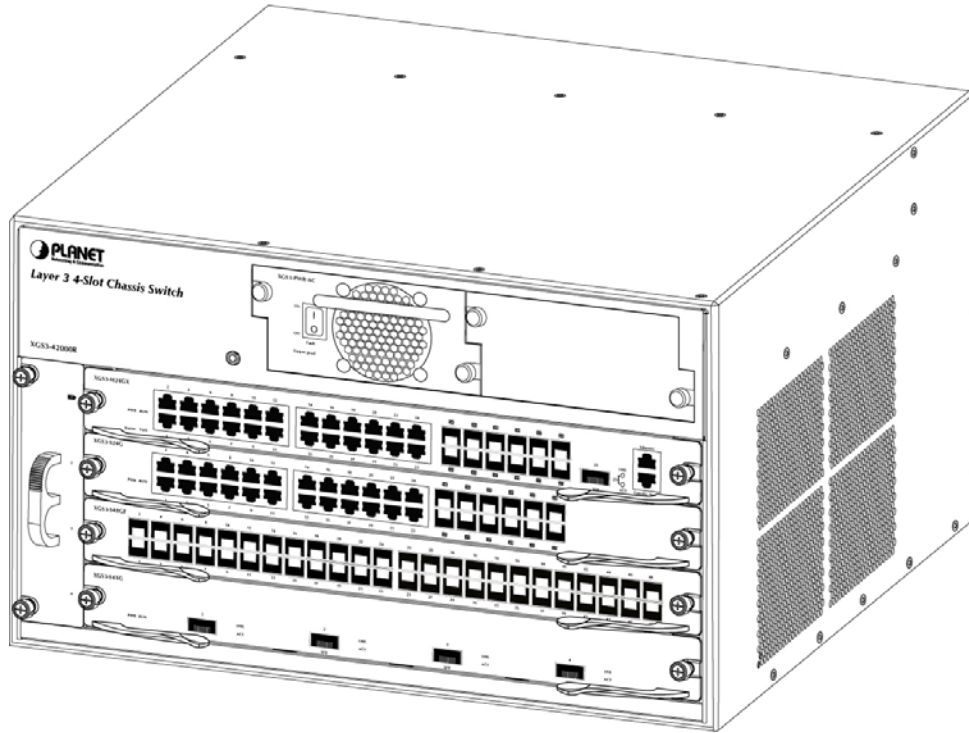

■ Front Panel – XGS3-42000R Chassis:

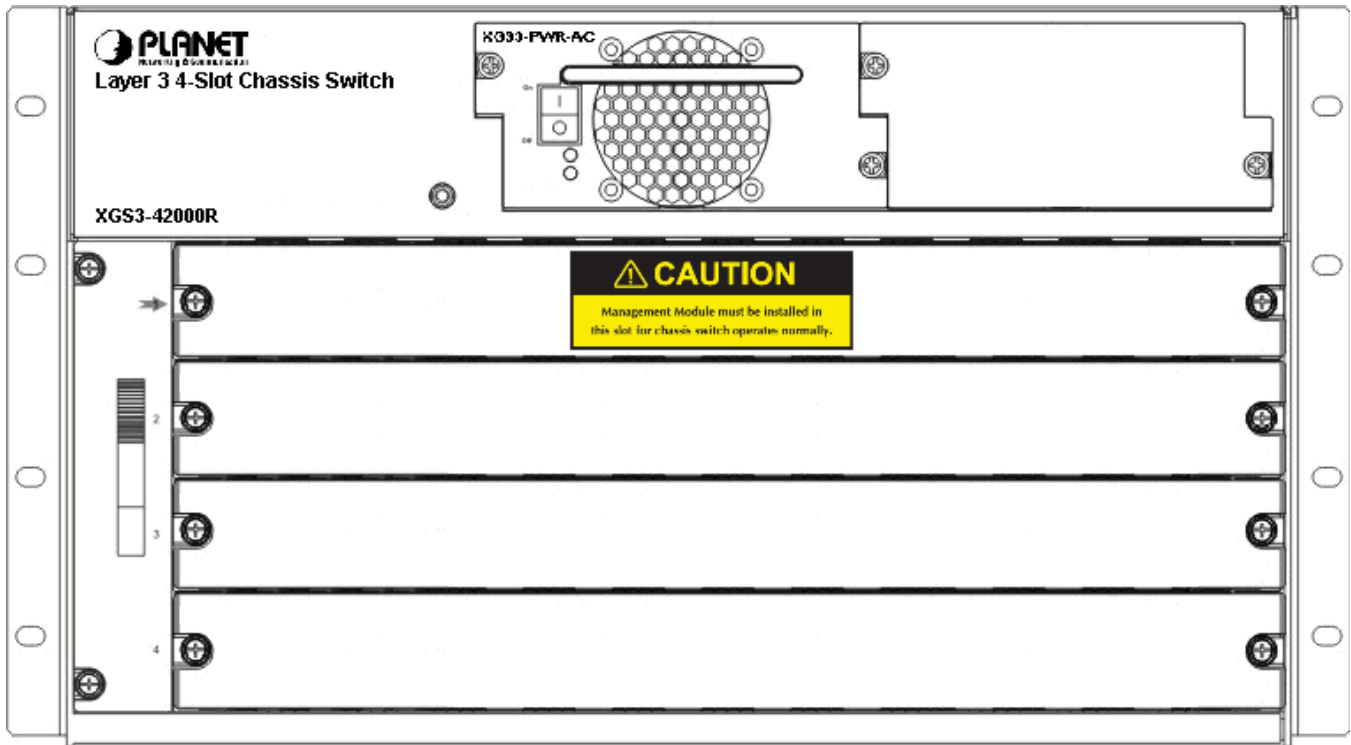

■ Rear Panel – XGS3-42000R Chassis:

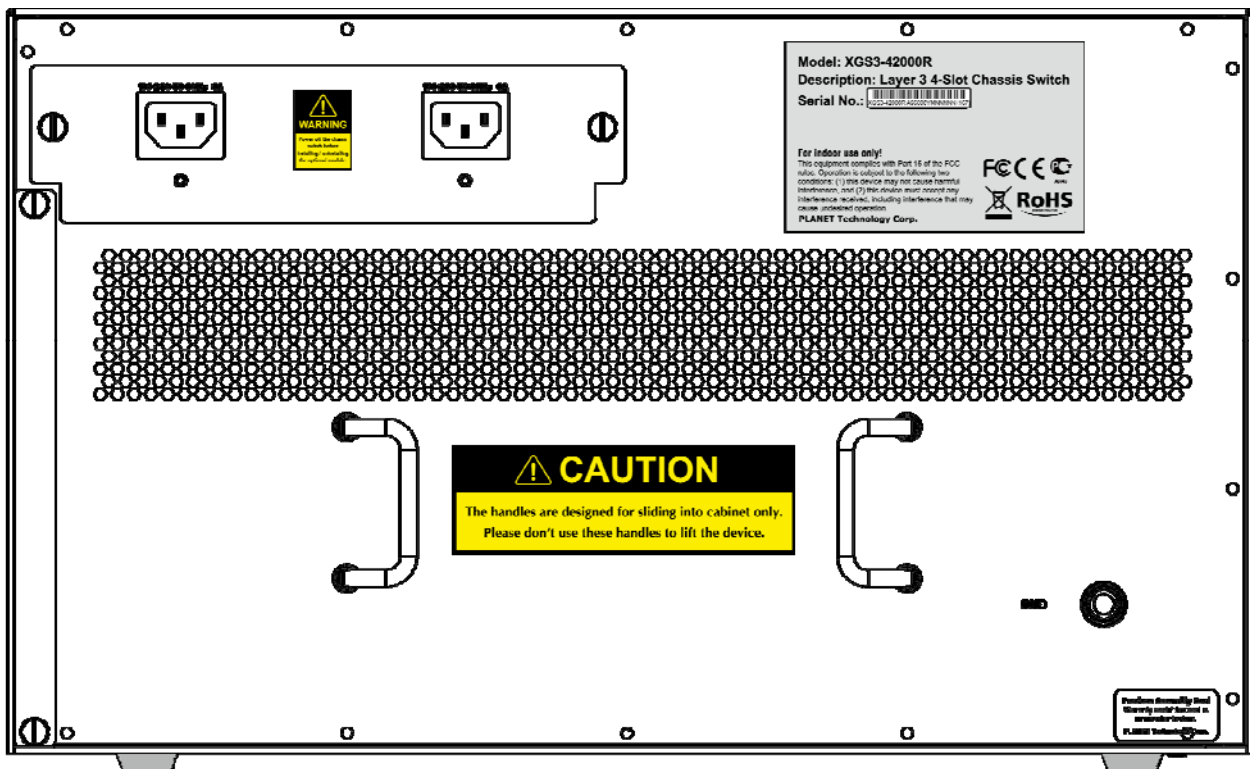

### 3.3.2 XGS3-M24GX Management Module Specification

■ **Dimensions:**

339 x 357 x 43mm (W x D x H)

■ **Front Panel – XGS3-M24GX Management Module:**

The unit front panel provides a simple interface monitoring the Management Module.

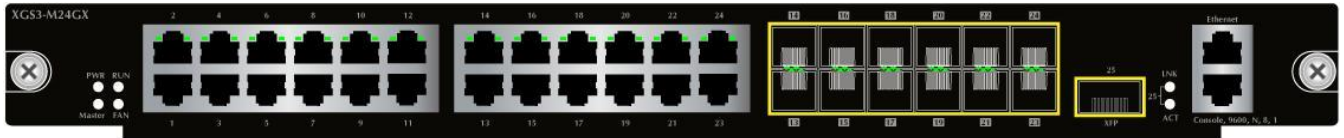

➤ **Gigabit TP interface**

10/100/1000Base-T Copper, RJ-45 Twist-Pair: Up to 100 meters.

➤ **Gigabit SFP slots**

1000Base-SX/LX mini-GBIC slot, SFP (Small Form Factor Pluggable) transceiver module: From 550 meters (Multi-mode fiber), up to 10/30/50/70/120 kilometers (Single-mode fiber).

➤ **10 Gigabit XFP slots**

10GBase-SR/LR mini-GBIC slot, XFP (10 Gigabit Small Form Factor Pluggable) transceiver module: From 300 meters (Multi-mode fiber), up to 10 kilometers (Single-mode fiber).

➤ **Console Port**

The console port is a RJ-45 type, RS-232 male serial port connector. It is an interface for connecting a terminal directly. Through the console port, it provides rich diagnostic information includes IP Address setting, factory reset, port management, link status and system setting. Users can use the attached RS-232 cable in the package and connect to the console port on the device.

Property	Specification
Connector	RJ-45 (receptacle), connects to character terminals
Connector type	RS-232, connects to PC serial port and running terminal emulator on PC
Baud rate	9600bps (default)

■ **LED definition - XGS3-M24GX Management Module:**

The front panel LEDs indicates instant status of port links, data activity, system operation, system power, master and system FAN, helps monitor and troubleshoot when needed.

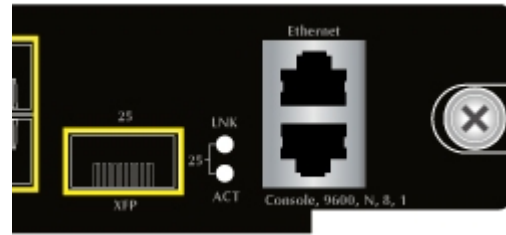
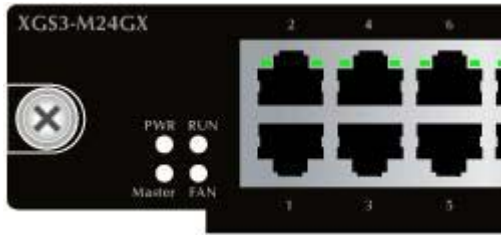

➤ **System**

LED	Color	Function
PWR	Green	Lights to indicate that Management Module has power.
	Off	To indicate the Management Module power off.
RUN	Green	<b>Blink slowly</b> to indicate that Management Module running in normal status. <b>Blink fast</b> to indicate that system loading (Management Module booting after hot plug in).
	Off	Running Status is failure.
Master	Green	Management Module operates at master mode.
	Off	Management Module operates at slave mode.
FAN	Green	FAN works normally.
	Red	FAN works abnormally.
	Off	FAN does not present.

➤ **10/100/1000Base-T interfaces**

LED	Color	Function
LNK/ACT	Green	To indicate the link through that port is successfully established with speed <b>10/100/1000Mbps</b> .
	Yellow	To indicate that the Management Module is actively sending or receiving data over that port.
	Off	No data go through the port.

➤ **SFP interfaces**

LED	Color	Function
LNK	Green	To indicate the link through that port is successfully established with speed <b>1000Mbps</b> .
	Off	No data go through the port.
ACT	Green	<b>Blink</b> to indicate that the Management Module is actively sending or receiving data over that port.

➤ **XFP interfaces**

LED	Color	Function
LNK	Green	To indicate the link through that port is successfully established with speed <b>10Gbps.</b>
	Off	No data go through the port.
ACT	Green	<b>Blink</b> to indicate that the Management Module is actively sending or receiving data over that port.

**3.3.3 XGS3-S24G Standard Module Specification**

■ **Dimensions:**

339 x 357 x 43mm (W x D x H)

■ **Front Panel – XGS3-S24G Standard Module:**

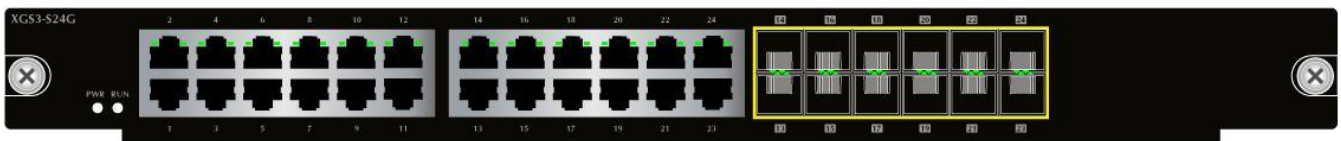

➤ **Gigabit TP interface**

10/100/1000Base-T Copper, RJ-45 Twist-Pair: Up to 100 meters.

➤ **Gigabit SFP slots**

1000Base-SX/LX mini-GBIC slot, SFP (Small Form Factor Pluggable) transceiver module: From 550 meters (Multi-mode fiber), up to 10/30/50/70/120 kilometers (Single-mode fiber).

■ **LED definition XGS3-S24G Standard Module:**

The front panel LEDs indicates instant status of port links, data activity, system operation and system power, helps monitor and troubleshoot when needed

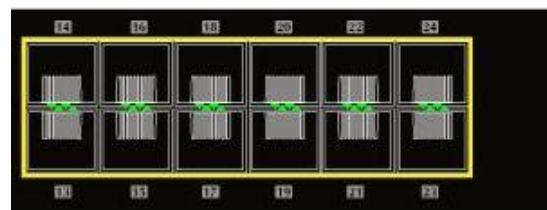
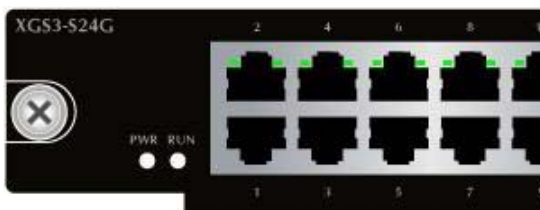



➤ **System**

LED	Color	Function
PWR	Green	Lights to indicate that Standard Ethernet Module has power.
	Off	To indicate the Standard Ethernet Module power off.
RUN	Green	<b>Blink slowly</b> to indicate that Standard Ethernet Module running in normal status. <b>Blink fast</b> to indicate that system loading (Standard Module booting after hot plug in).
	Yellow	Lights to indicate that Standard Ethernet Module shut down.
	Red	Lights to indicate that Standard Ethernet Module is failure.
	Off	Standard Ethernet Module is off and can be pulled out.

➤ **10/100/1000Base-T interfaces**

LED	Color	Function
LNK/ACT	Green	To indicate the link through that port is successfully established with speed <b>10/100/1000Mbps</b> .
	Yellow	To indicate that the Standard Ethernet Module is actively sending or receiving data over that port.
	Off	No data go through the port.

➤ **SFP interfaces**

LED	Color	Function
LNK	Green	To indicate the link through that port is successfully established with speed <b>1000Mbps</b> .
	Off	No data go through the port.
ACT	Green	<b>Blink</b> to indicate that the Standard Ethernet Module is actively sending or receiving data over that port.

### 3.3.4 XGS3-S48G Standard Module Specification

■ **Dimensions:**

339 x 357 x 43mm (W x D x H)

■ **Front Panel – XGS3-S48G Standard Module:**

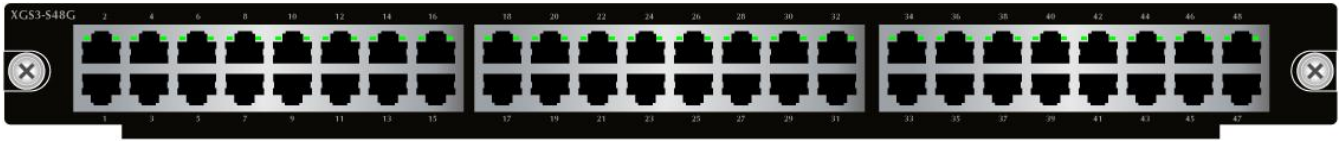

➤ **Gigabit TP interface**

10/100/1000Base-T Copper, RJ-45 Twist-Pair: Up to 100 meters.

■ **LED definition XGS3-S48G Standard Module:**

The front panel LEDs indicates instant status of port links and data activity, helps monitor and troubleshoot when needed.

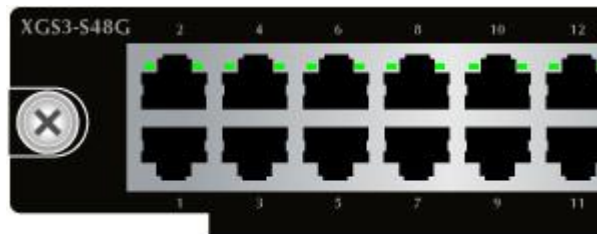

➤ **10/100/1000Base-T interfaces**

LED	Color	Function
LNK/ACT	Green	To indicate the link through that port is successfully established with speed <b>10/100/1000Mbps</b> .
	Yellow	To indicate that the Standard Ethernet Module is actively sending or receiving data over that port.
	Off	No data go through the port.

### 3.3.5 XGS3-S48GF Standard Module Specification

■ **Dimensions:**

339 x 357 x 43mm (W x D x H)

■ **Front Panel – XGS3-S48GF Standard Module:**

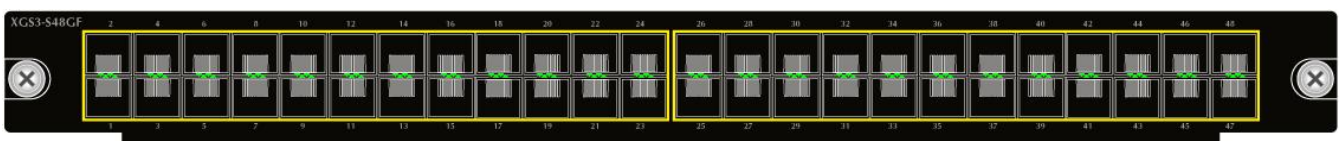

➤ **Gigabit SFP slots**

1000Base-SX/LX mini-GBIC slot, SFP (Small Form Factor Pluggable) transceiver module: From 550 meters (Multi-mode fiber), up to 10/30/50/70/120 kilometers (Single-mode fiber).

■ **LED definition XGS3-S48GF Standard Module:**

The front panel LEDs indicates instant status of port links, data activity, system operation and system power, helps monitor and troubleshoot when needed.

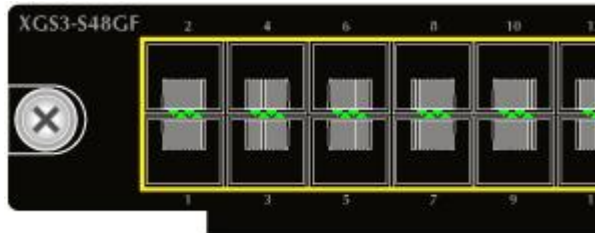

➤ **SFP interfaces**

LED	Color	Function
LNK	Green	To indicate the link through that port is successfully established with speed <b>1000Mbps.</b>
	Off	No data go through the port.
ACT	Green	<b>Blink</b> to indicate that the Standard Ethernet Module is actively sending or receiving data over that port.

### 3.3.6 XGS3-S4XG Standard Module Specification

■ **Dimensions:**

339 x 357 x 43mm (W x D x H)

■ **Front Panel – XGS3-S4XG Standard Module:**



➤ **10 Gigabit XFP slots**

10GBase-SR/LR mini-GBIC slot, XFP (10 Gigabit Small Form Factor Pluggable) transceiver module: From 300 meters (Multi-mode fiber), up to 10 kilometers (Single-mode fiber).

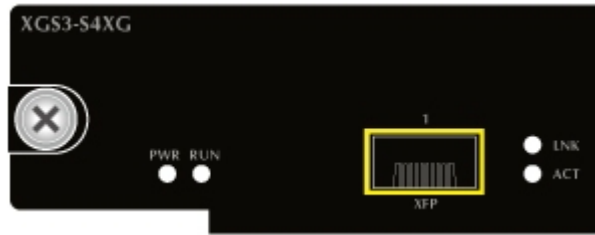

■ **LED definition XGS3-S4XG Standard Module:**

The front panel LEDs indicates instant status of port links and data activity, helps monitor and troubleshoot when needed.

➤ **System**

LED	Color	Function
PWR	Green	Lights to indicate that Standard Ethernet Module has power.
	Off	To indicate the Standard Ethernet Module power off.
RUN	Green	Blink slowly to indicate that Standard Ethernet Module running in normal status. Blink fast to indicate that system loading (Standard Module Booting after hot plug in).
	Yellow	Lights to indicate that Standard Ethernet Module shut down.
	Red	Lights to indicate that Standard Ethernet Module is failure.
	Off	Standard Ethernet Module is off and can be pulled out.

➤ **XFP interfaces**

LED	Color	Function
LNK	Green	To indicate the link through that port is successfully established with speed <b>10Gbps</b> .
	Off	No data go through the port.
ACT	Green	Blink to indicate that the Standard Ethernet Module is actively sending or receiving data over that port.

### 3.3.7 XGS3-PWR-AC AC Power Module Specification

■ **Front Panel – XGS3-PWR-AC Power Module:**

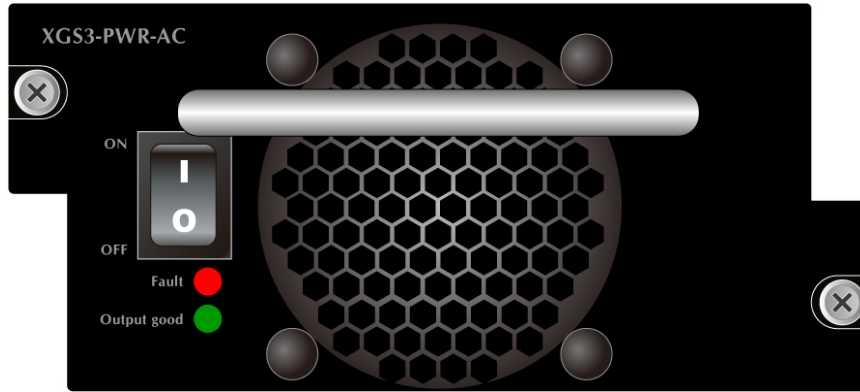

■ LED definition - **XGS3-PWR-AC** :

LED	Color	Function
Output Good	Green	Lights to indicate that the Power Module output status is okay.
	Off	To indicate the Power Module has no output.
Fault	Yellow	Faulty Power Module or Not turning-on the output switch,
	Off	The Power Module is working fine.

### 3.4 ENVIRONMENTAL SPECIFICATION

**Operating:**

**Temperature:** 0 ~ 50 Degree C  
**Relative Humidity:** 10% ~ 90% (non-condensing)

**Storage:**

**Temperature:** -10 ~ 70 Degree C  
**Relative Humidity:** 5% ~ 90% (non-condensing)

### 3.5 ELECTRICAL SPECIFICATION

**AC Dual Power Supplies :** Supports Power Redundant

**AC Power Input Voltage:** 100 ~ 240V AC, 50 / 60Hz, Auto-sensing.

**Power Consumption(System on with XGS3-M24GX):** 110V: Watts  
220V: Watts

**Power Consumption(Full Load):** 110V: TBD Watts  
220V: TBD Watts

## 3.6 REGULATORY COMPLIANCE

### EMI:

EN 55022 CLASS A:1998+A1 : 2000+A2 : 2003

EN61000-3-2:2000

EN61000-3-3: 1995+1A:2001

### EMS:

EN 55024:1998+A1:2001+A2:2003

IEC 61000-4-2:2001

IEC 61000-4-3:2002

IEC 61000-4-4:2004

IEC 61000-4-5:2001

IEC 61000-4-6:2004

IEC 61000-4-8:2001

IEC 61000-4-11:2004

### FCC:

FCC CFR Title 47 Part 15 Subpart B: 2005

CISPR 22:2003

ICES-003

## 3.7 REALIABILITY

MTBF > 50,000 hrs @ 25 Degree C

## 3.8 BASIC PACKAGING

■ The XGS3 Chassis Switch	X1
■ This Quick Installation Guide	X1
■ User's Manual CD	X1
■ RJ-45-to-DB9 Console Cable	X1
■ USB-to-DB9 Console Cable	X1
■ UTP Straight Network Cable	X1
■ Power Cord	X1
■ Ground Cable	X1
■ Two Rack-mounting Brackets with Attachment Screws	X1

### 3.9 PACKING DIMENSION

**Dimension:** 530mm (W) x 420mm (D) x 135mm (H)

**Weight:** < TBD > kg (Gross Weight)

1 pcs in one carton

