

Eaton.com/epdu

Eaton ePDU Product Catalog



Switch  N to Eaton.

EATON

Powering Business Worldwide



Table of contents

Product line overview	4
Choosing ePDU technologies	5
Understanding ePDU technologies	6
ePDU software options	9
Data Center ePDU units	10
<i>Designed specifically for data centers and IT environments, Eaton's Data Center ePDUs range from basic power distribution to the ability to monitor and manage power consumption</i>	
Basic ePDUs	10
<i>Provides reliable and cost-effective power distribution</i>	
FlexPDUs and Hot Swap Maintenance Bypass	14
<i>Increase power distribution from a single UPS / Enables easy UPS replacement without interruption to the connection load</i>	
Monitored ePDUs	16
<i>Remotely monitors the current draw of the unit and individual sections</i>	
Advanced Monitored ePDUs	19
<i>Provides outlet level monitoring for capacity planning and energy management</i>	
Switched ePDUs	20
<i>Provides remote power monitoring of both voltage and current and provides outlet-level control for on/off/reboot capabilities</i>	
Managed ePDUs	22
<i>Monitors and controls critical factors such as voltage, current and power factor down to the individual outlet</i>	
Eaton Automatic Transfer Switches	25
<i>Automatically transfers power from the primary source to the secondary source</i>	
Industrial ePDUs	27
<i>Frequently used in test and measurement applications, many of Eaton's Industrial ePDUs are designed to be controlled with Remote Emergency Power Off</i>	
Rack Power Module	41
<i>Delivers up to 36 kW of power to loads of various voltages, power cords and layouts</i>	
ePDU plugs and receptacles	42
Power cables and accessories	43
Space-saving mounting options	44
Cable restraint and management	45
Racks and airflow management	46
<i>Eaton provides a full line of racks and airflow management solutions to store, cool, power and secure critical IT equipment</i>	

Product line overview

Broad product portfolio

Eaton® offers the largest selection of rack mounted power distribution units available on the market, we call these Eaton ePDU® units. Our complete suite of products is designed specifically to help you meet rapidly escalating requirements.

High density power solutions

Eaton offers a number of ePDUs to meet your high power density needs. We offer both rackmount, and vertical mount three-phase models ranging from 50A to 80A input capacities. These sophisticated units allow an entire rack of equipment to be powered from a single power cord input.

24x7 reliability through circuit breakers

ePDUs use individual UL-rated branch circuit breakers that protect load segments (outlet groups), ensuring that an overloaded circuit does not affect other load segments, therefore increasing reliability. Typically, circuit breakers have flat rockers or are fully shrouded to prevent accidental on/off operation.

Rugged design for optimal performance and quick installation

Eaton ePDUs are designed to meet global safety standards. These units are engineered with rugged construction, have flexible mounting options, and multiple features ensuring the highest quality and customer satisfaction. Eaton engineers unique solutions for the most power intense environments.

Interact with our ePDUs online!

Please visit eaton.com/epdu to interact with different ePDU technologies. These tools provide you with an in-depth look of the technology of the units, plugs, receptacles and much more!



Monitored OU ePDU

Monitored ePDUs offer customers the opportunity to remotely monitor the current draw of individual sections via Ethernet or Serial. This, combined with state-of-the-art software, allows the user to aggregate the information from thousands of ePDUs in one location. This unit is part number VPC2864-3852 (66"W x 1.89"H x 2.0"D).

Choosing ePDU technologies

Eaton ePDU product search wizard makes it easy!

On eaton.com/epdu, Eaton's product search wizard is a simple interface that allows you to search over 1,000 products for the perfect solution. You can explore features, benefits and learn basic fundamentals of ePDUs, as well as interact with live demos. This search wizard allows you to filter ePDUs by:

- **Input plug**
- **Output receptacle**
- **Power rating**
- **Function**
- **TAA compliance**

The live search wizard walks you through power requirements and allows you to pick from specific ePDU inventories. Making the right decisions from the start can make a difference in the dependability and efficiency of an infrastructure. If you need help or have questions with a selection, you can use the live chat icon or call one of the listed support numbers on our website.

Eaton's complete offering of ePDU products in the search wizard and in this catalog are designated as either:

Top seller ePDUs - Eaton's most popular units

Build-to-order ePDUs - Specialized units

Custom ePDUs - Fully engineered unique configurations built to meet your desired solution

Eaton ePDU catalog numbering system

Eaton's smart style numbers help you understand our numbering system. Follow the example below to see what the letters and numbers mean within this ePDU catalog. Please note that this numbering scheme represents the majority of our part numbers, but not all.

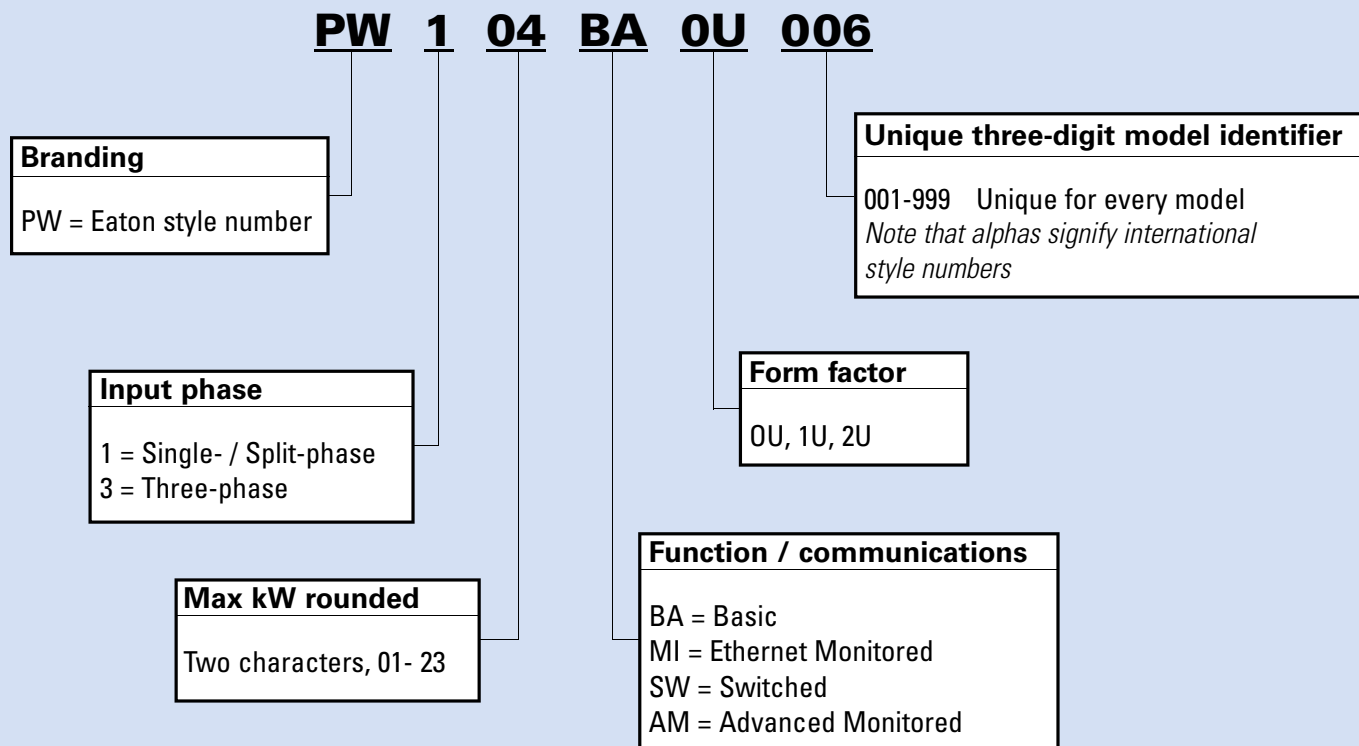

Eaton has introduced new part numbers to our product portfolio. Please see details below:

ePBZ
BZ = Basic

eMA
MA = Managed

eAM
AM = Advanced Monitored

Understanding ePDU technologies

Eaton’s ePDU technologies satisfy the demand of every data center. Eaton ePDUs offer single and dual chassis, five technology options, the broadest power range in the market and the ability to manufacture custom ePDUs. They also offer an arrangement of outlets (number and type) for every region.

Eaton ePDUs are distinguished for their quality, dependability and versatility. All products are designed for a specific application with an emphasis on safety and reliability. The Eaton line includes an extensive range of vertical, zero U products, which do not occupy server space in racks, as well as 1U and 2U formats. Environmental monitoring options are also available.

Feature	Basic (BA)	Monitored Network (MI)	Advanced Monitored (AM)	Switched (SW)	Managed (MA)	Automatic Transfer (AT)
Rugged Construction	✓	✓	✓	✓	✓	✓
Horizontal Products	✓	✓		✓		✓
Vertical Products	✓	✓	✓	✓	✓	
Local Current Display		✓	✓	✓	✓	
Current Monitoring Type		Section	Outlet	Section	Outlet	
Voltage Monitoring				✓	✓	
Serial Interface				✓	✓	
Ethernet Interface		✓	✓	✓	✓	
Environmental Sensors		✓*	✓	✓	✓	

*Available on some models

Industrial ePDUs

Frequently used in test and measurement applications, Eaton offers a variety of Industrial ePDU options, many which are designed to be controlled with Remote Emergency Power Off. Eaton offers a full range of products with this feature from basic North American models to 3-Phase international units. Use your own switches or simply plug-in our Remote Control Panel (RCP) into an ePDU.

For more information on Eaton’s line of Industrial ePDUs, refer to pages 27-40.





Basic (BA) – rugged construction and flexible mounting options (page 10)

Designed for reliable and cost-effective power distribution, Basic ePDUs have the form factor and receptacle choices to meet the needs of the demanding data center architect. With power levels ranging from 1.4 kW all the way to 17 kW, Eaton has the right Basic ePDU for any application.



FlexPDUs and Hot Swap Maintenance Bypass (page 14)

The Eaton FlexPDUs provide flexible output receptacle options from a single UPS. These products have a three-foot input cord, enabling them to be mounted in close proximity to the UPS.

Ideal for maintenance and UPS replacement, the Eaton Hot Swap Maintenance Bypass facilitates hot-swappable UPS replacement without shutting down equipment connected to the UPS.



Monitored Network (MI) (page 16)

Eaton Monitored ePDUs provide remote monitoring of the current draw of individual sections via Ethernet or serial communication. This capability, combined with state-of-the-art software allows you to aggregate the information from hundreds of ePDUs in one location. All Monitored ePDUs also include the Easy-Read digital LED ammeter for easy start-up and provisioning of servers.



Advanced Monitored (AM) – Current Monitoring Per Outlet (page 19)

Eaton Advanced Monitored ePDUs provide high accuracy monitoring for high-density, mission-critical server applications. By monitoring power consumption and energy trends at the outlet level, you are able to truly manage your data center. Integrated with Eaton's management software, you can monitor these units from any computer on the network. The new advanced LCD display provides outlet and section current information, voltage and kilowatt-hour readings, all at a single glance.



Switched (SW) – individual outlet switching and sequencing (page 20)

Designed for data centers needing remote site management, the Switched ePDUs provide remote power monitoring of both voltage and current. The current is also displayed on a local two-digit current meter. These units also monitor both temperature and humidity.



Managed (MA) (page 22)

Eaton Managed ePDUs allow you to monitor and control critical factors such as voltage, current and power factor. This level of information allows you to make the right decision when it comes to energy consumption in your data center. You can also control the power at the individual outlet level, switching it on, off or rebooting it. Integrated with Eaton's management software, you can control these units from any computer on the network server. The new advanced LCD display provides outlet and section current information, voltage and kilowatt-hour readings, all at a single glance.



Eaton Automatic Transfer Switches (AT) (page 25)

Designed for switching non phase synchronized AC power sources, the automatic transfer switch ePDUs intelligent circuitry monitors both inputs, providing a fast switch transfer from primary to secondary source power critical equipment without interruption. These ePDUs assure the highest level of redundancy to mission-critical applications.

Why monitor?

The unique monitoring function of Eaton ePDUs allows you to remotely monitor the current draw of individual outlets or sections over a network. This, combined with state-of-the-art software, allows the user to aggregate the information from hundreds of ePDUs in one location. All monitored ePDUs also include the Easy-Read digital LED ammeter for easy start-up and provisioning of servers. This feature allows remote monitoring of current for capacity planning and energy management.

Key features and benefits

- Access circuit-level and ePDU-level information worldwide
- Get a global view across your ePDUs from any PC or server with Intelligent Power® Manager software (*you can learn more about Intelligent Power Manager on page 9*)
- Receive warnings and alarms remotely

Advanced Monitoring



Advanced monitoring allows you to monitor down to the individual outlet.

Key features:

- Monitor power consumption in kilowatt hours at the individual outlet level requirement
- Readings available via Ethernet connection over a network (utilizing Eaton's Intelligent Power Manager software)
- Power consumption readings allow for power usage effectiveness (PUE) calculations
- Easy-read LCD screen reduces local monitoring time
- UL Listed (UL489) branch circuit breakers meet industry requirements
- Cisco EnergyWise Certified—Eaton's new ePDUs are Cisco EnergyWise Certified

400-volt solution

Eaton 400V ePDUs limit energy loss through transformers by avoiding the 480-208V conversion. These units use European standard, three-phase 400V phase-to-phase and 230V phase-to-neutral to replace 208V phase-to-phase in the U.S. Operating power supplies at 230V versus 208V typically increases power supply efficiency.

400V ePDUs also distribute almost twice the power on the same copper to achieve multiple reductions. Eaton offers a unique power distribution solution for 400V applications. These applications include:

- Containerized data centers
- Customers looking for global standard
- Progressive data centers looking for cost reductions and efficiency gains

You can find 400V ePDUs featured in the Monitored, Switched and Managed sections of this catalog, as well as on eaton.com/epdu.

400V ePDU part numbers *(for reference)*

Monitored

- VPC2864-3861
- VPC2864-3862

Switched

- IPV70U1-EP1-09L
- IPV70U2-EP1-09L

Managed

- eMA013
- eMA014

ePDU software options

Eaton offers a number of software management tools for you based on the number of ePDUs you need to manage.

Software	Rack Quantity Best Supported	Type of Software	Application	Cost
Web Browser / Email	1-25	Included requires web browser	Data Closet Small Network Stand Alone	Included
SNMP	1-1000	Integrates to Third party software	Small to Large Enterprise	Low-High
IPM	1-200	Eaton software free to try	Small to Medium Enterprise	Low-Medium
Power Xpert®	100-1000	Eaton enterprise solution	Facility or Large Enterprise	High

Web browser / email alerts

Every network connected ePDU comes standard with built-in web server and email alert capability. To connect to any ePDU using a standard web browser to configure, monitor and control. If your network allows connection to an SMTP server, the ePDU can be configured to send email alerts using a Post Office Protocol 3 email account.

SNMP

Every network-connected ePDU supports SNMP alerts and has a standard MIB available for integration into third party software solutions. SNMP supports full monitoring and control with read/write capability for all major variables.

Cisco EnergyWise certification

Cisco EnergyWise certification confirms Eaton's dedication to engineering quality IT products and speaks to the importance of power consumption and measurement in today's data center space. With Eaton ePDUs and Cisco Energywise Software you can monitor voltage, frequency, amps and watts for each receptacle on your network (available with Advanced Monitored and Managed ePDUs).

Intelligent Power Manager (IPM)

Eaton's Intelligent Power Manager software integrates seamlessly with our ePDUs, giving you the tools you need to monitor and manage the power in your data center environment. You can also measure power consumption and kWh, which will help you calculate power usage effectiveness of the devices attached. Better yet, our software is fully compatible with the most popular management platforms in the industry, including VMware, Microsoft and Citrix. Our software is free of charge for up to 10 nodes. Download and learn more today at eaton.com/intelligentpowermanager.



Eaton's IPM dashboard allows you to easily monitor your network







Power Xpert software

Ideal as a facility enterprise solution, Power Xpert supports the full offering of Eaton's electrical products and offers support for third-party products. Power Xpert monitors alarms, logs current readings and environmental sensors on ePDU. There is a web-based dashboard view that allows you to drill down to a specific ePDU. Using the optional reporting package, it can generate customized power utilization reports.

Power Xpert also allows you to customize the conditions under which alarms are triggered and can run deployment validation tools during installation so all key setup requirements are automatically validated. To learn more, please visit eaton.com/pxs.

Basic ePDUs - 0U

Eaton Basic ePDUs provide reliable and cost-effective power distribution.

Catalog Number	Style Number	Input Plug	Breaker	Max kW	Function	Cord (ft)	Orientation	Receptacles	Dimensions (H x W x D, in)
ePBZ98	ePBZ98	5-15P	15A	1.44	BA	6	0U	(18) 5-15R	48.0 x 1.5 x 1.5
ePBZ89 	ePBZ89	C14	None	1.44	BA	6	0U	(16) C13	28.0 x 1.9 x 2.2
ePBZ75	ePBZ75	5-15P	None	1.44	BA	15	0U	(14) 5-15R	23.9 x 1.5 x 1.5
ePBZ73	ePBZ73	5-15P	(1) 15A	1.44	BA	15	0U	(18) 5-15R	48.0 x 1.5 x 1.5
ePBZ97 	ePBZ97	5-20P	(1) 20A	1.92	BA	6	0U	(24) 5-20R	60.0 x 1.5 x 1.5
ePBZ96	ePBZ96	L5-20P	(1) 20A	1.92	BA	6	0U	(24) 5-20R	60.0 x 1.5 x 1.5
ePBZ74	ePBZ74	L5-20P/5-20P	None	1.92	BA	15	0U	(14) 5-20R	23.9 x 1.5 x 1.5
ePBZ72	ePBZ72	L5-20P/5-20P	(1) 20A	1.92	BA	15	0U	(18) 5-20R	48.0 x 1.5 x 1.5
ePBZ77	ePBZ77	L5-20P/5-20P	(1) 20A	1.92	BA	15	0U	(24) 5-20R	60.0 x 1.5 x 1.5
ePBZ71	ePBZ71	L5-20P/5-20P	(1) 20A	1.92	BA	15	0U	(30) 5-20R	72.0 x 1.5 x 1.5
ePBZ90	ePBZ90	L5-30P	(2) 20A	2.88	BA	15	0U	(24) 5-20R	40.0 x 1.9 x 2.1
PW103BA0U257	V70BC2-N-SL-009	L5-30P	(2) 20A	2.88	BA	9	0U	(24) 5-20R	66.0 x 2.0 x 1.89
ePBZ93 	ePBZ93	L6-20P	(1) 20A	3.33	BA	6	0U	(20) C13, (4) C19	42.0 x 1.9 x 2.4
PW103BA0U237	V70NB4-N-SL-009	L6-20P	None	3.33	BA	9	0U	(24) C13, (4) C19	66.0 x 2.0 x 1.89
ePBZ93	ePBZ93	L6-20P	None	3.33	BA	10	0U	(20) C13, (4) C19	40.0 x 1.9 x 2.2
ePBZ92	ePBZ92	L6-30P	(2) 20A	4.99	BA	6	0U	(20) C13, (4) C19	42.0 x 1.9 x 2.2
PW105BA0U239 	V70BF5-N-SL-009	L6-30P	(2) 20A	4.99	BA	9	0U	(24) C13, (4) C19	66.0 x 2.0 x 1.89
PW105BA0U412	LPC1224-1P	L14-30P	(6) 15A	4.99	BA	6	0U	(12) 5-15R	10.0 x 7.75 x 3.0
ePBZ80	ePBZ80	L6-30P	(2) 20A	4.99	BA	10	0U	(30) C13, (6) C19	52.9 x 1.9 x 2.2
PW306BA0U241	VPC2864-A2-3846	L21-20P	None	5.76	BA	9	0U	(30) 5-20R	66.0 x 2.0 x 1.89
PW306BA0U244 	VPC2864-3850	L21-20P	None	5.76	BA	9	0U	(36) C13, (6) C19	66.0 x 2.0 x 1.89
PW306BA0U246	VPC2864-3856	L21-20P	None	5.76	BA	9	0U	(18) 5-20R, (6) L6-20R	66.0 x 2.0 x 1.89
PW309BA0U409	VPC3106-C2-15	L21-30P	(3) 20A	8.65	BA	9	0U	(24) 5-20R	70.0 x 2.0 x 3.8
PW314BA0U251	VPC2864-3858	CS8365	(2) 20A (1) 30A	14.4	BA	9	0U	(24) C13, (4) C19, (2) L6-30R	66.0 x 2.0 x 1.89
PW314BA0U253 	VPC2864-3853	CS8365	(3) 20A	14.4	BA	9	0U	(30) C13, (6) C19	66.0 x 2.0 x 1.89



ePBZ89



ePBZ97



ePBZ93



PW105BA0U239









PW306BA0U244



PW314BA0U253

Basic ePDUs - 1U

Catalog Number	Style Number	Input Plug	Breaker	Max kW	Function	Cord (ft)	Orientation	Receptacles	Dimensions (H x W x D, in)
PW101BA1U140 	T982A1-N-SS-009	5-15P	(1) 15A	1.44	BA	9	1U	(12) 5-15R	1.75 x 19.0 x 7.0
ePBZ86	ePBZ86	5-15P	None	1.44	BA	10	1U	(12) 5-15R	1.7 x 17.3 x 2.3
ePBZ83	ePBZ83	5-15P	None	1.44	BA	15	1U	(12) 5-15R	1.7 x 17.3 x 2.3
PW102BA1U158	T982A2-N-SS-009	5-20P	(1) 20A	1.92	BA	9	1U	(12) 5-20R	1.75 x 19.0 x 7.0
ePBZ99 	ePBZ99	L5-20P	(1) 20A	1.92	BA	6	1U	(12) 5-20R	1.75 x 19 x 2.4
PW102BA1U159	T982A2-N-SL-009	L5-20P	(1) 20A	1.92	BA	9	1U	(12) 5-20R	1.75 x 19.0 x 7.0
ePBZ85	ePBZ85	5-20P	None	1.92	BA	10	1U	(12) 5-20R	1.7 x 17.3 x 2.3
ePBZ82	ePBZ82	L5-20P/5-20P ¹	None	1.92	BA	15	1U	(12) 5-20R	1.7 x 17.3 x 2.3
PW103BA1U190	T982C2-N-SL-009	L5-30P	(2) 20A	2.88	BA	9	1U	(12) 5-20R	1.75 x 19.0 x 7.0
ePBZ84	ePBZ84	L5-30P	(2) 20A	2.88	BA	10	1U	(10) 5-20R	1.7 x 17.0 x 3.5
ePBZ78	ePBZ78	L5-30P	(2) 20A	2.88	BA	15	1U	(20) 5-20R	1.7 x 17.0 x 3.5
ePBZ88 	ePBZ88	C20	None	3.33	BA	6	1U	(10) C13, (2) C19	1.72 x 19.0 x 2.4
PW103BA1U405	TPC2104	C20	(1) 20A	3.33	BA	9	1U	(16) C13	1.75 x 19.0 x 7.0
ePBZ95 	ePBZ95	L6-20P	None	3.33	BA	6	1U	(12) C13, (1) C19	1.72 x 19.0 x 2.4
PW103BA1U191	T982B3-N-SL-009	L6-20P	(1) 20A	3.33	BA	9	1U	(12) C13	1.75 x 19.0 x 7.0
ePBZ94 	ePBZ94	L6-30P	(2) 20A	4.99	BA	6	1U	(6) C19	1.72 x 19.0 x 2.4
PW103BA1U406	TPC2105-1-107	L6-30P	(2) 15A	3.33	BA	9	1U	(16) C13	1.75 x 19.0 x 7.0
PW105BA1U163 	T982F3-N-SL-009	L6-30P	(2) 15A	4.99	BA	9	1U	(12) C13	1.75 x 19.0 x 7.0
PW105BA1U192	T982F4-N-SL-009	L6-30P	(2) 15A	4.99	BA	9	1U	(8) C13, (4) C19	1.75 x 19.0 x 7.0
PW105BA1U404	T982G1-N-SL-009	L14-30P	(2) 15A	4.99	BA	9	1U	(12) 5-15R	1.75 x 19.0 x 7.0
ePBZ91	ePBZ91	L6-30P	(2) 20A	4.99	BA	10	1U	(10) C13	1.7 x 17.0 x 3.5
ePBZ79	ePBZ79	L6-30P	(2) 20A	4.99	BA	15	1U	(16) C13, (4) C19	1.7 x 17.0 x 5.1
PW314BA1U193 	T17C19250-3-009	CS8365	(6) 20A	14.4	BA	9	1U	(6) C19	1.75 x 19.0 x 7.0

1. These units ship with an adapter allowing for 5-20P input plug.





FlexPDUs

Eaton FlexPDUs increase power distribution from a single UPS.

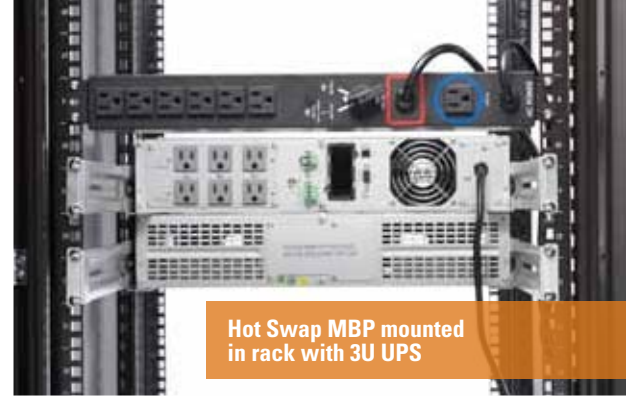
- 3-foot cord allows easy connection close to UPS without cable clutter
- Mounting bracket attaches directly to UPS
- Mounting bracket allows for vertical, 1U or UPS attachment



Hot Swap MBP mounted in rack with 3U UPS

Catalog Number	Style Number	Input Plug	Breaker	Max kW	Function	Cord (ft) ¹	Orientation	Receptacles	Dimensions (H x W x D, in)
EFLX1500R-PDU1U 	58015	5-15P	None	1.44	BA	3	1U	(12) 5-15R, (1) C19	1.7 x 17.3 x 2.3
EFLX2000R-PDU1U	58020	5-20P	None	1.92	BA	3	1U	(12) 5-20R	1.7 x 17.3 x 2.3
EFLX2000R-PDU1UL 	58021	5-20P	None	1.92	BA	3	1U	(5) L5-20R	2.0 x 17.3 x 3.0
EFLX3000R-PDU1UIEC 	68438	C20 Inlet	(2) 20A	3.33	BA	3	1U	(12) C13, (1) C19	1.7 x 17.3 x 2.3

1. Includes C19 to C14 and C19 to C20 jumper cables

Hot Swap Maintenance Bypass

Hot Swap MBPs enable easy UPS replacement without interruption to the connected load. Placing the Hot Swap MBP in bypass mode provides utility power to equipment while the UPS is being serviced.

Catalog Number	Style Number	Input Plug	Breaker	Max kW	Function	Cord (ft)	Orientation	Receptacles	Dimensions (H x W x D, in)
EHBPL1500R-PDU1U 	58115	5-15P	None	1.44	BA	8	2U	(6) 5-15R	2.1 x 17.3 x 3.8
EHBPL2000R-PDU1U	58120	5-20P	None	1.92	BA	8	2U	(6) 5-15R	2.1 x 17.3 x 3.8
EHBPL3000R-PDU1U	58130	L5-30P	(2) 20A	2.88	BA	3.3	2U	(5) 5-20R	2.1 x 17.3 x 3.8



FlexPDU mounted with 2U UPS



EFLX1500R-PDU1U



EFLX2000R-PDU1UL



EFLX13000R-PDU1UIEC



EHBPL3000R-PDU1U

Monitored ePDUs - OU

Eaton Monitored ePDUs enable you to remotely monitor the current draw of the unit and individual sections.

Catalog Number	Style Number	Input Plug	Breaker	Max kW	Function	Cord (ft)	Orientation	Receptacles	Dimensions (H x W x D, in)
PW101MI0U233	V70NA1-N-SS-109	5-15P	None	1.44	MI	9	OU	(24) 5-15R	66.0 x 2.0 x 1.89
PW102MI0U234	V70NA2-N-SS-109	5-20P	None	1.92	MI	9	OU	(24) 5-20R	66.0 x 2.0 x 1.89
PW102MI0U235	V70NA2-N-SL-109	L5-20P	None	1.92	MI	9	OU	(24) 5-20R	66.0 x 2.0 x 1.89
PW103MI0U236	V70BC1-N-SL-109	L5-30P	(1) 15A	2.88	MI	9	OU	(24) 5-15R	66.0 x 2.0 x 1.89
PW103MI0U238	V70NB4-N-SL-109	L6-20P	None	3.33	MI	9	OU	(24) C13, (4) C19	66.0 x 2.0 x 1.89
PW105MI0U240	V70BF5-N-SL-109	L6-30P	(2) 20A	4.99	MI	9	OU	(24) C13, (4) C19	66.0 x 2.0 x 1.89
PW105MI0U255	V70BJ3-N-SL-109	L14-30P	(2) 20A	4.99	MI	9	OU	(24) C13, (4) C19, (4) 5-20R	66.0 x 2.0 x 1.89
PW306MI0U242	VPC2864-A2-3847	L21-20P	None	5.76	MI	9	OU	(30) 5-20R	66.0 x 2.0 x 1.89
PW306MI0U243	VPC2864-3848	L21-20P	None	5.76	MI	9	OU	(24) C13, (3) C19, (6) 5-20R	66.0 x 2.0 x 1.89
PW306MI0U408	VPC2864-A1	L21-20P	None	5.76	MI	9	OU	(30) 5-15R	66.0 x 2.0 x 1.89
PW306MI0U245	VPC2864-3851	L21-20P	None	5.76	MI	9	OU	(36) C13, (6) C19	66.0 x 2.0 x 1.89
PW306MI0U247	VPC2864-3857	L21-20P	None	5.76	MI	9	OU	(18) 5-20R, (6) L6-20R	66.0 x 2.0 x 1.89
PW306MI0U416	VPC2864-3436	L21-20P	None	5.76	MI	10	OU	(42) C13	66.0 x 2.0 x 1.89
PW309MI0U248	VPC2864-3849	L21-30P	(3) 20A	8.64	MI	9	OU	(24) C13, (3) C19, (6) 5-20R	66.0 x 2.0 x 1.89
PW309MI0U250	VPC2864-3726	L21-30P	(3) 15A	8.64	MI	9	OU	(36) C13	66.0 x 2.0 x 1.89
PW309MI0U256	VPC2864-3852	L21-30P	(3) 20A	8.64	MI	9	OU	(30) C13, (6) C19	66.0 x 2.0 x 1.89
PW314MI0U252	VPC2864-3859	CS8365	(2) 20A (1) 30A	14.4	MI	9	OU	(24) C13, (4) C19, (2) L6-30R	66.0 x 2.0 x 1.89
PW314MI0U254	VPC2864-3854	CS8365	(3) 20A	14.4	MI	9	OU	(30) C13, (6) C19	66.0 x 2.0 x 1.89
PW317MI0U222	VPC3690	IEC309 460P9W	(6) 20A	17.3	MI	7	OU	(12) C13, (12) C19	66.0 x 4.0 x 1.89
VPC2864-3861	VPC2864-3861	IEC309 516P6W	None	14.4	MI	9	OU	(30) C13, (6) C19	66.0 x 2.0 x 1.83
VPC2864-3862	VPC2864-3862	IEC309 532P6W	(3) 20A	14.4	MI	9	OU	(30) C13, (6) C19	66.0 x 2.0 x 1.83

 These units have available temperature monitoring.



Optional sensors

SENSOR - T1-10

(1) Temperature sensor, 10' cable

SENSOR - T2-10

(2) Temperature sensor,
10' cable each



PW306MI0U247



PW309MI0U248



PW309MI0U250









PW309MI0U256



PW317MI0U222

Monitored ePDUs - 1U/2U

Catalog Number	Style Number	Input Plug	Breaker	Max kW	Function	Cord (ft)	Orientation	Receptacles	Dimensions (H x W x D, in)
PW101MI1U221	T982A1-N-SS-109	5-15P	(1) 15A	1.44	MI	9	1U	(12) 5-15R	1.75 x 19.0 x 7.0
PW101MI1U403	T982A2-F-SS-109	5-20P	(1) 20A	1.92	MI	9	1U	(12) 5-20R	1.75 x 19.0 x 7.0
PW102MI1U160 	T982A2-N-SL-109	L5-20P	(1) 20A	1.92	MI	9	1U	(12) 5-20R	1.75 x 19.0 x 7.0
PW103MI1U161	T982C2-N-SL-109	L5-30P	(2) 20A	2.88	MI	9	1U	(12) 5-20R	1.75 x 19.0 x 7.0
PW103MI1U162 	T982B3-N-SL-109	L6-20P	(1) 20A	3.33	MI	9	1U	(12) C13	1.75 x 19.0 x 7.0
PW105MI1U164	T982F3-N-SL-109	L6-30P	(2) 15A	4.99	MI	9	1U	(12) C13	1.75 x 19.0 x 7.0
PW105MI1U165 	T982F4-N-SL-109	L6-30P	(2) 15A	4.99	MI	9	1U	(8) C13, (4) C19	1.75 x 19.0 x 7.0
PW105MI2U402 	PC3783	L6-30P	(2) 20A	4.99	MI	15	2U	(20) C13	3.44 x 19.0 x 7.0
PW317MI2U141  	PC3623	IEC309 460P9W	(6) 20A	17.29	MI	10	2U	(12) C19	3.5 x 19.0 x 13.5

 These units have available temperature monitoring.



Optional sensors

SENSOR - T1-10

(1) Temperature sensor, 10' cable

SENSOR - T2-10

(2) Temperature sensor, 10' cable each

Front view



PW102MI1U160

Rear view



Front view



PW103MI1U162

Rear view



Front view



PW105MI1U165

Rear view



Front view









PW317MI2U141

Rear view



Advanced Monitored ePDUs

Eaton Advanced Monitored ePDU provides maximum power for both standard and blade server. Additionally this technology provides outlet level monitoring for capacity planning and energy management.

Catalog Number	Outlet Level Monitoring	Input Plug ¹	Breakers	Max kW	Orientation	Receptacles	Dimensions (H x W x D, in)
eAM008 	✓	L6-20P ²	None	3.3	0U	(20) C13, (4) C19	60.0 x 2.2 x 2.6
eAM001 	✓	L6-30P	(2) 20A	5.8	0U	(20) C13, (4) C19	68.0 x 2.2 x 2.6
eAM002 	✓	L21-20P	None	5.8	0U	(21) C13, (3) C19	60.0 x 2.2 x 2.6
eAM004 	✓	L21-30P	(3) 20A	8.6	0U	(21) C13, (3) C19	68.0 x 2.2 x 2.6
eAM003 	✓	CS8365	(3) 20A	12.6	0U	(21) C13, (3) C19	68.0 x 2.2 x 2.6
eAM005 	✓	IEC 309-460P9W	(6) 20A	17.3	0U	(12) C13, (12) C19	72.4 x 2.2 x 2.6

1. 10-ft cord length, all units

2. Detachable cordset, C20 cord is also included; 120V cords are optional. Please see accessories.



 **Optional sensors**
EMP001
 Environmental Monitoring
 Probe for Advanced
 Monitored and Managed
 ePDUs

Key technology features

- Outlet-level monitoring
- High accuracy monitoring
- Advanced LCD display
- Flexible mounting
- Color-coded section labeling



eAM008

eAM004

eAM005

Switched ePDUs

Eaton switched ePDUs provide remote power monitoring of both voltage and current and provide outlet-level control for on/off/reboot capabilities.

Catalog Number	Style Number	Input Plug	Breaker	Max kW	Function	Cord (ft)	Orientation	Receptacles	Dimensions (H x W x D, in)
PW101SW0U224 	IPV70A1-EP1-09S	5-15P	None	1.44	SW	9	0U	(16) 5-15R	66.0 x 2.0 x 1.89
PW102SW0U150 	IPV42A2-EP1-09L	L5-20P	None	1.92	SW	9	0U	(8) 5-15R	42.0 x 2.0 x 1.89
PW102SW0U151 	IPV70A5-EP1-09L	L5-20P	None	1.92	SW	9	0U	(24) 5-15R	66.0 x 2.0 x 1.89
PW103SW0U152 	IPV70C5-EP1-09L	L5-30P	(2) 15A	2.88	SW	9	0U	(16) 5-15R	66.0 x 2.0 x 1.89
PW103SW0U153 	IPV70B2-EP1-10L	L6-20P	None	3.33	SW	10	0U	(24) C13	66.0 x 2.0 x 1.89
PW105SW0U154 	IPV70F3-EP1-09L	L6-30P	(2) 15A	4.99	SW	9	0U	(16) C13	66.0 x 2.0 x 1.89
PW306SW0U155 	IPV70K1-EP1-09L	L21-20P	None	5.76	SW	9	0U	(24) 5-15R	66.0 x 2.0 x 1.89
PW306SW0U156 	IPV70M1-EP1-09L	L21-20P	None	5.76	SW	9	0U	(24) C13	66.0 x 2.0 x 1.89
PW309SW0U178 	IPV70R1-EP1-09L	L21-30P	(3) 20A	8.64	SW	9	0U	(24) C13	66.0 x 2.0 x 3.5
PW317SW0U400 	IPV70T2-EP1-12L	IEC309 460P9W	(6) 20A	17.29	SW	12	0U	(18) C13, (6) C19	66.0 x 2.0 x 4.0
PW317SW0U401 	IPV70T1-EP1-12L	IEC309 460P9W	(6) 20A	17.29	SW	12	0U	(12) C13, (12) C19	66.0 x 2.0 x 4.0
IPV70U1-EP1-09L 	IPV70U1-EP1-09L	IEC309 516P6W	None	14.4	SW	9	0U	(24) C13	66.0 x 2.0 x 1.83
IPV70U2-EP1-09L 	IPV70U2-EP1-09L	IEC309 516P6W	None	14.4	SW	9	0U	(18) C13, (6) C19	70.0 x 2.0 x 4.0
PW103SW2U413 ¹	IPC3401-NET	C20	(1) 20A	3.33	SW	NA ²	1U	(8) C13	1.7 x 19.0 x 9.5
PW103SW2U414 ¹	IPC3402-NET	C20	(1) 20A	3.33	SW	NA ²	1U	(8) 5-15R	1.7 x 19.0 x 9.5
PW105SW2U415 	IPC36F4N2USW15L	L6-30P	(2) 20A	4.99	SW	9	2U	(20) C13, (4) C19	3.5 x 19.0 x 9.5
PW105SW2U223 	IPC36F4N2USW09L	L6-30P	(2) 20A	4.99	SW	9	2U	(20) C13, (4) C19	3.5 x 19.0 x 9.5

1. Model does not have local or remote current or voltage monitoring but features local on/off buttons in addition to remote switching.

2. Input power cord sold separately.

 These units have available temperature monitoring.



Optional sensors

SENSOR - T1-10

(1) Temperature sensor, 10' cable

SENSOR - T2-10

(2) Temperature sensor,
10' cable each

SENSOR - T1H1-10

(1) Temperature and humidity
sensor, 10' cable

SENSOR - T2H1-10

(1) Temperature and humidity
sensor, 10' cable
(1) Temperature sensor, 10' cable



PW101SW0U224



PW102SW0U150



PW103SW0U152



PW103SW0U153











PW105SW0U154



PW309SW0U178

Managed ePDUs

Eaton Managed ePDUs allow you to monitor and control critical factors such as voltage, current and power factor down to the individual outlet.

Catalog Number	Outlet Level Monitoring	Outlet Level Switching	Input Plug ¹	Breakers	Max kW	Orientation	Receptacles	Dimensions (H x W x D, in)
eMA012 	✓	✓	L6-20P ²	None	3.3	0U	(20) C13, (4) C19	60.0 x 2.2 x 2.6
eMA006 	✓	✓	L21-20P	None	5.8	0U	(21) C13, (3) C19	60.0 x 2.2 x 2.6
eMA010 	✓	✓	L6-30P	(2) 20A	5.8	0U	(20) C13, (4) C19	68.0 x 2.2 x 2.6
eMA011 	✓	✓	L21-30P	(3) 20A	8.6	0U	(21) C13, (3) C19	68.0 x 2.2 x 2.6
eMA013 	✓	✓	IEC 309-516P6W	None	11.5	0U	(12) C13, (12) C19	68.0 x 2.2 x 2.6
eMA007 	✓	✓	CS8365	(3) 20A	12.6	0U	(21) C13, (3) C19	68.0 x 2.2 x 2.6
eMA009 	✓	✓	IEC 309-460P9W	(6) 20A	17.3	0U	(12) C13, (12) C19	72.4 x 2.2 x 2.6
eMA014 	✓	✓	IEC 309-532P6W	(6) 20A	17.3	0U	(12) C13, (12) C19	72.4 x 2.2 x 2.6

1. 10-ft cord length, all units

2. Detachable cordset, C20 cord is also included; 120V cords are optional. Please see accessories.



Optional sensors

EMP001
Environmental Monitoring Probe for Advanced Monitored and Managed ePDUs

Key technology features

- Outlet-level monitoring
- Outlet-level power switching (on/off/reboot)
- High accuracy monitoring
- Advanced LCD display
- Flexible mounting
- Color-coded section labeling



Color-coded receptacles



Advanced LCD display



eMA012

eMA010

eMA009

Managed



Managed ePDUs allow you to monitor and control critical factors such as voltage, current and power factor down to the individual outlet.

Key features:

- Monitor and control power consumption at the outlet level, including on, off and reboot
- Advanced LCD display offers easy user-interface and vast power information
- Single-phase and three-phase configurations provide solutions for SMB and networking closets, large data centers and blade server applications
- PUE level 3 rating determines high energy efficiency
- Environmental monitoring probe tracks internal and external temperatures, giving you key information to help reduce cooling costs – needs to be ordered separately
- Cisco EnergyWise Certified– Eaton’s new ePDUs are Cisco EnergyWise Certified

Color-coded receptacles



LEDs represent each outlet

Environmental monitoring

You can utilize the Environmental Monitoring Probe to track internal and external temperatures, humidity and contact closure. This information allows you to operate the ePDU up to 50°C (122° F), in turn reducing cooling costs. (Part number EMP001).



Advanced LCD display

This new advanced LCD display provides outlet and section current information, voltage and kilowatt-hour readings, all at a single glance. The display is accompanied with a three-button interface that allows you to navigate through the user-friendly menu structure. Dual-color display blinks when a system alarm is detected, providing local notification.



Network management interface





Local buttons allow for easy navigation of the menu

Serial port for local configuration and environmental monitoring, 10/100 Ethernet port for network connectivity



Eaton Automatic Transfer Switches

The Eaton eATS ePDUs automatically transfer power from the primary source to a secondary source.

Catalog Number	Style Number	Input Plug	Breaker	Max kW	Function	Cord (ft)	Orientation	Receptacles	Dimensions (H x W x D, in)
PWATSS515002 	T2235-A1-NNB09S	(2) 5-15P	None	1.44	AT	9	1U	(8) 5-15R	1.72 x 19.0 x 7.0
PULSTS1400R-1U	66027	(2) 5-15P	None	1.44	AT	6	1U	(6) 5-15R	1.72 x 19.0 x 9.8
PWATSS520003	T2235-A2-NNB09S	(2) 5-20P	None	1.92	AT	9	1U	(8) 5-20R	1.72 x 19.0 x 7.0
PWATSL520004	T2235-A2-NNB09L	(2) L5-20P	None	1.92	AT	9	1U	(8) 5-20R	1.72 x 19.0 x 7.0
PWATSL530005	T2235-C2-CNB09L	(2) L5-30P	(1) 20A	2.88	AT	9	1U	(8) 5-20R	1.72 x 19.0 x 9.5
PWATSL530007 	T2235-3369	(2) L5-30P	(1) 30A	2.88	AT	9	1U	(1) L5-30R	1.72 x 19.0 x 7.0
PWATSSC20001 	T2235-AB-NNBC20	(2) C20	None	1.92	AT	NA ¹	1U	(8) C13, (1) C19	1.72 x 19.0 x 7.0
PULSTS16AMPR-1U	66028	(2) C20	None	3.33	AT	6	1U	(6) C13, (1) C19	1.72 x 19.0 x 9.8
PWATSL630006 	T2235-F3-CNB09L	(2) L6-30P	(2) 15A	4.99	AT	9	1U	(12) C13	1.72 x 19.0 x 7.0
PWATSL630008	T2235-3358	(2) L6-30P	None	4.99	AT	9	1U	(1) L6-30R	1.72 x 19.0 x 7.0

1. Input power cord sold separately.



Intelligent Power Control

Catalog Number	Full Load	Receptacles	Circuit Breaker	EMI/RFI Filter	Surge Suppression	Input Plug	Cord (ft)	Ethernet Control	Serial Control (RS232)	Dimensions (H x W x D, in)
IPC3401	1920 VA @ 120V~ 3840 VA @ 240V~	(8) C13	(2) 20A	20A	270V	C20 Inlet	Power cables must be ordered separately. Refer to page 43 for power cable options.	No	Yes	1.7 x 19.0 x 9.5
IPC3401-NET	1920 VA @ 120V~ 3840 VA @ 240V~	(8) C13	(2) 20A	20A	270V	C20 Inlet		Yes	Yes	1.7 x 19.0 x 9.5
IPC3402	1920 VA	(8) 5-15R	(1) 20A	20A	270V	C20 Inlet		No	Yes	1.7 x 19.0 x 9.5
IPC3402-NET	1920 VA	(8) 5-15R	(1) 20A	20A	270V	C20 Inlet		Yes	Yes	1.7 x 19.0 x 9.5
IPC3402-A2	1920 VA	(8) 5-20R	(1) 20A	20A	270V	C20 Inlet		No	Yes	1.7 x 19.0 x 9.5
IPC3402-A2-NET	1920 VA	(8) 5-20R	(1) 20A	20A	270V	C20 Inlet		Yes	Yes	1.7 x 19.0 x 9.5
IPC3402-2756	2880 VA	(4) 5-20R, (4) 5-15R	(1) 20A, (1) 10A	N/A	270V	L5-30P	10	Yes	Yes	1.7 x 19.0 x 9.5
IPC3402-2930	2880 VA	(8) 5-15R	(1) 20A, (1) 10A	N/A	270V	L5-30P	10	Yes	Yes	1.7 x 19.0 x 9.5

Please refer to page 43 for power cable assemblies to match your country specific requirements.

(11) Indicator lights

- Main power to system-CB on
- Individual power on to outlets 1-8
- Data acquisition and remote disable

Remote or local control

- Serial RS232 port (DB9 Male) for direct computer or modem connection
- RS485 input/output for strapping up to 10 systems together over CAT.5 cable
- Local: one on/off switch for each outlet
- NET SYSTEMS ONLY: RJ45 for network connections (Ethernet)

Remote disable

With the push of a button, disable remote access to the IPC when needed

Power supply

The IPC3401 series features a full range power supply for operation at 100-240 Vac input/output

EMI/RFI filtering

- Common mode - line to ground
- Differential mode - line to line
- Filtered inlet isolates noise before entering the system
- Refer to chart 3 on page 40
- IPC3402-2756 and IPC3402-2930 do not have filtering

Spike/surge suppression (TVSS)

- Line to line
- Refer to chart 1 on page 40
- Multi-stage, both MOVs and SAPs

Outlet status

- Query the IPC for Outlet and Watch Dog status

Strapping

- Strapping allows up to 10 IPCs (80 outlets) to be controlled at one address
- Units are connected together via the RS485 "IN" and "OUT" connectors

Multiple time delay (MTD)

- Sequence power up and power down to outlets with a one second time delay (factory set)
- Set power on sequence to any combination of outlets
Set the MTD timing from 1 second to 999 seconds, i.e. 009 = 9 seconds



Software controls

- Multi-platform compatible
- Control via terminal emulation software
- Web interface for browser control

Commands available

- All outlets on/off or specific outlets on/off
- Set up and sequence on/off all outlets
- Create password and unit address
- Outlet naming (8 characters)
- Set up, enable or disable Watch Dog
- Display outlet and Watch Dog timer status
- Automatically receive update outlet status whenever there's a change
- Auto-reboot outlet 1 with a five-second delay on restart

Intelligent Power Control IPC3600 Series

Catalog Number	Full Load	Ethernet/ Serial	Receptacles	Circuit Breaker	EMI/RFI Filter	Surge Suppression	Input Plug	Cord (ft)	Dimensions (H x W x D, in)
IPC3601 	1920 VA @ 120V~ 3840 VA @ 240V~	Yes	(8) C13	(1) 20A	20A	Yes	C20 Inlet	Not Included	1.7 x 19.0 x 19.5
IPC3602 	1920 VA	Yes	(8) 5-15R	(1) 20A	20A	Yes	C20 Inlet	Not Included	1.7 x 19.0 x 19.5
IPC3601-F3-3316	5760 VA	Yes	(8) C13	(2) 15A	No	Yes	L6-30P	10	1.7 x 19.0 x 19.5



(12) Indicator lights

- Main power system on
- Power on to outlets 1-8
- Two data and ethernet link

EMI/RFI filtering

- Common mode - line to ground
- Differential mode -line to line
- Filtered inlet isolates noise before entering the system
- Refer to chart 4 on page 40

Spike/surge suppression

- Line to neutral (or line)
- Refer to chart 1 on page 40

Serial/ethernet

- Serial RS232 via RJ22 connector on the rear. 6' RJ22 to DB9 cable included
- Serial baud rate is 9600 default or 38,400 maximum
- Ethernet (10/100) network via RJ45 connector on the rear. 6' network cable included
- Network setup allows DHCP or any static public/private IP address

Software interfaces

- Web interface provides a graphic control interface through a Web browser
- Telnet interface provides a text menu control interface with any terminal emulation software
- SNMP allows read/write capability with trapping
- Email notification system provides email alerts or logs showing user activity

- Serial interface provides a text menu control interface with any terminal emulation software
- FTP utility allows firmware upgrades

Software security

- User name/password security
- Settings allow the administrator to disable unused interfaces

Software features

- Administrator and multiple users can be configured
- User level access can be limited to specific outlets
- Unit and outlet names can be configured
- Outlet groups can be created to perform an action on multiple outlets
- Outlet control includes individual, group and all outlet global control
- Outlet actions include on or off and reboot
- Global sequence allows all the outlets to be turned on or off in a preset sequence up to 999 seconds
- Outlet reboot automatically turns an outlet off and back on with one command at a preset time up to 999 seconds
- Email notification allows up to two email addresses to receive notifications of alerts or events

Auto-event scheduling

Administrator can configure on or off events for outlets or groups. The event occurs at the preset time daily or weekly.

Intelligent Power Control IPC3400 series

Catalog Number	Full Load	Receptacles	EMI/RFI Filter	Surge Suppression	Cord (ft)	Power Input Plug	Serial Control (RS232)	Ethernet Control	Dimensions (H x W x D, in)
IPC3400-A1	1440 VA	(4) 5-15R	15A	270V	9	5-15P	Yes	No	3.4 x 9.0 x 5.8
IPC3400-A1-NET 	1440 VA	(4) 5-15R	15A	270V	9	5-15P	Yes	Yes	3.4 x 9.0 x 5.8
IPC3400-AB	1440 VA/2880 VA	(4) C13	15A	270V	8	C14	Yes	No	3.4 x 9.0 x 5.8
IPC3400-AB-NET	1440 VA/2880 VA	(4) C13	15A	270V	8	C14	Yes	Yes	3.4 x 9.0 x 5.8



IPC3400-A1-NET

(6) Indicator lights

- (1) Main power
- (1) Data light
- (4) Power on to outlets 1-4

Communications

- RS232, Serial: 9600 baud only
- Optional ethernet control via RJ45 connector (add -NET to part number)
- Data terminal emulation software is required to communicate with the IPC internal command codes such as telnet or hyperterminal

EMI/RFI filtering

- Common mode - line to ground
- Differential mode - line to line
- Refer to chart 2 on page 40

Spike/surge suppression

- L-N, L-G, N-G
- Refer to chart 1 on page 40

Outlet status

Query the IPC for Outlet and Watchdog status, i.e. outlets are (on or off)

Multiple time delay (MTD)

- Turn outlets on or off at one time
- Sequence power up and power down to outlets 1 - 4 with a four-second time delay (factory set)
- Set power on sequence to any combination of outlets
- Set the MTD timing from one second to 999 seconds, i.e. 009 = 9 seconds

Password protection

For added security, a password feature is included which allows you to assign a three alphanumeric character password

Addressing

The IPC comes with a default address but you can also create your own with any four alphanumeric characters

Watch-dog/auto-reboot

- The IPC monitors the control connection and automatically reboot itself if the connection locks up. The auto-reboot is activated by the time-out period running down to zero. When this occurs the IPC shuts down all outlets for four seconds and restart in the default or user defined sequence
- Set the time out period to any number 0-9 where each digit represents 30 seconds, i.e. 3 = 120 seconds (user defined)

Commands available

- All outlets on/off
- Individual outlet on/off
- Set up and sequence on/off all outlets
- Create password and unit address
- Name outlets with eight character name
- Set up, enable or disable Watchdog
- Display outlet and Watchdog timer status

North American TPC115-10 series single-phase systems

120V~ OR 240V~, 15A, 20A and 30A, 50/60 Hz

Catalog Number	Full Load	Receptacles	Circuit Breaker	EMI/RFI Filter	Multi-Stage Surge Suppression	Cord (ft)	Input Plug	Dimensions (H x W x D, in)
TPC115-10-A	1440 VA	(10) 5-15R	(1) 15A	20A	270V/150V	9	5-15P	1.7 x 19.0 x 8.0
TPC115-10-A2	1920 VA	(10) 5-20R	(1) 20A	20A	270V/150V	9	5-20P	1.7 x 19.0 x 8.0
TPC115-10-B	2880 VA	(10) 6-15R	(2) 15A	20A	320V/270V	9	N/A	1.7 x 19.0 x 8.0
TPC115-10-C	2880 VA	(10) 5-15R	(2) 15A	30A	270V/150V	15	L5-30P	1.7 x 19.0 x 8.0
TPC115-10-D 	2880 VA	(10) 5-20R	(2) 15A	30A	270V/150V	15	L5-30P	1.7 x 19.0 x 8.0
TPC115-10-F	5760 VA	(10) 6-15R	(2) 15A	30A	320V/270V	15	L6-30P	1.7 x 19.0 x 8.0

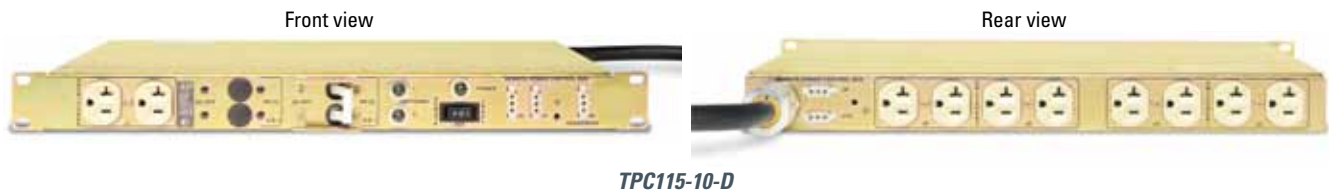

(10) NEMA outlets

- Two unswitched on front and eight switched on rear panel. Unswitched outlets are tied to the SW-II outlet section

(3) Indicator lights

- Main breaker power on and power to the unswitched outlets
- Power on to the SW-I outlets
- Power on to the SW-II outlets

Spike/surge suppression

- L-N, L-G, N-G
- Refer to Chart 1 on page 40

EMI/RFI filtering

- Common mode line to ground
- Differential mode line to line
- Refer to page 40

Local/off/remote switching

- Local: Power on or off to the switched outlets
- Off: When breaker is on but this switch is in the off mode, you have power to the unswitched outlets only
- Remote: Power on or off to the switched outlets via a remote device
- Latching remote, on LT systems, has the selection switch wired for remote/off/remote - There is no local control

Multiple time delay (MTD)

- Activated locally or remotely, SW-I outlets power up immediately, followed four seconds later by SW-II outlets which is followed four seconds later by the sequenced remote I/O port.
- Add /MTD after part number, i.e. TPC115-10-A/MTD

Remote I/O ports

- Three front/two rear (see page 39)
- Remote on/off and EPO control, EPO overrides remote and local control
- Sequence power up additional equipment down line (third connector on front panel)
- Latching remote feature - (N/C) EPO, momentary start – Add -LT to the part number when the MTD feature is not being used – Add /LT to the part number when the MTD feature is used

International TPC2365 series single-phase systems

110-125V/200-240V~,16A, Single Phase, 50/60 Hz

Catalog Number	Circuit Breaker	Multiple Time Delay	EMI/RFI Filter	Surge Suppression	Receptacles	Remote Control	Cord (ft)	Input Plug	Dimensions (H x W x D, in)
TPC2365 	(1) 20A	No	Yes (20A)	320V	(12) C13	Standard	Not Included	C20 Inlet	1.7 x 19.0 x 8.0
TPC2365/MTD	(1) 20A	Yes	Yes (20A)	320V	(12) C13	Standard	Not Included	C20 Inlet	1.7 x 19.0 x 8.0
TPC2365-LT	(1) 20A	No	Yes (20A)	320V	(12) C13	Latching	Not Included	C20 Inlet	1.7 x 19.0 x 8.0
TPC2365/LT	(1) 20A	Yes	Yes (20A)	320V	(12) C13	Latching	Not Included	C20 Inlet	1.7 x 19.0 x 8.0
TPC2365-2980	(1) 10A	Yes	Yes (30A)	320V	(12) C13	Latching	15	Bare Wire	1.7 x 19.0 x 8.0
TPC2365-3732	(1) 10A	Yes	Yes (30A)	320V	(12) C13	Latching	15	L6-30P	1.7 x 19.0 x 8.0



TPC2365

EMI/RFI filter

- Differential mode - line to line
- Common mode - line to ground
- Refer to Chart 4 on page 40

Spike/surge suppression

- Line to line
- Refer to Chart 1 on page 40

Remote selection switch

- Local: Power on or off to the switched outlets
- Off: When breaker is on but this switch is in the off mode, you do not have power to the outlets
- Remote: Power on or off to the switched outlets via a remote device
- Latching remote on LT models only, the selection switch is wired for remote/off/remote - There is no local control
- Refer to page 39 for remote configurations

Remote interface

- Remote on/off and EPO control - EPO overrides remote and local control
- Sequence power up additional equipment down line (standard on all units)
- Latching remote LT models only - normally closed EPO, momentary start

Optional multiple time delay (MTD)

- Activated locally or remotely, section 1 powers up, followed four seconds later by section 2 which is followed four seconds later section 3 then four seconds later the sequenced remote activates the next system in line

(5) Indicator lights

- Power to section 1, 2 and 3
- 115 Vac or 230 Vac input selected

Auto-voltage selection

The AVS system automatically senses the input voltage and adjusts the internal components to use that voltage for the output

North American TPC4100 series three-phase systems

120/208V~ Three-Phase WYE, 20A and 30A, 50/60 Hz

Catalog Number	Receptacles	Circuit Breaker	Remote	EMI/RFI Filter	Surge Suppression	Cord (ft)	Input Plug	Dimensions (H x W x D, in)
TPC4100-A2	(12) 5-20R	(3) 20A	No	30A	150V	9	L21-20P	1.7 x 19.0 x 9.5
TPC4100-B	(12) 6-15R	(3) 15A	No	30A	270V	9	L21-30P	1.7 x 19.0 x 9.5
TPC4100-AB 	(6) 5-15R, (6) 6-15R	(3) 15A	No	30A	150V	9	L21-30P	1.7 x 19.0 x 9.5
TPC4100-C	(12) 5-15R	(3) 15A	No	30A	150V	9	L21-30P	1.7 x 19.0 x 9.5
TPC4100-D	(12) 5-20R	(3) 20A	No	30A	150V	9	L21-30P	1.7 x 19.0 x 9.5
TPC3474	(6) 5-20R, (6) 6-20R	(3) 20A	Yes - Latching	No	150V	9	L21-30P	1.7 x 19.0 x 9.5



EMI/RFI filtering

- Common mode - line to ground
- Differential mode - line to line
- Refer to Chart 8 on page 40

Spike/surge suppression

- Line to line
- Refer to Chart 1 on page 40

(3) Indicator lights

Provided for each phase power on via breaker

North American PC2641 series three-phase systems

120/208V~ Three-Phase WYE, 30A, 50/60 Hz

Catalog Number	Full Load Per Phase	Receptacles	Main Circuit Breaker (on/off switch)	Secondary Circuit Breakers Per Phase	Unswitched Duplex Circuit Breaker	EMI/RFI Filter	Surge Suppression	Cord (ft)	Remote Control	Multiple Time Delay	Input Plug	Dimensions (H x W x D, in)
PC2641-D 	2880 VA	(14) 5-20R	(1) 30A	(3) 20A	(1) 20A	30A	320V	15	Standard Remote	No	L21-30P	3.4 x 19.0 x 14.5
PC2641-D-LT	2880 VA	(14) 5-20R	(1) 30A	(3) 20A	(1) 20A	30A	320V	15	Latching Remote	No	L21-30P	3.4 x 19.0 x 14.5
PC2641-D/MTD	2880 VA	(14) 5-20R	(1) 30A	(3) 20A	(1) 20A	30A	320V	15	Standard Remote	Yes	L21-30P	3.4 x 19.0 x 14.5
PC2641-D/LT	2880 VA	(14) 5-20R	(1) 30A	(3) 20A	(1) 20A	30A	320V	15	Latching Remote	Yes	L21-30P	3.4 x 19.0 x 14.5



PC2641-D

(14) NEMA outlets

- Two unswitched outlets
- 12 switched outlets, four per phase

(4) Indicator lights

- Main breaker power on to system and unswitched duplex
- Power on to PH-X, -Y, -Z outlets

Spike/surge suppression

- 320V MOV L-N
- Refer to Chart 1 on page 40

EMI/RFI filtering

- Common mode - line to ground
- Differential mode - line to line
- Refer to Chart 9 on page 40

Local/off/remote switching

- Local: Power on or off to the switched outlets
- Off: When breaker is on but this switch is in the off mode, you will have power to the unswitched outlets only
- Remote: Power on or off to the switched outlets via a remote device
- When using the latching remote, the selection switch is wired for remote/off/remote. There is no local control.

Multiple time delay (MTD)

- PH-X powers up immediately, followed four seconds later by PH-Y, which is followed four seconds later PH-Z, then four seconds later the sequenced remote activates the next system in line
- PC2641-D/MTD and PC2641-D/LT only models

(4) Remote I/O ports

- Remote on/off and EPO control, EPO overrides remote and local control
- Sequence power up additional equipment down line (standard on all units)
- Latching remote - normally closed EPO, momentary start. Units with LT in part number, i.e. PC2641-D-LT or /LT

This system is designed to be controlled locally or remotely via a remote control panel (refer to pages 38-39).

North American PC975 series three-phase systems

120/208V~ Three-Phase WYE, 30A, 50/60 Hz

Catalog Number	Full Load Per Phase	Main Circuit Breaker (on/off switch)	Secondary Circuit Breakers Per Phase	Unswitched Duplex Circuit Breaker	EMI/RFI Filter	Surge Suppression	Receptacles	Cord (ft)	Input Plug	Dimensions (H x W x D, in)
PC975, PC975-LT 	2880 VA	(4) 30A	(3) 2-Pole 20/20	20A thermal reset	30A	270V	(8) 5-20R and (3) L6-20R	15	L21-30P	3.4 x 19.0 x 14.5
PC975-1969, PC975-1969/LT	2880 VA	(4) 30A	N/A	20A thermal reset	30A	270V	(8) 5-20R and (3) L21-30R	15	L21-30P	3.4 x 19.0 x 14.5
PC975-2109, PC975-2109-LT	2880 VA	(4) 30A	(3) 1-Pole 20	15A thermal reset	30A	270V	(8) 5-15R and (3) L5-30R	15	L21-30P	3.4 x 19.0 x 14.5

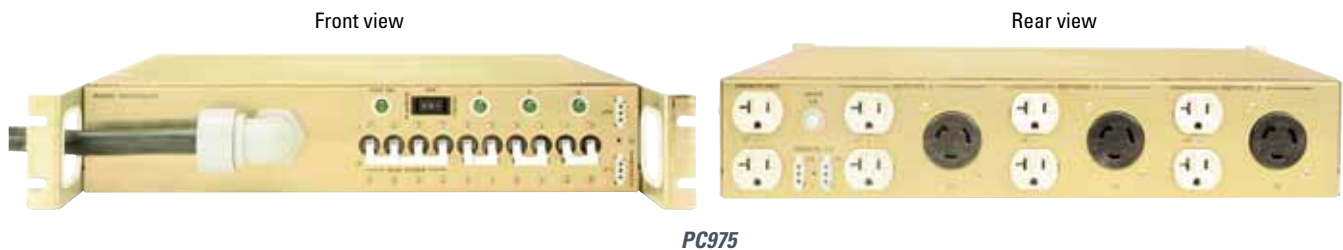

EMI/RFI filtering

- Common mode - line to ground
- Differential mode - line to line
- Refer to Chart 9 on page 40

Spike/surge suppression

- 270V MOV L-N
- Refer to Chart 1 on page 40

(4) Indicator lights

- Main breaker power on
- Power on to PH-X, Y and Z

Local/off/remote switching

- Local: Power on or off to the switched outlets
- Off: When breaker is on but this switch is in the off mode, you have power to the unswitched outlets only
- Remote: Power on or off to the switched outlets via a remote device
- When using the latching remote option, the selection switch is wired for remote/off/remote. There is no local control

Multiple time delay (MTD)

- Activated locally or remotely, PH-X powers up, followed four seconds later by PH-Y, which is followed four seconds later PH-Z, then four seconds later the sequenced remote activates the next system in line

(4 N/O) Remote I/O ports

- Remote on/off and EPO control, EPO overrides remote and local control
- Sequence power up additional equipment down line (standard on all units)
- Latching remote - (N/C) EPO, momentary start. LT systems

This system is designed to be controlled locally or remotely via a remote control panel (refer to pages 38-39).

International PC302-I/MTD three-phase systems

120/208V~ or 230/400V~ Three-Phase WYE, 20A, 50/60Hz

Catalog Number	Full load Per Phase	Main Circuit Breaker	Receptacles	EMI/RFI Filter Per Phase	Surge Suppression	Input	Dimensions (H x W x D, in)
PC302-I/MTD 	1920 VA or 3680 VA	(1) 20A	(14) C13	20A	270V	Terminal Block	3.4 x 19.0 x 14.5
PC302-I/LT	1920 VA or 3680 VA	(1) 20A	(14) C13	20A	270V	Terminal Block	3.4 x 19.0 x 14.5



PC302-I/MTD

EMI/RFI filter

- Differential mode
- Common mode
- Refer to Chart 2 on page 40

Spike/surge suppression

- Line to line
- Refer to Chart 1 on page 40

Voltage selection switch

- Select 120/208V~ or 230/400V~ input
- 120/208V~ input with 120V~ output
- 230/400V~ input with 230V~ output

Local/off/remote switching

- Local: on/off to switched outlets
- Off: When breaker is on but this switch is in the off mode, you will have power to the unswitched outlets only
- Remote: on/off to switched outlets via a remote control device
- Latching remote, the selection switch is wired for remote/off/remote. There is no local control on the PC302-I/LT

Remote control

- Remote on/off and EPO control, EPO overrides remote and local control
- Sequence power up additional equipment down line
- Latching remote - (N/C) EPO, momentary start on PC302-LT only

Multiple time delay (MTD)

- Activated locally or remotely, PH-X powers up, followed four seconds later by PH-Y, which is followed four seconds later PH-Z, then four seconds later the sequenced remote activates the next system in line

(6) Indicator lights

- Main power on
- Power to phase X, Y and Z
- 120/208V~ input selected
- 230/400V~ input selected

See pages 38-39 for optional control panels.

Required Cable Assembly Options:

CBL100: 20A with 12/5 cable 9' long terminated with a NEMA L21-20P for use in North America at 120/208V~

CBL102: 20A with 5x2.5mm Harmonized cable 9' long. A plug is not provided so that you can provide the country specific plug for use in Europe at 230/400V~



International PC2672 series three-phase systems

120/208V~ OR 230V/400V~, Three-Phase WYE, 30A, 50/60 Hz

Catalog Number	Full Load Per Phase	Circuit Breaker	Secondary Listed Breakers, (1) Each For The C19 Outlets	Secondary Listed Breakers, (1) Each For A Pair of C13 Outlets	Receptacles	EMI/RFI Filter	Cord (ft)	Dimensions (H x W x D, in)
PC2672 	2880 VA at 120/208V or 5520 VA at 230/400V	(3) 30A	(4) 16A	(6) 10A	(12) C13 (4) C19 (1) IEC309 32A	30A	5	5.2 x 19.0 x 16.5

Cable Assembly Options:

CBL113: 10/5 cable 9' long terminated with a NEMA L21-30P at one end and a mating IEC309 connector at the other end. For use in North America at 120/208V~

CBL114: 5x4.0 mm harmonized cable 9' long with an IEC309 connector at both ends. For use in Europe at 230/400V~



EMI/RFI filtering

- Common mode - line to ground
- Differential mode - line to line
- Refer to Chart 9 on page 40

(3) Indicator lights

- Power on to PH-X, -Y, -Z





(4) Remote I/O ports

- Two front / Two rear: one on each side is sequence and the other is for remote on/off and EPO control. The PC2672 is controlled remotely only
- Latching remote - (N/C) EPO between pins 2 & 3, momentary start between pins 1 & 3

This system is designed to be controlled locally or remotely via a remote control panel (refer to pages 38-39).

Non-rackmount power distribution units

UPS extension systems

Catalog Number	Circuit Breaker	Input Voltage	Output Voltage	EMI/RFI Filtering	Surge Suppression	Receptacles	Cord (ft)	Input Plug	Dimensions (H x W x D, in)
LPC120P 	(4) 15A	120V~ / 30A	20V~ / 30A	N/A	N/A	(8) 5-15R ¹	6	L5-30P	3.0 x 7.8 x 10.0
LPC208-1P 	N/A	240V~ / 30A	240V~ / 30A	N/A	N/A	(4) L6-30R	6	L6-30P	3.0 x 7.8 x 10.0
LPC208-2P 	(3) 20A	240V~ / 30A	240V / 30A	N/A	N/A	(3) L6-20R, (1) L6-30R	6	L6-30P	3.0 x 7.8 x 10.0
LPC1224-1P 	(6) 15A	120-240V~ / 30A	120V	N/A	N/A	(12) 5-15R ¹	6	L14-30P	3.0 x 7.8 x 10.0
LPC2872-1 	N/A	100-240V~ / 20A	100-240V~ / 20A	N/A	N/A	(6) C13	C20 Inlet	N/A	3.0 x 7.8 x 10.0

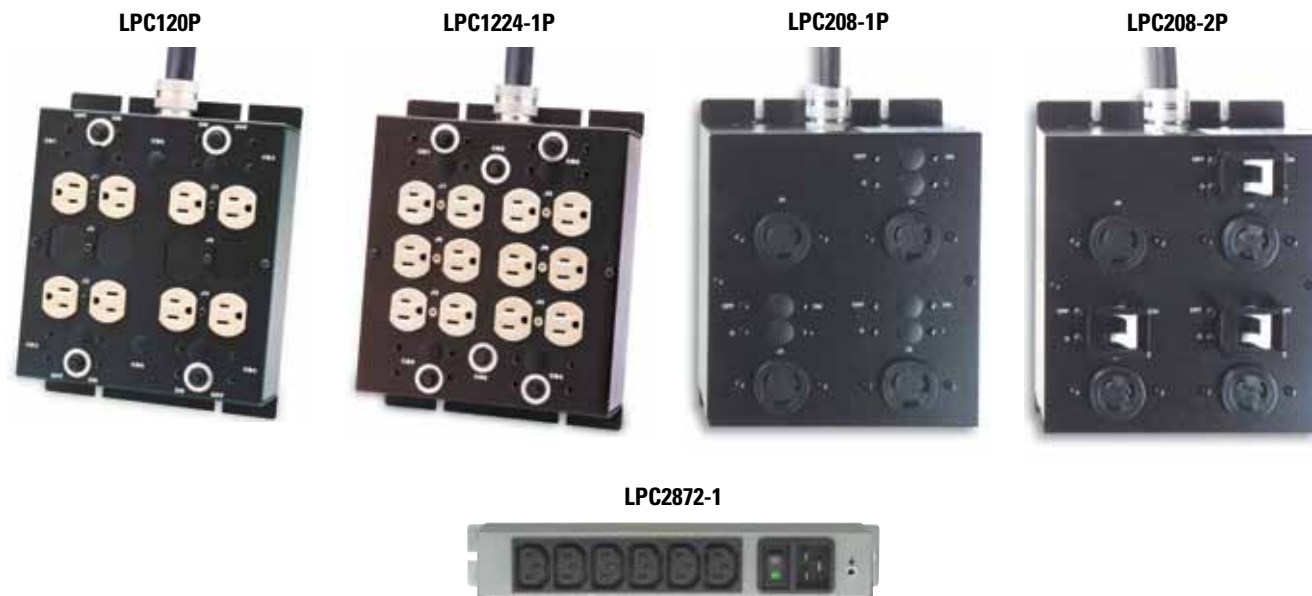

1. 15A thermal reset breaker for each duplex

2. Each L6-30R with a 2-pole 20A breaker and kick guard and (1) L6-30R unswitched outlet



Remote control panels

Allows immediate and complete 'power off' control from one button.

Model	Remote Type	Dimensions (H x W x D, in)	Color	Receptacle	Switch/EPO
RCP100-GRY 	Standard	1.73 x 19.0 x 2.0	Gray	None	2-position/normally open
RCP100-BLK	Standard	1.73 x 19.0 x 2.0	Black	None	2-position/normally open
RCP100-GRY-LT'	Latching	1.73 x 19.0 x 2.0	Gray	None	3-position/normally closed
RCP100-BLK-LT' 	Latching	1.73 x 19.0 x 2.0	Black	None	3-position/normally closed

1. Latching (LT) control panels must be ordered with power distribution units that are latching, identified by LT at the end of the part number.



RCP100-BLK-LT



RCP100-GRY

Rack mounted

- Flush mounted, 18 GA. Steel
- Painted FED-STD 595 #26559 light texture gray
- Optional: Painted FED-STD 595 #26038 black
- Remote cable is 15' long

Emergency Power Off (EPO)

- RCP100-GRY: Locking (N/O) EPO button for PDUs with the standard 3-pin remote I/O port. Turn to reset.
- RCP100-GRY-LT: Locking (N/C) EPO button for PDUs with the latching (LT) option. Turn to reset.
- Per European requirements, there is a yellow square behind the EPO button

On/off switch

- RCP100-GRY: 2-position ON/OFF switch
- RCP100-GRY-LT: 3-position spring return dial switch for OFF (turns unit off and holds off), ON (puts unit in a standby mode), START is a momentary action and powers up the unit

Sample remote circuits

Standard remote control interface

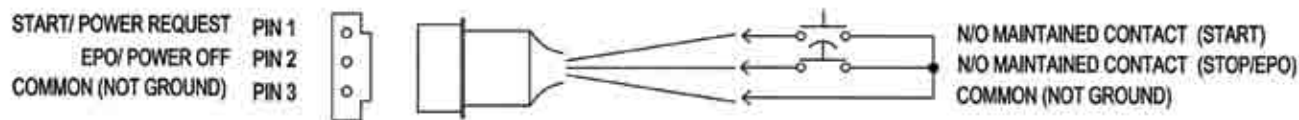

REMOTE START REQUIRES (2) CONDITIONS:

1. The on/off/remote switch must be in the remote position.
2. A maintained closure between pins 1 & 3 turns the unit on.

REMOTE POWER OFF REQUIRES (1) CONDITION:

Opening the maintained connection between pins 1 & 3 turns off the switched outlets.

REMOTE EPO REQUIRES (1) CONDITION:

A maintained contact between pins 2 & 3 turns off the switched outlets regardless of the position of the on/off/remote switch.

SEQUENCED REMOTE:

Connect pins 1, 2 & 3 of the sequence port to pins 1, 2 & 3 on any remote port of the slave unit. (Do not connect to another sequence port!)

The sequence port of the master unit activates four seconds after the final set of outlets turn on. Additional units may be daisy chained in this fashion.

CAUTION!

THIS TYPE OF REMOTE IS NOT TO BE SUBSTITUTED FOR A SAFETY INTERLOCK!

EPO is normally open, so removing the EPO connection will not shut down the power to the unit.

Latching remote LT control interface

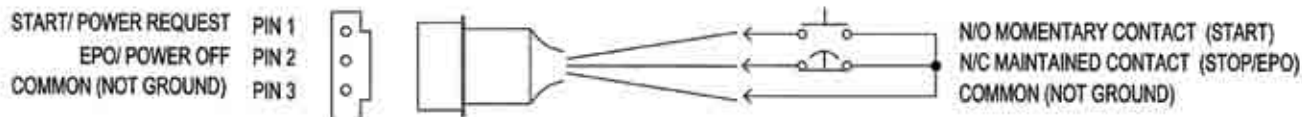

REMOTE START REQUIRES (2) CONDITIONS:

1. A maintained contact between pins 2 & 3.
2. A momentary contact between pins 1 & 3.

REMOTE POWER OFF OR EPO REQUIRES (1) CONDITION:

Opening the maintained connection between pins 2 & 3. Additional EPO or stop buttons can be connected in series between pins 2 & 3.

This turns off the switched outlets regardless of the remote switch position.

SEQUENCE REMOTE:

Connect pins 1 & 2 of the sequence port to any remote port on another -LT unit. The sequence port activates four seconds after the final set of outlets turn on. (Do not connect to another sequence port!)

NOTE: LT units are designed for remote operation only. Even when the REMOTE/OFF/LOCAL switch is set to LOCAL, the unit still requires a power request from the remote ports to turn the unit on.

REMOTE OPERATION: Most Eaton units have more than one remote connector. Unless labeled as SEQUENCE they are wired in parallel. Connection to only one remote connector is required. It is recommended that an Eaton control panel be ordered for use with your PDU. Connectors are provided for those who wish to wire their own switches or control panels. We recommend using 14 AWG wire and not exceeding 50 feet for any remote cable. Mating control panels can be seen on our website at eaton.com/epdu.

If additional remote connectors are needed: The female AMP connectors used in our Power Controllers are: three pin - part number 1-480304-0 and four pin part number 1-480425-0, and are used with AMP Socket Terminals, part number 60619-1. The mating male AMP connector is: three pin - part number 1-480305-0, and four pin - part number 1-480426-0 and are used with AMP male contacts part number 60620-1.

Industrial ePDUs environmental, surge suppression and EMI/RFI filter performance

Chart 1:

TVSS (Transient Voltage Surge Suppression) MOV Specifications			
Continuous AC Voltage	150 Vac	270 Vac	320 Vac
Continuous DC Voltage	200 Vdc	360 Vdc	420 Vdc
Max. DC Leakage	200 μ A	200 μ A	200 μ A
Low Varistor Voltage Limit	212 Vdc	389 Vdc	462 Vdc
High Varistor Voltage Limit	243 Vdc	453 Vdc	540 Vdc
Nominal Varistor Voltage	236 Vdc	424 Vdc	503 Vdc
Current For Varistor Voltage	1 mA	1 mA	1 mA
Max. Clamp Voltage 8x20 μ s	360V	680V	810V
Max. Clamp Voltage Test Current	100A	100A	100A
Peak Current Rating (1 Pulse)	12000A	10000A	10000A
Peak Current Rating (2 Pulse)	9000A	6500A	6500A
Energy Rating (10x1000 μ s)	170J	325J	385J
Energy Rating (8x20 μ s)	170J	325J	385J
Capacitance	1700 pF	970 pF	820 pF
Impulse Response Time	50 ns	50 ns	50 ns

Chart 2: 001-3000

EMI/RFI Filtering Common Mode Insertion Loss				
Mhz.	.2	1.0	2.0	10.0
dB.	15	25	45	50

Differential Insertion Loss				
Mhz.	.2	1.0	2.0	10.0
dB.	10	22	32	50

Chart 3: 010-0317

EMI/RFI Filtering Common Mode Insertion Loss						
Mhz.	.01	1	10	20	50	100
dB.	8	29	40	50	68	40

Differential Insertion Loss						
Mhz.	.01	1	10	20	50	100
dB.	8	23	45	58	32	28

Chart 4: 025-2023

EMI/RFI Filtering Common Mode Insertion Loss						
Mhz.	.15	.50	1.0	5.0	10.0	30.0
dB.	6	19	28	42	45	50

Differential Insertion Loss						
Mhz.	.15	.50	1.0	5.0	10.0	30.0
dB.	6	6	30	50	30	30

Chart 5: 025-3021

EMI/RFI Filtering Common Mode Insertion Loss						
Mhz.	.15	.50	1.0	5.0	10.0	30.0
dB.	6	19	28	42	45	50

Differential Insertion Loss						
Mhz.	.15	.50	1.0	5.0	10.0	30.0
dB.	2	40	60	65	57	55

Chart 6: 025-2833

EMI/RFI Filtering Common Mode Insertion Loss							
Mhz.	.1	.5	1.0	5.0	10.0	20.0	50.0
dB.	18	40	48	62	80	70	60

Differential Insertion Loss							
Mhz.	.1	.5	1.0	5.0	10.0	20.0	
dB.	21	33	41	50	50	50	

Chart 7: 025-4000

EMI/RFI Filtering Common Mode Insertion Loss						
Mhz.	.05	.20	1.0	5.0	20.0	100.0
dB.	0	35	71	75	66	48

Differential Insertion Loss						
Mhz.	.05	.20	1.0	2.0	5.0	10.0
dB.	20	30	72	63	58	51

Chart 8: 025-3031

EMI/RFI Filtering Common Mode Insertion Loss						
Mhz.	.05	.15	.50	1.5	5.0	20.0
dB.	4	18	38	44	50	50

Differential Insertion Loss						
Mhz.	.05	.15	.50	1.5	5.0	20.0
dB.	12	20	40	60	50	50

Rack Power Module

The Rack Power Module (RPM) delivers up to 36 kW (hardwire option required, BladeUPS connector limits to 12 kW) of power to loads of various voltages, power cords and layouts. The 3U RPM can be deployed in the same rack with the UPS and IT equipment; there's no need for a dedicated infrastructure rack. The resulting architecture has fewer cables to manage, fewer distribution points to monitor and greater flexibility for IT personnel to make changes without an electrician. This unit is typically deployed with the Eaton BladeUPS units.

Features:

- Provides plug-and-play primary distribution of power from a three-phase input source to secondary power distribution devices
- Serves data center loads with various voltages, power cord configurations and layouts
- Distributes three-phase power to 12 poles, grouped into two sets of six poles, with choice of output receptacle types
- Power Equalizer LED display gives quick visual indication of each circuit's load, reducing possibility of overloads and breakers tripped off line
- Load information available from the front of the rack, no need to check individual power strips in the rear of the cabinet (hot isle)
- Branch circuit monitoring option allows easy load monitoring over the network
- Installs in only 3U of space in EIA 19" rack or enclosure (or wall mounted), all hardware included
- Enables customer installation and changes without the services of a licensed electrician



RPM part number guide

(Base 3U RPM distribution box) **Y 0 3** **0** **0 0 0 0 0**

Input voltage
 1 = 208V
 2 = 400V

Input cords/connection
 0 = Hardwire
 1 = BladeUPS Connector 208V
 2 = IEC309-60 5 wire
 3 = L21-30P
 4 = BladeUPS Connector 400V











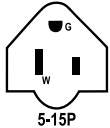
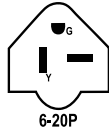

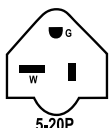
Input cords length
 0 = Hardwire
 1 = 6 feet
 2 = 10 feet
 3 = 15 feet
 4 = 20 feet

Metering choices
 1 = Power Equalizer
 2 = Energy Management System, NO Card
 3 = Energy Management System, with card

Output receptacle plate #1 & #2
 1 = L21-20R 9 = L14-30R
 2 = L21-30R A = C13 (208V)
 3 = L6-15R B = C19 (208V)
 4 = L6-20R C = C13 (230V) International
 5 = L6-30R D = C19 (230V) International
 6 = 5-15R E = L15-20R
 7 = 5-20R F = L15-30R
 8 = L14-20R

ePDU plugs and receptacles

Standard NEMA plugs

 <p>5-15P 120V 15A 1 phase straight blade</p>	 <p>6-20P 208V 20A 1 phase straight blade</p>	 <p>L21-20P 120/208V 20A, 3 phase wye</p>	 <p>L22-20P 277/480V 20A 3 phase wye</p>
 <p>5-20P 120V 20A 1 phase straight blade</p>	 <p>L6-20P 208V 20A 1 phase twist lock</p>	 <p>L21-30P 120/208V 30A 3 phase wye</p>	 <p>L22-30P 277/480V 30A 3 phase wye</p>
 <p>L5-20P 120V 20A 1 phase twist lock</p>	 <p>L6-30P 208V 30A, 1 phase</p>	 <p>L15-20P 208V 20A 3 phase delta</p>	
 <p>L5-30P 120V 30A 1 phase twist lock</p>	 <p>L14-30P 120/240V 30A 2 phase (split phase)</p>	 <p>L15-30P 208V 30A 3 phase delta</p>	



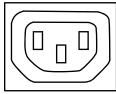
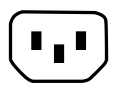
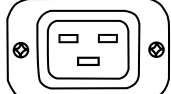
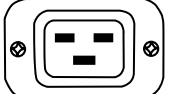

The IEC advantage:

The IEC320 and IEC309 connectors described below are the most commonly specified. The IEC connector system is used throughout the world. By utilizing an Eaton ePDU with the IEC connectors, you can attach the correct cable assembly for British, Australian, Continental European, North American and many other cable/connector configurations. This allows you to purchase and inventory one ePDU for shipment anywhere in the world.

IEC320

 <p>C13</p>	 <p>C14</p>	 <p>C19</p>	 <p>C20</p>
North American Europe	15 amp 10 amp	250 volts 250 volts	20 amp 16 amp
			250 volts 250 volts

IEC309

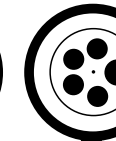
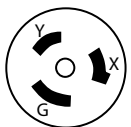
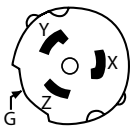
30A	60A	30A	60A	60A	60A
 <p>332P6 250V</p>	 <p>360P6 250V</p>	 <p>532P6 3ØY230/400V</p>	 <p>460P9 3Ø250V</p>	 <p>560P9 3ØY120/208V</p>	 <p>563P6 3ØY230/400V</p>
50A, 2P3W 250V	50A, 3P4W 3Ø250V				
 <p>HBLCS8265C</p>	 <p>HBLCS8365C</p>				

General ePDU environmental specifications

- Operating temperature is 0 to 50°C (32-122°F)
- Storage temperature is -40 to 70°C (-40 to 158°F)
- Altitude maximum 10,000 ft.
- Relative humidity is 95% max non-condensing

Power cables and accessories

By turning to Eaton, you can enjoy one-stop shopping for a full range of power quality and power distribution needs, including power cables. The Eaton cable portfolio includes nearly two dozen choices in three product categories including adapters, jumpers and splitters.

All Eaton power cables are tested and certified for use with Eaton products, such as ePDUs, rack power modules (RPMs) and UPSs—proven to deliver the reliability and service life needed for the most rigorous data center applications.

Splitter cables



CBL139 Splitter Cable
L14-30R to (2) L6-30R (4 ft/2 ft)



CBL143 Splitter Cable
L14-30R to (2) L5-30R (4 ft/2 ft)



CBL148 Splitter Cable
L14-20R to (2) L5-20R (4 ft/2 ft)



CBL149 Splitter Cable
L21-30R to (3) L5-30R (4 ft/2 ft/1 ft)



CBL150 Splitter Cable
L21-20R to (3) L5-20R (4 ft/2 ft/1 ft)

Additional accessories



EMP001
Environmental Monitoring Probe
Advanced Monitored and
Managed ePDUs only

Adapter cables



010-0032:
C14 to 5-15R
125V, 15A
1 foot, 16 AWG/3-wire



010-9335:
5-20P to C19
125V, 20A straight blade
8-foot, 12 AWG/3-wire



010-9337:
6-20P to C19
250V, 20A straight blade
8-foot, 12 AWG/3-wire



010-9339:
L5-20P to C19
125V, 20A twist-lock
8-foot, 12 AWG/3-wire



010-9341:
L6-20P to C19
250V, 20A twist-lock
8-foot, 12 AWG/3-wire



010-9342:
C20 Male to C19
20A
8-foot, 12 AWG/3-wire



010-0034:
8-foot, 12 AWG/3-wire
C19 to bare wire
(Pig Tail)



010-9334:
5-15P to C19
125V, 15A straight blade
8-foot, 14 AWG/3-wire



010-9336:
6-15P to C19
125V, 15A straight blade
8-foot, 14 AWG/3-wire



010-9338:
L5-15P to C19
125V, 15A twist-lock
8-foot, 14 AWG/3-wire



010-9340:
L6-15P C19 to
250V, 15A twist-lock
8-foot, 14 AWG/3-wire

Jumper Cables



010-0025: 8-foot
010-0027: 6-foot
010-0028: 4-foot
010-0029: 2-foot
C14 to C13



010-9365
C14 to C19, 8-foot



010-9369-03
C20 to C13, 3-foot
010-9369-06
C20 to C13, 6-foot

Outlet Caps



035-0113:
C13 outlet cap



035-0119:
C19 outlet cap

Temperature & humidity sensors



Optional sensors

SENSOR - T1-10
(1) Temperature sensor, 10' cable

SENSOR - T2-10
(2) Temperature sensor,
10' cable each

SENSOR - T1H1-10

(1) Temperature and humidity
sensor, 10' cable

SENSOR - T2H1-10

(1) Temperature and humidity
sensor, 10' cable
(1) Temperature sensor, 10' cable

Space-saving mounting options

Installing your new ePDU is quick and easy. There are models that mount horizontally in minimal rack space (1U or 2U), or vertically in rack side pockets or rear channels—or on a wall or floor, saving traditional U space for IT equipment.

The units come with all mounting hardware included, ready to install. There's no need to purchase additional mounting hardware or accessories. Some units use a button-mount system and can be mounted in keyhole-type openings in popular racks, with no tools required.

Horizontal mounting

Mounting Brackets Are Detachable With Several Mounting Options Shown

Front Flush

Optional Zero-U Bracket
Part Number - 001-1928-1

Rack Mounting Hole Specification Table

HOLE SPECIFICATION TABLE

A	Y	Z
1.75	.25	1.25
3.5	.875	1.75
5.25	.875	3.5

Vertical mounting

SUB-HRDWARE-017 - Standard mounting included, brackets come attached to units.

Tool-less Mounting

Button mount with clip feet

Blind mount to rail with clip feet

Bracket mount with clip feet

Mounting style for vertical Basic models with part numbers that start with EPBZ.

For a detailed mounting process, please refer to our mounting video on eaton.com/epdu

Space-saving mounting options

Industry standard keyhole button mounting

Variable clip-foot mounting

Attach clip foot to rail

Snap ePDU to clip foot

Mounting style for eAM and eMA only

Benefits of vertical mounts

Eaton ePDUs can be mounted vertically, allowing you to save valuable space. You can mount them vertically in rack side pockets, rear channels – or on a wall, which allows you to save traditional U space for IT equipment.

Cable restraints and management

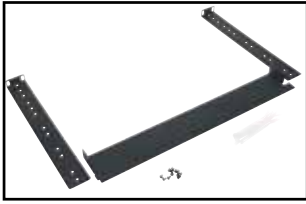

KIT-CABLRES-01



KIT-CABLRES-08



Transverse mounting



Transverse mounting

- Prevent downtime and accidental disconnection
- Secure cables/plugs to PDU
- Cable ties provide highest level of retention
- Black adjustable bracket versions allow front or rear mounting
 - KIT-CABLRES-01 - fits 9.5" deep units
 - KIT-CABLRES-03 - fits 7" deep units
- Fixed bracket versions allow attachment to rear only
 - KIT-CABLRES-08 - Black



Vertical Models	Cable Tray
V42 Series	KIT-CABLRES-21
V70A1 Series	KIT-CABLRES-24
V70A2 Series	KIT-CABLRES-24
V70AB Series	KIT-CABLRES-22
V70Bx Series	KIT-CABLRES-24
V70Cx Series	KIT-CABLRES-24
V70F1 Series	KIT-CABLRES-24
V70F2 Series	KIT-CABLRES-24
V70F3 Series	KIT-CABLRES-24
V70F4 Series	KIT-CABLRES-24
V70G1 Series	KIT-CABLRES-24
V70H1 Series	KIT-CABLRES-24
V70J1 Series	KIT-CABLRES-24
VPC1917-1	KIT-CABLRES-23
VPC1917-4,-5	KIT-CABLRES-23
VPC1917-6	KIT-CABLRES-24
VPC1917-7	KIT-CABLRES-23
VPC2769-A2	KIT-CABLRES-24
VPC2769-B2	KIT-CABLRES-23
VPC2864 Series	KIT-CABLRES-23
VPC3106 Series	KIT-CABLRES-23
AM/MA Series	KBLT01

Rackmount Models	Cable Tray
IPC34XX Series	KIT-CABLRES-01
IPC36XX Series	KIT-CABLRES-01
T17	KIT-CABLRES-03
T982 Series	KIT-CABLRES-03
TPC115-10 Series	KIT-CABLRES-08
T9092 Series	KIT-CABLRES-08
TPC2104 Series	KIT-CABLRES-08
TPC2105 Series	KIT-CABLRES-03
TPC2234 Series	KIT-CABLRES-08
T2235-Ax Series (Black 7")	KIT-CABLRES-03
T2235-Cx Series (Black 9.5")	KIT-CABLRES-01
T2235-Fx Series (Black 9.5")	KIT-CABLRES-01
TPC4100 Series	KIT-CABLRES-01

You must purchase cables separately.

Racks and airflow management

Once you've decided which Eaton ePDU is best for your application, it's time to find the perfect rack to install them in. Eaton's provides a full line of racks and airflow management solutions, for you to store, cool, power, manage and secure your critical IT equipment.

To view our entire portfolio of solutions, please visit powerquality.eaton.com.



Eaton Paramount enclosure system

Our premier enclosure platform, Paramount not only supports an industry leading 2,200 pounds of equipment in a fully welded frame, but it is also designed to adapt to the ever-changing requirements of the data center through a scalable and modular approach. Speed of deployment is essential to any company when considering time to market. Paramount's modularity and building block design ensures quick reconfigurations and minimizes downtime, protecting your initial investment.

Eaton Vantage S2 enclosure system

The Vantage S2 enclosure platform was designed with change in mind, which is why so many Fortune 500 companies have standardized on it. Eaton's forward-thinking design engineers continue to develop scalable enclosure solutions to help customers store their latest technology without having to change enclosure platforms, allowing them to maximize their original investment.



Active Airflow Manager

Eaton's HCS pressure based system with active airflow, when combined with best practices, improves performance metrics considerably. Allocating the correct amount of airflow at known intake locations is the key to reducing energy consumption while increasing equipment performance. Best practices such as blanking panels, proper perforated tile placement and the reduction of bypass airflow must be employed to ensure desired results.



HCS for third-party racks

Convert existing enclosures to the HCS to eliminate the incremental capital expense associated with having to add more CRAC units or other supplemental cooling.

Eaton Heat Containment System (HCS)

Eaton's HCS is a simple, scalable and low cost rack-based solution to cool up to 25 kW or more per enclosure without the expense of adding supplemental CRAC units to your data center. This patented technology is available on Eaton's Paramount and Vantage S2 enclosure systems and can also be field retrofitted to most manufacturers' enclosures. The HCS contains and directs the heat exhaust of your IT equipment through the chimney that is attached to the top rear of the enclosure. The hot air is then ducted to your existing CRAC units through a plenum ceiling or high air returns.



Photo courtesy of Humana

Visit powerquality.eaton.com to view Eaton's entire portfolio of racks, enclosures and airflow management solutions



UNITED STATES
8609 Six Forks Road
Raleigh, NC 27615
Toll Free: 1.800.356.5794

Eaton.com/epdu

CANADA
Ontario: 416.798.0112
Toll free: 1.800.461.9166

LATIN AMERICA
Aruba: 001 866 898 8812
Argentina (South Cone): +5411 4124
4000
Bahamas: 1 800 389 0368
Brazil: +55 113616 8500

Colombia: 01 800 518 1490
Costa Rica: 0 800 012 1716
Dominican Republic: 1 888 751 4862
Ecuador: from Andinatel: 1 999 170
(code after 800 is WSC 5649)
El Salvador: 800 6772
Mexico: + 52 (55) 9000-5252 or 01 800
08 EATON (32866)
Miami: 1 866 248 2224
Guatemala: 1 800 624 0099

Jamaica: 800 534 2102
Nicaragua: 001 800 220 1992
Panama: 00 800 226 6524
Peru: 0 800 54 514
Puerto Rico: 1 877 740 1707
Trinidad & Tobago: 1 800 206 0981
Venezuela: 0 800 100 8474

Eaton, Powerware, Power Xpert and ePDU
are trade names, trademarks, and/or service
marks of Eaton Corporation or its subsidiaries
and affiliates.