

ZQ630 Plus

Mobile Printers



User Guide



ZEBRA

Contents

Proprietary Statements	6
Document Conventions	8
Introduction to the ZQ630 Plus Printer	9
Unpacking and Inspection.....	10
Reporting Damage.....	10
ZQ630 Plus Technology	11
PowerPrecision+ (PP+) Battery 	11
Printing Technology.....	12
QR Code	13
Made for iPhone (MFi)	13
Near Field Communication (NFC).....	14
Color LCD Display	14
Radio-Frequency Identification (RFID)	14
RFID Calibration	16
ZQ630 Plus Overview	17
Getting Ready to Print	19
Battery.....	19
Removing the Battery	19
Removing the Battery Tape Insulator.....	20
Installing the Battery	21
Battery Safety	22
Charger Safety.....	22
AC Power Adapter	23

Charging the Battery	23
Ethernet and Charging Cradle	24
LED Status Indicator	24
Printer Operation with Cradle.....	26
1-Slot Battery Charger	27
Charging Status Indicators.....	27
3-Slot Battery Charger	28
Loading the Media into the ZQ630 Plus Printer	29
Loading Media Procedure.....	29
Loading Media in Peel-Off Mode	31
Operator Controls	32
Standard Control Panel.....	32
Normal Boot-up LED Behavior.....	33
Sleep Mode LED Behavior.....	33
Shutdown Behavior.....	33
Power LED Ring Behavior	34
LCD Control Panel	35
Status Bar Icons.....	36
Home Menu Screen	38
Home Screen Icons and Parameters.....	40
Alert Messages	41
Buttons.....	42
Power-Up Sequences	42
Runtime Sequences without LED Flashes.....	42
Sleep Mode.....	43
Adaptive Print Performance	44
Draft Mode	44
Verify the Printer is Working.....	45
Printing a Configuration Label.....	45
Connecting the Printer	46
Cable Communication.....	47
RS-232C Communications	47
USB Communications.....	47
Providing Strain Relief for Communications Cable	48
Installing Drivers and Connecting to a Windows-Based Computer ..	49
Installing the Drivers	49

Running the Printer Installation Wizard.....	51
What to Do If You Forget to Install Printer Drivers First	56
Connect to a Phone or Tablet.....	59
Zebra Setup Utilities.....	59
Adding a Printer through Zebra Setup Utilities.....	60
Wireless Communications with Bluetooth	67
Bluetooth Networking Overview	67
Bluetooth Security Modes	68
Bluetooth Minimum Security Modes	69
WLAN Overview	70
Setting Up the Software	71
Designing Labels	71
Using Pre-Printed Receipt Media.....	73
Black Mark Dimensions (Receipt Media).....	73
Label Areas	73
Label Design Examples	74
Keep-Out Areas	75
Near Field Communication (NFC).....	76
NFC Use Cases	77
Passive	77
Wearing the Printer	78
Swivel Belt Clip	78
Adjustable Shoulder Strap	79
Soft Case	80
Hand Strap.....	81
Hard Case.....	82
Waist Holster.....	83
Preventive Maintenance	84
Extending Battery Life.....	84
General Cleaning Instructions.....	84
LCD Control Panel Indicators	87
Troubleshooting Topics	88
Troubleshooting Tests	90
Printing a Configuration Label.....	90
Communications Diagnostics.....	90

Specifications	95
Printing Specifications.....	95
Memory and Communications Specifications	95
Label Specifications	96
Physical, Environmental and Electrical Specifications.....	96
CPCL Font and Bar Code Specifications and Commands.....	96
ZPL Font and Bar Code Specifications and Command	98
Communication Ports.....	99
ZQ630 Plus Dimensions	101
ZQ630 Plus Mounting Hole Dimensions	102
ZQ630 Plus Accessories.....	103
Appendix A.....	105
Interface Cables (RS-232 Cables).....	105
USB Cables	106
Appendix B.....	107
Media Supplies	107
Appendix C.....	107
Maintenance Supplies.....	107
Appendix D.....	108
Appendix E.....	129
Appendix F	130
Battery Disposal	130
Product Disposal.....	130
Appendix G	131
Using Zebra.com.....	131
Appendix H.....	133
Contact Support	133

Copyright

© 2023 Zebra Technologies Corporation and/or its affiliates. All rights reserved. ZEBRA and the stylized Zebra head are trademarks of Zebra Technologies Corporation, registered in many jurisdictions worldwide. All other trademarks are the property of their respective owners.

COPYRIGHTS AND TRADEMARKS: For complete copyright and trademark information, go to zebra.com/copyright

WARRANTY: For complete warranty information, go to zebra.com/warranty

END USER LICENSE AGREEMENT: For complete EULA information, go to zebra.com/eula

PATENTS: For complete patent information, go to zebra.com/patents

Terms of Use

Proprietary Statement: This manual contains proprietary information of Zebra Technologies Corporation and its subsidiaries ("Zebra Technologies"). It is intended solely for the information and use of parties operating and maintaining the equipment described herein. Such proprietary information may not be used, reproduced, or disclosed to any other parties for any other purpose without the express, written permission of Zebra Technologies.

Product Improvements: Continuous improvement of products is a policy of Zebra Technologies. All specifications and designs are subject to change without notice. **Liability Disclaimer:** Zebra Technologies takes steps to ensure that its published Engineering specifications and manuals are correct; however, errors do occur. Zebra Technologies reserves the right to correct any such errors and disclaims liability resulting therefrom.

Limitation of Liability: In no event shall Zebra Technologies or anyone else involved in the creation, production, or delivery of the accompanying product (including hardware and software) be liable for any damages whatsoever (including, without limitation, consequential damages including loss of business profits, business interruption, or loss of business information) arising out of the use of, the results of use of, or inability to use such product, even if Zebra Technologies has been advised of the possibility of such damages. Some jurisdictions do not allow the exclusion or limitation of incidental or consequential damages, so the above limitation or exclusion may not apply to you.

Monotype®, Intellifont® and UFST® are trademarks of Monotype Imaging, Inc. registered in the United States Patent and Trademark Office and may be registered in certain jurisdictions. Andy™, CG Palacio™, CG Century Schoolbook™, CG Triumvirate™, CG Times™, Monotype Kai™, Monotype Mincho™ and Monotype Sung™ are trademarks of Monotype Imaging, Inc. and may be registered in some jurisdictions. HY Gothic Hangu™ is a trademark of Hanyang Systems, Inc. Angsana™ is a trademark of Unity Progress Company (UPC) Limited. Andale®, Arial®, Book Antiqua®, Corsiva®, Gill Sans®, Sorts® and Times New Roman® are trademarks of The Monotype Corporation registered in the United States Patent and Trademark Office and may be registered in certain jurisdictions. Century Gothic™, Bookman Old Style™ and Century Schoolbook™ are trademarks of The Monotype Corporation and may be registered in certain jurisdictions. HGGothicB is a trademark of the Ricoh company, Ltd. and may be registered in some jurisdictions.

Univers™ is a trademark of Heidelberger Druckmaschinen AG, which may be registered in certain jurisdictions, exclusively licensed through Linotype Library GmbH, a wholly owned subsidiary of Heidelberger Druckmaschinen AG.

Futura® is a trademark of Bauer Types SA registered in the United States Patent and Trademark Office and may be registered in some jurisdictions.

TrueType® is a trademark of Apple Computer, Inc. registered in the United States Patent and Trademark Office and may be registered in certain jurisdictions.

All other product names are the property of their respective owners.

“Made for iPod”, “Made for iPhone”, and “Made for iPad” mean that an electronic accessory has been designed to connect specifically to iPod, iPhone, or iPad, respectively, and has been certified by the developer to meet Apple performance standards. Apple is not responsible for the operation of this device or its compliance with safety and regulatory standards. Note that the use of this accessory with iPod, iPhone, or iPad may affect wireless performance.

Bluetooth® is a registered trademark of the Bluetooth SIG.

© 1996–2009, QNX Software Systems GmbH & Co. KG. All rights reserved. Published under license by QNX Software Systems Co.

All other brand names, product names, or trademarks belong to their respective holders.

©2023 Zebra Technologies Corporation.

Works with:



Windows

Made for



iPod



iPhone



iPad

Certified by:



Document Conventions

Graphic icons are used throughout the guide. These icons and their associated meanings are described in the following list.



Caution • Warns you of the potential for electrostatic discharge.



Caution • Warns you of a potential electric shock situation.



Caution • Warns you of a situation where excessive heat could cause a burn



Caution • Advises you that failure to take or avoid a specific action could result in physical harm to you.



Caution • Advises you that failure to take or avoid a specific action could result in physical harm to the hardware.



Important • Advises you of information that is essential to complete a task.



Note • Indicates neutral or positive information that emphasizes or supplements important points of the main text.

Introduction to the ZQ630 Plus Printer

This guide gives you the information needed to operate ZQ630 Plus printers. They use some of the latest technologies such as an 802.11ac/Bluetooth® 4.1 dual radio, optional RFID capability, a smart battery with PowerPrecision+ functionality, Near Field Communication (NFC), a color LCD display and Made for iPhone® (MFi). MFi printers provide Apple co-processor (MFi) support which allows an Apple device such as an iPhone or iPad® to authenticate and connect over Bluetooth.



These printers use CPCL, ZPL and EPL programming languages. To create and print labels using these languages, refer to the Programming Guide for CPCL (p/n P1073699-001), ZPL (p/n P1012728-010) and EPL (p/n 14245L-002). Go to Appendix H for instructions on how to access manuals on zebra.com.

ZQ630 Plus Software Utilities:

- ZebraNet Bridge Enterprise™: printer configuration, fleet management
- Zebra Setup Utility: single printer configuration, quick setup
- Zebra Mobile Setup Utility: Android-based setup tool
- ZebraDesigner Pro v2: label design
- Zebra Designer Drivers: Windows® driver
- OPOS Driver: Windows driver
- Multiplatform SDK
- Zebra Downloader
- Printer Profile Manager Enterprise (PPME) (These utilities can be found on the Zebra website at zebra.com/support).

Unpacking and Inspection

- Check all exterior surfaces for damage.
- Open the media cover (refer to “Loading the Media” in the Getting Ready to Print section) and inspect the media compartment for damage.

In case shipping is required, save the carton and all packing material.



Note • Accessories may vary by region.

Reporting Damage

If you discover shipping damage:

- Immediately notify and file a damage report with the shipping company. Zebra Technologies Corporation is not responsible for any damage incurred during shipment of the printer and will not cover the repair of this damage under its warranty policy.
- Keep the carton and all packing material for inspection.
- Notify your authorized Zebra reseller.

ZQ630 Plus Technology

The ZQ630 Plus printer uses several technologies made popular in other Zebra Mobile Printer product lines, and newer, state-of-the-art technologies.

PowerPrecision+ (PP+) Battery

The ZQ630 Plus printer uses a 4-cell Li-Ion battery pack with integrated intelligence and data storage capability meeting PowerPrecision+ (PP+) functionality. This intelligent battery has the integrated technology required to collect the detailed realtime battery metrics needed to maximize useful battery life and ensure every battery is healthy and able to hold a full charge. In addition, technology inside the batteries tracks and maintains the metrics required to provide real-time visibility into more meaningful battery statistics, such as total cycle usage of the battery, whether the battery is old and should be retired or how long it takes a battery to fully charge.

Operating Temperature	Charging Temperature	Storage Temperature
-20–50°C (-4–122°F)	0–40°C (32–104°F)	-25–65°C (-13–149°F)



Important • The printer only functions properly with genuine Zebra smart battery packs. To achieve the best fast charging results, charge batteries at room temperature with the device powered off. Ideal charging conditions are within temperatures from 5–40°C (41–104°F).

The device always performs battery charging in a safe and intelligent manner. At higher temperatures, the device may for small periods of time alternately enable and disable battery charging to keep the battery at acceptable temperatures. Under abnormal temperatures the device indicates when charging is unable to be initiated via its LED and a notification that appears on the display.

The smart battery's health has three states: GOOD, REPLACE, and POOR. The battery health factor determines whether or not the printer can operate and what is communicated to you via the display.

# of Charge Cycles	Health	Power-up Message
<300	GOOD	None
≥300 but <550	REPLACE	"Battery Diminished Consider Replacing" *
≥550 but <600	REPLACE	"Warning-Battery Is Past Useful Life" *
≥600	POOR	"Replace Battery Shutting Down" **

* Warning accompanied by one long beep.

** Warning flashes on and off accompanied by beeping at a rate of once per second. After 30 seconds the printer shuts down.



Note • Power down the printer before removing the battery to minimize the risk of corruption.

Printing Technology

The ZQ630 Plus printer uses the Direct Thermal method to print human readable text, graphics and barcodes. It incorporates a sophisticated print engine for optimal printing under all operational conditions. Direct thermal printing uses heat to cause a chemical reaction on specially treated media. This reaction creates a dark mark wherever a heated element on the printhead comes in contact with the media. Since the printing elements are arranged very densely at 203 d.p.i. (dots per inch) horizontal and 200 d.p.i. vertical, highly legible characters and graphic elements may be created a row at a time as the media is advanced past the printhead. This technology has the advantage of simplicity, as there is no requirement for consumable supplies such as ink or toner. However, since the media is sensitive to heat, it gradually loses legibility over long periods of time, especially if exposed to environments with relatively high temperatures or in direct sunlight.

QR Code

The QR barcode includes human readable text URL, for example zebra.com/zq600plus-info, which links you to printer information and short videos on topics such as buying supplies, features overview, loading media, printing a configuration report, cleaning instructions, and accessory information.

Figure 1 • QR Code



Made for iPhone (MFi)

ZQ630 Plus printer supports communication with Apple devices running iOS 10 or later over a standalone Bluetooth 4.1 radio and the BT4.1 radio included with the 802.11ac (dual) radio.



Near Field Communication (NFC)

The ZQ630 Plus printer supports a passive NFC tag that complies with the Android Standard Tag format. The NFC tag is programmed from the factory and supports Bluetooth pairing to enable a tablet, smartphone, or mobile computer to automatically pair with the printer via a Bluetooth connection (within the bounds of the security profile being used).

The NFC tag also supports app launching whereby an app developed either by Zebra or a third party launches on a NFC-enabled smartphone, tablet or mobile computer. Similarly, the NFC tag enables launching to a web support page via a tablet, smartphone or mobile computer.

Color LCD Display

The ZQ630 Plus printer features a color, non-touch LCD display which supports a 288x240 pixel viewable area. You are able to view the display in both room light and night time conditions. The display is capable of displaying colored text and color images. In order to save power, the display dims after a configurable timeout.

Radio-Frequency Identification (RFID)

The ZQ630 Plus printer is equipped with an RFID encoder/reader that is integrated into the printer's printhead assembly. The ZQ630 Plus encodes (writes) information on ultra-thin UHF RFID transponders that are embedded in "smart" labels, tickets, and tags. The printer encodes the information, verifies proper encoding, and prints bar codes, graphics, and/or text on the label's surface. The ZQ630 Plus printer uses Zebra's extensive set of RFID commands running under ZPL programming language.

The RFID transponder is sometimes called the RFID tag or an inlay. The transponder is usually made of an antenna that is bonded to an integrated circuit (IC) chip. The IC chip contains the RF circuit, coders, decoders, and memory. If you hold an RFID label up to the light, you can see the transponder's antenna, and you can feel a bump in the label where the IC chip is located. The ZQ630 Plus can encode and verify EPC (Electronic Product Code) Generation 2 Class 1 UHF passive RFID tags, in addition to printing human readable text and conventional 1- and 2-D barcode information on Zebra supplied RFID thermal transfer media. EPC is a product numbering standard that can be used to identify a variety of items by using RFID technology. EPC Generation 2 tags offer advantages

over other tag types. The tag identification (TID) memory in a Generation 2 tag includes the chip manufacturer and model number information, which can be used to identify which optional features are present on the tag. These optional features include those for data content and security.

Gen 2 tags typically have a 96-bit EPC identifier, which is different from the 64-bit identifiers common in early EPC tags. The 96-bit EPC code links to an online database, providing a secure way of sharing product-specific information along the supply chain. Gen 2 tags also support much larger data structures. The size of user memory available (if any) varies by the model and manufacturer of the tag.

Encoding and printing of an RFID label usually are completed on the first try, but some failures may occur. If you experience consistent encoding failures, it may signal a problem with the RFID tags, your label formats, or with the transponder placement. If an RFID tag cannot be encoded, VOID is printed on the label. The printer then attempts to read/encode “n” labels before the next format is attempted, where “n” is specified by the ZPL programming language “^RS” command. Acceptable values of “n” are 1–10 and the default is 3. After printing the defined number of voided RFID labels, the printer default is No Action (Label format causing the error is dropped).

While you do not have control of where on the label the VOID is printed, you can control the length of the image. The start of the VOID image is always at the program position (or F0 if a backward program position). More information on the “^RS” command may be found in the RFID Programming Guide 3 available on zebra.com.

Go to “Appendix D” on page 108 for details on RFID menu options.



Note • RFID is an optional feature on the ZQ630 Plus and is a factory-installed option only.

RFID Calibration



RFID calibration sets communication parameters for your tag type. This procedure should be done after the printer has been calibrated for the media (length and gap settings), typically a label length calibration. During the RFID calibration process, the printer moves the media, calibrates the RFID tag position, and determines the optimal settings for the RFID media being used.

These settings include the programming position, the read/write power level to use. To restore the printer's default programming position at any time, use the "restore" option in the rfid.tag.calibrate SGD command.

Do not remove any labels or tag from the liner (label backing or 'web'). This allows the printer to determine RFID settings which do not encode adjacent tags.

Always do a Label Length Calibration and RFID Calibration when you change media type. It should not be necessary when simply replacing an empty roll of the same media.

Before beginning, load RFID media into the printer and perform the label length calibration.

1. Press **FEED**  once to advance one label.
2. Press **HOME** . Navigate to the RFID menu button and press the 'OK' on the keypad.
3. Use **LEFT** and **RIGHT ARROW** on the keypad to browse to the RFID CALIBRATE procedure. Press **OK** on the keypad.
4. The printer slowly feeds a label while adjusting the location and RFID read/write communication settings for your chosen RFID tag/label. The printer feeds an additional label in some cases when calibration has completed successfully with the display message reading: READY.
5. Remove the excess media. Media calibration finishes and you are ready to print.

ZQ630 Plus Overview

Figure 2 • Overview of Features

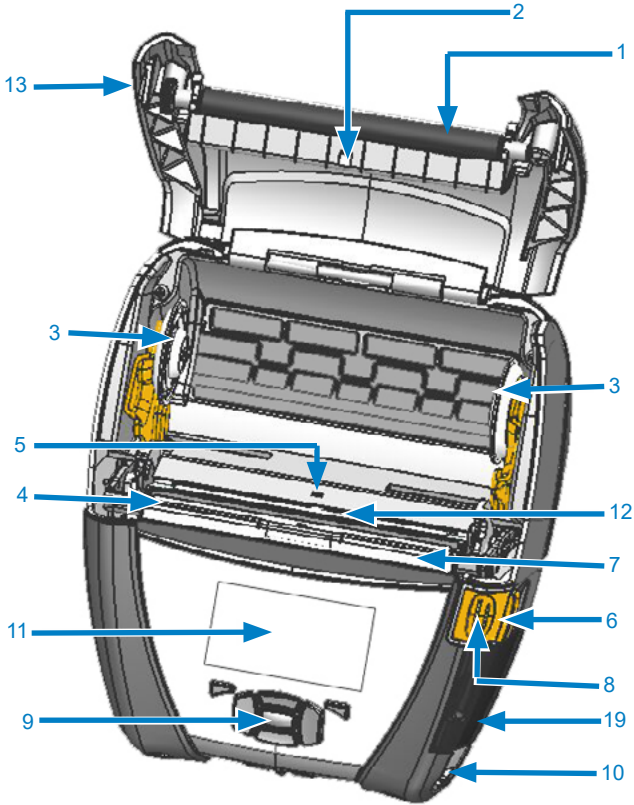

- 1. Platen Roller
- 2. Back Side Sensor
- 3. Media Support Disks
- 4. Tear Bar
- 5. Front Side Sensor
- 6. Peeler Lever
- 7. Peeler Bail
- 8. Latch Release Lever
- 9. Key Pad
- 10. Strap Post
- 11. Status Screen
- 12. Printhead
- 13. Media Cover
- 14. Belt Clip
- 15. Battery
- 16. DC Input
- 17. MAC Address Label
- 18. Docking Contacts
- 19. USB/RS-232 Comm Ports
- 20. Print Touch (NFC) Icon

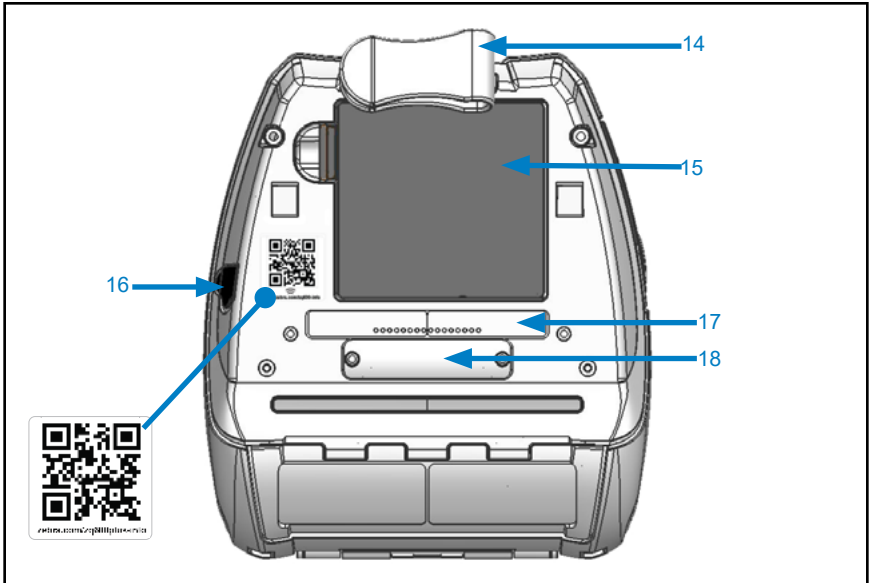

Note • Scanning the QR code with a smartphone provides printer-specific information at zebra.com/zq600plus-info.



Note • Tapping the Zebra Print Touch™ icon with a Near Field Communication (NFC) enabled smartphone provides instant access to printer-specific information. For more information about NFC and Zebra products, go to zebra.com/nfc. Bluetooth pairing applications via NFC is also possible. Refer to Zebra Multi-platform SDK for more information.



Getting Ready to Print

Battery

Installing/Removing Battery & Battery Tape Insulator

! *Important • Batteries are shipped in Sleep mode to preserve their maximum capacity while in storage prior to initial use. Plug in the AC adapter (“AC Power Adapter”) or insert the battery into the 1-Slot Battery Charger (“1-Slot Battery Charger”) or 3-Slot Battery Charger (“3-Slot Battery Charger”) to wake it up before using for the first time.*

Removing the Battery

1. If a belt clip is present on the bottom of the printer, rotate it such that it provides clearance for the battery or remove altogether.
2. Depress the latch on the battery pack (where indicated).
3. Rotate the pack away from the battery well. Lift the battery up and out of the printer.



Removing the Battery Tape Insulator

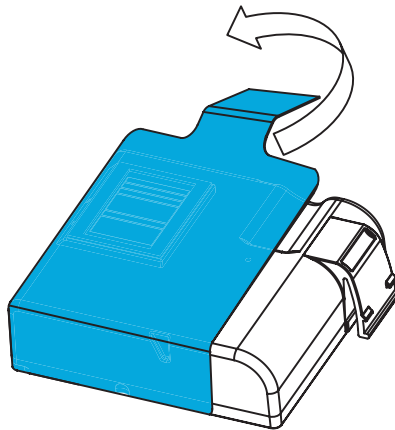

1. Pull up on the tape insulator tab located on the bottom of the battery pack.
2. Peel back the tape insulator and remove it from the top of the battery pack. Discard upon removal.



Caution • Battery can explode, leak, or catch fire if improperly charged or exposed to high temperature. Do not disassemble, crush, puncture, short external contacts or dispose in fire or water. Charge on a Zebra approved Lithium-Ion charger only.

Installing the Battery

1. Locate the battery compartment on the bottom of the printer (where indicated).
2. Swivel the belt clip (if present) to access the battery compartment or remove altogether.



3. Insert the battery into the printer as shown. (It is not possible to insert the pack in the incorrect orientation.)



4. Rock the battery into the compartment as shown until it locks in place.



Battery Safety



Caution • *Avoid accidental short circuiting of any battery. Allowing battery terminals to contact conductive material will create a short circuit which could cause burns and other injuries or could start a fire.*



Important • *Always dispose of used batteries properly. Refer to “Appendix F” on page 130 for more battery recycling information.*



Caution • *Use of any charger not approved specifically by Zebra for use with its batteries could cause damage to the battery pack or the printer and will void the warranty.*



Caution • *Do not incinerate, disassemble, short circuit, or expose to temperatures higher than 65°C (149°F).*

Charger Safety



Do not place any charger in locations where liquids or metallic objects may be dropped into the charging bays.

AC Power Adapter (p/n P1031365-024 with US Type-A Line Cord)

Figure 3 • AC Power Adapter Charging

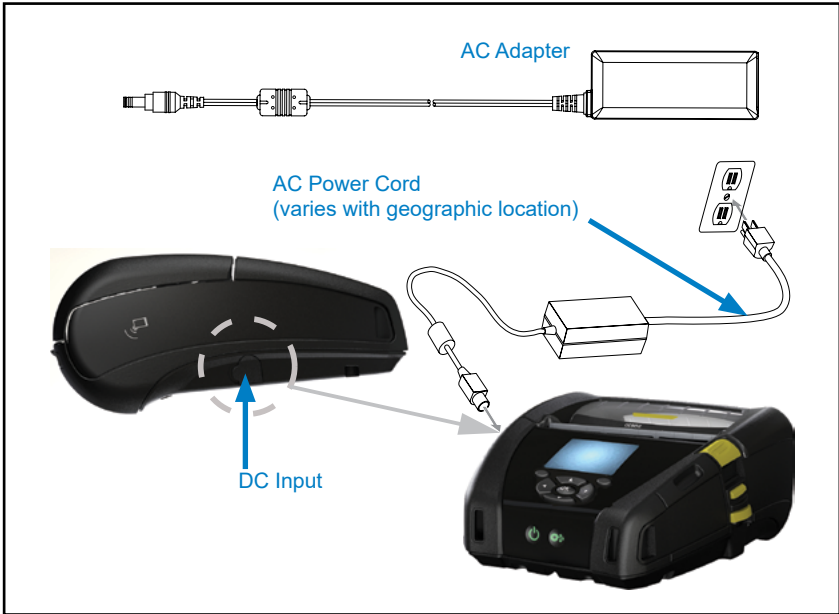

Charging the Battery

To charge the battery using an AC Power Adapter:

1. Open the protective cover on the printer to expose the DC input charger jack.
2. Connect the appropriate AC power cord for your location to the adapter, and then plug the power cord into an AC receptacle.
3. Plug the barrel plug from the AC adapter into the charger jack on the printer.
4. The printer powers up and begins charging. The printer can be left on or turned off at this point. Charging continues in either state.



Important • While it is possible to charge the battery when using the printer, charge times increase under this condition.

Ethernet and Charging Cradle

The ethernet cradle is an expansion base intended for use with the ZQ630 Plus printer. The cradle provides charging power to the docked printer and providing a standard 10/100 Mb/s Ethernet port for communication to the printer. The cradle also supplies battery charging power to the docked printer and acts as a supplementary power source.

The cradle features two LED's to indicate the status of the cradle: Solid green to indicate when power is provided to the input of the cradle; and blinking green to indicate Ethernet activity. The cradle allows you to dock the printer easily and remove it with the push of a button. The printer remains operable while docked, for example, the display is viewable, charge LED status is viewable, and printer controls and data entry are available. The printer still prints while docked and you are able to replace the media as well.

LED Status Indicator

LED Status	Indication
Solid Green	Power On
Blinking Green	Ethernet Activity



Note • Remove the docking contacts cover on the bottom of the printer before docking the printer in the cradle.



Note • Clean the docking contacts with a Zebra cleaning pen to remove any residue left behind by the label.

Figure 4 • Ethernet Cradle



Height	Width	Length
66.2 mm (2.6 in.)	200.6 mm (7.89 in.)	219.61 mm (8.64 in.)

Printer Operation with Cradle

- The ZQ630 Plus printer charges when placed in its cradle.
- Docking the printer in the cradle automatically turns the printer on to ensure it is available to be managed remotely.
- When the printer detects input power from the cradle, and the presence of a live Ethernet link, it automatically connects to the Ethernet network.
- The 802.11ac radio is turned off when the Ethernet link is active. It turns back on if the Ethernet link is no longer active.
- For printers with a Bluetooth radio, this interface remains active while the printer is in the cradle.
- The serial and USB ports remains active while the printer is in the cradle.
- The DC input barrel jack connector (see Figure 3) cannot be used while the printer is in the cradle. The DC barrel jack should be plugged directly into the cradle instead.



Note • The printer provides over voltage protection such that no damage occurs when voltages from 0-36V are applied at the DC Power jack. Upon application of voltage greater than 36V, the DC line fuse will permanently open to reduce fire hazard. The battery is only charged when 12VDC is applied using the Zebra AC adapter.

1-Slot Battery Charger (p/n SAC-MPP-1BCHGUS1-01SA with US Type-A Line Cord)

Use Case: Home Office/Small Business

The 1-Slot Battery Charger provides you with a single, spare battery charging solution. Similar to the 3-Slot Battery Charger, the single charger charges a 4-cell battery within 6 hours.

Figure 5 • 1-Slot Battery Charger

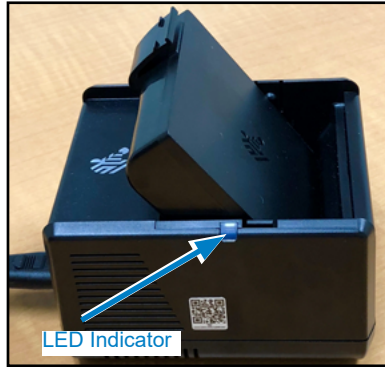

Charging Status Indicators

Both the 3-slot and 1-slot battery chargers use an LED indicator located next to each slot to indicate the charge state in either green, red, or amber as detailed below.

Mode	Charging Indication	Description
Charge Fault	● ○ ● ○	Fast blinking red
Charging (Healthy)	●	Solid amber
Charge Done (Healthy)	●	Solid green
Charging (Unhealthy)	●	Solid red
Charging Done (Unhealthy)	●	Solid red
Best Battery (Charging)	● ✨	Alternates between solid and bright bursts of amber
Best Battery (Charge Done)	● ✨	Alternates between solid and bright bursts of green

3-Slot Battery Charger **(p/n SAC-MPP-3BCHGUS1-01) Dual 3-Slot Battery Charger (p/n** **SAC-MPP-6BCHUS1-01) w/ US Type-A Line Cord**

Use Case: Settlement Room

The 3-Slot Battery Charger is a charging system for use with the 2-cell lithium-ion batteries used in the ZQ630 Plus printer. The 3-slot charger is capable of charging three 4-cell batteries simultaneously within 6 hours. It can either be used as a standalone charger or mounted on a 5-slot share cradle.

Figure 6 • 3-Slot Battery Charger



Note • For detailed information on the 1-Slot, 3-Slot Battery Charger and 3-Slot Dual Pack Charger, refer to the P1096323-101, P1096767-101 and P1097966-101 Quick Start Guides at zebra.com/zq600plus-info.

Loading the Media into the ZQ630 Plus Printer

You can operate the ZQ630 Plus printer in one of two different modes: Tear-Off or Peel-Off. Tear-Off mode allows you to tear off each label (or a strip of labels) after it is printed. In Peel-Off mode, the backing material is peeled away from the label as it is printed. When printing batches, after you remove the label, the next one is printed.

Loading Media Procedure

1. Open the printer (Figure 7).
 - a. Press the Latch Release button on the side of the printer as shown in (1) below. The media cover pops open.
 - b. Rotate the media cover back completely as shown at (2), exposing the media compartment and adjustable media supports.

Figure 7 • Opening the Printer



2. Pull the media supports apart (Figure 8) and insert the roll of media between the supports at (3) (follow the orientation shown). The supports secure the media in place and adjust to the width of the media. The media roll should be able to spin freely on the supports.

Figure 8 • Loading Media

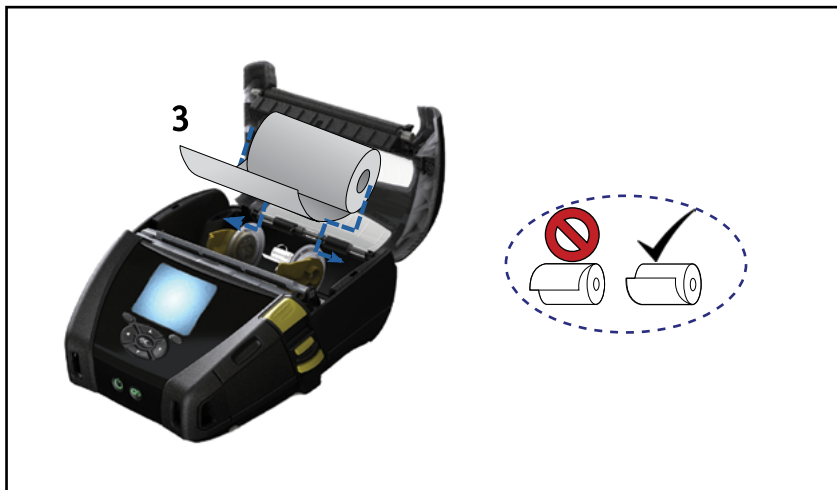

3. If you plan to use the printer in Tear-Off mode, close the media cover as shown at (4).

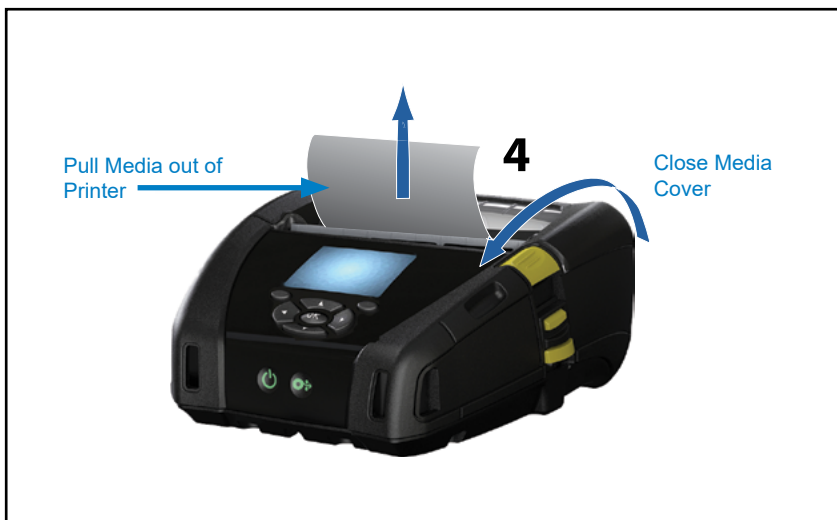

Note • Refer to the Programming Guide (P1012728-010) for information on changing the setting to adjust the media feed length via a Set-Get-Do (SGD).

Loading Media in Peel-Off Mode

If using the printer in Peel-Off mode:

1. Peel a few labels off of the media and load the roll described previously (Figure 8).
2. Press down on the latch release lever to open the media cover and load the media (Figure 8).
3. See Figure 9. Close the media cover (1).
4. Push the peeler lever up (2) and lock it in place to release the peeler bail into the “up” position (3). The media feeds between the peeler bail and platen.

Figure 9 • Activating Peeler Bar



5. Turn on the printer or press **FEED** on the front of the printer if the printer is already on.

The printer advances the media to the next label, if printing labels. If you are printing on journal media, the printer advances a short strip of media.

To disengage the peeler bail:

1. Open the media cover as previously described. The peeler bail automatically returns to the Up position.
2. Press the button on the peeler lever and press down on the peeler button to lock the cover in its original home position.

Operator Controls

The ZQ630 Plus printer comes equipped with a keypad control panel and a color LCD graphical user interface. The standard control panel is illustrated in Figure 10. The LCD interface allows easy display and selection of many printer functions as detailed on following pages.

Standard Control Panel

The standard control panel has multiple control buttons and two multipurpose indicators.

- The **POWER** button (Fig. 10) turns the printer On and off. It also puts the printer in Sleep mode and wakes it from sleep.
- The **FEED** button (Fig. 10) advances a length of media which is determined by the type of media being used. Label media advances to the next gap or bar sense marker. Journal (plain) media advances by a length determined by the printer's software.
- Four Way Navigation Buttons: **LEFT**, **RIGHT**, **UP**, and **DOWN** (Figure 12) allow you to scroll between functions on the LCD user space. (The Navigation Buttons do not apply to the Status Bar and Navigation Bar.)
- The **ENTER** button allows you to select the desired function highlighted on the LCD interface and is indicated by the word OK.
- Two software defined function keys (Fig. 12) allow you to select a function listed on the navigation bar

Figure 10 • Control Panel



Power Button

Press to turn unit on. There will be approximately a 20 second boot up time.
Press for 3 sec. to turn unit off.

Feed Button

Press to advance a blank label or a software-determined length of journal media.

Normal Boot-up LED Behavior

1. Press **POWER** (on/off) to turn the printer on.
2. When **POWER** is released, the power ring blinks as the printer boots up.
3. When the boot-up sequence is complete, the power ring stops blinking and remain steadily lit. The color of the power ring depends on the charge status.

Sleep Mode LED Behavior

1. Pressing **POWER** for less than 3 seconds puts the printer in Sleep mode.
2. During Sleep mode, the **POWER** LED slowly pulses either Green, Amber or Red depending upon whether or not the printer is charging successfully.

Shutdown Behavior

1. Press **POWER** for approximately 3 seconds to turn the printer off.
2. SHUTTING DOWN appears on the LCD prior to the printer shutting down.



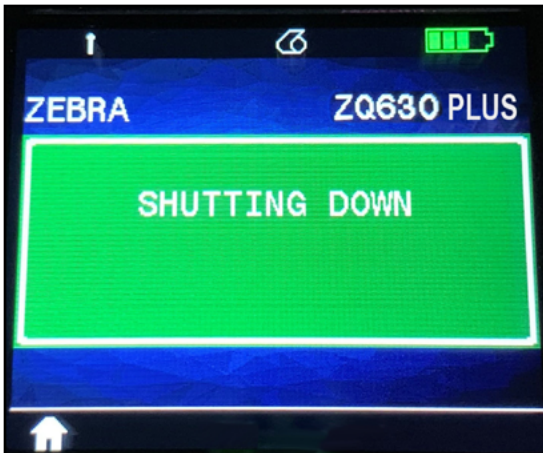





Figure 11 • Printer Shutdown





Power LED Ring Behavior

The **POWER** button is surrounded by a three-color (green, amber, red) LED ring. The **POWER** LED ring:

- Blinks once per 2 seconds green/amber/red during boot-up.
- Displays solid green when the printer is fully charged while on or off.
- Pulses green to indicate Sleep mode and not charging.
- Stays solid amber to indicate charging while on or off.
- Pulses amber to indicate charging while in Sleep mode.
- Stays solid red to indicate an unhealthy charging or charged battery when not in Sleep mode (either on or off).
- Flashes red twice per second indicating a charge fault.
- Pulses red to indicate unhealthy charging or charged battery when in Sleep mode.

	Blink green/amber/red during boot-up
	Power On/Charged Battery
	Pulse green Sleep Mode/Not Charging
	Power On/Battery Charging
	Charging in Sleep Mode
	Charging/Charge Complete (Unhealthy)
	Charging/Charge Complete (Unhealthy/Sleep Mode)
	Charge Fault

 = blinking

 = solid state

 = pulsing

LCD Control Panel

The color LCD control panel allows you to view the status of the ZQ630 Plus printer and have access to various printer alerts and messages. It also has multi-directional keys that allow navigation and selection of menu options affecting printer functions. These keys allow scrolling through the various options and settings. The **OK** button allows selection of the option or function displayed on the screen.

The top of the screen has a row of status icons, or a Status Bar, which indicate the state of various printer functions. The Status Bar is located above the Status Screen (Figure 12) along with a Navigation Bar. The Status Screen is the default display and is shown at power up. After navigating, the printer automatically returns to this screen after a short delay.

Figure 12 • LCD Control Panel

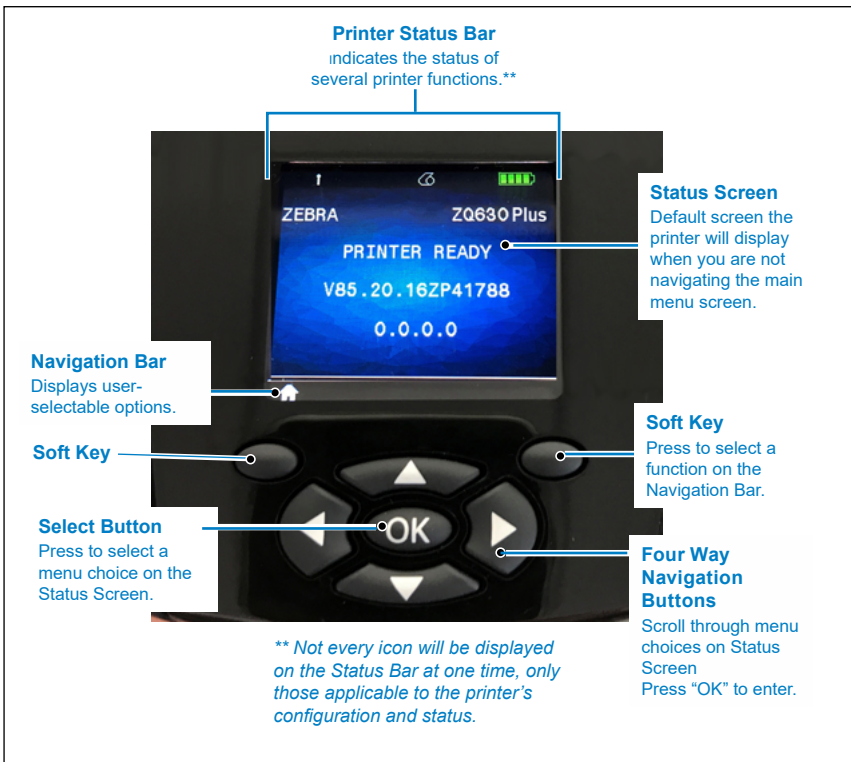

Status Bar Icons



Indicates Bluetooth connection status. The icon blinks to show that the printer is receiving label data via Bluetooth, and is **solid blue** when link is established. This icon appears only on printers with the Bluetooth wireless option installed.



Indicates that the printer is connected to a radio network via 802.11 protocols. The antenna icon blinks with no parentheses when looking for an access point. One set of solid signals with a blinking antenna indicates WLAN is associated and attempting authentication. Two sets of solid signals and solid antenna indicate the printer is successfully connected to the WLAN.

The icon and two signals blink to show the printer is receiving printer data via WLAN. The four bars  indicate the strength of the WLAN connection to the access point. These icons appear only with the 802.11 radio installed, for example, one **solid yellow** bar, two **solid green** bars, three **solid green** bars and four **solid green** bars.



The Ethernet icon **blinks green** when the printer is receiving label data via the Ethernet connection, and **solid green** when connected. It will not display on the status bar when the Ethernet is inactive. This icon appears only when the Ethernet option is installed and the printer is docked in Ethernet cradle.



The Data icon indicates data being sent to the printer, such as the icon **blinks green** when there is a label data transmission via the serial or USB ports. It is **solid green** when the parser is locked.





The Media Out icon **blinks red** when there is no media in the printer and appears solid white when there is media in the printer.



The Head Latch icon indicates if the media cover is closed or not properly latched. It appears unlocked and **blinks red** if open and will not appear if the cover is closed.

 The Error icon displays and **blinks red** if an error condition exists. The icon will not display if no printer error exists. Since there are separate icons for Media Out and Head Latch Open, these two alerts do not apply to the Error icon.

 The Battery Charge Level icon indicates the reported state of charge from the battery pack. In a non-charging state, four **solid green** bars indicates the battery level is greater than 80%. Three **solid green** bars indicates if the battery level is less than or equal to 80% but greater than 60%. Two **solid yellow** bars indicates if the level is less than or equal to 60% but greater than 40%. One **solid red** bar indicates if the battery level is less than or equal to 40% but greater than 20%. Zero bars (**solid red** battery outline) indicates if the level is less than or equal to 20%.

While the battery is charging, a lightning bolt appears in the battery icon  to indicate that charging is taking place. When the battery is charging and fully charged, four **blinking green** bars display. When the battery is charging and the level is greater than 80%, the battery icon alternates between four bars and three **blinking green** bars. When the battery is charging and the level is less than or equal to 80% but greater than 60%, the icon alternates between three bars and two **blinking yellow** bars. When the battery is charging and the level is less than or equal to 60% but greater than 40%, the icon alternates between two bars and one **blinking red** bar. When the battery is charging and the level is less than or equal to 40% the icon alternates between one bar and zero **blinking red** bars.

Home Menu Screen

The printer's control panel includes a display where you view the printer's status or change its operating parameters. After the printer completes the power-up sequence, it moves to the Idle Display screen (Figure 13). This screen includes the printer's current status, information such as firmware version and IP address, and a Home menu shortcut.

Press **LEFT SOFT KEY** to go to the Home Menu screen which displays graphical parameter options including Settings, Tools, Network, RFID, Language, Sensors, Ports, Communications and Battery (Figure 133). These options allow you to view the printer's status or change its operating parameters.

Figure 13 • Home Menu Screen



You can scroll between icons using the four-way arrow buttons. When an icon is highlighted (for example, SETTINGS), its text description displays in the middle of the navigation bar (see Figure 13), and can be selected by pressing **OK**. This takes you to the first screen (such as Darkness) under that parameter, which gives you status information specific to that option (Figure 14). To navigate to the next screen, press the **RIGHT ARROW**.

Figure 14 • Parameter Menu Screen Example







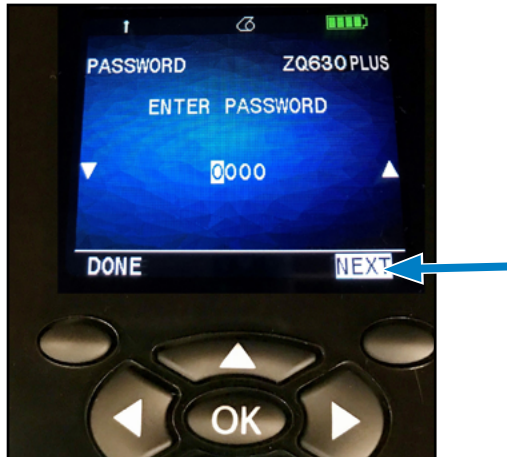



Some parameter settings, like Darkness, have a scroll option to view multiple setting choices. This option is identifiable by the presence of up and down scrolling arrows located on either side of the display (see Figure 14). Press the **UP ARROW** and **DOWN ARROW** on the keypad to scroll through a menu's options. In some cases, further actions appear on the right side of the status screen (see arrow in Figure 15). Press the **RIGHT SOFT KEY** to initiate said action.

Figure 15 • Scrolling Menu



Click the **LEFT SOFT KEY** to exit the screen, and again to return to the Home Menu screen to choose a different parameter.

Home Screen Icons and Parameters

Icon	Parameter
	See Settings menu in “Appendix D”
	See Tools menu in “Appendix D”
	See Network menu in “Appendix D”
	See RFID menu in “Appendix D”
	See Language menu in “Appendix D”
	See Sensors menu in “Appendix D”
	See Ports menu in “Appendix D”
	See Bluetooth menu in “Appendix D”

Alert Messages

The ZQ630 Plus printer also displays various blinking alerts, such as Media Out, Media Cover Open, or Battery Low. These alerts are broken up into Errors, Warnings, and Info with different color mapping used to differentiate one from the other (see the following table).

	INFO	WARNING	ERROR
Foreground Color (Text)	White	Black	White
Background Color	Green	Yellow	Red

Figure 16 • Error Alert Message









You can respond to actions by pressing one of the soft keys. Once the condition causing the alert is resolved (for example, loading media), the alert message clears. (Go to “Appendix G” on page 131 for a complete list of alerts for the ZQ630 Plus printer.

Buttons

You can use the ZQ630 Plus's multi-button interface to run the following power-up and runtime sequences.

Power-Up Sequences

Seq. #	Function	Keys	Button
1	Two Key Report	Hold down FEED while pressing POWER	 
2	Revert to Factory WML	Hold down the UP and DOWN ARROWS while pressing POWER	 
3	Forced Download	Hold down both SOFT KEYS while pressing POWER	 
4	Turn printer On or Off or to enter Sleep mode	POWER	



Note • You may need to revert to factory WML if some features were turned off in the custom WML, and there is a need to get to the “full” menu. Also, if a change was made that caused the WML system to lock up, reboot to restore functionality temporarily.



Note • A forced download is when the printer is powered up in a mode wherein it is running only the code that allows for firmware downloads to happen.

Runtime Sequences without LED Flashes

Seq. #	Function	Keys	Button
1	Media Feed	FEED	
2	Wake, if in Sleep mode	Any button	

Sleep Mode

The Sleep mode feature is a way the printer conserves battery life whereby the printer automatically goes into a sleep state after 20 minutes of inactivity. When the printer is in this state, no content is displayed on the LCD and no backlight. The printer indicates Sleep mode by a slow blinking green LED ring around the **POWER** Button.

If the **POWER** is pressed for less than 3 seconds, then the printer goes into Sleep mode. The printer indicates this on the LCD in the form of a SLEEPING info message (see Figure 17), which disappears when the display turns off.

Figure 17 • Sleep Mode Info Message



In Sleep mode, the green LED ring around the **POWER** button pulses approximately once every 3 seconds. Press any button on the printer to wake the printer from Sleep mode. Other power management features of the ZQ630 Plus printer include Wake on Bluetooth and Wake on WiFi (the printer exits Sleep mode due to data exchanged via Bluetooth 4.1 or a network message received over WiFi). The printer does not enter Sleep mode when docked in an Ethernet cradle.

To enable or disable Sleep mode, send the `power.sleep.enable` command to the printer using Zebra Setup Utilities (ZSU) and set it to On (default) or Off. To set the time after which the printer enters Sleep mode, send the `power.sleep.timeout` (in seconds) to the printer using the ZSU.

Adaptive Print Performance

The ZQ630 Plus printer uses PSPT PrintSmart Gen 2 technology which adapts to your print conditions such that print quality is not sacrificed. When the printer sees environmental conditions such as state of charge, battery health, cold temperature extremes, or high density printing, the printer adjusts print performance to preserve battery function and allow printing to continue. This may affect the speed and sound of printing but not the print quality.

Draft Mode

You can configure the printer to print in Draft mode via SGD command `media.draft_mode` (default is Off), which optimizes the printer for text-only printing. While in Draft mode, print speed increases from 4–5 ips (inches per second) with an approximately 22% reduction in optical density.



Note • For an explanation and a list of all SGD commands, refer to the Programming Guide (p/n P1012728-010) at: zebra.com/support.

Verify the Printer is Working

Before you connect the printer to your computer or mobile computer, make sure the printer is in proper working order. You can do this by printing a configuration label using the Two Key method. If you can't get this label to print, go to "Troubleshooting Topics" on page 88.

Printing a Configuration Label

1. Turn the printer off.
2. Load the media compartment with journal media (media with no black bars or gaps on the back).
3. Press and hold **FEED**.
4. Press and release the **POWER** and keep **FEED** pressed.
5. When printing starts, release **FEED**.

The unit:

- Prints a line of interlocking "x" characters to ensure all elements of the print head are working.
- Prints out the version of software loaded in the printer
- Prints the report.

The report indicates model, serial number, baud rate, and other detailed information on the printer's configuration and parameter settings. (See the "Troubleshooting Topics" on page 88 for sample printouts and a further instruction on how to use the configuration label as a diagnostic tool.)

Connecting the Printer

The printer must communicate with a host which sends the data to be printed. The ZQ630 Plus printer communicates in four basic ways:

1. By cable via either RS-232C or USB 2.0
 - Windows drivers that support printing via Serial, USB and the network are included in the Zebra Designer Driver which can be downloaded from zebra.com/drivers.
2. By means of a wireless LAN (Local Area Network) per 802.11 specifications (optional)
3. By means of the Ethernet when docked on the Ethernet cradle
4. By means of a Bluetooth short range radio frequency link

WinMobile®, Blackberry®, and Android devices use standard Bluetooth protocol.

The ZQ630 Plus printer is compatible with iOS devices, therefore printing via Bluetooth to an Apple device is possible.



Cable Communication



Caution • The printer should be turned off before connecting or disconnecting a communications cable.

The ZQ630 Plus printer can communicate by cable; the specific cable supplied with your printer varies with the host device and your model printer.

RS-232C Communications

The 14-pin serial connector on your communications cable plugs into the serial communications port on the side of the printer. The ZQ630 Plus printer also has a USB port.

USB Communications

The small 5-pin connector on the USB cable plugs into the printer. The connectors are keyed to assure correct alignment; do not try to force the cable if it does not plug in.

Figure 18 • Communications Options

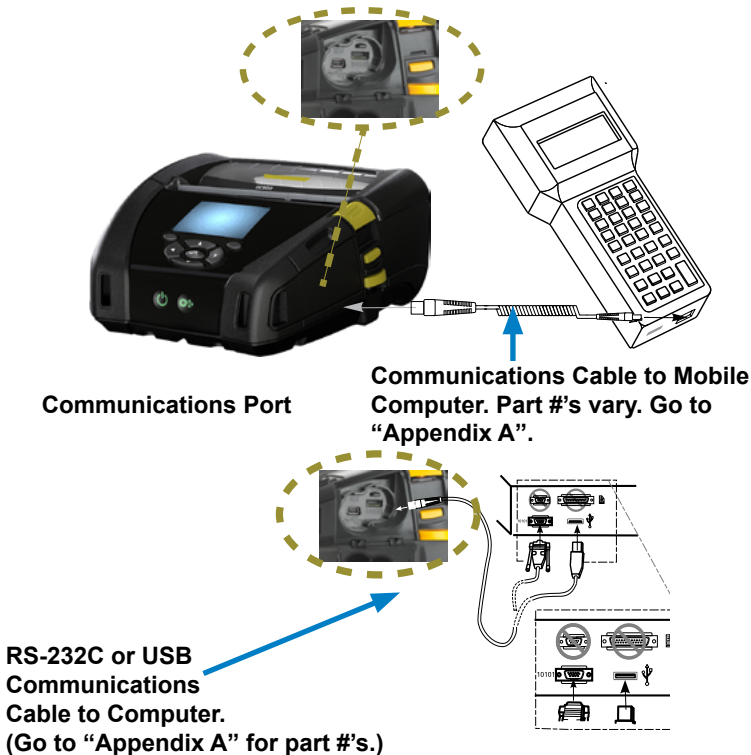

The other end of the cable must be plugged into the mobile computer (see Figure 18), or to a serial or USB port on a computer. The ZQ630 Plus printer is configured with the USB Open HCI interface driver allowing it to communicate with Windows-based devices.

Zebra Designer Driver uses Windows drivers that support printing via Serial, USB, and the network. Mobile computers and other communication devices may require the installation of special drivers to use the USB connection. Go to zebra.com/support for further details.

Providing Strain Relief for Communications Cable

When connecting either a USB or RS-232 communications cable to the printer permanently:

1. Access the communications port on the side of the printer next to the latch release lever.
2. Plug the connector into the appropriate port and align the plastic locking cap with the cut outs shown below.
3. Rotate the locking cap clockwise to lock the cable in place. (Turn counter clockwise to unlock the cable.)

Once locked in place, this provides strain relief for the cable and prevents the cable from disconnecting from the printer.



1. Insert connector in communications port.



2. Rotate locking cap clockwise to secure.



Note • Only one cable can be present in the USB/RS-232 communications port at a time for strain relief purposes.

Installing Drivers and Connecting to a Windows-Based Computer

To use your printer with a Microsoft Windows-based computer, you must first install the correct drivers.



Important • You may connect your printer to your computer using any available connections. However, do not connect any cables from your computer to the printer until you are instructed to do so. If you connect them at the wrong time, your printer will not install the correct printer drivers. To recover from incorrect driver installation, see “What to Do If You Forget to Install Printer Drivers First”.

Installing the Drivers

Follow these steps to install the correct drives.

1. Navigate to zebra.com/drivers.
2. Click **Printers**.
3. Select your printer model.
4. On the printer product page, click **Drivers**.
5. Download the appropriate driver for Windows.

The driver executable file (such as `zd86423827-certified.exe`) is added to your Download folder.

6. Run the executable file and follow the prompts.

When the setup is complete, you may add specific printers (go to “Running the Printer Installation Wizard” on page 55).

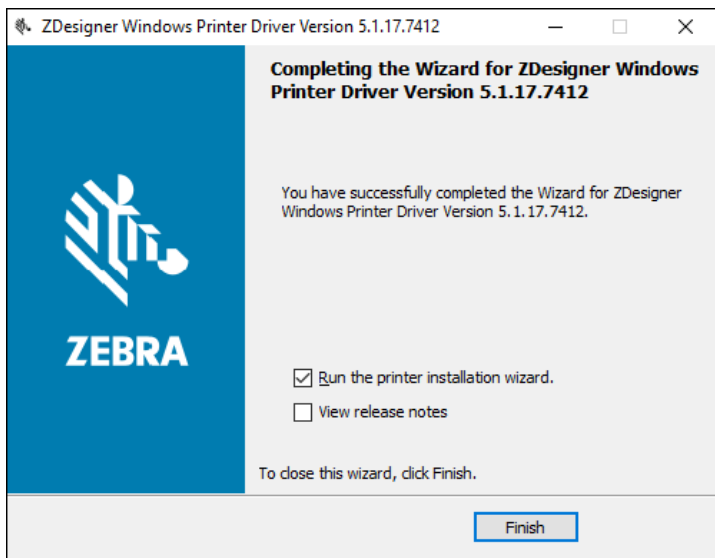

Running the Printer Installation Wizard

1. On the last screen of the driver installer, leave **Run the Printer Installation Wizard** checked, and then click **Finish**.

The printer driver wizard displays.

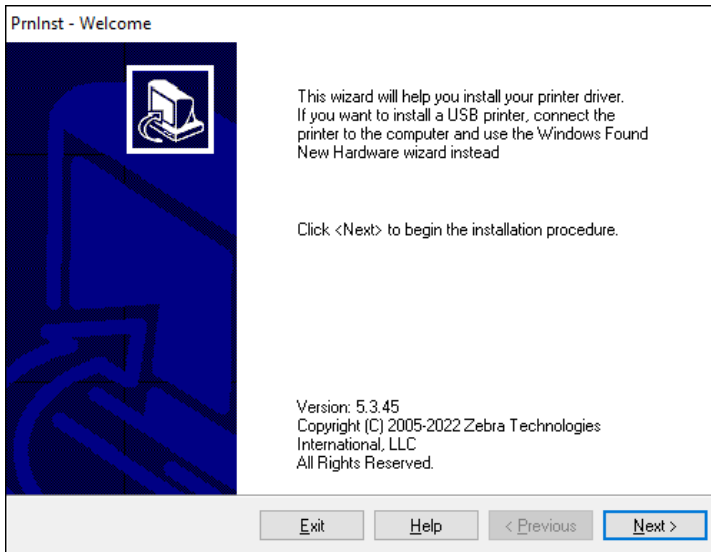

2. Click **Next**.

You are prompted to select an installation option.

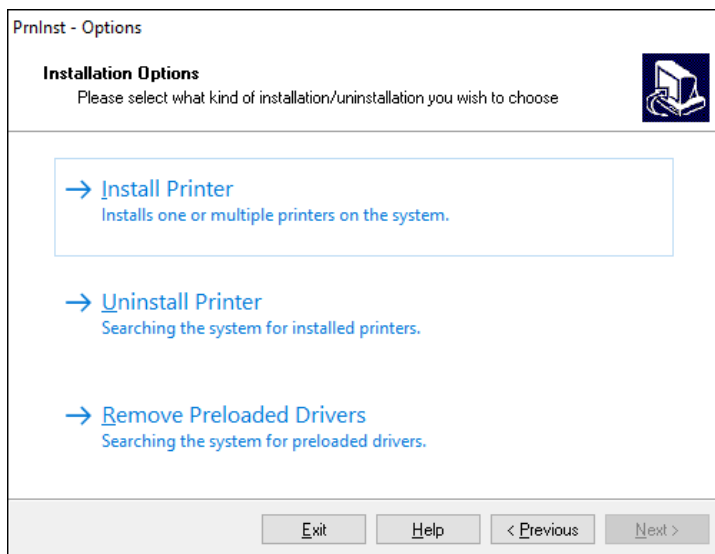

3. Click **Install Printer**.

The license agreement displays.

PrnInst - License Agreement

License Agreement
Please read the following license agreement carefully.



**END USER LICENSE AGREEMENT
(UNRESTRICTED SOFTWARE)**

IMPORTANT PLEASE READ CAREFULLY: This End User License Agreement ("EULA") is a legal agreement between you (either an individual or a company) ("Licensee") and Zebra Technologies Corporation ("Zebra") for Software, owned by Zebra and its affiliated companies and its third-party suppliers and licensors, that accompanies this EULA. For purposes of this EULA, "Software" shall mean machine-readable instructions used by a processor to perform specific operations. **BY USING THE SOFTWARE, LICENSEE ACKNOWLEDGES ACCEPTANCE OF THE TERMS OF THIS EULA. IF LICENSEE DOES NOT ACCEPT THESE TERMS, LICENSEE MAY NOT USE THE SOFTWARE.**

I accept the terms in the license agreement

I do not accept the terms in the license agreement

4. Read the important information and agree to the terms by selecting the **I Accept the Terms in the License Agreement button**. **Click Next**.

You are prompted to select a printer type (ZQ620 in this example). The model of the printer is located on the top next to the tear bar, or on the part sticker located underneath the printer.

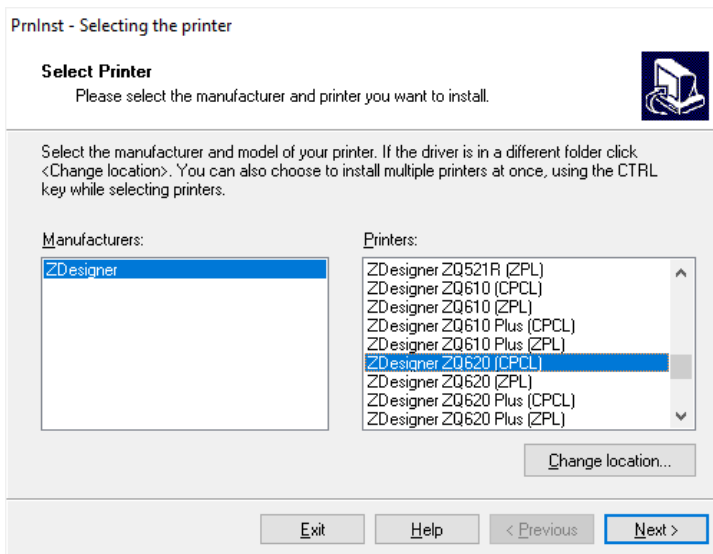

5. Click **Next**.

You are notified that the printer is already installed.

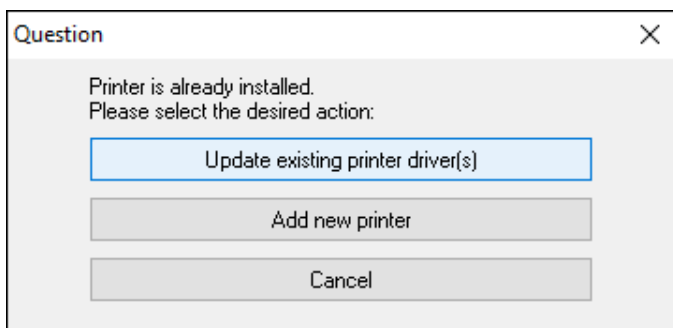

6. Click **Add new printer**.

You are prompted for a printer name, the port to which the printer will be connected, and the language for the printer display. In this example, select **USB002**.

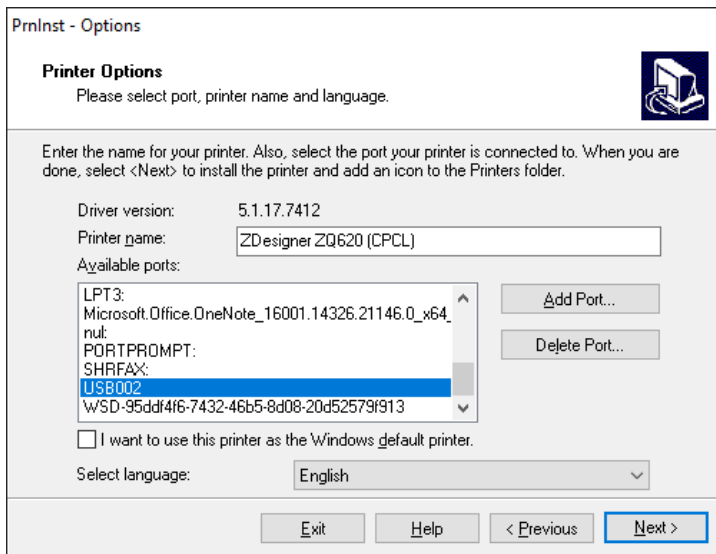

7. Click **Next**.

You are prompted to launch other setup wizards.

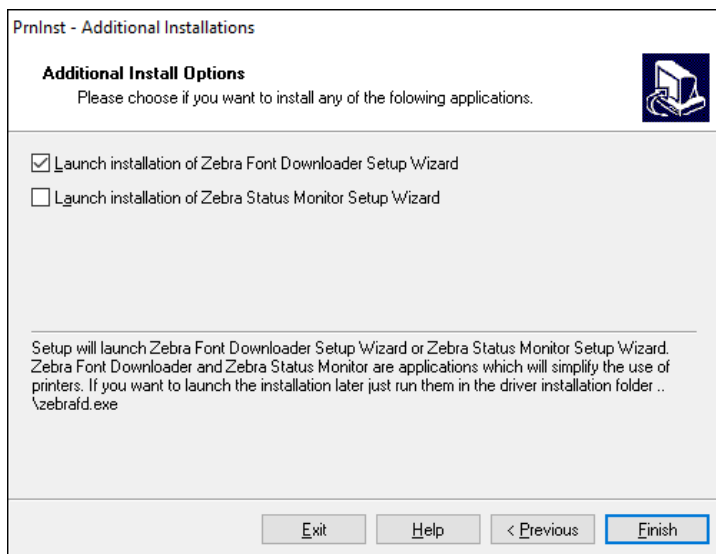

8. Click **Finish**.

After you install the drivers, connect the USB cord to the USB port on your printer (go to “USB Communications” on page 51).

As the printer boots up, your computer completes the driver installation and recognizes your printer. If you did not install the drivers first, see “What to Do If You Forget to Install Printer Drivers First”.

What to Do If You Forget to Install Printer Drivers First

If you plug in your Zebra printer before installing the drivers, the printer displays as an Unspecified device.

1. Follow the instructions in “Installing Drivers and Connecting to a Windows-Based Computer” on page 53.
2. Right-click on the Windows menu and select Device Manager.
 - Alternatively, enter Device Manger in the Windows search bar located in the Taskbar.

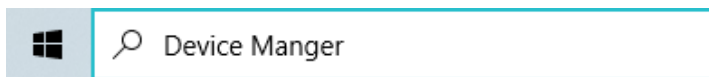

3. Click **Devices and Printers**

In this example, ZQ220 Plus is an incorrectly installed Zebra printer.

4. Find **Printers** from the list and select the arrow to expand the list.
5. Right-click on ZDesigner ZQ220 Plus (CPCL) to open the menu.

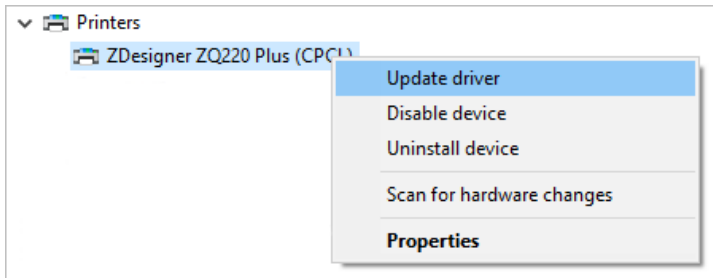

6. Click **Update Driver**.

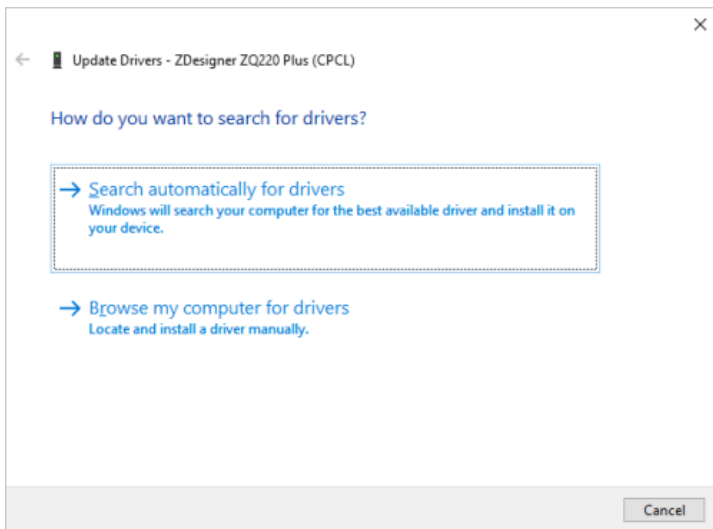

7. Click **Browse my computer for driver software**.

8. Click **Browse...** and navigate to the Downloads folder.

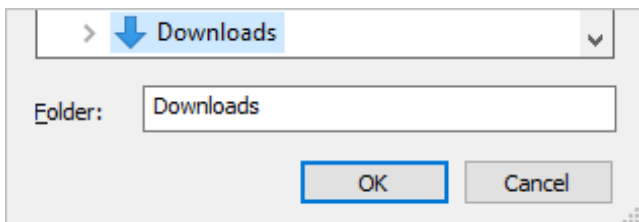

9. Click **OK** to select the folder.

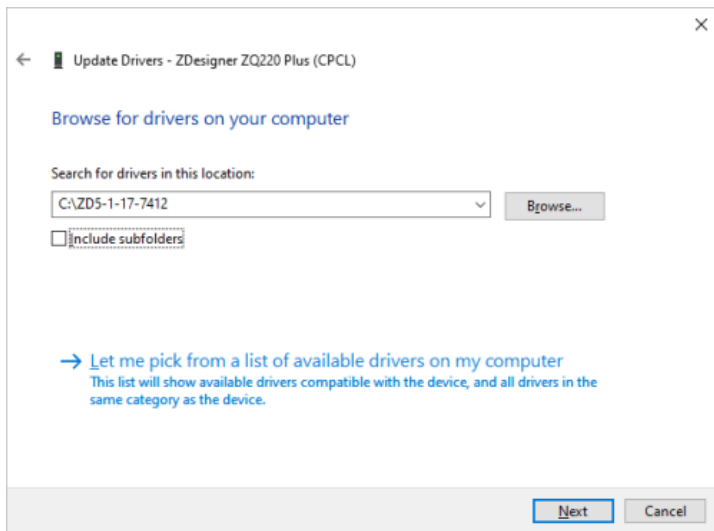

10. Click **Next**.

The device is updated with the correct drivers.

Connect to a Phone or Tablet

Download the free Zebra Printer Setup Utility app for your device.

- Android devices
- Apple devices

The applications support the following types of connectivity:

- Bluetooth Classic
- Bluetooth Low Energy (Bluetooth LE)
- Wired/Ethernet
- Wireless
- USB On-the-Go

For the User Guides for these printer setup utilities, go to zebra.com/setup.

Zebra Setup Utilities

Before configuring your printer for use on a Local Area Network (LAN), you need some basic information which enables you to establish the network configuration for your printer. Zebra Setup Utilities (ZSU) provides a quick and easy way to configure your printers for a variety of purposes, including setting them up for wireless communications either on a Local Area Network (LAN) or using the international Bluetooth communications standard.

Once Zebra Setup Utilities is downloaded to your computer, attach the USB cable to the printer and computer as shown in Figure 18.

Go to zebra.com/support to download ZSU, and go to “Appendix H” for details on navigating zebra.com.

Adding a Printer through Zebra Setup Utilities

If desired, use Zebra Setup Utilities to add printers to Windows using this procedure, after installing the drivers.

1. If necessary, install the Zebra Setup Utilities for Windows.
 - b. Go to zebra.com/setup and download Zebra Setup Utilities for Windows.
 - c. Run the zsu-xxxxxxx.exe file that you downloaded.
 - d. Follow the prompts in the IntallAwareWizard.
 - e. In the final screen of the wizard, click the checkbox next to Run Zebra Setup Utilities now, and then click Finish.
 - f. Follow the prompts in the System Prepare Wizard. If necessary, open the Zebra Setup Utilities program.
2. If necessary, open the Zebra Setup Utility program.

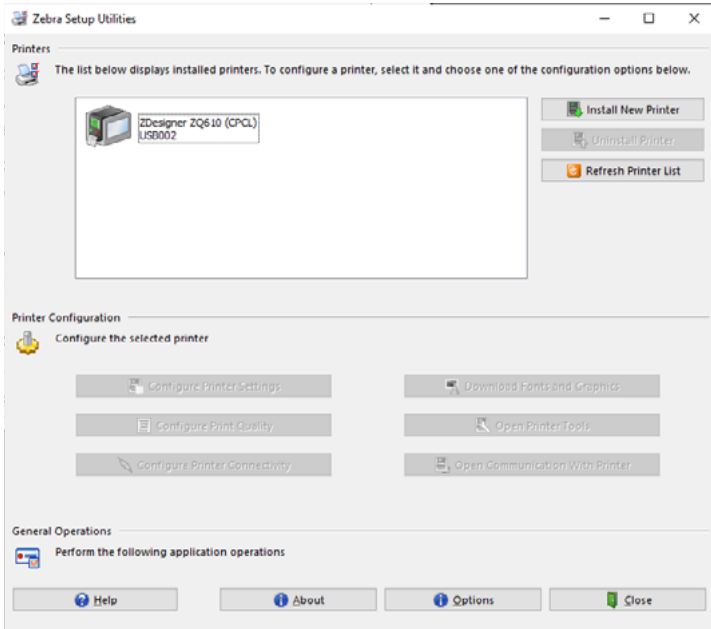

3. Click **Install New Printer**.

The printer driver wizard displays.

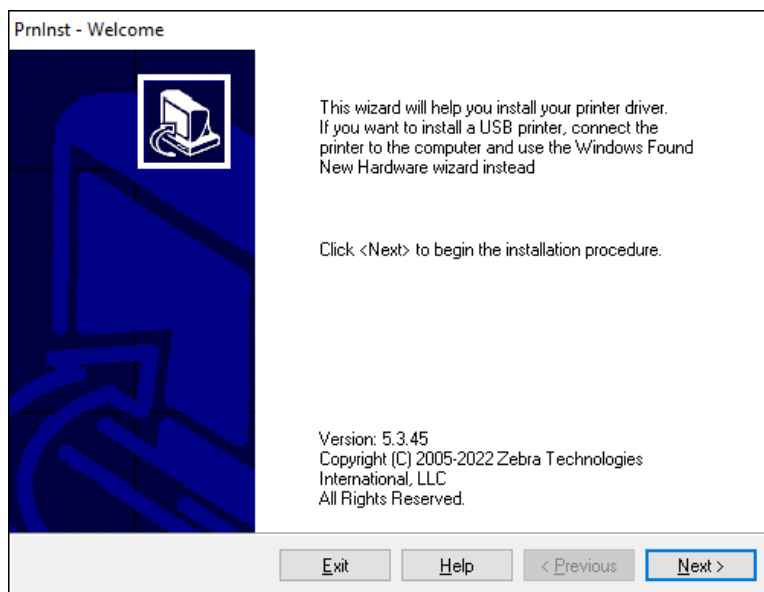

4. Click **Next**.

You are prompted to select an installation option.

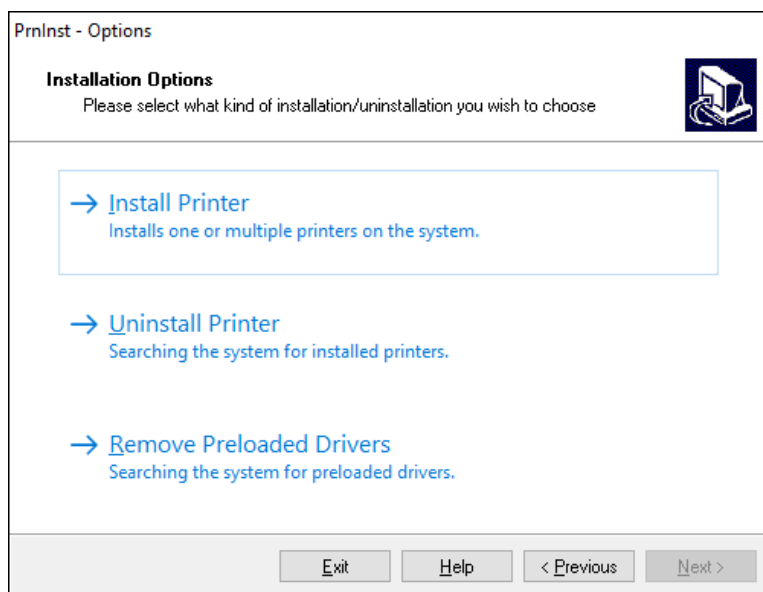

5. Click **Install Printer**.

You are prompted to select a printer type. The model type is located on top of the printer next to the tear bar, or on the part sticker located underneath the printer.

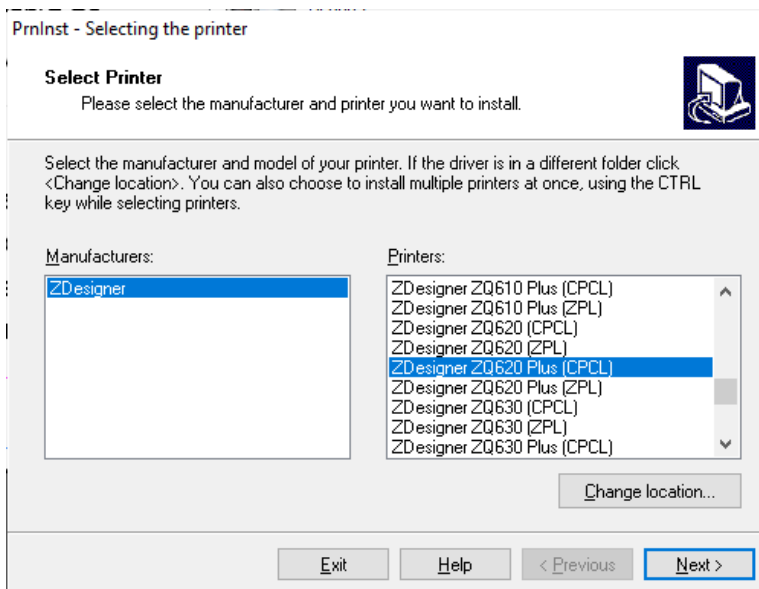

6. Click **Next**.

You are notified that the printer is already installed.

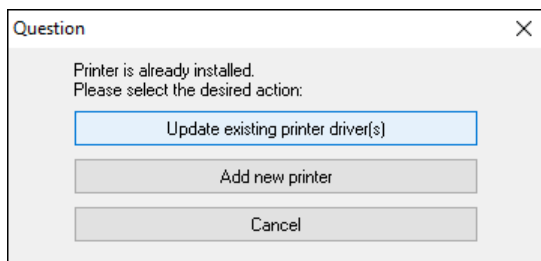

7. Click **Add new printer**.

You are prompted for a printer name, the port to which the printer is connected, and the language for the printer display. In this example, click **USB002**.

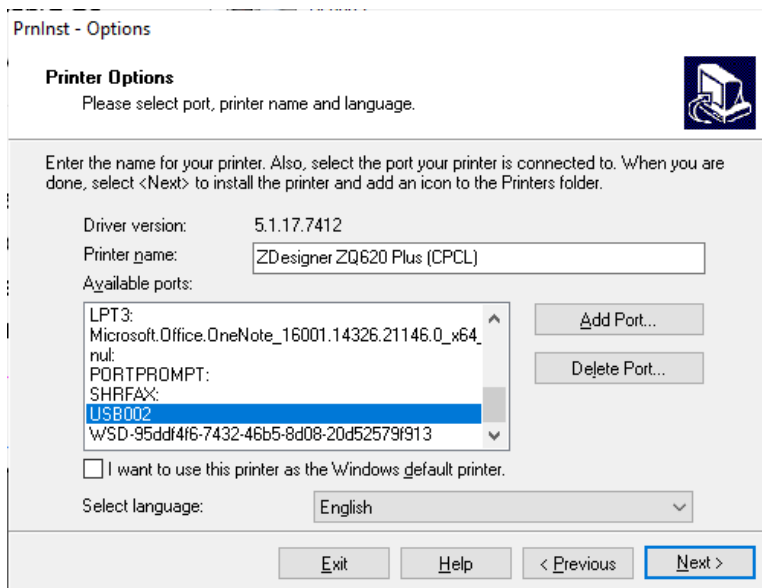

The screenshot shows the 'PrnInst - Options' dialog box. At the top, it says 'Printer Options' and 'Please select port, printer name and language.' Below this, there is a printer icon. The main area contains instructions: 'Enter the name for your printer. Also, select the port your printer is connected to. When you are done, select <Next> to install the printer and add an icon to the Printers folder.' The 'Driver version' is 5.1.17.7412. The 'Printer name' is 'ZDesigner ZQ620 Plus (CPCL)'. Under 'Available ports', a list includes LPT3, Microsoft.Office.OneNote_16001.14326.21146.0_x64_nul, PORTPROMPT:, SHRFAX:, USB002 (highlighted), and WSD-95ddf4f6-7432-46b5-8d08-20d52579f913. There are 'Add Port...' and 'Delete Port...' buttons. A checkbox for 'I want to use this printer as the Windows default printer.' is unchecked. The 'Select language:' dropdown is set to 'English'. At the bottom, there are 'Exit', 'Help', '< Previous', and 'Next >' buttons, with 'Next >' highlighted.

PrnInst - Options

Printer Options

Please select port, printer name and language.

Enter the name for your printer. Also, select the port your printer is connected to. When you are done, select <Next> to install the printer and add an icon to the Printers folder.

Driver version: 5.1.17.7412

Printer name: ZDesigner ZQ620 Plus (CPCL)

Available ports:

- LPT3:
- Microsoft.Office.OneNote_16001.14326.21146.0_x64_nul:
- PORTPROMPT:
- SHRFAX:
- USB002
- WSD-95ddf4f6-7432-46b5-8d08-20d52579f913

I want to use this printer as the Windows default printer.

Select language: English

Exit Help < Previous **Next >**

8. Click **Next**.

You are prompted to launch other setup wizards.

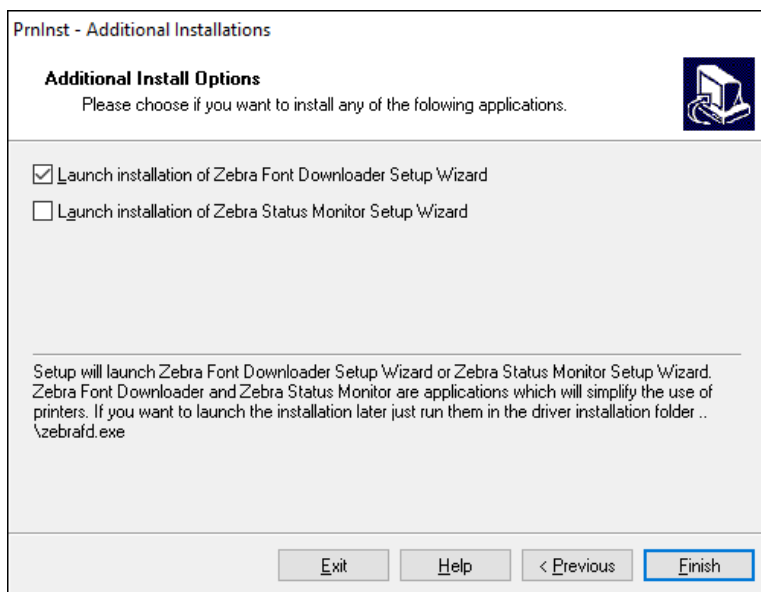

9. Check the desired options, and then click **Finish**.

The printer driver is installed. If you are prompted that other programs might be affected, click the appropriate option to continue.

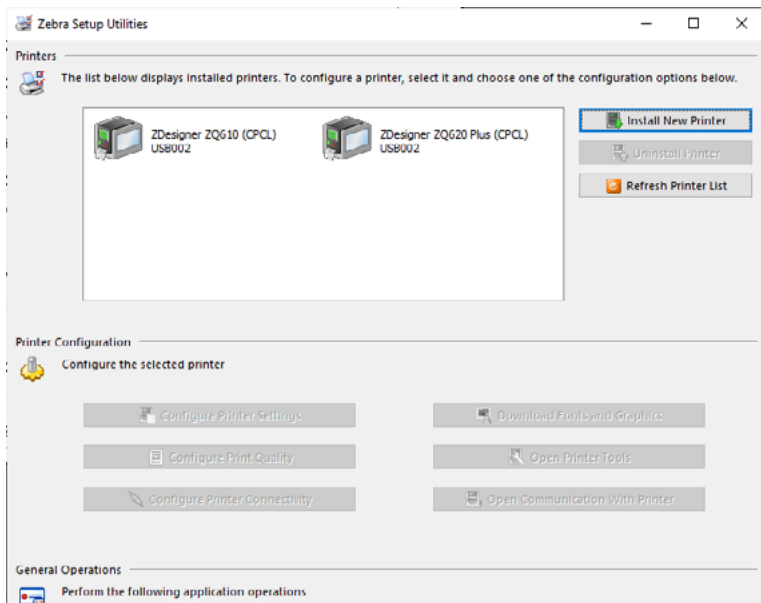

Wireless Communications with Bluetooth

Bluetooth is a worldwide standard for the exchange of data between two devices via radio frequencies. This form of point-to-point communication does not require access points or other infrastructure. Bluetooth radios are relatively low powered to help prevent interference with other devices running at similar radio frequencies. This limits the range of a Bluetooth device to about 10 meters (32 feet). The default for the ZQ630 Plus is Class 2, but the range can be set to Class 1 via a SGD (`bluetooth.power_class`) to increase power. Both the printer and the device it communicates with must follow the Bluetooth standard.

Bluetooth Networking Overview

Each Bluetooth enabled ZQ630 Plus printer is identified by a unique Bluetooth Device Address (BDADDR). This address resembles a MAC address whereby the first three bytes are vendor, and the last three bytes are device (for example, 00:22:58:3C:B8:CB). This address is labeled on the back of the printer via a barcode for ease of pairing. (For the dual radio, the MAC address label only represents WiFi MAC address (See Figure 19.) In order to exchange data, two Bluetooth enabled devices must establish a connection. Bluetooth software is always running in the background, ready to respond to connection requests. One device (known as the client) must request/initiate a connection with another. The second device (the server) then accepts or rejects the connection. A Bluetooth enabled ZQ630 Plus printer normally acts as a peripheral creating a miniature network with the host sometimes referred to as a “piconet”. Discovery identifies Bluetooth devices that are available for pairing whereby the controller device broadcasts a discovery request and devices respond. If a device is not discoverable, the controller cannot pair unless it knows the BDADDR or has previously paired with the device. If both devices support Bluetooth 2.1 or higher, they use Security Level 4 Secure Simple Pairing (SSP), a mandatory security architecture that features two association models: Numeric Comparison and Just Works (no user confirmation).

Bluetooth Security Modes

<p>Security Mode 1</p> <p>If a BT \geq 2.1 device is pairing with a BT \leq 2.0 device, it falls back to BT 2.0 compatibility mode and behaves the same as BT 2.0. If both devices are BT \geq 2.1, Secure Simple Pairing must be used according to the BT spec.</p>	<p>Security Mode 2</p> <p>If a BT \geq 2.1 device is pairing with a BT \leq 2.0 device, it falls back to BT 2.0 compatibility mode and behaves the same as BT 2.0. If both devices are BT \geq 2.1, Secure Simple Pairing must be used according to the BT spec.</p>	<p>Security Mode 3</p> <p>If a BT \geq 2.1 device is pairing with a BT \leq 2.0 device, it falls back to BT 2.0 compatibility mode and behaves the same as BT 2.0. If both devices are BT \geq 2.1, Secure Simple Pairing must be used according to the BT spec.</p>
--	--	--

Security Mode 4: Simple Secure Pairing

Simple Secure Pairing: a new security architecture introduced supported in BT \geq 2.1. Service-level enforced, similar to mode 2. Mandatory when both devices are BT \geq 2.1. There are four association models currently supported by mode 4. Security requirements for services must be classified as one of the following: authenticated link key required, unauthenticated link key required, or no security required. SSP improves security through the addition of ECDH public key cryptography for protection against passive eavesdropping and man-in-the-middle (MITM) attacks during pairing.

Numeric Comparison	Just Works
<p>Designed for situation where both devices are capable of displaying a six-digit number and allowing user to enter “yes” or “no” response. During pairing, user enters “yes” if number displayed on both devices matches to complete pairing. Differs from the use of PINs in legacy (BT \leq 2.0) pairing because the number displayed for comparison is not used for subsequent link key generation, so even if it is viewed or captured by an attacker, it could not be used to determine the resulting link or encryption key.</p>	<p>Designed for situation where one (or both) of the pairing devices has neither a display nor keyboard for entering digits (for example, Bluetooth headset). It performs authentication step 1 in the same manner as numeric comparison, but you cannot verify that both values match, so MITM (man-in-the-middle) protection is not provided. This is the only model in SSP that does not provide authenticated link keys.</p>

Each mode, except for Just Works, has Man-In-The-Middle (MITM) protection, meaning no third device can view the data being passed between the two devices involved. The SSP mode is usually negotiated automatically based on the capabilities of both the controller and follower. Lower security modes can be disabled via the `bluetooth.minimum_security_mode` SGD. The `bluetooth.minimum_security_mode` SGD sets the lowest security level at which the printer establishes a Bluetooth connection. The printer always connects at a higher security level if requested by the controller device. To change the security mode and security settings in the ZQ630 Plus printer, use Zebra Setup Utilities.

Bluetooth Minimum Security Modes

	BT Version of Controller Device (>2.1)
<code>bluetooth.minimum_security_mode=1</code>	Secure Simple Pairing Just Works/Numeric Comparison
<code>bluetooth.minimum_security_mode=2</code>	Secure Simple Pairing Just Works/Numeric Comparison
<code>bluetooth.minimum_security_mode=3</code>	Secure Simple Pairing Numeric Comparison
<code>bluetooth.minimum_security_mode=4</code>	Secure Simple Pairing Numeric Comparison
<code>bluetooth.bluetooth_PIN</code>	Not Used



`bluetooth.minimum_security_mode` **sets the lowest security level at which the printer establishes a Bluetooth connection. The printer always connects at a higher security level if requested by the controller device.**

The ZQ630 Plus printer also features bonding for Bluetooth. The printer caches pairing info so devices stay paired through power cycles and disconnects. This eliminates the need to repair on every connection establishment.

The `bluetooth.bonding` SGD is on by default.



Note • For detailed information on Bluetooth, refer to the Bluetooth Wireless User Guide (P1068791-002) at zebra.com/support.

In addition, the ZQ630 Plus printer supports passive Near Field Communication (NFC) technology. Using the “Print Touch” feature located on the side of the printer, end-users can automatically pair with a handheld device that supports NFC technology. The NFC tag has the printer’s BDADDR encoded in a URL on the tag. Simply touching the NFC handheld device to the “Print Touch” icon on the printer connects and pairs the handheld device to the printer.

WLAN Overview

ZQ630 Plus printers are optionally equipped with a Dual Radio that uses the industry standard 802.11 protocols and Bluetooth 4.1. They have the FCC ID number on the serial number label on the back of the unit.

- ZQ630 Plus Wireless Network Printers with the Zebra 802.11 WLAN radio module can be identified by the text “Wireless Network Printer” on the serial number label on the back of the printer.
- These printers allow communication as a node within a wireless local area network (WLAN). Methods of establishing communications to the printer varies with each application.

More information and LAN configuration utilities are included in the ZebraNet Bridge Enterprise™ program (version 2.8 and later).

Zebra Setup Utilities (ZSU) and Zebra Mobile Setup Utility can also be used to configure WLAN communications settings. Both ZebraNet Bridge Enterprise and ZSU may be downloaded from the Zebra Web site.

Figure 19 • BT/WLAN Communications



Setting Up the Software

The ZQ630 Plus printer uses Zebra's CPCL, ZPL or EPL Programming languages which were designed for mobile printing applications. CPCL and ZPL are fully described in the ZPL Programming Guide (p/n P1012728-010), CPCL Programming Guide (p/n P1073699-001) and ZPL II Programming Guide (p/n 46530L) available on-line at zebra.com/support. You can also use ZebraDesigner Pro v2, Zebra's Windows-based label creation program which uses a graphical interface to create and edit labels in either language (go to zebra.com/zebradesigner).

Designing Labels

The following examples provide guidelines for designing labels for the ZQ630 Plus printer, specifically for Gap Media, Black Bar Media and Journal Media. The illustrations for each media type define recommended tolerances, keep-out zones and safe printing zones designed to avoid any vertical registration issues during printing. Dimensions are determined based on product registration capabilities and Zebra-recommended media tolerances.

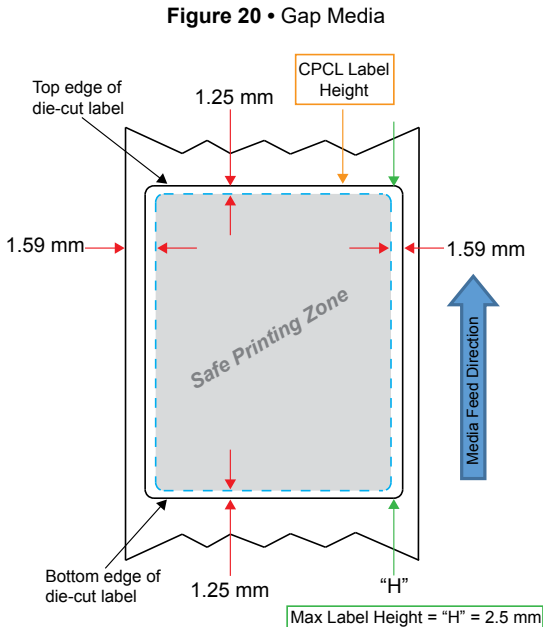

Figure 21 • Journal Media

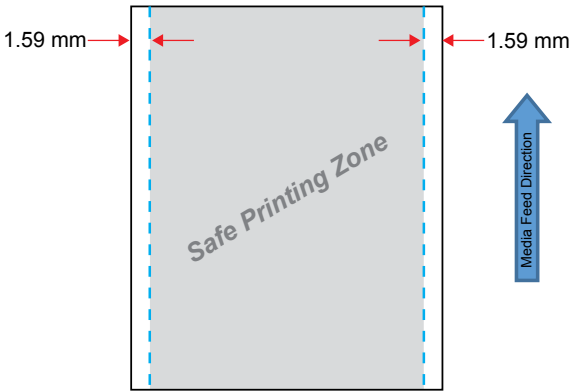
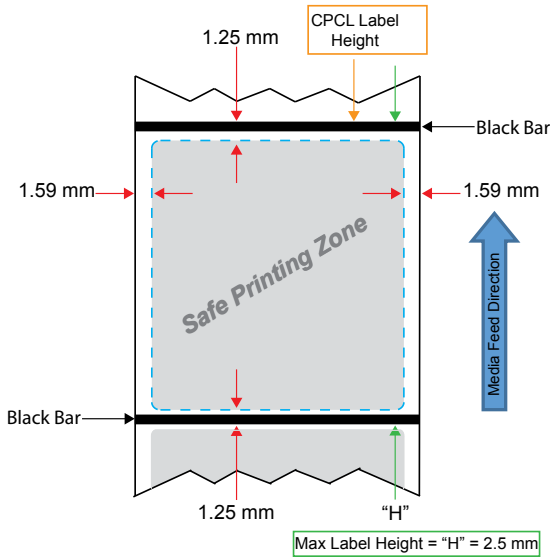

Figure 22 • Black Bar Label Media



Using Pre-Printed Receipt Media

ZQ630 Plus printers support alignment of pre-printed receipts by using the out of paper sensor located near the printhead.

Black Mark Dimensions (Receipt Media)

The reflective media black marks (or black bar/marks) should extend past the centerline of the roll on the front side of the paper.

- Minimum mark width: 15 mm (0.59 in.) perpendicular to the edge of the media, and centered within the width of the roll.
- Mark length: 4.8–6.0 mm (0.19–0.24 in.) parallel to the edge of the media.

Label Areas

The media/black bar sensor detects the dark, pre-printed bar on the media, so a path in the center of the paper must be kept free of dark, pre-printed graphics.



Note • *Dark, pre-printed graphics refer to any symbols, barcodes, text and/or colored areas that have been applied to the receipt paper rolls before they have ever been used in the printer.*

Figure 23 • Label Areas

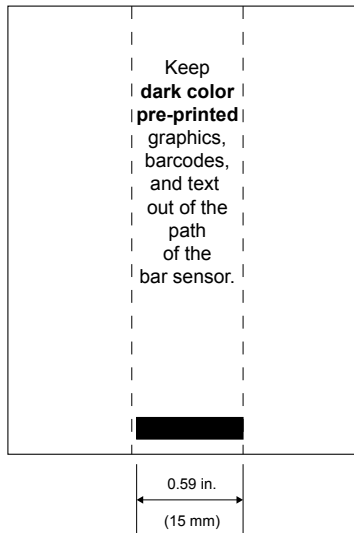

Label Design Examples

This section shows examples of labels with and without problems.

Figure 24 • Label Design Examples

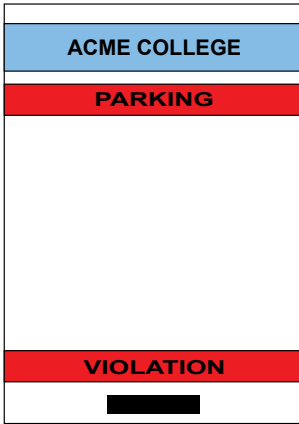

PROBLEM LABEL DESIGN

The dark color, pre-printed text and graphics are in the path of the black bar at the bottom of the receipt.

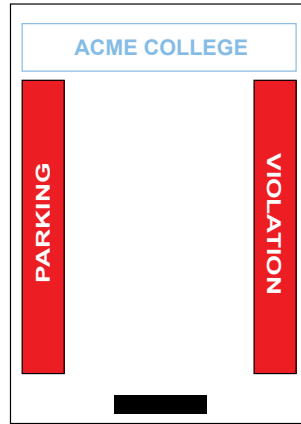

GOOD LABEL DESIGN

The center path to the black bar is free of dark color, pre-printed text and graphics.

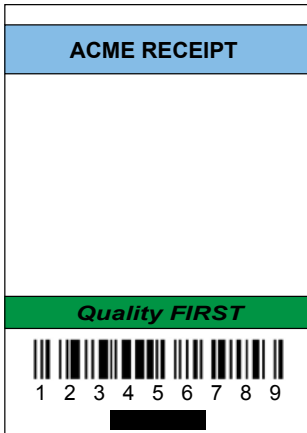

PROBLEM LABEL DESIGN

The dark color, pre-printed text and graphics are in the path of the black bar at the bottom of the receipt.

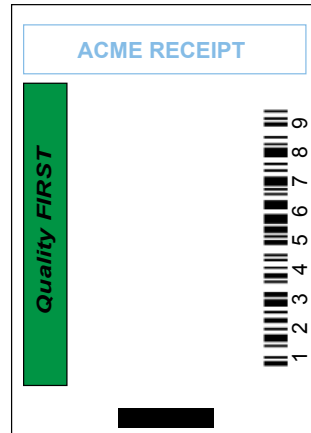

GOOD LABEL DESIGN

The center path to the black bar is free of dark color, pre-printed text and graphics.



Note • Complete information on using pre-printed receipt paper can be found in the FORM command in the CPCL Programming Guide (P1073699-001) at zebra.com/manuals.

Keep-Out Areas

At times, incomplete printing of text and/or graphics appear because minimum margins are not provided during label design. The recommended minimum margins, or Keep Out Areas, are shown in Figure 25.

Figure 25 • Keep Out Areas

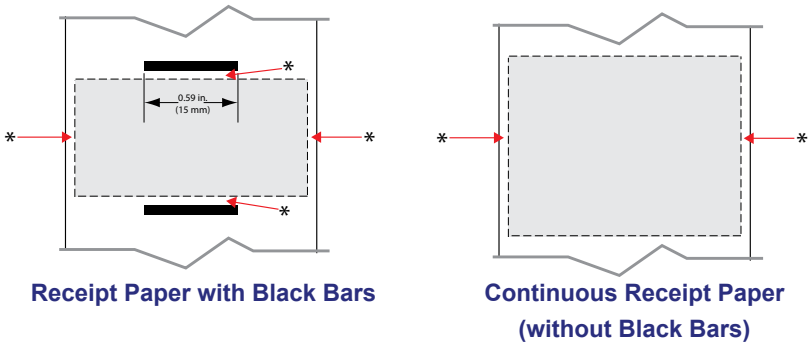

* Maintain a minimum “keep out area” of 1.59 mm (1/16 in.) from the two outer edges of the paper roll and from the black bars.

* Maintain a minimum “keep out area” of 1.59 mm (1/16 in.) from the two outer edges of the paper roll.



Note • The length of each Continuous receipt is determined by the data sent to the printer.

Near Field Communication (NFC)

Devices using NFC may be **active** or **passive**. A passive device, such as a ZQ630 Plus printer with an NFC tag, contains information that other devices can read, but the NFC tag does not read any information itself. An active device, such as a smartphone, can read the information on the printer's NFC tag, but the tag itself only transmits data to authorized devices.

Figure 26 • Near Field Communication (NFC) Pairing

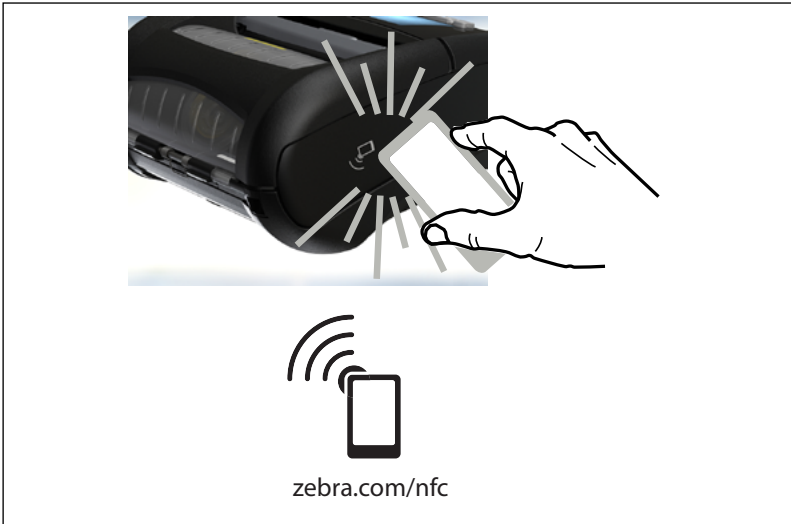

NFC Use Cases

Passive

- Bluetooth Pairing – causes a tablet, smart phone or mobile computer to automatically pair with the printer via a Bluetooth connection, within the bounds of the security profile being used. This shall contain the BT address and serial number of the printer.
- App launching – causes an app, developed either by Zebra or a third party, to be executed on a smart phone, tablet or mobile computer.
- Web site launching – causes a smart phone, tablet or mobile computer to display a web site developed by Zebra or a third party developer



Note • Tapping the Zebra Print Touch icon  with a Near Field Communication (NFC) enabled smartphone provide instant access to printer-specific information. For more information about NFC and Zebra products, go to zebra.com/nfc. Pairing Bluetooth applications via NFC is also possible. Go to zebra.com/sdk for more information.

Wearing the Printer

Swivel Belt Clip

The ZQ630 Plus printer has a plastic swivel belt clip (P1031365-028) included as a standard feature. To use:

1. Hook the clip over your belt.
2. Ensure the clip is securely attached to the belt.

The belt clip pivots to allow you to move freely while wearing the printer. In order to install or remove the plastic Belt Clip you need to remove the battery pack. The printer also has the option of using a more rigid metal belt clip (P1050667-031) which screws onto the printer using two 6-32 x 1/4 Pan Head Phillips screws. The metal clip also attaches to the printer while housed in the Hard Case (P1050667-034) using two 6-32 x 5/8 Pan Head Phillips screws.

Figure 27 • Printer with Belt Clips



Adjustable Shoulder Strap

Refer to Figure 28 if your printer is equipped with the shoulder strap option (p/n P1031365-192).

Figure 28 • Using the Optional Shoulder Strap



1. Insert the end of the shoulder strap behind the post on the front side of the printer and loop it around the post.



2. Insert the hole on the end of the strap over the metal post (circled) to secure.



3. Repeat the same steps on the opposite side of the printer.

Soft Case

The ZQ630 Plus printer has a soft case option (p/n P1050667-017) allowing you to carry the printer from your belt.

Figure 29 • Using the Soft Case



1. Lift up the top flap of the soft case which is secured with a self-fastener.



2. Slide the printer into the case such that the LCD display is visible through the plastic window.



Note • The shoulder strap option can be used with the soft case by securing the ends of the shoulder strap on the two metal rings on the soft case.

Hand Strap

The ZQ630 Plus hand strap accessory (p/n P1031365-027) attaches to the printer's cutouts to provide you with a convenient and secure method of carrying the printer.

Figure 30 • Using the Hand Strap



1. Insert the loop on the end of the strap through the cut out on the front of the printer as shown.



2. Loop the end of the strap back around the cut out and secure it over the button.





3. Repeat this process for the opposite end of the strap.

Hard Case

ZQ630 Plus printer has a two piece hard case option (P1050667-034) that also allows you to carry the printer from your belt with the metal belt clip (included), while also providing increased protection for the printer. It pivots via a hinge located on the back and snaps into place in front as shown below. The metal belt clip is mounted to the hard case and printer with two screws. If no belt clip is used, two shorter screws are used to hold the printer to the hard case.

Figure 31 • Using the Hard Case

<p>1. Insert the printer into the bottom half of the Hard Case shell.</p>	
<p>2. Rotate the top half of the Hard Case shell over the top of the printer and snap shut.</p>	
<p>3. Use a #1 Phillips Head driver to secure the two 6-32 x 5/8 screws to the bottom of the Hard Case.</p>	

Waist Holster

ZQ630 Plus printer has a waist holster option (p/n SG-MPP-Q4HLSTR1-01) that allows you to carry the printer around your waist for easy access.

1. Undo the snap on the Waist Strap which helps attach it to the printer Mount Pad.



2. Unlock the male D swivel clip (circled) on the Waist Strap from the female D clip on the printer Mount Pad to remove.



3. Align the holes on the Mount Pad with the mounting holes on the bottom of the printer (circled). Use a 4mm hex driver on the two 6-32 x 0.375" screws (green circle) and two #6 washers to attach the Mount Pad to the top of the printer. Attach the two (2) 6-32 x 0.625" screws (red circle) and washers on the bottom of the Mount Pad.

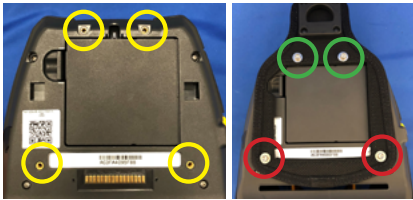

4. Connect the male D swivel clip on the Waist Strap to the female D clip on the printer Mount Pad. Snap shut to secure (opposite side) and rotate the Waist Strap 180°



5. Unsnap the Waist Strap and adjust the strap to the desired length.



6. Wrap the Waist Strap around your waist and snap the clip in place to secure. The printer should hang comfortably below the hip.

Preventive Maintenance

Extending Battery Life

- Never expose the battery to direct sunlight or temperatures over 40° C (104° F) when charging.
- Always use a Zebra charger designed specifically for Lithium-Ion batteries. Any other kind of charger may damage the battery.
- Use the correct media for your printing requirements. An authorized Zebra reseller can help you determine the optimum media for your application.
- If you print the same text or graphic on every label, consider using a pre-printed label.
- Choose the correct print darkness, and print speed for your media.
- Use software handshaking (XON/XOFF) whenever possible.
- Remove the battery if the printer won't be used for a day or more and you're not performing a maintenance charge.
- Consider purchasing an extra battery.
- Remember that any rechargeable battery loses its ability to maintain a charge over time. It can only be recharged a finite number of times before it must be replaced. Always dispose of batteries properly. Refer to Appendix F for more information on battery disposal.

General Cleaning Instructions



Caution • Avoid possible personal injury or damage to the printer. Never insert any pointed or sharp objects into the printer. Always turn off the printer before performing any cleaning procedures. Use care when working near the tear bars as the edges are very sharp.



Warning • The printhead can get very hot after prolonged printing. Allow it to cool off before attempting any cleaning procedures.



Only use a Zebra cleaning pen (not supplied with the printer) or a cotton swab with 90% medical grade alcohol for cleaning the printhead.



Caution • Use only cleaning agents specified in the following tables. Zebra Technologies Corporation will not be responsible for damage caused by any other cleaning materials used on this printer.

ZQ630 Plus Cleaning

Area	Method	Interval
Printhead	Use a Zebra cleaning pen to swab the thin gray line on the printhead, cleaning the print elements from the center to the outside edges of the printhead.	After every five rolls of media (or more often, if needed). When using linerless type media, cleaning is required after every roll of media.
Platen Surface (Linered)	Rotate the platen roller and clean it thoroughly with a fiber-free swab, or lint free, clean, damp cloth lightly moistened with medical grade alcohol (90% pure or better) (Figure 32).	After every five rolls of media (or more often, if needed)
Platen Surface (Linerless)	Rotate platen roller and clean with a fiber-free swab and 1 part liquid soap (Palmolive or Dawn) and 25 parts water. Use pure water to clean after soap/water mixture. (Figure 33)	Clean platen only if there is an issue during printing, for example, media not releasing from the platen. (see the following note).
Scraper (Linerless Units Only)	Use adhesive side of media to clean scraper on linerless units. (Figure 33)	After every five rolls of media (or more often, if needed).
Tear Bar	Clean thoroughly with 90% medical grade alcohol and a cotton swab. (Figure 32)	As needed
Printer Exterior	Water-dampened cloth or 90% medical grade alcohol wipe.	As needed
Printer Interior	Gently brush out printer. Ensure the Bar Sensor and Gap Sensor windows are free of dust. (Figure 32)	As needed
Interior of units with Linerless Platens	Clean thoroughly with 90% medical grade alcohol and a fiber-free swab. (See Figure 33 for specific target areas for interior cleaning.)	After every five rolls of media (or more often, if needed).



Note • This is an emergency procedure only to remove foreign contaminants (oils, dirt) from the platen that can damage the printhead or other printer components. This procedure will shorten or even exhaust the linerless platen's useable life. If the linerless media continues to jam after cleaning and feeding 1–2 m (3–5 ft.) of media, replace the platen.

Figure 32 • ZQ630 Plus Cleaning (Linered)

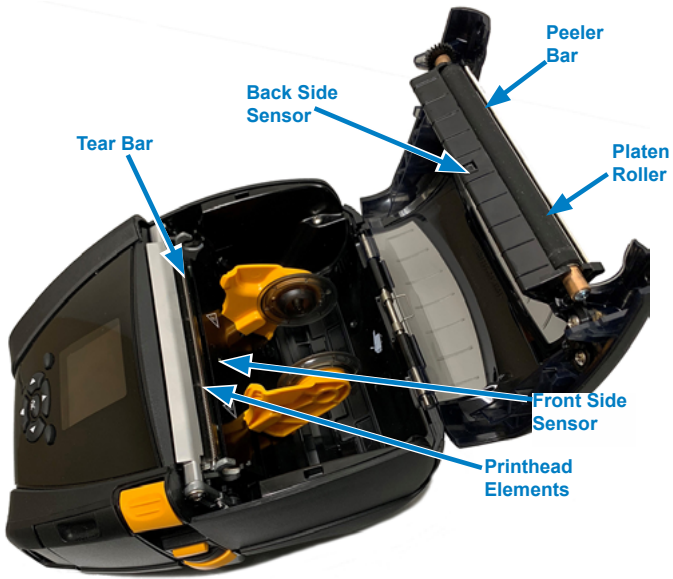
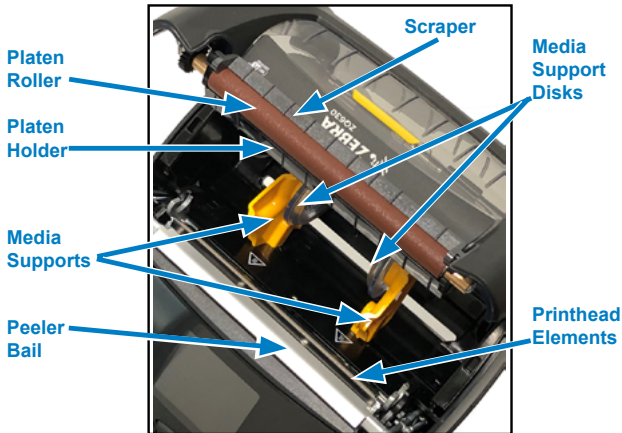

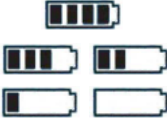







Figure 33 • ZQ630 Plus Cleaning (Linerless)



LCD Control Panel Indicators

The top of the display shows several icons which indicate the status of various printer functions. Check the indicator status, then refer to the Troubleshooting topic referenced in the chart to resolve the problem.

Icon	Status	Indication
	Solid blue	Bluetooth link established
	Not Present	Bluetooth link inactive
	Blinking blue	Connecting or transmitting labels
	Antenna Blinking	Looking for AP
	Antenna Blinking/1 Parenthesis Steady	WLAN Associated & Attempting Authentication
	Antenna and 2 Parentheses Steady	WLAN Associated and Authenticated
	Antenna and 2 Parentheses Blinking	Receiving Data
	Not Present	No Radio Present
	4 Green Bars	>80% charged
	3 Green Bars	60%-80% charged
	2 Yellow Bars	40%-60% charged
	1 Red Bar	20%-40% charged
	0 Bars (Red battery outline)	Low Battery
	4 green Blinking w/ Lightning Bolt	Charging >80% Capacity
	3 green Blinking w/ Lightning Bolt	Charging 60-80% Capacity
	2 yellow Blinking w/ Lightning Bolt	Charging 40-60% Capacity
	1 red Blinking w/ Lightning Bolt	Charging 20-40% Capacity
	0 Bars w/ red Lightning Bolt	Charging <20% Capacity
	Blinking red	Media cover open
	Blinking green	Receiving data
	Solid green	Ethernet Connected
	Not Present	No Ethernet Connection
	Blinking green	Data processing in progress
	Solid green	No data being processed
	Blinking red	Out of Media
	Solid white	Media present
	Blinking red	Error exists (excluding Media Out and Head Latch Open)
	Not Present	No error exists

Icon	Status	Indication
	4 green bars	802.11 signal strength > 75%
	3 green bars	802.11 signal strength <= 75%
	2 green bars	802.11 signal strength <= 50% but >25%
	1 yellow bar	802.11 signal strength <= 25%
	0 Bars	No Signal Strength

Troubleshooting Topics

1. No power:

- Check that battery is installed properly.
- Recharge or replace battery as necessary.



Caution • Always dispose of batteries properly. Go to “Appendix F” on page 130 for more information on proper battery disposal.

2. Media does not feed

- Ensure that the media cover is closed and latched.
- Check the spindle holding media for any binding.
- Ensure most recently printed label is removed (only in Peel mode).
- Ensure label sensor is not blocked.

3. Poor or faded print

- Clean the print head.
- Check the quality of media.

4. Partial or missing print

- Check the media alignment.
- Clean printhead.
- Ensure media cover is properly closed and latched.

5. *Garbled print*

- Check baud rate.

6. *No print*

- Check baud rate.
- Replace battery.
- Check cable to host device.
- Establish RF Link and/or restore LAN associativity.
- Invalid label format or command structure. Place printer in Communications Diagnostic (Hex Dump) Mode to diagnose problem.

7. *Reduced battery charge life*

- If battery is older than 1 year old, short charge life may be due to normal aging.
- Check battery health.
- Replace battery.

8. *flashing*

- Blinking green Data icon is normal while data is being received.

9. or *flashing*

- Check that media is loaded and that the media cover is closed and securely latched.

10. *Communication error*

- Check baud rate.
- Replace cable to the host device.

11. *Label jam*

- Open head release latch and media cover.
- Remove and reinstall media.

12. *Skip Labels*

- Check media for top of form sense mark or label gap.
- Check that the maximum print field has not been exceeded on label.
- Ensure bar or gap sensor is not blocked or malfunctioning.

13. Blank LCD screen

- Make sure printer is turned on.
- No application loaded or application corrupted: reload program.

14. No NFC Connectivity

- Ensure smartphone is positioned 3 inches (7.62 cm) or closer to the Print Touch icon on the side of the printer.

Troubleshooting Tests

Printing a Configuration Label

To print out a listing of the printer's current configuration follow these steps:

1. Turn the printer off. Load the media compartment with journal media (media with no black bars printed on the back).
2. Press and hold the **FEED**.
3. Press and release the **POWER** while keeping **FEED** pressed. When printing starts, release **FEED**.

See Figures 34, 34a, 34b for sample configuration printouts.



Note • *The configuration report can also be printed from the Info (Help) menu on the LCD.*

Communications Diagnostics

If there is a problem transferring data between the computer and the printer, put the printer in Communications Diagnostics mode (also referred to as DUMP mode). The printer prints ASCII characters and its text representation (or the period '.', if not a printable character) from data received from the host computer.

To enter Communications Diagnostics Mode:

1. Print a configuration label as previously described.
2. At the end of the diagnostics report, the printer prints: "Press FEED key to enter DUMP mode".
3. Press **FEED**. The printer prints: "Entering DUMP mode".



Note • *If FEED is not pressed within 3 seconds, the printer prints "DUMP mode not entered" and resumes normal operation.*

4. At this point, the printer is in DUMP mode and prints the ASCII hex codes of any data sent to it, and their text representation (or “.” if not a printable character).

Additionally, a file with a .dmp extension containing the ASCII information is created and stored in the printer’s memory. It can be viewed, cloned, or deleted using the ZebraNet Bridge application. For more information on ZebraNet Bridge, go to zebra.com/zebranetbridge.

To terminate the Communications Diagnostics Mode and re- turn the printer to normal operations:

1. Turn the printer off.
2. Wait 5 seconds.
3. Turn the printer on.

Contacting Technical Support

If the printer fails to print the configuration label, or you encounter problems not covered in the Troubleshooting section, contact Zebra Technical Support.

You must supply the following information:

- Model number and type (for example, ZQ630 Plus)
- Unit serial number (Found on the large label on the back of the printer, also found in the configuration label printout.)
- Product Configuration Code (PCC) (15 digit number found on the label on the back of the unit(“Appendix E”) and in the configuration label (Figure 34))

Figure 35 • ZQ630 Plus Configuration Label (cont.)



AC3FA4C68D41

Wireless:
Radio: 802.11 a/b/g/n/ac
Region: usa/canada
Country: usa/canada
Enabled: on
MAC Address: ac:3f:a4:C6:8D:40
IP Address: 0.0.0.0
Netmask: 255.255.255.0
Gateway: 0.0.0.0
Operating Mode: infrastructure
International Mode: off
Preamble Length: long
Security: none
Stored ESSID: 125
Associated: no
DHCP: on
DHCP CID type: 1
DHCP CID: ac3fa4c68d40
Power Save: on

Ethernet:
MAC Address: 00:07:4D:7A:7B:26
IP Address: 0.0.0.0
Netmask: 255.255.255.0
Gateway: 0.0.0.0
DHCP: on
DHCP CID type: 1
DHCP CID: 00074D7A7B26

Active Network Information:
Active Network: Unknown
IP Address: 0.0.0.0
Netmask: 255.255.255.0
Gateway: 0.0.0.0
TCP Port: 6101
Alternate TCP Port: 9100
TCP JSON Config Port: 9200
UDP Port: 6101
Remote Server:
Remote Server Port: 10013
TCP: on
UDP: on
LPD: on
DHCP: on
BOOTP: on
FTP: on
HTTP: on
SMTP: on
POP3: on
SNMP: on
TELNET: on
MIRROR: off
UDP Discovery: on
Weblink:
DHCP CID type: 1
DHCP CID: ac3fa4c68d40

Peripherals:
LCD: Installed

802.11 ac radio option installed. This section details the radio's network settings

Ethernet Information

Network Information

Peripherals Installed

Figure 36 • ZQ630 Plus Configuration Label (cont.)

```
Power Management:
In-activity Timeout:36000 Secs
Low-battery Timeout:60 Secs
Remote (DTR) pwr-off:Disabled
Voltage      :8.54
Low-bat Warning  :6.93(176)
Low-bat Shut-down :6.53(166)
Power On Cycles  :23
Battery Health   :good
Battery Cycle Count:NA

Memory:
Flash :134217728 Bytes
RAM   :8388608 Bytes

Label:
Width :576 dots, 72 mm
Height:65535 dots, 8191 mm

Sensors: (Adj)
Pres[DAC:128,Thr:60,Cur:0]
Label Removed
Media [91 (576 dots)]
Black Bar [DAC:136,Thr:70,Cur:0]
]
Gap [DAC:130,Thr:50,Cur:96]
Temperature :27C (62)
Voltage      :8.0V (255)

Resident Fonts:
Font      Sizes  Chars
-----
0         0- 6   20-FF
1         0     20-80
2         0- 1   20-59
4         0- 7   20-FF
5         0- 3   20-FF
6         0     20-44
7         0- 1   20-FF

File Directory:
File      Size
-----
E:2KEY.TXT      3507
E:TT0003M_.TTF 169188
134044672 Bytes Free

Command Language:
CCL Key '!' [21]

ZPL Configuration Information:
Rewind.....Print Mode
Mark.....Media Type
30.0.....Darkness
+00.....Tear Off Adjust
2030.....Label Length
72mm.....Print Width
7Eh.....Control Prefix
2Ch.....Delimiter
00.....Top Position
No Motion..Media Power Up
Feed...Media Head Closed
00.....Left Margin
576.....Dots per row
End ZPL Configuration
Print-head test: OK
End of report

Press FEED key to
enter DUMP mode
```

Flash and RAM Memory Installed

Maximum Label Size

Resident Human Readable Fonts Installed

Files loaded in printer memory (includes pre-scaled or scalable fonts)

CPCL and ZPL programming languages are supported

Specifications



Note • Printer specifications are subject to change without notice.

Printing Specifications

Parameter	ZQ630 Plus
Print Width	Up to 104 mm (4.1 in.)
Print Speed	101.6 mm (4 in.)/sec
	127 mm (5 in.)/sec in Draft Mode
Printhead Burn Line to Tear Edge Distance	4.06 mm (0.16 in.) +/- 0.25 mm (.01 in.)
Printhead Life	No less than 1 million in. of media fed using Zebra media.
Print Density	203 dots/in. or better

Memory and Communications Specifications

Parameter	ZQ630 Plus
Flash Memory	512 MB ¹
RAM Memory	256 MB ¹
Standard Communications	RS-232 serial port (14 Pin serial connector) Configurable Baud rate (from 9600 to 115.2 Kbps), parity and data bits. Software (X-ON/X-OFF) or hardware (DTR/STR) communication handshake protocols.
	USB 2.0 Full Speed Interface (12 Mbps)
Wireless Communication Options	1. Dual Radio: 802.11ac with Bluetooth v4.1 (both Classic & BLE) 2. Bluetooth v4.1 (both Classic & BLE)
Real Time Clock (RTC)	Time and date under application control. Refer to ZPL Programming Manual, available at www.zebra.com/manuals for RTC commands.
Ethernet	10 or 100 mps Ethernet auto detect when docked in cradle.

1. Memory configuration on your printer may be ascertained by printing a configuration label (go to "Printing a Configuration Label" on page 45).

Label Specifications

Parameter	ZQ630 Plus
Media Width	50.8 mm (2 in.) to 111 mm (4.4 in.) lined 50.8 mm (2 in.) to 109 mm (4.3 in.) linerless
Max/Min Label Length	12.7 to 812.8 mm (0.5 to 32 in.) maximum
Black Bar Sensor to Printhead Burnline Distance	15.87 mm (0.625 in.) +/- 0.635 mm (0.025 in.)
Media Thickness (except Tag)	3.2 to 7.5 mils (0.08128 to 0.1905 mm)
Max Tag Thickness	5.5 mils (0.1397 mm) or less
Max Label Roll Outer Diameter	66.8 mm (2.6 in.)
Inner Core Diameters**	19.05 mm (0.75 in.) or 34.925 mm (1.375 in.)
Black Mark Location	The reflective media black marks should be centered on media roll
Black Mark Dimensions	Minimum mark width: 12.7 mm (0.5 in.) Mark length: 2.4–11 mm (0.09–0.43 in.)



Note • Use Zebra brand direct thermal media that is outside wound. Media may be reflective (black mark) sensing, or transmissive (gap) sensing, die-cut, continuous or linerless. For die-cut labels, use only full auto dies.

**** The ZQ630 Plus printer supports coreless media which is 19 mm (0.75 in.) in inner diameter.**

Physical, Environmental and Electrical Specifications

Parameter	ZQ630 Plus
Weight w/ battery and no media	1.113 kg (2.45 lbs)
Temperature	Operating: -20–50°C (-4–122°F) with or without RFID option
	Storage: -25–65°C (-13–149°F) with or without RFID option
	Charging: 0–40°C (32–104°F) with or without RFID option
Relative Humidity	Operating/Storage: 10–90% non-condensing with or without RFID option
Battery	Smart Battery (4 cell) Lithium-Ion, 7.4 VDC (nominal); 6.8 Ahr min.
Intrusion Protection (IP) Rating	IP43 (without optional environmental case) IP54 (with case)

CPCL Font and Bar Code Specifications and Commands

Standard Fonts	25 bit-mapped fonts; 1 scalable font (CG Trimvirate Bold Condensed*)	
Available Optional Fonts	Optional International character sets: Chinese 16 x 16 (trad), 16 x 16 (simplified), 24 x 24 (simplified); Japanese 16 x 16, 24 x 24	
Linear Bar Codes Available	Barcode (CPCL Command)	
	Aztec (AZTEC) Codabar (CODABAR, CODABAR 16) UCC/EAN 128 (UCCEAN128) Code 39 (39, 39C, F39, F39C) Code 93 (93) Code 128 (128) EAN 8, 13, 2 and 5 digit extensions (EAN8, EAN82, EAN85, EAN13, EAN132, and EAN135) EAN-8 Composite (EAN8) EAN-13 Composite (EAN13) Plessey (PLESSEY) Interleaved 2 of 5 (I2OF5) MSI (MSI, MSI10, MSI1110) FIM/POSTNET (FIM) TLC39 (TLC39) UCC Composite A/B/C (128(Auto)) UPCA, 2 and 5 digit extensions (UPCA2 and UPCA5) UPCA Composite (UPCA) UPCE, 2 and 5 digit extensions (UPCE2 and UPCE5) UPCE Composite (UPCE) MaxiCode (MAXICODE) PDF 417 (PDF-417) Datamatrix (using ZPL emulation) (DATAMATRIX) QR Code (QR)	
2-D Bar Codes Available	RSS:	RSS-14 (RSS-Subtype 1) RSS-14 Truncated (RSS-Subtype 2) RSS-14 Stacked (RSS-Subtype 3) RSS-14 Stacked Omnidirectional (RSS-Subtype 4) RSS Limited (RSS-Subtype 5) RSS Expanded (RSS-Subtype 6)
Rotation Angles	0°, 90°, 180°, and 270°	

***Contains UFST from Agfa Monotype Corporation Downloadable optional bit-mapped & scalable fonts via Net Bridge software.**

ZPL Font and Bar Code Specifications and Command

Standard Fonts	15 bit-mapped fonts; 1 scalable font (CG Trimvirate Bold Condensed*)
Available Optional Fonts	Zebra offers font kits covering multiple languages including Simplified and Traditional Chinese, Japanese, Korean, Hebrew/Arabic, and others.
Linear Bar Codes Available 2-D Bar Codes Available	Barcode (CPCL Command)
	Aztec (^B0) Codabar (^BK) Codablock (^BB) Code 11 (^B1) Code 39 (^B3) Code 49 (B4) Code 93 (^BA) Code 128 (^BC) DataMatrix (^BX) EAN-8 (^B8) EAN-13 (^BE) GS1 DataBar Omnidirectional (^BR) Industrial 2 of 5 (^BI) Interleaved 2 of 5 (^B2) ISBT-128 (^BC) LOGMARS (^BL) Micro-PDF417 (^BF) MSI (^BM) PDF-417 (^B7) Planet Code (^B5) Plessey (^BP) Postnet (^BZ) Standard 2 of 5 (^BJ) TLC39 (^BT) UPC/EAN extensions (^BS) UPC-A (^BU) UPC-E (^B9) Maxi Code (^BD) QR Code (^BQ)
Rotation Angles	0°, 90°, 180°, and 270°

****Downloadable optional bit-mapped & scalable fonts via Net Bridge software.***

Communication Ports

RS-232C

Pin #	Signal Name	Type	Description
1	CTS	input	Clear To Send from host
2	TXD	output	Transmit Data
3	RXD	input	Receive Data
4	DSR	input	Data Set Ready: low to high transition turns printer on, high to low transition turns printer off (if enabled)
5	GND		Ground
6	DTR	output	Data Terminal Ready: set high when printer is on. Switched 5V (300mA max)
7	N/A		Do Not Use
8	RTS	output	Request To Send set high when printer is ready to accept a command or data
9	N/A		Do Not Use
10	N/A		Do Not Use
11	N/A		Do Not Use
12	N/A		Do Not Use
13	N/A		Do Not Use
14	N/A		Do Not Use

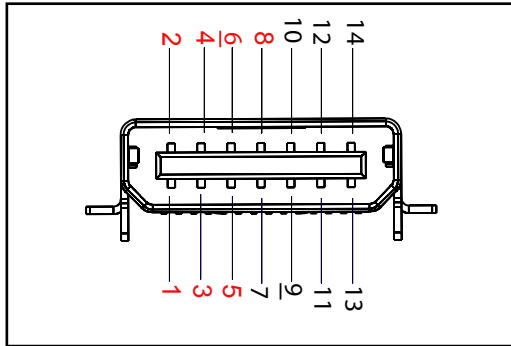

Figure 37 • RS-232C Communication Port

USB

Pin #	Signal Name	Type	Description
1	VBUS	-	USB Bus Power
2	USB-	bi-directional	I/O signals
3	USB+	bi-directional	I/O signals
4	USB_ID	-	Identifies A/B connector
5	Return		Ground

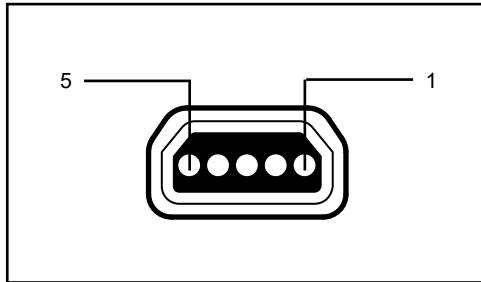
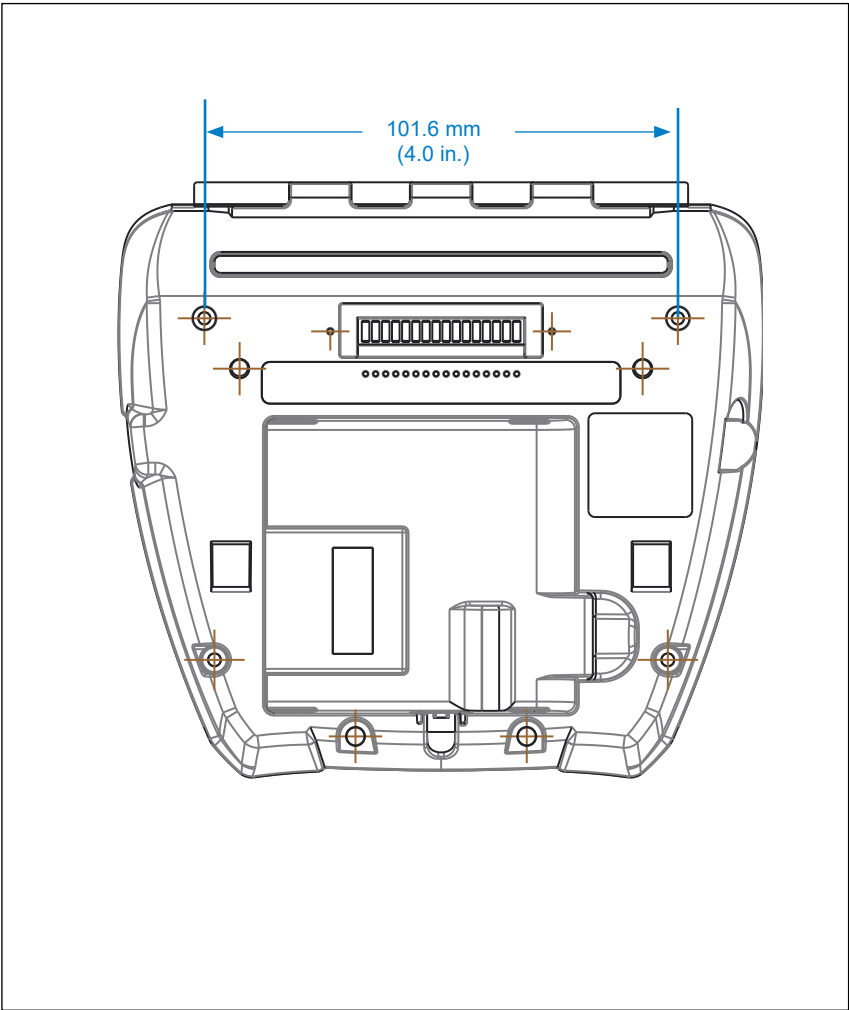

Figure 38 • USB Communication Port

Figure 39 • ZQ630 Plus Dimensions



Figure 40 • ZQ630 Plus Mounting Hole Dimensions



Use two M2.5 x 0.45 screws in the indicated positions above.

ZQ630 Plus Accessories

Part #	Description
BTRY-MPP-68MA1-01	KIT ACC ZQ630 SPARE SMART BATTERY
P1050667-007	KIT ACC QLn420 RUBBER DOOR I/O (15)
P1050667-010	KIT ACC QLn420 RUBBER DOOR DC JACK (15)
P1050667-017	KIT ACC QLn4/ZQ630 SOFT CASE (Includes Shoulder Strap)
P1050667-018	KIT ACC QLn4/ZQ63 -EC AC ADAPTER US (type A) CORD
P1050667-019	KIT ACC QLn4/ZQ63-EC AC ADAPTER UK (type G) CORD
P1050667-020	KIT ACC QLn4/ZQ63-EC AC ADAPTER EU/CHILE (type C) CORD
P1050667-021	KIT ACC QLn4/ZQ63-EC, AC ADAPTER, JAPAN CORD
P1050667-022	KIT ACC QLn4/ZQ6-EC AC ADAPTER BRAZIL CORD
P1050667-023	KIT ACC QLn4/ZQ63-EC AC ADAPTER ARGENTINA CORD
P1050667-024	KIT ACC QLn4/ZQ63-EC AC ADAPTER AUSTRALIA (type I) CORD
P1050667-025	KIT ACC QLn4/ZQ63-EC, AC ADAPTER,CN CORD
P1050667-026	KIT ACC QLn4/ZQ63-VC – 15V – 60V to 12V
P1050667-027	KIT ACC QLn4/ZQ63-EC, AC ADAPTER,TAIWAN CORD
P1050667-028	KIT ACC QLn4/ZQ63-EC AC ADAPTER, ISRAEL CORD
P1050667-029	KIT ACC QLn4/ZQ63-EC (NO ADAPTER, NO CORD)
P1050667-030	KIT ACC QLn4/ZQ63-VC (no adapter, no cord)
P1050667-031	KIT ACC QLn4/ZQ63 METAL BELT CLIP
P1050667-032	KIT ACC QLn4/ZQ63 Handi-Mount (compact, flexible RAM arm) with Base Plate
P1050667-033	KIT ACC QLn4/ZQ63 Handi-Mount (compact, flexible RAM arm) without Base Plate
P1050667-034	KIT ACC QLn4/ZQ63 ASSY HARD CASE W/METAL BELT CLIP
P1050667-035	KIT ACC QLn4/ZQ63 Mobile Mount for Forklifts (with U-arm bracket and fanfold bin)
P1050667-037	KIT ACC QLn4/ZQ63 MOBILE MOUNT PLATE
P1050667-038	KIT ACC QLn/ZQ6 DESKTOP STAND
P1050667-041	KIT ACC QLn4/ZQ63 BATTERY ELIMINATOR NO ADAPTER
P1050667-047	KIT ACC QLn4/ZQ63 RAM MOUNT PLATE
P1031365-024	KIT ACC,QLn/ZQ5/ZQ6,AC ADAPTER,US (type A) Cord

ZQ630 Plus Accessories cont.

P1031365-060	KIT ACC QLn/ZQ6 11 PIN Serial Cable (with strain relief) to MC3000
P1031365-061	KIT ACC QLn/ZQ6 Serial DEX Cable (with strain relief)
P1031365-062	KIT ACC QLn/ZQ6 Serial Cable (with strain relief) to RJ45
P1031365-063	Kit ACC SC2 LI-ION SMART CHARGER, US (type A) cord
P1031365-064	Kit ACC SC2 LI-ION SMART CHARGER, UK (type G) cord
P1031365-065	Kit ACC SC2 LI-ION SMART CHARGER, EU/CHILE (type C) cord
P1031365-066	Kit ACC SC2 LI-ION SMART CHARGER, AUSTRALIA (type I) cord
P1031365-067	Kit ACC SC2 LI-ION SMART CHARGER, BRAZIL
P1031365-068	Kit ACC SC2 LI-ION SMART CHARGER, CHINA CORD
P1031365-083	KIT ACC, QLn/ZQ5/ZQ6, AC ADAPTER, ARGENTINA CORD
P1031365-088	KIT ACC SC2 LI-ION SMART CHARGER, ISREAL CORD
P1031365-089	KIT, ACC, SC2 LI-ION SMART CHARGER, ARGENTINA CORD
P1031365-093	KIT ACC, QLn/ZQ5/ZQ6, AC ADAPTER, TAIWAN CORD
P1031365-094	KIT ACC, QLn/ZQ5/ZQ6, AC ADAPTER, JAPAN CORD
P1031365-095	KIT ACC SC2 LI-ION SMART CHARGER, TAIWAN CORD
P1031365-096	KIT ACC SC2 LI-ION SMART CHARGER, JAPAN CORD
P1031365-192	KIT ACC QLn SERIES SHOULDER STRAP
P1031365-104	KIT ACC QLn SERIAL CABLE (with strain relief) to LS2208 SCANNER EXTENDED
AC18177-5	MODEL UCLI72-4 QUAD BATTERY CHARGER (US line cord, see Sales for others)
SAC-MPP-3BCHGUS1-01	3-SLOT BATTERY CHARGER
SAC-MPP-6BCHUS1-01	DUAL 3-Slot BATTERY CHARGER
SAC-MPP-1BCHGUS1-01	1-SLOT BATTERY CHARGER
VAM-MPP-VHCH1-01	VEHICLE ADAPTER
P1065668-008	KIT, ACC, QLn, AC ADAPTER, STRAIGHT, 30W, HC with US (type A) CORD
SG-MPP-Q4HLSTR1-01	KIT, WAIST, STRAP, QLn420



Note • Go to “Appendix A” on page 105 for additional information on Data I/O cables.

Interface Cables (RS-232 Cables)

Part Number P1031365-053; DB-9 to 14-Pin Serial

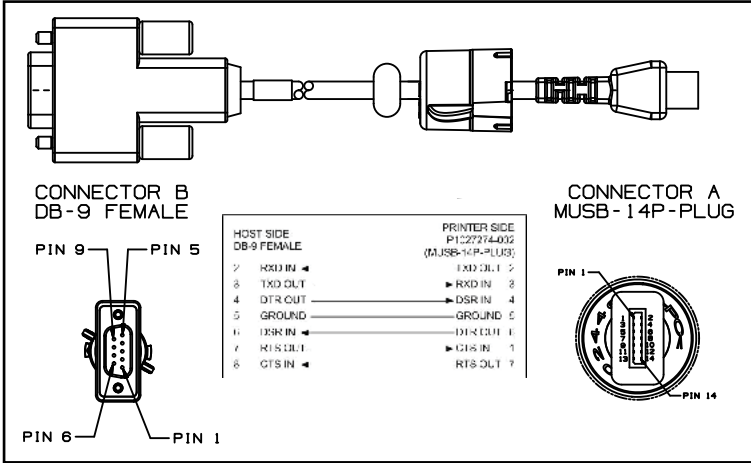

Part Number P1031365-052; 8-Pin DIN to 14-Pin Serial Cable

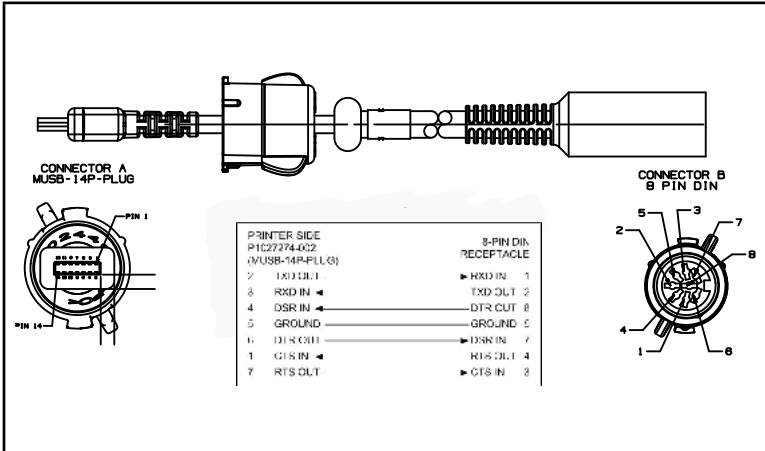

USB Cables

Part Number AT17010-1; USB A to USB Mini B Cable

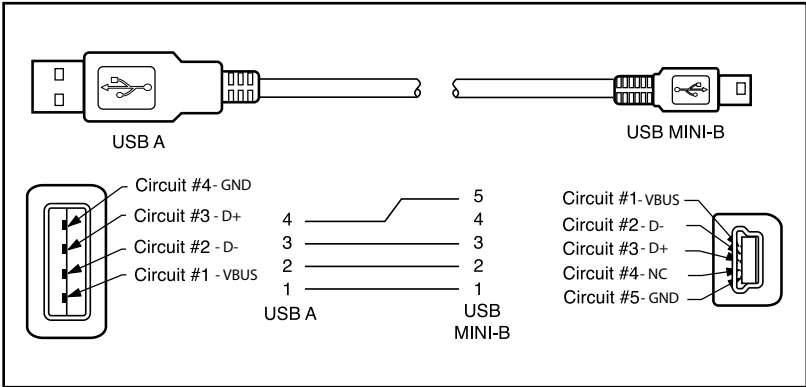

Part Number P1031365-055; 4 Position USB Mini to 4-Pin USB (w/ Strain Relief)

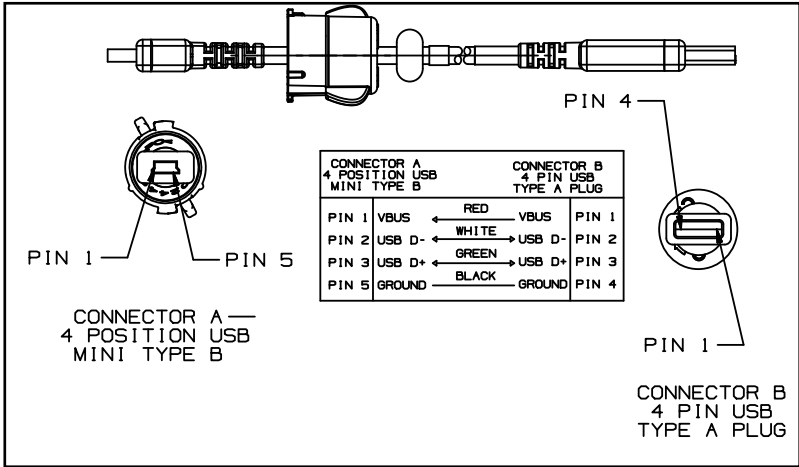

Note • Visit the Zebra website at: zebra.com/accessories for a listing of interface cables for all Zebra mobile printers.

Appendix B

Media Supplies

To insure maximum printer life and consistent print quality and performance for your individual application, it is recommended that only media produced by Zebra be used. This includes Zebra RFID media made for the ZQ630 Plus. Non-Zebra RFID media may not pass RFID calibration.

Advantages include:

- Consistent quality and reliability of media products.
- Large range of stocked and standard formats.
- In-house custom format design service.
- Large production capacity which services the needs of many large and small media consumers including major retail chains world wide.
- Media products that meet or exceed industry standards.

For more information, go to zebra.com/supplies.



Note • It is recommended that linerless media be stored at temperatures between 20°C and 35°C.

Appendix C

Maintenance Supplies

In addition to using quality media provided by Zebra, it is recommended that the printer be cleaned as prescribed in the maintenance section. The following item is available for this purpose:

- Cleaning Pen (12 pack): p/n 105950-035



SETTINGS Menu

DARKNESS -49
⬆

Set the darkness to the lowest setting that provides good print quality. If you set darkness too high, the label image may print unclearly, bar codes may not scan correctly, or the printhead may wear prematurely.

SGD: `print.tone_zpl`

PRINT SPEED 4.0
⬆

Select the speed for printing a label (given in inches per second). Slower print speeds typically yield better print quality.

SGD: `media.speed`

MEDIA TYPE MARK
⬆

Select the type of media that you are using.

SGD: `ezpl.media_type`

TEAR OFF 0
⬆

If necessary, adjust the position of the media over the tear bar after printing.

SGD: `ezpl.tear_off`

PRINT WIDTH 576
↑

Specify the width of the labels being used. The default value is the maximum width for the printer based on the printhead's DPI value.

SGD: [ezpl.print_width](#)

PRINT MODE REWIND
↑

Select a print mode that is compatible with your printer options.

SGD: [ezpl.print_mode](#)

LABEL TOP 0
↑

If necessary, shift the position of the image vertically on the label.

- Negative numbers move the image higher on the label (toward the printhead).
- Positive numbers move the image farther down on the label (away from the printhead) by the specified number of dots.

SGD: [zpl.label_top](#)

LEFT POSITION 0
↑

If necessary, shift the print position horizontally on the label. Positive numbers move the left edge of the image toward the center of the label by the number of dots selected, while negative numbers move the left edge of the image toward the left edge of the label.

SGD: [zpl.left_position](#)

REPRINT MODE OFF
↑

When reprint mode is enabled, you can reprint the last label printed either by issuing certain commands or by pressing the DOWN ARROW on the keypad.

SGD: [ezpl.reprint_mode](#)

LABEL LENGTH MAX
39

Set the maximum label length to a value that is at least 1.0 in. (25,4 mm) greater than the actual label length plus the interlabel gap. If you set the value to one that is smaller than the label length, the printer assumes that continuous media is loaded, and the printer cannot calibrate.

SGD: [ezpl.label_length_max](#)

LANGUAGE
ENGLISH

If necessary, change the language that the printer displays.

SGD: [display.language](#)



Note • The selections for this parameter are displayed in the actual language to make it easier to find one that you are able to read.



TOOLS Menu

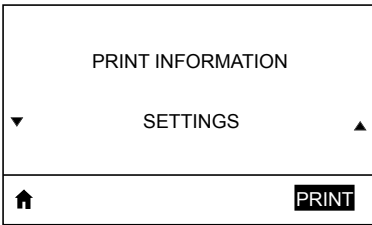

Prints a printer configuration label, sensor profile, barcode information, font information, images, formats, two-key report, and network settings.

SGD: `device.user_vars.display_wmlsg_printlist`

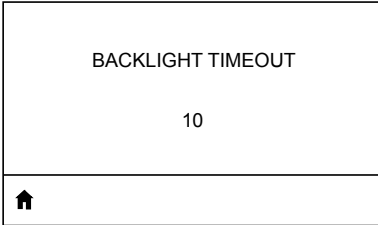

Sets the duration of the LCD backlight in seconds.

SGD: `display.backlight_on_time`

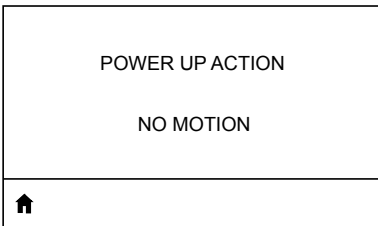

Set the action for the printer to take during the power-up sequence, for example, no motion, calibrate, etc.

SGD: `ezpl.power_up_action`

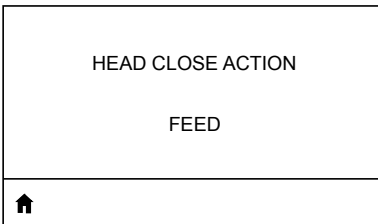

Set the action for the printer to take when you close the printhead, for example, feed, calibrate, etc.

SGD: `ezpl.head_close_action`

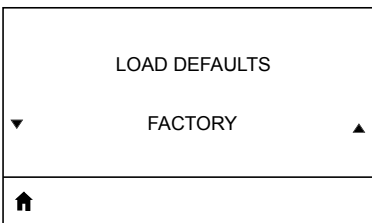

Restore specific printer, print server, and network settings back to the factory defaults. Use care when loading defaults because you need to reload all settings that you changed manually. This menu item is available through two user menus with different default values for each.

SGD: `ezpl.load_defaults`

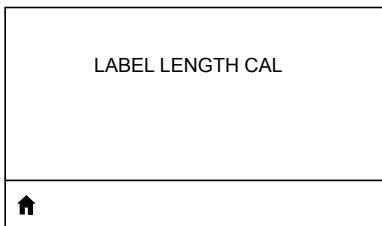

Calibrate the printer to adjust the length of the label.

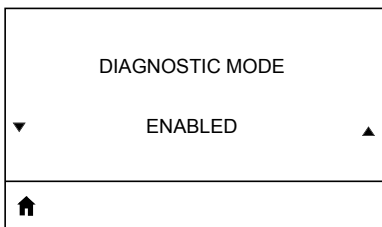

Use this diagnostic tool to cause the printer to output the hexadecimal values for all data received by the printer.

SGD: `device.user_vars.display_diagnostic_list`

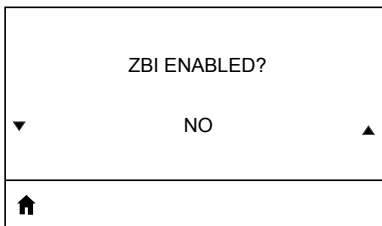

This menu item indicates if the Zebra Basic Interpreter (ZBI 2.0™) option is enabled on your printer. If you would like to purchase this option, contact your Zebra reseller for more information.

SGD: `zbi.key`

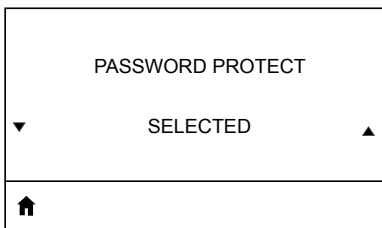

Select the level of password protection for user menu items. The default printer password is 1234.

SGD: `display.password.level`



NETWORK Menu

ACTIVE PRINT SERVER NONE
🏠

Informs you of the presence of an active server. Only one print server can be installed at a time, therefore the print server installed is the active print server.

SGD: [ip.active_network](#)

PRIMARY NETWORK WIRELESS
🏠

View or modify whether the wireless print server is considered primary. You may select which one is primary.

SGD: [ip.primary_network](#)

WLAN IP ADDRESS 0.0.0.0
🏠

View, and if necessary, change the printer's WLAN IP address.

SGD: [wlan.ip.addr](#)

WLAN SUBNET MASK 255.255.255.0
🏠

View, and if necessary, change the WLAN subnet mask.

SGD: [wlan.ip.netmask](#)

WLAN GATEWAY 0.0.0.0
🏠

View, and if necessary, change the default WLAN gateway.

SGD: [wlan.ip.gateway](#)

WLAN IP PROTOCOL ALL



This parameter tells if you (permanent) or the server (dynamic) selects the WLAN IP address.

SGD: [wlan.ip.protocol](#)

WLAN MAC ADDRESS 00:19:70:7A:20:44



View the WLAN Media Access Control (MAC) address of the wireless print server that is installed in the printer.

SGD: [wlan.mac_addr](#)

ESSID DSF802LESS54



The Extended Service Set Identification (ESSID) is an identifier for your wireless network. This setting, which cannot be modified from the control panel, gives the ESSID for the current wireless configuration.

SGD: [wlan.essid](#)

AP MAC ADDRESS 00:05:9A:3C:78:00



View the AP MAC address associated with the printer.

SGD: [wlan.bssid](#)

CHANNEL



View the wireless channel being used when the wireless network is active and authenticated.

SGD: [wlan.channel](#)

SIGNAL 0



View the wireless signal strength when the wireless network is active and authenticated.

SGD: [wlan.signal_strength](#)

WIRED IP ADDRESS 0.0.0.0



View, and if necessary, change the printer's wired IP address.

SGD: [internal_wired.ip.addr](#)

WIRED SUBNET MASK 255.255.255.0



View, and if necessary, change the printer's wired subnet mask.

SGD: [internal_wired.ip.netmask](#)

WIRED GATEWAY 0.0.0.0

View, and if necessary, change the wired gateway setting.

SGD: [internal_wired.ip.gateway](#)

WIRED IP PROTOCOL ALL

This parameter tells if you (permanent) or the server (dynamic) selects the IP address. If a dynamic option is chosen, this parameter tells the method(s) by which the wired or wireless server receives the IP address from the server.

SGD: [internal_wired.ip.protocol](#)

WIRED MAC ADDRESS 00:07:4D:3F:D3:B2
🏠

View, and if necessary, change the printer's network signal.

SGD: [internal_wired.mac_addr](#)

IP PORT 6101
🏠

This printer setting refers to the internal wired print servers port number that the TCP print service is listening on. Normal TCP communications from the host should be directed to this port.

SGD: [ip.port](#)

IP ALTERNATE PORT 9100
🏠

This command sets the port number of the alternate TCP port.

SGD: [ip.port_alternate](#)

PRINT INFORMATION ▼ NETWORK ▲
🏠

Print the specified information on one or more labels. This menu item is available through three user menus with different default values for each.

SGD: [device.user_vars.display_wmlsgd_printlist](#)

RESET NETWORK ▼ ▲
🏠

This option resets the wired or wireless print server and saves any changes that you made to any network settings.

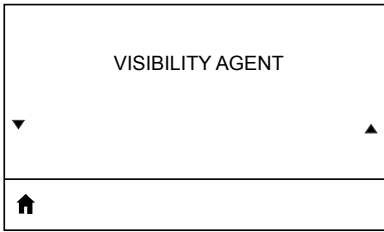

When the printer is connected to a wired or wireless network, it attempts to connect to Zebra's Asset Visibility Service via the Cloud-based Zebra Printer Connector using an encrypted, certificate-authenticated web socket connection. The printer sends Discovery Data and Settings and Alerts Data. Data printed via any label formats is NOT transmitted. To opt out of this feature, disable this setting.

SGD: `weblink.zebra_connector.enable`

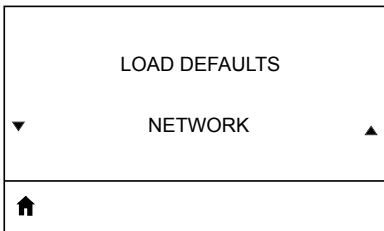

Restore specific printer, print server, and network settings back to the factory defaults. Use care when loading defaults because you need to reload all settings that you changed manually. This menu item is available through two user menus with different default values for each.

SGD: `ezpl.load_defaults`



RFID Menu

RFID STATUS RFID OK
🏠

Display the status of the RFID subsystem of the printer.

SGD: [rfid.error.response](#)

RFID CALIBRATE
🏠

Initiate tag calibration for RFID media. (Not the same as media calibration.) During the process, the printer moves the media, calibrates the RFID tag position, and determines the optimal settings for the RFID media being used.

SGD: [rfid.tag.calibrate](#)

READ RFID DATA EPC NONE
🏠

Read and return the specified tag data from the RFID tag.

SGD: [rfid.tag.read.content](#) & [rfid.tag.read.execute](#)

RFID TEST
🏠

During the RFID test, the printer attempts to read and write to a transponder.

SGD: [rfid.tag.test](#) & [rfid.tag.test.execute](#)

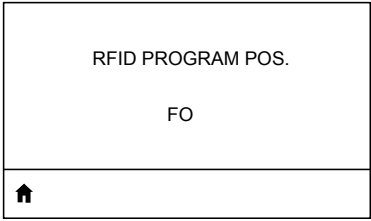

If the desired programming position (read/write position) is not achieved through RFID tag calibration, a value may be specified.

SGD: [rfid.position.program](#)

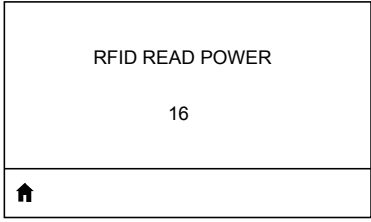

If the desired read power is not achieved through RFID tag calibration, a value may be specified.

SGD: [rfid.reader_1.power.read](#)

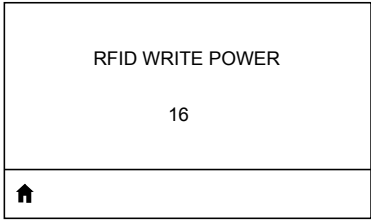

If the desired write power is not achieved through RFID tag calibration, a value may be specified.

SGD: [rfid.reader_1.power.write](#)

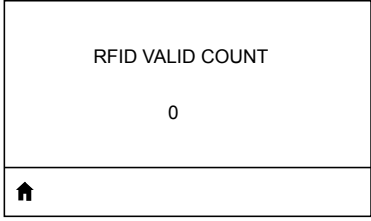

Resets the RFID valid label counter to zero.

SGD: [odometer.rfid.valid_resetable](#)

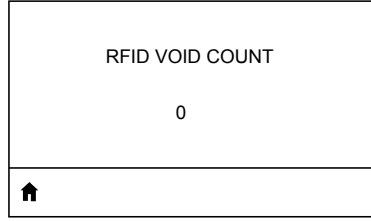

Resets the RFID void label counter to zero.

SGD: [odometer.rfid.void_resetable](#)



LANGUAGES Menu

LANGUAGE	
▼	ENGLISH ▲
⏪	

If necessary, change the language that the printer displays.

SGD: [display.language](#)



Note • The selections for this parameter are displayed in the actual languages to make it easier to find one that you are able to read.

COMMAND LANGUAGE	
▼	HYBRID_XML_ZPL ▲
⏪	

View or select the appropriate command language.

SGD: [device.languages](#)

COMMAND CHAR	
^ (5E)	
⏪	

The format command prefix is a two-digit hex value used as a parameter place marker in ZPL/ZPL II format instructions. The printer looks for this hex character to indicate the start of a ZPL/ZPL II format instruction. Set the format command character to match what is used in your label formats.

SGD: [zpl.format_prefix](#)

CONTROL CHAR	
~ (7E)	
⏪	

Set the control prefix character to match what is used in your label formats.

SGD: [zpl.command_prefix](#)

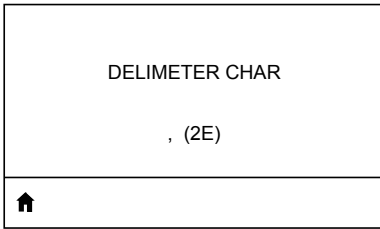

The delimiter character is a two-digit hex value used as a parameter place marker in ZPL/ZPL II format instructions. Set the delimiter character to match what is used in your label formats.

SGD: [zpl.delimiter](#)

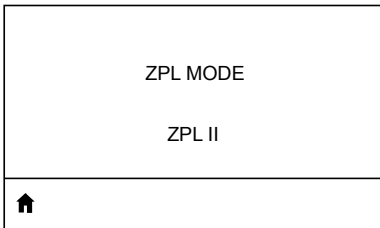

Select the mode that matches what is used in your label formats. This printer accepts label formats written in either ZPL or ZPL II, eliminating the need to rewrite any ZPL formats that already exist. The printer remains in the selected mode until it is changed in one of the ways listed here.

SGD: [zpl.zpl_mode](#)

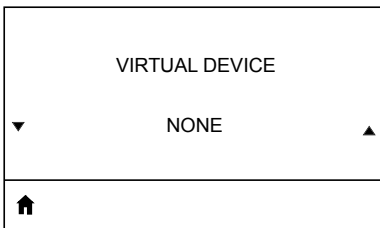

If any Virtual Device apps are installed on your printer, you may view or enable/disable them from this user menu. For more information about Virtual Devices, go to the User Guide for the appropriate Virtual Device, or contact your local reseller.

SGD: [apl.selector](#)



SENSORS Menu

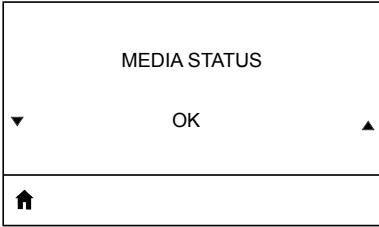

Informs you of the presence or absence of media in the printer.

SGD: [media.status](#)

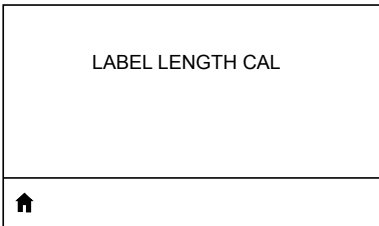

SGD: [zpl.calibrate](#)

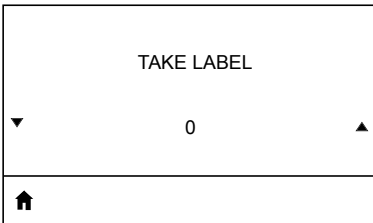

Set the intensity of the take label LED.

SGD: [ezpl.take_label](#)



Note • This value is set during sensor calibration. Do not change this setting unless you are told to do so by Zebra Technical Support or by an authorized service technician.



BLUETOOTH Menu

BLUETOOTH ADDRESS NO BLUETOOTH RADIO
⬆

View the Bluetooth address for the presence of a BT radio.

SGD: [bluetooth.address](#)

MODE PERIPHERAL
⬆

View the Bluetooth connection pair printer's device type—PERIPHERAL always be displays.

DISCOVERY ON
⬆

Select if the printer is "Discoverable" for Bluetooth device pairing. View the discovery status, for example, ON or OFF.

SGD: [bluetooth.discoverable](#)

CONNECTED NO
⬆

View the connection status of the BT radio, for example, YES or NO.

SGD: [bluetooth.connected](#)

BT SPEC VERSION NO RADIO



View the Bluetooth operational specification level.

SGD: [bluetooth.radio_version](#)

MIN SECURITY MODE 1



View, and change if necessary, the minimum level of applied security of the BT radio.

SGD: [bluetooth.minimum_security_mode](#)

MFI CAPABILITY PRESENT



Informs you of the presence or availability of Made for iPhone (MFi) capability.

SGD: [device.feature.mfi](#)

BAUD RATE 19200

Select the baud value that matches the one being used by the host computer.

SGD: [comm.baud](#)

DATA BITS 8

Select the data bits value that matches the one being used by the host computer.

SGD: [comm.data_bits](#)



BATTERY Menu



Indicates the current health of the battery, for example, Good, Past Useful Life, etc.

SGD: `power.health`

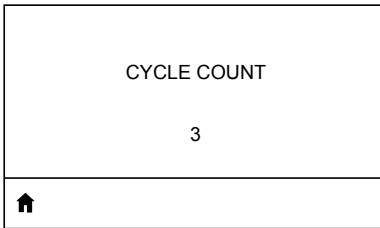

View the current charging cycle count of the battery.

SGD: `power.cycle_count`

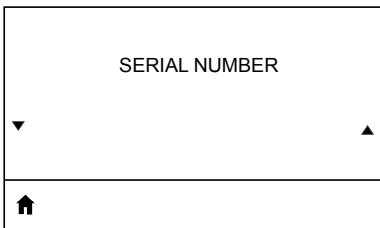

Indicates the serial number of the battery pack.

SGD: `power.serial_number_string`

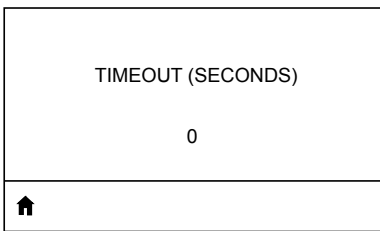

View, and if necessary, change the battery timeout.

SGD: `power.inactivity_timeout_alt`

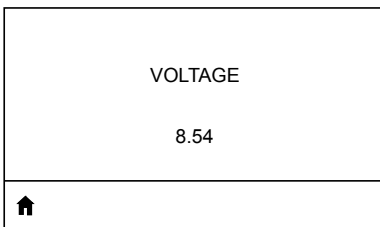

View the current voltage level of the battery pack.

SGD: `power.voltage`

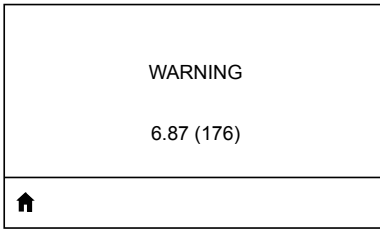

SGD: [power.low_battery_warning](#)

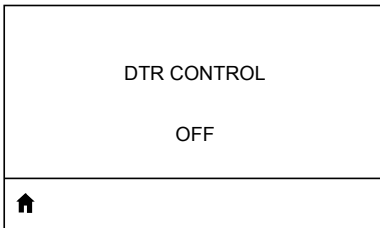

SGD: [power.dtr_power_off](#)

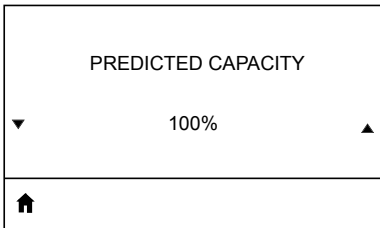

SGD: [power.relative_state_of_charge](#)

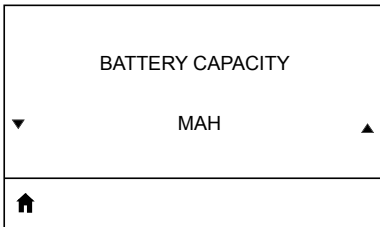

Battery capacity measured in mAH.

SGD: [power.remaining_capacity](#)

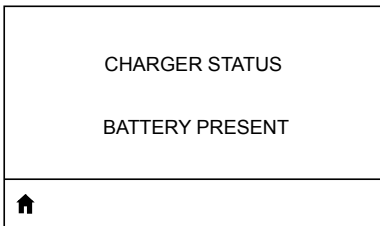

Indicates the presence of a battery charger.

SGD: [power.chrgr_status](#)

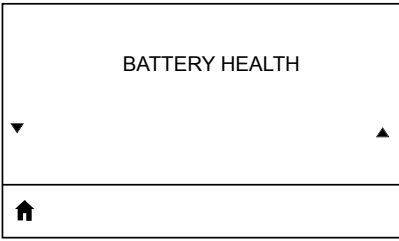

SGD: `power.percent_health`

Appendix E

Serial and PCC Number Locations for ZQ630 Plus printer



Important • Due to compliance and customs restraints, an integrator may not be able to ship a printer purchased in one country to another country based on the limitations imposed by regional SKUs. The country code identified in the printer SKU determines the area of the world in which the printer can be used.

Battery Disposal



The EPA certified RBRC® Battery Recycling Seal on the Lithium-Ion (Li-Ion) battery supplied with your printer indicates Zebra Technologies Corporation is voluntarily participating in an industry program to collect and recycle these batteries at the end of their useful life, when taken out of service in the United States or Canada. The RBRC program provides a convenient alternative to placing used Li-Ion batteries into the trash or the municipal waste stream, which may be illegal in your area.



Important • When the battery is depleted, insulate the terminals with tape before disposal.

Call 1-800-8-BATTERY for information on Li-Ion battery recycling and disposal bans/restrictions in your area.

Zebra Technologies Corporation's involvement in this program is part of our commitment to preserving our environment and conserving our natural resources.

Outside North America, follow local battery recycling guidelines.

Product Disposal

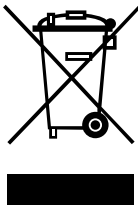

The majority of this printer's components are recyclable. Do not dispose of any printer components in unsorted municipal waste. Dispose of the battery according to your local regulations, and recycle the other printer components according to your local standards.

For more information, see our web site at: zebra.com/environment.

Using Zebra.com

The following examples illustrate the search function on Zebra’s website for finding specific documents and downloads.

Example: Find the ZQ6 Plus User Guides.

1. Go to zebra.com/support.
2. Scroll down and type a printer name in search box.

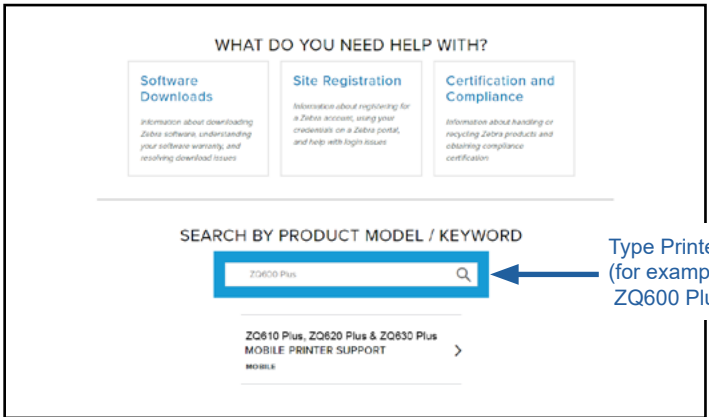

3. Scroll down on the ZQ6 Plus page for printer support pages.

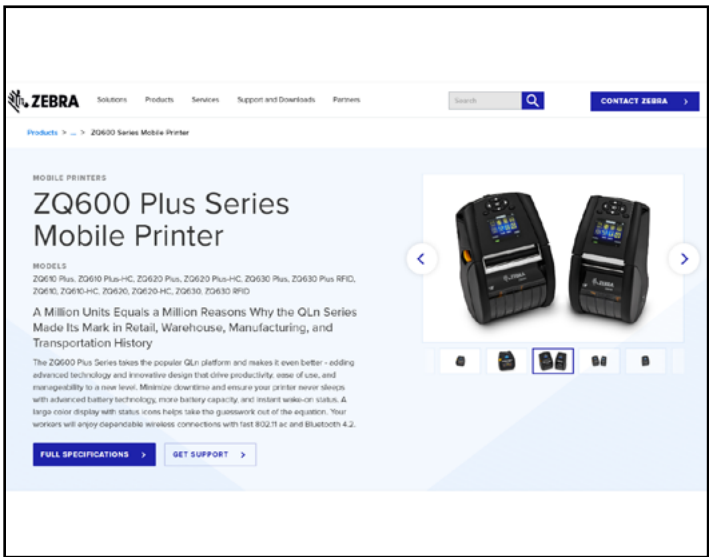

4. Click **Get Support** for How-To videos, manuals, drivers, firmware and software & utilities.

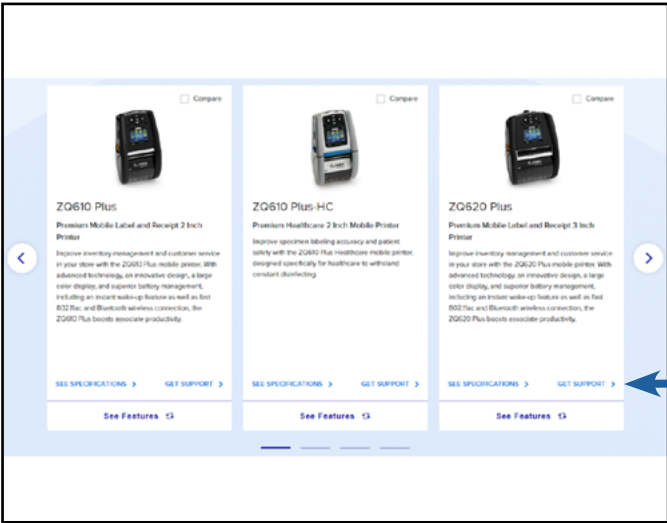

5. Click an expanded menu for various support topics.

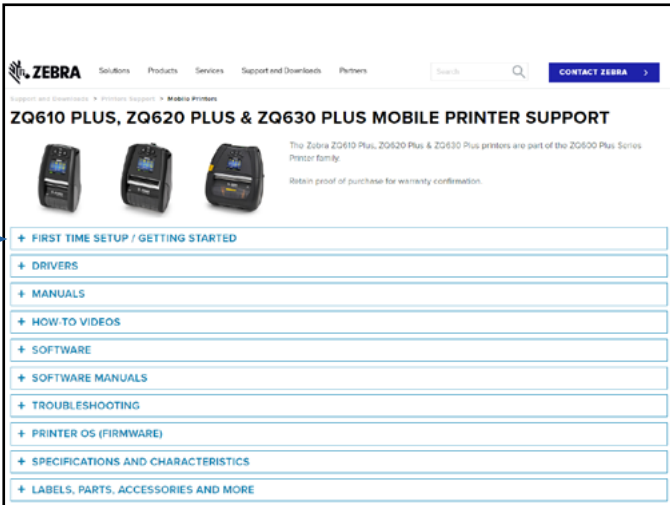

Appendix H

Contact Support

Go to zebra.com/contact to contact us with a specific problem with your printer, and have the following information on hand:

- Model number/type (for example, ZQ630 Plus)
- Unit serial number (go to “Appendix E”)
- Product Configuration Code (PCC) (go to “Appendix E”)

Contact and request support, or find your solution by:

- Submitting an online inquiry
- Requesting repair services
- Searching through the Discussion Forum
- Requesting support for Matrox Imaging Support products
- Initiating a chat through Services Virtual Assistant

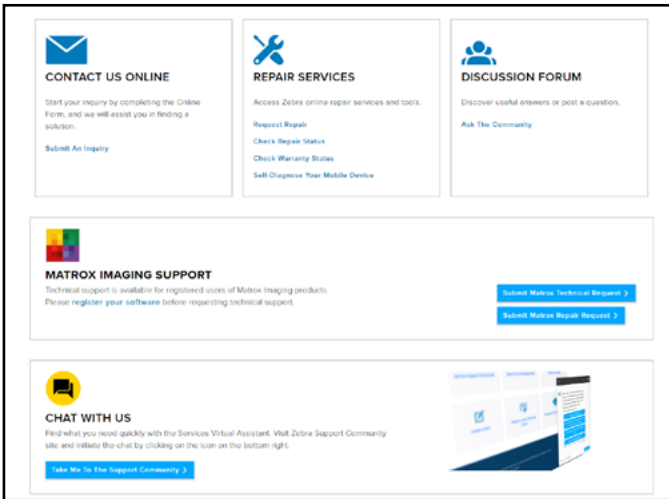

To contact support by phone, select your location from the drop-down menu and use the numbers provided.

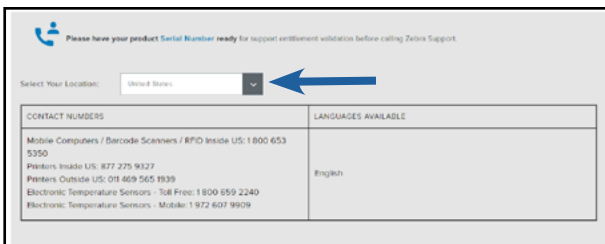

Index

A

Accessories 56–80, 81
Adaptive Print Performance 41
Alert Messages 38
Appendix A, USB Cables 83
Appendix B, Media Supplies 85
Appendix C, Maintenance Supplies 85
Appendix D, Parameters Menus 86
Appendix E, Serial and PCC 107
Appendix F, Battery Disposal 108
Appendix G, Using Zebra.com 109
Appendix H, Product Support 111

B

Battery, installing 18
Battery pack
 Power Precision 11
Battery Safety 21
Belt Clip 56
Black Mark Dimensions 52
Bluetooth 46
Bluetooth, minimum security modes
 48
Bluetooth, networking 46
Bluetooth, security modes 47

C

Cable Communication 43
Charger, battery 21–27
 1-Slot Charger 25
 3-Slot Charger 26
 Ethernet Cradles 23
Charger Safety 21
Communication Port 77
Communications Diagnostics 68
Configuration Label, sample 70
CPCL Font and Bar Code
 Specifications and Commands
 74
Cradles, Ethernet and Charging 23

D

Designing Labels 50
Dimensions, ZQ620 79
Document Conventions 8
Draft Mode 41

E

Ethernet Cradles 23

G

General Cleaning Instructions 62
Getting Ready to Print 18

H

Hard Case 60
Home Menu Screen 36
Home Screen Icons & Parameters 38

I

Installing the Battery 18
Introduction to the ZQ6 Printers 9

L

Label Areas 52
Label Design Examples 53
LCD Control Panel 33, 65

M

Made for iPhone (MFi) 13
Media, loading 27
Mounting Dimensions ZQ620 80

N

Near Field Communication (NFC) 13,
 54

P

Power Save Mode 40
Power-Up Sequences 39
Preventive Maintenance 62
Printer Status Icons 34
Printing Method
 Direct Thermal 12

Programming language
CPCL 9

Q

QR Code 12

R

RS-232C Communications 43

S

Shoulder Strap 57

Sleep Mode 40

Smart Battery, PowerPrecision+ 11

Smart Charger-2 (SC2) Single Battery
Charger 21

Soft Case 58, 60, 61

Specifications, label 74

Specifications, memory and
communications 73

Specifications, physical, environmental
and electrical 78

Specifications, printing 73

Status Bar Icons 34

T

Troubleshooting, tests 68

Troubleshooting, topics 66

V

Verify printer is working 42

W

Waist Holder 61

Wearing the Printer 56

WLAN, overview 49

Z

Zebra Setup Utilities 45

Zebra Setup Utility (Android) 45

ZPL Font and Bar Code Specifications
and Commands 76

ZQ6 Accessories 81



Zebra Technologies Corporation
3 Overlook Point
Lincolnshire, IL 60069 USA
P: +1 847.634.6700 or F: +1 847.913.8766