

hp
mp3130 series
digital projector



user's guide

Notice

This manual and any examples contained herein are provided “as is” and are subject to change without notice. Hewlett-Packard Company makes no warranty of any kind with regard to this manual, including, but not limited to, the implied warranties of merchantability and fitness for a particular purpose. Hewlett-Packard Company shall not be liable for any errors or for incidental or consequential damages in connection with the furnishing, performance, or use of this manual or the examples herein.

Consumer transactions in Australia and the United Kingdom: The above disclaimers and limitations shall not apply to consumer transactions in Australia and the United Kingdom and shall not affect the statutory rights of consumers.

© Copyright 2003-2004 Hewlett-Packard Development Company, L.P. Reproduction, adaptation, or translation without prior written permission is prohibited, except as allowed under the copyright laws.

The programs that control this product are copyrighted and all rights are reserved. Reproduction, adaptation, or translation of those programs without prior written permission of Hewlett-Packard Company is also prohibited.

Microsoft® and Windows® are US registered trademarks of Microsoft Corporation. Adobe® and Acrobat® are trademarks of Adobe Systems Incorporated.

Hewlett-Packard Company
Digital Projection and Imaging
1000 NE Circle Blvd.
Corvallis, OR 97330

Second Edition (December 2004)

1 Setting Up

What's in the Box?	8
Identifying Common Features	9
Projector at a glance	10
Projector buttons and lights	11
Back panel	12
Remote control	13
Accessories	15
Setting Up the Projector	16
To position projector	17
To set up on a table	19
To connect power	19
To connect a computer	20
To connect a handheld organizer	22
To connect video sources	23
Turning On and Off	27
To turn the projector on	27
To turn the projector off	28
To reset the projector	28
Making Basic Adjustments	29
To aim the projector	29
To adjust the focus and zoom	30

2 Giving Presentations

Using the Remote Control	31
Showing Presentations	33
To present from a computer	33
To change the source	34
To hide or show the display	34

3 Adjusting the Projector

Adjusting the Picture and Sound	35
To adjust the shape of the picture	35
To adjust the image according to the type of picture	36
To adjust other image settings	37
To adjust the audio	37
To adjust the projector setup	37
Using the On-Screen Menu	38
To change settings using the on-screen menu	39
Quick choice menu	40
Input menu	41
Adjust picture menu	42
Audio menu	44
Setup menu	44
Help menu	45

4 Maintaining the Projector

Performing Routine Maintenance	47
To get the projector status	47
To clean the projector lens	47
To replace the lamp module	48
To replace the battery in the remote control	50
Upgrading the Projector	51
To update the firmware	51

5 Installing Permanently

Installing the Projector	53
To mount the projector on a tripod	53
To install on a table	54
To install on the ceiling	55
To install for rear projection	56
To lock the projector	57

6 Fixing Problems

Troubleshooting Suggestions	59
Start-up problems	60
Picture problems	61
Sound problems	65
Interruption problems	65
Remote control problems	66
Testing the Projector	67
To run the projector diagnostics	67

7 Reference

Specifications	69
Safety Information	75
Safety precautions	75
Laser safety	75
LED safety	76
Mercury safety	76
Regulatory Information	77
U.S.A.	77
Canada	77
Japan	78
Korea	78
International	79

Index

The chapter explains how to install and set up the HP digital projector.

- “What’s in the Box?” on page 8
- “Identifying Common Features” on page 9
- “Setting Up the Projector” on page 16
- “Turning On and Off” on page 27
- “Making Basic Adjustments” on page 29

What's in the Box?

Before setting up your projector, be sure your shipping box includes the following items. If the shipping box does not contain any of the following items, contact HP.

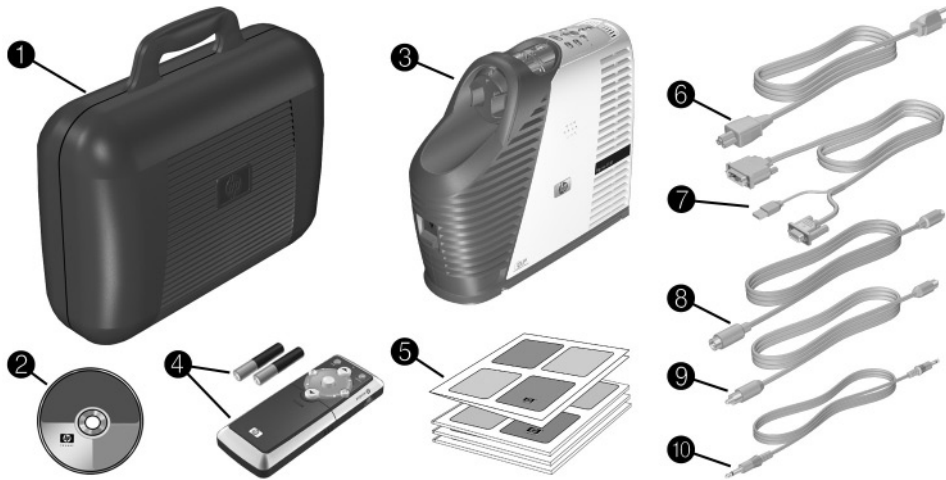

Identifying the contents of the box

Symbol	Item	Function
①	Carrying case	Carries and protects projector.
②	Documentation CD	Contains projector documentation.
③	Projector with lens cap	Displays images.
④	Remote control and two AAA batteries	Control projector.
⑤	<i>Quick Setup Guide</i> , warranty, support, and port activation documentation	Provide documentation to help get started and find support.
⑥	Power cord	Connects projector to power source.
⑦	M1-to-VGA/USB cable	Connects to computer.
⑧	S-video cable	Connects to S-video device.

Identifying the contents of the box *(continued)*

Symbol	Item	Function
⑨	Composite RCA video cable	Connects device with RCA composite video output.
⑩	Mini-phone audio cable	Connects audio source to projector.

Identifying Common Features

This section identifies common features and functions of the projector.

- “Projector at a glance” on page 10
- “Projector buttons and lights” on page 11
- “Back panel” on page 12
- “Remote control” on page 13
- “Accessories” on page 15

Projector at a glance

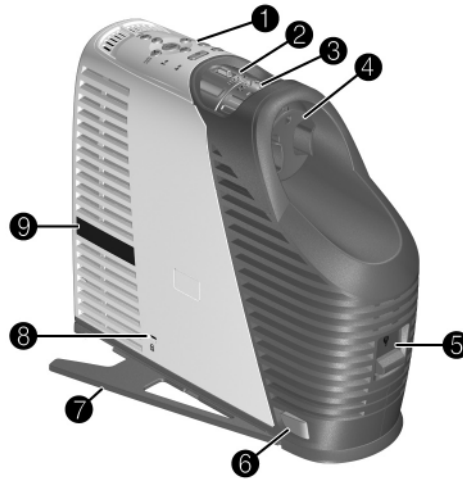

Identifying the projector

Symbol	Item	Function
①	Button panel	Contains buttons and lights.
②	Zoom ring	Enlarges picture size 100–120%.
③	Focus ring	Focuses at distances of 1.2 to 12 m (4 to 40 ft).
④	Lens cover	Protects lens.
⑤	Lamp latch	Releases lamp housing for replacement.
⑥	Tilt button	Adjusts the height of the picture and extends the supports.
⑦	Support	Adds extra stability to the projector.
⑧	Security slot	Secures the projector using a cable lock.
⑨	Receiver for remote control	Receives signals from the remote control (one on each side).

Projector buttons and lights

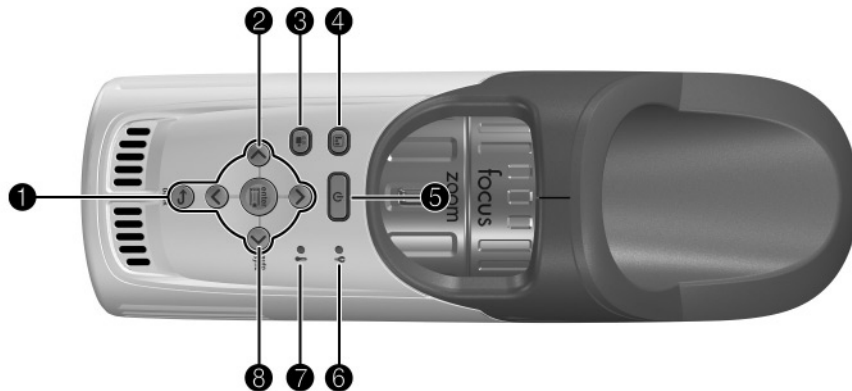

Identifying buttons and lights on the projector

Symbol	Item	Function
①	Enter button, back button, and directional arrows	Change projector settings using the on-screen menu.
②	Source button	Switches to the next input source.
③	Theater video button	Optimizes the picture for video input.
④	Business graphics button	Optimizes the picture for data input.
⑤	Power button	Turns the projector on or off.
⑥	Lamp-warning light	Turns on when lamp fails.
⑦	Temperature-warning light	Turns on when the internal temperature is too high.
⑧	Auto sync button	Resynchronizes the projector to input signal.

Back panel

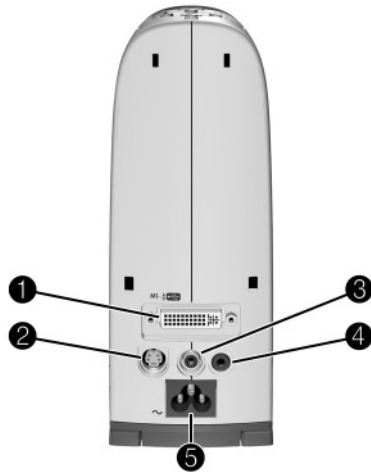

Identifying the back panel

Symbol	Item	Function
①	M1 input	Connects various equipment with analog- and digital-video output, including computers. Also supports USB-device output for controlling a mouse.
②	S-video input	Connects video input from devices like VCRs and DVD players.
③	Composite-video input	Connects video input from devices like VCRs.
④	Audio input	Connects audio source.
⑤	Main power	Connects power cord to projector.

Remote control



Before using the remote control, install two AAA batteries. See “To replace the battery in the remote control” on page 50.

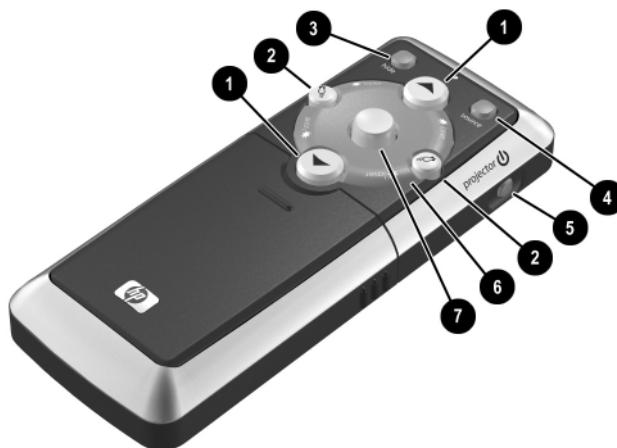

Identifying the remote control with case closed

Symbol	Item	Function
❶	Page-up and page-down down	Scroll up and down through pages on a connected computer.
❷	Left-click and right-click mouse functions	Perform left-click and right-click functions for a connected computer.
❸	Hide	Hides the display.
❹	Source	Switches to the next input source.
❺	Power	Powers on and off the projector.
❻	Laser ring	Turns on the laser pointer.
❼	Mouse button	Moves the mouse pointer on a connected computer.



WARNING: To reduce the risk of injury to the eyes, do *not* look directly into the remote control laser light, and do *not* point the laser light into anyone's eyes.

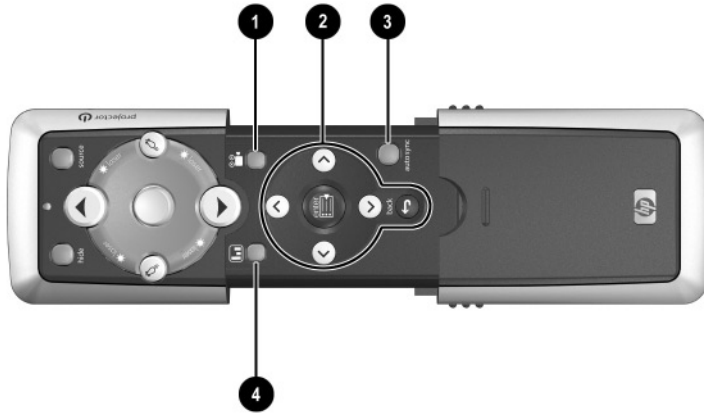

Identifying remote control with case open

Symbol	Item	Function
①	Theater video button	Optimizes the picture for video input.
②	Menu buttons	Change projector settings using the on-screen menu.
③	Auto sync	Resynchronizes the projector to the input signal.
④	Business graphics button	Optimizes the picture for data input.

Accessories

HP offers accessories that can enhance the operation of your HP projector. See your projector dealer or visit <http://www.hp.com> to purchase accessories such as these:

- Smart attachment module (connect a computer through your local network, add an optional 802.11b card for wireless computer connections, and more)
- Ceiling mount
- Projector screen
- Power cables
- Replacement lamp module
- Video cables

Setting Up the Projector

This section describes how to set up, plan, and connect the projector.

- “To position projector” on page 17
- “To set up on a table” on page 19
- “To connect power” on page 19
- “To connect a computer” on page 20
- “To connect a handheld organizer” on page 22
- “To connect video sources” on page 23

To position projector

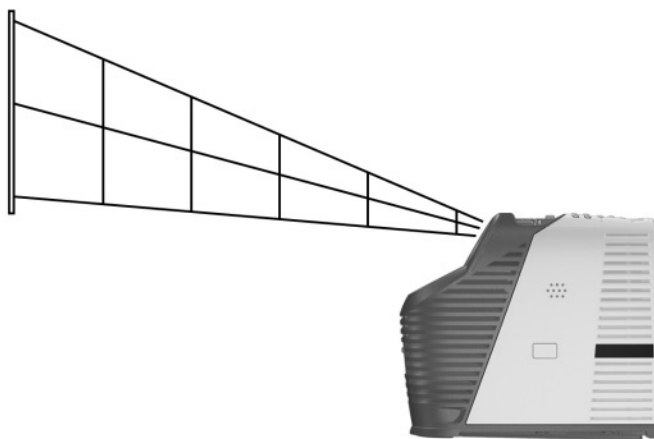

The following tables show you where to position the projector in relation to the screen.

Identifying image size relative to distance from screen

Image size (diagonal)		Image size (width)		Distance (lens to screen)	
30 in.	0.8 m	24 in.	0.6 m	47–48 in.	1.2 m
40 in.	1.0 m	32 in.	0.8 m	54–65 in.	1.4–1.6 m
60 in.	1.5 m	48 in.	1.2 m	81–97 in.	2.1–2.5 m
80 in.	2.0 m	64 in.	1.6 m	108–129 in.	2.7–3.3 m
100 in.	2.5 m	80 in.	2.0 m	135–161 in.	3.4–4.1 m
120 in.	3.0 m	96 in.	2.4 m	161–194 in.	4.1–4.9 m
150 in.	3.8 m	120 in.	3.0 m	202–242 in.	5.1–6.2 m
180 in.	4.6 m	144 in.	3.7 m	242–291 in.	6.2–7.4 m
200 in.	5.1 m	160 in.	4.1 m	269–323 in.	6.8–8.2 m
240 in.	6.1 m	192 in.	4.9 m	323–388 in.	8.2–9.8 m
270 in.	6.9 m	216 in.	5.5 m	363–436 in.	9.2–11.1 m
300 in.	7.6 m	240 in.	6.1 m	404–480 in.	10.3–12.0 m
330 in.	8.4 m	264 in.	6.7 m	444–480 in.	11.3–12.0 m

If you do not want to use the distance table, you can use the following equations to help determine where to install the projector relative to the screen.

Calculating projection dimensions

distance from lens to screen = $A \times$ width of screen

minimum and maximum distance from screen = B

width of screen = $0.8 \times$ diagonal of screen (for 4:3 screen)

projector lens below bottom of screen = $C \times$ width of screen (for 4:3 screen)

$A = 1.67$ to 2.00

$B = 1.2$ to 12 m (4 to 40 ft)

$C = 0.21$ to 0.45

To set up on a table

1. Place the projector on a stable platform located 1.2 to 12 m (4 to 40 ft) in front of the screen. Ideally, the platform should be lower than the bottom of the screen.
2. Connect one end of the power cord to the back of the projector and the other end to an electrical outlet.
3. When you first turn on the projector, set it to match the installation, if necessary. Open the on-screen menu and select **Setup > Projector position**. Then choose **Front Table** from the drop-down list—this is the default setting.

If you want to permanently install the projector on the ceiling or behind the screen, see “Installing the Projector” on page 53.

To connect power

- Connect one end of the power cord to the back of the projector ❶ and the other end to an electrical outlet ❷.

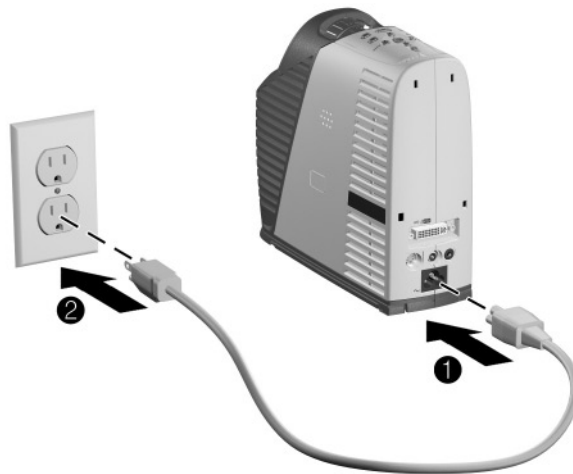

To connect a computer

Computer with VGA port

1. Connect the M1-to-VGA/USB cable between the M1 port on the projector **1** and the VGA port on the computer **2**.
2. (Optional) To allow the remote control to function as the computer mouse, connect the USB plug of the M1-to-VGA/USB cable into the USB port on the computer **3**.
3. (Optional) To get audio, connect the mini-phone audio cable between the audio port on the projector **4** and the computer **5**

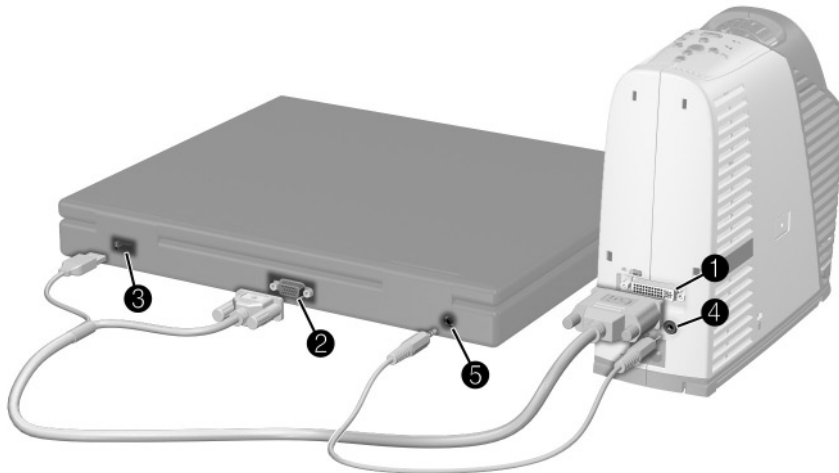

Computer with DVI port

The connections are similar to the VGA computer connection. For a visual aid, see the previous image.

1. Connect an M1-to-DVI/USB cable (available from HP) between the M1 port on the projector ❶ and the DVI port on the computer ❷.
2. (Optional) To allow the remote control to function as the computer mouse, connect the USB plug of the M1-to-DVI/USB cable into the USB port on the computer ❸.
3. (Optional) To get audio, connect the mini-phone audio cable between the audio port on the projector ❹ and the computer ❺.

To connect a handheld organizer

1. Be sure the handheld organizer has a VGA-out port. If necessary, install a VGA-out accessory card into the organizer.



Not all handhelds come with VGA-out ports. For example, the iPAQ Pocket PC requires a VGA-out PC Card with 15-pin connector.

2. Connect an M1-to-VGA/USB cable between the M1 port on the projector **1** and the other end to the VGA-out PC Card **2** on the organizer.



To connect video sources

S-video connection

Many DVD players and VCRs have S-video output.

1. Connect the S-video cable between the S-video port on the projector **1** and the video device **2**.
2. (Optional) To get audio, connect the mini-phone audio cable between the audio port on the projector **3** and the video device **4**. If the video device has RCA audio connectors, use a mini-phone to RCA adapter or cable.

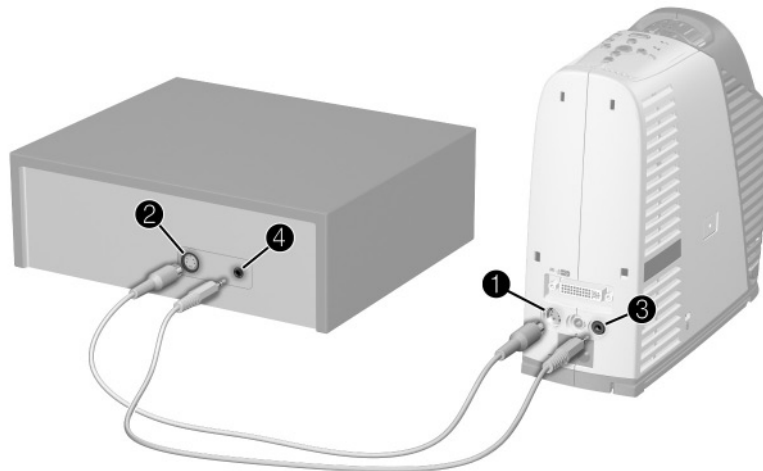

Composite video connection

Many VCRs and other video equipment have composite video output, a single RCA video output connector.

1. Connect the composite video cable (RCA connector) between the composite video port on the projector **1** and RCA video port on the video device **2**.
2. (Optional) To get audio, connect the mini-phone audio cable between the audio port on the projector **3** and the video device **4**. If the video device has RCA audio connectors, use a mini-phone to RCA adapter or cable.

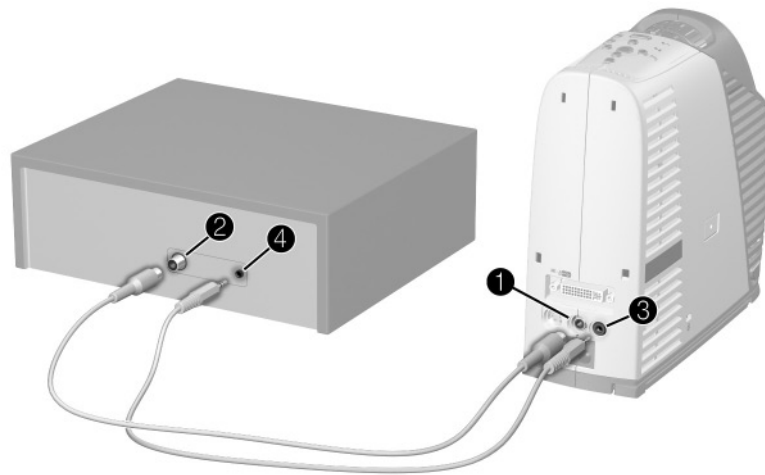

Component video connection

Many DVD players and other high-quality video devices provide component video output, usually three RCA connectors labeled YPbPr or YCbCr.

1. Connect an M1-to-component-video cable (available from HP) between the M1 port on the projector **1** and YPbPr or YCbCr port on the video device **2**.
2. (Optional) To get audio, connect the mini-phone audio cable between the audio port on the projector **3** and the video device **4**. If the video device has RCA audio connectors, use a mini-phone to RCA adapter or cable.

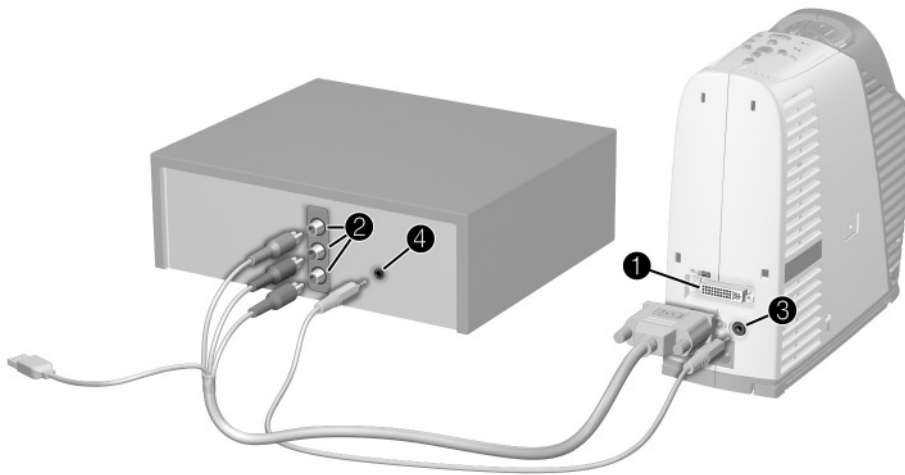

If your video device has twist-on BNC connectors labeled RGB or similar, use an M1-to-BNC cable (available from HP).

SCART connection

Several types of video devices provide a SCART video connection.

1. Connect an M1-to-SCART adapter cable (available from HP) to the M1 port on the projector **1**, then connect a SCART cable from the adapter to the SCART device **2**.
2. (Optional) To get audio, connect the mini-phone audio cable between the audio port on the projector **3** and the video device **4**. If the video device has RCA audio connectors, use a mini-phone to RCA adapter or cable.

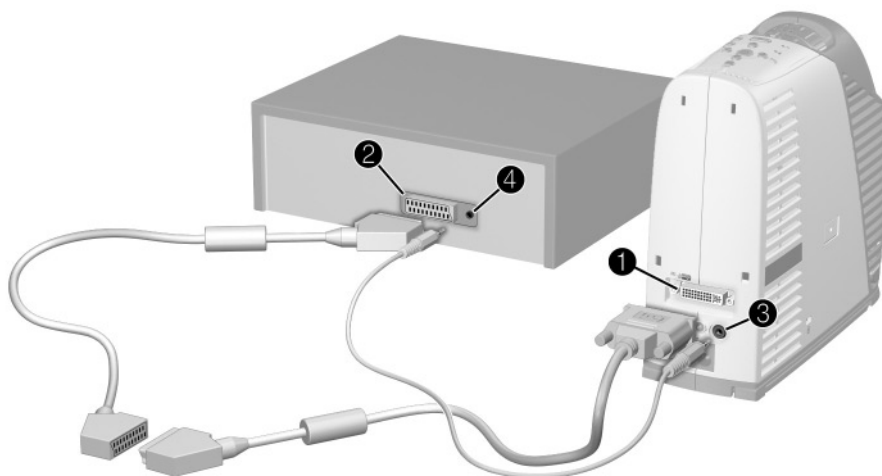

The SCART connector on the HP adapter cable contains a switch. If the picture does not seem clear with the switch set to one, set it to two.

Turning On and Off

This section provides instructions on turning the projector on and off.

- “To turn the projector on” on page 27
- “To turn the projector off” on page 28
- “To reset the projector” on page 28

To turn the projector on

1. Be sure the power cord is connected.
2. Remove the lens cap by pressing in on the tabs **1** on either side of the lens cap and pulling it straight out **2**.
3. Press the power button **3** on top of the projector, or press the power button on the remote control.



4. Connect and power on the source, such as computer, handheld organizer, or DVD player. See “Setting Up the Projector” on page 16 for more information.

To turn the projector off

1. Press the power button on the projector or remote control to turn off the projector. The power button blinks during the cool-down period, then the projector turns off.
2. You can disconnect video and audio equipment from the projector during the cool-down period, but not the power cord.
3. If you must unplug or remove the projector, wait until the power light stops blinking, then unplug the power cord.



CAUTION: Do *not* disconnect power until the projector has cooled down (the fan stops) and the power button stops blinking. Otherwise, you might shorten the life of the lamp.

If you try to turn on the projector again during the cool-down period, it does not turn on. Wait until the cool-down period ends and the power button stops blinking.

To reset the projector

If the projector becomes completely unresponsive, you can reset all circuits by disconnecting power.

1. Press the power button on the projector or remote control to turn off the projector, then wait until the cool-down period ends and the power button stops blinking. If the projector does not turn off, continue to the next step.
2. Unplug the power cable. Leave it unplugged for at least 15 seconds—longer if the projector has not cooled down.
3. Plug in the power cable again and press the power button to restart the projector.

Making Basic Adjustments

This section provides instructions on making basic adjustments to the projector.

- “To aim the projector” on page 29
- “To adjust the focus and zoom” on page 30

To aim the projector



Whenever you press the tilt button to aim the projector, the supports pop out from the base and provide extra stability.

- To raise the projected picture on the screen, press the tilt button ①, which causes the supports to pop out ②, and lift the front of the projector to the desired display angle ③. Release the tilt button to lock the adjustment.
- To lower the projected picture, press the tilt button while lowering the front of the projector. Release the tilt button to lock the adjustment.
- To store the projector, press the tilt button and lower the projector onto the base, then release the tilt button. Push the supports into the base.



When you tilt the projector up or down, the sides of the picture might become slanted. However, the projector automatically adjusts the picture, so the sides are vertical. To fine-tune this adjustment, see “To adjust the shape of the picture” on page 35.

To adjust the focus and zoom

1. Rotate the focus ring until the image becomes clear. The projector can be focused at distances of 1.2 to 12 m (4 to 40 ft).
2. Rotate the zoom ring to adjust the picture size from 100 to 120%.

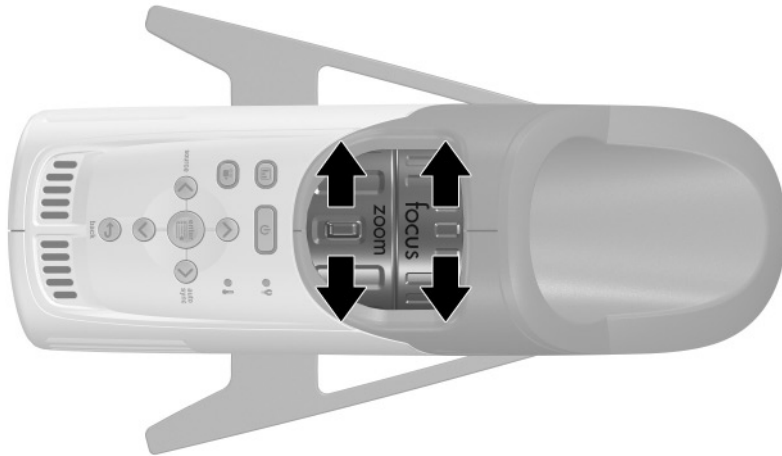

If the picture does not fit the screen, you might have to move the projector closer to the screen.

Giving Presentations





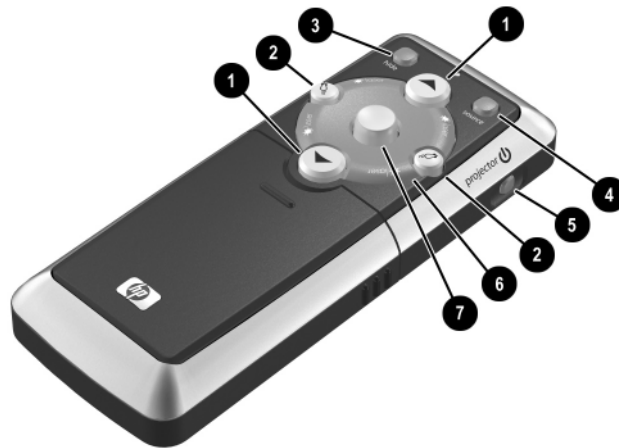

The chapter explains how to give presentations with the projector.

- “Using the Remote Control” on page 31
- “Showing Presentations” on page 33

Using the Remote Control



- To turn the project on or off, press the power button ⑤.
- To turn on the laser pointer, hold down the blue laser ring ⑥.
- To hide or unhide the projected picture, press the **hide** button ③.
- To switch to the next connected input source, press the **source** button ④.
- To operate as a mouse on a computer, tilt the mouse ⑦ button to move the pointer, and press the left-click ② or right-click ② button. This feature requires a USB connection between the projector and computer.

- To control page-up and page-down on a computer, press the page-up   and page-down   buttons. This feature requires a USB connection between the projector and computer.
- Slide the remote control case open to use additional buttons.
 - ❑ To optimize the picture for the type of input signal, press the business graphics  or the theater video  button.
 - ❑ To change projector settings using the on-screen menu, press **enter** and use the navigation buttons to make the changes. See “Using the On-Screen Menu” on page 38 for more details.
 - ❑ To exit from any on-screen menu or adjustment, press the **back**  button one or more times.
 - ❑ To adjust synchronization, press the **auto sync** button.

For a picture revealing the hidden remote control components, see “Remote control” on page 13.



From within a distance of 9 m (30 ft), aim the remote control at the side of the projector. If you are facing more toward the front or back of the projector, you might have to be as close as 2 m (6 ft).



WARNING: To reduce the risk of injury to the eyes, do *not* look directly into the remote control laser light, and do *not* point the laser light into anyone’s eyes.

Showing Presentations

This section describes several things you can do during presentations.



- “To present from a computer” on page 33
- “To change the source” on page 34
- “To hide or show the display” on page 34

To present from a computer



1. Be sure the computer is connected to the projector. See “To connect a computer” on page 20 for more information.
2. Be sure the computer and the projector are on. See “To turn the projector on” on page 27 for more information.



If the computer display is not projected on the screen, you might have to press a function key (such as **Fn + F4** or **Fn + F5**) to turn on the computer’s video port. See the video port card shipped with the projector for more information.

3. If you want to adjust the projected image, see “Adjusting the Picture and Sound” on page 35.
4. You can use the remote control to enhance your presentation. For more information, see “Using the Remote Control” on page 31.
 - To page through a presentation, press the page-up  or page-down  buttons.
 - To move the mouse pointer, tilt the mouse button.
 - To turn on the laser pointer, hold down the laser ring.



For the mouse and page-up  or page-down  operations, aim the remote control at the side of the projector from within a distance of 9 m (30 ft). If you are facing more toward the front or back of the projector, you might have to be as close as 2 m (6 ft).

These operations require a USB connection from the projector to the computer.



WARNING: To reduce the risk of injury to the eyes, do *not* look directly into the remote control laser light, and do *not* point the laser light into anyone’s eyes.

To change the source

To change the source, either:

- Press the **source** button on the projector or remote control.
- Open the on-screen menu, select **Input**, and select the port to which the input source is connected.

To hide or show the display

You can hide the display from your audience temporarily.

- Press the **hide** button on the remote control.
- Open the on-screen menu and select **Quick choice > Hide**.

The screen remains blank until you press the **hide** button again or any other button on the projector or remote control.



If you are using Microsoft PowerPoint, you can also press the **B** key or the **W** key to hide the display. The screen remains blank until you press the **B** key or the **W** key again.

Adjusting the Projector

This chapter describes how to make adjustments to the projector.

- “Adjusting the Picture and Sound” on page 35
- “Using the On-Screen Menu” on page 38





Adjusting the Picture and Sound

This section provides the following instructions on adjusting the picture and sound.

- “To adjust the shape of the picture” on page 35
- “To adjust the image according to the type of picture” on page 36
- “To adjust other image settings” on page 37
- “To adjust the audio” on page 37
- “To adjust the projector setup” on page 37



To adjust the shape of the picture

If the picture has slanted edges on the screen, you can straighten them. This is done by making *long* edges *shorter* until the picture is straight.

1. Open the on-screen menu and select **Adjust picture > Keystone correction**.
2. Adjust the keystone settings as needed using the menu buttons on the projector or remote control:
 - ❑ If the top of the picture is too wide or too narrow, press the up  or the down  button until the width is corrected. This adjustment overrides the automatic “vertical keystone” correction provided by the projector.
 - ❑ If one side of the picture is too tall or too short, press the left  or the right  button until the height is corrected.



- ❑ If you want to turn on automatic vertical keystone correction, press the **enter** button until this option is enabled.
 - ❑ If you want to disable the automatic correction, press the **enter** button until the option is disabled.
3. Press the **back**  button to save the settings.



If you adjust the keystone correction using the up  or down  buttons, the automatic correction is suspended until you manually enable it again or turn off the projector.

To adjust the image according to the type of picture

Use the picture mode buttons on the projector or the remote control to optimize the image.

- To optimize the picture for data presentations, press the business graphics  button.
The business graphics button turns on.
- To optimize the picture for video images, press the theater video  button.
The theater video button turns on.

If you adjust picture settings in the on-screen menu, the picture mode button turns off, indicating customized settings.

To adjust other image settings

The on-screen menu provides many settings that allow you to fine-tune the picture.

1. Open the on-screen menu and select **Adjust Picture**.
2. Change the picture adjustments as needed.

From the Adjust Picture menu, you can change basic and advanced picture options, such as brightness, contrast, aspect ratio, and keystone correction.

To get descriptions for all available picture adjustments, see “Adjust picture menu” on page 42.



To exit from any on-screen menu or adjustment, press the **back**  button one or more times.

To adjust the audio

1. Open the on-screen menu and select **Audio**.
2. Set the audio adjustments.

From the Audio menu, you can adjust audio settings such as mute, volume, treble, and bass.

To get descriptions for all available audio adjustments, see “Audio menu” on page 44.

To adjust the projector setup

1. Open the on-screen menu and select **Setup**.
2. Set the setup adjustments as needed.

From the Setup menu, you can select settings such as menu language, projector position, and lamp saver mode.

To get descriptions for all available setup adjustments, see “Setup menu” on page 44.

Using the On-Screen Menu

This section explains how to navigate the on-screen menu and provides function definitions. The tables in this section describe all the functions available in the on-screen menu for the firmware version at publication. If your firmware is a different version, some menus might differ from those shown.

- “To change settings using the on-screen menu” on page 39
- “Quick choice menu” on page 40
- “Input menu” on page 41
- “Adjust picture menu” on page 42
- “Audio menu” on page 44
- “Setup menu” on page 44
- “Help menu” on page 45



To exit from any on-screen menu or adjustment, press the **back**  button one or more times.

To change settings using the on-screen menu

You can change the on-screen menu settings with either the buttons on the projector or on the remote control.

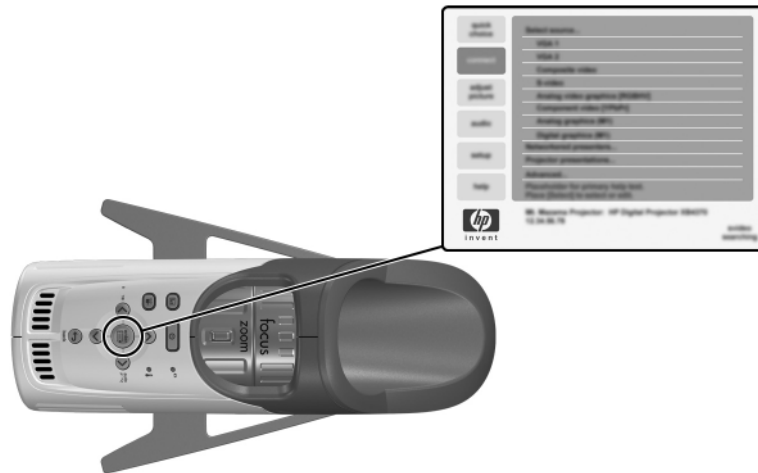

1. Press **enter** on the projector or the remote control to open the on-screen menu.
2. Press up **▲** or down **▼** to highlight the desired menu, and press **enter** to select the highlighted menu.
3. Press up **▲** or down **▼** to highlight the desired parameter, and press **enter** to select the highlighted option.
4. Press left **◀** or right **▶** or press up **▲** or down **▼** to select the desired setting. For certain settings, you see a different display while making the change.
5. Press **enter** or other indicated button to return to the menu.
6. To go to a different menu, press the **back** **↶** button, and select the menu.
7. To close the on-screen menu, press the **back** **↶** button one or more times as needed.

If nothing occurs for a period of time, the on-screen menu closes. To change the amount of time until the on-screen menu closes, open the on-screen menu and select **Setup > Timeout for menu**.

Quick choice menu

This menu provides quick access to commonly used functions from other menus. The menu in your projector might differ from the menu shown below.

Quick choice

Keystone correction	Corrects the slanted edges of an image. This function compensates for of an image that is not automatically corrected by the projector.
Reset keystone correction	Resets keystone correction to zero.
Next input	Searches for the next available signal from an input source.
Auto-sync	Resynchronizes the projector to the input signal. This can compensate for any change in the signal.
Hide	Removes all images from the screen.
Mute	Stops audio output.
Magnify	Enlarges a portion of the image. A menu is displayed that allows you to control vertical and horizontal pan and magnification level. The image must be enlarged before you can use pan.

Input menu

For a visual aid, see “Back panel” on page 12.

Input

Digital/analog graphics (M1)	Shows the digital or analog input to the M1 port. This port connects to several types of devices, including analog VGA and SCART devices and digital Digital Video Interface (DVI) devices. This connection is considered graphics or video input, depending on the device.
Composite video	Shows the input to the yellow composite port (the input to the right of the S-video port on the back panel). The port usually connects to a TV or VCR. This input is normally considered a video input.
S-video	Shows the input to the S-video port. This usually connects to a video device, such as a VCR, camcorder, or DVD player. This connection is normally considered a video input.
Source auto-search	Sets whether the projector automatically searches for input signals and displays the next one found.

Adjust picture menu

Adjust picture

Picture mode	Adjusts the color settings for the type of picture. You can optimize the picture for computer presentations or video output. The remote control and projector have buttons to change the picture mode.
Brightness	Brightens or darkens the image.
Contrast	Sets the difference between light and dark areas.
Color space	For certain component inputs, selects the type of signal encoding used by the input source. You can override the selection made by the projector.
Advanced picture >	Adjusts the advanced picture settings.
Color saturation	Adjusts the intensity of colors.
Tint	Shifts colors toward red or green.
Sharpness	Sharpens or softens the image.
Color temperature	Shifts colors toward red or blue.
Frequency	Adjusts the timing of the projector relative to a computer graphics card.
Tracking	Synchronizes the projector to a computer graphics card.
Vertical position	Shifts the image up or down within the projection area.
Horizontal position	Shifts the image left or right within the projection area.
Keystone correction	Corrects the slanted edges of an image. This function compensates for an image that is not automatically corrected by the projector.

Adjust picture *(continued)*

Reset keystone correction	Resets keystone correction to zero.
Aspect ratio	Selects the proportions of the image that is not automatically corrected by the projector. <ul style="list-style-type: none">• To automatically adapt to most inputs, select Best Fit.• To stretch the picture to cover the entire projection area, select Fill.• If a wide-screen picture seems stretched, select 16:9.• To show each picture dot as one projected dot, select 1-to-1.
Reset video settings	Resets this menu to default settings.

Audio menu

Audio

Mute	Stops the audio output.
Volume	Changes the loudness of the audio.
Treble	Changes the loudness of the higher frequencies.
Bass	Changes the loudness of the lower frequencies.
Reset audio settings	Resets this menu to the default values.

Setup menu

Setup

Language	Selects the language for the menus.
Lamp saver	Sets a lower light output for longer lamp life.
Projector position	Adjusts the image to match the orientation of the projector: upright or upside-down, in front of or behind the screen. Inverts or reverses the image accordingly.
Auto keystone	Sets whether slanted edges of an image are automatically corrected.
Timeout for menu	Sets how long the on-screen menu waits for input before it closes.
Reset lamp hours	For a new lamp, resets hours of use.
Reset all settings	Resets most of the menu settings to default.

Help menu

Help

About this projector	Displays information and status for the projector.
Diagnostics	Show tests for checking the operation of the projector and the remote control.

Maintaining the Projector

This chapter explains how to maintain the projector.

- “Performing Routine Maintenance” on page 47
- “Upgrading the Projector” on page 51

Performing Routine Maintenance

This section provides instructions on performing routing maintenance.

- “To get the projector status” on page 47
- “To clean the projector lens” on page 47
- “To replace the lamp module” on page 48
- “To replace the battery in the remote control” on page 50

To get the projector status

- Open the on-screen menu and select **Help > About this projector**. This screen shows information and status for the projector.

To clean the projector lens

- To minimize the risk of damaging or scratching the lens surface, blow dust particles off the lens with clean, dry, deionized air.

If this method does not work, use the following method:

- Wipe the lens in a single direction with a clean, dry cloth. Do not wipe back and forth across the lens.

If the cloth is dirty or smears the lens, wash the cloth. If the cloth is still dirty after washing it or the fabric is damaged, replace it.



CAUTION: Cleaning requires special consideration:

- Do not spray any type of fluid or cleaner directly on the lens surface. Cleaners might damage the lens.
 - Do not use fabric softener when washing a cleaning cloth or softener sheets when drying the cloth. Chemicals on the cloth might damage the surface of the lens.
 - Do not store a cleaning cloth in contact with the lens for a long time because doing so contaminates the lens with dye from the cloth. The cloth can be contaminated if left in the open air.
-

To replace the lamp module



WARNING: Replacing the lamp module requires special consideration:

- When the lamp nears its end of life, it might break. To reduce the risk of injury, be careful when removing the lamp module as broken glass might be present. For a ceiling installation, wear goggles and gloves when removing the lamp module. If the lamp is broken, contact HP about repairs that might be required.
 - Because the lamp assembly operates at a very high temperature, wait 30 minutes before removing the lamp module.
-

1. Turn off the projector and allow it to cool for 30 minutes.
2. Slide the latch upward on the front of the projector.
3. Slide the lamp housing off the projector.
4. Slide the new lamp housing onto the projector.
5. Push down the latch.

6. Turn on the projector. If the lamp does not turn on after the warm-up period, try reinstalling the lamp again.
7. Open the on-screen menu and select **Setup > Reset lamp hours**.



WARNING: The lamp contains a small amount of mercury. If the lamp breaks, adequately ventilate the area where the breakage occurred. Disposal of this lamp might be regulated due to environmental considerations. For disposal or recycling information, contact your local authorities or the Electronic Industries Alliance (<http://www.eiae.org>).

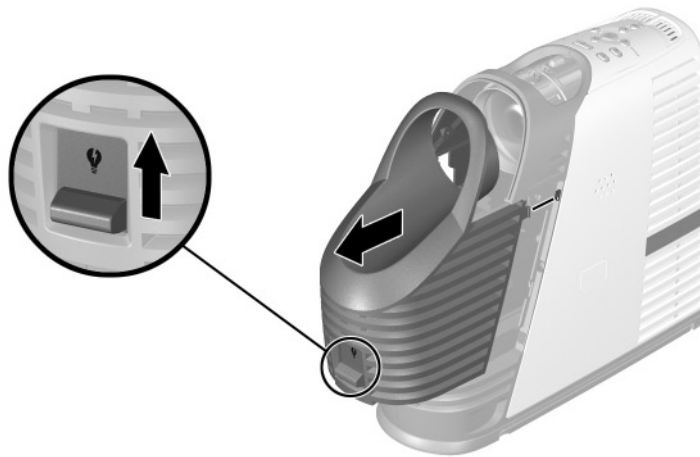

To replace the battery in the remote control

1. Slide the remote control case open to reveal the battery compartment.
2. On the back of the remote control remove the battery cover ❶ to reveal the batteries.
3. Remove the old batteries and install two new AAA batteries ❷.
4. Install the battery cover.

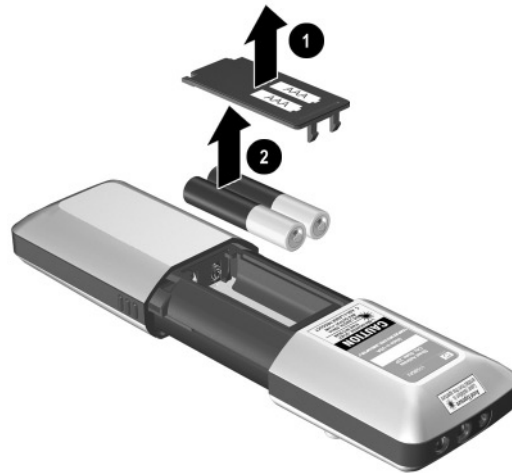

When discarding old batteries, contact your local waste-disposal provider regarding local restrictions on the disposal or recycling of batteries.



Upgrading the Projector

To update the firmware

HP might periodically release updated versions of the projector firmware to enhance the projector performance. The projector firmware version is shown in the on-screen menu at **Help > About this projector**. Check for updated versions at http://www.hp.com/go/proj_firmware.

USB method

1. On a computer with a VGA port and USB port, go to the HP projector upgrade website (see introduction for this section) and download the latest file intended for a USB upgrade.
2. Connect the M1-to-VGA/USB cable between the M1 port on the projector and the VGA port on the computer.
3. Connect the USB plug of the M1-to-VGA/USB cable into the USB port on the computer. This connection is required.
4. On the computer, run the file you downloaded by double-clicking the file. Follow the on-screen instructions. Do not turn off the projector until you are prompted.

Installing Permanently

This chapter explains how to permanently install the digital projector.

Installing the Projector

This section provides instructions on how to permanently install the projector.

- “To mount the projector on a tripod” on page 53
- “To install on a table” on page 54
- “To install on the ceiling” on page 55
- “To install for rear projection” on page 56
- “To lock the projector” on page 57

To mount the projector on a tripod

The projector includes standard tripod mount on the bottom of the projector. This allows the projector to be mounted on tripods readily available at camera and other electronic stores.



CAUTION:

- The tripod should be capable of supporting a weight of at least 5 lb. Refer to the owner’s manual that came with your tripod for more information.
- Do not overtighten the tripod mount screw. Doing so could strip the screw and cause the projector to fall off the tripod.

-
1. If necessary, remove the tripod mounting block from the tripod.
 2. If there is a guide pin on the tripod mounting block, align it with the guide pin hole on the bottom of the projector.

3. Attach the tripod mounting block to the tripod mount hole on the bottom of the projector.
4. Attach the projector and tripod mounting block to the tripod according to the tripod manufacturer's instructions.

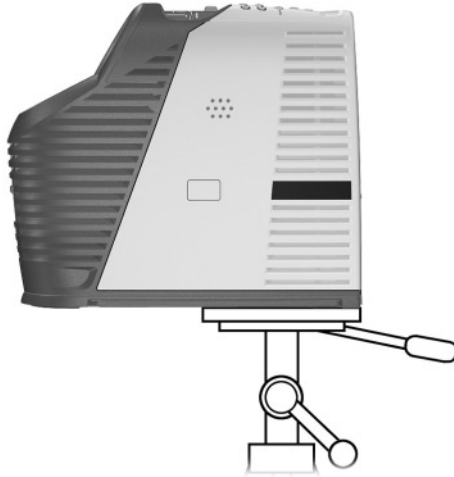

To install on a table

This installation is covered in detail in Chapter 1. See “Setting Up the Projector” on page 16 for more information.

To install on the ceiling



WARNING: To minimize the risk of injury from improperly installed equipment, it is recommended that a professional installer performs the ceiling installation.

1. Align the end of the ceiling-mount bracket with the center hole in the lower-mount bracket, and firmly secure it with a washer and bolt.
2. Attach the mounting bracket to the projector. See the instructions that came with the ceiling mount.
3. Attach the ceiling-mount bracket to the ceiling, and firmly secure with four screws capable of holding 4 kg (10 lb). The ceiling-mount bracket must be located 1.2 to 12 m (4 to 40 ft) in front of the screen. See the table in “Setting Up the Projector” on page 16.

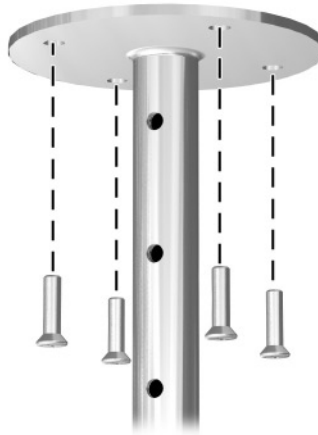

4. Adjust the on-screen menu to match your settings. Open the on-screen menu and select **Setup > Projector position**. Then select **Front Ceiling** from the drop-down list.

To install for rear projection

1. Place the projector 1.2 to 12 m (4 to 40 ft) behind a translucent screen that is designed for rear projection.

See “To set up on a table” on page 19 or “To install on the ceiling” on page 55 for more instructions.

2. Open the on-screen menu and select **Setup > Projector position**. Then select **Rear Table** or **Rear Ceiling** from the drop-down list.

To lock the projector

The projector includes a built-in slot to secure the projector with a cable and a lock (such as the Kensington MicroSaver lock system, available at many computer stores).

1. Wrap the cable around a secure object, such as a table leg. Loop the cable to create a slip knot around the stationary object, and be sure it cannot slip off.
2. Insert the lock ❶ into the hole and twist the key ❷.

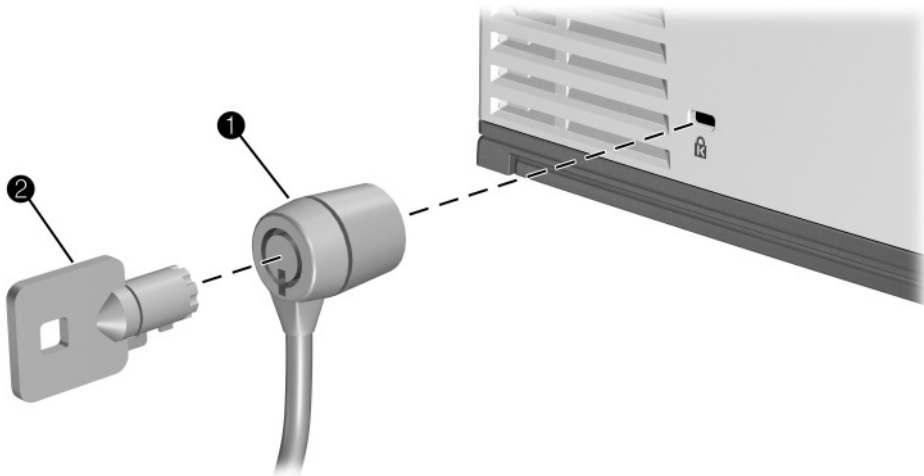

Fixing Problems

This chapter describes potential problems and offers suggestions to help correct them.

- “Troubleshooting Suggestions” on page 59
- “Testing the Projector” on page 67

Troubleshooting Suggestions

To use this section, find the problem statement that is closest to your problem, then try each bulleted item one at a time until your problem is fixed. If the suggestions do not solve your problem, contact HP. See the *Support Guide* included with the projector.

- “Start-up problems” on page 60
- “Picture problems” on page 61
- “Sound problems” on page 65
- “Interruption problems” on page 65
- “Remote control problems” on page 66

Start-up problems

If no lights or sounds turn on:

- ❑ Be sure that the power cable is securely connected to the projector and the other end is plugged into an outlet with power.
- ❑ Press the power button again.

If nothing is projected but the projector seems to start up:

- ❑ Be sure the lens cap has been removed.
- ❑ Check the front of the projector—the latch for the lamp module should be down.
- ❑ If the lamp indicator is on, replace or reinstall the lamp module. If the lamp indicator is blinking, turn off the projector and allow it to cool before restarting it—replace the lamp module if the indicator continues to blink.
- ❑ If the temperature indicator is on or blinking, turn off the projector and allow it to cool before restarting it. If the warning light turns on or blinks again, contact HP for assistance.

If the projector makes a “ticking” sound, if the projector lamp does not turn on, and if the lamp indicator is on or blinking:

- ❑ The projector lamp is too hot to light. Turn the projector off and wait for it to cool before turning it on again.
- ❑ The projector lamp is not making a good connection. Turn off the projector and allow it to cool. Then, on the front of the projector, slide the latch for the lamp module up and down. Be sure it is all the way down.
- ❑ The projector lamp has reached the end of its life. Replace the lamp.

Picture problems

If the image is not displayed on the screen, but the HP startup screen is displayed:

- ❑ Press the **source** button on the projector or remote control.
- ❑ Turn off or disable the notebook or desktop computer screen saver function.
- ❑ For a computer connection, ensure your notebook computer's external video port is turned on. See the video port card shipped with the projector. On some notebooks, for example, press the **Fn + F4** function keys to turn on the external video port.
- ❑ Verify that the right input source is connected. Open the on-screen menu and select **Input**. Then set the correct input port where the equipment is connected.
- ❑ Verify that auto search is enabled. Open the on-screen menu and select **Input > Source auto-search**.

If the wrong input source is displayed:

- ❑ Press the **source** button on the projector or the remote control to select another active input source.
- ❑ Verify that the right input source is connected. Open the on-screen menu and select **Input**. Then set the correct input source.
- ❑ Verify that the projector is enabled for auto-searching. Open the on-screen menu and select **Input > Source auto-search**.
- ❑ If the input source might turn off and on, open the on-screen menu and select **Input**. Set **Source auto-search** to **Disabled** and select the correct input source.

If the image is out of focus:

- ❑ Be sure the lens cap is removed.
- ❑ While displaying the on-screen menu, adjust the focus ring. (The image size should not change; if it does, you are adjusting the zoom not the focus.)
- ❑ Ensure the projection screen is 1.2 to 12 m (4 to 40 ft) from the projector.
- ❑ For a computer connection, set the display resolution on the computer to 1024 x 768 pixels.
- ❑ Check the projection lens to see if it needs cleaning.

If an upside-down or reversed image is displayed:

- ❑ The projector has been set to the wrong position setting. Open the on-screen menu, select **Setup > Projector position**, and select the correct setting.

If the image is too small or too large:

- ❑ Adjust the zoom ring on top of the projector.
- ❑ Be sure the projector is 1.2 to 12 m (4 to 40 ft) from the projection screen.
- ❑ Open the on-screen menu and select **Adjust picture > Aspect ratio**. Set to **Best Fit** or **Fill**. For a wide-screen picture, try setting the aspect ratio to **16:9**.

If the image has slanted edges:

- ❑ As much as possible, reposition the projector so that it is centered on the screen and below the bottom or above the top of the screen.
- ❑ The projector can automatically correct slanted sides of the picture when the projector is tilted up or down. However, additional corrections might be required in certain situations. Open the on-screen menu and select **Adjust picture > Keystone correction**. Adjust the horizontal and vertical settings as needed or enable or disable the auto keystone correction.

If a scrolling or cut-off image is displayed:

- ❑ Press the **auto sync** button on the projector or remote control.
- ❑ If digital magnification is activated, press **enter** to cancel it.
- ❑ For a computer connection, turn everything off, then power on the projector first and power on the notebook or desktop computer second.
- ❑ For a computer connection, if the above steps do not correct the display image, adjust the resolution of the notebook or desktop computer to 1024 x 768 pixels.

If the image is flickering or unstable:

- ❑ Press the **auto sync** button on the projector panel or remote control.
- ❑ For a computer connection, set the display resolution to 1024 x 768 pixels.
- ❑ For a computer connection, open the on-screen menu, select **Adjust picture > Advanced picture**, and adjust the **Frequency** or **Tracking**.

If the image is stretched:

- ❑ Open the on-screen menu and select **Adjust picture > Aspect ratio**. Set to **Best fit** or **Fill**. For a wide-screen picture, set the aspect ratio to **16:9**. Or set the aspect ratio to **1-to-1**.

If the image disappears from the computer screen:

- ❑ For a notebook computer, you might be able to turn on both the external VGA port and the built-in screen. See the computer manual or the projector's video port guide.

If the projected colors seem slightly wrong:

- ❑ If the theater video button on the projector is not lit, try pressing the theater video button on the projector or remote control.
- ❑ Open the on-screen menu and select **Adjust picture > Advanced picture**. Adjust the advanced settings as needed.

- ❑ Open the on-screen menu and select **Adjust picture > Color space**. Change the selection.
- ❑ Open the on-screen menu and select **Help > Diagnostics**. Run color tests.

If the projected colors seem completely wrong:

- ❑ For a YPbPr or RGB input device, be sure all the video connectors are correctly matched.
- ❑ Be sure the pins on the cable connectors are not bent or broken.
- ❑ Open the on-screen menu and select **Adjust picture > Color space**. Change the selection.
- ❑ Open the on-screen menu and select **Help > Diagnostics**. Run color tests.
- ❑ Reset the picture settings to the factory-default settings. See the following problem.

If the picture settings are completely wrong and you cannot fix them:

- ❑ Reset the projection settings to the factory-default settings. To do this, hold down the down **▼** + up **▲** + right **➤** buttons on the projector for 5 seconds. (This does not reset attachment module settings.)

If a DVI device causes an error message or garbage on the screen:

- ❑ Certain high-definition digital sources incorporate High-bandwidth Digital-Content Protection (HDCP) content protection. Such content cannot be displayed by this projector. If the device has another output port, such as S-video, try connecting that port to the projector.

If the projector stops responding to all controls:

- ❑ If possible, turn off the projector, then unplug the power cord and wait at least 15 seconds before reconnecting power.

Sound problems

If no sound is coming out of the projector:

- ❑ Be sure you have an audio cable securely connected between the projector and the input device.
- ❑ Be sure that the mute and volume settings are correct on the input device, such as a computer, DVD player, or camcorder.
- ❑ Open the on-screen menu and select **Audio**. Check the following settings:
 - ◆ Mute is turned off.
 - ◆ Volume is correct.

Interruption problems

If the lamp indicator or temperature indicator turns on or blinks:

- ❑ If the lamp indicator turns on, the lamp has failed. Install a new lamp.
- ❑ If the lamp indicator blinks, the lamp is not able to light. Wait for the projector to cool, then try starting it again. If the indicator blinks again, install a new lamp.
- ❑ If the temperature indicator turns on or blinks, the projector is too hot. See the following problem.

If the projector suddenly shuts down and the temperature light turns on:

- ❑ If the temperature light is blinking, the fan is not working. Allow the projector to cool for several minutes.
- ❑ If the temperature light is steady, the projector has overheated. Allow it to cool for several minutes.
- ❑ If airflow is obstructed, remove the obstruction.
- ❑ If possible, remove any sources of excess heat in the room.
- ❑ If the condition occurs after restarting the projector, contact HP to have the projector serviced or repaired.

If the lamp shuts off during a presentation:

- ❑ A minor power surge might cause the lamp to shut off. Wait a few minutes, then power on the projector.
- ❑ The lamp module might have burned out. Replace the lamp module.

If the lamp burns out or makes a popping sound:

- ❑ When the lamp reaches its end of life, it might burn out and make a popping sound. If this happens, the projector will not turn back on until the lamp module has been replaced.
- ❑ If the lamp breaks, contact HP about repairs that might be required.

Remote control problems

If the remote control does not operate:

- ❑ If the indicator light on the front of the remote control blinks when you press buttons, the remote control is working properly. If the light does not blink, install two new AAA batteries in the remote control.
- ❑ Be sure nothing is blocking the remote control receiver on the side of the projector. Move to within 9 m (30 ft) of the projector. If you are facing more toward the front or back of the projector, you might have to move as close as 2 m (6 ft).
- ❑ Open the on-screen menu and select **Help > Diagnostics**. Run remote control test.

If only the mouse and page-up and page-down buttons do not work:

- ❑ Be sure you have a USB connection between the projector and the computer.
- ❑ Open the on-screen menu and select **Help > Diagnostics**. Run remote control test and USB test.

Testing the Projector

The on-screen menu contains diagnostic tests you can use to verify the proper operation of the projector and the remote control.

To run the projector diagnostics

1. Open the on-screen menu and select **Help > Diagnostics**.
2. Select a test to perform.

This chapter lists the specifications, safety information, and regulatory information for the projector.

- “Specifications” on page 69
- “Safety Information” on page 75
- “Regulatory Information” on page 77

Specifications

Because HP continually improves its products, the following specifications are subject to change. For the latest specifications, visit the HP website at <http://www.hp.com>.

Identifying the projector specifications

Resolution	XGA
Technology	DLP
Video connectors	M1-DA (digital and analog) input, optional M1-DA cables for VGA, DVI, component-video (3 RCA) and SCART S-video input Composite-video input (1 RCA)
Audio connectors	Mini-phone audio input
Optional connectors	Optional smart attachment module provides network, USB, and Compact Flash support

Identifying the projector specifications (continued)

IR receivers	On left and right sides of projector
Size	197 mm x 78 mm x 231 mm (7.8 in. x 3.0 in. x 9.1 in.)
Weight	1.7 kg (3.8 lb)
Lens	2.02 to 1.68 throw ratio (distance/width)
Optical zoom	1.2:1
Digital zoom	Yes
Keystone	Automatic correction: up to $\pm 30^\circ$ vertical Manual correction: up to $\pm 30^\circ$ vertical, up to $\pm 12^\circ$ horizontal
Audio	2-W peak sound
Lamp	180-W P-VIP lamp, 1.1-mm arc 2000 hours (half life) Lamp-saver mode reduces lamp power to 156 W, extends rated life to up to 3000 hours Replacement lamp: L1621A
Light engine	0.7 12° DDR DMD XGA
Color system	Two preset color modes are available: Business graphics Theater video
Remote control	USB mouse with laser pointer
Mounting options	Ceiling and tabletop, tripod mounting, front and rear projection
Security	Kensington lock compatible
Power	100 to 240 V at 50 to 60 Hz

Identifying the projector specifications *(continued)*

Noise level 37 dBA

Environment

Operating:

Temperature: 10 to 35°C (50 to 95°F)

Humidity: 80% RH max, non-condensing

Altitude: up to 3,000 m (10,000 ft), up to 25°C (77°F)

Storage:

Temperature: -20 to 55°C (-4 to 131°F)

Humidity: 80% RH max, non-condensing

Altitude: up to 12,000 m (40,000 ft)

Analog Video Mode Compatibility

Compatibility	Resolution	V-Sync (Hz)	H-Sync (kHz)
VGA	640 x 350	70	31.5
	640 x 350	85	37.9
	640 x 400	85	37.9
	640 x 480	60	31.5
	640 x 480	72	37.9
	640 x 480	75	37.5
	640 x 480	85	43.3
	720 x 400	70	31.5
	720 x 400	85	37.9
SVGA	800 x 600	56	35.2
	800 x 600	60	37.9
	800 x 600	72	48.1
	800 x 600	75	46.9
	800 x 600	85	53.7
XGA	1024 x 768	60	48.4
	1024 x 768	70	56.5
	1024 x 768	75	60.0
	1024 x 768	85	68.7
SXGA	1280 x 1024	60	63.98
	1280 x 1024	75	79.98
SXGA+	1400 x 1050	60	63.98
MAC LC 13	640 x 480	66.66	34.98
MAC II 13	640 x 480	66.68	35

Analog Video Mode Compatibility (continued)

Compatibility	Resolution	V-Sync (Hz)	H-Sync (kHz)
MAC 16	832 x 624	74.55	49.725
MAC 19	1024 x 768	75	60.24
MAC	1152 x 870	75.06	68.68
MAC G4	640 x 480	60	31.35
MAC G4	640 x 480	120	68.03
MAC G4	1024 x 768	120	97.09
i Mac DV	640 x 480	117	60
i Mac DV	800 x 600	95	60
i Mac DV	1024 x 768	75	60
i Mac DV	1152 x 870	75	68.49
i Mac DV	1280 x 960	75	75
i Mac DV	1280 x 1024	75	90.9

Digital Video Mode Compatibility

Compatibility	Resolution	V-Sync (Hz)	H-Sync (kHz)
VGA	640 x 350	70	31.5
	640 x 350	85	37.9
	640 x 400	85	37.9
	640 x 480	60	31.5
	640 x 480	72	37.9
	640 x 480	75	37.5
	640 x 480	85	43.3
	720 x 400	70	31.5
	720 x 400	85	37.9
SVGA	800 x 600	56	35.2
	800 x 600	60	37.9
	800 x 600	72	48.1
	800 x 600	75	46.9
	800 x 600	85	53.7
XGA	1024 x 768	60	48.4
	1024 x 768	70	56.5
	1024 x 768	75	60.0
SXGA	1280 x 1024	60	63.98

Safety Information

Safety precautions



WARNING: Observe the following precautions to reduce the risk of injury.

- To prevent eye injury, do not look directly into the lens when the lamp is on. Do not point the laser light into anyone's eyes.
- To prevent electrical shock, do not expose the projector to rain or moisture. Do not open the projector except as instructed by the manual.
- To reduce the risk of fire or electrical shock, do not allow small metallic objects to get inside the projector. Carry the projector only in its protective case, and do not store paper clips or other small objects inside the case.
- Allow the projector to cool before removing any cover and touching internal components, as instructed by the manual.
- Keep paper and other combustible material away from the projector lens to prevent the possibility of fire.
- Use only an approved power cord rated for the voltage and current marked on the product label. Do not overload any outlet or extension cord.

Laser safety

The laser pointer on the remote control is certified as Class 2 laser device according to the U.S. Department of Health and Human Services Radiation Performance Standard and International Standards IEC 825/IEC 825-1 (EN60825/EN60825-1). This device is not considered harmful, but the following precautions are recommended:

- Ensure proper use by reading and following the instructions carefully.
- If the unit requires service, contact an authorized HP service center.
- Do not attempt to make any adjustment to the unit.
- Avoid direct exposure to the laser beam.

LED safety

The infrared ports located on the digital projector and remote control are classified as Class 1 LED devices according to International Standard IEC 825-1 (EN60825-1). This device is not considered harmful, but the following precautions are recommended:

- If the unit requires service, contact an authorized HP service center.
- Do not attempt to make any adjustment to the unit.
- Avoid direct eye exposure to the infrared LED beam. Be aware that the beam is invisible light and cannot be seen.
- Do not attempt to view the infrared LED beam with any type of optical device.

Mercury safety



WARNING: This digital projector lamp contains a small amount of mercury. If the lamp breaks, adequately ventilate the area where the breakage occurred. Disposal of the lamp might be regulated due to environmental considerations. For disposal or recycling information, please contact your local authorities or the Electronic Industries Alliance at <http://www.eiae.org>.

Regulatory Information

This section presents information that shows how your digital projector complies with regulations in certain regions. Any modifications to your digital projector not expressly approved by HP could void the authority to operate the digital projector in these regions.

U.S.A.

This digital projector has been tested and found to comply with the limits for a Class B digital device, pursuant to Part 15 of the FCC Rules. These limits are designed to provide reasonable protection against harmful interference in a residential installation.

This digital projector generates, uses, and can radiate radio frequency energy. If not installed and used in accordance with the instructions, it can cause harmful interference to radio communications. However, there is no guarantee that interference will not occur in a particular installation. If this digital projector does cause harmful interference to radio or television reception (which can be determined by unplugging the unit), try the following:

- Reorienting or relocating the receiving antenna.
- Relocating the digital projector with respect to the receiver.
- Connecting the digital projector's power cord to another power outlet.

Connections to peripheral devices

To maintain compliance with FCC Rules and Regulations, use properly shielded cables with this device.

For more information, consult your dealer, an experienced radio/television technician, or, prepared by the Federal Communications Commission, *How to Identify and Resolve Radio-TV Interference Problems*. This booklet is available from the U.S. Government Printing Office, Washington, DC 20402, Stock Number 004-000-00345-4. At the first printing of this manual, the telephone number was 202-512-1800.

Canada

This Class B digital apparatus complies with Canadian ICES-003.

Japan

この装置は、情報処理装置等電波障害自主規制協議会（VCCI）の基準に基づくクラスB情報技術装置です。この装置は、家庭環境で使用することを目的としていますが、この装置がラジオやテレビジョン受信機に近接して使用されると受信障害を引き起こすことがあります。

取り扱い説明書に従って正しい取り扱いをして下さい。

Korea

사용자 안내문 : **B** 급 기기

이 기기는 비업무용으로 전자파적합등록을 받은 기기이오니, 주거지역에서는 물론, 모든 지역에서 사용 하실 수 있습니다.

International

For regulatory identification purposes, your product is assigned a regulatory model number. The regulatory model number for your product is listed in the declaration of conformity. This regulatory number is different from the marketing name and product number.

DECLARATION OF CONFORMITY

According to ISO/IEC Guide 22 and EN 45014

Manufacturer's Name: Hewlett Packard Company
Manufacturer's Address: Hewlett Packard Company
 Digital Projection & Imaging
 1000 NE Circle Blvd.
 Corvallis, OR 97330-4239

Declares, that the product(s):

Product Name: Digital Projector
Model Number(s): mp3130/mp3135 series
Regulatory Model: CRVSB-03AP

Conforms to the following product specifications:

Safety: IEC 60950:1999/ EN 60950:2000

IEC 60825-1:1993 +A1 / EN 60825-1:1994 +A11 Class 1 LED
 GB4943-1995

EMC: EN 55022: 1998 Class B [1]

CISPR 24:1997 / EN 55024: 1998
 IEC 61000-3-2:1995 / EN 61000-3-2:2000
 IEC 61000-3-3:1994 / EN 61000-3-3:1995+A1:2001
 GB9254-1998
 FCC Title 47 CFR, Part 15 Class B/ANSI C63.4:1992
 AS/NZS 3548:1995 Rules and Regulations of Class B

Supplementary information:

The product herewith complies with the requirements of following Directives and carries the CE marking accordingly:

-Low Voltage Directive: 73/23/EEC

-EMC Directive: 89/336/EEC

[1] The product was tested in a typical configuration with Hewlett Packard Personal Computer peripherals.

This device complies with Part 15 of the FCC Rules. Operation is subject to the following two conditions:

(1) this device may not cause harmful interference, and (2) this device must accept any interference received, including interference that may cause undesired operation.

Corvallis, Oregon, September 1, 2003



Steve Brown, General Manager

European Contact for regulatory topics only: Hewlett Packard GmbH, HQ-TRE, Herrenberger Straße 140, 71034 Boeblingen, Germany. (FAX:+49-7031-143143).

USA Contact: Hewlett Packard Co., Corporate Product Regulations Manager, 3000 Hanover Street, Palo Alto, CA 94304. Phone: (650) 857-1501.

A

- accessories
 - listing 15
- adjust picture 37
- aiming the projector
 - raising and lowering 29
- analog video mode
 - compatibility 72
- audio
 - adjusting 37

B

- back panel
 - identifying 12
- business graphics mode
 - see* picture mode
- buttons
 - projector 11
 - remote control 13

C

- ceiling installation
 - setting up 55
- component video connection
 - connecting video source 25
- composite video connection
 - connecting video source 24
- configuration
 - using on-screen menu 39
- connecting input sources
 - component video connection 25

- composite video connection 24
- computer with DVI port 21
- computer with VGA port 20
- handheld organizer 22
- SCART connection 26
- with S-video 23

- connections
 - see* back panel
- contents
 - in the box 8

D

- dimensions
 - of screen and room 17
- distance
 - setting up in relation to image 16

F

- firmware
 - updating 51
- focus
 - adjusting 30
 - range of 30

G

- graphics mode
 - see* picture mode

H

- handheld organizer
 - connecting 22
- hide button 34

I

image

adjusting 37

input/output connectors

see back panel

installation

see ceiling installation *see* rear projection installation *see* table installation**K**

Kensington lock 57

keystone correction

adjusting 35

L

lamp module

replacing 48

lamp saver mode 37

language

changing 37

laser pointer 31

laser safety

precautions 75

LED safety

precautions 76

lens

care 47

cleaning 47

lights

identifying 11

location

see ceiling installation *see* rear projection installation *see* table installation

lock 57

M

maintenance

routine maintenance 47

menu

see on-screen menu

mercury 49

O

on-screen menu

about menu definitions 45

adjust picture menu definitions 42

audio menu definitions 44

input menu definitions 41

quick choice menu definitions 40

setup menu definitions 44

using 38, 39

optimizing image 36

P

picture

adjusting 37

picture mode

changing 32, 36

definition 36

power

turning off 28

turning on 27

presentations

changing source 34

from a computer 33

projector

adjusting 35

identifying parts 10

maintaining 47

setting up 16

troubleshooting 59

upgrading 51

R

- rear panel
 - see* back panel
- rear projection installation
 - setting up 56
- remote control
 - battery replacement 50
 - identifying with doors closed 13
 - identifying with doors open 14
 - using 31
- resetting
 - projection settings 64
 - projector 28

S

- safety information
 - laser safety 75
 - LED 76
 - precautions 75
- SCART connection
 - connecting video source 26
- security
 - locking 57
- setup
 - adjusting 37
 - see also* ceiling installation
 - see also* rear projection
 - see also* table installation
- slanted edges
 - see* keystone correction
- sound
 - see* audio
- source
 - changing 34
- specifications
 - of the projector 69

- status
 - of projector 47
- S-video connection
 - connecting video source 23

T

- table installation
 - setting up 19
- testing
 - diagnostics 67
- theater video mode
 - see* picture mode
- tripod
 - mounting on 53
- troubleshooting
 - interruption problems 65
 - picture problems 61
 - remote control problems 66
 - sound problems 65
 - start-up problems 60
 - suggestions 59
- turning off 28
- turning on 27

U

- upgrading 51
- using 34

V

- video mode
 - see* picture mode
- video sources 23

Z

- zoom
 - adjusting 30
 - range of 30

