

# Phased Array Antennas

Iulian Rosu, YO3DAC / VA3IUL, <http://www.gsl.net/va3iul>

- [Introduction](#)
- [Main Characteristics of Array Antennas](#)
- [Array Antenna Field Regions](#)
- [Techniques to increase the Antenna Gain and change the Radiation Pattern](#)
- [Phased Array Antennas](#)
- [Array Antenna Elements](#)
- [Patch Antenna Elements](#)
- [Slot Antenna Elements](#)
- [Hertzian Dipole Array Antennas](#)
- [Array Antenna Radiation Patterns](#)
- [Array Factor \(AF\)](#)
- [Array Antenna Patterns – Broadside \(Boresight\) Array and End-fire Array](#)
- [Phased Array Antenna Beamforming](#)
- [Array Antenna Scanned Beam \(Beam Steering\)](#)
- [Grating Lobes of Phased Array Antenna](#)
- [The Ordinary End-fire Array](#)
- [Thinned Phased Array Antenna](#)
- [Nonuniformly Spaced Array Antennas](#)
- [Mutual Coupling between Antenna Elements](#)
- [Frequency Bandwidth of Array Antenna](#)
- [Antenna Element Failure Analysis](#)
- [Scan Blindness](#)
- [Array Factor plots for Phased Array Antennas](#)
- [Sparse Array Antennas](#)
- [Phase Shifters used in Electronically Controlled Phased Array Antennas](#)

## Introduction

First **Antenna** was invented and built in 1888 by [Heinrich Hertz](#) in his experiments to prove the existence of waves predicted by the electromagnetic theory of [James C. Maxwell](#).

The name Antenna was coined by [Guglielmo Marconi](#) in 1895, and is coming from the Latin name **ANTEMNA**, which is the pole on a mast, from which ship sails are set.

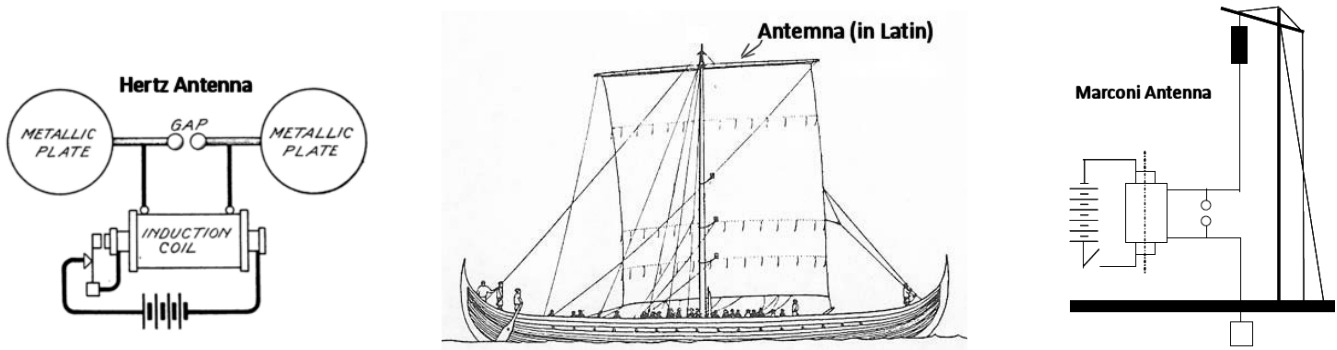

- **Antenna** can be seen as the interface between the radio waves which are propagating through free space and electric currents moving in metal conductors.
- A radio **transmitter** supplies an electric current to the antenna's terminals, and the antenna radiates the energy from the current as **electromagnetic waves** (also named **radio waves**).
- In a radio **receiver**, an antenna intercepts some of the power of the transmitted radio waves in order to produce an electric current at its terminals, that is applied to the input of the receiver to be amplified.

**Antennas are essential components of ALL radio equipment**

## Main Characteristics of Array Antennas

- **Radiation Pattern**  
Is a graphical representation (or mathematical function) of the radiation properties of an antenna as a function of geometric (typically spherical) coordinates.
- **Directivity**
  - The **Antenna Directivity** is the ratio of radiation intensity in a given direction from an antenna to the radiation intensity averaged over all directions. If that particular direction is not specified, then the direction in which maximum intensity is observed, can be taken as the directivity of that antenna.
  - The directivity of a non-isotropic antenna is equal to the ratio of the radiation intensity in a given direction to the radiation intensity of the isotropic source.
  - Antenna Array **directivity** is the measure of how concentrated the antenna gain is in a given direction relative to an isotropic radiator. It follows a  $10 \cdot \log(N)$  relationship, where N is the number of elements in the array.
  - The **Directivity Resolution** of an antenna (Rayleigh resolution) may be defined as equal to half the beamwidth between first nulls (**FNBW / 2**).

For example, an antenna whose pattern FNBW / 2 = 2° has a resolution of 1°, so the antenna may distinguish between two adjacent geostationary orbit satellites separated by 1°.

- **Effective Area**

Effective area (aperture)  $A_e$  of an antenna represents the ratio of the available power at the terminals of the antenna to the power flux density from a plane wave incident normal to the antenna. The effective area is related to the antenna directivity  $D$ :

$$A_e = (\lambda^2 * D) / 4\pi$$

- **Aperture Efficiency**

- Aperture Efficiency ( $e_a$ ) of an antenna, is the ratio of the **effective radiating area** ( $A_e$ ) to the **physical area** of the aperture ( $A_{phys}$ ).

$$e_a = A_e / A_{phys} \quad (0 < e_a < 1)$$

- An antenna has an aperture through which the power is radiated. This radiation should be effective with minimum losses. The physical area of the aperture should also be taken into consideration, as the effectiveness of the radiation depends upon the area of the aperture, physically on the antenna.

- **Antenna Efficiency**

- **Antenna Efficiency** is the ratio of the radiated power of the antenna to the input power accepted by the antenna.
- The Antenna Efficiency has to do only with ohmic losses in the antenna. In transmitting antenna, these losses involve power fed to the antenna which is not radiated but heats the antenna structure,
- Antenna should radiate the power given at its input, with minimum losses.
- A **lossless antenna** is an antenna with an antenna efficiency of 0dB (or 100%).

- **Gain**

- **Antenna Gain** is the product of the **Efficiency** and the **Directivity** of an antenna.

$$G = k * D$$

where k (dimensionless) is the **efficiency factor** ( $0 \leq k \leq 1$ )

- If the **antenna efficiency** is not 100%, the **Gain** is less than the **Directivity**.
- Gain is usually measured in dB. Unlike antenna directivity, **antenna gain** takes into account the losses that occur, and hence focuses on the antenna efficiency.
- Gain of an antenna is the ratio of the radiation intensity in a given direction to the radiation intensity that would be obtained if the power accepted by the antenna were radiated in all directions (isotropically).
- **Array Antenna Gain** equals  $10 * \log(N)$ , plus the embedded **element gain** ( $G_e$ ), minus the ohmic and scan losses ( $N$  is the number of elements in the array):

$$\text{Array Antenna Gain} = 10 * \log(N) + G_e - \text{LOSS}_{\text{OHMIC}} - \text{LOSS}_{\text{SCAN}}$$

- As defined, the gain does not include losses from impedance mismatches.
  - The "**Realized Gain**" considers the impedance mismatch and is therefore relative to the power matched to the transmission line.
  - The realized gain depends on the matching of the network.  
Since mismatch will result in additional losses, **realized gain** is smaller than **gain**. The **gain** in return is smaller than the **directivity** due to the radiation efficiency.
  - Only for an ideal lossless antenna and perfect matching can the three parameters (directivity, gain, realized gain) be theoretically equal.
- **Radiation Resistance**  
The total amount of energy radiated from a transmitting antenna can be measured in terms of a **Radiation Resistance** which is the resistance that, when replacing the antenna, at the feeder will consume the same amount of power that is radiated.
  - **Radiation Pattern Beamwidth**  
The angular separation between two identical points on opposite sides of the maximum of the radiation pattern.  
Generally, the value definition is the half-power (3dB) point (HPBW).
  - **Polarization**  
Indicates the time-varying direction of the **electric field vector** – vertical, horizontal, and circular polarization are typical.
    - Linear polarizations are defined as vertical, horizontal or slanted, while circular polarizations can rotate right or left (in the right-hand sense or left-hand sense).
  - **Bandwidth**  
The frequencies for which matching is acceptable (e.g. VSWR less than 2), define the antenna bandwidth.
    - Depending on the useable frequencies, the bandwidth is the factor between the lowest ( $f_L$ ) and highest frequency ( $f_H$ ): **BW =  $f_H / f_L$**   
Antennas are defined as broadband when the factor is equal to or greater than 2.
  - **Input Impedance**  
The ratio of voltage to current at the input terminals of the antenna.

## Array Antenna Field Regions

When a high frequency current flows in an antenna, it generates a high frequency electromagnetic field in the surrounding space. The surrounding space of an antenna is usually subdivided (classified) into three regions: the **reactive near-field** region, the **radiating near-field** (Fresnel) region and the **far-field** (Fraunhofer) region.

These regions are useful to identify the field structure to know which simplification can be applied, but there is no precise boundary nor abrupt change in the field configuration.

Even these regions were predicted years before (wave-zones mentioned by [Braun](#)), first author who published about regions around the antenna was [Schelkunoff](#) in the mid 1930's, followed later by [Friis](#) and [Kraus](#). Was mentioned that the space around an antenna may be separated into two regions: one next to the antenna known as the “**antenna region**” and one outside the antenna, known as the “**outer region**”. The boundary between the two regions (which is a sphere whose center is at the middle of the antenna) may be arbitrary taken to be at a radius **R**:

$$R = \frac{2L^2}{\lambda}$$

where **L** is the antenna greatest dimension (length) and  $\lambda$  is the wavelength.

Initially, the distinction between fields at a large distance and those nearer to the antenna was emphasized by subdividing the “**outer region**” into two regions: the one near the antenna called the **near-field**, or Fresnel region, and the one at a large distance called the **far-field**, or Fraunhofer region.

Later, were coined names as **reactive near-field** for “**antenna region**”, **radiating near-field** for the Fresnel region, and **far-field** for Fraunhofer region.

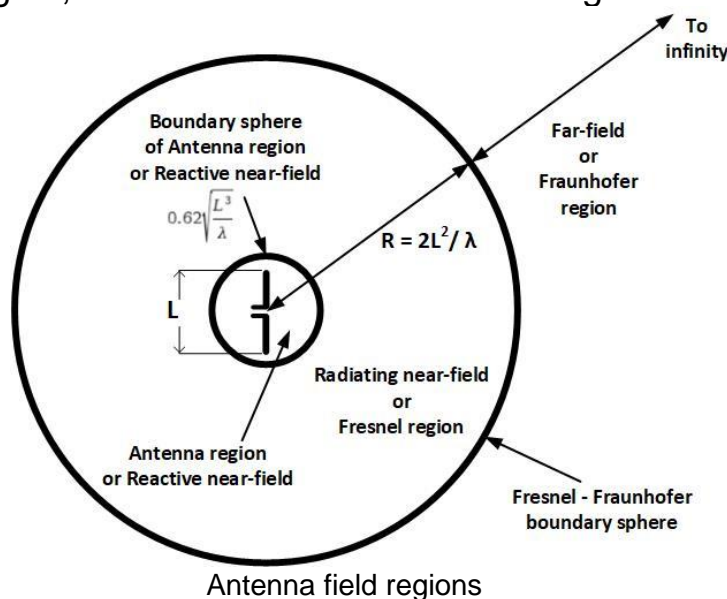

These antenna regions were named after the physicists Fresnel and Fraunhofer due to the analogy of the antenna fields with their inventions and discoveries in optics.

In the **radiating near-field** Fresnel region, the radial field may be appreciable and the shape of the field pattern is, in general, a function of the distance to the antenna.

In the **far-field** Fraunhofer region, **E** and **H** field vectors are transverse to the direction of propagation and orthogonal to each other, and the impedance of the field  $|\mathbf{E}|/|\mathbf{H}|$  at each location approaches the free-space wave impedance of 377 Ohms. The shape of the field pattern is independent of the radius (distance to antenna) at which it is taken.

However, **the distance from an antenna, where far-field conditions are met, depends on the dimensions of the antenna in respect to the wave length.**

For smaller antennas (e.g. a half-wave dipole) the wave fronts radiated from the antenna become almost parallel at much closer distance compared to electrically large antennas.

A good approximation for small antennas is that far-field conditions are reached at:

$$R = 2\lambda$$

- **Reactive Near Field Region**

In the immediate vicinity of the antenna, there is the reactive near field. In this region, the fields are predominately reactive fields, which means the **Electric-E** and the **Magnetic-H** fields are out of phase by 90° to each other (recall that for propagating or radiating fields, the fields are orthogonal/perpendicular but are in phase).

For antenna's greatest dimension **L**, the boundary of the **reactive near-field** region **R** is commonly given as:

$$R < \sqrt{\frac{L^3}{\lambda}}$$

- **Radiating Near Field (Fresnel) Region**

The **radiating near-field** or Fresnel region, is the region between the **reactive near-field** and **far-field**. In this region, the reactive fields are not dominant and the radiating fields begin to emerge. However, unlike the far-field region, here the shape of the radiation pattern may vary appreciably with distance **R** from the antenna.

For **antenna dimension L**, the boundary of the **radiating near-field** region **R** is commonly given by:

$$R = 0.62\sqrt{\frac{L^3}{\lambda}} < R < \frac{2L^2}{\lambda}$$

Note that depending on the values of **R** and the wavelength, this field may or may not exist.

- **Far Field (Fraunhofer) Region**

As is defined, the far-field is the region far from the antenna. In this region, the radiation pattern does not change the shape with distance **R** (although the fields still die-off as **1/R**, the power density dies-off as **1/R<sup>2</sup>**). This region is dominated by radiated fields, with the **Electric-E** and **Magnetic-H** fields orthogonal to each other and the direction of propagation as with plane waves.

If the **maximum linear dimension** of an antenna is the length **L**, then the following three conditions must be all satisfied to be in the **far-field** region:

- 1)  $R > \frac{2L^2}{\lambda}$
- 2)  $R > > L$
- 3)  $R > > \lambda$

The equations **1)** and **2)** from above, ensure that the power radiated in a given direction from distinct parts of the antenna are approximately parallel (see figure below). This helps ensure the fields in the far-field region behave like plane waves.

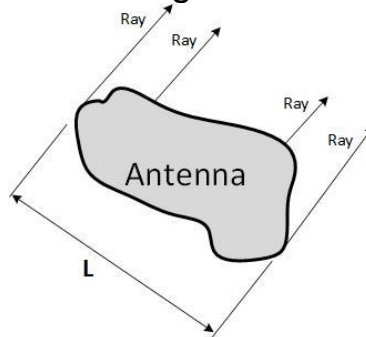

**In the Far-Field the Rays from any point on the antenna are approximately parallel**

- Note that the dimension **L** of an Array Antenna is the **longest distance between array's extremities**. Depending by the number of antenna elements and by the antenna array type, it is possible that the dimension **L of an Array Antenna** to be many times greater than the dimension **L of a single antenna element**. Thus, we can see how greater could be the far-field starting range of an Array Antenna compared to the far-field range of a **single antenna element**.
- Note that the sign “much greater than  $\gg$ ” (equations 2 and 3) is typically assumed satisfied if the left side of the equations is at least 10 times larger than right side.

The far-field equation number 3) come from the statement that near a radiating antenna, there are reactive fields (see reactive near field region, above), that typically have the **Electric-E** fields and **Magnetic-H** fields die-off with distance as  $1/R^2$  and  $1/R^3$ .

The equation number 3) ensures that these near fields are gone, and we are left with the radiating fields, which fall-off with distance as  $1/R$ .

- In arrays, the far-field distance of  $R > (2 * L^2) / \lambda$ , may not be sufficient for low-sidelobe designs. As the observation distance moves in from infinity, the first sidelobe rises and the null starts filling. Then the sidelobe becomes a shoulder on the now wider main beam, and the second null rises. This process continues as the distance decreases. To first order, the results are dependent only on design sidelobe level.
- The far-field region is referred as **Fraunhofer region**, a carryover term from optics.
- The far-field region is the most important field, as this determines the antenna's radiation pattern. Also, antennas are used to communicate wirelessly from long distances, so this is the region of operation for most of the antennas.

## Techniques how to increase the Antenna Gain and change the Radiation Pattern

For some applications, single element antennas are unable to meet the **gain** or the **radiation pattern** requirements.

To create a **high gain antenna**, which radiates radio waves in a narrow beam pointed to a desired direction, few techniques can be used:

1. One technique is to use **large metal surfaces** such as parabolic reflectors, horns or dielectric lenses which **change the direction of the radio waves by reflection or refraction**, to focus the radio waves from a single low gain antenna into a beam. This type of antenna is called an **Aperture Antenna**. Parabolic dish and horns are examples of aperture antennas. Their gain increases with increased dimension.

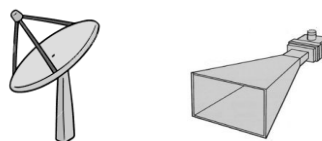

Parabolic dish and horn antennas

2. Increasing the **size of the antenna** (Antenna Aperture), the larger antenna becomes **more directive due to the periodic current distribution** across the antenna. Although this method does not require external circuitry for control, the direction of the beam is fixed and the number of sidelobes increases.

Examples include electrically long dipoles, horns, and waveguides.

- It follows from elementary diffraction theory that if **L** is the **maximum dimension of an antenna** in a given plane, and  $\lambda$  is the wavelength of the radiation, then the **minimum angle resolution  $\theta$**  within which the radiation can be concentrated in that plane is:  $\theta \approx \lambda / L$  where  $\theta$  is in radians

3. An antenna that consists of a single driven element connected to the feed-line, and other elements which are not connected (called parasitic elements) is named **Parasitic Array**. Yagi-Uda antenna (invented in 1926 by [Shintaro Uda](#) and published by [Hidetsugu Yagi](#)) is an example of Parasitic Array.

Yagi-Uda antenna use a driven element (which is a dipole or a folded dipole), and one or more parasitic elements, as reflectors and directors. This antenna can provide **high gain in a particular direction** (from the driven element to the directors).

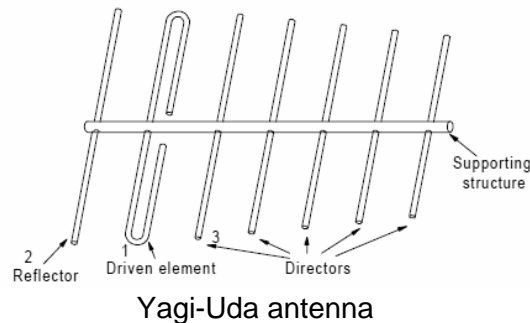

4. Another technique to increase the gain and to narrow the beamwidth is using an **Array Antenna**, which is a system of similar antenna elements oriented similarly to get greater directivity in a desire direction.

- If the single antenna element is repeated according to the periodicity of the current distribution, an **Array Antenna** is created.
- The amplitude and phase of the signals to individual **radiating antenna elements** can be adjusted to control both, the beam direction and sidelobe levels, creating a **Phased Array Antenna**.

This results in a significantly more complex feeding network with higher losses than the other methods.

- The antenna elements are usually separated by a distance of  $\lambda/2$  (half-wavelength) in order to minimize the coupling between them (mutual coupling).
- Larger separations result in higher grating lobes (unwanted beams).

-- In a **Phased Array Antenna**, the radio waves radiated by each individual antenna elements combine and superpose, adding together (interfering constructively) to enhance the power radiated in desired directions, and cancelling (interfering destructively) to reduce the power radiated in other directions --

## Phased Array Antennas

The **Phased Array Antenna** was invented in 1905 by [Karl F. Braun](#).

Karl F. Braun also discovered the point-contact semiconductor (1874) and also invented and built the first cathode-ray tube CRT, and the first CRT oscilloscope (1897).

He shared a Nobel Prize in Physics (1907) together with Guglielmo Marconi.



**Karl F. Braun** mentioned in his Nobel Prize lecture the following experiments he did:

*"I found in 1902 that an antenna, inclined at somewhat less than  $10^\circ$  to the horizon, formed a kind of directional receiver. The receptivity showed a clearly defined maximum for waves passing through the vertical plane in which the antenna was situated. The results were published in March of 1903. A directional transmitter is made up in the following way Fig 12.*

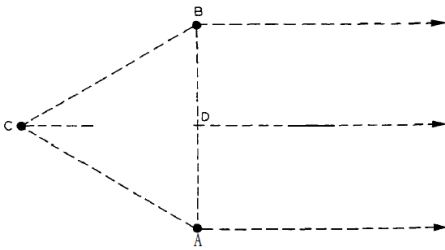

Fig. 12.

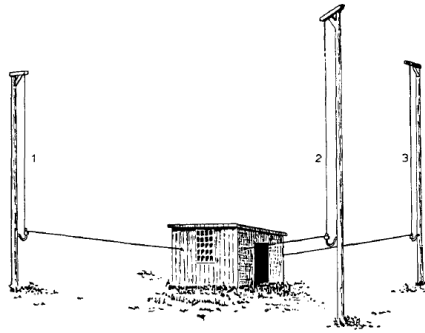

Fig. 13.

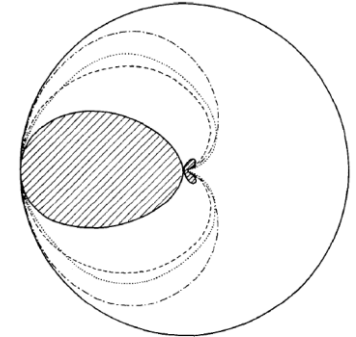

Fig. 14.

*It is assumed that the antennae A and B, located at corners of an equilateral triangle, are equal in phase, but are delayed by a quarter of a cycle of oscillation relative to antenna C, which is in the third corner. The height CD of the triangle is to be a quarter wavelength. The radiation will then prefer the direction CD. The wave emanating from C will reach AB at the moment that A and B start to oscillate.*

*In Fig. 13 is shown, schematically, the layout used.*

*The field was measured at a fair distance away, that is to say, in the so-called wave-zone. There was satisfactory agreement between theory and observation, and the results were checked in various ways. It was further shown that the experimental layout functioned in the desired sense. By suitable distribution of the amplitudes in the three transmitters, a field as in Fig. 14 was calculated (the singly dotted curve is the measured field). The radial vectors represent the range. If the roles of the three transmitters are exchanged - by simply tripping a changeover switch - the preferred direction can be rotated through  $120^\circ$  or  $60^\circ$ ."*

The basic property of a **Phased Array Antenna** is that the relative position of the antenna elements with respect to each other introduces relative phase shifts in the radiation vectors, which can then add **constructively** in some directions or **destructively** in others.

This is a direct consequence of the translational phase-shift property of Fourier transforms:

**A translation in Space or in Time becomes a Phase Shift.**

**Phased Array Antennas** are used to radiate power towards a desired angular sector.

- The number, the geometrical arrangement, and relative amplitudes and phases of the array elements depend on the angular pattern that must be achieved.

Once a Phased Array Antenna has been designed to focus the beam towards a particular direction, the beam it can be **steered** towards some other direction by changing the relative phases of the array elements (the physical antenna structure can be stationary).

This process is called **Steering** or **Scanning**.

- By properly adjusting the relative **Phase** or **Amplitude** of the array elements, radiation pattern of the array is steered in a desired direction, or the main beam is suppressed along undesired directions.
- The beam steering works on both, transmit and receive.  
By changing the relative amplitude and phase across the beam, we can steer the beam and reduce the sidelobes of the resulting beam pattern.
- On the transmit side, sidelobes are usually unwanted radiations of energy in unwanted directions. On the receive side, sidelobes allow signals into the receiver from unwanted directions, which will interfere with signals from desired direction.
- The Phased Array Antenna can also be used to increase the overall gain, provide diversity reception, cancel out interference from a particular set of directions, determine the **direction of arrival (DOA)** of the incoming signals, maximize the signal to interference plus noise ratio (SINR), etc.
- The radiation pattern of an Antenna Array is determined by the **type** of individual elements used, their **orientation**, their **position** in space, and the **amplitude and phase** of the currents feeding them.
- The individual antennas, part of the Phased Array Antenna (called **antenna elements**), are usually connected to a single receiver or a transmitter by feed-lines that feed the power to the elements in a specific phase relationship.
- Performances of the individual antenna elements part of the Antenna Array system should not be underestimated or treated superficially, otherwise the entire performances of the array will deteriorate.
- The fields radiated from a **linear array antenna** are a superposition (sum) of the fields radiated by each **antenna element** in the presence of the other elements. Each antenna element has an excitation parameter, which is: current for a dipole, voltage for a slot, and mode voltage for a multiple-mode element.

## Array Antenna Elements

There are many categories of antennas: wire antennas (e.g., dipole, monopole, loop); aperture antennas (e.g., horn); reflector antennas (e.g., parabolic, corner); lens antennas; microstrip or printed antennas (e.g. patch, slot, PIFA).

Small individual antennas, such as quarter-wave monopoles and half-wave dipoles (or derivatives of them), don't have much directivity (or gain); they are omnidirectional antennas which radiate radio waves over a wide angle. However, these antennas can be used as antenna elements in a Phased Array Antenna system.

- In most cases, the elements of a Phased Array Antenna are identical. This is not necessary, but it is often convenient, simpler, and more practical.
- The individual **antenna elements** of a Phased Array Antenna may be of any form as: wires, patches, slots, apertures, etc.

Due to their multiple advantages and easier implementation, one of the most used **antenna elements** are the **Printed Microstrip Antennas**.

- From the printed microstrip category, **Patch Antennas** are the most used elements in Phased Array Antennas for various applications, from long range military radar antennas to short distance commercial automotive radar sensors.

## Patch Antenna Elements

A microstrip patch antenna consists of a very thin metallic patch placed a small fraction of a wavelength above a conducting ground-plane.

The patch and ground-plane are separated by a dielectric. The patch conductor is normally copper and can assume any shape, but simple geometries generally are used, and this simplifies the analysis and performance prediction.

The substrate is usually non-magnetic. The relative permittivity of the substrate is normally in the region between 1 and 4, which enhances the fringing fields that account for radiation, but higher values may be used in special circumstances.

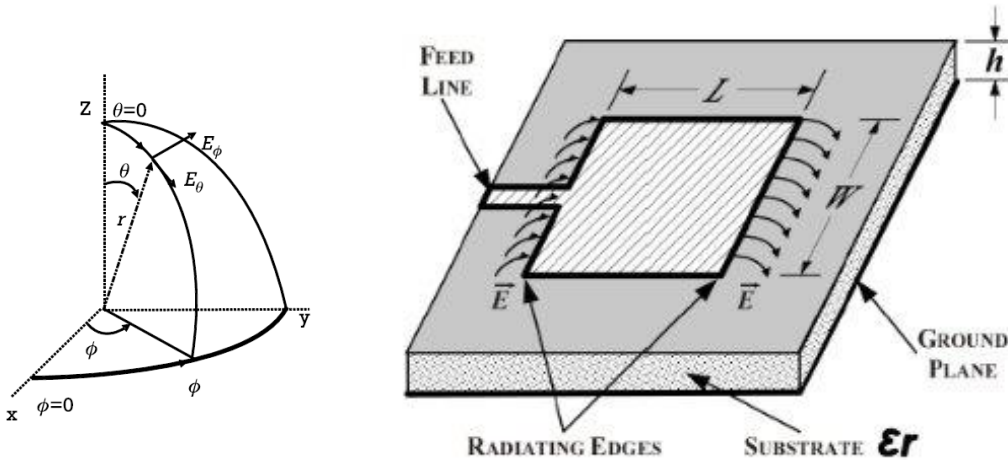

Patch Antenna with direct feed connection

- Due to its simple geometry, the halfwave rectangular patch is the most commonly used microstrip antenna. It is characterized by its length **L**, width **W** and thickness **h**.
- The two ends of the antenna can be viewed as radiating edges due to fringing fields along each edge of width **W**. The width **W** is about one wavelength, but on the other hand to get higher bandwidth usually  $W < 2*L$  ( $W = 1.5*L$  is typical).
- The two radiating edges are separated by a distance **L**. The two edges along the sides of length **L** are often referred to as non-radiating edges.
- The length **L** is approximately half guided wavelength ( $\lambda_g/2$ ), where  $\lambda_g = \lambda/\sqrt{\epsilon_r}$ , and  $\epsilon_r$  is the permittivity (dielectric constant) of the substrate.  
The width **W** of the radiating edge, which is not critical, is chosen first.  
If a square geometry is chosen it can be arranged to produce circularly polarized waves. The length **L** is slightly less than a half-wavelength in the dielectric ( $\lambda_g/2$ ).  
The calculation of the precise value of the dimension **L** of the square patch is carried out by an iteration procedure.
- To obtain an initial value of **L** function of resonant frequency **f<sub>r</sub>**, we use equation:

$$L = c / (2f_r \sqrt{\epsilon_r})$$

- The resonant frequency **f<sub>r</sub>** of the patch antenna is given by:  $f_r = c / (2L \sqrt{\epsilon_r})$
- The typical shapes of the patch antenna are rectangular, square, elliptical, or circular, while the rectangular patch is the most common configuration.

- Based on the transmission line model and assuming  $L$  of a half-wavelength  $\lambda/2$ , the rectangular patch antenna can be considered as a resonating open-end transmission line with a perfect reflection at the open end.
- Since the end of the patch is open circuit, the current is zero at the end. The current is maximum and minimum at the center and beginning of the patch, respectively. The voltage is at a maximum of  $+V$  at the end, while it is at a minimum of  $-V$  at the beginning.
- As illustrated in figure above, there are fringing E-fields near the surface at both ends. Since they are in phase along the Y-direction, they add up in phase and produce radiation.

### Patch Antenna Impedance Matching and Return Loss

- The width  $W$  of the patch antenna determines the input impedance, bandwidth, and radiation pattern. The larger the width  $W$  is, the lower the input impedance becomes.
- For a square patch, the input impedance varies from  $200 \Omega$  to  $300 \Omega$ .
- The input impedance can be reduced to  $50 \Omega$  by increasing the width  $W$ , which makes the antenna to occupy much space. This would be a problem in array antennas where is limited space, and methods to lower the input impedance without increasing the size are desirable.
- Another commonly used method is to use a quarter-wavelength transmission line printed on the same substrate, to transform the high input impedance of the patch to a lower system impedance of  $50 \Omega$  or  $75 \Omega$

However, the microstrip matching section is itself a radiating element due to the discontinuity in line width, and the radiation from it may add to that of the antenna in ways that are difficult to determine.

- For a feed point at the radiating edge, the input impedance is maximum, and for a feed point at the center of the patch, the input impedance is zero. Thus, the input impedance can be controlled by adjusting the position of the feed point. A match to  $50 \Omega$  may be achieved by suitably locating the feed point.

The variation of **input resistance**  $R(x)$  as a function of feed-point position is approximated:

$$R(x) = R_0 \cos^2\left(\frac{\pi x}{L}\right)$$

where  $R_0$  is the resistance at the edge of the patch and  $x$  is the distance from the edge.

- The variation of **input resistance** in frequency with **feed position** is very minimal as the probe approaches the center of the radiating patch.
- The patch antenna **impedance bandwidth** can be increased by increasing the substrate thickness and also by decreasing the dielectric permittivity (increasing the Q-factor).
- The radiated electric field is zero at the center of the patch, maximum (positive) at one side, and minimum (negative) on the opposite side.
- The patch far-field radiation pattern is orientated orthogonal to the surface conductor.
- The surface conductor does not form the radiating element as it does in a dipole or a monopole antenna. Instead, **radiation occurs from along patch edges**.

- Feeding the patch antenna along the centerline is the most common situation (minimizes higher-order modes and cross-polarization).

## Feeding the Patch Antenna element

Different methods are available to feed the microstrip patch antennas. These methods can be contacting and non-contacting methods.

- In the contacting method, the RF power is fed directly to the radiating patch using a connecting element such as a microstrip line.
- In the non-contacting method, power is transferred between the microstrip line and the radiating patch through electromagnetic coupling.

There are many patch antenna feed methods but the four most used and popular feeding techniques are: microstrip line feed, coaxial probe feed (both contacting schemes), aperture coupling and proximity coupling (both non-contacting schemes), inset feed.

- **Microstrip Line Feed**

Line Feed has the advantage that the feed can be etched on the same substrate to provide a planar structure. There are three main methods for **microstrip line feed**:

- The conducting strip is connected directly to the edge of the microstrip patch.
- Instead connecting the feed line directly to the edge of the patch, a notch cut in the patch (inset feed) can be used to improve the return loss and the bandwidth of the antenna. The **inset feed** technique utilizes the reduction in electric field strength to effectively “tap” a lower impedance drive point.

The inset feed distorts the equivalent slot radiation due to the change in geometry.

- The quarter-wave  $\lambda/4$  transformer method uses the transmission line equation, which provides the geometric mean of the input resistance and the characteristic impedance of the  $\lambda/4$  transmission line.

The  $\lambda/4$  feed minimizes the equivalent slot field distortion due to the narrower, high-impedance line required for impedance matching.

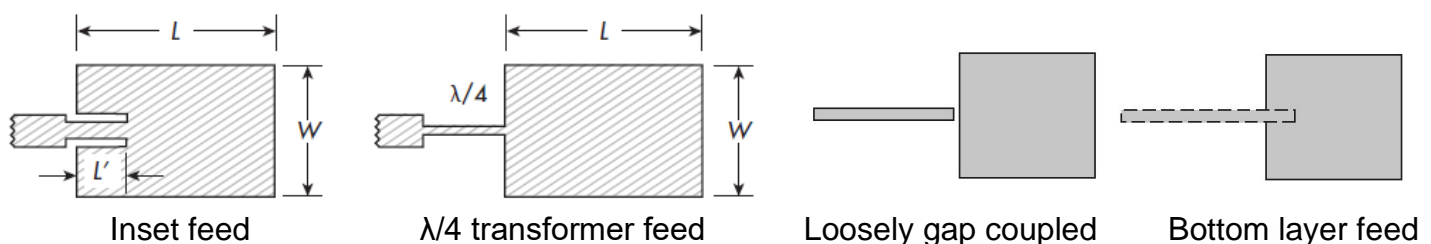

- **Coaxial Feed**

A coaxial connector is used to connect to the antenna (central pin connected to the patch, and the outer conductor to the ground).

The major advantage of this is that the feed can be placed at any location inside the patch in order to match with its input impedance.

The disadvantage is that it provides narrow bandwidth (5%) and is complex to model.

- **Aperture Coupled Feed**

In this technique, the radiating patch and the microstrip feed line are separated by the ground plane. The patch and the feed line are coupled through a slot in the ground plane. The coupling slot is centered below the patch, leading to low cross polarization

due to symmetry of the configuration. Since the ground plane separates the patch and the feed line, spurious radiation is minimized.

The main disadvantage of this feed technique is that it is difficult to fabricate due to multiple layers, which also increases the antenna thickness.

- **Proximity Coupled Feed**

This type of feed is also called as the electromagnetic coupling scheme.

Two dielectric substrates are used and the feed line is between the two substrates.

The radiating patch is on top of the upper substrate.

The main advantage of this feed technique is that it eliminates spurious feed radiation and provides very high bandwidth (as high as 13%).

The major disadvantage of this feed scheme is that it is difficult to fabricate because of the two dielectric layers which need proper alignment.

- **Inset Feeding**

- The inset feeding is one of the best techniques for perfect impedance matching.

- Impedance of the patch varies with feeding location, and various antenna performance parameters as return loss, bandwidth, and radiation can be controlled by adjusting the inset point of the patch.

- For better results, the feeding line should have the impedance equal to the characteristics impedance at the point inside of patch, usually of 50  $\Omega$ .

- The inset feed introduces a physical notch, which in turn introduces a junction capacitance.

- The physical notch and its corresponding junction capacitance influence the resonance frequency of the patch antenna.

- As the inset feed-point moves from the edge toward the center of the patch the resonant input impedance decreases monotonically and reaches zero at the center. When the value of the inset feed point approaches the center of the patch, the input resistance also changes rapidly.

There is an equation to calculate the position of inset feed point for a desired impedance, usually where the input impedance is 50 ohms:

$$Y_0 = \frac{L}{\pi} \cos^{-1} \left( \sqrt{\frac{Z_{in}}{R_{in}}} \right)$$

where,  $Y_0$  is the distance from the feeding point to the edge of the patch,  $L$  is the patch length, and  $Z_{in}$  and  $R_{in}$  are the resonant input impedance and resonant input resistance respectively.

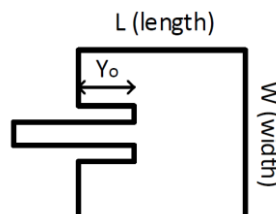

Patch Antenna Inset Feeding

- Experimentally was discovered that adjusting the **inset feed point  $Y_0$**  together with adjusting the width  **$W$**  of the patch and also adjusting the width of the notch, best antenna performances would be achieved, especially when the patch is used as an element in a Phased Array Antenna.

## Slot Antenna Elements

A **slot antenna** consists of a metal surface (ground plane), usually a flat plate, with one or more holes or slots cut out.

- When the plate is driven as an antenna by an applied radio frequency current, the slot radiates electromagnetic waves in a way similar to a **dipole antenna**. The shape and size of the slot, as well as the driving frequency, determine the radiation pattern.
- The slot antenna act as a magnetic dipole instead of an electric dipole; the magnetic field is parallel to the long axis of the slot and the electric field is perpendicular. Thus, the radiation pattern of a slot antenna can be the same as of a dipole antenna.

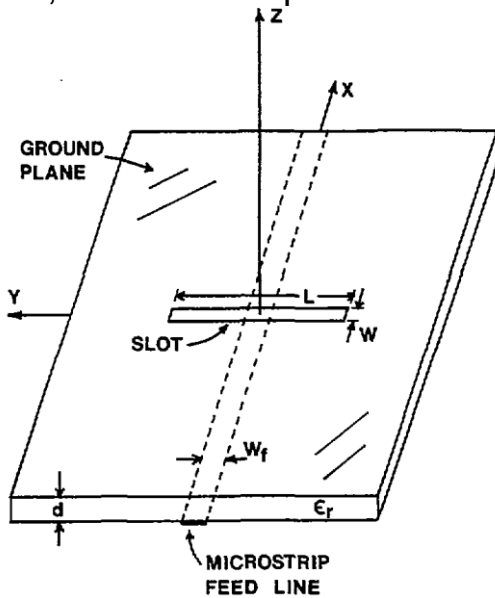

$$W = \frac{1}{2f_r \sqrt{\mu_o \epsilon_o}} \sqrt{\frac{2}{\epsilon_r + 1}}$$

$$L = \frac{1}{2f_r \sqrt{\epsilon_{reff}} \sqrt{\mu_o \epsilon_o}}$$

Microstrip slot antenna fed by a center oriented microstrip line

Where  $W$  is the width of the slot,  $L$  is the length of the slot,  $f_r$  is the resonant frequency,  $\epsilon_o$  is the permittivity in free space,  $\mu_o$  is the permeability in free space,  $\epsilon_r$  is the dielectric substrate,  $\epsilon_{reff}$  is the effective dielectric constant of the substrate, and  $d$  is the height of the substrate. In the equation could be also a  $\Delta L$  (mainly related to the height of the substrate), which is the extended increment length, that should be added to the length of the slot, but usually this is not a significant length.

In a conventional **microstrip-fed slot antenna** (figure above), a narrow rectangular slot is cut in the ground plane, and the slot is excited by a microstrip feedline with a short or an open circuit termination.

- With this feed configuration, a good impedance match has been achieved for a narrow slot, and an impedance bandwidth of approximately 20% has been obtained.
- However, as the width of the slot increases, the radiation resistance of the slot antenna increases proportionately. This, in turn, reduces the impedance bandwidth of the antenna even though the size of the slot is larger.
- The feed structures of the conventional transverse slot antenna are either center oriented (as in figure above) or are offset oriented.
- The center-feed has a larger value of radiation impedance than an offset feed. This means that the impedance bandwidth of a center-feed is less than for an offset-feed.

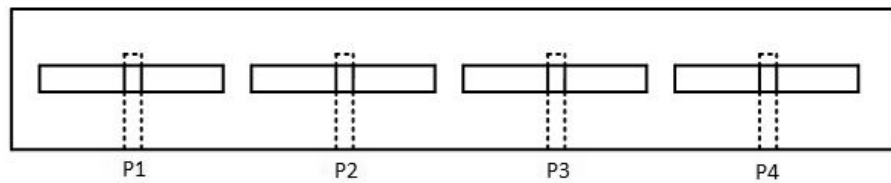

Four elements rectangular slotted array antenna

- For optimal radiation characteristics, the length of all slots is taken to be at their resonant length. For rectangular slots, this length is typically around  $0.49\lambda$ . For round-ended slots, the modified round-ended slot length values, differed from the typical rectangular slot lengths by 1% to 3% only.
- The position of the slots along the length of the array plays an important role in ensuring feeding the slots in phase.
- The phase shift between consecutive slots is determined by the electrical distance  $2\pi d/\lambda_g$ , with  $\lambda_g$  being the **guide wavelength** defined as the distance traveled by the electromagnetic wave along the length of the waveguide to undergo a phase shift of  $2\pi$  radians.

When the radiowaves are conducted by a waveguide, and the antenna consists of multiple slots in the waveguide, this is called a **slotted waveguide array antenna**.

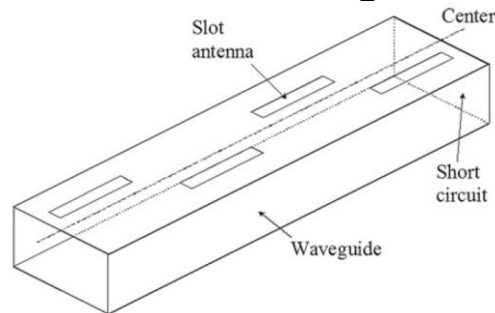

Slotted waveguide array antenna

- Multiple slots act as a directive array antenna and can emit a narrow fan-shaped beam of microwaves.

There are two widely used types of slotted waveguide array antennas:

**1. Longitudinal slotted waveguide array antenna**, where the slots' axis is parallel to the axis of the waveguide, and the antenna pattern is similar to a collinear antenna. This antenna is usually mounted vertically, and its radiation pattern is omnidirectional. The same as collinear antenna, the gain of the longitudinal slotted waveguide array increase by 3dB for each doubling of the number of slots.

**2. Transverse slotted waveguide antenna**, where the slots are almost perpendicular to the axis of the waveguide but skewed at a small angle, with alternate slots skewed at opposite angles.

This array radiates a dipole type pattern in the plane perpendicular to the antenna, and a very sharp beam in the plane of the antenna.

Due to this sharp radiated beam, this array antenna is used in microwave marine radars, mounted horizontally on a mechanical drive that rotates the antenna scanning the arrays fan-shaped beam by  $360^\circ$ .



## Feeding Patch Antenna Elements in a Phased Array

There are few possibilities how to feed and how to arrange patch elements to form a Phased Array Antenna.

Each feeding option have advantages and disadvantages on their implementation.

- The most elementary Antenna Array is the **Linear Array** in which the array element centers lie along a straight line.
- When the array element centers are located in a plane it is said to be a **Planar Array**.

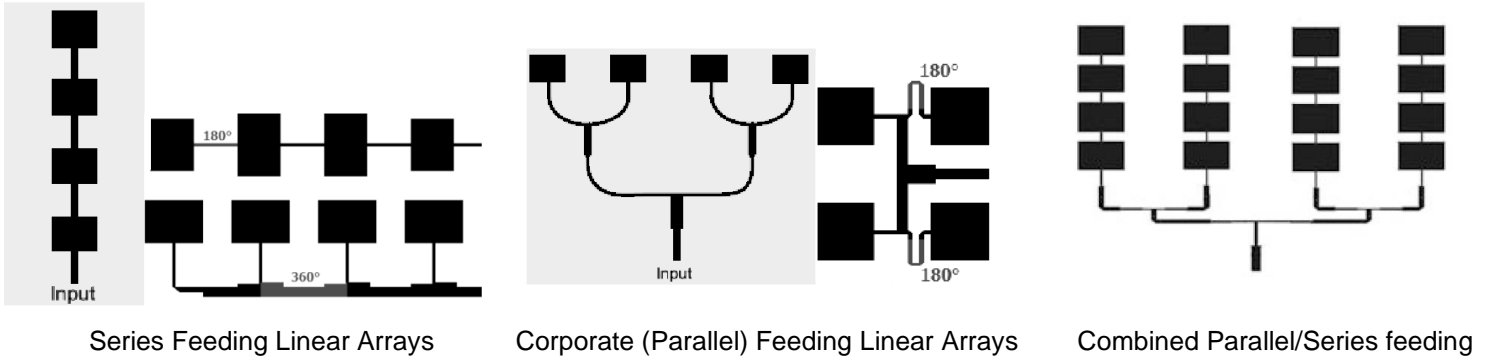

- **Series Feed Patch Array:**

- Advantages: Reduced Feed Length, Reduced Losses, Lower Sidelobe.
- Disadvantages: Beam Tilt with Frequency, Narrow Bandwidth.

- **Corporate (Parallel) Feed Patch Array:**

- Advantages: Equal Power at all Elements, Larger Bandwidth, Modular in Nature.
- Disadvantages: Higher Feed Losses, Higher Cross Polarization.

- **Combination of Series and Corporate Feed Patch Array:**

- Combined Advantages and Disadvantages from the above.

- If the array antenna system is one in which each antenna element of the operating array is connected to a separate generator, this is often called an **active array**.

- When a single generator excites all the elements through a network of power dividers and phase shifters, the antenna may be called a **passive array**.

Such an antenna does not have the obvious identical performance for every element that the infinite active array has. Furthermore, reflections from the elements do not necessarily return to the generator, but may be absorbed in terminations or reradiated in other directions depending on the particular network used. Thus, the passive array is actually more complicated to analyze than the active one. The active array not only is relatively simple, but also it provides the concepts and fundamental limitations for any array antenna.

## Hertzian Dipole Array Antennas

The infinitesimal **Hertzian Dipoles** (dipole with total length  $\ll \lambda$ ) are the simplest antenna elements outside of point sources (isotropic).

- Dipole antennas are linearly polarized and have an antenna pattern that is proportional to  $\sin \Theta$  when oriented in the **z**-direction.

Placing several of these dipole antennas in the vicinity of each other causes the dipole elements to interact. In other words, the dipoles all radiate and receive time-varying fields from each other. This interaction is called **mutual coupling**, which will be discussed later.

**Examples:**

**Ex.1).** An 8-element linear array lying along the **x-axis** with spacing  $d = \lambda/2$  has the array antenna pattern shown in figure below.

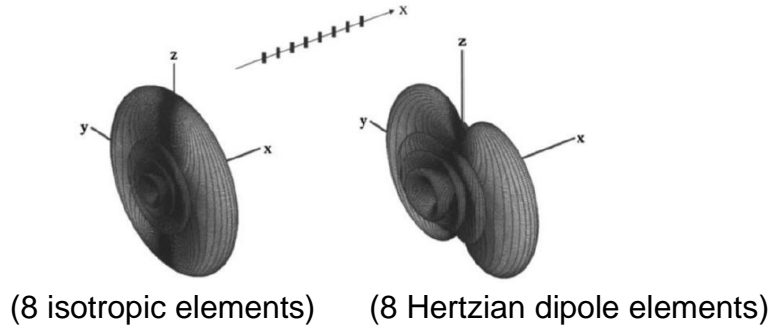

Antenna pattern of an 8-element linear array (dipole elements placed on **x-axis** and oriented in **z-direction**)

- The array factor of isotropic antenna elements (left figure) has no polarization, because point sources have no polarization. Its directivity is 9dB. The peak occurs at  $\Phi = 90^\circ$  for all  $\Theta$  angles.
- Replacing the point sources (isotropic elements) with **z-directed** Hertzian dipole antennas having each a directivity of 1.76dB, results in the array antenna pattern shown in the above right figure. This antenna pattern is  $\Theta$ -polarized with no radiation in the **z-direction**, because the element pattern has a null in that direction. The directivity of this dipole array is 11.9dB and can be calculated using numerical integration of the **array factor** times the **element pattern**.

**Ex.2).** An 8-element linear array lying along the **z-axis** with spacing  $d = \lambda/2$  has the array antenna pattern shown in figure below:

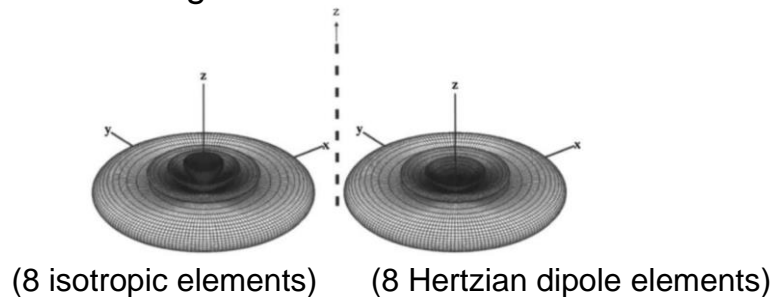

Antenna pattern of an 8-element linear array (dipole elements placed on **z-axis** and oriented in **z-direction**)

- Even though the Hertzian dipole array on **x-axis** has the same number and the same type of elements as the Hertzian dipole array placed on **z-axis**, its directivity is 14.6dB (2.7dB higher).
- Unlike with point sources (isotropic elements), the orientation of the dipole elements relative to the array has a significant effect on the array directivity and on the array antenna pattern.

# Array Antenna Radiation Patterns

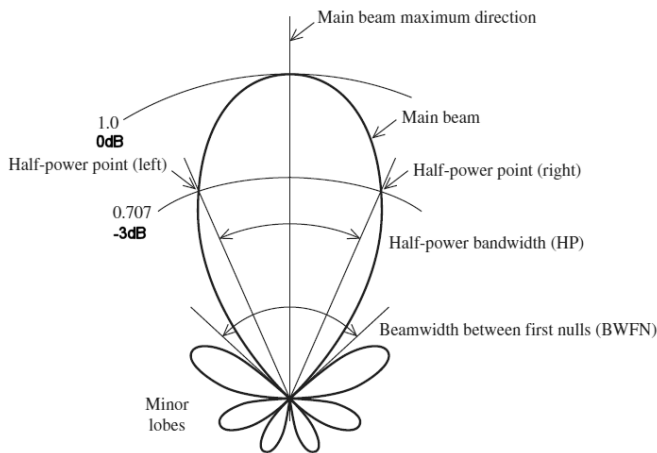

Antenna pattern in polar 2D coordinates

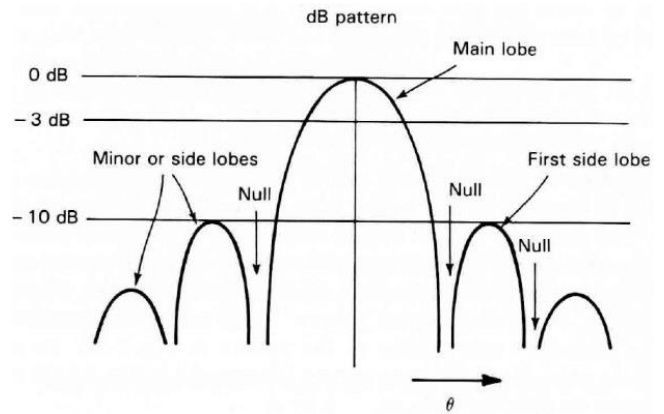

Antenna pattern in rectangular coordinates in dB

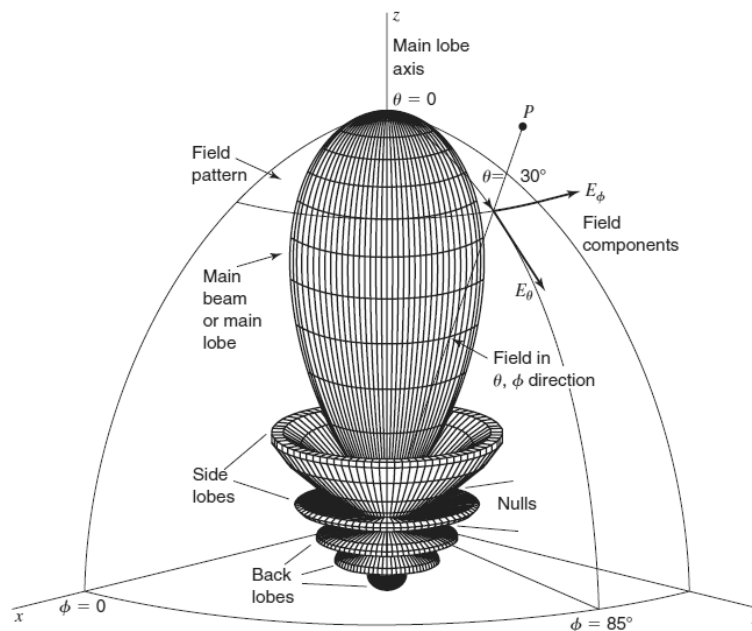

Antenna fields pattern in 3D coordinates

- Phased Array Antenna give a great flexibility in designing the radiation pattern because there are so many variables that can be adjusted.
- The overall **radiation pattern** of an antenna array is the product of the **Element Factor** (the radiation pattern of a single antenna element) multiplied by an **Array Factor (AF)**, which depends on how the antenna array is arranged.

For **Phased Antenna Arrays** using identical radiating antenna elements, there are at least five types of controls that can be used to shape the overall pattern of the antenna system:

1. The **geometrical configuration** of the overall Array Antenna (linear, circular, rectangular, spherical, etc.).
2. The relative **spacing** between the radiating elements.
3. The excitation **amplitude** of the individual radiating elements.
4. The excitation **phase** of the individual radiating elements.
5. The relative **pattern** of the individual radiating elements.

## Array Factor (AF)

- **Array Factor (AF)** is directly influenced by the number of antenna elements, by the inter-element spacing, and by the excitation amplitude.

$$AF = \sum_{i=1}^N a_i e^{(kd_i \cos \theta + \phi_i)}$$

where  $\mathbf{N}$  is the number of antenna elements,  $\mathbf{a}_i$  is the excitation amplitude,  $\mathbf{d}_i$  is the inter-element spacing,  $\phi_i$  is the excitation phase, and  $\mathbf{k}$  is the propagation constant for the  $i^{\text{th}}$  element.

- The number of antenna elements  $\mathbf{N}$  in an antenna array plays an important role in beam forming, beam steering, and interference reduction.

In the figure below is plotted the Array Factor (AF) of an antenna array by varying the number of the antenna elements while keeping the spacing between two consecutive elements as  $\lambda/2$  and  $\phi_i = 90^\circ$ . The results are normalized with respect to the maximum value of the main lobe.

- It has found that the Half Power Beam Width (HPBP) is decreased with an increase in the number of elements, but with a minor reduction in the Side Lobe Level (SLL).

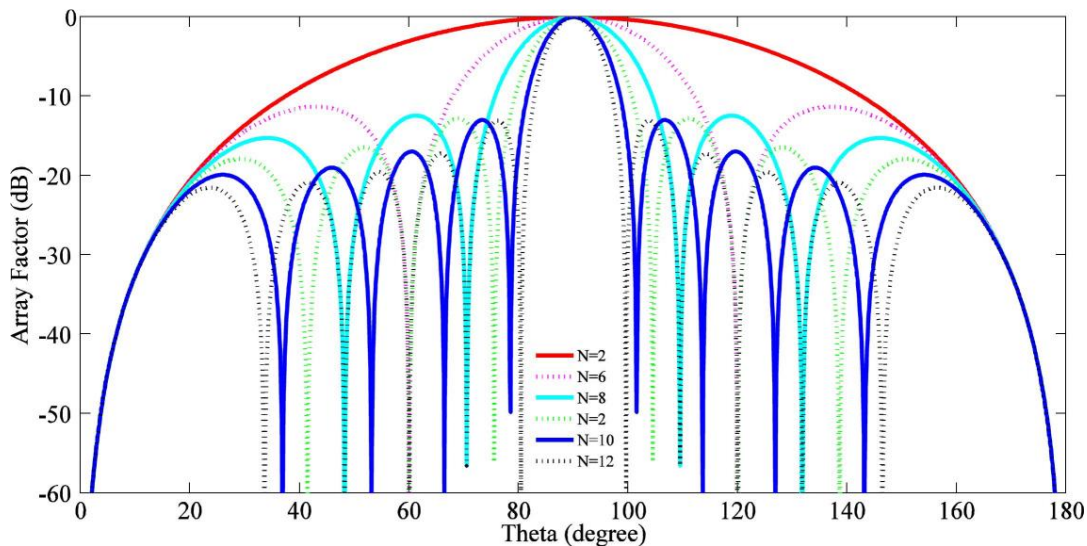

Array Factor (AF) varied with number of antenna elements (N from 2 to 12)

- The array factor, so the performance of the antenna array, is also dependent on the distance  $\mathbf{d}$  between two consecutive antenna elements.

In the plot below could be observed the effect of spacing  $\mathbf{d}$  on the radiation characteristics of an array antenna. A simulation has been carried out with spacing  $\mathbf{d}$  changing from  $\lambda/2$  to a relatively small separation, up to  $d = \lambda/10$ .

It has been demonstrated that the distance between the elements should be close to  $\lambda/2$ .

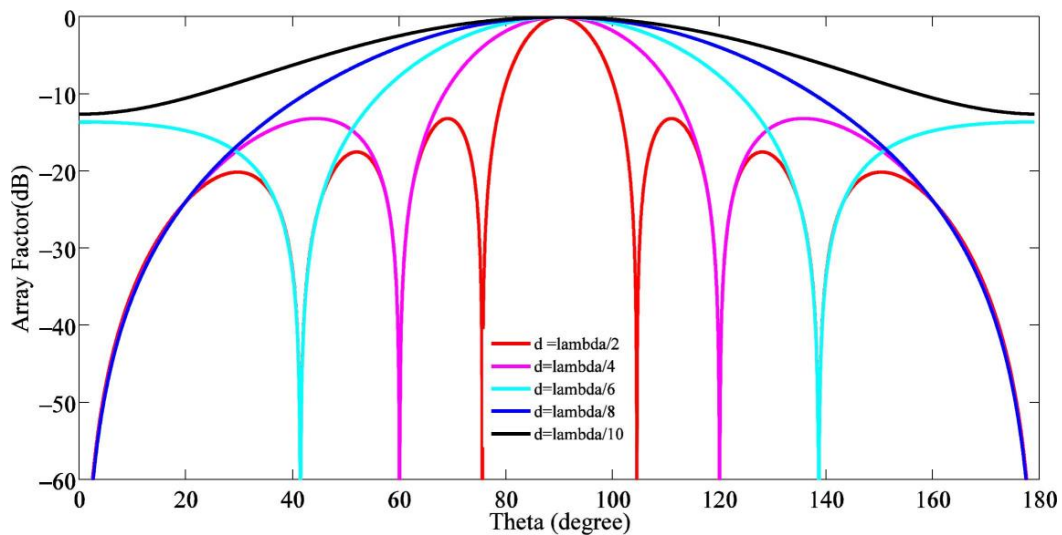

Array Factor (AF) varied with distance between elements,  $d$  decreasing from  $\lambda/2$  to  $\lambda/10$

- **Excitation amplitude** for each individual element, commonly known as a **weight factor**, also changes radiation characteristics of an array antenna. If the inter-element spacing and excitation phase are fixed (i.e., the inter-element spacing between two adjacent antenna elements is  $\lambda/2$  while excitation phase for each element is  $90^\circ$ ) changing the **excitation amplitude** value for various elements of an array antenna, we can change the overall array pattern.

In the plot below, a comparative analysis of weighted and un-weighted array antenna design is presented. Could be observed that for equal amplitude excitation, the **Half Power Beam Width (HPBW)** is decreased and the **Side Lobe Level (SLL)** is increased, while for unequal amplitude excitation, the SLL is reduced and the HPBW is increased.

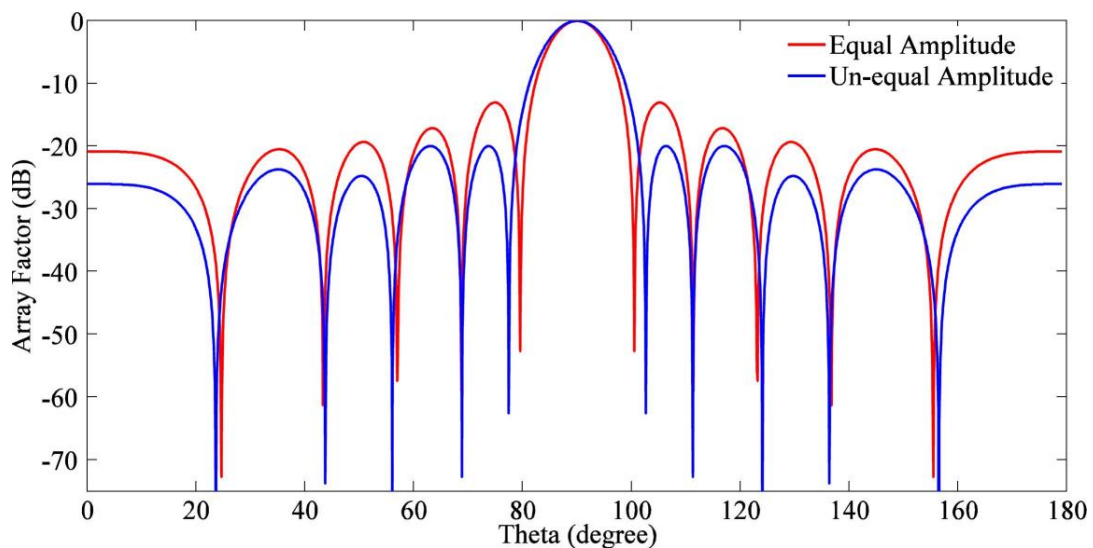

Array Factor (AF) varied for equal and unequal excitation amplitude

- The excitation amplitude of each **antenna element** could be optimized for minimum Side Lobe Level (SLL) and keeping in the same time a good compromise for Half Power Beam Width (HPBW).
- Considerable improvement in the HPBW has been observed while the SLL is suppressed (doing amplitude optimization) with increasing number of antenna elements, as is shown in the plot below.

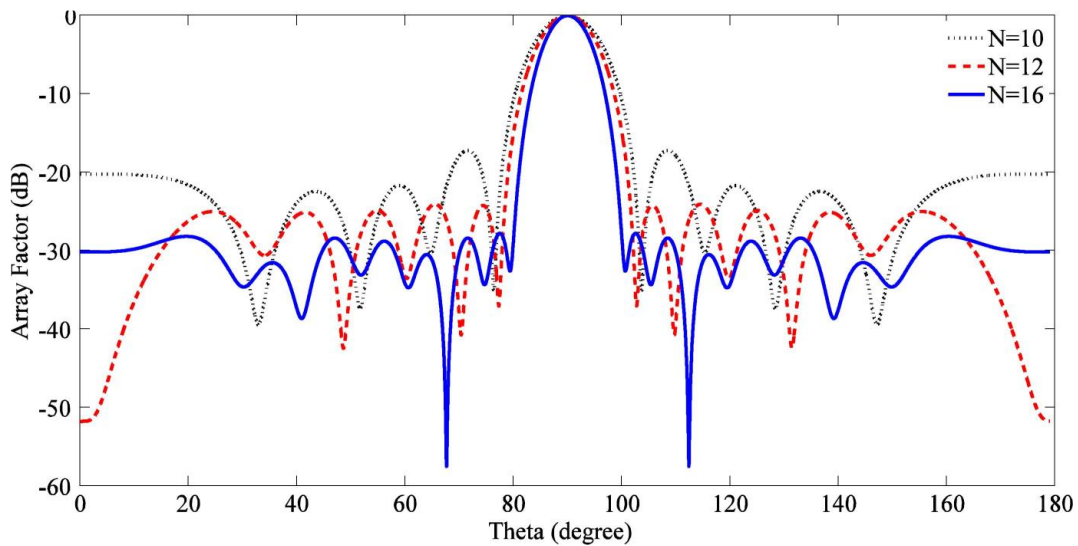

Array Factor (AF) varied with N and optimized excitation amplitude

- The performance of an array antenna is also dependent on the distance between two consecutive elements. Mathematical algorithms are used to obtain the optimum values of inter-element spacing.
- Higher values of inter-element spacing contributed to higher number of side lobes, narrower main lobe, higher directivity, and lower Half Power Beam Width (HPBW).
- Inter-element spacing equals to  $\lambda/2$  was found to be the most suitable value for planar array antenna design based on the analysis.
- Meanwhile, higher number of antenna elements increased the value of directivity of the planar array with narrower HPBW.

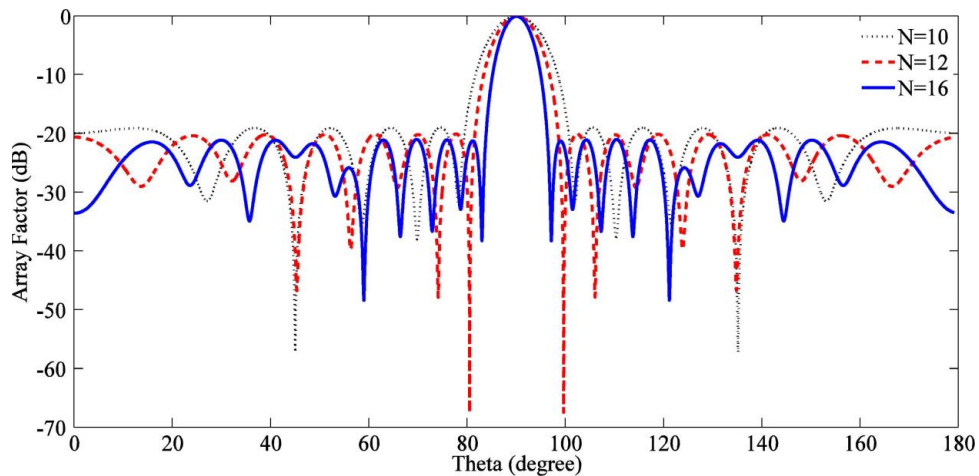

Array Factor (AF) when inter-element spacing was optimized

The **Normalized Array Factor**  $f(\Psi)$  for an **N** element, uniformly excited, equally spaced linear array (UE, ESLA) that is centered about the coordinate origin is:

$$f(\Psi) = \frac{\sin(N\Psi/2)}{N \sin(\Psi/2)}$$

where the wave number (array phase function)  $\Psi = kd \sin \theta + \delta$ ;  
 $\delta$  is the phase difference between the two sources

## Conclusions after analyzing the Array Factor plots for various number of elements **N**:

- As **N** increases, the main lobe narrows (beamwidth decreases).
- As **N** increases, there are more side lobes in one period of  $f(\Psi)$ .  
The number of full lobes (one main lobe and the side lobes) in one period of  $f(\Psi)$  equals  $N - 1$ .  
There will be  $N - 2$  side lobes, and one main lobe in each period.
- The minor lobes (side lobes) have the width  $2\pi/N$  in the variable  $\Psi$ , and the major lobes (main and grating lobes) are twice this width ( $4\pi/N$ ).
- $|f(\Psi)|$  is symmetric about  $\pi$ .
- The side lobe peaks decrease with increasing **N**.
- A measure of the side lobe peaks is the **Side Lobe Level (SLL)** which is defined as:

$$\text{SSL} = \frac{|\text{maximum value of largest side lobe}|}{|\text{maximum value of main lobe}|} \quad (\text{often expressed in dB})$$

- It is observed that in concurrence with the principle of conservation of energy the total energy remains constant in an array antenna.

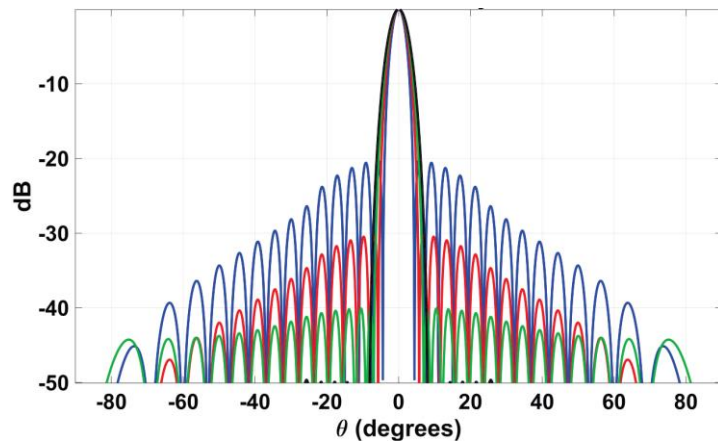

HPBW vs SLL in a 30 element Linear Array Antenna

- As the Side Lobe Level SLL decreases, the energy in the main lobe increases leading to beam broadening. Thus, SLL lowering is a trade-off with HPBW and thereby the gain and efficiency of an array antenna.

The **Directivity** of the array antenna can be defined as the ratio of radiation intensity in a given direction from the array antenna to the radiation intensity averaged over all directions.

- The directivity of the linear antenna array can be improved by controlling the inter-element spacing and the excitation amplitude.
- Lower value of directivity is observed for lower value of inter-element spacing **d** and vice versa.
- Significant variations of directivity can be seen for **d =  $\lambda/4$**  and **d =  $\lambda/2$** , however very slight changes are observed for directivity with **d >  $\lambda/2$** .  
Therefore, inter-element spacing equal to  $\lambda/2$  is favored to achieve higher directivity in planar array antenna.

- The directivity of planar array antenna increases with the number of antenna elements. This indicates that, higher directivity of array antenna can be achieved by placing large number of **N** antenna elements in the array aperture.

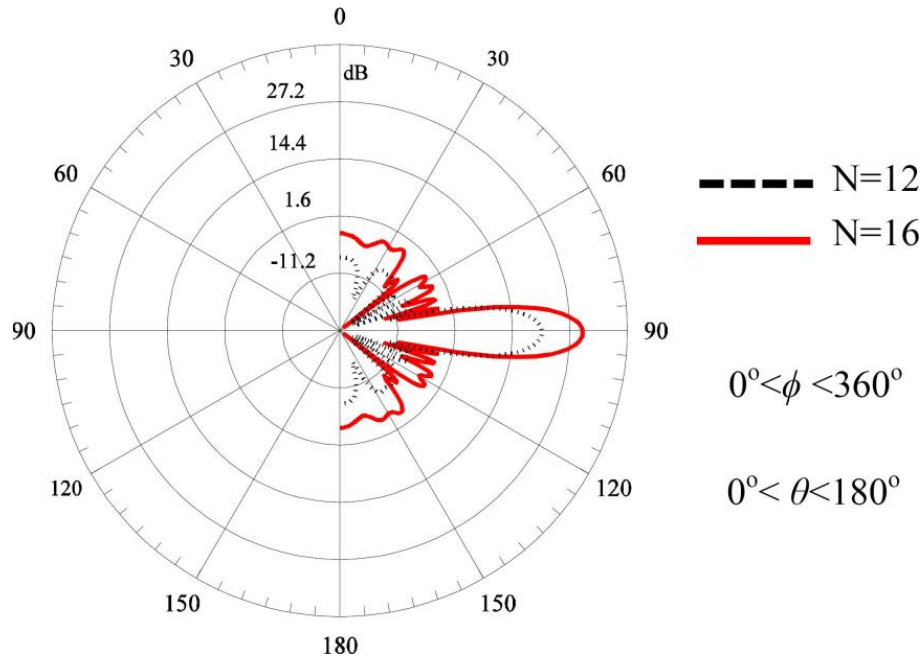

2D plot of directivity for optimized excitation amplitude and inter-element spacing

Another important application of linear array antenna is the **Null Control**:

- The **null control** refers to control the radiation pattern in a way such that a relatively small amount of power is received/radiated in certain directions.
- On the transmitting side, the null control is used for transmitting low power in the directions where an eavesdropper is present.
- On the receiver, it is used to reduce the amount of power received from interferers.
- The null control can be achieved by controlling the parameters as: excitation amplitude, excitation phase, inter-element spacing, and the number of elements.
- It is important to mention that, always reducing the amount of power in one direction means that power is increased in another direction. Ideally, the power is decreased in the direction of interferers and the main beam is increased in the same direction. Generally, it is hard to accomplish this, and it is needed to do a tradeoff.

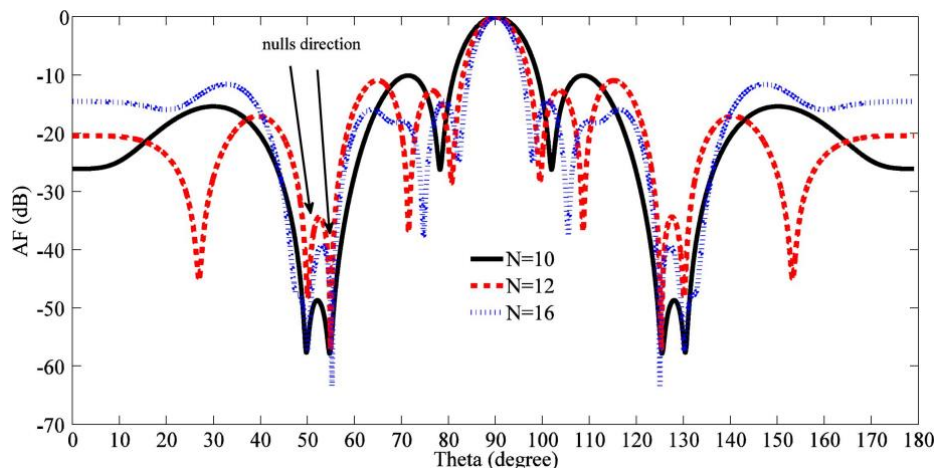

Array Factor (AF) when nulls are imposed at  $\theta=50^\circ$ ,  $55^\circ$ ,  $125^\circ$ , and  $130^\circ$



## Array Antenna Patterns – Broadside (Boresight) Array and End-fire Array

- An Antenna Array is said to be **Broadside Array** if the main beam is perpendicular to the axis of the array ( $\theta = 90^\circ$ ).

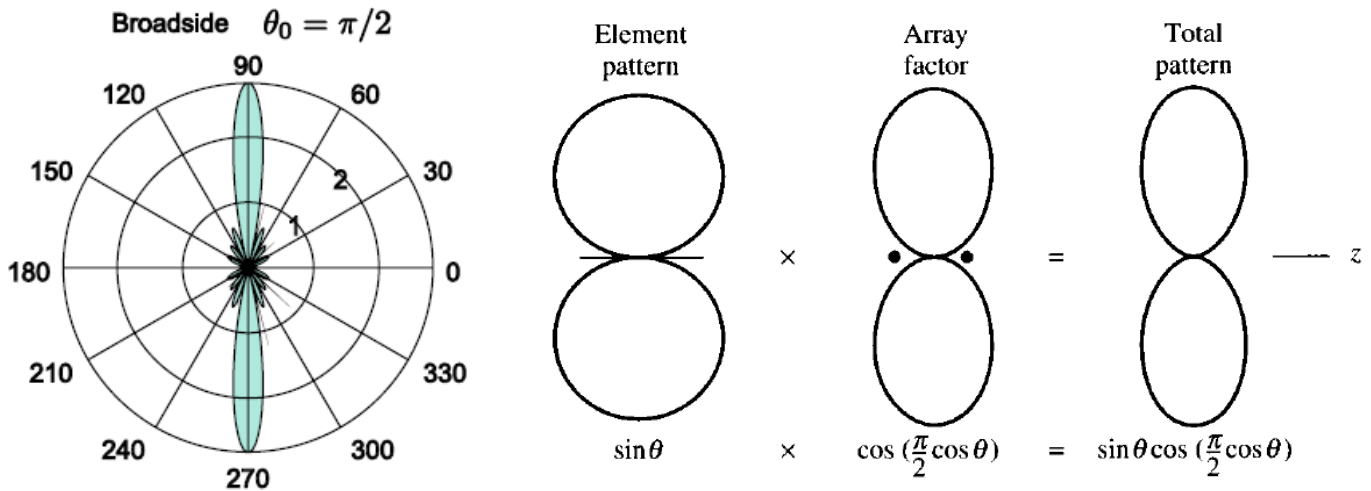

- For optimum performance, both the **Element factor (pattern)** and the **Antenna factor AF**, should have their maxima at  $\theta = \pi/2 = 90^\circ$ .
- The maximum of the broadside array factor occurs when the **array phase function  $\Psi$**  is zero.

$$\Psi = \beta + kd \cos \theta \big|_{\theta = 90^\circ} = 0$$

$$\Rightarrow \beta = 0 \text{ (phase angle)}$$

For a broadside array, in order the above equation to be satisfied with  $\theta = 90^\circ$ , the **phase angle  $\beta$**  must be zero, which means, all elements of the Array Antenna must be driven with the same phase.

- For a broadside array and  $\beta = 0^\circ$ , the given spacing between elements is  $d = \lambda/2$ .

$$\Psi = \left(\frac{2\pi}{\lambda} d \cos \theta\right) = \pi \cos \theta$$

- An Array Antenna is said to be **End-fire array** if the main beam is along the axis of the array ( $\theta = 0^\circ$  or  $180^\circ$ )

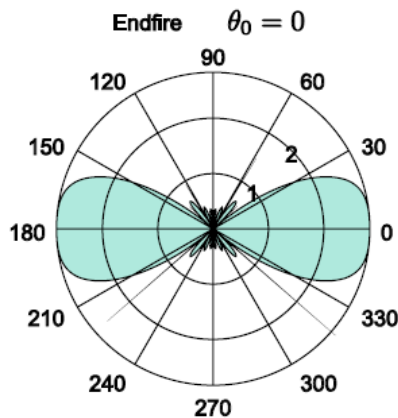

The maximum of the end-fire array factor occurs when the array phase function  $\Psi = 0$

$$\Psi = \beta + kd \cos\theta \Big|_{\theta=0^\circ \text{ or } \theta=180^\circ} = 0$$

$$\beta = -kd \text{ for } \theta = 0^\circ$$

$$\beta = kd \text{ for } \theta = 180^\circ$$

- The **Half Power Beam Width (HPBW)** of the **broadside array** is less than that of the **end-fire array** (narrower beam), but the directivity of the end-fire array is larger than the broadside array. End-fire excitation has a fat main lobe and a simple coherent excitation is not optimal solution for directivity.
- For long arrays ( $Nd \gg \lambda$ ) uniformly excited linear antenna array, the **Half Power Beam Width (HPBW)** is approximately:

$$\text{HPBW} = 0.886 \frac{\lambda}{Nd} \csc \theta_0 \quad \text{near broadside}$$

and

$$\text{HPBW} = 2 \sqrt{0.886 \frac{\lambda}{Nd}} \quad \text{end-fire}$$

( $\theta_0$  = main beam pointing angle)

- A commonly quoted beamwidth is the **First Null Beamwidth FNBW** (or **Null to Null Beamwidth**). This is the angular separation from which the magnitude of the radiation pattern decreases to zero (negative infinity dB) away from the main beam.
  - The angular span between the first pattern nulls adjacent to the main lobe, is called as the **First Null Beam Width FNBW**.
  - **FNBW** is the angular separation, quoted away from the main beam, which is drawn between the null points of the radiation pattern, on its major lobe.

**Example:** A broadside beam (with maximum at  $\theta=90^\circ$ ), if the pattern goes first to zero at  $60^\circ$  and also at  $120^\circ$ , the **First Null Beamwidth (FNBW)** is:  $120^\circ - 60^\circ = 60^\circ$

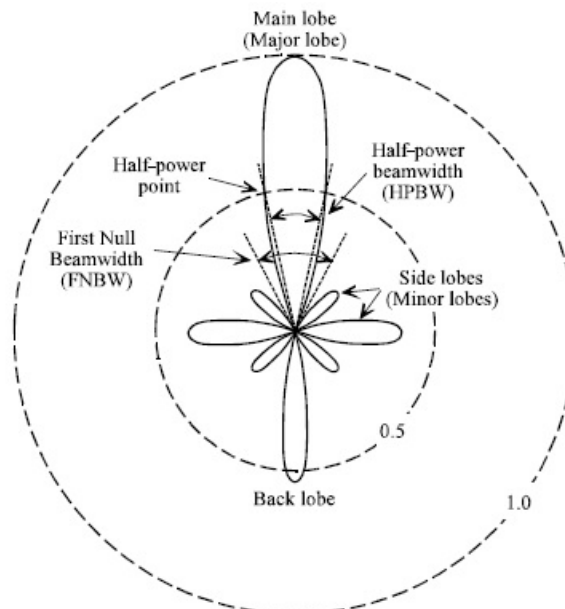

The main beam nulls are where the **Array Factor  $f(\Psi)$**  first goes to zero in a plane containing the linear array.

For long array antennas (length  $L = Nd \gg \lambda$ ), we can approximate the **First Null Beamwidth FNBW** (or Null-to-Null Beamwidth) as follows:

$$\text{FNBW} = \frac{2\lambda}{Nd} \quad \text{near broadside}$$

$$\text{FNBW} = 2\sqrt{\frac{2\lambda}{Nd}} \quad \text{end-fire}$$

- Both **HPBW** and **FNBW** depends on the **Array Antenna length  $Nd$**  and **main beam pointing angle  $\theta_0$** .
- Comparing the equations for **HPBW** and **FNBW**, we can see that HPBW is roughly one-half of the corresponding **FNBW** value for long, uniformly excited linear arrays.
- **Antenna Array Directivity  $D$**  represents the increase in the radiation intensity in the direction of maximum radiation over a single element.

Antenna Array directivity is determined entirely from the radiation pattern.

The directivity  **$D$**  of a broadside array of isotropic elements is given by:

$$D = 2 \frac{Nd}{\lambda} \quad \text{where: } N=\text{nr. of elements, } d=\text{spacing between elements}$$

- The antenna elements in an actual array are not **isotropic point sources**. Instead, they have **directionality** that is proportional to their size. The antenna elements also have **frequency, impedance, and polarization** properties which are not associated with isotropic point sources.
- Normally, the elements of an array antenna are spaced relatively close together, so an antenna element is typically no larger than  $\lambda/2 \times \lambda/2$  in area in a square lattice. As such, the **element pattern** is too small to have sidelobes. A typical element pattern for an antenna array in the X-Y plane can be reasonably approximated by  **$\cos\Theta$**  or  **$\sin\Phi$**  or the change in the projected area of the element.
- Element spacing in an array is determined by the distance between phase centers of adjacent elements. An isotropic point source actually represents the phase center of the antenna element, which is the center of a sphere of constant phase radiated by the antenna. This phase center moves with frequency and angle so, in actuality, it only exists for a portion of a sphere at a given frequency.
- The array antenna pattern, or the directivity of the array, depends by the directivity of the elements in the array.

$$\text{Array pattern} = \text{Element pattern} \times \text{Array factor}$$

There are several important differences between the **array pattern** and the **array factor**:

- First, the **array antenna pattern** has a polarization that is determined by the array elements. Usually, all the antenna elements are oriented in the same direction, so the array polarization is the same as the polarization of a single antenna element. However, it is possible to orient the elements in a way that causes the array antenna pattern to have a different polarization from the element pattern.
- A second difference is that the **element pattern** forms an envelope that contains the much faster oscillating **array factor**.

The element pattern enhances the array factor in the direction of the element pattern peak and suppresses the array factor in direction of element pattern minima.

- A final difference is that **element orientation** is important, because the element directivity and polarization are a function of angle.
  - If the **peak of the element pattern** points in the same direction as the **array factor peak**, then the array pattern main beam is enhanced.
  - If an element pattern null points in the direction of the array factor peak, then the antenna pattern has a null in that direction.
- Usually, the array elements have very broad patterns that cannot be steered. Thus, the **array element patterns** remain fixed in space.
  - When the peak of the array factor and the peak of the element pattern align, then the main beam of the resulting antenna pattern is a maximum, while the sidelobes far from the main beam are reduced.
  - When the array factor is **steered**, the element pattern remains **stationary**. Thus, the product of the array factor and main beam changes as the main beam is steered.
  - Steering the main beam reduces the peak of the **array antenna pattern** due to the decrease in the **element pattern**. The element pattern also causes a squint in the main beam away from broadside. Thus, a correction to the steering phase for the array factor is necessary to make sure that the peak of the antenna pattern points to the desired angle.
- Unlike with point sources, the **orientation of the element** relative to the array has a significant effect on the **directivity** and on the **antenna pattern** of the array.

## Phased Array Antenna Beamforming

- **Beamforming**, or **spatial filtering**, is done by combining signals in an array antenna in such mode that signal directed in particular direction get constructive interference when others expect destructive interference.
- In order to achieve **spatial selectivity**, beamforming can be used in both, transmitting and receiving.
- In a linear array antenna, we get sharper beam if put more elements into array. A sharper beam means a narrower 3dB beamwidth (HPBW).

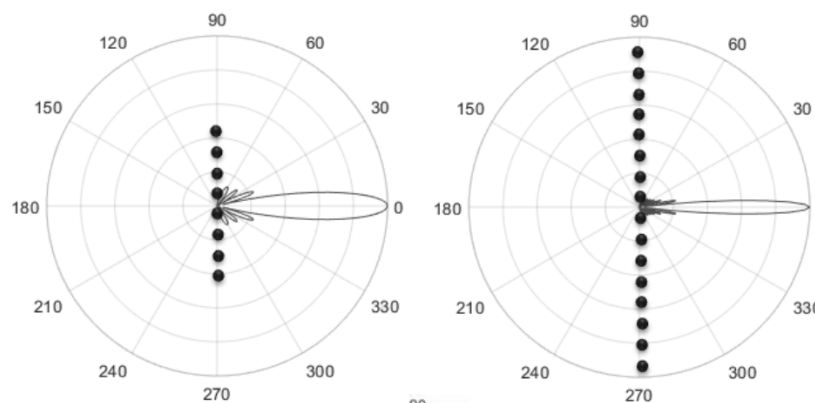

Linear antenna arrays with 8 and 16 elements and their antenna pattern

- Another way of arranging the antenna elements in an array is to align the elements in a two-dimensional square form.

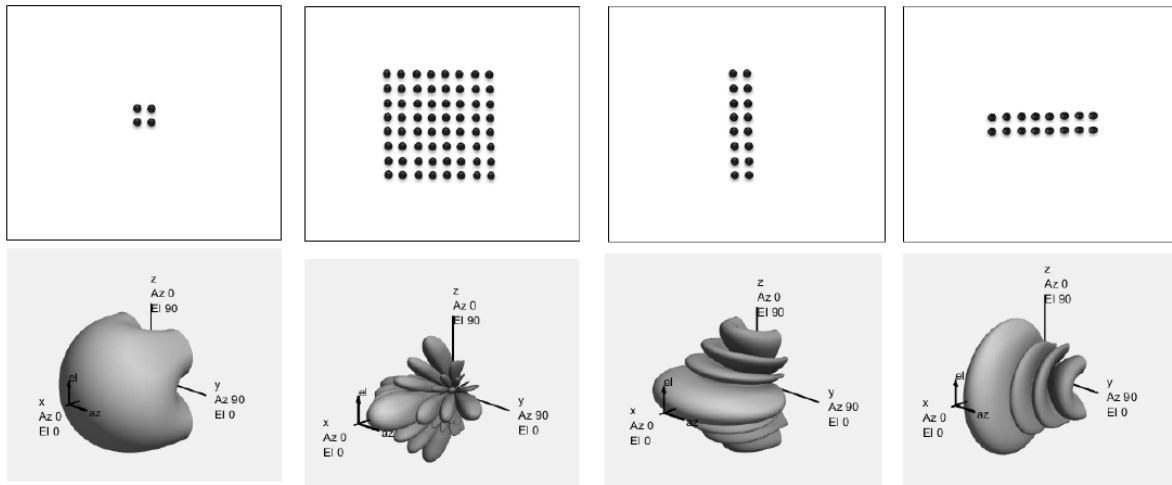

Two-dimensional array antennas and their antenna pattern

## Principle of Beamforming

There are three main approaches to get Beamforming in an Array Antenna system:

- Analog Beamforming
  - Digital Beamforming
  - Hybrid Beamforming
- In the **Analog Beamforming** approach a phase shift is applied to each antenna element in the array followed by coherent power summation. The RF signal is phase adjusted per antenna element in the RF domain, for a single signal after DAC in transmit mode. Analog beamforming can only apply a spatial filter on a single signal. Analog beamforming is relatively cheap to integrate and allows better coverage of a system.

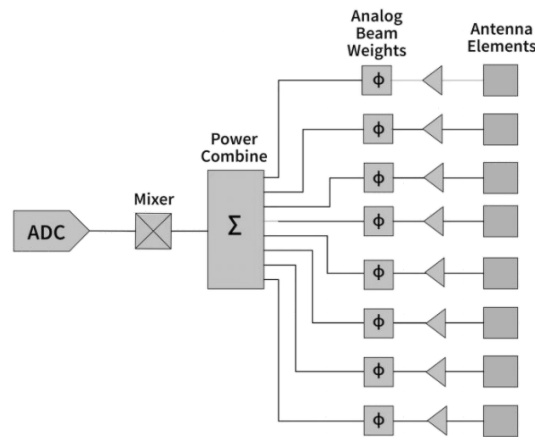

Analog Beamforming

Advantages of Analog Beamforming:

- Simple hardware implementation.
- Beam with full array gain.

### Disadvantages of Analog Beamforming:

- Single beam.
- Number of beams is fixed by hardware and cannot be changed.

- In a **Digital Beamforming** approach the beams are formed using complex digital weights, rather than with analog phase shifters.
  - A full receiver chain from antenna element to digits is required at every element in the array.
  - Due to high complexity of RF routing (Mixing and Local Oscillator) the digital beamforming approach cannot be used at mmWave frequencies.

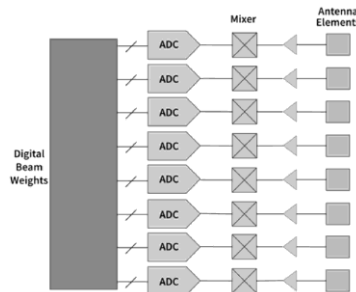

Digital Beamforming

- Digital beamforming applies amplitude and phase variations in the digital domain, before the DAC in transmit mode. Every element requires an individual DAC/ADC and baseband processing.
- With digital beamforming, parts of the same signal can be radiated in different directions, or signals from different directions can be received simultaneously and extracted individually, or interference from certain directions can be mitigated. It also allows frequency-selective beamforming.
- Digital beamforming is more flexible and can improve the capacity of a system. However, it is more costly and power consuming compared to analog beamforming.

### Advantages of Digital Beamforming:

- Extreme flexibility with number of beams and nulls.
- Can provide high number of beams.
- Number of beams can be changed dynamically with no change in hardware.

### Disadvantages of Digital Beamforming:

- Highest DC Power.
- Highest hardware complexity - full RF chain per element in the array.

- **Hybrid Beamforming** combines the advantages of analog and digital beamforming.

In Hybrid Beamforming, there is a formation of analog (sub-array) beams from a portion of the full array.

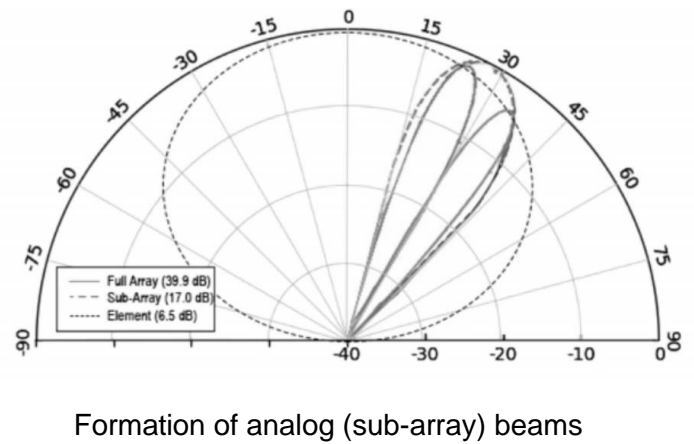
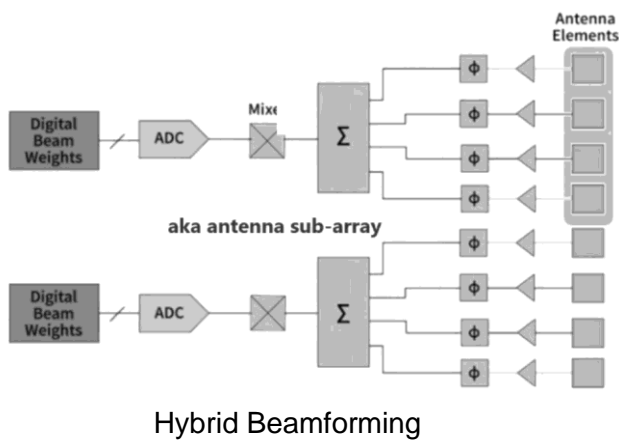

- In Hybrid Beamforming, each ADC/DAC of the digital beamformer is connected to multiple elements featuring an analog beamformer on top.
- Hybrid beamforming can be used to leverage the power of digital beamforming without requiring a transceiver chain for each antenna element.
- Hybrid Beamforming can provide many beams and nulls, and does not require a full RF chain per element, only a full RF chain per sub-array.
- Hybrid Beamforming approach it is suitable to be used at mmWave frequencies.

## Array Antenna Scanned Beam (Beam Steering)

- A **Phased Array Antenna** is typically designed to have maximum directive gain at broadside, that is, at  $\theta = 90^\circ$  (for an array along the x-axis).

But in some applications the goal is to direct the main lobe of the radiation pattern at an angle other than the **broadside** or **end-fire** directions.

The scan angle of the pattern dictates this **steered angular location**.

- The scan pattern can be obtained by introducing a phase difference to elements of the array antenna.

This is the basic principle of **electronic scanning** for phased array antennas.

- One way of achieving Beam Steering is to switch ON and OFF certain antenna elements of the array.
- Another way is to control the relative phase and amplitude of the signals from groups of array elements, or each individual element. With a large enough array antenna and sophisticated enough electronic control and feed system, beam steering antennas can be made that direct the main lobe of the antenna anywhere to the maximum beam angle, relatively rapidly steer the beam, and even create multiple lobes that are independently steered.
- A 2D phased array with the right beamforming control system is able to generate a beam that can be scanned side-to-side (azimuth) and up-and-down (elevation). The gain of the antenna elements and the number of antenna elements dictates the gain of the array, as well as the directivity of each element. Generally, the optimum gain for a phased array antenna is at “broadside” or “boresight” which is directly perpendicular to the linear or flat panel phased array antenna.
- The phased array gain drops as a cosine function of the angle from broadside.

At  $\pm 60^\circ$  from broadside a phased array antenna exhibits half the gain at broadside, and zero at end-fire conditions ( $\pm 90^\circ$  from broadside).

- To achieve a full  $360^\circ$  coverage with a phased array antenna typically requires four phased array antennas or a mechanically rotating antenna (gimbal system). Widening the antenna element spacing is a way of enhancing the beam scanning angle of a phased antenna array. However, there is a practical limitation to element spacing, as grating lobes generate ambiguity problems when the elements are spaced further than fraction of the smallest operating wavelength for a given antenna element design. At extreme angles for a given antenna element spacing, side lobes are also generated by phased arrays that are not negligible, and often variable attenuators are used to enhance sidelobe suppression performance.
- Electronic scanning can be constructed with:
  - **Phase scanning.** The beam of antenna points in a direction that is normal to the radiated phase front. In phased array antennas, this phase front is adjusted to steer the beam by individual control of the phase excitation of each radiating element. The phase shifters are electronically actuated to permit rapid scanning and are adjusted in phase to a value between 0 and  $2\pi$  rad.
  - **Time-delay scanning.** Phase scanning are frequency-sensitive. However, time-delay scanning is independent of frequency. Delay lines are used instead of phase shifters, providing an incremental delay from element to element. Individual time-delay circuits are naturally too cumbersome to be added to each radiating element, and a reasonable compromise may be reached by adding one time-delay network to a group of elements (subarray) where each element has its own phase shifter. Time-delay overcomes instantaneous bandwidth limitation of phase shifters.
  - **Frequency scanning.** Frequency rather than phase may be used as the active parameter to exploit the frequency-sensitive characteristics of phase scanning. At one particular frequency, all antenna radiators are in phase. As the frequency is changed, the phase across aperture tilts linearly, and the beam is scanned. Frequency-scanning array antennas are relatively simple and inexpensive to implement.
  - **Beam switching.** Avoids use of variable phase shifters. With properly designed antenna lenses or reflectors, a number of independent beams may be formed by feeds at the focal surface. Each beam has substantially the gain and beamwidth of the whole antenna. All the beams lie in one plane, and greater antenna complexity is required for switching beams in both planes.
  - **Digital beamforming.** For receiving, the output from each antenna element may be amplified and digitized. The signal is then processed by a computer, which can include the formation of multiple simultaneous beams (formed with appropriate aperture illumination weighting) and adaptively derived nulls in the beam patterns to avoid spatial interference or jamming.
  - **Analog or digital phase shifters** (ferrite or semiconductor diodes) are also used for beam scanning.
- **Linear Array Antennas** have the following scan limitations:
  - Phase scanned in only a plane containing line of elements.
  - Beamwidth in a plane perpendicular to the line of element centers is determined by the element beamwidth in that plane (limitation of realizable gain).



- When is required to form a high gain pencil beam, or beam scanning in any direction, multidimensional arrays are used.

When the scanning is required to be continuous, the feeding system must be capable of continuously varying the progressive phase  $\theta$  between the elements.

Assuming that the maximum radiation of the array antenna is required to be oriented at angle  $\theta_0$ , or in other words, to “electronically” rotate, or steer, the array pattern towards some other direction, without physically rotating the antenna.

To accomplish this, the progressive phase excitation  $\beta$  between the elements must be adjusted so that:

$$\Psi = \beta + kd \cos\theta_0 = 0$$

$$\beta = -kd \cos\theta_0$$

which is named **steering phase**

- Thus, by controlling the progressive phase difference between the antenna-elements, the maximum radiation can be squinted in any desired direction to form a scanning array. This is the basic principle of scanning array operation.

Basically, a **Phased Array Antenna** system is a combination of **N** antennas made to get:

- A higher gain antenna system.
- An increased directivity antenna system.
- Ability to get steerable and directive radiated signal.

The fundamental configuration for elements in an array is the **Linear Antenna Array** shown in the picture below.

- The output of each element can be controlled in amplitude and phase as indicated by the **attenuators** and **phase shifters**.
- **Amplitude** and **Phase** control provide for custom shaping of the **radiation pattern** and for **scanning** of the pattern in space.
- A **Power Distribution Network** is used to route the signal to each antenna element.

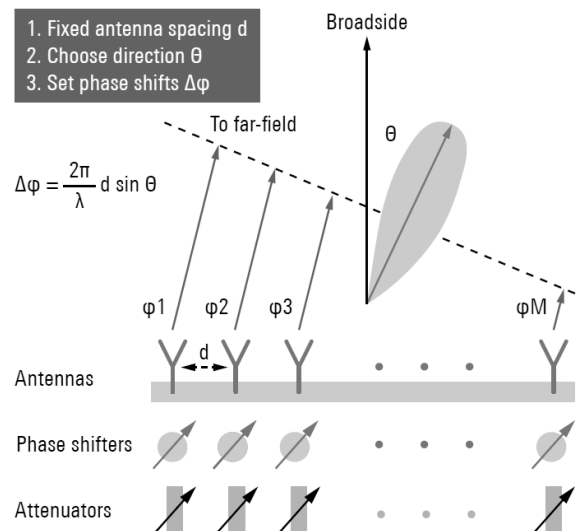
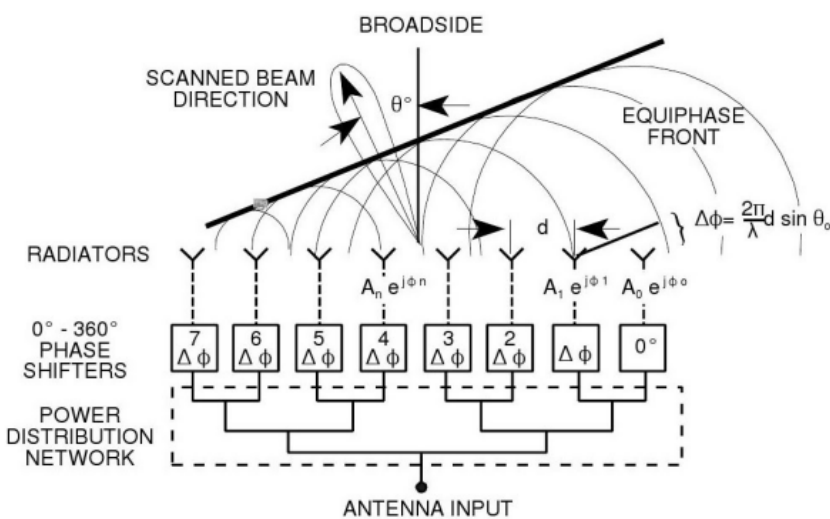

Scanned beam array block diagrams

- Electronic scanning of a **phased array antenna** (varying the phase and amplitude of each element) results in a beam distortion with scan angle.

- This distortion represents a spread of the beam shape and a consequent reduction in **antenna array gain**, known as **Scan Loss**.
- At the origin, where the boresight angle is zero, there is no scan loss.

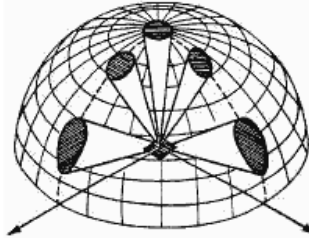

Array Antenna Beam Distortion (Scan Loss)

- In general, the scanning range of phased array antenna means 3dB-coverage, or half-power beamwidth (HPBW), and is limited by the **radiating element pattern**. For example, for **patch antenna elements**, the HPBW is limited to about 90°-100°. For rectangular arrays, the 3dB beam contour is approximately elliptical.
- As the beam is steered to a wider angle, the scan loss increases due to the element pattern and the scanning range is limited. Therefore, in order to achieve the wide-angle scanning (140° or more), the antenna element pattern should be widened.
- If the antenna element has a wide beam pattern, the scan loss is small and a wider range can be scanned. However, the element spacing is limited to  $\lambda/2$  or less to avoid the ambiguity problems caused by grating lobes, so the wide-angle elements should be designed within a physical size smaller than  $\lambda/2$ . As the beam is steered to a wider angle, arises a problem that the side lobe level rises to a non-negligible level.
- A second method to achieve wide-angle scanning is using **pattern reconfigurable antenna (PRA)** elements. The PRA elements often have antenna sizes larger than  $\lambda/2$  due to the addition of the multiple feeding networks, parasitic elements, and switching networks. In these cases, because the element spacing should be set wide, the array becomes a sparse array and the grating lobes occur.
- An antenna array with uniform illumination (equal elements amplitude) results in relative high level of the first side lobe levels, which may be unacceptable for some applications due to regulatory, interference, or stealth reasons.

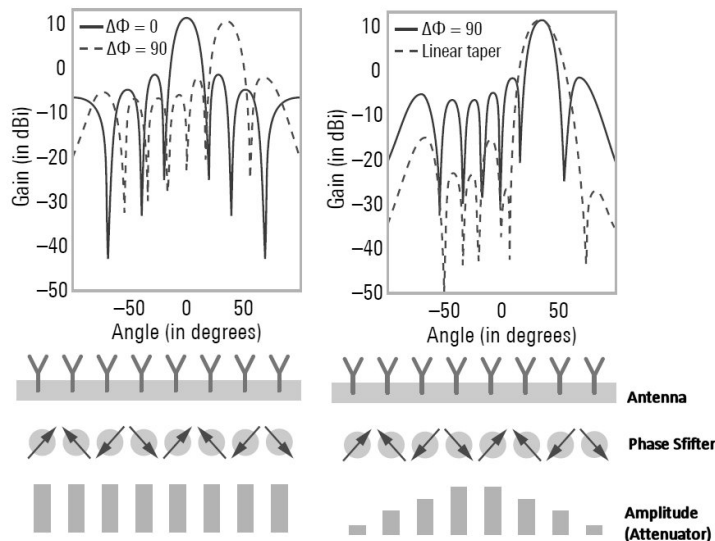

Amplitude weighting of each antenna element for reducing grating lobes during steering

- Decreasing the gain (amplitude levels) of the outside elements results in an increased main beam width. The grating lobe levels are usually controlled by applying window functions. Every change of the weights leads to a change in the radiation pattern, while each window has its own set of advantages and drawbacks.
- **Tapering** is the process of assigning different gains (levels) to the various antenna elements within the array, where the center elements are assigned the highest gains, and the outer elements are assigned lower gains.
- Note that, the more quickly element gain is reduced as the elements get farther from the center of the array, the greater the suppression of side lobes.
- Taper comes at a price. When taper is applied, the directivity is less than uniform illumination for the same size array antenna, and the beamwidth is broader.
- The radiation pattern of the single-antenna element used in the array is called the “**primary pattern**”. The isolated element pattern is measured with all other elements open-circuited. This result is not quite the same as with all other elements absent, except for canonical minimum scattering antennas.
- If the array consists of non-isotropic but identical elements, the effect of the primary pattern can be accounted relatively easily. Since the radiation due to every element is weighted by the primary pattern, the total radiation pattern of an array is the product of the **primary pattern** (single antenna element) and the **Antenna Factor (AF)**.

### **Array Radiation Pattern = Primary Pattern x Array Factor**

- An important and useful parameter is the **scan impedance**; it is the impedance of an antenna element as a function of **scan angles**, with all antenna elements excited by the proper amplitude and phase. From this, the **scan reflection coefficient** can be obtained. Array performance is then obtained by multiplying the isolated element power pattern (normalized to 0dB max), times the isotropic array factor, times the impedance mismatch factor  $(1-|\Gamma|^2)$ .
- An array antenna of identical elements, with identical magnitudes, and with a progressive phase is called a **Uniform Array Antenna**.

### **Frequency Scanning - Beam Squint**

When a wavefront approaches an array of elements, there's a time delay between elements based on the wavefront angle  $\theta$  relative to broadside radiation.

- For a single frequency, the beam steering can be accomplished by replacing the time delay with a phase shift. This works for narrow-band waveforms, but for wideband waveforms, where the beam steering is produced by a phase shift, the beam can shift direction as a function of frequency.

Such a situation can be intuitively explained if it is acknowledged that a time delay is a linear phase shift vs. frequency.

- Thus, for a given beam direction, the phase shift required changes as a function of frequency.
- Or, inversely, for a given phase shift, the beam direction changes as a function of frequency.

- The concept of the beam angle changing as a function of frequency is called **Beam Squint**.

Previously, was shown that the phase shift  $\Delta\Phi$  applied to the elements across the array antenna as a function of beam angle is:

$$\Delta\Phi = \frac{2\pi d \sin\theta}{\lambda}$$

where:  $d$  is the distance between antennas,  $\theta$  is the beam angle, and  $\lambda$  is the wavelength.

Inversely, can compute the beam angle as a function of the phase shift:

$$\theta = \arcsin\left(\frac{\Delta\Phi}{2\pi} \times \frac{\lambda}{d}\right)$$

The phase in the last equation is periodic and repeats every  $2\pi$ .

Using equations above, the beam direction deviation (beam squint  $\Delta\theta$ ) can be calculated:

$$\Delta\theta = \arcsin\left(\frac{f_0}{f} \sin\theta_0\right) - \theta_0$$

where:  $f_0$  is the center frequency,  $f_0/f$  is the frequency deviation, and  $\theta_0$  is the angle at  $f_0$ .

A few observations on beam squint:

- As the beam angle increases away from broadside, so too does the deviation in beam angle vs. frequency.
- A frequency below the center frequency causes a larger deviation than a frequency above the center frequency.
- A frequency below the center frequency moves the beam further away from broadside.
- The beam squint, or deviation in steering angle vs. frequency, is caused by approximating a time delay with a phase shift.  
Implementing **beam steering** with **true time-delay** units doesn't have this problem.
- In digital beamforming, true time delay can be implemented in the DSP logic and digital beamforming algorithms. Therefore, a phased array architecture in which every element is digitized would lend itself naturally to overcome the beam-squint problem.
- In hybrid beamforming, there's a combination of analog beamforming for subarrays followed by digital beam forming for the full array. This can offer some natural beam squint mitigation worth considering. Beam squint is only subject to the subarray, which is a much wider beamwidth, so it's more tolerant to a beam-angle deviation. Thus, if the subarray beam squint is tolerable, then the hybrid beamforming architecture can be implemented with phase shifters in the subarrays, followed by true time delay in the digital beamforming.

## Grating Lobes of Phased Array Antenna

- **Grating Lobes** are unwanted beams in most applications since they transmit and receive energy in unwanted directions. The power radiated by the antenna array gets divided between the main beam and the grating lobe. The power efficiency in the direction of the main beam is consequently reduced.
- **Grating lobes occur when the spacing between elements are large enough to permit in-phase addition of radiated fields in more than one direction.**

**Array Antennas with inter-element spacing  $d$  greater than the wavelength  $\lambda$ , always have Grating Lobes (multiple main beams or fringes).**

- Figure below shows some additional examples of grating lobes for various spacings:  $d = 2\lambda$ ,  $d = 4\lambda$ , and  $d = 8\lambda$ .

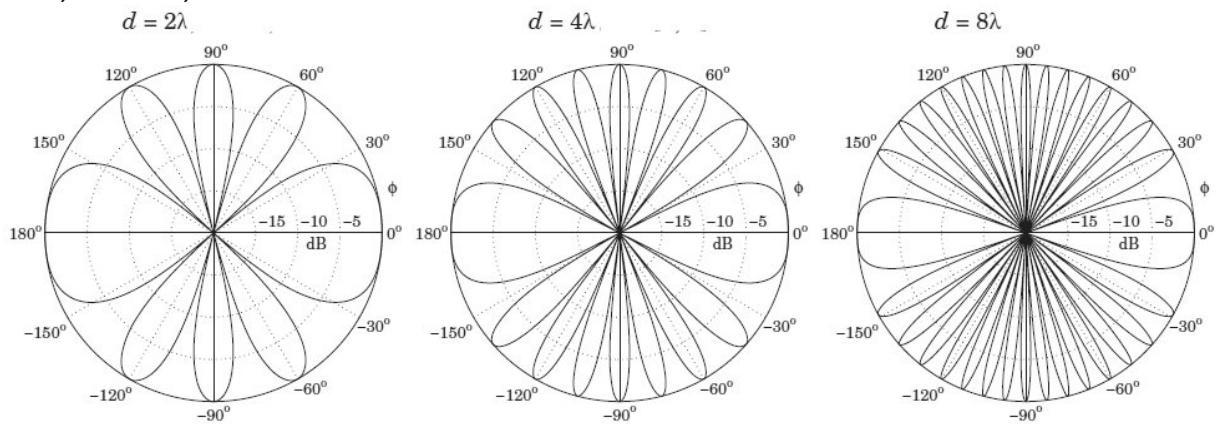

Grating lobes of two-element antenna array

- The antenna pattern of an antenna element (which forms the array) may reduce the grating lobes to acceptable levels and allow a wider element spacing.
- To avoid grating lobes the array antenna should be designed so that the maximum distance between antennas  $d_{max}$  to be:

$$d_{max} < \left| \frac{\lambda_0 - \beta_{max}}{\sin \theta_{max}} \right|$$

where  $\beta_{max}$  is the largest phase difference, and  $\theta_{max}$  is the scan angle that maximize the phase difference  $\beta$  where the first grating lobe occur.

- Making the element spacing  $d_{max}$  less than  $\lambda/2$  will ensure that no grating lobes occur for any scan angle.
- To ensure that there are no grating lobes, the separation between the antenna elements should not be equal to multiples of a wavelength, otherwise additional maxima will appear.
- In a multi-element transmitting array antenna, to reduce the sidelobe levels, don't have to drive the outer antenna elements harder than the inner elements.
- Thus, for side lobe reduction, this can be mitigated through various methods: by using non-uniform antenna element spacing, by applying an amplitude taper over the array,

leveraging windowing techniques already known from designing finite impulse response (FIR) filters, or using genetic algorithms.

- Grating lobes occur in an array antenna when the spacing between elements is great enough to permit all the elements to add in phase in one or more directions other than the direction of the main lobe.

## The Ordinary End-fire Array

- In many applications, array antennas are required to produce a single **pencil beam**.
- The array factor for a broadside array produces a fan beam, although the proper selection of array elements may yield a total pattern that has a single pencil beam.

Another way to achieve a single pencil beam is by the proper design of an end-fire array. Ordinary end-fire conditions to produce a single pencil beam are:

$$d < \frac{\lambda}{2} \left(1 - \frac{1}{2N}\right) ; \quad \alpha = \pm \beta d$$

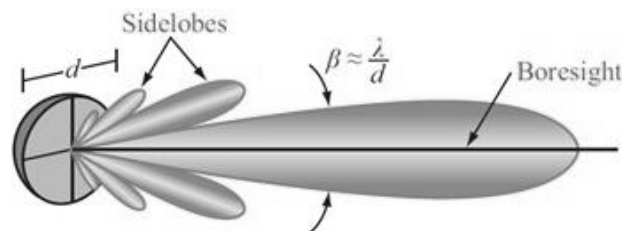

An array satisfying these conditions produces a single end-fire beam and no grating lobe with a peak in the direction  $\theta = 0^\circ$  for  $\alpha = -\beta d$  and in the direction  $\theta = 180^\circ$  for  $\alpha = \beta d$ .

## Thinned Phased Array Antenna

- A number of applications, as satellite receiving antennas or ground-based high-frequency radars, require a narrow-scanned beam, but not commensurably high antenna gain.
- Since the array beamwidth is related to the largest dimension of the aperture, it is possible to remove many of the elements, or to “thin” the array, without significantly changing its beamwidth.
- The array gain will be reduced in approximate proportion to the fraction of elements removed, because the gain is related directly to the area of the illuminated aperture.
- Thus, a **Thinned Array** can offer essentially the same beamwidth with less directivity and fewer elements. Directivity is approximately equal to the number of elements **N**. Mutual coupling effects are also significantly reduced.
- The average sidelobe level (power) for a linear array antenna is **1/N**. Regular **thinning** produces grating lobes, but these can be partially suppressed by randomizing the element spacings. A special kind of thinned array uses variable element spacing to produce an equivalent amplitude taper. The goal is to produce a sidelobe envelope that tapers down.
- The thinned array procedure can make it possible to build a highly directive array antenna with reduced gain for a fraction of the cost of a filled array.

- The cost is further reduced by exciting the array antenna with a uniform illumination, thus saving the cost of a complex power divider network.

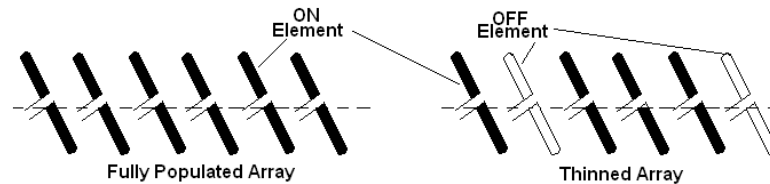

- A thinned array (or density tapered array), turns elements OFF in a uniform array with a periodic lattice in order to obtain a **spatial taper** that results in low sidelobes. The normalized desired amplitude taper serves as a probability density function for a uniform array that is to be thinned.
- The elements that are turned OFF are connected to a matched load and deliver no signal to form a beam. The elements that are turned OFF are not removed from the aperture, so the element lattice is not disturbed.
- In a thinned array, the elements either have an amplitude of **one** or **zero**. Elements with an amplitude of one are connected to the feed network, while elements with an amplitude of zero are connected to a matched load and do not contribute to a signal to the array output. Elements that correspond to a high amplitude have a greater probability of being turned ON than those that correspond to a low-sidelobe amplitude taper. This type of taper has some advantages including:
  - It is a cheap method to implement an **amplitude taper**. Designing, building, and testing low-sidelobe feed networks is expensive. Thinned arrays use cheap uniform feed networks.
  - A narrow beamwidth for a small number of active elements. Active elements are more expensive, especially if each element has a transmitter and/or receiver.
  - The mutual coupling is more well-defined than for an array with variable spacing between elements. Knowing the mutual coupling effects makes the array antenna more predictable and easier to design.
- **Thinning** works best for **large array antennas**, since the statistics are more reliable for a large number of elements.

## Nonuniformly Spaced Array Antennas

Sidelobe synthesis of array antennas could be done also by variation of antenna **elements spacings**, designing a **nonuniformly spaced array antenna**.

- Thinned array antennas (described above) have a large but finite number of possible active element locations.
- In contrast, nonuniformly spaced (or aperiodic arrays) have an infinite number of possible element locations.
- All elements in nonuniformly spaced arrays are active.
- In nonuniformly spaced arrays, the optimum spacing between the array antenna elements are obtained using firefly algorithms. Numerical analysis is performed to calculate the far-field radiation characteristics of the array antenna.

- Initial attempts at nonuniformly spaced arrays were based upon trial and error.
- The minimum allowed distance between the antenna elements is defined in such a way that mutual coupling between the elements can be ignored.
  - Mutual coupling effects between antenna elements are easier to characterize for periodic spacing than for aperiodic spacing.
  - Thinned arrays with periodic spacing are more desirable than nonuniformly spaced arrays, because the feed network for the thinned arrays is much easier to design.
  - Also, implementing nonuniform spacing on planar arrays is extremely difficult.

## Mutual Coupling between Antenna Elements

- The antenna elements in a real array antenna are not isotropic or isolated sources. The array element radiation pattern is determined as a pattern taken with a feed at a single element in the array, and all other elements are terminated by the matched loads.
- The pattern of an “active element” is different from the pattern of an isolated array element, which reveals the radiation pattern of an array element in free space without coupling from “neighbor elements”.
- An active array element pattern depends on the position of the element in the array: antenna patterns of edge elements differ from the patterns of elements center located.

**Example:** if we place two antenna elements (**A** and **B**) nearby, the resulting antenna coupling will affect both antenna radiations and their terminal properties as is mentioned:

- Behavior in **Transmit mode**:
  - **Modified radiation:**  
If the antenna **A** is driven with a signal, the radiated field by antenna **A** and intercepted by antenna **B**, will cause also a radiation from antenna **B**. Hence, the total radiation is a combination of **A** and **B** antenna elements, so the effective radiation when we drive antenna **A** is thus changed.
  - **Modified input impedance characteristics:**  
Power radiated by antenna element **B** is intercepted again by antenna **A**, which results in changes of current flowing to antenna **A**, so the input impedance of antenna element **A** is modified.
- Behavior in **Receive mode**:
  - If a received plane wave impinges on antenna **A**, current will flow on antenna **A**, power will be reradiated (scattered) by antenna **A**, some reradiated power from antenna **A** is received by antenna **B**, which will cause radiation by antenna **B**. Further, some power will be received by antenna **A**, thus the current on antenna **A** is modified (so the input impedance of the antenna element **A** is modified).
- **Effective receive aperture** of the antenna element **A** depends on loading of antenna element **B**, and vice versa.



- **Mutual Coupling** effect may be controlled by:
  - the radiation patterns of the two antenna elements.
  - the distribution of the antenna elements near-fields.
  - the spacing between antenna elements.
  - antenna elements loading.
- Mutual coupling changes the **radiation resistance** of the coupled antenna elements. This effect can lead to a **poor impedance match** and often, depending on the feed mechanism, to a **poor aperture illumination** and increase of sidelobes.
- The array antenna inter-element coupling effects may produce **increased sidelobes**, main **beam squint**, increased main **beamwidth**, **shifted nulls**, and **array blindness** for some scan angles.  
**Gain, polarization, and far-field pattern**, are also affected by the mutual coupling.
- Therefore, it is very important to study the array antenna parameters, including inter-elements **mutual coupling effects**.
- Mutual coupling is especially important problem when the number of antenna elements is small often excluding the use of conventional beam synthesis techniques.
- Mutual coupling doesn't change the amplitude and phase distribution for corporate fed arrays, but it will change the amplitude distribution in series fed array antennas.
- The phase slope is an important factor in mutual coupling.  
 The **impedance match** is very dependent on the **phase slope**.
- The difference in amplitude between adjacent radiator elements in an array antenna is usually small and can be ignored.
- Mutual coupling in the E-plane for dipole elements is small and sometimes is ignored. Similarly, mutual coupling for slot elements is small in the H-plane.
- An element cannot be characterized on reflection using passive elements to simulate mutual coupling conditions.
- An active element radiation pattern surrounded by others elements can be described using coupling scattering coefficients (S parameters).  
 Impedance matrix of the antenna array contains all the inter-element mutual impedances.
- In principle, the mutual impedances, are calculated between two antenna elements, with all the other elements open circuited.
- The mutual impedance between any two antenna elements in the array is found by dividing the open-circuit voltage at one element by the current at the other element.
- The analysis of mutually-coupled antennas in a multiple-input multiple-output (MIMO) antenna array system is performed in two folds:
  - mutual coupling between the elements of the antenna array.
  - mutual coupling between the transmit and receive antennas.
- Mutual coupling between the antenna elements causes the **active impedance** and the **returned power** to vary with **excitation phase**.  
 The returned power is caused by departure from conjugate match between the antenna element impedance and the generator impedance.  
 The element active impedance is the impedance measured while all the other elements are excited with the appropriate phase.

- The active impedance of each element in a practical phased array varies with scan angle, because of mutual coupling between the elements.
- The associated mismatch causes power to be returned to the generators, thereby reducing the gain realized by the array and by the element.  
Also, the element pattern, measured in the proper environment of surrounding elements, deviates from the ideal pattern in proportion to this effect.
- Mutual coupling is inherently unavoidable in a closely-spaced array of elements.
- There is a loss of antenna element efficiency caused by the mutual coupling, and since coupling increases with closer spacing, this accounts for the lower gain expected from ideal antenna elements with reduced allotted area.

### Examples of impedance measurements for coupling between antenna elements

- Table below shows the variation of the reactive portion (j) vs number of elements, of a central antenna element. The antenna elements of the array are  $\lambda/4$  monopoles.

No. rows	No. columns	Total number of elements	Reactive portion of impedance (ohms)
3	3	9	+j5.9
5	5	25	+j3.2
7	7	49	+j2.4
9	9	81	+j2.1
11	11	121	+j2.0
25	25	625	+j1.8

Reactive impedance of a central antenna element vs array size

### Conclusions:

- The reactive impedance portion (j) decreases when the number of array elements increases as shown in table above.
  - The impedance of the  $\lambda/4$  monopole with  $\lambda/2$  spacing tends to be purely resistive as the number of surrounding loaded monopoles increases.
  - The resistive part of the impedance is relative insensitive to the array size.
- Table below shows the input impedance of few  $\lambda/4$  monopoles elements part of an 11x11 element antenna array.

Element position	Reactive portion of impedance (ohms)
Center element (0,0)	+j2
Edge element of the center row	+j7
Corner element	+j12
Isolated element (Reference)	+j21

Reactive impedance of an antenna element as a function of its location in a 11x11 array

### Conclusions:

- The imaginary (reactive) part of the input impedance (j) varies with element position.
- Calculations shows that the real (resistive) input impedance portion is relatively insensitive to element position in the 11x11 element array.

- Table below presents the experimentally measured coupling scattering S-parameters for the central row elements in a linear antenna array ( $\lambda/4$  monopoles, 11x1 elements) operating at 1.3 GHz. Data shows the coupling coefficient  $S_{0n}$  between the central active monopole marked as number 0 and the  $n^{\text{th}}$  element in row. The distance between the adjacent elements is about half of the wavelength  $\lambda/2$ .

Element #	1	2	3	4	5
$S_{0n}$ (dB)	-10	-22	-32	-38	-43

Coupling coefficient (in dB) between central array element and the element number  $n$

### Conclusions:

- The measurements show that the coupling between adjacent elements is about 10dB, while the coupling value between the central and 5<sup>th</sup> element is 43dB.
- The beam of multiple-feed antenna elements is controlled by changing the phase and amplitude of the signals going into the various antenna feeds.
- An antenna array system must account not only for the interaction that occurs between the antenna elements, but also for the interaction that occurs on their driving feed networks.
- The antenna pattern is changed by setting the input power and relative phasing at its various ports. At the same time, the input impedances at the ports change with the antenna pattern. Since input impedance affects the performance of the nonlinear driving circuit, the changing antenna pattern affects the overall system performance. **EM simulation software** is commonly used to simulate antennas with multiple feeds, including phased arrays, stacked radiators with different polarizations, and single apertures with multiple feed points.
- An EM simulation software enables communication between the circuit and antenna, thus automatically accounting for the coupling between the circuit and the antenna in an easy-to-use framework.
- The EM simulation is necessary because the antenna elements interact with each other, which can significantly degrade the antenna's performance. An extreme example of this is **scan blindness**, where the interaction between the elements causes no radiation to occur at certain scan angles.
- The coupling between the elements can also lead to resonances in the feed network. In order to optimize the feed network to account for deficiencies in the antenna, the entire array antenna combined with the entire feeding circuit must be optimized. It is critical to simulate the feed network itself since resonances can build up due to the loading at the antenna ports.

### Frequency Bandwidth of Array Antenna

- The **Frequency Bandwidth** (BW) of phased array antennas is described as being composed of two effects: the **aperture effects** and the **feed effects**. In both effects, it is the path-length differences that contribute to the frequency bandwidth sensitivity of a phased array.

For a parallel-fed array (equal line length), the feed network does not contribute to a change in phase with frequency, and so only the aperture effect remains.

- Frequency Bandwidth of an array antenna is affected by many factors, including change of element input impedances with frequency, change of array spacing in wavelengths that may allow grating lobes, change in element beamwidth, and so on.
- When an array antenna is scanned with fixed units of phase shift, provided by phasers, there is also a frequency bandwidth limitation as the position of the main beam will change with frequency.
- When the array antenna is scanned with time-delay circuits, the beam position is independent of frequency to first order.
- An array antenna, where the antenna elements are fed in parallel (corporate feed) and scanned by phase shift, modulo  $2\pi$ , has limited frequency bandwidth: for wideband operation, constant lengths rather than constant phases are required. The approximate limit is given by:

$$\text{Bandwidth (\%)} \approx \text{Beamwidth (}^\circ\text{)}$$

- For wider frequency bandwidths, time-delay networks have to be introduced to supplement the phase shifters.
- However, phased array antennas have the potential of operating over very wide frequency bandwidths. The high-end of the frequency bandwidth is limited by the physical size of the antenna elements, which must be spaced close enough in the array to avoid generation of grating lobes.
- For wide instantaneous bandwidth (rather than tunable bandwidth), the time-delay circuits have to be added to prevent the beam from being scanned as the frequency is changed.
- The impedance of the radiating antenna element at the aperture (with closely spaced elements) is approximately independent of frequency, but the element must be matched over the wide bandwidth. This is difficult to achieve without exciting harmful surface waves when scanning. Impedance matching with one octave bandwidth for scanning angles  $\pm 60^\circ$  could be obtaining in practice.

## Antenna Element Failure Analysis

- When the antenna elements fail, the array antenna response will degrade.

For example, a rectangular 16x4 array antenna with  $\lambda/2$  spaced elements, if some of the antenna elements fails working, the antenna array pattern will change, as is shown in the plots below.

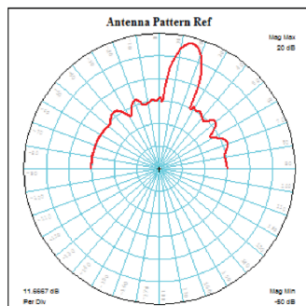

Failure rate = 2%  
(element #9)

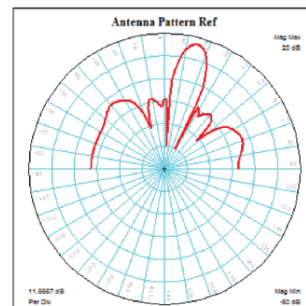

Failure rate = 5%  
(element #9, #36, #55)

Antenna pattern of a 16x4 array antenna with failing elements

## Array Element failure always results in side lobe response degradation.

- In a Phased Array Antenna by adding amplitude control, the phased array can form multiple beams with beamwidths determined by the entire size of the array.
- The beam shape of the Phased Array Antenna is determined by the element size and also by the element shape.
- Each radiating element in an array antenna receives a portion of the power radiated by the other elements in transmit, or scatters power into neighboring elements in reception. The transmitted and the received antenna patterns are identical, so the problem can be analyzed either way.
- The radiation from each antenna element excites currents on its neighboring elements that also radiate.
- In a Phased Array Antenna, the effective element pattern changes due to scattering of power from neighboring elements.
- This leads to mutual coupling, which we describe and analyze by mutual impedance (admittance, or scattering) matrices. This phenomenon causes the input impedance of the antenna elements to change as we scan the antenna array.
- The mutual coupling can lead to **scan blindness** when the feed reflection coefficient grows due to mutual coupling, and the array totally reflects the signal into the feed network. If we want the exact pattern designed for, we must compensate the feeding coefficients for the mutual coupling.

## Scan Blindness

- The phenomenon of scan blindness in phased array antennas is a condition that results from array elements mutual coupling and can bring about essentially complete cancellation of the antenna radiated beam at certain scan angles.
- Scan blindness has been observed to occur in microstrip patch arrays or microstrip dipoles when the combination of dielectric constant and substrate thickness is such as to support a tightly bound surface wave, one with a phase velocity that is sufficiently slow so that it couples to an array grating lobe. A particular case is illustrated by arrays of microstrip patches etched on dielectric substrates.
- In **Patch Array Antennas** the surface coupling existing between antenna elements can sometimes lead to **scan blindness**, in which case, effectively, at some scan angles no power is transmitted or received by the array antenna.

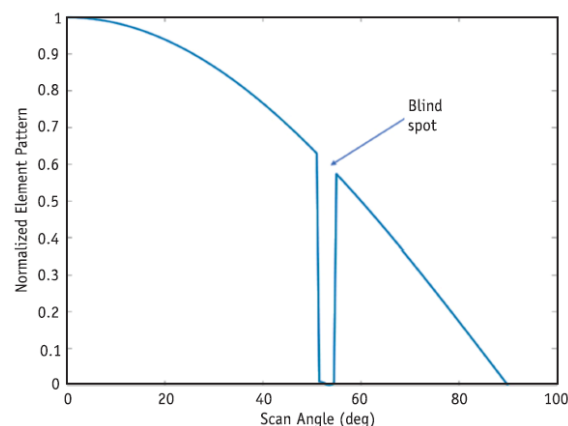

Scan Blindness Phenomenon

- Some authors correlated the TM surface wave propagation constant with the observed blindness angle. The dielectric layer itself supports a surface wave, and although the boundary conditions are perturbed by the array patch or dipole structure, the location of the blindness is often predicted very accurately by the surface wave propagation constant. The mechanism for coupling into the surface wave is that the periodic perturbations of the surface wave traveling (slowly) in, for example, the negative “x” direction, form a grating lobe that would radiate into the positive  $\Theta$  angle, but that it is exactly canceled by the array beam, also at the positive  $\Theta$  direction.
- The scan blindness can also occur with **electrically thin substrates**.
- **True scan blindness** is defined as the scan angle at which the magnitude of reflection coefficient becomes unity.
- True scan blindness does not occur in infinite arrays, but a severe mismatch in input impedance or, equivalently, a significant dip in the active element pattern generally takes place at a scan angle where the infinite array is blind.
- The blindness mechanism is explained as a "forced surface wave" or as a "leaky wave", resonant response of the slow wave structure by the phased array. Since the grounded dielectric substrate of the printed patch array supports a slow surface, scan blindness may occur. At this scan angle, all the power incident on the array is trapped in the non-radiating surface wave, resulting in total reflection.
- The existence of two or more surface waves on the substrate will lead to multiple regions of scan blindness.
- At scan blindness, the **input impedance** of any patch in the array has a **zero real part** and **very large reactive part**. The patches are thus open circuited and this is the reason why the resonant modes of the array at scan blindness correspond closely to the modes of a grounded ferrite substrate with no printed conductor on the surface.
- To obtain compact size and wide bandwidth, a substrate with higher permittivity and a thicker profile has been extensively used in the microstrip array antenna design. However, this substrate results in the increased **surface wave** excitation. In a microstrip array antenna, the severe surface waves increase the mutual coupling between array elements, which cause impedance and pattern anomalies associated with **scan blindness**.
- Mutual coupling has a direct impact on the performance of multi-element array antenna systems. The interaction between antenna elements degrades S-parameters, and as a result, the scan blindness of the radiation pattern for the adjacent coupled elements in the array increases. The mutual coupling can result in severe degradation to the antenna's radiation characteristics. While surface waves are weakly excited in very thin grounded dielectric substrates, space-waves dominate and show strong coupling when antennas are in close proximity. To minimize this phenomenon a compact **DGS (Defective Ground Structure)** can be used to eliminate blindness of a phased array antenna. DGS causing suppression in mutual coupling, does not affect other characteristics such as co-polarized radiation over principal planes, gain, and input impedance compared to other approaches with conventional microstrip patch.

- Array scan blindness, remains an issue that must be accounted for in any array development.  
It can usually be avoided by using smaller element spacings, and very careful use of dielectric substrates or superstrates, or any coupling structures like transmission lines and baluns at the array face.

## Array Factor plots for Phased Array Antennas

In 1937 [George Brown](#) working for RCA published for the first time the **array factor plots** for Phased Array Antennas with two isotropic elements with equal amplitude excitations for various combinations of excitation phase  $\alpha$ , and element spacing,  $d$ .

The plots also show a unit circle (dashed) representing the radiation from a hypothetical isotropic point source with the same input current.

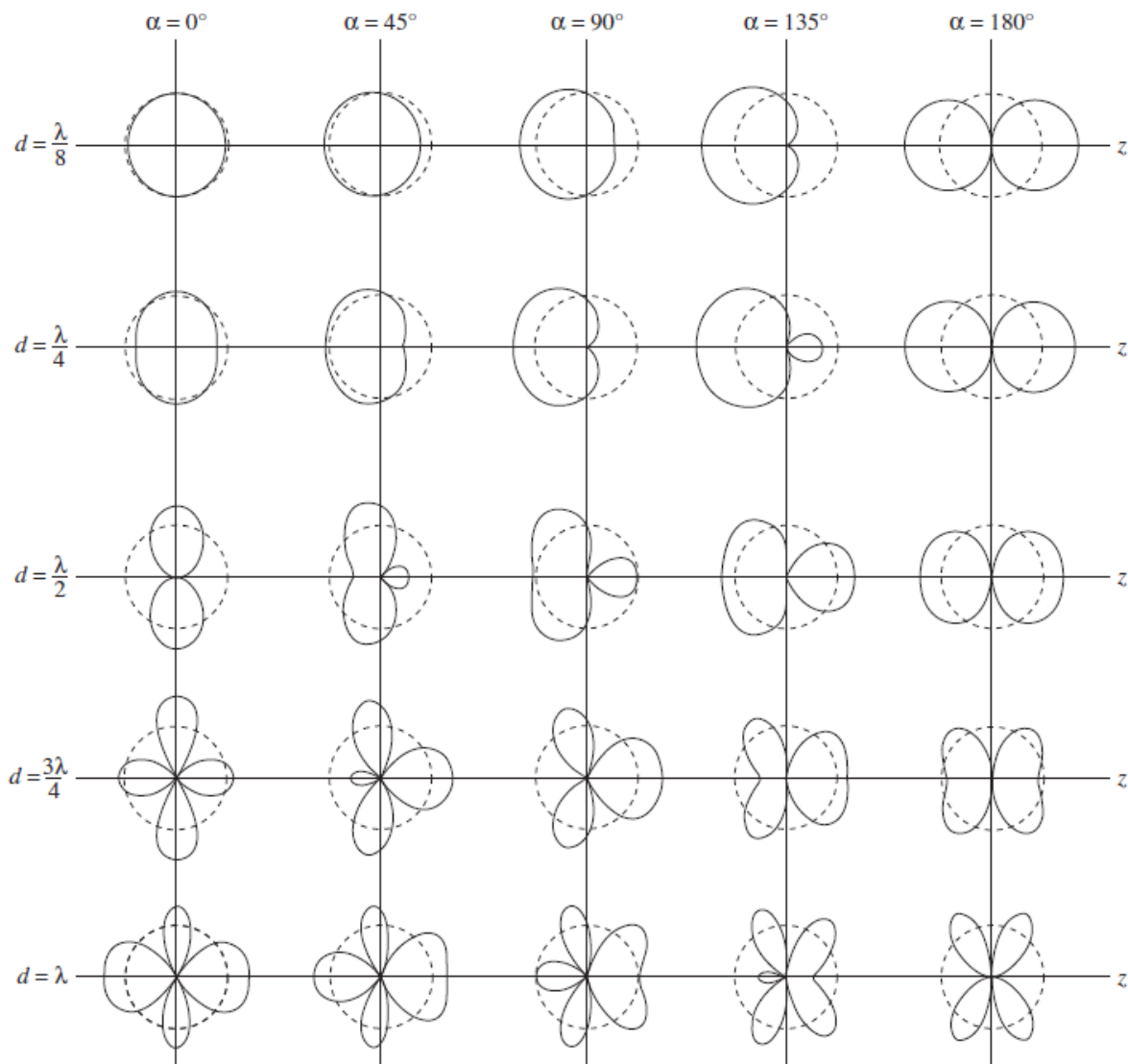

Patterns of Phased Array Antennas with two isotropic elements (G.Borrow)

## Sparse Array Antennas

The arrangement of the antenna elements on the array aperture is chosen such that the synthesized continuous aperture current distribution can be sampled optimally in a discrete manner.

This can be done either by placing the unequally fed elements at equal intervals separated by a half-wavelength ( $\lambda/2$ ) or smaller, or by placing equally fed elements at nonuniform separations. The former category is called the **Dense Antenna Arrays (DAA)** and the latter one is called the **aperiodic or nonuniform antenna arrays**.

- **Aperiodic Antenna Arrays** in general may also be referred to as **Sparse Antenna Arrays (SAA)** and will be referred as such going forward.
- A Sparse Array Antenna is an array in which many antenna elements have a value of zero. Sparse arrays need fewer antenna elements than Uniform Linear Arrays (ULA) to realize a given aperture.
- Sparse array antennas have aperture widths equal to full array antennas but are sparsely populated.
- Sparse array antennas were developed to increase cost efficiency by reducing the number of array antenna elements, with the performance degradation being relatively small or even close to the performance of conventional arrays.  
The configuration of the sparse array design is widely needed in various practical communication systems that have limited antenna size and weight, as well as cost efficiencies, such as radar equipment, satellite communications, and other space communications.
- Failure or absence of either the first antenna element or the last element in an array of  $N$  elements reduces the array aperture by one unit. Failure of both antenna elements reduces the array aperture by two units. Hence, in the analysis of thinned/sparse arrays, or when analyzing arrays with elements failures, it is generally assumed that the first and the last antenna elements are always functional, intact and active so that the array aperture is preserved.
- A sparse array antenna contains substantially fewer driven radiating elements than a conventional uniformly spaced array with the same beamwidth having identical elements. Interelement spacings in the sparse array antenna can be chosen such that no large grating lobes are formed and sidelobes (Side Lobe Level - SLL) are reduced.
- A sparse array antenna has an average element spacing greater than  $\lambda$ .
- Sparse arrays have grating lobes in the far field pattern due to the large spacing of elements residing in a rectangular or triangular grid. Random element spacing removes the grating lobes but produces large variations in element density across the aperture. In fact, some areas are so dense that the elements will overlap.
- Side Lobe Level SLL is inversely proportional to the aperture length and the number of elements.
- The SLL envelope is almost constant with respect to the variation of the scan angle.



- Sparse array antenna directivity is directly proportional to the number of active elements.
- Low Discrepancy Sequence (LDS) method could be used for generating the element spacing in sparse planar arrays. This nonrandom alternative finds an element layout that reduces the grating lobes while maintaining and keeping the elements far enough apart (average element spacing larger than  $\lambda$ ) for practical construction. From a practical fabrication perspective, it's needed that the elements are distributed on the aperture in a manner that the physical antenna elements do not touch. LDS arrays could use about 80% less elements than a fully populated array on a square grid.
- Periodic sparse arrays have grating lobes with the same gain as the main beam. A random distribution of elements in the sparse array lowers the grating lobes to a level of the surrounding sidelobes.
- For a given number of antenna elements, sparse array antennas provide larger apertures and higher degrees of freedom than full arrays (e.g., ability to detect more source signals through direction-of-arrival (DOA) estimation).
- Another advantage of sparse arrays is that they are less affected by mutual coupling compared to Uniform Linear Arrays (due to larger average distance between antenna elements).
- For a dense array, thinning (removing elements from a regular grid) and aperiodic spacing (spacing between elements are not constant) imitate low sidelobe amplitude distributions through an amplitude density across the aperture.
- Sparse array antennas have far field patterns with low sidelobes near the main beam and increased sidelobe levels farther from the main beam.
- The fragility of a sparse array antenna gives a measure of how vulnerable the array antenna is to its' element's failures. Fragility is defined as the number of essential elements to the total number of elements in the sparse array.  
An antenna element is said to be essential if its failure/absence alters or introduces holes into the antenna pattern.
- Detection of failed elements in the physical array (to compensate the altered beam pattern) is a challenge for sparse array analysis.

Sparse array antenna design techniques can be classified as:

- Mathematical calculation methods and structured algorithms,
- Probability statistics and stochastic processes,
- Polynomial factorization method,
- a combinatory mathematical method by using cyclic different sets,
- Low Discrepancy Sequence method,
- Mutual coupling effects method,
- Fourier transform-based techniques,
- Deterministic methodologies,
- Hybridization of the above techniques.

Sparse Array antenna optimization methods:

- Gradient-based optimizers,
  - Array thinning,
  - Convex optimization,
  - Random sampling,
  - Utilize special array structures.
- The design method for sparse array antennas is based on either traditional synthesis methods (mentioned above) or trial and error. A genetic algorithm could be used to determine the positions of the transmit and receive array elements by setting the ambiguity function of the virtual array as the match function.
  - A common mistake in sparse array antenna design is that the design is focus solely on the mathematical aspect of antenna array synthesis and neglect the electromagnetic (EM) portion of antenna array design.

### **Advantages of Sparse Array Antennas:**

- Disruption of periodicity in the placement of antenna elements in the array alleviates the onset of the grating lobes.
- Larger separations between the array elements leads to a reduction in the mutual coupling, thus having a minimal impact on the antenna performance. Place the elements far enough away from each other so that the array can be fabricable.
- Sparse arrays achieve high taper efficiency for SLL reduction, closer in comparison to the amplitude tapered conventional antenna arrays.
- The reduction in the number of elements in the fixed array aperture compared to the conventional antenna arrays leads to reduction in size, weight, aperture, and power-cost (SWAP-C) resources.

### **Disadvantages of Sparse Array Antennas:**

- The reduction in the number of elements leads to the reduction in the directive gain of array.
- Irregular array antenna elements placement complicates the realization of the RF feed circuitry in the back end of the array in case of phased array antennas.
- Side Lobe Level SLL reduction is proportional to the number of elements, so for ultralow sidelobe level (lesser than  $-30\text{dB}$  to  $-40\text{dB}$ ), a large number of elements leading to a bigger array aperture are required.
- More sensitive to element failure than full array antennas.

The sparse array antenna configuration can be synthesized based on the desired radiation pattern. This pattern is generated based on the phase excitation parameters of each element, the amplitude, and the relative phase difference between the array elements.

### **Example of Sparse Array Antenna design:**

The configuration of a sparse array antenna is designed by developing a 9-element sparse array, as shown in figure below:

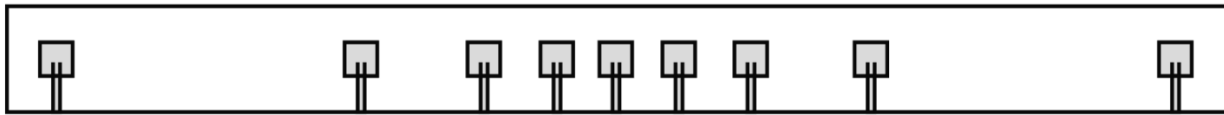

9-element sparse array antenna

Determination of the distance between the elements of the sparse array could be carried out using equation:

$$d_n = 1/I_n$$

where:  $d_n$  is the coefficient of distance between array elements, and  $I_n$  is the excitation coefficient of each element amplitude.

Furthermore, the amplitude current excitation coefficient will be transformed to the element spacing coefficient for each element and multiplied by the ideal distance between array elements  $\lambda/2$ .

This parameter is the coefficient for determining the distance of each element in the sparse array configuration and determining its location in the sparse array arrangement.

The process of this method starts by determining the aperture length of the sparse array antenna configuration and calculating the distance coefficient between elements  $d_n$  for each array element. Then, we calculate the number of elements that match the aperture length, then multiply the distance coefficient  $d_n$  by the distance between standard elements  $\lambda/2$ , and finally set up a linear configuration of the sparse antenna array from the result of multiplying the distance coefficient by  $\lambda/2$ .

The radiation pattern produced by this 9-element sparse array antenna configuration has a main lobe magnitude of 25.1dB with a half power bandwidth (HPBW) of  $0.5^\circ$  and a peak SLL performance of  $-33.4$ dB. These results show a significant improvement when compared to the conventional uniform spacing array configuration with equal aperture, which has the main lobe magnitude of 19.6dB with HPBW  $3.8^\circ$  and a peak SLL of  $-13.3$ dB.

### [Phase Shifters used in Electronically Controlled Phased Array Antennas](#)

- Phase Array Antennas are controlled by **phase shifters**, **switches**, and **attenuators**.
- Phased Array systems generally comprise a plurality of radiating elements each of which generally has a **phase shifter** associated therewith.
- In the transmit mode the phase shifters determine the direction of the radiated beam emitted by electronically changing the amount of phase shift produced by these phase shifters the beam can be made to scan a preselected spatial volume.
- In practice, the transmitted beam scans a spatial volume in incremental steps. The **scanning accuracy** of a given volume is dependent upon the size of the incremental step or the **phase shift per step** of the phase shifters.
- The **resolution** of a received signal in a phased array is dependent upon the **size of the incremental steps** of the phase shifter, since the **phase error** between adjacent elements is usually a fixed percentage of the magnitude of the bit of the phase shifter. A given radiated beam has side lobes caused by these errors.
- These side lobes reduce the energy contained in a transmitted beam and decrease the signal to noise ratio in the received return.

- Hence, one method of increasing the energy in the main transmitted beam and increasing the signal to noise ratio of the signal received, is to reduce the phase shifter errors between adjacent elements.  
This can be effectively accomplished by reducing the magnitude of the incremental steps, more steps are needed to provide the proper amount of total phase shift from the phase shifter.
- So, one of the most important components have been the **phase shifters**, but more recently **variable amplitude control** has become important as well.
- The first components for phase control were waveguide ferrite phase shifters, but diode devices, transistor circuits, MEMS switches, and ferroelectric phase shifters are all finding applications.  
Many phase shifters are analog devices, wherein the differential phase between states is a function of voltage or pulse length or some other analog parameter.
- Ferrite phase shifters can handle high power from S-band to 60GHz and beyond. Ferrites phase shifters can offer a variety of switching speeds, starting at about one microsecond for toroid designs, and insertion loss as low as 0.5dB.
- A linear antenna array system consists of N equally spaced identical elements. Each phase shifter has a special electrical control circuit that can change progressively the phase of the received (or transmitted) signal.

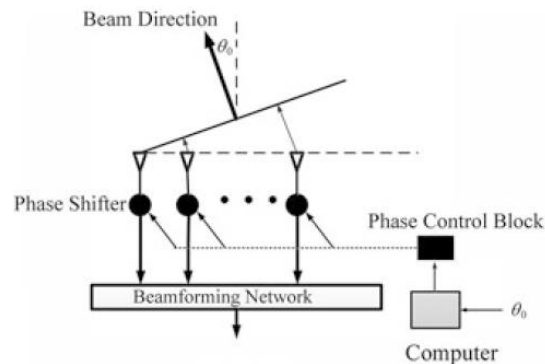

- Radiation pattern and the beam direction can be changed using **Analog Phase Shifters** that vary their phases continuously from  $0^\circ$  to  $360^\circ$ . Such electronically controllable phase shifters are very expensive and typically are not used in practice.
- Most of the Phase Shifters are digitally controlled, named **Digital Phase Shifters**. **Digital Phase Shifters** realize phase shifts with a discrete difference equal to  $\Delta = 2\pi / 2^q$ , where  $q$  is the number of bits, and  $2^q$  is the number of states of the digital phase shifter.

### Digital Phase Shifters – Number of phase steps vs Number of bits

- A **one-bit** ( $q=1$ ) digital phase shifter produces only **2 phases**:  $0^\circ$  and  $180^\circ$  ( $0$  and  $\pi$ )
- A **two-bit** ( $q=2$ ) digital phase shifter can realize **4 phases**:  $0, \pi/2, \pi, 3\pi/2$ .  
A two-bit phase shifter ( $q=2$ ) provides four phase states within the phase range:  $0^\circ$ - $360^\circ$  ( $0^\circ, 90^\circ, 180^\circ, 270^\circ$ ), with discrete steps of  **$90^\circ$**  ( $360^\circ / 4$ ).  
The array factor value does not change for scan angles from  $21^\circ$  to  $30^\circ$  and from  $30.5^\circ$  to  $40.5^\circ$ .

- A **three-bit** ( $q=3$ ) digital phase shifter can realize **8 phases**:  $0, \pi/4, \pi/2, 3\pi/4, \pi, 5\pi/4, 3\pi/2, 7\pi/4$ .  
A three-bit phase shifter ( $q=3$ ) gives eight possible phase states starting from  $0^\circ$  to  $360^\circ$ , with discrete steps of  **$45^\circ$**  ( $360^\circ / 8$ ). ( $0^\circ, 45^\circ, 90^\circ, 135^\circ, 180^\circ, 225^\circ, 270^\circ, 315^\circ$ )  
The beam pointing remains constant for the angular ranges:  $43^\circ$ - $49^\circ$  and  $49^\circ$ - $55.5^\circ$ .
  - A **four-bit** phase shifter ( $q=4$ ) corresponds to **16 possible phase steps** with a discrete step equal to  **$22.5^\circ$**  ( $360^\circ / 16$ ). ( $0^\circ, 22.5^\circ, 45^\circ, 67.5^\circ, 90^\circ, 112.5^\circ, 135^\circ, 157.5^\circ, 180^\circ, 202.5^\circ, 225^\circ, 247.5^\circ, 270^\circ, 292.5^\circ, 315^\circ, 337.5^\circ$ ).
  - A **five-bit** ( $q=5$ ) digital phase shifter have **32 discrete steps** with  **$11.25^\circ$**  phase resolution ( $360^\circ / 32$ ).
  - A **six-bit** ( $q=6$ ) digital phase shifter have **64 discrete steps** with  **$5.625^\circ$**  phase resolution ( $360^\circ / 64$ ).
- Due to the nature of the stepped phase shift introduced by the **digital phase shifters**, it will be a **phase error function** that will affect the main beam and the side lobes of the array antenna.

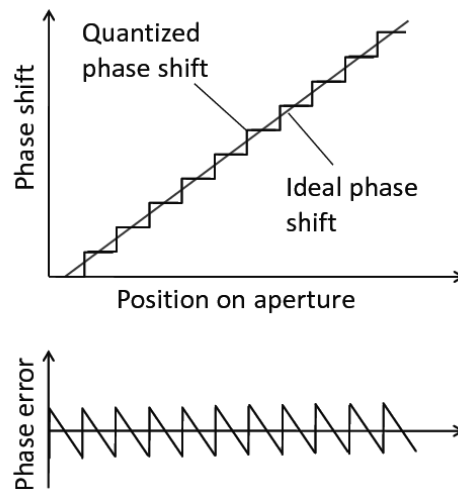

Phase error due to digital phase shift steps

It is seen that the error between the ideal curve and its approximation is a periodic function of the X coordinate.

- Periodic phase errors cause main lobe attenuation, produce a set of lobes called "**quantization lobes**", and cause error in the main beam pointing position. Quantization lobe values depend only on the scanning angle position and do not depend on the array amplitude distribution.
- Since the array is itself discrete, the positions of the elements on the sawtooth are important. There are two well defined cases:
  - The first case is when the number of elements is less than the number of steps. In this case the phase errors assume a random nature.
  - The second case has two or more elements per phase step, and the discrete (array) case is approximated by a continuous case.
- A method offered to reduce these parasitic lobes is to randomize the periodic **phase error**. This method significantly reduces the parasitic lobes, while increases the **average power sidelobe level**.

## Phase Shifters topologies

Phase shifters can use switched transmission lines and PIN diodes to change the phase in discrete phase steps.

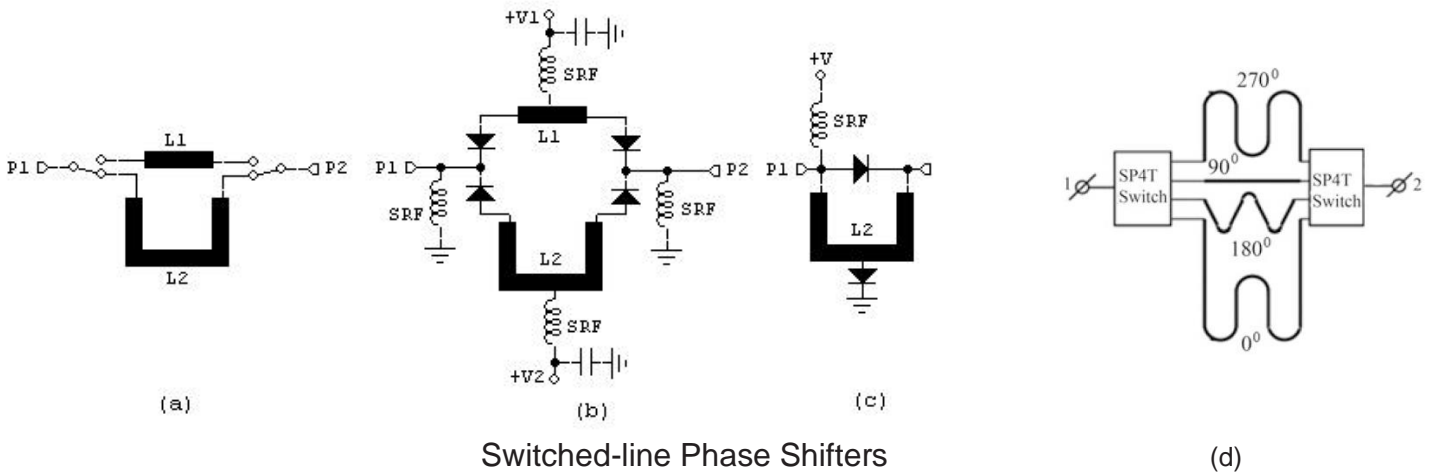

The standard switched-line Phase Shifter is using switched transmission line segments, getting different path length and determining in this way the amount of phase shift.

- The simplest switched-line Phase Shifter is dependent only on the lengths of line used. One of the two transmission lines is labeled as a “reference” line, and the other as a “delay” line.
- An important advantage of this circuit is that the phase shift will be approximately a linear function of frequency, getting a wideband frequency range of the circuit.
- The phase shift created is dependent only by the length of the transmission lines, making the Phase Shifter very stable over time and temperature.
- PIN diodes may suffer for insertion loss tolerance or peak power capability, but both characteristics don't affect the phase shift.
- Typically, to avoid the phase errors the isolation of the switches must exceed 20dB in the required frequency band.
- Insertion loss of the switched-line Phase Shifter is equal to the loss of the SPDT switches plus the line losses.
- By switching the signal between two pre-determined lengths of transmission lines it is possible to realize a specific phase shift ( $\Delta\phi$ ) at a given frequency.

$$\Delta\phi = \frac{2\pi (L2 - L1)}{\lambda}$$

where  $\Delta\phi$  is the phase shift,  $(L2 - L1)$  is the difference between the physical lengths of the delay line  $L2$  and the reference line  $L1$ , and  $\lambda_g$  is the **guide wavelength**.

$$\lambda_g = \frac{\lambda}{\sqrt{\epsilon_r}} \qquad \lambda_g = \frac{c}{f\sqrt{\epsilon_r}}$$

$\lambda$  is the wavelength in vacuum,  $\epsilon_r$  is the dielectric constant of the substrate,  $f$  is the frequency, and  $c$  is the speed of light.

- To reduce the number of PIN diodes could be used the circuit in the figure above (c), replacing the reference L1 line with a series PIN diode.

In this circuit, for the 180° phase shift, both PIN diodes are in the OFF position, and the RF signal passes through line L2 with  $\lambda/2$  length, providing a 180° phase shift.

The shunt diode is placed at the middle of L2, at  $\lambda/4$  wavelength from its ends.

- The phase shift value deviates linearly from the intended value as the frequency of the signal deviates in either direction from the center (nominal) frequency.
- Switched-line Phase Shifters generally are used for 90° and 180° phase shifts. When path L2 is a half-lambda ( $\lambda/2$ ) longer than path L1, switching from path L1 to path L2 introduces an increased phase delay of 180°. So, to get a 180° phase shift the required physical length difference should be  $\Delta L = \lambda/2$ .
- In a practical design, resonance could appear in the OFF line when the line length is a multiple of  $\lambda/2$ , and the phases will interfere in a way to reflect much of the incoming power back to the input port. Thus, both lengths (L1 and L2) must not be multiples of  $\lambda/2$ . The resonant frequency will be slightly shifted due to the series junction capacitances of the reversed biased diodes, or of the parasitic capacitances of the SPDT mechanical switches.
- The lengths L1 and L2 must be carefully selected to avoid phase errors, high return loss, and high insertion loss.

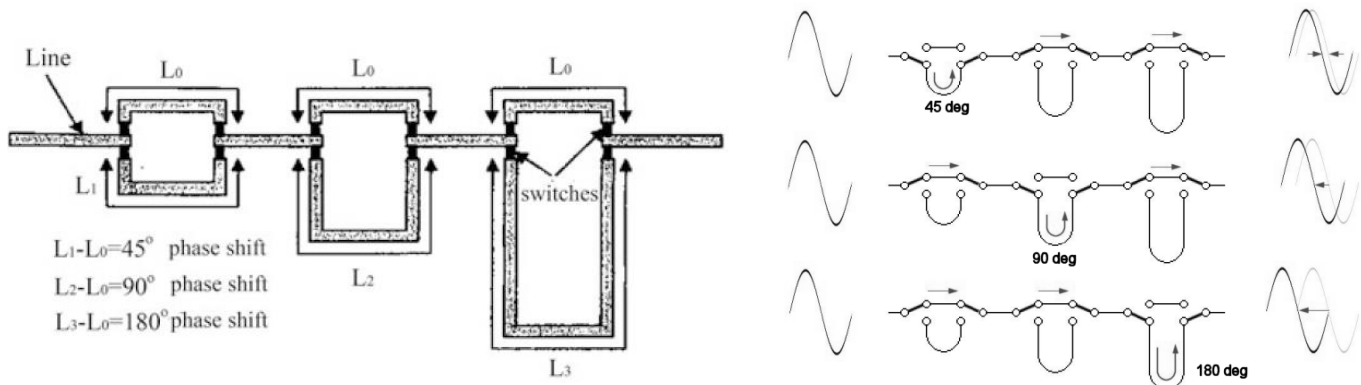

Three-Bit switched-line phase shifter and Signal Path

## References:

1. *Antennas – 1<sup>st</sup> and 2<sup>nd</sup> Editions – Kraus*
2. *Antennas - Theory and Practice - Schelkunoff, Friis*
3. *Advanced Antenna Theory - Schelkunoff*
4. *Antenna Arrays – A Computational Approach - Haupt*
5. *Microwave Antenna Theory and Design - Silver*
6. *Phased Array Antennas 2<sup>nd</sup> Edition - Hansen*
7. *Phased Array Theory and Technology – Mailloux*
8. *Approximate Antenna Modeling for CAD - Visser*
9. *Modern Antenna Design – Milligan*
10. *Antenna Theory and Design - 3<sup>rd</sup> Edition - Stutzman, Thiele*
11. *Antenna Arrays and Automotive Applications - Rabinovich, Alexandrov*
12. *5G Primer for MIMO - Phased-Array Antennas – National Instruments*
13. *5G Phased Array Antenna Design – Pandey*
14. *Linear Antenna Arrays – Nikolova*
15. *The Element-Gain Paradox for a Phased-Array Antenna - Hannan*
16. *Linear Antenna Arrays - Antenna Engineering*
17. *Antenna Array Testing - Conducted and OTA – Rohde & Schwarz*
18. *Antennas and Propagation - Jacobs University*
19. *Lecture Notes - Antennas – Aksoy*
20. *Antenna Array Design Choices & Characterization - Rohde & Schwarz*
21. *mmWave 5G Beamforming and Phased Array Basics – Anokiwave*
22. *Wide-Angle Scanning Phased Array Antenna - Ahn, Hwang*
23. *Patch Antenna Arrays and Feeding Networks – Moshkin*
24. *Sparse Phased Array Antennas - Theory and Applications – Kedar*
25. *Sparse Linear Antenna Arrays: A Review - Patwari*
26. *A Series-fed Microstrip Patch Array - EuCAP 2013*
27. *Characterizing Active Phased Array Antennas - Rohde & Schwarz*
28. *Demystifying over-the-air (OTA) testing - Rohde & Schwarz*
29. *Radio and Microwave Wireless Systems – Hum*
30. *5G New Radio - An Insight into Physical Layer Antennas and MIMO – Anritsu*
31. *3D Printed Dielectric Lenses Increase Antenna Gain and Widen Beam Scanning Angle - 3D Fortify*

<http://www.qsl.net/va3iul>