

# INTRODUCING POLARIS® POWER™ PORTABLE GENERATORS

- + Digital Inverter
- + Fuel-Efficient
- + Quiet
- + Compact
- + Lightweight
- + 21 Hour Run-Time
- + Highly Portable
- + 3-Year Limited Warranty



# SPORTSMAN®

POLARIS SPORTSMAN ENGINEERED PARTS, ACCESSORIES & APPAREL



ENGINEERED PARTS ACCESSORIES & APPAREL

**POLARIS**

All riders pictured are trained professionals. Polaris® recommends that all riders take a training course. Do not attempt maneuvers beyond your capability. Always wear a helmet and other safety apparel. Never drink and ride. All off-road vehicles depicted in this brochure may feature Polaris® parts and accessories and are not standard features of the base models they accompany. All performance and/or feature and benefit claims are based upon competitive data available at time of printing. For your nearest dealer, call 1-800-POLARIS or go to [www.polaris.com](http://www.polaris.com).

Polaris Sales Inc., 2100 Hwy. 55, Medina, MN 55340 (763) 542-0500 Fax (763) 542-0599  
 Polaris Industries LTD, 50 Prairie Way, Winnipeg, Manitoba, Canada R2J 3J8 (204) 925-7100 Fax (204) 925-7110

EMEA1 9930074



Unless noted, trademarks are the property of Polaris® Industries Inc. 509® is a registered trademark of 509. Inc. Amara® is a registered trademark of Kuraray Co. Ltd. of Japan. AP-360® is a registered trademark of TK. Bighorn® is a registered trademark of Cheng Shin Rubber USA, Inc. Bluetooth® is a registered trademark of Bluetooth Sig. Inc. Break-Up® is a registered trademark of Haas Outdoors, Inc. Browning® is registered trademark of Browning Corporation. ChatterBox® is a trademark of ChatterBox USA. Cordura® is a registered trademark of Invista North America S.A.R.L. Daewoo® is a registered trademark of Daewoo International Corporation. Fly F2® is a registered trademark of Western Power Sports, Inc. Fly Racing® is a registered trademark of Western Power Sports, Inc. FXR® is a registered trademark of Factory Racewear. iPhone® and iPod® are registered trademarks of Apple Computer, Inc. TTP® is a registered trademark of Carlisle Intangible Company. Jensen® is a registered trademark of Recoton Audio Corp. JL Audio® is a registered trademark of JL Audio, Inc. Kevlar® is a registered trademark of DuPont. Kolpin® is a registered trademark of Kolpin Outdoors, Inc. Lowrance® is a registered trademark of Navico, Inc. Lycra® is a registered trademark of INVISTA North America S.A.R.L. Maxxis® is a registered trademark of Cheng Shin Rubber Ind. Co., Ltd. Mossy Oak® is a registered trademark of Haas Outdoors, Inc. Nivomat® is a registered trademark of ZF Sachs AG. OGIO® is a registered trademark of Ogio International, Inc. PIAA® is the registered trademark of PIAA Corporation. Polyfil® is a registered trademark of J & P Coats Limited Corp. Quick-Dry® is a registered trademark of Innovative Fashion Group Corp. SAE® is a registered trademark of Society of Automotive Engineers, Inc. Sedona® is a trademark of Western Power Sports, Inc. Sirius® is a registered trademark of Ampspeaker APS Corporation. SIXR™ is a trademark of Cheng Shin Rubber Ind. Co., Ltd. Snell® is a registered trademark of Snell Memorial Foundation, Inc. SSV WORKS® is a registered trademark of SSV Works, LLC. TekVest® is a registered trademark of Tekrider, Inc. Velcro® is a registered trademark of Velcro Industries B.V. Ltd Co. Netherlands. Walker Evans® is a registered trademark of Walker Evans Racing. WARN® is a registered trademark of WARN® Industries, Inc. YKK® is a registered trademark of YKK Corporation. Prices and availability are subject to change at any moment. Copyright © 2014 Polaris® Industries. All rights reserved.

2015 EMEA VERSION



**POLARIS**<sup>®</sup>

ENGINEERED PARTS  
ACCESSORIES & APPAREL

# MORE GREAT ESCAPES.



**MAKE YOUR OWN ADVENTURE WITH PRECISION-BUILT  
ACCESSORIES THAT WILL TAKE YOU THERE.**

Because the horizon starts where the road ends, outfit your Sportsman<sup>®</sup> with accessories that are specifically designed help you maximize your time on the trail. So put more road behind you and more excitement in front of you with Polaris Engineered Accessories™.



# ENGINEERING NEVER STOPS

When engineering is done well, when design is dialed-in down to the smallest detail, it's not always easy to notice. But it makes a world of difference. Lines are cleaner. Angles are tighter. The package is complete. For the Polaris Engineered™ team, fine-tuning accessories for seamless integration is what it's all about.

“The entire team is working together and integrating our processes,” says Steve Eastman, Vice President of PG&A. “We’re working further up front between the design of the vehicle and the accessories that go with that vehicle.”

From testing different UV ray exposures on various materials, beating on bumpers in the workroom, listening to riders and getting out and riding on their own time — Polaris® Engineers never stop listening and never stop refining.

“With a Polaris Engineered™ product, you know it's the world's best. They are designed specifically for our vehicles, ensuring high quality designs that meet our customers' needs,” says Dave Longren, Vice President of Off-Road Vehicles. “You know when you buy an accessory or part from us, it's the best.”

The Polaris® team knows that hard work, harder testing and endless innovating is key to making solutions that optimize any ride.

“We make the best products in power sports and that's a real tribute to the superiority of our engineering and the emphasis that we have on integration, innovation and quality,” says Eastman.



LOCK & RIDE® REAR CARGO BOX – PAGE 45

SPORTSMAN XP® FRONT BRUSHGUARD – PAGE 35

FRONT RACK EXTENDER – PAGE 42

POLARIS® HD 3500 LB WINCH – PAGE 21

FRONT A-ARM GUARDS – PAGE 36

SPORTSMAN XP® REAR BRUSHGUARDS – PAGE 35

# 2015

## SPORTSMAN® PARTS, ACCESSORIES & APPAREL

SPORTSMAN ACE™	PG 10–15
WINCHES	PG 16–21
PLOWS	PG 22–25
TRACKS	PG 26–27
PACKAGES	PG 28–33
BUMPERS & GUARDS	PG 34–37
TIRES & WHEELS	PG 38–39
WINDSHIELDS	PG 40–41
RACKS	PG 42–43
STORAGE	PG 44–48
HUNTING	PG 49
LIGHTING	PG 50–51
POLARIS® INNOVATION	PG 52–53
COMFORT & ELECTRONICS	PG 54–55
SCRAMBLER®	PG 56–57
LUBRICANTS & VEHICLE CARE	PG 58–59
MAINTENANCE PARTS	PG 60–61
RAMPS & COVERS	PG 62–63
TRAILERS & ACCESSORIES	PG 64
HERITAGE	PG 65
HELMETS	PG 66–67
GOGGLES	PG 68
GLOVES	PG 69
OGIO® BAGS	PG 70
JERSEYS	PG 71
BASE LAYERS	PG 71
TECH	PG 71
PROTECTION	PG 72
YOUTH	PG 72
ANNIVERSARY CASUAL APPAREL	PG 73
MEN'S CASUAL APPAREL	PG 74–75
WOMEN'S CASUAL APPAREL	PG 76
YOUTH CASUAL APPAREL	PG 77
BEANIES & CAPS	PG 77
SIZE CHART	PG 77

ICON LEGEND		
	AUTO-STOP	
	DUST RESISTANT	
	FULL-COVERAGE	
	INNER LINER	
	UV RESISTANT	
	WATER RESISTANT	



**POLARIS**<sup>®</sup>

ENGINEERED PARTS  
ACCESSORIES & APPAREL

# WORK

PUT YOUR WHEELS TO THE GRINDSTONE.

Rugged and reliable Polaris Engineered Accessories™ like winches, brush guards and lighting solutions are engineered to work harder so you can knock out your to-do list. So when you have your work cut out for you, add more power to your machine and get more done with your day.





**POLARIS**<sup>®</sup>

ENGINEERED PARTS  
ACCESSORIES & APPAREL

# HUNT

## HOT PURSUIT.

Whether the game you are hunting is big or small, Polaris Engineered Accessories™ give you an advantage — camouflage Lock & Ride® storage, rugged protection and high-performance winches ensure your vehicle is ready for the chase.





**POLARIS**<sup>®</sup>

ENGINEERED PARTS  
ACCESSORIES & APPAREL

# PLAY

LEVEL THE PLAYING FIELD.

Fuel your passion for exhilaration with Polaris Engineered Accessories™. They look right, fit perfectly and operate with integrity so you can turn any terrain into your playground.





**POLARIS**<sup>®</sup>

ENGINEERED PARTS  
ACCESSORIES & APPAREL

**SPORTSMAN  
ACE**<sup>™</sup>

WANT MORE FROM YOUR NEW SPORTSMAN ACE<sup>™</sup>? THEN ADD MORE TO IT. POLARIS ENGINEERED ACCESSORIES<sup>™</sup> BUILT FOR YOUR VEHICLE GIVE YOU THE COMFORT AND CONFIDENCE YOU WANT IN YOUR NEW KIND OF OFF ROAD EXPERIENCE.



## SPORTSMAN ACE<sup>™</sup> STORAGE



### LOCK & RIDE<sup>®</sup> REAR CARGO BOX **NEW**

- Lock & Ride<sup>®</sup> technology: Cargo Box installs without tools using twin Lock & Ride<sup>®</sup> plungers that lock box into vehicle's cargo space
- Hard plastic construction keeps cargo secure and protected
- Lid has a dustproof, weatherproof seal and latches closed with two heavy-duty clamps
- Lock (not included) can be added to secure lid
- Handles make it easy to carry Cargo Box to and from vehicle
- D-rings on top of box serve as tie-down points for bungees, straps, cargo nets, etc.
- Can be used with other accessories such as a rear panel and other storage solutions
- Polaris<sup>®</sup>-branded

2879707  
SPORTSMAN ACE<sup>™</sup>



### OGIO<sup>®</sup> LOCK & RIDE<sup>®</sup> 3-PIECE DELUXE CARGO BAG **NEW**

- Installs in vehicle's rear cargo space in seconds without tools using Lock & Ride<sup>®</sup> anchor technology
- Versatile, spacious storage solution is ideal for carrying camping or touring gear, including riding apparel and food
- Cargo Box provides a large, formed, weather-sealed cargo space
- Pair of side storage bags provide versatile, easily accessible cargo space
- One side storage bag is a thermal bag; keeps food/drinks cold or hot
- Cargo Box lid has new dust gasket; seals out dust and elements to protect cargo
- Cargo Box has four interior pockets — two mesh/two fabric pockets — with zippered closures
- Side bags attach securely to cargo bag using adjustable straps and durable buckles
- Side bags can be attached or removed in seconds without tools
- Polaris<sup>®</sup> and OGIO<sup>®</sup>-branded

2879704  
SPORTSMAN ACE<sup>™</sup>



### SIDE BAGS **NEW**

- An innovative cargo solution that holds small items without using space in the rear cargo box
- Bag secures to the vehicle framework using integrated straps
- No tools required for installation or removal
- Convenient cargo space for a wide variety of small items
- Bag has zippered compartment to securely hold cargo and mesh outside pocket
- Sold as a set of 2
- Incompatible with doors
- Polaris<sup>®</sup>-branded

2880542  
SPORTSMAN ACE<sup>™</sup>



### TRAIL BAG **NEW**

- Securely holds cargo in 4 zippered compartments
- Durable bag construction built for use in demanding off-road conditions
- Adjustable Velcro<sup>®</sup> straps secure bag to vehicle frame
- Install or remove bag quickly and easily; no tools required
- Bag and cargo are in secure location inside vehicle frame
- Can be used with all other accessories, including rear panels, cargo boxes, etc.
- Polaris<sup>®</sup>-branded

2879705  
SPORTSMAN ACE<sup>™</sup>



### OVERHEAD STORAGE BAG **NEW**

- Securely holds cargo in 3 zippered compartments
- Durable bag construction built to perform in demanding off-road conditions
- Install or remove quickly and easily; no tools required
- Attaches securely to vehicle frame
- Cargo is conveniently close and easily accessible from driver's seat
- Can be used with any SPORTSMAN ACE<sup>™</sup> roof
- Polaris<sup>®</sup>-branded
- Does not work with Front Rack Audio (2880458)

2879706  
SPORTSMAN ACE<sup>™</sup>





# SPORTSMAN ACE™ CAB & COMFORT

## LOCK & RIDE



### LOCK & RIDE® POLY SPORT ROOF **NEW**

- Lock & Ride™ technology: Install or remove quickly and easily without tools
- Provides a rider with overhead protection and shade
- Rigid construction: Strong, durable, lightweight
- All mounting hardware included
- Engineered to prevent warping in high-heat conditions
- Integrated drainage channels route rain water away from driver
- Can be used with other accessories such as a windshield, rear panel, audio, etc.

2879691  
SPORTSMAN ACE™



### CANVAS ROOF **NEW**

- Provides shade and reliable overhead protection from rain and off-road spray
- Durable canvas construction
- As conditions change, roof can be installed or removed in seconds without tools
- Roof attaches securely to vehicle frame using integrated, self-locking mounting hardware
- Adjustable straps secure rear of roof to vehicle frame
- Folds for easy, compact storage

2879692  
SPORTSMAN ACE™



### CANVAS CAB **NEW**

- Cab provides rider with protection and enhanced comfort for a more enjoyable riding experience
- Included are: Canvas roof/rear panel and canvas doors
- All components install quickly and easily using provided mounting hardware
- Components can be used to suit rider preference and the day's conditions; i.e., cab can be used without doors attached, etc.
- Doors and rear panel feature clear plastic windows for excellent visibility
- Doors feature aluminum frames with durable canvas exterior and durable, reliable hinges and latches
- Requires the use of accessory Full Poly Windshield (2879693, sold separately)
- Requires the removal of accessory SPORTSMAN ACE™ Sport Doors (2879697) if previously installed

2880646  
SPORTSMAN ACE™

## LOCK & RIDE



### LOCK & RIDE® FULL POLY WINDSHIELD **NEW**

- Windshield is made of impact- and shatter-resistant .236" polycarbonate with hard coat on both sides
- Lock & Ride™ technology: Install or remove the windshield in minutes without tools
- Includes all mounting hardware
- Can be used with other accessories such as roof, doors, audio, etc.

2879693  
SPORTSMAN ACE™

## LOCK & RIDE



### LOCK & RIDE® MID POLY WINDSHIELD **NEW**

- Lock & Ride™ technology: Install or remove windshield in minutes without tools
- Provides protection while also allowing airflow to reach the rider
- Ideal for hot and dusty conditions
- Strong, durable, impact-resistant polycarbonate
- Includes all mounting hardware
- Can be used with other accessories such as roof, doors, audio, etc.

2879694  
SPORTSMAN ACE™

## LOCK & RIDE



### LOCK & RIDE® SPORT POLY WINDSHIELD **NEW**

- Distinctive, sporty styling with gradient tint
- Integrated styling complements vehicle
- Provides protection and allows airflow to reach the rider
- Includes all mounting hardware
- Can be used with other accessories such as roof, audio, etc.

2879695  
SPORTSMAN ACE™



### SPORT DOORS **NEW**

- Steel frame and strong plastic exterior
- Integrated styling to match vehicle
- Premium fit and finish; no cutting, welding or drilling required
- Add style with custom SPORTSMAN ACE™ Sport Door Graphics (sold separately)

2879697  
SPORTSMAN ACE™



### SPORT DOOR GRAPHICS **NEW**

- Rugged, durable wrap material
- Adhesive-backed for easy installation
- Custom cut to fit the SPORTSMAN ACE™ Sport Doors (2879697, sold separately)
- Includes right and left door graphics and squeegee for application
- Polaris® SPORTSMAN ACE™-branded

2880259 | Bright White  
2880685 | Sage Green  
2880686 | Voo Doo Blue  
SPORTSMAN ACE™

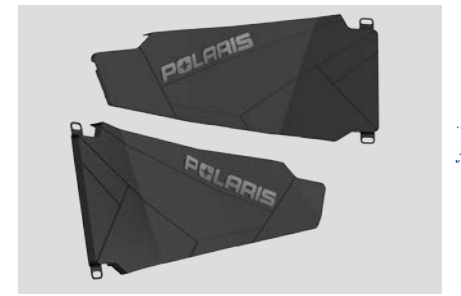

### DOOR LINERS **NEW**

- Durable, weatherproof construction for reliable performance during off-road riding
- Upper Door Liners feature modest padding to provide passengers with enhanced comfort while riding
- Liners are styled to coordinate with upholstery of vehicle's rear seats for a finished, integrated look
- Liners install easily, attaching to interior door framework
- Upper Door Liners are branded with Polaris® logo

2879431 | Upper Front Door Liners  
SPORTSMAN ACE™



### LOWER DOOR EXTENSIONS **NEW**

- Add these Lower Door Extensions to create full door coverage for enhanced rider comfort and protection
- Extensions install on Sport Doors (2879697, sold separately) and create a single, integrated door unit
- Extensions feature strong, durable steel frame with black hard-plastic exterior

2880272  
SPORTSMAN ACE™

## LOCK & RIDE

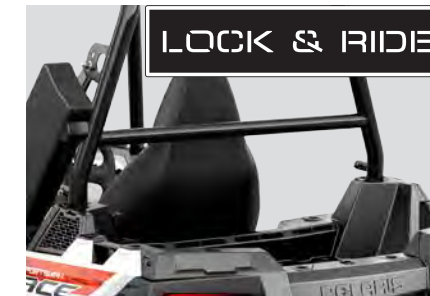

### LOCK & RIDE® POLY REAR PANEL **NEW**

- Lock & Ride™ technology: Install or remove in minutes without tools
- Includes all mounting hardware
- For best performance, use with a windshield on the vehicle
- Can be used with other accessories such as roof, cargo bags, etc.

2879696  
SPORTSMAN ACE™



### MESH REAR PANEL **NEW**

- Protects rider from dust, spray, shifting cargo
- Provides modest shade and dust protection
- Permits ventilation, airflow and visibility
- Install or remove panel quickly and easily; no tools required
- Mounts securely to vehicle frame using adjustable fasteners
- Panel folds for easy, compact storage
- Can be used with all accessories, including roofs, audio, Trail Bag, rear cargo boxes, doors, etc.

2879711  
SPORTSMAN ACE™

## LOCK & RIDE



### LOCK & RIDE® FULL POLY WINDSHIELD **NEW**

- Windshield is made of impact- and shatter-resistant .236" polycarbonate with hard coat on both sides
- Lock & Ride™ technology: Install or remove the windshield in minutes without tools
- Includes all mounting hardware
- Can be used with other accessories such as roof, doors, audio, etc.

2879693  
SPORTSMAN ACE™

## LOCK & RIDE



### LOCK & RIDE® MID POLY WINDSHIELD **NEW**

- Lock & Ride™ technology: Install or remove windshield in minutes without tools
- Provides protection while also allowing airflow to reach the rider
- Ideal for hot and dusty conditions
- Strong, durable, impact-resistant polycarbonate
- Includes all mounting hardware
- Can be used with other accessories such as roof, doors, audio, etc.

2879694  
SPORTSMAN ACE™

## LOCK & RIDE



### LOCK & RIDE® SPORT POLY WINDSHIELD **NEW**

- Distinctive, sporty styling with gradient tint
- Integrated styling complements vehicle
- Provides protection and allows airflow to reach the rider
- Includes all mounting hardware
- Can be used with other accessories such as roof, audio, etc.

2879695  
SPORTSMAN ACE™



### MTX® OVERHEAD AUDIO POD **NEW**

- Bluetooth® connectivity for wireless audio
- USB port for charging mobile devices in waterproof storage locker
- LCD display shows audio information; convenient LED lights shine toward rider
- Auxiliary connection through headphone jack
- Dual 6" speakers and tweeters that direct sound toward rider
- Installs in less than 15 minutes; includes all wiring
- Mounts on vehicle frame in designated mounting positions
- Durable, sealed, hard-plastic black housing
- Can be used with a roof and windshield; cannot be used with Overhead Storage Bag
- Co-branded with Polaris® and premium audio supplier MTX

2879703  
SPORTSMAN ACE™



### CONVEX REAR VIEW MIRROR **NEW**

- Durable, weatherproof construction, designed to perform in all off-road riding conditions
- Installs easily: Mount bolts into your choice of pre-designated mounting locations on vehicle frame
- Mirror attaches to mount and is adjustable
- Convex design provides broad, expanded view of what's behind or alongside the vehicle
- Can be used with all roofs, soft tops and windshields

2880531  
SPORTSMAN ACE™



### REAR VIEW MIRROR **NEW**

- Mounts securely on the vehicle frame and provides an expansive view of what's behind the vehicle
- Convex design provides excellent view of area behind vehicle
- Gives rider enhanced awareness of other vehicles and surroundings
- Can be used in conjunction with accessories such as roof, windshield, etc.
- Easily adjustable by hand

2879712  
SPORTSMAN ACE™



# SPORTSMAN ACE™ PROTECTION



## EXTREME FRONT BRUSHGUARD **NEW**

- Brushguard reliably enhances front-end protection of vehicle
- Ideal for trail riding
- Provides outstanding headlight protection
- Strong 1.25" (3.2 cm) diameter steel tube construction
- Durable, scratch-resistant black powder-coated finish
- Installs easily in pre-drilled mounting locations
- Integrated styling complements the vehicle's great look
- Can be used with any winch or plow system
- Includes integrated mounting tabs for auxiliary lighting

2879698

SPORTSMAN ACE™



## EXTREME REAR BRUSHGUARD **NEW**

- Brushguard reliably enhances back-end protection of vehicle
- Ideal for trail riding
- Provides outstanding taillight protection
- Strong 1.25" (3.2 cm) diameter steel tube construction
- Durable, scratch-resistant black powder-coated finish
- Installs easily in pre-drilled mounting locations
- Integrated styling complements the vehicle's great look
- Can be used with a tow hitch or auxiliary lighting

2879699

SPORTSMAN ACE™



## NERF BARS **NEW**

- Nerf Bars provide extra protection at sides of vehicle
- Durable plate steel construction
- Black powder-coated finish
- Corrosion- and scratch-resistant
- Quickly attaches to the vehicle with a 17-mm socket
- Low-profile design hugs bodywork to slide over obstacles without compromising ground clearance
- Adds custom style
- Polaris™-branded

2879700

SPORTSMAN ACE™



## FENDER FLARE KIT **NEW**

- Install an Fender Flare Kit to add extra style and experience great protection from mud and water spray kicked up by the tires
- Extends bodywork additional 3" for extra protection from mud and water
- Ideal for vehicles running accessory wheels with wider offsets
- Gives the vehicle a sporty custom look
- Features graphics with SPORTSMAN ACE™ branding

2879718

SPORTSMAN ACE™



## MUD FLAPS **NEW**

- Strong, durable plastic Mud Flaps extend beyond edge of front-end bodywork
- Mud Flaps block more mud, spray and debris kicked up by vehicle's front tires
- Works with or without Fender Flares (2879718, sold separately)
- Does not work with the Prospector Pro™ Track kit

2880100

SPORTSMAN ACE™

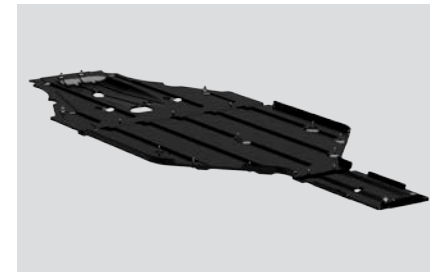

## SKID PLATE **NEW**

- Valuable, reliable protection for the undercarriage that is fully exposed to the rigors of off-road environments
- Strong, durable, lightweight HMW (high-molecular weight) polyethylene construction withstands off-road impacts to protect the vehicle's underside
- This 3/8" skid plate replaces the stock skid plate
- Three-piece skid plate is molded specifically for the Polaris® SPORTSMAN ACE™ undercarriage so it installs properly and fits correctly while maintaining maximum ground clearance
- All mounting hardware included

2880543

SPORTSMAN ACE™



## FRONT A-ARM GUARDS **NEW**

- Lightweight, durable, reliable A-Arm protection
- UHMW polyethylene construction delivers strength and low coefficient of friction so guards slide freely over rocks
- Molded construction and ribbing for optimized strength and rigidity
- Not compatible with Prospector Pro Track Kits
- Guards absorb impacts and retain their shape rather than bending as metal guards can
- Engineered with drain channels to evacuate water and mud
- Easy to install in place of stock guards

2879870

SPORTSMAN ACE™



## REAR A-ARM GUARDS **NEW**

- Lightweight, durable guards provide reliable A-Arm protection
- HMW polyethylene construction delivers strength and low coefficient of friction so guards slide freely over rocks
- Molded construction and ribbing for optimized strength and rigidity
- Not compatible with Prospector Pro Track Kits
- Guards absorb impacts and retain their shape rather than bending as metal guards can
- Engineered with integrated drain channels to evacuate water and mud
- Easy to install in place of stock guards

2879710

SPORTSMAN ACE™

# SPORTSMAN ACE™ PERFORMANCE



## GUN SCABBARD MOUNT **NEW**

- Strong, durable steel construction with durable black finish
- Lock & Ride® technology: Install or remove mount in seconds without tools
- Pro-Fit, Winch, and RZR® customization
- Securely and reliably holds a gun boot (not included)
- Mounts on side of vehicle frame so it does not work with a door installed on the same side of the vehicle

2879702

SPORTSMAN ACE™

Works with Gun boots listed on page 49



## ELECTRONIC POWER STEERING (EPS) KIT **NEW**

- Enjoy smooth, easy, precisely responsive automotive-quality steering
- EPS provides a light steering feel in all situations, including low-speed maneuvering through challenging terrain
- Enjoy riding more and stay fresher throughout a day of riding

2880453

MY15 SPORTSMAN ACE™

## ADDITIONAL SPORTSMAN ACE™ PRODUCTS

SPORTSMAN ACE™ Plow Mount  
See Page 24

SPORTSMAN ACE™ Track Mount  
See Page 27

SPORTSMAN ACE™ Cover  
See Page 63

# SPORTSMAN ACE™ WINCHES



## WARN® PROVANTAGE WINCHES **NEW**

- WARN® PROVANTAGE winch optimized for Polaris® SPORTSMAN ACE™
- Fully sealed contactor, motor & drivetrain
- Three-stage planetary gear train for smooth efficient operation
- All metal gear housing and gears for maximum durability
- Durable corrosion resistant finish black powder coat finish
- Oversized hook for maximum durability
- Ergonomic clutch handle
- Patented roller disc brake
- Limited life time warranty for mechanical components. Limited 3 year warranty for electrical components
- Includes all components required for installation

2880596 | 3,500 Lb. Winch

SPORTSMAN ACE™

2880599 | 2,500 Lb. Winch

SPORTSMAN ACE™



## POLARIS® HD WINCHES **NEW**

- Fully integrated design – installs to vehicle in 10 minutes
- Fully sealed contactor, motor and drivetrain
- 6 gauge wiring maximizes current flow
- Cut metal gears for maximum durability
- Low speed gearing for optimized plow control
- Durable corrosion resistant finish
- 1 year warranty
- Upgrades available (synthetic rope, auto stop, wireless remote and plow rope)
- Includes all components required for installation

2879709 | 3,500 Lb. Winch

SPORTSMAN ACE™

2879708 | 2,500 Lb. Winch

SPORTSMAN ACE™



**POLARIS®**

ENGINEERED PARTS  
ACCESSORIES & APPAREL

# PULL YOUR WEIGHT.

GET YOUR JOB DONE WITH RUGGED WINCHES THAT ARE READY TO PULL.

## HEAVY-DUTY PULLING POWER FOR YOUR JOB

### DESIGNED FOR POLARIS® VEHICLES

- Integrated mounting locations for a perfect fit
- One number and one price for winch, remote, contactor, mount and wiring

### HIGHEST QUALITY MATERIALS

- Steel spools and cut metal gears for greater durability
- Fully-sealed contactor, motor and drive train keep water out
- Corrosion-resistant finish withstands the elements

### EXTENSIVE LAB AND FIELD TESTING

- Contactors, controls and winch assemblies tested 10,000+ cycles
- Rigorous performance testing in labs and in the field ensure your winch works when you need it most
- Strength testing ensures superior driveline strength



When your ride leads to extreme conditions, look to a Polaris® WARN® winch. These workhorse winches have proven their performance and durability around the globe with an unrivaled combination of premium components built for pulling heavy loads.



### HD HEAVY DUTY SERIES

The HD line delivers industry-leading quality and durability with best-in-class value — powered by quality features including sealed motors and contactors, a roller fairlead, wired remote control and proven pulling power.

FOR MORE INFORMATION ON WINCHES,  
SEE PAGES 20-21.



# WINCH INTEGRATION



## DESIGNED SPECIFICALLY FOR YOUR VEHICLE

A PRE-WIRED CHASSIS, INNOVATIVE MOUNTING TECHNOLOGY, AND INTEGRATED HANDLEBAR CONTROL SWITCH MAKE INSTALLING AND USING YOUR WINCH EASIER THAN EVER

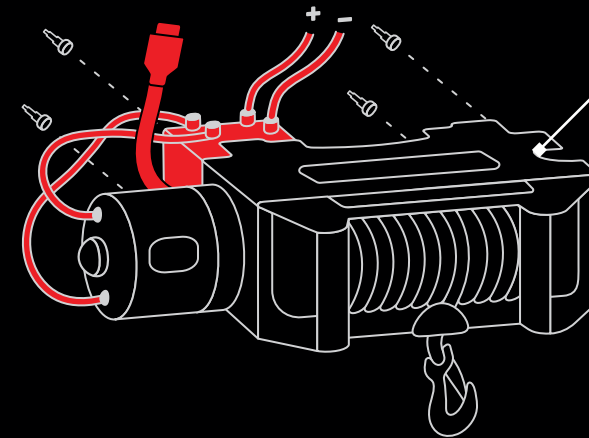

### QUALITY ENGINEERED WINCH

- Sportsman® winches are perfectly fit for your vehicle
- Pre-mounted contactor reduces installation time from hours to minutes
- Easy four bolt installation – Just match up the designated mounting points on the vehicle chassis with the winch mounting points and secure bolts

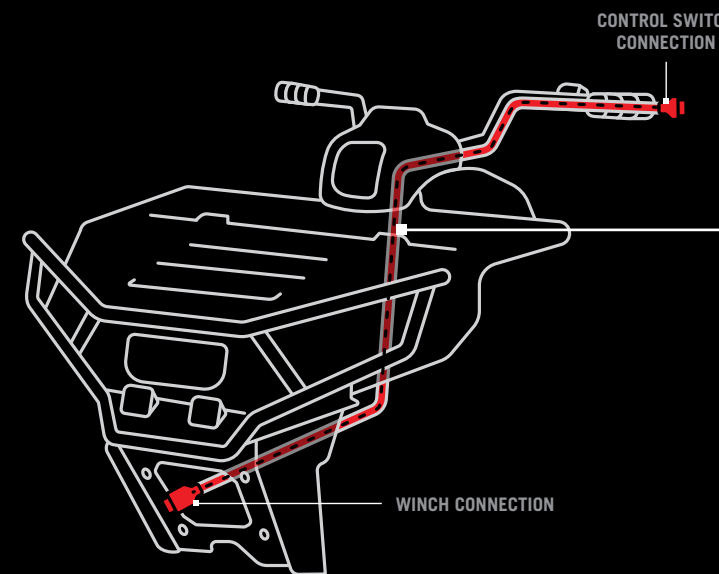

### PRE-WIRED CHASSIS

- Every 2015 Polaris Sportsman® model has a factory-installed wire built into the vehicle chassis, so your vehicle is 100% ready for a Polaris Engineered™ winch
- No plastic cutting or modification required
- Quick clip connection points for easy wire joining
- Simply connect power cables to battery for a power source

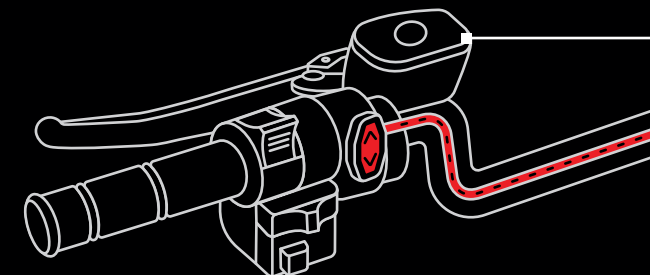

### IMPROVED HANDLEBAR CONTROL

- Handlebar switch fastens on with two screws and one quick clip wire connection
- Positioned for intuitive control while riding



# WINCHES



## WARN® PROVANTAGE 3500 LB. WINCH **NEW**

- WARN® PROVANTAGE winch optimized for Polaris® SPORTSMAN®
- 3500 lbs of pulling capacity
- Fully sealed contactor, motor and drivetrain
- 50' of 3/16" high strength aircraft quality steel cable
- Three-stage planetary gear train for smooth efficient operation
- All metal gear housing and gears for maximum durability
- 6 gauge wiring maximizes current flow
- Durable corrosion resistant finish
- Oversized hook for maximum durability
- Ergonomic clutch handle
- Patented roller disc brake
- Integrated handle bar mounted switch
- Limited life time warranty for mechanical components. Limited 3 year warranty for electrical components
- Includes all components required for installation

2880594

ALL MY 15 SPORTSMAN® VEHICLES

2880596\*

SPORTSMAN ACE™

\* Single corded remote control switch

AVAILABLE OCTOBER 2014



## WARN® PROVANTAGE 2500 LB. WINCH **NEW**

- WARN® PROVANTAGE winch optimized for Polaris® SPORTSMAN®
- 2500 lbs of pulling capacity
- Fully sealed contactor, motor & drivetrain
- 50' of 3/16" high strength aircraft quality steel cable
- Three-stage planetary gear train for smooth efficient operation
- All metal gear housing and gears for maximum durability
- Durable corrosion resistant finish black powder coat finish
- Oversized hook for maximum durability
- Ergonomic clutch handle
- Patented roller disc brake
- Integrated handle bar mounted switch
- Limited life time warranty for mechanical components. Limited 3 year warranty for electrical components
- Includes all components required for installation

2880595

ALL MY 15 SPORTSMAN® VEHICLES

2880599\*

SPORTSMAN ACE™

\* Single corded remote control switch

AVAILABLE OCTOBER 2014

**H-D** HEAVY DUTY SERIES

## 3500 LB. WINCH



### POLARIS® HD 3500 LB. WINCH **NEW**

- 3500 lbs of pulling capacity
- Fully integrated design – installs to vehicle in 10 minutes
- 3 step installation – bolt winch to the Sportsman®, connect to battery and plug in handlebar control switch
- Fully sealed contactor, motor and drivetrain
- 6 gauge wiring maximizes current flow
- 50' of 5mm premium high strength synthetic rope
- Cut metal gears for maximum durability
- Durable corrosion resistant finish
- Low speed gearing for optimized plow control
- Integrated handle bar mounted switch
- 1 year warranty
- Performance upgrades; auto stop, wireless remote and plow rope (sold separately)
- Includes all components required for installation

2880435

SPORTSMAN® XP 850/1000, SCRAMBLER® MY 13-15

2880434

SPORTSMAN® 570/570 SP, SPORTSMAN® ETX

2879709

SPORTSMAN ACE™

Requires more installation steps. No handlebar control switch.

4015094 | Retro-Fitting Winch Wire Harness

SPORTSMAN® 400/500/800/570/570 SP, SPORTSMAN® ETX, SPORTSMAN® XP 850/1000

Must be used with winches MY 10-14

LIMITED AVAILABILITY UNTIL SEPTEMBER 2014

**H-D** HEAVY DUTY SERIES

## 2500 LB. WINCH

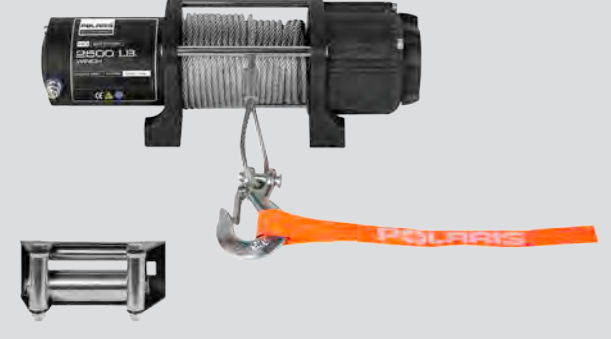

### POLARIS® HD 2500 LB. WINCH **NEW**

- 2500 lbs of pulling capacity
- Fully integrated design – installs to vehicle in 10 minutes
- 3 step installation – bolt winch to the Sportsman®, connect to battery and plug in handlebar control switch
- Fully sealed contactor, motor and drivetrain
- 6 gauge wiring maximizes current flow
- 50' of 3/16" high strength steel cable
- Cut metal gears for maximum durability
- Low speed gearing for optimized plow control
- Durable corrosion resistant finish
- Integrated handle bar mounted switch
- 1 year warranty
- Upgrades available (synthetic rope, auto stop, wireless remote and plow rope)
- Includes all components required for installation

2880433

SPORTSMAN® XP 850/1000, SCRAMBLER® MY 13-15

2880432

SPORTSMAN® 570/570 SP, SPORTSMAN® ETX

2879708

SPORTSMAN ACE™

Requires more installation steps. No handlebar control switch.

4015094 | Retro-Fitting Winch Wire Harness

SPORTSMAN® 400/500/800/570/570 SP, SPORTSMAN® ETX, SPORTSMAN® XP 850/1000

Must be used with winches MY 10-14

LIMITED AVAILABILITY UNTIL SEPTEMBER 2014



### POLARIS® PRO HD WINCH UPGRADE KIT

- Auto-Stop technology stops winch to eliminate stress on driveline components
- Winch stops when Auto-Stop Collar on rope contacts fairlead
- Auto-Stop prevents overlifting of plows, over-retrieving on pulls
- Corrosion-free, polished aluminum Hawse™ fairlead

2879149

POLARIS® HD 2500 AND 3500 LB. WINCHES

Requires use of synthetic rope (not included)

### WINCH ROPE

Polaris® winch ropes are designed to work with the Polaris® winch of the same rating. Always use the rope that is sized appropriately for your winch.

2878888

POLARIS® HD 2500 AND 3500 LB. WINCHES

### POLARIS® WIRELESS WINCH REMOTE

2877221

POLARIS® OR POLARIS® WARN® ATV WINCH KITS

### POLARIS® WINCH CONTACTOR

4015095

### POLARIS® WINCH ACCESSORY KIT

2876105

### SCRAMBLER® 850 AND 1000 WINCH WIRING KIT

2879919

SCRAMBLER® XP 850 MY 13-15, SCRAMBLER® XP 1000 MY 15

### 50 FT STEEL WINCH CABLE

2878890

POLARIS® HD 2500 AND 3500 LB. WINCHES



# PLOW INTEGRATION

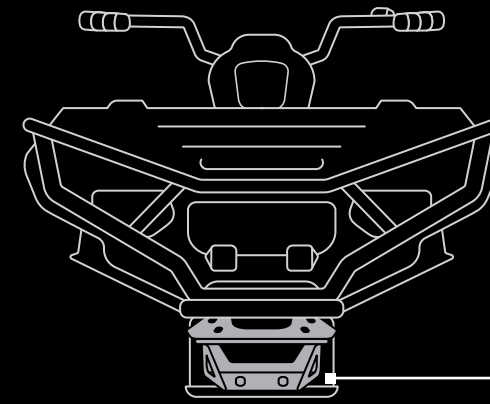

## SEAMLESS FIT

DRIVE UP, CLIP IN AND GO — THE INTEGRATED POLARIS ENGINEERED™ GLACIER® PRO PLOWING SYSTEM SIMPLIFIES ADDING OR REMOVING YOUR PLOW

2015 Sportsman® models come pre-mounted for your plow system, making installation and removal as simple as possible.

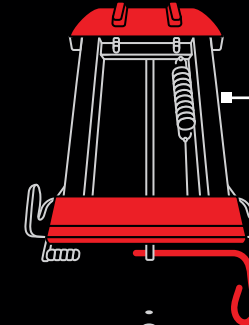

## DRIVE-UP FRAME ATTACHMENT

The auto-retracting kickstand on the redesigned frame attachment ensures your plow system is at the right height for drive-up installation and removal.

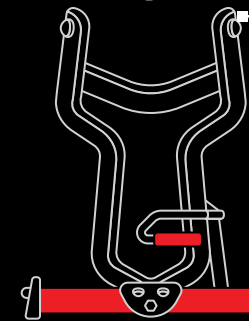

## ROBUST FRAME

A plow system is only as strong as its frame, and Polaris Engineered™ plow frames are as durable as it gets. Made to push across a broader expanse of the plow blade, Glacier® PRO plow frames ensure more efficient plowing and enhanced plow system reliability.

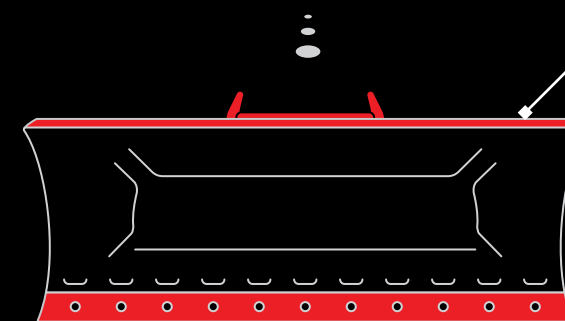

## BETTER BLADES

Available in strong steel or poly materials, Polaris Engineered™ plow blades cover 40% more surface area for quicker snow removal.

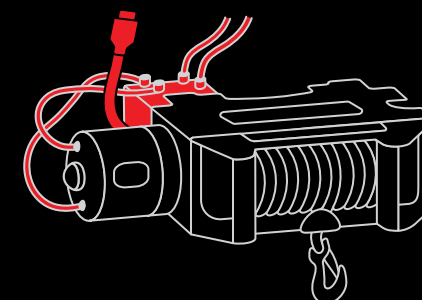

## WINCH CONTROL

Leverage your plow by adding a Polaris Engineered™ winch. You not only get greater blade lift and control, but also total integration with your vehicle.



# GLACIER® PRO ATV PLOW SYSTEMS

Push more snow faster and more efficiently with our taller plow blades, more effective push angle and more efficient transfer of your ATV pushing power to the blade.

- Plow installs in seconds with Polaris®-exclusive Lock & Ride® technology
- Innovative push-point geometry applies ATV's pushing power efficiently to the plow blade
- Taller 17" high blade — 40% more surface area for quicker snow removal
- Forward pivot point creates greater maximum-blade lift height: 18"
- Innovative shear-pin system protects plow and ATV from unexpected impacts
- Choose from poly or steel blades, each one taller than ever to push more snow
- Accessory Power Angle: Push-button control of blade angle from the seat

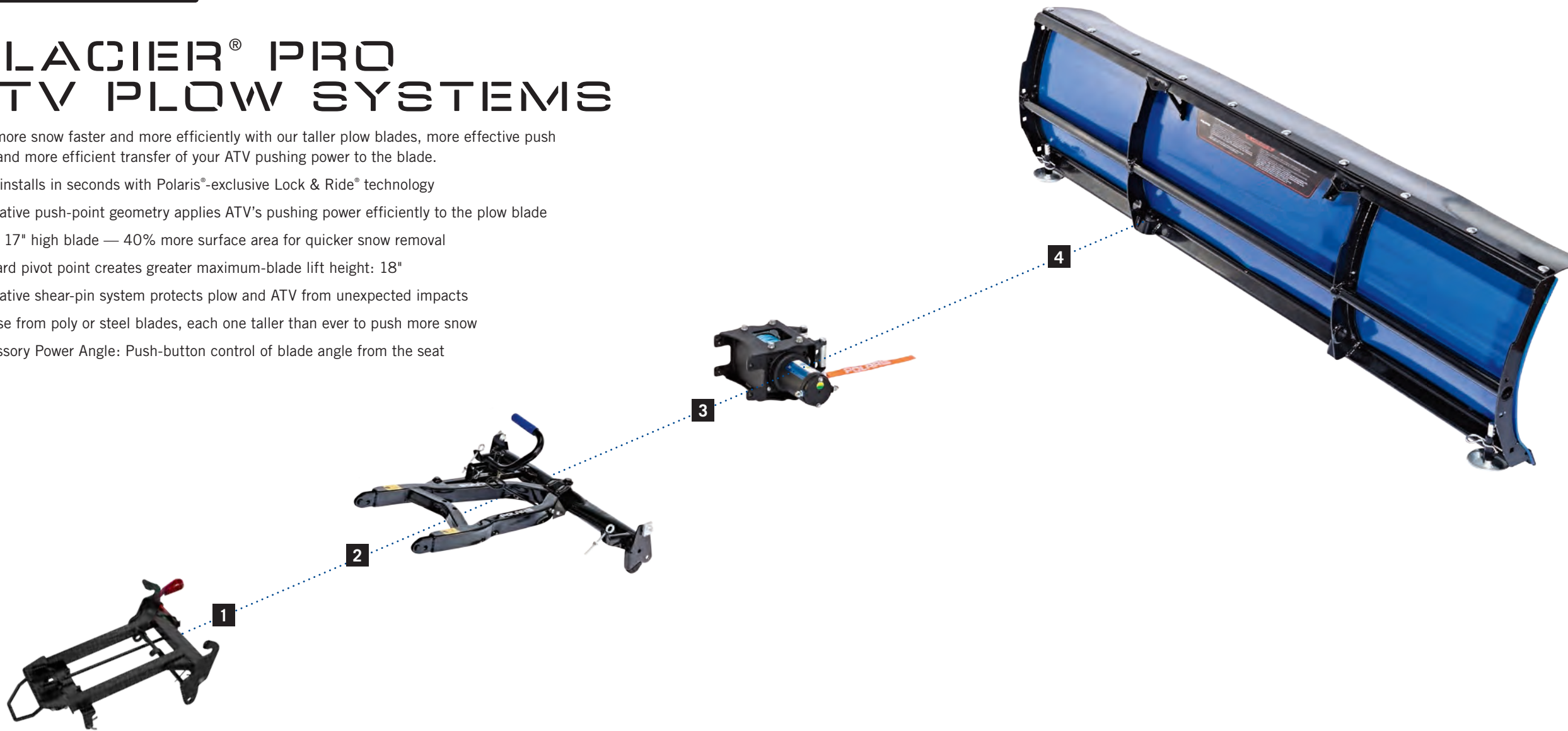

### PLOW BLADE SNOW DEFLECTOR

- Helps confine snow, boosting plow capacity
- Designed for easy on and off

2879866 | 66"

2871808 | 60"



### PLOW MARKER

- Helps driver monitor plow blade position
- Sold in pairs

2872726



### REAR TIRE CHAINS

- Size C, for 25" (63.5 cm) or 26" (66 cm) tires

2877952



### SPORTSMAN ACE™ PLOW ANGLE ADAPTOR KIT

- Allows the rider to control plow angle and blade height from inside the cab
- Kit includes shifter control handle and wiring

2880836

SPORTSMAN ACE™

Required to use Plow Angle Kit (2879635) on SPORTSMAN ACE™ models

## STEP 1: SELECT A FRAME ATTACHMENT

### INTEGRATED PLOW MOUNT FRAME ATTACHMENT

· Available September 2014

2880437 Sportsman® xp 850/1000 MY 15, Sportsman® Touring 850/1000 MY 15, Scrambler® My 15

2880436 MY 15 Sportsman® 570 sp, 570 and etx

### PLOW MOUNT FRAME ATTACHMENT

2879634

SPORTSMAN ACE™

### PLOW MOUNT FOR MY 14 AND OLDER VEHICLES

2879632

SPORTSMAN® XP 550/850 MY 09-14, SPORTSMAN® TOURING MY 09-14, SPORTSMAN® X2 550/850 MY 10-14, SCRAMBLER® MY 13-14

2879633

SPORTSMAN® 570 MY 14, SPORTSMAN® TOURING 570 MY 14, SPORTSMAN® 400, 500, 800 MY 11-14, SPORTSMAN® TOURING 500, 800 MY 08-13, SPORTSMAN® BIG BOSS® MY 11-13

## STEP 2: SELECT A FRAME

### PLOW FRAME

2879630

ALL GLACIER® PRO ATV PLOW MOUNTS AND FRAME ATTACHMENTS

### DOES YOUR VEHICLE HAVE TRACKS?



### GLACIER® PRO PLOW EXTENSION

2879719

ALL GLACIER® PRO ATV PLOW MOUNTS  
Plow Extension for use when using the Prospector Pro® Track System

## STEP 3: SELECT A LIFT

POLARIS® HD 3500 LB. WINCH  
POLARIS® HD 2500 LB. WINCH  
WARN® PROVANTAGE 3500 LB. WINCH  
WARN® PROVANTAGE 2500 LB. WINCH

See pages 20-21

### PLOW WINCH ROPE

- Replaces your winch rope or cable for plowing
- Stands up to repeated, sharp angled pulls used to lift plow blades
- 8' (243.8 cm) of .25" (.6 cm) braided rope

2878483

POLARIS® HD 2500 AND 3500 LB. WINCHES

## STEP 4: SELECT A BLADE

### 66" POLY BLADE

2879637

GLACIER® PRO ATV PLOW SYSTEM

### STEEL BLADE

2879638 | 60"

2879639 | 52"

GLACIER® PRO ATV PLOW SYSTEM

### PLOW ANGLE, ATV

2879635

GLACIER® PRO ATV PLOW SYSTEM

2880836 required for use on SPORTSMAN ACE™



PART #	SERVICE PARTS
2879867	66" Standard Wear Bar
2871806	60" Standard Wear Bar
2877210	52" Standard Wear Bar
2879868	66" Heavy-Duty Wear Bar
2873426	60" Heavy-Duty Wear Bar
2205063	Shear Pin Replacement
2205071	Quick Release Skid Shoes
2873423	Heavy-Duty Skid Shoes
2879872	Curb Finder
2872655	Coil Spring Spacer
2876463	Front Spring Pre-Load Adjusters



# PROSPECTOR PRO® TRACKS

Polaris® Prospector Pro® track systems are designed, engineered and built specifically for Polaris® ATVs such as the Sportsman® XP. These tracks offer the best in performance, reliability and durability in all four seasons with absolutely no compromise of vehicle cargo capacity or pulling power.

- Optimized rubber compounds made from a harder compound for better durability in 4-season applications
- NEW track design provides:
  - Improved durability in 4-season application
  - Enhanced control when turning and side hilling
- Longer and wider footprint with front dual stabilizer for better stability
- Polaris®-specific gearing provides 1:1 ratio to:
  - Minimize track slip, providing better climbing ability and improved traction in deep snow
  - Improve top speed by approximately 5%
  - Reduce operating RPM for a quieter ride
- Exclusive Polaris®-optimized hub geometry that minimizes feedback and eases steering effort
- Flexible lug design for the highest level of deep snow performance by lifting in deep snow as opposed to digging
- NEW Polaris®-exclusive composite frame to:
  - Improve ride quality
  - Reduce ice build-up
  - Reduce weight



## STEP 1: SELECT A MOUNT

### PROSPECTOR PRO® MOUNT

2879457  
SPORTSMAN 550/850/1000 MY 09-15, SPORTSMAN® TOURING 550/850/1000 MY 10-15, SPORTSMAN® X2 550/850 MY 10-14, SCRAMBLER® 850/1000 MY 13-14

2879497  
SPORTSMAN® 570 MY 14-15, SPORTSMAN® ETX MY 15, SPORTSMAN® 570 TOURING MY 14-15, SPORTSMAN® 570 X2 MY 15

2880072  
SPORTSMAN® X2 500/800 MY 08-14, SPORTSMAN® TOURING 500/800 MY 08-14

### SPORTSMAN ACE® MOUNT

2879751  
SPORTSMAN ACE™

## STEP 2: ADD TRACKS

### PROSPECTOR PRO® TRACKS

2879720  
SPORTSMAN® XP 550/850 MY 09-14, SPORTSMAN® TOURING 550/850 MY 09-14, SCRAMBLER® MY 13-14, SPORTSMAN® X2 550/850 MY 10-14

2880020  
SPORTSMAN® 570 MY 14, SPORTSMAN® 570 TOURING MY 14, SPORTSMAN® 500/600/700/800 MY 05-14, SPORTSMAN® TOURING 500/800 MY 08-14, SPORTSMAN® X2 500/800 MY 08-14, SPORTSMAN ACE™

### BIG BOSS® 6X6 TRACK KIT

2878421  
BIG BOSS® 6X6  
Does not fit Glacier® III or Glacier® II plows

### BIG BOSS® 6X6

Does not fit Glacier® III or Glacier® II plows



# SPORTSMAN<sup>®</sup> XP 1000 PACKAGES

MAKE YOUR MACHINE PERFORM AT ITS PEAK WITH PACKAGES FOR YOUR SPORTSMAN<sup>®</sup> XP 1000. POLARIS ENGINEERED ACCESSORY<sup>™</sup> PACKAGES SEAMLESSLY INTEGRATE AND PERFORM FLAWLESSLY TO OPTIMIZE YOUR MACHINE FOR THE ULTIMATE PERFORMANCE WHETHER HUNTING, WORKING OR TRAIL RIDING.

## TRAIL PACKAGE



## HUNT PACKAGE



## WORK PACKAGE





# SPORTSMAN® 570 / ETX PACKAGES

WANT MORE FROM YOUR MACHINE? THEN ADD MORE TO IT. POLARIS® TAKES THE GUESSWORK OUT OF GETTING THE JOB DONE WITH ACCESSORY PACKAGES FOR YOUR 570 / ETX. SO GET BUSY GETTING MORE OUT OF YOUR WORK, TRAIL OR HUNT TIME WITH PACKAGES BUILT FOR YOUR ATV.

## HUNT PACKAGE



## TRAIL PACKAGE

## WORK PACKAGE



# SPORTSMAN ACE™ PACKAGES

ADD MORE TO YOUR MACHINE WITH SPORTSMAN ACE™ ACCESSORY PACKAGES. DESIGNED TO OPTIMIZE COMFORT, PROTECTION, AND STORAGE, POLARIS ENGINEERED™ ACCESSORY PACKAGES TAKE THE GUESSWORK OUT OF GETTING THE JOB DONE.

## TRAIL COMFORT PACKAGE



## PROTECTION PACKAGE



## STORAGE PACKAGE





# BUMPERS & GUARDS

ADD THE PROTECTION OF A BUMPER OR BRUSHGUARD AND DO MORE – YOUR OPTIMIZED SPORTSMAN® WILL BE ABLE TO WITHSTAND ALMOST ANYTHING THE OFF ROAD WORLD CAN DISH OUT.



### SPORTSMAN® 570 / ETX FRONT BRUSHGUARD

- Distinctive off-road styling helps customize for Sportsman® 570
- Provide your Sportsman® 570 with additional protection from trail hazards
- Durable black powder-coating for long-lasting, scratch-resistant finish
- Integrated mounting location for easy installation
- Front brushguard is integrated with mounting locations for accessory lighting

2879714

SPORTSMAN® 570 MY 14-15, SPORTSMAN® 570 TOURING MY 14-15, SPORTSMAN® ETX



### SPORTSMAN® 570 / ETX REAR BRUSHGUARD

- Distinctive off-road styling helps customize Sportsman® 570
- Provide your Sportsman® 570 with additional protection from trail hazards
- Durable black powder-coating for long-lasting, scratch-resistant finish
- Material is steel
- Attach in designated, integrated mounting locations on the Sportsman® 570 frame
- Include rear ATV brushguard and mounting hardware

2879715

SPORTSMAN® 570 MY 14-15, SPORTSMAN® 570 TOURING MY 14-15, SPORTSMAN® ETX



### SPORTSMAN® XP FRONT BRUSHGUARD

- Integrated styling designed to enhance the look of your Sportsman® XP
- Provide your Sportsman® XP with additional protection from trail hazards
- Durable black wrinkle powder-coating for long-lasting, scratch-resistant finish
- Integrated mounting location for easy installation
- Front brushguard is integrated with mounting locations for accessory lighting

2878709

SPORTSMAN® XP 550/850 MY 09-15, SPORTSMAN® TOURING 550/850 MY 10-15, SPORTSMAN® X2 550/850, SPORTSMAN® XP 1000, SPORTSMAN® XP 1000 TOURING



### SPORTSMAN® XP REAR BRUSHGUARD

- Integrated styling designed to enhance the look of your Sportsman® XP
- Provide your Sportsman® XP with additional protection from trail hazards
- Durable black wrinkle powder-coating for long-lasting, scratch-resistant finish
- Material is steel
- Attach in designated, integrated mounting locations
- Includes rear brushguard and mounting hardware

2878710

SPORTSMAN® XP 550/850 MY 09-15, SPORTSMAN® XP 1000



### SPORTSMAN® 570 / ETX FRONT A-ARM GUARDS **NEW**

- Lightweight, durable guards provide reliable A-Arm protection
- HMW polyethylene construction delivers strength and low coefficient of friction so guards slide freely over rocks
- Molded construction and ribbing for optimized strength and rigidity
- Guards absorb impacts and retain their shape rather than bending as metal guards can
- Engineered with integrated drain channels to evacuate water and mud
- Easy to install in place of stock guards

2879889

SPORTSMAN® 570 MY 14-15, SPORTSMAN® ETX, SPORTSMAN® 570 TOURING, SPORTSMAN® 570 X2



### SPORTSMAN® 570 / ETX REAR A-ARM GUARDS **NEW**

- Lightweight, durable guards provide reliable A-Arm protection
- HMW polyethylene construction delivers strength and low coefficient of friction so guards slide freely over rocks
- Molded construction and ribbing for optimized strength and rigidity
- Guards absorb impacts and retain their shape rather than bending as metal guards can
- Engineered with integrated drain channels to evacuate water and mud
- Easy to install in place of stock guards

2880679

SPORTSMAN® 570 MY 14-15, SPORTSMAN® ETX, SPORTSMAN® 570 TOURING, SPORTSMAN® 570 X2



# BUMPERS & GUARDS



## SPORTSMAN® XP FRONT A-ARM GUARDS **NEW**

- Lightweight, durable guards provide reliable A-Arm protection
- HMW polyethylene construction delivers strength and low coefficient of friction so guards slide freely over rocks
- Molded construction and ribbing for optimized strength and rigidity
- Guards absorb impacts and retain their shape rather than bending as metal guards can
- Engineered with integrated drain channels to evacuate water and mud
- Easy to install in place of stock guards

2880644

SPORTSMAN® 550/850 MY 10-15, SPORTSMAN® XP 1000

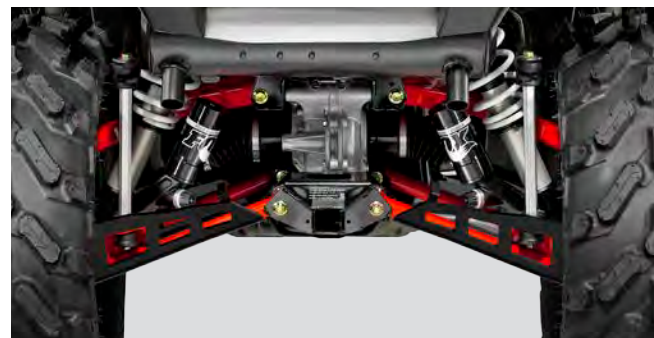

## SPORTSMAN® XP REAR A-ARM GUARDS **NEW**

- Lightweight, durable guards provide reliable A-Arm protection
- HMW polyethylene construction delivers strength and low coefficient of friction so guards slide freely over rocks
- Molded construction and ribbing for optimized strength and rigidity
- Guards absorb impacts and retain their shape rather than bending as metal guards can
- Engineered with integrated drain channels to evacuate water and mud
- Easy to install in place of stock guards

2880678

SPORTSMAN® 550/850 MY 10-15, SPORTSMAN® XP 1000



## FRONT BRUSHGUARD

- Provide your Sportsman® with additional protection from trail hazards
- Distinctive off-road styling helps you customize your ride
- Durable black wrinkle powder-coating for long-lasting, scratch-resistant finish
- Front bumpers have integrated mounting locations for accessory lighting
- Integrated mounting locations for easy installation
- Compatible with all Polaris® plow systems and winches

2878669

SPORTSMAN® 400/500/800 MY 11-14, SPORTSMAN® TOURING 500/800 MY 11-14, SPORTSMAN® BIG BOSS® MY 11-14



## REAR BRUSHGUARD

- A great addition in both form and function
- Tough 2" (5.1 cm) diameter tubing

2878046

SPORTSMAN® 500/600/700/800 MY 05-14, SPORTSMAN® 400 MY 11-14



## SPORTSMAN® TOURING REAR BRUSHGUARD

- Designed specifically for the Sportsman® Touring
- Adds heavy-duty rear protection and a custom look

2878324

SPORTSMAN® TOURING 550/850 MY 10-15, SPORTSMAN® XP 1000, SPORTSMAN® XP TOURING 1000



## FENDER FLARE KIT

- Provides an additional 3" of coverage for extra protection from mud and water
- Ideal for ATVs running accessory wheels with wider offsets
- Provides a custom look to your Sportsman® XP

2878687

SPORTSMAN® XP 550/850 MY 09-15, SPORTSMAN® XP 1000



## DELUXE FRONT BRUSHGUARD

- Adds protection for the grill and headlights
- Creates a custom look that sets your Sportsman® apart
- Integrates with any winch or plow system

2876102-418

SPORTSMAN® 500/600/700/800 MY 05-10, SPORTSMAN® X2 500/800 MY 05-10, SPORTSMAN® TOURING 500/800 MY 05-10, SPORTSMAN® 6X6 MY 09-10



## DELUXE REAR BRUSHGUARD

- Provide your Sportsman® with additional protection from trail hazards
- Distinctive off-road styling helps you customize your ride
- Durable black wrinkle powder-coating for long-lasting, scratch-resistant finish
- Integrated mounting locations for easy installation

2878670

SPORTSMAN® 400/500/800 MY 11-14



## BODY GUARD

- Provides outstanding protection for front and rear fenders
- Strong and durable 16-gauge, 1.5" (3.8 cm) tube construction

2878341

SPORTSMAN® XP 550/850 MY 09-15, SPORTSMAN® XP 1000

Does not fit with Sportsman® XP Fender Flare Kit 2878687



## SPORTSMAN® XP EXTREME REAR BRUSHGUARD

- Provides your Sportsman® with additional protection from trail hazards
- Distinctive off-road styling helps you customize your ride
- Durable black wrinkle powder-coating for long-lasting, scratch-resistant finish
- Integrated mounting locations for easy installation

2876607 | Black Wrinkle

SPORTSMAN® XP 550/850 MY 09-13



## SPORTSMAN® X2® REAR BUMPER

- Designed specifically for the Sportsman® X2
- Adds style and rear protection

2877686

SPORTSMAN® 500, 800 X2 MY 06-14



## HANDGUARDS

2876883 | White

2876846 | Black

2876845 | Red

FITS ALL SPORTSMAN® MODELS

Requires 2879380

## HANDGUARD MOUNT (NOT SHOWN)

2879380

FITS ALL SPORTSMAN® MODELS



# TIRES & WHEELS

## STEP 1: CHOOSE YOUR TIRE

CHOOSE THE BEST TIRE FOR THE WAY YOU RIDE

- TRAIL**
  - Tread patterns optimized for extreme traction
  - Side walls tested for supreme durability
  - Ideal for both hard pack and loose trail
- ROCK**
  - Flexible "grippy" tread
  - Aggressive side bite
- DESERT**
  - Provides traction and durability
  - Built to perform in sand, jagged rocks or any other extreme terrain
- SNOW**
  - Handles extreme cold
  - Holds shape and provide traction
- UTILITY**
  - Industry leading anti-puncture side walls
  - Aggressive long lasting tread
- MUD**
  - Extra deep treads
  - Full wall side bite

## STEP 2: CHOOSE YOUR WHEEL



<b>THRASHER™ 14" LUSTER WHEEL</b> 1522241-410   14" X 6" FRONT 1522242-410   14" X 8" REAR SPORTSMAN™ XP MY 09-14, SPORTSMAN™ TOURING, SPORTSMAN™ XP MY 10-14, SPORTSMAN™ X2 550/850 MY 10-14, SCRAMBLER XP MY 13-14	<b>THRASHER™ 14" FLAT BLACK</b> 1522241-458   14" X 6" FRONT 1522242-458   14" X 8" REAR SPORTSMAN™ XP MY 09-14, SPORTSMAN™ TOURING, SPORTSMAN™ XP MY 10-14, SPORTSMAN™ X2 550/850 MY 10-14, SCRAMBLER XP MY 13-14	<b>REBLR™ 14" FLAT BLACK BEADLOCK WHEEL*</b> 1522238-458   14" X 7" FRONT 1522239-458   14" X 8" REAR SPORTSMAN™ MY 05-14	<b>VADER™ 14" LUSTER WHEEL</b> 1521992-410   14" X 7" FRONT 1521993-410   14" X 8" REAR SPORTSMAN™ MY 05-14	<b>VADER™ 14" FLAT BLACK WHEEL</b> 1521992-521   14" X 7" FRONT 1521993-521   14" X 8" REAR SPORTSMAN™ MY 05-14	<b>WREC™ 14" LUSTER WHEEL</b> 1521994-410   14" X 7" FRONT 1521995-410   14" X 8" REAR SPORTSMAN™ MY 05-14	<b>WREC™ 14" FLAT BLACK WHEEL</b> 1521994-521   14" X 7" FRONT 1521995-521   14" X 8" REAR SPORTSMAN™ MY 05-14	<b>SIXR™ 14" LUSTER WHEEL</b> 1521507-410   14" X 7" FRONT 1521508-410   14" X 8" REAR SPORTSMAN™ MY 05-14	<b>SIXR™ 14" FLAT BLACK WHEEL</b> 1521507-521   14" X 7" FRONT 1521508-521   14" X 8" REAR SPORTSMAN™ MY 05-14	<b>SIXR™ 14" MACHINED WHEEL</b> 1521507-266   14" X 7" FRONT 1521508-266   14" X 8" REAR SPORTSMAN™ MY 05-14
---	---	--	--	--	---	---	---	---	---

## STEP 3: ADD YOUR LUG NUTS



### METRIC LUG NUTS FOR ALUMINUM WHEELS

- 2877385 | Set of 4
- 2877384 | Set of 16
- SPORTSMAN™ XP 550/850 MY 09-14, SPORTSMAN™ TOURING 550/850 MY 09-14, SPORTSMAN™ X2 550/850 MY 10-14, SCRAMBLER XP 850 MY 13-14

### SAE® LUG NUTS FOR ALUMINUM WHEELS

- 2876754 | Set of 4
- 2877409 | Set of 16
- SPORTSMAN™ MY 05-14

## STEP 4: ADD YOUR RINGS

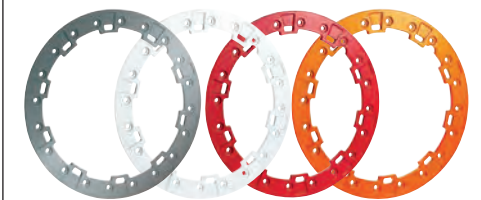

### 14" FORGE BILLET RINGS

- 1522244-266 | Machined **NEW**
- 1522244-133 | White
- 1522244-293 | Indy Red
- 1522244-589 | Orange Crush
- 14" beadlock wheels only

## REPLACEMENT CAPS



### CENTER CAPS

- 1522243-437 | Luster
- 1522243-458 | Flat Black
- Only fit THRASHER™ wheels
- 1521509-410 | Luster
- 1521509-521 | Flat Black
- Fit all wheels except THRASHER™

**MOTO ATTACK 14" TIRES**  
This 8-ply 14" Moto Attack Tire features advanced radial construction, aggressive deep-tread and side-bite traction to provide a Polaris® ATV, RZR® or RANGER™ rider or racer with outstanding traction, handling and long-lasting durability. These tires are ready to race, haul and roll with great handling in deep mud trenches, gravel, hard- or soft-pack trails and sand.

5414980 | 26" X 9" FRONT  
5414981 | 26" X 11" REAR

2880037	2880033	2880024	2880084	2880085	2880086	2880087	2880090	2880088	2880089
---------	---------	---------	---------	---------	---------	---------	---------	---------	---------

**SEDONA® RIPS AW 14" TIRES**  
With its aggressive, 1 1/2" deep treads, this 6-ply radial tire delivers outstanding performance on extreme terrain. Traction is excellent in deep ruts and in mud.

5413344 | 26" X 9" FRONT  
5413345 | 26" X 11" REAR

2880038	2880034	2880025	2879292	2879296	2879300	2879304	2878882	2878884	2878886
---------	---------	---------	---------	---------	---------	---------	---------	---------	---------

**MAXXIS® BIGHORN® 14" TIRES**  
The tread pattern and wide footprint give this 6-ply radial outstanding traction, and its shoulder lugs help protect the sidewalls.

2876905 | 26" X 9" FRONT  
2876906 | 26" X 11" REAR

2880039	2880035	2880026	2879294	2879298	2879302	2879306	2878434	2878030	2878032
---------	---------	---------	---------	---------	---------	---------	---------	---------	---------

**MOTO MUD 14" TIRES**  
With 1.5" deep lugs and side paddles all the way to the wheel, the 27" MOTO MUD will power your Polaris® ATV, Ranger® or RZR™ through the muddiest conditions out there. Built using 8-ply-rated Armor Belt™ construction these tires will churn through anything with authority. Bring a tow strap so your friends don't get left behind.

5415249 | 27" X 9" X 14" FRONT  
5415368 | 27" X 11" X 14" REAR

2880692	2880691	2880693	2880694	2880695	2880696	2880697	2880698	2880699	2880700
---------	---------	---------	---------	---------	---------	---------	---------	---------	---------

**ITP® BAJA CROSS 14" TIRES**  
8-ply, extended-life rubber compound and innovative overlapping tread pattern provide a smooth, predictable ride and slow-wear characteristics.

5414127 | 26" X 10" FRONT  
5414120 | 26" X 11" REAR

2880040	2880036	2880027	2879295	2879299	2879303	2879307	2878432	2878435	2878437
---------	---------	---------	---------	---------	---------	---------	---------	---------	---------

\* Requires 14" Forged Billet Rings 1522244-133, 1522244-293 or 1522244-589



# WINDSHIELDS

OUTFIT YOUR ATV FOR MORE VISIBILITY. ANY CUSTOM WINDSHIELD WILL FIT SEAMLESSLY ON YOUR SPORTSMAN AND INSTALL IN A MATTER OF SECONDS THANKS TO POLARIS®-EXCLUSIVE LOCK & RIDE® TECHNOLOGY.



**LOCK & RIDE**

### LOCK & RIDE® ACCESSORY BAR MOUNT

- Attaches to the windshield and has a 1" (2.4 cm) tube for a near-endless array of accessory mounting options

2878403

ALL SPORTSMAN® MODELS

### WINDSHIELD AMPS MOUNT

- Portable devices such as a GPS or PDA can be attached or removed in seconds using Lock & Ride®

- Requires Lock & Ride® Accessory Bar Mount 2878403 (sold separately)

2878404

ALL SPORTSMAN® MODELS

### CUP HOLDER

- Conveniently holds a cup, can or thermal mug on the inside of the windshield

- Requires Lock & Ride® Accessory Bar Mount 2878403 (sold separately)

2878402

ALL SPORTSMAN® MODELS

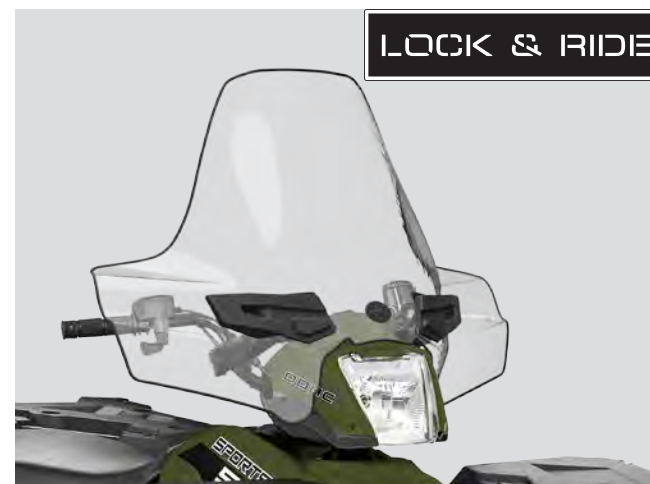

**LOCK & RIDE**

Tall 19.25" (48.9 cm) Clear

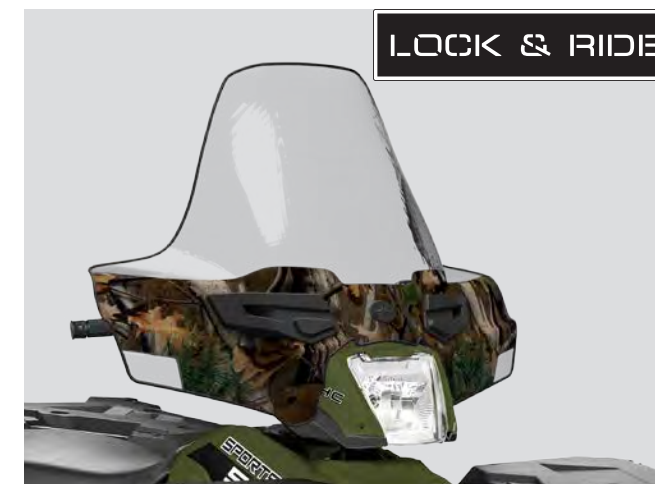

**LOCK & RIDE**

Tall 19.25" (48.9 cm) Polaris Pursuit® Camo



**LOCK & RIDE**

Mid 15.5" (39.4 cm) Black

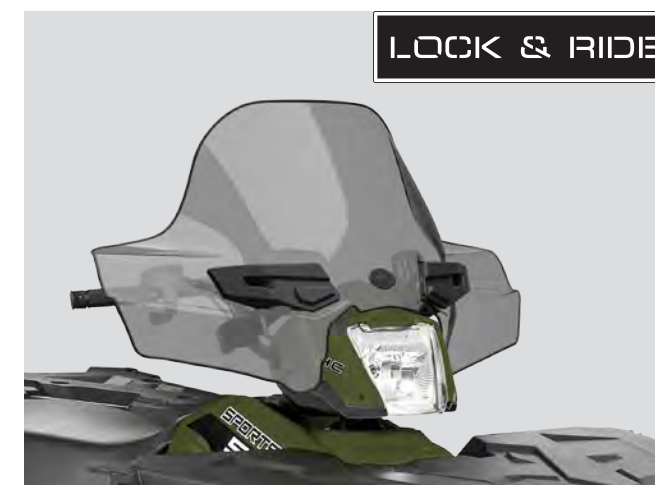

**LOCK & RIDE**

Mid 15.5" (39.4 cm) Smoke



**LOCK & RIDE**

Low 9.5" (24.1 cm) Black

### LOCK & RIDE® SPORTSMAN® XP AND SP WINDSHIELDS

2880539-409 | Tall 19.25" (48.9 cm) Clear

2880539-587 | Tall 19.25" (48.9 cm) Polaris Pursuit® Camo

2880540-070 | Mid 15.5" (39.4 cm) Black

2880540-412 | Mid 15.5" (39.4 cm) Smoke

2880541-070 | Low 9.5" (24.1 cm) Black

SPORTSMAN® 570 SP, SPORTSMAN® XP 850/1000

### LOCK & RIDE® SPORTSMAN® WINDSHIELDS

2878389-587 | Tall 19.25" (48.9 cm) Polaris Pursuit® Camo

2878389 | Tall 19.25" (48.9 cm) Clear

2878388-070 | Mid 15.5" (39.4 cm) Black

2878388 | Mid 15.5" (39.4 cm) Smoke

2878387 | Low 9.5" (24.1 cm) Black

SPORTSMAN® 400/500/800 MY 05-15, SPORTSMAN® 6X6 MY 09-15, SPORTSMAN® X2 MY 10-15,

SPORTSMAN® TOURING 500/800 MY 08-15, SPORTSMAN® 570 MY 14-15, SPORTSMAN® 570 TOURING MY 14-15

Does not fit Sportsman® 570 SP



# RACKS

GET MORE OUT OF YOUR RIDE WITH BOLT-ON VERSATILITY. RACK EXTENDERS PUT A SECURE BARRIER AROUND YOUR CARGO AND PROVIDE COUNTLESS TIE-DOWN POINTS FOR BUNGIES, STRAPS, NETS OR WHATEVER ELSE YOU USE TO HOLD DOWN YOUR GEAR.



## SPORTSMAN® 570 RACK EXTENDERS

- Material is steel
- Attach in designated, integrated mounting locations on the Sportsman® 570 front/back cargo rack
- Includes ATV Front Rack Extender and mounting hardware
- Durable, flat black powder-coated finish

### A. FRONT RACK EXTENDER

2879716  
SPORTSMAN® 570 MY 14-15, SPORTSMAN® 570 TOURING MY 14-15, SPORTSMAN® ETX

### B. REAR RACK EXTENDER

2879717  
SPORTSMAN® 570 MY 14-15, SPORTSMAN® 570 TOURING MY 14-15, SPORTSMAN® ETX



## SPORTSMAN® XP RACK EXTENDERS

- Durable, black wrinkle powder-coated finish
- 4.5" (11.4 cm) tall to provide additional cargo hauling support
- Tough, rugged tubular steel construction
- Multiple integrated tie-down points to secure cargo
- Integrates with Polaris® Lock & Ride® Cargo Boxes and Gun Boots

### C. FRONT RACK EXTENDER

2879890  
SPORTSMAN® XP 550/850/1000 MY 09-15, SPORTSMAN® TOURING 550/850/1000 MY 09-15, SPORTSMAN® X2 550/850 MY 10-15  
DOES NOT FIT VEHICLES WITH FRONT CARGO BOX (2877951)

### D. REAR RACK EXTENDER

2879891  
SPORTSMAN® XP 550/850/1000 MY 09-15



## SPORTSMAN® XP COMPOSITE RACK EXTENDERS

- 4.5" (11.4 cm) tall to provide additional cargo hauling support
- Tough, rugged, glass-filled nylon construction
- Multiple integrated tie-down points to secure cargo
- Integrate with Polaris® Lock & Ride® Rear Cargo Boxes and Gun Boots

### E. FRONT RACK EXTENDER

2876598  
SPORTSMAN® XP 550/850 MY 09-15, SPORTSMAN® X2 550/850 MY 10-14  
Does not fit models with front cargo box installed  
Fits models with flat rack only

### F. REAR RACK EXTENDER

2876599  
SPORTSMAN® XP 550/850/1000 MY 09-15



## TOURING REAR RACK EXTENDER

- Designed specifically for the Sportsman® Touring
- Adds extra tie-down points for cargo
- Works with Gun Boot Mount

2876486-418  
SPORTSMAN® TOURING 500/800 MY 08-14  
2878385  
SPORTSMAN® TOURING 550/850 MY 10-14



## SPORTSMAN® RACK EXTENDERS

- Strong tubular construction provides rigid protection and a secure place to attach tie-down straps or cargo nets
- Install easily onto the front cargo rack
- Black finish coordinates with cargo rack and overall styling of the Sportsman® for an integrated look
- Work with Sportsman® Cargo Box and Gun Boot Mount

### G. FRONT RACK EXTENDER

2878671  
SPORTSMAN® 400/500/800 MY 11-14, SPORTSMAN® BIG BOSS® MY 11-14, SPORTSMAN® TOURING 500 MY 11-14

### H. REAR RACK EXTENDER

2878672  
SPORTSMAN® 500/800 MY 11-14



## SPORTSMAN® RACK EXTENDERS

- Perfect for securing gear bags while you ride
- Made of powder-coated steel, 4.5" (11.4 cm) tall
- Work with Sportsman® Cargo Box and Gun Boot Mount

### J. FRONT RACK EXTENDER

2878044  
SPORTSMAN® MY 05-10

### K. REAR RACK EXTENDER

2878045  
SPORTSMAN® MY 05-10



# STORAGE

MAKE SURE YOUR GEAR RIDES AS SAFELY AS YOU DO. WITH LOCK & RIDE<sup>®</sup> TECHNOLOGY, YOU CAN HAVE MORE STORAGE FOR YOUR SPORTSMAN<sup>®</sup> IN 10 SECONDS.



LOCK & RIDE



### OG10<sup>®</sup> SEMI-RIGID REAR BAG

- Exclusive Polaris<sup>®</sup> lid-mount dust gasket
- Internal storage compartments
- Two easy-fastening snap buckles
- Material is durable high-denier polyester fabric
- Lock & Ride<sup>®</sup> mounting atop the rear cargo rack
- Includes mounting hardware

2879911 | Polaris Pursuit<sup>®</sup> Camo  
SPORTSMAN<sup>®</sup> 400/550/550 X2/570/800, SPORTSMAN<sup>®</sup> XP 550/850/1000 MY 09-15,  
SPORTSMAN<sup>®</sup> 400/600/700/800 MY 05-13



LOCK & RIDE



### OG10<sup>®</sup> SEMI-RIGID REAR BAG

- Exclusive Polaris<sup>®</sup> lid-mount dust gasket
- Internal storage compartments
- Two easy-fastening snap buckles
- Material is durable high-denier polyester fabric
- Lock & Ride<sup>®</sup> mounting atop the rear cargo rack
- Includes mounting hardware

2879256 | Black  
SPORTSMAN<sup>®</sup> 400/550/550 X2/570/800, SPORTSMAN<sup>®</sup> XP 550/850/1000 MY 09-15,  
SPORTSMAN<sup>®</sup> 400/600/700/800 MY 05-13



LOCK & RIDE



### LOCK & RIDE<sup>®</sup> FRONT CARGO BOX

- Lock & Ride<sup>®</sup>: Installs or removes quickly and easily without tools
- Keeps your gear dry, secure and protected
- Replaces stock rack, adds convenient storage location
- Durable injection-molded construction
- Styled to match the Sportsman<sup>®</sup> XP

2877951  
SPORTSMAN<sup>®</sup> XP 550/850/1000 MY 09-15, SPORTSMAN<sup>®</sup> X2 550/850/1000 MY 10-15  
Does not fit with Front Rack Extender 2879890

LOCK & RIDE



### LOCK & RIDE<sup>®</sup> REAR CARGO BOX

- Lock & Ride<sup>®</sup>: Installs or removes quickly and easily without tools
- Keeps your gear dry and safe with full gasket design
- Large storage capacity; space for 2 full-faced helmets plus gear
- Lockable for additional security

2876601  
SPORTSMAN<sup>®</sup> XP 550/850/1000 MY 09-15

### LOCK & RIDE<sup>®</sup> CARGO BOX BACKREST

- Provides extra back support and comfort on your Sportsman<sup>®</sup> XP
- Attaches to Lock & Ride<sup>®</sup> Rear Cargo Box 2876601

2877943  
FITS ALL SPORTSMAN<sup>®</sup> XP MODELS  
Intended for operator use only





# STORAGE



LOCK & RIDE

### LOCK & RIDE® 1-UP TOURING REAR CARGO BOX

- Lock & Ride® technology for easy on and off
- The ideal storage box when riding solo on your Sportsman® Touring

2877957

SPORTSMAN® TOURING 500/800 MY 08-14, SPORTSMAN® TOURING 550/850 MY 10-14

Does not work with Touring Rear Rack Extender 2878385 or Lock & Ride® Touring Rear Cargo Box 2878154

### 1-UP TOURING CARGO BOX BACKREST

- Adds back support and extra comfort when riding solo

2877219

SPORTSMAN® TOURING 500/800 MY 08-14, SPORTSMAN® TOURING 550/850 MY 10-14

ATTACHES TO LOCK & RIDE® 1-UP SPORTSMAN® TOURING REAR CARGO BOX 2877957



LOCK & RIDE

### LOCK & RIDE® REAR CARGO BOX

- Lock & Ride® technology for easy on and off
- Large capacity, with locking latches and lid gaskets
- Molded handles for easy transport
- Works with Rack Extender, Gun Boot, Cargo Pocket Bags

2875176

SPORTSMAN® 500/600/700/800 MY 05-14, SPORTSMAN® 450 MY 06-07, SPORTSMAN® 570 MY 14

### LOCK & RIDE® REAR CARGO BOX BACKREST

- Provides extra back support and comfort on your Sportsman®
- Attaches to Lock & Ride® Rear Cargo Box

2876367

FITS SPORTSMAN® LOCK & RIDE® REAR CARGO BOX (2875176)

Intended for operator use only



LOCK & RIDE

### LOCK & RIDE® BACKREST

- Fits with Lock & Ride® Gun Boot Mount and Rack Extenders
- Adds back support and riding comfort
- Locks in place in seconds
- Fully adjustable for all-day comfort
- Fits with Lock & Ride® Gun Boot Mount and Rack Extenders

2876616

SPORTSMAN® XP MY 09-14, SPORTSMAN® 850/1000

Does not fit with Lock & Ride® Cargo Box 2876601 installed

2879887

SPORTSMAN® 570 MY 14, 570 SP, ETX

2878513

SPORTSMAN® 500/800 MY 11-14

Does not fit with Lock & Ride® Cargo Box 2876601 installed



LOCK & RIDE

### LOCK & RIDE® FRONT CARGO BOX

- Installs in seconds with Lock & Ride® technology
- Provides a covered, protected cargo space
- Latches down securely to keep cargo safe from rough weather, dirt and dust
- Additional cargo can be strapped onto the top surface of the Cargo Box with multiple tie-down points

2878235

SPORTSMAN® 400/500/800 MY 11



LOCK & RIDE

### LOCK & RIDE® REAR STORAGE BOXES

- Lock & Ride® for easy on and off
- Made of heavy-duty polyethylene
- 1,400 cu. in. (3,556 cu. cm) of storage volume
- Sealed for extra protection from moisture
- Sold in pairs

2878000

SPORTSMAN® TOURING 550/850 MY 11-14, SPORTSMAN® 570 TOURING MY 11-14

Slight interference with Sportsman® Touring 550/850 MY 11-14 passenger handles



### SEMI-RIGID TOURING CARGO BAG

- Large-capacity, heavy-duty vinyl bag
- 3 zippered openings, removable dividers
- Attaches to rack with Velcro® straps

2877220

SPORTSMAN® TOURING 500/800 MY 08-10, SPORTSMAN® 570 TOURING MY 14



### POCKET BAG

- Provides easy access to water, maps, small items
- Straps to cargo box or bag with Velcro® attachment loops
- Works with Sportsman® and Sportsman® XP Lock & Ride® Rear Cargo Boxes
- Sold individually

2875372-070 | Black

Requires Velcro® Attachment Loops 2875339



### VELCRO® ATTACHMENT LOOPS

2875339



### FRONT CARGO BAG

- Provides convenient storage for small tools and gear
- Heavy-duty polyester construction
- Includes handle for easy transport

2876602

SPORTSMAN® XP MY 09-14, SPORTSMAN® X2 550/850 MY 10-14





# STORAGE



## POD BAG

- Provides easy access to items
- Features a convenient map pouch for easy viewing

2876605

SPORTSMAN® XP 550/850 MY 09-14, SPORTSMAN® TOURING 550/850 MY 10-14, SPORTSMAN® X2 550/850 MY 10-14



## FRONT POUCH BAG

- Fits under Sportsman® XP front rack
- Stores tools and spare plugs
- Water-resistant fabric and zippers

2876615

SPORTSMAN® XP 550/850 MY 09-14



## FENDER BAG

- Perfect place to store gear and snacks
- Easy to access while seated
- Pockets hold water bottles

2876604

FITS ALL SPORTSMAN® MODELS



## LOCK & RIDE

## LOCK & RIDE® REAR CARGO BOX

- Lock & Ride® system for easy on/off
- Fits in either side of rear box
- Heavy-duty double-wall lid with molded hinges for easy open/close
- Sold individually

2877921

SPORTSMAN® X2 MY 07-14



**POLARIS®**

ENGINEERED PARTS  
ACCESSORIES & APPAREL

# HUNTING

WITH POLARIS ENGINEERED ACCESSORIES,™ YOU CAN TURN YOUR ATV INTO THE ULTIMATE HUNTING MACHINE. OUR HUNTING ACCESSORIES ARE PURPOSEFULLY BUILT TO MEET THE NEEDS OF YOUR GUNS, GEAR AND ANYTHING ELSE YOU TAKE INTO THE WOODS.



## GUN BOOTS

- Designed to attach to Polaris® Sportsman®
- Features padded interior, dustproof, water-resistant
- Accommodates shotguns, right-hand bolt-action rifles

2872677 | Black

2872677-419 | Mossy Oak®  
ALL POLARIS® GUN BOOT MOUNTS

## LOCK & RIDE

### LOCK & RIDE® GUN BOOT MOUNTS (NOT SHOWN)

- Lock & Ride® system mounts on right
- High-impact case secures firearm over any terrain
- Work with Cargo Box, Cargo Bag, Cargo Extenders

2878337

SPORTSMAN® 400/500/800 MY 11-14

2876920

SPORTSMAN® 500/600/700/800 MY 05-10

2877381

SPORTSMAN® XP 550/850 MY 09-14

2878001

SPORTSMAN® TOURING 550/850 MY 10-14

2876493

SPORTSMAN® TOURING 500/800 MY 08-14

2875783

SPORTSMAN® X2 500/550/800/850

2879888

SPORTSMAN® 570 MY 14-15, SPORTSMAN® 570 TOURING MY 14-15



# LIGHTING

INSTALL AUXILIARY LIGHTING AND LIGHT UP THE TRAIL, THE JOB, THE CAMPSITE OR THE PARTY. WHATEVER THE OCCASION, MAKE MORE OF YOUR DAY WITH CUSTOMIZED LIGHTING THAT LET'S YOU USE YOUR SPORTSMAN® AROUND-THE-CLOCK.

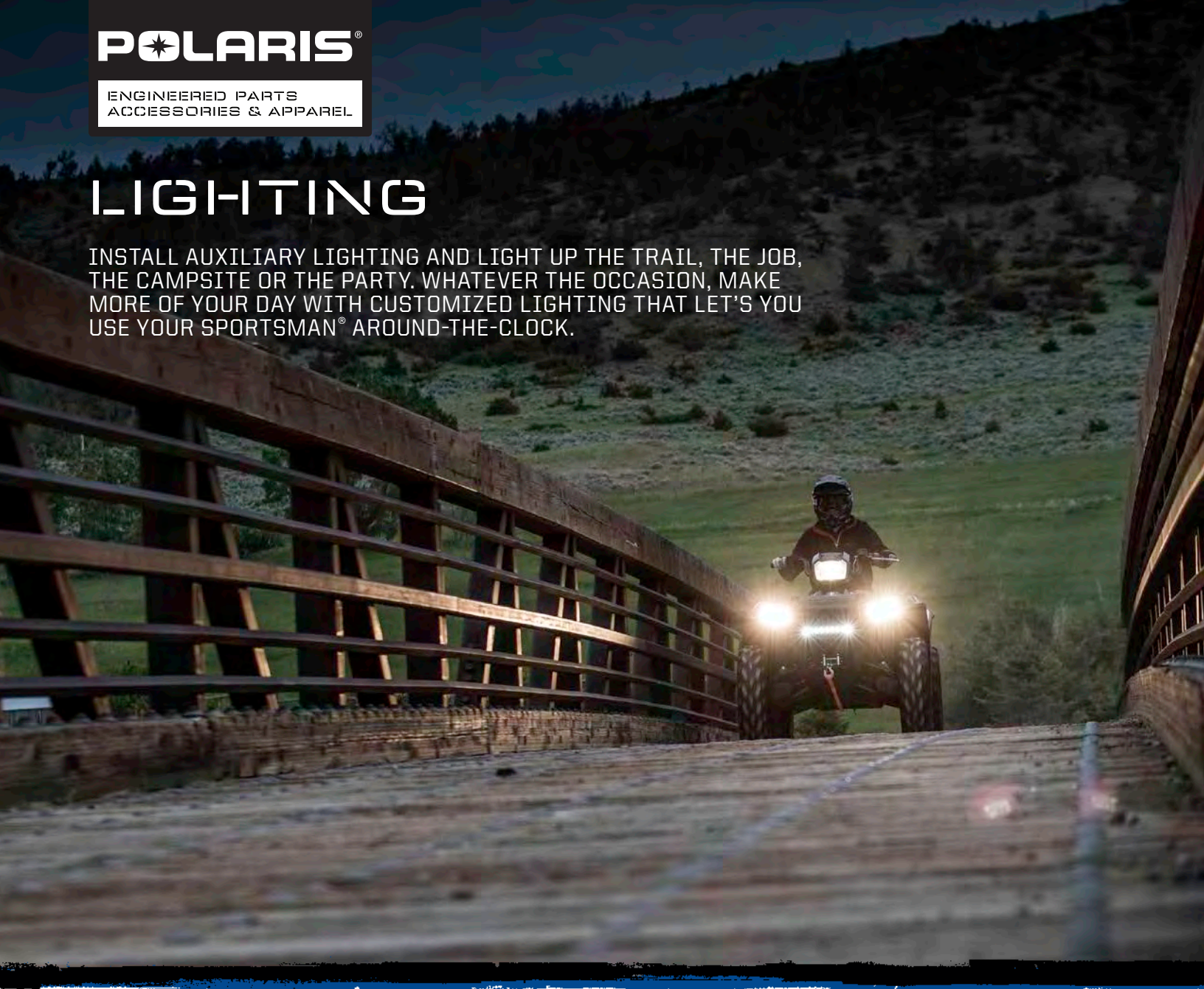

### 12" LIGHT BAR

- Convenient, versatile lighting that will enhance your riding experience
- 12" LED Light Bar elevates the vehicle's sporty, high-performance style
- Polaris®-exclusive and manufactured by Vision X
- Installs quickly and easily into designated mounting locations and connects to vehicle's electrical system
- Delivers reliable performance and outstanding value
- Premium 3-watt LED lights with max output of 2,100 lumens
- Custom combination of spot and flood lenses provide optimal light beam projection

2879500 | Black Housing

POLARIS® FRONT BRUSHGUARD

2100

See Harness Chart



### 13" LED LIGHT BAR NEW

- Convenient, versatile lighting that will enhance your riding experience
- 13" LED Light Bar elevates the vehicle's sporty, high-performance style
- Polaris®-exclusive and manufactured by Vision X
- Installs quickly and easily into designated mounting locations and connects to vehicle's electrical system
- Delivers reliable performance and outstanding value
- Dustproof and waterproof up to one meter; tested to IP67 standards
- Premium 5-watt CREE XPG-2 LEDs
- 13.39" x 2.76" x 2.17" (34 cm x 7 cm x 5.5 cm)

2880530

SPORTSMAN ACE™, SPORTSMAN® 570, SPORTSMAN® ETX

Requires LED harness 2879863 (sold separately).

See harness chart on page 51 for specifics.

Installation instructions are included with the LED harness.

3168



### 2" LED LIGHT

- Max output of 900 lumens
- Weatherproof connectors with plug-and-play harness
- Die-cast aluminum housing with interlocking omni-link system and stainless steel hardware

2878715

POLARIS® FRONT BRUSHGUARDS

See Harness Chart



### RALLY LIGHT

- 4" (10.2 cm) lens with 35-watt halogen bulb
- Sold individually

2877335

POLARIS® FRONT BRUSHGUARDS

See Harness Chart



### ADJUSTABLE ALUMINUM BILLET CLAMPS

- Adjustable to fit either 1.5" or 1.75" tubing
- Premium look and secure, reliable performance
- Sold in pairs

2878798

SPORTSMAN ACE™



### BILLET CLAMP

- Premium look and secure, reliable performance
- Sold individually

2878906

SPORTSMAN ACE™

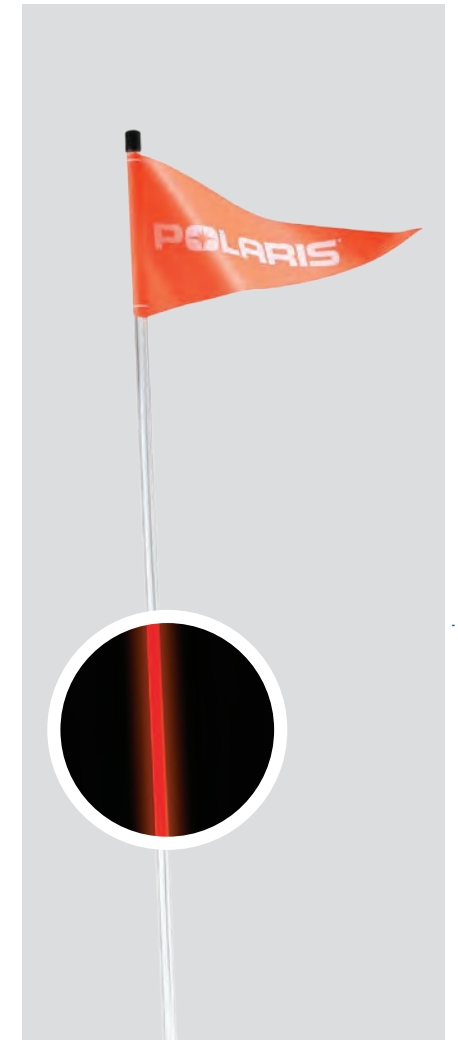

### LIGHTED WHIP FLAG

- Enhances visibility; ideal for hills and dunes
- Includes wiring harness and switch
- May require 2878907 or 2878906 based on mounting location

2878772

ALL SPORTSMAN®/SPORTSMAN® XP MODELS

### UNIVERSAL LED HARNESS (NOT SHOWN)

2879863

- This harness is required for installation of LED Headlight Kits (sold separately)

570, SPORTSMAN® 570 TOURING, 400, 800, BIG BOSS®, 550, 550 X2, SPORTSMAN® 550 TOURING, 850, SPORTSMAN® 850 TOURING, SCRAMBLER® 850

### DUAL LIGHT HARNESS (NOT SHOWN)

- Required for installation of 2" LED light
- Connections for 2 LED lights

2878770

### FRONT BUMPER WIRE HARNESS (NOT SHOWN)

2877910

ALL SPORTSMAN®/SPORTSMAN® XP MODELS

## LIGHTS: WHERE TO MOUNT THEM AND WHAT YOU'LL NEED

Auxiliary lighting is most commonly installed on top of the vehicle frame or on a front brushguard. All Polaris® brushguards come with pre-drilled holes for light installation. Choose your lighting, then choose the right lighting harness for your preferred mounting location.

Light	12" 3W LED Light Bar	2" 10W LED Light Bar	5" 10W LED Light Bar	Rally Light
<b>Harness Needed for All ATV</b>	2879863	2878770 or 2879863	2878770 or 2879863	2877910



**POLARIS®**

ENGINEERED PARTS  
ACCESSORIES & APPAREL

# POLARIS® INNOVATION

TECHNOLOGY AT YOUR FINGERTIPS FOR YOUR COMFORT, CONVENIENCE AND SAFETY. BECOME FULLY CONNECTED TO YOUR MACHINE – BECOME FULLY CONNECTED TO YOUR RIDE – EVERY STEP OF THE WAY.



## POLARIS® INTERACTIVE DIGITAL DISPLAY **NEW**

Simple and seamless — Polaris® has developed the first of its kind; this display will put you at the center of your riding experience in a whole new way.

- 4.3" high-resolution, full-color, LCD digital display
- Smartphone connectivity\* via Bluetooth™ displays text message and missed call indicator, phone battery life and cell signal strength
- Diagnostics screen displays vehicle fault codes, descriptions and suggested actions to resolve issues
- Vehicle Immobilizer and security function allow you to lock your vehicle with a passcode
- GPS Connectivity offers exact location information including elevation, latitude/longitude, compass bearings, as well as recording your route so you can find trails again

2880402

## POLARIS® INTERACTIVE DIGITAL DISPLAY INSTALL KIT **NEW**

- Includes all new instrument panel, necessary mounting hardware, wiring harness, etc. to install the Polaris® Interactive Digital Display

AVAILABLE OCTOBER 2014

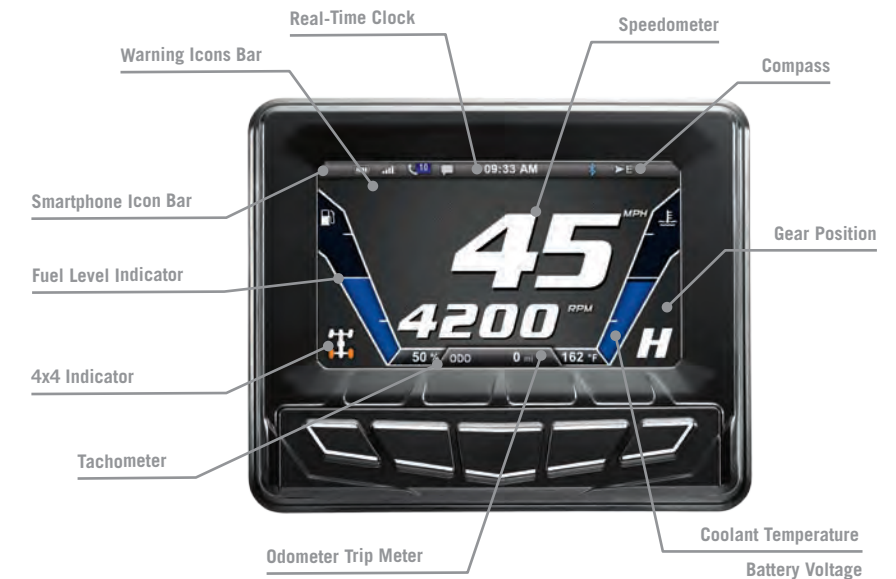

Plan and record your route so you can find trails again



Check missed calls and text messages without pulling out your phone

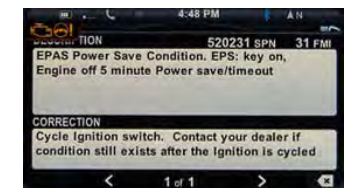

Diagnostics screen displays fault codes and suggested actions to take

## COMING SOON

### POLARIS® LINK **NEW** POWERED BY RIDERX™

Become integrated into your riding experience with the Polaris® Link, powered by RiderX™. The wireless link easily plugs into your vehicle to record diagnostics and information. The data is transferred wirelessly via Bluetooth™ to your cellular device, where you review with your RiderX™ mobile application.\* Polaris Link supplies data to your phone wirelessly from your machine including:

- Real-Time Gauge with speed, RPM and average miles per gallon
- Vehicle Statistics including fuel rate, battery voltage and engine hours
- Vehicle Diagnostics that display error codes and preferred dealer communication

\*Full functionality requires compatible Bluetooth® smartphones

### POLARIS WIRELESS LINK HARNESS **NEW**

- Wiring harness connects Polaris Wireless Link for most versatile connection in the greatest number of off-road locations to your machine
- Harness connects easily to vehicle electrical system and to the link

To download the RiderX™ app

TEXT ORV1



TO 82350





# COMFORT & ELECTRONICS

CUSTOMIZE YOUR SPORTSMAN® FOR MORE COMFORT AND STYLE. WHEN YOU'RE FEELING GOOD BEHIND THE HANDLEBARS, YOUR DAY ON THE TRAIL WILL BE THAT MUCH BETTER.



## WATERPROOF BLUETOOTH AUDIO **NEW**

- MBQuart Audio Technology
- Kit includes four mounting configurations
- Self-contained wireless audio unit provides a rider with rich, powerful, high-quality audio
- Mounts easily to the handlebars, roll cage or fits in your dashboard storage area
- IPX4 rated for water and dust resistance
- Simple controls on top of unit adjust volume and function
- Audio unit has Bluetooth connectivity with voice prompts and voice commands (voice commands on iOS only)
- Internal LiPo rechargeable battery provides 12 hours of music between charges
- Unit can be easily removed from your ATV between rides for recharging and for use in other applications

2880458

ALL SPORTSMAN® AND SPORTSMAN ACE™ MODELS



SPORTSMAN ACE™  
FITS 1.5" ROPS



SPORTSMAN® RACK  
HARD MOUNTS USING PUSH DARTS, REQUIRES DRILLING



SPORTSMAN®, 570 SP, 850, 1000  
MOUNTS AROUND SPEEDOMETER  
AND PUSH DARTS TO THE POD



SPORTSMAN® 570, 850, 1000, ETX  
MOUNTS AROUND SPEEDOMETER  
AND PUSH DARTS TO THE POD



## HANDLEBAR-MOUNTED MIRROR

- For added safety on or off the trail

2877222

ALL SPORTSMAN® MODELS AND TRAIL BOSS®, TRAIL BLAZER®, SCRAMBLER® MY 10-14



## THROTTLE/THUMB WARMERS

- Keeps throttle thumb warm
- Complete kit includes all wiring

2877364

TRAIL BOSS®, TRAIL BLAZER®, SCRAMBLER® MY 10-13



## HAND WARMERS

- Keep both hands warm while riding
- Complete kit includes all wiring

2877363

ALL SPORTSMAN® MODELS AND TRAIL BOSS®, TRAIL BLAZER®, SCRAMBLER® MY 10-13

2878302 | Passenger Hand Warmers  
SPORTSMAN® TOURING 550/850



## SEALINE® ELECTRONICS CASE

- Waterproof and submersible to provide the best protection
- Soft sides with clear panel; touch-screen compatible
- You can talk and hear with the phone in the case
- Available with or without output jack
- Meets IP-X7 standards
- Optimized for iPhone®

2879318 | With Jack  
ALL SPORTSMAN® MODELS

2879319 | Without Jack  
ALL SPORTSMAN® MODELS



## PASSENGER FOOT RISERS

- Raise passenger foot rests 3" (7.6 cm) or 7" (17.8 cm)
- Increase comfort for shorter passengers
- Made of tough plastic, with non-slip surface

### 3" PASSENGER FOOT RISERS

2877919  
SPORTSMAN® TOURING 550/850 MY 10-14, SPORTSMAN® X2 550/850 MY 10-14

2875782  
SPORTSMAN® X2 500/800 MY 06-09, SPORTSMAN® TOURING 500/800 MY 08-13

### 7" PASSENGER FOOT RISERS

2876885  
SPORTSMAN® X2 MY 06-09, SPORTSMAN® TOURING 500/800 MY 08-14



## WHIP FLAG

- Maximizes visibility on hilly terrain
- Required by law in many areas
- 2-piece kit: 8' whip and bright flag

2878799

SPORTSMAN® X2 (REQUIRES BILLET CLAMP 2878906 AND MUST ATTACH TO BRUSHGUARD), SPORTSMAN® XP, SPORTSMAN®



## BLUE XENON HEADLIGHT BULBS

- Over 50% brighter than stock bulbs
- 98% xenon gas, 12 volts, 50 watts

2876464

SPORTSMAN® XP MY 09-14, SPORTSMAN® MY 05-14



## LICENSE PLATE KIT

- Everything you need to create an ATV license

2873270

ALL SPORTSMAN® MODELS

## LOCK & RIDE® ANCHOR

2876519

2876420

Refer to your accessory instructions for fitment

## LOCK & RIDE® ANCHOR KIT, LONG

2877427

Refer to your accessory instructions for fitment

## HORN KIT

2872897

## SPORTSMAN® XP FOX® SHOCKS KIT **NEW**

- Remote reservoir for outstanding performance
- Compression-adjustable to customize the ride
- Improves handling
- Rebuildable design

2879892

SPORTSMAN® 850, SPORTSMAN® XP 1000



# SCRAMBLER®

TAKE YOUR SCRAMBLER® XP TO THE PINNACLE OF PERFORMANCE AND STYLE WITH POLARIS ENGINEERED ACCESSORIES™ LIKE BRUSH GUARDS, A REAR CARGO RACK AND A LOCK & RIDE® WINDSHIELD. ADD MORE MOJO WITH PARTS MADE FOR YOUR MACHINE.



### LOCK & RIDE® WINDSHIELD (NOT SHOWN)

- Polaris®-exclusive Lock & Ride™ technology
- Installs or removes quickly and easily without tools
- Strong, durable, protective polycarbonate construction
- Mid-height, 15" tall, for excellent protection and visibility
- Smoke finish with custom Scrambler XP 850 graphics

2879140

SCRAMBLER XP 850 MY 13-15, SCRAMBLER XP 1000

### LARGE REAR RACK (NOT SHOWN)

- Polaris®-exclusive Lock & Ride™ technology
- Installs or removes quickly and easily without tools
- Strong, durable, lightweight tube construction
- Doubles the usable surface area of the rear rack
- Provides countless tie-down opportunities
- Black wrinkle-coat finish

2879139

SCRAMBLER XP 850 MY 13-15, SCRAMBLER XP 1000

Does not work with Ogio Scrambler Bag

### WINCH WIRING HARNESS (NOT SHOWN)

- Lets rider connect Sportsman® XP winch to Scrambler®
- Required with any Polaris® winch

2879919

SCRAMBLER XP 850 MY 13-15, SCRAMBLER XP 1000

### REAR BASH GUARD

- Strong, durable, lightweight aluminum construction
- Protects drivetrain at rear of vehicle
- Engineered for easy installation
- Aggressive racing styling

2879138

SCRAMBLER XP 850 MY 13-15, SCRAMBLER XP 1000



## HD WINCHES AND GLACIER® PLOWS

Available for ScramblerXP 850  
See page 21 for Winches and page 24 for Plows



### BRUSHGUARD

- Strong, durable, lightweight aluminum construction
- Protects front end of vehicle
- Engineered for easy installation
- Has mounting locations for auxiliary lights (sold separately)
- Aggressive styling looks great on vehicle
- Can be used with winch and plow

2879136

SCRAMBLER XP 850 MY 13-15, SCRAMBLER XP 1000

### HANDGUARDS

2876883 | White

2876846 | Black

2876845 | Red

ALL SPORTSMAN® MODELS WITH HANDGUARD MOUNT 2879380  
SCRAMBLER XP 1000

### HANDGUARD MOUNT

2879380

ALL SPORTSMAN® MODELS, SCRAMBLER XP 1000

### HANDLEBAR HEADLIGHT

- Custom pod for integrated look and style
- 2 high-powered 1,800-lumen LED lights
- Provides directional lighting for better riding experience
- Durable, rugged die-cast aluminum housing
- Kit includes everything needed for easy installation

2879245

SCRAMBLER XP 850 MY 13-15, SCRAMBLER XP 1000

### FOX® SUSPENSION

- Remote reservoir for outstanding performance
- Compression-adjustable to customize the ride
- Improves handling
- Rebuildable design

2879258

SCRAMBLER XP 850 MY 13-15, SCRAMBLER XP 1000

### OGIO® SCRAMBLER® BAG **NEW**

- Exclusive Polaris® lid-mounted Dust Gasket keeps contents of the bag free from debris and dust
- Semi-rigid bag provides a versatile, protected storage solution
- Semi-rigid construction holds its shape when empty, provides the fullest, most-accessible cargo space
- Premium materials and construction provide reliable weatherproof protection for cargo
- Multiple zippered compartments
- Large lid features overhang lip to seal out moisture and dust
- Polaris-exclusive Lock & Ride® technology: Install/remove bag quickly and easily without tools
- OGIO®- and Polaris®-branded

2879925

SCRAMBLER XP 1000, SCRAMBLER® 850

Does not work with rear rack 2879139





# LUBRICANTS & VEHICLE CARE

POLARIS ENGINEERED™ LUBRICANTS ARE ENGINEER APPROVED, DESIGNED AND TESTED TO MEET THE NEEDS OF YOUR POLARIS® HIGH-PERFORMANCE 4-STROKE ENGINE.



### EXTENDED LIFE ANTI-FREEZE 50/50 FORMULATION **NEW**

- Extended 5-year service interval
- New organic acid technology
- Hard water compatible
- No scaling = better heat transfer
- New yellow coloration

2880514 | 1 US Quart | 12 per case  
 2880513 | 1 US Gallon | 6 per case  
 2880512 | 55 US Gallon Drum

### AGL PLUS

- Full synthetic friction-reducing formulation, extreme pressure film protection for severe operating temperatures
- Prevents rust, oxidation, foam and corrosion of internal ATV transmission components

2878068 | Quart | 12 per case  
 2878069 | Gallon | 6 per case  
 2878070 | 2.5 Gallon | 2 per case  
 2879594 | 55 Gallon

### DEMAND DRIVE PLUS

- Formulated for lubricity, corrosion and oxidation protection in all operating conditions
- Replaces Demand Drive Fluid, LT Demand Drive Fluid, and ADC Fluid

2877922 | Quart | 12 per case  
 2877923 | 2.5 Gallon | 2 per case

### ATV ANGLE DRIVE FLUID

2876160 | Quart | 12 per case  
 2872276 | 2.5 Gallon | 2 per case

### ALL-SEASON GREASE

- Low-temperature pliability for protection at cold start-up as well as excellent high-speed and high-temperature protection

2871322 | 3 oz. 4-pack | 6 per case  
 2871423 | 14 oz. | 10 per case  
 2871312 | Grease Gun Kit | 4 per case

### U-JOINT GREASE

2871515 | 3 oz 4-pack | 24 per case  
 2871551 | 14 oz | 10 per case

### SYNTHETIC DIESEL ENGINE OIL **NEW**

- All-Season 5W-40 Formula
- Excellent cold weather protection
- Ultimate protection in severe duty applications

2879832 | Quart | 12 per case

### SUMMER 15W40 DIESEL OIL

- Multi grade lubricant designed for heavy duty equipment
- Excellent wear protection during high temperature applications

2878473 | 2 Quart Bottle | 8 per case  
 2878471 | Oil Change Kit | 4 per case

### CARBON CLEAN FUEL TREATMENT

- Dissolves gum and varnish in fuel system
- Prevents and cleans carbon in combustion chamber
- Excellent fuel stabilizer for storage
- Formulated for both 2- and 4-cycle engines
- Absorbs water and stabilizes fuel

2871326 | 12 oz. | 12 per case

### PREMIUM ETHANOL FUEL STABILIZER

- Prevents fuel oxidation and system corrosion
- Significantly reduces gum and varnish formation
- Protects fuel system components
- Formulated for both 2- and 4-cycle engines

2870652 | Quart | 12 per case  
 2872280 | 2.5 Gallon | 2 per case



### PS-4 OIL CHANGE KITS

- 2202166 | Sportsman ACE™ 570, RZR®/Ranger® 570, Twin 600, 700, 800  
 2877473 | Sportsman™ 330-570, XP 550/850/1000  
 2880913 | Sportsman® ETX, Sportsman ACE™, Ranger® ETX  
 2879129 | RZR® XP 2011-2012  
 2879323 | Ranger® 900 / RZR® 900, 1000



### PS-4 EXTREME DUTY OIL CHANGE KITS

- 2879004 | Sportsman ACE™ 570, RZR®/Ranger® 570, Twin 600, 700, 800  
 2878924 | Sportsman™ 330-570, XP 550/850/1000  
 2879130 | RZR® XP 2011-2012  
 2879324 | Ranger® 900/RZR® 900, 1000



### ORV MAINTENANCE KIT

- Kit includes:
  - 1.5 quarts of AGL
  - 1 quart of Angle Drive Fluid
  - 1 pint of Demand Drive Fluid
  - 1 3oz. tube of All-Season Grease
- Services all ATV, Rangers, and RZR's

2888471



### PS-4 EXTREME DUTY ENGINE OIL

- Ultimate high-temperature engine protection
- Prevents thermal breakdown
- Maximum rust and corrosion protection
- Designed for professional grade and high-temp 4-cycle applications

2878920 | Quart (12 per case)  
 2878922 | 2 Quart (8 per case)  
 2878919 | Gallon (4 per case)  
 2879003 | 16 Gallon  
 2879002 | 55 Gallon  
 2879001 | 330 Gallon Tote



### PS-4 SYNTHETIC ENGINE OIL

- Maximum engine protection in cold and hot conditions
- Easy starting in extreme cold
- Extra rust and corrosion protection
- Extends gear and clutch life
- Designed specifically for Polaris® 4-cycle engines

2876244 | Quart | 12 per case  
 2877490 | 2 Quart | 8 per case  
 2876245 | Gallon | 4 per case  
 2876247 | 16 Gallon  
 2876246 | 55 Gallon  
 2878814 | 330 Gallon Tote



### XP WASH™ **NEW**

- Removed the most intense and stubborn dirt and trail build up easily
- A foaming, highly concentrated wash
- Superior water beading

2830203

### XP SPRAY WASH™ **NEW**

- Effortless cleaning power – simply spray on, spray off and go
- A biodegradable, high-performance wash ideal for removing dirt, oils and carbon build up

2830202

### POLARIS® POLISH **NEW**

- Protection and shine have never looked so good or been so easy – spray on, wipe off and go
- Ideal on painted and plastic surfaces
- Contains carnauba wax

2830207

### NEVER RUST SPRAY **NEW**

- Brutal conditions demand superior protection, be prepared for any climate before and after you ride
- Synthetic formula protects against rust and corrosion while lubricating metal surfaces
- High resistance to water wash out

2830209

### INSTANT SHINE & DETAILER **NEW**

- Cleans, polishes and protects plastic and painted surfaces
- Be quick, be effective, be ready to go
- Spray and wipe formula

2830204

### ALL PURPOSE CLEANER **NEW**

- Biodegradable formula removes dirt and grime effortlessly
- Use on netting, seats, wheels, tires, plastic, and metal surfaces

2830205

### MUD SHIELD™ PRE TREATMENT **NEW**

- Pre-treat and protect, engineered for the most extreme conditions
- Makes cleaning your vehicle easier and faster
- Inhibits the adhesion of dirt, mud and snow

2830208

\* Extreme Cold      Extreme Hot \*

← PS-4 Extreme Duty →  
 ← PS-4 →

-40F/-40C    0F/-20C      100F/40C    130F/55C

< EXTREME COLD EASY START  
 EXTREME HEAT WEAR PROTECTION >



# MAINTENANCE PARTS

POLARIS ENGINEERED™ PARTS ARE DESIGNED AND ENGINEERED TO OPTIMIZE YOUR VEHICLE'S PERFORMANCE AND DELIVER THE TRUE HIGH-PERFORMANCE YOU DEMAND.



### ORV AIR FILTERS

- 99.9% efficient in blocking dirt in extreme testing
- Superior filter capacity: Traps 32% more contaminants than the closest competitor
- Costs half as much as compared to leading aftermarket brands



### ORV OIL FILTERS

- The Polaris® filter (#2540086) traps particles 64% smaller in size than the competition, resulting in lower levels of contamination in your engine
- The Polaris® filter has 44% less restriction than the competition to ensure adequate lubrication in all conditions



### ORV BATTERIES

- We use only the highest quality batteries
- Engineered and tested to fit and perform on our machines



### ORV BRAKE PADS

- High performance in any temperature and condition: wet, dry or mud
- Designed with the same material used by high-end motorcycles

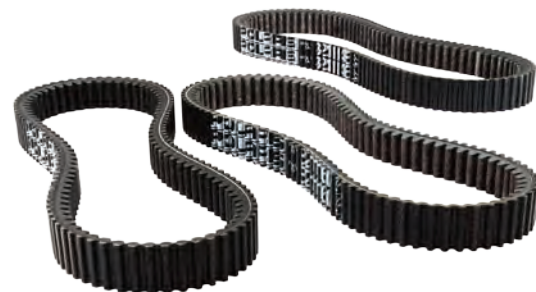

### ORV DRIVE BELTS

- Lowest tolerances (.188") provide highest performance
- The Polaris® Kevlar® belt provides 2x longer belt life than the competitor's "Heavy-Duty" belt

VEHICLE MODEL	AIR FILTER	PRE-FILTER	BELT	OIL FILTER	BATTERY	BRAKE PAD FRONT	BRAKE PAD REAR
Outlaw® 50	0453906	0453905	0453455	N/A	4011181	0450421	0450433
PHOENIX™ 200	1253355	N/A	0452496	0452462	4011434	0454664	N/A
Sportsman® ETX	7080595	5811633	3211077	2521231	4140006	2202412	2204088
SPORTSMAN ACE™	2521372	N/A	3211149	2521231	4140006	1911228	2202413
SPORTSMAN ACE™ 570	2521372	N/A	3211169	2540086	4140006	1911228	2202413
Sportsman® 570/ Sportsman® Touring/EPS/SP	7080595	5811633	3211113	2521424	4140006	2202412	2204088
Sportsman® X2 570 EPS	7080595	5811633	3211113	2521424	4140006	2202412	2204088
Sportsman® 850/1000/ Sportsman® Touring/SP	7080595	5811633	3211160	2520799	4011496	2203628	2203628
Scrambler® 850/XP 1000	7080595	5811633	3211160	2520799	4011496	2203628	2203628

All models listed are MY 15. For past models, please visit <http://www.polaris.com/en-us/atv-ranger-rzr/parts-manuals>

### FIT CHARTS

1. GO TO THE "DEALER EXTRANET."
2. UNDER "NEWS, FORMS AND LINKS" CLICK ON "PURE POLARIS."
3. FIND THE REFERENCE AND FITMENT CHART FOR YOUR VEHICLE.

### REFERENCE MANUALS

1. GO TO THE "DEALER EXTRANET."
2. UNDER "NEWS, FORMS AND LINKS" CLICK ON "TECHNICAL PARTS."
3. FIND THE QUICK REFERENCE MANUAL FOR YOUR VEHICLE.



# RAMPS & COVERS

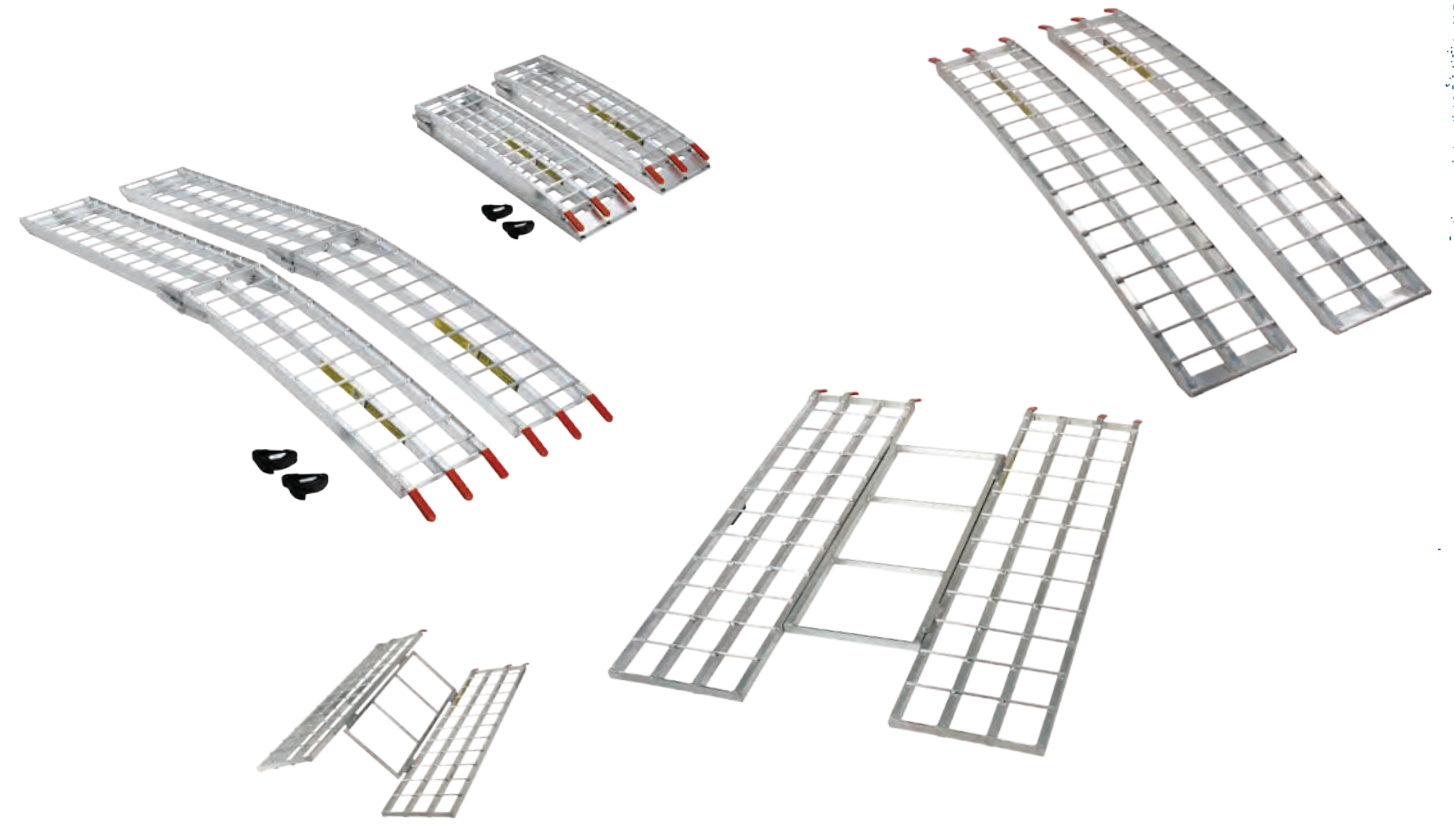

**FOLDING HEAVY-DUTY ALUMINUM  
ARCHED RAMPS**

- Fold up for transport
- Strong enough to hold up to 1,500 lb. (680.7 kg)
- Include safety straps and instructions
- Sold in pairs

2875387

**LIGHTWEIGHT TRI-FOLD RAMP**

- Handles up to 1,500 lb. (680.7 kg)
- Folds up to fit under ATV during transport
- Includes safety straps and instructions

2875385 | 72" x 51"  
2875860 | 82" x 51"

**ALUMINUM ARCHED LOADING RAMPS**

- Each ramp measures 76" x 12" (23.2 x 30.5 cm)
- Combined capacity up to 2,000 lb. (907.2 kg)
- Easily transportable
- Sold in pairs

2875384



**SPORTSMAN® COVER**

- Provides protection during transport and storage
- Rugged 600-denier polyester won't flap in wind
- Breathable polyurethane coating

2876614  
ALL SPORTSMAN® (EXCEPT 300/400, X2, SPORTSMAN® TOURING)  
2877999  
ALL SPORTSMAN® TOURING  
2877998  
SPORTSMAN® X2



**SPORTSMAN ACE™ COVER NEW**

- Durable, protective, weather-resistant canvas construction
- Ratcheting perimeter strap secures cover to vehicle for sure fit while trailering
- Has multiple tie-in points to enhance the cover's fit around the vehicle
- Compatible with cab's components and brushguards
- Polaris® SPORTSMAN ACE™-branded

2880056



# TRAILERS & ACCESSORIES

## ENCLOSED ATV TRAILERS

The Polaris® brand of enclosed trailers is the ultimate combination of quality, style and versatility. With a variety of sizes and price points to choose from, this brand is among the most diverse in the industry. Introducing the market's first Side by Side UTV package, we've revolutionized the way you'll tow, and store, your Polaris® ATV machines. Standard features include all-aluminum box-tube framework, .030" exterior side panels and torsion ride axles. Box lengths range from 8' to 20'.



FOR MORE INFO, PLEASE VISIT:  
[WWW.POLARIS-TRAILERS.COM](http://WWW.POLARIS-TRAILERS.COM)

### PC6.5X16 QUICK SPECS

Payload Capacity: 4325#  
Interior Dim (LxWxH): 15' 10" X 77" X 76"  
Overall Dim (LxWxH): 21' 7" X 101" X 8' 1"  
Axles: (2) 3500# Braked  
Wheels/Tires: 15" White Mod / 205/75D15  
GVWR: 6000#

## OPEN ATV TRAILERS

Polaris® ATV trailers are available in widths of 83", 84", 88" or 96" inches, accommodating a variety of ATV models and sizes. With a number of ATV-specific features, including surface-mounted D-rings, side or rear-stowing ramps, rear edge protectors and wheel jacks on larger trailer models, these trailers are ready to haul, right out of the box.

### PATV 83X14 QUICK SPECS

Payload Capacity: 2565#  
Deck Dim (LxW): 168" X 83"  
Overall Dim (LxW): 18' X 102"  
Axles: (1) 3500# Idler (Leaf)  
Wheels/Tires: 15" Silver Mod / 205/75D15  
GVWR: 2990#

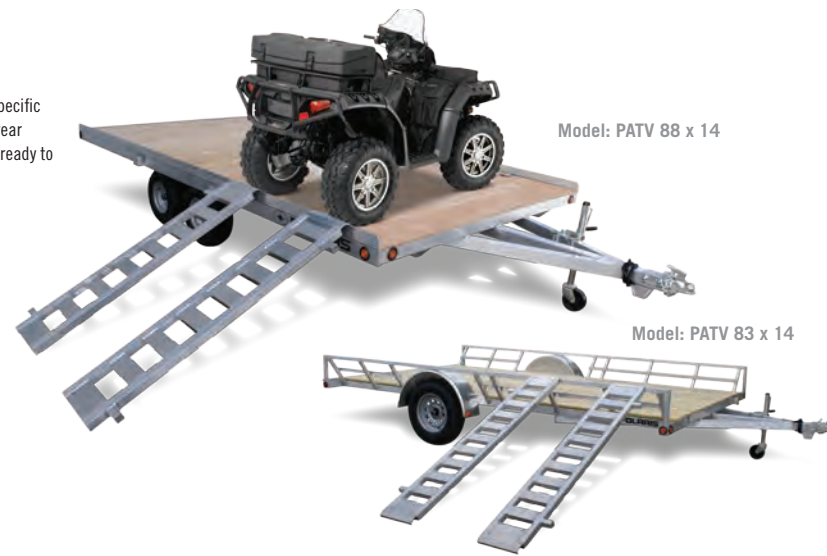

## STEEL UTILITY CART — TANDEM AXLE

- Tandem, sealed-bearing axle design; articulating center pivot provides reliable travel over rough terrain
- Designed to military specifications; military-tested and proven
- Cart has a 1,000-lb. (453.6 kg) payload capacity
- Holds up to 17 cu. ft. (5.2 cu. m) of heaping material such as brush
- Drop-down tailgate for easy loading and dumping
- Pin hitch
- Rolls on 18" x 9.5" x 8" (45.7 x 24.13 x 20.3 cm) off-road tires
- Overall size 60.9" x 35.1" x 12"
- Interior size 57.7" x 31.7" x 12"



Polaris® and its vehicle body designs and names are registered trademarks of Polaris® Industries Inc. Used under license. Polaris® designs, engineers, manufactures and markets snowmobiles, all-terrain vehicles (ATVs), Victory® motorcycles and the Polaris® RANGER® for recreational and utility use. Information about the complete line of Polaris® products, apparel and vehicle accessories is available from authorized Polaris® dealers or anytime from the Polaris® homepage at [www.polarisindustries.com](http://www.polarisindustries.com).



**STRAPS, RED RATCHET**  
2859047-01



**DROP RECEIVER HITCH DRAW BAR**  
• Fits 1-1/4" (3.2 cm) receiver  
• Accepts trailer balls with 3/4" (1.9 cm) shank

**ATV 3" DROP RECEIVER HITCH DRAW BAR**  
2877981

**ATV 1" DROP RECEIVER HITCH DRAW BAR**  
2877476



**TRAILER BALL AND SHANK**  
**1-7/8" TRAILER BALL, 3/4" SHANK**  
2877602

**2" TRAILER BALL, 3/4" SHANK**  
2877603

**POLARIS®**

ENGINEERED PARTS  
ACCESSORIES & APPAREL

# HERITAGE

VISIT [POLARIS.COM](http://POLARIS.COM) TO LEARN MORE

Category	Product Name	PN	Price	Fitment
Windshields	Lock & Ride® Sportsman® XP Windshield, Tall Camo	2878392-587		Sportsman® XP 550/850 MY 09-14, Sportsman® Touring 550/850 MY 10-14, Sportsman® X2 550/850 MY 10-14
Windshields	Lock & Ride® Sportsman® XP Windshield, Tall Clear	2878392		Sportsman® XP 550/850 MY 09-14, Sportsman® Touring 550/850 MY 10-14, Sportsman® X2 550/850 MY 10-14
Windshields	Lock & Ride® Sportsman® XP Windshield, Mid Black	2878391-070		Sportsman® XP 550/850 MY 09-14, Sportsman® Touring 550/850 MY 10-14, Sportsman® X2 550/850 MY 10-14
Windshields	Lock & Ride® Sportsman® XP Windshield, Mid Clear	2878391		Sportsman® XP 550/850 MY 09-14, Sportsman® Touring 550/850 MY 10-14, Sportsman® X2 550/850 MY 10-14
Windshields	Lock & Ride® Sportsman® XP Windshield, Low Black	2878390		Sportsman® XP 550/850 MY 09-14, Sportsman® Touring 550/850 MY 10-14, Sportsman® X2 550/850 MY 10-14
Racks	Front Rack Extender	2877746		Trail Boss® MY 10-13
Racks	Rear Rack	2878002		Trail Blazer®, Scrambler® MY 10-13
Storage	Rear Cargo Box	2875678		Trail Boss®, Trail Blazer®, Scrambler® MY 10-13
Storage	Lock & Ride® Touring Rear Cargo Box	2878154		Sportsman® Touring 550/850 MY 11-14
Storage	Lock & Ride® Small Rear Box	2878111		Sportsman® Touring 550/850 MY 11-14
Storage	Lock & Ride Backrest	2876368		Sportsman® 500/600/700/800 MY 05-10, Sportsman® 400 MY 05, Sportsman® 450 MY 06-07 Does not fit with Lock & Ride® Cargo Box 2876601 installed
Protection	Nerf Bars	2876843		Outlaw®
Protection	Aluminum A-Arm Guards	2877601		Outlaw®
Accessories	Outlaw® Shock Covers	2875968		Outlaw®
Accessories	Replacement Netting	2877211		Outlaw®
Trailers & Accessories	Tow Hitch	2873036		Trail Blazer®, Scrambler® MY 10-13



# HELMETS

WEARING A HELMET WHEN YOU RIDE IS JUST AS IMPORTANT AS REMEMBERING YOUR KEYS. THANKS TO POLARIS INNOVATION, YOU CAN STILL LOOK GOOD WHILE PROTECTING YOUR HEAD AND YOUR LIFE.



## FLY® F2

- Composite construction shell made of aircraft-grade woven carbon fiber and Kevlar® composite materials for superior, lightweight strength
- Dual-density EPS liner for impact absorption
- Multi-port air induction cooling system with tri-vent goggle anti-fog vents
- Removable washable liner and cheek pads
- Snell® M2010-, DOT- and ECE-approved

- 2865110 | Sly | XS-5XL
- 2865111 | Podium | XS-5XL
- 2865112 | Dominate | XS-5XL

- 2864218 | Black/VooDoo Blue | XS-2XL
- 2864208 | Black/Hi-Vis Yellow | XS-2XL
- 2863185 | Platinum Ice | XS-2XL

## FLY F2® HELMET REPLACEMENT PARTS

- 2863165 | Breath Deflector
- 2864211 | Replacement Visor | Black/Hi-Vis
- 2864357 | Replacement Visor | Black/VooDoo Blue
- 2863202 | Replacement Visor | Race Orange
- 2863162 | Visor Screw Kit
- 286316401 | Cold Weather Plug Kit | XS/S
- 286316403 | Cold Weather Plug Kit | M/L
- 286316409 | Cold Weather Plug Kit | XL/2XL
- 2863199 | Cheek Pad | 40mm | XS
- 2863198 | Cheek Pad | 35mm | S, M, L
- 2863197 | Cheek Pad | 30mm | XL
- 2863196 | Cheek Pad | 25mm | 2XL
- 2863195 | Cheek Pad | 20mm | 3XL



Sly



Podium



Dominate



Black/VooDoo Blue



Black/Hi-Vis Yellow



Platinum Ice

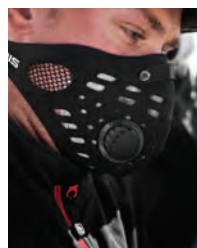

## RZ MASK

- 286224203 | Black | Regular
- 286224206 | Black | XL
- 2863189 | Large Replacement Filters | OSFM | 3 per pack
- 2863190 | X-Large Replacement Filters | OSFM | 3 per pack



## KTP HELMET

The unique, multi-purpose KTP features a face shield that slides up and down. It even works with goggles in the shield-up position.

- ABS thermo-injected shell
- Air-intake, flow-through ventilation system
- Fully removable, washable liner
- Adjustable visor, adjustable chin strap, movable polycarbonate eye shield replaces need for goggles
- DOT approved

- 2869364 | Black Gloss | S-2X

Black Gloss

## DEMON 1.1 HELMET

- Lightweight, protective composite fiberglass shell
- Dual-density EPS liner for impact absorption
- Aerodynamic, multi-channel flow-through ventilation system
- Moisture-wicking QwickDry® removable, washable liner
- Snell® M2010 and DOT-approved

- 2864179 | Assault | S-3X
- 2864176 | Red Gloss | S-3X
- 2864177 | Orange Gloss | S-3X
- 2864178 | Silver Gloss | S-3X

## REPLACEMENT VISOR

- 2864186 | Red Gloss
- 2864187 | Orange Gloss
- 2864188 | Silver Gloss
- 2864189 | Assault® Matte

## DEMON REPLACEMENT PARTS

- 2861233 | Breath Deflector
- 2869484 | Visor Screw Kit



Red Gloss



Orange Gloss



Silver Gloss



Assault® Special Edition

## TENACITY HELMET

- Lightweight polycarbonate shell
- Mouth air-intake vent, eyebrow vents and six rear vents
- Removable, washable liner
- DOT/ECE-approved

- 2864180 | Red Gloss | S-2X
- 2860144 | Black Matte | S-2X
- 2864183 | Retro Gloss | S-3X
- 2864181 | Magenta Gloss | S-2X

## TENACITY REPLACEMENT VISOR

- 2864190 | Red Gloss
- 2864191 | Magenta Gloss
- 2864193 | Black Matte
- 2862120 | Visor Screw Kit



Black Matte



Red Gloss



Magenta Gloss



White Gloss



Retro Gloss



**POLARIS®**

ENGINEERED PARTS  
ACCESSORIES & APPAREL

# GOGGLES

KEEP DEBRIS OUT SO YOU CAN KEEP YOUR EYES WHERE THEY BELONG - ON THE TRAIL. POLARIS®-EXCLUSIVE GOGGLES ARE DESIGNED WITH YOUR RIDE IN MIND SO YOUR LOOK CAN BE MORE INTEGRATED FROM VISOR TO VEHICLE.

## 509® FOR POLARIS®

### 509® DIRT PRO GOGGLES

509® for Polaris® goggles are loaded with performance-driven innovations for avid riders who insist on the best eye protection. These goggles provide the ultimate combination of protection, comfort, ventilation, tear-off compatibility and style.

**Size:** Oversized frame and lens fit inside all standard moto helmets' goggle port and provide broad visibility.

**Lens:** Protective, shatterproof, single-pane chrome lens; non-vented dirt lens has a durable anti-scratch and anti-fog coating; blocks 100% of UV rays and is easily interchangeable with accessory lenses.

**Strap:** Innovative hinged-strap mount allows the goggles to remain flush against the face for optimized protection and comfort; ensures that the goggles form a seal against the face to block dirt, dust and wind; adjustable, silicon-backed strap remains securely in place when positioned on helmet.

**Foam:** Triple-layer foam construction consists of 3 layers of moisture-wicking foam of varying densities for a comfortable fit on the face.

**Tear-Off Compatible:** Unique triple tear-off post design includes 2 posts on the lens and a third adjustable post attached to the strap for enhanced tear-off installation and removal.

**Nose Guard:** Rigid, vented nose guard protects nose and can be installed or removed in seconds.

**Ventilation:** 13-port vent system (7 on top, 7 at base of frame) promotes fresh air circulation for comfort and fog prevention.

A. 2864327 | Carbon Blue (chrome lens) | OSFM

B. 2863427 | Signature Red (chrome lens) | OSFM

C. 2864328 | Carbon Yellow (chrome lens) | OSFM

D. 2863426 | Signature Black (chrome lens) | OSFM

E. 2863429 | Blockade Orange (chrome lens) | OSFM

F. 2863428 | Blockade Black (chrome lens) | OSFM

### 509® DIRT PRO REPLACEMENT LENSES

2863430 | Chrome | OSFM

2863431 | Clear | OSFM

2863432 | Brown Polarized | OSFM

2863433 | Tear-Offs | 6 per pack | OSFM



### POLARIS® TRAIL GOGGLES

2863434 | Black | OSFM

### POLARIS® TRAIL GOGGLES REPLACEMENT LENS

2863482 | Clear | OSFM



**POLARIS®**

ENGINEERED PARTS  
ACCESSORIES & APPAREL

# GLOVES

GRIP UP AND GO. POLARIS® GLOVES ARE THE PERFECT MIX OF LIGHTWEIGHT COMFORT AND ENGINEERED DURABILITY FOR A PERFECT FIT AND FUNCTION.



### FLY GLOVE

These lightweight gloves from the FLY Racing® for Polaris® Collection deliver outstanding protection and a sure grip while keeping hands comfortable.

**Shell:** Lycra® back panels stretch to provide a comfortable fit and are complemented by the embossed neoprene flex-knuckle system designed for protection and flexibility.

**PALM:** Lightly padded palm for extra comfort; durable construction with a reinforced thumb.

**Additional Features:** Soft-Flex TPR (thermoplastic rubber) graphics offer extra protection; adjustable TPR wrist closure system; silicone finger grippers for increased grip and control.

A. 2864209 | Black/Hi-Vis Yellow | S-3X

B. 2864219 | Black/Voodoo Blue | S-3X

C. 2863194 | Platinum Ice | S-3X



**POLARIS®**

ENGINEERED PARTS  
ACCESSORIES & APPAREL

## OGIO® BAGS

OGIO® BAGS FOR POLARIS® ARE HIGH-PERFORMANCE CARGO CARRIERS. BALLISTIC-GRADE MATERIALS AND EXCLUSIVE BRANDING GIVE YOU MORE FOR YOUR ON AND OFF ROAD JOURNEYS.

**A. OGIO® RIG 9800 BAG**  
2864212 | Subtle Stripe



**B. OGIO® 8800 TRUCKER**  
2864213 | Subtle Stripe



**C. OGIO® LOADER 7600**  
2864214 | Subtle Stripe



**D. ENDURANCE DUFFLE**  
2864215 | Subtle Stripe



**E. BANDIT BACKPACK**  
2864216 | Subtle Stripe



**F. WATERPROOF BACKPACK**  
2864217 | Charcoal Gray



**POLARIS®**

ENGINEERED PARTS  
ACCESSORIES & APPAREL

## JERSEYS

### FLY RACING® JERSEYS

Developed by avid off-road riders, this lightweight, colorful jersey from the FLY Racing® for Polaris® Collection features materials and construction that promote airflow to keep an active rider cool and comfortable.

**Fabric:** Lightweight 100% polyester panels combine with mesh ventilation panels in key areas to promote airflow and dissipate body heat.

**Graphics:** Vibrant, permanent sublimated graphics, including Polaris® and FLY Racing® branding.

**Additional Features:** Low-profile, multi-directional Lycra® stretch collar; non-restrictive shorty cuffs with elastic sleeves help reduce arm pump; extended tail helps keep jersey tucked into pants; tagless printed collar eliminates tag irritation.

2864210 | Black/Hi-Vis Yellow | S-3X

2864220 | Black/VooDoo Blue | S-3X



## BASE LAYERS

### U.P. BASE LAYER

- 93% polyester and 7% spandex jersey knit
- Reflective logos

2864030 | Top | Grey | S-3XL

2864031 | Bottom | Grey | S-3XL

### BLACK ICE BASE LAYER

- 93% polyester and 7% spandex jersey knit
- Contrast stitching, reflective logos

2864033 | Top | Black | S-3XL

2864032 | Bottom | Black | S-3XL



## TECH WEAR

### PRO JACKET

- GORE-TEX® product technology *Guaranteed to Keep You Dry®*
- Max vent with 2-way adjustable pit zips and back vent
- Asymmetric style uses 330D nylon shell and 3M® Scotchlite® reflective
- Durable 2-way YKK® Vision® zippers for adjustable and comfortable fit
- Drawcord adjustable neck, waist and Lycra® cuffs to keep snow out

2865003 | Red | S-3XL

2865002 | Black | S-3XL; MT-2XLT

### PRO BIB

- GORE-TEX® product technology *Guaranteed to Keep You Dry®*
- 330D nylon shell with ballistic nylon reinforcement and 3M® Scotchlite® reflective
- Articulated knees with integrated EVA knee pads for added protection
- Durable, YKK® full-length 2-way adjustable water-resistant leg zippers
- External chest pocket and 2 side pockets

2865007 | Black | S-3XL; MT-2XLT





**POLARIS**

ENGINEERED PARTS  
ACCESSORIES & APPAREL

# PROTECTION

**TEKVEST**



**TEKVEST® FREESTYLE**

2862189 | S-3X



**TEKVEST® SUPER SPORT**

2862190 | S-3X



**TEKVEST® SHOULDER PADS**

2862192 | S-3X

# YOUTH

## YOUTH MX HELMET

2860174 | Black | S-M-L

2862171 | Red | S-M-L

2862172 | Blue | S-M-L

## YOUTH RZ MASK

2863191 | Black | OSFM

## YOUTH RZ MASK REPLACEMENT FILTERS

(NOT SHOWN)

2863192 | OSFM | 3 per pack

## POLARIS® YOUTH GOGGLES

2863435 | Black | OSFM

## YOUTH SONIC™ GLOVES

2863406 | Black | S-M-L

2863407 | Red | M-L

## YOUTH AERO GLOVES

2862187 | Black | S-M-L

## YOUTH TEKVEST® (70-100 LB)

2862191 | Black



**POLARIS**

ENGINEERED PARTS  
ACCESSORIES & APPAREL

# 60<sup>TH</sup> ANNIVERSARY RETRO CASUAL APPAREL



## SIGNATURE RETRO HOODIE

- 100% cotton
- The ultimate in durability — with a shoulder-to-shoulder self-fabric neck taping
- Polaris® logo aglets
- Kangaroo pockets

2865087 | S-3XL

## ANNAPURNA MID-LAYER

- 100% polyester polar fleece, anti-static/anti-pill
- Zippered hand warmer pockets
- Polaris® logo on left chest; ellipse on back of shoulders

2864019 | S-5XL

## RETRO TRUCKER CAP

- 8-stitch bill allows you to adjust the brim exactly to your own specifications
- 100% cotton front panels on the back and bill
- 100% polyester mesh back panels
- Soft brush front panels, constructed and fused buckram
- Snap-back closure

2865103 | OSFM

## THROWBACK HOODIE

- 100% cotton
- The ultimate in durability — with a shoulder-to-shoulder self-fabric neck taping and 4-thread safety stitch at all seams
- 2-needle cover stitch at bottom, sleeves and body
- Kangaroo pockets

2865097 | S-3XL

## RETRO PULLOVER

- 100% cotton sub jersey with a bio-wash finish that makes the fabric extremely soft
- The ultimate in durability — with a shoulder-to-shoulder self-fabric neck taping and 4-thread safety stitch at all seams
- 2-needle cover stitch at bottom, sleeves and body

2865091 | S-3XL



## SEE PAGE 77 FOR SIZE CHARTS

When ordering, add size code to part number.  
XS:01, S:02, M:03, M-Short:04, M-Tall:05,  
L:06, L-Short:07, L-Tall:08, XL:09, XL-  
Short:10, XL-Tall:11, 2XL:12,  
2XL-Tall :13, 3XL:14, 4XL:15, 5XL:16



# MEN'S CASUAL APPAREL



## VERTICAL CLIMB PERFORMANCE SHELL

- 88% polyester and 12% spandex jersey fleece shoulders and sleeves
- 100% nylon shell with 100g Thermo<sup>®</sup> and quilting
- Two zippered hand-warmer pockets
- Polaris<sup>®</sup> logo on left chest and left sleeve; star on back of neck

2864028 | Black | S-3XL

2864029 | Red/Black | S-3XL



## BLACKCOMB 1/4 ZIP

- 100% polyester sweater knit with a fleece back
- Woven nylon fabric on shoulders with tight quilting
- Left chest pocket with YKK<sup>®</sup> zipper
- 3" collar
- 2-needle collar finish at neck

2865086 | Black | S-3XL



## SLOPE HOODIE

- 92% polyester and 8% spandex blend
- The ultimate in durability — with a shoulder-to-shoulder self-fabric neck taping and 2-needle, 4-thread cover seaming at cuffs and sleeves
- Unlined 2-piece hood with self-fabric taping
- Woven, wrap-around patch

2865083 | S-3XL



## TETON CHECK SOFT-SHELL

- 100% polyester soft-shell jacket with 3000/3000 lamination
- Full-zip front with two zippered hand-warmer pockets
- Star on left chest, Polaris<sup>®</sup> logo on back of left shoulder

2864027 | Black Plaid | S-3XL



## TETON CHECK FLANNEL

- 100% cotton yarn dye
- Full-button front with collar and button cuffs
- Star on left chest, Polaris<sup>®</sup> logo on back of shoulders

2864026 | Black Plaid | S-3XL



## OPS TECH LONG SLEEVE

- Effective mid-layer in layering system
- AP-360<sup>®</sup> wicking and antimicrobial
- Excellent moisture wicking performance
- Far-infrared (heat enhancing), anti-static/anti-pill

2864096 | Black | S-5XL



## ANNAPURNA MID-LAYER

- 100% polyester polar fleece, anti-static/anti-pill
- Zippered hand warmer pockets
- Polaris<sup>®</sup> logo on left chest; ellipse on back of shoulders

2864020 | Black | S-5XL



## CALLAGHAN VALLEY PLAID

- 62% polyester, 33% Rayon, and 5% spandex twill weave
- Embroidered star at lower placket
- 5-thread safety stitch at all seams
- Shirrtail hem

2865080 | S-3XL



## BACKCOUNTRY FLANNEL

- 100% cotton lightweight brushed flannel
- 5-thread safety stitch at all seams
- Front yoke
- Left chest pocket

2865081 | S-3XL



## TRAILBLAZER STRIPE

- 65% polyester, 34% Rayon, and 1% spandex
- 5-thread safety stitch at all seams
- Reactive printed stripe detail on front
- Back yoke
- Polaris<sup>®</sup> logo embroidery above chest pocket

2865082 | S-3XL

### SEE PAGE 77 FOR SIZE CHARTS

When ordering, add size code to part number.  
 XS:01, S:02, M:03, M-Short:04, M-Tall:05,  
 L:06, L-Short:07, L-Tall:08, XL:09, XL-  
 Short:10, XL-Tall:11, 2XL:12, 2XL-Tall :13,  
 3XL:14, 4XL:15, 5XL:16



# WOMEN'S CASUAL APPAREL

## BLACK ICE BASE LAYER TOP

- 88% polyester and 12% spandex jersey knit, contrast stitching, reflective script logos

2864060 | Black | S-3XL

## BLACK ICE BASE LAYER PANT

- 88% polyester and 12% spandex jersey knit
- Polaris® script logo near left ankle

2864061 | Black | S-3XL

## OPS TECH LONG SLEEVE

- Effective mid-layer in layering system
- AP-360° wicking and antimicrobial
- Excellent moisture-wicking performance
- Far-infrared (heat enhancing), anti-static, anti-pill

2864097 | Black | XS-3XL, 1W-3W

## BLACKCOMB 1/4 ZIP

- Long-sleeve poly knit fleece 1/4 zip mock

2865130 | S-3XL

## KAUMAJET 1/2 ZIP

- 85% polyester and 5% spandex blend
- 2-needle cover stitch at bottom, sleeves and body
- Upper-collar and center-back-neck embroidery
- Self-fabric neck taping center front to opposite center front

2865098 | S-3XL

## OLYMPIC FULL ZIP FLEECE

- 92% polyester and 8% spandex blend
- Mock neck
- Self-fabric neck taping center front to opposite center front
- 4-needle cover stitch at bottom and sides
- 2-needle cover stitch at sleeve ends

2865099 | S-3XL

## SAWATCH RANGE HOODIE

- 100% cotton
- 4-thread safety stitch at all seams
- 2-needle cover stitch at bottom, sleeves and body
- Kangaroo pockets
- 2-piece hood

2865095 | S-3XL

## FOOTHILLS FLANNEL

- 100% cotton lightweight brushed flannel with a bio-wash finish that makes the fabric extremely soft
- Double-turned, clean-finish hem
- 5-thread safety stitch at all seams
- Princess seams throughout

2865094 | S-3XL

## EAGLE RIVER GARAGE SHIRT

- 60% cotton and 40% polyester Poplin weave
- Flattering, fitted cut
- Full button front with left chest pocket
- Polaris® logo on left chest; ellipse on back of shoulders

2864103 | Navy | S-3XL

2864104 | Black | S-3XL



# YOUTH CASUAL APPAREL

## SLOPE HOODIE

- 92% polyester and 8% spandex blend
- The ultimate in durability — with a shoulder-to-shoulder self-fabric neck taping and 2-needle, 4-thread cover seaming at cuffs and sleeves
- Unlined 2-piece hood with self-fabric taping
- Woven, wraparound patch

2865084 | XS-XL

## YOUTH BLACKCOMB 1/4 ZIP

- 100% polyester sweater knit with a fleece back
- Woven nylon fabric on shoulders with tight quilting
- Left chest pocket with YKK® zipper
- 3" collar
- 2-needle collar finish at neck

2865131 | Boys | S-XL

## SAWATCH RANGE HOODIE

- 100% cotton
- 4-thread safety stitch at all seams
- 2-needle cover stitch at bottom, sleeves and body
- Kangaroo pockets
- 2-piece hood

2865096 | S-XL



# BEANIES & CAPS



## SIGNATURE BEANIE

- 100% acrylic with 3M® Thinsulate®

2865142 | Red | OSFM

2865141 | Black | OSFM



## THROWBACK CAP

- Wool/spandex blend
- Flexfit sizing S/M and L/XL
- Metal retro Polaris® "P" logo

2865144 | Gray | S/M

2865138 | Gray | L/XL



## SLOPE CAP

- 8-stitch bill allows you to adjust the brim exactly to your own specifications
- 100% cotton twill hat
- Features soft-brushed, constructed and fused buckram
- Snap-back closure

2865100 | OSFM

2865101 | Youth



# SIZING CHARTS

## MEN'S JACKET SIZING

Size	Chest	Waist	Hips	Sleeve*	Inseam	Size Code
Small	35-38	31-33	35-37	33	32	02
Medium	38-41	33-35	37-40	34	32.5	03
Large	41-45	35-38	40-43	35	33	06
X-Large	45-48	38-42	43-47	36	33.5	09
2X-Large	48-52	42-45	47-50	37	34	12
3X-Large	52-58	45-52	50-56	38	34	14
4X-Large	58-65	52-61	56-63	39	35	15
5X-Large	65-70	61-63	63-68	40	35	16

## WOMEN'S JACKET SIZING

Size	Chest	Waist	Hips	Sleeve*	Inseam	Size Code
Small	34-36	24-27	34-37	30	30.5	02
Medium	36-38	27-29	37-40	31	30.5	03
Large	38-40	29-33	40-43	32	31	06
X-Large	40-42	33-36	43-46	32.5	31	09
2X-Large	42-44	36-40	46-49	33	31	12

\* Measure sleeve length from center back neck

## YOUTH JACKET SIZING

Size	Height	Chest	Waist	Hips	Sleeve*	Inseam	Size Code
X-Small	41-46	22-24	19-21	23-26	22	21	01
Small	46-52	24-27	21-24	26-29	24	22.5	02
Medium	52-58	27-30	24-26	29-32	27	26.5	03
Large	58-64	30-33	26-28	32-35	30	29.5	06
X-Large	64-67	33-36	28-30	35-37	33	32.5	09

## ADULT HELMET SIZE CONVERSIONS

Size	Hat Size	Inches	Metric	Size Code
X-Small	6.75	21.25	54	01
Small	6.875-7	21.625-22	55-56	02
Medium	7.125-7.25	22.375-22.75	57-58	03
Large	7-7.5	23.125-23.625	59-60	06
X-Large	7.625-7.75	24-24.375	61-62	09
2X-Large	7.875-8	24.75-25.125	63-64	12
3X-Large	8	25-26	65	14

## YOUTH HELMET SIZE CONVERSIONS

Size	Circumference	Metric	Size Code
Adjustable	Fits S-L	51-54	00
Small	20.375	51	02
Medium	20.875	53	03
Large	21.375	55	06