

Members of the Postal Micro Cabinet Club 1874



The following pages detail some of what is currently known about the members whose images appear in the above montage of the members of the Postal Micro Cabinet Club 1874. Though some may find this tedious and boring there will be some whose slide collection contain slides by these microscopists. The author hopes that where more detail is available then it should be sent to the editor of our Journal or the Postal Microscopical Society's Balsam Post in the form of a small article or letter and thus share our knowledge. Inclusion of detail in this article is limited only by the limit of the knowledge of the author!

This year (2023) as many will already be aware, marks the 150th Anniversary of the formation of the Postal Microscopical Society. Shortly after it's formation a montage of members images was produced (in 1874). The montage shows vignettes of members of the Postal Micro Cabinet Club. The

names and addresses of these members were present on the original document but subsequently lost. Fortunately, in 1958, Thomas Alfred Wright (24th January 1905 – 1977) succeeded in collating these details from a similar montage dated 1875 (the whereabouts of that montage is currently unknown). The name of the Club was altered in October 1875 to its present identity, The Postal Microscopical Society.

The original plan was to produce a document, for the Celebration issue of the Balsam Post, detailing some aspects and interests of each of the 64 original members plus their image from the montage. An article was prepared and submitted but rejected on the grounds of being too long to be comfortably included.

Rather than let this work go to waste I am presenting it here. The montage appears regularly at PMS/Quekett meetings for those able to attend. The montage images are courtesy of Mike Samworth.

Those individuals recorded as members of the Quekett Microscopical Club are marked with an asterisk (*).

Another montage was produced in 1878 consisting of 73 individuals, including 6 "ladies". Those individuals appearing in both the 1874 and 1878 montages are marked with the symbol §. By 1903 the only member appearing in this montage and still appearing in the PMS Membership listing was Edwin Tutte.

Montage Photograph Reference Index

Photograph	Name	Photograph	Name
1	Smith, Richard (Jun.)*	33	Atkinson, Alfred §
2	Elliott, Arthur	34	K(y)(i)ngdon, Francis Boughton
3	Locock, Revd. William	35	Hey, William Hamilton
4	Holmes, Thomas Wainman §	36	Colsell, George Dannatt*
5	Tutte, Edwin	37	Dannat, George
6	Brennan, Rev. Samuel Arthur	38	Jackson, Rev. John Kidson
7	Inman, Thomas	39	Wade, Benjamin George
8	Nicholson, Augustus	40	Hutcheson, John Cross
9	Moore, Daniel*	41	Sargent, John*/Sargent, William
10	George, Charles Frederick*	42	Allen, Frank James
11	Jones, Lewis John Fillis	43	Sear, William Lane
12	Cole, Arthur Charles*	44	Rowe, Thomas Smith
13	Case, William	45	Lisle, Thomas
14	Pocklington, Henry*	46	Watkins, Charles James
15	Johnson, T. S. (Thomas Simister?)	47	Hincks, Samuel Charles
16	Kingsbury, Francis John	48	Addis, William*
17	Carpenter, John*	49	Smith, Edwin
18	Holmes, Charles Denton	50	Wilson, Andrew
19	Mello, Rev. John Magens	51	Mason, Thomas Edward
20	Philip, Robert Harris	52	Griffith, Rev. Charles Higman
21	Salt, Revd. Francis Gardner	53	Simmonds, Joseph Edmund*
22	Lewis, William Bevan	54	Nicholson, William Ostler
23	Rotheram, John	55	Jones, Charles John
24	Bellingham, Benjamin	56	Ford, John
25	Williams, John Michael*	57	Everett, James
26	Beulah, John*	58	Believed to have been West, Tuffen. (Both portrait and name were removed at some period from the only known copy of the lithograph) §
27	Whiteley, John William	59	Ball, Thomas
28	Jenkinson, William (Thomas)	60	Burton, John Robert
29	Freeman, Henry Edwards*	61	Wheeler, Daniel
30	Hope, James Chadwick	62	Harrison, John Simpson
31	Pocklington, John Robert	63	Pocklington, Christopher
32	Allen, Alfred Uriah*§	64	Moore, Richard Harwood

There were at least two other members noted as joining in the first year [1873] (still members of the Postal Microscopical Society in 1891-2), who do not feature in the montage:

Miss Emily Elizabeth Jarrett ^(present in the 1878 montage), of Camerton Court, Bath (a Land and Colliery owner, who died 31st December 1911, unmarried, with an estate to the value of £70,714 1s. 9d.)

Henry Nathan Maynard ^(present in the 1878 montage), Mem.Inst.C.E., 171 The Grove, Hammersmith, W. and 7 Westminster Chambers, London, S.W. (died in 1899).

Also joining in 1874, the date of this montage, is one Thomas Curties* ^(present in the 1878 montage), F.R.M.S., 244 High Holborn, London, W., an Optician working with Charles Baker (and one of the executors of his Will).

A record as follows "The Postal Microscopical Society - Classified List of Objects shown from its commencement to the end of the 4th year, June 1877" was produced in 1878 by Tuffen West. As well as the object name the record also shows which microscopist was responsible for submitting the slides. If records exist for a member they are included in each members' listing below under the heading "Objects circulated to June 1877". There are many Science Gossip [SG], Journal of the Postal Microscopical Society [JPMS], Journal of the Quekett Microscopical Club [JQMC] and English Mechanic and World of Science [EM] references, abbreviated as in the square brackets.

1. Richard Smith (Jun.) F.R.M.S. (Born: 16th February 1836 Stone, Staffordshire; Died:28th August 1900 St. John's Wood, Middlesex)



Known Addresses:

- Stone Mill, Stone, Staffordshire (1861)
- Osmaston Road, Derby (1867)
- Stone House, Bridge Street, Belper, Derbyshire (1871)
- 8 Lady Somerset Road, N.W. (*Kentish Town*)(1874-1878 – Richard Smith in Electoral Registers)
- Gower Street, Stone, Staffordshire (1881)
- 6 Marlborough Hill, St. John's Wood, Middlesex (1897,1898,1900)

References:

- SG Vol.8. April 1872: Crystals of Oxalurate of Ammonia for other good mounted objects; anatomical preferred. - R. Smith, Jun., Stone House, Belper.
- SG Vol.8. May 1872: Sections of Uterine Tumour stained with carmine and mounted in glycerine, in exchange for other equally good objects. - R. Smith, Jun., Stone House, Belper.

Objects circulated to June 1877:

- Minerals & Geology (Crystals, Vegetable Products): Citric Acid; Strychnine; Sugar
- Minerals & Geology (Crystals from Altered Veg. Matters): Napthaline
- Insecta – Syrphidae: *Eristalis tenax*, tongue
- Insecta – Aphaniptera: Flea, heart; Flea, gizzard; Flea, gizzard from above
- Animal Tissues – Muscular Fibre: Muscle from Gizzard of Fowl
- Animal Tissues – Digestive Organs: Tongue of Dog
- Parts of Vertebrata – Kidney: Rat's Kidney, stained

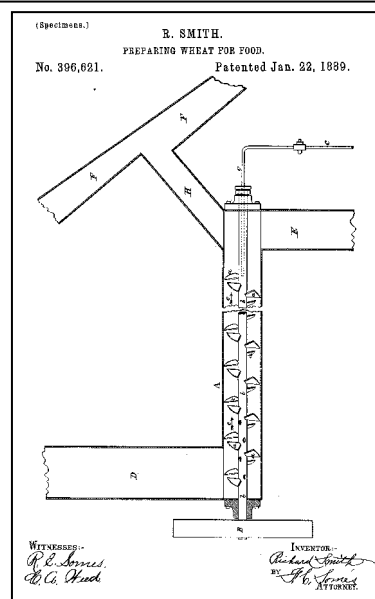
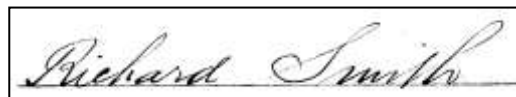

bp. 19th February 1836 Saint Michael's, Stone, Staffordshire
parents – Richard and Sarah Smith

In the 1861 Census @ Stone Mill, Stone, Staffordshire:

Richard Smith, age 58, a Corn Miller employing 6 men, b. Addington, Gloucestershire

Sarah Smith, age 49, b. Isle of Sheppey, Staffordshire

Richard Smith, age 25, a Corn Miller's Assistant, b. Stone, Staffordshire (hence "Jun.")

John M(aison/arson) Smith, age 22, a Corn Miller's Assistant, b. Stone, Staffordshire

Elizabeth Smith, age 21, b. Stone, Staffordshire

Edwin Smith, age 14, a Scholar, b. Stone, Staffordshire (see Edwin Smith No.49)

Richard Smith married Martha Winkle 24th August 1867 St. Peter, Derby, Derbyshire by Licence.

A Patent was issued to him at the Lady Somerset Road address on the 1st August 1876 in respect of the invention of "improvement in keys for locks" as set forth in his petition recorded 21st March 1876".

Another Patent issued for Furrowing Millstones, R. Smith, Gover Streets, Stone: December 1879.

In the 1881 Census age 45, a Miller employing 8 men and 1 boy, b. Stone, Staffordshire

bu. Highgate Cemetery (a few yards behind the grave of Karl Marx).

Inscription (main face):

"STONE", Richard Smith 16 February 1836, 28 August 1900, of Stone in Staffordshire, Macclesfield in Cheshire, and London. After years of patient investigation he patented on the 6th October 1887 his improved treatment of Wheat Corn and Brown Wheat which made the manufacture of Hovis bread possible.

Inscription (left face):

"DOT", Martha Smith, widow of Stoney, born 28 December 1844, died 10 April 1929.

The patent mentioned on the inscription is described as follows (relating to the figure above):

"For the purpose of carrying my invention into practice I take the germ of the wheat, which has been previously separated in any suitable manner from the other parts of the wheat-berry, and subject such germs to the action of superheated steam. After the flavour of the wheat germs is imparted to the steam, I subject broken wheat to the action of the same steam, whereby the empyreumatic flavour of the wheatgerm is imparted to the broken wheat. I also mix the steam-cooked wheat-germs with broken wheat or wheatflour.

The figure of the accompanying drawing is a longitudinal vertical section of an apparatus for carrying out my invention."

Elected a Fellow of the Royal Microscopical Society 1892. In 1898 members list Smith Richard, F.R.M.S., 6 Marlborough Hill, N.W.

Elected to the Quekett Microscopical Club 16th December 1893. In 1897 members list Smith Richard, F.R.M.S., 6 Marlborough Hill, N.W.

Entry, for Richard Smith, 6 Marlborough Hill, N.W., in The Illustrated Catalogue of the Royal Photographic Society's International Exhibition at the Crystal Palace, 1898. Page 186:

Twenty-two Photomicrographs. Richard Smith

Blossom of Wheat.

1. Stigma and Anthers. X 12.

2. Stigma and Anthers. X 26.

3. Part Stigma. X 52.

4. and 5. Beardlets of "Wheat. X 30. (These are for drying the germ end of the berry in the same way that the hairs of the beard dry the other end.)

Wheat Bran.

6. Outer skin of Bran. X 60.
7. Middle skin of Bran. X 60.
8. Inner skin of Bran. X 60,

Wheat Germ.

9. Vertical Longitudinal Section. X 38. (Shows germination just beginning).
10. Horizontal Longitudinal Section. X 25.
11. Transverse Section. X 25.
12. Core of Wheat Berry. (Analogous to core of apple.) X 70

Wheat Bran.

13. Vertical Section. X 400.
14. Oblique Section. X 70.
15. Endosperm of Wheat. (With most of the starch washed out to show the gluten.) X 300
16. Indian Wheat Berry, in section showing the larva of a weevil.

Wheat Straw.

17. to 22. Sections to close under the ear from the first knot. X 20. (18 shows the flag round the straw before the flag has unfolded.)

Probate: Smith, Richard, of 6 Marlborough Hill, St. John's Wood, Middlesex, died 28th August 1900. Probate London 11th October 1900 to Henry John Howard Bull, solicitor and Edward Fordham Spence, barrister-at-law, Effects £30,517 3s.

2. Arthur Elliott



(Missing from listing by T. A. Wright)

Unable to identify this individual in the records.

Objects circulated to June 1877:

- Ferns: *Asplenium filix mas* scales

There is a quote by an Arthur Elliott in 1891 as follows which may have some relevance:

"...there is no doubt that this Jena glass, which has done such wonders in the field of microscopy, is destined to teach us some new things in the world of photography." from *Photography in America: The formative years, 1839-1900* by William Welling.

3. Rev. William Locock (Born: 25th July 1828 St. Pancras, Middlesex; Died: 30th December 1894 Bristol)



Known Addresses:

- Lee Park, Lee, Kent (1851)
- The Parsonage, East Haddon, Northamptonshire (1861)
- Corscombe Rectory, Dorchester (1869-1877)
- 7 Alexandra Road, Clifton, Gloucestershire (1881 PMS Members List)
- 13 Alexandra Road, Clifton, Gloucestershire (1882 PMS Members List – Circuit h; 1884 Bristol Microscopical Society)
- Wolverton House, Clarendon Road, Redland, Bristol (1894)
- 27 Fernbank Road, Redland, Bristol

Occupations:

Curate and Vicar

References:

- Author of "Theory and Practice of Perspective, together with the Application of the same to Drawing from Nature" (1852)
- SG Vol.10. June 1874 : Star-fish Tubercles, Seed-case for Polariscope, or *Puccinia umbilici*, offered for other good Objects - Send stamped envelope and objects to Rev. W. Locock, Corscombe Rectory, Dorchester.
- SG September 1875 contains a description of "a contrivance for securing slides on a turntable".
- At the Quekett Microscopical Club meeting of 24th September 1875 "The Rev. W. Locock, who

was introduced to the Club by Mr. Curties, exhibited and described a contrivance for securing slides in any position on a turntable." (JQMC Ser. 1. Vol.IV, pg 123.)

- Earwig. JPMS Vol.2. pg.247. 1883
- Urticating Hairs of Caterpillars. JPMS Vol.5. pg.246. 1886
- Tongue of Cricket. JPMS Vol.6. pp.54-55. 1887
- Spinnerets of Spider to Mount. JPMS Vol.7. pg.51. 1888

- Mounting. JPMS Vol.10. pp.287-288. 1891

Objects circulated to June 1877:

- Fungi: *Puccinnia prunosum*
- Wood Sections: Butchers Broom; Gorse
- Seeds & Seed Vessels: Membranous seed pod; *Nemesia* seed case
- Insecta - Conopidae: *Conops*, head
- Insecta – Homoptera: *Psylla*, Australian cocoon (sub nom Work of Beetle on Gum Tree)
- Hymenoptera – Ichneumonidae: Ichneumon Fly
- Coleoptera – Dyticidae: *Dytiscus marginalis*, spiracles
- Coleoptera – Staphylinidae: *Staphylinus* gizzard
- Coleoptera – Geotrupidae: *Geotrupes stercorarius* (Dor Beetle), spiracle
- Coleoptera – Cuculioridae: Diamond Beetle, gizzard
- Parts of Vertebrata – Hoofs, Horns, &c.: Badger Claw, cross section
- Animal Tissues – Tendon: Tendon from Rat's Tail

His mother Susanna, a widow in the 1851 Census, was recorded as a Landed Proprietor. Attended Blackheath Proprietary for eight years and then briefly St. John's College. In 1852 admitted into Holy Orders – "William Locock, B.A., Gonville and Caius College, Cambridge" and subsequently obtained the Curacy of Hempstead. In 1854 moved to the vicarage of East Haddon, nr. Northampton and in the same year married Ada Burt on 15th June at Lee, Kent. He was also, in that year, elected as a member of the Architectural Society of the Archdeaconry of Northampton. Four children were born to the couple: Ada Fanny (1855), Henry (1856 d. 1862), William Frank (1859) and Alfred Henry (1863). Introduced to the Club by Mr. Curties. Awarded the living at Corscombe, Dorset in 1869 and resigned the position in 1878. Hon. Secretary of the Bristol Microscopical Society in 1884. When he died his probate record recorded him as leaving estate valued £3,779 19s. 7d. He was buried on the 3rd January 1895 in Holy Trinity, Westbury-on-Trym, Gloucestershire.

4. Thomas Wainman Holmes (Born: circa 1844 Leeds, Yorkshire; Died: 2nd July 1919 Bradford, Yorkshire)



Known Addresses:

- New Row, Baildon, Yorkshire (1861)
- Baildon, Leeds (1874)
- 8 Rushcroft Terrace, Baildon, Shipley (1881, 1884, 1895) [1881 - business 29 Booth Street and Providence Mills, Baildon, T. and W. W. Holmes]
- 5 Hustlergate, Bradford (1895)
- Commercial Buildings, Park Row, Leeds and Dale Street Chambers, Bradford (1896, 1906-1909)
- 3 Dale Street, Bradford (1910, 1911)
- Northgate, Baildon (1910, 1911)
- Jenny Lane, Baildon, Yorkshire (1911)
- 23 Picadilly, Bradford (1912 – Office address)
- 38 Marlborough Road, Bradford (1919)

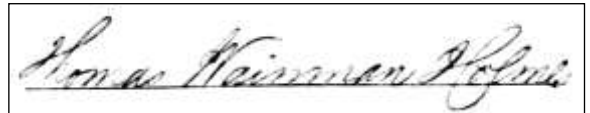

Occupations:

Worsted Manufacturer (1861); Worsted Spinner and Manufacturer (1881, 1882); Worsted Spinners and Stuff Manufacturers (1882); Accountant (1891, 1896, 1901, 1911)

Objects circulated to June 1877:

- Diatomaceae: *Isthmia enervis*
- Root Sections: *Sonerathra* root
- Wood Sections: *Arranthe elongata*(?)
- Entozoa: *Trichina* from Pork
- Insecta - Muscidae: Blow Fly, ovipositor
- Insecta – Heteroptera: *Naucoris cimicoides*
- Hymenoptera – Tenthredinidae: Sawfly, stomach
- Hymenoptera – Ichneumonidae: *Microgaster glomeratus* subnom, Cocoons &c.
- Orthoptera – Euplexoptera: Earwig wing
- Coleoptera – Dyticidae: *Dytiscus marginalis*, larva
- Coleoptera – Staphylinidae: *Staphylinus*, subnom Dung Beetle
- Parts of Vertebrata – Hoofs, Horns, &c.: Human Nail
- Vascular System - Injected Preparations &c.: Toe of White Mouse, injected
- Parts of Vertebrata – Reproductive Organs: Ova of Frog

On 13th April 1869 married Sarah Dean (5 years his junior) by Licence at All Saints, Bingley, Yorkshire.

A son (Isaac Horatio) was born in 1870, a daughter (Sarah Eveline) was born in 1871 and another son (Douglas Dean) in 1878. The business partnership associated with the Tweed Manufacturing firm of Joseph Taylor and Co., in which Thomas Wainman Holmes was a partner, was dissolved on the 29th February 1872. Admitted to the Grade of Zelator in the Rosicrucian United College of Manchester, Liverpool and the Northern Counties (The Freemason 27th March 1875). T. W. Holmes was invested Prov. S.G.D. in the Grand Mark Lodge of West Yorkshire (at Fearnley lodge No.58) October 1880.

He was recorded as the owner of The Angel Inn, Baildon (1882-1893), having inherited the property from his father.

His manufacturing company (William Wainman Holmes and Thomas Wainman Holmes, worsted spinners and stuff manufacturers) filed for Liquidation in 1882 as noted in The Journal of Fabrics 19th May. The firm of John Routh and Co., Accountants, in which T. W. Holmes was a partner, was dissolved 7th July 1896. In 1908 Recorded as a Subscriber to The Royal Masonic Institution for Maintaining, Clothing, and Educating Sons of Freemasons 1907, 1908 and 1909. When he died his probate record recorded him as leaving estate valued £356 18s. 6d.

He was mentioned as being active in The Order of the Golden Dawn (The Hermetic Order of the Golden Dawn, more commonly the Golden Dawn, was a secret society – founded in 1887 - devoted to the study and practice of occult Hermeticism and metaphysics – Occult Science - during the late 19th and early 20th centuries).

5. Edwin Tutte (Born: 1st October 1826 Fareham, Hampshire; Died: 12th February 1909 Fareham, Hampshire)



Piano Tuner (1881); Pianoforte Dealer (1890-1906); Builder (1891, 1901)

Known Addresses:

- West Street, Fareham, Hampshire (1871)
- Fribourg Villa (102?), Fareham, Hants (1881-1885 – PMS Members List [on Circuit n in 1881,1882])
- Lausaune Villa, (102?) Fareham, Hants (1886-1887 – PMS Members List)
- 102 West Street, Fareham, Hants (1881-1891 – PMS Members List, 1880 - Kelly's Directory)
- 10 West Street, Fareham, Hampshire (1903-1909)

Occupations:

Master Builder, employing 4 men and 3 boys (1871); Registrar of Marriages for Fareham Union (1880-1889); Carpenter and Builder and Registrar of Marriages (1880,1889); Builder and

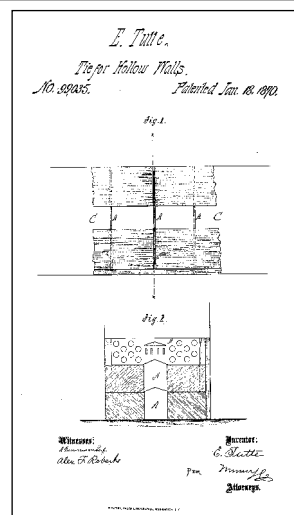

References:

- Foot of Fly. JPMS Vol.5. pg.120. (1 plate) 1886

Objects circulated to June 1877:

- Diatomaceae: *Isthmia enervis*
- Various Diatomaceae: Cuxhaven
- Zoophyta – Corallia: *Alcyonium digitatum*
- Mollusca: Oyster embryos; Oyster embryos, moving
- Insecta – Imperfectly named (or Massed): Urinal fly, foot; Urinal fly, proboscis
- Insecta – Homoptera: *Aphrodora spinnaria*(?), head &c.; *Aphrodora spinnaria*(?), saws; Sage Fly, saws
- Hymenoptera – Tenthredinidae: Gooseberry Sawfly, saws; Sawfly saws x4 slides; Sawfly, reproducing organ
- Neuroptera – Hemerobiidae: Lace Wing Fly, eggs
- Neuroptera – Thysanoptera: Thrips, with saws
- Araneae: *Tegenaria civilis*, Anchorage

Business name in 1859 – Tutte and Ings.

Married Louisa Miriam Newland in 1860. A son (Hubert Edwin Cave) was born 30th April 1867 Fareham, Hampshire (he eventually became a PMS Member, still living at 10 West Street, in 1936). In 1865 and 1868 he and Augustus Nicholson (No. 8) were elected Auditors of the Fareham Literary Institute.

He lodged two patents:

British Patent 1339 30th April 1869 for “Construction of Hollow Walls” & U.S. Patent 99,035 18th January 1870 for “An improved Tie for Hollow Walls” (see illustration).

A daughter (Mary Agnes Louisa) was born 6th February 1872 Fareham, Hampshire. At the Choral Society's Concert at Fareham 1878, 18th April 1882 and 1889 he was the Flute player in the performance and in 1885 was responsible for the Clarinet parts.

When he died his probate record recorded him as leaving estate valued £6,173 6s. 6d. He was buried 19th February 1909 at Wickham Road Cemetery, Fareham - Grave No. 110 (Non-conformist).

6. Rev. Samuel Arthur Bren(n)an (Born: 1837; Died: 10th January 1908 Ballycastle, co. Antrim, Northern Ireland)



Known Addresses:

- Kingston Lodge, Golden-ball (1862)
- Kingston Lodge, County of Dublin (1864)
- Agolagh, Cushendun, co. Antrim (1867-1874, 1882-1908, 1890 – Belfast Naturalists' Field Club Members List)
- Pomeroy, co. Tyrone (1875)
- Allan Rock, Dungannon, Co. Tyrone (1881)
- Agolagh, Knocknacarry (1893,1908)

References:

- SG Vol.7. November 1871 : Wanted Microscopic Slides for unmounted material, scales of sea fish, &c - Rev. Samuel A. Brennan, Agolagh, Cushendun, co. Antrim.
- SG Vol.11. May 1875 : Wanted, Plants of *Valisneria*, and other Plants suitable for Aquarium. - S. A. Brennan, Pomeroy, co. Tyrone.
- SG Vol.11. August 1875 : Plants of *Linstrea cristata* for *L. rigida*, *Cystopteris alpina*, *Pseudothyrium alpestre*, *Cystopteris montana*, *Osmundu regalis* (tasselled), *Woodsias*. - Rev. S. A. Brennan, Pomeroy, County Tyrone.
- SG Vol.17. June 1881 : Wanted, number nine of the "Quarterly Journal of Microscopical Science." Please communicate with the Rev. S. A. Brennan, Allan Rock, Dungannon, Co. Tyrone.
- Shamrock. JPMS Vol.7. pg.51. 1888
- Fairy Folk-Lore, Co. Antrim, The Journal of the Royal Historical and Archaeological Association of Ireland, 9(78), 59–63 (1889)
- Submitted numerous notes on local nature to The Irish Naturalist. These included regular observations on the arrivals of summer migrant birds, seasonal notes on nature and even a comment on a plague of rats at Cushendun in 1897.
- *Sphaerotheca Mors-Uvae* (Berkl. and Curtis) in Ireland. Journal of Botany Vol.38, 1900; and The Irish Naturalist Vol.10.,1901.
- Plants of Co. Antrim, The Irish Naturalist 10, no. 11 (1901): 229–229.
- Many other notes on Botanical observations in the Journal of Botany. (1884-1898), inc. on *Rubi*, *Hieracia* &c.

Objects circulated to June 1877:

- Minerals & Geology (Silicious): Agate
- Minerals & Geology (Crystals, Vegetable Products): Cinchonidine Carbazolate; Salicine
- Diatomaceae: *Lichmophora splendida*; *Pleurosigma strigilis*
- Hymenoptera – Vespidae: Hornet, tongue
- Neuroptera – Hemerobiidae: Lace Wing Fly, larva
- Parts of Vertebrata – Hairs: Bat
- Parts of Vertebrata – Scales: Eel scales
- Animal Tissues – Muscular Fibre: Muscle from Insect
- Vascular System - Injected Preparations &c.: Human lung in Health

The Rev. S. A. Brennan was summoned to the Magistrates Court in June 1892 accused by the Fisheries inspector of catching salmon in the sea by means of a fixed net which was not legally erected and for which no certificate had been given. The charges were dismissed and an appeal lodged by the inspector in October 1892. The result of the appeal I have not been able to determine.

He became a member, Jun. Soph. (Junior Sophister – i.e. a second or third year student) of the Dublin University Zoological and Botanical Association in 1859. He received his B.A. at Trinity College Dublin in 1861 and his Divinity Testimonium was in the same year. He was ordained Deacon in 1861. Became a Priest in 1864, successively Curate of Rathmoylon, Drumconrath and Fertullagh (Meath); Seagoe and Shankill (Dromore, and allymoney (Connor). He became Rector of Cushendun 1867-1872. He resigned his position in Altadesert for the Rectorship of Cushendun again 1882-1908. He married Leititia Augusta Logan on the 11th August 1864 at Charlestown, co. Louth. He was the Hon. Local Secretary of North Antrim for The Royal Society of Antiquaries.

Three herbarium specimens from the Watson Botanical Exchange Club are recorded viz:

Eriocaulon aquaticum from Lough Corrib, August 1895; *Pyrola media* from Tyrone, Kildress, July 1897; *Pyrola media* from Tyrone, Kildress, July 1897.

Probate of the Will of Rev. Samuel Arthur Brennan late of Knocknacarry (Cushendun) County Antrim Clerk, granted 7th February 1908, who died 10 January 1908 granted at Belfast to Rev. John Matthew Young and Rev. Charles Leslie Garnett Clerks. Leaves portraits to cousin James Eustace Brennan and other to cousins Herbert Eustace Brennan and Dr. Richard Brennan. Leaves his farm in Agolagh to his estranged daughter Frances Emily Augusta Victoria Brennan. Effects £312 18s. 10d.

He left his herbarium to The Ulster Museum. Collected specimens also present in the Henry William Lett Herbarium housed at the National Botanic Gardens, Glasnevin, Dublin, Ireland. Many specimens listed in "County Antrim Scarce, Rare & Extinct Vascular Plant Register and Checklist of Species" by Stan Beesley (2006). He also submitted readings to Symons's Monthly Meteorological Magazine (September 1891).

Obituary in The Irish Naturalist Vol.17. 1908.

He was buried in Layde Church of Ireland Parish Churchyard, Ballymena, County Antrim, Northern Ireland.



7. Thomas Inman MD. (Born: 27th January 1820 Rutland Street, Leicester, Leicestershire; Died: 3rd May 1876 Clifton, nr. Bristol)



Known Addresses:

- 16 Rodney Street, Mount Pleasant, Liverpool, Lancashire (1851,1852,1853,1854)
- 181 Lord Street, North Meols, Lancashire (1851)
- 29 Rodney Street, Liverpool (1857,1858 - Members List of the Literary and Philosophical Society of Liverpool (Elected 21st October 1844, President 1856-1857, 1857-1858), 1859-1873 - List of the Fellows, Members, Extra-Licentiate and Licentiate of the Royal College of Physicians of London – Elected 1859)
- 12 Rodney Street, Liverpool (1869)
- 8 Vyvyan Terrace, Bristol (1874-1876, List of the Fellows, Members, Extra-Licentiate and Licentiate of the Royal College of Physicians of London)

Thomas Inman



Occupations:

1st Examination for the Degree of Bachelor of Medicine (King's College) in the year 1841: Materia Medica and Pharmaceutical Chemistry – [First Division pass], Exhibition and Gold Medal. 1st Examination for Honours – Anatomy and Physiology – 1st Examination for Honours – Chemistry; Surgeon (1845,1851); Lect. On Principles and Practice of Medicine, Liverpool School of Medicine, Physician to Northern Hospital (1857,1858), Consulting Physician to The Royal Infirmary, Liverpool (1873)

References:

- Spontaneous Combustion (1855)
- On certain Painful Muscular Affections (1856)
- 14th Ordinary Meeting at the Royal Institution on 18th May 1857 read a paper "An Account of some of the Volcanoes of Italy"
- The Phenomena of Spinal Irritation and Other Functional Diseases. John Churchill, London (1858)
- On Myalgia: its Nature, Causes and treatment (1860)
- The Foundation for a new Theory and Practice of Medicine, (1860)
- On the Preservation of Health; or, plain directions how to avoid the doctor (1868/1869)
- On Climate and Its Influences.
- Ancient Faiths embodied in Ancient Names Vol. I. by Thomas Inman, Liverpool 1868 (printed for the Author)
- The Restoration of Health, &c., (1870)
- Ancient Pagan and Modern Christian Symbolism Exposed and Explained by Thomas Inman, Liverpool 1869 (Revised and enlarged by John Newton 1875)
- Ancient Faiths and Modern: a Dissertation upon Worships ... before the Christian Era, &c., 1876
- Clifton Oolite. JPMS Vol.1. pg.97. 1882
- Hair of Deer. JPMS Vol.2. pg.251. 1883
- Feet of Blow-Fly. JPMS Vol.3. pg.121. 1884
- Sections of Mountain Limestone. JPMS Vol.6. pp.116-117. 1887
- Coal-Ashes as a Micro Slide. JPMS Vol.10. pg.286. 1891
- Sections of Bristles. JPMS Vol.10. pg.288. 1891
- Papers published in the Proceedings of the Literary and Philosophical Society of Liverpool (from An Index to the Proceedings of the Literary and Philosophical Society of Liverpool – Volumes I to LXII. 1912):
 - Adaptability to altered circumstances an attribute of life. XIV, 63.
 - History of the English Alphabet. XXV, 191.
 - Voluntary and involuntary motions in the Animal and Vegetable World. III, 34
 - The Aborigines of Australia. II, 18.
 - Some of the Geographical and other Peculiarities of Australia. II, 12.
 - The Punishment of Death in cases of Murder. VI, 72.
 - The Natural History and Microscopical Characters of Hair. VII. 83, 219.
 - Remarks on a Memorial to Jeremiah Horrocks, the Astronomer (by Thomas Inman [President], and others). XIII, 5.
 - The Feet of Insects. VI. 209.
 - The causes that determine the fall of leaves. IV. 89.
 - The Distinction between Animal and Vegetable Life. VI. 113.
 - A means employed for removing and erecting Menhirs. XXX. 103.
 - The Antiquity of certain Christian and other Names. XX, 113.
 - Cockle and Oyster Shells from a layer of them embedded in the ground near the Church of Trinita Del Monte, Rome (exhibited by Thomas Inman. XXVII. P.xxxvi (Natural History Notes)
 - An Account of the Stalagmite Cave of Adelsberg. XXVII, p.xxxviii (Natural History Notes)
 - Pillar Stones, Stone Circles etc. XXI, 85.
 - Circulation in the closed cells and lymphatic hairs of certain Plants. IV, 26.
 - Inaugural Presidential Address. XI. 18.
 - The Scenic Effects produced by Water. XXVII, 215.

Objects circulated to June 1877:

- Minerals & Geology (Earths): Limestone Mountain, Clifton; Limestone Mountain, new section
- Seeds & Seed Vessels: Ivory nut
- Zoophyta – Corallia: Coral, fossil from Carb. Limestone Clifton
- Polyzoa: Bryzoon Fossil
- Insecta – Anoplura: *Phthirus inguinalis*, Crab Louse & Eggs ; *Haematopinus suis* from Hog
- Insecta - Muscidae: Blow Fly, feet

- Insecta – Lepidoptera: Moth tongue
- Trombidina: *Trombidium holosericeum*
- Parts of Vertebrata – Hairs: Black Bristles
- Parts of Vertebrata – Bone: Saurian Bone from Australia; Coprolite containing bone
- Parts of Vertebrata – Tooth: Human Molar Crown

Thomas was the second son of Charles Inman, a partner in Pickford's carrying company, and later director of the Bank of Liverpool. Schooled in Wakefield, he was apprenticed to his uncle, Richard Inman, M.D. of Preston, Lancashire. He entered King's College, London and graduated M.B. in 1842 and M.D. in 1844 at the University of London.

Dr. Thomas Inman was a part-time Lecturer in the Liverpool (Royal) Infirmary School of Medicine, successively on Botany, Medical Jurisprudence, Materia Medica with Therapeutics, and the Principles with the Practice of Medicine, 1846-61 (according to the title page of his *On The Restoration of Health*, 2nd ed., 1872, and *University College Liverpool Calendar... 1899-1900*, p.245), and served as Secretary to the School 1847-55 (Henry A. Ormerod, *The Early History of the Liverpool Medical School from 1834 to 1877* [1953], p.32). He was a Non-Resident Fellow of the Botanical Society of Edinburgh in 1866.

Interestingly the medical principle "First do no harm" is attributed to him.

Married Jennet (Janet) Leighton Newham 10th June 1844 Braddan, Isle of Man. A son (Charles Arthur) was born in 1845, a daughter (Jennet Maud) in 1848, another son (Edwin H) in 1850 and a further daughter (Zoe Anne) in 1857. He took on the role of Secretary for the British Association for the Advancement of Science meeting 20th September 1854 at Liverpool. When he died his probate record recorded him as leaving estate valued just under £16,000. He was buried at Arnos Vale Cemetery, Bristol

8. Augustus Nicholson (Born: 11th October 1788 Fareham, Hampshire; Died: 16th May 1881 Fareham, Hampshire)



Known Addresses:

- 92 West Street, Fareham, Hampshire (1840-1861)
- 38 West Street, Fareham, Hampshire (1871-1881)

Occupations:

Shopkeeper, appointed a Postmaster 30th May 1821; Bookseller (1819,1841); Postmaster (1843, 1844); Postmaster and Agent for Atlas Fire and Life (1852); Organiser of a Circulating Library (1852); Postmaster, Printer, Bookseller and Stationer (1855); Bookseller and Printer, employing 2 persons (1861); Retired Businessman (1871)

References:

- SG Vol.3. September 1867 : *Melicerta ringens* may be obtained on application to A. Nicholson, Fareham. A small bottle or sealed quill should accompany the request.
- SG Vol.4. February 1868 : Santonine. - A few first-class slides for other good mounted objects. - A. N., Fareham.
- SG Vol.5. August 1869 : *Vibrio tritici*, in growing wheat, or other objects offered for Paste Eels. - A. N., 38, West Street, Fareham, Hants.
- SG Vol.7. August 1871 : Paste Eels wanted. A full equivalent for a few will be thankfully given. - A. N., Fareham.
- SG Vol.8. March 1872 : Slides of beautiful diatoms from the Yarra, Melbourne, Victoria, in exchange for other equally good slides. - A. N., Fareham.
- SG Vol.9. January 1873 : A FEW finely-figured Santonine slides (Polar) offered for other good

slides. - N., Fareham.

- Birds'-Head Processes in *Gemellaria*. JPMS Vol.1. pg.187. 1882
- *Pediculus vestimenti*. JPMS Vol.2. pg.123 1883
- Wheat-Eels (*Anguillula tritici*), JPMS Vol.2. pp.241-242 1883
- Hairs from Foot, Throat, and Tail of *Ornithorhynchus Paradoxus*. JPMS Vol.3. pg.121. 1884
- *Batrachospermum*. JPMS Vol.4. pp.119-120. 1885
- Santonine. JPMS Vol.5. pg.119. 1886
- *Anguillula tritici*. JPMS Vol.5. pg.122. 1886
- Foraminifera from Hollow Flint. JPMS Vol.5. pg.240 (1 plate). 1886
- Gizzard of Flea. JPMS Vol.6. pg. 114. 1887
- Slides of Crystals. JPMS Vol.6. pg.115. 1887
- *Acidium compositarium*. JPMS Vol.7. pg.115. 1888

Objects circulated to June 1877:

- Minerals & Geology (Crystals, Vegetable Products): Santonine
- Diatomaceae: *Aulacodiscus*, R. Congo; *Pleurosigma formosum*
- Various Diatomaceae: Felsted
- Polycistina: Recent
- Foraminifera: *Orbiculina*
- Zoophyta – Corallia: *Alcyonium digitatum* (?) spicules
- Echinodermata: *Ophiocoma rosula*, disc; *Solaster papposa*; Starfish scales; starfish bones; *Holothuria tremula* scales; *Holothuria tremula* scales #2
- Mollusca: *Helix hortensis*, palate; *Helix aspersa*, egg shell films
- Orthoptera – Achetidae: *Acheta domestica*, gastric teeth
- Coleoptera – Cuculioridae: Gizzard of Beetle
- Crustaceae – Decapoda – Pycnogonidae: *Pycnogonium*; *Pycnogonium*, young of, subnom parasite of
- Acarina: sub nom Parasite from Mouse; *Dermaleichnus*(?), Pheasant
- Araneae: Spider, female
- Parts of Vertebrata – Hairs: Human Shavings

Married Elizabeth Ellyett on 18th June 1818. A son Alfred Ellyett Nicholson was born 27th August 1819.

From Hampshire Telegraph and Sussex Chronicle etc., Wednesday, May 18, 1881:

"One of the oldest inhabitants of Fareham has just 'joined the majority'. Mr. Augustus Nicholson died on Monday night, at the age of 94. He filled the office of Postmaster in the town for about 50 years, and on his retirement nearly 20 years ago, a memorial got up by the late Dr. Case (see No.13), and signed by the principal residents in Fareham, was sent to the Postmaster General, who granted Mr. Nicholson a superannuation allowance of £80. per annum. To show the great difference between the postal business now and formerly, he used to relate that on one occasion he sent away the postman of the Titchfield, Stubbington, and Warsash Districts with one letter. Mr. Nicholson was of a kind and cheerful disposition, and was held in great esteem by his neighbours and friends."

When he died his probate record recorded him as leaving estate valued at £571 18s. 3d. He was buried at St. Peter and St. Paul, Fareham Hampshire.

9. Daniel Moore* M.D. (Born: 28th January 1840 Hastings, East Sussex; Died: 18th August 1904 Heavitree, Devonshire)



Known Addresses:

- Trinity Square, Newington, Surrey (1861 - Lodger)
- Hastings Dispensary, 62 High street, Upper Norwood (1867-1876)
- 79 High Street, Hastings (The Handbook of Hastings, St. Leonards 1864; St. Andrews Medical Graduates Association 1868)
- Hastings Lodge, Victoria Road, Upper Norwood, S.E. (1871-1878 – QMC Members List –Elected 27th March 1868)
- 3 Wellington Square, St. Mary in the Castle, Hastings, Sussex (1870,1871)
- Dulwich Wood, Upper Norwood (1874)
- Hasting Square, Camberwell, London (1881)
- "Lunatic Asylum", Cranbourne Hall, Grouville, Jersey, Channel Islands (1881)
- Hastings Lodge, Dulwich Wood Park, Upper Norwood, S.E. (1883)
- "Woodthorpe", Sydenham Hill Road, Sydenham, Lewisham, London (1891-1895)
- "Cheriton", Tormoham and Torquay, Devon (1901)
- "Crom-a-Boo", Heavitree, Devonshire (1903-1904)



Occupations:

Medical Student (1861); Surgeon (1867); General Practitioner M.D.St.Andrews, M.R.C.S.E. and L.S.A, not practicing (1871); Dr. of Medicine, St. Andrews, Surgeon etc. (1881)

References:

- On the Generative Processes of the Oyster, Mussel, and Cockle. By Daniel Moore, M.D. {Read Oct. 23, 1874}, JQMC Ser. 1. Vol.IV, pp.11-17.
- On *Bucephalus llaimeanus* and another Allied Organism. By Daniel Moore, M.D. {Read April 23rd, 1875}, JQMC Ser. 1. Vol.IV, pp.50-57, 1 plate.
- JPMS Vol.1. pg.95. 1882: Eggs of Louse of Vieillot's Pheasant.
- *Pediculus capitis*. JPMS Vol.2. pp.122-123 1883
- Palpal Organs of Spiders. JPMS Vol.3. pg.46. 1884
- Chalcedony. JPMS Vol.3. pg.120. 1884
- Generative Gland of Oyster. JPMS Vol.4. pg.120. 1885
- *Aphrophora spumaria*, Cuckoo-Spit. JPMS Vol.5. pg.50. 1886
- Parasites to Mount and Spiral Fibres in Rhubarb JPMS Vol.7. pg.116. 1888
- Pygidium of Flea. JPMS Vol.10. pg.91. 1891
- Wing of Earwig. JPMS Vol.10. pg.362. 1891

Objects circulated to June 1877:

- Minerals & Geology (Crystals): Alum; Potash nitrate
- Minerals & Geology (Crystals, Vegetable Products): Oxalic Acid
- Fungi: *Compositarum*; *Triphragmium ulmariae*
- Ferns: Scale from fern
- Spiral & Pitted Structures: Rhubarb – spiral vessels from
- Mollusca: Oyster shell, stained section; *Mytilus edulis*, testis; *Odostomia* shell & tongue
- Insecta – Anoplura: *Pediculus capitis*; Parasite of Pigeon, *Goniocotes compar*; Parasite of Partridge, *Menopon perdicis*
- Insecta – Homoptera: *Aphrophora spinnaria*, head &c.; *Psylla*
- Parts of Vertebrata – Scales: Roach
- Animal Tissues – Muscular Fibre: Muscle from Mouse

He married Anna Sarah Miller on the 17th October 1865 at St. Giles, Camberwell, by Licence. Sadly Anna died shortly thereafter following the birth of a daughter, Annie Harriette (1866). On 26th November 1866 he re-married with Henrietta Sturge. Together they had a number of children over the next 12 years, Thomas Sturge (1870), Daniel Henry (1871), Henrietta (1872), George Edward (1873), Ellen/Helen (1874), Joseph Herbert (1876) and Sarah Hannah (1878). Henrietta (his wife) died 12th December 1903 and Daniel was not long in following her passing away on 18th August 1904. His probate record recorded him as leaving estate valued at £14,081 4s. 5d. He was buried at Camberwell Old Cemetery, Camberwell, Southwark, London (Square 56, Grave 18948).

10. Charles Frederick George*, M.R.C.S., L.S.A., (Born: 30th August 1833 Kirton-in-Lindsey, Lincolnshire; Died: 11th November 1923 Kirton-in-Lindsey, Lincolnshire)



Known Addresses:

- North Green, Kirton in Lindsey, Lincolnshire (1841)
- The Grove, Grove Lane, Kirton-in-Lindsey, Hull (1871-1881 –PMS Members List 1881)
- Belle Vue House, Kirton-in-Lindsey, Hull (1882-1911 [on Circuit d 1882-1883], PMS Vice President and President Elect [1883], PMS President [1884], QMC Member [1880-1887 – Elected 25th June 1880], PMS Members List [1882-1886])

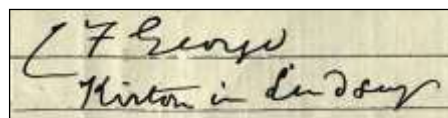

Occupations:

Surgeon's Apprentice (1851); Surgeon &c. (1861, 1881); Medical Practitioner M.R.C.S. & M., L.S.A., Landowner (1871); Medical, General Practitioner, Registered (1891); Surgeon, retired from active practice (1901); retired Surgeon (1911)

References:

- SG Vol.8. May 1872 : For *Haemalopinus suis* (Pig Louse) and *Polyxenus Lagurus* (Pencil-tail), unmounted, send well-mounted object of interest to C. F. George, Kirton



Lindsey, Lincolnshire.

- On "The Blyborough Tick" (*Argas Fischerii*), JQMC SERIES 1, VOLUME IV, 1874-1877 pp.223-225 (see illustrations)
- SG Vol.11. October 1875 : *Obisium trombidioides*, for other Chelifers, alive or well mounted. - C. F. George, The Grove, Kirton Lindsey.
- SG Vol.13. November 1877 : Wanted, Nos. 7, 9, 10, 11, 14, 15, 16, and 17 of the "Entomologist's Monthly Magazine" (the first four belonging to the first volume, and the others to the second volume). For numbers of the third volume, microscopic slides, or cash, or would like the first and second volumes, or either of them. - C. F. George, The Grove, Kirton Lindsey.
- White Mites by C. F. George, SG Vol. 14. 1878 pp.34-35.
- On the Mite of the Humble Bee *Gamasus* by C.F. George, SG Vol. 15. 1879 pp.81-82.
- Notes on a Curious Mite (*Calyptostoma Hardyi*), SG Vol. 15. 1879 pp.249-260
- IV. A Further Contribution to the Knowledge of British Oribatidae (Part I.) by A. D. Michel, F.L.S., F.R.M.S. (with the assistance of C. F. George, M.R.C.S.E.) (Journal of the Royal Microscopical Society Volume 3, Issue 1, pages 32–43, February 1880)
- SG Vol.17. January 1881 : Wanted, the "Entomologist" for September, 1879, No. 196, also the other numbers up to the present time, for microscopic slides or cash. - C. F. George, The Grove, Kirton Lindsey.
- "Wanted, the 'Entomologist' for September 1879, No.196, also the other numbers up to the present time, for microscopic slides or cash. – C.F. George, The Grove, Kirton Lindsey." SG Vol. 17. 1881
- *Arrenurus perforatus* – A New Water-Mite, SG Vol. 17. 1881 p.269
- On British Freshwater Mites No.I., SG Vol. 18. 1882 pp.193-194
- On British Freshwater Mites No.II., SG Vol. 18. 1882 pp.249-250
- On British Freshwater Mites No.III., SG Vol. 18. 1882 pp.272-273
- Water-Collecting Apparatus. JPMS Vol.1. pp.158-160. 1882.
- Sting of Sand Wasp, JPMS Vol.2. pg.52 1883
- On the Palpi of Fresh-Water Mites as Aids to distinguishing Sub-Families. JPMS Vol.2. pp.73-75. 1883 and Society Vol.3. pp.91-92. 1884
- *Trichodectes scalaris*. JPMS Vol.2. pg.121 1883
- *Odynerus, posterior portion of Abdomen*. JPMS Vol.2. pp.124-125 (1 plate) 1883
- Antennae of Flea. JPMS Vol.2. pg.248. 1883
- Glow Worm. JPMS Vol.2. pg.249. 1883
- On British Freshwater Mites No.IV., SG Vol. 19. 1883 pp.10-11
- On British Freshwater Mites No.V., SG Vol. 19. 1883 pp.36-37
- On British Freshwater Mites No.VI., SG Vol. 19. 1883 pp.80-82 & SG Vol. 19. 1883 pp.180-181
- Mite from *Gamasus Coleopratorum*. JPMS Vol.2. pg.244 1883
- *Labidostomma luteum*. JPMS Vol.2. pg.245 (1 plate) 1883
- The British Freshwater Mites, SG Vol. 20. 1884 pp.80-81
- Mites from Pheasant. JPMS Vol.3. pg.42 (1 plate). 1884
- White Mites. JPMS Vol.3. pp.42-43 (1 plate). 1884
- The Yorkshire Naturalists' Union at Spurn Point [3rd September 1884; *Bdella hexophthalma* noted; new to Britain by C. F. George]. Nat., November 1884, p.92
- Presidential Address – JPMS, Vol.IV. January 1885 pp.1-5
- Notes on *Hydrachnides*, SG Vol. 21. 1885 pp.39-40
- Sting, Maxillae and Labium of *Melecta Punctata*. JPMS Vol.4. pg.258. (1 plate) 1885
- Scale Insect from Rind of Orange. JPMS Vol.4. pg.262. 1885
- Combs of the Black Scorpion.
- *Arrenurus* [a species found, presumably near Kirton-in-Lindsey, on 3rd August 1885, which the recorder feels disposed to call *A. luteus*, if not already named] by C. F. George. SG March 1886, p.68
- Bees. JPMS Vol.5. pp.243-245. 1886
- *Sirex juvencus* [and its occurrence, also that of *S. gigas*, at and near Kirton-in-Lindsay] by C. F. George. SG November 1886, p.259.
- Tongue of Cricket. JPMS Vol.6. pp.53-54 (1 plate). 1887
- SG Vol.24. July 1888 : Wanted, vols. 14-19 of "Entomologist's Monthly Magazine," or any of them, in numbers or otherwise; also numbers from January 1886 to present time, inclusive. Will give in exchange numbers of "Popular Science Review," microscopic slides, or cash. - C. F. George, Kirton-in-Lindsay.

- Tingis. JPMS Vol.7. pg.111. 1888
- *Laelaps arvolica* – Parasite of Water-Rat (*Arvicola amphibius*), SG Vol. 25. 1889 pp.6-7
- Parasites on Rats and Mice [*Laelaps arvolica* George on *Mus sylvaticus*; locality not given, possibly Kirton-in-Lindsey] by C. F. George. Science Gossip, May 1889 p.116.
- *Coccus cataphractus*. JPMS Vol.9. pg.281. (1 plate) 1890
- Preponderance of the Female in *Sirex gigas* and *S. juvencus*, in North Lincolnshire by C. F. George. Nat. April 1891, p.124.
- How I Saved My Hive of Bees, SG Vol. 27. 1891 pg.166
- *Microgaster glomeratus*. JPMS Vol.10. pg.363. 1891
- *Arrhenurus ornatus* nov.sp. SG 18 new series pp.204-205. 1901.
- Lincolnshire water mites; third list. The Naturalist 1902 pp.13-14. (Hydrachnidae)
- Lincolnshire Fresh-water Mites. Naturalist (83, 84, 5 figs., 111, 112, 8 figs., 215-216, 252 3 figs., 304 2figs., 421,422, 5 figs. 1903)
- Lincolnshire Mites. *Epicrius*. The Naturalist 1906.
- Hints on collecting and preserving fresh-water mites. Hastings Naturalist. Vol.1. No.2. pp.71-73. 1907.
- Lincolnshire Mites. *Rhyncholophidae*. The Naturalist. pp.11-45, 179-180, 259-260, 357-359. 1907.
- Some British Earthmites (*Trombidiidae*). The Naturalist 1908 pp.333-336, 377, 452-454, pl.xlii.
- Some British Earthmites (*Trombidiidae*). The Naturalist 1909. pp. 282-282, 423-424.
- Notes on the Crista of some British Earthmites. The Naturalist 1911. No.652. pp.200-201.
- *Bdella hexophthalma* Gervais. The Naturalist 1912 pp.47-48, 2 figs.
- Some British Earthmites. *Labidostomma luteum* Kramer. The Naturalist 1912 pp.74-75, 183-184, 236-237, text figs.
- *Rhyncholophus niger*. The Naturalist 1912 pg.252.
- *Ritteria nemorum* Koch. The Naturalist 1913 pp109-110, 1 plate.
- *Gamasus ignotus* nov. sp. in Lincolnshire. The Naturalist 1913 pp.139-140, 2 text figs.
- The mites known as *Rhagidia*. The Naturalist 1913 pp.196-197, 4 text figs.
- A new mite, *Ottonia Sheppardi*. The Naturalist 1913 pp.287-288, text figs.
- New Mites. The Naturalist 1913 pp.383-384, 1 text fig.

Objects circulated to June 1877:

- Diatomaceae: *Triceratium quinque*
- Foraminifera: from Sand
- Insecta – Diptera: Sheep tick (ked)
- Insecta – Homoptera: *Coccus* scale insect from orange
- Hymenoptera – Crabonidae: Sand Wasp, proboscis, abdomen, sting (3 slides)
- Hymenoptera – Eumenidae: *Oydnerus partum*, male, apex of abdomen; *Oydnerus partum*, maxillae, labrum, sting &c.
- Hymenoptera – Apidae: *Melecta punctata*, maxillae, labrum, sting; *Melecta punctata*, maxilla, labrum, sting
- Coleoptera – Dermestidae: *Anthrenus* larva subnom hair larva *Dermestes*
- Pseudoscorpion: Chelifer

Catalogue of Zoological Preparations in the Quekett Microscopical Club Collection 1902 List:

- Acarina: *Argas fischerii* (Blyborough Tick) x3

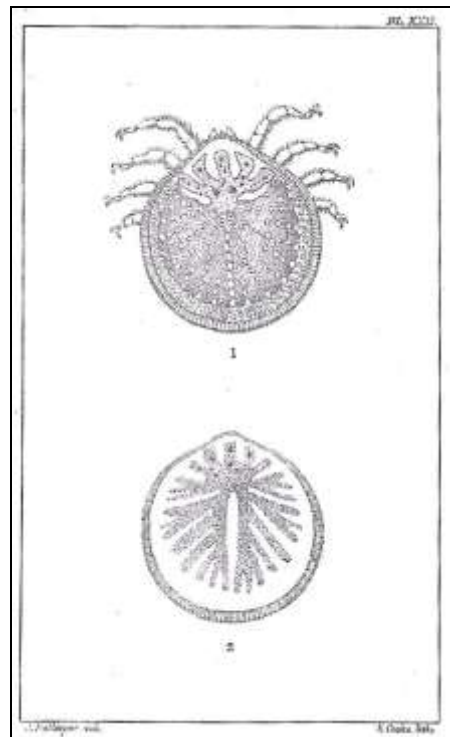
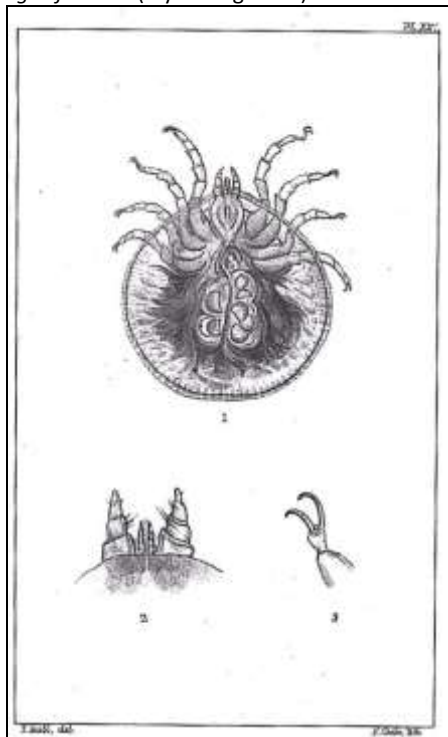

JQMC SERIES 2, VOLUME XV, 1923-1927 Page 114:

"...He was educated at Lincoln Grammar School and Wakefield Proprietary School; his medical training was at St. Thoms' Hospital, where he became House Surgeon. He was afterwards appointed Medical Officer to the Willoughton District of Gainsborough Union and of the Kirton District of Brigg Union."

His father was also a Surgeon and General Practitioner. Charles married Mary Ann Gibson Poynter on the 25th November 1858. With her he fathered the following children, Frederick (1859), Annie Bell (1861), Helen (1862), Henry (1864), Mary (1865), Emily (1867) and Ernest (1871). He died 11th November 1923. His probate record recorded him as leaving estate valued at £26,353 19s.

11. Lieut.-Col. Lewis John Fillis Jones (Born: 19th January 1835 Portsmouth, Hampshire; Died: 1906 Westgate on Sea, Kent)



Known Addresses:

- 24 Jermyn Street, St. James Square, Westminster, London (lodger 1871)
- Westgate-on-Sea, Isle of Thanet (1874)
- Sandhurst – Ambarrow Farm (1880)
- St. Bernards, Maple Road, Kingston on Thames, Surrey (1881)
- "Appleton", St. Mildred Road, Margate, Kent (1891)
- 4 Collingwood Terrace, Westgate on Sea, Kent (1901)



Occupations:

Ensigns - 7th Foot (1854); Lieutenant 7th Foot (1854); Captain in H. M. 8th Regiment of Infantry (1856,1860); Major in the Army (1861,1871); Lieut. Colonel (1872,1881); Lieut. Colonel, Army, retired (1891,1901)

Objects circulated to June 1877:

- Insecta – Anoplura: Parasite of Fowl, eggs, *Menopon pallidum*; Parasite of Ground Hornbill, eggs
- Insecta - Muscidae: House Fly, eggs
- Insecta – Lepidoptera: *Papilio Regiae*, eggs; *Phlogophora meticulosa* (Angle Shades) eggs
- Neuroptera – Scaldidae: *Sialis lutaria*, eggs, subnom Eggs of May Fly
- Parts of Vertebrata – Skin: Foot, section
- Parts of Vertebrata – Nerve Structure & Organs of Special Sense: Spinal Cord of Sheep

Lewis John Fillis Jones to differentiate him from the many Jones' in the Army was nicknamed "Inkerman" from the fact of being severely wounded at that battle, see below.

In Historical record of the King's Liverpool Regiment of Foot [microform] : containing an account of the formation of the regiment in 1685 and of its subsequent services to 1881 : also succession list of the officers who served in each of the regimental ranks, with biographical notices and summaries of their war services, by Richard Cannon. Entry No. 134.:

"Lewis John Fillis Jones, ensign (Seventh Fusiliers), 14th July, 1854; lieutenant (Seventh Fusiliers), 8th December, 1854; captain (Eighty-eighth Foot) 27th May, 1856. Exchanged to the King's 31st January, 1860. Major (by brevet) 16th April, 1861, served in the Crimea with the Seventh Fusiliers from 20th October, 1854 ; present at the siege of Sebastopol, at the battle of Inkermann (wounded) ; at the repulse of the sorties of 26th October, 1854, 5th April, 1855 (wounded) and 9th May, 1855; at the attack and capture of the quarries on 7th June (wounded), and at the attack on the Redan on 18th June, when he was severely wounded in three places. He was also wounded in the trenches on 27th March 1855 (medal and clasp, and Fifth Class of Order of Medjidie. In 1857-58 he served with the Eighty-eighth Regiment in the Mutiny campaign, was present at the actions near Cawnpore of General Windham's force in November, 1857, also at the action of Bloognapore, the capture of Calpee, and the subjugation of Oudh (medal and clasps). On 16th July, 1861; he was appointed adjutant of a depot battalion, and on 21st January, 1872, he retired from the service with the honorary rank of lieutenant-colonel ; his brother, Jeremy Peyton Jones, served in the regiment from 3rd July, 1858, until 17th April, 1880."

Lewis John Fillis Jones married Sarah Jane Crawley, 6th September 1860 at Steeple Ashton Parish Church, Wiltshire, by Licence. There appears to have been one child as a result – Mary F. (1863). Quite what happened to the marriage thereafter I have been unable to determine but another marriage, this time Lieutenant-Colonel Lewis Jones to Louisa Mary Wood took place 6th May 1874. From this union there were children – Catherine Loftus (1876) and Lewis Jeremy (1879), Louisa Mary (1881). Just prior to this marriage (1871,1872) Major Lewis John Fillis Jones, being in money difficulties, made an arrangement with his creditors to Sell his Commission.

12. Arthur Charles Cole* F.R.M.S. (Born: 27th October 1821 Eastcheap, E.C., Middlesex; Died: 24th December 1900 Wandsworth, Middlesex)



Known Addresses:

- 66 St. Domingo Vale, Anfield, Liverpool (1870,1872)
- Everton, Liverpool (1874)
- 62 St. Domingo Vale, Everton, Liverpool (1877)
- 58 Oxford Gardens, W. (1880 [Cole, A. and Son – Preparer of Microscopic Objects])
- St. Domingo House, 53 Oxford Gardens, Notting Hill, London, W. (1878-1887 PMS, QMC and RMS Members List)
- St. Domingo House, 171 Ladbrooke Grove Road, Notting Hill, London, W. (1888,1889 PMS Members List, Hon. Member 1888-1894 Liverpool Microscopical Society)
- 29 Thurleigh Road, Battersea (1891)
- 29 Thurleigh Road, Wandsworth Common, London, S.W. (1905 Naturalists' Universal Directory)??
- "York House", Poole Road, Bournemouth (1914)??

Occupations:

Professor of Music (1851, 1861); Preparer of Microscopic Objects (1871); Microscopist (1881, 1883, 1891 [recorded as being Deaf in 1891 Census return])

References:

- SG January 1872: 'Choice slides of selected Diatomaceae in exchange for unmounted and unprepared insects in perfect condition, and properly preserved in spirit or otherwise. - Address Arthur C. Cole, 66, St. Domingo Vale, Everton, Liverpool.'



- SG December 1880/February 1881/May 1881, November 1881 inside front cover

Advertisement as 'Arthur C. Cole, F.R.M.S., and Son.' At St. Domingo House, 53 Oxford Gardens, Notting Hill, London, W.

- SG May 2nd 1881 (image right)
- Author of the weekly publication 'Studies in Microscopical Science' beginning on May 6th 1882. Each issue came with a slide (one of which is illustrated) and was priced at 1s for the text and slide.
- SG June 1882 Microscopy Section: 'Studies in Microscopical Science. - We doubt whether any department of natural science is exhibiting so much diligence as microscopy. This is evidenced by the increasing current of microscopical literature. Mr. Arthur C. Cole, F.R.M.S., has commenced contributions from his own extensive stock of practical knowledge under the above title. The first two parts are beautifully got up, the coloured illustrations being exquisite. We wish the new venture hearty success.'
- In The Northern Microscopist June 1882 - 'Studies in Microscopical Science. - Under this title an 8vo. Eight page journal is issued at weekly intervals, edited by A. C. Cole, F.R.M.S., to accompany a series of preparations intended to show the students how microscopical work should be prepared. Three numbers have been issued, each illustrated by means of a well executed chromo-lithograph, the first showing the yellow fibro-cartilage in the ear of the cow, magnified 333 diameters; the second illustrates a doubly stained section of the stem of copper beech, *Fagus cuprea*, while the third show a transverse section of the shaft of a long human bone. The illustrations are exceedingly well done, and the slides sent out with them excellent, and beside this, the letterpress gives one the whole of the information known to refer to the subjects under consideration. We notice several important omissions in the Bibliography, but this section, no doubt, will be rendered more complete as time goes by.'
- In the Northern Microscopist July 1882 a review of the next four Studies in Microscopical science and also 'Starches. - A series of twenty four sections of starch bearing vegetables and starch granules has been sent out by Mr. A. C. Cole, F.R.M.S., for the use of botanical students. We have been favoured with a set of these preparations, which demonstrate very clearly the forms of the starches, the manner in which they are borne in the plant, and show us clearly that very different means must be employed for preparing the various kinds in a state of purity.....'
- SG October 1882: 'Studies in Microscopical Science. - (Edited by A. C. Cole, F.R.M.S.) The scientific and artistic merit of these weekly issues, instead of falling beneath the high character they attained at first, have, if possible, improved upon it.....'
- Author of - Popular Microscopical Studies - London 1883-4
- Studies in Microscopical Science, 4 Volumes 1883-1886
- The methods of Microscopical Research 1884
- SG January 1884: 'Studies in Microscopic Science. - Edited by A. C. Cole, F.R.M.S. - We very much regret that in the paragraph in our last issue on "A New Morphological Institution" we inadvertently over-stated the relationships which existed between Mr. A. C. Cole and Mr. J. E. Ady, in the first volume of this admirable work, which was so well done, and so thoroughly successful from all points, literary, scientific, and artistic, that we deem it a great pity any difference of opinion should exist among those who contributed to so great a success. We inadvertently stated that M. Ady was the actual and Mr. A. C. Cole the nominal editor; whereas the legal status of the relationship was that Mr. Ady edited the "Studies", under "the advice and direction" of Mr. Cole. Mr. Cole's name appeared all through as editor, and the weekly parts of the 2nd vol. now issuing, also bear his name as editor. The preface to the first volume states that all the articles except three were written by Mr. J. E. Ady. This much, however, appears certain, that to Mr. Cole belongs the credit and honour of bringing out the "Studies".....'

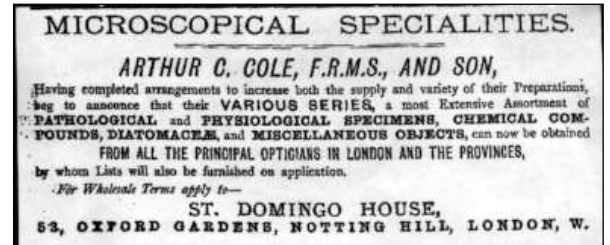
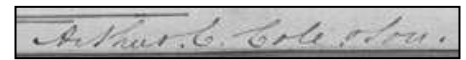

Objects circulated to June 1877:

- Diatomaceae: *Navicula lyra*; Arranged
- Polycystina: Grouped
- Vascular System - Injected Preparations &c.: Human skin, injected & stained; Ileum of Puppy; Human Colon, injected; Human Lung in Pneumonia
- Parts of Vertebrata – Kidney: Seal Kidney; Proventriculus of Fowl
- Parts of Vertebrata – Nerve Structure & Organs of Special Sense: Human Cerebellum; Human Spinal Cord
- Parts of Vertebrata – Pathological: Human Lung in Pneumonia

Slides donated to the Quekett Microscopical Club Collection 1874 List:

- Spicules: *Acanthogorgia johnsoni*
- Spicules of *Eunicea* sp.; *Gorgonia*; *Homophyton githago*; *Leptogorgia*; *Lophogorgia (Leptogorgia) palma*; *Melithaea*; *Melithaea coccinea*; *Melithaea ochracea*; *Muricea*; *Phyllogorgia dilatata*; *Plexaura* sp.; *Plexaura salicornoides* (x2); *Primnoa verticulosa*; *Pterogorgia petechizans*; *Rhipidogorgia flabellum*; *Xiphigorgia anceps*
- Mixed Foraminifera – China Seas; Dog's Bay, Ireland; Red Sea, 105 Fathoms
- Selected Polycystina – Springfield, Barbados
- Sori of *Cyrtomium anomophyllum*
- *Arachnoidiscus Ehrenbergii* in situ; *Asterolampra* (various); *Isthmia*; *Stictodiscus?*; *Triceratium brachiatum*; *Triceratium turatella*; Mixed diatoms

Catalogue of the Diatomaceae in the Cabinet of the Quekett Microscopical Club 1895 list (additional items):

- *Aulacodiscus africanus*; *Aulacodiscus margaritaceus*; *Coscinodiscus symmetricus?*; *Euodia barbadense*; *Pyxilla variabilis*; Singapore (selected); *Triceratium coniferum*; *Triceratium favus* var. *septangulatum*; *Triceratium scitulum*; *Triceratium venosum*; *Triceratium zonatulatum*

Catalogue of Zoological Preparations in the Quekett Microscopical Club Collection 1900 List (additional items):

- Radiolaria: Spread, opaque; Group, fancy (opaque), Springfield Barbados

Catalogue of Zoological Preparations in the Quekett Microscopical Club Collection 1902 List (additional items):

- Anatomical Preparations: Skin, Frog (injected); Bone, femur, frog (longitudinal section); Cerebellum, Cat (section); Brain, Frog (section); Spinal Cord, Frog (section); Spinal Cord, Cat (section) x2; Nerve Fibres, Frog; Tongue Frog (transverse section); Tongue, Rabbit (transverse section); Proventriculus, Fowl (section); Stomach, Frog (section); Ileum, Frog; Ileum, Rabbit (injected); Ileum, Cat (injected) x2; Colon, Rabbit (injected); Colon, Frog; Liver, Frog (section) x2; Lung, Fowl (section); Haemin (blood) crystals, Frog; Lymphatic gland, Cat (section); Spleen, Frog (section); Kidney, Frog (section) x2; Kidney, Snake (section); Kidney, Cat (section); Kidney, Rat (section) x2; Kidney, Rabbit (section);

Ovary, Frog (section); Ovary, Cat (section); Testicle, Frog (section); Testicle, Monkey (section); Penis, Monkey (transverse section); Pigment Cells, Frog

- Human Anatomical Preparations: Skin; Mammary Glands (Schirrus); Cerebellum (section); Optic nerve (section); Tongue (section, injected); Thyroid Gland (section); Stomach (wall) (section) (Cancer); Small Intestine (Peyer's patch) (section); Liver (section) (Amyloid); Liver (section) (Fatty degeneration); Larynx (foetal) (section, injected); Lung (Croup); Lung x3; Aorta (section); Lymphatic Gland (section); Spleen (amyloid) (section); Kidney (Fatty degen.) (section); Kidney (Amyloid) (section); Ovary (section); Uterus (section); Penis of Child (section, injected) x2; Umbilical cord (section)

Arthur Charles Cole married Emily Shute on 8th October 1845. The couple had the following children – Rose Emily (1846), Martin James (1847), Florence Harriet (1849), twins Ethel and Ethelbert (1850), Mary Hope (1852), Gertrude Mary (1853) and Arthur Joseph (1855). He joined the Microscopical Society of Liverpool in 1873 and was awarded Honorary membership in 1881. He joined the Quekett Microscopical Club in 1876 and was elected a Fellow of the Royal Microscopical Society in 1879 (no longer listed in the Fellows list 1898). He was present at the Third Annual Dinner of the Quekett Microscopical Club 23rd November 1878. A company was formed in conjunction with his son Martin James Cole, supplying prepared slides of their own manufacture as well as those from all the major suppliers. The partnership, however, was terminated in 1880 as evidenced by an entry in the London Gazette of 7th January 1881:

"NOTICE is hereby given that the Partnership heretofore subsisting between the undersigned, Arthur Charles Cole and Martin James Cole, carrying on the business of Microscopists, at 53, Oxford-gardens, Notting Hill, in the county of Middlesex, has this day been dissolved by mutual consent. The business will in future be carried on by the said Arthur Charles Cole, who will pay all debts owing by, and receive all moneys due to the said late firm. — Dated this 14th day of December, 1880."

In 1881 his wife Emily was recorded as being a Microscopist's Assistant. He was present at a Royal Microscopical Society meeting 27th November 1889 exhibiting - Transverse Section of Human Left Median Nerve, stained for Photomicrography; and photograph of same slide. Optical Vesical of a Human Embryo in the sixth week. T.S.

By 1891, however (and possibly associated with the dissolution of the father/son partnership) Emily was to be found at a completely different address to her husband and was describing herself as 'a widow, living on her own means'. Arthur Charles Cole died on the 24th December 1900 from Senile Decay. Portrait in The Microscope Vol. VII. No. 11 January/February 1950 page 309 - References from the Cumulative Index: Cole, Arthur Charles, 5,273(1945); 7,309(1950); 15, 10(1965). He was buried in Ealing & Old Brentford Cemetery on the 29th December 1900, joining his wife, Emily, who had been interred there 20th April 1900.

There is a familial link with the mounter Arthur Cottam through the family lines of his mother Elizabeth Barraud.

His slides normally bear a little crest bearing a Bulls head, surrounded by the words 'Cole Deum' which means Worship God. Achieved a Prize Medal at the Exposition Universelle in Paris 1867 (see slide image above).



13. William Case M.D. (Born: December 1811 Portsea, Hampshire; Died: 29th (31st ?) March 1879 Fareham, Hampshire)



pp.113-114. 1887

Known Addresses:

- West Street, Fareham, Hampshire (1841-1851, Member of the Phrenological Association 1841)
- 50 West Street, Fareham, Hampshire (1861)
- "Fortsview", 64 High Street, Fareham, Hampshire (1871)
- Fareham, Hampshire (1874)
- High Street, Fareham (1878 White's Directory – under Surgeons – William Case L.R.C.P.E.)

Occupations:

Licentiate Society of Apothecaries, London (1832), Member Society of Apothecaries (1834), Surgeon (1841); General Practitioner (1851); Registrar of Births and Deaths for Fareham District (1852); L.R.C.P.Ed. General Practitioner (1859, 1861, 1871)

References:

- Gizzard of Beetle. JPMS Vol.4. pg.257. 1885
- *Coccus* from Malta Orange. JPMS Vol.5. pp.121-122. 1886
- Flint. JPMS Vol.5. pg.241. 1886
- *Stenocephalus agilis*. JPMS Vol.6.



Objects circulated to June 1877:

- Minerals & Geology (Crystals, Vegetable Products): Asparagine
- Sounding – Foraminifera: Challenger Dredgings
- Echinodermata: *Ophiocoma rosula*
- Annelida: Aphrodite spines
- Mollusca: *Loligo*, horny framework of sucker
- Insecta – Anoplura: *Pediculus capitis*; Parasite of Pigeon, eggs, *Goniocotes compar*; Parasite of Quail, *Menopon fulvomaculatus*
- Insecta – Syrphidae: *Eristalis tenax*, tongue
- Insecta – Chironomides: *Chaoborus*, Glass larva
- Orthoptera – Blathidae: Cockroach, foreign, gizzard
- Orthoptera – Euplexoptera: Earwig, gizzard
- Coleoptera – Dyticidae: *Colymbetes*? gizzard sub nom Gizzard of small water beetle
- Coleoptera – Cuculioridae: Gizzard of Beetle
- Crustaceae – Ichthyophthira – Caligina: Garfish Parasite
- Crustaceae – Decapoda – Pycnogonidae: *Ammothea*
- Ixodea: Ixodes from Tortoise, proboscis
- Trombidina: *Trombidium phalangii*, head



- Pseudoscorpia: Chelifer
- Araneae: *Tegenaria civilis*, Oesophagus, tongue

The image of the Old Turnpike Toll gates at Fareham is believed to show Dr. Case in his chaise.

He was President of the Portsmouth Medical Society (date unknown) and President of the Fareham Literary and Scientific Institute (1865, 1870, 1875). Also in 1866 and 1876 President of The Fareham and South Hants Horticultural Society. He was an Executive Committee member of the Fareham Liberal Registration Association in 1872.

William Case married Louisa Henrietta Dewes on 7th July 1838 (d.1st December 1847) with whom he had six children – George Henry (1839), Amy Louisa (1840), Arthur Molesworth (1841), Percy William (1843), Jessie Henrietta (1844) and Hugh Elliotson (1846). His wife Louisa died in 1847. In the 1851 Census he is recorded as a Widower. Also at the home was a Governess – Margaret Eliza Buckland, 11 years his junior. He married Margaret Eliza in 1852. The couple went on to have 2 children – Edith Margaret (1853), Mabel Mary (1856).

William died 29th March 1879 at Fareham, Hampshire and his estate was valued at just under £4,000. He was buried 3rd April 1879 at Holy Trinity, Fareham, Hampshire.

14. Henry Pocklington* F.R.M.S. (Born: 1842 Boston, Lincolnshire; Died: 13th June 1913 Leeds, Yorkshire)



Known Addresses:

- 12 Margaret Street, Sculcoates, Hull, Yorkshire (1871)
- Leeds (1874)
- 4 Cedar Grove, Armley, Leeds (1878-1881, 1889)
- Bardon (Barden) Grove, Armley and 20 Park Row, Leeds (1882-1886 – PMS Members Listing - Circuit c 1882-1884)
- Prudential Buildings, 20 Park Row, Leeds (1888, 1902) [Office]
- In 1890 recorded address as 41 Virginia Road, Mount Preston, Leeds. (Royal Microscopical Society Fellows List)
- 12A Mount Preston, Leeds, Yorkshire (1891)
- 41 Virginia Road, Leeds (1889, 1892-1905)
- 11 Regent Park Terrace, Leeds, Yorkshire (1910-1913)

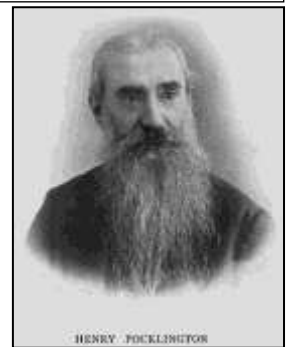
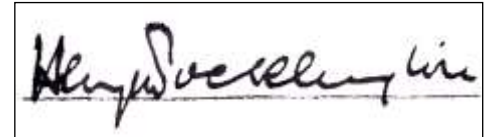

Occupations:

Inspector of Agents and Surveyors with Insurance Co. (1871); Branch Manager Fire & Life Insurance (1881); District Manager, Commercial Union Life & Fire Assurance Co. Limited (1888); Manager Fire & Life Insurance Co. (1891); Manager Insurance Co. (1901); Pensioned District Manager Assurance Co. (1911)

References:

- A stick without end, SG, Vol. 3, page 187 (1867)
- Articles - EM, Vol. 11, pages 327, 357, 423, 428, 476-477, 478, and 549 (1870)
- Cyclosis in *Anacharis*, EM, Vol. 11, pages 553 (1870)
- Microscopical jottings in town and country II, III and IV, EM, Vol. 11, pages 363, 410 and 436 (1870)
- The microscope – how to chose it and how to use it, EM, Vols. 11, pages 531-532, 578-579, and Vol. 12, pages 4-5, 26-27, 49-50 and 78 (1870)
- Articles - EM, Vol. 12, pages 15-16, 22, 23, 43, 46, 90, 109-110, 135-136, 154, 165, 166, 215, 225-226, 238, 260 and 301 (1870)
- On the arrangement of a cabinet for microscopical objects, EM, Vol. 12, page 289 (1870)
- SG August 1870: Exchange. - Burnet Brand (*Aregma acuminatum*). Stamped envelope and any object of interest to H. P., 12, Margaret Street, Hull.
- SG October 1870: Primrose Brand (*Puccinia primula*). - Send addressed envelope and any (vegetable) object of interest to H. P., 12, Margaret Street, Hull.
- SG April 1871: *Xenodochus Carbonarius* wanted in exchange for mounted section of cuttle-bone, ferns or vegetable cuticles at option of sender. - H. P., 12, Margaret Street, Hull.
- The optical analysis of bees-wax, The Pharmaceutical Journal, Vol. 2, page 81 (1871)
- Articles - EM, Vol. 13, pages 14, 23, 70, 132, 191, 233, 261-262, 285, 331, 367, 382-383, 391 and 463-464 (1871)
- Articles - EM, Vol. 22, pages 541 and 565 (1871)
- The microscope in pharmacy, Canadian Pharmaceutical Journal, Vol. 5, page 309 (1872)
- A chapter in microscopy, Canadian Pharmaceutical Journal, Vol. 5, page 209 (1872)
- The Optical Analysis of Beeswax. Pharmaceutical Journal II. 1872 pp.81-82.
- Some starches microscopically and polariscopically considered, The Year Book of Pharmacy, pages 8, 16, 17, 21, 75, 85, 90, etc. (1872)
- The microscope in pharmacy, The Pharmaceutical Journal, Vol. 2, pages 621, 661, 678-679, 701, 782 and 821 (1872); Pharmaceutical Journal and Transactions 1872.
- Leaves microscopically considered, EM, Vol. 16, pages 279-280 and 352 (1872)
- SG Vol.8. June 1872 : *Aecidium Ari* offered in exchange for equally rare fungi, good botanical or polariscope objects. - Henry Pocklington, 12, Margaret Street, Hull.
- Articles - on beeswax and microscopical examination of plants, The Year Book of Pharmacy, page 555 (1873)
- Sugar and its adulterations, EM, Vol. 17, page 189 (1873)
- Canella alba and Pomegranate barks. Monthly Microscopical Journal IX. 1873. pp.234-236.
- The Colour of the Wing-cases of Cantharides. Pharmaceutical Journal III. 1873. pp.681-682.
- The Colour of Cantharides. Pharmaceutical Journal III. 1873. pp.949-951.
- Mr. Sorby on the colouring matter of leaves, Pharmaceutical Journal Ser.3, IV pp.489-491. 1874.
- M. Chautard's classification of the absorption bands of chlorohyll. Pharmaceutical Journal, 4, 1874, pp.61-63.
- Structure of *Boehmeria nivea*. Monthly Microscopical Journal, 12, 1874, pp.95-96.

- Sugar, chemically and optically considered. *Pharmaceutical Journal* 5. 1875. pp746-749.
- The action of the induced current upon the intra-cellular protoplasmic circulation in plants. *Pharmaceutical Journal*. 5. 1875. pp.761-764.
- The use of optical analysis in pharmacy, *The Year Book of Pharmacy*, page 607 (1875)
- Hardened Glass, *Nature* Vol.12. pp.125-126 (1875)
- *Monthly Microscopical Journal: Transactions of the Royal Microscopical Society* (1875) H. Pocklington elected to RMS, Vol. 13, page 93.
- Some Practical Applications of Polarised Light. *Pharmaceutical Journal*. 6. 1876. pp.81-83, 121-122, 161-162, 421-422, 501,503, 602-602, 663-664, 741-743, 762-763, 842-843, 902-903.
- The Use of Optical Analysis in pharmacy. *Pharmaceutical Journal*. 6. 1876. pp.246-248.
- Royer de la Bastie's toughened glass. *Pharmaceutical Journal*. 6. 1876. pp.251-252.
- On some recent researches in vegetable chromatology. *Pharmaceutical Journal*. 6. 1876. pp.341-343.
- *The Naturalist: Journal of the Yorkshire Naturalists' Union* (1878) records of meetings, new series, Vol. 4, pages 64 and 95
- *The Naturalist: Journal of the Yorkshire Naturalists' Union* (1879) record of Jan. 21 meeting, new series, Vol. 4, page 124
- *The Naturalist: Journal of the Yorkshire Naturalists' Union* (1882) report of lecture by Henry Pocklington to the Wakefield Naturalist's and Philosophical Society, new series, Vol. 6, page 152
- Colours of Beetles' Wing-Cases. *JPMS* Vol.1. pp.189-191. 1882
- Some Notes on Hydrokinone Developers (A communication to the Leeds Photographic Society), *The British Journal of Photography* 14th September 1883 pp.542-543.
- Notes on Developers (A communication to the Leeds Photographic Society), *The British Journal of Photography* 18th April 1884 pg.249.
- *The Phrenological Journal and Science of Health* (1888) Report on a lecture by Henry Pocklington on the microscope as a home help, Vol. 76, pages 157-158
- Section of Potato. *JPMS* Vol.8. pg.51. 1889

Objects circulated to June 1877:

- Minerals & Geology (Crystals): Soda Bibo[†].
- Fungi: *Mucor mucedo*; *Erysiphe*
- Marchantiaceae: *Marchantia* – section of capsule
- Spiral & Pitted Structures: Potato tuber – pitted tissue
- Fibres: Mistletoe Bird Lime
- Raphides & Sphaeraphides: *Scilla nutans* (Bluebell) raphides in section of bulb
- Seeds & Seed Vessels: *Sphenogyne speciosa*; Brazil nut section shell
- Echinodermata: *Chrisodota*(?) *violacea*, dermal plates
- Entozoa: *Trichina* in Glycerine
- Insecta – Aphaniptera: *Pulex gallinæ* (Fowl)
- Parts of Vertebrata – Skin: Skin of Rat's Tail

Henry Pocklington married Emma Janette Lilly in 1869. The couple had 4 of children over the ensuing years - Henry Cabourn (1870), Elizabeth Ida Lilian (1871), Edith Gertrude (1875) and William Edgar (1881). Listed as a Member of the Yorkshire Naturalists Union in 1889 (Pocklington, Henry, F.R.M.S., Cedar Grove, Armley, Leeds) and in the 1889 Fellows list of the Royal Microscopical Society (Pocklington, Henry, 41 Virginia Road, Mount Preston, Leeds – Elected 1875; no longer listed in 1898 list). Elected a member of the Leeds Geological Association in 1874 (both he and his son, William Edgar, were recorded as members in 1900, but only Henry Pocklington was still a member in 1905).

He delivered a lecture (17th February 1874) to the Young Men's Literary Society at Oxford Place, Leeds on the subject of Sugar – Chemically, optically and physiologically explained. At the Leeds Naturalists' Field Club Conversazione (16th February 1875) he 'exhibited with the microscope chalk showing foraminifera, as lectured upon by Dr. Carpenter.' Recorded as the President in the Chair at the Leeds Naturalists' Field Club and Scientific Association meeting (17th 26th May 1875) and 3rd December 1878. Elected a Member of the Yorkshire Geological and Polytechnic Society in 1876 when at Cedar Grove, Armley. Elected a member of the Quekett Microscopical Club on 28th September 1877 (and remained a member until post 1901). At the Leeds Mechanics' Institution Conversazione of 26th January 1876 he exhibited one of Mr. Browning's spectroscopes, fitted with the compound slit devised by the late Sir Charles Wheatstone. Member of the Yorkshire Naturalists' Union in 1877.

In the *Naturalists' Directory 1877-1905* F.R.M.S, Memb. British Association, etc., 20 Park Row, Leeds. Interests: Phaen. Plants, Phys., Mic., Photog. At Leeds Naturalists' Club 26th April 1881 read a paper "Notes on Modern Chromatics" and illustrated his remarks by experiments.

At Leeds Young Men's Christian Association Club 29th November 1888 delivered a lecture "Science as a Recreation", also at Leeds Young Men's Christian Association Club 21st February 1889 delivered a lecture "The Minute in Nature" with limelight illustrations. At the Leeds Geological Association (of which he was a member) meeting 23rd May 1881 he delivered a lecture "How to examine a plant microscopically, with special reference to geology." He described the instruments essential to the microscopical examination of plants, and the various reagents to be used, all of which could be obtained for seven pounds. The methods to be pursued in making sections of plant stem were dealt with at some length, and the typical structure of the stem of Monocotyledonous and Dicotyledonous stems described with the aid of black board diagrams. The lecture concluded with brief descriptions of the structure of certain aberrant stems belonging to exotic climbing plants, and several orders peculiar for their departure from the ordinary type. A large series of slides were exhibited illustrative of the general subject.

In 1898 a member of The Thoresby Society when at 20 Park Row, Leeds.

He was recorded in the "Botaniker-Adresbuch (1902) as Pocklington, Henry M.B.A. 20 Park Row, Leeds, Yorks. Also recorded as a subscriber to Harry Speight's book "The Craven and North-West Yorkshire Highlands. viz. Pocklington, Henry, F.R.M.S., 41 Virginia Road, Leeds.

After his death on 3rd June 1913 his estate was valued at £6,022 12s. 3d. Obituaries appeared in the Proceedings of the Insurance Institute of Yorkshire (1908) with a picture of Henry Pocklington inside front cover, and President's address on pages 15-26 and the Journal of the Royal Society of Arts (1913) Obituary of Henry Pocklington, Vol. 61.

Henry, his parents and his siblings in the 1861 Census:

- Christopher Pocklington, age 43, an Insurance Agent, b. Boston, Lincolnshire
- Eliza Pocklington, age 43, b. Lynn, Norfolk
- Eliza A. Pocklington, age 16, a Scholar, b. Boston, Lincolnshire
- Christopher Pocklington, age 14, a Scholar, b. Skirbeck, Lincolnshire
- Emma Pocklington, age 12, a Scholar, b. Skirbeck, Lincolnshire
- John Rob. Pocklington, age 7, a Scholar, b. Stilton, Huntingdonshire
- Annie Pocklington, age 5, a Scholar, b. Eye nr. Peterboro, Northampton

The reason for enumerating the family is that the three brothers all appear in the montage: Henry (No.14, this entry), John Robert (No.31) and Christopher (No.63). Henry appears in the 1851 Census return for the family – Henry Pocklington, age 8, a Scholar at home, b. Boston, Lincolnshire. He warranted an entry in the volume "Leading Insurance Men of the British Empire by R.B. Caverly and George Nugent-Bankes (1892) as follows: "Pocklington, Henry, the Leeds Manager of the Commercial Union Assurance Company, entered upon his career of a District Manager in the year 1869, in the service of the Britannia Fire Association, whom he represented first at Exeter and Hull, and subsequently at Leeds, having supervision of the counties of Yorkshire, Durham, Northumberland, and Lincolnshire. He at the same time acted for other offices, in the capacity of Surveyor and Assessor of Losses. He entered upon his present duties as District Manager for the Commercial Union Assurance Company in January of 1878, when that Company opened their Yorkshire Branch, and being in want of a good Insurance man to supervise its business, were fortunate enough to obtain Mr. Pocklington's services. Mr. Pocklington was at one time a frequent contributor to the scientific press. He is very strongly in favour of the thorough practical education in their business of young Insurance men, and devotes much of his spare time to the furtherance of this object. He is a Fellow of the Royal Microscopical Society of many years' standing, a Member of the Yorkshire Geological and Polytechnical Society, of the Society of Chemical Industries, and of several other scientific and literary societies."

15. T. S. Johnson



Missing from T. A. Wright's 1875 listing

Unable to find any PMS references other than a mention by John Ford in one of the Notebooks (1881) referring to a Johnson and if the Circuit information can be located it might be possible to identify this individual.

However, it is likely that this is one Thomas Simister Johnson, a Pharmaceutical Chemist – Mr. T. S. Johnson of Manchester (1871,1876)

Note: *Santonine*, see *Objects Circulated to June 1877* below, is a drug widely used in the past as an anthelmintic (used to expel parasitic worms, helminths, and other internal parasites).

Known Addresses:

- Bury New Road (1868)
- 3 Broughton Terrace, Gt. Clowes Street, Lower Broughton (1869,1871)
- 102 Great Clowes Street, Lower Broughton (1873,1874)
- 75 Bury New Road, Manchester (1875,1877)
- 5 Holyrood Terrace, Malvern, Worcestershire (1878-1885)

Objects circulated to June 1877:

- Minerals & Geology (Crystals, Vegetable Products): Santonine
- Hairs – vegetable: Buckthorn
- Sedes Indeterminatae: Feet of Beetle

bp. 25th December 1839, St. Michael, Macclesfield, Cheshire.

parents – Thomas and Mary Johnson

Thomas Simister Johnson married Anna Anne Mellor in 1864 at Macclesfield, Cheshire.

Registered as a Pharmaceutical Chemist on 31st December 1868 (27th October 1869), Certificate No.1157.

When son Herbert Mellor Johnson (b. 13th January 1868) was baptised (30th April 1868) the parents' address was given as Bury New Road.

When daughter Eleanor (b. 5th September 1869) was baptised (30th September 1869) the parents' address was given as 3 Broughton Terrace, Gt. Clowes Street, Lower Broughton.

In the 1871 Census @ 3 Broughton Terrace, Salford, Lancashire:

Thomas S. Johnson, age 31, Pharmaceutical Chemist, Letter Receiver and Telegraphist, b. Macclesfield, Chester

Anna A(nne) Johnson, age 29, b. Macclesfield, Chester

Mary L. Johnson, age 4, b. Manchester, Lancashire

Eleanor Johnson, age 1, b. Manchester, Lancashire

In the Post Office Directory for Manchester 1873:

Johnson, Thomas Simister, 102 Great Clowes Street, Lower Broughton

When daughter Florence (b. 12th August 1874) was baptised (19th November 1874) parents' address given as 102 Gt. Clowes Street.

In the Post Office Directory of Chemists and Druggists 1876 and Pharmaceutical Journal and Transactions 1875,1877:

Johnson, Thomas Simister, 75 Bury New Road, Manchester.

In Kelly's Directory of Worcestershire (Great Malvern) 1880:

Johnson, Thos. Simister, chemist & druggist, 5 Holyrood Terr.

isted in the Members list of the Society of Chemical Industry 1881 at 5 Holyrood Terrace, Malvern, Worcestershire

In the 1881 Census @ 5 Holyrood Terrace, Great Malvern, Worcestershire:

Thomas S. Johnson, age 41, a Pharmaceutical Chemist (master), b. Macclesfield, Cheshire

Anna A. Johnson, age 39, b. Prestbury, Cheshire

Mary L. Johnson, age 14, a Scholar, b. Manchester, Lancashire

Herbert M(ellor) Johnson, age 13, a Scholar, b. Manchester, Lancashire

Eleanor Johnson, age 11, a Scholar, b. Manchester, Lancashire

Florence Johnson, age 6, a Scholar, b. Manchester, Lancashire

Laura Johnson, age 5, a Scholar, b. Manchester, Lancashire

Agnes M(ellor) Johnson, age 3, b. Malvern, Worcestershire

Recorded in the 1885 Register of Pharmaceutical Chemists and Year Book of Pharmacy 1884 at 5 Holyrood Terrace, Malvern.

Thomas Simister Johnson d. 29th September 1885 at Malvern. bu. Macclesfield Cemetery. In the same plot his wife Anna Anne Johnson and a daughter Florence.

Death notice in The Chemist and Druggist 15th November 1885

Probate: Johnson, Thomas Simister (Personal Estate £5,735 6s. 7d.) Granted 14th November 1885. "The Will of Thomas Simister Johnson, formerly of Bury New Road, Manchester in the County of Lancashire, but late of 5 Holyrood Terrace, Great Malvern, in the County of Worcester, Pharmaceutical Chemist, who died 29th September 1885 at 5 Holyrood Terrace, was proved at the Principal Registry by John Mellor of Kerridge End House, Rainow near Macclesfield in the County of Chester, Estate Agent and Valuer, one of the Executors."

16. Francis John Kingsbury (Born: *circa* 1832 Cheselborne, Dorset; Died: 31st October 1919 Camberwell, Surrey)



Known Addresses:

- 23 Berkeley Villas, Loughborough Park, Brixton (1870)
- 7 Loughborough Park Road, Brixton (1874,1875)
- 11 Loughborough Park Road, Brixton, S.W. (1879)
- 65 Paulet Road, Camberwell, London (1881-1891)
- 16 Upstall Street, Camberwell, S.E.
- 16 Upstall Street, Lambeth, London (1901-1919)
- 251 Railton Road, Lambeth (1909)



Occupations:

Solicitor's Clerk (1871); Solicitor's Managing Clerk (1881); Catholic Apostolic Priest (1891,1901,1911)

References:

- SG Vol.11. May 1875 : Parasites (unmounted), for good Mounted Objects. List exchanged. - F. J. Kingsbury, 7 Loughborough-Park Road, Brixton, S.W.

Objects circulated to June 1877:

- Minerals & Geology (Crystals Animal): Uric Acid
- Confervaceae: *Dasya coccinea*; Adriatic Seaweed
- Raphides & Sphaeraphides: *Echinocactus visiraya*(?) – Sphaeraphides from
- Pollen: Camelia Sunflower
- Foraminifera: Connemara

- Insecta – Anoplura: *Pediculus* sub. nom. *Pvestmentii*(?); Vial Fly (probably *Haematopinus ventricosa* from Rabbit sub nom *Trichodecles* from Gull); Parasite of Turkey, *Gonicotes stylifer*; Parasite of Pheasant, *Gonicotes colchici*
- Insecta – Heteroptera: *Cimex lectularius*; *Stenocephalus agilis*
- Insecta – Homoptera: Apis, plant bug
- Insecta – Lepidoptera: *Orgyia antiqua* (Vapourer Moth) larva
- Coleoptera – Halticidae: *Haltica ulmorum* (Turnip Beetle)
- Sedes Indeterminatae: Insect
- Araneae: Saeticus scenicus, male
- Parts of Vertebrata – Scales: Dog Fish scales
- Parts of Vertebrata – Hoofs, Horns, &c.: Rhinoceros Horn

17. John Carpenter* (Born: *circa* 1842 Greenwich, Kent; Died: ?)



Known Addresses:

- Holme Dale, Lewisham Village, Kent (1861)
- Waltham Cross, Herts (1868,1869, 1873)
- 38 Cornwall Street, Fulham, S.W. (1870,1871)
- 16 Ifield Road, Brompton, S.W. (1870) Note: Not at this address in the 1871 Census.
- Turners Hill (Turner's Hill), Cheshunt (1874)
- Cheshunt, Herts. (1877,1879)
- 3 Alexandra Terrace, Croydon, Surrey (1881)
- 6 Hill Street, Stamford Hill, Hackney, London (1891)
- 11 Victoria Parade, Hornsey, Middlesex (1901)

References:

- SG December 1868: 'Sections of *Aristolochia siphon*, and Laburnum; scales of *Eleagnus* and *Sherardia* (mounted), for other Mounted Objects. - J. Carpenter, Waltham Cross, Herts.'
- SG March 1869: 'Sections of *Wellingtonia* (mounted) *Gigantea* and Cuticle of *Yucca* for other objects (mounted). - J. Carpenter, Waltham Cross, Herts.'
- SG May 1869: 'Oblique and Vertical Sections of *Pteris aquilina* (showing scaliform ducts) in exchange for

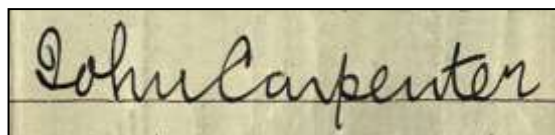

other good objects. - Send lists to John Carpenter, Waltham Cross, Herts.'

- SG July 1869 Notes and Queries: 'Vegetable Hairs.- Those interested in the hairs of plants as microscopic objects will find beautiful stellate examples on the under side of the leaves, and on the stems of *Aralia papyrifera*, the Chinese rice-paper plant, fine specimens of which may be seen in the Subtropical Gardens at Battersea Park. I have a small quantity of the leaf, and shall be glad to send some to any of your correspondents on receipt of address and stamps to cover postage. I have also a small quantity of pollen of *Cobea scandens*, and a few mounted slides of same for exchange. - J. Carpenter, Waltham Cross, Herts.'
- SG April 1870: Capsule of Moss (*Funaria hygrometrica*), mounted, offered for a small quantity of *Alyssum olympicum* seed unmounted, or other good objects. - John Carpenter, 16 Ifield Road, Brompton, S.W.'
- SG May 1870: Article in Microscopy Section - Hair of *Tillandsia* - Jno. Carpenter, 16 Ifield Road, Brompton.
- SG April 1871: A very nice article on Stellate Hairs of Plants by John Carpenter.

- SG February 1873: 'Fungi. - *Coleosporium pingue* and *Melampsora populina*, mounted, also petal of *Correa cardinalis*, showing stellate hairs, and *Funaria hugrometrica*, - for good sections of Coal, Teeth, or other good objects. - John Carpenter, Waltham Cross, Herts.'
- SG April 1874: Well-mounted Slides of Stellate Scales from rare ferns; viz., *Nothochlaena laevis* and *Goniophlebium sepultum*; also same in situ, for really good Slides. - J. Carpenter, Turners Hill, Cheshunt.
- SG July 1874: Plants of *Valisneria spiralis*, for good Slides or Material. - J. Carpenter, Turner's Hill, Cheshunt.
- SG December 1874: 'A few good slides for Foraminifera from Dog's Bay, &c., unmounted. - J. Carpenter, Turners Hill, Cheshunt.'
- SG May 1877: Slides of post-pliocene Foraminifera, &c., in balsam, also Journal of Horticulture for 1876, for Coal Fossils or polished Sections of Corals, &c. - J. Carpenter, Cheshunt, Herts.
- SG March 1879: "Conchology," by W. Wood, vol. i., 59 hand-coloured plates, in good condition. Wanted, Nicholson's "Palaeontology," or offers. - J. Carpenter, Cheshunt, Herts.
- Seaweed; Seeds. JPMS Vol.2. pg.241 1883
- Foraminifera to mount in Balsam. JPMS Vol.5. pg.50. 1886
- *Haltica fuscipes*. JPMS Vol.5. pp.50-51 (1 plate). 1886
- *Onasma* Cuticle. JPMS Vol.7. pg.51. 1888
- Spiral Vessels to Mount. JPMS Vol.7. pg.117. 1888

Objects circulated to June 1877:

- Confervaceae: Marine Algae
- Ferns: *Dicksonia antarctica*; *Platyterium alpicorne* spores
- Leaves: Yucca – cross section
- Hairs – vegetable: Nettle stinging hairs; *Deutzia scabra*
- Hardened Cellular Tissue: Pear, sclerogen
- Raphides & Sphaeraphides: *Aristolochia* cross section – Sphaeraphides in stem
- Sounding – Foraminifera: Deep Sea Soundings
- Zoophyta – Corallia: *Campanularia volubilis*
- Insecta – Empididae: *Hilara cilipes*
- Coleoptera – Halticidae: *Haltica fuscipes* (from Hollyhock)

Despite his notes appearing in the JPMS his name does not appear in any of the Members Lists.

The 1861 and 1871 Census records have been searched for Waltham Cross and Turner's Hill with no results.

The birthplaces of the children given in the 1891 census confirms we have the correct John Carpenter.

There is a record of a John Carpenter in the Members Listing of the Quekett Microscopical Club 1871:

Carpenter, John, 38 Cornwall Street, Fulham, S.W. (Elected 26th August 1870)

The same does not appear in the 1872 listing or thereafter.

He does appear at this address in the 1871 Census:

John Carpenter, age 28, a Clerk, b. Greenwich, Kent

Elizabeth Carpenter (wife), aged 24, b. Cheshunt, Hertfordshire

(The 1851 census records him living with his widowed mother Lucy)

In the 1881 Census @ 3 Alexandra Terrace, Croydon, Surrey:

John Carpenter, age 38, a Fruiterer employing 1 boy, b. Kent

Elizabeth Carpenter, age 30, b. Hertfordshire

Harry Carpenter, age 9, a Scholar, b. Middlesex

Ernest Carpenter, age 6, a Scholar, b. Hertfordshire

Edith Carpenter, age 6, a Scholar, b. Hertfordshire

Griffen Carpenter, aged 5, a Scholar, b. Hertfordshire (Griffen Coulson Carpenter)

Ethel Carpenter, age 2, , b. Hertfordshire

In the 1891 Census @ 6 Hill Street, Stamford Hill, Hackney, London:

John Carpenter, age 48, a Fruiterer, b. Greenwich

Eliza Carpenter, age 39, b. Cheshunt

Harry Carpenter, aged 19, an Assistant Fruiterer, b. Chelsea

Queenie Carpenter, age 16, a Florist, b. Waltham Cross

Coulson Carpenter, age 14, b. Waltham Cross

Ethel Carpenter, age 12, b. Waltham Cross

Eva Carpenter, aged 4, b. Waltham Cross

In the 1901 Census @ 11 Victoria Parade, Hornsey, Middlesex:

John Carpenter, age 59, a Fruiterer, b. Greenwich, Kent

Elizabeth Carpenter, age 50, b. Cheshunt, Hertfordshire

Ernest G. S. Carpenter, age 29, a Fruiterer, b. Cheshunt, Hertfordshire

Eva Carpenter, age 12, b. Clapton, Essex

Doris Carpenter, age 9, b. Clapton, Essex

In the 1911 Census @ 105 Muswell Avenue, Hornsey, Middlesex:

John Carpenter, age 69, retired , shopkeeper, b. Greenwich, Kent

Elizabeth Carpenter, age 60, b. Cheshunt, Hertfordshire

Ernest Carpenter, age 40, Wholesale Fruit Salesman, b. Cheshunt, Hertfordshire

Edith Carpenter, aged 36, b. Cheshunt, Hertfordshire

Coulson Carpenter, aged 34, Clerk, b. Cheshunt, Hertfordshire

Doris Carpenter, age 19, Teacher in Private School, b. Clapton, Middlesex



18. Charles Denton Holmes (Born: circa 1842 Kingston upon Hull, East Yorkshire; Died: 13th October 1938 Kingston upon Hull, East Yorkshire)



Known Addresses:

- The Tannery, Anlaby Road, Kingston-upon-Hull (1851)
- 1 Tan Yard Lane, Kingston-upon-Hull (1861)
- 41 Arlington Street, Kingston-upon-Hull (1871)
- 6 West Parade, Anlaby Road, Hull (1881-1938, 1881-1886 PMS Members List – Circuit d 1882-83) [Works – Alfred Street]

Occupations:

Scholar (1851); Engineer (1861); Engineer and Boiler Maker, employing 298 men and 69 boys (1871); Engineer & Boiler Maker Employing About 400 Men & Boys (1881); Engine and Boiler Maker (1891,1901); Manufacturer of Marine Engines and Boilers etc. (1911)

In Kelly's Directory of Hull, Yorkshire 1899:

- Holmes, Charles Denton, West Parade (6 West Parade in 1893)
- Holmes, Charles D. & Co.,

Mechanical Engineers & boiler makers, Alfred Street

References:

- SG October 1883 Microscopy Section: 'Mounting Insect Organs, &c. - W. B. (previous correspondent) asks for more information on above subject. The following is the method I have adopted for some time, with satisfactory results. Soak insect or organ in liquor potassae for a day, or longer, if large. Wash and lay out upon the glass slip, arrange in position, and gently press while in the water with another slip. Remove to weak solution of acetic acid for a few hours, or longer, if not desired to finish rapidly. Wash again in clean water, and transfer to glass slip and drop on spirits of wine; arrange the object and put over another clean slip; gently press and lightly fasten with thread; place one end down in a small quantity of spirits of wine and leave for a few hours, which hardens in position. Then remove thread and gently lift off one slip, the whole still wet with the spirit, when the object will adhere to one of the slips; drop on absolute alcohol and work object into centre of slide. Then apply oil of cloves, and in a few hours the object will be ready for the balsam to finish. I generally put slides away for a month or two to dry, but if put in a warm place they will be ready for finishing with a ringing cement in much less time. For finishing I usually use shellac cement first, and then finish with black or any other colour preferred. - Charles D. Holmes, Hull.'

Objects circulated to June 1877:

- Diatomaceae: *Aulacodiscus pruinosus*; *Aulacodiscus scaber*
- Leaves: Laurel – section
- Insecta – Scatomyzides: *Scathophaga*, Dung Fly
- Insecta – Tachydromidae: *Platypalpus* sp.
- Insecta – Hybotidae: *Hybos* sp.
- Insecta – Tipulides: *Tipula*, marsh
- Insecta – Imperfectly named (or Massed): *Diptera* (male and female)
- Hymenoptera – Tenthredinidae: Sawfly, ovipositor
- Parts of Vertebrata – Entire Animals: *Hippocampus*, young

His engineering firm specialised in Maritime engines, boilers and fittings. The company was a major employer in the area, employing 298 men and 69 boys in 1871 and 400 men and boys by 1881. The company works were at Alfred Street, Hull. (Image Right: HOLMES Duplex Boiler Feed Pump By Charles D. Holmes & Co Ltd, Engineers, Hull. Twin Cylinders 2" x 1 1/2" x 4" Stroke. Approx 28" Long.)

He married Jane Pauling in 1879. The following children were born – Kate (1871), Fanny (1872) and Edith Mary (1884). He died 13th October 1938 and his estate was valued £397,030 6s. 5d.



19. Rev. John Magens Mello M.A., F.G.S., President Derby Mic. Club (Born: 10th January 1836 St. Georges, Bloomsbury, London; Died: 14th April 1914 Warwick, Warwickshire)



Known Addresses:

- 18 Upper Bedford Place, St. George, Bloomsbury, Middlesex (1841)
- 21 Endsleigh Street, St. Pancras, Middlesex (1851)
- 4 Grove Bank, St. Alkmund, Derbyshire (1861)
- The Rectory (St. Thomas'), Brampton, St. Thomas, Chesterfield (1863-1882) Brampton Parish Church – St. Thomas the Apostle.: Vicar John Magens Mello M.A., 1863; Rector John Magens Mello M.A., 1867, also 1882 – Naturalists' Universal Directory
- New Road, Brampton, Derbyshire (1871-1881)
- The Vicarage, Mapperley Village, near Derby (1872-1901)
- Cliff Hill (Cliff House), Warwick, Warwickshire (1911-1914)

Occupations:

Scholar (1851); Curate of All Saints, Derby, B.A. (1861); Rector of Brampton St. Thomas (1871,1881); Vicar of Mapperley, Derbyshire (1891,1901); Clergyman Priest of the Established Church (1911)

References:

- SG Vol.8. April 1872 : Polariscopic and other objects; rare Chemical Crystals, Polyzoa, &c., mounted or unmounted, for other good objects. Address, Rev. J. M. Mello, The Rectory, Brampton, St. Thomas, Chesterfield. (also Rev. J. M. Mello, F.G.S., &c., Mapperley Village, near Derby – member of The Burton on Trent Natural History and Archaeological Society 1896/7)
- SG Vol.8. August 1872 : Elaterite, Calcite, Fluor, and other Derbyshire minerals, for foreign, Cornish, or Scotch Minerals. - Rev. J. M. Mello, Brampton, St. Thomas's, Chesterfield. (also Rev. J. M. Mello, F.G.S., &c., Mapperley Village, near Derby – member of The Burton on Trent Natural History and Archaeological Society 1896/7)
- On some Bone-caves in Creswell Crags, Quarterly Journal of the Geological Society of London volume 31. (1875)
- Handbook to the Geology of Derbyshire by The Rev. J. Magens Mello, M.A., F.G.S. (Illustrated with a Geological Map, Sections, &c.). Published by Bemrose and Sons, Derby and Paternoster Row, London. 1876. (rev.1891)
- The Bone-caves of Creswell Crags—2nd Paper, Quarterly Journal of the Geological Society of London volume 32. (1876)
- Rock-Structure, Popular Science Monthly Volume 9, August 1876
- The Bone-caves of Creswell Crags—Third Paper, Quarterly Journal of the Geological Society of London volume 33. (1877)
- Further Discoveries in the Cresswell Caves, with William Boyd Dawkins, Quarterly Journal of the Geological Society of London volume 35. (1879)
- Supplementary notes to An Hour at the Microscope by Tuffen West. JPMS Vol.1. pp.39-40. 1882.
- Quartz: Its Varieties and Formation, Popular Science Monthly Volume 23, June 1883
- Pitchstone from Arran. JPMS Vol.6. pp.117-118. 1887
- Eozoon Canadense. JPMS Vol.6. pg.119. 1887
- Lepidolite. JPMS Vol.6. pg.119. 1887

Objects circulated to June 1877:

- Minerals & Geology (Metals and their ores): Gold Dust
- Minerals & Geology (Silicious): Calcedony; Pitchstone, Arran; Lepidolite; Diorite; Elvanite, Cornwall; Olivine
- Diatomaceae: *Orthoseira arenariara*
- Fungi: *Peziza villosa*; *Trichobasis rubigovera*
- Ferns: *Asplenium lucidum* scales; *Niphobolus lingua*
- Wood Sections: Willow – section; Honeysuckle
- Fossil Woods & Coal: *Endogenites erosa*
- Hairs – vegetable: *Correa Harrisii*
- Fossil Foraminifera: *Eozoon canadense*
- Polyzoa: *Aetea dilatata* on Alga
- Insecta – Tabanidae: Breeze Fly
- Insecta – Lepidoptera: *Morpho menelaus*
- Parts of Vertebrata – Skin: Adder's Head, skin



Recorded as Rev. James Magen Mello in T. A. Wright's listing.

John Magens Mello married Charlotte Nottidge, in 1859. Their union resulted in the following children – Alice Charlotte (1860) and Katharine Inez (1870). His interests were primarily as an Archaeologist and Geologist. He was a Fellow of the Geological Society. Known by his middle name Magens, the surname of one of his father's partners in the bank of Dorrien, Magens, Mello & Co. He studied at St John's College, Oxford passing his Final Classical Examination in 1858 and obtaining a BA in 1859 and an MA in 1863. Member of the Midland Scientific Association 1863.

He first visited Creswell Crags in 1876 and in subsequent years, with the permission of the Duke of Portland, carried out excavations at Church Hole, Robin Hoods Cave and Mother Grundy's Parlour in collaboration with the eminent palaeontologist Professor William Boyd Dawkins of Owens College, Manchester and Thomas Heath from Derby Museum who managed the excavations. Mello had a keen interest in Darwinism. He was President of the Derbyshire Natural History Society in 1887. He was President of the Derbyshire Microscopical Society in 1878 and "read a capital paper on the Carboniferous Flora, which he illustrated with drawings, microscopic slides, and specimens" at a meeting on the 25th February 1878. John Magens Mello died 14th April 1914 and his estate was then valued at £9,250 12s. 9d.

20. Robert Harris Philip (Born: circa 1852 Hull, East Yorkshire; Died: (15th?) 13th April 1912 Hull, East Yorkshire)



Yorkshire (1911,1912)

Known Addresses:

- 58 Whitefriargate, Kingston-upon-Hull (1851)
- 10 Prince Street, Kingston-upon-Hull (1861)
- 27 Anlaby Road, Hull (1871-1873)
- 28 Prospect Street, Hull (1874-1882 from adverts in English Mechanic)
- 6 Laurel Grove Park Road, Sculcoates, Yorkshire (1881-1890)
- 4 Grove Street, Stepney, Hull (1882,1883 English Mechanic)
- 8 Hutt Street, Kingston-upon-Hull (1891)
- 296 Beverley Road, Hull (1899-1901)
- 447 Beverley Road, Hull,

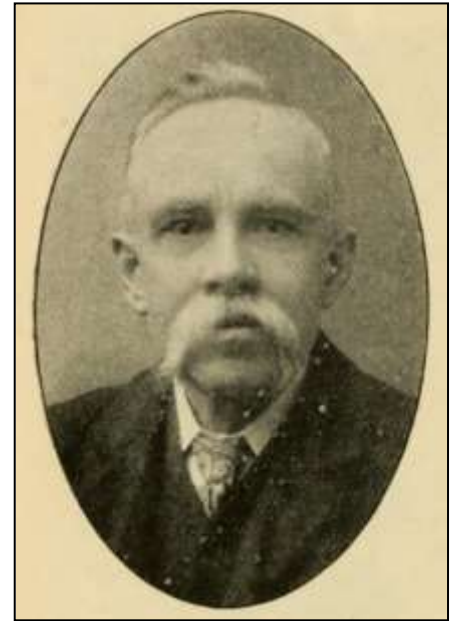
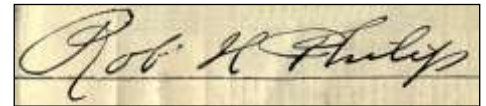

Occupations:

Oil Merchants Clerk (1871); Oil Merchant (1881,1891,1901, 1911)

References:

- SG Vol.9. January 1873 : For mixed Seeds, comprising several beautiful as microscopic objects, send stamped envelope and object of interest to R. H. Philip, Anlaby Road, Hull.
- SG Vol.9. May 1873 : Wanted, Geological Slides, Diatoms and other good Slides, - R. H. Philip, Anlaby Road, Hull.
- SG Vol.9. June 1873 : Good Polariscopes Objects - Brown and White Stearine , Palm-nut and Cocoa-nut Oils, Ozokerit or Erd-wachs, for other good slides, - R. H. Philip, Anlaby Road, Hull.
- SG Vol.10. January 1874 : Section of Cuttle-bone, ground-plan (opaque), and of Charob-seed (*sic*) (polar), for other good objects. - Send list to R. H. Philip, 23, Prospect Street, Hull.
- SG Vol.10. June 1874 : Wanted, Scientific Books; good Microscopic Slides offered in exchange. - R. H. Philip, 23, Prospect Street, Hull.
- SG Vol.10. December 1874 : Good Microscopical Slides for others, or for good unmounted Material. Lists exchanged. - R. H. Philip, 23, Prospect Street, Hull.
- SG Vol.11. January 1875 : For sections of Charob (*sic*) seed, a good Polariscopes Object, and Morva seed, showing Oleo-resin Cells, send stamped envelope and object of interest to R. H. Philip, 23, Prospect Street, Hull.
- SG Vol.11. July 1875 : Slides of various Fatty Acids, forming brilliant objects for the polariscopes, and other good mounted Objects for exchange. - R. H. Philip, 28, Prospect Street, Hull.
- SG Vol.11. November 1875 : Unmounted Microscopic Material for other, or for Slides. Lists exchanged. - R. H. Philip, 28, Prospect Street, Hull.
- SG Vol.12. January 1876 : For six species of Zoophytes, unmounted, send other good Microscopic Objects to R. H. Philip, 28, Prospect Street, Hull.
- SG Vol.13. February 1877 : For Sections of Palm Nut, Polar, and Cotton-seed, showing oleo-resin cells, send other good unmounted objects to R. H. Philip, 28, Prospect Street, Hull.
- SG Vol.13. May 1877 : Good Microscopic Slides offered in exchange for Scientific Books or Instruments, or unmounted material. - R. H. Philips, 28, Prospect Street, Hull.
- JPMS Vol.1. March/June/September/December 1882 and JPMS Vol.1. pp.56,108,207. 1882: Sales: Microscopic Objects for Mounting. Fifty preparations, accurately named, 2/6. - R. Philip, 4 Grove Street, Stepney, Hull.
- Paper in conjunction with F. W. Mills 1901 - The Diatomaceae of the Hull District. (Transactions of the Hull Scientific and Field Naturalists Club Vol 1. pp. 157-223).

Objects circulated to June 1877:

- Diatomaceae: *Bidulphia pulchella*
- Various *Acarus domesticus* Diatomaceae: Troy, U.S.A.
- Leaves: *Deutzia scabra* - stained
- Hardened Cellular Tissue: Pear, crystals in section
- Seeds & Seed Vessels: Areca Nut section; Sesame seed section; Mowa seed section
- Foraminifera: March
- Mollusca: Octopus (shell/cuttle bone section)
- Gamasea: *Gamasus* from Fly
- Scorpionidae: Black Scorpion, comb & sting (2 slides)
- Parts of Vertebrata - Kidney: Rabbit Kidney

Robert Harris Philip was born in 1852 to Robert Philip, a Stationer and Homeopathic Chemist, and his wife Hannah. The two parents went on to run a series of businesses - Mantle Maker, employing from 6 to 16 hands (1861) and Emigration Agent, Draper and Bottle Dealer (1871). In 1873 he was awarded a first class certificate and prize in his Elementary Animal Physiology Class run by the Hull Young People's Christian and Literary Institute Science School and Art Night Class. In 1879 Robert Harris Philip married Jane Elizabeth (Lily) Belt on the 6th August and went on to father the following children - Roland (1880), Maurice (1883), Evelyn Mary (1884), Oswald (1885), Kenneth (1887), Eric (1890) and Alan (1897). An

article in the *Chess Player's Chronicle* of 1877, pp. 186-187, listed him as one of 28 players in a team representing Britain in a correspondence match with America. In 1880 he was a member of Hull Church Institute Chess Club, and was at that time the club champion. When Edmund Thorold gave a simultaneous display at the club on 16/01/1880, Robert Harris Philip won his game against the visitor. He played regularly for Hull in the Woodhouse Cup as a member of the Hull United Liberals team. He played for Yorkshire against Lancashire at Bradford on 18/06/1887, and continued playing for Yorkshire up to and including 1903. He played for the North & East Ridings against the West Riding at the De Grey Rooms, York, on 28/11/1903. His microscopical interest was primarily as a Diatomist. He catalogued Normans Diatoms. His collection of 3000 slides was donated to Hull Museum. His collections, together with those by George Norman were burnt in World War II. He was Hon. Secretary of the Hull Royal Institution Microscopical Society in 1879, President of the Hull Scientific and Field Club in 1899, 1900 (later vice-president) and Secretary of the Yorkshire Micro-Zoology and Micro-Botany Committee (Yorkshire Naturalists' Union).

The Naturalist printed an Obituary 1912, pg.150 (includes portrait above) and pg. 327. Another obituary appeared in the Transactions of the Hull Scientific Field Naturalists' Club 4(4): pp219-220. On his death his estate was valued £3,155 11s. 7d.

21. Rev. Francis Gardner Salt (Born: 26th December 1829 Windsor, Hants Co. Nova Scotia; Died: 9th January 1878 Brighton, Sussex)



Known Addresses:

- St John's College, Cambridge (1853, 1854)
- The Rectory, Heydon, Norfolk (1856, 1861)
- Dilham Grange, Norfolk (1862)
- Bishops Wood (Bishopwood) Vicarage, Breewood, Staffordshire (1867-1878)
- also Bishops Wood Vicarage, Penkridge, Staffordshire.
- 3 Denmark Terrace, Brighton (1878)

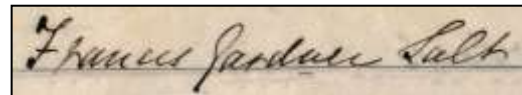

Occupations:

B.A. from St. John's College, Cambridge. Admitted into Holy Orders (1854); The Hampshire Advertiser (Southampton, England), Saturday, September 01, 1860: "The Rev. Francis Gardner Salt, B.A., formerly Curate of Heydon, in this county, has been appointed to be Domestic Chaplain to the Marquis of Townshend."; Curate of Dilham and Horning (1861,1865); Perpetual Curacy of Bishopwood, Staffordshire and Chaplain to the Marquess Townshend (1867,1871)

Objects circulated to June 1877:

- Minerals & Geology (Crystals, Vegetable Products): Salicine
- Diatomaceae: *Heliopelta Leeuwenhoek*
- Various Diatomaceae: Guano
- Polycistina: from Barbadoes
- Echinodermata: Starfish plates
- Insecta – Aphaniptera: *Pulex irritans* (male and female)
- Hymenoptera – Tenthredinidae: Sawfly, ovipositor
- Hymenoptera – Vespidae: *Vespa*, Wasp tongue; Wasp sting
- Hymenoptera – Apidae: *Apis mellifera*, Honey Bee, sting
- Coleoptera – Dyticidae: *Dytiscus marginalis*, leg
- Araneae: Spider, female
- Parts of Vertebrata – Scales: Brown Carp
- Parts of Vertebrata – Nerve Structure & Organs of Special Sense: Tapetum, Eye of Sheep

In 1848 admitted to St. John's College, Cambridge. Four years later receiving his. B.A. He was ordained Deacon 22nd May 1853, Priest in 1854 and Curate of Bradwell, Suffolk in 1855. He went on to become Curate of Heydon Norfolk (1857-1861, Curate of Dillham with Honig (1862-1865), Curate of Harleston (1866-1868), Vicar of Bishopwood, Staffordshire (1869-1877) and latterly Lic. Priest in the Diocese of Chichester. Francis Gardner Salt married Mary Gilbertson on 4th September 1856. The following children were born – Francis Howard Gardner (1857), Cecil Henry (1858), Lewes Herbert (1860), Ernest George (1861), Spencer William (1862) and Edith Mary (1864). In 1866 he advertised in the Ipswich Journal "The Rev. F. G. Salt (Camb.) wished to meet with Two Boys under 10 years of age, to educate with three of his own sons. – Address, Harleston, Norfolk.". Upon his death his estate was valued at just under £7,000. He was buried at Brighton Parochial Cemetery, Sussex on 14th January 1878

22. William Bevan-Lewis, F.R.M.S., L.R.C.P.Lond.,M.R.C.S. (Born: 21st May 1847 Cardigan, Cardiganshire, Wales; Died: 14th October 1929 Northampton, Northamptonshire)



Known Addresses:

- Buckinghamshire County Pauper Lunatic Asylum (1869)
- College Street, Rotherham, Yorkshire (1871)
- Burry Port, South Wales (1874)
- Cardigan (1858-1884)
- West Riding Pauper Lunatic Asylum, Stanley cum Wrenthorpe, Yorkshire (1881)
- West Riding Asylum, Stanley Road, Wakefield (1881-1911)
- Elsinore, Dyke Road Avenue, Brighton Patcham, Sussex (1911)
- Priory Street, Cardigan, Cardiganshire (1929)

Occupations:

Assistant Medical Officer, Bucks County Pauper Lunatic Asylum, Stone, nr. Aylesbury (1869); M.R.C.S., L.S.A. & L.R.C.P.London, House Surgeon Dispensary, Rotherham

(1870, 1871); Physician and Medical Director West Riding

Asylum (1879); Physician of the London College (1881); Lecturer at the Leeds School of Medicine for B.Sc. and F.S.C. courses (1887); Lecturer on mental disease – Owens College, Manchester (1891); Medical Superintendent of Wakefield Lunatic Asylum (1898); Pensioned Asylum Medical Superintendent (1911)

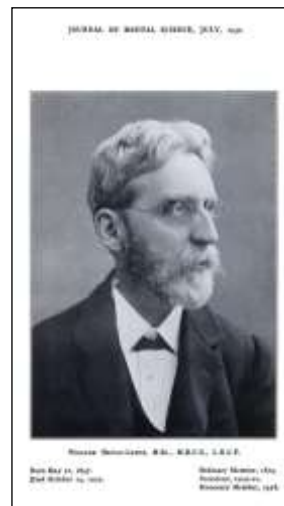

William Bevan-Lewis

References:

- SG Vol.11. February 1875 : Mounted Micro-fungi, for mounted and named Diatoms: also Micro-material of all kinds required. Lists exchanged. - Dr. B. Lewis, Burry Port, South Wales.
- A new process of preparing and staining fresh brain for microscopic examination. Monthly Microscopical Journal, 16, 1876, pp.105-110.
- Preparation of sections of cerebral and cerebellar cortex for microscopic examination. Quarterly Journal of Microscopical Science, 16, 1876, pp.69-76.
- On a new freezing microtome for the preparation of sections of the brain and spinal cord. Journal of Anatomical Physiology, 11, 1877, pp.537-539.
- The relationships of the nerve-cells of the cortex to the lymphatic system of the brain. Proceeding of the Royal Society, 26, 1878, pp.326-334.
- Application of freezing methods to the microscopic examination of the brain. Journal of the Microscopical Society, 1, 1878, pp.358-360.
- The cortical lamination of the motor area of the brain. Proceedings of the Royal Society, 27, 1878, pp.38-49. (with Henry Clarke)
- On the comparative structure of the cortex cerebri. Proceeding of the Royal Society, 29, 1879, pp.234-237; Philosophical Transactions, 171, 1881, pp.35-64.
- On the comparative structure of the brain in rodents. Proceedings of the Royal Society, 33, 1882, pp.15-21; Philosophical Transactions, 173, 1883, pp.699-746.
- The Human Brain: Histological and Coarse Methods of Research : A Manual for Students and Asylum Medical Officers (1882)
- Insanity at the Puerperal, Climacteric, and Lactational Periods. Wood's Medical and Surgical Monographs Vol.VI., No.2, May 1890.
- A Text-Book of Mental Diseases with Special Reference to the Pathological Aspects of Insanity (1899)
- On the Formation of Character: an Address to the Nursing Staff at the Retreat, York (1st November 1906). Printed in the Journal of Psychiatry January 1907, pp.121-137.

Objects circulated to June 1877:

- Confervaceae: *Plocamium coccineum* in fruit
- Fungi: Polycistis trompholygodes(?); *Puccinnia anemones* spores; *Puccinnia umbilici*; *Puccinnia variabilis*
- Wood Sections: *Carex arenaria*
- Zoophyta – Corallia: *Sertularia cupressina*
- Insecta – Anoplura: Parasite of Humming Bird, eggs
- Coleoptera – Cuculioridae: Green Weevil Bug. Diamond Beetle
- Crustaceae – Lophyropoda – Cirripedia: *Balanus* sp. Barnacle, penis
- Crustaceae – Lophyropoda – Caprellina: *Caprella linearis* subnom *Pycnogonum*
- Araneae: Adiante, poison fangs
- Parts of Vertebrata – Scales: Carder Fish skin
- Parts of Vertebrata – Bone: Human Bone, section

In 1865 whilst in his first year at Guy's Hospital examinations in medicine he was awarded first prize of £30.

Admitted as a member of the Royal College of Surgeon in 1868. In the List of the Fellows, Members, Extra-Licentiates and Licentiate of the Royal College of Physicians of London 1868 [Elected], 1870, 1872, 1873, 1877, 1883, 1884:- Lewis, William Bevan, Cardigan (Elected 1868) (a Licentiate). His appointment to the Buckinghamshire County Pauper Lunatic Asylum in 1869 came with a salary of £80 per annum with board and apartments in the Asylum. He resigned the position in 1870 through ill-health. William Bevan Lewis married Rose Eve Keay in 1870. They had no children.

Admitted a Fellow of the Royal Microscopical Society 5th February 1873 (no longer listed in 1898).

In 1878 the English Pathologist, William Bevan-Lewis described the giant cells in the precentral convolution of the brain. Became a member of the Medico-psychological Association of Great Britain and Ireland in 1879.

In the List of the Fellows, Members, Extra-Licentiate and Licentiate of the Royal College of Physicians of London 1886-1913:- Lewis, William Bevan, West Riding Asylum, Wakefield (Elected 1868) (a Licentiate). In 1892 at the Sixtieth Annual Meeting of The British Medical Association he was President of the Psychology Section.

In 1898 one Henry Yeo, A Manchester Journalist, was sent to prison for twelve months for Criminally libelling Dr. W. Bevan Lewis, the Medical Superintendent of Wakefield Lunatic Asylum (the nature of the libel was as follows: "It would appear that the general effect of the alleged libel was to charge the complainant with culpable inhumanity, despicable and moral conduct, and other offences of a like extraordinary character....In cross-examination witness [William Bevan Lewis] stated that he considered Yeo was insane when he was in the Wakefield Asylum, and it was possible that he was a lunatic still.").

He was awarded a non-professorial position in Mental Diseases and Psychiatry at Leeds University 1904-1908 and a professorial position 1909-1910. The Vice-Chancellor of the University conferred a Master of Science degree to him on 30th June 1905.

He was elected an Honorary Member of the Medico-Psychological Association in 1918.

When he died in 1929 his estate valued £8,897 10s. 10d. His death was reported in The Lancet of 26th October 1929 and an obituary in the same named publication of 2nd November 1929. An extensive Obituary was printed in the British Medical Journal 2nd November 1929 pp.833-834.

23. John Rotherham



- Characeae: *Chara fragilis*, anthers and globules
- Zoophyta – Corallia: Star Coral
- Entozoa: *Trichina spiralis*
- Mollusca: Whelk, tongue
- Insecta – Thysanura: *Lepisma scales*
- Hymenoptera – Formicidae: Garden Ant
- Coleoptera – Telephoridae: Soldier Beetle
- Coleoptera – Cuculioridae: Diamond Beetle, thorax

Known Addresses:

- 236 South Street Park, Sheffield (1874)

The address – 236 South Street Park, Sheffield – was occupied by one Isaac Swind(o)(e)n in 1858-1861 (Ref: White's Directory and Topography of Sheffield 1862 records 236 South Street (Park) as being occupied by Henry Raynes. Isaac Swinden was listed at 236 South Street, Park, Sheffield in the List of British Entomologists, printed in the Entomologists Annual 1858 (1859).

The Entomologist's Weekly Intelligencer), by Michael Wilkinson in 1879 and by Mrs. Ellen Davidson in 1905.

possibly related:

SG February 1867: Diamond Beetle (mounted) for other objects of interest. - J. R., 172, George Street, Aberdeen.

Objects circulated to June 1877:

- Minerals & Geology (Metals and their ores): Lapis Lazuli
- Minerals & Geology (Silicious): Granite
- Minerals & Geology (Crystals, Vegetable Products): Salicine
- Minerals & Geology (Crystals from Altered Veg. Matters): Aniline Picrate
- Diatomaceae: *Amphiprora alata*

There was a John Rotherham, age 24, b. Povey, Derbyshire, a Silver Chaser, living at 12 Granville Lane, Sheffield Park, Sheffield in 1871.

It would be worth checking John Rotherham who died 6th September 1879, age 65. Reported in the Sheffield Daily Telegraph of 13th September 1879. bu. 9th September 1879, Staveley, Derbyshire.

Both the above a different surname spelling to the T. A. Wright transcription.

24. Benjamin Bellingham (Born: 2nd April 1844 Dudley, Worcestershire; Died: circa 1890 Dudley, Worcestershire)



Known Addresses:

- 126 Stourbridge Road, Dudley, Worcestershire (1871)
- Round Oak, Brierley Hill, Staffordshire (1871, 1872)
- Stirchley, Salop (1874)
- 205 Wolverhampton Street, Dudley (1881-1884 PMS Members List -1881-83 Circuit f.)

Occupations:

Agent for Iron Works (1871); Auctioneer (1881)

References:

- SG Vol.7. May 1871 : *Anacharis* prepared for polariscope, and several species of Sphagnum offered for stamped address, and any object of interest; especially *Deutzia scabra*. - Benj. Bellingham, Round Oak, Brierley Hill.
- SG Vol.8. March 1872 : Cuticle of Palmyra Leaf (from Ceylon) prepared for polariscope (unmounted), offered for stamped envelope, and any object of microscopical interest [except botanical]. - B. Bellingham, Brierley Hill, Staffordshire.

Objects circulated to June 1877:

- Diatomaceae: *Pinnularia viridis*
- Fungi: *Aecidium compositarum*; *Aecidium Epilobii*
- Wood Sections: Water Plantain

- Cuticles: Chili Pine
- Spiral & Pitted Structures: Rhubarb – spiral vessels from
- Polycistina: Fossil Barbadoes
- Polyzoa: *Electra verticillata*
- Insecta - Muscidae: House Fly, larva
- Insecta – Lepidoptera:, part of wing; *Argynnis lathoma*, basal part of hind wing x2
- Insecta – Unknown: A. amphildalmus(?) wing
- Insecta – Lepidoptera: *Papilio paris*
- Coleoptera - Dermestidae: *Dermestes lardarius* (Bacon Beetle)
- Parts of Vertebrata – Bone: Human Skull
- Parts of Vertebrata – Tooth: Fossil Shark Tooth
- Animal Tissues – Digestive Organs: Salivary Gland
- Vascular System - Injected Preparations &c.: Toe of White Mouse; Air bladder of Eel

Benjamin Bellingham married Myra Price in 1866, Dudley, Staffordshire. They had children as follows – Sarah Alice (1867), Myra Agnes/Agnes Myra (1869), Harold (1870), Theodora (1874). His wife died in 1876 and he remarried to Elizabeth (surname unknown) in 1878. Another two children were born – John Currie (1882) and Graham Stacey (1884). A notice dissolving the partnership between John Bent and Benjamin Bellingham, Auctioneers, Valuers and Bankruptcy Accountants of Dudley appeared in the London Gazette of 31st December 1878 (the company "John Bent and Bellingham" was continued by Benjamin Bellingham). Benjamin Bellingham died before the 1891 Census when his wife Elizabeth was recorded as a widow.

25. John Michael Williams* F.R.M.S. (Born: 1838 Holywell, Wales; Died: 25th March 1925 Liverpool, Merseyside)

Known Addresses:

- 51 Balliol Road, Walton on the Hill, Lancashire (1871 - Member of the Liverpool Microscopical Society Elected 1871, Hon. Treasurer 1887-1891, Member of Council 1893,1906,1909,1910,1912, Vice-President 1894,1895,1911,1912)
- Bootle, Liverpool (1874)
- The Hawthorns, Hawthorn Road, Bootle, Liverpool (1877-1883 QMC Members List – Elected 23rd May 1880)
- 9 Hawthorne Rd North, Bootle Cum Linacre, Lancashire (1881)
- 156 Chatham Street, Liverpool (1888,1901, 1888-1895 Liverpool Microscopical Society)
- 4 Exchange Alley, Liverpool (1889, 1890,1901)
- 20 Hackins Hey, Liverpool (1903;1898 RMS Members List – Elected 1884, not listed in 1901)
- 31 Grove Park, Toxteth, Liverpool (1911-1925,1906-1924 Liverpool Microscopical Society)

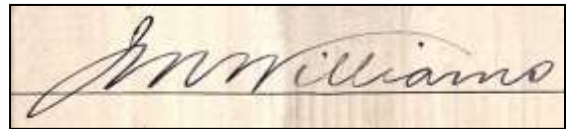

Occupations:

Cotton Broker (1871,1881,1891,1901,1911)

References:

- SG Vol.13. May 1877 : British Land, Freshwater, and Marine Shells to exchange for others. - W., The Hawthorns, Hawthorn Road, Bootle, Liverpool.
- SG Vol.19. June 1883 : To exchange or otherwise - *Cypraea*, *Conus*, *Oliva*, and other genera. - J. M.

W., The Hawthorns, Bootle, Liverpool.

- Cupric Acid. JPMS Vol.6. pg.116. 1887
- (*Oliva*) *candicans* – Mr. J. M. Williams, of Liverpool, whose collection of the genus is probably the finest extant, possesses a pure albino example, typical in form. It was procured in France, and, so far, is unique. (Proceedings of the Malacological Society Vol.VI 1904-05 pg. 65)

Objects circulated to June 1877:

- Wood Sections: White Pine – longitudinal section; Climber (Malphiaceae)
- Cuticles: Aloe Leaf
- Neuroptera – Ephemerae: *Ephemera* sp., cast skin
- Crustaceae – Icthyophthira – Caligina: *Caligus diaphanus*
- Araneae: *Epeira diadema*, Garden Spider, male
- Parts of Vertebrata – Hairs: Hedgehog spines

John Michael Williams married Elinor Crompton in 1864. They went on to have quite a large family – David (1866), Florence (1867), Eleanor G. (1868), Harold Crompton (1869), Horace Spencer (1872), Lucy Hester (1874), Eliza Ayre (1877) and Marion (1879). He exhibited a vast array of slides at meetings of the Liverpool Microscopical Society. When John Michael Williams died in 1925 his estate was valued £47,119 12s. 6d. He was buried in Toxteth Park Cemetery, Toxteth, Liverpool. Examples of his slides were deposited in the cabinets of the Liverpool Microscopical Society. He was a member of the Conchological Society of Great Britain and Ireland (elected 1889). His shell collection was bought by Arthur Blok at SAR in 1926

- 1926: Jackson, J. W., Obituary Notice: John Michael Williams. -- Journal of Conchology, 18: 9-10.
- A private collector from Liverpool whose shell collection was bought by Arthur Blok at SAR (Stamford Auction Rooms?) in 1926

Dr.(?) John Michael Williams (1838-1925) British Malacologist.

26. John Beulah*. (Born: circa 1834 Bracken Hill, Broughton, Lincolnshire; Died: 29th June 1918 Brigg, Lincolnshire)



Known Addresses:

- Bracken Hill, Brigg, Lincolnshire (1867-1881)
- Bracken Hill House, Broughton, Lincolnshire (1871-1881 – QMC Members List 1875-1881 – Elected 26th November 1875)
- Brigg, Lincolnshire (1874)
- possibly Standish House, Boston
- Raventhorpe, Brigg [Raventhorpe, Appleby] (1882-1911 QMC Members List – 1882-1901, 1904-1911)
- Albert House, Brigg (1914-1918 QMC Members List – 1914-1918)

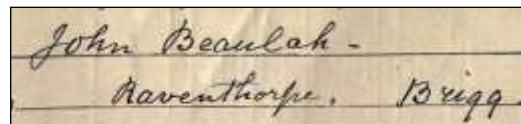

Occupations:

Farmer of 340 acres of land, employing 4 labourers and 4 boys (1871); Farmer of 300 acres, employing 11 labourers and 2 boys (1881); Farmer (1891,1901,1911)

References:

- SG Vol.3. October 1867 Recent Shells. - *Vertigo edentula*

for other British Shells. - J. Beulah, Bracken Hill, Brigg.

- *Nycteribia* from Bat. JPMS Vol.4. pg.261. 1885
- *Dermanyssus*. JPMS Vol.5. pg.119. 1886



Objects circulated to June 1877:

- Diatomaceae: *Auliscus sculptus*
- Insecta – Anoplura: *Haematopinus spinulosus* from Rat; Parasite of Peacock, *Goniodes falcicornis*; Parasite of Cockerel
- Insecta – Diptera: *Nycteribidia* (Bat Fly)
- Insecta – Aphaniptera: *Pulex talpae* (Mole)
- Hymenoptera *Aclisia dytici* – Vespidae: *Vespa*, Wasp wing; Hornet, male organs
- Gamasea: *Gamasus coleoptratorum* (Beetle Mite); *Gamasus hilaris* from Bat
- Pseudoscorpia: Chelifer

Catalogue of Zoological Preparations in the Quekett Microscopical Club Collection 1900 List (if different from above):

- Acarina: *Dermaleichus parinus* (from Blue Tit); *Pteroptus vespertilionis* (from Bat); *Gamasus* (from Mole)

Catalogue of Zoological Preparations in the Quekett Microscopical Club Collection 1902 List (if different from above):

- Hemiptera: *Cimex columbarius* (parasite on Pigeon) (female); *Docophorus humeralis* (parasite on Whimbrel) (male and female); *Goniodes falcicornis* (parasite on Peacock); *Goniodes hologaster* (parasite on Fowl) (male and female); *Goniodes stylifer* (parasite on Turkey) (male and female); *Haematopinus spinulosus* (parasite on Rat) (male and female); *Nirmus camaratus*(?) (parasite on Blackcock); *Nirmus uncinus* (parasite on Hooded Crow) (male and female)

He collected Land and Freshwater Shells in Lincolnshire between the years 1860-1865 (mentioned in the Transactions of the Lincolnshire Naturalists' Union). Entered Brigg Grammar School in 1881 and left in 1885 – Address – Bracken Hill, Brigg. An ordinary Member of the Conchological Society of Great Britain and Ireland (1886,1888,1889,1890,1891,1893,1894). In 1914 the following was recorded in the Who's Who in Business: - "BEAULAH, J. & J., Pea Growers and Merchants, Boston. Hours of Business: 7 a.m. to 6 p.m. Established in 1880 by John Beulah, J.P., and Josiah Beulah, the present principals. Staff: About 500. Speciality: Marrowfat Green Peas in Bulk or Packets. Patents: Inventors of the " Ideal " Pea Cooker and Strainer; " Ureka " Soaking Tablet. Connection: United Kingdom, Foreign, Colonial. Contractors to H.M. Government. Telephone: No. 106 Boston. Telegraphic Address: " Beulah, Boston." Bankers: Capital and Counties Bank, Ltd."

He married Annie Briggs in 1863. During the next few years they produced the following children – Annie (1864), Catharine Mary (1868), John (1870) and Edward Albert (1873). Vice Chairman of the Glanford Brigg Union - John Beulah, Raventhorpe, Broughton - (Kelly's Directory – date unknown) John Beulah of Raventhorpe led a group from the Yorkshire Naturalists Union and the Lincolnshire Naturalists Union in a Conchology foray to Goole Moor, Broughton Woods and Twigmoor Gullery taking in Gull Ponds, High Wood, Scawby Park and Woods and Broughton Lane Plantation, on Saturday 1st June 1895. John Beulah's group was also to include any Coleopterists amongst the party. On his demise in 1918 his estate was valued £13,734 6s. 8d. Nature of 1st August 1918 notes – "Among the recent additions to the Municipal Museums, Hull, we notice the collection of birds' eggs, land, freshwater, and marine shells, all from Lincolnshire, formed by the late John Beulah, of Raventhorpe."

Councillor John Beulah, Mayor of Boston, Lincolnshire, 1891. A subscriber to the Association for the Protection of Property against Incendiarism – John Beulah, Bracken Hill – 1865. In 1913 Chairman of the Board of Guardians of The Glanford Brigg Poor Law Union. His portrait, as Mayor of Boston, was painted by Ernest Townsend. His collection of Lincolnshire Non-Marine Molluscs is believed lost.



27. John William Whiteley (Born: circa 1844 Hull, East Yorkshire; Died: 15th January 1910 Headingley, Leeds, West Yorkshire)



Known Addresses:

- 22 Frances Street, Sculcoates, Hull, Yorkshire (1851)
- 19 Charles Street, Sculcoates, Yorkshire (1861)
- 4 Russell Street, Sculcoates, Hull, Yorkshire (1871)
- 9 Norwood Street, Hull (1874)
- 46 Fountain Street, Hull (1881,1882)
- 7 Brudenell Mount, Headingley with Burley, Yorkshire (1891)
- 46 Ash Grove, Headingley cum Burley, Yorkshire (1901-1910)

Occupations:

Fruit Merchant's Clerk (1861); Merchant's Clerk (1871); Cashier for a Fruit Broker (1881); Sugar Traveller (1891); Sugar Commercial Agent (1901); Commercial Traveller (1910)

Objects circulated to June 1877:

- Diatomaceae: *Navicula didyma*; *Pleurosigma attenuatum*
- Foraminifera: Orbitulites
- Polyzoa: *Gemillaria loriculata*
- Mollusca: Pinna shell, section
- Insecta - Muscidae: Blow Fly, stomach
- Orthoptera – Achetidae: *Acheta domestica*, tongue
- Coleoptera – Dyticidae: *Dytiscus marginalis*, hylorus?

- Coleoptera – Lampyridae: *Lampyris noctilusa* (Glow Worm)
- Coleoptera – Cuculioridae: Diamond Beetle, elytron
- Vascular System - Injected Preparations &c.: Ear Drum of Frog, injected
- Parts of Vertebrata – Kidney: Sheep Kidney, injected

John William Whiteley married Ann Eliza Martin in 1871. They had no issue. On his death he left estate valued £420 2s. He was buried at Lawnswood Cemetery, Adel (Leeds), Yorkshire.

28. William Jenkinson (Born: 4th January 1829 London, Middlesex; Died: 13th May 1913 Ranmmor, Sheffield, South Yorkshire)



Known Addresses:

- Occupation Road, Brightside Bierlow, Yorkshire (1851)
- Birkendale View, Nether Hallam, Sheffield, Yorkshire (1861)
- Bollam, East Retford, Nottinghamshire (1871)
- Bollam nr. Retford (1874) (1881)
- 9 (79) Surrey Street, Sheffield (1886,1890, 1891)
- 36 Nether Green Road, Upper Hallam, Yorkshire (1901-1913)
- 32 Sheaf Garden Terrace, Sheffield, Yorkshire

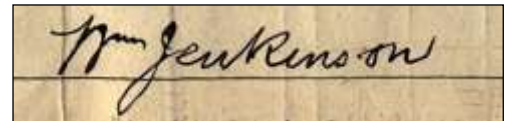

Occupations:

Paper Maker (1857); Paper Makers Foreman (1861); Paper Makers Manager (1871); Stationer (1881); Paper and Twine Merchant (1891); Paper Dealer – retired (1901); Wholesale Stationer – retired, (1911)

References:

- SG Vol.22. March 1886 : A Williams freezing and imbedding microtome, by Swift & Son, for good high-power objective or other offers. - W. Jenkinson, 9 Surrey Street, Sheffield.
- SG Vol.26. August 1890 : Wanted offers for an 1/6 water immersion objective. Powell & Lealand's new formula. - Jenkinson, 79 Surrey Street, Sheffield.

Objects circulated to June 1877:

- Diatomaceae: *Gomphonema*; *Isthmia nervosa*
- Mollusca: *Littorina* (periwinkle) tongue
- Insecta – Anoplura: *Haematpinus asini* from Horse
- Insecta - Muscidae: Blow Fly, alimentary canal; Blow Fly, genitive organs (male); Blow Fly, genitive organs (female)
- Hymenoptera – Vespidae: Wasp sting
- Orthoptera – Euplexoptera: *Forficula auricularia* (Earwig)
- Gamasea: *Gamasus coleoplatorum* (Beetle Mite)
- Parts of Vertebrata – Hoofs, Horns, &c.: Ox horn, cross section
- Vascular System - Injected Preparations &c.: Monkey's Lung; Lung of Rat; Human Tongue, section

Married Elizabeth Marsh in 1857. She passed away 3rd June 1873. A very short time thereafter he married again, to Fanny Bell on the 15th November 1873. No children. William Jenkinson died in 1913 leaving estate valued £5,204 16s. 9d. He was buried at Sheffield General Cemetery, Sheffield, Yorkshire where Fanny, his wife) was interred with him in 1918.

29. Henry Edwards Freeman* (Born: 1840 Swindon, Wiltshire; Died: 1st June 1929 New Southgate, Middlesex)



Known Addresses:

- Church Croft, Hungerford [Boarding School] (1851)
- Walcott Farm, Swindon (1861)
- 10 Durnford Road East, Islington (1871,1872 QMC Members List – Elected 28th June 1871)
- 1 Rose Villas (Rose Villa), Colney Hatch Road, Wood Green, N. (1873,1874)
- 48 Woodstock Road, Finsbury Park, N (1875-1877 QMC Members List)
- 1 Templeton Road, Finsbury Park, London, N. (1878-1883)
- 60 Plimsoll Road, Finsbury Park, N. (1883-1886)
- 104 Shaftsbury Road, Islington (1887-1899)
- "Ashleigh", Priory Road, Hornsey, Middlesex (1901)
- 69 Limes Avenue, New Southgate, N. (1911-1929)
- Walcot, Limes Avenue, New Southgate, N. (1904,1906,1908,1909,1911,1916 QMC list)

Occupations:

Scholar (1851); Attorney's Clerk (1861); Solicitor's Accountant (1871); Solicitor's Clerk (1901); Law Clerk (1911)

References:

- SG April 1883: '*Scorpio Gervasii Gonyleptes, Scolopendra*, and various large insects from Chili (in spirit) offered for good microscopic or lantern slides. Send list to H. E. Freeman, 1 Templeton Road, Finsbury Park, N.'
- SG January 1884: 'Wanted, *Stylopae*, various species. Well-prepared slides of rare Acari in exchange. - H. E. Freeman, 60 Plimsoll Road, Finsbury Park, N.'
- Present at a Royal Microscopical Society meeting 27th November 1899 exhibiting - Parasite of Humble Bee, *Trichodactylus* sp.
- SG Vol.8. September 1872 : Wanted, Silicious Cuticles, &c. for polariscope, in exchange for Diatomaceas and other good objects. - H. E. Freeman, 1, Rose Villas, Wood Green, N.
- SG Vol.9. August 1873 : For living *Melicerta* send small tube or bottle and box with stamped address to H. E. Freeman, Rose Villa, Wood Green, N.
- SG Vol.10. June 1874 : Wanted, the first twelve numbers of the Quekett Journals Two dozen good Slides offered. - H. E. Freeman, Rose Villa, Wood Green, N.
- SG Vol.11. May 1875 : Wanted, Parasite of Bat (*Nycteridia*), also Ixodes from Boa or Snakes. Good exchange given. - H. E. Freeman, 48, Woodstock Road, Finsbury Park, N.
- The British Journal of Photography Vol.23. 4th February 1876. pg.60: Wanted, lantern transparencies in exchange for good microscopic slides. List of subjects exchanged. – Address, H. E. Freeman, 48 Woodstock Road, Finsbury Park, N.
- SG Vol.12 1876 No.143, p.260: Midges and Thunder-flies
- SG Vol.12. April 1876 : Wanted, first and third Reports of QuekettClub, also Mole Crickets, for good Micro. Slides. - H. E. Freeman, 43, Woodstock Road, Finsbury Park. N.
- SG Vol.13. April 1877 : Wanted, Fleas and Parasites from Bats, also Ixodes (Ticks) from foreign animals: good slides or books in exchange. - H. E. Freeman, 48, Woodstock Road, N.
- SG Vol.13. October 1877 : Wanted rare Ticks (Ixodes) Fleas, Animal Parasites and Acari, in exchange for good Slides of similar objects, or others of more general interest. - H. E. Freeman, 48, Woodstock Road, Finsbury Park, N.
- SG Vol.14. July 1878 : *Haematopinus spinulosus* from rat, and *H. vituli* from calf, offered for other animal parasites. Send list to H. E. Freeman, 1, Templeton Road, Finsbury Park, N.
- JPMS Vol.1. March 1882and JPMS Vol.1. pg.56. 1882. Exchanges: Parasite of Cat, *Trichodectes subrostratus*, *Haematopinus* from Rat, and many others, offered for similar objects. Braula and Stylops of Bee, *Haematopinus* of Seal and Sea-Lion especially desired. Please send list to H. E. Freeman, 1, Templeton Road, Finsbury Park, N.
- Fleas. JPMS Vol.2. pg.51 1883
- SG Vol.19. April 1883 : *Scorpio Gervasii, Gonyleptes, Scolopendra*, and various large insects from Chili (in spirit) offered for good microscopic or lantern slides. Send list to H. E. Freeman, 1 Templeton Road, Finsbury Park, N.
- The Holothuridae. JPMS Vol.2. pg.244 1883
- Flea from Wild Rabbit. JPMS Vol.2. pg.248. 1883
- Palate of Doris. JPMS Vol.2. pg.250. 1883
- SG Vol.20. January 1884 : Wanted, *Stylopae*, various species. Well-prepared slides of rare Acari in exchange. - H. E. Freeman, 60 Plimsoll Road, Finsbury Park, N.
- Larva of Corethra (Glass Larva). JPMS Vol.3. pp.43-44. 1884
- Cutting Glass-Circles. JPMS Vol.3. pg.47. 1884
- Chalcedony. JPMS Vol.3. pg.119. 1884
- *Caligus rupens*. JPMS Vol.3. pg.120. 1884
- Exuvia of Pupa of *Circopides* (Frog-Hopper). JPMS Vol.3. pg.120. 1884
- SG Vol.20. October 1884 : Mange mites and allied genera wanted in exchange for rare and well-mounted Acari, including *Glyciphagus plumiger, Myobia, Cheyletus flabellifer*, &c. - H. E. Freeman, 60 Plimsoll Road. Finsbury Park, N.
- SG Vol.21. April 1885 : Wanted, axial crystals, quartz plates, &c, for table polariscope, in exchange for lantern and micro-slides. - H. E. Freeman, 60 Plimsoll Road, Finsbury Park, N.
- Trophi of Bee (Melecta). JPMS Vol.4. pg.260. 1885
- Foraminifera, to fix to the slide. JPMS Vol.4. pg.260. 1885
- Nycteribia from Bat; Pteroptia from English Bat; The Mule-Ticks. JPMS Vol.4. pg.282. 1885

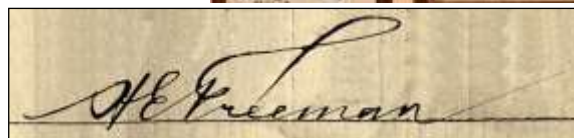

- SG Vol.22. January 1886 : Wanted, axial crystals, selenite figures, plates, wedges, &c, for small polar tourmalines, micro, or lantern slides. - H. E. Freeman, 60 Plimsoil Road, Finsbury Park, N.
- SG Vol.22. June 1886 ; The Scientific Enquirer June 1886: Wanted, botflies [*Oestrus boris* and *Oestnis ovis*], with the larva; and pupae preserved in acetic acid or spirit, or mounted, in exchange for rare Acari, Foraminifera, and other micro-slides. - H. E. Freeman, 60 Plimsoil Road, Finsbury Park, N.
- Tail of Larva of Puss-Moth; Living Insects. JPMS Vol.5. pg.52. 1886
- Fish Parasites. JPMS Vol.5. pp.117-118 (1 plate). 1886
- Weevils. JPMS Vol.5. pg.121. 1886
- *Caligus*. The Scientific Enquirer June 1886 pg.87.
- Sections of Coal. The Scientific Enquirer June 1886 pg.90.
- Scientific Names. The Scientific Enquirer June 1886 pg.91.
- *Templetonia nitida* and Parasite of Elephant. JPMS Vol.5. pg.187. 1886
- Kerosene. The Scientific Enquirer August 1886 pg.153.
- Cleaning Diatoms. The Scientific Enquirer August 1886 pp.153-154.
- Retina. The Scientific Enquirer August 1886 pg.155.
- Development of Fleas. The Scientific Enquirer January 1887 pg.13.
- Occidental Bezoar. The Scientific Enquirer June 1887 pp.111-112.
- Orange Insects. The Scientific Enquirer June 1887 pp.112-113.
- Eggs of Bot-Fly. JPMS Vol.7. pg.51. 1888
- English *Tingis*. JPMS Vol.7. pg.111. 1888
- *Testacella*. JPMS Vol.7. pg.117. 1888
- *Coccus cataphractus*. JPMS Vol.9. pg.280. 1890
- Cidarid Spine. JPMS Vol.10. pg.91. 1891
- Larva of Bot-Fly (*Gasterophilus Equii*) in the Egg. JPMS Vol.10. pg.282. 1891

Objects circulated to June 1877:

- Confervaceae: *Batrachospermum*
- Polycistina: from Barbadoes
- Fossil Foraminifera: from Chalk
- Zoophyta – Corallia: *Gorgonia* spicules
- Insecta – Anoplura: Parasite of Goose, *Trinoton conspurcatum*
- Insecta – Aestridae: *Gasterophilus* head; *Gasterophilus*, eggs; *Gasterophilus*, larva; *Gasterophilus*, ovipositor
- Insecta – Syrphidae: *Rhingia rostrata*; *Syrirta pipiens*
- Insecta – Dolichopidae: *Dolichopus simplex*
- Insecta – Bibionides: *Bibio marci* (as Gadfly)
- Insecta – Aphaniptera: *Sircopsyllus galliniceus* (Chigoe of Fowl); *Pulex* of Hedgehog, with Acari
- Insecta – Aphaniptera: *Pulex* of Wild Rabbit (male)
- Insecta – Homoptera: *Cercopidae* pupal exuviae
- Insecta – Lepidoptera: *Lasiocampa quercus* (Oak Eggar) antenna
- Hymenoptera – Tenthredinidae: Sawfly
- Orthoptera – Blathidae: *Blatta germanica*, Cockroach, head
- Coleoptera – Dermestidae: *Anthrenus* larva, subnom *Dermestes* larva
- Crustaceae – Lophyropoda – Cirripedia: *Balanus* sp. Barnacle
- Hypopus: Hypopus on Hedgehog Flea
- Araneae: *Tegenaria civilis*, palpi
- Parts of Vertebrata – Hairs: Wool Alpaca, woven; Porcupine Quill
- Parts of Vertebrata – Bone: Metacarpal Bone of Turtle
- Vascular System - Injected Preparations &c.: Human Skin, injected

Catalogue of Zoological Preparations in the Quekett Microscopical Club Collection 1902 List:

- Acarina: Halacarus notops; Hypopus arvicola (from Mole); Ixodes sp. (from Rabbit); Leptus sp. (from Mole)
- Pseudoscorpionida: Chelifer muscorum
- Hemiptera: Gyropus gracilis (parasite on Guinea Pog) (female); Haematopinus quadrumanus (parasite on Monkey); Haematopinus sp. (parasite on Seal); Haematopinus sp. (parasite on Cretan Goat) (female); Trichodectes scalaris (parasite of Calf) x2; Trichodectes subrostratus (parasite of Cat); Trichodectes sp. (parasite of Weasel); Trinoton conspurcatum (parasite of Goose)
- Pulicidae: Pulex sp. (parasite of Rat) (male)
- Eggs, Gasterophilus equi (Horse Bot Fly)

He was baptised 24th January 1841 at Swindon Wesleyan Chapel when aged 7 months and 2 weeks.

Henry attended boarding school (Church Croft, Hungerford) and on leaving took up a position with a firm of Solicitors as a Clerk, later an Accountant. He married Elizabeth Mary Laslett in 1867. The couple had the following children over the next twenty years – Ann[ie] Charlotte (1868), Henry George (1869), Emily Sarah (1872), Kate Maria (1874), Ernest William (1876), Florence Minnie (1885) and Elsie Mountford (1888).

Elected a Member of the Quekett Microscopical Club 23rd June 1871. Appears in the Members lists until 1918. When Henry Edwards Freeman died in 1929 his estate was valued £801 7s. 7d.



30. James Chadwick Hope (Born: 1846 Manchester, Lancashire; Died: 12th July 1923 Higher Broughton, Salford, Lancashire)



Known Addresses:

- 81, Shude Hill, Manchester (1871)
- Weaste, Pendlebury (1873)
- 61 Fenn(e)y St., Bury New Road, Manchester (1874,1876)
- 13, Great Cheetham Street, Manchester (1877)
- 48 Gt Cheetham St, Broughton In Salford, Lancashire (1881-1891)
- 312 Broughton Road, Broughton, Lancashire (1901)
- 44 West Heath Drive, Golders Green, Middlesex (1911)
- 7 Hope Street, Higher Broughton, Salford (1923)



Occupations:

Accountants Clerk (1871); Accountant (1873); Insurance Clerk (1881); Insurance Manager (1891); Manager of Insurance Co. (1901); retired Insurance Manager (1911)

References:

- SG Vol.7. September 1871 : Peristome of *Funaria hygrometrica* (mounted to show hygrometric process); also Rose, Strawberry, and Meadowsweet Brands, for other good mounted objects. - J. C.

Hope, 81, Shude Hill, Manchester.

- SG Vol.10. December 1874 : Peristome of *Funaria* (to show Hygrometric experiment), Pollen of Mallow, Citric Acid, &c., for other well-mounted Slides. - J. C. H., 61, Fenney Street, Broughton, Manchester.
- SG Vol.13. February 1877 : Pollen of Hollyhock, Mallow Stamens, &c., for other well mounted slides. - J. C. H., 13, Great Cheetham Street, Manchester.
- Cement – Brunswick Black and Gold Size. JPMS Vol.6. pg.117. 1887

Objects circulated to June 1877:

- Minerals & Geology (Crystals, Vegetable Products): Citric Acid; Santonine
- Diatomaceae: *Campylodiscus costatus*
- Various Diatomaceae: Mixed
- Confervaceae: *Volvox globator*; Marine Algae
- Fungi: *Puccinnia anemones*; Fungus on leaf – section
- Mosses: *Funaria hygrometrica*
- Ferns: Scalariform vessels
- Pollen: Mallow; *Cobaea scandens*
- Myriapoda: Centipede tracheae
- Neuroptera – Myrmelionidae: Ant Lion from South Carolina
- Orthoptera – Achetidae: *Acheta domestica*, male organ
- Parts of Vertebrata – Hairs: Horse Hair
- Vascular System - Injected Preparations &c.: Toe of Long-eared Bat

James Chadwick Hope married Sarah Annie Abram by licence at the Cathedral and Parish Church of Manchester in 1873. They had two children – Charles Alexander (1874) and Arthur Herbert (1877). His estate when he passed away was valued at £3,516 11s. 6d.

31. John Robert Pocklington (Born: 1st January 1854 Stilton, Huntingdonshire; Died: 9th January 1929 Virden, Manitoba, Canada)



Known Addresses:

- Ivy Lodge, Bickenham Lane, Weston, Somerset (1861)
- Wedsbury Villa, Woolcott Park, Bristol (1870,1871)
- Sydenham, Bristol (1874)
- East Side – Queen Street, Virden, Manitoba, Canada (1921)
- Virden, Manitoba, Canada (1929)

Occupations:

Scholar (1861); Clerk in an Insurance Office (1871); Caretaker (1921)

References:

- SG Vol.6. September 1870 : Scales of Salmon, Bass, Mackerel, and Hake. - Send stamped envelope, and object of interest, to J. R. P., Wedsbury Villa, Woolcott Park, Bristol.
- SG Vol.6. December 1870 : FORAMINIFEROUS SAND AND SCALES OF PILCHARD and Salmon Peel. Stamped envelope and object to J. R. Pocklington, Woolcott Park, Bristol.
- SG Vol.7. April 1871 : *Coleosporium petasitis*. - For this micro-fungus send stamped envelope to J. R. Pocklington, Woolcott Park, Bristol.

Objects circulated to June 1877:

- Minerals & Geology (Earths): Lime Carb. deposit from Aqueduct
- Minerals & Geology (Silicious): Slag, Copper Furnace
- Fungi: *Aregma bulbosum*
- Ferns: Silvery; *Ceterach officinarum*; *Dansea alata* fructification; *Gompholobium sepulcus*(?)
- Annelida: *Aphrodite aculeata*

- Parts of Vertebrata – Skin: Human Skin, polar
- Parts of Vertebrata – Hairs: Human Hair; Horse Hair
- Parts of Vertebrata – Bone: Fossil Bone
- Vascular System - Injected Preparations &c.: Nose of Mouse
- Sedes Incertae vel Incognitae: Gompholophobium sepullum(?)

John Robert Pocklington married Elizabeth Ann Featherstone/Featherington Porter in 1878. The couple arrived in Canada 1897. He and Elizabeth appear in the 1921 Canadian Census in Brandon, Manitoba. Notice of his demise appeared in the Brandon Daily Sun (Brandon, Manitoba) 10th January 1929. He was buried in Virden Cemetery, Manitoba, Canada. Elizabeth died 25th February 1932 and was also buried in Virden Cemetery, Manitoba, Canada. No further information has been forthcoming.

See also his brothers: Henry Pocklington (No.14) and Christopher Pocklington (No.63).

32. Alfred Uriah Allen*⁵ (Born: 16th August 1833 Green Street. Cambridge, Cambridgeshire; Died: 24th March 1898 Bath, Somerset)



Known Addresses:

- Green Street. Cambridge, Cambridgeshire (1833-1841)
- Fore Hill, Ely Holy Trinity, Cambridgeshire (1851)
- High Street, Histon, Cambridgeshire (1861)
- Felstead, Essex (1871,1874)
- 1 Cambridge Place, Bath [Lyncombe & Widcombe] (1881-1891 PMS Members List-1898, 1875-1876 QMC Members List – Elected 25th September 1874)

Offices:

- 1873-1898 - Hon. Secretary and Treasurer of the Postal Microscopical Society (co-founder)
- 1881 - Vice-President Bath Microscopical Society
- 1882 - President Bath Microscopical Society
- 1882-1897 - Produced the Journal of Microscopy and Natural Science (JPMS)
- 1883 - Ex-President Bath Microscopical Society
- Proprietor of The Scientific Enquirer from 1886 to 1888.
- Portrait in The Microscope Vol. VII. No. 11 January/February 1950 page 309

Occupations:

Draper's Apprentice (1851); Grocer and Baker employing 1 man and 1 apprentice (1861); Grocer (1871); Retired Wine Merchant (1881); editor Journal Microscopy (1891)

References:

- SG June 1869 Notes and Queries: *"An Interloper. - On looking at my cabinet of moths a few days ago, I was surprised to find the head and throat of a Deaths-head moth covered with what I first supposed to be a vegetable growth, which extended beyond the tips of the antennae; but on closer examination, it proved to be hair from the breast of the moth, eaten off by a maggot or gentle nearly an inch long. The moth was given to me last year by a friend the day after it emerged from chrysalis, when I killed it by sousing it very liberally with benzole, which I am told is a certain preservative; the case also contains nearly an ounce of camphor. I am greatly puzzled to know how the maggot got into the case. I have mounted some of the hair, and find it makes a beautiful object for the microscope. Should any of your readers like to have some of it, I shall be pleased to send them a small quantity on receipt of address with stamp. - Alfred Allen, Felstead, Essex."*
- SG August 1870: *"Mecophila ovinus. - 'Sheep tick' mounted in exchange for injection or other good mounted slide. - A. Allen, Felstead, Essex."*
- SG December 1871: *'Sheep Tick. - For a well-mounted specimen send address, &c., to A. Allen, Felstead, near Chelmsford.'*
- SG November 1872: *"Crystals for Polariscopes - A variety offered in exchange for other well mounted slides. - Send List to Alfred Allen, Felstead."*
- SG January 1873: *"Crystals for Polariscopes - A variety, well mounted, to exchange. - Send list of duplicate slides or material to A. Allen, Felstead, Essex"*
- A small article appearing in SG February 1873:-
- *"BAD COKE AND THE MICROSCOPE - In a closed iron stove I burn coke, which I think is unusually bad this year, and whilst burning I find a liquid perpetually dripping from the chimney, which, of course, is a great nuisance, as I am obliged to keep a vessel under it to catch it. After very many fruitless attempts I have succeeded in producing from it a very beautiful polariscopic object. With a powerful light and deep-coloured selenite the colours are very rich and brilliant; also without the selenite plate, with the polarizer turned 'dark', many of the ramifications appear to stand out in very bold relief, of a fine gold colour. From causes which I am at present quite unable to determine, this liquid gives a greater diversity of slides than anything I have ever yet met with. I have five or six totally different - indeed, you would scarcely*

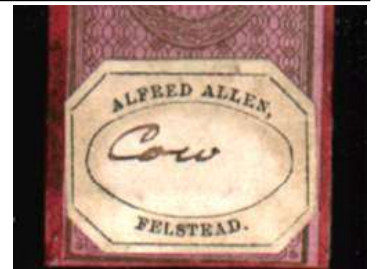
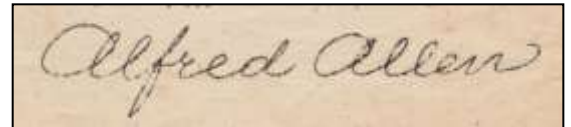

detect a 'family likeness' in a dozen. I have a few mounted slides of the above, which for want of a better name, I call 'Distillation from the vapour of coke', and shall be glad to exchange them for anything special. - Alfred Allen."

- Following this in the April issue of SG for 1873 is the following in the exchange columns: "DISTILLATION FROM VAPOUR OF COKE - An interesting slide of this remarkable liquid will be given in exchange for any specially good object. - Send list to Alfred Allen, Felstead, Essex."
- In May Alfred Allen wrote - in SG May 1873: "GUM-DAMAR - On your Correspondence page, March 1872, you give a receipt for making gum-damar. I have tried, but cannot dissolve the gum in turpentine. I have some which has now been in turpentine for more than a month, and it has simply formed an amorphous mass at the bottom of the bottle. I shall esteem it a favour if any of your readers can assist me. - Alfred Allen." And in the same volume in the Exchange column - "A VARIETY of Microscopic Slides. - Send list for list, to Alfred Allen, Felstead, Essex."
- The August issue for 1873 sees an entry in the Notices to Correspondents column thanking Alfred Allen for a slide and commenting "There can be no doubt that you have succeeded in improving the preparation". This may well refer to the Coke Vapour polariscope object.
- In September of 1873 a small article appears in Science Gossip: "CRYSTALS OF THE WILLOW. - In answer to 'C.E.B.', Salicine is obtained, according to Thompson's Dictionary of Chemistry, in the following manner; viz. By boiling willow bark with water, precipitating the decoction by acetate of lead, diffusing the precipitate after washing through water, and decomposing it by a current of sulphohydric gas, filtering, evaporating and crystallizing out the salicine. As the above is a process which none but a chemist will be likely to carry out with any degree of success, and as salicine is a common article of commerce, your correspondent had better purchase a few pennyworths of any druggist: he will find it is soluble in cold, but more soluble in hot water. It is soluble also in alcohol. - Alfred Allen, Felstead."
- At the Seventh annual Meeting of the Postal Microscopical Society on Thursday, September 30th 1880 at the Charing Cross Hotel, Mr. Allen exhibited some of Mr. C. Vance Smith's decolorized and excellently double stained vegetable sections.
- SG August 1875: Wanted, complete set "Journal Quekett Micro. Club"; good micro. Slides given in exchange. Also Smiths "Diatomaceae" in two vols.; will give Cash or Slides in exchange. - A. Allen, Felstead, Essex.
- JPMS Vol.1. March 1882 and JPMS Vol.1. pg.56. 1882: Wanted. - Journal of the Royal Microscopical Society, Vol.1. 1878; Knowledge, Nos. 1 and 2 (November 11 and 18, 1881.) - A. Allen, 1, Cambridge Place, Bath
- JPMS Vol.1. pp.150-151. 1882: Dendritic Spots on Paper
- JPMS Vol. 2. July 1883: Wanted. - Parts 4 and 6 of Vol.1., 1878 Journal of the Royal Microscopical Society. Will give in exchange Vol.1. (bound) of JPMS, or the year's parts of Vol.II, as published. - Address Editor, 1, Cambridge Place, Bath
- Bone Bed, Lyme Regis. JPMS Vol.8. pg.190. 1889

Objects circulated to June 1877:

- Minerals & Geology (Crystals, Vegetable Products): Citric Acid
- Minerals & Geology (Crystals from Altered Veg. Matters): From Vapour of Coke
- Cuticles: Geranium petal
- Hairs - vegetable: *Onormia taurica*; *Deutzia gracilis* calycine hair
- Fossil Foraminifera: from Centre of Flint
- Entozoa: Worm (?) from decayed tooth
- Myriapoda: Centipede *Geophilus*
- Insecta - Diptera: Parasite of Flying Fox (male); Parasite of Flying Fox (female)
- Insecta - Muscidae: *Musca domestica* (House Fly), pair
- Insecta - Culicidae: *Culex canlans*, head
- Insecta - Imperfectly named (or Massed): Fly ovipositor
- Insecta - Lepidoptera: *Saturnia pavonia minor* (Emperor Moth), antenna; *Lasiocampa quercus* (Oak Eggar) antenna; Moth chrysalis
- Hymenoptera - Tenthredinidae: Sawfly (male); Sawfly leg
- Hymenoptera - Ichneumonidae: Ichneumon Fly
- Hymenoptera - Pteromalidae: *Callimoine* sp. (subnom "Small Ichneumon Fly or Winged Ant")
- Coleoptera - Dermestidae: *Dermestes lardarius* (Bacon Beetle) subnom from butterfly cabinet
- Coleoptera - Elateridae: Wire Worm
- Acarina: *Acarus domesticus* sub nom Parasite from Starling

Alfred Uriah Allen married Clara Bentall in 1859. They went on to have just one daughter - Emily Mary Allen (1860). Emily Mary Allen, the daughter, died on 29th July 1948 aged 87, of cerebral thrombosis. She moved from Felstead to Bath with her father and lived at the 1 Cambridge Place address until shortly before her death. In her later years she was almost blind. Much of Alfred Allen's collection of slides went, on his death, to Mr. E. Peacock. Alfred Allen also edited and published The Scientific Enquirer 1886, 1887 after which it ceased publication due to ill-health. When Alfred Uriah Allen died he left estate valued at £3821 11s 1d. He was buried at St. James' Cemetery, Bath.

See Alfred Atkinson (next entry) for Letters initiating the formation of the PMS.



33. Alfred Atkinson⁵, C.E. (Born: 16th March 1843 Broughton, Lincolnshire; Died: 26th November 1927 Brigg, Lincolnshire)



Known Addresses:

- Stanford Terrace, Scawby and Sturton Brigg, Lincolnshire (1861)
- Bridge Street, Broughton, Brigg, Lincolnshire (1871)
- Brigg, Lincolnshire (1873-1891 PMS Members List - PMS President 1873/4, 1874/5 & 1881)
- 33 Brocklesby Ox, Broughton, Lincolnshire (1881)
- Bridge St., Broughton, Glanford Brigg, North Lindsey, Lincolnshire (1891)
- 33 Bridge Street, Glanford Brigg, Lincolnshire (1891-1927)

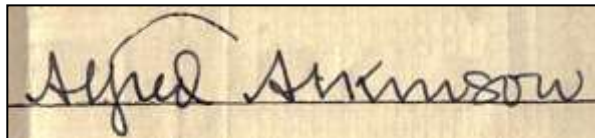

Occupations:

Civil Engineer – pupil (1861); Civil Engineer (1871, 1881, 1891, 1901); Civil Engineer, Associate Member of the Institute of Civil Engineers, working for the Commissioners of the Ancholme Drainage and Navigation Surveys to His Majesty's Commissioners of Sewers for the County of Lincoln (1911)

References:

Gamasus coleoptratorum. JPMS Vol.2. pg.56 1883

The Caulking of a Pre-Historic Ship. The Scientific Enquirer July 1886 pp.108.

Author of Notes on an Ancient Boat Found at Brigg in: Archaeologia Vol 50 Part 2 1887

Objects circulated to June 1877:

- Mollusca: Pinna shell, section
- Insecta – Diptera: Sheep Tick (Ked), *Melophagus ovinus*, male and female
- Insecta – Tabanidae: *Chrysops caecutiens*, tongue &c.
- Insecta – Culicidae: *Culex canlans*
- Insecta – Imperfectly named (or Massed): Marsh Fly
- Insecta – Aphaniptera: *Pulex* of Rat
- Acarina: *Pteropus vespertilionis* Bat Mite
- Gamasea: *Gamasus coleoptratorum* (Beetle Mite)
- Ixodea: *Ixodes* sp.; *Ixodes* from Pigeon
- Araneae: *Argyroneta aquatica*

The following text is from the submission proposing his admission to The Institution of Civil Engineers 1st January 1885:

"He entered the office of his father, the late Mr. W. C. Atkinson, Civil Engineer of Brigg, as pupil in 1859, and subsequently became his partner. He was appointed in 1870 Engineer to the Commissioner of the Ancholme Drainage and Navigation; and in 1871 Surveyor to Her Majesty's Commissioners of Sewers for the County of Lincoln, acting for the Wapentakes of Manley, Corringham and Aslaoe; both these offices he still holds. Under these drainage boards he has charge (in addition to the Ancholme Navigation) of the drains, sluices, pumping engines, floodbanks and defences of about forty-five thousand acres of low lands adjoining the rivers Humber and Trent."

He never married. Hibaldstow Bridge, over the River Ancholme, was rebuilt in 1889 to a design by Alfred Atkinson. Atkinson was also responsible for Cadney Bridge, rebuilt in 1882. His estate valuation on his death was £ 8,377 3s. 1d.

The following extracts are important in that they are the roots of the Postal Microscopical Society.

The letter that sparked it off by Alfred Atkinson (SG - May 1873)

"MICROSCOPIC POSTAL CABINETS - The following is a scheme I wish to submit to the readers of Science Gossip. Let a certain number of persons living in different parts of the country, say twelve, A, B, C, &c. &c., agree to form a postal cabinet with A as manager. A small entrance fee and subscription (a shilling in each case would probably be enough) would be paid by each member to the manager, who would provide a box capable of holding at least a dozen microscopic slides, and which should be as light as is consistent with the safety of its contents during its transmission by post. A would then put into the box an object likely to interest the other members, and forward it by post to B, who, after examining A's object, would add a slide of his own, and forward the box to C. C would add another slide, and send it to D, and so on; then when the box arrives in the hands of L it contains eleven slides; he adds a twelfth, and returns the box to A, who takes out his own slide, replaces it by a new one, and then sends it to the next member (B), who does likewise. Thus, when each person receives the cabinet, it contains eleven new slides and his own, which he retains. It would of course be necessary to have a code of rules, but they might be very brief. The most important would be one limiting the time each member could keep the box. With twelve members it should make the circuit in a month or five weeks. Two boxes might be established, so that each member might receive a fresh lot of objects about once a fortnight. I have borrowed the above idea from the system of MS. Magazines, which has been adopted for many years by persons who use Pitman's phonetic shorthand. A further advantage would arise to the members of such an association as I have proposed, if each member were allowed to make brief notes as to his own object, or those of the other members. - Alfred Atkinson."

SG July 1873 -

MICROSCOPIC POSTAL CABINETS. - I think that Mr. Alfred Atkinson's proposal, at page 111, is a very good one; and, in default of a better man, should be most happy to become a member of such a society. - J. R. Davies.

There was a further article supporting the idea in the July issue.

"MICROSCOPIC POSTAL CABINETS - Some two or three years ago I proposed a plan similar to that suggested by Mr. Atkinson in SG for May; but being at that time unable to find others like-minded, my scheme fell to the ground. I should like slightly to alter Mr. Atkinson's proposal in this way; viz. For a dozen members let there be two small boxes provided, size of each 1¼in. deep, 1½in. wide, 3½in long - without rack; these would each hold one dozen objects, separately wrapped in several folds of tissue paper: each member could then put in two objects instead of one. In addition to the objects, a few sheets of white paper, pinned together by one corner, should be added for queries, remarks, suggestions,

and replies, a new lot being added each month; but the old one should always take the circuit twice, after which any suggestion of interest should be copied out by the president and sent to the editors of SG and the ENGLISH MECHANIC, the papers themselves being retained for the society by the president. With respect to entrance-fee, as each member will pay his own postage, I think sixpence will be sufficient, yet I do not object to a shilling if thought desirable. I have now simply to add that if Mr. Atkinson will send me his address, I think I can guarantee him at least six members. Alfred Allen, Felstead, Essex.

This was followed in the December issue of that year by the following letter;

"THE POSTAL MICRO-CABINET CLUB. - Many of the readers of SG will remember that in the May number there appeared a suggestion respecting the formation of a circulating cabinet for microscopic objects. As the address of Mr. Atkinson, the writer of the notice, was not inserted, I was unable to write to him privately, and too busy to reply through your pages at that time; but I did so in August, and at the same time stated that if Mr. Atkinson would favour me with his address I felt sure that I could find him six gentlemen who would be willing to join in so pleasing an undertaking. I then set to work to look up my half-dozen friends, and when towards the end of August I received a letter from Mr. A., instead of six I had found thirty members, and had also roughly framed a set of rules. We have now a club formed of thirty-six members, who are divided into three circuits, which we call Northern, Central and Southern; Mr. Atkinson, the first proposer being our president. Our method of proceeding in the first instance is this: an empty box is sent to the first member on each circuit, who places in it a slide and sends it on to the next, who does the same &c. &c. The twelfth member, who puts last slide into the box, instead of returning it to first member will send it to Hon. Sec., who will send it round next circuit, then the next; and when it has been the entire circuit of the club it will again be sent to first member, who will take out his own slide and replace it by another. When it is conjectured that each box has gone half round its own circuit another box will be started again, so when the club is in thorough working order each member will be supposed to receive a box about once a week. Suggestions, hints, and criticisms are requested from all members: from these I hope, as opportunity offers, to cull little scraps of information that may from time to time enrich the pages of SCIENCE GOSSIP. Alfred Allen, Hon. Sec."

This letter was then followed by The Postal Micro-Cabinet Club Rules. In SG February 1874 is a further letter from Alfred Allen which initially makes mention of an object currently being circulated, viz. a scorpions sting, but latterly goes on to say;

'THE POSTAL MICRO-CABINET CLUB. - Since sending you a copy of rules, which appeared in the December part of Science Gossip, I have received letters from several gentlemen wishing to join the club: these, as we now have our full complement of members, I have been obliged to refuse; but have since determined that, after 1st January, the president and myself will be pleased to conduct a SECOND CLUB (if agreeable) under the same rules as our present club. I shall be glad to receive all applications for membership as early as possible. Alfred Allen.

In SG March 1874 the following appeared;

'THE POSTAL MICRO-CABINET CLUB. - The above club, of which a notice appeared in SG for December last, together with a copy of rules, is now working well, and is likely to prove quite a success. The "Notes and Queries" department, to which every member is invited (and mostly accepts the invitation) to contribute, being by no means the least attractive part of the scheme. We shall be glad to increase our number of members, now numbering thirty six, divided into three circuits of twelve members each. Any microscopist who would like to join us, will please write to Alfred Allen, Hon. Sec., Felstead, Essex.

34. Francis Boughton K(y)(i)ngdon F.R.M.S. (Born: 3rd November 1848 Southampton, Hampshire; Died: 27th May 1920 Bowral, New South Wales, Australia)



Microscopical Society member.)

Not in T. A. Wright's 1875 listing

Known Addresses:

- 1 Mount Vernon, Magdalen Road, Exeter, Devon (1851)
- Day's Field, Southerhay?, St. Sidwell, Exeter, Devon (1861)
- 23 King Street, St. John, Margate, Kent (1871)
- 221 Darlinghurst Road, Sydney, New South Wales, Australia (1879 & RMS Fellow Elected 1878)
- 69 Darlinghurst Road, Sydney, New South Wales, Australia (1888-1890)
- 5 Elizabeth Street, Sydney, N.S.W. (1893)
- c/o A. B. Cobb, Esq., Margate Bank, Margate (1898 – RMS Fellows List – Hon. Secretary of the Royal Society of New South Wales, Sydney, N. S. Wales)
- Deanery Cottage, Bowral, N. S. Wales (1901 – RMS Fellows List – Hon. Secretary of the Royal Society of New South Wales, Sydney, N. S. Wales)

Occupations:

Scholar (1861); Banker's Clerk (1871); Secretary of the Tourist Association, Sydney (1912); also recorded as an Agriculturist having been awarded a £5 prize by the Royal Agricultural Society for his examination results in Chemistry Applied to Agriculture when at the Royal Agricultural College, Cirencester in 1866.

References:

- Earwig, *Forficula auricularia*. JPMS Vol.2. pp.245-247 1883
- Gum Dammar. JPMS Vol.10. pg.350. 1891 (by which time he was no longer recorded as a Postal

Objects circulated to June 1877:

- Confervaceae: Freshwater Algae
- Echinodermata: *Ophiocoma rosula*, dental plates; *Ophiocoma* sp.; *Asterina gibbosa*; Echinus pedicel; *Thyone papillosa* calc. plates from skin
- Polyzoa: *Aetea dilatata*; *Membranipora pilosa*
- Mollusca: *Haliotis tuberculata* tongue; *Trochus crassus* tongue
- Insecta – Anoplura: Vial Fly (probably *Haematopinus ventricosa* from Rabbit sub nom Trichodecles from Gull); Parasite of Pheasant, Mellors, eggs
- Insecta - Muscidae: *Caliphora vomitoria* (Blow Fly); Blow Fly, stomach
- Insecta – Mycetophilides: *Mycetobia* (as Gnat)
- Insecta – Lepidoptera: *Biston hertarius* (Brindled Beauty) eggs; Moth caterpillar with cheese mites
- Orthoptera – Euplexoptera: *Forficula auricularia* (Earwig)

- Sedis Indeterminatae: Fly, un-named
- Crustaceae – Lophyropoda – Gammarina: *Talitrus locustra*
- Crustaceae – Decapoda – Macroura: *Palsemon*, Prawn tail plates
- Gamasea: *Dermanyssus arium* from Linnet; *Gamasus* from Fly

Baptised 8th January 1849. In the Register of Shipping 1855-1879 he was recorded as one of the Owners of Title of 'Enmore' 60304, a steam screw vessel, a schooner, built at Stockton on Tees in 1872. Member of the Royal Agricultural Society of England in 1868, elected 1867. Member of the Margate Microscopical Club 1871. By 1886 the family had decamped to 69 Darlington Road, Sydney, New South Wales. Recorded as a Churchwarden at St. Saviour's, Redfern Parish, Sydney in 1886. He registered a New South Wales Mining Patent No.4247 on 25th January 1893 relating to a roasting furnace for antimony and other ores. His address given at the time was 5 Elizabeth Street, Sydney, N.S.W. He married Florence Elizabeth Evans at Woollahra, New South Wales on 3rd August 1904. Four children – Roger, Joan, Courtney William Trehunsey Kyngdon (1910) and Louise?. He died in 1920. Buried at Bowral General Cemetery, Bowral, N.S. Wales, Australia.

35. William Hamilton Hey (Born: 18th December 1853 Southwark, Surrey; Died: 4th November 1879 Rochford, Essex)



Known Addresses:

- 10 Arthur Villas, George Street, Romford, Essex (1871)
- Springfield, Chelmsford (1874,1875)
- Rochford, Essex (1879)

Occupations:

Police Constable (1871); Inspector of Police, Essex Constabulary(1879)

References:

- SG Vol.10. October 1874 : For a small section of the Bread-fruit Tree, send stamped directed envelope to W. H. Hey, Upminster, Romford.

Objects circulated to June 1877:

- Minerals & Geology (Metals and their ores): Antimony Nat.
- Fossil Woods & Coal: Wood, Lulworth
- Insecta – Heteroptera: Nettle Bug, head &c.
- Insecta – Lepidoptera: Moth antennae
- Hymenoptera – Tenthredinidae: Sawfly
- Gamasea: *Gamasus coleopratorum* (Beetle Mite)

William Hamilton Hey married Ellen Georgina Cole 12th April 1876 at St. Anne and St. Lawrence, Elmstead, Essex. They produced a son William Montague (1877) and Kate Frederica Mary (1880) whom he never saw.

Upon his death he left Personal Estate to the value £450. He was buried on the 11th November 1879 at Holy Trinity, Springfield, Essex. In the Essex Newsman of Saturday 8th November 1879:

"Death Inspector Hey. We regret to announce the death, which occurred at Rochford on the 4th inst., of Mr. William Hamilton Hey inspector in the Essex constabulary, and grandson of the Rev. G. B. Hamilton, of Chelmsford. Mr. Hey caught a severe cold about two months ago, while in the execution of his duties, and the course of his ailment was very rapid. Deceased was a highly intelligent and zealous officer, and unwearied in the discharge of his duties. As a police officer he will be much missed, and he leaves many friends to deplore his sudden death."

36. George Dannatt Colsell* (Born: circa 1853 Greenwich, Kent; Died: 13th February 1918 Catford, Kent)



Known Addresses:

- 27 London Street, Greenwich, Kent (1871)
- 5 Union Place, Greenwich, S.E. (1874)
- 5 Austin Fryers, E.C. (1876,1877,1878,1879,1880,1881 – QMC Members List)
- 5 Hamilton Terrace, Hyde Vale, Greenwich (1881)
- 2 Royal Exchange Buildings, E.C. (1882,1883 – QMC Members List)
- 1 Dermody Road, East Down, Lewisham (1884,1886,1887, 1888 – QMC Members list, no longer listed thereafter)
- "Heathbank", Lewisham Park Road, Lewisham (1891, 1893)
- 1 Dermody Road, Lewisham (1888, 1891)
- 162(A) High Street, Lewisham (1896, 1898)
- 17 Lewisham Park Crescent (1896)
- 54 Lee Park, Lee, Lewisham [Blackheath, S.E.] (1899,1900, 1901, 1902, 1907), Office – 75 Old Broad Street, S.E. (1899), 3 Copthall Buildings, E.C. (1900,1901,1902)
- Ferndale, Brownlow Road, Bounds Green, N. (1904)
- Osborne Lodge, Maidstone Road, New Southgate, N. (1905,1906,1907,1908,1909), Office – 31 Threadneedle Street, E.C. (1906)
- 5 Lee Park, Lee, Lewisham (1910, 1912,1913, 1915)

- Stock Exchange (1910,1915)
- 30 Pattenden Road, Catford, Kent (1918)

Occupations:

Book Keeper (1871); Stock Brokers Clerk (1881); Stockbroker (1891, 1901,1911); Broker for Fielding & Son. (The Post Office London Directory 1890 & 1895)

References:

- SG No.218. February 1883: Greenwich Microscopical Society. – "At the Annual Meeting, held at the lecture hall on the 20th December (1882) last, Mr. George D. Colsell, of 5 Hamilton Terrace, Hyde Vale, Greenwich, was elected Hon. Secretary of this society"

- SG No.232. April 1884: "Greenwich Microscopical Society. – At the Annual meeting held last month (March 1884) Mr. T. W. Dannatt, of No.21. The Circus, Greenwich, was unanimously elected hon.sec. of this society, in place of Mr. G. D. Colsell, resigned.

Objects circulated to June 1877:

- Various Diatomaceae: Waveney
- Fungi: *Aecidium compositarum*; *Puccinnia pruinorum*; *Puccinnia menthae*
- Ferns: *Platyserium alaicorne* spores
- Hairs – vegetable: Cotton; Cotton – East Indies
- Starches: Potato
- Pollen: Mallow; *Scorzonera*
- Seeds & Seed Vessels: Ivory nut
- Polycistina: Fossil Blomfield
- Fossil Foraminifera: from Chalk
- Echinodermata: *Spatangus* spines
- Insecta – Anoplura: Parasite of Burrowing Owl, eggs
- Insecta – Heteroptera: *Cimex lectularius*
- Hymenoptera – Cynipidae: *Cynips* sp.
- Coleoptera – Dyticidae: *Dytiscus*, foot
- Coleoptera – Melolonthidae: *Melolontha vulgaris* (Cockchafer), larva spiracle
- Parts of Vertebrata – Hoofs, Horns, &c.: Hoof of Ass; Sheep Horn, cross section

Elected a member of the Quekett Microscopical Club 34th March 1876. Elected Hon. Secretary of Greenwich Microscopical Society 20th December 1882 (taking over from his cousin George Dannatt [No.37.]

Listed in the Naturalists' Universal Directory of 1888: Colsell, George Dannatt, 1 Dermody Road, East Down, Lewisham. Interests: Horticulture, Electricity and Microscopy.

George Dannatt Colsell married Julia Underwood in 1883. He had issue Elsie Muriel (1884), George Harold (1886). He was taken into partnership by Messrs. Fielding and Son, of Cophthall Court, E.C. in February 1889. Upon his death his estate was valued at £749 6s. 3d.

He was the cousin of George Dannatt (No.37), son of his uncle on his mother's side (i.e. his mother's brother's son).

37. George Dannatt (Born: circa 1853; Died: 21st February 1929, Blackheath, London)



Known Addresses:

- 20 Nelson Street, Greenwich, Kent (1871)
- 5 The Circus, Greenwich, S.E. (1881-1883
PMS Listing -1882-1883 Circuit I, 1881 –Hon. Sec. Greenwich Microscopical Society)
- 21 The Circus, Greenwich (1874,1884)
- Lyndale (6), Westcombe Park Road, Blackheath, S.E (1884-1889 PMS Listing, 1891-1929)

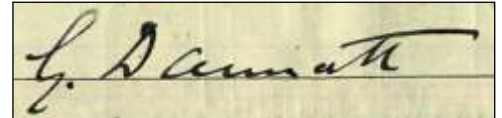

Occupations:

Working in father's Provision Merchants shop – position unknown (1871); Provision Merchant (1881, 1891, 1901, 1911)

References:

- SG No.185. 1880: "Metropolitan Societies, &c., Their Meetings" by George Dannatt, Hon. Sec. Greenwich Microscopical Society.
- SG No.232. April 1884: "Greenwich Microscopical Society. – At the Annual meeting held last month (March 1884) Mr. T. W. Dannatt, of No.21. The Circus, Greenwich, was unanimously elected hon.sec. of this society, in place of Mr. G. D. Colsell, resigned.

Objects circulated to June 1877:

- Various Diatomaceae: On seaweed
- Seeds & Seed Vessels: Pine seed scale; Cotton plant seeds
- Mollusca: Limpet (*Patella vulgata*) palate
- Insecta – Aphaniptera: *Pulex felis* (from Dog)
- Insecta – Lepidoptera: Fritillary wing
- Coleoptera – Melolonthidae: *Melolontha vulgaris* (Cockchafer), larva spiracle
- Coleoptera – Telephoridae: Soldier Beetle
- Parts of Vertebrata – Skin: Snake Skin
- Parts of Vertebrata – Hoofs, Horns, &c.: Chamois Horn, cross section; Elephant Foot; Nylghan

George Dannatt married Mary Georgiana Boothroyd in 1876. In the next few years they had a large family comprising George H. (1877), Percy B. (1879), Alfred K. (1883), Mary L. (1885), Frank C. (1888), Robert M. (1891). On his demise he left estate valued at £28,346 14s. 3d.

He was the cousin of George Dannatt Colsell (No.36).

38. Rev. John Kidson Jackson (Born: 15th June 1834 Boston Spa, Yorkshire; Died: 17th December 1898 Blackpool, Lancashire)



Known Addresses:

- possibly - Willington, Bishop Auckland, Durham (1868)
- Talbot Street, Oldbury, Birmingham (1870-1872)
- Oldbury, Birmingham (1874)
- Trentham Road, Trentham, Staffordshire (1881)
- 40 Hawkshead Street South, Southport, Lancashire (1889-1891)
- 27 Caledonia Road, Batley, Yorkshire (1891)
- 48 Claremont Road, Handsworth, Birmingham (1898)

Occupations:

Methodist New Connexion Minister (1871-1898)

References:

- SG Vol.6. October 1870 : A few Slides of Fossil Sections, in Shale, from Northumberland Coal-field, for rare Parasites, Injections, or really good material. - Rev. J. K. Jackson, Talbot Street, Oldbury, Birmingham.
- SG Vol.7. December 1871 : One dozen good slides (two dozen if requested) of selected Diatoms, Spicules, &c, for Bermuda earth, genuine Ichaboe guano, or equal diatom material. - Rev. J. K. Jackson, Talbot Street, Oldbury, Birmingham.
- SG Vol.8. April 1872 : A liberal exchange in selected Diatoms, Spicules, &c., for real Upper Peruvian guano; presence of *A. formosus* to be test of genuineness. - J. K. Jackson, Talbot Street, Oldbury,

Birmingham.

- SG Vol.8. December 1872 : A liberal number of good slides of spicules and selected diatoms, for material containing any *Aulacodiscus*, *Eupodiscus*, *Isthmia*, or *Arachnoidiscus*, or for a bit of Glass-rope Sponge. - J. K. Jackson, Talbot Street, Oldbury, Birmingham.
- SG Vol.10. October 1874: Diatoms, Spicules, Fungi, Plant Hairs, &c. (good Slides), for material containing *A. Ehrenbergii*, *A. Oreganus* *A. Kittoni*, *E. argus*, any *Isthmia* or *Auliscus*. - J. K. Jackson Oldbury, Birmingham. | Warwickshire |

Objects circulated to June 1877:

- Diatomaceae: *Diatoma marina*; *Isthmia evervis*; *Navicula strangulata*
- Various Diatomaceae: Guano; Various
- Zoophyta – Corallia: *Gorgonia* spicules
- Entozoa: Worm coughed from throat
- Insecta – Heteroptera: Jungle Bug; Another Jungle Bug
- Orthoptera – Mantidae: Mantis
- Parts of Vertebrata – Hairs: Ferrets Hair
- Parts of Vertebrata – Scales: Eel Skin
- Animal Tissues – Digestive Organs: Palate of Toad
- Parts of Vertebrata – Kidney: Rabbit Kidney; Bladder of Dog

He was baptised at St. Peter, Leeds, Yorkshire on 17th August 1834. He married Mary Ann Armstrong in 1863 Barnsley, Yorkshire. The following children were born to them – Ben Leslie (1865), Percy Armstrong (1867), Leonard S. (1874). He was the Methodist New Connexion representative for Longton, Hanley District 23rd-25th May 1854, 1864, 1882 and 1884. At the 1870, 1871 and 1874 Conferences of the same he was representing Oldbury and Tipton. In 1876 represented Lindley, Halifax District. In 1885, 1887 he represented Halifax (North), Yorkshire and was elected President. By 1888 and 1889 he was noted as ex-President of the Connexion (having been President in 1887 and Guardian Representative in 1888) and represented Southport, Liverpool District. In 1891 he now represented Batley, Yorkshire and by 1895 was recorded as Missionary Secretary. On his death his estate was valued at £472. Buried at Longton Cemetery, Spring Garden Road, Longton, Stoke-on-Trent, Staffordshire.

39. Benjamin George Wade (Born: circa 1846 Deptford, Kent; Died: 1929 West Ashford, Kent)



Known Addresses:

- 52 High Street, Chatham, Kent (1871, 1874, 1881)
- 45 High Street, Chatham, Kent (1882)
- Sittingbourne, Kent (1884)
- 35 High Street, Sittingbourne, Kent (1891)
- Castle Street, Coseley, near Bilston (1894)
- 17 West Street, Blue Town, Sheerness, Kent (1901, 1911)



Occupations:

Outfitter (1871, 1881); Tailor (1891); Naval Outfitter (1901, 1911)

Objects circulated to June 1877:

- Minerals & Geology (Crystals): Magnesium Platino-Cyanide
- Desmidea: Desmids
- Confervaceae: *Tilota elegans* with Diatoms
- Zoophyta – Corallia: *Laomedea gelatinosa*
- Echinodermata: *Asterina gibbosa*; *Echinus* pedicel
- Insecta – Geomyzides: *Opomyza germinationis*, male
- Insecta – Scatomyzides: *Scatophaga*, Dung Fly
- Insecta – Empidae: *Empis livida*

- Insecta – Chironomides: *Corethra plumicornis*
- Insecta – Heteroptera: *Notonecta glauca*, Water Boatman, head
- Insecta – Homoptera: *Cercopis sanguinolenta*

- Insecta – Lepidoptera: *Anthropera filipendulae* (Burnet moth) antenna; *Bombyx mori* (Silkworm Moth) larva
- Hymenoptera – Tenthredinidae: Sawfly
- Hymenoptera – Ichneumonidae: *Ophion lutens*
- Coleoptera – Elateridae: Wire Worm
- Coleoptera – Coccinellidae: *Coccinella variabilis*
- Trombidina: *Trombidium holosericeum*

He married Ann Corby 27th March 1874. Their children were Arthur C. (1875), Ernest (1877), Kate B. (1881). Filed for bankruptcy in January 1884. Amusingly when filling out his 1911 Census return he included a missive in the 'no. of years married' column, viz. 38 "seems longer".

40. John Cross Hutcheson (Born: 1st April 1843 Glasgow, Lanarkshire, Scotland; Died: 29th November 1921 Glasgow, Lanarkshire, Scotland)



Known Addresses:

- 64 Buccleuch St, Glasgow (1851)
- 8 Lansdowne Crescent, Glasgow (1869-1921)

Occupations:

Warehouse Salesman (1871); of the Gowanbank Foundry Co., Glasgow (1871 Census); 708 Garscube Road, Glasgow (1880); Founder (1895-1918 Electoral Registers)

References:

- SG Vol.5. 1869: British Plants in exchange for other British Plants. - Send list to J. C. Hutcheson, 8, Lansdowne Crescent, Glasgow.
- SG Vol.6. October 1870: British Plants (dried) for other British Plants. - Send lists to J. C. Hutcheson, 8, Lansdowne Crescent, Glasgow.
- SG Vol.7. September 1871: British Plants (dried) in exchange for others. Send lists to John C. Hutcheson, 8, Lansdowne Crescent, Glasgow.
- SG Vol.7. December 1871: *Volvox globator* (mounted), in exchange for other good mounted microscopic objects. - John C. Hutcheson, 8, Lansdowne Crescent, Glasgow.
- SG February 1872: 'Spicules of *Alcyonium digitatum* and *Spongilla fluviatilis* mounted in exchange for other good mounted objects. - John C. Hutcheson, 8 Lansdowne Crescent, Glasgow.'
- SG April 1872: 'Young state of *Balanus balanoides*; Scalariform tissue from Fern; Spicules of *Halichondria panicea*; Palates of Mollusca for other mounted objects. - John C. Hutcheson, 8 Lansdowne Crescent, Glasgow.'
- SG June 1872: 'Spicules from *Doris tuberculata* mounted for other mounted objects. - John C. Hutcheson, 8 Lansdowne Crescent, Glasgow.'
- SG August 1872: '*Tubifera ivulorum* and spicules of *Grantia compressa* for other good mounted objects. - J. C. Hutcheson, 8 Lansdowne Crescent, Glasgow.'
- SG November 1872: 'Spicules of *Halichondria sanguinea* and *Grantia botryoides* for other good mounted objects. - J. C. Hutcheson, 8 Lansdowne Crescent, Glasgow.'
- SG February 1873: 'Diatoms. - *Cymbella*, *Cocconema*, *Denticula*, *Epithemia*, &c. mounted, for other good mounted objects. - John C. Hutcheson, 8



Lansdowne Crescent, Glasgow.'

- SG April 1873: 'Diatoms. - *Himantidium pectinale*, *Synedra radians*, *Actinanthidium Thwaitesii*, *Navicula Smithii*, &c., mounted, for other good mounted objects. - John C. Hutcheson, 8 Lansdowne Crescent, Glasgow.'
- SG May 1873: 'Diatom. - *Achnanthidium lanceolatum* mounted, for other good mounted objects. - John C. Hutcheson, 8 Lansdowne Crescent, Glasgow.'
- SG June 1873: 'Diatom. - *Pinnularia radiosa*, mounted, for other good mounted objects. - John C. Hutcheson, 8 Lansdowne Crescent, Glasgow.'
- SG August 1873: 'Desmids. - *Tetmemorus*, *Enastrum anthidium*, *Cosmarium*, &c., mounted for other good mounted objects. - John C. Hutcheson, 8 Lansdowne Crescent, Glasgow.'
- SG May 1874: 'Microscopic Slides in exchange for others. - Send lists to John C. Hutcheson, 8 Lansdowne Crescent, Glasgow.'
- SG April 1875: 'Microscopic slides for others. - Send lists to John C. Hutcheson, 8 Lansdowne Crescent, Glasgow.'
- SG December 1882: 'Wanted, living specimens of *Trichomanes radicans*, *Pteris serrulata*, *Pteris cretica*, *Platyterium alicorne*, *Lomaria gibba*. Microscopic slides offered in exchange. - J.C.H., 8 Lansdowne Crescent, Glasgow.'

Objects circulated to June 1877:

- Raphides & Sphaeraphides: Dock petiole – Sphaeraphides in

Slide image from QMC Collection courtesy of Jacky McPherson.

Listed as Hutchinson by T. A. Wright.

Elected a resident member of the Glasgow Society of Field Naturalists 16th June 1874. He reported on an Excursion to Blairmore in June 1875 – "Mr. J. C. Hutcheson reported that owing to the stormy nature of the day this dredging excursion had not been a great success".

On his death he left estate valued at £37,829 1s. 10d. He was buried at Glasgow Necropolis.

41(a). John Sargent* (Born: circa 1848 Holmwood, Surrey; Died: 1911 Richmond, Surrey)



Note: The PMS members listing records two individuals – John Sargent and William Sargent. My listing of 1875 states that the photograph in the montage is of William Sargent, but John Sargent has been indicated elsewhere, possibly mis-transcribed at some juncture. Whichever (and I've listed both) neither are still listed in the 1878 membership listing.

Known Addresses:

- Chaloner Street, Cockermouth, Cumberland (1851)
- Fritchley, Crich, near Derby (1871-1874; QMC Members list)
- 56 Richmond Grove, Chorlton on Medlock, Lancashire (1891) – Fiancee's home.
- Rivonswood, Kew Road, Richmond, Surrey (1901)
- 63 Selwyn Avenue, Richmond, Surrey (1911)

Occupations:

Scholar (1861); Turner (1871 – father John Grant Sargent was a Wood Turner master employing 14 men and 4 boys); Sugar Machinery Engineer (1891); Mechanical Engineer (1901); Machinery Agent (1911)

References:

- SG Vol.6. October 1870 : Transverse Section of Rush, and Leaf of Evergreen Oak (mounted) in exchange for other well-mounted objects of interest. - J. Sargent, Jun., Fritchley, near Derby.
- SG Vol.6. November 1870 : For Bramble Brand, and Scales of Bream and Tench, &c. send stamped directed envelope, or any object of interest to J. Sargent, jun., Fritchley, near Derby.
- SG Vol.6. December 1870 : For longitudinal section of boxwood, send stamped envelope and any object of interest, except seeds, to J. Sargent, jun., Fritchley, near Derby.
- SG Vol.7. May 1871 : Twelve varieties of wood sections offered for two good slides. Diatoms preferred. - J. Sargent, Jun., Fritchley, near Derby.
- SG Vol.7. June 1871 : Ox Parasites. - For stamped envelope and any object of interest (seeds excepted) - J. Sargent, Jun., Fritchley, near Derby.
- SG Vol.7. August 1871 : For Grayling Scales send stamped envelope to J. Sargent, Jun., Fritchley, near Derby. (Any microscopic object acceptable.)
- SG Vol.7. October 1871 : Eggs of Crane-Fly for stamped envelope and object of microscopical interest. - J. Sargent., Jun., Fritchley, near Derby.
- SG Vol.7. November 1871 : *Trichobasis fallens* and other Micro-fungi for stamped envelope and object of microscopical interest. - J. Sargent, jun., Fritchley, near Derby.
- SG Vol.8. April 1872 : For Hairs of Angora and Pekan send stamped envelope and objects of microscopical interest to J. Sargent, Jun., Fritchley, near Derby.
- SG Vol.8. May 1872 : For Parasite of Humble Bee, send stamped envelope and any microscopic object to J. Sargent, Jun., Fritchley, near Derby.
- SG Vol.8. June 1872 : Leaf of *Onosma tauricum* with peculiar stellate hairs (mounted) in exchange for other well-mounted objects. - J. Sargent, Jun., Fritchley, near Derby.
- SG Vol.8. August 1872 : Asbestos, mounted for polariscope, offered for other well mounted objects. - J. Sargent, Jun., Fritchley, near Derby.
- SG Vol.9. June 1873 : For a piece of Vegetable Tissue, send stamped and directed box with good unmounted object to Wm. Sargent, Jun., Caverswall, Cheadle, Staffordshire.
- SG Vol.9. July 1873 : Spicules of *Gorgonia flabellum* (mounted) for other good mounted objects. - Send list to J. Sargent, Jun., Fritchley, near Derby.
- SG Vol.9. August 1873 : Monthly Microscopical Journal, 1872, and Grevillea, vol. i., offered for good microscopic slides. - J. Sargent, Jun., Fritchley, near Derby.
- *Hypopus muscarum*. JPMS Vol.2. pg.56 1883

Objects circulated to June 1877:

- Confervaceae: *Cladophora rupestris*
- Fungi: *Xenodochus carbonarius*
- Wood Sections: Date Palm
- Seeds & Seed Vessels: African Palm fruit section
- Echinodermata: Lingtheria spiniferous(?) tubercles; Echinus spines, section
- Polyzoa: *Bugula ciliata*
- Hymenoptera – Apidae: *Apis mellifera* glands & nerves from head (2 slides)
- Coleoptera – Dyticidae: *Dytiscus marginalis*, spiracles
- Parts of Vertebrata – Skin: Scalp, section
- Parts of Vertebrata – Hairs: Mammoth Fossil section; Whisker of Seal, section; Badger Foot Pad, section
- Parts of Vertebrata – Feathers: Woodpecker crest
- Vascular System - Injected Preparations &c.: Human lung in Health

Slide image from QMC Collection courtesy of Jacky McPherson.

John Sargent married Emily Parker in 1892. I have found no indication that they had any children. He was elected a member of the Quekett Microscopical Club 26th July 1872.



41(b). William Sargent (Born: 1821 Caverswall, Staffordshire; Died: 9th March 1893 Caverswall, Staffordshire)

See image above.

Known Addresses:

- Caverswall (Village/Grocer's Shop), Staffordshire (1871-1893) (also Caverswall, Cheadle, Staffordshire)

Occupations:

W. Sargant - Grocer, Provision Dealer, Draper, Postmaster, Wesleyan Local Preacher (1871); Grocer and Provision Dealer employing 1 man (1881); Grocer, Provision Dealer and Draper (1891); Grocer, Provision and General Dealer (1893)

W. Sargant Jun. – Scholar, Instructed at home (1871; Grocer's Assistant (1881,1891)

References:**These SG references bear the identity of his son (Jun.):**

- SG Vol.8. August 1872: Wanted, in exchange for a mounted specimen of larva of *Aphrophora spumaria*, a Wing-case of Green Weevil, well mounted in balsam. - Address, sending the object and stamped envelope, W. Sargant, Jun., Caverswall, Cheadle, Staffordshire.
- SG Vol.8. November 1872: Wanted in exchange for a good unmounted object, a good specimen of *Actinocyclus Ralfsii*, well mounted in balsam. - Send stamped box or envelope, with the object, to W. Sargant, Jun., Caverswall, Cheadle, Staffordshire.
- SG Vol.8. December 1872: For a good unmounted object, a Palate of Dog-whelk, well mounted as an opaque object. Send object and stamped box to Wm. Sargant, Jun., Caverswall, Cheadle, Staffordshire.
- SG Vol.9. June 1873: For a piece of Vegetable Tissue, send stamped and directed box with good unmounted object to Wm. Sargant, Jun., Caverswall, Cheadle, Staffordshire.
- SG Vol.10. February 1874: Wanted, good mounted Injections. I will give Stained Tissue. - Send stamped envelope to Wm. Sarjeant, Jun., Caverswall, Stafford.
- SG Vol.10. April 1874: For Slide of Cholestrine, send stamped box and well mounted Slide of Urinary Deposits to Wm. Sargant, jun., Caverswall, Stoke-on-Trent.
- SG Vol.10. June 1874: For Mounted Section of Cuttle-bone send unmounted good transparent injection, preserved in glycerine, to W. Sargant, Jun., Caverswall, Stoke-on-Trent.
- SG Vol.10. August 1874: I HAVE a spare slide of Diatoms from Norfolk. - Send good slide for 1-inch objective, not polar, to W. Sargant, Jun., Caverswall, Stoke-on-Trent.
- SG Vol.10. December 1874: For *Aecidium Thesii* send good unmounted Object for inch (not polar) to W. Sargant, jun., Caverswall, Stoke-on-Trent.
- SG Vol.11. May 1875: For exchange, Normandy's "Commercial Analysis," quite new, one leaf only gone. Geological slides preferred. - Apply to Wm. Sargant, jun., Caverswall, Stoke-on-Trent.
- SG Vol.13. July 1877: Wanted, good section of Agate or other mineral for polariscope. Two good Slides for polariscope given in exchange. - Wm. Sargant, jun., Caverswall, Stoke-on-Trent.
- SG Vol.13. December 1877: A good writing-diamond, for glass slides for mounting. - Apply, sending sample slide, to Wm. Sargant, junr. Caverswall, Stoke-on-Trent.
- SG Vol.14. March 1878 : For a Slide of Crystals for Polar send two good Prepared but Unmounted Entomological Objects to Wm. Sargant, Jun., Caverswall, Stoke-on-Trent.
- SG Vol.14. June 1878 : Material for slide of crystals for Polariscope in exchange for good unmounted Entomological object (not wing). - Wm. Sargant, junr., Caverswall, Stoke-on-Trent.

Objects circulated to June 1877 (W. Sargant):

- Photographs: Crystal Palace
- Crystals - Animal: Hippuric Acid; Cholesterone from ovary in dropsy
- Diatomaceae: *Heliopelta Leuwenhoekii*
- Various Diatomaceae: Colon
- Cuticles: Oat
- Vascular System – Injected Preparations &c.: Human Lip
- Nerve Structure of Organs of Special Sense: Brain of Brown Rat
- Ledis Incertae vel Incognitae: *Acetabularia*

Based on the image in the montage depicting a young to middle aged man it seems likely that William Sargant senior is the actual member of the PMS depicted.

He was baptised 7th February 1821 Caverswall, Staffordshire

He married Eliza Holdcroft, six years his junior, in 1857 at Wolstanton, Staffordshire. The couple had five children – William (1859), Eliza (1860), Clara (1863), Charles Edward (1865) and Henry Holdcroft (1869).

Probate: Sargant, William, of Caverswall, Staffordshire, grocer, provision and general dealer, died 9th March 1893. Probate London 17th July to Eliza Sargant, widow. Effects £701 18s. 11d.

Probate: Sargant, William, of Caverswall, Staffordshire, died 9th March 1893. Probate London 21st November 1904 to William Sargant, gentleman. Effects £24 9s. 6d. Former grant July 1893.

There is a Criminal record for one William Sarjeant in Staffordshire on 29th June 1841, aged 20, for Larceny (theft of personal property) for which he received a 12 month prison sentence. Not sure at present whether this is relevant, but I hope not.



42. Frank James Allen (Born: 17th April 1854 Shepton Mallet, Somerset; Died: 28th December 1942 Letchworth, Hertfordshire)



Known Addresses:

- Towns End, Shepton Mallet, Somerset (1861,1874)
- Fairlight, Westbury on Trym, Bristol, Gloucestershire (1871)
- 26 Moore Street, Chelsea, London (1881)
- 21 Chad Road, Edgbaston, Warwickshire (1891)
- "Beech Lawn", Pickersleigh Road, Great Malvern, Worcestershire
- 8 Halifax Road, Cambridge, Cambridgeshire (1908-1931)
- Arana, Hitchin Road, Letchworth, Hertfordshire (1942)

F. J. Allen



Occupations:

Scholar (1861); Student in Chemistry (1871); Cambridge B.A. (1881); Professor of Physiology at Mason College (1887); Physician, Professor of Physiology (1891)

Licentiate of the Royal College of Physicians. (1901)

Registered 1883. Allen, Frank James, Shepton Mallet

References:

- Fatty Acids to Prepare for the Microscope: JPMS Vol.1. pg.193. 1882.
- Holothuria. JPMS Vol.2. pp.243-244 1883
- Saw Fly. JPMS Vol.2. pp.249-250. 1883
- Feet of Insects. JPMS Vol.3. pp.121-122. 1884
- Winged Atom. JPMS Vol.3. pg.121. 1884
- Fowl Flea. JPMS Vol.4. pg.41. 1885
- *Nycteribia*. JPMS Vol.4. pg.261. 1885
- Crystallisation. JPMS Vol.6. pg.116. 1887
- Glycerine Jelly v. Canada Balsam. JPMS Vol.6. pg.117. 1887
- Hind Leg of *Ailantus Scrophularia*. JPMS Vol.6. pp.118-119. 1887
- Potassic Sulphate. JPMS Vol.8. pg.189. 1889
- Palate of *Cyclostoma elegans* and Aniline Blue Stain. JPMS Vol.10. pg.90. 1891
- *Ixodes ricinus* (Ferret Tick). JPMS Vol.10. pg.91. 1891
- *Gonia Macrocephala*. JPMS Vol.10. pp.281-282 1891
- Borax to Crystallise on Slide. JPMS Vol.10. pg.pp.286-287. 1891
- To Make Chromic Acid. JPMS Vol.10. pp.288-289. 1891
- Note discussing the formation of the Earth and development of life thereon. Nature 16th February 1922 pg.207.
- Nature 12th September 1925:
The Word "Australopithecus" and Others.
...it may be said that although scientific names need not be literature, and therefore need not follow any philological rules, yet where they pretend to be derived from Greek, or Latin, or any other particular language, good taste demands that they should conform to the structural system of that language.
We "scientists" are contemptuous when the un-scientific misuse our terms: if we wish to avoid the contempt of literary folk, we should be careful how we use theirs.
- The Great Church Towers of England. Cambridge University Press 1932.

Objects circulated to June 1877:

- Minerals & Geology (Crystals): Potash Prussiate
- Confervaceae: Seaweed
- Echinodermata: *Holothuria tremula* scales
- Mollusca: *Cyclostoma elegans*, palate; *Trochus crassus* tongue
- Insecta - Muscidae: *Tachina ferox*
- Insecta – Dolichopidae: *Dolichopus longicornis*
- Insecta - Asilidae: *Dioctria rufipes*
- Insecta – Tabanidae: *Tabanus luridus*; *Chrysops caecutiens*
- Insecta – Tipulidae: *Tipula*, marsh
- Insecta – Aphaniptera: *Pulex galliniae* (Fowl)
- Insecta – Homoptera: *Phylloxera*
- Hymenoptera – Vespidae: *Vespa crabro* (Hornet), parts of
- Trombidina: Crab-like mite; *Raphignathus*, long legged mite
- Opiliona: *Opilio*
- Pseudoscorpia: Chelifer
- Sedes Incertae vel Incognitae: *Gonia macrocephala*



The son of a Cheese Dealer from Shepton Mallet was educated at Taunton School and gained admission to St John's college in 1875 where he gained a first-class degree (First Class in the Natural Science Tripos) in 1878 proceeding to M.A. in 1882, becoming an M.D. in 1895. He started his working

career at St Georges Hospital in London before becoming Professor of Physiology at Mason University College Birmingham (1887 to 1899). An interesting event took place whilst in Birmingham: "...Prof. Allen gallantly captured a dog suffering from rabies and in doing so was bitten by the animal. He went to the Pasteur Institute in Paris for treatment, and described his experiences as a patient at the Institute in the Birmingham Medical Review of 1898." He was a member of the British Medical Association from 1887.

Entry in The Naturalists' Universal Directory of 1896 and 1905: Allen, F. J., 21 Chad Road, Edgbaston, Birmingham, Warwickshire, England. Interests: Comparative Physiology.

Subscriber to Notes and Queries for Somerset and Dorset in March 1909.

He was secretary and editor of publications of the Cambridge Antiquarian Society from 1913 until 1930 and was keenly interested in biochemistry, music and was also an authority on church architecture (with a quite specific interest in spires). Member (joined 1884) of the Somerset Archaeological and Natural History Society 1908-1919.

Appears in the Report of the 86th Meeting of the British Association for the Advancement of Science 1916: Accessions to Photographs of Geological Interest 1912 – [5249] Westleigh Quarry, near Burlescombe, Contorted Carboniferous Limestone, Quarter Plate – photographed by F. J. Allen, M.A., D.Sc, 8 Halifax Road, Cambridge.

He never married and when he retired he moved to Cambridge and was living at 8 Halifax Road from 1908 until 1931 before moving to Hitchin Road, Letchworth where he passed away. He left estate valued at £2,669 11s. 11d. He was cremated on 30th December 1942 at Cambridge Crematorium. An obituary appeared in The British Medical Journal 16th January 1943 pg.86 and also in Nature 151: pp.132-133, 30th January 1943. His death was also reported in The Lancet of 9th January 1943.



43. William Lane Sear (Born: circa 1830 London; Died: 7th December 1905 Margate, Kent)



Known Addresses:

- 24, Cecil Square, Margate, Kent (1865-1872)
- The Briars, Canterbury Road, Margate, Kent (1881, 1891)
- "Brookdyn" (4), Garfield Road, Margate, Kent (1901, 1903)
- "Brookdyn", 8 Garfield Road, Margate, Kent (1905)

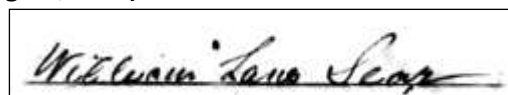

Occupations:

Auctioneer (1861); Civil Engineer (1862); Architect (1868, 1881, 1891, 1901 [retired], 1903); Architect and Surveyor (1871)

References:

- SG Vol.8. 1872 December 1872 A number of fine pupae, including fourteen *Acherontia atropos*, to exchange for good slide; well mounted. - W. Lane Sear, 24, Cecil Square, Margate, Kent.
- SG Vol.13. November 1877 : Some splendid living Chrysalides of Death's-Head, *Acherontia Atropos* to exchange for Microscopical injections. - W. Lane Sear, Margate.
- SG Vol.14. November 1878 : Several immense living Chrysalides of *Acherontia Atropos* offered in exchange for good Natural History Slides or microscopical accessories. - W. Lane Sear, Margate, Kent.
- Turkey Rhubarb. JPMS Vol.1. pg.94. 1882

- Caligus. JPMS Vol.5. pg.120. (1 plate) 1886

Objects circulated to June 1877:

- Mosses: *Funaria hygrometrica*
- Wood Sections: White Pine – Cross section; Beech – cross section; Oak – cross section
- Zoophyta – Corallia: *Laomedea gelatinosa*
- Echinodermata: *Ophiocoma rosula*, spines
- Polyzoa: *Gemillaria loriculata*; *Plumatella repens*, statoblasts
- Mollusca: Limpet (*Patella vulgata*) palate
- Myriapoda: *Scolopendra morsitans*
- Insecta – Diptera: Sheep tick (ked)
- Insecta – Scatomyzidae: Dipterous Fly
- Insecta - Muscidae: *Glossina morsitans* (Tsetse Fly)
- Insecta – Heteroptera: *Cimex lectularius*, eggs & young
- Insecta – Lepidoptera: *Saturnia pavonia minor* (Emperor Moth), head
- Orthoptera – Gryllidae: Locust wing
- Crustaceae – Ichthyophthira – Caligina: *Caligus Mulleri*
- Crustaceae – Decapoda – Pycnogonidae: *Pycnogonium*
- Gamasea: *Gamasus* from Humble Bee
- Hypopus: *Hypopus muscorum*
- Araneae: *Ciniflo cularia*(?), fangs &c.
- Sedes Incertae vel Incognitae: *P. serratus*

Partnership between William Jacobs and William Lane Sear, Canterbury, Dover and Margate, Auctioneers, Estate Agents and Accountants, was dissolved 12th June 1862. He was architect to Cobb Estates, Margate and the estates of Lord Lurgan. He was also surveyor to Lurgan Improvement Commission 1850-1857.

He was baptised 17th October 1830 at St. Mark's Church, Kennington, London. William Lane Sear married Mary Newport Symonds after Banns on 21st October 1862 at St. John the Evangelist, St. Pancras, Middlesex. With wife Mary the couple produced the following children – Mary Jane (1863), Merton (1865), Ida Constance (1869).

He acted together with Samuel Pointon, both of the Literary Institution, Margate, in the disposal of the museum of the Margate Literary Society, in May 1867. Hon. Librarian of the Margate Microscopical Club 1871. William Lane Sear was involved in the prosecution of a con-man forging promissory notes. in 1874.

On his death his estate was valued at £27,657 0s. 6d.

44. Thomas Smith Rowe, M.D. (Born: 8th November 1825 St. John's, Margate, Kent; Died: 28th November 1907 Margate, Kent)



Known Addresses:

- 24 Union Crescent, Margate, Kent (1871)
- Cecil Street, Margate (Transactions of the Epidemiological Society 1891-2 – Elected 1863)
- 1 Union Crescent, Margate (1894-1907, Transactions of the Epidemiological Society 1894-5, 1906)

Occupations:

General Practitioner (1871, 1881, 1891); President of Margate Microscopical Club (1874); Medical Officer to the Convalescent Home for Orphans, Cliftonville, Margate (1875); Senior Surgeon to the Royal Sea Bathing Infirmary, Margate (1877); M.D. Retired (1901); also Justice of the Peace.

Objects circulated to June 1877:

- Various Diatomaceae: On Seaweed
- Confervaceae: *Spyridia filamentosa*
- Fungi: *Septoria fraxini*; *Trichobasis menthe*; Fungus on thistle
- Hardened Cellular Tissue: Pear, Sclerogen in situ
- Raphides & Sphaeraphides: Aloe – raphides in leaf
- Seeds & Seed Vessels: Ox-eye Daisy seeds
- Echinodermata: *Spatangus* spines
- Polyzoa: *Calenicella ventricosa*
- Insecta – Anoplura: Crab Louse (sub. nom. *Pediculus pubis*)
- Insecta – Aestridae: *Gasterophilus*, larva in eggs

- Ixodea: *Ixodes ricinus* Ferret
- Araneae: *Ciniflo ferox*, subnom House Spider from English Snake
- Parts of Vertebrata – Skin: Exuvium
- Parts of Vertebrata – Feathers: Ptarmigan foot
- Parts of Vertebrata – Bone: Fossil Reptilian vertebra
- Parts of Vertebrata – Tooth: *Diplodus* in Shale

Received Doctorate of Medicine from the University of Edinburgh in August 1850. He was commended for his dissertation "On the Intermingled Relations of Mind and Body". Thomas Smith Rowe was recorded as seeking damage, as one of the owners (1858), for the loss of the vessel "Pandora" due to negligence.

Baptised 18th December 1825 at a Wesleyan Methodist Chapel in London. Married Ellen Rosa Betts in 1858 at Upper Deal. The couple had one child – Arthur Walton Rowe (27th September 1859). Thomas Smith Rowe was in partnership (as Surgeons) with one George Henry Hoffman. The partnership was dissolved on 31st December 1860. Subsequently another partnership was formed between himself and one George Allan Heron as Surgeons, Accoucheurs, and General Practitioners. This partnership was dissolved on the 31st March 1873. Fellow of the Royal Medical and Chirurgical Society of London (elected in 1863). There is a record of a marriage of a son Arthur Walton Rowe (Geologist, Archeologist and Antiquary) in 1887 but no other mention of him appears in the Census records examined (Walton was Thomas Smith Rowe's mother's maiden name). In 1888 both are listed as being Honorary Medical Officers to the Convalescent Branch at Margate of The Victoria Hospital for Children. Recorded as a member of the Kent Archaeological Society 1871-1898. He is listed as being a minor shareholder in the Bank of British North America (1901, 1903, 1904, 1905, 1907). Also listed in the 1906 non-resident Members listing of the Epidemiological Society of London (Elected 1863). Upon the death of Thomas Smith Rowe his estate (Arthur Walton Rowe, executor) was £10,278 12s. 10d. His headstone in Margate Cemetery records "For many years visiting Surgeon to the Royal Sea Bathing Hospital and Founder of the Margate Creche". Still listed as a Member of the Kent Archaeological Society in 1909.

An Authenticated Prescription from "Medical consultation book, a pharmacological and clinical book of reference, containing the therapeutics of a full list of the officinal and non-officinal articles of the materia medica, with a consideration of the action of medicine, including an extensive collection of favorite prescriptions from the most reliable authorities of the medical profession, and so classified as to be of ready access for authenticated treatment of each disease, in its different stages and complications, etc. designed for the consultation room" by Hachenberg, G.P (1893).

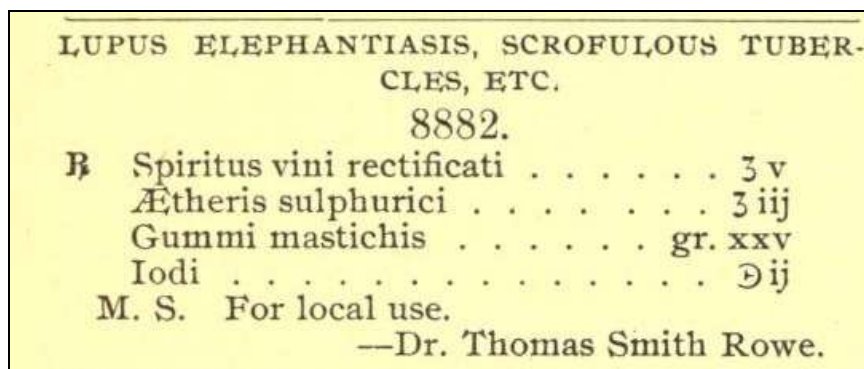

The recipe is in old Apothecaries nomenclature:
 Spiritus vini rectificati - 5 drachms (19.45 grams) [Rectified Spirit - Ethyl Alcohol]
 Aetheris sulphurici - 3 drachms (11.67 grams) [Sulphuric ether - Diethyl ether]
 Gummi mastichis - 25 grains (1620mg = 1.62 grams) [Gum Mastic]
 Iodi - 2 scruples (2.592 grams) [Iodine]

45. Thomas Lisle (Born: 8th May 1823 Wolverhampton, Staffordshire; Died: 10th September 1895 Wolverhampton, Staffordshire)



Known Addresses:

- Melbourne Street, Wolverhampton, Staffordshire (1851)
- Moorfields, Wolverhampton (1861-1874)
- Falcon Works, Moorfields, Wolverhampton (1866)
- Villiers Street, Moorfields, Wolverhampton (1868)
- 4 Villiers St., Wolverhampton (1871-1876)
- Lower Villiers Street, Wolverhampton (1876)
- 9 Upper Villiers Street, Wolverhampton, Staffordshire (1881)
- 10 Upper Villiers Street, Wolverhampton, Staffordshire (1891)

Occupations:

Japanner's Clerk (1851); Tin and Japan Manufacturer, employing 57 men, 29 boys, 24 women and 15 girls (1861); Clerk for Henry Fearncombe and Co. (1861); Cycle Maker (1868); Japanner's Clerk (1871); Commercial Clerk in the Japan Trade (1881); Japanner's Clerk (1891); Commercial Clerk/Cashier (1895)

References:

- A note on Organ Pipes appeared in English Mechanic and Mirror of Science 30th November 1866 pg.157.
- SG Vol.9. June 1873 : Fossil Diatoms, - Well-mounted Slides for Diatomaceous material, or other Slides. - Thos. Lisle, Moorfields, Wolverhampton
- SG Vol.9. November 1873 : Fossil Diatoms, 15 Localities, mounted, for other Slides or Objects. -

Thomas Lisle, Moorfields, Wolverhampton.

- SG Vol.9. December 1873 : Carpenter's "Microscope and its Revelations," wanted for Slides. - Thomas Lisle, Moorfields, Wolverhampton.
- SG Vol.10. March 1874 : Fossil Diatoms, well mounted, for Selenites. - Thos. Lisle, Moorfields, Wolverhampton.
- SG Vol.10. May 1874 : Send stamped envelope and object for Sections of Horn, Hoof, and Cuttlebone, to Thomas Lisle, Moorfields, Wolverhampton.
- SG Vol.12. January 1876 : Two Slides of Fossil Infusoria, for one of selected and named Diatoms. - Thomas Lisle, Villers Street, Wolverhampton.
- SG Vol.12. May 1876 : The "Micrographical Dictionary" Wanted, - exchange or cash. - Thomas Lisle, Villiers Street, Wolverhampton.
- Mounting Polyzoa and Rotifers. The Midland Naturalist Vol.2. pg.76. 1879.
- SG Vol.15. December 1879 : Ripple-mark gatherings from Barmouth, rich in foraminifera, &c., exchange for unmounted material or slides. - Thomas Lisle, Villiers Street, Wolverhampton.
- Glycerine Jelly Mounts. JPMS Vol.1. pg.49. 1882.
- Tracheal System of Caterpillar. JPMS Vol.3. pg.120. 1884
- Cement for Finishing Slides. JPMS Vol.6. pp.119-120. 1887
- Cements for Liquid Mounts. JPMS Vol.10. pg.288. 1891

Objects circulated to June 1877:

- Minerals & Geology (Earths): Limestone from Wren's Nest Hill, Dudley
- Various Diatomaceae: On *Plocamium*
- Confervaceae: Weed from thermal pool, Matlock
- Insecta - Muscidae: Blowfly, teeth
- Insecta – Aphaniptera: Flea, head of Spigidum(?)
- Insecta – Homoptera: *Coccus* sub. nom. Insect; *Apides*; Another *Apides*
- Orthoptera – Achetidae: *Acheta domestica*, parts of
- Parts of Vertebrata – Hairs: Human Beard
- Parts of Vertebrata – Kidney: Human Kidney

Thomas Lisle married Eliza Green 19th October 1847 at St. Georges, Wolverhampton, Staffordshire. His children were as follows – Helen Amy (1849), Kate (1852), Emma (1854), Ann Eliza (1856), Elizabeth (1859) and Thomas Arthur (1863).

An interesting advertisement in The Musical Times of 1st October and 1st November 1866:

"THE VIOLIN HOLDER enables the Performer to hold his Instrument firmly with the chin alone, without the assistance of the left hand. Manufactured by Thomas Lisle, Falcon Works, Moorfields, Wolverhampton. Price, post free, 20 stamps."

In English Mechanic and Mirror of Science 16th November 1866 and Routledge's Magazine for boys December 1866:



And another in The Boys' Journal, Vol. 8. 1867:

"THE ATLANTIC YACHT RACE. Models of the Yachts 'Henrietta', 'Fleetwing' and 'Vesta' 20in. long, may be had of Thomas Lisle, Moorfields, Wolverhampton; price, Hull 7s. 6d., Spars 1s. 6d., Sails 1s. 6d. Box 1s. Rigged 15s, and Box 1s. 6d. Bronzed to imitate copper bottoms, 2s. extra."

Quite what occurred to change his status from Manufacturer employing some 125 people in 1881 to a Clerk in the same industry is unknown.

However, the 1891 census does record him as "Deaf" and this may well have impacted his ability to run a large business. By the time of his death the value of his estate was a mere £242 10s. 2d. He was buried at Merridale Cemetery, Wolverhampton, Staffordshire.



46. Charles James Watkins, F.E.S. (Born: 12th July 1846 Lightpill, Gloucestershire; Died: 27th May 1907 Nailsworth, Gloucestershire)



Known Addresses:

- Rock Mill House, Painswick, Gloucestershire (1851)
- Kings Mill House, Painswick, Gloucestershire (1871, 1874, 1881-1882 PMS Listing [1882 Circuit g], 1888 [Member of the Wesley Scientific Society], 1891)
- 2 Edley Villas, Brooke Street, Gloucester (1879)
- 3 Regent Street, Gloucester Barton St Michael, Gloucester (1881)
- 'Belle Vue', Watledge, Nailsworth, Gloucestershire (1907)

Occupations:

Pin Machinist (1871 – his father was Peter Watkins was recorded as a Pin Manufacturer, employing 30 hands); Naturalist (1879, 1881); Pin Manufacturers Clerk (1891); Manager of a Pin Factory (1901)

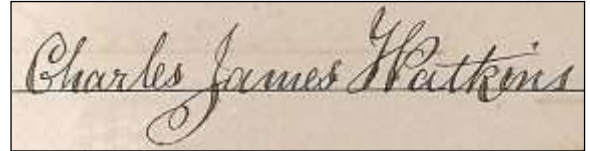

References:

- SG Vol.8. May 1872 : Wings and sections of British and Foreign Lepidoptera, named, for other good microscopic material. - Chas. J. Watkins, Painswick, Gloucestershire.
- SG Vol.11. April 1875 : Wanted, good named Algae, Mosses, Seeds, Parasites, &c , for other good named Objects for mounting. - C. J. Watkins, Painswick, Gloucestershire.
- SG Vol.13. June 1877 : Unmounted duplicates of *AECidium ari* on *Arum maculatum*, in exchange for other good, named species - Charles J. Watkins, King's Mill House, Painswick, Gloucestershire.
- JPMS Vol.1. March 1882 and JPMS Vol.1. pg.56. 1882: Exchanges: A few good mounts of Horn and hoof Sections, Diatoms, etc., also various interesting, named, unmounted Objects, in exchange for well-mounted slides. – Chas. J. Watkins, King's Mill House, Painswick.
- SG Vol.18. November 1882 : A SELECTION of well-mounted double-stained vegetable sections, also some selected Desmids, all on ground slips, in exchange for good works on natural history. - Chas. J. Watkins, King's Mill House, Painswick, Gloucestershire.
- The Scientific Enquirer March, April, May, June, July, August, September, October, November, December 1886, January 1887: Microscopical Slide Labels for Animal and Vegetable Kingdom, toned paper, 6d. per 100; Samples of 33 kinds, 2d. – Chas. Watkins
- The Scientific Enquirer March, April, May, June, July, August, September, October, November, December 1886, January 1887: Insects in Spirit and Dry, selected for Mounting. New List ready. Chas. Watkins, King's Mill House, Painswick, Gloucestershire
- Insect Puzzle. The Scientific Enquirer June 1886 pp.96.
- Preserving Crustacea. The Scientific Enquirer December 1886 pp.224-225.
- The Scientific Enquirer December 1886, January, February 1887: Hand-painted Lantern Slides of Micro Objects, also Micro Preparations, in exchange for named cabinet specimens of Diptera and Hymenoptera not in collection. – Chas. Watkins, Painswick, Gloucestershire.
- Preserving Larvae of Lepidoptera. The Scientific Enquirer January 1887 pp.34-35.
- The Scientific Enquirer February, March, April, May, June, July, August, September, October, November, December 1887: Microscopical. – Slips, Thin Covers, Media, Cements, etc., 33 kinds of Labels; samples 2d. Unmounted Objects as fine Polariscope Horn and Hoof Sections, Insects, Zoophytes, brilliant selected Show Objects from Exotic Lepidoptera, etc. – Chas. Watkins, King's Mill House, Painswick, Gloucestershire.
- The Scientific Enquirer March, April, May, June, July, August, September, October 1887: Natural History and Musical Works, Oolitic Fossil Coral, Micro Preparations, in exchange for named cabinet specimens of Diptera and Hymenoptera not in collection, - Chas. Watkins, Painswick, Gloucestershire.
- The Scientific Enquirer May, July 1887: Good named, Mounted and Unmounted Microscopic Objects in exchange for named Cabinet Specimens of Diptera, Hymenoptera and Hemiptera not in collection. – Chas. J. Watkins, King's Mill House, Painswick, Gloucestershire.
- Aphides. The Scientific Enquirer June 1887 pg.111.
- The Scientific Enquirer August 1887: This season's British Lycaena Arion, taken by myself. In exchange for named Cabinet specimens of Diptera, Hymenoptera, etc. – Chas. J. Watkins, King's Mill House, Painswick, Gloucestershire.
- SG Vol.24. March, 1888 : Wanted, "Wesley Naturalist" for March, 1887; will give in exchange micro materials or objects. - C. J. Watkins, Painswick, Gloucestershire.
- SG Vol.24. March, 1888 : Wanted, insect cabinet, six or eight drawers, with frames to glasses. Will give in exchange hand-painted lantern slides of micro-objects, books on natural history, fine crystal and rock micro-slides, or mounting materials. - C. J. Watkins, Painswick, Gloucestershire.
- In The Wesley Naturalist Vol. II. March; April; May; July; August; September; October; December 1888: "Unmounted Insects, 200 species. Scales showing Villi, 100 species. List free. 30 slide Label samples, 2d. Mounting materials. C. J. Watkins, Kings Mill House, Painswick, Gloucestershire."
- SG Vol.26. March 1890 : Wanted, No. i (March, 1887), "Wesley Naturalist," in exchange for two good mounted, or twelve named, selected, unmounted micro-objects. - Charles Watkins, Painswick, Gloucestershire.

- SG Vol.26. December 1890 : Duplicates of named British diptera. Desiderata, named British micro lepidoptera, hymenoptera, hemiptera, orthoptera, neuroptera. - C. J. Watkins, King's Mill House, Painswick, Gloucestershire.
- Some Notes on Lepidoptera from the Painswick District. Proceedings of the Bristol Naturalists' Society Vol.VIII. Part III (1897) 1899 pp.274-278

Objects circulated to June 1877:

- Photographs: Microphotograph – 165 Eminent Women
- Minerals & Geology (Crystals): Magnesium Platino-Cyanide
- Ferns: *Niphobolus lingua* hairs
- Hairs – vegetable: *Correa Harrisii* – on petal
- Starches: Calabar Bean; Arrowroot from Cape Coast Castle
- Seeds & Seed Vessels: *Paulownia imperialis*
- Echinodermata: *Ophiocoma neglecta*
- Polyzoa: *Aetea dilatata*; *Bugula ciliata*
- Insecta – Lepidoptera: *H. cupido*, part of hind wing; *Urania leilus*, wing
- Coleoptera – Telephoridae: *Telephorus lividus*
- Coleoptera – Cuculioridae: Diamond Beetle, tarsus
- Coleoptera – Coccinellidae: *Coccinella variabilis*
- Sedes Indeterminatae: *Argynesthia*, micromoth, front wing
- Parts of Vertebrata – Hairs: Blower of Whale
- Parts of Vertebrata – Hoofs, Horns, &c.: Hoof of Ass; Sheep Horn, cross section; Koodoo (sic) Horn, cross section
- Parts of Vertebrata – Tooth: Whalebones, cross section
- Parts of Vertebrata – Nerve Structure & Organs of Special Sense: Human Brain, stained

He attended the National School at Painswick. In his middle-years he was impeded in his interests and business pursuits by illness. He contributed Entomological observations to "The Flora and Fauna of Gloucestershire". Charles James Watkins married Katherine Hill, 13th October 1879 St. James, Gloucester, by Licence. They had no children. He was elected a Fellow of the Entomological Society in 1900. When Charles died his estate was valued at £2998 12s. 1d. His extensive collection of insects, noted for its completeness and rare specimens, was acquired by the Bristol Museum & Art Gallery after his death as a result of Cancer. He had maintained a diary of his Entomological adventures for more than 40 years. He was buried at Holy Trinity, Amberley Churchyard, Amberley, Stroud, Gloucestershire. His headstone includes the inscription "With Christ, which is far better". An obituary appeared in The Proceeding of the Cotteswold Naturalists' Club Vol.XVI, Part 1 1907 with 1 plate (VIII) reproduced above showing him outside Painswick House (even though he wasn't actually a member of the organisation). Another Obituary appeared in The Entomologist's Record and Journal of Variation, Vol.XIX, No.8. 15th August 1907, pp.194-195.

47. Samuel Charles Hincks (Born: circa 1828 Walsall, Staffordshire; Died: 21st June 1894 Farnham, Surrey)



Known Addresses:

- Amersham Road (1852)
- New Cross, Greenwich (1861)
- Badshot Lee, Farnham (1861)
- Southfield, Runfold, Farnham, Surrey (1871)
- Runfold Lodge, Farnham, Surrey (1872-1891)

Occupations:

Scholar (1851); Ironmonger (1851); Artist (1851,1871,1881); Living on own means (1891)

References:

- SG June 1872: 'Lepisma saccharina. - Send stamped envelope. - S. C. Hincks, Runfold Lodge, Farnham, Surrey.'
- SG February 1876: 'Rhubarb, beautifully showing spiral vessels, and Raphides, in exchange for objects of interest. - S. C. Hincks, Runfold, Farnham, Surrey.'
- SG April 1878 Microscopy Section: 'Sap Crystals. - The sap of the Scotch Fir contains very beautiful



crystals; they may be obtained at this season of the year by cutting a slice through the bark, from the underside of the branch; in a few days the sap will flow containing the crystals. - S. C. Hincks.'

- SG April 1878: 'Mounted slides of *Craterium pyriforme* in exchange for well-mounted Slides of interest. - S. C. Hincks, Farnham, Surrey.'
- SG January 1879: 'A good 24-inch four-draw telescope in exchange. Wanted, good slides, Slacks "Marvels of Pond Life", or other books on microscopic subjects. - S. C. Hincks, Runfold, Farnham, Surrey.'
- SG February 1879 Microscopy Section: 'How to remove Canada Balsam from Slides. - I know that microscopists sometimes find it difficult to remove Canada balsam from old slides, or unsuccessfully mounted ones. I have always found the following plan a very good one: Place the slides in an oven for two or three days, the Canada balsam will then easily chip off with a knife, then wash them in soda water. - S. C. Hincks.'
- SG, Vol. 14, 1878, pg.88: Sap crystals
- SG, Vol. 15, 1879 pp.61-62: How to remove Canada balsam from slides
- The Journal of Microscopy and Natural Science, Vol. 8, 1889 pg.190: Scotch fir

Objects circulated to June 1877:

- Minerals & Geology (Crystals): Copper Sulph.

- Minerals & Geology (Crystals, Vegetable Products): Salicine
- Various Diatomaceae: On Seaweed
- Confervaceae: *Volvox globator*
- Fungi: Fungus on Larch Stem
- Ferns: Scales; *Cibotium princeps*
- Cuticles: Potato tuber
- Spiral & Pitted Structures: Rhubarb – spiral vessels & raphides in situ
- Raphides & Sphaeraphides: Rhubarb – Sphaeraphides in
- Seeds & Seed Vessels: *Sapucaia* nut – spiral vessel of shell
- Insecta – Thysanura: *Lepisma* scales
- Insecta – Anoplura: Parasite of Starling *Docophorus leontodon*
- Insecta - Muscidae: *Caliphora vomitoria* (Blow Fly)
- Insecta – Imperfectly named (or Massed): Fan tail fly (male)
- Insecta – Aphaniptera: *Pulex* of Water Rat
- Coleoptera – Cicindelidae: *Cicindela campestris* (Tiger Beetle) elytron
- Coleoptera – Dyticidae: *Dytiscus marginalis*, male leg
- Coleoptera – Lucanidae: *Lucanus cervus* (Stag Beetle) spiracle
- Sedis Indeterminatae: Water Beetle
- Araneae: Hair of Tarantula
- Parts of Vertebrata – Hoofs, Horns, &c.: Ear of Mouse
- Animal Tissues – Cartilage: Mouse Ear
- Parts of Vertebrata – Reproductive Organs: Hen's Egg, Rough Shell

Samuel Charles Hincks, for much of his life worked as an Artist (though not a good one!). However, I have found no record of any of his works save for a picture of a falcon that appeared on an auction site. It was not a good image!

He married Mary Ann Hincks on 2nd October 1852 at St. Paul, Deptford. They had an only child – Clara (1853). His estate was valued at his death £8,236 8s. 9d.

48. William Addis* (Born: *circa* 1840 Clerkenwell, London; probably died December 1905 Hackney, London)



Known Addresses:

- 28 Wilmer Gardens, Shoreditch (1861)
- 5 John Street, Hackney Road (1865)
- 4 Duncan Road, Hackney (1871)
- 28 Benyon Road, St. John, Hackney, London, N. (1874-1878)
- 66 Spencer Road (1877)
- 44 Herbert Street, New North Road, Hoxton, N. (1879-1883) – Business address
- 13 Duncan Square, Hackney, London (1881 Census – Home address)
- 19 Ash Grove, Hackney, London (1891, 1901 – Home Address)

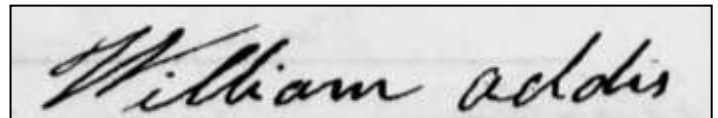

Occupations:

Tooth Brush Maker (1877,1881), Brush Maker (1865,1891), Bone Brush Maker (1901)

Objects circulated to June 1877:

- Minerals & Geology (Crystals, Vegetable Products): Gallic Acid
- Ferns: *Pteris aquilina*
- Wood Sections: Deal – section; Yew – cross section; Willow; Alder – section; Oak – cross section; Clematis – cross section
- Cuticles: Oat
- Seeds & Seed Vessels: *Paulownia imperialis*; *Campanula carpatica*
- Mollusca: *Helix*, palate
- Insecta - Muscidae: Blow Fly, spiracles
- Parts of Vertebrata – Hoofs, Horns, &c.: Hoof of Horse; Rhinoceros Horn

Married Elizabeth Ann Miller in December 1865.

Elected a member of the Quekett Microscopical Club 23rd June 1876, address 28 Benyon Road, Southgate Road, N. In members list 1876-1878 at the Benyon Road address. At Herbert Street address in 1879-1883. Doesn't appear in members listing after 1883 until re-elected on 20th February 1891 and continues to appear in the list at the Herbert Street address until 1897.

In the 1881 census at 13 Duncan Square, Hackney, living with wife Elizabeth, four daughters – Mary A., Alice Ada, Rayner Lucy, Harriett, and one son – William John. By 1891 he has another two daughters listed – Elizabeth Jane Martha and Jessie. In 1901 Census another son – George Samuel.

In the Chemist and Druggist, 24th March 1900:

"Mr. T. Booth Jackson has purchased the business of William Addis & Son, bone and ivory brush manufacturers, at 44 Herbert Street, New North Road, N., but will carry on the same under the old firm's name."

Advertisement (above) in The Chemist and Druggist 25th August 1900.

49. Edwin Smith



Known Addresses:

- Stone, Staffordshire (1874)

Objects circulated to June 1877:

- Various Diatomaceae: from Barrow
- Fungi: *Badhamia capsulifera*
- Equisetaceae: *Equisetum* stem tr. section
- Foraminifera: Porto Seguro
- Insecta - Muscidae: Blowfly, winglet
- Insecta – Lepidoptera: *Papilio paris*, part of wing; *Sphinx convolvuli* (Unicorn Hawk) larva spiracles; Moth foot
- Orthoptera – Achetidae: *Acheta domestica*, tongue
- Parts of Vertebrata – Skin: Human Skin
- Animal Tissues – Muscular Fibre: Muscle from Gizzard of Fowl

Though there are records of Edwin Smiths' all over the UK I could find only a single record of one in Stone, Staffordshire in 1871. This was a Miller by occupation, of Mill Lane, Stone in business with his father and brother. He was born *circa* 1846 in Stone, Staffordshire so would have been about 27 or 28 years old by the time of the production of the montage. In the 1872 Post Office Directory of Stone: John and Edwin Smith, Millers, Stone Mills. This Edwin Smith died on 20th October 1876, age 29. His Probate record states that he had under £2,000 of effects.

See Richard Smith No.1. as this individual appears to be his brother!

The records below, I believe, are not related to the above Edwin Smith.

The Monthly Microscopical Journal (RMS 1873) – Mr. Edwin Smith describes a new sub-stage for the microscope, and certain appliances for illumination. (Edwin Smith, M.A., Nottingham). Also appears in the Midland Naturalist (Vol.I. 1878) viz: On Freshwater Life, I. Entomostraca, 16-17, 33-37; II. Rotifera, 94-96 125-128; III. Infusoria, 289-292, 320-323. Nature (1873), however, has advertisements from Messrs. Edwin Smith and Co., who appear to be a London based company.

Also SG Vol.23. May 1887: For exchange, "Quekett Club Journal," vols. IV., V., VI. Wanted, Bell's edition of White's "Selborne," or offers. - E. Smith, Hale End, Chingford.

Also: 1882 International Scientists' Directory – Edwin Smith, M.A., Forest Road, W. Nottingham and recorded as a Principal Contributor to Vol.1. 1878 The Midland Naturalist. Was a Member and Vice-President of the Nottingham Literary and Philosophical Society 1878. This Edwin Smith was recorded as the President of the Natural Science Section of the Nottingham Literary and Philosophical Society.

- Freshwater Life. – 1. Entomostraca. The Midland Naturalist Vol.1. pp.16-17, pp.33-37, 1878
- Freshwater Life. – 2. Rotifera. The Midland Naturalist Vol.1. pp.94-96, pp.125-128, 1878
- Freshwater Life. – 3. Infusoria. The Midland Naturalist Vol.1. pp.289-292, pp.320-323, 1878

References:

Varnish for "Ringling" Slides. JPMS Vol.4. pg.122. 1885 (he doesn't, however, appear in the 1885/6 Members List)

Also an Edwin Smith in the 1858 List of British Entomologists at 3 Jersey Cottages, Hewlett Street, Cheltenham whose interest was British Lepidoptera.

50. Andrew Wilson SSC (Born: 18th October 1833 Edinburgh; Died: ?)

Note: SSC = Society of Solicitors in the Supreme Courts of Scotland



Known Addresses:

- 17 Union Place, Edinburgh (1861)
- 56 George Square (1864,1865,1867,1868)
- 21 Dick Place (1865)
- Vernenna Cottage, Sciennes Hill (1866)
- 5 Arniston Place (1867-1869)
- 4 York Place (1869,1871)
- Mary Ville, Ferry Road (1871-1876)
- York Place, Edinburgh (1875)
- Redbraes Cottage, Broughton Road (1877-1880)
- 5 London Street (1880-1885)
- 30 St. Andrew Square (1884)
- 2 Albert Terrace, Trinity

Objects circulated to June 1877:

- Diatomaceae: *Campylodiscus undulatus*
- Fossil Woods & Coal: Objects from Coal Ash
- Minerals & Geology (Crystals, Vegetable Products): Rolling Stones
- Echinodermata: *Chrisodota(?) violacea*, dermal plates
- Annelida: Leech, *Hirudo medicinalis*, jaws & teeth
- Insecta – Heteroptera: *Corixa Geoffroy*

- Sedis Indeterminatae: Beetle cornea for multiple images

References:

Acts of the General Assembly of the Church of Scotland 1638-1842: Member of the Church Law Society – Andrew Wilson, S.S.C., Leith (1843)
 The Post Office Annual Directory 1844: Wilson, Andrew, S.S.C., 8 Smith's Place, Leith
 Post Office Edinburgh and Leith Directory 1849-50: Wilson, Andrew S.S.C., 21 Bernard Street
 Post Office Edinburgh and Leith Directory 1850-51: Wilson, Andrew S.S.C., 21 Bernard Street
 Post Office Edinburgh and Leith Directory 1854-55: Wilson, Andrew, S.S.C., 21 Bernard Street – house, 8 Smith's Place
Note : The above five entries must refer to a different Andrew Wilson as he would have only been 21 by 1854.
 Oliver and Boyd's New Edinburgh Almanac 1857: Secretary of Leith Public Library – Andrew Wilson SSC
 Post Office Edinburgh and Leith Directory 1864-65: (Solicitors) Leburn, Henderson and Wilson, 56 George Square
 Post Office Edinburgh and Leith Directory 1865-66: Wilson, Andrew, S.S.C. (Leburn, Henderson and Wilson), 21 Dick Place
 Post Office Edinburgh and Leith Directory 1865-66: (Solicitors) Leburn, Henderson and Wilson, 56 George Square
 Register of Voters for the City of Edinburgh and the Burgh of Leith 1865-6: Andrew Wilson, Solicitor, Supreme Courts, 21 Dick Place
 Register of Voters for the City of Edinburgh and the Burgh of Leith 1866-7: Andrew Wilson, Solicitor, Supreme Courts, Verbena Cottage, Sciennes Hill
 Register of Voters for the City of Edinburgh and the Burgh of Leith 1867-1869: Andrew Wilson, Solicitor, Supreme Courts, 5 Arniston Place
 Oliver and Boyd's New Edinburgh Almanac 1868: Certificated Writers to the Signet: Wilson, Andrew S.S.C. (Messrs. Leburn, Henderson & Wilson), 56 George Square
 The New Edinburgh, Leith, and county household directory 1867,1868: Solicitors before the Supreme Courts: Leburn, Henderson and Wilson, 56 George Square
 The new Edinburgh, Keith and County business directory 1869: Leburn, Henderson and Wilson, S.S.C., 4 York Place
 Register of Voters for the City of Edinburgh and the Burgh of Leith 1871-1876: Andrew Wilson, Solicitor, Supreme Courts, Mary Ville, Ferry Road
 Oliver and Boyd's New Edinburgh Almanac 1871: Certificated Writers to the Signet: Wilson, Andrew S.S.C. (Messrs. Leburn, Henderson & Wilson), 4 York Place
 The Post Office Edinburgh & Leith Directory 1873-75: Messrs. Leburn, Henderson & Wilson S.S.C., 4 York Place
 The Post Office Edinburgh & Leith Directory 1875-76: Wilson, Andrew, S.S.C. and N.P. (Messrs. Leburn, Henderson, & Wilson), Maryville, Ferry Road
 Register of Voters for the City of Edinburgh and the Burgh of Leith 1877-1880: Andrew Wilson, Solicitor, Supreme Courts, Redbraes Cottage, Broughton Road
 List of the Fellows of the Society of Antiquaries of Scotland 1879: Wilson, Andrew, S.S.C., Redbraes, Broughton Road (Elected 1871)
 Register of Voters for the City of Edinburgh and the Burgh of Leith 1880-1885: Andrew Wilson, Solicitor, Supreme Courts, 5 London Street
 Oliver and Boyd's New Edinburgh Almanac 1884: Official List of the Certified Writers to the Signet - Wilson, Andrew, S.S.C., 30 St. Andrew Square
 Register of Voters for the City of Edinburgh and the Burgh of Leith 1886-1891: Andrew Wilson, Solicitor, Supreme Courts, 2 Albert Terrace, Trinity

b. 18th October 1833 (parents – Andrew Wilson and Janet Wilson (nee Mcintosh))
 bp. St. Cuthberts, Edinburgh

possibly in the 1841 Census, age 30+, a solicitor of Golf House, South Leith

In the 1861 Census @ 17 Union Place, Edinburgh:

Andrew Wilson (father), age 53, a retired Clothier, b. Edinburgh
 Janet Wilson (mother), aged 50, b. Edinburgh
 Andrew Wilson, age 27, a Managing Law Clerk Supreme Court, b. Edinburgh
 Ann Wilson (sister), age 24, b. Edinburgh
 Alexr. M. Wilson (brother), aged 22, a Writers Signet Clerk, b. Edinburgh

In the 1881 Census : 5 London Street, Edinburgh:

Andrew Wilson, age 47, a Solicitor in the Supreme Courts, b. Edinburgh, Midlothian
 Mary Wilson (wife), age 46, b. Aberdeen, Aberdeenshire
 Andrew A. M. Wilson, age 15, a Scholar, b. Edinburgh, Midlothian (Andrew Alexander Matthew)
 Eva M. St.M. Wilson, age 9, a Scholar, b. Edinburgh, Midlothian (Eva Mary St.Michael b. 29th September 1871)
 Alexander M. Wilson, age 6, a Scholar, b. Edinburgh, Midlothian

In the 1891 Census @ 2 Albert Terrace, Leith:

Andrew Wilson, age 57, a Solicitor, b. Edinburgh
 Mary Wilson, aged 56, b. Aberdeen
 Andrew A. M. Wilson, aged 25, a Student of Music, b. Edinburgh
 Eva Mary Wilson, age 19, b. Edinburgh
 Alex M. Wilson, age 16, a Shipping Agents Apprentice, b. Edinburgh



51. Thomas Edward Mason M.D. (Born: November 1841 Deal, Kent; Died: 7th June 1888 Deal, Kent)



Known Addresses:

- 116 Beach Street, Deal, Kent (1871-1888)
- 116 Esplanade, Deal (1873,1874)

Occupations:

General Practitioner, M.R.C.S., L.S.A. (1871); Medical Officer for the Borough and Port of Deal (1873); Admiralty Surgeon and Agent for Deal (1875); Medical Practitioner (1881)

References:

- SG Vol.9. August 1873 : Eupodiscus Argus. - Well-mounted slides for other Diatoms mounted and named. Send slide and stamped address to M. D., 116, Esplanade, Deal.
- SG Vol.10. June 1874 : Well-mounted Diatoms for other equally well-mounted' Slides - entomological preferred. Lists exchanged. - M. D., The Esplanade, Deal.
- SG Vol.10. September 1874 : *Epithemia Hyndmanii*, *E. Zebra*, *E. Argus*, *Hydrosseira triquetra*, *Triceratium favus*, for well-mounted Slides of other Diatoms named. - Send list to M. D., The Esplanade, Deal.
- SG Vol.11. August 1875 : Foraminifera from chalk, well-mounted in balsam, for any other good Slide, mounted. No seeds or crystals. Many others to exchange. - M. D., 116, Esplanade, Deal.
- SG Vol.12. July 1876 : Wanted, Fossil Bones and Teeth, or portions of the same, for section-cutting. Offer in exchange well-mounted Microscopic Slides. - M. D., 116, Esplanade, Deal.

Objects circulated to June 1877:

- Diatomaceae: *Orthoseira spinosa*
- Sounding – Foraminifera: Dredgings
- Mollusca: *Cyclostoma elegans*
- Insecta – Anoplura: Parasite of Wood Pigeon, *Lipococcus baculus*, male
- Insecta – Bombylidae: *Bombylius medius*
- Insecta – Heteroptera: *Stenocephalus agilis*
- Insecta – Homoptera: Cicada from East Indies, head; *Apis* from *Arenaria*
- Insecta – Lepidoptera: *Mainestra Pisi* (Broom Moth), larval skin
- Hymenoptera – Uroceridae: *Urocerus gigas*, ovipositor
- Hymenoptera – Cynipidae: *Cynips linguicola*(?), ovipositor
- Hymenoptera – Apidae: *Apis mellifera*, Honeybee, head
- Coleoptera – Dyticidae: *Dytiscus marginalis*, spiracles
- Ixodea: *Ixodes ricinus* Ferret

Thomas Edward Mason was baptised on the 30th November 1841 in Deal, Kent. Medical education at Guy's Hospital. Graduated St. Andrews University in 1862. Admitted a Licentiate of the Society of Apothecaries 30th April 1863 and in the same year Member of the Royal College of Surgeons. He was initiated into The Wellington Lodge, Deal on 26th May 1863. He was at one time Captain of the Deal company of Artillery Volunteers and latterly Surgeon to the same. In 1867, following a fire at Walmer Castle, he instigated the formation of a Volunteer Fire Brigade unit, of which he was elected Superintendent. Married one Caroline Slater on 22nd January 1871. The same year saw the birth of their first child Maud and was followed by Mary (1873), George (1875), Edward (1876) and Alfred (1877). On his death, from Heart Disease, he left Estate valued at £3,536 13s 4d. An Obituary was printed in the British Medical Journal of 30th June 1888 (pg.146).

52. Rev. Charles Higman Griffith (Born: 14th April 1829 Tottenham (Bune Castle?), Middlesex; Died: 1st April 1896 Stratfield Turgis, Hampshire)



Known Addresses:

- St. John's Square, St. James Clerkenwell, Middlesex (1841-1851)
- Wrotham, Kent (1853-1857)
- The Rectory, Stratfield Turgis, Winchfield, Hampshire (1857-1875)
- St. Swithin Street, Winchester, Hampshire (1873,1874)
- Stratfield Turgis Rectory, Hampshire (1874-1891)
- Stratfield Turgis, Winchfield (1895)

Occupations:

Crockford's Clerical Directory 1868,1874 and 1885 provide a resume of his career: Griffith, Charles Higman, Stratfield Turgis, Winchfield, Hants. – Literate; Deac. 1852 and Pr. 1853 by Bp of Win. R. of Stratfield Turgis, Dio. Win. 1862. (Patron Duke of Wellington; R.'s Inc. £500 and Ho; Pop. 195) Formerly C. of St. George's, Wrotham, Kent, 1853-57, Stratfield Turgis

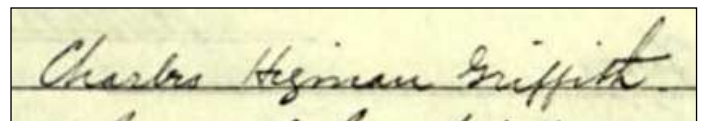

1858-62.
Mentor in Classics (1851)

References:

- SG Vol.9. April 1873 : *Helix obvoluta* for *Dreissena polymorpha*, *Vitrina pellucida*, or *Planorbis lineatus*. - C. Griffith, St. Swithin Street, Winchester.

- SG Vol.10. November 1874 : Fossils from the Chalk and Red Crag for Wenlock Limestone, Mountain Limestone, or Carboniferous Fossils. - C. Griffith, St. Swithin Street, Winchester.
- SG Vol.23. November 1887 : Specimens of *Isnardia palustris*, collected by Borrer. Wanted, L. C, 8th ed., 24, 1493, 1503, 1580, 1651, 1703, 1827. Wanted, a good mount of *Cocidomyia destructor*; good exchange. - Rev. C. H. Griffith, Stratfield Turgiss, Winchfield, Hants.
- Author "A History of Strathfield Saye" 1892.

Objects circulated to June 1877:

- Minerals & Geology (Crystals): Magnesium Platino-Cyanide
- Wood Sections: *Rosa canina*
- Leaves: Rhododendron
- Echinodermata: *Chrisodota(?) violacea*, dermal plates
- Mollusca: Whelk, tongue
- Parts of Vertebrata – Scales: Sole
- Parts of Vertebrata – Kidney: Human Kidney

He was a Day Pupil of Charterhouse March 1839–November 1847. He married Hannah Mockridge 27th September 1853 at the Parish Church, Bradford, Somerset, by Licence, and soon began filling the Rectory with his children – William Charles Easton (1854), Edith Mary (1856), Gertrude (1857), Catherine Alice (1859) and Llewlyn Griffydh (1861). He held the living at Stratfield Turgis (gross value on 1889 £500) from 1862.

"The Rev. Charles Higman Griffith was rector of the parish for nearly his whole working life, which spanned most of the 2nd half of the 19th century. He cluttered the rectory gardens with all sorts of weird and wonderful scientific instruments. His most important work was carried out between 1868 and 1870 to determine how best to measure air temperature. During the first half of the 19th century weather observers devised a wide variety of shelters to keep both direct and indirect solar radiation from their thermometers. Following a grant of £45 from the Royal Society, nine different thermometer shelters were erected in the meadow south of the rectory, and for 18 months Griffith recorded thermometer readings 3 times a day. The results were analysed in 1871 and the consensus among the great meteorological minds was that the beehive on stilts was the best. The Stevenson Screen thus became the standard thermometer shelter - and so it remains in most countries."

On 15th January 1879 he was elected to the Committee of the Meteorological Society and in the same year was responsible for the Entomological Report to that body. A letter by him appeared in the Reading Mercury in July 1880 relating the life-cycle of the Gooseberry Caterpillar. On the death of the Duke of Wellington in 1884 the Rev. C. H. Griffith was one of those preceding his coffin into the church, read the committal and pronounced the blessing at the end of the interment. When the Rev. Charles Higman Griffith died his estate was valued at £848 1s. 1d.

53. Joseph Edmund Simmonds* (Born: circa 1847 Chelsea, Middlesex; Died: 1st October 1916 West Derby, Lancashire)

Known Addresses:

- 3 Chapel Place, Chelsea, London (1871–1881)
- 2 Chapel Place, Park Walk, Chelsea (1872)
- 32 Cornwall St., Moore Park Road, Fulham, S.W. (1873, 1874 QMC Members List – Elected 27th June 1873)
- 13 Ann's Terrace, near Walham Green, S.W. (1875–1880 QMC Members List & 1887)
- Royal Exotic Nursery, King's Road, Chelsea, S.W. (1881–1888 QMC Members List)
- 2 Elthron Road, Fulham, London (1888–1891)
- 95 Alderson Road, Wavertree, Liverpool, Lancashire (1911)

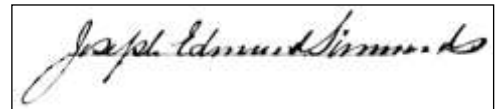

Occupations:

Book keeper (1871); Cashier (1872); Clerk [Horticultural] (1881); Cashier (1888, 1891); Accountant (1901); Book keeper to Horticultural Printers (1911)

References:

- SG Vol.9. January 1873 : Leaves of *Deutzia scabra* and *Aralia papyrifera* (Rice paper plant) showing stellate hairs, in exchange for any mounted object. - J. R.(sic) Simmonds, 32, Cornwall Street, Moore Park Road, Fulham, S.W
- At the QMC Special Exhibition Meeting 29th April 1881 Mr. J. E. Simmonds exhibited *Hydra vulgaris*.

Objects circulated to June 1877:

- Minerals & Geology (Metals and their ores): Silver Nat.
- Ferns: *Polypodium aureum*
- Wood Sections: Screw Pine
- Zoophyta – Corallia: *Sertularia argentea*
- Annelida: Aphrodite hystria(?)
- Mollusca: *Trochus crassus* tongue
- Insecta – Diptera: Sheep tick (ked)
- Insecta – Tabanidae: *Chrysops caecutiens*, head
- Insecta – Tipulides: Crane Fly
- Insecta – Lepidoptera: Butterfly wing

He married Selina Rickets 2nd September 1872 at St. Luke, Chelsea, after Banns, and fathered the following child with her – Joseph William (1879). His wife died in 1886 at the early age of 39. His son had died 4 years previously. He remarried in 1888 to Caroline Mellard, a widow. She bore him a son – Ernest in 1890 (d.1910). Joseph Edmund Simmonds was buried in Allerton Cemetery, Allerton, Liverpool.

54. William Ostler Nicholson (Born: 1846 Broughton, Lincolnshire; Died: March 1924 London)



Known Addresses:

- Nicholsons Yard, Brigg, Lincolnshire (1861)
- 11 Market Place, Glanford Brigg, Lincolnshire (1871-1881)
- Brigg, Lincolnshire (1872, 1874, 1876)
- 12 Granville Square, Clerkenwell (1884, Electoral Registers 1885-1889 [Two rooms on ground floor, furnished])
- 22 Amwell Street, Amwell, Clerkenwell, London (1891)
- 13 Granville Square, London, W.C. (Register of Chemists and Druggists 1885, 1898, 1899)
- 1 Highbury Mansions, Upper Street, Islington, London (Street Directory 1900, Census 1901 and Electoral Register, 1902)
- "Newbury", Telford Avenue, Wandsworth (Electoral Register 1903)
- 144 Telford Avenue, Wandsworth (Electoral Registers 1905-1907)
- 72 Sistova Road, Balham, S.W., London (1911)
- 43A Midmoor Road, Clapham (Electoral Register 1913)
- 58 Bedford Hill, Balham, London, S.W.12. (Register of Chemists and Druggists 1919, Electoral Registers 1921-1923)

Occupations:

Student (1861); Chemist and Druggist (1871, 1885, 1898, 1899, 1919); Chemist, Druggist and Wine Merchant (1881); Secretary (1889); Secretary and Assistant Manager of Printing and Publishing Company (1891); Type-setting Machinist (1901); Photographic Paper Maker (1911)

References:

- SG Vol.8. August 1872 :Mounted objects including rare *Acarus (Actysia Dytics)* various parasites, and other objects of interest. - Send list W. O. Nicholson, Brigg.
- *Aclisia Dytisci*. JPMS Vol.4. pg.258. (1 plate) 1885
- Articles in The Transactions and Proceedings of the Chemical Society (Authors Henry Saunders Carpenter and William Ostler Nicholson):
 - Estimation of Hydrogen Peroxide, 1885, Abstract, 430 (originally Analyst 9, pp.94-96).
 - Examination of water for organisms, 1885, Abstract. pp.442-443 (originally Analyst, 9, pp.36-41). Also appears in Journal of the Royal Microscopical Society Ser.II, Vol.V. Part 3. June 1885, pp.560-561
- The Chemical News Vol.52. No.1357. 27th November 1885 Front page: Quantity of Chemical Apparatus of general utility, including about 4½ oz. Platinum Vessels, Balance by Wolters, two microscopes, Spectroscope by Browning, Induction coil, - all in perfect condition. Whole or part to be Sold cheap. – Can be seen by appointment, or particulars obtained from W. O. Nicholson, 12 Granville Square, W.C.
- The Journal of Gas Lighting, Water Supply, & Sanitary Improvement, 15th December 1885 pg.1062. Correspondence – London Water Supply and Bacteria.
- Advertisement in The Chemist and Druggist November 1885 to February 1886:

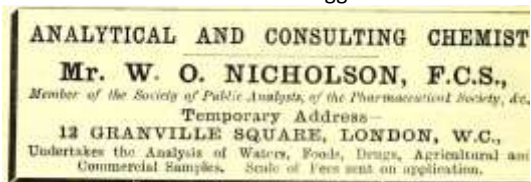

- Advertisement in The Chemist and Druggist 1st November 1919: Getleman, qualified, elderly; wide experience good-class,.... Dispensing and Counter; Manager or Assistant (married) undertake books; 3 years last; replaced by returned sold excellent references. Nicholson, 58 Bedford Hill, Balham, S.W.

Objects circulated to June 1877:

- Wood Sections: Walnut
- Insecta – Culicidae: Gnat
- Insecta – Heteroptera: *Notonecta glauca*, Water Boatman, head
- Coleoptera – Geotrupidae: *Geotrupes stercorarius* (Dor Beetle), mouth
- Hydrachnea: *Aclisia dytici*
- Gamasea: *Dermanyssus arium* from Canary, cast skin
- Hypopus: *Hypopus muscorum*
- Ixodes: *Ixodes* from Hare's neck; *Ixodes* from Lady's neck
- Araneae: *Epeira diadema*, Garden Spider, male
- Animal Tissues – Digestive Organs: Tongue of Cat

He was first registered as a Chemist and Druggist on 31st December 1868. Initiation into Freemasons, Ancholme Lodge 2nd March 1876. Listed as a member of the Society of Chemical Industry (1884, 1885, 1887). Was married to Jessie Curtis Kemp 24th June 1889 at St. Marks, Clerkenwell, after Banns. They had one child – Kathleen Gabrielle (1890). His name appeared in the list of people whose registration as a Chemist and Druggist was to be removed from the Register, published in the Pharmaceutical Journal 25th November 1899 and the Chemist and Druggist 2nd December 1899. He was, however, still recorded in the Register in 1919. He was buried 7th March 1924 Camden, London.



55. Charles John Jones (Born: 24th November 1820 London, Middlesex; Died: ?)



Known Addresses:

- HopPole Inn, Foregate Street, Chester, Cheshire (1861 – Visitor)
- Beauchamp Street (Post Office Directory 1865)
- 16 Beauchamp Street, Stockport, Cheshire (1871,1874,1881,1883)
- Gilmore Range, Shaw Heath, Stockport, Cheshire (1872-1876)
- 16 Gilmore Range, Shaw Heath, Stockport, Cheshire (1878)
- 18 Beauchamp Street, Stockport, Cheshire (Kelly's Directory 1892)

Occupations:

Solicitor's Clerk (1861); Solicitor's Managing Clerk (1871); Accountant (1881,1882,1892)

References:

- SG Vol.8. September 1872 : *Parmelia parietina*, on receipt of good unmounted object and stamped addressed envelope. - C. J. Jones, Gilmore Range, Shaw Heath, Stockport.
- SG Vol.12. April 1876 : Fruit of *Xenodochus carbonarius*, and Spores of *Puccinia graminis*, for well-mounted Entomological Slides or sections of Wood, &c - C. J. Jones, Gilmore Range, Shaw Heath, Stockport.

Objects circulated to June 1877:

- Confervaceae: *Ptilota elegans*
- Fungi: *Puccinia graminis* spores
- Wood Sections: Cedar – vertical section

- Hairs – vegetable: *Alyssum montanum*
- Fibres: China glass – stained
- Mollusca: Limpet (*Patella vulgata*) palate
- Insecta – Anoplura: Parasite of Wood Pigeon, *Lipeurus baculus*; Parasite of Stork, eggs in situ
- Insecta – Lepidoptera: Moth caterpillar
- Orthoptera – Blathidae: *Blatta germanica*, Cockroach, head
- Orthoptera – Achetidae: *Acheta domestica*, head with tongue
- Orthoptera – Euplexoptera: *Forficula auricularia* (Earwig)
- Coleoptera – Dyticidae: *Dytiscus marginalis*, spiracles
- Sedis Indeterminatae: Beetle, section of ear?
- Crustaceae – Decapoda – Macrourea: *Homarus vulgaris*, Lobster, skin hairs
- Ixodea: *Ixodes ricinus* Ferret
- Parts of Vertebrata – Skin: Webbed Skin from Duck's Foot
- Parts of Vertebrata – Feathers: Peacock

He was baptised at St. Dunstan in the East, London on 26th January 1826. His parents are listed as John Lee Jones (Solicitor) and Jane Sarah Jones, of 5 Mincing Lane. In the 1861 Census recorded as married, lodging (a visitor) at the Hopole Inn, Chester. He was born in London.

A wife – Louisa – is recorded in the 1871 Census, but no children are listed. He married Louisa Phillips 4th October 1870 Dilwyn, Herefordshire.

In the 1881 Census he is recorded as a Widower.

56. John Ford (Born: circa 1826 Derby, Derbyshire; Died: 30th May 1899 Kew, Surrey)



Known Addresses:

- 1 Bank Place, Preston (1851)
- 5 Red Lion Square, Stamford (1861-1871)
- Stamford (1872)
- Wolverhampton (1874)
- Wood View, Newbridge Crescent, Wolverhampton (1876, 1878)
- 1 Market Street, Wolverhampton (1878 Subscriber to Ray Society) (Offices of The Midland Counties Evening Express newspaper. – also branch addresses: 4 Bridge Street, Walsall and 6 Union Street, Dudley. Proprietors G. M. Martin and J. Ford.)
- The Uplands, Tettenhall, Wolverhampton (1880 & 1881-1884 PMS Members List, Subscriber to Ray Society)
- Clifton Road, Tettenhall, Staffordshire (1881)
- Chronicle Office, Wolverhampton (Birmingham Natural History and Microscopical Society 1881)
- 1 Cumberland Road, Kew, Surrey (1899)

Occupations:

Newspaper Proprietor (1851); Bookseller and Stationer employing 2 men and 3 boys (1861);

Bookseller and Printer employing 1 man, 4 boys and 1 female assistant (1871);

Newspaper Proprietor (1881); Private Secretary (1891)

References:

- SG February 1872: 'Well Mounted Slides of Entomological specimens, Leaf Fungi, &c., for other good microscopic objects. Lists exchanged. - J. Ford, Stamford.'
- SG August 1872: 'Well-mounted slides for the Microscope, comprising Cluster-



cups (*Aecidium epilobii*), polariscope objects, entomological preparations, &c., in exchange for other good specimens. Lists exchanged. - J. Ford, Hamford. (corrected in September to Stamford)

- SG September 1872: 'Hairs from seed-pod of *Leucodendron argentum* (Zanzibar), mounted for polariscope, Pollen of Mallow, Cluster-cups from Willow-herb, &c., for other well mounted objects.-J. Ford, Stamford.'
- SG October 1872: 'Spiracles of Privet Caterpillar, Larva of Cockchaffer and Blowfly, well mounted, for other good mounted objects. - J. Ford, Stamford.'
- SG May 1873: 'Scales of Fern, *Nothochlaena laevis* (a beautiful slide for the polariscope), for any other well-mounted object. - J. Ford, Stamford.'
- In SG January 1876 : 'Sections: Four well cut, unmounted sections (Orange, Lemon, Pepper, and Olive trees), for each good Slide of Insects, Diatoms, &c., for good unmounted Material. - H. L., Chronicle Office, Wolverhampton.'" - whilst this, on the face of it, doesn't appear to have anything to do with John Ford, it merits further investigation. Immediately below this is another entry 'Well Mounted Microscopic Slides, various, for others of good quality. Lists exchanged. - J. Ford, Newbridge Crescent, Wolverhampton.' - It is possible that the two entries were a means of getting round the three line restriction for adverts imposed by the publishers and that H. L. is in fact John Ford with his work address.
- SG July 1878 Exchange Colum: 'Beautiful opaque object (mounted), *Orbiculina*, from Bermuda, for other good Foraminifera or Diatoms. - J. Ford, Wood View, Newbridge Crescent, Wolverhampton.'
- SG August 1878: '*Orbiculina*, from Bermuda. A beautiful object, well mounted, in exchange for other good slides. - J. Ford, Wood-view, Newbridge Crescent, Wolverhampton.'
- SG September 1880: 'Foraminifera, marine algae, with diatoms in situ, characteristic animal and vegetable hairs, &c. (well-mounted), for other good slides or material. Lists exchanged. - J. Ford, The Uplands, Tettenhall, Wolverhampton.'
- SG October 1880 Microscopy Section: 'Finishing Slides. - Many suggestions have been made public from time to time with regard to methods of finishing microscopic slides. For example, a write in the recent number of the "American Monthly Microscopical Journal" advocates a very elaborate process, which includes the application of thick copal furniture varnish by means of a knife point and the turn-table. The slide, we are told, must then be laid aside for "at least a week", to harden, and then the superfluous varnish may be cleaned off the glass slip with cotton, stone and water - a very roundabout and troublesome process, to say the least of it. To save inexperienced hands from needless trials of patience, waste of time, and unsatisfactory results, I am induced (with the Editors permission) to state briefly what I have found in practice to be a very simple, easy, rapid, and thoroughly satisfactory method of finishing off balsam or dammar-mounted slides. The process is not by any means new, and I make no claim to originality in regard to it; but I have found it to work so admirably in a collection of several thousand specimens, that I feel sure young hands will be thankful for the information. Take some old canada balsam and dilute with benzole until it is thin enough to flow freely from a sable or camel-hair pencil (the former, of what is known as the "duck" size, is undoubtedly the better tool). Apply this with the turn-table in the usual way, so as to make a neat rind around and slightly projecting over the edge of the thin glass cover. Amongst the advantages of this process may be enumerated the following: 1. There is no risk of spoiling slides bu "running in", as too often happens with asphalte and some other coloured varnishes. 2. If the mounting of the preparation has been done with care, and there is not more than a slight exudation of balsam or dammar beyond the edge of the cover-glass, there need be no preliminary cleaning-off before "ringing" the slide - an important consideration in regard to the saving of time and trouble. 3. The ring of balsam dries quickly and sets hard. 4. No after-cleaning process, like that above alluded to, is required; the slide being ready for the cabinet within a few minutes. 5. The process will be found easy of accomplishment by the veriest tyro, and the result is neat and satisfactory. - J. Ford, Wolverhampton.'
- SG October 1881: 'Stained vegetable tissues, marine algae (foreign and British) with diatoms in situ, choice plant and animal hairs, foraminifera, &c., all well mounted, for other good slides. - J. Ford, Tettenhall, Wolverhampton.'
- The Northern Microscopist November 1881 -: 'Vegetable tissues stained, and foraminifera, all well mounted, for other good slides. J. Ford, Tettenhall, Wolverhampton.'
- JPMS Vol.1. pg.193. 1882: Dr. Hunt's American Cement for Ringing Slides.
- SG March 1882 in the Zoology section a reply to an enquiry 'How do Eels Breed?'
- SG September 1882 Geology Section: 'What is Jet? - A paragraph in the last number of Science Gossip, with respect to the origin of jet, set me looking through a variety of scientific works and periodicals, but with very little result. The subject does not seem to have received very much attention. In the volume of SG for 1871, I found the only article of any length relative to jet, which I have yet come across; but in this the writer speaks of it as a kind of resin, pitch, or gum, a description which does not at all commend itself to my mind. It appears to me that the brief notice given in a much older work, "The Penny Cyclopaedia", is more in accordance with fact. Therein I read: "Jet, a variety of coal, which occurs sometimes in elongated reniform masses, and sometimes in the form of branches, with a woody structure.". On the table before me I have a section of Jet, prepared by Mr. Wheeler; viewed under a low power of the microscope, its "woody structure" is unmistakable. - J. Ford, Wolverhampton.'

Objects circulated to June 1877:

- Equisetaceae: *Equisetum hyemale* cuticle
- Leaves: Beyrhamia?
- Cuticles: Wheat
- Seeds & Seed Vessels: Date stone section; Ivory nut
- Insecta – Diptera: Sheep tick (ked)
- Insecta – Tipulidae: Crane Fly, head
- Insecta – Heteroptera: *Tingis ciliata*
- Insecta – Lepidoptera: *Sphinx ligustri* (Privet Hawk) larva spiracles
- Hymenoptera – Tenthredinidae: Sawfly, ovipositor
- Neuroptera – Libellidae: Dragon fly, jaws
- Coleoptera – Dytiscidae: *Dytiscus marginalis*, gizzard
- Opiliones: Thalangium part (as spider peculiar leg)
- Parts of Vertebrata – Hairs: *Ornithorhynchus*
- Parts of Vertebrata – Bone: Vertebra, *Orthosaurus*
- Parts of Vertebrata – Tooth: *Chenoptychuis*(?) from Shale
- Parts of Vertebrata – Hoofs, Horns, &c.: Rhinoceros Horn

John Ford married Eliza Sarah Briggs, 4th February 1849 Saint Peter, Nottingham. They had the following children – William Henry (*circa* 1850), John James (*circa* 1853, would appear to have removed to Sydney, Australia where he died in 1886), Eliza Sarah (*circa* 1858), Alfred Henry (*circa* 1859), Caroline Sforza (*circa* 1864) and Edgar Harry (*circa* 1870). On his death his estate was valued at £4,957 19s. 10d.

57. James Everett (Born: *circa* 1849 Chelmsford, Essex; Died: 6th July 1920 West Kensington, Middlesex)



Known Addresses:

- Friends Meeting House, Mercers Road, Islington St. George, London (1871)
- 3 Gt. Tower St., London, E.C. [Office] (1874) - also address of The Tower Hill Microscopical Club
- 117 Walworth Road, Newington, London (1881)
- 45 Claremont Road, West Ham, Essex (1891)
- 170 Kennington Park Road, S.E., London (1911)
- 56 Charleville Road, West Kensington, Middlesex (1920)

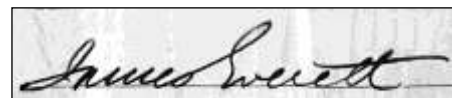

Occupations:

Clerk to Drysalers (1871); Grocer Master employing 2 men and 1 boy, also Traveller in Tea Trade (1881); Commercial Traveller (1891); Wholesale Grocer (1911)

Objects circulated to June 1877:

- Confervaceae: *Hydrodictyon utriculatum*
- Ferns: *Platyserium alcicorne*; Exotic Fern
- Hairs – Vegetable: Yellow Lily section showing internal hairs sub. nom. raphides in Yellow Lily
- Starches: Arrowroot
- Fossil Foraminifera: Fossil
- Insecta – Diptera: *Melophagus ovinus* (Sheep Ked)
- Insecta – Culicidae: Mosquito
- Insecta – Lepidoptera: *Cypris morpho*, wing; *Unrania celyes* wing
- Hymenoptera – Apidae: *Bombus terrestris* (Humble Bee), tongue
- Coleoptera – Dyticidae: *Dytiscus marginalis*, male leg
- Sedis Indeterminatae: Beetle from New Granada, leg
- Araneae: Spider, *Epeira calophida*(?), male, side view
- Parts of Vertebrata – Skin: Jaw of Sae Fish

In The Monthly Microscopical Journal: Transactions of the Royal Microscopical Society 1st April 1874 (page 192): " Tower Hill Microscopical Club. This Society was formed about a year ago in connection with the establishment of Messrs. Harrison and Crossfield, of Great Tower Street, City, and is the first one in conjunction with the tea trade."

In light of the above it would appear that 3 Great Tower Street was the address of James Everett's employer – Messrs. Harrisons and Crosfield associated with the Tea trade.

At the QMC Annual Soiree of 16th April 1875 Mr. J. Everett exhibited "Moller's Diatom Type Slide, &c."

According to records he married Ann Davidson in June 1875 (she was later recorded as Fanny in the Census records). They had the following children: Percy James (1876), Ethel Fanny (1877), Albert George (1879) and Arthur Bennett (1881). At his death his estate was valued at £311.

58. Tuffen West^s, F.L.S., F.R.M.S. etc. (Born: 15th August 1823 Brighouse, Yorkshire; Died: 19th March 1891 Frensham, Surrey)

Known Addresses:

- High Street, Gateshead, Durham (1841)
- 8 Hemblington Cottages, Queen's Road, Dalston (1853)
- 8 Hemblington Cottages, Haggerstone West, Shoreditch, Middlesex (1861), Elected a Fellow of the Linnean Society 19th January 1860
- The Retreat, Gate Fulford, Yorkshire (1871 – Patient) **Note:** In 1870-72, John Marius Wilson's Imperial Gazetteer of England and Wales description of Fulford included – " The York cemetery, the York cavalry barracks, and the Quakers' lunatic asylum, called the Retreat, are here.". Presumably West at this point had suffered a mental breakdown, perhaps due to overwork or the death of his brother William West, a Lithographic Artist (d. 27th May 1870 at Bethlehem Royal Hospital, Lambeth Road, Surrey) with whom he was also closely associated with his work.
- Frensham, Farnham, Surrey (1874-1882, RMS Fellow 1879 [Elected FRMS 13th October 1852], PMS President 1875-1878)
- Furnell House, Shortfield Common, Frensham, Surrey (1881-1891), Hon. Mem. Liverpool Microscopical Society 1887-1891. **Note:** *The Times Friday, May 03, 1907* ran the following advertisement – "TO BE SOLD, FURNELL HOUSE (for many years the residence of the late Tuffen West, Esq.), Frensham, three miles from Farnham, containing two reception rooms, eight bed rooms, bath room, and the usual domestic offices; pleasure grounds and gardens about 1a. 3r., and two cottages. Freehold. Immediate possession.- NASH and SONS, Auctioneers, Farnham.



Occupations:

Surgeon's Apprentice (1841); Engraver and Draftman [*sic*] (1861); Microscopic Artist (1871); retired Microscopic Artist (1881)

References:

- Microscopical Illustrations in Vine Disease by Quarles Harris (2nd 1853)
- On the Structure of *Rhabdonema* and other Diatomaceae with compound frustules. Transactions of the Microscopical Society of London Vol.VI (New Series) 1858 pp.186-188
- A Synopsis of the British Diatomaceae with Remarks on their Structure, Functions and Distribution', by William Smith F.L.S. with 'The Plates by Tuffen West', Member of the Microscopical Society of London

- On some Points in the Minute Structure of Flowers, and Hairs Attached to them. The British Association Meeting (1858)
- On the Epidermal Cells of the Petals of Plants (1858)
- Half Hours with the Microscope by Edwin Lankester. Illustrated from Nature by Tuffen West (1859)
- How to Gather Diatoms. Recreative Science No.1. 1859
- The foot of the fly, its structure and action: Elucidated by comparison with the feet of other insects, &c. London: R. Taylor. (1860)
- The Common Objects of the Microscope by Rev. J. G. Wood. With 400 Illustrations by Tuffen West (1861)
- On some Points of Interest in the Structure and Habits of Spiders. British Association for the Advancement of Science (11th September 1861)
- The Crown Animacule by Philip Henry Gosse, F.R.S., with illustrations by the Author, engraved by Tuffen West, F.L.S. (1861)
- The Lowest Forms of Life by the Editor of The Popular Science Review with Illustrations by the Author and Dr. J. B. Hicks, F.L.S., engraved by G. H. Ford and Tuffen West F.L.S. (1861)
- On Disease of the Kidney and Dropsy by S. J. Goodfellow, M.D., F.R.C.P., Physician to the Middlesex Hospital and Joint Lecturer on Medicine at the Middlesex Hospital Medical College, with Illustrations from Nature by Tuffen West. (1862)
- Routledge's Illustrated Natural History by the Rev. J. G. Wood, M.A., F.L.S. With illustrations by Wolf, Zwecker, Weir, Coleman, Wood, Harvey, Sowerby, and Tuffen West. (1863)
- The *Volvox Globator*, by J. Braxton Hicks, M.D., F.R.S., and the Amoeba, its Development, Structure and Habits by Prof. Williamson, F.R.D. Both articles illustrated by Tuffen West. Popular Science Review (April 1866)
- *Hydrae* by Rev. W. Houghton, M.A., F.L.S. Plates by Tuffen West. Popular Sciecn Review (July 1866)
- The Microscope: its History, Construction, and Application. by Jabez Hogg, F.L.S., F.R.M.S. with upward of 500 illustrations by Tuffen West (1867, 10th Ed. 1882)
- An Hour at the Microscope. JPMS Vol.1. pp.34-39 (2 plates),90-94 (1 plate),145-149 (3 plates) 1882.
- JPMS Vol.1. pp.187-188. 1882: Birds'-Head Processes in Gemellaria.
- Half an Hour at the Microscope. JPMS Vol.2. pp.41-48 (5 plates), 109-115 (5 plates), 231-237 (2 plates) 1883; Vol.3. pp.32-42 (2 plates), pp.113-118 (1 plate), pp.247-252 (1 plate). 1884; Vol.4. pp.34-40 (6 plates). pp.114-119 (2 plates), pp.252-257 (4 plates) 1885; Vol.5. pp.43-48 (3 plates), pp.113-115 (1 plate), pp.239-240 (1 plate) 1886; Vol.6. pp.49-53 (3 plates), pp.111-113, pp.179-186 (3 plates) 1887; Vol.7. pp.47-50 (3 plates), pp.180-183 (3 plates), pp.255-259 (2 plates) 1888; Vol.8. pp.120-123 (1 plate), pp.188-189 (1 plate), pp.250-251 (1 plate) 1889; Vol.9. pp.56-60 (3plates), pp.137-141 1890; Vol.10. pp.21-25 (1 plate), pp.87-90 (1 plate) 1891
- Palate of Whelk. JPMS Vol.2. pg.251. 1883
- Hantsch's Fluid. JPMS Vol.4. pp.41-42. 1885
- Ferret-Tick. JPMS Vol.4. pg.263 (1 plate). 1885
- Markings on Diatoms, Spines and Bones of *Ophiocoma rosula*, Sections of *Alcyonium digitatum* and Very Young Fish, just hatched. JPMS Vol.10. pp.350-351. 1891

Objects circulated to June 1877:

- Fungi: *Aecidium Periclimeni*
- Seeds & Seed Vessels: *Hellaria aquatica*
- Zoophyta – Corallia: *Alcyonium digitatum* longitudinal section
- Echinodermata: *Ophiocoma rosula*, as in life
- Insecta – Anoplura: *Haematopinus eurysternus* from Ox; *Haematopinus* from Hog; Parasite of Fowl, eggs; *Lipeurus variabilis*
- Neuroptera – Ephemeraidae: *Ephemera* sp., cast skin
- Neuroptera – Hemeroibiidae: Lace Wing Fly, larva
- Gamasea: *Dermanyssus arium* from Linnet
- Ixodea: *Ixodes* from Tortoise
- Trombidina: *Cheyletus eruditus*
- Araneae: *Thomisus (Xysticus) cristatus* spider, cast skin

Quaker Birth record for Tuffen West (Quarterly Meeting of Yorkshire Entry 271 & Monthly Meeting of Brighouse Entry 647:

"On the fifteenth Day of the eighth Month One Thousand Eight Hundred and twenty three was born at Leeds in the Parish of Leeds in the county of York, unto William West of Leeds, Druggist, and Jane, his wife, a son who was named Tuffen."

Married Mary Hannah Daviss in 1854. They had children as follows: Samuel Tuffen (1855-1855) and Frederick Tuffen (1856-1875). On the demise of wife Mary in 1860 he later remarried one Emma Margaret Newland (they had no children). When he died in 1891 his probate record states an estate of value £5,440 1s. 5d. He was buried 24th March 1891 at Frensham St. Mary the Virgin.



Tuffen West Grave, St. Mary the Virgin, Frensham

A very comprehensive Obituary Notice is printed in The Journal of Microscopy and Natural Science of the Postal Microscopical Society, Volume 10 pp.154-155 (1891) and a shorter one in The Journal of Botany July 1891. Also an obituary appeared in the Journal of the Royal Microscopical Society and was reprinted in JPMS Vol.10. pp.334-338 (1891).

The following appeared in 'The Microscope', Vol. XI (1891) An Illustrated Monthly Magazine for the Student of Nature's Little Things:

Mr. Tuffen West (1823 - 1891), the microscopical draughtsman, died in England, recently at the age of sixty-eight. He was unrivaled as a draughtsman and an illustrator, and his love for his subject supplied him with never-failing energy. It was not, however, solely for his artistic ability that his collaboration was eagerly sought by authors, for it was well known that he was both able and willing to help in the most varied directions of scientific and pathological research. Work by others, which had passed through his hands, not only obtained very considerable security against error, but not infrequently received important additions and elucidations. His good nature in these matters was occasionally somewhat imposed upon, and papers and books were published which really owed quite as much to the man whose name appeared only as illustrator as they did to him who assumed the role of author. In a general way, he rendered these services with pleasure and because he delighted in his work, but there were instances of this kind of partnership which he felt to be unfair, and concerning which he would remark, with a smile, "My poverty, not my will, consents. Nothing that he undertook was ever scamped. Thus it follows that few original papers are to be credited to his pen. His work stands chiefly in other men's names. A paper on the mechanism of the feet of insects was of his own contribution to science, the one in which he took most pride. Four years of his life were devoted to the illustrations of Blackwell's volumes on English spiders and five to those of Smith on Diatomaceae."

59. Thomas Ball (Born: *circa* 1832 Long Sutton, Lincolnshire; Died: ?)



- Acarina: *Dermaleichus*, Greenfinch
- Hydrachnea: *Achlysia dytici*
- Gamasea: *Dermanyssus avium*
- Trombidina: *Trombidium phalangii*, from Harvest man

Known Addresses:

- Market Place, Brigg, Lincolnshire (1861)
- Brigg (1867-1874)
- South side of Market Place, Glanford Brigg, Lincolnshire (1871)

Occupations:

Druggist [employing 2 apprentices] (1861, 1871)

References:

- SG Vol.3. - November 1867 : Good British Land Shells for *Limnoea glutinosa*, *Unio margartiferus*, &c - Thos. Ball, Brigg, Lincolnshire.
- SG Vol.5. - July 1869 : Foreign Land Shells offered for British Land and Marine Shell- Thomas Ball, Brigg, Lincolnshire.
- Palpi of Trombidium. JPMS Vol.10. pg.289. 1891

Objects circulated to June 1877:

- Mollusca: *Limax maximus*; *Onchidoris bilamellata*
- Insecta – Culicidae: *Culex canlans*, head
- Insecta – Aphaniptera: Flea, gizzard
- Hymenoptera – Apidae: *Apis mellifera* (Honey Bee) sting and poison bag
- Coleoptera – Dyticidae: *Dytiscus marginalis*, gizzard



It would appear from the records that there was a birth out of wedlock viz. William Goodwin Ball (1867) Note: Goodwin was Thomas' mother's maiden name. The child appears in the 1871 Census with Thomas and his new wife Eliza Matilda Lloyd whom he married in 1870. The Ball family emigrated to New Zealand arriving 4th August 1878 aboard the "Mary Fisher" embarking at London. The Second cabin contained - Mr Thomas Ball, Mrs Eliza Ball, Wm. Goodwin Ball (1867), Catherine Ann Ball (1868), Eliza Lucy Ball (1871), Thomasina Ball (1872), Ethel Ball (1873), Mary Una Ball (1875), Ellinor [Eleanor] Ball (1876), Winifred Ball (1877), Mrs Catherine Ball, senr. (his mother), There is one child missing from this list who presumably died in infancy – Alice Lydia Ball (1870). He was recorded in The Post Office Directory of Chemists and Druggists 1876 at Market Place, Brigg.

60. John Robert Burton, F.R.M.S. (Born: circa 1811 Hatfield Broad Oak, Essex; Died: 20th November 1878 Ingatestone, Essex)



Known Addresses:

- 182 Great Dover Street, St. Mary Newington, Lambeth (1851)
- 189 Great Dover St., Borough, S.E. (1869 - RMS Members List – Elected 9th October 1861)
- "Huskards", Ingatestone, Essex (1871-1878)
- Ingatestone, Essex (1874)
- Great Dover Street, Southwark (1875)

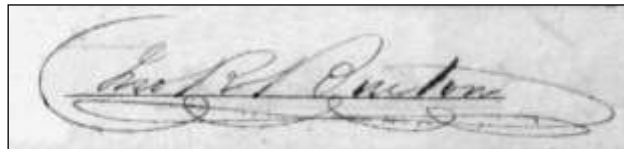

Occupations:

Compounder (1838); Wine Merchant (1851); Merchant (1871)

Objects circulated to June 1877:

- Minerals & Geology (Silicious): Jasper, Brecciated; Nephrite; Pitchstone
- Minerals & Geology (Crystals): Copper Sulp.
- Wood Sections: Common Rush
- Leaves: *Deutzia scabra*
- Cuticles: Geranium petal
- Hairs – Vegetable: *Eleaganus* leaf scales

- Infusoria: *Vaginicola valvata*
- Mollusca: Oyster embryos; *Arion ater* tongue; Whelk, tongue
- Insecta – Tipulidae: Crane Fly, head
- Insecta – Lepidoptera: Butterfly proboscis
- Hymenoptera – Tenthredinidae: Sawfly, saws
- Orthoptera – Achetidae: *Acheta domestica*, gizzard
- Coleoptera – Dytiscidae: *Dytiscus marginalis*, eye
- Pseudoscorpia: Chelifer
- Araneae: *Salticus scenicus* (Hunting Spider), eggs
- Parts of Vertebrata – Hoofs, Horns, &c.: Human Nail, section
- Parts of Vertebrata – Scales: Perch Scales
- Parts of Vertebrata – Feathers: Humming Bird

An advertisement in The Medical Directory for Ireland 1859, for the British Empire Mutual Life Assurance Company, 32 New Bridge Street, Blackfriars, London, records J. R. Burton Esq., 189 Great Dover Street, as one of their Directors. (Also listed in 1860.)

The 1851 Census includes his wife (Fanny, age 40). The 1871 Census includes his wife Frances (rather than Fanny), age 60, b. Selston, Notts.

A short obituary entry in the Journal of the Royal Microscopical Society Vol.II pg.333:

Mr. John Robert Burton (a successful merchant, an one of the founders of the "British Empire Life" and "Perpetual Building Society", on the management of which he continued to the last) died at his residence, Huskards, Ingatestone, on the 20th November 1878. He was elected a Fellow of the Society in 1861, and though rarely seen at the meetings, was much attached to the use of the Microscope, and occupied himself in his leisure hours with mounting objects.

On John Robert Burton's death he left estate valued just under £25,000, Will proved by Charles Robert Burton of 3 Broadway, Ludgate Hill, London, Auctioneer (a nephew). He was buried on the 26th November 1878 at St. Andrew, Barnston, Essex.



61. Daniel Wheeler, M.R.C.S., L.S.A., F.O.S. etc. (Born: circa 1818 Croydon, Surrey; Died: 26th February 1894 Chelmsford, Essex)



Known Addresses:

- Reigate (?)
- Duke Street, Chelmsford, Essex (1848,1851)
- New Bridge Street, Chelmsford, Essex (1861-1871)
- Chelmsford (1874 & 1881-1886 PMS Members List)
- 11 New Bridge Street, Chelmsford, Essex (1881)
- 11 New London Road, Chelmsford, Essex (1891)

Occupations:

Surgeon (1849); Member of the Royal College Of Surgeons of England, Licentiate of the Apothecaries Company of London and General Practitioner (1851, 1861); M.R.C.S.Eng. L.A.C., Surgeon and General Practitioner (1871, 1881); Duly Registered Medical Practitioner (1891)

References:

- *Cuscuta trifolii*. Phytologist i. 753.

Objects circulated to June 1877:

- Diatomaceae: *Epithemia Ralfsii*
- Various Diatomaceae: Guano; New Zealand
- Foraminifera: Mediterranean
- Fossil Foraminifera: from Centre of Flint
- Tissues –Vegetale: Indian Rice

- Zoophyta – Corallia: *Gorgonia*, New Zealand
- Entozoa: *Trichina spiralis*
- Insecta – Anoplura: Parasite of Wood Pigeon, *Lipeococcus baculus*

- Insecta – Aestridae: *Gasterophilus*, larva in eggs
- Insecta – Syrphidae: Drone Fly, ovipositor; Drone Fly, mouth of larva
- Insecta – Homoptera: Apides larva and image from gall of Poplar petiole
- Insecta – Lepidoptera: *Sphinx ligustri* (Privet Hawk) proboscis
- Parts of Vertebrata – Skin: Skin of Guinea Pig
- Parts of Vertebrata – Hairs: Guinea Pig
- Parts of Vertebrata – Tooth: Ox Tooth, cross section

Educated at Guy's and St. Thomas's Hospitals. Member of the Royal College Of Surgeons of England in 1841. Licentiate of the Apothecaries Company of London 13th January 1842. One of the surgeons to the Chelmsford and Essex Dispensary and Infirmary, to the Chelmsford Workhouse, Admiralty Surgeon and agent, and Certifying Surgeon under the Factories Act. Daniel Wheeler married Elizabeth Perkins in 1849. The union produced the following children - Daniel Martin Brumwell (1850), Mary Elizabeth (1852), Ada Charlotte (1854), Richard Perkins (1856), Edmund Griffith (1857) Louisa Florence (1861), Lillian Constance (1863) and Annie Gertrude (1868). Recorded as being the Medical Officer of No.9. District, Chelmsford Union and Medical Referee to the British Empire Life Office (1853). He was a Subscriber to the volume "A New Flora of the Neighbourhood of Reigate, Surrey: Containing the Flowering Plants and Ferns of the District" by John Alexander Brewer (1856). Society of Arts Board for Chelmsford in 1860, 1861, 1862. Elected an Ordinary Fellow of the Obstetrical Society of London in 1860. A Subscriber to the publication "Religio medici, Urn burial, and Christian morals" 1894 (originally published in 1643). A memoir recalls that he enjoyed the occasional day's fishing. When Daniel Wheeler died in 1894 he left estate valued £2,614 7s. 6d.

62. John Simpson Harrison, F.R.M.S. (Born: *circa* 1845 Beverley, Yorkshire; Died: 5th October 1886 Malton, Yorkshire)



Known Addresses:

- 5 School Street, North Myton, Hull (1861)
- 6 Portland Street, Myton, Yorkshire (1871)
- 86, Portland Street, Hull, Yorkshire (1872)
- 48 Lowgate, Hull (1873-1877)
- 4 Middle Street, Kingston-upon-Hull (Electoral Register 1874)
- 4 Cross Street, Kingston-upon-Hull (Electoral Register 1874)
- Lowgate, Kingston-upon-Hull.
- Care of A. Jubb, Esq., Huddersfield. (as recorded in the Journal of the Royal Microscopical Society 1879)
- The Gazette Office, Malton, Yorkshire (1880 Office)
- Newbegin, Malton, Yorkshire (1881)
- Wellington Villa, Norton, Malton, Yorkshire (1882 PMS circuit c)



Occupations:

Booksellers Apprentice (1861); Booksellers Assistant (1871); Printer (1878);

Bookseller (1881); Bookseller, Stationer and Printer (1886)

References:

- SG Vol.8. May 1872 : Wanted, three or four specimens of the Large Stag Beetle (*LucanusCervus*), for dissection, for microscopic slides. - Address J. S. Harrison, 86, Portland Street, Hull.
- SG Vol.9. December 1873 : Several Duplicate Microscopic Slides for others; Entomological preferred. - J. S. Harrison, 48, Lowgate, Hull.
- SG Vol.10. June 1874 : Monthly microscopical Journal, vols. 9 and 10, bound, and other Entomological and Microscopic Books, for first-class Entomological Slides. -J. S. Harrison, 48, Lowgate, Hull.
- SG Vol.10. September 1874 : Wanted, a quantity of smooth- skinned Larvae, large Grasshoppers or other insects suitable for dissection, alive or fresh killed; Microscopic and Entomological Books and other things. - J. S. Harrison, 48, Lowgate, Hull.
- SG Vol.11. April 1875 : Wanted, any quantity of *Dytiscus marginalis*, or other Dyticidae, alive or fresh-killed, for Dissection, for Micro-slides, Cash, &c - J. S. Harrison, 48, Lowgate, Hull.
- SG Vol.11. November 1875 : Smith's best 1/8th Objective, with screw adjusting collar, and Kirby & Spence's "Entomology," 4 vols., original edition, with MS. notes, by Mr. Spence, for a good 1/8th or 1/12th. A little cash given as well, if required. - J. S. Harrison, 48, Lowgate, Hull.
- SG Vol.12. April 1876 : A German Immersion I-25th (a capital Diatom Lens), and a little cash, for a good Immersion 1-12th or 1-16th; wet and dry fronts preferred. - J. S. Harrison, 48, Lowgate, Hull.
- SG Vol.13. January 1877 : First 6 vols, of Science-Gossip, bound in two, for micro-slides, &c., &c. - J. S. Harrison, 48, Lowgate, Hull.
- SG Vol.13. July 1877 : Student's Polariscope, a good 1/2-in. or good 3/4 in, for good 1in. Object Glasses: two required; Swift's or Crouch's preferred. - J. S. Harrison, 48, Lowgate, Hull.
- SG Vol.16. July 1880 : A GOOD triple nose-piece and a little cash, in exchange for a good one-inch objective. - J. S. Harrison, The Gazette Office, Malton, Yorkshire.
- On the Adulteration of Coffee. JPMS Vol.1. pp.115-118 (1 plate). 1881.

Objects circulated to June 1877:

- Insecta – Diptera: Sheep tick (ked), male
- Insecta – Tipulidae: *Tipula*, marsh; *Tipula*, ovipositor
- Coleoptera – Coccinellidae: *Coccinella variabilis*; Ladybird, larva & pupa
- Parts of Vertebrata – Hoofs, Horns, &c.: Human Finger Nail
- Parts of Vertebrata – Feathers: Blue Chatterer

John Simpson Harrison married Charlotte Mary Johnson in 1868. The couple had the following children – Charles Hilary (1869), Elisabeth Annie (1872), Herbert George (1874). Filed for Bankruptcy in 1878 as reported in The Solicitors' Journal of 14th September 1878. Elected a Fellow of the

Royal Microscopical Society Elected 11th December 1878. His wife died at the early age of 35 in 1879. He was recorded as a member of The Hull Royal Institution Microscopical Society in 1879. John Simpson Harrison died in 1886 leaving estate valued £623 2s. 6d.

63. Christopher Pocklington F.R.M.S. (Born: 1845 Skirbeck, Lincolnshire; Died: 11th January 1905 Bristol, Gloucestershire)



Known Addresses:

- Ivy Lodge, Bickenham Lane, Weston, Somerset (1861)
- Heathfield House, Parkstone, Dorset (1871)
- Bradford, Yorkshire (1874)
- 4, Sydenham Hill, Cotham, Bristol (1875)
- Melrose Villa, 4 Sydenham Hill, Bristol (1880 Slater's Directory)
- 22 Cunliffe Villas, Manningham, Bradford (1881; RMS Fellows list 1889 – Elected 12th April 1882)
- 14 Bertram Road, Manningham, Bradford, Yorkshire (1891)
- 17 Sydenham Hill, Bristol, Gloucestershire (1901)
- "Melrose", Sydenham Hill, Bristol (1905)

Occupations:

Scholar (1861); Assistant Schoolmaster (1871); Manager of the General Fire and Life Assurance Co., 31 Clare Street, Bristol (1880); Private Tutor of English, Classics and Science (1891)?; Assistant Secretary to an Insurance Co. (1901)

References:

- SG Vol.6. August 1870: Exchange. - Sundew (*Drosera rotundifolia*). Stamped envelope and any object of interest to C. P., Post Office, Parkstone, near Poole, Dorset.
- SG Vol.6. September 1870: *Osmunda regalis*, Fructification of. - C. P. Parkstone, Poole, Dorset.
- SG Vol.11. September 1875: A fine specimen of the new volute *V. Elliolti*, for *Harparosa*. Other

exchanges wanted. - C. Pocklington, 4, Sydenham Hill, Cotham, Bristol.

and possibly

- SG Vol.10. May 1874: *Puccinia huxi*. - Send stamped envelopes and objects of interest to C. P., Innox Cottage, Corscombe, Dorchester.
- SG Vol.10. June 1874: For Brittle Star-fish, send stamped envelope and object to C. P., Innox Cottage, Corscombe.

Objects circulated to June 1877:

- Minerals & Geology (Silicious): Calcedony
- Raphides & Sphaeraphides: *Tabaiba* – raphides of
- Myriapoda: Centipede trachae
- Coleoptera – Lampyridae: *Lampyris noctilusa* (Glow Worm), organs in head; *Lampyris noctilusa* (Glow Worm), light organs
- Trombidina: *Trombidium holosericeum*
- Vascular System - Injected Preparations &c.: Tongue of Cat

Listed as a Fellow of the Royal Historical Society in 1881-1889.

Listed as a member of the Yorkshire Naturalists' Union in 1889: Pocklington, Christopher, F.R.M.S., 22 Cunliffe Villas, Manningham, Bradford.

He died unmarried on 11th January 1905. He left estate valued £2,178 2s. 2d.

See also his brothers: Henry Pocklington (No.14) and John Robert Pocklington (No.31).

64. Richard Harwood Moore (Born: circa 1838 Bath, Somerset; Died: 3rd June 1910 Bath, Somerset)



Known Addresses:

- 4 Victoria Terrace, Tiverton, Somerset (1871)
- 4 Abbey Street, Bath (business address 1871,1873,1879, 1882)
- Pulteney Gardens, Bath (1874)
- 13 Pulteney Gardens, Bath (1881-1891 PMS Members List [President 1896], Hon. Sec. Bath Microscopical Society 1881/1882/1883/1884/1889/1890, 1885 - President-Elect Bath Microscopical Society, 1886 - President Bath Microscopical Society). Recorded as 13 Pulteney Gardens, Pulteney Road, Widcombe, Bath in the 1889 Kelly's Directory.
- 5 Lime Grove, Pulteney Gardens, Bath, Somerset (1901-1910)



Occupations:

Accountants Clerk (1871); High Bailiff of Bath County Court (1881,1891,1899,1901); Secretary to the Liberal Building Society (1891)

References:

- Organisms from the recently discovered Roman baths in Bath (Plate of strata deposits). JPMS Vol.2. pp.133-140 (1 plate) 1883.
- Naphthaline. JPMS Vol.3. pg.119. 1884
- Antennae of Cockroach. JPMS Vol.3. pg.120. 1884
- *Senecio Vulgaris*. JPMS Vol.3. pp.237-247 (2 plates). 1884

- *Anagallis arvensis*. JPMS Vol.5. pp.133-143 (3 plates). 1886
- *Cristatella mucedo*. JPMS Vol.6. pp.65-79 (3 plates). 1887
- *Linaria Cymbalaria*. JPMS Vol.6. pp.193-204 (3 plates). 1887
- Piper. JPMS Vol.9. pg.282. 1890
- Spiracles of Wire-worm and *Chrysops caecutiens*. JPMS Vol.10. pg.90. 1891

Objects circulated to June 1877:

- Fungi: *Compositarum*; *Arcyria rinicea?*; *Aregma bulbosum*
- Raphides & Sphaeraphides: *Echinocactus visiraya* – Sphaeraphides from
- Flower: *Erica hiemales*, corolla &c.
- Seeds & Seed Vessels: *Ecaemoscarpus(?)* seed; Toad Flax *Linaria*
- Polycistina: from Barbadoes
- Fossil Foraminifera: from Gravesend
- Sounding – Foraminifera: Atlantic Deep
- Mollusca: Limpet (*Ecaemoscarpus(?)*) *Patella vulgata* palate
- Myriapoda: Centipede *Lithobius*
- Insecta – Anoplura: Parasite of Gull, *Docophorus lari*
- Insecta – Imperfectly named (or Massed): Fly ovipositor
- Hymenoptera – Apidae: *Bombus terrestris* (Humble Bee), tongue; *Bombus terrestris* (Humble Bee), pollen basket
- Coleoptera – Dyticidae: *Dytiscus marginalis* foot, 2nd pair
- Coleoptera – Melolonthidae: *Melolontha vulgaris* (Cockchafer), antennae
- Trombidina: *Trombidium holosericeum*
- Araneae: *Epeira diadema*, Garden Spider, male
- Parts of Vertebrata – Hairs: Porcupine Quill
- Parts of Vertebrata – Scales: Eel Skin

Richard Harwood Moore married Sarah Jane Targett in 1865. The following children were born to them – Harwood Clapham (1868), Alfred Bartlett (1869), George Ernest (1872), Richard Herbert (1876). He audited the Postal Microscopical Society accounts 1881-1883. Recorded as a Subscriber to the Ray Society in 1882: Bath Microscopical Society, care of R. H. Moore, Esq., 4 Abbey Street, Bath. He was appointed (with others) on a subcommittee, in 1895, to inspect Sewage Works periodically on behalf of the Parochial Council. Listed as an Alderman of Bath City Council in 1897. In 1902 recorded as an Alderman of Bath City Council. On the death of Richard Harwood Moore at Bath Union Workhouse Infirmary his estate was valued £1,974 12s. Buried 8th June 1910 at Smallcombe Vale Cemetery, Bath.

A tablet to his memory appears at the Baptist Burial Ground at the bottom of Lyncombe Hill, Bath: " In Memory of Richard Harwood Moore who Entered into Rest June 3rd aged 71 years. This Tablet is Erected by the Members of this Church & Congregation in Grateful Recognition of his Long & Selfdenying Labours as Deacon, Treasurer, Sunday School Teacher and President of the Junior C. E. Society, Extending over a Period of 53 years."