

**RONTEK**  
PRODUTOS DE QUALIDADE

Aqui tem Preço, Qualidade  
e Bom Atendimento

**2ª Ed. 2020**

# Catálogo de Produtos

[www.sta-eletronica.com.br](http://www.sta-eletronica.com.br)

Mala Direta  
Básica  
9912350220/2017-DR/SPM  
Sist. e Tecnol. Aplicada  
Correios  
FECHAMENTO AUTORIZADO  
PODE SER ABERTO PELA E.C.T



RONTEK.COM.BR



RONTEKTVOFICIAL



STARONTEK

**STA**  
Sistemas e Tecnologia Aplicada

# Baterias Cilíndricas Li-Ion

**SANYO SAMSUNG Panasonic®**

Código	Emb.	Capac.(mAh)	Dim.(mm)	Tamanho	Obs.	Tensão(V)
036052	1 pç	4.000mAh	21x70mm	21700	Samsung - Alta Desc. 35A	3,6
036051	1 pç	4.250mAh	20x70mm	20700	Sanyo - Alta Desc. 15A	3,6
036287	1 pç	3.500mAh	18x65mm	18650	LG - Alta Desc.10A	3,7
035518	1 pç	3.450mAh	18x65mm	18650	Sanyo - Alta Desc. 10A	3,6
036551	1 pç	3.350mAh	18x65mm	18650	Sanyo - Alta Desc. 2C - c/ top -c/ pcm	3,7
036548	1 pç	3.350mAh	18x65mm	18650	Sanyo - Alta Desc. 10A	3,6
035462	1 pç	3.350mAh	18x65mm	18650	Panasonic - Alta Desc. 2C	3,6
036533	1 pç	3.350mAh	18x65mm	18650	Panasonic - Alta Desc. 2C - c/ top	3,6
036288	1 pç	3.000mAh	18x65mm	18650	LG - Alta Desc. 20A	3,7
035520	1 pç	3.000mAh	18x65mm	18650	Samsung - Alta Desc. 15A	3,6
035521	1 pç	2.900mAh	18x65mm	18650	Panasonic - Alta Desc. 10A	3,6
036547	1 pç	2.600mAh	18x65mm	18650	Samsung - Alta Desc. 2C	3,6
036534	1 pç	2.600mAh	18x65mm	18650	Samsung 2C c/ top c/ PTC 2,9A	3,6
035460	1 pç	2.600mAh	18x65mm	18650	Samsung - Alta Desc. 2C	3,6
036552	1 pç	2.600mAh	18x65mm	18650	Samsung - 2C - c/ top	3,6
036409	1 pç	2.600mAh	18x65mm	18650	LG - 1C	3,6
035519	1 pç	2.500mAh	18x65mm	18650	Samsung - Alta Desc. 20A	3,6
035414	1 pç	2.200mAh	18x65mm	18650	Sanyo - 1C	3,6



Confira mais baterias na pág. 7

## NOVIDADES

Faça já seu pedido!

(11) 4617-8530

(11) 3719-2500

**Baterias Cilíndricas de LiFePO<sub>4</sub>**  
(Fosfato de Lítio Ferro). São mais seguras e estáveis que as baterias de Li-Ion. Maior vida útil que as baterias de Li-Ion.

Código	Emb.	Capac.(mAh)	Dim.(mm)	Tamanho	Obs.	Tensão(V)
036407	1 pç	450mAh	17x33mm	17330	1C - c/ top	3,2
035753	1 pç	600mAh	14x50mm	14500	Alta Descarga 3C - c/ top	3,2
036049	1 pç	1500mAh	18x65mm	18650	Alta Descarga 5C p/ ferramentas	3,2
035751	1 pç	1500mAh	18x65mm	18650	Alta Descarga 3C	3,2
036084	1 pç	3000mAh	26x65mm	26650	Conector A58 c/ PCM	3,2
036085	1 pç	3000mAh	26x65mm	26650	Conector microfit-2p - s/ PCM	3,2
035752	1 pç	3300mAh	26x65mm	26650	Alta Descarga - 3C	3,2
036046	1 pç	5000mAh	33x70,43mm	33700	Alta Descarga 5C p/ ferramentas	3,2



Packs de baterias desenvolvidos de acordo com a especificação do projeto do cliente.



Pack Alexa



Pack Li-Íon



Pack LiPO



Pack LiFePO<sub>4</sub>



Pack LiSOCL<sub>2</sub>



Pack Li-Íon

Ni-Cd

Ni-Mh

Li-Ion

Li-Po

Alcalina

Lítio

Li-FePO<sub>4</sub>



**3,6V 3350mAh**  
 • Li-Ion • 8A • Samsung - E  
 • 18x65mm • 13A pico  
**036548**



**3,6V 3350mAh**  
 • Li-Ion • 4,8A • Panasonic - T  
 • 18x65mm • C/ Top • C/ PCM  
**036533**



**3,6V 2600mAh**  
 • Li-Ion • 2C • Samsung  
 • 18x65mm • c/ PTC 2,9A  
**036547**



**3,7V 2600mAh**  
 • Li-Ion • 2C • Samsung - T  
 • 18x65mm • C/ Top • C/ PCM  
 • C/ PTC 2,9A  
**036534**



**3,7V 2600mAh**  
 • Li-Ion • 2C • Samsung - T  
 • 18x65mm • C/ Top • C/ PCM  
**036552**



**3,7V 3350mAh**  
 • Li-Ion • 4,8A • Sanyo - E  
 • 18x65mm • C/ Top • C/ PCM  
**036551**



**3,7V 2200mAh**  
 • Li-Ion • 5C  
 • 18x65mm • Emb c/2pçs  
**036550**



**3,7V 2200mAh**  
 • Li-Ion • 1C  
 • 18x65mm  
**036546**



**3,7V 3000mAh**  
 • Li-Ion • 1C  
 • 18x65mm • C/ Terminal  
**036553**



**3,7V 3000mAh**  
 • Li-Ion • 1C  
 • 18x65mm • C/ Terminal  
**036537**



**3,7V 2600mAh**  
 • Li-Ion • 1C • 18x65mm  
 • c/ Terminal • 2pçs  
**036549**



**3,7V 2200mAh**  
 • Li-Ion • 1C  
 • 18x65mm • c/ Terminal  
**036554**



**3,7V 2200mAh**  
 • Li-Ion • 1C  
 • 18x65mm • C/ Terminal  
**036538**



**3,6V 19.000mAh**  
 • LiSOC12 • D  
 • 34x61mm  
**036561**



**3,7V 1100mAh**  
 • Li-Po • c/ PCB  
 • 1C • 4,87x37,15x60,39mm  
**036544**



**3,7V 1000mAh**  
 • Li-Po • Conector JST  
 de 3 fios c/ PCB  
 • 1C • 6,68x29,19x49,8mm  
**036545**



**3,7V 900mAh**  
 • Li-Po • c/ PCB  
 • 1C • 6,22x33,66x44,8mm  
**036543**



**3,7V 210mAh**  
 • Li-Po • Conector  
 JST-PHR3 c/ PCB  
 • 1C • 4,4x20x30mm  
**036542**



**1,2V 3000mAh**  
 • NiMh • 10C  
 • SC • 23x43mm  
**036555**



**1,2V 2500mAh**  
 • NiMh • AA  
 • 14x50mm • Emb c/2pçs  
**036559**



**1,2V 850mAh**  
 • NiMh • AAA  
 • 11x44mm  
**036558**



**1,2V 700mAh**  
 • NiMh • AAA  
 • 11x44mm  
**036556**

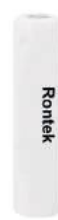

**1,2V 600mAh**  
 • NiCd • AA  
 • 15x49mm  
**036560**



**7,2V 3000mAh**  
 • NiMh • 6 Células  
 • Conector Macho 62006-2p  
 • (22,41x44,52x129,29mm)  
**036557**



**7,4V 1000mAh**  
 • Li-Po • Conector 3 Vias  
 • c/ cabo 24awg  
 • (6,45x50,63x68,28mm)  
**036541**



**1,5V 3000mAh**  
 • LiFeS2 • AA  
 • 15x50mm • 2pçs  
**036535**



**1,5V 1100mAh**  
 • LiFeS2 • AAA  
 • 11x44mm • 2pçs  
**036536**



**3V 50mAh**  
 • LiMnO2 • CR1225  
 • 12,5x2,5mm  
**036114**



**9V**  
 • (26x17x48mm) - Alcalina  
**036518** Shirink c/1  
**036517** Blister c/1



**Alcalina C 1,5V**  
 • 7100mAh (26x50mm) • Emb. 2 pçs  
**036519**



**AA 1,5V**  
 • (15x50mm) - Alcalina  
**036514** Emb: 2 pçs  
**036515** Emb: 4 pçs  
**036516** Granel



**AAA 1,5V**  
 • (11x45mm) - Alcalina  
**036511** Emb: 2 pçs  
**036512** Emb: 4 pçs  
**036513** Granel



**Alcalina D 1,5V**  
 • 14250mAh (32,5x60mm) • Emb. 2 pçs  
**036520**



**Carregador USB Duplo**  
 • USB 2.0 • p/ Li-Ion • 750mA  
 • Tamanhos: 26650/18650/16430/14500  
**036524**



**P/ 3 Células 12,6V 20A**  
 • p/ Li-Ion e Li-Po • c/ balanceamento  
 • c/ temperatura • Descarga Cont. 20A  
 • 60x40x3,6mm  
**036603**



**P/ 4 Células 16,8V 15A**  
 • p/ Li-Ion e Li-Po • Descarga Cont. 15A  
 • c/ balanceamento  
 • c/ temperatura • 60X40X3,6mm  
**036604**



**P/ 5 Células 21V 18A**  
 • p/ Li-Ion e Li-Po • Descarga Cont. 18A  
 • c/ balanceamento • c/ temperatura  
 • 60x40x3,6mm  
**036605**



**P/ 4 Células 12,8V 18A**  
 • p/ LiFePO4 • Descarga Cont. 18A  
 • c/ balanceamento  
 • c/ temperatura • 60x40x7,2mm  
**036607**



**P/ 4 Células 12,8V 30A**  
 • p/ LiFePO4 • Descarga Cont. 30A  
 • c/ balanceamento • c/ temperatura  
 • 56x48x4mm  
**036606**



**Carregador p/ bateria de Li-Ion**  
 • Tensão de Entrada: 4.5v ~ 5.5v - • Tensão de Saída: 4.2v • Corrente de carga: 1A  
 • Conector Mini USB - 2,7x1,9x0,5mm p/ 1 bateria chip TP4056  
**036525**

**Regulador de tensão step down ajustável**

- Tensão Mínima de Entrada 4,5V • Tensão Máxima de Entrada 35V • Tensão Mínima de Saída 1,25V • Tensão Máxima de Saída 30V • Corrente Máxima de Saída 2A Chip LM2596

**036526****Regulador de tensão step down ajustável**

- Tensão Mínima de Entrada 4 V • Tensão Máxima de Entrada 40 V • Tensão Mínima de Saída 1,25 V • Tensão Máxima de Saída 37V • Corrente Máxima de Saída 2A chip LM2596

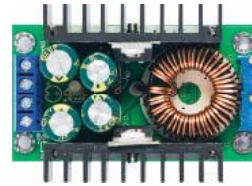
**036527****Regulador de tensão step down ajustável**

- Tensão Mínima de Entrada 7 V • Tensão Máxima de Entrada 40 V • Tensão Mínima de Saída 1,2 V • Tensão Máxima de Saída 35V • Corrente Máxima de Saída 9A 300W

**036528****Regulador de tensão step up ajustável**

- Tensão Mínima de Entrada 3,5 V • Tensão Máxima de Entrada 32V • Tensão Mínima de Saída 5 V • Tensão Máxima de Saída 35 V • Corrente Máxima de Saída 2A

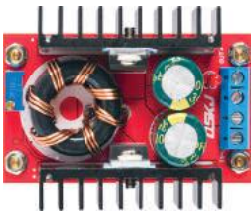
**036529****Regulador de tensão step up ajustável**

- Tensão Mínima de Entrada 10 V • Tensão Máxima de Entrada 32 V • Tensão Mínima de Saída 12 V • Tensão Máxima de Saída 35 V • Corrente Máxima de Saída 10A 150W

**036530****Regulador de tensão step up ajustável**

- Tensão Mínima de Entrada 0,9 V • Tensão Máxima de Entrada 5 V • Tensão Mínima de Saída 5 V • Tensão Máxima de Saída 5 V • Corrente Máxima de Saída 0,5A

**036531****Regulador de tensão step down ajustável USB**

- Tensão Mínima de Entrada 6 V • Tensão Máxima de Entrada 24 V • Tensão Mínima de Saída 5,1 V • Tensão Máxima de Saída 5,2V • Corrente Máxima de Saída 3A

**036532****Carregador p/ bateria Li-Ion/Li-PO**

- Conversor AC/DC • Bivolt
- Entrada 127/220 CA
- p/4 Baterias de Li-ion/Li-po
- Saída Cc 16,8V - 1,5A

**036521****Carregador p/ bateria LiFePO4**

- Conversor AC/DC • Bivolt
- Entrada 127/220 CA
- p/2 Baterias de Lifepo4
- Saída Cc 6,4V - 1,2A

**036522****Carregador p/ bateria LiFePO4**

- Conversor AC/DC • Bivolt
- Entrada 127/220 CA
- p/4 Baterias de Lifepo4
- Saída Cc 12,8V - 1,5A

**036523****Saco Anti Chama**

- P/ transporte seguro de baterias p/ Bateria LiPo • 18x23mm

**036539****Conector Din forma A**

- Din 43650-m27 3p+T • Preto

**036540****Fonte Chaveada Regulavel 100V 20A**

- C/ Proteção Contra Sobretensão/ Corrente/ Temperatura. • Potência Dc Máxima de 2500w • Tensão 110v-127v 60hz • Voltagem de 2500w • Tensão 110v-127v 60hz Voltagem

**036510****Micro Ventilador USB**

- Com Bateria Interna de Lítio Ion 18650 1200mAh • Cor Preta

**036602**

**1 - Baterias, Pilhas, Carregadores e Testadores****Baterias Recarregáveis**

Chumbo Seladas	8
Lítio Ferro - LiFePO <sub>4</sub>	9
Lítio - Ion	10
Lítio Polímero	15
Lítio Titanato	10
Níquel Cádmio - NiCd	25
Níquel Metal Hidreto - NiMh - Consumidor	32
Níquel Metal Hidreto - NiMh - Industrial	23
Tipo Botão	33

**Baterias Recarregáveis - Aplicações**

Aspiradores de pó	31
Câmeras fotográficas	31
Modelismo	31
Rádio comunicadores	31
Telefone sem fio	27

**Baterias Recarregáveis de Li-Ion -****Marcas Famosas**

Panasonic	10
Samsung	10
Sanyo	10

**Packs de Baterias**

Conectores para Baterias	49
Conexões Metálicas	48
Fios de Silicose	48
Fitas de Alta Temperatura	48
Indicadores de Tensão para Packs	40
Isolantes para packs de baterias	48
Packs de Li-Ion, LiFePO <sub>4</sub> e NiMh	21
Placas PCM e BMS para packs de baterias	42
Polyswitches	48
PVC Termoretátil	48
Termistor NTC	48
Termostratos para baterias	48

**Pilhas e Baterias Não Recarregáveis**

Alcalinas - 1,5V - Botões	37
Alcalinas 1,5V/6V/12V - Cilíndricas	38
Alcalinas 9V	38
Lítio 3,6V - Cilíndricas - Minamoto	34
Lítio 3,6V - Cilíndricas - Rontek	33
Lítio 3V - Botões	35
Zinco Manganês (Comuns) - 1,5V	40
Zinco Manganês (Comuns) - 9V	40

**Pilhas e Baterias Não Recarregáveis -****Aplicações**

Aparelhos Auditivos	39
Câmeras Fotográficas	40
Lanternas	40

**Pilhas e Baterias Não Recarregáveis -****Marcas Famosas**

Duracell	38
Maxell	37
Sony	38

**Pilhas e Baterias - Acessórios**

Analisadores de Baterias	40
Carregadores de Baterias	40
Conversores CC/CC-AC/DC	47
Porta Pilhas	52
Suportes para Pilhas	52
Testadores de Baterias	42

**2 - Conectores**

Abraçadeiras Lacs e Marcadores	82
Adaptadores e Emendas	54
Adaptadores e Tomadas	79
Adaptadores para Monitores e DB	67
Adaptadores Para Mouses e Teclados, Din e Mini Din	67
Adaptadores USB, Firewire e HDMI	65
Alojamentos, Conectores e Mini Jumper	77
Barras de Bornes PCI e Conectores Bendal	80
Barras de Pinos PCI	76
Capas D-Subs	69
Capas Flexíveis para RJ45	72
Centronics e Conjunto de Retenção	69
Conectores BNC	64
Conectores de Porcelana	79
Conectores Micro Circulares e Circulares	77

**2 - Conectores**

Conectores Tipo Bloco, Emenda e Bornes KRE	77
Conexões Excon	82
Conjunto de Retenção e USB	69
Conversores e Seletores Ópticos	54
Conversores, Extensores e Repetidores HDMI	58
Conversores, Divisores e Adaptadores CATV	74
DC - Plugs e Jacks	73
D-Subs	68
Emendas e Tomadas de Sobrepor RJ45	72
Emendas Rosqueáveis	80
Espaçadores e Fixadores	81
Filtros, Plugs e Jacks Modulares para Telefonia	70
Filtros de Linha e Régua de Tomada	79
Garras Tipo Jacaré e Plugs Banana	78
Kit para Notebook e Adaptadores USB	65
Pino Tomada para Cabos	79
Placas de Captura de Vídeo	59
Plugs e Jacks	60
Plugs e Jacks Modulares para Redes	71
Protetor de Cabos, Spirais e Aplicadores	81
Seletores de Vídeo Game	57
Soquetes Torneados, Estanhados e Dourados	76
Splitter, Switches e Conversores HDMI e VGA	57
Vídeo Baloon	76

**3 - Cabos Montados**

Cabos BNC	90
Cabos de Força	91
Cabos de Rede e Telefonía	90
Cabos DVI e DisplayPort	87
Cabos HDMI	86
Cabos Ópticos e Diversos	83
Cabos USB e Cabos Diversos	88
Cabos VGA e Cabos Diversos	89
Extensão para Cabo de Fonte ATX	90

**4 - Energia Solar**

Luminária Solar	120
-----------------	-----

**5 - Fios e Cabos em Rolos**

Cabos Bicolores	92
Cabos Especiais	92
Cabos Flat, Manga e RGB	93
Cabos Flexíveis	93
Cabos para Microfones, Guitarras e Philips	93
Cabos 4 Pares - CFTV	93
Cabos PP	92

**6 - Áudio, Vídeo e CATV**

Agulhas para Toca Discos	94
Arandelas e telas para Falantes	93
Caixas de Som e Antenas	93
Cúpula (Dome) Para Micro Câmera	94
Fones de Ouvido	95
Microfones e Acessórios	95
Suporte para TV e Caixas Acusticas	93

**7 - Automotivos**

Bluetooth para Carro	96
Cabos Tipo Chupeta	96
Conectores e Carregadores USB Automotivo	96
Medidor de Pressão Pneumático	96
Plugs Cigarreiras	96
Relé para Carro	96
Sinalizador Giroflex	96
Suporte para Celular	96

**8 - Acessórios para Celulares**

Carregador USB, Cabos e Adaptadores	97
-------------------------------------	----

**9 - Eletroeletrônicos**

Arduinos	100
Autotransformadores	108
Caixas Plásticas para Montagens	97
Chaves Elétricas	102
Controles Remotos para lâmpadas e Ventiladores	108
Espelho com Carregador USB	108
Fusíveis de Vidro (Latão)	106
Fusíveis para Microondas	106
Inversores de Tensão e Fontes de Alimentação	107
Maletas	99
Microswitches	103
Porta Fusíveis	106
Potenciômetros e Foto Células LDR	105
Relés	106
Sensores de Presença e Campanha Eletrônica	108
Sensores Magnéticos	106
Trimpots	105
Tubos Termo Retráteis	107

**10 - Led e Iluminação**

Fitas de LED e Controle Remoto	109
Lâmpadas de LED e Luz de Emergência	109
Lanternas de LED	109
Leds Bicolores e Sunled	109
Leds Redondos, Tipo "Chapéu" e Retangulares	109
Suporte para LEDs e Adaptadores	109

**11 - Ferramentas**

Alicates de Bico e Corte	113
Alicates Digitais	111
Alicates para Cabos	113
Cadinho	119
Canivete de Chaves	112
Escova Anti Estática e Magnetizador/Desmagnetizador	113
Esponja	119
Estação de Solda	119
Ferramenta de Inserção e de Impacto	114
Ferros de Solda, Resistência para Ferros de Solda	118
Pontas para Ferros de Solda	118
Frequencímetro	112
Gaveteiro p/ Componentes	114
Kit Mini Chaves e Chaves de Fenda	112
Limpeza e Proteção	115
Lupas	114
Mala de Ferramentas	114
Malha Dessoldadora	118
Mini Lupa	114
Multímetro Digital	111
Pinças	114
Pistola de Solda Fire e Pistola de cola quente	115
Pontas de Prova	111
Protoboards	115
Pulseira e Tornozeira Antiestática	110
Solda e Pasta para Soldar	120
Sugador de Solda, Suporte para Rolo de Solda	119
Termômetros e Multímetros	110
Terrômetro e Termômetros	112
Testador de Cabos de Rede e HDMI	112
Testador e Detetor de Tensão	110

**12 - Bicicletas**

Buzinas, Cadeados e Suporte para Celular	121
Lanternas e Faróis de LED	121
Mochila com Carregador Solar	121

**13 - Informática**

Cabos Para Bateria EXT	122
Cooler para Notebook e Ventiladores USB	122
Estabilizadores e Nobreaks	122
Leitor de Cartão de Memória e Mesa para Notebook	122
Repetidor de Sinal Wi-Fi e Hub USB	122
Ventiladores AC/DC e Grades para Micro Ventiladores	122

**Baterias Seladas de Chumbo:** Baixo custo por watt-hora. 4V, 6V e 12V. Alta capacidade entre 1,3Ah até 35Ah. Livres de manutenção. Não tem efeito memória. Devem ser descartadas adequadamente para não poluir.



**4V 4Ah**  
 • (100x46x46mm)  
 • Plástico ABS  
**036044**



**6V 1,3Ah**  
 • (97x25x51mm)  
 • Plástico ABS  
**001240**  
**033853**



**6V 2,8Ah**  
 • (100x67x34mm)  
 • Plástico ABS  
**033532**



**6V 4Ah**  
 • (101x70,5x48mm)  
 • P/ alarme e luz de emergência  
 • Plástico ABS  
**032692**



**6V 4,5Ah**  
 • (106x70x47mm)  
 • P/ alarme e luz de emergência  
 • Plástico ABS  
**033419**



**6V 5Ah**  
 • (70x47x101mm)  
 • P/ alarme, nobreaks e luz de emergência • Plástico ABS  
**035537**

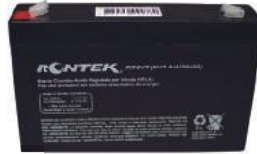

**6V 7Ah**  
 • (151x34x100mm)  
 • Plástico ABS  
**036146**



**6V 7,2Ah**  
 • (151x34x100mm)  
 • Plástico ABS  
**035745**



**6V 12Ah**  
 • (151x51x95mm) • P/ brinquedos elétricos(moto) • Plástico ABS  
**033533**



**12V 1,3Ah**  
 • (97,5x43,5x52mm)  
 • Plástico ABS  
**001242**  
**032690**



**12V 2,2Ah**  
 • (178x36x62mm)  
 • Plástico ABS  
**001243**  
**032691**



**12V 4Ah**  
 • (90x70x107mm)  
 • Plástico ABS  
**033422**



**12V 5Ah**  
 • (90x70x106mm)  
 • Plástico ABS  
**035744**  
**036145**



**12V 5,5Ah**  
 • (151x65x100mm)  
 • P/ alarme • Plástico ABS  
**036441**



**12V 7Ah**  
 • (151x65,5x94mm)  
 • P/ alarme, nobreaks e luz de emergência • Plástico ABS  
**001024**  
**032693**



**12V 7,2Ah**  
 • (151x65x100mm) • P/ alarme, nobreaks e luz de emergência  
 • Plástico ABS  
**035081**  
**033420**



**12V 9Ah**  
 • (151x65x100mm)  
 • P/ alarme, nobreaks e luz de emergência • Plástico ABS  
**035082**  
**033421**





**12V 12Ah**  
 • (151x99x96mm)  
 • Plástico ABS  
**001245**  
**033667**



**12V 18Ah**  
 • (181x77x167mm)  
 • Plástico ABS  
**002087**



**12V 26Ah**  
 • (166x175x125mm)  
 • Plástico ABS  
**035746**



**12V 35Ah**  
 • (196x131x170mm)  
 • Plástico ABS  
**035747**

Seladas LiFePO<sub>4</sub>

**Baterias Seladas de Li Fe PO<sub>4</sub>** (Fosfato de Lítio Ferro). Última geração de baterias seladas, para veículos e equipamentos médicos, longa vida - 500 ciclos, recarga 3x mais rápida, 60% mais leve que a bateria selada de chumbo.

**6V 4,5Ah**  
 • Li Fe PO<sub>4</sub>  
 • Descarga máx: 5A  
 • Carga máx: 3A  
 • Peso: 0,65kg  
 • (107x70x47mm)  
**035805**



**12V 7,5Ah**  
 • Li Fe PO<sub>4</sub>  
 • Descarga máx: 10A  
 • Carga máx: 5A  
 • Peso: 0,95kg  
 • (151x66x100mm)  
**035806**



Cilíndricas LiFePO<sub>4</sub>

**Baterias Cilíndricas de Li Fe PO<sub>4</sub>** (Fosfato de Lítio Ferro): São mais seguras e estáveis que as baterias de Li-Ion, Maior vida útil que as baterias Li-Ion - até 1000 ciclos. A tensão de 3,2V é própria para packs que substituem baterias seladas de 6V e 12V. Tensão de descarga bem estável. Corrente de descarga elevada. Menos prejudiciais ao meio ambiente que as baterias Li-Ion. Precisam de placa PCM.



**3,2V 450mAh**  
 • LiFePO<sub>4</sub>  
 • 1C • c/ top  
 • 17x33mm  
**036407**



**3,2V 600mAh**  
 • LiFePO<sub>4</sub>  
 • Descarga máx: 1.800mA  
 • 3C • c/ top  
 • 14x50mm  
**035753**



**3,2V 1500mAh**  
 • LiFePO<sub>4</sub>  
 • Descarga máx: 7.500mA  
 • 5C • p/ ferramentas  
 • 18x65mm  
**036049**



**3,2V 1500mAh**  
 • LiFePO<sub>4</sub>  
 • Descarga máx: 4.500mA  
 • 3C  
 • 18x65mm  
**035751**



**3,2V 3000mAh**  
 • LiFePO<sub>4</sub>  
 • Conector A58  
 • c/ PCM  
 • 26x65mm  
**036084**



**3,2V 3000mAh**  
 • LiFePO<sub>4</sub>  
 • Conector Microfit-2P(300202hm)  
 • s/ PCM  
 • 26x65mm  
**036085**



**3,2V 3300mAh**  
 • LiFePO<sub>4</sub>  
 • Descarga máx: 9.900mA  
 • 3C  
 • 26x65mm  
**035752**



**3,2V 5000mAh**  
 • LiFePO<sub>4</sub>  
 • Descarga máx: 25.000mA  
 • 5C • 33x70,43mm  
 • p/ ferramentas  
**036046**

Baterias Cilíndricas de Li Fe PO<sub>4</sub> 3,2V

PREÇOS SOB CONSULTA!

- LFP10370-150 - 150mAh - 10,5x37 mm
- LFP10440-200 - 200mAh - 10,5x44 mm
- LFP14430-400 - 400mAh - 14,5x43 mm
- LFP14500-400 - 400mAh - 14,5x49,5 mm
- LFP14500-500 - 500mAh - 14,5x49,5 mm
- LFP14500B-500 - 500mAh - 14,5x50,5 mm
- LFP14500B-600 - 600mAh - 14,5x50,5 mm
- LFP16340B-400 - 400mAh - 16,7x34 mm
- LFP18500-800 - 800mAh - 18,7x49,5 mm

- LFP18500-1000 - 1000mAh - 18,7x49,5 mm
- LFP18650-1400 - 1400mAh - 18,7x65,5 mm
- LFP22650-2000 - 2000mAh - 23x65,5 mm
- LFP32670-5000 - 5000mAh - 33x68 mm
- LFP18650P-1100 - 1100mAh - 18,7x65,5 mm
- LFP26650P-2300 - 2300mAh - 26,5 - 65,5mm



Titanato de Lítio

**Baterias de Titanato de Lítio:**  
Longa vida útil de até 10.000 ciclos.  
Alta corrente de carga e descarga.



**2,4V 1300mAh**  
• Titanato de Lítio  
• 18x65mm  
• Descarga máx: 13A  
• Carga máx: 2,6A  
**035808**



**2,4V 500mAh**  
• Titanato de Lítio  
• 14x50mm  
• 30C  
**036408**

Cilíndricas Li-Ion

**Baterias de Li-Ion:** Formato cilíndrico. Podem ser usadas mais de 500 vezes. Alta densidade de energia por volume. Baixo peso. Capacidade(mAh) de 600mAh até 5.000mAh. Baixa resistência Interna. Tensões entre 3,6 e 3,7v. Alta segurança quando usadas com placa PCM. Alguns modelos tem alta corrente de descarga (A).

Cilíndricas Li-Ion - Marcas famosas - Alta Descarga

Código	Embalagem	Capac.(mAh)	Dim.(mm)	Tamanho	Obs.	Tensão(V)
036052	1 pç	4.000mAh	21x70mm	21700	Samsung - Alta Desc. 35A	3,6
036051	1 pç	4.250mAh	20x70mm	20700	Sanyo - Alta Desc. 15A	3,6
036287	1 pç	3.500mAh	18x65mm	18650	LG - Alta Desc.10A	3,7
035518	1 pç	3.450mAh	18x65mm	18650	Sanyo - Alta Desc. 10A	3,6
036551	1 pç	3.350mAh	18x65mm	18650	Sanyo - Alta Desc. 4,8A - c/ top -c/ pcm	3,7
036548	1 pç	3.350mAh	18x65mm	18650	Sanyo - Alta Desc. 10A	3,6
035462	1 pç	3.350mAh	18x65mm	18650	Panasonic - Alta Desc. 2C	3,6
036533	1 pç	3.350mAh	18x65mm	18650	Panasonic - Alta Desc. 2C - c/ top	3,6
036288	1 pç	3.000mAh	18x65mm	18650	LG - Alta Desc. 20A	3,7
035520	1 pç	3.000mAh	18x65mm	18650	Samsung - Alta Desc. 15A	3,6
035521	1 pç	2.900mAh	18x65mm	18650	Panasonic - Alta Desc. 10A	3,6
036547	1 pç	2.600mAh	18x65mm	18650	Samsung - Alta Desc. 2C	3,6
036534	1 pç	2.600mAh	18x65mm	18650	Samsung 2C c/ top c/ PTC 2,9A	3,6
035460	1 pç	2.600mAh	18x65mm	18650	Samsung - Alta Desc. 2C	3,6
036552	1 pç	2.600mAh	18x65mm	18650	Samsung - 2C - c/ top	3,6
036409	1 pç	2.600mAh	18x65mm	18650	LG - 1C	3,6
035519	1 pç	2.500mAh	18x65mm	18650	Samsung - Alta Desc. 20A	3,6
035414	1 pç	2.200mAh	18x65mm	18650	Sanyo - 1C	3,6



**SANYO SAMSUNG Panasonic**

## Cilíndricas Li-Ion Alta Descarga- Sem TOP

Código	Embalagem	Capac.(mAh)	Dim.(mm)	Tamanho	Obs.	Tensão(V)	Foto
036149	1 pç	5.000mAh	26x65mm	26650	Alta Descarga 10A	3,6	
036148	1 pç	3.350mAh	18x65mm	18650	Alta Descarga 6A	3,6	
036147	1 pç	3.000mAh	18x65mm	18650	Alta Descarga 6A	3,6	
036344	1 pç	2.600mAh	18x65mm	18650	Alta Descarga 13A	3,7	
036142	1 pç	2.600mAh	18x65mm	18650	Alta Descarga 10A	3,6	
035703	1 pç	2.600mAh	18x65mm	18650	Alta Descarga 5A	3,6	
036047	1 pç	2.600mAh	18x65mm	18650	P/ Ferramentas 5C	3,7	
036550	2 pçs	2.200mAh	18x65mm	18650	Alta Descarga 5C	3,7	
035700	1 pç	2.200mAh	18x65mm	18650	Alta Descarga 11A	3,6	
035702	1 pç	2.200mAh	18x65mm	18650	Alta Descarga 5A	3,6	
034196	2 pçs	2.200mAh	18x65mm	18650	Alta Descarga 5C	3,7	
035701	1 pç	2.050mAh	18x65mm	18650	Alta Descarga 6A	3,6	
035699	1 pç	2.000mAh	18x65mm	18650	Alta Descarga 20A	3,6	
036048	1 pç	1.500mAh	18x65mm	18650	P/ Ferramentas 15C	3,6	

## Cilíndricas Li-Ion - Sem TOP







Código	Embalagem	Capac.(mAh)	Dim.(mm)	Tamanho	Obs.	Tensão(V)	Foto
034542	2 pçs	3.000mAh	18x65mm	18650	1C	3,7	
034073	2 pçs	2.600mAh	18x65mm	18650	1C	3,6	
036546	1 pç	2.200mAh	18x65mm	18650	1C	3,6	
030352	1 pç	2.200mAh	18x65mm	18650	1C	3,7	
034081	2 pçs	2.200mAh	18x65mm	18650	1C	3,7	
001920	1 pç	2.000mAh	18x65mm	18650	1C	3,6	

035834	1 pç	1.800mAh	18x65mm	18650	p/ fotopolimerizador	3,6
--------	------	----------	---------	-------	----------------------	-----

036144	1 pç	1.500mAh	18x50mm	18500	Alta Descarga 2C	3,6
033998	2 pçs	1.400mAh	18x49mm	18490	1C	3,6





## Cilíndricas Li-Ion - Sem TOP

Código	Embalagem	Capac.(mAh)	Dim.(mm)	Tamanho	Obs.	Tensão(V)	Foto
001156	1 pç	1.800mAh	17x67mm	17670	1C	3,6	
030800	1 pç	1.200mAh	17x50mm	17500	1C	3,6	
034119	2 pçs	750mAh	17x36mm	17360	1C	3,6	
030802	1 pç	600mAh	16x34mm	16340	1C	3,6	
033990	2 pçs	1.000mAh	14x65mm	14650	1C	3,6	
035707	1 pç	850mAh	14x50mm	14500	1C	3,7	
034770	1 pç	650mAh	14x50mm	14500	1C	3,7	
035748	1 pç	350mAh	10,5x44mm	10440	1C	3,7	















## Cilíndricas Li-Ion - Com TOP

Código	Embalagem	Capac.(mAh)	Dim.(mm)	Tamanho	Obs.	Tensão(V)	Foto
035456	2 pçs	4.400mAh	26x67mm	26670	1C	3,7	
036347	1 pç	3.500mAh	18x65mm	18650	1C	3,6	
035689	1 pç	3.400mAh	18x65mm	18650	C/PCM - 1C	3,7	
036374	1 pç	3.150mAh	18x65mm	18650	1C	3,7	
034543	2 pçs	3.000mAh	18x67mm	18650	1C	3,7	
036345	1 pç	2.600mAh	18x65mm	18650	C/PCM - 1C	3,6	
036346	1 pç	2.600mAh	18x65mm	18650	1C	3,7	
035688	1 pç	2.200mAh	18x65mm	18650	C/PCM - 1C	3,7	



## Cilíndricas Li-Ion - Com TOP

Código	Embalagem	Capac.(mAh)	Dim.(mm)	Tamanho	Obs.	Tensão(V)	Foto
035592	1 pç	600mAh	16x34mm	16340	1C	3,7	
036348	1 pç	900mAh	14x50mm	14500	C/PCM - 1C	3,7	

## Cilíndricas Li-Ion - Com Terminais



Código	Embalagem	Capac.(mAh)	Dim.(mm)	Tamanho	Obs.	Tensão(V)	Foto
 036553	1 pç	3.000mAh	18x65mm	18650	1C	3,7	
 036537	1 pç	3.000mAh	18x65mm	18650	1C - Rontek	3,6	
 036549	2 pçs	2.600mAh	18x65mm	18650	1C	3,7	
036064	1 pç	2.600mAh	18x65mm	18650	Conector JST-XHP-3P - 1C	3,7	
 036140	1 pç	2.450mAh	18x65mm	18650	Conector 396203HA - 1C	3,7	
034137	2 pçs	2.600mAh	18x65mm	18650	1C	3,7	
 036554	1 pç	2.200mAh	18x65mm	18650	1C	3,6	
 036538	1 pç	2.200mAh	18x65mm	18650	1C - Rontek	3,7	

## Cilíndricas Li-Ion - Com Terminais

Código	Embalagem	Capac.(mAh)	Dim.(mm)	Tamanho	Obs.	Tensão(V)	Foto
034131	2 pçs	1.400mAh	18,6x51,9mm	18490	1C	3,7	
034535	2 pçs	1.400mAh	18x49mm	18490	1C	3,6	
034791	2 pçs	750mAh	14x50mm	14500	1C	3,7	







**Baterias de Li-Ion:** Formato Prismático. Podem ser usadas mais de 500 vezes. Vários tamanhos disponíveis. Alta densidade de energia por volume. Baixo peso. Capacidade (mAh) de 650mAh até 1400mAh Baixa resistência Interna. Tensões entre 3,6 e 3,7V. Alta segurança quando usadas com placa PCM.

## Li-Ion Prismáticas









Código	Embalagem	Capac.(mAh)	Dim.(mm)	Obs.	Tensão(V)	Foto
035835	1 pç	1.700mAh	10x34x50	C/ PVC - 1C	3,6	
001825	1 pç	1.400mAh	10x34x48	C/ PVC - 1C	3,6	
035595	1 pç	1.100mAh	6x34x53	5C	3,6	
034010	2 pçs	800mAh	6x30x48	C/ PVC - 1C	3,6	
034547	1 pç	800mAh	6x30x48	ICR - Alumínio - 1C	3,7	
034548	1 pç	800mAh	6x30x52	conector JST PHR3 c/PCB - 1C	3,7	
033874	1 pç	680mAh	18x26x49	1C	9V	

**Baterias de Li-Polímero:** Podem ser usadas de 300 a 500 vezes. Baixa espessura. Vários tamanhos disponíveis. Alta densidade de energia por volume. Baixo peso. Capacidade (mAh) de 200mAh até 2600mAh. Baixa resistência interna. Tensões entre 3,6 e 3,7V. Vida útil elevada. Alta segurança quando usadas com placa PCM.

## Li-Polímero - Alta Descarga

Código	Embalagem	Capac.(mAh)	Dim.(mm)	Obs.	Tensão(V)	Foto
036297	1 pç	3200mAh	5,5x50x82,5	2C - Sem PCM	3,7	
036295	1 pç	3000mAh	6x45,5x135	10C - Sem PCM	3,7	
036296	1 pç	2800mAh	6x51x86	2C - Sem PCM	3,7	
036294	1 pç	2200mAh	8x34,5x96,5	25C - Sem PCM	3,7	
036293	1 pç	2100mAh	6x44,5x90,5	20C - Sem PCM	3,7	
036292	1 pç	1900mAh	6,2x34,5x97	10C - Sem PCM	3,7	
036291	1 pç	1400mAh	7x35x65	10C - Sem PCM	3,7	
036290	1 pç	1050mAh	5,5x35x62	10C - Sem PCM	3,7	
036289	1 pç	750mAh	6,2x30,5x52	10C - Sem PCM	3,7	
036427	1 pç	3.650mAh	135x45x5,5	2C Conector MN51021-3P C/ PCB	3,7	
036428	1 pç	2.500mAh	57x50,5x8,8	2C Conector MN51021-3P C/ PCB	3,7	
036429	1 pç	1.500mAh	65x35,5x7	2C Conector MN51021-3P C/ PCB	3,7	
036082	1 pç	750mAh	9x25x40	30C Conec JST-5YP-02T-01F	3,7	
036045	1 pç	750mAh	9x25x40	25C Conec JST-5YP-02T-01F	3,7	

## Li-Polímero - 1C



Código	Embalagem	Capac.(mAh)	Dim.(mm)	Obs.	Tensão(V)	Foto
036426	1 pç	5.000mAh	74x64x8,9	Conector MN51021-3P C/ PCB	3,7	
035677	1 pç	2.600mAh	8x45x66	Conector 51021-3P C/ PCB	3,7	
034546	1 pç	1.800mAh	10x31x49	Conector A58 C/ PCB	3,7	
035489	1 pç	1.300mAh	9x30x47	Conector 51021-3P C/ PCB	3,7	
035488	1 pç	1.150mAh	8x30x50	Conector 51021-3P C/ PCB	3,7	
 036544	1 pç	1.100mAh	5x37x56	C/ PCB	3,7	
035690	1 pç	1.100mAh	5x37x56	Conector 51021-3P C/ PCB	3,7	
035692	1 pç	1.050mAh	5x35x60	Conector 51021-3P C/ PCB	3,7	







## Li-Polímero - 1C

Código	Embalagem	Capac.(mAh)	Dim.(mm)	Obs.	Tensão(V)	Foto
033547	1 pç	1.050mAh	5x45x55	Conector MJJAE-ILG 3 Vias	3,7	
035807	1 pç	1050mAh	7x35x53	Conector HRS DF13-3S	3,7	
036285	1 pç	1050mAh	7x35x53	26AWG (6cm)	3,7	
035647	1 pç	1.000mAh	10,5x34x43	Conector 51021-3P C/ PCB	3,6	
034545	1 pç	1.000mAh	5x37x62	Conector JST-PHR3 C/ PCB	3,7	
036319	1 pç	1.000mAh	7x30x48	Conector JST-PHR3 C/ PCB	3,7	
 036545	1 pç	1.000mAh	7x30x48	Conector JST de 3 fios C/ PCM	3,7	

Li-Polímero - 1C

Código	Embalagem	Capac.(mAh)	Dim.(mm)	Obs.	Tensão(V)	Foto
035386	1 pç	950mAh	8x34x40	C/ TAG	3,7	
035678	1 pç	900mAh	7x34x43	Conector 51021-3P C/ PCB	3,7	
035679	1 pç	900mAh	6x38x40	Conector DF135P C/ PCB	3,7	
 036543	1 pç	900mAh	6,5x34x43	C/ PCB	3,7	
035487	1 pç	850mAh	6x31x49	Conector 51021-3P C/ PCB	3,7	
035042	1 pç	800mAh	5x30x50	conector JST-PHR-3P	3,7	
035921	1 pç	800mAh	6x30x52	C/ PCM conector JST-PHR3	3,7	

## Li-Polímero - 1C

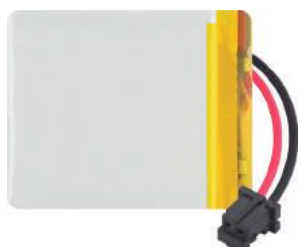
Código	Embalagem	Capac.(mAh)	Dim.(mm)	Obs.	Tensão(V)	Foto
034549	1 pç	800mAh	6x34x45	conector 51021-3P c/PCB	3,7	
034544	1 pç	650mAh	3x35x59	Conector JST-PHR-3P c/ PCB	3,7	
036479	1 pç	500mAh	7x35x56	28AWG 6CM	3,7	
034794	1 pç	450mAh	3x30x40	Conector 51021-3P C/ PCB	3,7	
035038	1 pç	400mAh	6x20x35	Conector 51021-2P	3,7	
034795	1 pç	310mAh	4x31x35	Conector A58	3,7	

**Li-Polímero - 1C**

Código	Embalagem	Capac.(mAh)	Dim.(mm)	Obs.	Tensão(V)	Foto
035486	1 pç	290mAh	6x20x31	C/ TAG Sem PCM	3,7	
035039	1 pç	210mAh	4x20x31	Conector MN51021-3P	3,7	
036430	1 pç	210mAh	4x20x31	Conector GPS JST-PHR3 C/ PCB	3,7	
 036542	1 pç	210mAh	4x20x31	Conector GPS JST-PHR3 C/ PCB	3,7	
035680	1 pç	200mAh	6x14x35	Conector JST-PHR-3P C/ PCB	3,7	

**Rontek recarregáveis especiais**

**Baterias Li-Íon Polímero 3,7V**

PREÇOS SOB CONSULTA!

- LIP301020-30 - 30mAh - 3.1x10.5x20.5 mm
- LIP301030-60 - 60mAh - 3.1x10.5x30.5 mm
- LIP301040-30 - 100mAh - 4.6x12.5x25.5 mm
- LIP501235-160 - 160mAh - 5.2x12.5x35.5 mm
- LIP502030-250 - 250mAh - 5.2x20.5x30.5 mm
- LIP702030-350 - 350mAh - 7.2x20.5x30.5 mm
- LIP902030-500 - 500mAh - 9.2x20.5x30.5 mm
- LIP502248-500 - 500mAh - 5.2x22.5x48.5 mm
- LIP762533-600 - 600mAh - 7.7x25.5x33.5 mm
- LIP503035-520 - 520mAh - 5.2x30.5x35.5 mm
- LIP523048-780 - 780mAh - 5.3x30.5x48.5 mm
- LIP603048-900 - 900mAh - 6.2x30.5x48.5 mm
- LIP803048-1200 - 1200mAh - 8.2x30.5x48.5 mm
- LIP603443-1000 - 1000mAh - 6.2x34.5x43.5 mm
- LIP383450-700 - 700mAh - 3.9x34.5x50.5 mm
- LIP523450-1000 - 1000mAh - 5.3x34.5x50.5 mm

- LIP783450-1400 - 1400mAh - 7.9x34.5x50.5 mm
- LIP103450-1800 - 1800mAh - 10.2x34.5x50.5 mm
- LIP553560-1200 - 1200mAh - 5.6x35.5x60.5 mm
- LIP853560-1600 - 1600mAh - 8.6x35.5x60.5 mm
- LIP503562-1100 - 1100mAh - 5.2x35.5x62.5 mm
- LIP503562-1250 - 1250mAh - 5.2x35.5x62.5 mm
- LIP604045-1200 - 1200mAh - 6.2x40.5x45.5 mm
- LIP584060-1500 - 1500mAh - 5.9x40.5x60.5 mm
- LIP804050-1700 - 1700mAh - 8.2x40.5x50.5 mm
- LIP584060-1500 - 1500mAh - 5.9x40.5x60.5 mm
- LIP705056-2000 - 2000mAh - 7.2x50.5x56.5 mm
- LIP855165-3200 - 3200mAh - 8.7x51x65 mm
- LIP606090-4000 - 4000mAh - 6.2x60.5x90.5 mm
- LIP756090-5000 - 5000mAh - 7.7x60.5x90.5 mm
- LIP9055102-600 - 6000mAh - 9.2x55.5x102.5mm





**3,7V 1S1P**  
 • 20x20x68mm • c/ placa PCM MOD 1  
**036214** - 2200mAh  
**036215** - 2600mAh  
**036216** - 3000mAh

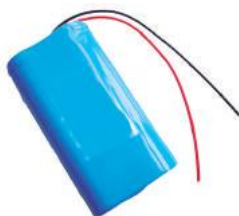

**3,7V 1S2P**  
 • 38x20x68mm • c/ placa PCM MOD 1  
**036217** - 4400mAh  
**036218** - 5200mAh  
**036329** - 6000mAh



**3,7V 1S3P**  
 • 56x20x68mm • c/ placa PCM MOD 1  
**036153** - 6600mAh  
**036154** - 7800mAh  
**036155** - 9000mAh



**3,7V 1S3P**  
 • 30x38x68mm • c/ placa PCM MOD 2D  
**036156** - 6600mAh  
**036157** - 7800mAh  
**036158** - 9000mAh



**3,7V 1S4P**  
 • 74x20x68mm • c/ placa PCM MOD 1  
**036159** - 8800mAh  
**036160** - 10400mAh  
**036161** - 12000mAh



**3,7V 1S4P**  
 • 38x38x68mm • c/ placa PCM MOD 2  
**036162** - 8800mAh  
**036163** - 10400mAh  
**036164** - 12000mAh

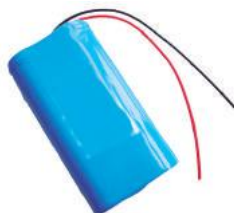

**7,4V 2S1P**  
 • 38x20x68mm • c/ placa PCM MOD 1  
**036165** - 2200mAh  
**036166** - 2600mAh  
**036167** - 3000mAh



**7,4V 2S2P**  
 • 74x20x68mm • c/ placa PCM MOD 1  
**036168** - 4400mAh  
**036169** - 5200mAh  
**036170** - 6000mAh



**7,4V 2S2P**  
 • 38x38x68mm • c/ placa PCM MOD 2  
**036171** - 4400mAh  
**036172** - 5200mAh  
**036173** - 6000mAh



**7,4V 2S3P**  
 • 110x20x68mm • c/ placa PCM MOD 1  
**036174** - 6600mAh  
**036175** - 7800mAh



**7,4V 2S3P**  
 • 56x38x68mm • c/ placa PCM MOD 2  
**036176** - 6600mAh  
**036177** - 7800mAh



**7,4V 2S4P**  
 • 74x38x68mm • c/ placa PCM MOD 2  
**036178** - 12000mAh



**7,4V 2S5P**  
 • 92x38x68mm • c/ placa PCM MOD 2  
**036179** - 15000mAh



**11,1V 3S1P**  
 • 56x20x68mm • c/ placa PCM MOD 1  
**036180** - 2200mAh  
**036181** - 2600mAh  
**036182** - 3000mAh



**11,1V 3S3P**  
 • 56x56x68mm • c/ placa PCM MOD 3  
**036183** - 6600mAh  
**036184** - 7800mAh



**11,1V 3S4P**  
 • 74x56x68mm • c/ placa PCM MOD 3  
**036185** - 12000mAh



**11,1V 3S5P**  
 • 92x56x68mm • c/ placa PCM MOD 3  
**036186** - 15000mAh



**12,6V 2100mAh**  
 • Compatível c/ Alexa  
 • echo DOT 3ª geração  
 • Funciona de 7 a 8hs no vol.máx.  
**036596**



**14,8V 4S1P**  
 • 74x20x68mm • c/ placa PCM MOD 1  
**036187** - 2200mAh  
**036188** - 2600mAh  
**036189** - 3000mAh



**14,8V 4S3P**  
 • 110x38x68mm • c/ placa PCM MOD 3  
**036190** - 7800mAh



**14,8V 4S4P**  
• 74x74x68mm • c/ placa PCM MOD 4  
**036191** - 1200mAh



**14,8V 4S5P**  
• 92x74x68mm • c/ placa PCM MOD 4  
**036192** - 1500mAh



**14,8V 4S10P**  
• 182x74x68mm • c/ placa PCM MOD 4  
**036193** - 3000mAh



**18,5V 5S3P**  
• 92x56x68mm • c/ placa PCM MOD 3  
**036194** - 900mAh



**18,5V 6S3P**  
• 110x56x68mm • c/ placa PCM MOD 3  
**036195** - 900mAh



**25,9V 7S3P**  
• 128x56x68mm • c/ placa PCM MOD 3  
**036196** - 900mAh



**37V 10S5P**  
• 182x92x68mm • c/ placa PCM MOD 5  
**036197** - 1500mAh



**48,1V 13S5P**  
• 236x92x68mm • c/ placa PCM MOD 5  
**036198** - 1500mAh

Packs LiFePo4 e NiMh



**6,4V 2S4P**  
• 74x38x68mm • c/ placa PCM MOD 2  
**036199** - 600mAh



**6,4V 2S10P**  
• 74x92x68mm • c/ placa PCM MOD 5  
**036200** - 1500mAh

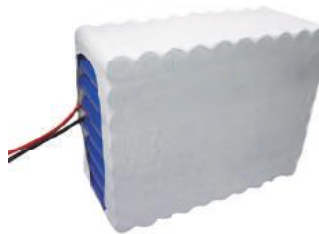

**12,8V 4S20P**  
• 182x146x68mm • c/ placa PCM MOD 8  
**036201** - 3000mAh



**3,6V 3S1P**  
• 47x16x52mm • c/ placa PCM MOD 1  
**036202** - 900mAh



Packs de baterias desenvolvidos de acordo com a especificação do projeto do cliente.

**Packs de Baterias**



**Baterias de NiMh:** Podem ser usadas de 500 a 700 vezes. Tensão de 1,2V. Capacidade(mAh) entre 300mAh e 8000mAh. Não tem efeito memória. Substituem as baterias de NiCd na maioria das aplicações e poluem muito menos

## NiMh - Com Top 1,2V

Código	Embalagem	Capac.(mAh)	Dim.(mm)	Tamanho	Obs.	Foto
034776	2 pçs	8.000mAh	33x61	D		
031575	2 pçs	4.500mAh	26x50	C		
035459	2 pçs	4.500mAh	26x50	C		
034007	2 pçs	4.000mAh	26x50	C		
031574	2 pçs	1.500mAh	26x50	C		
001916	4 pçs	600mAh	11x45	AAA		
002810	2 pçs	600mAh	11x45	AAA		

## NiMh - Sem Top 1,2V - P/ Ferramentas

Código	Embalagem	Capac.(mAh)	Dim.(mm)	Tamanho	Obs.	Foto
035951	1 pç	3.000mAh	23x43	SC	30A	
001924	1 pç	2.500mAh	23x43	SC	10C	
035858	1 pç	1.900mAh	23x43	SC	10C	
035857	1 pç	1.700mAh	22x32	4/5SC	10C	

## NiMh - Sem Top 1,2V

Código	Embalagem	Capac.(mAh)	Dim.(mm)	Tamanho	Obs.	Foto
<b>NOVO</b> 036555	1 pç	3.000mAh	23x43	SC	Alta Desc. - 10C	
035467	1 pç	3.000mAh	23x43	SC	Alta Desc. - 10C - Rontek	
001212	1 pç	3.000mAh	23x43	SC		
035749	1 pç	2.400mAh	22x32	4/5SC		
035750	1 pç	2.500mAh	17x49	A		
034129	2 pçs	2.100mAh	17x49	A		
034124	2 pçs	4.500mAh	18,3x66,8	4/3A	Extra Grande	
034796	2 pçs	3.800mAh	17x66	4/3A		
035034	1 pç	3.500mAh	17X66	4/3A		
034016	2 pçs	3.300mAh	17x66	4/3A		
035859	1 pç	3.100mAh	17x66	4/3A	3C	
034128	2 pçs	1.800mAh	17x43	4/5A		
035687	1 pç	1600mAh	17x28,5	2/3A	Alta Desc. - 10C	
035455	2 pçs	1.200mAh	17x29	2/3A		

NiMh - Sem Top 1,2V

Código	Embalagem	Capac.(mAh)	Dim.(mm)	Tamanho	Obs.	Foto
--------	-----------	-------------	----------	---------	------	------

001900	1 pç	1.000mAh	16,5x28,5	1/2A		
--------	------	----------	-----------	------	--	--



<b>NOVO</b> 036559	2 pçs	2.500mAh	14x50	AA		
034792	2 pçs	2.500mAh	14x50	AA	Rontek	
030402	1 pç	2.300mAh	15x49	AA		
030401	1 pç	2100mAh	15x49	AA		
033995	2 pçs	1.800mAh	15x49	AA		
034562	1 pç	1.800mAh	15x49	AA		
001902	1 pç	1.300mAh	15x49	AA		



001214	1 pç	1.200mAh	14x43	4/5AA		
--------	------	----------	-------	-------	--	--



030049	1 pç	900mAh	11x44	AAA		
033179	1 pç	900mAh	11x44	AAA		
<b>NOVO</b> 036558	1 pç	850mAh	11x44	AAA		
035540	1 pç	850mAh	11x44	AAA	Rontek	
<b>NOVO</b> 036556	1 pç	700mAh	11x44	AAA		
001910	1 pç	700mAh	11x44	AAA	Rontek	
035468	1 pç	700mAh	11x44	AAA	Alta Desc. - 10C	
034017	4 pçs	600mAh	11x44	AAA		
034537	2 pçs	600mAh	11x44	AAA		



034015	4 pçs	300mAh	11x29	2/3AAA		
--------	-------	--------	-------	--------	--	--



NiMh - Com Terminais 1,2V

Código	Embalagem	Capac.(mAh)	Dim.(mm)	Tamanho	Obs.	Foto
--------	-----------	-------------	----------	---------	------	------

034130	2 pçs	1.800mAh	23x35,5	4/5SC		
--------	-------	----------	---------	-------	--	--



034057	2 pçs	3.500mAh	17x66	4/3A		
--------	-------	----------	-------	------	--	--



030981	1 pç	1.100mAh	17x28,5	2/3A		
--------	------	----------	---------	------	--	--





## NiMh - Com Terminais 1,2V

Código	Embalagem	Capac.(mAh)	Dim.(mm)	Tamanho	Obs.	Foto
034769	2 pçs	2.500mAh	15x51	AA		
034774	2 pçs	2.300mAh	15x51	AA		
035542	2 pçs	2.200mAh	15x51	AA		
034445	4 pçs	2.100mAh	15x51	AA		
034443	4 pçs	1.800mAh	15x51	AA		
034013	4 pçs	1.300mAh	15x51	AA		
034083	2 pçs	1.300mAh	15x51	AA		

034052	4 pçs	900mAh	11x45	AAA		
035541	4 pçs	800mAh	11x45	AAA		
001908	1 pç	700mAh	11x45	AAA		

**Baterias de NiCd:** Podem ser usadas de 700 a 1000 vezes. Tensão de 1,2V. Capacidade(mAh) entre 300mAh e 5000mAh. Efeito memória muito reduzido. Devem ser descartadas adequadamente para não poluir. Baterias muito resistentes a abusos.

## NiCd - Com Top 1,2V

Código	Embalagem	Capac.(mAh)	Dim.(mm)	Tamanho	Obs.	Foto
035046	2 pçs	5.000mAh	33x61	D		
034034	2 pçs	4.500mAh	36x61	D		
035045	2 pçs	4.000mAh	33x61	D		

033994	2 pçs	2.500mAh	26x50	C		
--------	-------	----------	-------	---	--	---



030684	2 pçs	800mAh	15x50	AA		
001077	2 pçs	600mAh	15x50	AA		
033438	1 pç	600mAh	15x50	AA		

001216	4 pçs	300mAh	11x45	AAA		
--------	-------	--------	-------	-----	--	---

NiCd - Sem Top 1,2V

Código	Embalagem	Capac.(mAh)	Dim.(mm)	Tamanho	Obs.	Foto
001500	1 pç	2.000mAh	26x50	C	Alta Temperatura	
033993	2 pçs	2.000mAh	23x43	SC		
001882	1 pç	1.800mAh	23x43	SC		
034056	2 pçs	1.000mAh	22x32	4/5SC	FLAT TOP	
001881	1 pç	600mAh	17x28	2/3A		
034086	4 pçs	900mAh	14X50	AA		
034012	4 pçs	800mAh	15X49	AA		
001921	1 pç	600mAh	15x49	AA	Rontek	
 036560	1 pç	600mAh	15x49	AA		
031439	1 pç	300mAh	11x45	AAA		

NiCd - Com Terminais 1,2V

Código	Embalagem	Capac.(mAh)	Dim.(mm)	Tamanho	Obs.	Foto
034444	2 pçs	1.800mAh	23x43mm	SC		
033997	2 pçs	900mAh	15x51mm	AA		
031573	1 pç	600mAh	15x51mm	AA		
033996	2 pçs	600mAh	15x51mm	AA		
034071	2 pçs	300mAh	11x45mm	AAA		



**2,4V 300mAh**  
 • NiCd • Conector Un. • 2x2/3AA  
 • (14x28x30mm)  
**001075**



**2,4V 300mAh**  
 • NiCd • Conector Un. Tipo GP  
 • 2x2/3AA • (14x28x30mm)  
**033157**



**2,4V 300mAh**  
 • NiCd • Conector A58 • 2x2/3AA  
 • (14x28x30mm)  
**001870**



**2,4V 300mAh**  
 • NiCd • Conector M63 • 2x2/3AA  
 • (14x28x30mm)  
**001538**



**2,4V 600mAh**  
 • NiMH • Conector GP.  
 • 2xAAA • (11x20x45mm)  
**033158**



**2,4V 600mAh**  
 • NiCd • Conector Un. • 2xAA  
 • (15x27x52mm)  
**032707**



**2,4V 600mAh**  
 • NiCd • Conector Un. • 2xAA  
 • (15x27x52mm)  
**001872**



**2,4V 600mAh**  
 • NiMH • Conector Un. • 2xAAA  
 • (11x20x45mm)  
**030050**



**2,4V 600mAh**  
 • NiMH • Conector Un-Tipo GP • 2xAAA  
 • (11x20x45mm)  
**031624**



**2,4V 600mAh**  
 • NiMH • Conector A58 • 2xAAA  
 • (11x20x45mm) • Polar. invertida  
**030985**



**2,4V 600mAh**  
 • NiMH • Conector A58 • 2xAAA  
 • (11x20x45mm)  
**030765**



**2,4V 600mAh**  
 • NiMH • Conector Molex • 2xAAA  
 • (11x20x45mm)  
**033562**



**2,4V 600mAh**  
 • NiMH • Conector Molex • 2xAAA  
 • (11x21x44mm)  
**034136**



**2,4V 600mAh**  
 • NiMH • Conector 51021-2P  
 • (6x33x36mm)  
**033871**



**2,4V 800mAh**  
 • NiMH Panasonic hhr P105 • 2xLAAA  
 • (11x22x54mm) • Blister  
**030990**



**2,4V 800mAh**  
 • NiMH • Conector Un. • 2xLAAA  
 • (11x22x54mm)  
**033367**



**2,4V 830mAh**  
 • NiMH hhr P105 • 2xLAAA  
 • (11x22x54mm)  
**033570**



**2,4V 1500mAh**  
 • NiMH • Conector Un. • 2xAA  
 • (15x30x52mm)  
**002110**



**2,4V 1500mAh**  
 • NiMH Panasonic hhr P513 • 2xAA  
 • (14,5x34x49mm)  
**030992**



**2,4V 1500mAh**  
 • NiMH Panasonic hhr P513 • 2xAA  
 • (14,5x34x49mm)  
**033572**



**3,6V 300mAh**  
• NiCd • Conector Un. • 3x2/3AA  
• (14x30x42mm)  
**001874**



**3,6V 300mAh**  
• NiCd • Conector Un. • 3x2/3AA  
• (14x30x42mm)  
**032709**



**3,6V 300mAh**  
• NiCd • Conector Un. • 3x2/3AA  
• (14x30x42mm)  
**001514**



**3,6V 300mAh**  
• NiCd • Conector Un. Tipo GP  
• 3x2/3AA • (14x30x42mm)  
**033161**



**3,6V 300mAh**  
• NiCd • Conector M63 • 3x2/3AA  
• (14x30x42mm)  
**001516**



**3,6V 300mAh**  
• NiCd • Conector M63 • 3x2/3AA  
• (14x30x42mm)  
**033181**



**3,6V 300mAh**  
• NiCd • Conector Molex • 3x2/3AA  
• (14x30x42mm)  
**001515**



**3,6V 300mAh**  
• NiMH • Conector Molex • 3x2/3AAA  
• (11x33x30mm)  
**001273**



**3,6V 300mAh**  
• NiCd • Conector Molex • 3AAA  
• (11x31x44mm)  
**034361**



**3,6V 300mAh**  
• NiCd • Conector MJ JST • 3x2/3AA  
• (14x30x42mm)  
**032708**



**3,6V 300mAh**  
• NiMH • Conector Un. Tipo GP  
• 3xAAA • (11x31x44mm)  
**033346**



**3,6V 300mAh**  
• NiMH • Conector Un. • 3xAAA  
• (11x31x44mm)  
**033344**



**3,6V 300mAh**  
• NiMH • Conector Un. • 3x2/3AAA  
• (11x31x30mm)  
**001895**



**3,6V 300mAh**  
• NiMH • Conector Un. • 3x2/3AAA  
• (11x33x30mm)  
**033180**



**3,6V 300mAh**  
• NiMH • Conector Un • Tipo GP  
• 3x2/3AAA • (11x33x30mm)  
**031203**



**3,6V 350mAh**  
• NiCd • Conector Molex • 3xAAA  
• (11x31x44mm)  
**031519**



**3,6V 350mAh**  
• NiCd • Conector Un. • 3xAAA  
• (11x31x44mm)  
**034132**



**3,6V 600mAh**  
• NiCd • Conector Un. • 3xAA  
• (14x47x42mm)  
**032711**



**3,6V 600mAh**  
• NiMH • Conector Un. • 3x2/3AA  
• (14x30x42mm)  
**001899**



**3,6V 600mAh**  
• NiMH • Conector Un. Tipo GP  
• 3x2/3AA • (14x30x42mm)  
**032012**



**3,6V 600mAh**  
• NiMH • Conector GP • 3xAA  
• (14x42x47mm)  
**035044**



**3,6V 600mAh**  
• NiMH • Conector JX (MJ-JST)  
• 3x2/3AA • (14x30x42mm)  
**032013**



**3,6V 600mAh**  
• NiMH • Conector JX (MJ-JST)  
• 3x2/3AA • (14x30x42mm)  
**033440**



**3,6V 600mAh**  
• NiCd • Conector Un. • 3xAA  
• (14x47x42mm)  
**001074**



**3,6V 600mAh**  
• NiCd • Conector Un. • 3xAA  
• (14x47x42mm)  
**033831**



**3,6V 600mAh**  
• NiCd • Conector Un. • 3xAA  
• (14x47x42mm)  
**001517**



**3,6V 600mAh**  
• NiCd • Conector Un. Tipo GP • 3xAA  
• (14x47x42mm) • Blister Premium  
**034074**



**3,6V 600mAh**  
• NiCd • Conector Un. Tipo GP • 3xAA  
• (14x47x42mm)  
**031205**



**3,6V 600mAh**  
• NiCd • Conector Un. Tipo GP • 3xAA  
• (14x47x42mm)  
**033166**



**3,6V 600mAh**  
• NiCd • Conector M63 • 3xAA  
• (14x47x42mm) • Blister Premium  
**034080**



**3,6V 600mAh**  
• NiCd • Conector M63 • 3xAA  
• (14x47x42mm)  
**001875**



**3,6V 600mAh**  
• NiCd • Conector M63 • 3xAA  
• (14x47x42mm)  
**032710**



**3,6V 600mAh**  
• NiCd • Conector Molex • 3xAA  
• (14x47x42mm)  
**001518**



**3,6V 600mAh**  
• NiCd • Conector Molex • 3xAA  
• (14x47x42mm)  
**033436**



**3,6V 600mAh**  
• NiCd • Conector MJ JST • 3xAA  
• (14x47x42mm)  
**001519**



**3,6V 600mAh**  
• NiCd • Conector MJ JST • 3xAA  
• (14x47x42mm)  
**033182**



**3,6V 600mAh**  
• NiMH • Conector Un. • 3xAAA  
• (11x33x45mm)  
**001544**



**3,6V 600mAh**  
• NiMH • Conector Un. Tipo GP  
• 3xAAA • (11x31x44mm)  
**031204**



**3,6V 600mAh**  
• NiMH • Conector Un. Tipo GP  
• 3xAAA • (11x31x44mm)  
**033163**



**3,6V 600mAh**  
• NiMH • Conector M63 • 3xAAA  
• (11x33x45mm)  
**001465**



**3,6V 600mAh**  
 • NiMH • Conector Molex • 3xAAA  
 • (11x33x45mm)  
**032705**



**3,6V 600mAh**  
 • NiMH • Conector Molex • 3xAAA  
 • (11x33x45mm) Blister Premium  
**033864**



**3,6V 600mAh**  
 • NiMH • Conector Molex • 3xAAA  
 • (11x33x45mm) Blister  
**001897**



**3,6V 300mAh**  
 • NiMH • Conector Molex • 3xAAA  
 • (11x30x45mm)  
**033345**



**3,6V 600mAh**  
 • NiMH • Conector JST • 3xAAA  
 • (11x33x45mm)  
**001896**



**3,6V 700mAh**  
 • NiMH • Conector Panasonic hhr P107  
 • 3xAAA • (12x32x49mm)  
**033573**



**3,6V 800mAh**  
 • NiMH • Conector JST • 3xAAA  
 • (11x31x44mm)  
**035041**



**3,6V 800mAh**  
 • NiCd • Conector Un. • 3xAA  
 • (14x47x42mm)  
**001876**



**3,6V 800mAh**  
 • NiCd • Conector Un. • 3xAA  
 • (14x47x42mm)  
**033183**



**3,6V 830mAh**  
 • NiMH • Conector P104 • 5/4AAA  
 • (14x42x50mm)  
**033571**



**3,6V 850mAh**  
 • NiMH • Conector Molex • 3XAAA  
 • (14x42x47mm)  
**031625**



**3,6V 850mAh**  
 • NiMH • Conector tipo Panasonic hhr P104 • 3xLAAA • (12x32x54mm)  
**034079**



**3,6V 1000mAh**  
 • NiMH • Conector JST-XHR-3P  
 • 3xAA • (12x44x47mm)  
**033574**



**3,6V 1300mAh**  
 • NiMH • Conector Un. • 3xAA  
 • (14x47x42mm)  
**001194**



**3,6V 1300mAh**  
 • NiMH • Conector M63 • 3xAA  
 • (14x47x42mm)  
**001389**



**4,8V 600mAh**  
 • NiCd • Conector Un. • 4xAA  
 • (15x51x58mm)  
**002107**



**4,8V 600mAh**  
 • NiCd • Conector Un. • 4xAA  
 • (14x56x50mm)  
**033575**



**6V 600mAh**  
 • NiCd • Conector Un. • 5xAA  
 • (15x52x75mm)  
**033171**



**3,6V 600mAh**  
 • NiCd • Para uso em Talkabout  
 • (15x51x45mm)  
**033147**



**3,6V 600mAh**  
 • NiCd • Para uso em Talkabout  
 • (15x51x45mm)  
**034134**



**3,6V 700mAh**  
 • NiMH • Talkabout 4 contatos  
 • (11x33x46,5mm)  
**031139**



**4,8V 700mAh - Motorola**  
 • NiMH • Talkabout BP38 • 4 contatos  
 • Dist. cont. centro a centro: 8,5mm  
**031477**



**4,8V 700mAh - Motorola**  
 • NiMH • Talkabout BP38 • 4 contatos  
 • Dist. cont. centro a centro: 22mm  
 (50x32x40mm)  
**031200**



**7,2V 600mAh**  
 • NiCd • Pack  
 • (17x51x57mm)  
**001830**



**3,7V 680mAh**  
 • Lítio Ion-NP20 • Cássio  
 • Para câmera fotográfica  
 (50x32x40mm)  
**031138**



**11,1V 4000mAh**  
 • Li-Po • Conec XT 60 Fêmea 12AWG /  
 JST-XH-4P/22AWG • 30C • C/ PCB  
**035683**



**11,1V 2300mAh**  
 • Li-Po • Conec XT 60 Fêmea 14AWG/  
 JST-XH-4P 22AWG • 90C • C/ PCB  
**035681**



**11,1V 1800mAh**  
 • Li-Po • Conec XT 60 Fêmea 14AWG/  
 JST-XH-4P 22AWG • 45C Com PCB  
**035682**



**11,1V 1800mAh**  
 • Li-Po • Conec XT 60 Fêmea 14AWG/  
 JST-XH-4P 22AWG • 25C • (105x35x23mm)  
**035613**



**11,1V 1300mAh**  
 • Li-Po • Conec XT 60 Fêmea 14AWG/  
 JST-XH-4P 22AWG • 25C • (22x34x105mm)  
**035614**



**9,6V 1300mAh**  
 • NiMH • 62006/2P  
 • Pack • (15x60x102mm)  
**001914**



**9,6V 800mAh**  
 • NiCd • 62006/2P  
 • Pack • (16x60x102mm)  
**001880**



**7,4V 1000mAh - Rontek**  
 • Li-Po • Conector • 3 vias  
 • c/ cabo 24awg • (6,8x56x76mm)  
**035617**



**7,4V 1000mAh**  
 • Li-Po • Conector 3 Vias • c/ cabo 24awg  
 • (6,8x56x76mm)  
**036541**



**7,2V 3000mAh**  
 • NiMH • 6 Células SC  
 • Conector Macho 62006-2p  
 • (23x46x138mm)  
**036557**



**7,2V 3000mAh - Rontek**  
 • NiMH • 62006/2P  
 • Estojó (23x46x138mm)  
**001913**



**7,2V 2500mAh**  
 • NiMH • Conector Tamiya  
 • AA  
**035612**



**7,2V 1800mAh**  
 • NiCd • 62006/2P  
 • Estojó (23x51x131mm)  
**001879**



**7,2V 650mAh**  
 • NiMH • Conector Jst Smp 02  
 • 10C • 6AAA • (21,5x31,5x46mm)  
**033739**



**Pack para Aspirador de Pó**  
 • Electrolux Ergorápido  
 • 12V • 2100 mAh • NiMH  
**035561**

**SINÔNIMO  
DE QUALIDADE!**



**AA 2700mAh**  
• 1,2V • NiMh • (15x50mm)  
**031209** Blister: 2 pçs



**AA 2500mAh**  
• 1,2V • NiMh • (15x50mm)  
**031453** Blister: 1 pç  
**002808** Blister: 2 pçs  
**033866** Blister Premium: 2 pçs  
**002325** Blister: 4pçs



**AA 2300mAh**  
• 1,2V • NiMh • (15x50mm)  
**002809** Blister: 2 pçs  
**001905** Blister: 4pçs



**AA 2100mAh**  
• 1,2V • NiMh AA • (15x50mm)  
**002807** Blister: 2 pçs  
**033865** Blister Premium: 2 pçs  
**001491** Blister: 4pçs



**AA 1300mAh**  
• 1,2V • NiMh • (15x50mm)  
**001068** Blister: 2 pçs



**AA 900mAh**  
• 1,2V • NiCd • (15x50mm)  
**001229** Blister: 2 pçs



**AA 700mAh**  
• 1,2V • NiCd • (15x50mm)  
**030683** Blister: 2 pçs



**AAA 1100mAh**  
• 1,2V • NiMh • (11x45mm)  
**035469** Blister: 2 pçs



**AAA 1000mAh**  
• 1,2V • NiMh • (11x45mm)  
**033867** Blister Premium: 2 pçs  
**030286** Blister: 2 pçs  
**030287** Blister: 4pçs



**AAA 900mAh**  
• 1,2V • NiMh • (11x45mm)  
**002816** Blister: 2 pçs  
**002326** Blister: 4 pçs



**AAA 700mAh**  
• 1,2V • NiMh • (11x45mm)  
**002811** Blister: 2 pçs  
**001918** Blister: 4 pçs



**8,4V**  
• NiMh • (16x25x48mm) • Blister  
**001915** 250mAh  
**035786** 270mAh - PVC Verde  
**034539** 350mAh





**3,6V CR2032**  
 • Li Ion • 2x32mm  
 • CR2032 • Emb c/ 5 pçs  
**035814**



**3,6V 80mAh**  
 • NiMh • 16x19mm  
 • 2 Pinos  
**035594**



**3,6V 60mAh**  
 • NiCd • 2 pinos • (16x19mm)  
 • Blister  
**001549**



**3,6V 60mAh**  
 • NiCd • 2 pinos • (16x19mm)  
 • A granel  
**001373**



**3,6V 60mAh**  
 • NiCd • 3 pinos  
 • (16x19mm) • Blister  
**001945**



**3,6V 60mAh**  
 • NiMh • (16x19mm) • 2 Pinos  
 • Shrink: 4 pçs  
**034068**



**3,6V 60mAh**  
 • NiMh • (16x19mm)  
 • 3 Pinos  
**033859**

Não Recarregáveis • Lítio Cilíndricas

Lítio Cilíndricas LiSOC12 - 3,6V - RONTEK

Código	Embalagem	Capac.(mAh)	Dim.(mm)	Tam.	Obs.	Foto
<b>036561</b>	1 pç	19.000mAh	34x61	D	C/ Top	
<b>033326</b>	1 pç	19.000mAh	34x61	D	C/ Top - Rontek	
<b>033989</b>	2 pçs	3.300mAh	17x50,5		C/ Top	
<b>033328</b>	1 pç	2.400mAh	14x50	AA	C/ Top	
<b>033329</b>	1 pç	2.400mAh	14x50	AA	C/ Fio	
<b>035430</b>	1 pç	2.400mAh	14x50	AA	C/ Terminais e Fios de 8cm	
<b>033330</b>	1 pç	1.200mAh	14x25	1/2AA	C/ Top	

Lítio Cilíndricas LiSOC12 - 3,6V - MINAMOTO

Código	Embal.	Capac.(mAh)	Dim.(mm)	Tam.	Obs.	Corrente Cont.(mA)	Max. Corrente de Pulso (mA)	Foto
--------	--------	-------------	----------	------	------	--------------------	-----------------------------	------

<b>035714</b>	1 pç	19.000mAh	34x61,5	D	Alta Capacidade	200	350	
---------------	------	-----------	---------	---	-----------------	-----	-----	---

<b>035717</b>	1 pç	13.000mAh	34x61,5	D	Alta Descarga	1800	3000
---------------	------	-----------	---------	---	---------------	------	------

<b>000566</b>	1 pç	8.500mAh	26,2x50,5	C		100	250	
---------------	------	----------	-----------	---	--	-----	-----	---

<b>035716</b>	1 pç	6.000mAh	26,2x50,5	C	Alta Descarga	1000	2000
---------------	------	----------	-----------	---	---------------	------	------

<b>034560</b>	1 pç	4.000mAh	18,5x50,5			100	200	
---------------	------	----------	-----------	--	--	-----	-----	---

<b>034559</b>	1 pç	3.400mAh	17,5x50,5	A		100	200
---------------	------	----------	-----------	---	--	-----	-----

<b>035715</b>	1 pç	2.800mAh	17,5x50	A	Alta Descarga	500	1000
---------------	------	----------	---------	---	---------------	-----	------

<b>036112</b>	1 pç	2.000mAh	17x33,5	2/3A	C/ TOP	50	100	
---------------	------	----------	---------	------	--------	----	-----	---

<b>000564</b>	1 pç	2.500mAh	14,5x50,5	AA		80	150	
---------------	------	----------	-----------	----	--	----	-----	--

<b>034558</b>	1 pç	2.100mAh	14,5x50,5	AA	Alta Descarga	400	1000
---------------	------	----------	-----------	----	---------------	-----	------

<b>000565</b>	1 pç	2.500mAh	15x50	AA		80	150	
---------------	------	----------	-------	----	--	----	-----	---

<b>035719</b>	1 pç	2.100mAh	14,5x50,5	AA	Alta Descarga	400	1000
---------------	------	----------	-----------	----	---------------	-----	------

<b>036113</b>	1 pç	1.650mAh	14,5x33,5	2/3AA	C/ TOP	50	100	
---------------	------	----------	-----------	-------	--------	----	-----	---

<b>000562</b>	1 pç	1.200mAh	14,5x25,5	1/2AA		30	80	
---------------	------	----------	-----------	-------	--	----	----	---

<b>034567</b>	1 pç	750mAh	14,5x25	1/2AA	Alta Descarga	100	250
---------------	------	--------	---------	-------	---------------	-----	-----

<b>000563</b>	1 pç	1.200mAh	14x25	1/2AA		30	80	
---------------	------	----------	-------	-------	--	----	----	---

<b>035718</b>	1 pç	750mAh	14,5x25	1/2AA	Alta Descarga	100	250
---------------	------	--------	---------	-------	---------------	-----	-----

Capacitor de alto pulso



**Capacitor de alto pulso**  
• 3,6V • 140ASEG • 0,5A-2A Máx  
• 15,1x20,5mm  
**036117**



**Capacitor de alto pulso**  
• 3,6V • 250ASEG • 0,75A-3A Máx  
• 15,1x26,5mm  
**036116**







**Capacitor de alto pulso**  
• 3,6V • 560ASEG • 2A-5A Máx  
• 15,1x50,5mm  
**036118**

Exemplos de como utilizar o capacitor



O capacitor de alto pulso é usado em conjunto com baterias de LiSOC12 para aumentar seu desempenho em aplicações onde elevadas correntes de pico são exigidas. Além disso elimina o problema da passivação das baterias LiSOC12.





## Lítio Cilíndricas LiSOC12 - 3,6V - UNMOON

Código	Embalagem	Capac.(mAh)	Dim.(mm)	Tam.	Obs.	Foto
035756	1 pç	2.600mAh	14,5x50,5	AA	C/ Top	
035757	1 pç	2.600mAh	14,5x50,5	AA	C/ Terminais Axiais	
035754	1 pç	1.200mAh	14x25	1/2AA	C/ Top	
035755	1 pç	1.200mAh	14x25	1/2AA	C/ Terminais Axiais	

## Lítio Cilíndricas LiFeS2 - 1,5V

Código	Embalagem	Capac.(mAh)	Dim.(mm)	Tam.	Obs.	Foto
036535	2 pçs	3.000mAh	15x50	AA		
036536	2 pçs	1.100mAh	11x44	AAA		

## Lítio Botões LiMnO2 - 3V

Código	Embalagem	Capac.(mAh)	Dim.(mm)	Tam.	Obs.	Foto
001026	1 pç	38mAh	16x2	CR1620		
002506	1 pç	35mAh	12,5x2	CR1220		
032860	1 pç	200mAh	20x3,2	CR2032		
032859	1 pç	140mAh	20x2,5	CR2025		
032858	2 pçs	70mAh	20x1,6	CR2016		
034755	1 pç	200mAh	20x3,2	CR2032		
034754	1 pç	140mAh	20x2,5	CR2025		

Lítio Botões LiMnO2 - 3V

Código	Embalagem	Capac.(mAh)	Dim.(mm)	Tam.	Obs.	Foto
001840	1 pç	770mAh	24,5x7,7	CR2477		
001838	1 pç	530mAh	24,5x5	CR2450		
001839	1 pç	280mAh	24,5x3	CR2430		
001837	1 pç	200mAh	20x3,2	CR2032		
001836	1 pç	190mAh	20x2,5	CR2025		
001835	1 pç	75mAh	20x1,6	CR2016		

001153	1 pç	1000mAh	24,5x7,7	CR2477	
000575	1 pç	530mAh	24,5x5	CR2450	
000574	1 pç	280mAh	24,5x3	CR2430	
031345	1 pç	200mAh	20x3,2	CR2032	



036467	1 pç	500mAh	30x3,2	CR3032	
035593	20 pçs	530mAh	24,5x5	CR2450	Não Magnética
001363	1 pç	530mAh	24,5x5	CR2450	
035431	1 pç	280mAh	24,5x3	CR2430	Marca: GLD
035815	1 pç	280mAh	24x3,0	CR2430	
003119	1 pç	300mAh	23x3,5	CR2335	
036466	1 pç	130mAh	23x2,0	CR2320	
036465	1 pç	150mAh	20x2,5	CR2025	
036464	1 pç	75mAh	20x1,6	CR2016	
036463	1 pç	120mAh	16x3,2	CR1632	
003113	1 pç	70mAh	16x2	CR1620	
003112	1 pç	50mAh	16x1,6	CR1616	
036462	1 pç	25mAh	12,5x1,6	CR1216	
003109	1 pç	38mAh	12,5x2	CR1220	
NOVO 036114	1 pç	50mAh	12,5x2,5	CR1225	
036461	1 pç	30mAh	10x2,5	CR1025	



003120	1 pç	530mAh	23,4x5	CR2354	
036115	1pç	260mAh	23x3	CR2330	
033988	20 pçs	300mAh	24x5,3	CR2050	
034022	20 pçs	200mAh	20,3x2	CR2032	
036460	1 pç	30mAh	9,5x2,7	CR927	



Lítio Botões LiMnO2 com terminais



**3V (CR2032)**  
 • Lítio (20x3,2mm)  
 • Com 3 terminais para solda uso vertical  
**001359** Emb c/1pç  
**034908** Emb c/100pçs



**3V (CR2032)**  
 • Lítio (20x3,2mm) c/ 2 term axiais  
 • Para solda para placa de circuito impresso uso vertical  
**034934** Emb c/20pçs  
**034909** Emb c/25pçs



**3V (CR2032)**  
 • Lítio (20x3,2mm) com 3 terminais p/ placa de circuito impresso • Dist. entre terminais: 15,2mm  
**034933** Emb c/20pçs  
**034912** Emb c/100pçs



**3V (CR2032)**  
 • Lítio (20x3,2mm) com 2 terminais  
 • Para placa de circuito impresso  
 • Distância entre terminais: 15,6mm  
**000579** Emb c/1pç  
**034907** Emb c/100pçs



**3V (CR2032)**  
 • Lítio (20x3,2mm) com 3 terminais  
 • Para placa de circuito impresso  
 • Distância entre terminais: 17,8mm  
**034947** Emb c/20pçs  
**034913** Emb c/100pçs



**3V (CR2032)**  
 • Lítio (20x3,2mm) com 2 terminais p/  
 placa de circuito impresso uso vertical  
**001361** Granel  
**034914** Emb c/100pçs



**3V (CR2032)**  
 • Lítio (20x3,2mm)  
 • 2 terminais de 3mm  
 de altura • Emb c/20pçs  
**036110**



**3V (CR2032)**  
 • Lítio (20x3,2mm)  
 • Com hastes chatas radiais  
**001362** Granel  
**034915** Emb c/100pçs



**3V (CR2032)**  
 • Lítio (20x3,2mm) 2 terminais radiais  
 • Para placa de circuito impresso  
**000577** Granel  
**034910** Emb c/100pçs



**3V (CR2032)**  
 • Lítio (20x3,2mm) com 2 term.  
 • Para placa de circuito impresso  
**034932** Emb c/20pçs

**Botões Maxell**



**Lítio 3V (CR1220)**  
 • 3V botão • (12,5x2,0mm)  
**035659** Emb: 5 pçs



**Lítio 3V (CR 1616)**  
 • 3V botão • (16x1,6mm)  
**035660** Emb: 5 pçs



**Lítio 3V (CR 1620)**  
 • 3V botão • (16x2mm)  
**035661** Emb: 5 pçs



**Lítio 3V (CR1632)**  
 • 3V botão • (16x3,2mm)  
**035662** Emb: 5 pçs



**Lítio 3V (CR 2016)**  
 • 3V botão • (20x1,6mm)  
**033150** Emb: 5 pçs



**Lítio 3V (CR 2025)**  
 • 3V botão • (20x2,5mm)  
**033152** Emb: 5 pçs



**Lítio 3V (CR2032)**  
 • 3V botão • (20x3,2mm)  
**033149** Emb: 5 pçs



**Lítio 3V (CR2032)**  
 • 3V botão • (20x3,2mm)  
**036349** Emb: 5 pçs



**Alcalina (LR54/LR1130)**  
 • 1,5V botão • (11,6x3,05mm)  
**035654** Emb: 10 pçs



**Alcalina (LR41)**  
 • 1,5V botão • (7,85x3,6mm)  
**035655** Emb: 10 pçs



**Alcalina (LR 44/A76)**  
 • 1,5V botão • (11,6x5,4mm)  
**033151** Emb: 10 pçs  
**036350** Emb: 10 pçs



**Lítio 1,5v**  
 • Pilha botão óxido de Prata  
 • Livre de Mercurio 1,55V  
**035656** Emb. 5 pçs SR936SW 394  
**035657** Emb. 10 pçs SR927SW 395  
**035658** Emb. 10 pçs SR920SW 371

**Botões Alcalinas - 1,5V**

Código	Embalagem	Capac.(mAh)	Dim.(mm)	Tam.	Obs.	Foto
002255	10 pçs	160mAh	11,6x5,4	LR44	A76	
033144	10 pçs	150mAh	11,6x5,4	LR44	A76	
033140	10 pçs	200mAh	6,8x2,6	LR66	LR626 377 G4	
033141	10 pçs	300mAh	11,6x3,05	LR54	LR1130	
001338	1 pç	200mAh	15x6,05	LR9		



**AA 1,5V**  
• (15x50mm) - Alcalina  
**030015** Emb: 2 pçs  
**033040** Emb: 4 pçs



**AAA 1,5V**  
• (11x45mm) - Alcalina  
**030014** Emb: 2 pçs



**AAAA 1,5V**  
• (42,5x8,3mm) - Alcalina  
**034793** Emb: 2 pçs



**9V**  
• (26x17x48mm) - Alcalina  
**030016** Blister: 1 pç - Rontek  
**034930** Emb: A granel - Golden Power



**AA 1,5V**  
• (15x50mm) - Alcalina  
**036514** Emb: 2 pçs  
**036515** Emb: 4 pçs  
**036516** Granel



**AAA 1,5V**  
• (11x45mm) - Alcalina  
**036511** Emb: 2 pçs  
**036512** Emb: 4 pçs  
**036513** Granel



**9V**  
• (26x17x48mm) - Alcalina  
**036518** Shrink c/1  
**036517** Blister c/1



**Alcalina C 1,5V**  
• 7100mAh (26x50mm) • Emb. 2 pçs  
**036519**



**Alcalina D 1,5V**  
• 14250mAh (32,5x60mm) • Emb. 2 pçs  
**036520**



**6V PX28A**  
• (13x25mm) • Emb.: Blister  
**001346** Emb: 1 pç



**12V A23**  
• (10x28,3mm) Golden Power  
**033143** Emb: 5 pçs



**12V A27**  
• (10x28,3mm) Golden Power  
**034201** Emb: 50 pçs



**1,5V N**  
• (11x28,5mm) • Alcalina  
**034456** Emb: 2 pçs



**12V A23**  
• (10x28,3mm) Minamoto  
**001349**



**12V A23**  
• 60mAh • (10x28,3mm)  
**030987**



**12V A23**  
• (10x28,3mm) • Emb c/50pçs  
**035852**



**12V A27**  
• (8x28,5mm)  
**033142** Emb: 5 pçs

Duracell



**Alcalina 9V**  
• 9V (47x26x16mm) • Emb. 1 pç  
**001283**



**Alcalina 12V**  
• 12V N (10,5x28,5mm) • Emb. 1 pç  
**001287**



**Alcalina AAA**  
• 1,5V AAA (10,5x43mm) • Emb: 2 pçs  
**034805**



**Alcalina AA**  
• 1,5V AA (14x50mm) • Emb: 2 pçs  
**034804**



**Alcalina C**  
• 1,5V C (26x50mm) • Emb. 2 pçs  
**034803**



**Alcalina D**  
• 1,5V D (32,5x60mm) • Emb. 2 pçs  
**034802**

Sony



**Alcalina AA**  
• 1,5V AA • (15x50mm)  
**034809** Emb. 2 pçs  
**034808** Emb. 4 pçs



**Alcalina AAA**  
• 1,5V AAA • (11x45mm)  
**034810** Emb. 4 pçs



**Alcalina D**  
• 1,5V Stamina Plus D  
• (33x61mm)  
**034811** Emb. 2 pçs



**Alcalina 9V**  
• 9V • (17x26x48mm)  
**031082** Emb. 1 pç



**Ultra AAA**  
• 1,5V Zinco/Carvão AAA • (11x45mm)  
• Ultra Heavy Duty  
**034812** Emb. 4 pçs



**Ultra C**  
• 1,5V Zinco/Carvão C • (26x50mm)  
• Ultra Heavy Duty • Emb. 2 pçs  
**034814**



**Ultra D**  
• 1,5V Zinco/Carvão D • (33x61mm)  
• Ultra Heavy Duty • Emb. 2 pçs  
**034815**

Panasonic



**Lítio 3V (CR2032)**  
Lítio 3V (CR2032)  
• 3V botão • (20x3,2mm)  
**034801** Blister c/ 5 pçs



**1,5V AA Alcalina**  
• (15x50mm)  
**036133** Blister c/ 2 pçs  
**036134** Blister c/ 4 pçs



**1,5V AAA Alcalina**  
• (11x45mm)  
**036135** Blister c/ 2 pçs  
**036136** Blister c/ 4 pçs



**1,5V Alcalina D**  
• (32,5x60mm)  
**036138** Blister c/ 2 pçs



**9V Alcalina**  
• (47x25x17mm)  
**036137** Blister c/ 1pç



**1,5V AA**  
• (15x50mm)  
**036139** Emb. 52 pçs



**1,5V AAA**  
• (11x45mm)  
**036038** Emb. 40 pçs



**Panasonic para aparelhos auditivos**  
• 1,4V Zinc Air  
• Emb. 6 pçs  
**034806** - PR 13H (5,3x7,8mm)  
**034807** - PR 312H (3,6x7,8mm)



**9V 350mAh**  
 • Heavy Duty (26x17x48mm)  
**000528** Blister: 1 pç  
**034202** Emb: 10 pçs



**AA 1,5 Rontek**  
 • ZnMn • (15x50mm) • Emb: Blister  
**033042** Blister: 2 pçs  
**034114** Shrink: 4 pçs  
**035675** Caixa: 60 pçs



**AAA 1,5 Rontek**  
 • ZnMn • (11x45mm)  
**033043** Blister: 2 pçs  
**030556** Blister: 4 pçs  
**034033** Shrink: 4 pçs  
**035622** Caixa: 60 pçs



**9V Rontek**  
 • ZnMn • (26x18x49mm)  
**030550** Emb: 1 pç



**9V Rontek**  
 • ZnMn • (26x18x49mm)  
**034772** Caixa c/10 pçs

Para Lanternas e Câmeras fotográficas



**6V 5500mAh Rontek**  
 • Pilha 6V 5500mAh(a 200mA) Zn Cl  
 • (70x70x99mm)  
**030861**



**3V 1300 mAh CR 123A**  
 • Pilha de Lítio • (17x34mm)  
**000568** 1300 mAh Emb: 1 pç  
**034067** 1300 mAh Emb: 4 pçs



**3V 1500 mAh CR 123A**  
 • Pilha de Lítio • (17x34mm)  
 • C/ Top  
**035691** Emb: 1 pç



**3V 160mAh**  
 • Pilha de Lítio 1/3N • (10,5x10mm)  
**001353**



**3V 750mAh**  
 • Pilha de Lítio 1/2AA • (14x25mm)  
**002886**



**3V 850mAh**  
 • Pilha de Lítio • CR2  
 • (15,6x27mm)  
**034189**



**3V 2400mAh**  
 • Pilha de Lítio  
 • (17x45mm)  
**001565**



**6V 1300mAh**  
 • Pack c/ duas pilhas de Lítio de 3V  
 • 2CR5 • (45x34x17mm)  
**001351**

Indicadores, Analisadores e Carregadores de Baterias



**Indicador de Tensão 33V**  
 • Indicador de tensão para packs de baterias de Li-Ion / Polímero / NiMH (51x26x4mm)  
**033520**



**Analisador de Baterias 20V / 2A**  
 • Executa testes de carga, descarga, resistência interna, ciclagem, vida útil e medida da capacidade em baterias NiMH, NiCd, Lítio-Ion, LítioPo e bateria selada.  
**031766**



**Carregador IMAX-B6**  
 • C/ Balanceamento p/ Baterias (NiMH/NiCd 1.2V-18V • Li-Ion 7.4V-22.2V • LiFePO<sub>4</sub> 6.4V-19.2V, Bateria de Chumbo 2V-20V) • Carga:5A • Descarga:1A  
**035809**



**Carregador IMAX-B3 Pro Compact**  
 • C/ Balanceamento p/ baterias (Lipo, Radio controle (barcos, Aéros, drones, carros, etc) e para baterias de airsoft. • Entrada: AC 100V-240V • Saída: 850mA • Display: 3x Bicolor LED • Plugue de alimentação: US Plug (igual ao americano)  
**036312**





**Carregador p/ bateria de chumbo**  
 • Conversor CA/CC • BIVOLT • VAC  
 Saída CC 6V/1A • Modelo 2197  
 • (67,5x52,5x40,5mm)  
**034565**



**Carregador p/ bateria de chumbo**  
 • Conversor CA/CC • BIVOLT • VAC  
 Saída CC 12V  
**034564** - 1A  
**036411** - 2A



**Carregador p/ bateria de chumbo**  
 • Bivolt • Entrada 127/220 CA  
 • P/ Bat. 12V - 1A  
**036336**



**Carregador p/ bateria de Li-Ion/Li-Po**  
 • Conversor CA/CC • BIVOLT • 127/220 CA/  
 Saída CC 4,2V 0,8A.  
**036083**



**Carregador p/ Bateria de Li-Ion/Li-PO**  
 • Bivolt • Entrada 127/220 CA • Para  
 bateria de Li\_Ion ou Li\_Po  
**034550** - P/ 1 Bat. 4,2V - 0,8A  
**036304** - P/ 1 Bat. 4,2V - 3A  
**034551** - P/ 2 Bat. 8,4V - 1,5A  
**034552** - P/ 3 Bat. 12,6V - 1,5A



**Carregador p/ Bateria de LiFePO4**  
 • P/1 Bateria de LiFePO4 • Bivolt • Entrada  
 127/220 CA • Saída CC 3,65V - 1A  
**036410**



**Carregador Universal de Baterias**  
 • LI-ION/LiFePO4/NIMH/NiCd • Entrada DC  
 5V CC - Corrente de Saída 1000ma P/2 X  
 Li-Ion 18650 3.7v/ 2 X NiMH AA/AAA - 1.2v/2  
 X LiFePO4 - 3.2v  
**036072**



**Carregador p/ baterias NiCd/NiMh  
 AA ou AAA**  
 • 110V • p/ 1 Bateria NiCd/NiMh • corrente de  
 Carga:150ma • Tempo de Carga: Bateria AAA  
 900mah 7,8 Horas Bateria AA 1.300mah 12  
 Horas Bateria AA 2100mah 18,2 Horas  
**003197**



**Carregador p/ Baterias AA ou AAA**  
 • NiCd/NiMh • Bivolt • Entrada Dc 5v Cc  
 Saída: 1,2v 150mA  
**035616** - P/ 4 Baterias  
**035615** - P/ 2 Baterias



**Carregador inteligente c/ fonte**  
 • P/ baterias de Lítio • CR123A, 17335,  
 16340. • Tensão de Entrada 9 a 12v,  
 • Tensão de Saída 4,2v  
**036050**



**Carregador USB Duplo**  
 • USB 2.0 • p/ Li-Ion • 750mA  
 • Tamanhos: 26650/18650/16430/25600  
**036524**



**Carregador de Baterias Magnético**  
 • USB 2.0 • p/ Li-Ion e NiMh • 500mA  
 • Qualquer tamanho  
**036352**



**Carregador para Baterias NiCd/NiMh**  
 • Carrega Baterias NiCd/NiMh  
 Tamanhos: AA e AAA Corrente de  
 Carga:120mA Em Blister  
**030906** - 2xAA ou 2xAAA ou 9V



**Carregador Sony Bivolt**  
 • Carregador 15 horas • Inteligente  
 Sony Bivolt • NiMh 1 ou 2 AA ou AAA  
 • Corrente de carga 900mA • Blister  
**032704** 2 Baterias 1000mAh



**Bateria Auxiliar**  
 • Bateria Auxiliar portátil p/ carregar  
 celular, ipod, iphone e outros  
 • Li-Ion compatível USB  
**034916** - 1800mAh - PT  
**034095** - 1300mAh - AZ



**Carregador p/ bateria Li-Ion/Li-PO**  
 • Conversor AC/DC • Bivolt  
 • Entrada 127/220 CA  
 • p/4 Baterias de Li-Ion/Li-po  
 • Saída Cc 16,8V - 1,5A  
**036521**



**Carregador p/ bateria LiFePO4**  
 • Conversor AC/DC • Bivolt  
 • Entrada 127/220 CA  
 • p/2 Baterias de Lifepo4  
 • Saída Cc 6,4V - 1,2A  
**036522**



**Carregador p/ bateria LiFePO4**  
 • Conversor AC/DC • Bivolt  
 • Entrada 127/220 CA  
 • p/4 Baterias de Lifepo4  
 • Saída Cc 12,8V - 1,5A  
**036523**



**MBT-LAB2 - Para baterias de chumbo**  
 • Testa o estado da carga de baterias de chumbo-ácido de 2V, 4V, 6V, 8V e 12V, de 1Ah até 200Ah. Um ventilador de refrigeração integrado dissipa o calor do teste e o circuito está protegido contra sobre tensão. O invólucro de borracha rugosa protege contra impactos. Inclui cabos de teste. Requer baterias 4 AA (não incluídas).  
**036018**



**MBT-1 - Para 40 tipos de baterias**  
 • Testa baterias Alcalinas de 1,5V, 6V, 9V e 12V, baterias recarregáveis de NiMh de 1,2V e baterias não recarregáveis de lítio de 1,5V e 3V e baterias recarregáveis de Li-Ion de 3,6V. Os tipos de bateria são claramente identificados ao lado dos contatos apropriados. Usa baterias 4 AA (não incluídas).  
**036015**



**Mini-9RL - Para 12 tipos de baterias**  
 • Testa baterias alcalinas de 1,5V e 9V, baterias não recarregáveis de lítio de 3V, baterias recarregáveis de Lítio-Ion de 9V e baterias recarregáveis de NiMh de 1,2 e 9V. Usa baterias 4 AAA (não incluídas).  
**036017**



**Mini-MBT - Para 15 tipos de baterias**  
 • Testa baterias alcalinas de 1,5V, e 9V, baterias recarregáveis de Lítio-Ion de 3,6V, baterias recarregáveis de NiMh de 1,2V e baterias não recarregáveis de lítio de 3V. Os tipos de bateria são claramente identificados ao lado dos contatos apropriados. Seu tamanho pequeno o torna ideal para uso em caixas de ferramentas ou uso doméstico. Usa baterias 4 AAA (não incluídas).  
**036016**

**Testadores de pilhas e baterias, medidor portátil e carga eletrônica**



**Medidor portátil**  
 • Medidor portátil de resistência interna de bateria  
**036425**



**Carga Eletrônica**  
 • CC 300W Programável  
**036424**



**Teste Pilhas/Baterias**  
 • Verifica tensões de pilhas e baterias  
 • Tipos AA/AAA/C/D/N e 9V  
 • Embalagem: Blister  
**030914**



**Teste Pilhas/Baterias**  
 • Verifica tensões de pilhas e baterias  
 • Tipos AA/AAA/C/D/N e 9V  
 • Embalagem: Blister  
**031657**



**Teste Pilhas/Baterias**  
 • Verifica tensões de pilhas e baterias  
 • Tipos AA/AAA/C e D  
 • Embalagem: Blister  
**030915**













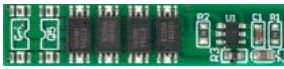



**Teste Pilhas/Baterias**  
 • Para LiPo, LiFe, Li-Ion, NiMh e NiCd  
 • Indica tensão total, tensão das células, célula com menor tensão, célula com maior tensão, diferença entre a menor e a maior tensão e capacidade restante(%)  
**036143**







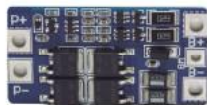

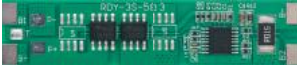

**Alarme com buzina p/ baterias de Lítio Ion**  
 • Buzzer (Alarme) com voltímetro que apita quando a bateria está com baixa voltagem prevenindo o desgaste e aumentando a vida útil das células da bateria. Indicado para baterias de uso em aeromodelos, drones e Helicóptero. - Compatível com baterias: 1-8S Lipo (de 1 a 8 células) / Li-ion / LiMn / Li-Fe - Painel digital que informa a voltagem. - Precisão de detecção de tensão: +\_0,01V. - Unidade faixa de exibição de tensão: 0,5 ~ 4,5V - Faixa de tensão de modo de teste 1S: 4-15V - Opção de ajustar a voltagem de alerta do alarme em: 2,7 ~ 3,8V ou OFF- Dimensões : 40mm x 25 milímetros x 11 milímetros - Peso: 9g  
**036303**

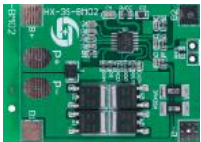

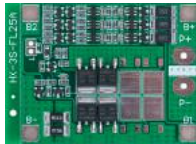





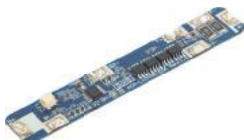

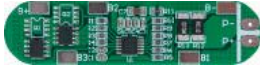

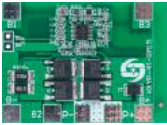







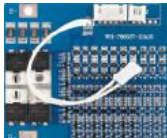







**Placas de Proteção de Packs de Baterias de Li-Ion e LiFePO4**





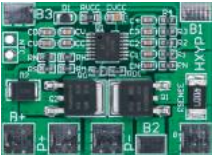

Código	Núm de células	Li-Ion ou LiFePO4	Corrente Desc.Cont	Corrente Desc.Pico	Balanceamento	Controle de temperatura	Medidas (mm)	Foto
034541	1	Li-Ion/Li-Po	2A	5A	NÃO	NÃO	26,01X3,65X1,75	
035771	1	Li-Ion/Li-Po	2,5A	3,3A	NÃO	SIM	35,10X7,62X1,99	
035920	1	Li-Ion/Li-Po	2,5A	3A	NÃO	NÃO	13,5X1,80	
035772	1	Li-Ion/Li-Po	6A	9A	NÃO	SIM	35,07X7,50X1,88	
035473	1	Li-Ion/Li-Po	6A	8,5A	NÃO	NÃO	38,29X7,50X3,37	
035471	1	Li-Ion/Li-Po	7A	8,8A	NÃO	NÃO	35,30X7,46X1,99	

Código	Núm de células	Li-Ion ou LiFePO <sub>4</sub>	Corrente Desc.Cont	Corrente Desc.Pico	Balanceamento	Controle de temperatura	Medidas (mm)	Foto
035470	1	Li-Ion/Li-Po	8A	12A	NÃO	NÃO	38x7,70x1,90	
035773	1	Li-Ion/Li-Po	8A	11A	NÃO	SIM	35,10X7,56X1,91	
035919	1	Li-Ion/Li-Po	10A	14A	NÃO	NÃO	35,33X7,40X2,41	
035774	1	Li-Ion/Li-Po	11A	15A	NÃO	SIM	35,27X7,60X2,12	
035472	1	Li-Ion/Li-Po	12A	15A	NÃO	NÃO	35X7,33X2	
035762	2	Li-Ion/Li-Po	3A	4,7A	NÃO	NÃO	36,78X6,37X2,10	
034540	2	Li-Ion/Li-Po	4A	9,5A	NÃO	SIM	43,18X8,10X1,90	
035474	2	Li-Ion/Li-Po	5A	9A	NÃO	NÃO	38,24X8,05X2,50	
035476	2	Li-Ion/Li-Po	6A	8A	NÃO	NÃO	17,41X17,41X2,70	
036002	2	Li-Ion/Li-Po	6A	7,3A	NÃO	NÃO	38,24X8,05X2,50	
035759	2	Li-Ion/Li-Po	7A	16A	NÃO	NÃO	40,95X8,03X2,10	
035760	2	Li-Ion/Li-Po	10A	11A	SIM	NÃO	40,90X17,80X3,70	
035475	2	Li-Ion/Li-Po	10A	16A	NÃO	NÃO	40,72X15,77X3,63	
036003	2	Li-Ion/Li-Po	15A	31A	SIM	NÃO	47,36X23,75X4,05	
035761	2	Li-Ion/Li-Po	15A	30A	NÃO	NÃO	45,79X19,95X3,55	

Código	Núm de células	Li-Ion ou LiFePO <sub>4</sub>	Corrente Desc.Cont	Corrente Desc.Pico	Balanceamento	Controle de temperatura	Medidas (mm)	Foto
036353	3	Li-Ion/Li-Po	4A	8A	NÃO	NÃO	51X10X3	
036376	3	Li-Ion/Li-Po	4,5A	6A	NÃO	NÃO	59,90X13X2,40	
036397	3	Li-Ion/Li-Po	7A	20A	NÃO	NÃO	45,85X20X3,60	
036360	3	Li-Ion/Li-Po	7A	21,5A	NÃO	SIM	50X38,15X3,6	
036354	3	Li-Ion/Li-Po	9A	19,5A	NÃO	NÃO	50X16X3	
035764	3	Li-Ion/Li-Po	10A	17,8A	SIM	NÃO	53X17,20X2,70	
036355	3	Li-Ion/Li-Po	15A	28,5A	SIM	SIM	56X45,33X4	
035478	3	Li-Ion/Li-Po	15A	26A	SIM	NÃO	58X19,83X55	
 036603	3	Li-Ion/Li-Po	20A	30A	SIM	SIM	60x40x4	
035763	3	Li-Ion/Li-Po	100A	120A	SIM	SIM	70,10X60X9,6	
035480	4	Li-Ion/Li-Po	2A	10A	NÃO	NÃO	72,56X17,67X2,66	
033519	4	Li-Ion/Li-Po	2A	20A	NÃO	NÃO	100,12x16x2,67	

Código	Núm de células	Li-Ion ou LiFePO <sub>4</sub>	Corrente Desc.Cont	Corrente Desc.Pico	Balaceamento	Controle de temperatura	Medidas (mm)	Foto
035481	4	Li-Ion/Li-Po	4A	20A	NÃO	NÃO	35,74X35,74X3,61	
036356	4	Li-Ion/Li-Po	6A	20A	NÃO	NÃO	72,56X17,67X2,66	
036357	4	Li-Ion/Li-Po	8A	20A	NÃO	NÃO	72,56X17,67X2,66	
036358	4	Li-Ion/Li-Po	11A	20A	NÃO	SIM	50X40X3,60	
035765	4	Li-Ion/Li-Po	12A	20A	NÃO	SIM	35,40X34,75X3,60	
 036604	4	Li-Ion/Li-Po	15A	20A	SIM	SIM	60X40X3,6	
035766	4	Li-Ion/Li-Po	100A	120A	SIM	SIM	70,10X60X9,6	
035704	5	Li-Ion/Li-Po	10A	36A	NÃO	NÃO	70X16X2,6	
 036605	5	Li-Ion/Li-Po	18A	20A	SIM	SIM	60x40x3,6	
035705	6	Li-Ion/Li-Po	10A	25A	SIM	SIM	64,5X35,75X4,10	
035706	7	Li-Ion/Li-Po	10A	30A	SIM	SIM	76,10X65,30X7,61	

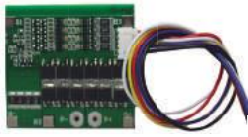
Código	Núm de células	Li-Ion ou LiFePO <sub>4</sub>	Corrente Desc.Cont	Corrente Desc.Pico	Balanceamento	Controle de temperatura	Medidas (mm)	Foto
035484	10	Li-Ion/Li-Po	16A	20A	NÃO	NÃO	62X32X10	
035482	13	Li-Ion/Li-Po	22A	25A	NÃO	NÃO	61,15X34X9	
035483	13	Li-Ion/Li-Po	16A	20A	NÃO	NÃO	65x52x10	
035485	16	Li-Ion/Li-Po	25A	30A	NÃO	NÃO	77X61X8,20	
036366	1	LiFePO <sub>4</sub>	2,5A	3A	NÃO	NÃO	30,26X3,75X1,99	
036363	1	LiFePO <sub>4</sub>	3A	4A	NÃO	NÃO	38X7,6X2	
036364	1	LiFePO <sub>4</sub>	4A	9,5A	NÃO	NÃO	38,22X7,6X1,99	
036365	1	LiFePO <sub>4</sub>	5A	8,7A	NÃO	NÃO	38X7,57X1,98	
036367	1	LiFePO <sub>4</sub>	10A	17A	NÃO	NÃO	40,66X12,30X3,61	
036335	2	LiFePO <sub>4</sub>	5A	8,5A	NÃO	NÃO	36x15x2	
036359	2	LiFePO <sub>4</sub>	8,5A	17A	NÃO	NÃO	40,46X15,77X3,66	
036361	4	LiFePO <sub>4</sub>	7A	20A	NÃO	SIM	38,35X28X3,6	
036362	4	LiFePO <sub>4</sub>	13A	17A	NÃO	SIM	56X35,61X2,45	
 036607	4	LiFePO <sub>4</sub>	18A	20A	SIM	SIM	60X40X7,2	

Código	Núm de células	Li-Ion ou LiFePO <sub>4</sub>	Corrente Desc.Cont	Corrente Desc.Pico	Balanceamento	Controle de temperatura	Medidas (mm)	Foto
 <b>036606</b>	4	LiFePO <sub>4</sub>	30A	40A	SIM	SIM	56x48x4	
<b>035767</b>	4	LiFePO <sub>4</sub>	30A	53A	SIM	SIM	56X48,26X4,10	
<b>035770</b>	4	LiFePO <sub>4</sub>	30A	34A	SIM	SIM	56X48,26X4,10	
<b>035768</b>	4	LiFePO <sub>4</sub>	30A	35A	SIM	NÃO	64X56X7,50	
<b>035769</b>	4	LiFePO <sub>4</sub>	100A	120A	SIM	SIM	70,10X60X9,6	

Conversores CC/CC



**Carregador p/ bateria de Li-Ion**  
 • Tensão de Entrada: 4.5v ~ 5.5v - • Tensão de Saída: 4.2v • Corrente de carga: 1A  
 • Conector Mini USB - 2,7x1,9x0,5mm p/ 1 bateria chip TP4056  
**036525**

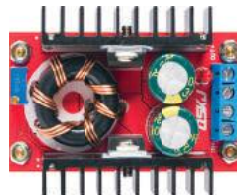

**Regulador de tensão step up ajustável**  
 • Tensão Mínima de Entrada 10 V • Tensão Máxima de Entrada 32 V • Tensão Mínima de Saída 12 V • Tensão Máxima de Saída 35 V • Corrente Máxima de Saída 10A 150W  
**036530**



**Regulador de tensão step up ajustável USB**  
 • Tensão Mínima de Entrada 0,9 V • Tensão Máxima de Entrada 5 V • Tensão Mínima de Saída 5 V • Tensão Máxima de Saída 5 V • Corrente Máxima de Saída 0,5A  
**036531**



**Regulador de tensão step down ajustável USB**  
 • Tensão Mínima de Entrada 6 V • Tensão Máxima de Entrada 24 V • Tensão Mínima de Saída 5,1 V • Tensão Máxima de Saída 5,2V • Corrente Máxima de Saída 3A  
**036532**



**Regulador de tensão step down ajustável**  
 • Tensão Mínima de Entrada 4,5V • Tensão Máxima de Entrada 35V • Tensão Mínima de Saída 1,25V • Tensão Máxima de Saída 30V • Corrente Máxima de Saída 2A Chip LM2596  
**036526**



**Regulador de tensão step down ajustável**  
 • Tensão Mínima de Entrada 4 V • Tensão Máxima de Entrada 40 V • Tensão Mínima de Saída 1,25 V • Tensão Máxima de Saída 37V • Corrente Máxima de Saída 2A chip LM2596  
**036527**



**Regulador de tensão step down ajustável**  
 • Tensão Mínima de Entrada 7 V • Tensão Máxima de Entrada 40 V • Tensão Mínima de Saída 1,2 V • Tensão Máxima de Saída 35V • Corrente Máxima de Saída 9A 300W  
**036528**



**Regulador de tensão step up ajustável**  
 • Tensão Mínima de Entrada 3,5 V • Tensão Máxima de Entrada 32V • Tensão Mínima de Saída 5 V • Tensão Máxima de Saída 35 V • Corrente Máxima de Saída 2A  
**036529**

**PVC termoretráteis para packs de baterias**

**Tubos Termo Retráteis PVC**

• Próprio para montagem de packs de baterias

• Embalagem: 1m	<b>035997</b> Ø: 49mm - vd	<b>035918</b> Ø: 95mm - az	• Embalagem: 150m	<b>036309</b> Ø: 42,6mm - vm
<b>003096</b> Ø: 25mm - bc	<b>035999</b> Ø: 54mm - am	<b>031491</b> Ø: 95mm - bc	<b>036393</b> Ø: 133,55mm - az	<b>035695</b> Ø: 49,7mm - az
<b>035987</b> Ø: 31mm - am	<b>035998</b> Ø: 54mm - az	<b>035982</b> Ø: 95mm - pt	• Embalagem: 200m	<b>002155</b> Ø: 49,7mm - br
<b>035986</b> Ø: 31mm - az	<b>003098</b> Ø: 54,1mm - bc	<b>031493</b> Ø: 133mm - bc	<b>036396</b> Ø: 19,10mm - az	<b>035867</b> Ø: 49,7mm - pt
<b>003097</b> Ø: 31mm - bc	<b>036000</b> Ø: 54mm - pt	<b>035983</b> Ø: 152mm - bc	<b>036395</b> Ø: 19,10mm - br	<b>036310</b> Ø: 49,7mm - vm
<b>035988</b> Ø: 31mm - pt	<b>036001</b> Ø: 54mm - vd	<b>035984</b> Ø: 178mm - bc	<b>036394</b> Ø: 19,10mm - vd	<b>035874</b> Ø: 49,7mm - am
<b>035989</b> Ø: 31mm - vd	<b>035976</b> Ø: 63mm - am	<b>035985</b> Ø: 197mm - bc	<b>001406</b> Ø: 25mm - br	<b>001408</b> Ø: 54,1mm - br
<b>030057</b> Ø: 38mm - bc	<b>035975</b> Ø: 63mm - az	• Embalagem: 100m	<b>036308</b> Ø: 25,5mm - vm	<b>035868</b> Ø: 54,1mm - pt
<b>035991</b> Ø: 42mm - am	<b>035977</b> Ø: 63mm - pt	<b>036076</b> Ø: 25,5mm - pt	<b>002741</b> Ø: 31,8mm - br	<b>035696</b> Ø: 54,1mm - az
<b>035990</b> Ø: 42mm - az	<b>031492</b> Ø: 63mm - bc	<b>036073</b> Ø: 25,5mm - az	<b>035693</b> Ø: 31,8mm - az	<b>035697</b> Ø: 63,6mm - az
<b>001028</b> Ø: 42mm - bc	<b>031489</b> Ø: 63mm - bc	<b>036075</b> Ø: 25,5mm - am	<b>035865</b> Ø: 31,8mm - pt	<b>001532</b> Ø: 63,6mm - br
<b>035992</b> Ø: 42mm - pt	<b>035978</b> Ø: 63mm - vd	<b>036074</b> Ø: 25,5mm - vd	<b>035872</b> Ø: 31,8mm - am	<b>035876</b> Ø: 63,6mm - am
<b>035993</b> Ø: 42mm - vd	<b>035979</b> Ø: 76mm - am	<b>036078</b> Ø: 38,2mm - vd	<b>003005</b> Ø: 38,2mm - br	<b>035869</b> Ø: 63,6mm - pt
<b>035995</b> Ø: 49mm - am	<b>035917</b> Ø: 76mm - az	<b>036079</b> Ø: 38,2mm - am	<b>001407</b> Ø: 42,6mm - br	<b>036311</b> Ø: 63,6mm - vm
<b>035994</b> Ø: 49mm - az	<b>031490</b> Ø: 76mm - bc	<b>036077</b> Ø: 38,2mm - az	<b>035694</b> Ø: 42,6mm - az	<b>002743</b> Ø: 76,32mm - br
<b>001029</b> Ø: 49,7mm - bc	<b>035980</b> Ø: 76mm - pt	<b>036080</b> Ø: 38,2mm - pt	<b>035873</b> Ø: 42,6mm - am	<b>035877</b> Ø: 76,32mm - am
<b>035996</b> Ø: 49mm - pt	<b>035981</b> Ø: 95mm - am		<b>035866</b> Ø: 42,6mm - pt	<b>035870</b> Ø: 76,32mm - pt



**Tags, Polyswitchs, Termistor, Termostato e outros**

**Tag Simples**  
• Retangular • Aço Inox  
**035965** - 0.1x5x25mm-100g  
**035962** - 0.1x3x15mm-100g  
**035959** - 0.1x4x18mm-100g  
**035958** - 0.1x5x32mm-100g

**Tag Simples**  
• Retangular • c/ furo  
• Aço Inox  
**035956** - 0.1x5x25mm-100g  
**035957** - 0.1x3x20mm-100g

**Tag**  
• Aço Inox • 100g  
• 0.1x11x14mm  
**035972**

**Tag**  
• Aço Inox • 100g  
• 0.1x4x23mm  
**035960**

**Tag**  
• Aço Inox • 100g  
• 0.1x6x15mm • Y-1 Pino  
**035961**

**Rolo de Fita**  
• Retangular  
**035969** - 0.1x5mm - 24m - Aço Inox  
**035970** - 0.1x4mm - 28m - Aço Inox  
**035971** - 0.1x7mm - 18m - Aço Inox  
**035963** - 0.15x7mm - 1m - Niquel Puro  
**035964** - 0.15x4mm - 1m - Niquel Puro

**Fita Aço Inox**  
• Fita Aço inox• 18650  
**035966** - 2 Bat - 0.12x27mm - 4.8m  
**035967** - 3 Bat - 0.12x47mm - 3.8m  
**035968** - 4 Bat - 0.12x67mm - 2.5m

**Polyswitch**  
• PTC p/ Baterias • Polyswitch  
**035797** 1,2A    **035801** 4,5A  
**035798** 1,75A    **035802** 6A  
**035799** 2A    **035803** 8A  
**035800** 3,5A    **035804** 9A

**Fusível Térmico**  
• 72°C • 10A  
**036307**

**Termistor**  
• NTC 1%  
**035795** 10k  
**035796** 100k

**Termostato**  
• 250V • Metal • 5A  
**035943** - 65°C  
**036299** - 55°C  
**036300** - 60°C  
**036301** - 70°C  
**036302** - 75°C

**Suporte para bateria 18650**  
• Suporte espaçador para 18650.  
Os suportes podem ser montados conforme a necessidade do cliente.  
**035932** - p/ 1 Bateria  
**036305** - p/ 2 Bateria  
**036306** - p/ 3 Bateria

**Fita adesiva para alta temperatura**  
• 260°/300°C • 33mm  
**035698** - 10mm  
**035949** - 18mm

**Fios de Silicone**  
• 200°C • 1m  
12AWG  
**035953** - PT    • 20AWG • 305M    • 22AWG  
**035952** - VM    **036404** - BR    **036399** - BR  
14 AWG    **036405** - PT    **036400** - PT  
**035948** - PT    **036406** - VM    **036401** - VM  
**035954** - VM    **036403** - AZ    **036402** - AZ

**Isolantes**  
**035934** - ø18 mm - Cartela c/100  
**035935** - ø18 mm - Cartela c/50  
**035936** - ø18 mm - Cartela c/35  
**035937** - ø18 mm - Cartela c/25  
**035933** - Fita 63 mm - Rolo c/200m  
**035938** - ø18 mm - Cartela c/100  
**035940** - 18x36mm - Cartela c/50  
**035941** - 18x54mm - Cartela c/35  
**035942** - 18x72mm - Cartela c/25  
**035939** - 10x65mm - Cartela c/48

**Saco Anti Chama**  
• p/ Bateria LiPo • Safe Bag  
• 18x23mm  
**036539**





**Tipo "T"**  
 • Conector uso geral tipo T macho e fêmea  
**031241**



**JST VHR-3P**  
 • Conector Jst Vhr-3p  
 • 15cm  
**035391**



**JST PAP-3P 24AWG**  
 • Conector JST PAP-3P 24AWG  
 • 15cm  
**035742**



**MJJST-SYP-02T-01 F**  
 • Conector fêmea  
 • Uso geral e modelismo  
**001524**



**MJJST-SYP-02T-01 M**  
 • Conector macho uso geral e modelismo • Polaridade  
**031526** Polarid. Invertida  
**001564** Polarid. Normal



**BBLI 26 AWG Fêmea**  
 • Conector BBLI macho para uso em modelismo 26AWG  
 • Rabicho: 15cm  
**001237**



**BBLI 22 AWG**  
 • Conector BBLI macho para uso em modelismo 22AWG  
 • Rabicho: 40cm  
**002754**

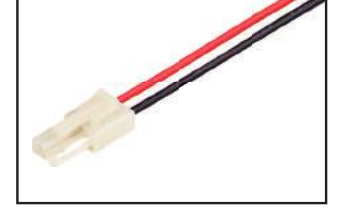

**KET 6100024-2P**  
 • Conector fêmea para uso geral e modelismo 22AWG  
 • Rabicho: 15cm  
**031765**



**18 AWG**  
 • Conector fêmea para uso geral e modelismo • Rabicho: 15cm  
**001563**



**18 AWG**  
 • Conector macho para uso geral e modelismo • Rabicho: 15cm  
**031497** Fio Silicone  
**001236** Fio Normal



**BBL-3P**  
 • Conector macho para uso geral, Modelismo e Rádios Futaba 26AWG • Rabicho: 15cm  
**001238**

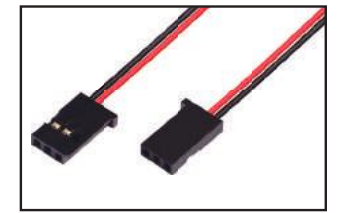

**BBL-3P**  
 • Conector macho para uso geral, Modelismo e Rádios Futaba 22AWG • Rabicho: 40cm  
**002755**



**Futaba 3 Vias**  
 • Conector macho 3 vias para uso geral, Modelismo e Rádios Futaba 22AWG • Rabicho: 26cm  
**030870**



**BBL-3P**  
 • Conector macho 3 vias para uso geral e modelismo • Rádios JR  
 • Rabicho: 26cm  
**032649**



**Molex 87439-3**  
 • Conector para uso geral 3 vias com dois fios fêmea  
 • Rabicho: 17cm  
**030548**



**51004-3P**  
 • Conector fêmea tipo Molex 7x5 mm para uso geral e telefonia • Rabicho: 15cm  
**031263**



**51021-2P**  
 • Conector de uso geral  
 • Rabicho: 30cm  
**036030**



**51021**  
 • Conector fêmea tipo Molex 5x3 mm para uso geral e telefonia  
 • Rabicho: 15cm  
**031265** - 3P  
**035676** - 3P



**Dubon-2P**  
 • Conector fêmea uso geral  
 • Rabicho: 15cm  
**031267**



**Dubon-2P Mini**  
 • Conector Mini Dubon 2.0mm 26awg (Similar a Excon 2004 02 HA)  
 • R. 15cm  
**033441**



**XT 60**  
• Conector Macho / Fêmea Sem fio  
**036371**



**PHR2**  
• 30cm  
**036380** - 22AWG  
**036381** - 26AWG



**PHR4**  
• 30cm • 22AWG  
**036382**

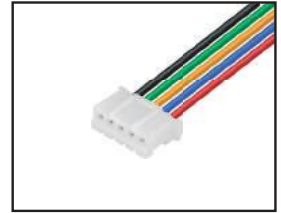

**PHR5**  
• 30cm  
**036383** - 22AWG  
**036384** - 26AWG



**SMP-2P**  
• 30cm  
**036385** - 22AWG  
**036386** - 26AWG



**5557-1 - 2P**  
• 30cm  
**036387** - 20AWG  
**036388** - 24AWG



**A1255H-5P**  
• 15cm • 28AWG  
**036274**



**Conjunto de terminal Faston**  
• Macho / Fêmea • 1,3 á 0,32mm<sup>2</sup>  
**036390** - 187  
**036391** - 250



**Conjunto de terminal Faston**  
• Macho / Fêmea • 0,82 á 0,32mm<sup>2</sup>  
**036389** - 110



**Clip 9V**  
• Conector para baterias 9V  
**034869** - 180° Emb: 100 pçs  
**034328** - 180° Emb: 20 pçs  
**034037** - 90° Emb: 20pçs



**Conector Wafer**  
• A51021-3P  
**035818**



**Conector PCB**  
• Com 3 Terminais Dourados  
• Usado Em Fotopolimerizador  
**036081**



**2510-3P**  
• Conector Fêmea uso geral e telefonia • Rabicho: 15cm  
**031269**



**51006-3P**  
• Conector para uso geral • Rabicho: 15cm  
**031262**



**HRS DF13-3S**  
• Conector fêmea uso geral e telefonia • Rabicho: 15cm  
**031261**

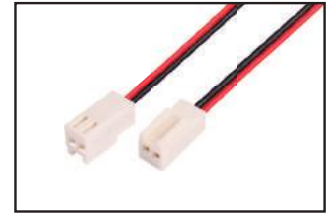

**5051-2P**  
• Conector de uso geral • Rabicho: 30cm  
**036026**



**5051-2P**  
• Conector fêmea tipo Molex para uso geral e telefonia • Rabicho: 15cm  
**031270**



**JST ELP-2P**  
• Conector uso geral e telefonia • Rabicho: 15cm  
• Par com JST ELR-2P  
**031271**



**JAE-2P / UL 1007-2**  
• 15cm  
**036009**

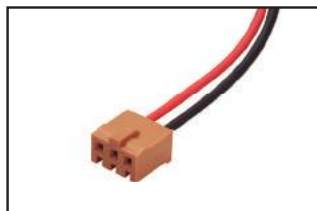

**JAEILG-3P**  
• Conector fêmea para uso geral e  
Telefonia • Rabicho: 15cm  
**030008**



**ZHR-2P**  
• Conector uso geral e telefonia  
• Rabicho: 15cm  
**031273**



**5264-2P**  
• Cabo Com Conector Molex  
• Rabicho: 30cm  
**036027**



**2510-2P**  
• Conector fêmea uso geral  
e telefonia • Rabicho: 15cm  
**031268**



**JST ELR-2P**  
• Conector para uso geral  
e telefonia • Rabicho: 15cm  
• Par com JST ELP-2P  
**031272**



**51021-2P**  
• Conector fêmea tipo Molex  
para uso geral e telefonia  
• Rabicho: 15cm  
**031264**

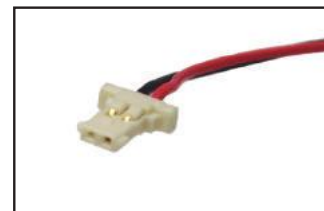

**28 AWG**  
• Conector macho para uso geral e  
modelismo • Rabicho: 15cm  
**035791**



**SAN-2P**  
• Conector uso geral e telefonia  
• Rabicho: 15cm  
**031266**



**XHP-2P**  
• Conector de uso geral  
• Rabicho: 30cm  
**036028**



**JST XHP-2P**  
• Conector uso geral e telefonia  
• Rabicho: 15cm  
**031274**



**JST PHR-3P**  
• 25 AWG • Rabicho: 25cm  
**036066**



**PHR-2P**  
• Conector uso geral e telefonia  
• Rabicho: 15cm  
**031275**



**Mitsumi A58**  
• Conector para uso geral • 24AWG  
e telefonia • Rabicho: 17cm  
**035608**



**Mitsumi A58**  
• Conector para uso geral  
e telefonia • Rabicho: 30cm  
**036029**

**001525**



**001365**



**001239**



**Conectores F p/ Baterias de Telefones sem Fio**

• Conector fêmea para uso geral e telefonia  
• Rabicho: 15cm

**001525** A58(MT) Mitsumi

**001365** MJUST

**001239** 5264/2 - Tipo Molex

**000661** M63 Mitsumi

**001486** Universal com Anel PT

**030826** Universal sem Anel Tipo GP



**000661**



**001486**



**030826**



**Suporte CR2032**  
• Suporte para pilha botão CR2032  
**035950**



**Suporte Universal**  
• Suporte para diversas pilhas botões CR 2032/2025/2016 • Emb. 25 pçs  
**034019**



**Suporte Universal**  
• Suporte para diversas pilhas botões CR 2032/2025/2016 • Emb. 25 pçs  
**034943**



**Suporte Universal**  
• Suporte para diversas pilhas botões CR 2430/2450/2477 • Emb. 10 pçs  
**034020**



**Suporte Rápido**  
• Usado para pilha botão CR2032  
**030480**



**Suporte Vertical**  
• Usado para diversas pilhas botões CR2032/2025/2016 • Emb. 10 pçs  
**034522**



**Porta Pilhas 4x18650**  
• Suporte para 4 baterias • RTL18650  
**035466**



**Porta Pilhas 3x18650**  
• Suporte para 3 baterias • RTL18650  
**035465**



**Porta Pilhas 2x18650**  
• Suporte para 2 baterias • RTL18650  
**035464**



**Porta Pilhas 1x18650**  
• Suporte para 1 bateria • RTL18650  
**035463**



**Porta Pilhas**  
• Suporte para 1 pilha • C/ rabicho • Emb. 10 pçs  
**034517** AA  
**035293** AAA



**Porta Pilhas 1xAA MAGUS**  
• Suporte para 1 pilha AA Formato I (1/2 SP6) • Com rabicho  
**034881** - Branco  
**036220** - Preto



**Porta Pilhas 1xAA MAGUS**  
• Suporte para 1 pilha AA Formato I (1/2 Sp1) • Com rabicho  
**034882** - Branco  
**036221** - Preto



**Porta Pilhas 2xAA MAGUS**  
• Suporte para 2 pilhas AA em fileira • Com rabicho  
**034886** - Branco  
**036225** - Preto



**Porta Pilhas 2xAA MAGUS**  
• Suporte para 2 pilhas AA paralelas formato fechado • Com rabicho  
**034884** - Branco  
**036223** - Preto



**Porta Pilhas 2xAA**  
• Suporte para 2 pilhas AA em paralelo • Com rabicho • Emb. 10 pçs  
**034478**



**Porta Pilhas 2xAA MAGUS**  
• Suporte para 2 pilhas AA tipo canoa em paralelo • com rabicho  
**034885** - Branco  
**036224** - Preto



**Porta Pilhas 2xAA**  
• Suporte para 2 pilhas AA tipo Canoa • Com rabicho • Emb. 10 pçs  
**034104**  
**035401** - V-E



**Porta Pilhas 2xAA MAGUS**  
• Suporte para 2 pilhas AA Formato I em paralelo • com rabicho  
**034883** - Branco  
**036222** - Preto



**Porta Pilhas 3xAA MAGUS**  
• Suporte para 3 pilhas AA Formato canoa em paralelo • Com rabicho  
**034889** - Branco  
**036228** - Preto



**Porta Pilhas 4xAA MAGUS**  
 • Suporte para 4 pilhas AA 2 paralelas na frente e 2 atrás com rabicho  
**034888** - Branco  
**036227** - Preto



**Porta Pilhas 4xAA**  
 • Suporte para 4 pilhas AA  
 • Com rabicho • Emb. 10 pçs  
**034021**



**Porta Pilhas 4xAA MAGUS**  
 • Suporte para 4 pilhas AA 2 fileiras com 2 pilhas com rabicho  
**034887** - Branco  
**036226** - Preto



**Porta Pilhas 4xAA MAGUS**  
 • Suporte para 4 pilhas AA tipo canoa  
 • Com rabicho  
**034890** - Branco  
**036229** - Preto



**Porta Pilhas 4xAA**  
 • Suporte para 4 pilhas AA tipo Canoa  
 • Com rabicho • Emb. 10 pçs  
**034345** - AA  
**034043** - AAA



**Porta Pilhas 6xAA**  
 • Suporte para pilhas AA 3 paralelas na frente e 3 atrás • Com rabicho  
**034891** - Branco  
**036230** - Preto



**Porta Pilhas 2xAAA**  
 • Suporte para 2 pilhas AAA tipo Canoa • Com rabicho • Emb. 10 pçs  
**035294**



**Porta Pilhas**  
 • Suporte para 3 pilhas tipo Canoa • Emb. 10 pçs  
**035404** - AA  
**034518** - AAA



**Porta Pilhas 12V**  
 • Suporte p/ 1 pilha de 12V • Tipo A23 (10,5x28,5mm) • Emb. 20 pçs  
**034044**



**Porta Pilhas D - Magus**  
 • Suporte p/ pilhas • Tipo grande D  
**035160** - 1 Pilha - Branco  
**035161** - 2 Pilhas - Branco  
**035162** - 3 Pilhas - Branco  
**035163** - 4 Pilhas - Branco  
**036231** - 1 Pilha - Preto  
**036232** - 2 Pilhas - Preto  
**036233** - 3 Pilhas - Preto  
**036234** - 4 Pilhas - Preto



**Porta Pilhas**  
 • c/ tampa • c/ chave ON-OFF  
**036420** - 2xAA  
**036421** - 3xAA  
**036422** - 2xAAA  
**036423** - 3xAAA



**Porta Pilhas P/1 Bateria**  
 • 1S1P • 18650 • c/ PCM • 3A  
**036412**



**Porta Pilhas P/2 Baterias**  
 • 1S2P • 18650 • c/ PCM • 5A  
**036413**



**Porta Pilhas P/3 Baterias**  
 • 1S3P • 18650 • c/ PCM • 5A  
**036414**



**Porta Pilhas P/4 Baterias**  
 • 1S4P • 18650 • c/ PCM • 5A  
**036415**



**Porta Pilhas P/2 Baterias**  
 • 2S1P • 18650 • c/ PCM • 5A  
**036416**



**Porta Pilhas P/4 Baterias**  
 • 2S2P • 18650 • c/ PCM • 5A  
**036417**



**Porta Pilhas P/3 Baterias**  
 • 3S1P • 18650 • c/ PCM • 4A  
**036418**



**Porta Pilhas P/4 Baterias**  
 • 4S1P • 18650 • c/ PCM • 4A  
**036419**



**Conversor Fita K7 / MP3**  
 • Conversor K7 para Mp3  
 • Inclusos cabos e software  
 • Acompanha fone de ouvido  
**033455**



**Seletor Óptico TOSLINK**  
 • Bidirecional 3x1  
 • Chaveador de cabo óptico  
 • 3 x fêmea para 1 fêmea  
**031952**



**Adaptador Óptico Toslink**  
 • 90°  
 • Embalagem: 20 pçs  
**036061**



**Adaptador Óptico Toslink**  
 • Emenda fêmea / fêmea  
 • Embalagem: 10 pçs  
**034506**  
**035411** V.E



**Conversor Coaxial p/ Óptico**  
 • RCA Fêmea/Toslink Fêmea  
 • Acompanha fonte  
**031951**



**Conversor Óptico Toslink**  
 • Para cabo coaxial com conector RCA  
 • Acompanha fonte  
**033188**



**Amplificador Óptico TOSLINK**  
 • Amplificador de sinal digital óptico  
 Toslink fêmea • Entrada até 5m  
 • Saída até 20m • Acompanha fonte  
**033189**

**Adaptadores e Emendas**



**P1 Stereo M/P2 Stereo F**  
 • Adaptador de plástico P1(2,5mm)  
 stereo macho para P2 (3,5mm) stereo  
 fêmea • Emb. 10 pçs  
**034906**



**P2 Stereo M/P1 F**  
 • Adaptador de plástico P2(3,5mm)  
 stereo macho para P1(2,5mm) fêmea  
 • Emb. 10 pçs  
**034362** Mono  
**035206** stereo



**P10 Stereo F/P2 Stereo M**  
 • Adaptador de plástico P2(3,5mm)  
 stereo macho para P10(6,35mm)  
 fêmea • Emb. 10 pçs  
**035193**



**P2 Mono M/P10 F**  
 • Adaptador de plástico P2(3,5mm)  
 mono macho para P10(6,35mm)  
 fêmea • Emb. 10 pçs  
**035205** F. Mono  
**034363** F. Stereo



**P10 Stereo F/P2 Mono M**  
 • Adaptador de plástico P10(6,35mm)  
 stereo fêmea para P2(3,5mm) mono  
 macho • Emb. 10 pçs  
**035266**



**P2 Mono M/Jack Europeu**  
 • Adaptador de plástico P2(3,5mm)  
 mono macho para tipo europeu-  
 (9,5mm) fêmea  
**031414**



**P2 Stereo M/KRE3**  
 • Adaptador de plástico P2 (3,5mm)  
 stereo macho para KRE3 • Emb. 5 pçs  
**035291**



**2xRCA F/P2 Stereo M**  
 • Adaptador de plástico 2xRCA fêmea  
 para P2(3,5mm) stereo macho  
 • Emb. 20 pçs  
**034032**



**2xP2 Stereo F/P2 Stereo M**  
 • Adaptador de plástico 2xP2(3,5mm)  
 stereo fêmea para P2(3,5mm) stereo  
 macho • Emb. 20 pçs  
**034327**



**P2 Stereo F/P2 Stereo F (emenda P2)**  
 • Adaptador de plástico P2 (3,5mm) p/  
 P2 (3,5mm) stereo fêmea  
 • Emb. 10 pçs  
**034262**



**P10 F/F**  
 • Adaptador de plástico emenda fêmea  
 P10 (6,35mm) para fêmea P10  
 (6,35mm) Mono  
**031991**



**P2 F/P10 Stereo M**  
 • Adaptador de plástico P2(3,5mm)  
 fêmea para P10 (6,35mm) stereo  
 macho • Emb. 10 pçs  
**035194** P2 Stereo  
**034364** P2 Mono



**P2 Mono F/P10 Mono M**  
 • Adaptador de plástico P2(3,5mm) fêmea para P10(6,35mm) mono macho • Emb. 10 pçs  
**035211**



**P10 Stereo M/2 P2 Stereo F**  
 • Adaptador de plástico P10(6,35mm) stereo macho para 2P2(3,5mm) stereo fêmea • Emb. 10 pçs  
**035213**



**P10 Stereo M/2 P10 Stereo F**  
 • Adaptador de plástico P10 (6,35mm) stereo macho para 2P10 (6,35mm) stereo fêmea • Emb. 10 pçs  
**034831**



**P10 Mono M/2 P10 Mono F**  
 • Adaptador de plástico P10 (6,35mm) mono macho para 2xP10 (6,35mm) mono fêmea • Emb. 10 pçs  
**034837**



**2xRCA F/P10 M**  
 • Adaptador de plástico 2 x RCA fêmea para P10(6,35mm) macho  
 • Emb. 20 pçs  
**035092**  
**035195**



**2xRCA F/P10 M**  
 • Adaptador de plástico 2 x RCA fêmea p/ P10(6,35mm) macho • Emb. 10 pçs  
**034827** P10 Mono  
**034828** P10 Stereo



**2xRCA F/P2 Stereo M**  
 • Adaptador de plástico 2 x RCA fêmea para P2(3,5mm) stereo macho  
 • Emb. 10 pçs  
**034826**



**2xRCA F/P2 Mono M**  
 • Adaptador de plástico 2 x RCA fêmea para P2(3,5mm) mono macho  
**033145**



**2xRCA F/RCA M**  
 • Adaptador de plástico 2 x RCA fêmea para RCA macho  
**031413**



**P10 Mono M/RCA F**  
 • Adaptador de plástico P10(6,35mm) mono macho para RCA fêmea  
 • Emb. 10 pçs  
**035201**



**P10M/RCA F**  
 • Adaptador de níquel P10 (6,35mm) Mono macho para RCA fêmea  
 • Emb. 10 pçs  
**034511** P10 Mono  
**034576** P10 Stereo



**P10M/RCA M**  
 • Adaptador de níquel P10(6,35mm) macho para RCA macho  
**032885** P10 Mono  
**032886** P10 Stereo



**P10 Stereo M/P2 F**  
 • Adaptador de níquel P10(6,35mm) stereo macho para P2(3,5mm) fêmea  
 • Emb. 10 pçs  
**034365** P2 Mono  
**035093** P2 Mono V.E.



**P10 Stereo F/F**  
 • Adaptador de níquel P10(6,35mm) stereo fêmea para P10(6,35mm) fêmea • Emb. 5 pçs  
**035049**



**XLR F/F**  
 • Adaptador de níquel XLR(canon) fêmea para XLR(canon) fêmea 3 pinos  
 • Emb. 5 pçs  
**034287**



**XLR F/P10 Mono M**  
 • Adaptador de níquel XLR(canon) fêmea 3 pinos para P10(6,35mm) mono macho • Emb. 5 pçs  
**034288**



**XLR M/XLR M**  
 • Adaptador de níquel XLR (canon) macho 3 pinos para canon XLR macho  
 • Emb. 5 pçs  
**034835**



**XLR M/P10 Mono F**  
 • Adaptador de níquel XLR(canon) macho 3 pinos para jack P10(6,35mm) mono fêmea • Emb. 5 pçs  
**035304**



**P10 F/P2 Stereo M**  
 • Adaptador de níquel P2(3,5mm) stereo macho para P10(6,35mm) fêmea • Emb. 10 pçs  
**035196** P10 Stereo  
**035197** P10 Mono



**P2 M/RCA F**  
 • Adaptador de níquel P2(3,5mm) mono macho para RCA fêmea  
**031290** Mono  
**031289** Stereo



**P2 4 Pólos**  
• Adaptador / conversor CTIA para OMTF para fone de ouvido 3.5mm  
**035037**



**2xRCA F/RCA F**  
• Adaptador de plástico 2xRCA fêmea para RCA Fêmea • Emb. 10 pçs  
**034816**



**2xRCA F/RCA M**  
• Adaptador de plástico 2xRCA fêmea para RCA macho • Emb. 10 pçs  
**034482**



**2xRCA M/RCA F**  
• Adaptador de plástico 2 x RCA macho para RCA fêmea  
• Emb. 10 pçs  
**035208**  
**034282**



**2xRCA M/RCA M**  
• Adaptador de plástico 2xRCA macho para RCA macho  
• Emb. 10 pçs  
**035207**



**2xRCA + S-VHS F/F**  
• Adaptador de plástico 2xRCA fêmea + S-VHS fêmea para 2xRCA fêmea + S-VHS fêmea  
**033201**



**3xRCA F/F**  
• Adaptador de plástico tipo emenda 3xRCA fêmea para 3xRCA fêmea  
• Emb. 10 pçs  
**034830**



**3xRCA F/F**  
• Adaptador de plástico tipo emenda 3xRCA fêmea para 3xRCA fêmea AZ/VD/VM • Emb. 10 pçs  
**035214**



**3xRCA F/F**  
• Adaptador de plástico tipo emenda 3xRCA fêmea para 3xRCA fêmea BR/VM/AM • Emb. 10 pçs  
**035215**



**2xRCA F/F**  
• Adaptador de plástico tipo emenda 2xRCA fêmea para 2xRCA fêmea  
**035212**



**RCA F/F**  
• Adaptador de plástico emenda RCA fêmea para RCA fêmea  
• Emb. 20 pçs  
**034113**



**RCA F/M**  
• Adaptador de plástico RCA macho para RCA fêmea 90° níquel  
• Emb. 10 pçs  
**034283** VM  
**034284** PT



**RCA F/F**  
• Adaptador emenda RCA fêmea para RCA fêmea  
**031415**



**BNC F/RCA M**  
• Adaptador de níquel BNC fêmea para RCA macho • Emb. 10 pçs  
**035095**  
**034271**



**BNC M/RCA F**  
• Adaptador de níquel BNC macho para RCA fêmea • Emb. 10 pçs  
**034212**



**BNC F/M c/ rosca**  
• Adaptador de níquel BNC fêmea para F macho com rosca • Emb. 10 pçs  
**034270**



**F F/BNC M**  
• Adaptador de níquel F fêmea para BNC macho • Emb. 10 pçs  
**034484**



**F M/BNC F**  
• Adaptador de níquel F macho para BNC fêmea rápido  
**033289**



**F F/RCA M**  
• Adaptador de níquel F fêmea para RCA macho • Emb. 10 pçs  
**034215**



**F M/RCA F**  
• Adaptador de níquel F macho para RCA fêmea  
**035830** Emb c/10pçs





**Mini UHF F/F**  
• Adaptador de níquel mini UHF fêmea para fêmea  
**030933**



**F F/F**  
• Adaptador de níquel F fêmea para F fêmea • Emb. 50 pçs  
**035116**



**F M/M**  
• Adaptador de níquel F macho para F macho • Emb. 20 pçs  
**034516**



**BNC M/F**  
• Adaptador de níquel BNC macho para BNC fêmea  
**030082**



**BNC M/KRE2**  
• Adaptador BNC macho para conector KRE2 • Emb. 10 pçs  
**035096**



**BNC F/KRE2**  
• Adaptador BNC fêmea para conector KRE2 • Emb. 10 pçs  
**034521**



**RCA F/KRE2**  
• Adaptador de níquel RCA fêmea para KRE2 • Emb. 10 pçs  
**034304**

Seletores de Vídeo Game



**Seletor Vídeo Game**  
• Seletor 3 entradas para 1 saída  
• Acompanha Blister  
**033271**



**Seletor Vídeo Game**  
• Seletor 4 entradas para 1 saída  
• Acompanha Blister  
**033272**

Splitter HDMI e Switchs



**Splitter HDMI 1X4**  
• Permite ligações entre Vídeos, Monitores e TVs • 1 entrada para 4 saídas  
**031953**



**Switch HDMI 3X1**  
• Cabo Switch HDMI 3X1  
• Usa 1 monitor para 3 micros  
• 3 entradas para 1 saída  
**032864**



**Switch HDMI**  
• Permite ligações entre Vídeos, Monitores e TVs  
**031432** 2 entradas para 1 saída  
**031433** 4 entradas para 1 saída



**Switch HDMI 3X1**  
• Permite ligações entre Vídeos, Monitores e TVs • 3 entradas para 1 saída  
**034845**



**Switch HDMI 3X1**

• Permite ligações entre Vídeos, Monitores e TVs • 3 entradas para 1 saída  
**034320**



**Switch HDMI 5X1**

• Permite ligações entre Vídeos, Monitores e TVs • 5 entradas para 1 saída  
**033837**



**Switch HDMI 5X1**

• Permite ligações entre Vídeos, Monitores e TVs • 5 entradas para 1 saída  
**036057**



**Conversor VGA/HDMI**

• VGA/HDMI com saída de áudio P2  
• Cabos inclusos: 1 USB A macho x 1 mini USB macho • Alimentação: USB  
**033836**

**Conversor HDMI/VGA - Só áudio/Sem imagem**

• Serve para conectar o notebook, laptop, ultrabook, Apple TV, Mac Mini, HD DVD, HD DV com saída HDMI em modelos antigos de projetor, TV ou monitor de vídeo com interface VGA. Somente para visualização de tela grande. Suporte de saída de vídeo em VGA: 480i/576i/480p/576p/720p/720i/1080i / 1920 \* 1200 @ 60Hz (Max). Alimentado pelo dispositivo de conexão HDMI. Chip receptor HDMI com equalizador, suporta 8/10/12bit de cor intensa, taxa de dados até 2.25GHz. Consumo de energia: 190mA. Permite que um projetor VGA use o Apple Airplay, espelhamento de iPad para a Apple TV.  
**034323**



**Conversor HDMI/VGA - Áudio/Imagem**

• Entrada HDMI macho, P2 para áudio x saída VGA fêmea; Suporte de saída de vídeo em VGA: 1920 \* 1080 @ 60Hz (Max); Caixa de alumínio; Acompanha cabo USB A macho para Micro USB; Comprimento do cabo: 16 cm; Dimensões (mm): 54x42x14; Compatível com HDCP HDMI compatível com entrada de resolução: 480i, 576i, 480p, 576p, 720p, 1080i, 1080p; VGA compatível com resolução de saída de: 640X480, 800X600, 1024X768, 1280X720, 1280x768, 1280x800, 1280x1024, o 1360x768, 1600x1200, 1920x1080 • Alimentação: 5Vdc  
**033601**



**Conversor HDMI/VGA - Áudio/Imagem**

• Entrada de vídeo suportados: HDMI 1080p / 720p / 1080i; Saída suportados: VGA: 480P / 50Hz, 480P / 60Hz, 720P / 50Hz, 720P / 60Hz, 1080p / 50Hz, 1080p / 60Hz; Suporta todos as principais entradas de áudio digital e converte áudio para saída analógica estéreo através do conector jack de 3,5mm; Suporta o mesmo formato como entrada. Sem upscaling ou downscaling de resoluções. Seu visor final precisa ser compatível com a resolução sobre a entrada VGA do dispositivo por exemplo, fonte para os 720p de resolução de 1280 x 720 precisa de ser compatível na exibição com uma proporção de imagem de 16:9, para a entrada de 1080p, 1920 x 1080 deve ser compatível na entrada da tela do dispositivo VGA. Compatível com o protocolo HDCP 1.2.; Instala-se em segundos; Desenvolvido a partir do dispositivo HDMI com Fonte a de 5V da própria porta HDMI (não usa fonte externa).  
**035273**



**Conversor VGA/HDMI**

• Adaptador de plástico tipo emenda 2xRCA fêmea para 2xRCA fêmea  
**035114**



**Conversor VGA/HDMI + USB**

• VGA/HDMI • Compatível com HDMI 1.3  
• Converte vídeo VGA • Usb 2 canais de áudio em HDMI • Exibe em HDTV/monitor  
• Cabo: 32cm  
**035314**



**Conversor HDMI/RCA**

• HDMI/RCA Vídeo + Audio  
• Caixa: 1 pç  
**035070**



**Conversor VGA/AV**

• Acompanha cabos:  
• VG/VGA • RCA/RCA-S Vídeo 4 pinos  
• Cabo de Força USB (aceita Windows 2000, XP, 7 e Vista)  
**032862**



**Extensor HDMI X RJ45**

• Extensor HDMI x RJ45 (Transmissor) + RJ45 x HDMI (Receptor) • Distância de até 100m • Transmite sinais HDMI até 100m para 1 ou mais TVs  
• Com Fonte Inclusa  
**035100**



**Extensor HDMI X RJ45**

• Extensor HDMI x RJ45 (Transmissor) + RJ45 x HDMI (Receptor) • Distância de até 100m • Transmite sinais HDMI até 100m para 1 ou mais TVs  
• Com Fonte Inclusa  
**033460**



**Extensor para HDMI - 100m**

- Extensor de HDMI1080p 3D para cabo AF LAN CAT 6 ate 100m • Não precisa configurar
- Velocidade transmissão 2,25 Gbps em 1080 p/ 3D
- Compatível HDCP • Embalagem com 1 módulo TX e 1 módulo RX • 2 fontes de alimentação de 5V
- Manual do Usuario

**033913**



**Extensor para HDMI - 30m**

- Extensor de HDMI1080p 3D para cabo AF LAN CAT 6 ate 30m • Não precisa configurar
- Velocidade transmissão 2,25 Gbps em 1080 p/ 3D
- Compatível HDCP • Embalagem com 1 módulo TX e 1 módulo RX • 1 fonte de alimentação de 5V
- Manual do Usuario

**033911**



**Extensor para HDMI**

- Extensor de HDMI1080p 3D para cabo AF LAN CAT 6 • Não precisa configurar
- Velocidade transmissão 2,25 Gbps em 1080 p/ 3D
- Compatível HDCP • Embalagem com 1 módulo TX e 1 módulo RX • 2 fontes de alimentação de 5V
- Manual do Usuario

**035277** Alcance de até 60m

**035581** Alcance de até 60m V.E

**035405** Alcance de até 120m



**Repetidor de Sinal HDMI**

- Repetidor de sinal HDMI
- Alcance de até 35m

**031954**



**Repetidor/Regenerador HDMI**

- Adaptadores / Repetidor de HDMI, regenera o sinal HDMI de entrada pela decodificação e re-codificação para um novo sinal de HDMI padrão para que ele possa ampliar o leque transmissão sem degradação, estende 1080p até a distância de transmissão de 40m (sinal de baixa resolução pode ser transmitido mais longe), sem fonte externa de energia, plug and play, fácil de instalar, HDMI é compatível com HDMI 1.3

**035278**



**Adaptador/Conversor/Extensor USB/RJ45**

- Estende uma conexão USB até 45m por Cat5e/Cat6. A distância USB para USB padrão é de apenas 15 pés. Isso pode tornar difícil a utilização de dispositivos USB, especialmente em uma área ampla. Nosso USB sobre Cat5e / 6 extender permite que você estenda a conexão USB em até 45m usando cabos Cat5e / 6. A instalação é simples. Basta conectar uma peça em seu computador ou hub USB e a outra peça em seu dispositivo periférico USB e conectar um cabo de rede Ethernet entre os dois. O dispositivo é auto-alimentado por isso não há necessidade de conectar adaptadores de energia externos. Para um melhor desempenho, recomenda-se o uso de cabos Cat6 STP. Ideal para uso com câmeras USB, impressoras, webcams, extensões do teclado / mouse e qualquer outro dispositivo USB. Utiliza o patch cord Cat5/Cat5E/Cat6 padrão (não incluído)

**034321**



**Conversor HDMI/SDI**

- Conversor HDMI/SDI
- HD/SDI e 3G/SDI
- Embalagem: 1 pç

**035077**



**Conversor SDI/HDMI**

- Conversor SDI/HDMI
- HD/SDI e 3G/SDI
- Embalagem: 1 pç

**035076**



**Placa de Captura USB 2.0 DVR 4 Canais**

- Placa de Captura Usb 2.0 DVR de 4 Canais
- Captura de HDTV para segurança de residências, locais de trabalho, lojas e outros.

**034244**

**Placa de Captura de Vídeo**

- Placa de captura de vídeo usb
- 1 canal, não precisa de driver • USB 2.0 vídeo grabber com áudio, pode capturar vídeo de alta qualidade e arquivos de áudio direto pela interface USB 2.0 sem placa de som • Não usa fonte externa e não há necessidade driver (software editor é opcional) • Suporta ntsc, formato de vídeo pal. entrada de vídeo: um composto RCA, 1 s-video • Entrada de áudio: Áudio estéreo (RCA) • Dimensão: (l) x 78(w) x 30(h) 20mm • Suporta barramento USB • Suporta resolução de vídeo em HD (720p)

**035302**





**P10 Mono**  
• Plug P10(6,35mm) plástico mono sem rabicho • PT • Emb. c/ 10 pçs  
**035145**



**P10 Jack**  
• Plug Jack P10(6,35mm) plástico • Com rabicho • PT • Emb. 20 pçs  
**034577** Mono  
**034513** Stereo



**P10 Mono**  
• Plug P10(6,35mm) plástico mono com rabicho • Emb. 20 pçs  
**035210** PT  
**034481** VM



**P10 Stereo**  
• Plug P10(6,35mm) plástico stereo com rabicho • Emb. 20 pçs  
**035191** PT  
**034366** VM



**P10 Mono**  
• Plug P10(6,35mm) mono com rabicho • Emb. 20 pçs  
**035546** Níquel  
**035547** Dourado



**P10 Stereo**  
• Plug P10(6,35mm) stereo com rabicho • Emb. 20 pçs  
**035192** Níquel  
**034368** Dourado



**P10 Mono Dourado**  
• Plug P10(6,35mm) dourado mono polarizado com rabicho  
**031183**



**P10 Mono Dourado**  
• Plug P10(6,35mm) dourado mono polarizado com rabicho  
**030935**



**P10 Níquel**  
• Plug P10(6,35mm) níquel VM com mola longa • Emb. 10 pçs  
**034496** Mono  
**034578** Stereo



**P10 Stereo Dourado**  
• Plug P10(6,35mm) dourado AM com mola longa  
**031389** Stereo



**P10 Ponta Dourada**  
• Plug P10(6,35mm) • Ponta dourada com rabicho • Emb. 10 pçs  
**034504** Mono



**P10 Dourado**  
• Plug P10(6,35mm) dourado com mola longa • Emb. 20 pçs  
**034369** Mono  
**034250** Stereo



**P10 Níquel 90°**  
• Plug P10(6,35mm) níquel 90° • Emb. 10 pçs  
**035254** Mono  
**035258** Stereo



**P10 Níquel 90°**  
• Plug P10(6,35mm) • Níquel 90° • Emb. 10 pçs  
**034503** Stereo  
**035303** Mono



**P1**  
• Plug P1 (2,5mm) plástico sem rabicho • PT • Emb. 20 pçs  
**035078** Mono



**P2**  
• Plug P2 (3,5mm) plástico sem rabicho • PT • Emb. 20 pçs  
**034371** Mono  
**034264** Stereo



**P2 Mono**  
• Plug P2(3,5mm) Mono • Não Isolado • Emb. 100 pçs  
**034523**



**P2 Mono**  
• Plug P2(3,5mm) plástico mono com rabicho • Emb. 20 pçs  
**034111** PT  
**034372** VM



**P2 Stereo**  
• Plug P2(3,5mm) plástico stereo com rabicho • Emb. 20 pçs  
**035257** PT  
**034413** VM



**P2 4 Pólos**  
• Plug P2(3,5mm) plástico 4 pólos com rabicho • Emb. 10 pçs  
**035256**



**P2 Mono**

• Plug P2(3,5mm) mono com rabicho  
• Emb. 20 pçs  
**035251** Níquel  
**034373** Dourado



**P2 Stereo**

• Plug P2(3,5mm) stereo com rabicho  
• Emb. 20 pçs  
**035544** Níquel  
**034374** Dourado



**P2 Jack**

• Jack P2(3,5mm) níquel fêmea para cabo com rabicho • Emb. 10 pçs  
**034375** Mono  
**035255** Stereo



**P1 Níquel**

• Plug P1(2,5mm) níquel com rabicho  
• Emb. 20 pçs  
**035259** Mono  
**034249** Stereo



**RCA M**

• Plug RCA plástico Macho  
• 4mm  
**035311** PT - Emb 10pçs  
**035312** VM - Emb 10pçs



**RCA Jack**

• Jack RCA plástico fêmea  
• 4mm • Com rabicho • Emb. 20 pçs  
**034579** VM  
**034509** PT



**RCA M**

• Plug RCA plástico macho 4mm  
• Com rabicho • Emb. 20 pçs  
**035296** PT  
**034377** VM



**RCA M**

• Plug RCA plástico macho 4mm  
• Com rabicho • Emb. 20 pçs  
**034510** BR



**RCA M**

• Plug RCA plástico macho 4mm  
• Com rabicho reforçado • Emb. 10 pçs  
**035047** BR



**RCA M 90°**

• Plug RCA Macho Plástico 90° 4mm  
• Sem rabicho e Reforçado  
**033529** VM - Emb. 1pç  
**035313** PT - Emb. 10pçs



**RCA M 90°**

• Plug RCA Macho Plástico 90° 4mm  
• Sem rabicho e Reforçado  
**033299** BR  
**033300** AM  
**033301** AZ  
**033302** VD



**RCA M Níquel**

• Plug RCA níquel macho polarizado  
6mm • Com rabicho • Emb. 20 pçs  
**035252** 6mm - VM  
**035253** 6mm - PT



**RCA M Dourado**

• Plug RCA dourado macho polarizado  
com rabicho • Emb. 20 pçs  
**034210** VM - 6mm  
**034211** PT - 6mm  
**034378** PT - 4mm  
**034842** VM - 4mm



**RCA M Dourado**

• Plug RCA dourado macho 6mm  
**031407** VM  
**031408** PT



**RCA M Níquel**

• Plug RCA níquel macho 4mm  
**033340** PT - Emb: 1pç  
**035260** PT - Emb: 10pçs



**RCA M Níquel**

• Plug RCA macho níquel  
• Emb. 10 pçs  
**034261** VM



**RCA M Dourado**

• Plug RCA dourado macho  
• Emb. 10 pçs  
**035261** PT  
**035548** VM



**RCA Jack Dourado**

• Plug RCA dourado fêmea polarizado  
6mm • Com rabicho • Emb. 10 pçs  
**034380** PT  
**034235** VM



**P1 Jack Mono**

• Jack P1(2,5mm) mono fêmea para  
placa de circuito impresso com rosca  
**030228**



**P1 Jack Stereo**

• Jack P1(2,5mm) stereo fêmea para  
placa de circuito impresso sem rosca  
**030223**



**P2 Jack Mono**  
• Jack P2(3,5mm) mono fêmea para solda sem rosca • Emb. 20 pçs  
**034457**



**P2 Jack Mono**  
• Jack P2(3,5mm) mono fêmea para solda com rosca • Emb. 50 pçs  
**034224**



**P2 Jack Mono**  
• Jack P2(3,5mm) mono fêmea para solda sem rosca  
**030230**



**P2 Jack**  
• Jack P2(3,5mm) fêmea para solda sem rosca • Emb. 20 pçs  
**034490** P2 Mono  
**034581** P2 Stereo



**P2 Jack Stereo**  
• Jack P2(3,5mm) stereo fêmea para placa de circuito impresso com rosca • Emb. 20 pçs  
**034039**



**P2 Jack Mono**  
• Jack P2(3,5mm) fêmea para solda com rosca • Emb. 20 pçs  
**034497**



**P2 Jack Stereo**  
• Jack P2(3,5mm) stereo fêmea para placa de circuito impresso com rosca • Emb. 50 pçs  
**034527**



**P2 Jack Stereo**  
• Jack P2(3,5mm) stereo fêmea • Emb. 20 pçs • c/ rosca  
**034293**



**P10 Jack**  
• Jack P10(6,35mm) fêmea níquel para cabo 4mm com rabicho  
**031395** Mono - Emb: 1 pç  
**034824** Stereo - Emb: 10pçs



**P10 Jack Mono Fechado**  
• Jack P10(6,35mm) mono fêmea circuito fechado p/ solda • Emb. 10 pçs  
**034500**



**P10 Jack**  
• Jack P10(6,35mm) fêmea p/ solda • Emb. 10 pçs  
**034825** - Mono circuito Aberto  
**034499** - Stereo circuito Fechado



**P10 Jack Stereo Aberto**  
• Jack P10(6,35mm) stereo fêmea circuito aberto p/ solda • Emb. 10 pçs  
**034253**



**P10 Jack Mono Aberto**  
• Jack P10(6,35mm) mono fêmea circuito aberto p/ solda • Emb. 10 pçs  
**034242**



**P10 Jack Mono Fechado**  
• Jack P10(6,35mm) mono fêmea circuito fechado para solda • Emb. 10 pçs  
**034252**



**P10 Jack S Fechado**  
• Jack P10(6,35mm) stereo fêmea circuito fechado para solda • Emb. 10 pçs  
**034498**



**P10 Jack S Aberto**  
• Jack P10(6,35mm) stereo fêmea circuito aberto para solda • Emb. 10 pçs  
**034243**



**P10 Jack M Fechado**  
• Jack P10(6,35mm) mono fêmea circuito fechado para solda • Emb. 10 pçs  
**034512**



**P10 Jack S Aberto**  
• Jack P10(6,35mm) stereo fêmea circuito aberto para solda • Emb. 10 pçs  
**034285**



**P10 Jack S Fechado**  
• Jack P10(6,35mm) stereo fêmea circuito fechado para solda • Emb. 10 pçs  
**035281**



**P10 Jack**  
• Jack P10(6,35mm) stereo fêmea com 4 terminais e porca • Emb. 100 pçs  
**036317**



**RCA Jack**  
 • Jack RCA fêmea para placa de circuito impresso  
**030236** VM  
**030237** PT



**RCA Jack Dourado Painel**  
 • Jack RCA dourado fêmea para solda rosca painel  
 • Emb. 20 pçs  
**034381** VM  
**034313** PT



**RCA Jack Níquel Painel**  
 • Jack RCA níquel fêmea para solda rosca painel • Emb. 20 pçs  
**034382** VM  
**034055** PT



**RCAX2 Jack Vertical**  
 • Jack RCA níquel dupla fêmea vert. para placa de circuito impresso  
**030238**

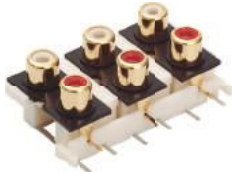

**RCAX6 Jack Vertical**  
 • Jack RCA 6 fêmeas dourado para placa de circuito impresso  
**030235**



**Borne Caixa Acústica**  
 • Borne plástico de pressão PT e VM uso geral  
**036318** 2 vias Emb c/ 20pçs  
**034905** 4 vias Emb c/ 10pçs



**Borne Caixa Acústica**  
 • Borne plástico de pressão PT e VM uso geral  
**034782** 2 vias Emb c/ 5pçs



**XLR 3 Pinos**  
 • Conector para microfone canon (XLR) com 3 pinos para cabo  
 • Emb. 5 pçs  
**035204** Macho  
**035203** Fêmea c/ trava



**XLR 3 Pinos**  
 • Conector para microfone canon (XLR) com 3 pinos para cabo  
**031423** Fêmea c/ trava  
**031425** Macho



**XLR 3 Pinos**  
 • Conector para microfone canon (XLR) com 3 pinos para cabo  
 • Emb. 5 pçs  
**035199** Fêmea c/ trava  
**035209** Macho s/ trava



**XLR 5 Pinos**  
 • Conector para microfone canon (XLR) com 5 pinos para cabo  
 • Emb. 5 pçs  
**034488** Fêmea c/ trava  
**034489** Macho



**XLR F Painel 3 Pinos**  
 • Conector para microfone canon (XLR) com trava fêmea 3 pinos para painel • Emb. 5 pçs  
**034222**



**XLR Painel 3 Pinos**  
 • Conector para microfone canon (XLR) sem trava macho 3 pinos para painel • Emb. 5 pçs  
**035200**



**XLR F. Painel Trava 3 Pinos**  
 • Conector canon (XLR) com trava fêmea 3 pinos para painel • PT  
**035563** Emb c/5pçs



**Speakon 4 Vias**  
 • Conector para caixa acústica 4 vias para cabo sistema seguro de travamento • Emb. 5 pçs  
**035094** Macho  
**034227** Fêmea



**Speakon M 8 Vias**  
 • Conector para caixa acústica macho 8 vias para cabo sistema seguro de travamento com rabicho  
**030196**



**Speakon F Painel 4 Vias**  
 • Conector para caixa acústica fêmea 4 vias para painel sistema seguro de travamento • Emb. 10pçs  
**035216**



**Speakon F Painel 4 Vias**  
 • Conector para caixa acústica fêmea 4 vias sistema seguro de travamento p/ painel • (3,1x2,6cm) • Emb: 10pçs  
**034781**



**Speakon F Painel 4 Vias**  
 • Conector para caixa acústica fêmea 4 vias sistema seguro de travamento para painel • (4x4cm)  
**030245**



**Speakon F Painel 8 Vias**  
 • Conector para caixa acústica fêmea 8 vias sistema seguro de travamento para painel  
**030197**



**BNC M RG59/U**

• Conector BNC macho para solda cabo RG59/U  
• Emb. 20 pçs  
**034819**



**BNC M Rabicho**

• Conector BNC macho p/ aparafusar cabo RG58/59 c/ rabicho  
• Emb. 20 pçs  
**035263**



**BNC M Luva Proteção**

• Conector BNC macho p/ aparafusar sem solda • Cabo RG58/59 • Com luva proteção  
**031562**



**BNC M Crimpar RG174/U (50R)**

• BNC macho crimpar RG174/U  
• (50R) • Cabo 3mm  
**032001**



**BNC M Crimpar RG58/U (50R)**

• BNC macho crimpar RG58/U  
• (50R) • Emb. 20 pçs  
**035264**



**BNC M Crimpar RG58/U (75R)**

• BNC macho crimpar RG58/U  
• (75R)  
**031567**



**BNC M Crimpar RG59/U (75R)**

• BNC macho crimpar RG59/U  
• (75R)  
**031560**



**BNC M Clamp RG59/U (75R)**

• Conector BNC macho para conexão em 90° • (75R)  
**031377**



**BNC M Crimpar RG6/U (75R)**

• Conector BNC macho para crimpar cabo RG6/U uso em TV a cabo • (75R)  
**030910**



**BNC M RG59**

• Conector BNC macho para crimpar cabo RG59  
**031561**



**BNC M RG6/U (75R)**

• Conector BNC macho para crimpar cabo RG6/U • (75R) • Emb. 10 pçs  
**034123**



**BNC M RG59/U**

• Conector BNC macho para crimpar cabo RG59/U • Emb. 5 pçs  
**035262** Pino Fixo . Emb. 5 pçs  
**033583** Pino Solto . Emb. 10 pçs



**BNC F/F Emenda**

• Conector BNC para emenda de cabo coaxial • Emb. 10 pçs  
**034823**



**BNC F Cabo**

• Conector BNC fêmea para aparafusar sem solda • Rabicho plást.  
**031683**



**BNC F Painel**

• Conector BNC fêmea para painel • Com rosca • Emb. 10 pçs  
**034507**



**BNC F Painel**

• Conector BNC fêmea para painel com porca e arruela • Emb. 10 pçs  
**035270**



**BNC F Painel**

• Conector BNC fêmea PVC para painel c/ porca e arruela • Emb. 10 pçs  
**035289**



**BNC F / Painel**

• Conector BNC fêmea para painel para parafusos • Emb. 10 pçs  
**034505**



**BNC M/2 F**

• Conector BNC macho para 2 fêmeas BNC • Emb. 10 pçs  
**034246**



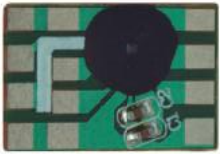

**Placa conversora**

• Placa Conversora USB A x PS2  
**035974**



**Kit para Notebook**

• Kit de adaptadores • Mini mouse óptico USB  
• Cabo RJ45/RJ45 • Cabo RJ11/RJ11  
• Cabo 6 M/6 M Firewire • Cabo USB A M/AF  
• Fone de ouvido 2P2 Stereo • 2 Adapt. tipo 1F/Tipo 2M  
• USB A M/Mini USB 4PA • USB A M/USB B M  
• USB A M/USB A M • USB A M/Mini USB BM 5P  
**030479**



**Kit p/ Notebook**

• Teclado • Hub Slim 4 portas USB  
• Mini mouse óptico USB  
• RJ45/RJ45  
**030619**



**Multi Adaptador USB M**

• Multi Adaptador USB Macho • USB B Macho • Mini USB 5 Pinos • Mini USB 4 Pinos • Mini USB 4 Pinos • Firewire  
• Fêmea USB B  
**031238**



**USB A M 2.0/RJ45 F**

• USB A macho 2.0/RJ45 fêmea  
• Embalagem: Blister  
**030947**



**USB A M/PS2 F**

• USB A macho / PS2 fêmea para 6P  
• Emb. 10 pçs  
**034045**



**USB A F/F**

• USB A fêmea para  
USB A fêmea • Emb. 5 pçs  
**035223**



**USB A M/Mini USB 5P**

• USB A macho / mini USB  
**030474** Mini USB M  
**033423** Mini USB F



**USB A M/Micro USB M**

• USB A macho / micro USB Macho  
**033211** Micro USB 8P



**USB A F/Mini Din 6P M**

• USB A fêmea / mini Din 6P macho  
**030476**



**USB A M/USB B M**

• USB A macho / USB B macho  
**030686**



**USB A F/F**

• USB fêmea / fêmea • Cor: Azul  
• 3.0 • Emb. 5 pçs  
**034840**



**USB A M/USB A M**

• USB A macho / USB A macho  
**030074**  
**035406**



**USB A F/RJ45**

• USB A fêmea / RJ45 macho  
• Emb. 5 pçs  
**035305**



**USB A M/USB B F**

• USB A macho / USB B fêmea  
**030073**



**USB B M/USB B M**

• USB B macho / USB B macho  
• Embalagem: Blister  
**030475**



**Adaptador Firewire**

• Firewire tipo 1 fêmea / tipo 2 fêmea  
**030071**



**Adaptador Firewire**

• Firewire tipo 1 fêmea / tipo 2 macho  
**030072**



**Micro USB/HDMI**

• Adaptador micro USB p/ HDMI  
• Preto • Embalagem: Blister  
**035120**  
**033453**



**HDMI M/HDMI F**

• HDMI macho / HDMI fêmea  
• 90° dourado • Emb. 5 pçs  
**035221**



**HDMI M/HDMI F**  
 • HDMI macho / fêmea dourado  
 • Ângulo 270°  
**034854**



**HDMI M/HDMI F**  
 • HDMI macho / fêmea dourado  
 • Ângulo 90°  
**034855**



**HDMI F/HDMI F**  
 • HDMI fêmea / fêmea dourado Emb c/5pçs  
**035565**



**Micro HDMI M/HDMI F**  
 • Micro HDMI macho / HDMI fêmea dourado dobrável 90° + 1 rotação 180°  
**033764**



**HDMI F/HDMI F**  
 • HDMI fêmea / HDMI fêmea dourado dobrável 90° + 1 rotação 180°  
**033765**



**HDMI M/Mini HDMI F**  
 • HDMI macho / Mini HDMI fêmea dobrável 90°  
**033766**



**Mini HDMI M/HDMI F**  
 • Mini HDMI macho / HDMI fêmea dour. dobrável 90° + 1 rotação 180°  
**033767**



**HDMI M / F**  
 • HDMI macho / HDMI fêmea dourado dobrável 90°  
**033772**



**Mini HDMI M/HDMI F**  
 • Mini HDMI macho / HDMI fêmea  
 • Emb. 5 pçs  
**035222**



**Mini HDMI F/HDMI M**  
 • Mini HDMI fêmea / HDMI macho  
**032854**



**HDMI M/2 RJ45 F**  
 • Adaptador HDMI M x 2RJ45 F • Dupla porta cabo de rede extender CAT 5E/6  
 • Níquel  
**035315**



**HDMI F/DVI F**  
 • HDMI fêmea/DVI (24+1) fêmea  
**033876**



**HDMI F/DVI M**  
 • HDMI fêmea/DVI (24+1) macho Emb c/5pçs  
**035564**



**HDMI M/DVI D F**  
 • HDMI macho/DVI D (24+1) fêmea  
**031938**



**DVI M/VGA F**  
 • DVI A (12+5) macho / DB15HD VGA Fêmea  
**030996**



**DVI M/VGA F**  
 • DVI D(18+1) macho / DB15 HD VGA fêmea  
**030921**



**DVI M/VGA F**  
 • DVI D macho / DB15HD VGA fêmea  
 • Emb. 5 pçs  
**035097** DVI-D 24+5  
**035220** DVI-D 24+1



**DVI F/VGA M**  
 • DVI D (24+5) fêmea / DB15HD VGA macho  
**030473**



**Adaptadores DB - Slim**  
 • Connfly  
 • Embalagem: 10 pçs  
**032583** DB9 F / DB9 F  
**032585** DB9 M / DB9 M



**DB9 F/DB9 F Slim**  
 • DB9 fêmea / DB9 fêmea  
 • Slim • Emb. 5 pçs  
**035101**



**DB15 M/DB15 F Slim**  
• DB15 macho / DB15 fêmea slim  
**030085**



**DB25 M/DB25 F Slim**  
• DB25 macho / DB25 fêmea slim  
**030787**



**DB9 M/DB9 F - Slim**  
• DB9 macho / DB9 fêmea  
• Slim  
**030084**



**DB9 F/F**  
• DB9 fêmea / fêmea • Emb. 10 pçs  
**034346**



**DB9 M/M**  
• DB9 macho / macho  
**003160**



**DB15 VGA F/F**  
• DB15 VGA fêmea / fêmea  
• Emb. 5 pçs  
**034302**



**VGA F X VGA F**  
• DB15 VGA fêmea / fêmea  
**035218**



**VGA M X RJ45 F**  
• VGA Macho / RJ45 Fêmea  
**035554**



**DB25 M/DB25 F**  
• DB25 macho / DB25 fêmea  
**003219**



**DB25 M/2xBNC F**  
• DB25 macho / 2xBNC fêmea  
**033148**



**DB9 M/Mini Din M**  
• DB9 macho / Mini Din macho 6 pinos  
**003215**



**DB9 F/Mini Din M**  
• DB9 fêmea / Mini Din macho 6 pinos  
**003216**



**DB9 F/Mini Din F**  
• DB9 fêmea / Mini Din fêmea 6 pinos  
**003217**



**RCA F/Mini Din M**  
• RCA Jack / Mini Din macho 4 pinos  
**030075**



**Emenda Mini Din F/F**  
• Emenda Mini Din fêmea 6 pinos / Mini Din fêmea 6 pinos  
**003223**



**Mini Din M/Din F**  
• Mini Din macho 6 pinos / Din fêmea 5 pinos  
**003218**



**Din M/Mini Din M**  
• Din macho 5 pinos / Mini Din macho 6 pinos  
**003220**



**Din F/Mini Din F**  
• Din fêmea 5 pinos / Mini Din fêmea 6 pinos  
**003221**



**Din F 5 Pinos Painel**  
• Soquete Din 5 pinos fêmea p/ painel  
**032610** 180° - Emb c/ 1 pç  
**035923** 180° - Emb c/ 10pçs  
**033337** 240° - Emb c/ 1 pç



**Mini Din F 5 Pinos Painel**  
• Soquete Din 5 pinos fêmea  
• Para Painel 180°  
**033907**



**Mini Din F**  
• Mini Din fêmea 6 pinos  
**003146**



**Mini Din M**  
• Mini Din macho 5 pinos  
• Embalagem: 10 pçs  
**034487**



**Mini Din M**  
• Mini Din macho 6 pinos  
**003151**



**Mini Din M**  
• Mini Din macho 3 pinos  
• Emb. 10 pçs  
**034341**



**Mini Din M**  
• Mini Din macho 4 pinos  
**034871**



**Mini Din M**  
• Mini Din macho 8 pinos  
• Emb. 10 pçs  
**035279**



**Mini Din F 4 Pinos Painel**  
• Mini Din fêmea 4 pinos  
• Painel PCI  
**003153**



**Mini Din F 6 Pinos**  
• Mini Din fêmea 6 pinos  
• Painel PCI  
**033225**



**Mini Din F 4 Pinos Tipo W**  
• Mini Din fêmea 4 pinos  
• Tipo W PCI  
**003156**



**Mini Din F 8 Pinos Tipo H**  
• Mini Din fêmea 8 pinos  
• Tipo H PCI  
**003157**



**Mini Din F 4 Pinos Tipo H**  
• Mini Din fêmea 4 pinos  
• Tipo H PCI  
**003158**



**Mini Din F 6 Pinos Tipo W**  
• Mini Din fêmea 6 pinos  
• Tipo W PCI • Emb. 100 pçs  
**034342**



**Din forma A**  
• Din 43650-m27 3p+T  
• Preto  
**036540**



**D-SUBS**



**D-Sub p/ Cabo Flat (IDC)**  
• D-Sub para cabo flat • Connfly  
**031863** DB9 Fêmea - Emb. 1 pç  
**032568** DB9 Fêmea - c/ Blind. - Emb. 1 pç  
**032569** DB9 Macho - c/ Blind. - Emb. 1 pç  
**031865** DB25 Fêmea - Emb. 1 pç  
**031866** DB25 Macho - Emb. 1 pç



**D-Sub HD Ângulo Reto p/ PCI Curto**  
• DB15 fêmea HD • Connfly  
• Distância entre os terminais: 4,8mm  
**031871** DB15 HD - Emb: 9 pçs



**D-Sub HD Ângulo Reto p/ PCI Longo**  
• DB15 HD fêmea • Connfly  
• Distância entre os terminais: 5,8mm  
**033787** - Emb: 1 pç



**D-Sub Reto 180° p/ PCI**  
• Connfly  
**032560** DB09 Fêmea - Emb: 10 pçs  
**032561** DB09 Macho - Emb: 10 pçs  
**034642** DB25 Fêmea - Emb: 1 pç  
**032559** DB25 Macho - Emb: 1 pç



**D-Sub HD Reto p/ PCI**  
• Connfly  
**031899** DB15 Fêmea - Emb: 1 pç  
**031900** DB15 Macho - Emb: 1 pç  
**031902** DB26 HD Macho - Emb: 1 pç  
**031901** DB26 HD Fêmea - Emb: 10 pçs



**D-Sub Reto p/ PCI**  
• Connfly • Curto  
**031867** DB9 Fêmea - Emb: 1 pç  
**031868** DB9 Macho - Emb: 1 pç  
**031869** DB25 Fêmea - Emb: 1 pç  
**031870** DB25 Macho - Emb: 1 pç



**D-Sub p/ Solda Fio 180°**  
 • Connfly  
**031856** DB9 Fêmea - Emb: 10 pçs  
**031857** DB9 Macho - Emb: 10 pçs  
**031852** DB15 Fêmea - Emb: 10 pçs  
**031853** DB15 Macho - Emb: 10 pçs  
**031854** DB25 Fêmea - Emb: 1 pç  
**031855** DB25 Macho - Emb: 1 pç  
**033463** DB37 Fêmea - Emb: 10 pçs



**D-Sub p/ Solda Fio 180°**  
 • Connfly  
**002596** DB15 Macho - Emb: 1 pç  
**002600** DB25 Fêmea - Emb: 1 pç  
**035115** DB25 Macho - Emb: 20 pçs  
**033232** DB37 Fêmea Ouro - Emb: 1 pç  
**033233** DB37 Macho Ouro - Emb: 1 pç



**D-Sub HD p/ Solda Fio 180°**  
 • Connfly • Emb c/ 1pç  
**031858** DB15 HD Fêmea  
**031859** DB15 HD Macho  
**031860** DB26 HD Fêmea  
**034087** DB15 HD Fêmea  
**002599** DB15 HD Fêmea



**D-Sub para Solda Fio 180°**  
 • DB25 fêmea • Connfly  
 • Azul com porcas  
**033885** Emb. 1 pç



**D-Sub p/ Cabo Flat (IDC)**  
 • D-sub com trava • Connfly  
**032563** DB09 Macho - Emb. 1 pç  
**032564** DB15 Fêmea - Emb. 1 pç  
**032565** DB15 Macho - Emb. 1 pç  
**032566** DB25 Fêmea - Emb. 1 pç  
**032567** DB25 Macho - Emb. 1 pç  
**034678** DB25 Macho - Emb. 50 pçs



**Centronic M p/ Solda**  
 • Connfly • 50 pinos  
**035072** Emb. 1 pç



**Centronic M p/ Solda**  
 • Connfly • 50 pinos angular  
**035071** Emb. 1 pç



**Centronic F p/ Solda**  
 • Connfly • 50 pinos com trava  
**035073** Emb. 1 pç



**Capas D-Sub Kit Longo**  
 • D-Sub Kit Longo • Connfly • Emb c/ 1pç  
**031885** p/ DB9 Cinza  
**033791** p/ DB15 Cinza  
**031879** p/ DB25 Cinza  
**031887** p/ DB9 Preto  
**033792** p/ DB15 Preto  
**031881** p/ DB25 Preto  
**031884** p/ DB37 Preto  
**031883** p/ DB37 Cinza



**Capas D-Sub Kit Curto**  
 • Capas kit curto • Connfly • Emb c/ 1pç  
**031888** p/ DB 9 Preto  
**031886** p/ DB 9 Cinza  
**033228** p/ DB 9 Marfim  
**033230** p/ DB 15 Marfim  
**033229** p/ DB 15 Preto  
**031880** p/ DB 25 Cinza  
**031882** p/ DB 25 Preto  
**002651** p/ DB25 Cinza



**Capas D-Sub Metálicas**  
 • Connfly • Emb c/ 1pç  
**034632** Kit Curto p/ DB25  
**035653** Kit Longo p/ DB15  
**034619** Kit Longo p/ DB09

Capa para cabo flat e Conjunto de Retenção



**Capa p/ Cabo Flat**  
 • Hood 9 pinos para cabo flat  
 • Preto  
**034476** Emb. 10 pçs  
**036483** Emb. 1 pç



**Conjunto de Retenção**  
 • Kit curto • Connfly  
 • 2 parafusos, 2 porcas e 4 anilhas  
**034630** - Emb. 50 pçs



**Conjunto de Retenção**  
 • Kit de retenção 2 parafusos + 2 porcas + 4 anilhas  
 • Curtos • Connfly  
**035342** Emb. 1 kit



**Conjunto de Retenção Macho**  
 • Kit de retenção  
 • 1 parafuso longo 44mm  
 • Connfly  
**035343** - Emb. 1 kit



**USB A F**

- USB A fêmea níquel
- Connfly

**032586** - Emb. 10 pçs



**USB A M p/ Solda**

- USB A macho p/ solda níquel
- Connfly

**032589** - Emb. 100 pçs



**USB B DIP**

- USB B Dip níquel
- Connfly

**034616** - Emb. 80 pçs



**USB B 2.0**

- USB B 2.0 • macho

**035229**



**Mini USB M p/ Solda**

- Mini USB M 4 pinos p/ solda
- Connfly

**032588** Emb. 50 pçs

**Filtros, Plugs e jacks modulares p/ telefonia**



**Filtro p/ Telefonia**

- Micro Filtro ADSL • 2 saídas

**034146**



**Filtro p/ Telefonia**

- Micro Filtro ADSL • 1 saída

**034147**



**Filtro p/ Telefonia**

- 2RJ11Fx1RJ11M • 2 saídas

**030299**



**Adaptador M/F Rotatório-RJ11**

- Adaptador rotatório não permite torção do fio do telefone • PT

**030249**



**Adaptador Modular Triplex**

- Adaptador 6P4C fêmea / 2x6P4C fêmea

**030927**



**Emenda 6P4C-RJ11**

- Emenda 6P4C fêmea / fêmea
- Emb. 10 pçs

**034340**



**Emenda 6P6C**

- Emenda 6P6C fêmea / fêmea

**003134**



**Adaptador Modular RJ11**

- Adaptador 2x6P4C fêmea/6P4C Macho • Embalagem: 5 pçs

**034452**



**Adaptador Modular RJ11**

- RJ11 Macho x 5RJ 11 Fêmea

**035569** Emb. 5 pçs



**Plug RJ 11 Quadrado**

- 4P2C • Connfly
- Embalagem: 50pçs

**034737**



**Plug RJ 11 Quadrado**

- 4P2C • Connfly
- Embalagem: 100pçs

**003127**



**Plug RJ 11 Quadrado**

- 4P4C • Connfly
- Embalagem: 120 pçs

**034713**



**Plug RJ 11 Redondo**

- 6P4C • Connfly
- Embalagem: 50 pçs

**034669**



**Plug RJ 11 Quadrado**

- 6P4C • Connfly
- Embalagem: 50 pçs

**031905**



**Plug RJ 11 Quadrado**

- 6P4C • Connfly
- Embalagem: 100 pçs

**003128**



**Plug RJ 12 Quadrado**

- 6P6C • Connfly
- Embalagem: 50 pçs

**034650**



**Plug RJ 12 Branco**  
 • 6P6C • Connfly  
 • Embalagem: 50 pçs  
**031906**

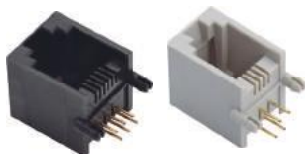

**Jack Modular**  
 • 4P4C PCI  
**003144** - 180° PT  
**003142** - 90°CZ



**Jack PCI 6P4C 90° Metaltex**  
 • 6P4C-PCI • 90°  
**034475** Preto



**Jack PCI 6P6C**  
 • 6P6C • Connfly  
 • Embalagem: 10 pçs  
**034733**



**Jack PCI 6P6C 90°**  
 • 6P6C • Connfly • 90°  
 • Embalagem: 1 pç  
**031921**



**Jack PCI 6P6C 90°**  
 • 6P6C • Connfly • 90°  
**034731** CZ-Emb.10 pçs  
**034743** PT-Emb.120 pçs  
**003143** PT-Emb.1 pç



**Jack PCI 6P6C Metaltex**  
 • TFC-66 Modular Jack PCB  
 • 6P6C • 180° • PT  
**033897**



**Jack TFC 88 Metaltex**  
 • 8P8C  
 • PT  
**032257**



**Jack TFN 88**  
 • PCB 90° 8P8C  
 • PT  
**032672**

Plugs e Jacks Modulares para Redes



**Plug 8P8C Quadrado**  
 • 8P8C • Connfly • Cat 6  
 • Embalagem: 50 pçs  
**034612**



**Plug 8P8C Quadrado Curto**  
 • 8P8C • Connfly • Cat 5  
**031910** - Emb: 1 pç  
**034691** - Emb: 200 pçs



**Plug 8P8C Metaltex**  
 • 8P8C • Connfly  
 • RJ45 8P8C • Cat 6  
**035020**



**Plug 8P8C Redondo**  
 • 8P8C • Connfly • Emb c/ 1pç • Cat 5  
**031911**  
**035853**



**Plug 8P8C Redondo**  
 • 8P8C • Cat6E Blindado  
 • Embalagem: 100 pçs  
**034308**



**Plug 10P10C Quadrado**  
 • 10P10C • Connfly  
 • Embalagem: 50 pçs  
**034617**



**Keystone 5e**  
 • Keystone • T568A/B • Emb. 5 pçs  
**034310**



**Keystone 5e**  
 • Keystone • Com tampa  
**033028**



**Keystone 6e**  
 • Keystone • Cat 6e • Emb. 5 pçs  
**035292** - 180°  
**034275** - 180°  
**034309** - 90°



**Jack PCI 8P8C**  
• 8P8C • Connfly  
**031917** Emb: 1 pç  
**034708** Emb: 80 pçs



**Jack PCI 4X8P8C**  
• 4X8P8C • Connfly  
• Embalagem: 20 pçs  
**034637**



**Jack PCI 2X8P8C Blindado**  
• 2X8P8C 2 portas • Connfly  
• Embalagem: 40 pçs  
**034680**



**Jack PCI 4X8P8C Blindado**  
• 4X8P8C • 4 portas • Connfly  
• Embalagem: 20 pçs  
**034732**



**Jack PCI 8P8C Blindado 90°**  
• 8P8C • Connfly • Blindado  
• Embalagem: 10 pçs  
**034198**



**Jack PCI 8P8C 90°**  
• 8P8C • Connfly • Emb c/10pçs  
**031924**



**Jack PCI 8P8C 90°**  
• 8P8C • Connfly  
**034742** - Emb: 100pçs - CZ  
**034035** - Emb: 10pçs - PT



**Jack PCI 8P8C Vertical**  
• 8P8C • Connfly • Emb. 10 pçs  
**034706** CZ  
**034664** PT



**Jack PCI 10P10C 90°**  
• 10P10C  
• Cinza  
**003140**



**Jack PCI 4P4C 90°**  
• 4P4C com fios (Soquete 616M)  
• AM/PT 52mm • VM/VD 190mm  
**035515** Sem haste  
**033024** Com haste



**Emenda RJ45 (1X1)**  
• Plástica • Emb. 10 pçs  
**034297**



**Emenda RJ45 (1X1)**  
• Plástica • Gelo  
**030596**



**Emenda RJ45 (1X1)**  
• Plástica  
**003135**



**2XRJ45 F/RJ45 M**  
• 2xRJ45 F / RJ45 M • Emb. 5 pçs  
**034486**



**DB9 M/RJ45 F**  
• DB9 M/ Jack 8P8C  
**003212**



**DB25 F/Jack 8P8C**  
• DB25 Fêmea/Jack 8P8C  
**030247**



**DB9 F/RJ45 F**  
• DB9 F / Jack 8P8C • Emb. 10 pçs  
**034115**



**Tomada de Sobrepor RJ45**  
• 8P8C Bege  
**003137**



**Tomada de Sobrepor RJ45**  
• Com porta e sem conector • Gelo  
**003139**



**Capas p/ RJ45 Flexíveis**  
• Connfly  
**034648** Cinza - Emb: 100 pçs  
**035421** Cinza - Emb: 50 pçs  
**035549** Preto - Emb: 50 pçs  
**034649** Preto - Emb: 100 pçs  
**034624** Azul - Emb: 100 pçs

**035420** Azul - Emb: 50 pçs  
**035550** Branco - Emb: 50 pçs  
**034714** Branco - Emb: 100 pçs  
**035551** Amarelo - Emb: 50 pçs  
**034668** Amarelo - Emb: 100 pçs



**P4 Plug DC**

- Plug tipo P4 para DC
- (5,5x2,1x18mm)

**034446** - Emb: 30pçs

**P4 Plug DC**

- Plug tipo P4 para DC
- **033798** - 5,5x2,5x17,5mm
- **033797** - 5,5x2,1x17,5mm

**P4 Plug DC**

- Plug tipo P4 para DC
- (5,5x2,1x22,5mm) • Emb. 30 pçs

**034125**

**P4 Plug DC**

- Plug tipo P4 para DC s/ Rabicho
- Emb. 30 pçs
- **034048** 1,4x3,5x9mm
- **036004** 1,4x3,5x9mm
- **034388** 1x3,8x9mm
- **035297** 1x2,5x9mm

**P4 Plug DC**

- Plug tipo P4 p/ DC • Sem rabicho
- (1,4x3,8x9,5mm) • Emb. 30 pçs

**034051**

**P4 Plug DC**

- Plug tipo P4 para DC • Com rabicho
- (1,4x2,5x9mm) • Emb. 30 pçs
- **034389** - 1,4x2,5x9mm
- **035298** - 2,1x5,5x9,5mm

**P4 Plug DC**

- Plug tipo P4 para DC
- (2,1x5,5x14mm) • Emb. 30 pçs
- **034049** s/ rab.
- **036005** s/ rab.
- **034390** c/ rab.

**P4 Plug DC**

- Plug tipo P4 para DC
- (2,5x5,5x9mm) • Emb. 30 pçs
- **034263** s/ rabicho
- **035295** c/ rabicho

**P4 Plug DC**

- Plug tipo P4 para DC
- (2,5x5,5x14mm) • Emb. 30 pçs
- **034050** sem rabicho
- **034061** com rabicho

**P4 Plug DC**

- Plug tipo P4 para DC com rabicho
- (3,1x6,3x14mm) • Emb. 30 pçs

**034120**

**P4 Plug DC**

- Plug tipo P4 para DC com rabicho
- (0,7x2,5x10mm)

**035831** Emb c/10pçs

**P4 Jack DC**

- Jack tipo P4 DC fêmea
- Com rabicho • Emb. 10 pçs
- **034291** 2,5mm
- **034290** 2,1mm

**P4 Jack DC**

- Jack tipo P4
- DC Fêmea • Emb. 30 pçs
- **034306** 2,5 x 5,5mm
- **034305** 2,1 x 5,5mm

**P4 Jack DC**

- Jack tipo P4 DC fêmea 2mm
- Para solda • Emb. 50 pçs

**035280**

**P4 Jack DC**

- Jack tipo P4 DC fêmea 1mm
- Para placa de circuito impresso

**030232**

**P4 Jack DC**

- Jack tipo P4 DC fêmea 1mm
- Para placa de circuito impresso
- Emb. 10 pçs

**035088**

**P4 Jack DC**

- Jack tipo P4 DC fêmea 2,5mm
- Para solda • Emb. 50 pçs
- **035282**
- **034574**

**P4 Jack DC**

- Jack tipo P4
- DC fêmea
- **032615** 2,1x5,5mm
- **032616** 2,5x5,5mm

**P4 Jack DC**

- Jack tipo P4
- DC fêmea
- **035144** 2,1x5,5mm - Emb: 10 pçs
- **032618** 2,5x5,5mm

**P4 Jack DC**

- Jack tipo P4 DC fêmea
- Para chassis • Emb. 10 pçs
- **034289** 2,1x5,5mm
- **034392** 2,5x5,5mm



**Cachimbo/Conversor**  
 • Conversor tipo cachimbo • Simples  
 • 75 para 300 Ohms • Emb. 20 pçs  
**034247**



**Cachimbo/Conversor**  
 • Conversor tipo cachimbo • Rápido  
 • 75 para 300 Ohms  
**031140**



**Cachimbo/Conversor**  
 • Conversor tipo cachimbo  
 • Entrada Jack F rápido / saída plug F  
 • 75 para 300 Ohms  
**031381**



**Cachimbo/Conversor**  
 • Conversor tipo cachimbo simples  
 • Plug Europeu de 9,5mm  
 • 75 para 300 Ohms  
**031379**



**Divisor de Sinal**  
 • Divisor para antena TV 2 vias  
 • 5/900 Mhz • Emb. 10 pçs  
**034234**



**Divisor de Sinal**  
 • Divisor para antena TV 3 vias  
 • 5/900 Mhz • Emb. 10 pçs  
**034237**



**Divisor de Sinal**  
 • Divisor para antena TV 4 vias  
 • 5/900 Mhz  
**030942**



**Divisor de Sinal**  
 • Divisor para antena TV 2 vias  
 • 5/2250 Mhz • Emb. 5 pçs  
**034248**



**Divisor de Sinal**  
 • Divisor para antena TV 3 vias  
 • 5/2300 Mhz • Emb. 5 pçs  
**034495**



**Tipo F**  
 • Conector F fêmea com rosca para painel  
**031370**



**Tipo F Torre**  
 • Conector F fêmea tipo torre  
 • Para PCI 180° • Emb. 10 pçs  
**034192**



**Tipo F**  
 • Conector F fêmea PCI 180°  
 • Emb. 10 pçs  
**034193**



**Tipo F**  
 • Conector F fêmea com rosca para painel • Emb. 20 pçs  
**034194**



**Tipo F**  
 • C/ Rosca e Porca de Fim de Curso Soldada No Final • Emb. 20 pçs  
**036007**



**Tipo F**  
 • Conector F fêmea com rosca para painel • Emb. 20 pçs  
**034820**



**Adaptador M KRE/P4**  
 • Adaptador plug tipo P4 DC 5,5mm p/ KRE2 macho para conexão de cameras c/ fontes • Emb. 20 pçs  
**035099**



**Adaptador F KRE/P4**  
 • Adaptador jack tipo P4 DC fêmea 5,5mm para KRE2 para conexão de câmeras com fontes • Emb. 20 pçs  
**035098**



**Tipo F**  
 • Conector F macho RCF  
 • Compressão RG 6/U (75R)  
**031427**



**Tipo F**  
 • Conector F macho  
 • Compressão com anel  
**033288** RG-59/U (75R) AZ Emb c/ 1pç  
**035924** RG-6/U (75R) AM Emb c/ 10pçs  
**033287** RG-6/U (75R) AZ Emb c/ 1pç



**Tipo F**  
 • Conector F macho compressão  
 • (75R)  
**033286** RG-59/U  
**033285** RG-6/U



**Tipo F**  
 • Conector F macho Compressão  
 • Porca azul para cabo RG/6U (75R)  
 • Emb. 10 pçs  
**035271**



**Tipo F**  
 • Conector F macho compressão  
 • Porca metal para cabo RG/6U (75R)  
**032004**



**Tipo F**  
 • Conector F macho RCF  
 • Compressão RG 59/U  
**035118** - Emb: 10pçs  
**031428** - Emb: 1pç



**RCA p/ TV a cabo**  
 • Conector RCA macho  
 • Compressão RG 6/U • (75R)  
**031426**



**BNC p/ TV a cabo**  
 • Conector BNC macho  
 • Compressão • (75R)  
**034524** RG59 - Emb: 10pçs  
**031429** RG6/U - Emb: 1pç



**Tipo F**  
 • Conector F macho  
 • Para cabo RG6/U • (75R)  
**035310** - Emb: 10pçs



**Tipo F**  
 • Conector F macho  
 • Para cabo RG58/U • (50R)  
**030963**



**Tipo F**  
 • Conector F macho • Para cabo RG59/U • (75R) • Emb. 50 pçs  
**034238**



**Tipo F**  
 • Conector F macho com anel • Para cabo RG59/U • (75R) • Emb. 50 pçs  
**035267**



**Tipo F**  
 • Conector F macho com anel • Para cabo RG6/U • (75R) • Emb. 50 pçs  
**034821**



**Tipo F**  
 • Conector F macho • Para cabo RG6/U • (75R) • Emb. 50 pçs  
**034239**



**Tipo F**  
 • Conector F macho conexão tipo twister • P/ cabo RG58/U • (50R)  
**030966**



**Tipo F**  
 • Conector F macho conexão tipo twister • P/ cabo RG59/U • (75R)  
**030967**



**Tipo F**  
 • Conector F macho conex. tipo twister • p/ cabo RG6/U • (75R) • Emb. 50 pçs  
**035265**



**Emenda F F/M**  
 • Adaptador de níquel F fêmea para F macho 90°  
**035113** - Emb: 20pçs



**Emenda F F/M**  
 • Adaptador de níquel F fêmea para F macho • Emb. 10 pçs  
**035268**



**Tipo T**  
 • Adaptador de níquel F macho rápido para duas F fêmeas • Emb. 10 pçs  
**034494**



**Tipo T**  
 • Adaptador de níquel F tipo T • 3 fêmeas • Emb. 10 pçs  
**034822**



**UHF Mini**  
 • Conector UHF mini macho  
 • Para cabo RG59/U  
**034230** - RG58/U (50R) Emb c/ 10pçs  
**030912** - RG59/U (75R) Emb c/ 1pç  
**030913** - RG6/U (75R) Emb c/ 1pç



**UHF Mini F**  
 • Conector UHF mini fêmea para cabo • Para cabo RG58/U • (50R)  
**033702**



**Video Baloon BNC**

- Transceptor passivo de vídeo 1 canal • Proteção contra raio e supressão de interferência c/ filtragem de ruído cabo UTP
- Dist. máx. 500m • Emb. 2 pçs

**033763**



**Video Baloon**

- Vídeo Transmissor Baloon
- 01 canal passivo CCTV
- Via par trançado • Full Motion • Dist. máx. 330m

• Emb. 2 pçs  
**033775**



**Video Baloon**

- Video Baloon BNC Macho
- Via par trançado
- 75 Ohms/300 Ohms

Passivo  
**033774**



**Video Baloon**

- Vídeo Baloon BNC macho 75 Ohms • RJ45 100 Ohms

• Emb. 2 pçs  
**033773**



**Video Baloon BNC**

- Vídeo Baloon BNC para uso em CFTV, cabo UTP, distância máxima:

500m • Emb. 2pçs  
**033491**

Soquetes torneados, Estanhados e Dourados, Barras de Pino e Conectores • PCI



**Soquetes Torneados Estanhados e Dourados**

- Soquetes - Barras • Connfly
- 031808** Barra 1X40 Pinos - Estanhado - Emb: 1 pç
- 031933** Barra 2X40 Pinos - Estanhado - Emb: 10 pçs
- 031934** Barra 1X40 Pinos - Dourado - Emb: 1 pç
- 031935** Barra 2X40 Pinos - Dourado - Emb: 1 pç
- 030178** Barra 1X40 Pinos - Estanhado - Emb: 1 pç



**Soquetes Torneados Estanhados**

- Diâmetro do furo: 1.3mm • Connfly
- 031798** 08 Pinos - Emb: 1 pç
- 031818** 14 Pinos - Emb: 34 pçs
- 031800** 16 Pinos - Emb: 1 pç
- 031803** 24 Pinos Estreito - Emb: 20 pçs
- 031804** 24 Pinos Largo - Emb: 1 pç
- 031805** 28 Pinos Estreito - Emb: 1 pç
- 031806** 28 Pinos Largo - Emb: 17 pçs
- 031807** 40 Pinos Largo - Emb: 1 pç



**Soquetes PLCC**

- Soquete • Connfly
- 032555** 28 Pinos - Embalagem: 1 pç
- 032557** 52 Pinos - Embalagem: 1 pç



**Soquetes TEXTTOOL**

- Dourado • Connfly
- Verde
- 032573** 24mm - 24 Pinos - Embalagem: 1 pç
- 032574** 24mm - 28 Pinos - Embalagem: 1 pç
- 034700** 24mm - 40 Pinos - Embalagem: 1 pç



**Soquetes Estampados**

- Connfly
- 031810** 08 Pinos - Emb: 60 pçs
- 031811** 14 Pinos - Emb: 34 pçs
- 031812** 16 Pinos - Emb: 30 pçs
- 031815** 24 Pinos - Emb: 20 pçs
- 031816** 28 Pinos - Emb: 1 pç
- 031817** 40 Pinos - Emb: 1 pç



**Barra de Pino 180° p/ PCI**

- Connfly
- 034946** 1x40 180° P. 2,54mm - Emb: 1 pç
- 032536** 2x40 180° P. 2,54mm - Emb: 1 pç



**Barra de Pino 90° p/ PCI**

- Connfly
- 032538** 2x40 90° P. 2,54mm - Emb. 10 pçs



**Barra de pino p/ PCI 180°**

- Com duplo isolador 180° • Connfly
- 032553** 1x40 180° A/C/B=6/12/3mm 21mm - Passo: 2,54mm - Emb. 1 pç
- 032554** 2x40 180° A/H/B=5/17/3mm 25mm - Passo: 2,54mm - Emb. 1 pç



**Barra de Pino 90° p/ PCI**

- Embalagem: 1 pç
- 030177** 1x40 - 15mm 90° Passo 2,54mm



**Barra de Pino p/ PCI c/ Duplo Isolador 180°**

- Embalagem: 1 pç
- 030183** 2x40 20mm 180° Passo 2,54mm
- 030182** 2x40 8,2mm 180° Passo 2,54mm



**Conector p/ Cabo Flat 180° com Travas Curtas**

- 34 pinos - Latch • Connfly
- Embalagem: 1 pç
- 031824**



**Conectores p/ Cabo Flat 180° Trava**  
• Connfly

- 031819** 14 Pinos - Trava Curta - Emb: 1 pç
- 031820** 16 Pinos - Trava Curta - Emb: 8 pçs
- 031821** 20 Pinos - Trava Curta - Emb: 7 pçs
- 031822** 26 Pinos - Trava Curta - Emb: 6 pçs
- 031823** 40 Pinos - Trava Curta - Emb: 4 pçs
- 031825** 10 Pinos - Trava Longa - Emb: 21 pçs
- 031827** 16 Pinos - Trava Longa - Emb: 14 pçs
- 031829** 26 Pinos - Trava Longa - Emb: 1 pç
- 031830** 34 Pinos - Trava Longa - Emb: 12 pçs
- 031831** 40 Pinos - Trava Longa - Emb: 7 pçs



**Conectores Flat F**  
• Conectores para cabo flat com ejetor • P. 2,54mm

- 031850** 06 Pinos - Emb: 1 pç
- 031851** 08 Pinos - Emb: 10 pçs
- 032528** 10 Pinos - Emb: 1 pç
- 031846** 14 Pinos - Emb: 10 pçs
- 031847** 16 Pinos - Emb: 1 pç
- 032529** 20 Pinos - Emb: 10 pçs
- 031848** 24 Pinos - Emb: 10 pçs
- 032530** 26 Pinos - Emb: 10 pçs
- 031849** 40 Pinos - Emb: 5 pçs
- 033227** 64 Pinos - Emb: 1 pç



**Alojamento p/ Cabo Flat**  
• Conectores flat passo 2,54mm

- 031832** 10 Pinos 90° - Emb: 1 pç
- 031833** 10 Pinos 180° - Emb: 1 pç
- 031834** 14 Pinos 90° - Emb: 1 pç
- 031835** 14 Pinos 180° - Emb: 10 pçs
- 031837** 16 Pinos 180° - Emb: 1 pç
- 031838** 20 Pinos 90° - Emb: 1 pç
- 031840** 26 Pinos 90° - Emb: 6 pçs
- 031841** 26 Pinos 180° - Emb: 1 pç
- 031842** 34 Pinos 90° - Emb: 1 pç
- 031843** 34 Pinos 180° - Emb: 10 pçs
- 031844** 40 Pinos 90° - Emb: 8 pçs
- 031845** 40 Pinos 180° - Emb: 8 pçs



**Alojamento p/ conectores Flat**  
• Conectores flat passo 2mm - Latch

- Connfly
- 032522** 10 Pinos 90°-Emb. 20 pçs
- 032523** 10 Pinos 180°-Emb. 20 pçs
- 034695** 14 Pinos 90°-Emb. 200 pçs
- 032525** 14 Pinos 180°-Emb. 20 pçs
- 032526** 16 Pinos 90°-Emb. 20 pçs
- 032527** 16 Pinos 180°-Emb. 20 pçs



**Conector p/ cabo Flat DIP Plug**

- Conectores passo 2,54mm
- Connfly
- 034672** 10 Pinos - Emb: 160 pçs
- 032532** 14 Pinos - Emb: 50 pçs
- 032533** 16 Pinos - Emb: 50 pçs
- 034682** 20 Pinos - Emb: 90 pçs



**Conectores Header**

- Conectores Header fêmea Passo 2,54mm / 8,5mm
- Connfly
- 034683** 4 Pinos - Emb: 380 pçs
- 034730** 2X6 Pinos - Emb: 260 pçs
- 034728** 2X8 Pinos - Emb: 180 pçs
- 034711** 2X10 Pinos - Emb: 160 pçs



**Mini Jumper**

- Aberto • 2,54mm • Connfly
- 032552** - Com haste - Emb: 100 pçs
- 032551** - Sem haste - Emb: 100 pçs
- 034673** - Sem haste - Emb: 2000 pçs

Conectores Circulares e Micro Circulares • IDC



**Conector Micro Circular**

- Tipo circular com porca de travamento
- Ligação dos fios por solda • 5A / 500 Vac • Prensa cabo metálico • Conjunto macho e fêmea • Compr. Total: (M+F) 84,4mm • Connfly • Emb: 5 peças
- 032594** 5 Pinos



**Conector Micro Circular**

- Tipo circular com porca de travamento
- Ligação dos fios por solda • 5A / 500 Vac • Prensa cabo metálico • Conjunto macho e fêmea • Compr. Total: (M+F) 56mm • Connfly • Emb: 5 peças
- 032590** 4 Pinos



**Conector Circular (MIKE)**

- Tipo circular com porca de travamento
- Ligação dos fios por solda
- 5A / 500 Vac • Prensa cabo metálico
- Conjunto macho e fêmea
- Embalagem: 10 pçs
- 034023** 2 Pinos
- 034203** 3 Pinos
- 034204** 4 Pinos
- 034024** 5 Pinos
- 034105** 6 Pinos
- 034394** 7 Pinos
- 034025** 8 Pinos



- Conector MC4 Solar Painel**  
Macho/Fêmea  
**036398**

Conectores, Emendas e Bornes • Elétrica



**Conector Tipo Bloco**

- Tipo bloco
- 032641** 4 Pinos
- 032642** 8 Pinos



**Emenda Fio Duplo**

- Conectores tipo emenda p/ fio com até 1,5mm • 10a 250v • 12x12x20mm
- Emb. 10 pçs
- 034191**



**Bornes KRE para PCI**

- Altura: 14,5mm • Med. do furo: 0,8 x 0,9mm • Dist. entre pinos: 5mm • 16A / 250 VAC • Para fios de até 2,5mm
- Furo quadrado • Emb. 20 pçs
- 034232** 2 Pinos
- 034053** 3 Pinos



**Bornes KRE p/ PCI Metalx**

- Tipo KRE 180° para cabos 22/14 AWG • Altura: 10,00mm
- Distância entre pinos: 5mm 10A
- 032670** 2 P. - CZ
- 032671** 2 P. - AZ



**Garra Jacaré Isolada**

• Isolada • A medida do conector é sem a capa

- 034228** PT 27mm - Emb: 20 pçs
- 034314** VM 27mm - Emb: 20 pçs
- 034395** PT 35mm - Emb: 20 pçs
- 035387** VM 35mm - Emb: 10 pçs
- 034396** VM 44mm - Emb: 100 pçs



**Garra Jacaré Isolada**

• Isolada • 50mm medida do conector sem capa • PT e VM

- 034784** - Emb: 20 pçs



**Garra Jacaré Isolada**

• Isolada 20A • A medida do conector é sem a capa • 65mm • Emb. 10 pçs

- 035287** VM
- 034266** PT



**Garra Jacaré Isolada**

• A medida do conector é sem a capa

- 035184** PT 35mm - Emb: 10 pçs
- 030266** VM 35mm - Emb: 10 pçs
- 034779** VM 50mm - Emb: 20 pçs
- 034780** VM 50mm - Emb: 20 pçs



**Garra Jacaré Isolada**

• Alta Corrente 50A • Medida do conector é s/ a capa • 100mm

- Emb. 10 pçs
- 035285** VM
- 035286** PT



**Garra Jacaré p/ Chupeta**

• Cabo Tipo "Chupeta" para bateria automotiva • PT e VM 150mm • Par

- 035402** Níquel



**Garra Jacaré p/ Chupeta**

• Cabo Tipo "Chupeta" para bateria automotiva • PT e VM 150mm • Par

- 033980** Cobre



**Garra Jacaré p/ Chupeta**

• Cabo Tipo "Chupeta" para bateria automotiva • PT e VM 73mm

- Saco c/ 10 pares
- 036056**

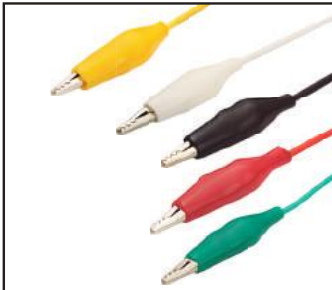

**Kit Garra Jacaré**

• Kit 5 Pares Jacarés 40mm • Emb. 2 kits • Rab. 50cm (PT/VM/VD/AM/BR)

- 034040**



**Plug Banana**

• Ouro

- 034116** PT - Emb: 20 pçs
- 034117** VM - Emb: 20 pçs
- 032876** AM - Emb: 1 pç
- 032877** VD - Emb: 1 pç

- 032878** BR - Emb: 1 pç
- 035491** AZ - Emb: 10 pçs

**Plug Banana**

• Níquel

- 034397** VD - Emb: 20 pçs
- 034398** AZ - Emb: 20 pçs
- 034399** AM - Emb: 20 pçs

- 034307** PT - Emb: 20 pçs
- 034852** VM - Emb: 20 pçs

**Jacks e Bornes banana**



**Jack Banana**

• Níquel

- 030259** PT
- 030260** VM



**Jack Banana**

• Níquel • Emb. 10 pçs

- 034519** VM
- 034520** PT



**Jack Banana**

• Níquel • Emb. 10 pçs

- 035301** PT
- 035299** VM



**Jack Banana**

• Níquel • Emb. 10 pçs

- 034401** PT
- 035300** VM
- 034299** VM



**Jack Banana**

• Níquel • Emb. 10 pçs

- 034300** VM Níquel
- 034301** PT Níquel



**Jack Banana**

• Níquel • Emb. 20 pçs • PT

- 034477**



**Bornes p/ Pino Banana**

• Conjunto duplo de bornes para solda pino 4mm banana • Plástico PT e VM

- Emb. 10 pçs
- 034038**



**Pino Adaptador Padrão INMETRO**  
 • Benjamin 1x2  
**031611** 1X2 PT  
**031614** 1X2 BG



**Pino Adaptador Padrão INMETRO**  
 • Plug T padrão novo 3 pinos  
 • 4 saídas 10A 250V  
 • Aprovado pelo Inmetro • PT  
**033014**



**Pino Adaptador Padrão Antigo**  
 • Adaptador padrão antigo 2 pinos redondos + 2 pinos chatos • 10A 250V  
 • Aprovado pelo Inmetro • BR  
**033012**



**Pino Adaptador Padrão Antigo**  
 • Adaptador padrão antigo 3 pinos redondos + 2 chatos e 1 redondo para 3 pinos padrão novo • 10A 250V  
 • Aprovado pelo Inmetro • BR  
**033013**



**Tomada Painel**  
 • Tomada com fixação por pressão, ligação dos fios por solda ou terminal faston • Porta fusível 5x20mm 10A/250Vac • 3 Terminais • PT  
**030270**



**Tomada Painel**  
 • Tomada com fixação por pressão, ligação dos fios por solda • 10A / 250 Vac • 3 Terminais • PT  
**030271** - 15A  
**035409** - 10A



**Tomada Painel PCI**  
 • Para PCI ligação dos fios por solda • 10A/250Vac • PT • 15A  
 • 3 Terminais 90°  
**030272**



**Tomada Painel**  
 • Fixação por parafuso, ligação dos fios por solda • 10A/250Vac  
 • 3 terminais • Emb. 5 pçs  
**034332**



**Tomada Painel**  
 • Fixação por parafuso, ligação dos fios por solda • 2,5A/250Vac  
 • 2 terminais tipo 8  
**030273**



**Tomada Painel**  
 • Fixação por pressão, ligação dos fios por solda • 6A/250Vac • 2 terminais, entrada para pino chato ou redondo  
 • Emb. 5 pçs  
**034449**



**Tomada Painel**  
 • Tomada p/ chassis p/ solda  
 • 2 terminais tipo 8  
 • Emb. 10 pçs  
**035050**



**Tomada Pino p/ Cabo**  
 • Com prensa cabo • 10A/250Vac  
 • 3 terminais • Emb. 10 pçs  
**034798** - Fêmea  
**034453** - Macho



**Filtro de Linha Power Line**  
 • Bivolt 10A • Cabo 3x0,75x1,0mt  
 • Bege  
**035841** - 3 Tomadas  
**035842** - 4 Tomadas  
**035843** - 5 Tomadas  
**035849** - 5 Tomadas Espaçadas  
**035844** - 6 Tomadas  
**035845** - 8 Tomadas  
**035846** - 10 Tomadas



**Filtro de Linha Power Line**  
 • Bivolt 10A • Cabo 3x0,75x1,0mt  
 • Preto  
**035837** - 3 Tomadas  
**035838** - 4 Tomadas  
**035839** - 5 Tomadas  
**035840** - 6 Tomadas



**Régua de Tomada**  
 • Régua Rack (3X4) • Bivolt  
 • Cabo 3x1,5x1,5mt • Preto  
**035848** - 8 Tomadas 16A  
**035847** - 12 Tomadas 10A



**Extensão Padrão novo**  
 • Preto • Cabo de força 3x0,75mm  
 • 1metro • 10A • Bivolt • 4 Tomadas  
 • Parte traseira para fixação  
**032716**

## Conectores de Porcelana



**Conector Porcelana 350°**  
 • 2 Polos sem furo de fixação  
 • 600V - 25A • Fios até 6mm<sup>2</sup>  
**034148**



**Conector Porcelana 350°**  
 • 2 Polos com furo de fixação  
 • 600V - 25A • Fios até 6mm<sup>2</sup>  
**034149**



**Conector Porcelana 350°**  
 • 2 Polos sem furo de fixação  
 • 600V - 30A • Fios até 10mm<sup>2</sup>  
**034152**



**Conector Porcelana 350°**  
 • 2 Polos com furo de fixação  
 • 600V - 50A • Fios até 16mm<sup>2</sup>  
**034151**



**Conector Porcelana 350°**  
 • 3 Polos com furo de fixação  
 • 600V - 25A • Fios até 6mm<sup>2</sup>  
**034150**



**Conector Porcelana 350°**  
 • 3 Polos sem furo de fixação  
 • 600V - 30A • Fios até 10mm<sup>2</sup>  
**034153**



**Conector Porcelana 350°**  
 • 3 Polos com furo de fixação  
 • 600V - 50A • Fios até 16mm<sup>2</sup>  
**034154**



**Barra 12 Bornes**  
 • Para fio de até 4mm<sup>2</sup>  
 • Polietileno (812)  
**033349**



**Barra 12 Bornes**  
 • Para fio de até 6mm<sup>2</sup>  
 • Polietileno (112)  
**033350**



**Barra 12 Bornes**  
 • Para fio de até 6mm<sup>2</sup>  
 • Polietileno (212)  
**033351**



**Barra 12 Bornes**  
 • Para fio de até 10mm<sup>2</sup>  
 • Polietileno (612)  
**033352**



**Barra 12 Bornes**  
 • Para fio de até 16mm<sup>2</sup>  
 • Polietileno (712)  
**033353**



**Barra 12 Bornes**  
 • Para fio de até 16mm<sup>2</sup>  
 • Baquelite (512)  
**035139**



**Barra 12 Bornes**  
 • Para fio de até 6mm<sup>2</sup>  
 • Baquelite (412)  
**033354**



**Barra 12 Bornes M/F**  
 • Para fio de até 4mm<sup>2</sup>  
 • Polietileno (812 p/o)  
**033355**



**Barra 12 Bornes M/F**  
 • Para fio de até 6mm<sup>2</sup>  
 • Polietileno (112 p/o)  
**033356**



**Conector Bendal**  
 • BQ CI - 10A 500V  
 • 2 vias (100-302)  
**033357**



**Conector Bendal**  
 • BQ CI - 10A 500V  
 • 3 vias (100-303)  
**033358**



**Conector Bendal**  
 • BQ CI - 10A 500V  
 • 4 vias (100-304)  
**033359**



**Conector Bendal**  
 • BQ CI - 10A 500V  
 • 5 vias (100-305)  
**033360**

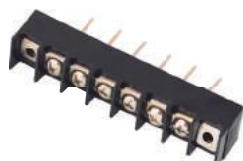

**Conector Bendal**  
 • BQ CI - 10A 500V  
 • 6 vias (100-306)  
**033361**



**Conector Bendal**  
 • BQ CI - 10A 500V  
 • 12 vias (100-312)  
**033362**

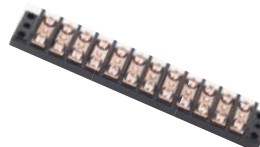

**Conector Bendal**  
 • Barra com 12 bornes  
 • PT (100-112) c/ fixação  
**033363**



**Emendas Rosqueáveis Crimper**  
 • Isolação: 1000V • Temperatura máxima 105°C  
 • Embalagens: 100 pçs  
**033429** Bitola 0,8 a 4,5mm<sup>2</sup> . AZ  
**033368** Bitola 0,8 a 2,5mm<sup>2</sup> . CZ  
**033369** Bitola 1,5 a 6,0mm<sup>2</sup> . LJ  
**033370** Bitola 1,5 a 10 mm<sup>2</sup> . AM  
**033371** Bitola 4,5 a 17mm<sup>2</sup> . VM

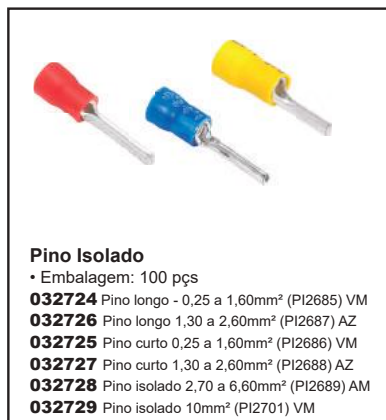

**Pino Isolado**

• Embalagem: 100 pçs

- 032724** Pino longo - 0,25 a 1,60mm<sup>2</sup> (PI2685) VM
- 032726** Pino longo 1,30 a 2,60mm<sup>2</sup> (PI2687) AZ
- 032725** Pino curto 0,25 a 1,60mm<sup>2</sup> (PI2686) VM
- 032727** Pino curto 1,30 a 2,60mm<sup>2</sup> (PI2688) AZ
- 032728** Pino isolado 2,70 a 6,60mm<sup>2</sup> (PI2689) AM
- 032729** Pino isolado 10mm<sup>2</sup> (PI2701) VM

**Ilhós Isolado**

• Embalagem: 100 pçs

- 032743** 0,50mm<sup>2</sup> (CT3804) BR
- 032744** 0,75mm<sup>2</sup> (CT3805) CZ
- 032745** 1,00mm<sup>2</sup> (CT3806) VM
- 032746** 1,50mm<sup>2</sup> (CT3807) PT
- 035734** 1,50mm<sup>2</sup> (CT3907) PT
- 032747** 2,50mm<sup>2</sup> (CT3808) AZ
- 032748** 4,00mm<sup>2</sup> (CT3809) CZ
- 032749** 6,00mm<sup>2</sup> (CT3810) AM

**Terminal Compressão**

• Embalagem: 100 pçs

- 032750** 10mm<sup>2</sup> (AT7217)
- 032751** 16mm<sup>2</sup> (AT7223)
- 032752** 25mm<sup>2</sup> (AT7228)
- 032753** 35mm<sup>2</sup> (AT7234)

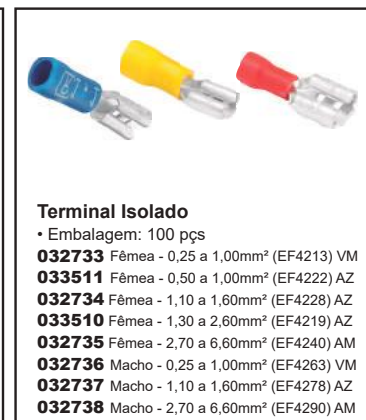
**Terminal Isolado**

• Embalagem: 100 pçs

- 032733** Fêmea - 0,25 a 1,00mm<sup>2</sup> (EF4213) VM
- 033511** Fêmea - 0,50 a 1,00mm<sup>2</sup> (EF4222) AZ
- 032734** Fêmea - 1,10 a 1,60mm<sup>2</sup> (EF4228) AZ
- 033510** Fêmea - 1,30 a 2,60mm<sup>2</sup> (EF4219) AZ
- 032735** Fêmea - 2,70 a 6,60mm<sup>2</sup> (EF4240) AM
- 032736** Macho - 0,25 a 1,00mm<sup>2</sup> (EF4263) VM
- 032737** Macho - 1,10 a 1,60mm<sup>2</sup> (EF4278) AZ
- 032738** Macho - 2,70 a 6,60mm<sup>2</sup> (EF4290) AM

**Acoplador de Nylon**

• Embalagem: 100 pçs

- 032739** Fêmea - 0,25 a 1,00mm<sup>2</sup> (NA4501) VM
- 032740** Fêmea - 1,10 a 1,60mm<sup>2</sup> (NA4503) AZ
- 032741** Macho - 0,25 a 1,00mm<sup>2</sup> (NA4511) VM
- 032742** Macho - 1,10 a 1,60mm<sup>2</sup> (NA4513) AZ

**Forquilha Isolado**

• Embalagem: 100 pçs

- 032721** 0,25 a 1,60mm<sup>2</sup> (FR2464) VM
- 032722** 1,30 a 2,60mm<sup>2</sup> (FR2479) AZ
- 032723** 2,70 a 6,60mm<sup>2</sup> (FR2493) AM

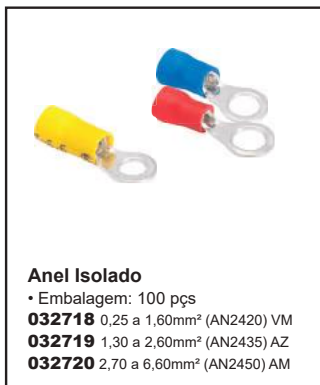
**Anel Isolado**

• Embalagem: 100 pçs

- 032718** 0,25 a 1,60mm<sup>2</sup> (AN2420) VM
- 032719** 1,30 a 2,60mm<sup>2</sup> (AN2435) AZ
- 032720** 2,70 a 6,60mm<sup>2</sup> (AN2450) AM

**Luva de Emenda Hollingsworth**

• Embalagem: 100 pçs

- 032730** 0,25 a 1,60mm<sup>2</sup> (LU2690) VM
- 032731** 1,30 a 2,60mm<sup>2</sup> (LU2692) AZ
- 032732** 2,70 a 6,60mm<sup>2</sup> (LU2694) AM

## Espaçadores e Fixadores Hellaermantyton

**PF3**• Pino fixador  
• Emb. 500 pçs**032195** Cor: Natural**PF1**• Pino fixador  
• Emb. 200 pçs**032194** Cor: Natural**ECI**• ECI 3,0 espaçador  
• Emb. 100 pçs**032184** Cor: Natural**ECI**• ECI 6,4 espaçador  
• Emb. 100 pçs**032185** Cor: Natural**ECI**• ECI 6,4 espaçador  
• Emb. 100 pçs**032925** Cor: Preto**ECI**• ECI 9,4 espaçador  
• Emb. 100 pçs**032924** Cor: Natural**LKCS/A**• Fixador adesivo  
• Emb. 100 pçs**032193** Cor: Natural**Clip Fixador RA6**

• (Ø6mm) Adesivos p/ fixação de fios, cabos e tubos • Emb. 100 pçs

**033468** Cor: Natural**Clip Fixador RA9**

• (Ø9mm) Adesivos p/ fixação de fios, cabos e tubos • Emb. 100 pçs

**033469** Cor: Natural**Clip Fixador RA13**

• (Ø13mm) Adesivos p/ fixação de fios, cabos e tubos • Emb. 100 pçs

**033471** Cor: Natural

## Protetor de Cabos Hellaermantyton

**Cabo Prensa**

• Protetor de cabo quando atravessa a chapa metálica, evita que o cabo desconecte do ponto de ligação quando puxados (9.7x10.9x10.7mm)

• Nylon 6.6 Preto • Emb. 100 pçs

**033567** Cabos Chatos**Cabo Prensa**

• Protetor de cabo quando atravessa a chapa metálica, evita que o cabo desconecte do ponto de ligação quando puxados (12.0x13.5x11.2mm)

• Nylon 6.6 Preto • Emb. 100 pçs

**033568** Cabos Redondos

**SDM Abraçadeira Nylon 6,6**

- 035528** 100 x 2,5 x 1,0mm - Natural - Emb. 100 pçs
- 035530** 150 x 3,6 x 1,2mm - Natural - Emb. 100 pçs
- 035532** 200 x 4,7 x 1,3mm - Natural - Emb. 100 pçs
- 035529** 100 x 2,5 x 1,0mm - Preto - Emb. 100 pçs
- 035531** 150 x 3,6 x 1,2mm - Preto - Emb. 100 pçs
- 035533** 200 x 4,7 x 1,3mm - Preto - Emb. 100 pçs



**SDM Abraçadeira Nylon**

- 035534** 100 x 2,5 x 1,0mm - Colorida - Emb. Pote c/ 500 pçs
- 035535** 150 x 3,6 x 1,2mm - Colorida - Emb. Pote c/ 500 pçs
- 035536** 200 x 4,7 x 1,3mm - Colorida - Emb. Pote c/ 500 pçs



**Abraçadeiras, Aplicadores, Lacres e Marcadores Hellermannityton**

**Abraçadeira Nylon Insulok Hellermann**  
• Emb c/ 100pçs

- 035782** T18R 100 x 2,50mm - Preto
- 035652** T18R 100 x 2,50mm - Transparente
- 035722** T30R 150 x 3,60mm - Transparente
- 035665** T30R 150 x 3,60mm - Preto
- 035666** T50R 200 x 4,60mm - Transparente
- 035651** T50R 200 x 4,60mm - Preto
- 035910** T80I 300 x 4,60mm - Transparente
- 035664** T80I 300 x 4,60mm - Preto
- 032922** T120R 390 x 7,60mm - Transparente
- 032923** T120R 390 x 7,60mm - Preto

**Abraçadeira Q-tie c/ abertura na Cabeça**  
• Para Inserção Rápida com duas ranhuras na fita asseguram o encaixe • Função pré-fechointegrada • Embalagem: 100 pçs

**033681** 260,0 x 9,0 x 62,0mm

**Lacre Cartelado Nylon Insulok**  
• S30 • Medidas: 3,80x27x8mm  
• Lacre Cartelado para Malotes, Lixos Hospitalares e outros etc  
• Embalagem: 200 pçs • AM

**033467**

**Abraçadeira Robusto "verde"**  
• Produzida com material "verde", possui uma cabeça arredondada que se molda ao diâmetro da amarração facilitando assim a colocação das abraçadeiras em lugares com pouco espaço  
• Embalagem: 100 pçs

- 033676** 105,0 x 2,6 x 24,0mm - Natural
- 033662** 105,0 x 2,6 x 24,0mm - Preto
- 033675** 210,0 x 4,7 x 50,0mm - Preto

**Aplicador de Marcadores**  
• Aceita todos os tamanhos de marcadores Hellermannityton

**033409**

**Spiral**  
• Embalagem: Rolo

- 035443** 1/2 PE - Branco - Rolo: 50m
- 035444** 1/2 PE - Preto - Rolo: 50m
- 032188** 1/4 PE - Branco - Rolo: 50m
- 032192** 1/4 PE - Preto - Rolo: 50m
- 032190** 3/4 PE - Branco - Rolo: 50m
- 032189** 3/4 PE - Preto - Rolo: 50m

**Spiral Blister**  
• Embalagem: 2m

- 033466** 1/2 PE - Branco
- 033485** 1/2 PE - Preto

**Conexões Excon**



**Conexões Excon**

- 032768** Con. 2,0mm M. 03 V. 90° p/ Circ. Impr. Emb. c/ 200 pçs 200103WR001
- 032799** Term. 2008 2,0mm Rolo c/ 10000 pçs 200800TC351
- 032268** Con. 2,5mm 05 V. 180° 250105WV001-SC200
- 032275** Con. 2,5mm 06 V. 90° 250106WR001-SC200
- 032307** Con. KK 2,5mm 07 V. 90° 251207WR054-SC200
- 032308** Con. KK 2,5mm 08 V. 90° 251208WR054-SC200
- 032299** Con. KK 2,5mm 09 V. 180° 251209WV054-SC200
- 032310** Con. KK 2,5mm 10 V. 90° 251210WR054-SC200
- 032830** Con. KK 2,5mm M. 14 V. 90° p/ Circ. Impr. Emb. c/ 200 pçs 251214WR054
- 032780** Con. Micro Fit 3,00mm M. 04 V. 90° p/ Circ. Impr. Emb. c/ 200 pçs 300104WR003

- 032782** Con. Micro Fit 3,0mm M. 10 V. 90° p/ Circ. Impr. Emb. c/ 200 pçs 300110WR003
- 032833** Con. Pol. 3,96mm Emb. c/ 200 pçs 396100HK201
- 032841** Con. Mini Fit 4,2mm M. 02 V. 90° p/ Circ. Impr. Emb. c/ 200 pçs 420102WS051
- 032792** Con. Mini Fit 4,2mm M. 20 V. 90° c/ Peg. p/ Circ. Impr. Emb. c/ 200 pçs 420120WF051
- 032825** Con. 5,08mm M. 04 V. 90° p/ Circ. Impr. 508304WR051. Emb. c/ 200 pçs
- 032793** Aloj. 5,00mm 02 V. p/ Circ. Impr. Emb. c/ 200 pçs 508902HA001
- 032844** Aloj. 5,0/7,5mm 02 V. p/ Circ. Impr. Emb. c/ 200 pçs 509002HA001
- 032843** Con. 5,0/7,5mm M. 02 V. 180° p/ Circ. Impr. Emb. c/ 200 pçs 509002WV001
- 032400** Aloj. 5,0/7,5mm 05 V. 509005HA001-SC200



**Cabo Óptico Toslink**  
Cabo macho / macho • Ø: 5mm  
• Plug e mini plug  
**036058** Comp: 1,8m



**Cabo Óptico Toslink**  
Cabo macho / macho • Ø: 5mm  
• Plug e mini plug  
**031946** Comp: 1,8m



**Cabo Óptico Toslink**  
Cabo macho / macho • Ø: 4mm  
• HL 1625 - A  
**031947** Comp: 1,8m  
**031948** Comp: 3m  
**035248** Comp: 5m  
**031949** Comp: 5m



**Cabo Óptico Toslink**  
Cabo macho / macho • Ø: 6mm  
• Plug e mini plug  
**033190** Comp: 1,8m



**Speakon M/F**  
• Speakon macho / fêmea  
4 pinos  
**031981** Comp: 1,8m



**Speakon M/ P10 Mono M**  
• Speakon macho / P10(6,35mm)  
macho • Níquel • PT  
**035317** Comp: 10m



**P10 Stereo M/2xRCA M**  
• P10(6,35mm) stereo macho 2xRCA  
macho VM e BR  
**035185** Comp: 2m  
**033305** Comp: 5m



**P10 Stereo M/M**  
• P10(6,35mm) stereo macho para  
P10(6,35mm) stereo macho  
**035181** Comp: 3m



**P10 Mono M/M**  
• P10(6,35mm) mono macho para  
P10(6,35mm) mono macho  
**036474** Comp: 3m  
**031368** Comp: 5m



**P10 Mono M 90°/F**  
• P10(6,35mm) mono macho 90° para  
P10(6,35mm) mono fêmea  
**033193** Comp: 1,8m



**P10 Mono M/F**  
• P10(6,35mm) mono macho para  
P10(6,35mm) mono fêmea  
**033194** Comp: 1,8m



**USB / P10 Mono M**  
• Cabo Interface p/ instrumentos  
musicais USB para P10 mono macho  
**035316** Comp: 3m



**P10 Mono M / Canon F (XLR)**  
• P10(6,35mm) mono macho níquel p/  
canon(XLR) 3 pinos fêmea  
**035244** Comp: 5m



**P10 Mono M / Canon(XLR)**  
• P10(6,35mm) mono macho níquel p/  
canon(XLR) 3 pinos fêmea c/ trava  
**031367** Comp: 5m



**P10 Mono M/Canon(XLR)**  
• P10(6,35mm) mono macho níquel  
para canon(XLR) 3 pinos fêmea c/trava  
**031559** Comp: 5m



**Canon(XLR) M/F**  
• Canon(XLR) macho 3 pinos para  
Canon(XLR) fêmea 3 pinos com trava  
**031557** Comp: 5m



**Canon(XLR) F/F**  
• Canon(XLR) fêmea 3 pinos para  
Canon(XLR) fêmea 3 pinos com trava  
**031558** Comp: 5m



**P2 Mono M/P10 Mono M**  
• P2(3,5mm) mono macho para  
P10(6,35mm) mono macho  
**035122** Comp: 1,8m  
**033303** Comp: 1,8m



**P1 Stereo M/P2 Stereo M**  
• P1 (2,5mm) stereo macho para P2  
(3,5mm) stereo macho • CZ  
**031554** Comp: 1,8m



**P2 Stereo M/M**  
• P2 (3,5mm) stereo macho para P2  
(3,5mm) stereo macho emborrachado  
**035117** Comp: 1,5m  
**035188** Comp: 3m



**P2 Stereo M/M**  
 • P2 (3,5mm) stereo macho para P2 (3,5mm) stereo macho níquel  
**035109** Comp: 2m



**P2 Stereo M x Emenda rabicho**  
 P2 (3,5mm) stereo macho para x Emenda rabicho  
**035620** Comp: 1,15m



**P2 Stereo M/F**  
 • P2 (3,5mm) stereo macho para P2(3,5mm) stereo fêmea dourado emborrachado  
**030581** Comp: 1,5m



**P2 Stereo M/F**  
 • P2(3,5mm) stereo macho p/ P2 (3,5mm) stereo fêmea emborrachado  
**031794** Comp: 1,5m  
**030849** Comp: 2m  
**035186** Comp: 3m



**P2 Stereo M/2xP2 Stereo F**  
 • P2(3,5mm) stereo macho p/ 2 P2 (3,5mm) stereo fêmea • 4 pólos  
 • Níquel • BR  
**035249** Comp: 0,17m



**P2 Stereo M/2x F**  
 • P2(3,5mm) stereo macho para dois P2(3,5mm) stereo fêmea • BR  
**032422** Comp: 0,17m



**P2 Stereo M/2xP2 Stereo F**  
 • P2(3,5mm) stereo macho p/ 2 P2 (3,5mm) stereo fêmea • 4 pólos  
 • Níquel • BR  
**035075** Comp: 0,15m



**P2 Stereo M/2xP2 Stereo F**  
 • P2(3,5mm) stereo macho p/ 2 P2 (3,5mm) stereo fêmea • 2 pólos  
 • Níquel • PT  
**035036** Comp: 0,15m



**P2 Stereo F/F**  
 • P2(3,5mm) stereo fêmea para P2 (3,5mm) stereo fêmea níquel emborrac.  
**034570** Comp: 1,5m  
**031670** Comp: 1,8m



**P2 Stereo F/2xRCA M**  
 • P2(3,5mm) stereo fêmea para 2 x RCA macho níquel  
**035182** Comp: 1,8m



**P2 Stereo M/2xRCA M**  
 • P2(3,5mm) stereo macho para 2 x RCA macho • Níquel  
**035108** Comp: 1,8m  
**035183** Comp: 3,0m  
**035187** Comp: 5,0m



**P2 Stereo M/2xRCA M**  
 • P2(3,5mm) stereo macho para 2 x RCA macho dourado  
**033275** Comp: 1,8m



**RCA M/2xRCA F**  
 • RCA macho para 2 x RCA fêmea dourado  
**033192** Comp: 0,15m



**RCA F/2xRCA M**  
 • RCA fêmea para 2 x RCA macho dourado  
**033191** Comp: 0,15m



**P2S M/2xRCA F**  
 • P2(3,5mm) stereo macho para 2 x RCA fêmea níquel  
**031977** Comp: 1,8m



**P2 4 Pólos/3xRCA M**  
 • P2 com 4 pólos / 3 x RCA macho  
 • Câmera Sony  
**030575** Comp: 1,5m



**P2 4 Pólos 90º/3xRCA M**  
 • P2 com 4 pólos 90º / 3 x RCA macho  
**032870** Comp: 2m



**3xRCA M/M**  
 • 3 x RCA macho para 3 x RCA macho para A/V • Níquel • BR / VM / AM  
**030852** Comp: 1,8m  
**035119** Comp: 5m



**3xRCA M/M**  
 • 3 x RCA macho para 3 x RCA macho dourado • Cabo emborrachado  
**002652** Comp: 1,8m  
**033599** Comp: 5m  
**033600** Comp: 10m



**3xRCA M/M**  
 • 3 x RCA macho para 3 x RCA macho dourado emborrachado  
**034790** Comp: 2m



**3xRCA M/M**  
 • 3 x RCA macho para 3 x RCA macho dourado com corpo plástico para vídeo componente 75 Ohms  
**031354** Comp: 1,8m



**2xRCA M/M**  
 • 2 x RCA macho para 2 x RCA macho dourado  
**030851** Dourado - Comp: 1,8m  
**031365** Níquel - Comp: 1,8m



**2xRCA M/M**  
 • 2 x RCA macho para 2 x RCA macho dourado emborrachado  
**031356** Comp: 1,8m

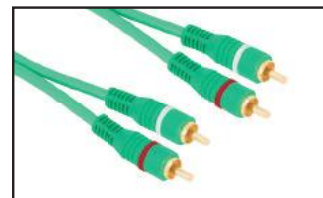

**2xRCA M/M**  
 • 2 x RCA macho para 2 x RCA macho dourado emborrachado  
**031996** Comp: 5m



**2xRCA M/M 90°**  
 • 2 x RCA macho para 2 x RCA macho 90° emborrachado  
**032638** Comp: 3,0m  
**032639** Compr: 5,0m

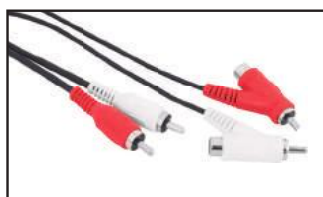

**2xRCA M/M**  
 • 2xRCA macho para 2xRCA macho/fêmea  
 1,8m  
**033294**



**2xRCA M/M**  
 • 2 x RCA macho para 2 x RCA macho dourado emborrachado  
**035179** Comp: 1,8m  
**031631** Comp: 10m



**2xRCA M/M**  
 • 2 x RCA macho para 2 x RCA macho dourado emborrachado  
**034566** Comp: 10m



**2xRCA M/M**  
 • 2 x RCA macho para 2 x RCA macho  
**035180** Níquel - Comp: 1,8m  
**034437** Dourado - Comp: 3m



**RCA M/M**  
 • RCA macho p/ RCA macho níquel AM  
**031998** Comp: 1,8m  
**034859** Comp: 3m  
**034860** Comp: 5m



**RCA M/F**  
 • RCA macho p/ RCA fêmea níquel AM  
**034861** Comp: 3m



**SVHS(Mini Din) M/M**  
 • 4 pinos macho para 4 pinos macho  
**031361** Comp: 1,8m



**SVHS(Mini Din) M/M**  
 • 4 pinos macho para 4 pinos macho  
**031364** Comp: 2m



**SVHS(Mini Din) M/M**  
 • 4 pinos macho para 4 pinos macho  
**030076** Comp: 1,8m



**Din M/F**  
 • Din macho 5 pinos para Din fêmea  
**031360** Comp: 1,8m



**Din M/M**  
 • Din macho 5 pinos para Din macho 5 pinos  
**031359** Comp: 1,8m



**F M/M**  
 • F macho para F macho RG59  
**030855** Comp: 1,8m sem rosca  
**030856** Comp: 1,8m com rosca



**F M/M 90°**  
 • F macho rápido para F macho rápido 90° com cabo RG59/U  
**031363** Comp: 2m



**F M/M TV a Cabo**  
 • F macho para F macho conector dourado rosca c/ cabo RG6/U para uso em TV a cabo • (75R)  
**031362** Comp: 3m



**F M/M TV a Cabo**  
 • F macho para F macho rosca c/ cabo RG59 para uso em TV a cabo • (75R)  
**036109** Comp: 1,7m



**HDMI M/M**  
 • HDMI macho / macho 1/4 dourado  
 • Com ferrite  
**033589** Comp: 1,8m



**HDMI M/M**  
 • HDMI macho / macho 1/4 dourado  
 • Com ferrite  
**033588** Comp: 1,8m



**HDMI M/M**  
 • HDMI macho / macho 1/4 dourado  
 dobrável 90°  
**033592** Comp: 1,8m



**HDMI M/M**  
 • HDMI macho / macho 1/4 dourado  
 • Com ferrite  
**033590** Comp: 1,8m



**HDMI M/Mini HDMI**  
 • HDMI macho / mini HDMI • Dourado  
**035106** Comp: 1,5m  
**030920** Comp: 1,5m  
**034405** Comp: 1,8m



**HDMI M/Mini HDMI**  
 • HDMI macho / mini HDMI macho  
 • Dourado • Blindado  
**034853** Comp: 3m



**HDMI F/F**  
 • HDMI fêmea / fêmea • Dourado  
**031169** Comp: 1,8m



**HDMI M/M**  
 • HDMI 19P macho / macho de alta  
 velocidade  
**033838** Comp: 1,8m



**HDMI M/M**  
 • HDMI 1,3 macho / macho com ferrite  
 alta velocidade • Nylon  
**031713** Comp: 1,8m



**HDMI M/M Blister**  
 • HDMI macho / macho dourado alta  
 velocidade • Com ferrite  
**030917** Comp: 1,5m



**HDMI M/M**  
 • HDMI macho / macho 1,4  
**033584** Comp: 1,8m



**HDMI M/M**  
 • HDMI macho 1,4 / macho 90°  
 • Com ferrite  
**033587** Comp: 1,8m



**HDMI M/HDMI M**  
 • HDMI macho 1,4 / HDMI macho  
**033585** - C/ Ferrite - Comp: 1,8m  
**035104** - C/ Ferrite - Comp: 3m  
**035105** - C/ Ferrite - Comp: 5m



**HDMI M/M**  
 • HDMI macho 1,4 / macho dourado  
**033905** - C/ Ferrite - Comp: 5m  
**035103** - C/ Ferrite - Comp: 10m  
**035433** - C/ Ferrite - Comp: 15m  
**033895** - C/ Ferrite - Comp: 20m  
**035825** - C/ Ferrite - Comp: 20m



**HDMI M/M**  
 • HDMI macho / macho 2.0  
**036275** Comp: 1,8m  
**036313** Comp: 5m



**HDMI M/F**  
 • HDMI macho 1,4 / fêmea dourado  
 • Com ferrite  
**035102** Comp: 1,8m



**HDMI M/Micro M**  
 • HDMI macho 19 pinos / micro HDMI  
 macho • Com ferrite  
**033593** Comp: 1,8m



**HDMI M/Mini HDMI**  
 • HDMI macho 1,4 / mini HDMI macho  
 dourado • Com ferrite  
**033591** Comp: 1,5m



**HDMI M/M**  
 • HDMI 1,4 macho / macho coloridos  
 • Blindado  
**033447** RS - Comp: 1,80m  
**033448** BR - Comp: 1,50m  
**033450** RX - Comp: 1,50m  
**033856** RX - Comp: 1,80m  
**033855** VM - Comp: 1,80m



**HDMI M/F**  
• HDMI macho / fêmea dourado  
**031165** Comp: 3m



**HDMI M/VGA M + 3 x RCA M**  
• HDMI macho / VGA macho + 3 RCA dourado VM-BR-AM • Com ferrite  
**033760** Comp: 1,5m



**Mini HDMI M/VGA F**  
• Cabo mini HDMI/VGA fêmea + áudio • PT  
**034849** Comp: 0,15m



**DVI D (24+1)M/HDMI M**  
• DVI D(24+1) macho / HDMI macho • Com ferrite  
**030087** Comp: 1,8m



**HDMI M/VGA**  
• HDMI Macho dourado / VGA macho obs: Esse cabo funciona apenas em equipamentos que tenha um conversor próprio de sinal.  
**033761** Comp: 1,5m



**DVI D (24+1) M/HDMI M**  
• DVI D(24+1) macho / HDMI macho  
**030993** Comp: 1,5m



**DVI D(24+1) M/M**  
• DVI D(24+1) macho / macho c/ ferrite  
**030578** Comp: 1,8m  
**030579** Comp: 3m



**DVI D(24+5)M/VGA F**  
• DVI D (24+5) macho / VGA fêmea  
**032872** Comp: 2m



**Mini DVI/VGA**  
• Mini DVI / VGA fêmea  
**032423** Comp: 0,17m



**Display Port M/HDMI M**  
• Display Port macho / HDMI macho • Dourado • Blindado  
**034900** Comp: 1,8m



**Display Port M/M**  
• Display Port macho / macho  
**032865** Comp: 1,8m - Niquel  
**034847** Comp: 1,8m - Dourado



**Display Port M/HDMI F**  
• Display Port macho / HDMI fêmea  
**032866** Comp: 0,20m



**Display Port M/DVI F**  
• Display Port macho / DVI fêmea  
**032867** Comp: 0,24m



**DB15 VGA F/Mini Display Port M**  
• DB15 VGA fêmea / mini Display Port macho  
**035121** Comp: 0,40m  
**032868** Comp: 0,40m



**Mini Display Port/HDMI**  
• Mini Display Port / HDMI  
**034846** Comp: 0,15m



**Mini Display Port**  
• Mini Display Port macho / HDMI / DVI/DP • Blindado  
**034850** Comp: 0,15m



**USB A 2.0 M/DB25 F**  
• USB A 2.0 macho / DB25 fêmea • Embalagem: Blister  
**030065** PT - Comp: 1,8m  
**030973** TR - Comp: 3m



**USB A 2.0 M/DB9 M**  
• USB A 2.0 macho / DB9 macho  
**035107** Comp: 1,8m  
**030974** Comp: 3m



**USB A 2.0 M/F**  
 • USB A 2.0 macho / fêmea  
**033966** Comp: 1,8m - Preto  
**030063** Comp: 1,8m - Bege  
**030971** Comp: 3m - Bege  
**034777** Comp: 3m - Preto

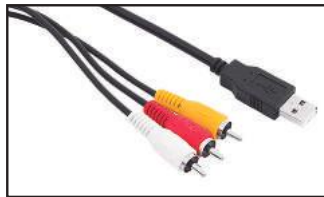

**USB A 2.0 F/3xRCA M**  
 • USB A 2.0 fêmea / 3 x RCA macho  
**033307** Comp: 1,8m



**USB A 2.0 M/3xRCA M**  
 • USB A 2.0 macho / 3 x RCA macho  
**033308** Comp: 1,8m



**USB A 2.0 M/P2 4C M**  
 • USB A macho / P2(3,5mm) 4C  
**033310** Comp: 1,8m



**USB A 2.0 F/P2(3,5mm) 4C M**  
 • USB A fêmea / P2(3,5mm) 4C  
**033309** Comp: 0,30m - Preto  
**036008** Comp: 0,30m - Preto



**USB A 2.0 M/Mini USB**  
 • USB A 2.0 macho / mini USB macho  
**035227** Comp: 0,30m - Preto



**USB A 2.0 M/Mini USB**  
 • USB A 2.0 macho / mini USB  
**035230** Comp: 1,8m - Preto - Sem filtro  
**031003** Comp: 1,8m - Preto - Com filtro  
**033597** Comp: 5m - Preto - Com filtro



**USB A 2.0 M/Mini USB M**  
 • USB A 2.0 macho / Mini USB macho  
**035112** Comp: 1,8m - Cinza



**USB A 2.0 F/RJ45 M**  
 • USB A 2.0 fêmea / RJ45 macho  
 • Tensão 5/10V  
**033908** Comp: 1,8m - Preto



**USB A 2.0 F/Mini USB**  
 • USB A 2.0 fêmea / mini USB 5 pinos  
 • Comp: 0,30m - Preto  
**033311** Comp: 0,30m - Preto



**USB A 2.0 M/M**  
 • USB A 2.0 Macho/Macho  
**030468** Comp: 2m - Preto  
**035110** Comp: 2m - Bege



**USB A 2.0 M/Micro USB**  
 • USB A 2.0 macho / Micro USB B macho 5 pinos  
**033413** Comp: 1,8m - Preto  
**035400** Comp: 1,8m - Preto  
**036482** Comp: 5m - Preto



**USB B M/F 2.0**  
 • USB B Macho/USB B Fêmea  
 • 50cm • 2.0  
**036062**



**USB B Mini F/M**  
 • USB B Mini Fêmea/Mini USB B Macho  
 • 5 pinos • 30cm • 2.0  
**036063**



**USB A 2.0 M/USB B M**  
 • USB A 2.0 Macho / USB B Macho  
**031551** Comp: 1,8m - Preto  
**031552** Comp: 1,8m - Cinza  
**031550** Comp: 3m - Cinza



**USB/Micro USB 3.0**  
 • USB A 3.0 macho / Micro USB B 3.0  
**035228** Comp: 1,5m - Preto  
**033762** Comp: 1,5m - Azul  
**035408** Comp: 1,8m - Azul

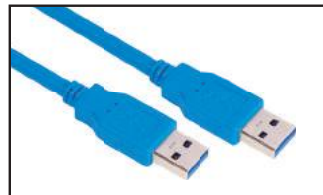

**USB A 3.0 M/M**  
 • USB A 3.0 macho / macho  
**031973** Comp: 2m - Azul

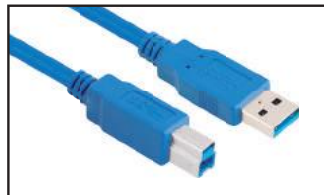

**USB A 3.0 M/USB B M**  
 • USB A 3.0 macho / USB B macho Super Speed  
**032881** Comp: 3m - Azul



**USB A 2.0 M/USB C M**  
 • USB A 2.0 macho / USB C macho  
**035552** Comp: 2m - Preto



**USB A 2.0 M/F**  
 • USB A 2.0 macho / fêmea Retrãtil  
**031236** Comp: 1m





**Adaptador USB A 2.0 M/PS2 F**

• USB A 2.0 macho / PS2 fêmea  
**031196** Comp: 0,30m - Preto



**Conversor USB A 2.0 M/2xPS2 F**

• USB A 2.0 macho/ 2 x PS2 fêmea  
 • Emb: Blister  
**030580** Comp: 0,15m



**MP7/USB A M**

• MP7/USB A macho retrátil  
**030300** Comp: 0,80m - Preto



**Multi Adaptador USB Retrátil**

• USB A M • USB B F. • Mini USB 5 P  
 • Mini USB 4P • Mini USB 4P • Firewire  
**031237** Comp: 1m



**USB A M/M p/ Link entre Micros**

• Cabo para transferência de dados bidirecional entre micros, notebooks e outros • Emb: Blister  
**033518** Comp: 1,8m



**Cabo p/ Console Wii**

• Cabo para vídeo game Wii  
**033550** Comp: 0,85m

Cabos Seriais, Monitores e outros



**Cabo p/ Console Xbox 360**

• Cabo para vídeo game Xbox 360  
**033551** Comp: 1m



**VGA F/MINI DVI**

• VGA fêmea / mini DVI • Para Apple Macbook, IMac Apple e Ibook  
**031308** Comp: 0,4m

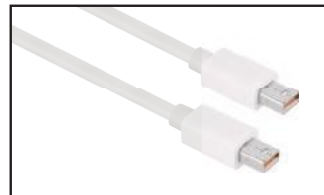

**Mini DP/Apple**

• Cabo mini Display Port para computadores Apple  
**033454** Comp: 1,8m - Branco



**VGA M/M**

• VGA macho / VGA macho • Dourado com ferrite  
**035553** Comp: 1,8m  
**033712** Comp: 15m  
**035321** Comp: 20m



**VGA M/F**

• VGA macho / fêmea com Ferrite  
**030576** Comp: 1,8m - Preto



**VGA M/F**

• VGA macho / fêmea  
**031280** Comp: 3m - Preto



**VGA M/F**

• VGA macho / fêmea  
**030068** Comp: 1,5m - Branco  
**031966** Comp: 2m - Branco  
**031965** Comp: 5m - Branco  
**031968** Comp: 5m - Preto



**VGA M/M**

• VGA macho / macho com ferrite  
**033490** Comp: 1,4m - Preto  
**030069** Comp: 1,8m - Preto  
**031962** Comp: 2m - Branco  
**035226** Comp: 3m - Preto



**VGA M/M**

• VGA macho / macho com ferrite  
**031958** Comp: 5m - Preto  
**031959** Comp: 10m - Preto  
**031960** Comp: 15m - Preto  
**031961** Comp: 15m - Branco



**VGA M/M**

• VGA macho / macho  
**034359** Comp: 1,5m - Bege  
**031279** Comp: 1,8m - Bege  
**033758** Comp: 1,8m - Preto  
**033759** Comp: 3m - Preto



**DB9 M/F**

• DB9 macho / fêmea pino a pino  
**031283** Comp: 1,8m - Bege  
**035399** Comp: 1,8m - Bege  
**035320** Comp: 3m - Bege  
**031284** Comp: 3m - Bege



**VGA M/3xRCA M**

• VGA macho / 3 x RCA macho c/ ferrite  
**030070** Comp: 1,8m - Preto  
**030970** Comp: 3m - Preto



**VGA M/3XRCA M**

• VGA macho / 3 X RCA macho dourado  
**031969** Comp: 2m - Preto  
**031970** Comp: 5m - Preto

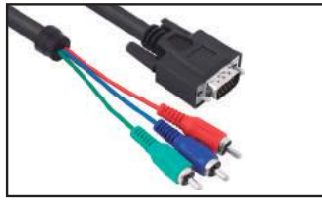

**VGA M/3XRCA M**

• VGA macho / 3 X RCA macho níquel  
**031994** Comp: 3m  
**031995** Comp: 5m

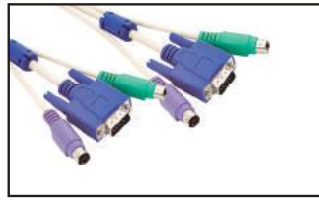

**VGA M+2xPS2M/VGAM+2xPS2M**

• VGA macho + 2 PS2 macho 6 pinos /  
 VGA macho + 2 PS2 macho 6 pinos  
**030582** Comp: 1,80m  
**031964** Comp: 3m



**VGA/2xDB15F**

• VGA macho / 2 x DB15 VGA fêmea  
**033306** Comp: 0,3m



**BNC M/M**

• BNC macho / macho  
**034862** Comp: 1,50m - Dourado  
**031980** Comp: 1,80m - Níquel



**DMS 59/2XVGA**

• Cabos Dms-59 para 2 X VGA  
 • Diâmetro: 5,2mm  
**034190** Comp: 0,15m



**Extensão p/ Cabo de Fonte ATX**

• Para fonte ATX  
 • Emb: 5pçs  
**034841** Comp: 0,16m

Cabos de Rede

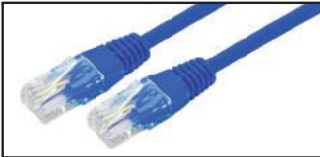

**Pach Cord 5e-RJ45/RJ45**

• Pach Cord 5e-RJ45 / RJ45  
**035234** Comp: 1,5m - Azul  
**031348** Comp: 1,5m - Azul  
**035238** Comp: 2m - Azul  
**035243** Comp: 3m - Azul  
**034180** Comp: 3m - Azul - Blindado

**036315** Comp: 3m - Azul  
**032623** Comp: 3m - Azul  
**036010** Comp: 5m - Azul  
**035236** Comp: 5m - Azul  
**036011** Comp: 10m - Azul  
**035240** Comp: 10m - Azul  
**036012** Comp: 15m - Azul  
**034948** Comp: 15m - Azul  
**036013** Comp: 20m - Azul  
**034949** Comp: 20m - Azul



**Pach Cord 5e-RJ45/RJ45**

• Pach Cord 5e-RJ45 / RJ45  
**030303** Comp: 1,5m - Cinza

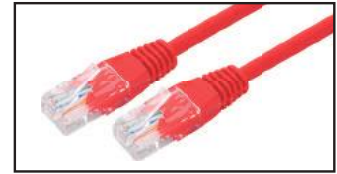

**Pach Cord 5e-RJ45/RJ45**

• Pach Cord 5e-RJ45 / RJ45  
**032621** Comp: 2m - Vermelho  
**032624** Comp: 3m - Vermelho  
**032627** Comp: 5m - Vermelho  
**032630** Comp: 10m - Vermelho



**Pach Cord 5e-RJ45/RJ45**

• Pach Cord 5e-RJ45 / RJ45  
**032619** Comp: 2m - Verde  
**032622** Comp: 3m - Verde  
**035239** Comp: 5m - Verde  
**032628** Comp: 10m - Verde

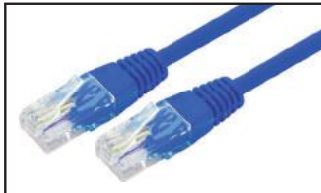

**Pach Cord 6e-RJ45/RJ45**

• Pach Cord 6e-RJ45 / RJ45 • Azul  
**035397** Comp: 2m  
**035398** Comp: 2m - 7/0.195CU(COBRE)  
**035327** Comp: 3m  
**035241** Comp: 5m



**Pach Cord 5e-RJ45/RJ45**

• Pach Cord 5e-RJ45 / RJ45  
**035235** Comp: 1,5m - Cinza  
**031351** Comp: 3m - Cinza  
**035237** Comp: 5m - Cinza



**RJ45/RJ45 Retrátil**

• RJ45 / RJ45  
 • Cabo Retrátil  
**030302** Comp: 1,5m - Preto

Telefonia • Cabos e Adaptadores



**RJ11M/2 RJ11 F**

• RJ11 6P4C 1 macho / 2 fêmeas  
**035233** Comp: 2,5m - Preto



**RJ11M/2 RJ11 F**

• RJ11 6P4C 1 macho / 2 fêmeas  
**033338** Comp: 2,5m - Marfim



**Extensão RJ11**

• Espiral  
**035242** Comp: 1,5m - Preto



**RJ11/RJ11**  
 • RJ11 6P4C  
**035231** Comp: 2m - Preto V.E  
**036276** Comp: 2m - Preto  
**031156** Comp: 5m - Preto  
**031157** Comp: 7m - Preto  
**031158** Comp: 10m - Preto  
**035232** Comp: 15m - Preto



**RJ11/RJ11**  
 • RJ11 6P4C  
**031150** Comp: 2m - Cinza  
**035412** Comp: 5m - Branco  
**031152** Comp: 7m - Cinza  
**035413** Comp: 10m - Branco  
**031154** Comp: 15m - Cinza

Elétrica • Cabos de Força Wegflex



**Cabos de Força 180°**  
 • Cabo 2 pinos macho 180° / rabicho  
**032657** 2,5A - 0,5mm<sup>2</sup> - Comp: 1,5m - PT  
**032658** 2,5A - 0,5mm<sup>2</sup> - Comp: 2m - PT



**Cabos de Força 180°**  
 • Cabo 2 pinos macho 180° / rabicho  
**032659** 6A - 0,75mm<sup>2</sup> - Comp: 2m - PT  
**034082** 6A - 0,75mm<sup>2</sup> - Comp: 3m - PT  
**032660** 10A - 1mm<sup>2</sup> - Comp: 2m - PT  
**032661** 10A - 1,5mm<sup>2</sup> - Comp: 2m - PT



**Cabos de Força 180°**  
 • Cabo 2 pinos macho 180° / fêmea 180° • 2,5A  
**032663** 0,50mm<sup>2</sup> - Comp: 1,5m - PT



**Cabos de Força 180°**  
 • Cabo 3 pinos macho 180° / rabicho • 10A  
**032662** 0,75mm<sup>2</sup> - Comp: 2m - PT



**Cabos de Força M/F 180°**  
 • Cabo 3 pinos macho 180° / fêmea 180°  
**032666** 0,75mm<sup>2</sup> X1,5m - 10A - Preto  
**032667** 0,75mm<sup>2</sup> X3m - 6A - Preto  
**032668** 1,5mm<sup>2</sup> X2m - 10A - Preto  
**032669** 1,5mm<sup>2</sup> X3m - 10A - Preto



**Cabos de Força M/F 90°**  
 • Cabo 3 pinos macho 90° / fêmea 180° • 6A  
**032664** 0,75mm<sup>2</sup> X1,5m - Preto  
**032665** 0,75mm<sup>2</sup> X3m - Preto



**Cabos de Força p/ Notebook**  
 • Cabo 3 pinos macho / fêmea 180°  
**034920** 0,75mm<sup>2</sup> X1,5m - Preto



**Cabos de Força p/ TV Samsung**  
 • Cabo PP chato macho / fêmea  
 • Gravador Samsung • PT  
**035516** 0,50mm<sup>2</sup> X1,5m - Preto

Cabos Flexíveis • Elétrica

FIOS E CABOS

**Cabos Flexíveis**

• Emb: Rolo c/ 100m  
**034978** - 0,14mm -26 AWG - Marrom  
**034987** - 0,14mm -26 AWG - Preto  
**034986** - 0,14mm -26 AWG - Branco  
**034985** - 0,14mm -26 AWG - Cinza  
**034984** - 0,14mm -26 AWG - Roxo  
**034981** - 0,14mm -26 AWG - Amarelo  
**034979** - 0,14mm -26 AWG - Vermelho  
**034980** - 0,14mm -26 AWG - Laranja  
**034982** - 0,14mm -26 AWG - Verde  
**034983** - 0,14mm -26 AWG - Azul  
**034997** - 0,20mm -24 AWG - Preto  
**034996** - 0,20mm -24 AWG - Branco  
**034995** - 0,20mm -24 AWG - Cinza  
**034994** - 0,20mm -24 AWG - Roxo  
**034993** - 0,20mm -24 AWG - Azul  
**034992** - 0,20mm -24 AWG - Verde  
**034991** - 0,20mm -24 AWG - Amarelo  
**035001** - 0,30mm -22 AWG - Amarelo



**035000** - 0,30mm -22 AWG - Laranja  
**034999** - 0,30mm -22 AWG - Vermelho  
**034990** - 0,20mm -24 AWG - Laranja  
**034989** - 0,20mm -24 AWG - Vermelho  
**034988** - 0,20mm -24 AWG - Marrom  
**035003** - 0,30mm -22 AWG - Azul  
**035004** - 0,30mm -22 AWG - Roxo  
**035002** - 0,30mm -22 AWG - Verde  
**034998** - 0,30mm -22 AWG - Marrom  
**035005** - 0,30mm -22 AWG - Cinza

**035006** - 0,30mm -22AWG - Branco  
**035007** - 0,30mm -22 AWG - Preto  
**035850** - 0,50mm -20 AWG - Preto  
**032153** - 0,50mm -20 AWG - Marrom  
**032155** - 0,50mm -20 AWG - Lilás

**032160** - 1mm -16 AWG - Branco  
**032166** - 1mm -16 AWG - Verde

**Cabo Chato 26 AWG**

• Colorido • Embalagem em rolo  
**035010** 03 Vias - Rolo: 100m  
**035069** 04 Vias - Rolo: 100m  
**035008** 05 Vias - Rolo: 50m  
**035135** 05 Vias - Rolo: 500m  
**035009** 06 Vias - Rolo: 50m  
**035011** 08 Vias - Rolo: 50m  
**035012** 10 Vias - Rolo: 50m

**035374** 10 Vias - Rolo: 300m  
**035013** 12 Vias - Rolo: 50m  
**035014** 16 Vias - Rolo: 50m  
**035334** 20 Vias - Rolo: 50m  
**035015** 26 Vias - Rolo: 50m



**Cabos para testes - Ultra Flexível Tiaflex**

• Cabos 0,25mm<sup>2</sup> • Rolo: 100m

**033217** BR  
**033218** CZ  
**033219** AM  
**033220** VD  
**033221** VM  
**033222** AZ  
**033223** PT

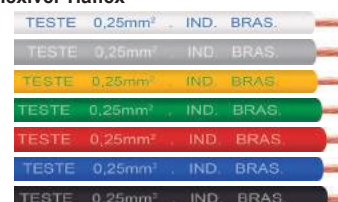

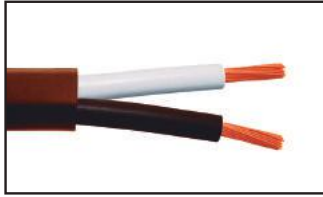

**Cabo PP Redondo**  
 • Pvc 70c Nm247-5- 300/500v  
**035902** 2x0,50 Preto Cl5 Az - Mr  
**035904** 2x1,00 Preto Cl5 Az-mr  
**035905** 2x0,75 Preto Cl5 Az-mr  
**035901** 2x1,50 Preto Cl5 Az-mrvd/am  
**035898** 3x0,50 Preto Cl5 Az-mr-vd/am  
**035900** 3x0,75 Preto Cl5 Az-mrvd/am  
**035897** 3x1,00 Preto Cl5 Az-mr-vd/am  
**035896** 3x1,50 Preto Cl5 Az-mr-vd/am



**Cabo PP Plano**  
 • Pvc 70c Nm247-5- 300v  
**035899** 2x0,50 Preto Cl5 Az-mr  
**035903** 2x0,75 Preto Cl5 Az-mr

**Cabos Especiais**



**Cabo RGC58**  
 • Cabo RGC58 Celular 50 Ohms  
 • Condutor Interno: Cobre nu  
 • Isolamento: Pe expando,  $\text{AE}$  7,25mm  
 • Condutor externo  
 • 1ª Blindagem: Fita de poliéster Aluminizada  
 • 2ª Blindagem: Trança de cobre estanhado  $\text{AE}$  7,75mm  
 • Capa: Pe,  $\text{AE}$  10,15mm  
 • PT  
**034428** Rolo: 100m



**Cabo RG213 50 Ohms**  
 • Cabo RG 213 50 Ohms, ANATEL ABNTNBR - 6244 (resistência à propagação de chama) • Condutor Interno: Corda de Cobre Nu, 7 X 0,75 Mm,  $\text{Ø}$  2,26mm . Isolamento: Pe,  $\text{Ø}$  7,25mm • Condutor Externo: Trança de cobre nu com cobertura de 96%,  $\text{Ø}$  8,11mm • Capa: Pvc,  $\text{Ø}$  10,31mm  
**034424** Rolo: 100m



**Cabo RGC6**  
 • Cabo Celular 75 Ohms, especificado segundo as normas: ABNT NBR-6244 (resistência à propagação a chama), resolução 382 (anatel). condutor interno: Aço cobreado,  $\text{AE}$  0,82mm, isolamento: PE expando,  $\text{AE}$  3,70mm, condutor externo: 1ª blindagem: fita de poliéster aluminizada, 2ª blindagem: trança cobre estanhado c/ cobertura de 60%,  $\text{AE}$  4,2mm, capa: Pvc,  $\text{AE}$  5,8mm  
**034425** Rolo: 100m - PT



**Cabo RGC213CCA**  
 • Cabo RGC213CCA Celular 50 ohms  
 • Especificado segundo as normas: CP-744 da ANATEL.  
 • Condutor interno: Alumínio cobreado,  $\text{Ø}$  2,61 mm  
 • Isolamento: PE expando,  $\text{Ø}$  7,25 mm  
 • Condutor externo: 1ª blindagem: Fita de poliéster aluminizada, 2ª blindagem: Trança de cobre estanhado  $\text{Ø}$  7,75 mm  
 • Capa : PE,  $\text{Ø}$  10,15 mm  
**033257** Rolo: 100m - PT



**Cabo RGC59**  
 • 75 Ohms Especificado Segundo as normas: Abnt Nbr-6244 (resistência à propagação a chama), resolução 382 (anatel), condutor Interno: Aço cobreado,  $\text{AE}$  0,81mm, isolamento: PE expando,  $\text{AE}$  3,60mm, condutor externo: 1ª blindagem: Fita de poliéster aluminizada, 2ª Blindagem: Trança de cobre estanhado c/ cobertura de 60%, b 4,2mm, capa: PVC,  $\text{AE}$  5,8mm • PT  
**034427** Rolo: 100m

**Cabos para Telefonia, Alto Falantes, Polarizados, Coaxiais e Microfones**



**Cabo p/ Telefonia 30awg**  
 PT • Embalagem: Rolo carretel de papelão com 305m  
**031441** Cabo Chato - 2 pares  
**035458** Cabo Chato - 3 pares



**Cabo Bicolor p/ Alto Falantes**  
 • Paralelo bicolor VM/PT Indicado p/ alto falantes • Emb: Rolo com 100m  
**031682** Espessura: 0,20mm<sup>2</sup>  
**035245** Espessura: 0,75mm<sup>2</sup>  
**031569** Espessura: 1,0mm<sup>2</sup>  
**035410** Espessura: 1,0mm<sup>2</sup>  
**031570** Espessura: 1,5mm<sup>2</sup>



**Cabo Polarizado Tiaflex**  
 • Para Áudio Externo • PT • Cobre  
 • Rolo: 100m  
**032910** 2 x 0,20mm<sup>2</sup>



**Cabo Polarizado Tiaflex**  
 • P/ Áudio VM/PT • Rolo: 100m • Cobre  
**032888** 2 x 0,50mm<sup>2</sup>



**Cabo Polarizado Tiaflex**  
 • Para áudio cristal • Rolo: 100m  
 • Estanhado  
**032890** 2 x 0,30mm<sup>2</sup>



**Cabo Coaxial RF 75OHMS**  
 • Flexível • Rolo: 100m Cristal • 24AWG  
**032912** (RF75) 75 OHMS



**Cabos Coaxiais IFE**  
 • RF 75 75R • Rolo: 100m  
**032186** 0,6/3,7mm - Preto

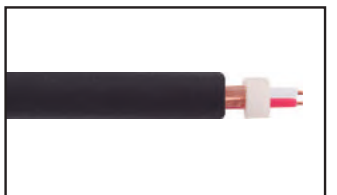

**Cabo p/ Microfone**  
 • AFE Microfone Stereo  
 • Diâm. ext: 4mm • Rolo: 100m  
**032909** 2 x 0,14mm<sup>2</sup> - Preto



**Cabo p/ Microfone**  
• AFE blindagem espiral  
• Rolo: 100m • PT  
**032900** 4 x 0,14mm2



**Cabo Stereo Philips**  
• Emborrachado • Rolo: 100m  
**032896** 2 x 0,20mm2 - Preto



**Cabo MANGA IFE**  
• Cinza • Connfly  
• AWG com Blindagem • Rolo: 100m  
**032093** 12X22 AWG - Antex



**Cabo MANGA Tiaflex**  
• AWG • Rolo: 100m  
**034325** 2x22 - 3,90mm s/b-BG  
**033321** 4x22 - 5,30mm c/b-Tr-PT  
**035140** 4x26 - 4,60mm s/b-BG  
**034163** 5x26 - 4,60mm s/b-BG  
**034902** 5x26 - 4,60mm c/b-PT  
**034161** 6x26 - 5,15mm c/b-BG  
**034554** 8x26 - 5,80mm s/b-PT  
**034160** 8x26 - 5,80mm s/b-BG  
**034069** 10x26 - 6,20mm c/b-PT

Informática • Cabos para CFTV e FLAT



**Cabos 4 Pares p/ CFTV**  
• 4 pares 24AWG com marcação de metro em metro • Caixa: 305m  
**033870** - CAT 5 - Azul  
**030621** - CAT 5 - Azul  
**034195** - CAT 5 - Branco  
**033418** - CAT 5 - Preto  
**035067** - CAT 5 - Cinza  
**035448** - CAT 5 - Azul  
**035833** - CAT 5 - Vermelho



**Cabos 4 Pares p/ CFTV**  
• 4 pares 24AWG • Marcação de metro em metro • Caixa: 305m  
**035447** - CAT 5 - Azul  
**035685** - CAT 5 - Azul  
**035449** - CAT 6e - Cinza  
**036502** - CAT 6e - Vermelho  
**036501** - CAT 6e - Azul  
• Caixa: 100m  
**035686** - CAT 5 - Azul



**Cabos Flat 28 AWG (IDC)**  
• Cinza • Connfly  
• Embalagem: Carretel 76,5m  
**031889** 10 VIAS  
**031890** 14 VIAS  
**031891** 16 VIAS  
**031893** 26 VIAS



**031894** 34 VIAS  
**031895** 40 VIAS  
**031896** 50 VIAS  
**031897** 60 VIAS

Suporte de tv, Arandelas, Telas para falantes e caixa de som • Acessórios

ÁUDIO, VÍDEO E CATV



**Arandelas**  
• Alto falantes Full Range coaxial.  
• Potência 100W PMPO.  
• Fixação: garras de pressão por molas.  
• Aplicações em: forros de gesso, divisórias, paredes e outros • 6"  
**030077** Sem difusor



**Telas para Alto Falantes**  
• Telas metálicas e aros plástico para alto falantes  
• Não acompanha parafusos  
• PT • Emb: 2 pçs  
**030780** Diâmetro de 8"  
**030782** Diâmetro de 12"



**Caixa de Som p/ Computador USB**  
• Caixa de Som p/ Computador  
• USB  
**031709** Preto



**Mini Caixa de Som Amplificada c/ Bluetooth e Lâmpada de Led**  
• Caixa de som amplificada c/ Bluetooth  
• Bateria de Li Ion recarregável  
• Com controle remoto  
• Carregador interno s/n Rádio 75db  
• Distorção <1,0%  
• Tempo de operação aproximado: 6 horas  
**034000** Branca



**Caixas de Som**  
• Produto Nacional • Potência: 150W PMPO/15W RMS • 2 Canais  
• Woofer 4" com borda e Tweeter  
• MID Range 2 • Impedância: 4/8 Ohms • (18,5x13x11cm)  
• Para som ambiente  
**030103** Caixa PT - Emb: 1pç  
**030104** Caixa BR - Emb: 1pç



**Caixas de Som - Tipo Cubo 6"**  
• Caixa de Som Potência: 200W PMPO/20W RMS • Woofer 6/ Tweeter com borda • Impedância: 8 HMD  
• (195x195mm) • Para som ambiente  
**031761** Caixa PT - Emb: 1pç  
**031762** Caixa BR - Emb: 1pç



**Caixas de Som - Tipo Cubo 5"**  
• Caixa de som • Potência: 150W PMPO / 15W RMS • (140x140mm)  
**034568** Caixa BR - Emb: 1pç  
**034569** Caixa PT - Emb: 1pç  
**034758** Caixa CZ - Emb: 1pç



**Suporte fixo p/ TV LED, LCD Plasma e 3D**  
• Fixação Na Parede Para Tvs e Monitores Plasma, Lcd Ou Led • Compatíveis Com Qualquer Padrão de Fixação Até 71 Polegadas /  
• Fácil Correção de Nivelamento e Posicionamento, Através dos Rasgos de Ajuste • Acompanha Kit Para Fixação, Suporta Até 60 Kg.  
**035891**



**Antena Digital Portatil Interna**  
 • Antena de Tv Digital • Recebe Sinais Vhf/uhf/hdtv/fm • Frequências:45-862mhz.  
 • ganho de Amplificador: 4db, Vswr: 1,5 • Impedância: 75 Ohms. Cabo Coaxial de 5 Mt Com Conector Macho  
**035892**



**Antena p/ Rádio**  
 • AM /FM  
**033410** Comp: 3m



**Antena Parabólica**  
 • Antena TV Interna Parabólica  
 • UHF/VHF/FM com Seleto  
 • 75/300 Ohms  
**031147**



**Cúpula (Dome) p/ Micro Camera**  
 • Cúpula e sub cúpula PC-526 c/ abertura definida para micro camera  
 • Acrílico fumê • Furação p/ fixação  
 • Patola  
**031742**

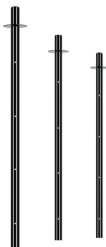

**Suporte Prolongador**  
 • Para caixa de som • PT  
**036452** - 60cm  
**036451** - 80cm  
**036450** - 100cm



**Tripé**  
 • para caixa de som • PT  
**036455**



**Alça para caixa de som**  
 • PT  
**036457** - 16x23x7mm  
**036456** - 16x27,5x7mm



**Suporte para caixa de som**  
 • Som ambiente  
**036453** - PT  
**036454** - BR



**Agulha Leson**  
 • P/ toca disco • AG - 1001S  
**035167**



**Agulha Leson**  
 • P/ toca disco • VN - 100S  
**035168**



**Agulha Leson**  
 • P/ toca disco • AG - 3306S  
**035169**



**Agulha Leson**  
 • P/ toca disco • AG - 1001D  
**035170**



**Agulha Leson**  
 • P/ toca disco • VN - 100D  
**035171**



**Agulha Leson**  
 • P/ toca disco • AXSIS I / IX  
**035172**



**Agulha Leson**  
 • P/ toca disco • AXSIS II / IIX  
**035173**



**Agulha Leson**  
 • P/ toca disco • AG - 80  
**035174**



**Agulha Leson**  
 • P/ toca disco • AG - 180  
**035175**



**Agulha Leson**  
 • P/ toca disco • GS - 11  
**035176**

**Auricular P2 Stereo**

- Fone auricular 15mW com plug P2(3,5mm) • Fios siliconados
- Embalagem: Blister

**031207** Comp: 1,2m**Microfone Eletreto**

- Microfone eletreto
- Emb. 50 pçs

**034939** T. G 10x7 DG09767**034940** 6x3 DG6027**Globo p/ Microfones**

- Globo para Microfone

**033341** Preto**034058** Prata**Suporte p/ Microfone**

- Com rosca metálica

**031666****Microfone Dinâmico**

- Dinâmico Unidirecional c/ fio: 3m
- Impedância: 500 OHM + ou - 30%
- 50/14000hz • 73dB • Plástico

**031646** Prata**Microfone Dinâmico**

- Dinâmico c/ fio: 5m • Impedância: 500 OHM • 50/14000hz • 73dB
- Plástico

**031645** Prata**Microfone Dinâmico**

- Com fio: 2,5m • Dinâmico • Plástico
- Imped: 500 OHM • Freq. Resp: 50 / 14000hz • Sensib: 73dB

**032495** Preto**Microfone Dinâmico**

- Com fio: 2,5m • Dinâmico • Plást.
- Imped: 500 OHM • Freq. Resp: 50 / 14000hz • Sensib: 73dB • Prata

**032496****Microfone Dinâmico**

- Com fio: 3,0m • Dinâmico • Plást.
- Imped: 500 OHM • Freq. Resp: 50 / 15000hz • Sensib: 73dB

**032498****Microfone Dinâmico**

- Com fio: 3,0m • Dinâmico • Plástico
- Imped: 500 OHM • Freq. Resp: 50 / 15000hz • Sensib: 73dB • PR e CZ

**032499****Microfone Dinâmico**

- Com fio 5m • Dinâmico
- Imped: 600 OHM - 50/1400hz - 72dB Pt839 • Plást.

•Baixo Ruído  
**030828** Preto**Cápsulas p/ Microfones (31644)**

- Cápsula para microfone LD6630
- (31644)

**034059** Emb. 2 pçs**031660** Emb. 1 pç**Cápsulas p/ Microfones (31647)**

- Cápsula para microfone DM158
- (31647) • Emb. 2 pçs

**034060****Cápsulas p/ Microfones (31645)**

- Cápsula para microfone DM208
- (31645)

**036059****Cápsulas p/ Microfones CP-DM**

- Cápsula para microfone CP-DM

**031662**



**Soquete p/ Plug Cigarreira Automotivo**  
 • Soquete p/ Plug Cigarreira • Emb. 10 pçs  
**034277**



**Plug Cigarreira**  
 • Plug cigarreira automotivo • 20mm  
 • T4215 1 1 VIA  
**030923**



**Plug Cigarreira**  
 • Plug cigarreira automotivo  
 • C/ USB  
**035318**



**Plug Cigarreira**  
 • Plug cigarreira automotivo  
 • Plug P4 c/ 1,5m • Níquel • PT  
**035288**



**Plug Cigarreira**  
 • Plug cigarreira automotivo 5V 1A  
 • Para Iphone 5 • 8 pinos • Níquel  
**035307**



**Adaptador 1x2 p/ Acendedor de Cigarro**  
 • Adaptador Automotivo 1x2  
**030924**



**Plug Cigarreira**  
 • Plug Cigarreira Automotivo 5V 1A  
 • Micro 5 pinos • Níquel  
**035306**



**Plug Cigarreira**  
 • Plug Cigarreira Automotivo 2A  
 • C/ Fusível e Mola de Prot. do Cabo  
**030946**



**Plug Cigarreira**  
 • Plug cigarreira automotivo simples com fusível • Emb. 10 pçs  
**035283**



**Plug Cigarreira**  
 • Plug Cigarreira automotivo simples  
 • Proteção do cabo  
**031417**



**Plug Cigarreira**  
 • Plug cigarreira automotivo 2A  
 • Com fusível • Emb. 10 pçs  
**035284**



**Plug Cigarreira 2 X USB**  
 • Carregador duplo para caminhão e carro  
 • Entrada para 24V e 12V  
 • Saídas de USB 5V 2100mAh e USB 5V 1000mAh • Cor: Preto  
**033548**



**Plug Cigarreira 2X USB**  
 • Carregador duplo para carro  
 Entrada para 12V  
 • Saídas de USB 5V 1000mAh e USB 5V 2100mAh • Cor: Branco  
**034876**



**Bluetooth p/ Carro**  
 • Saída P2 (3,5mm)  
 • 3.0V  
**034002**



**Suporte p/ Celular**  
 • Suporte Universal para Celular para Carro • Rotação 360° • Sistema de fixação com ventosa • PT  
**033489**



**Suporte p/ Celular**  
 • Suporte Universal para Celular para Carro • Rotação 360° • Sistema de fixação com ventosa • PT  
**033804**



**Rele p/ Carro**  
 • Rele para carro 12VDC  
 • 40A • Emb: 5 pçs  
**034778**



**Conector Automotivo**  
 • Conector fêmea plástico dourado  
 • Emb: 10 pçs  
**035393** - 2 Vias  
**035395** - 4 Vias  
**035396** - 6 Vias



**Medidor de Pressão Pneumático**  
 • Chaveiro c/ Display LCD • Deslig. auto • Quatro tipos de unidades: PSI, Bar, Kgf/cm2 e Kpa • 1 bateria CR2032-3V • (42x20x33mm)  
**100032**



**Sinalizador Giroflex**  
 • Sinalizador eletrônico giroflex • 12V com base magnética • Amarelo  
**033461**



**Cabo Extensão Cigarreira**  
 • Cabo extensão cigarreira com garra jacaré  
 • 15A/12V  
**033297** Comp: 5m  
**033196** Comp: 10m



**Cabo Tipo Chupeta**  
 • Cabo tipo "Chupeta" para bateria automotiva  
 • 100A  
**033424** Comp: 2,5m



**Fusível Automotivo**  
 • 32V • Va - Mini  
 • Emb: 10 pçs  
**036208** - 7,5A    **036210** - 15A  
**036209** - 10A    **036211** - 20A

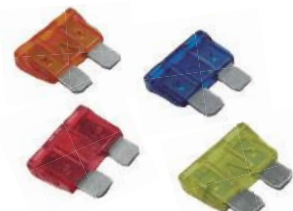

**Fusível Automotivo**  
 • 32V • Va - Lamina  
 • Emb: 10 pçs    **036205** - 15A  
**036203** - 7,5A    **036206** - 20A  
**036204** - 10A    **036207** - 40A



**Carregador USB**

- Carregador Bivolt
- Saída USB para Ipad e outros

**035276****Adaptador USB/Mini Micro**

- Adaptador USB para mini / micro / Apple UC-211 • Embalagem: Blister

**033496** Comp: 0,15m - Branco**Cabo Iphone**

- Cabo USB para Iphone 5, 5S e 6

**033598** Comp: 1m - Branco**Cabo Iphone**

- Cabo USB para Iphone 5 e 5S

**033844** Comp: 1m - Branco**Adaptador Iphone 5/Iphone 4**

- Adaptador Iphone 5 macho para Iphone 4 fêmea

**035275****Adaptador Iphone 5/Mini USB**

- Adaptador Iphone 5 macho para mini USB fêmea

**035570** - Branco Emb c/10pcs**Adaptador Iphone 5/Micro USB**

- Adaptador Iphone 5 macho para Micro USB fêmea

**036055** - Branco Emb c/10pcs**Cabo USB/Micro USB p/ Samsung**

- USB 3.0 para micro USB p/ Samsung Galaxy Note 3 • Tensão 5/10v

**033909** Comp: 0,07m - Branco**Extensão p/ Iphone, Ipad e Ipad**

- Cabo extensão

**033452** Comp: 1m - Branco**Cabo para Iphone, Ipad e Ipad**

- USB A macho para conector universal Apple • (HL0510)

**035111** Comp: 1m - Branco**031972** Comp: 1m - Branco**Cabo p/ Iphone e Ipad e outros**

- Cabo USB A / Iphone 5 macho
- Mini USB F • iPhone 4, 3, Ipad 1 e 2 F

**033845** Comp: 0,2m - Branco**USB A M/Iphone**

- USB A Macho / Iphone • Retrátil
- Embalagem: Blister

**033451** Comp: 0,8m - Branco**Cabo 4x1 p/ Iphone e Outros**

- Cabo 4x1 p/ Iphone e Outros
- USB para Ipad, iPhone 4, 4s, P1000, Micro USB, iPhone 5 • Não passa dados, apenas carrega

**034787** Comp: 1,2m - Branco**Cabo p/ Iphone e Ipad**

- USB + 3 RCA macho para Iphone e Ipad para TV

**033710** Comp: 1,2m - Branco

## Caixas Plásticas para Montagem Patola • Acessórios

## ELETROELETRÔNICA

**Caixas Plásticas ABS/PP**

- PB 046/3 2 RJ Gabinete injetado sob alta pressão em 2 metades • Fechamento por encaixe de pino interno c/ furação lateral p/ 2 RJ • (21x33x46mm)

**034921** - Preto**Caixas Plásticas ABS/PP**

- Plástico ABS com guias e torres para PCI

**031595** PB 201 - (40x70x85mm) - Preto**031596** PB 202 - (50x70x97mm) - Preto**031597** PB 203 - (44x85x97mm) - Preto**Caixas Plásticas ABS/PP**

- PB-090TE Caixa injetada sob alta pressão com acabamento fosco • Tampa com abas externas para fixação • ABS • (25x65x90mm)

**033656** - Bege**Caixas ABS/PP**

- PB112/2 Plástico ABS com guias e torres para PCI • (36x85x123mm)

**031591** - Preto



**Caixas ABS/PP**

• PB 119 Plástico ABS com guias e torres para PCI • (65x112x190mm)  
**031593** - Preto



**Caixas ABS/PP c/ Alças**

• PB 211 plástico ABS com guias e torres para PCI • Com alças  
• (70x137x150mm)  
**031598** - Preto



**Caixas ABS/PP**

• PB 046 Plástico ABS com guias, abas para fixação com tampa lisa  
• (19x36x46mm)  
**031587** - Preto



**Caixas Plásticas ABS/PP**

• Plástico ABS com guias e torres para PCI  
**031592** PB 114 - (55x97x148mm) - Preto  
**031594** PB 119/2 - (52x110x190mm) - Preto  
**031590** PB 112 - (52x85x123mm) - Preto



**Caixas ABS/PP**

• PB 055/4F plástico ABS, tampa com abas para fixação externa  
• (37x54x170mm)  
**033802** - Preto



**Caixas Plásticas ABS/PP**

• PB065 gabinete injetado sob alta pressão de injeção, formato trapezoidal c/ acabamento fosco c/ tampa p/ fechamento da caixa c/ travas laterais  
• Material ABS • (28x43x65mm)  
**033830** -Preto



**Caixas Plásticas ABS/PP**

• PB 075 plástico ABS com tampa e abas para equipamentos em geral  
• (37x60x75mm)  
**032436** - Preto



**Caixas ABS/PP**

• PB/107 caixas plásticas p/ mont. (PB/107) • Gabinete injetado sob alta pressão de injeção para montagem de equipamentos, acabamento fosco tampa c/ abas p/ fixação do produto material ABS • (40x73x100mm)  
**033803** - Preto



**Caixas Plásticas ABS/PP**

• PB111 - Plástico 85x85x123mm - Gab Injetado Sob Alta Pressão de Injeção Guias e Torres p/ Fixação de C.I. .  
**035819**



**Caixas ABS/PP**

• PB 060 plástico ABS com tampa e abas para equipamentos em geral  
• (30x52x64mm)  
**032435** - Preto



**Caixas ABS/PP**

• Gabinete Injetado Sob Alta Pressão de Injeção;acabamento Fosco;guias e Torres Para Fixação do Circuito Impresso;tampa Com Abas Para Fixação do Produto. material Abs • (33x75x116mm)  
**033655** - Preto



**Caixas ABS/PP**

• PB112-TE gabinete injetado sob alta pressão de injeção c/ acabamento fosco • Guias e torres p/ fixação de circuito impresso • Tampa fixada por parafusos (não acompanham)  
• (54x85x123mm) • ABS  
**035024** - Preto



**Caixas ABS/PP**

• PB 115-TE plástico ABS com guias e torres para PCI • Não acompanham parafusos • (52x112x160mm)  
**033425** - Preto



**Caixas ABS/PP**

• PB-064 gabinete injetado sob altapressão de injeção  
• Acabamento fosco com abas para fixação  
• Tampa lisa  
• (25X44X64mm) • ABS  
**033657** - Preto



**Caixas ABS/PP**

• PB-050 gabinete injetado sob alta pressão de injeção para montagem de equipamentos em geral  
• Acabamento fosco  
• tampa com abas para fixação  
• (29x43x52mm) • ABS  
**033660** - Preto



**Caixas ABS/PP**

• PB 170TP plástico ABS com tampa trilho para PCI  
• (90x120x180mm)  
**032433** - Preto



**Caixas ABS/PP**

• Gabinete injetado sob alta pressão de injeção formato trapezoidal com acabamento fosco Tampa para fechamento da caixa com travas lateraisl • ABS  
• (33x72x84mm)  
**035578** - Preto



**Caixas ABS/PP**

• Caixas plásticas para montagens (gabinete para pilhas)  
• Acabamento semi-polido com contato  
• (23x33x57mm) • ABS  
**033659** - Preto



**Caixas ABS/PP**

• (CR-095CHCLB) Acabamento fosco  
• Alojamento para bateria • Suporte para transporte baixo c/ furo p/ chave Hh • Espaço p/ gravação de logotipo  
• Fixação por 1 parafuso central 2,9 X 9,5mm • (22x62x95mm) • ABS  
**033658** - Preto



**Caixas Plásticas ABS/PP**

• Gabinete injetado em ABS(V0) com acabamento fosco • Abertura para respiro • Terminais de aço 1020 bicromatizados • Fundo com terminais abertos ou com terminais imperdíveis  
• Presilhas de fixação injetadas em ABS • Pannel frontal • Moldura injetada para fixação do pannel • Trilho para placa PCI • (98x98x135mm)  
**033411** - Preto



**Caixas Plásticas ABS/PP**

• DIN (98x48mm/3VV) com gabinete injetado em ABS(V0) ou Noril (V0)  
• Acabamento fosco • Fundo fechado sem terminais • Rasgo de 36x11 sem presilhas para fixação • Pannel frontal vermelho (translúcido) • Moldura para fixação do pannel • (42x90x20mm)  
**033412** - Vermelho  
**033557** - Cinza



**Caixas ABS/PP**

• CF-070 Gabinete injetado com acabamento fosco c/ pino plug redondo maciço • Abertura para chave hh  
• Fechamento com cola ou ultrasom  
• (47x60x85mm) • ABS  
**033661** - Preto

• Mala modelo MP desenvolvida pela Patola para equipamentos de campo. Com estrutura robusta é um produto altamente resistente e leve. Possui acabamento refinado e design arredado que valorizam cada detalhe do produto. Possui fechos com travamento duplo que são simples e fáceis de abrir, garantem um travamento sob alta pressão que impedem a abertura ocasional do sistema. A criação de uma saída especial de ar permite a despressurização da mala e facilita a sua abertura. Todos os pinos e encaixes são precisos e garantem a proteção ideal contra pó e água para transporte do seu equipamento.



**Maleta 0025 (95x195x250mm)**  
**033664**



**Maleta 0020 (85x138x200mm)**  
**033663**



**Maleta 0010 (80x200x325)**  
**035820**



**Maleta 0008 (64x130x160)**  
**035821**



**Maleta 0050 (180x340x470mm)**  
**033666**



**Maleta 0035 (150x260x350mm)**  
**033665**



#### Arduino UNO R3 c/ Cabo USB

• Arduino é uma plataforma de computação open-source baseado em uma simples placa com entradas e saídas tanto digitais como analógicas. Possui um próprio ambiente de desenvolvimento que implementa a Linguagem C.

**035723**



#### Servo Motor SG90

• O Micro Servo Motor 9g Tower Pro é um servo de alta qualidade e excelente para as suas necessidades, seja em aeromodelismo ou em projetos de robótica com Arduino, PIC, Raspberry e entre outros. Este servo se adequa para helicópteros RC e aviões de marca como Hitec, Futaba GWZ, JR e etc.

**035724**



#### Modulo IR Sensor de Obstaculos

• Modulo sensor infravermelho IR de obstaculo refre LM393 Arduino.

**035725**



#### teclado membrana matricial 4x4 16 teclas

• O teclado matricial 4x4 é ideal para utilização em pequenos projetos acadêmicos onde se deseja realizar tarefas de controle de acesso, configurações do sistema, entre outras que necessitam de uma interface com botões"

**035726**



#### CONVERSOR DC/DC STEP UP XL6009

• Conversor DC/DC Step UP (elevador de tensão) que tem como base o CI CN6009, tendo um ótimo rendimento e fácil aplicação em projetos onde se deseja um baixo consumo de energia.

**035727**



#### Modulo Emissor e Receptor RF315 MHZ

• Este módulo é popularmente usado em controle remoto, e em alguns caso para transmissão de dados em baixa velocidade e curta distância, onde por exemplo você poderá enviar dados de um sensor, ou controlar o acionamento de um dispositivo."

**035728**



#### Modulo Gravador de voz e Player ISD1820

• Esse módulo, reproduz tudo por 10 segundos e grava acionando o botão rec o que quiser. Seria como se houvesse um robô falando sozinho, bom para usar em pic, arduino e outros

**035729**

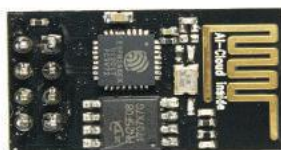

#### Módulo WI-FI ESP8266 ESP-01

• O módulo WIFI ESP8266 modelo ESP01 é capaz de colocar seu projeto conectado na internet, assim fazendo com que você seja capaz de acessa-lo, controlá-lo adquirir informações de forma remota. Em outras palavras essa é a porta de acesso para a Internet das Coisas "

**035730**



#### Módulo Sensor LOR LUZ Luminosidade Fotoresistor

• Sensor foto-sensível para detecção de luz, possui saída digital para indicar a presença de luz e potenciômetro para regular a intensidade de luz de acionamento.

**035731**



#### Nano v3 Pin Header Soldered

• O Nano v3.0 é uma placa de desenvolvimento da plataforma Arduino com tamanho muito reduzido. Esta placa contém o microcontrolador ATMEGA328P-AU que possui 32 KBytes de memória Flash. Por ter o tamanho reduzido, pode ser encaixado diretamente na protoboard e é ideal para projetos que necessitam ocupar pouco espaço físico

**035732**



#### DG007 Plataforma Robotica Chassis em Acrilico com 2 motores 6vdc

• As placas de chassis são feitas em acrílico, com uma grande variedade de furos que facilitam a montagem de microcontroladores como o Arduino, sensores, baterias, etc. Simplesmente aperte as duas plataformas pré-cortadas em conjunto, anexe os motores junto do controlador de robótica e sensores que não estão inclusos.

**035733**



#### Plataforma Robótica

• Plataforma Robotica Chassi Tank

**036033**



**Plataforma Robótica**  
• Chassi 2WD com 2 rodas  
**036105**



**Plataforma Robótica**  
• Chassi R 2W redondo com 2 rodas  
**036104**



**Plataforma Robótica**  
• Chassi 4WD com 4 rodas  
**036106**



**Plataforma Robótica**  
• Chassi Rover com 2 motores e 2 encoders  
**036377**



**Placa PRO mini**  
• 5V  
**036107**



**Placa MOD 1R**  
• Modulo com 1 rele p/ robótica  
**036100**



**Placa MOD 2R**  
• Modulo com 2 reles p/ robótica  
**036101**

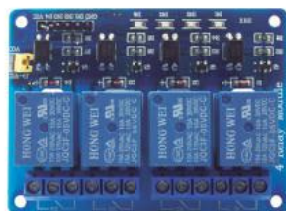

**Placa MOD 4R**  
• Modulo com 4 reles p/ robótica  
**036102**



**Placa MOD 8R**  
• Modulo com 8 reles p/ robótica  
**036103**



**Placa HC-SR04**  
• Modulo sonar p/ robótica  
**036099**



**Placa HC-05**  
• Modulo sonar p/ robótica  
**036378**



**Placa HC-06**  
• Modulo sonar p/ robótica  
**036379**



**Chassi Rover**  
• Plataforma Robótica  
• 4 motores • 4 Encoders  
**036500**



**Conjunto 4 rodas**  
• p/ Chassi  
**036499**



**Sinalizador Elétrico**  
• Com Buzzer • 220V • 20mA  
**036578** - VM



**Sinalizador Elétrico**

- AD16 • AC/DC • 12V • 20mA    • AD16 • AC/DC • 24V • 20mA    • AD16 • AC • 220V • 20mA
- 036580** - AZ                      **036587** - AM                      **036585** - VD
- 036579** - AM                      **036589** - VD                      **036583** - AM
- 036581** - VD                      **036588** - AZ                      **036586** - VM
- 036582** - VM                      **036590** - VM                      **036584** - AZ



**Botão de Pulso**  
• 6MM • VM • 250V • 3A  
**036577**



**Chave Seletor**  
• 2 Posições 16MM  
com chave 250V 3A  
**036576**



**Chave Seletora**  
• 3A • PT • 240V • 20mA  
**036569** - *cl* 3 Posições N/O+N/O  
**036568** - *cl* 2 Posições N/C



**Botão de Emergência**  
• 10A • VM • 12V • 20mA  
**036570** - Com Trava N/C  
**036571** - Pulso



**Botão de comando**  
• S/ Retenção • N/O • 240V • 3A  
**036573** - VD  
**036575** - AM  
**036574** - VM  
**036572** - PT

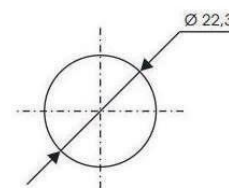
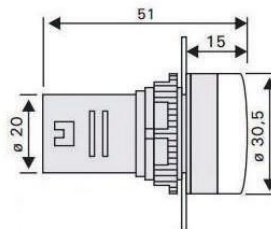

**Chave Push Button MARGIRIUS**  
• Push button 2 pólos • 1A / 120Vac  
0,5A / 250Vac ON-OFF  
**034961** Com trava  
**034975** Sem trava



**Chave Botão**  
• Campainha botão interno • 6A /  
125Vac ou 3A 250Vac • Emb. 10 pçs  
**034451**



**Chave Botão**  
• Botão liga / desliga • 6A / 125Vac 3A /  
250Vac • Emb. 10 pçs  
**034047**



**Chave Push Button**  
• Push button 2 pólos 6 term.  
• 3A / 125Vac 1A / 250Vac ON-OFF  
**030208**



**Chave Push Button**  
• Push button 1A / 250Vac  
• Emb. 10 pçs  
**034108** PT - N/F  
**034408** VM - N/F  
**034107** VM - N/A  
**034407** PT - N/A



**Chave Push Button MARGIRIUS**  
• Interruptor 1A com carga resistiva em  
120Vac ou 0,5A com carga resistiva  
em 250Vac  
**034959** CS-390 NF/P1 - N. Fechado - VM  
**034960** CS-390 NA/P1 - N. Aberto - VD



**Chave Alavanca MARGIRIUS**  
• Interruptor unipolar 6A com carga  
resistiva em 120Vac ou 3A com carga  
resistiva em 250Vac  
**034957** CS-301D-AFB2FP1 - PT  
**034958** CS-301D-AEB2FP1 - VM



**Chave Alavanca**  
• 3A / 250Vac 6A / 125Vac • 1 pólo 2  
terminais on-off • Emb.: 10 pçs  
**030615**



**Chave Alavanca**  
 • 3A/250Vac 6A / 125Vac  
 • 1 pólo 3 terminais • 10 pçs  
**030214** ON-OFF  
**030206** ON-OFF-ON



**Chave Alavanca**  
 • 3A / 250Vac 6A / 125Vac  
 • 2 pólos 6 terminais • 10 pçs  
**030207** ON-OFF  
**030205** ON-OFF-ON



**Chave Alavanca**  
 • Liga / desliga 3A / 250Vac 90°  
 • 2 Terminais  
**030610**



**Chave Alavanca**  
 • Liga / desliga 15A/250Vac  
 • 2 terminais • Embalagem: 5 pçs  
**034525**



**Chave Alavanca**  
 • Liga / desliga / liga 15A/250Vac  
 • 3 terminais • Embalagem: 5 pçs  
**034818**



**Chave Alavanca**  
 • Liga / desliga 15A/250Vac 6 terminais  
 • On-Off • Emb: 10 pçs  
**034455**



**Chave Alavanca MARGIRIUS**  
 • Interruptor bipolar 10A com carga resistiva em 120v~ ou 6A com carga resistiva em 250v~ ½ Cv em 20/250v~  
**034955** - CS-301C-MB1S/SS



**Chave Alavanca MARGIRIUS**  
 • Interruptor 15A com carga resistiva em 120v~ ou 10A com carga resistiva em 250v~ (contato Q) • Unipolar  
**034968** - 14123A1B1P1Q



**Chave Alavanca MARGIRIUS**  
 • Interruptor 15A com carga resistiva em 120v~ ou 10A com carga resistiva em 250v~ (contato Q) • Bipolar  
**034965** - 14223A1B1P1Q



**Chave Alavanca MARGIRIUS**  
 • Interruptor 6A com carga resistiva em 120v~ ou 3A com carga resistiva em 250v~ • Unipolar  
**034956** - CS-301D-MB1P1



**Chave Tecla MARGIRIUS**  
 • Interruptor 15A com carga resistiva em 120v~ ou 10A com carga resistiva em 250Vac (contato Q) • Bipolar  
**034966** - 14223- MFT1FP1Q



**Chave Tecla MARGIRIUS**  
 • Interruptor 6A com carga resistiva em 120v~ ou 3A com carga resistiva em 250Vac (contato S) • Unipolar  
**034964** - 16101 MFTFE2S



**Chave Alavanca MARGIRIUS**  
 • Bipolar 15A/250Vac  
 • 3 posições • Metal  
**035348** - 14201A1B1P1Q - 2 Posições  
**035349** - 14203A1B1P1Q - 3 Posições



**Chave Tecla MARGIRIUS**  
 • Interruptor 6A com carga resistiva em 120v~ ou 3A com carga resistiva em 250Vac (contato S) • Unipolar  
**034974** - 16123-M2FT4FE3S



**Chave Tecla MARGIRIUS**  
 • Interruptor 10A com carga resistiva em 120Vac (contato Q) • Unipolar  
**034976** - 33121 M1FT1FW1Q/63



**Chave Tecla MARGIRIUS**  
 • Interruptor 6A com carga resistiva em 120Vac (contato Q) • Bipolar  
**034967** - 15223-MFT1FPQ1S



**Mini Chave**  
 • Liga/Desliga 3A/250Vac  
 • Embalagem: 10 pçs  
**034438** - 2 Term. VM  
**034439** - 2 Term. CZ  
**034440** - 3 Term. PT



**Mini Chave**  
 • Liga/desliga  
 • 2A/250Vac 2 Terminais  
 • Embalagem: 10 pçs  
**030599** PT  
**030600** VM  
**035611** PT



**Mini Chave**  
 • Liga/desliga  
 • 2A/250Vac 3 terminais  
 • Emb: 10 pçs  
**030602** PT  
**030603** VM



**Mini Chave**  
 • Liga/desliga  
 • 2A/250Vac 4 terminais  
**030605** VM Emb: 10pçs



**Mini Chave**  
 • Liga/desliga Momentânea  
 • 6A / 250 Vac 2 terminais  
**030606** PT Emb.: 10pçs



**Chaves Sobrepor**

• Chaves KCD7  
• PT  
**032675** 2 Term. Mod.101



**Chave H-H Solda**

• HH 2 Pólos 0.3A/125 Vac 0.15A/220 Vac • Solda • (28,5x13x7,8mm)  
• Embalagem: 10 pçs  
**030209**



**Chave H-H Mini Solda**

• HH 2 Pólos 0.3A/125 Vac 0.15A/220 Vac • Solda • (19x7,5x6,8mm)  
• Embalagem: 10 pçs  
**030210**



**Chave H-H Mini PCI**

• HH 2 Pólos 0.3A/125 Vac 0.15A/220 Vac • PCI • (19x7,5x6,8mm)  
• Embalagem: 10 pçs  
**030211**



**Chave H-H PCI 3 Posições**

• HH 2 Pólos 0.3A/125 Vac 0.15A/220 Vac • 3 Pos. PCI • (28,5x13x7,8mm)  
Haste 5mm • Embalagem: 10 pçs  
**030212**



**Chave Tátil 90° c/ Suporte**

• Chave 9 • (10,7x8,4x9mm)  
• Embalagem: 100 pçs  
**031304**



**Chave Tátil**

**031305** Chave 6x6 - Botão 4,3mm - Emb: 100 pçs  
**034169** Chave 6x6 - Botão 5mm - Emb: 100 pçs  
**003122** Chave 6x6 - Botão 6mm - Emb: 100 pçs  
**003121** Chave 6x6 - Botão 9mm - Emb: 100 pçs  
**003123** Chave 6x6 - Botão 11mm - Emb: 100 pçs  
**003124** Chave 6x6 - Botão 13mm - Emb: 100 pçs  
**033415** Chave 12x12 - Botão 7mm - Emb: 100 pçs  
**034698** Chave 12x12x4 - p/SMD - Emb: 100 pçs  
**032572** Chave 12x12x4 - p/PCI - Emb: 50 pçs



**Chave Botão**

• 8,5x8,5mm c/ trava  
• Embalagem: 20 pçs  
**034273**



**Chaves Dip Switch**

• Connfly  
**034656** 180° 2 Vias - Emb. 72 pçs  
**033790** 180° 3 Vias - Emb. 10 pçs  
**034674** 180° 3 Vias - Emb. 52 pçs  
**034658** 180° 4 Vias - Emb. 40 pçs  
**034653** 90° 2 Vias - Emb. 72 pçs  
**035345** 90° 6 Vias - Emb. 20 pçs



**034675** 90° 5 Vias - Emb. 33 pçs  
**035344** 90° 6 Vias - Emb. 20 pçs  
**034654** 90° 8 Vias Emb. 21 pçs  
**034676** 180° 5 Vias - Emb. 33 pçs  
**034657** 180° 8 Vias - Emb. 21 pçs

**Chave Tátil com KNOB**

• 12x12mm  
**036494** BR - Emb: 10 pçs  
**036493** VM - Emb: 10 pçs  
**036495** PT - Emb: 10 pçs  
**036496** AZ - Emb: 10 pçs  
**036497** VD - Emb: 10 pçs  
**036498** AM - Emb: 10 pçs

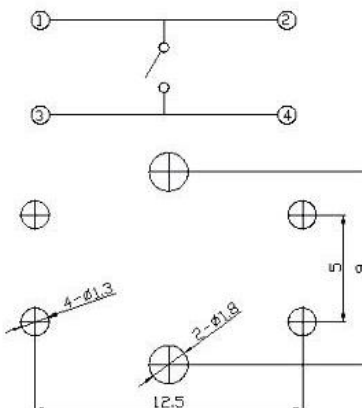
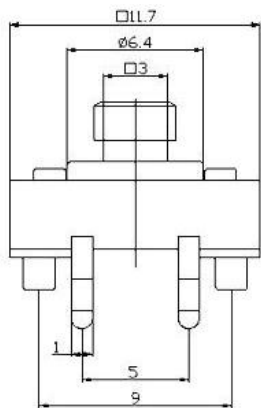
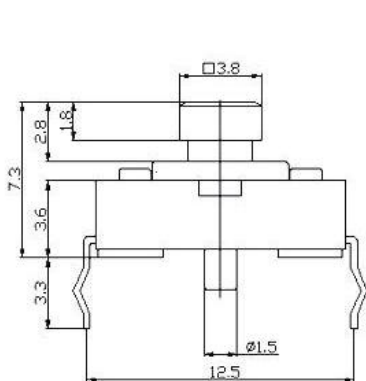

1. Environment temperature: -25°C~+70°C
2. Relative Humidity: (40°C) ≤95%
3. Rating: DC12V. 50mA
4. Contact Resistance : ≤0.03Ω
5. Insulation Resistance: ≥100MΩ
6. Dielectric Strength : AC250V (50Hz/ 1minute)
7. Electrically Life:100,000Cycles
8. Travel:0.25±0.05mm
9. Operating Force:180±50gf 280±50gf



**Micro Interruptor MARGIRIUS**

• Interruptor 20A com carga resistiva em 120Vac ou 15A c/ carga resistiva em 250Vac, funções Na, Nf ou reversível

**034963****Micro Interruptor MARGIRIUS**

• Interruptor 20A com carga resistiva em 120Vac ou 15A c/ carga resistiva em 250Vac

**034962****Microswitch 5A**

• 5A 250V • (20x10x6mm)

• Emb. 10 pçs

**031781****Microswitch 5A c/ Roldana**

• 5A 250V • (20x10x6mm)

• Haste 19mm • Emb. 10 pçs

**034410****034122****Microswitch 5A**

• 5A 250V • (20x10x6mm)

• Haste 30mm • Emb. 10 pçs

**034062****Microswitch 5A**

• 5A 250V • (20x10x6mm)

• Haste 30mm • Emb. 10pçs

**034775****Microswitch 15A**

• 15A 250V • (28x16x10mm)

• 1 NA • Emb: 10 pçs

**034783****Microswitch 16A**

• 16A 250V

• (28x16x10mm) • Emb. 5 pçs

**034029** 16A**034063** 16A - Preto**Microswitch 16A c/ Roldana**

• 250V • (28x16x10mm)

• Roldana 14mm

**002588** 16A**031785** 16A**Microswitch c/ Roldana**

• 250V (28x16x10mm) • 15A

• Roldana 22mm • Emb: 5pçs

**034064****Microswitch 16A com Haste**

• 250V • (28x16x10mm)

• Haste 27mm • Haste • Emb. 5 pçs

**034411** 16A**034065** 16A - Preto

## Trimpot, potenciômetros e foto célula

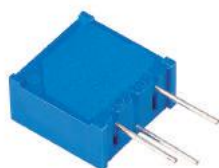
**Trimpot 1 volta**

• 3386H • Embalagem: 50 peças

**032472** 1K**032477** 50K**Trimpot 15 voltas**

• 3006P • Embalagem: 25 peças

**032447** 2K**032451** 50K**032453** 200K**032455** 1M**Potenciômetro 10 Voltas**

• Pot. 10 Voltas

**035583** 200R Ohms- Emb. 1 pç**035586** 500R Ohms- Emb. 1 pç**035783** 1K Ohms- Emb. 1 pç**030186** 1K Ohms- Emb. 1 pç**035585** 2K Ohms- Emb. 1 pç**035587** 5K Ohms- Emb. 1 pç**035784** 10K Ohms- Emb. 1 pç**035584** 20K Ohms- Emb. 1 pç**035588** 50K Ohms- Emb. 1 pç**030192** 100K Ohms- Emb. 1 pç**Dial Knob p/ Potenciômetro**

• Dial (Knob) • Potenciômetro 10 Voltas

**035582****035832****Foto Célula LDR**

• 10K Ohm • Mais luz menor resistência • Emb. 10 pçs

**034412** LDR 5mm**034027** LDR 10mm**036351** LDR 20mm



**Relé 5V Metaltex**  
 • Relé com bobina de 5V p/ corrente contínua • Cont. reversível p/ 250VCA  
**034099** 2 cont. de 2A - Emb. 1 pç



**Relé 12V**  
 • Relé com bobina de 12V p/ corrente contínua • Cont. reversível p/ 250VCA  
**033857** 1 cont. de 15A - Emb. 1 pç  
**035340** 1 cont. de 12A - Emb. 1 pç  
**033203** 2 cont. de 2A - Emb. 25 pçs



**Relé 24V**  
 • Relé com bobina de 24V p/ corrente contínua • Cont. Reversível p/ 250VCA  
**033205** 1 cont. de 15A - Emb. 25 pçs  
**035341** 1 cont. de 12A - Emb. 1 pç  
**033204** 2 cont. de 2A - Emb. 25 pçs



**Relé Reed**  
 • Ampola Reed 2 x 14 NA  
 • Embalagem: 20 pçs  
**030174** Ampola VD  
**002573** Ampola BR  
**035370** Ampola VD Hamlin MDCG

Sensores Magnéticos

Item	Sensor tipo	Código	Distância de Acionamento	Visual Orientativo Sem Escala	Embalagem	Informação
1	Sobrepor Adesivo	<b>034893</b>	12mm		1pç	• Contato normalme nte aberto (NA) • Fixação adesiva • (25,7x13,6x6mm) • Cor: BR
2		<b>034894</b>	22mm		1pç	
1		<b>034895</b>	30mm		1pç	
4	Embutir Imã Ferrite	<b>034896</b>	10mm		1pç	• Tubular 2 Cabos 22AWG com 300mm • Contato Normalmente aberto(NA) • Imã Ferrite • Dist. mínima de Acionamento em superfícies Não magnéticas 10mm•Cor: BR

Fusíveis de Vidro (Latão) Dekfuse

**Fusíveis 20AG**

• Medida: 5x20mm • Emb: 100 pçs  
**000867** 0,1A  
**000868** 0,2A  
**000871** 0,5A  
**000872** 0,8A  
**000873** 1A  
**000874** 2A  
**000875** 3A  
**000876** 4A  
**000877** 5A  
**000878** 6A



IPI 0%  
**000879** 7A  
**000885** 8A  
**000880** 10A  
**000881** 15A  
**000882** 20A  
**000883** 25A  
**000884** 30A

**Fusíveis 3AG**

• Medida: 6x32mm • Emb: 100 pçs  
**000865** 0,25A  
**000866** 0,5A  
**000852** 2A  
**000853** 3A  
**000854** 4A  
**000855** 5A  
**000856** 6A  
**000858** 8A  
**000859** 10A  
**000886** 15A



**000862** 20A  
**000863** 25A  
**000864** 30A

Fusíveis para Microondas Dekfuse

**Fusíveis de Vidro c/ Mola**

• Medida: 6x40mm  
 • Embalagem: 10 pçs  
**033782** 0,8A  
**033783** 0,7A



**Fusíveis 3AG Cerâmicos**

• Medida: 6x32mm  
 • Embalagem: 10 pçs  
**033781** 8A  
**033780** 10A  
**033779** 15A  
**033778** 20A  
**033777** 25A



Porta Fusíveis



**Porta Fusível PCI**  
 • Para CI  
 • Até 10A (6x30mm) • Emb. 30 pçs  
**034872** 16-030B



**Porta Fusível MARGIRIUS**  
 • Porta fusível • 250VAC  
 • Para painel  
**034971** 15A-5x20mm - PT  
**035446** 15A-5x20mm - VM  
**034972** 20A-6,35x32mm - PT



**Porta Fusível Painel**  
 • 3AG(6x32mm) • 15A 250VAC  
 • PT • Emb. 10 pçs  
**034106**



**Porta Fusível Painel**  
 • 20AG(5x20mm) 250VAC  
 • PT • Emb. 20 pçs  
**034026**



**Porta Fusível Meio Fio**  
 • 250Vac  
 • PT • Emb. 20 pçs  
**034259** 20AG (5x20mm)  
**034260** 3AG (6x32mm)



**Porta Fusível PCI MARGIRIUS**  
 • (5x20mm) 10A • 110Vac / 250Vac  
 • Rasgo do encaixe: 27x12,4mm  
**034973**



**Porta Fusível PCI**  
 • 20AG(5x20mm) 250VAC c/ tampa  
 • PCI 25x9x13mm • 4A • Emb. 20 pçs  
**034046**



**Porta Fusível Fusi-Bras**  
 • Para CI (PF-11750 LJ) 250VAC  
 • Até 10A (5x20mm) - VM  
**032427**



**Porta Fusível MARGIRIUS**  
 • Para CI (5x20mm)  
 • 6A em 110Vca / 250Vca  
**034970** PT  
**034969** VM



**Porta Fusível Fusi-Bras**  
 • Para CI (PF-11005)  
 • Até 10A(5x20mm)  
**032428** PT



**Porta Fusível Fusi-Bras**  
 • Com rabicho (PF- 0520)  
 • Até 10A(5x20mm) eng. rápido  
**032426**



**Porta Fusível Fusi-Bras**  
 • Com rabicho (PF- 0550)  
 • Até 15A(6,35x32mm) t. rosca  
**032429**



**Porta Fusível Fusi-Bras**  
 • Com rabicho (PF- 1550)  
 • Até 25A • Meio fio  
 • Para Carro  
**032430**

Tubos Termo Retráteis

**Tubos Termo Retráteis Emborrachados Pretos**

- Encolhimento de 70°C a 115°C
- Encolhimento rádial 50%
- Encolhimento longitudinal 10%

<b>000742</b> 1mm - Emb: 2m	<b>000747</b> 6mm - Emb: 2m	<b>032176</b> 40,1mm - Emb: 50m	
<b>000743</b> 1,5mm - Emb: 2m	<b>000748</b> 9mm - Emb: 2m	<b>001845</b> 4,5mm - Emb: 100m	<b>001841</b> 1mm - Emb: 200m
<b>000744</b> 2,5mm - Emb: 2m	<b>000749</b> 12mm - Emb: 2m	<b>001846</b> 6mm - Emb: 100m	<b>001842</b> 1,5mm - Emb: 200m
<b>000745</b> 3mm - Emb: 2m	<b>032177</b> 50,8mm - Emb: 25m	<b>001847</b> 9mm - Emb: 100m	<b>001843</b> 2,5mm - Emb: 200m
<b>000746</b> 4,5mm - Emb: 2m	<b>032175</b> 25,4mm - Emb: 50m	<b>001848</b> 12mm - Emb: 100m	<b>001844</b> 3mm - Emb: 200m



**Tubos Termo Retráteis Emborrachados Coloridos**

- Encolhimento de 70°C a 115°C
- Encolhimento rádial 50%
- Encolhimento longitudinal 10%

<b>003040</b> 1mm VD - Emb: 2m	
<b>003039</b> 1mm TR - Emb: 2m	
<b>003081</b> 12mm TR - Emb: 2m	<b>002664</b> 1mm TR - Emb: 200m
<b>002668</b> 4,5mm TR - Emb: 100m	<b>002147</b> 1mm AZ - Emb: 200m
<b>002670</b> 9mm TR - Emb: 100m	<b>002658</b> 2,5mm AM - Emb: 200m
<b>002671</b> 12mm TR - Emb: 100m	<b>036150</b> 3,5mm TR - Emb: 200m
	<b>036151</b> 6mm TR - Emb: 200m



Inversor de tensão, fonte chaveada e fonte de alimentação



**Inversor de Tensão**  
 • 12V DC para 110VAC  
 • Com garra tipo jacaré cabo • 5m  
**033492** 300W  
**033493** 600W



**Fonte Chaveada 12V**  
 • AC/DC P4 • Bivolt 110/240  
 • 50/60hz 12v • 1A  
**035361** (GL-Z60713-02)  
**035385**



**Fonte de Alimentação**  
 • Fontes Diversas para instrumentos musicais  
 • Entrada: 100-240V  
**034597** Para teclados Yamaha - Saída: 12V 2A  
**034596** Para pedais de guitarra - 1 pedal - Saída: 9V 300mA  
**034582** Para pedais de guitarra - 5 pedais - Saída: 9V 500mA - Estabilizada



**Fonte Chaveada**  
• 12V 2A  
• AC/DC 110/220V • MAX P4 C+  
**035035**



**Fonte Chaveada p/ uso Geral**  
• AC/DC 110/240V • 12V  
**035165** P4 C+ - 1A  
**035166** P4 C+ - 2A



**Fonte Chaveada**  
• AC/DC 110/240V • 12V  
**034462** F 100W  
**034533** F 60W



**Fonte Chaveada 100V 20A**  
• C/ Proteção Contra Sobretensão/ Corrente/ Temperatura. • Potência Dc Máxima de 2500w • Tensão 110v-127v 60hz • Voltagem de 2500w • Tensão 110v-127v 60hz Voltagem  
**036510**



**Fonte de Alimentação**  
• Fontes diversas para câmeras, motos elétricas, monitores, TV's, DVDs e telefones • Entrada: 100-240V  
**034594** Para bateria selada - 12V 800mA  
**034592** Para moto elétrica - 6V 900mA  
**034598** Para monitor LG / Samsung - Automática - 12V 3A  
**034878** Para Monitor LG / Samsung - Automática - 14V 3A  
**034583** Para DVDs - Automática - 9V 2A  
**034589** Para tel sem fio - Panasonic PQLV19 - 6V 500mA  
**034591** Para tel sem fio - Panasonic PQLV219 - 6,5V 500mA



**Fonte Transformadores**  
• Conversores de energia  
**034590** Entrada: 220V - Saída: 110V 30W  
**034593** Entrada: 110V - Saída: 220V 60W

**AutoTransformadores**

• Entrada 110V /220V • Saída: 110V / 220V  
• Frequência: 60Hz • Gabinete: Metálico de Alta Resistência  
**035887** 500VA  
**035890** 750VA  
**035882** 1010VA  
**035883** 1500VA  
**035884** 2000VA  
**035885** 3000VA  
**035886** 4000VA  
**035888** 5000VA  
**035889** 7000VA



Controle Remoto, Sensor de presença e Campainha



**Controle Remoto p/ Ventilador e Lâmpada**  
• Controle remoto p/ lâmpada e ventilador, c/ controle remoto s/ fio de parede p/ ventilador de teto • função liga/desliga • 4 níveis de luminosidade • Timer para desligamento automático • Não requer passagem de fios pela tubulação  
**033816**



**Controle Remoto p/ Ventilador de Parede**  
• Controle remoto para ventilador de parede • Função liga/desliga • 4 níveis de velocidade • Timer para desligamento automático  
**033818**



**Controle Remoto p/ Lâmpada e Ventilador**  
• Para lâmpada e ventilador de teto • Função liga/desliga • 4 níveis de luminosidade • Timer p/ desligamento automático  
**033814**



**Controle Remoto p/ Lâmpada e Ventilador de teto**  
• Função liga/desliga • 4 velocidades de rotação e reversão • (função liga / desliga compatível c/ lâmpadas econômicas (pl) e incandescentes  
**033815**



**Espelho com carregador USB**  
• Carregador USB SMART III  
• Conexão USB padrão • 1 Tomada NBR 14532 • Entrada 90V-240V 50/60HZ  
• Saída USB 5V/1A  
**033813**



**Campainha Eletrônica**  
• Sem fio • Alcance: Até 8m  
• Embalagem: Blistre  
**033553**



**Sensor de Presença**  
• Soquete E27 com sensor de presença  
**035434**



**Sensor de Presença**  
• Com suporte p/ fixação (parede ou teto) • Alcance de até 5m • Emb: caixa  
**033495**

**Led Tipo Chapéu**

- 030467** 2,1 a 2,3V 4,8x8,4mm - 100° 350mCd - VM Transp. Chapéu - 3mm - Emb: 50 pçs
- 030821** 3,1 a 3,4V 35° 5000mCd VD Transp. Chapéu - 5mm - Emb: 50 pçs
- 030020** 3,2 a 3,4V 120° 1000mCd AZ Chapéu - 3mm - Emb: 50 pçs



**Led Redondo**

- 030814** 1,9 a 2,1V 35° 200mCd VM - 3mm - Emb: 50 pçs
- 030815** 1,9 a 2,1V 35° 1000mCd VM - 3mm - Emb: 50 pçs
- 030024** 1,9 a 2,1V 25° 2500mCd VM - 3mm - Emb: 50 pçs
- 030812** 3,1 a 3,4V 35° 200mCd VD Transp. - 3mm - Emb: 50 pçs
- 030813** 3,1 a 3,4V 35° 2500mCd VD Transp. - 3mm - Emb: 50 pçs
- 032010** 3,1 a 3,4V 35° 4000mCd VD Transp. - 3mm - Emb: 100 pçs
- 032011** 3,1 a 3,4V 35° 5000mCd VD Transp. - 3mm - Emb: 100 pçs
- 030817** 1,9 a 2,1V 45° 2500mCd AM Transp. - 3mm - Emb: 50 pçs
- 030823** 1,9 a 2,1V 35° 1000mCd VM Transp. - 5mm - Emb: 50 pçs
- 030820** 3,1 a 3,4V 35° 2500mCd VD Transp. - 5mm - Emb: 50 pçs
- 003225** 3,1a 3,4V 70° 6500mCd VD - 5mm - Emb: 50 pçs

**Led Redondo**

- 003229** 3,2 a 3,4V 20° 900mCd Rosa - 5mm - Emb: 50 pçs
- 030028** 1,9 a 2,1V 45° 5000mCd VM - 8mm - Emb: 50 pçs
- 030026** 3,1 a 3,4V 45° 1100mCd VD - 8mm - Emb: 50 pçs
- 030025** 3,2 a 3,4V 45° 5000mCd AZ - 8mm - Emb: 50 pçs
- 030029** 1,9 a 2,1V 45° 5000mCd AM - 8mm - Emb: 50 pçs
- 031300** 3,2 a 3,4V 45° 11000mCd VD Transp. - 10mm - Emb: 50 pçs
- 033721** 1,9 a 2,1v 100° 350mCd LR - 4,8x2,8mm - Emb: 50 pçs
- 033719** 1,9 a 2,1V 100° 350mCd BR - 4,8x2,8mm - Emb: 50 pçs
- 033720** 1,9 a 2,1V 100° 350mCd AM - 4,8x2,8mm - Emb: 50 pçs

**Led Retangular**

- 1,9 a 2,1V 7,05x4,8x2,8mm
- 120° 200mCd • Emb: 50 peças
- 030362** - AZ

Leds Bicolores e Sunled



**Led Bicolor / Tricolor**

- Embalagem: 50 pçs
- 031704** Tricolor VD/VM/AZ - 2 Pernas - 3mm
- 031705** Tricolor VD/VM/AZ - 4 Pernas - 5mm

**Led Redondo 3mm Sunled**

- Embalagem: 1000 pçs
- 031685** 1,9 a 2,1V 35° 200mCd AM Difuso
- 031687** 1,9 a 2,1V 35° 200mCd VD Difuso
- 031691** 1,9 a 2,1V 25° 2500mCd VM Transparente
- 031692** 3,2 a 3,4V 35° 5000mCd AZ Transparente

**Led Redondo 5mm Sunled**

- Embalagem: 1000 pçs
- 031694** 1,9 a 2,1V 45° 2500mCd VM Transparente
- 031696** 3,2 a 3,4V 45° 5000mCd AZ Transparente

Suporte para Leds e Adaptadores



**Suporte para Leds Implastec**

- Com rosca
- 032030** 5mm - Preto



**Adaptador Emenda Fita de Led**

- Adaptador de Plástico tipo Emenda para fita de led 127 VAC
- 033890**



**Cabo Adaptador de fita de Led**

- Cabo Adaptador
- 10A
- 033581**



**Fitas de Leds**

- Rolo com 5m • 60 leds por metro
- 032645** AZ

Lâmpadas, Lanternas e Outros



**Controle Remoto**

- Para fita de led RGB
- 20 funções 144W/12V 288W 24V
- 033531**



**Lâmpada de Led Giratória**

- Lâmpada de led giratória com leds coloridos • Bivolt (110-240v)
- 034879**



**Lâmpadas de Led**

- 240° • Corpo alumínio com dissipador de calor • Bivolt (110-240v)
- 034414** 7W - 560 Lumens 3000K - BR Quente



**Lâmpada decorativa**

- Mini Bulbo Bolinha LED 1W E27 127V (44x65mm)
- 036431** - Branco Quente
- 036433** - Branco Frio
- 036432** - Vermelho
- 036434** - Azul
- 036435** - Amarelo
- 036436** - Verde



**Lanterna de Cabeça 7 Leds**

- Lanterna de 7 Leds • (70x65x38mm)
- 3 pilhas AAA não inclusas
- 035368** Cor: Preto / Cinza



**Lanterna 48 Leds**

- Lanterna de 48 Leds com 3 funções.
- Luz branca para uso em camping / sinalização • Material: PS • Com gancho para pendurar • 03 pilhas AA não inclusas
- Emb: Caixa
- 033706**



**Lanterna Lampião**

- Super Led com zoom, controle de foco e Intensidade • 3 Pilhas AAA
- 034091** Cor: Preto
- 034092** Cor: Azul
- 034093** Cor: Verde
- 034094** Cor: Laranja

**Lanterna de Led Retrátil**

- 1 led 3 pilhas AAA
- Retrátil com foco ajustável (11,5x5,2x3,0cm) • Sem pilha

**034528****Lanterna Chaveiro**

- Led 5mm • 2 pilhas botões (Inclusas) • (4,2x2,4x0,9mm) • Emb: Blister

**030154** Azul**030059** Preto**Mini Lanterna de LED**

- Led • 2 pilhas botões (Inclusas) • (2,8x1,8x5,3mm) • Emb: Caixa

**030156** Preto**030157** Azul**Lanterna para Notebook**

- Lanterna c/ haste flexível para notebook • 13 leds USB • Emb: Blister

**034786****Lanterna de Led Tripla**

- 26 leds (BR/VM) 3 pilhas AA • Corpo metálico • Função pisca-pisca ideal p/ ter no carro • (22,8x2,9cm)

**034529****Lanterna Recarregável**

- Recarregável bivolt 5 leds 16,5x5cm • Bateria inclusa • Tomada padrão INMETRO • Emb: Blister

**033026****Lanterna Abajur 18 LEDS**

- Recarregável (Bivolt) plug AC • Brilho ajustável 3,9 e 18 leds • Bateria inclusa • Embalagem: Blister

**031435** Tipo: Porco**031437** Tipo: Coelho

## FERRAMENTAS

## Equipamentos de Testes • Testadores de tensão, Antiestáticas e Outros

**Teste de Tensão Digital**

- Detector de tensão CA de 90 a 1000 V
- Indicação por led e audível
- 2 Pilhas • (20x148x25mm)

**032507** Emb. Blister**Detetor de Tensão**

- Detetor de tensão indutivo 50 a 1000 VAC • Indicação sonora / visual
- 2 Pilhas

**030061** Emb. Blister**Teste de Tensão**

- Detetor de tensão
- 110/220V

**002103** Emb. Blister**Pulseira Antiestática**

- Pulseira antiestática com velcro e garras jacaré

**000766****Tornozeleira Antiestática**

- Tornozeleira antiestática com velcro

**030809****Termômetro Digital Triplo - Hikari**

- Display Digital Triplo • (HKT220)
- Com relógio integrado • Resolução 0,1°C / 0,1°F • Precisão: ± 2°C
- Medidas: 85x65x20mm • Peso: 75g

**033465****Multímetro Analógico**

- Tensão DC/AC 0 a 10/50/250/1000V
- Corrente DC 0,5 / 50 / 500mA
- Ohms x 10/x100/x1k • Decibéis: 20 / 62dB • (60x90x30mm) • Blister

**030831****Multímetro YX360 TRN-A**

- Analógico Tensão DCV 100m / 500m / 2.5/10/50/250/1000V • Tensão ACV 10 / 50/250V/1000V • DCA: 50µ / 2.5m / 25m /250mA • Ohms x1/x10

• (150x100x36mm) • Blister  
**031655****Multímetro YX360 TRD**

- Analógico Tensão DC 0.1 / 0.25 / 2.5 / 10 / 50 / 250 / 1000V • AC 10 / 50 / 250 / 750V • DC: 50µ / 2.5m / 25m / 0.25A • Capac: 10uF Ohm x1 /x10 /x1k/x100K dB
- -10dB-+22dB • 2 baterias AA
- (160x125x42mm) • Blister

**032506****Multímetro Digital DT9203**

- Digital Dt9203a.dcv:200mv-1000v.acv:2v-750v.dca:2ma-20a.cap:2nf-20uf.ohm:-200-20m.fonte de Alimentação: 9v.dimen-sões: 191x89x35mm

**032504****Multímetro Digital**

- Digital DC 10A DCV 200m-1000V ACV 2-700V ACA 20m-10A DCA 2m-10A Ohms 200-200M • Capac: 2nF-20µF FREQ 2K/20KHz • Bat. 9V • (90x189x31,5mm) • Blister

**031652**



**Multímetro Digital**

• Digital-Tensão DC/AC 1000/750V  
Corrente DC 10A/200mA-2000-  
kOhms-Teste Diodos-HFE-Cat II  
300V-Display 1999/3 1/2 • Bateria  
9V • (70x126x26mm) • Blister  
**001849**



**Multímetro Digital**

• Digital-Tensão DC/AC 1000/750-  
CorrenteDC 10A/200mA-2000kOhms-  
-Teste Diodos-HFE-Cat II 300V-Display  
1999/3 1/2 • Bateria 9V  
• (70x126x26mm) • Caixa  
**001850**



**Multímetro Digital 3 1/2 Dígitos**

• Digital-Tensão DC/AC 500V • DC: 10A  
/ 200mA-2000kOhms Teste Diodos  
HFE-Data Hold-Cat II 300V • Display  
1999/3 1/2 • Bateria 9V  
• ( 73x130x40mm) • Blister  
**030832**



**Multímetro Digital 3 1/2 Dígitos**

• Digital Tensão DC200mV • 600V  
AC200V • 600V Corrente DC200uA  
• 10A • Teste de Diodos • Buzzer  
Continuidade • Teste Transistor  
• 1 Bateria 9V 6F22 • (138x69x31mm)  
• Caixa • PT  
**031795**



**Mult. Digital MD1500 ICEL**

• 3 1/2 dígitos • Tensão contínua: 1000  
vdc • Tensão alternada: 700vac  
• Corr. cont.: 10a • Resis: 200 Ohms  
• Capac: 200uf • Display (lcd), 3 1/2  
dígitos • Transistores: hfe 0~1000  
• Auto Power Off • Contin. e diodos  
• Teste de contr. remoto: infravermelho  
• Teste de linha viva • 1 bateria de 9V  
• (92x192x39mm) • Caixa  
**031104**



**Mult. c/ Capacímetro ICEL**

• Escalas: 200pF/2nF/20nF/200nF/2uF/  
20uF/200uF/2.000uF/20.000uF • Display  
LCD: 3 1/2 DÍG. • Data Hold • Auto Power Off  
• Alim. : 1x 9V Bat • Dim.: 186x86x41mm  
• Peso: 270g • Blister  
**036325**



**Mult. 3 1/2 Dig. MD6111 ICEL**

•Tensão DC/AC: 1000V / 750V  
• Corrente DC/AC: 20A • Res: 200M Ω  
• Capac: 200µF • Freq: 200K HZ • Teste  
de Diodos e Cont. • Temp: 40° 1000° C  
• Auto Power OFF Ident. de fase  
• 1 bateria de 9V IEC 1010 CAT-II  
• Memória (Data Hold) • Display 1999 3  
1/2 • Blister  
**031107**



**MULTÍMETRO AUTO SCAN P/SMD**

• Auto scan variação automática inteligente  
SMD RC Resistencia capacitancia testador  
medidor diode verificação 170x31x17mm  
**036060**



**Alicate Digital com Temperatura**

• Alicates Digital • Tensão DC/AC  
1/1000/1/750V • Corrente 0,1 até  
1000A 200/20k/2M Ohms • Data Hold  
• Bateria 9V-Cat II 1000V/Cat III 600V  
• Display 1999/3 1/2 • Temperatura  
sonda Tipo K • (95x235x42mm)  
**002304**



**Alicate Digital**

• Alicates Digital • Tensão DC/AC  
1/1000/1/750V • Corr: 0,1 até 1000A  
200/20k/2M Ohms • Data Hold  
• Bateria 9V • Cat II 1000V/Cat III 600V  
• Display 1999/3 1/2 • (95x235x42mm)  
**001851**



**Alicate Digital AD9900 ICEL**

• Display: 2000 Cont. • Corrente AC: 1000A  
• Tensão AC/DC: 750/1000V • Continuidade  
• Resistência: 200/20kOhms • Data Hold  
• Abertura da garra: 55mm • Alimentação: 1 x  
bat. 9 V 6F22 IEC1010 – CAT.II 1000V , CAT  
III 600V • Dim e Peso: 230x68x37mm, 240g  
**036326**



**Alicate Digital AD 7910 ICEL**

• Temperatura: -50 ~1000°C • Teste de Diodo  
• Continuidade • Detecção de Voltagem  
• Abertura da Garra: 52mm (2) • Alimentação:  
Bat. 9v  
• Tipo 6f22  
**035328**



**Alicate Digital Teste Diodo 9901A Icel**

• Tensão DC: 1.000V • Tensão AC: 750V  
• Corrente AC: 20 / 200 / 1.000A  
• Resistência: 2000k ohm • Resistência de isolamento:  
(com unidade opcional) • Teste de continuidade  
• Teste de diodo • Peak Hold  
• Abertura da garra: 55mm • Display: 1999  
**031099**



**Ponta de Prova ICEL**

• Ponta de osciloscópio  
**031117** 20Mhz - PP20  
**031118** 60Mhz - PP60  
**031119** 100Mhz - PP100



**Pontas de Prova ICEL**

• Para multímetros • Compr. 1m  
• CAT IV 1000V • 20A  
• Tamanho da ponta: 150mm  
**031120** P-6000 Ponta: 140mm



**Ponta de Prova Hikari**

• Comprimento de Cabo: 920mm,Segurança:  
CAT III 1000V,Revestimento do Cabo: PVC de  
Média Flexibilidade, Isolação: 1000V AC/DC  
**036283** HK-3  
**036284** HK-7



**Pontas de Prova**  
 • Para multímetros • Pinça 10cm  
 • Compr. 1m  
**035247**



**Pontas de Prova**  
 • Para multímetros • Pinça 13cm  
**035246** 1,00m  
**002654** 1,10m

**Fusível para instrumento de medição e multímetros**  
 • 1000V  
**036212** 11A - C-10X38KF  
**036281** 44A - C-10X35KF



**Terrômetro TR4120 ICEL**  
 • Analógico • Escalas: 10/100/1.000Ω  
 • Exatidão: 3% do F.E. • Tensão de terra: 30V AC (50Ω/V) • Galvanômetro: Tipo "pivot manca" • 8 pilhas de 1,5V AA  
 • Maleta para transporte  
**033002**



**Termômetro Infravermelho TD930 ICEL**  
 • Visor de Cristal Líquido (Lcd) • funções: Temperatura em °C ou °F • Registro de máximo e mínimo, e desligamento automático • Indicação de pilha fraca: O visor exibirá o símbolo de uma pilha • Seleção de escalas: automática (-35 °C a +230 °C / -31 °F a +446 °F) • Temperatura de Armazenagem: de -10°C a +60°C  
 • Umidade relativa de operação: de 10 a 90% sem condensação • alimentação: 1 x Cr2032  
 • Duração da pilha: 40 Horas de uso contínuo  
 • Desligamento automático: Após 15 segundos  
 • Taxa de amostragem: 1 segundo  
 • Emissividade: 0,95  
**035336**



**Termômetro Infravermelho HT-455**  
 • Display LCD duplo com iluminação  
 • congelamento de leitura • função máximo e mínimo para exibição dos maiores e menores valores • desligamento automático  
 • Dimensões: 160X97X43mm.  
**036282**



**Frequencímetro FC2400 ICEL**  
 • Display Led: 8 Díg. • Freqü: 50M e 2.400MHz  
 • Resol: 0,01 a 1kHz • Sensib: 30m Vrms  
 • Período: De 20n a 2S • Base de Tempo: TCXO  
 • WARM-UP: 10 min. • Conec. tipo BNC  
 • Exatidão da Freq: ± (2PPM + 1D)  
 • Imped. de Entr: 50/1MΩ • Atenuação: X1 e X20  
 • 127/220V • (270x215x100mm) • Peso: 1,6Kg  
**033003**



**Testador de Cabos HDMI e Mini HDMI**  
 • Com 2 Plugs verifica a continuidade do cabo, aberto, curto, invertido ou cruzado • Embalagem: Blister  
**034005**



**Testador de Cabos de Rede**  
 • Lan RJ45 • RJ11  
 • Embalagem: Caixa  
**030961**



**Testador de Cabos de Rede**  
 • Lan RJ45 • RJ11 • BNC • USB  
 • Embalagem: Caixa  
**032631**

**Testador de Cabos**

- Localizador de cabos
- Kit ponteira indutiva e teste zumbidor que analisa a continuidade de fios e cabos
- Rastreia fios e cabos energizados
- Identifica o estado da linha telefônica (livre, tocando e ocupada)

**033522**

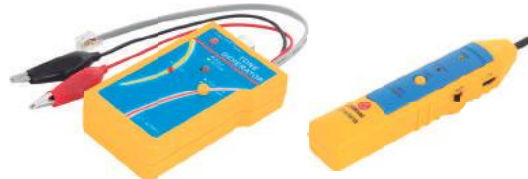

Manuais • Canivetes e Kits de chaves



**Canivete de Chaves 16 funções**  
 • Chave soquete 8/9/10mm  
 • Chave de fenda e Phillips  
 • Extensão para soquete  
 • Chave inglesa 8/10/15mm  
 • Chave allen 2/2, 5/3/4/5/6 mm  
 • Chave de parafuso de raio  
 • Chaves em aço e superfície em plástico  
 • (37x27x14cm)  
**100100**



**Canivete de Chaves 14 funções**  
 • Chave Allen: 2/2, 5/3/4/5/6/8 mm  
 • Chave de Fenda  
 • Chave phillips  
 • Extrator de corrente  
 • Chaves em aço inoxidável e superfície em níquel galvanizado  
 • (37x27x14cm)  
**100101**



**Kit Mini Chaves**  
 • Kit com 31 modelos diferentes de chaves Torx, Phillips, Fenda e Allen  
**033498**



**Chave de Fenda de Precisão**  
 • Kit com 6 chaves de fenda de precisão multiuso  
**031329**





**Escova Anti Estática ICEL**  
 • Escova anti estática  
**035337** - 2 Cerdas  
**035338** - 4 Cerdas



**Magnetizador/Desmagnetizador**  
 • Magnetiza e desmagnetiza pontas de chaves de fenda e outras • Blister  
**033521**



**Alicate de Bico 160mm**  
 • Comprimento: 160mm  
 • Empunhadura reforçada bicolor  
 • Embalagem: Blister  
**030950**



**Alicate de Corte 160mm**  
 • Diagonal • Comprimento: 160mm  
 • Empunhadura reforçada bicolor  
 • Embalagem: Blister  
**030948**



**Alicate de Corte Nevatron**  
 • Corte rente (flush cut) de 5"  
 • Corte de fios de cobre até 1,3 mm máx (16AWG) • Opções para safety clip (clip de segurança), evita espirrar o lide nos olhos do operador  
 • Embalagem: Blister  
**032983**



**Alicate de Bico Nevatron**  
 • Alicates de 5" com bico largo de 3mm  
 • Comprimento: 20mm  
 • Embalagem: Blister  
**032982**



**Mini Alicate de Corte**  
 • Mini alicates de corte diagonal com mola tipo arame • Comprimento: 125mm (FR0011) • Embalagem: Blister  
**000762**



**Mini Alicate de Corte**  
 • Mini alicates de corte diagonal  
 • Comprimento: 110mm  
 • Galvanizado • Embalagem: Blister  
**033612**



**Decapador Automático de Fios**  
 • Decapador 18AWG/22AWG  
 • Permite ajustar o comprimento da decapagem • Embalagem: Blister  
**000773**



**Alicate de Corte / Decapador**  
 • Decapador / cortador 0,5/6mm  
 • Permite decapar 2 ou mais fios simultaneamente • Blister  
**000774**



**Decapador de Cabo Coaxial**  
 • Alicates decapador amarelo para Cabo Coaxial • blister  
**035403**



**Decapador de Cabo Coaxial**  
 • Decapador de cabos coaxiais RG58 / 59/62/6. Ajuste da lâmina p/ cada tipo de cabo.(FR0018) • Blister  
**000761**  
**036006** - v.e



**Decapador Universal**  
 • Decapador universal de fios de 3,5 a 9mm  
 • Blister  
**030955**



**Para Crimpar BNC HT336C**  
 • Alicates de crimpar BNC HT336C (HT301C) RG6/59/62 com catraca  
 • Embalagem: Blister  
**032002**



**Alicate p/ Crimpar RJ12/11 c/ Catraca**  
 • Alicates de crimpar 8P8C- 6P6C Modular (10P+8P+6P) com catraca HT568R • Embalagem: Blister  
**032636**



**Alicate de Crimpar RJ11/12**  
 • Alicates de crimpar para 6P6C/4C/2C (FR0021-FR0005 )  
 • Embalagem: Blister  
**000764**



**Alicate de Crimpar RJ45**  
 • Alicates de crimpar 8P8C (FR0007-FR0020)  
 • Embalagem: Blister  
**000763**



**Alicate de Compressão F**  
 • Alicates prova d'agua de compressão para conectores F e cabos RG59 e RG6(4c-5c) • Embalagem: Blister  
**031443**



**Alicates Multifunções**

- Prova d' água de compressão c/ Lâmina de corte p/ conect.s F/RCA/ BNC e cabos RG59 e RG6 (4c-5c)
  - Embalagem: Blister
- 031715**



**Alicate Multifunções**

- Alicate Prova d' água de compressão a conectores F e cabos RG59 e RG6(4c-5c) • Embalagem: Blister
- 031330**



**Ferramenta de Inserção**

- Ferramenta de Inserção tipo Krone HT
  - Embalagem: Blister
- 030951**



**Ferramenta de Impacto**

- Ferramenta de impacto puch down para terminal 110/88 • Emb: Blister
- 030952** C/ ajuste - AM - Comp: 18cm  
**030953** S/ ajuste - CZ - Comp: 14,5cm

Mala c/ Ferramentas e Gaveteiros



**Mala c/ Ferramentas 11 Pçs**

- Kit com 11 ferramentas para reparos eletrônicos contendo: • 2 alicates ( Bico longo 5" e diagonal 6")
  - Pinça ponta reta • Canivete • 2 limas
  - 3 chaves (de fenda e phillips de 3x75mm e de precisão) • Estojo de zíper
- 031323**



**Gaveteiro p/ Componentes**

- 20 divisórias e 10 gavetas cristal
  - (A280xL222xP243mm)
- 033017** - 5 bases - VM  
**033019** - 5 bases - AZ  
**033020** - 5 bases - CZ  
**034904** - 5 bases - PT



**Régua Divisória**

- Cristal
- 033364** Régua divisória GVT1

Lupas, suportes, pinças e Lampadas para Lupas



**Lupa de Mesa**

- Led • 3X e 10X
- 002796** 127V Azul  
**002797** 127V Gelo  
**002093** 220V Azul  
**002092** 220V Gelo



**Lupa Redonda**

- Lupa com grampo 5X e 8X
- 001441** 8X 127V  
**001442** 8X 220V  
**000985** 5X 220V



**Lupa Retângular**

- Lupa com grampo 5X
- 002815** 220V



**Suporte de Placa c/ Lupa ICEL**

- Suporte com lupa
  - Lente: 2,5X
- 035133**



**Mini Lupa de Mesa**

- Mini lupa de mesa com garra
  - Lente: 2,5X
- 001443**



**Lupa de Cabeça 2,2X**

- Para usar na cabeça com cinta regulável • Lente: 2,2X
- 031333**



**Lupa de Cabeça 4,8X**

- Com lente satélite para usar na cabeça com cinta regulável
  - Lente: 4,8X
- 031334**



**Lupa de Mão**

- 0,75mm
  - Embalagem: Caixa
- 002059**



**Pinça 125mm Lisa**

- 125mm em aço inox • Reta lisa
  - Embalagem: Blister
- 000770**



**Pinça 125mm Serrilhada**

- 125mm em Aço Inox
  - Reta serrilhada
- 000771** Emb: Blister



**Pinça 125mm Curva**  
 • 125mm em aço inox  
 • Curva serrilhada  
**000772** Emb: Blister



**Pinça de Precisão**  
 • 125mm em aço inox de precisão  
**002102** Emb: Blister



**Pinça Aranha**  
 • Tipo aranha  
**002094**

Solda e Pistola de cola quente



**Pistolas de Cola Quente Hikari**  
 • Embalagem: Blister • Bivolt  
**031740** 21K155 40W



**Pistola de Solda Hikari Fire**  
 • Embalagem: Blister  
**031764** 127V - 45W  
**033031** 220V - 40W

Protoboards



**Protoboard 690 Posições**  
 • Protoboard 690 posições  
 • Connfly  
**031928**



**Protoboard 760 Posições**  
 • Protoboard 760 posições  
 • Connfly  
**031929**



**Protoboard 1360 Posições**  
 • Protoboard 1360 posições  
 • Com terminais • Connfly  
**031930**



**Protoboard 1640 Posições**  
 • Protoboard 1640 posições  
 • Com terminais • Connfly  
**031932**

**Protoboard 2360 Posições**  
 • Protoboard 2360 Posições  
 • Com terminais • Connfly  
**032602**

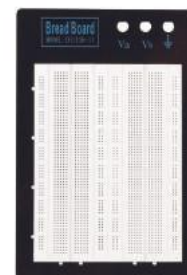

Elétrica e Mecânica Implastec • Limpeza e Proteção



**Isopropanol**  
 • Isopropanol não corrosivo  
**031484** Cont: 110ml  
**031485** Cont: 250ml  
**031486** Cont: 500ml  
**032035** Cont: 1 lt  
**032034** Cont: 5 lt



**Pasta Térmica**  
 • Bisnaga com pasta térmica  
 • Embalagem: Bisnaga  
**031479** Cont: 50gr  
**031478** Cont: 10gr



**Pasta Térmica**  
 • Pasta térmica • Embalagem: Pote  
**032032** Cont: 1000gr  
**035028** Cont: 500gr  
**035027** Cont: 100gr



**Pasta Térmica Alta Condutividade**  
 • Thermal Silver  
**032027** Seringa - Cont: 5gr  
**034461** Pote - Cont: 500gr



**Pasta Térmica**  
• Pasta térmica  
**032033** Cont: 15gr



**Fluxo de Solda**  
• Fluxo para solda para fluxagem de peças a base de cobre ou estanhadas. Produto inflamável.  
**033880** Cont: 500ml  
**033881** Cont: 250ml

**Pasta de cobre**  
• Deve ser aplicada em conexões de diversas composições, tais como: Condutores cobre-cobre, Cobre-Alumínio, latão- cobre e cobre aço  
**036129** Cont: 50g  
**036130** Cont: 100g  
**036131** Cont: 500g  
**036132** Cont: 1000g



**Graxa de Silicone**  
• Pote com graxa de silicone  
**031482** Cont: 10gr



**Pasta de Solda**  
• Soldatec  
• Embalagem: 50gr  
**031483**



**Limpa Telas**  
• Limpa Telas  
• 60ml  
**035030**  
**035090** S/F



**Cleaner Limpador de uso Geral**  
• O Cleaner é utilizado Industrialmente em eletroeletrônicos p/ limpeza de placas de circuito impresso (pci) e outras limpezas, tintas e vernizes e tinta para impressão  
**035511** Cont: 250ml  
**035512** Cont: 500ml  
**035513** Cont: 1l  
**035514** Cont: 5l



**Isopropanol - Aerosol**  
• Isopropanol 99,8% para limpeza em eletrônica: placas de circuito, mecanismos, eletrô-eletrônicos, gravadores, Leitores ópticos  
• Não corrosivo • Uso Profissional  
**034586** Cont: 227ml



**Limpa Contato**  
• Tetrafluoretano CR 2 ONU 3159  
• Não inflamável • Sem CFC  
**031480** Cont: 150ml / 120gr



**Contatec Limpa Contato**  
• Limpa contato Contatec butano CR2 1 ONU 1011  
**031481** Cont: 210ml / 130gr



**Ar Comprimido Implastec**  
• Ar Comprimido aerosol, não inflamável sem CFC  
**031487** Cont: 164ml



**Congelante Implastec**  
• Congelante aerossol • Congelador de circuitos • Auxilia na localização de falhas • Não inflamável s/ CFC  
**033347** Cont: 125ml / 150gr



**Verniz Incolor Implastec**  
• Para acabamento em circuito Impresso, protege e Isola • Aceita solda com secagem rápida  
**032028** Cont: 300ml



**CCL Aéro Spray**  
• Limpa contato de material elétrico  
**031221** Cont: 300ml



**Desengripante/Lubrificante Autobelle**  
• Desengripa mecanismos emperrados, lubrifica e protege contra ferrugem e corrosão  
**031220** Cont: 300ml



**Grafite Spray Autobelle**  
• Grafite lubrificante seco  
**031222** Cont: 250ml/100gr



**WD - 40 Aerosol**  
• Óleo desengripante, lubrificante e anticorrosivo  
**031618** Cont: 500ml  
**031502** Cont: 300ml  
**031617** Cont: 100ml



**Lubritec Aerosol Implastec**  
• Desengripante para uso geral, parafusos, cadeados, fechadura, carros, bicicletas, engrenagens e outros  
**034587** Cont: 420ml/300gr



**Contacmatic Aéro Spray**  
• Solvente para remoção de óleos, graxas, fluxos de solda, poeira e outros contaminantes  
• Não contém CFC  
**031217** Cont: 200ml  
**031218** Cont: 350ml



**Silicone Aéreo Spray Autobelle**

• Protege e dá brilho, combate a ferrugem e a oxidação

**031219** Cont: 300ml

**HelaClean**

• Fluido para limpeza de placas de circuito impresso e contatos elétricos em geral, tais como: réles, contadores, chaves e potenciômetros sem deixar resíduo na superfície aplicada, devido à sua alta evaporação • Indicado para a limpeza e remoção de óleos, graxas e gorduras • Não ataca borracha • Não contém CFC

**033477** Cont: 300ml



**Fospro**

• Restaura a condutividade elétrica, lubrifica, limpa e protege contra corrosões • Obs: não deve ser usado em P.C.I • Não contém CFC

**033476** Cont: 300ml

**TekBond**



**Espanja mágica**  
• Leve 3 e pague 2

**036235**



**Adespec fixa tudo**  
• 20g

**036236**



**Adesivo araldite Hobby**

• SGA

**036238** - Peso 6gr - Seringa blister

**036237** - Peso 16g - Blister

**036239** - Peso 25g - Seringa blister



**Cola Vinil**  
• 17g • Blister

**036240**



**Cola Tudo Multiuso**

• 20g • Blister

**036241**



**Cola de contato**

• 30g • Blister

**036242**



**Adesivo Anaeróbico trava parafuso**

•BMT 115 Azul • 10g • Blister

**036243**



**Tekspray Desengripante**

• 180g/300ml

**036244**



**Tekspray Silicone Spray**

• 300ml

**036245**



**Tekspray Limpa Contato**

• 300ml

**036246**



**Tekspray Grafite Seco**

• 200ML • 100g

**036247**



**Tekspray Vaselina**

• 210g/300ml

**036248**



**Tekspray graxa branca**

• 200g/300ml

**036249**



**Adesivo inst**

• 20g • Blister

**036250** - 725

**036251** - 793



**Super cola**

• Blister

**036252** - 2g



**Super cola**

• Blister

**036253** - 3g Gel



**Super cola**

• Blister

**036254** - 5g



**Cola Universal**  
• 17g • Blister  
**036255**

**Cola branca PVA extra**  
• 500ml  
**036256**

**Adesivo de silicone**  
• Acetico • 50g • Blister  
**036257** - Transparente  
**036258** - Branco

**Espuma expansiva de PU**  
• 320g/500ml  
**036259**



**Fita Crepe**  
• Blister  
**036260** - 18x50mm  
**036261** - 24x50mm  
**036262** - 48x50mm

**Fita Silver**  
• 48x5mm  
**036270** - Preto

**Fita dupla face**  
• Blister • Espuma  
**036266** - 12x1,5mm  
**036267** - 19x1,5mm  
**036268** - 24x1,5mm

**Fita dupla face**  
• Blister • Acrilica  
**036263** - 12x2mm  
**036264** - 19x2mm  
**036265** - 25x2mm

Soldagem • Resistência, Pontas p/ ferros de Solda, Ferros de Solda e outros



**Resistência p/ Ferros de Solda ICEL**  
**031066** 30W/127V  
**031073** 40W/220V  
**031074** 60W/127V

**Resistência p/ Estação de Solda Toyo**  
**031092** TS920 e TS930 biv.

**Pontas p/ Ferros de Solda Hikari**  
• Hikari Plus  
• Embalagem: 4pçs  
**031730** 30W Fenda: 2mm  
**031731** 30W Conica: 1mm  
**031732** 40W Fenda: 2,7mm  
**031733** 40W Conica: 1,2mm  
**031734** 60W Fenda: 2,7mm  
**031735** 60W Conica: 1,5mm



**Pontas p/ Estação de Solda Toyo**  
Pontas cônicas • Emb: 2 pçs  
**034767** p/ Est. TS-920 / 930  
**034766** p/ Est. TS905

**Pontas p/ Estação de Solda Hikari**  
• Pontas Cônicas Hikari  
**034936** 1mm MTB - 933/936-B/938  
**034937** 0,4mm MTLB - 933/936-B/938  
**034938** 0,4mm MTI - 933/936-B/938

**Ponta p/ Estação de Solda Icel**  
• Pontas cônicas • Emb: 2 pçs  
**035153** 25/35 Watts  
**035154** 45 Watts

**Malha Dessoldadora**  
• Malha dessoldadora  
• 2,5mm  
**035429** Comp: 1,5m



**Fita Dessoldadora**  
• Fita dessoldadora no Clean  
• Dim: 2,5mm x 1,5mm  
**035331**

**Ferro de Solda Icel**  
• Resist. níquel cromo com ponta rosqueável  
• 210mm / 110gr  
**035123** - 25W - T. Máx. 410° - 127V  
**035125** - 35W - T. Máx. 430° - 127V  
**035127** - 45W - T. Máx. 460° - 127V  
**035126** - 35W - T. Máx. 430° - 220V  
**035128** - 45W - T. Máx. 460° - 220V

**Ferro de Solda Hikari Plus SC**  
• Embalagem: Em Blister  
**031724** - (21K001U) PLUS SC30 - 25W P 110V  
**031725** - (21K002U) PLUS SC30 - 25W P 220V  
**031726** - (21K003U) PLUS SC40 - 34W P 110V  
**031727** - (21K004U) PLUS SC40 - 34W P 220V  
**031728** - (21K005U) PLUS SC60 - 50W P 110V  
**031729** - (21K006U) PLUS SC60 - 50W P 220V

**Ferro de Solda Hikari Plus SC**  
• Embalagem: Em Blister  
**035159** - (21K001U) PLUS SC30 - 25W P 110V



**Ferro de Solda Hikari Power**  
 • Emb: Em Blister  
**033032** - (SC85 - Voltagem: 220V)  
**032713** - (SC90 - Voltagem: 127V)



**Cadinho**  
 • Controle eletrônico de temperatura  
 • Faixa de temperatura: 200°C ~ 480°C  
 • Estab. de temperatura: ±2°C  
**035155** SE 150 - 150W Dim. Cav. 50mm (150x95x63mm)



**Estação de Solda Hikari HK936-A**  
 • Estação de solda analógica Hikari 936A 60W • Calibrável 200~480°  
 • Resistência de cerâmica  
**035381** - Voltagem: 127V  
**035711** - Voltagem: 220V



**Estação de Solda ICEL**  
 • Estação de solda analógica com temp. ajustável 160° a 420°C  
 • Painel de Led • Ponta aterrada e Intercambiável sem parafuso • Bi-volt (manual) • Resist. cerâmica 48w/24vac  
**035339** - (170x120x100mm)



**Sugador de Solda Hikari**  
 • Corpo de Alumínio ZD-192 ESD  
 • Bico de Teflon Intercambiável  
 • Embalagem: Em Blister  
**031738**



**Sugador de Solda Icel**  
 • Corpo de alumínio • Bico de teflon Intercambiável  
 • Embalagem: Blister  
**035131**



**Sugador de Solda**  
 • Corpo de alumínio  
 • Bico de teflon intercambiável  
 • Embalagem: Blister  
**031310**



**Sugador de Solda AFR Nevatron**  
 • Corpo de alumínio • Bico de teflon Intercambiável • (20x200mm)  
 • Embalagem: Blister  
**032985**- 20x200mm - PT - SUG 201  
**032986**- 20x185mm - AZ - SUG 301



**Sugador de Solda AFR ZUMP Nevatron**  
 • Corpo de alumínio • Bico de teflon intercambiável  
 • (20x200mm) • Embalagem: Blister  
**032988**



**Sugador de Solda AFR Master Nevatron**  
 • Corpo de Alumínio • Bico de teflon intercambiável  
 • (24x210mm) • Embalagem: Blister  
**032987**



**Suporte p/ Rolo de Solda Hikari**  
 • Suporte para Rolo de Solda CT-321  
**031739**



**Esponja p/ Estação de Solda ICEL**  
**031750** TS-905 Toyo  
**031751** TS-920 e 930 Toyo



**Esponja Vegetal 802 Hexacon Nevatron**  
 • (65x45x10mm)  
**032994**



**Esponja Metálica com Suporte**  
 • Esponja metálica não Abrasiva com suporte limpador de ponta  
**035332** HSE-20  
**035333** HSE-599S



**Exaustor de fumaça**  
 • Filtro de Carbono Ativado, Inclinação Ajustável/ Esd, Baixo Nível de Ruído, vazão: 1,08 M³/mim, Consumo de Energia: 23w, Dimensões: 220x270x170mm  
**036041** 127V  
**036042** 220V



**Sup. Ferro de Solda HK10 Hikari**  
 • Com mola cromada e Esponja • Blister  
**031736**



**Sup. Ferro de Solda DS001**  
 • Com mola cromada e esponja  
**031309**



**Sup. p/ Ferro de Solda Icel**  
 • Com mola cromada e esponja  
**035132**



**Protetor para Bico de Sugador de Solda AFR Nevatron**  
• Amarelo  
**032993**



**Bico de Teflon Intercambiável AFR Nevatron**  
• Branco  
**032992**



**Solda 1mm**  
• Solda 1mm-63 Snx37 Pb  
• Embalagem: 25gr/4m  
**031016**



**Solda**  
• Solda - 63 Snx37 Pb  
**031014** 0,5mm - Peso 500gr  
**031015** 0,8mm - Peso 500gr



**Solda 1mm**  
• Solda 1mm-60 Snx40 Pb  
**031017** - Peso 125gr



**Solda**  
• Solda 60Snx Pb40 LBX10  
• Peso: 500gr  
**031018** 1mm-60 Snx40  
**031019** 1,5mm-60 Snx40



**Pasta para Soldar**  
• Pasta para Soldar  
**031260** - Peso 110gr



**Solda pasta SMD**  
• 30gr • s/ prata • Seringa  
• 63% SN x 37% PB  
**036125**



**Solda 0,8mm**  
• 63x37x4,60 MT  
**036124**



**Solda em cartela 1mm**  
• 60x40x1,0 MT  
**036128**



**Solda 0,5MM**  
• 63x37x6,0 MT  
**036123**



**Solda 1mm**  
• 60x40x3,75 MT  
**036122**



**Fluxo pastoso**  
• 30gr • DS390 • Seringa  
**036127**



**Pasta para Soldar SMD**  
• 30gr • c/ prata • Seringa  
• 62% SN x 2,0% AG x 36% PB  
**036126**

CARREGADOR SOLAR

Energia Solar • Painel Carregador Solar



**Painel Carregador Solar 20W**  
• Próprio para instalações em áreas externas, capta a energia do sol para alimentação de vários dispositivos  
• Incluso: 1 painel, 2 lâmpadas de Led 3W e 1 bateria recarregável (lâmpadas acesas por até 8 horas com a bateria carregada)  
**034926**



**Painel Carregador Solar 10W**  
• Próprio para instalações em áreas externas, capta a energia do sol para alimentação de vários dispositivos  
• Incluso: 1 painel, 2 lâmpadas de Led 3W e 1 bateria recarregável (lâmpadas acesas por até 20 horas com a bateria carregada)  
**034925**



**Conector MC4 Solar Painel**  
Macho/Femea  
**036398**



**Lanterna 5 Leds**

• Leds brancos • 3 funções: (contínuo / piscante/perseguição) • Resistente à água • Baterias: 4xAAA

**100000** Bateria não inclusa - Cinza

**Lanterna 1 Led**

• Led 1 Watts focalizador • 2 funções: (contínuo/piscante) • Resistente à água • Bat 3xAAA

**100001** Bateria não inclusa - Branco

**Lanterna 9 Leds**

• Leds brancos • 1 função: (contínuo) • Resistente à água • Baterias: 3xAAA

**100003** Bateria não inclusa - Preto

**Lanterna 9 Leds**

• Leds brancos • 1 função: (contínuo) • Resistente à água • Baterias: 3xAAA

**100043** Bateria não inclusa - Prata

**Faról para Capacete**

• 4 Leds vermelhos • 3 funções: (contínuo / piscante / perseguição) • Resist à água • Baterias: 1XCR2032

**100005** Bateria não inclusa

**Faról 3 Leds**

• 3 Leds brancos • 1 led 0,5 Watts • 2 Funções: (contínuo/piscante) • Resistente à água • Baterias: 2XAAA

**100006** Bateria não inclusa

**Faról 3 Leds**

• 3 Leds vermelhos • 1 led 0,5 Watts • 2 Funções: (contínuo/piscante) • Resistente à água • Baterias: 2XAAA

**100007** Bateria não inclusa

**Faról 3 Leds**

• 3 Leds brancos super • 2 funções: (contínuo/piscante) • Resistente à água • Baterias: 2XAAA

**100008** Bateria não inclusa

**Faról 3 Leds**

• Leds vermelhos super • 2 funções: (contínuo/piscante) • Resistente à água • Baterias: 2XAAA

**100009** Bateria não inclusa

**Kit Faróis Caveirinha**

• 1 Fárol com 2 leds brancos • 1 fárol com 2 Leds vermelhos • 2 Funções (contínuo e piscante) • Resistente à água • Baterias inclusas: 2xCR2032

**100092** Kit c/ 2 Caveirinhas - Vermelho

**100093** Kit c/ 2 Caveirinhas - Branco

**Kit Faróis com presa**

• 1 Fárol com 2 leds brancos • 1 fárol com 2 leds vermelhos • 2 funções (contínuo e piscante) • Resistente à água • Baterias inclusas: 2xCR2032

**100095** Kit c/ 2 faról - Azul

**100094** Kit c/ 2 faról - Preto

**Lanterna RONTEK Solar**

• Lanterna para bicicleta • Energia Solar • 2 funções: Constante flash - off

• Embalagem: Blister

**100139**

**Faról Ciclofaixa Virtual Laser**

• 5 Leds Vermelhos • 2 Feixes de laser • 260° de visibilidades • 3 funções com 9 modos • Resist. à água • Acomp. sup. de fácil fixação • Certificado CE Rohs de aprovação • Bat: 2xAAA inclusas

**100099**

**Lanterna 1 Led**

• Led 1 Watts • Metal • 2 funções: (contínuo / piscante) • Resistente à água • Baterias: 3xAAA não inclusas

**100002** - Preto

**Mochila c/ Carregador Solar**

• Com kit adaptadores

**100021**

**Suporte RONTEK p/ Celulares**

• Tamanho universal para guidões • Suporte ajustável interno entre 35-83mm sendo compatível com todos os tamanhos de telefone

**100036**



**Hub USB 2.0 4 Portas**  
• Hub USB 2.0 com 4 portas USB  
**033514**



**Hub USB 2.0 4 Portas Slim**  
• Hub com 4 portas USB  
**030622**



**Hub USB 2.0 3 Portas**  
• Hub com 3 Portas USB 2.0 mais 1 RJ45 aceita Mac Os X, não requer driver para Apple, tablet, computador, circuito banda larga com transmissão Interf. USB • Compatível com desktop e laptop • 10/100 Mbps • (96x12x11mm)  
**034090**



**Cooler p/ Notebook USB**  
• Plástico ABS • RFJG30A  
• Cooler 120x120mm com led  
• (345x320x36mm) • Emb. Caixa  
**033894**



**Cooler p/ Notebook USB**  
• Plástico ABS • RFJG30A  
• Cooler 120x120mm com led  
• (345x320x36mm) • Emb. Caixa  
**033316**



**Repetidor de Sinal Wi-Fi**  
• Suporta diversos sinais de wi-fi antenas de 2dbi. Taxas de transmissão de até 300mbps • 1 porta 10/100mbps / auto negociação de Ethernet Lan  
• Possui Firewall  
**034318**



**Ventiladores Bivolt AC**  
• Alumínio • 127/220V  
0,21/0,14A • (120x120x38mm)  
**031010** - Rolamento - PT  
**031011** - Mancal - Metal PT  
**035855** - Mancal - Metal PT - v.e



**Ventiladores DC 12V CC**  
• 12V CC 0,28A • 3000RPM  
• (80x80x25mm)  
**002258** Com led azul



**Ventiladores DC 12V CC**  
• 12V CC • PT  
**031009** 40x40x10mm-0,11A-6000rpm  
**002265** 40x40x20mm-0,13A-6000rpm  
**002263** 60x60x25mm-0,14A-4000rpm  
**002257** 80x80x25mm-0,17A-3000rpm  
**002264** 120x120x25mm-0,4A-2200rpm



**Micro Ventilador USB**  
• Com Bateria Interna de Lítio Ion 18650 1200 Mah • Cor Preta  
**036602**



**Grade p/ Micro Ventiladores**  
• Grade metálica de proteção  
**035423** (80x80mm)  
**035422** (120x120mm)  
**035424** (150x150mm)



**Ventilador USB**  
• Mini Ventilador USB  
• Embalagem: Caixa  
**033443** - Cinza • (150x96x146mm)  
**033444** - Preto • (200x100x200mm)



**Leitor de Cartão de Memória**  
• Leitor de cartão de memória SD  
• Embalagem: Blister  
**030960**



**Leitor de Cartão de Memória X4**  
• Leitor de cartão de memória 4 em 1  
• Tipos: M2, MS, DUO, MICRO SD e SD • Embalagem: Blister  
**031234**



**Leitor de Cartão de Memória**  
• Leitor de cartão R303 USB3.0  
• Tipos: Mobile-SD, SDHC, MMC, SDXC, MMC40, RS, MMC, MMC, PLUS, MMC, MICRO e MINI SD  
• (8,5x43x14mm)  
**033523**



**Mesa p/ Notebook**  
• Fácil montagem  
• (380x250x45mm)  
**031659**

**Linha completa de baterias de Lítio Íon e Lítio Polímero**

**STA**  
Sistemas e Tecnologia Aplicada  
Desde 1988

**RONTEK**  
34545 3.7V 1000mAh  
CUIDADO: Não curto-circuito, não incinerar, não perfurar, não aquecer, não aquecer, não aquecer.  
MADE IN CHINA  
REGARREGAVEL

**RONTEK**  
34545 3.7V 1000mAh

LP423040  
450mAh 3.7V PCL

**SAIYO SAMSUNG Panasonic**

**Faça já seu pedido!**



Inscreva-se em nosso canal  
[youtube.com/rontektvoficial](https://youtube.com/rontektvoficial)

### Informações sobre abreviações no Catálogo Rontek

Cores:

Amarelo	AM	Cinza	CZ
Azul	AZ	Vermelho	VM
Branco	BR	Dourado	DR
Laranja	LR	Preto	PT
Verde	VD	Prata	PR

Medidas e unidades:

Milímetro	MM
Centímetro	CM
Metro	M
Litro	L
Kilograma	KG

Sigla V.E "Versão Econômica"

Essa sigla acrescida a um código do produto específico tem significado que o produto é similar. Que se assemelha com outro, ou outros, de um modo geral. No todo algo parecido, com as mesmas características, porém outro produto e em sua maioria das vezes outros fabricantes.

**Orientações sobre a compra:** Consultar disponibilidade do estoque e/ou prazo de chegada dos produtos; Podemos alterar os valores dos produtos sem aviso prévio, assim como corrigir possíveis erros de informação que estão no catálogo. As fotos são ilustrativas, podendo haver diferenças em relação ao produto. As medidas indicadas para pilhas e baterias tem uma tolerância de mais ou menos 1,5mm; consulte nossos vendedores sobre condições de pagamento. Faturamento mínimo de R\$ 300,00; Despachamos para todo o Brasil. Por correio com frete em nota fiscal cobrado no boleto bancário e em caso de pagamento a vista cobrado anteriormente no fechamento do pedido. Por transportadora a escolha do cliente e com frete por conta e risco do mesmo.

**Garantia:** O prazo máximo para troca é de 15 dias úteis após a chegada na S.T.A. Devolução por defeito de fabricação será aceita impreterivelmente até 180 dias após a data de emissão da nossa Nota Fiscal, desde que respeitadas as condições do nosso termo de garantia. Frete por conta do cliente.

**Orientações sobre Impostos:** Verifique no catálogo a alíquota de IPI para cada produto. Verificar a incidência de substituição tributária. ICMS incluso no preço.

**Montagem de Packs de Bateria:** Para a montagem é obrigatório informar as dimensões máximas de montagem, tensão, corrente e a aplicação. Assim como o desenho de montagem. Caso tenha fios, necessário informar a bitola e o comprimento do mesmo. Informar modelo de conector.

**Orientações para devolução:** Só aceitaremos devoluções com Nota Fiscal; O valor do produto devolvido, deve ser o mesmo da NF de Origem (NF emitida pela STA) NF de devolução deve conter nos dados adicionais o numero da NF de origem emitida no prazo máximo de 180 dias; Para NFs de devolução em desacordo com as exigências legais, entraremos em contato para emissão de uma nova NF ou carta de correção, porém caso o cliente não concorde ou não retorne com a solicitação em 1 dia útil recusaremos a NF e devolveremos a mesma com frete a pagar. Devoluções só serão aceitas com prévia autorização dos vendedores. Materiais sem conserto e com garantia, serão substituídos por novos produtos, entregues no próximo pedido do cliente. Caso não tenha estoque disponível, o crédito será efetuado em desconto no boleto bancário.

**Optante Simples Nacional:** Poderá optar por destacar o valor do IPI e da Substituição tributária no campo "OUTRAS DESPESAS ACESSÓRIAS", porém para isto, deverá informar a base e o valor do IPI e da Substituição tributária nos "DADOS ADICIONAIS DA NOTA FISCAL." Informações Baseadas na Resolução CGSN 094/2011. Artigo 57 §§ 5º e 7º.

### Segue abaixo tabela de CFOPs para cada modelo de Nota Fiscal de devolução

#### SÃO PAULO

CFOP: 5.202 - DEVOLUÇÃO DE COMPRA PARA COMERCIALIZAÇÃO
CFOP: 5.201 - DEVOLUÇÃO DE COMPRA PARA INDUSTRIALIZAÇÃO
CFOP: 5.556 - DEVOLUÇÃO DE COMPRA PARA USO E CONSUMO

CFOP: 5.411 - DEVOLUÇÃO DE COMPRA PARA COMERCIALIZAÇÃO COM MERCADORIA SUJEITA AO REGIME DE SUBSTITUIÇÃO TRIBUTÁRIA
CFOP: 5.410 - DEVOLUÇÃO DE COMPRA PARA INDUSTRIALIZAÇÃO COM MERCADORIA SUJEITA AO REGIME DE SUBSTITUIÇÃO TRIBUTÁRIA
CFOP: 5.413 - DEVOLUÇÃO DE COMPRA PARA USO E CONSUMO COM MERCADORIA SUJEITA AO REGIME DE SUBSTITUIÇÃO TRIBUTÁRIA

#### OUTROS ESTADOS

CFOP: 6.202 - DEVOLUÇÃO DE COMPRA PARA COMERCIALIZAÇÃO
CFOP: 6.201 - DEVOLUÇÃO DE COMPRA PARA INDUSTRIALIZAÇÃO
CFOP: 6.556 - DEVOLUÇÃO DE COMPRA PARA USO E CONSUMO

CFOP: 6.411 - DEVOLUÇÃO DE COMPRA PARA COMERCIALIZAÇÃO COM MERCADORIA SUJEITA AO REGIME DE SUBSTITUIÇÃO TRIBUTÁRIA
CFOP: 6.410 - DEVOLUÇÃO DE COMPRA PARA INDUSTRIALIZAÇÃO COM MERCADORIA SUJEITA AO REGIME DE SUBSTITUIÇÃO TRIBUTÁRIA
CFOP: 6.413 - DEVOLUÇÃO DE COMPRA PARA USO E CONSUMO COM MERCADORIA SUJEITA AO REGIME DE SUBSTITUIÇÃO TRIBUTÁRIA

# Vendas

## Horário de atendimento das 8h às 17:30h

karol.alves@sta-eletronica.com.br  
marcia.duarte@sta-eletronica.com.br  
gislene.luz@sta-eletronica.com.br  
alex.alves@sta-eletronica.com.br  
adriana.alves@sta-eletronica.com.br  
andressa.kely@sta-eletronica.com.br  
joyce.santos@sta-eletronica.com.br

Tel:(11) 4617-8531  
Tel:(11) 4617-2781  
Tel:(11) 4617-2792  
Tel:(11)4617-2798  
Tel:(11) 4617-2797  
Tel:(11) 4617-8533  
Tel:(11) 4617-8532

Whatsapp: (11) 95041-4042  
Whatsapp: (11) 96472-8172  
Whatsapp: (11) 99560-7328  
Whatsapp: (11) 97538-9444  
Whatsapp: (11) 94199-8561  
Whatsapp: (11) 96476-7688  
Whatsapp: (11) 95037-0361

### Escritório STA - Sta Ifigênia

Contato: Wilson Carlos

Tel: (11) 3337-1020 / 99387-0796 / 97698-6061

Email: wilson@sta-eletronica.com.br

### Consulta

de Preços e Disponibilidade

de Produtos

sta@sta-eletronica.com.br



S.T.A. Sistemas e Tecnologia Aplicada | Rua Matrix, 35. Cotia/SP. CEP 06714-360

[www.sta-eletronica.com.br](http://www.sta-eletronica.com.br) | [www.stacorp.com.br](http://www.stacorp.com.br) | [www.rontek.com.br](http://www.rontek.com.br)

Telefones: (11) 4617-8530 | 3719-2500

Fax: (11) 4617-8535 | 3714-0310

[www.rontek.com.br](http://www.rontek.com.br) |  [www.youtube.com/rontektvoficial](https://www.youtube.com/rontektvoficial) |  [www.facebook.com/starontek](https://www.facebook.com/starontek)



Ajude a preservar o **meio ambiente.**  
**Recicle!**